

2023  
**SIDING  
COLLECTION**

Vinyl & Polymer Siding, Trim,  
Accessories and Railing Products

**Product Catalog**

Vinyl & Polymer Siding Products

Vinyl Carpentry®  
Soffit & Vertical Siding

Vinyl Carpentry® Accessories

Restoration Millwork®  
Cellular PVC Trim

CertaWrap™  
Weather Resistant Barrier

EverNew® Vinyl Railing

Posts and Columns

EverNew® Vinyl Decking



# CORRECTION NOTICE

Unfortunately, we experienced a typographical error in the Siding Product Catalog. We want to ensure the accuracy and professionalism of our literature and apologize for any confusion this may have caused. Enclosed is a correction notice with the error rectified.

Please insert notice into Catalog and use for reference.

We appreciate your understanding and cooperation in this matter.

## COLOR AVAILABILITY ON PAGE 12

**NEW**  
SHAKE/SHINGLE  
UNDERSILL TRIM  
COLORS

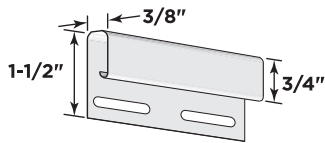

**Product Code: 56917**  
Finish: Matte  
Length: 12' 6"  
Pieces/Ctn.: 12  
Lin. Ft./Ctn.: 150  
Cartons/Pallet: 84  
lbs./Ctn.: ≤ 13

Shake/Shingle Undersill Trim is **no longer available** in Autumn Yellow

## COLOR AVAILABILITY ON PAGE 18

**NEW**  
DOUBLE 4"  
CLAPBOARD  
SOLID COLORS

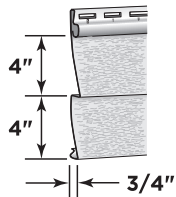

**Product Code: 33110**  
Finish: Rough Cedar  
Length: 12' 6"  
Thickness: .046"  
Exposure: 8"  
Projection: 3/4"  
Panels/Ctn.: 24  
Squares/Ctn.: 2  
Cartons/Pallet: 12/16\*  
lbs./Ctn.: ≤ 110

Monogram Double 4" Clapboard, Double 5" Clapboard and Double 5" Dutchlap are **no longer available** in Buckskin, Light Maple and Hearthstone

**NEW**  
DOUBLE 5"  
CLAPBOARD  
SOLID COLORS

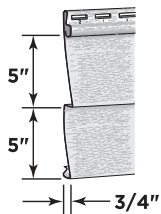

**Product Code: 33122**  
Finish: Rough Cedar  
Length: 12'  
Thickness: .046"  
Exposure: 10"  
Projection: 3/4"  
Panels/Ctn.: 20  
Squares/Ctn.: 2  
Cartons/Pallet: 8/14\*\*  
lbs./Ctn.: ≤ 102

**NEW**  
DOUBLE 5"  
DUTCHLAP  
SOLID COLORS

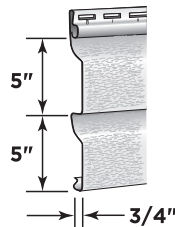

**Product Code: 33125**  
Finish: Rough Cedar  
Length: 12'  
Thickness: .046"  
Exposure: 10"  
Projection: 3/4"  
Panels/Ctn.: 20  
Squares/Ctn.: 2  
Cartons/Pallet: 10  
lbs./Ctn.: ≤ 105

## PRODUCT IMAGE ON PAGE 49

**STARTER STRIP  
FOR CEDARBOARDS  
INSULATED SIDING**

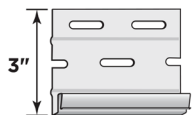

**Product Code: 53609**  
Finish: Matte  
Length: 12' 6"  
Width: 3"  
Pieces/Ctn.: 24  
Lin. Ft./Ctn.: 300  
Cartons/Pallet: 35  
lbs./Ctn.: ≤ 44

The Illustration for Starter Trip for Cedarboards Insulated Siding was missing



**CertainTeed**

Ceilings • Gypsum • Insulation • Roofing • Siding • Trim  
20 Moores Road, Malvern, PA 19355 | 800-233-8990 | certainteed.com

©01/24 CertainTeed, Printed in the USA, Code No. 04-30-3819-US-EN

## WHAT'S NEW

Below are the NEW additions for this product catalog

### SIDING PRODUCTS

#### Northwoods® Single 7" Perfection Shingles

Panel is available in the following colors -  
Smoky Gray (83) and Snow (31)

#### COMING SOON! -

#### Northwoods Single 7" Sawmill Shingles

New panel will be available in the following solid colors -

Charcoal Gray (46), Colonial White (01),  
Flagstone (97), Granite Gray (34),  
Midnight Blue (45), Natural Clay (60),  
Pacific Blue (27), Sable Brown (29),  
Savannah Wicker (59), Smoky Gray (83),  
Sterling Gray (33)

#### COMING SOON! -

#### CERTApLank™ Single 7" Reinforced Siding

New panel will be available in the following solid colors -

Castle Stone (37), Charcoal Gray (46),  
Colonial White (01), Flagstone (97),  
Forest (47), Granite Gray (34),  
Natural Clay (60), Pacific Blue (27),  
Savannah Wicker (59), Sterling Gray (33)

#### MainStreet™ Double 4" Clapboard, Double 5" Clapboard, Double 4" Dutchlap and Double 5" Dutchlap Siding

Panels are available in the following colors -  
Wedgewood Blue (89), and Weathered Wood (90)

#### Triple 2" Solid and Vented Beaded Soffit

Panels are available in the following color -  
Bermuda Blue (26)

### ACCESSORIES

#### 3/8" J-Channel

Available in the following colors -  
Bermuda Blue (26), Castle Stone (37),  
Charcoal Gray (46), Flagstone (97),  
Forest (47), Granite Gray (34),  
Pacific Blue (27),

#### 5/8" J-Channel

Available in the following color - Black (54)

#### COMING SOON! -

#### Trim Coil

Will be available in the following colors -  
Olive Grove (84), Wedgewood Blue (89),  
and Weathered Wood (90)

#### Shake/Shingle Undersill Trim

Available in the following color -  
Smoky Gray (83)

#### COMING SOON! -

#### Mounting Blocks

New Universal Block, Recessed Split Block,  
Dryer Vent and Surface Mount will be  
available in the following solid colors -  
Arbor Blend Solid (57), Autumn Red (23),  
Autumn Yellow (10), Brownstone (40), Buckskin (41),  
Castle Stone (37), Cedar Blend Solid (48),  
Charcoal Gray (46), Colonial White (01),  
Cypress (42), Desert Tan (07), Espresso (43),  
Flagstone (97), Forest (47), Frontier Blend Solid (51),  
Granite Gray (34), Hearthstone (19),  
Heritage Cream (11), Herringbone (04),  
Light Maple (55), Melrose (39), Midnight Blue (45),  
Mountain Cedar (17), Natural Clay (60),  
Olive Grove (84), Oxford Blue (32), Pacific Blue (27),  
Sable Brown (29), Sandstone Beige (15),  
Savannah Wicker (59), Seagrass (30), Slate (44),  
Smoky Gray (83), Snow (31), Spruce (16),  
Sterling Gray (33), Wedgewood Blue (89),  
Weathered Wood (90), and Tuxedo (56)

New Jumbo Block, Intake Exhaust, Meter Base  
and Mini Blocks are available in the  
following solid color -

Colonial White (01)

New Electrical Box also available

## Table of Contents

Color Matrix .....	2
Accessory Matrix.....	4
<b>Shake &amp; Shingle Siding</b>	
Cedar Impressions® Polymer Shake & Shingle Siding .....	5
Cedar Impressions® Accessories .....	7
Northwoods® Vinyl Shake & Shingle Siding .....	10
<b>Insulated Siding</b>	
CedarBoards™ and CedarBoards™ XL Insulated Siding.....	11, 18
CedarBoards™ Accessories.....	12
<b>Reinforced Siding</b>	
CERTApLank™ Reinforced Siding.....	14
Reverse Board & Batten Reinforced Siding.....	14, 18
<b>Vinyl Siding</b>	
Monogram® .....	15
Monogram® XL .....	16
Restoration Classic™.....	17
Board & Batten.....	18
Carolina Beaded™ .....	18
MainStreet™ .....	20
American Legend™.....	22
Encore™ .....	23
<b>Vinyl Carpentry® Soffit &amp; Vertical Siding</b>	
Invisivent® Triple 3-1/3" Soffit .....	24
Perimeter™ Triple 3-1/3" Soffit .....	24
Ironmax™ Soffit .....	25
Beaded Soffit .....	26
Universal Soffit.....	27
Value Soffit .....	28
<b>Vinyl Carpentry® Accessories</b>	
Corner Systems.....	29
Window & Door Trim .....	35
Wall Transitions.....	37
Soffit Transitions.....	38
J-Channel.....	39
Functional Trim .....	40
Starter Strips .....	42
Soffit Trim .....	43
Mounting Blocks.....	45
<b>House Wrap</b>	
CertaWrap™ Weather Resistant Barrier & Housewrap .....	47
CertaWrap™ Tape.....	48
<b>Tools</b>	
Shingle Repair Kit & Monogram Zipper Tool.....	49
<b>Restoration Millwork® Cellular PVC Trim</b> .....	50
<b>EverNew® Vinyl Railing</b> .....	63
<b>Posts and Columns</b> .....	76
<b>EverNew® Vinyl Decking</b> .....	77





## Accessory Matrix

PRODUCT CODE # >	CORNER SYSTEMS	DECORATIVE TRIM	J-CHANNEL	FUNCTIONAL TRIM	STARTER STRIPS	SOFFIT TRIM
51401	3/4" CORNERPOST WOODGRAIN					
51402	3/4" CORNERPOST MATTE					
51404	1" CORNERPOST WOODGRAIN					
51409	1-1/4" INSULATED CORNERPOST					
51412	3/4" INSIDE CORNERPOST					
51436	1-1/4" INSIDE CORNERPOST					
51446	INDIVIDUAL 5" SAWMILL CORNER					
51405	D7 STAGGERED PERFECTION MITERED CORNERPOST					
51451	7" PERFECTION MITERED OFFSET CORNERPOST					
51469	T5 SAWMILL MITERED OFFSET CORNERPOST					
51406	D7, D9 ROUGH-SPLIT MITERED CORNERPOST					
51450	TRADITIONAL SUPERCORNER™					
51452	1-1/4" TRADITIONAL SUPERCORNER™					
51420	FLUTED SUPERCORNER™					
51447	CORNICE MOLDING					
51424	CORNICE MOLDING RECEIVER					
55817	FINISH BOARD					
55812	BAND BOARD					
55815	3/8" J-CHANNEL					
50306	1/2" J-CHANNEL					
50310	5/8" J-CHANNEL					
50303	3/4" J-CHANNEL					
50302	1" J-CHANNEL					
50301	SHAKE / SHINGLE UNDERSILL TRIM					
56817	DUAL UNDERSILL TRIM					
56916	UNDERSILL TRIM					
56904	2-1/4" VINYL STARTER STRIP					
53602	2-1/2" METAL STARTER STRIP					
53610	4" METAL SHINGLE STARTER STRIP					
53604	5" METAL REMODELING STARTER STRIP					
53609	STARTER STRIP FOR INSULATED SIDING					
53612	METAL STARTER STRIP FOR CERTAPLANK					
52506	3/4" F-CHANNEL					
52502	5/8" F-CHANNEL					
52504	1/2" H BAR					
52505	3/8" H BAR					
52507	3/4" H BAR					

### SIDING PRODUCTS

#### CEEDAR IMPRESSIONS™

D7" PERFECTION	•	•	•	•	•	•	•	•	•	•	•	•	•	•	•	•	•	•	•	•
S7" PERFECTION	•	•	•	•	•	•	•	•	•	•	•	•	•	•	•	•	•	•	•	•
INDIVIDUAL 5" SAWMILL	•	•	•	•	•	•	•	•	•	•	•	•	•	•	•	•	•	•	•	•
T5" SAWMILL	•	•	•	•	•	•	•	•	•	•	•	•	•	•	•	•	•	•	•	•
ROUGH-SPLITS	•	•	•	•	•	•	•	•	•	•	•	•	•	•	•	•	•	•	•	•
<b>COMING SOON!</b>																				
<b>NORTHWOODS™</b>																				
S7" SAWMILL	•	•	•	•	•	•	•	•	•	•	•	•	•	•	•	•	•	•	•	•
S7" PERFECTION	•	•	•	•	•	•	•	•	•	•	•	•	•	•	•	•	•	•	•	•
S7" ROUGH-SPLIT*	•	•	•	•	•	•	•	•	•	•	•	•	•	•	•	•	•	•	•	•
<b>CEEDARBOARDS™</b>																				
INSULATED HORIZONTAL SIDING	•	•	•	•	•	•	•	•	•	•	•	•	•	•	•	•	•	•	•	•
INSULATED BOARD & BATTEN	•	•	•	•	•	•	•	•	•	•	•	•	•	•	•	•	•	•	•	•
<b>COMING SOON!</b>																				
<b>CERTAPLANK™</b>																				
S7" WOODGRAIN	•	•	•	•	•	•	•	•	•	•	•	•	•	•	•	•	•	•	•	•
<b>MONOGRAM® &amp; MONOGRAM® XL</b>																				
RESTORATION CLASSIC™	•	•	•	•	•	•	•	•	•	•	•	•	•	•	•	•	•	•	•	•
<b>BOARD &amp; BATTEN</b>																				
S7" & S8" VERTICAL	•	•	•	•	•	•	•	•	•	•	•	•	•	•	•	•	•	•	•	•
S7" REVERSE VERTICAL	•	•	•	•	•	•	•	•	•	•	•	•	•	•	•	•	•	•	•	•
<b>CAROLINA BEADED™</b>																				
MAINSTREET™	•	•	•	•	•	•	•	•	•	•	•	•	•	•	•	•	•	•	•	•
<b>AMERICAN LEGEND™</b>																				
ENCORE™	•	•	•	•	•	•	•	•	•	•	•	•	•	•	•	•	•	•	•	•

#### VINYL CARPENTRY® SOFFIT & VERTICAL SIDING

INVISIVENT® TRIPLE 3-1/3"	•	•	•	•	•	•	•	•	•	•	•	•	•	•	•	•	•	•	•	•
PERIMETER T3-1/3"	•	•	•	•	•	•	•	•	•	•	•	•	•	•	•	•	•	•	•	•
IRONMAX™ D5"	•	•	•	•	•	•	•	•	•	•	•	•	•	•	•	•	•	•	•	•
BEADED T2"	•	•	•	•	•	•	•	•	•	•	•	•	•	•	•	•	•	•	•	•
UNIVERSAL T4"	•	•	•	•	•	•	•	•	•	•	•	•	•	•	•	•	•	•	•	•
UNIVERSAL D5"	•	•	•	•	•	•	•	•	•	•	•	•	•	•	•	•	•	•	•	•
VALUE T4" & D5"	•	•	•	•	•	•	•	•	•	•	•	•	•	•	•	•	•	•	•	•

This is a suggested list. Some jobs may have unique requirements or a special use of accessories. Please consult product descriptions for available colors. Not all products available in all colors.

\*3/4" Accessories may be used with Northwoods Single 7" Straight Edge Rough-Split Shakes provided product is not tight in accessory pocket.

## Cedar Impressions® Polymer Shingle Siding - Sawmill Finish

### INDIVIDUAL 5" SAWMILL SHINGLES

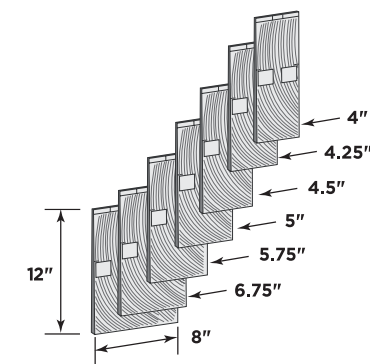

Product Code: **30146**

Finish: Sawmill  
Length: 7 Sizes - 4", 4.25", 4.5", 5", 5.75", 6.75", 8"  
Exposure: 5"  
Projection: Shingle is 1/2", installs in 1" accessory  
Panels/Ctn.: 168  
Squares/Ctn.: .33  
Linear Ft./Ctn.: -80  
Cartons/Pallet: 18  
lbs./Ctn.: ≤ 44

### TRIPLE 5" STRAIGHT EDGE SAWMILL SHINGLES

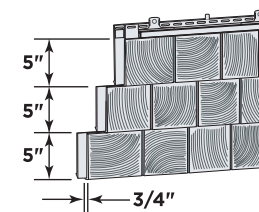

Product Code: **30106**

Finish: Sawmill  
Length: 60"  
Exposure: 15"  
Projection: 3/4"  
Panels/Ctn.: 8  
Squares/Ctn.: .50  
Cartons/Pallet: 20  
lbs./Ctn.: ≤ 43

## Cedar Impressions® Polymer Shingle Siding - Perfection Finish

### SINGLE 7" STRAIGHT EDGE PERFECTION SHINGLES

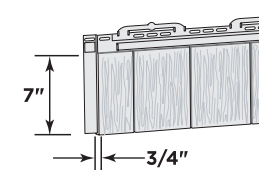

Product Code: **30137**

Finish: Perfection  
Length: 73.5"  
Exposure: 7"  
Projection: 3/4"  
Panels/Ctn.: 14  
Squares/Ctn.: .50  
Cartons/Pallet: 32  
lbs./Ctn.: ≤ 43

### DOUBLE 7" STRAIGHT EDGE PERFECTION SHINGLES

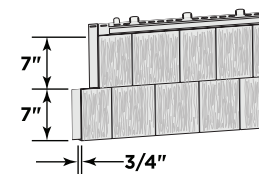

Product Code: **30144**

Finish: Perfection  
Length: 48"  
Exposure: 14"  
Projection: 3/4"  
Panels/Ctn.: 11  
Squares/Ctn.: .50  
Cartons/Pallet: 16  
lbs./Ctn.: ≤ 42

**Recommended trim:** CertainTeed recommends the use of Restoration Millwork PVC trim for the most authentic look of genuine cedar. If you choose to use CertainTeed vinyl accessories, the following solid colors are the best comparable options:  
Natural Blend = Buckskin, Cedar Blend = Cedar Blend Solid, Driftwood Blend = Granite Gray or Charcoal Gray, Rustic Blend = Sable Brown

## Polymer Siding Products

Product Code	30146 Individual 5" Sawmill Shingles	30106 Triple 5" Straight Edge Sawmill Shingles	30137 Single 7" Perfection Shingles	30144 Double 7" Straight Edge Perfection Shingles
Colonial White (01)	•	•	•	•
Autumn Red (23)		•		•
Autumn Yellow (10)				•
Bermuda Blue (26)				•
Brownstone (40)		•		•
Buckskin (41)		•		•
Castle Stone (37)		•		•
Charcoal Gray (46)		•	•	•
Cypress (42)		•	•	•
Desert Tan (07)		•		•
Espresso (43)		•		•
Flagstone (97)		•	•	•
Forest (47)		•		•
Granite Gray (34)		•	•	•
Hearthstone (19)		•	•	•
Heritage Cream (11)		•		•
Herringbone (04)		•		•
Light Maple (55)		•		•
Melrose (39)		•		•
Midnight Blue (45)		•		•
Mountain Cedar (17)		•		•
Natural Clay (60)	•	•	•	•
Pacific Blue (27)		•	•	•
Sable Brown (29)		•	•	•
Savannah Wicker (59)	•	•	•	•
Seagrass (30)	•	•	•	•
Slate (44)		•		•
Snow (31)				•
Spruce (16)		•		•
Sterling Gray (33)	•	•	•	•
Wedgewood Blue (89)		•		•
Weathered Wood (90)		•		•
► Cedar Blend (79)			•	
► Driftwood Blend (80)			•	
► Natural Blend (78)			•	
► Rustic Blend (82)			•	
Cedar Blend - Light (70)	•			
Cedar Blend - Med. (71)	•			
Cedar Blend - Dark (72)	•			
Driftwood Blend - L. (94)	•			
Driftwood Blend - M. (95)	•			
Driftwood Blend - D. (96)	•			
Natural Blend - Light (86)	•			
Natural Blend - Med. (87)	•			
Natural Blend - Dark (88)	•			
Rustic Blend - Light (73)	•			
Rustic Blend - Med. (74)	•			
Rustic Blend - Dark (75)	•			

► CONSISTENT VARIEGATED COLOR THROUGHOUT THE PANEL

≤ Heaviest weight listed - varies by color.

## Cedar Impressions® (continued) Polymer Shingle Siding - Perfection Finish

### DOUBLE 7" STAGGERED PERFECTION SHINGLES

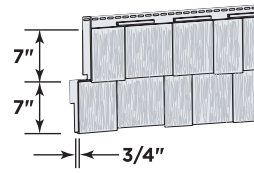

**Product Code: 30143**  
Finish: Perfection  
Length: 48"  
Exposure: 14"  
Projection: 3/4"  
Panels/Ctn.: 11  
Squares/Ctn.: .50  
Cartons/Pallet: 16  
lbs./Ctn.: ≤ 44

### SINGLE 6-1/3" PERFECTION SHAPES

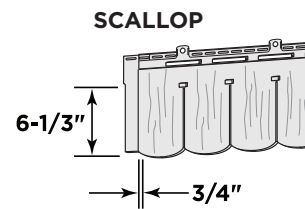

**Product Code: 30147**  
Finish: Perfection  
Length: 42"  
Exposure: 6-1/3"  
Projection: 3/4"  
Panels/Ctn.: 18  
Squares/Ctn.: .33  
Cartons/Pallet: 15  
lbs./Ctn.: ≤ 38

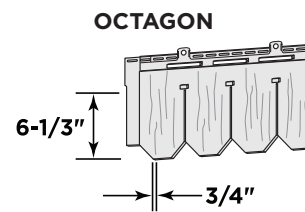

**Product Code: 30148**  
Finish: Perfection  
Length: 42"  
Exposure: 6-1/3"  
Projection: 3/4"  
Panels/Ctn.: 18  
Squares/Ctn.: .33  
Cartons/Pallet: 15  
lbs./Ctn.: ≤ 35

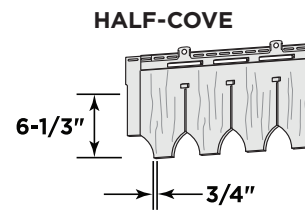

**Product Code: 30149**  
Finish: Perfection  
Length: 42"  
Exposure: 6-1/3"  
Projection: 3/4"  
Panels/Ctn.: 18  
Squares/Ctn.: .33  
Cartons/Pallet: 15  
lbs./Ctn.: ≤ 32

## Cedar Impressions® Polymer Shake Siding - Rough-Split Finish

### DOUBLE 7" STRAIGHT EDGE ROUGH-SPLIT SHAKES

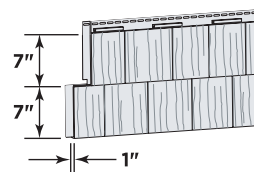

**Product Code: 30141**  
Finish: Rough-Split  
Length: 57"  
Exposure: 14"  
Projection: 1"  
Panels/Ctn.: 9  
Squares/Ctn.: .50  
Cartons/Pallet: 16  
lbs./Ctn.: ≤ 47

### DOUBLE 9" STAGGERED ROUGH-SPLIT SHAKES

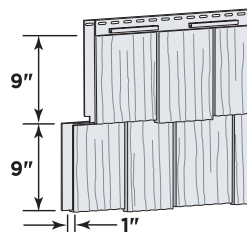

**Product Code: 30136**  
Finish: Rough-Split  
Length: 57"  
Exposure: 18"  
Projection: 1"  
Panels/Ctn.: 7  
Squares/Ctn.: .50  
Cartons/Pallet: 16  
lbs./Ctn.: ≤ 50

## Polymer Siding Products

Product Code	30143	30147	30148	30149	30141	30136
	Double 7" Staggered Perfection Shingles	Single 6-1/3" Perfection Shapes - Scallop	Single 6-1/3" Perfection Shapes - Octagon	Single 6-1/3" Perfection Shapes - Half-Cove	Double 7" Straight Edge Rough-Split Shakes	Double 9" Staggered Rough-Split Shakes
Colonial White (01)	●	●	●	●	●	●
Autumn Red (23)	●	●	●		●	●
Autumn Yellow (10)						
Buckskin (41)	●				●	●
Charcoal Gray (46)	●	●	●		●	●
Cypress (42)	●	●				
Desert Tan (07)	●					
Flagstone (97)	●				●	●
Forest (47)	●				●	●
Granite Gray (34)	●				●	●
Hearthstone (19)	●				●	●
Heritage Cream (11)	●					
Herringbone (04)	●					
Light Maple (55)	●					
Mountain Cedar (17)	●				●	●
Natural Clay (60)	●	●	●	●	●	●
Pacific Blue (27)	●	●	●	●	●	●
Sable Brown (29)	●				●	●
Savannah Wicker (59)	●	●			●	●
Seagrass (30)	●					
Spruce (16)	●				●	●
Sterling Gray (33)	●	●	●	●	●	●

## Cedar Impressions® Accessories

### INDIVIDUAL 5" SAWMILL CORNER

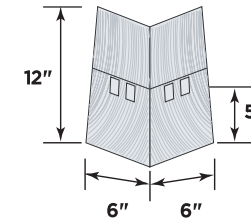

**Product Code: 51405**  
Finish: Sawmill  
Exposure: 5"  
Pieces/Ctn.: 24  
Lin. Ft./Ctn.: 10'  
Cartons/Pallet: 45  
lbs./Ctn.: ≤ 12

### T5" STRAIGHT EDGE SAWMILL OFFSET MITERED CORNERPOST

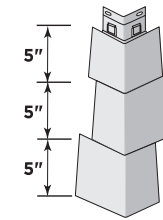

**Product Code: 51406**  
Finish: Sawmill  
Pieces/Ctn.: 32  
Lin. Ft./Ctn.: 40'  
Cartons/Pallet: 12  
lbs./Ctn.: ≤ 17

### 7" PERFECTION OFFSET MITERED CORNERPOSTS

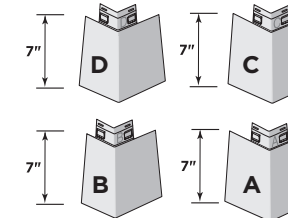

**Product Code: 51459**  
Finish: Perfection  
Length: 4 Pieces - 7" each  
Pieces/Ctn.: 40  
Lin. Ft./Ctn.: 23' 4"  
Cartons/Pallet: 24  
lbs./Ctn.: ≤ 15

For use with Single 7" Perfection and Double 7" Perfection

## Polymer Siding Products

Product Code	51405	51406	51459		
	Individual 5" Sawmill Corner	T5" Straight Edge Sawmill Offset Mitered Cornerpost	7" Perfection Offset Mitered Cornerposts		
Colonial White (01)	●	●	●		
Autumn Red (23)		●	●		
Autumn Yellow (10)			●		
Bermuda Blue (26)			●		
Brownstone (40)		●	●		
Buckskin (41)		●	●		
Castle Stone (37)		●	●		
Charcoal Gray (46)		●	●		
Cypress (42)		●	●		
Desert Tan (07)		●	●		
Espresso (43)		●	●		
Flagstone (97)		●	●		
Forest (47)		●	●		
Granite Gray (34)		●	●		
Hearthstone (19)		●	●		
Heritage Cream (11)		●	●		
Herringbone (04)		●	●		
Light Maple (55)		●	●		
Melrose (39)		●	●		
Midnight Blue (45)		●	●		
Mountain Cedar (17)		●	●		
Natural Clay (60)	●	●	●		
Pacific Blue (27)		●	●		
Sable Brown (29)		●	●		
Savannah Wicker (59)	●	●	●		
Seagrass (30)	●	●	●		
Slate (44)		●	●		
Snow (31)			●		
Spruce (16)			●		
Sterling Gray (33)	●	●	●		
Wedgewood Blue (89)		●	●		
Weathered Wood (90)		●	●		
▶ Cedar Blend (79)			●		
▶ Driftwood Blend (80)			●		
▶ Natural Blend (78)			●		
▶ Rustic Blend (82)			●		
Cedar Blend - Light (70)	●				
Cedar Blend - Med. (71)	●				
Cedar Blend - Dark (72)	●				
Driftwood Blend - L. (94)	●				
Driftwood Blend - M. (95)	●				
Driftwood Blend - D. (96)	●				
Natural Blend - Light (86)	●				
Natural Blend - Med. (87)	●				
Natural Blend - Dark (88)	●				
Rustic Blend - Light (73)	●				
Rustic Blend - Med. (74)	●				
Rustic Blend - Dark (75)	●				

**Recommended trim:** CertainTeed recommends the use of Restoration Millwork PVC trim for the most authentic look of genuine cedar. If you choose to use CertainTeed vinyl accessories, the following solid colors are the best comparable options:  
Natural Blend = Buckskin, Cedar Blend = Cedar Blend Solid,  
Driftwood Blend = Granite Gray or Charcoal Gray, Rustic Blend = Sable Brown

▶ CONSISTENT VARIEGATED COLOR THROUGHOUT THE PANEL



## Cedar Impressions® Accessories (continued)

### D7" STAGGERED PERFECTION MITERED CORNERPOST

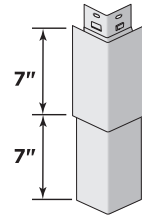

**Product Code: 51451**  
 Finish: Perfection  
 Length: 14"  
 Pieces/Ctn.: 20  
 Lin. Ft./Ctn.: 23' 3"  
 Cartons/Pallet: 32  
 lbs./Ctn.: ≤14

### D7" STRAIGHT EDGE ROUGH-SPLIT MITERED CORNERPOST

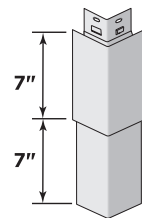

**Product Code: 51450**  
 Finish: Rough-Split  
 Length: 14"  
 Pieces/Ctn.: 20  
 Lin. Ft./Ctn.: 23' 4"  
 Cartons/Pallet: 24  
 lbs./Ctn.: ≤17

### D9" STAGGERED ROUGH-SPLIT MITERED CORNERPOST

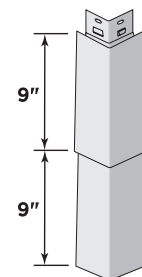

**Product Code: 51432**  
 Finish: Rough-Split  
 Length: 18-1/2"  
 Pieces/Ctn.: 20  
 Lin. Ft./Ctn.: 31  
 Cartons/Pallet: 18  
 lbs./Ctn.: ≤21

## Polymer Siding Products

Product Code	51451 D7" Staggered Perfection Mitered Cornerpost	51450 D7" Straight Edge Rough-Split Mitered Cornerpost	51432 D9" Staggered Rough-Split Mitered Cornerpost
Colonial White (01)	●	●	●
Autumn Red (23)	●	●	●
Buckskin (41)	●	●	●
Charcoal Gray (46)	●	●	●
Cypress (42)	●		
Desert Tan (07)	●		
Flagstone (97)	●	●	●
Forest (47)	●	●	●
Granite Gray (34)	●	●	●
Hearthstone (19)	●	●	●
Heritage Cream (11)	●		
Herringbone (04)	●		
Light Maple (55)	●		
Mountain Cedar (17)	●	●	●
Natural Clay (60)	●	●	●
Pacific Blue (27)	●	●	●
Sable Brown (29)	●	●	●
Savannah Wicker (59)	●	●	●
Seagrass (30)	●		
Spruce (16)	●	●	●
Sterling Gray (33)	●	●	●

## Cedar Impressions® Accessories (continued)

### CORNICE MOLDING

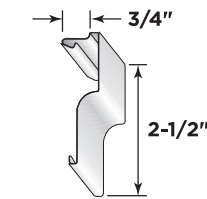

**Product Code: 55817**  
 Finish: Matte  
 Length: 12' 6"  
 Pieces/Ctn.: 10  
 Lin. Ft./Ctn.: 125  
 Cartons/Pallet: 64  
 lbs./Ctn.: ≤16

For use with Cornice Receiver or Deluxe F-Channel

### CORNICE RECEIVER

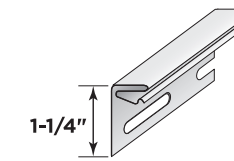

**Product Code: 55812**  
 Finish: Matte  
 Length: 12' 6"  
 Pieces/Ctn.: 24  
 Lin. Ft./Ctn.: 300  
 Cartons/Pallet: 35  
 lbs./Ctn.: ≤28

For use with Cornice Molding, Finish Board and Band Board

### NEW SHAKE/SHINGLE UNDERSILL TRIM COLOR

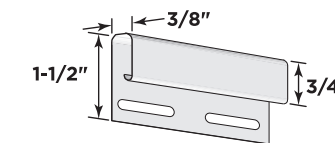

**Product Code: 56917**  
 Finish: Matte  
 Length: 12' 6"  
 Pieces/Ctn.: 12  
 Lin. Ft./Ctn.: 150  
 Cartons/Pallet: 84  
 lbs./Ctn.: ≤13

### 4" METAL SHINGLE STARTER STRIP

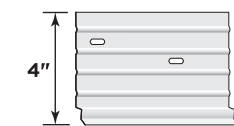

**Product Code: 53610**  
 Finish: Mill  
 Length: 10'  
 Width: 4"  
 Pieces/Ctn.: 25  
 Lin. Ft./Ctn.: 250  
 Cartons/Pallet: 35  
 lbs./Ctn.: ≤78

For use with Cedar Impressions Shake and Shingle Panels

## Vinyl Carpentry® Accessories

Product Code	55817 Cornice Molding	55812 Cornice Receiver	56917 Shake/Shingle Undersill Trim	53610 4" Metal Shingle Starter Strip
No Color		●		●
Colonial White (01)	●			
Autumn Red (23)	●		●	
Autumn Yellow (10)	●		●	
Bermuda Blue (26)	●		●	
Brownstone (40)	●		●	
Buckskin (41)	●		●	
Castle Stone (37)	●		●	
Cedar Blend Solid* (48)	+		+	
Charcoal Gray (46)	●		●	
Cypress (42)	●		●	
Desert Tan (07)	●		●	
Espresso (43)	●		●	
Flagstone (97)	●		●	
Forest (47)	●		●	
Granite Gray (34)	●		●	
Hearthstone (19)	●		●	
Heritage Cream (11)	●		●	
Herringbone (04)	●		●	
Light Maple (55)	●		●	
Melrose (39)	●		●	
Midnight Blue (45)	●		●	
Mountain Cedar (17)	●		●	
Natural Clay (60)	●		●	
Pacific Blue (27)	●		●	
Sable Brown (29)	●		●	
Sandstone Beige (15)	●		●	
Savannah Wicker (59)	●		●	
Seagrass (30)	●		●	
Slate (44)	●		●	
Smoky Gray (83)			★	
Snow (31)	●		●	
Spruce (16)	●		●	
Sterling Gray (33)	●		●	
Wedgewood Blue (89)	●		●	
Weathered Wood (90)	●		●	

+ SOLID COLOR

\* Solid color accessory used with the Cedar Impressions Single 7" Cedar Blend panel.

★ NEW COLOR

# Northwoods® Vinyl Shake & Shingle Siding

**COMING SOON!**  
SINGLE 7" STRAIGHT EDGE SAWMILL SHINGLES

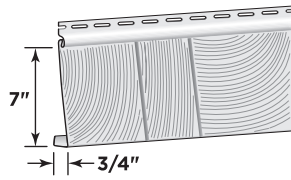

**Product Code: 60109**  
Finish: Sawmill  
Length: 10' 1"  
Exposure: 7"  
Projection: 3/4"  
Panels/Ctn.: 17  
Squares/Ctn.: 1  
Cartons/Pallet: 18  
lbs./Ctn.: ≤ 65

**NEW COLORS**  
SINGLE 7" STRAIGHT EDGE PERFECTION SHINGLES

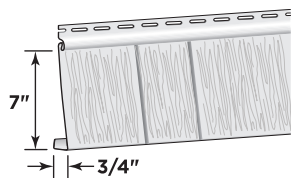

**Product Code: 60108**  
Finish: Perfection  
Length: 10' 1"  
Exposure: 7"  
Projection: 3/4"  
Panels/Ctn.: 17  
Squares/Ctn.: 1  
Cartons/Pallet: 18  
lbs./Ctn.: ≤ 65

SINGLE 7" STRAIGHT EDGE ROUGH-SPLIT SHAKES

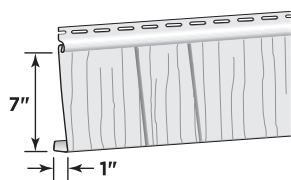

**Product Code: 60106**  
Finish: Rough-Split  
Length: 10' 1"  
Exposure: 7"  
Projection: 1"  
Panels/Ctn.: 17  
Squares/Ctn.: 1  
Cartons/Pallet: 19  
lbs./Ctn.: ≤ 59

## Vinyl Siding Products

Product Code	60109 Single 7" Straight Edge Sawmill Shingles	60108 Single 7" Straight Edge Perfection Shingles	60106 Single 7" Straight Edge Rough-Split Shakes
Autumn Red (23)		●	●
Castle Stone (37)		●	
Charcoal Gray (46)	☆	●	
Colonial White (01)	☆	●	●
Cypress (42)		●	●
Desert Tan (07)		●	●
Espresso (43)		●	
Flagstone (97)	☆	●	●
Granite Gray (34)	☆	●	●
Hearthstone (19)		●	
Herringbone (04)		★	
Midnight Blue (45)	☆	●	
Natural Clay (60)	☆	●	●
Pacific Blue (27)	☆	●	●
Sable Brown (29)	☆	●	●
Sandstone Beige (15)		●	●
Savannah Wicker (59)	☆	●	●
Seagrass (30)		●	
Slate (44)		●	
Smoky Gray (83)	☆	★	
Sterling Gray (33)	☆	●	●

★ NEW COLOR  
☆ COMING SOON

# CedarBoards™ Insulated Siding

DOUBLE 6" CLAPBOARD

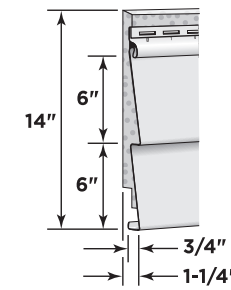

**Product Code: 58134**  
Finish: Rough Cedar  
Length: 12' 6"  
Thickness: .044"  
Exposure: 12"  
Projection: 1-1/4"\*  
Panels/Ctn.: 8  
Squares./Ctn.: 1  
Cartons/Pallet: 9  
lbs./Ctn.: ≤ 63

SINGLE 7" CLAPBOARD

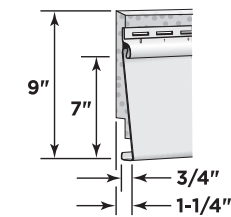

**Product Code: 58106**  
Finish: Rough Cedar  
Length: 12' 3"  
Thickness: .044"  
Exposure: 7"  
Projection: 1-1/4"\*  
Panels/Ctn.: 14  
Squares./Ctn.: 1  
Cartons/Pallet: 12  
lbs./Ctn.: ≤ 56

SINGLE 12" VERTICAL BOARD & BATTEN - 10'

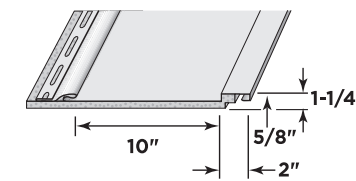

**Product Code: 58153**  
Finish: Rough Cedar  
Length: 10'  
Thickness: .052"  
Exposure: 12"  
Projection: 1-1/4"\*  
Panels/Ctn.: 10  
Squares./Ctn.: 1  
Cartons/Pallet: 9  
lbs./Ctn.: ≤ 59

# CedarBoards™ XL Extended Length Insulated Siding

DOUBLE 6" - 16' 8" CLAPBOARD

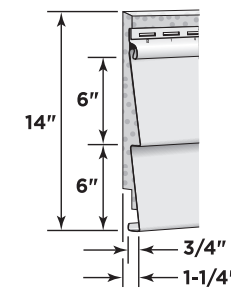

**Product Code: 58145**  
Finish: Rough Cedar  
Length: 16' 8"  
Thickness: .044"  
Exposure: 12"  
Projection: 1-1/4"\*  
Panels/Ctn.: 6  
Squares./Ctn.: 1  
Cartons/Pallet: 12  
lbs./Ctn.: ≤ 54

SINGLE 7" - 16' 8" CLAPBOARD

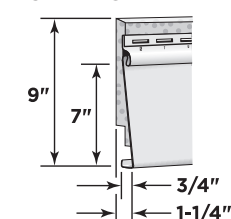

**Product Code: 58144**  
Finish: Rough Cedar  
Length: 16' 8"  
Thickness: .044"  
Exposure: 7"  
Projection: 1-1/4"\*  
Panels/Ctn.: 10  
Squares./Ctn.: 1  
Cartons/Pallet: 12  
lbs./Ctn.: ≤ 57

\* Complete Assembly Projection  
≤ Heaviest weight listed - varies by color.

## Vinyl Siding Products

Product Code	58134 Double 6" Clapboard (Rough Cedar)	58106 Single 7" Clapboard (Rough Cedar)	58153 Single 12" Vertical Board & Batten - 10' (Rough Cedar)	58145 Double 6" XL Clapboard (Rough Cedar)	58144 Single 7" XL Clapboard (Rough Cedar)
Buckskin (41)	●	●			
Colonial White (01)	●	●	●	●	●
Cypress (42)	●	●		●	●
Desert Tan (07)	●	●			
Granite Gray (34)	●	●	●	●	●
Heritage Cream (11)	●	●			
Herringbone (04)			●		
Light Maple (55)	●	●			
Natural Clay (60)	●	●	●	●	●
Oxford Blue (32)	●	●			
Sandstone Beige (15)	●	●			
Savannah Wicker (59)	●	●	●	●	●
Snow (31)			●		
Sterling Gray (33)	●	●	●	●	●
Autumn Red (23)	●	●	●		
Charcoal Gray (46)	●	●		●	●
Flagstone (97)	●	●		●	●
Pacific Blue (27)	●	●		●	
Sable Brown (29)	●	●			
Spruce (16)	●	●			



## CedarBoards™ Accessories

### 1-1/4" CORNERPOST - 10' WOODGRAIN With Foam Insert

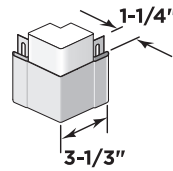

**Product Code: 51412**  
 Finish: Woodgrain  
 Length: 10'  
 Face: 3-1/3"  
 Pieces/Ctn.: 10  
 Lin. Ft./Ctn.: 100  
 Cartons/Pallet: 12  
 lbs./Ctn.: ≤ 42

### 1-1/4" INSIDE CORNERPOST

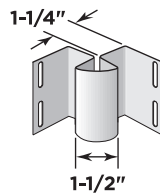

**Product Code: 51446**  
 Finish: Matte  
 Length: 10'  
 Channel: 1-1/4"  
 Pieces/Ctn.: 10  
 Lin. Ft./Ctn.: 100  
 Cartons/Pallet: 15  
 lbs./Ctn.: ≤ 31

### 1-1/4" TRADITIONAL SUPERCORNER™ With Foam Insert

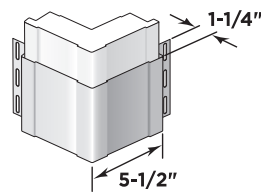

**Product Code: 51447**  
 Finish: Matte  
 Length: 20'  
 Pieces/Ctn.: 6  
 Lin. Ft./Ctn.: 120  
 Cartons/Pallet: 8  
 lbs./Ctn.: ≤ 80

### 3-1/2" LINEAL With Foam Insert

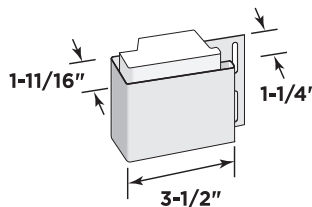

**Product Code: 54707**  
 Finish: Matte  
 Length: 20'  
 Pieces/Ctn.: 10  
 Lin. Ft./Ctn.: 200  
 Cartons/Pallet: 23  
 lbs./Ctn.: ≤ 63

### FINISH BOARD

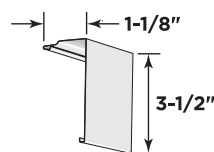

**Product Code: 55815**  
 Finish: Rough Cedar  
 Length: 12' 6"  
 Pieces/Ctn.: 10  
 Lin. Ft./Ctn.: 125  
 Cartons/Pallet: 49  
 lbs./Ctn.: ≤ 19

For use with Cornice Receiver

\* Complete Assembly  
 ≤ Heaviest weight listed - varies by color.

## Vinyl Siding Products

Product Code	51412 1-1/4" Cornerpost -10' Woodgrain w/Foam Insert	51446 1-1/4" Inside Cornerpost	51447 1-1/4" Traditional SuperCorner w/Foam Insert	54707 3-1/2" Lineal w/Foam Insert	55815 Finish Board
Colonial White (01)	●	●	●	●	●
Autumn Red (23)	●	●			
Buckskin (41)	●	●			
Charcoal Gray (46)	●	●			
Cypress (42)	●	●			
Desert Tan (07)	●	●			
Flagstone (97)	●	●			
Granite Gray (34)	●	●			
Heritage Cream (11)	●	●			
Herringbone (04)	●	●			
Light Maple (55)	●	●			
Natural Clay (60)	●	●			
Oxford Blue (32)	●	●			
Pacific Blue (27)	●	●			
Sable Brown (29)	●	●			
Sandstone Beige (15)	●	●			
Savannah Wicker (59)	●	●			
Snow (31)	●	●			
Spruce (16)	●	●			
Sterling Gray (33)	●	●			

## CedarBoards™ Accessories (continued)

### BAND BOARD With Foam Insert

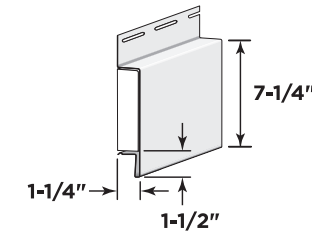

Dimensions shown as installed with Cornice Receiver

### CORNICE RECEIVER

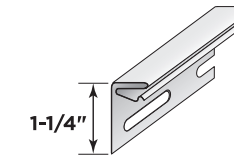

For use with Cornice Molding, Finish Board and Band Board

### 1-1/4" POCKET J-CHANNEL

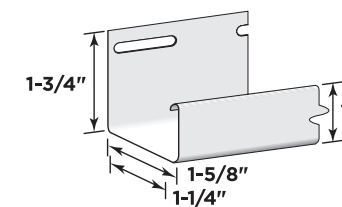

**Product Code: 55814**  
 Finish: Rough Cedar  
 Length: 16' 8"  
 Pieces/Ctn.: 5  
 Lin. Ft./Ctn.: 82' 5"  
 Cartons/Pallet: 16  
 lbs./Ctn.: ≤ 33

**Product Code: 55812**  
 Finish: Matte  
 Length: 12' 6"  
 Pieces/Ctn.: 24  
 Lin. Ft./Ctn.: 300  
 Cartons/Pallet: 35  
 lbs./Ctn.: ≤ 28

**Product Code: 50301**  
 Finish: Matte  
 Length: 12' 6"  
 Channel: 1-1/4"  
 Pieces/Ctn.: 48  
 Lin. Ft./Ctn.: 600  
 Cartons/Pallet: 20  
 lbs./Ctn.: ≤ 79

### STARTER STRIP FOR CEDARBOARDS INSULATED SIDING

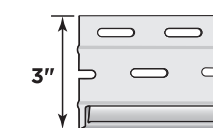

**Product Code: 53609**  
 Finish: Matte  
 Length: 12' 6"  
 Width: 3"  
 Pieces/Ctn.: 24  
 Lin. Ft./Ctn.: 300  
 Cartons/Pallet: 35  
 lbs./Ctn.: ≤ 44

≤ Heaviest weight listed - varies by color.

## Vinyl Siding Products

Product Code	55814 Band Board w/Foam Insert	55812 Cornice Receiver	50301 1-1/4" Pocket J-Channel	53609 Starter Strip For Insulated Siding
No Color		●		●
Colonial White (01)	●		●	
Autumn Red (23)			●	
Buckskin (41)			●	
Charcoal Gray (46)			●	
Cypress (42)			●	
Desert Tan (07)			●	
Flagstone (97)			●	
Granite Gray (34)			●	
Heritage Cream (11)			●	
Herringbone (04)			●	
Light Maple (55)			●	
Natural Clay (60)			●	
Oxford Blue (32)			●	
Pacific Blue (27)			●	
Sable Brown (29)			●	
Sandstone Beige (15)			●	
Savannah Wicker (59)			●	
Snow (31)			●	
Spruce (16)			●	
Sterling Gray (33)			●	

For more information call 800-233-8990  
[www.certainteed.com](http://www.certainteed.com)

## CERTaplank® Reinforced Siding & Accessories

COMING SOON!

### SINGLE 7" WOODGRAIN REINFORCED CLAPBOARD

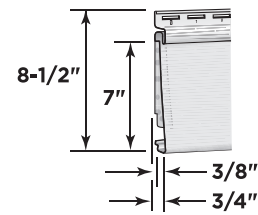

**Product Code: 63106**  
Finish: Woodgrain  
Length: 12' 4-1/2"  
Thickness: .046"  
Exposure: 7"  
Projection: 3/4"\*  
Panels/Ctn.: 14  
Squares/Ctn.: 1  
Cartons/Pallet: 15  
lbs./Ctn.: ≤ 66

COMING SOON!

### METAL STARTER STRIP FOR CERTAPLANK REINFORCED SIDING

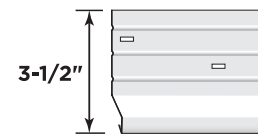

**Product Code: 53612**  
Finish: Mill  
Length: 10'  
Width: 3-1/2"  
Pieces/Ctn.: 25  
Lin. Ft./Ctn.: 250'  
Cartons/Pallet: 35  
lbs./Ctn.: 65

## Reverse Board & Batten Reinforced Siding

### SINGLE 7" REVERSE BOARD & BATTEN - REINFORCED SIDING

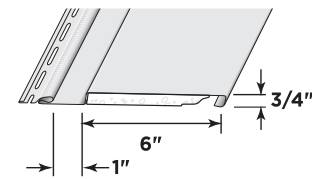

**Product Code: 63108**  
Finish: Woodgrain  
Length: 10'  
Thickness: .046"  
Exposure: 7"  
Projection: 3/4"  
Panels/Ctn.: 16  
Squares./Ctn.: .93  
Cartons/Pallet: 12  
lbs./Ctn.: ≤ 62

\* Complete Assembly  
≤ Heaviest weight listed - varies by color.

## Vinyl Siding Products

Product Code	63106 Single 7" Clapboard (Woodgrain)	53612 Metal Starter Strip for CERTaplank Reinforced Siding	63108 Single 7" Reverse Board & Batten - (Woodgrain) Reinforced
No Color		☆	
Colonial White (01)	☆		●
Castle Stone (37)	☆		
Granite Gray (34)	☆		●
Natural Clay (60)	☆		●
Savannah Wicker (59)	☆		●
Sterling Gray (33)	☆		●
Autumn Red (23)			●
Charcoal Gray (46)	☆		●
Flagstone (97)	☆		
Forest (47)	☆		
Midnight Blue (45)			●
Pacific Blue (27)	☆		●
Sable Brown (29)			●

☆COMING SOON

## Monogram®

### DOUBLE 4" CLAPBOARD SOLID COLORS

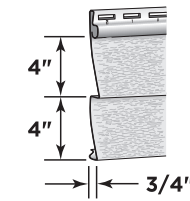

**Product Code: 33110**  
Finish: Rough Cedar  
Length: 12' 6"  
Thickness: .046"  
Exposure: 8"  
Projection: 3/4"  
Panels/Ctn.: 24  
Squares./Ctn.: 2  
Cartons/Pallet: 12/16\*  
lbs./Ctn.: ≤ 110

### DOUBLE 4" CLAPBOARD BLEND COLORS

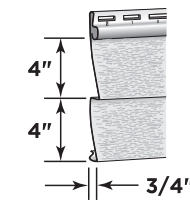

**Product Code: 33101**  
Finish: Rough Cedar  
Length: 12' 6"  
Thickness: .046"  
Exposure: 8"  
Projection: 3/4"  
Panels/Ctn.: 24  
Squares./Ctn.: 2  
Cartons/Pallet: 12  
lbs./Ctn.: ≤ 110

### DOUBLE 5" CLAPBOARD SOLID COLORS

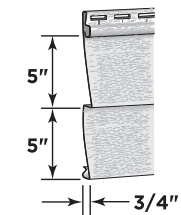

**Product Code: 33122**  
Finish: Rough Cedar  
Length: 12'  
Thickness: .046"  
Exposure: 10"  
Projection: 3/4"  
Panels/Ctn.: 20  
Squares./Ctn.: 2  
Cartons/Pallet: 8/14\*\*  
lbs./Ctn.: ≤ 102

### DOUBLE 5" DUTCHLAP SOLID COLORS

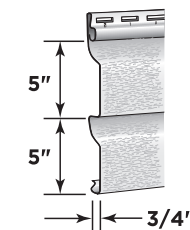

**Product Code: 33125**  
Finish: Rough Cedar  
Length: 12'  
Thickness: .046"  
Exposure: 10"  
Projection: 3/4"  
Panels/Ctn.: 20  
Squares./Ctn.: 2  
Cartons/Pallet: 10  
lbs./Ctn.: ≤ 105

### DOUBLE 5" DUTCHLAP BLEND COLORS

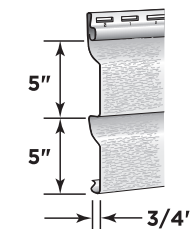

**Product Code: 33103**  
Finish: Rough Cedar  
Length: 12'  
Thickness: .046"  
Exposure: 10"  
Projection: 3/4"  
Panels/Ctn.: 20  
Squares./Ctn.: 2  
Cartons/Pallet: 10  
lbs./Ctn.: ≤ 105

≤ Heaviest weight listed - varies by color.

## Vinyl Siding Products

Product Code	33110 Double 4" Clapboard Solid Colors (Rough Cedar)	33101 Double 4" Clapboard Blend Colors (Rough Cedar)	33122 Double 5" Clapboard Solid Colors (Rough Cedar)	33125 Double 5" Dutchlap Solid Colors (Rough Cedar)	33103 Double 5" Dutchlap Blend Colors (Rough Cedar)
Buckskin (41)	●		●	●	
Castle Stone (37)	●		●	●	
Colonial White (01)	●		●	●	
Cypress (42)	●		●	●	
Desert Tan (07)	●		●	●	
Granite Gray (34)	●		●	●	
Heritage Cream (01)	●		●	●	
Herringbone (04)	●		●	●	
Light Maple (55)	●		●	●	
Natural Clay (60)	●		●	●	
Oxford Blue (32)	●		●	●	
Sandstone Beige (15)	●		●	●	
Savannah Wicker (59)	●		●	●	
Seagrass (30)	●		●	●	
Smoky Gray (83)	●		●	●	
Sterling Gray (33)	●		●	●	
Wedgewood Blue (89)	●		●	●	
Weathered Wood (90)	●		●	●	
Autumn Red (23)	●		●	●	
Brownstone (40)	●		●	●	
Charcoal Gray (46)	●		●	●	
Espresso (43)	●		●	●	
Flagstone (97)	●		●	●	
Forest (47)	●		●	●	
Hearthstone (19)	●		●	●	
Melrose (39)	●		●	●	
Midnight Blue (45)	●		●	●	
Olive Grove (84)	●		●	●	
Pacific Blue (27)	●		●	●	
Sable Brown (29)	●		●	●	
Slate (44)	●		●	●	
Spruce (16)	●		●	●	
Tuxedo (56)	●		●	●	
Arbor Blend (57)		●			●
Cedar Blend (79)		●			●
Driftwood Blend (80)		●			●
Frontier Blend (51)		●			●
Natural Blend (78)		●			●
Rustic Blend (82)		●			●
Weathered Blend (53)		●			●

\* 12 Cartons/Pallet: Autumn Red, Brownstone, Charcoal Gray, Espresso, Flagstone, Forest, Hearthstone, Melrose, Midnight Blue, Mountain Cedar, Pacific Blue, Sable Brown, Slate and Spruce. 16 Cartons/Pallet: All other colors.

\*\* 8 Cartons/Pallet: Autumn Red, Brownstone, Charcoal Gray, Espresso, Flagstone, Forest, Hearthstone, Melrose, Midnight Blue, Pacific Blue, Sable Brown, Slate and Spruce. 14 Cartons/Pallet: All other colors.



# Monogram<sup>®</sup> XL Extended Length Siding

## DOUBLE 4" CLAPBOARD-16' 8"

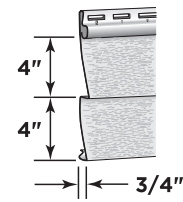

**Product Code: 33114**  
Finish: Rough Cedar  
Length: 16' 8"  
Thickness: .046"  
Exposure: 8"  
Projection: 3/4"  
Panels/Ctn.: 18  
Squares./Ctn.: 2  
Cartons/Pallet: 16  
lbs./Ctn.: ≤ 112

## DOUBLE 5" DUTCHLAP-16'

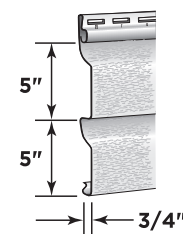

**Product Code: 33126**  
Finish: Rough Cedar  
Length: 16'  
Thickness: .046"  
Exposure: 10"  
Projection: 3/4"  
Panels/Ctn.: 15  
Squares./Ctn.: 2  
Cartons/Pallet: 14  
lbs./Ctn.: ≤ 107

## DOUBLE 4" CLAPBOARD-20'

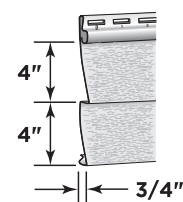

**Product Code: 33139**  
Finish: Rough Cedar  
Length: 20'  
Thickness: .046"  
Exposure: 8"  
Projection: 3/4"  
Panels/Ctn.: 15  
Squares./Ctn.: 2  
Cartons/Pallet: 16  
lbs./Ctn.: ≤ 114

## DOUBLE 4" CLAPBOARD - 25'

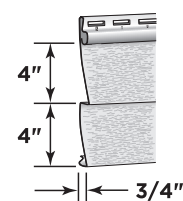

**Product Code: 33145**  
Finish: Rough Cedar  
Length: 25'  
Thickness: .046"  
Exposure: 8"  
Projection: 3/4"  
Panels/Ctn.: 12  
Squares./Ctn.: 2  
Cartons/Pallet: 16  
lbs./Ctn.: ≤ 116

Monogram XL 25' lengths are in stock and can be ordered with standard lead times. Minimum order requirement for 25' lengths:

### Stocking Distributor

- One pallet minimum in full pallet quantities
- Each pallet must be the same profile - can mix colors on same pallet
- Orders above one pallet must be ordered in **even full pallet quantities (2, 4, 6 or 8 pallets)**

### Non-Stocking Distributor

- Two pallet minimum in full pallet quantities with no surcharge
- Each pallet must be the same profile - can mix colors on same pallet
- Orders above one pallet must be ordered in **even full pallet quantities (2, 4, 6 or 8 pallets)**

Please contact your Territory Sales Manager regarding stocking status

## Vinyl Siding Products

Product Code	33114 Double 4" Clapboard - 16' 8" (Rough Cedar)	33126 Double 5" Dutchlap - 16' (Rough Cedar)	33139 Double 4" Clapboard - 20' (Rough Cedar)	33145 Double 4" Clapboard - 25' (Rough Cedar)	
COLOR	Castle Stone (37)	●		●	●
	Colonial White (01)	●	●	●	●
	Cypress (42)	●	●	●	●
	Granite Gray (34)	●	●	●	●
	Heritage Cream (11)	●	●	●	●
	Natural Clay (60)	●	●	●	●
	Oxford Blue (32)	●	●	●	●
	Savannah Wicker (59)	●	●	●	●
	Sterling Gray (33)	●	●	●	●
	DELUXE	Brownstone (40)	●		●
Charcoal Gray (46)		●		●	●
Espresso (43)		●		●	●
Melrose (39)		●		●	●
Midnight Blue (45)		●		●	●
Pacific Blue (27)		●		●	●
Sable Brown (29)		●		●	●
Slate (44)		●		●	●

## Restoration Classic<sup>™</sup>

## DOUBLE 4" CLAPBOARD

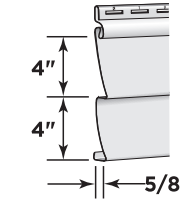

**Product Code: 36110**  
Finish: Select Cedar  
Length: 12' 6"  
Thickness: .044"  
Exposure: 8"  
Projection: 5/8"  
Panels/Ctn.: 24  
Squares./Ctn.: 2  
Cartons/Pallet: 16  
lbs./Ctn.: ≤ 106

## DOUBLE 4-1/2" DUTCHLAP

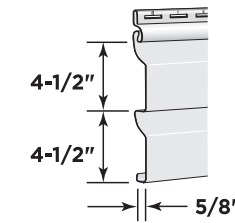

**Product Code: 36119**  
Finish: Select Cedar  
Length: 12' 1"  
Thickness: .044"  
Exposure: 9"  
Projection: 5/8"  
Panels/Ctn.: 22  
Squares./Ctn.: 2  
Cartons/Pallet: 16  
lbs./Ctn.: ≤ 102

## DOUBLE 5" CLAPBOARD

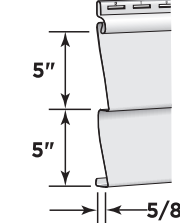

**Product Code: 36122**  
Finish: Select Cedar  
Length: 12'  
Thickness: .044"  
Exposure: 10"  
Projection: 5/8"  
Panels/Ctn.: 20  
Squares./Ctn.: 2  
Cartons/Pallet: 17  
lbs./Ctn.: ≤ 99

## DOUBLE 4-1/2" CLAPBOARD

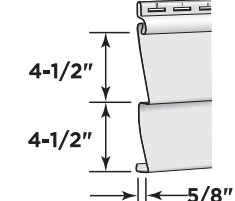

**Product Code: 36118**  
Finish: Smooth  
Length: 12' 1"  
Thickness: .044"  
Exposure: 9"  
Projection: 5/8"  
Panels/Ctn.: 22  
Squares./Ctn.: 2  
Cartons/Pallet: 14  
lbs./Ctn.: ≤ 106

## TRIPLE 3" CLAPBOARD

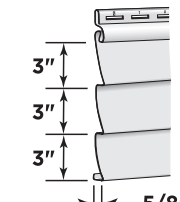

**Product Code: 36132**  
Finish: Smooth  
Length: 12' 1"  
Thickness: .044"  
Exposure: 9"  
Projection: 5/8"  
Panels/Ctn.: 22  
Squares./Ctn.: 2  
Cartons/Pallet: 14  
lbs./Ctn.: ≤ 111

## Vinyl Siding Products

Product Code	36110 Double 4" Clapboard (Select Cedar)	36119 Double 4-1/2" Dutchlap (Select Cedar)	36122 Double 5" Clapboard (Select Cedar)	36118 Double 4-1/2" Clapboard (Smooth)	36132 Triple 3" Clapboard (Smooth)
COLOR	Autumn Yellow (10)	●	●		
	Buckskin (41)	●	●		
	Castle Stone (37)	●	●		
	Colonial White (01)	●	●	●	●
	Cypress (42)	●	●	●	●
	Desert Tan (07)	●	●	●	
	Granite Gray (34)	●	●	●	●
	Heritage Cream (11)	●	●	●	
	Herringbone (04)	●	●	●	●
	Light Maple (55)	●	●	●	
DELUXE	Natural Clay (60)	●	●	●	●
	Oxford Blue (32)	●	●	●	
	Savannah Wicker (59)	●	●	●	●
	Seagrass (30)	●	●	●	
	Smoky Gray (83)	●	●		
	Sterling Gray (33)	●	●	●	●
	Autumn Red (23)	●	●		
	Charcoal Gray (46)	●	●		
	Espresso (43)	●	●		
	Flagstone (97)	●	●		
Forest (47)	●	●			
Hearthstone (19)	●	●			
Melrose (39)	●	●			
Midnight Blue (45)	●	●			
Mountain Cedar (17)	●	●			
Olive Grove (84)	●	●			
Pacific Blue (27)	●	●			
Sable Brown (29)	●	●			
Slate (44)	●	●			
Spruce (16)	●	●			

## Board & Batten

### SINGLE 12" VERTICAL BOARD & BATTEN - 10' INSULATED

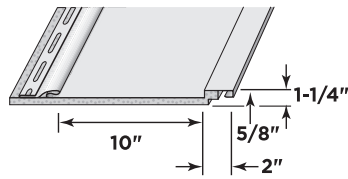

**Product Code: 58153**  
 Finish: Rough Cedar  
 Length: 10'  
 Thickness: .052"  
 Exposure: 12"  
 Projection: 1-1/4"  
 Panels/Ctn.: 10  
 Squares./Ctn.: 1  
 Cartons/Pallet: 9  
 lbs./Ctn.: ≤ 59

### SINGLE 8" VERTICAL BOARD & BATTEN - 12' 6"

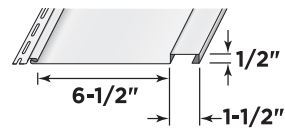

**Product Code: 34137**  
 Finish: Rough Cedar  
 Length: 12' 6"  
 Thickness: .048"  
 Exposure: 8"  
 Projection: 1/2"  
 Panels/Ctn.: 12  
 Squares./Ctn.: 1  
 Cartons/Pallet: 28  
 lbs./Ctn.: ≤ 57

### SINGLE 8" VERTICAL BOARD & BATTEN - 10'

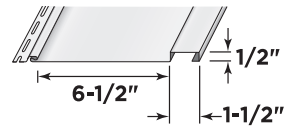

**Product Code: 34138**  
 Finish: Rough Cedar  
 Length: 10'  
 Thickness: .048"  
 Exposure: 8"  
 Projection: 1/2"  
 Panels/Ctn.: 15  
 Squares./Ctn.: 1  
 Cartons/Pallet: 24  
 lbs./Ctn.: ≤ 55

### SINGLE 7" VERTICAL BOARD & BATTEN - 10'

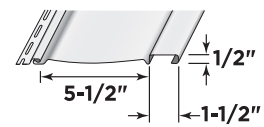

**Product Code: 34136**  
 Finish: Rough Cedar  
 Length: 10'  
 Thickness: .052"  
 Exposure: 7"  
 Projection: 1/2"  
 Panels/Ctn.: 34  
 Squares./Ctn.: 2  
 Cartons/Pallet: 12  
 lbs./Ctn.: ≤ 112

### SINGLE 7" REVERSE BOARD & BATTEN - REINFORCED SIDING

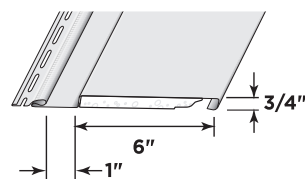

**Product Code: 63108**  
 Finish: Woodgrain  
 Length: 10'  
 Thickness: .046"  
 Exposure: 7"  
 Projection: 3/4"  
 Panels/Ctn.: 16  
 Squares./Ctn.: .93  
 Cartons/Pallet: 12  
 lbs./Ctn.: ≤ 62

\* Complete Assembly  
 ≤ Heaviest weight listed - varies by color.

## Vinyl Siding Products

Product Code	58153 Single 12" Vertical Board & Batten - 10' (Rough Cedar) Insulated	34137 Single 8" Vertical Board & Batten - 12' 6" (Rough Cedar)	34138 Single 8" Vertical Board & Batten - 10' (Rough Cedar)	34136 Single 7" Vertical Board & Batten - 10' (Rough Cedar)	63108 Single 7" Reverse Board & Batten - (Woodgrain) Reinforced
Castle Stone (37)				●	
Colonial White (01)	●	●	●	●	●
Cypress (42)		●	●	●	
Desert Tan (07)		●	●		
Granite Gray (34)	●	●	●	●	●
Herringbone (04)	●	●	●	●	
Light Maple (55)		●	●		
Natural Clay (60)	●	●	●	●	●
Sandstone Beige (15)		●	●		
Savannah Wicker (59)	●	●	●	●	●
Smoky Gray (83)				●	
Snow (31)	●	●	●		
Sterling Gray (33)	●	●	●	●	●
Wedgewood Blue (89)				●	
Weathered Wood (90)				●	
Autumn Red (23)	●			●	●
Brownstone (40)				●	
Charcoal Gray (46)				●	●
Espresso (43)				●	
Flagstone (97)				●	
Forest (47)				●	
Hearthstone (19)				●	
Melrose (39)				●	
Midnight Blue (45)				●	●
Pacific Blue (27)				●	●
Sable Brown (29)				●	●
Slate (44)				●	
Spruce (16)				●	
Tuxedo (56)				●	

## Carolina Beaded™

### SINGLE 6-1/2" BEADED

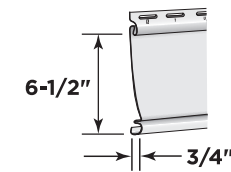

**Product Code: 38102**  
 Finish: Brushed  
 Length: 12' 4"  
 Thickness: .044"  
 Exposure: 6-1/2"  
 Projection: 3/4"  
 Panels/Ctn.: 30  
 Squares./Ctn.: 2  
 Cartons/Pallet: 12  
 lbs./Ctn.: ≤ 111

## Vinyl Siding Products

Product Code	38102 Single 6-1/2" Beaded (Brushed)
Castle Stone (37)	●
Colonial White (01)	●
Cypress (42)	●
Desert Tan (07)	●
Granite Gray (34)	●
Heritage Cream (11)	●
Herringbone (04)	●
Light Maple (55)	●
Natural Clay (60)	●
Oxford Blue (32)	●
Sandstone Beige (15)	●
Savannah Wicker (59)	●
Seagrass (30)	●
Snow (31)	●
Sterling Gray (33)	●

≤ Heaviest weight listed - varies by color.



# MainStreet™

## Vinyl Siding Products

# MainStreet™ (continued)

## Vinyl Siding Products

**NEW** DOUBLE 4" CLAPBOARD  
COLORS

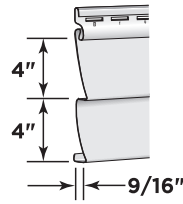

**Product Code: 39110**  
Finish: Woodgrain  
Length: 12' 6"  
Thickness: .042"  
Exposure: 8"  
Projection: 9/16"  
Panels/Ctn.: 24  
Squares./Ctn.: 2  
Cartons/Pallet: 16  
lbs./Ctn.: ≤ 99

TRIPLE 3" CLAPBOARD

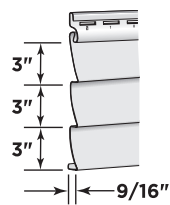

**Product Code: 39131**  
Finish: Brushed  
Length: 12' 1"  
Thickness: .042"  
Exposure: 9"  
Projection: 9/16"  
Panels/Ctn.: 22  
Squares./Ctn.: 2  
Cartons/Pallet: 14  
lbs./Ctn.: ≤ 100

**NEW** DOUBLE 5" CLAPBOARD  
COLORS

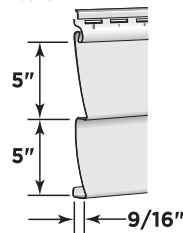

**Product Code: 39122**  
Finish: Woodgrain  
Length: 12'  
Thickness: .042"  
Exposure: 10"  
Projection: 9/16"  
Panels/Ctn.: 20  
Squares./Ctn.: 2  
Cartons/Pallet: 17  
lbs./Ctn.: ≤ 93

**NEW** DOUBLE 4" DUTCHLAP  
COLORS

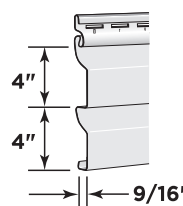

**Product Code: 39113**  
Finish: Woodgrain  
Length: 12' 6"  
Thickness: .042"  
Exposure: 8"  
Projection: 9/16"  
Panels/Ctn.: 24  
Squares./Ctn.: 2  
Cartons/Pallet: 16  
lbs./Ctn.: ≤ 101

**NEW** DOUBLE 5" DUTCHLAP  
COLORS

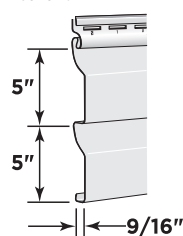

**Product Code: 39125**  
Finish: Woodgrain  
Length: 12'  
Thickness: .042"  
Exposure: 10"  
Projection: 9/16"  
Panels/Ctn.: 20  
Squares./Ctn.: 2  
Cartons/Pallet: 14  
lbs./Ctn.: ≤ 93

Product Code	39110 Double 4" Clapboard (Woodgrain)	39131 Triple 3" Clapboard (Brushed)	39122 Double 5" Clapboard (Woodgrain)	39113 Double 4" Dutchlap (Woodgrain)	39125 Double 5" Dutchlap (Woodgrain)
Autumn Yellow (10)	●		●	●	●
Castle Stone (37)	●		●	●	●
Colonial White (01)	●	●	●	●	●
Cypress (42)	●		●	●	●
Desert Tan (07)	●	●	●	●	●
Granite Gray (34)	●		●	●	●
Heritage Cream (11)	●	●	●	●	●
Herringbone (04)	●		●	●	●
Natural Clay (60)	●	●	●	●	●
Oxford Blue (32)	●	●	●	●	●
Sandstone Beige (15)	●	●	●	●	●
Savannah Wicker (59)	●	●	●	●	●
Seagrass (30)	●		●	●	●
Snow (31)	●	●	●	●	●
Sterling Gray (33)	●	●	●	●	●
Wedgewood Blue (89)	★		★	★	★
Weathered Wood (90)	★		★	★	★
Autumn Red (23)	●		●	●	●
Charcoal Gray (46)	●		●	●	●
Flagstone (97)	●		●	●	●
Forest (47)	●		●	●	●
Hearthstone (19)	●		●	●	●
Pacific Blue (27)	●		●	●	●
Sable Brown (29)	●		●	●	●
Spruce (16)	●		●	●	●

★ NEW COLOR

SINGLE 6-1/2" BEADED

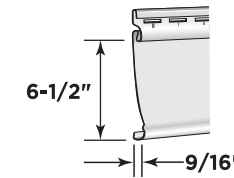

**Product Code: 39102**  
Finish: Brushed  
Length: 12' 4"  
Thickness: .042"  
Exposure: 6-1/2"  
Projection: 9/16"  
Panels/Ctn.: 30  
Squares./Ctn.: 2  
Cartons/Pallet: 15  
lbs./Ctn.: ≤ 71

SINGLE 8" CLAPBOARD

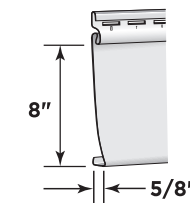

**Product Code: 39104**  
Finish: Woodgrain  
Length: 12' 6"  
Thickness: .042"  
Exposure: 8"  
Projection: 5/8"  
Panels/Ctn.: 24  
Squares./Ctn.: 2  
Cartons/Pallet: 16  
lbs./Ctn.: ≤ 96

Product Code	39102 Single 6-1/2" Beaded (Brushed)	39104 Single 8" Clapboard (Woodgrain)
Colonial White (01)	●	●
Cypress (42)	●	
Desert Tan (07)	●	
Granite Gray (34)	●	
Natural Clay (60)	●	
Sandstone Beige (15)	●	
Savannah Wicker (59)	●	
Sterling Gray (33)	●	

# American Legend™

## Vinyl Siding Products

### DOUBLE 4" CLAPBOARD

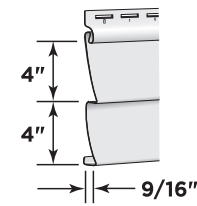

**Product Code: 40110**  
 Finish: Woodgrain  
 Length: 12' 6"  
 Thickness: .042"  
 Exposure: 8"  
 Projection: 9/16"  
 Panels/Ctn.: 24  
 Squares./Ctn.: 2  
 Cartons/Pallet: 16  
 lbs./Ctn.: ≤ 100

### DOUBLE 4-1/2" DUTCHLAP

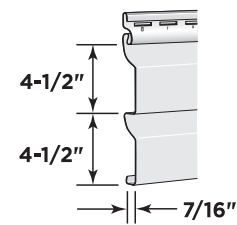

**Product Code: 40119**  
 Finish: Woodgrain  
 Length: 12' 1"  
 Thickness: .042"  
 Exposure: 9"  
 Projection: 9/16"  
 Panels/Ctn.: 22  
 Squares./Ctn.: 2  
 Cartons/Pallet: 16  
 lbs./Ctn.: ≤ 97

### DOUBLE 5" CLAPBOARD

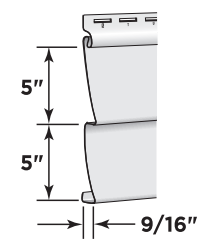

**Product Code: 40122**  
 Finish: Woodgrain  
 Length: 12'  
 Thickness: .042"  
 Exposure: 10"  
 Projection: 9/16"  
 Panels/Ctn.: 20  
 Squares./Ctn.: 2  
 Cartons/Pallet: 20  
 lbs./Ctn.: ≤ 93

Product Code	40110 Double 4" Clapboard (Woodgrain)	40119 Double 4-1/2" Dutchlap (Woodgrain)	40122 Double 5" Clapboard (Woodgrain)
Autumn Yellow (10)	●	●	
Buckskin (41)	●	●	
Colonial White (01)	●	●	●
Cypress (42)	●	●	●
Desert Tan (07)	●	●	●
Granite Gray (34)	●	●	●
Heritage Cream (11)	●	●	●
Herringbone (04)	●	●	●
Light Maple (55)	●	●	
Natural Clay (60)	●	●	●
Oxford Blue (32)	●	●	●
Savannah Wicker (59)	●	●	●
Seagrass (30)	●	●	●
Snow (31)	●	●	●
Sterling Gray (33)	●	●	●
Autumn Red (23)	●	●	●
Charcoal Gray (46)	●	●	●
Flagstone (97)	●	●	●
Forest (47)	●	●	●
Hearthstone (19)	●	●	●
Spruce (16)	●	●	●

# Encore™

## Vinyl Siding Products

### DOUBLE 4" CLAPBOARD

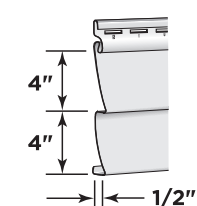

**Product Code: 43110**  
 Finish: Woodgrain  
 Length: 12' 6"  
 Thickness: .040"  
 Exposure: 8"  
 Projection: 1/2"  
 Panels/Ctn.: 24  
 Squares./Ctn.: 2  
 Cartons/Pallet: 16  
 lbs./Ctn.: ≤ 88

### DOUBLE 4-1/2" DUTCHLAP

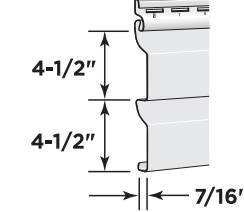

**Product Code: 43119**  
 Finish: Woodgrain  
 Length: 12' 1"  
 Thickness: .040"  
 Exposure: 9"<sup>†</sup>  
 Projection: 7/16"  
 Panels/Ctn.: 22  
 Squares./Ctn.: 2  
 Cartons/Pallet: 16  
 lbs./Ctn.: ≤ 86

### DOUBLE 5" CLAPBOARD

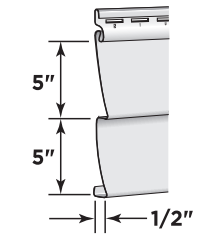

**Product Code: 43122**  
 Finish: Woodgrain  
 Length: 12'  
 Thickness: .040"  
 Exposure: 10"  
 Projection: 1/2"  
 Panels/Ctn.: 20  
 Squares./Ctn.: 2  
 Cartons/Pallet: 17  
 lbs./Ctn.: ≤ 84

Product Code	43110 Double 4" Clapboard (Woodgrain)	43119 Double 4-1/2" Dutchlap (Woodgrain)	43122 Double 5" Clapboard (Woodgrain)
Buckskin (41)	●	●	
Castle Stone (37)	●	●	●
Colonial White (01)	●	●	●
Cypress (42)	●	●	●
Desert Tan (07)	●	●	●
Heritage Cream (11)	●	●	
Herringbone (04)	●	●	●
Light Maple (55)	●	●	●
Natural Clay (60)	●	●	●
Oxford Blue (32)	●	●	●
Sandstone Beige (15)	●	●	●
Savannah Wicker (59)	●	●	●
Seagrass (30)	●	●	●
Snow (31)	●	●	●
Sterling Gray (33)	●	●	●



## Invisivent® Triple 3-1/3" Soffit

### TRIPLE 3-1/3" INVISIVENT® (Soffit Use Only)

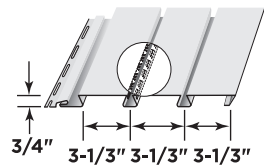

Ventilation (NFA/Sq. Ft.: 10")

**Product Code: 46228**  
 Finish: Matte  
 Length: 12'  
 Thickness: .044"  
 Exposure: 10"  
 Projection: 3/4"  
 Panels/Ctn.: 10  
 Squares./Ctn.: 1  
 Cartons/Pallet: 20  
 lbs./Ctn.: ≤ 62

### TRIPLE 3-1/3" SOLID VERTICAL SIDING & SOFFIT

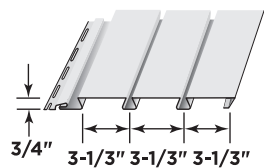

**Product Code: 46229**  
 Finish: Matte  
 Length: 12'  
 Thickness: .044"  
 Exposure: 10"  
 Projection: 3/4"  
 Panels/Ctn.: 10  
 Squares./Ctn.: 1  
 Cartons/Pallet: 20  
 lbs./Ctn.: ≤ 65

## Perimeter™ Triple 3-1/3" Soffit

### PERIMETER TRIPLE 3-1/3" HIDDEN VENT SOFFIT (Soffit Use Only)

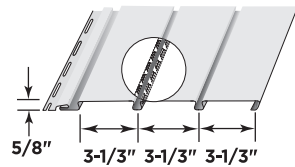

Ventilation (NFA/Sq. Ft.: 9.65")

**Product Code: 46230**  
 Finish: Matte  
 Length: 12'  
 Thickness: .040"  
 Exposure: 10"  
 Projection: 5/8"  
 Panels/Ctn.: 20  
 Squares/Ctn.: 2  
 Cartons/Pallet: 14  
 lbs./Ctn.: ≤ 94

### PERIMETER TRIPLE 3-1/3" SOLID VERTICAL SIDING & SOFFIT

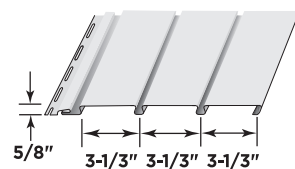

**Product Code: 46231**  
 Finish: Matte  
 Length: 12'  
 Thickness: .040"  
 Exposure: 10"  
 Projection: 5/8"  
 Panels/Ctn.: 20  
 Squares/Ctn.: 2  
 Cartons/Pallet: 14  
 lbs./Ctn.: ≤ 103

## Vinyl Carpentry® Soffit & Vertical Siding

Product Code	46228 Triple 3-1/3" InvisiVent® Soffit (Soffit Use Only) (Matte)	46229 Triple 3-1/3" Solid Soffit & Vertical Siding (Matte)	46230 Perimeter Hidden Vent Soffit (Soffit Use Only) (Matte)	46231 Perimeter Solid Soffit & Vertical Siding (Matte)
Charcoal Gray (46)			•	•
Colonial White (01)	•	•	•	•
Desert Tan (07)	•	•	•	•
Granite Gray (34)	•	•	•	•
Herringbone (04)			•	•
Natural Clay (60)	•	•	•	•
Sandstone Beige (15)	•	•	•	•
Savannah Wicker (59)	•	•	•	•
Snow (31)	•	•	•	•
PR Black (54)			+	+

Note: All vented soffits are soffit use only. + Soffit Use Only

## Ironmax™ Soffit

### DOUBLE 5" SOLID SOFFIT & VERTICAL SIDING

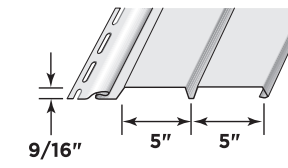

### DOUBLE 5" FULLY VENTED SOFFIT (Soffit Use Only)

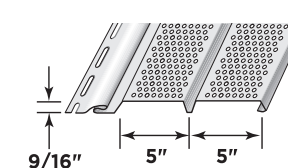

Ventilation (NFA/Sq. Ft.: 6.4")

**Product Code: 47201**  
 Finish: Woodgrain  
 Length: 12'  
 Thickness: .046"  
 Exposure: 10"  
 Projection: 9/16"  
 Panels/Ctn.: 20  
 Squares/Ctn.: 2  
 Cartons/Pallet: 14  
 lbs./Ctn.: ≤ 104

**Product Code: 47205**  
 Finish: Woodgrain  
 Length: 12'  
 Thickness: .046"  
 Exposure: 10"  
 Projection: 9/16"  
 Panels/Ctn.: 20  
 Squares/Ctn.: 2  
 Cartons/Pallet: 14  
 lbs./Ctn.: ≤ 101

## Vinyl Carpentry® Soffit & Vertical Siding

Product Code	47201 Double 5" Solid Soffit & Vertical Siding (Woodgrain)	47205 Double 5" Fully Vented Soffit (Soffit Use Only) (Woodgrain)
Colonial White (01)	•	•
Desert Tan (07)	•	•
Granite Gray (34)	•	•
Light Maple (55)	•	•
Natural Clay (60)	•	•
Sable Brown (29)	+	•
Sandstone Beige (15)	•	•
Savannah Wicker (59)	•	•
Snow (31)	•	•
Sterling Gray (33)	•	•

Note: All vented soffits are soffit use only. + Soffit Use Only

## Beaded Soffit

### NEW TRIPLE 2" SOLID SOFFIT & VERTICAL SIDING

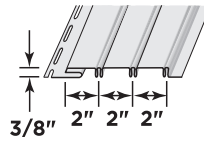

**Product Code: 46209**  
 Finish: Smooth  
 Length: 12' 6"  
 Thickness: .039"  
 Exposure: 6"  
 Projection: 3/8"  
 Panels/Ctn.: 16  
 Squares./Ctn.: 1  
 Cartons/Pallet: 20  
 lbs./Ctn.: ≤ 65

### NEW TRIPLE 2" VENTED SOFFIT (Soffit Use Only)

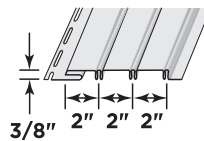

**Product Code: 46211**  
 Finish: Smooth  
 Length: 12' 6"  
 Thickness: .039"  
 Exposure: 6"  
 Projection: 3/8"  
 Panels/Ctn.: 16  
 Squares./Ctn.: 1  
 Cartons/Pallet: 20  
 lbs./Ctn.: ≤ 64

Invisibly-Vented (NFA/Sq. Ft.: 1.6")

## Vinyl Carpentry® Soffit & Vertical Siding

Product Code	46209 Triple 2" Solid Soffit & Vertical Siding (Smooth)	46211 Triple 2" Vented Soffit (Soffit Use Only) (Smooth)
Bermuda Blue (26)	★	★
Colonial White (01)	●	●
Desert Tan (07)	●	●
Natural Clay (60)	●	●
Sandstone Beige (15)	●	●
Savannah Wicker (59)	●	●
Snow (31)	●	●
Sterling Gray (33)	●	●

Note: All vented soffits are soffit use only.

★ NEW COLOR

## Universal Soffit

### TRIPLE 4" SOLID SOFFIT & VERTICAL SIDING

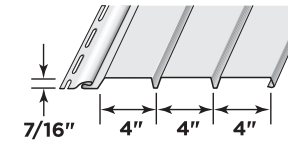

**Product Code: 48216**  
 Finish: Matte  
 Length: 12'  
 Thickness: .040"  
 Exposure: 12"†  
 Projection: 7/16"  
 Panels/Ctn.: 16  
 Square Ft./Ctn.: 192  
 Cartons/Pallet: 18  
 lbs./Ctn.: ≤ 82

### TRIPLE 4" FULLY VENTED SOFFIT (Soffit Use Only)

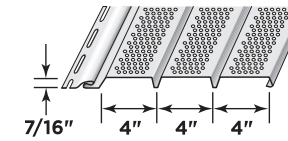

**Product Code: 48224**  
 Finish: Matte  
 Length: 12'  
 Thickness: .040"  
 Exposure: 12"†  
 Projection: 7/16"  
 Panels/Ctn.: 16  
 Square Ft./Ctn.: 192  
 Cartons/Pallet: 18  
 lbs./Ctn.: ≤ 80

Ventilation (NFA/Sq. Ft.: 5.9")

### TRIPLE 4" CENTER VENTED SOFFIT (Soffit Use Only)

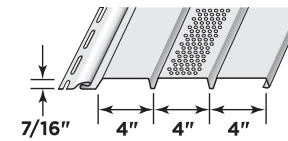

**Product Code: 48220**  
 Finish: Matte  
 Length: 12'  
 Thickness: .040"  
 Exposure: 12"†  
 Projection: 7/16"  
 Panels/Ctn.: 16  
 Square Ft./Ctn.: 192  
 Cartons/Pallet: 18  
 lbs./Ctn.: ≤ 81

Ventilation (NFA/Sq. Ft.: 2")

### DOUBLE 5" SOLID SOFFIT (Soffit Use Only)

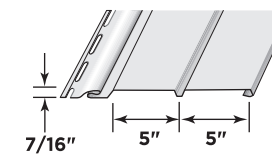

**Product Code: 48222**  
 Finish: Woodgrain  
 Length: 12'  
 Thickness: .040"  
 Exposure: 10"  
 Projection: 7/16"  
 Panels/Ctn.: 20  
 Squares/Ctn.: 2  
 Cartons/Pallet: 17  
 lbs./Ctn.: ≤ 94

### DOUBLE 5" FULLY VENTED SOFFIT (Soffit Use Only)

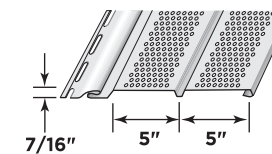

**Product Code: 48223**  
 Finish: Woodgrain  
 Length: 12'  
 Thickness: .040"  
 Exposure: 10"  
 Projection: 7/16"  
 Panels/Ctn.: 20  
 Squares/Ctn.: 2  
 Cartons/Pallet: 17  
 lbs./Ctn.: ≤ 90

Ventilation (NFA/Sq. Ft.: 6.4")

## Vinyl Carpentry® Soffit & Vertical Siding

Product Code	48216 Triple 4" Solid Soffit & Vertical Siding (Matte)	48224 Triple 4" Fully Vented Soffit (Soffit Use Only) (Matte)	48220 Triple 4" Center Vented Soffit (Soffit Use Only) (Matte)	48222 Double 5" Solid Soffit (Soffit Use Only) (Woodgrain)	48223 Double 5" Fully Vented Soffit (Soffit Use Only) (Woodgrain)
Autumn Red (23)	●	●			
Brownstone (40)	●	●			
Buckskin (41)	●	●			
Castle Stone (37)	●	●			
Charcoal Gray (46)	●	●			
Colonial White (01)	●	●	●	●	●
Cypress (42)	●	●			
Desert Tan (07)	●	●		●	●
Espresso (43)	●	●			
Flagstone (97)	●	●			
Forest (47)	●	●			
Granite Gray (34)	●	●			
Hearthstone (19)	●	●			
Heritage Cream (11)	●	●			
Herringbone (04)	●	●		●	●
Light Maple (55)	●	●		●	●
Melrose (39)	●	●			
Midnight Blue (45)	●	●			
Natural Clay (60)	●	●		●	●
Oxford Blue (32)	●	●			
Pacific Blue (27)	●	●			
Sable Brown (29)	●	●			
Sandstone Beige (15)	●	●		●	●
Savannah Wicker (59)	●	●		●	●
Slate (44)	●	●			
Snow (31)	●	●	●		
Sterling Gray (33)	●	●		●	●
Black (54)	+	+			
Musket Brown (49)	+	+		+	+

† Dimensions shown are nominal.

+ Soffit Use Only

Note: All vented soffits are soffit use only.

## Value Soffit

### TRIPLE 4" SOLID SOFFIT (Soffit Use Only)

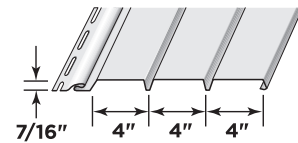

**Product Code: 49216**  
 Finish: Matte  
 Length: 12'  
 Thickness: .036"  
 Exposure: 12"†  
 Projection: 7/16"  
 Panels/Ctn.: 16  
 Square Ft./Ctn.: 192  
 Cartons/Pallet: 18  
 lbs./Ctn.: ≤ 74

### TRIPLE 4" FULLY VENTED SOFFIT (Soffit Use Only)

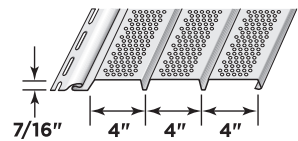

**Product Code: 49224**  
 Finish: Matte  
 Length: 12'  
 Thickness: .036"  
 Exposure: 12"†  
 Projection: 7/16"  
 Panels/Ctn.: 16  
 Square Ft./Ctn.: 192  
 Cartons/Pallet: 18  
 lbs./Ctn.: ≤ 72

Ventilation (NFA/Sq. Ft.: 5.9")

### TRIPLE 4" CENTER VENTED SOFFIT (Soffit Use Only)

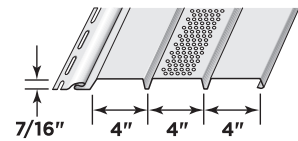

**Product Code: 49220**  
 Finish: Matte  
 Length: 12'  
 Thickness: .036"  
 Exposure: 12"†  
 Projection: 7/16"  
 Panels/Ctn.: 16  
 Square Ft./Ctn.: 192  
 Cartons/Pallet: 18  
 lbs./Ctn.: ≤ 73

Ventilation (NFA/Sq. Ft.: 2")

### DOUBLE 5" SOLID SOFFIT (Soffit Use Only)

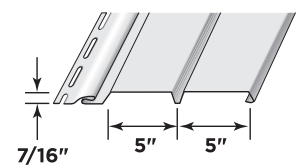

**Product Code: 49204**  
 Finish: Matte  
 Length: 12'  
 Thickness: .036"  
 Exposure: 10"  
 Projection: 7/16"  
 Panels/Ctn.: 20  
 Squares./Ctn.: 2  
 Cartons/Pallet: 17  
 lbs./Ctn.: ≤ 86

### DOUBLE 5" FULLY VENTED SOFFIT (Soffit Use Only)

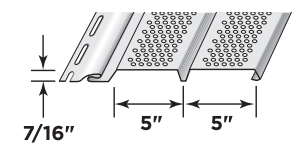

**Product Code: 49208**  
 Finish: Matte  
 Length: 12'  
 Thickness: .036"  
 Exposure: 10"  
 Projection: 7/16"  
 Panels/Ctn.: 20  
 Squares./Ctn.: 2  
 Cartons/Pallet: 17  
 lbs./Ctn.: ≤ 83

Ventilation (NFA/Sq. Ft.: 6.4")

† Dimensions shown are nominal.  
 ≤ Heaviest weight listed - varies by color.

## Vinyl Carpentry® Soffit & Vertical Siding

Product Code	49216 Triple 4" Solid Soffit (Soffit use only) (Matte)	49224 Triple 4" Fully Vented Soffit (Soffit use only) (Matte)	49220 Triple 4" Center Vented Soffit (Soffit use only) (Matte)	49204 Double 5" Solid Soffit (Soffit use only) (Matte)	49208 Double 5" Fully Vented Soffit (Soffit use only) (Matte)
Colonial White (01)	●	●	●	●	●
Desert Tan (07)	●	●			
Natural Clay (60)	●	●			
Sandstone Beige (15)	●	●			
Savannah Wicker (59)	●	●			
Snow (31)	●	●			

Note: All Value soffits are soffit use only.

## Corner Systems Standard Face Dimension

### 3/4" CORNERPOST - 10' WOODGRAIN

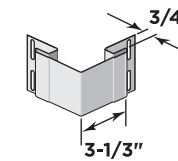

**Product Code: 51401**  
 Finish: Woodgrain  
 Length: 10'  
 Face: 3-1/3"  
 Pieces/Ctn.: 10  
 Lin. Ft./Ctn.: 100  
 Cartons/Pallet: 15  
 lbs./Ctn.: ≤ 39

### 3/4" CORNERPOST - 10' MATTE

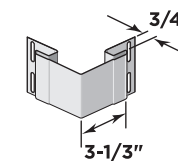

**Product Code: 51404**  
 Finish: Matte  
 Length: 10'  
 Face: 3-1/3"  
 Pieces/Ctn.: 10  
 Lin. Ft./Ctn.: 100  
 Cartons/Pallet: 15  
 lbs./Ctn.: ≤ 41

### 3/4" CORNERPOST - 12' WOODGRAIN

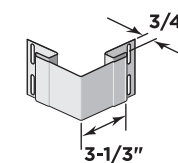

**Product Code: 51402**  
 Finish: Woodgrain  
 Length: 12'  
 Face: 3-1/3"  
 Pieces/Ctn.: 10  
 Lin. Ft./Ctn.: 120  
 Cartons/Pallet: 15  
 lbs./Ctn.: ≤ 46

### 3/4" CORNERPOST - 20' WOODGRAIN

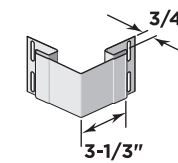

**Product Code: 51458**  
 Finish: Woodgrain  
 Length: 20'  
 Face: 3-1/3"  
 Pieces/Ctn.: 6  
 Lin. Ft./Ctn.: 120  
 Cartons/Pallet: 24  
 lbs./Ctn.: ≤ 50

## Vinyl Carpentry® Accessories

Product Code	51401 3/4" Cornerpost - 10' (Woodgrain)	51404 3/4" Cornerpost - 10' (Matte)	51402 3/4" Cornerpost - 12' (Woodgrain)	51458 3/4" Cornerpost - 20' (Woodgrain)
Colonial White (01)	●	●	●	●
Autumn Red (23)	●			
Autumn Yellow (10)	●			
Bermuda Blue (26)	●			
Brownstone (40)	●			
Buckskin (41)	●			
Castle Stone (37)	●			
Charcoal Gray (46)	●			
Cypress (42)	●	●		
Desert Tan (07)	●	●		
Espresso (43)	●			
Flagstone (97)	●			
Forest (47)	●			
Granite Gray (34)	●	●	●	
Hearthstone (19)	●			
Heritage Cream (11)	●			
Herringbone (04)	●	●		
Light Maple (55)	●	●		
Melrose (39)	●			
Midnight Blue (45)	●			
Mountain Cedar (17)	●			
Natural Clay (60)	●	●	●	
Olive Grove (84)	●			
Oxford Blue (32)	●			
Pacific Blue (27)	●			
Sable Brown (29)	●			
Sandstone Beige (15)	●	●		
Savannah Wicker (59)	●	●	●	
Seagrass (30)	●			
Slate (44)	●			
Smoky Gray (83)	●			
Snow (31)	●	●		
Spruce (16)	●			
Sterling Gray (33)	●	●	●	
Tuxedo (56)	●			
Weathered Wood (90)	●			
Wedgewood Blue (89)	●			
Arbor Blend (57)	●			
Cedar Blend (79)	●			
Driftwood Blend (80)	●			
Frontier Blend (51)	●			
Natural Blend (78)	●			
Rustic Blend (82)	●			
Weathered Blend (53)	●			

≤ Heaviest weight listed - varies by color.



## Corner Systems

Standard Face Dimension

### 1-1/4" CORNERPOST - 10' WOODGRAIN With Foam Insert

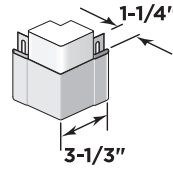

**Product Code: 51412**  
Finish: Woodgrain  
Length: 10'  
Face: 3-1/3"  
Pieces/Ctn.: 10  
Lin. Ft. /Ctn.: 100  
Cartons/Pallet: 12  
lbs./Ctn.: ≤ 42

### 1" CORNERPOST - 10' WOODGRAIN

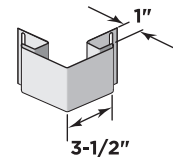

**Product Code: 51409**  
Finish: Woodgrain  
Length: 10'  
Face: 3-1/2"  
Pieces/Ctn.: 10  
Lin. Ft. /Ctn.: 100  
Cartons/Pallet: 12  
lbs./Ctn.: ≤ 50

## Corner Systems

Inside

### 3/4" INSIDE CORNERPOST

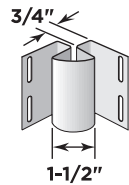

**Product Code: 51436**  
Finish: Matte  
Length: 10'  
Face: 3/4"  
Pieces/Ctn.: 10  
Lin. Ft. /Ctn.: 100  
Cartons/Pallet: 24  
lbs./Ctn.: ≤ 29

### 1-1/4" INSIDE CORNERPOST

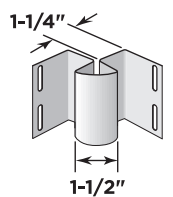

**Product Code: 51446**  
Finish: Matte  
Length: 10'  
Face: 1-1/4"  
Pieces/Ctn.: 10  
Lin. Ft. /Ctn.: 100  
Cartons/Pallet: 15  
lbs./Ctn.: ≤ 31

## Vinyl Carpentry Accessories

Product Code	51412 1-1/4" Cornerpost - 10' (Woodgrain)	51409 1" Cornerpost - 10' (Woodgrain)	51436 3/4" Inside Cornerpost (Matte)	51446 1-1/4" Inside Cornerpost (Matte)
Colonial White (01)	●	●	●	●
Autumn Red (23)	●	●	●	●
Autumn Yellow (10)			●	
Bermuda Blue (26)			●	
Brownstone (40)			●	
Buckskin (41)	●	●	●	●
Castle Stone (37)			●	
Cedar Blend Solid (48)			+	
Charcoal Gray (46)	●	●	●	●
Cypress (42)	●	●	●	●
Desert Tan (07)	●	●	●	●
Espresso (43)			●	
Flagstone (97)	●	●	●	●
Forest (47)		●	●	
Granite Gray (34)	●	●	●	●
Hearthstone (19)		●	●	
Heritage Cream (11)	●		●	●
Herringbone (04)	●		●	●
Light Maple (55)	●		●	●
Melrose (39)			●	
Midnight Blue (45)			●	
Mountain Cedar (17)		●	●	
Natural Clay (60)	●	●	●	●
Olive Grove (84)			●	
Oxford Blue (32)	●		●	●
Pacific Blue (27)	●	●	●	●
Sable Brown (29)	●	●	●	●
Sandstone Beige (15)	●	●	●	●
Savannah Wicker (59)	●	●	●	●
Seagrass (30)		●	●	
Slate (44)			●	
Smoky Gray (83)			●	
Snow (31)	●	●	●	●
Spruce (16)	●	●	●	●
Sterling Gray (33)	●	●	●	●
Tuxedo (56)			●	
Weathered Wood (90)			●	
Wedgewood Blue (89)			●	
Arbor Blend (57)			+	
Frontier Blend (51)			+	

+ SOLID COLOR

**Recommended accessory colors for Monogram Blends**  
The following colors are the best comparable trim options:  
Natural Blend = Buckskin, Cedar Blend = Cedar Blend Solid,  
Driftwood Blend = Granite Gray or Charcoal Gray, Rustic Blend = Sable Brown,  
Weathered Blend = Weathered Wood

## Corner Systems

Wide Faced Dimension

### TRADITIONAL SUPERCORNER™ With Foam Insert

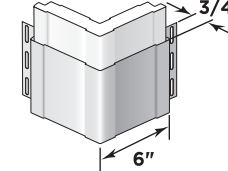

**Product Code: 51420**  
Finish: Matte  
Length: 20'  
Pieces/Ctn.: 6  
Lin. Ft. /Ctn.: 120  
Cartons/Pallet: 9  
lbs./Ctn.: ≤ 77

### 1-1/4" TRADITIONAL SUPERCORNER™ With Foam Insert

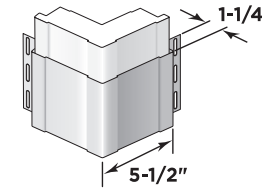

**Product Code: 51447**  
Finish: Matte  
Length: 20'  
Pieces/Ctn.: 6  
Lin. Ft. /Ctn.: 120  
Cartons/Pallet: 8  
lbs./Ctn.: ≤ 80

### FLUTED SUPERCORNER™ With Foam Insert

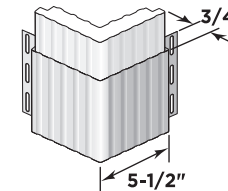

**Product Code: 51424**  
Finish: Matte  
Length: 20'  
Pieces/Ctn.: 6  
Lin. Ft. /Ctn.: 120  
Cartons/Pallet: 10  
lbs./Ctn.: ≤ 81

### 3-1/2" LINEAL

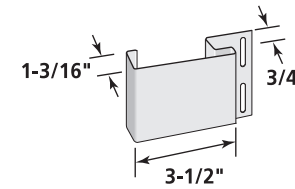

**Product Code: 54706**  
Finish: Matte  
Length: 20'  
Pieces/Ctn.: 10  
Lin. Ft. /Ctn.: 200  
Cartons/Pallet: 30  
lbs./Ctn.: ≤ 51

### 5" LINEAL

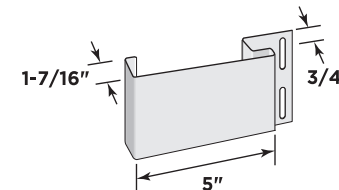

**Product Code: 54712**  
Finish: Matte  
Length: 20'  
Pieces/Ctn.: 10  
Lin. Ft. /Ctn.: 200  
Cartons/Pallet: 15  
lbs./Ctn.: ≤ 64

## Vinyl Carpentry Accessories

Product Code	51420 Traditional SuperCorner With Foam Insert	51447 1-1/4" Traditional SuperCorner With Foam Insert	51424 Fluted SuperCorner With Foam Insert	54706 3-1/2" Lineal	54712 5" Lineal
Colonial White (01)	●	●	●	●	●
Desert Tan (07)	●			●	
Herringbone (04)				●	
Natural Clay (60)				●	
Sandstone Beige (15)	●			●	
Savannah Wicker (59)	●			●	
Snow (31)	●			●	●

## Corner Systems Cedar Impressions

### INDIVIDUAL 5" SAWMILL CORNER

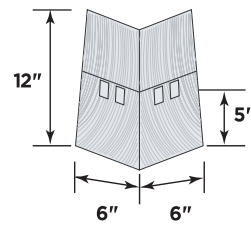

**Product Code: 51405**  
Finish: Sawmill  
Exposure: 5"  
Pieces/Ctn.: 24  
Lin. Ft./Ctn.: 10'  
Cartons/Pallet: 45  
lbs./Ctn.: ≤ 12

### T5" STRAIGHT EDGE SAWMILL OFFSET MITERED CORNERPOST

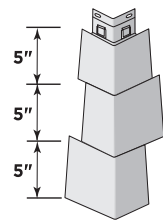

**Product Code: 51406**  
Finish: Sawmill  
Pieces/Ctn.: 32  
Lin. Ft./Ctn.: 40'  
Cartons/Pallet: 12  
lbs./Ctn.: ≤ 17

### 7" PERFECTION OFFSET MITERED CORNERPOSTS

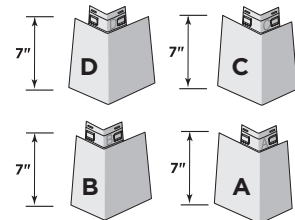

**Product Code: 51459**  
Finish: Perfection  
Length: 4 Pieces - 7" each  
Pieces/Ctn.: 40  
Lin. Ft./Ctn.: 23' 4"  
Cartons/Pallet: 24  
lbs./Ctn.: ≤ 15

For use with Single 7" Perfection and Double 7" Perfection

**Recommended trim:** CertainTeed recommends the use of Restoration Millwork PVC trim for the most authentic look of genuine cedar. If you choose to use CertainTeed vinyl accessories, the following solid colors are the best comparable options:  
Natural Blend = Buckskin, Cedar Blend = Cedar Blend Solid,  
Driftwood Blend = Granite Gray or Charcoal Gray, Rustic Blend = Sable Brown

## Polymer Siding Products

Product Code	51405 Individual 5" Sawmill Corner	51406 T5" Straight Edge Sawmill Offset Mitered Cornerpost	51459 7" Perfection Offset Mitered Cornerposts		
Colonial White (01)	●	●	●		
Autumn Red (23)		●	●		
Autumn Yellow (10)			●		
Bermuda Blue (26)			●		
Brownstone (40)		●	●		
Buckskin (41)		●	●		
Castle Stone (37)		●	●		
Charcoal Gray (46)		●	●		
Cypress (42)		●	●		
Desert Tan (07)		●	●		
Espresso (43)		●	●		
Flagstone (97)		●	●		
Forest (47)		●	●		
Granite Gray (34)		●	●		
Hearthstone (19)		●	●		
Heritage Cream (11)		●	●		
Herringbone (04)		●	●		
Light Maple (55)		●	●		
Melrose (39)		●	●		
Midnight Blue (45)		●	●		
Mountain Cedar (17)		●	●		
Natural Clay (60)	●	●	●		
Pacific Blue (27)		●	●		
Sable Brown (29)		●	●		
Savannah Wicker (59)	●	●	●		
Seagrass (30)	●	●	●		
Slate (44)		●	●		
Snow (31)			●		
Spruce (16)		●	●		
Sterling Gray (33)	●	●	●		
Wedgewood Blue (89)		●	●		
Weathered Wood (90)		●	●		
► Cedar Blend (79)			●		
► Driftwood Blend (80)			●		
► Natural Blend (78)			●		
► Rustic Blend (82)			●		
Cedar Blend - Light (70)	●				
Cedar Blend - Med. (71)	●				
Cedar Blend - Dark (72)	●				
Driftwood Blend - L. (94)	●				
Driftwood Blend - M. (95)	●				
Driftwood Blend - D. (96)	●				
Natural Blend - Light (86)	●				
Natural Blend - Med. (87)	●				
Natural Blend - Dark (88)	●				
Rustic Blend - Light (73)	●				
Rustic Blend - Med. (74)	●				
Rustic Blend - Dark (75)	●				

► CONSISTENT VARIEGATED COLOR THROUGHOUT THE PANEL

## Corner Systems Cedar Impressions

### D7" STAGGERED PERFECTION MITERED CORNERPOST

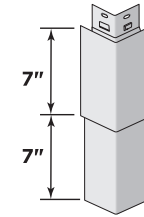

**Product Code: 51451**  
Finish: Perfection  
Length: 14"  
Pieces/Ctn.: 20  
Lin. Ft./Ctn.: 23' 3"  
Cartons/Pallet: 32  
lbs./Ctn.: ≤ 14

### D7" STRAIGHT EDGE ROUGH-SPLIT MITERED CORNERPOST

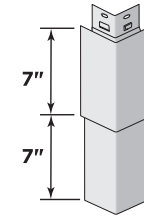

**Product Code: 51450**  
Finish: Rough-Split  
Length: 14"  
Pieces/Ctn.: 20  
Lin. Ft./Ctn.: 23' 4"  
Cartons/Pallet: 24  
lbs./Ctn.: ≤ 17

### D9" STAGGERED ROUGH-SPLIT MITERED CORNERPOST

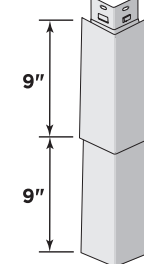

**Product Code: 51432**  
Finish: Rough-Split  
Length: 18-1/2"  
Pieces/Ctn.: 20  
Lin. Ft./Ctn.: 31  
Cartons/Pallet: 18  
lbs./Ctn.: ≤ 21

## Vinyl Carpentry Accessories

Product Code	51451 D7" Staggered Perfection Mitered Cornerpost	51450 D7" Straight Edge Rough-Split Mitered Cornerpost	51432 D9" Staggered Rough-Split Mitered Cornerpost		
Colonial White (01)	●	●	●		
Autumn Red (23)	●	●	●		
Buckskin (41)	●	●	●		
Charcoal Gray (46)	●	●	●		
Cypress (42)	●				
Desert Tan (07)	●				
Flagstone (97)	●	●	●		
Forest (47)	●	●	●		
Granite Gray (34)	●	●	●		
Hearthstone (19)	●	●	●		
Heritage Cream (11)	●				
Herringbone (04)	●				
Light Maple (55)	●				
Mountain Cedar (17)	●	●	●		
Natural Clay (60)	●	●	●		
Pacific Blue (27)	●	●	●		
Sable Brown (29)	●	●	●		
Savannah Wicker (59)	●	●	●		
Seagrass (30)	●				
Spruce (16)	●	●	●		
Sterling Gray (33)	●	●	●		

## Corner Systems Specialty

### BAY WINDOW CORNERPOST

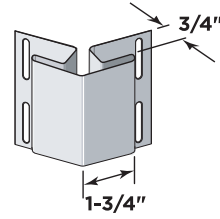

**Product Code: 51445**  
 Finish: Matte  
 Length: 10'  
 Face: 1-3/4"  
 Pieces/Ctn.: 10  
 Lin. Ft./Ctn.: 100  
 Cartons/Pallet: 21  
 lbs./Ctn.: ≤ 32

## Vinyl Carpentry Accessories

Product Code	51445 Bay Window Cornerpost	
Colonial White (01)	●	
Granite Gray (34)	●	
Natural Clay (60)	●	
Sterling Gray (33)	●	

## Window & Door Trim

### 3-1/2" LINEAL

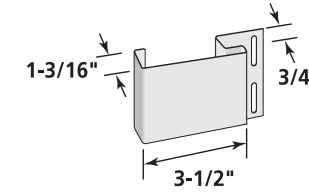

**Product Code: 54706**  
 Finish: Matte  
 Length: 20'  
 Pieces/Ctn.: 10  
 Lin. Ft./Ctn.: 200  
 Cartons/Pallet: 30  
 lbs./Ctn.: ≤ 51

Use with new window & door starter strip (53605)

### 5" LINEAL

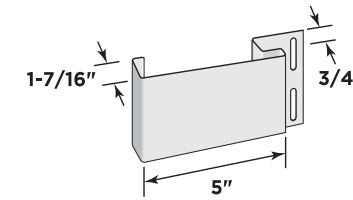

**Product Code: 54712**  
 Finish: Matte  
 Length: 20'  
 Pieces/Ctn.: 10  
 Lin. Ft./Ctn.: 200  
 Cartons/Pallet: 15  
 lbs./Ctn.: ≤ 64

Use with new window & door starter strip (53605)

### 3-1/2" LINEAL With Foam Insert

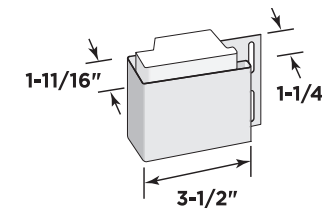

**Product Code: 54707**  
 Finish: Matte  
 Length: 20'  
 Pieces/Ctn.: 10  
 Lin. Ft./Ctn.: 200  
 Cartons/Pallet: 23  
 lbs./Ctn.: ≤ 63

Use with new window & door starter strip (53605)

### 2-1/2" WINDOW & DOOR CASING

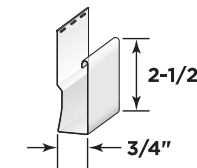

**Product Code: 55813**  
 Finish: Matte  
 Length: 12' 6"  
 Pieces/Ctn.: 20  
 Lin. Ft./Ctn.: 250  
 Cartons/Pallet: 24  
 lbs./Ctn.: ≤ 52

## Vinyl Carpentry Accessories

Product Code	54706 3-1/2" Lineal	54712 5" Lineal	54707 3-1/2" Lineal With Foam Insert	55813 2-1/2" Window & Door Casing	
Colonial White (01)	●	●	●	●	
Desert Tan (07)	●				
Herringbone (04)	●				
Natural Clay (60)	●				
Sandstone Beige (15)	●				
Savannah Wicker (59)	●				
Snow (31)	●	●			



## Window & Door Trim

### CROWN MOLDING

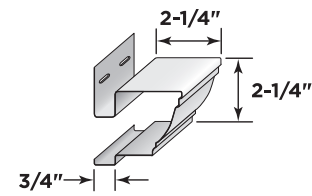

**Product Code: 55804**  
 Finish: Matte  
 Length: 10'  
 Pieces/Ctn.: 10  
 Lin. Ft./Ctn.: 100  
 Cartons/Pallet: 12  
 lbs./Ctn.: ≤ 35

### CROWN MOLDING CAP

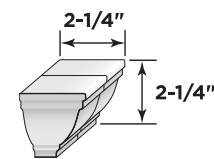

**Product Code: 55805**  
 Finish: Matte  
 Pairs/Ctn.: 10  
 Cartons/Pallet: 60  
 lbs./Ctn.: ≤ 2

Each whole unit represents a pair and can be cut in half to create left and right end caps.

## Vinyl Carpentry Accessories

Product Code	55804 Crown Molding	55805 Crown Molding Cap	
Colonial White (01)	●	●	

## Wall Transitions Band Board

### BAND BOARD With Foam Insert

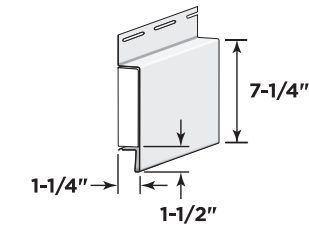

**Product Code: 55814**  
 Finish: Rough Cedar  
 Length: 16' 8"  
 Pieces/Ctn.: 5  
 Lin. Ft./Ctn.: 82' 5"  
 Cartons/Pallet: 16  
 lbs./Ctn.: ≤ 33

Dimensions shown as installed with Cornice Receiver

### 5" DOUBLE CHANNEL LINEAL

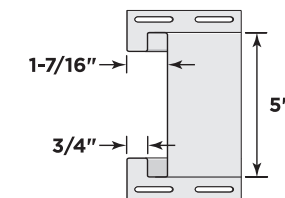

**Product Code: 54714**  
 Finish: Matte  
 Length: 18'  
 Pieces/Ctn.: 10  
 Lin. Ft./Ctn.: 180  
 Cartons/Pallet: 15  
 lbs./Ctn.: ≤ 66

## Vinyl Carpentry Accessories

Product Code	55814 Band Board With Foam Insert	54714 5" Double Channel Lineal	
Colonial White (01)	●	●	

## Soffit Transitions Decorative

### CORNICE MOLDING

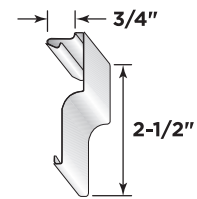

**Product Code: 55817**  
 Finish: Matte  
 Length: 12' 6"  
 Pieces/Ctn.: 10  
 Lin. Ft. /Ctn.: 125  
 Cartons/Pallet: 32  
 lbs./Ctn.: ≤ 16

For use with Cornice Receiver or Deluxe F-Channel

### CORNICE RECEIVER

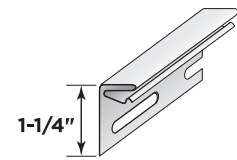

**Product Code: 55812**  
 Finish: Matte  
 Length: 12' 6"  
 Pieces/Ctn.: 24  
 Lin. Ft. /Ctn.: 300  
 Cartons/Pallet: 35  
 lbs./Ctn.: ≤ 28

For use with Cornice Molding, Finish Board and Band Board

### FINISH BOARD

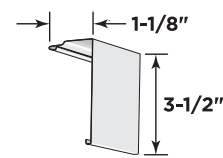

**Product Code: 55815**  
 Finish: Rough Cedar  
 Length: 12' 6"  
 Pieces/Ctn.: 10  
 Lin. Ft. /Ctn.: 125  
 Cartons/Pallet: 40  
 lbs./Ctn.: ≤ 19

For use with Cornice Receiver

### DELUXE F-CHANNEL

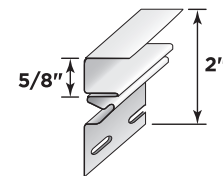

**Product Code: 52503**  
 Finish: Matte  
 Length: 12' 6"  
 Channel: 5/8"  
 Pieces/Ctn.: 24  
 Lin. Ft. /Ctn.: 300  
 Cartons/Pallet: 32  
 lbs./Ctn.: ≤ 39

For use as soffit receiver and to receive Cornice Molding

## Vinyl Carpentry Accessories

Product Code	55817 Cornice Molding	55812 Cornice Receiver	55815 Finish Board	52503 Deluxe F-Channel
No Color		●		●
Colonial White (01)	●		●	
Autumn Red (23)	●			
Autumn Yellow (10)	●			
Bermuda Blue (26)	●			
Brownstone (40)	●			
Buckskin (41)	●			
Castle Stone (37)	●			
Cedar Blend Solid* (48)	+			
Charcoal Gray (46)	●			
Cypress (42)	●			
Desert Tan (07)	●			
Espresso (43)	●			
Flagstone (97)	●			
Forest (47)	●			
Granite Gray (34)	●			
Hearthstone (19)	●			
Heritage Cream (11)	●			
Herringbone (04)	●			
Light Maple (55)	●			
Melrose (39)	●			
Midnight Blue (45)	●			
Mountain Cedar (17)	●			
Natural Clay (60)	●			
Pacific Blue (27)	●			
Sable Brown (29)	●			
Sandstone Beige (15)	●			
Savannah Wicker (59)	●			
Seagrass (30)	●			
Slate (44)	●			
Snow (31)	●			
Spruce (16)	●			
Sterling Gray (33)	●			
Wedgewood Blue (89)	●			
Weathered Wood (90)	●			

+ SOLID COLOR

\* Solid color accessory used with the Cedar Impressions Single 7" Cedar Blend; and Monogram Double 4" Clapboard, Double 5" Clapboard and Double 5" Dutchlap Cedar Blend panels.

## J-Channel

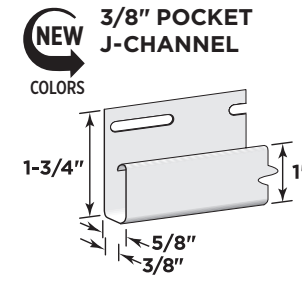

**Product Code: 50306**  
 Finish: Matte  
 Length: 12' 6"  
 Channel/  
 Pocket Height: 3/8"  
 Back Height: 5/8"  
 Pieces/Ctn.: 48  
 Lin. Ft. /Ctn.: 600  
 Cartons/Pallet: 30  
 lbs./Ctn.: ≤ 55

For use with Beaded Triple 2" Soffit and with CERTAPLANK Siding as a sill trim.

### 1/2" POCKET J-CHANNEL

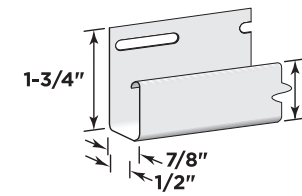

**Product Code: 50305**  
 Finish: Matte  
 Length: 12' 6"  
 Channel/  
 Pocket Height: 1/2"  
 Back Height: 7/8"  
 Pieces/Ctn.: 48  
 Lin. Ft. /Ctn.: 600  
 Cartons/Pallet: 30  
 lbs./Ctn.: ≤ 58

### 5/8" POCKET J-CHANNEL

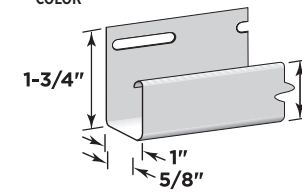

**Product Code: 50310**  
 Finish: Matte  
 Length: 12' 6"  
 Channel/  
 Pocket Height: 5/8"  
 Back Height: 1"  
 Pieces/Ctn.: 48  
 Lin. Ft. /Ctn.: 600  
 Cartons/Pallet: 30  
 lbs./Ctn.: ≤ 60

### 3/4" POCKET J-CHANNEL

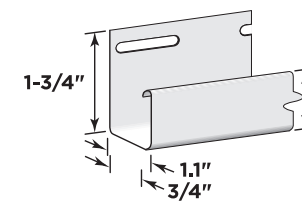

**Product Code: 50303**  
 Finish: Matte  
 Length: 12' 6"  
 Channel/  
 Pocket Height: 3/4"  
 Back Height: 1.1"  
 Pieces/Ctn.: 48  
 Lin. Ft. /Ctn.: 600  
 Cartons/Pallet: 25  
 lbs./Ctn.: ≤ 61

### 3/4" POCKET FLEXIBLE J-CHANNEL

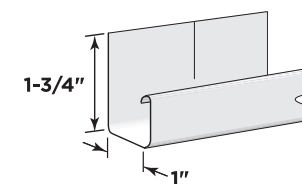

**Product Code: 50309**  
 Finish: Matte  
 Length: 12' 6"  
 Channel/  
 Pocket Height: 3/4"  
 Back Height: 1"  
 Pieces/Ctn.: 10  
 Lin. Ft. /Ctn.: 125  
 Cartons/Pallet: 50  
 lbs./Ctn.: ≤ 20

## Vinyl Carpentry Accessories

Product Code	50306 3/8" Pocket J-Channel	50305 1/2" Pocket J-Channel	50310 5/8" Pocket J-Channel	50303 3/4" Pocket J-Channel	50309 3/4" Pocket Flexible J- Channel
Colonial White (01)	●	●	●	●	
White (62)					●
Autumn Red (23)		●	●	●	
Autumn Yellow (10)		●	●	●	
Bermuda Blue (26)	★			●	
Brownstone (40)		●	●	●	
Buckskin (41)		●	●	●	
Castle Stone (37)	★	●	●	●	
Cedar Blend Solid* (48)					+
Charcoal Gray (46)	★	●	●	●	
Cypress (42)		●	●	●	
Desert Tan (07)	●	●	●	●	
Espresso (43)		●	●	●	
Flagstone (97)	★	●	●	●	
Forest (47)	★	●	●	●	
Granite Gray (34)	★	●	●	●	
Hearthstone (19)		●	●	●	
Heritage Cream (11)		●	●	●	
Herringbone (04)		●	●	●	
Light Maple (55)		●	●	●	
Melrose (39)		●	●	●	
Midnight Blue (45)		●	●	●	
Mountain Cedar (17)		●	●	●	
Natural Clay (60)	●	●	●	●	
Olive Grove (84)		●	●	●	
Oxford Blue (32)		●	●	●	
Pacific Blue (27)	★	●	●	●	
Sable Brown (29)		●	●	●	
Sandstone Beige (15)	●	●	●	●	
Savannah Wicker (59)	●	●	●	●	
Seagrass (30)		●	●	●	
Slate (44)		●	●	●	
Smoky Gray (83)		●	●	●	
Snow (31)	●	●	●	●	
Spruce (16)		●	●	●	
Sterling Gray (33)	●	●	●	●	
Tuxedo (56)		●	●	●	
Weathered Wood (90)		●	●	●	
Wedgewood Blue (89)		●	●	●	
Arbor Blend (57)					+
Black (54)		+	+	★	
Frontier Blend (51)					+
Musket Brown (49)		●			

★ NEW COLOR

+ SOLID COLOR

\* Solid color accessory; + Soffit Use Only  
 Cedar Blend Solid use with Cedar Blend panels

### Recommended accessory colors for Monogram Blends

The following colors are the best comparable trim options:  
 Natural Blend = Buckskin, Cedar Blend = Cedar Blend Solid,  
 Driftwood Blend = Granite Gray or Charcoal Gray, Rustic Blend = Sable Brown,  
 Weathered Blend = Weathered Wood

## J-Channel (continued)

### 1" POCKET J-CHANNEL

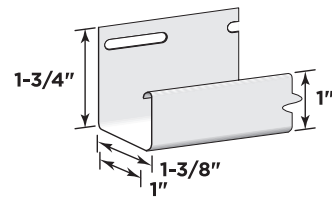

**Product Code: 50302**  
 Finish: Matte  
 Length: 12' 6"  
 Channel/  
 Pocket Height: 1"  
 Back Height: 1-3/8"  
 Pieces/Ctn.: 40  
 Lin. Ft. /Ctn.: 500  
 Cartons/Pallet: 18  
 lbs./Ctn.: ≤ 59

### 1-1/4" POCKET J-CHANNEL

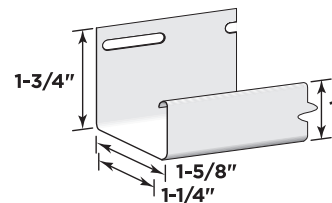

**Product Code: 50301**  
 Finish: Matte  
 Length: 12' 6"  
 Channel/  
 Pocket Height: 1-1/4"  
 Back Height: 1-5/8"  
 Pieces/Ctn.: 48  
 Lin. Ft. /Ctn.: 600  
 Cartons/Pallet: 20  
 lbs./Ctn.: ≤ 79

## Functional Trim

### NEW TRIM COIL PVC Coated COLORS

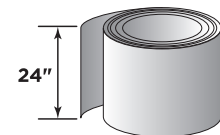

PVC coated one side only  
 Do not use trim coil over treated lumber

**Product Code: 56901**  
 Finish: Striated  
 Length: 50'  
 Thickness: .019"  
 Width: 24"  
 Rolls/Ctn.: 1  
 Cartons/Pallet: 32  
 lbs./Ctn.: ≤ 25

## Vinyl Carpentry Accessories

Product Code	50302 1" Pocket J-Channel	50301 1-1/4" Pocket J-Channel	56901 Trim Coil	
Colonial White (01)	●	●	●	
Autumn Red (23)	●	●	●	
Autumn Yellow (10)			●	
Brownstone (40)			●	
Buckskin (41)	●	●	●	
Castle Stone (37)			●	
Cedar Blend Solid* (48)			+	
Charcoal Gray (46)	●	●	●	
Cypress (42)	●	●	●	
Desert Tan (07)	●	●	●	
Espresso (43)			●	
Flagstone (97)	●	●	●	
Forest (47)	●		●	
Granite Gray (34)	●	●	●	
Hearthstone (19)	●		●	
Heritage Cream (11)		●	●	
Herringbone (04)		●	●	
Light Maple (55)		●	●	
Melrose (39)			●	
Midnight Blue (45)			●	
Mountain Cedar (17)	●		●	
Natural Clay (60)	●	●	●	
Olive Grove (84)			★	
Oxford Blue (32)		●	●	
Pacific Blue (27)	●	●	●	
Sable Brown (29)	●	●	●	
Sandstone Beige (15)	●	●	●	
Savannah Wicker (59)	●	●	●	
Seagrass (30)	●		●	
Slate (44)			●	
Smoky Gray (83)			●	
Snow (31)		●	●	
Spruce (16)	●	●	●	
Sterling Gray (33)	●	●	●	
Weathered Wood (90)			★	
Wedgewood Blue (89)			★	
Black (54)			●	
Musket Brown (49)			●	

★ NEW COLOR  
 + SOLID COLOR  
 \* Solid color accessory:  
 Cedar Blend Solid use with Cedar Blend panels

## Functional Trim (continued)

### DUAL UNDERSILL TRIM

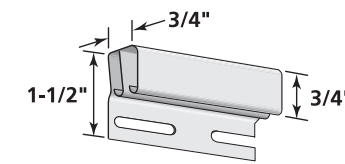

**Product Code: 56916**  
 Finish: Matte  
 Length: 12' 6"  
 Pieces/Ctn.: 12  
 Lin. Ft. /Ctn.: 150  
 Cartons/Pallet: 48  
 lbs./Ctn.: ≤ 22

### UNDERSILL TRIM

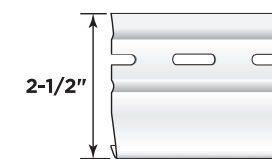

**Product Code: 56904**  
 Finish: Matte  
 Length: 12' 6"  
 Pieces/Ctn.: 48  
 Lin. Ft. /Ctn.: 600  
 Cartons/Pallet: 35  
 lbs./Ctn.: ≤ 46

### NEW SHAKE/SHINGLE UNDERSILL TRIM COLOR

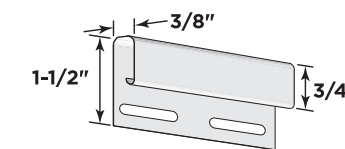

**Product Code: 56917**  
 Finish: Matte  
 Length: 12' 6"  
 Pieces/Ctn.: 12  
 Lin. Ft. /Ctn.: 150  
 Cartons/Pallet: 48  
 lbs./Ctn.: ≤ 13

### DRIP CAP

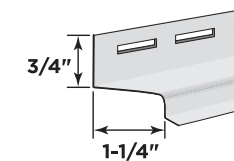

**Product Code: 56907**  
 Finish: Matte  
 Length: 12' 6"  
 Width: 1-1/4"  
 Pieces/Ctn.: 24  
 Lin. Ft. /Ctn.: 300  
 Cartons/Pallet: 35  
 lbs./Ctn.: ≤ 31

## Vinyl Carpentry Accessories

Product Code	56916 Dual Undersill Trim	56904 Undersill Trim	56917 Shake/ Shingle Undersill Trim	56907 Drip Cap	
Colonial White (01)	●	●	●	●	
Autumn Red (23)		●	●		
Autumn Yellow (10)		●	●		
Bermuda Blue (26)			●		
Brownstone (40)		●	●		
Buckskin (41)	●	●	●		
Castle Stone (37)		●	●		
Cedar Blend Solid* (48)		●	+		
Charcoal Gray (46)		●	●		
Cypress (42)	●	●	●		
Desert Tan (07)	●	●	●		
Espresso (43)		●	●		
Flagstone (97)		●	●		
Forest (47)		●	●		
Granite Gray (34)	●	●	●		
Hearthstone (19)		●	●		
Heritage Cream (11)	●	●	●		
Herringbone (04)	●	●	●		
Light Maple (55)	●	●	●		
Melrose (39)		●	●		
Midnight Blue (45)		●	●		
Mountain Cedar (17)		●	●		
Natural Clay (60)	●	●	●		
Olive Grove (84)		●	●		
Oxford Blue (32)	●	●	●		
Pacific Blue (27)		●	●		
Sable Brown (29)		●	●		
Sandstone Beige (15)	●	●	●		
Savannah Wicker (59)	●	●	●		
Seagrass (30)	●	●	●		
Slate (44)		●	●		
Smoky Gray (83)		●	★		
Snow (31)	●	●	●		
Spruce (16)		●	●		
Sterling Gray (33)	●	●	●		
Tuxedo (56)		●			
Weathered Wood (90)		●	●		
Wedgewood Blue (89)		●	●		
Arbor Blend (57)		+			
Frontier Blend (51)		+			

★ NEW COLOR  
 + SOLID COLOR  
 \* Solid color accessory:  
 Cedar Blend Solid use with Cedar Blend panels

**Recommended accessory colors for Monogram Blends**  
 The following colors are the best comparable trim options:  
 Natural Blend = Buckskin, Cedar Blend = Cedar Blend Solid,  
 Driftwood Blend = Granite Gray or Charcoal Gray, Rustic Blend = Sable Brown,  
 Weathered Blend = Weathered Wood



## Starter Strips

### 2-1/4" VINYL STARTER STRIP

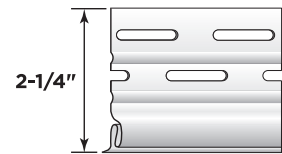

**Product Code: 53601**  
 Finish: Matte  
 Length: 12' 6"  
 Width: 2-1/4"  
 Pieces/Ctn.: 40  
 Lin. Ft. /Ctn.: 500  
 Cartons/Pallet: 30  
 lbs./Ctn.: ≤ 59

For use with all sidings except Cedar Impressions, CedarBoards, Monogram and Monogram XL.

### 2-1/2" METAL STARTER STRIP

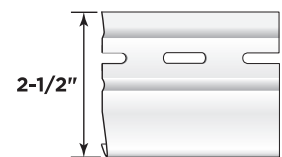

**Product Code: 53602**  
 Finish: Mill  
 Length: 10'  
 Width: 2-1/2"  
 Pieces/Ctn.: 50  
 Lin. Ft. /Ctn.: 500  
 Cartons/Pallet: 35  
 lbs./Ctn.: ≤ 75

For use with all sidings except Cedar Impressions, and CedarBoards.

### 4" METAL SHINGLE STARTER STRIP

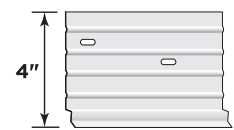

**Product Code: 53610**  
 Finish: Mill  
 Length: 10'  
 Width: 4"  
 Pieces/Ctn.: 25  
 Lin. Ft. /Ctn.: 250  
 Cartons/Pallet: 35  
 lbs./Ctn.: ≤ 78

For use with Cedar Impressions Shake and Shingle Panels

### 5" METAL STARTER STRIP

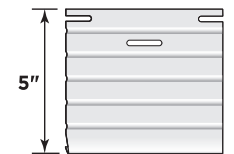

**Product Code: 53604**  
 Finish: Mill  
 Length: 10'  
 Width: 5"  
 Pieces/Ctn.: 25  
 Lin. Ft. /Ctn.: 250  
 Cartons/Pallet: 30  
 lbs./Ctn.: ≤ 72

Remodeling Metal Starter Strip. For use with all sidings except Cedar Impressions and CedarBoards.

### STARTER STRIP FOR CEDARBOARDS INSULATED SIDING

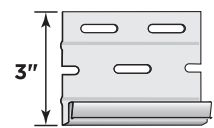

**Product Code: 53609**  
 Finish: Matte  
 Length: 12' 6"  
 Width: 3"  
 Pieces/Ctn.: 24  
 Lin. Ft. /Ctn.: 300  
 Cartons/Pallet: 35  
 lbs./Ctn.: ≤ 44

≤ Heaviest weight listed - varies by color.

## Vinyl Carpentry Accessories

Product Code	53601	53602	53610	53604	53609	53605	53612
	2-1/4" Vinyl Starter Strip	2-1/2" Metal Starter Strip	4" Metal Shingle Starter Strip	5" Metal Starter Strip	Starter Strip for Insulated Siding	Window & Door Starter Strip	Metal Starter Strip for CERTAPLANK Reinforced Siding
No Color	●	●	●	●	●	●	☆

☆COMING SOON

### WINDOW & DOOR STARTER STRIP

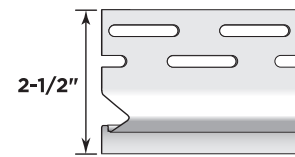

**Product Code: 53605**  
 Finish: Matte  
 Length: 10'  
 Pieces/Ctn.: 36  
 Lin. Ft. /Ctn.: 360  
 Cartons/Pallet: 27  
 lbs./Ctn.: ≤ 35

For use with lineals

### COMING SOON! METAL STARTER STRIP FOR CERTAPLANK REINFORCED SIDING

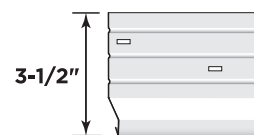

**Product Code: 53612**  
 Finish: Mill  
 Length: 10'  
 Width: 3-1/2"  
 Pieces/Ctn.: 25  
 Lin. Ft./Ctn.: 250'  
 Cartons/Pallet: 35  
 lbs./Ctn.: 65

## Soffit Trim

### 3/4" F-CHANNEL

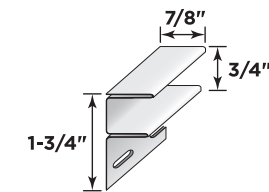

**Product Code: 52506**  
 Finish: Matte  
 Length: 12' 6"  
 Channel: 3/4"  
 Pieces/Ctn.: 24  
 Lin. Ft. /Ctn.: 300  
 Cartons/Pallet: 35  
 lbs./Ctn.: ≤ 44

### 5/8" F-CHANNEL

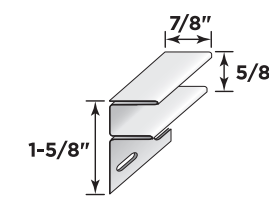

**Product Code: 52502**  
 Finish: Matte  
 Length: 12' 6"  
 Channel: 5/8"  
 Pieces/Ctn.: 24  
 Lin. Ft. /Ctn.: 300  
 Cartons/Pallet: 35  
 lbs./Ctn.: ≤ 39

### DELUXE F-CHANNEL

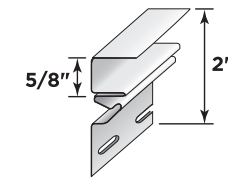

**Product Code: 52503**  
 Finish: Matte  
 Length: 12' 6"  
 Channel: 5/8"  
 Pieces/Ctn.: 24  
 Lin. Ft. /Ctn.: 300  
 Cartons/Pallet: 32  
 lbs./Ctn.: ≤ 39

For use as soffit receiver and to receive Cornice Molding

≤ Heaviest weight listed - varies by color.

## Vinyl Carpentry Accessories

Product Code	52506	52502	52503	
	3/4" F-Channel	5/8" F-Channel	Deluxe F-Channel	
No Color			●	
Colonial White (01)	●	●		
Desert Tan (07)		●		
Natural Clay (60)		●		
Sandstone Beige (15)		●		
Savannah Wicker (59)		●		
Snow (31)		●		
Black (54)		●		
Musket Brown (49)		●		

For more information call 800-233-8990  
[www.certainteed.com](http://www.certainteed.com)

## Soffit Trim (continued)

### 1/2" H-BAR

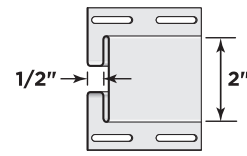

**Product Code: 52504**

Finish: Matte  
Length: 12' 6"  
Channel: 1/2"  
Pieces/Ctn.: 10  
Lin. Ft. /Ctn.: 125  
Cartons/Pallet: 39  
lbs./Ctn.: ≤ 29

For use with most soffits and vertical siding

### 3/8" H-BAR

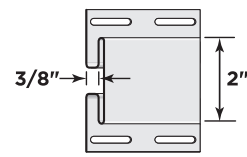

**Product Code: 52505**

Finish: Matte  
Length: 12' 6"  
Channel: 3/8"  
Pieces/Ctn.: 10  
Lin. Ft. /Ctn.: 125  
Cartons/Pallet: 53  
lbs./Ctn.: ≤ 28

For use with Beaded Soffit

### 3/4" H-BAR

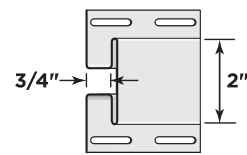

**Product Code: 52507**

Finish: Matte  
Length: 12' 6"  
Channel: 3/4"  
Pieces/Ctn.: 10  
Lin. Ft. /Ctn.: 125  
Cartons/Pallet: 42  
lbs./Ctn.: ≤ 32

For use with Reverse Board & Batten, Perimeter & Triple 3-1/3 InvisiVent & solid soffit.  
Can also be used with Monogram & Restoration Classic in horizontal applications.

## Vinyl Carpentry Accessories

Product Code	52504 1/2" H-Bar	52505 3/8" H-Bar	52507 3/4" H-Bar	
No Color				
Colonial White (01)	●	●	●	
Autumn Red (23)			●	
Charcoal Gray (46)			●	
Granite Gray (34)			●	
Midnight Blue (45)			●	
Natural Clay (60)			●	
Pacific Blue (27)			●	
Sable Brown (29)			●	
Savannah Wicker (59)			●	
Sterling Gray (33)			●	

## Mounting Blocks Siding & Accessories

### COMING SOON! DRYER VENT

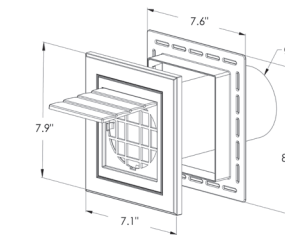

**Product Code: 56501**

Finish: Woodgrain  
Overall Width: 7.6"  
Overall Height: 8.4"  
Overall Depth: 1.4"  
Pieces/Ctn.: 5  
Cartons/Pallet: 200  
lbs./Ctn.: ≤ 2.57

### COMING SOON! UNIVERSAL BLOCK

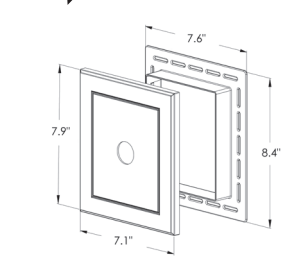

**Product Code: 56502**

Finish: Woodgrain  
Overall Width: 7.6"  
Overall Height: 8.4"  
Overall Depth: 1.4"  
Pieces/Ctn.: 10  
Cartons/Pallet: 144  
lbs./Ctn.: ≤ 4.66

### COMING SOON! SURFACE MOUNT BLOCK

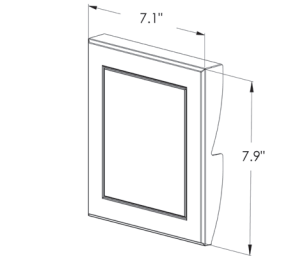

**Product Code: 56503**

Finish: Woodgrain  
Overall Width: 7.1"  
Overall Height: 7.9"  
Overall Depth: 1.2"  
Pieces/Ctn.: 10  
Cartons/Pallet: 200  
lbs./Ctn.: ≤ 2.51

### COMING SOON! RECESSED SPLIT

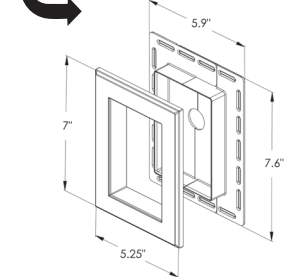

**Product Code: 56504**

Finish: Woodgrain  
Overall Width: 5.9"  
Overall Height: 7.6"  
Overall Depth: 1.4"  
Pieces/Ctn.: 10  
Cartons/Pallet: 150  
lbs./Ctn.: ≤ 3.77

## Vinyl Siding Products

Product Code	56501 Dryer Vent (Woodgrain)	56502 Universal Block (Woodgrain)	56503 Surface Mount Block (Woodgrain)	56504 Recessed Split (Woodgrain)
Arbor Blend Solid* (57)	☆/+	☆/+	☆/+	☆/+
Autumn Red (23)	☆	☆	☆	☆
Autumn Yellow (10)	☆	☆	☆	☆
Brownstone (40)	☆	☆	☆	☆
Buckskin (41)	☆	☆	☆	☆
Castle Stone (37)	☆	☆	☆	☆
Cedar Blend Solid* (48)	☆/+	☆/+	☆/+	☆/+
Charcoal Gray (46)	☆	☆	☆	☆
Colonial White (01)	☆	☆	☆	☆
Cypress (42)	☆	☆	☆	☆
Desert Tan (07)	☆	☆	☆	☆
Espresso (43)	☆	☆	☆	☆
Flagstone (97)	☆	☆	☆	☆
Forest (47)	☆	☆	☆	☆
Frontier Blend Solid* (51)	☆/+	☆/+	☆/+	☆/+
Granite Gray (34)	☆	☆	☆	☆
Hearthstone (19)	☆	☆	☆	☆
Heritage Cream (11)	☆	☆	☆	☆
Herringbone (04)	☆	☆	☆	☆
Light Maple (55)	☆	☆	☆	☆
Melrose (39)	☆	☆	☆	☆
Midnight Blue (45)	☆	☆	☆	☆
Mountain Cedar (17)	☆	☆	☆	☆
Natural Clay (60)	☆	☆	☆	☆
Olive Grove (84)	☆	☆	☆	☆
Oxford Blue (32)	☆	☆	☆	☆
Pacific Blue (27)	☆	☆	☆	☆
Sable Brown (29)	☆	☆	☆	☆
Sandstone Beige (15)	☆	☆	☆	☆
Savannah Wicker (59)	☆	☆	☆	☆
Seagrass (30)	☆	☆	☆	☆
Slate (44)	☆	☆	☆	☆
Smoky Gray (83)	☆	☆	☆	☆
Snow (31)	☆	☆	☆	☆
Spruce (16)	☆	☆	☆	☆
Sterling Gray (33)	☆	☆	☆	☆
Wedgewood Blue (89)	☆	☆	☆	☆
Weathered Wood (90)	☆	☆	☆	☆
Tuxedo (56)	☆	☆	☆	☆

+ SOLID COLOR

☆ COMING SOON

\* Solid color accessory:

Arbor Blend Solid use with Arbor Blend panels,  
Cedar Blend Solid use with Cedar Blend panels and  
Frontier Blend Solid use with Frontier Blend panels

**Recommended accessory colors for Monogram Blends**

The following colors are the best comparable trim options:  
Natural Blend = Buckskin, Cedar Blend = Cedar Blend Solid,  
Driftwood Blend = Granite Gray or Charcoal Gray, Rustic Blend = Sable Brown,  
Weathered Blend = Weathered Wood

≤ Heaviest weight listed - varies by color.

## Mounting Blocks Siding & Accessories

### COMING SOON! METER BASE

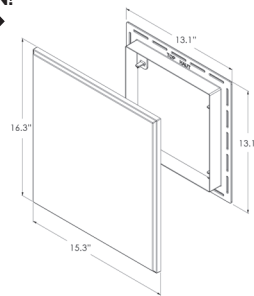

**Product Code: 56505**  
Finish: Woodgrain  
Overall Width: 15.3"  
Overall Height: 16.4"  
Overall Depth: 1.4"  
Pieces/Ctn.: 5  
Cartons/Pallet: 75  
lbs./Ctn.: ≤ 8.28

### COMING SOON! INTAKE EXHAUST

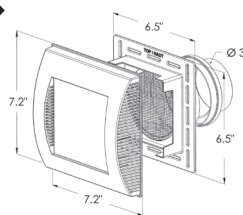

**Product Code: 56506**  
Finish: Woodgrain  
Overall Width: 7.2"  
Overall Height: 7.2"  
Overall Depth: 5.3"  
Pieces/Ctn.: 5  
Cartons/Pallet: 126  
lbs./Ctn.: ≤ 2.96

### COMING SOON! MINI BLOCK

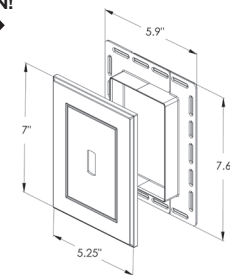

**Product Code: 56507**  
Finish: Woodgrain  
Overall Width: 5.9"  
Overall Height: 7.6"  
Overall Depth: 1.4"  
Pieces/Ctn.: 10  
Cartons/Pallet: 150  
lbs./Ctn.: ≤ 3.77

### COMING SOON! JUMBO BLOCK

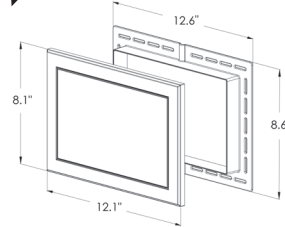

**Product Code: 56508**  
Finish: Woodgrain  
Overall Width: 12.6"  
Overall Height: 8.6"  
Overall Depth: 1.4"  
Pieces/Ctn.: 5  
Cartons/Pallet: 144  
lbs./Ctn.: ≤ 3.87

### COMING SOON! ELECTRIC BOX\*

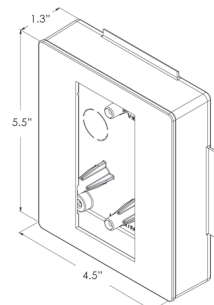

**Product Code: 56509**  
Finish: Matte  
Overall Width: 4.5"  
Overall Height: 5.5"  
Overall Depth: 1.3"  
Pieces/Ctn.: 10  
Cartons/Pallet: 225  
lbs./Ctn.: ≤ 3.88

\* Electric box used in conjunction with Universal Block part.  
≤ Heaviest weight listed - varies by color.

## Vinyl Siding Products

Product Code	56505	56506	56507	56508	56509
	Meter Base (Woodgrain)	Intake Exhaust (Woodgrain)	Mini Block (Woodgrain)	Jumbo Block (Woodgrain)	Electric Box (Matte)
No Color					☆
Colonial White (01)	☆	☆	☆	☆	

☆ COMING SOON

## CertaWrap™ Premium Weather Resistant Barrier

### PREMIUM 3' x 100' ROLL

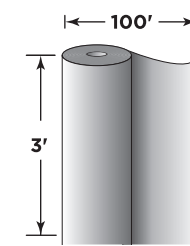

**Product Code: 69230**  
Finish: No Finish  
Length: 100'  
Width: 3'  
Thickness: 12.9 mils  
Rolls/Pallet: 144  
Sq. Ft./Roll: 300  
lbs./Roll: ≤ 7  
lbs./Pallet: ≤ 1,008

(sold per pallet - 144 rolls per pallet)

### PREMIUM 3' x 165' ROLL

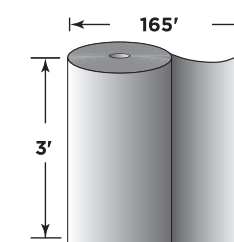

**Product Code: 69236**  
Finish: No Finish  
Length: 165'  
Width: 3'  
Thickness: 12.9 mils  
Rolls/Pallet: 96  
Sq. Ft./Roll: 495  
lbs./Roll: ≤ 12  
lbs./Pallet: ≤ 1,152

(sold per pallet - 96 rolls per pallet)

### PREMIUM 4.5' x 200' ROLL

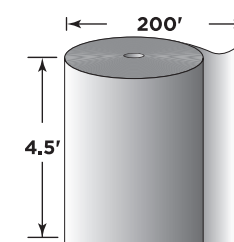

**Product Code: 69231**  
Finish: No Finish  
Length: 200'  
Width: 4.5'  
Thickness: 12.9 mils  
Rolls/Pallet: 32  
Sq. Ft./Roll: 900  
lbs./Roll: ≤ 20  
lbs./Pallet: ≤ 640

(sold per pallet - 32 rolls per pallet)

### PREMIUM 5' x 200' ROLL

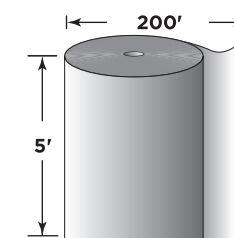

**Product Code: 69237**  
Finish: No Finish  
Length: 200'  
Width: 5'  
Thickness: 12.9 mils  
Rolls/Pallet: 32  
Sq. Ft./Roll: 1,000  
lbs./Roll: ≤ 22  
lbs./Pallet: ≤ 704

(sold per pallet - 32 rolls per pallet)

### PREMIUM 9' x 100' ROLL

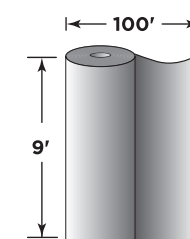

ASK ABOUT  
CO-BRANDING!

**Product Code: 69232**  
Finish: No Finish  
Length: 100'  
Width: 9'  
Thickness: 12.9 mils  
Rolls/Pallet: 40  
Sq. Ft./Roll: 900  
lbs./Roll: ≤ 21  
lbs./Pallet: ≤ 840

(sold per pallet - 40 rolls per pallet)

9' x 100' is also available in a co-brand option.  
(3 pallet order minimum - 120 roll minimum)

## House Wrap

Product Code	69230	69236	69231	69237	69232	69233	69241
	Premium 3' x 100' Roll	Premium 3' x 165' Roll	Premium 4.5' x 200' Roll	Premium 5' x 200' Roll	Premium 9' x 100' Roll	Premium 9' x 150' Roll	Standard 9' x 100' Roll
White (62)	●	●	●	●	●	●	
No Color (00)							●

### PREMIUM 9' x 150' ROLL

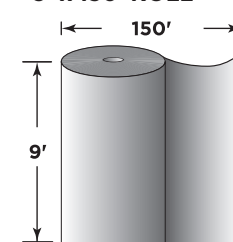

**Product Code: 69233**  
Finish: No Finish  
Length: 150'  
Width: 9'  
Thickness: 12.9 mils  
Rolls/Pallet: 36  
Sq. Ft./Roll: 1,350  
lbs./Roll: ≤ 31  
lbs./Pallet: ≤ 1,116

(sold per pallet - 36 rolls per pallet)

## CertaWrap™ Standard Housewrap

### STANDARD 9' x 100' ROLL

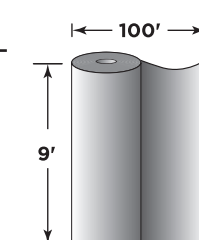

**Product Code: 69241**  
Finish: No Finish  
Length: 100'  
Width: 9'  
Thickness: 5.0 mils  
Rolls/Pallet: 78  
Sq. Ft./Roll: 900  
lbs./Roll: ≤ 15  
lbs./Pallet: ≤ 840

(sold per pallet - 78 rolls per pallet)



# CertaWrap™ Tape

**CERTATAPE™  
CONSTRUCTION TAPE  
1-7/8" x 165' ROLL**

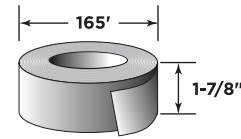

**Product Code: 69921**  
 Finish: No Finish  
 Length: 165'  
 Width: 1-7/8'  
 Rolls/Case: 24  
 lbs./Roll: 1 (approx.)  
 Cases/Pallet: 48  
 lbs./Ctn.: ≤ 18

For use to seal overlaps, seams, and penetrations

## House Wrap

Product Code	69921	
	1-7/8" x 165' Roll	
Sandstone Beige (15)	●	

# Tools

## SHINGLE REPAIR KIT

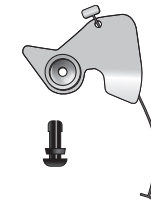

**NOTE:**  
 6 repair clips per kit  
 24 kits per carton (144 clips per ctn.)  
 Each kit contains enough pieces (6)  
 to replace a single panel

**Product Code: 57994**  
 Finish: No Finish  
 Kits/Ctn.: 24  
 Cartons/Pallet: 60  
 lbs./Ctn.: ≤ 3

Use one kit to repair one Double 7" Legacy Perfection Panel, Double 7" Staggered Perfection Panel, or all Rough-Split Panel Profiles

## MONOGRAM ZIPPER TOOL

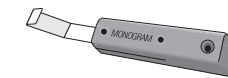

**Product Code: 57999**  
 Finish: No Finish  
 Pieces/Ctn.: 1  
 Cartons/Pallet: 50  
 lbs./Ctn.: ≤ 1

Panel removal tool for Monogram siding only



**NEW SHINGLE REPAIR KIT FOR  
 DOUBLE 7" (30144) & SINGLE 7" (30137)  
 PERFECTION PANELS, AND  
 TRIPLE 5" (30144) SAWMILL PANELS**

## Tools

Product Code	57994	57999	
	Shingle Repair Kit	Monogram Zipper Tool	
No Color (00)	●	●	

Trimboards

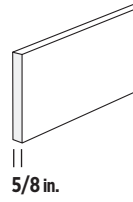
Smooth/Smooth, Natural White			FULL UNIT			HALF UNIT		
Nominal	Actual	Order Number*	PCS/UNIT	LF/UNIT	Weight** lbs/UNIT	PCS/UNIT	LF/UNIT	Weight** lbs/UNIT
 5/8 in. 5/8 in. x 6 in. x 18 ft.	5/8 in. x 5-1/2 in. x 18 ft.	11040618005F	160	2,880	2,791	—	—	—
5/8 in. 5/8 in. x 10 in. x 18 ft.	5/8 in. x 9-1/4 in. x 18 ft.	11041018005F	100	1,800	2,925	—	—	—
1 in. 1 in. x 3 in. x 18 ft.	3/4 in. x 2-1/2 in. x 18 ft.	11050318005F	288	5,184	2,728	—	—	—
1 in. 1 in. x 4 in. x 18 ft.	3/4 in. x 3-1/2 in. x 18 ft.	11050418005	260	4,680	3,531	104	1,872	1,538
1 in. 1 in. x 5 in. x 18 ft.	3/4 in. x 4-1/2 in. x 18 ft.	11050518005F	200	3,600	3,494	—	—	—
1 in. 1 in. x 6 in. x 18 ft.	3/4 in. x 5-1/2 in. x 18 ft.	11050618005	160	2,880	3,425	64	1,152	1,656
1 in. 1 in. x 8 in. x 18 ft.	3/4 in. x 7-1/4 in. x 18 ft.	11050818005	108	1,944	3,101	48	864	1,655
1 in. 1 in. x 10 in. x 18 ft.	3/4 in. x 9-1/4 in. x 18 ft.	11051018005	90	1,620	3,265	40	720	1,737
1 in. 1 in. x 12 in. x 18 ft.	3/4 in. x 11-1/4 in. x 18 ft.	11051218005	72	1,296	3,191	32	576	1,700
1 in. 1 in. x 16 in. x 18 ft.	3/4 in. x 15-1/4 in. x 18 ft.	11051618005	54	972	3,611	24	432	1,721
3/4 in. 5/4 in. x 4 in. x 18 ft.	1 in. x 3-1/2 in. x 18 ft.	11060418005	208	3,744	3,863	104	1,872	2,036
3/4 in. 5/4 in. x 5 in. x 18 ft.	1 in. x 4-1/2 in. x 18 ft.	11060518005F	160	2,880	3,029	—	—	—
3/4 in. 5/4 in. x 6 in. x 18 ft.	1 in. x 5-1/2 in. x 18 ft.	11060618005	128	2,304	3,659	64	1,152	1,934
3/4 in. 5/4 in. x 8 in. x 18 ft.	1 in. x 7-1/4 in. x 18 ft.	11060818005	96	1,728	3,622	48	864	1,916
3/4 in. 5/4 in. x 10 in. x 18 ft.	1 in. x 9-1/4 in. x 18 ft.	11061018005	80	1,440	3,829	40	720	2,019
3/4 in. 5/4 in. x 12 in. x 18 ft.	1 in. x 11-1/4 in. x 18 ft.	11061218005	64	1,152	3,734	32	576	1,972
3/4 in. 5/4 in. x 16 in. x 18 ft.	1 in. x 15-1/4 in. x 18 ft.	11061618005H	—	—	—	24	432	2,041

Trimboards

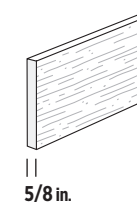
TrueTexture® Woodgrain/Smooth, Natural White			FULL UNIT			HALF UNIT		
Nominal	Actual	Order Number*	PCS/UNIT	LF/UNIT	Weight** lbs/UNIT	PCS/UNIT	LF/UNIT	Weight** lbs/UNIT
 5/8 in. 5/8 in. x 6 in. x 18 ft.	5/8 in. x 5-1/2 in. x 18 ft.	12040618005F	160	2,880	2,791	—	—	—
5/8 in. 5/8 in. x 8 in. x 18 ft.	5/8 in. x 7-1/4 in. x 18 ft.	12040818005F	120	2,160	2,765	—	—	—
5/8 in. 5/8 in. x 10 in. x 18 ft.	5/8 in. x 9-1/4 in. x 18 ft.	12041018005F	100	1,800	2,925	—	—	—
5/8 in. 5/8 in. x 12 in. x 18 ft.	5/8 in. x 11-1/4 in. x 18 ft.	12041218005F	80	1,440	2,851	—	—	—
3/4 in. 1 in. x 4 in. x 12 ft.	3/4 in. x 3-1/2 in. x 12 ft.	12050412005F	260	3,120	2,341	—	—	—
3/4 in. 1 in. x 6 in. x 12 ft.	3/4 in. x 5-1/2 in. x 12 ft.	12050612005F	160	1,920	2,268	—	—	—
3/4 in. 1 in. x 8 in. x 12 ft.	3/4 in. x 7-1/4 in. x 12 ft.	12050812005F	108	1,296	2,132	—	—	—
3/4 in. 1 in. x 10 in. x 12 ft.	3/4 in. x 9-1/4 in. x 12 ft.	12051012005F	90	1,080	2,169	—	—	—
3/4 in. 1 in. x 12 in. x 12 ft.	3/4 in. x 11-1/4 in. x 12 ft.	12051212005F	72	864	2,119	—	—	—
3/4 in. 1 in. x 4 in. x 18 ft.	3/4 in. x 3-1/2 in. x 18 ft.	12050418005	260	4,680	3,531	104	1,872	1,538
3/4 in. 1 in. x 5 in. x 18 ft.	3/4 in. x 4-1/2 in. x 18 ft.	12050518005F	200	3,600	3,535	—	—	—
3/4 in. 1 in. x 6 in. x 18 ft.	3/4 in. x 5-1/2 in. x 18 ft.	12050618005	160	2,880	3,425	64	1,152	1,514
3/4 in. 1 in. x 8 in. x 18 ft.	3/4 in. x 7-1/4 in. x 18 ft.	12050818005	108	1,944	3,101	48	864	1,655
3/4 in. 1 in. x 10 in. x 18 ft.	3/4 in. x 9-1/4 in. x 18 ft.	12051018005	90	1,620	3,265	40	720	1,737
3/4 in. 1 in. x 12 in. x 18 ft.	3/4 in. x 11-1/4 in. x 18 ft.	12051218005	72	1,296	3,191	32	576	1,700
3/4 in. 1 in. x 16 in. x 18 ft.	3/4 in. x 15-1/4 in. x 18 ft.	12051618005	54	972	3,611	24	432	1,721
1 in. 5/4 in. x 4 in. x 12 ft.	1 in. x 3-1/2 in. x 12 ft.	12060412005F	208	2,496	2,574	—	—	—
1 in. 5/4 in. x 6 in. x 12 ft.	1 in. x 5-1/2 in. x 12 ft.	12060612005F	128	1,536	2,439	—	—	—
1 in. 5/4 in. x 8 in. x 12 ft.	1 in. x 7-1/4 in. x 12 ft.	12060812005F	96	1,152	2,415	—	—	—
1 in. 5/4 in. x 10 in. x 12 ft.	1 in. x 9-1/4 in. x 12 ft.	12061012005F	80	960	2,553	—	—	—
1 in. 5/4 in. x 12 in. x 12 ft.	1 in. x 11-1/4 in. x 12 ft.	12061212005F	64	768	2,489	—	—	—
1 in. 5/4 in. x 4 in. x 18 ft.	1 in. x 3-1/2 in. x 18 ft.	12060418005	208	3,744	3,861	104	1,872	2,036
1 in. 5/4 in. x 5 in. x 18 ft.	1 in. x 4-1/2 in. x 18 ft.	12060518005F	160	2,880	3,029	—	—	—
1 in. 5/4 in. x 6 in. x 18 ft.	1 in. x 5-1/2 in. x 18 ft.	12060618005	128	2,304	3,659	64	1,152	1,935
1 in. 5/4 in. x 8 in. x 18 ft.	1 in. x 7-1/4 in. x 18 ft.	12060818005	96	1,728	3,622	48	864	1,916
1 in. 5/4 in. x 10 in. x 18 ft.	1 in. x 9-1/4 in. x 18 ft.	12061018005	80	1,440	3,829	40	720	2,019
1 in. 5/4 in. x 12 in. x 18 ft.	1 in. x 11-1/4 in. x 18 ft.	12061218005	64	1,152	3,734	32	576	1,972
1 in. 5/4 in. x 16 in. x 18 ft.	1 in. x 15-1/4 in. x 18 ft.	12061618005H	—	—	—	24	432	2,041

**Bending:** The ability to bend trimboards and profiles varies greatly based on board thickness and width, profile shape, bend radius, and heat source type. CertainTeed recommends reviewing our installation instructions or using a professional PVC bending resource.

**Special Order Program:** CertainTeed has the ability to manufacture products in different lengths and widths that are not shown in this Specification Guide. We would be glad to discuss opportunities. Please contact your CertainTeed Territory Manager for product guidelines, minimum quantities and pricing.

\*To order full units, add F to the end of the order number. To order a half unit, add H to the end of the order number, where applicable.  
 \*\*Weights include pallet.

\*To order full units, add F to the end of the order number. To order a half unit, add H to the end of the order number, where applicable.  
 \*\*Weights include pallet.

Trimboards

J-Pocket Smooth, Natural White			FULL UNIT			HALF UNIT		
Nominal	Actual	Order Number*	PCS/UNIT	LF/UNIT	Weight** lbs/UNIT	PCS/UNIT	LF/UNIT	Weight** lbs/UNIT
5/4 in. x 4 in. x 12 ft. J-Pocket	1 in. x 3-1/2 in. x 12 ft.	11160412005F	156	1,872	1,591	—	—	—
5/4 in. x 6 in. x 12 ft. J-Pocket	1 in. x 5-1/2 in. x 12 ft.	11160612005F	96	1,152	1,344	—	—	—
5/4 in. x 4 in. x 18 ft. J-Pocket	1 in. x 3-1/2 in. x 18 ft.	11160418005	156	2,808	2,400	104	1,872	1,663
5/4 in. x 6 in. x 18 ft. J-Pocket	1 in. x 5-1/2 in. x 18 ft.	11160618005	96	1,728	2,028	64	1,152	1,411

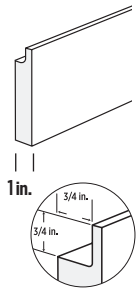

Built-in J-Pocket for siding

J-Pocket TrueTexture® Woodgrain, Natural White			FULL UNIT			HALF UNIT		
Nominal	Actual	Order Number*	PCS/UNIT	LF/UNIT	Weight** lbs/UNIT	PCS/UNIT	LF/UNIT	Weight** lbs/UNIT
5/4 in. x 4 in. x 12 ft. J-Pocket	1 in. x 3-1/2 in. x 12 ft.	12160412005F	156	1,872	1,591	—	—	—
5/4 in. x 6 in. x 12 ft. J-Pocket	1 in. x 5-1/2 in. x 12 ft.	12160612005F	96	1,152	1,344	—	—	—
5/4 in. x 4 in. x 18 ft. J-Pocket	1 in. x 3-1/2 in. x 18 ft.	12160418005	156	2,808	2,400	104	1,872	1,663
5/4 in. x 6 in. x 18 ft. J-Pocket	1 in. x 5-1/2 in. x 18 ft.	12160618005	96	1,728	2,028	64	1,152	1,411

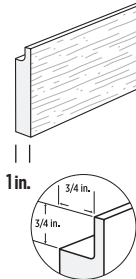

Built-in J-Pocket for siding

Fiber Cement Skirtboards

TrueTexture® Woodgrain/Smooth, Natural White			FULL UNIT		
Nominal	Actual	Order Number*	PCS/UNIT	LF/UNIT	Weight** lbs/UNIT
5/4 in. x 6 in. x 12 ft.	1 in. x 5-1/2 in. x 12 ft.	12360612005F	64	768	879
5/4 in. x 8 in. x 12 ft.	1 in. x 7-1/4 in. x 12 ft.	12360812005F	48	576	1,018

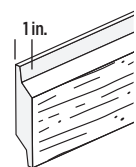

\*To order full units, add F to the end of the order number. To order a half unit, add H to the end of the order number, where applicable.  
 \*\*Weights include pallet.

Trimboards with Cut-Outs

J-Pocket Smooth, Natural White			FULL UNIT			HALF UNIT		
Nominal	Actual	Order Number*	PCS/UNIT	LF/UNIT	Weight** lbs/UNIT	PCS/UNIT	LF/UNIT	Weight** lbs/UNIT
5/4 in. x 4 in. x 18 ft.	1 in. x 3-1/2 in. x 18 ft.	11165018005	156	2,808	2,556	104	1,872	1,900

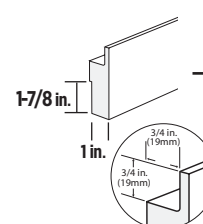

Built-in J-Pocket for siding and cut-out for Window Flange

J-Pocket TrueTexture® Woodgrain, Natural White			FULL UNIT			HALF UNIT		
Nominal	Actual	Order Number*	PCS/UNIT	LF/UNIT	Weight** lbs/UNIT	PCS/UNIT	LF/UNIT	Weight** lbs/UNIT
5/4 in. x 4 in. x 18 ft. J-Pocket	1 in. x 3-1/2 in. x 18 ft.	12165018005	156	2,808	2,551	104	1,872	1,900

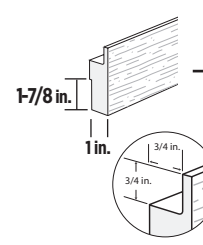

Built-in J-Pocket for siding and cut-out for Window Flange

Smooth, Natural White			FULL UNIT			HALF UNIT		
Nominal	Actual	Order Number*	PCS/UNIT	LF/UNIT	Weight** lbs/UNIT	PCS/UNIT	LF/UNIT	Weight** lbs/UNIT
5/4 in. x 4 in. x 18 ft.	1 in. x 3-1/2 in. x 18 ft.	11065018005	156	2,808	4,611	104	1,872	2,409

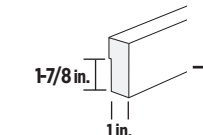

TrueTexture® Woodgrain, Natural White			FULL UNIT			HALF UNIT		
Nominal	Actual	Order Number*	PCS/UNIT	LF/UNIT	Weight** lbs/UNIT	PCS/UNIT	LF/UNIT	Weight** lbs/UNIT
5/4 in. x 4 in. x 18 ft.	1 in. x 3-1/2 in. x 18 ft.	12065018005	156	2,808	4,611	104	1,872	2,409

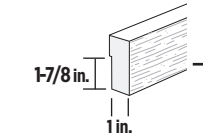

Fascia

Smooth, Natural White			FULL UNIT		
Nominal	Actual	Order Number	PCS/UNIT	LF/UNIT	Weight** lbs/UNIT
3/4 in. x 8 in. x 18 ft.	3/4 in. x 7-1/4 in. x 18 ft.	11430818005F	36	648	1,205
3/4 in. x 10 in. x 18 ft.	3/4 in. x 9-1/4 in. x 18 ft.	11431018005F	32	576	1,260

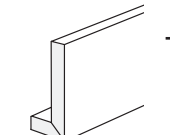

TrueTexture® Woodgrain, Natural White			FULL UNIT		
Nominal	Actual	Order Number	PCS/UNIT	LF/UNIT	Weight** lbs/UNIT
3/4 in. x 8 in. x 18 ft.	3/4 in. x 7-1/4 in. x 18 ft.	13430818005F	36	648	1,205
3/4 in. x 10 in. x 18 ft.	3/4 in. x 9-1/4 in. x 18 ft.	13431018005F	32	576	1,260

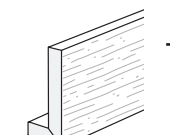

\*To order full units, add F to the end of the order number. To order a half unit, add H to the end of the order number, where applicable.  
 \*\*Weights include pallet.

InvisiPro® Hidden Fastening System

Trimboard (with grooves) Smooth, Natural White			HALF UNIT		
Nominal	Actual	Order Number	PCS/UNIT	LF/UNIT	Weight** lbs/UNIT
5/4 in. x 4 in. x 10 ft.	1 in. x 3-1/2 in. x 10 ft.	11260410005H	104	1,040	1,108
5/4 in. x 6 in. x 10 ft.	1 in. x 5-1/2 in. x 10 ft.	11260610005H	64	640	1,075

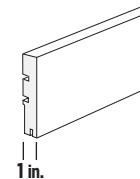

Trimboard (with grooves) TrueTexture™ Woodgrain, Natural White			HALF UNIT		
Nominal	Actual	Order Number	PCS/UNIT	LF/UNIT	Weight** lbs/UNIT
5/4 in. x 4 in. x 10 ft.	1 in. x 3-1/2 in. x 10 ft.	13260410005H	104	1,040	1,108
5/4 in. x 6 in. x 10 ft.	1 in. x 5-1/2 in. x 10 ft.	13260610005H	64	640	1,075

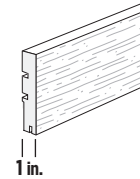

J-Pocket (with grooves) Smooth, Natural White			HALF UNIT		
Nominal	Actual	Order Number	PCS/UNIT	LF/UNIT	Weight** lbs/UNIT
5/4 in. x 4 in. x 10 ft.	1 in. x 3-1/2 in. x 10 ft.	11360410005H	104	1,040	1,108
5/4 in. x 6 in. x 10 ft.	1 in. x 5-1/2 in. x 10 ft.	11360610005H	64	640	1,075

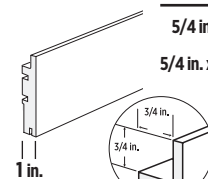

Built-in J-Pocket for siding

J-Pocket (with grooves) TrueTexture™ Woodgrain, Natural White			HALF UNIT		
Nominal	Actual	Order Number	PCS/UNIT	LF/UNIT	Weight** lbs/UNIT
5/4 in. x 4 in. x 10 ft.	1 in. x 3-1/2 in. x 10 ft.	13360410005H	104	1,040	1,108
5/4 in. x 6 in. x 10 ft.	1 in. x 5-1/2 in. x 10 ft.	13360610005H	64	640	1,075

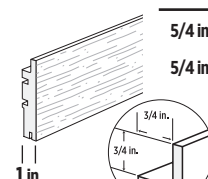

Built-in J-Pocket for siding

Nail Hem Flange* White		CARTONS			
Nominal Length	Actual Length	Order Number	PCS/CTN	LF/CTN	Weight† lbs/CTN
10 ft.	9 ft. 11-3/4 in.	60093910005C	36	360	54

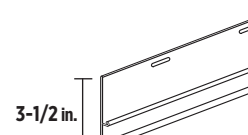

\*Same flange as used on One-Piece Corner

Starter Flange, White		CARTONS			
Nominal Length	Actual Length	Order Number	PCS/CTN	LF/CTN	Weight† lbs/CTN
10 ft.	9 ft. 11-3/4 in.	60053410001C	36	360	29

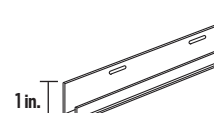

\*\*Weights include pallet. †Weights include carton.

One-piece Corners

Smooth, Natural White			FULL UNIT			HALF UNIT		
Nominal	Actual	Order Number*	PCS/UNIT	LF/UNIT	Weight** lbs/UNIT	PCS/UNIT	LF/UNIT	Weight** lbs/UNIT
5/4 in. x 4 in. x 4 in. x 10 ft.	1 in. x 3-1/2 in. x 3-1/2 in. x 10 ft.	31060410005	72	720	1,288	36	360	693
5/4 in. x 4 in. x 4 in. x 20 ft.	1 in. x 3-1/2 in. x 3-1/2 in. x 20 ft.	31060420005	72	1,440	2,499	36	720	1,422
5/4 in. x 6 in. x 6 in. x 10 ft.	1 in. x 5-1/2 in. x 5-1/2 in. x 10 ft.	31060610005	48	480	1,370	24	240	734
5/4 in. x 6 in. x 6 in. x 20 ft.	1 in. x 5-1/2 in. x 5-1/2 in. x 20 ft.	31060620005	48	960	2,772	24	480	1,502

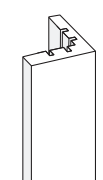

J-Pocket Smooth, Natural White			FULL UNIT			HALF UNIT		
Nominal	Actual	Order Number*	PCS/UNIT	LF/UNIT	Weight** lbs/UNIT	PCS/UNIT	LF/UNIT	Weight** lbs/UNIT
5/4 in. x 4 in. x 4 in. x 10 ft. J-Pocket	1 in. x 3-1/2 in. x 3-1/2 in. x 10 ft.	31160410005	72	720	1,059	36	360	579
5/4 in. x 4 in. x 4 in. x 20 ft. J-Pocket	1 in. x 3-1/2 in. x 3-1/2 in. x 20 ft.	31160420005	72	1,440	2,095	36	720	1,163
5/4 in. x 6 in. x 6 in. x 10 ft. J-Pocket	1 in. x 5-1/2 in. x 5-1/2 in. x 10 ft.	31160610005	48	480	1,129	24	240	615
5/4 in. x 6 in. x 6 in. x 20 ft. J-Pocket	1 in. x 5-1/2 in. x 5-1/2 in. x 20 ft.	31160620005	48	960	2,157	24	480	1,128

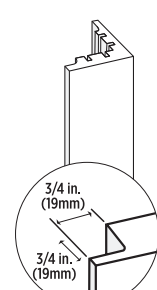

Built-in J-Pocket for siding

TrueTexture™ Woodgrain, Natural White			FULL UNIT			HALF UNIT		
Nominal	Actual	Order Number*	PCS/UNIT	LF/UNIT	Weight** lbs/UNIT	PCS/UNIT	LF/UNIT	Weight** lbs/UNIT
5/4 in. x 4 in. x 4 in. x 10 ft.	1 in. x 3-1/2 in. x 3-1/2 in. x 10 ft.	33060410005	72	720	1,288	36	360	693
5/4 in. x 4 in. x 4 in. x 20 ft.	1 in. x 3-1/2 in. x 3-1/2 in. x 20 ft.	33060420005	72	1,440	2,499	36	720	1,365
5/4 in. x 6 in. x 6 in. x 10 ft.	1 in. x 5-1/2 in. x 5-1/2 in. x 10 ft.	33060610005	48	480	1,370	24	240	734
5/4 in. x 6 in. x 6 in. x 20 ft.	1 in. x 5-1/2 in. x 5-1/2 in. x 20 ft.	33060620005	48	960	2,772	24	480	1,502

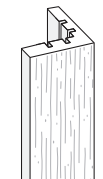

J-Pocket TrueTexture™ Woodgrain, Natural White			FULL UNIT			HALF UNIT		
Nominal	Actual	Order Number*	PCS/UNIT	LF/UNIT	Weight** lbs/UNIT	PCS/UNIT	LF/UNIT	Weight** lbs/UNIT
5/4 in. x 4 in. x 4 in. x 10 ft. J-Pocket	1 in. x 3-1/2 in. x 3-1/2 in. x 10 ft.	33160410005	72	720	1,059	36	360	579
5/4 in. x 4 in. x 4 in. x 20 ft. J-Pocket	1 in. x 3-1/2 in. x 3-1/2 in. x 20 ft.	33160420005	72	1,440	2,095	36	720	1,163
5/4 in. x 6 in. x 6 in. x 10 ft. J-Pocket	1 in. x 5-1/2 in. x 5-1/2 in. x 10 ft.	33160610005	48	480	1,129	24	240	615
5/4 in. x 6 in. x 6 in. x 20 ft. J-Pocket	1 in. x 5-1/2 in. x 5-1/2 in. x 20 ft.	33160620005	48	960	2,290	24	480	1,261

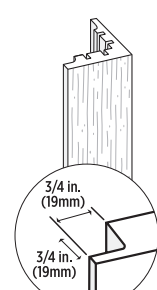

Built-in J-Pocket for siding

Nail Hem Flange*** White		CARTONS			
Nominal Length	Actual Length	Order Number	PCS/CTN	LF/CTN	Weight† lbs/CTN
10 ft.	9 ft. 11-3/4 in.	60093910005C	36	360	54



Two flanges needed per 10' corner; Four flanges needed per 20' corner

InvisiPro Hidden Fastening System Product

\*\*\*Same flange as used on Trimboard and J-Pocket (with grooves)

\*To order full units, add F to the end of the order number. To order a half unit, add H to the end of the order number, where applicable.

\*\*Weights include pallet. †Weights include carton.



Column Wraps

Column Wrap Smooth, Natural White				FULL UNIT		
Nominal	Actual	Order Number	PCS/UNIT	LF/UNIT	Weight** lbs/UNIT	
8 in. x 8 in. x 9 ft.	8 in. x 8 in. x 9 ft.	71380809005F	12	108	515	
10 in. x 10 in. x 9 ft.	10 in. x 10 in. x 9 ft.	71301009005F	12	108	685	

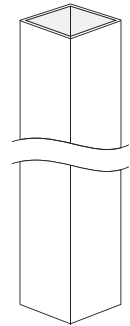

Must order Column Wrap and Trim Kit for complete Column.

Classic Cap/Base Trim Kit* Smooth, Natural White				FULL UNIT		
Nominal	Actual	Order Number	PCS/UNIT	LF/UNIT	Weight** lbs/UNIT	
8 in. x 8 in.	8 in. x 8 in.	61480801005F	4	n/a	57	
10 in. x 10 in.	10 in. x 10 in.	61401001005F	4	n/a	66	

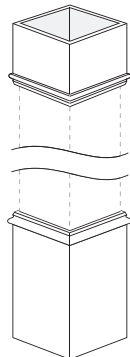

\*Column Wrap not included. Must order Column Wrap and Trim Kit for complete Column.

Estate Cap/Base Trim Kit* Smooth, Natural White				FULL UNIT		
Nominal	Actual	Order Number	PCS/UNIT	LF/UNIT	Weight** lbs/UNIT	
8 in. x 8 in.	8 in. x 8 in.	61680801005F	4	n/a	61	
10 in. x 10 in.	10 in. x 10 in.	61601001005F	4	n/a	73	

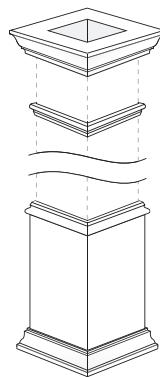

\*Column Wrap not included. Must order Column Wrap and Trim Kit for complete Column.

CustomCraft™ 1-1/2 in. Thick for Custom Fabrication

Trimboard Smooth/Smooth, Natural White				HALF UNIT		
Nominal	Actual	Order Number	PCS/UNIT	LF/UNIT	Weight** lbs/UNIT	
1-1/2 in. x 10 in. x 18 ft.	1-1/4 in. x 9-1/4 in. x 18 ft.	11071018005H	20	360	1,456	

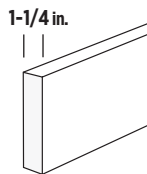

Sheet Smooth/Smooth, Natural White				HALF UNIT		
Nominal	Actual	Order Number	PCS/UNIT	LF/UNIT	Weight** lbs/UNIT	
1-1/2 in. x 4 ft. x 8 ft.	1-1/4 in. x 4 ft. x 8 ft.	21074808005H	10	80	1,295	

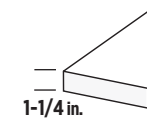

CustomCraft is made to order and available in half units only.

\*\*Weights include pallet.

Sheets

Smooth/Smooth, Natural White				FULL UNIT			HALF UNIT		
Nominal	Actual	Order Number*	PCS/UNIT	LF/UNIT	Weight** lbs/UNIT	PCS/UNIT	LF/UNIT	Weight** lbs/UNIT	
3/8 in. x 4 ft. x 8 ft.	3/8 in. x 4 ft. x 8 ft.	21014808005	25	200	1,077	12	96	553	
3/8 in. x 4 ft. x 10 ft.	3/8 in. x 4 ft. x 10 ft.	21014810005	25	250	1,270	12	120	661	
3/8 in. x 4 ft. x 18 ft.	3/8 in. x 4 ft. x 18 ft.	21014818005	25	450	2,313	12	216	1,220	
1/2 in. x 4 ft. x 8 ft.	1/2 in. x 4 ft. x 8 ft.	21024808005	25	200	1,247	12	96	635	
1/2 in. x 4 ft. x 10 ft.	1/2 in. x 4 ft. x 10 ft.	21024810005	25	250	1,602	12	120	820	
1/2 in. x 4 ft. x 18 ft.	1/2 in. x 4 ft. x 18 ft.	21024818005	25	450	2,826	12	216	1,465	
5/8 in. x 4 ft. x 8 ft.	5/8 in. x 4 ft. x 8 ft.	21044808005	25	200	1,686	12	96	847	
5/8 in. x 4 ft. x 10 ft.	5/8 in. x 4 ft. x 10 ft.	21044810005	25	250	2,065	12	120	1,043	
5/8 in. x 4 ft. x 18 ft.	5/8 in. x 4 ft. x 18 ft.	21044818005	25	450	3,621	12	216	1,847	
3/4 in. x 4 ft. x 8 ft.	3/4 in. x 4 ft. x 8 ft.	21034808005	20	160	1,638	10	80	854	
3/4 in. x 4 ft. x 10 ft.	3/4 in. x 4 ft. x 10 ft.	21034810005	20	200	2,058	10	100	1,078	
3/4 in. x 4 ft. x 12 ft.	3/4 in. x 4 ft. x 12 ft.	21034812005	20	240	2,464	10	120	1,289	
3/4 in. x 4 ft. x 18 ft.	3/4 in. x 4 ft. x 18 ft.	21034818005	21	378	3,907	10	180	1,945	
3/4 in. x 4 ft. x 20 ft.	3/4 in. x 4 ft. x 20 ft.	21034820005	21	420	4,070	10	200	2,125	
1 in. x 4 ft. x 8 ft.	1 in. x 4 ft. x 8 ft.	21054808005	20	160	2,215	10	80	1,143	
1 in. x 4 ft. x 10 ft.	1 in. x 4 ft. x 10 ft.	21054810005	20	200	2,745	10	100	1,421	
1 in. x 4 ft. x 12 ft.	1 in. x 4 ft. x 12 ft.	21054812005	20	240	3,271	10	120	1,693	
1 in. x 4 ft. x 18 ft.	1 in. x 4 ft. x 18 ft.	21054818005	18	324	4,412	9	162	2,309	
1 in. x 4 ft. x 20 ft.	1 in. x 4 ft. x 20 ft.	21054820005	16	320	4,407	8	160	2,319	

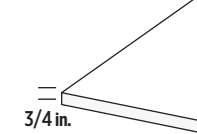
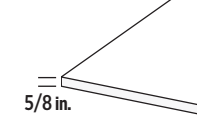
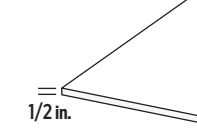
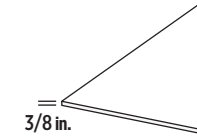

CustomCraft Sheet Smooth/Smooth, Natural White				HALF UNIT		
Nominal	Actual	Order Number	CustomCraft available in half units only.	PCS/UNIT	LF/UNIT	Weight** lbs/UNIT
1-1/2 in. x 4 ft. x 8 ft.	1-1/4 in. x 4 ft. x 8 ft.	21074808005H		10	80	1,295

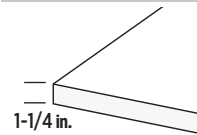

TrueTexture™ Woodgrain/Smooth, Natural White				FULL UNIT			HALF UNIT		
Nominal	Actual	Order Number*	PCS/UNIT	LF/UNIT	Weight** lbs/UNIT	PCS/UNIT	LF/UNIT	Weight** lbs/UNIT	
3/8 in. x 4 ft. x 8 ft.	3/8 in. x 4 ft. x 8 ft.	22014808005	25	200	1,077	12	96	553	
1/2 in. x 4 ft. x 8 ft.	1/2 in. x 4 ft. x 8 ft.	22024808005	25	200	1,247	12	96	634	
3/4 in. x 4 ft. x 8 ft.	3/4 in. x 4 ft. x 8 ft.	22034808005	20	160	1,638	10	80	854	

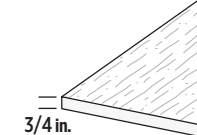
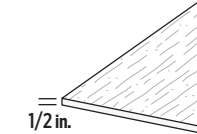
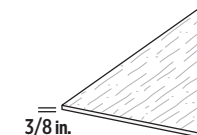

\*To order full units, add F to the end of the order number. To order a half unit, add H to the end of the order number, where applicable.

\*\*Weights include pallet.

**Beadboard** Reversible Panels

Traditional Tongue & Groove, Natural White <sup>1</sup>			FULL UNIT			HALF UNIT		
Nominal	Actual	Order Number*	PCS/UNIT	LF/UNIT	Weight** lbs/UNIT	PCS/UNIT	LF/UNIT	Weight** lbs/UNIT
1/2 in. x 5-1/2 in. x 18 ft.	1/2 in. x 5-1/8 in. x 18 ft.	8300005	200	3,600	2,642	100	1,800	1,430

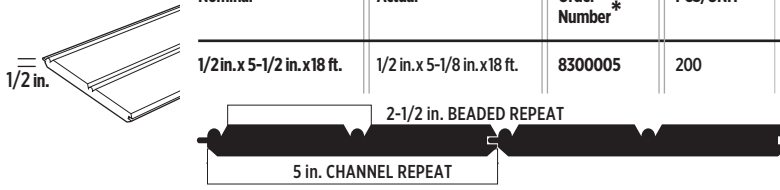

<sup>1</sup>Reversible beaded or channel repeat

2TL, TightLap, Natural White <sup>1</sup>			FULL UNIT			HALF UNIT		
Nominal	Actual	Order Number*	PCS/UNIT	LF/UNIT	Weight** lbs/UNIT	PCS/UNIT	LF/UNIT	Weight** lbs/UNIT
1/2 in. x 6 in. x 18 ft.	1/2 in. x 5-3/4 in. x 18 ft.	11225318005	224	4,032	2,648	96	1,728	1,255

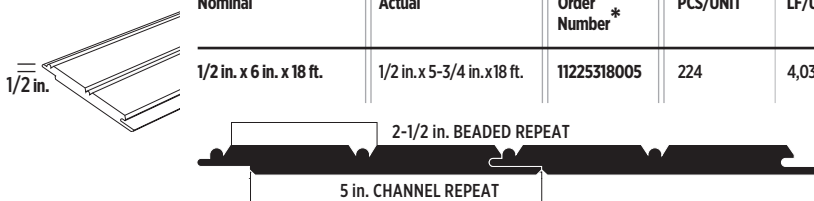

<sup>1</sup>Reversible beaded or channel repeat

3TL, TightLap, Natural White <sup>1</sup>			FULL UNIT			HALF UNIT		
Nominal	Actual	Order Number*	PCS/UNIT	LF/UNIT	Weight** lbs/UNIT	PCS/UNIT	LF/UNIT	Weight** lbs/UNIT
1/2 in. x 8-1/2 in. x 18 ft.	1/2 in. x 8-1/4 in. x 18 ft.	11225418005	200	3,600	3,884	100	1,800	1,852

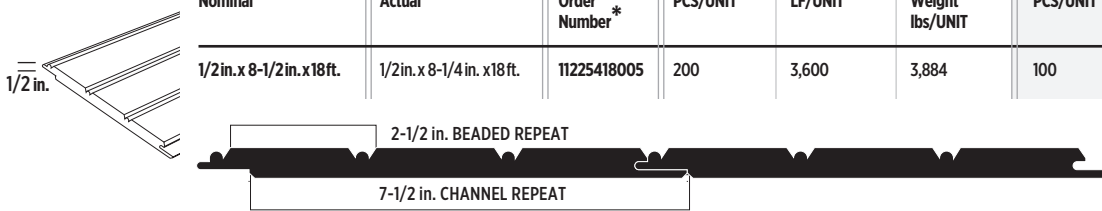

<sup>1</sup>Reversible beaded or channel repeat

**Beadboard Panels** Non-Reversible Panels

Beaded, Natural White			FULL UNIT			HALF UNIT		
Nominal	Actual	Order Number*	PCS/UNIT	LF/UNIT	Weight** lbs/UNIT	PCS/UNIT	LF/UNIT	Weight** lbs/UNIT
1/2 in. x 4 ft. x 8 ft.	1/2 in. x 4 ft. x 8 ft.	21224808005	25	200	1,218	12	96	621
1/2 in. x 4 ft. x 10 ft.	1/2 in. x 4 ft. x 10 ft.	21224810005	25	250	1,709	12	120	872

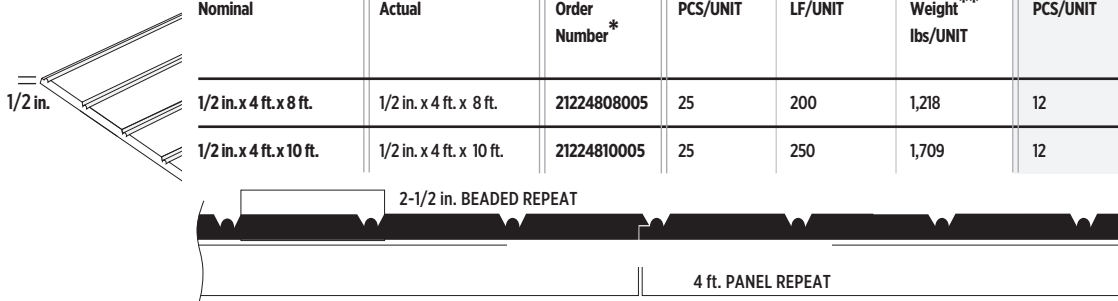

**WP4/Nickel Gap** Reversible Panel

WP4/Nickel Gap, TightLap <sup>1</sup> , Natural White <sup>1</sup>			FULL UNIT			HALF UNIT		
Nominal	Actual	Order Number*	PCS/UNIT	LF/UNIT	Weight** lbs/UNIT	PCS/UNIT	LF/UNIT	Weight** lbs/UNIT
3/4 in. x 6 in. x 18 ft.	3/4 in. x 5-3/4 in. x 18 ft.	11935318005F	72	1,296	1,800	--	--	--

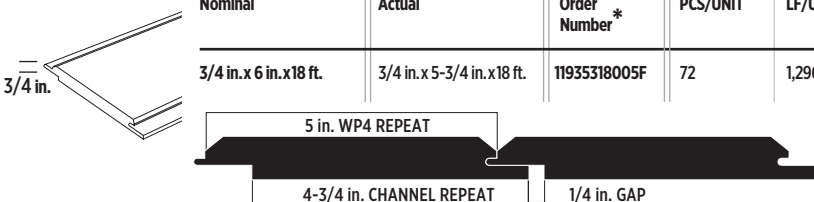

<sup>1</sup>Reversible WP4 or Nickel Gap repeat

\*To order full units, add F to the end of the order number. To order a half unit, add H to the end of the order number, where applicable.

\*\*Weights include pallet.

**Profiles**

Smooth, Satin Finish, Natural White		CARTONS			
Nominal/Actual	Order Number	Length	PCS/CTN	LF/CTN	Weight <sup>†</sup> lbs/CTN
<b>BRICKMOULD</b>					
1-1/8 in. x 2 in. x 7 ft.	41020207005B	7 ft.	14	98	50
1-1/8 in. x 2 in. x 10 ft.	41020210005B	10 ft.	14	140	65
1-1/8 in. x 2 in. x 17 ft.	41020217005B	17 ft.	14	238	100
<b>PAINT GRADE BRICKMOULD</b>					
1-1/8 in. x 2 in. x 7 ft.	41025107005B	7 ft.	14	98	45
1-1/8 in. x 2 in. x 10 ft.	41025100005B	10 ft.	14	140	60
1-1/8 in. x 2 in. x 17 ft.	41025116005B	17 ft.	14	238	100
<b>J-CHANNEL BRICKMOULD</b>					
1-1/4 in. x 2 in. x 17 ft.	41151517005B	17 ft.	12	204	90
<b>#49 CROWN</b>					
11/16 in. x 3-5/8 in. x 16 ft.	41040416005B	16 ft.	8	128	50
<b>#47 CROWN</b>					
11/16 in. x 4-5/8 in. x 16 ft.	41040516005B	16 ft.	6	96	50
<b>#45 CROWN</b>					
9/16 in. x 5-1/4 in. x 16 ft.	41041316005B	16 ft.	7	112	45
<b>RAMS CROWN</b>					
1-13/32 in. x 2-1/16 in. x 16 ft.	41141616005B	16 ft.	8	128	55
<b>BASE CAP</b>					
11/16 in. x 1-1/8 in. x 16 ft.	41070816005B	16 ft.	32	512	50
<b>RAKE</b>					
1 in. x 2 in. x 16 ft.	41111216005B	16 ft.	10	160	50
<b>QUARTER ROUND</b>					
3/4 in. x 3/4 in. x 16 ft.	41062116005B	16 ft.	38	608	65
<b>DRIP CAP</b>					
11/16 in. x 1-5/8 in. x 16 ft.	41030316005B	16 ft.	22	352	60
<b>SHINGLE MOULD</b>					
11/16 in. x 1-5/8 in. x 16 ft.	41080316005B	16 ft.	18	288	30
<b>BED MOULD</b>					
9/16 in. x 1-5/8 in. x 16 ft.	41050616005B	16 ft.	24	384	50
<b>LATTICE</b>					
1/4 in. x 1-1/2 in. x 16 ft.	41202016005B	16 ft.	50	800	75

<sup>†</sup>Weights include carton.

Profiles continued

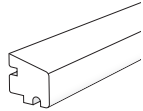
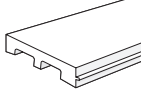
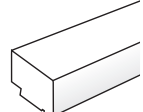
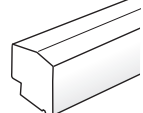
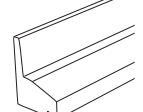
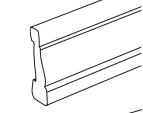
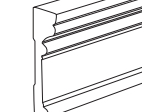
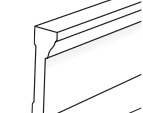
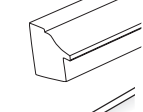
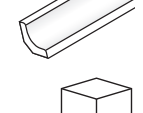
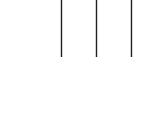
Smooth, Satin Finish, Natural White		CARTONS				
Nominal/Actual	Order Number	Length	PCS/CTN	LF/CTN	Weight <sup>†</sup> lbs/CTN	
<b>SILL NOSE</b>						
 1-5/16 in. x 1-3/8 in. x 16 ft.	4110116005B	16 ft.	9	144	50	
<b>SILL</b>						
 1-1/4 in. x 5 in. x 16 ft.	41131416005B	16 ft.	3	48	50	
<b>HISTORIC SILL</b>						
 1-3/4 in. x 2-13/16 in. x 16 ft.	41122416005B	16 ft.	4	64	50	
<b>NEW ENGLAND SILL</b>						
 1-3/4 in. x 2-1/32 in. x 16 ft.	41123016005B	16 ft.	6	96	70	
<b>WATER TABLE</b>						
 2 in. x 2-3/4 in. x 16 ft.	41253216005B	16 ft.	5	80	60	
<b>356 CASING</b>						
 1 1/16 in. x 2-1/4 in. x 16 ft.	41181816005B	16 ft.	16	256	50	
<b>RB3 CASING</b>						
 1-7/64 in. x 3-7/16 in. x 16 ft.	41171716005B	16 ft.	8	128	55	
<b>BACK BAND</b>						
 1-3/16 in. x 4-1/2 in. x 16 ft.	41090916005B	16 ft.	4	64	45	
<b>ADJUSTABLE BACK BAND</b>						
 1-11/32 in. x 1-13/32 in. x 16 ft.	41161916005B	16 ft.	10	160	50	
<b>COVE MOULDING</b>						
 3/4 in. x 3/4 in. x 16 ft.	41192116005B	16 ft.	50	800	60	
<b>INSIDE CORNER POST</b>						
 1-1/4 in. x 1-1/4 in. x 10 ft.	41010110005B	10 ft.	9	90	30	

<sup>†</sup>Weights include carton.

Special Order Profiles

Special Order Profiles must be ordered in full carton quantities. Extended lead times will apply. Contact your CertainTeed Territory Manager for product guidelines, minimum quantities and pricing.

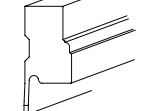
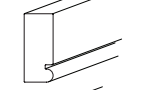
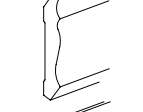
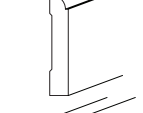
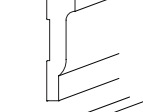
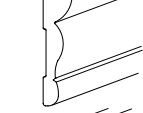
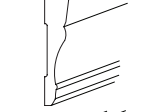
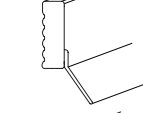
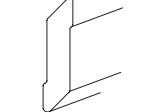
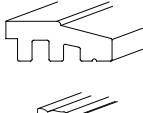
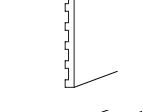
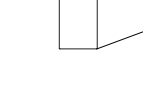
Smooth, Satin Finish, Natural White		CARTONS				
Nominal/Actual	Order Number	Length	PCS/CTN	LF/CTN	Weight <sup>†</sup> lbs/CTN	
<b>FLANGED BRICKMOULD</b>						
 1-1/4 in. x 2 in. x 17 ft.	41024617005B	17 ft.	12	204	100	
<b>FLORIDA BRICKMOULD</b>						
 1 1/16 in. x 1-5/8 in. x 17 ft.	41020317005B	17 ft.	28	476	140	
<b>#49 CROWN SCANT</b>						
 9/16 in. x 3-5/8 in. x 16 ft.	41044016005B	16 ft.	10	160	53	
<b>#623 CENTURY BASEBOARD</b>						
 9/16 in. x 3-1/4 in. x 16 ft.	41075016005B	16 ft.	10	160	55	
<b>3" SHINGLE RAKE</b>						
 3/4 in. x 3-1/8 in. x 16 ft.	41114116005B	16 ft.	10	160	60	
<b>A-3 COLONIAL CASING</b>						
 1/2 in. x 2 in. x 16 ft.	41184216005B	16 ft.	22	362	64	
<b>A-6 CLASSIC CASING</b>						
 9/16 in. x 2-3/4 in. x 16 ft.	41184316005B	16 ft.	14	224	47	
<b>GARAGE DOOR STOP</b>						
 7/16 in. x 1-15/16 in. x 16 ft.	41224716005B	16 ft.	14	224	40	
<b>ATTIC (GABLE) VENT LOUVER</b>						
 1 1/16 in. x 3-1/2 in. x 16 ft.	41214416005B	16 ft.	7	112	60	
<b>ATTIC (GABLE) VENT SILL</b>						
 1-1/8 in. x 3-1/4 in. x 16 ft.	41214516005B	16 ft.	5	80	65	
<b>WINDOW SILL WITH CASING</b>						
 2-3/16 in. x 6-3/4 in. x 16 ft.	41134916005B	16 ft.	2	32	45	
<b>TRANSOM MULL</b>						
 1-1/16 in. x 1-1/2 in. x 16 ft.	41134816005B	16 ft.	12	192	80	

<sup>†</sup>Weights include carton.

Hidden Fastening System

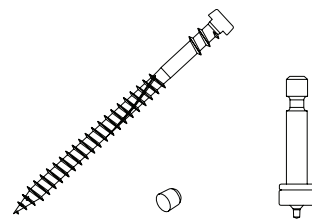

Smooth – 2 in. Screws		CARTONS		
Description	Order Number	Boxes/CTN	Net Weight lbs/CTN	CTN/Pallet
50 LF Box- 75 screws (2in.), 80 plugs 1 setting tool	63180130005CL	10	11	48
250 LF Box- 375 screws (2in.), 400 plugs 3 setting tools	63180135005CL	4	7.75	32
750 LF Box- 1,125 Screws (2in.) 1,200 plugs 6 setting tools	63180140005CL	1	15	75
TrueTexture™ Woodgrain – 2 in. Screws		CARTONS		
Description	Order Number	Boxes/CTN	Net Weight lbs/CTN	CTN/Pallet
50 LF Box- 75 screws (2in.), 80 plugs 1 setting tool	63380130005CL	10	11	48
250 LF Box- 375 screws (2in.), 400 plugs 3 setting tools	63380135005CL	4	7.75	32
750 LF Box- 1,125 Screws (2in.) 1,200 plugs 6 setting tools	63380140005CL	1	15	75
Smooth – 2-3/4 in. Screws		CARTONS		
Description	Order Number	Boxes/CTN	Net Weight lbs/CTN	CTN/Pallet
250 LF Box- 375 screws (2-3/4 in.), 400 plugs 3 setting tools	63182335005CL	4	7.75	32
750 LF Box- 1,125 Screws (2-3/4in.) 1,200 plugs 6 setting tools	63182340005CL	1	15	75
TrueTexture Woodgrain – 2-3/4 in. Screws		CARTONS		
Description	Order Number	Boxes/CTN	Net Weight lbs/CTN	CTN/Pallet
250 LF Box- 375 screws (2-3/4 in.), 400 plugs 3 setting tools	63382335005CL	4	7.75	32
Replacement Plugs Smooth		CARTONS		
Description	Order Number	Boxes/CTN	Net Weight lbs/CTN	CTN/Pallet
40 LF Bag- Plug only 40 plugs	633800004005CL	10	1.25	150
Replacement Plugs TrueTexture™		CARTONS		
Description	Order Number	Boxes/CTN	Net Weight lbs/CTN	CTN/Pallet
40 LF Bag- Plug only 40 plugs	631800004005CL	10	1.25	150

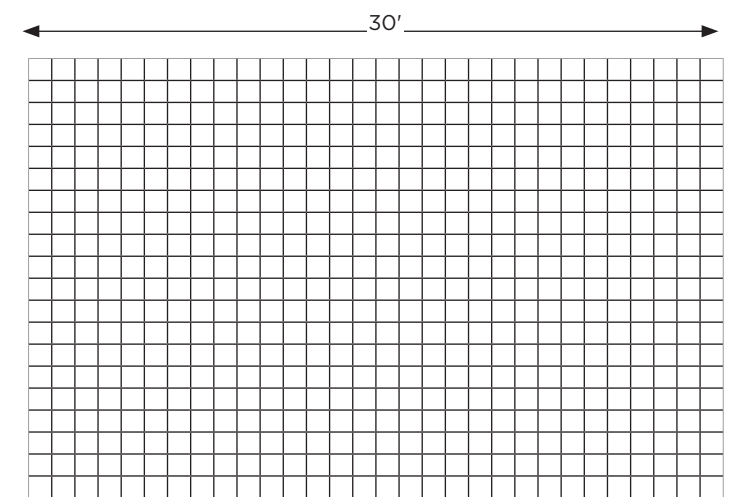

Railing Take-Off Sheet

Directions:

- We recommend making multiple copies of this form.
- Check each box below that applies to your application; Refer to your FRD Product Catalog (with MSRP pricing) to calculate job quote.
- Contact Customer Service for review and/or assistance.
- Use for both Residential & Commercial take-offs.

Type of Railing\* & Color

- Oxford vinyl  
 White
- Kingston vinyl  
 White  Almond  Clay

\*Refer to the EverNew Railing Product Matrix to best determine which railing system works best for code application.

Attachment Method

- Routed (Oxford only)  Wood  Concrete
- Bracketed  
 Bracketed with concrete post support kit (vinyl only)  
 Attached to post-sleeve over application

Height of Section

- 36"  42"

Type of Baluster Infill (not available in all sizes)

- Oxford vinyl  Square  Classic  Aluminum
- Kingston vinyl  Square  Traditional  Aluminum

Type of Post

- Square

Vinyl Post Cap Options (not available in all colors)

- Gothic  Flat Internal  Flat External  Ball
- New England
- Solar Cap 5"x 5" (includes adaptor for 4"x 4" posts)  
 White  Black

Vinyl Post Trim Options (not available in all colors)

- 1-Piece Post Trim (available in 4x4 & 5x5)
- 2-Piece Post Trim (available in 4x4)
- 4-Piece Post Trim (available in 4x4, 5x5, & 6x6)

ADA Handrail Required?

- Yes  No  White

Porch Posts & Columns (not available in all colors)

- Structural Vinyl Porch Posts  
 4x4 Colonial  5x5 Colonial  5x5 Square
- Structural Vinyl Columns  
 8" Round Non-Tapered  8" Round Tapered  
 10" Round Tapered  8" Square



For Routed System - Oxford (Without Brackets)

Catalog No.	Routed Post Support Options	Packaged Quantity	Weight
71450	Post Support Kit (concrete), flat (37-1/2" actual height), for routed system only	1	8.0
71451	Post Support Kit (concrete), flat (43-1/2" actual height), for routed system only	1	8.0
71452	Post Support Kit (concrete), stair (48" actual height), for routed system only	1	11.0
71455	Post Support Kit (wood), flat (42-1/2" actual height)	1	9.5
71456	Post Support Kit (wood), flat (49-1/2" actual height)	1	9.5
71457	Post Support Kit (wood), stair (54" actual height)	1	9.5
Kit includes: welded pipe & plate; (2) E-Z set brackets, railing plate & screw; concrete anchors (concrete mount) or bolts (wood mount); nuts & washers			

For Bracketed Systems - Oxford and Kingston

Catalog No.	Bracketed Post Support Options	Packaged Quantity	Weight
71455	Post Support Kit (wood), flat (42-1/2" actual height)	1	9.5
71456	Post Support Kit (wood), flat (49-1/2" actual height)	1	9.5
71457	Post Support Kit (wood), stair (54" actual height)	1	9.5
Kit includes: welded pipe & plate, (2) E-Z set brackets, railing plate & screw, bolts (wood mount), nuts & washers			
714610	EZ Set II Bracketed Post Support Kit (concrete), flat (37-1/2 actual height) Kit includes: welded pipe & plate, (4) internal blocks, hardware and concrete anchors	1	8.0
714611	EZ Set II Bracketed Post Support Kit (concrete), flat (43-1/2 actual height) Kit includes: welded pipe & plate, (4) internal blocks, hardware and concrete anchors	1	8.0
714615	The Mount 36" height (includes 4" molded PVC guides)	1	12.0
714616	The Mount 42" height (includes 4" molded PVC guides)	1	14.0
714617	The Mount Mounting Hardware for Wood & Composite Applications Kit includes: (4) 5/16-18x1" bolts; (4) 5/16-18x6" bolts; (8) flat, SAE washers; (4) #10x3/4" self drilling screws; (1) post mount leveling plate; (1) post mount mounting plate; (4) 5/16-18 hex nuts; (1) bag of (16) #10x1.000 self drilling screws; (1) instruction sheet	1	3.6
714618	The Mount Mounting Hardware for Concrete Applications Kit includes: (4) 5/16-18x1" bolts; (8) flat, SAE washers; (4) #10x3/4" self drilling screws; (1) post mount leveling plate; (1) bag of (16) #10x1.000 self drilling screws; (4) concrete anchors; (1) instruction sheet	1	1.5

Catalog No.	Boxed Railing Kits (include top + bottom rails and balusters)	Actual Length	White	Packaged Quantity	Wt.
<b>FLAT Flat Sections</b>					
20970	6' Oxford Section, Square Balusters	71-1/2"	•	1	28.9
20978	8' Oxford Section, Square Balusters	95-1/2"	•	1	31.6
20986	10' Oxford Section, Square Balusters	119-1/2"	•	1	36.0
20472	6' Oxford Section, Classic Balusters	71-1/2"	•	1	28.9
20480	8' Oxford Section, Classic Balusters	95-1/2"	•	1	31.6
20488	10' Oxford Section, Classic Balusters	119-1/2"	•	1	36.0
<b>STAIR Stair Sections</b>					
20971	6' Oxford Section, Square Balusters	71-1/2"	•	1	25.7
20979	8' Oxford Section, Square Balusters	95-1/2"	•	1	28.4
20987	10' Oxford Section, Square Balusters	119-1/2"	•	1	36.0
20473	6' Oxford Section, Classic Balusters	71-1/2"	•	1	25.7
20481	8' Oxford Section, Classic Balusters	95-1/2"	•	1	28.4
20489	10' Oxford Section, Classic Balusters	119-1/2"	•	1	36.0

Oxford Boxed Kits Without Brackets can be used with either brackets or routed post system.

Catalog No.	Posts	White	Packaged Quantity	Wt.
<b>Square Posts - Flat</b>				
66153	End Post Flat (a) - 4" x 4" x 38"	•	1	4.0
66152	Line Post Flat (b) - 4" x 4" x 38"	•	1	4.0
66151	Corner Post Flat (c) - 4" x 4" x 38"	•	1	4.0
66156	Line Post 45° (g) - 4" x 4" x 38"	•	1	4.0
649538	Blank Post - 4" x 4" x 38"	•	1	4.1
<b>Square Posts - Stair</b>				
64631L	Flat to Stair Corner Post Left (d) - 4" x 4" x 38"	•	1	4.0
64631R	Flat to Stair Corner Post Right (e) - 4" x 4" x 38"	•	1	4.0
66252	Line Post Stair (f) - 4" x 4" x 48"	•	1	5.0
64632	Flat to Stair Line Post (h) - 4" x 4" x 38"	•	1	4.0
66253	End Post Stair (i) - 4" x 4" x 48"	•	1	5.0
66558	Inground End Post Stair - 4" x 4" x 75"	•	1	7.0
649548	Blank Post - 4" x 4" x 48"	•	1	5.2

Refer to page 67 for mounting hardware and gate information.  
Refer to page 76 for finishing accessories.  
Refer to page 76 for porch posts and columns.

# Oxford Boxed Kits Without Brackets

3-1/2' High / 6', 8' & 10' Wide Vinyl Railing

Catalog No.	Boxed Railing Kits (include top + bottom rails and balusters)	Actual Length	White	Packaged Quantity	Wt.
<b>FLAT Flat Sections</b>					
20974	6' Oxford Section, Square Balusters	71-1/2"	•	1	31.1
20982	8' Oxford Section, Square Balusters	95-1/2"	•	1	36.0
20990	10' Oxford Section, Square Balusters	119-1/2"	•	1	37.8
20476	6' Oxford Section, Classic Balusters	71-1/2"	•	1	31.1
20484	8' Oxford Section, Classic Balusters	95-1/2"	•	1	36.0
20492	10' Oxford Section, Classic Balusters	119-1/2"	•	1	37.8
<b>STAIR Stair Sections</b>					
20975	6' Oxford Section, Square Balusters	71-1/2"	•	1	27.3
20983	8' Oxford Section, Square Balusters	95-1/2"	•	1	36.0
20991	10' Oxford Section, Square Balusters	119-1/2"	•	1	37.8
20477	6' Oxford Section, Classic Balusters	71-1/2"	•	1	27.3
20485	8' Oxford Section, Classic Balusters	95-1/2"	•	1	36.0
20493	10' Oxford Section, Classic Balusters	119-1/2"	•	1	37.8

Oxford Boxed Kits Without Brackets can be used with either brackets or routed post system.

Catalog No.	Square Posts	White	Packaged Quantity	Wt.
<b>Flat Sections</b>				
66163	End Post Flat (a) - 4" x 4" x 44"	•	1	5.0
66162	Line Post Flat (b) - 4" x 4" x 44"	•	1	5.0
66161	Corner Post Flat (c) - 4" x 4" x 44"	•	1	5.0
66166	Line Post 45° (g) - 4" x 4" x 44"	•	1	5.0
649544	Blank Post - 4" x 4" x 44"	•	1	4.7
<b>Stair Posts</b>				
64641L	Flat to Stair Corner Post Left (d) - 4" x 4" x 44"	•	1	4.5
64641R	Flat to Stair Corner Post Right (e) - 4" x 4" x 44"	•	1	4.5
66462	Line Post Stair (f) - 4" x 4" x 51-1/2"	•	1	4.5
64642	Flat to Stair Line Post (h) - 4" x 4" x 44"	•	1	4.5
66463	End Post Stair (i) - 4" x 4" x 51-1/2"	•	1	5.5
66568	Inground End Post Stair - 4" x 4" x 75"	•	1	7.5
649552	Blank Post - 4" x 4" x 51-1/2"	•	1	5.7

Refer to page 68 for mounting hardware and gate information.  
 Refer to page 73 for finishing accessories.  
 Refer to page 76 for porch posts and columns.

# Oxford Mounting Hardware & Replacement Packs

3' High

Vinyl Railing

Catalog No.	Mounting Hardware	White	Packaged Quantity	Wt.
<b>Bracket Hardware Options</b>				
71348	T-Rail Rail Mount Hardware Pack, flat*	•	1	1.0
71349	T-Rail Rail Mount Hardware Pack, stair*	•	1	1.0
71343	T-Rail Rail Mount Hardware Pack, 45°*	•	1	1.1
71344	T-Rail Rail Mount Hardware Pack, column**	•	1	0.5
*Pack includes: 4 aluminum brackets, 2 2x4 and 2 T-Rail vinyl covers, screws **Pack includes: 2 aluminum brackets, 1 2x4 and 1 T-Rail vinyl cover, screws				
<b>Post Support Options</b>				
71450	Post Support Kit (concrete), flat (37-1/2" actual height), for routed system only		1	8.0
71452	Post Support Kit (concrete), stair (48" actual height), for routed system only		1	11.0
71455	Post Support Kit (wood), flat (42-1/2" actual height)		1	9.5
71457	Post Support Kit (wood), stair (54" actual height) Kit includes: Welded pipe & plate, (2) EZ set brackets, railing plate & screw, concrete anchors (concrete mount) or bolts (wood mount), nuts & washers		1	9.5
714610	EZ Set II Bracketed Post Support Kit (concrete), flat (37-1/2" actual height) Kit includes: Welded pipe and plate, (4) internal blocks, hardware and concrete anchors		1	8.0
714615	The Mount 36" height (includes 4" molded pvc guides)		1	12.0
714617	The Mount Mounting Hardware for Wood & Composite Applications Kit includes: (4) 5/16-18x1" bolts; (4) 5/16-18x6" bolts; (8) flat, SAE washers; (4) #10x3/4" self drilling screws; (1) post mount leveling plate; (1) post mount mounting plate; (4) 5/16-18 hex nuts; (1) bag of (16) #10x1.000 self drilling screws; (1) instruction sheet		1	3.6
714618	The Mount Mounting Hardware for Concrete Applications Kit includes: (4) 5/16-18x1" bolts; (8) flat, SAE washers; (4) #10x3/4" self drilling screws; (1) post mount leveling plate; (1) bag of (16) #10x1.000 self drilling screws; (4) concrete anchors; (1) instruction sheet  For complete installation of The Mount, order both The Mount and either Hardware kit, depending upon application.		1	1.5
<b>Gates</b> (builds up to 60" wide gate)				
631021	3' Oxford Gate Kit, Square Balusters	•	1	35.7
631042	3' Oxford Gate Kit, Classic Balusters	•	1	36.3
Kit includes: (2) aluminum reinforced uprights, (2) upright caps, (2) 2x4 aluminum reinforced rails, (10) balusters, (16) stainless steel screws, (2) self-closing gate hinges, (1) gate latch.				
<b>Replacement Packs</b>				
28504	Oxford 8' Rail Pack, Flat	•	1	17.0
28508	Oxford 8' Rail Pack, Stair	•	1	17.0
37153F	Square Baluster Replacement Pack, 39-1/4"*	•	19	13.4
47042F	Classic Baluster Replacement Pack, 33-1/4"	•	19	13.4
* Square 39-1/4" baluster requires field cutting for 3'				

Refer to page 73 for finishing accessories.  
 Refer to page 76 for porch posts and columns.

**Oxford Mounting Hardware & Replacement Packs**

**3-1/2' High**

**Vinyl Railing**

Catalog No.	Mounting Hardware	White	Packaged Quantity	Wt.
<b>Bracket Hardware Options</b>				
71348	T-Rail Rail Mount Hardware Pack, flat*	•	1	1.0
71349	T-Rail Rail Mount Hardware Pack, stair*	•	1	1.0
71343	T-Rail Rail Mount Hardware Pack, 45°**	•	1	1.1
71344	T-Rail Rail Mount Hardware Pack, column**	•	1	0.5
*Pack includes: 4 aluminum brackets, 2 2x4 and 2 T-Rail vinyl covers, screws **Pack includes: 2 aluminum brackets, 1 2x4 and 1 T-Rail vinyl cover, screws				
<b>Post Support Options</b>				
71451	Post Support Kit (concrete), flat (43-1/2" actual height), for routed system only		1	8.0
71452	Post Support Kit (concrete), stair (48" actual height), for routed system only		1	11.0
71456	Post Support Kit (wood), flat (49-1/2" actual height)		1	9.5
71457	Post Support Kit (wood), stair (54" actual height) Kit includes: Welded pipe & plate, (2) EZ set brackets, railing plate & screw, concrete anchors (concrete mount) or bolts (wood mount), nuts & washers		1	9.5
714611	EZ Set II Bracketed Post Support Kit (concrete), flat (43-1/2" actual height) Kit includes: Welded pipe and plate, (4) internal blocks, hardware and concrete anchors		1	8.0
714616	The Mount 42" height (includes 4" molded pvc guides)		1	14.0
714617	The Mount Mounting Hardware for Wood & Composite Applications Kit includes: (4) 5/16-18x1" bolts; (4) 5/16-18x6" bolts; (8) flat, SAE washers; (4) #10x3/4" self drilling screws; (1) post mount leveling plate; (1) post mount mounting plate; (4) 5/16-18 hex nuts; (1) bag of (16) #10x1.000 self drilling screws; (1) instruction sheet		1	3.6
714618	The Mount Mounting Hardware for Concrete Applications Kit includes: (4) 5/16-18x1" bolts; (8) flat, SAE washers; (4) #10x3/4" self drilling screws; (1) post mount leveling plate; (1) bag of (16) #10x1.000 self drilling screws; (4) concrete anchors; (1) instruction sheet For complete installation of The Mount, order both The Mount and either Hardware kit, depending upon application.		1	1.5
<b>Gates (builds up to 60" wide gate)</b>				
631023	3-1/2' Oxford Gate Kit, Square Balusters	•	1	39.3
631044	3-1/2' Oxford Gate Kit, Classic Balusters Kit includes: (2) aluminum reinforced uprights, (2) upright caps, (2) 2x4 aluminum reinforced rails, (10) balusters, (16) stainless steel screws, (2) self-closing gate hinges, (1) gate latch.	•	1	38.7
<b>Replacement Packs</b>				
28504	Oxford 8' Rail Pack, Flat	•	1	17.0
28508	Oxford 8' Rail Pack, Stair	•	1	17.0
37153F	Square Baluster Replacement Pack, 39-1/4"	•	19	13.4
47043F	Classic Baluster Replacement Pack, 39-1/4" * Square 39-1/4" baluster requires field cutting for 3'	•	19	13.4

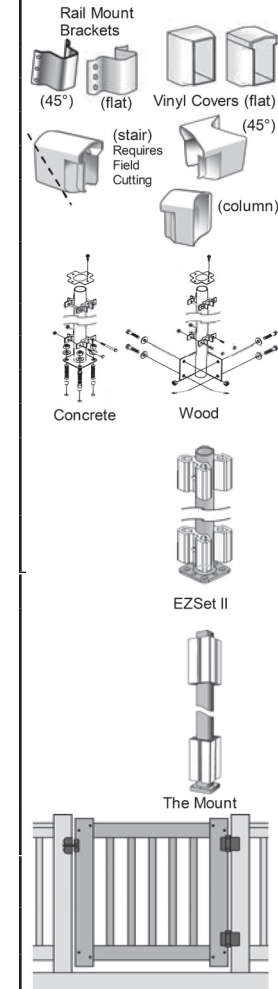

Refer to page 73 for finishing accessories.  
Refer to page 76 for porch posts and columns.

**Oxford Steep Stair, Replacement Packs & Aluminum Balusters**

**Vinyl Railing**

**Oxford - Steep Stair**

Catalog No.	Steep Stair Rail Packs* 37°-42° Applications (include top + bottom rails)	Actual Length	White	Packaged Quantity	Wt.
28393	6' Oxford Rail Pack, Stair	71-1/2"	•	1	14.5
28394	8' Oxford Rail Pack, Stair Routed for steep stair (37°-42°) applications	95-1/2"	•	1	18.0
<b>Steep Stair Baluster Packs</b> (include section quantities of balusters)					
37159F	Square Baluster 6' Pack, 37-3/4"		•	11	9.5
37161F	Square Baluster 8' Pack, 37-3/4"		•	15	12.9
*Works with routed system only. Refer to pages 65 & 66 for post information.					

**Oxford - Replacement Packs**

Catalog No.	Replacement Packs Oxford Railing	White	Packaged Quantity	Wt.
28504	Oxford 8' Rail Pack, Flat	•	1	17.0
28508	Oxford 8' Rail Pack, Stair	•	1	17.0
37153F	Square Baluster Replacement Pack, 39-1/4"	•	19	13.4
47042F	Classic Baluster Replacement Pack, 33-1/4"	•	19	13.4
47043F	Classic Baluster Replacement Pack, 39-1/4" *Square 39-1/4" baluster requires field cutting for 3'	•	19	13.4

Catalog No.	Aluminum Baluster Rail Component Packs for use with 3' & 3-1/2' Aluminum Balusters (sold separately) (Includes top + bottom rails)	Actual Length	White	Packaged Quantity	Wt.
28614	6' Oxford Rail Pack, Flat	71-1/2"	•	1	15.3
28814	8' Oxford Rail Pack, Flat	95-1/2"	•	1	20.5
28617	6' Oxford Rail Pack, Stair	71-1/2"	•	1	15.3
28818	8' Oxford Rail Pack, Stair Routed for 3/4" Round Aluminum Balusters	95-1/2"	•	1	20.5
<b>Aluminum Baluster Component Packs for use with Aluminum Baluster Rail Component Packs (sold separately) includes 20 ea - 3/4" Round Aluminum Balusters (15 balusters/6' section and 20 balusters/8' section)</b>					
<b>3' Tall Sections</b>					
362033	33" Aluminum Baluster 3/4" Pack, Round (Flat sections), Black			20	1.5
362031	31" Aluminum Baluster 3/4" Pack, Round (Stair sections), Black			20	1.4
<b>3-1/2' Tall Sections</b>					
362039	39" Aluminum Baluster 3/4" Pack, Round (Flat sections), Black			20	1.7
362037	37" Aluminum Baluster 3/4" Pack, Round (Stair sections), Black			20	1.6
<b>Aluminum Baluster Gate Kits (builds up to 60" wide gate) for use with 3' &amp; 3-1/2' Aluminum Balusters (sold separately) 60" wide gate uses 11 balusters</b>					
631025	3' Gate Kit for Round Aluminum Balusters		•	1	27.8
631026	3-1/2' Gate Kit for Round Aluminum Balusters Kit includes: (2) aluminum reinforced uprights, (2) upright caps, (2) 2x4 aluminum reinforced rails, (16) stainless steel screws, (2) self-closing gate hinge, (1) gate latch		•	1	30.8

Refer to page 73 for finishing accessories.  
Refer to page 76 for porch posts and columns.



# Kingston Boxed Kits With Brackets

3' High / 6', 8' & 10' Wide

Vinyl Railing

Catalog No.	Boxed Railing Kits (Includes: top + bottom rails, balusters, crush block & rail mount bracket hardware)	Actual Length	White	Almond	Clay	Pkgd Quant.	Wt.
<b>FLAT Sections with Flat Brackets</b>							
285006	6' Kingston Section, Square Balusters	68-1/2"	•	•	•	1	22.1
285008	8' Kingston Section, Square Balusters	92-1/2"	•	•	•	1	30.2
285010	10' Kingston Section, Square Balusters	116-1/2"	•	•	•	1	36.4
285206	6' Kingston Section, Traditional Balusters	68-1/2"	•	•	•	1	22.1
285208	8' Kingston Section, Traditional Balusters	92-1/2"	•	•	•	1	30.2
285210	10' Kingston Section, Traditional Balusters	116-1/2"	•	•	•	1	36.4
<b>STAIR Sections with Stair Brackets (crush block not required)</b>							
286006	6' Kingston Section, Square Balusters	68-1/2"	•	•	•	1	20.9
286008	8' Kingston Section, Square Balusters	92-1/2"	•	•	•	1	28.4
286206	6' Kingston Section, Traditional Balusters	68-1/2"	•	•	•	1	20.9
286208	8' Kingston Section, Traditional Balusters	92-1/2"	•	•	•	1	28.4
<b>Blank Posts</b>							
649538	4" x 4" x 38" Square Post		•	•	•	1	4.1
649544	4" x 4" x 44" Square Post		•	•	•	1	4.7
<b>Mounting Hardware</b>							
<b>Bracket Hardware Options</b>							
704132	Kingston Rail Mount Hardware Pack, flat*		•	•	•	1	2.0
704246	Kingston Rail Mount Hardware Pack, stair/steep stair**		•	•	•	1	3.0
704147	Kingston Rail Mount Hardware Pack, column***		•	•	•	1	1.4
704145	Kingston Rail Mount Hardware Pack, 45° *		•	•	•	1	2.8
704143	Kingston Rail Mount Hardware Pack, 22-1/2° *		•	•	•	1	2.8
*Pack Includes: (4) aluminum brackets, (4) vinyl covers, (1) crush block & screws			**Pack Includes: (4) aluminum brackets, (4) vinyl covers & screws				
			***Pack Includes: (2) aluminum brackets, (2) vinyl covers, (1) crush block & screws				
<b>Post Support Options</b>							
714610	EZ Set II Bracketed Post Support Kit (concrete), flat (37-1/2" actual height) Kit includes: welded pipe & plate, (4) internal blocks, hardware and concrete anchors					1	8.0
714615	The Mount 36" height					1	12.0
714617	The Mount Mounting Hardware for Wood & Composite Applications Kit includes: (4) 5/16-18x1" bolts; (4) 5/16-18x6" bolts; (8) flat, SAE washers; (4) #10x3/4" self drilling screws; (1) post mount leveling plate; (1) post mount mounting plate; (4) 5/16-18 hex nuts; (1) bag of (16) #10x1.000 self drilling screws; (1) instruction sheet					1	3.6
714618	The Mount Mounting Hardware for Concrete Applications Kit includes: (4) 5/16-18x1" bolts; (8) flat, SAE washers; (4) #10x3/4" self drilling screws; (1) post mount leveling plate; (1) bag of (16) #10x1.000 self drilling screws; (4) concrete anchors; (1) instruction sheet.					1	1.5
For complete installation of The Mount, order both The Mount and either Hardware kit, depending upon application.							
<b>Gates (builds up to 60" wide gate)</b>							
631011	3' Kingston Gate Kit, Square Balusters		•	•	•	1	34.3
631012	3' Kingston Gate Kit, Traditional Balusters		•	•	•	1	35.3
Kit includes: (2) aluminum reinforced uprights, (2) upright caps, (2) 2x3-1/2 aluminum reinforced rails, (10) balusters, (16) stainless steel screws, (2) self-closing gate hinges, (1) gate latch.							
<b>Replacement Packs</b>							
284195	Kingston 8' Rail Pack, Flat		•	•	•	2	17.0
284196	Kingston 8' Rail Pack, Stair		•	•	•	2	17.0
389218F	Square Baluster Replacement Pack, 39-1/4"		•	•	•	18	13.4
371018F	Traditional Baluster Replacement Pack, 33-1/4" *39-1/4" Baluster may require field cutting		•	•	•	18	9.9
<b>Steep Stair</b>							
284296	Kingston 8' Rail Pack, Steep Stair		•	•	•	2	17.0
389218F	Square Baluster Replacement Pack, 39-1/4" *39-1/4" Baluster may require field cutting		•	•	•	18	13.4
371018F	Traditional Baluster Replacement Pack, 33-1/4"		•	•	•	18	9.9
704246	Kingston Rail Mount Hardware Pack, stair/steep stair** **Pack Includes: (4) aluminum brackets, (4) vinyl covers & screws		•	•	•	1	3.0

Refer to page 71 for color codes.  
Refer to page 73 for finishing accessories.  
Refer to page 76 porch posts and columns.

# Kingston Boxed Kits With Brackets

3-1/2' High / 6', 8' & 10' Wide

Vinyl Railing

Catalog No.	Boxed Railing Kits (Includes: top + bottom rails, balusters, crush block & rail mount bracket hardware)	Actual Length	White	Almond	Clay	Pkgd Quant.	Wt.
<b>FLAT Sections with Flat Brackets</b>							
285016	6' Kingston Section, Square Balusters	68-1/2"	•	•	•	1	22.1
285018	8' Kingston Section, Square Balusters	92-1/2"	•	•	•	1	30.2
285020	10' Kingston Section, Square Balusters	116-1/2"	•	•	•	1	36.4
<b>STAIR Sections with Stair Brackets (crush block not required)</b>							
286306	6' Kingston Section, Square Balusters	68-1/2"	•	•	•	1	22.1
286308	8' Kingston Section, Square Balusters	92-1/2"	•	•	•	1	30.2
<b>Blank Posts</b>							
649544	4" x 4" x 44" Square Post		•	•	•	1	4.7
649548	4" x 4" x 48" Square Post		•	•	•	1	4.1
649552	4" x 4" x 51-1/2" Square Post		•	•	•	1	4.0
<b>Mounting Hardware</b>							
<b>Bracket Hardware Options</b>							
704132	Kingston Rail Mount Hardware Pack, flat*		•	•	•	1	2.0
704246	Kingston Rail Mount Hardware Pack, stair/steep stair**		•	•	•	1	3.0
704147	Kingston Rail Mount Hardware Pack, column***		•	•	•	1	1.4
704145	Kingston Rail Mount Hardware Pack, 45° *		•	•	•	1	2.8
704143	Kingston Rail Mount Hardware Pack, 22-1/2° *		•	•	•	1	2.8
*Pack Includes: (4) aluminum brackets, (4) vinyl covers, (1) crush block & screws			**Pack Includes: (4) aluminum brackets, (4) vinyl covers & screws				
			***Pack Includes: (2) aluminum brackets, (2) vinyl covers, (1) crush block & screws				
<b>Post Support Options</b>							
714611	EZ Set II Bracketed Post Support Kit (concrete), flat (43-1/2" actual height) Kit includes: welded pipe & plate, (4) internal blocks, hardware and concrete anchors					1	8.0
714616	The Mount 42" height (includes 4" molded pvc guides)					1	14.0
714617	The Mount Mounting Hardware for Wood & Composite Applications, Kit includes: (4) 5/16-18x1" bolts; (4) 5/16-18x6" bolts; (8) flat, SAE washers; (4) #10x3/4" self drilling screws; (1) post mount leveling plate; (1) post mount mounting plate; (4) 5/16-18 hex nuts; (1) bag of (16) #10x1.000 self drilling screws; (1) instruction sheet					1	3.6
714618	The Mount Mounting Hardware for Concrete Applications, Kit includes: (4) 5/16-18x1" bolts; (8) flat, SAE washers; (4) #10x3/4" self drilling screws; (1) post mount leveling plate; (1) bag of (16) #10x1.000 self drilling screws; (4) concrete anchors; (1) instruction sheet					1	1.5
For complete installation of The Mount, order both The Mount and either Hardware kit, depending upon application.							
<b>Gates (builds up to 60" wide gate)</b>							
631013	3-1/2' Kingston Gate Kit, Square Balusters		•	•	•	1	37.5
Kit includes: (2) aluminum reinforced uprights, (2) upright caps, (2) 2x3-1/2 aluminum reinforced rails, (10) balusters, (16) stainless steel screws, (2) self-closing gate hinges, (1) gate latch.							
<b>Replacement Packs</b>							
284195	Kingston 8' Rail Pack, Flat		•	•	•	2	17.0
284196	Kingston 8' Rail Pack, Stair		•	•	•	2	17.0
389218F	Square Baluster Replacement Pack, 39-1/4" *39-1/4" Baluster may require field cutting		•	•	•	18	13.4
<b>Steep Stair</b>							
284296	Kingston 8' Rail Pack, Steep Stair		•	•	•	2	17.0
389218F	Square Baluster Replacement Pack, 39-1/4" *39-1/4" Baluster may require field cutting		•	•	•	18	13.4
704246	Kingston Rail Mount Hardware Pack, stair/steep stair** **Pack Includes: (4) aluminum brackets, (4) vinyl covers & screws		•	•	•	1	3.0

Refer to page 73 for finishing accessories.  
Refer to page 76 for porch posts and columns.

Almond Color: specify "AL" after part number.  
Clay Color: specify "C" after part number.



# Kingston Aluminum Balusters

3' & 3-1/2' High / 6' & 8' Wide Vinyl Railing

Catalog No.	Aluminum Baluster Rail Component Packs for use with Aluminum Balusters (sold separately) Top and bottom rail only (hardware packs sold separately)	Actual Length	Color			Pkgd Quant.	Wt.
			White	Almond	Clay		
<b>FLAT Packs with Flat Brackets</b>							
286395	6' Kingston Rail Pack-Use with Round Aluminum Balusters	68-1/2"	•	•	•	1	13.6
288395	8' Kingston Rail Pack-Use with Round Aluminum Balusters	92-1/2"	•	•	•	1	18.3
<b>STAIR Packs with Stair Brackets (crush block not required)</b>							
286396	6' Kingston Rail Pack-Use with Round Aluminum Balusters	68-1/2"	•	•	•	1	13.6
288396	8' Kingston Rail Pack-Use with Round Aluminum Balusters	92-1/2"	•	•	•	1	18.3
<b>Aluminum Baluster Component Packs for use with Aluminum Baluster Rail Component Packs (sold separately) includes 20-3/4" Round Aluminum Balusters (15 balusters/6' section and 20 balusters/8' section)</b>							
<b>3' Tall Sections</b>							
362033	33" Aluminum Baluster 3/4" Pack, Round (Flat sections), Black					20	1.5
362031	31" Aluminum Baluster 3/4" Pack, Round (Stair sections), Black					20	1.4
<b>3-1/2' Tall Sections</b>							
362039	39" Aluminum Baluster 3/4" Pack, Round (Flat sections), Black					20	1.7
362037	37" Aluminum Baluster 3/4" Pack, Round (Stair sections), Black					20	1.6
<b>Aluminum Baluster Gate Kits (builds up to 60" wide gate) for use with 3' &amp; 3-1/2' Aluminum Balusters (sold separately) 60" wide gate uses 11 balusters</b>							
			White	Almond	Clay	Pkgd Quant.	Wt.
631025	3' Gate Kit for Round Aluminum Balusters		•	•	•	1	27.8
631026	3-1/2' Gate Kit for Round Aluminum Balusters Kit includes: (2) aluminum reinforced uprights, (2) upright caps, (2) 2x4 aluminum reinforced rails, (16) stainless steel screws, (2) self-closing gate hinge, (1) gate latch		•	•	•	1	30.8
<b>Mounting Hardware</b>							
<b>Bracket Hardware Options</b>							
704132	Kingston Rail Mount Hardware Pack, flat*		•	•	•	1	2.0
704246	Kingston Rail Mount Hardware Pack, stair/steep stair**		•	•	•	1	3.0
704147	Kingston Rail Mount Hardware Pack, column***		•	•	•	1	1.4
704145	Kingston Rail Mount Hardware Pack, 45° *		•	•	•	1	2.8
704143	Kingston Rail Mount Hardware Pack, 22-1/2° *		•	•	•	1	2.8
			*Pack Includes: (4) aluminum brackets, (4) vinyl covers, (1) crush block & screws				
			**Pack Includes: (4) aluminum brackets, (4) vinyl covers & screws				
			***Pack Includes: (2) aluminum brackets, (2) vinyl covers, (1) crush block & screws				







Refer to page 73 for finishing accessories.

Refer to page 76 for porch posts and columns.

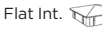
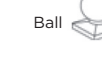
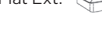
# Finishing Accessories

(for use with Vinyl Railing Systems)

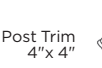
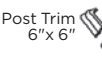
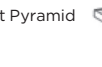
Vinyl Railing

Catalog No.	Finishing Accessories	Color			Min. Ord. Quantity	Box Wt.
		White	Almond	Clay		
<b>Caps and Trims</b>						
	70409 Gothic Cap, External - 4" x 4"	•	•		1	0.6
	70411 Flat Cap, Internal - 4" x 4"	•	•	•	1	0.1
	70492 Ball Cap, External - 4" x 4"	•	•		1	0.4
	70414 Flat Cap, External - 4" x 4"	•	•	•	1	0.3
	70426 New England Cap, External - 4" x 4"	•	•	•	1	0.5
	70450 Matte Finish Decorative Post Trim - 4" x 4"	•	•	•	1	0.2
	70484 Decorative Post Trim - 5" x 5"	•		•	1	0.3
	70401 Post Base Trim Cover, 2 piece - 4" x 4"	•	•	•	1	0.1
	70407 Porch Post Trim, 4 piece - 5" x 5"	•	•	•	1	0.5
	70480 Porch Post Trim, 4 piece - 4" x 4"	•	•		1	0.5
	73048 Post Trim, 4 piece - 6" x 6" - Works with all sizes	•	•		1	0.9
	73047 Flat Pyramid Cap 6" x 6"	•			1	0.7

Almond Color: specify "AL" after part number.  
Clay Color: specify "C" after part number.

## Finishing Accessories

(for use with Vinyl Railing Systems)

Vinyl Railing

Square Post	Catalog No.	Blank Post (for use with Vinyl Railing Systems)	White	Almond	Clay	Packaged Quantity	Pack Wt.
	<b>Square Posts</b>						
	649538	4" x 4" Post, 38" length	•	•	•	1	4.1
	649544	4" x 4" Post, 44" length	•	•	•	1	4.7
	649548	4" x 4" Post, 48" length	•	•	•	1	5.2
	649552	4" x 4" Post, 51-1/2" length	•	•	•	1	5.8
	6495107	4" x 4" Decorative Post Cover, 107" length	•	•	•	1	12.5
	5395107	5" x 5" Decorative Post Cover, 107" length	•	•		1	14.0
	73046	6" x 6" Decorative Post Cover, 120" length	•			1	13.0

Catalog No.	Hardware	Packaged Quantity	Box Wt.
27635	Drop Pin Kit	1	2.5
71413	1-5/8" EZ Set Post Bracket	1	0.7

## Decorative Finishing Accessories

(for use with Vinyl Railing Systems)

Vinyl Railing

5" x 5" Solar Cap	Catalog No.	Decorative Post Caps and Trim	Packaged Quantity	Box Wt.
	<b>Solar Cap 5" x 5" Includes Adapter for 4" x 4" Posts</b>			
	840031	Solar Cap 5" x 5" - White	1	2.0
	840032	Solar Cap 5" x 5" - Black	1	2.0

## Handrail - Aluminum

Aluminum Railing

1-14		Catalog No.	Sections	White	Packaged Quantity	Wt.
		74089	1-1/2" Diameter Aluminum End Cap (1) <i>Finishes open end of Handrail</i>	•	1	1.0
		74083	1-1/2" OD 180° End Loop (4) <i>Finishes steps or handicap ramps</i>	•	1	4.0
		74084	1-1/2" OD - 90° Corner (5) <i>For inside or outside 90° corners</i>	•	1	3.0
		74085	1-1/2" OD - 90° Post/Wall Return (6) <i>Terminates handrail into wall or post at 90°</i>	•	1	2.0
		74080	1-1/2" OD x 80" Aluminum Handrail (7)	•	1	8.0
		74104	1-1/2" OD x 104" Aluminum Handrail (8)	•	1	11.0
		74120	1-1/2" OD x 120" Aluminum Handrail (9)	•	1	14.0
		74081	Straight Wall Return (3) <i>Terminates handrail straight into a wall or post</i>	•	1	1.0
		74070	Handrail Straight Joiner (2) <i>Connects straight runs of handrail</i>	NA	1	0.1
		74069	Handrail Joint Ring (12) <i>Used to finish the connection between pieces (optional)</i>	•	1	0.1
		74028	Handrail Bracket Assembly (10)* <i>Connects handrail to wall or post</i>	•	1	2.6
		74029	Handrail EZ Post Attachment Kit (11) <i>Connects handrail bracket to post when using EverNew</i>	NA	1	1.8
		74071	Handrail Inside Corner Bracket (13) <i>Connects inside corner to post</i>	•	1	1.2
		74088	Aluminum External Joiner (14)	•	1	0.5

\*Spacing of brackets should be 6 feet on center.

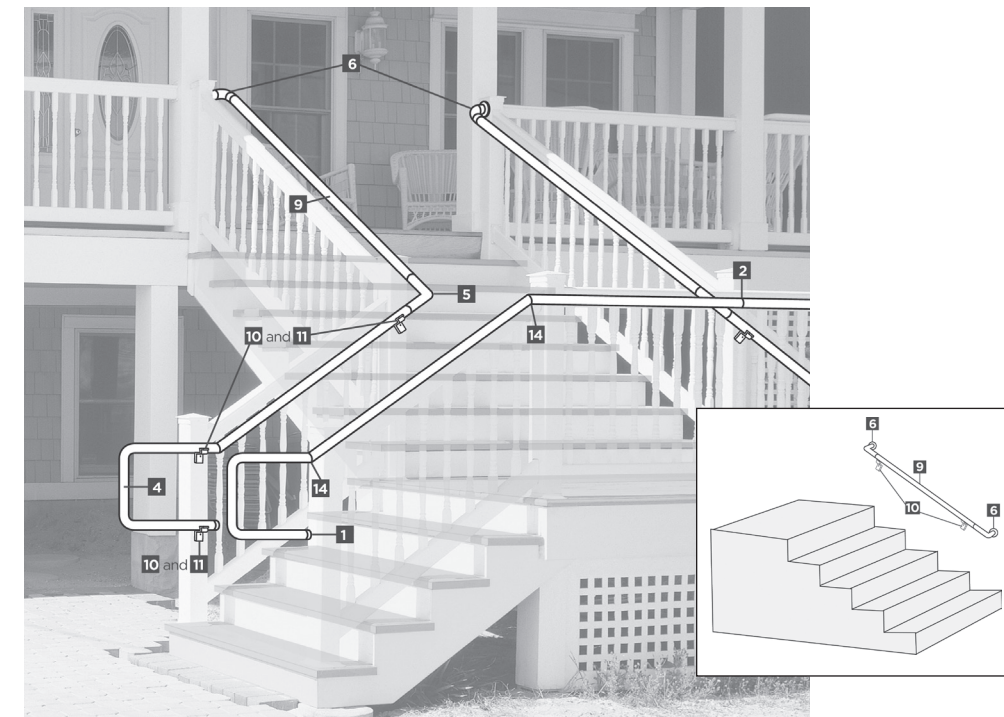

## Posts and Columns

## Posts and Columns

### Porch Posts

Catalog No.	Structural Porch Posts	White	Almond	Clay	Packaged Quantity	Wt.
73020	Colonial Porch Post - 4" x 4" x 108"	•	•		1	22.7
73019	Square Porch Post - 5" x 5" x 108"	•	•	•	1	23.8
*Includes tie-down mounting plates and 4-piece post trim for top & bottom						
Catalog No.	Decorative Porch Posts, Non-Structural	White	Almond	Clay	Packaged Quantity	Wt.
6495107	Decorative Porch Post Cover - 4" x 4" x 107"	•	•	•	1	12.5
5395107	Decorative Porch Post Cover - 5" x 5" x 107"	•	•		1	14.0
73046	Decorative Porch Post Cover - 6" x 6" x 120"	•			1	13.0

### Columns

Catalog No.	Columns and Trim Sets	Packaged Quantity	Wt.
<b>Columns (with Mounting Plates)</b>			
73030	Round Tapered Column 8" x 108"	1	37.0
73031	Round Tapered Column 10" x 108"	1	45.0
73032	Round Non-Tapered Column - 8" x 108"	1	36.0
73033	Square Column - 8" x 8" x 108"	1	37.0
<b>Trim Set (includes Cap, Base, Ring and Mounting Hardware)</b>			
73035	8" Round Tapered Cap/Base Trim Set	1	5.0
73036	8" Round Non-Tapered Cap/Base Trim Set	1	5.0
73037	10" Round Tapered Cap/Base Trim Set	1	5.0
73038	8" Square Cap/Base Trim Set	1	5.0

For complete column installation, order both column and trim set.

## Posts, Columns and Accessories

## Posts, Columns and Accessories

Catalog No.	Post Size	Type	Floor/Ceiling Space Required		Notes
			Outer Dimensions		
<b>For Non Structural Posts</b>					
Decorative Post Trim	70450	4" x 4"	1 Piece	5-1/4" x 5-1/4"	Matte Finish
Decorative Post Trim	70484	5" x 5"	1 Piece	6-1/2" x 6-1/2"	
Decorative Post Trim	73048	6" x 6"	4 Piece	8-3/8" x 8-3/8"	
Post Base Trim	70401	4" x 4"	2 Piece	5-1/2" x 5-1/2"	
<b>For Porch Posts</b>					
Porch Post Trim	70407	5" x 5"	4 Piece	7-7/8" x 7-7/8"	Packaged with Porch Post
Porch Post Trim	70480	4" x 4"	4 Piece	6-1/4" x 6-1/4"	Packaged with Porch Post
<b>For Columns</b>					
Round Tapered Column	73035*	8"	1 Piece	Bottom 10-7/8" x 10-7/8" Top 9-1/8" x 9-1/8"	Sold as a kit with cap, base/trim
Round Tapered Column	73037*	10"	1 Piece	Bottom 13" x 13" Top 11-1/4" x 11-1/4"	Sold as a kit with cap, base/trim
Round Column Non Tapered	73036*	8"	1 Piece	Bottom 10-7/8" x 10-7/8" Top 10-7/8" x 10-7/8"	Sold as a kit with cap, base/trim
Square Column	73038*	8"	1 Piece	Bottom 11-1/4" x 11-1/4" Top 11-1/4" x 11-1/4"	Sold as a kit with cap, base/trim

\*Required for complete column installation Note - Not all trims available in all colors

## EverNew® Vinyl Decking

## Vinyl Decking

Catalog No.	Deck Planks 1-1/2" x 5-1/2"	White	Colors	Min. Ord. Quantity	Wt.
119145	Deck Plank x 145" (12')	•	•	1	12.5
119193	Deck Plank x 193" (16') - minimum quantity 25 pcs.	•	•	25	17.0
119241	Deck Plank x 241" (20')* - full pallet orders only	•	•	50	21.0
*Available only as part of half or full truckload.					

Catalog No.	Fill Pieces	White	Colors	Min. Ord. Quantity	Wt.
129145	Fill Piece x 145" (12')	•	•	1	0.7
129193	Fill Piece x 193" (16') - minimum quantity 50 pcs.	•	•	50	0.7
129241	Fill Piece x 241" (20') - 100 pcs. quantity only	•	•	100	0.9
Fill pieces not included with planks - order separately. 2' of fill piece per 1' of plank.					

Catalog No.	End Covers	White	Colors	Min. Ord. Quantity	Wt.
<b>End Cover "C" Channel</b>					
139144	End Cover x 144" (12')	•	•	1	2.5
70820P	End Cover Fastener (price/pack, 25/pack)	•	•	1	0.3

Catalog No.	Fascia	White	Colors	Min. Ord. Quantity	Wt.
<b>Fascia Board 7/8" Profile</b>					
349096	7/8" x 3" x 96" (8')	•	•	1	2.0
319096	7/8" x 1-1/2" x 96" (8')	•	•	1	1.5
70822P	Fascia Cover Plug 3/4" (price/pack, 25/pack)	•	•	1	7.5
70787P	#8 x 1-1/2" Stainless Steel Screw (price/pack, 100/pack)			1	1.0

Almond Color: specify "AL" after part number.

Gray and Almond Colors: specify "G" or "AL" after part number.



CENTRALIA, IL  
866.755.7636

MOBERLY, MO  
800.892.5850

MT. PLEASANT, IA  
800.258.5809

SPRING HILL, KS  
800.490.4320

Proudly  
Supplied  
By



Visit our website at [www.midambuilding.com](http://www.midambuilding.com)