

// Most Comprehensive Selection of Garage Doors



RESIDENTIAL GARAGE DOORS

Exemplary in quality, safety and design







CONTENTS

- 6 Hörmann Flexibility
- 8 Unsurpassed Reliability, Energy Efficiency and Safety

WOOD

- 14 Polaris 9200

ALUMINUM

- 18 Aries 8200
- 22 Solaris 7200

HIGH DENSITY POLYETHYLENE (HPDE)

- 26 Sirius 6200

STEEL CARRIAGE HOUSE

- 30 Tucana 5250
- 34 Phoenix 5200

STEEL

- 38 Taurus 4250
- 42 Orion 3100 & 3200
- 46 Gemini & Orion with TimberLast™ Finish
- 50 Gemini 2100 & 2200
- 54 Pegasus 1100

- 58 Residential Door Options
- 60 Hörmann Residential Product Overview
- 64 Galaxy Paint System
- 66 Extreme Package Upgrade
- 68 SilentDrive® Garage Door Openers
- 70 Hörmann Commercial Doors

Everything you have always wanted in a garage door

Your garage door is the single largest moving part in your home and it is used more often than any other doors or entries. At Hörmann, we understand how important it is to keep your most valued investment from the damages caused by nature and other unwanted elements. We are constantly pushing our knowledge and experience to provide a safe, secure, energy efficient and convenient access to your home. No matter which design suits your needs, you will never compromise on quality and safety with a Hörmann door.





We aim to satisfy your individual needs

At Hörmann we understand that not every home comes from the same cookie cutter. It is our goal to satisfy your individual needs. If you are unable to find what you're looking for from our product offering, please do not hesitate to contact your authorized Hörmann dealer / installer. You may be surprised how flexible we can be.





“A good name must be earned.”

This was the philosophy August Hörmann, founder of the company, believed in when he started manufacturing steel doors in his metalworking shop back in the 1930s. Since then, Hörmann has become one of the world's leading door manufacturers and a global leader in today's building components industry. The family's name has become synonymous to brand quality products covering a wide range of doors in residential and commercial applications. Constant innovation, quality assurance and close proximity to customers are the keys to the company's permanent growth and lasting success. Operated by the third and fourth generation, the grandson and great grandsons of the company's founder, Hörmann currently serves customers in more than 30 countries with a multitude of quality products.



1 German Engineered, American Made Quality

The Hörmann range of residential doors and openers are specially designed and developed to meet the requirements of the North American market without compromising the Hörmann standard for quality and design offering superior protection and safety.



2 Uncompromising Safety

At Hörmann your safety always comes first. With our Exclusive FingerGuard™ pinch resistant section joints and components, the danger of trapped fingers is greatly reduced. The joint and hinges provide an excellent seal and prevent finger injuries inside and outside.



3 Highest Standards in Component Quality

Every individual door component is meticulously engineered and tested rigorously. Once they are up to Hörmann's high standards, these components are manufactured with the highest craftsmanship using only top quality materials.



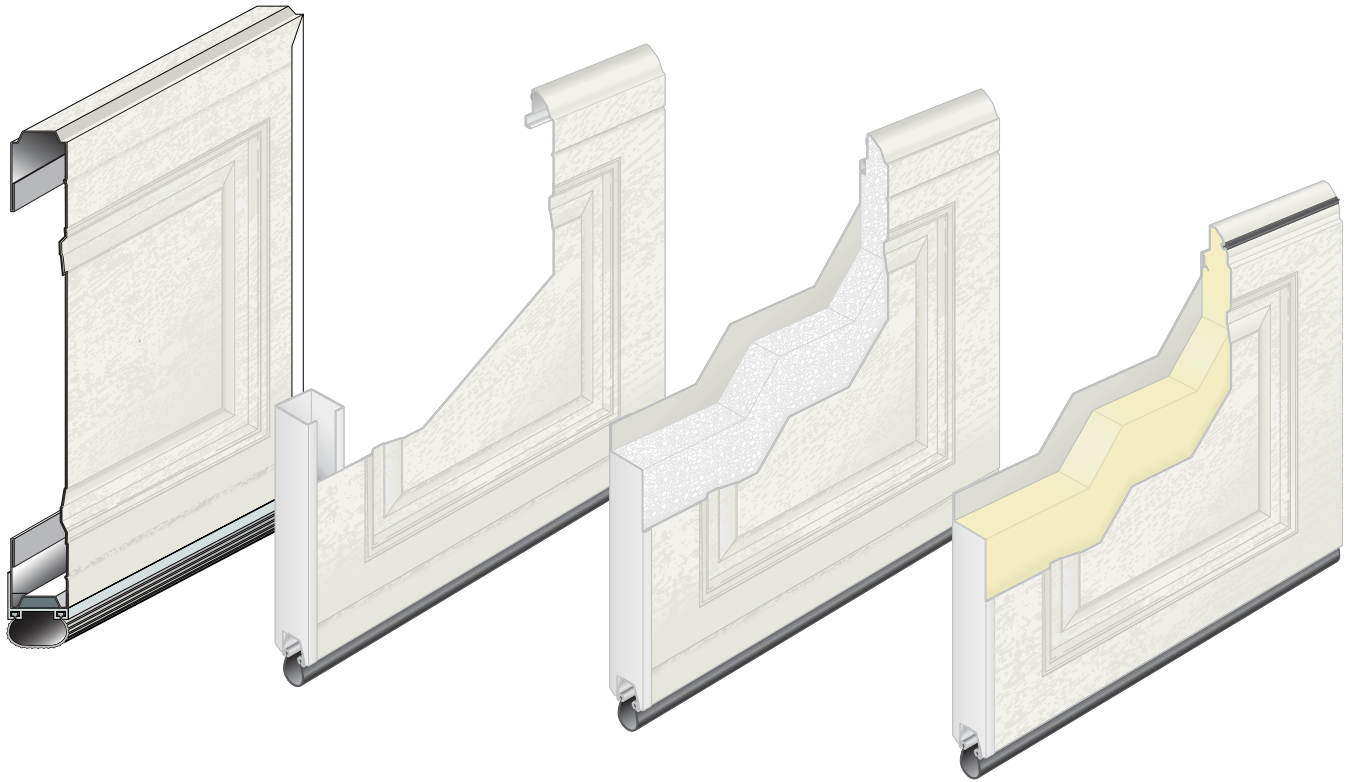

4 Uniform Panel Designs

All Hörmann steel garage door series (Pegasus, Gemini, Orion and Taurus) share same panel design impressions. Unlike our competition, in which the shapes, sizes and distances between the panels are different from one model to the next, the Hörmann steel garage doors have exact same look throughout the collections.



5 Maximum Protection Against Elements

Most Hörmann Garage doors come standard with a plethora of factory installed seals to maximize the protection against the outside elements while further enhancing the insulation properties of your garage door.



6 Superior Energy Efficiency

Hörmann offers a wide choice of insulation to make your door well insulated in harsh climates. Whether polystyrene core or injected polyurethane foam insulation, your home is well protected from outside elements.

7 Perfect Complement

The Hörmann SilentDrive® Openers are a perfect match for your garage doors. With an efficient DC motor construction and a very quiet operation, it is an ideal companion for your Hörmann garage door.

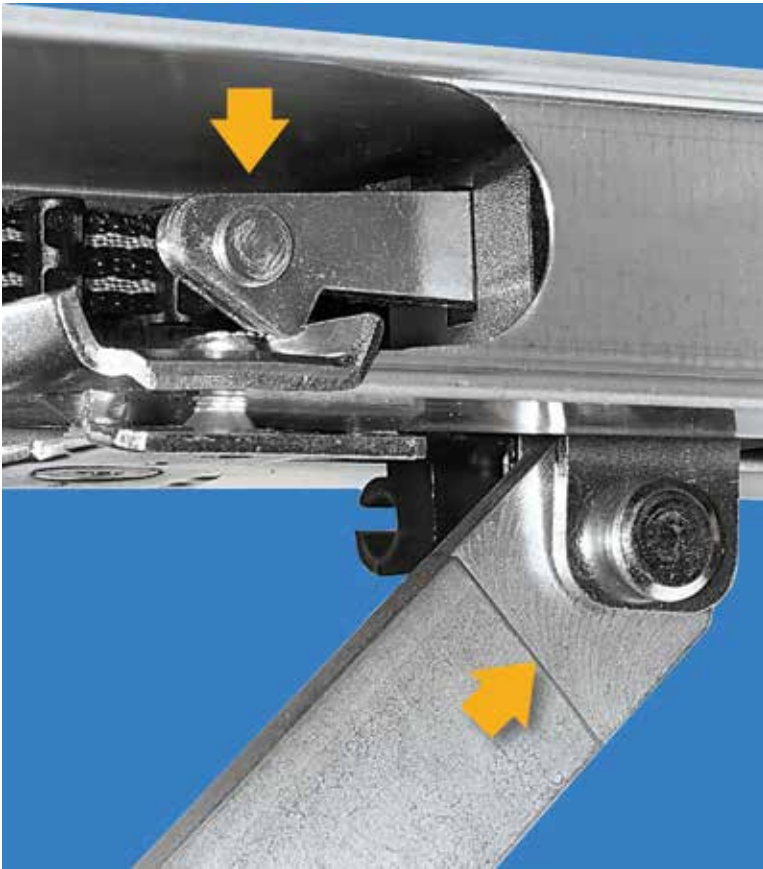

LIMITED LIFETIME
WARRANTY*

8

Extra Layer of Security

In all Hörmann SilentDrive® openers, the anti-lift kit automatically engages in the operator rail's stop when the door is closed and locks immediately after. It is secured against forced opening to secure the door even when the power fails.

9

Industry Leading Warranty

Most Hörmann residential door sections are protected with a Limited Lifetime warranty. We also include unmatched hardware and spring warranties across our entire product line.

*Excludes Solaris 8200 & Polaris 9200 Series

Natural beauty of real wood without compromising quality

The Hörmann Polaris Collection series of doors are constructed from a fine selection of real wood handcrafted with careful attention to detail to provide a durable, prestigious and long lasting quality door. Natural wood offers a distinctive and unique grain texture that will give your home a special appeal. Choose from a wide selection of standard designs or create your own look from a simple yet elegant E-Series or the more sophisticated C-series.





E-Series



C-Series

FEATURE VALUES

- Frame thickness: 1 1/8" & face material thickness: 1/4" plywood face and 3/4" overlay thickness
- 5 1/2" end stiles & 10" center stiles
- Many custom arch designs are available
- R-Value of 6.3
- Thick tongue and groove face applied (C-series only)
- Threaded inserts (concealed fasteners)
- Commercial grade torsion hardware
- Struts on all doors (minimum one 2 1/4" strut per door)
- Standard finish: prime painted ready for field finishing
- Stain grade door face material available



*Ask your dealer for details

WOOD / POLARIS 9200

Prestigious natural look and handcrafted quality

PANEL DESIGNS (Top Sections Shown with 01S Windows)



Fairmont



Richfield

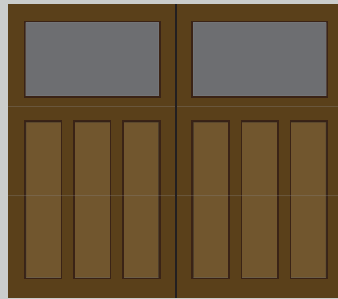

Worthington



Baxter

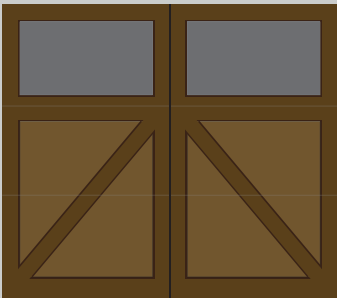

Rochester

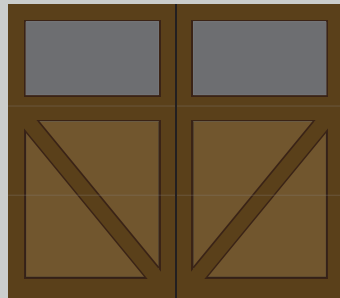

Woodbury

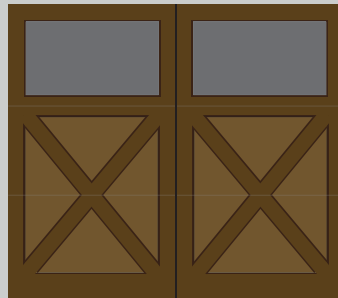

Hastings

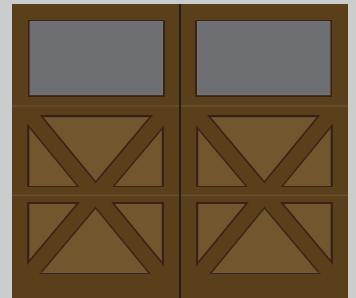

Marshall

WINDOW DESIGNS (Top Sections Shown)

Rectangular Designs



01S



02S



03S



04S



06S (Standard)



08S



09S

Arch Designs



01A



02A



03A



04A



06A



08A



E-Series

C-Series

WOOD OPTIONS (Unfinished)

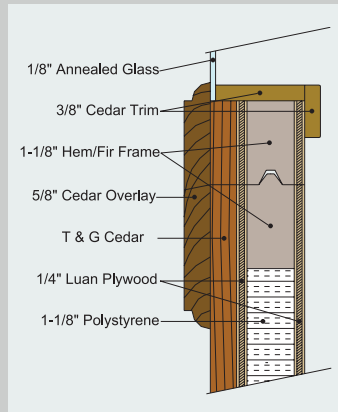
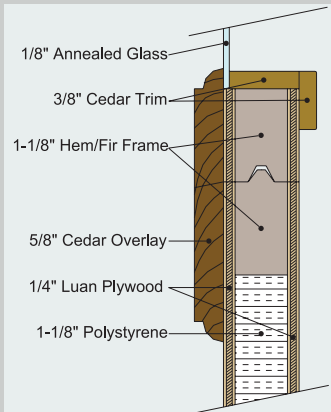

Cedar

Redwood

Knotty Alder



Vertical Grain Fir

Mahogany

HARDWARE OPTIONS

(Decorative & Powder Coated)



Malleable Iron



Stamped Steel



ALUMINUM / ARIES 8200

Classical natural look and unbeatable durability

Beautiful natural look with the durability of aluminum

The Hörmann Aries Collection offers the durability and weather resistant properties of aluminum with the sophisticated appearance of natural wood. The virtually maintenance free Aries Collection features commercial grade extruded aluminum stiles and rails mechanically fastened at joints to create a high strength door frame.

Surprise your neighbors with truly lifelike wood grain powder coated finishes without compromising the modern conveniences and the durability of an aluminum door.





FEATURE VALUES

- 2" thick extruded 6063-T5 aluminum with optional expanded polystyrene form-fitted insulation
- Precisely engineered Tongue and Groove section joints
- Extruded aluminum design and mullion overlays are permanently adhered and configured to allow many design styles
- Many custom arch designs are available
- U-shaped vinyl bottom weather seal factory installed for weather protection
- Clear 1/8" single pane glass standard (Other glass options available)
- Optional 1/2" insulated glass available



*Ask your dealer for details

ALUMINUM / ARIES 8200

Classical natural look and unbeatable durability

PANEL DESIGNS (Top Sections Shown with 01S Windows)



Aspen

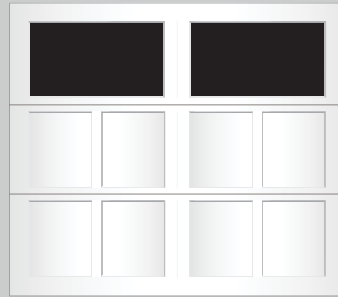

Spokane

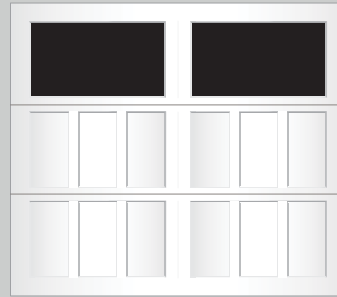

Helena

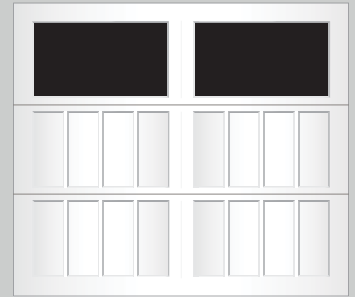

Jackson



Missoula

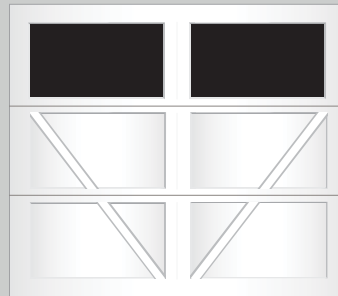

Logan

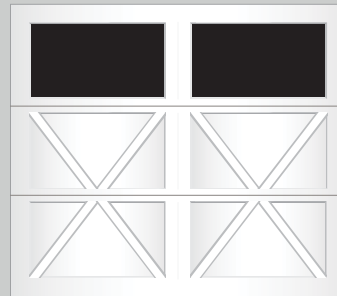

Keystone

WINDOW DESIGNS (Top Sections Shown)

Rectangular Designs



01S (Standard)



02S



03S



04S



06S



08S



09S

Arch Designs



01A



02A



03A



04A



06A



08A



Tongue & Groove Section Joint



The Hörmann Aries 8200 is constructed with precisely engineered Tongue and Groove section joints that utilize an enclosed box type construction with a flexible gasket that reduces air infiltration creating a weather-tight seal.

Energy Efficiency



The bottom weather seal keeps out wind, rain, debris and other elements. Optional 3-layer sandwich construction with insulating polystyrene core increases energy savings (R-value 5.6)

COLOR OPTIONS

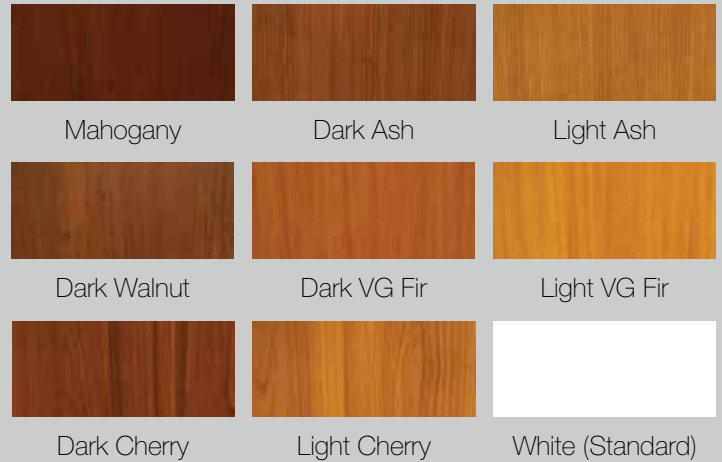

HARDWARE OPTIONS

(Decorative & Powder Coated)



Malleable Iron



Stamped Steel



An exceptional choice for contemporary homes

The Hörmann Solaris Collection provides a modern look and maximizes the natural light in any garage. The 1¾" thick high quality glazing frames in anodized aluminum and wide range of design options have proven a winning combination designed for strength and durability.





FEATURE VALUES

- Pinch-resistant section joints interior and exterior
- Various panel & glazing options
- Between section weather seal
- Fully enclosed aluminum rails
- Standard bottom weather seal



*Ask your dealer for details

PANEL & GLAZING OPTIONS



Clear Anodized
Aluminum



Insulated
Aluminum Laminate



Polyurethane Insulated
Steel Section



Smooth Anodized



Painted (Galaxy Paint System)



Clear (Standard)



Frosted



Brown Tinted



Smoked



Feather Etched



Tundra



FingerGuard™ Pinch Resistant



Solaris 7200 comes standard with the FingerGuard™ section joint and hinges provide air-tight seal and prevent finger injuries inside and outside.

Between Section & Glazing Seals



Factory installed between section weather seal and glazing seal offer maximum protection from the outside elements while further enhancing the insulation properties of a door.

COLOR OPTIONS



Clear Anodized (Standard)

*Just a few of unlimited color options available using Hörmann Galaxy Paint System



White*

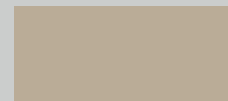

Sandstone*

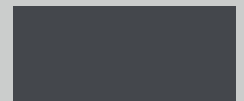

Slate Grey*



Mahogany Brown*

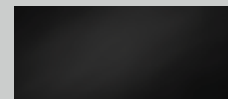

Black*

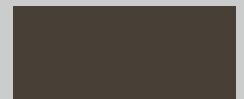

Dark Bronze*

POWDER COATED HARDWARE OPTIONS

- Available Colors: White, Bronze and Black
- Section and Mounting Hardware
- Jamb Brackets, Flags, End and Center Bearing Supports



TOP WEATHER SEAL OPTION



Alternate choice with extraordinary durability

The Hörmann Sirius 6200 offers the visual appeal of high quality wood raised panels and the unique durability of high-density polyethylene (HDPE) that is virtually maintenance-free and never needs painting. Impervious to any outside elements, the Sirius 6200 will not rust, delaminate, dent or warp to withstand the rigors of everyday activities. The energy efficient CFC-free polystyrene insulation with laminated backer provides an effective weather barrier.





FEATURE VALUES

- Constructed of high density polyethylene (HDPE) panels held in place by rigid aluminum framing. Virtually maintenance free, never needs painting, will not rust or rot, resists minor scratches and impacts
- Energy efficient R-Value of 5.0
- Expanded polystyrene insulation with laminated backer allows smooth operation, increases energy savings and provides a clean finish to the inside of your garage door
- Vinyl weather seal between sections and panels offer extra protection against the elements, dust and insects
- Ship lap section joints & seals are engineered for an extra tight seal for security and protection against the elements
- U-shaped vinyl bottom weather seal in aluminum retainer factory installed for a tight floor seal and protection against the weather and other elements



*Ask your dealer for details

PANEL DESIGNS



Traditional



Country

WINDOW DESIGNS



Standard



Cross



Cathedral



Cascade



Sunrise (4 panel)



Sherwood

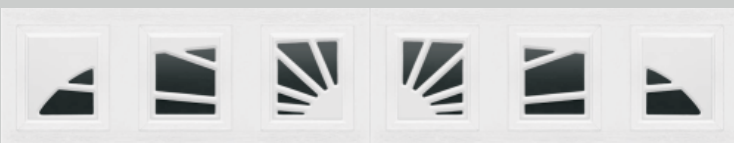

Sunrise (6 panel)

Non-insulated glass.



Lasting Durability



Woodgrain-textured, high density polyethylene panels provide strength and corrosion resistance in any environment.

Extra Protection



Vinyl weather seal between the sections and the U-shaped bottom weather seal help keep the weather and other unwanted elements out to protect your home.

COLOR OPTIONS

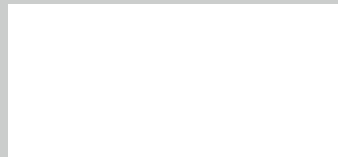

White

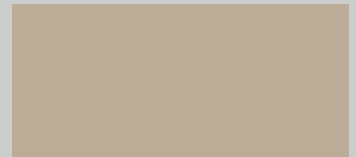

Sandstone

Standard arrangements

(7' and 8' high doors)



8' wide



16' wide



9' wide



18' wide

DECORATIVE HARDWARE OPTIONS



Spade - Stamped Steel



Spear - Wrought Iron



Elegant Handle

Special arrangements at no additional charge

(7' and 8' high doors)



9' wide



18' wide

The perfect choice for beauty and safety

The Hörmann Tucana Collection offers the beauty of recessed panel design and unsurpassed safety of our FingerGuard™ pinch-resistant joints. The virtually maintenance-free Tucana Collection of doors feature a tough steel front and back with polystyrene core, giving an R value of 6.9. A wide range of standard designs is available to complement your home.





FEATURE VALUES

- 2" thick galvanized, finish painted and laminated 25 ga. steel sections that will not rot or warp like wood
- Special recessed panel designs enhance your home with a retro look
- 3-layer sandwich construction with polystyrene core bonded to steel front and back provides a rugged construction and quiet operation and a clean finish to the inside of your garage
- Available in 21" and 24" section heights
- Safe pinch-resistant section joints interior and exterior reduce the risk of accidents and injuries during opening and closing
- R-Value of 6.9 provides energy efficiency to save you money
- Factory installed between section and side seals add extra layer of protection against unwanted elements
- Bottom weather seal with aluminum retainer for years of rust-free operation



*Ask your dealer for details

STEEL CARRIAGE HOUSE / TUCANA 5250
Retro re-creation of beauty and exceptional durability

PANEL DESIGNS

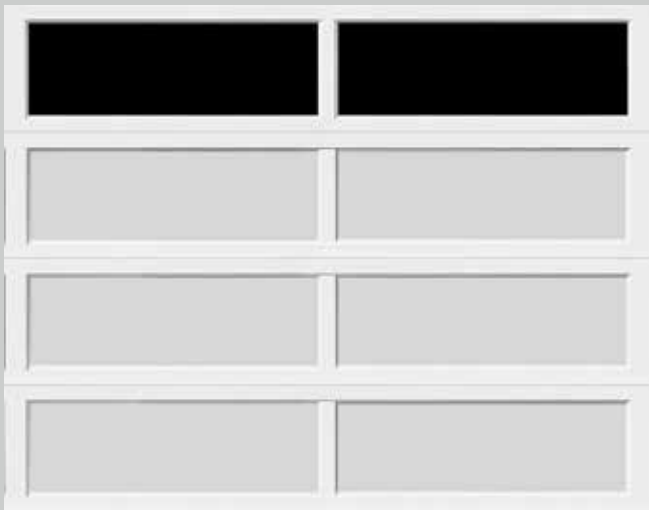

Longwood with Standard windows



Sorrento with 4 pane windows



Sanford with 2 pane windows

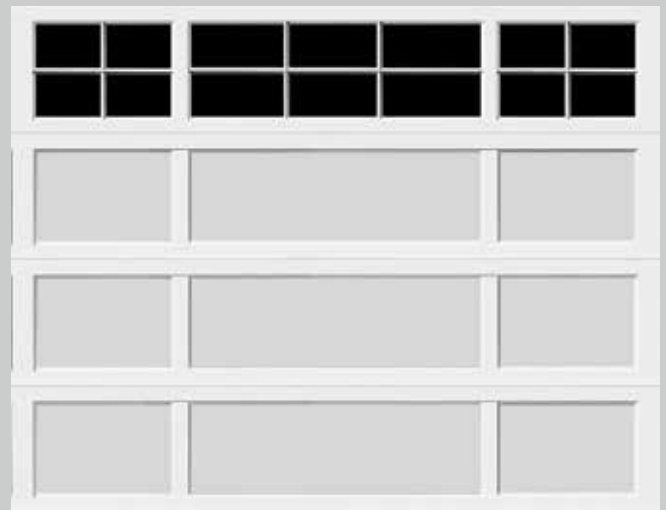

Davenport with 4 & 6 pane windows

WINDOW DESIGNS



Glazed standard short



Glazed 2 pane



Glazed 4 pane



Glazed standard long



Glazed 3 pane



Glazed 6 pane



Durability and Safety

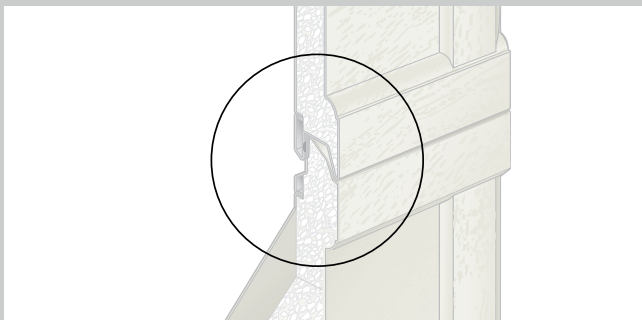

The pinch resistant profiles of top and bottom rails are molded to the section in a one piece construction.

Hörmann Tucana 5250 collection's unique design feature adds value to your home with safety, beauty and solid structural integrity.

POWDER COATED HARDWARE OPTIONS

- Commercial Grade Hardware
- Double Wide Track (Long Horizontals)
- Jamb Brackets, Flaps, End and Center Bearing Supports
- Struts if Required



COLOR OPTIONS

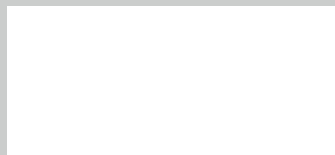

White

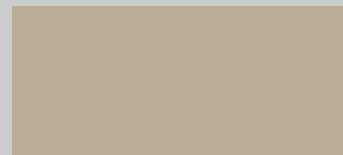

Sandstone

Hörmann's exclusive Galaxy Paint System is available to further customize your new Tucana door with 28 semi-custom colors or unlimited color matching capabilities.

MADE TO ORDER DESIGNS



Whether you are matching an existing recessed panel door or have a custom panel arrangement in mind, Hörmann can deliver the perfect look that you are looking for. Simply provide your Hörmann Authorized Dealer with the panel dimensions for your custom door and we will provide an engineering drawing for your approval.

STEEL CARRIAGE HOUSE / PHOENIX 5200

Classic look and long lasting durability

The outstanding choice for individual beauty and safety

The Hörmann Phoenix 5200 offers a unique combination of classical beauty and durability of a steel door. Ageless custom designs matched with modern features that include our exclusive FingerGuard™ pinch resistant joints, polystyrene core and 25 ga. (.019" min) steel skin give you the unsurpassed safety, durability and energy efficiency.





FEATURE VALUES

- 2" thick galvanized, finish painted and laminated 25 ga. steel sections that will not rot or warp like wood
- Special carriage house designs enhance your home with a classic appearance
- 3-layer sandwich construction with polystyrene core bonded to steel front and back provides a rugged construction and quiet operation and a clean finish to the inside of your garage
- Safe pinch-resistant section joints interior and exterior reduce the risk of accidents and injuries during opening and closing
- R-Value of 6.9 provides energy efficiency to save you money
- Factory installed between section and side seals add extra layer of protection against unwanted elements
- Bottom weather seal with aluminum retainer for years of rust-free operation



*Ask your dealer for details

STEEL CARRIAGE HOUSE / PHOENIX 5200

Classic look and long lasting durability

PANEL DESIGNS (Top Sections Shown with Glazed 1 pane Windows)



Gilbert (Single)



Gilbert (Double)



Mesa I



Mesa II



Chandler I



Chandler II



Tempe I

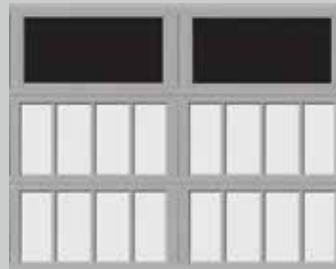

Tempe II



Scottsdale

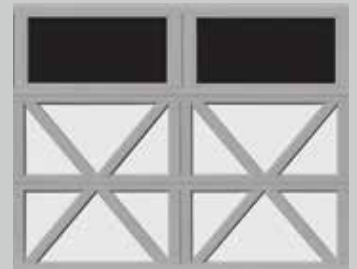

Glendale

WINDOW DESIGNS



Glazed 1 pane



Glazed 3 pane



Glazed 6 pane



Glazed arch 1 pane



Glazed arch 3 pane



Glazed arch 6 pane



Durability and Safety

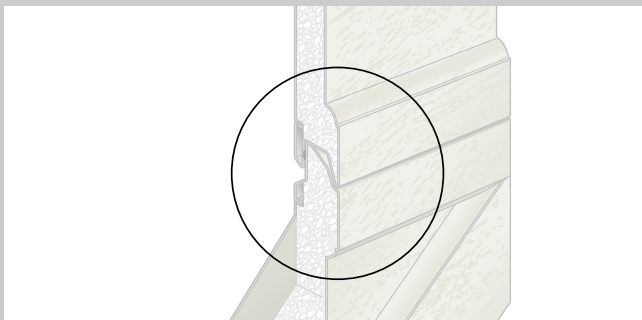

The pinch resistant profiles of top and bottom rails are molded to the section in a one piece construction.

Hörmann Phoenix 5200 collection's unique design feature adds value to your home with safety, beauty and solid structural integrity.

COLOR OPTIONS



Hörmann Phoenix collection comes in classic white. You can custom paint your new Phoenix door using Hörmann's exclusive Galaxy Paint System with 28 semi-custom colors or unlimited color matching capabilities.

POWDER COATED HARDWARE OPTIONS

- Commercial Grade Hardware
- Double Wide Track (Long Horizontals)
- Jamb Brackets, Flags, End and Center Bearing Supports
- Struts if Required



DECORATIVE HARDWARE OPTIONS



Spade - Stamped Steel



Spear - Wrought Iron

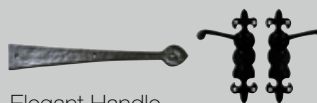

Elegant Handle

STEEL / TAURUS 4250

Exceptional quality and uncompromising safety

The ultimate choice in efficiency, safety and quality

Hörmann Taurus 4250 offers you the very best of safety, convenience and quality with unmatched innovations in modern technology. FingerGuard™ pinch resistant joints with environment-friendly polyurethane foam insulation, in between section seal and heavy-duty steel hardware offer you the most energy-efficient (R-value 16.1) and safe door that will last.



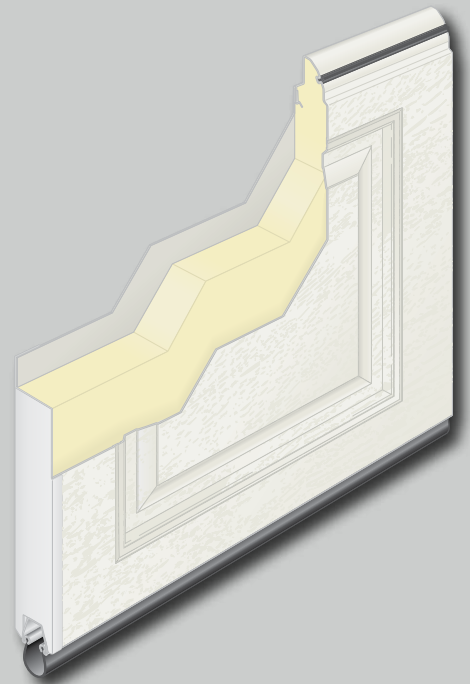

FEATURE VALUES

- 1 $\frac{3}{4}$ " thick galvanized, finish painted and laminated 25 ga. steel sections are beautiful and durable for everyday use
- Heavy duty 3-layer sandwich construction injected with 100% CFC & HCFC polyurethane foam that fills all cavities and bonds to the front and back steel panels for superior insulation properties, strength and construction
- Safe pinch-resistant section joints interior and exterior reduce the risk of accidents and injuries during opening and closing
- Energy efficient 16.1 R-Value for maximum energy cost savings
- Between section weather seal keeps out rain, dust and insects
- Commercial grade hinges and roller carriers provide extra durability and higher structural integrity to the door



*Ask your dealer for details

STEEL / TAURUS 4250

Exceptional quality and uncompromising safety

PANEL DESIGNS

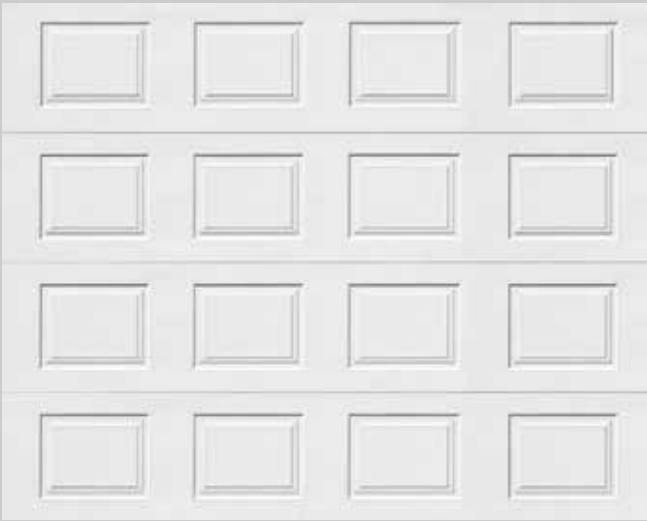

Traditional (Woodgrain)



Ranch (Woodgrain)



Flush (Smooth)



Ribbed (Stucco)

STAINLESS STEEL & ALUMINUM FULL VIEW WINDOW OPTIONS

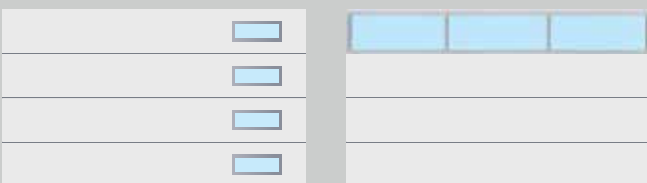

STAINLESS STEEL ACCENT DESIGN OPTIONS

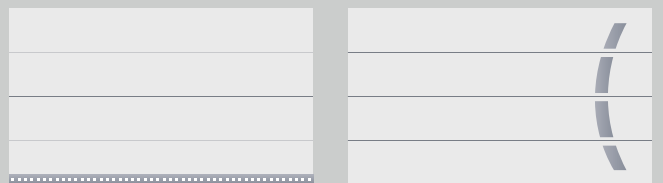
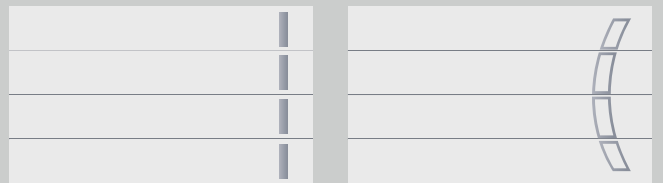



Energy Efficient and Durable



Heavy duty steel hardware in Taurus 4250 series are firmly fastened through 4 layers of steel for reliable operation and long lasting service life.

The environment-friendly 100% CFC & HCFC free injected polyurethane core provides the best possible insulation.

COLOR OPTIONS

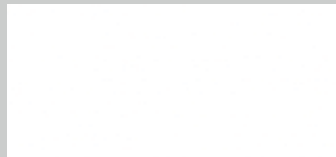

White

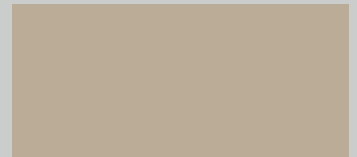

Sandstone*

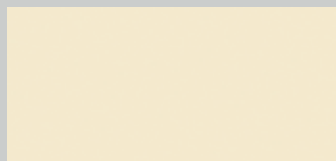

Almond**

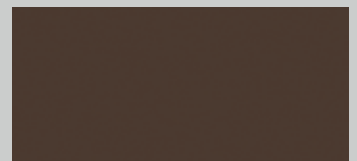

Brown**

* Color achieved in Ribbed and Flush Designs by utilizing Hörmann Galaxy Paint System.

** Color achieved in all designs by utilizing Hörmann Galaxy Paint System.

Dark colors with light reflective value of 10 or lower, require additional strutting.

POWDER COATED HARDWARE OPTIONS

- Commercial Grade Hardware
- Double Wide Track (Long Horizontals)
- Jamb Brackets, Flags, End and Center Bearing Supports
- Struts if Required



MANUAL LOCK OPTIONS



All around best value in insulated door in its class

Looking for a versatile door that offers safety, durability and efficiency? Look no further. The Hörmann Orion collection features the proven FingerGuard™ pinch resistant section joints and polystyrene core insulation sandwiched and bonded between steel skins to offer you the best value in safety, energy efficiency and unbeatable durability.





FEATURE VALUES

- 1³/₈" thick (Orion 3100) and 2" thick (Orion 3200) galvanized & primed 25 ga. steel with top coat finish for years of protection against the elements
- 3-layer sandwich construction with polystyrene core bonded to steel front and back increases energy savings and provides a very smooth and quiet operation
- Safe pinch-resistant section joints interior and exterior reduce the risk of accidents and injuries during opening and closing
- R-Value of 6.3 (Orion 3100) and 8.9 (Orion 3200) reduces energy costs
- White painted end stiles for a clean finish interior
- Factory installed between section and side seals add extra layer of protection against unwanted elements
- Bottom weather seal with aluminum retainer for years of rust-free operation



*Ask your dealer for details

PANEL DESIGNS



Traditional (Woodgrain)



Ranch (Woodgrain)



Country (Woodgrain)

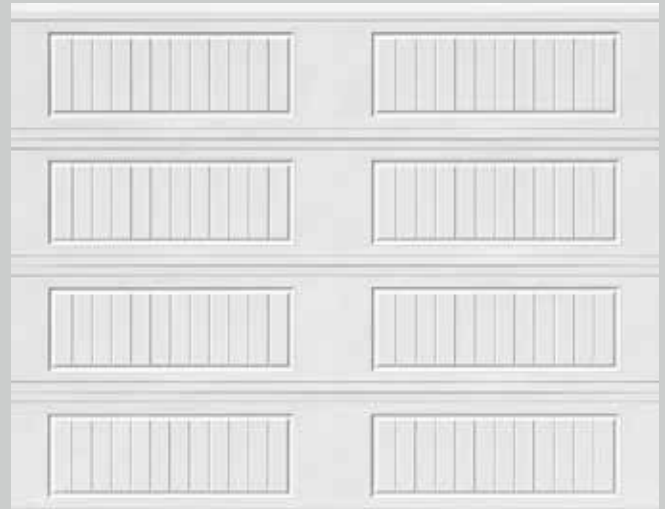

Cottage (Woodgrain)

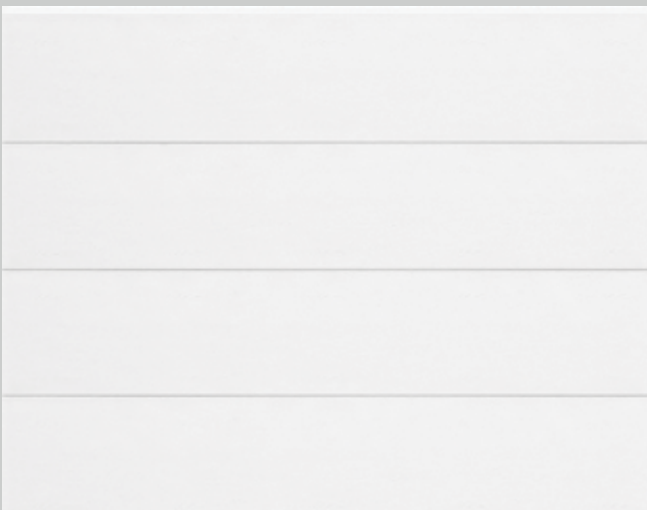

Flush (Stucco)



Microgroove¹ (Stucco) ¹Not available for 3100 Series



Maximum Protection and Energy Savings



Custom-fit polystyrene foam insulation increases energy saving and adds strength and rigidity to the door.

Factory installed between section weather seals and side seals offer maximum protection against the outside elements while further enhancing the insulation properties of a door.

COLOR OPTIONS

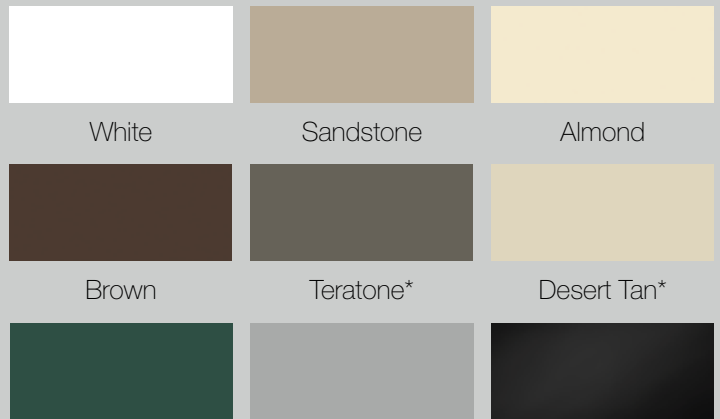

*Not available for 3100 Series

HARDWARE OPTIONS (Decorative & Powder Coated)



Spade - Stamped Steel



Spear - Wrought Iron



Elegant Handle



STEEL / GEMINI & ORION with TimberLast™ Finish
Natural beauty and long lasting durability

Elegant look of real wood with the durability of steel

The Hörmann TimberLast™ finish offers the durability of steel with the elegant look of natural wood. Giving you the choice in selecting a non-insulated or insulated door, the virtually maintenance free TimberLast™ finish is available for both Gemini and Orion Collection. The range of options gives you choices to beautify your home while increasing your energy savings.

Series	Gemini 2110	Orion 3210
Steel Thickness	25 ga.	25 ga.
Section Thickness	2 in.	2 in.
R - Value	Up to 7.4 with Opt. Insulation	8.9
Polystyrene Core Insulation	Optional	Standard





FEATURE VALUES

- Safe pinch-resistant section joints interior and exterior reduce the risk of accidents and injuries during opening and closing
- R-Value of 8.9 (Orion 3210) reduces energy costs
- Bi-directional grain wood patterns for realistic and natural appearance
- Bonded galvanized fully boxed center stiles and end stiles will not warp, twist or deform like other similar competitor components (Gemini 2110)
- White painted end stiles for a clean finish interior (Orion 3210)
- Factory installed between section and side seals add extra layer of protection against unwanted elements
- Bottom weather seal with aluminum retainer for years of rust-free operation



*Ask your dealer for details

STEEL / GEMINI & ORION with TimberLast™ Finish
Natural beauty and long lasting durability

PANEL DESIGNS

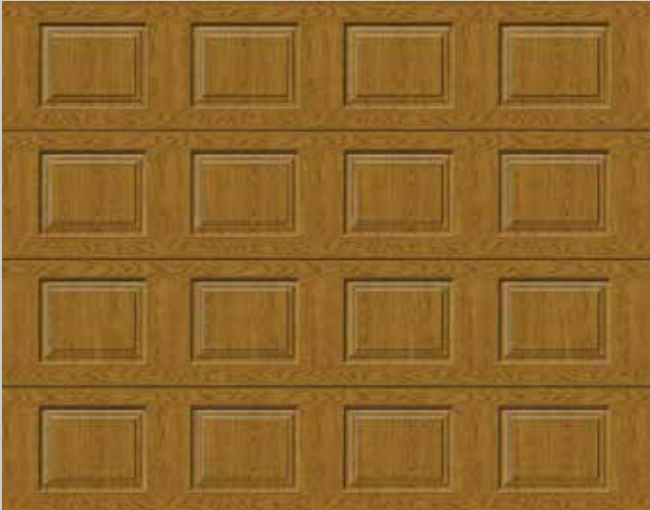

Traditional (Golden Oak)



Ranch (Medium Oak)



Country (Walnut)



Cottage (Rosewood)



Maximum Protection and Energy Savings



Custom formed polystyrene insulation core (Orion 3210) and between section weather and side seals increases energy savings and adds strength and rigidity to the door.

COLOR OPTIONS



Golden Oak



Medium Oak



Walnut



Rosewood

POWDER COATED HARDWARE OPTIONS

- Commercial Grade Hardware
- Double Wide Track (Long Horizontals)
- Jamb Brackets, Flags, End and Center Bearing Supports
- Struts if Required



DECORATIVE HARDWARE OPTIONS



Spade - Stamped Steel



Spear - Wrought Iron

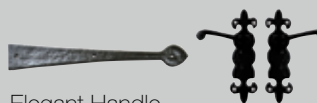

Elegant Handle

A unique combination of safety, economy and selection

The Hörmann Gemini collection offers all the choices, safety and durability without breaking your budget. Economical, yet the Gemini collection features FingerGuard™ pinch resistant section joints, nine available colors and a choice of two steel thicknesses: 24 ga. (.022" min) and 25 ga. (.019" min). The optional polystyrene insulation with vinyl backcover offer a sensible solution in energy savings.





FEATURE VALUES

- 2" thick galvanized and finish painted 25 ga.(Gemini 2100) or 24 ga.(Gemini 2200) steel for superior strength and durability
- Safe pinch-resistant section joints interior and exterior reduce the risk of accidents and injuries during opening and closing
- Optional CFC Free polystyrene insulation with vinyl backcover (R-Value of 7.4) provides clean finished door with added energy saving benefits
- Factory installed between section and side seals add extra layer of protection against unwanted elements
- Bonded galvanized fully boxed center stiles and end stiles will not warp, twist or deform like other similar competitor components
- Bottom weather seal with aluminum retainer for years of rust-free operation



*Ask your dealer for details

PANEL DESIGNS



Traditional (Woodgrain)



Ranch¹ (Woodgrain)



Country¹ (Woodgrain)

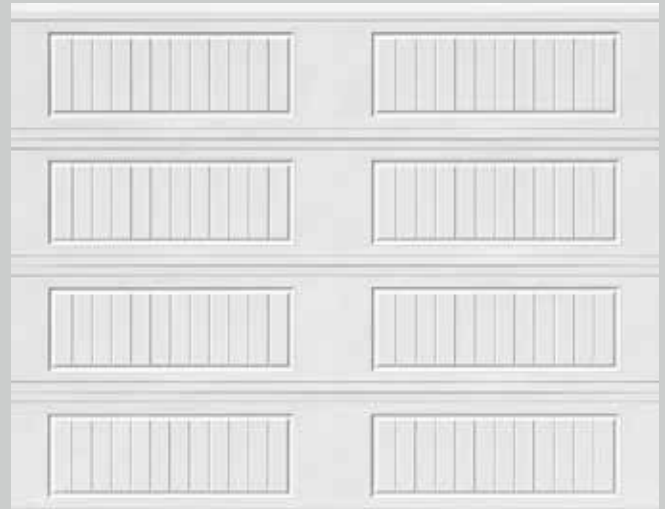

Cottage¹ (Woodgrain)

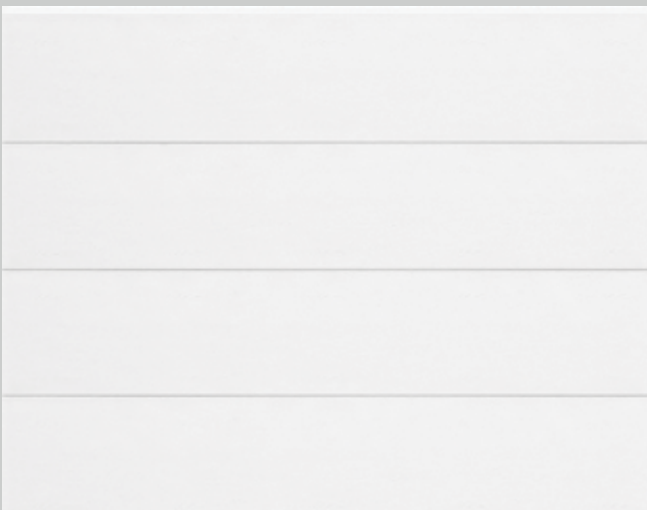

Flush² (Stucco)



Ribbed² (Stucco)

¹Not available for 2200 Series
²Not available for 2100 Series



Maximum Strength and Increased Energy Savings



The Gemini 2100 & 2200 features unique construction with full box stile (vertical supports) for both maximum strength and quiet operation.

Factory installed between section weather seals and side seals offer maximum protection against the outside elements while further enhancing the door's insulating properties for doors with optional insulation.

COLOR OPTIONS

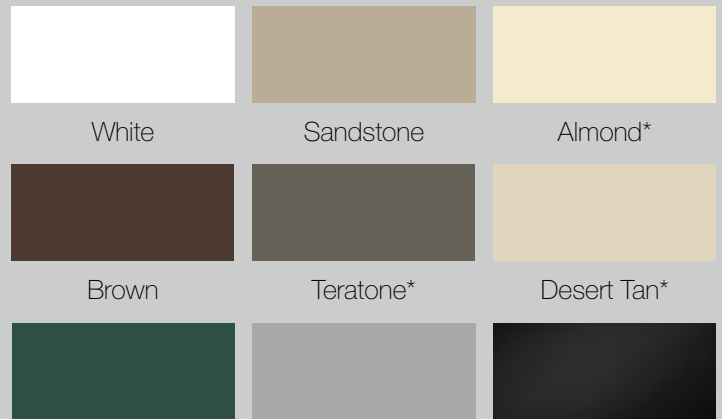

*Not available for 2200 Series

DECORATIVE HARDWARE OPTIONS



Spade - Stamped Steel



Spear - Wrought Iron



Elegant Handle

STEEL / PEGASUS 1100

Ultimate economy and everyday efficiency

Unbeatable combination of economy & efficiency

The Hörmann Pegasus Collection offers you practical designs and options that are efficient and economical. The virtually no-maintenance Pegasus Collection features 25 gauge hot-dipped galvanized pre-painted steel with a baked-on polyester enamel finish. The optional polystyrene insulation with vinyl backcover offer an economical energy savings.





FEATURE VALUES

- Heavy-duty 25 Ga. steel is hot dipped galvanized with a baked-on enamel finish and embossed woodgrain texture for years of maintenance-free beauty
- Precisely engineered tongue and groove section joints create weather-tight seal that reduces air infiltration
- Optional textured vinyl-backed polystyrene insulation (R-value 4.3) is bonded to each section to provide quiet, energy efficient operation and protection from elements
- Steel panel edges are hemmed for safety and structural strength
- Bottom weather seal with aluminum retainer for years of rust-free operation



*Ask your dealer for details

STEEL / PEGASUS 1100
Ultimate economy and everyday efficiency

PANEL DESIGNS



Traditional (Woodgrain)



Ranch (Woodgrain)



For a wider selection of styles and colors, please check out our entire family of high quality garage doors at www.hormann.us



Safety and Performance

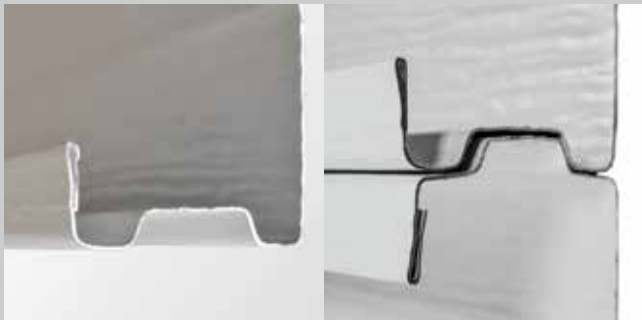

The Pegasus 1100 steel panel edges are hemmed for safety and precisely engineered tongue and groove section joints reduce air infiltration creating a weather-tight seal.

COLOR OPTIONS

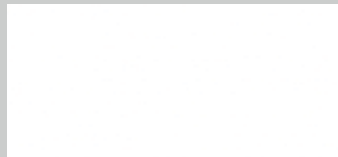

White

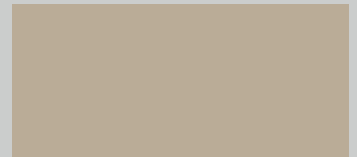

Sandstone

Hörmann's exclusive Galaxy Paint System is available to further customize your new Tucana door with 28 semi-custom colors or unlimited color matching capabilities.

DECORATIVE HARDWARE OPTIONS



Spade - Stamped Steel



Spear - Wrought Iron



Elegant Handle

STEEL DOOR WINDOW DESIGNS (FOR PEGASUS, GEMINI, ORION & TAURUS SERIES)

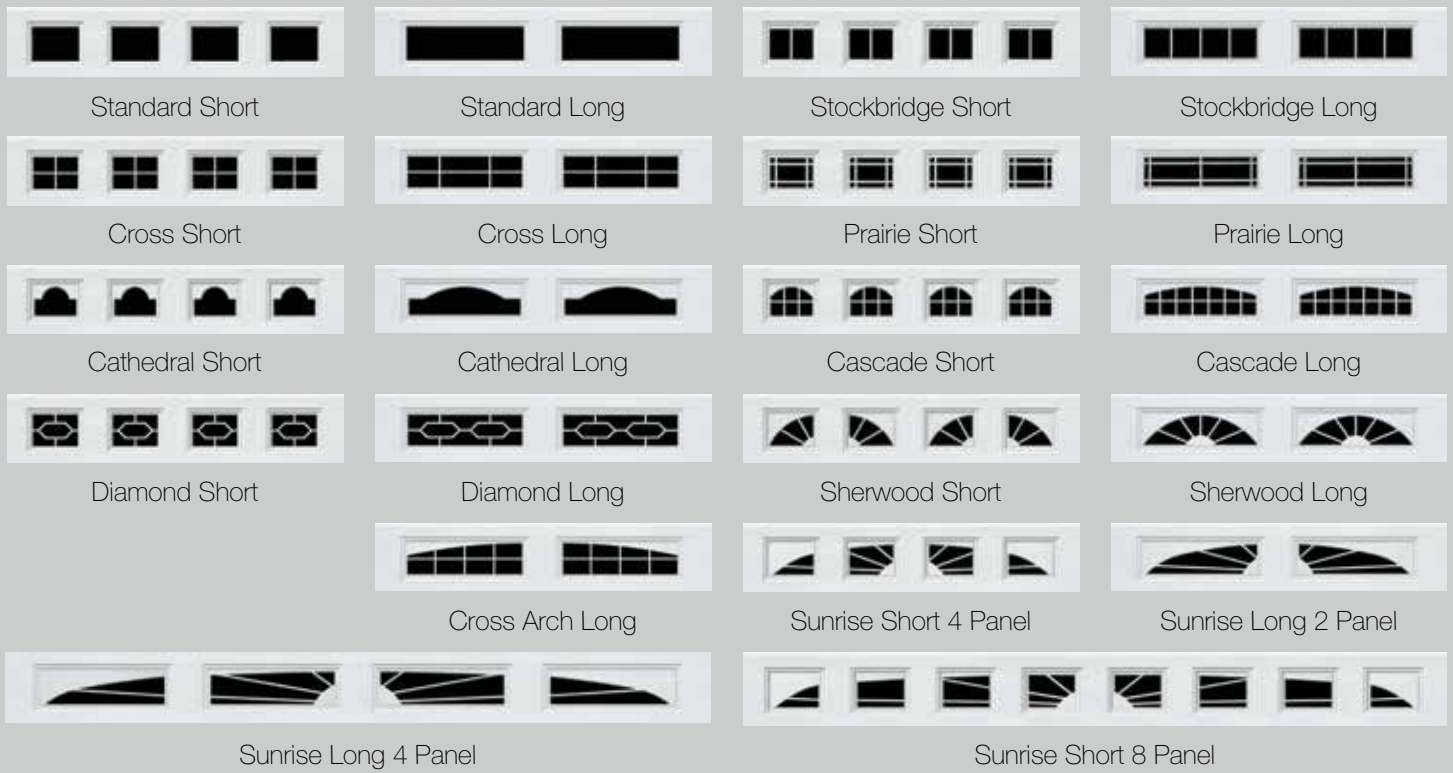

STEEL DOOR SURFACE FINISH



WINDOW GLASS



COMMON DOOR OPTIONS



4" Bottom
Weather Seal



Exterior Vinyl
Weatherstrip



Top Header Seal



2¼"/22 Ga. or
3"/20 Ga.
Additional Strut



15" Radius Track
14¾" Min. Headroom Req.



T-Handle Snap Latch
Lock System w/ 2 Keys



Lift Handle &
Step Plate Kit



Various Lock Options



Anti-Drop Device for
Torsion Spring

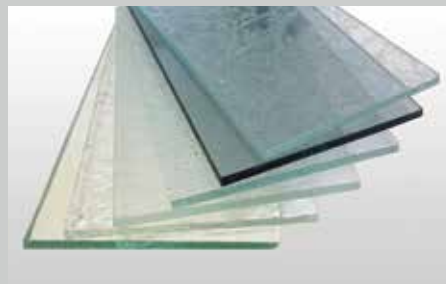

Window Pane Glass

HÖRMANN RESIDENTIAL PRODUCT OVERVIEW

● = Standard
○ = Optional

		Polaris	Aries	Solaris	Sirius	Tucana	Phoenix	
		9200	8200	7200	6200	5250	5200	
Exterior steel thickness		–	–	–	–	25 ga.	25 ga.	
Backcover Material		–	–	–	Ins. w/ Vinyl Back	27 ga.	27 ga.	
Section thickness		2¼ in.	2 in.	1¾ in.	1¾ in.	2 in.	2 in.	
R - Value		6.3	5.6 w/ Opt. Ins.	Glass Dependent	5.0	6.9	6.9	
Section design	Traditional	Special Wood Designs	Special Aluminum Designs	Various Glazed and Aluminum Section Designs	●	Special Recessed Panel Designs	Special Carriage House Designs	
	Ranch				–			
	Country				●			
	Cottage				–			
	Flush				–			
	Ribbed				–			
	Microgroove				–			
Section height	18"	Various Section Heights Available	Various Section Heights Available	Various Section Heights Available	–	●	–	
	19½"				●	–	–	
	21"				●	●	–	
	24"				●	●	–	
	28"				–	–	●	
	32"				–	–	●	
Extreme Package		–	–	–	–	–	–	
Windload certified drawings		–	–	–	–	–	–	
Bottom weather seal		●	●	●	●	●	●	
Between section weather seal		–	–	●	●	●	●	
External texture	Woodgrain	100% Wood	Extruded Aluminum Frame	Clear Anodized Aluminum	●	●	●	
Backcover texture	Stucco				–	●	●	
Safety features	Pinch resistant sections	–	–	●	–	●	●	
	Anti-drop (torsion only)	–	–	○	○	○	○	
Springs	Black painted extension	–	–	–	●	–	–	
	Black painted torsion	●	●	●	●	●	●	
	Galvanized torsion	–	–	○	○	○	○	
End & center stiles	Galvanized	–	–	–	–	–	–	
	Painted	–	–	–	–	●	●	
	Aluminum	–	●	●	●	–	–	
Tracks	12" Radius	–	–	●	●	●	–	
	15" Radius	●	●	○	○	○	●	
	Special radius as needed	○	○	○	○	○	○	
	Low headroom	○	○	○	○	○	○	
	High-lift	○	○	○	○	○	○	
	Vertical lift	–	○	○	○	○	○	

	Taurus	Orion			Gemini			Pegasus
	4250	3100	3200	3210	2200	2110	2100	1100
	25 ga.	25 ga.	25 ga.	25 ga.	24 ga.	25 ga.	25 ga.	25 ga.
	25 ga.	27 ga.	27 ga.	27 ga.	Insulated w/ Vinyl Back			
	1¾ in.	1¾ in.	2 in.	2 in.	2 in.	2 in.	2 in.	2 in.
	16.1	6.3	8.9	8.9	7.4 with Optional Insulation			4.3 w/ Opt. Ins.
	●	●	●	●	●	●	●	●
	●	●	●	●	-	●	●	●
	-	●	●	●	-	●	●	-
	-	●	●	●	-	●	●	-
	○	●	●	-	●	-	-	-
	●	-	-	-	●	-	-	-
	-	-	●	-	-	-	-	-
	●	●	●	●	●	●	●	●
	-	-	-	-	-	-	-	-
	●	●	●	●	●	●	●	●
	-	-	-	-	●	-	-	-
	-	-	-	-	-	-	-	-
	-	-	-	-	-	-	-	-
	○	-	○	○	-	-	-	-
	○	-	○	○	○	○	○	-
	●	●	●	●	●	●	●	●
	●	●	●	●	●	●	●	-
	●	●	●	●	●	●	●	●
	●	●	●	●	-	-	-	-
	●	●	●	●	●	●	●	-
	○	○	○	○	○	○	○	-
	○	●	●	●	●	●	●	●
	●	●	●	●	●	●	●	●
	○	○	○	○	○	○	○	○
	-	-	-	-	●	●	●	-
	●	●	●	●	-	-	-	●
	-	-	-	-	-	-	-	-
	●	●	●	●	●	●	●	●
	○	○	○	○	○	○	○	○
	○	○	○	○	○	○	○	○
	○	○	○	○	○	○	○	○
	○	○	○	○	○	○	○	○
	○	○	○	○	○	○	○	○

HÖRMANN RESIDENTIAL PRODUCT OVERVIEW

● = Standard
○ = Optional

		Polaris	Aries	Solaris	Sirius	Tucana	Phoenix	
		9200	8200	7200	6200	5250	5200	
Rollers	Nylon with 11 ball bearings	●	●	●	●	●	●	
Colors (For detailed color info, see page XX)	White	Unfinished: Cedar, Redwood, Knotty Alder, Vertical Grain Fir and Mahogany	Std. Color: White Std. Woodtones: Mahogany, Dark Cherry & Walnut Additional Colors: Light Cherry, Light Ash, Dark Ash, Light Fir & Dark Fir	Clear anodized aluminum standard Other colors available via Galaxy Paint System	●	●	●	
	Sandstone				●	●	–	
	Almond				–	–	–	
	Desert Tan				–	–	–	
	Brown				–	–	–	
	Teratone				–	–	–	
	Hunter Green				–	–	–	
	Grey				–	–	–	
	Black				–	–	–	
Window options (For detailed window information, see page XX) See page XX for decorative window options.	Glazed (short/long)	Window insert & designs custom manufactured	Window insert & designs custom manufactured	–	short only	Window insert & designs custom manufactured	Window insert & designs custom manufactured	
	Diamond (short/long)				–			
	Stockbridge (short/long)				–			
	Prairie (short/long)				–			
	Cross (short/long)				short only			
	Cathedral (short/long)				short only			
	Cascade (short/long)				short only			
	Sherwood (short/long)				short only			
	Sunrise (short/long)				short only			
	Cross Arch (long)				–			
Glass options	Clear (non-insulated)	○	○	○	○	○	●	
	Clear (insulated)	○	○	○	–	○	○	
	Frosted (non-insulated)	○	○	○	–	○	○	
	Frosted (insulated)	○	○	○	–	○	○	
	Smoked (non-insulated)	○	○	○	–	○	○	
	Smoked (insulated)	○	○	○	–	○	○	
	Brown tinted (non-insulated)	○	○	○	–	○	○	
	Brown tinted (insulated)	○	○	○	–	○	○	
	Feather etched (non-insulated)	○	○	○	–	○	○	
	Feather etched (insulated)	○	○	○	–	○	○	
	Tundra (non-insulated)	○	○	○	–	○	○	
	Tundra (insulated)	○	○	○	–	○	○	
Standard warranty	Section	1 yr.	Limited Lifetime	10 yrs.	Limited Lifetime			
	Hardware	5 yrs.	5 yrs.	5 yrs.	3 yrs.	10 yrs.	10 yrs.	
	Torsion (Extension) Springs	5 yrs.	5 yrs.	7 yrs.	7 (1) yrs.	7 (3) yrs.	10 (3) yrs.	
Extreme package warranty	Section	–						
	Hardware	–						
	Torsion Springs	–						
Opener attachment bracket		○	○	○	–	○	○	
Lift handles & step plate kit		○	○	●	○	○	○	
Slide lock		○	○	●	○	○	○	

GALAXY PAINT SYSTEM
 Precise and unlimited color choices



SEMI-CUSTOM COLORS

						
Almond	Brown	Pebble Grey	Beige	Brown Beige	Pale Brown	Mahogany Brown
						
Desert Tan	Hunter Green	Copper Brown	Carmine Red	Deep Crimson	Wine Red	Chestnut Brown
						
Sadstone	Grey	Cement Grey	Moss Grey	Reed Green	Reseda Green	Leaf Green
						
Teratone	Black	Agate Grey	Slate Grey	Pigeon Blue	Signal Blue	Sapphire Blue

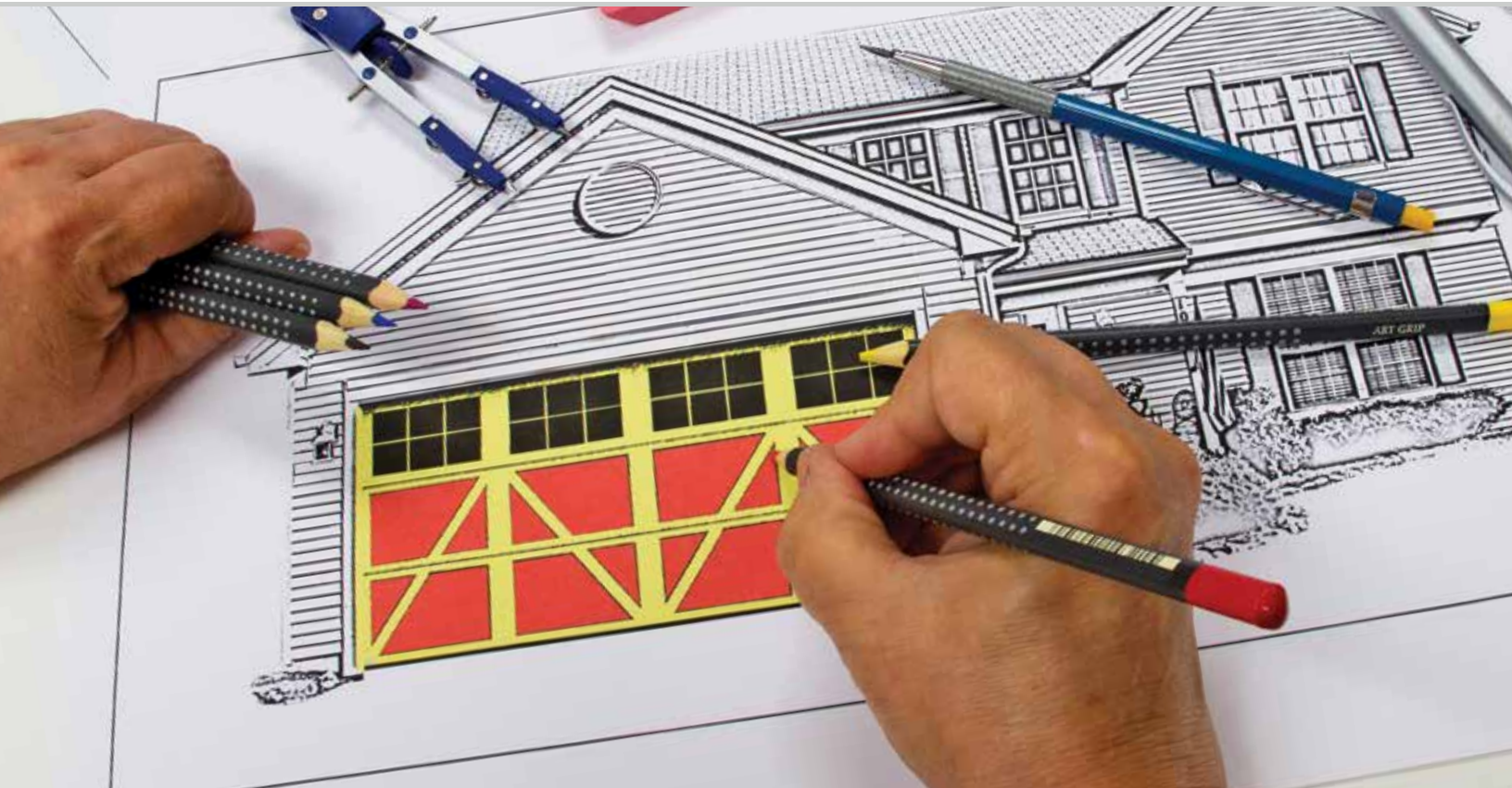

CUSTOM COLORS

Your home is as unique as you and your family so why settle with a color selected from a handful of choices? Express yourself with the Galaxy Paint System.

The Galaxy Paint System utilizes today's state-of-the-art color matching technology to match any submitted color within the tightest of tolerances.

With the Galaxy Paint System, you will not only be confident that you have purchased the highest quality and safest garage door for your home but one that will match the color of its exterior with a factory finish that will last.

PAINT SYSTEM FEATURES

- Galaxy Paint System is available on the following door series: Orion 3100/3200, Taurus 4250, Phoenix 5200, Tucana 5250 & Solaris 7200.
- Choose from any of the 28 semi-custom colors or submit a sample of your desired color to your Hörmann Dealer for a genuine custom finish.
- Galaxy Paint System is a factory applied top coat sprayed over the pre-painted steel. This is an added layer of protection and does not affect the Limited Lifetime warranty of the sections, however, the top coat itself will be covered for a period of one (1) year against crazing, blistering, peeling, chalking, or fading as defined in the Galaxy Paint System warranty.
- The paint system utilizes a high quality catalyzed acrylic urethane that is far superior to any exterior paints that are typically used by a painting contractor.
- To prevent webbing or missed spots, all components are painted separately, cured and then assembled prior to packaging.
- Considering the cost of rollers, brushes, cleaners, drop cloths and time spent while painting the door yourself or hiring an expensive painting contractor, the Galaxy Paint System provides a more cost effective solution and will retain the superior finish much longer.

HÖRMANN ADVANTAGES

- **Unlimited color matching capability for a perfect color match**
- **Paint that far exceeds the quality of anything available for on-site finishing**
- **Factory painted prior to final assembly**

Extra Peace of Mind

The Hörmann Extreme Package door upgrade is a perfect choice for any homeowner or builder who is seeking peace of mind from a durable and well built product with premium components without compromising safety and the flexibility of choices.

Extreme Package upgrades are available for Hörmann Orion 3200/3210 and Taurus 4250 series and includes all the features that you can only expect from Hörmann such as pinch-resistant section joints, factory installed between section weather & side seals and much more.

With the heavy duty hardware added to an already solidly built design, the new Extreme Package upgrade is windload certified to minimum 90 MPH. Each door size is now available with the certified drawing with drawing number and maximum design loads allowed.

EX
Extreme





Commercial Grade Hardware

The usage of heavier steel means the extra layer of protection. The door components such as hinges become mechanical plates rather than the moving parts for rugged use in harsh climates and the extremely windy and open areas.



Extra Jamb Brackets & Side Locks

In high wind areas, the jamb brackets and side locks included in the Extreme package minimize the damage caused by bending and deflection of the door mounting and secure your door against back action and reduces the risk of any damage to your opener or exposing your garage to the elements or intruders.



3 Inch Struts

In most cases, the Extreme package includes 3" struts of a heavier gauge galvanized steel to make your door a structural part of your home. The 3" struts provide extra strength and prevent gradual deformation of your door from those extreme conditions in rugged urban and rural areas.



25,000 Cycle Torsion Springs*

Whether you live in an extreme condition or have a busy garage, 25,000 cycle torsion springs offer you the extra long life you need in harsh environments or multiple daily openings and closings.

* Extreme package is also available with extension springs. Extension springs are NOT covered in the Limited Lifetime Warranty.



Windload Certified[†]

Extreme package upgrades are tested to withstand winds up to 90 miles per hour for those open areas where high gusting winds are a factor.



Limited Lifetime Warranty

The Extreme Package upgrade offers you the peace of mind by extending warranty on door sections, hardware and springs* as long as you own your home.

[†] To purchase and install a Hörmann windload certified door, customer assumes the responsibility to review and follow the pressure requirements established for the application as defined in the local building codes.

The Perfect Match

Hörmann SilentDrive® garage door openers are the perfect companion to your garage door. All SilentDrive® openers are built with a DC motor and a composite aramid fiber reinforced belt drive system that provide a very quiet operation, dramatically enhancing your total quality experience. The adjustable “soft” start and “soft” stop feature allows minimum wear on the door and opener, ensuring a quiet-running door at every stage of opening and closing. With a SilentDrive® opener you’ll benefit not only from the safety features compliant with UL 325 requirements but from the unique Hörmann Beltension Guard™ and the EngageLock™.



1 Beltension Guard™ is built into the opener rail to maintain proper belt tension for the life of the opener. This ensures quiet, trouble-free operation, and eliminates costly and inconvenient service calls.

3 Aramid fiber reinforced belt will not rust, limits wear & tear, resists moisture and never needs lubrication. This special belt system provides a quiet ride and many years of worry free operation.

2 EngageLock™ is also built into the opener rail to eliminate door back drive action in the event of a power loss, securing your home and property.



SilentDrive® 5500 Series



- Ultra quiet operation
- Long-lasting
- Maximum convenience
- Unique safety features

SilentDrive® 7500 Series



- Ultra quiet operation
- Long-lasting
- Maximum convenience
- Unique safety features
- Accelerated opening

SilentDrive® 8500 Series



- Ultra quiet performance
- Long-lasting
- Maximum convenience
- Unique safety features
- Accelerated opening
- For doors 12' high

Standard Accessories



Deluxe Wall Console Station

Operates the door from inside your garage and independently operates opener lights. A separate lock button eliminates the need to unplug the operator during extended absences.



Mini transmitter

The conveniently sized transmitter allows you to control up to four separate doors.



Optional Accessories



Wireless keypad

Lighted and covered keypad allows for wireless remote access to your garage with your own programmable personal security code for your convenience. Stores up to 3 personal codes.



Single button transmitter

Used as an additional device for operating a single door.

All SilentDrive® openers are built with a DC motor and come with a belt drive system. The DC motor and Belt Drive System make for very quiet operation, dramatically enhancing your total quality experience.

The dual bulb and lens covers diffuse the lighting in your garage while you enter or exit your garage. A three minute auto delay shuts your lights off automatically for your convenience.



*Ask your dealer for details

A Complete Selection of High Quality Commercial Doors

Hörmann commercial doors offer a wide range of styles, sizes and design options. Sophisticated engineering and state-of-the-art manufacturing provide the basis for durable, reliable and long-lasting quality products.



► H-425U Door with Aluminum Full-view Windows



▲ H-720A Door with Clear Windows & Smooth Anodized Aluminum Sections





◀ H-325S Door with Opti-View Windows

Everything you've always wanted in a garage door, and more.

HÖRMANN



Our promise to you.

As one of the world's leading manufacturers of doors we're committed to providing the best quality, value, and selection. Whether residential or commercial; whether steel, aluminum, wood, or high density polyethylene;

whether traditional or contemporary; we have the door you're looking for. Each Hörmann door gives you the perfect array of benefits and options with the drive to match.



Hörmann LLC, Montgomery, IL
Headquarters and Manufacturing Plant



Environmental commitment has been part of our corporate culture for decades. From our manufacturing processes to the products we make.

In everything we do we strive to minimize energy and use of resources through efficient processes, long-lasting quality and innovative engineering.

AVAILABLE FROM:



Call us ► 1 877 OK HORMANN (1-877-654-6762)

Hörmann LLC, 5050 Baseline Road, Montgomery, Illinois 60538

Phone: 630-859-3000 Fax: 630-859-8122

Email: info@hormann.us www.hormann.us



Printed in USA.
©Hörmann LLC
H/E/PPK/#3000 VERSION 2, PRINT 02.18)

CENTRALIA, IL
866.755.7636

MOBERLY, MO
800.892.5850

MT. PLEASANT, IA
800.258.5809

SPRING HILL, KS
800.490.4320

Proudly
Supplied
By



Visit our website at www.midambuilding.com