



MOULDING

Products Catalog



NASHVILLE, TENNESSEE



ABOUT

Warren Brothers



Warren Brothers is the premier supplier of quality millwork products to the Middle Tennessee, Northern Alabama, Northern Georgia, and Central Kentucky markets.

Warren Brothers is located on Massman Drive, Nashville, Tennessee, and has been serving customers continuously since 1853.

Warren Brothers offers an extensive selection of windows, doors, mouldings, stair parts, hardware, and columns.

THE FINEST QUALITY

From the clean sophisticated lines of painted trim to the timeless quality of solid wood, mouldings are the final touches that enhance any room with a finish that expresses personal style.

With hundreds of years of combined experience, we take enormous pride in creating the finest quality products.

CUSTOM MOULDINGS

If you wish to create a moulding that is not found in our collection, our workshop can produce custom tooling to precisely match sketched drawings, architectural blueprints, or existing wood samples.

TABLE OF CONTENTS

- TYPES OF MOULDINGS AND SPECIES..... 04
- S4S BOARDS..... 06
- SHEET STOCK 07
- NICKEL GAP/SHIP LAP..... 07
- BASEBOARDS..... 08
- BASE CAP | PENCIL..... 10
- CAPS..... 11
- BULLNOSE | BACKBANDS 11
- PANEL 11
- CASING..... 12
- TRADITIONAL CROWN..... 14
- COVE CROWN..... 15
- DESIGNER CROWN 16
- BASE AND CROWN BLOCKS..... 16
- ROSETTE..... 17
- PLINTH BLOCK..... 17
- SILL 17
- STOOLS 18
- SHOE | QUARTER ROUND | SHOE..... 18
- JAMBS..... 19
- COVE..... 19
- STOPS 20
- CHAIR RAIL 21
- GLASS BEAD..... 21
- MULL CASING 22
- MISCELLANEOUS..... 23
- EXPLORE MORE PRODUCTS..... 24



TYPES OF MOULDING

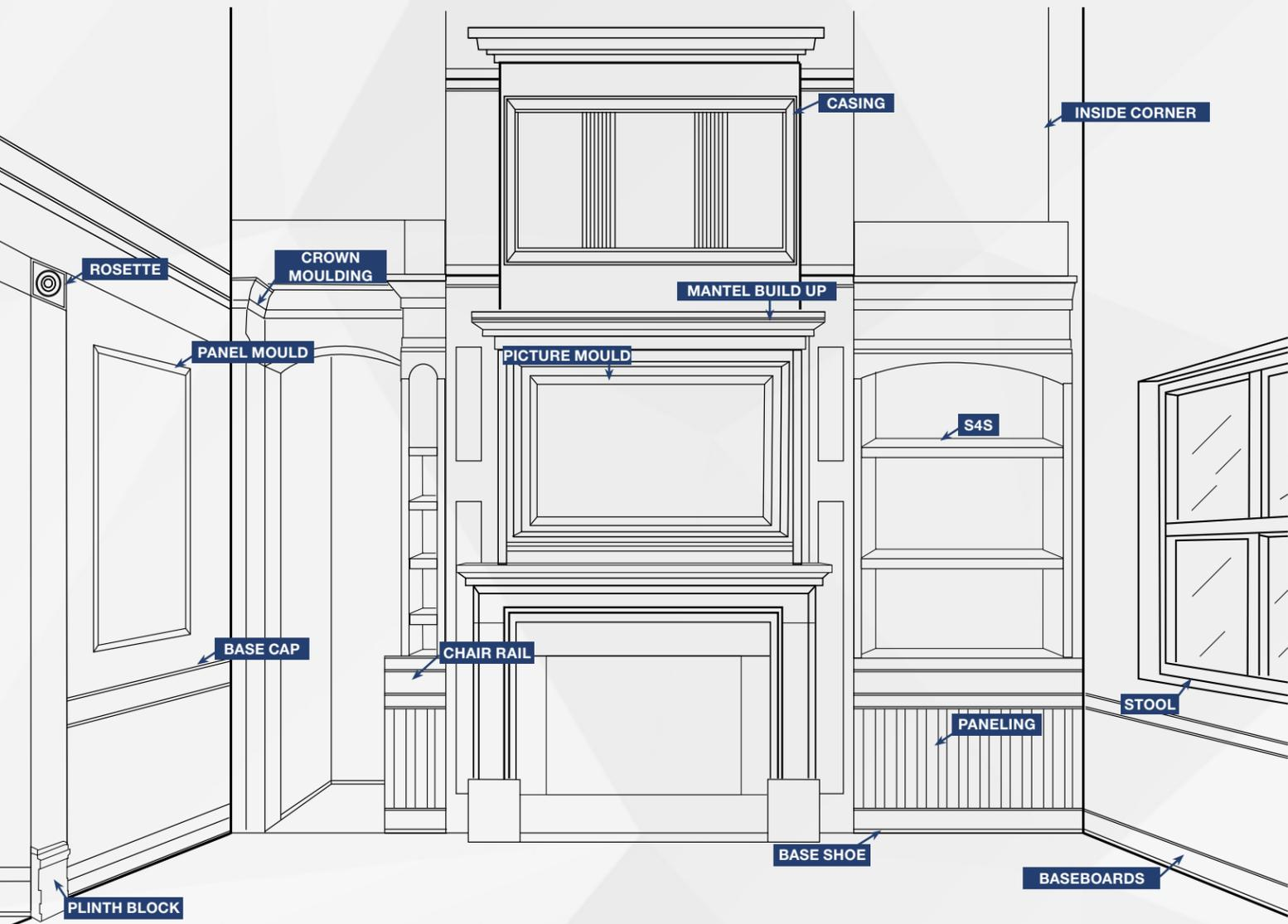

SPECIES & FINISHES

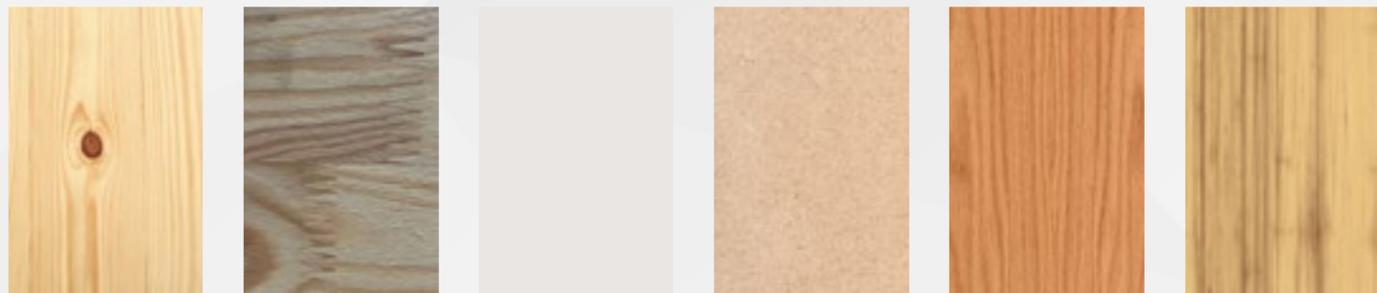

Solid Pine Finger-Jointed Pine Primed Finger-Jointed Pine Medium Density Fiberboard Oak Poplar

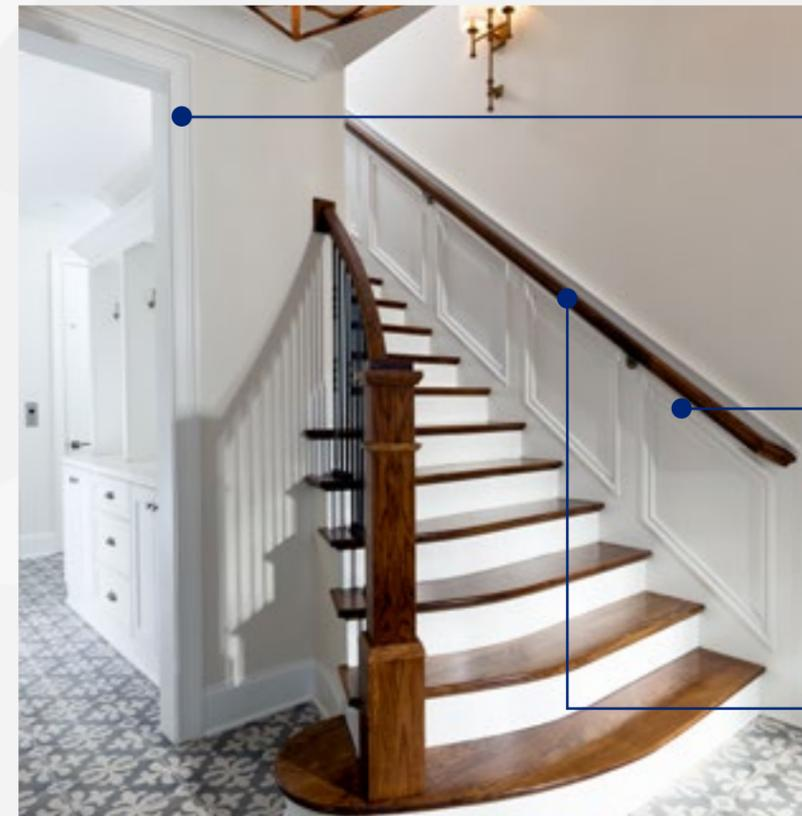

CASING

W-342
Pine - Primed
3/4" x 3-1/2"



PANELING

W-533
Pine Primed
1 1/16" x 1-3/4"



HAND RAIL

6010
Oak
2-1/4" x 2-7/16"



COVE CROWN

W-653
MDF
3/4" x 5-1/4"



BASEBOARD

W-163B
MDF
9/16" x 7-1/4"



CASING

W-78
Pine Primed
7/8" x 3-1/2"

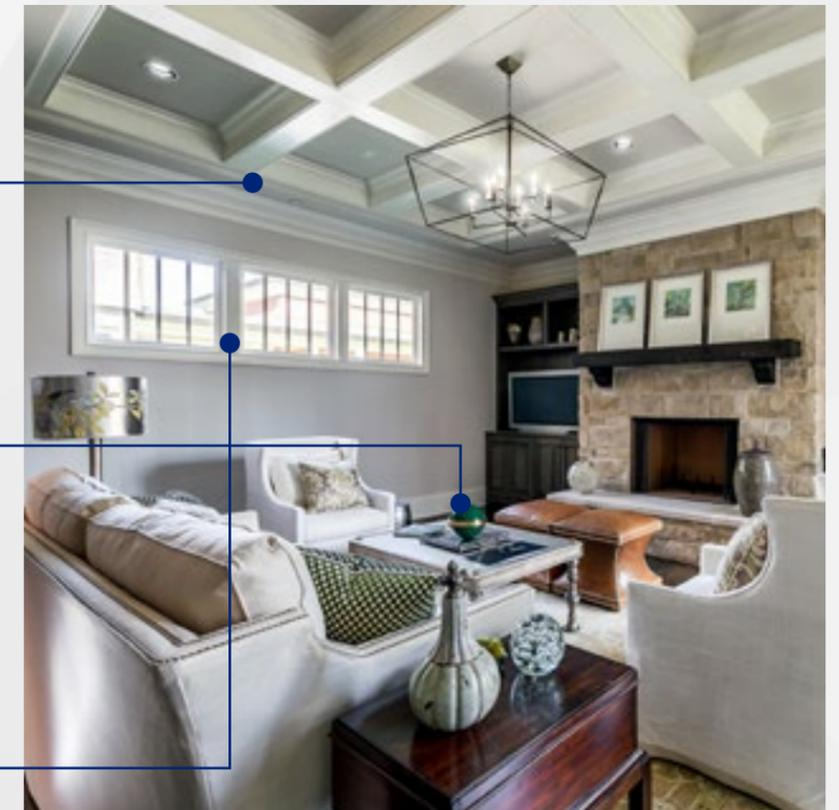

S4S BOARDS

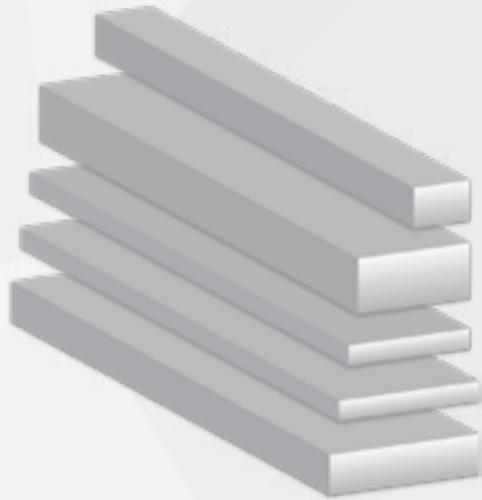

S4S BOARDS

S4S stands for “surfaced on four sides,” which means that the wood is finished and smooth on all four sides. It is used for a variety of purposes, such as shelving, window ledges, baseboards, and casings.

All S4S wood items are moulding grade.

Stock Code	Nominal Size	Dimensions	Species
W-254	N/A	1/2" x 3/4"	Pine Primed
1/2 x 1-1/2	N/A	1/2" x 1-1/2"	Poplar F/J
W-249	N/A	11/16" x 1-1/2"	Pine Primed
W-267	N/A	1/4" x 13/8"	Pine Solid
W-266	N/A	1/4" x 1-5/8"	Pine Solid
W-962	N/A	7/16" x 2"	Pine Solid
1 x 2 W-247	1" x 2"	11/16" x 2"	Pine Solid, Primed
1 x 2 W-247	1" x 2"	3/4" x 2"	Poplar, F/J
5/4 x 2	5/4" x 2"	1" x 2"	Poplar F/J
W-1429	N/A	11/16" x 3"	Pine Primed
W-1430	1" x 4"	1/16" x 3-1/2"	MDF, Pine Primed
W-1430	1" x 4"	3/4" x 3-1/2"	Pine Solid, PVC
5/4x4	5/4" x 4"	1" x 3-1/2"	PVC
1 x 6	1" x 6"	11/16" x 5-1/2"	Pine Primed, MDF
1 x 6	1" x 6"	3/4" x 5-1/2"	Pine Solid, PVC
5/4 x 6	5/4" x 6"	1" x 5-1/2"	Pine Primed, PVC
1 x 8	1" x 8"	11/16" x 7-1/4"	Pine, Primed, MDF
1 x 8	1" x 8"	3/4" x 7-1/4"	Poplar Solid, PVC, Oak, Pine Solid
1 x 12	1" x 12"	11/16" x 11-1/4"	Pine Primed, MDF
1 x 12	1" x 12"	3/4" x 11-1/4"	PVC, Oak, Pine Solid, Poplar Solid, F/J
5/4 x 12	5/4" x 12"	1" x 11-1/4"	Poplar, F/J
5/4 x 12	5/4" x 12"	3/4" x 18"	Poplar, F/J

SHEET STOCK

PLYWOOD SHEET STOCK

Species	Dimensions
Beaded Birch Plywood	1/4" x 4' x 8'
Birch Plywood	3/4" x 4' x 8' 1/4" x 4' x 8'
MDF	11/16" x 4' x 8' 11/16" x 16" x 8' 1" x 4' x 8'

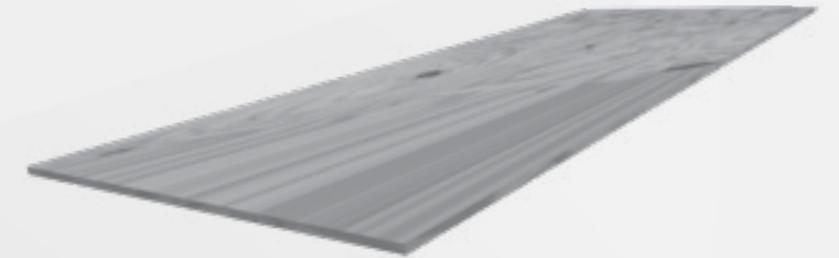

NICKEL GAP/SHIP LAP



1X6 NICKEL GAP

MDF
9/16" x 5-3/4"



1X8 NICKEL GAP

MDF
9/16" x 7-3/4"



BEADED CEILING

Spruce Solid
3/4" x 5-1/4"

BASEBOARDS

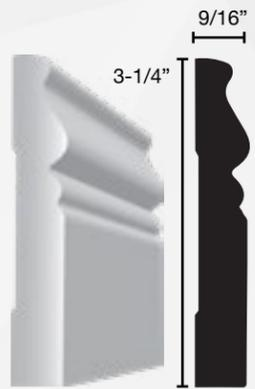

W-615
Pine - Primed
9/16" x 3-1/4"



W-616
Pine - Primed
9/16" x 4-1/4"



W-617
Pine - Primed, Clear
9/16" x 5-1/4"



W-619
Pine - Primed
9/16" x 7-1/4"



W-27
MDF
1/2" x 9-1/4"



W-163B
MDF
9/16" x 7-1/4"

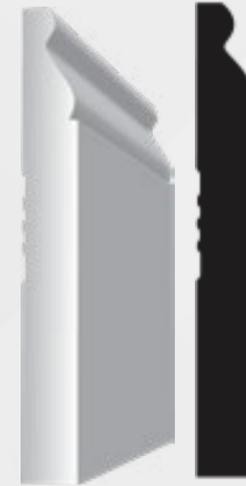

W-163A
MDF
9/16" x 5-1/4"

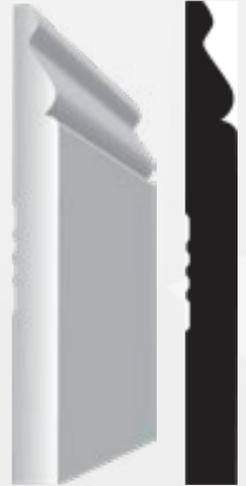

W-617
MDF
1/2" x 5-1/4"



W-709
Pine - Primed
9/16" x 7-1/4"



W-509
Pine - Primed
9/16" x 5-1/2"



W-713
Pine - Primed, Clear
9/16" x 3-1/4"



W-683
Pine - Primed
9/16" x 3-1/2"



W-623
Pine - Primed, Solid
9/16" x 3-1/4"
MDF, Oak
1/2" x 3-1/4"



W-620
Pine - Primed, Solid
9/16" x 4-1/4"
MDF, Oak
1/2" x 4-1/4"



W-618
Pine - Primed, Solid | MDF
9/16" x 5-1/4"



W-649
Pine - Primed
9/16" x 7-1/4"



W-647
Pine - Primed
9/16" x 5-1/4"

BASE CAP

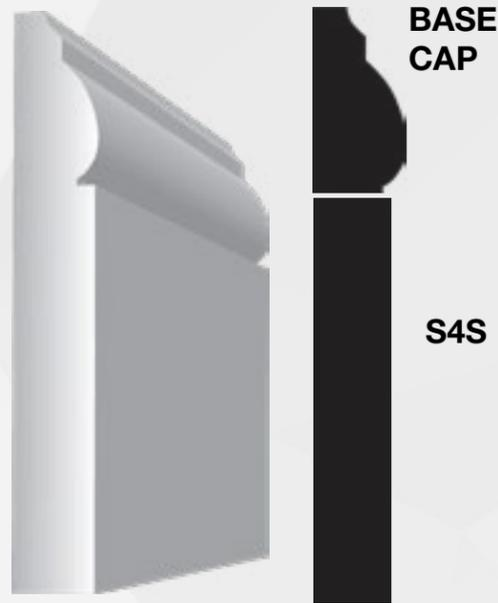

Example of S4S with a base cap

BASE CAP MOULDINGS

A base cap is a decorative trim that sits on top of a dimensional board at the floor to create a two-piece baseboard.

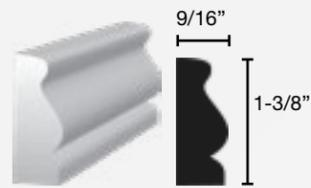

W-116
Pine - Solid
9/16" x 1-3/8"



W-117
Pine - Solid
9/16" x 1-3/8"



W-118
Pine - Solid
5/8" x 1-1/4"



W-119
Pine - Solid
5/8" x 7/8"



W-94
Pine - Primed
11/16" x 1-1/8"



W-163
Pine - Primed, Solid
11/16" x 1-3/8"

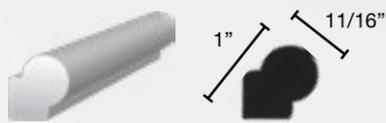

PENCIL W-926
Poplar - Solid
11/16" x 1"

CAPS



CAP W-288
Pine - Primed
1-5/8" x 1-1/16"



CAP W-198
Pine - Primed
2" x 1-3/8"



CAP W-FPRBC
Pine - Primed
1-1/16" x 1-9/16"



CAP W-291
Pine - Primed
11/16" x 1-9/16"

BULLNOSE & BACKBANDS

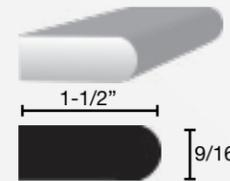

BULLNOSE W-150
Pine - Primed
9/16" x 1-1/2"



BACKBAND PR280
Pine - Primed
11/16" x 1-1/16"



BACKBAND W-281
Pine - Solid
11/16" x 1-1/8"



BACKBAND W-283
Pine - Primed
11/16" x 1-1/8"

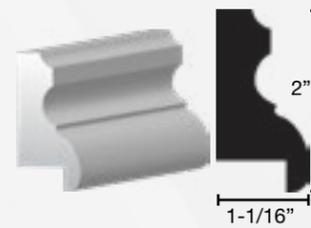

PM250R5
Poplar - Solid
1-1/16" x 2"



W-125
Pine - Primed
11/16" x 2"



W-720-A
Pine - Solid
3/8" x 5/8"



W-729
Pine - Solid
1-1/4" x 9/16"

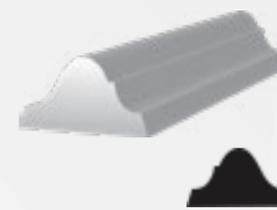

W-730-B
Pine - Primed
5/8" x 1-1/8"



W-533
Pine - Primed
11/16" x 1-3/4"

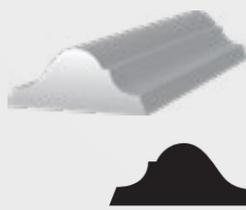

W-730-C
Pine - Primed
5/8" x 1-5/8"

PANEL

PENCIL

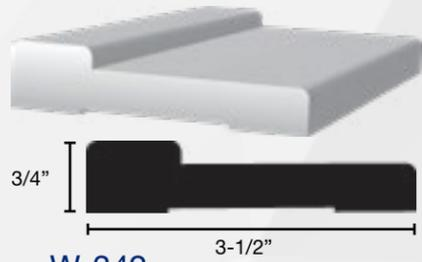

W-342

Pine - Primed
3/4" x 3-1/2"



W-386

Pine - Primed, Solid
5/8" x 2-1/4"

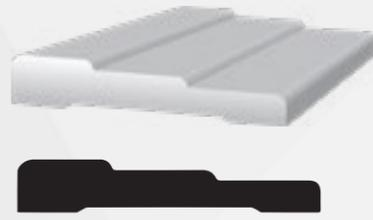

W-683

Pine - Primed
11/16" x 3-1/4"

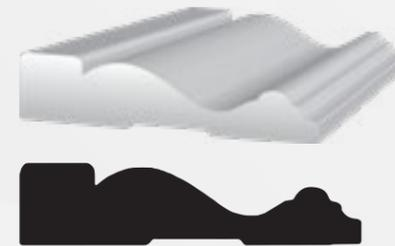

W-350

Pine - Primed
3/4" x 3-1/2"



W-445

Pine - Primed, Solid
11/16" x 3-1/4"
MDF
5/8" x 3-1/4"

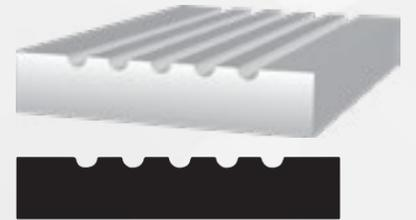

W-501

Pine - Primed
11/16" x 3-1/2"

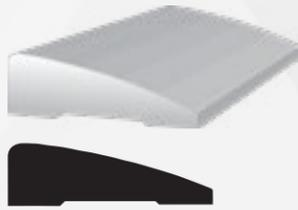

W-327

Pine - Primed, Solid
11/16" x 2-1/4"

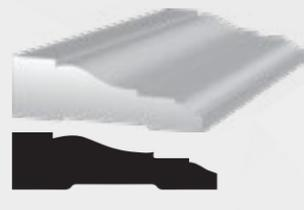

W-366

Pine - Primed, Solid
11/16" x 2-1/4"
MDF, Oak
5/8" x 2-1/4"



W-366-W

Pine - Primed, Solid | MDF
11/16" x 3-1/4"

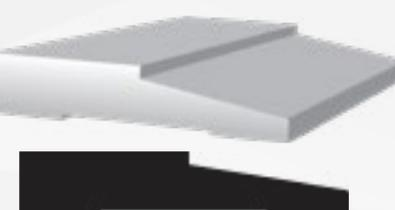

W-349

Pine - Primed
11/16" x 3-1/2"

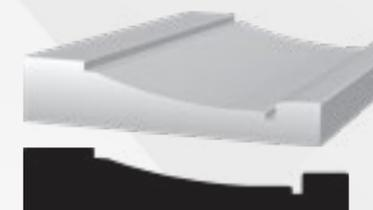

W-345

Pine - Primed
3/4" x 3-1/2"



109

MDF
3/4" x 3-1/2"



W-356

Pine - Primed, Solid
11/16" x 2-1/4"
MDF
5/8" x 2-1/4"

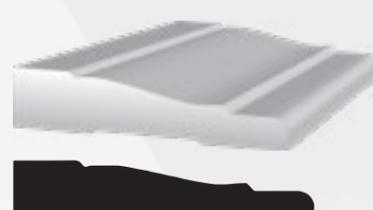

W-444

Pine - Primed
11/16" x 3-1/4"



W-444-W

Pine - Solid
11/16" x 3-1/2"



W-78

Pine - Primed
7/8" x 3-1/2"



W-425

Poplar FJ
1" x 4-1/4"

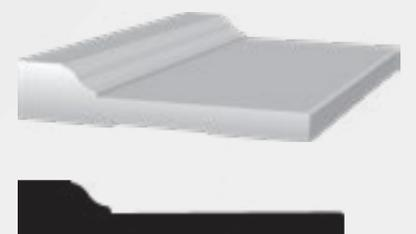

W-329

MDF
11/16" x 3-1/2"



W-341

Pine - Primed
11/16" x 3-1/2"



W-383

Pine - Primed
11/16" x 3-1/2"



W-384

Pine - Primed
11/16" x 4-1/2"



W-RB2

Pine - Primed
11/16" x 2-3/4"

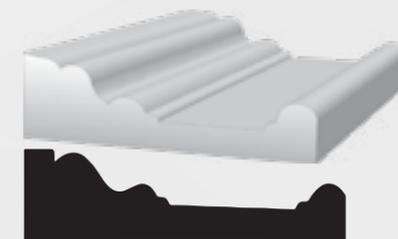

W-RB3

Pine - Primed, Solid
1-1/16" x 3-1/2"

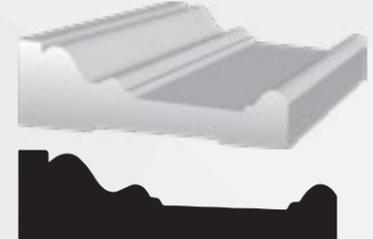

W-RB3

MDF
1-1/16" x 3-1/2"



1X4 (W-1430)

MDF | Pine Primed
11/16" x 3-1/2"

Pine Solid | PVC
3/4" x 3-1/2"

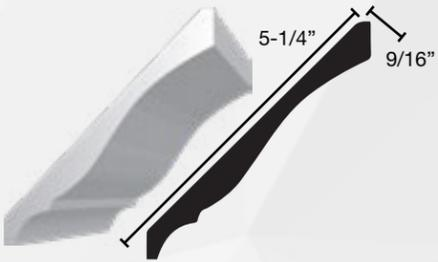

W-46

Pine - Primed, Solid | MDF
9/16" x 5-1/4"

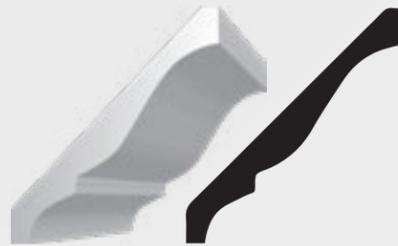

W-47

Pine - Primed Solid | MDF
9/16" x 4-5/8"

CROWN MOULDING

Crown moulding is installed at the intersection of the wall and ceiling, adding depth and dimension to a room.

COVE CROWN

Cove base moulding can hide gaps between uneven floors and baseboards.

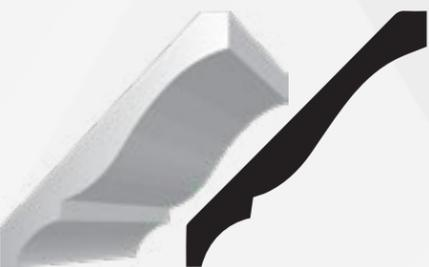

W-48

Pine - Primed
9/16" x 4-1/4"

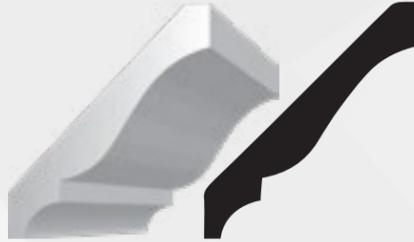

W-49

**Pine - Primed Solid
MDF, Oak**
9/16" x 3-5/8"

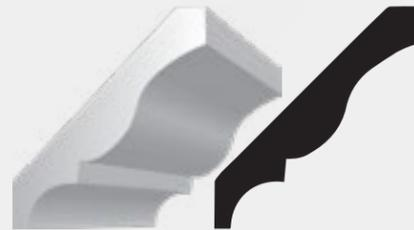

W-51

Pine - Primed Solid
9/16" x 3-1/4"



W-653

MDF
3/4" x 5-1/4"



W-43

Pine - Primed
11/16" x 6-5/8"



W-508

MDF
9/16" x 7-1/4"



W-60

Pine - Solid
9/16" x 1-3/4"



W-501

MDF
3/4" x 5-1/4"

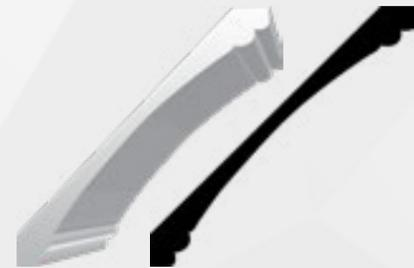

W-601

Pine - Primed
3/4" x 7-1/4"



W-BC-4

Pine - Primed
11/16" x 4-1/4"

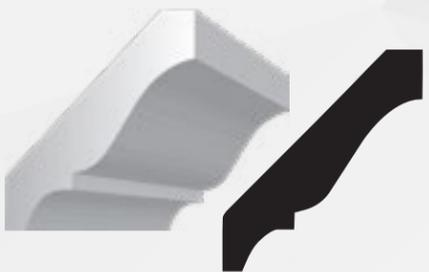

W-52

Pine - Primed, Solid
9/16" x 2-3/4"

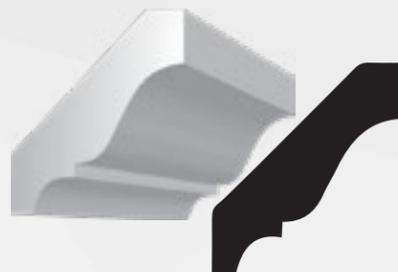

W-54

Pine - Primed, Solid
9/16" x 2-1/4"



W-BC-5

Pine - Primed | MDF
11/16" x 5-1/4"



W-BC-7

MDF
3/4" x 7-1/4"

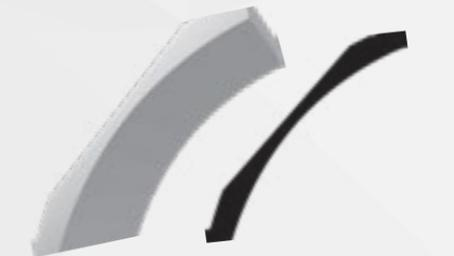

W-505

MDF
1" x 7"

DESIGNER CROWN



W-5 CURTIS

MDF
5/8" x 5"



W-7 CURTIS

MDF
11/16" x 7"



W-45

Pine Primed
11/16" x 5-1/4"

BASE & CROWN BLOCKS



W-CI3

Pine - Inside Corner
Works for 3-5/8" crown or smaller

W-CI5

Pine - Inside Corner
Works for 5-1/4" crown or smaller

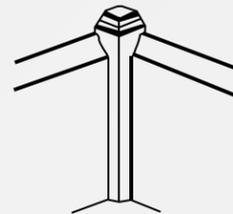

W-BI5

Pine - Inside Corner
Works for 5-1/4" base or smaller

ROSETTE

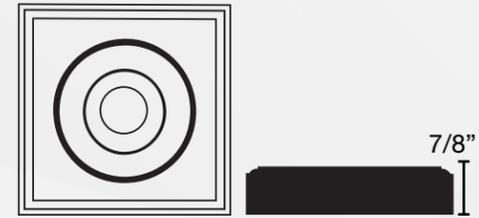

ROSETTE W-502

Pine Solid
3-3/4" x 3-3/4"



PLINTH BLOCK



PLINTH BLOCK W-503

Pine Solid
3-1/2" x 8" x 1-1/8"



SILL

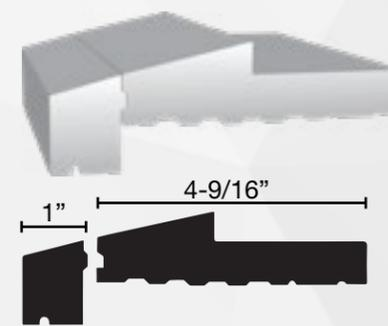

TRANSOM SILL & SILL NOSE

Pine Primed
1" x 4-9/16"

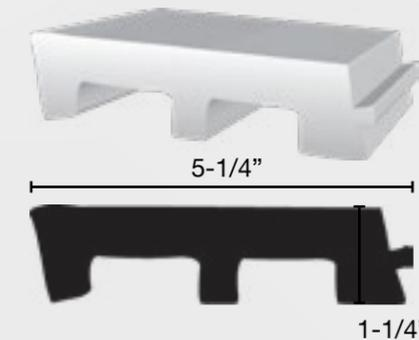

MAIN SILL

PVC
1-1/4" x 5-1/4"

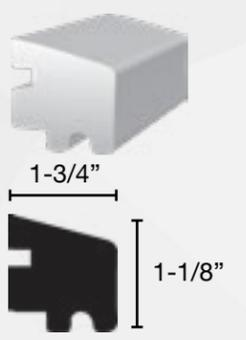

SILL NOSING

PVC
1-1/8" x 1-3/4"



STOOL MOULDINGS

Stool moulding for windows usually serves as a window frame sill cap, and jamb moulding acts as a vertical perimeter frame of a window or door frame.

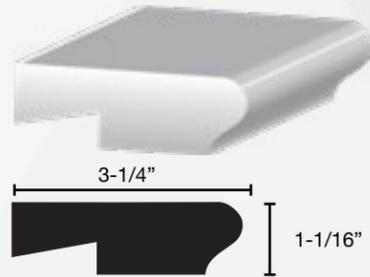

W-1077
Pine Solid
1-1/16" x 3-1/4"



W-1021
Pine Primed
11/16" x 5-1/4" & 7-1/4"
MDF
5/8" x 5-1/4"



W-1099
Pine Primed
11/16" x 2-1/2"

SHOE | QUARTER ROUND | SHOE OPTION

*These items are often used in place of shoe

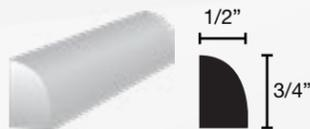

SHOE W-126
Pine Primed, Solid
Red & White Oak
3/4" x 1/2"



QUARTER ROUND W-105
Pine Primed, Solid
Red & White Oak
11/16" x 11/16"

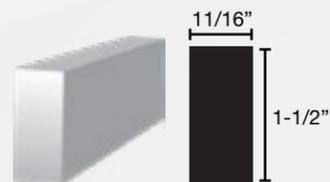
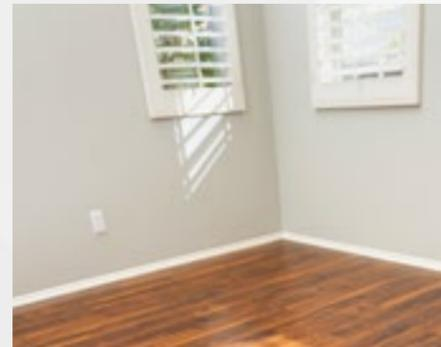

S4S W-249*
Pine Primed
11/16" x 1-1/2"



STOP W-876
Pine Primed, Solid
3/8" x 1-3/8"



S4S W-254*
Pine Primed
3/4" x 1/2"



FLAT

Pine Solid, Clear, Primed
6'8" x 4-9/16"
8' x 4-9/16"

Pine Solid, Primed
16'3" x 4-9/16"

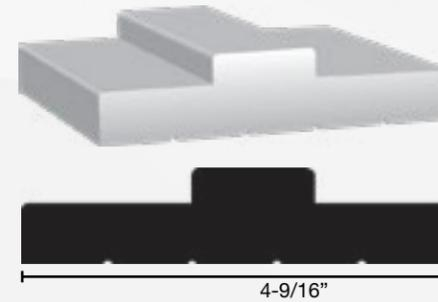

SUPER JAMB

Primed
6'8" x 4-9/16"
8' x 4-9/16"
8' x 6-9/16"

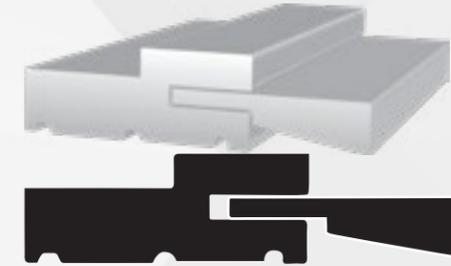

SPLIT JAMB

Pine Solid, Clear Primed
6'8" x 5"

Primed
8' x 5"
8' x 7"



EXTERIOR JAMB

Pine Solid, Primed,
Composite Primed Textured,
Mahogany, Frame saver primed
6'8" x 4-9/16"
6'8" x 6-9/16"
17'0" x 4-9/16"
6'8" x 4-9/16"



MULL POST

Call for full list.



W-94
MDF
11/16" X 1-1/8"



W-100
Pine Solid, Red & white Oak
11/16" x 11/16"



W-85
Pine Solid
1-3/4" x 7/16"

COVE

STOPS

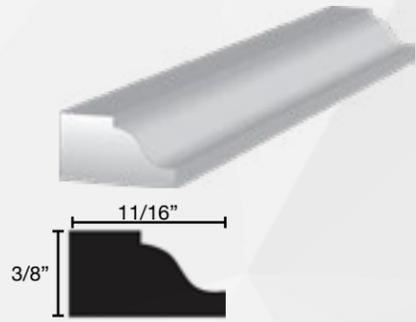

W-942
Pine Solid
11/16" x 3/8"



W-254
Pine - Primed Solid
1/2" x 9/16"



W-935
Pine Solid
7/16" x 1-5/8"

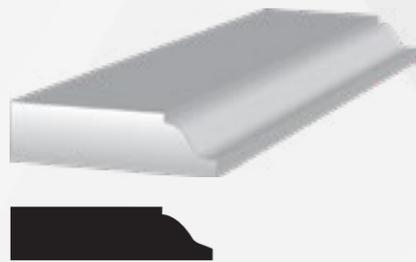

W-936
Pine - Primed, Solid
3/8" x 1-3/8"



W-938
Pine Primed
3/8" x 1-1/8"



W-940
Pine Solid
3/8" x 7/8"



W-876
Pine Solid
3/8" x 1-3/8"



W-816
Pine - Primed, Solid
3/8" x 1-3/8"



BIFOLD W-BF-1
Pine Solid
11/16" x 1-1/4"



BIFOLD W-BS-2
Pine - Primed Solid, MDF
5/8" x 5/8"

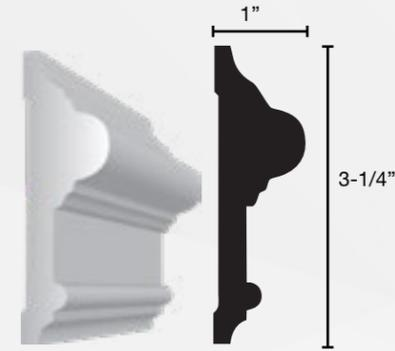

W-299
Pine Primed
1" x 3-1/4"

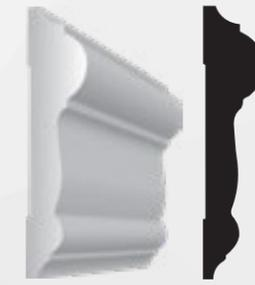

W-297
Pine Primed, MDF
11/16" x 3"



W-390
Pine - Primed Solid
11/16" x 2-5/8"



W-401
MDF
7/16" x 5-1/4"



W-295
Pined Primed
11/16" x 3-7/8"



W-158
MDF
9/16" x 7/16"



W-148
Pine - Primed, Solid | MDF
3/8" x 3/8"

GLASS BEAD

MULL CASING



MULL CASING

Mull strip has a simple, straight profile and is typically added between the door and sidelites of an exterior door unit to enhance aesthetics.

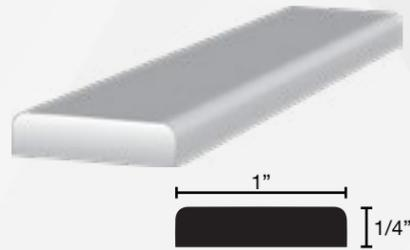

W-972-S

Pine Solid
1/4" x 1"

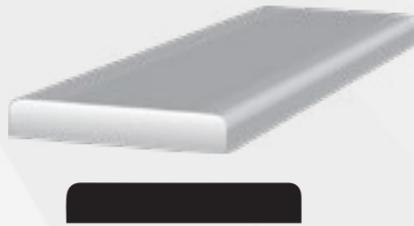

W-972-N

Pine Solid
1/4" x 1-1/2"

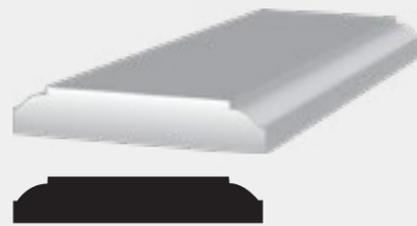

W-987

Pine Solid
3/8" x 2"



W-972-M

Pine Solid
1/4" x 2"



W-972-W

Pine Solid
1/4" x 3-1/2"



W-988

Pine Solid
3/8" x 1-1/2"

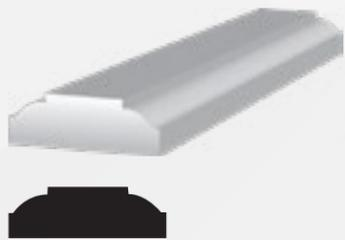

W-989

Pine Solid
3/8" x 1-3/8"



SCREEN W-142

Pine Solid
1/4" x 3/4"



W-876-8'

Pine Primed Solid"
3/8" x 1-1/8"

MISCELLANEOUS



FULL ROUND W-233

Pine Solid
1-1/4" x 1-1/4"

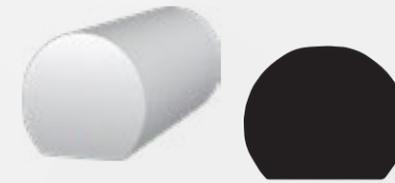

HAND RAIL W-231

Pine Solid
1-5/8" x 1-9/16"



HAND RAIL 240

Pine Solid
1-1/4" x 2-1/4"

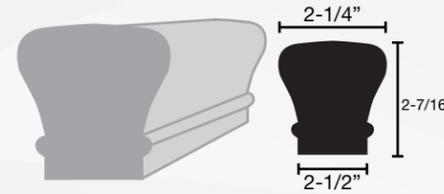

HAND RAIL 6010

Red Oak
2-1/4" x 2-7/16"



LATTICE W-266

Pine Solid
1/4" x 1-5/8"



LATTICE W-267

Pine Solid
1/4" x 1-3/8"

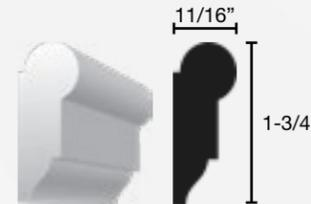

PICTURE W-273

Pine Primed
11/16" x 1-3/4"



SHINGLE W-210

Pine Solid
11/16" x 1-5/8"



BATTEN W-962

Pine Solid
7/16" x 2"



CHAMFER STRIP W-84

Pine Solid
11/16" x 11/16"

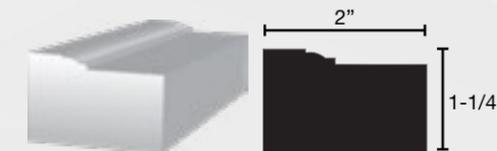

BRICK MOULD W-180

Pine Primed Solid **Frame Saver Primed**
PVC **Composite Textured**
Mahogany **1-1/4" x 2"**

EXPLORE MORE PRODUCTS



HIGH-QUALITY
MILLWORK
LIVES HERE

NEXT DAY DELIVERY AVAILABLE IN MOST OF OUR SERVICE AREAS

- Order by 5pm for next-day delivery
- Our custom millwork shop can create wood radius trim, curved stair rails, special starting steps, and round top doorways to bring your ideas to life
- Choose from over 40 types of casing for our interior door units without adding lead time to your order
- We offer the most extensive line of interior and exterior entry door systems in Middle Tennessee
- We are your one-stop source for windows, doors, mouldings, hardware, stair and rail systems
- Our lean manufacturing process allows us to offer custom capabilities with short lead times
- Our experienced and knowledgeable sales team has over 100 years of combined experience



SCAN QR CODE
TO VIEW STAIRS,
RAILINGS,
COLUMNS, DOORS &
WINDOWS CATALOG





[WARRENBROS.COM](https://warrenbros.com)



October 2023

 615-885-0355

 700 Massman Drive,
Nashville, TN 37210-3724

 warrenbros@pamudo.com