



[www.carolinastair.com](http://www.carolinastair.com)



# CAROLINA

STAIR SUPPLY

EDITION 15

# Wood & Iron

Search Houzz.com for Carolina Stair

316 Herrick Street, Uhrichsville, Ohio 44683

Tel: 800-364-3269

Tel: 740-922-3333

Fax: 740-922-3330





# Table of Contents

- Special Order Species ..... 2
- Contemporary Series..... 5
- Buckeye Series ..... 6
- Hampton Series ..... 7
- Carolina Series ..... 8-9
- Square Savannah Series ..... 10
- Savannah Series ..... 11
- Biltmore Series ..... 12
- Traditional Series..... 13
- Victorian Newels ..... 14
- Victorian Accessories ..... 15
- Rail Profiles ..... 16-17
- Fittings - Quarterturns, Goosenecks ..... 18
- Fittings - Easements, Caps, Turnouts, Volutes ..... 19
- Linear ..... 20
- Treads, Riser, Linear Items..... 21
- Custom Turnings ..... 22-31
- Iron Finish Options ..... 32
- Powder Coated Regular Twist & Scroll..... 33
- Tapered & Hammered Balusters ..... 34
- Ribbon Twist ..... 35
- Forged Gothic ..... 36
- Hand Forged Balusters ..... 37
- Wave & Curl Forged Balusters ..... 38
- Knee Wall Balusters ..... 39
- Square Stamped & Modern ..... 40
- Iron Accessories & Rail Zip Clip ..... 41
- Fusion & Horizontal Bar ..... 43
- Olé Iron Slides™ Indoor & Outdoor ..... 44-45
- Accessories ..... 46



316 Herrick Street, Uhrichsville, Ohio 44683

Tel: 800-364-3269  
 Tel: 740-922-3333  
 Fax: 740-922-3330

## The 3X Concept

Developed to increase ordering efficiency, the 3X Concept ensures a perfect fit by simply trimming off the excess length from the top of the baluster. It can be applied to the following:

- Page 9: #4415-P  
 #4415-F  
 #4415-T
- Page 11: #5011-P  
 #4011-P  
 #4011-F
- Page 12: #5715-P  
 #5715-F  
 #5715-R



We also offer a priming service for all of our products. Available in flat or gloss white finish.

*Pictured:*  
 Left: 5015  
 Right: 4003-F

All newels and balusters featured in this catalog are available in Oak or Poplar.

In addition to our Oak and Poplar parts that we stock, we are pleased to offer all of the products in this catalog, by special order, in the following species:



We have now added a **New 5-axis** router to our lineup in manufacturing, giving us the ability not only to increase volume on our standard products but also allowing us to offer new products: **Curved Rake Rail, Ornate Baluster Panels, Knock-Down Stair Kits, or Fully Assembled Curves and Straights.**

**Custom Curved Handrail and Ascending Fitting:**

We can provide curved rake rails and transitional fittings down to a 6" radius in most detailed profiles and down to a 4.5" radius with non-detailed profiles—curved transitional fittings (when your stair goes from straight to curved or curved to straight). We can also add custom plows widths and depths to the underside of our CNC rails allowing for square top balusters or to fit over a metal cap.

**Pre-fits:**

Is your curved staircase or metal cap rails already exist? No problem, let our team field laser measure and manufacture pre-fit CNC rail to match as built curved stairs and drop-over metal cap rails.

We also do custom iron panels, balusters & metal rails. So give us a call on your parts; we can help you get the job done, whether they're stock or custom.





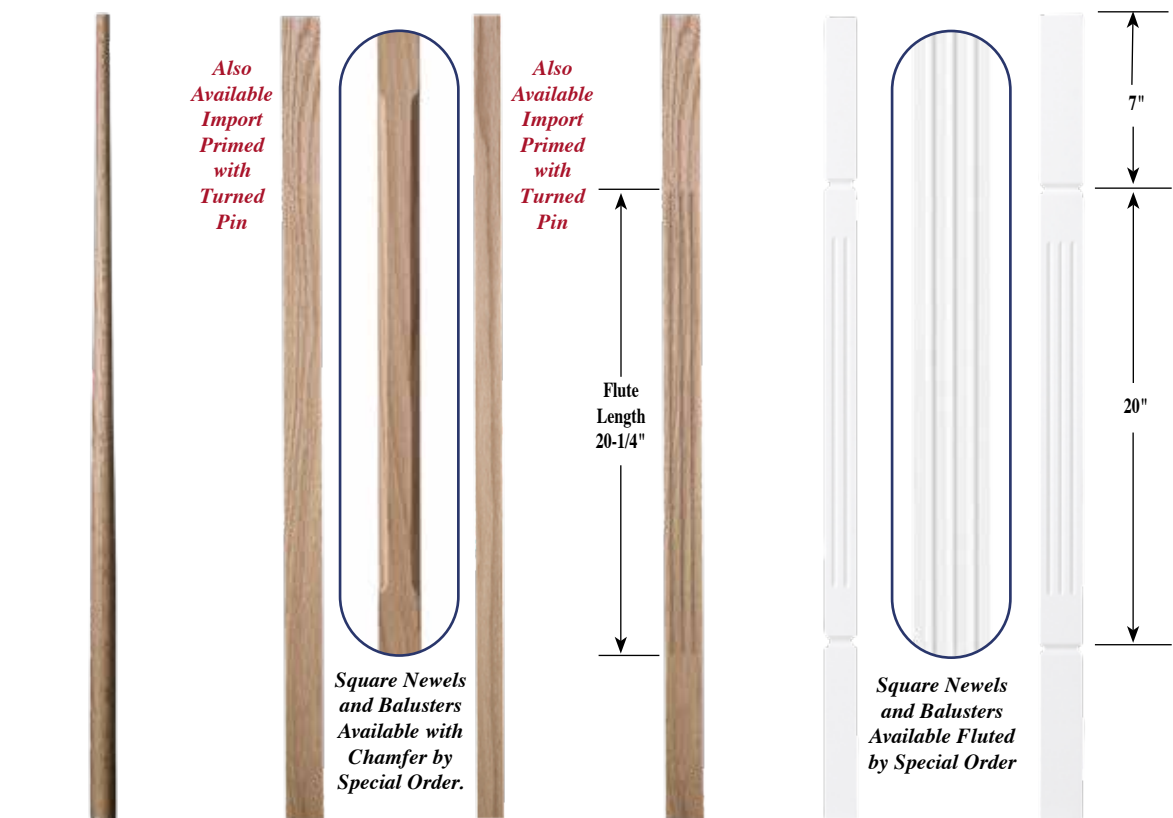

0150-P	0175-P	0125-P	0175-F	0125-VFL	0175-VFL
Round Pool Cue	1-3/4" x 31"	1-1/4" x 31"	1-3/4" x 31"	1-1/4" x 31"	1-3/4" x 31"
1-3/16" x 36"	1-3/4" x 34"	1-1/4" x 34"	1-3/4" x 34"	1-1/4" x 34"	1-3/4" x 34"
1-3/16" x 39"	1-3/4" x 36"	1-1/4" x 36"	1-3/4" x 36"	1-1/4" x 36"	1-3/4" x 36"
1-3/16" x 41"	1-3/4" x 39"	1-1/4" x 39"	1-3/4" x 39"	1-1/4" x 39"	1-3/4" x 39"
Includes Dowel	1-3/4" x 42"	1-1/4" x 42"	1-3/4" x 42"	1-1/4" x 42"	1-3/4" x 42"

800-364-3269

Available in most species

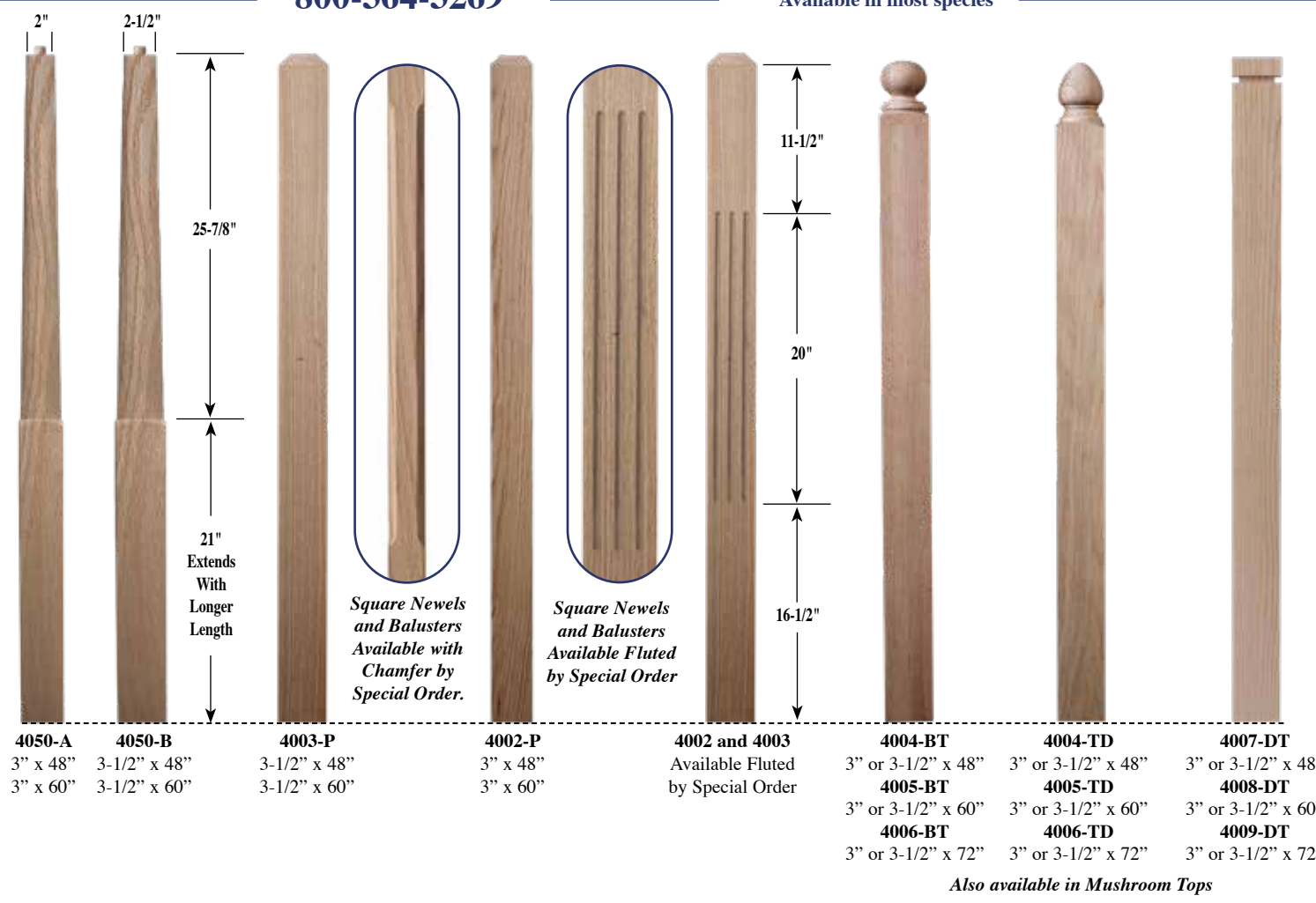

Contemporary

Newels



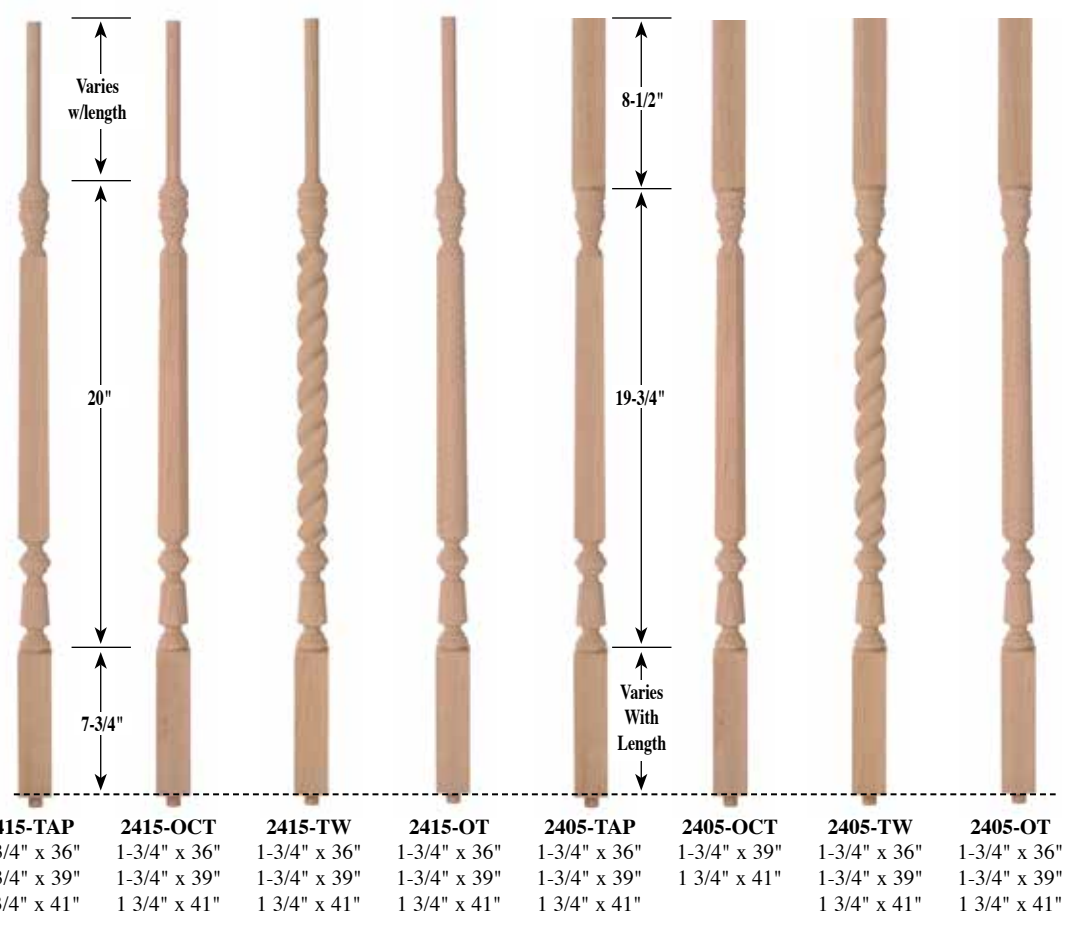

By Special Order

800-364-3269

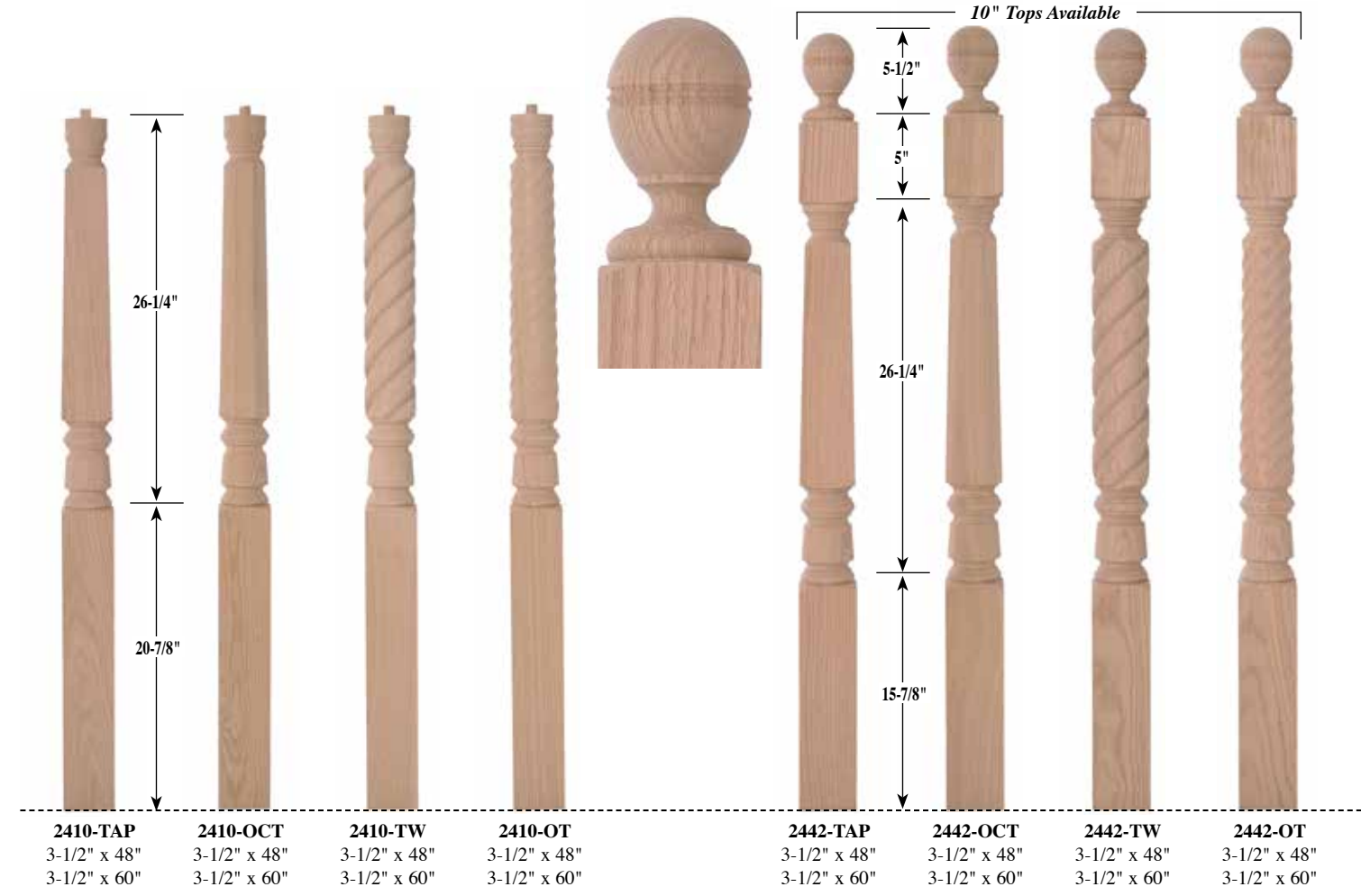

This series available in octagon by special order.  
(Excluding # 5205P & #5200P)

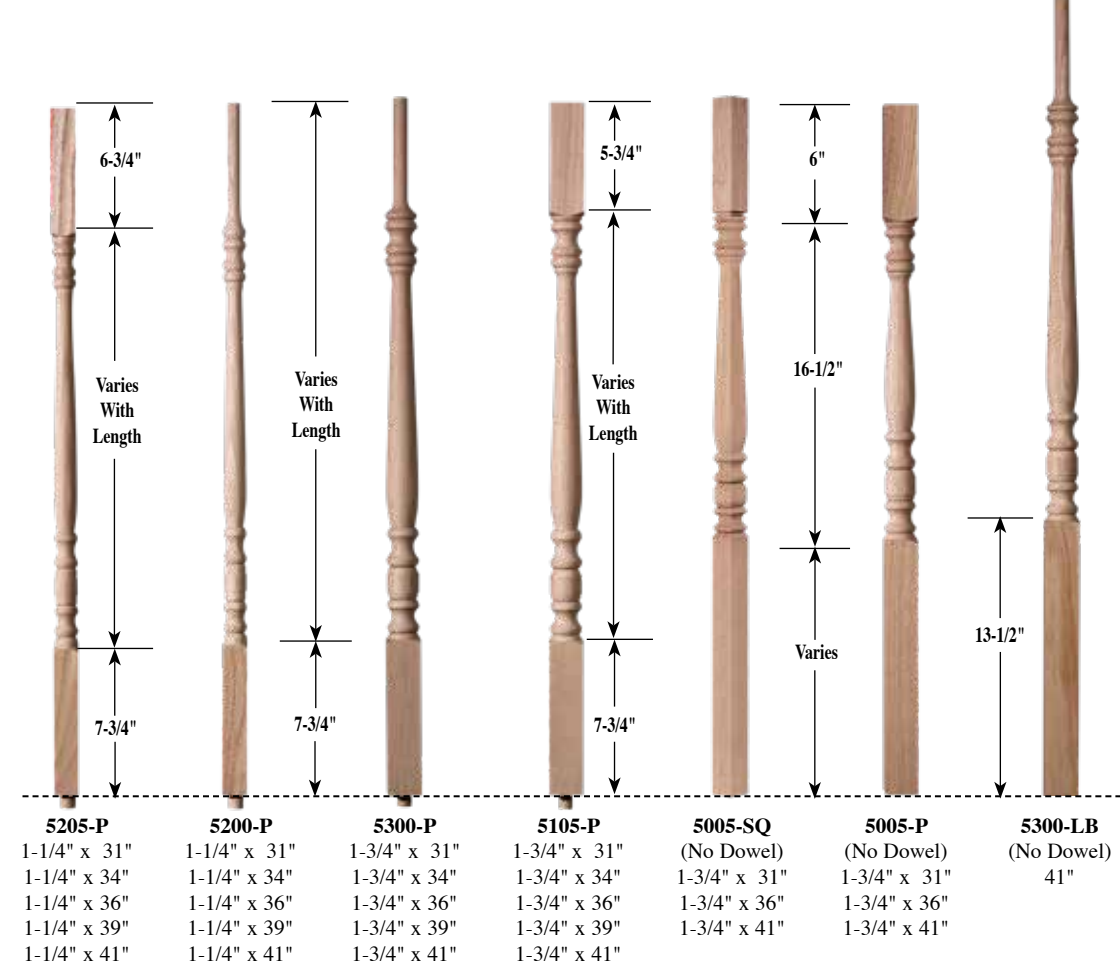

Available in most species

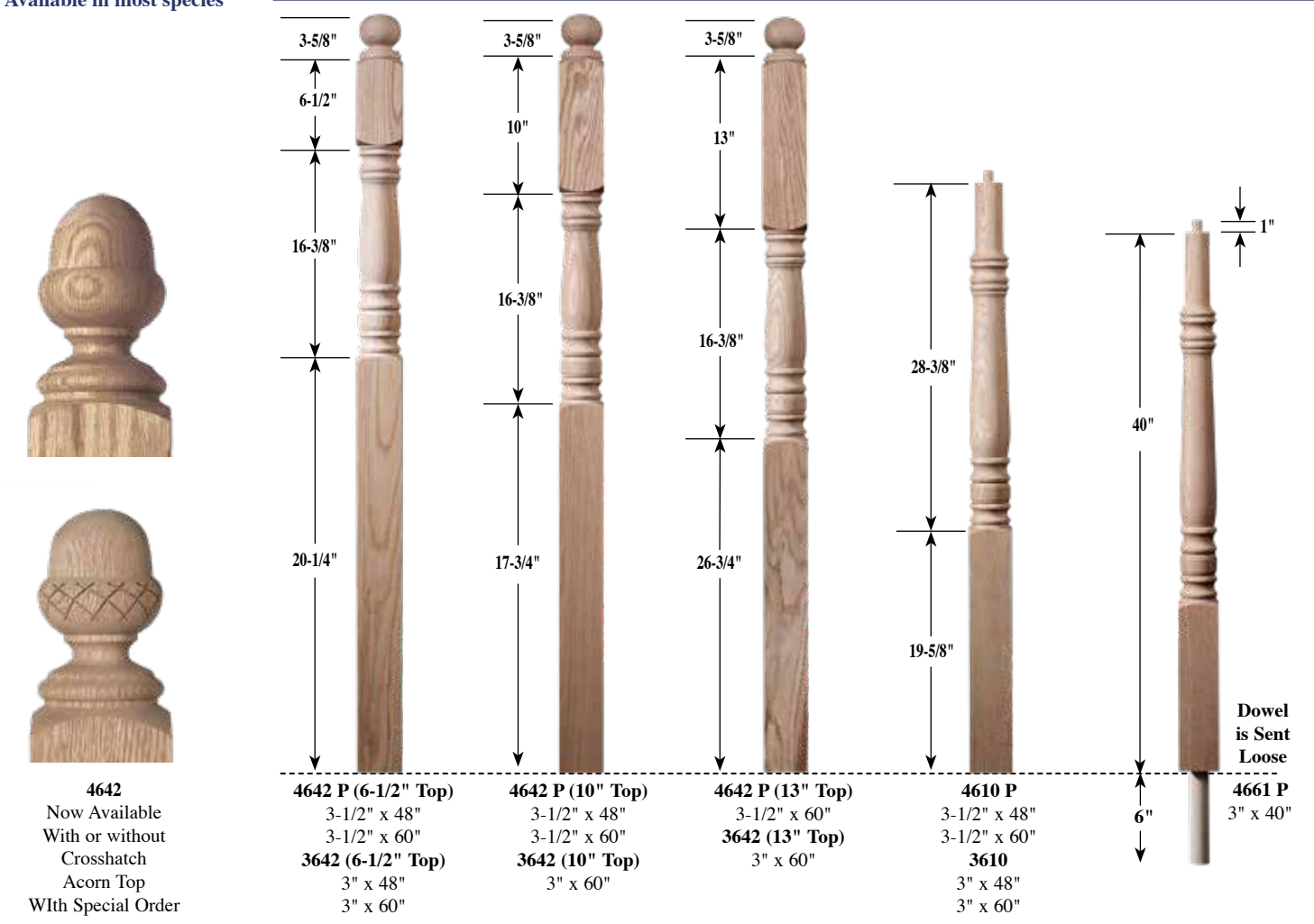



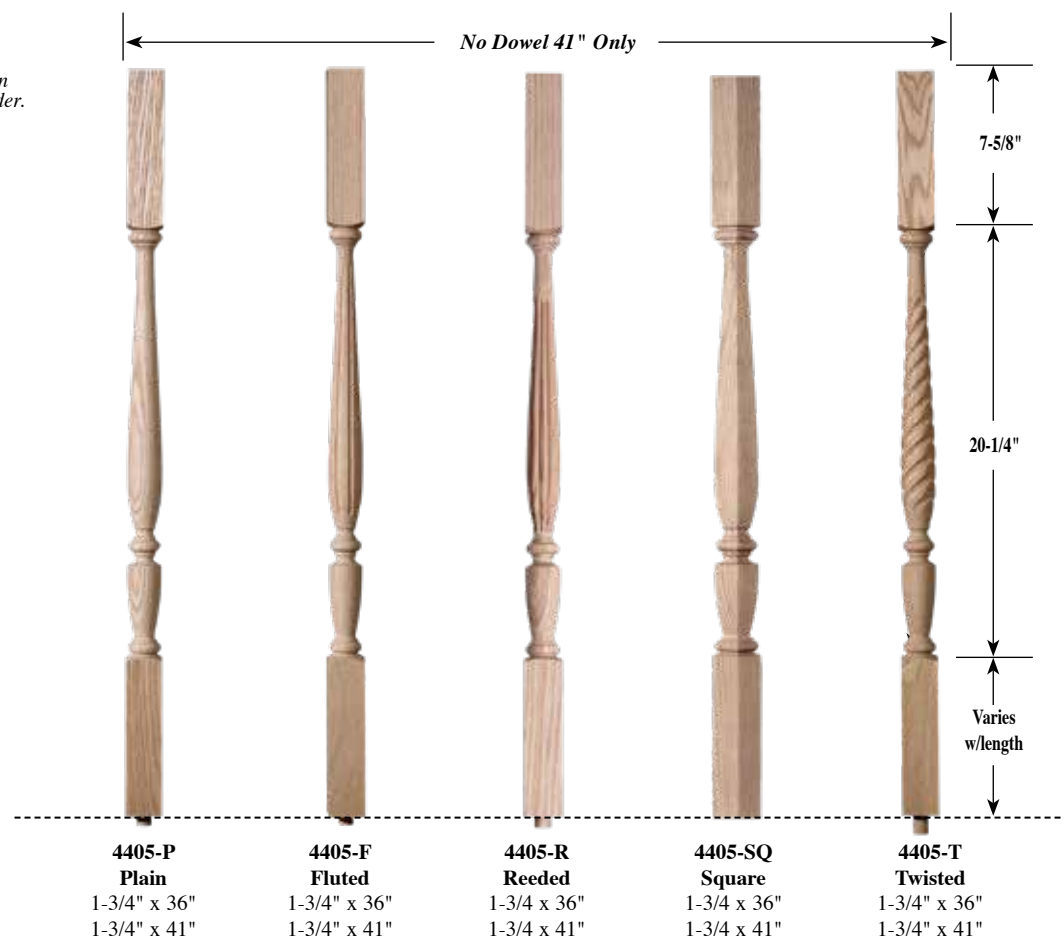

 This series available in octagon by special order.

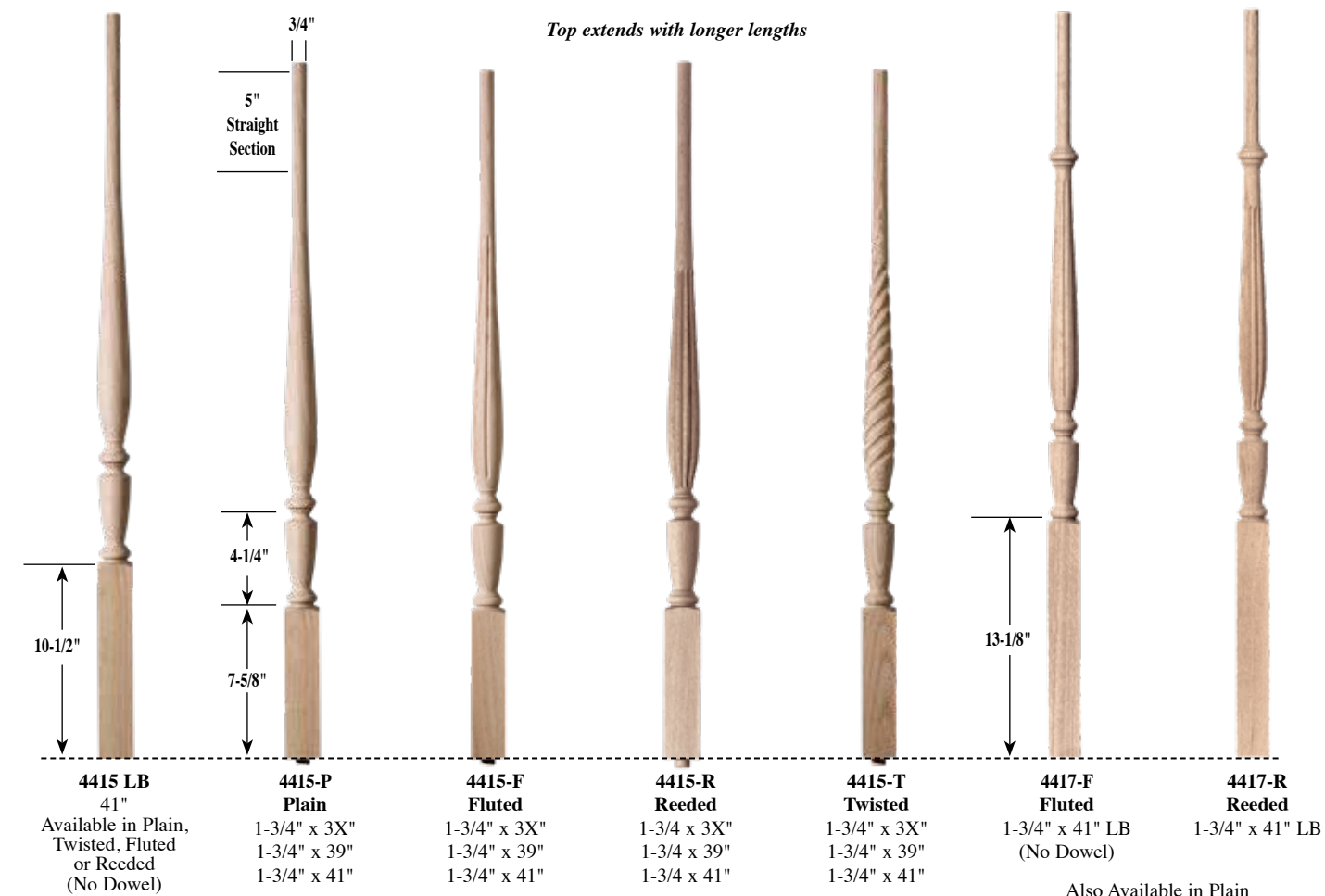

800-364-3269



Available in most species

 This series available in octagon by special order.



**4442**  
Now Available With or without Crosshatch Acorn Top With Special Order

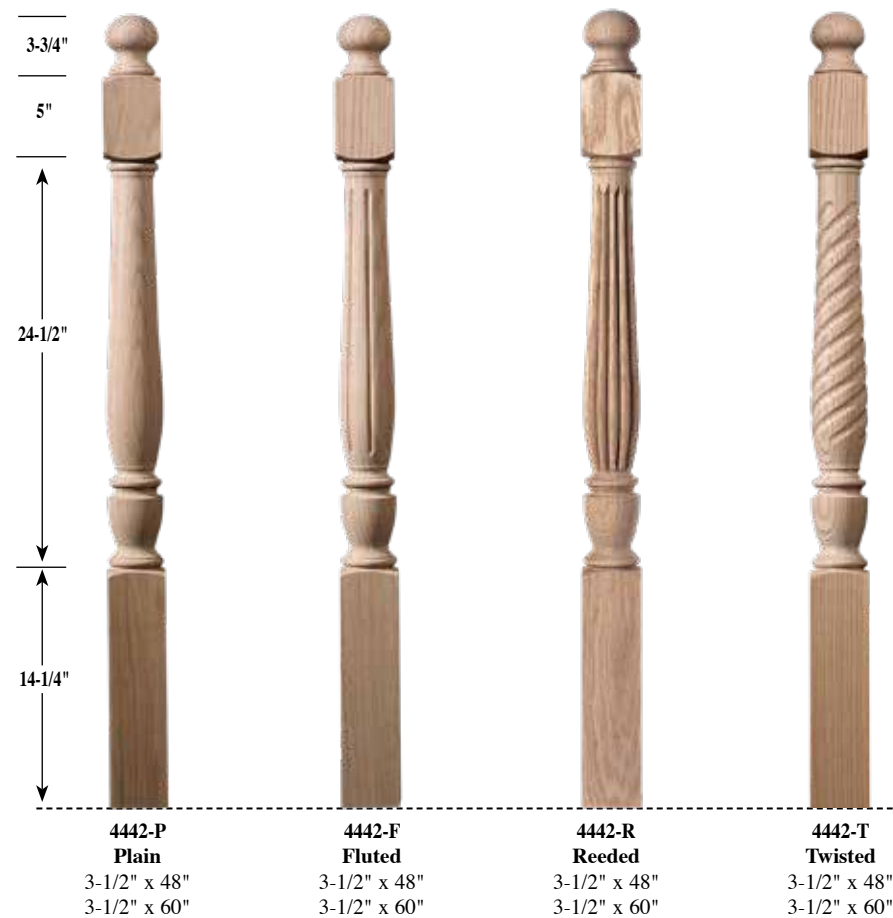

When ordering #4442 series, please specify 5", 10", or 13" top. 10" & 13" Top Available in 60" Only

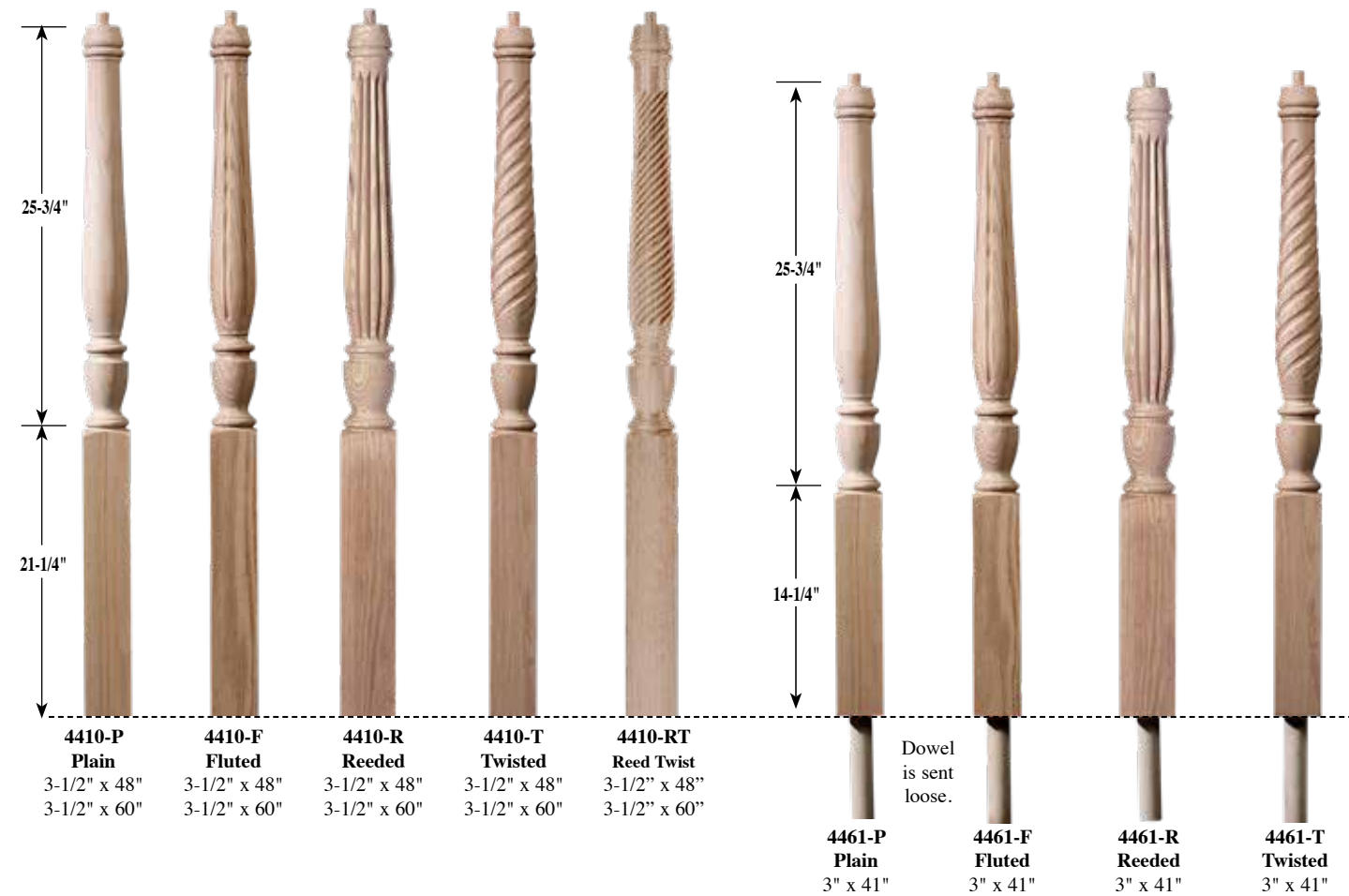



By Special Order

800-364-3269

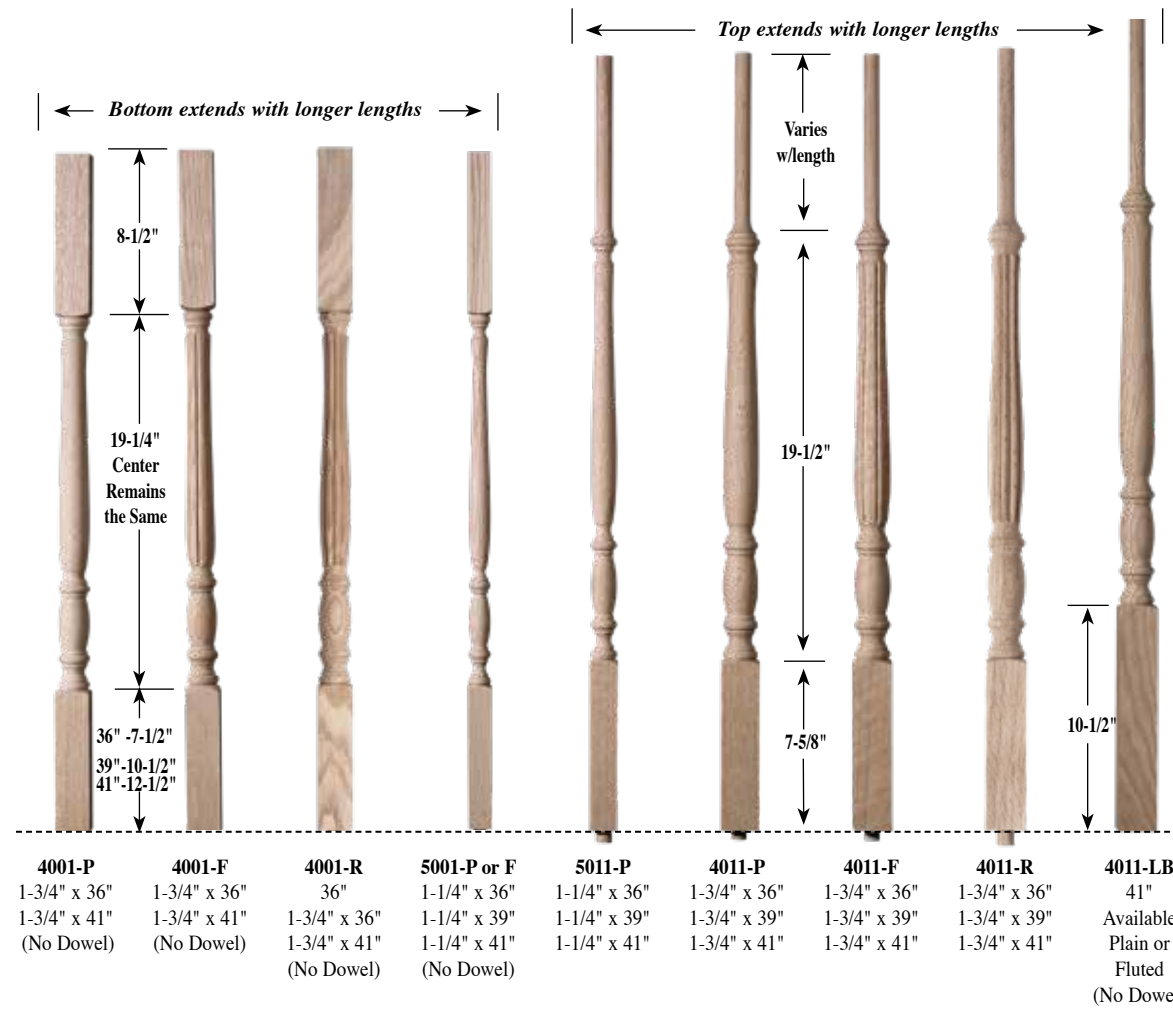
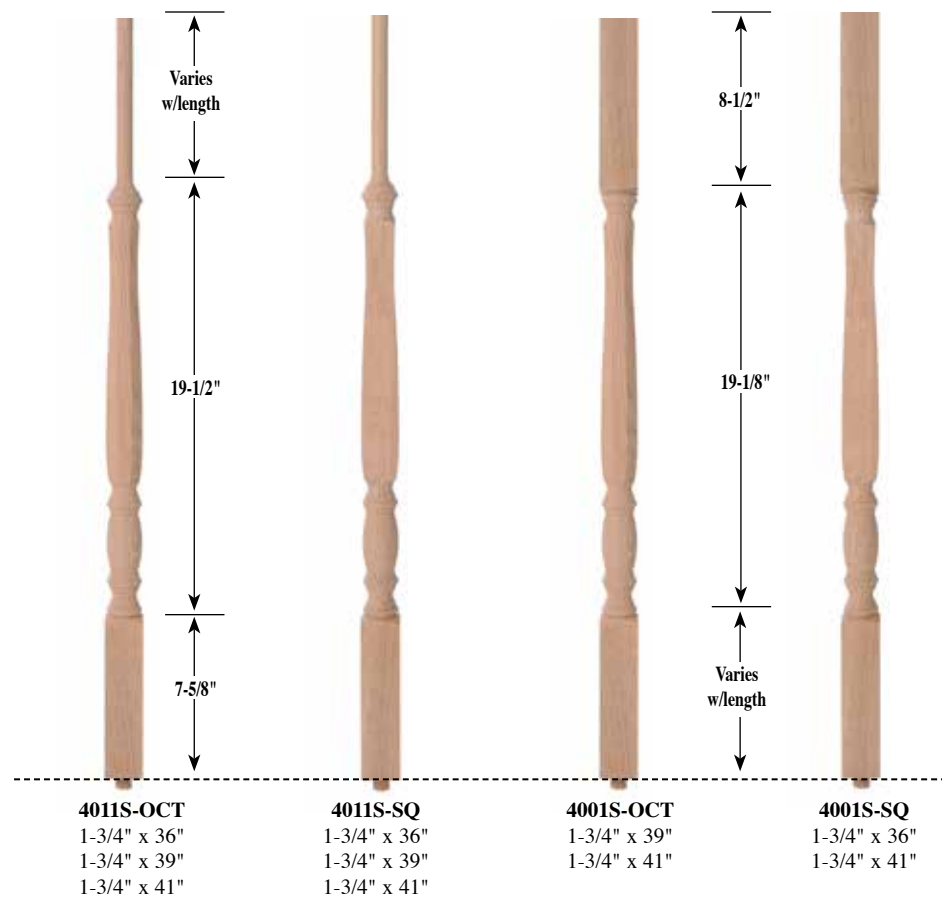

Available in most species

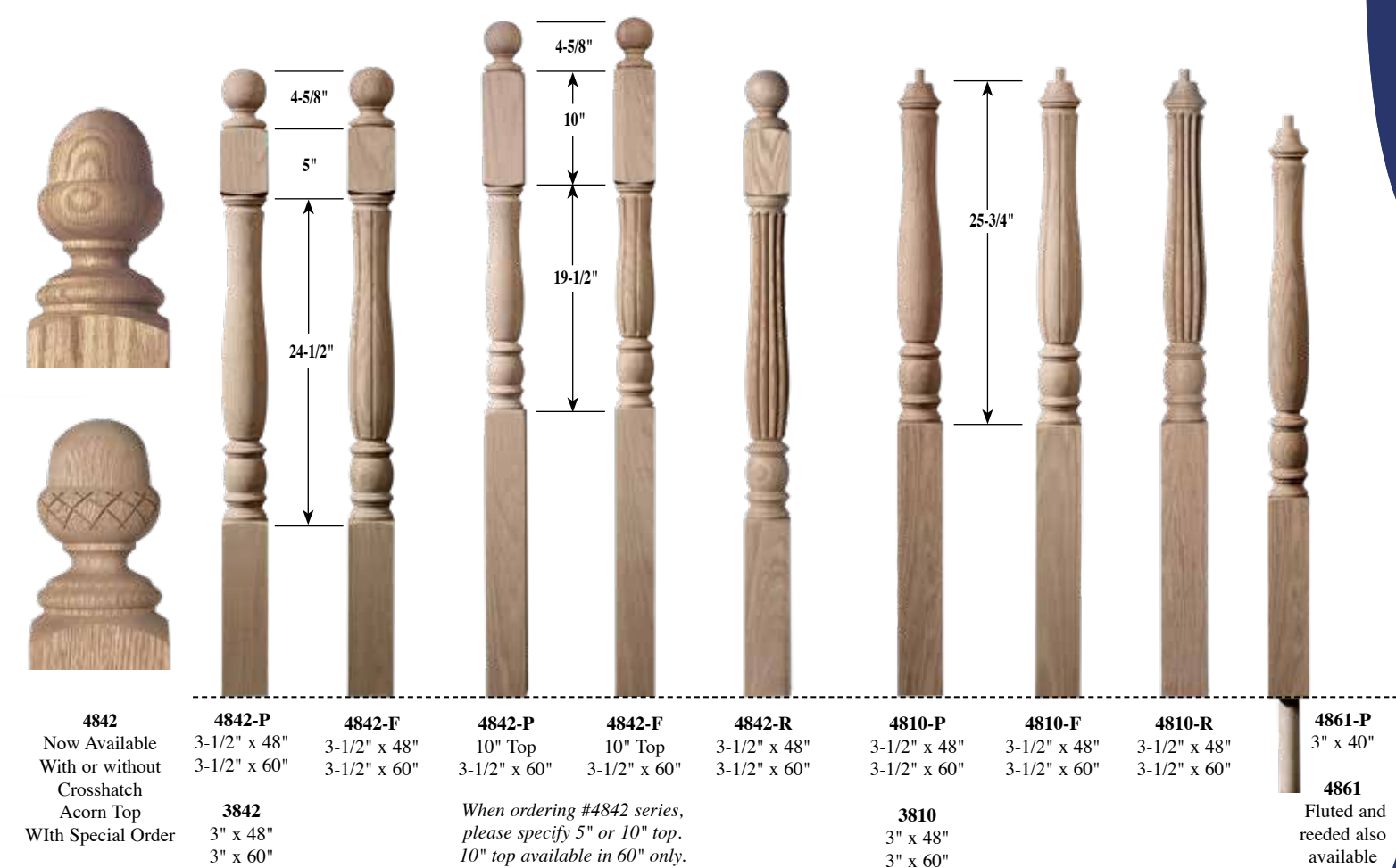
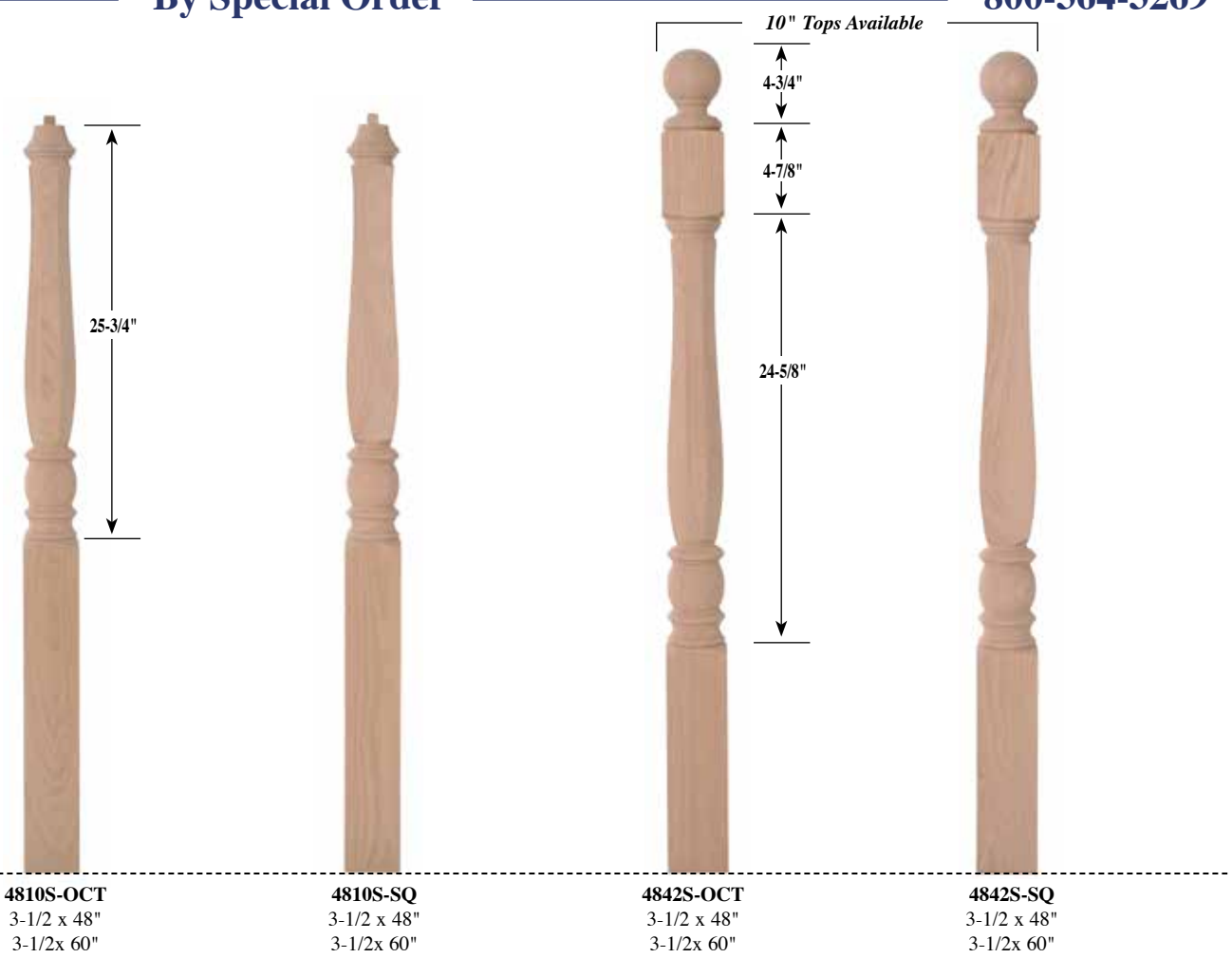



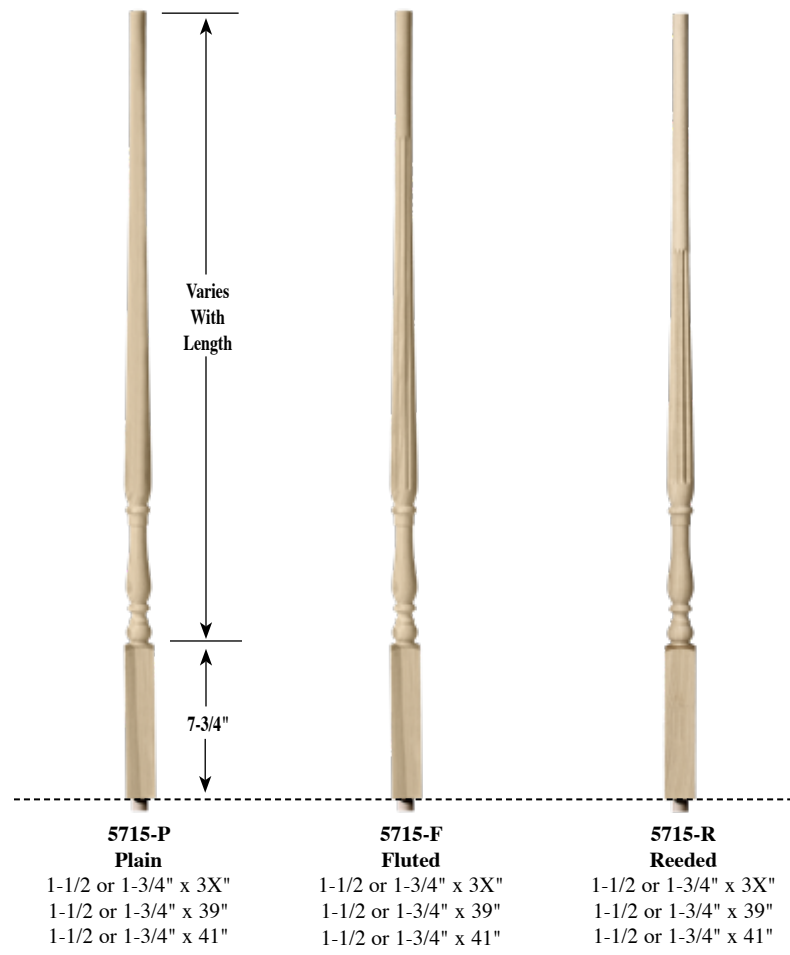

800-364-3269

Below are examples of the newel top options that are available for the items in our Traditional line of Wood Stair Parts.

All traditional balusters can be fluted, twisted, or reeded upon request.

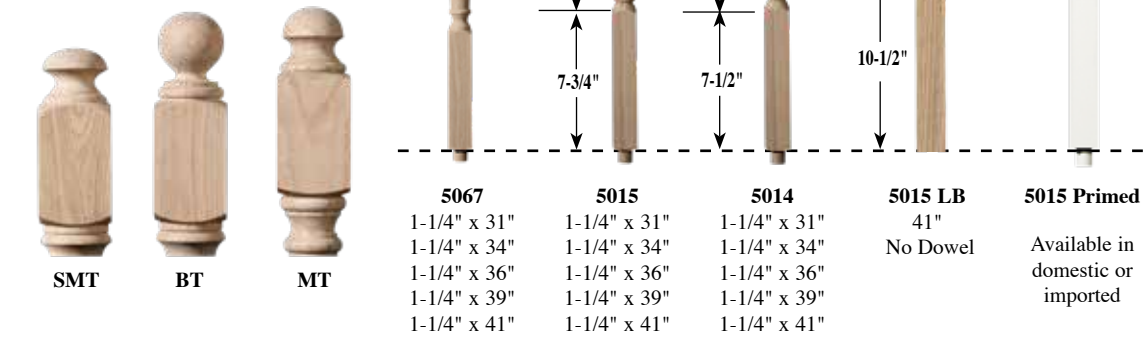

Available in most species

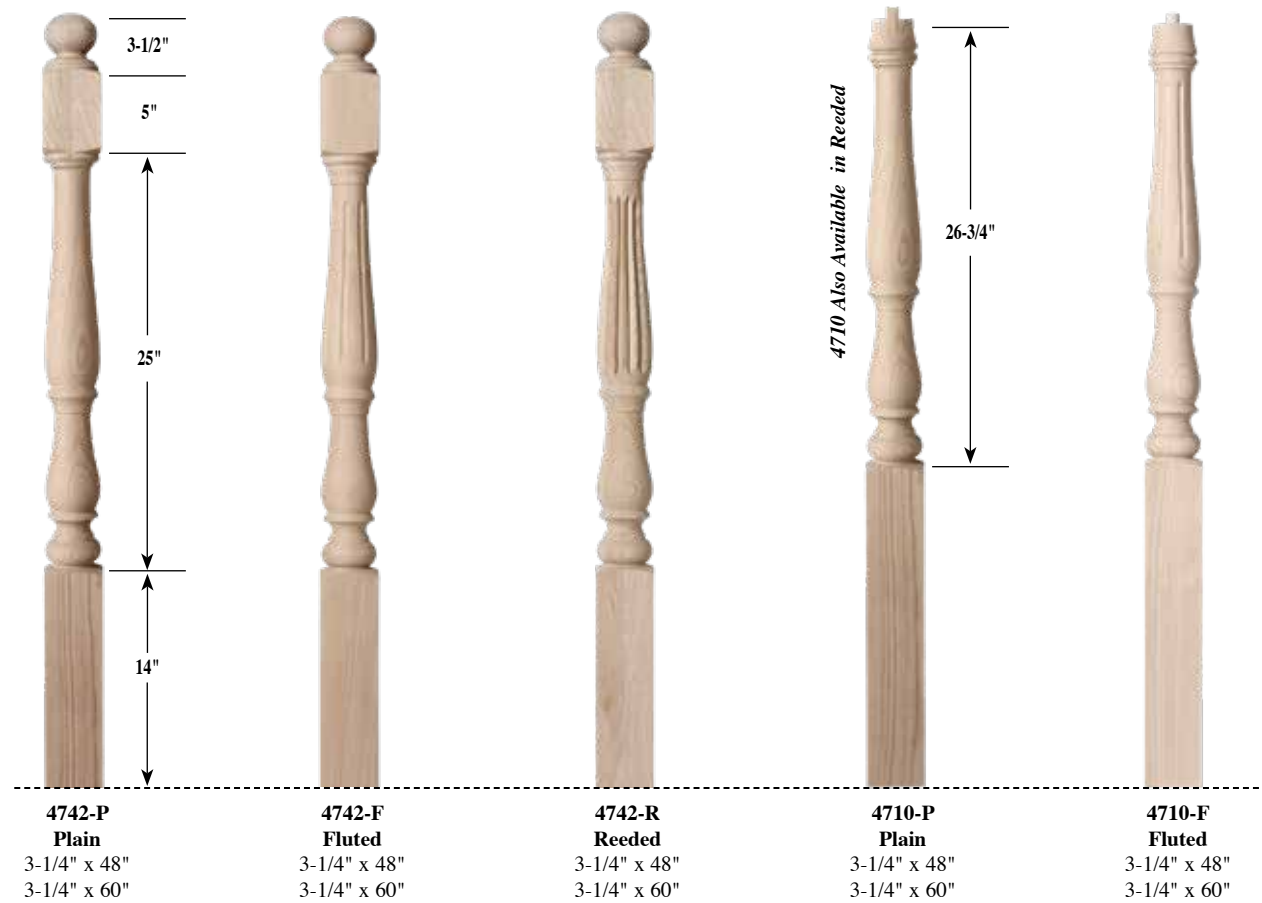

60" Available in 5", 10" or 13" Top Block Please specify when ordering.  
Newels Also Available in 3-1/2" by Special Order.

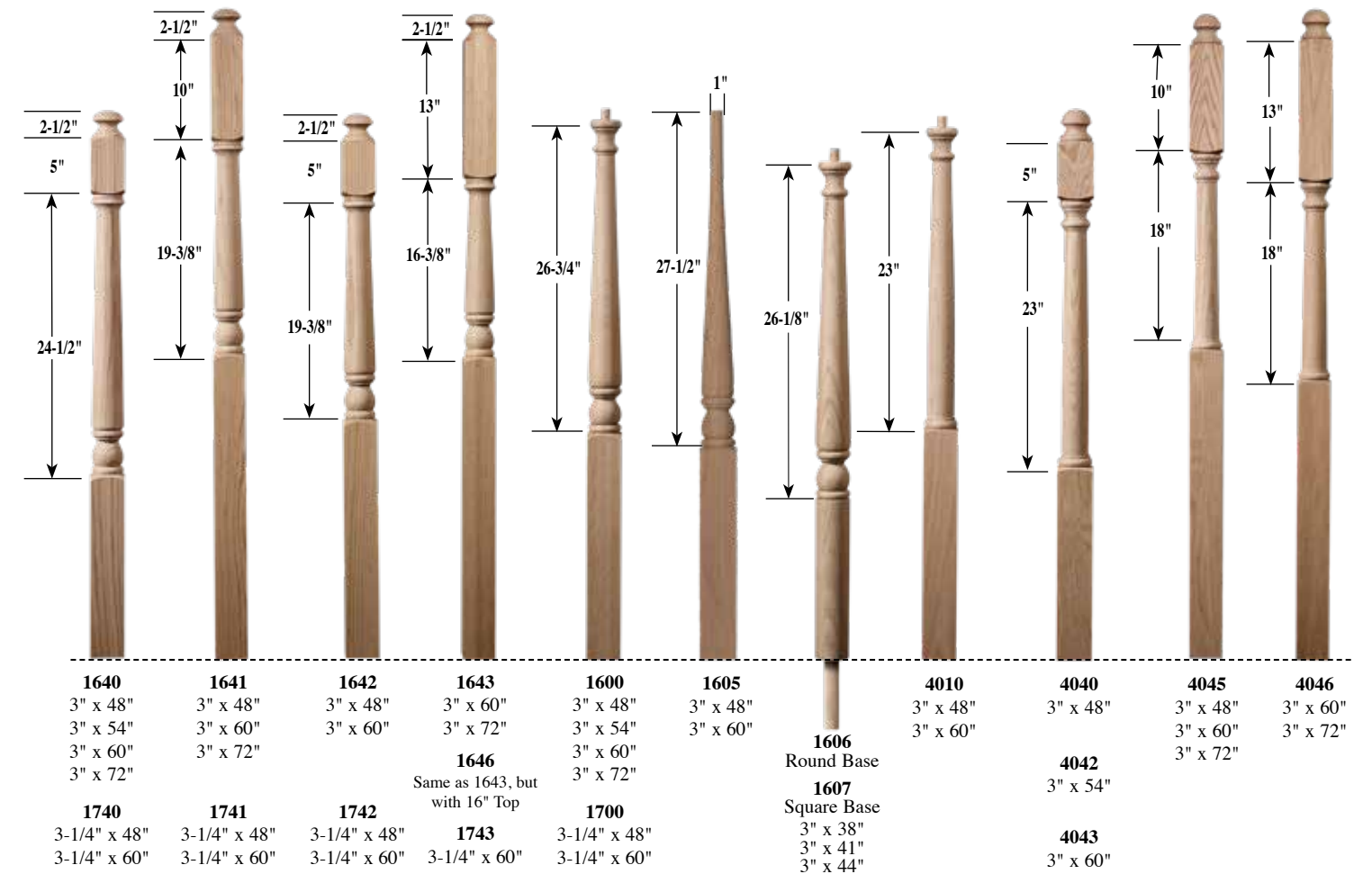



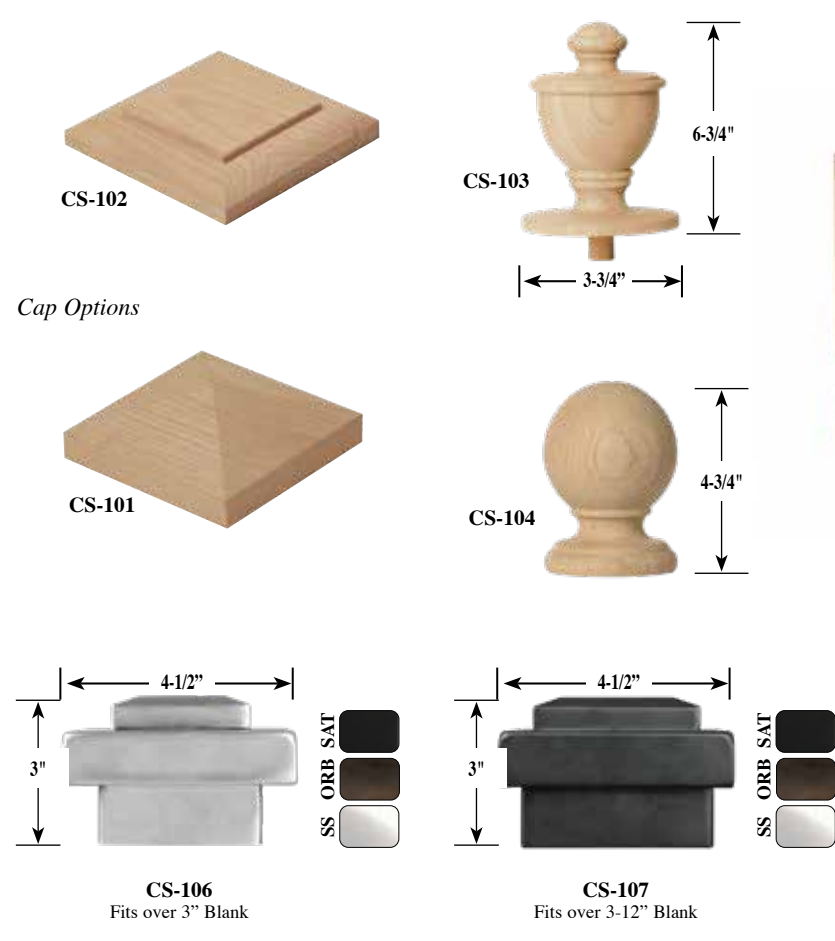
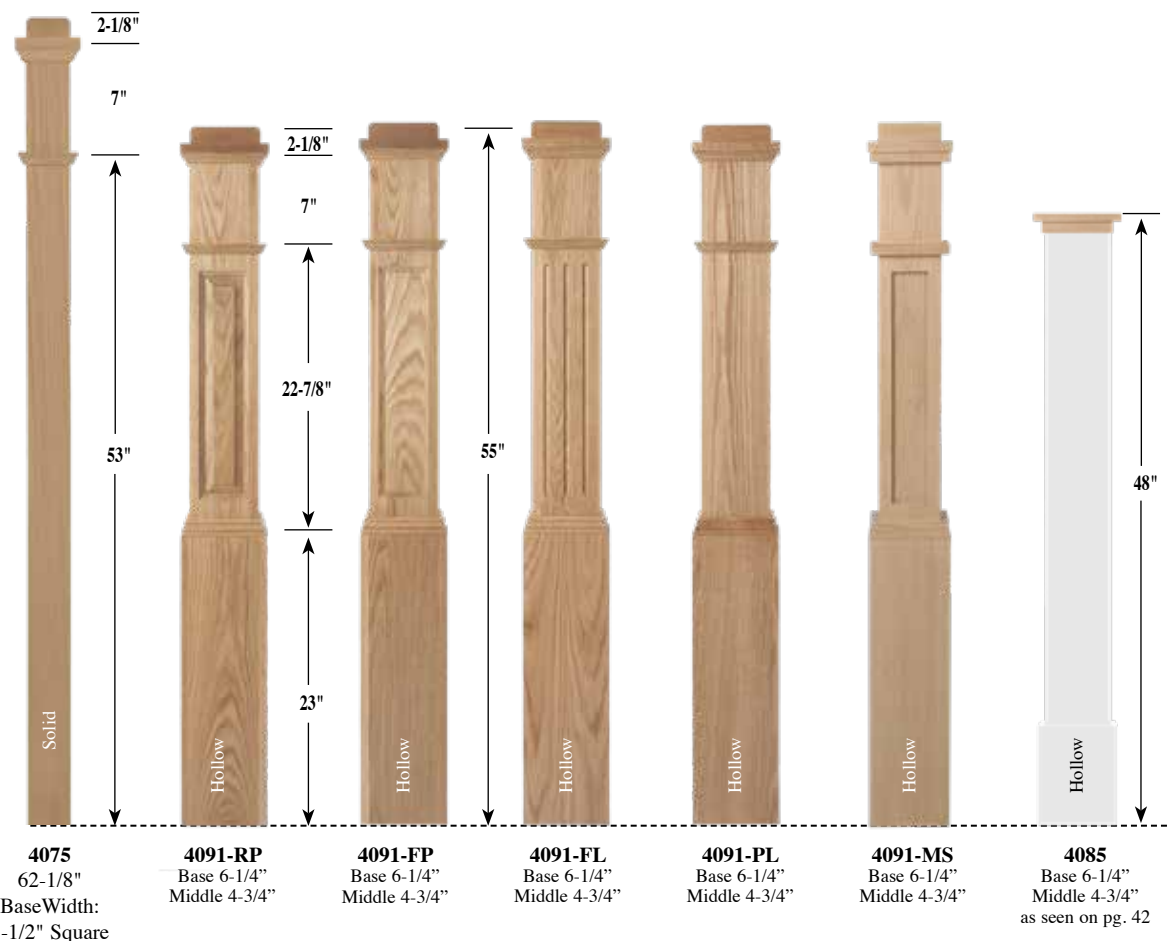

4091 Caps for Box Newels.  
Can make virtually any fitting.  
Can make to fit 4091, 4092, 4095 or 4392  
Customer must specify

800-364-3269

Available in most species





**#70 6010**  
Traditional Bending Rail  
6010 B 7 Pieces

**#71 6115**  
Mid-Western Bending Rail  
6115 B 8 Pieces

**#72 6210**  
Traditional Bending Rail  
6210 B 8 Pieces

**#73 6300**  
Carolina Bending Rail  
6300 B

**6005**

**6410**  
Bending Rail & Fittings Available  
Williamsport

**#75 6519**  
Hampton Bending Rail  
6519 B 8 Pieces

**#76 6600**  
Raleigh Bending Rail  
6600 B 10 Pieces

**#77 6700**  
Georgian Bending Rail  
6700 B 8 Pieces

**#78 6800**  
Charleston Bending Rail  
6800 B 8 Pieces

**8100**  
Bending Rail & Fittings Available  
Savannah

**8200**  
Bending Rail & Fittings Available  
Colonial

**8300**  
Bending Rail & Fittings Available  
Newport

**#79 6900**  
Raleigh Jr. Bending Rail  
6900 B 8 Pieces

**6000**  
Bending Rail & Fittings Available  
For Plowed Please Specify 1-3/4" or 1-1/4"

**6025**  
r = 3/8"  
3-1/2" 5-1/2"  
1-5/8"  
1-5/8"  
1-3/4"  
Modern

**9400**

**9500**

**9600**

**9700**

**8400**

**8500**

**8700**  
Bending Rail & Fittings Available

**R-1**  
Bending Rail & Fittings Available

**R-2**  
Bending Rail & Fittings Available

**R-3**  
Bending Rail & Fittings Available

**8800**  
Bending Rail & Fittings Available

**8900**  
Bending Rail & Fittings Available

**9100**  
Bending Rail & Fittings Available

**9200**

**R-5**  
Bending Rail & Fittings Available

**R-6**  
Bending Rail & Fittings Available

**R-7**  
Bending Rail & Fittings Available

**R-8**  
Bending Rail & Fittings Available

**9000**

**9300**

**R-4 Allied**  
Allied

**R-9**  
Bending Rail & Fittings Available

**R-10**  
Bending Rail & Fittings Available

**R-11**  
Bending Rail & Fittings Available

**R-15**  
Bending Rail & Fittings Available  
Mincey



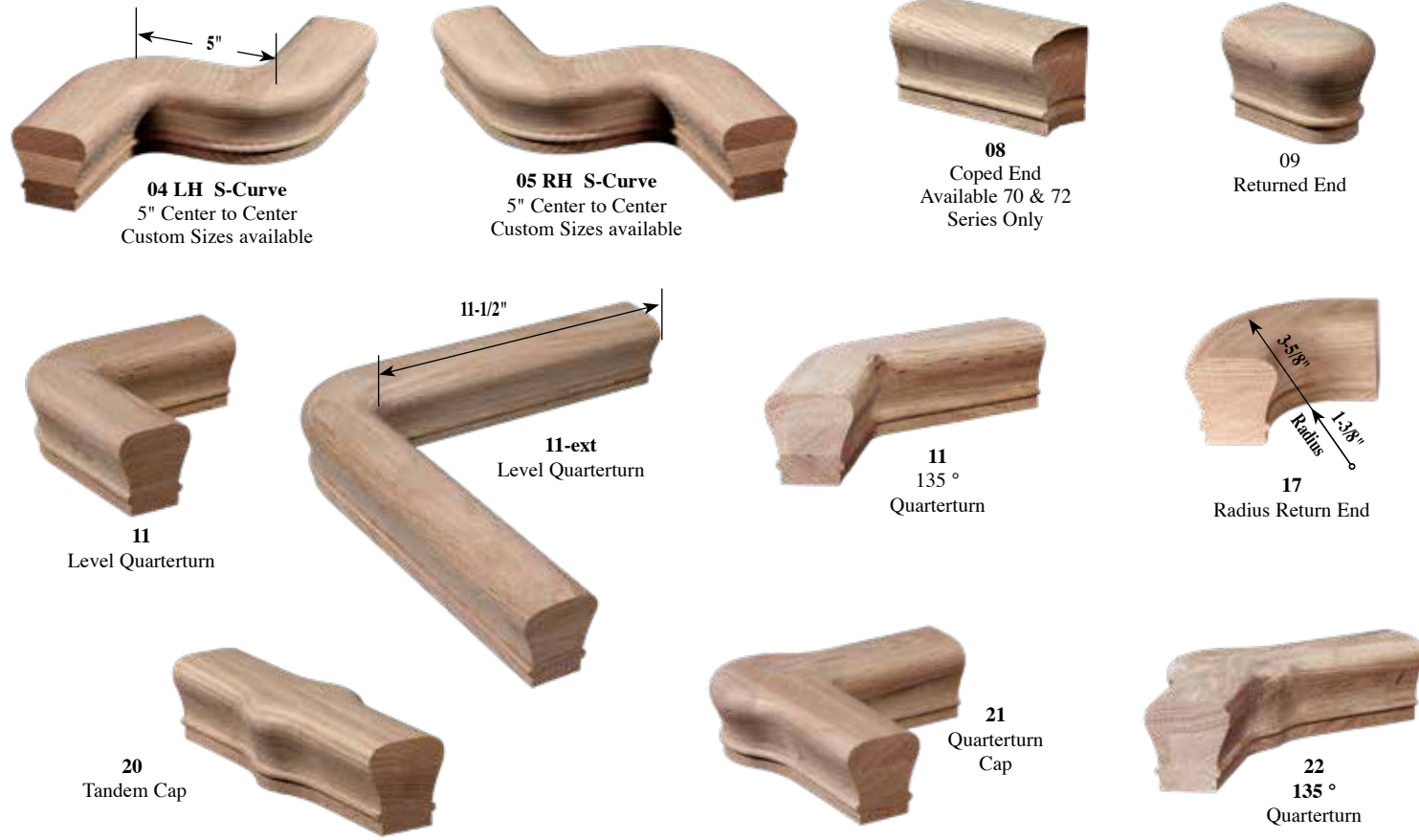

800-364-3269

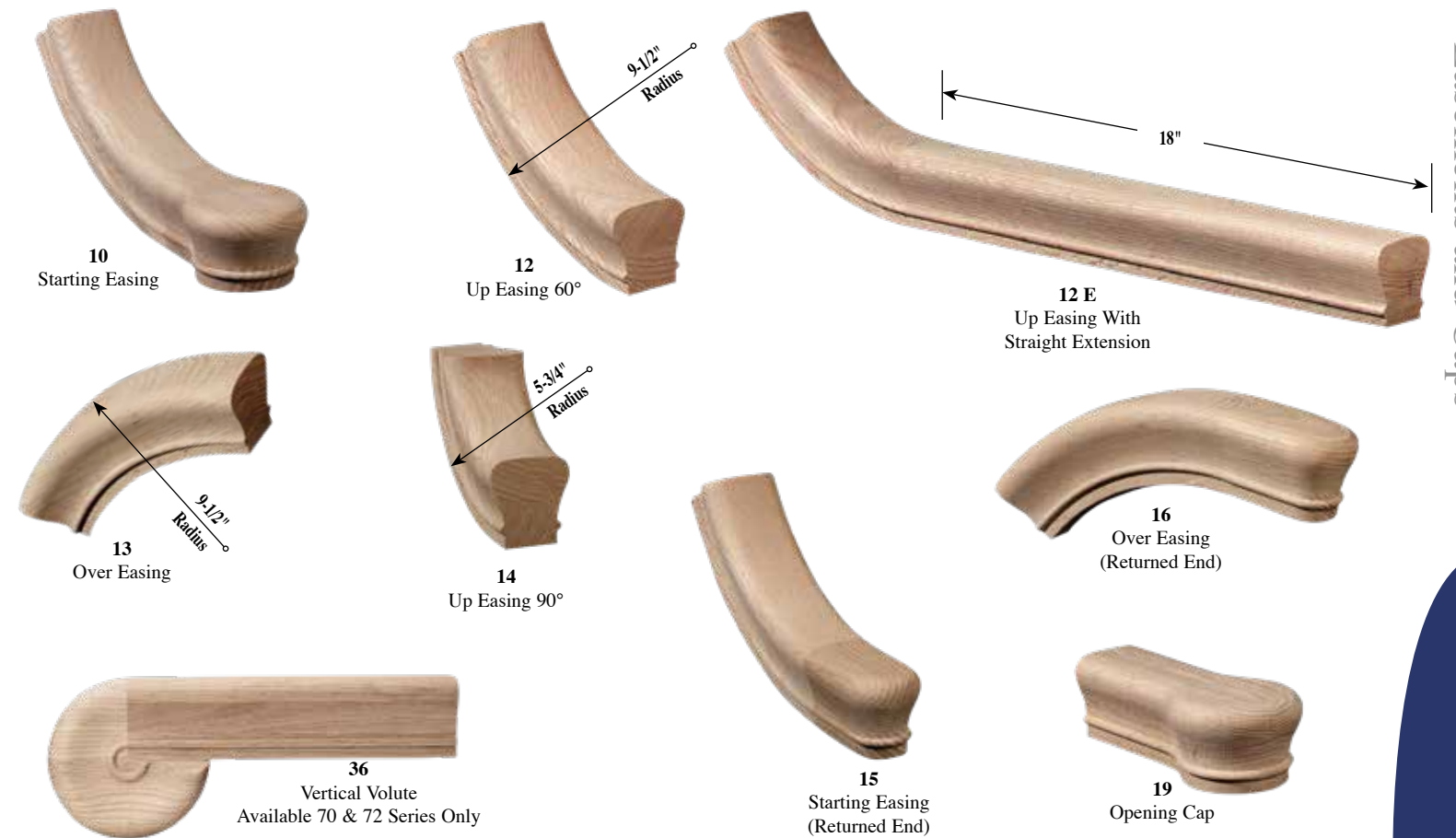

Available in most species



70 & 73 Series are 4-7/8" from center of newel to center of handrail.  
All other profiles are 5-1/8".

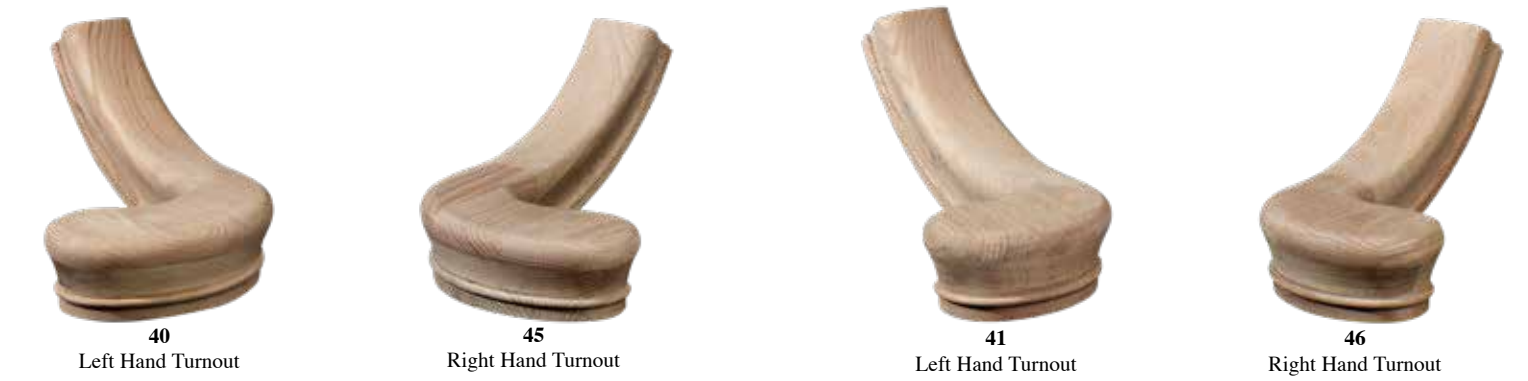

4-7/8" From Center of Newel to Center of Handrail

2-7/8" From Center of Newel to Center of Handrail



**8085**  
Nosing  
1-1/16" x 1-1/2"

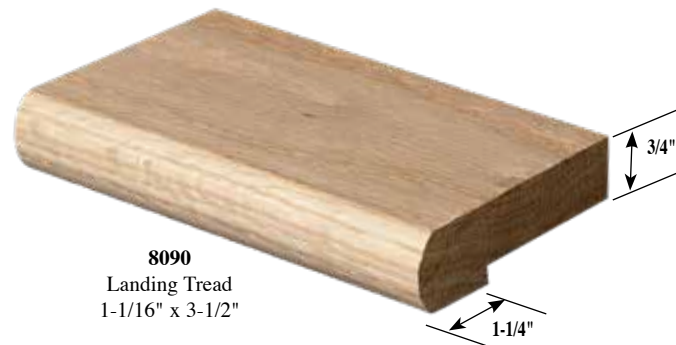

**8090**  
Landing Tread  
1-1/16" x 3-1/2"

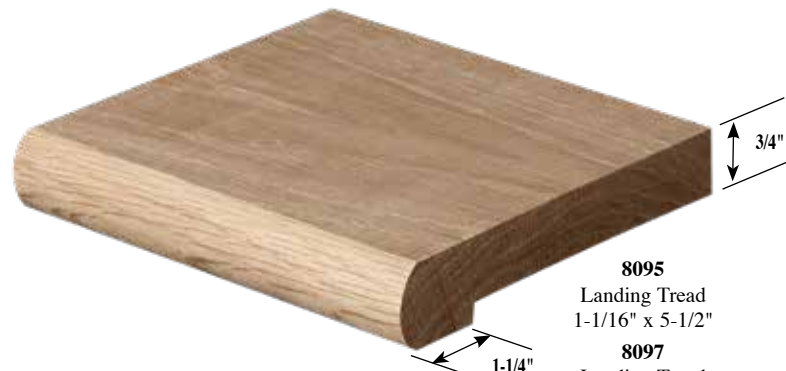

**8095**  
Landing Tread  
1-1/16" x 5-1/2"



**6910 - Cove Mold**  
3/4" x 3/4"  
**6904 - Cove Mold**  
1/2" x 5/8"  
**6902 - Cove Mold**  
5/8" x 5/8"



**6912**  
Stringer Mold  
1-3/8" x 5/8"



**6915**  
Stringer Cap  
5/8" x 1/2"

Available Sizes  
Fittings Now Available  
1-1/2"  
1-3/4"  
2"  
2-3/8"  
2-7/8"  
2-1/8"



**RND-1**  
Round Rail  
Special Order



**6040**  
Wall Rail  
1-1/2" x 1-1/2"



**6042**  
Wall Rail  
1-5/16" x 2-1/4"  
Fittings Now Available  
Easements & Quarterturns



**6043**  
Wall Rail  
1-3/4" x 1-5/8"



**6044**  
Fusion Handrail  
2-1/8" w x 2" h  
7/8" Flat Bottom

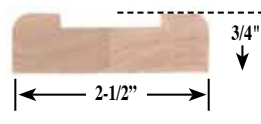

**1001-MS**



**1000**  
Fillet  
3/16" x 1-1/4"  
3/16" x 1-3/4"



**1001**  
Shoe Rail  
3/4" x 3-1/8" x 1-3/4" Plow  
3/4" x 2-3/8" x 1-1/4" Plow



**1002**  
Flat Fillet  
3/16" x 1-1/4"  
3/16" x 1-3/4"



**8010**  
Reversible Single  
"Bull Nose" Starting Step  
Specify: 36", 42", 48", 54" or 60"  
Measurement is distance from "notch to notch."  
Also available in bowed front.



**8010 F**  
Reversible False End  
Starting Step

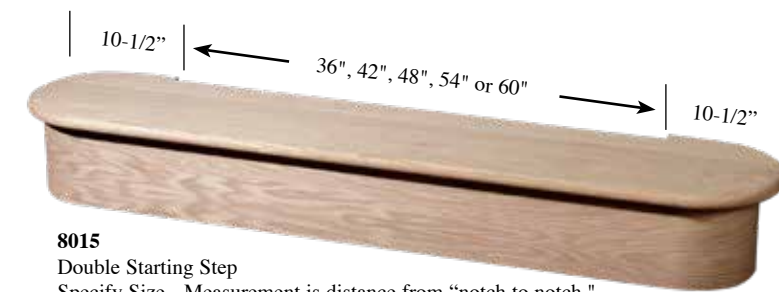

**8015**  
Double Starting Step  
Specify Size - Measurement is distance from "notch to notch."  
Also available in bowed front.



**8070**  
10-1/2" Tread  
**8071** 11-1/2" Tread  
Specify " 36", 42", 48" 54", 60" or 72"  
1-1/2" Mitre Return: RH, LH or Double

8072, 8073, 8074, 8075 & 8076

Available prefinished in stock Minwax colors

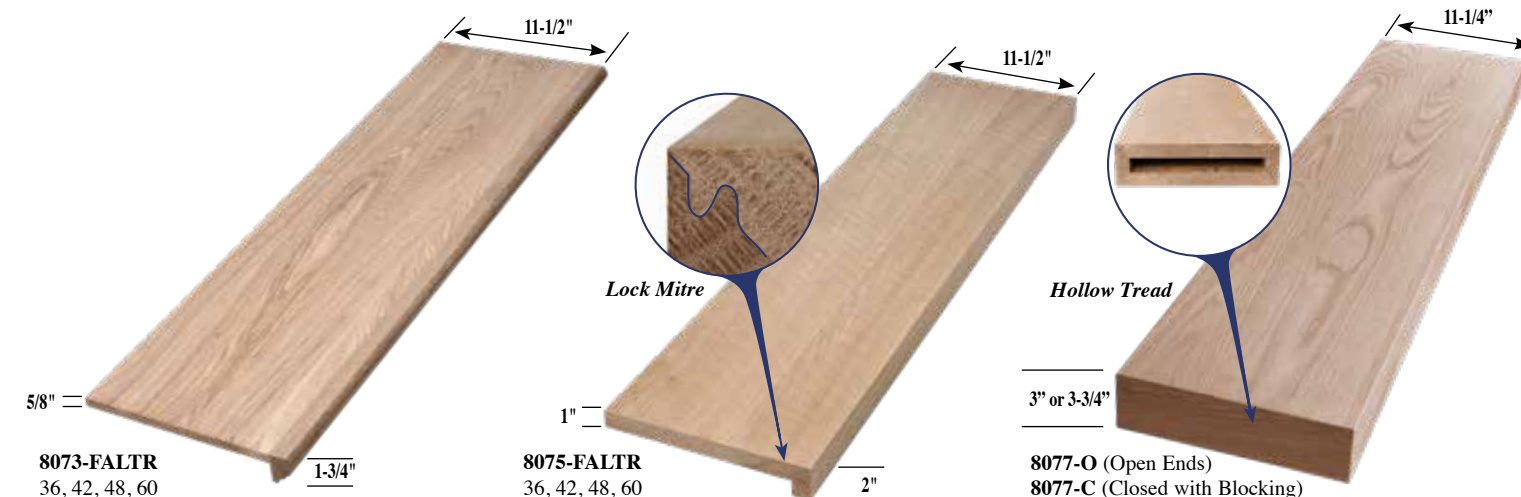

**8073-FALTR**  
36, 42, 48, 60  
False full-length tread.  
Left hand or right hand available upon request.  
Available prefinished in stock Minwax colors

**8075-FALTR**  
36, 42, 48, 60  
False full-length tread.  
Left hand or right hand available upon request.

**8077-O** (Open Ends)  
**8077-C** (Closed with Blocking)  
42, 48, 60

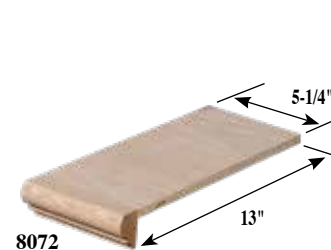

**8072**  
False End  
(No M.R.)

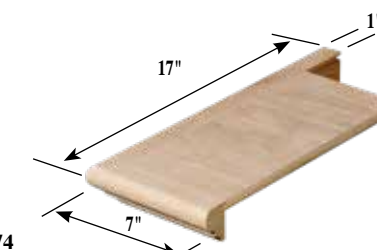

**8074**  
M.R. False End  
Specify: RH or LH



**8076**  
False Riser  
1/2" thick



**Winder Tread Panels**  
**8078-TPNL**  
1" x 25" x 42"  
1" x 25" x 48"  
1" x 25" x 60"



**97 "STR" Stringer**  
1" or 3/4" thick



**8080**  
Riser  
Specify Size:  
3/4" x 36", 42", 48", 54" or 60"  
1 x 8" S4S 1 x 6" S4S 1 x 4" S4S



Custom Profiles

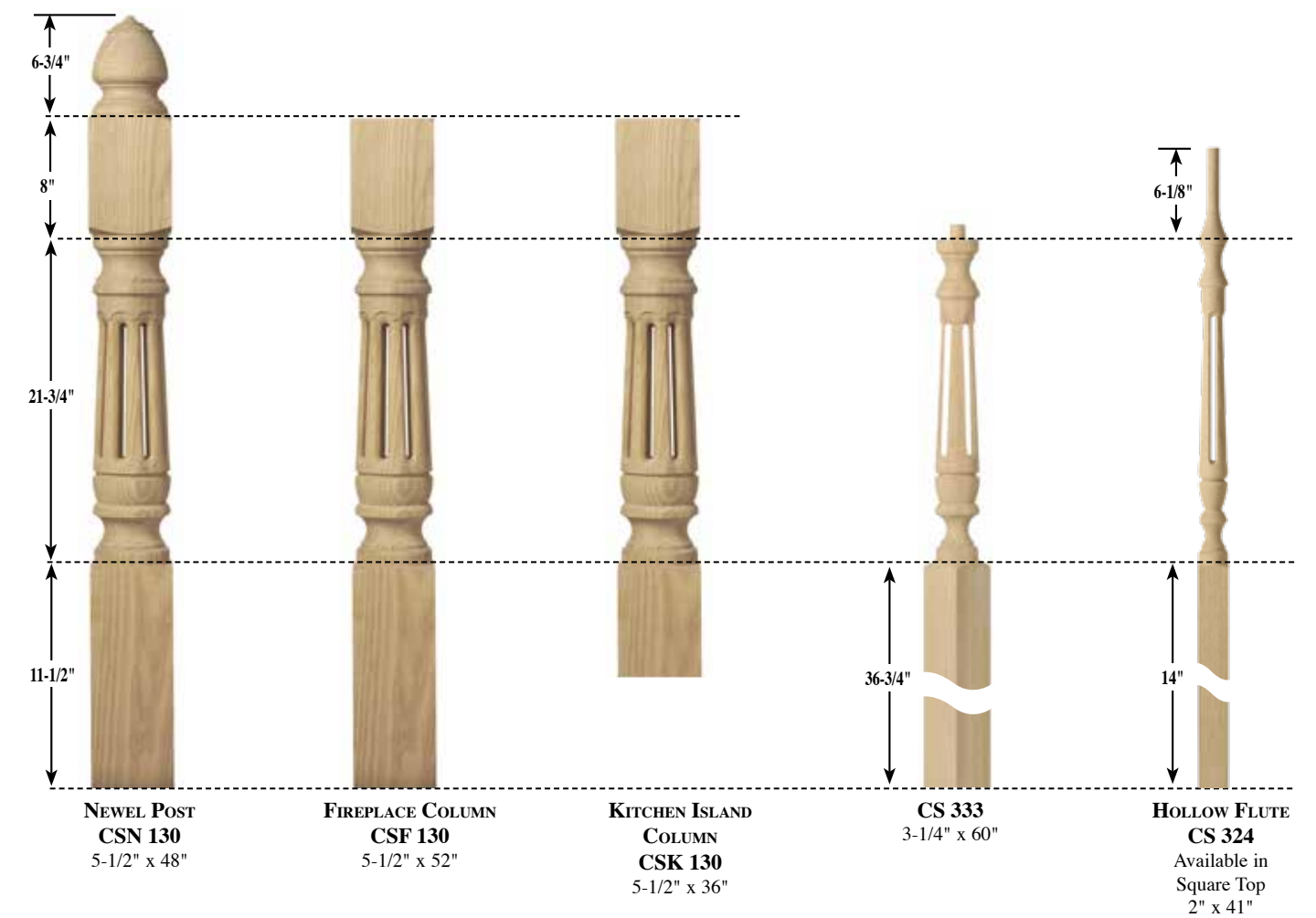
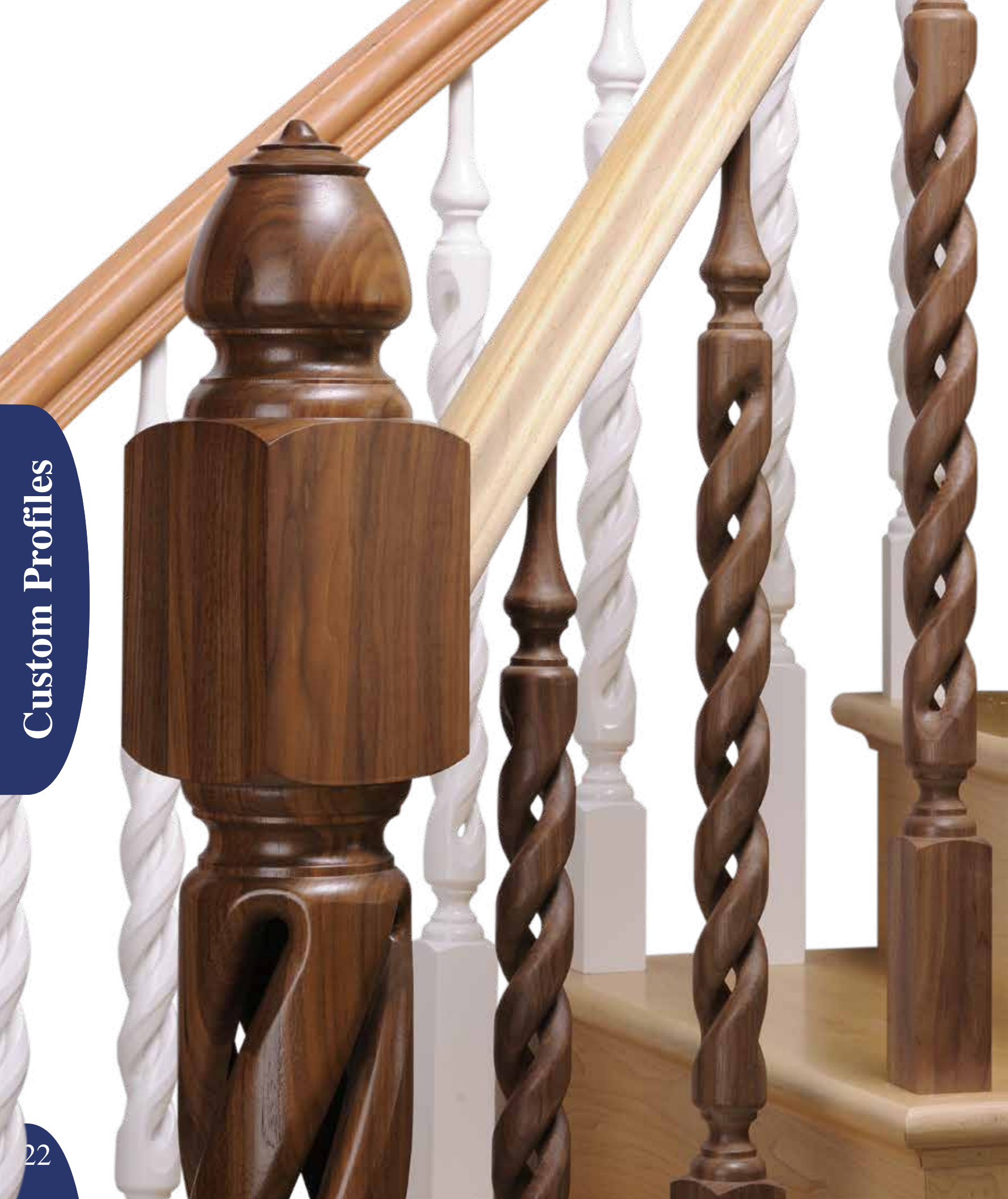

Available in most species

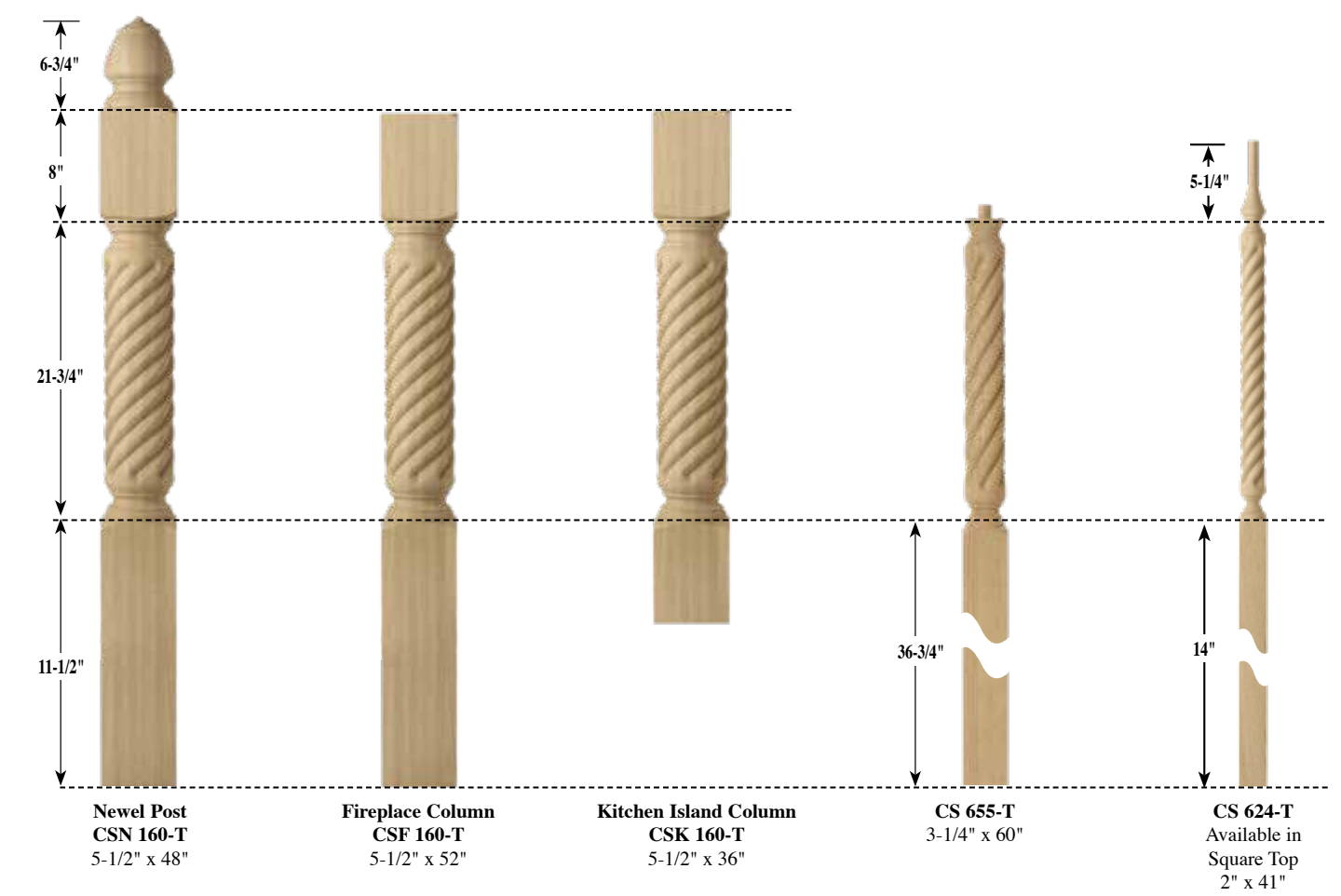

Floridian Series

Custom Profiles

Carrabelle Series

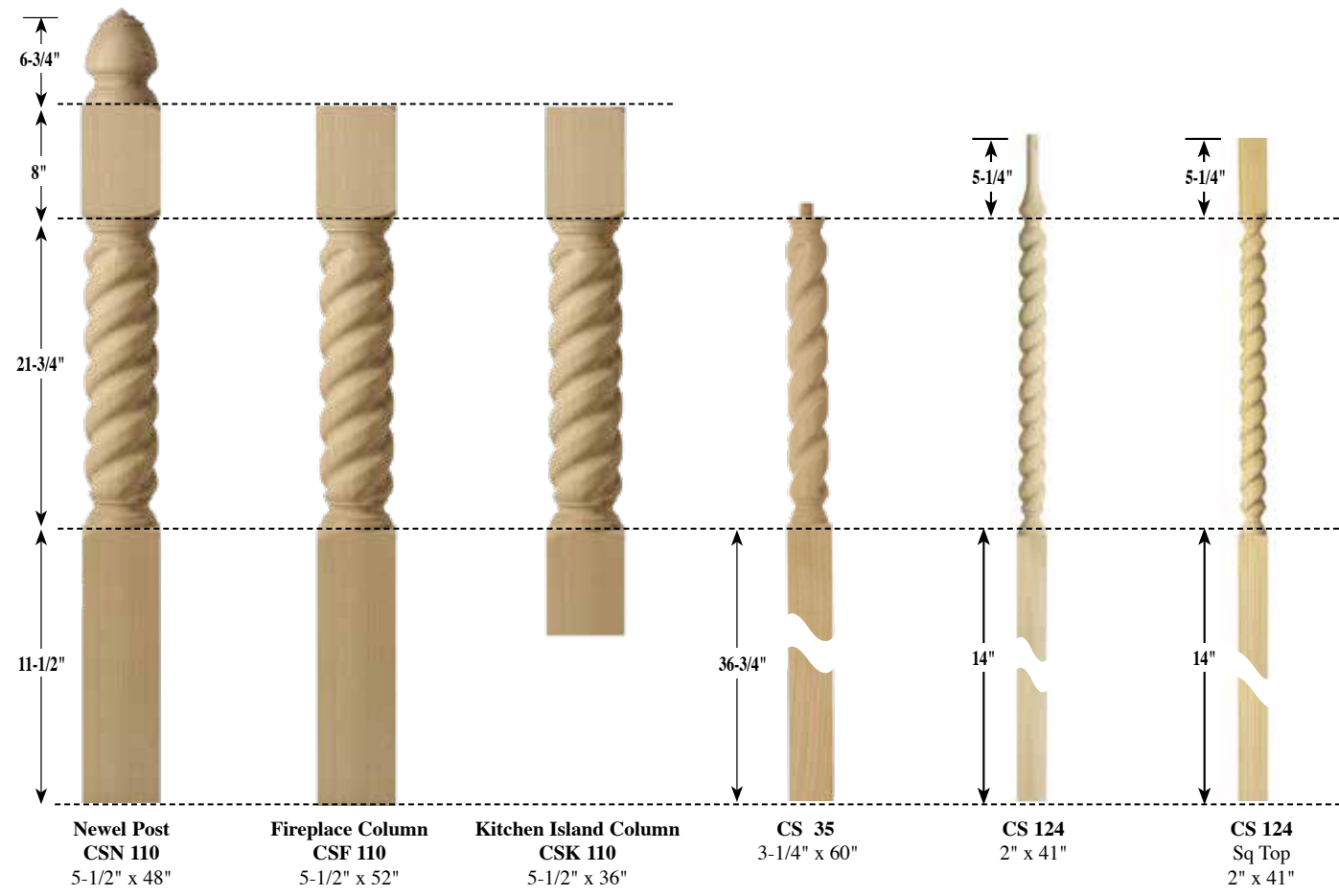

800-364-3269

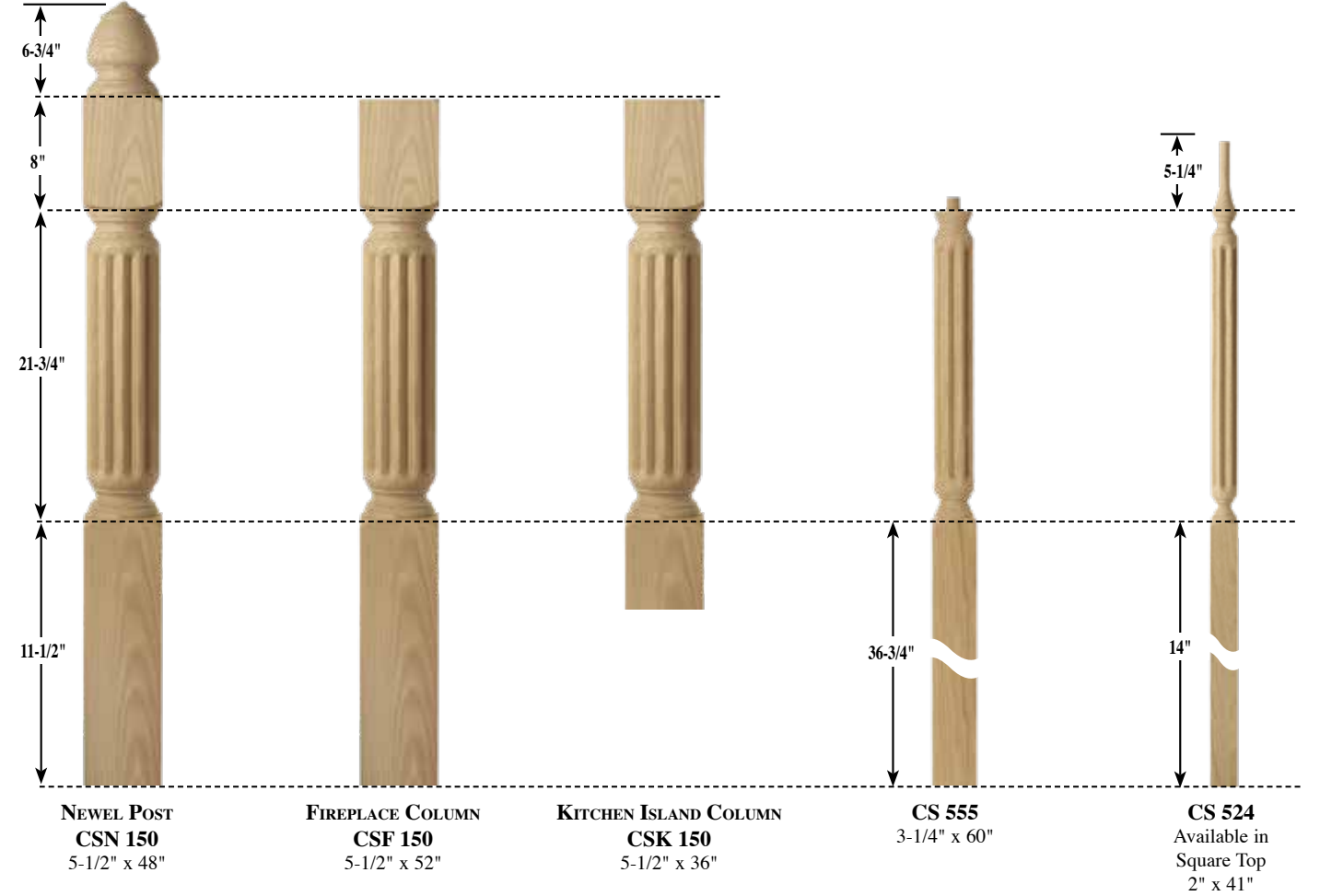

Available in most species

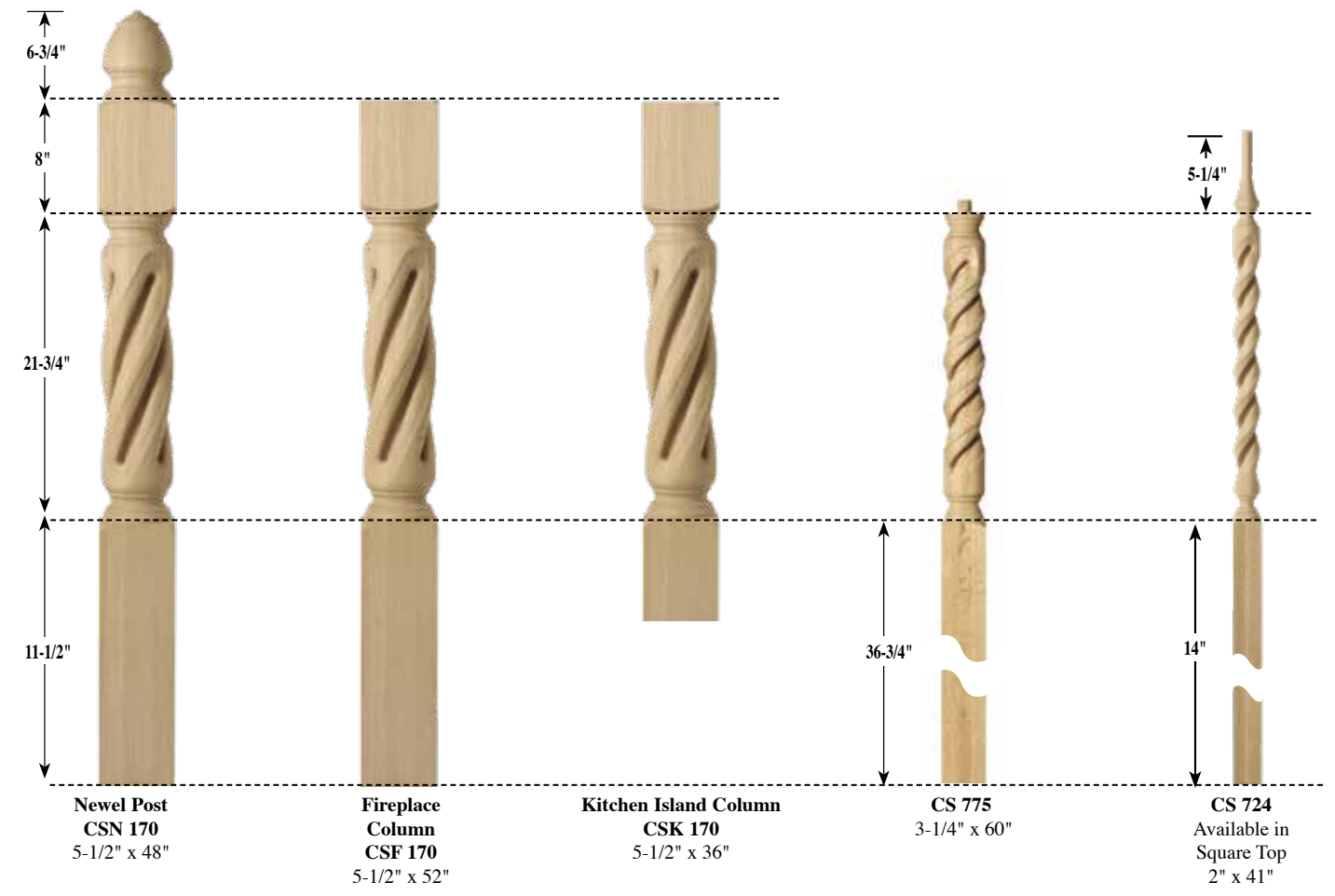
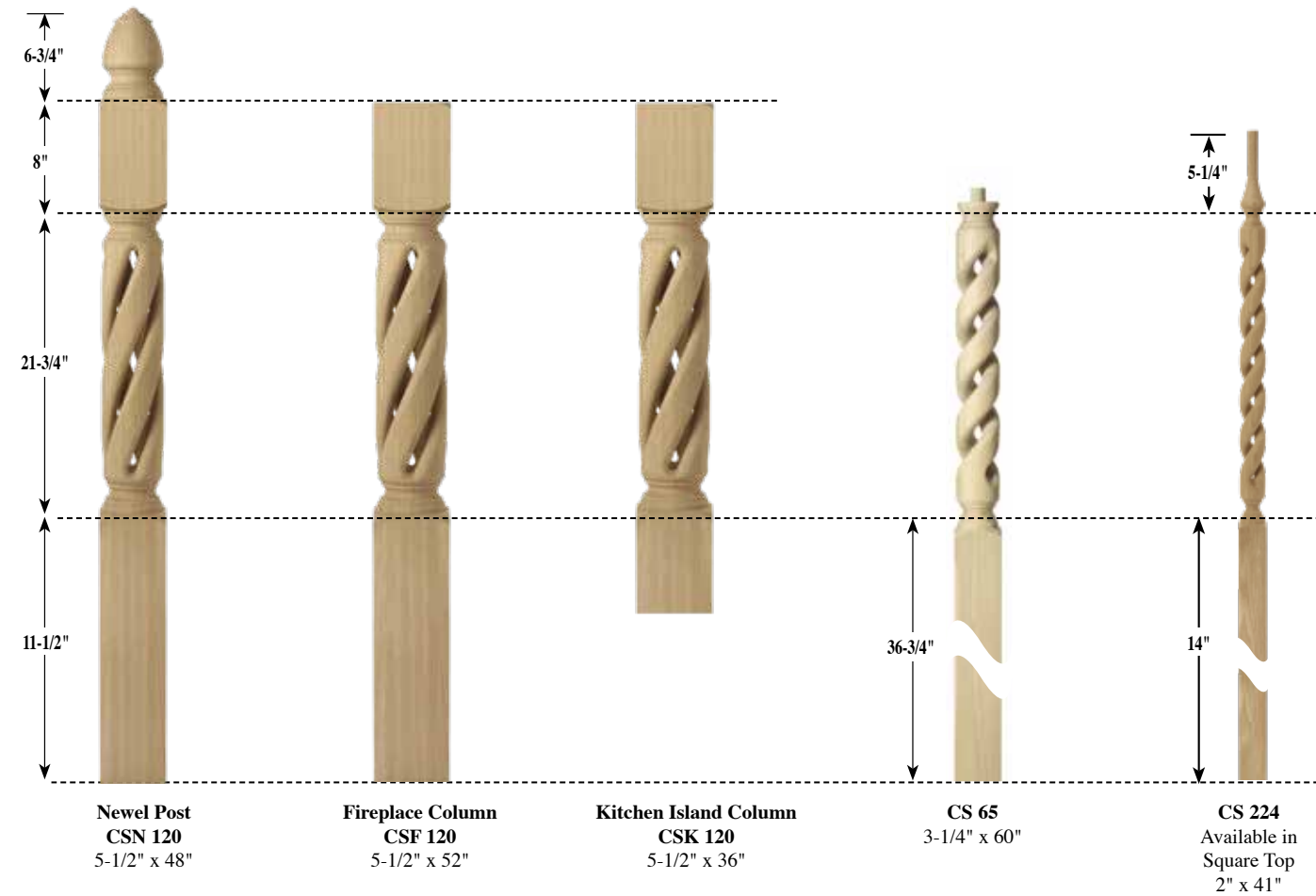





N-1 6-1/4" x 48" N-2 7" x 45" N-3 6" x 55" N-4 6-1/2" x 72" N-5 8" x 55" N-6 4" x 69"

800-364-3269

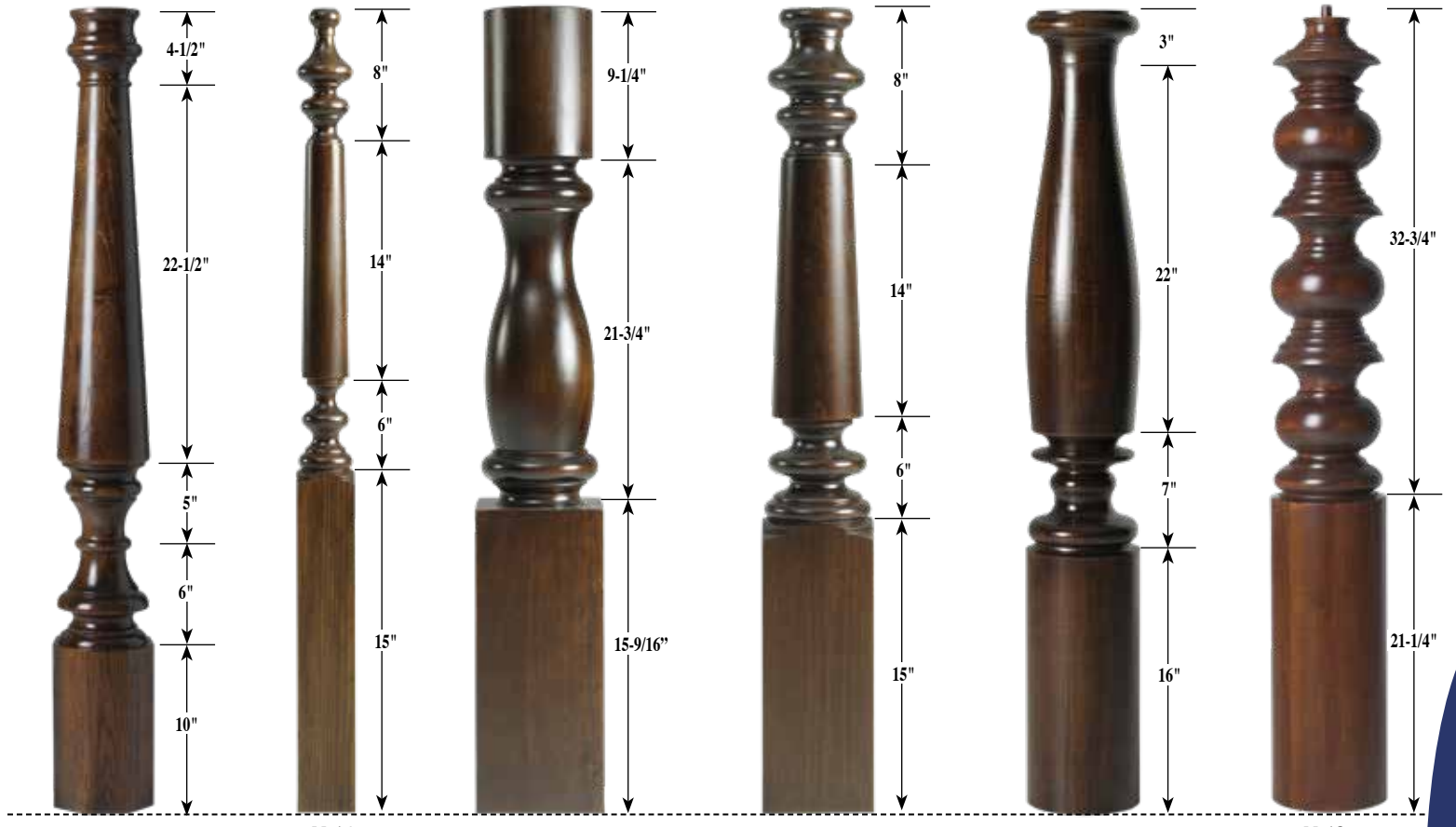

N-13 6" x 48" N-14 3-1/2" x 43" N-15 8" x 46" N-16 6" x 43" N-17 7" x 49" N-18 8" x 54"

Available in most species

\*All custom newels can be turned in various blank sizes. Changing the size may alter some of the detail.

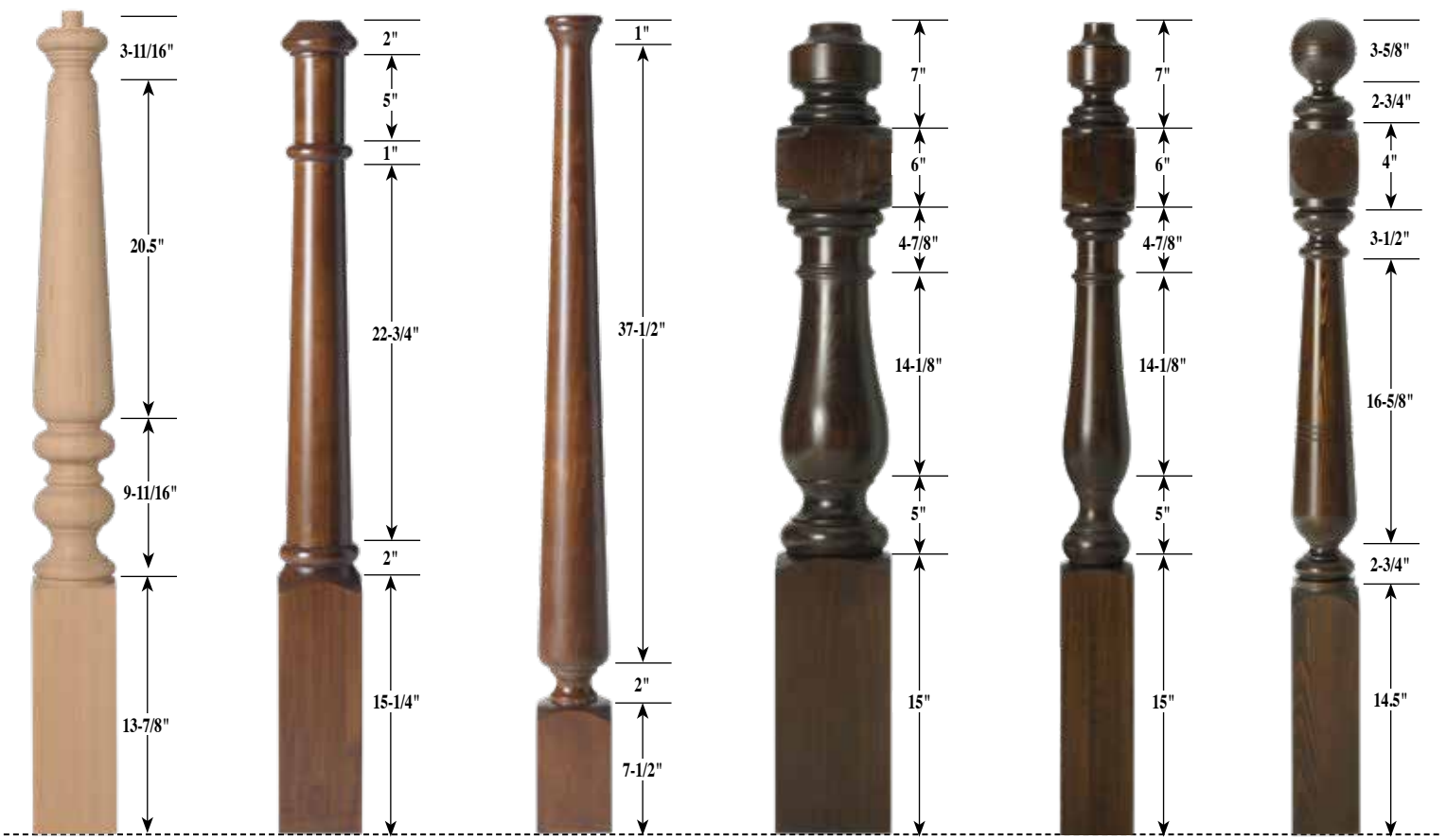

N-7 5" x 48" N-8 5" x 48" N-9 4-1/2" x 48" N-10 8" x 52" N-11 5" x 52" N-12 4" x 48"



N-19 8" x 48" N-20 6-1/2" x 44" N-21 4-5/8" x 48" N-22 6" x 54" N-23 7-1/2" x 51" N-24 7" x 44"

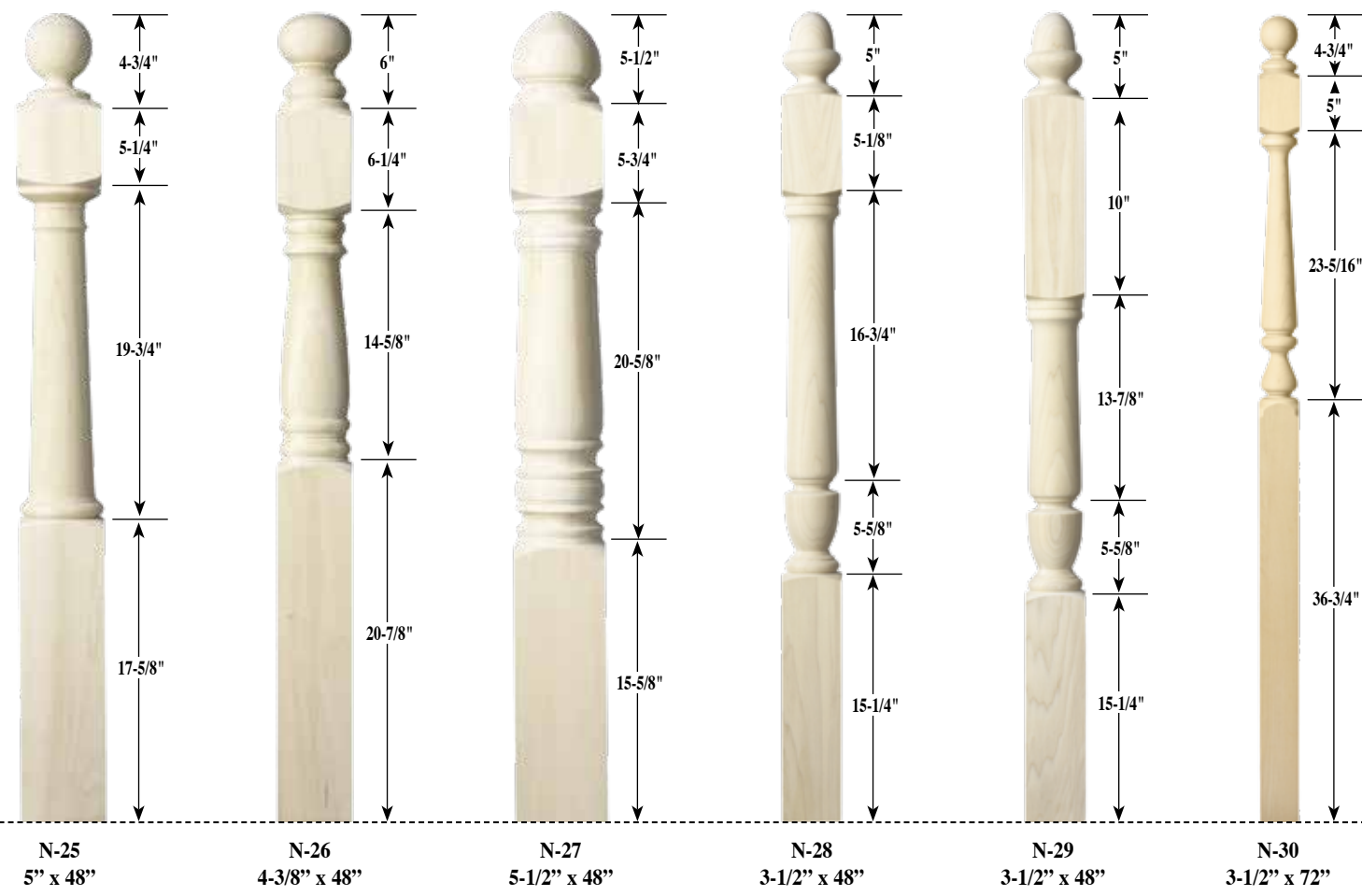

800-364-3269

Available in most species

\*All custom newels can be turned in various blank sizes. Changing the size may alter some of the detail.

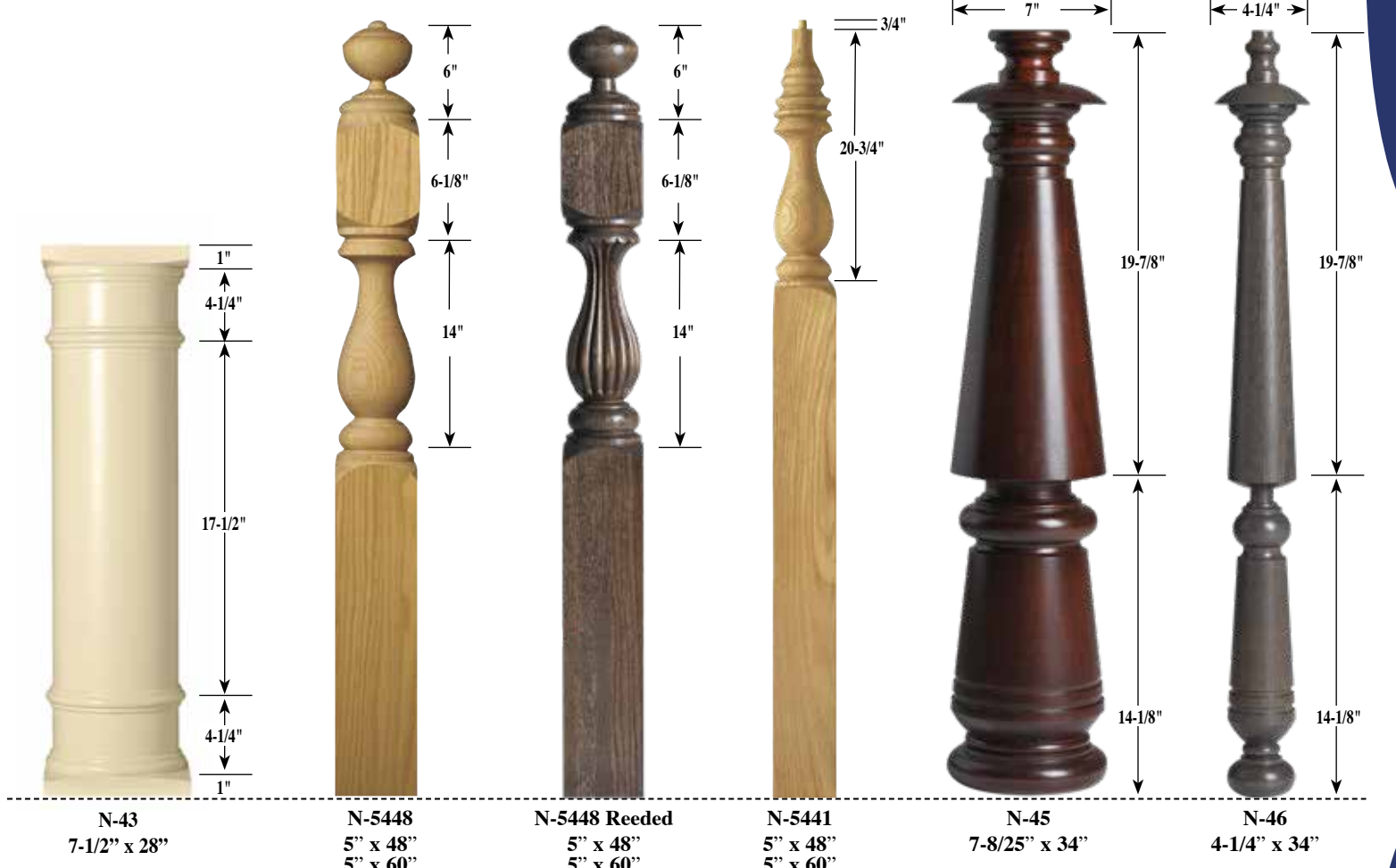



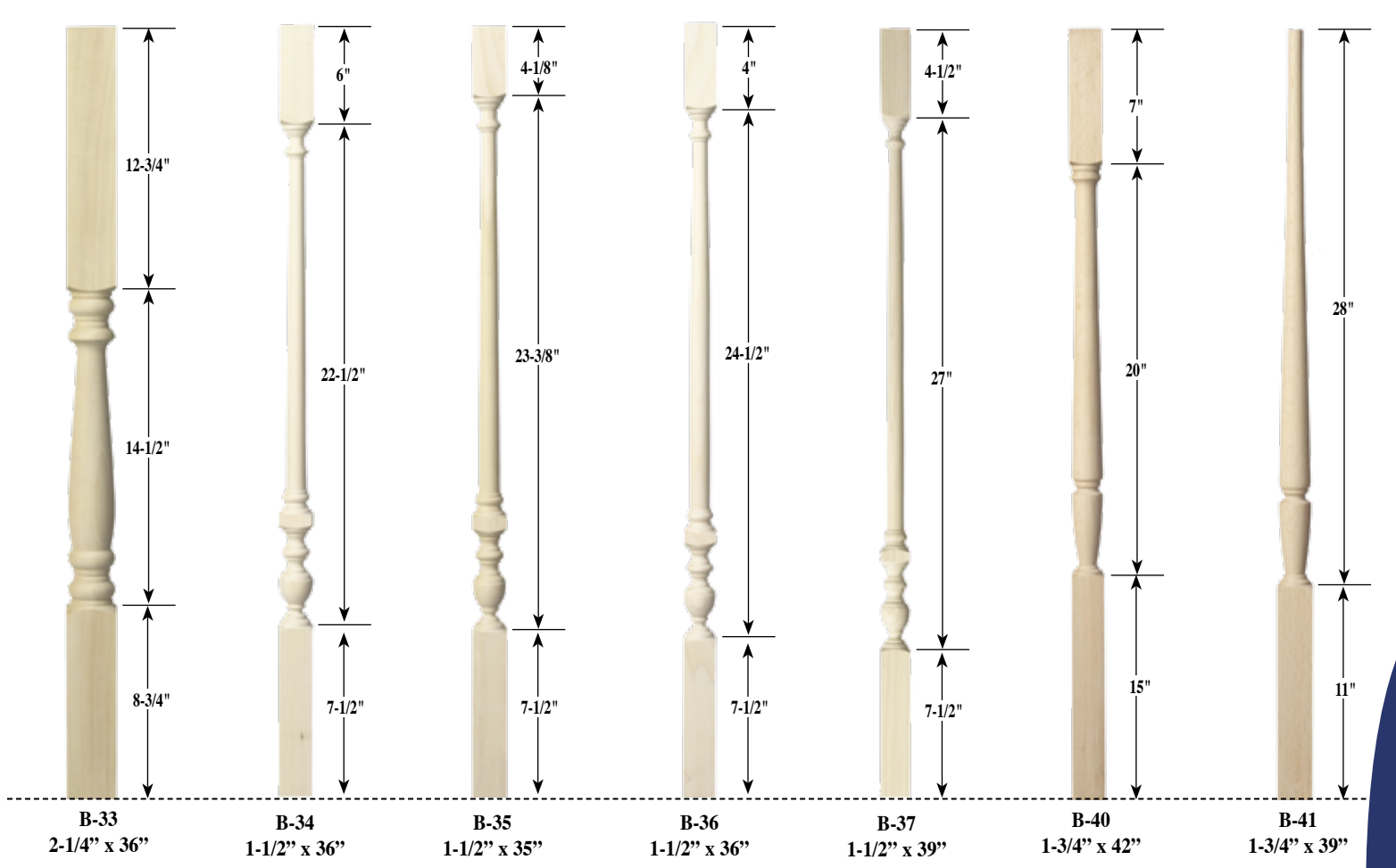
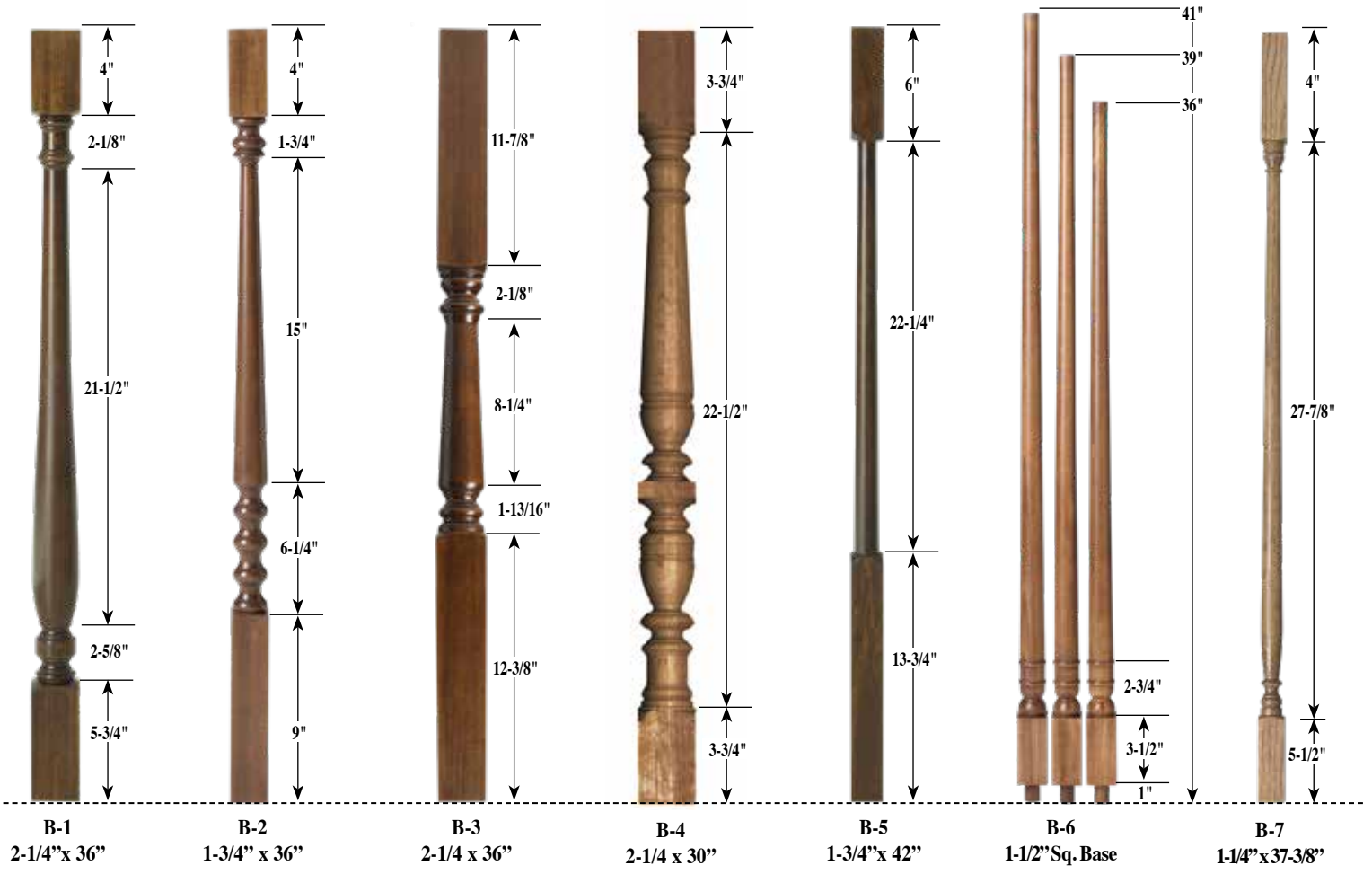

800-364-3269

Available in most species

\*All custom newels can be turned in various blank sizes. Changing the size may alter some of the detail.

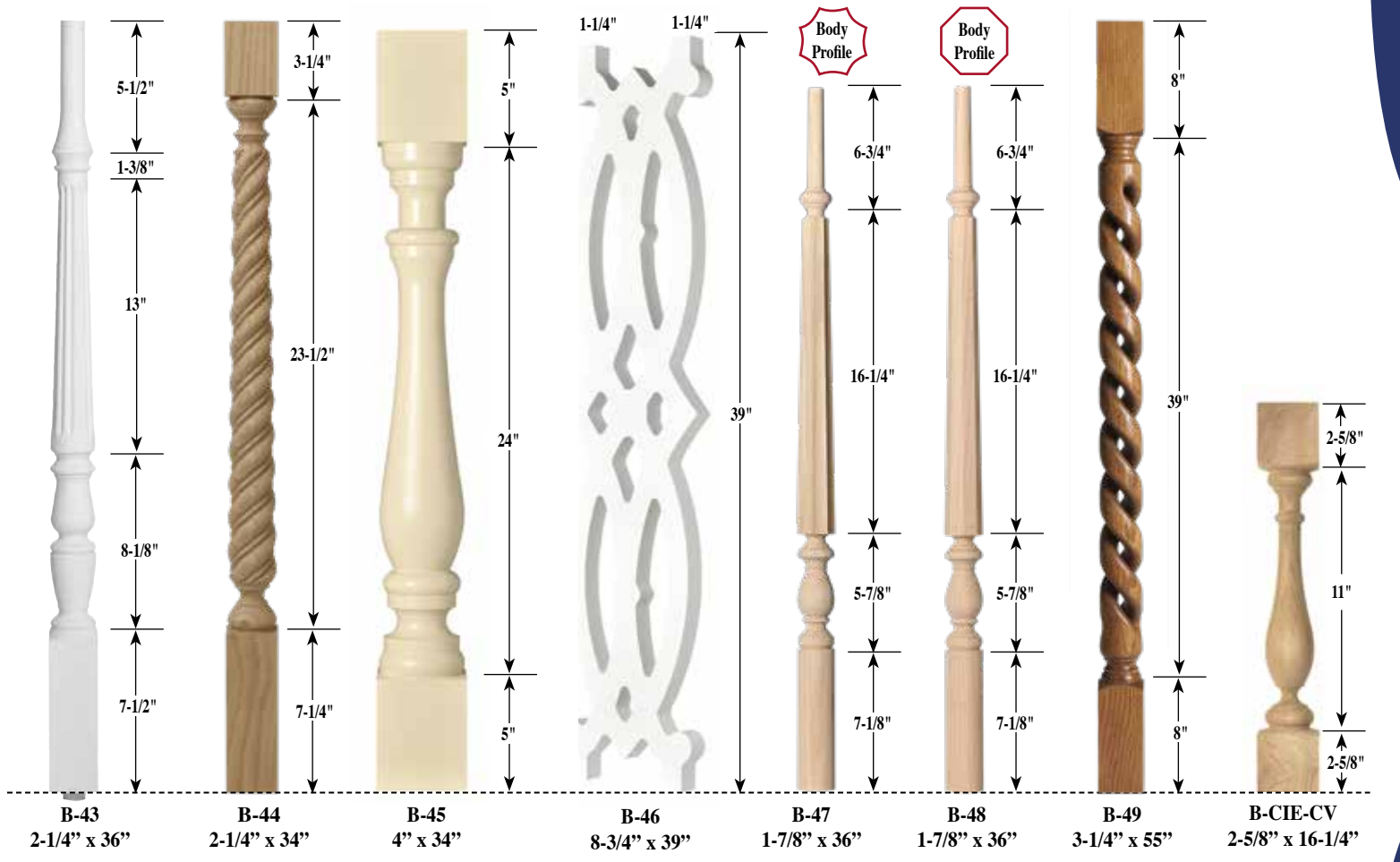
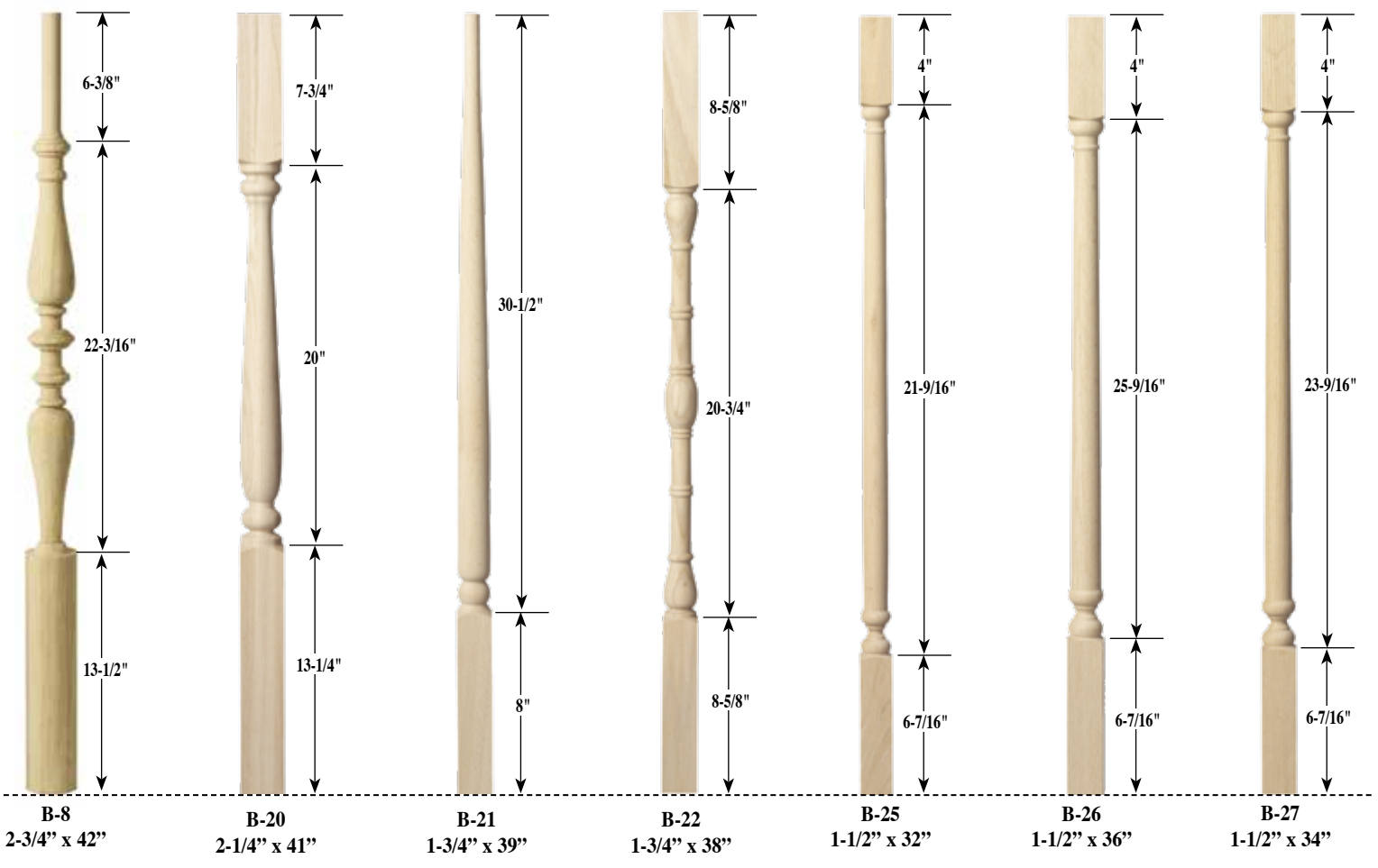





# Iron

316 Herrick Street, Uhrichsville, Ohio 44683

Tel: 800-364-3269

Tel: 740-922-3333

Fax: 740-922-3330



## Finish Options

The process of powder coating involves applying dry pigments using an electrostatic process, then baking them on to create a lasting and durable, as well as beautiful, finish.

The products found in the following section implement the powder coating technique. When ordering, please use the Finish Options Guide below.

Please indicate the type of finish by using the following abbreviations:

- AN = Antique Nickel
- B = Flat Black Powder Coat
- SP = Grey Speckled Powder Coat
- SAT = Satin Black
- CV = Copper Vein Powder Coat
- ORC = Oil Rubbed Copper
- ORB = Oil Rubbed Bronze

Example: CS 16.5.5-B = Carolina Stair Flat Black Twist & Basket Newel

Finish Options

 AN	 SAT
 SP	 B
 CV	 ORC
 ORB	<i>Iron Chain Color Samples Available Upon Request</i>



800-364-3269

T in the available color charts refers that all balusters are only available in tube.

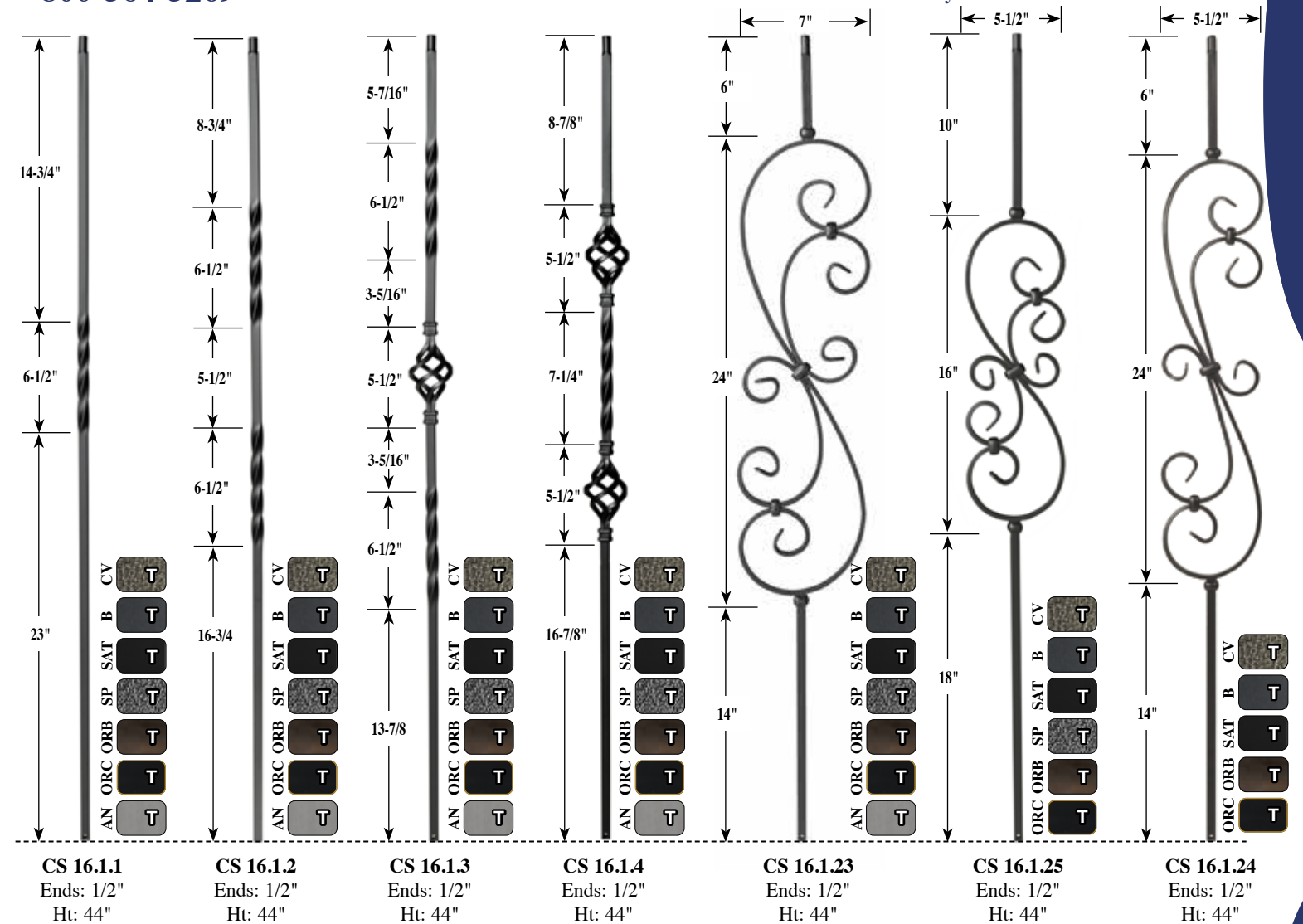





800-364-3269

T in the available color charts refers that all balusters are only available in tube.

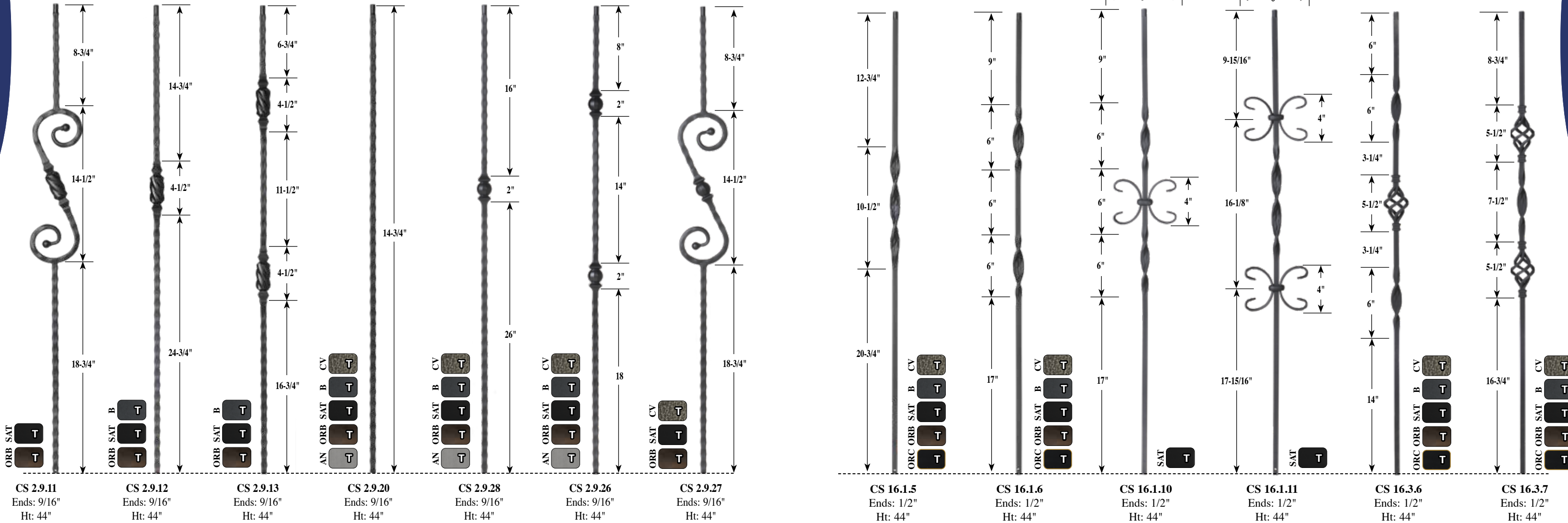





800-364-3269

T in the available color charts refers that all balusters are only available in tube.

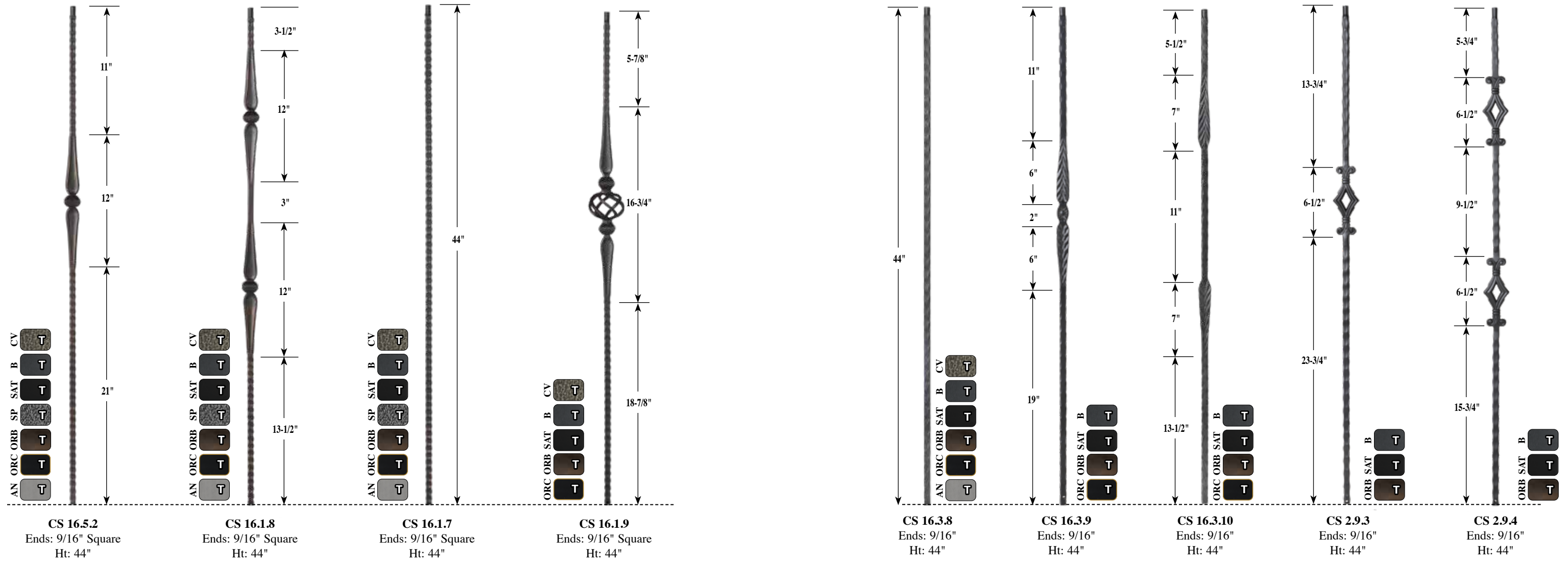





# Iron Balusters

# Knee Wall Balusters

800-364-3269

T in the available color charts refers that all balusters are only available in tube.

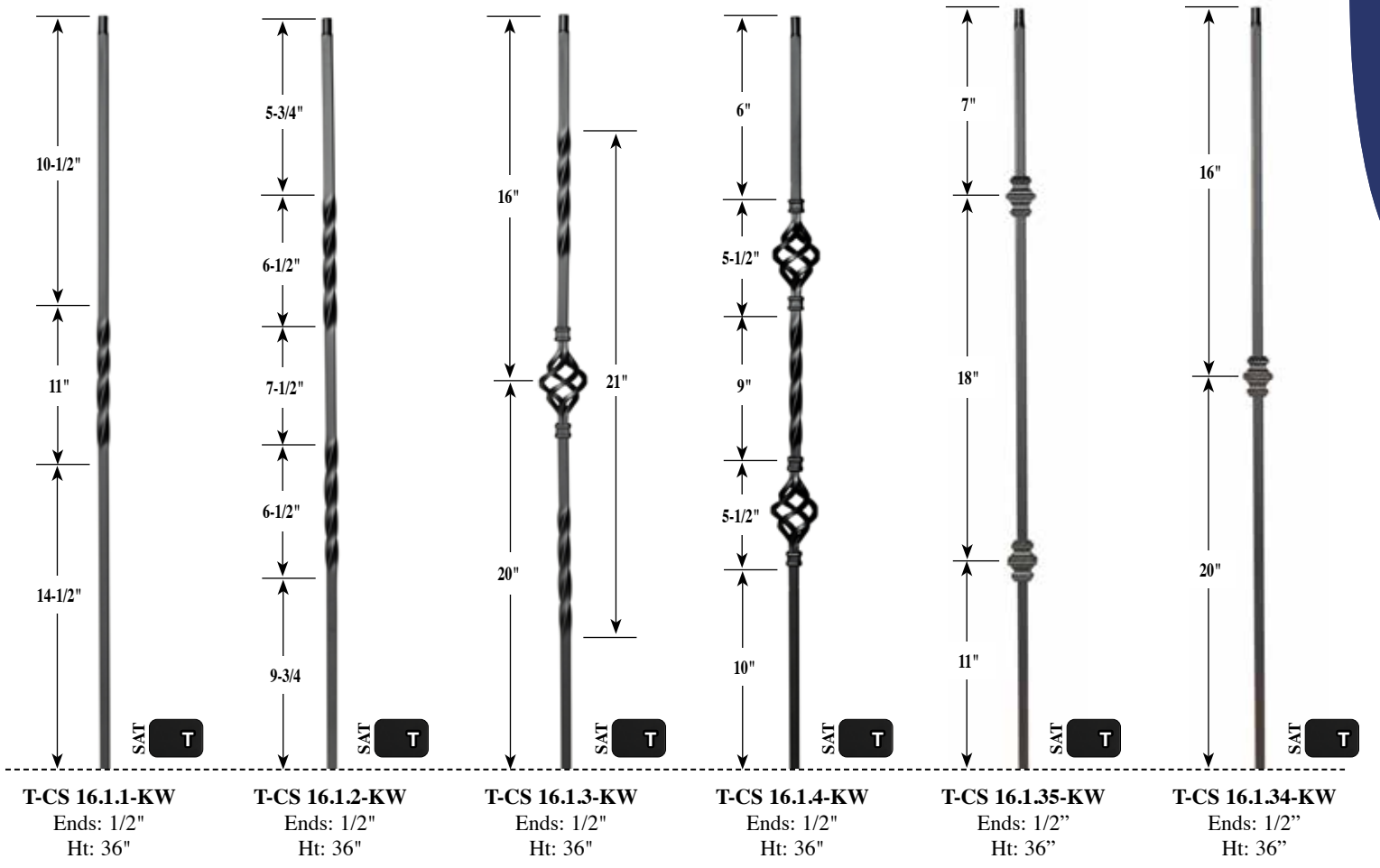
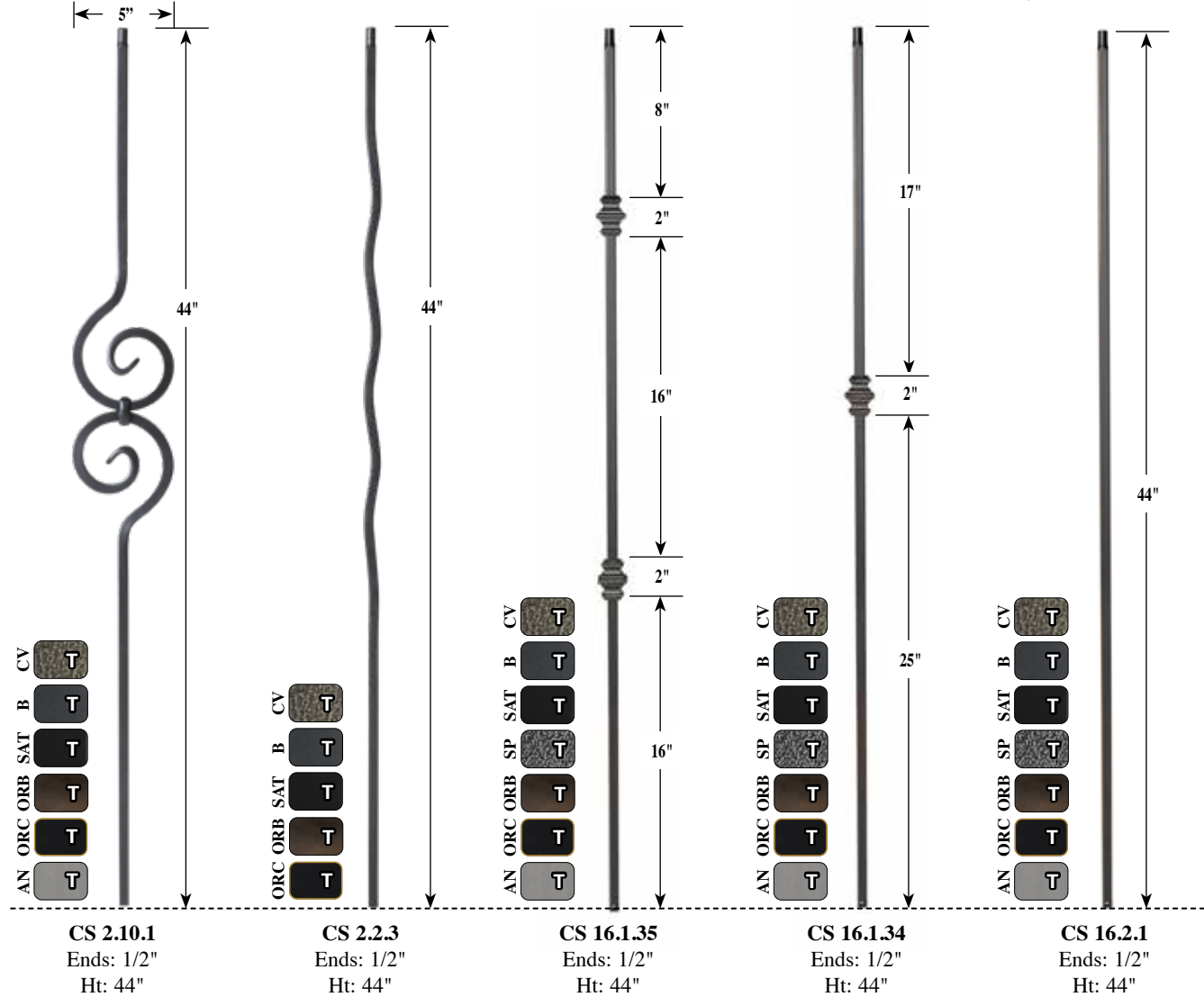

Wave & Curl Forged

Regular Twist and Knuckle





800-364-3269

T in the available color charts refers that all balusters are only available in tube.

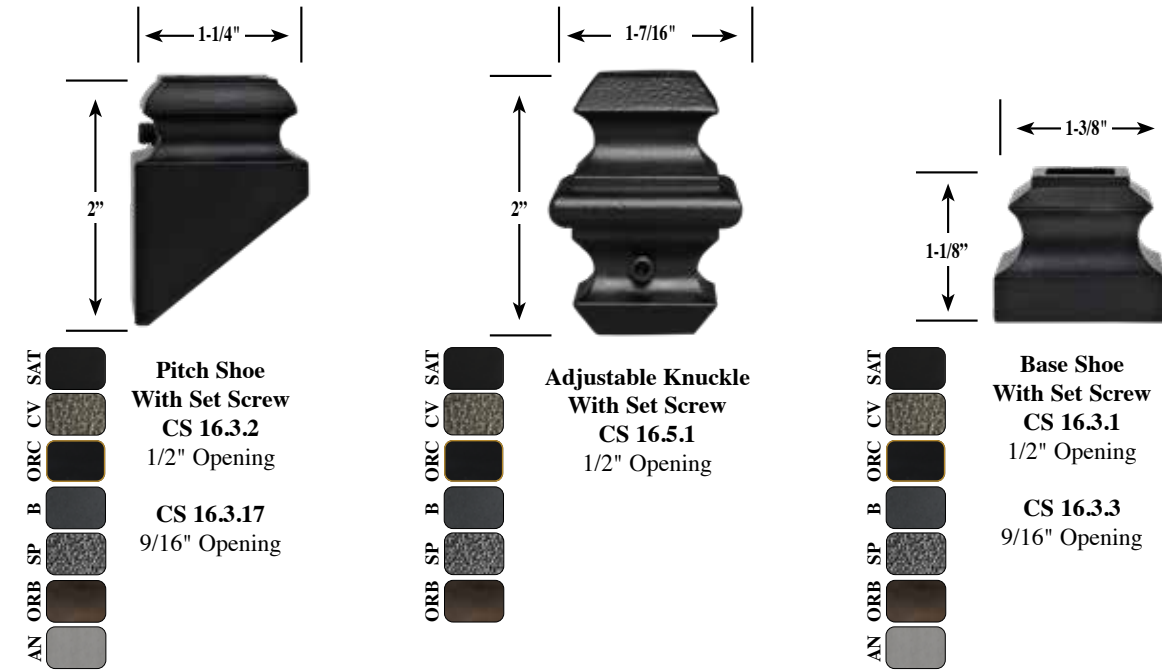
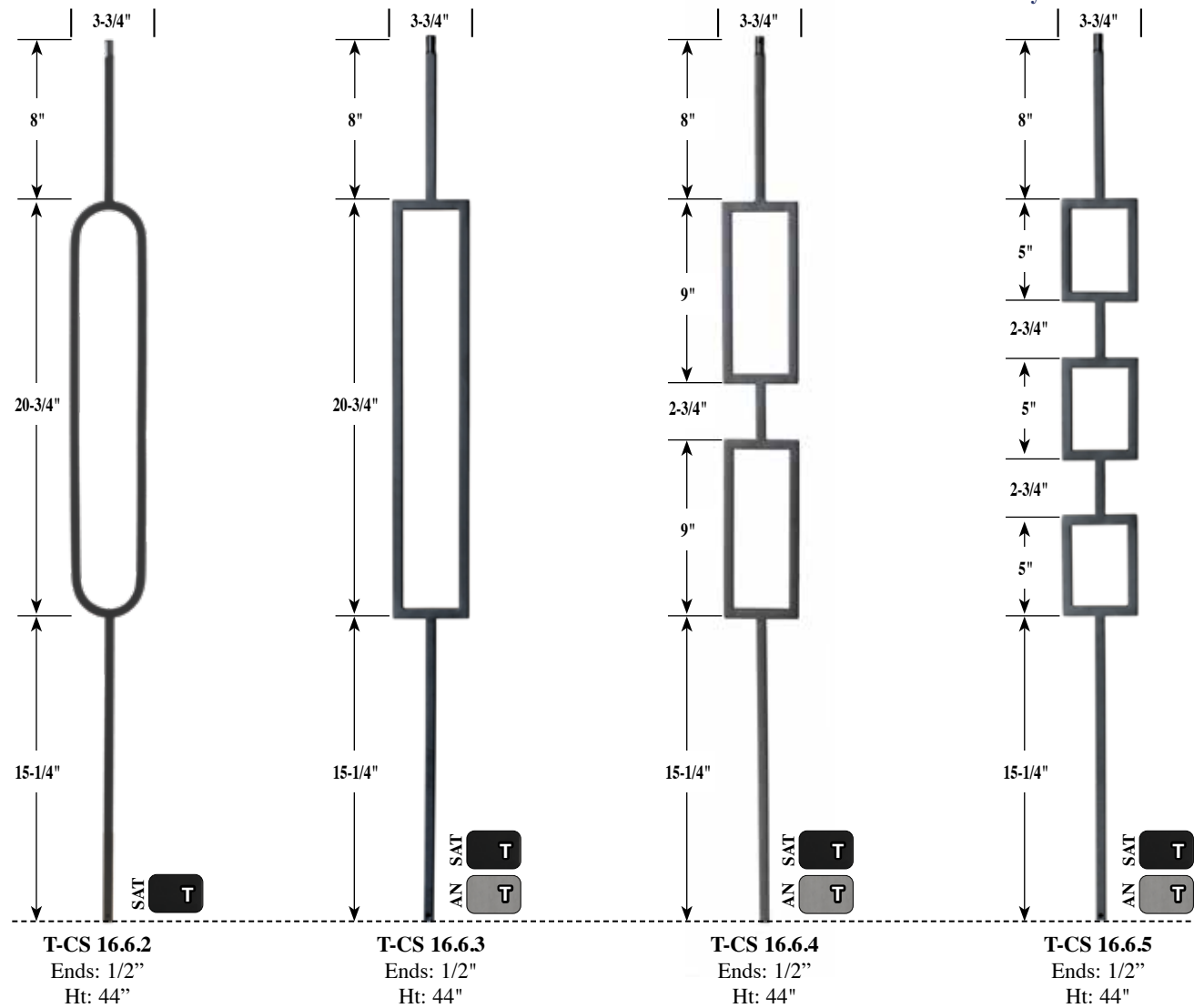

Epoxy Kit

800-364-3269

T in the available color charts refers that all balusters are only available in tube.



Zip Clip Installation



Install Clip To Handrail and Tread

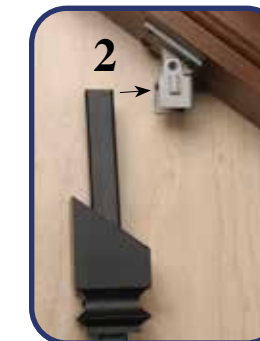

Slide Iron Baluster In Place With Shoes Installed

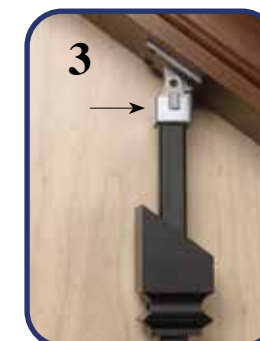

Snap Retaining Clip In Place



Slide Shoe In Place And Tighten



2 Flat Shoes  
Z-CS16.3.1  
1/2" Opening  
SAT, ORC, ORB

1 Pitch & 1 Flat Shoe  
Z-CS16.3.2  
1/2" Opening  
SAT, ORC, ORB

2 Pitch Shoes  
Z-CS16.3.4  
1/2" Opening  
SAT, ORC, ORB

Zip Clip Shoe Dimensions

Flat Shoe = L 1-7/16" x W 1-7/16" x H 1-1/4"  
Pitch Shoe = L 1-1/4" x W 1-1/4" x H 2-1/2"





Custom Box Newel by CSS • Baluster: CSPLA • Rail: R15 • Fittings: Oversize R15-10 Cap

Custom Box Newel by CSS • Horizontal Bar: T-CS 5.1.1-SAT • Rail: 8700 • Tread: 8075

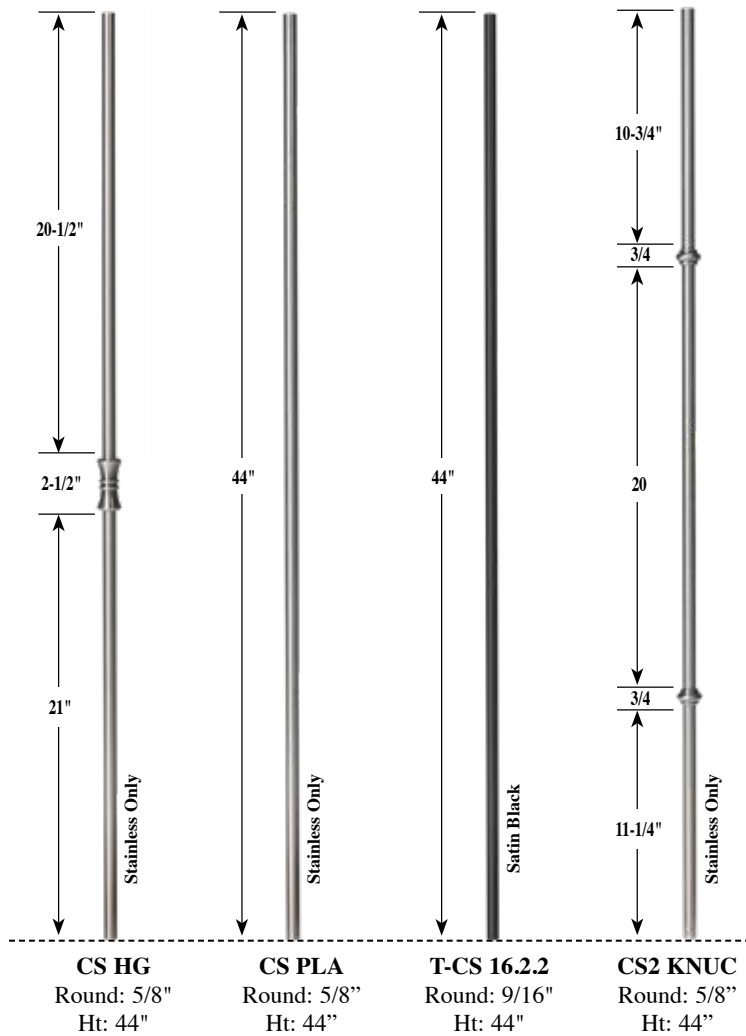



# Ole' Iron Slides™

With the advent of the adjustable iron slide baluster, the do it yourself person can now design and install their own balustrade. Using only a drill, screwdriver and an allen wrench, the adjustable iron baluster can replace your old wood spindles without the expense of a professional. Leave your wood rail and newels in place, remove the wood spindles and replace them with a wrought iron balustrade quickly and without a big mess. Presto, you have a new design flavor for your living area.

**Allen Wrenches Required: 4mm & 2mm**

Ole Iron Slides™ is a trademarked and patented adjustable baluster owned by Carolina Stair Supply Inc.

Scan this code to watch the video

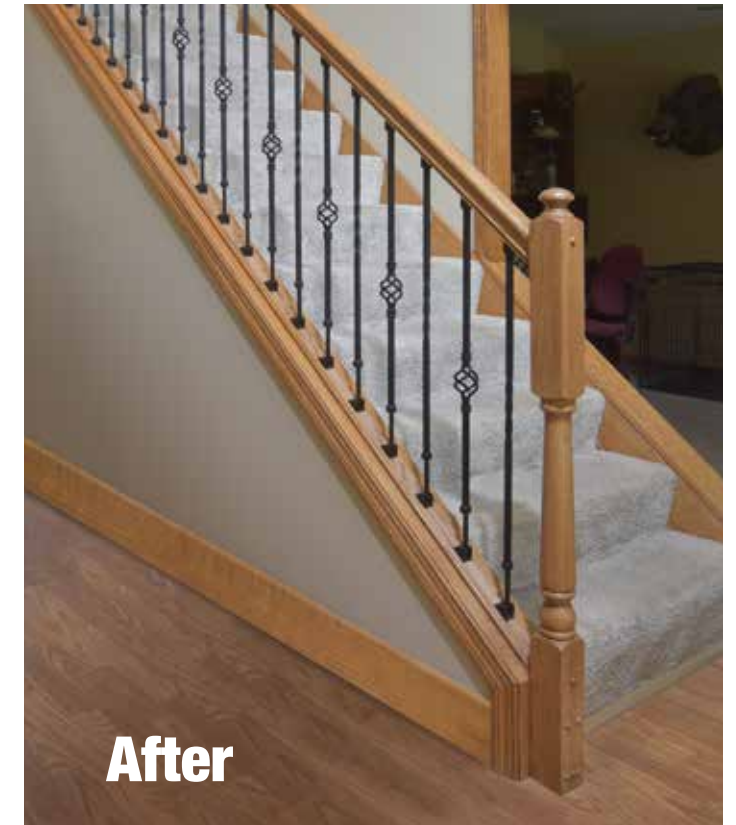

**Patent No.:**  
 7,614,612 B2    7,909,311 B2    D610,716 S    D637,315 S  
 8,418,335 B2    D614,477 S    8,978,337 B2

Each baluster comes with loose ISSW in the package.

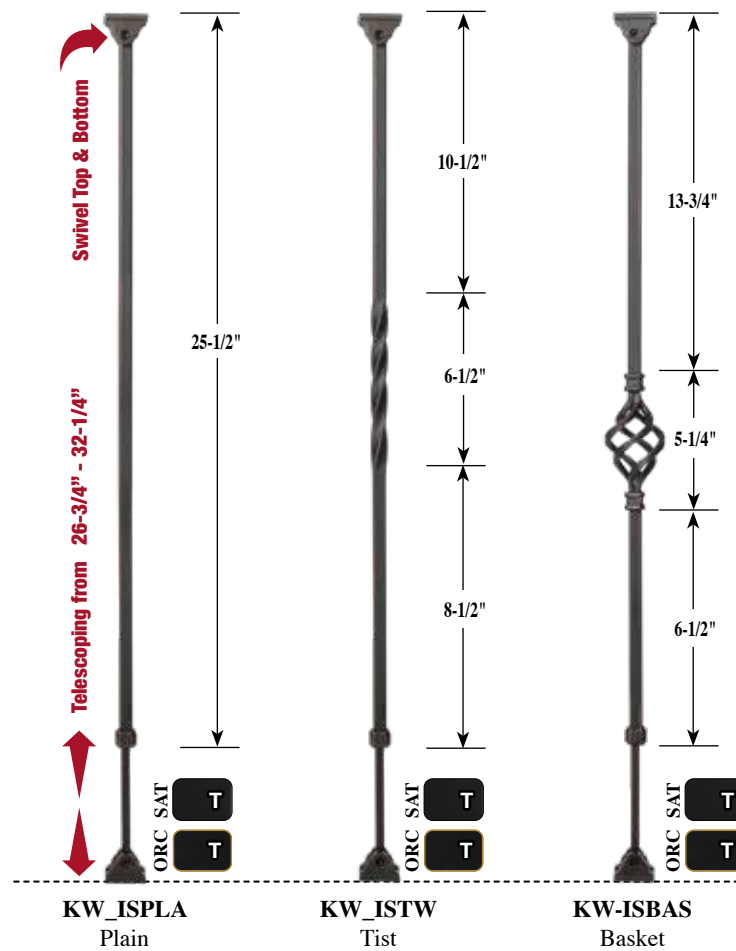
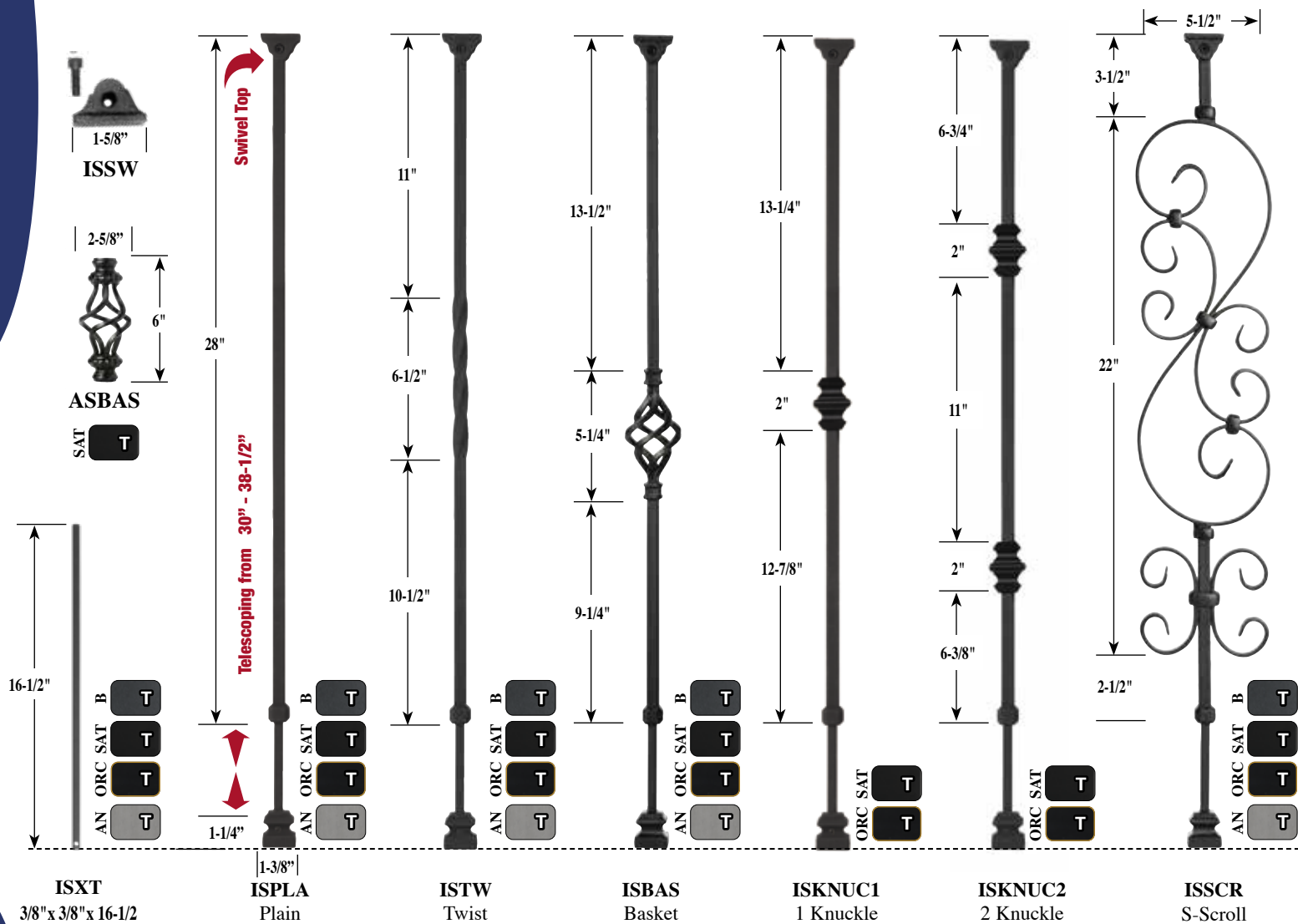

**Also Available in Outdoor Aluminum Balusters  
 Telescoping from 34" - 42"**

**MISTW-EXT-SAT**  
 Ends: 5/8" Aluminum  
 Twist

**MISBAS-EXT-SAT**  
 Ends: 5/8" Aluminum  
 Basket



Telescopes  
 26-3/4" - 32-1/4"

Ole Iron Slides™

Ole Iron Slides™

Ole Iron Slides™ Knee Wall





1010  
Flush Plug 1"



1020  
Rail Bolt



1030  
Wall Bracket



1032-HD  
Wall Bracket

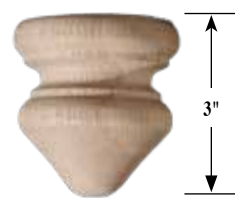

1070  
Drop Cap  
Available in 3" and  
3-1/2" diameter

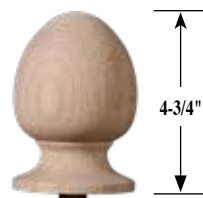

1075  
Newel Finial

Items 1030 & 1032 available in the following finishes:  
Bright Brass • Antique Brass • Dull Chrome • Satin Nickel  
Satin Black • Oil Rubbed Bronze • Oil Rubbed Copper



1060 Oval Rosette  
5-1/2"H x 4-1/4"W  
1064 Oval Rosette  
6-1/2"H x 4-1/2"W



1063 Rectangle Rosette  
6"H x 4-5/8"W



1062  
Round Rosette  
4-3/8" Round

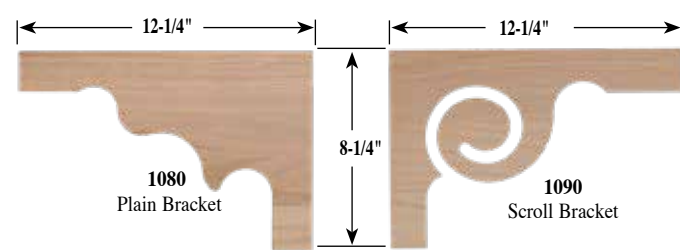

1080  
Plain Bracket

1090  
Scroll Bracket

1/4" Thick



1103  
Newel Anchor



1104  
Newel Anchors  
3" & 3-1/2" Sizes Available



1106  
Spin Driver  
(to be used  
with Dowel  
Lockscrews)



1107  
Dowel  
Lockscrews  
(24 per pack)

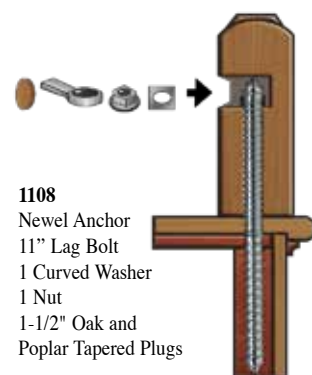

1108  
Newel Anchor  
11" Lag Bolt  
1 Curved Washer  
1 Nut  
1-1/2" Oak and  
Poplar Tapered Plugs

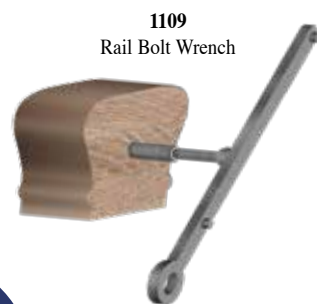

1109  
Rail Bolt Wrench



2000  
Key Lock



3004  
Newel  
Anchor



3006  
Newel Anchor



3007  
Hardware  
Combination Kit







# CAROLINA

STAIR SUPPLY

316 Herrick Street, Uhrichsville, Ohio 44683

Tel: **800-364-3269**  
Tel: **740-922-3333**  
Fax: **740-922-3330**

