



**IMPORTANT FOR FUTURE REFERENCE**  
Please complete this information and retain this manual for the life of the equipment.

Model # \_\_\_\_\_

Serial # \_\_\_\_\_

Date Purchased \_\_\_\_\_

# Installation and Operation Manual For Electric Fryers Covering Models AEP Series

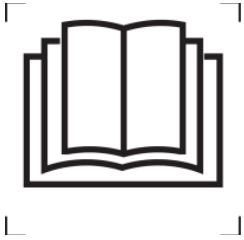

## Warning Page

### TO THE PURCHASER, OWNER AND STORE MANAGER

Please review these warning prior to posting them in a prominent location for reference

#### WARNING

DO NOT store or use gasoline or other flammable vapors and liquids in the vicinity of this or any other appliance.

#### WARNING

Improper installation, alteration, service or maintenance can cause property damage, injury or death. Read the installation, operating and maintenance instructions thoroughly before installing or servicing this appliance.

#### WARNING

Installation, maintenance and repairs should be performed by an Anets Authorized Service and Parts (ASAP) company technician or other qualified personnel. Installation, maintenance or repairs by unauthorized and unqualified personnel will void the warranty.

#### WARNING

Installation and all connections must be made according to national and local regulations and codes in force.

#### WARNING

A country approved all pole circuit breaker with a minimum open contact gap of 3mm must be used for proper installation.  
(CE countries)

#### WARNING

During the warranty period if a customer elects to use a non-original part or modifies an original part purchased from Anets and/or its Authorized Service and Parts (ASAP) companies, this warranty will be void. In addition, Anets and its affiliates will not be liable for any claims, damages or expenses incurred by the customer which arises directly or indirectly, in whole or in part, due to the installation of any modified part and/or received from an unauthorized service center.

#### WARNING

This appliance, when installed, must be electrically grounded in accordance with local codes, or in the absence of local codes, with the National Electrical Code, ANSI/NFPA 70, or the Canadian Electrical Code, CSA C22.2, as applicable.

#### WARNING

Adequate means must be provided to LIMIT the movement of this appliance without depending on the electrical cord connection. Single appliances equipped with legs must be stabilized by installing anchor straps. All appliances equipped with casters must be stabilized by installing restraining chains.

#### WARNING

DO NOT alter or remove structural material on the appliance to accommodate placement under a ventilation hood.

#### WARNING

This appliance is intended for commercial/professional use only and should be operated by fully trained and qualified personnel. It is not intended for continuous mass production of food.

#### WARNING

This appliance is intended for indoor use only.

#### WARNING

If the power supply cord is damaged, it must be replaced by an Anets Authorized Service and Parts (ASAP) company technician or a similarly qualified person in order to avoid a hazard. In Europe, supply cords must be oil resistant, sheathed flexible cable not lighter than ordinary polychloroprene or other equivalent synthetic elastomer-sheathed cord (Code designation 60245 IEC 57).

#### WARNING

The power supply must be disconnected before servicing, maintaining or cleaning this appliance.

#### WARNING

The appliance is NOT water jet stream approved. DO NOT clean the appliance with a water jet or steam cleaner.

#### WARNING

DO NOT attempt to move this appliance or transfer hot liquids from one container to another when the unit is at operating temperature or filled with hot liquids. Serious personal injury could result if skin comes in contact with the hot surfaces or liquids.

#### WARNING

DO NOT sit or stand on this appliance. The appliance's front panel, tank, splash back, tank cover, work shelf, drain board is not a step. Serious injury could result from slipping, falling or contact with hot liquids.

#### WARNING

NEVER use the appliance as a step for cleaning or accessing the ventilation hood. Serious injury could result from slips, trips or from contacting hot liquids.

#### WARNING

Potential fire danger exists if the cooking oil level is below the minimum indicated level. The cooking oil level should NOT be allowed to fall below the minimum indicated level line at any time. The use of old cooking oil can be dangerous as it will have a reduced flash point and be more prone to foaming over.

#### WARNING

The contents of the crumb catch and/or filter pan of any filter system must be emptied into a fireproof container at the end of each day. Some food particles can spontaneously combust if left soaking in certain types of oil or shortening.

#### WARNING

Completely shut the appliance down when shortening/oil is being drained from the appliance. This will prevent the appliance from heating up during the draining and filling process. Serious injury can occur.

#### WARNING

DO NOT operate appliance unless all panels and access covers are attached correctly.

#### WARNING

It is recommended that this appliance be inspected by a qualified service technician for proper performance and operation on a yearly basis.

## Table of Contents

<b>Warning Page</b>	<b>-----2</b>
<b>Fryer Warranty</b>	<b>-----4</b>
<b>Installation</b>	<b>-----5</b>
<b>Filter Procedures for Flat Paper Filter Systems</b>	<b>-----9</b>
<b>Filter Procedures for Envelope Paper Filter Systems</b>	<b>-----11</b>
<b>ANETS I12 Computer Quick Programming card</b>	<b>-----13</b>
<b>Anets Digital controller</b>	<b>-----17</b>
<b>Troubleshooting Chart</b>	<b>-----18</b>



**ORIGINAL EQUIPMENT LIMITED WARRANTY**

**General Warranty**

Anets, Inc. warrants to the original user of its commercial cooking appliances and related equipment that said appliances and related equipment will be free from defects in material and workmanship under normal use for a period of one (1) year from the date of installation, with appropriate documentation, to a maximum of fifteen (15) months from the date of manufacture, subject to the following additions, exceptions, exclusions and limitations.

**What is covered**

This warranty is limited to the repair or replacement at the Company's option, without charge, of any part found to be defective within the warranty period and reasonable expenses incurred for freight and material for the installation of such part; in addition, the Company's obligation shall be limited to reimbursement for normal labor on such parts.

Anets, Inc. agrees to pay the Authorized Service and Parts Distributor, for any labor and material required to repair or replace, at the Company's option, any part which may fail due to defects in material or workmanship during the above general warranty period.

**Gold Line Fryers**

For its standard fryers, the Company warrants to the original user any stainless-steel fry tank or cooking vessel to be free from defects for a period of (1) year parts and labor and 10 year frypot or cooking vessel Part only from the date of manufacture. Labor and freight shall be the responsibility of the end user after the first year.

**Griddles**

The Company warrants to the original user any griddle to be free from defects for a period of (1) year parts and labor only from the date of installation, with appropriate documentation, to a maximum of fifteen (15) months from the date of manufacture.

**Pasta Cooker**

The Company warrants to the original user any stainless-steel water cooking vessel to be free from defects for a period of one (1) year parts and labor and 5 years Frypot or cooking vessel part only after year one from the date of manufacture. Labor and freight shall be the responsibility of the end user after the first year.

**Limitations to Fry Tank and Cooking Vessel Warranty**

After the expiration of the general warranty period, any additional warranty on fry tanks or cooking vessels shall only obligate the Company to repair or replace, at its option, any fry tank or cooking vessel which it determines to be defective. Claims under this item shall be supported by a statement detailing the defect, and the Company may require the return of the fry tank or cooking vessel claimed to be defective. Labor, freight and any additional parts shall be the responsibility of the end user.

**How to Keep Your Warranty in Force**

- Make sure any shipping damages are reported immediately. Damages of this nature are the responsibility of the carrier and must be reported by the receiver.
- Install the unit properly. This is the responsibility of the installer and the procedures are outlined in the manual.
- Do not install it in a home or residence.
- Maintain it properly. This is the responsibility of the user of the appliance and the procedures are outlined in the manual.
- Adjustments, such as calibration, leveling, tightening of fasteners or plumbing or electrical connections normally associated with initial installation. These procedures are outlined in the manual and are NOT covered by warranty.
- If it is damaged due to flood, fire or other acts of God, this is not covered under this warranty.
- Use it for what it is intended. If it is used for a purpose other than for which it was intended or designed, resulting damages are not covered under the warranty.
- Make sure that it has the correct voltage, gas supply and/or good quality water. If a failure is due to poor water quality, harsh chemical action, erratic voltage or gas supplies, these damages are not covered under the warranty.
- Do not materially alter or modify from the condition in which it left the factory.
- Do not obliterate, remove or alter the serial number rating plate.
- Use only Genuine OEM parts from Anets, Inc. or its Authorized Parts and Service Distributors. Repairs are not covered by the warranty.
- If any other failure occurs which is not attributable to a defect in materials or workmanship, it is not covered.
- Food truck & mobile installations may void warranty. Combustion related issues will not be covered.

This warranty specifically excludes parts which wear or would be replaced under normal usage, including, but not limited to, baskets, tube racks, electric lamps, fuses, interior or exterior finishes, o-rings and gaskets.

**Limits to the Warranty**

Outside the United States of America and Canada, this warranty is limited to the replacement of parts and Anets, Inc. will not bear any other expense be it labor, mileage, freight or travel.

Charges for mileage over one hundred (100) miles, travel time over two (2) hours, overtime and holiday charges are not covered under this warranty. These charges are the responsibility of the individual or firm requesting these services.

If any oral statements have been made regarding the appliance, these statements do not constitute warranties and are not part of the contract of sale. This limited warranty constitutes the complete, final and exclusive statement with regard to warranties.

THIS LIMITED WARRANTY IS EXCLUSIVE AND IS IN LIEU OF ALL OTHER WARRANTIES WHETHER WRITTEN, ORAL OR IMPLIED, INCLUDING, BUT NOT LIMITED TO ANY WARRANTY OF MERCHANTABILITY OR FITNESS FOR A PARTICULAR PURPOSE OR WARRANTY AGAINST LATENT DEFECTS.

**Limitations of Liability**

In the event of a warranty or other claim, the sole obligation of Anets, Inc. will be the repair or replacement, at the Company's option, of the appliance or the component part. This repair or replacement will be at the expense of Anets, Inc. except as limited by this warranty statement. Any repair or replacement under this warranty does not constitute an extension in time to the original warranty. Parts covered under this warranty will be repaired or replaced, at the Company's option, with new or functionally operative parts. The liability of Anets, Inc. on any claim of any kind, including claims based on warranty, express or implied contract, negligence, strict liability or any other legal theories will be exclusively the repair or replacement of the appliance. This liability will not include, and the purchaser specifically renounces any right to recover special, incidental, consequential or other damages of any kind, including, but not limited to, injuries to persons, damage to property, loss of profits or anticipated loss of the use of this appliance.

If any provision of this warranty is unenforceable under the law of any jurisdiction, that provision only will be inapplicable there, and the remainder of the warranty will remain unaffected. The maximum exclusion or limitation allowed by law will be substituted for the unenforceable provision.

**How to Obtain Warranty Service**

First direct your claim to the Anets, Inc. Authorized Service and Parts Distributor, [www.anets.com/asap.asp](http://www.anets.com/asap.asp) closest to you giving complete model, serial and code numbers, voltage, gas type, and description of the problem. Proof of the date of installation and/or the sales slip may also be required. If this procedure fails to be satisfactory, write the National Service Manager, Anets, Inc., P. O. Box 501, Concord, NH. 03302-0501. USA  
This warranty gives you certain specific legal rights; you may have other rights which vary from state to state.

Anets, Inc., P.O. Box 501, Jct. I-89 & I-93 Concord, NH 03302-0501

553 Route 3A, Bow, NH 03304 USA

Tel: (603)225-6684 Fax: (603)228-5231 [www.ANETS.com](http://www.ANETS.com)

L14-022 Rev 4. 12. 2018

## Installation

### General Installation Requirements

Although it may be possible for you to install and set up your new appliance, it is **STRONGLY** recommended that you have this done by a qualified professional. A qualified professional will ensure that the installation is safe and meets local or national building, electrical, and fire codes.

Where conflict exists between instructions in this manual, and local or national codes or regulations, installation and operation shall comply with the codes or regulations in the locale in which the appliance is installed.

### Installation Clearances

The clearances shown below are for combustible and non-combustible installations and will allow for safe and proper operation of your appliance

	<b>Combustible Construction</b> Inches (Centimeters)	<b>Non-Combustible Construction</b> Inches (Centimeters)
Back	6.0" (15.24cm)	0.00" (0.0cm)
Sides	6.0" (15.24cm)	0.00" (0.0cm)
Floor	6.0" (15.24cm)	6.0" (15.24cm)
Aisle	35.0" (88.90cm)	35.0" (88.90cm)

#### **WARNING**

DO NOT obstruct the flow of ventilation air openings around the appliance. Adequate clearance around the appliance is necessary for servicing and proper component ventilation. Ensure that you meet the minimum clearance requirements specified in this manual.

#### **WARNING**

DO NOT install this appliance next to a water cooker, or use in any way in which water can come in contact with the hot oil. Splash over of water into hot oil may result in a steam eruption, potentially causing hot oil to be ejected from the fryer, and creating a burn hazard.

## Electrical Connections

It is advised that this appliance be connected to a power supply that is controlled by the ventilation system. This will prevent the appliance from being operated without the ventilation hood on. If your appliance is single phase, it requires a hardwired, flexible conduit electrical connection, using conductors sized appropriately for the power requirements listed below. Hardwired units require installation of a restraint device mounted to substantial building structure.

ELECTRIC REQUIREMENTS		Nominal Amps Per Line (50/60 HZ)											
		Single Phase (2 wires + ground)					3 Phase (3 wire+ground)				3 Phase "Y" (4 wire+ground)		
Models	KW/HR	208V	220V	230V	240V	480V	208V	220V	240V	480V	380/220V	400/230V	415/240V
AEP (14,18)	17	82	78	74	71	36	48	45	41	21	26	25	24
AEP (14R,18R)	22	106	100	96	92	46	62	58	53	27	34	32	31
AEP (14X,14TX)	14	67.3	64.7	60.9	58.3	29.2	38.9	36.7	33.7	16.8	21.3	20.2	19.5

Note: 1. Each fryer requires it's own separate power cord. 2 Power supply for Basket lift is wired into the fryer's high voltage line terminal block, except for 480V which requires another separate 115V (6.8 amp) power cord connection to the unit.

### CAUTION

Connecting the appliance to the wrong power supply may damage the appliance and void the warranty

### WARNING

This appliance must be connected to a power supply having the same voltage and phase as specified on the data plate located on the inside of the appliance door. DO NOT attempt to connect the appliance to an electrical supply other than that indicated on the data plate. Electrical connection should be performed by a qualified electrician

### WARNING

The electrical connection used by this appliance must comply with local codes. If there are no local codes that apply, refer to the National Electrical Code (NEC), ANSI/NFPA 70 for installation in the US. In Canada, refer to CSA Standard C22.2 and local codes. In other cases, refer to local and national codes and regulations.

### WARNING

The appliance must be grounded in accordance with local code, comply with the NEW and ANSI/NFPA No. 70 latest edition (for US and Canadian installations). In all other cases, refer To local and national codes and regulations. To comply with European requirements, European models are equipped with an equalization-bonding clamp. An equalization bonding lead must be connected to this clamp to provide sufficient protection against potential difference. This clamp, located on the rear of the appliance is marked with the following universal symbol... 

### WARNING

A country approved all pole circuit breaker with a minimum open contact gap of 3mm must be used for proper installation. (CE countries)

### WARNING

This equipment must be installed so that the plug (if used) is accessible unless other means for disconnection from the power supply (e.g: circuit breaker) is provided.

### WARNING

If this appliance is permanently connected to fixed wiring, it must be connected by means of copper wires having a temperature rating of not less than 167°F (75°C), and have a local means of disconnection from all poles from the mains included in the fixed wiring in accordance with local codes.

### WARNING

All power connection wiring for this appliance must be made in accordance with the wiring diagrams(s) located on the appliance.

### CAUTION

Leakage current of this appliance may exceed 10 mA. When permanently connected, a high integrity protective system employing an RCD rated at 30 mA must be used with this appliance.

## Installation

### CAUTION

This equipment is manufactured for the use on a particular voltage and phase which is specified on the rating plate located on the inside of the door.

When your fryers arrive, inspect carefully noting any damage on the freight bill. If concealed damage is found after you have accepted the equipment, report it to the carrier immediately as all claims must be filled within 15 days of the receipt of the shipment. Also, be sure to keep all packing materials as these will be necessary to make any claim.

Follow these installation instructions carefully. A proper installation is important for the operation of the fryers.

All installations must conform to all local and national codes.

Do not block the area around the casters and under the fryers. Contact the Authorized Anets Frialator representative for any service related problems. Routine maintenance may be performed by qualified personnel.

The duct system, the hood system and the fryers must be cleaned on a regular basis and must be kept clear of any grease build up.

### Ventilation

A proper ventilation system is also an important part of the installation.

### Clearances

Minimum clearance of 6" (15cm) must be maintained from combustible construction on each side and the rear of the equipment. This equipment may be installed on combustible floors.

Maintain a minimum of 24"(61cm) clearance in front of the fryer to provide for proper operation, maintenance and servicing.

Wiring diagram(s) are located in the back of the service manual and inside the fryers.

Regular cleaning of this equipment, as well as the hood, is an important part of proper maintenance.

### Once the fryers are in place:

Leveling the fryers will help ensure proper operation. To level the fryers loosen the two set screws on the caster stem. Rotate the collar of the caster to raise or lower the height of the unit. Tighten set screws to lock the adjustment. Casters should be adjusted so that the fryers are level and at the correct height under the hood system.



## Installation

### EQUIPMENT SET UP AND SHUT DOWN PROCEDURES

**NOTE:** Should you experience a power failure, your fryers will shut off automatically. Once the power predetermined temperature has been reached, the unit has been restored, press the  key to turn the fryer back ON. If the machine is being filtered, close the RED return valve so that the filter does not run if the machine is left unattended. Do not attempt to restart the fryers until the power is restored.

#### Filling the fryer with oil:

It is very important to make sure the oil level is correct before attempting to heat shortening in your Anets fryer.

Liquid shortening can be poured directly into the fry tank until the correct level has been reached. This is indicated by a line on the right hand side of the inside of the tank.



**NOTE:** The “COLD” level is considered to be the “MINIMUM” oil level and the “HOT” level is considered to be the “MAXIMUM” oil level.

For solid shortening, the shortening must be cut into small blocks about 1" (2.54 Cm) in size. These small blocks must be placed under and around the heating elements.

The fryer can now be turned ON.

#### Set-Up:

**NOTE:** Please read the Operating instructions thoroughly before attempting to operate this equipment.

Press the  key on either side of the full vat computer, or the right  key for the right side and the left  key for the left side of a split vat computer to turn the unit ON.

The computer display will light and the heating elements will begin to heat and will be controlled by the computer/controller.

**NOTE:** It is recommended that melt cycle be used. This will extend the shortening life. In melt cycle the shortening turns from solid to liquid gradually through short, controlled bursts of heat. Once the predetermined temperature has been reached, the unit will exit the melt cycle and go to normal operation.

**NOTE:** Should you experience a power failure, your fryers will shut off automatically. Once the power predetermined temperature has been reached, the unit will exit the melt cycle and go to normal operation.

Make sure that the shortening is at the proper level after cooking temperature has been reached. It may be necessary to add shortening to maintain the proper level.

**NOTE:** When adding solid shortening to an empty fry tank, first remove the baskets and support racks and fill the bottom of the tank with shortening, continue to pack the remaining shortening into the tank. Place the basket support rack on top of the shortening before turning the unit ON.

For liquid shortening fill to the level lines indicated on the side of the tank.

**NOTE: Recommended cooking batch is 3lbs (1.4kg) per basket.** Maximum cooking batch is not to exceed 5lb (2.27kg) per standard electric fryer (14" wide) basket, or 7.5lb (3.40kg) per Large electric Fryer (18" wide) basket.

#### CAUTION:

Excessive loading or loading of over-wet food can cause surge boiling.

#### Shut Down:

Press the corresponding  key to turn the fryer OFF. The computer display will go blank and all heating functions will cease.

**NOTE:** When the fryer is not being used, place the cover over the fry tank. (The covers are optional and do not come with fryer unless ordered.)



## Filter Procedures for Flat Paper Filter Systems

### Flat Paper Filter Systems

#### NOTE:

When working with hot oil ALWAYS wear oil proof, insulated gloves.

#### WARNING

**NEVER** - Run the filter system without a filter bag/paper.

**NEVER** - Empty the oil from the fryer before turning OFF the fryer burners.

**NEVER** - Store the Filter Unit anywhere other than in the fryer filter cavity.

Continuous operation is **not allowed!** Only intermittent operation with max. 3 consecutive pump cycles followed by at least 20 minutes break with empty oil compartment.

a. Slide the filter pan out. Carefully remove filtered residue off the filter media. Examine the filter media for clogged or torn areas. Refer to filter media replacement instructions following this section. Reinstall the pan.

b. Turn the fryer that is to be filtered OFF (See Standby Shutdown). Remove the baskets from the fryer tank(s). Use the clean out brush to lift out the tube screens.

c. Check the pickup tube screen by unscrewing the cap counterclockwise. Any debris should be cleaned from the screen before using the filter system. Reinstall the screen by screwing the cap back on clockwise. Do not over-tighten.

d. Slowly open the blue handled drain valve for the tank being filtered. If necessary use the clean-brush to clear the crumbs from the drain. Use the brush to clean the sides of the tank as the oil drains.

#### WARNING

**This filter pan is only large enough to hold the contents of one (1) tank at once, during the filter process.**

e. When the tank is empty, close the blue handled drain valve. Open the red handled return valve to the tank you are filtering. This will start the pump and return the oil to the bottom of the fry tank.

f. When bubbles are seen coming out of the oil return spout, close the red handled valve to turn the pump off. If necessary add more oil to the tank to return the oil level to the fill mark.

**The fryer is now ready for use.**

### DRAINING A TANK

The filter system is also used to drain the fryers. You will need a container capable of holding 400F oil and protective gloves.

a. Rotate the drain down spout so that it extends in the container that you want to drain the shortening into.

b. Open the blue handled drain valve for the tank to be drained. The oil will drain into the container you have chosen. When the container is full or the fry tank is empty, close the blue handled drain valve. If the container was full repeat this step until fryer tank is empty.

c. Once tank is completely empty add new shortening and follow fryer start up Procedures.

#### WARNING

**The power supply must be disconnected before Servicing or cleaning the appliance.**

#### Preparing the filter for use:

- Slide drawer forward until it stops.
- Grasp the Left and Right handles of the Paper Retaining Frame and lift upward to remove it.
- Remove the filter paper or pad by folding the edges inward so that the debris is collected.
- Lift the Paper Support Screen out of the pan.
- The Pan, Paper Support Screen and Paper Retaining Frame can now be cleaned.

**NOTE:** Be sure that the filter pan is free of any debris which could cause the paper and hold down ring not to seat properly.

## **Filter Procedures for Flat Paper Filter Systems**

- Place the Paper Support Screen in the bottom of the pan.
- Place filter Paper or Pad over screen making sure that there is an equal amount of excess paper on each side.
- Place the Retaining Frame on the paper or pad making sure that all edges are being pressed down evenly.
- Slide filter drawer back under fryer making sure that the oil return pipe locates into its mating connection.

### **CAUTION:**

**Be careful when using the clean out rod. Damage to the drain valve may result.**

### **WARNING:**

**Hot shortening can cause severe injury. Take care when filtering or disposing of hot shortening. Protective gear such as gloves, apron, face shield and sleeves should be worn.**

Allow all of the shortening to return to the tank. Bubbles will be produced in the vat when all the shortening has been returned. This means that the return lines have been cleared.

- Close the RED Return Valve, by pushing upward on the Red Return Valve Handle. This will turn the pump off.
- Press the  key and the Display will show "OFF".
- Allow the Drain and Return lines to drain for at least 5 minutes before removing filter pan to reduce dripping.

**Your machine is now ready to use.**

## Filter Procedures for Envelope Paper Filter Systems

### NOTE:

When working with hot oil **ALWAYS** wear Oil-proof, insulated gloves.

**NEVER** • Run the filter system without a filter bag/paper.

**NEVER** • Empty the oil from the fryer before turning **OFF** the fryer burners.

**NEVER** • Store the UFM Filter Unit anywhere other than in the fryer filter cavity.

Continuous operation is **not allowed!** Only intermittent operation with max. 3 consecutive pump cycles followed by at least 20 minutes break with empty oil compartment.

a. Slide the filter pan out. Carefully remove filtered residue off the filter media. Examine the filter media for clogged or torn areas. Refer to filter media replacement instructions following this section. Reinstall the pan.

b. Turn the fryer that is to be filtered **OFF** (See Standby Shutdown). Remove the baskets from the fryer tank(s). Use the clean out brush to lift out the tube screens. If there are excess crumbs in the fryer tank, remove them with the crumb scoop.

c. If you have replaced the filter media or remove crumbs and debris, sprinkle Precoat Filter Aid on the filter paper.

d. Check the drain spout to ensure that it is in the drain tower and over the filter pan opening.

e. Slowly open the blue handled drain valve for the tank being filtered. If necessary use the clean-brush to clear the crumbs from the drain. Use the brush to clean the sides of the tank as the oil drains.

f. Slowly open the blue handled drain valve for the tank being filtered. If necessary use the clean-brush to clear the crumbs from the drain. Use the brush to clean the sides of the tank as the oil drains.

### WARNING

**This filter pan is only large enough to hold the contents of one (1) tank at once, during the filter process.**

g. When the tank is empty, close the blue handled drain valve. Open the red handled return valve to the tank you are filtering. This will start the pump and return the oil to the bottom of the fry tank.

h. When bubbles are seen coming out of the oil return spout, close the red handled valve to turn the pump off.

If necessary add more oil to the tank to return the oil level to the fill mark. The fryer is now ready for use.

### DRAINING A TANK

The filter system is also used to drain the fryers. You will need a container capable of holding 400F oil and protective gloves.

a. Rotate the drain down spout so that it extends in the container that you want to drain the shortening into.

b. Open the blue handled drain valve for the tank to be drained. The oil will drain into the container you have chosen. When the container is full or the fry tank is empty, close the blue handled drain valve. If the container was full repeat this step until fryer tank is empty.

c. Once tank is completely empty add new shortening and follow fryer start up procedures.

### WARNING

**The power supply must be disconnected before servicing or cleaning the appliance.**

### FILTER MEDIA REPLACEMENT

The filter module stores neatly under the fryer when not in use. The unit is very easy to use and allows for quick installation and filtration, even under the busiest conditions. Follow the procedures below to change the filter media.

## Filter Procedures for Envelope Paper Filter Systems

### WARNING

**At operating temperature, the shortening is the fryer may be hotter than 375°F (190°C). This hot, melted shortening will cause severe burns. Do not let the hot shortening touch your skin or clothing. Always wear insulated oil-proof gloves when working on the filter system. It will be easier and safer if the filter assembly has cooled to room temperature before handling any filter parts.**

- a. With the filter pan empty of oil, remove the filter pickup assembly into the filter media by grasping the filter pan handle filter pan and slide the filter pan assembly and gently pull the assembly toward the front back into the fryer cabinet of the fryer.
- b. Separate the filter pickup tube from the filter pickup screen assembly by pulling up on the pickup tube just above where it connects to the pickup screen assembly. Lift pickup tube and swing it to the left, until it rests on the left hand side of the filter pan.
- c. Grab filter screen pickup assembly lift handles and carry it to a trash barrel and shake off heavy discard any debris that may be built upon the top of the assembly.
- d. Unscrew the filter paper clip bracket from the filter paper support screen and slide the filter paper support screen out of the filter paper clip bracket.
- e. Remove filter paper support screen from the filter envelope.
- f. All of the filter pick up assembly parts can be washed in a dish washer or a pot sink. Flush out the suction tube assembly with hot water. After cleaning, it is very important to thoroughly dry the parts before reassembling. Water and oil do not mix. Water in hot oil will cause the oil to splatter.
- g. Start reassembling the filter pick up assembly by sliding the new filter paper on to the filter paper support rack. Ensure that the hole in the filter paper goes over the pick up tube assembly threaded connector.
- h. Fold the open end of the bag in two folds. The first fold should be approximately 1 inch from the end and the second should be over the edge of the rack assembly.
- i. Slide the clip screen over the folded end of the filter paper. Ensure the opening of the clip screen goes over the pick up tube connection. Screw the suction tube connection onto the threaded connection.
- j. Place the filter pickup assembly into the filter pan and slide the filter pan assembly back into the fryer cabinet.
- k. Filter unit is now ready for use.

# ANETS I12 Computer Quick Programming card

ANETS I12 Cooking Computer  
ANETS P/N 60149509 and 60149510

## 1 Key Locations and Functions:

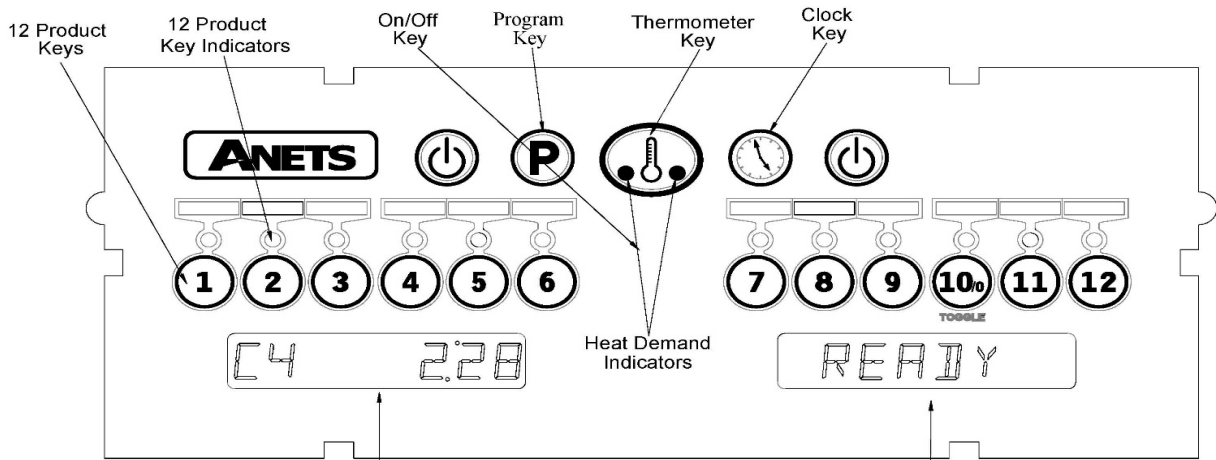

Displays show current operation. Throughout this text, a left only display will be printed as [C4 2:28]. When both left and right displays should be interpreted together, this text will show them as [C4 2:28] [READY].

### 1.1 To turn the appliance ON:

If power is applied to the appliance, the displays will show **OFF**. Press the  key.

Displays will show one of the following:

**MELT**; **HEATING**, or **READY**. Some messages may show in both left and right displays. Wait for the appliance to heat up to the **READY** condition before cooking.

### 1.2 To turn the appliance OFF:

Press the  key. Display will momentarily show the software version number **0149509-** or **0149510-**, and then **OFF**.

### 1.3 To start a cook:

When the display is showing **READY** the appliance has reached set temperature and is ready to cook. Press the desired product key, and place product into the vat. The indicator above the product key will flash to indicate the cook timer is running. In the example above, product 4 is cooking with 2 minutes and 28 seconds remaining. The right side display of the dual vat control shown above, has no running cook timers, and shows **READY**.

Multiple cooks may run together. While cooks are running, the displays will always show the cook with the least time remaining. Longer running cooks will flash their indicators at a slower rate. Cook time remaining on these keys may be checked by pressing the  key then pressing a product key.



# Anets I12 Computer Quick Programming card





ANETS I12 Cooking Computer  
ANETS P/N 60149509 and 60149510

## 1.4 To cancel a cook:

Press and hold the product key to cancel a running cook. If no other cooks are pending, controller displays will return to **READY**.

## 1.5 To check Actual and Set temperatures:

To view the actual vat temperature, press the  key. The display will show **ACT 347F** or **ACT 175C**, where "F" is Fahrenheit, and "C" is Celsius. After a few moments, the display will return to **MELT**; **HEATING**, or **READY** if no cooks are running. [Cn mm:ss] will display for any cooks still running.

To view the set temperature, press the  key twice. The display will show **SET 350F** or **SET 177C**, where "F" is Fahrenheit, and "C" is Celsius. After a few moments, the display will return to **MELT**; **HEATING**, or **READY**, or, [CKn mm:ss] for any cook still running.

## 1.6 To View Current Settings for Cook, Shake, Hold, and Hold Pre-Alarm:

To view the current settings for any product key, press the  key, followed by the desired product key. The display will show [Cn mm:ss], followed by [Sn mm:ss], then [Hn mm:ss], ending with [Pn mm:ss]. Where "n" is the key number, and "mm:ss" is the time setting.

After a few moments, the display will return to **MELT**; **HEATING**, or **READY**, or, [Cn mm:ss] for any cook still running.

Example displays using key 1:

Key 1 Cook Time [C1] is set for 3 minutes and 28 seconds.

Key 1 Shake Time [S1] is set for 2 minutes and :00 seconds before the end of the Cook. *Default value is 00:00, or inactive.*

Key 1 Hold Time [H1] is set for 15:00 minutes. This is the amount of time cooked product may sit in holding bins before a new batch is started. *Default value is 00:00, or inactive.*

Key 1 Hold Pre-Alarm [P1] is set for 00:00 and is inactive (*default setting*). When activated his alarm warns the operators that the Hold Time is about to run out.

In a few moments, the display will return to **READY**.



# ANETS I12 Computer Quick Programming card

ANETS I12 Cooking Computer Service  
ANETS P/N 60149509 and 60149510



## 1.7 To perform a Boil Out operation:

Normal maintenance of a fryer requires regular tank cleaning. This process involves draining the vat of oil and filling with water. Cleaning solution is added, and the control is set to boil by one of the following methods:

### 1.7.1 Automatic Boil Entry (Water Detection):

Fill the appliance with water and turn the appliance on. Heat will be applied to the vat warming the water. This control will detect the presence of water by temperatures not rising above the boiling point of water; 212°F (100°C). After a time at this temperature, displays will show

**PRESS 0 TO BOIL**

Heat will be disabled until the operator responds to this prompt. Pressing the [10/0] key is a **YES** response to the boil prompt. If pressed, display will show **BOIL**. Heat will maintain vat temperature at 185°F (85°C) for cleaning as long as the control remains on. To exit boil mode control must be turned off.

*Warning: Pressing any other key at the **PRESS 0 TO BOIL** prompt is regarded by the control as a **NO** response. With this response, the control will apply heat to the vat as if oil were present in the vat. With water in the vat, a rolling boil will result. This will cause undesirable foam over conditions. And, a potential steam burn hazards to operators performing cleaning operations.*

### 1.7.2 Manual Boil Entry:

After filling an empty vat with water, turn the appliance on. Press the



key and enter key sequence [2], [1], [2]. *If control is set to display in the Celsius scale, press [1], [10/0], [10/0] keys to manually enter boil mode.* The display will show **BOIL** to indicate entry into boil mode.

To exit boil mode, control must be turned off.

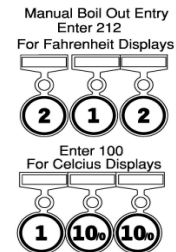



# Anets Digital controller

## 1. Keypad and Display Functions:

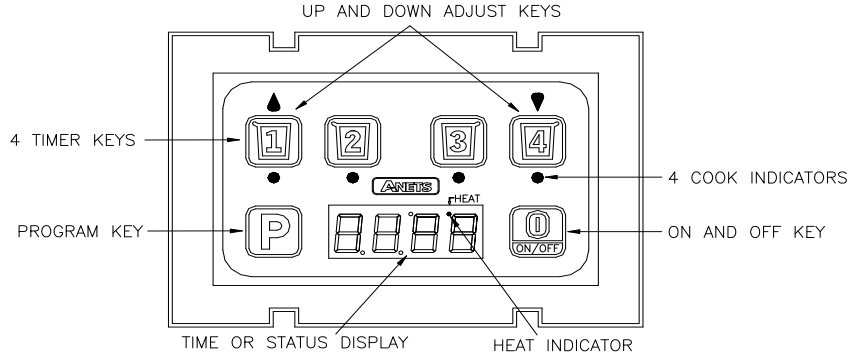

## 2. Normal Operations: (for the operator)

### 2.1. To turn control ON:

Press the [I/O] key. Display will momentarily show the current Appliance Type "APLx" for 2 seconds and then to one of the normal displays shown here.

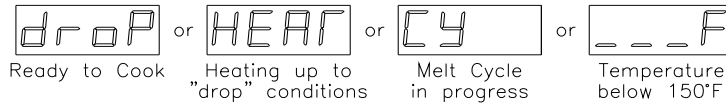

### 2.2. To turn control OFF:

Press and hold the [I/O]key for 3 seconds. Display will show [oFF].



### 2.3. To Start a Cook Timer:

Press a Timer Key T1-T4 to start a cook timer in this group.



### 2.4. To Cancel a Cook Timer:

Press the Timer key until light below the key is off.

### 2.5. To Perform a Boil Out:

Press the [P] key and the Down arrow key simultaneously. To exit boil mode, turn controller off.

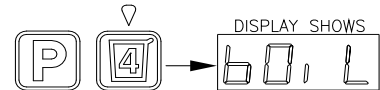

### 2.6. To Display Vat Temperature and Set Temperature:

Press the Program [P] and [I/O] key simultaneously. Display will show the actual VAT temperature, either xxx°F or xxx°C(350°F in this example).



Press the [P] key. Display now shows the SET temperature.



Press the [P] key. Display again displays actual vat temperature. To exit, make no key presses for 3 seconds and display will return to normal display.

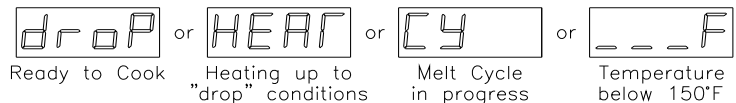

# Anets Digital controller

Anets Compact Digital Control 60143804

### 3. To Enter Programming: (for the store manager)

Press the Program [P] key and [I/O] key simultaneously for 2 seconds. Vat temperature will display momentarily, then display will show one of two possible displays; [butt] for Button or [Loc] for Locked.



If locked, press the UP arrow key TWO times, then the down arrow key TWO times to unlock.



Display shows:

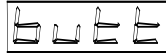

#### 3.1. To set timers T1-T4:

Select a timer key to change. The light below the key will illuminate. The display will show the current timer setting in MM:SS format.



Press the UP arrow key or DOWN arrow key to adjust the timer value. The value will change in steps of 5seconds each. When set, press the [P] key to save setting and continue. The display will return to [butt].



Repeat section 3.1 for other timer keys.

#### 3.2. To Change Cook Temperature:

While display is showing [butt], momentarily press the [P] key. Display will show xxx°F or xxx°C, the current temperature setting. The default setting is 350°F (177°C)



Press and hold the UP arrow key or DOWN arrow key to change the temperature setting. A single key press will increment or decrement the setting by one degree. When set, press the [P] key to save setting and continue.



#### 3.3. To Change Melt Cycle type:

Display will show the current melt cycle setting.

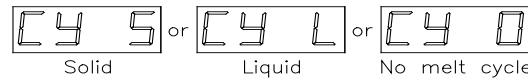

Press the UP arrow key or DOWN arrow key to adjust the melt cycle type.

When set, press the [P] key to save setting and continue.



#### 3.4. To Change Pass Word Requirement:

Display will show the current lock status.

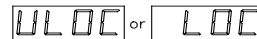

Press the UP arrow key or DOWN arrow key to change lock setting for future entry into programming menus. When set, press the [P] key to save setting and continue.



#### 3.5. To Change °F or °C Display:

Display will show the current temperature scale setting.

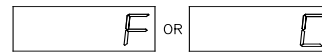

Press the UP arrow key or DOWN arrow key to change scale setting. When set, press the [P] key to save setting and continue.



#### 3.6. To exit Level 1 Programming:

With the display is showing:

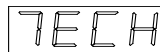

Press the [P] key to exit. The display returns to normal.

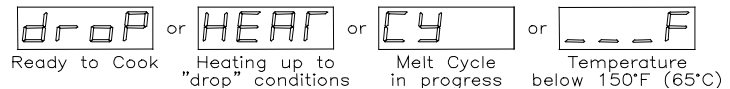

## Troubleshooting Chart

PROBLEM	PROBABLE CAUSE	CORRECTIVE ACTION
Computer does not come on nothing shows in either display	A. Main circuit breaker is turned off B. Fryer fuse is blown	A. Locate the correct building circuit breaker and turn OFF and back ON again.  B. Call an Authorized Service Technician
Computer heat light comes on but elements do not heat	A. If the oil is hot the Hi - Limit may be tripped	A. Allow the oil to cool, reset the Hi Limit and turn the computer OFF and back ON again.
Computer display shows "OFF" and cannot be turned "ON".	A. Bad computer	A. Locate the correct building circuit breaker and turn OFF and back ON again. If this does not reset the computer call an Authorized Service Technician.
RED return valve is open no pump sound can be heard	A. RED return valve not fully open B. Filter circuit breaker may be tripped C. Filter motor Thermal Overload may be tripped D. Sensor switch may be loose	A. Pull slightly on the RED return valve handle  B. Locate the filter circuit breaker behind the door of the left hand fryer and reset it. C. Push RED reset button located on end of filter motor, behind the door of left hand fryer. D. If the mounting screws are loose try to tighten them, if this is not possible call an Authorized Service Agency.
Drain valve is closed and the computer has been reset but still shows "DRAINING" or "TURN OFF"	A. Blue drain valve is not fully closed B. Sensor switch may be loose	A. Apply a little more pressure to close the valve  B. If the mounting screws are loose try to tighten them, if this is not possible call an Authorized Service Agency.
Drain valve is open, the oil is draining slowly or not at all.	A. Blue drain valve is not fully open B. Drain is plugged with debris	A. Apply a little more pressure to open the valve  B. Use the clean out rod to clear the drain valve from inside the fry vat. If this does not clear the blockage, CLOSE the Blue drain valve and follow the instructions for clearing the main drain line. CAUTION: Some HOT oil may come out when the cap is removed. Remove the two wing nuts from the end cap (do NOT lose these.) Use the clean out rod to clear the main drain tube. Install the end cap along with its gasket and four screws. Do not overtighten these screws or remove drain "T" cleanout access covers, by removing thumb screws (do not loose screws). Then clean drain, replace access cover and thumb screws

## NOTES



**Mailing Address: P.O. Box 501, Concord, NH 03302-0501**

**Physical Address: 553 Route 3A, Bow, NH 03304**

**Tel: 603-225-6684**

**Fax: 603-225-8472**

**Customer Support: [service@Anets.com](mailto:service@Anets.com)**

**Web: [www.Anets.com](http://www.Anets.com)**

Anets

PRINTED IN USA

150-000010 RA (8/2019)