**INSTALLATION • OPERATION
OWNER'S MANUAL**



Incogneeto™ Buffet Warming System

Models B651-U, B652-U

Part Numbers 658900, 659000



CookTek Induction Systems, LLC

Toll Free: +1 (888) COOKTEK
Toll Free Fax: +1 (888) COOKFAX
Phone: +1 (312) 563-9600
Fax: +1 (312) 432-6220

www.cooktek.com
customerservice@cooktek.com

CookTek Induction Systems, LLC

Toll Free: +1 (888) COOKTEK
Toll Free Fax: +1 (888) COOKFAX
Phone: +1 (312) 563-9600
Fax: +1 (312) 432-6220

www.cooktek.com
customerservice@cooktek.com

Antes de Começar:

Por favor, certifique-se de que este cabo de energia está ligado firmemente à sua unidade CookTek ANTES de ligar a unidade à tomada de energia e antes de tentar funcionar com ela.

- Não toque na placa de cerâmica (no cimo do Cooktop) imediatamente depois da sua utilização. O calor emitido pelo tabuleiro será transferido para a placa de cerâmica, fazendo com que esta fique quente ao toque.
- A assistência técnica deste produto só pode ser realizada por um agente de assistência técnica autorizado ou por pessoal da CookTek. Não tente abrir a unidade nem efectuar assistência técnica de qualquer tipo. Para informações referentes à assistência técnica, por favor entre em contacto com a CookTek pelo telefone 1-312-563-9600.
- O aparelho deve estar ligado à terra. Ligue apenas a uma tomada correctamente ligada à terra. Antes de funcionar com o aparelho, leia as instruções relativas à ligação à terra e os Requisitos para Instalação Eléctrica na Página 3 deste folheto. Não utilize um cabo de extensão.

SPANISH

Antes de utilizar el anafe (cooktop), realice lo siguiente:

- Retire todo el material de embalaje.
- Coloque la unidad sobre una superficie seca, plana, dura, estable y no inflamable.
- Mantenga la unidad alejada de otras fuentes de calor y deje un margen de al menos 5 cm para que el aire circule por los lados y las partes anterior y posterior de la unidad.

Por su seguridad, nunca corte, quite ni inutilice la conexión eléctrica (tierra) del enchufe. No utilice nunca el anafe con un enchufe adaptador ni un cable prolongador.

ADVERTENCIA: Se puede producir un choque eléctrico por un enchufe conectado a tierra de manera incorrecta. Si tiene alguna duda relacionada con las instrucciones de conexión a tierra, póngase en contacto con un electricista cualificado.

Antes de comenzar:

Asegúrese de que el cable eléctrico está unido firmemente a la unidad CookTek ANTES de conectar la unidad a la electricidad y antes de intentar utilizarla.

- No toque la placa cerámica (situada en la parte superior del anafe) inmediatamente después de utilizarla. El calor de la cazuela se transferirá a la placa cerámica y hará que ésta se caliente.
- La revisión de este producto únicamente puede realizarla un operario de mantenimiento autorizado o el personal de CookTek. No intente abrir la unidad ni realizar ninguna labor de mantenimiento. Para obtener información sobre el mantenimiento, póngase en contacto con CookTek llamando al 1-312-563-9600.
- Este aparato se debe conectar a tierra. Enchúfelo únicamente a una toma conectada a tierra de manera adecuada. Antes de utilizarlo, lea las instrucciones de conexión a tierra y los “Requisitos de la instalación eléctrica” de la página 3 de este folleto. No utilice cables prolongadores.

POLISH

Przed rozpoczęciem używania urządzenia Cooktop, należy wykonać poniższe czynności:

- Usunąć wszystkie elementy opakowania.
- Ustawić urządzenie na suchej, poziomej, twardej, stabilnej i niepalnej powierzchni.
- Ustawić urządzenie z dala od innych źródeł ciepła i zapewnić wokół urządzenia wolną przestrzeń, co najmniej 0,5 cm, aby umożliwić obieg powietrza. Dla bezpieczeństwa użytkownika nie wolno nigdy przecinać, wyjmować ani wyłączać połączenia elektrycznego (uziemienia) z wtyczki. Stosując urządzenie Cooktop nie wolno używać złącza pośredniego ani przedłużacza.

OSTRZEŻENIE: Niewłaściwe uziemienie wtyczki może spowodować porażenie prądem elektrycznym. W przypadku wątpliwości dotyczących instrukcji uziemienia należy skontaktować się z wykwalifikowanym elektrykiem.

Przed rozpoczęciem używania:

Należy sprawdzić, czy przewód zasilania jest pewnie przymocowany do modułu CookTek PRZED podłączeniem urządzenia do gniazdka zasilania i przed rozpoczęciem jego używania.

- Nie dotykać płyty ceramicznej (lub wierzchniej części urządzenia Cooktop) bezpośrednio po zakończeniu jego używania. Wysoka temperatura patelni może przenosić się na płytę ceramiczną, stwarzając możliwość oparzenia w przypadku jej dotknięcia.
- Obsługa serwisowa tego produktu może być prowadzona jedynie przez upoważnionego pracownika serwisu lub przez personel firmy CookTek. Nie podejmować samodzielnej próby otwarcia urządzenia ani nie wykonywać żadnych napraw. Aby uzyskać informacje dotyczące obsługi serwisowej, należy skontaktować się z firmą CookTek pod numerem 1-312-563-9600.
- Niniejsze urządzenie wymaga uziemienia. Podłączać jedynie do właściwie uziemionego gniazda. Przed użyciem należy przeczytać instrukcję dotyczącą uziemienia oraz część „Wymogi instalacji elektrycznej” na stronie 3 niniejszej ulotki. Nie używać przedłużacza.

PORTUGUESE

Antes de funcionar com o seu Cooktop, faça o seguinte:

- Retire todo o material de embalagem.
- Coloque a unidade numa superfície seca, nivelada, rígida, estável e não inflamável.
- Mantenha a unidade afastada de outras fontes de calor e deixe um espaço de pelo menos 5 cm nos lados, frente e traseira da unidade, para circulação do ar.

Para sua segurança, nunca corte, retire nem desactive a ligação eléctrica (terra) da ficha. Nunca utilize uma ficha adaptadora nem cabo de extensão com o Cooktop.

ADVERTÊNCIA: Uma ficha incorrectamente ligada à terra pode provocar choque eléctrico. Se tiver alguma questão sobre estas instruções de ligação à terra, por favor consulte um electricista qualificado.

PREPARING YOUR COOKTEK BUFFET UNIT FOR USE

Before operating your buffet, do the following:

- Remove all packing material and save for subsequent shipment or in case of concealed shipping damage.
- Keep unit away from other heat sources and allow at least two (2) inches clearance for air circulation at sides, front and rear of the unit. If either the air intake or exhaust outlet is blocked, the internal temperature will rise, causing an error code to occur.

Grounding Instructions:

The buffet must be properly grounded. In the event of an electrical short circuit, grounding reduces the risk of electric shock by providing a safe path for the electric current. The buffet has a power cord with a 3-prong grounding plug, which must be used in a compatible and properly grounded outlet. It is the owner's responsibility to replace any 2-prong wall outlet with a properly grounded 3-prong wall receptacle.

For your safety, never cut, remove, or disable the electrical (ground) connection from the plug. Never use an adapter plug or an extension cord with the buffet.

WARNING: Electric shock can result from an improperly grounded plug. Please consult a qualified electrician if you have any questions about these grounding instructions.

Before you begin:

Please make sure that this power cord is firmly attached to your CookTek unit BEFORE plugging the unit into the power receptacle and before attempting operation.

ELECTRICAL INSTALLATION REQUIREMENTS

Every installation site has different electrical wiring. Because many different local codes exist, it is the Owner and Installer's responsibility to comply with those codes. CookTek is not responsible for any consequential damages as a result of failure to comply with installation requirements.

- Read all installation instructions carefully before starting installation.
- Remove buffet carefully from carton.
- Remove all loose packaging and accessories and save for subsequent shipment or in case of concealed shipping damage.
- It is the responsibility of the installer to comply with all federal, state and local codes.
- Any installation not matching the specifications discussed in this manual automatically voids the product's warranty. tag must be positioned over.

MECHANICAL INSTALLATION

- Install the mounting tracks per the installation sheet provided with either the single unit tracks or the rail kit as appropriate. Also see instructions at the end of this manual.
- Insert the unit with the Antenna side sticker away from the customer. This is the side of the unit that the Magneeto™ II
- To install the unit on the tracks, hook one side of the springs onto the track and then compress the other side of the mounting springs and snap it into the track. See assembly drawing.



GENERAL INFORMATION

Model Types

B651-U - 100-120VAC model

B652-U - 200-240VAC model

User Interface Buttons

Power button - Use this button to turn the unit on and off. A green LED will indicate when the unit is on.



Lock button - Use this button to prevent users from adjusting settings. Pressing this button three times will lock the unit. When the unit is locked, the only button that will continue to work is the Power button. To unlock the unit, press the Lock button three times. The red LED to the right of the button will indicate when the unit is locked.



Up and Down Arrows - These buttons allow you to quickly set the temperature.



Alphanumeric display - Displays holding temperature (Fahrenheit or Celsius) and error code information.



Per la propria sicurezza, non tagliare, rimuovere o disattivare mai il collegamento elettrico di terra dalla spina. Non utilizzare mai una spina adattatore o un cavo elettrico di prolunga per collegare il piano cottura.

AVVERTENZA: una spina elettrica non correttamente collegata all'impianto di terra può provocare scosse elettriche. Rivolgersi a un elettricista qualificato in caso di domande su queste istruzioni di messa a terra.

Prima di iniziare:

Assicurarsi che questo cavo di alimentazione sia collegato saldamente all'unità CookTek PRIMA di collegare l'unità alla presa elettrica e prima di metterla in funzione.

- Non toccare la piastra di ceramica (o la superficie del piano cottura) subito dopo l'uso. Il calore della pentola si trasferisce alla piastra di ceramica, rendendola estremamente calda. • Questo prodotto può essere riparato esclusivamente da un tecnico autorizzato o dal centro di assistenza CookTek. Non tentare di aprire l'unità o di eseguire interventi di manutenzione di alcun tipo. Per informazioni sull'assistenza, contattare la CookTek al numero 1-312-563-9600.
- Questo apparecchio deve essere collegato a terra. Collegarlo esclusivamente a una presa elettrica dotata di messa a terra. Prima di mettere in funzione l'unità, leggere le istruzioni di messa a terra e i Requisiti di installazione elettrica a pagina 3 di questo opuscolo. Non utilizzare un cavo elettrico di prolunga.

NORWEGIAN

Før du bruker komfyren, må du gjøre følgende:

- Fjern all emballasje.
- Plasser enheten på et tørt, jevnt, hardt, stabilt og brannsikkert underlag.
- Hold enheten unna andre varmekilder, og la det være minst 5 cm klaring for luftventilasjon på sidene, foran og på baksiden av enheten.

For din egen sikkerhet må du ikke kutte, fjerne eller ødelegge den elektriske (jordede) kopligen fra kontakten. Ikke bruk en adapterkontakt eller skjøteledning for komfyren.

ADVARSEL: Elektrisk støt kan oppstå fra kontakt som ikke er korrekt jordet. Ta kontakt med en kvalifisert elektriker dersom du har spørsmål om disse jordingsinstruksene. Før du begynner:

Kontroller at strømkabelen er satt helt inn i CookTek-enheten FØR du kopler enheten til stikkkontakten og før bruk.

- Den keramiske platen (eller overflaten på komfyren) må ikke berøres umiddelbart etter bruk. Varme fra kjeler vil overføres til den keramiske platen og gjøre den varm.
- Dette produktet kan bare repareres av en autorisert serviceagent eller av CookTek-ansatte. Ikke prøv å åpne enheten eller utføre reparasjoner av noe slag. For serviceinformasjon, kontakt CookTek på tlf. 1-312-563-9600.
- Dette produktet må jordes. Må kun koples til et korrekt jordet støpsel. Før bruk bør du lese jordingsinstruksene og kravene til elektrisk installasjon på side 3 i denne veiledningen. Ikke bruk skjøteledning.

- Dieses Produkt darf nur durch bevollmächtigte Wartungstechniker oder das Fachpersonal von CookTek gewartet werden. Versuchen Sie nicht, das Gerät zu öffnen und selbst zu warten. Nähere Informationen zur Wartung erhalten Sie bei CookTek unter der Rufnummer 1-312-563-9600.
- Das Gerät muss geerdet werden. Der Stecker muss in eine ordnungsgemäß geerdete Steckdose gesteckt werden. Vor dem Öffnen lesen Sie bitte die Anweisungen zu Schutzkontakt/Erdung und die Anforderungen an die elektrische Installation auf Seite 3 dieses Handbuchs. Verwenden Sie kein Verlängerungskabel.

GREEK

Πριν θέσετε το Cooktop σας σε λειτουργία, εκτελέστε τα ακόλουθα:

- Αφαιρέστε όλα τα υλικά συσκευασίας.
- Τοποθετήστε τη μονάδα σε μια στεγνή, επίπεδη, σκληρή, σταθερή και μη εύφλεκτη επιφάνεια.
- Διατηρήστε τη μονάδα μακριά από άλλες πηγές θερμότητας και αφήστε κενό τουλάχιστον 2 ίντσες (5 εκατοστά) για την κυκλοφορία του αέρα στα πλαϊνά, το μπροστινό μέρος και το πίσω μέρος της μονάδας.

Για την ασφάλειά σας, ποτέ μην κόψετε, αφαιρέσετε ή απενεργοποιήσετε την ηλεκτρική (γείωση) σύνδεση από το φως. Μη χρησιμοποιήσετε ποτέ προσαρμογέα φως ή καλώδιο προέκτασης (μπαλαντέζα) με το Cooktop.

ΠΡΟΕΙΔΟΠΟΙΗΣΗ: Ένα εσφαλμένα γειωμένο φως μπορεί να έχει ως αποτέλεσμα την ηλεκτροπληξία. Παρακαλείστε να συμβουλευτείτε αρμόδιο ηλεκτρολόγο εάν έχετε τυχόν ερωτήσεις σχετικά με αυτές τις οδηγίες γείωσης.

Πριν ξεκινήσετε:

Βεβαιωθείτε ότι αυτό το ηλεκτρικό καλώδιο είναι σταθερά συνδεδεμένο στη μονάδα CookTek σας ΠΡΙΝ συνδέσετε το φως της μονάδας σε ηλεκτρική πρίζα και πριν προσπαθήσετε να θέσετε τη μονάδα σε λειτουργία.

- Μην αγγίξετε την κεραμική πλάκα (ή το άνω μέρος του Cooktop) αμέσως μετά τη χρήση. Η θερμότητα από την κοιλότητα θα μεταφερθεί στην κεραμική πλάκα. Ως εκ τούτου, αυτή θα είναι πολύ ζεστή για να την αγγίξετε.
- Οι εργασίες επισκευής του προϊόντος αυτού πρέπει να πραγματοποιούνται μόνο από εξουσιοδοτημένο αντιπρόσωπο επισκευών ή από προσωπικό της CookTek. Μην επιχειρήσετε να ανοίξετε τη μονάδα ή να εκτελέσετε οποιαδήποτε εργασία επισκευής σε αυτήν. Για πληροφορίες σχετικά με τις επισκευές, επικοινωνήστε με την CookTek στον τηλεφωνικό αριθμό 1-312-563-9600.
- Η συσκευή αυτή πρέπει να είναι γειωμένη. Συνδέστε μόνο σε σωστά γειωμένη πρίζα. Πριν τη λειτουργία, διαβάστε τις οδηγίες γείωσης και τις απαιτήσεις ηλεκτρικής εγκατάστασης στη σελίδα 3 του παρόντος φυλλαδίου. Μη χρησιμοποιείτε καλώδιο προέκτασης (μπαλαντέζα).

ITALIAN

Prima di mettere in funzione il piano cottura, eseguire le seguenti operazioni:

- Rimuovere tutto il materiale di imballaggio.
- Collocare l'unità su una superficie asciutta, piana, rigida, stabile e non infiammabile.
- Tenere l'unità lontana da altre fonti di calore e lasciare almeno 5 centimetri di spazio per consentire la circolazione dell'aria tutto intorno all'unità.

GENERAL OPERATION

Plug the buffet into a grounded, single-phase receptacle. Models will run on 100-120VAC drawing up to 650W, or on 200-240VAC drawing a maximum of 650W. Check rating plate on unit to verify correct voltage and wattage. Voltages below 120VAC or 240VAC can result in less than rated power and slower heating times. This appliance is designed for holding food products only.

This unit is equipped with SmarTag™ technology, using RFID to provide precise temperature control.



This unit requires a Magneeto™ II for operation. The Incogneeto™ unit will not work with a Magneeto™ I module or an RFID equipped chafing dish.



CONTROL BOX
CONFIGURATION







Note: For proper operation, an independent, dedicated circuit should be used for up to 3 units installed on a 15A (120VAC) circuit, 4 units installed on a 20A (120VAC) circuit, or up to 5 units installed on a 20A (240VAC) circuit.





To operate this buffet unit

- Press the Power button to turn the unit on. The green LED next to the power button will illuminate. 
- Place a Magneeto™ II on the counter top and position it over top of the unit until the LED begins flashing and the SmarTag™ LED will illuminate. 
- Place an induction compatible dish on the top of the Magneeto™ II. The Pan Detect LED will illuminate. 

Make sure the dish is covering the temperature sensor on the Magneeto™ II, but do not cover the RFID tag. The unit will start at 80°F, or the last entered temperature. Press the Up and Down Arrows to select desired temperature from the preset choices.  

- Fahrenheit Settings (80-190 degrees): 80, 150, 160, 165, 170, 175, 180, 185, 190
- Celsius Settings (30-85 degrees): 30, 40, 50, 60, 65, 70, 75, 80, 85
- Once you have chosen your preferred temperature, the unit will begin to heat the dish. The letter F or C will flash when the dish is heating. When the dish has reached the set temperature, the letter F or C will remain solid on the display.
- To lock the controls, press the Lock button three times (the red LED to the right of the lock button will illuminate to indicate the unit is locked). This will prevent temperature settings from being changed. The Power button will continue to function while locked. To unlock the controls, press the lock button three more times.   
- When you are finished using the unit, press the Power button. The green Power LED will go out. Remove the dish from the unit. 

PROGRAMMING A MAGNEETO™ II



- Starting with the unit off, hold the Down Arrow while pressing the Power button.  
- The display will start with the text “CLR.” Use this to clear the tag (the unit will no longer enter auto mode). Otherwise, use the Up and Down Arrows to select a temperature.
- To set the tag, press the Lock Button twice. The display will read “TAG SET.”  
- Repeat if necessary with other Magneeto™ IIs.

MAGNEETO™ II OPERATION (MGRFID02, 607700)

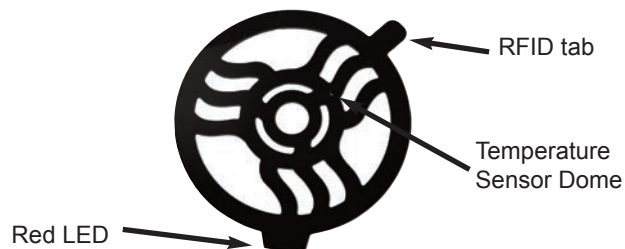
- With Incogneeto™ or MB061 unit turned on, place Magneeto™ II on counter top in expected vicinity of unit (ribbed side down). Slowly slide the Magneeto™ II around until the red light flashes.
- Placement where the light flashes brightest is the optimum position.
- Place induction compatible dish on top of Magneeto™ II for warming. **Make sure the dish covers the temperature sensor, but do not cover the RFID tab with the dish.** Locating may also be performed with the dish already on the Magneeto™ II.







CHANGE TEMPERATURE SCALE

Starting with the unit off, hold down the Up Arrow while pressing the Power button. Then use the Down Arrow to select the desired scale. Powering the unit off completes the selection.   

Note: if a button is not pressed for more than five minutes, the unit will power off keeping the previously set temperature scale.

CHANGE TEMPERATURE OPTIONS (SHORT/LONG)

Starting with the unit off, hold down both the Up and Down Arrows and press the Power button. Use the arrows to select “NUM” and press the Lock button. Use the arrows again to select “PART” or “FULL” for the partial or full set of temperatures. Press the Power button to set the value.     

APPROVED FOR COMMERCIAL USE

CookTek's buffet is in conformance with UL 197 and CSA 22.2 No. 109 standards and bears the commercially rated approvals. CookTek's buffet is in conformance with European Economic Area standards and bears the CE marking signifying European Conformity.

Pour votre sécurité, ne jamais couper, déconnecter ou désactiver le raccordement électrique (terre) de la prise de courant. Ne jamais utiliser un adaptateur ou une rallonge électrique avec l'appareil Cooktop.

MISE EN GARDE : Une prise de courant incorrectement raccordée à la terre engendre un risque de choc électrique. Pour toute question concernant ces instructions de mise à la terre, consulter un électricien qualifié.

Avant de commencer :

S'assurer que le câble d'alimentation est solidement fixé à l'appareil CookTek AVANT de raccorder l'appareil à une prise de courant et d'essayer de le faire fonctionner.

- Ne pas toucher la plaque de céramique (ou la partie supérieure de l'appareil Cooktop) immédiatement après utilisation. La chaleur de la casserole se transmet à la plaque de céramique, aussi celle-ci est chaude au toucher.
- L'entretien de cet appareil ne peut être effectué que par un réparateur agréé ou par un membre du personnel de CookTek. Ne jamais essayer d'ouvrir l'appareil ni de le réparer. Pour des informations concernant l'entretien, contacter CookTek au +1-312-563-9600.
- Cet appareil doit être raccordé à la terre. Le brancher exclusivement à une prise de courant correctement raccordée à la terre. Avant utilisation, lire les instructions de raccordement à la terre, ainsi que les exigences en matière d'installation électrique figurant à la page 3 du présent manuel. Ne pas utiliser de câble de rallonge.

GERMAN

Vor Inbetriebnahme des Cooktop verfahren Sie bitte wie folgt:

- Entfernen Sie das gesamte Verpackungsmaterial.
- Stellen Sie das Gerät auf eine trockene, ebene, harte, stabile und nicht brennbare Fläche.
- Halten Sie das Gerät von anderen Wärmequellen fern und lassen Sie um das Gerät herum (vorne, hinten und seitlich) mindestens 5 cm für die Luftzirkulation frei.

Zu Ihrer eigenen Sicherheit darf das Erdungskabel keinesfalls vom Stecker abgetrennt, entfernt oder in schadhaftem Zustand verwendet werden. Benutzen Sie für Ihren Cooktop niemals einen Steckeradapter oder ein Verlängerungskabel..

WARNHINWEIS: Ein nicht fachgemäß geerdeter Stecker kann zu einem Stromschlag führen. Falls Sie noch Fragen zu diesen Anweisungen in Zusammenhang mit Schutzkontakt und Erdung haben, wenden Sie sich bitte an einen Elektrofachmann.

Bevor Sie beginnen:

Dieses Netzkabel muss fest mit dem CookTek verbunden sein, BEVOR Sie das Gerät an die Steckdose anschließen und es in Betrieb nehmen.

- Berühren Sie die Keramikplatte (oder Oberfläche des Cooktop) nicht unmittelbar nach Gebrauch. Die Hitze der Pfanne überträgt sich auf die Keramikplatte, die dann ebenfalls heiß wird.

Voordat u begint:

Controleer eerst of dit snoer stevig aan uw CookTek-apparaat is bevestigd VOOR-DAT u de stekker van het toestel in het stopcontact steekt en u probeert het te gebruiken.

- Raak de keramische plaat (of de bovenkant van de kooktop) nooit onmiddellijk na gebruik aan. De hitte van de pan wordt op de keramische plaat overgebracht zodat deze heet is bij aanraking.
- Dit product mag uitsluitend worden gerepareerd door een geautoriseerd servicebedrijf of door personeel van CookTek. Probeer niet om het toestel open te maken of op enige wijze te repareren. Neem voor informatie over onderhoud en reparatie contact op met CookTek op 001-312-563-9600.
- Dit toestel moet worden geaard. Alleen aansluiten op een goed geaard stopcontact. Lees voor het gebruik de aardingsinstructies en de vereisten voor de elektrische aansluiting op pagina 3 van dit boekje. Gebruik geen verlengsnoer.

FINNISH

Ennen keittotason käyttöä toimi seuraavasti:

- Poista kaikki pakkausmateriaalit.
- Laita laite kuivalle, tasaiselle, kovalle, tukevalle ja palamattomalle pinnalle.
- Pidä laite erossa muista lämmönlähteistä ja jätä laitteen sivuille, eteen ja taakse vähintään 10 cm (2 tuumaa) vapaa tilaa ilmalle kiertää.

Turvallisuussyistä älä koskaan leikkaa, irrota tai pura sähköliitoksia (maadoitusjohto) pistokkeesta. Älä koskaan käytä keittotason kanssa sovittipistoketta tai jatkojohtoa.

VAROITUS: Väärin maadoitettu pistoke voi aiheuttaa sähköiskun. Neuvottele valtuutetun sähköasentajan kanssa, jos sinulla on kysyttävää näistä maadoitusohjeista.

Ennen kuin aloitat:

Varmista, että tämä virtajohto on tiukasti kiinnitetty CookTek:iin ENNEN laitteen pistokkeen työntämistä pistorasiaan ja ennen käyttökokeilua.

- Älä koske keraamista levyä (keittotason päällä) heti käytön jälkeen. Astian kuumuus siirtyy keraamiseen levyyn kuumentaen sen liian kuumaksi koskettaa.
- Tätä tuotetta saa huoltaa ainoastaan valtuutettu huoltopiste tai CookTekin henkilökunta. Älä yritä avata laitetta ja suorittaa sille minkäänlaisia huoltotoimia. Tietoja huollosta saat soittamalla CookTekiin numeroon +1-312-563-9600.
- Tämä laite täytyy suojamaadoittaa. Liitä ainoastaan oikein suojamaadoitettuun pistorasiaan. Ennen käyttöä lue maadoitusohjeet ja sähköasennusvaatimukset tämän lehtisen sivulta 3. Älä käytä jatkojohtoa.

FRENCH

Avant d'utiliser l'appareil Cooktop, effectuer les opérations suivantes :

- Retirer tous les matériaux d'emballage.
- Placer l'appareil sur une surface sèche, plane, solide, stable et non inflammable.
- Placer l'appareil à distance de toute autre sources de chaleur et laisser un espace libre d'au moins 5 cm (2 pouces) des deux côtés, à l'avant et à l'arrière de celui-ci pour permettre la circulation de l'air.

TIMER OPERATION

- To enable/disable the timer feature, see "Setting the Timer" below.
- If the timer is enabled, the timer will start counting when a pan is placed on the unit and the Heating or At Temp LED will turn on.
- The timer will count up to the preset interval (in minutes). When the interval is reached, the unit will start to beep once per second to alert the operator and flash "DonE" on the display. The unit will continue to maintain the temperature of the pan when the timer is expired.
- The timer is reset when the pan is removed from the unit and the Heating or At Temp LED turns off. The next time a pan is placed on the unit the timer will start again from the beginning.
- To view the elapsed time from when the pan was placed on the unit, press the Lock button once. This will display the time (in minutes) from when the pan was placed on the unit for 5 seconds. After 5 seconds the normal temperature display will return.

● Heating

● At Temp

● Heating

● At Temp



SETTING THE TIMER

The IHW units are equipped with a timer alarm that can be set to alert the operator when a pan has been on the unit for a period of time up to 240 minutes (4 hours).

To enable/disable the timer:

- Starting with the unit off, hold the Down Arrow while pressing the Power Button.
- Release the buttons when the display comes on. Use the Up and Down Arrows to toggle through the options until "t En" is shown on the display. Press the Lock Button once to select the enable option.
- Press the Up and Down arrows to toggle between the two setting options "on" and "off." When the desired option is displayed, press the Lock Button once to enter this option. The display will flash three times to indicate the option has been saved.
- Press the Power Button to exit this mode.



To set the timer interval:

- Starting with the unit off, hold the Down Arrow while pressing the Power Button.
- Release the buttons when the display comes on. Use the Up and Down Arrows to toggle through the options until "t Int" is shown on the display. Press the Lock Button to select the interval option.
- Press the Up and Down Arrows to increase or decrease the amount of time desired for the timer interval. When the desired time (displayed in minutes) is shown, press the Lock Button to enter this option. The display will flash three times to indicate the option has been saved.
- Press the Power Button to exit this mode.



TROUBLESHOOTING

Symptom	Probable Cause	Possible Solution
No power (No lights or fan noise)	<ul style="list-style-type: none"> Unit unplugged No power to receptacle 	<ul style="list-style-type: none"> Plug unit into appropriate receptacle Make sure that receptacle is energized Check wall switches Check circuit breaker Plug a different electronic device into the receptacle to make sure that power is present
Pan does not heat	<ul style="list-style-type: none"> Pan is not induction efficient Pan not centered 	<ul style="list-style-type: none"> Use induction efficient pan Center pan
Buffet suddenly stops heating	<ul style="list-style-type: none"> Possible power brown out Circuit shared with another electrical device Safety shut-off engaged 	<ul style="list-style-type: none"> Assure proper voltage/power levels Make sure the buffet is not sharing a circuit with other electrical devices The safety shut-off will engage if an empty pan is left on the buffet surface while the unit is working at full power. Make sure that the buffet surface is clear. Wait 15-20 minutes for the unit to reset.
Pan does not get hot enough even though power levels are set to maximum - induction efficient pan in use	<ul style="list-style-type: none"> Extension cord in use Circuit shared with another electrical device 	<ul style="list-style-type: none"> DO NOT use extension cords. Extension cords may affect the power levels reaching the appliance. Make sure that the buffet is not sharing a circuit with other electrical devices.
Pan heats unevenly, does not maintain heat level, or overheats	<ul style="list-style-type: none"> Pan is not induction efficient Pan bottom may not be flat enough Pan not centered Pan diameter is less than 7" or more than 12" 	<ul style="list-style-type: none"> Use induction efficient pan Use flatter pan Center pan Use an induction efficient pan that is between 7"-12" (17.8-30.5cm) in diameter

UNIT DIMENSIONS

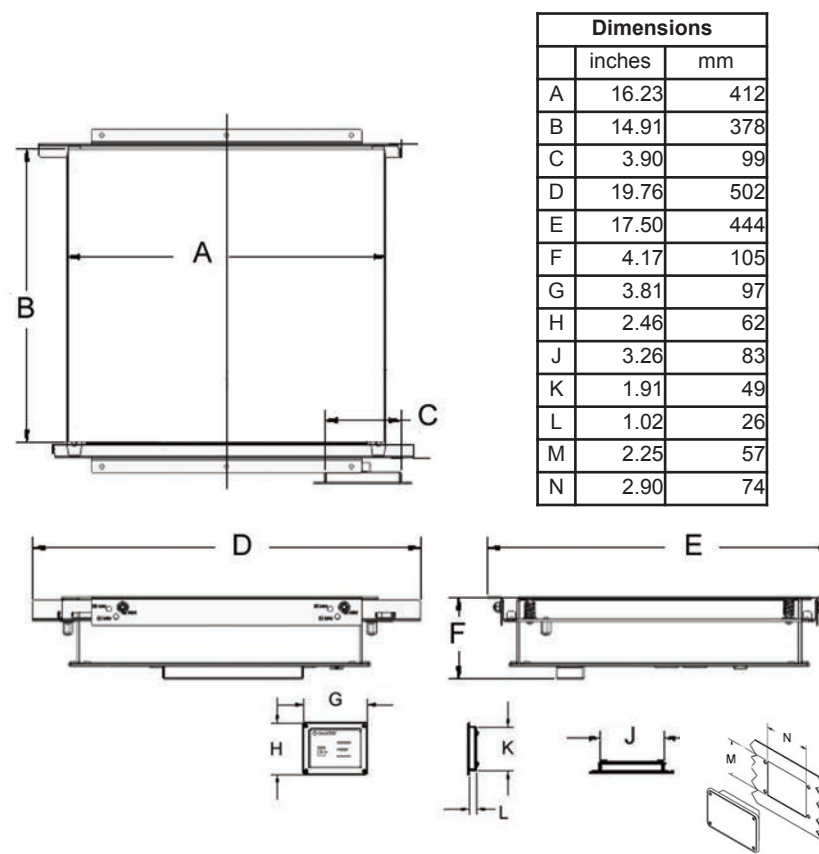

MANUAL TRANSLATION ADDENDUM - DUTCH

Doe het volgende voordat u uw kooktop gaat gebruiken:

- Verwijder al het verpakkingsmateriaal
- Zet het toestel op een droge, vlakke, harde, stabiele en onbrandbare ondergrond
- Houd het toestel uit de buurt van andere warmtebronnen en zorg dat er aan de voor- en achterkant en de zijkanten minstens 5 cm vrij is voor luchtcirculatie.

Voor uw veiligheid mag u nooit de elektrische (massa) aansluiting uit de stekker snijden, verwijderen of uitschakelen. Gebruik nooit een aangepaste stekker of een verlengsnoer met de kooktop.

WAARSCHUWING: Een verkeerd geaarde stekker kan u een elektrische schok bezorgen. Raadpleeg een erkende elektricien als u vragen heeft over deze aardingsinstructies.

CARE AND CLEANING

Incogneeto™ Buffet Unit

Your CookTek Induction Buffet is easy to keep clean. Be sure to follow these easy instructions:

- Turn the unit OFF and remove the plug from any power outlets prior to cleaning.
- Never immerse the buffet in water or put in in the dishwasher.

Magneeto™ II (MGRFID02, 607700)

Cleaning:

- When needed, clean the Magneeto™ II with a mild soap or detergent.
- Do not place the Magneeto™ II in the dishwasher.

Care and Cautions:

- The induction unit RFID antenna is located in the back of the unit. The Magneeto™ II RFID tab must be positioned over the antenna.
- Use the Magneeto™ II ONLY with Incogneeto™ and MB061 series 650 watt RFID induction units. DO NOT use the Magneeto™ II with any other induction appliance, as it may be damaged.
- Pan bottom size should be between 7" and 12" (17.8-30.5 cm) in diameter. The dish/pan bottom must be flat and in contact with the temperature sensor dome or overheating will result.
- Some upward bowing of the Magneeto™ II when hot and a dish is removed is normal and will disappear with cooling or when a dish is placed on top.
- Do not significantly bend or twist the Magneeto™ II as damage may result.

IMPORTANT INFORMATION

- Never heat an empty pan. It may damage the buffet or cookware, and overheat the unit. When overheating occurs, an error code will flash on the display and the buffet will shut itself off automatically. When the internal temperature returns to normal, the buffet can be used again.
- Remember to turn the buffet off after each use.
- Keep the buffet away from gas and electric ranges or open flames. Do not place in the oven. If the ambient air temperature is above 110°F, the buffet may not function properly.
- Be sure to dry off the outside of the pan before use. Water droplets on the outside of the pan may begin to boil and spatter as the pan temperature rises.
- Do not use aluminum foil on top of the buffet.
- Do not use the buffet near a faucet, swimming pool, sink, or other areas where water can be found.
- Never store the buffet outside or upside down.
- Do not obstruct, block, or alter the air entrance or outlet. Do not stick foreign objects into these openings.
- Do not strike or damage the buffet. Do not put the buffet in your luggage. Throwing or dropping the buffet can damage the internal components or crack the buffet, voiding your warranty. If the buffet becomes cracked, unplug immediately and do not use.

ERROR CODES

In the event of a possible malfunction, your CookTek Incogneeto™ Buffet will display an error code on the alphanumeric display. Some models will beep a specific number of times, indicated by the error and flash the lights on the control box. Please consult the following table when encountering an error code.

To reset error conditions, remove the pan from the unit and press the Power button, or unplug the unit.

Error	Error Cause	Displayed Message	Troubleshooting
1	Broken Temperature Sensor	E-01	Service required
3	Over current (peak)	E-03	Try different cookware. Service may be required.
6	High line voltage	E-06	To reset, unplug unit, wait 5 seconds, and plug in again. If problem persists, have an electrician monitor the line voltage.
7	Hardware failure	E-07	Service required.
8	Zero cross failure	E-08	Turn unit off, then on. Plug unit into outlet on different circuit breaker. If problem persists, service is required on device
10	Magneeto™ II RTD Failure	E-10	Magneeto™ II needs repair. Service needed for Magneeto™ II.
11	Tag communication	E-11	Ensure the RFID tag on the pan is properly located.
12	RFID reader failure	E-12	Service required.
13	User interface error	E-13	Check control panel connection, cycle power. Service required
16	Critical error	E-16	Call dealer for service. Service required.

WARRANTY STATEMENT - US & CANADA ONLY

All commercial cooking and holding equipment manufactured by CookTek is warranted against defects in materials and workmanship for a period of three years from the date of shipment from CookTek's factory. All non-electrical equipment such as pans, bags, and pellet assemblies are warranted against defects in materials and workmanship for a period of 90 days from the date of shipment from CookTek's factory.

IMPORTANT! A valid proof of purchase, and Serial Number (s) showing date of purchase is required to obtain Warranty Service.

This warranty is for the benefit of the original purchaser and is non-transferable. Any defects in materials or workmanship, which are brought to the attention of CookTek by written notification within the aforesaid warranty period will be repaired or replaced, at CookTek's discretion, with new or recertified products or parts. **THIS IS THE SOLE REMEDY FOR ANY BREACH OF THIS WARRANTY. IN NO EVENT WILL COOKTEK BE LIABLE FOR DAMAGES OF ANY KIND, WHETHER DIRECT OR INDIRECT, SPECIAL OR CONSEQUENTIAL. THIS WARRANTY IS THE COMPLETE AND ONLY WARRANTY, EXPRESS OR IMPLIED IN LAW OR FACT, INCLUDING BUT NOT LIMITED TO, WARRANTIES OF MERCHANTABILITY, SUITABILITY, QUALITY, OR FITNESS FOR ANY PARTICULAR PURPOSE. THIS WARRANTY DOES NOT INCLUDE ANY THIRD PARTY INSTALLATION, REMOVAL OR DAMAGE COSTS including (but not limited to) LABOR, MATERIALS AND TRAVEL FOR CAULKING IN DROP-IN ("BUILT-IN") UNITS, OR REPAIRS / REPLACEMENT OF FUSES, BREAKERS, MILLWORK AND / OR COUNTER-TOPS).**

This warranty is void if it is determined that upon inspection by CookTek or one its Authorized International Distributors that the equipment has been modified, misused, misapplied, improperly installed, or damaged in transit or by fire, flood or act of God. Broken Glass-Ceramic tops are considered abuse and are NOT covered. Warranty will be considered void if the serial nameplate has been removed or defaced or if the unit has been opened or modified in any way or service has been attempted by unauthorized personnel.

The prices charged by CookTek for its products are based upon the limitations in this warranty. Seller's obligation under this warranty is limited to the repair of covered defects without charge by CookTek or one of its Authorized International Distributors

This warranty is valid in the continental United States of America (USA) and Canada only. It is valid only if purchased through an authorized Cooktek Representative or Dealer. To receive Warranty Service in the USA, please call CookTek's Customer Service Department at 1 (888) 266-5835, or (312) 563-9600. A Returns Authorization (RA) number will be issued along with instructions for returning goods for service (or their replacement). The RA number must be written clearly or printed on the outside of the return shipping container, or on the address label when returning units for service (continued...)

IMPORTANT SAFETY PRECAUTIONS

- To reduce the risk of fire, electric shock or injury, please read, follow, and save all instructions.
- Never immerse the cords, plugs, or appliance in water.
- Supervise carefully when appliance is used near children. Keep children away from appliance when in operation.
- Always unplug appliance immediately after use and allow for cooling time if handling, transporting, or storing.
- Do not use any appliance that has a damaged cord or plug, or one that has malfunctioned or been damaged. Consult the warranty and follow instructions for service.
- Do not use any accessories or attachments that are not recommended by the manufacturer. Use of unapproved accessories may cause injuries and void the warranty.
- The pan on the appliance will heat continuously as long as the power is ON. The pan will be hot and caution should be exercised when working on or near the appliance.
- Do not let the power cord touch hot surfaces or hang over the edge of the counter. Do not move the appliance with electric power is connected. Do not move the appliance while a hot pan or pan containing hot liquids is on top of the appliance.
- To disconnect the appliance, press the Power button and wait for the LED to no longer be illuminated. You may then remove the plug from the outlet.
- Do not use CookTek Buffet for anything other than its intended use as described in this manual. This unit is designed to heat food and is not intended for laboratory or industrial use.
- Do not put food or unopened cans on the buffet surface.
- This product may only be serviced by an authorized service agent or by CookTek personnel. Do not attempt to open the unit or perform service of any kind. For service information, contact CookTek at +1 (312) 563-9600.
- This appliance must be grounded. Connect only to a properly grounded outlet. Before operating, read grounding instructions and Electrical Installation Requirements on page 2 of this booklet. Do not use an extension cord.
- Do not overcook food or leave appliance unattended while in use.
- In the unlikely event of a grease fire, smother flame by covering pan with a tight-fitting lid, cookie sheet, or flat tray. **DO NOT USE WATER.** When the fire is under control, turn off appliance and unplug from wall.
- Use only induction compatible and efficient cookware.
- Place buffet on a level, hard, stable, non-flammable surface before use.

BEST PRACTICES

Stone is a natural material with random defects in any given piece. Cracking can occur due to these defects alone. Cracks can also occur when pre-existing weak points are subjected to additional stress or forces. Mechanical forces caused by poor support, shifting joints in the support structure, and weight distribution will cause excess stress on the stone. Heat differentials that cause one portion of the stone to try to expand while other portions remain fixed (ie, heat lamps, heat from equipment below stone, hot items on the stone, etc.) will cause excess stress. In extensive testing conducted by CookTek, no natural stone was found to interfere with the performance of the wireless communications, or absorb excess heat from the electromagnetic induction waves associated with the Incogneeto and Magneeto 2 equipment.

- Any temperature gain that occurs inside the cabinet where an Incogneeto is mounted contributes to heating the stone. Be sure to supply adequate ventilation.
- Tensile strength of natural stone is proportionally linear with thickness - prolonged intensive use applications are best suited with 3cm stone.
- 3cm thick natural stone dissipates heat much better than 2cm stone. For prolonged intensive use applications, thicker stone is more durable.
- The stone is not generally heated by the induction waves, but some heating will occur from radiation back from a hot pan. Allowing as much stone around the edge of the Incogneeto as possible will act as a buffer and improve the strength of the whole system.
- CookTek recommends that natural stone be 3cm thick in high use applications. Synthetic or “engineered stone” at 2cm thick is acceptable in all applications (but may also require plywood substrate).
- CookTek further recommends that cabinets have sufficient ventilation to keep interior compartment as close to room temperature as possible.
- At least 8 inches of additional stone surface should be allowed from the edge of the Incogneeto to the final edge of any piece of stone.
- Heat lamps should not be used above an Incogneeto unless they are interlocked to prevent heating when a pan is not present.
- Do not put the Incogneeto near the mechanical support seam in the cabinet.

INSTALLATION RAIL SYSTEM FORMULA

To ensure maximum functionality of the Incogneeto unit, the combined thickness of the countertop and wood substrate must be between 30 and 40mm (1.18” to 1.57”).

Thickness of stone (countertop) + Thickness of wood substrate = Combined thickness of stone/wood substrate (this measurement should be 30-40mm)

Rail system conversions: 1.18 inches = 30mm
1.26 inches = 32mm
1.57 inches = 40mm

Match total thickness to
closest rail setting and install
locknuts

Units received without an RA number will be refused at our shipping dock and may encounter a delay in service. Units must be taken or shipped to the factory with transportation charges prepaid for service. CookTek will provide return freight. If instead, the unit(s) is handled under CookTek’s Advanced Replacement Program (ARP), CookTek will pay for shipping both ways, but the unit(s) being replaced must be returned. Instructions and alternate courses of action will be provided by Customer Service. Please save all packaging materials for possible use in shipping. CookTek assumes no liabilities whatsoever for any damages incurred in transit. PLEASE BE SURE TO USE ADEQUATE PACKAGING AND A RELIABLE SHIPPING METHOD OR, IF USING THE ARP PROGRAM, USE THE SAME BOX THE REPLACEMENT UNIT ARRIVED IN FOR THE RETURN.

OUTSIDE THE USA AND CANADA

CookTek offers NO warranty outside of the USA and Canada. Warranty is offered and performed at the discretion of CookTek’s local Authorized International Distributor. Contact details can be found at www.cooktek.com/find-rep, or by calling +1 (312) 563-9600.

For additional information and other details concerning warranty, please contact our Customer Service Department at:

CookTek Induction Systems, LLC • www.cooktek.com
In the USA, Tel: (888) COOKTEK, 1 (888) 266-5835 • Fax: 1 (888) 266-5329
Outside the USA, Tel: +1 (312) 563-9600 • Fax: +1 (312) 432-6220

INSTALLATION INSTRUCTIONS

INSTALLATION FOR 20mm GRANITE WITH 20 mm OR 12 mm WOOD SUBSTRATE

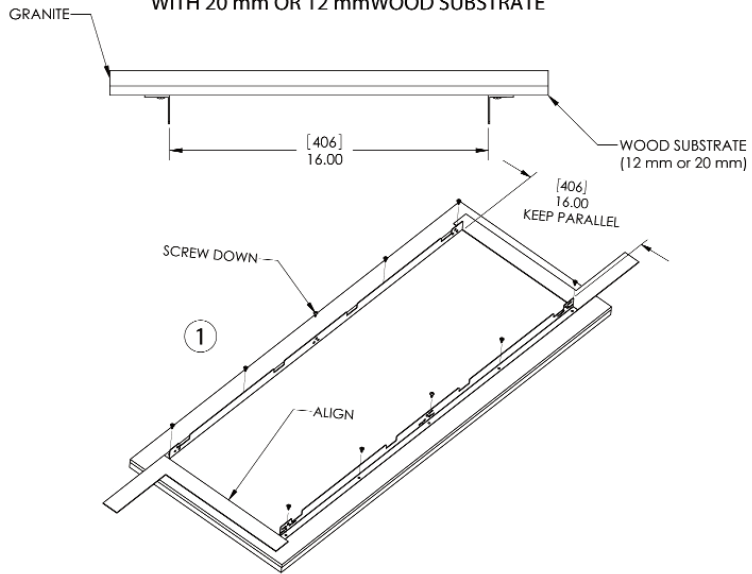

2 ADJUST BRACKET FOR DESIRED COUNTER TOP THICKNESS

40mm (nominal) COUNTER THICKNESS

32mm (nominal) COUNTER THICKNESS

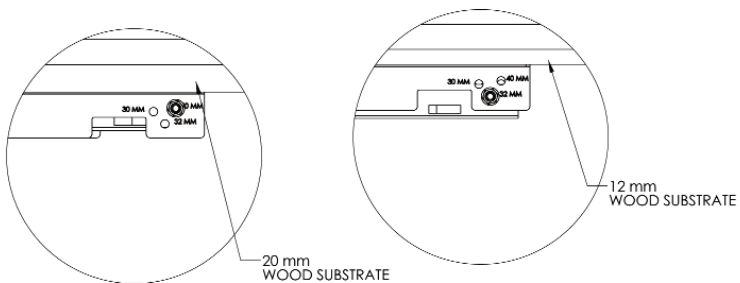

TO INSTALL UNDER COUNTER

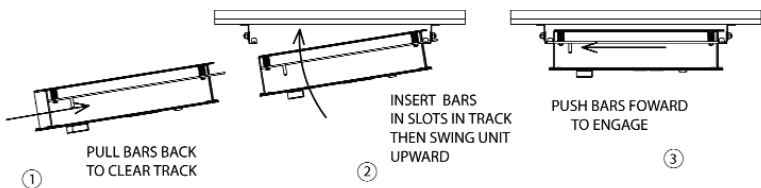

INSTALLATION FOR 30mm GRANITE

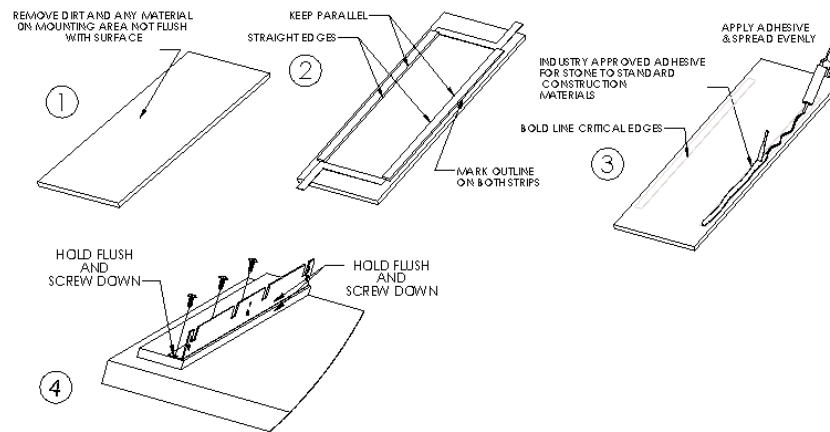
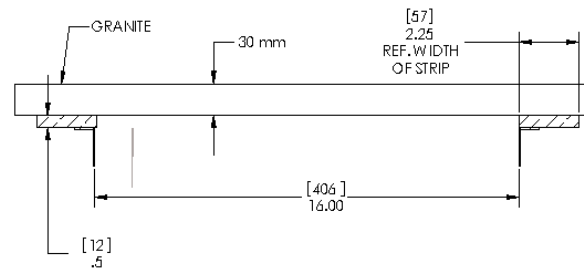

5 INSTALL TRACKS IN APPROPRIATE MOUNTING HOLES AND FASTEN

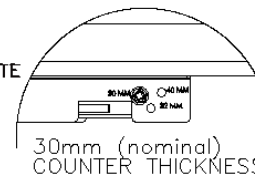

TO INSTALL UNDER COUNTER

