



CH.IBGS.BMC.U.GSB.8

Island Buffet

Heated - Stone Top & Stainless Steel Panels



Product Information:

- Fitted with an underbench bain marie and heated gantry CH.BMC.U.GSB
- Adjustable digital temperature controller allows food to be held between +65°C to +90°C (food must be heated above 65°C before being placed in the bain marie)
- Wet or dry operation (temperature varies greatly when run dry, should not be left unattended for long periods of time)
- Fitted with 10mm thick toughened glass gantry with overhead Quartz IR heat lamps to provide heat and illumination to the product below
- Pans are recessed to minimise water condensation on surrounding bench top
- Culinaire buffet units can be customised to suit any application (minimum dimensions of buffet unit shown below)
- Additional items can be incorporated into the buffet unit such as plate dispensers, plate shelves under, induction warming units, etc.
- Internal framing is constructed from a heavy-duty stainless steel to endure the day to day use in a busy environment
- Heavy-duty non-marking 75mm swivel castors, two with brakes
- Manual fill and manual empty, value operated waste
- Stoddart has a selection of pre-finished melamine boards available, or specify finishes to suit your decor (prices may vary).

Product Code:

CH	Culinaire Heated
IBGS	Island Buffet - Granite Top - Stainless Steel Cladding
BMC	Bain Marie - Counter Line
U	Under Bench
GSB	Flat Glass Gantry - Black Painted Centre Section - Adhesive Fix
8	8 Modules

Optional Extras:

Radius Well	
Add R to code after the .U	CH.IBGS.BMC.UR.GSB.8
(If required, must be nominated at time of order)	

Technical Data:

Dimensions: W x D x H:	3080 x 790 x 1095
Total Connected Load:	7.8kW
Electrical Connection:	240V 3Ø + N + E
Phase 1 Connection:	
Phase 2 Connection:	
Phase 2 Connection:	

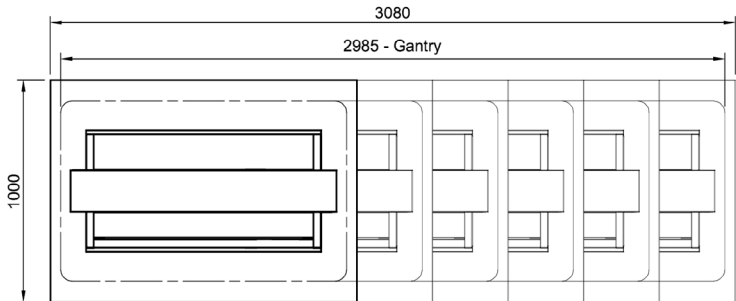

Plan View

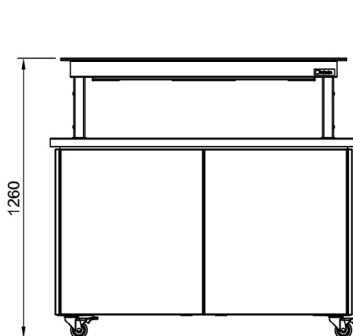

Front Elevation

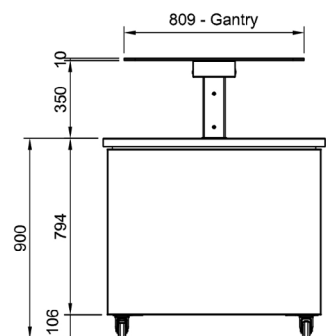

End Elevation

All Culinaire products are supplied with a 12 month parts and labour warranty as standard.

Due to continuous product research and development, the information contained herein is subject to change without notice.

Revision: September 2, 2020 - A

www.stoddart.com.au

www.stoddart.co.nz



Proudly Manufactured
in Australia

