



CH.IBSJ.BMC.U.GSB.6

Island Buffet

Heated - Stainless Steel Top & Joinery Panels



Product Information:

- Fitted with an underbench bain marie and heated gantry CH.BMC.U.GSB
- Adjustable digital temperature controller allows food to be held between +65°C to +90°C (food must be heated above 65°C before being placed in the bain marie)
- Wet or dry operation (temperature varies greatly when run dry, should not be left unattended for long periods of time)
- Fitted with 10mm thick toughened glass gantry with overhead Quartz IR heat lamps to provide heat and illumination to the product below
- Pans are recessed to minimise water condensation on surrounding bench top
- Culinaire buffet units can be customised to suit any application (minimum dimensions of buffet unit shown below)
- Additional items can be incorporated into the buffet unit such as plate dispensers, plate shelves under, induction warming units, etc.
- Internal framing is constructed from a heavy-duty stainless steel to endure the day to day use in a busy environment
- Heavy-duty non-marking 75mm swivel castors, two with brakes
- Manual fill and manual empty, value operated waste
- Stoddart has a selection of pre-finished melamine boards available, or specify finishes to suit your decor (prices may vary).

Product Code:

| | |
|------|---|
| CH | Culinaire Heated |
| IBSJ | Island Buffet - Stainless Steel Top - Joinery Cladding |
| BMC | Bain Marie - Counter Line |
| U | Under Bench |
| GSB | Flat Glass Gantry - Black Painted Centre Section - Adhesive Fix |
| 6 | 6 Modules |

Optional Extras:

Radius Well

Add **R** to code after the .U
(If required, must be nominated at time of order)

CH.IBSJ.BMC.UR.GSB.6

Technical Data:

Dimensions: W x D x H: 2400 x 1000 x 1260
 Total Connected Load: 5.7kW
 Electrical Connection: 240V 3Ø + N + E
 Phase 1 Connection:
 Phase 2 Connection:
 Phase 2 Connection:

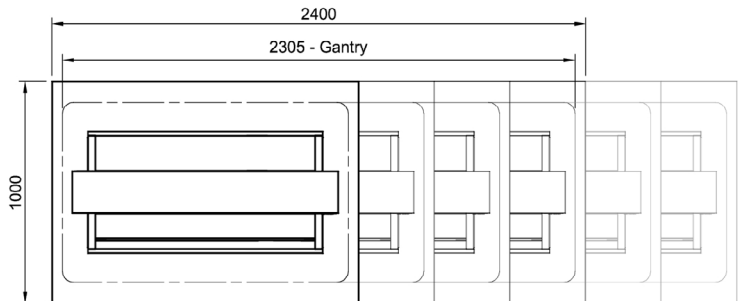

Plan View

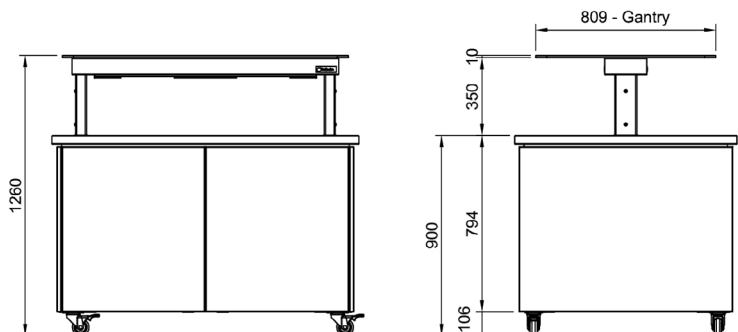

Front Elevation

End Elevation

All Culinaire products are supplied with a 12 month parts and labour warranty as standard.

Due to continuous product research and development, the information contained herein is subject to change without notice.

Revision: September 2, 2020 - A

www.stoddart.com.au

www.stoddart.co.nz



Proudly Manufactured
in Australia

