



Island Buffet

Refrigerated - Stone Top & Stainless Steel Panels



Product Information:

- Buffet unit is fitted with an under bench cold well, CR.CWCF.U.GSF
- Adjustable digital temperature controller allows food to be held between +2°C to +4°C in a maximum of 32°C ambient temperature
- The blown air design passes cold air over and under the food pans creating an even cooling effect (product in the pans must not restrict the cold air flow stream blowing across the top of the pans)
- Fitted with a stainless steel gantry support frame and light surround
- 10mm toughened flat glass gantry fitted with high impact, low energy L.E.D. lighting
- Culinaire buffet units can be customised to suit any application (minimum dimensions of buffet unit shown below)
- Additional items can be incorporated into the buffet unit such as plate dispensers, plate shelves under, induction warming units, etc.
- Internal framing is constructed from a heavy-duty stainless steel to endure the day to day use in a busy environment
- Heavy-duty non-marking 75mm swivel castors, two with brakes
- A ventilation grill is fitted to the base panels to ensure adequate ventilation to the refrigeration unit. Location will vary depending on the cold well size
- Removable condensate drip tray for water collection (no plumbing to waste required). Condensate container to be emptied between service periods
- Optional condensate burn off tray can be fitted to buffet unit at the time of manufacture
- Stoddart has a selection of standard stone tops available, or specify finishes to suit your decor (prices may vary).

Product Code:

CR	Culinaire Refrigerated
IBGS	Island Buffet - Granite Top - Stainless Steel Cladding
CWCF	Cold Well - Counter Line - Fan Forced
U	Under Bench
GSF	Flat Glass Gantry - Stainless Steel Fixings
5	5 Modules

Optional Extras:

Condensate Burn Off Tray

Factory fitted
(If required, must be nominated at time of order)

CR.T5.ET

Technical Data:

Dimensions: W x D x H:	2060 x 1000 x 1260
Total Connected Load:	0.9kW
Electrical Connection:	10A plug & lead fitted

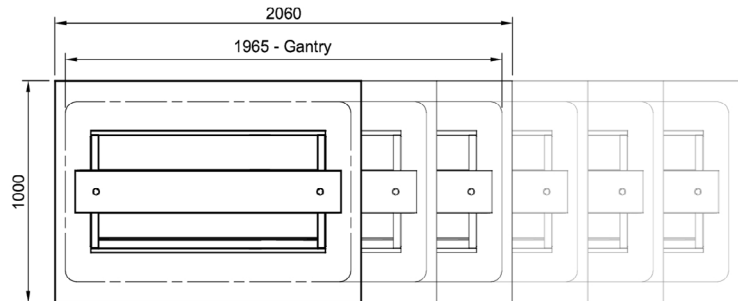

Plan View

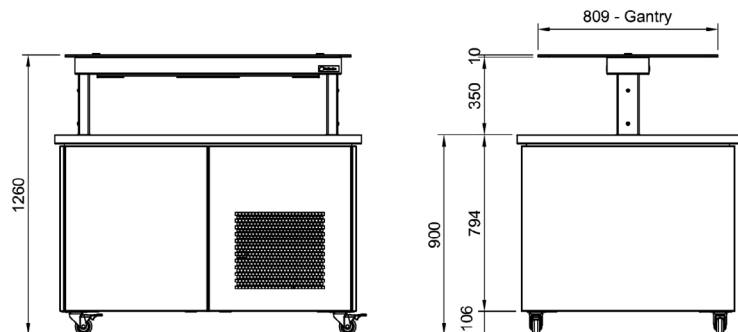

Front Elevation

End Elevation

All Culinaire products are supplied with a 12 month parts and labour warranty as standard.

Due to continuous product research and development, the information contained herein is subject to change without notice.

Revision: September 2, 2020 - A

www.stoddart.com.au

www.stoddart.co.nz



Proudly Manufactured
in Australia