

PLAN

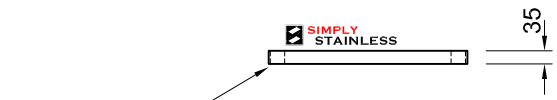

STAINLESS STEEL
SOCKETS IN ALL
CORNERS

FRONT ELEVATION

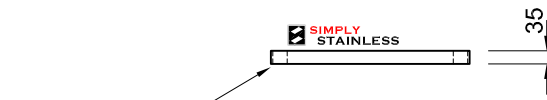

STAINLESS STEEL
SOCKETS IN ALL
CORNERS

SIDE ELEVATION

21-US-6-0600

 SIMPLY STAINLESS <small>www.simplystainless.com Modular Sinks Tables and Shelving</small>
<small>CI GROUP PTY LTD COPYRIGHT ©</small>
<small>This drawing is the property of CI GROUP PTY LTD trading as SIMPLY STAINLESS, and it may not be copied, reproduced or modified in whole or in part, without prior written permission of CI GROUP PTY LTD.</small>
21-US-6-0600 UNDER SHELF

SCALE 1:20

CONSTRUCTION NOTES:

1. TOPS MADE FROM 1.2mm STAINLESS STEEL WITH STAINLESS STEEL SOCKETS AT CORNERS.

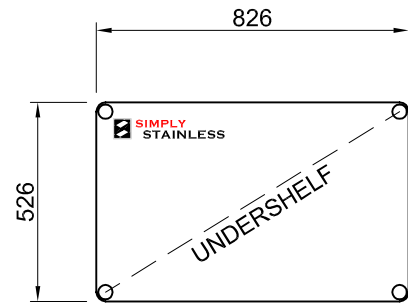

PLAN



STAINLESS STEEL
SOCKETS IN ALL
CORNERS

FRONT ELEVATION

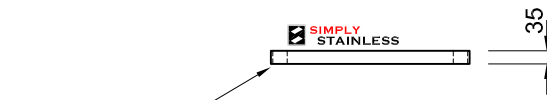

STAINLESS STEEL
SOCKETS IN ALL
CORNERS

SIDE ELEVATION

21-US-6-0900

 SIMPLY STAINLESS <small>www.simplystainless.com Modular Sinks Tables and Shelving</small> <small>CI GROUP PTY LTD COPYRIGHT ©</small> <small>This drawing is the property of CI GROUP PTY LTD trading as SIMPLY STAINLESS, and it may not be copied, reproduced or modified in whole or in part, without prior written permission of CI GROUP PTY LTD.</small>
21-US-6-0900 UNDER SHELF

SCALE 1:20

CONSTRUCTION NOTES:

1. TOPS MADE FROM 1.2mm STAINLESS STEEL WITH STAINLESS STEEL SOCKETS AT CORNERS.

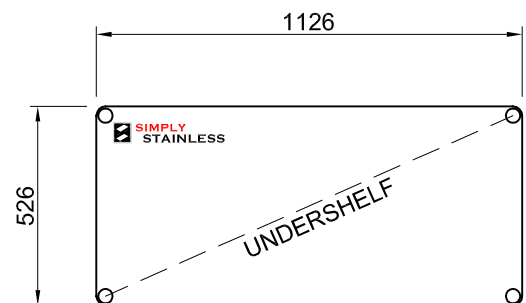

PLAN

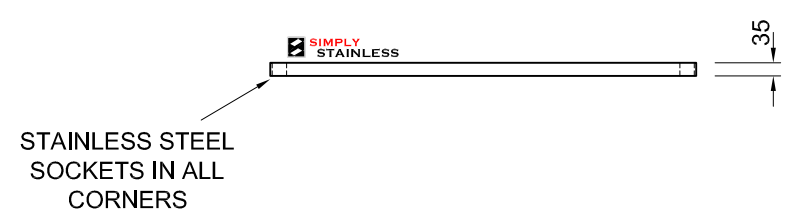

FRONT ELEVATION

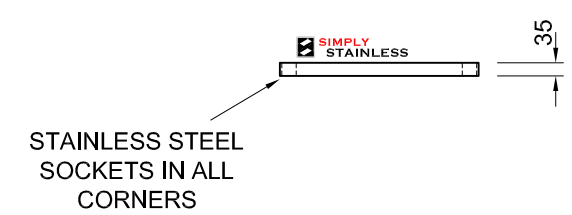

SIDE ELEVATION

21-US-6-1200

 SIMPLY STAINLESS <small>www.simplystainless.com Modular Sinks Tables and Shelving</small>
<small>CI GROUP PTY LTD COPYRIGHT ©</small> <small>This drawing is the property of CI GROUP PTY LTD trading as SIMPLY STAINLESS, and it may not be copied, reproduced or modified in whole or in part, without prior written permission of CI GROUP PTY LTD.</small>
21-US-6-1200 UNDER SHELF

SCALE 1:20

- CONSTRUCTION NOTES:
1. TOPS MADE FROM 1.2mm STAINLESS STEEL WITH STAINLESS STEEL SOCKETS AT CORNERS.

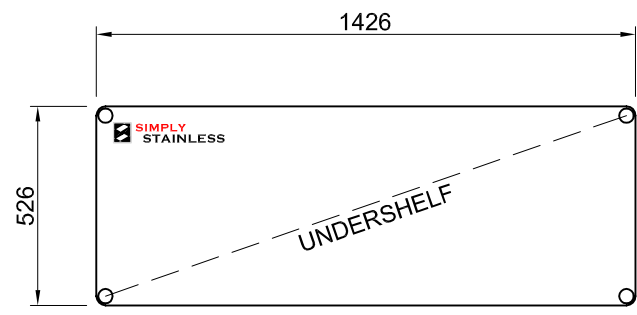

PLAN

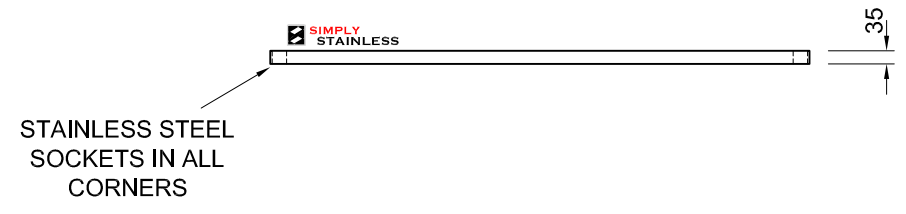

FRONT ELEVATION

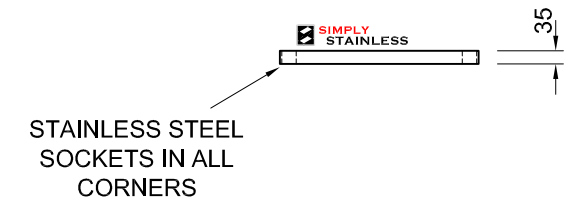

SIDE ELEVATION

21-US-6-1500

 SIMPLY STAINLESS <small>www.simplystainless.com Modular Sinks Tables and Shelving</small>
<small>CI GROUP PTY LTD COPYRIGHT ©</small> <small>This drawing is the property of CI GROUP PTY LTD trading as SIMPLY STAINLESS, and it may not be copied, reproduced or modified in whole or in part, without prior written permission of CI GROUP PTY LTD.</small>
21-US-6-1500 UNDER SHELF

SCALE 1:20

- CONSTRUCTION NOTES:
1. TOPS MADE FROM 1.2mm STAINLESS STEEL WITH STAINLESS STEEL SOCKETS AT CORNERS.

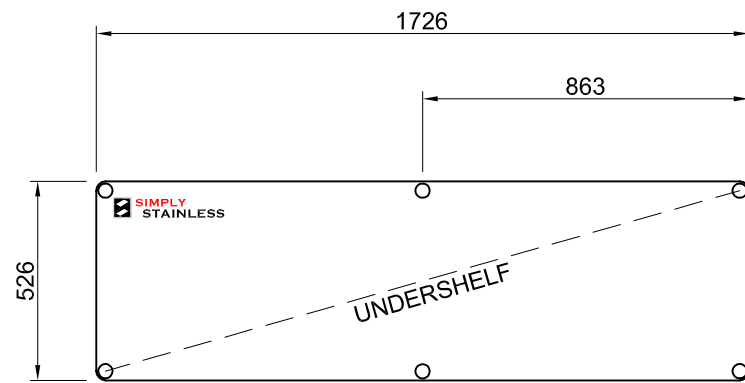

PLAN

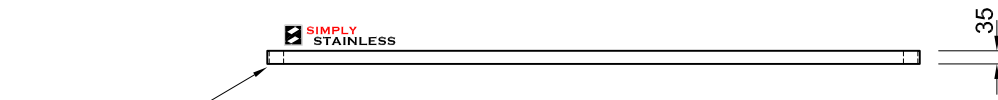

STAINLESS STEEL
SOCKETS IN ALL
CORNERS

SIDE ELEVATION

FRONT ELEVATION

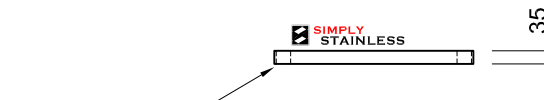

STAINLESS STEEL
SOCKETS IN ALL
CORNERS

SIDE ELEVATION

21-US-6-1800

 <p>www.simplystainless.com Modular Sinks Tables and Shelving</p> <p>CI GROUP PTY LTD COPYRIGHT ©</p> <p>This drawing is the property of CI GROUP PTY LTD trading as SIMPLY STAINLESS, and it may not be copied, reproduced or modified in whole or in part, without prior written permission of CI GROUP PTY LTD.</p> <p>21-US-6-1800 UNDER SHELF</p>

SCALE 1:20

CONSTRUCTION NOTES:

1. TOPS MADE FROM 1.2mm STAINLESS STEEL WITH STAINLESS STEEL SOCKETS AT CORNERS.

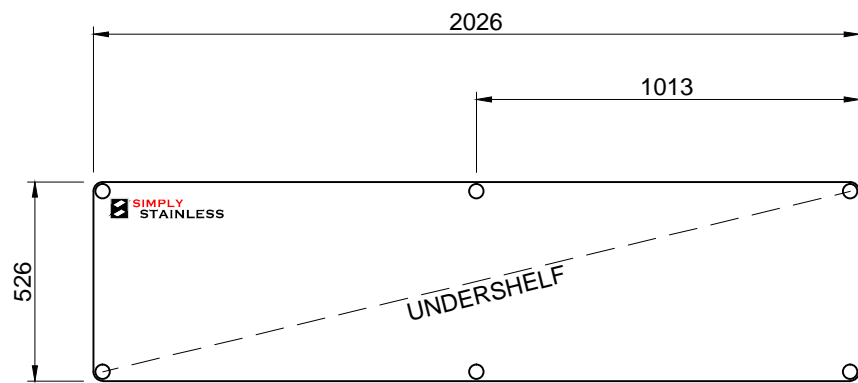

PLAN

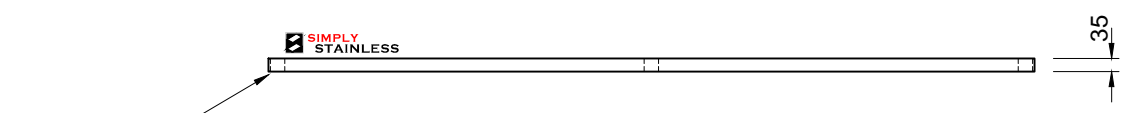

STAINLESS STEEL SOCKETS IN ALL CORNERS

FRONT ELEVATION

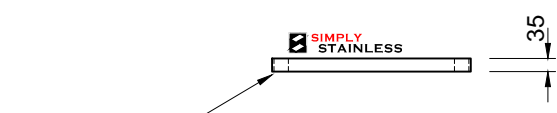

STAINLESS STEEL SOCKETS IN ALL CORNERS

SIDE ELEVATION

21-US-6-2100

SIMPLY STAINLESS
 www.simplystainless.com
 Modular Sinks Tables and Shelving

CI GROUP PTY LTD COPYRIGHT ©

This drawing is the property of CI GROUP PTY LTD trading as SIMPLY STAINLESS, and it may not be copied, reproduced or modified in whole or in part, without prior written permission of CI GROUP PTY LTD.

21-US-6-2100
UNDER SHELF

SCALE 1:20

- CONSTRUCTION NOTES:**
1. TOPS MADE FROM 1.2mm STAINLESS STEEL WITH STAINLESS STEEL SOCKETS AT CORNERS.

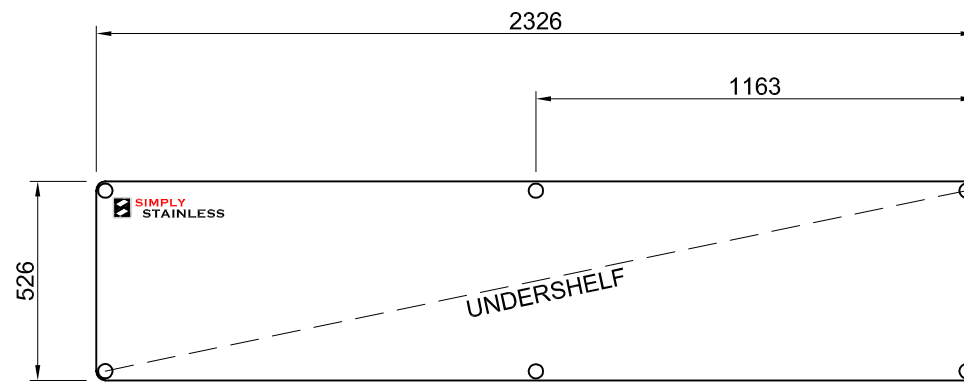

PLAN



FRONT ELEVATION

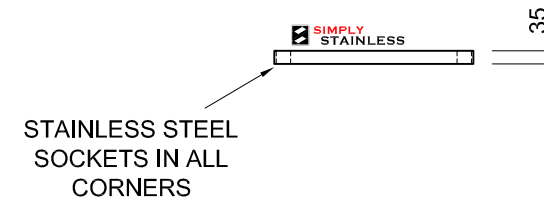

SIDE ELEVATION

21-US-6-2400

 <p>www.simplystainless.com Modular Sinks Tables and Shelving</p> <p>CI GROUP PTY LTD COPYRIGHT ©</p> <p>This drawing is the property of CI GROUP PTY LTD trading as SIMPLY STAINLESS, and it may not be copied, reproduced or modified in whole or in part, without prior written permission of CI GROUP PTY LTD.</p> <p>21-US-6-2400 UNDER SHELF</p>

SCALE 1:20

CONSTRUCTION NOTES:

1. TOPS MADE FROM 1.2mm STAINLESS STEEL WITH STAINLESS STEEL SOCKETS AT CORNERS.

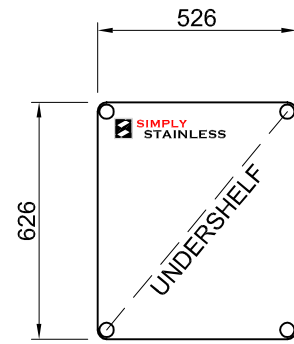

PLAN

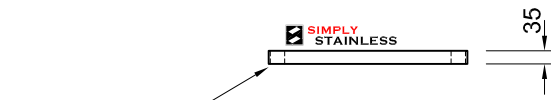

STAINLESS STEEL
SOCKETS IN ALL
CORNERS

FRONT ELEVATION

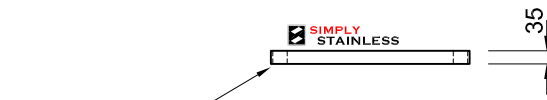

STAINLESS STEEL
SOCKETS IN ALL
CORNERS

SIDE ELEVATION

21-US-7-0600



www.simplystainless.com
Modular Sinks Tables and Shelving

CI GROUP PTY LTD COPYRIGHT ©

This drawing is the property of CI GROUP PTY LTD trading as SIMPLY STAINLESS, and it may not be copied, reproduced or modified in whole or in part, without prior written permission of CI GROUP PTY LTD.

21-US-7-0600
UNDER SHELF

SCALE 1:20

CONSTRUCTION NOTES:

1. TOPS MADE FROM 1.2mm STAINLESS STEEL WITH STAINLESS STEEL SOCKETS AT CORNERS.

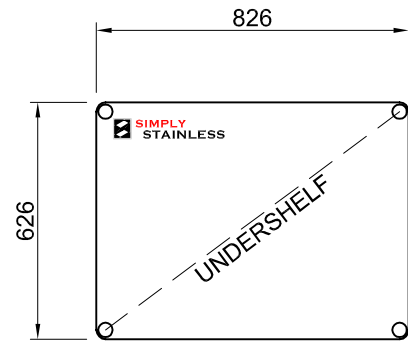

PLAN

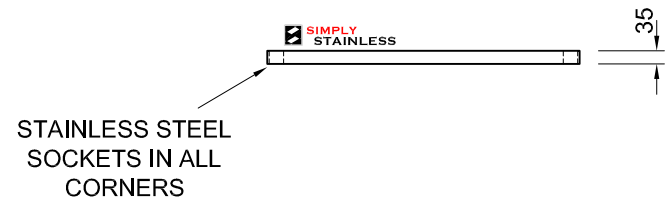

FRONT ELEVATION

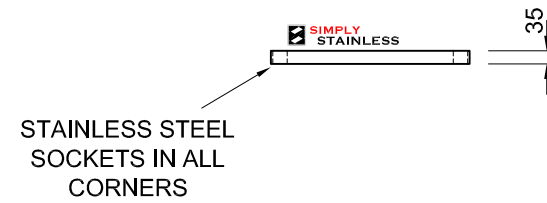

SIDE ELEVATION

21-US-7-0900

 SIMPLY STAINLESS <small>www.simplystainless.com Modular Sinks Tables and Shelving</small>
<small>CI GROUP PTY LTD COPYRIGHT ©</small> <small>This drawing is the property of CI GROUP PTY LTD trading as SIMPLY STAINLESS, and it may not be copied, reproduced or modified in whole or in part, without prior written permission of CI GROUP PTY LTD.</small>
21-US-7-0900 UNDER SHELF

SCALE 1:20

CONSTRUCTION NOTES:

1. TOPS MADE FROM 1.2mm STAINLESS STEEL WITH STAINLESS STEEL SOCKETS AT CORNERS.

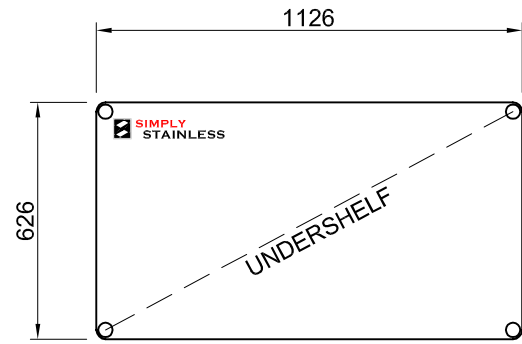

PLAN

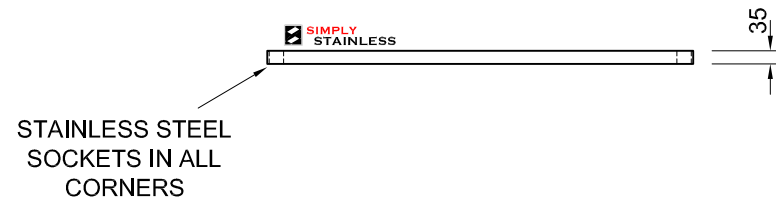

FRONT ELEVATION

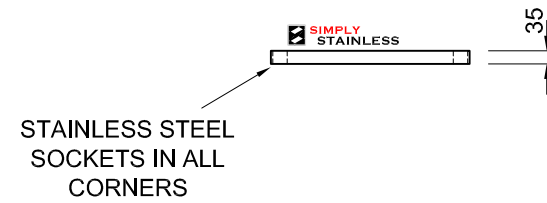

SIDE ELEVATION

21-US-7-1200

 SIMPLY STAINLESS <small>www.simplystainless.com</small> <small>Modular Sinks Tables and Shelving</small>
<small>CI GROUP PTY LTD COPYRIGHT ©</small> <small>This drawing is the property of CI GROUP PTY LTD trading as SIMPLY STAINLESS, and it may not be copied, reproduced or modified in whole or in part, without prior written permission of CI GROUP PTY LTD.</small>
21-US-7-1200 UNDER SHELF

SCALE 1:20

CONSTRUCTION NOTES:

1. TOPS MADE FROM 1.2mm STAINLESS STEEL WITH STAINLESS STEEL SOCKETS AT CORNERS.

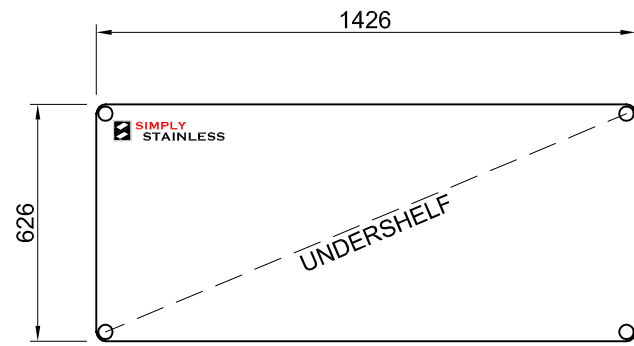

PLAN

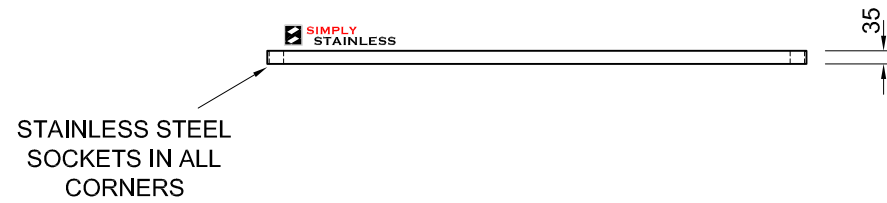

FRONT ELEVATION

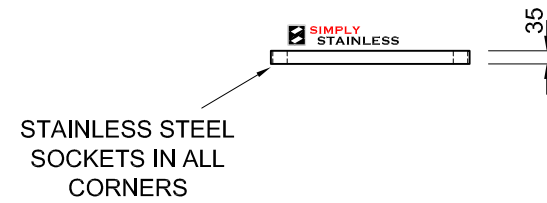

SIDE ELEVATION

21-US-7-1500

 SIMPLY STAINLESS <small>www.simplystainless.com Modular Sinks Tables and Shelving</small>
<small>CI GROUP PTY LTD COPYRIGHT ©</small> <small>This drawing is the property of CI GROUP PTY LTD trading as SIMPLY STAINLESS, and it may not be copied, reproduced or modified in whole or in part, without prior written permission of CI GROUP PTY LTD.</small>
21-US-7-1500 UNDER SHELF

SCALE 1:20

CONSTRUCTION NOTES:

1. TOPS MADE FROM 1.2mm STAINLESS STEEL WITH STAINLESS STEEL SOCKETS AT CORNERS.

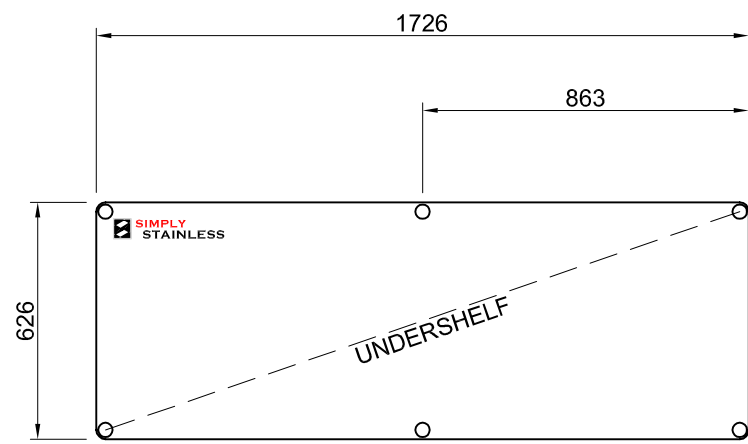

PLAN

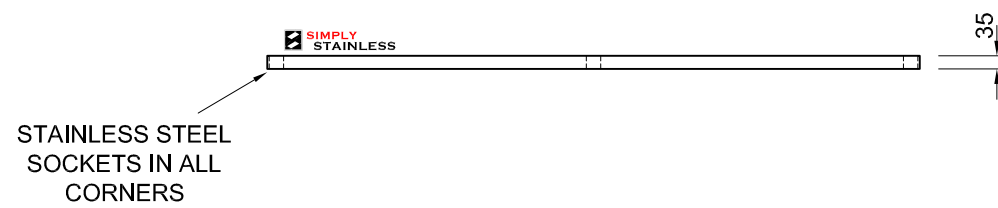

FRONT ELEVATION

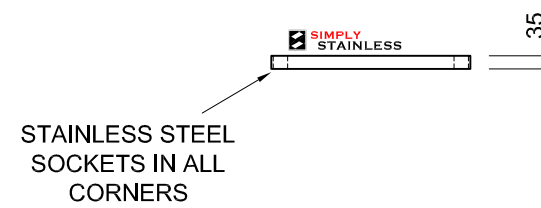

SIDE ELEVATION

21-US-7-1800

 <p>SIMPLY STAINLESS www.simplystainless.com Modular Sinks Tables and Shelving</p> <p>CI GROUP PTY LTD COPYRIGHT ©</p> <p>This drawing is the property of CI GROUP PTY LTD trading as SIMPLY STAINLESS, and it may not be copied, reproduced or modified in whole or in part, without prior written permission of CI GROUP PTY LTD.</p> <p>21-US-7-1800 UNDER SHELF</p>

SCALE 1:20

CONSTRUCTION NOTES:

1. TOPS MADE FROM 1.2mm STAINLESS STEEL WITH STAINLESS STEEL SOCKETS AT CORNERS.

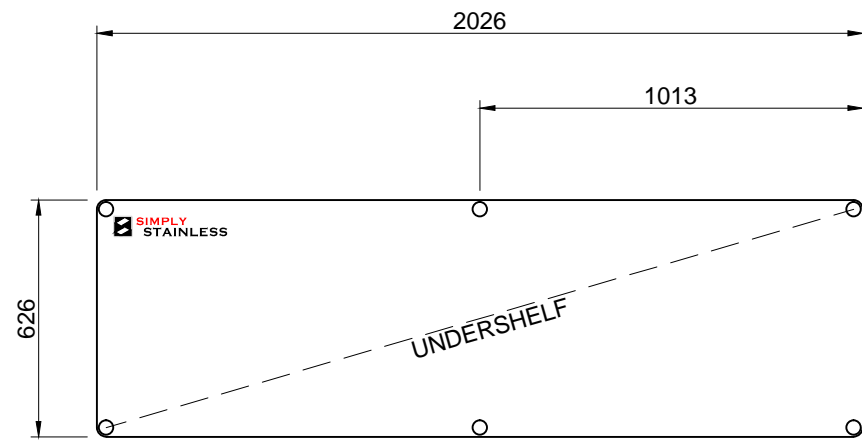

PLAN

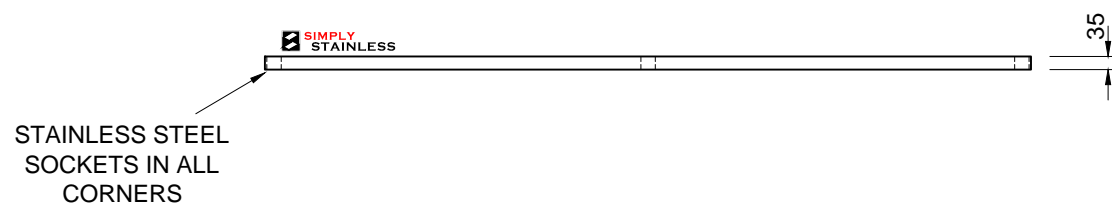

FRONT ELEVATION

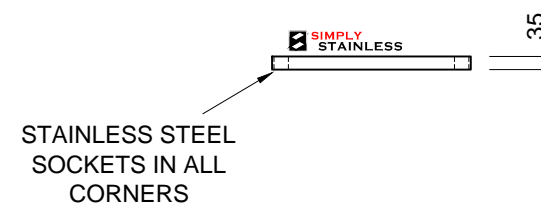

SIDE ELEVATION

21-US-7-2100

 <p>SIMPLY STAINLESS www.simplystainless.com Modular Sinks Tables and Shelving</p> <p>CI GROUP PTY LTD COPYRIGHT ©</p> <p><small>This drawing is the property of CI GROUP PTY LTD trading as SIMPLY STAINLESS, and it may not be copied, reproduced or modified in whole or in part, without prior written permission of CI GROUP PTY LTD.</small></p> <p>21-US-7-2100 UNDER SHELF</p>
--

SCALE 1:20

CONSTRUCTION NOTES:

1. TOPS MADE FROM 1.2mm STAINLESS STEEL WITH STAINLESS STEEL SOCKETS AT CORNERS.

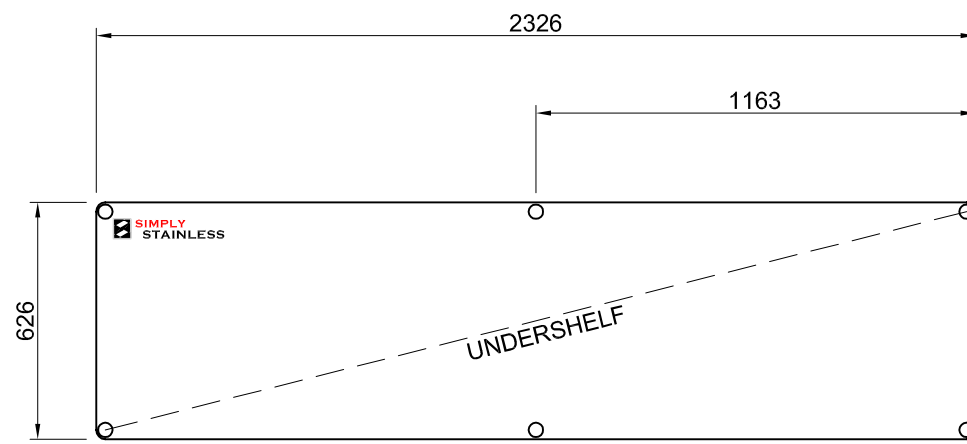

PLAN

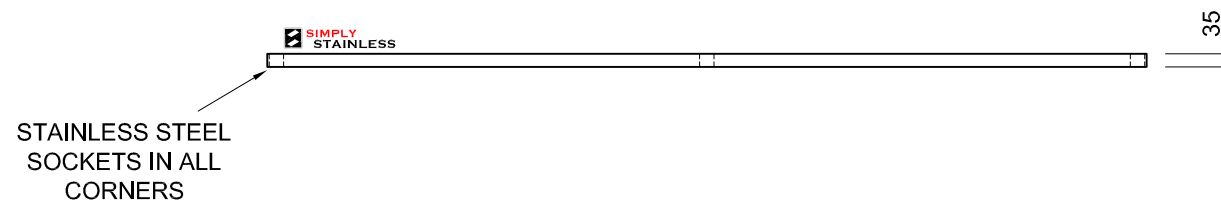

FRONT ELEVATION

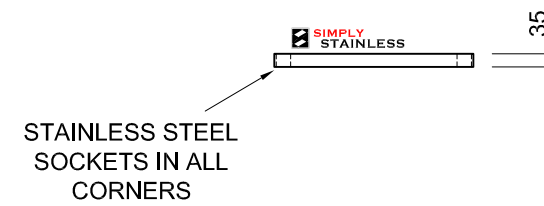

SIDE ELEVATION

21-US-7-2400

 <p>www.simplystainless.com Modular Sinks Tables and Shelving</p> <p>CI GROUP PTY LTD COPYRIGHT ©</p> <p>This drawing is the property of CI GROUP PTY LTD trading as SIMPLY STAINLESS, and it may not be copied, reproduced or modified in whole or in part, without prior written permission of CI GROUP PTY LTD.</p> <p>21-US-7-2400 UNDER SHELF</p>

SCALE 1:20

CONSTRUCTION NOTES:

1. TOPS MADE FROM 1.2mm STAINLESS STEEL WITH STAINLESS STEEL SOCKETS AT CORNERS.