

Specification, Installation and Operation Manual

Bain Marie

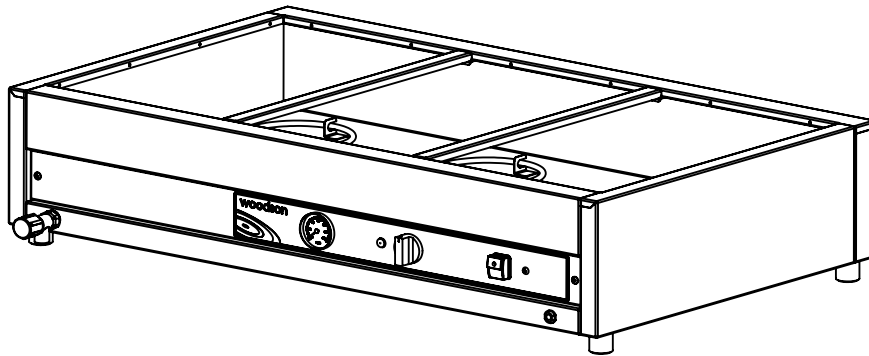

Models:

W.BMA22 / W.BMA23 / W.BMA24 / W.BMA25
W,BMA26 / W.BMS11 / W.BML21

A guide on the use, care and maintenance
of your quality Woodson product

Page Intentionally Left Blank

Introduction

Your New Woodson Product	3
Australia and New Zealand Warranty	4
<i>Warranty Period</i>	
<i>Warranty Registration</i>	
General Precautions	4

Installation

Product Overview.	5
Setting Up	6
<i>Handling</i>	
<i>Unpacking</i>	
<i>Positioning</i>	
<i>Disposal</i>	
Electrical Connection	7
<i>Information</i>	
Plumbing Connections	7
<i>Information</i>	

Specification

Technical Specifications	8
<i>W.BMAxx</i>	
<i>W.BMS11</i>	
<i>W.BML21</i>	

Operation

Initial Start-up & Operation	10
<i>Bain Marie - Initial Start-up</i>	
<i>Bain Marie - Operation (Wet Unit Only)</i>	
GN Pans, Loading Bain Marie.	11
<i>Gastronorm Pans</i>	
<i>Loading Bain Marie</i>	
Food Safety.	11
<i>Food Temperature</i>	
<i>Food Storage</i>	
<i>Bain Marie</i>	

Cleaning and Maintenance

Cleaning	12
<i>General Information</i>	
<i>Corrosion Protection</i>	
<i>Surface Finish</i>	
<i>Cleaning Schedule</i>	
<i>Materials Required</i>	
<i>Bain Marie (Daily)</i>	
<i>Descaling the Unit (Monthly)</i>	
<i>Element Protection (Daily)</i>	
Troubleshooting	14

Your New Woodson Product

Thank you for choosing this quality Woodson product.

All Woodson products are designed and manufactured to meet the needs of food service professionals. By caring for and maintaining your new Woodson product in accordance with these instructions, will provide many years of reliable service.

Stoddart is a wholly Australian owned company, which manufactures and/or distributes a comprehensive range of food service equipment for kitchens, food preparation and presentation. Stoddart products are manufactured and/or engineered in Australia to provide excellent results whilst offering value-for-money, ease-of-use and reliability.

**Carefully read this instruction booklet, as it contains important advice for safe installation, operation and maintenance.
Keep this booklet on hand in a safe place for future reference by other operators or users.**

Disclaimer

The manufacturer and distributor cannot be held responsible or liable for any injuries or damages of any kind occurred to persons, units or others, due to abuse and misuse of this unit in regards to installation, removal, operation, servicing or maintenance, or lack of conformity with the instructions indicated in this documentation.

All units made by the manufacturer are delivered assembled, where possible, and ready to install. Any installation, removal, servicing, maintenance and access or removal of any parts, panels or safety barriers that is not permitted, does not comply in accordance to this documentation, or not performed by a **TRAINED AND AUTHORISED SPECIALIST** will result in the **IMMEDIATE LOSS OF THE WARRANTY.**

The manufacturer cannot be held responsible or liable for any unauthorized modifications or repairs. All modifications or repairs must be approved by the manufacturer in writing before initiating. All modifications or repairs performed to this unit must be performed at all times by a **TRAINED AND AUTHORISED SPECIALIST.**

**Stoddart design, manufacture & distribute Food Service Equipment (appliances) exclusively for the commercial market.
This appliance is not designed nor intended for household or domestic use & must not be used for this purpose.**

This product is intended for commercial use, and in line with Australian electrical safety standards the following warnings are provided:

- This product is not intended for use by persons (including children) with reduced physical, sensory or mental capabilities, or lack of experience and knowledge, unless they have been given supervision or instruction concerning the use of the product by a person responsible for their safety. Children should be supervised to ensure that they do not play with the product
- If the supply cord is damaged, it must be replaced by the manufacturer, its service agent or similarly qualified persons in order to avoid a hazard



Warranty & Registration

Australia and New Zealand Warranty

Warranty Period

Stoddart 12 month on-site parts and labour warranty (terms and conditions apply), from the time of purchase.

To view or download the warranty terms and conditions visit: <http://www.stoddart.com.au/warranty-information>

Warranty Registration

To register your new product, go to the Stoddart warranty page: <http://www.stoddart.com.au/warranty-registration>



General Precautions

When using any electrical unit, safety precautions must always be observed.

Our units have been designed for high performance. Therefore, the unit must be used exclusively for the purpose for which it has been designed.

- All units **MUST** be installed according to the procedures stated in the installation section of this manual
- In the case of new personnel, training is to be provided before operating the equipment
- **DO NOT** use this unit for any other purpose than its intended use
- **DO NOT** store explosive substances such as aerosol cans with a flammable propellant in or near this unit
- Keep fingers out of “pinch point” areas
- Unit is not waterproof **DO NOT** use jet sprays, hoses or pour water over/on the exterior of the unit
- Only use this unit with voltage specified on the rating label
- **Do NOT** remove any cover panels that may be on the unit
- **DO NOT** use sharp objects to activate controls
- **DO NOT** use sharp objects to remove ice from the unit
- If any fault is detected, refer to troubleshooting
- The manufacturer declines any liability for damages to persons and/or things due to an improper/wrong and/or unreasonable use of the machine
- Only specifically trained/qualified Technicians (Stoddart, one of our service agents, or a similarly qualified persons) should carry out any and all repairs, maintenance and services

Product Overview

	WARNING
	<p>The water in the unit and the surfaces of this unit are HOT when operating. Take caution and do NOT place any part of the body in the water.</p>

Large Bain Marie - W.BMA23

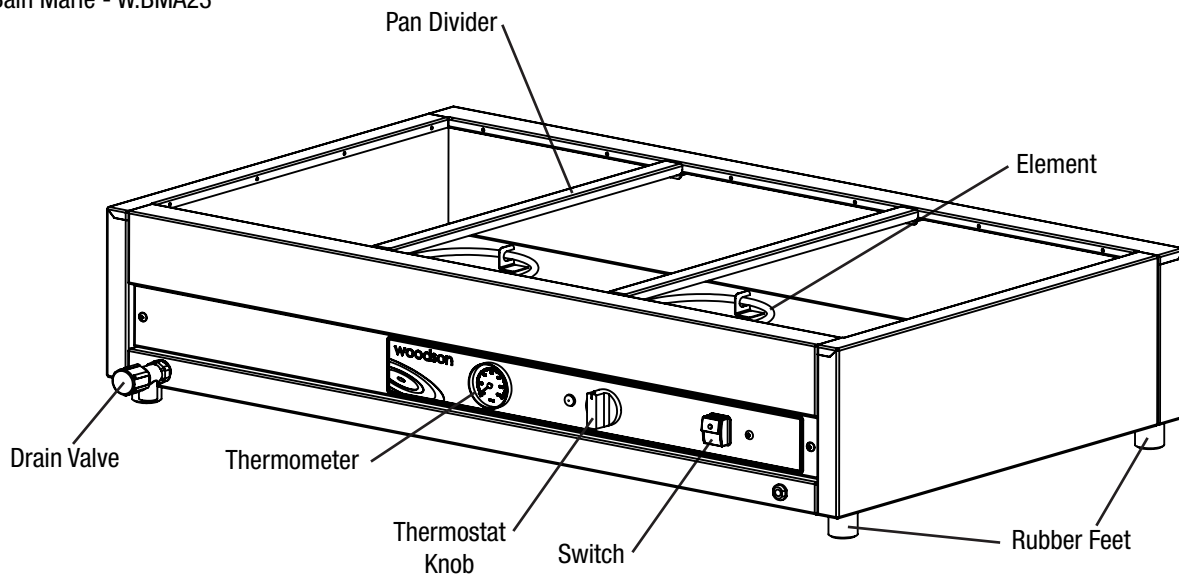

Woodson bain maries are for wet use only.

Setting Up

	WARNING
	<p>Improper installation, adjustments, alterations, service or maintenance can cause property damage, injury or death.</p>

Handling

- Use suitable means to move the unit;
 - For smaller items use two people
 - For large items a fork lift, pallet trolley or similar (the forks should reach completely beneath the pallet)

Unpacking

- Check the unit for damage before and after unpacking. If unit is damaged, contact the distributor and manufacturer
- Should any item have physical damage, report the details to the freight company and to the agent responsible for the dispatch within seven (7) days of receipt. No claims will be accepted or processed after this period
- The unit is supplied fully assembled
- Remove all protective plastic film, tapes, ties and packers before installing and operating
- Clean off any remaining residue from the interior/exterior of the unit using a clean cloth dampened with warm soapy water

Positioning

- Choose an area that is well ventilated and provides access for future maintenance
- Place the unit on a level stable work surface capable of supporting its weight
- Do not position the unit in:
 - Wet areas
 - Near heat and/or steam sources
 - Near flammable substances
- Allow an air gap between the unit and other objects or surfaces. A minimum gap of 100mm from all sides is recommend for normal operational use (if the unit is near any heat sensitive material we suggest you allow additional space)

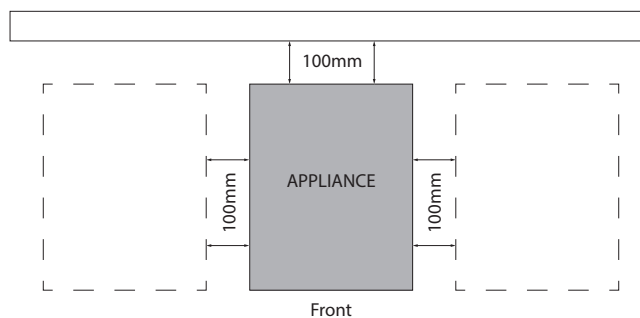

- Please consult national and local standards to ensure that your unit is positioned in accordance with any existing requirement

Disposal

- At the end of the appliance's working life, make sure it is scrapped & components recycled properly
- Current environmental protection laws in the state/country of use must be observed
- Doors must be removed before disposal (if applicable)
- Power supply cable must be removed before disposal
- For further information on the recycling of this product, contact the local dealer/agent or the local body responsible for waste disposal

Electrical Connection

Information

	WARNING
	<p style="text-align: center;">This unit must be installed in accordance with AS/NZS 60335.1</p> <p>Some procedures in this manual require the power to the equipment to be turned off and isolated. Turn the power OFF at the power point and unplug the power supply lead by the plug body. If the power point is not readily accessible turn the equipment off at the isolation switch or the circuit breaker in the switchboard. Attach a yellow “CAUTION-DO NOT OPERATE” tag. This must be performed where relevant unless the procedures specify otherwise.</p> <p style="text-align: center;">FAILURE TO DO SO MAY RESULT IN ELECTRIC SHOCK.</p>

Single Phase Units:

- Supplied and fitted with an appropriately rated plug and lead, indicated as:
- 10A plug & lead fitted

Notes:

- If the supply cord is damaged, it must be replaced by the manufacturer, its service agent or similarly qualified persons in order to avoid a hazard. Please contact Stoddart for parts and we will advise how to do this in order to avoid any electrical hazard
- The power cable should be dry and/or isolated from moisture or water

Plumbing Connections

	IMPORTANT
	<p style="text-align: center;">This unit must be installed in accordance with AS/NZ 3500.1</p>

	IMPORTANT
	<p style="text-align: center;">This unit must be operated on potable water. If the water has a high mineral content, pretreatment may be necessary or your warranty could be voided.</p>

Information

- Bain Marie must be drained DAILY to a bucket or to a tundish via the drain valve

Technical Specifications

W.BMAxx

Specifications	W.BMA22	W.BMA23	W.BMA24	W.BMA25	W.BMA26
Model	W.BMA22	W.BMA23	W.BMA24	W.BMA25	W.BMA26
Height	245mm	245mm	245mm	245mm	245mm
Width	705mm	1030mm	1355mm	1680mm	2005mm
Depth	600mm	600mm	600mm	600mm	600mm
Bain Marie Capacity	4 x 1/2 GN Pans	6 x 1/2 GN Pans	8 x 1/2 GN Pans	10 x 1/2 GN Pans	12 x 1/2 GN Pans
Power	1.2kW 10A plug & lead fitted	1.8kW 10A plug & lead fitted	2.4kW 10A plug & lead fitted	2.4kW 10A plug & lead fitted	2.4kW 10A plug & lead fitted

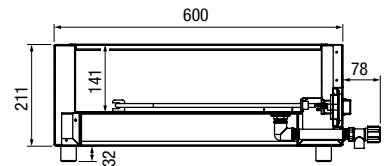
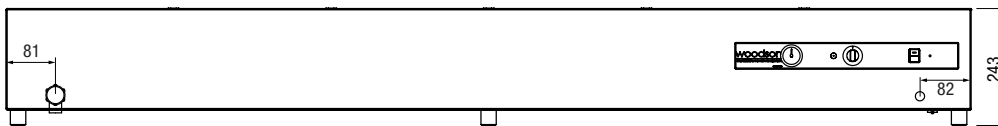
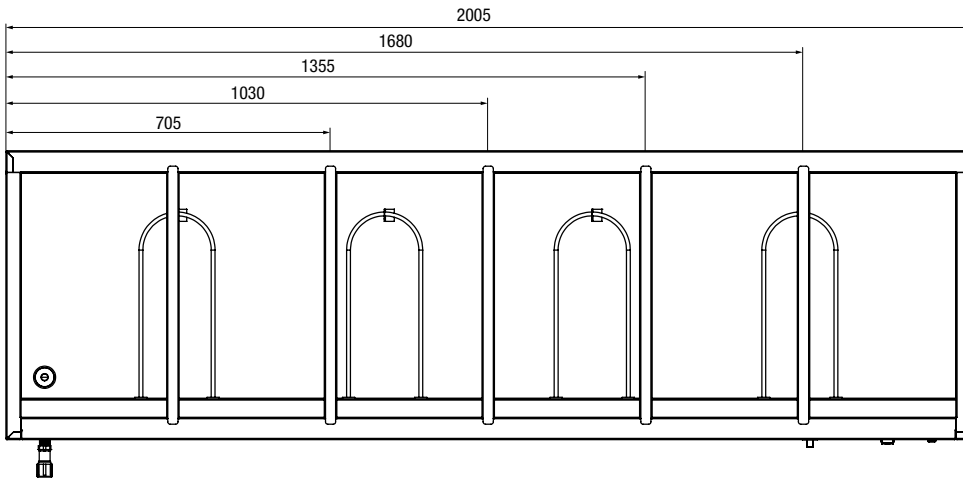

Due to continuous product research and development, the information contained herein is subject to change without notice.

W.BMS11

Specifications

Model	W.BMS11
Height	290mm
Width	370mm
Depth	600mm
Bain Marie Capacity	3 x 1/3 GN Pans
Power	0.75kW 10A plug & lead fitted

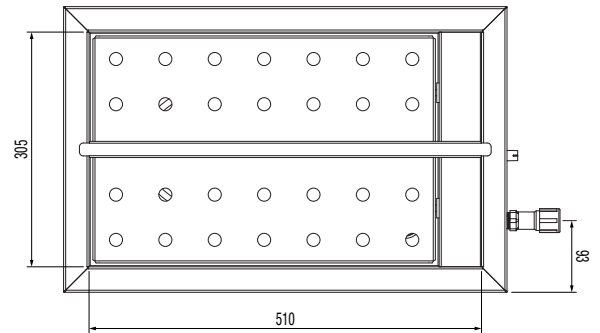

Top View

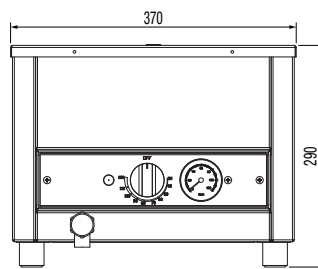

Front View

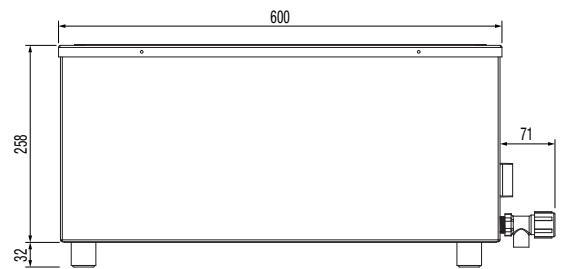

Side View

W.BML21

Specifications

Model	W.BML21
Height	290mm
Width	705mm
Depth	600mm
Bain Marie Capacity	4 x 1/2 GN Pans
Power	1.5kW 10A plug & lead fitted

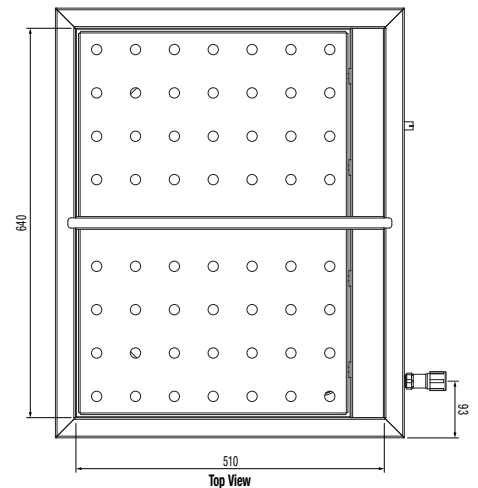

Top View

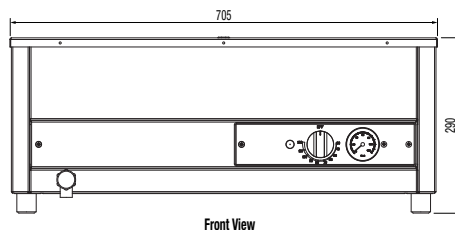

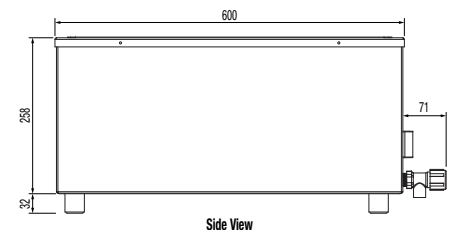

Front View



Side View

Initial Start-up & Operation

	IMPORTANT
	<p style="text-align: center;">Water with a low chloride levels must be used! Water with high chloride levels will cause corrosion to the unit.</p> <p style="text-align: center;">For areas with a high chloride content (ie. SA, WA or country areas) demineralised water should be used in all cases.</p>

	WARNING
	<p style="text-align: center;">The water in the unit and the surfaces of this unit are HOT when operating. Take caution and do NOT place any part of the body in the water.</p>

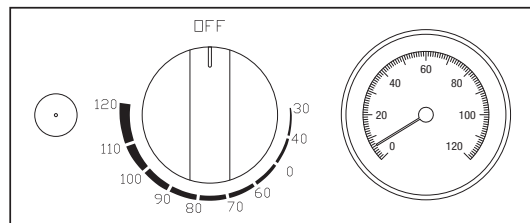

Bain Marie - Initial Start-up

- Before switching ON the unit - The element covers, dividers and shelves need to be placed in the unit
- Fill unit with water. Ensure the elements are submerged in water (minimum of 10mm)
- Turn the thermostat Dial to the required setting. Ensure the unit is heating to operating temperature
- Leave the Bain Marie to operate with water in the unit for 3 - 4 hours, checking water levels hourly
- Allow the unit to cool, drain the unit using the valve. Once this is complete, clean the whole unit, including the Gastronorm pans

Bain Marie - Operation (Wet Unit Only)

Do not use Grids/Racks in bottom of pans as this causes a loss of heat transfer between the bottom of the pan (heat source) and the product in the pan. Poor performance will occur with the use of Grids/Racks and the manufacturer will not cover warranty costs if this is found to be the source of heating problems with the units.

- Fill unit with water. Ensure the elements are submerged in water (minimum of 10mm). Hot or cold water can be used. Hot water will save on heating time and power consumption. The unit can be filled with a bucket
- Do NOT switch ON the unit until after the unit has been filled with water to the required level
- A lemon slice or a few drops of lemon juice should be added to the water daily to reduce the build-up of scale in the unit
- Adjust the thermostat dial to the desired operating temperature (temperature range is 30°C -120°C) allow approximatley 10-15 minutes to heat up
- Check water levels while the unit is in use, top up the water level as required ensuring elements remain submerged
- This unit MUST be completely emptied/drained and re-filled with fresh water daily
- Water MUST not be recycled. After being in the unit, all water MUST be treated as waste water. Do NOT drink and/or serve to persons
- **Mobile units:** Let the water cool then drain into a suitable container
- Do not use the top of the unit as a serving area

Note: The thermometer is meant as guide only. It indicates the temperature of the water (when used as a wet unit) or the temperature under the food pans (when used as a dry unit). It does not indicate the temperature of the food. Use a temperature probe on the food items to ensure the well is maintaining the food temperature above 65°C.

Due to continuous product research and development, the information contained herein is subject to change without notice.

GN Pans, Loading Bain Marie

Gastronorm Pans

- All Gastronorm pans and extra dividers are sold separately
- Each module can hold one 1/1 pan, two 1/2 pans, three 1/3 pans, four 1/4 pans, six 1/6 pans and nine 1/9 pans. Pan depths are 25mm, 65mm, 100mm and 150mm. Contact your distributor about the best possible depth for the product you intend to display
- For 1/6 and 1/9 Gastronorm pans, extra dividers are required

Loading Bain Marie

- Ensure that the Bain Marie is switched ON and has reached operating temperature before placing any food in the unit
- All food placed in the unit **MUST** be pre-heated/cooked
- Only Gastronorm pans are to be placed in the unit

Food Safety

Food Temperature

- All food **MUST** be pre-heated/cooked before placing in the unit. Attempting to cook food with this unit can lead to food poisoning
- Ensure the unit is maintaining the food temperature over 65°C
- The temperature reached on the temperature gauge is the water/air temperature, **NOT** the food temperature
- It is important to regularly monitor the food temperature in the Bain Marie

	IMPORTANT
	This unit is not designed to cook products, it only maintains them above the regulated 65°C serving temperature.

Food Storage

- All storage of food should comply with local health standards and regulations
- All pans should be cleaned and placed in night storage. No pans should be left in the unit
- This unit is **NOT** designed to store product after hours. The unit **MUST** be switched OFF
- If the unit is moved for night storage, ensure the castors are locked (mobile units only)

Bain Marie

- Drain the unit Daily, no water should remain in the unit
- Ensure the benches around the unit are cleaned continuously to prevent contaminants entering the pans
- When operating, the surfaces may be hot
- Signage should be displayed for personal and customers to ensure no one will burn themselves

Cleaning

General Information





- Cleaning is recommended for health and safety purposes and to prolong the life of the unit
- Do NOT use abrasive pads or cleaners on the stainless steel or any other metal parts of the unit
- Do NOT use industrial chemical cleaners, caustic based cleaners or bleaches and bleaching agents, as many will damage the metals and plastics used on this unit
- Do NOT remove any screws and/or panels for cleaning (unless directed)
- This unit is NOT waterproof, do NOT hose, do NOT pour water directly onto the unit, do NOT immerse in water

Corrosion Protection

- Stainless steel exhibits good resistance to corrosion however, if not properly maintained stainless steel can rust and/or corrode
- Any sign of mild rust and/or corrosion should be thoroughly cleaned with warm soapy water and dried as soon as possible
- NEVER use abrasive pads or cleaners for cleaning
- All metal surfaces should be checked while cleaning for damage, scuffs or scrapes as these can lead to rust and further damage to the product
- Mild rust and/or corrosion can be treated with a commercial cleaning agent that contains citric/oxalic/nitric/phosphoric acid. Do NOT use cleaning agents with chlorides or other harsh chemicals as this can cause corrosion. After treatment, wash with warm (not hot) soapy water and dry thoroughly
- Thoroughly wipe the surfaces dry after cleaning and do NOT let water pool on the unit. Check crevices and folds for pooling
- When using, ensure all liquids and moisture is cleaned up straight away. Food liquids such as juices from vegetables and fruits should NOT be left on preparation surfaces
- Do NOT leave items on the stainless steel such as cutting boards, rubber mats and bottles

Surface Finish

- To protect the polish, stainless steel should be dried by wiping a dry soft cloth in the same direction as grained polished finish
- For NON-food contact surfaces, a light oil can be wiped on the surfaces with a cloth to enhance the stainless steel surface. Wipe in the direction of the grain
- Some commercial stainless steel cleaners can leave residue or film on the metal; this may trap fine particles of food on the surface, thus deeming the surfaces not food safe

	<p style="text-align: center;">IMPORTANT</p> <p>Threaded fasteners can loosen in service. Regular inspection and adjustment should be carried out as required</p>		<p style="text-align: center;">WARNING</p> <p>This unit is NOT waterproof, do NOT hose. DO NOT pour water directly onto the unit. DO NOT immerse in water</p>
	<p style="text-align: center;">IMPORTANT</p> <p>Some commercial stainless steel cleaners leave residue or film on the metal that may entrap fine particles of food, deeming the surface not FOOD SAFE</p>		<p style="text-align: center;">WARNING</p> <p>Wait until the unit has cooled to a safe temperature before undertaking any cleaning or maintenance. Contact with hot surfaces can cause burns and serious injury</p>

	IMPORTANT
	<p>Corrosion Prevention:</p> <p>This unit MUST be completely drained, cleaned and emptied DAILY. Leaving water in the unit for an extended period while continually topping up with water, will cause the chloride levels to increase. As the water evaporates the chlorides and other impurities are left behind becoming concentrated.</p> <p>Without daily cleaning the concentrated build up of chlorides and impurities in the water will corrode the stainless steel of the unit.</p> <p>Failure to completely drain, clean and empty the unit daily will void the warranty!</p>

Cleaning Schedule

- Daily cleaning is required for the Bain Marie unit and external surfaces. This will help to maintain and prolong the efficiency of your unit
- The unit must be drained and cleaned at the end of each work day

Materials Required

- Stainless Cleaner
- Non Abrasive Cleaning pad
- Clean Sanitised Cloth
- Paper Towel
- Warm soapy water
- Appropriate PPE (Personal Protective Equipment)

Bain Marie (Daily)

1. Isolate from the power supply
2. The unit MUST be drained before cleaning. Ensure the waste connection is left OPENED to allow sufficient drainage while cleaning
3. Remove all Dividers, Element Covers & Gastronorm Pans
4. Dividers, Element Covers & Gastronorm Pans can be cleaned in a kitchen sink with warm soapy water. Thoroughly wipe dry with a soft cloth after cleaning, do NOT allow to air dry
5. Clean the unit and elements with warm (not hot) soapy water and a sponge. After cleaning, flush the unit with water
6. Ensure all due care is taken when cleaning the elements, as they can become damaged
7. Thoroughly wipe the unit and elements dry with a soft cloth. Do NOT let water pool in the unit, check crevices and folds

Descaling the Unit (Monthly)

1. Descaling is recommended for health and safety purposes and to prolong the life of the unit
2. The unit MUST be descaled monthly to remove any scaling and build-up in the unit and on the elements. Element covers should be descaled at the same time as the unit
3. To descale, a descaling solution needs to be purchased. The descaling solution should be used as per directions on the packaging
4. Remove all food and pans from the unit before descaling
5. Ensure the unit is rinsed and thoroughly cleaned after descaling

Element Protection (Daily)

1. Every day, the empty unit should be filled with clean water. A lemon slice or a few drops of lemon juice should be added daily to the water
2. As required, adding a commercial cleaning agent that contains citric/oxalic/nitric/phosphoric and boiling for 45 minutes will help to prolong the life of the Bain Marie. Do NOT use cleaning agents with chlorides or other harsh chemicals as this can cause corrosion
3. Do NOT fill the unit with cold water if the elements are hot
4. Water with high mineral content needs be filtered
5. When cleaning, clean the elements properly and allow to dry before switching the unit back ON

Troubleshooting

- If any faults/issues occur with the unit, follow the below troubleshooting procedures
- If the troubleshooting procedures do not correct the problem, contact the Stoddart Service Department

	WARNING
	Technician tasks are only to be completed by qualified service people. Check faults before calling service technician.

Task Type - (O) = Operator
(T) = Technician Task

Problem	Possible Causes	Task	Remedy
Unit does not operate / start	The mains isolating switch on the wall, circuit breaker or fuses are OFF at the power board	O	Turn isolating switch, circuit breaker or fuses ON
	The power switch of the unit is OFF	O	Turn the power switch ON
	Electrical wiring damaged	T	Replace / Fix electrical wiring
Unit does not reach temperature	Temperature not set to the right setting	O	Check setting and adjust the temperature
	Exhaust fan above the unit	O	Move unit / exhaust fan
	Cold items in units	O	Remove items and heat properly
	Cold water in the unit	O	Close the water valve / Wait 30 minutes
	Temperature gauge broken	T	Replace temperature gauge
	Thermostat or Temperature probe broken	T	Replace thermostat
	Mineral deposits on element	T	Filter water
Food not at desired temperature	Element blown	T	Replace element
	Thermostat set incorrectly	O	Adjust thermostat
Water pooling around the unit	Unit is not reaching required temperature	O/T	See above
	Drain not in the tundish / Bucket overflowing	O	Place drain in the tundish / Clear and replace bucket
Corrosion	Unit not level	O	Place unit on a level surface
	Connection seals / drain valve broken	T	Replace seals / drain valve
	Poor water quality	T	Test water quality
Scale build up	Not being drained, cleaned and emptied daily	O	Follow cleaning schedule of user manual
	Scale build up on elements and unit	O	Descale unit

Australia

Service / Spare Parts

Tel: 1300 307 289

Email: service@stoddart.com.au

Email: spares@stoddart.com.au

Sales

Tel: 1300 79 1954

Email: sales@stoddart.com.au

www.stoddart.com.au

Australian Business Number: 16009690251

New Zealand

Service / Spare Parts

Tel: 0800 935 714

Email: service@stoddart.co.nz

Email: spares@stoddart.co.nz

Sales

Tel: 0800 79 1954

Email: sales@stoddart.co.nz

www.stoddart.co.nz

New Zealand Business Number: 6837694

International

Service / Spare Parts

Tel: +617 3440 7600

Email: service@stoddart.com.au

Email: spares@stoddart.com.au

Sales

Tel: +617 3440 7600

Email: sales@stoddart.com.au

www.stoddart.com.au