

SPECIFICATION, INSTALLATION AND OPERATION MANUAL

READ ALL INSTRUCTIONS BEFORE USE

Counter Top Pizza Conveyor Oven P18/P24

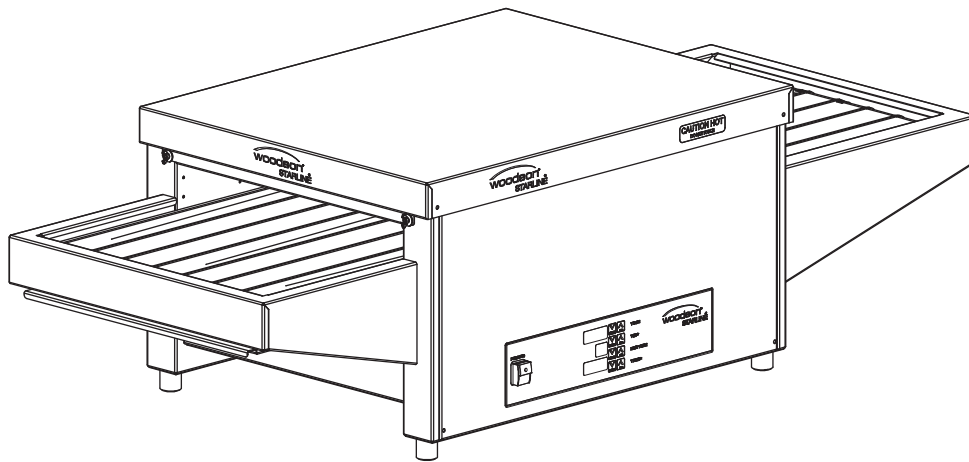

Models:

W.CVP.C.18 / W.CVP.C.18L / W.CVP.C.24 / W.CVP.C.24L

A guide on the use, care and maintenance
of your quality Woodson Starline product

Page Intentionally Left Blank

Introduction

Your New Woodson Product	3
Australia and New Zealand Warranty	4
<i>Warranty Period</i>	
<i>Warranty Registration</i>	
General Precautions	4

Installation

Product Overview.	5
Setting Up	6
<i>Handling</i>	
<i>Unpacking</i>	
<i>Positioning</i>	
<i>Disposal</i>	
Electrical Connection	7
<i>Information</i>	
Wiring Diagram.	8
<i>W.CVP.C.18 / W.CVP.C.24</i>	
Technical Specifications	9
<i>W.CVP.C.18</i>	
<i>W.CVP.C.24</i>	

Operation

Operating Instructions	10
<i>Control Panel information</i>	
<i>Operation Adjustments</i>	
<i>Cross Flow Air/Ventilation</i>	
<i>Switching Unit Off</i>	

Cleaning and Maintenance

Cleaning	12
<i>General Information</i>	
<i>Corrosion Protection</i>	
<i>Surface Finish</i>	
<i>Cleaning Schedule</i>	
<i>Materials Required</i>	
<i>Cleaning Procedure - Conveyor and Crumb Tray</i>	
<i>Cleaning Procedure - External Surfaces</i>	
Troubleshooting	14

Your New Woodson Product

Thank you for choosing this quality Woodson product.

All Woodson products are designed and manufactured to meet the needs of food service professionals. By caring for and maintaining your new Woodson product in accordance with these instructions, will provide many years of reliable service.

Stoddart is a wholly Australian owned company, which manufactures and/or distributes a comprehensive range of food service equipment for kitchens, food preparation and presentation. Stoddart products are manufactured and/or engineered in Australia to provide excellent results whilst offering value-for-money, ease-of-use and reliability.

**Carefully read this instruction booklet, as it contains important advice for safe installation, operation and maintenance.
Keep this booklet on hand in a safe place for future reference by other operators or users.**

Disclaimer

The manufacturer and distributor cannot be held responsible or liable for any injuries or damages of any kind occurred to persons, units or others, due to abuse and misuse of this unit in regards to installation, removal, operation, servicing or maintenance, or lack of conformity with the instructions indicated in this documentation.

All units made by the manufacturer are delivered assembled, where possible, and ready to install. Any installation, removal, servicing, maintenance and access or removal of any parts, panels or safety barriers that is not permitted, does not comply in accordance to this documentation, or not performed by a **TRAINED AND AUTHORISED SPECIALIST** will result in the **IMMEDIATE LOSS OF THE WARRANTY.**

The manufacturer cannot be held responsible or liable for any unauthorized modifications or repairs. All modifications or repairs must be approved by the manufacturer in writing before initiating. All modifications or repairs performed to this unit must be performed at all times by a **TRAINED AND AUTHORISED SPECIALIST.**

**Stoddart design, manufacture & distribute Food Service Equipment (appliances) exclusively for the commercial market.
This appliance is not designed nor intended for household or domestic use & must not be used for this purpose.**

This product is intended for commercial use, and in line with Australian electrical safety standards the following warnings are provided:

- This product is not intended for use by persons (including children) with reduced physical, sensory or mental capabilities, or lack of experience and knowledge, unless they have been given supervision or instruction concerning the use of the product by a person responsible for their safety. Children should be supervised to ensure that they do not play with the product
- If the supply cord is damaged, it must be replaced by the manufacturer, its service agent or similarly qualified persons in order to avoid a hazard



Warranty & Registration

Australia and New Zealand Warranty

Warranty Period

Stoddart 12 month on-site parts and labour warranty (terms and conditions apply), from the time of purchase.

To view or download the warranty terms and conditions visit: <http://www.stoddart.com.au/warranty-information>

Warranty Registration

To register your new product, go to the Stoddart warranty page: <http://www.stoddart.com.au/warranty-registration>



General Precautions

When using any electrical unit, safety precautions must always be observed.

Our units have been designed for high performance. Therefore, the unit must be used exclusively for the purpose for which it has been designed.

- All units **MUST** be installed according to the procedures stated in the installation section of this manual
- In the case of new personnel, training is to be provided before operating the equipment
- **DO NOT** use this unit for any other purpose than its intended use
- **DO NOT** store explosive substances such as aerosol cans with a flammable propellant in or near this unit
- Keep fingers out of “pinch point” areas
- Unit is not waterproof **DO NOT** use jet sprays, hoses or pour water over/on the exterior of the unit
- Only use this unit with voltage specified on the rating label
- **Do NOT** remove any cover panels that may be on the unit
- **DO NOT** use sharp objects to activate controls
- **DO NOT** use sharp objects to remove ice from the unit
- If any fault is detected, refer to troubleshooting
- The manufacturer declines any liability for damages to persons and/or things due to an improper/wrong and/or unreasonable use of the machine
- Only specifically trained/qualified Technicians (Stoddart, one of our service agents, or a similarly qualified persons) should carry out any and all repairs, maintenance and services

Product Overview

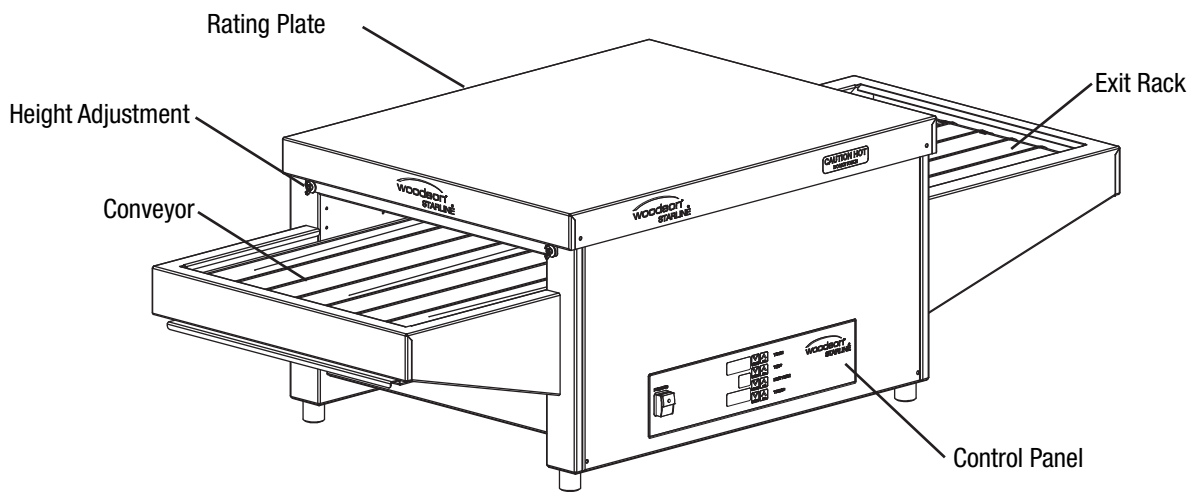
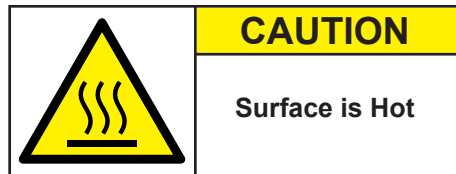

Setting Up

	WARNING
	<p>Improper installation, adjustments, alterations, service or maintenance can cause property damage, injury or death.</p>

Handling

- Use suitable means to move the unit;
 - For smaller items use two people
 - For large items a fork lift, pallet trolley or similar (the forks should reach completely beneath the pallet)

Unpacking

- Check the unit for damage before and after unpacking. If unit is damaged, contact the distributor and manufacturer
- Should any item have physical damage, report the details to the freight company and to the agent responsible for the dispatch within seven (7) days of receipt. No claims will be accepted or processed after this period
- The unit is supplied fully assembled
- Remove all protective plastic film, tapes, ties and packers before installing and operating
- Clean off any remaining residue from the interior/exterior of the unit using a clean cloth dampened with warm soapy water

Positioning

- Choose an area that is well ventilated and provides access for future maintenance
- Place the unit on a level stable work surface capable of supporting its weight
- Do not position the unit in:
 - Wet areas
 - Near heat and/or steam sources
 - Near flammable substances
- Allow an air gap between the unit and other objects or surfaces. A minimum gap of 100mm from all sides is recommend for normal operational use (if the unit is near any heat sensitive material we suggest you allow additional space)

	INFORMATION
	<p>Do not cover Air Vents. Allow a minimum air gap of 100mm around the unit.</p>

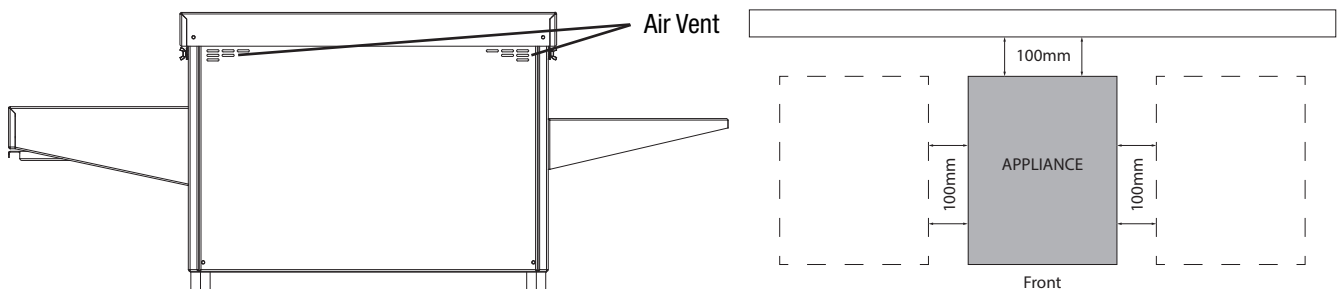

- Please consult national and local standards to ensure that your unit is positioned in accordance with any existing requirement

Disposal

- At the end of the appliance's working life, make sure it is scrapped & components recycled properly
- Current environmental protection laws in the state/country of use must be observed
- Doors must be removed before disposal (if applicable)
- Power supply cable must be removed before disposal
- For further information on the recycling of this product, contact the local dealer/agent or the local body responsible for waste disposal

Due to continuous product research and development, the information contained herein is subject to change without notice.

Electrical Connection

Information

	WARNING
	<p>This unit must be installed in accordance with AS/NZS 60335.1</p> <p>Some procedures in this manual require the power to the equipment to be turned off and isolated. Turn the power OFF at the power point and unplug the power supply lead by the plug body. If the power point is not readily accessible turn the equipment off at the isolation switch or the circuit breaker in the switchboard. Attach a yellow “CAUTION-DO NOT OPERATE” tag. This must be performed where relevant unless the procedures specify otherwise.</p> <p>FAILURE TO DO SO MAY RESULT IN ELECTRIC SHOCK.</p>

Three Phase Units 3Ø + N + E:

- **W.CV.P.C.18 (15A 3Ø + N + E)**
 - Supplied with 2 metre lead, no plug for 5 wire 3Ø + N + E hard wiring on site by a qualified electrician
 - Optional factory fitted plug is available (W.CVS.PL32.3PH)
- **W.CV.P.C.24 (20A 3Ø + N + E)**
 - Supplied with 2 metre lead, no plug for 5 wire 3Ø + N + E hard wiring on site by a qualified electrician
 - Optional factory fitted plug is available (W.CVS.PL32.3PH)

On-site Connection:

- The electrical supply must comply with the rating plate data
- Ensure that the machine is connected to a suitably rated power source
- Disconnection must be incorporated in the fixed wiring in accordance with the wiring rules
- To connect the power, the unit has a terminal block supplied inside the service compartment

Notes:

- If the supply cord is damaged, it must be replaced by the manufacturer, its service agent or similarly qualified persons in order to avoid a hazard. Please contact Stoddart for parts and we will advise how to do this in order to avoid any electrical hazard
- The power cable should be dry and/or isolated from moisture or water

Wiring Diagram

W.CVP.C.18 / W.CVP.C.24

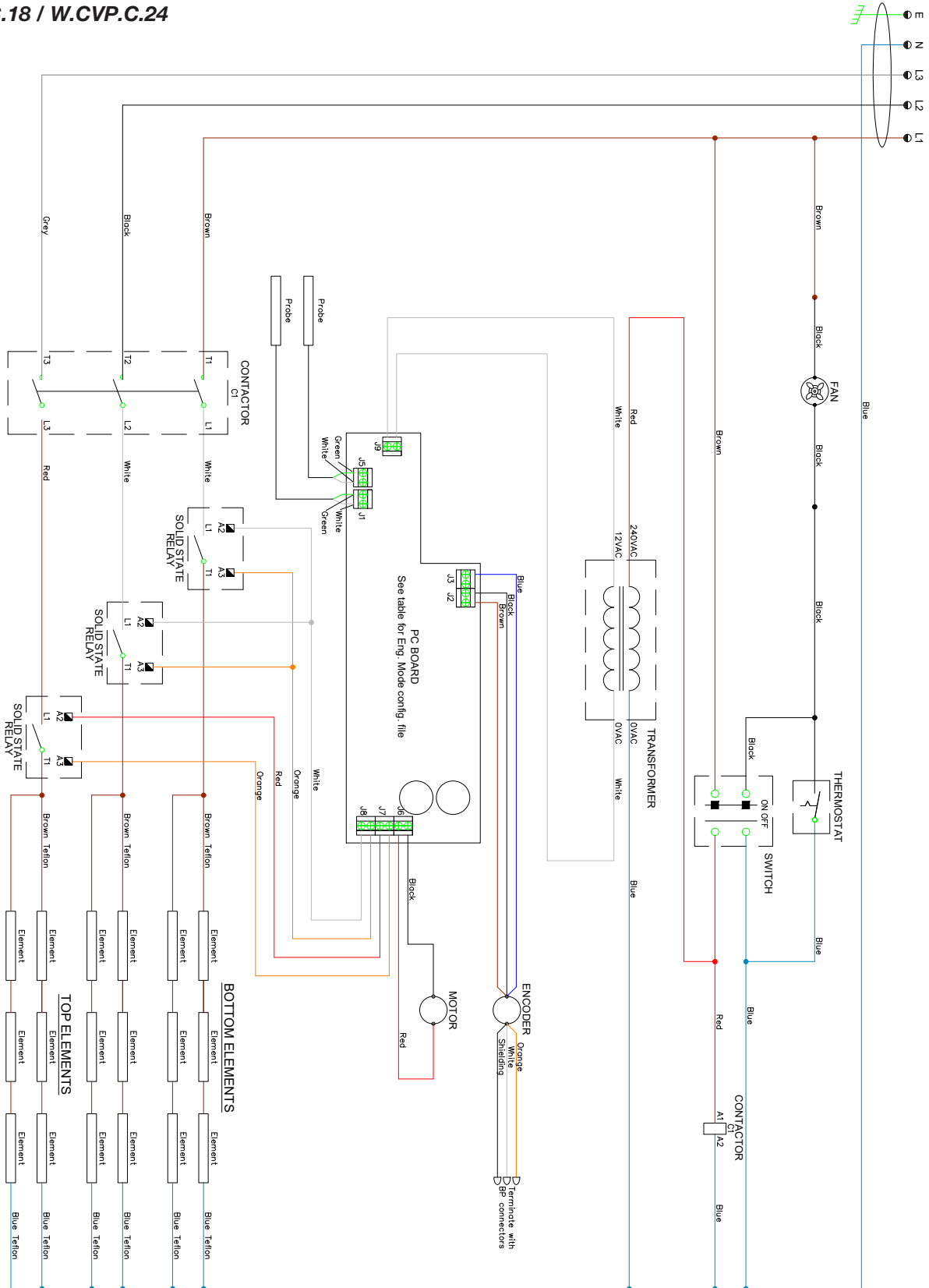

Due to continuous product research and development, the information contained herein is subject to change without notice.

Technical Specifications

W.CVP.C.18

Specifications

Model	W.CVP.C.18
Height	440mm
Width	1500mm
Depth	610mm
Power	10.8kW 15A 3Ø + N + E

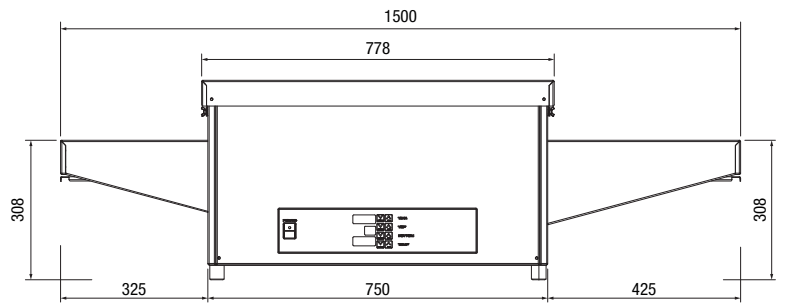
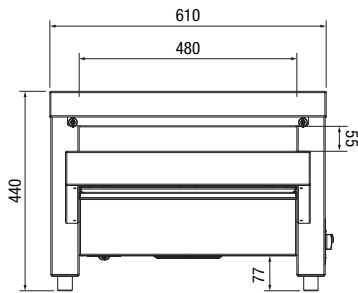
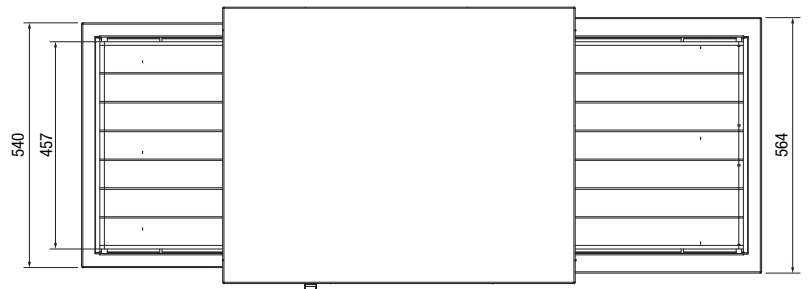

W.CVP.C.24

Specifications

Model	W.CVP.C.24
Height	440mm
Width	1500mm
Depth	765mm
Power	14.4kW 20A 3Ø + N + E

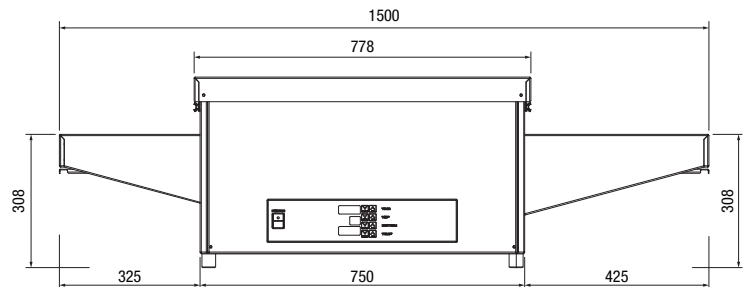
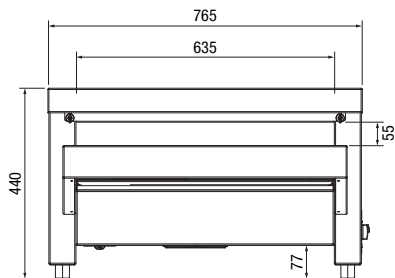
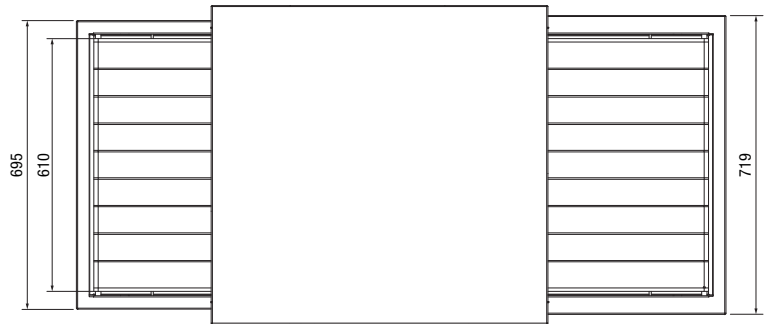

Operating Instructions

Upon setting up your equipment, the following steps must be followed to setup the timer and temperature:
When this unit is initially switched on, the display will show pre-set factory settings.

Control Panel information

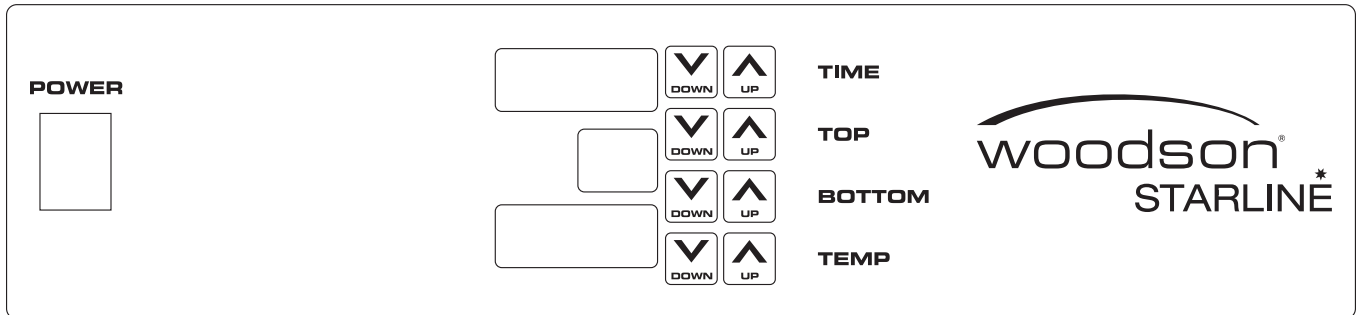

Belt Speed “Time”:

- The time is controlled via the top two **▼ ▲** buttons. The display shows the set time as (MMSS)
- To change the time settings, Press and hold the time **▼ ▲** buttons for a minimum of 2 seconds to adjust in 30 second increments. For more precise adjustment press and release to adjust in 5 second increments
- The time in the chamber is from when the product enters the chamber to when it exits the chamber

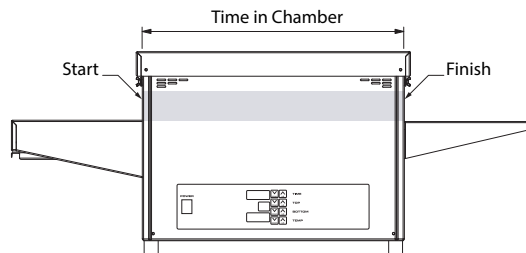

Elements “Top / Bottom”:

- The top and bottom elements are controlled via the top and bottom **▼ ▲** buttons. The display will show numbers between 0-99 which indicates a percentage (%) value of the effective power sent to each element.
For example: If the top element is set at 99% and the bottom element is set at 50%, there will be approximately double the energy coming from the top element as there is coming from the bottom element
- To change the element settings, press the top or bottom **▼ ▲** buttons. Each press will move the number by 1

Temperature “Temp”:

- The temp is controlled via the temp **▼ ▲** buttons. The display will show numbers between 50-350 this is °C
- To change the temp settings, press the temp **▼ ▲** buttons. The temperature can be set between 50°C-350°C adjusted in 5°C increments. The display will read the new adjusted temperature in the oven after approximately 10 seconds

Notes:

- If the temp set-point is higher than the element percentages can reach, then the elements will pulse at the top and bottom element % setting and the unit will become a radiant cooker. For most cooking, this will produce less consistent results
- For example: Temp set to 350°C, top element set to 80% and bottom element set to 50%. There would not be enough energy running to the elements to reach 350°C. This would cause the top element to pulse at exactly 80% and the bottom at pulse at exactly 50%
- It is not recommended to run the unit at 350°C

Operation Adjustments

1. Turn the unit on at the **“Power Switch”**
2. Adjust the belt speed **“Time”** to the required setting
3. Set the **“Top”** element to 90%
4. Set the **“Bottom”** element to 99%
5. Set the **“Temp”** to 250°C
6. Place food on the conveyor
7. Adjust as required: increase/decrease the conveyor **“Time”**, **“Top”** element and **“Bottom”** element and/or **“Temp”**. Repeat this process until the desired results have been achieved
8. Once satisfied with the results, record the settings for future reference (Refer to our recipe guide for ideas and base settings)
9. Repeat this process for different foods

Notes:

- After 60 seconds the settings will save to the control memory. The unit will now show these settings at start up
- It is recommended to time the belt speed from when the food item starts to enter the oven to when it starts to come out. This is the time the belt takes to pass through the oven

Cross Flow Air/Ventilation

- For best results there needs to be no cross-flow air/ventilation (no external fans pointed at the unit). This affects the air curtain at entrance and exit of the oven chamber, causing temperature instability in the unit.
- Adjust the height of the oven chamber entrance and exit guard to a minimum height above the food product to minimise external airflow entering the unit

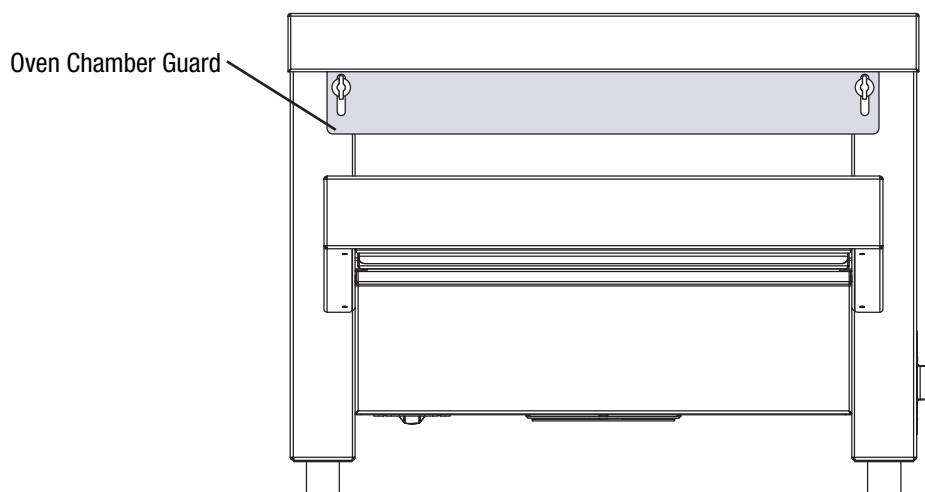

Switching Unit Off

- Do not unplug the unit for at least 30 minutes after the unit is switched. The fan runs on an internal thermostat which keeps the internals cool and helps to remove excess heat from elements and oven chamber

Cleaning

General Information





- Cleaning is recommended for health and safety purposes and to prolong the life of the unit
- Do NOT use abrasive pads or cleaners on the stainless steel or any other metal parts of the unit
- Do NOT use industrial chemical cleaners, caustic based cleaners or bleaches and bleaching agents, as many will damage the metals and plastics used on this unit
- Do NOT remove any screws and/or panels for cleaning (unless directed)
- This unit is NOT waterproof, do NOT hose, do NOT pour water directly onto the unit, do NOT immerse in water

Corrosion Protection

- Stainless steel exhibits good resistance to corrosion however, if not properly maintained stainless steel can rust and/or corrode
- Any sign of mild rust and/or corrosion should be thoroughly cleaned with warm soapy water and dried as soon as possible
- NEVER use abrasive pads or cleaners for cleaning
- All metal surfaces should be checked while cleaning for damage, scuffs or scrapes as these can lead to rust and further damage to the product
- Mild rust and/or corrosion can be treated with a commercial cleaning agent that contains citric/oxalic/nitric/phosphoric acid. Do NOT use cleaning agents with chlorides or other harsh chemicals as this can cause corrosion. After treatment, wash with warm (not hot) soapy water and dry thoroughly
- Thoroughly wipe the surfaces dry after cleaning and do NOT let water pool on the unit. Check crevices and folds for pooling
- When using, ensure all liquids and moisture is cleaned up straight away. Food liquids such as juices from vegetables and fruits should NOT be left on preparation surfaces
- Do NOT leave items on the stainless steel such as cutting boards, rubber mats and bottles

Surface Finish

- To protect the polish, stainless steel should be dried by wiping a dry soft cloth in the same direction as grained polished finish
- For NON-food contact surfaces, a light oil can be wiped on the surfaces with a cloth to enhance the stainless steel surface. Wipe in the direction of the grain
- Some commercial stainless steel cleaners can leave residue or film on the metal; this may trap fine particles of food on the surface, thus deeming the surfaces not food safe

	<p style="text-align: center;">IMPORTANT</p> <p>Threaded fasteners can loosen in service. Regular inspection and adjustment should be carried out as required</p>		<p style="text-align: center;">WARNING</p> <p>This unit is NOT waterproof, do NOT hose. DO NOT pour water directly onto the unit. DO NOT immerse in water</p>
	<p style="text-align: center;">IMPORTANT</p> <p>Some commercial stainless steel cleaners leave residue or film on the metal that may entrap fine particles of food, deeming the surface not FOOD SAFE</p>		<p style="text-align: center;">WARNING</p> <p>Wait until the unit has cooled to a safe temperature before undertaking any cleaning or maintenance. Contact with hot surfaces can cause burns and serious injury</p>

Cleaning Schedule

- Daily cleaning is required for the oven conveyor, crumb tray and external surfaces. This will help to maintain and prolong the efficiency of your oven
- The unit should be cleaned at the end of each work day

Materials Required

- Stainless Cleaner
- Non Abrasive Cleaning pad
- Clean Sanitised Cloth
- Paper Towel
- Container of warm water
- Nylon Brush
- Appropriate PPE (Personal Protective Equipment)

Cleaning Procedure - Conveyor and Crumb Tray

1. Isolate from the power supply
2. Using a good quality nylon brush remove crumbs and small food items from the conveyor. (Switch the unit on to move the conveyor forward, then switch off)
3. Wipe clean using a cloth dampened (not wet) with clean warm water until all soil has been removed. (Switch the unit on to move the conveyor forward, then switch off)
4. Empty and clean the crumb tray. This should be done on a regular basis

Cleaning Procedure - External Surfaces

1. Isolate from the power supply
2. Wearing Personal Protective Equipment (PPE), apply Stainless Cleaner with the Cleaner pad to the external surfaces
3. Scrub any baked on soil with the cleaner pad in the same direction as grained polish
4. Wipe clean using a cloth dampened with clean warm water until all Stainless Cleaner and soil has been removed
5. Using a clean sanitised cloth, thoroughly wipe the stainless steel and metal parts dry. Do NOT let water pool on the unit. Check crevices and folds

Note: In some areas, particularly seaside environments, stainless steel can be subject to surface discolouration or “tea staining”. This can be removed with an appropriate cleaning agent which contains 10% sodium citrate. Ask your supplier of cleaning chemicals for a suitable brand.

Troubleshooting

- If any faults/issues occur with the unit, follow the below troubleshooting procedures
- If the troubleshooting procedures do not correct the problem, contact the Stoddart Service Department

	WARNING
	Technician tasks are only to be completed by qualified service people. Check faults before calling service technician.

Task Type - (O) = Operator
(T) = Technician Task

Problem	Possible Causes	Task	Possible Corrective Action
Unit won't turn on	Unit is not plugged into a suitable power point	O	Plug unit in
	Power switch is in the "Off" position	O	Change the power switch to the "ON" position
	Power Point is faulty	T	Arrange a qualified Technician to repair the power point
	Isolator Switch is "Off"	O	Turn Isolator Switch "On"
Conveyor not turning on	Conveyor Motor faulty	T	Lubricate / replace conveyor motor
	Conveyor speed dial not responding	T	Replace speed dial / Computer board (whichever is applicable)
	Bearings Worn	T	Replace Gear Head
Conveyor chain binds up in operation	Sprocket worn	T	Replace sprocket
	Belt loose	T	Remove a chain link
	Foreign object in belt	O	Remove foreign object from belt
Unit is overheating	Airflow blockage	O	Clear dirt / dust from fan guard and/ or clear all air vents around the unit of any obstructions
	Fan not working	T	Replace fan
Unit is not heating	Elements not working	T	Replace Elements as required
	Temp switch / Computer board not working	T	Replace switch / Computer board (whichever is applicable)
	Solid State Relay contactor failed	T	Replace Solid State Relay contactor
Inconsistent cooking of Product	Speed too slow/fast	O	Adjust speed settings as required
	Element % too low/high	O	Adjust element settings as required
	Temperature set too low/high	O	Adjust temperature settings as required
	Cross flow air/ventilation	O	Move any fans away from unit Adjust height of entrance and exit oven chamber guard to minimise external airflow entering the unit
	Inconsistent quantities of ingredients for same product. Frozen or thawed. Placement on conveyor varies	O	Control quantities of product used Use different settings fo frozen and thawed Place product in the same location
	Elements not working	T	Replace Elements as required

Due to continuous product research and development, the information contained herein is subject to change without notice.

Australia

Service / Spare Parts

Tel: 1300 307 289

Email: service@stoddart.com.au

Email: spares@stoddart.com.au

Sales

Tel: 1300 79 1954

Email: sales@stoddart.com.au

www.stoddart.com.au

Australian Business Number: 16009690251

New Zealand

Service / Spare Parts

Tel: 0800 935 714

Email: service@stoddart.co.nz

Email: spares@stoddart.co.nz

Sales

Tel: 0800 79 1954

Email: sales@stoddart.co.nz

www.stoddart.co.nz

New Zealand Business Number: 6837694

International

Service / Spare Parts

Tel: +617 3440 7600

Email: service@stoddart.com.au

Email: spares@stoddart.com.au

Sales

Tel: +617 3440 7600

Email: sales@stoddart.com.au

www.stoddart.com.au