

**SPECIFICATION, INSTALLATION
AND OPERATION MANUAL**
READ ALL INSTRUCTIONS BEFORE USE

**MOBILE PLATE DISPENSERS
AMBIENT & HEATED**

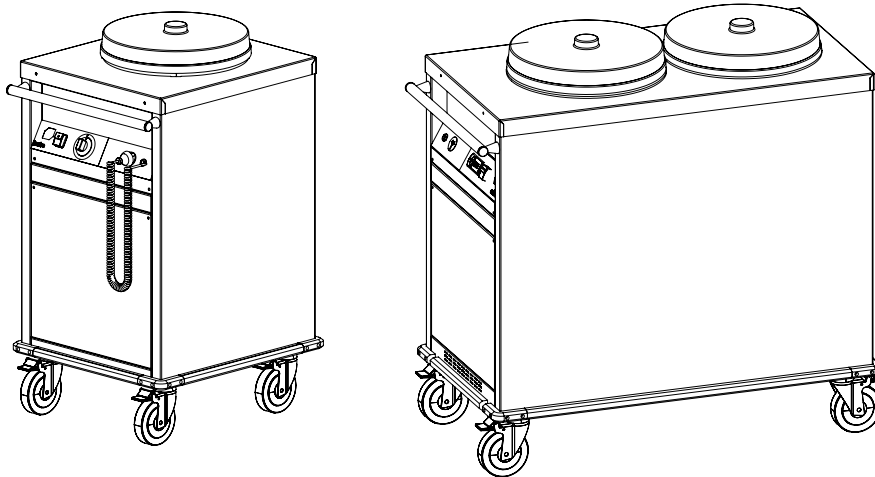

Models:

CA.PD.1, CA.PD.1.230, CA.PD.2, CA.PD.2.850,
CH.PD.HS.1, CH.PD.HS.2 & CH.PD.HF.2

A guide on the use, care and maintenance
of your quality Culinaire product

Page Intentionally Left Blank

Introduction

Your New Culinaire Product	3
Australia and New Zealand Warranty	4
<i>Warranty Period</i>	
<i>Warranty Registration</i>	
General Precautions	4

Installation

Product Overview	5
Setting Up	6
<i>Handling</i>	
<i>Unpacking</i>	
<i>Positioning</i>	
Electrical Connection	7

Specification

Technical Specifications	8
<i>Code Explanation</i>	
<i>CA.PD.1 / CA.PD.1.230</i>	
<i>CA.PD.2 / CA.PD.2.850 / CH.PD.HS.2 / CH.PD.HF.2</i>	

Operation

Initial Start-up & Operation	10
<i>Mobile Plate Dispensers - Initial Start-up</i>	
<i>CA.PD.1, CA.PD.1.230 & CH.PD.HS.1</i>	
<i>Thermostat (Single Tube Only) - Operation</i>	
<i>CA.PD.2, CA.PD.2.850, CH.PD.HS.2 & CH.PD.HF.2</i>	
<i>Electronic Controller (Duel Tube Only) - Operation</i>	
Temperature Adjustment (Mobile Plate Dispensers)	12
Plate Dispensers	13
<i>Plating Tubes</i>	
<i>Plug Tidy Socket</i>	
<i>Castors</i>	
<i>Loading Mobile Plate Dispensers</i>	
<i>Moving the Unit</i>	

Cleaning and Maintenance

Cleaning	14
<i>Cleaning and Maintenance Schedule</i>	
<i>Materials Required</i>	
<i>General Information</i>	
<i>Corrosion Protection</i>	
<i>Surface Finish</i>	
<i>External Surfaces</i>	
Troubleshooting	15
<i>Troubleshooting Procedures</i>	
Disposal	15

Your New Culinaire Product

Thank you for choosing this quality Culinaire product.

All Culinaire products are designed and manufactured to meet the needs of food service professionals. By caring for and maintaining your new Culinaire product in accordance with these instructions, will provide many years of reliable service.

Stoddart is a wholly Australian owned company, which manufactures and/or distributes a comprehensive range of food service equipment for kitchens, food preparation and presentation. Stoddart products are manufactured and/or engineered in Australia to provide excellent results whilst offering value-for-money, ease-of-use and reliability.

Carefully read this instruction booklet, as it contains important advice for safe installation, operation and maintenance.
Keep this booklet on hand in a safe place for future reference by other operators or users.

Disclaimer

The manufacturer and distributor cannot be held responsible or liable for any injuries or damages of any kind that occur to persons, units or others, due to abuse and misuse of this unit in regards to installation, removal, operation, servicing or maintenance, or lack of conformity with the instructions indicated in this documentation.

All units made by the manufacturer are delivered assembled, where possible, and ready to install. Any installation, removal, servicing, maintenance and access or removal of any parts, panels or safety barriers that is not permitted, does not comply in accordance to this documentation, or not performed by a **TRAINED AND AUTHORISED SPECIALIST** will result in the **IMMEDIATE LOSS OF THE WARRANTY.**

The manufacturer cannot be held responsible or liable for any unauthorised modifications or repairs. All modifications or repairs must be approved by the manufacturer in writing before initiating. All modifications or repairs performed to this unit must be performed at all times by a **TRAINED AND AUTHORISED SPECIALIST.**

**Stoddart design, manufacture & distribute Food Service Equipment (appliances) exclusively for the commercial market.
This appliance is not designed nor intended for household or domestic use and must not be used for this purpose.**

This product is intended for commercial use, and in line with Australian electrical safety standards the following warnings are provided:

- This product is not intended for use by persons (including children) with reduced physical, sensory or mental capabilities, or lack of experience and knowledge, unless they have been given supervision or instruction concerning the use of the product by a person responsible for their safety. Children should be supervised to ensure that they do not play with the product
- If the supply cord is damaged, it must be replaced by the manufacturer, its service agent or similarly qualified persons in order to avoid a hazard



Warranty & Registration

Australia and New Zealand Warranty

Warranty Period

All Stoddart manufactured and distributed products are covered by Stoddart's standard Australia and New Zealand Product Warranty (minimum 12 month on-site parts and labour, terms and conditions apply). Further to this standard warranty, certain products have access to an extended warranty. Full terms, conditions and exclusions can be found using the below Link/QR code.

Warranty Registration

To register your new product, Follow the below Link/QR code.

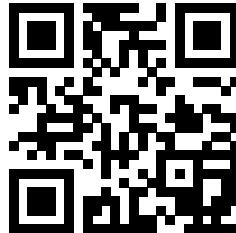

www.stoddart.com.au/warranty-information

General Precautions

When using any electrical unit, safety precautions must always be observed.

Our units have been designed for high performance. Therefore, the unit must be used exclusively for the purpose for which it has been designed.

- All units **MUST** be installed according to the procedures stated in the installation section of this manual
- In the case of new personnel, training is to be provided before operating the equipment
- **DO NOT** use this unit for any other purpose than its intended use
- **DO NOT** store explosive substances such as aerosol cans with a flammable propellant in or near this unit
- Keep fingers out of "pinch point" areas
- Unit is not waterproof **DO NOT** use jet sprays, hoses or pour water over/on the exterior of the unit
- Only use this unit with voltage specified on the rating label
- **DO NOT** remove any cover panels that may be on the unit
- **DO NOT** use sharp objects to activate controls
- If any fault is detected, refer to troubleshooting
- The manufacturer declines any liability for damages to persons and/or things due to an improper/wrong and/or unreasonable use of the machine

Product Overview

	CAUTION
	Surface is HOT!

Code	Explanation
CH	= Culinaire Heated
CA	= Culinaire Ambient
PD	= Plate Dispenser
HS	= Static Heating
HF	= Fan Forced Heating
1	= Single Tube
2	= Dual Tube
230 - 850	= Plate Size Variation

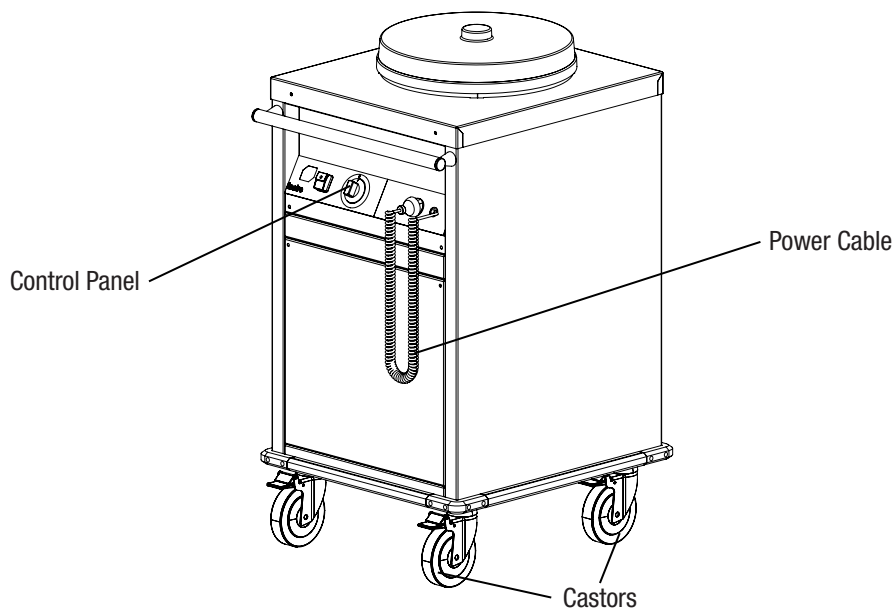

Setting Up

	WARNING
	Improper installation, adjustments, alterations, service or maintenance can cause property damage, injury or death.

Handling

- Use suitable means to move the unit;
 - For smaller items use two people
 - For large items a fork lift, pallet trolley or similar (the forks should reach completely beneath the pallet)

Unpacking

- Check the unit for damage before and after unpacking. If unit is damaged, contact the distributor and manufacturer
- Should any item have physical damage, report the details to the freight company and to the agent responsible for the dispatch within seven (7) days of receipt. No claims will be accepted or processed after this period
- The unit is supplied fully assembled
- Remove all protective plastic film, tapes, ties and packers before installing and operating
- Clean off any remaining residue from the interior/exterior of the unit using a clean cloth dampened with warm soapy water

Positioning

- Choose an area that is well ventilated and provides access for future maintenance
- Place the unit on a level stable work surface capable of supporting its weight
- Do not position the unit in:
 - Wet areas
 - Near heat and/or steam sources
 - Near flammable substances
- Allow an air gap between the unit and other objects or surfaces. A minimum gap of 100mm from all sides is recommend for normal operational use (if the unit is near any heat sensitive material we suggest you allow additional space)

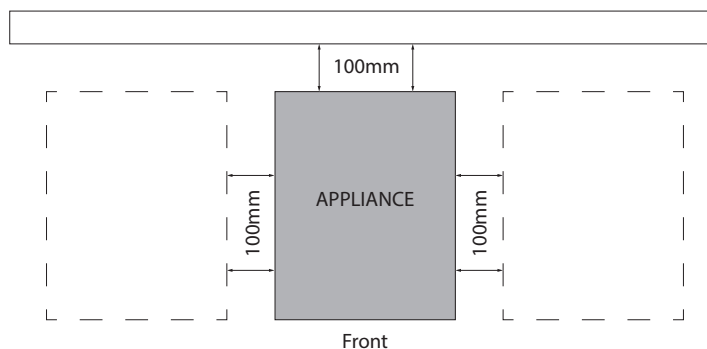

- Please consult national and local standards to ensure that your unit is positioned in accordance with any existing requirement

Electrical Connection

	WARNING
	<p style="text-align: center;">This unit must be installed in accordance with AS/NZS 60335.1</p> <p>Some procedures in this manual require the power to the equipment to be turned off and isolated. Turn the power OFF at the power point and unplug the power supply lead by the plug body. If the power point is not readily accessible turn the equipment off at the isolation switch or the circuit breaker in the switchboard. Attach a yellow “CAUTION-DO NOT OPERATE” tag. This must be performed where relevant unless the procedures specify otherwise.</p> <p style="text-align: center;">FAILURE TO DO SO MAY RESULT IN ELECTRIC SHOCK.</p>

Single Phase Units:

- Supplied and fitted with an appropriately rated plug and lead, indicated as:
 - 10A plug & lead fitted

Notes:

- If the supply cord is damaged, it must be replaced by the manufacturer, its service agent or similarly qualified persons in order to avoid a hazard. Please contact Stoddart for parts and we will advise how to do this in order to avoid any electrical hazard
- The power cable should be dry and/or isolated from moisture or water

Technical Specifications

Code Explanation

Code	Explanation
CH	= Culinaire Heated
CA	= Culinaire Ambient
PD	= Plate Dispenser
HS	= Static Heating
HF	= Fan Forced Heating
1	= Single Tube
2	= Dual Tube
230 - 850	= Plate Size Variation

CA.PD.1 / CA.PD.1.230

SPECIFICATIONS			
Model	CA.PD.1	CA.PD.1.230	CH.PD.HS.1
Width	565mm	565mm	565mm
Depth	655mm	655mm	655mm
Height	960mm	960mm	960mm
Capacity	Approx. 60 plates Suits 270-305mm plates	Approx. 60 plates Suits up to 230mm plates	Approx. 60 plates Suits 270-305mm plates
Voltage	N/A	N/A	220-240V, 50Hz
Power (kW)	N/A	N/A	0.6kW - 10A plug & lead fitted
Connection	N/A	N/A	1 Phase, Neutral, Earth
Temperature Range	N/A	N/A	65-90°C

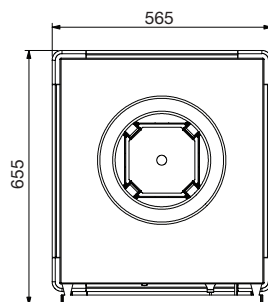

Plan View

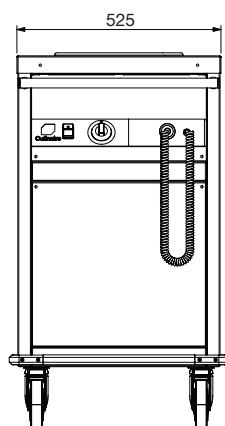

Front Elevation

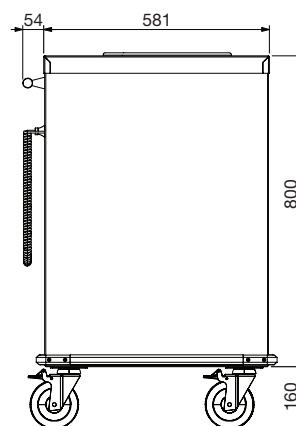

End Elevation

Due to continuous product research and development, the information contained herein is subject to change without notice.

CA.PD.2 / CA.PD.2.850 / CH.PD.HS.2 / CH.PD.HF.2

SPECIFICATIONS				
Model	CA.PD.2	CA.PD.2.850	CH.PD.HS.2	CH.PD.HF.2
Width	565mm	510mm	565mm	565mm
Depth	1076mm	910mm	1076mm	1076mm
Height	960mm	960mm	960mm	960mm
Capacity	Approx. 120 plates - Suits 270-305mm plates			
Voltage	N/A	N/A	220-240V, 50Hz	
Power (kW)	N/A	N/A	2.25kW - 10A plug & lead fitted	
Connection	N/A	N/A	1 Phase, Neutral, Earth	
Temperature Range	N/A	N/A	65-90°C	

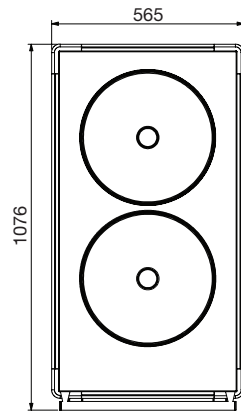

Plan View

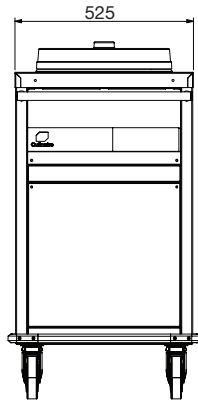

Front Elevation

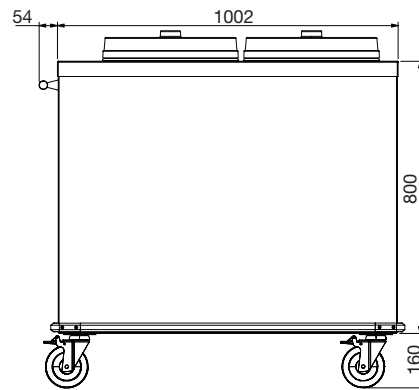

End Elevation

Initial Start-up & Operation

Mobile Plate Dispensers - Initial Start-up

Note: Ambient units only need to be cleaned.

- Before switch ON the unit, ensure the unit is installed correctly.
- Switch ON and check the cabinet is heating up. Check the temperature after 45 minutes to ensure the unit has reached operating temperature.
- Leave the unit to operate for 1 - 2 hours to remove any fumes or odours.
- Allow the unit to cool. Once cooled, clean the whole unit.
- Your unit is now ready to operate.

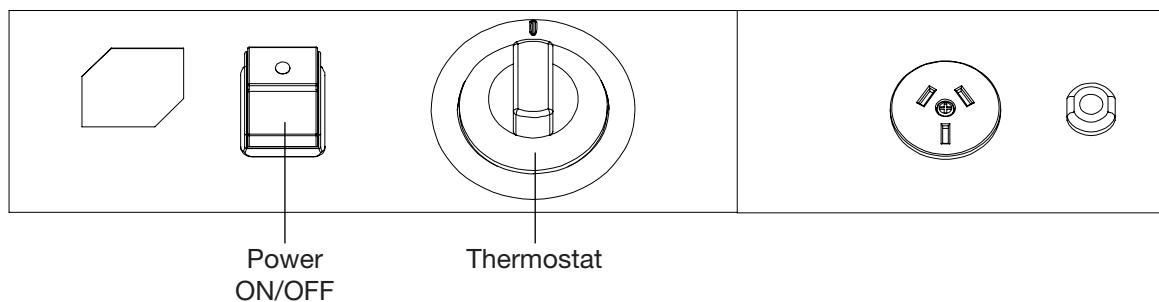

CA.PD.1, CA.PD.1.230 & CH.PD.HS.1

Thermostat (Single Tube Only) - Operation

Note: Ambient units do NOT have any switches or controller

- The unit can be switched ON or OFF with the POWER button on the front of the unit.
- The POWER button is a protection switch. No other switch can operate if the POWER button is OFF
- The elements can be switch ON or OFF and the temperature can be adjusted with the THERMOSTAT KNOB. The THERMOSTAT KNOB is located on the front of the unit.
- The thermostat temperature can be set between 30°C to 85°C. Twist the knob around reaching the desired temperature.
- The thermostat probe only measures the temperature of the water/air, NOT the plate temperature. The temperature can be checked using the TEMPERATURE GAUGE.

Note: The thermometer is meant as guide only. It indicates the temperature under the food pans (when used as a dry unit). It does not indicate the temperature of the food. Do not use the top of the unit as a serving area.

	WARNING
	<p>The water in the well and the surfaces of this unit are HOT when operating. Take caution and do NOT place any part of the body in the water.</p>

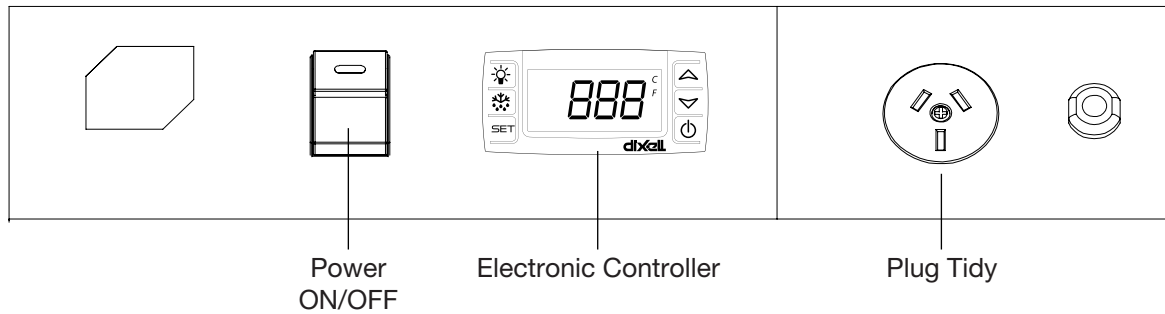

CA.PD.2, CA.PD.2.850, CH.PD.HS.2 & CH.PD.HF.2

Electronic Controller (Duel Tube Only) - Operation

Note: Ambient units do NOT have any switches or controller

- The unit can be switched ON or OFF with the POWER button on the front of the unit.
- The POWER button is a protection switch. No other switch can operate if the POWER button is OFF
- The temperature can be set between 65°C and 90°C, setting the temperature is below. The temperature is factory set at 70°C.
- Different modes require different temperatures.
- Pressing the SET button can mute any alarm that may occur.
- The temperature probe only measures the temperature of the water/air, NOT the plate temperature.

Note: The thermometer is meant as guide only. It indicates the temperature under the food pans (when used as a dry unit). It does not indicate the temperature of the food. Do not use the top of the unit as a serving area.



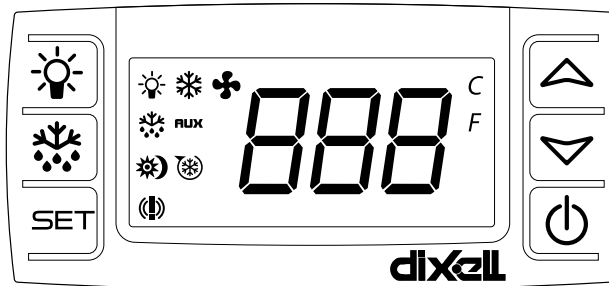

	WARNING
<p>The water in the well and the surfaces of this unit are HOT when operating. Take caution and do NOT place any part of the body in the water.</p>	

Temperature Adjustment (Mobile Plate Dispensers)



- The temperature can be set between 65°C and 95°C. How to set the temperature is shown below
- Different modes require different temperatures
- The temperature probe only measures the temperature of the water/air, NOT the food temperature



KEY FUNCTIONS:

SET	To display target set point; in programming mode it selects a parameter or confirm an operation.
 (DEF)	To start a manual defrost.
 (UP)	To see the maximum stored temperature; in programming mode it browses the parameter codes or increases the displayed value.
 (DOWN)	To see the minimum stored temperature; in programming mode it browses the parameter codes or increases the displayed value.
	To switch the instrument OFF, if onF = oFF .
	Not enabled.

KEY COMBINATIONS:



 + 	To lock and unlock the keyboard.
SET + 	To return to the room temperature display.

HOW TO SEE THE SET POINT:



1. Push and immediately release the **SET** key, the display will show the set point value
2. Push and immediately release the **SET** key or wait 5 seconds to display the probe value again

HOW TO CHANGE THE SET POINT:

1. Push the **SET** key for more than 2 seconds to change the set point value
2. The value of the set point will be displayed and the “°C” LED starts blinking
3. To change the set point value push the  or  arrows within 10 seconds
4. To memorise the new set point value push the **SET** key again or wait 10 seconds

Note: To enter in programming mode. (Contact the Stoddart Service Department)

Plate Dispensers

Plating Tubes

- Plating tubes dispense the plates. Place metal cover plate in the tube to protect the crockery.
- At least one plate should be sitting above the top of the unit for easy access. Do NOT use if hands have to be placed into the tube to remove the plates.



- Lids (Optional) ensure all plates get heated. Place the lids on top of the tubes, they do not screw in.
- Lids are sold separately.

Plug Tidy Socket

- The 'plug tidy' socket is on the side of the unit next to the electrical cable. It MUST be used when moving the unit.
- There is NO power that flows in the socket and its purpose is to ensure the power cord is NOT damaged or persons cannot be injured when the unit is being moved.

Castors

- To lock, push the brake down. To unlock, push the brake release down.
- All castors are a hard wearing design, locking and unlocking the brakes should be operated by foot.

Loading Mobile Plate Dispensers

- The unit is designed only for plates up 310mm. No other types of items should be placed in the unit.
- Load only with clean, dry plates. Do NOT dry plates in the unit.
- Take caution when serving as plates are HOT.
- Plates can be placed in the unit when it is heating up, no pre-heating is required. Allow 45 minutes for the unit to heat to normal operating temperature.
- For greater heating of the plates ensure the lids are placed ON.
- The unit is design for only for 75 kg of plates per tube, if more weight is required contact your distributor or manufacturer.
- If items, such as cutlery, fall into the bottom of the unit, switch the unit OFF and allow to cool before retrieving.

	IMPORTANT
	<p>This unit is not designed to cook or warm products, no food should be placed in the unit.</p>

Moving the Unit

- The unit MUST be switched OFF and unplugged when moving. Plug the plug into the 'plug tidy'.
- Push the unit, Do NOT pull, injuries can occur. Ensure pathway is clear before pushing the unit. Always look where the unit is heading and watch for hazards.
- Push on the handle of the unit. Do NOT push the on the body of the unit
- Ensure the castors are unlocked before moving and locked after moving.
- More than 1 person maybe required to move the unit. Speak to your distributor or manufacturer about the weight of your unit.

Cleaning

Cleaning and Maintenance Schedule

- Daily cleaning is required for the unit. This will help to maintain and prolong the efficiency of your unit
- The unit should be cleaned at the end of each work day

Materials Required

- Stainless Cleaner
- Non Abrasive Cleaning pad
- Clean Sanitised Cloth
- Paper Towel
- Container of warm water
- Appropriate PPE (Personal Protective Equipment)

General Information





- Cleaning is recommended for health and safety purposes and to prolong the life of the unit
- **DO NOT** use abrasive pads or cleaners on the stainless steel or any other metal parts of the unit
- **DO NOT** use industrial chemical cleaners, flammable cleaners, caustic based cleaners or bleaches and bleaching agents, as many will damage the metals and plastics used on this unit
- **DO NOT** remove any screws and/or panels for cleaning (unless directed)
- This unit is **NOT** waterproof, **DO NOT** hose, **DO NOT** pour water directly onto the unit, **DO NOT** immerse in water

Corrosion Protection

- Stainless steel exhibits good resistance to corrosion however, if not properly maintained stainless steel can rust and/or corrode
- Any sign of mild rust and/or corrosion should be thoroughly cleaned with warm soapy water and dried as soon as possible
- NEVER use abrasive pads or cleaners for cleaning
- All metal surfaces should be checked while cleaning for damage, scuffs or scrapes as these can lead to rust and further damage to the product
- Mild rust and/or corrosion can be treated with a commercial cleaning agent that contains citric/oxalic/nitric/phosphoric acid. **DO NOT** use cleaning agents with chlorides or other harsh chemicals as this can cause corrosion. After treatment, wash with warm (not hot) soapy water and dry thoroughly
- Thoroughly wipe the surfaces dry after cleaning. **DO NOT** let water pool on the unit. Check crevices and folds for pooling
- When using, ensure all liquids and moisture is cleaned up straight away. Food liquids such as juices from vegetables and fruits should not be left on preparation surfaces
- **DO NOT** leave items on the stainless steel such as cutting boards, rubber mats and bottles

Surface Finish

- To protect the polished surface of the stainless steel, it should be dried using a clean dry soft cloth. A light oil can be applied to enhance the stainless steel surface, using a clean cloth apply the oil in the same direction as grained polished finish
- Some commercial stainless steel cleaners can leave residue or film on the metal; this may trap fine particles of food on the surface, thus deeming the surfaces not food safe

	<p style="text-align: center;">IMPORTANT</p> <p style="text-align: center;">Threaded fasteners can loosen in service. Regular inspection and adjustment should be carried out as required</p>		<p style="text-align: center;">WARNING</p> <p style="text-align: center;">This unit is NOT waterproof, do NOT hose. DO NOT pour water directly onto the unit. DO NOT immerse in water</p>
	<p style="text-align: center;">IMPORTANT</p> <p style="text-align: center;">Some commercial stainless steel cleaners leave residue or film on the metal that may entrap fine particles of food, deeming the surface not FOOD SAFE</p>		<p style="text-align: center;">WARNING</p> <p style="text-align: center;">Wait until the unit has cooled to a safe temperature before undertaking any cleaning or maintenance. Contact with hot surfaces can cause burns and serious injury</p>

External Surfaces

1. Isolate from the power supply
2. Using a clean cloth dampened (not wet) with clean warm soapy water until all soil has been removed
3. Using a clean sanitised cloth, thoroughly wipe the stainless steel and metal parts dry. Do NOT let water pool on the unit. Check crevices and folds

Due to continuous product research and development, the information contained herein is subject to change without notice.

Troubleshooting

Troubleshooting Procedures

- If any faults/issues occur with the unit, follow the below troubleshooting procedures
- If the troubleshooting procedures do not correct the problem, contact the Stoddart Service Department

	WARNING
	Technician tasks are only to be completed by qualified service people. Check faults before calling service technician.

(O) = Operator
(T) = Technician Task

Problem	Possible Causes	Task	Remedy
Unit does not operate / start	The mains isolating switch on the wall, circuit breaker or fuses are OFF at the power board	O	Turn isolating switch, circuit breaker or fuses ON
	The power switch of the unit is OFF	O	Turn the power switch ON
	Electrical wiring damaged	T	Replace / Fix electrical wiring
Unit not heating	Temperature not set to the right setting	O	Check setting and adjust the temperature
	Electronic Controller broken	T	Replace controller
	Temperature probe broke	T	Replace probe
	Element/s blown	T	Replace element/s
Unable to adjust temperature	Element / thermostat failure	T	Test and replace the element or thermostat if necessary

Disposal

If the appliance is no longer of use, please dispose in an environmentally correct way.

The distributor / retailer can contact their local metal recycling centre to collect the remaining cabinet, shelves, etc.

There may be special requirements or conditions. Information on the disposal of refrigeration appliances can be obtained from:

- Your supplier
- Government authorities (The local council, Ministry of the Environment, etc.)



Discarded electric appliances are recyclable and should not be discarded in the domestic waste! Please actively support us in conserving resources and protecting the environment by returning this appliance to the collection centres (if available).



Dispose of packaging in accordance to applicable legal regulations.

Page Intentionally Left Blank

Australia

Service / Spare Parts

Tel: 1300 307 289

Email: service@stoddart.com.au

Email: spares@stoddart.com.au



Service Request

www.stoddart.com.au

Australian Business Number: 16009690251

Sales

Tel: 1300 79 1954

Email: sales@stoddart.com.au

New Zealand

Service / Spare Parts

Tel: 0800 935 714

Email: service@stoddart.co.nz

Email: spares@stoddart.co.nz



Service Request

www.stoddart.co.nz

New Zealand Business Number: 6837694

Sales / Spare Parts

Tel: 0800 79 1954

Email: sales@stoddart.co.nz

Email: spares@stoddart.co.nz

International

Service / Spare Parts

Tel: +617 3440 7600

Email: service@stoddart.com.au

Email: spares@stoddart.com.au



Service Request

www.stoddart.com.au

Sales

Tel: +617 3440 7600

Email: sales@stoddart.com.au