

SPECIFICATION, INSTALLATION AND OPERATION MANUAL

READ ALL INSTRUCTIONS BEFORE USE

BAIN MARIE HOT CUPBOARD - COUNTER LINE / UNDER BENCH

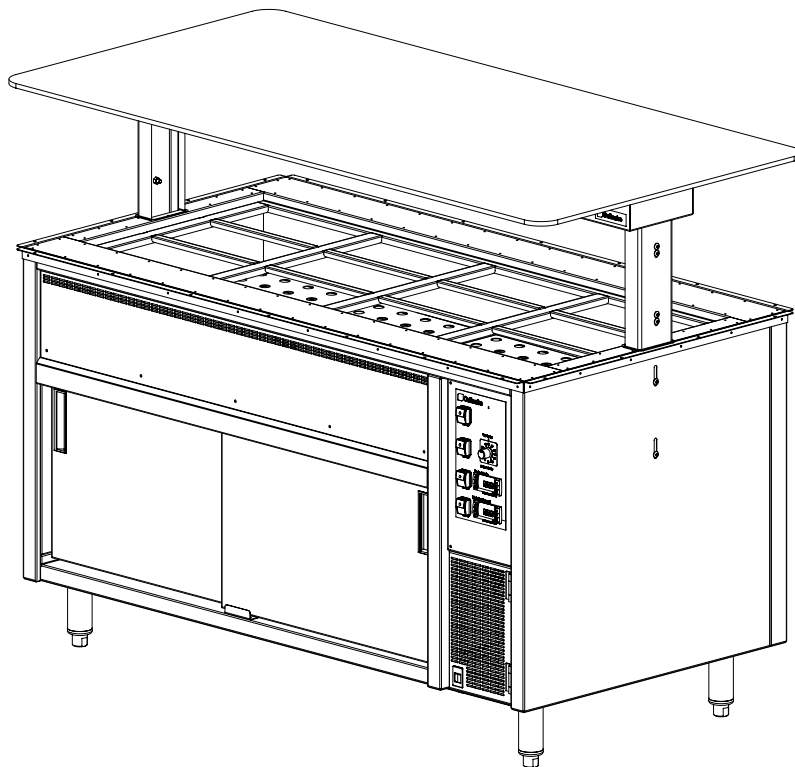

Models:

CH.BMHC.U.GSF.3 / CH.BMHC.U.GSF.4 / CH.BMHC.U.GSF.5 / CH.BMHC.U.GSF.6 / CH.BMHC.U.GSF.7 / CH.BMHC.U.GSF.8
CH.BMHC.U.GSB.3 / CH.BMHC.U.GSB.4 / CH.BMHC.U.GSB.5 / CH.BMHC.U.GSB.6 / CH.BMHC.U.GSB.7 / CH.BMHC.U.GSB.8
(Includes Radius Well Models)

A guide on the use, care and maintenance
of your quality Culinaire product

Page Intentionally Left Blank

Introduction

| | |
|--|---|
| Your New Culinaire Product. | 3 |
| Australia and New Zealand Warranty | 4 |
| <i>Warranty Period</i> | |
| <i>Warranty Registration</i> | |
| General Precautions | 4 |

Installation

| | |
|--|---|
| Product Overview. | 5 |
| Setting Up | 6 |
| <i>Handling</i> | |
| <i>Unpacking</i> | |
| <i>Positioning</i> | |
| Plumbing Connections | 7 |
| <i>Information</i> | |
| Electrical Connection | 8 |
| Custom Bench Top (under counter) | 8 |
| <i>Well Opening Sizes (under counter)</i> | |
| Shelves. | 9 |
| <i>Shelf Installation</i> | |
| <i>Work Shelf Optional Extras</i> | |
| Bain Marie Element Covers & Dividers | 9 |
| <i>Bain Marie Element Covers</i> | |
| <i>Bain Marie Dividers</i> | |

Specification

| | |
|--|----|
| Technical Specifications | 10 |
| <i>Code Explanation</i> | |
| <i>CH.BMHC.U.GSF & CH.BMHC.U.GSB</i> | |

Operation

| | |
|--|----|
| Control Panel | 12 |
| Initial Start-up & Operation | 12 |
| <i>Bain Marie Hot Cupboard - Operation</i> | |
| <i>Bain Marie - Initial Start-up</i> | |
| <i>Using as a Dry Unit</i> | |
| <i>Using as a Wet Unit</i> | |
| <i>Loading Bain Marie</i> | |
| <i>Loading Hot Cupboard</i> | |
| <i>Loading Restrictions</i> | |
| Food Safety. | 14 |
| <i>Food Temperature</i> | |
| <i>Food Storage</i> | |
| <i>Bain Marie</i> | |
| Gastronorm (GN) Pans | 14 |
| <i>Gastronorm Pans</i> | |
| Temperature Adjustment | 15 |
| Gantry Operation | 16 |
| Replacing Heat Lamp Bulbs | 16 |

Cleaning and Maintenance

| | |
|--|----|
| Cleaning | 17 |
| <i>Cleaning and Maintenance Schedule</i> | |
| <i>Materials Required</i> | |
| <i>General Information</i> | |
| <i>Corrosion Protection</i> | |
| <i>Surface Finish</i> | |
| <i>Hot Cupboard (Daily)</i> | |
| <i>Bain Marie (Daily)</i> | |
| <i>Element Protection (Daily)</i> | |
| <i>Descaling the Unit (Monthly)</i> | |
| <i>External Surfaces (Daily)</i> | |
| <i>Glass (Daily)</i> | |
| Troubleshooting | 19 |
| Disposal | 20 |

Your New Culinaire Product

Thank you for choosing this quality Culinaire product.

All Culinaire products are designed and manufactured to meet the needs of food service professionals. By caring for and maintaining your new Culinaire product in accordance with these instructions, will provide many years of reliable service.

Stoddart is a wholly Australian owned company, which manufactures and/or distributes a comprehensive range of food service equipment for kitchens, food preparation and presentation. Stoddart products are manufactured and/or engineered in Australia to provide excellent results whilst offering value-for-money, ease-of-use and reliability.

Carefully read this instruction booklet, as it contains important advice for safe installation, operation and maintenance.
Keep this booklet on hand in a safe place for future reference by other operators or users.

Disclaimer

The manufacturer and distributor cannot be held responsible or liable for any injuries or damages of any kind that occur to persons, units or others, due to abuse and misuse of this unit in regards to installation, removal, operation, servicing or maintenance, or lack of conformity with the instructions indicated in this documentation.

All units made by the manufacturer are delivered assembled, where possible, and ready to install. Any installation, removal, servicing, maintenance and access or removal of any parts, panels or safety barriers that is not permitted, does not comply in accordance to this documentation, or not performed by a **TRAINED AND AUTHORISED SPECIALIST** will result in the **IMMEDIATE LOSS OF THE WARRANTY.**

The manufacturer cannot be held responsible or liable for any unauthorised modifications or repairs. All modifications or repairs must be approved by the manufacturer in writing before initiating. All modifications or repairs performed to this unit must be performed at all times by a **TRAINED AND AUTHORISED SPECIALIST.**

**Stoddart design, manufacture & distribute Food Service Equipment (appliances) exclusively for the commercial market.
This appliance is not designed nor intended for household or domestic use and must not be used for this purpose.**

This product is intended for commercial use, and in line with Australian electrical safety standards the following warnings are provided:

- This product is not intended for use by persons (including children) with reduced physical, sensory or mental capabilities, or lack of experience and knowledge, unless they have been given supervision or instruction concerning the use of the product by a person responsible for their safety. Children should be supervised to ensure that they do not play with the product
- If the supply cord is damaged, it must be replaced by the manufacturer, its service agent or similarly qualified persons in order to avoid a hazard



Warranty & Registration

Australia and New Zealand Warranty

Warranty Period

All Stoddart manufactured and distributed products are covered by Stoddart's standard Australia and New Zealand Product Warranty (minimum 12 month on-site parts and labour, terms and conditions apply). Further to this standard warranty, certain products have access to an extended warranty. Full terms, conditions and exclusions can be found using the below Link/QR code.

Warranty Registration

To register your new product, Follow the below Link/QR code.

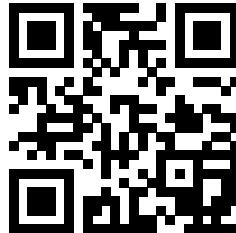

www.stoddart.com.au/warranty-information

General Precautions

When using any electrical unit, safety precautions must always be observed.

Our units have been designed for high performance. Therefore, the unit must be used exclusively for the purpose for which it has been designed.

- All units **MUST** be installed according to the procedures stated in the installation section of this manual
- In the case of new personnel, training is to be provided before operating the equipment
- **DO NOT** use this unit for any other purpose than its intended use
- **DO NOT** store explosive substances such as aerosol cans with a flammable propellant in or near this unit
- Keep fingers out of "pinch point" areas
- Unit is not waterproof **DO NOT** use jet sprays, hoses or pour water over/on the exterior of the unit
- Only use this unit with voltage specified on the rating label
- **DO NOT** remove any cover panels that may be on the unit
- **DO NOT** use sharp objects to activate controls
- If any fault is detected, refer to troubleshooting
- The manufacturer declines any liability for damages to persons and/or things due to an improper/wrong and/or unreasonable use of the machine

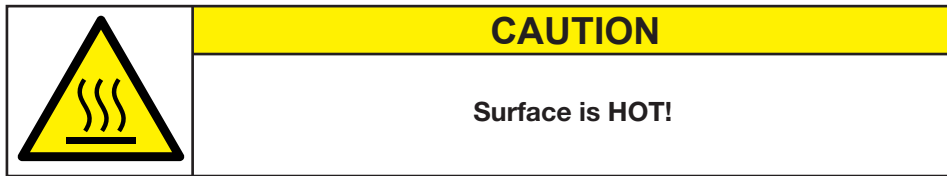
Product Overview

| Code | Explanation |
|--------|---|
| CH | = Culinaire Heated |
| BMHC | = Bain Marie - Hot Cupboard - Counterline |
| U | = Under Bench |
| GSF | = Stainless Steel Fixings |
| GSB | = Black Painted Centre Section - Adhesive Fixed |
| R | = Radius Well |
| 3 to 8 | = 3 to 8 Module |

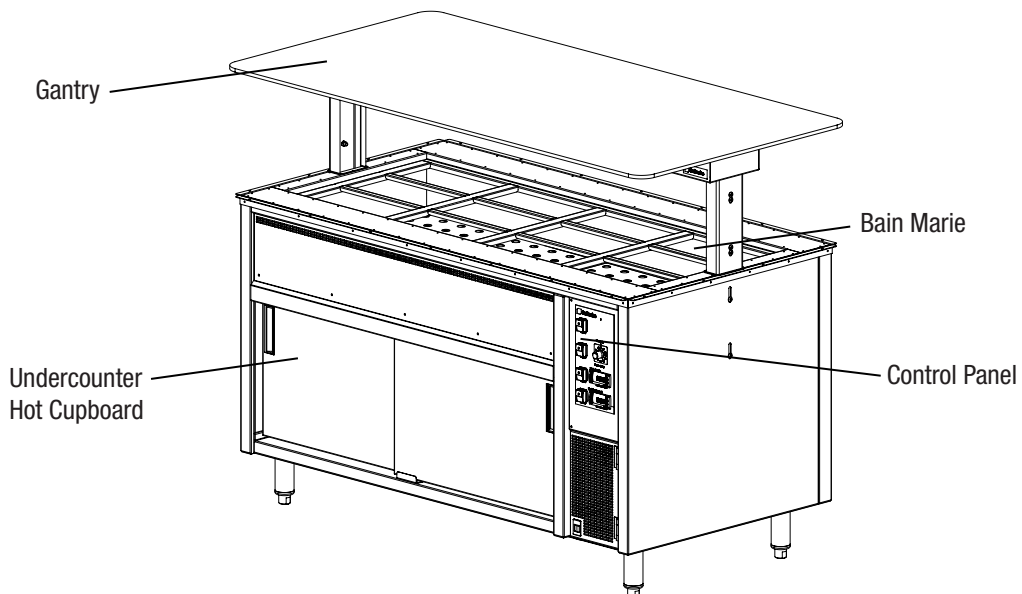

Setting Up

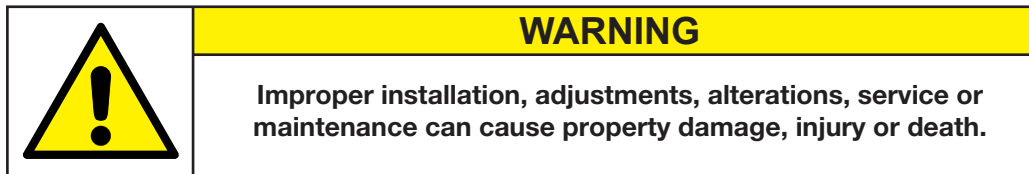

Handling

- Use suitable means to move the unit;
 - For smaller items use two people
 - For large items a fork lift, pallet trolley or similar (the forks should reach completely beneath the pallet)

Unpacking

- Check the unit for damage before and after unpacking. If unit is damaged, contact the distributor and manufacturer
- Should any item have physical damage, report the details to the freight company and to the agent responsible for the dispatch within seven (7) days of receipt. No claims will be accepted or processed after this period
- The unit is supplied fully assembled
- Remove all protective plastic film, tapes, ties and packers before installing and operating
- Clean off any remaining residue from the interior/exterior of the unit using a clean cloth dampened with warm soapy water

Positioning

- Choose an area that is well ventilated and provides access for future maintenance
- Place the unit on a level stable work surface capable of supporting its weight
- Do not position the unit in:
 - Wet areas
 - Near heat and/or steam sources
 - Near flammable substances
- Allow an air gap between the unit and other objects or surfaces. A minimum gap of 100mm from all sides is recommend for normal operational use (if the unit is near any heat sensitive material we suggest you allow additional space)

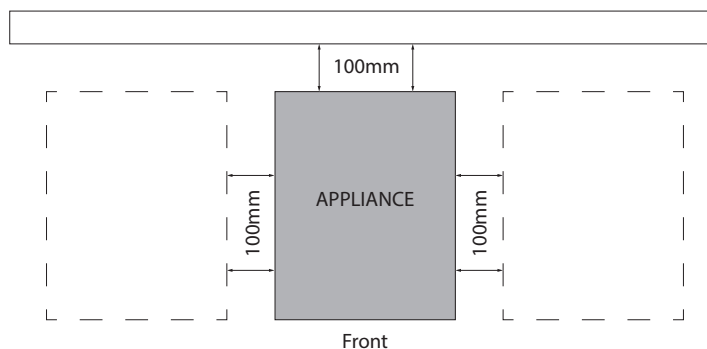

- Please consult national and local standards to ensure that your unit is positioned in accordance with any existing requirement

Plumbing Connections

| | |
|---|---|
|  | IMPORTANT |
| | <p>This unit must be installed in accordance with AS/NZ 3500.1</p> |

| | |
|---|---|
|  | IMPORTANT |
| | <p>This unit must be operated on potable water. If the water has a high mineral content, pretreatment may be necessary or your warranty could be voided.</p> |

Information

- The unit is supplied with a G 1½" BSP drainage connection
- The waste water connection screws into the drainage connection. The wastewater **MUST** be tested for leakages after being installed
- The unit **MUST** be on a level surface for the water to drain properly
- The bain maire is fitted with an overflow which maintains the correct water level in the well
- Before use, the water purity needs to be checked; high mineral water can corrode the elements and taint the water/food. If needed, a filtration system should be installed
- The unit is supplied with a G ½" BSP Water Connection for filling the well. The water valve **MUST** be tested for leakages after being installed
- The water connection can be connected to either a hot or cold water supply (hot produces quicker start up times)
- It is recommended that the bain maire is connected to the water mains and drained to a tundish
- The unit must be connected to a drain and either a hot or cold water supply (hot produces quicker start up times) with an isolation tap.

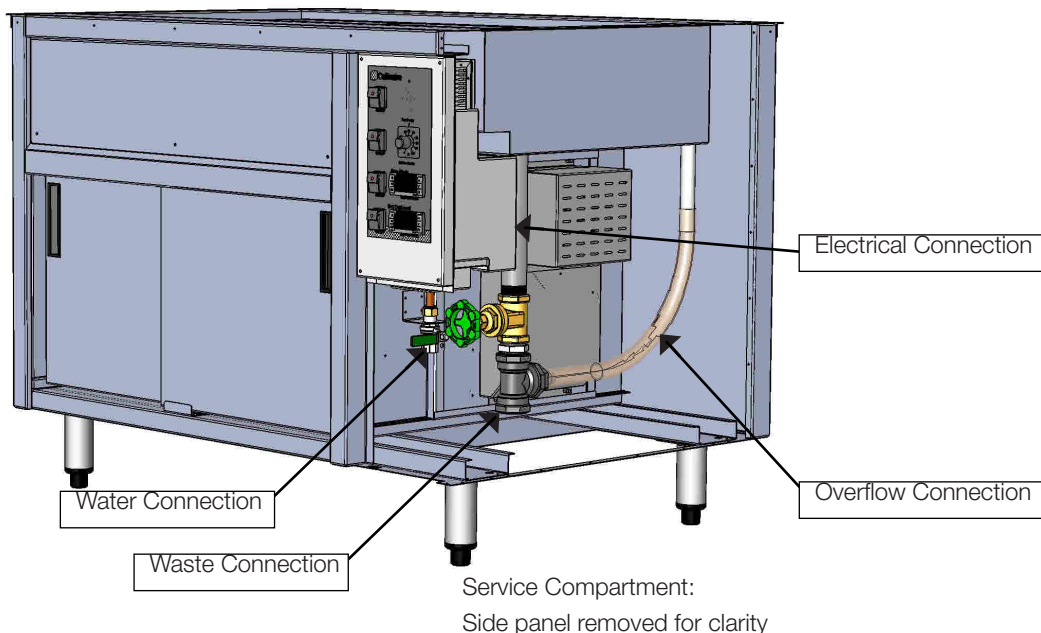

Electrical Connection

| | |
|---|---|
|  | WARNING |
| | <p>This unit must be installed in accordance with AS/NZS 60335.1</p> <p>Some procedures in this manual require the power to the equipment to be turned off and isolated. Turn the power OFF at the power point and unplug the power supply lead by the plug body. If the power point is not readily accessible turn the equipment off at the isolation switch or the circuit breaker in the switchboard. Attach a yellow “CAUTION-DO NOT OPERATE” tag. This must be performed where relevant unless the procedures specify otherwise.</p> <p>FAILURE TO DO SO MAY RESULT IN ELECTRIC SHOCK.</p> |

Single Phase Units:

- Supplied and fitted with an appropriately rated plug and lead, indicated as:
 - 10A plug & lead fitted
 - 15A plug & lead fitted
 - 20A plug & lead fitted
- A terminal block for on-site connection, by a licensed electrician will be supplied inside the unit service compartment, indicated as:
 - 1Ø+N+E

Three Phase Units:

- Supplied and fitted with an appropriately rated plug and lead, indicated as:
 - 32A plug & lead fitted
- A terminal block for on-site connection, by a licensed electrician will be supplied inside the unit service compartment, indicated as:
 - 3Ø + N + E

Notes:

- If the supply cord is damaged, it must be replaced by the manufacturer, its service agent or similarly qualified persons in order to avoid a hazard. Please contact Stoddart for parts and we will advise how to do this in order to avoid any electrical hazard
- The power cable should be dry and/or isolated from moisture or water

Custom Bench Top (under counter)

Well Opening Sizes (under counter)

- Finished opening sizes to bench top should be 5mm smaller than the well opening sizes shown below
- As an example, the finished opening size in the bench for a 3 module bain marie will be 993mm x 507mm
- Ensure sufficient support to provided to the bain marie to support the weight of the unit when filled with water
- Well sizes may vary slightly due to the manufacture process. It is recommended that measurements be taken on the actual unit being fitted
- Pan divider are not provided with under counter units. Sold separately

| WELL OPENING SIZES TO BAIN MARIE | | |
|----------------------------------|-------|-------|
| Module | Width | Depth |
| 3 | 998 | 512mm |
| 4 | 1338 | 512mm |
| 5 | 1678 | 512mm |
| 6 | 2018 | 512mm |
| 7 | 2358 | 512mm |
| 8 | 2698 | 512mm |

Shelves

Shelf Installation

Note: Do not use pliers when installing shelf clips

1. The shelf support pin needs to be facing up
2. Squeeze the pin to fit the bottom of the clip in
3. The shelf clips clip into the rail
4. All four pins for the shelf need to be at the same height for a level shelf
5. The outer frame of the shelf fits over the shelf

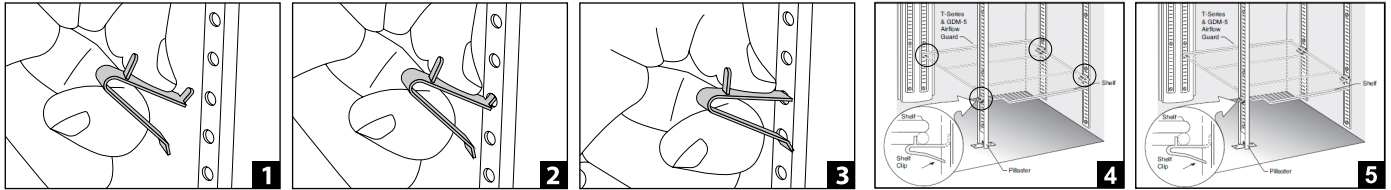

Work Shelf Optional Extras

| Description | | Model | Details |
|-------------------|----------|----------------|----------------|
| Work Shelf | 3 Module | CA.WS.3 | 1080mm x 250mm |
| Factory fitted | 4 Module | CA.WS.4 | 1420mm x 250mm |
| | 5 Module | CA.WS.5 | 1760mm x 250mm |
| | 6 Module | CA.WS.6 | 2100mm x 250mm |
| | 7 Module | CA.WS.7 | 2440mm x 250mm |
| | 8 Module | CA.WS.8 | 2780mm x 250mm |

Bain Marie Element Covers & Dividers

Bain Marie Element Covers

- Element covers are placed over the top of the elements for protection

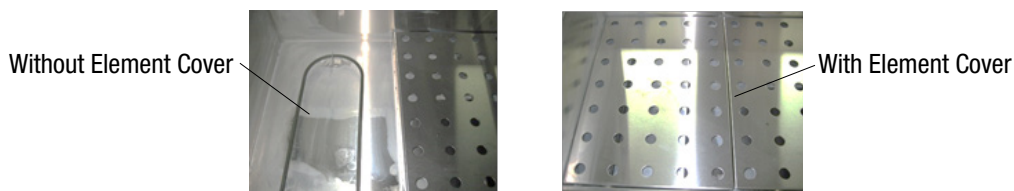

Bain Marie Dividers

- Install as shown when 1/1 module dividers are provided
- 1/2 dividers are sold separately

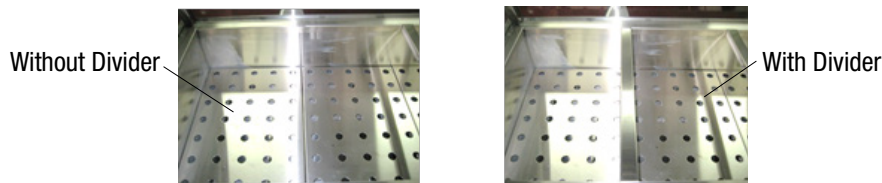

Technical Specifications

Code Explanation

| Code | Explanation |
|--------|---|
| CH | = Culinaire Heated |
| BMHC | = Bain Marie - Hot Cupboard - Counterline |
| U | = Under Bench |
| GSF | = Stainless Steel Fixings |
| GSB | = Black Painted Centre Section - Adhesive Fixed |
| R | = Radius Well |
| 3 to 8 | = 3 to 8 Module |

CH.BMHC.U.GSF & CH.BMHC.U.GSB

| SPECIFICATIONS | | | |
|---------------------|------------------------------------|------------------------------------|------------------------------------|
| Temperature Range | 65-90°C | | |
| Water Connection | 15mm Diameter | | |
| Waste Connection | 50mm Diameter | | |
| Model | CH.BMHC.U.GSF.3 CH.BMHC.U.GSB.3 | CH.BMHC.U.GSF.4 CH.BMHC.U.GSB.4 | CH.BMHC.U.GSF.5 CH.BMHC.U.GSB.5 |
| Width | 1203mm | 1543mm | 1883mm |
| Depth | 830mm | 830mm | 830mm |
| Height | 1260mm | 1260mm | 1260mm |
| Bain Marie Capacity | 3 x 1/1 Gastronorm Pans | 4 x 1/1 Gastronorm Pans | 5 x 1/1 Gastronorm Pans |
| Voltage | 220-240V, 50Hz | 220-240V, 50Hz | 220-240V, 50Hz |
| Power (kW) | 4.65kW | 5.7kW | 7.15kW |
| Connection | 1 Phase, Neutral, Earth | | 3 Phase, Neutral, Earth |
| Model | CH.BMHC.U.GSF.6 CH.BMHC.U.GSB.6 | CH.BMHC.U.GSF.7 CH.BMHC.U.GSB.7 | CH.BMHC.U.GSF.8 CH.BMHC.U.GSB.8 |
| Width | 2222mm | 2563mm | 2903mm |
| Depth | 830mm | 830mm | 830mm |
| Height | 1260mm | 1260mm | 1260mm |
| Bain Marie Capacity | 6 x 1/1 Gastronorm Pans | 7 x 1/1 Gastronorm Pans | 8 x 1/1 Gastronorm Pans |
| Voltage | 220-240V, 50Hz | 220-240V, 50Hz | 220-240V, 50Hz |
| Power (kW) | 7.9kW | 10.3kW | 11.4kW |
| Connection | 3 Phase, Neutral, Earth | | |

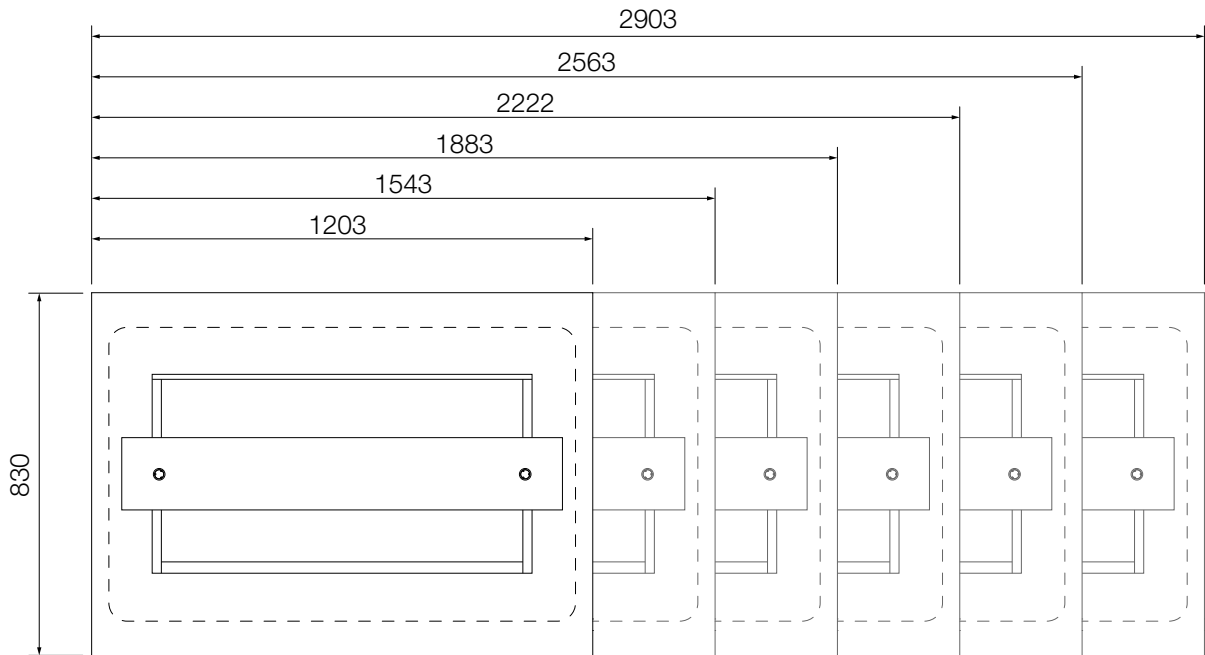

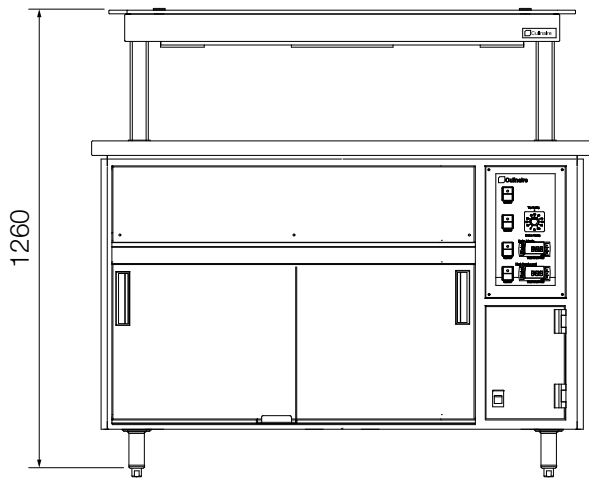

Plan View

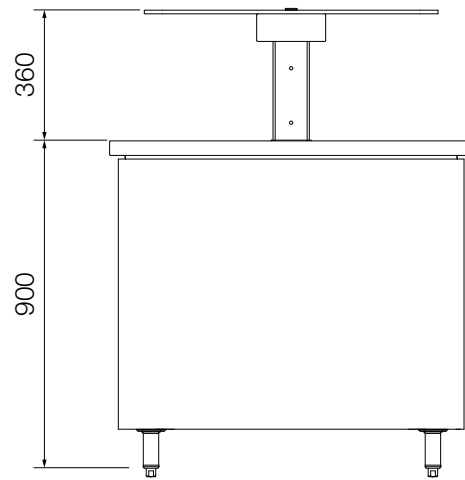

Front Elevation



End Elevation

| | |
|---|--|
|  | IMPORTANT |
| | <p style="text-align: center;">Water with a low chloride levels must be used! Water with high chloride levels will cause corrosion to the unit.</p> <p style="text-align: center;">For areas with a high chloride content (ie. SA, WA or country areas) demineralised water should be used in all cases.</p> |
|  | WARNING |
| | <p style="text-align: center;">The water in the unit and the surfaces of this unit are HOT when operating. Take caution and do NOT place any part of the body in the water.</p> |

Control Panel

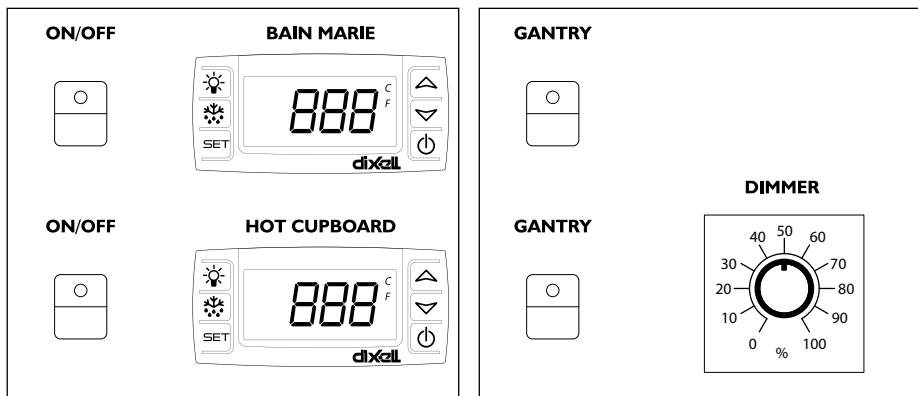

Initial Start-up & Operation

Bain Marie Hot Cupboard - Operation

Do not use Grids/Racks in bottom of pans as this causes a loss of heat transfer between the bottom of the pan (heat source) and the product in the pan. Poor performance will occur with the use of Grids/Racks and Culinaire will not cover warranty costs if this is found to be the source of heating problems with the units.

- The Bain Marie and the hot cupboard have separate power switches that allow either section to operate when needed
- The Bain Marie can be switched ON or OFF with the BAIN MARIE button
- The hot cupboard can be switched ON or OFF with the HOT CUPBOARD button
- The POWER button is a protection switch. No other switch can operate if the POWER button is OFF

Bain Marie - Initial Start-up

- Before switching ON the unit - The element covers, dividers and shelves need to be placed in the unit
- Fill unit with water using the ball valve provided or manually fill with a suitable container to bottom of the overflow or approx. Ensure the elements are submerged in water (minimum of 10mm)
- Turn the electronic controller ON. Ensure the well is heating to operating temperature
- Leave the bain marie to operate with water in the well for 3 - 4 hours
- Check the water level of the bain marie hourly
- Allow the unit to cool, drain the well using the ball valve provided either in the service compartment or under the unit. After, clean the whole unit, including the Gastronorm pans

Due to continuous product research and development, the information contained herein is subject to change without notice.

Using as a Dry Unit

Note: The Baine Marie is designed and recommended for wet operation, running the Baine Marie as a dry unit can create a wider range of temperature variations.

- Turn main tank element switch to high for approximately 10-15 minutes and adjust back to the desired running temperature

Using as a Wet Unit

- Fill unit with water. Ensure the elements are submerged in water (minimum of 10mm). Hot or cold water can be used. Hot water will save on heating time and power consumption
- A lemon slice or a few drops of lemon juice should be added to the water daily to reduce the build-up of scale in the unit
- Turn the electronic controller ON and set to the required temperature allow approximately 10-15
- Check water levels while the unit is in use, top up the water level as required ensuring elements remain submerged
- This unit **MUST** be completely emptied/drained and re-filled with fresh water daily
- Water **MUST** not be recycled. After being in the unit, all water **MUST** be treated as waste water. Do **NOT** drink and/or serve to persons

Loading Bain Marie

- Ensure that the Bain Marie is switched ON and has reached operating temperature before placing any food in the unit
- All food **MUST** be pre-heated/cooked above the regulated 65°C serving temperature before placing in the unit
- Only Gastronorm pans are to be placed in the well
- All food products must sit below top edge of the GN pan in order for the food to stay hot
- Food should be left in the unit no longer than 2 hours

Loading Hot Cupboard

- Ensure that the unit is switched ON and have reached operating temperature before placing any food in the unit
- All food **MUST** be pre-heated/cooked above the regulated 65°C serving temperature before placing in the unit
- Do not adjust/move base shelf clips
- No items should be stored on the floor of the unit, preventing air circulation

| | |
|---|---|
|  | IMPORTANT |
| | <p>Do not adjust/move base shelf clips. No items should be stored on the floor of the unit, preventing air circulation</p> |

Loading Restrictions

- Ensure the heat vents are **NOT** covered when serving items and gastronorm pans are in the unit. Airflow restrictions will change the temperature within the cupboard
- Overloading the shelves can bend and damage the shelves and shelf clips

Food Safety

Food Temperature

- All food **MUST** be pre-heated/cooked before placing in the unit. Attempting to cook food with this unit can lead to food poisoning
- The temperature reached on the temperature gauge is the water/air temperature, **NOT** the food temperature
- It is important to regularly monitor the food temperature with a temperature probe to ensure it is above the regulated 65°C serving temperature

| | |
|---|---|
|  | IMPORTANT |
| | This unit is not designed to cook products, it only maintains them above the regulated 65°C serving temperature. |

Food Storage

- All storage of food should comply with local health standards and regulations
- All pans should be cleaned and placed in night storage. No pans should be left in the unit
- This unit is **NOT** designed to store product after hours. The unit **MUST** be switched OFF
- If the unit is moved for night storage, ensure the castors are locked (mobile units only)

Bain Marie

- Drain the well, no water should remain in the well
- Ensure the benches around the well are cleaned continuously to prevent contaminants entering the pans
- When operating, the surfaces may be hot
- Signage should be displayed for personal and customers to ensure no one will burn themselves

Gastronorm (GN) Pans

Gastronorm Pans



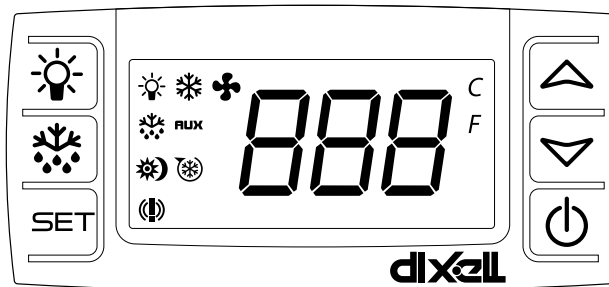

- All Gastronorm pans and extra dividers are sold separately
- Each module can hold one 1/1 pan, two 1/2 pans, three 1/3 pans, four 1/4 pans, six 1/6 pans and nine 1/9 pans. Pan depths are 25mm, 65mm, 100mm and 150mm. Contact your distributor about the best possible depth for the product you intent to display
- For 1/6 and 1/9 Gastronorm pans, extra dividers are required

Temperature Adjustment



- The temperature can be set between 65°C and 95°C. How to set the temperature is shown below
- Different modes require different temperatures
- The temperature probe only measures the temperature of the water/air, NOT the food temperature



KEY FUNCTIONS:

| | |
|--|---|
| SET | To display target set point; in programming mode it selects a parameter or confirm an operation. |
|  (DEF) | To start a manual defrost. |
|  (UP) | To see the maximum stored temperature; in programming mode it browses the parameter codes or increases the displayed value. |
|  (DOWN) | To see the minimum stored temperature; in programming mode it browses the parameter codes or increases the displayed value. |
|  | To switch the instrument OFF, if onF = oFF . |
|  | Not enabled. |



KEY COMBINATIONS:

| | |
|---|--|
|  +  | To lock and unlock the keyboard. |
| SET +  | To return to the room temperature display. |

HOW TO SEE THE SET POINT:

- SET** 
1. Push and immediately release the **SET** key, the display will show the set point value
 2. Push and immediately release the **SET** key or wait 5 seconds to display the probe value again

HOW TO CHANGE THE SET POINT:

1. Push the **SET** key for more than 2 seconds to change the set point value
2. The value of the set point will be displayed and the "°C" LED starts blinking
3. To change the set point value push the  or  arrows within 10 seconds
4. To memorise the new set point value push the **SET** key again or wait 10 seconds

Note: To enter in programming mode. (Contact the Stoddart Service Department)

Gantry Operation

| | |
|---|--|
|  | IMPORTANT |
| | <p>Where a gantry is fitted over the bain marie, ensure that the lamps are always on when operating as a wet unit.</p> |

Power

- Heat Lamps can be switched ON or OFF with the GANTRY button on the unit
- Lamps MUST be switched ON when the unit is in operation. Steam from operating as a wet unit and/or steam from foods can pool on the lamps and damage the wiring

Surfaces

- Nothing should be stored on the top of the gantry
- When operating, the surfaces may be hot. Signage should be displayed for personal and customers to ensure no one will burn themselves

Rear Sliding Doors

- As glass can be HOT, ensure the rear door slide are OPENED and CLOSED with the glass pulls

Replacing Heat Lamp Bulbs

- Bulbs should be allowed to cool for 10 - 15 minutes before removing
 - All heat lamp fitting are spring loaded for easy replacement
 - Heat lamp bulbs should only be replaced with gloves or a soft cloth. No skin should touch the new bulb. If skin touches the new bulb, wipe the bulb with a soft cloth and rubbing alcohol to remove all possible oils
1. Isolate from the power supply
 2. Squeeze the ends of the lamp shield bars to remove
 3. Holding the old bulb with a soft cloth or glove, press into one of the sockets, rotate out and remove
 4. Holding the new bulb with a soft cloth or glove, press into one of the sockets, rotate in and slowly release the bulb into the other socket, ensuring that the bulb does NOT become broken
 5. Re-install the lamp shield bars

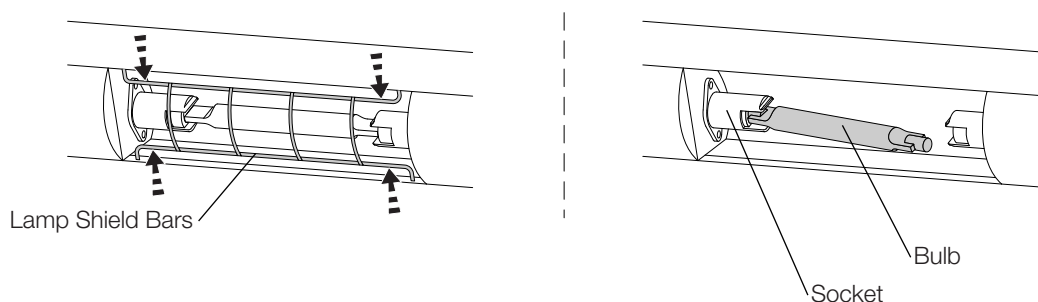

Cleaning

Cleaning and Maintenance Schedule

- Daily cleaning is required for the unit. This will help to maintain and prolong the efficiency of your unit
- The unit should be cleaned at the end of each work day

Materials Required

- Stainless Cleaner
- Non Abrasive Cleaning pad
- Clean Sanitised Cloth
- Paper Towel
- Container of warm water
- Appropriate PPE (Personal Protective Equipment)

General Information





- Cleaning is recommended for health and safety purposes and to prolong the life of the unit
- **DO NOT** use abrasive pads or cleaners on the stainless steel or any other metal parts of the unit
- **DO NOT** use industrial chemical cleaners, flammable cleaners, caustic based cleaners or bleaches and bleaching agents, as many will damage the metals and plastics used on this unit
- **DO NOT** remove any screws and/or panels for cleaning (unless directed)
- This unit is **NOT** waterproof, **DO NOT** hose, **DO NOT** pour water directly onto the unit, **DO NOT** immerse in water

Corrosion Protection

- Stainless steel exhibits good resistance to corrosion however, if not properly maintained stainless steel can rust and/or corrode
- Any sign of mild rust and/or corrosion should be thoroughly cleaned with warm soapy water and dried as soon as possible
- NEVER use abrasive pads or cleaners for cleaning
- All metal surfaces should be checked while cleaning for damage, scuffs or scrapes as these can lead to rust and further damage to the product
- Mild rust and/or corrosion can be treated with a commercial cleaning agent that contains citric/oxalic/nitric/phosphoric acid. **DO NOT** use cleaning agents with chlorides or other harsh chemicals as this can cause corrosion. After treatment, wash with warm (not hot) soapy water and dry thoroughly
- Thoroughly wipe the surfaces dry after cleaning. **DO NOT** let water pool on the unit. Check crevices and folds for pooling
- When using, ensure all liquids and moisture is cleaned up straight away. Food liquids such as juices from vegetables and fruits should not be left on preparation surfaces
- **DO NOT** leave items on the stainless steel such as cutting boards, rubber mats and bottles

Surface Finish

- To protect the polished surface of the stainless steel, it should be dried using a clean dry soft cloth. A light oil can be applied to enhance the stainless steel surface, using a clean cloth apply the oil in the same direction as grained polished finish
- Some commercial stainless steel cleaners can leave residue or film on the metal; this may trap fine particles of food on the surface, thus deeming the surfaces not food safe

| | | | |
|---|---|---|--|
|  | <p style="text-align: center;">IMPORTANT</p> <p>Threaded fasteners can loosen in service. Regular inspection and adjustment should be carried out as required</p> |  | <p style="text-align: center;">WARNING</p> <p>This unit is NOT waterproof, do NOT hose. DO NOT pour water directly onto the unit. DO NOT immerse in water</p> |
|  | <p style="text-align: center;">IMPORTANT</p> <p>Some commercial stainless steel cleaners leave residue or film on the metal that may entrap fine particles of food, deeming the surface not FOOD SAFE</p> |  | <p style="text-align: center;">WARNING</p> <p>Wait until the unit has cooled to a safe temperature before undertaking any cleaning or maintenance. Contact with hot surfaces can cause burns and serious injury</p> |

Hot Cupboard (Daily)

1. Isolate from the power supply
2. Remove Shelves from the Hot Cupboard. Shelves can be cleaned in a kitchen sink with warm soapy water. Thoroughly wipe dry with a soft cloth after cleaning, do NOT allow to air dry
3. Wipe the hot cupboard clean using a cloth dampened (not wet) with clean warm water until all soil has been removed
4. Using a clean sanitised cloth, thoroughly wipe the stainless steel and metal parts dry. Do NOT let water pool on the unit. Check crevices and folds

Bain Marie (Daily)

1. Isolate from the power supply
2. The unit MUST be drained before cleaning. Ensure the waste connection is left OPENED to allow sufficient drainage while cleaning
3. Remove all Dividers, Element Covers & Gastronorm Pans
4. Dividers, Element Covers & Gastronorm Pans can be cleaned in a kitchen sink with warm soapy water. Thoroughly wipe dry with a soft cloth after cleaning, do NOT allow to air dry
5. Clean the unit and elements with warm (not hot) soapy water and a sponge. After cleaning, flush the unit with water
6. Ensure all due care is taken when cleaning the elements, as they can become damaged
7. Thoroughly wipe the unit and elements dry with a soft cloth. Do NOT let water pool in the unit, check crevices and folds

Element Protection (Daily)

1. Every day, the empty unit should be filled with clean water. A lemon slice or a few drops of lemon juice should be added daily to the water
2. As required, adding a commercial cleaning agent that contains citric/oxalic/nitric/phosphoric and boiling for 45 minutes will help to prolong the life of the Bain Marie. Do NOT use cleaning agents with chlorides or other harsh chemicals as this can cause corrosion
3. Do NOT fill the unit with cold water if the elements are hot
4. Water with high mineral content needs be filtered
5. When cleaning, clean the elements properly and allow to dry before switching the unit back ON

Descaling the Unit (Monthly)

1. Descaling is recommended for health and safety purposes and to prolong the life of the unit
2. The unit MUST be descaled monthly to remove any scaling and build-up in the unit and on the elements. Element covers should be descaled at the same time as the unit
3. To descale, a descaling solution needs to be purchased. The descaling solution should be used as per directions on the packaging
4. Remove all food and pans from the unit before descaling
5. Ensure the unit is rinsed and thoroughly cleaned after descaling

External Surfaces (Daily)

1. Isolate from the power supply
2. Wearing Personal Protective Equipment (PPE), apply Stainless Cleaner with the Cleaner pad to the external surfaces
3. Scrub any baked on soil with the cleaner pad in the same direction as grained polish
4. Wipe clean using a cloth dampened with clean warm water until all Stainless Cleaner and soil has been removed
5. Using a clean sanitised cloth, thoroughly wipe the stainless steel and metal parts dry. Do NOT let water pool on the unit. Check crevices and folds

Glass (Daily)

1. Clean the glass with a glass cleaner or warm (not hot) soapy water, and a sponge
2. Wiping dry with a squeegee is best

Troubleshooting

- If any faults/issues occur with the unit, follow the below troubleshooting procedures
- If the troubleshooting procedures do not correct the problem, contact the Stoddart Service Department

| | |
|---|---|
|  | WARNING |
| | Technician tasks are only to be completed by qualified service people. Check faults before calling service technician. |

(O) = Operator
(T) = Technician Task

| Problem | Possible Causes | Task | Remedy |
|---------------------------------|---|------|---|
| Unit does not operate / start | The mains isolating switch on the wall, circuit breaker or fuses are OFF at the power board | O | Turn isolating switch, circuit breaker or fuses ON |
| | The power switch of the unit is OFF | O | Turn the power switch ON |
| | Electrical wiring damaged | T | Replace / Fix electrical wiring |
| Unit does not reach temperature | Temperature not set to the right setting | O | Check setting and adjust the temperature |
| | Exhaust fan above the unit | O | Move unit / exhaust fan |
| | Cold items in units | O | Remove items and heat properly |
| | Cold water in the unit | O | Close the water valve / Wait 30 minutes |
| | Temperature gauge broken | T | Replace temperature gauge |
| | Thermostat or Temperature probe broken | T | Replace thermostat |
| | Mineral deposits on element | T | Filter water |
| Food not at desired temperature | Element blown | T | Replace element |
| | Thermostat set incorrectly | O | Adjust thermostat |
| | Unit is not reaching required temperature | O/T | See above |
| Water pooling around the unit | Drain not in the tundish / Bucket overflowing | O | Place drain in the tundish / Clear and replace bucket |
| | Unit not level | O | Place unit on a level surface |
| | Connection seals / drain valve broken | T | Replace seals / drain valve |
| Corrosion | Poor water quality | T | Test water quality |
| | Not being drained, cleaned and emptied daily | O | Follow cleaning schedule of user manual |
| Scale build up | Scale build up on elements and unit | O | Descale unit |

Disposal

If the appliance is no longer of use, please dispose in an environmentally correct way.

The distributor / retailer can contact their local metal recycling centre to collect the remaining cabinet, shelves, etc.

There may be special requirements or conditions. Information on the disposal of refrigeration appliances can be obtained from:

- Your supplier
- Government authorities (The local council, Ministry of the Environment, etc.)



Discarded electric appliances are recyclable and should not be discarded in the domestic waste! Please actively support us in conserving resources and protecting the environment by returning this appliance to the collection centres (if available).



Dispose of packaging in accordance to applicable legal regulations.

Australia

Service / Spare Parts

Tel: 1300 307 289

Email: service@stoddart.com.au

Email: spares@stoddart.com.au



Service Request

www.stoddart.com.au

Australian Business Number: 16009690251

Sales

Tel: 1300 79 1954

Email: sales@stoddart.com.au

New Zealand

Service / Spare Parts

Tel: 0800 935 714

Email: service@stoddart.co.nz

Email: spares@stoddart.co.nz



Service Request

www.stoddart.co.nz

New Zealand Business Number: 6837694

Sales

Tel: 0800 79 1954

Email: sales@stoddart.co.nz

International

Service / Spare Parts

Tel: +617 3440 7600

Email: service@stoddart.com.au

Email: spares@stoddart.com.au



Service Request

www.stoddart.com.au

Sales

Tel: +617 3440 7600

Email: sales@stoddart.com.au