

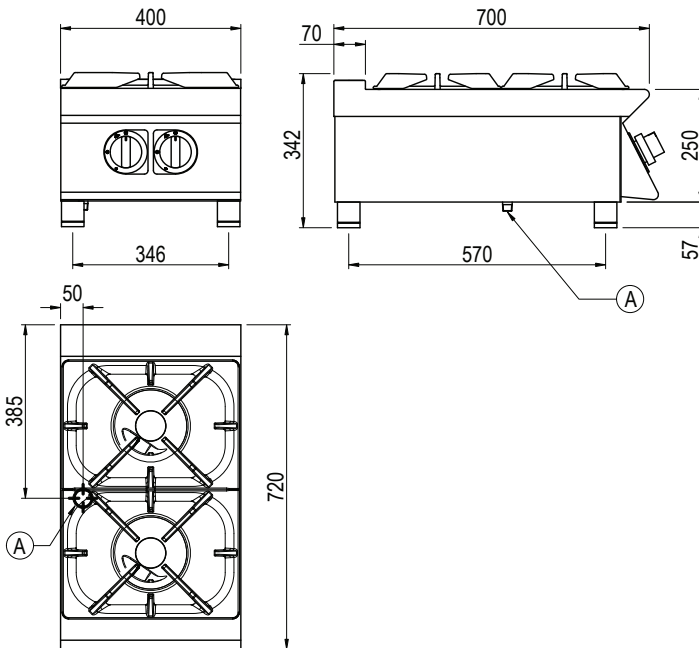

Product Information:

- Class leading, European style, professional quality and reliability since 1963
- 700 series, high performance open burners (2 x 28.8 MJ/h)
- Black enamelled cast iron trivets; acid, alkaline and flame resistant with extra long fingers to allow use with small and large pots
- Open burners complete with flame failure device and pilot burner, both heavily protected against accidental impact and overflows
- Temperature regulation via variable power flame control
- Robust 304 grade stainless steel construction with rounded corners for improved cleaning
- Hermetically sealed, pressed work surface with raised edges to protect from overflow
- 24-month warranty

General Drawing:



Specifications:

Model	CG720TT	
W x D x H (mm)	400 x 720 x 342	
Weight	30kg	
Packed Dimensions (mm)	450 x 825 x 570	
Packed Weight (mm)	35kg	
	Natural	Universal LPG
Gas Connection	1/2" BSP	1/2" BSP
Minimum Normal Test Gas Pressure	1.3 kPa	2.75 kPa
Maximum Normal Test Gas Pressure	3.5 kPa	3.5 kPa
Nominal Test Point Pressure	1.0 kPa	2.65 kPa
Total Nominal Gas Consumption	58 MJ/h	58 MJ/h

Note: It is the responsibility of the installing gas plumber to ensure correct supply and connection sustaining appropriate pressure, when all installed gas appliances are operating at maximum.

Legend:

A Gas Connection