

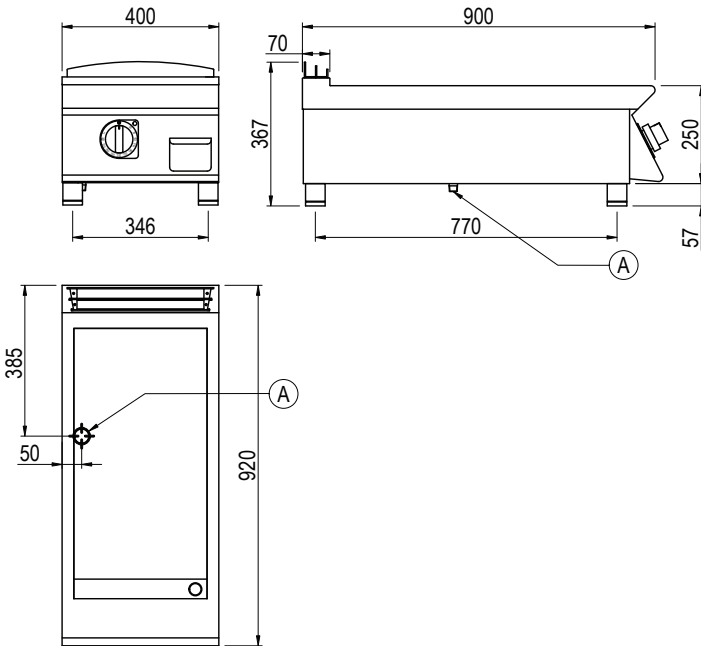

Product Information:

- Class leading, European style, professional quality and reliability since 1963
- 900 series, electric frytop with 12mm smooth mild steel plate (8.6kW)
(also available in 12mm ribbed mild steel plate)
- Heating elements with Hi-limit temperature protection
- Temperature regulation via thermostat (50°C – 300°C)
- Indicator light to monitor the correct operation of the appliance
- Robust 304 grade stainless steel construction with rounded corners for improved cleaning
- Hermetically sealed, pressed work surface with raised edges to protect from overflow
- Removable grease tray
- 24-month warranty

General Drawing:



Specifications:

Model - Smooth	FLE92TFT
Model - Ribbed	FRE92TFT
W x D x H (mm)	400 x 920 x 367
Weight	70kg
Cooktop (mm)	340 x 640
Packed Dimensions (mm)	430 x 930 x 400
Packed Weight (mm)	77kg
Electrical Connection	3Ø + N + E 415VAC / 50Hz / 8.6kW

Legend:

A Electrical Connection

