

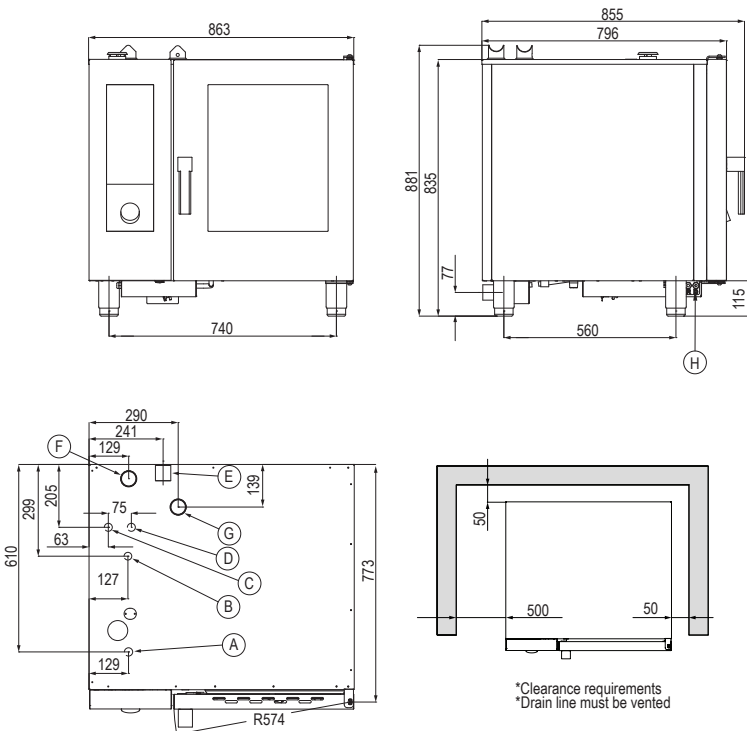

Product Information:

- **Symbiotic Steam (patented)** innovative, heavy duty, highly efficient, dual boiler generation and steam injection oven
- **Steam Tuner (patented)** exclusive feature allows actual tuning of saturated steam
- **Meteo System (patented)** for precise control and saturation levels
- Automatic descaling system for oven and boiler
- Integrated recirculating cleaning via tablet, with liquid detergent dispenser installed if preferred
- Large 9" innovative touch screen interface
- Over 120 pre-set cooking programs, 1,000+ additional programs - 9 phase memory available
- Automatic, adaptive cooking, rack control, regeneration, sous vide and smoking programs
- Easy Service function, Recipe tuner, and Chef's note software all as standard
- 6-speed inverter controlled fan for increased precision, control and reliability
- LED lighting for superior cavity illumination
- USB connection, HACCP
- Supplied with integrated hand shower, multi-point core temperature probe, drain kit and advanced scale reduction filter
- Left hand hinge door option available, this variation is 30mm wider and is made to order
- All combi ovens are supplied with either Standard or Reverse Osmosis Filtration system
- 48-month warranty (Terms and conditions apply)

General Drawing:



Heat Source: 500mm clearance from an external heat source is required in order to protect the oven control components and allow access to the service panel. For clearances under 500mm, it is mandatory for Stoddart heat shields to be fitted while still maintaining a minimum clearance of 300mm to provide access to the service compartment. Failure to adhere to minimum clearances may void the oven warranty or add service costs due to lack of access.

Non-Heat Source: Generally 300mm clearance is required from the control panel side to allow access to the service panel. Any distance under 300mm, may add service costs due to lack of access.

Due to continuous product research and development, the information contained herein is subject to change without notice.

Revision: 04 - 09/02/2022 - A

www.stoddart.com.au
www.stoddart.co.nz



Specifications:

Model - Standard Filter	SEHG061WT.SF	
Model - Reverse Osmosis	SEHG061WT.RO	
W x D x H (mm)	863 x 855 x 881	
Weight	142kg	
Capacity	6 x 1/1 GN Pans	
Packed Dimensions (mm) / Weight		
Electrical Connection	1Ø + N + E 240VAC / 50Hz / 1.5kW	
Gas Connection	Natural	Universal LPG
Minimum Normal Test Gas Pressure	3/4" BSP 1.3 kPa	3/4" BSP 2.75 kPa
Maximum Normal Test Gas Pressure	3.5 kPa	3.5 kPa
Nominal Test Point Pressure	1.0 kPa	2.7 kPa
Total Nominal Gas Consumption	43.2 MJ/h	43.2 MJ/h

Note: It is the responsibility of the installing gas plumber to ensure correct supply and connection sustaining appropriate pressure, when all installed gas appliances are operating at maximum.

Cold Water Connection	3/4 BSP 150-350 kpa Min 10°C - Max 35°C	
Water Quality Requirements	Hardness	60-100ppm
	TDS	<100mg/L
	Cl Chloride	<32mg/L

Legend:

- A Electrical Connection
- B Steam Generation Water Inlet 3/4" BSP
- C Wash System Water Inlet 3/4" BSP
- D Drain Connection 40mm
- E Humidity Vent
- F Detergent & Rinse Aid Inlet
- G Gas Emission Exhaust
- H Gas Inlet 3/4" BSP