

**SPECIFICATION, INSTALLATION
AND OPERATION MANUAL**
READ ALL INSTRUCTIONS BEFORE USE



Models:
VCC

Page Intentionally Left Blank

1.0 Introduction

1.1 Your New Adande Product3
1.2 Australia and New Zealand Warranty4
1.2.1 Warranty Period	
1.2.2 Warranty Registration	
1.3 Warnings5
1.4 Safety Symbols5
1.5 Important Safety Instructions6
1.5.1 Electrical	
1.5.2 Operational Use and Cleaning	
1.5.3 General	
1.6 What is Adande®7
1.7 Adande® Explained7

2.0 Installation

2.1 Setting Up8
2.1.1 Handling	
2.1.2 Unpacking	
2.1.3 Positioning	
2.2 Refrigeration9
2.2.1 Climate Classes	
2.3 Electrical Connection9
2.4 Plumbing9

3.0 Specification

3.1 General Drawing10
3.1.1 VCC1.SCW / VCC1.GCW	

4.0 Operation

4.1 Initial Start-up & Operation11
4.1.1 Controller	
4.1.2 Initial Start Up	
4.1.3 Food Temperature	
4.1.4 Loading Restrictions	
4.1.6 Temperature adjustment	
4.1.7 Locking and Unlocking the Controller	
4.1.8 Defrost	
4.1.9 Drawer Open Alarm	
4.1.10 Error Alarm	
4.1.11 Temperature Alarm	
4.1.12 After Service - Information	
4.1.13 After Service - Storage	

5.0 Cleaning and Maintenance

5.1 Cleaning15
5.1.1 Cleaning Schedule	
5.1.2 Materials Required	
5.1.3 General Information	
5.1.4 Corrosion Protection	
5.1.5 Surface Finish	
5.1.6 Internal / External Surfaces	
5.1.7 Ventilation Panels	
5.2 Troubleshooting17
5.2.1 Troubleshooting Procedures	
5.3 Disposal17

6.0 Declaration of Conformity

6.1 Adande® Refrigeration18
-------------------------------------	-----

1.1 Your New Adande Product

Thank you for choosing this quality Adande product.

All Adande products are designed and manufactured to meet the needs of food service professionals. By caring for and maintaining this new Adande product in accordance with these instructions, will provide many years of reliable service.

Stoddart is a wholly Australian owned company, which manufactures and/or distributes a comprehensive range of food service equipment for kitchens, food preparation and presentation. Stoddart products are manufactured and engineered to provide excellent results whilst offering value-for-money, ease-of-use and reliability.

Carefully read this instruction booklet, as it contains important advice for safe installation, operation and maintenance. Keep this booklet on hand in a safe place for future reference by other operators or users.

Disclaimer

The manufacturer/distributor cannot be held responsible or liable for any injuries or damages of any kind that occur to persons, units or others, due to abuse and misuse of this unit in regards to installation, removal, operation, servicing or maintenance, or lack of conformity with the instructions indicated in this documentation.

All units made by the manufacturer/distributor are delivered assembled, where possible, and ready to install. Any installation, removal, servicing, maintenance and access or removal of any parts, panels or safety barriers that is not permitted, does not comply in accordance to this documentation, or not performed by a **TRAINED AND AUTHORISED SPECIALIST** will result in the **IMMEDIATE LOSS OF THE WARRANTY.**

The manufacturer/distributor cannot be held responsible or liable for any unauthorised modifications or repairs. All modifications or repairs must be approved by the manufacturer/distributor in writing before initiating. All modifications or repairs performed to this unit must be performed at all times by a **TRAINED AND AUTHORISED SPECIALIST.**

**Stoddart design, manufacture & distribute Food Service Equipment (appliances) exclusively for the commercial market.
This appliance is not designed nor intended for household or domestic use and must not be used for this purpose.**

This product is intended for commercial use, and in line with Australian electrical safety standards the following warnings are provided:

- This product is not intended for use by persons (including children) with reduced physical, sensory or mental capabilities, or lack of experience and knowledge, unless they have been given supervision or instruction concerning the use of the product by a person responsible for their safety. Children should be supervised to ensure that they do not play with the product
- If the supply cord is damaged, it must be replaced by the manufacturer, its service agent or similarly qualified persons in order to avoid a hazard



Warranty & Registration

1.2 Australia and New Zealand Warranty

1.2.1 Warranty Period

All Stoddart manufactured and distributed products are covered by Stoddart's standard Australia and New Zealand Product Warranty (minimum 12 month on-site parts and labour, terms and conditions apply). Further to this standard warranty, certain products have access to an extended warranty. Full terms, conditions and exclusions can be found using the below Link/QR code.

1.2.2 Warranty Registration

To register your new product, Follow the below Link/QR code.

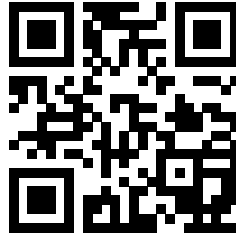









www.stoddart.com.au/warranty-information

1.3 Warnings

	WARNING
	<p>Follow the IMPORTANT SAFETY INSTRUCTIONS outlined in this user guide before operating this appliance. Failing to do so can result in death, electric shock, fire or injury to persons</p>

WARNING	DO NOT store explosive substances such as aerosol cans with a flammable propellant in or near this unit
	This product is not intended for use by persons (including children) with reduced physical, sensory or mental capabilities, or lack of experience and knowledge, unless they have been given supervision or instruction concerning the use of the product by a person responsible for their safety.
	Children should be supervised to ensure that they do not play with the product
	Keep clear of obstruction all ventilation openings in the appliance enclosure or in the structure for building-in
	Do not use mechanical devices or other means to accelerate the defrosting process, other than those recommended by the manufacturer
	Do not damage the refrigerant circuit
	Do not use electrical appliances inside the food storage compartments of the appliance, unless they are of the type recommended by the manufacturer
	In order to reduce flammability hazards the servicing of this appliance must be carried out by a technician, qualified and trained in the use of Hydrocarbon Refrigerant

1.4 Safety Symbols

Symbol	Description
	<p>Electrical Warning Symbol</p> <p>To indicate hazards arising from high voltages</p>
	<p>General Warning</p> <p>To signify a general warning/caution An appropriate safety instruction should be followed</p>
	<p>Flammable Materials</p> <p>Flammable Gas Hydrocarbon Refrigerant</p>
	<p>Low Temperature</p> <p>Low temperature/Freezing conditions An appropriate safety instruction should be followed</p>
	<p>Protective Earth (Ground)</p> <p>To identify any terminal which is intended for connection to an external conductor for protection against electric shock in case of a fault, or the terminal of a protective earth (ground) electrode</p>
	<p>Do Not Pressure Wash</p> <p>Do Not Pressure Wash the appliance</p>
	<p>Disposal of Hazardous Waste</p> <p>Disposal of Hazardous Waste The appliance contains hazardous waste which is harmful to the environment. Correct procedures in line with WEEE directive should be followed when disposing of the appliance, including removable/replaceable items like:</p> <ol style="list-style-type: none"> Refrigerant Gas/oil Insulated container Controller
	<p>Recycling of Packaging</p> <p>Dispose of packaging responsibly, recycling where possible in accordance to applicable local regulations</p>

1.5 Important Safety Instructions

1.5.1 Electrical

- The operator/end user shall not remove ANY of the access panels
- Disconnect the electrical supply before any maintenance or cleaning by removing the plug from the electrical socket
- Only one mains supply should be inserted to the unit at any time
- Ensure safe routing of the electrical cabling
- Check Inlet Cables for damage before use. If damaged, isolate from the electrical supply and replace the cabling
- Only the electrical cables supplied with the appliance at the point of purchase, or by a qualified service engineer is to be used with this appliance
- This appliance is to be installed in accordance with regional and local electrical codes

1.5.2 Operational Use and Cleaning

- Cleaning and user maintenance shall not be made by children without supervision.
- All cleaning and servicing requires the appliance to be switched off at the front/ isolated from the power source and disconnected.
- Ensure the drawers are kept shut between openings.
- Do not lean on the drawer when fully extended.
- If modules have been stacked, into a VCS2, avoid opening more than one drawer at a time.
- Ensure foodstuffs that give out acidic odours like vinegar, onions, etc. are sealed before placing in the insulated container.
- Do not place hot pans directly onto the plastic surface of the container, always use the metal cooling racks.
- Remove all foodstuffs from the drawer container before removing for cleaning.
- Do NOT drop the container into the container support cradle.

1.5.3 General

- This product is not intended for use by persons (including children) with reduced physical, sensory or mental capabilities, or lack of experience and knowledge, unless they have been given supervision or instruction concerning the use of the product by a person responsible for their safety. Children should be supervised to ensure that they do not play with the product
- The appliance should be used as provided and in accordance with this manual
- Adequate provision should be made for lifting and positioning the appliance in accordance with local policy codes
- Do not overfill the drawer or exceed the maximum loading of 40kg (30kg VLS) per drawer
- Do not sit, stand or apply additional downward pressure on an open drawer
- Do not operate appliance with any panels removed
- Do not clean appliance with any panels removed
- When the appliance is being transported it should be sat firmly on its castors/feet with the brakes applied. The machine should be strapped upright to a flat pallet during transport
- Ensure appliance is installed and maintained on a flat, clean and level surface
- If mounted on a castor base, ensure brakes are applied to the front two castors
- The room in which the appliance is kept should be dry and sufficiently ventilated
- No obstructions should be placed directly in front of the condenser air outlet (vent at the front of the unit, at the rear on VCR model)
- The machine should be regularly inspected and checked against the requirements of this Operations Manual
- Should a fault occur with the appliance immediately isolate/disconnect the incoming power supply
- Only Adande trained engineers are permitted to service or carry out repairs to this appliance

1.6 What is Adande®

Adande® is a new method of cold storage developed as a series of refrigerated drawers that offer storage temperature flexibility in 1°C increments between -22°C and +15°C.

Each refrigerated drawer:

- Provides stable temperature storage
- A removable container to act as temporary cool and safe product storage
- Gives full plan area access providing space efficient storage
- Is easily cleaned or replaced
- Can be supplied configured as a blast chiller

1.7 Adande® Explained



Adande® uses standard technology and refrigeration parts but in a completely new and patented way.

A dedicated fridge engine supplies refrigerant to an evaporator coil assembly. The evaporator coil assembly then supplies cooling to the insulated container and is sized to maintain up to 40kg (30kg VLS) of product at any set point temperature, in the range of -22°C and +15°C.



VCC

2.1 Setting Up

	<p style="text-align: center;">WARNING</p> <p>Improper installation, adjustments, alterations, service or maintenance can cause property damage, injury or death.</p>
	<p style="text-align: center;">IMPORTANT</p> <p style="text-align: center;">THE INSULATED CONTAINER SHOULD BE UNLOADED BEFORE MOVING</p>
	<p style="text-align: center;">IMPORTANT</p> <p style="text-align: center;">TO AVOID DAMAGING THE POWER SUPPLY CABLE IT MUST BE OFF THE GROUND WHEN MOVING THE UNIT.</p>

2.1.1 Handling

- Use suitable means to move the unit;
 - For smaller items use two people
 - For large items a fork lift, pallet trolley or similar (the forks should reach completely beneath the pallet)

2.1.2 Unpacking

- Check the unit for damage before and after unpacking. If unit is damaged, contact the distributor and manufacturer
- Should any item have physical damage, report the details to the freight company and to the agent responsible for the dispatch within seven (7) days of receipt. No claims will be accepted or processed after this period
- The unit is supplied fully assembled
- Remove all protective plastic film, tapes, ties and packers before installing and operating
- Clean off any remaining residue from the interior/exterior of the unit using a clean cloth dampened with warm soapy water
- Ensure the Adande® units cord-set is firmly secured in place by the supplied P clip
- Ensure the Adande® unit is positioned on a clean, level and stable surface

2.1.3 Positioning

- Ensure the unit is positioned on a level surface to allow all the condensation to properly burn off and prevent the burn off tray overflowing
- It is important that the Adande® drawer is installed and maintained on a flat, clean and level surface to ensure correct operation
- The room should be dry and sufficiently ventilated to allow good airflow around the clearance stated above, and to minimize moisture intake
- When positioning the unit, avoid direct sunlight, warm drafts and heated areas for the unit to maintain the normal operating temperature. Do not position the unit in:
 - Wet areas
 - Near heat and/or steam sources
 - Near flammable substances
- Optimum performance is obtained at ambient temperatures between 16°C and 40°C
- The air outlet grill **MUST** be kept clear at all times to maintain optimum performance
- The Adande® drawer can be mounted on rubber feet, rollers or castors. When mounted on a castor base, the front two castors should have their brakes ON during normal use
- Please consult national and local standards to ensure that your unit is positioned in accordance with any existing requirement

2.2 Refrigeration

The system is fully operational as soon as it leaves the factory. No addition setup is required.

	Warning
	<p>FLAMMABLE GAS</p> <p>R600a</p> <p>SYSTEM CHARGED WITH FLAMMABLE REFRIGERANT AND MUST BE SERVICED BY A QUALIFIED TECHNICIAN</p>

2.2.1 Climate Classes

The unit has been designed and tested to operate at climate class 4. Refer to the Technical Specifications of this manual or the unit rating label for the climate class number.

CLIMATE CLASSES		
Test Room Climate Class	Ambient temperature °C	Relative humidity %
0	20°C	50
1	16°C	80
2	22°C	65
3	25°C	60
4	30°C	55
5	40°C	40
6	27°C	70

2.3 Electrical Connection

	WARNING
	<p>DANGEROUS VOLTAGE</p> <p>Some procedures in this manual require the power to the equipment to be turned off and isolated. Turn the power OFF at the power point and unplug the power supply lead by the plug body. If the power point is not readily accessible turn the equipment off at the isolation switch or the circuit breaker in the switchboard. Attach a yellow “CAUTION-DO NOT OPERATE” tag. This must be performed where relevant unless the procedures specify otherwise. FAILURE TO DO SO MAY RESULT IN ELECTRIC SHOCK.</p>

Single Phase Units:

- Supplied and fitted with an appropriately rated plug and lead, indicated as:
 - 10A plug & lead fitted

Notes:

- If the supply cord is damaged, it must be replaced by the manufacturer, its service agent or similarly qualified persons in order to avoid a hazard. Please contact Stoddart for parts and we will advise how to do this in order to avoid any electrical hazard
- The power cable should be dry and/or isolated from moisture or water

2.4 Plumbing

The unit is supplied with a condensate burn-off tray. No additional drainage or plumbing is required.

3.1 General Drawing

3.1.1 VCC1.SCW / VCC1.GCW

Specifications

Model	VCC1.SCW
W x D x H (mm)	450 x 800 x 845
Weight	113kg
Capacity	60 Litres
Operation	-22°C to +15°C
Refrigerant	R600a
Climate Class	4
Max Ambient	40°C
Power	220 - 240V 10A plug & lead

Specifications

Model	VCC1.GCW
W x D x H (mm)	450 x 800 x 900
Weight	113kg
Capacity	60 Litres
Operation	-22°C to +15°C
Refrigerant	R600a
Climate Class	4
Max Ambient	40°C
Power	220 - 240V 10A plug & lead

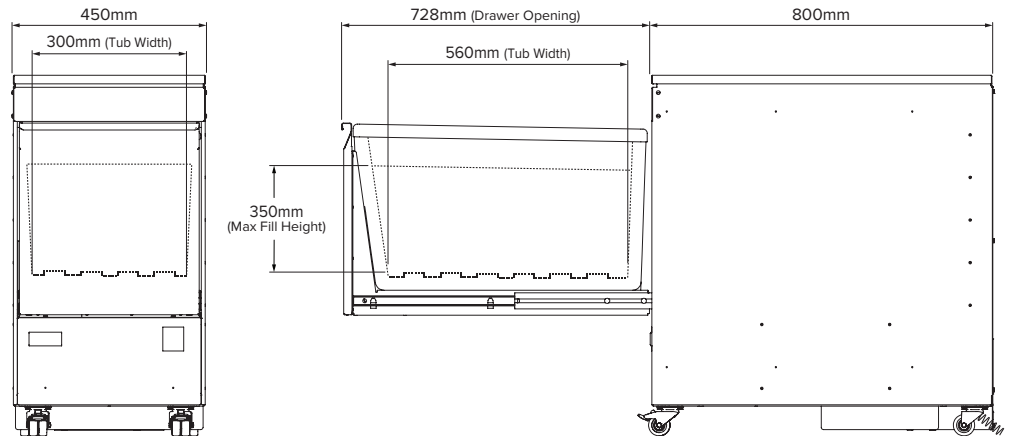



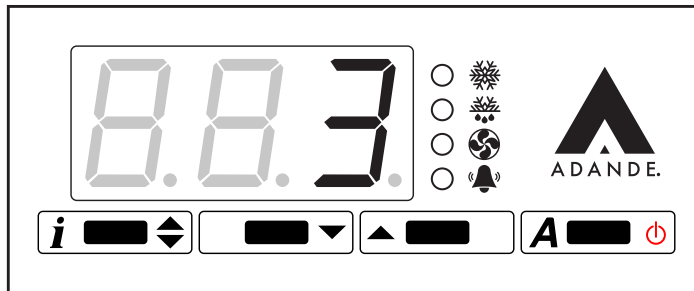

4.1 Initial Start-up & Operation

	IMPORTANT
	<p>Adande units are not designed for use as a servery cabinet with multiple extended drawer openings and scooping of products such as Ice-cream/Sorbet/Gelato and or frozen berries.</p> <p>Extended drawer openings will result in decreased efficiency of the refrigeration system and may lead to temperature uncertainty.</p> <p>For optimal energy efficiency and temperature stability the drawers should always be closed firmly and as quickly as possible during use.</p>

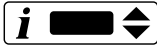
4.1.1 Controller



-  Information (Set Temperature/Scroll Menu)
-  Scroll Down (Decrease Temperature/Manual Defrost)
-  Scroll Up (Increase Temperature)
-  Power ON/OFF

- A helpful video tutorial for the Adande controller can be viewed using the QR Code:

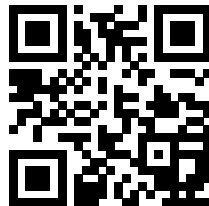

4.1.2 Initial Start Up

- Before switching ON the unit, ensure the unit is installed correctly
- Once switched ON, check that the air is flowing within the unit
- After 45 minutes check the cabinet temperature has reached 3°C
- Leave the unit to operate for 1-2 hours to remove any fumes or odours
- Clean the whole unit before placing in product

4.1.3 Food Temperature

- Ensure the unit is maintaining temperature is between -22°C - 15°C
- Ensure the drawers are CLOSED when not loading to maintain temperature

4.1.4 Loading Restrictions

- Drawer must not be filled past the MAX fill line

4.1.6 Temperature adjustment

1. Press and hold the “set temperature” button, this will display the current set point
2. Adjust the set point by holding the “set temperature” button and press the “Scroll up” or “Scroll down” buttons until required set point is displayed
3. Release all buttons. The temperature is now set

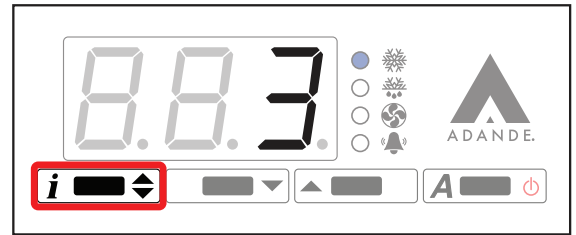

4.1.7 Locking and Unlocking the Controller

1. Press and hold the “Information” button six times until the LOC parameter is displayed
2. Press and hold the “Information” button, while holding the information button press “Scroll up” or “Scroll down” to select YES or NO
Yes = Locked
No = Unlocked
3. Release all buttons



4.1.8 Defrost

The refrigeration system automatically defrosts.

If a manual defrost is required:

1. Press the “Scroll down” button on the control panel for 3 seconds during a defrost “DEF” will show up on the display panel. Once defrost has finished “REC” (recovery) will be displayed until the unit reaches its set point



4.1.9 Drawer Open Alarm

If the drawer is open for more than 3 minutes, the Drawer Open alarm will be triggered, an audible alarm will sound and “DO” will flash on the display panel.

When the alarm has been activated, the Adande® drawer will alarm both visually and audibly.

To silence the audible alarm close the drawer. The alarm light and flashing display will continue to show until the drawer has been fully closed.

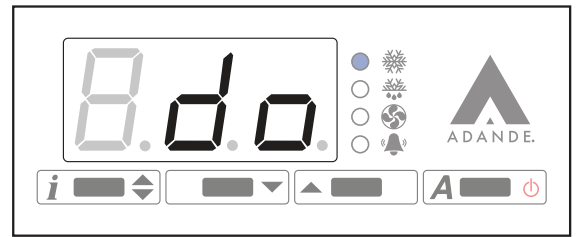

Note: there is no cooling to the insulated container when the drawer is open

4.1.10 Error Alarm

If display reads “E1” or “E2”, a temperature probe has failed, contact the Stoddart service department.

The Adande® drawer will operate with a 5 minute on / 5 minute off cycle in the event of an “E1” failure. This will help to maintain the stored product at a safe temperature, but precise temperature control will be lost. “E2” will only affect defrosts, and these will be timed to maintain operation of the unit. Contact the Stoddart service department, as soon as possible for either fault.

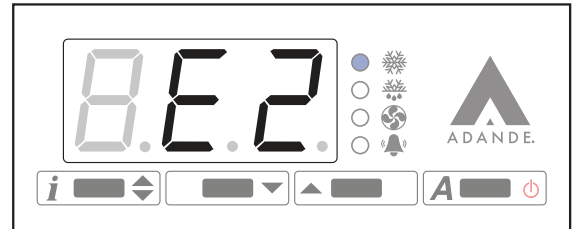

4.1.11 Temperature Alarm

If "HI" should appear on the display, the drawer temperature has exceeded its set point by 7°C and product core temperature should be checked. This alarm may also be triggered if the Adande® drawer has recently been turned on loaded with warm product or left open for a long period of time. If the temperature does not return to the set point temperature, contact the Stoddart service department.

If "LO" should appear on the display, the drawer temperature has fallen below its set point by 7°C and product core temperature should be checked. This alarm may also be triggered if the Adande® drawer's temperature set point has recently been increased. If the temperature does not return to the set point temperature, contact the Stoddart service department.

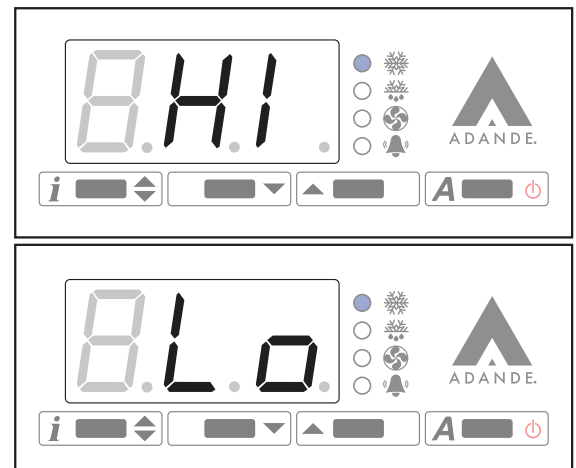

4.1.12 After Service - Information

- The unit should NOT be turned OFF after service
- The unit will maintain set temperature after service
- Ensure all drawers are closed

4.1.13 After Service - Storage

- Products can either be stored in the unit or placed in night storage. Do NOT place warm items in the unit to chill over night
- All storage of product should comply with local health standards and regulations

5.1 Cleaning

5.1.1 Cleaning Schedule

- Regular cleaning is recommended for the unit. This will help to maintain and prolong the efficiency of the unit

5.1.2 Materials Required

- Stainless Cleaner
- Non Abrasive Cleaning pad
- Clean Sanitised Cloth
- Paper Towel
- Warm Soapy Water
- Appropriate PPE (Personal Protective Equipment)

5.1.3 General Information





- Cleaning is recommended for health and safety purposes and to prolong the life of the unit
- DO NOT** use abrasive pads or cleaners on the stainless steel or any other metal parts of the unit
- DO NOT** use industrial chemical cleaners, caustic based cleaners or bleaches and bleaching agents, as many will damage the metals and plastics used on this unit
- DO NOT** remove any screws and/or panels for cleaning (unless directed)
- This unit is **NOT** waterproof, **DO NOT** hose, **DO NOT** pour water directly onto the unit, **DO NOT** immerse in water

5.1.4 Corrosion Protection

- Stainless steel exhibits good resistance to corrosion however, if not properly maintained stainless steel can rust and/or corrode
- Any sign of mild rust and/or corrosion should be thoroughly cleaned with warm soapy water and dried as soon as possible
- NEVER use abrasive pads or cleaners for cleaning
- All metal surfaces should be checked while cleaning for damage, scuffs or scrapes as these can lead to rust and further damage to the product
- Mild rust and/or corrosion can be treated with a commercial cleaning agent that contains citric/oxalic/nitric/phosphoric acid. **DO NOT** use cleaning agents with chlorides or other harsh chemicals as this can cause corrosion. After treatment, wash with warm (not hot) soapy water and dry thoroughly
- Thoroughly wipe the surfaces dry after cleaning. **DO NOT** let water pool on the unit. Check crevices and folds for pooling
- When using, ensure all liquids and moisture is cleaned up straight away. Food liquids such as juices from vegetables and fruits should not be left on preparation surfaces
- DO NOT** leave items on the stainless steel such as cutting boards, rubber mats and bottles

5.1.5 Surface Finish

- To protect the polish, stainless steel should be dried by wiping a dry soft cloth in the same direction as grained polished finish
- For NON-food contact surfaces, a light oil can be wiped on the surfaces with a cloth to enhance the stainless steel surface. Wipe in the direction of the grain
- Some commercial stainless steel cleaners can leave residue or film on the metal; this may trap fine particles of food on the surface, thus deeming the surfaces not food safe

	<p style="text-align: center;">IMPORTANT</p> <p style="text-align: center;">Threaded fasteners can loosen in service. Regular inspection and adjustment should be carried out as required</p>		<p style="text-align: center;">WARNING</p> <p style="text-align: center;">This unit is NOT waterproof, DO NOT hose. DO NOT pour water directly onto the unit. DO NOT immerse in water</p>
	<p style="text-align: center;">IMPORTANT</p> <p style="text-align: center;">Some commercial stainless steel cleaners leave residue or film on the metal that may entrap fine particles of food, deeming the surface not FOOD SAFE</p>		<p style="text-align: center;">WARNING</p> <p style="text-align: center;">This unit includes refrigeration components. Cold surfaces can burn DO NOT touch these surfaces</p>

	IMPORTANT
	<p>Always isolate the appliance before doing any cleaning or maintenance. The dirt and grease deposits should be removed weekly using the following procedures:</p>

5.1.6 Internal / External Surfaces

1. Isolate the unit from the power supply
2. Clean the heated seal using a clean cloth dampened (not wet) with clean warm soapy water
3. Always remove any contents from the containers before lifting from the supports.
4. Clean the insulated container with an anti-bacterial cleanser.
5. Brush any loose dirt from the condenser situated inside at the back of the drawer cavity
6. Clean the steel surfaces with an anti-bacterial cleaner, with the active ingredient that confers its antiseptic property being chloroxylenol (C₈H₉ClO), comprising of 4.8% of the total admixture.
7. Do not use steel pads, wire brushes, scrapers or chloride cleaners to clean the stainless steel, some parts have painted surfaces, these should be cleaned with a mild soap solution as previously instructed

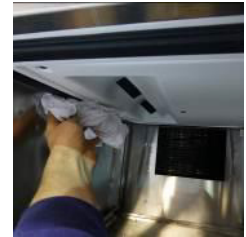

Heated Seal



Condenser

5.1.7 Ventilation Panels

1. Use a vacuum and/or brush to remove dust and debris from the filter and all ventilation panels
2. Do NOT use water or a hose to remove dust or debris

5.2 Troubleshooting

5.2.1 Troubleshooting Procedures

- If any faults/issues occur with the unit, follow the below troubleshooting procedures
- If the troubleshooting procedures do not correct the problem, contact the Stoddart Service Department

	WARNING
	Technician tasks are only to be completed by qualified service people. Check faults before calling service technician.

Problem	Possible Causes	Possible Corrective Action
Unit does not operate/start	The main switch of the unit is OFF	Turn the main switch ON
	Condenser unit is OFF	Turn ON condenser unit
	Electrical wiring damaged	Contact the Stoddart service department
	Condenser unit broken	Contact the Stoddart service department
	Faulty electronic controller	Contact the Stoddart service department
	Loose power cable	Check power cable has not come loose at the back of the unit
Unit is too warm	Warm items in unit	"Pre-chill / Remove items / Wait 30min for items to chill"
	Air not circulating	Remove any items above max fill line
	Too many items in the unit (overloaded)	Remove any items above max fill line
	Defrost cycle is ON / just finished	Wait 30min for cabinet to cool
	Temperature probe broken / disabled	Contact the Stoddart service department
	Set point temperature too high	Contact the Stoddart service department
	Temperature probe damaged	Contact the Stoddart service department
	Undercharge	Contact the Stoddart service department
	Faulty electronic controller	Contact the Stoddart service department
Direct sunlight	Block sunlight, window shades	
Unit is too cold	Temperature probe broken/disabled	Contact the Stoddart service department
	Faulty electronic controller	Contact the Stoddart service department
	Continuous cycle setting ON (integral units)	Contact the Stoddart service department
	Set point temperature too low	Contact the Stoddart service department

5.3 Disposal

If the appliance is no longer of use, please dispose in an environmentally correct way.

Contact a qualified service technician:

- To recover all refrigerant
- To remove the compressor or remove the oil from the compressor

The distributor / retailer can contact their local metal recycling centre to collect the remaining cabinet, shelves, etc.

There may be special requirements or conditions. Information on the disposal of refrigeration appliances can be obtained from:

- Your supplier
- Government authorities (The local council, Ministry of the Environment, etc.)



Discarded electric appliances are recyclable and should not be discarded in the domestic waste! Please actively support us in conserving resources and protecting the environment by returning this appliance to the collection centres (if available).



Dispose of packaging responsibly, recycling where possible in accordance to applicable local regulations.

6.1 Adande® Refrigeration

ADANDE® REFRIGERATION
45 Pinbush Road, South Lowestoft Industrial Estate
Lowestoft, Suffolk, United Kingdom, NR33 7NL

Product: Professional Refrigerated open deck display cabinet
Serial nos: 5000-10000
We declare that the following product models:

VCS R2 VI
VCR R2 VI
VCM R2 VI
VLS R2 VI
VCC R2 VI
HCS R2 VI; HCR R2 VI;
VCM-BC R1 VI; VCS-T R2 VI; VCM-T R2 VI;



Comply with the requirements of the European Directives:

The Machinery Directive 2006/42/EC
The Low Voltage Directive 2014/35/EU
The Electromagnetic Compatibility Directive 2014/30/EU
The Pressure Equipment Directive 2014/68/EU
The Food Equipment Regulation (EC) 2004/1935
The Ecodesign Regulation (EU) 2015/1095
The Energy Labelling Regulation (EU) 2015/1094
The Fluorinated Greenhouse gases Regulation (EU) 517/2014
The Restriction of use of Hazardous Substances (RoHS2) Directive 2011/65/EU

In accordance with the transposed harmonised European Standards:

EN ISO 12100:2010 Safety of machinery. General principles for design. Risk assessment and risk reduction
EN ISO 13857:2008 Safety of machinery. Safety distances to prevent hazard zones being reached by upper and lower limbs
EN 60204-1:2006+A1:2009 Safety of machinery – Electrical equipment of machines – Part 1: General requirements
EN 378-1:2016 Refrigerating systems and heat pumps. Safety and environmental requirements. Basic requirements, definitions, classification and selection criteria
EN 61000-6-1:2007 Electromagnetic compatibility (EMC). Generic standards. Immunity for residential, commercial and light-industrial environments
EN 61000-6-3:2007+A1:2011 Electromagnetic compatibility (EMC). Generic standards. Emission standard for residential, commercial and light-industrial environments
EN IEC 60335-1:2012 + A1:2014 Household and similar electrical appliances – Part 1: General requirements
EN IEC 60335-2-89:2010 + A1:2016 Household and Similar Electrical Appliances – Safety – Part 2-89: Particular requirements for commercial refrigerating appliances with incorporated or remote refrigerant condensing unit or compressor
EN 50581:2012 Technical documentation for the assessment of electrical and electronic products with respect to the restriction of hazardous substances
EN ISO 1459 with the ergonomic principles of EN614-1 and EN 614-2

Signed for and on behalf of: ADANDE® REFRIGERATION
Place of issue: Lowestoft
Date of issue: 03/03/20
Name: Ian Wood
Position: Managing Director
Signature:



The technical file for this machinery will be prepared on demand by Adande Refrigeration

Australia

Service / Spare Parts

Tel: 1300 307 289

Email: service@stoddart.com.au

Email: spares@stoddart.com.au

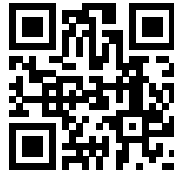

Service Request

Sales

Tel: 1300 79 1954

Email: sales@stoddart.com.au

www.stoddart.com.au

Australian Business Number: 16009690251

New Zealand

Service / Spare Parts

Tel: 0800 935 714

Email: service@stoddart.co.nz

Email: spares@stoddart.co.nz



Service Request

Sales

Tel: 0800 79 1954

Email: sales@stoddart.co.nz

www.stoddart.co.nz

New Zealand Business Number: 6837694

International

Service / Spare Parts

Tel: +617 3440 7600

Email: service@stoddart.com.au

Email: spares@stoddart.com.au



Service Request

Sales

Tel: +617 3440 7600

Email: sales@stoddart.com.au

www.stoddart.com.au