

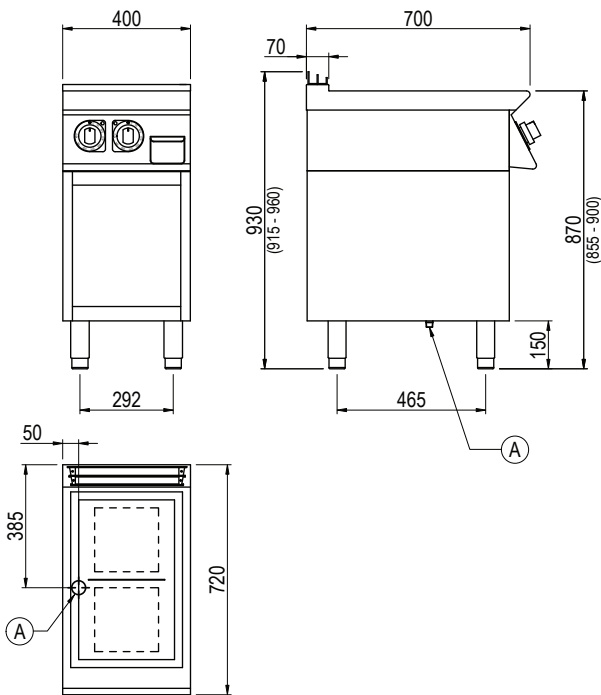

Product Information:

- Class leading, European style, professional quality and reliability since 1963
- 700 series, ultra-thick, reinforced radiant plate with 2 independent cooking zones (2.1kW)
- Heating elements with Hi-limit temperature protection
- Temperature regulation via thermostat (50°C – 400°C)
- Robust 304 grade stainless steel construction with rounded corners for improved cleaning
- Removable grease tray
- Open base with optional doors available (SPGI.2016437)
- Height adjustable stainless steel feet for a 900mm working height
- 24-month warranty

General Drawing:



Specifications:

Model	TE720GT
W x D x H (mm)	400 x 720 x 930
Weight	70kg
Plate Dimensions (mm)	300 x 500
Packed Dimensions (mm)	450 x 825 x 1200
Packed Weight (mm)	75kg
Electrical Connection	3Ø + N + E 415VAC / 50Hz / 4.2kW

Legend:

A Electrical Connection