



## SPECIFICATION, INSTALLATION AND OPERATION MANUAL

READ ALL INSTRUCTIONS BEFORE USE



### Hood Type Dishwasher

Model:

AH800EPRS / AH800EES / AH60.42EPRS / AH60.42EES

Page Intentionally Left Blank



## 1.0 Introduction

1.1 Your New Aristarco Product . . . . .	3
1.2 Australia and New Zealand Warranty . . . . .	4
1.3 General Precautions . . . . .	4
1.4 Product Overview. . . . .	5
1.5 Machine identification . . . . .	5
1.6 Symbols . . . . .	6
1.7 Definitions . . . . .	6
1.8 Personal Protective Equipment (PPE) . . . . .	7
1.9 Protection Devices And Shields Installed . . . . .	7
1.10 Information Regarding Use And Maintenance . . . . .	8

## 2.0 Specification

2.1 General Drawing . . . . .	9
2.1.1 AH800EPRS	
2.1.2 AH800EES	
2.1.3 AH60.42EPRS	
2.1.4 AH60.42EES	

## 3.0 Installation

3.1 Setting Up . . . . .	11
3.1.1 Unpacking	
3.1.2 Positioning	
3.2 Electrical Connection . . . . .	12
3.2.1 Information	
3.2.2 Phase Rotation	
3.2.3 Low Power Option - AH800EPRS / AH800EES	
3.2.4 Low Power Option - AH60.42EPRS / AH60.42EES	
3.3 Plumbing - AH800EPRS / AH60.42EPRS . . . . .	14
3.3 Plumbing - AH800EES / AH60.42EES . . . . .	15
3.4 ESD Connection . . . . .	17
3.5 External Controller (optional) . . . . .	19

## 4.0 Commissioning

4.1 Initial Start-up and Operation . . . . .	21
4.1.2 Inspection and Power-up	
4.1.2 Control Panel	
4.1.3 Initial Start-up	

## 5.0 Operation

5.1 Operation. . . . .	24
5.1.1 Water Loading	
5.1.2 Heating	
5.1.3 Wash Cycle Selection	
5.2 Green Standby Energy Saving Function. . . . .	25
5.3 Programming (User) . . . . .	25

## 6.0 Cleaning and Maintenance

6.1 Cleaning . . . . .	26
6.1.1 Cleaning Schedule	
6.1.2 Materials Required	
6.1.3 General Information	
6.1.4 Corrosion Protection	
6.1.5 Surface Finish	
6.2 Run Cleaning Cycle / Power Off. . . . .	27
6.3 External Surfaces. . . . .	28
6.4 Cleaning the Air Trap . . . . .	28
6.5 Cleaning the Wash/Spray Arms . . . . .	28
6.6 Descaling. . . . .	28
6.7 Troubleshooting . . . . .	29
6.8 Alarms . . . . .	30

Due to continuous product research and development, the information contained herein is subject to change without notice.

www.stoddart.com.au

www.stoddart.co.nz



## 1.0 Introduction

### 1.1 Your New Aristarco Product

Thank you for choosing this quality Aristarco product.

All Aristarco products are designed and manufactured to meet the needs of food service professionals. Caring for and maintaining this new Aristarco product in accordance with these instructions, will provide many years of reliable service.

Stoddart is a wholly Australian owned company, which manufactures and/or distributes a comprehensive range of food service equipment for kitchens, food preparation and presentation. Stoddart products are manufactured and engineered to provide excellent results whilst offering value-for-money, ease-of-use and reliability.

---

**Carefully read this instruction booklet, as it contains important advice for safe installation, operation and maintenance. Keep this booklet on hand in a safe place for future reference by other operators or users.**

#### Disclaimer

The manufacturer/distributor cannot be held responsible or liable for any injuries or damages of any kind that occur to persons, units or others, due to abuse and misuse of this unit in regards to installation, removal, operation, servicing or maintenance, or lack of conformity with the instructions indicated in this documentation.

All units made by the manufacturer/distributor are delivered assembled, where possible, and ready to install. Any installation, removal, servicing, maintenance and access or removal of any parts, panels or safety barriers that is not permitted, does not comply in accordance to this documentation, or not performed by a **TRAINED AND AUTHORISED SPECIALIST** will result in the **IMMEDIATE LOSS OF THE WARRANTY.**

The manufacturer/distributor cannot be held responsible or liable for any unauthorised modifications or repairs. All modifications or repairs must be approved by the manufacturer/distributor in writing before initiating. All modifications or repairs performed to this unit must be performed at all times by a **TRAINED AND AUTHORISED SPECIALIST.**

**Stoddart design, manufacture & distribute Food Service Equipment (appliances) exclusively for the commercial market. This appliance is not designed nor intended for household or domestic use and must not be used for this purpose.**

This product is intended for commercial use, and in line with Australian electrical safety standards the following warnings are provided:

- This product is not intended for use by persons (including children) with reduced physical, sensory or mental capabilities, or lack of experience and knowledge, unless they have been given supervision or instruction concerning the use of the product by a person responsible for their safety. Children should be supervised to ensure that they do not play with the product
- If the supply cord is damaged, it must be replaced by the manufacturer, its service agent or similarly qualified persons in order to avoid a hazard



### 1.2 Australia and New Zealand Warranty

All Stoddart manufactured and distributed products are covered by Stoddart's standard Australia and New Zealand Product Warranty. For product registration and to view the warranty period, full terms, conditions and exclusions your new product, follow the below Link/QR code.

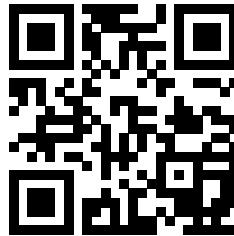

[www.stoddart.com.au/warranty-information](http://www.stoddart.com.au/warranty-information)

### 1.3 General Precautions

When using any electrical unit, safety precautions must always be observed.

Our units have been designed for high performance. Therefore, the unit must be used exclusively for the purpose for which it has been designed.

- All units **MUST** be installed according to the procedures stated in the installation section of this manual
- In the case of new personnel, training is to be provided before operating the equipment
- **DO NOT** use this unit for any other purpose than its intended use
- **DO NOT** store explosive substances such as aerosol cans with a flammable propellant in or near this unit
- Keep fingers out of "pinch point" areas
- Unit is not waterproof **DO NOT** use jet sprays, hoses or pour water over/on the exterior of the unit
- Only use this unit with voltage specified on the rating label
- **DO NOT** remove any cover panels that may be on the unit
- **DO NOT** use sharp objects to activate controls
- If any fault is detected, refer to troubleshooting
- The manufacturer declines any liability for damages to persons and/or things due to an improper/wrong and/or unreasonable use of the machine
- Only specifically trained/qualified Technicians (Stoddart, one of our service agents, or a similarly qualified persons) should carry out any and all repairs, maintenance and services

## 1.0 Introduction

### 1.4 Product Overview

This dishwasher is designed to wash various types of crockery, dishes and glasses of commercial businesses such as bars, restaurants, canteens, etc. Any other use without express permission, or failure to follow the instructions given in this manual, will void the warranty.

Items contaminated by high foaming detergent, petrol or paints, pieces of steel or iron, corrosive or alkaline chemicals and solvents, must not be washed in the dishwasher. Aluminium items must be washed using chemical detergents/rinse-aids suitable for that material.

Item	Description
1	Rating/Data plate
2	Control panel
3	Adjustable feet
4	Detergent and rinse aid dosing access panel
5	Basket support
6	Lower wash arm
7	Tank filters

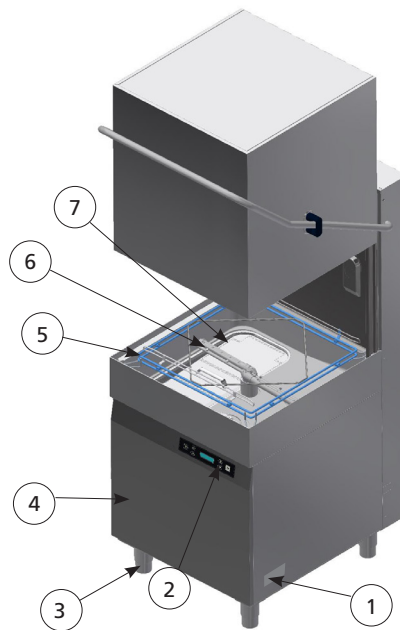

### 1.5 Machine identification

Identification is displayed on the Rating/Data plate affixed to the machine; the following is an example with the meaning of the data given.

To contact the manufacturer, always refer to the details given on the Rating/Data plate.





- MODEL:** Full manufacture model number
- TYPE:** Machine type
- CODE:** Machine code
- S/N:** Machine serial number
- ARTICLE:** Stoddart model number
- Electrical Connection:** 380-415V ~ 50 Hz / Total Amps
- Power:** Total connected load
- IP24:** Ingress protection rating
- Electronic Code:** PCB program code

<b>ARLSTARCO</b>		ARLSTARCO SPA Via del lavoro 30 31033 Castelfranco Veneto (TV) MADE IN ITALY - CF/PI 01823140262	
MODEL	XXXX		
TYPE	XXXX	380-415 ~ 50Hz	
CODE	XXXX	☐ XX A	
S/N	XXXX	POWER XXXX W	
ARTICLE	XXXX		
WATER SUPPLY	200-500 kPa/MAX 60°C	IP24	
Electronic code:	XXXX	PW: XXXX	
Imported by: STODDART www.stoddart.com.au		WMTS-101 WM-022258	

Do not remove the Rating/Data plate or make it illegible. Do not remove the Rating/Data plate's transparent protection.

### 1.6 Symbols

This manual describes situations and activities that require levels of attention and precaution indicated by the symbols listed below: Throughout the text, symbols with safety warnings briefly highlight the types of hazards. The drawings and diagrams in the manual supplement the information but are not intended to be a detailed representation of the machine supplied.

	<p style="text-align: center;"><b>WARNING</b></p> <p style="text-align: center;">Electrical hazards</p>
	<p style="text-align: center;"><b>IMPORTANT</b></p> <p style="text-align: center;">Failure to follow instructions can cause damage to people and goods</p>
	<p style="text-align: center;"><b>IMPORTANT</b></p> <p style="text-align: center;">Failure to follow instructions can cause damage to the dishwasher</p>
	<p style="text-align: center;"><b>IMPORTANT</b></p> <p style="text-align: center;">Indications or situations which require particular attention</p>

### 1.7 Definitions

Listed below are the definitions of the main terms used:

**Installer:** The person responsible for machine installation, adjustment, use, maintenance, cleaning, repair and transport.

**User:** The person who takes care of the machine operation, regular maintenance and cleaning.

**Operator for normal machine use:** An operator who has been informed and trained regarding the tasks and hazards involved in normal machine use.

**After-sales service or specialised technician:** An operator instructed/trained by the Manufacturer and who, based on their professional and specific training, experience and knowledge of the safety regulations, is able to assess the operations to be carried out on the machine and recognise and prevent any risks. Their competence encompasses mechanical, electromechanical and electronics fields.

**Customer:** The person/party who purchased the machine and/or who manages and uses it (e.g. company, businessperson, firm).

**Manufacturer:** The manufacturer/importer of the machine.

**Dealer:** Authorised dealer.

**Danger:** A source of possible injury or harm.

**Hazardous situation:** Any situation where a user or installer is exposed to one or more hazards.

**Risk:** A combination of probabilities and risks of injury or harm in a hazardous situation.

**Protection devices:** Safety measures consisting of the use of specific technical means (shields and safety devices) for protecting operators from hazards.

**Shield:** An element of a machine used in a specific way to provide protection by means of a physical barrier.

**Safety device:** A device (other than a shield) that eliminates or reduces the risk; it can be used alone or in conjunction with a shield.

**Emergency stop device:** A set of components for the emergency stop function; the device is activated with a single action and prevents or reduces damage to people/machines/property/animals.

**Electrocution:** An accidental discharge of electric current on a human body.

## 1.0 Introduction

### 1.8 Personal Protective Equipment (PPE)

The following table lists the main personal protective equipment to be used during the various stages of the machine's life cycle.

	<b>IMPORTANT</b>
	<b>Failure to use PPE exposes operators to health risks.</b>

Task	Protective garments 	Safety Footwear 	Gloves 	Glasses 	Hard Hat 
Transport	---	●	○	---	---
Handling	●	●	○	---	---
Unpacking	○	●	○	---	---
Installation	○	●	○	●	---
Normal use	●	●	●*	○	---
Adjustments	○	●	---	---	---
Routine cleaning	○	●	●*	○	---
Heavy cleaning	○	●	●*	○	---
Maintenance	○	●	○	---	---
Dismantling	○	●	○	---	---
Scrapping	○	●	○	---	---

#### Legend

○	PPE Required
●	PPE available or to be used if necessary
---	PPE Not Required

\* Gloves must be used for exposure to high temperatures and suitable for contact with corrosive substances.

### 1.9 Protection Devices And Shields Installed

The machine has fixed protection devices (side panels, casings, covers, etc.) rigidly secured and removable or accessible only with utensils or tools. The doors (fixed or hinged) which access the electrical fittings, can only be opened with utensils or tools.



	<b>IMPORTANT</b>
	<b>The machine must not be handled with fixed shields removed due to possible components under pressure, hot or exposing live parts.</b>

	<b>IMPORTANT</b>
	<b>Some of the illustrations below depict the machine without protection devices or shields solely for descriptive purposes. It is absolutely forbidden to use the machine without these protection devices.</b>



### 1.10 Information Regarding Use And Maintenance

All mechanical, thermal, and electrical risks have been neutralised or safely contained for use. Nonetheless, certain residual risks may occur if specific precautions and measures are not taken. The subsequent table outlines these potential risks.

	<b>IMPORTANT</b>
	<b>Machine maintenance operations must be carried out by a qualified technician with the obligation to wear personal safety devices and suitable equipment.</b>
	<b>WARNING</b>
	<b>Isolate electricity and water supply to machine each time panels are removed. Place a sign on the electric control panel indicating machine undergoing maintenance.</b>
	<b>IMPORTANT</b>
	<b>Do not open the dishwasher door when in use. Always turn the dishwasher off before accessing the inside.</b>

Residual Risk	Situation
<b>Electrocution</b>	During contact with electrical circuit components in the course of extraordinary maintenance when the main electrical panel is not isolated.
<b>Burns</b>	As a result of contact with hot parts during maintenance without gloves and suitable clothing. Contact with hot items/dishes when removing the load without letting it cool first. Contact with internal parts of the machine if accessed in an unsafe way.
<b>Chemical risk</b>	In the event of contact with detergents, rinse aids or descaling acids during cleaning and routine maintenance.
<b>Crushing or cutting injuries</b>	From contact with moving parts of the machine during loading/unloading, if accessed in an unsafe way
<b>Falls</b>	In case of wet or soiled floor.
<b>Tipping over</b>	During machine handling if the load is unbalanced and/or appropriate equipment is not used.

## 2.0 Specification

### 2.1 General Drawing

#### 2.1.1 AH800EPRS

<b>Model</b>	AH800EPRS
<b>W x D x H (mm)</b>	657 x 793 x 2016
Note: Dimensions do not include handle. Hood open	
<b>Weight</b>	126kg
<b>Packed Dimensions (mm)</b>	770 x 930 x 1720
<b>Packed Weight</b>	145kg
<b>Total Connected Load</b> - Convertible to:	9.55kW 6.75kW (low power option)
Note: Unit can be converted to low power option on site by a qualified electrician. This may affect the output of the unit.	
<b>Electrical Connection</b>	3Ø+N+E 415VAC / 50Hz (Lead fitted, onsite connection)
<b>Water Quantity Per Cycle</b>	2.5 Litres
<b>Water Connection</b>	1.5m Hose / 3/4" BSP
<b>Water Inlet Pressure</b>	100 - 500KPA
<b>Tempered water supply</b>	10°C - 60°C
<b>Waste Connection</b>	2m Hose / ø20.5mm

#### Legend:

<b>A</b>	Electrical Connection
<b>B</b>	Water Connection
<b>C</b>	Drain Connection
<b>D</b>	Detergent Line
<b>E</b>	Rinse-Aid Line

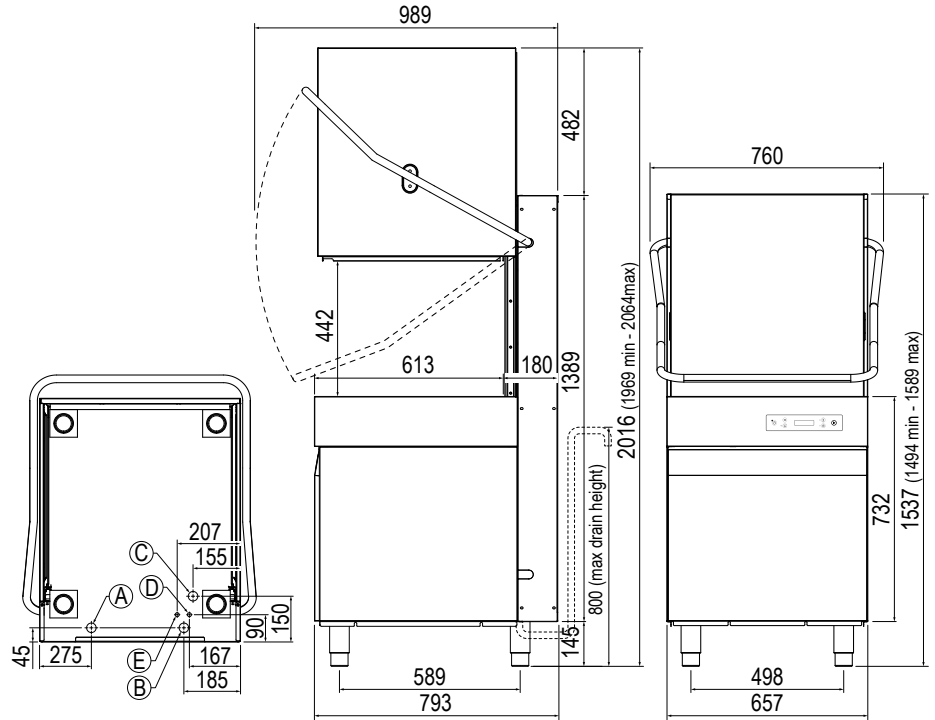

#### 2.1.2 AH800EES

<b>Model</b>	AH800EES
<b>W x D x H (mm)</b>	657 x 793 x 2294
Note: Dimensions do not include handle. Hood open	
<b>Weight</b>	163kg
<b>Packed Dimensions (mm)</b>	770 x 930 x 1870
<b>Packed Weight</b>	182kg
<b>Total Connected Load</b> - Convertible to:	9.55kW 6.75kW (low power option)
Note: Unit can be converted to low power option on site by a qualified electrician. This may affect the output of the unit.	
<b>Electrical Connection</b>	3Ø+N+E 415VAC / 50Hz (Lead fitted, onsite connection)
<b>Water Quantity Per Cycle</b>	2.5 Litres
<b>Water Connection</b>	1.5m Hose / 3/4" BSP
<b>Water Inlet Pressure</b>	100 - 500KPA
<b>Tempered water supply</b>	10°C - 25°C
<b>Waste Connection</b>	2m Hose / ø20.5mm

#### Legend:

<b>A</b>	Electrical Connection
<b>B</b>	Water Connection
<b>C</b>	Drain Connection
<b>D</b>	Detergent Line
<b>E</b>	Rinse-Aid Line

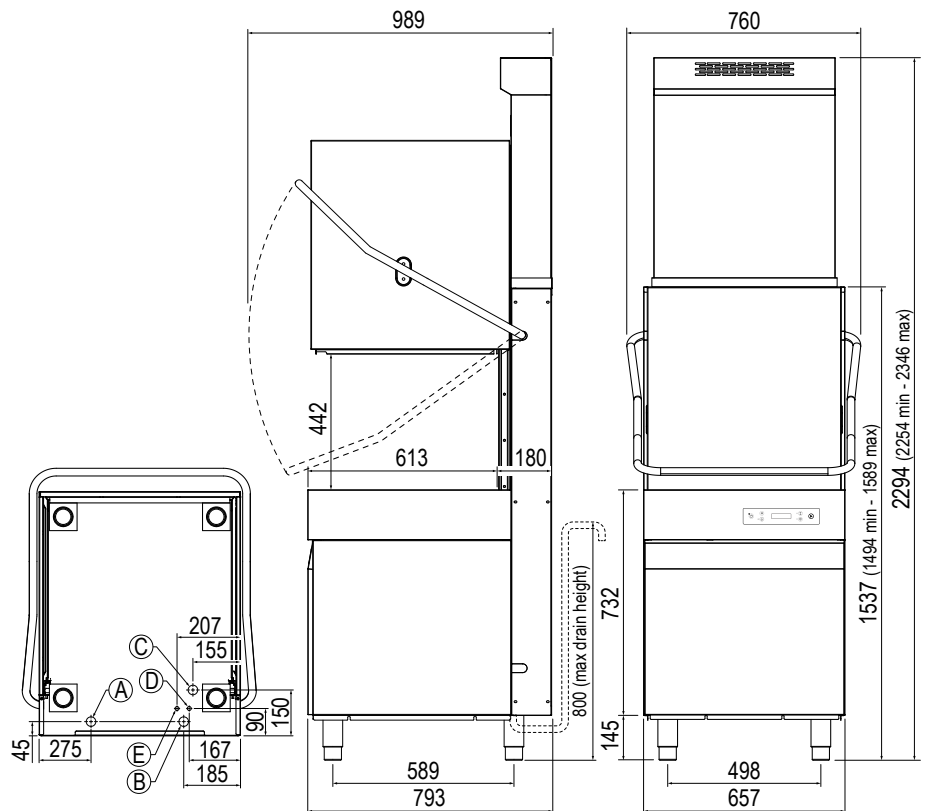

## 2.0 Specification

### 2.1.3 AH60.42EPRS

<b>Model</b>	AH60.42EPRS
<b>W x D x H (mm)</b>	657 x 793 x 2016
Note: Dimensions do not include handle. Hood open	
<b>Weight</b>	141kg
<b>Packed Dimensions (mm)</b>	770 x 930 x 1720
<b>Packed Weight</b>	160kg
<b>Total Connected Load</b> - Convertible to:	
	14.8kW 10.3kW (low power option)
Note: Unit can be converted to low power option on site by a qualified electrician. This may affect the output of the unit.	
<b>Electrical Connection</b>	3Ø+N+E 415VAC / 50Hz (Lead fitted, onsite connection)
<b>Water Quantity Per Cycle</b> 2.5 Litres	
<b>Water Connection</b>	1.5m Hose / 3/4" BSP
<b>Water Inlet Pressure</b>	100 - 500KPA
<b>Tempered water supply</b>	10°C - 60°C
<b>Waste Connection</b>	2m Hose / ø20.5mm

Legend:	
<b>A</b>	Electrical Connection
<b>B</b>	Water Connection
<b>C</b>	Drain Connection
<b>D</b>	Detergent Line
<b>E</b>	Rinse-Aid Line

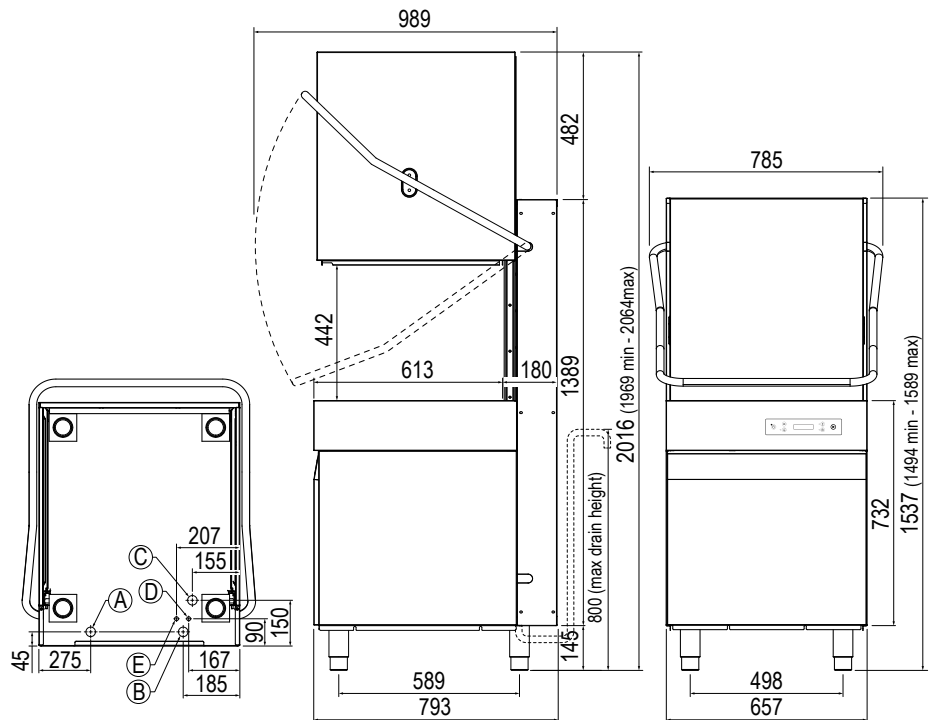

### 2.1.4 AH60.42EES

<b>Model</b>	AH60.42EES
<b>W x D x H (mm)</b>	657 x 793 x 2294
Note: Dimensions do not include handle. Hood open	
<b>Weight</b>	179kg
<b>Packed Dimensions (mm)</b>	770 x 930 x 2254
<b>Packed Weight</b>	198kg
<b>Total Connected Load</b> - Convertible to:	
	14.8kW 10.3kW (low power option)
Note: Unit can be converted to low power option on site by a qualified electrician. This may affect the output of the unit.	
<b>Electrical Connection</b>	3Ø+N+E 415VAC / 50Hz (Lead fitted, onsite connection)
<b>Water Quantity Per Cycle</b> 2.5 Litres	
<b>Water Connection</b>	1.5m Hose / 3/4" BSP
<b>Water Inlet Pressure</b>	100 - 500KPA
<b>Tempered water supply</b>	10°C - 25°C
<b>Waste Connection</b>	2m Hose / ø20.5mm

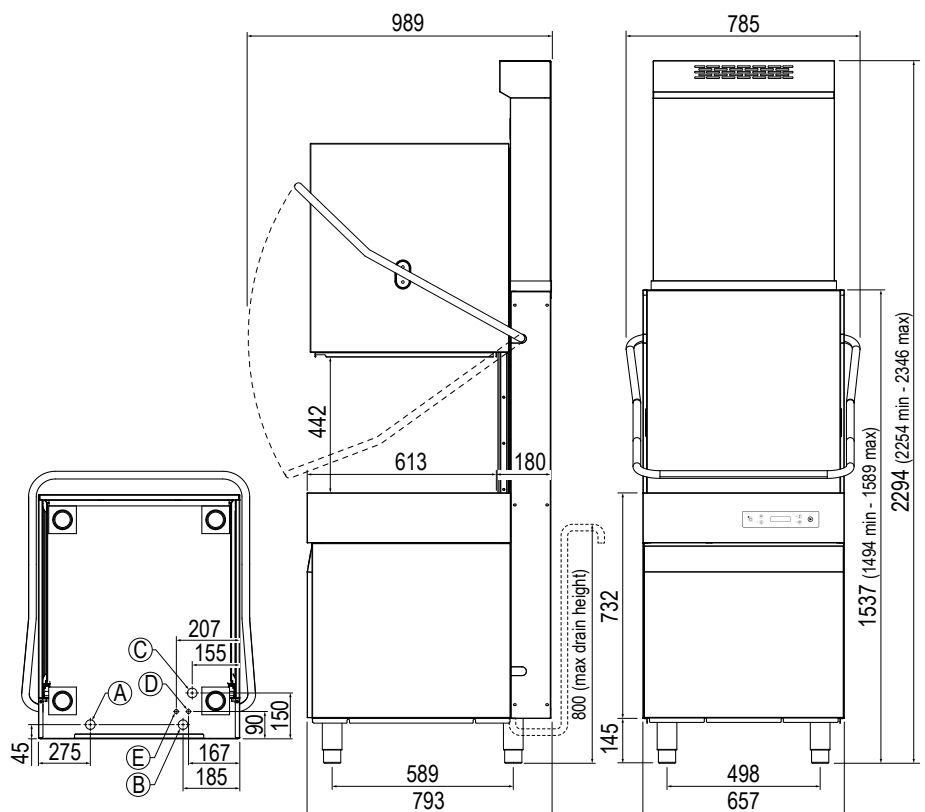

Legend:	
<b>A</b>	Electrical Connection
<b>B</b>	Water Connection
<b>C</b>	Drain Connection
<b>D</b>	Detergent Line
<b>E</b>	Rinse-Aid Line



Due to continuous product research and development, the information contained herein is subject to change without notice.

## 3.0 Installation

### 3.1 Setting Up

	<b>IMPORTANT</b>
	<p><b>Do not turn power on before completing installation and fitting the cover panels.</b></p>
	<b>WARNING</b>
	<p><b>Disconnect electricity and water supply to machine each time panels are removed. Place a sign on the electric control panel indicating machine undergoing maintenance.</b></p>
	<b>IMPORTANT</b>
	<p><b>Failure to follow instructions can cause damage to the dishwasher</b></p>

The packed machine must be unloaded and transported with a forklift truck, making sure to slot the forks in the pallet front on. Once on the ground, before being taken to the installation site, remove the packaging, lift the machine with the forks between the pallet and base, always in a diagonal and rear position, lift then remove the pallet and position the machine on the ground.

Using a pallet trolley (suitable for the weight to be lifted - see net weight in the data table), slot the forks under the base of the machine, placing cardboard between the pallet truck and the machine to avoid damaging it. Do not lift the machine too high from the ground during transport and make sure the route is flat and free of any obstructions. Before moving the machine, check the passageway size of doors and the space for steering operations.

#### 3.1.1 Unpacking

- Check the unit for damage before and after unpacking. If unit is damaged, contact the distributor and manufacturer
- Should any item have physical damage, report the details to the freight company and to the agent responsible for the dispatch within 48 hours of receipt. No claims will be accepted or processed after this period
- The unit is supplied fully assembled except for units with Energy Saving Device (ESD)
- Remove all protective plastic film, tapes, ties and packers before installing and operating
- Clean off any remaining residue from the interior/exterior of the unit using a clean cloth dampened with warm soapy water

#### 3.1.2 Positioning

- When moving the unit, ensure the cabinet is upright at all times
- Do not drag the unit across the floor as legs may become damaged
- When positioning the unit, avoid direct sunlight, warm drafts and heated areas for the unit to maintain the normal operating temperature
- Ensure the unit is positioned on a level surface
- Please consult national and local standards to ensure that your unit is positioned in accordance with any existing requirement

## 3.0 Installation

### 3.2 Electrical Connection

#### 3.2.1 Information

	<b>WARNING</b>
	<p>This unit must be installed in accordance with local electrical regulations/requirements.</p> <p>Some procedures in this manual require the power to the equipment to be turned off and isolated. Turn the power OFF at the power point and unplug the power supply lead by the plug body. If the power point is not readily accessible turn the equipment off at the isolation switch or the circuit breaker in the switchboard.</p> <p>Attach a yellow "CAUTION-DO NOT OPERATE" tag. This must be performed where relevant unless the procedures specify otherwise.</p> <p><b>FAILURE TO DO SO MAY RESULT IN ELECTRIC SHOCK.</b></p>

#### Three Phase Units:

- Power supply cable fitted (without plug) to the unit for on-site connection, by a licensed electrician. Indicated as:  
- 3Ø + N + E

#### Notes:

- If the power supply cable is damaged, it must be replaced by the manufacturer, its service agent or similarly qualified persons in order to avoid a hazard. Please contact Stoddart for parts and we will advise how to do this in order to avoid any electrical hazard
- The power cable should be dry and/or isolated from moisture or water
- Refer to Page 15 for back panel removal. Refer to Page 17 for front panel removal

#### 3.2.2 Phase Rotation

	<b>IMPORTANT</b>
	<p>Phase Rotation <b>MUST</b> be confirmed.</p> <p>Ensure the motor is rotating as per direction arrow on the motor housing. Failure to do this may void warranty!</p>

Once the unit has been connected to the power supply, confirm that the motor is rotating as per direction arrow on the motor housing (accessed from the back of the unit) using a phase rotation meter. Direction of motor is counter clockwise (CCW).

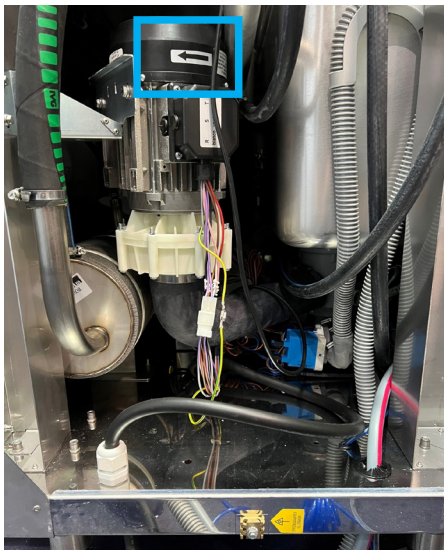

Phase rotation meter connected to supply terminal, accessed through front of unit



Due to continuous product research and development, the information contained herein is subject to change without notice.

## 3.0 Installation

### 3.2.3 Low Power Option - AH800EPRS / AH800EES

To access the control box follow instructions on page 17 "3.5 External Controller".

#### Factory Setting

Power 9550W  
 IL1=12A IL2=9A IL3=20A  
 MAIN CABLE 5G 4mm<sup>2</sup>

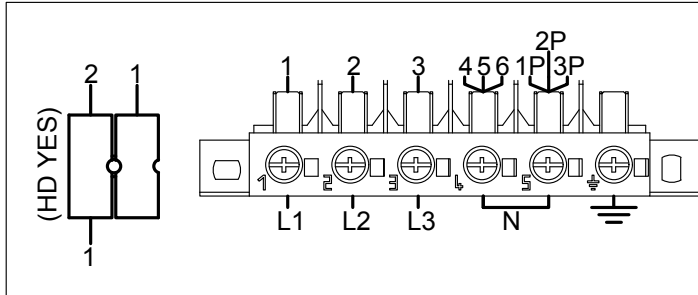

#### Low Power Option

Power 6750W  
 IL1=12A IL2=9A IL3=9A  
 MAIN CABLE 5G 4mm<sup>2</sup>

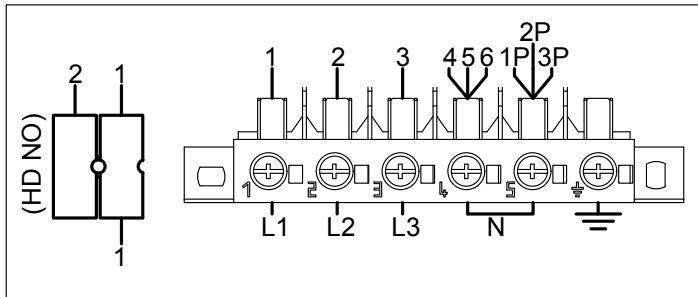

### 3.2.4 Low Power Option - AH60.42EPRS / AH60.42EES

#### Factory Setting

Power 14800W  
 IL1=12A IL2=9A IL3=21A  
 MAIN CABLE 5G 4mm<sup>2</sup>

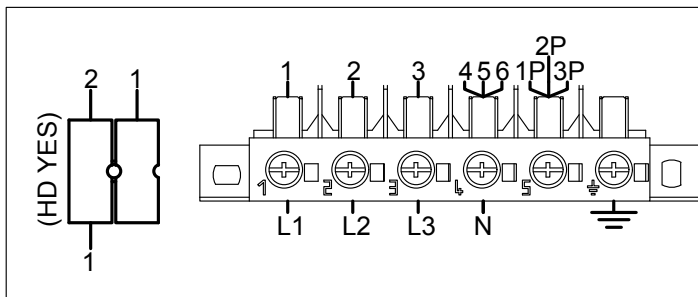





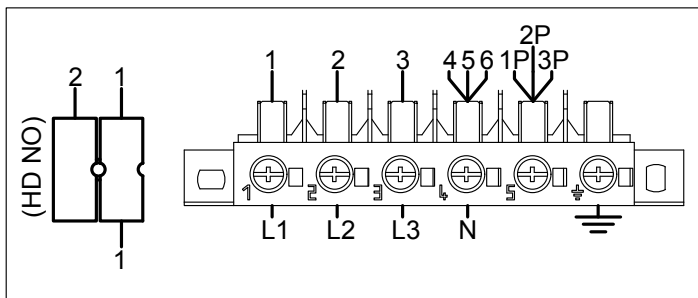



#### Low Power Option

Power 10300W  
 IL1=12A IL2=9A IL3=15A  
 MAIN CABLE 5G 4mm<sup>2</sup>



## 3.0 Installation

### 3.3 Plumbing - AH800EPRS / AH60.42EPRS

	<b>IMPORTANT</b>			
	This unit must be installed in accordance with the Plumbing Code of Australia (PCA)			
	<b>IMPORTANT</b>			
	This unit must be installed in accordance with the specified water temperature, pressure and quality limits stated in the user manual			
	<b>IMPORTANT</b>			
	<table><tr><td></td><td>Min 10°C – Max 60°C</td></tr><tr><td></td><td>100-500 kPa (1-5 Bar)</td></tr></table>		Min 10°C – Max 60°C	
	Min 10°C – Max 60°C			
	100-500 kPa (1-5 Bar)			

Make sure the water supply pressure is between 100-500 kPa dynamic (1-5 Bar). This measurement must be carried out during the first water filling; if the pressure is higher, install a pressure limiting valve (PLV) at the source.

If the water has a high content of calcium and magnesium salts, with hardness > 20°f, it is advisable to install a water softener. Each machine is supplied with a water filling rubber hose with a 3/4" connection which must be connected to the mains water supply.

The drain pipe must be connected to either a p-trap/s-trap spigot or tundish within 2m of the machine with a maximum drain height of 800mm.

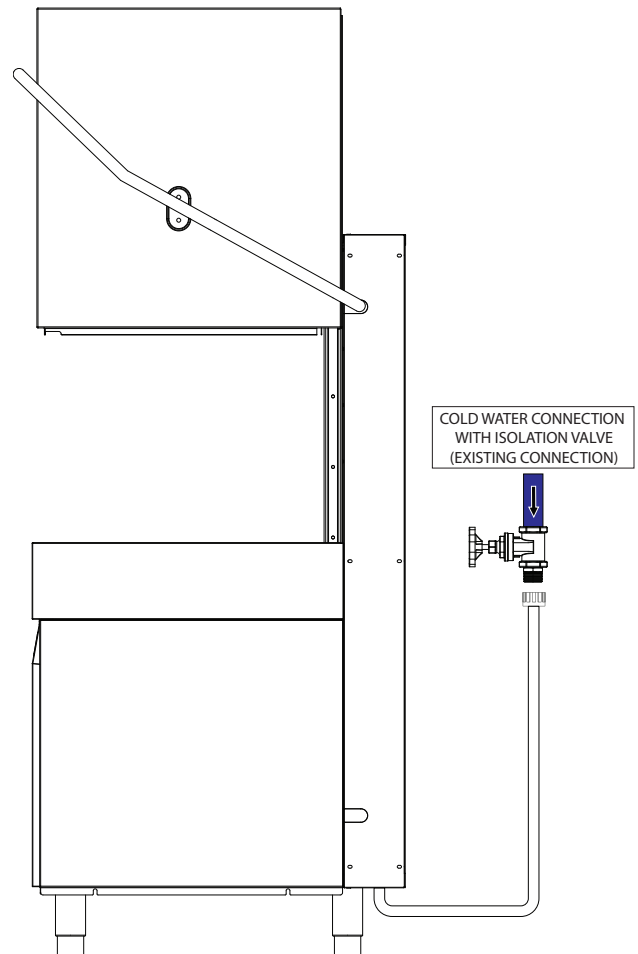

Due to continuous product research and development, the information contained herein is subject to change without notice.

[www.stoddart.com.au](http://www.stoddart.com.au)







[www.stoddart.co.nz](http://www.stoddart.co.nz)

## 3.0 Installation

### 3.3 Plumbing - AH800EES / AH60.42EES

	<b>IMPORTANT</b>
	<p>This unit must be installed in accordance with AS/NZS 3500.1. The unit must be installed with the supplied Dual Check Valve</p>

	<b>IMPORTANT</b>
	<p>This unit must be installed in accordance with the specified water temperature, pressure and quality limits stated in the user manual</p>

	<b>IMPORTANT</b>			
	<table style="width: 100%; border-collapse: collapse;"> <tr> <td style="text-align: center; width: 20%;">  </td> <td style="text-align: center;">Min 10°C – Max 25°C</td> </tr> <tr> <td style="text-align: center;">  </td> <td style="text-align: center;">100-500 kPa (1-5 Bar)</td> </tr> </table>		Min 10°C – Max 25°C	
	Min 10°C – Max 25°C			
	100-500 kPa (1-5 Bar)			

Make sure the water supply pressure is between 100-500 kPa dynamic (1-5 Bar). This measurement must be carried out during the first water filling; if the pressure is higher, install a pressure limiting valve (PLV) at the source. Connect the dual check valve 'A' and, 3/4" Nipple (Male) 'B' to the **cold water** connection

If the water has a high content of calcium and magnesium salts, with hardness > 20°f, it is advisable to install a water softener. Each machine is supplied with a water filling rubber hose with a 3/4" connection which must be connected to the mains water supply.

The drain pipe must be connected to either a p-trap/s-trap spigot or tundish within 2m of the machine with a maximum drain height of 800mm.

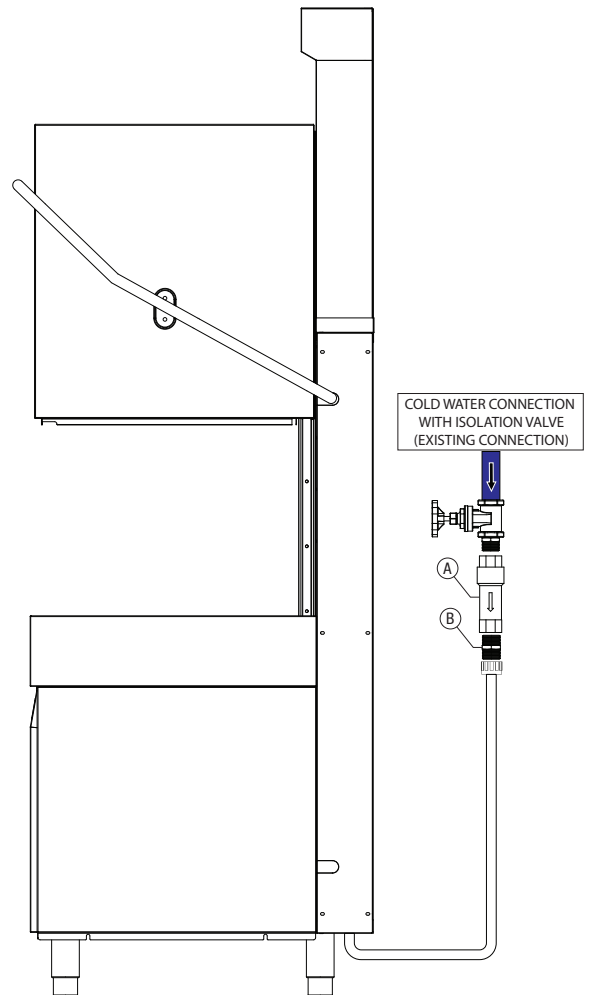

Due to continuous product research and development, the information contained herein is subject to change without notice.



Page Intentionally Left Blank

## 3.0 Installation

### 3.4 ESD Connection

	<b>WARNING</b>
	<p><b>Unit MUST BE Disconnected from electricity and water supply</b></p>

	<b>IMPORTANT</b>
	<p><b>Failure to follow instructions can cause damage to the dishwasher</b></p>

1. Remove five bolts from the ESD and dishwasher
2. Remove the four back panel bolts
3. Loosen and partially remove (5mm) the six side panel screws
4. Remove the back panel from the dishwasher
5. Lift the ESD into position, remove the protection strip from the hose chute
6. Lower the ESD into position then secure using the 4 previously removed bolts
7. Reinstall the back panel
8. Tighten the six side panel bolts to secure the back panel
9. Re-install the with the five previously removed back panel bolts

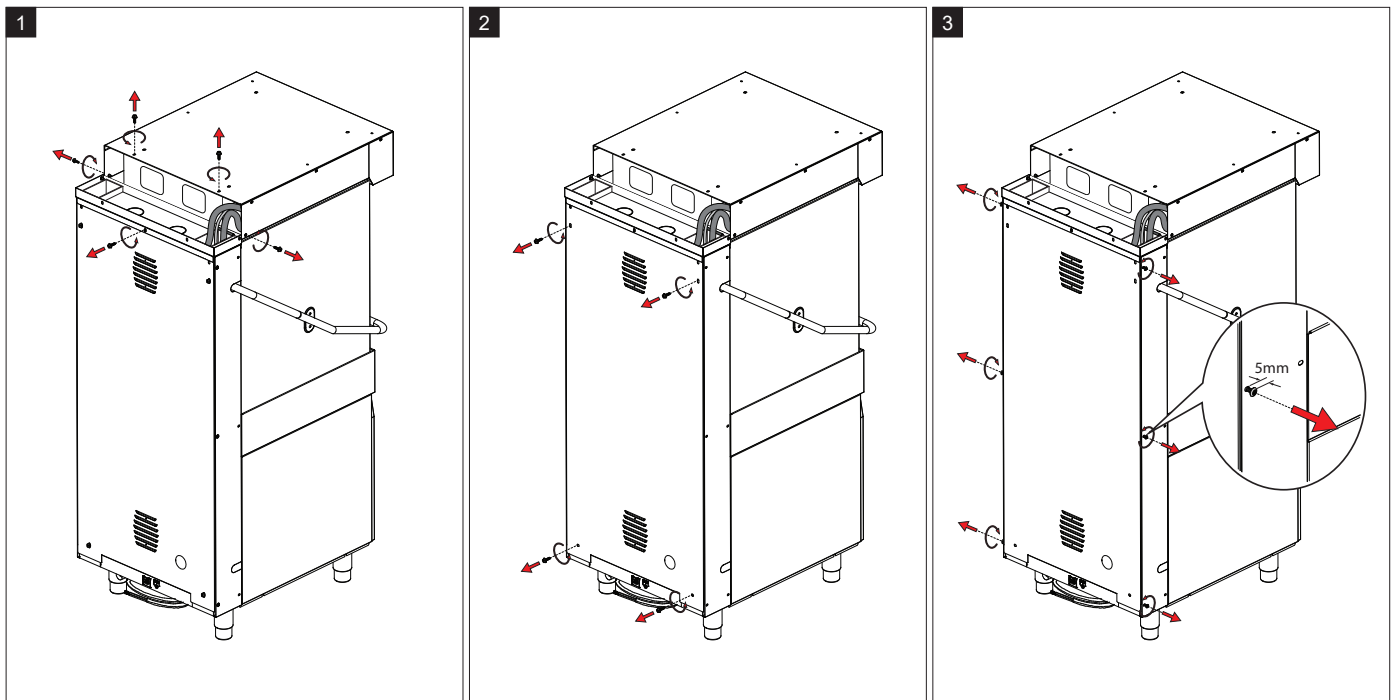

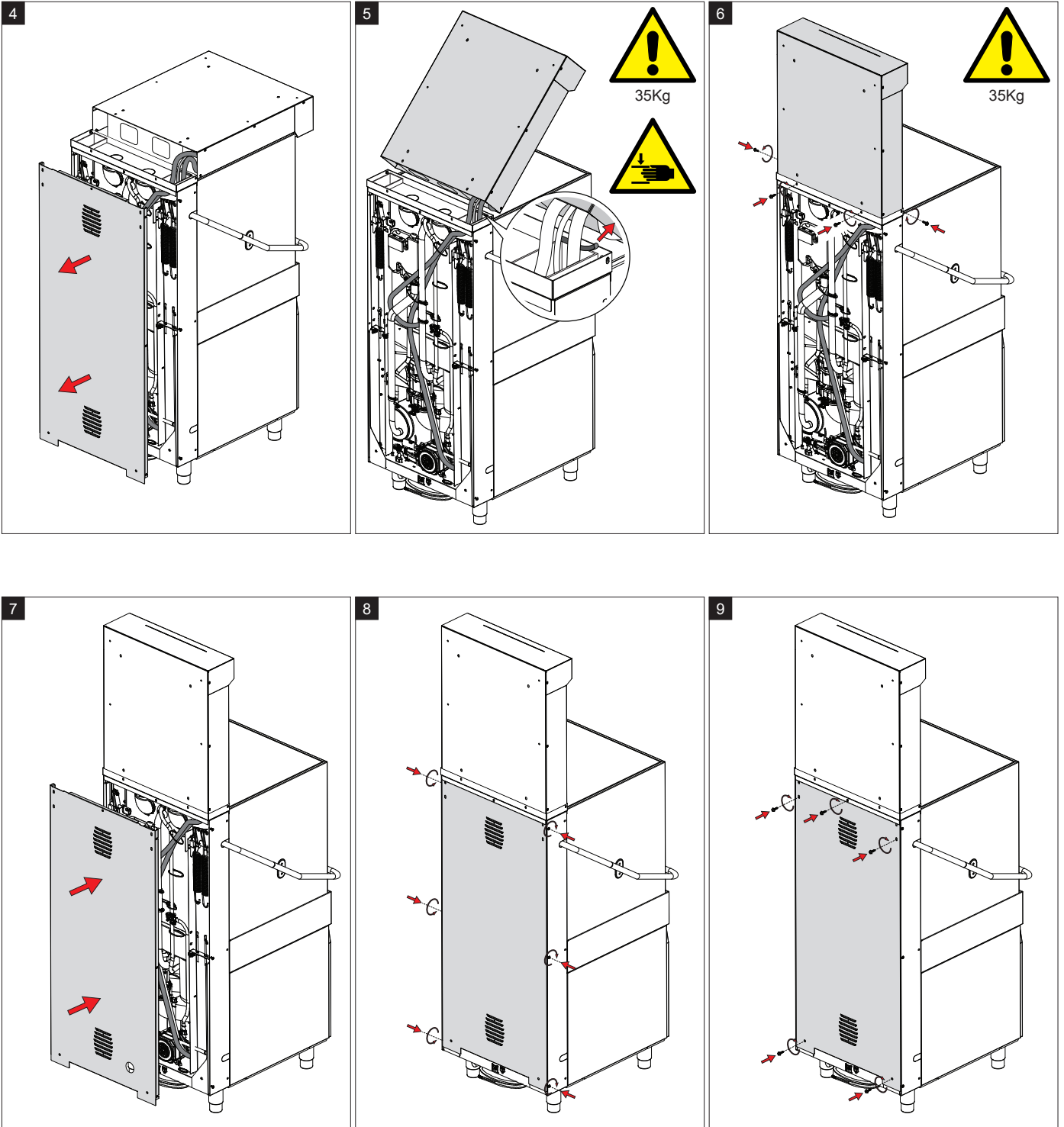

### 3.0 Installation



Due to continuous product research and development, the information contained herein is subject to change without notice.

## 3.0 Installation

### 3.5 External Controller (optional)

	<b>WARNING</b>
	<p><b>Unit MUST BE Disconnected from electricity and water supply</b></p>
	<b>IMPORTANT</b>
	<p><b>Failure to follow instructions can cause damage to the dishwasher</b></p>

1. Remove the two bolts from the front fascia. Carefully remove the front fascia and place to the side of the unit (take care not to damage the control panel ribbon cable)
2. Remove the cross support bar and three bolts
3. Feed the external control panel ribbon cable through the flange hole on the underside of the unit
4. Lift and remove the control box from the unit
5. Remove the control box cover
6. Disconnect the front fascia ribbon cable and connect the external control panel ribbon cable
7. Disconnect the front Fascia earth cable and connect the external control panel earth cable
8. Re-install the control box cover then place back inside the unit. Re-install the cross support bar
9. Re-install the front fascia panel
10. The external control panel can be mounted to the top rear sides of the unit by removing two rear screws and one side screw then attaching. For wall mounting or bench mounting remove the rear bracket, then secure to wall/bench with appropriate fixings

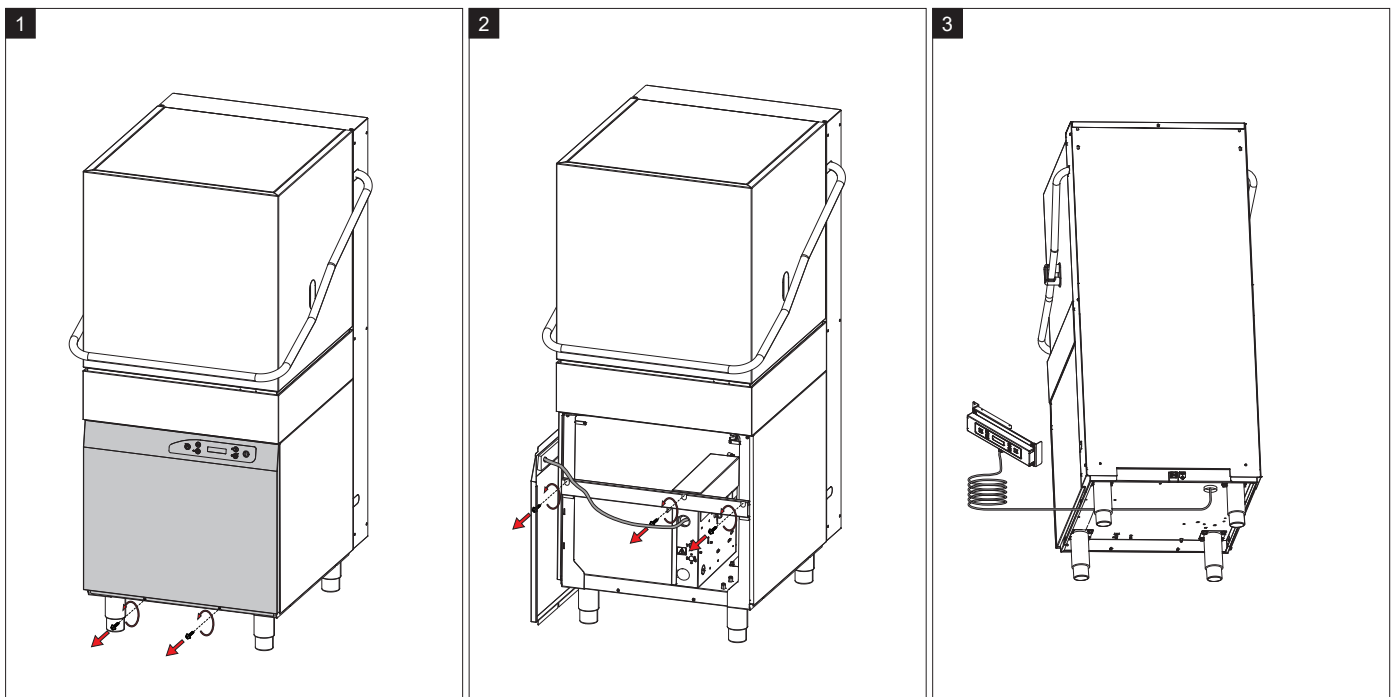

## 3.0 Installation

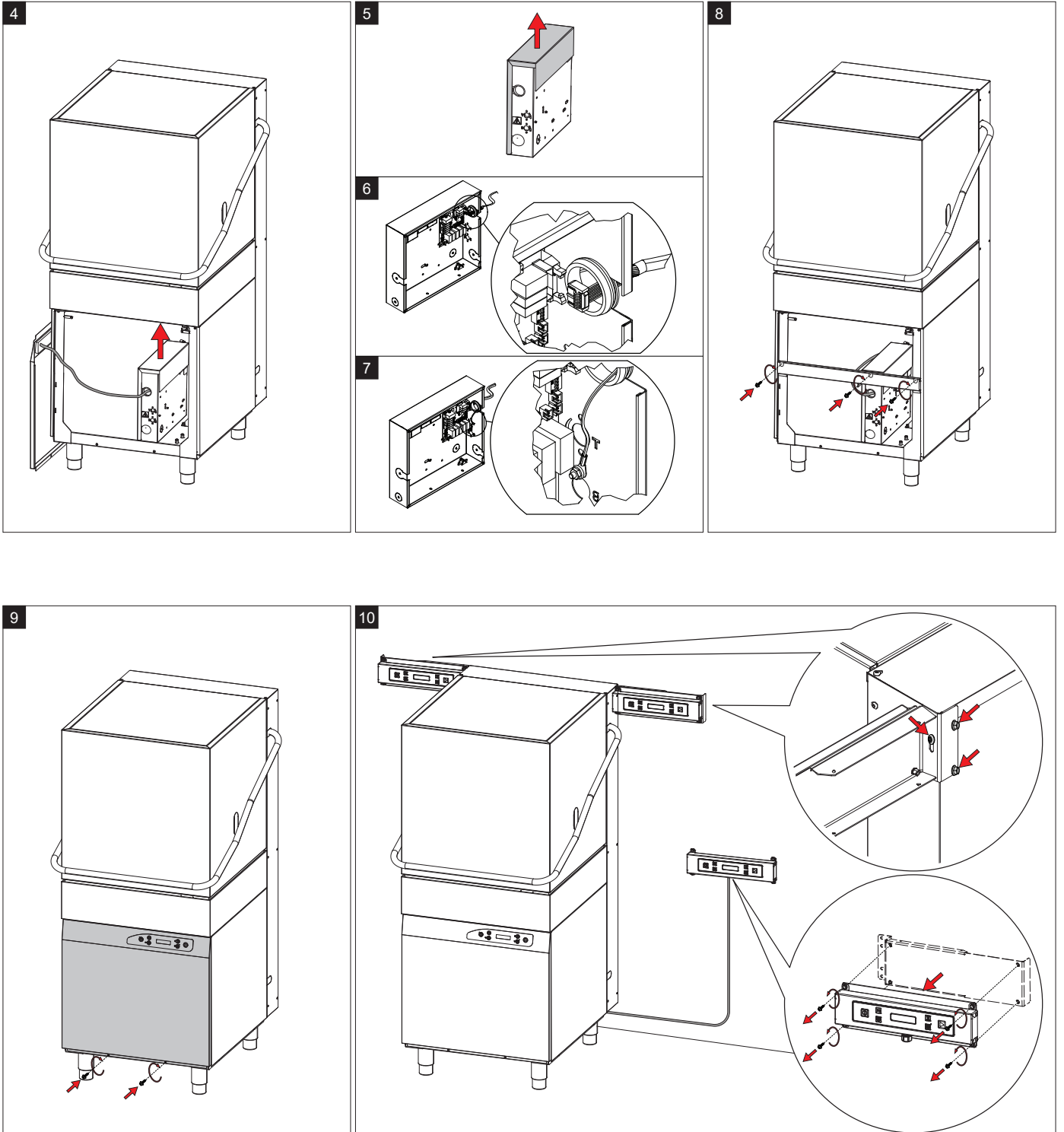

Due to continuous product research and development,  
the information contained herein is subject to change without notice.

## 4.0 Commissioning

### 4.1 Initial Start-up and Operation

#### 4.1.2 Inspection and Power-up

- Check the water connection and drain connection (see paragraph 4.3)
- Check the electrical connections and that the power supply matches that specified on the Rating/Data plate
- Check the detergent/rinse-aid lines are connected
- Make sure there are not foreign objects inside the washing chamber and tank
- Make sure all the cover panels and safety devices are fitted
- Switch the machine on at the power source

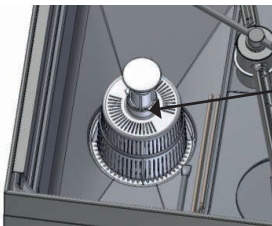

Make sure the overflow and the pump filter are properly fitted

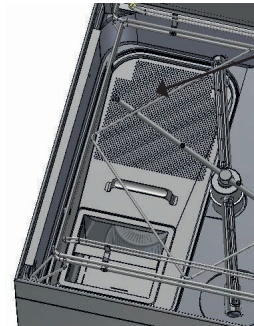

Make sure the surface filters are in place

#### 4.1.2 Control Panel

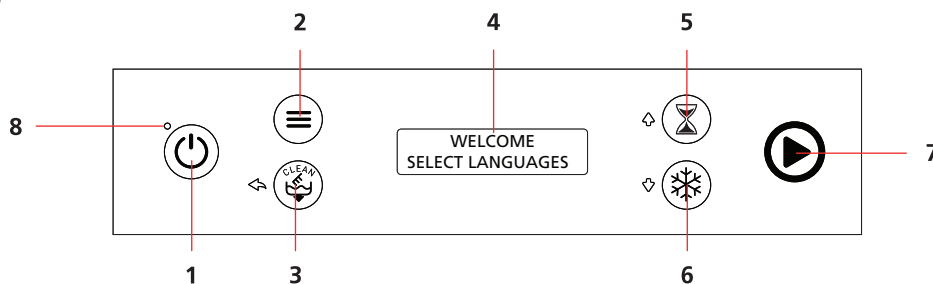

1. ON-OFF button (press and hold 2 seconds for ON)
2. Programming menu access button (press and hold for 3 seconds)
3. Drain pump/Self-cleaning button and ESC function when programming
4. LCD display
5. Select cycles and up/increase (+) function button used in programming
6. Down/decrease (-) function button when programming
7. Start cycle light and Enter function when programming
8. Power indicator: Green ON, Red OFF

When the machine is OFF, the message “OFF” appears on the display with the power indicator ‘8’ red.

#### 4.1.3 Initial Start-up

First time, the display shows a series of data that the installer must enter.

Once the data has been set, it will no longer be requested when switching on, unless the initial state is restored from the menu.

Note: Pressing button 3 during the setup process, returns to the previous screen.

1. First time, the display shows a series of data that the installer must enter. Press button 7 to confirm



## 4.0 Commissioning

2. Select the preferred language using the up/down buttons. Press button 7 to confirm



3. The electronic code will be displayed on the screen, check it matches the rating plate. Press button 7 to confirm

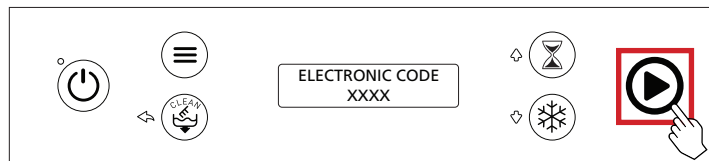

4. In order to optimise detergent dosing to suit local water quality, set the water hardness specific to the location using the up/down buttons. Press button 7 to confirm. To retain the preset factory settings of 25°F only press button 7

Note: (1°F = 10mg/l CaCO<sub>3</sub>). For local water hardness refer to: <https://store.brita.com.au/pages/know-your-water>

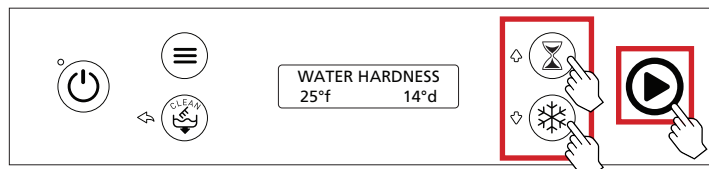

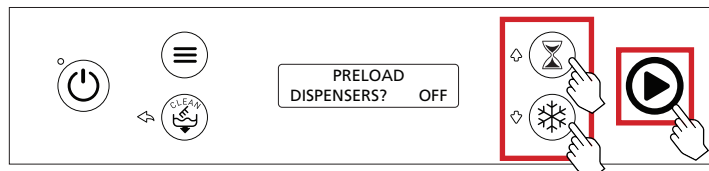

5. Select ON for “Pre-load Dispensers” with the up/down buttons. Press button 7 to confirm.

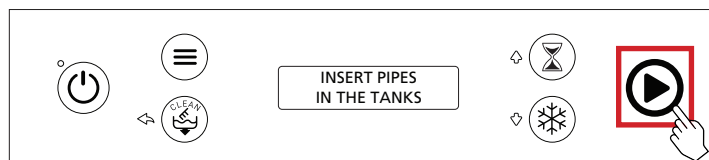

6. Insert the Rinse-Aid and Detergent lines into the appropriate Rinse-Aid and Detergent bottles.  
(Rinse-aid line = blue, detergent line = clear)

- Remove the bottle caps from both detergent and rinse-aid
- Drill a 8mm hole in the centre of each cap (ensure all swarf is removed from the cap)
- Feed the detergent line and the rinse aid hose through the bottle caps
- Attach the weights to each line
- Place both lines and weight back into the bottles and secure bottle caps (ensure to place correct line in the correct chemical)
- Press button 7 to confirm



	<b>IMPORTANT</b>
	<p><b>Only Stoddart provided detergent/rinse-aid should be used. Other products may lead to voidance of warranty!</b></p> <p><b>DO NOT use cleaning agents with chlorines or other harsh chemicals as this can cause corrosion.</b></p>

## 4.0 Commissioning

7. Press button 7 to activate the detergent pre-load function (button 7 blinks white). When completed press button 7 to confirm.

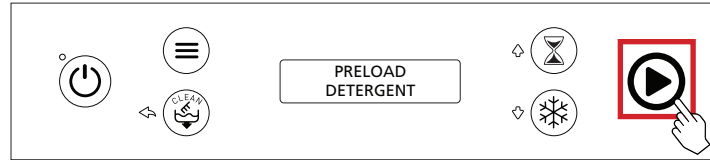

8. Press button 7 to activate the rinse-aid pre-load function (button 7 blinks white). When completed press button 7 to confirm.

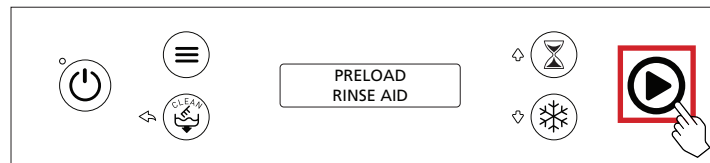

9. By pressing the button 1, the first time use sequence ends, and the unit will turn off.





## 5.0 Operation

### 5.1 Operation

#### 5.1.1 Water Loading

- Press button 1 to turn the unit on, the unit will automatically fill with water

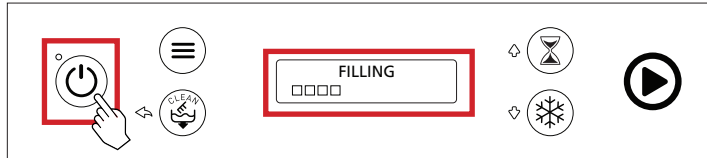

#### 5.1.2 Heating

- During heating, button '7' is yellow. If the wash cycle is launched with a cold tank, the cycle does not start, and a message appears on the display
- When the START button turns green, the temperatures have been reached and the machine is ready for wash cycle

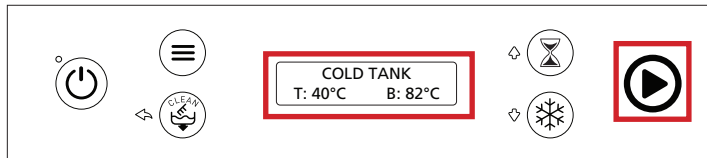

#### 5.1.3 Wash Cycle Selection

- Select the wash cycle using the up/down buttons (Glasses, Cups, Dishes, Intensive). Press button 7 to confirm. The wash cycle can only be started when the door is closed, the wash tank is full, and water heated (green START button)

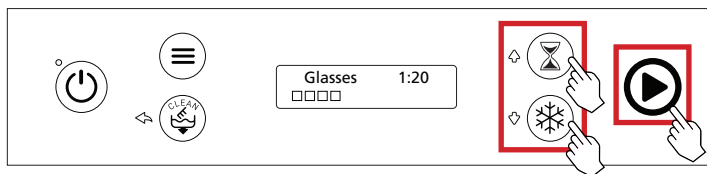

- When the wash cycle has started, the start button turns blue, and the cycle time countdown begins, with the horizontal bar scrolling. The running cycle can be stopped by pressing the START button. If the door is opened for more than 10 seconds during the wash cycle, the cycle is reset

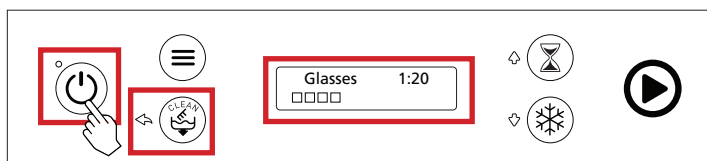

- At the end of the wash cycle, the START button blinks green and the display shows the message "END CYCLE" until the door is opened

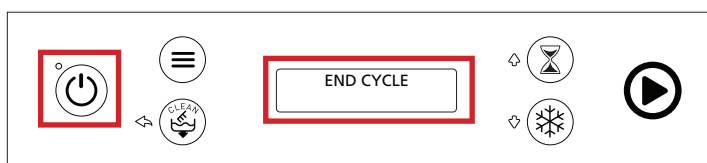

- To turn the machine off refer to section 6.2 'Cleaning Cycle / Power OFF' Page page 20

## 5.0 Operation

### 5.2 Green Standby Energy Saving Function

Green function: The purpose of this function is to enable the reduction of boiler and tank temperatures during periods of machine inactivity by regulating the standby temperatures to a lower setting. When this function is active, the display will indicate “GREEN FUNC. ON.” Once the wash cycle starts, the heating elements will return to their standard operating settings.

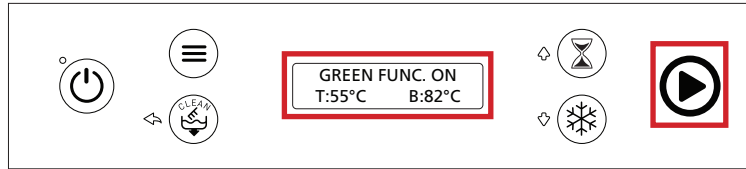

### 5.3 Programming (User)

With the machine OFF, press the “access programming menu” button (2) for 3 seconds and confirm with the “start cycle” button (7). With the buttons 5 (+) and 6 (-), move to the parameter to modify and press the “start cycle” button (7) to enable the edit. Using the buttons 5 (+) and 6 (-), select the desired value and confirm by pressing the “start cycle” button (7) again. Press the “ESC” button (3) twice to exit programming. In the programming menu the user can change the following values

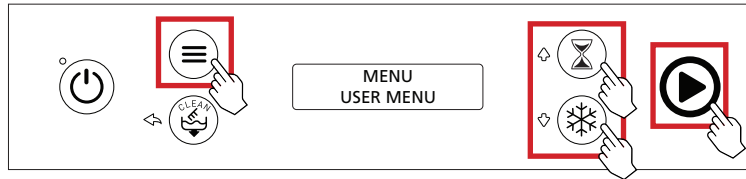

Description	Value	Default parameters
Language	IT,UK,FR,ES,DE,PT,NL	ENGLISH
Temperature	°C / °F	°C
Acoustic signal	Off / On	Off
Initial message	Off / On	Off
Initial text	*****	---
Brightness	15 - 90 %	75 %
Automatic start cycle (Wash cycle starts when hood closes)	Off / On	OFF
Total cycles	0 - 999999	---

## 6.0 Cleaning and Maintenance

### 6.1 Cleaning

#### 6.1.1 Cleaning Schedule

- Regular cleaning is recommended for the unit. This will help to maintain and prolong the efficiency and life of the unit

#### 6.1.2 Materials Required

- Stainless Cleaner
- Non Abrasive Cleaning pad
- Clean Sanitised Cloth
- Paper Towel
- Warm Soapy Water
- Appropriate PPE (Personal Protective Equipment)

#### 6.1.3 General Information



- Cleaning is recommended for health and safety purposes and to prolong the life of the unit
- DO NOT** use abrasive pads or cleaners on the stainless steel or any other metal parts of the unit
- DO NOT** use industrial chemical cleaners, flammable cleaners, caustic based cleaners or bleaches and bleaching agents, as many will damage the metals and plastics used on this unit
- DO NOT** remove any screws and/or panels for cleaning (unless directed)
- This unit is **NOT** waterproof, **DO NOT** hose, **DO NOT** pour water directly onto the unit, **DO NOT** immerse in water

#### 6.1.4 Corrosion Protection

- Stainless steel exhibits good resistance to corrosion however, if not properly maintained stainless steel can rust and/or corrode
- Any sign of mild rust and/or corrosion should be thoroughly cleaned with warm soapy water and dried as soon as possible
- NEVER use abrasive pads or cleaners for cleaning
- All metal surfaces should be checked while cleaning for damage, scuffs or scrapes as these can lead to rust and further damage to the product
- Mild rust and/or corrosion can be treated with a commercial cleaning agent that contains citric/oxalic/nitric/phosphoric acid. **DO NOT** use cleaning agents with chlorines or other harsh chemicals as this can cause corrosion. After treatment, wash with warm (not hot) soapy water and dry thoroughly
- Thoroughly wipe the surfaces dry after cleaning. **DO NOT** let water pool on the unit. Check crevices and folds for pooling
- When using, ensure all liquids and moisture is cleaned up straight away. Food liquids such as juices from vegetables and fruits should not be left on any surfaces
- DO NOT** leave items on the stainless steel such as cutting boards, rubber mats and bottles

#### 6.1.5 Surface Finish

- To protect the polished surface of the stainless steel, it should be dried using a clean dry soft cloth. A light oil can be applied to enhance the stainless steel surface, using a clean cloth apply the oil in the same direction as grained polished finish
- Some commercial stainless steel cleaners can leave residue or film on the metal; this may trap fine particles of food on the surface, thus deeming the surfaces not food safe

	<b>IMPORTANT</b> Daily cleaning is required to aid in the prevention/reduction of soil and limescale build-up
	<b>WARNING</b> This unit is <b>NOT</b> waterproof, <b>DO NOT</b> hose. <b>DO NOT</b> pour water directly onto the unit. <b>DO NOT</b> immerse in water
	<b>IMPORTANT</b> Some commercial stainless steel cleaners leave residue or film on the metal that may entrap fine particles of food, deeming the surface not <b>FOOD SAFE</b>

## 6.0 Cleaning and Maintenance

### 6.2 Run Cleaning Cycle / Power Off

At the end of the service period run the “Drain and Self Clean” cycle, this is done with the unit turned on.

1. Remove the basket and any loose items
2. Remove the upper tank filter from the base of the unit
3. Remove the overflow plug

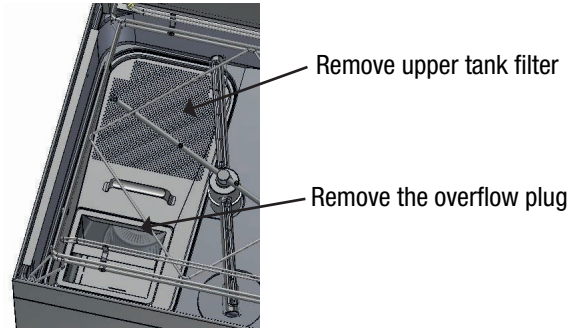

4. Close the dishwasher door
5. Press and hold the “drain pump button” (3) for 3 seconds. The display will show “REMOVE OVERFLOW PIPE!” and “TANK DRAINING” (button 7 will turn purple)

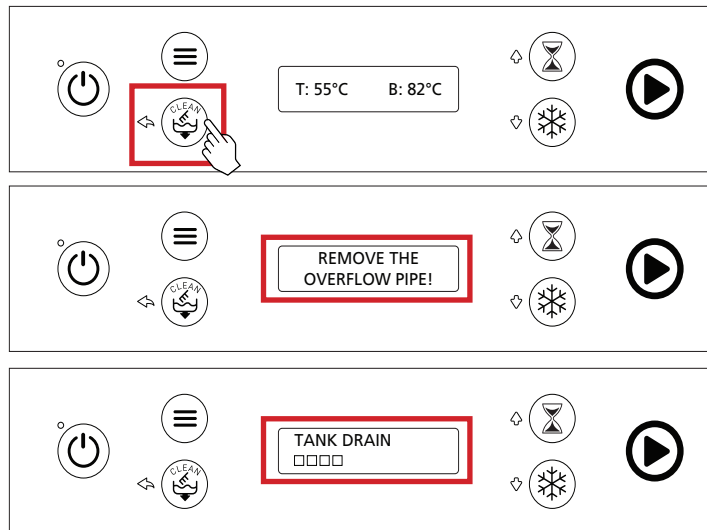

6. When the tank has drained the display will show “SELF-CLEANING”



7. After the cleaning cycle has finished the unit will drain then go into “OFF” mode.

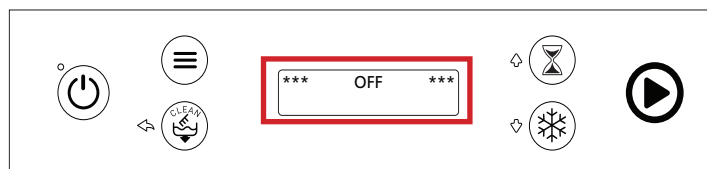

Note: If the door is left open after pressing the “drain pump button” (3), the unit will only drain the tank, then standby for five minutes, after which it will go to OFF mode without cleaning.

## 6.0 Cleaning and Maintenance

### 6.3 External Surfaces

1. Using a clean cloth dampened (not wet) with clean warm soapy water until any grime has been removed
2. Using a clean sanitised cloth, thoroughly wipe the stainless steel and metal parts dry. Do NOT let water pool on the unit. Check crevices and folds

### 6.4 Cleaning the Air Trap

The air trap is located at the back left of the wash tank below the upper tank filter

1. Remove the upper tank filter
2. Using a cloth wipe below the air trap, be careful not to rotate/move the air trap
3. Re-install the upper tank filter

### 6.5 Cleaning the Wash/Spray Arms

Periodic cleaning of the wash/spray arms may be required if blockage occurs.  
If the spray nozzles are blocked descale the machine (refer to 6.6 descaling)

1. Remove the wash/spray arms securing screws
2. Remove the wash/spray arms
3. Remove the end caps and clear any blockage from the wash arm then re-install the end caps
4. After cleaning, re-install the wash/spray arm and secure with the previously removed screws

### 6.6 Descaling

Periodic descaling may be required to remove limescale build up. Use a quality descaling solution from a reputable company.

1. Personal protection measures (PPE) must be taken when handling this product
2. Refer to SDS or MSDS of product, or request these documents before commencing any de-scaling
3. Ensure the overflow pipe to the machine is inserted, and stainless-steel filters are in correct placement as if in standard operation
4. Descal machine when machine is full of water as if in standard operation
5. Please refer to product being used for correct dosage rates, but for a general guide the following can be used
6. Add 250mls per 5 litres of capacity water of the machine into the washtank.

**Note:** In case of very heavy lime build up, firstly spray on undiluted solution with a sprayer onto affected areas.

**\*\*Guide only, refer to Descaler for specific quantities\*\***

- Hood Type dishwashers: 1000ml of solution

7. Select and run the 'Intensive Cycle' - 9 minutes
8. Press and hold the "drain pump button" (3) for 3 seconds. The display will show "REMOVE OVERFLOW PIPE!" and "TANK DRAINING" (button 7 will turn purple). Refer to 6.1.6 Cleaning Function
9. Turn the machine on to refill, select and run the 'Dishes Cycle' - 2 minute
10. Machine has now been descaled and is ready for operation

## 6.0 Cleaning and Maintenance

### 6.7 Troubleshooting

- If any faults/issues occur with the unit, follow the below troubleshooting procedures
- If the troubleshooting procedures do not correct the problem, contact the Stoddart Service Department

	<b>WARNING</b>
	<b>Technician tasks are only to be completed by qualified service people. Check faults before calling service technician.</b>

Problems	Solution
The control panel/display does not light up	<ul style="list-style-type: none"> <li>• Make sure the wall power switch is turned on and that the circuit breaker has not tripped</li> <li>• Make sure the plug is properly inserted in the socket</li> </ul>
The tank does not fill with water	<ul style="list-style-type: none"> <li>• Check the supply water and that the shut-off valve is open</li> <li>• Make sure the air trap outlet is clean (refer to 6.4 cleaning the air trap)</li> <li>• Check proper operation of the solenoid filling valve and internal filter</li> <li>• Make sure the overflow is fitted in place</li> </ul>
Water filling does not stop when the level is reached	<ul style="list-style-type: none"> <li>• Ensure the drain plug has been correctly seated</li> <li>• Make sure the air trap outlet is clean (refer to 6.4 cleaning the air trap)</li> <li>• Do not leave water in washtank overnight, if tank has been left full overnight drain and start again</li> </ul>
Inadequate washing results	<ul style="list-style-type: none"> <li>• Make sure the detergent used is the correct type and in the right dose (as recommended by the manufacturer)</li> <li>• Make sure the wash arm nozzles are not clogged/blocked with arms able to spin freely</li> <li>• Ensure dishes have been pre-rinsed to remove excess product before placing in machine</li> <li>• Make sure the tank water temperature is greater than 55°C</li> <li>• Make sure the pump filter is not clogged by impurities</li> <li>• The wash cycle is too short. Repeat the cycle</li> <li>• Washtank water is too contaminated, run the cleaning cycle, once complete re-fill the machine</li> <li>• Check the water hardness of the supply water, if water hardness is different to the settings contact the Stoddart service department</li> </ul>
Unsatisfactory rinse result	<ul style="list-style-type: none"> <li>• Check the water supply pressure</li> <li>• Make sure the rinse arm nozzles are not clogged/blocked with arms able to spin freely</li> <li>• Make sure there is rinse aid in the bottle</li> <li>• Check the rinse water temperature (80-85°C)</li> <li>• Plastics do not dry properly in commercial dishwashers and will require manual drying</li> </ul>
Excessive foam in the tank Large bubbles	<ul style="list-style-type: none"> <li>• Large bubbles indicate too much protein in the water such as: Fats, Grease, and Dairy products. Run the cleaning cycle, once complete re-fill the machine</li> <li>• Ensure dishes have been pre-rinsed to remove excess product before placing in machine</li> </ul>
Excessive foam in the tank Small tight Bubbles	<ul style="list-style-type: none"> <li>• Small tight bubbles indicate high foaming detergent has migrated/been used in the machine. Rinse any detergents from dishes that have been pre-soaked</li> <li>• Ensure the tank has not been cleaned with unsuitable cleaners. Drain the tank and rinse thoroughly before new wash cycles</li> <li>• If foaming detergent has been used, drain and refill the tank with water until the foam is gone</li> </ul>
Front door leaking water or opening during cycle	<ul style="list-style-type: none"> <li>• Caps on end of wash arms missing or not fitted correctly. Push the caps in to seat correctly, if missing contact the Stoddart service department</li> <li>• Ensure wash arms are fitted and spinning freely</li> <li>• Machine not level. Check level and adjust feet as required</li> <li>• Water level too high due to drain pump blockage. Check the drain upstand in machine for blockage. If problem persists contact the Stoddart service department</li> <li>• Incorrect loading of product in dish rack. Check product has been loaded correctly</li> <li>• Ensure door frame has been cleaned</li> <li>• Ensure the roller catch located at the top of the door is clean and moving</li> </ul>
Water leaking	<ul style="list-style-type: none"> <li>• Isolate power and water supply, check drain hose is connected or for any damage</li> <li>• Isolate power and water supply, check water inlet hose is connected or for any damage</li> <li>• If problem persists isolate the power and water supply, contact the Stoddart service department</li> </ul>

## 6.0 Cleaning and Maintenance

### 6.8 Alarms

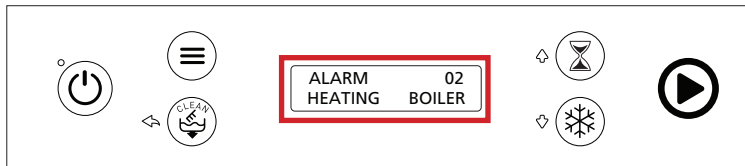

- Errors 01, 05, 09, 10, 12 are critical (button 7 is fixed red) and shut down the machine completely. To reinstate the machine, request technical assistance. To reset these errors, the PCB must be switched off and then on again (ON-OFF button 1).
- With errors 02, 03, 04, 06, 07 and 08 button 7 continues to blink red until the error is reset (press button 3). If the problem persists, request technical assistance.
- With error 13 the machine goes to the first installation sequence. It is necessary to request the assistance of a technician who must enter the machine model code.

Alarm	Display Message	Description	User checks
<b>Alarm 01</b>	Tank Filling	TANK not filling	<ul style="list-style-type: none"> <li>• Tap does not supply water</li> <li>• Overflow pipe placed incorrectly or not inserted</li> <li>• Rinse arm nozzles clogged</li> <li>• Inlet pipe constricted</li> </ul>
<b>Alarm 02</b>	Boiler Heating	BOILER not heating	<ul style="list-style-type: none"> <li>• Contact Stoddart service department</li> </ul>
<b>Alarm 03</b>	Tank Heating	TANK not heating	<ul style="list-style-type: none"> <li>• Contact Stoddart service department</li> </ul>
<b>Alarm 04</b>	Tank Draining	No TANK draining within time-out	<ul style="list-style-type: none"> <li>• Check cleaning of filters</li> <li>• Make sure the drain hose is not blocked or pinched</li> </ul>
<b>Alarm 05</b>	Boiler Filling	BOILER not filling	<ul style="list-style-type: none"> <li>• Tap does not supply water</li> <li>• Constricted inlet pipe"</li> </ul>
<b>Alarm 06</b>	Boiler Probe	Boiler probe temperature outside range	<ul style="list-style-type: none"> <li>• Contact Stoddart service department</li> </ul>
<b>Alarm 07</b>	Tank Probe	Tank probe temperature outside range	<ul style="list-style-type: none"> <li>• Contact Stoddart service department</li> </ul>
<b>Alarm 08</b>	Thermostop Time-Out	Thermostop time-out before rinse	<ul style="list-style-type: none"> <li>• Contact Stoddart service department</li> </ul>
<b>Alarm 09</b>	Boiler Safety Sw	Boiler safety thermostat intervention	<ul style="list-style-type: none"> <li>• The display shows: ALARM BYPASS, push 'ESC' for 5 seconds. When the alarm will be bypassed from the display by pushing the "CLEAN" button for 5 seconds, the dishwasher is able to run cold washing and rinsing cycles, this will not sanitise the dishes/glasses when cleaning. A technician MUST investigate and reset the machine, contact the Stoddart service department.</li> </ul>
<b>Alarm 10</b>	Tank Safety Sw	Tank safety thermostat intervention	<ul style="list-style-type: none"> <li>• The display shows: ALARM BYPASS, push 'ESC' for 5 seconds. When the alarm will be bypassed from the display by pushing the "CLEAN" button for 5 seconds, the dishwasher is able to run cold washing and rinsing cycles, this will not sanitise the dishes/glasses when cleaning. A technician MUST investigate and reset the machine, contact the Stoddart service department.</li> </ul>
<b>Alarm 12</b>	Panel Connection	No communication with circuit board	<ul style="list-style-type: none"> <li>• Contact Stoddart service department</li> </ul>
<b>Alarm 13</b>	Parameter Error!	The parameters have been compromised	<ul style="list-style-type: none"> <li>• Contact Stoddart service department</li> </ul>
<b>Alarm 15</b>	Service Warning	The number of cycles for carrying out maintenance have been reached (60,000)	<ul style="list-style-type: none"> <li>• Machine can still operate but the machine MUST be serviced, contact Stoddart service department</li> </ul>

## Australia

### Service / Spare Parts

Tel: 1300 307 289

Email: [service@stoddart.com.au](mailto:service@stoddart.com.au)

Email: [spares@stoddart.com.au](mailto:spares@stoddart.com.au)

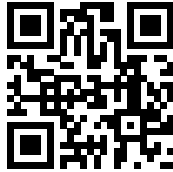

Service Request

### Sales

Tel: 1300 79 1954

Email: [sales@stoddart.com.au](mailto:sales@stoddart.com.au)

[www.stoddart.com.au](http://www.stoddart.com.au)

Australian Business Number: 16009690251

## New Zealand

### Service / Spare Parts

Tel: 0800 935 714

Email: [service@stoddart.co.nz](mailto:service@stoddart.co.nz)

Email: [spares@stoddart.co.nz](mailto:spares@stoddart.co.nz)

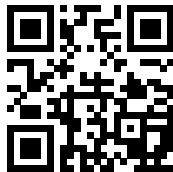

Service Request

### Sales

Tel: 0800 79 1954

Email: [sales@stoddart.co.nz](mailto:sales@stoddart.co.nz)

[www.stoddart.co.nz](http://www.stoddart.co.nz)

New Zealand Business Number: 6837694

## International

### Service / Spare Parts

Tel: +617 3440 7600

Email: [service@stoddart.com.au](mailto:service@stoddart.com.au)

Email: [spares@stoddart.com.au](mailto:spares@stoddart.com.au)



Service Request

### Sales

Tel: +617 3440 7600

Email: [sales@stoddart.com.au](mailto:sales@stoddart.com.au)

[www.stoddart.com.au](http://www.stoddart.com.au)



WMTS-101  
WM-022258