

Blank space for 787-9 and 10 variants

Instructions

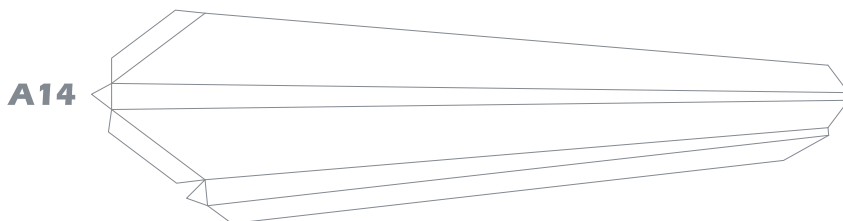

Scan



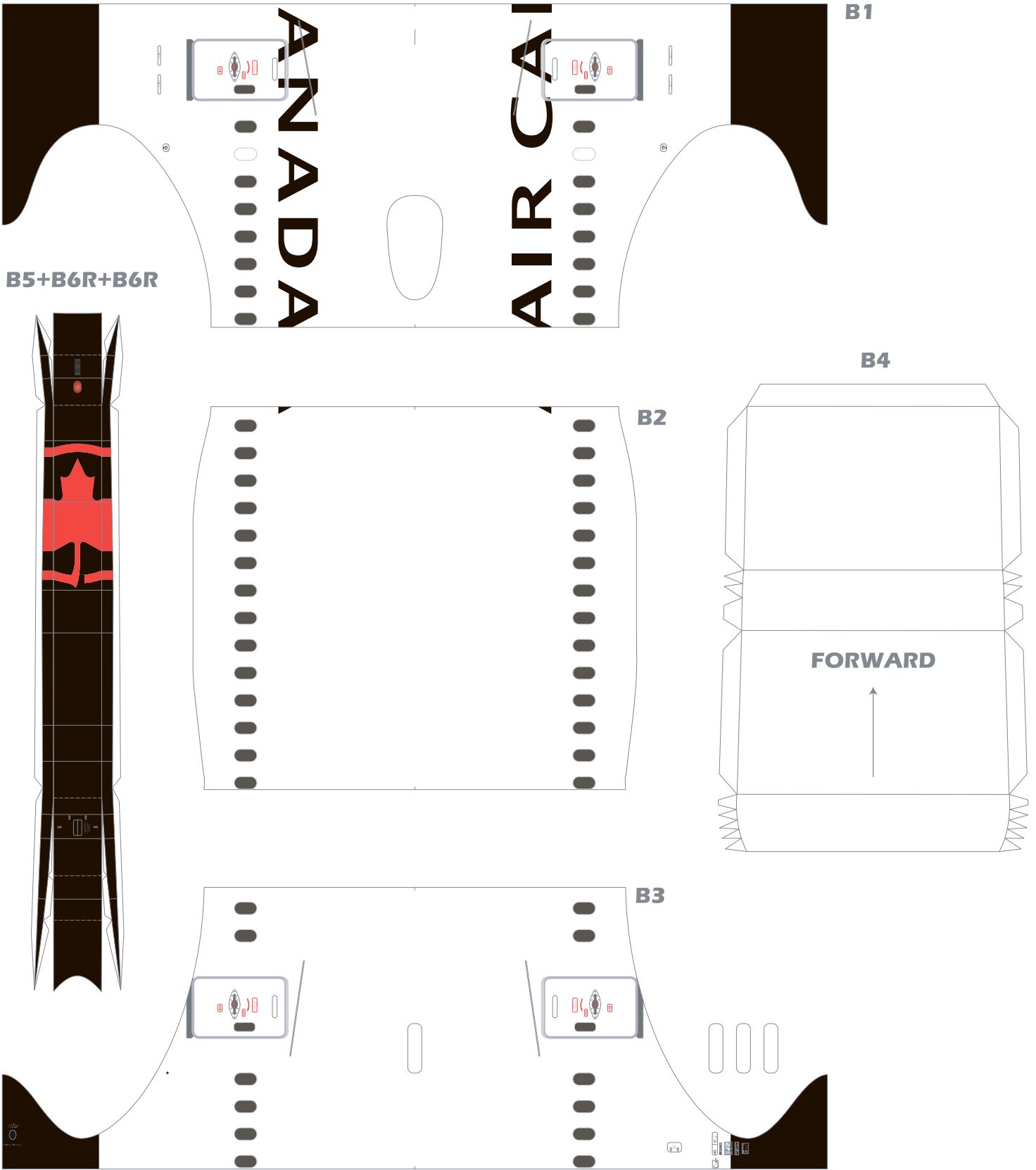

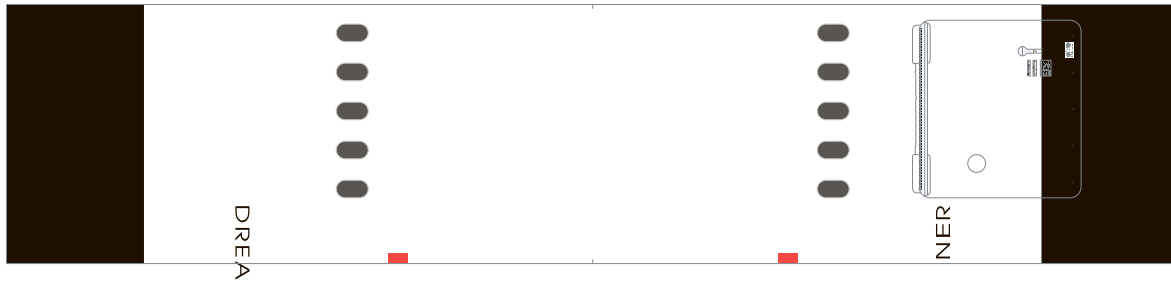

C1

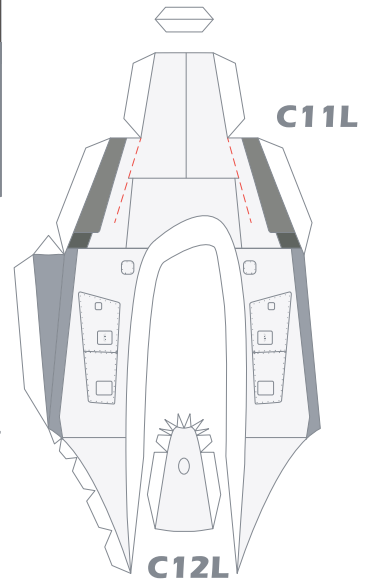

C11L

C12L

Blank space for 787-9 and 10 variants

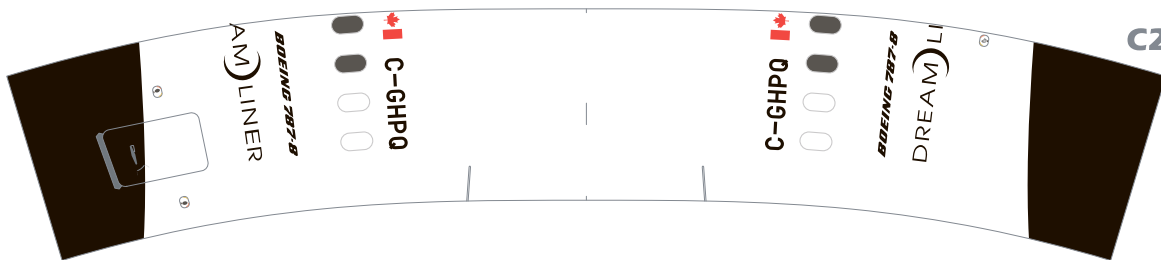

C2

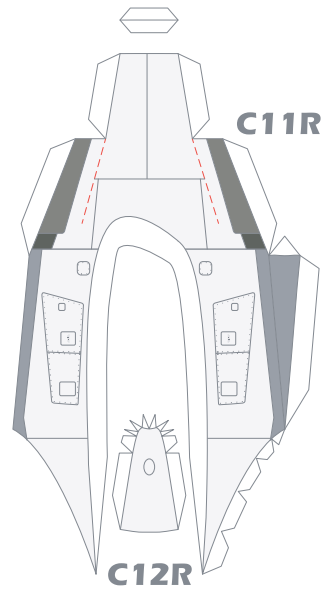

C11R

C12R

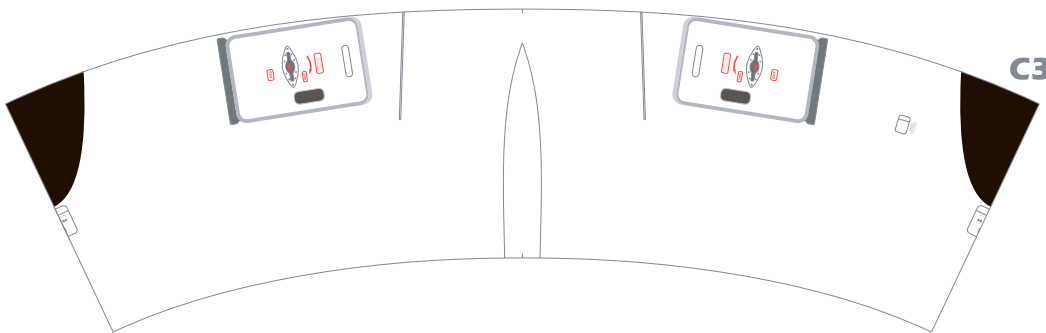

C3

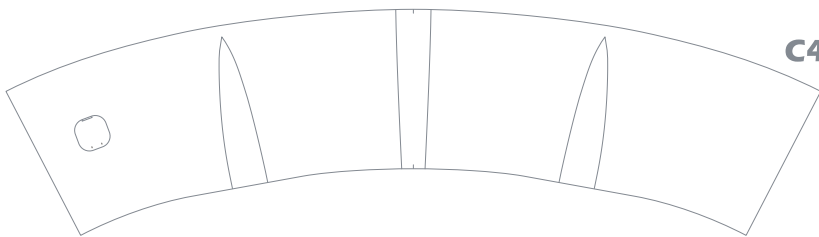

C4



C8



C9

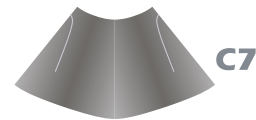

C7

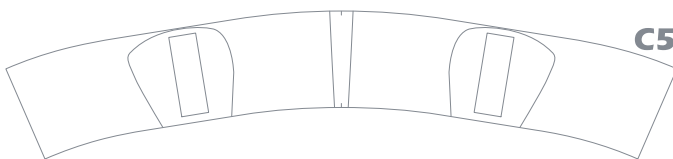

C5

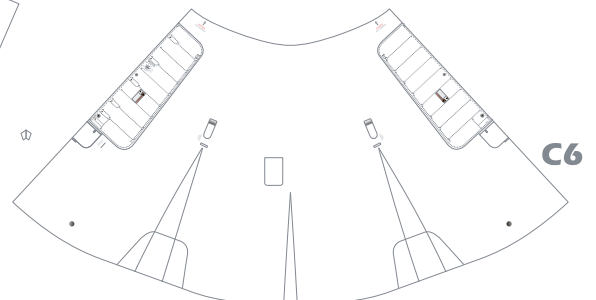

C6



C10L



C10R

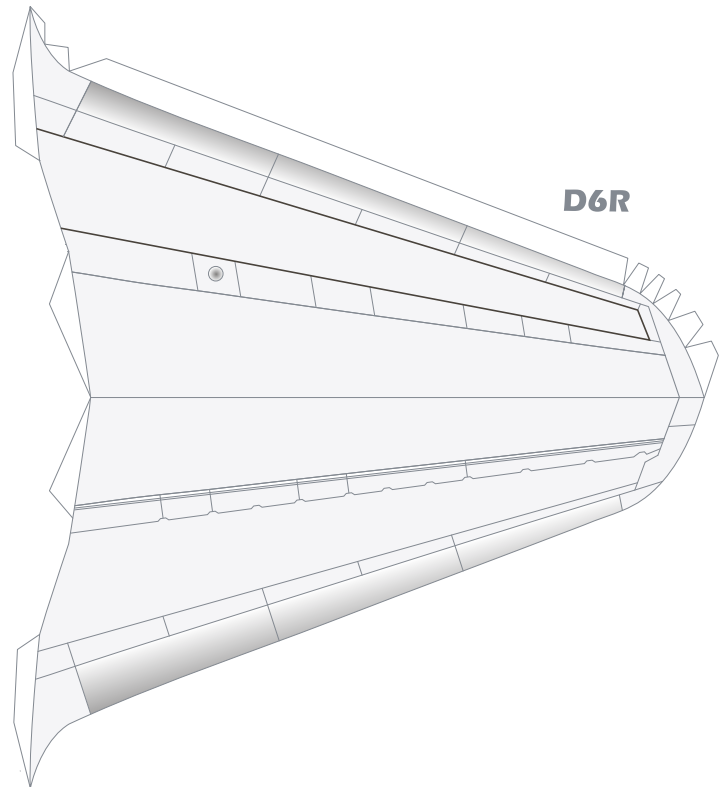
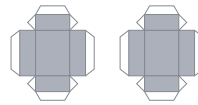
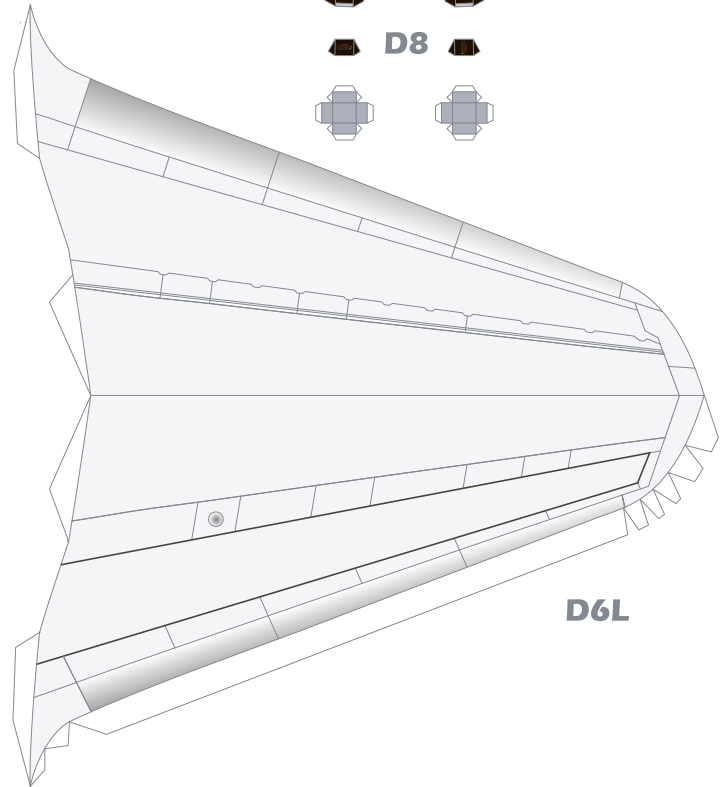
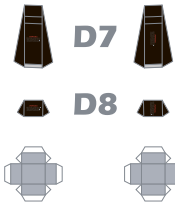
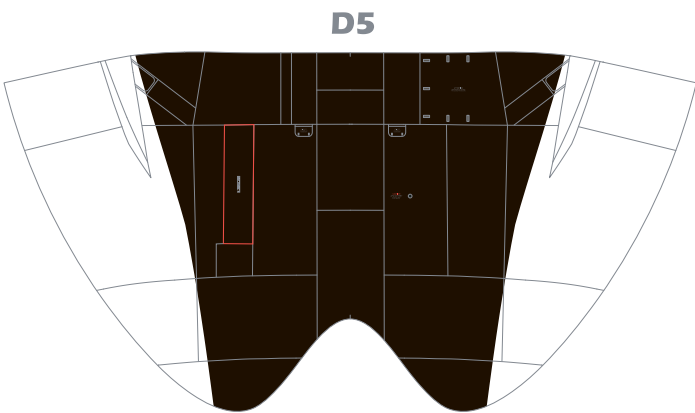
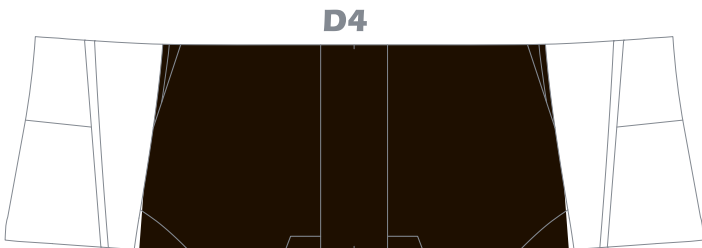
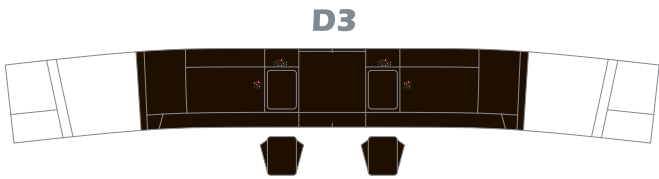
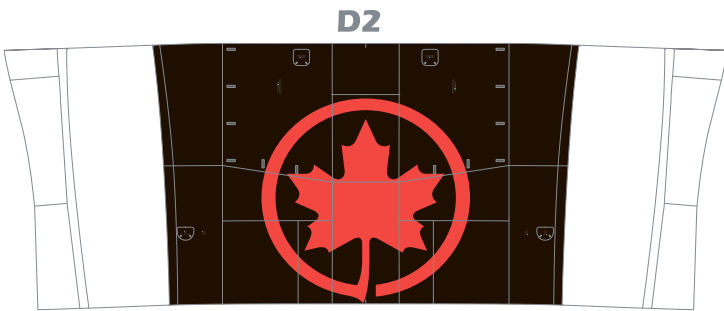
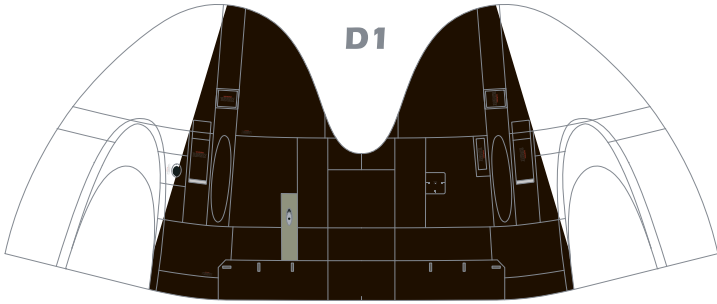



E2L



E2R

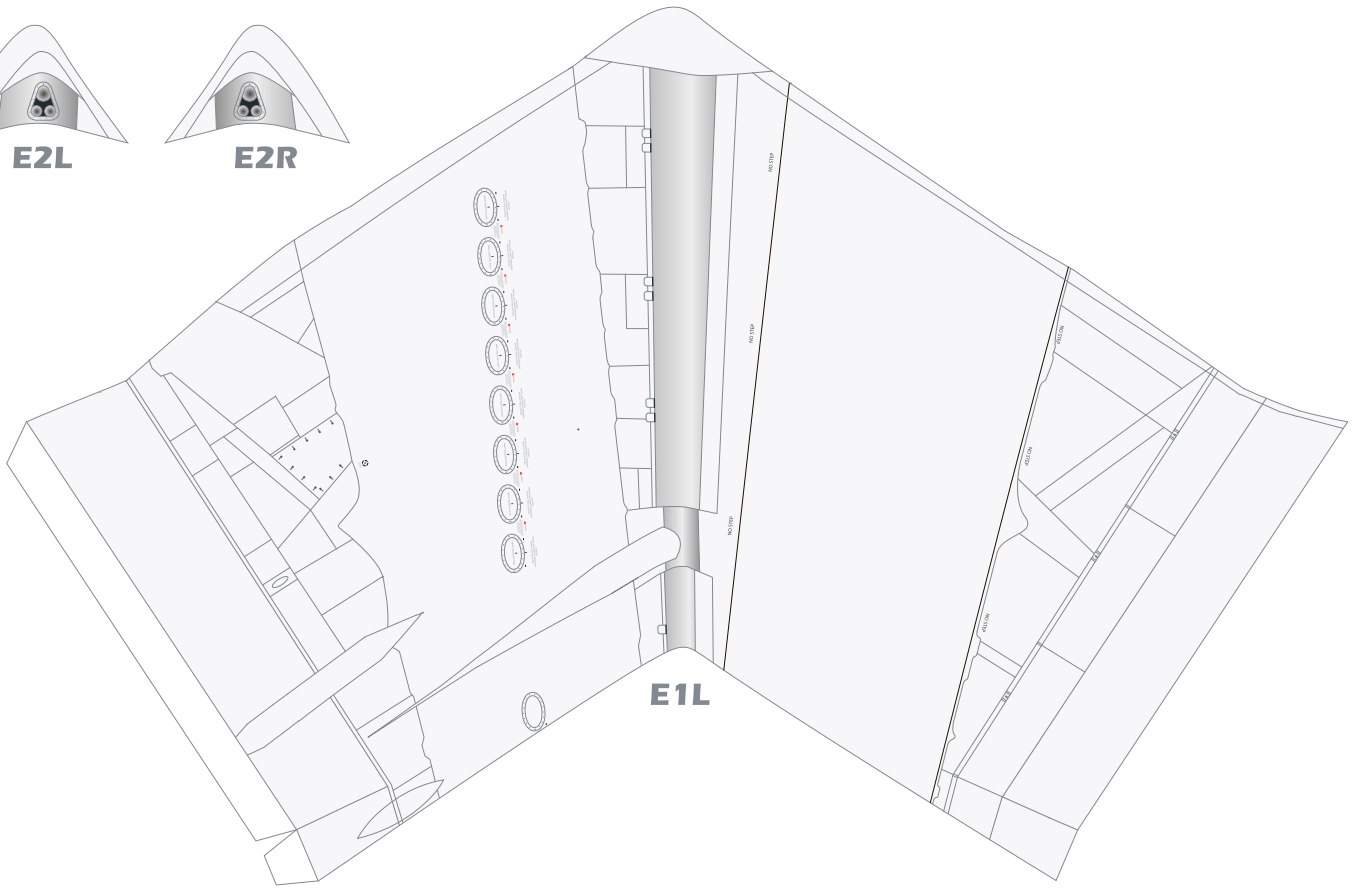

E1L

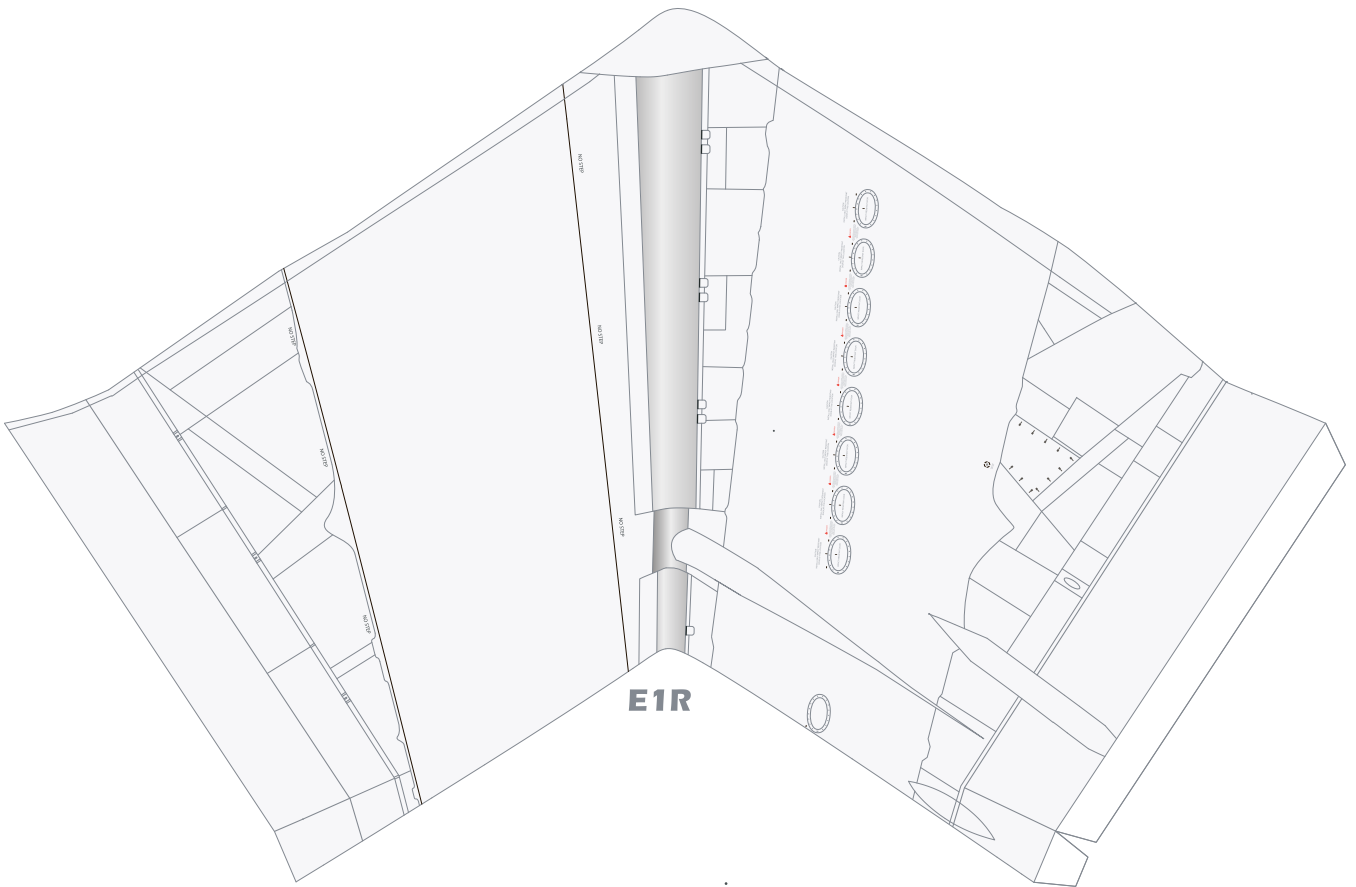

E1R

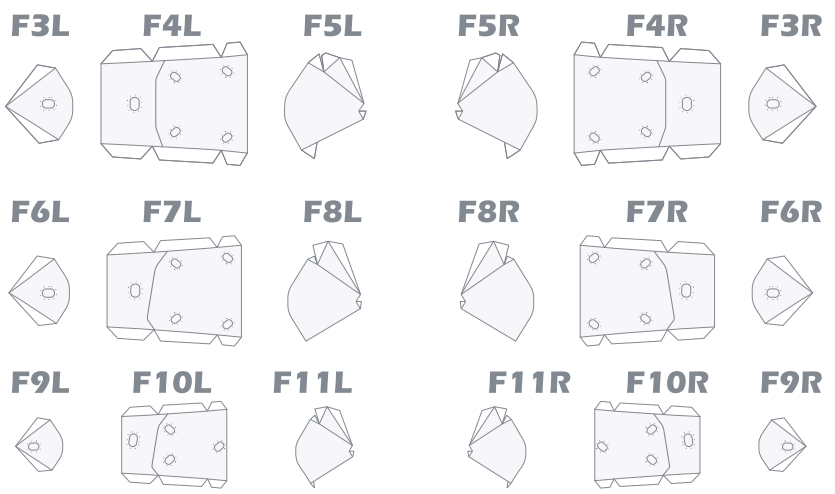
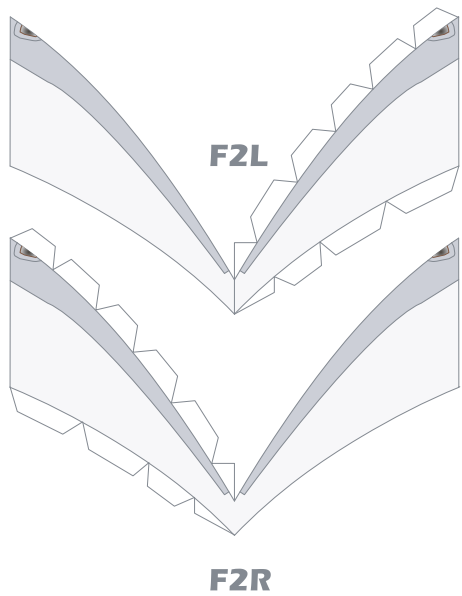
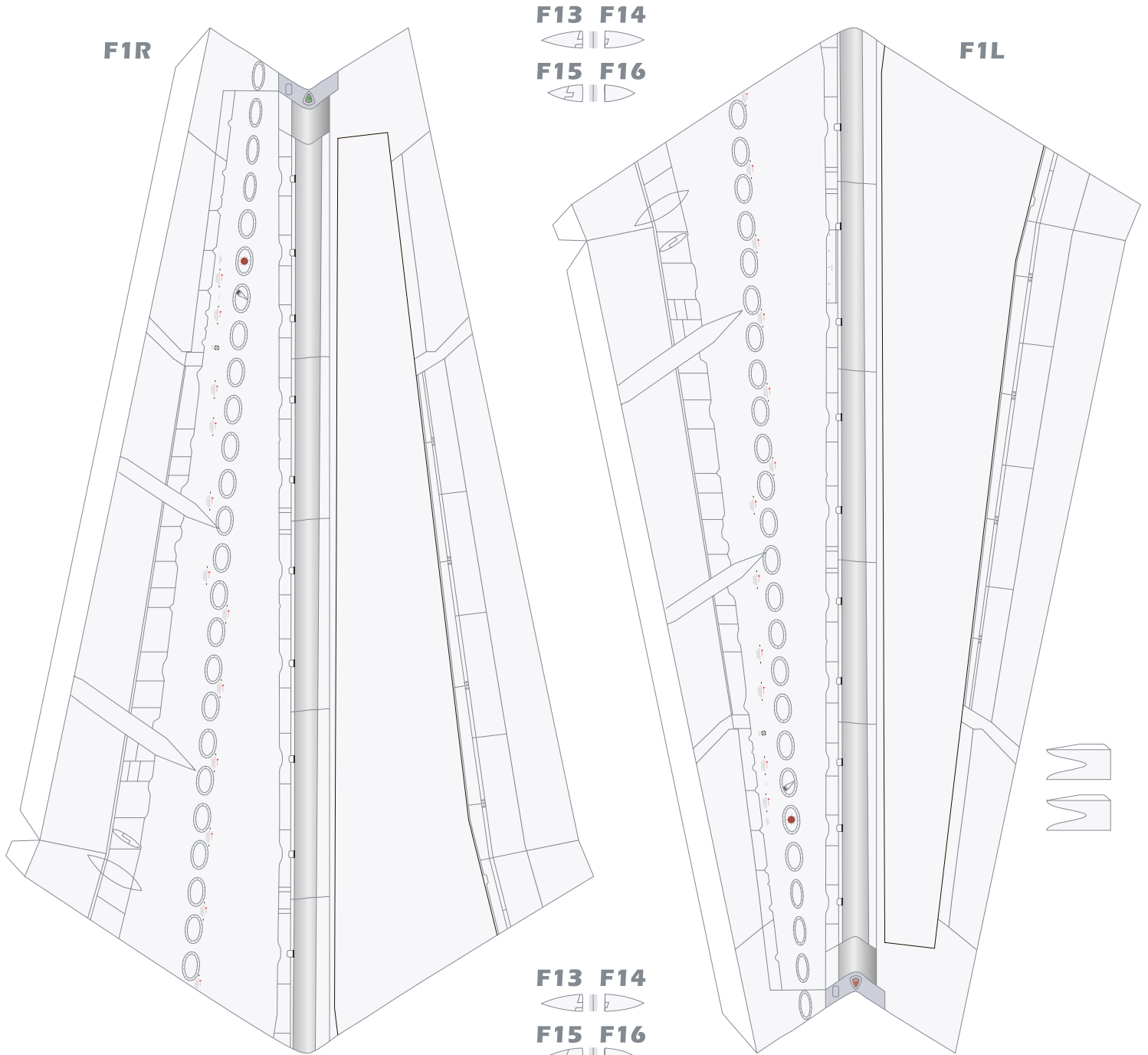

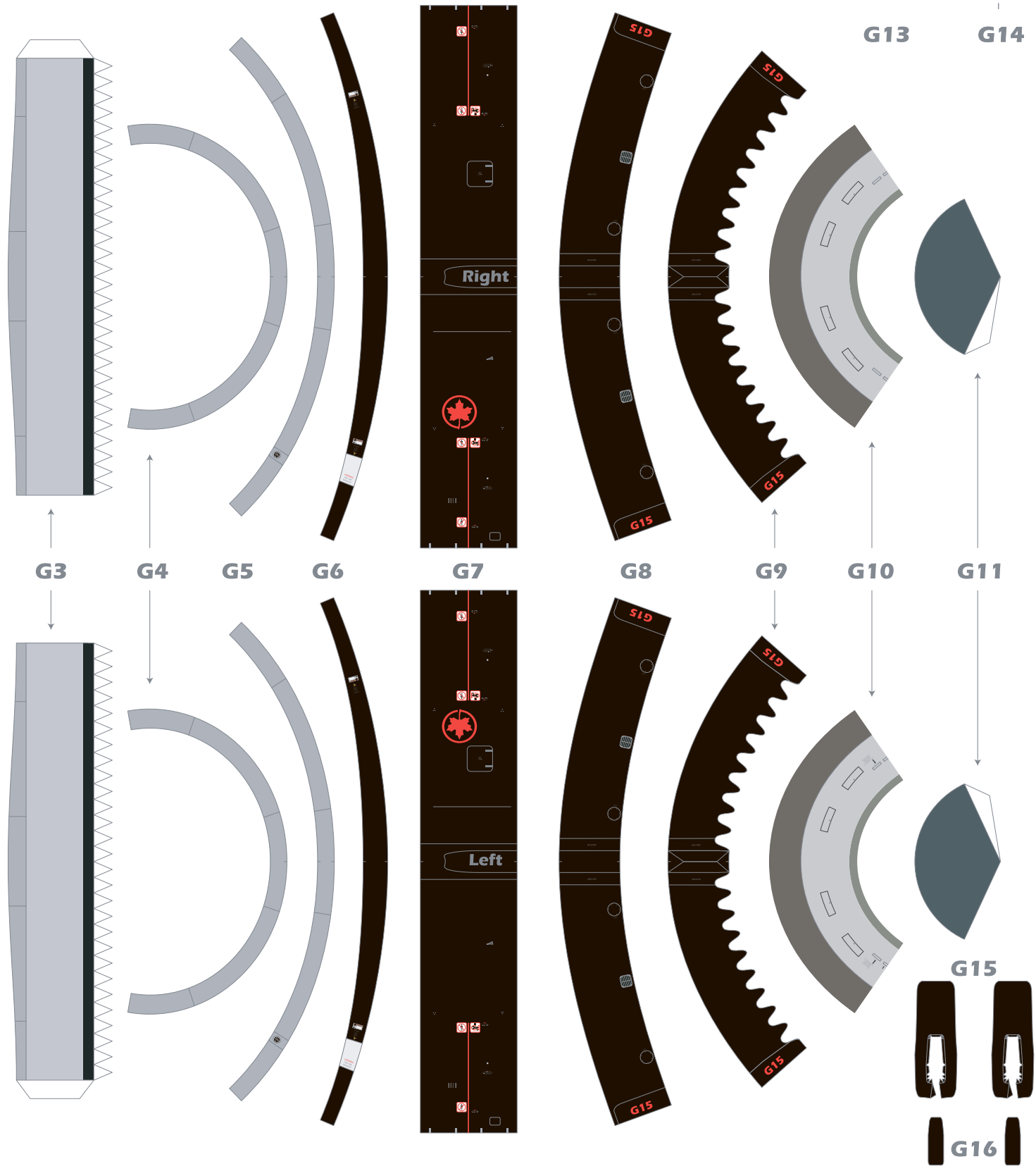

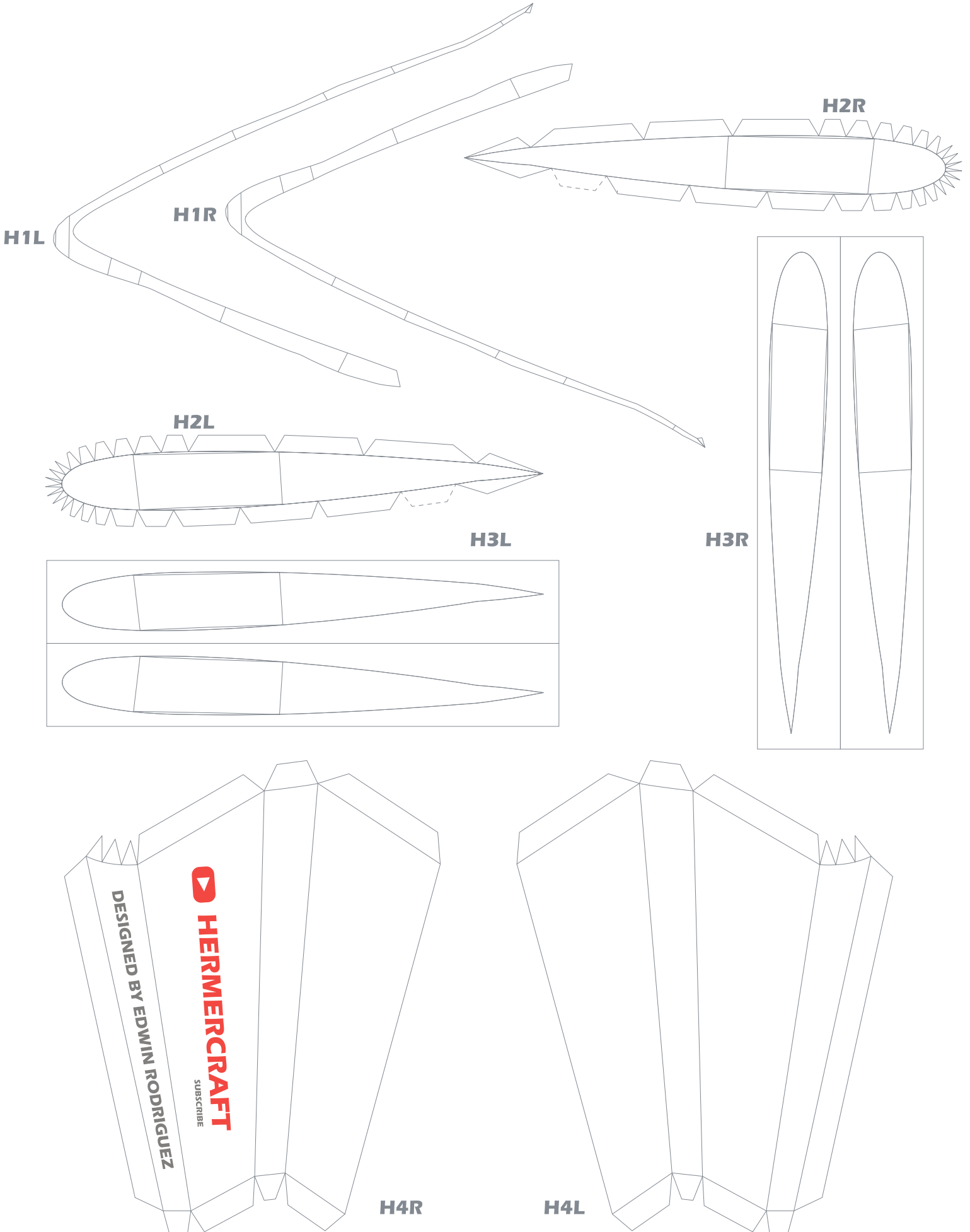

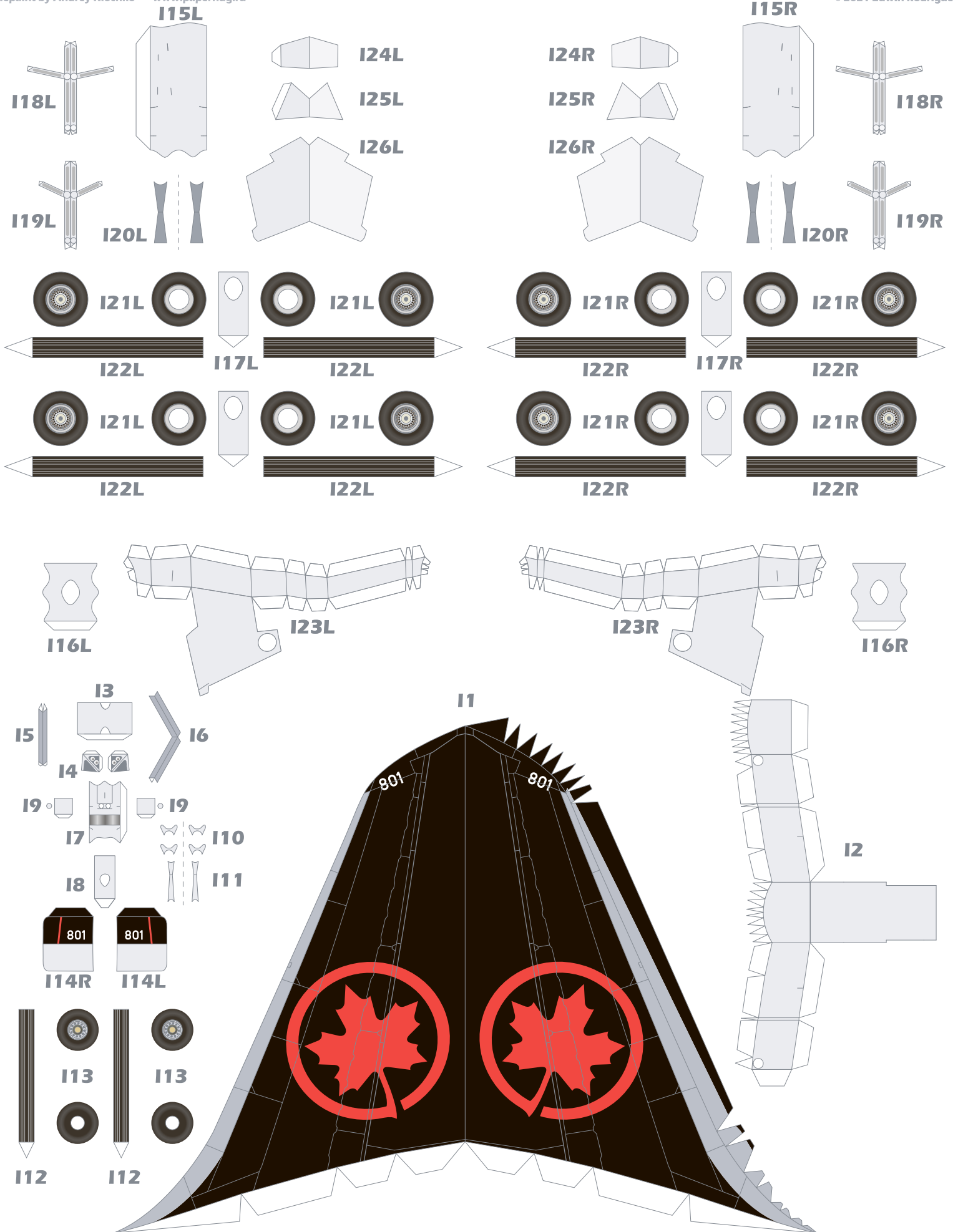

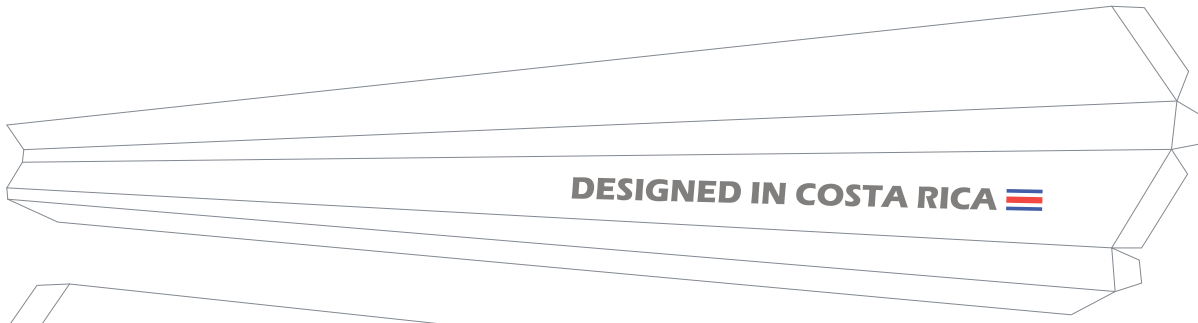

J1L



J1R

