

Blank space for 787-10 variant

Instructions



Scan

A14

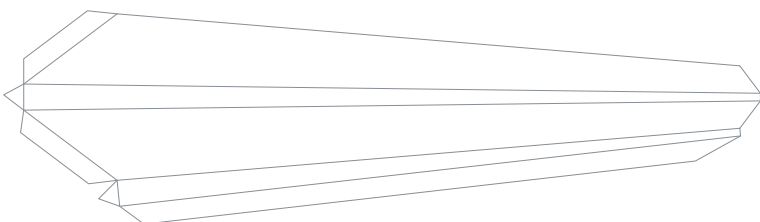

A16L

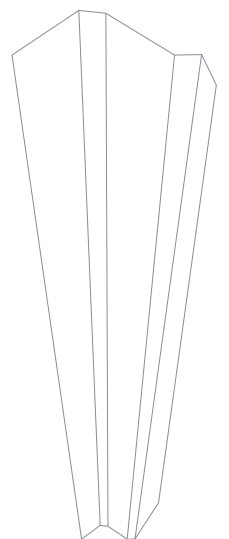

A16R

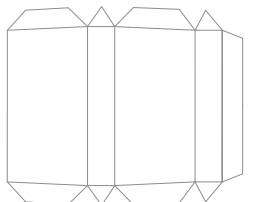

A15

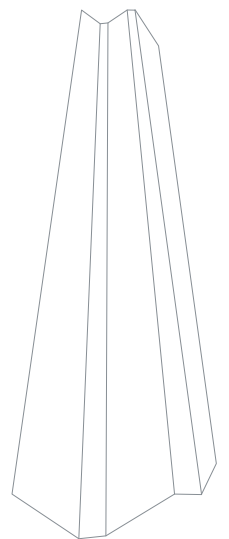

A17R

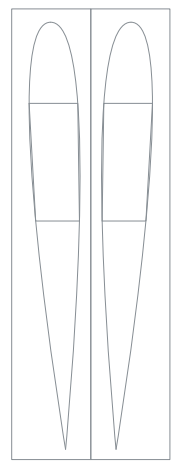

A20



A21



A22



A23



A24L



A24R

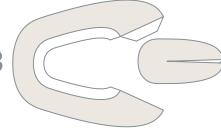

A18

A19

A17L

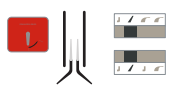
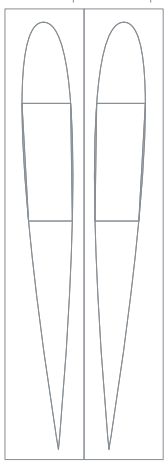

A6L



A6R

A5

A4

A3

A2

A1

A12

A11

A10

A9

A8

A7

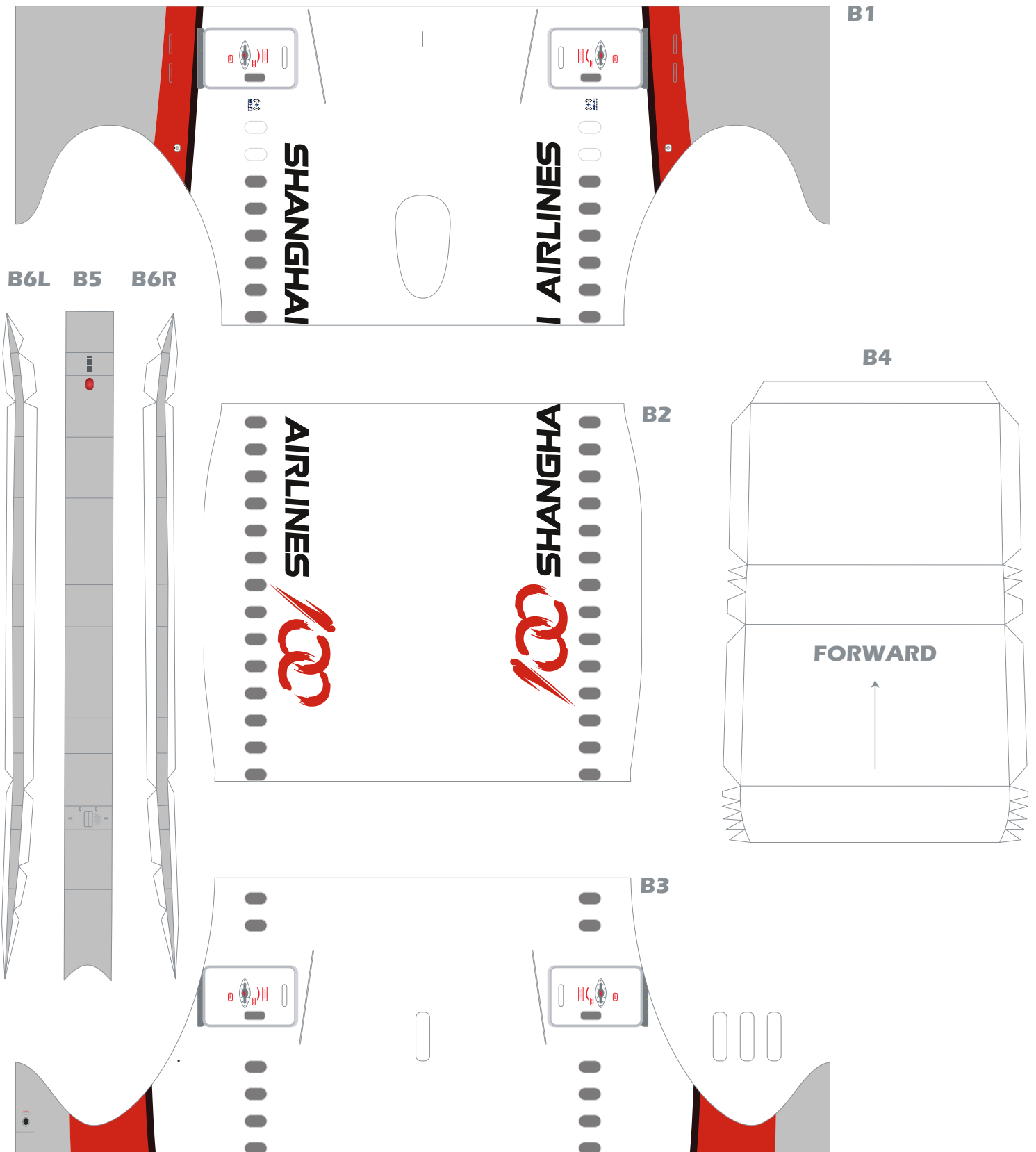

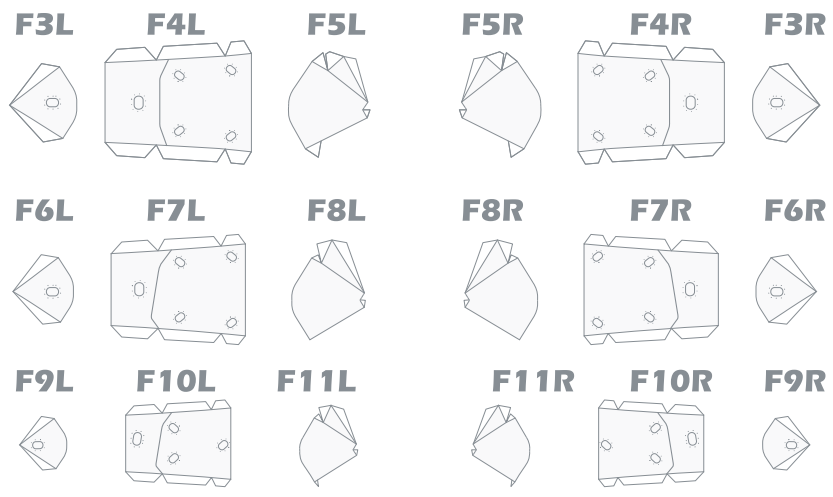
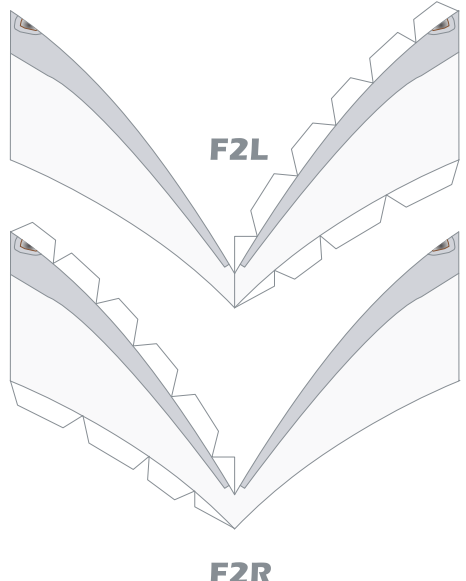
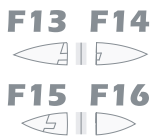
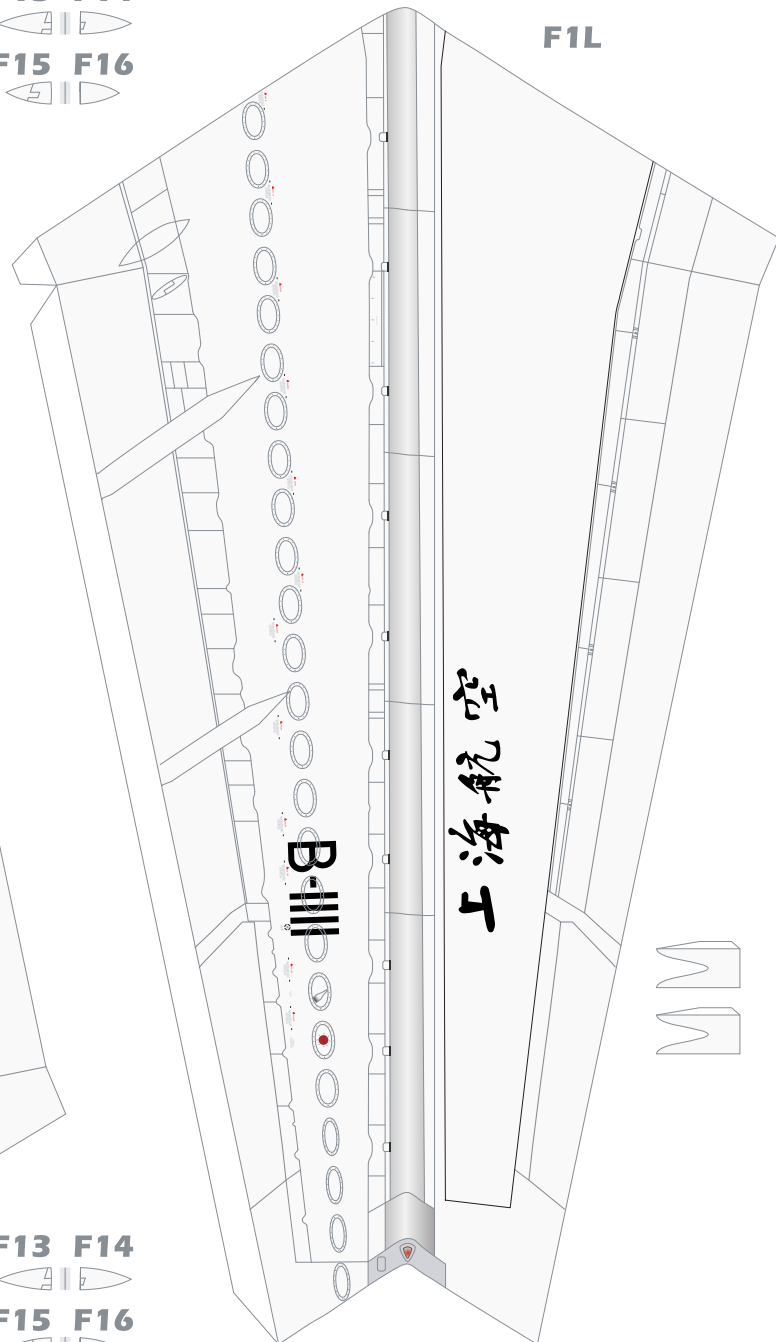
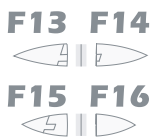
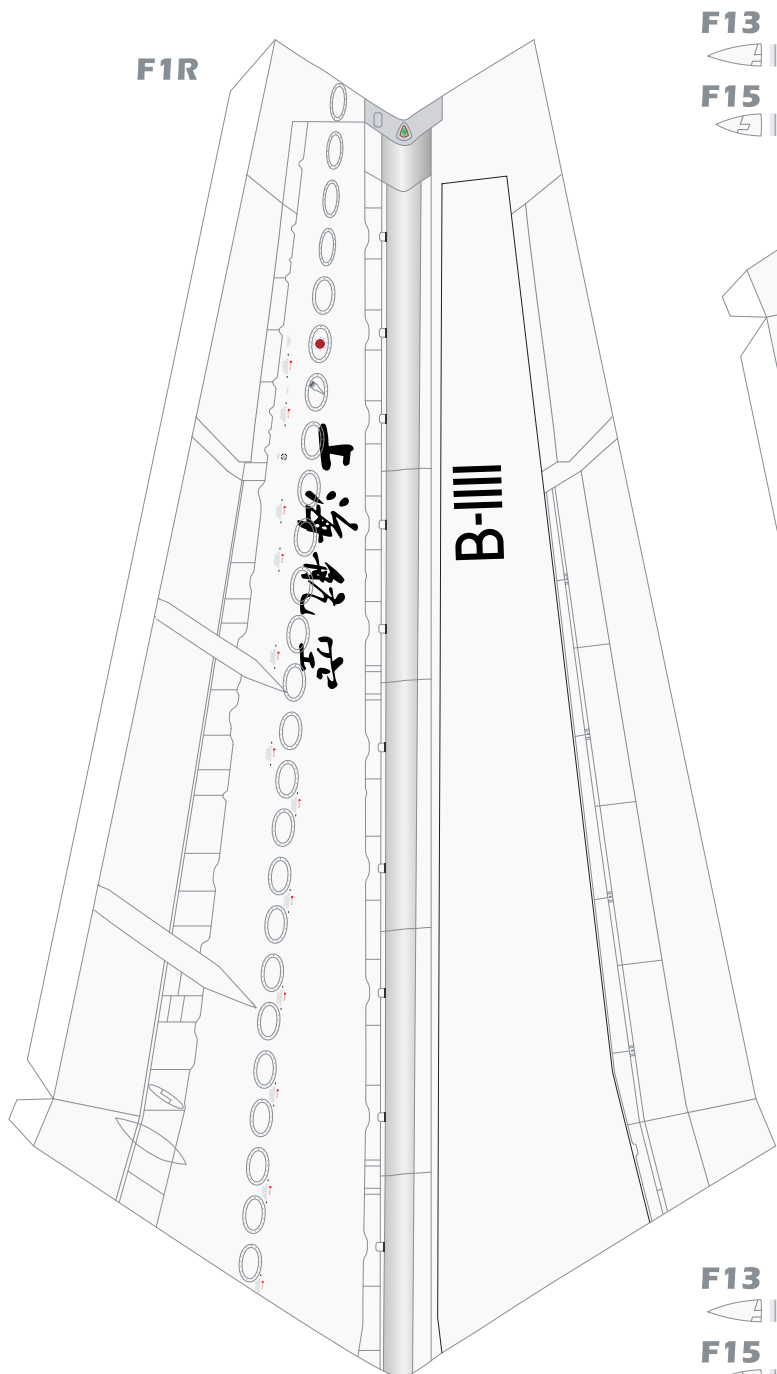

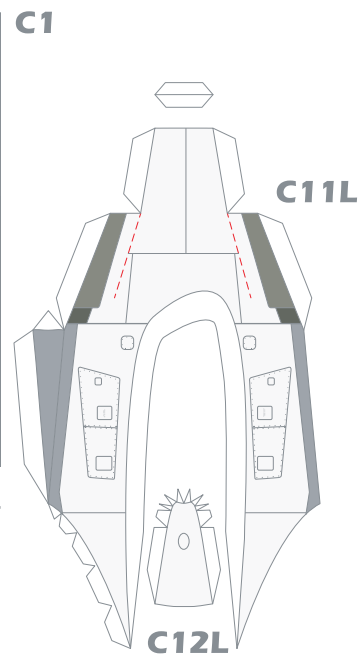
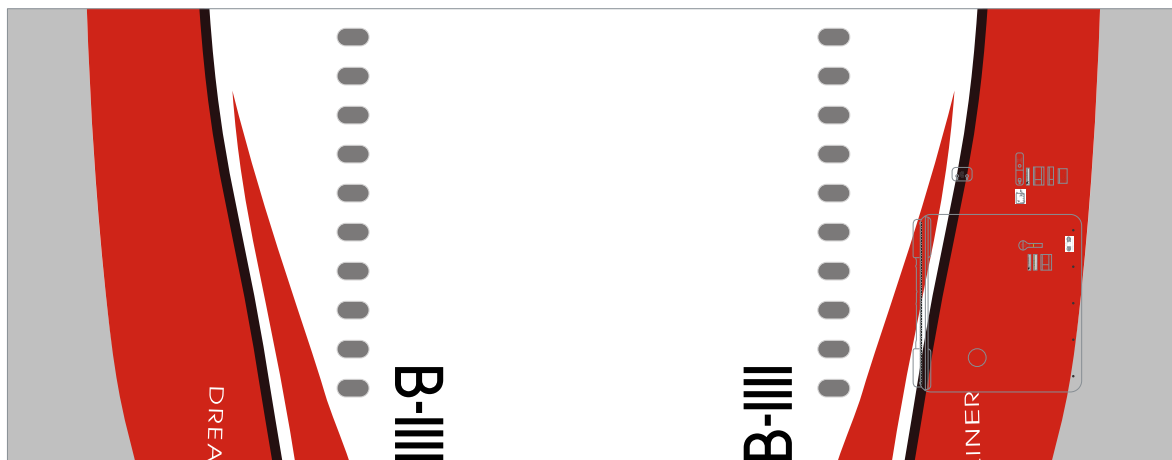

Blank space for 787-10 variant

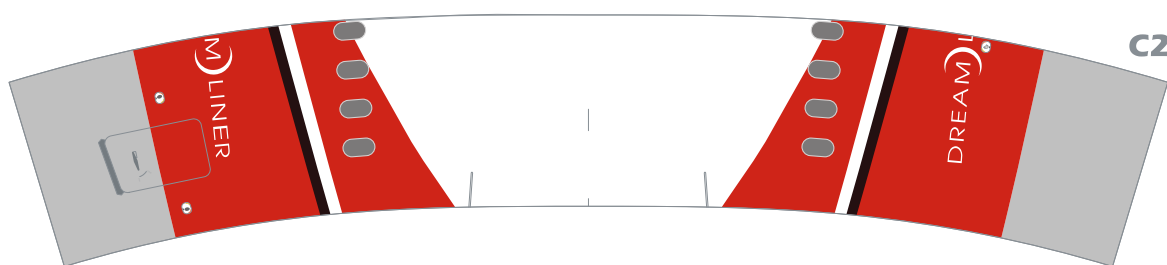

C2

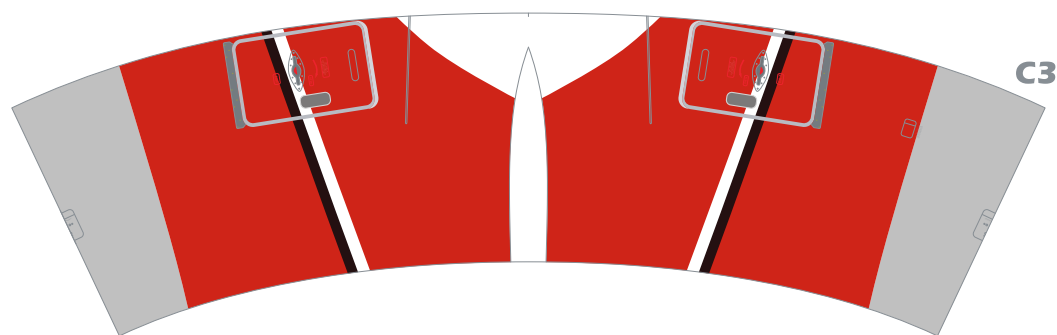
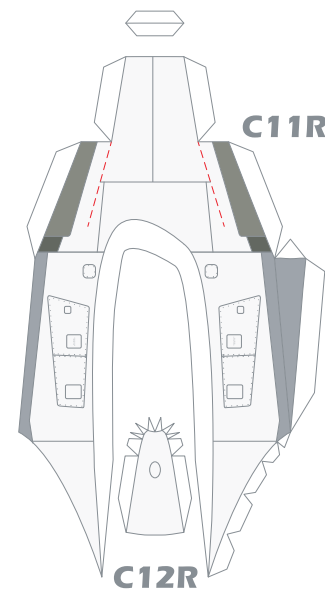

C3

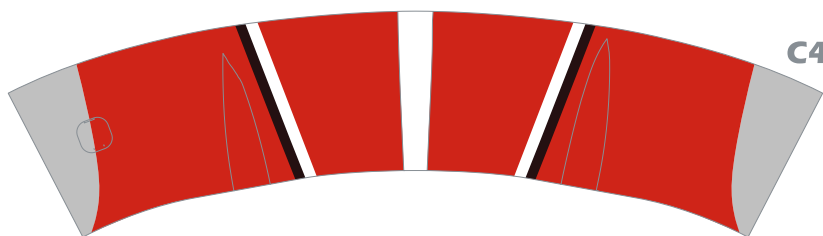

C4



C5



C10L



C10R



C6



C8



C9

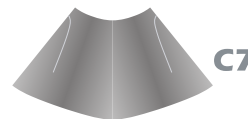

C7

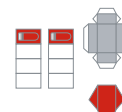

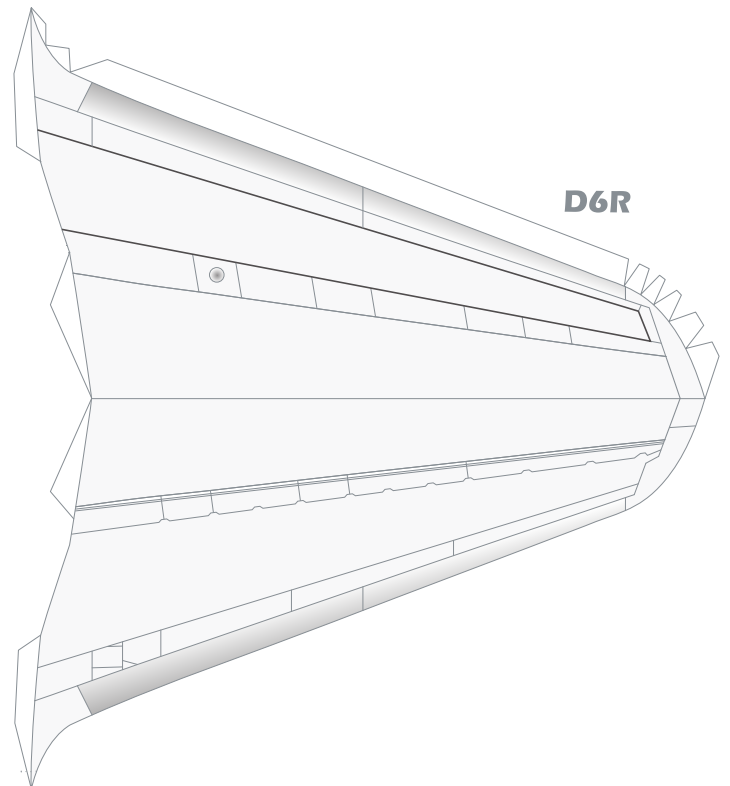
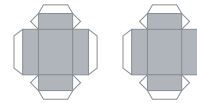
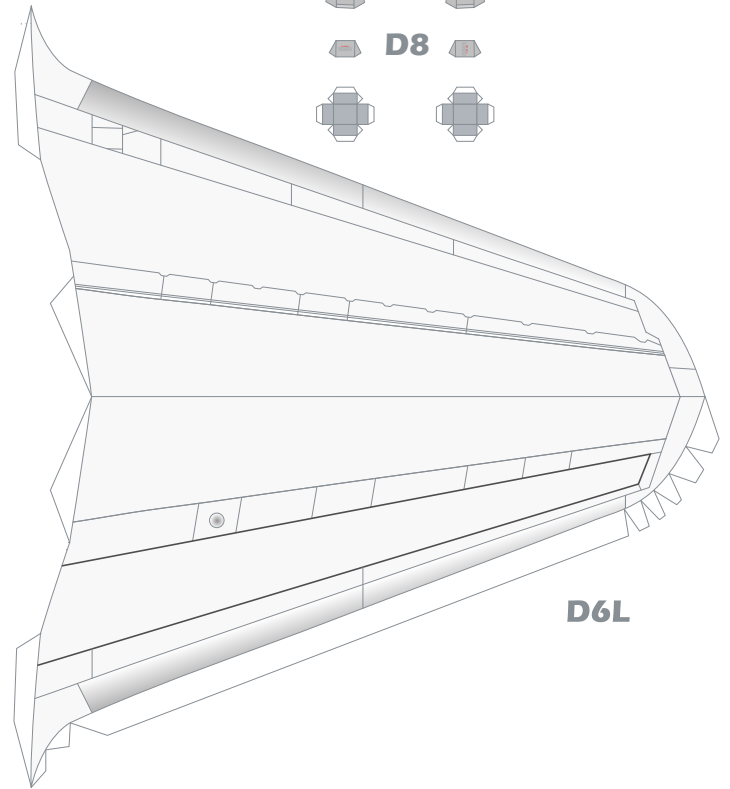
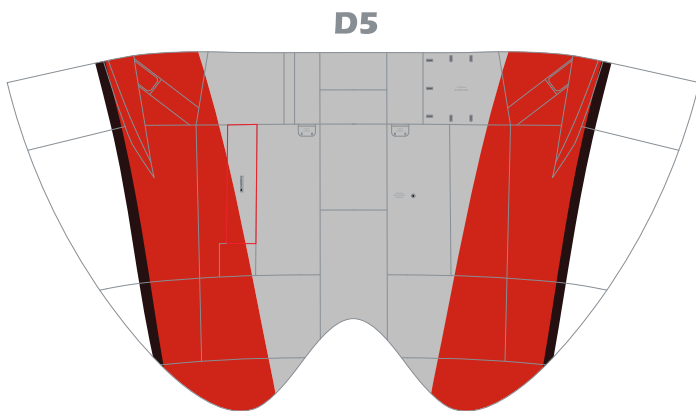
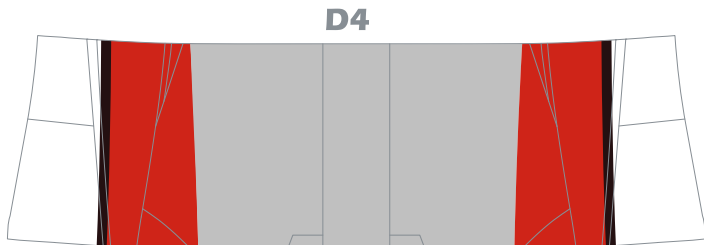
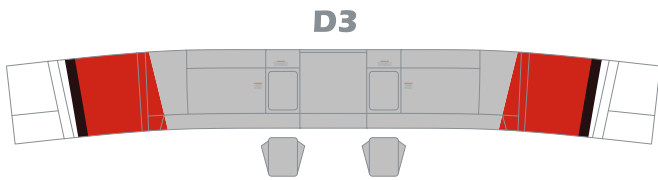
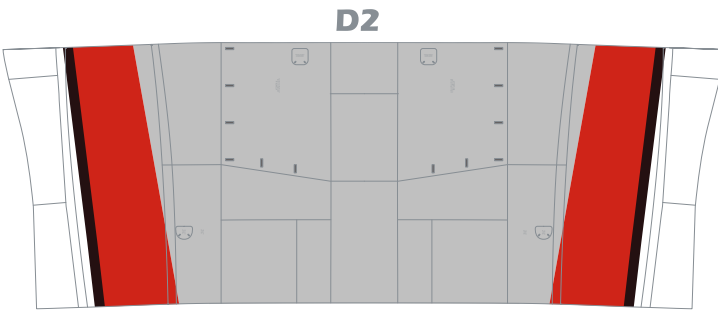
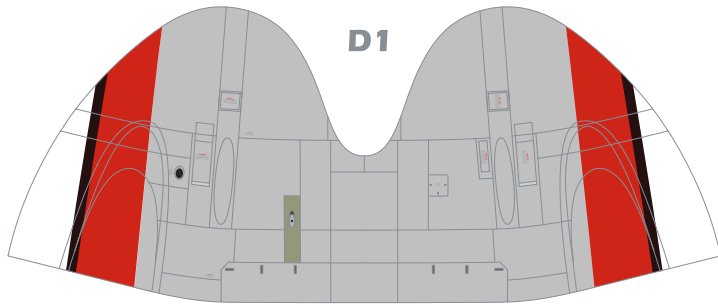

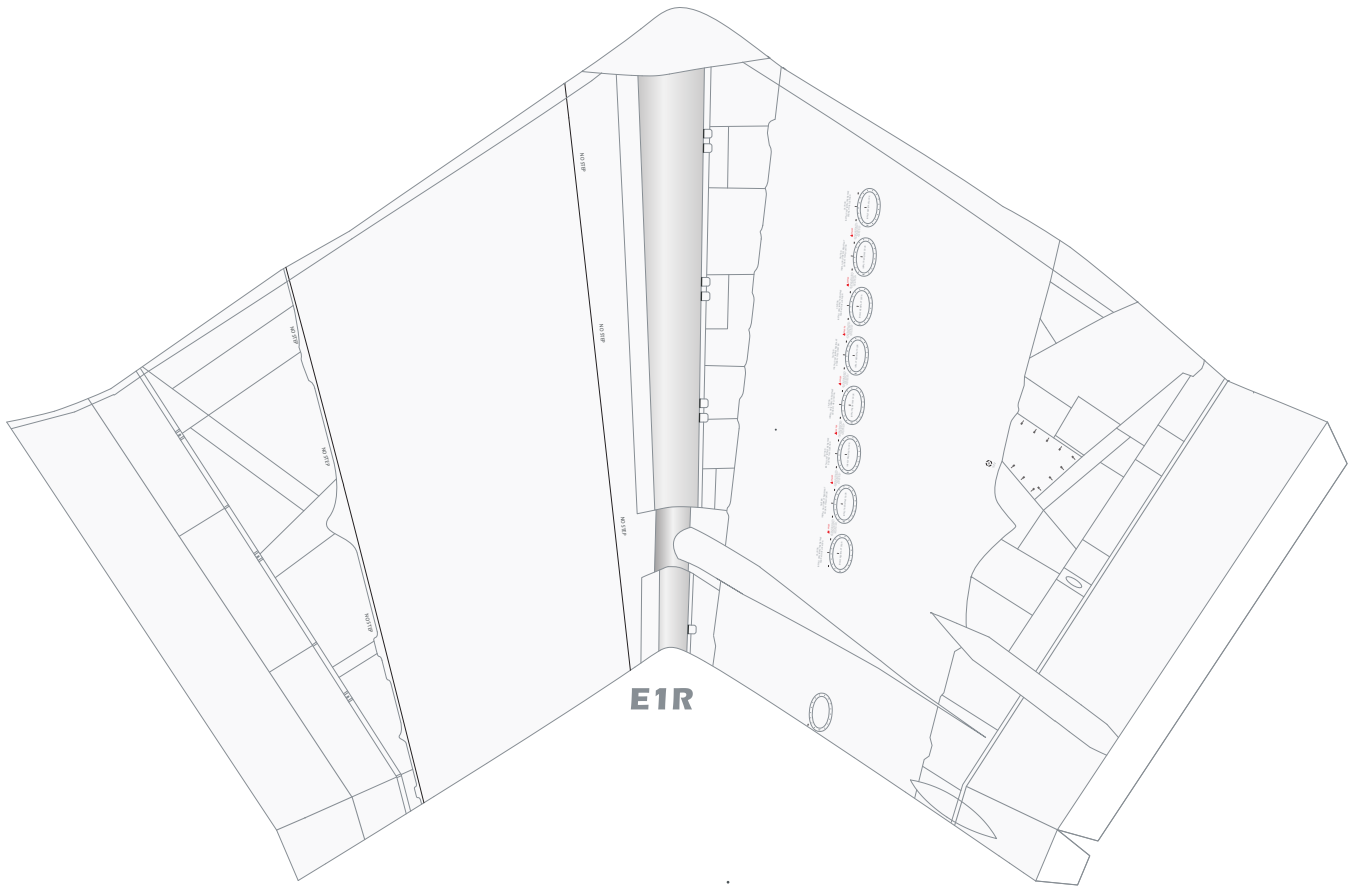
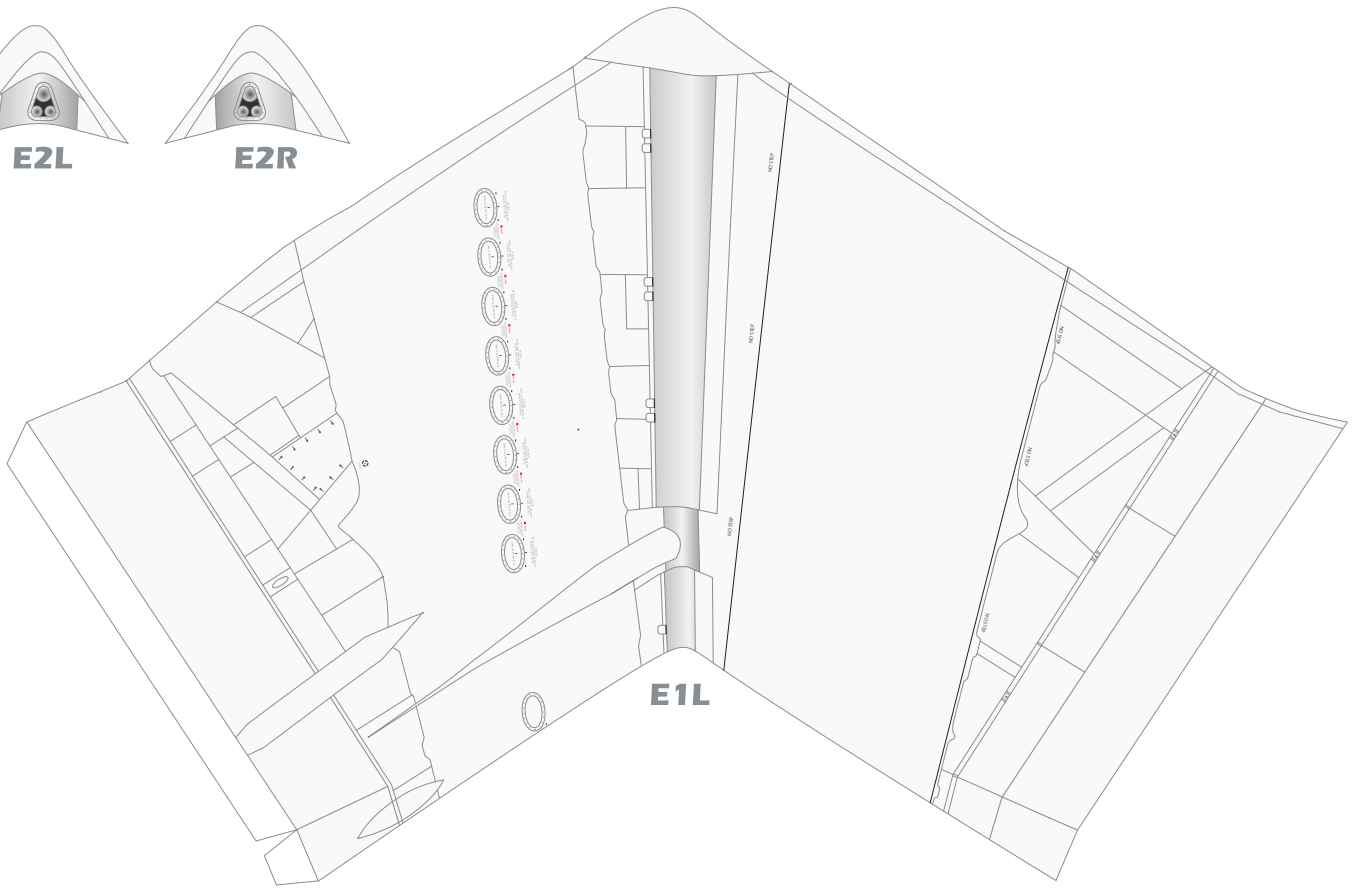

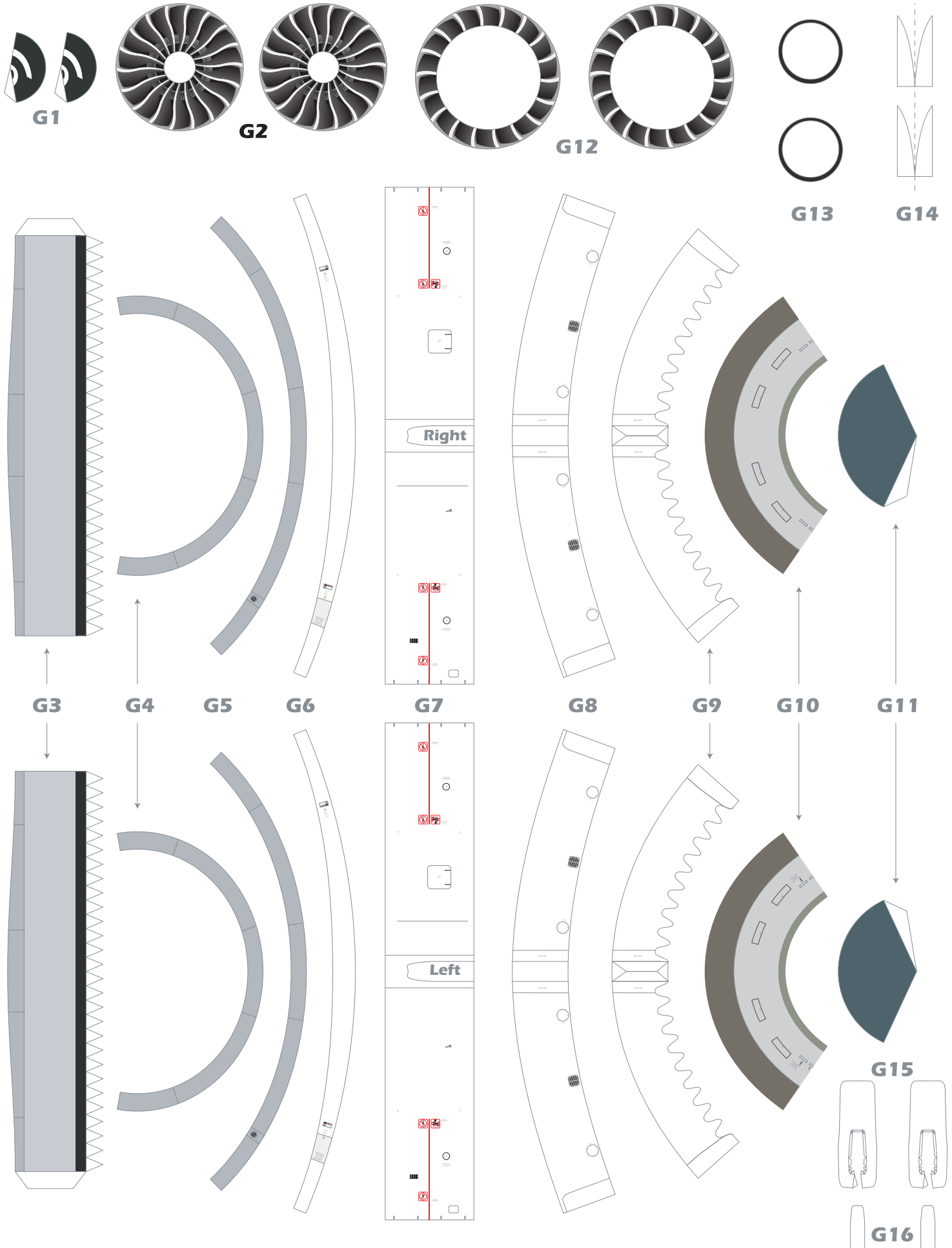

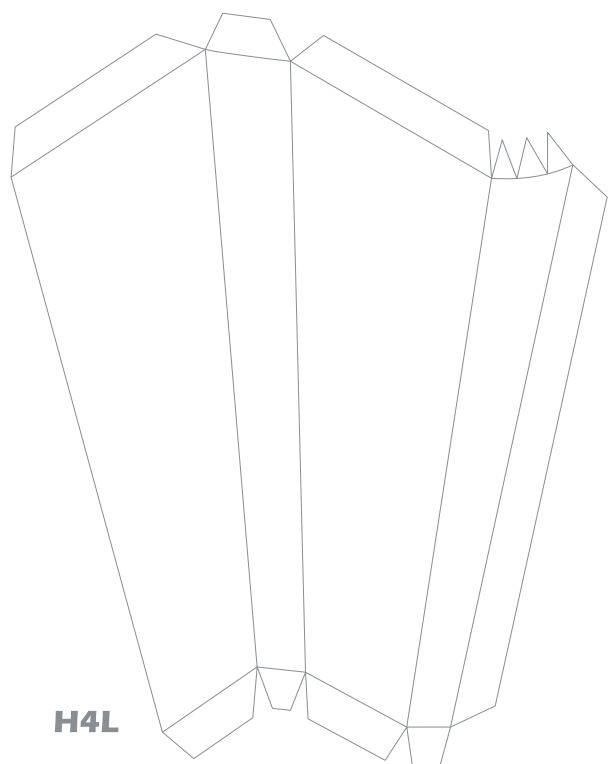
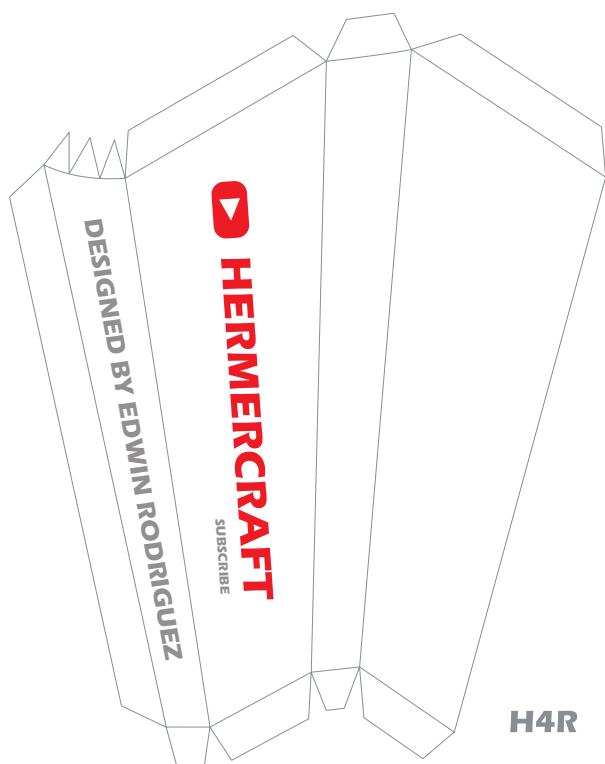
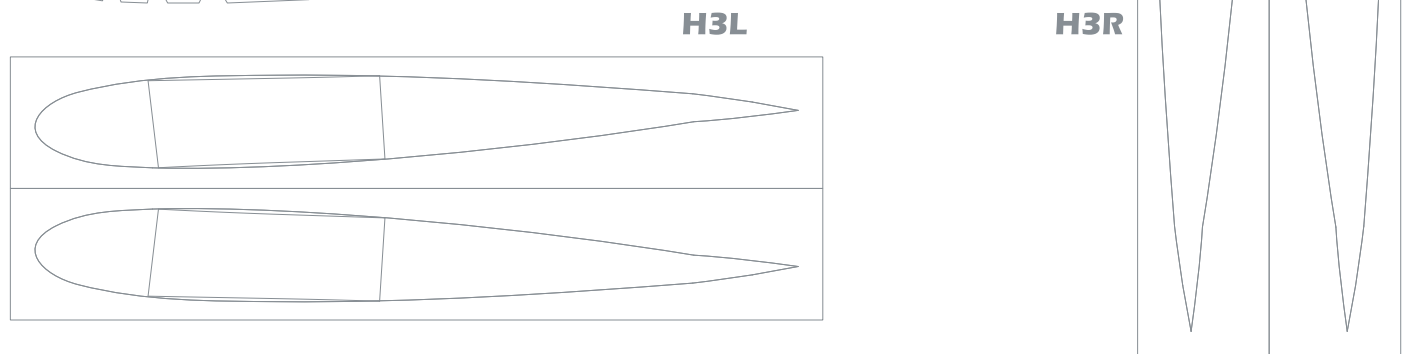
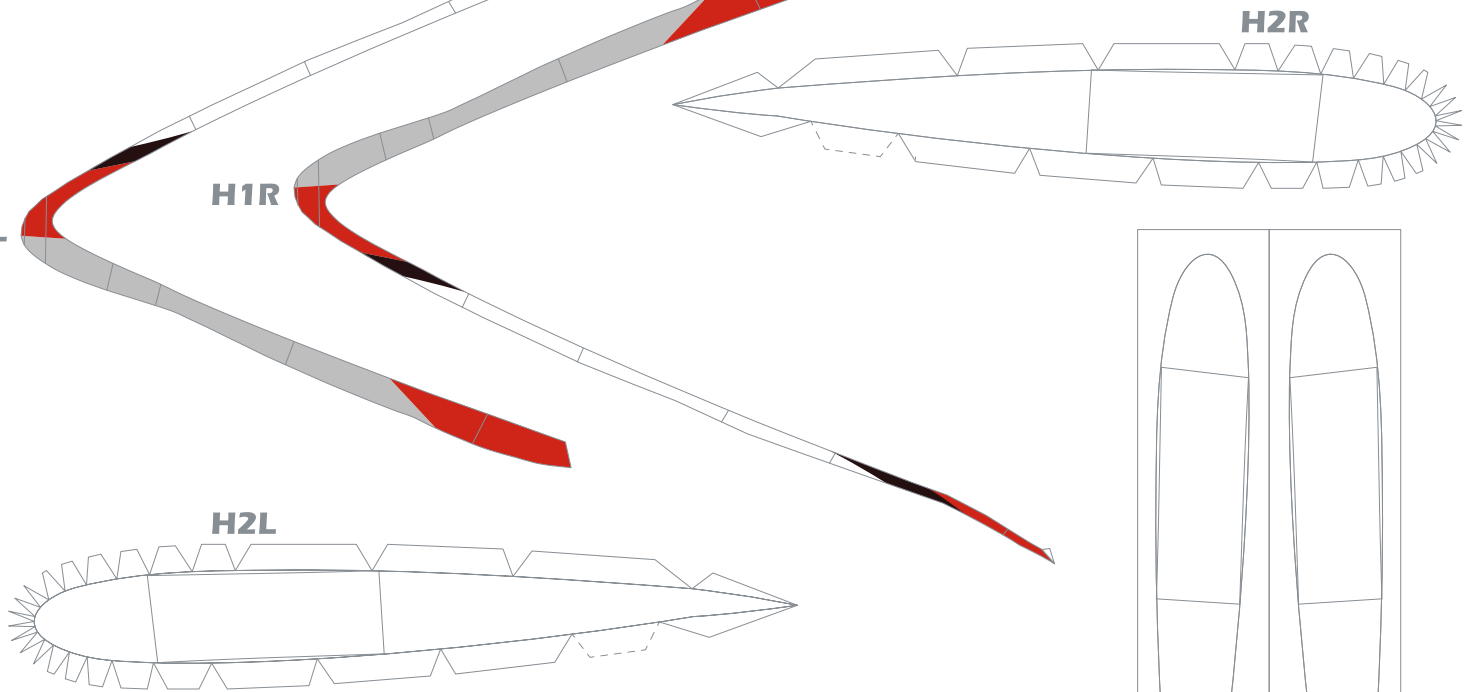
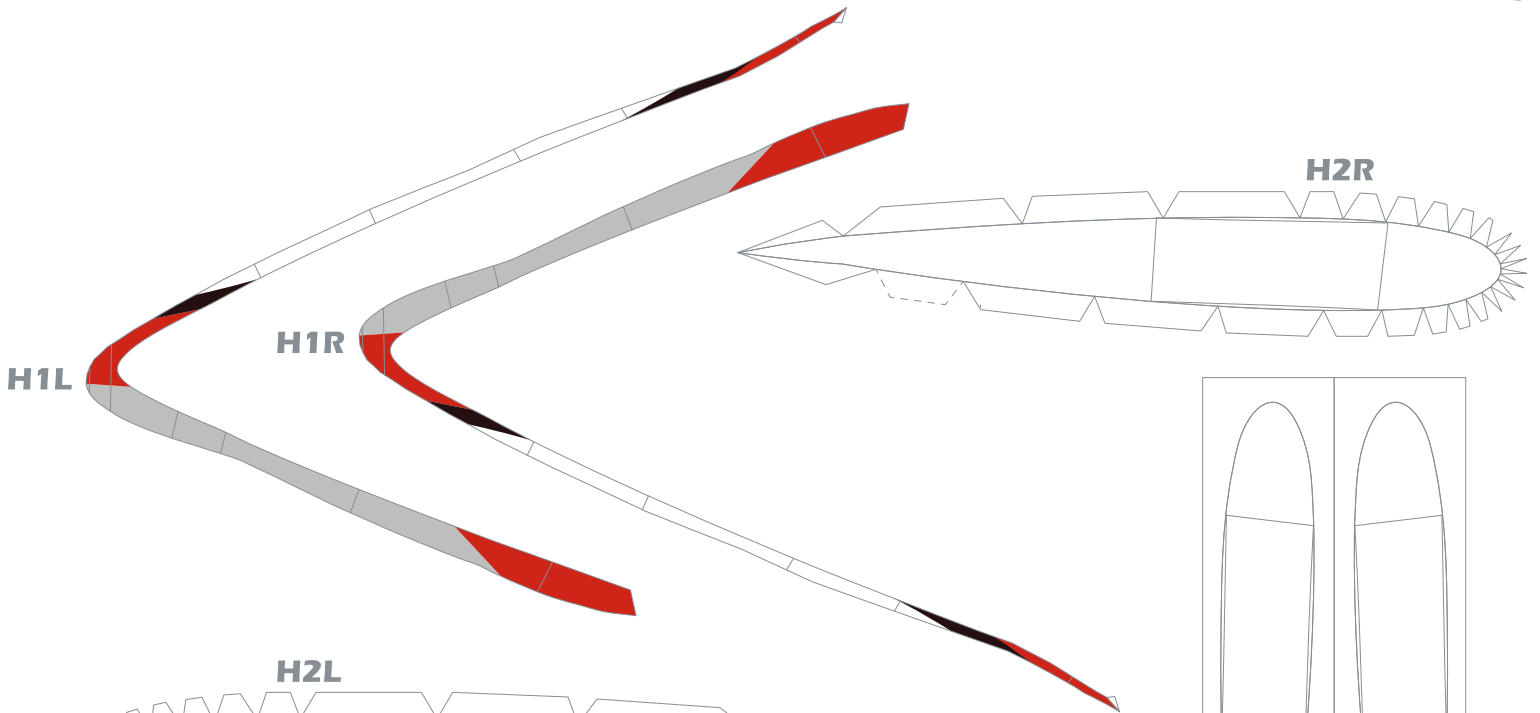

H4R

H4L



Repainted by: Michael Tsai

© 2021 Edwin Rodriguez

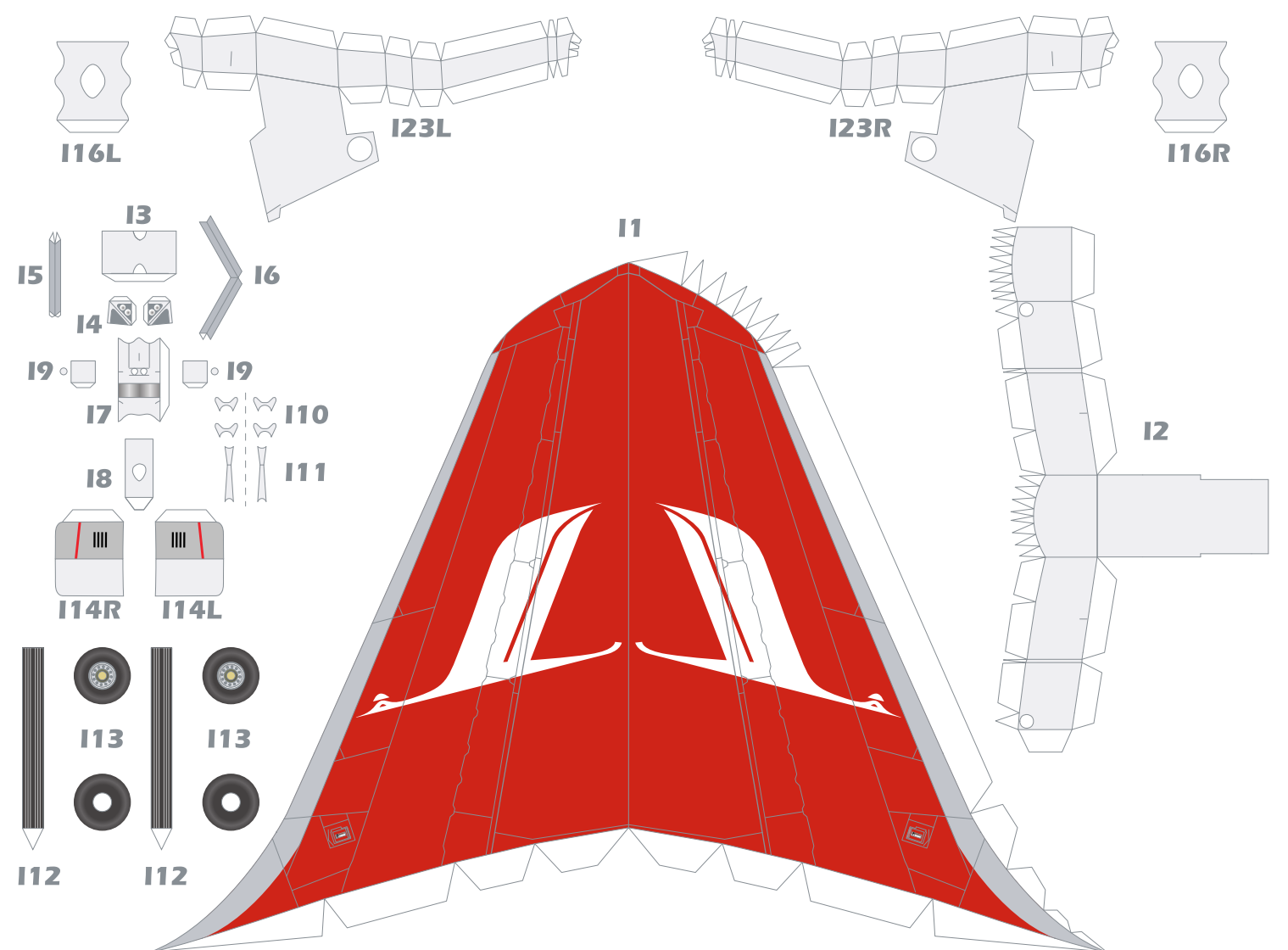
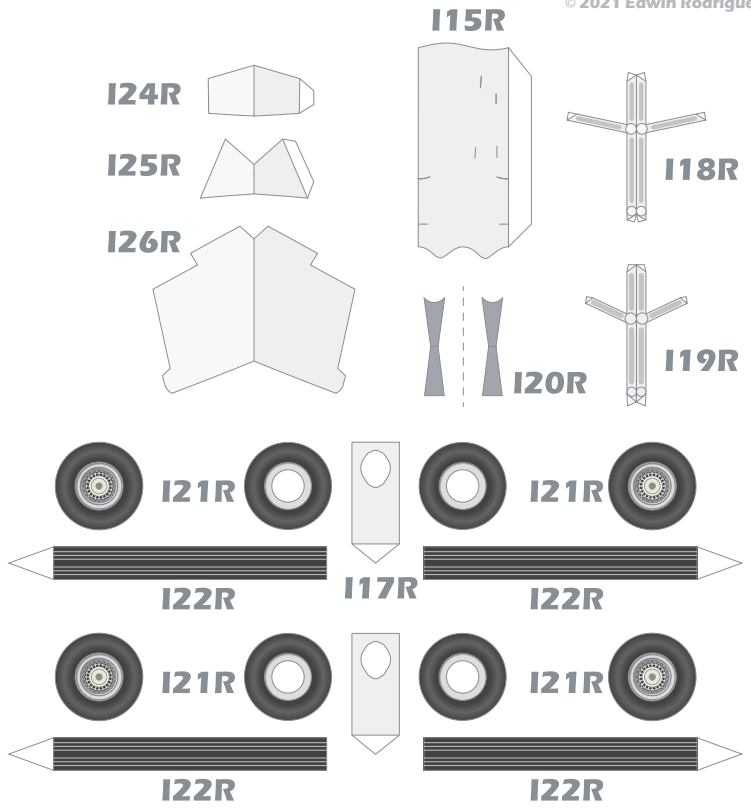
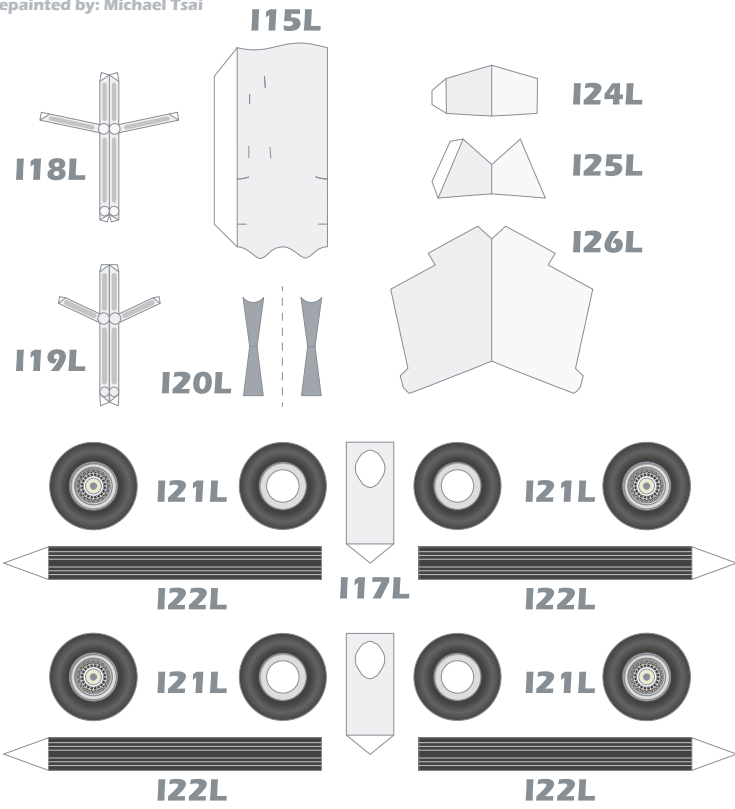

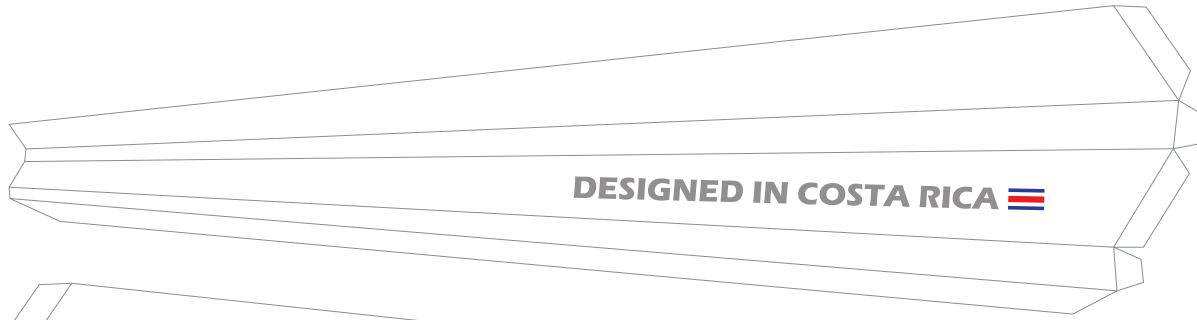

J1L



J1R

