

Blank space for 787-10 variant

Instructions



Scan

A14

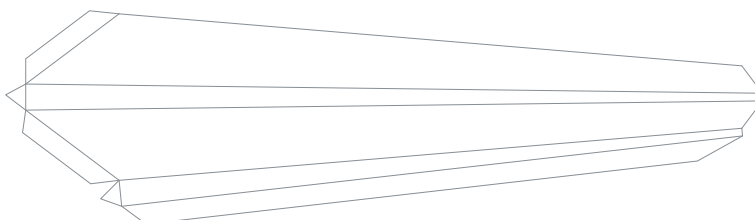

A16L

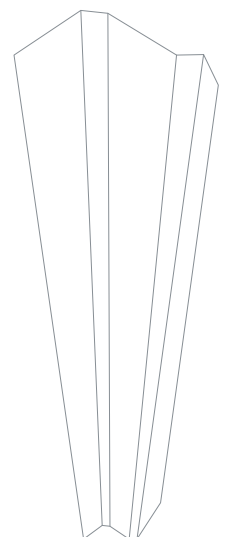

A16R

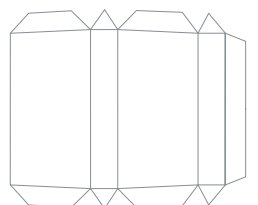

A15

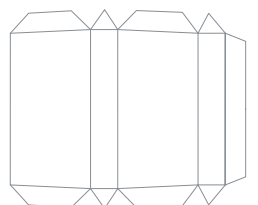

A17R

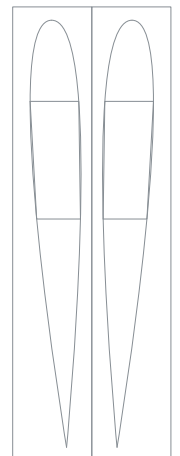

A20



A21



A22



A23



A24L



A24R



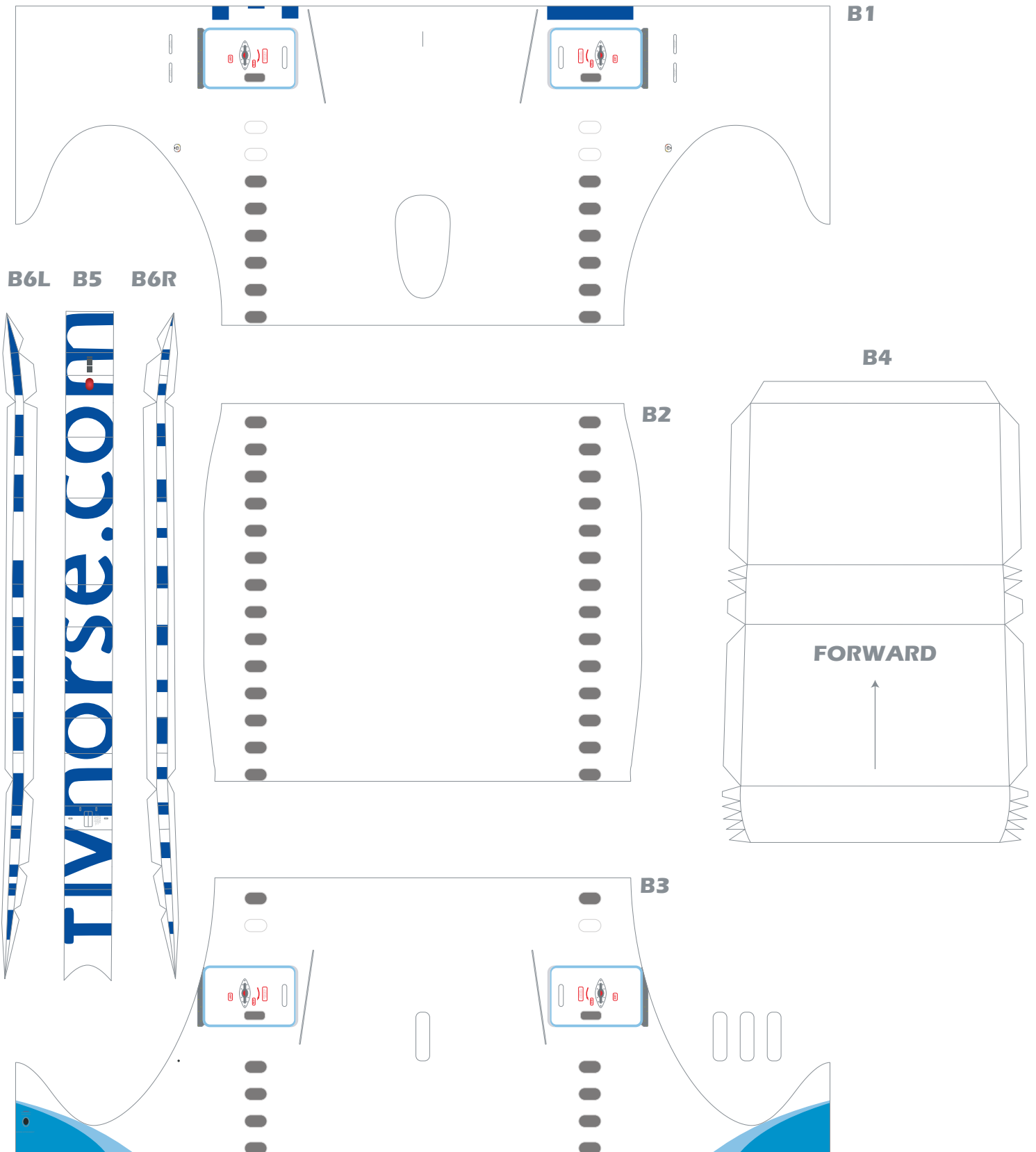

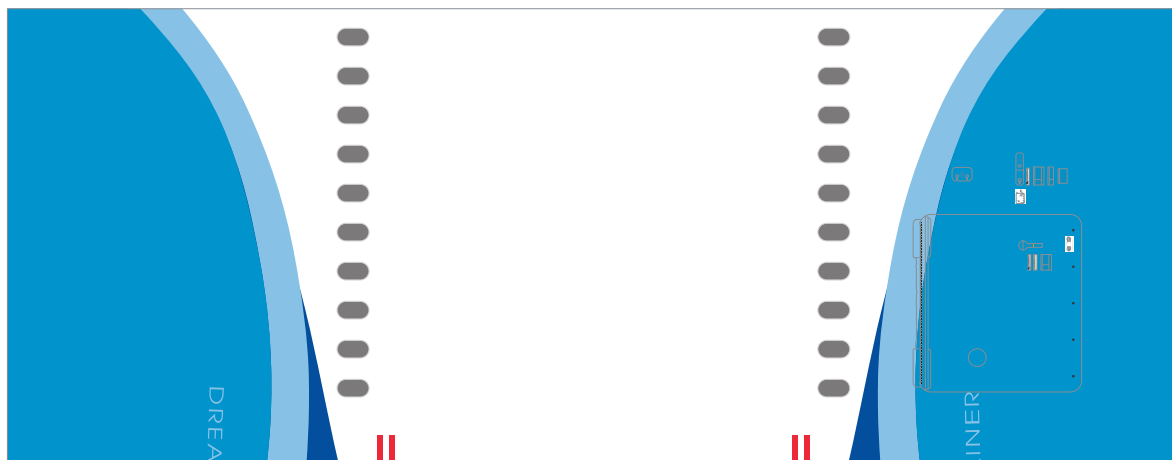

Blank space for 787-10 variant

C1

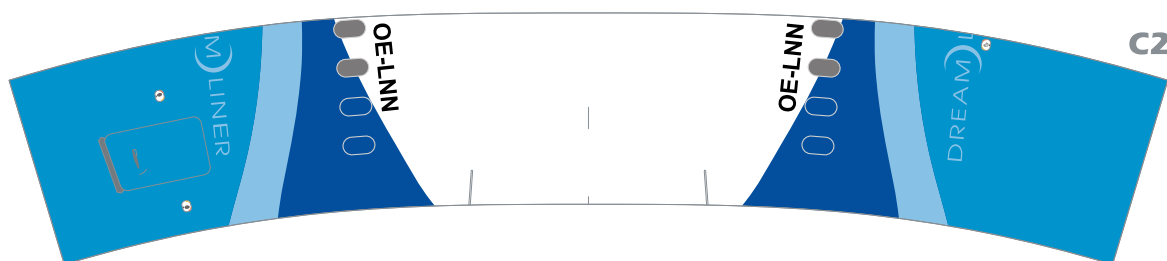
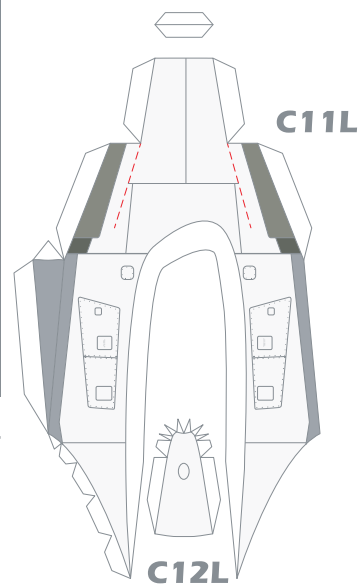

C2

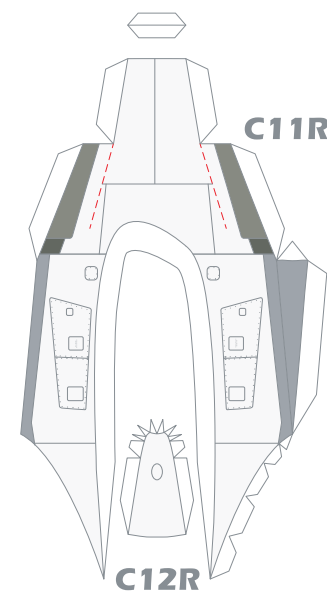

C3

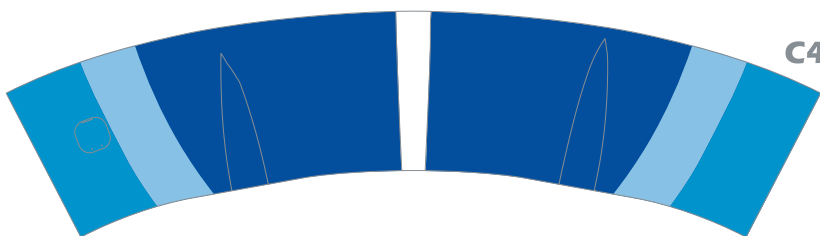

C4



C8

C9

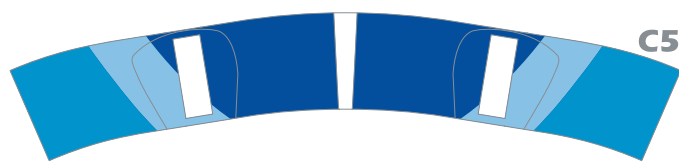

C5

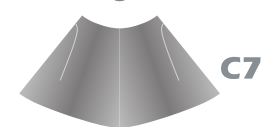

C7



C10L



C10R

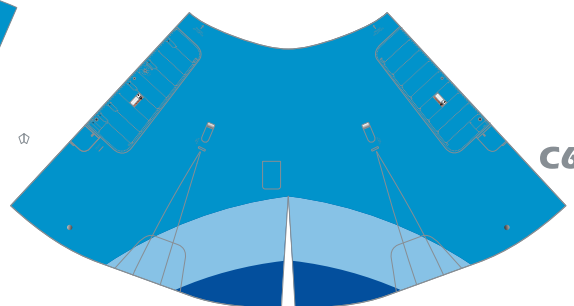

C6

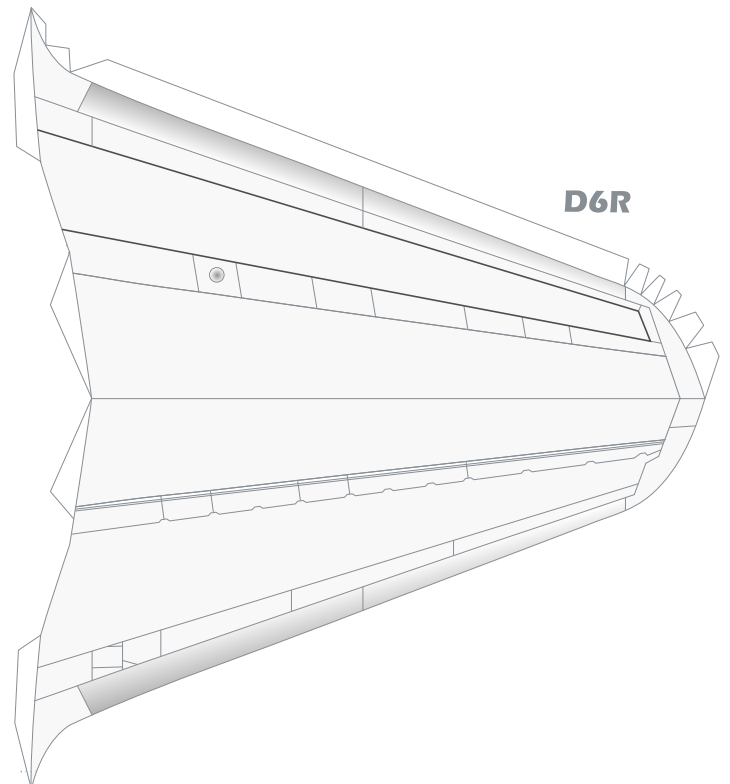
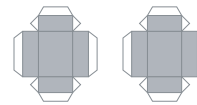
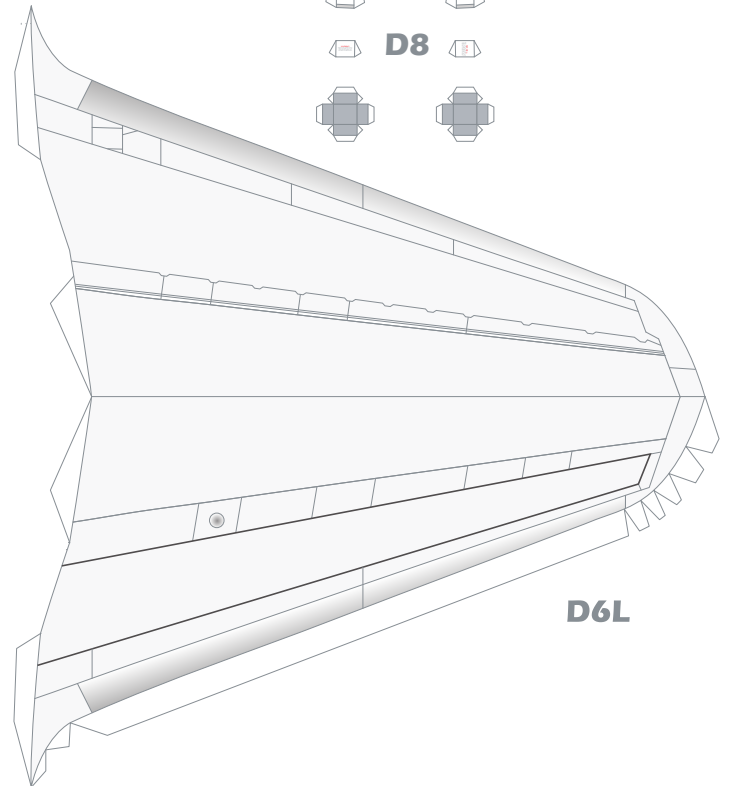
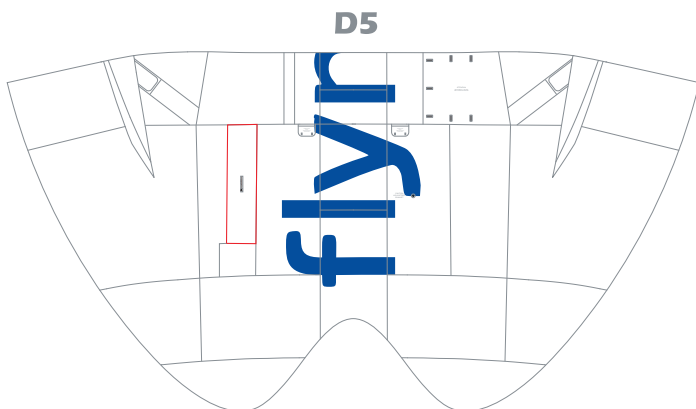
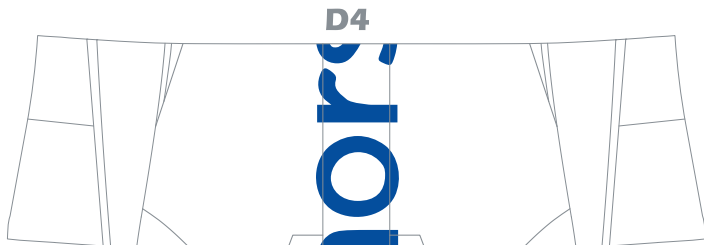
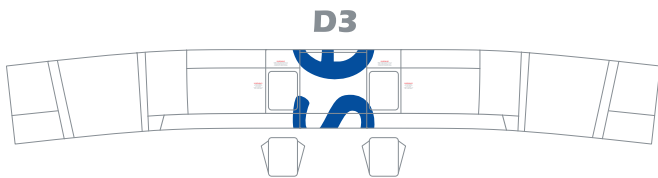
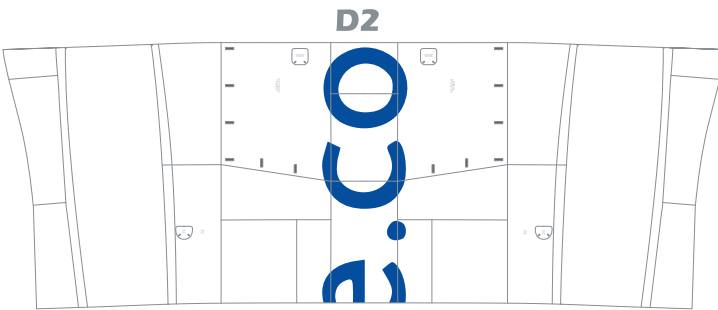
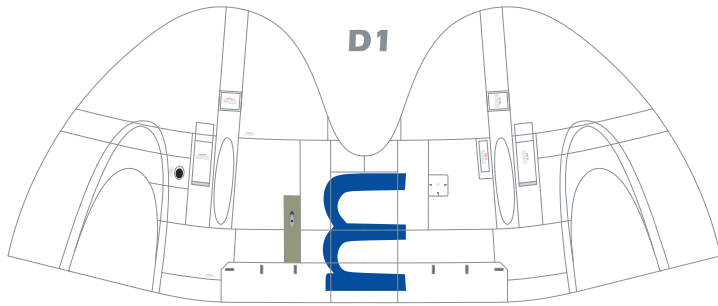

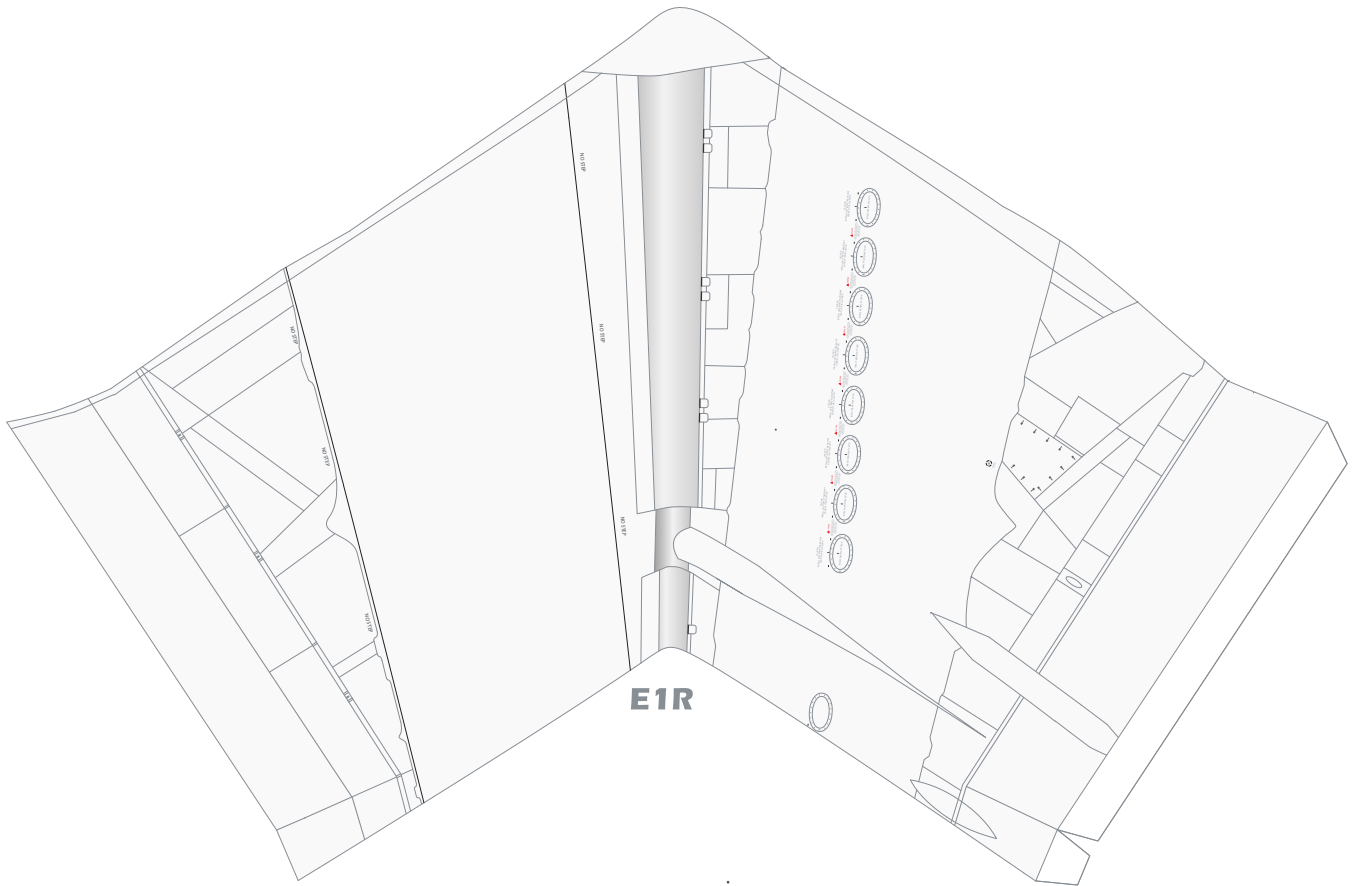
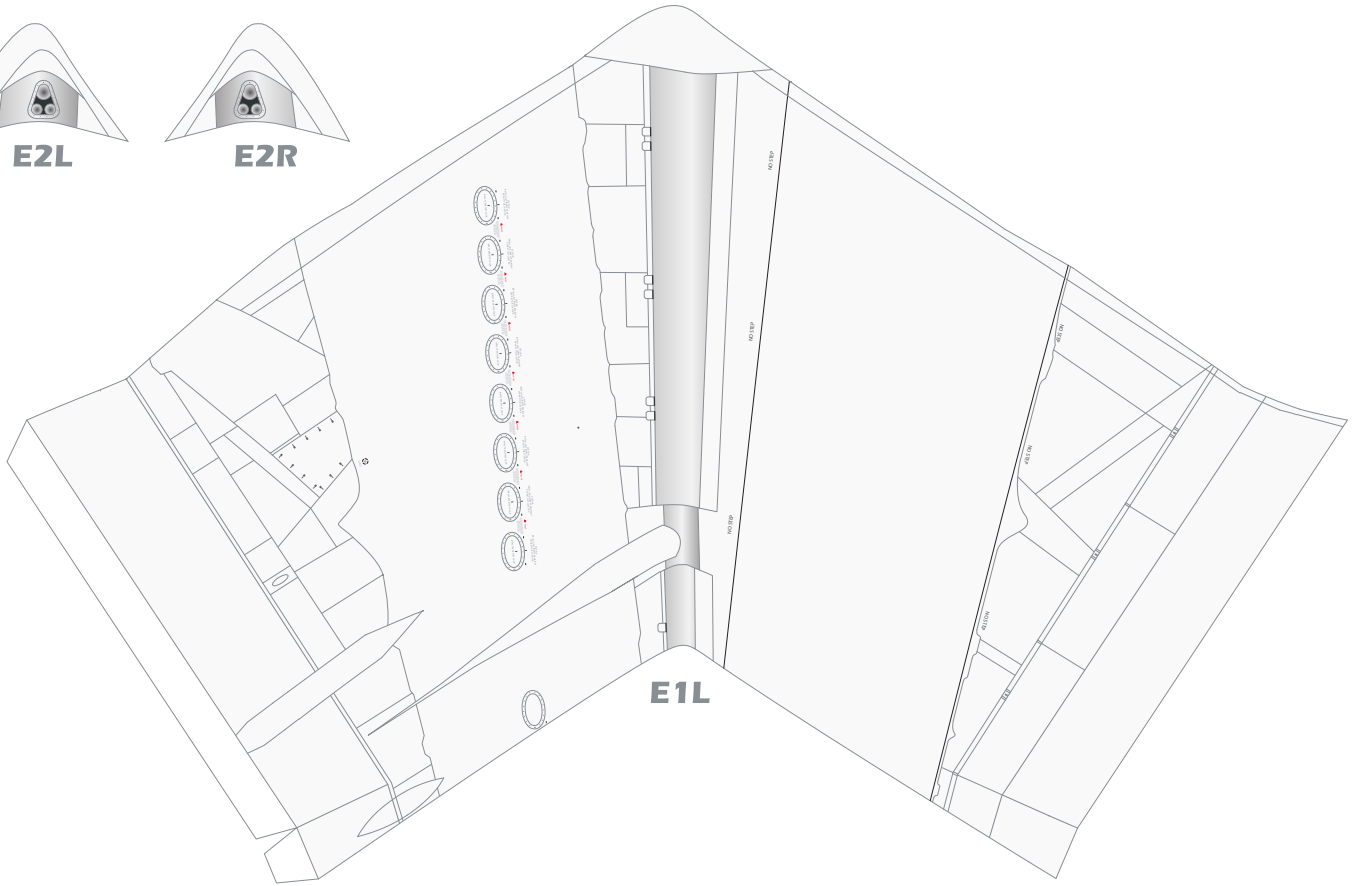

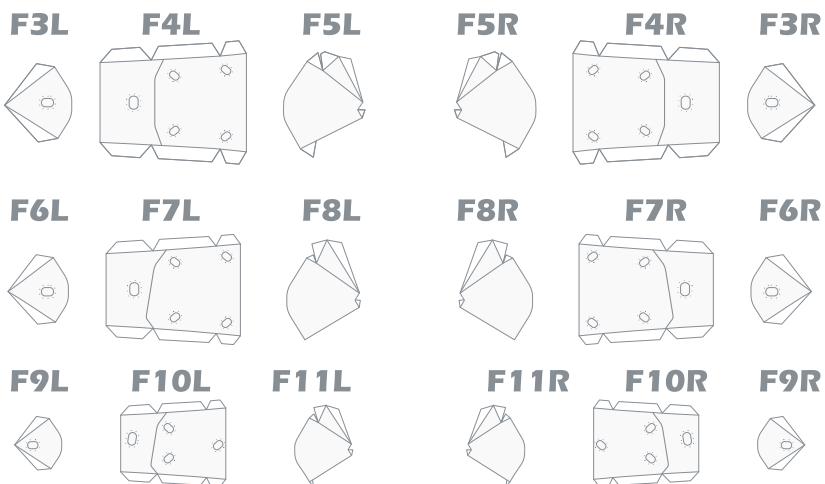
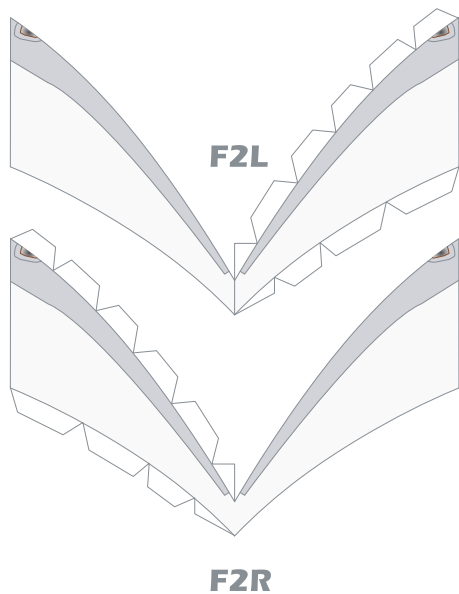
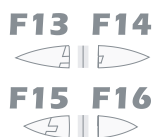
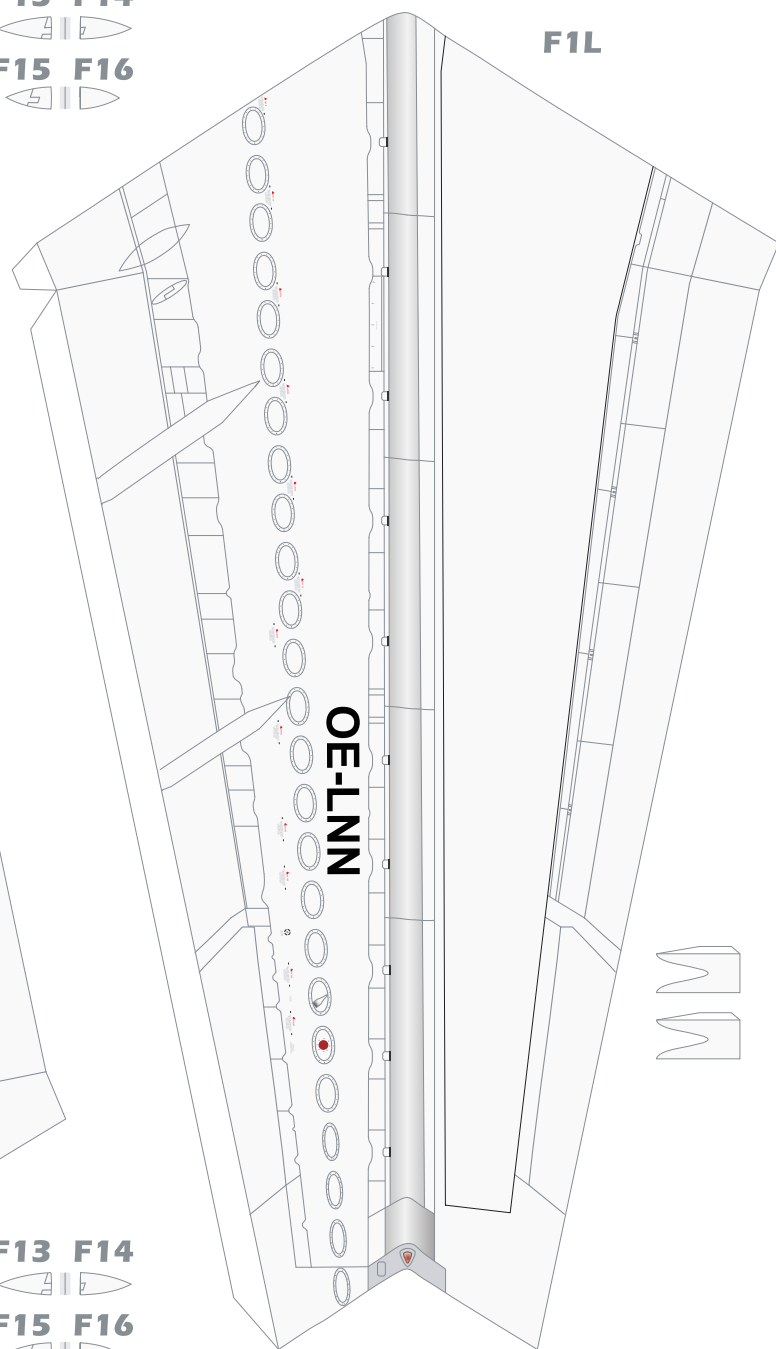
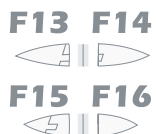
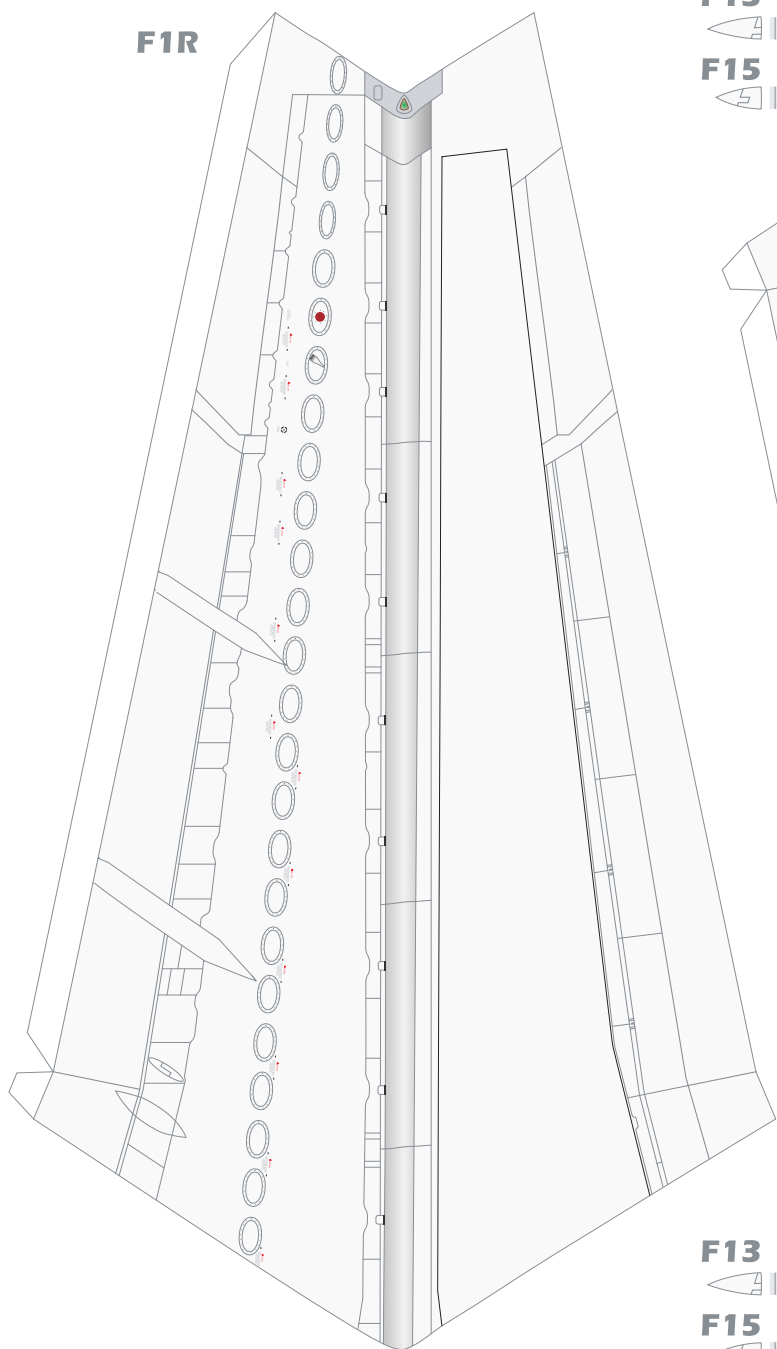

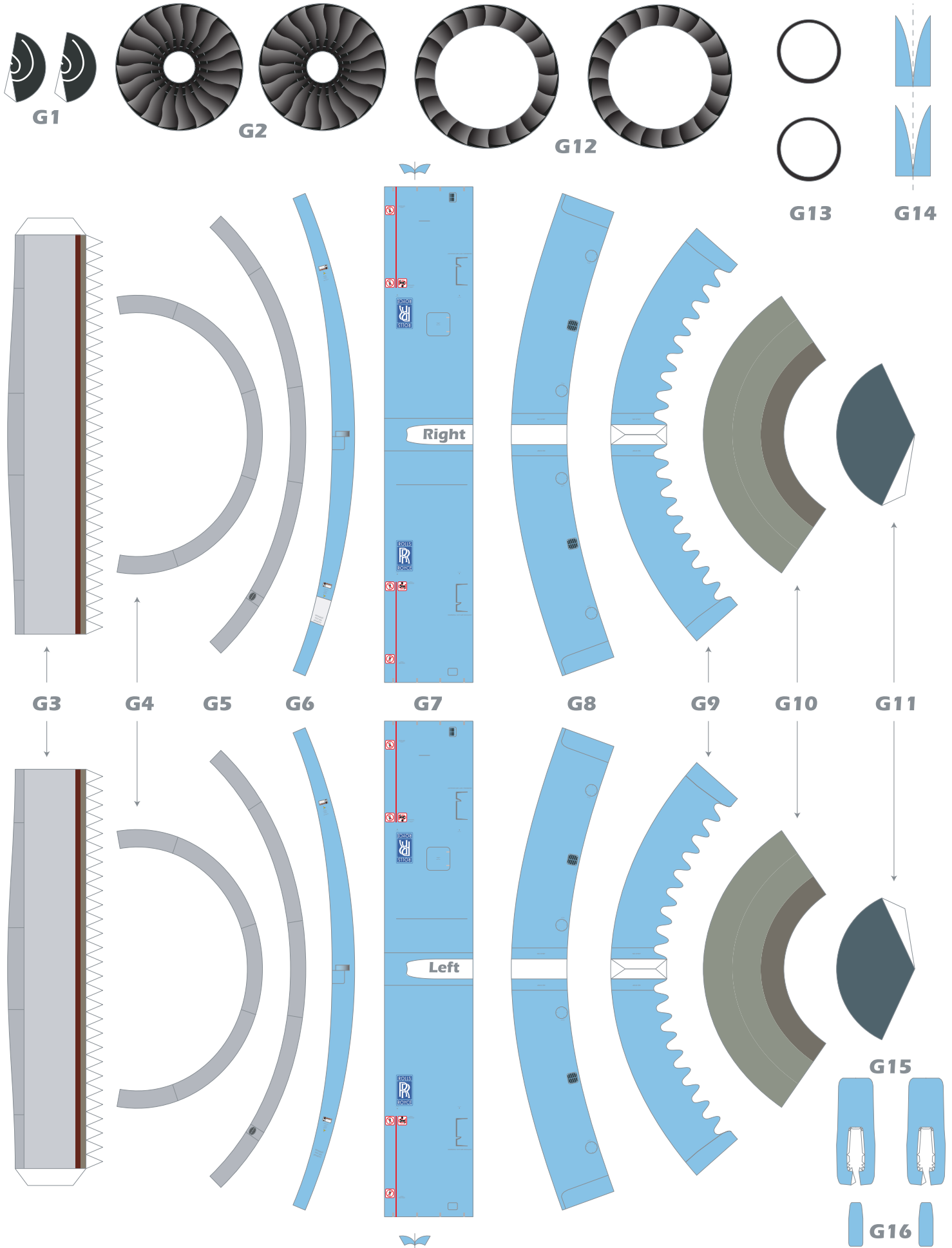

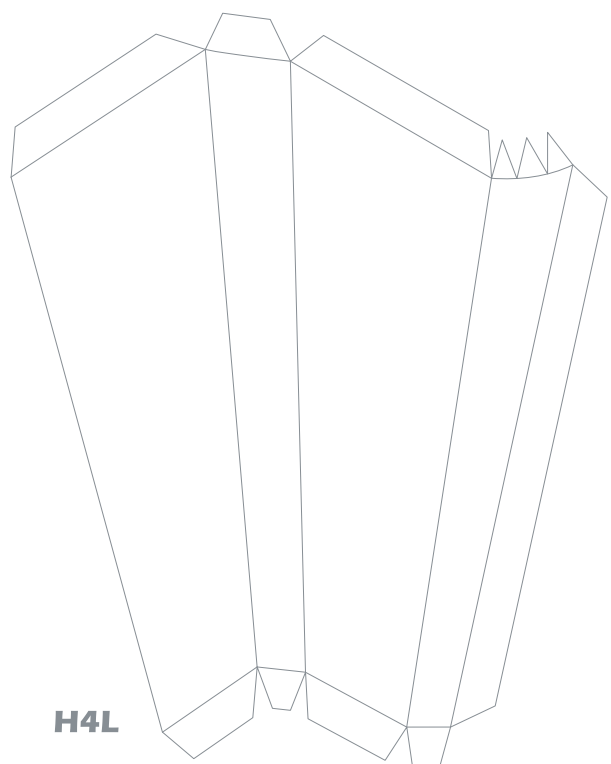
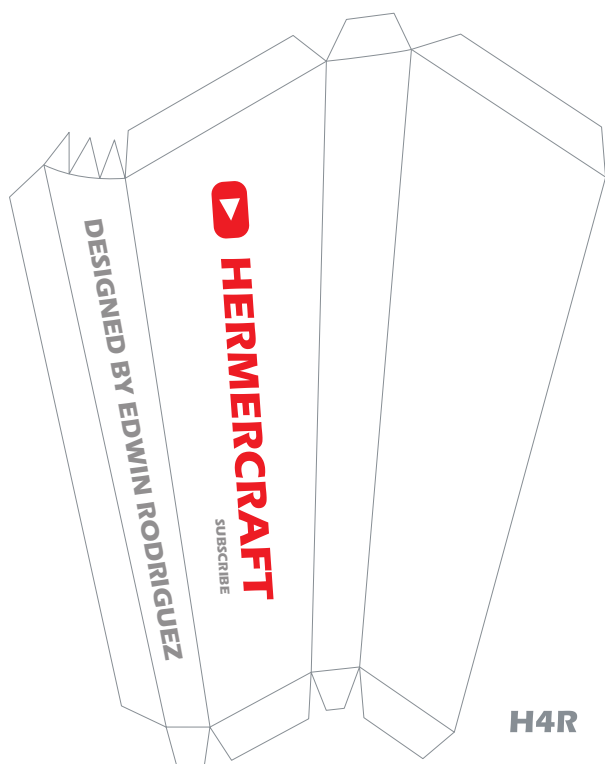
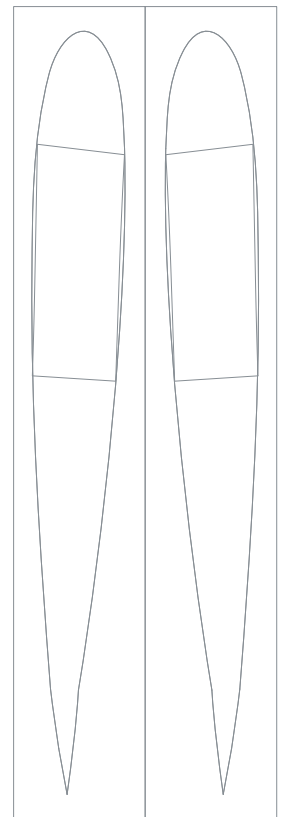
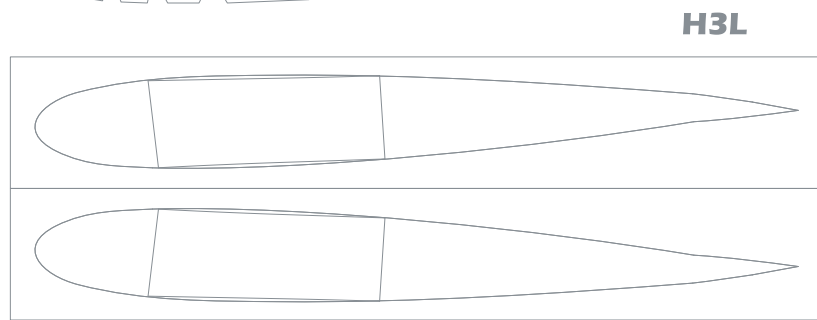
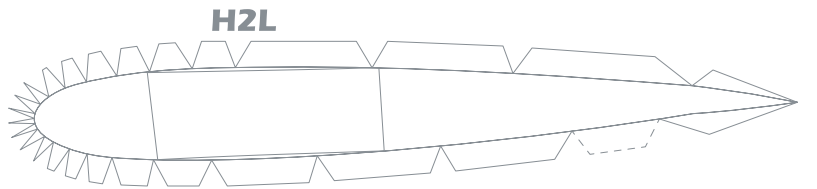
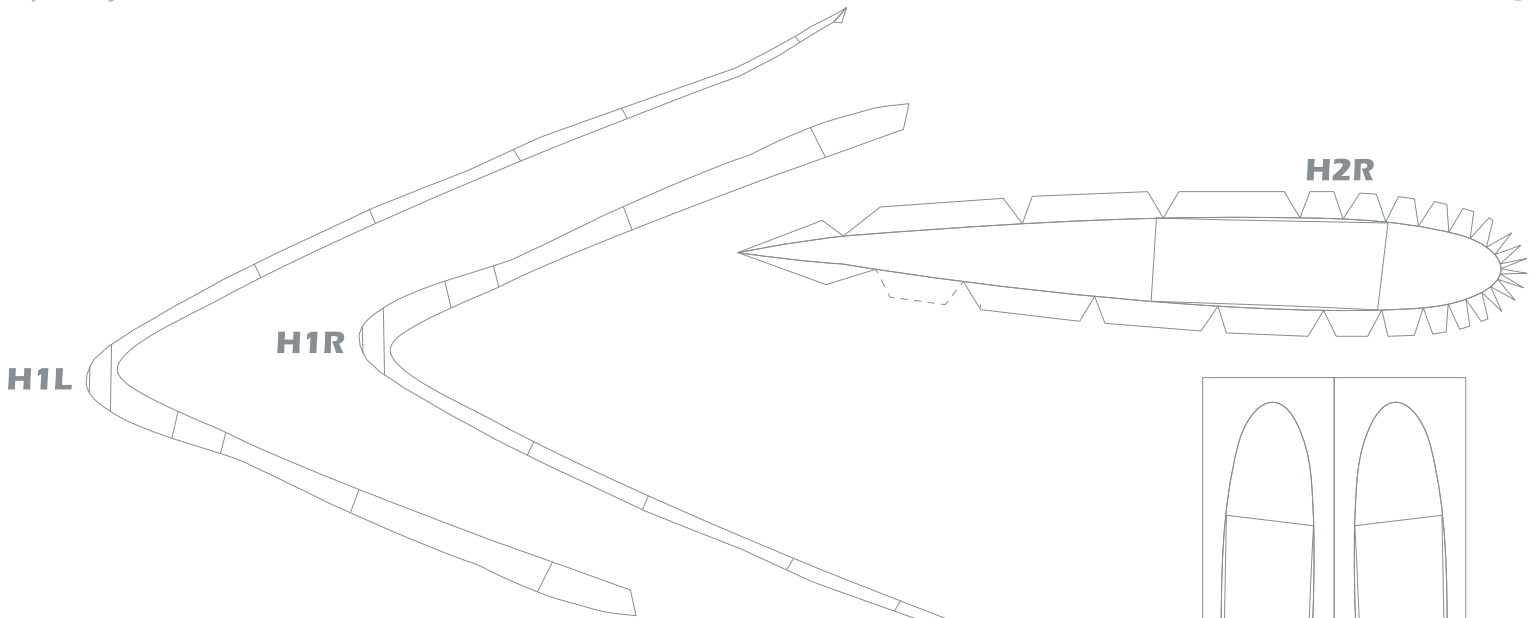



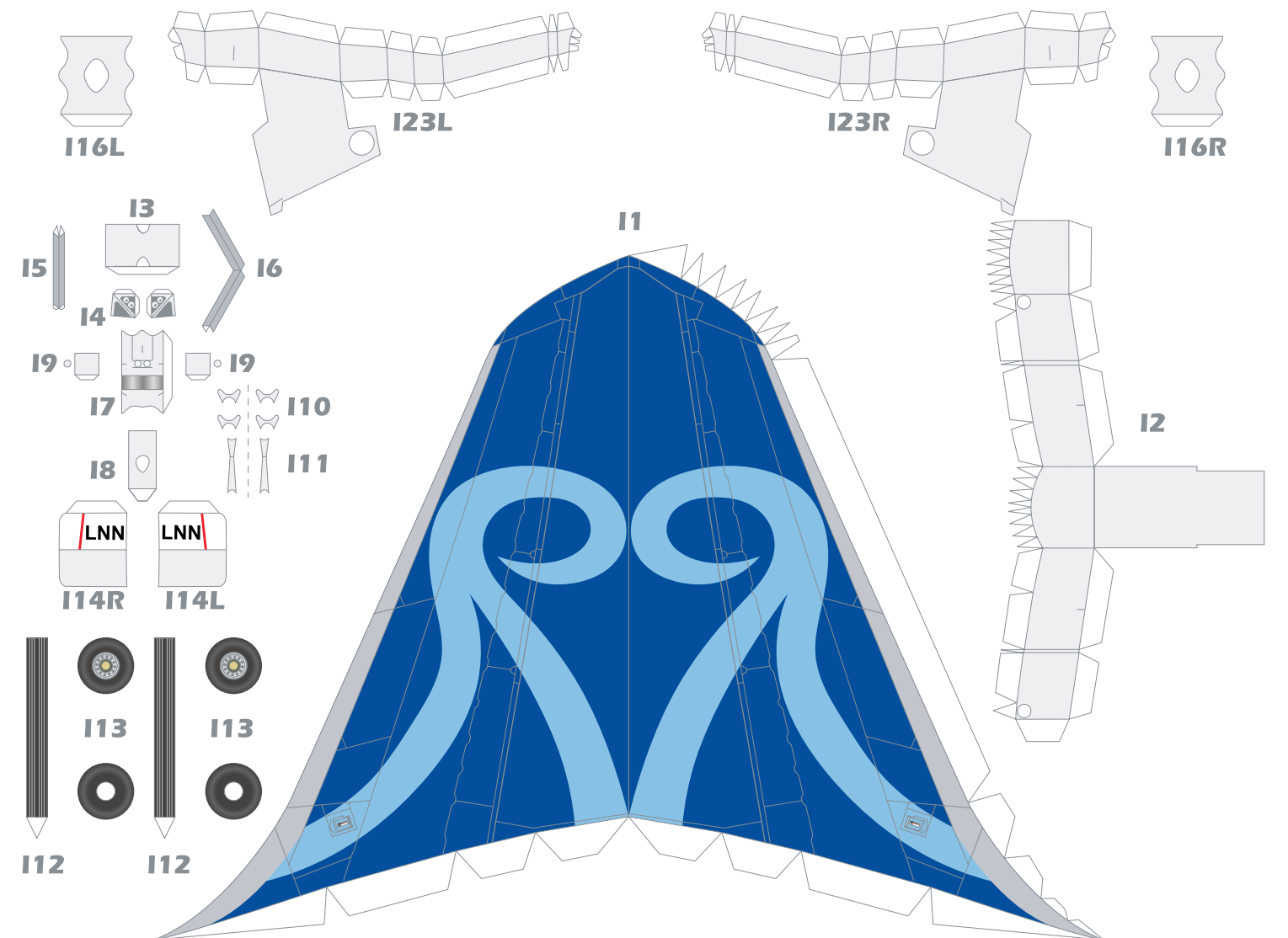
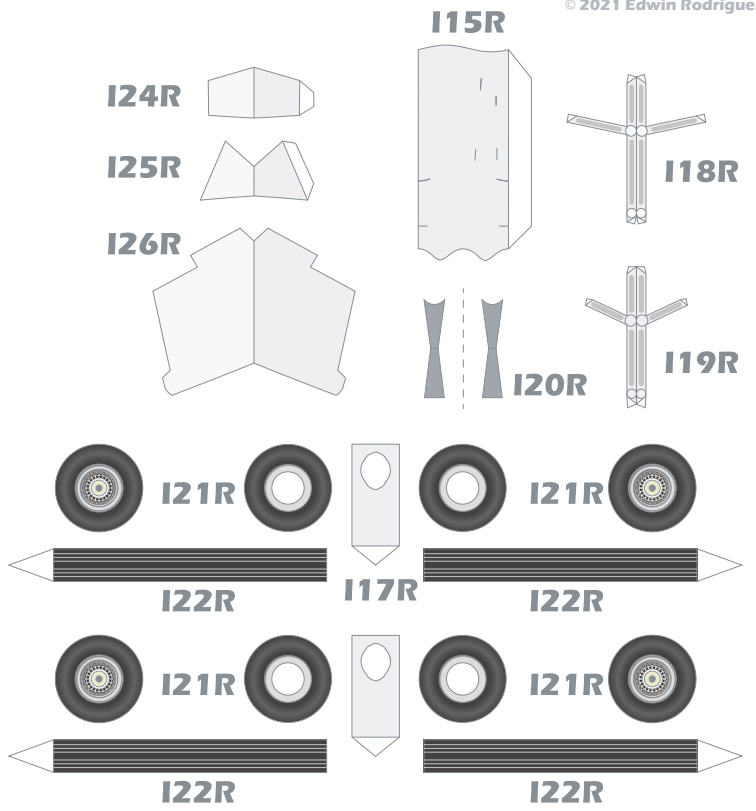
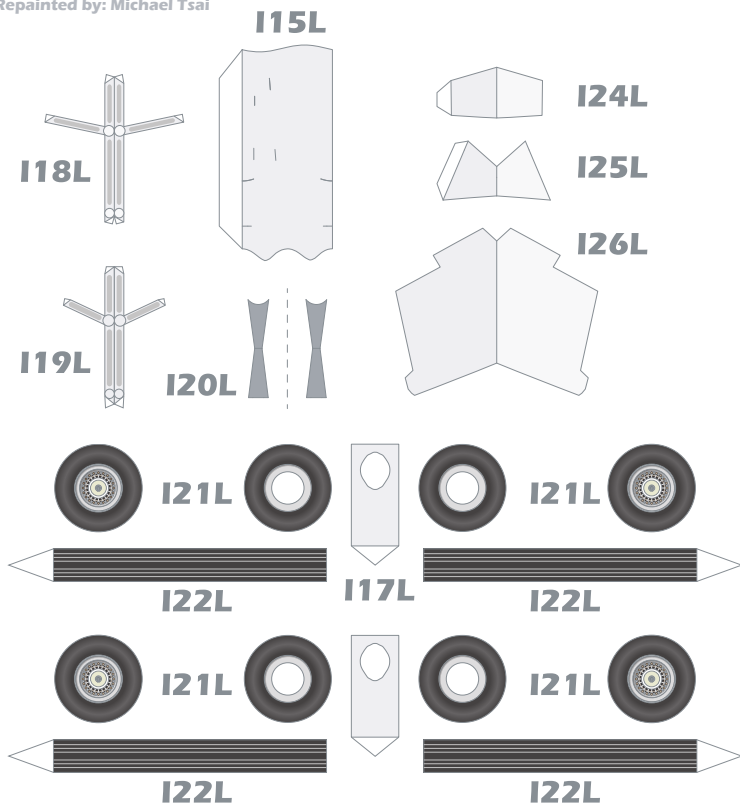

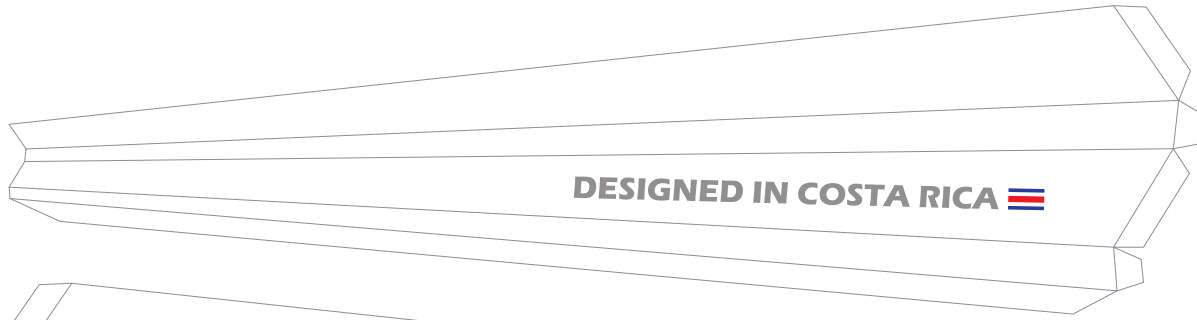

J1L



J1R

