



HEKMAN®

A HOWARD MILLER COMPANY

ASSEMBLY INSTRUCTION FOR 24928 PUB TABLE

HARDWARE LIST

NO.	ITEM	DESCRIPTIN	QTY.
1		Bolt M8X25 MM	12
2		Flat washer M8X25 MM	12
3		Wrench	1

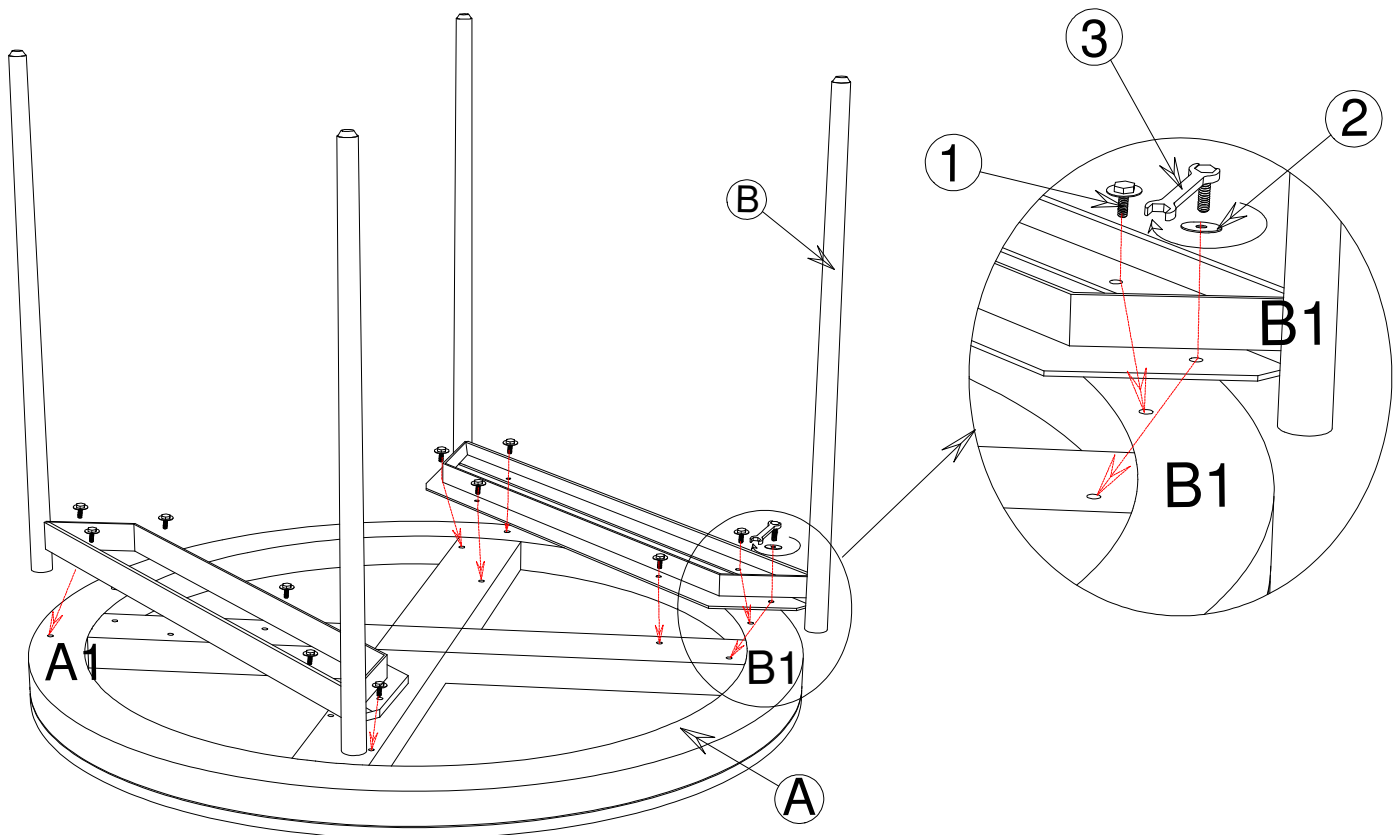

TO ASSEMBLY :

- STEP 1 : Unpack pub table and turn the top (A) upside down. on a clean, soft surface.
- STEP 2 : Match the iron legs(B). use matching marks A1-A1 & B1-B1 on top (A).
- STEP 3 : Align holes in legs (B) with holes on bottom of top (A) and slide it into position.
- STEP 4 : Thread the flat washer(2) , bolt (1) to leg (B) . Do not tighten bolts fully.
- STEP 5 : Tighten bolts in step 4 fully with wrench (3) then carefully turn the pub table upright.