

**Easy Assembly — Wire Management Tray, SmartMoves Deluxe Charging Station, Dropdown Keyboard Drawer, and Undermount Shelf**

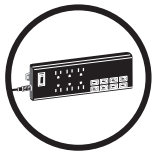

**Wire Management Tray Assembly**

Attach the Wire Management Tray using the screws provided. Refer to the Desktop Accessory Diagram for the predrilled holes in location D.

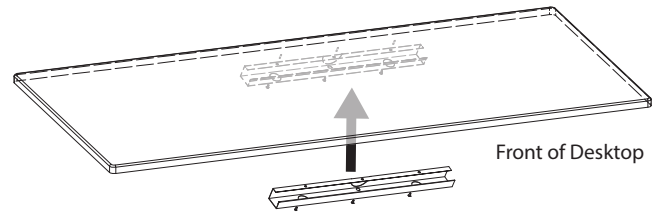

**SmartMoves Deluxe Charging Station Assembly**

Attached the SmartMoves Deluxe Charging using the screws provided. Refer to the Desktop Accessory Diagram for the predrilled holes in location E.

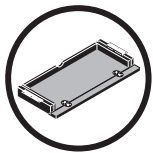
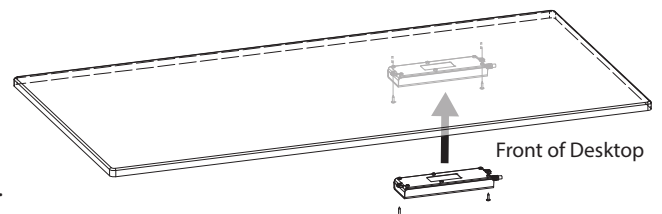

**Dropdown Keyboard Drawer or Undermount Shelf Assembly**

Install six wood screws in the predrilled holes. Refer to the Desktop Accessory Diagram for the predrilled holes in location G.

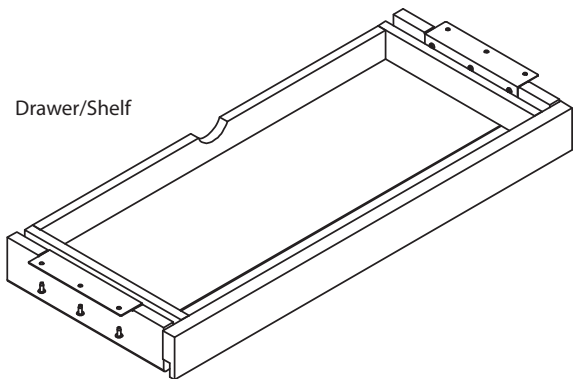

**Desktop Accessory Diagram**

Use this easy diagram to locate the correct predrilled holes for your SmartMoves Accessories. Note that a few Accessories have optional locations to best suit your needs.

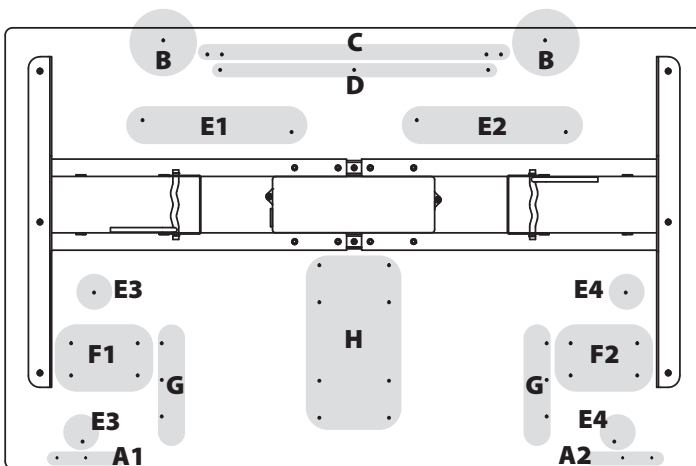

**A1, A2**  
Memory Height Keypad  
Two location options:  
Front left or right.



**B** Elevated Shelf



**C** Modesty Panel



**D** Wire Management Tray



**E1, E2, E3, E4**  
SmartMoves Deluxe Charging Station  
Four location options: Front left or right, back left or right.



**F1, F2**  
CPU Caddy  
Two location options:  
Front left or right.

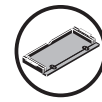

**G** Dropdown Keyboard Drawer or Undermount Shelf



**H** Keyboard Tray