

PRICING EFFECTIVE MARCH 2023

# CREDENTIALS™

*Price & Specification Guide*

PDF updated April 17, 2023

Gunlocke®

## VENEER 1 (SELECT)

### NATURAL FC CHERRY

A. Cinnamon/Biltmore	NC260
B. Lowell Ash	NC394
C. Medium Red	NC512
D. Light	NC701
E. Shaker	NC774
F. Burnished	NC777

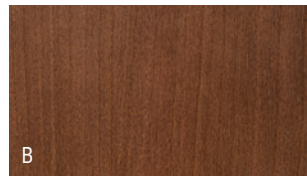

### NATURAL FC MAPLE

G. Natural	NE800
H. Harvest	NE856



### NATURAL FC WALNUT

I. Florence	NT579
J. Light	NT601
K. Skyline	NT625
L. Nutmeg	NT629
M. Pinnacle	NT679
N. Sumatra	NT693
O. Ebony	NT509
(Use OP TopFin Only)	

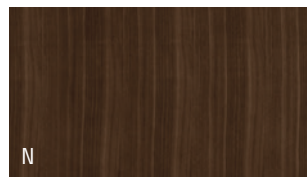
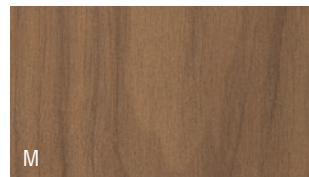
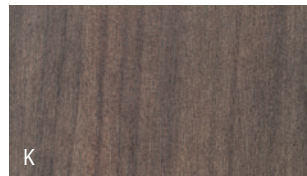
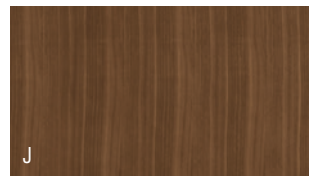

## VENEER 2 (PREMIUM)

### NATURAL QC WALNUT

A. Florence	QT579
B. Light	QT601
C. Skyline	QT625
D. Nutmeg	QT629
E. Pinnacle	QT679
F. Sumatra	QT693
G. Ebony	QT509
(Use OP TopFin Only)	

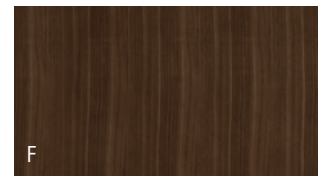
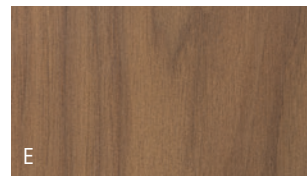
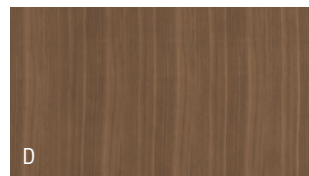
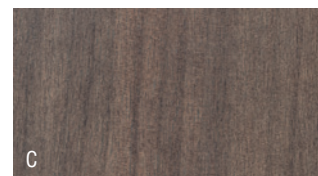
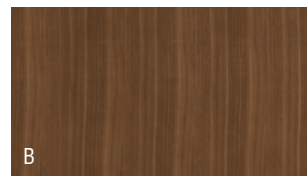
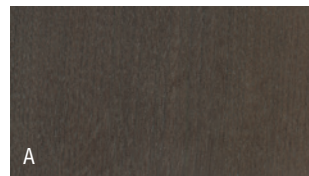

### NATURAL RIFT CUT OAK

H. Light	RF301
I. Dark	RF331
J. Phantom Ecu	RF912
(Use OP TopFin Only)	
K. Fawn Cypress	RF108



# ORDERING OPTION CODES

Credentials  
05/22

## UV TOP FINISH

Open Pore Low Sheen	OP
Full Fill ClearTech™	FF
Full Fill Top ≤ 120" Length(+\$273)	
Full Fill Top > 120" Length(+\$436)	

## PULLS

Metal Pull - Champagne Silver	MPS
Metal Pull - Dark Bronze	MPZ
Integral Wood Pull	FPW

## PENCIL LIP COLOR

Pencil Lip - Champagne Silver	PLS
Pencil Lip - Dark Bronze	PLZ

## BACK PAINTED GLASS DOORS/TACKZONE

Ice White	WH
Black	BK
Muslin	ML

## BACK PAINTED GLASS TOPS

Ice White, Acid Etched	TWH
Black, Acid Etched	TBK
Muslin, Acid Etched	TML

## DESKTOP OPTION

Standard Veneer	TVN
-----------------	-----

### Faux Leather Inlay

White (+\$1,653)	TLW
Black (+\$1,653)	TLB
Chocolate (+\$1,653)	TLC

### Back Painted Glass Insert

Ice White, Acid Etched (+\$2,313)	TGW
Black, Acid Etched (+\$2,313)	TGB
Muslin, Acid Etched (+\$2,313)	TGM

## PERSONAL CORNER

### LEATHER

White	CWH
Black	CBL
Chocolate	CCH

### VINYL

White	VWH
Black	VBL
Chocolate	VCH

## MODESTY PANEL SET #1

No Mod Required (deduct \$841)	MN
Finished Modesty Panel	MY

## MODESTY PANEL SET #2 TROUGH BRIDGES

No Mod Required (deduct \$1,380)	MN
Wall Access Panel	AP

## LOCKS

Locks Yes	LY
Locks No	LN

## KEYING

Field Installed Locks	FL
-----------------------	----

### FACTORY-INSTALLED

Random Key Numbers	
Silver	RMS
Black	RMB

### Designated Key Numbers

Specify a number between:	
Silver	FT100TAS - FT150TAS
Black	FT100TA - FT150TA

## GRAIN DIRECTION

Standard Veneer Direction	VLG
Cross/Short Veneer Direction	VST

## MAGNETIC ACCESSORIES PAINT COLOR

White	AWH
Black	ABK
Muslin	AML

## OFFICE NUMBER

Specify a number to identify each office	OFC1-OFC199
--	-------------

## PULLS

Metal Pull - Champagne Silver



Metal Pull - Dark Bronze



Integral Wood Pull



## LEATHER DETAILS

Leather Desk Inlay



Leather Tray for Overhead Cubby



Leather Box Drawer Insert



## MISC. DETAILS

Grommet



Printer Pedestal



Height Adjustable Desk



General Information . . . . .	2-6	Overheads . . . . .	118-138
Conditions of Sale . . . . .	2	Single Wall Mount Overheads . . . . .	118-123
GSA Terms & Conditions . . . . .	3-4	Double High Wall Mount Overheads . . . . .	124-127
Warranty . . . . .	5	Tackboards . . . . .	128-131
Delivery Information . . . . .	6	Back Painted Glass Whiteboards . . . . .	132-134
Veneers & Finishes . . . . .	7	Wood Magnetic Tackzone . . . . .	135-137
Edge Detail & Pull Options . . . . .	8	Shelves for Segmented Tackzone . . . . .	138
Pedestal Legend . . . . .	9	Miscellaneous	
Filing . . . . .	10-11	Round Tables & Bases . . . . .	139
Product Reference . . . . .	13-31	Accessories . . . . .	140-149
Features + Advantages . . . . .	14-15	Fabric Grade Pricing . . . . .	150-153
Technical Specifications . . . . .	16-18	Weights + Cubes . . . . .	154-162
Worksurface UV Finishes . . . . .	19		
Height Reference . . . . .	20		
Desktop Leather Inlay and Glass Insert Locations . . . . .	21		
Worksurface Veneer Grain Directions . . . . .	22-23		
Grommets & Trough Locations . . . . .	24-25		
Metal Pull Locations . . . . .	26		
Integral Wood Pull Locations . . . . .	27		
Specification Tips . . . . .	28		
Wire Management . . . . .	29-30		
Product Specifications . . . . .	31		
Unitized Casegoods . . . . .	33-105		
Freestanding Table Desks . . . . .	34-40		
Double Pedestal Desks . . . . .	41		
Single Pedestal Desks . . . . .	42-43		
Extensions . . . . .	44-51		
Runoff Desks . . . . .	52-57		
Bridges . . . . .	58-59		
Credenza & Return Components . . . . .	60-63		
Pedestals . . . . .	64-75		
Layers Pedestals . . . . .	76-87		
Modesty / Access / Support Panels . . . . .	88-93		
Brackets / Storage . . . . .	94-98		
Mobile Pedestals . . . . .	99		
Cushions . . . . .	100		
Trough Inserts . . . . .	101		
Height Adjustable Desks . . . . .	102-105		
Storage . . . . .	107-117		
Lateral Files . . . . .	108-109		
Bookcases . . . . .	110		
Hinged Door Cabinets . . . . .	111		
Closets . . . . .	112-115		
Storage Box . . . . .	116		
Utility Cabinets . . . . .	117		

**INTRODUCTION**

The Gunlocke Company is dedicated to providing the finest products and service possible. This price list reflects that commitment. Included is a current listing of our casegood models.

Seating and Lounge are presented in a separate price list. Contact your Gunlocke Customer Services Representative for more information, (800) 828-6300.

Designed for easy use, each page of this price list, and the inside front cover fold out provide all information required to order a product correctly. Should additional information be needed, contact your Gunlocke customer service representative.

**PRICING**

Prices shown cover standard product specifications. Any changes or alterations, other than those listed, will be subject to an additional charge. Prices include cartoning and freight. Authorization and pricing must be secured in advance for orders or contracts calling for large quantities, indefinite quantities, or extended delivery dates. Prices are subject to change without notice; the most current prices are published on <http://www.gunlocke.com>.

**ORDERING**

To expedite order entry and to assure proper service, email or fax all orders directly to:

**The Gunlocke Company**

Attn: Order Entry  
One Gunlocke Drive  
Wayland, New York 14572  
585-728-5111  
585-728-8350 FAX  
800-828-6300  
[www.gunlocke.com](http://www.gunlocke.com)

Gunlocke will not be responsible for duplicate orders if purchase orders are left unmarked.

**ACKNOWLEDGMENT**

Each order will be acknowledged by Gunlocke. Customers should check each acknowledgment for accuracy and immediately notify Gunlocke of any discrepancies. The printed acknowledgment is the final agreement between The Gunlocke Company and the customer, superseding all previous communications regarding the order.

**SPECIFICATION CHANGES**

Gunlocke reserves the right to change specifications for the improvement of products at any time, without notice.

**ORDER CHANGES**

Gunlocke is not required to accept changes in orders after confirmation. Reasonable changes are subject to additional charges for labor, material and administrative costs.

Order changes of acknowledgment may result in re-scheduling of product.

**RETURNED MERCHANDISE**

No merchandise may be returned without prior authorization.

**SHOWROOMS**

For all showroom locations and tour information, please reference the showrooms page online at: [www.gunlocke.com/inspiration/showrooms](http://www.gunlocke.com/inspiration/showrooms)

**CANCELLATIONS**

Cancellation of orders cannot be accepted since every order is manufactured according to customer specifications.

**STORAGE**

If delivery cannot be made and products are ready, Gunlocke will transfer products to a storage facility and products will be invoiced at that time. The customer is responsible for storage charges and assumes and bears all risks associated with the storage of that product.

**TERMS**

Net 30 days from date of invoice. A service charge of eighteen percent (18%) per year or .0004931% per day, compounded monthly, will be added to balance due beyond the thirtieth day. Products are shipped FOB factory, freight prepaid and allowed. Title passes to purchaser and Gunlocke's responsibility ceases when shipment is accepted for transportation by a carrier. A full explanation of all payment terms is found on order and invoice forms.

**ORDERING INFORMATION**

**1a.** Intended use: The furniture on this schedule is intended for use by Government executives (or equivalent military rank) in the Executive, Judicial and Legislative Branches of the Federal Government. To help customers make a good purchasing decision based on their needs and budget, GSA has established four grades of furniture. Grade (1) includes furniture that tends to be the most expensive on this schedule, grade (2) furniture tends to be more moderately priced and grades (3) and (4) furniture tend to be affordably priced when compared to grades (1) and (2). Some pieces of furniture on this schedule may be significantly higher in price than GSA Traditional and Contemporary Executive Special Order Program furniture. The ordering agency or service is responsible for determining furniture appropriate for use in its offices which will fit within its budget and comply with applicable Federal or internal agency procurement regulations. Please see reverse for GSA terms and conditions.

**Grade 1** All exposed solid parts such as top rims, base rails etc. (except decorative accents, inlays and painted parts) shall be the same species as the face veneer. Top and bottom edges of drawer fronts shall be solid wood in the same species as the face veneers. Drawer sides and backs shall be solid wood.

**Grade 2** Exposed wood panel trim and trim on tops shall be the same wood species as the face veneer on the top. Some or all other exposed solid parts, such as base rails can be an alternative wood species (such as poplar or gum) different from the face veneers. Exposed, finished engineered wood core material such as MDF is acceptable only for the edges of drawer fronts. Drawer sides shall be solid wood or veneer core plywood/laminated construction. Silea is grade 2.

**Grade 3** Most or all exposed solid parts can be an alternative wood species (such as poplar or gum), different from the face veneers. Exposed, finished engineered wood core material such as MDF is acceptable only for the edges of drawer fronts. Drawer sides shall be solid wood or veneer core plywood/laminated construction. Medley, Kennsington, Credentials, and all tables are grade 3.

**Grade 4** Most or all exposed solid parts can be an alternative wood species (such as poplar or gum), different from the face veneers. Exposed, finished engineered wood core material such as MDF is acceptable only for the edges of drawer fronts. Drawer sides shall be composite wood material construction such as MDF. Trio is grade 4.

1. **Maximum Order Threshold:**  
SIN# 33721 . . . . . \$250,000
2. **Minimum order:** \$2,000 list
3. **Geographic coverage:**  
48 contiguous states and DC (CONUS)
4. **Points of production:**  
Wayland, NY, Steuben County, USA  
Hickory, NC, Catawba County, USA
5. **Discount Statement:** Discount is applied to List Price.  
**Structure in List \$:**  
\$2,000 – \$100,000 list . . . . . 60.5%  
\$100,001 – \$400,000 list . . . . . 62.7%  
\$400,001 – MOT (\$1,428,571 List). . . . . 65.0%  
Over MOT (\$1,428,572 List). . . . . Negotiable  
\* These discounts apply to single purchase orders, shipping to the same place in the same time period
6. **Quantity Discount:** See above
7. **Payment terms:**  
1% 23 days Net 30 days from date of shipment, for product only, for all electronic invoices processed through a Federal payment system, (including, but not limited to, WAWF, IPP, etc.). All other invoice sales are Net 30 days from date of shipment. Prompt payment terms are not applicable to credit card orders.
8. **Government Credit Cards** are accepted above and below the micro-purchase levels.  
Written confirmation and authorized signatures are required. Activities may verbally provide card information, but products shall be confirmed in writing.  
Use of credit cards shall be at the time of order placement with cards charged at the time of shipment, see GSAR 552-232-80 (C).  
There are no additional discounts for using a credit card.
9. **Foreign items:** None
- 10a. **Time of delivery:** 60 days ARO
- 10b. **Expedited delivery:** Contact Gunlocke
- 10c. **Overnight and 2-day delivery:** Contact Gunlocke
- 10d. **Urgent requirements:** Contact Gunlocke
11. **FOB point(s):** F.O.B. Origin, with freight being paid by Gunlocke for all deliveries within CONUS.
12. **Ordering address(es):**  
The Gunlocke Company  
c/o Authorized Gunlocke GSA Dealer  
One Gunlocke Drive  
Wayland, NY 14572  
Phone: (800) 828-6300  
Fax: (585) 728-8350
13. **Payment address(es):**  
The Gunlocke Company LLC  
13367 Collections Center Drive  
Chicago, IL 60693
14. **Warranty provision:** See warranty on page 5
15. **Export packing charges:**  
Write for quotation on export packaging.
16. **Terms and conditions of Government commercial credit card acceptance:** Credit Cards are accepted.
17. **Terms and conditions of rental, maintenance, and repair:** Not applicable
18. **Terms and conditions of installation:**  
Installation services shall be priced at a rate not to exceed 30% of the net product price, per project. The minimum order charge for installation shall be \$175.00. Projects involving extraordinary circumstances which require installation charges exceeding the proposed installation rates will be submitted to the GSA Contracting Officer for review and approval.
19. **Project Management:**  
\$65 Per Hour, inclusive of IFF
20. **Reconfiguration and Relocation Services:**  
\$65 Per Hour, inclusive of IFF
21. **Design/Layout Services:**  
\$65 Per Hour, inclusive of IFF
22. **Terms and conditions of repair:**  
Refer to Gunlocke Customer Support
23. **List of service and distribution:** Points: Not applicable
24. **Participating dealers:** A list of participating dealers will be supplied to any government agency upon request or is available on our website at www.gunlocke.com.
25. **Preventative maintenance:**  
Not applicable. Instruction sheets available upon request.
26. **Environmental attributes:** Gunlocke has an active environmental program. Please call (800) 828-6300 for details.
27. **Data universal number system:**  
(DUNS) number is 19-993-6550
28. **CCR registration/Cage Code:** The Gunlocke Company is registered in the DoD CCR. Cage Code - 26574
29. **Returns:**  
No returns of goods will be accepted without written consent and shipping instructions from Gunlocke, and the Government customer will be required to pay all return freight charges. A restocking fee of 30% net will apply on all authorized returns provided Gunlocke receives goods in the condition in which they left the factory. No credit will be given if goods cannot be reused. Special order items are in no event subject to return. Goods must be returned within 70 days of shipment from factory.
30. **Cancellations:** No charge prior to production. After production has begun (5 days ARO), only the actual costs that the contractor can demonstrate will be billed to the customer if the merchandise cannot be resold within a reasonable period of time (90 days).
31. **Inside Delivery:** Gunlocke rates are for dock-to-dock delivery and do not include inside delivery, un-cartoning or set up. If desired, arrangements for inside delivery must be made and approved when the order is placed and will have a corresponding fee of 7% of list price of the order with a minimum charge of \$75. Requests for un-cartoning and set up will be coordinated with a Gunlocke Dealer with applicable charges applied to the order.
32. **Federal Tax ID # 22-3887942**



## 12 YEAR WARRANTY

Subject to the limitations set forth below. The Gunlocke Company warrants to the original purchaser all product in this price list to be free from defects in material and workmanship for a twelve year period from the date of shipment. This 12-year warranty applies to all products sold and installed by a Gunlocke authorized agent for normal commercial single shift service. Gunlocke will repair, or at its option, replace defective merchandise, free of charge. The following components not manufactured by Gunlocke have the following warranties:

- **High wear components** such as casters and glides are warranted for five years after date of shipment to original owner.
- **Electrical components** warranted 10 years from date of manufacture with exception of lamps and ballasts which are not warranted. This includes Fluorescent Tasklights.
- **LED tasklights** are warranted for 3 years from date of shipment to original owner.
- **Drawer suspensions** are warranted for lifetime of product after shipment to original owner.
- **Personal corners** including covering (leather) are warranted for three years of single shift and normal use after shipment to original owner.
- **Height adjustable electrical components** are warranted for five years of single shift and normal use after shipment to original owner.

Any non-standard material selected by the customer is not warranted. Neither does this warranty apply to damage resulting from accident, alteration, or misuse, as well as damage from normal wear and tear such as dents, nicks, scratches, fading and improper maintenance. That is, Gunlocke's warranty is only valid if products are given proper use and care. Gunlocke assumes no responsibility for product damages resulting from improper installation or user modification.

## WOOD FURNITURE

Wood owes its inherent beauty to variations in color, grain, and texture, and therefore, these variations are not considered defects. There may be minor variations from one piece of furniture to the next even though they are finished at the same time. Exposure to light and the aging process will cause a darkening of natural wood products. Light finishes on wood products do not mask the natural characteristics of wood. The Gunlocke Company does not guarantee the exact matching of grain, pattern, and color.

These finishes do not cover any of the natural characteristics of the wood, including nature's colorations, pitch pockets, and the variations of steambent wood. Merchandise will not be replaced because of these natural variations.

It is expressly understood and agreed that the buyer's sole and exclusive remedy for any and all losses or damages resulting from nonconforming goods, or from any other cause, shall be repair or replacement of defective parts, and that Gunlocke shall not be liable for damages or injury to persons or property, nor for replacement of the entire commercial unit, if repair or replacement of defective parts can reasonably render the unit conforming.

All warranty claims must be made in writing by the original owner. Owner may be required to produce the invoice or other evidence to establish that a claim is within the warranty period. Warranty claims may be submitted on the Gunlocke website.

<https://apps.gunlockeadvantage.com/QualityFeedback/>

As stated and illustrated on the website, serial numbers are required to process a warranty claim. No person, firm or corporation is authorized to assume for Gunlocke any liability in connection with the sale or installation of Gunlocke products except as stated above.

All other warranties, expressed or implied, are excluded. Gunlocke shall not be liable for incidental or consequential damages of any sort.

Within the Continental USA, all orders above \$20,000 list are shipped FOB factory, freight prepaid and allowed. All orders less than \$20,000 list will be subject to a \$200 net freight charge. Products shipped to Alaska and Hawaii FOB factory, freight prepaid and allowed to port of embarkation. Customer is responsible for freight charges from port of embarkation to final destination.

An anticipated shipping date is indicated on the order acknowledgment. Gunlocke cannot accept responsibility for shipping delays caused by outside sources or unforeseen problems. Delay of shipments requested by customers must be approved by Gunlocke. Any resultant storage charges will be charged to the customer.

Gunlocke may await completion of the entire order and ship all at once or may make partial shipments from time to time at its sole discretion unless the customer requests in writing that partial shipments are needed and Gunlocke approves the specific shipping schedule. Additional charges may apply.

Gunlocke is not liable for any delay or failure to deliver or perform due to strikes, lock-outs, or other labor or transportation difficulties, delay of sources or supply, accidents, fires, acts of God, or any other causes of like or unlike nature beyond the control of Gunlocke.

**LIABILITY**

Gunlocke products and their packaging are tendered to a transportation company only after passing rigid quality control inspection. At that time, title to the product is passed to the purchaser. However the transportation company assumes all liability from acceptance of shipment through its delivery. That is, Gunlocke's liability ceases at the time of shipment.

**FILING OF CLAIMS**

All claims for damage or loss must be submitted via our website at: <https://apps.gunlockeadvantage.com/QualityFeedback/> within 15 days after receipt of merchandise. Do not return freight damaged merchandise to Gunlocke. Follow the steps below to expedite processing and resolution of claims.

**For Visible Damage**

1. Make damage notation on delivery receipt and have driver sign. Do not reject or refuse the shipment.
2. Immediately contact Gunlocke Traffic Department at 585-728-8268.
3. Hold damaged carton and all interior packing for carrier's inspection. These materials will be needed to substantiate the claim.

**For Concealed Damage**

1. Open cartons within 15 days of receipt and inspect.
2. Follow steps 2, and 3 as listed under Visible Damage.
3. Do not remove product from delivered destination.

**For Loss**

1. Be sure loss notation is made on delivery receipt and have driver sign.
2. Contact Gunlocke Traffic Department at 585-728-8268.

Should transportation company seek to limit its liability on concealed, loss, or damage claims, please contact Gunlocke's traffic department. After a thorough investigation of the claim, the traffic department will provide you with guidance in corresponding with the carrier.

Returned merchandise, regardless of delivery method, will not be accepted unless specifically authorized by Gunlocke.

**For Damage or Loss of Parcel Post or UPS Shipment**

Notify the Gunlocke traffic department immediately at 585-728-8268.

**NORMAL DELIVERY**

All normal ground transportation by Gunlocke will be made on a dock-to-dock basis. The Gunlocke traffic department will determine the recommended method of shipment according to the ship to destination. If the delivery on a shipment takes longer than 2 hours to be unloaded, an additional charge will be billed at \$60/hour at 15 minute increments. Gunlocke reserves the absolute right to determine the method of shipping unless special delivery instructions have been previously approved.

**Gunlocke will make every effort in honoring delivery requests as stated on orders. However, the Company shall have no liability for failure to deliver, perform or delay in delivery due to any cause outside the control of Gunlocke. The Company assumes no liability for costs incurred due to delayed or late deliveries.**

If a guaranteed delivery time is needed please call Gunlocke Traffic Department at 585-728-8268 for a quote as additional charges will apply. Weekend or after hours deliveries are subject to additional charges.

**WEEKEND DELIVERY**

A \$500 charge will apply on weekend delivery after 3:00 PM Friday through Sunday evenings.

**DROP SHIP / JOB SITE DELIVERY**

Orders under \$50,000 list will incur a \$125 charge for ship to locations other than a designated dealer warehouse.

**INSIDE DELIVERY**

Inside delivery must be noted on order. A minimum \$100 charge will apply.

**SPECIAL DELIVERY**

Please contact the Gunlocke traffic department for special delivery services such as inside delivery, weekend or after hour deliveries, reconsignment or other special needs. These are billable services.

**Gunlocke will make every effort in honoring delivery requests as stated on orders. However, the Company shall have no liability for failure to deliver, perform or delay in delivery due to any cause outside the control of Gunlocke. The Company assumes no liability for costs incurred due to delayed or late deliveries.**

**DOCK RESTRICTIONS**

Gunlocke trailers are 53' x 102"; when attached to truck cab the total length is 75'. If delivery dock will not accommodate trucks of this sizes, the Gunlocke traffic department must be contacted prior to shipping. Alternate arrangements can be made; additional charges may apply.

**CREDENTIALS CASEGOODS**

Credentials is offered in three select veneers and two premium veneers. All exposed surfaces utilize select plain sliced Cherry, Maple or Walnut veneers or premium Quarter Cut Walnut or Rift Cut Oak veneers.

Specialty Finishes:

- Gunlocke so that a finish formulation can be developed to match the special finish and color.
- Review the approval sample provided by Gunlocke.
- Written approval and sign off is required for Gunlocke customer service.
- Once written approval and sign off is received, the special finish order will be acknowledged.

**Note:** See Gunlocke Advantage website for special finish request forms.

**All Casegoods & Tables Purchase Orders:**

- 10% list upcharge per wood unit to base veneer option receiving special finish.
- \$250 net formulation fee for special finish.

**Note:** This procedure and related costs apply to new and previously formulated special finishes. Special finish orders may receive additional lead time.

**UV TOP FINISH**

Credentials worksurfaces feature two low emitting UV finish options that enhance the beauty of natural wood and ensures the depth, clarity, color consistency and durability throughout the life of the product.

UV finish options

<b>Full-fill Cleartech (upcharge)</b>	<b>FF</b>
<b>Open Pore Low Sheen</b>	<b>OP</b>

**CREDENTIALS VENEERS**

veneer 1 (select)

<b>Plain Sliced Cherry</b>
<b>Plain Sliced Maple</b>
<b>Plain Sliced Walnut</b>

veneer 2 (premium)

<b>Quarter Cut Walnut</b>
<b>Rift Cut Oak</b>

**NOTE:** For FSC Certified Product add "FSC" to beginning of finish option code. Example: FSCNC260. A 5% list upcharge will be applied per unit ordered with FSC option.

**EDGE DETAILS – square**

profiles/cope

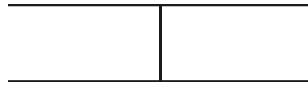

**PULL OPTIONS**

Credentials is available in a metal pull and an integral wood finger pull.  
The metal pull is available in an anodized silver and dark bronze finish.

**METAL PULL**

Top Mount  
-Top of pedestal fronts

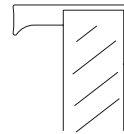
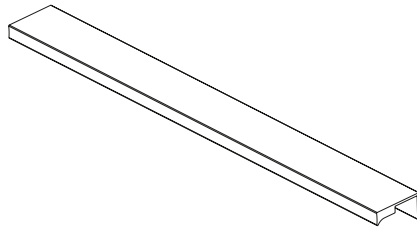

Face Mount  
-Face of closet/storage doors

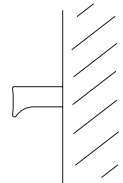
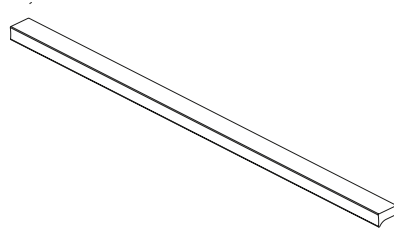

**INTEGRAL WOOD PULL**

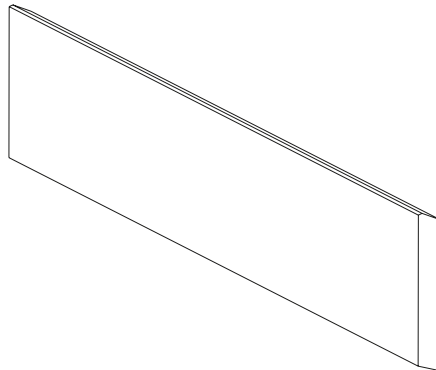

**PEDESTAL LEGEND**

NOTE: Left hand pedestals shown below.

**FULL HEIGHT**

[---]= (HIDDEN BOX DRAWER)

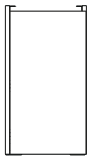

-X  
FALSE



-2  
FILE

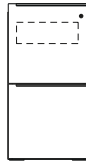

-3  
(BOX)  
BOX  
FILE

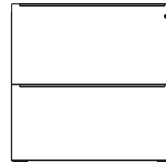

-4  
LATERAL  
LATERAL

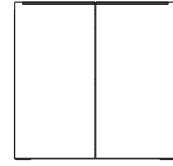

-5  
HINGED DOOR

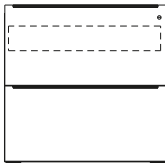

-7  
(BOX)  
BOX  
LATERAL

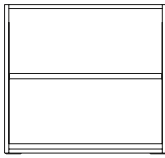

-SH  
OPEN SHELF

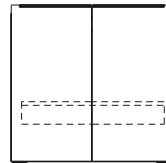

-P  
PRINTER PED

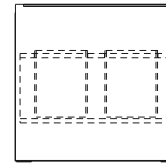

-T  
TRASH RECEPTACLE  
INCLUDES 2 TRASH CANS

**LAYERS HEIGHT**



-X  
FALSE



-A  
(BOX)  
FILE

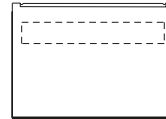

-B  
(BOX)



-5  
HINGED DOOR

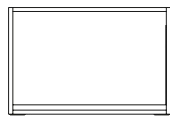

-SH  
OPEN SHELF

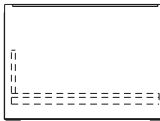

-P  
PRINTER PED

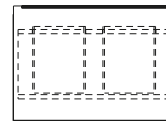

-T  
TRASH RECEPTACLE  
INCLUDES 2 TRASH CANS

**MOBILE PEDESTAL**

-Optional Face Lock

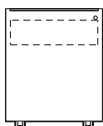

NOTE: LEATHER BOX DRAWER INSERTS MUST BE ORDERED SEPARATELY.

**STANDARD FILING OPTIONS**  
**WOOD PEDESTALS**

**15 wide file drawers**

- A. Letter – side to side
- B. Legal – side to side

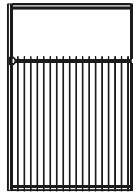

A

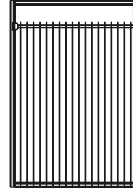

B

**18 wide file drawers**

- C. Letter – side to side
- D. Legal – side to side
- E. Letter – front to back

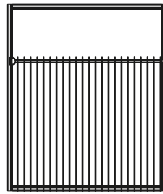

C

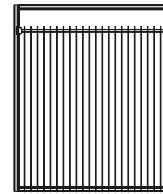

D

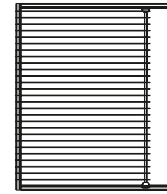

E

**30 wide file drawers**

- F. Letter – side to side
- G. Legal – side to side
- H. Letter – front to back

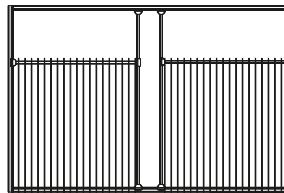

F

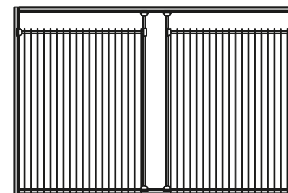

G

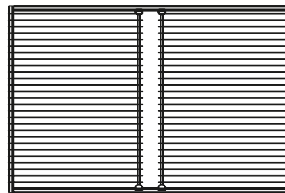

H

**36 wide file drawers**

- I. Letter – side to side
- J. Legal – side to side
- K. Letter – front to back
- L. Legal – front to back

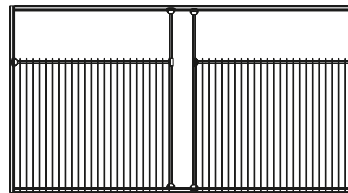

I

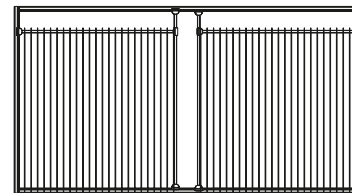

J

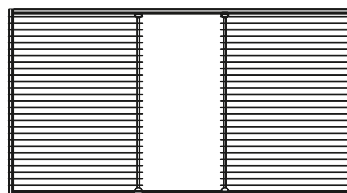

K

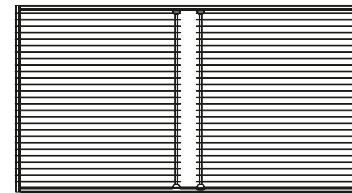

L

**INSIDE DRAWER DIMENSIONS**

**WOOD DRAWERS**

Pedestal width	Drawer type	D	W	H
15 letter width	24 box	14 1/16	11 3/8	3 1/4
	24 file	17 1/16	11 3/8	9 1/8
18 letter width	30 box	14 1/16	14 3/8	3 1/4
	30 file	17 1/16	14 3/8	9 1/8
30 width	box	14 1/16	26 3/8	3 1/4
	lateral	17 1/16	26 3/8	9 1/8
36 width	box	14 1/16	32 3/8	3 1/4
	lateral	17 1/16	32 3/8	9 1/8

**LOCKS & KEYING**

Locks are standard on all below worksurface storage units. Two lock options are available. When the factory installed lock option is selected lock cores are installed at the factory. Note: when the random option is selected some units may be shipped with the same key number. When the field installed lock option is selected each unit is shipped with an empty lock cylinder. Locks are Silver or Black.

factory installed locks option code

Option 1

**silver random keys** **RMS**

**black random keys** **RMB**

Option 2 Specify a number between

**SILVER Designated Keys** **100TAS - 150TAS**

**BLACK Designated Keys** **100TA - 150TA**

Field installed locks are also available. When field installed locks are specified each unit is shipped with an empty lock cylinder. A separate line item must be ordered to receive the numbered lock cores for field installation. Field installed locks are available at an additional charge of \$9 list per lock core.

Field installed lock core set, specify model # and key number (add \$9 list per core):

model number Specify a number between

**SILVER Designated Keys** **ACLCKFLD** **100TAS - 200TAS**

**BLACK Designated Keys** **ACLCKFLD** **100TA - 200TA**

**Note:** Add \$9 list per lock core.





Product Reference . . . . . 13-31

- Features + Advantages . . . . . 14-15
- Technical Specifications . . . . . 16-18
- Worksurface UV Finishes. . . . . 19
- Height Reference . . . . . 20
- Desktop Leather Inlay and Glass Insert Locations . . . . . 21
- Worksurface Veneer Grain Directions . . . . . 22-23
- Grommets & Trough Locations . . . . . 24-25
- Metal Pull Locations. . . . . 26
- Integral Wood Pull Locations . . . . . 27
- Specification Tips . . . . . 28
- Wire Management . . . . . 29-30
- Product Specifications. . . . . 31

ATTRIBUTE	FEATURE	ADVANTAGE
<b>STYLE/DESIGN</b>	Hand selected veneer	<ul style="list-style-type: none"> <li>• Quarter cut walnut and plain sliced cherry, maple, and walnut</li> <li>• Rift cut oak</li> </ul>
	Refined aesthetic	<ul style="list-style-type: none"> <li>• Clean, modern design</li> <li>• Layering and various planes</li> <li>• Refined details</li> <li>• Integral wood pull or metal pull</li> <li>• Mitered worksurfaces with waterfall veneer</li> <li>• Optional locking on all units</li> </ul>
	High end material selection	<ul style="list-style-type: none"> <li>• Stone</li> <li>• Leather</li> <li>• Back painted glass</li> <li>• Stainless steel desk base</li> <li>• Dark bronze and champagne silver hardware</li> </ul>
<b>PLANNING FLEXIBILITY</b>	Large breadth of line	<ul style="list-style-type: none"> <li>• Numerous components can be used together to create a variety of planning requirements for size and storage</li> </ul>
<b>FUNCTIONALITY</b>	Accessory track/trough system	<ul style="list-style-type: none"> <li>• Provides sit-to-stand solution in office</li> <li>• Electric driven system with three preset heights</li> <li>• Height range of 29.5"-42"</li> <li>• Integrated in mitered wood base</li> <li>• Charcoal black metal shroud for clean aesthetic in up position</li> </ul>
<b>STORAGE</b>	Soft close hardware	<ul style="list-style-type: none"> <li>• Hidden bottom mount suspension on soft close drawers</li> <li>• Soft close hinges on all doors</li> </ul>
	Cantilevered worksurfaces	<ul style="list-style-type: none"> <li>• Provides unique aesthetic and conferencing end</li> </ul>
	Magnetic tackzone	<ul style="list-style-type: none"> <li>• Backpainted glass and wood tackzone provide magnetic surface for posting papers and magnetic accessories</li> </ul>
	Hidden box drawers	<ul style="list-style-type: none"> <li>• Provides clean lines and fewer fronts</li> <li>• Includes veneered front</li> <li>• Optional leather inserts</li> </ul>
	Overhead door options	<ul style="list-style-type: none"> <li>• Hinged, soft lift, or sliding door overheads</li> </ul>
	Various pedestal options	<ul style="list-style-type: none"> <li>• Drawers, doors, open shelves, printer storage, and trash can</li> </ul>

ATTRIBUTE	FEATURE	ADVANTAGE
<b>TECHNOLOGY INTEGRATION</b>	Wire management	<ul style="list-style-type: none"> <li>• Worksurface trough with pencil lip</li> <li>• Flush grommet with door options</li> </ul>
	Wall access	<ul style="list-style-type: none"> <li>• Optional hinged wall access panels provide simple, clean wire management</li> </ul>
	Lighting	<ul style="list-style-type: none"> <li>• Standard high efficiency LED tasklighting</li> <li>• Recessed into bottom of overhead for clean aesthetic</li> </ul>
	Worksurface power	<ul style="list-style-type: none"> <li>• Power unit can be installed beneath grommet, in worksurface trough or in kneespace for easy access</li> </ul>
<b>SUSTAINABILITY</b>	Design for the environment	<ul style="list-style-type: none"> <li>• FSC certified products available</li> <li>• LEED IEQ 4.5 compliant finish</li> <li>• High percentage of recycled content: 66% post industrial and 9% post consumer yielding an RC value factor of 42%</li> <li>• Energy Efficient LED task lighting</li> </ul>
<b>DURABILITY</b>	Drawer system	<ul style="list-style-type: none"> <li>• Dowel construction—strength</li> <li>• Superior filing capability—extruded file rail integral to drawer</li> <li>• UV finish on drawers—scratch and chemical resistant</li> <li>• 5-sided drawers—can adjust or remove in field without unloading drawers</li> </ul>
	Optional full fill or open pore finish	<ul style="list-style-type: none"> <li>• UV cured finish on worksurfaces—durable top coat</li> <li>• Robotic sprayer—uniformity of finish</li> <li>• Depth, clarity, color consistency, and durability</li> </ul>
	12-year warranty	<ul style="list-style-type: none"> <li>• Backed by Gunlocke's 12-year warranty</li> </ul>

## veneers

All exposed wood surfaces utilize select Plain Sliced Cherry, Maple, Walnut veneers or premium Quarter Cut Walnut, or Rift Cut Oak veneers. These veneers are carefully selected and slip matched to assure balance and consistency.

## WOOD TOPS

Wood veneer tops feature a balanced 3-ply construction and are 1 1/2" thick. Each top has a 3/32" thick external solid-wood band on all sides.

Standard tops are constructed of 45 lb particleboard.

Tops connect to the chassis with wood screws through the inset top panel of the pedestals and steel angle brackets.

## CHASSIS/PEDESTAL CONSTRUCTION

All wood pedestals are made with veneer end panels and fronts which are constructed with 3/4" thick balanced 3-ply panels. End panels are connected with an inset top, back, and bottom panel which is made of 3/4" thick 3-ply particle board. Panels are securely fastened together with cam fasteners in conjunction with solid wood dowels that are securely adhered with PVA (white polyvinyl acetate) glue. A 1 1/16"H x 2 7/16"W 3-ply particle board is mounted to the underside of the inset bottom panel. A threaded steel glide plate is attached to the hardwood stretcher to provide a durable connection between the glide and the bottom of pedestal. The glide plate is 10-gauge or 0.134" thick steel.

Steel glide plates are attached to single end panels with screws. End panels are pre-bored to accept the stem of the glide. The threaded steel glide plate provides a durable connection from glide to bottom of unit end panel.

Each unit is equipped with a minimum of four adjustable glides.

## OVERHEAD/STORAGE CONSTRUCTION

All wood panels are constructed with 1" thick balanced 3-ply panels. The top, end, and bottom panels are securely fastened together with wooden dowels that are adhered with PVA (white polyvinyl acetate) glue. This construction method eliminates any visible assembly fasteners.

Wall mount cabinets are mounted to the wall with a spade and "Z" bracket attachment method. Steel barrel nuts and spade brackets are securely mounted through the back of wall mount cabinets. All units ship with a steel Z bracket. This bracket is mounted to the wall by field installers. Installers are responsible for selecting and supplying appropriate fasteners for wall conditions.

Units with hinged doors include 95° soft close hinges. Hinges are fully adjustable.

## LAYERS UNITS

All layers runoffs and bridges include a wood box to sit on the low height credenza unit. Layers box includes a protective non-skid strip on bottom edge to protect lower worksurface. Layers units provide 7 3/4" of height difference.

## GLIDES

Glides provide 1 1/8" of vertical leveling adjustment. Glide bottom is durable nonrust nylon.

## DRAWERS

All drawers are constructed of four sides and a bottom, which are attached to a drawer front with screws for easy removal. Drawer fronts feature matched veneer within each pedestal set.

The drawer side material is vinyl-clad particleboard, finished with a roll-coated 7-level UV cured polyester/acrylic finish that provides a high level of chemical and scratch resistance. The drawers are fastened together at each corner with dowel joinery for maximum drawer

strength. The bottom material is a 3-ply substrate consisting of medium density fiberboard core with a melamine face and backer.

Optional leather organization trays are available for all box drawers.

## PULLS

Units are available in a continuous metal pull or an integral wood pull.

The drawer front on credenza and return pedestals overlay the worksurface for an uninterrupted appearance. The drawer front on the desk pedestals are below the worksurface to keep main worksurface clean.

Integral wood pull is on a 35° bevel and provides a seamless wood look to the station.

Continuous metal pull is an anodized aluminum pull available in a dark bronze or champagne silver finish. The metal pull on pedestal fronts aligns with metal pull on 24D closets. The metal pull on overhead doors aligns with metal pull on 18D closets.

## SUSPENSIONS

Credentials casegoods utilizes zinc-coated steel, high-grade drawer suspensions which feature an integrated soft close mechanism. The suspensions are bottom mount and are concealed under the drawer body for a cleaner appearance when opening/closing drawers. Box drawer suspensions are 15" depth full extension and are load rated for 100 lb static load, 90 lb dynamic load. File and lateral file drawers are 18" depth full extension and are load rated for 150 lb static load, 135 lb dynamic load. Lateral files include an anti-tip mechanism that prevents more than one drawer from being opened at the same time.

**HINGES**

Units with hinged doors include 95° soft close hinges. Hinges are fully adjustable.

**FILING**

The file hanging system is an integral part of the drawer. A highly durable black plastic extrusion is securely fastened into a route on the top of the drawer. The plastic extrusion and steel folder rails allow side to side and front to back filing in file and lateral file drawers. The plastic extrusion was designed to promote optimum filing capacity within the drawer while providing a durable, reliable and maintenance free filing system. (See filing capability section for technical information on drawer dimensions.)

**LOCKS**

Silver or black face locks are optional on all desks, credenzas, returns, modular pedestals, and storage units. Each pedestal is independently locked. Lock plugs are either factory or field installed.

**KEYING**

Keying is available either factory or field installed. Factory installed keying offers two options: random or designated. When the random keying option is selected an arbitrary key number will be assigned to the unit. Note: some furniture units may have like key numbers when random keying is selected. When the designated keying option is selected a key number must be specified between 100TAS-150TAS for silver lock core and 100TA-150TA for black lock cores. All keys are solid brass. When the field installed keying option is selected, a lock cylinder will not be included in the furniture unit.

**WIRE MANAGEMENT**

Wire management capabilities include optional worksurface grommets and worksurface troughs. Chassis include wire cutouts in kneewell for seamless wire management between pedestals and adjoining units.

Trough worksurfaces provide a 1" wire management gap on the back edge of the worksurface. An anodized aluminum pencil lip is included with each trough worksurface. The tackzone sits below the worksurface on the top edge of the pedestal end panels. A trough worksurface is REQUIRED for all tackzone applications.

Under worksurface wire managers (Model #ACWM) are sold separately to conceal wires between pedestals. These units house and manage wire horizontally around a station.

Wall access is accommodated in credenza, bridge and return units. Two options are available. (1) No modesty panel provides direct access to wall. (2) The hinged access panel option provides access to the wall as needed, creates a cavity behind the panel to mount a power strip (not provided) and houses cords behind panel. The panel hinges and clips on and off to provide occasional access as needed.

**POWER UNIT**

A power unit may be ordered separately to add integrated power to the station. The unit includes 3 power outlets – 2 power outlets on top surface and 1 power outlet on the end. Ships with 6 ft power cord with standard plug. UL listed.

The unit can be mounted in various applications: 1) to bottom of worksurface beneath grommets, 2) to bottom of worksurface in trough opening, 3) as power strip inside wall access panels or kneespace.

**TECHNICAL SPECIFICATIONS****GROMMET**

3.250" x 5.875" rectangular grommet. Grommet bezel is inset flush to top of worksurface. Includes a hinged door that is on a dampening hinge for smooth open/close. Door material may be specified as wood veneer or back painted glass.

**LIGHTING**

Recessed low-profile LED overhead lighting is standard and INCLUDED in all overhead cabinets. They do NOT need to be purchased separately. LED lighting provides high efficiency, low energy lighting with a long life. All LED light strips are encased in a silver aluminum extrusion and include a built-in microswitch to turn the light on/off. Lights are field installed. All units include a 10' cord with a standard plug. Light temperature is 3200K.

**MONITOR ARM**

Monitor arm is EVO2. Monitor arm is silver finish. Monitor arm can be mounted inside grommet hole, desktop trough, or clamped to edge of desk.

Product specs are listed below:

Vertical range: +/- 5.2" from horizontal

Horizontal range: 18.6"

Rotation: 360° at two joints, 180° from center

Monitor tilt: 90° up, 20° down from center

Monitor pivot: Landscape to portrait

Monitor compatibility: VESA monitor compatible - 75mm & 100mm VESA adapters included

Cable management: Cables are managed beneath arm

Mounting options: Desk clamp, grommet mount, or trough mount

Monitor weight: 7-20lbs

## ACCESSORIES

All accessories include imbedded magnets and can be positioned anywhere on wood tackzone and back painted glass tackzone. The accessories provide quick access to files, pencils, and other work utensils. Units are painted standard white, muslin, and black to match glass colors.

## PERSONAL CORNER + DESKPADS

Personal corners can be used between two perpendicular worksurfaces to create an ergonomic corner for user. Deskpads are used in-line. All units are wrapped in leather or vinyl. The bottom surface has a felt lining to protect the worksurface. The chassis is made from 10-gauge aluminum. Personal corners are 36"W x 12 1/2"D. Deskpads are 36"W x 18"D. Units are designed to fit over 1 1/2" thick worksurfaces. Desk inlays are Dolce faux leather and are available in three colors.

## ORGANIZATIONAL TRAYS

Leather organization trays can be used in box drawers and in cubby of 1H overheads. All units are wrapped in leather. The bottom surface has a protective felt lining.

## STAINLESS STEEL BASE

Stainless steel base units include a brushed stainless base. Unit is constructed of 1 1/2" square stainless steel tubing. Units are fully welded for seamless construction.

Three top options are available – 1) wood top, 2) stone top, 3) back painted glass top. Units with a wood top are rabbetted into base with a 1/2" top exposed on all sides. Back painted glass tops and stone tops include a recessed plywood subtop for glass/stone. Stone tops include a template for stone so it can be purchased locally.

## TACKBOARDS

Tackboards are constructed of 7/8" thick material comprised of a 1/8" thick hardboard glued in between a layer of 3/8" thick pressboard on each side. The fabric is precisely aligned and fitted to the tackboard and adhered to the rigid hardboard with staples.

A trough worksurface is REQUIRED for all tackzone applications.

## BACK PAINTED GLASS

Doors and tackzone back painted glass units are captured by an extruded aluminum mitered frame which is powder coated to match. Frame is 3/4" thick and 1 3/4" high. The frame is low profile allowing only 1/16" visible frame around the perimeter of the glass from the front view. Back painted glass is 4mm thick and is available on doors, and in the "tackzone" of overhead storage. Tackzone glass units are magnetized with a steel backer. These units can also act as a whiteboard with use of dry-erase markers. 6 magnets are included with each magnetized whiteboard.

Worksurfaces and desktop inserts in back painted glass are frameless and are acid etched to eliminate fingerprinting.

A trough worksurface is REQUIRED for all tackzone applications.

## CLEANING BACK PAINTED GLASS

All back painted glass should be cleaned with a soft lint free cloth and non-ammonia based cleaner only.

## FINISH

Natural veneer is subject to nature's quality control. Each species will exhibit differences in grain pattern and tone. This is to be expected and, in fact, contributes to the beauty and individuality of each product. Flat Cut veneers emphasize the variations of wood by exhibiting cathedrals in the grain pattern. Quarter Cut and Rift Cut veneers are a premium cut that maintains variations in the grain but without cathedral patterns. Stratawood is a natural, FSC®-certified reconstituted veneer that is designed to exhibit a straight-grain pattern, absent of cathedrals or other significant grain and tone variations.

Worksurfaces, desktops, and tabletops are protected by one of the world's most advanced UV cured finish coatings, available in Full Fill ClearTech® or Open Pore low sheen finish, applied by state-of-the-art finishing equipment. Both finishes meet the stringent requirements for VOC emissions and air quality. Cured in a specially designed ultraviolet oven, the finish fuses to the wood, forming a durable shield that provides a high level of scratch, stain, chemical, and heat resistance, plus a high level of clarity.

Chassis, storage, overheads, and veneer bases are finished with a 30 sheen, conversion varnish finish.

All colors and species are not available on all products. Please refer to front cover of price lists for availability of finishes.

For the technical specifications see the Finish System Guide & Technical specifications available at [www.gunlocke.com/finishsystem](http://www.gunlocke.com/finishsystem).

## CLEANING FINISH

Regular dusting and occasional cleaning are recommended to maintain your wood finish. To clean, dampen a soft cloth with luke warm water and gently wipe the wood in the direction of the grain. A mild solution of Murphy's oil soap and water may also be used. Avoid cleaners with oil, waxes, or silicones as they may create a hazy look.

Credentials worksurfaces feature two low emitting UV finish options that enhance the beauty of natural wood and ensures the depth, clarity, color consistency and durability throughout the life of the product.

**OPEN PORE UV FINISH**

The Gunlocke Open Pore UV Finish delivers a luxurious look-and-feel, while maintaining a high-level of durability and repairability.

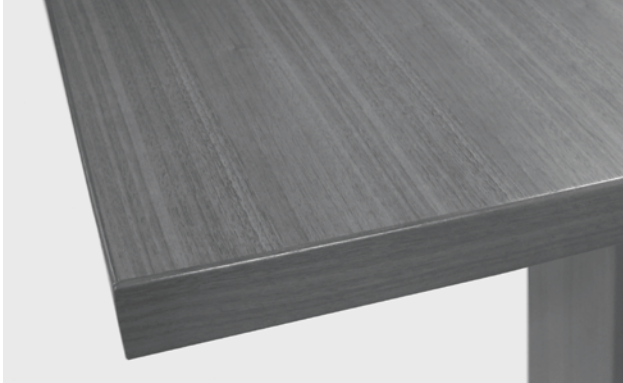

- Open pore finish (natural texture of woodgrain is present)
- 20 sheen
- Solvent based UV cured finish with low emitting qualities
- Open pore finish allows for greater repairability

**CLEARTECH™ FULL FILLED UV FINISH**

The ClearTech™ finishing system is a full-filled UV finish that provides superior durability with strong water, chemical and heat resistance.



- Full-filled finish (provides exceptional depth and clarity)
- 40 sheen
- Solvent based UV cured finish with low emitting qualities
- Superior durability

## STANDARD UNIT HEIGHTS FOR CREDENTIALS:

unit	height
Worksurface	1 1/2
Layers Pedestal	20 3/16
Layers Pedestal + Worksurface	21 11/16
2H Pedestal	27 15/16
2H Pedestal + Worksurface	29 7/16

unit	height
3H Storage	43 7/16
4H Storage	57 7/16
5H Storage	75 15/16
6H Storage	84 7/16
1H Overhead	19 1/2
2H Overhead	28

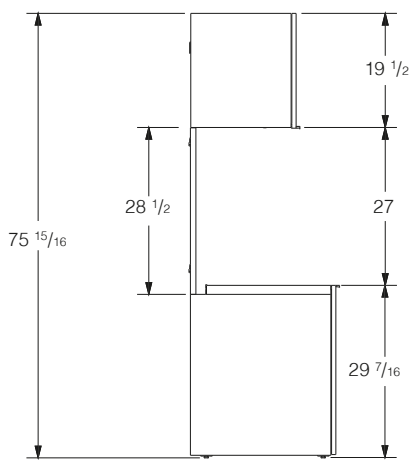

Standard Height Credenza  
1 High Overhead

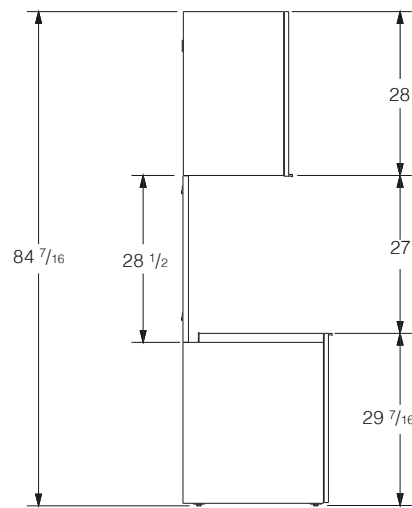

Standard Height Credenza  
2 High Overhead

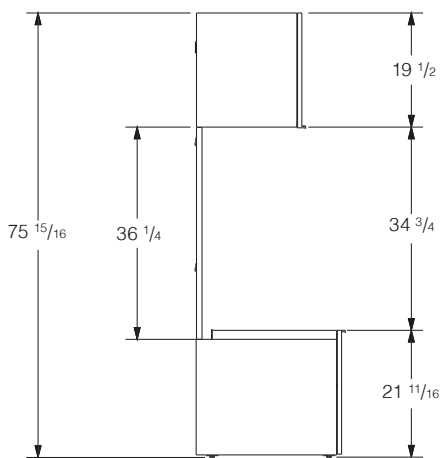

Layers Height Credenza  
1 High Overhead

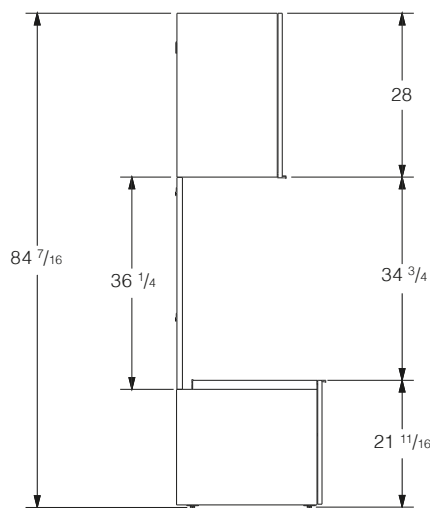

Layers Height Credenza  
2 High Overhead



# DESKTOP LEATHER INLAY AND GLASS INSERT LOCATIONS

Desks and Extensions are available with a Faux Leather inlay or a back painted glass insert.

option picks

Standard Veneer	<b>TVN</b>
Faux Leather Inlay	
White (+\$1,653)	<b>TLW</b>
Black (+\$1,653)	<b>TLB</b>
Chocolate (+\$1,653)	<b>TLC</b>
Back Painted Glass Insert (Acid Etched)	
Ice White (+\$2,313)	<b>TGW</b>
Black (+\$2,313)	<b>TGB</b>
Muslin (+\$2,313)	<b>TGM</b>

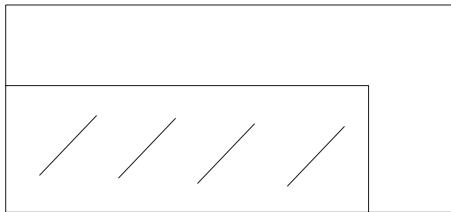

Freestanding Desk with Modesty Panel Base  
(LH desk shown)  
Ex. GA2DTRM3672L-3WW

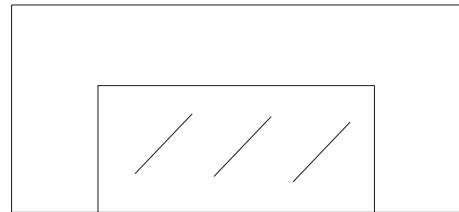

Freestanding Double Pedestal Desks &  
Freestanding Miter Base Desk  
Ex. GA2DRO3672-32WW  
GA2DTRR3672-WW

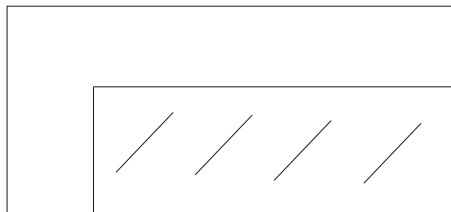

Freestanding Desk with Height Adjustable Base  
(LH desk shown)  
Ex. GA2DTRA3672L-WW

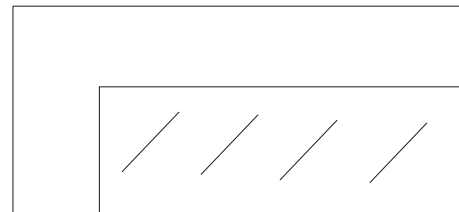

Single Pedestal Desks & All Extension Desks  
(LH desk shown)  
Ex. GA2DRO3672L-3WW

## WORKSURFACE VENEER GRAIN DIRECTIONS:

Note: All vertical faces on chassis and storage are vertical grain.

### FREESTANDING DESK

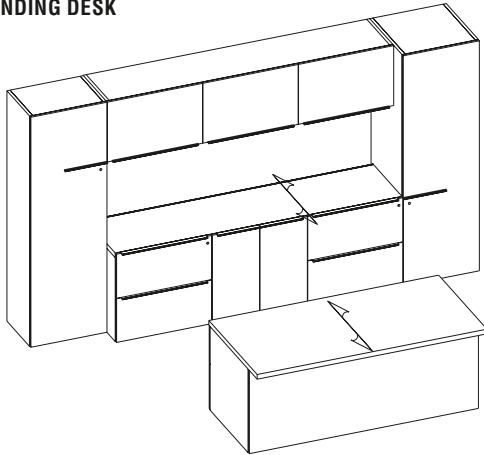

Freestanding Desk – short grain  
Full Base Credenza – short grain

### L STATION

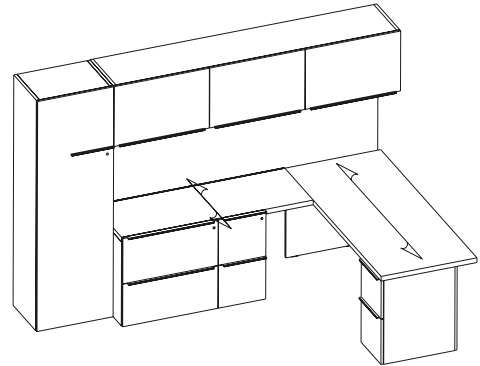

Single Pedestal Desk / Extension – long grain  
Modular Return – short grain

### U STATION

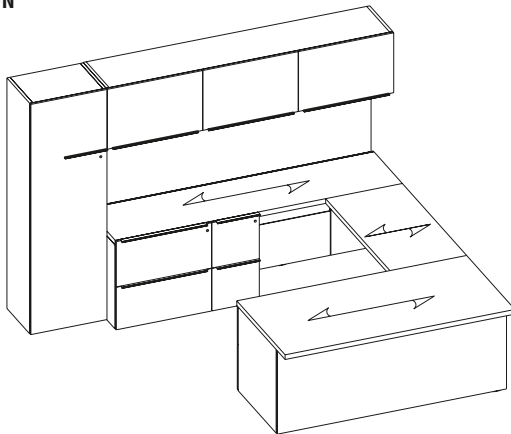

Single Pedestal Desk / Extension – long grain  
Bridge –short grain  
Modular Credenza –long grain

## WORKSURFACE VENEER GRAIN DIRECTIONS:

Note: All vertical faces on chassis and storage are vertical grain.

### LAYERS WORKWALL L STATION

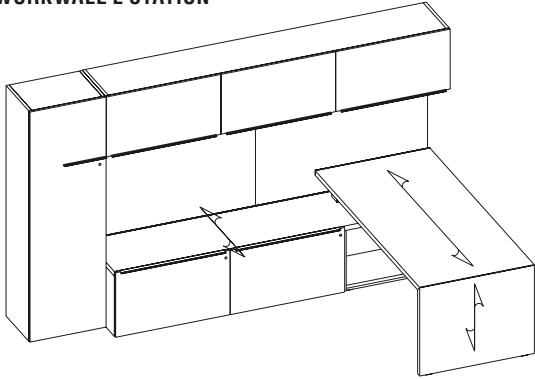

Layers Mitered Runoff Desk – long grain  
Layers Full Bank Credenza – short grain

### WORKWALL L STATION

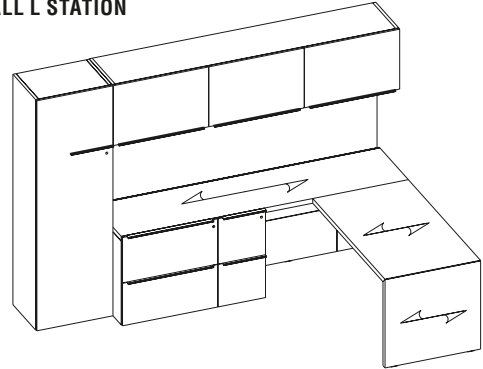

Mitered Runoff Desk – short grain  
Modular Credenza – long grain

### WORKWALL U STATION

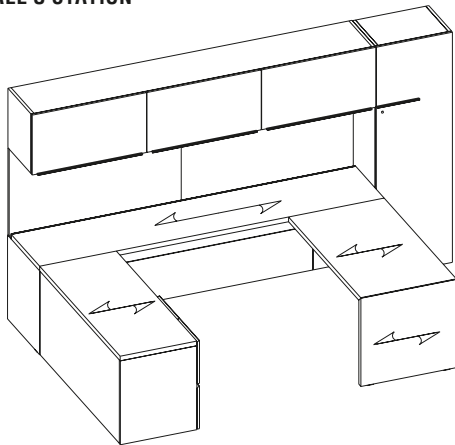

Mitered Runoff Desk –short grain  
Modular Credenza – long grain  
Modular Return – short grain

**Credentials worksurfaces are available with an optional grommet.**

- Grommet is recessed into worksurface and includes a dampening mechanism for smooth open / close.
- Grommet door cover is available in veneer or back painted glass.
- A 1" slot is included for cords and/or monitor arm clamps.

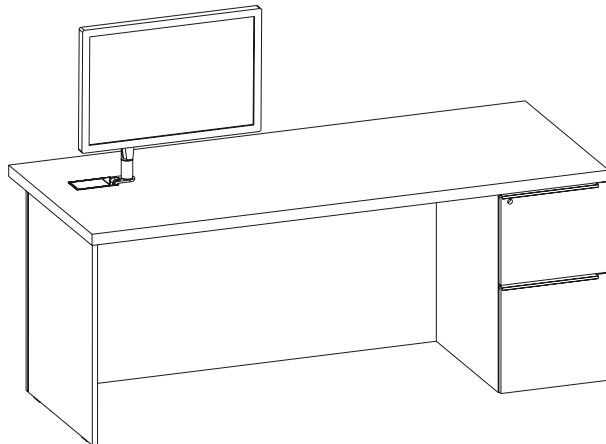

Grommet shown in Single Pedestal Desk with Monitor Arm

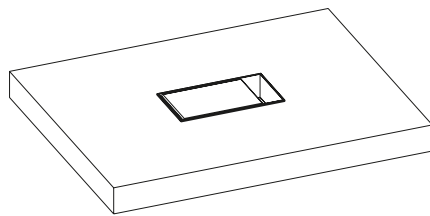

Grommet door closed

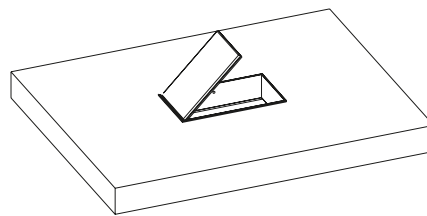

Grommet door open

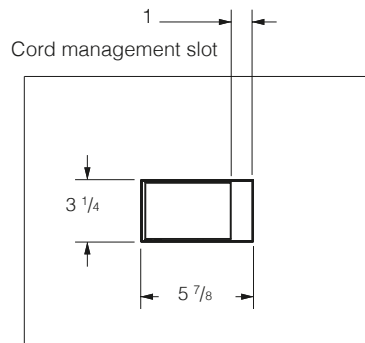

Grommet dimensions

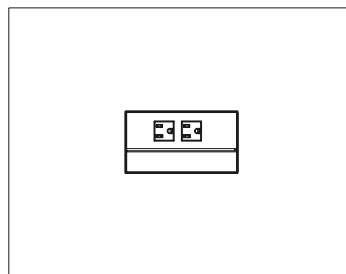

Top view shown with power unit – ACPWRT  
ACPWRT must be ordered separately  
(shown without door)

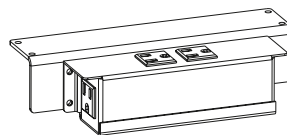

**The worksurface trough is integral to the design and configuration of the product.**

- The trough provides a  $1 \frac{11}{16}$ " gap for cords, power access, and monitor arm clamping.
- All trough worksurfaces include a metal pencil lip.
- The tackzone is recessed into trough area – below worksurface level and sits on end panel of pedestal/chassis.
- Plastic Trough Insert is required and must be ordered separately across entire length of trough (see page 101 to order).

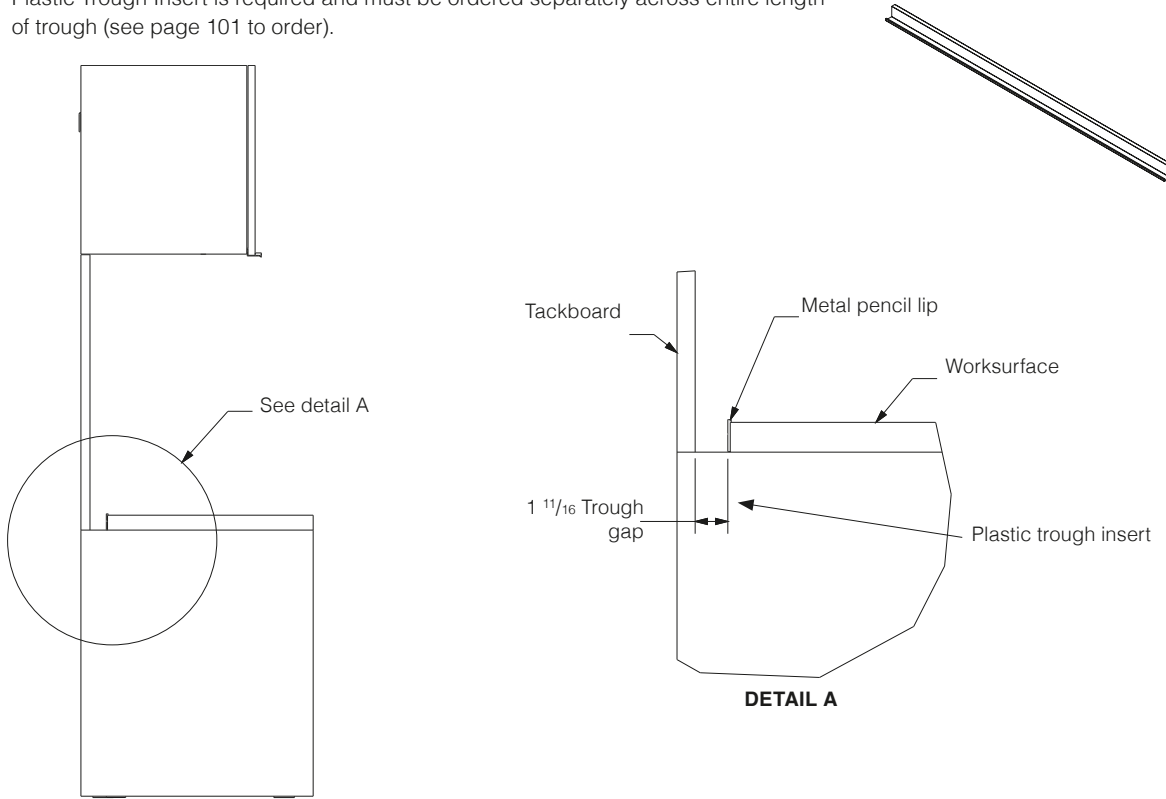

**A trough worksurface is REQUIRED in ALL tackzone applications.**

- The trough can be on a single worksurface or span across multiple units.
- In situations where the trough spans multiple units, each individual unit MUST be specified with a trough worksurface.

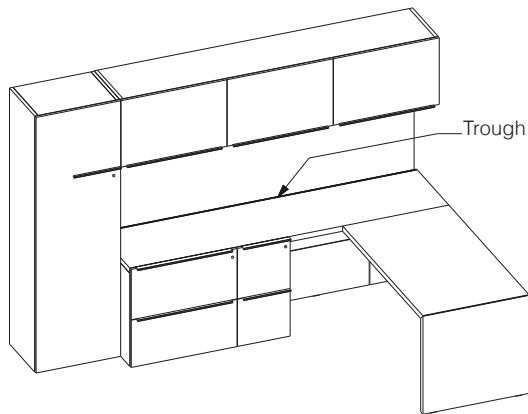

**EXAMPLE 1:**  
Back edge of credenza

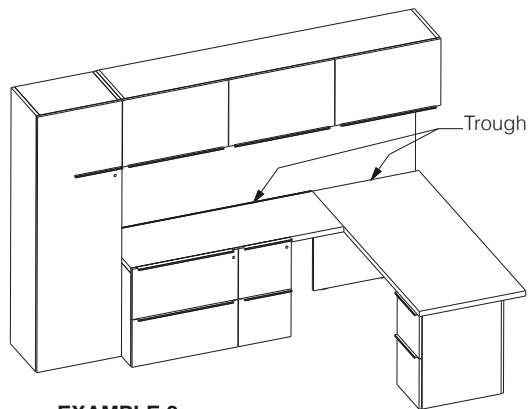

**EXAMPLE 2:**  
Back edge of return  
and  
Left hand end of desk

# METAL PULL LOCATIONS

## Metal pull locations are shown below.

Left hand units shown where applicable.

### DESK PEDESTALS

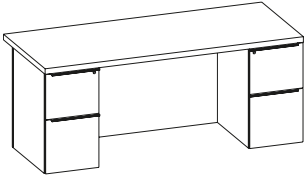

### MODULAR PEDESTALS

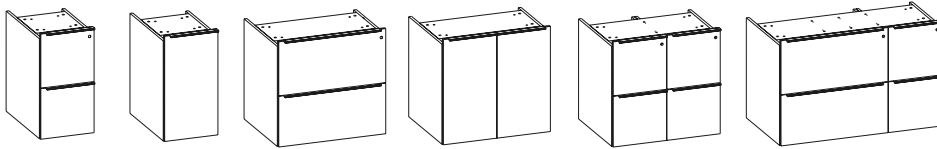

### STORAGE

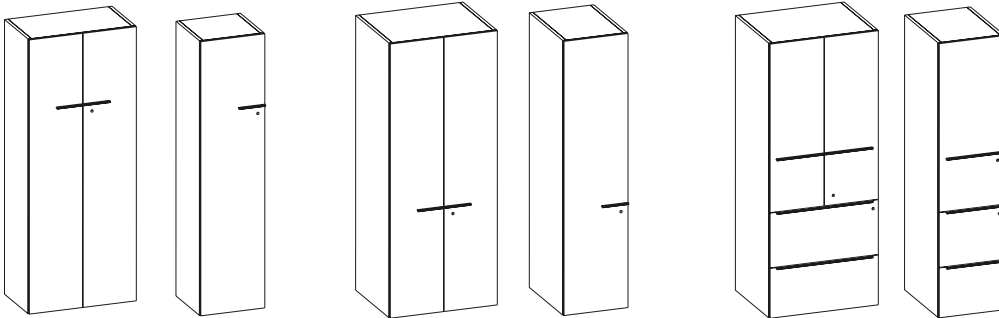

18D CLOSETS

24D CLOSETS

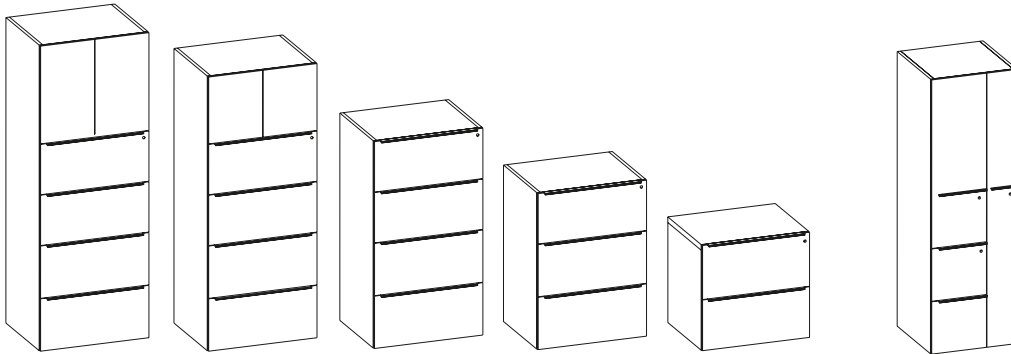

### OVERHEADS

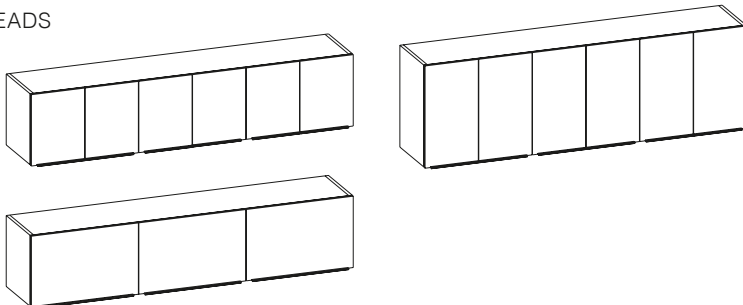

**Integral wood pull locations are shown below.**

Left hand units shown where applicable.

DESK PEDESTALS

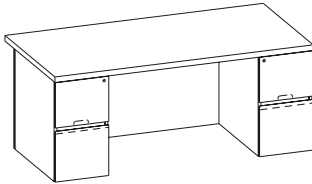

--- dashed line indicates bevel / hidden finger pull

MODULAR PEDESTALS

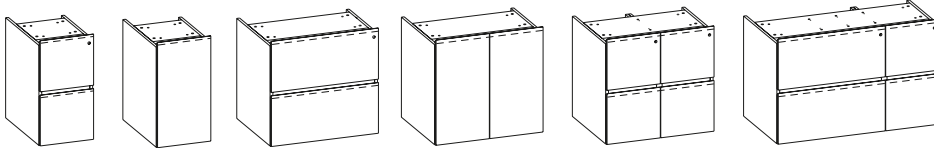

STORAGE

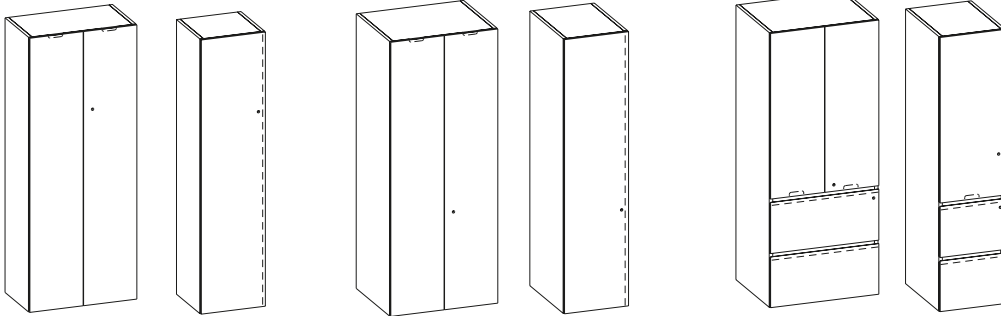

18D CLOSETS

24D CLOSETS

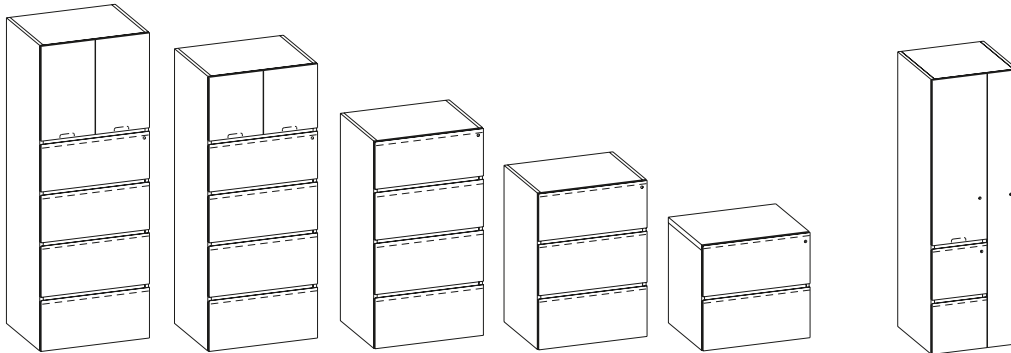

OVERHEADS

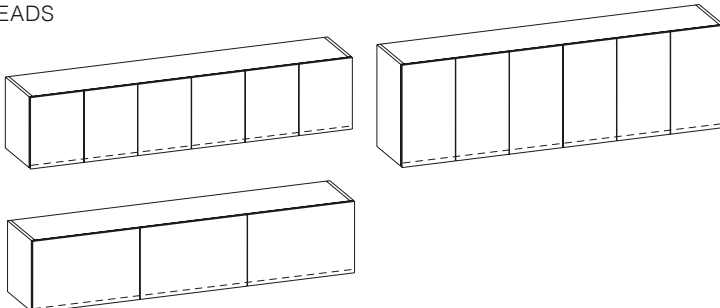

## STEP 1: SELECT CONFIGURATION

FREESTANDING DESK

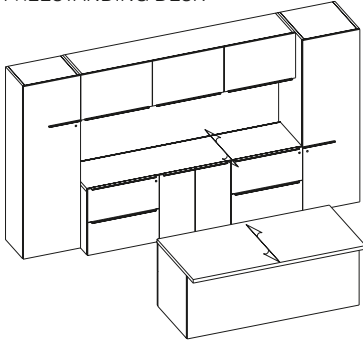

U STATION

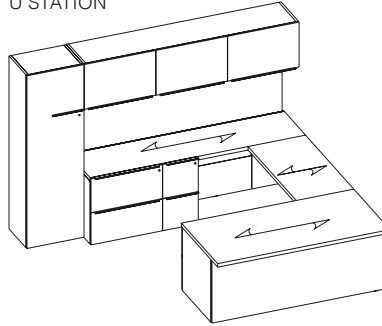

WORKWALL U STATION

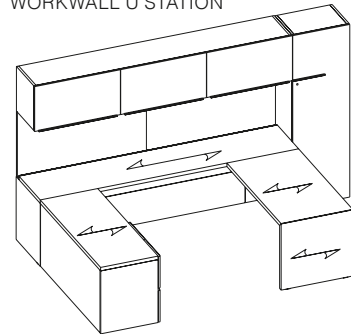

L STATION

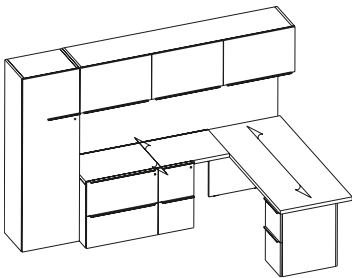

WORKWALL L STATION

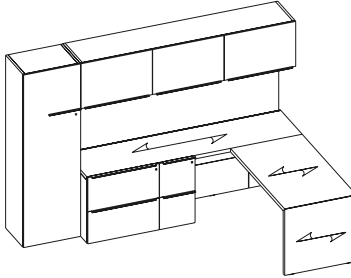

LAYERS WORKWALL L STATION

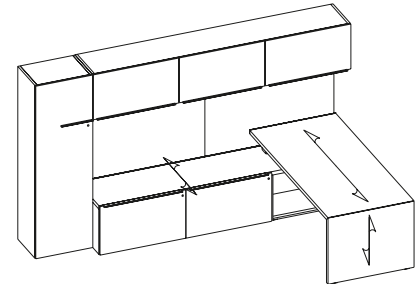

## STEP 2: BEGIN WITH DESKING COMPONENTS

- Desk, extensions, runoffs, and full bank credenzas are unitized
- Credenzas and returns are built from modular components which must be specified separately

## STEP 3: BE SURE TO SPECIFY TROUGH LOCATIONS ALONG ENTIRE LENGTH OF TACKZONE

- Plastic Trough Insert is REQUIRED and must be ordered separately across entire length of trough

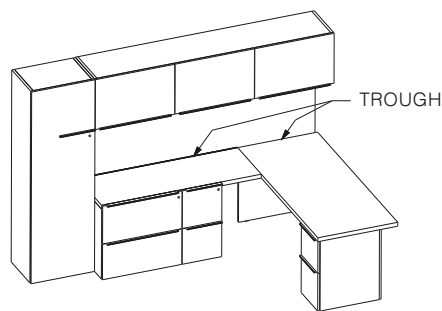
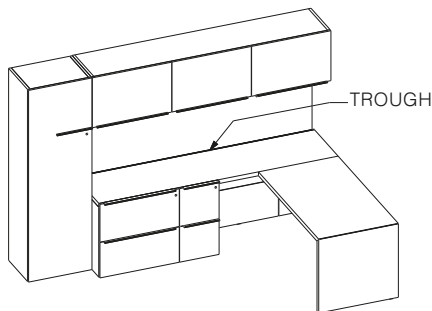

## STEP 4: ADD FREESTANDING STORAGE

- Lateral files, bookcases, closets, storage box, and utility cabinets

## STEP 5: ADD OVERHEADS AND TACKZONE

- Fabric tackboard, magnetic glass whiteboards, and wood tackzones are available
- Recessed tasklights are INCLUDED with all overhead cabinets

## STEP 6: INSERT ACCESSORIES

- Leather box drawer inserts, power units, magnetic accessories, monitor arms, etc.

## STEP 7: OFFICE # OPTION

- An office # option is included on all models ("OFC1" through "OFC199")
- Each individual office must be specified with its own unique office #
- All components for each office must be specified with the same office # option



**GROMMET SPECIFICATIONS**

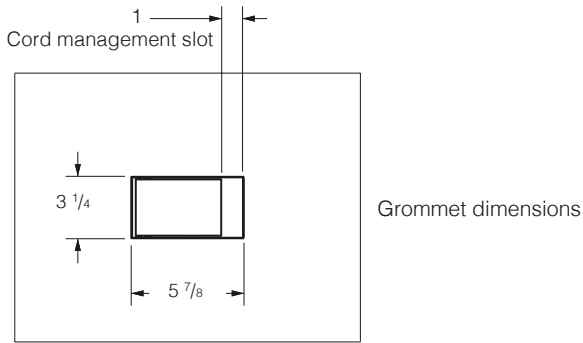

**GROMMET LOCATIONS**

Credenzas, Returns, Bridges

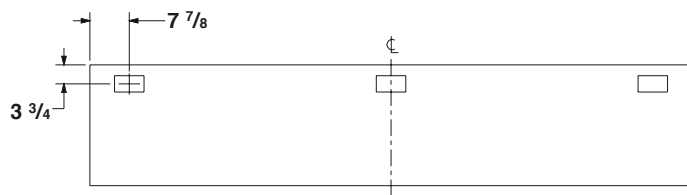

Pedestal Desks and Run-offs; Miter Desks, Extensions, and Run-offs; Slab Base Extensions and Run-offs

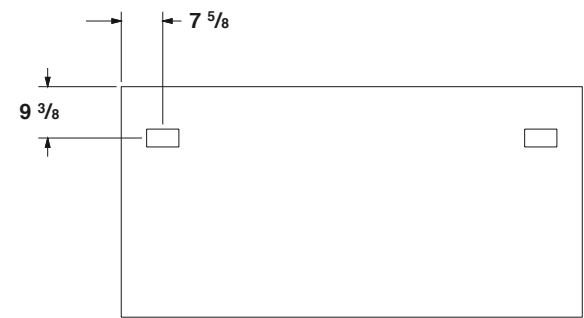

Stainless Metal Base Desks, Extensions, and Runoffs

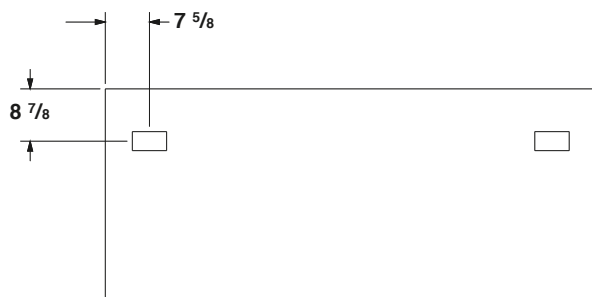

Layers Run-off Tops

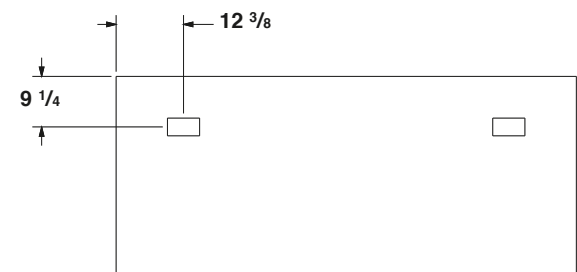

Height Adjustable Desks

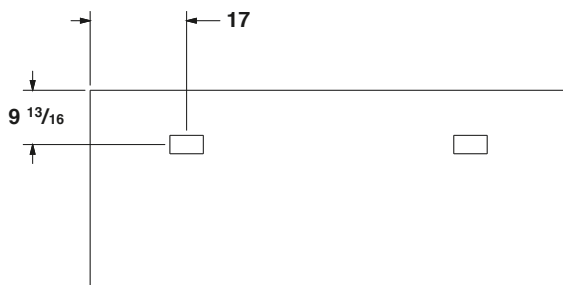

Height Adjustable Extensions

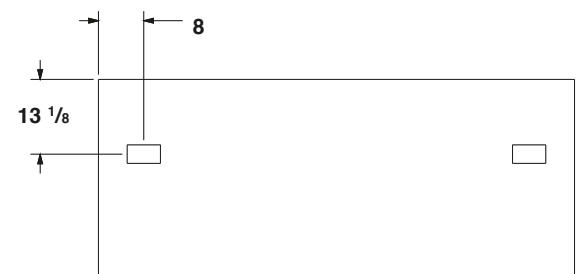

## GROMMET LOCATIONS

Modesty Panel Base Desks

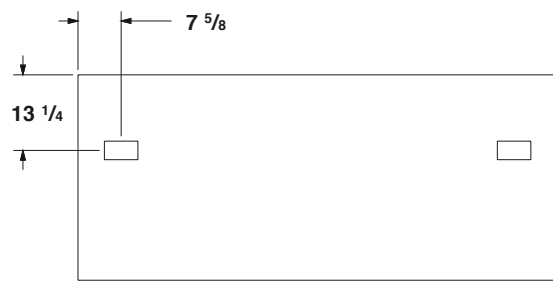

Modesty Panel Base Extensions (No Trough)

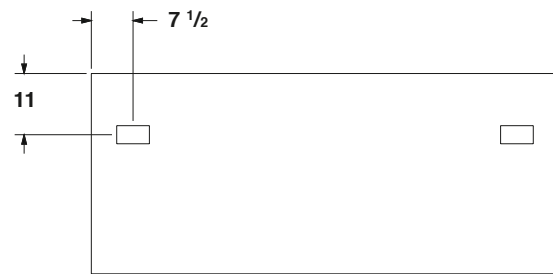

Modesty Panel Base Extensions (Trough End)

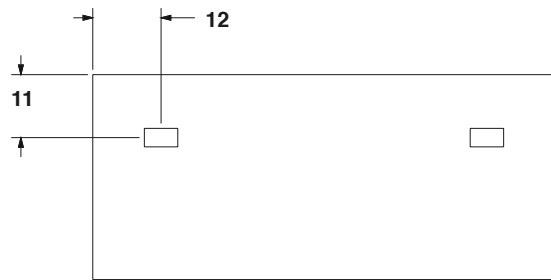

### HEIGHT ADJUSTABLE WORKSURFACES

Worksurfaces are actual widths. A 1" clearance gap is required for any height adjustable top on all sides. Moving worksurfaces can collide with other components. It is important to ensure free range of motion prior to operating the table. Please contact Gunlocke's Tailored Solutions department (GUNTS) for special worksurface size requirements if standard models do not provide 1" gaps. Adjacent worksurfaces need to be self supporting. A wall mount bracket may be used.

### HEIGHT ADJUSTABLE BASE

Electric height adjustable base unit is available in a 2-Stage lifting column with an offset C-Leg design. The height adjustable base is a compact 2-part lifting column. A lifting column is an electric linear actuator integrated into a stable guide. The sophisticated motor system is completely hidden inside the column. The control box is powered by 110-120V /60Hz. Standby power is 0.1 Watts. Height range is 29" to 45". Lifting columns are rated for 225 lbs. dynamic load per column and are connected to tops using steel support brackets. Pedestals taller than 24 H" when placed under the height adjustable table will limit range in lowest position.

### HEIGHT ADJUSTABLE COMPONENTS

Height adjustable components include:

- Qty (2) height adjustable lifting columns
- Qty (1) control box
- Qty (5) keypad options from basic to premium
- Qty (2) cables connecting lifting columns to control box
- Qty (1) standard plug power cable to connect control box to power source

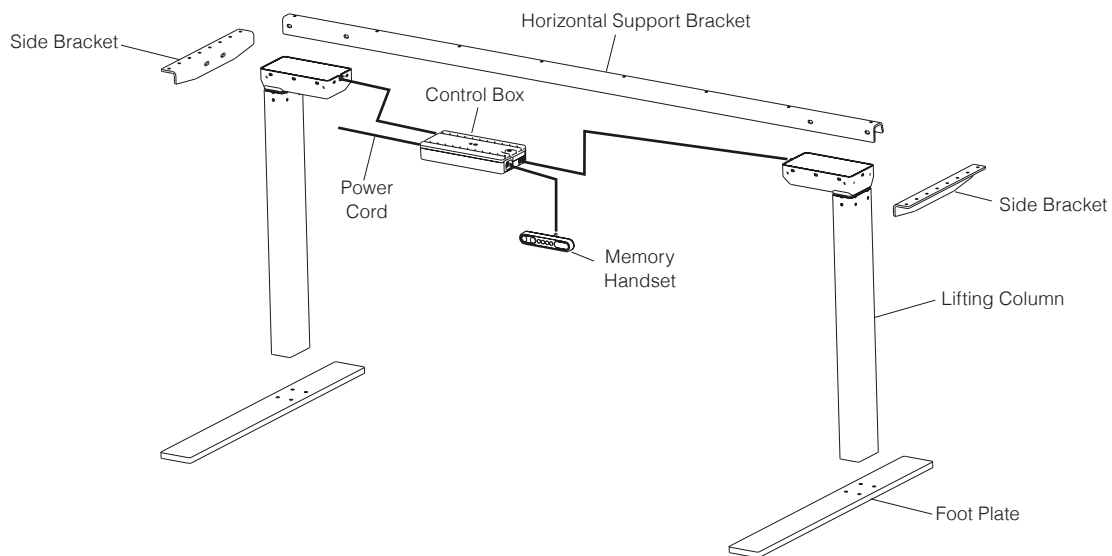



Unitized Casegoods . . . . . 33-105

- Freestanding Table Desks . . . . . 34-40
- Double Pedestal Desks . . . . . 41
- Single Pedestal Desks . . . . . 42-43
- Extensions . . . . . 44-51
- Runoff Desks . . . . . 52-57
- Bridges . . . . . 58-59
- Credenza & Return Components . . . . . 60-63
- Pedestals . . . . . 64-75
- Layers Pedestals . . . . . 76-87
- Modesty / Access / Support Panels . . . . . 88-93
- Brackets / Storage . . . . . 94-98
- Mobile Pedestals . . . . . 99
- Cushions . . . . . 100
- Trough Inserts . . . . . 101
- Height Adjustable Desks . . . . . 102-105

# FREESTANDING TABLE DESKS

Stainless metal base

Credentials

05/22

	D	W	H	model number	veneer 1	veneer 2
<b>WOOD TOP</b>	30	72	29 7/16	<b>GA2DTRL3072-W</b>	10,154	11,170
	36	72	29 7/16	<b>GA2DTRL3672-W</b>	10,466	11,514
	36	78	29 7/16	<b>GA2DTRL3678-W</b>	10,781	11,860
	36	84	29 7/16	<b>GA2DTRL3684-W</b>	11,104	12,215

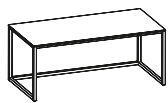

User Side

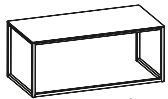

Approach Side

- Optional 10" height modesty panel with 6" overhang

## PRODUCT INFO

Stainless base is 1.5" square stainless tube with brushed finish

Fully welded seamless assembly

1.5" worksurface is rabbeted into stainless base assembly - H" top thickness is visible on all sides

short grain veneer on worksurface

## TO ORDER PLEASE SPECIFY THE FOLLOWING:

1.		<b>MODEL NUMBER</b>
2.		<b>FINISH</b>
3.		<b>TOP UV FINISH TYPE</b>
4.		<b>MODESTY</b>
5.		<b>GROMMET</b>
6.		<b>OFFICE #</b>

See set 1 below for grommet option codes

No Grommet **GN**  
 Left **GL** \_\_\_ (Add +\$191)  
 Right **GR** \_\_\_ (Add +\$191)  
 Left & Right **GB** \_\_\_ (Add +\$382)

\_\_\_ = add grommet bezel color and door finish to complete option pick.

**SV** = silver bezel, veneer door  
**BV** = black bezel, veneer door  
**WG** = silver bezel, white glass door  
**MG** = silver bezel, muslin glass door  
**BG** = black bezel, black glass door

See inside front cover for required option codes

Example: **GLSV** = left grommet, silver bezel, veneer door

Example

**GA2DTRL3072-W.NC215.FF.MY.GN.OFC1**  
 GA2DTRL3072-W    NC215    FF    MY    GN    OFC1  
 MODEL NUMBER    FINISH    TOP UV FINISH    MODESTY    GROMMET    OFFICE #

	D	W	H	model number	list
<b>GLASS TOP</b>	30	72	29 7/16	<b>GA2DTRL3072-G</b>	16,679
	36	72	29 7/16	<b>GA2DTRL3672-G</b>	17,194
	36	78	29 7/16	<b>GA2DTRL3678-G</b>	17,711
	36	84	29 7/16	<b>GA2DTRL3684-G</b>	18,243

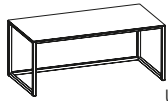

User Side

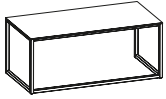

Approach Side

• Back painted glass is 1/2" thick.

**STONE TOP**

(stone top ordered separately)

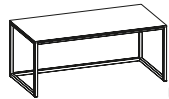

User Side

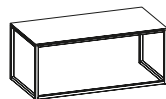

Approach Side

30	72	29 7/16	<b>GA2DTRL3072-S</b>	8,135
36	72	29 7/16	<b>GA2DTRL3672-S</b>	8,389
36	78	29 7/16	<b>GA2DTRL3678-S</b>	8,640
36	84	29 7/16	<b>GA2DTRL3684-S</b>	8,900

- Gunlocke will provide a template for the stone to be sourced locally. Contact GUNCS for template.
- Template is for 2cm (3/4") thick stone top.

**PRODUCT INFO**

Stainless base is 1.5" square stainless tube with brushed finish

Fully welded seamless assembly

Includes a 1" plywood subtop

**TO ORDER PLEASE SPECIFY THE FOLLOWING:**

1.  **MODEL NUMBER**
2.  **BACK PAINTED GLASS COLOR (ONLY FOR GLASS TOPS)**
3.  **OFFICE #**

**See inside front cover for required option codes**

Example

GA2DTRL3072-G.TWH.OFC1  
 GA2DTRL3072-G      TWH      OFC1  
 MODEL NUMBER      BACK PAINTED GLASS COLOR      OFFICE #

# FREESTANDING TABLE DESKS

Credentials

05/22

Modesty panel base

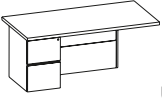
	D	W	H	model number	veneer 1	veneer 2
<b>PEDESTAL LEFT</b>  User Side	36	72	29 7/16	<b>GA2DTRM3672L-3WW</b>	9,117	10,030
	36	78	29 7/16	<b>GA2DTRM3678L-3WW</b>	9,390	10,330
	36	84	29 7/16	<b>GA2DTRM3684L-3WW</b>	9,673	10,641

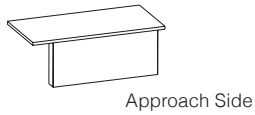

- 10" overhang approach side
- 15" overhang on conference end
- Pedestal is 18" width w/ hidden upper box drawer

## PRODUCT INFO

Short grain veneer on worksurface

## TO ORDER PLEASE SPECIFY THE FOLLOWING:

1.  **MODEL NUMBER**
2.  **FINISH**
3.  **TOP UV FINISH TYPE**
4.  **DESKTOP INSERT**
5.  **PULL**
6.  **GROMMET**
7.  **LOCKING**
8.  **KEYING**
9.  **OFFICE #**

See inside front cover for required option codes

Example

GA2DTRM3672L-3WW.NC215.FF.TVN.MPS.GN.LY.RMS.OFC1

GA2DTRM3672L-3WW	NC215	FF	TVN	MPS	GN	LY	RMS	OFC1
MODEL NUMBER	FINISH	TOP UV FINISH	DESKTOP INSERT	PULL	GROMMET	LOCKING	KEYING	OFFICE #

### See set 2 below for grommet option codes

No Grommet **GN**  
 Left **GL** \_\_\_ (Add +\$191)

\_\_\_ = add grommet bezel color and door finish to complete option pick.

**SV** = silver bezel, veneer door  
**BV** = black bezel, veneer door  
**WG** = silver bezel, white glass door  
**MG** = silver bezel, muslin glass door  
**BG** = black bezel, black glass door

Example: **GLSV** = left grommet, silver bezel, veneer door



	D	W	H	model number	veneer 1	veneer 2
<b>PEDESTAL RIGHT</b>	36	72	29 7/16	<b>GA2DTRM3672R-3WW</b>	9,117	10,030
	36	78	29 7/16	<b>GA2DTRM3678R-3WW</b>	9,390	10,330
	36	84	29 7/16	<b>GA2DTRM3684R-3WW</b>	9,673	10,641

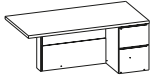

User Side

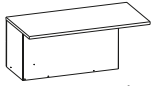

Approach Side

- 10" overhang approach side
- 15" overhang on conference end
- Pedestal is 18" width w/ hidden upper box drawer

**PRODUCT INFO**

Short grain veneer on worksurface

**TO ORDER PLEASE SPECIFY THE FOLLOWING:**

1.  **MODEL NUMBER**
2.  **FINISH**
3.  **TOP UV FINISH TYPE**
4.  **DESKTOP INSERT**
5.  **PULL**
6.  **GROMMET**
7.  **LOCKING**
8.  **KEYING**
9.  **OFFICE #**

See inside front cover for required option codes

Example

GA2DTRM3672R-3WW.NC215.FF.TVN.MPS.GN.LY.RMS.OFC1

GA2DTRM3672R-3WW	NC215	FF	TVN	MPS	GN	LY	RMS	OFC1
<b>MODEL NUMBER</b>	<b>FINISH</b>	<b>TOP UV FINISH</b>	<b>DESKTOP INSERT</b>	<b>PULL</b>	<b>GROMMET</b>	<b>LOCKING</b>	<b>KEYING</b>	<b>OFFICE #</b>

**See set 3 below for grommet option codes**

No Grommet Right **GN**  
Right **GR** \_\_\_\_ (Add +\$191)

\_\_\_\_ = add grommet bezel color and door finish to complete option pick.

- SV** = silver bezel, veneer door
- BV** = black bezel, veneer door
- WG** = silver bezel, white glass door
- MG** = silver bezel, muslin glass door
- BG** = black bezel, black glass door

Example: **GRSV** = right grommet, silver bezel, veneer door

# FREESTANDING TABLE DESKS

Credentials  
05/22

Height adjustable base

	D	W	H	model number	veneer 1	veneer 2
<b>CONFERENCE END LEFT</b>	36	72	29 7/16	<b>GA2DTRAK3672L-WW</b>	14,521	15,974
	36	78	29 7/16	<b>GA2DTRAK3678L-WW</b>	15,016	16,519
	36	84	29 7/16	<b>GA2DTRAK3684L-WW</b>	15,523	17,077

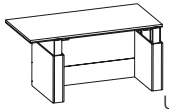

User Side

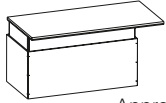

Approach Side

- 6" overhang approach side
- 12" overhang on conference end
- Provides sit-to-stand electric height adjustment
- Height adjustable mechanism is integrated into a wood base
- Includes black metal shroud to conceal height adjustable hardware when in raised position
- 29" to 45" height adjustment range

## PRODUCT INFO

Short grain veneer on worksurface

## TO ORDER PLEASE SPECIFY THE FOLLOWING:

- - 
  - 
  - 
  - 
  -
- MODEL NUMBER**  
**FINISH**  
**TOP UV FINISH TYPE**  
**DESKTOP INSERT**  
**GROMMET**  
**OFFICE #**

### See set 3 below for grommet option codes

No Grommet **GN**  
Right **GR** \_\_\_ (Add +\$191)

\_\_\_ = add grommet bezel color and door finish to complete option pick.

**SV** = silver bezel, veneer door  
**BV** = black bezel, veneer door  
**WG** = silver bezel, white glass door  
**MG** = silver bezel, muslin glass door  
**BG** = black bezel, black glass door

Example: **GRSV** = right grommet, silver bezel, veneer door

See inside front cover for required option codes

Example

**GA2DTRAK3672L-WW.NC215.FF.TVN.GN.OFC1**  
GA2DTRAK3672L-WW NC215 FF TVN GN OFC1  
MODEL NUMBER FINISH TOP UV FINISH DESKTOP INSERT GROMMET OFFICE #

	D	W	H	model number	veneer 1	veneer 2
<b>CONFERENCE END RIGHT</b>	36	72	29 7/16	<b>GA2DTRAK3672R-WW</b>	14,521	15,974
	36	78	29 7/16	<b>GA2DTRAK3678R-WW</b>	15,016	16,519
	36	84	29 7/16	<b>GA2DTRAK3684R-WW</b>	15,523	17,077

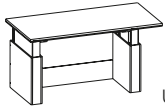

User Side

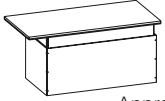

Approach Side

- 6" overhang approach side
- 12" overhang on conference end
- Provides sit-to-stand electric height adjustment
- Height adjustable mechanism is integrated into a wood base
- Includes black metal shroud to conceal height adjustable hardware when in raised position
- 29" to 45" height adjustment range

**PRODUCT INFO**

Short grain veneer on worksurface

**TO ORDER PLEASE SPECIFY THE FOLLOWING:**

1.  **MODEL NUMBER**
2.  **FINISH**
3.  **TOP UV FINISH TYPE**
4.  **DESKTOP INSERT**
5.  **GROMMET**
6.  **OFFICE #**

**See set 2 below for grommet option codes**

No Grommet **GN**  
Left **GL** \_\_\_\_ (Add +\$191)

\_\_\_\_ = add grommet bezel color and door finish to complete option pick.

- SV** = silver bezel, veneer door
- BV** = black bezel, veneer door
- WG** = silver bezel, white glass door
- MG** = silver bezel, muslin glass door
- BG** = black bezel, black glass door

Example: **GLSV** = left grommet, silver bezel, veneer door

**See inside front cover for required option codes**

Example

**GA2DTRAK3672R-WW.NC215.FF.TVN.GN.OFC1**

GA2DTRAK3672R-WW	NC215	FF	TVN	GN	OFC1
<b>MODEL NUMBER</b>	<b>FINISH</b>	<b>TOP UV FINISH</b>	<b>DESKTOP INSERT</b>	<b>GROMMET</b>	<b>OFFICE #</b>

# FREESTANDING TABLE DESKS

Credentials

05/22

Miter end panel base

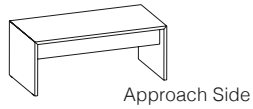
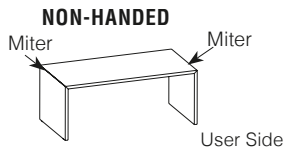

D	W	H	model number	veneer 1	veneer 2
36	72	29 7/16	<b>GA2DTRR3672-WW</b>	7,282	8,011
36	78	29 7/16	<b>GA2DTRR3678-WW</b>	7,503	8,255
36	84	29 7/16	<b>GA2DTRR3684-WW</b>	7,728	8,501

- 10" height modesty panel standard with 6" overhang

## PRODUCT INFO

Short grain veneer on worksurface

## TO ORDER PLEASE SPECIFY THE FOLLOWING:

1.  **MODEL NUMBER**
2.  **FINISH**
3.  **TOP UV FINISH TYPE**
4.  **DESKTOP INSERT**
5.  **GROMMET**
6.  **OFFICE #**

See set 1 below for grommet option codes

No Grommet **GN**  
 Left **GL** \_\_\_ (Add +\$191)  
 Right **GR** \_\_\_ (Add +\$191)  
 Left & Right **GB** \_\_\_ (Add +\$382)

\_\_\_ = add grommet bezel color and door finish to complete option pick.

**SV** = silver bezel, veneer door  
**BV** = black bezel, veneer door  
**WG** = silver bezel, white glass door  
**MG** = silver bezel, muslin glass door  
**BG** = black bezel, black glass door

See inside front cover for required option codes

Example: **GLSV** = left grommet, silver bezel,

Example

GA2DTRR3672-WW.NC215.FF.TVN.GN.OFC1

GA2DTRR3672-WW	NC215	FF	TVN	GN	OFC1
MODEL NUMBER	FINISH	TOP UV FINISH	DESKTOP INSERT	GROMMET	OFFICE#

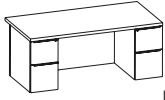
	D	W	H	model number	veneer 1	veneer 2
 User Side	36	72	29 7/16	<b>GA2DRO3672-32WW</b>	10,157	11,173
	36	78	29 7/16	<b>GA2DRO3678-32WW</b>	10,462	11,509
	36	84	29 7/16	<b>GA2DRO3684-32WW</b>	10,775	11,854

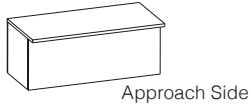

- Full modesty panel with 6" overhang
- -3 pedestals include hidden upper box drawer
- 72" and 78" width units include 15" width pedestal
- 84" width units include 18" width pedestal

**PRODUCT INFO**

Short grain veneer on worksurface

**TO ORDER PLEASE SPECIFY THE FOLLOWING:**

1.  **MODEL NUMBER**
2.  **FINISH**
3.  **TOP UV FINISH TYPE**
4.  **DESKTOP INSERT**
5.  **PULL**
6.  **GROMMET**
7.  **LOCKING**
8.  **KEYING**
9.  **OFFICE #**

See set 1 below for grommet option codes

- No Grommet **GN**
- Left **GL** \_\_\_ (Add +\$191)
- Right **GR** \_\_\_ (Add +\$191)
- Left & Right **GB** \_\_\_ (Add +\$382)

\_\_\_ = add grommet bezel color and door finish to complete option pick.

- SV** = silver bezel, veneer door
- BV** = black bezel, veneer door
- WG** = silver bezel, white glass door
- MG** = silver bezel, muslin glass door
- BG** = black bezel, black glass door

**See inside front cover for required option codes**

Example: **GLSV** = left grommet, silver bezel, veneer door

Example

**GA2DRO3672-32WW.NC215.FF.TVN.MPS.GN.LY.RMS.OFC1**

GA2DRO3672-32WW	NC215	FF	TVN	MPS	GN	LY	RMS	OFC1
<b>MODEL NUMBER</b>	<b>FINISH</b>	<b>TOP UV FINISH</b>	<b>DESKTOP INSERT</b>	<b>PULL</b>	<b>GROMMET</b>	<b>LOCKING</b>	<b>KEYING</b>	<b>OFFICE #</b>

# SINGLE PEDESTAL DESKS

Credentials  
05/22

Left hand

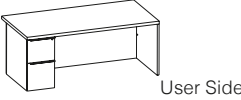
	D	W	H	model number	veneer 1	veneer 2
<b>PEDESTAL LEFT NO TROUGH</b> 	30	72	29 7/16	<b>GA2DRO3072L-3WW</b>	8,240	9,065
	36	72	29 7/16	<b>GA2DRO3672L-3WW</b>	8,494	9,345
	36	78	29 7/16	<b>GA2DRO3678L-3WW</b>	8,747	9,623
	36	84	29 7/16	<b>GA2DRO3684L-3WW</b>	9,013	9,915

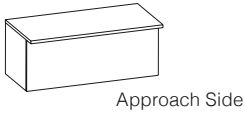

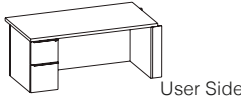
	D	W	H	model number	veneer 1	veneer 2
<b>PEDESTAL LEFT TROUGH RIGHT END</b> 	30	72	29 7/16	<b>GA2DRO3072TL-3WW</b>	8,240	9,065
	36	72	29 7/16	<b>GA2DRO3672TL-3WW</b>	8,494	9,345
	36	78	29 7/16	<b>GA2DRO3678TL-3WW</b>	8,747	9,623
	36	84	29 7/16	<b>GA2DRO3684TL-3WW</b>	9,013	9,915

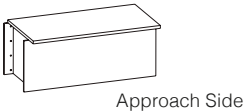

- Full modesty panel with 6" overhang
- -3 pedestals include hidden upper box drawer
- 72" and 78" width units include 15" width pedestal
- 84" width units include 18" width pedestal
- Trough end units are required when a tackzone spans over the end of the desk worksurface
- Trough units include a metal pencil lip

**NOTE:** Plastic Trough Insert is REQUIRED and must be ordered separately across entire length of trough. Single Pedestal desks have 6" overhang, deducting 6" from the overall trough insert length.

## PRODUCT INFO

Long grain veneer on worksurface

## TO ORDER PLEASE SPECIFY THE FOLLOWING:

- - 
  - 
  - 
  - 
  - 
  - 
  - 
  - 
  -
- MODEL NUMBER**  
**FINISH**  
**TOP UV FINISH TYPE**  
**DESKTOP INSERT**  
**PULL**  
**GROMMET**  
**LOCKING**  
**KEYING**  
**PENCIL LIP COLOR (TROUGH ONLY)**  
**OFFICE #**

See set 1 below for grommet option codes

No Grommet **GN**  
Left **GL** \_\_\_ (Add +\$191)  
Right **GR** \_\_\_ (Add +\$191)  
Left & Right **GB** \_\_\_ (Add +\$382)

\_\_\_ = add grommet bezel color and door finish to complete option pick.

**SV** = silver bezel, veneer door  
**BV** = black bezel, veneer door  
**WG** = silver bezel, white glass door  
**MG** = silver bezel, muslin glass door  
**BG** = black bezel, black glass door

Example: **GLSV** = left grommet, silver bezel, veneer door

See inside front cover for required option codes

Example

GA2DRO3072L-3WW.NC215.FF.TVN.MPS.GN.LY.RMS.OFC1  

GA2DRO3072L-3WW	NC215	FF	TVN	MPS	GN	LY	RMS	OFC1
MODEL NUMBER	FINISH	TOP UV FINISH	DESKTOP INSERT	PULL	GROMMET	LOCKING	KEYING	OFFICE #

	D	W	H	model number	veneer 1	veneer 2
<b>PEDESTAL RIGHT NO TROUGH</b>	30	72	29 7/16	<b>GA2DRO3072R-3WW</b>	8,240	9,065
	36	72	29 7/16	<b>GA2DRO3672R-3WW</b>	8,494	9,345
	36	78	29 7/16	<b>GA2DRO3678R-3WW</b>	8,747	9,623
	36	84	29 7/16	<b>GA2DRO3684R-3WW</b>	9,013	9,915

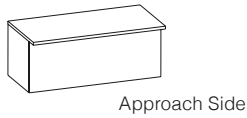
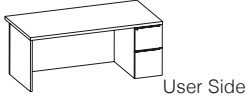

<b>PEDESTAL RIGHT TROUGH LEFT END</b>	30	72	29 7/16	<b>GA2DRO3072TR-3WW</b>	8,240	9,065
	36	72	29 7/16	<b>GA2DRO3672TR-3WW</b>	8,494	9,345
	36	78	29 7/16	<b>GA2DRO3678TR-3WW</b>	8,747	9,623
	36	84	29 7/16	<b>GA2DRO3684TR-3WW</b>	9,013	9,915

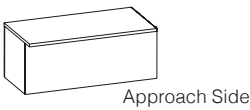
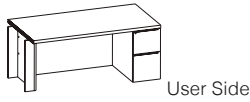

- Full modesty panel with 6" overhang
- -3 pedestals include hidden upper box drawer
- 72" and 78" width units include 15" width pedestal
- 84" width units include 18" width pedestal
- Trough end units are required when a tackzone spans over the end of the desk worksurface
- Trough units include a metal pencil lip

**NOTE:** Plastic Trough Insert is REQUIRED and must be ordered separately across entire length of trough. Single Pedestal desks have 6" overhang, deducting 6" from the overall trough insert length.

**PRODUCT INFO**

Long grain veneer on worksurface

**TO ORDER PLEASE SPECIFY THE FOLLOWING:**

- MODEL NUMBER
- FINISH
- TOP UV FINISH TYPE
- DESKTOP INSERT
- PULL
- GROMMET
- LOCKING
- KEYING
- PENCIL LIP COLOR (TROUGH ONLY)
- OFFICE #

See set 1 below for grommet option codes

- No Grommet **GN**
- Left **GL** \_\_\_ (Add +\$191)
- Right **GR** \_\_\_ (Add +\$191)
- Left & Right **GB** \_\_\_ (Add +\$382)

\_\_\_ = add grommet bezel color and door finish to complete option pick.

- SV** = silver bezel, veneer door
- BV** = black bezel, veneer door
- WG** = silver bezel, white glass door
- MG** = silver bezel, muslin glass door
- BG** = black bezel, black glass door

Example: **GLSV** = left grommet, silver bezel, veneer door

See inside front cover for required option codes

Example

**GA2DRO3072R-3WW.NC215.FF.TVN.MPS.GN.LY.RMS.OFC1**

GA2DRO3072R-3WW	NC215	FF	TVN	MPS	GN	LY	RMS	OFC1
MODEL NUMBER	FINISH	TOP UV FINISH	DESKTOP INSERT	PULL	GROMMET	LOCKING	KEYING	OFFICE #

# EXTENSIONS

Left hand | stainless metal base

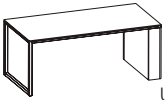
	D	W	H	model number	veneer 1	veneer 2
<b>BASE LEFT NO TROUGH</b>  <p>User Side</p>	30	72	29 7/16	<b>GA2XRL3072L-W</b>	9,140	10,055
	36	72	29 7/16	<b>GA2XRL3672L-W</b>	9,420	10,363
	36	78	29 7/16	<b>GA2XRL3678L-W</b>	9,703	10,675
	36	84	29 7/16	<b>GA2XRL3684L-W</b>	9,994	10,994

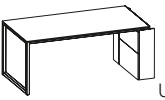
	D	W	H	model number	veneer 1	veneer 2
<b>BASE LEFT TROUGH RIGHT END</b>  <p>User Side</p>	30	72	29 7/16	<b>GA2XRL3072TL-W</b>	9,140	10,055
	36	72	29 7/16	<b>GA2XRL3672TL-W</b>	9,420	10,363
	36	78	29 7/16	<b>GA2XRL3678TL-W</b>	9,703	10,675
	36	84	29 7/16	<b>GA2XRL3684TL-W</b>	9,994	10,994

- Optional 10" height modesty panel with 6" overhang
- Trough end units are required when a tackzone spans over the end of the desk worksurface.
- Trough units include a metal pencil lip

**NOTE:** Plastic Trough Insert is REQUIRED and must be ordered separately across entire length of trough.

## PRODUCT INFO

Stainless base is 1.5" square stainless tube with brushed finish

1.5" worksurface is rabbeted into stainless base assembly. 1/2" top thickness is visible on all sides

Long grain veneer on worksurface

## TO ORDER PLEASE SPECIFY THE FOLLOWING:

1.  **MODEL NUMBER**
2.  **FINISH**
3.  **TOP UV FINISH TYPE**
4.  **DESKTOP INSERT**
5.  **MODESTY**
6.  **GROMMET**
7.  **PENCIL LIP COLOR (TROUGH ONLY)**
8.  **OFFICE #**

### See set 3 below for grommet option codes

No Grommet **GN**  
Right **GR** \_\_\_ (Add +\$191)

\_\_\_ = add grommet bezel color and door finish to complete option pick.

**SV** = silver bezel, veneer door  
**BV** = black bezel, veneer door  
**WG** = silver bezel, white glass door  
**MG** = silver bezel, muslin glass door  
**BG** = black bezel, black glass door

Example: **GRSV** = right grommet, silver bezel, veneer door

**See inside front cover for required option codes**

Example

**GA2XRL3072L-W.NC215.FF.TVN.MY.GN.OFC1**

GA2XRL3072L-W	NC215	FF	TVN	MY	GN	OFC1
<b>MODEL NUMBER</b>	<b>FINISH</b>	<b>TOP UV FINISH</b>	<b>DESKTOP INSERT</b>	<b>MODESTY</b>	<b>GROMMET</b>	<b>OFFICE #</b>

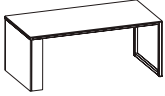

	D	W	H	model number	veneer 1	veneer 2
<b>BASE RIGHT NO TROUGH</b>  User Side	30	72	29 7/16	<b>GA2XRL3072R-W</b>	9,140	10,055
	36	72	29 7/16	<b>GA2XRL3672R-W</b>	9,420	10,363
	36	78	29 7/16	<b>GA2XRL3678R-W</b>	9,703	10,675
	36	84	29 7/16	<b>GA2XRL3684R-W</b>	9,994	10,994

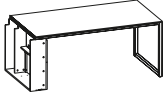
	D	W	H	model number	veneer 1	veneer 2
<b>BASE RIGHT TROUGH LEFT END</b>  User Side	30	72	29 7/16	<b>GA2XRL3072TR-W</b>	9,140	10,055
	36	72	29 7/16	<b>GA2XRL3672TR-W</b>	9,420	10,363
	36	78	29 7/16	<b>GA2XRL3678TR-W</b>	9,703	10,675
	36	84	29 7/16	<b>GA2XRL3684TR-W</b>	9,994	10,994

- Optional 10" height modesty panel with 6" overhang
- Trough end units are required when a tackzone spans over the end of the desk worksurface.
- Trough units include a metal pencil lip

**NOTE:** Plastic Trough Insert is REQUIRED and must be ordered separately across entire length of trough.

**PRODUCT INFO**

Stainless base is 1.5" square stainless tube with brushed finish

1.5" worksurface is rabbeted into stainless base assembly. 1/2" top thickness is visible on all sides

Long grain veneer on worksurface

**TO ORDER PLEASE SPECIFY THE FOLLOWING:**

1.  **MODEL NUMBER**
2.  **FINISH**
3.  **TOP UV FINISH TYPE**
4.  **DESKTOP INSERT**
5.  **MODESTY**
6.  **GROMMET**
7.  **PENCIL LIP COLOR (TROUGH ONLY)**
8.  **OFFICE #**

**See set 2 below for grommet option codes**

No Grommet      **GN**  
Left                **GL** \_\_\_\_ (Add +\$191)

\_\_\_\_ = add grommet bezel color and door finish to complete option pick.

**SV** = silver bezel, veneer door  
**BV** = black bezel, veneer door  
**WG** = silver bezel, white glass door  
**MG** = silver bezel, muslin glass door  
**BG** = black bezel, black glass door

Example: **GLSV** = left grommet, silver bezel, veneer door

**See inside front cover for required option codes**

Example

GA2XRL3072R-W.NC215.FF.TVN.MY.GN.OFC1						
GA2XRL3072R-W	NC215	FF	TVN	MY	GN	OFC1
<b>MODEL NUMBER</b>	<b>FINISH</b>	<b>TOP UV FINISH</b>	<b>DESKTOP INSERT</b>	<b>MODESTY</b>	<b>GROMMET</b>	<b>OFFICE #</b>

# EXTENSIONS

Left hand | modesty panel base

**Credentials**  
05/22

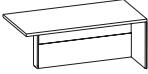
	D	W	H	model number	veneer 1	veneer 2
<b>BASE LEFT NO TROUGH</b>  User Side	30	72	29 7/16	<b>GA2XRM3072L-W</b>	7,517	8,270
	36	72	29 7/16	<b>GA2XRM3672L-W</b>	7,749	8,524
	36	78	29 7/16	<b>GA2XRM3678L-W</b>	7,981	8,780
	36	84	29 7/16	<b>GA2XRM3684L-W</b>	8,222	9,045

## BASE LEFT TROUGH RIGHT END



User Side

30	72	29 7/16	<b>GA2XRM3072TL-W</b>	7,517	8,270
36	72	29 7/16	<b>GA2XRM3672TL-W</b>	7,749	8,524
36	78	29 7/16	<b>GA2XRM3678TL-W</b>	7,981	8,780
36	84	29 7/16	<b>GA2XRM3684TL-W</b>	8,222	9,045

- 10" overhang approach side
- 15" overhang on conference end
- Trough end units are required when a tackzone spans over the end of the desk worksurface.
- Trough units include a metal pencil lip

**NOTE:** Plastic Trough Insert is REQUIRED and must be ordered separately across entire length of trough.

## PRODUCT INFO

Long grain veneer on worksurface

## TO ORDER PLEASE SPECIFY THE FOLLOWING:

1.  **MODEL NUMBER**
2.  **FINISH**
3.  **TOP UV FINISH TYPE**
4.  **DESKTOP INSERT**
5.  **GROMMET**
6.  **PENCIL LIP COLOR (TROUGH ONLY)**
7.  **OFFICE #**

### See set 3 below for grommet option codes

No Grommet **GN**  
Right **GR** \_\_\_ (Add +\$191)

\_\_\_ = add grommet bezel color and door finish to complete option pick.

**SV** = silver bezel, veneer door  
**BV** = black bezel, veneer door  
**WG** = silver bezel, white glass door  
**MG** = silver bezel, muslin glass door  
**BG** = black bezel, black glass door

Example: **GRSV** = right grommet, silver bezel, veneer door

See inside front cover for required option codes

Example

GA2XRM3072L-W.NC215.FF.TVN.GN.OFC1

GA2XRM3072L-W	NC215	FF	TVN	GN	OFC1
<b>MODEL NUMBER</b>	<b>FINISH</b>	<b>TOP UV FINISH</b>	<b>DESKTOP INSERT</b>	<b>GROMMET</b>	<b>OFFICE #</b>

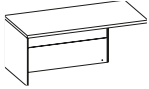
	D	W	H	model number	veneer 1	veneer 2
<b>BASE RIGHT NO TROUGH</b>   <p>User Side</p>	30	72	29 7/16	<b>GA2XRM3072R-W</b>	7,517	8,270
	36	72	29 7/16	<b>GA2XRM3672R-W</b>	7,749	8,524
	36	78	29 7/16	<b>GA2XRM3678R-W</b>	7,981	8,780
	36	84	29 7/16	<b>GA2XRM3684R-W</b>	8,222	9,045

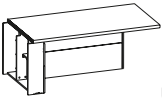
	D	W	H	model number	veneer 1	veneer 2
<b>BASE RIGHT TROUGH LEFT END</b>   <p>User Side</p>	30	72	29 7/16	<b>GA2XRM3072TR-W</b>	7,517	8,270
	36	72	29 7/16	<b>GA2XRM3672TR-W</b>	7,749	8,524
	36	78	29 7/16	<b>GA2XRM3678TR-W</b>	7,981	8,780
	36	84	29 7/16	<b>GA2XRM3684TR-W</b>	8,222	9,045

- 10" overhang approach side
- 15" overhang on conference end
- Trough end units are required when a tackzone spans over the end of the desk worksurface.
- Trough units include a metal pencil lip

**NOTE:** Plastic Trough Insert is REQUIRED and must be ordered separately across entire length of trough.

**PRODUCT INFO**

Long grain veneer on worksurface

**TO ORDER PLEASE SPECIFY THE FOLLOWING:**

1.  **MODEL NUMBER**
2.  **FINISH**
3.  **TOP UV FINISH TYPE**
4.  **DESKTOP INSERT**
5.  **GROMMET**
6.  **PENCIL LIP COLOR (TROUGH ONLY)**
7.  **OFFICE #**

**See set 2 below for grommet option codes**

No Grommet **GN**  
 Left **GL** \_\_\_ (Add +\$191)

\_\_\_ = add grommet bezel color and door finish to complete option pick.

**SV** = silver bezel, veneer door  
**BV** = black bezel, veneer door  
**WG** = silver bezel, white glass door  
**MG** = silver bezel, muslin glass door  
**BG** = black bezel, black glass door

Example: **GLSV** = left grommet, silver bezel, veneer door

**See inside front cover for required option codes**

Example

**GA2XRM3072R-W.NC215.FF.TVN.GN.OFC1**

GA2XRM3072R-W	NC215	FF	TVN	GN	OFC1
<b>MODEL NUMBER</b>	<b>FINISH</b>	<b>TOP UV FINISH</b>	<b>DESKTOP INSERT</b>	<b>GROMMET</b>	<b>OFFICE #</b>

# EXTENSIONS

Left hand | height adjustable base

**Credentials**  
05/22

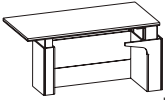
	D	W	H	model number	veneer 1	veneer 2
<b>CONFERENCE END LEFT NO TROUGH</b>  <p>User Side</p>	30	72	29 7/16	<b>GA2XRAK3072L-W</b>	13,602	14,963
	36	72	29 7/16	<b>GA2XRAK3672L-W</b>	14,080	15,489
	36	78	29 7/16	<b>GA2XRAK3678L-W</b>	14,559	16,016
	36	84	29 7/16	<b>GA2XRAK3684L-W</b>	15,053	16,559

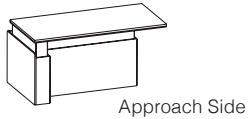

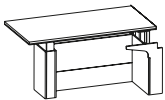
<b>CONFERENCE END LEFT TROUGH RIGHT END</b>  <p>User Side</p>	30	72	29 7/16	<b>GA2XRAK3072TL-W</b>	13,602	14,963
	36	72	29 7/16	<b>GA2XRAK3672TL-W</b>	14,080	15,489
	36	78	29 7/16	<b>GA2XRAK3678TL-W</b>	14,559	16,016
	36	84	29 7/16	<b>GA2XRAK3684TL-W</b>	15,053	16,559

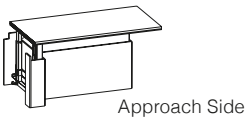

- 10" overhang approach side
- 15" overhang on conference end
- Trough end units are required when a tackzone spans over the end of the desk worksurface.
- Trough units include a metal pencil lip
- Provides sit-to-stand electric height adjustment
- Height adjustable mechanism is integrated into a wood base
- Includes black metal shroud to conceal height adjustable hardware when in raised position
- 29" to 45" height adjustment range
- If attaching to a bridge, specify bridge model for use with height adjustable extensions
- If attaching to a return, a 3" shorter width modesty or wall access panel must be used on return

**NOTE:** Plastic Trough Insert is REQUIRED and must be ordered separately across entire length of trough.

## PRODUCT INFO

Long grain veneer on worksurface

## TO ORDER PLEASE SPECIFY THE FOLLOWING:

1.		<b>MODEL NUMBER</b>
2.		<b>FINISH</b>
3.		<b>TOP UV FINISH TYPE</b>
4.		<b>DESKTOP INSERT</b>
5.		<b>GROMMET</b>
6.		<b>PENCIL LIP COLOR (TROUGH ONLY)</b>
7.		<b>OFFICE #</b>

### See set 3 below for grommet option codes

No Grommet **GN**  
Right **GR** \_\_\_ (Add +\$191)

\_\_\_ = add grommet bezel color and door finish to complete option pick.

**SV** = silver bezel, veneer door  
**BV** = black bezel, veneer door  
**WG** = silver bezel, white glass door  
**MG** = silver bezel, muslin glass door  
**BG** = black bezel, black glass door

Example: **GRSV** = right grommet, silver bezel, veneer door

### See inside front cover for required option codes

Example

<b>GA2XRAK3072L-W.NC215.FF.TVN.GN.OFC1</b>					
GA2XRAK3072L-W	NC215	FF	TVN	GN	OFC1
<b>MODEL NUMBER</b>	<b>FINISH</b>	<b>TOP UV FINISH</b>	<b>DESKTOP INSERT</b>	<b>GROMMET</b>	<b>OFFICE #</b>

	D	W	H	model number	veneer 1	veneer 2
<b>CONFERENCE END RIGHT NO TROUGH</b>	30	72	29 7/16	<b>GA2XRAK3072R-W</b>	13,602	14,963
	36	72	29 7/16	<b>GA2XRAK3672R-W</b>	14,080	15,489
	36	78	29 7/16	<b>GA2XRAK3678R-W</b>	14,559	16,016
	36	84	29 7/16	<b>GA2XRAK3684R-W</b>	15,053	16,559

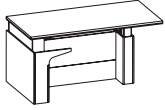

User Side

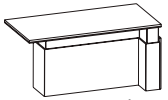

Approach Side

**CONFERENCE END RIGHT TROUGH LEFT END**

	30	72	29 7/16	<b>GA2XRAK3072TR-W</b>	13,602	14,963
	36	72	29 7/16	<b>GA2XRAK3672TR-W</b>	14,080	15,489
	36	78	29 7/16	<b>GA2XRAK3678TR-W</b>	14,559	16,016
	36	84	29 7/16	<b>GA2XRAK3684TR-W</b>	15,053	16,559

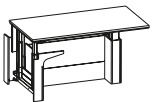

User Side

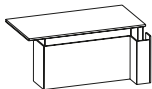

Approach Side

- 10" overhang approach side
- 15" overhang on conference end
- Trough end units are required when a tackzone spans over the end of the desk worksurface.
- Trough units include a metal pencil lip
- Provides sit-to-stand electric height adjustment
- Height adjustable mechanism is integrated into a wood base
- Includes black metal shroud to conceal height adjustable hardware when in raised position
- 29" to 45" height adjustment range
- If attaching to a bridge, specify bridge model for use with height adjustable extensions
- If attaching to a return, a 3" shorter width modesty or wall access panel must be used on return

**NOTE:** Plastic Trough Insert is REQUIRED and must be ordered separately across entire length of trough.

**PRODUCT INFO**

Long grain veneer on worksurface

**TO ORDER PLEASE SPECIFY THE FOLLOWING:**

1.  **MODEL NUMBER**
2.  **FINISH**
3.  **TOP UV FINISH TYPE**
4.  **DESKTOP INSERT**
5.  **GROMMET**
6.  **PENCIL LIP COLOR (TROUGH ONLY)**
7.  **OFFICE #**

**See set 2 below for grommet option codes**

No Grommet **GN**  
Left **GL** \_\_\_ (Add +\$191)

\_\_\_ = add grommet bezel color and door finish to complete option pick.

**SV** = silver bezel, veneer door  
**BV** = black bezel, veneer door  
**WG** = silver bezel, white glass door  
**MG** = silver bezel, muslin glass door  
**BG** = black bezel, black glass door

Example: **GLSV** = left grommet, silver bezel, veneer door

**See inside front cover for required option codes**

Example

**GA2XRAK3072R-W.NC215.FF.TVN.GN.OFC1**

GA2XRAK3072R-W	NC215	FF	TVN	GN	OFC1
<b>MODEL NUMBER</b>	<b>FINISH</b>	<b>TOP UV FINISH</b>	<b>DESKTOP INSERT</b>	<b>GROMMET</b>	<b>OFFICE #</b>

# EXTENSIONS

Left hand | miter end panel base

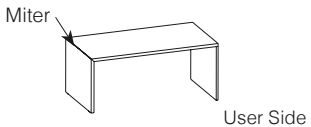
	D	W	H	model number	veneer 1	veneer 2
<b>BASE LEFT NO TROUGH</b> 	30	72	29 7/16	<b>GA2XRR3072L-W</b>	6,872	7,560
	36	72	29 7/16	<b>GA2XRR3672L-W</b>	7,083	7,792
	36	78	29 7/16	<b>GA2XRR3678L-W</b>	7,297	8,028
	36	84	29 7/16	<b>GA2XRR3684L-W</b>	7,516	8,269

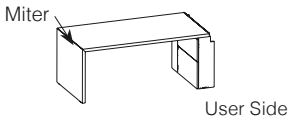
	D	W	H	model number	veneer 1	veneer 2
<b>BASE LEFT TROUGH RIGHT END</b> 	30	72	29 7/16	<b>GA2XRR3072TL-W</b>	6,872	7,560
	36	72	29 7/16	<b>GA2XRR3672TL-W</b>	7,083	7,792
	36	78	29 7/16	<b>GA2XRR3678TL-W</b>	7,297	8,028
	36	84	29 7/16	<b>GA2XRR3684TL-W</b>	7,516	8,269

- 6" overhang approach side
- Trough end units are required when a tackzone spans over the end of the desk worksurface.
- Trough units include a metal pencil lip

**NOTE:** Plastic Trough Insert is REQUIRED and must be ordered separately across entire length of trough.

### PRODUCT INFO

Long grain veneer on worksurface

### TO ORDER PLEASE SPECIFY THE FOLLOWING:

1.		<b>MODEL NUMBER</b>	
2.		<b>FINISH</b>	
3.		<b>TOP UV FINISH TYPE</b>	
4.		<b>DESKTOP INSERT</b>	
5.		<b>GROMMET</b>	
6.		<b>PENCIL LIP COLOR (TROUGH ONLY)</b>	
7.		<b>OFFICE #</b>	

**See inside front cover for required option codes**

Example

**GA2XRR3072L-W.NC215.FF.TVN.GN.OFC1**

GA2XRR3072L-W	NC215	FF	TVN	GN	OFC1
MODEL NUMBER	FINISH	TOP UV FINISH	DESKTOP INSERT	GROMMET	OFFICE #

**See set 3 below for grommet option codes**

No Grommet    **GN**  
Right            **GR** \_\_\_ (Add +\$191)

\_\_\_ = add grommet bezel color and door finish to complete option pick.

**SV** = silver bezel, veneer door  
**BV** = black bezel, veneer door  
**WG** = silver bezel, white glass door  
**MG** = silver bezel, muslin glass door  
**BG** = black bezel, black glass door

Example: **GRSV** = right grommet, silver bezel, veneer door

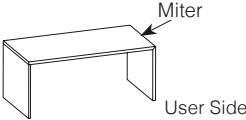
	D	W	H	model number	veneer 1	veneer 2
<b>BASE RIGHT NO TROUGH</b> 	30	72	29 7/16	<b>GA2XRR3072R-W</b>	6,872	7,560
	36	72	29 7/16	<b>GA2XRR3672R-W</b>	7,083	7,792
	36	78	29 7/16	<b>GA2XRR3678R-W</b>	7,297	8,028
	36	84	29 7/16	<b>GA2XRR3684R-W</b>	7,516	8,269

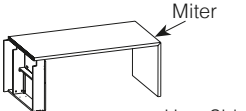
	D	W	H	model number	veneer 1	veneer 2
<b>BASE RIGHT TROUGH LEFT END</b> 	30	72	29 7/16	<b>GA2XRR3072TR-W</b>	6,872	7,560
	36	72	29 7/16	<b>GA2XRR3672TR-W</b>	7,083	7,792
	36	78	29 7/16	<b>GA2XRR3678TR-W</b>	7,297	8,028
	36	84	29 7/16	<b>GA2XRR3684TR-W</b>	7,516	8,269

- 6" overhang approach side
- Trough end units are required when a tackzone spans over the end of the desk worksurface.
- Trough units include a metal pencil lip

**NOTE:** Plastic Trough Insert is REQUIRED and must be ordered separately across entire length of trough

**PRODUCT INFO**

Long grain veneer on worksurface

**TO ORDER PLEASE SPECIFY THE FOLLOWING:**

1.  **MODEL NUMBER**
2.  **FINISH**
3.  **TOP UV FINISH TYPE**
4.  **DESKTOP INSERT**
5.  **GROMMET**
6.  **PENCIL LIP COLOR (TROUGH ONLY)**
7.  **OFFICE #**

**See set 2 below for grommet option codes**

No Grommet **GN**  
 Left **GL** \_\_\_ (Add +\$191)

\_\_\_ = add grommet bezel color and door finish to complete option pick.

**SV** = silver bezel, veneer door  
**BV** = black bezel, veneer door  
**WG** = silver bezel, white glass door  
**MG** = silver bezel, muslin glass door  
**BG** = black bezel, black glass door

Example: **GLSV** = left grommet, silver bezel, veneer door

**See inside front cover for required option codes**

Example

<b>GA2XRR3072R-W.NC215.FF.TVN.GN.OFC1</b>					
GA2XRR3072R-W	NC215	FF	TVN	GN	OFC1
<b>MODEL NUMBER</b>	<b>FINISH</b>	<b>TOP UV FINISH</b>	<b>DESKTOP INSERT</b>	<b>GROMMET</b>	<b>OFFICE #</b>

# RUNOFF DESKS

Left hand | stainless metal base

**Credentials**  
05/22

	D	W	H	model number	veneer 1	veneer 2
<b>STANDARD BASE LEFT</b>  <p>User Side</p>	30	48	29 7/16	<b>GA2RRL3048L-W</b>	7,766	8,544
	30	54	29 7/16	<b>GA2RRL3054L-W</b>	7,998	8,799
	36	54	29 7/16	<b>GA2RRL3654L-W</b>	8,240	9,065
	36	60	29 7/16	<b>GA2RRL3660L-W</b>	8,487	9,337

- Optional 10" height modesty panel with 6" overhang

## LAYERS OVERLAPPING BASE LEFT



30	72	29 7/16	<b>GA2RLRL3072L-W</b>	8,155	8,972
30	78	29 7/16	<b>GA2RLRL3078L-W</b>	8,565	9,422
36	78	29 7/16	<b>GA2RLRL3678L-W</b>	8,992	9,892
36	84	29 7/16	<b>GA2RLRL3684L-W</b>	9,440	10,384

- Optional 10" height modesty panel with 6" overhang
- Layers units overlap low height credenza worksurfaces
- Includes layers box
- Unit is free-floating on lower credenza worksurface
- Includes pencil lip on end of unit

## PRODUCT INFO

Stainless base is 1.5" square stainless tube with brushed finish

1.5" worksurface is rabbeted into stainless base assembly - H" top thickness is visible on all sides

Short grain veneer on worksurface

## TO ORDER PLEASE SPECIFY THE FOLLOWING:

1.	<input type="text"/>	<b>MODEL NUMBER</b>
2.	<input type="text"/>	<b>FINISH</b>
3.	<input type="text"/>	<b>TOP UV FINISH TYPE</b>
4.	<input type="text"/>	<b>MODESTY</b>
5.	<input type="text"/>	<b>GROMMET</b>
6.	<input type="text"/>	<b>PENCIL LIP COLOR (LAYERS ONLY)</b>
7.	<input type="text"/>	<b>OFFICE #</b>

### See set 3 below for grommet option codes

No Grommet **GN**  
Right **GR** \_\_\_ (Add +\$191)

\_\_\_ = add grommet bezel color and door finish to complete option pick.

**SV** = silver bezel, veneer door  
**BV** = black bezel, veneer door  
**WG** = silver bezel, white glass door  
**MG** = silver bezel, muslin glass door  
**BG** = black bezel, black glass door

Example: **GRSV** = right grommet, silver bezel, veneer door

### See inside front cover for required option codes

Example

**GA2RRL3048L-W.NC215.FF.TVN.MY.GN.PLS.OFC1**

GA2RRL3048L-W	NC215	FF	TVN	MY	GN	PLS	OFC1
<b>MODEL NUMBER</b>	<b>FINISH</b>	<b>TOP UV FINISH</b>	<b>DESKTOP INSERT</b>	<b>MODESTY</b>	<b>GROMMET</b>	<b>PENCIL LIP COLOR</b>	<b>OFFICE #</b>



	D	W	H	model number	veneer 1	veneer 2
<b>STANDARD BASE RIGHT</b>	30	48	29 7/16	<b>GA2RRL3048R-W</b>	7,766	8,544
	30	54	29 7/16	<b>GA2RRL3054R-W</b>	7,998	8,799
	36	54	29 7/16	<b>GA2RRL3654R-W</b>	8,240	9,065
	36	60	29 7/16	<b>GA2RRL3660R-W</b>	8,487	9,337



- Optional 10" height modesty panel with 6" overhang

**LAYERS OVERLAPPING  
BASE RIGHT**

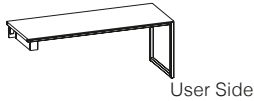

30	72	29 7/16	<b>GA2RLRL3072R-W</b>	8,155	8,972
30	78	29 7/16	<b>GA2RLRL3078R-W</b>	8,565	9,422
36	78	29 7/16	<b>GA2RLRL3678R-W</b>	8,992	9,892
36	84	29 7/16	<b>GA2RLRL3684R-W</b>	9,440	10,384

- Optional 10" height modesty panel with 6" overhang
- Layers units overlap low height credenza worksurfaces
- Includes layers box
- Unit is free-floating on lower credenza worksurface
- Includes pencil lip on end of unit

**PRODUCT INFO**

Stainless base is 1.5" square stainless tube with brushed finish

1.5" worksurface is rabbeted into stainless base assembly - H" top thickness is visible on all sides

Short grain veneer on worksurface

**TO ORDER PLEASE SPECIFY THE FOLLOWING:**

- MODEL NUMBER**
- FINISH**
- TOP UV FINISH TYPE**
- MODESTY**
- GROMMET**
- PENCIL LIP COLOR (LAYERS ONLY)**
- OFFICE #**

**See set 2 below for grommet option codes**

No Grommet **GN**  
Left **GL** \_\_\_\_ (Add +\$191)

\_\_\_\_ = add grommet bezel color and door finish to complete option pick.

**SV** = silver bezel, veneer door  
**BV** = black bezel, veneer door  
**WG** = silver bezel, white glass door  
**MG** = silver bezel, muslin glass door  
**BG** = black bezel, black glass door

Example: **GLSV** = left grommet, silver bezel, veneer door

**See inside front cover for required option codes**

Example

GA2RRL3048R-W.NC215.FF.TVN.MY.GN.PLS.OFC1

GA2RRL3048R-W	NC215	FF	TVN	MY	GN	PLS	OFC1
<b>MODEL NUMBER</b>	<b>FINISH</b>	<b>TOP UV FINISH</b>	<b>DESKTOP INSERT</b>	<b>MODESTY</b>	<b>GROMMET</b>	<b>PENCIL LIP COLOR</b>	<b>OFFICE#</b>

# RUNOFF DESKS

Left hand | miter panel base

**Credentials**  
05/22

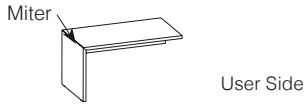
	D	W	H	model number	veneer 1	veneer 2
<b>STANDARD BASE LEFT</b> 	30	48	29 7/16	<b>GA2RRR3048L-W</b>	5,840	6,425
	30	54	29 7/16	<b>GA2RRR3054L-W</b>	6,015	6,617
	36	54	29 7/16	<b>GA2RRR3654L-W</b>	6,196	6,817
	36	60	29 7/16	<b>GA2RRR3660L-W</b>	6,381	7,020

- 6" overhang approach side

## LAYERS OVERLAPPING BASE LEFT

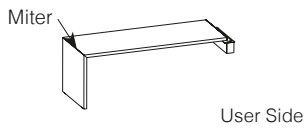

30	72	29 7/16	<b>GA2RLRR3072L-W</b>	6,134	6,748
30	78	29 7/16	<b>GA2RLRR3078L-W</b>	6,439	7,084
36	78	29 7/16	<b>GA2RLRR3678L-W</b>	6,758	7,434
36	84	29 7/16	<b>GA2RLRR3684L-W</b>	7,099	7,810

- 6" overhang approach side
- Layers units overlap low height credenza worksurfaces
- Includes layers box
- Unit is free-floating on lower credenza worksurface
- Includes pencil lip on end of unit

### PRODUCT INFO

Short grain veneer on worksurface

### TO ORDER PLEASE SPECIFY THE FOLLOWING:

1.	<input type="text"/>	<b>MODEL NUMBER</b>
2.	<input type="text"/>	<b>FINISH</b>
3.	<input type="text"/>	<b>TOP UV FINISH TYPE</b>
4.	<input type="text"/>	<b>GROMMET</b>
5.	<input type="text"/>	<b>PENCIL LIP COLOR (LAYERS ONLY)</b>
6.	<input type="text"/>	<b>OFFICE #</b>

#### See set 3 below for grommet option codes

No Grommet **GN**  
Right **GR** \_\_\_\_ (Add +\$191)

\_\_\_\_ = add grommet bezel color and door finish to complete option pick.

**SV** = silver bezel, veneer door  
**BV** = black bezel, veneer door  
**WG** = silver bezel, white glass door  
**MG** = silver bezel, muslin glass door  
**BG** = black bezel, black glass door

Example: **GRSV** = right grommet, silver bezel, veneer door

#### See inside front cover for required option codes

Example

GA2RRR3048L-W.NC215.FF.TVN.GNS.PLS.OFC1						
GA2RRR3048L-W	NC215	FF	TVN	GN	PLS	OFC1
<b>MODEL NUMBER</b>	<b>FINISH</b>	<b>TOP UV FINISH</b>	<b>DESKTOP INSERT</b>	<b>GROMMET</b>	<b>PENCIL LIP COLOR</b>	<b>OFFICE #</b>

**STANDARD  
BASE RIGHT**

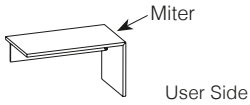

D	W	H	model number	veneer 1	veneer 2
30	48	29 7/16	<b>GA2RRR3048R-W</b>	5,840	6,425
30	54	29 7/16	<b>GA2RRR3054R-W</b>	6,015	6,617
36	54	29 7/16	<b>GA2RRR3654R-W</b>	6,196	6,817
36	60	29 7/16	<b>GA2RRR3660R-W</b>	6,381	7,020

- 6" overhang approach side

**LAYERS OVERLAPPING  
BASE RIGHT**

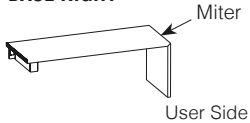

30	72	29 7/16	<b>GA2RLRR3072R-W</b>	6,134	6,748
30	78	29 7/16	<b>GA2RLRR3078R-W</b>	6,439	7,084
36	78	29 7/16	<b>GA2RLRR3678R-W</b>	6,758	7,434
36	84	29 7/16	<b>GA2RLRR3684R-W</b>	7,099	7,810

- 6" overhang approach side
- Layers units overlap low height credenza worksurfaces
- Includes layers box
- Unit is free-floating on lower credenza worksurface
- Includes pencil lip on end of unit

**PRODUCT INFO**

Short grain veneer on worksurface

**TO ORDER PLEASE SPECIFY THE FOLLOWING:**

- MODEL NUMBER**
- FINISH**
- TOP UV FINISH TYPE**
- GROMMET**
- PENCIL LIP COLOR (LAYERS ONLY)**
- OFFICE #**

**See set 2 below for grommet option codes**

No Grommet **GN**  
Left **GL** \_\_\_ (Add +\$191)

\_\_\_ = add grommet bezel color and door finish to complete option pick.

**SV** = silver bezel, veneer door  
**BV** = black bezel, veneer door  
**WG** = silver bezel, white glass door  
**MG** = silver bezel, muslin glass door  
**BG** = black bezel, black glass door

Example: **GLSV** = left grommet, silver bezel, veneer door

**See inside front cover for required option codes**

Example

GA2RRR3048R-W.NC215.FF.TVN.GN.PLS.OFC1						
GA2RRR3048R-W	NC215	FF	TVN	GN	PLS	OFC1
<b>MODEL NUMBER</b>	<b>FINISH</b>	<b>TOP UV FINISH</b>	<b>DESKTOP INSERT</b>	<b>GROMMET</b>	<b>PENCIL LIP COLOR</b>	<b>OFFICE #</b>

# RUNOFF DESKS

Left hand | pedestal

Credentials

05/22

	D	W	H	model number	veneer 1	veneer 2
<b>STANDARD PEDESTAL LEFT</b>	30	48	29 7/16	<b>GA2RRO3048L-3W</b>	7,003	7,704
	30	54	29 7/16	<b>GA2RRO3054L-3W</b>	7,211	7,933
	36	54	29 7/16	<b>GA2RRO3654L-3W</b>	7,426	8,170
	36	60	29 7/16	<b>GA2RRO3660L-3W</b>	7,652	8,418

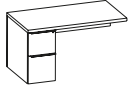

User Side

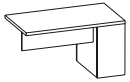

Approach Side

- 6" overhang approach side
- -3 pedestals include hidden upper box drawer
- All units include 15" width pedestal

## LAYERS OVERLAPPING PEDESTAL LEFT

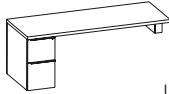

User Side

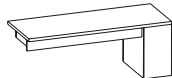

Approach Side

30	72	29 7/16	<b>GA2RLRO3072L-3W</b>	7,355	8,091
30	78	29 7/16	<b>GA2RLRO3078L-3W</b>	7,722	8,495
36	78	29 7/16	<b>GA2RLRO3678L-3W</b>	8,104	8,915
36	84	29 7/16	<b>GA2RLRO3684L-3W</b>	8,512	9,364

- 6" overhang approach side
- -3 pedestals include hidden upper box drawer
- All units include 15" width pedestal
- Layers units overlap low height credenza worksurfaces
- Includes layers box
- Unit is free-floating on lower credenza worksurface
- Includes pencil lip on end of unit

## PRODUCT INFO

Short grain veneer on worksurface

## TO ORDER PLEASE SPECIFY THE FOLLOWING:

1.		<b>MODEL NUMBER</b>
2.		<b>FINISH</b>
3.		<b>TOP UV FINISH TYPE</b>
4.		<b>PULL</b>
5.		<b>MODESTY</b>
6.		<b>GROMMET</b>
7.		<b>PENCIL LIP COLOR (LAYERS ONLY)</b>
8.		<b>LOCKING</b>
9.		<b>KEYING</b>
10.		<b>OFFICE #</b>

See inside front cover for required option codes

Example

GA2RRO3048L-3W.NC215.FF.TVN.MPS.MY.GN.PLS.LY.RMS.OFC1

GA2RRO3048L-3W	NC215	FF	TVN	MPS	MY	GN	PLS	LY	RMS	OFC1
MODEL NUMBER	FINISH	TOP UV FINISH	DESKTOP INSERT	PULL	MODESTY	GROMMET	PENCIL LIP COLOR	LOCKING	KEYING	OFFICE #

### See set 3 below for grommet option codes

No Grommet **GN**  
Right **GR** \_\_\_ (Add +\$191)

\_\_\_ = add grommet bezel color and door finish to complete option pick.

**SV** = silver bezel, veneer door  
**BV** = black bezel, veneer door  
**WG** = silver bezel, white glass door  
**MG** = silver bezel, muslin glass door  
**BG** = black bezel, black glass door

Example: **GRSV** = right grommet, silver bezel, veneer door

	D	W	H	model number	veneer 1	veneer 2
<b>STANDARD PEDESTAL RIGHT</b>	30	48	29 7/16	<b>GA2RRO3048R-3W</b>	7,003	7,704
	30	54	29 7/16	<b>GA2RRO3054R-3W</b>	7,211	7,933
	36	54	29 7/16	<b>GA2RRO3654R-3W</b>	7,426	8,170
	36	60	29 7/16	<b>GA2RRO3660R-3W</b>	7,652	8,418

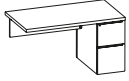

User Side

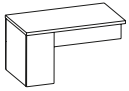

Approach Side

- 6" overhang approach side
- -3 pedestals include hidden upper box drawer
- All units include 15" width pedestal

**LAYERS OVERLAPPING PEDESTAL RIGHT**

	30	72	29 7/16	<b>GA2RLRO3072R-3W</b>	7,355	8,091
	30	78	29 7/16	<b>GA2RLRO3078R-3W</b>	7,722	8,495
	36	78	29 7/16	<b>GA2RLRO3678R-3W</b>	8,104	8,915
	36	84	29 7/16	<b>GA2RLRO3684R-3W</b>	8,512	9,364

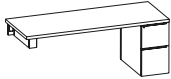

User Side

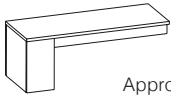

Approach Side

- 6" overhang approach side
- -3 pedestals include hidden upper box drawer
- All units include 15" width pedestal
- Layers units overlap low height credenza worksurfaces
- Includes layers box
- Unit is free-floating on lower credenza worksurface

**PRODUCT INFO**

Short grain veneer on worksurface

**TO ORDER PLEASE SPECIFY THE FOLLOWING:**

- MODEL NUMBER
- FINISH
- TOP UV FINISH TYPE
- PULL
- MODESTY
- GROMMET
- PENCIL LIP COLOR (LAYERS ONLY)
- LOCKING
- KEYING
- OFFICE #

**See set 2 below for grommet option codes**

No Grommet **GN**  
Left **GL** \_\_\_ (Add +\$191)

\_\_\_ = add grommet bezel color and door finish to complete option pick.

**SV** = silver bezel, veneer door  
**BV** = black bezel, veneer door  
**WG** = silver bezel, white glass door  
**MG** = silver bezel, muslin glass door  
**BG** = black bezel, black glass door

Example: **GLSV** = left grommet, silver bezel, veneer door

**See inside front cover for required option codes**

Example

GA2RRO3048R-3W.NC215.FF.TVN.MPS.GN.PLS.LY.RMS.OFC1  
GA2RRO3048R-3W NC215 FF TVN MPS MY GN PLS LY RMS OFC1  
MODEL NUMBER FINISH TOP UV FINISH DESKTOP INSERT PULL MODESTY GROMMET PENCIL LIP COLOR LOCKING KEYING OFFICE #

# BRIDGES

Standard

**Credentials**

05/22

	D	W	H	model number	veneer 1	veneer 2
<b>STANDARD</b> 	24	42	29 7/16	<b>GA2BRG2442-WW</b>	3,182	3,501
	24	48	29 7/16	<b>GA2BRG2448-WW</b>	3,273	3,602
	24	54	29 7/16	<b>GA2BRG2454-WW</b>	3,366	3,703

- Optional no modesty panel (deduct -\$841) or full height modesty panel

## FOR USE WITH HEIGHT ADJUSTABLE EXTENSIONS

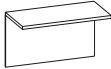

24	42	29 7/16	<b>GA2BRG2442A-WW</b>	3,182	3,501
24	48	29 7/16	<b>GA2BRG2448A-WW</b>	3,273	3,602
24	54	29 7/16	<b>GA2BRG2454A-WW</b>	3,366	3,703

- Optional no modesty panel (deduct -\$841) or full height modesty panel

## LAYERS FOR USE WITH STANDARD OR HEIGHT ADJUSTABLE DESKS/EXTENSIONS



24	66	29 7/16	<b>GA2BLRG2466-W</b>	3,345	3,680
24	72	29 7/16	<b>GA2BLRG2472-W</b>	3,436	3,781
24	78	29 7/16	<b>GA2BLRG2478-W</b>	3,535	3,890

- No modesty panel
- Layers units overlap low height credenza worksurfaces
- Includes layers box
- Unit is free-floating on lower credenza worksurface

## PRODUCT INFO

Short grain veneer on worksurface

## TO ORDER PLEASE SPECIFY THE FOLLOWING:

1.	<input type="text"/>	<b>MODEL NUMBER</b>
2.	<input type="text"/>	<b>FINISH</b>
3.	<input type="text"/>	<b>TOP UV FINISH TYPE</b>
4.	<input type="text"/>	<b>MODESTY</b>
5.	<input type="text"/>	<b>GROMMET</b>
6.	<input type="text"/>	<b>OFFICE #</b>

### See set 4 below for grommet option codes

No Grommet **GN**  
Center **GC** \_\_\_ (Add +\$191)

\_\_\_ = add grommet bezel color and door finish to complete option pick.

**SV** = silver bezel, veneer door  
**BV** = black bezel, veneer door  
**WG** = silver bezel, white glass door  
**MG** = silver bezel, muslin glass door  
**BG** = black bezel, black glass door

Example: **GCSV** = center grommet, silver bezel, veneer door

### See inside front cover for required option codes

Example

GA2BRG2442-WW.NC215.FF.MY.GN.OFC1

GA2BRG2442-WW	NC215	FF	MY	GN	OFC1
<b>MODEL NUMBER</b>	<b>FINISH</b>	<b>TOP UV FINISH</b>	<b>MODESTY</b>	<b>GROMMET</b>	<b>OFFICE #</b>

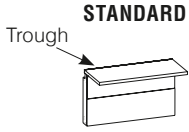

**STANDARD**

D	W	H	model number	veneer 1	veneer 2
21 1/4	42	29 7/16	<b>GA2BRG2442T-WW</b>	4,129	4,543
21 1/4	48	29 7/16	<b>GA2BRG2448T-WW</b>	4,220	4,643
21 1/4	54	29 7/16	<b>GA2BRG2454T-WW</b>	4,316	4,748

- Optional no modesty panel (deduct -\$1,380) or wall access panel
- Trough back units are required when a tackzone spans over the back of the worksurface
- Trough units include a metal pencil lip

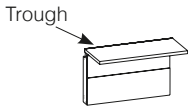

**FOR USE WITH HEIGHT  
ADJUSTABLE EXTENSIONS**

21 1/4	42	29 7/16	<b>GA2BRG2442TA-WW</b>	4,129	4,543
21 1/4	48	29 7/16	<b>GA2BRG2448TA-WW</b>	4,220	4,643
21 1/4	54	29 7/16	<b>GA2BRG2454TA-WW</b>	4,316	4,748

- Optional no modesty panel (deduct -\$1,380) or wall access panel
- Trough back units are required when a tackzone spans over the back of the worksurface
- Trough units include a metal pencil lip

**NOTE:** Plastic Trough Insert is REQUIRED and must be ordered separately across entire length of trough.

**PRODUCT INFO**

Short grain veneer on worksurface

**TO ORDER PLEASE SPECIFY THE FOLLOWING:**

- |    |                      |                                       |
|----|----------------------|---------------------------------------|
| 1. | <input type="text"/> | <b>MODEL NUMBER</b>                   |
| 2. | <input type="text"/> | <b>FINISH</b>                         |
| 3. | <input type="text"/> | <b>TOP UV FINISH TYPE</b>             |
| 4. | <input type="text"/> | <b>MODESTY</b>                        |
| 5. | <input type="text"/> | <b>PENCIL LIP COLOR (TROUGH ONLY)</b> |
| 6. | <input type="text"/> | <b>OFFICE #</b>                       |

**See inside front cover for required option codes**

Example

**GA2BRG2442T-WW.NC215.FF.MY.PLS.OFC1**

GA2BRG2442T-WW	NC215	FF	MY	PLS	OFC1
<b>MODEL NUMBER</b>	<b>FINISH</b>	<b>TOP UV FINISH</b>	<b>MODESTY</b>	<b>PENCIL LIP COLOR</b>	<b>OFFICE #</b>

# CREDENZA WORKSURFACES

Standard & trough back

**Credentials**

05/22

	D	W	H	model number	veneer 1	veneer 2
<b>STANDARD</b> 	24	60	1 1/2	<b>GA2CWR2460-W</b>	1,994	2,194
	24	66	1 1/2	<b>GA2CWR2466-W</b>	2,099	2,310
	24	72	1 1/2	<b>GA2CWR2472-W</b>	2,212	2,434
	24	78	1 1/2	<b>GA2CWR2478-W</b>	2,321	2,554
	24	84	1 1/2	<b>GA2CWR2484-W</b>	2,436	2,681
	24	90	1 1/2	<b>GA2CWR2490-W</b>	2,561	2,818
	24	96	1 1/2	<b>GA2CWR2496-W</b>	2,685	2,955
	24	102	1 1/2	<b>GA2CWR24102-W</b>	2,877	3,165
	24	108	1 1/2	<b>GA2CWR24108-W</b>	3,134	3,448
	24	114	1 1/2	<b>GA2CWR24114-W</b>	3,415	3,758
	24	120	1 1/2	<b>GA2CWR24120-W</b>	3,726	4,099

## TROUGH BACK

Trough



24	60	1 1/2	<b>GA2CWR2460T-W</b>	1,994	2,194
24	66	1 1/2	<b>GA2CWR2466T-W</b>	2,099	2,310
24	72	1 1/2	<b>GA2CWR2472T-W</b>	2,212	2,434
24	78	1 1/2	<b>GA2CWR2478T-W</b>	2,321	2,554
24	84	1 1/2	<b>GA2CWR2484T-W</b>	2,436	2,681
24	90	1 1/2	<b>GA2CWR2490T-W</b>	2,561	2,818
24	96	1 1/2	<b>GA2CWR2496T-W</b>	2,685	2,955
24	102	1 1/2	<b>GA2CWR24102T-W</b>	2,877	3,165
24	108	1 1/2	<b>GA2CWR24108T-W</b>	3,134	3,448
24	114	1 1/2	<b>GA2CWR24114T-W</b>	3,415	3,758
24	120	1 1/2	<b>GA2CWR24120T-W</b>	3,726	4,099

- Trough back units are required when a tackzone spans over the back of the worksurface
- Trough units include a metal pencil lip

**NOTE:** Plastic Trough Insert is REQUIRED and must be ordered separately across entire length of trough.

## PRODUCT INFO

Long grain veneer on worksurface

## TO ORDER PLEASE SPECIFY THE FOLLOWING:

1.  **MODEL NUMBER**
2.  **FINISH**
3.  **TOP UV FINISH TYPE**
4.  **GROMMET (STANDARD TOP ONLY)**
5.  **PENCIL LIP COLOR (TROUGH ONLY)**
6.  **OFFICE #**

### See set 5 below for grommet option codes

No Grommet **GN**  
 Left **GL** \_\_\_ (Add +\$191)  
 Right **GR** \_\_\_ (Add +\$191)  
 Center **GC** \_\_\_ (Add +\$191)

\_\_\_ = add grommet bezel color and door finish to complete option pick.

**SV** = silver bezel, veneer door  
**BV** = black bezel, veneer door  
**WG** = silver bezel, white glass door  
**MG** = silver bezel, muslin glass door  
**BG** = black bezel, black glass door

Example: **GCSV** = center grommet, silver bezel, veneer door

See inside front cover for required option codes

Example

**GA2CWR2460-W.NC215.FF.GN.PLS.OFC1**

GA2CWR2460-W	NC215	FF	GN	PLS	OFC1
<b>MODEL NUMBER</b>	<b>FINISH</b>	<b>TOP UV FINISH</b>	<b>GROMMET</b>	<b>PENCIL LIP COLOR</b>	<b>OFFICE #</b>

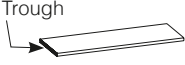

	D	W	H	model number	vener 1	vener 2
<b>TROUGH LEFT END</b> 	24	60	1 1/2	<b>GA2CWR2460TL-W</b>	1,994	2,194
	24	66	1 1/2	<b>GA2CWR2466TL-W</b>	2,099	2,310
	24	72	1 1/2	<b>GA2CWR2472TL-W</b>	2,212	2,434
	24	78	1 1/2	<b>GA2CWR2478TL-W</b>	2,321	2,554
	24	84	1 1/2	<b>GA2CWR2484TL-W</b>	2,436	2,681
	24	90	1 1/2	<b>GA2CWR2490TL-W</b>	2,561	2,818
	24	96	1 1/2	<b>GA2CWR2496TL-W</b>	2,685	2,955
	24	102	1 1/2	<b>GA2CWR24102TL-W</b>	2,877	3,165
	24	108	1 1/2	<b>GA2CWR24108TL-W</b>	3,134	3,448
	24	114	1 1/2	<b>GA2CWR24114TL-W</b>	3,415	3,758
	24	120	1 1/2	<b>GA2CWR24120TL-W</b>	3,726	4,099

- Trough left end units are required when a tack zone spans over the left end of the worksurface.
- Trough units include a metal pencil lip

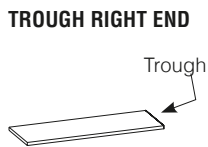

24	60	1 1/2	<b>GA2CWR2460TR-W</b>	1,994	2,194
24	66	1 1/2	<b>GA2CWR2466TR-W</b>	2,099	2,310
24	72	1 1/2	<b>GA2CWR2472TR-W</b>	2,212	2,434
24	78	1 1/2	<b>GA2CWR2478TR-W</b>	2,321	2,554
24	84	1 1/2	<b>GA2CWR2484TR-W</b>	2,436	2,681
24	90	1 1/2	<b>GA2CWR2490TR-W</b>	2,561	2,818
24	96	1 1/2	<b>GA2CWR2496TR-W</b>	2,685	2,955
24	102	1 1/2	<b>GA2CWR24102TR-W</b>	2,877	3,165
24	108	1 1/2	<b>GA2CWR24108TR-W</b>	3,134	3,448
24	114	1 1/2	<b>GA2CWR24114TR-W</b>	3,415	3,758
24	120	1 1/2	<b>GA2CWR24120TR-W</b>	3,726	4,099

- Trough back units are required when a tackzone spans over the back of the worksurface
- Trough units include a metal pencil lip

**NOTE:** Plastic Trough Insert is REQUIRED and must be ordered separately across entire length of trough.

**PRODUCT INFO**

Long grain veneer on worksurface

**TO ORDER PLEASE SPECIFY THE FOLLOWING:**

- |    |                      |                                       |
|----|----------------------|---------------------------------------|
| 1. | <input type="text"/> | <b>MODEL NUMBER</b>                   |
| 2. | <input type="text"/> | <b>FINISH</b>                         |
| 3. | <input type="text"/> | <b>TOP UV FINISH TYPE</b>             |
| 4. | <input type="text"/> | <b>GROMMET</b>                        |
| 5. | <input type="text"/> | <b>PENCIL LIP COLOR (TROUGH ONLY)</b> |
| 6. | <input type="text"/> | <b>OFFICE #</b>                       |

**See set 5 below for grommet option codes**

No Grommet	<b>GN</b>
Left	<b>GL</b> ___ (Add +\$191)
Right	<b>GR</b> ___ (Add +\$191)
Center	<b>GC</b> ___ (Add +\$191)

\_\_\_ = add grommet bezel color and door finish to complete option pick.

**SV** = silver bezel, veneer door  
**BV** = black bezel, veneer door  
**WG** = silver bezel, white glass door  
**MG** = silver bezel, muslin glass door  
**BG** = black bezel, black glass door

**See inside front cover for required option codes**

Example: **GCSV** = center grommet, silver bezel, veneer door

Example

**GA2CWR2460TL-W.NC215.FF.GN.PLS.OFC1**

GA2CWR2460TL-W	NC215	FF	GN	PLS	OFC1
<b>MODEL NUMBER</b>	<b>FINISH</b>	<b>TOP UV FINISH</b>	<b>GROMMET</b>	<b>PENCIL LIP COLOR</b>	<b>OFFICE #</b>

# RETURN WORKSURFACES

Standard

**Credentials**

05/22

	D	W	H	model number	veneer 1	veneer 2
<b>STANDARD</b>						
	24	42	1 1/2	<b>GA2RWR2442-W</b>	1,710	1,882
	24	48	1 1/2	<b>GA2RWR2448-W</b>	1,798	1,978
	24	54	1 1/2	<b>GA2RWR2454-W</b>	1,893	2,083
	24	60	1 1/2	<b>GA2RWR2460-W</b>	1,994	2,194
	24	66	1 1/2	<b>GA2RWR2466-W</b>	2,099	2,310
	24	72	1 1/2	<b>GA2RWR2472-W</b>	2,212	2,434

## PRODUCT INFO

Short grain veneer on worksurface

## TO ORDER PLEASE SPECIFY THE FOLLOWING:

1.  **MODEL NUMBER**
2.  **FINISH**
3.  **TOP UV FINISH TYPE**
4.  **GROMMET**
5.  **OFFICE #**

### See set 5 below for grommet option codes

No Grommet **GN**  
 Left **GL** \_\_\_ (Add +\$191)  
 Right **GR** \_\_\_ (Add +\$191)  
 Center **GC** \_\_\_ (Add +\$191)

\_\_\_ = add grommet bezel color and door finish to complete option pick.

**SV** = silver bezel, veneer door  
**BV** = black bezel, veneer door  
**WG** = silver bezel, white glass door  
**MG** = silver bezel, muslin glass door  
**BG** = black bezel, black glass door

### See inside front cover for required option codes

Example: **GCSV** = center grommet, silver bezel, veneer door

### Example

<b>GA2RWR2442-W.NC215.FF.GN.OFC1</b>				
GA2RWR2442-W	NC215	FF	GN	OFC1
<b>MODEL NUMBER</b>	<b>FINISH</b>	<b>TOP UV FINISH</b>	<b>GROMMET</b>	<b>OFFICE #</b>

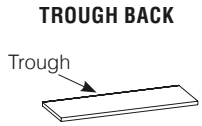

D	W	H	model number	veneer 1	veneer 2
24	42	1 1/2	<b>GA2RWR2442T-W</b>	1,710	1,882
24	48	1 1/2	<b>GA2RWR2448T-W</b>	1,798	1,978
24	54	1 1/2	<b>GA2RWR2454T-W</b>	1,893	2,083
24	60	1 1/2	<b>GA2RWR2460T-W</b>	1,994	2,194
24	66	1 1/2	<b>GA2RWR2466T-W</b>	2,099	2,310
24	72	1 1/2	<b>GA2RWR2472T-W</b>	2,212	2,434

- Trough back units are required when a tackzone spans over the back of the worksurface
- Trough units include a metal pencil lip

**NOTE:** Plastic Trough Insert is REQUIRED and must be ordered separately across entire length of trough.

**PRODUCT INFO**

short grain veneer on worksurface

**TO ORDER PLEASE SPECIFY THE FOLLOWING:**

1.  **MODEL NUMBER**
2.  **FINISH**
3.  **TOP UV FINISH TYPE**
4.  **PENCIL LIP COLOR**
5.  **OFFICE #**

**See inside front cover for required option codes**

Example

GA2RWR2442T-W.NC215.FF.PLS.OFC1

GA2RWR2442T-W	NC215	FF	PLS	OFC1
<small>MODEL NUMBER</small>	<small>FINISH</small>	<small>TOP UV FINISH</small>	<small>PENCIL LIP COLOR</small>	<small>OFFICE #</small>

# PEDESTALS

Full height | left hand

**Credentials**

05/22

	D	W	H	model number	veneer 1	veneer 2
<b>15" WIDTH FALSE PEDESTALS</b>	24	15	27 <sup>15</sup> / <sub>16</sub>	<b>GA2MPW2415L-LW</b>	1,420	1,563



- For use with: standard or trough back worksurfaces  
no modesty panel applications



	24	15	27 <sup>15</sup> / <sub>16</sub>	<b>GA2MPW2415L-XBW</b>	1,484	1,634
--	----	----	----------------------------------	------------------------	-------	-------

- For use with: standard or trough back worksurfaces  
wall access panel or full back panel applications



	24	6 <sup>1</sup> / <sub>2</sub>	27 <sup>15</sup> / <sub>16</sub>	<b>GA2MPW2415L-XEW</b>	1,484	1,634
--	----	-------------------------------	----------------------------------	------------------------	-------	-------

- For use with: standard or trough left end worksurfaces  
no modesty or full back panel applications
- Aligns with wall access panel on adjoining bridge or return

## PRODUCT INFO





TO ORDER PLEASE SPECIFY THE FOLLOWING:

- MODEL NUMBER**
- FINISH**
- OFFICE #**

**See inside front cover for required option codes**

Example

**GA2MPW2415L-LW.NC215.OFC1**  
 GA2MPW2415L-LW      NC215      OFC1  
 MODEL NUMBER      FINISH      OFFICE #

	D	W	H	model number	veneer 1	veneer 2
<b>15" WIDTH</b>						
FILE   FILE	24 7/8	15	27 15/16	<b>GA2MPW2415L-2W</b>	3,736	4,110
						
BOX   BOX   FILE	24 7/8	15	27 15/16	<b>GA2MPW2415L-3W</b>	3,736	4,110
						
<b>18" WIDTH</b>						
FILE   FILE	24 7/8	18	27 15/16	<b>GA2MPW2418L-2W</b>	3,926	4,320
						
BOX   BOX   FILE	24 7/8	18	27 15/16	<b>GA2MPW2418L-3W</b>	3,926	4,320
						

**PRODUCT INFO**

All pedestals have optional face locks

Hinged door cabinets do not lock

-3 and -7 pedestals include hidden upper box drawer

**TO ORDER PLEASE SPECIFY THE FOLLOWING:**

- 1.  **MODEL NUMBER**
- 2.  **FINISH**
- 3.  **PULL**
- 4.  **LOCKING**
- 5.  **KEYING**
- 6.  **OFFICE #**

**See inside front cover for required option codes**

Example

**GA2MPW2415L-2W.NC215.MPS.LY.RMS.OFC1**









GA2MPW2415L-2W	NC215	MPS	LY	RMS	OFC1
<b>MODEL NUMBER</b>	<b>FINISH</b>	<b>PULL</b>	<b>LOCKING</b>	<b>KEYING</b>	<b>OFFICE #</b>

# PEDESTALS

Full height | left hand

Credentials

05/22

	D	W	H	model number	veneer 1	veneer 2
<b>30" WIDTH</b>						
LATERAL FILE 	24 7/8	30	27 15/16	<b>GA2MPW2430L-4W</b>	4,260	4,687
				• Optional face lock		
BOX   BOX   LATERAL FILE 	24 7/8	30	27 15/16	<b>GA2MPW2430L-7W</b>	4,260	4,687
				• Optional face lock		
HINGED DOOR 	24 7/8	30	27 15/16	<b>GA2MPW2430L-5W</b>	3,736	4,110
OPEN SHELF 	24 7/8	30	27 15/16	<b>GA2MPW2430L-SHW</b>	3,347	3,682
				• Optional face lock		
PRINTER 	24 7/8	30	27 15/16	<b>GA2MPW2430L-PW</b>	3,945	4,340
TRASH RECEPTACLE 	24 7/8	30	27 15/16	<b>GA2MPW2430L-TW</b>	3,945	4,340
				• Includes quantity (2) brushed satin aluminum trash cans		
FILE   FILE + BOX   BOX   FILE 	24 7/8	30	27 15/16	<b>GA2MPW2430L-23W</b>	6,726	7,399
				• Optional face lock		
OPEN CUBBY   BOX   LATERAL FILE 	24 7/8	30	27 15/16	<b>GA2MPW2430L-BW</b>	4,135	4,550
				• Optional face lock		

## PRODUCT INFO

Hinged door cabinets do not lock

-B pedestals include hidden upper box drawer









## TO ORDER PLEASE SPECIFY THE FOLLOWING:

1.  **MODEL NUMBER**
2.  **FINISH**
3.  **PULL**
4.  **LOCKING**
5.  **KEYING**
6.  **OFFICE #**

See inside front cover for required option codes

Example

GA2MPW2430L-4W.NC215.MPS.LY.RMS.OFC1  
 GA2MPW2430L-4W    NC215    MPS    LY    RMS    OFC1  
 MODEL NUMBER    FINISH    PULL    LOCKING    KEYING    OFFICE #

	D	W	H	model number	veneer 1	veneer 2
<b>36" WIDTH</b>						
LATERAL FILE 	24 7/8	36	27 15/16	<b>GA2MPW2436L-4W</b>	4,776	5,255
	• Optional face lock					
BOX   BOX   LATERAL FILE 	24 7/8	36	27 15/16	<b>GA2MPW2436L-7W</b>	4,776	5,255
	• Optional face lock					
HINGED DOOR 	24 7/8	36	27 15/16	<b>GA2MPW2436L-5W</b>	4,187	4,607
OPEN SHELF 	24 7/8	36	27 15/16	<b>GA2MPW2436L-SHW</b>	3,747	4,122
	• Optional face lock					
PRINTER 	24 7/8	36	27 15/16	<b>GA2MPW2436L-PW</b>	4,420	4,863
TRASH RECEPTACLE 	24 7/8	36	27 15/16	<b>GA2MPW2436L-TW</b>	4,420	4,863
	• Includes quantity (2) brushed satin aluminum trash cans					
FILE   FILE + BOX   BOX   FILE 	24 7/8	36	27 15/16	<b>GA2MPW2436L-23W</b>	7,065	7,773
	• Optional face lock					
OPEN CUBBY   BOX   LATERAL FILE 	24 7/8	36	27 15/16	<b>GA2MPW2436L-BW</b>	4,631	5,095
	• Optional face lock					

**PRODUCT INFO**

Hinged door cabinets do not lock

-B pedestals include hidden upper box drawer

**TO ORDER PLEASE SPECIFY THE FOLLOWING:**

- |    |                      |                     |
|----|----------------------|---------------------|
| 1. | <input type="text"/> | <b>MODEL NUMBER</b> |
| 2. | <input type="text"/> | <b>FINISH</b>       |
| 3. | <input type="text"/> | <b>PULL</b>         |
| 4. | <input type="text"/> | <b>LOCKING</b>      |
| 5. | <input type="text"/> | <b>KEYING</b>       |
| 6. | <input type="text"/> | <b>OFFICE #</b>     |

See inside front cover for required option codes

Example





GA2MPW2436L-4W.NC215.MPS.LY.RMS.OFC1  
 GA2MPW2436L-4W    NC215    MPS    LY    RMS    OFC1  
 MODEL NUMBER    FINISH    PULL    LOCKING    KEYING    OFFICE #

# PEDESTALS

Full height | left hand

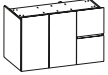
Credentials

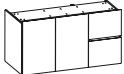
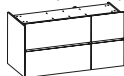
05/22

	D	W	H	model number	veneer 1	veneer 2
<b>45" WIDTH</b> HINGED DOOR + FILE   FILE 	24 7/8	45	27 15/16	<b>GA2MPW2445L-52W</b>	6,726	7,399
LATERAL FILE + BOX   BOX   FILE 	24 7/8	45	27 15/16	<b>GA2MPW2445L-43W</b>	7,200	7,921
BOX   BOX   LATERAL FILE + FILE   FILE 	24 7/8	45	27 15/16	<b>GA2MPW2445L-72W</b>	7,200	7,921
<b>54" WIDTH</b> HINGED DOOR + FILE   FILE 	24 7/8	54	27 15/16	<b>GA2MPW2454L-52W</b>	7,299	8,030
LATERAL FILE + BOX   BOX   FILE 	24 7/8	54	27 15/16	<b>GA2MPW2454L-43W</b>	7,830	8,614
BOX   BOX   LATERAL FILE + FILE   FILE 	24 7/8	54	27 15/16	<b>GA2MPW2454L-72W</b>	7,830	8,614

## PRODUCT INFO

All pedestals have optional face locks

Hinged door cabinets do not lock

-3 and -7 pedestals include hidden upper box drawer

## TO ORDER PLEASE SPECIFY THE FOLLOWING:

1.  **MODEL NUMBER**
2.  **FINISH**
3.  **PULL**
4.  **LOCKING**
5.  **KEYING**
6.  **OFFICE #**



See inside front cover for required option codes

Example

GA2MPW2445L-52W.NC215.MPS.LY.RMS.OFC1

GA2MPW2445L-52W	NC215	MPS	LY	RMS	OFC1
<b>MODEL NUMBER</b>	<b>FINISH</b>	<b>PULL</b>	<b>LOCKING</b>	<b>KEYING</b>	<b>OFFICE #</b>

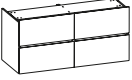
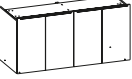

	D	W	H	model number	veneer 1	veneer 2
<b>60" WIDTH</b>						
LATERAL FILE 	24 7/8	60	27 15/16	<b>GA2MPW2460L-44W</b>	7,674	8,442
HINGED DOOR 	24 7/8	60	27 15/16	<b>GA2MPW2460L-55W</b>	6,726	7,399
OPEN CUBBY   BOX   LATERAL FILE 	24 7/8	60	27 15/16	<b>GA2MPW2460L-BBW</b>	7,443	8,188

**PRODUCT INFO**

All pedestals have optional face locks

Hinged door cabinets do not lock

-B pedestals include hidden upper box drawer

**TO ORDER PLEASE SPECIFY THE FOLLOWING:**

- 1.  **MODEL NUMBER**
- 2.  **FINISH**
- 3.  **PULL**
- 4.  **LOCKING**
- 5.  **KEYING**
- 6.  **OFFICE #**

**See inside front cover for required option codes**

Example

GA2MPW2460L-44W.NC215.MPS.LY.RMS.OFC1  
 GA2MPW2460L-44W    NC215    MPS    LY    RMS    OFC1  
 MODEL NUMBER    FINISH    PULL    LOCKING    KEYING    OFFICE #

# PEDESTALS

Full height | right hand

**Credentials**

05/22

	D	W	H	model number	veneer 1	veneer 2
--	---	---	---	--------------	----------	----------

**15" WIDTH  
FALSE PEDESTALS**

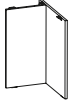

24	15	27 15/16	<b>GA2MPW2415R-LW</b>	1,420	1,563
----	----	----------	-----------------------	-------	-------

- For use with: standard or trough back worksurfaces  
no modesty panel applications



24	15	27 15/16	<b>GA2MPW2415R-XBW</b>	1,484	1,634
----	----	----------	------------------------	-------	-------

- For use with: standard or trough back worksurfaces  
wall access or full back panel applications

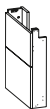

24	6 1/2	27 15/16	<b>GA2MPW2415R-XEW</b>	1,484	1,634
----	-------	----------	------------------------	-------	-------

- For use with: standard or trough left end worksurfaces  
no modesty or full back panel applications
- Aligns with wall access panel on adjoining bridge or return

**PRODUCT INFO**





TO ORDER PLEASE SPECIFY THE FOLLOWING:

1.  **MODEL NUMBER**
2.  **FINISH**
3.  **OFFICE #**

See inside front cover for required option codes

Example

<b>GA2MPW2415R-LW.NC215.OFC1</b>		
GA2MPW2415R-LW	NC215	OFC1
<b>MODEL NUMBER</b>	<b>FINISH</b>	<b>OFFICE #</b>

	D	W	H	model number	veneer 1	veneer 2
<b>15" WIDTH</b>						
FILE   FILE	24 7/8	15	27 15/16	<b>GA2MPW2415R-2W</b>	3,736	4,110
						
BOX   BOX   FILE	24 7/8	15	27 15/16	<b>GA2MPW2415R-3W</b>	3,736	4,110
						
<b>18" WIDTH</b>						
FILE   FILE	24 7/8	18	27 15/16	<b>GA2MPW2418R-2W</b>	3,926	4,320
						
BOX   BOX   FILE	24 7/8	18	27 15/16	<b>GA2MPW2418R-3W</b>	3,926	4,320
						

**PRODUCT INFO**

All pedestals have optional face locks

Hinged door cabinets do not lock

-3 and -7 pedestals include hidden upper box drawer

**TO ORDER PLEASE SPECIFY THE FOLLOWING:**

- 1.  **MODEL NUMBER**
- 2.  **FINISH**
- 3.  **PULL**
- 4.  **LOCKING**
- 5.  **KEYING**
- 6.  **OFFICE #**

**See inside front cover for required option codes**

Example









GA2MPW2415R-2W.NC215.MPS.LY.RMS.OFC1  
 GA2MPW2415R-2W    NC215    MPS    LY    RMS    OFC1  
 MODEL NUMBER    FINISH    PULL    LOCKING    KEYING    OFFICE #

# PEDESTALS

Full height | right hand

**Credentials**

05/22

	D	W	H	model number	veneer 1	veneer 2
<b>30" WIDTH</b>						
LATERAL FILE 	24 7/8	30	27 15/16	<b>GA2MPW2430R-4W</b>	4,260	4,687
BOX   BOX   LATERAL FILE 	24 7/8	30	27 15/16	<b>GA2MPW2430R-7W</b>	4,260	4,687
HINGED DOOR 	24 7/8	30	27 15/16	<b>GA2MPW2430R-5W</b>	3,736	4,110
OPEN SHELF 	24 7/8	30	27 15/16	<b>GA2MPW2430R-SHW</b>	3,347	3,682
PRINTER 	24 7/8	30	27 15/16	<b>GA2MPW2430R-PW</b>	3,945	4,340
TRASH RECEPTACLE 	24 7/8	30	27 15/16	<b>GA2MPW2430R-TW</b>	3,945	4,340
				• Includes quantity (2) brushed satin aluminum trash cans		
FILE   FILE + BOX   BOX   FILE 	24 7/8	30	27 15/16	<b>GA2MPW2430R-32W</b>	6,726	7,399
OPEN CUBBY   BOX   LATERAL FILE 	24 7/8	30	27 15/16	<b>GA2MPW2430R-BW</b>	4,135	4,550

## PRODUCT INFO

All pedestals have optional face locks

Hinged door cabinets do not lock

-B pedestals include hidden upper box drawer

## TO ORDER PLEASE SPECIFY THE FOLLOWING:









- |    |                      |                     |
|----|----------------------|---------------------|
| 1. | <input type="text"/> | <b>MODEL NUMBER</b> |
| 2. | <input type="text"/> | <b>FINISH</b>       |
| 3. | <input type="text"/> | <b>PULL</b>         |
| 4. | <input type="text"/> | <b>LOCKING</b>      |
| 5. | <input type="text"/> | <b>KEYING</b>       |
| 6. | <input type="text"/> | <b>OFFICE #</b>     |

See inside front cover for required option codes

Example

**GA2MPW2430R-4W.NC215.MPS.LY.RMS.OFC1**

GA2MPW2430R-4W	NC215	MPS	LY	RMS	OFC1
<b>MODEL NUMBER</b>	<b>FINISH</b>	<b>PULL</b>	<b>LOCKING</b>	<b>KEYING</b>	<b>OFFICE #</b>

	D	W	H	model number	veneer 1	veneer 2
<b>36" WIDTH</b>						
LATERAL FILE 	24 7/8	36	27 15/16	<b>GA2MPW2436R-4W</b>	4,776	5,255
BOX   BOX   LATERAL FILE 	24 7/8	36	27 15/16	<b>GA2MPW2436R-7W</b>	4,776	5,255
HINGED DOOR 	24 7/8	36	27 15/16	<b>GA2MPW2436R-5W</b>	4,187	4,607
OPEN SHELF 	24 7/8	36	27 15/16	<b>GA2MPW2436R-SHW</b>	3,747	4,122
PRINTER 	24 7/8	36	27 15/16	<b>GA2MPW2436R-PW</b>	4,420	4,863
TRASH RECEPTACLE 	24 7/8	36	27 15/16	<b>GA2MPW2436R-TW</b>	4,420	4,863
				• Includes quantity (2) brushed satin aluminum trash cans		
BOX   BOX   FILE+ FILE   FILE 	24 7/8	36	27 15/16	<b>GA2MPW2436R-32W</b>	7,065	7,773
OPEN CUBBY   BOX   LATERAL FILE 	24 7/8	36	27 15/16	<b>GA2MPW2436R-BW</b>	4,631	5,095

**PRODUCT INFO**

All pedestals have optional face locks

Hinged door cabinets do not lock

-B pedestals include hidden upper box drawer

**TO ORDER PLEASE SPECIFY THE FOLLOWING:**

1.  **MODEL NUMBER**
2.  **FINISH**
3.  **PULL**
4.  **LOCKING**
5.  **KEYING**
6.  **OFFICE #**

**See inside front cover for required option codes**

Example





**GA2MPW2436R-4W.NC215.MPS.LY.RMS.OFC1**  
 GA2MPW2436R-4W    NC215    MPS    LY    RMS    OFC1  
 MODEL NUMBER    FINISH    PULL    LOCKING    KEYING    OFFICE #

# PEDESTALS

Full height | right hand

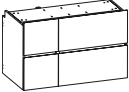
Credentials

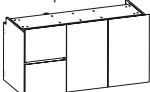
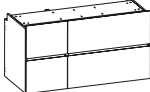
05/22

	D	W	H	model number	veneer 1	veneer 2
<b>45" WIDTH</b>						
HINGED DOOR + FILE   FILE 	24 7/8	45	27 15/16	<b>GA2MPW2445R-25W</b>	6,726	7,399
LATERAL FILE + BOX   BOX   FILE 	24 7/8	45	27 15/16	<b>GA2MPW2445R-34W</b>	7,200	7,921
BOX   BOX   LATERAL FILE + FILE   FILE 	24 7/8	45	27 15/16	<b>GA2MPW2445R-27W</b>	7,200	7,921
<b>54" WIDTH</b>						
HINGED DOOR + FILE   FILE 	24 7/8	54	27 15/16	<b>GA2MPW2454R-25W</b>	7,299	8,030
LATERAL FILE + BOX   BOX   FILE 	24 7/8	54	27 15/16	<b>GA2MPW2454R-34W</b>	7,830	8,614
BOX   BOX   LATERAL FILE + FILE   FILE 	24 7/8	54	27 15/16	<b>GA2MPW2454R-27W</b>	7,830	8,614

## PRODUCT INFO

All pedestals have optional face locks

Hinged door cabinets do not lock

-3 and -7 pedestals include hidden upper box drawer

## TO ORDER PLEASE SPECIFY THE FOLLOWING:

- |    |                      |                     |
|----|----------------------|---------------------|
| 1. | <input type="text"/> | <b>MODEL NUMBER</b> |
| 2. | <input type="text"/> | <b>FINISH</b>       |
| 3. | <input type="text"/> | <b>PULL</b>         |
| 4. | <input type="text"/> | <b>LOCKING</b>      |
| 5. | <input type="text"/> | <b>KEYING</b>       |
| 6. | <input type="text"/> | <b>OFFICE #</b>     |

See inside front cover for required option codes

Example

GA2MPW2445R-25W.NC215.MPS.LY.RMS.OFC1  
 GA2MPW2445R-25W    NC215    MPS    LY    RMS    OFC1  
 MODEL NUMBER    FINISH    PULL    LOCKING    KEYING    OFFICE #

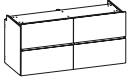
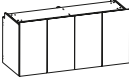
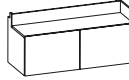
	D	W	H	model number	veneer 1	veneer 2
<b>60" WIDTH</b> LATERAL FILE 	24 7/8	60	27 15/16	<b>GA2MPW2460R-44W</b>	7,674	8,442
HINGED DOOR 	24 7/8	60	27 15/16	<b>GA2MPW2460R-55W</b>	6,726	7,399
OPEN CUBBY   BOX   LATERAL FILE 	24 7/8	60	27 15/16	<b>GA2MPW2460R-BBW</b>	7,443	8,188

**PRODUCT INFO**

All pedestals have optional face locks

Hinged door cabinets do not lock

-BB pedestals include hidden upper box drawer

**TO ORDER PLEASE SPECIFY THE FOLLOWING:**

1.  **MODEL NUMBER**
2.  **FINISH**
3.  **PULL**
4.  **LOCKING**
5.  **KEYING**
6.  **OFFICE #**

**See inside front cover for required option codes**

Example



GA2MPW2460R-44W.NC215.MPS.LY.RMS.OFC1  
 GA2MPW2460R-44W    NC215    MPS    LY    RMS    OFC1  
 MODEL NUMBER    FINISH    PULL    LOCKING    KEYING    OFFICE #

# LAYERS PEDESTALS

Low height | left hand

**Credentials**

05/22

	D	W	H	model number	veneer 1	veneer 2
<b>15" WIDTH</b>						
FALSE PEDESTALS	24	15	20 <sup>3</sup> / <sub>16</sub>	<b>GA2MLPW2415L-LW</b>	1,350	1,486
				<ul style="list-style-type: none"> <li>For use with: standard or trough back worksurfaces no modesty panel applications</li> </ul>		
	24	15	20 <sup>3</sup> / <sub>16</sub>	<b>GA2MLPW2415L-XBW</b>	1,410	1,552
				<ul style="list-style-type: none"> <li>For use with: standard or trough back worksurfaces wall access panel or full back panel applications</li> </ul>		

## PRODUCT INFO

TO ORDER PLEASE SPECIFY THE FOLLOWING:

1.  **MODEL NUMBER**
2.  **FINISH**
3.  **OFFICE #**

See inside front cover for required option codes

Example

**GA2MLPW2415L-LW.NC215.OFC1**

GA2MLPW2415L-LW	NC215	OFC1
<b>MODEL NUMBER</b>	<b>FINISH</b>	<b>OFFICE #</b>



	D	W	H	model number	veneer 1	veneer 2
<b>15" WIDTH</b>						
BOX   FILE	24 7/8	15	20 3/16	<b>GA2MLPW2415L-AW</b>	3,548	3,904



<b>18" WIDTH</b>						
BOX   FILE	24 7/8	18	20 3/16	<b>GA2MLPW2418L-AW</b>	3,729	4,103



**PRODUCT INFO**

All pedestals have optional face locks

Hinged door cabinets do not lock

-A and -B pedestals include hidden upper box drawer

**TO ORDER PLEASE SPECIFY THE FOLLOWING:**

- 1.  **MODEL NUMBER**
- 2.  **FINISH**
- 3.  **PULL**
- 4.  **LOCKING**
- 5.  **KEYING**
- 6.  **OFFICE #**

**See inside front cover for required option codes**

Example





GA2MLPW2415L-AW.NC215.MPS.LY.RMS.OFC1  
 GA2MLPW2415L-AW    NC215    MPS    LY    RMS    OFC1  
 MODEL NUMBER    FINISH    PULL    LOCKING    KEYING    OFFICE #

# LAYERS PEDESTALS

Low height | left hand

Credentials

05/22

	D	W	H	model number	veneer 1	veneer 2
<b>30" WIDTH</b>						
BOX   LATERAL FILE	24 7/8	30	20 3/16	<b>GA2MLPW2430L-BW</b>	4,050	4,456
				• Optional face lock		
HINGED DOOR	24 7/8	30	20 3/16	<b>GA2MLPW2430L-5W</b>	3,548	3,904
						
OPEN SHELF	24 7/8	30	20 3/16	<b>GA2MLPW2430L-SHW</b>	3,179	3,498
						
PRINTER	24 7/8	30	20 3/16	<b>GA2MLPW2430L-PW</b>	3,747	4,122
						
TRASH RECEPTACLE	24 7/8	30	20 3/16	<b>GA2MLPW2430L-TW</b>	5,816	6,399
				• Includes quantity (2) brushed satin aluminum trash cans		

## PRODUCT INFO

Hinged door cabinets do not lock

-A and -B pedestals include hidden upper box drawer

## TO ORDER PLEASE SPECIFY THE FOLLOWING:

1.  **MODEL NUMBER**
2.  **FINISH**
3.  **PULL**
4.  **LOCKING**
5.  **KEYING**
6.  **OFFICE #**

See inside front cover for required option codes

Example

GA2MLPW2430L-BW.NC215.MPS.LY.RMS.OFC1

GA2MLPW2430L-BW	NC215	MPS	LY	RMS	OFC1
<b>MODEL NUMBER</b>	<b>FINISH</b>	<b>PULL</b>	<b>LOCKING</b>	<b>KEYING</b>	<b>OFFICE #</b>

	D	W	H	model number	veneer 1	veneer 2
<b>36" WIDTH</b>						
BOX   LATERAL FILE 	24 7/8	36	20 3/16	<b>GA2MLPW2436L-BW</b>	4,533	4,987
				• Optional face lock		
HINGED DOOR 	24 7/8	36	20 3/16	<b>GA2MLPW2436L-5W</b>	3,977	4,375
OPEN SHELF 	24 7/8	36	20 3/16	<b>GA2MLPW2436L-SHW</b>	3,564	3,921
PRINTER 	24 7/8	36	20 3/16	<b>GA2MLPW2436L-PW</b>	4,202	4,623
TRASH RECEPTACLE 	24 7/8	36	20 3/16	<b>GA2MLPW2436L-TW</b>	4,202	4,623
				• Includes quantity (2) brushed satin aluminum trash cans		

**PRODUCT INFO**

Hinged door cabinets do not lock

-A and -B pedestals include hidden upper box drawer

**TO ORDER PLEASE SPECIFY THE FOLLOWING:**

- 1.  **MODEL NUMBER**
- 2.  **FINISH**
- 3.  **PULL**
- 4.  **LOCKING**
- 5.  **KEYING**
- 6.  **OFFICE #**

**See inside front cover for required option codes**

Example

**GA2MLPW2436L-BW.NC215.MPS.LY.RMS.OFC1**  
 GA2MLPW2436L-BW    NC215    MPS    LY    RMS    OFC1  
 MODEL NUMBER    FINISH    PULL    LOCKING    KEYING    OFFICE #

# LAYERS PEDESTALS

Low height | left hand

**Credentials**

05/22

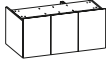
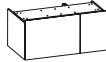
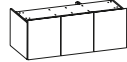
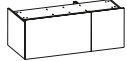
	D	W	H	model number	veneer 1	veneer 2
<b>45" WIDTH</b>						
HINGED DOOR + BOX   FILE	24 7/8	45	20 3/16	<b>GA2MLPW2445L-5AW</b>	6,388	7,027
						
BOX   LATERAL FILE + BOX   FILE	24 7/8	45	20 3/16	<b>GA2MLPW2445L-BAW</b>	6,838	7,523
						
<b>54" WIDTH</b>						
HINGED DOOR + BOX   FILE	24 7/8	54	20 3/16	<b>GA2MLPW2454L-5AW</b>	6,933	7,627
						
BOX   LATERAL FILE + BOX   FILE	24 7/8	54	20 3/16	<b>GA2MLPW2454L-BAW</b>	7,436	8,181
						

## PRODUCT INFO

All pedestals have optional face locks

Hinged door cabinets do not lock

-A and -B pedestals include hidden upper box drawer

## TO ORDER PLEASE SPECIFY THE FOLLOWING:

1.  **MODEL NUMBER**
2.  **FINISH**
3.  **PULL**
4.  **LOCKING**
5.  **KEYING**
6.  **OFFICE #**

See inside front cover for required option codes

Example

GA2MLPW2445L-5AW.NC215.MPS.LY.RMS.OFC1

GA2MLPW2445L-5AW	NC215	MPS	LY	RMS	OFC1
<b>MODEL NUMBER</b>	<b>FINISH</b>	<b>PULL</b>	<b>LOCKING</b>	<b>KEYING</b>	<b>OFFICE #</b>

	D	W	H	model number	veneer 1	veneer 2
--	---	---	---	--------------	----------	----------

**60" WIDTH**

BOX | LATERAL FILE +  
BOX | LATERAL FILE

24 7/8	60	20 3/16	<b>GA2MLPW2460L-BBW</b>	7,293	8,023
--------	----	---------	-------------------------	-------	-------

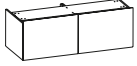

HINGED DOOR +  
HINGED DOOR

24 7/8	60	20 3/16	<b>GA2MLPW2460L-55W</b>	6,388	7,027
--------	----	---------	-------------------------	-------	-------

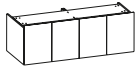

**PRODUCT INFO**

Hinged door cabinets do not lock

-A and -B pedestals include hidden upper box drawer

**TO ORDER PLEASE SPECIFY THE FOLLOWING:**

1.  **MODEL NUMBER**
2.  **FINISH**
3.  **PULL**
4.  **LOCKING**
5.  **KEYING**
6.  **OFFICE #**

**See inside front cover for required option codes**

Example

**GA2MLPW2460L-BBW.NC215.MPS.LY.RMS.OFC1**

GA2MLPW2460L-BBW	NC215	MPS	LY	RMS	OFC1
<b>MODEL NUMBER</b>	<b>FINISH</b>	<b>PULL</b>	<b>LOCKING</b>	<b>KEYING</b>	<b>OFFICE #</b>

# LAYERS PEDESTALS

Low height | right hand

**Credentials**

05/22

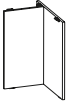
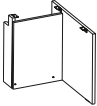
	D	W	H	model number	veneer 1	veneer 2
<b>15" WIDTH</b>						
FALSE PEDESTALS	24	15	20 <sup>3</sup> / <sub>16</sub>	<b>GA2MLPW2415R-LW</b>	1,350	1,486
	<ul style="list-style-type: none"> <li>For use with: standard or trough back worksurfaces no modesty panel applications</li> </ul>					
	24	15	20 <sup>3</sup> / <sub>16</sub>	<b>GA2MLPW2415R-XBW</b>	1,410	1,552
	<ul style="list-style-type: none"> <li>For use with: standard or trough back worksurfaces wall access panel or full back panel applications</li> </ul>					

## PRODUCT INFO

TO ORDER PLEASE SPECIFY THE FOLLOWING:

1.  **MODEL NUMBER**
2.  **FINISH**
3.  **OFFICE #**

**See inside front cover for required option codes**

Example

GA2MLPW2415R-LW.NC215.OFC1  
 GA2MLPW2415R-LW    NC215    OFC1  
 MODEL NUMBER    FINISH    OFFICE #

	D	W	H	model number	veneer 1	veneer 2
<b>15" WIDTH</b>						
BOX   FILE	24 7/8	15	20 3/16	<b>GA2MLPW2415R-AW</b>	3,548	3,904



<b>18" WIDTH</b>						
BOX   FILE	24 7/8	18	20 3/16	<b>GA2MLPW2418R-AW</b>	3,729	4,103



**PRODUCT INFO**

All pedestals have optional face locks

Hinged door cabinets do not lock

-A and -B pedestals include hidden upper box drawer

**TO ORDER PLEASE SPECIFY THE FOLLOWING:**

- 1.  **MODEL NUMBER**
- 2.  **FINISH**
- 3.  **PULL**
- 4.  **LOCKING**
- 5.  **KEYING**
- 6.  **OFFICE #**

**See inside front cover for required option codes**

Example





GA2MLPW2415R-AW.NC215.MPS.LY.RMS.OFC1  
 GA2MLPW2415R-AW    NC215    MPS    LY    RMS    OFC1  
 MODEL NUMBER    FINISH    PULL    LOCKING    KEYING    OFFICE #

# LAYERS PEDESTALS

Low height | right hand

Credentials

05/22

	D	W	H	model number	veneer 1	veneer 2
<b>30" WIDTH</b>						
BOX   LATERAL FILE 	24 7/8	30	20 3/16	<b>GA2MLPW2430R-BW</b>	4,050	4,456
				• Optional face lock		
HINGED DOOR 	24 7/8	30	20 3/16	<b>GA2MLPW2430R-5W</b>	3,548	3,904
OPEN SHELF 	24 7/8	30	20 3/16	<b>GA2MLPW2430R-SHW</b>	3,179	3,498
PRINTER 	24 7/8	30	20 3/16	<b>GA2MLPW2430R-PW</b>	3,747	4,122
TRASH RECEPTACLE 	24 7/8	30	20 3/16	<b>GA2MLPW2430R-TW</b>	5,816	6,399
				• Includes quantity (2) brushed satin aluminum trash cans		

## PRODUCT INFO

Hinged door cabinets do not lock

-A and -B pedestals include hidden upper box drawer

## TO ORDER PLEASE SPECIFY THE FOLLOWING:

1.  **MODEL NUMBER**
2.  **FINISH**
3.  **PULL**
4.  **LOCKING**
5.  **KEYING**
6.  **OFFICE #**

See inside front cover for required option codes

Example

GA2MLPW2430R-BW.NC215.MPS.LY.RMS.OFC1

GA2MLPW2430R-BW	NC215	MPS	LY	RMS	OFC1
<b>MODEL NUMBER</b>	<b>FINISH</b>	<b>PULL</b>	<b>LOCKING</b>	<b>KEYING</b>	<b>OFFICE #</b>



	D	W	H	model number	veneer 1	veneer 2
<b>36" WIDTH</b>						
BOX   LATERAL FILE 	24 7/8	36	20 3/16	<b>GA2MLPW2436R-BW</b>	4,533	4,987
				• Optional face lock		
HINGED DOOR 	24 7/8	36	20 3/16	<b>GA2MLPW2436R-5W</b>	3,977	4,375
OPEN SHELF 	24 7/8	36	20 3/16	<b>GA2MLPW2436R-SHW</b>	3,564	3,921
PRINTER 	24 7/8	36	20 3/16	<b>GA2MLPW2436R-PW</b>	4,202	4,623
TRASH RECEPTACLE 	24 7/8	36	20 3/16	<b>GA2MLPW2436R-TW</b>	4,202	4,623
				• Includes quantity (2) brushed satin aluminum trash cans		

**PRODUCT INFO**

Hinged door cabinets do not lock

-A and -B pedestals include hidden upper box drawer

**TO ORDER PLEASE SPECIFY THE FOLLOWING:**

- |    |                      |                     |
|----|----------------------|---------------------|
| 1. | <input type="text"/> | <b>MODEL NUMBER</b> |
| 2. | <input type="text"/> | <b>FINISH</b>       |
| 3. | <input type="text"/> | <b>PULL</b>         |
| 4. | <input type="text"/> | <b>LOCKING</b>      |
| 5. | <input type="text"/> | <b>KEYING</b>       |
| 6. | <input type="text"/> | <b>OFFICE #</b>     |

**See inside front cover for required option codes**

Example



**GA2MLPW2436R-BW.NC215.MPS.LY.RMS.OFC1**  
 GA2MLPW2436R-BW    NC215    MPS    LY    RMS    OFC1  
 MODEL NUMBER    FINISH    PULL    LOCKING    KEYING    OFFICE #

# LAYERS PEDESTALS

Low height | right hand

Credentials

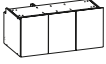
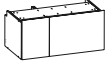
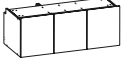
05/22

	D	W	H	model number	veneer 1	veneer 2
<b>45" WIDTH</b>						
HINGED DOOR + BOX   FILE	24 7/8	45	20 3/16	<b>GA2MLPW2445R-A5W</b>	6,388	7,027
						
BOX   LATERAL FILE + BOX   FILE	24 7/8	45	20 3/16	<b>GA2MLPW2445R-ABW</b>	6,838	7,523
						
<b>54" WIDTH</b>						
HINGED DOOR + BOX   FILE	24 7/8	54	20 3/16	<b>GA2MLPW2454R-A5W</b>	6,933	7,627
						
BOX   LATERAL FILE + BOX   FILE	24 7/8	54	20 3/16	<b>GA2MLPW2454R-ABW</b>	7,436	8,181
						

## PRODUCT INFO

All pedestals have optional face locks

Hinged door cabinets do not lock

-A and -B pedestals include hidden upper box drawer

## TO ORDER PLEASE SPECIFY THE FOLLOWING:

1.  **MODEL NUMBER**
2.  **FINISH**
3.  **PULL**
4.  **LOCKING**
5.  **KEYING**
6.  **OFFICE #**

See inside front cover for required option codes

Example

GA2MLPW2445R-A5W.NC215.MPS.LY.RMS.OFC1

GA2MLPW2445R-A5W	NC215	MPS	LY	RMS	OFC1
<b>MODEL NUMBER</b>	<b>FINISH</b>	<b>PULL</b>	<b>LOCKING</b>	<b>KEYING</b>	<b>OFFICE #</b>

	D	W	H	model number	veneer 1	veneer 2
--	---	---	---	--------------	----------	----------

**60" WIDTH**

BOX | LATERAL FILE +  
BOX | LATERAL FILE

24 7/8	60	20 3/16	<b>GA2MLPW2460R-BBW</b>	7,293	8,023
--------	----	---------	-------------------------	-------	-------

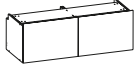

HINGED DOOR +  
HINGED DOOR

24 7/8	60	20 3/16	<b>GA2MLPW2460R-55W</b>	6,388	7,027
--------	----	---------	-------------------------	-------	-------

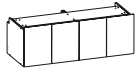

**PRODUCT INFO**

All pedestals have optional face locks

Hinged door cabinets do not lock

-A and -B pedestals include hidden upper box drawer

**TO ORDER PLEASE SPECIFY THE FOLLOWING:**

1.  **MODEL NUMBER**
2.  **FINISH**
3.  **PULL**
4.  **LOCKING**
5.  **KEYING**
6.  **OFFICE #**

**See inside front cover for required option codes**

Example

**GA2MLPW2460R-BBW.NC215.MPS.LY.RMS.OFC1**  
 GA2MLPW2460R-BBW    NC215    MPS    LY    RMS    OFC1  
 MODEL NUMBER    FINISH    PULL    LOCKING    KEYING    OFFICE #

# CREDENZA MODESTY PANELS

Full height

**Credentials**

05/22

## FINISHED BACK PANEL



D	W	H	model number	veneer 1	veneer 2
$\frac{3}{4}$	58 $\frac{1}{2}$	27 $\frac{15}{16}$	<b>GA2MCF60-W</b>	1,545	1,700
$\frac{3}{4}$	64 $\frac{1}{2}$	27 $\frac{15}{16}$	<b>GA2MCF66-W</b>	1,630	1,794
$\frac{3}{4}$	70 $\frac{1}{2}$	27 $\frac{15}{16}$	<b>GA2MCF72-W</b>	1,717	1,890
$\frac{3}{4}$	76 $\frac{1}{2}$	27 $\frac{15}{16}$	<b>GA2MCF78-W</b>	1,799	1,979
$\frac{3}{4}$	82 $\frac{1}{2}$	27 $\frac{15}{16}$	<b>GA2MCF84-W</b>	1,891	2,081
$\frac{3}{4}$	88 $\frac{1}{2}$	27 $\frac{15}{16}$	<b>GA2MCF90-W</b>	1,986	2,186
$\frac{3}{4}$	94 $\frac{1}{2}$	27 $\frac{15}{16}$	<b>GA2MCF96-W</b>	2,089	2,299
$\frac{3}{4}$	100 $\frac{1}{2}$	27 $\frac{15}{16}$	<b>GA2MCF102-W</b>	2,230	2,454
$\frac{3}{4}$	106 $\frac{1}{2}$	27 $\frac{15}{16}$	<b>GA2MCF108-W</b>	2,387	2,626
$\frac{3}{4}$	112 $\frac{1}{2}$	27 $\frac{15}{16}$	<b>GA2MCF114-W</b>	2,559	2,816
$\frac{3}{4}$	118 $\frac{1}{2}$	27 $\frac{15}{16}$	<b>GA2MCF120-W</b>	2,735	3,009

- Specify width to match worksurface width
- Example: 90" worksurface = 90" finished back panel

## PRODUCT INFO

TO ORDER PLEASE SPECIFY THE FOLLOWING:

1.  **MODEL NUMBER**
2.  **FINISH**
3.  **OFFICE #**

See inside front cover for required option codes

Example

GA2MCF60-W.NC215.OFC1  
 GA2MCF60-W      NC215      OFC1  
 MODEL NUMBER      FINISH      OFFICE #

**FINISHED BACK PANEL**

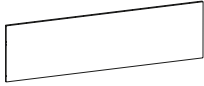

D	W	H	model number	veneer 1	veneer 2
$\frac{3}{4}$	58 1/2	20 3/16	<b>GA2MLCF60-W</b>	1,472	1,620
$\frac{3}{4}$	64 1/2	20 3/16	<b>GA2MLCF66-W</b>	1,545	1,700
$\frac{3}{4}$	70 1/2	20 3/16	<b>GA2MLCF72-W</b>	1,630	1,794
$\frac{3}{4}$	76 1/2	20 3/16	<b>GA2MLCF78-W</b>	1,713	1,886
$\frac{3}{4}$	82 1/2	20 3/16	<b>GA2MLCF84-W</b>	1,797	1,977
$\frac{3}{4}$	88 1/2	20 3/16	<b>GA2MLCF90-W</b>	1,887	2,077
$\frac{3}{4}$	94 1/2	20 3/16	<b>GA2MLCF96-W</b>	1,981	2,180
$\frac{3}{4}$	100 1/2	20 3/16	<b>GA2MLCF102-W</b>	2,117	2,330
$\frac{3}{4}$	106 1/2	20 3/16	<b>GA2MLCF108-W</b>	2,267	2,494
$\frac{3}{4}$	112 1/2	20 3/16	<b>GA2MLCF114-W</b>	2,427	2,671
$\frac{3}{4}$	118 1/2	20 3/16	<b>GA2MLCF120-W</b>	2,597	2,858

- Specify width to match worksurface width
- Example: 90" worksurface = 90" finished back panel

**PRODUCT INFO**

TO ORDER PLEASE SPECIFY THE FOLLOWING:

1.  **MODEL NUMBER**
2.  **FINISH**
3.  **OFFICE #**

See inside front cover for required option codes

Example

GA2MLCF60-W.NC215.OFC1  
 GA2MLCF60-W      NC215      OFC1  
 MODEL NUMBER      FINISH      OFFICE #

# CREDENZA WALL ACCESS PANELS

**Credentials**  
05/22

Full height

## WALL ACCESS PANEL



D	W	H	model number	veneer 1	veneer 2
5 11/16	24	26 1/2	<b>GA2MCA24-W</b>	1,910	2,102
5 11/16	27	26 1/2	<b>GA2MCA27-W</b>	1,971	2,169
5 11/16	30	26 1/2	<b>GA2MCA30-W</b>	2,032	2,236
5 11/16	33	26 1/2	<b>GA2MCA33-W</b>	2,095	2,306
5 11/16	36	26 1/2	<b>GA2MCA36-W</b>	2,161	2,378
5 11/16	39	26 1/2	<b>GA2MCA39-W</b>	2,228	2,452
5 11/16	42	26 1/2	<b>GA2MCA42-W</b>	2,272	2,500
5 11/16	45	26 1/2	<b>GA2MCA45-W</b>	2,321	2,554
5 11/16	48	26 1/2	<b>GA2MCA48-W</b>	2,368	2,606
5 11/16	51	26 1/2	<b>GA2MCA51-W</b>	2,417	2,659
5 11/16	54	26 1/2	<b>GA2MCA54-W</b>	2,463	2,710
5 11/16	57	26 1/2	<b>GA2MCA57-W</b>	2,514	2,766
5 11/16	60	26 1/2	<b>GA2MCA60-W</b>	2,564	2,822
5 11/16	63	26 1/2	<b>GA2MCA63-W</b>	2,616	2,878
5 11/16	66	26 1/2	<b>GA2MCA66-W</b>	2,668	2,936
5 11/16	69	26 1/2	<b>GA2MCA69-W</b>	2,722	2,995
5 11/16	72	26 1/2	<b>GA2MCA72-W</b>	2,775	3,053

- Specify width to match kneewell space between pedestals
- Example: (90" worksurface) - (15" LH pedestal) - (15" RH pedestal) = 60" wall access panel

## PRODUCT INFO

TO ORDER PLEASE SPECIFY THE FOLLOWING:

1.  **MODEL NUMBER**
2.  **FINISH**
3.  **OFFICE #**

See inside front cover for required option codes

Example

GA2MCA24-W.NC215.OFC1  
 GA2MCA24-W      NC215      OFC1  
MODEL NUMBER      FINISH      OFFICE #

**FINISHED BACK PANEL**



D	W	H	model number	veneer 1	veneer 2
3/4	38 1/4	27 15/16	<b>GA2MRF39-W</b>	1,288	1,418
3/4	41 1/4	27 15/16	<b>GA2MRF42-W</b>	1,327	1,460
3/4	44 1/4	27 15/16	<b>GA2MRF45-W</b>	1,366	1,504
3/4	47 1/4	27 15/16	<b>GA2MRF48-W</b>	1,399	1,540
3/4	50 1/4	27 15/16	<b>GA2MRF51-W</b>	1,435	1,579
3/4	53 1/4	27 15/16	<b>GA2MRF54-W</b>	1,472	1,620
3/4	56 1/4	27 15/16	<b>GA2MRF57-W</b>	1,510	1,662
3/4	59 1/4	27 15/16	<b>GA2MRF60-W</b>	1,545	1,700
3/4	62 1/4	27 15/16	<b>GA2MRF63-W</b>	1,588	1,748
3/4	65 1/4	27 15/16	<b>GA2MRF66-W</b>	1,630	1,794
3/4	68 1/4	27 15/16	<b>GA2MRF69-W</b>	1,674	1,842
3/4	71 1/4	27 15/16	<b>GA2MRF72-W</b>	1,717	1,890

- Specify width to match worksurface width
- Example: 60" worksurface = 60" finished back panel

**NOTE:** A 3" shorter width modesty is required when used with a height adjustable desk.

**PRODUCT INFO**

TO ORDER PLEASE SPECIFY THE FOLLOWING:

1.  **MODEL NUMBER**
2.  **FINISH**
3.  **OFFICE #**

See inside front cover for required option codes

Example

GA2MRF39-W.NC215.OFC1  
 GA2MRF39-W      NC215      OFC1  
 MODEL NUMBER      FINISH      OFFICE #

# RETURN WALL ACCESS PANELS

Full height

**Credentials**

05/22

## WALL ACCESS PANEL

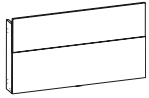

D	W	H	model number	veneer 1	veneer 2
5 11/16	21	26 1/2	<b>GA2MRA21-W</b>	1,855	2,042
5 11/16	24	26 1/2	<b>GA2MRA24-W</b>	1,910	2,102
5 11/16	27	26 1/2	<b>GA2MRA27-W</b>	1,971	2,169
5 11/16	30	26 1/2	<b>GA2MRA30-W</b>	2,032	2,236
5 11/16	33	26 1/2	<b>GA2MRA33-W</b>	2,095	2,306
5 11/16	36	26 1/2	<b>GA2MRA36-W</b>	2,161	2,378
5 11/16	39	26 1/2	<b>GA2MRA39-W</b>	2,228	2,452
5 11/16	42	26 1/2	<b>GA2MRA42-W</b>	2,272	2,500
5 11/16	45	26 1/2	<b>GA2MRA45-W</b>	2,321	2,554
5 11/16	48	26 1/2	<b>GA2MRA48-W</b>	2,368	2,606
5 11/16	51	26 1/2	<b>GA2MRA51-W</b>	2,417	2,659
5 11/16	54	26 1/2	<b>GA2MRA54-W</b>	2,463	2,710
5 11/16	57	26 1/2	<b>GA2MRA57-W</b>	2,514	2,766
5 11/16	60	26 1/2	<b>GA2MRA60-W</b>	2,564	2,822

- Specify width to match kneewell space between pedestals
- Example: (60" worksurface) - (15" LH pedestal) = 45" wall access panel

**NOTE:** A 3" shorter width wall access panel is required when used with a height adjustable desk.

## PRODUCT INFO

TO ORDER PLEASE SPECIFY THE FOLLOWING:

1.  **MODEL NUMBER**
2.  **FINISH**
3.  **OFFICE #**

See inside front cover for required option codes

Example

GA2MRA21-W.NC215.OFC1  
 GA2MRA21-W      NC215      OFC1  
 MODEL NUMBER      FINISH      OFFICE #



	D	W	H	model number	veneer 1	veneer 2
--	---	---	---	--------------	----------	----------

**FULL HEIGHT**

INTERMEDIATE SUPPORT  
FOR USE WITH  
MODESTY PANEL

$\frac{3}{4}$	14	27 1/2	<b>GA2MSP12-W</b>	851	937
---------------	----	--------	-------------------	-----	-----



T-SUPPORT FOR USE WITH  
NO MODESTY PANEL

8	12	27 1/2	<b>GA2MSPT12-W</b>	725	799
---	----	--------	--------------------	-----	-----



**LAYERS LOW HEIGHT**

INTERMEDIATE SUPPORT  
FOR USE WITH  
MODESTY PANEL

$\frac{3}{4}$	5 11/16	20 3/16	<b>GA2MLSP12-W</b>	379	418
---------------	---------	---------	--------------------	-----	-----



T-SUPPORT FOR USE WITH  
NO MODESTY PANEL

8	5 11/16	20 3/16	<b>GA2MLSPT12-W</b>	688	758
---	---------	---------	---------------------	-----	-----



**PRODUCT INFO**

TO ORDER PLEASE SPECIFY THE FOLLOWING:

1.  **MODEL NUMBER**
2.  **FINISH**
3.  **OFFICE #**

See inside front cover for required option codes

Example

<b>GA2MSP12-W.NC215.OFC1</b>		
GA2MSP12-W	NC215	OFC1
<b>MODEL NUMBER</b>	<b>FINISH</b>	<b>OFFICE #</b>

**WALL MOUNT BRACKET**

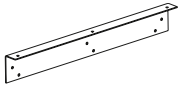

D	W	H	model number	list
2 1/2	19	1 1/4	<b>MDWLBK24</b>	130
2 1/2	25	1 1/4	<b>MDWLBK30</b>	140

**WALL MOUNT BRACKET**

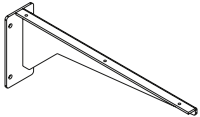

3 1/8	20 3/16	7 1/8	<b>ACWCB20</b>	244
3 1/8	15 3/16	7 1/8	<b>ACWCB15</b>	228

- For use with 24" tops to provide support on an end condition

- For use with 24" tops to provide support on center as an alternative to a T-bracket

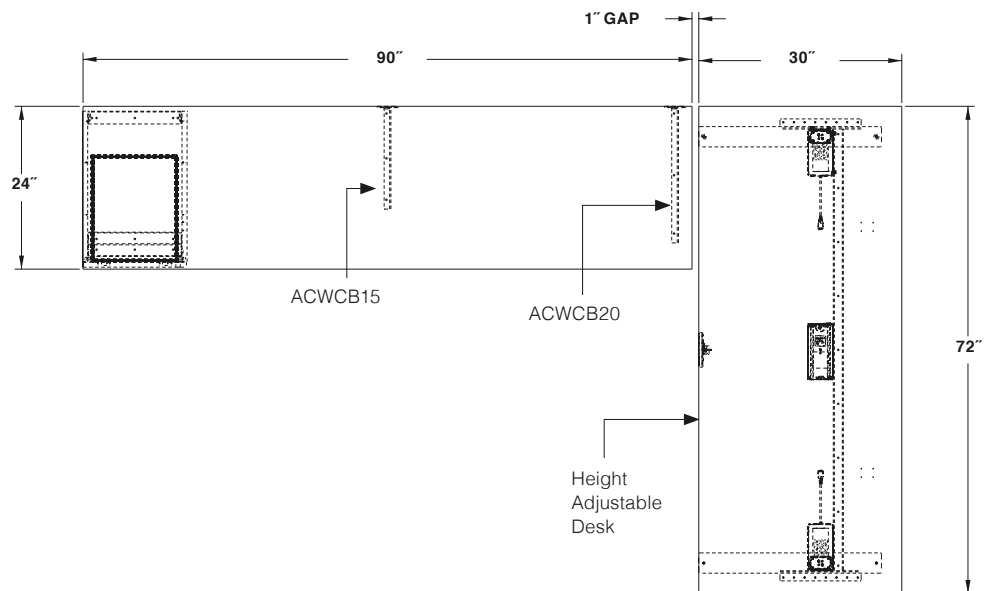

**PRODUCT INFO**

TO ORDER PLEASE SPECIFY THE FOLLOWING:



1.  **MODEL NUMBER**

**NOTE: Office # option not required**

**See inside front cover for required option codes**

Example

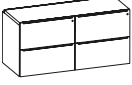
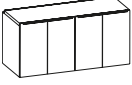
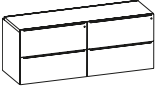
MDWLBK24  
MDWLBK24  
MODEL NUMBER

	D	W	H	model number	veneer 1	veneer 2
<b>60" WIDTH</b>						
-44	24 7/8	60	27 15/16	<b>GA2CFS2460T-44WW</b>	9,730	10,704
						
-55	24 7/8	60	27 15/16	<b>GA2CFS2460T-55WW</b>	8,760	9,637
						
<b>72" WIDTH</b>						
-44	24 7/8	72	27 15/16	<b>GA2CFS2472T-44WW</b>	10,879	11,967
						
-55	24 7/8	72	27 15/16	<b>GA2CFS2472T-55WW</b>	9,787	10,766
						

- Trough back units are required when a tackzone spans over the back of the worksurface
- Trough units include a metal pencil lip

**NOTE:** Plastic Trough Insert is REQUIRED and must be ordered separately across entire length of trough.

**PRODUCT INFO**

Short grain veneer on worksurface

Doors do not lock

**TO ORDER PLEASE SPECIFY THE FOLLOWING:**

- |    |                      |                                       |
|----|----------------------|---------------------------------------|
| 1. | <input type="text"/> | <b>MODEL NUMBER</b>                   |
| 2. | <input type="text"/> | <b>FINISH</b>                         |
| 3. | <input type="text"/> | <b>TOP UV FINISH TYPE</b>             |
| 4. | <input type="text"/> | <b>PULL</b>                           |
| 5. | <input type="text"/> | <b>MODESTY</b>                        |
| 6. | <input type="text"/> | <b>LOCKING</b>                        |
| 7. | <input type="text"/> | <b>KEYING</b>                         |
| 8. | <input type="text"/> | <b>PENCIL LIP COLOR (TROUGH ONLY)</b> |
| 9. | <input type="text"/> | <b>OFFICE #</b>                       |

See inside front cover for required option codes

Example

GA2CFS2460T-44WW.NC215.FF.MPS.MY.LY.RMS.PLS.OFC1  
 GA2CFS2460T-44WW    NC215    FF    MPS    MY    LY    RMS    PLS    OFC1  
 MODEL NUMBER    FINISH    TOP UV FINISH    PULL    MODESTY    LOCKING    KEYING    PENCIL LIP COLOR    OFFICE #

# FULL BANK STORAGE CREDENZAS

Credentials  
05/22

Trough back

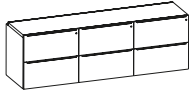
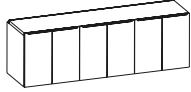
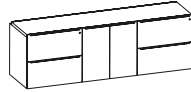
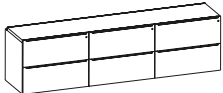
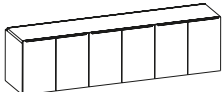
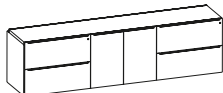
	D	W	H	model number	veneer 1	veneer 2
<b>90" WIDTH</b>						
-444	24 7/8	90	27 15/16	<b>GA2CFS2490T-444WW</b>	14,197	15,618
						
-555	24 7/8	90	27 15/16	<b>GA2CFS2490T-555WW</b>	12,738	14,013
						
-454	24 7/8	90	27 15/16	<b>GA2CFS2490T-454WW</b>	13,708	15,080
						
<b>108" WIDTH</b>						
-444	24 7/8	108	27 15/16	<b>GA2CFS24108T-444WW</b>	16,151	17,767
						
-555	24 7/8	108	27 15/16	<b>GA2CFS24108T-555WW</b>	14,513	15,965
						
-454	24 7/8	108	27 15/16	<b>GA2CFS24108T-454WW</b>	15,599	17,160
						

- Trough back units are required when a tackzone spans over the back of the worksurface
- Trough units include a metal pencil lip

**NOTE:** Plastic Trough Insert is REQUIRED and must be ordered separately across entire length of trough.

## PRODUCT INFO

Short grain veneer on worksurface

Doors do not lock

## TO ORDER PLEASE SPECIFY THE FOLLOWING:

- MODEL NUMBER**
- FINISH**
- TOP UV FINISH TYPE**
- PULL**
- MODESTY**
- LOCKING**
- KEYING**
- PENCIL LIP COLOR (TROUGH ONLY)**
- OFFICE #**

See inside front cover for required option codes

Example

GA2CFS2490T-444WW.NC125.FF.MPS.MY.LY.RMS.PLS.OFC1

GA2CFS2490T-444WW	NC125	FF	MPS	MY	LY	RMS	PLS	OFC1
<small>MODEL NUMBER</small>	<small>FINISH</small>	<small>TOP UV FINISH</small>	<small>PULL</small>	<small>MODESTY</small>	<small>LOCKING</small>	<small>KEYING</small>	<small>PENCIL LIP COLOR</small>	<small>OFFICE #</small>

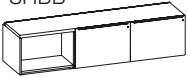
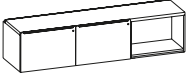
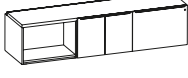
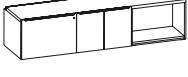
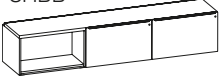
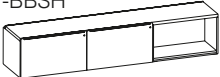
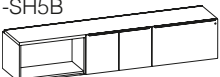
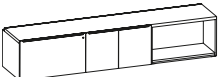
	D	W	H	model number	veneer 1	veneer 2
<b>90" WIDTH</b>						
-SHBB 	24 7/8	90	20 3/16	<b>GA2CLFS2490T-SHBBW</b>	12,798	14,079
-BBSH 	24 7/8	90	20 3/16	<b>GA2CLFS2490T-BBSHW</b>	12,798	14,079
-SH5B 	24 7/8	90	20 3/16	<b>GA2CLFS2490T-SH5BW</b>	12,338	13,572
-B5SH 	24 7/8	90	20 3/16	<b>GA2CLFS2490T-B5SHW</b>	12,338	13,572
<b>108" WIDTH</b>						
-SHBB 	24 7/8	108	20 3/16	<b>GA2CLFS24108T-SHBBW</b>	14,586	16,046
-BBSH 	24 7/8	108	20 3/16	<b>GA2CLFS24108T-BBSHW</b>	14,586	16,046
-SH5B 	24 7/8	108	20 3/16	<b>GA2CLFS24108T-SH5BW</b>	14,066	15,474
-B5SH 	24 7/8	108	20 3/16	<b>GA2CLFS24108T-B5SHW</b>	14,066	15,474
				<ul style="list-style-type: none"> <li>• Trough back units are <u>required</u> when a tackzone spans over the back of the worksurface</li> <li>• Trough units include a metal pencil lip</li> </ul>		
<p><b>NOTE:</b> Plastic Trough Insert is REQUIRED and must be ordered separately across entire length of trough.</p>						

**PRODUCT INFO**

Short grain veneer on worksurface

Doors do not lock

**TO ORDER PLEASE SPECIFY THE FOLLOWING:**

- |    |                      |                                       |
|----|----------------------|---------------------------------------|
| 1. | <input type="text"/> | <b>MODEL NUMBER</b>                   |
| 2. | <input type="text"/> | <b>FINISH</b>                         |
| 3. | <input type="text"/> | <b>TOP UV FINISH TYPE</b>             |
| 4. | <input type="text"/> | <b>PULL</b>                           |
| 5. | <input type="text"/> | <b>MODESTY</b>                        |
| 6. | <input type="text"/> | <b>LOCKING</b>                        |
| 7. | <input type="text"/> | <b>KEYING</b>                         |
| 8. | <input type="text"/> | <b>PENCIL LIP COLOR (TROUGH ONLY)</b> |
| 9. | <input type="text"/> | <b>OFFICE #</b>                       |

See inside front cover for required option codes

Example

GA2CLFS2490T-SHBBW.NC215.FF.MPS.MY.LY.RMS.PLS.OFC1  
 GA2CLFS2490T-SHBBW NC215 FF MPS MY LY RMS PLS OFC1  
 MODEL NUMBER FINISH TOP UV FINISH PULL MODESTY LOCKING KEYING PENCIL LIP COLOR OFFICE #

# LAYERS FULL BANK STORAGE CREDENZAS

**Credentials**  
05/22

Trough back

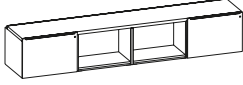
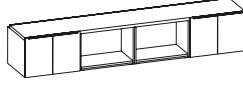
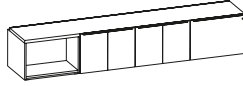
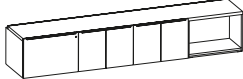
	D	W	H	model number	veneer 1	veneer 2
<b>120" WIDTH</b>						
-BSHB	24 7/8	120	20 3/16	<b>GA2CLFS24120T-BSHBW</b>	16,818	18,500
						
-5SH5	24 7/8	120	20 3/16	<b>GA2CLFS24120T-5SH5W</b>	16,818	18,500
						
-SH55B	24 7/8	120	20 3/16	<b>GA2CLFS24120T-SH55BW</b>	16,696	18,366
						
-B55SH	24 7/8	120	20 3/16	<b>GA2CLFS24120T-B55SHW</b>	16,696	18,366
						

- Trough back units are required when a tackzone spans over the back of the worksurface
- Trough units include a metal pencil lip

**NOTE:** Plastic Trough Insert is REQUIRED and must be ordered separately across entire length of trough.

## PRODUCT INFO

Short grain veneer on worksurface

Doors do not lock

## TO ORDER PLEASE SPECIFY THE FOLLOWING:

1.  **MODEL NUMBER**
2.  **FINISH**
3.  **TOP UV FINISH TYPE**
4.  **PULL**
5.  **MODESTY**
6.  **LOCKING**
7.  **KEYING**
8.  **PENCIL LIP COLOR (TROUGH ONLY)**
9.  **OFFICE #**

See inside front cover for required option codes

Example

GA2CLFS24120T-BSHBW.NC215.FF.MPS.MY.LY.RMS.PLS.OFC1

GA2CLFS24120T-BSHBW	NC215	FF	MPS	MY	LY	RMS	PLS	OFC1
<b>MODEL NUMBER</b>	<b>FINISH</b>	<b>TOP UV FINISH</b>	<b>PULL</b>	<b>MODESTY</b>	<b>LOCKING</b>	<b>KEYING</b>	<b>PENCIL LIP COLOR</b>	<b>OFFICE #</b>

	D	W	H	model number	veneer 1	veneer 2
<b>18" WIDTH</b> BOX   FILE	21 3/8	18	21 15/16	<b>GA2MPD1818-AW</b>	4,101	4,512



**PRODUCT INFO**

Includes 2 locking casters and 2 non-locking casters

Includes inset top panel

Includes hidden box drawer

**TO ORDER PLEASE SPECIFY THE FOLLOWING:**

- 1.  **MODEL NUMBER**
- 2.  **FINISH**
- 3.  **PULL**
- 4.  **LOCKING**
- 5.  **KEYING**
- 6.  **OFFICE #**

**See inside front cover for required option codes**

Example

**GA2MPD1818-AW.NC215.MPS.LY.RMS.OFC1**

GA2MPD1818-AW	NC215	CPM	LY	RMS	OFC1
<b>MODEL NUMBER</b>	<b>FINISH</b>	<b>PULL</b>	<b>LOCKING</b>	<b>KEYING</b>	<b>OFFICE #</b>

# CUSHIONS

**Credentials**  
05/22

	D	W	H	model number	fabric grades			COM/4
					1	2	3	
<b>MOBILE PEDESTAL CUSHIONS</b>								
	19 3/4	17 3/4	1 1/2	<b>GAAMPD-CUSH1818</b>	627	645	669	689

## LAYERS CREDENZA CUSHIONS FOR STANDARD WORKSURFACE



23 3/4	30	1 1/2	<b>GAACLPD-CUSH2430</b>	706	733	760	789
23 3/4	36	1 1/2	<b>GAACLPD-CUSH2436</b>	762	796	831	867

## LAYERS CREDENZA CUSHIONS FOR TROUGH BACK WORKSURFACES



21	30	1 1/2	<b>GAACLPD-CUSH2130T</b>	706	733	760	789
21	36	1 1/2	<b>GAACLPD-CUSH2136T</b>	762	796	831	867

### PRODUCT INFO

COM Fabric	(yds)
CUSH1818	0.75
CUSH2430	1.00
CUSH2436	1.25
CUSH2430T	1.00
CUSH2436T	1.25

COM Leather	(sq ft)
CUSH1818	12.75
CUSH2430	17.00
CUSH2436	21.25
CUSH2430T	17.00
CUSH2436T	21.25

### TO ORDER PLEASE SPECIFY THE FOLLOWING:

- MODEL NUMBER**
- FABRIC**
- FLAMMABILITY**
- OFFICE #**

For standard flammability rating, please specify CTB117, for California 133 and Boston fire-code treatment, please specify CTB113

**Option Codes:**  
U = CTB117

**See inside front cover for required option codes**

#### Example

<b>GAAMPD-CUSH1818.FABRIC.U.OFC1</b>			
GAAMPD-CUSH1818	FABRIC	U	OFC1
<b>MODEL NUMBER</b>	<b>FABRIC</b>	<b>FLAMMABILITY</b>	<b>OFFICE #</b>



	D	W	H	model number	list
<b>TROUGH INSERT</b>	3	28 1/4	3	<b>GAATROUGH30</b>	172
	3	34 1/4	3	<b>GAATROUGH36</b>	175
	3	40 1/4	3	<b>GAATROUGH42</b>	178
	3	46 1/4	3	<b>GAATROUGH48</b>	184
	3	52 1/4	3	<b>GAATROUGH54</b>	187
	3	58 1/4	3	<b>GAATROUGH60</b>	190
	3	64 1/4	3	<b>GAATROUGH66</b>	270
	3	70 1/4	3	<b>GAATROUGH72</b>	273
	3	76 1/4	3	<b>GAATROUGH78</b>	278
	3	82 1/4	3	<b>GAATROUGH84</b>	281
	3	88 1/4	3	<b>GAATROUGH90</b>	286
	3	94 1/4	3	<b>GAATROUGH96</b>	290
	3	100 1/4	3	<b>GAATROUGH102</b>	295
	3	106 1/4	3	<b>GAATROUGH108</b>	298
	3	112 1/4	3	<b>GAATROUGH114</b>	300
3	118 1/4	3	<b>GAATROUGH120</b>	307	

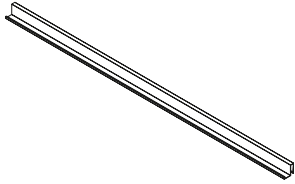

Profile:

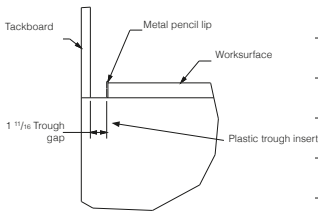

**EXAMPLE A**

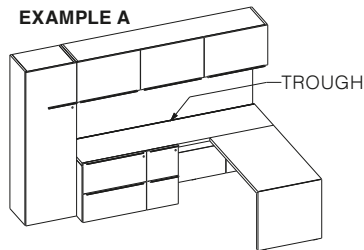

**EXAMPLE B**

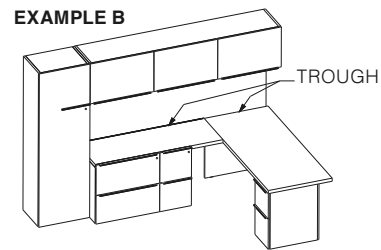

Trough insert is required across the entire length of trough.

**EXAMPLE A:** 108" back edge of credenza = 108" Trough Insert

**EXAMPLE B:** (72" back edge of return) + (36" LH end of desk) - (6" Desk overhang) = 102" Trough Insert

**NOTE:** overhang only needs to be deducted from overall length for single pedestal desks

**PRODUCT INFO**

Trough insert is black plastic

**TO ORDER PLEASE SPECIFY THE FOLLOWING:**

1.  **MODEL NUMBER**
2.  **OFFICE #**

**See inside front cover for required option codes**

Example

GAATROUGH30.OFC1	
GAATROUGH30	OFC1
<small>MODEL NUMBER</small>	<small>OFFICE #</small>

# HEIGHT ADJUSTABLE BASES

**Credentials**  
05/22

	for use with top sizes	D	W	H	model number	list
<b>BASES</b>	24 x 42	21	42	26 5/8	<b>BSHAT2142</b>	3,078
	24 x 48	21	48	26 5/8	<b>BSHAT2148</b>	3,092
	24 x 54	21	54	26 5/8	<b>BSHAT2154</b>	3,110
	24 x 60	21	60	26 5/8	<b>BSHAT2160</b>	3,124
	24 x 66	21	66	26 5/8	<b>BSHAT2166</b>	3,142
	24 x 72	21	72	26 5/8	<b>BSHAT2172</b>	3,157

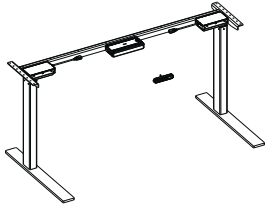

30/36 x 48	27	48	26 5/8	<b>BSHAT2748</b>	3,124
30/36 x 54	27	54	26 5/8	<b>BSHAT2754</b>	3,142
30/36 x 60	27	60	26 5/8	<b>BSHAT2760</b>	3,157
30/36 x 66	27	66	26 5/8	<b>BSHAT2766</b>	3,176
30/36 x 72	27	72	26 5/8	<b>BSHAT2772</b>	3,191

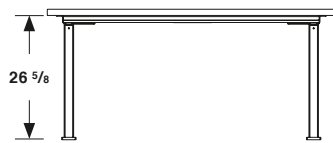

Base at lowest height setting

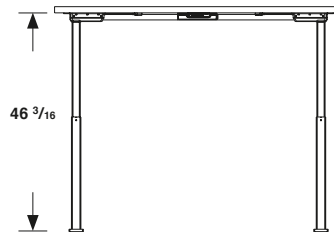

Base at tallest height setting

## PRODUCT INFO

TO ORDER PLEASE SPECIFY THE FOLLOWING:

1.  **MODEL NUMBER**
2.  **BASE COLOR**

**BASE COLOR OPTIONS:**  
**BK** Black  
**SV** Silver

See inside front cover for required option codes

Example

BSHAT2760.BK  
 BSHAT2760 BK  
 MODEL NUMBER BASE COLOR

	D	W	H	model number	veneer 1	veneer 2
<b>24" TOPS</b> 	24	42	1 1/2	<b>GA2DWRA2442-W</b>	1,710	1,882
	24	48	1 1/2	<b>GA2DWRA2448-W</b>	1,798	1,978
	24	54	1 1/2	<b>GA2DWRA2454-W</b>	1,893	2,083
	24	60	1 1/2	<b>GA2DWRA2460-W</b>	1,994	2,194
	24	66	1 1/2	<b>GA2DWRA2466-W</b>	2,099	2,310
	24	72	1 1/2	<b>GA2DWRA2472-W</b>	2,212	2,434

**PRODUCT INFO**

**TO ORDER PLEASE SPECIFY THE FOLLOWING:**

1.
2.
3.
4.
5.
6.

**MODEL NUMBER**  
**FINISH**  
**TOP UV FINISH TYPE**  
**GRAIN DIRECTION**  
**GROMMET**  
**OFFICE #**

**See set 1 below for grommet option codes**

**No Grommet GN**  
Left **GL (Add +\$191)**  
Center **GC (Add +\$191)**  
Right **GR (Add +\$191)**  
Both **GB (Add +\$382)**

**Add grommet bezel color and door finish to complete option pick.**

**SV** = silver bezel, veneer door  
**BV** = black bezel, veneer door  
**WG** = silver bezel, white glass door  
**BG** = black bezel, black glass door  
**MG** = silver bezel, muslin glass door

**See inside front cover for required option codes**

**Example: GLSV = left grommet, silver bezel, veneer door**

Example

GA2DWRA2442-W.NC215.FF.VLG.GN.OFC1

GA2DWRA2442-W	NC215	FF	VLG	GN	OFC1
<small>MODEL NUMBER</small>	<small>FINISH</small>	<small>TOP UV FINISH</small>	<small>GRAIN DIRECTION</small>	<small>GROMMET</small>	<small>OFFICE #</small>

# HEIGHT ADJUSTABLE TOPS

**Credentials**  
05/22

	D	W	H	model number	veneer 1	veneer 2
<b>30" TOPS</b> 	30	48	1 1/2	<b>GA2DWRA3048-W</b>	2,092	2,302
	30	54	1 1/2	<b>GA2DWRA3054-W</b>	2,216	2,439
	30	60	1 1/2	<b>GA2DWRA3060-W</b>	2,392	2,632
	30	66	1 1/2	<b>GA2DWRA3066-W</b>	2,545	2,801
	30	72	1 1/2	<b>GA2DWRA3072-W</b>	2,616	2,878

<b>36" TOPS</b> 	36	48	1 1/2	<b>GA2DWRA3648-W</b>	2,445	2,691
	36	54	1 1/2	<b>GA2DWRA3654-W</b>	2,586	2,846
	36	60	1 1/2	<b>GA2DWRA3660-W</b>	2,736	3,010
	36	66	1 1/2	<b>GA2DWRA3666-W</b>	2,945	3,241
	36	72	1 1/2	<b>GA2DWRA3672-W</b>	3,010	3,312

## PRODUCT INFO

TO ORDER PLEASE SPECIFY THE FOLLOWING:

1.  **MODEL NUMBER**
2.  **FINISH**
3.  **TOP UV FINISH TYPE**
4.  **GRAIN DIRECTION**
5.  **GROMMET**
6.  **OFFICE #**

See set 1 below for grommet option codes

**No Grommet GN**  
 Left **GL (Add +\$191)**  
 Right **GR (Add +\$191)**  
 Both **GB (Add +\$382)**

**Add grommet bezel color and door finish to complete option pick.**

**SV** = silver bezel, veneer door  
**BV** = black bezel, veneer door  
**WG** = silver bezel, white glass door  
**BG** = black bezel, black glass door  
**MG** = silver bezel, muslin glass door

**Example: GLSV = left grommet, silver bezel, veneer door**

See inside front cover for required option codes

Example

GA2DWRA3048-W.NC215.FF.VLG.GN.OFC1

GA2DWRA3048-W	NC215	FF	VLG	GN	OFC1
<b>MODEL NUMBER</b>	<b>FINISH</b>	<b>TOP UV FINISH</b>	<b>GRAIN DIRECTION</b>	<b>GROMMET</b>	<b>OFFICE #</b>

# HEIGHT ADJUSTABLE MODESTY PANEL

Optional | for use with 30" and 36" Tops

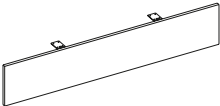
	D	W	H	model number	veneer 1	veneer 2
<b>MODESTY PANELS</b> 	3/4	48	10	<b>GA2DMHA48-W</b>	952	1,048
	3/4	54	10	<b>GA2DMHA54-W</b>	1,004	1,106
	3/4	60	10	<b>GA2DMHA60-W</b>	1,059	1,166
	3/4	66	10	<b>GA2DMHA66-W</b>	1,119	1,232
	3/4	72	10	<b>GA2DMHA72-W</b>	1,164	1,281

- Optional 10" height modesty panel with 6" overhang

**PRODUCT INFO**

TO ORDER PLEASE SPECIFY THE FOLLOWING:

- |    |                      |                     |
|----|----------------------|---------------------|
| 1. | <input type="text"/> | <b>MODEL NUMBER</b> |
| 2. | <input type="text"/> | <b>FINISH</b>       |
| 3. | <input type="text"/> | <b>OFFICE #</b>     |

**See inside front cover for required option codes**

Example

**GA2DMHA48-W.NC215.OFC1**  
 GA2DMHA48-W      NC215      OFC1  
 MODEL NUMBER      FINISH      OFFICE #









Storage . . . . .	107-117
Lateral Files . . . . .	108-109
Bookcases . . . . .	110
Hinged Door Cabinets . . . . .	111
Closets . . . . .	112-115
Storage Box . . . . .	116
Utility Cabinets . . . . .	117
Overheads . . . . .	118-138
Single Wall Mount Overheads . . . . .	118-123
Double High Wall Mount Overheads . . . . .	124-127
Tackboards . . . . .	128-131
Back Painted Glass Whiteboards . . . . .	132-134
Wood Magnetic Tackzone . . . . .	135-137
Shelves for Segmented Tackzone . . . . .	138
Miscellaneous	
Round Tables & Bases . . . . .	139
Accessories . . . . .	140-149
Fabric Grade Pricing . . . . .	150-153
Weights + Cubes . . . . .	154-162

# LATERAL FILES

Layers & 2 high

**Credentials**

05/22

	D	W	H	model number	veneer 1	veneer 2
<b>30" WIDTH LAYERS</b>						
STANDARD	24 7/8	30	21 11/16	<b>GA2LFSLH2430-WW</b>	5,250	5,776
						
<b>36" WIDTH LAYERS</b>						
STANDARD	24 7/8	36	21 11/16	<b>GA2LFSLH2436-WW</b>	5,510	6,062
						
<b>30" WIDTH 2 HIGH</b>						
STANDARD	24 7/8	30	29 7/16	<b>GA2LFS2H2430-WW</b>	5,526	6,079
						
W/ TROUGH BACK	24 7/8	30	29 7/16	<b>GA2LFS2H2430T-WW</b>	5,526	6,079
						
<b>36" WIDTH 2 HIGH</b>						
STANDARD	24 7/8	36	29 7/16	<b>GA2LFS2H2436-WW</b>	5,800	6,381
						
W/ TROUGH BACK	24 7/8	36	29 7/16	<b>GA2LFS2H2436T-WW</b>	5,800	6,381
						

- Trough back units are required when a tackzone spans over the back of the worksurface
- Trough units include a metal pencil lip

**NOTE:** Plastic Trough Insert is REQUIRED and must be ordered separately. Freestanding Lateral Files and Hinged Door Cabinets require their own trough insert.

## PRODUCT INFO

All units have a finished back

All pedestals have optional face locks

Layers height includes hidden upper box drawer

## TO ORDER PLEASE SPECIFY THE FOLLOWING:

1.  **MODEL NUMBER**
2.  **FINISH**
3.  **TOP UV FINISH TYPE**
4.  **GRAIN DIRECTION**
5.  **PULL**
6.  **LOCKING**
7.  **KEYING**
8.  **PENCIL LIP COLOR (TROUGH ONLY)**
9.  **OFFICE #**

**Grain Direction:** specify grain direction to match that of adjoining unit.

**Example:**  
Specify "VST" short grain if next to:  
-Unitized Full Bank Credenza, Desk, or Extension

Specify "VLG" long grain if next to:  
-Modular Single Pedestal Credenza, or Return





See inside front cover for required option codes

Example

GA2LFSLH2430-WW.NC215.VLG.MPS.LY.RMS.PLS.OFC1

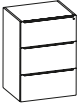
GA2LFSLH2430-WW	NC215	FF	VLG	MPS	LY	RMS	PLS	OFC1
MODEL NUMBER	FINISH	TOP UV FINISH	GRAIN DIRECTION	PULL	LOCKING	KEYING	PENCIL LIP COLOR	OFFICE #

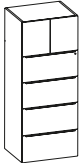

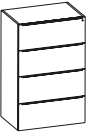
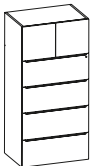
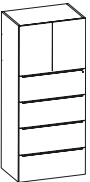
	D	W	H	model number	veneer 1	veneer 2
<b>30" WIDTH</b>						
	3 HIGH	24 7/8	30	43 7/16	<b>GA2LFS3H2430-WW</b>	7,629 8,392
	4 HIGH	24 7/8	30	57 7/16	<b>GA2LFS4H2430-WW</b>	9,368 10,306
	5 HIGH	24 7/8	30	75 15/16	<b>GA2LFS5H2430-WW</b>	12,618 13,881
	6 HIGH	24 7/8	30	84 7/16	<b>GA2LFS6H2430-WW</b>	13,580 14,939
<b>36" WIDTH</b>						
	3 HIGH	24 7/8	36	43 7/16	<b>GA2LFS3H2436-WW</b>	8,010 8,812
	4 HIGH	24 7/8	36	57 7/16	<b>GA2LFS4H2436-WW</b>	9,837 10,822
	5 HIGH	24 7/8	36	75 15/16	<b>GA2LFS5H2436-WW</b>	13,251 14,577
	6 HIGH	24 7/8	36	84 7/16	<b>GA2LFS6H2436-WW</b>	14,260 15,687

**NOTE:** 5 High and 6 High Lateral Files do not have locks on top doors. These doors are equipped with touch latches and free swing hinges.

**PRODUCT INFO**

All units have a finished back

All pedestals have optional face locks

5H and 6H Lateral Files do not lock on top doors.

**TO ORDER PLEASE SPECIFY THE FOLLOWING:**

- 1.  **MODEL NUMBER**
- 2.  **FINISH**
- 3.  **PULL**
- 4.  **LOCKING**
- 5.  **KEYING**
- 6.  **OFFICE #**

**See inside front cover for required option codes**

Example









GA2LFS3H2430-WW.NC215.MPS.LY.RM.OFC1  
 GA2LFS3H2430-WW    NC215    MPS    LY    RMS    OFC1  
 MODEL NUMBER    FINISH    PULL    LOCKING    KEYING    OFFICE #

# BOOKCASES

2 High | 6 high

Credentials

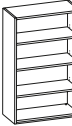
05/22

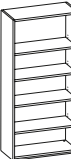
		D	W	H	model number	veneer 1	veneer 2
<b>30" WIDTH</b>							
	2 HIGH	16 7/8	30	29 7/16	<b>GA2BKN2H1830-W</b>	3,207	3,529
	3 HIGH	16 7/8	30	43 7/16	<b>GA2BKN3H1830-W</b>	3,850	4,236
	4 HIGH	16 7/8	30	57 7/16	<b>GA2BKN4H1830-W</b>	4,623	5,087
	5 HIGH	16 7/8	30	75 15/16	<b>GA2BKN5H1830-W</b>	5,544	6,099
	6 HIGH	16 7/8	30	84 7/16	<b>GA2BKN6H1830-W</b>	6,655	7,321
<b>36" WIDTH</b>							
	2 HIGH	16 7/8	36	29 7/16	<b>GA2BKN2H1836-W</b>	3,594	3,954
	3 HIGH	16 7/8	36	43 7/16	<b>GA2BKN3H1836-W</b>	4,316	4,748
	4 HIGH	16 7/8	36	57 7/16	<b>GA2BKN4H1836-W</b>	5,176	5,694
	5 HIGH	16 7/8	36	75 15/16	<b>GA2BKN5H1836-W</b>	6,213	6,835
	6 HIGH	16 7/8	36	84 7/16	<b>GA2BKN6H1836-W</b>	7,456	8,202

## PRODUCT INFO

All units have a finished back

6-high bookcases must be attached to wall

## TO ORDER PLEASE SPECIFY THE FOLLOWING:

1.  **MODEL NUMBER**
2.  **FINISH**
3.  **OFFICE #**

See inside front cover for required option codes

Example

GA2BKN2H1830-W.NC215.OFC1  
 GA2BKN2H1830-W    NC215    OFC1  
 MODEL NUMBER    FINISH    OFFICE #

	D	W	H	model number	veneer 1	veneer 2
<b>30" WIDTH LAYERS</b>						
STANDARD	24 7/8	30	21 11/16	<b>GA2HDCLH2430-WW</b>	3,990	4,389



<b>36" WIDTH LAYERS</b>						
STANDARD	24 7/8	36	21 11/16	<b>GA2HDCLH2436-WW</b>	4,411	4,853



<b>30" WIDTH 2 HIGH</b>						
STANDARD	24 7/8	30	29 7/16	<b>GA2HDC2H2430-WW</b>	4,202	4,623



W/ TROUGH BACK



	24 7/8	30	29 7/16	<b>GA2HDC2H2430T-WW</b>	4,202	4,623
--	--------	----	---------	-------------------------	-------	-------

<b>36" WIDTH 2 HIGH</b>						
STANDARD	24 7/8	36	29 7/16	<b>GA2HDC2H2436-WW</b>	4,641	5,106



W/ TROUGH BACK



	24 7/8	36	29 7/16	<b>GA2HDC2H2436T-WW</b>	4,641	5,106
--	--------	----	---------	-------------------------	-------	-------

- Trough back units are required when a tackzone spans over the back of the worksurface
- Trough units include a metal pencil lip

**NOTE:** Plastic Trough Insert is REQUIRED and must be ordered separately. Freestanding Lateral Files and Hinged Door Cabinets require their own trough insert.

**PRODUCT INFO**

All units have a finished back

Units do not lock

**TO ORDER PLEASE SPECIFY THE FOLLOWING:**

- |    |                      |                                      |
|----|----------------------|--------------------------------------|
| 1. | <input type="text"/> | <b>MODEL NUMBER</b>                  |
| 2. | <input type="text"/> | <b>FINISH</b>                        |
| 3. | <input type="text"/> | <b>TOP UV FINISH</b>                 |
| 4. | <input type="text"/> | <b>GRAIN DIRECTION</b>               |
| 5. | <input type="text"/> | <b>PULL</b>                          |
| 6. | <input type="text"/> | <b>PENCIL LIP COLOR(TROUGH ONLY)</b> |
| 7. | <input type="text"/> | <b>OFFICE #</b>                      |

**Grain Direction:** specify grain direction to match that of adjoining unit.

**Example:**  
Specify "VST" short grain if next to:  
-Unitized Full Bank Credenza, Desk, or Extension

Specify "VLG" long grain if next to:  
-Modular Single Pedestal Credenza, or Return

**See inside front cover for required option codes**

Example

GA2HDCLH2430-WW.NC215.OP.VLG.MPS.PLS.OFC1						
GA2HDCLH2430-WW	NC215	OP	VLG	MPS	PLS	OFC1
<b>MODEL NUMBER</b>	<b>FINISH</b>	<b>TOP UV FINISH</b>	<b>GRAIN DIRECTION</b>	<b>PULL</b>	<b>PENCIL LIP COLOR</b>	<b>OFFICE #</b>

# CLOSETS – 18D

5 High

**Credentials**

05/22

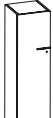
	D	W	H	model number	veneer 1	veneer 2
<b>18" WIDTH LEFT HAND</b> 	17 3/4	18	75 15/16	<b>GA2CLC5H1818L-WW</b>	5,701	6,272
	17 3/4	18	75 15/16	<b>GA2CLS5H1818L-WW</b>	6,352	6,988
	17 3/4	18	75 15/16	<b>GA2CLD5H1818L-WW</b>	7,101	7,812

- CLC = Coat hook with (1) adjustable shelf
- CLS = (4) adjustable shelves
- CLD = Coat hook with (1) adjustable shelf | Divider | (4) adjustable shelves

## 18" WIDTH RIGHT HAND

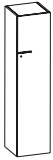

17 3/4	18	75 15/16	<b>GA2CLC5H1818R-WW</b>	5,701	6,272
17 3/4	18	75 15/16	<b>GA2CLS5H1818R-WW</b>	6,352	6,988
17 3/4	18	75 15/16	<b>GA2CLD5H1818R-WW</b>	7,101	7,812

- CLC = Coat hook with (1) adjustable shelf
- CLS = (4) adjustable shelves
- CLD = Coat hook with (1) adjustable shelf | Divider | (4) adjustable shelves

## 24" WIDTH LEFT HAND

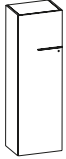

17 3/4	24	75 15/16	<b>GA2CLD5H1824L-WW</b>	8,161	8,978
--------	----	----------	-------------------------	-------	-------

- CLD = Coat hook with (1) adjustable shelf | Divider | (4) adjustable shelves

## 24" WIDTH RIGHT HAND

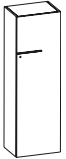

17 3/4	24	75 15/16	<b>GA2CLD5H1824R-WW</b>	8,161	8,978
--------	----	----------	-------------------------	-------	-------

- CLD = Coat hook with (1) adjustable shelf | Divider | (4) adjustable shelves

## 30" WIDTH

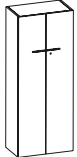

17 3/4	30	75 15/16	<b>GA2CLS5H1830-WW</b>	9,210	10,132
17 3/4	30	75 15/16	<b>GA2CLD5H1830-WW</b>	9,940	10,935

- CLS = (4) adjustable shelves
- CLD = Coat hook with (1) adjustable shelf | Divider | (4) adjustable shelves

### PRODUCT INFO

All units have a finished back

All units have optional face locks

### TO ORDER PLEASE SPECIFY THE FOLLOWING:

1.	<input type="text"/>	<b>MODEL NUMBER</b>
2.	<input type="text"/>	<b>FINISH</b>
3.	<input type="text"/>	<b>PULL</b>
4.	<input type="text"/>	<b>LOCKING</b>
5.	<input type="text"/>	<b>KEYING</b>
6.	<input type="text"/>	<b>OFFICE #</b>

See inside front cover for required option codes

Example

GA2CLC5H1818L-WW.NC215.MPS.LY.RMS.OFC1

GA2CLC5H1818L-WW	NC215	MPS	LY	RMS	OFC1
<b>MODEL NUMBER</b>	<b>FINISH</b>	<b>PULL</b>	<b>LOCKING</b>	<b>KEYING</b>	<b>OFFICE #</b>

	D	W	H	model number	veneer 1	veneer 2
<b>18" WIDTH LEFT HAND</b> 	17 3/4	18	84 7/16	<b>GA2CLC6H1818L-WW</b>	6,381	7,020
	17 3/4	18	84 7/16	<b>GA2CLS6H1818L-WW</b>	7,113	7,825
	17 3/4	18	84 7/16	<b>GA2CLD6H1818L-WW</b>	7,951	8,747

- CLC = Coat hook with (2) adjustable shelves
- CLS = (5) adjustable shelves
- CLD = Coat hook with (2) adjustable adjustable shelf | Divider | (5) adjustable shelves

**18" WIDTH RIGHT HAND**

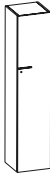

17 3/4	18	84 7/16	<b>GA2CLC6H1818R-WW</b>	6,381	7,020
17 3/4	18	84 7/16	<b>GA2CLS6H1818R-WW</b>	7,113	7,825
17 3/4	18	84 7/16	<b>GA2CLD6H1818R-WW</b>	7,951	8,747

- CLC = Coat hook with (2) adjustable shelves
- CLS = (5) adjustable shelves
- CLD = Coat hook with (2) adjustable adjustable shelf | Divider | (5) adjustable shelves

**24" WIDTH LEFT HAND**



17 3/4	24	84 7/16	<b>GA2CLD6H1824L-WW</b>	9,146	10,061
--------	----	---------	-------------------------	-------	--------

- CLD = Coat hook with (2) adjustable shelves | Divider | (5) adjustable shelves

**24" WIDTH RIGHT HAND**

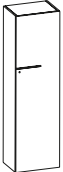

17 3/4	24	84 7/16	<b>GA2CLD6H1824R-WW</b>	9,146	10,061
--------	----	---------	-------------------------	-------	--------

- CLD = Coat hook with (2) adjustable shelves | Divider | (5) adjustable shelves

**PRODUCT INFO**

All units have a finished back

All units have optional  
face locks

**TO ORDER PLEASE SPECIFY THE FOLLOWING:**

- |    |                      |                     |
|----|----------------------|---------------------|
| 1. | <input type="text"/> | <b>MODEL NUMBER</b> |
| 2. | <input type="text"/> | <b>FINISH</b>       |
| 3. | <input type="text"/> | <b>PULL</b>         |
| 4. | <input type="text"/> | <b>LOCKING</b>      |
| 5. | <input type="text"/> | <b>KEYING</b>       |
| 6. | <input type="text"/> | <b>OFFICE #</b>     |

See inside front cover for required option codes

Example

GA2CLC6H1818L-WW.NC215.MPS.LY.RMS.OFC1  
 GA2CLC6H1818L-WW    NC215    MPS    LY    RMS    OFC1  
 MODEL NUMBER    FINISH    PULL    LOCKING    KEYING    OFFICE #

# CLOSETS – 24D

5 High

Credentials

05/22

	D	W	H	model number	veneer 1	veneer 2
<b>18" WIDTH LEFT HAND</b> 	24 7/8	18	75 15/16	<b>GA2CLC5H2418L-WW</b>	5,999	6,600
	24 7/8	18	75 15/16	<b>GA2CLS5H2418L-WW</b>	6,683	7,353
	24 7/8	18	75 15/16	<b>GA2CLD5H2418L-WW</b>	7,471	8,219

- CLC = Closet rod with (1) adjustable shelf
- CLS = (4) adjustable shelves
- CLD = Closet rod with (1) adjustable shelf | Divider | (4) adjustable shelves

## 18" WIDTH RIGHT HAND

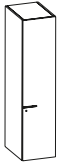

24 7/8	18	75 15/16	<b>GA2CLC5H2418R-WW</b>	5,999	6,600
24 7/8	18	75 15/16	<b>GA2CLS5H2418R-WW</b>	6,683	7,353
24 7/8	18	75 15/16	<b>GA2CLD5H2418R-WW</b>	7,471	8,219

- CLC = Closet rod with (1) adjustable shelf
- CLD = Closet rod with (1) adjustable shelf | Divider | (4) adjustable shelves

## 24" WIDTH LEFT HAND

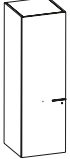

24 7/8	24	75 15/16	<b>GA2CLD5H2424L-WW</b>	8,596	9,457
--------	----	----------	-------------------------	-------	-------

- CLD = Closet rod with (1) adjustable shelf | Divider | (4) adjustable shelves

## 24" WIDTH RIGHT HAND

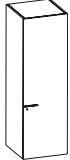

24 7/8	24	75 15/16	<b>GA2CLD5H2424R-WW</b>	8,596	9,457
--------	----	----------	-------------------------	-------	-------

- CLD = Closet rod with (1) adjustable shelf | Divider | (4) adjustable shelves

## 30" WIDTH

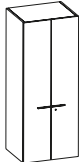

24 7/8	30	75 15/16	<b>GA2CLS5H2430-WW</b>	9,692	10,663
24 7/8	30	75 15/16	<b>GA2CLD5H2430-WW</b>	10,462	11,509

- CLS = (4) adjustable shelves
- CLD = Closet rod with (1) adjustable shelf | Divider | (4) adjustable shelves

### PRODUCT INFO

All units have a finished back

All units have optional face locks

Metal pull height matches 29H pedestal pulls

### TO ORDER PLEASE SPECIFY THE FOLLOWING:

1.	<input type="text"/>	<b>MODEL NUMBER</b>
2.	<input type="text"/>	<b>FINISH</b>
3.	<input type="text"/>	<b>PULL</b>
4.	<input type="text"/>	<b>LOCKING</b>
5.	<input type="text"/>	<b>KEYING</b>
6.	<input type="text"/>	<b>OFFICE #</b>

See inside front cover for required option codes

Example

GA2CLC5H2418L-WW.NC215.MPS.LY.RMS.OFC1

GA2CLC5H2418L-WW	NC215	MPS	LY	RMS	OFC1
<b>MODEL NUMBER</b>	<b>FINISH</b>	<b>PULL</b>	<b>LOCKING</b>	<b>KEYING</b>	<b>OFFICE #</b>

	D	W	H	model number	veneer 1	veneer 2
<b>18" WIDTH LEFT HAND</b>	24 7/8	18	84 7/16	<b>GA2CLC6H2418L-WW</b>	6,721	7,394
	24 7/8	18	84 7/16	<b>GA2CLS6H2418L-WW</b>	7,488	8,237
	24 7/8	18	84 7/16	<b>GA2CLD6H2418L-WW</b>	8,368	9,206



- CLC = Closet rod with (2) adjustable shelves
- CLS = (5) adjustable shelves
- CLD = Closet rod with (2) adjustable adjustable shelf | Divider | (5) adjustable shelves

**18" WIDTH RIGHT HAND**



24 7/8	18	84 7/16	<b>GA2CLC6H2418R-WW</b>	6,721	7,394
24 7/8	18	84 7/16	<b>GA2CLS6H2418R-WW</b>	7,488	8,237
24 7/8	18	84 7/16	<b>GA2CLD6H2418R-WW</b>	8,368	9,206

- CLC = Closet rod with (2) adjustable shelf
- CLS = (5) adjustable shelves
- CLD = Closet rod with (2) adjustable shelf | Divider | (5) adjustable shelves

**24" WIDTH LEFT HAND**

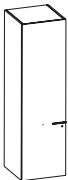

24 7/8	24	84 7/16	<b>GA2CLD6H2424L-WW</b>	9,622	10,585
--------	----	---------	-------------------------	-------	--------

- CLD = Closet rod with (2) adjustable shelf | Divider | (5) adjustable shelves

**24" WIDTH RIGHT HAND**



24 7/8	24	84 7/16	<b>GA2CLD6H2424R-WW</b>	9,622	10,585
--------	----	---------	-------------------------	-------	--------

- CLD = Closet rod with (2) adjustable shelf | Divider | (5) adjustable shelves

**PRODUCT INFO**

All units have a finished back

All units have optional face locks

Metal pull height matches 29H pedestal pulls

**TO ORDER PLEASE SPECIFY THE FOLLOWING:**

- |    |                      |                     |
|----|----------------------|---------------------|
| 1. | <input type="text"/> | <b>MODEL NUMBER</b> |
| 2. | <input type="text"/> | <b>FINISH</b>       |
| 3. | <input type="text"/> | <b>PULL</b>         |
| 4. | <input type="text"/> | <b>LOCKING</b>      |
| 5. | <input type="text"/> | <b>KEYING</b>       |
| 6. | <input type="text"/> | <b>OFFICE #</b>     |

**See inside front cover for required option codes**

Example



GA2CLC6H2418L-WW.NC215.MPS.LY.RMS.OFC1  
 GA2CLC6H2418L-WW    NC215    MPS    LY    RMS    OFC1  
 MODEL NUMBER    FINISH    PULL    LOCKING    KEYING    OFFICE #

# STORAGE BOX

5 High | 6 high

Credentials

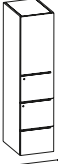
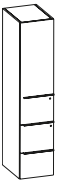
05/22

	D	W	H	model number	veneer 1	veneer 2
<b>5 HIGH</b>						
	18" WIDTH LEFT HAND	24 7/8	18	75 15/16	<b>GA2SBH5H2418L-WW</b>	7,420 8,163
		<ul style="list-style-type: none"> <li>Includes (2) adjustable shelves behind doors</li> <li>(2) file drawers bottom, door upper</li> </ul>				
	18" WIDTH RIGHT HAND	24 7/8	18	75 15/16	<b>GA2SBH5H2418R-WW</b>	7,420 8,163
		<ul style="list-style-type: none"> <li>Includes (2) adjustable shelves behind doors</li> <li>(2) file drawers bottom, door upper</li> </ul>				
	30" WIDTH	24 7/8	30	75 15/16	<b>GA2SBH5H2430-WW</b>	11,053 12,159
		<ul style="list-style-type: none"> <li>Includes (2) adjustable shelves behind doors</li> <li>(2) file drawers bottom, door upper</li> </ul>				
<b>6 HIGH</b>						
	18" WIDTH LEFT HAND	24 7/8	18	84 7/16	<b>GA2SBH6H2418L-WW</b>	8,831 9,715
		<ul style="list-style-type: none"> <li>Includes (3) adjustable shelves behind door</li> <li>(2) file drawers bottom, door upper</li> </ul>				
	18" WIDTH RIGHT HAND	24 7/8	18	84 7/16	<b>GA2SBH6H2418R-WW</b>	8,831 9,715
		<ul style="list-style-type: none"> <li>Includes (3) adjustable shelves behind door</li> <li>(2) file drawers bottom, door upper</li> </ul>				
	30" WIDTH	24 7/8	30	84 7/16	<b>GA2SBH6H2430-WW</b>	12,738 14,013
		<ul style="list-style-type: none"> <li>Includes (3) adjustable shelves behind door</li> <li>(2) file drawers bottom, door upper</li> </ul>				

## PRODUCT INFO

All units have a finished back

All units have optional face locks

## TO ORDER PLEASE SPECIFY THE FOLLOWING:

1.	<input type="text"/>	<b>MODEL NUMBER</b>
2.	<input type="text"/>	<b>FINISH</b>
3.	<input type="text"/>	<b>PULL</b>
4.	<input type="text"/>	<b>LOCKING</b>
5.	<input type="text"/>	<b>KEYING</b>
6.	<input type="text"/>	<b>OFFICE #</b>

See inside front cover for required option codes

Example

GA2SBH5H2418L-WW.NC215.MPS.LY.RMS.OFC1					
GA2SBH5H2418L-WW	NC215	MPS	LY	RMS	OFC1
<b>MODEL NUMBER</b>	<b>FINISH</b>	<b>PULL</b>	<b>LOCKING</b>	<b>KEYING</b>	<b>OFFICE #</b>



	D	W	H	model number	veneer 1	veneer 2
<b>5 HIGH</b>						
	LEFT HAND	24 7/8	24	75 15/16	<b>GA2UTC5H2424L-WW</b>	11,590 12,750
	RIGHT HAND	24 7/8	24	75 15/16	<b>GA2UTC5H2424R-WW</b>	11,590 12,750
<b>6 HIGH</b>						
	LEFT HAND	24 7/8	24	84 7/16	<b>GA2UTC6H2424L-WW</b>	13,294 14,624
	RIGHT HAND	24 7/8	24	84 7/16	<b>GA2UTC6H2424R-WW</b>	13,294 14,624

**Note:** Tall door hinges off center divider on utility cabinets for side access to integral wood pulls.

**PRODUCT INFO**

All units have a finished back

All units have optional face locks

**TO ORDER PLEASE SPECIFY THE FOLLOWING:**

- 1.  **MODEL NUMBER**
- 2.  **FINISH**
- 3.  **PULL**
- 4.  **LOCKING**
- 5.  **KEYING**
- 6.  **OFFICE #**

**See inside front cover for required option codes**

Example

GA2UTC5H2424L-WW.NC215.MPS.LY.RMS.OFC1  
 GA2UTC5H2424L-WW    NC215    MPS    LY    RMS    OFC1  
 MODEL NUMBER    FINISH    PULL    LOCKING    KEYING    OFFICE #

# WALL MOUNT OVERHEADS

Hinged | wood doors

Credentials

05/22

## 1 HIGH

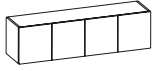

D	W	H	model number	veneer 1	veneer 2
18	30	19 1/2	<b>GA2WCH1H30-WW</b>	4,531	4,985
18	36	19 1/2	<b>GA2WCH1H36-WW</b>	4,735	5,210
18	60	19 1/2	<b>GA2WCH1H60-WW</b>	7,941	8,736
18	66	19 1/2	<b>GA2WCH1H66-WW</b>	8,292	9,122
18	72	19 1/2	<b>GA2WCH1H72-WW</b>	8,664	9,531
18	78	19 1/2	<b>GA2WCH1H78-WW</b>	9,386	10,326
18	84	19 1/2	<b>GA2WCH1H84-WW</b>	9,800	10,780
18	90	19 1/2	<b>GA2WCH1H90-WW</b>	10,230	11,254
18	96	19 1/2	<b>GA2WCH1H96-WW</b>	10,666	11,734
18	102	19 1/2	<b>GA2WCH1H102-WW</b>	11,116	12,228
18	108	19 1/2	<b>GA2WCH1H108-WW</b>	11,593	12,753

- Units are available in wood integral pull only
- Recessed LED tasklights included

## PRODUCT INFO

Doors do not lock

Door widths:

30" = (2) doors

36" = (2) doors

60" = (4) doors

66" = (4) doors

72" = (4) doors

78" = (4) doors

84" = (6) doors

90" = (6) doors

96" = (6) doors

102" = (6) doors

108" = (6) doors

Hidden cubbies behind doors

TO ORDER PLEASE SPECIFY THE FOLLOWING:

1.	<input type="text"/>	<b>MODEL NUMBER</b>
2.	<input type="text"/>	<b>FINISH</b>
3.	<input type="text"/>	<b>PULL</b>
4.	<input type="text"/>	<b>OFFICE #</b>

See inside front cover for required option codes

Example

<b>GA2WCH1H30-WW.NC215.MPS.OFC1</b>			
GA2WCH1H30-WW	NC215	MPS	OFC1
<b>MODEL NUMBER</b>	<b>FINISH</b>	<b>PULL</b>	<b>OFFICE #</b>

**1 HIGH**

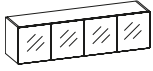

D	W	H	model number	veneer 1	veneer 2
18	30	19 1/2	<b>GA2WCH1H30-WG</b>	5,115	5,628
18	36	19 1/2	<b>GA2WCH1H36-WG</b>	5,352	5,888
18	60	19 1/2	<b>GA2WCH1H60-WG</b>	8,942	9,837
18	72	19 1/2	<b>GA2WCH1H72-WG</b>	9,775	10,753
18	90	19 1/2	<b>GA2WCH1H90-WG</b>	11,526	12,680
18	108	19 1/2	<b>GA2WCH1H108-WG</b>	13,090	14,400

- Recessed LED tasklights included

**PRODUCT INFO**

Doors do not lock

Door widths:

30" = (2) doors

36" = (2) doors

60" = (4) doors

72" = (4) doors

90" = (6) doors

108" = (6) doors

Hidden cubbies behind doors

**TO ORDER PLEASE SPECIFY THE FOLLOWING:**

1.  **MODEL NUMBER**
2.  **FINISH**
3.  **GLASS COLOR**
4.  **OFFICE #**

**See inside front cover for required option codes**

Example

**GA2WCH1H30-WG.NC215.WH.OFC1**  
 GA2WCH1H30-WG    NC215    WH    OFC1  
 MODEL NUMBER    FINISH    GLASS COLOR    OFFICE #

# WALL MOUNT OVERHEADS

Soft lift | wood doors

**Credentials**

05/22

## 1 HIGH

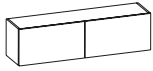

D	W	H	model number	veneer 1	veneer 2
18	60	19 1/2	<b>GA2WCF1H60-WW</b>	8,275	9,104
18	72	19 1/2	<b>GA2WCF1H72-WW</b>	9,033	9,937
18	90	19 1/2	<b>GA2WCF1H90-WW</b>	10,666	11,734
18	108	19 1/2	<b>GA2WCF1H108-WW</b>	12,093	13,303

- Units are available in wood integral pull only
- Recessed LED tasklights included

### PRODUCT INFO

Doors do not lock

Door widths:

60" = (2) doors

72" = (2) doors

90" = (3) doors

108" = (3) doors

Hidden cubbies behind doors

TO ORDER PLEASE SPECIFY THE FOLLOWING:

1.  **MODEL NUMBER**
2.  **FINISH**
3.  **PULL**
4.  **OFFICE #**

**See inside front cover for required option codes**

Example

GA2WCF1H60-WW.NC215.MPS.OFC1

GA2WCF1H60-WW	NC215	MPS	OFC1
<b>MODEL NUMBER</b>	<b>FINISH</b>	<b>PULL</b>	<b>OFFICE #</b>

**1 HIGH**

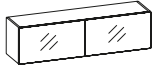

D	W	H	model number	veneer 1	veneer 2
18	60	19 1/2	<b>GA2WCF1H60-WG</b>	9,328	10,262
18	72	19 1/2	<b>GA2WCF1H72-WG</b>	10,200	11,221
18	90	19 1/2	<b>GA2WCF1H90-WG</b>	12,023	13,226
18	108	19 1/2	<b>GA2WCF1H108-WG</b>	13,666	15,033

- Recessed LED tasklights included

**PRODUCT INFO**

Doors do not lock

Door widths:

60" = (2) doors

72" = (2) doors

90" = (3) doors

108" = (3) doors

Hidden cubbies behind doors

**TO ORDER PLEASE SPECIFY THE FOLLOWING:**

1.  **MODEL NUMBER**
2.  **FINISH**
3.  **GLASS COLOR**
4.  **OFFICE #**

**See inside front cover for required option codes**

Example

**GA2WCF1H60-WG.NC215.WH.OFC1**  
 GA2WCF1H60-WG    NC215    WH    OFC1  
 MODEL NUMBER    FINISH    GLASS COLOR    OFFICE #

# WALL MOUNT OVERHEADS

Sliding | wood doors

**Credentials**

05/22

## 1 HIGH

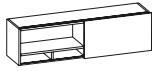

D	W	H	model number	veneer 1	veneer 2
18	60	19 1/2	<b>GA2WCS1H60-WW</b>	8,275	9,104
18	72	19 1/2	<b>GA2WCS1H72-WW</b>	9,033	9,937
18	90	19 1/2	<b>GA2WCS1H90-WW</b>	10,666	11,734
18	108	19 1/2	<b>GA2WCS1H108-WW</b>	12,093	13,303

- No pulls required
- Recessed LED tasklights included

### PRODUCT INFO

Doors do not lock

Door widths:

60" = (1) doors

72" = (1) doors

90" = (2) doors

108" = (2) doors

Hidden cubbies behind doors

TO ORDER PLEASE SPECIFY THE FOLLOWING:

1.  **MODEL NUMBER**
2.  **FINISH**
3.  **OFFICE #**

**See inside front cover for required option codes**

Example

**GA2WCS1H60-WW.NC215.OFC1**

GA2WCS1H60-WW	NC215	OFC1
<b>MODEL NUMBER</b>	<b>FINISH</b>	<b>OFFICE #</b>

**1 HIGH**

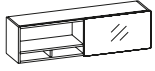

D	W	H	model number	veneer 1	veneer 2
18	60	19 1/2	<b>GA2WCS1H60-WG</b>	9,328	10,262
18	72	19 1/2	<b>GA2WCS1H72-WG</b>	10,200	11,221
18	90	19 1/2	<b>GA2WCS1H90-WG</b>	12,023	13,226
18	108	19 1/2	<b>GA2WCS1H108-WG</b>	13,666	15,033

- Recessed LED tasklights included

**PRODUCT INFO**

Doors do not lock

Door widths:  
60" = (1) doors  
72" = (1) doors  
90" = (2) doors  
108" = (2) doors

Hidden cubbies behind doors

**TO ORDER PLEASE SPECIFY THE FOLLOWING:**

1.  **MODEL NUMBER**
2.  **FINISH**
3.  **GLASS COLOR**
4.  **OFFICE #**

**See inside front cover for required option codes**

Example

**GA2WCS1H60-WG.NC215.WH.OFC1**  
 GA2WCS1H60-WG    NC215    WH    OFC1  
 MODEL NUMBER    FINISH    GLASS COLOR    OFFICE #

# WALL MOUNT OVERHEADS

Hinged | wood doors

Credentials

05/22

## 2 HIGH

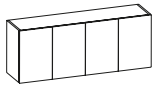

D	W	H	model number	veneer 1	veneer 2
18	30	28	<b>GA2WCH2H30-WW</b>	6,481	7,130
18	36	28	<b>GA2WCH2H36-WW</b>	6,789	7,469
18	60	28	<b>GA2WCH2H60-WW</b>	9,650	10,616
18	66	28	<b>GA2WCH2H66-WW</b>	10,095	11,106
18	72	28	<b>GA2WCH2H72-WW</b>	10,558	11,615
18	78	28	<b>GA2WCH2H78-WW</b>	11,383	12,523
18	84	28	<b>GA2WCH2H84-WW</b>	11,901	13,092
18	90	28	<b>GA2WCH2H90-WW</b>	12,442	13,687

- Units are available in wood integral pull only
- Recessed LED tasklights included

### PRODUCT INFO

Doors do not lock

Door widths:

30" = (2) doors

36" = (2) doors

60" = (4) doors

66" = (4) doors

72" = (4) doors

78" = (4) doors

84" = (6) doors

90" = (6) doors

TO ORDER PLEASE SPECIFY THE FOLLOWING:

- MODEL NUMBER**
- FINISH**
- PULL**
- OFFICE #**

See inside front cover for required option codes

Example

**GA2WCH2H30-WW.NC215.MPS.OFC1**

GA2WCH2H30-WW	NC215	MPS	OFC1
<b>MODEL NUMBER</b>	<b>FINISH</b>	<b>PULL</b>	<b>OFFICE #</b>



**2 HIGH**

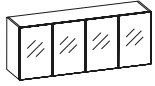

D	W	H	model number	veneer 1	veneer 2
18	30	28	<b>GA2WCH2H30-WG</b>	7,361	8,098
18	36	28	<b>GA2WCH2H36-WG</b>	7,713	8,485
18	60	28	<b>GA2WCH2H60-WG</b>	10,910	12,002
18	72	28	<b>GA2WCH2H72-WG</b>	11,953	13,149
18	90	28	<b>GA2WCH2H90-WG</b>	14,067	15,475

- Recessed LED tasklights included

**PRODUCT INFO**

Doors do not lock

Door widths:

30" = (2) doors

36" = (2) doors

60" = (4) doors

72" = (4) doors

90" = (6) doors

**TO ORDER PLEASE SPECIFY THE FOLLOWING:**

1.  **MODEL NUMBER**
2.  **FINISH**
3.  **GLASS COLOR**
4.  **OFFICE #**

**See inside front cover for required option codes**

Example

**GA2WCH2H30-WG.NC215.WH.OFC1**  
 GA2WCH2H30-WG    NC215    WH    OFC1  
 MODEL NUMBER    FINISH    GLASS COLOR    OFFICE #

# WALL MOUNT OVERHEADS

Sliding | wood doors

Credentials

05/22

## 2 HIGH

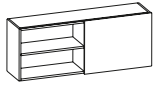

D	W	H	model number	veneer 1	veneer 2
18	60	28	<b>GA2WCS2H60-WW</b>	10,069	11,077
18	72	28	<b>GA2WCS2H72-WW</b>	11,021	12,125
18	90	28	<b>GA2WCS2H90-WW</b>	12,983	14,283

- No pulls required
- Recessed LED tasklights included

### PRODUCT INFO

Doors do not lock

Door widths:  
 60" = (1) doors  
 72" = (1) doors  
 90" = (2) doors

TO ORDER PLEASE SPECIFY THE FOLLOWING:

1.  **MODEL NUMBER**
2.  **FINISH**
3.  **OFFICE #**

See inside front cover for required option codes

Example

**GA2WCS2H60-WW.NC215.OFC1**

GA2WCS2H60-WW	NC215	OFC1
<small>MODEL NUMBER</small>	<small>FINISH</small>	<small>OFFICE #</small>

**2 HIGH**

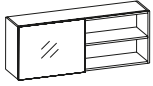

D	W	H	model number	veneer 1	veneer 2
18	60	28	<b>GA2WCS2H60-WG</b>	11,392	12,533
18	72	28	<b>GA2WCS2H72-WG</b>	12,486	13,736
18	90	28	<b>GA2WCS2H90-WG</b>	14,693	16,163

- Recessed LED tasklights included

**PRODUCT INFO**

Doors do not lock

Door widths:  
60" = (1) doors  
72" = (1) doors  
90" = (2) doors

**TO ORDER PLEASE SPECIFY THE FOLLOWING:**

1.  **MODEL NUMBER**
2.  **FINISH**
3.  **GLASS COLOR**
4.  **OFFICE #**

**See inside front cover for required option codes**

Example

**GA2WCS2H60-WG.NC215.WH.OFC1**

GA2WCS2H60-WG	NC215	WH	OFC1
<small>MODEL NUMBER</small>	<small>FINISH</small>	<small>GLASS COLOR</small>	<small>OFFICE #</small>

# TACKBOARDS

Standard

**Credentials**  
05/22

	D	W	H	yards	model number	fabric grades			COM/4
						1	2	3	
<b>STANDARD</b>									
	7/8	30	28 1/2	1.25	<b>GAATKW30</b>	998	1,024	1,051	1,078
	7/8	36	28 1/2	1.25	<b>GAATKW36</b>	1,046	1,078	1,114	1,148
	7/8	60	28 1/2	2.00	<b>GAATKW60</b>	1,215	1,267	1,320	1,376
	7/8	66	28 1/2	2.25	<b>GAATKW66</b>	1,240	1,292	1,345	1,401
	7/8	72	28 1/2	2.50	<b>GAATKW72</b>	1,288	1,345	1,407	1,472
	7/8	78	28 1/2	2.50	<b>GAATKW78</b>	1,326	1,393	1,461	1,530
	7/8	84	28 1/2	2.75	<b>GAATKW84</b>	1,361	1,428	1,496	1,565
	7/8	90	28 1/2	3.00	<b>GAATKW90</b>	1,420	1,490	1,568	1,644
	7/8	96	28 1/2	3.00	<b>GAATKW96</b>	1,480	1,556	1,640	1,722
2-PIECE	7/8	102	28 1/2	3.50	<b>GAATKW102</b>	2,042	2,126	2,216	2,305
2-PIECE	7/8	108	28 1/2	4.00	<b>GAATKW108</b>	2,113	2,206	2,301	2,398
2-PIECE	7/8	120	28 1/2	4.00	<b>GAATKW120</b>	2,432	2,530	2,632	2,736

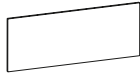

FABRIC

- Dimensioned from full height trough worksurface to bottom of overhead.
- A trough worksurface is required for ALL tackzone.
- Tackboards listed on this page are all standard "railroad".

**PRODUCT SPECIFICATIONS:**

**STANDARD**

The fabric on all Gunlocke tackboards is applied in a railroad fashion.

- Tackboard widths less than or equal to 96" are one piece
- Tackboards greater than 96" are two piece and the fabric is pattern matched
- When ordering individual wall mount tackboards to be placed side by side, the fabric pattern will be random matched. If a fabric pattern match is required, contact Gunlocke Bid/Quote for a special quote.

**SPECIAL**

Fabric applied "up the roll" is a special application. Please see guidelines below and contact Gunlocke Bid/Quote for a special quote.

- Fabrics used on tackboard 48" and under in width can be applied "up the roll"
- Tackboards greater than 48" in width can only be applied railroaded, due to fabric height limitations

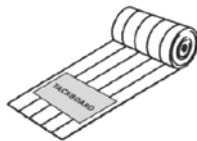
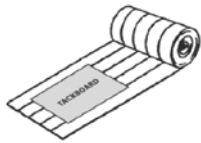

**PRODUCT INFO**

See yards listed above for COM fabric requirement

102, 108, and 120 wide tackboards are 2-piece

**TO ORDER PLEASE SPECIFY THE FOLLOWING:**

1.	<input type="text"/>	<b>MODEL NUMBER</b>
2.	<input type="text"/>	<b>FABRIC</b>
3.	<input type="text"/>	<b>FSC TACKBOARD</b>
4.	<input type="text"/>	<b>OFFICE #</b>

**FSC Tackboard Options:**

**FSC** = FSC Required (+5% COM upcharge)  
**NR** = FSC Not Required

**COM FABRIC REQUIREMENT**

All COM must be shipped prepaid to Gunlocke with package side marked with:

- Dealer Name
- Dealer Purchase Order Number
- Gunlocke Pattern Number

See inside front cover for required option codes

Example

<b>GAATKW30.FABRIC.FSC.OFC1</b>			
GAATKW30	FABRIC	FSC	OFC1
MODEL NUMBER	FABRIC	FSC TACKBOARD	OFFICE #

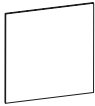
	D	W	H	yards	model number	fabric grades			COM/4
						1	2	3	
 FABRIC	7/8	30	48	1.25	<b>GAATKW1H30</b>	1,215	1,241	1,268	1,295
	7/8	36	48	1.25	<b>GAATKW1H36</b>	1,240	1,272	1,308	1,342
	7/8	42	48	1.50	<b>GAATKW1H42</b>	1,288	1,329	1,368	1,411
	7/8	48	48	1.50	<b>GAATKW1H48</b>	1,326	1,367	1,406	1,449

- Dimensioned from trough worksurface to top of 1 high overhead (or 5 high storage)
- A trough worksurface is required for ALL tackzone.

**TOP OF 2 HIGH OVERHEAD**

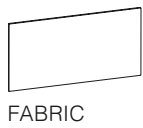

7/8	30	56 1/2	1.75	<b>GAATKW2H30</b>	1,240	1,266	1,293	1,320
7/8	36	56 1/2	1.75	<b>GAATKW2H36</b>	1,288	1,320	1,356	1,390
7/8	42	56 1/2	1.75	<b>GAATKW2H42</b>	1,326	1,367	1,406	1,449
7/8	48	56 1/2	1.75	<b>GAATKW2H48</b>	1,361	1,402	1,441	1,484

- Dimensioned from trough worksurface to top of 2 high overhead (or 6 high storage)
- A trough worksurface is required for ALL tackzone.
- Tackboards to top of 1H overheads are standard "railroad". Tackboards to top of 2H overheads are "up the roll".

**PRODUCT SPECIFICATIONS:**

**STANDARD**

The fabric on all Gunlocke tackboards is applied in a railroad fashion.

- Tackboard widths less than or equal to 96" are one piece
- Tackboards greater than 96" are two piece and the fabric is pattern matched
- When ordering individual wall mount tackboards to be placed side by side, the fabric pattern will be random matched. If a fabric pattern match is required, contact Gunlocke Bid/Quote for a special quote.

**SPECIAL**

Fabric applied "up the roll" is a special application. Please see guidelines below and contact Gunlocke Bid/Quote for a special quote.

- Fabrics used on tackboard 48" and under in width can be applied "up the roll"
- Tackboards greater than 48" in width can only be applied railroaded, due to fabric height limitations

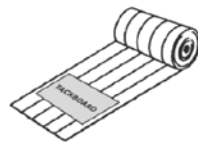
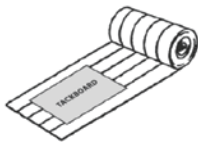

**PRODUCT INFO**

See yards listed above for COM fabric requirement

**TO ORDER PLEASE SPECIFY THE FOLLOWING:**

1.  **MODEL NUMBER**
2.  **FABRIC**
3.  **FSC TACKBOARD**
4.  **OFFICE #**

**FSC Tackboard Options:**

**FSC** = FSC Required (+5% COM upcharge)  
**NR** = FSC Not Required

**COM FABRIC REQUIREMENT**

All COM must be shipped prepaid to Gunlocke with package side marked with:

- Dealer Name
- Dealer Purchase Order Number
- Gunlocke Pattern Number

**See inside front cover for required option codes**

Example

<b>GAATKW1H30. FABRIC.FSC.OFC1</b>			
GAATKW1H30	FABRIC	FSC	OFC1
<b>MODEL NUMBER</b>	<b>FABRIC</b>	<b>FSC TACKBOARD</b>	<b>OFFICE #</b>

# LAYERS TACKBOARDS

Standard

## STANDARD

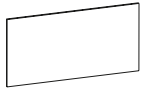

FABRIC

	D	W	H	yards	model number	fabric grades			COM/4
						1	2	3	
	7/8	30	36 1/4	1.25	<b>GAATLKW30</b>	1,046	1,072	1,099	1,126
	7/8	36	36 1/4	1.25	<b>GAATLKW36</b>	1,215	1,247	1,283	1,317
	7/8	60	36 1/4	2.00	<b>GAATLKW60</b>	1,240	1,292	1,345	1,401
	7/8	66	36 1/4	2.25	<b>GAATLKW66</b>	1,288	1,340	1,393	1,449
	7/8	72	36 1/4	2.50	<b>GAATLKW72</b>	1,326	1,383	1,445	1,510
	7/8	78	36 1/4	2.50	<b>GAATLKW78</b>	1,361	1,428	1,496	1,565
	7/8	84	36 1/4	2.75	<b>GAATLKW84</b>	1,420	1,487	1,555	1,624
	7/8	90	36 1/4	3.00	<b>GAATLKW90</b>	1,480	1,550	1,628	1,704
	7/8	96	36 1/4	3.00	<b>GAATLKW96</b>	2,042	2,118	2,202	2,284
2-PIECE	7/8	102	36 1/4	3.50	<b>GAATLKW102</b>	2,113	2,197	2,287	2,376
2-PIECE	7/8	108	36 1/4	4.00	<b>GAATLKW108</b>	2,220	2,313	2,408	2,505
2-PIECE	7/8	120	36 1/4	4.00	<b>GAATLKW120</b>	2,477	2,575	2,677	2,781

- Dimensioned from full height trough worksurface to bottom of overhead.
- A trough worksurface is required for ALL tackzone.
- Tackboards listed on this page are all standard "railroad".

### PRODUCT SPECIFICATIONS:

#### STANDARD

The fabric on all Gunlocke tackboards is applied in a railroad fashion.

- Tackboard widths less than or equal to 96" are one piece
- Tackboards greater than 96" are two piece and the fabric is pattern matched
- When ordering individual wall mount tackboards to be placed side by side, the fabric pattern will be random matched. If a fabric pattern match is required, contact Gunlocke Bid/Quote for a special quote.

#### SPECIAL

Fabric applied "up the roll" is a special application. Please see guidelines below and contact Gunlocke Bid/Quote for a special quote.

- Fabrics used on tackboard 48" and under in width can be applied "up the roll"
- Tackboards greater than 48" in width can only be applied railroaded, due to fabric height limitations

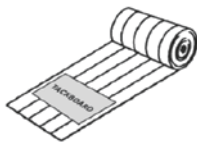
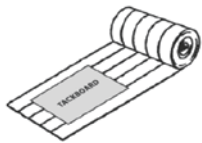

### PRODUCT INFO

See yards listed above for COM fabric requirement

102, 108, and 120 wide tackboards are 2-piece

### TO ORDER PLEASE SPECIFY THE FOLLOWING:

1.  **MODEL NUMBER**
2.  **FABRIC**
3.  **FSC TACKBOARD**
4.  **OFFICE #**

#### FSC Tackboard Options:

**FSC** = FSC Required (+5% COM upcharge)  
**NR** = FSC Not Required

#### COM FABRIC REQUIREMENT

All COM must be shipped prepaid to Gunlocke with package side marked with:

- Dealer Name
- Dealer Purchase Order Number
- Gunlocke Pattern Number

See inside front cover for required option codes

Example

GAATLKW30.FABRIC.FSC.OFC1  
 GAATLKW30      FABRIC      FSC      OFC1  
 MODEL NUMBER      FABRIC      FSC TACKBOARD      OFFICE #

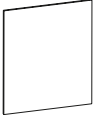
	D	W	H	yards	model number	fabric grades			COM/4
						1	2	3	
<b>TOP OF 1 HIGH OVERHEAD</b>  FABRIC 	7/8	30	55 3/4	1.75	<b>GAATLKW1H30</b>	1,240	1,266	1,293	1,320
	7/8	36	55 3/4	1.75	<b>GAATLKW1H36</b>	1,288	1,320	1,356	1,390
	7/8	42	55 3/4	1.75	<b>GAATLKW1H42</b>	1,326	1,367	1,406	1,449
	7/8	48	55 3/4	1.75	<b>GAATLKW1H48</b>	1,361	1,402	1,441	1,484

- Dimensioned from trough worksurface to top of 1 high overhead (or 5 high storage)
- A trough worksurface is required for ALL tackzone.

**TOP OF 2 HIGH OVERHEAD**

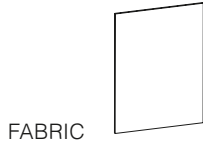

7/8	30	64 1/4	2.00	<b>GAATLKW2H30</b>	1,288	1,314	1,341	1,368
7/8	36	64 1/4	2.00	<b>GAATLKW2H36</b>	1,326	1,358	1,394	1,428
7/8	42	64 1/4	2.00	<b>GAATLKW2H42</b>	1,361	1,402	1,441	1,484
7/8	48	64 1/4	2.00	<b>GAATLKW2H48</b>	1,420	1,461	1,500	1,543

- Dimensioned from trough worksurface to top of 2 high overhead (or 6 high storage)
- A trough worksurface is required for ALL tackzone.
- Layers tackboards to top of 1H and 2H overheads are "up the roll".

**PRODUCT SPECIFICATIONS:**

**STANDARD**

The fabric on all Gunlocke tackboards is applied in a railroad fashion.

- Tackboard widths less than or equal to 96" are one piece
- Tackboards greater than 96" are two piece and the fabric is pattern matched
- When ordering individual wall mount tackboards to be placed side by side, the fabric pattern will be random matched. If a fabric pattern match is required, contact Gunlocke Bid/Quote for a special quote.

**SPECIAL**

Fabric applied "up the roll" is a special application. Please see guidelines below and contact Gunlocke Bid/Quote for a special quote.

- Fabrics used on tackboard 48" and under in width can be applied "up the roll"
- Tackboards greater than 48" in width can only be applied railroaded, due to fabric height limitations

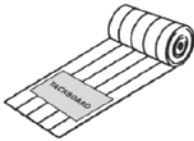
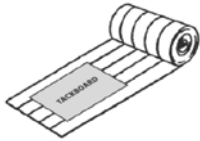

**PRODUCT INFO**

See yards listed above for COM fabric requirement

**TO ORDER PLEASE SPECIFY THE FOLLOWING:**

1.  **MODEL NUMBER**
2.  **FABRIC**
3.  **FSC TACKBOARD**
4.  **OFFICE #**

**FSC Tackboard Options:**

**FSC** = FSC Required (+5% COM upcharge)  
**NR** = FSC Not Required

**COM FABRIC REQUIREMENT**

All COM must be shipped prepaid to Gunlocke with package side marked with:

- Dealer Name
- Dealer Purchase Order Number
- Gunlocke Pattern Number

**See inside front cover for required option codes**

Example

**GAATLKW30.FABRIC.FSC.OFC1**  
 GAATLKW30      FABRIC      FSC      OFC1  
 MODEL NUMBER      FABRIC      FSC TACKBOARD      OFFICE #

# WHITEBOARDS

Standard

Credentials

05/22

	D	W	H	model number	list
<b>STANDARD</b>	3/4	30	28 1/2	<b>GAATGW30-GSA</b>	1,881
	3/4	36	28 1/2	<b>GAATGW36-GSA</b>	2,137
	3/4	60	28 1/2	<b>GAATGW60-GSA</b>	3,503
<b>MAGNETIC</b>	3/4	66	28 1/2	<b>GAATGW66-GSA</b>	4,008
	3/4	72	28 1/2	<b>GAATGW72-GSA</b>	4,272
	3/4	78	28 1/2	<b>GAATGW78-GSA</b>	4,737
	3/4	84	28 1/2	<b>GAATGW84-GSA</b>	5,381
2-PIECE	3/4	90	28 1/2	<b>GAATGW90-GSA</b>	5,629
2-PIECE	3/4	96	28 1/2	<b>GAATGW96-GSA</b>	5,900
2-PIECE	3/4	102	28 1/2	<b>GAATGW102-GSA</b>	6,149
	3/4	108	28 1/2	<b>GAATGW108-GSA</b>	6,411

- **NOTE:** Quantity 6 magnets are included with each unit 72"W and less. Quantity 12 magnets are included with each unit 84"W and greater. Magnets can also be ordered separately.

## PRODUCT INFO

TO ORDER PLEASE SPECIFY THE FOLLOWING:

1.  **MODEL NUMBER**
2.  **GLASS COLOR**
3.  **OFFICE #**

**NOTE:** Whiteboards are GSA (TAA) compliant standard.

See inside front cover for required option codes

Example

GAATGW30-GSA.WH.OFC1  
 GAATGW30-GSA      WH      OFC1  
 MODEL NUMBER      GLASS COLOR      OFFICE #



**TOP OF 1 HIGH OVERHEAD**

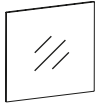

MAGNETIC

D	W	H	model number	select
3/4	30	48	<b>GAATGW1H30-GSA</b>	3,503
3/4	36	48	<b>GAATGW1H36-GSA</b>	4,008
3/4	42	48	<b>GAATGW1H42-GSA</b>	4,272
3/4	48	48	<b>GAATGW1H48-GSA</b>	4,737

- Dimensioned from trough worksurface to top of 1 high overhead (or 5 high storage)
- A trough worksurface is required for ALL tackzone.

**TOP OF 2 HIGH OVERHEAD**

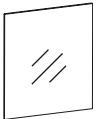

MAGNETIC

3/4	30	56 1/2	<b>GAATGW2H30-GSA</b>	4,008
3/4	36	56 1/2	<b>GAATGW2H36-GSA</b>	4,272
3/4	42	56 1/2	<b>GAATGW2H42-GSA</b>	4,737
3/4	48	56 1/2	<b>GAATGW2H48-GSA</b>	5,381

- Dimensioned from trough worksurface to top of 2 high overhead (or 6 high storage)
- A trough worksurface is required for ALL tackzone.
- **NOTE:** Quantity 6 magnets are included with each unit 72"W and less. Quantity 12 magnets are included with each unit 84"W and greater. Magnets can also be ordered separately.

**PRODUCT INFO**

TO ORDER PLEASE SPECIFY THE FOLLOWING:

1.  **MODEL NUMBER**
2.  **GLASS COLOR**
3.  **OFFICE #**

**NOTE:** Whiteboards are GSA (TAA) compliant standard.

**See inside front cover for required option codes**

Example

GAATGW1H30-GSA.WH.OFC1  
 GAATGW1H30-GSA      WH      OFC1  
 MODEL NUMBER      GLASS COLOR      OFFICE #

# SEGMENTED WHITEBOARDS

**Credentials**  
05/22  
Top of Overhead

	D	W	H	model number	list
<b>TOP OF 1 HIGH OVERHEAD</b> 	3/4	30	48	<b>GAATGW1H30-XGSA</b>	4,028
	3/4	36	48	<b>GAATGW1H36-XGSA</b>	4,612
	3/4	42	48	<b>GAATGW1H42-XGSA</b>	4,916
	3/4	48	48	<b>GAATGW1H48-XGSA</b>	5,454

MAGNETIC

- Dimensioned from trough worksurface to top of 1 high overhead (or 5 high storage)
- A trough worksurface is required for ALL tackzone.

## TOP OF 2 HIGH OVERHEAD

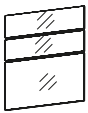

MAGNETIC

3/4	30	56 1/2	<b>GAATGW2H30-XGSA</b>	4,612
3/4	36	56 1/2	<b>GAATGW2H36-XGSA</b>	4,916
3/4	42	56 1/2	<b>GAATGW2H42-XGSA</b>	5,454
3/4	48	56 1/2	<b>GAATGW2H48-XGSA</b>	6,187

- Dimensioned from trough worksurface to top of 2 high overhead (or 6 high storage)
- A trough worksurface is required for ALL tackzone.
- **NOTE:** Quantity 6 magnets are included with each unit 72"W and less. Quantity 12 magnets are included with each unit 84"W and greater. Magnets can also be ordered separately.
- Shelves must be ordered separately.

## PRODUCT INFO

TO ORDER PLEASE SPECIFY THE FOLLOWING:

1.  **MODEL NUMBER**
2.  **GLASS COLOR**
3.  **OFFICE #**

**NOTE:** Whiteboards are GSA (TAA) compliant standard.

**See inside front cover for required option codes**

Example

**GAATGW1H30-XGSA.WH.OFC1**  
 GAATGW1H30-XGSA    WH    OFC1  
 MODEL NUMBER    GLASS COLOR    OFFICE #

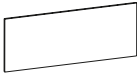
	D	W	H	model number	veneer 1	veneer 2	
<b>STANDARD</b>    <b>MAGNETIC</b>	7/8	30	28 1/2	<b>GAATWD30</b>	1,887	2,064	
	7/8	36	28 1/2	<b>GAATWD36</b>	2,003	2,191	
	7/8	60	28 1/2	<b>GAATWD60</b>	2,707	2,961	
	7/8	66	28 1/2	<b>GAATWD66</b>	2,865	3,134	
	7/8	72	28 1/2	<b>GAATWD72</b>	3,110	3,402	
	7/8	78	28 1/2	<b>GAATWD78</b>	3,207	3,508	
	7/8	84	28 1/2	<b>GAATWD84</b>	3,382	3,699	
	7/8	90	28 1/2	<b>GAATWD90</b>	3,830	4,189	
	2-PIECE	7/8	96	28 1/2	<b>GAATWD96</b>	3,943	4,312
	2-PIECE	7/8	102	28 1/2	<b>GAATWD102</b>	4,059	4,440
	2-PIECE	7/8	108	28 1/2	<b>GAATWD108</b>	4,281	4,683
	2-PIECE	7/8	120	28 1/2	<b>GAATWD120</b>	4,420	4,835

• **NOTE:** Quantity 6 magnets are included with each unit 72"W and less. Quantity 12 magnets are included with each unit 84"W and greater. Magnets can also be ordered separately.

**PRODUCT INFO**

TO ORDER PLEASE SPECIFY THE FOLLOWING:

- 1.  **MODEL NUMBER**
- 2.  **FINISH**
- 3.  **OFFICE #**

See inside front cover for required option codes

Example

GAATWD30.NC215.OFC1  
 GAATWD30      NC215      OFC1  
 MODEL NUMBER      FINISH      OFFICE #

# WOOD MAGNETIC TACKZONE

**Credentials**

05/22

Top of Overhead

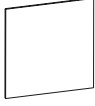
	D	W	H	model number	veneer 1	veneer 2
<b>TOP OF 1 HIGH OVERHEAD</b>  MAGNETIC	7/8	30	48	<b>GAATWD1H30</b>	2,707	2,961
	7/8	36	48	<b>GAATWD1H36</b>	2,865	3,134
	7/8	42	48	<b>GAATWD1H42</b>	3,110	3,402
	7/8	48	48	<b>GAATWD1H48</b>	3,207	3,508

- Dimensioned from trough worksurface to top of 1 high overhead (or 5 high storage)
- A trough worksurface is required for ALL tackzone.

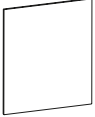
	D	W	H	model number	veneer 1	veneer 2
<b>TOP OF 2 HIGH OVERHEAD</b>  MAGNETIC	7/8	30	56 1/2	<b>GAATWD2H30</b>	2,865	3,134
	7/8	36	56 1/2	<b>GAATWD2H36</b>	3,110	3,402
	7/8	42	56 1/2	<b>GAATWD2H42</b>	3,207	3,508
	7/8	48	56 1/2	<b>GAATWD2H48</b>	3,382	3,699

- Dimensioned from trough worksurface to top of 2 high overhead (or 6 high storage)
- A trough worksurface is required for ALL tackzone.

- **NOTE:** Quantity 6 magnets are included with each unit 72"W and less. Quantity 12 magnets are included with each unit 84"W and greater. Magnets can also be ordered separately.

<p><b>PRODUCT INFO</b></p>	<p>TO ORDER PLEASE SPECIFY THE FOLLOWING:</p> <p>1. <input type="text"/> <b>MODEL NUMBER</b></p> <p>2. <input type="text"/> <b>FINISH</b></p> <p>3. <input type="text"/> <b>OFFICE #</b></p> <p><b>See inside front cover for required option codes</b></p> <p>Example</p> <hr/> <p>GAATWD1H30.NC215.OFC1</p> <table> <tr> <td>GAATWD1H30</td> <td>NC215</td> <td>OFC1</td> </tr> <tr> <td><small>MODEL NUMBER</small></td> <td><small>FINISH</small></td> <td><small>OFFICE #</small></td> </tr> </table>	GAATWD1H30	NC215	OFC1	<small>MODEL NUMBER</small>	<small>FINISH</small>	<small>OFFICE #</small>
GAATWD1H30	NC215	OFC1					
<small>MODEL NUMBER</small>	<small>FINISH</small>	<small>OFFICE #</small>					

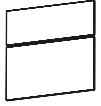
	D	W	H	model number	veneer 1	veneer 2
<b>TOP OF 1 HIGH OVERHEAD</b>  MAGNETIC	7/8	30	48	<b>GAATWD1H30-X</b>	3,112	3,404
	7/8	36	48	<b>GAATWD1H36-X</b>	3,298	3,607
	7/8	42	48	<b>GAATWD1H42-X</b>	3,578	3,913
	7/8	48	48	<b>GAATWD1H48-X</b>	3,689	4,035

- Dimensioned from trough worksurface to top of 1 high overhead (or 5 high storage)
- A trough worksurface is required for ALL tackzone

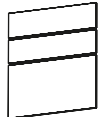
	D	W	H	model number	veneer 1	veneer 2
<b>TOP OF 2 HIGH OVERHEAD</b>  MAGNETIC	7/8	30	56 1/2	<b>GAATWD2H30-X</b>	3,298	3,607
	7/8	36	56 1/2	<b>GAATWD2H36-X</b>	3,578	3,913
	7/8	42	56 1/2	<b>GAATWD2H42-X</b>	3,689	4,035
	7/8	48	56 1/2	<b>GAATWD2H48-X</b>	3,891	4,257

- Dimensioned from trough worksurface to top of 2 high overhead (or 6 high storage)
- A trough worksurface is required for ALL tackzone.
- **NOTE:** Quantity 6 magnets are included with each unit 72"W and less. Quantity 12 magnets are included with each unit 84"W and greater. Magnets can also be ordered separately.
- Shelves must be ordered separately.

<p><b>PRODUCT INFO</b></p>	<p>TO ORDER PLEASE SPECIFY THE FOLLOWING:</p> <p>1. <input type="text"/> <b>MODEL NUMBER</b></p> <p>2. <input type="text"/> <b>FINISH</b></p> <p>3. <input type="text"/> <b>OFFICE #</b></p> <p><b>See inside front cover for required option codes</b></p> <p>Example</p> <hr/> <p><small>GAATWD1H30-X.NC215.OFC1</small></p> <table border="0"> <tr> <td><small>GAATWD1H30-X</small></td> <td><small>NC215</small></td> <td><small>OFC1</small></td> </tr> <tr> <td><small>MODEL NUMBER</small></td> <td><small>FINISH</small></td> <td><small>OFFICE #</small></td> </tr> </table>	<small>GAATWD1H30-X</small>	<small>NC215</small>	<small>OFC1</small>	<small>MODEL NUMBER</small>	<small>FINISH</small>	<small>OFFICE #</small>
<small>GAATWD1H30-X</small>	<small>NC215</small>	<small>OFC1</small>					
<small>MODEL NUMBER</small>	<small>FINISH</small>	<small>OFFICE #</small>					

	D	W	H	model number	veneer 1	veneer 2
WOOD 	8	30	1	<b>GA2ASF830-W</b>	934	1,028
	8	36	1	<b>GA2ASF836-W</b>	1,005	1,107
	8	42	1	<b>GA2ASF842-W</b>	1,145	1,260
	8	48	1	<b>GA2ASF848-W</b>	1,278	1,407
	8	60	1	<b>GA2ASF860-W</b>	1,457	1,604
	8	66	1	<b>GA2ASF866-W</b>	1,557	1,713
	8	72	1	<b>GA2ASF872-W</b>	1,645	1,810
	8	78	1	<b>GA2ASF878-W</b>	1,726	1,900
	8	84	1	<b>GA2ASF884-W</b>	1,824	2,008
	8	90	1	<b>GA2ASF890-W</b>	2,041	2,246
2-PIECE	8	96	1	<b>GA2ASF896-W</b>	2,112	2,324
2-PIECE	8	102	1	<b>GA2ASF8102-W</b>	2,186	2,406
2-PIECE	8	108	1	<b>GA2ASF8108-W</b>	2,256	2,482
2-PIECE	8	120	1	<b>GA2ASF8120-W</b>	2,914	3,207
2-PIECE	8	144	1	<b>GA2ASF8144-W</b>	3,294	3,625

• WHEN PLACING MULTIPLE SHELVES END TO END, PLEASE CONTACT GUNTS FOR A SPECIAL SET OF SHELVES WITH A DOWEL PIN FOR ALIGNMENT SHELF TO SHELF

• STANDARD 2-PIECE SHELVES INCLUDE DOWEL PIN

**PRODUCT INFO**

TO ORDER PLEASE SPECIFY THE FOLLOWING:

1.  **MODEL NUMBER**

2.  **FINISH**

3.  **OFFICE #**

See inside front cover for required option codes

Example

---

GA2ASF830-W.NC215.OFC1

GA2ASF830-W	NC215	OFC1
<small>MODEL NUMBER</small>	<small>FINISH</small>	<small>OFFICE #</small>

	D	W	H	model number	veneer 1	veneer 2
	42 dia.		1 1/2	<b>GA2TRD42-W</b>	4,858	5,345
	48 dia.		1 1/2	<b>GA2TRD48-W</b>	5,727	6,301
	2-PIECE 54 dia.		1 1/2	<b>GA2TRD54-W</b>	6,857	7,543
	2-PIECE 60 dia.		1 1/2	<b>GA2TRD60-W</b>	7,156	7,873

**PRODUCT INFO**

TO ORDER PLEASE SPECIFY THE FOLLOWING:

- 1.  **MODEL NUMBER**
- 2.  **FINISH**
- 3.  **TOP UV FINISH TYPE**
- 4.  **OFFICE #**

**See inside front cover for required option codes**

Example

**GA2TRD42-W.NC215.FF.OFC1**

GA2TRD42-W	NC215	FF	OFC1
<b>MODEL NUMBER</b>	<b>FINISH</b>	<b>TOP UV FINISH</b>	<b>OFFICE #</b>

# RECESSED LED TASKLIGHTS

Replacements

Credentials

05/22

	D	W	H	model number	list
<b>RECESSED LED TASKLIGHTS</b>					
	5/8	24	5/8	<b>ACLEDD24-R</b>	787
	5/8	54	5/8	<b>ACLEDD54-R</b>	1,099
	5/8	72	5/8	<b>ACLEDD72-R</b>	1,663

Tasklights are INCLUDED with all overhead cabinets.  
They do NOT need to be purchased separately.

- LED lighting provides high efficiency, low energy lighting with a long life.
- All LED light strips are encased in a silver aluminum extrusion and include a built-in microswitch to turn the light on/off.
- Lights are field installed.
- All units include a 10' cord with a standard plug.
- Tasklights are recessed into bottom panel of overhead cabinet.
- Light temperature 3200K

## PRODUCT INFO

See product specs above

TO ORDER PLEASE SPECIFY THE FOLLOWING:

1.  **MODEL NUMBER**

**NOTE: Office # option not required**

**See inside front cover for required option codes**

Example

ACLEDD24-R  
ACLEDD24-R  
MODEL NUMBER



	D	W	H	model number	list
<b>MAGNETS</b>	$\frac{3}{8}$ dia.		$\frac{1}{2}$	<b>SAMAGNET</b>	99



- **NOTE:** Quantity 6 magnets are included with each unit 72"W and less. Quantity 12 magnets are included with each unit 84"W and greater.
- Magnets are silver

**PRODUCT INFO**

TO ORDER PLEASE SPECIFY THE FOLLOWING:

1.  **MODEL NUMBER**

**See inside front cover for required option codes**

Example

SAMAGNET  
SAMAGNET  
MODEL NUMBER

	D	W	H	model number	list
<b>BENEATH WORKSURFACE WIRE MANAGER</b>	3 1/4	30	1	<b>ACWM</b>	111

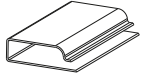

**PRODUCT INFO**

TO ORDER PLEASE SPECIFY THE FOLLOWING:

1.  **MODEL NUMBER**

**NOTE: Office # option not required**

**See inside front cover for required option codes**

Example

---

ACWM  
ACWM  
MODEL NUMBER

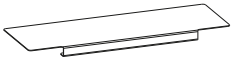
	D	W	H	model number	list
<b>PERSONAL CORNER</b>					
	12 1/2	36	1 7/8	<b>GAACORNER</b>	1,134

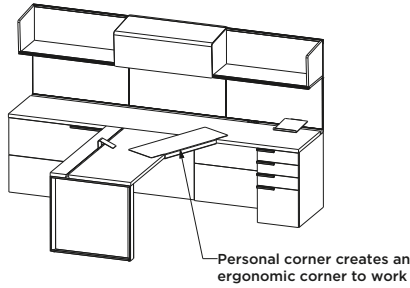

<b>DESKPAD</b>					
	18	36	1 7/8	<b>GAADSKPAD</b>	1,604

**PRODUCT INFO**

Designed for 1.5" thick worksurfaces.

**TO ORDER PLEASE SPECIFY THE FOLLOWING:**

1.  **MODEL NUMBER**
2.  **LEATHER/VINYL COLOR**
3.  **OFFICE #**

**Leather Color:**  
**CBL** = Black  
**CWH** = White  
**CCH** = Chocolate

**Vinyl Color:**  
**VBL** = Black  
**VWH** = White  
**VCH** = Chocolate

**See inside front cover for required option codes**







Example

GAACORNER.CWH.OFC1  
 GAACORNER                      CWH                      OFC1  
 MODEL NUMBER                      LEATHER COLOR                      OFFICE #

# ORGANIZATION TRAYS

Leather

**Credentials**  
05/22

	D	W	H	model number	list
<b>15" BOX DRAWER INSERT</b> 	13 <sup>15</sup> / <sub>16</sub>	11 <sup>11</sup> / <sub>16</sub>	3	<b>GAATRAYBOX15</b>	889
	<ul style="list-style-type: none"> <li>For use in 15" wide box drawers</li> </ul>				
<b>18" BOX DRAWER INSERT</b> 	13 <sup>15</sup> / <sub>16</sub>	14 <sup>11</sup> / <sub>16</sub>	3	<b>GAATRAYBOX18</b>	976
	<ul style="list-style-type: none"> <li>For use in 18" wide box drawers</li> </ul>				
<b>30" BOX DRAWER INSERT</b> 	13 <sup>15</sup> / <sub>16</sub>	26 <sup>11</sup> / <sub>16</sub>	3	<b>GAATRAYBOX30</b>	1,663
	<ul style="list-style-type: none"> <li>For use in 30" wide box drawers</li> </ul>				
<b>36" BOX DRAWER INSERT</b> 	13 <sup>15</sup> / <sub>16</sub>	32 <sup>11</sup> / <sub>16</sub>	3	<b>GAATRAYBOX36</b>	1,820
	<ul style="list-style-type: none"> <li>For use in 36" wide box drawers</li> </ul>				
<b>15" TRAY FOR OVERHEADS WITH CUBBY</b>  (Sliding & soft lift doors ONLY)	13 <sup>15</sup> / <sub>16</sub>	13 1/4	3	<b>GAATRAYLTR15</b>	775
	<ul style="list-style-type: none"> <li>Letter tray for use in 1 high overheads with 15" wide cubbies.</li> <li>For sliding door and soft lift door overhead, with width dimension in 15" increments = 60"w, 90"w, 120"w</li> <li>Not for use with hinged doors. Hinge location prevents leather tray from fitting in opening.</li> </ul>				
<b>18" TRAY FOR OVERHEADS WITH CUBBY</b>  (Sliding & soft lift doors ONLY)	13 <sup>15</sup> / <sub>16</sub>	16 1/4	3	<b>GAATRAYLTR18</b>	847
	<ul style="list-style-type: none"> <li>Letter tray for use in 1 high overheads with 18" wide cubbies</li> <li>For sliding door and soft lift door overhead, with width dimension in 18" increments = 72"w, 108"w</li> <li>Not for use with hinged doors. Hinge location prevents leather tray from fitting in opening.</li> </ul>				

## PRODUCT INFO

### TO ORDER PLEASE SPECIFY THE FOLLOWING:

- MODEL NUMBER**
- LEATHER COLOR**
- OFFICE #**

**Leather Color:**

**CBL** = Black  
**CWH** = White  
**CCH** = Chocolate

See inside front cover for required option codes

Example

GAATRAYBOX15.CWH.OFC1  
 GAATRAYBOX15      CWH      OFC1  
 MODEL NUMBER      LEATHER COLOR      OFFICE #

	D	W	H	model number	list
<b>15" PENCIL TRAY</b>	3	11 5/16	1 1/4	<b>ACPT15-GAA</b>	113

**18" PENCIL TRAY**

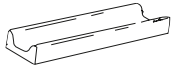

	3	14 5/16	1 1/4	<b>ACPT18-GAA</b>	120
--	---	---------	-------	-------------------	-----

[W] [W]  
vener 1 vener 2

**CENTER DRAWER**

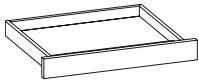

	17 5/8	21 3/4	2 15/16	<b>GS2CDWSD-</b> [ ]	795 878
--	--------	--------	---------	----------------------	---------

**INTERIOR DIMENSIONS**

D = 15 1/2  
W = 18 1/4  
H = 1 3/8

**PRODUCT INFO**

Center drawer includes pencil tray

**TO ORDER PLEASE SPECIFY THE FOLLOWING:**

1.  **MODEL NUMBER**
2.  **FINISH** • Finish option not required for pencil trays

**NOTE: Office # option not required**

**See inside front cover for required option codes**

Example

<b>ACCD19.NC215</b>	
ACCD19	NC215
<b>MODEL NUMBER</b>	<b>FINISH</b>

POWER UNIT

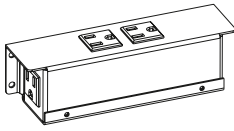

D	W	H	model number	list
1 3/4	3	1 3/4	<b>ACPWRT</b>	735

- Includes 3 power outlets - 2 power outlets on top surface and 1 power outlet on end of unit.
- Ships with 6 ft power cord with standard plug
- UL listed
- Mounting bracket included for use installation in the following applications:
  - To bottom of worksurface beneath grommets
  - To bottom of worksurface in trough opening of trough worksurfaces
  - As power strip inside wall access panels or beneath desks

PRODUCT INFO

TO ORDER PLEASE SPECIFY THE FOLLOWING:





1.  MODEL NUMBER

**NOTE: Office # option not required**

**See inside front cover for required option codes**

Example

ACPWRT  
ACPWRT  
MODEL NUMBER

	D	W	H	model number	list
<b>FOR USE WITH 15" W FILE DRAWERS</b> 	1/8	15	1	<b>ACFLR15-AA</b>	41
<b>FOR USE WITH 18" W FILE DRAWERS</b> 	1/8	18	1	<b>ACFLR18-AA</b>	42
<b>FOR USE WITH 30" W LATERAL FILES</b> 	1/8	30	1	<b>ACFLR30-AA</b>	46
<b>FOR USE WITH 36" W LATERAL FILES</b> 	1/8	36	1	<b>ACFLR36-AA</b>	51

**PRODUCT INFO**

TO ORDER PLEASE SPECIFY THE FOLLOWING:

1.  **MODEL NUMBER**

**NOTE: Office # option not required**

**See inside front cover for required option codes**

Example

ACFLR15-AA  
ACFLR15-AA  
MODEL NUMBER

TRASH CAN

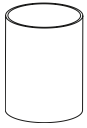

D	W	H	model number	list
9 3/4	9 3/4	12	<b>ACTRASH</b>	898

Quantity 2 trash cans are included with all (-T) pedestals.  
They do not need to be purchased separately.

- Satin brushed aluminum finish

PRODUCT INFO

TO ORDER PLEASE SPECIFY THE FOLLOWING:

1.  **MODEL NUMBER**

**NOTE: Office # option not required**

**See inside front cover for required option codes**

Example

---

**ACTRASH**  
ACTRASH  
MODEL NUMBER



	D	W	H	model number	veneer 1	veneer 2
<b>SAMPLE TOP</b>	18	18	1 1/2	<b>GAATOP1818-W</b>	1,368	1,495

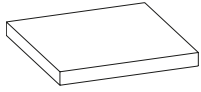

**PRODUCT INFO**

TO ORDER PLEASE SPECIFY THE FOLLOWING:

- 1.  **MODEL NUMBER**
- 2.  **FINISH**
- 3.  **TOP UV FINISH TYPE**
- 4.  **OFFICE #**

**See inside front cover for required option codes**

Example

**GAATOP1818-W.NC215.FF.OFC1**

GAATOP1818-W	NC215	FF	OFC1
<b>MODEL NUMBER</b>	<b>FINISH</b>	<b>TOP UV FINISH</b>	<b>OFFICE #</b>

# FABRIC GRADE PRICING

**Credentials**  
05/22

model number	1	2	3	COM/4	5	6	7	8	9	10	11	12	13	14	15	16
<b>GAAMPD-CUSH1818</b>	627	645	669	689	720	745	771	801	827	856	884	912	948	974	1,008	1,044
<b>GAACLPD-CUSH2430</b>	706	733	760	789	829	865	897	935	969	1,008	1,048	1,083	1,131	1,164	1,208	1,255
<b>GAACLPD-CUSH2436</b>	762	796	831	867	914	961	1,002	1,050	1,094	1,140	1,188	1,232	1,292	1,337	1,393	1,451
<b>GAACLPD-CUSH2130T</b>	706	733	760	789	829	865	897	935	969	1,008	1,048	1,083	1,131	1,164	1,208	1,255
<b>GAACLPD-CUSH2136T</b>	762	796	831	867	914	961	1,002	1,050	1,094	1,140	1,188	1,232	1,292	1,337	1,393	1,451
<b>GAATKW30</b>	998	1,024	1,051	1,078	1,115	1,151	1,183	1,216	1,254	1,288	1,329	1,359	1,404	1,441	1,484	1,528
<b>GAATKW36</b>	1,046	1,078	1,114	1,148	1,194	1,236	1,279	1,324	1,364	1,409	1,456	1,499	1,557	1,599	1,653	1,709
<b>GAATKW60</b>	1,215	1,267	1,320	1,376	1,450	1,521	1,583	1,658	1,727	1,799	1,871	1,943	2,032	2,101	2,188	2,277
<b>GAATKW66</b>	1,240	1,292	1,345	1,401	1,475	1,546	1,608	1,683	1,752	1,824	1,896	1,968	2,057	2,126	2,213	2,302
<b>GAATKW72</b>	1,288	1,345	1,407	1,472	1,551	1,633	1,703	1,787	1,864	1,944	2,026	2,105	2,206	2,283	2,381	2,483
<b>GAATKW78</b>	1,326	1,393	1,461	1,530	1,621	1,713	1,790	1,882	1,970	2,061	2,153	2,241	2,351	2,436	2,546	2,660
<b>GAATKW84</b>	1,361	1,428	1,496	1,565	1,656	1,748	1,825	1,917	2,005	2,096	2,188	2,276	2,386	2,471	2,581	2,695
<b>GAATKW90</b>	1,420	1,490	1,568	1,644	1,744	1,845	1,931	2,029	2,125	2,226	2,326	2,420	2,545	2,640	2,759	2,884
<b>GAATKW96</b>	1,480	1,556	1,640	1,722	1,834	1,940	2,035	2,143	2,246	2,357	2,466	2,569	2,703	2,807	2,939	3,072
<b>GAATKW102</b>	2,042	2,126	2,216	2,305	2,425	2,542	2,642	2,761	2,873	2,991	3,111	3,221	3,368	3,480	3,620	3,767
<b>GAATKW108</b>	2,113	2,206	2,301	2,398	2,526	2,655	2,761	2,891	3,013	3,140	3,266	3,390	3,547	3,668	3,820	3,977
<b>GAATKW120</b>	2,432	2,530	2,632	2,736	2,874	3,009	3,127	3,263	3,394	3,529	3,665	3,797	3,967	4,096	4,257	4,427
<b>GAATKW1H30</b>	1,215	1,241	1,268	1,295	1,332	1,368	1,400	1,433	1,471	1,505	1,546	1,576	1,621	1,658	1,701	1,745
<b>GAATKW1H36</b>	1,240	1,272	1,308	1,342	1,388	1,430	1,473	1,518	1,558	1,603	1,650	1,693	1,751	1,793	1,847	1,903
<b>GAATKW1H42</b>	1,288	1,329	1,368	1,411	1,465	1,522	1,570	1,623	1,675	1,731	1,787	1,837	1,907	1,960	2,023	2,090
<b>GAATKW1H48</b>	1,326	1,367	1,406	1,449	1,503	1,560	1,608	1,661	1,713	1,769	1,825	1,875	1,945	1,998	2,061	2,128
<b>GAATKW2H30</b>	1,240	1,266	1,293	1,320	1,357	1,393	1,425	1,458	1,496	1,530	1,571	1,601	1,646	1,683	1,726	1,770
<b>GAATKW2H36</b>	1,288	1,320	1,356	1,390	1,436	1,478	1,521	1,566	1,606	1,651	1,698	1,741	1,799	1,841	1,895	1,951
<b>GAATKW2H42</b>	1,326	1,367	1,406	1,449	1,503	1,560	1,608	1,661	1,713	1,769	1,825	1,875	1,945	1,998	2,061	2,128
<b>GAATKW2H48</b>	1,361	1,402	1,441	1,484	1,538	1,595	1,643	1,696	1,748	1,804	1,860	1,910	1,980	2,033	2,096	2,163
<b>GAATLKW30</b>	1,046	1,072	1,099	1,126	1,163	1,199	1,231	1,264	1,302	1,336	1,377	1,407	1,452	1,489	1,532	1,576
<b>GAATLKW36</b>	1,215	1,247	1,283	1,317	1,363	1,405	1,448	1,493	1,533	1,578	1,625	1,668	1,726	1,768	1,822	1,878
<b>GAATLKW60</b>	1,240	1,292	1,345	1,401	1,475	1,546	1,608	1,683	1,752	1,824	1,896	1,968	2,057	2,126	2,213	2,302
<b>GAATLKW66</b>	1,288	1,340	1,393	1,449	1,523	1,594	1,656	1,731	1,800	1,872	1,944	2,016	2,105	2,174	2,261	2,350
<b>GAATLKW72</b>	1,326	1,383	1,445	1,510	1,589	1,671	1,741	1,825	1,902	1,982	2,064	2,143	2,244	2,321	2,419	2,521
<b>GAATLKW78</b>	1,361	1,428	1,496	1,565	1,656	1,748	1,825	1,917	2,005	2,096	2,188	2,276	2,386	2,471	2,581	2,695
<b>GAATLKW84</b>	1,420	1,487	1,555	1,624	1,715	1,807	1,884	1,976	2,064	2,155	2,247	2,335	2,445	2,530	2,640	2,754
<b>GAATLKW90</b>	1,480	1,550	1,628	1,704	1,804	1,905	1,991	2,089	2,185	2,286	2,386	2,480	2,605	2,700	2,819	2,944
<b>GAATLKW96</b>	2,042	2,118	2,202	2,284	2,396	2,502	2,597	2,705	2,808	2,919	3,028	3,131	3,265	3,369	3,501	3,634
<b>GAATLKW102</b>	2,113	2,197	2,287	2,376	2,496	2,613	2,713	2,832	2,944	3,062	3,182	3,292	3,439	3,551	3,691	3,838
<b>GAATLKW108</b>	2,220	2,313	2,408	2,505	2,633	2,762	2,868	2,998	3,120	3,247	3,373	3,497	3,654	3,775	3,927	4,084
<b>GAATLKW120</b>	2,477	2,575	2,677	2,781	2,919	3,054	3,172	3,308	3,439	3,574	3,710	3,842	4,012	4,141	4,302	4,472

model number	17	18	19	20	21	22	23	24	25	26	27	col	L1	L2	L3	L4	L5
<b>GAAMPD-CUSH1818</b>	1,080	1,104	1,140	1,170	1,205	1,239	1,305	1,372	1,444	1,509	1,576	689	901	1,129	1,358	1,589	1,795
<b>GAACLPD-CUSH2430</b>	1,303	1,335	1,379	1,423	1,467	1,510	1,600	1,687	1,779	1,868	1,956	789	1,073	1,378	1,681	1,986	2,263
<b>GAACLPD-CUSH2436</b>	1,506	1,548	1,604	1,656	1,712	1,767	1,882	1,992	2,102	2,214	2,327	867	1,219	1,603	1,981	2,363	2,707
<b>GAACLPD-CUSH2130T</b>	1,303	1,335	1,379	1,423	1,467	1,510	1,600	1,687	1,779	1,868	1,956	789	1,073	1,378	1,681	1,986	2,263
<b>GAACLPD-CUSH2136T</b>	1,506	1,548	1,604	1,656	1,712	1,767	1,882	1,992	2,102	2,214	2,327	867	1,219	1,603	1,981	2,363	2,707
<b>GAATKW30</b>	1,573	1,603	1,645	1,687	1,731	1,773	1,860	1,942	2,033	2,118	2,202						
<b>GAATKW36</b>	1,763	1,803	1,855	1,908	1,963	2,017	2,126	2,229	2,338	2,447	2,555						
<b>GAATKW60</b>	2,363	2,425	2,512	2,595	2,680	2,768	2,940	3,110	3,282	3,455	3,627						
<b>GAATKW66</b>	2,388	2,450	2,537	2,620	2,705	2,793	2,965	3,135	3,307	3,480	3,652						
<b>GAATKW72</b>	2,579	2,651	2,748	2,841	2,939	3,034	3,229	3,419	3,615	3,811	4,002						
<b>GAATKW78</b>	2,767	2,846	2,953	3,059	3,166	3,278	3,493	3,705	3,921	4,139	4,349						
<b>GAATKW84</b>	2,802	2,881	2,988	3,094	3,201	3,313	3,528	3,740	3,956	4,174	4,384						
<b>GAATKW90</b>	3,002	3,090	3,209	3,325	3,441	3,561	3,800	4,034	4,274	4,513	4,745						
<b>GAATKW96</b>	3,203	3,296	3,424	3,549	3,679	3,808	4,068	4,324	4,584	4,841	5,096						
<b>GAATKW102</b>	3,907	4,009	4,152	4,285	4,423	4,565	4,846	5,120	5,403	5,686	5,960						
<b>GAATKW108</b>	4,129	4,239	4,392	4,537	4,686	4,838	5,143	5,440	5,744	6,045	6,342						
<b>GAATKW120</b>	4,591	4,706	4,870	5,026	5,188	5,352	5,675	5,995	6,321	6,643	6,963						
<b>GAATKW1H30</b>	1,790	1,820	1,862	1,904	1,948	1,990	2,077	2,159	2,250	2,335	2,419						
<b>GAATKW1H36</b>	1,957	1,997	2,049	2,102	2,157	2,211	2,320	2,423	2,532	2,641	2,749						
<b>GAATKW1H42</b>	2,155	2,204	2,269	2,329	2,394	2,461	2,591	2,721	2,850	2,978	3,109						
<b>GAATKW1H48</b>	2,193	2,242	2,307	2,367	2,432	2,499	2,629	2,759	2,888	3,016	3,147						
<b>GAATKW2H30</b>	1,815	1,845	1,887	1,929	1,973	2,015	2,102	2,184	2,275	2,360	2,444						
<b>GAATKW2H36</b>	2,005	2,045	2,097	2,150	2,205	2,259	2,368	2,471	2,580	2,689	2,797						
<b>GAATKW2H42</b>	2,193	2,242	2,307	2,367	2,432	2,499	2,629	2,759	2,888	3,016	3,147						
<b>GAATKW2H48</b>	2,228	2,277	2,342	2,402	2,467	2,534	2,664	2,794	2,923	3,051	3,182						
<b>GAATLKW30</b>	1,621	1,651	1,693	1,735	1,779	1,821	1,908	1,990	2,081	2,166	2,250						
<b>GAATLKW36</b>	1,932	1,972	2,024	2,077	2,132	2,186	2,295	2,398	2,507	2,616	2,724						
<b>GAATLKW60</b>	2,388	2,450	2,537	2,620	2,705	2,793	2,965	3,135	3,307	3,480	3,652						
<b>GAATLKW66</b>	2,436	2,498	2,585	2,668	2,753	2,841	3,013	3,183	3,355	3,528	3,700						
<b>GAATLKW72</b>	2,617	2,689	2,786	2,879	2,977	3,072	3,267	3,457	3,653	3,849	4,040						
<b>GAATLKW78</b>	2,802	2,881	2,988	3,094	3,201	3,313	3,528	3,740	3,956	4,174	4,384						
<b>GAATLKW84</b>	2,861	2,940	3,047	3,153	3,260	3,372	3,587	3,799	4,015	4,233	4,443						
<b>GAATLKW90</b>	3,062	3,150	3,269	3,385	3,501	3,621	3,860	4,094	4,334	4,573	4,805						
<b>GAATLKW96</b>	3,765	3,858	3,986	4,111	4,241	4,370	4,630	4,886	5,146	5,403	5,658						
<b>GAATLKW102</b>	3,978	4,080	4,223	4,356	4,494	4,636	4,917	5,191	5,474	5,757	6,031						
<b>GAATLKW108</b>	4,236	4,346	4,499	4,644	4,793	4,945	5,250	5,547	5,851	6,152	6,449						
<b>GAATLKW120</b>	4,636	4,751	4,915	5,071	5,233	5,397	5,720	6,040	6,366	6,688	7,008						

# FABRIC GRADE PRICING

**Credentials**  
05/22

model number	1	2	3	COM/4	5	6	7	8	9	10	11	12	13	14	15	16
<b>GAATLKW1H30</b>	1,240	1,266	1,293	1,320	1,357	1,393	1,425	1,458	1,496	1,530	1,571	1,601	1,646	1,683	1,726	1,770
<b>GAATLKW1H36</b>	1,288	1,320	1,356	1,390	1,436	1,478	1,521	1,566	1,606	1,651	1,698	1,741	1,799	1,841	1,895	1,951
<b>GAATLKW1H42</b>	1,326	1,367	1,406	1,449	1,503	1,560	1,608	1,661	1,713	1,769	1,825	1,875	1,945	1,998	2,061	2,128
<b>GAATLKW1H48</b>	1,361	1,402	1,441	1,484	1,538	1,595	1,643	1,696	1,748	1,804	1,860	1,910	1,980	2,033	2,096	2,163
<b>GAATLKW2H30</b>	1,288	1,314	1,341	1,368	1,405	1,441	1,473	1,506	1,544	1,578	1,619	1,649	1,694	1,731	1,774	1,818
<b>GAATLKW2H36</b>	1,326	1,358	1,394	1,428	1,474	1,516	1,559	1,604	1,644	1,689	1,736	1,779	1,837	1,879	1,933	1,989
<b>GAATLKW2H42</b>	1,361	1,402	1,441	1,484	1,538	1,595	1,643	1,696	1,748	1,804	1,860	1,910	1,980	2,033	2,096	2,163
<b>GAATLKW2H48</b>	1,420	1,461	1,500	1,543	1,597	1,654	1,702	1,755	1,807	1,863	1,919	1,969	2,039	2,092	2,155	2,222

model number	17	18	19	20	21	22	23	24	25	26	27	col	L1	L2	L3	L4	L5
<b>GAATLKW1H30</b>	1,815	1,845	1,887	1,929	1,973	2,015	2,102	2,184	2,275	2,360	2,444						
<b>GAATLKW1H36</b>	2,005	2,045	2,097	2,150	2,205	2,259	2,368	2,471	2,580	2,689	2,797						
<b>GAATLKW1H42</b>	2,193	2,242	2,307	2,367	2,432	2,499	2,629	2,759	2,888	3,016	3,147						
<b>GAATLKW1H48</b>	2,228	2,277	2,342	2,402	2,467	2,534	2,664	2,794	2,923	3,051	3,182						
<b>GAATLKW2H30</b>	1,863	1,893	1,935	1,977	2,021	2,063	2,150	2,232	2,323	2,408	2,492						
<b>GAATLKW2H36</b>	2,043	2,083	2,135	2,188	2,243	2,297	2,406	2,509	2,618	2,727	2,835						
<b>GAATLKW2H42</b>	2,228	2,277	2,342	2,402	2,467	2,534	2,664	2,794	2,923	3,051	3,182						
<b>GAATLKW2H48</b>	2,287	2,336	2,401	2,461	2,526	2,593	2,723	2,853	2,982	3,110	3,241						

# WEIGHTS + CUBES

**Credentials**  
05/22

model number	weight	cubes	#locks	page
ACFLR15-AA	1 lbs.	0.1	-	147
ACFLR18-AA	1 lbs.	0.2	-	147
ACFLR30-AA	1 lbs.	0.2	-	147
ACFLR36-AA	1 lbs.	0.3	-	147
ACLEDD24-R	1 lbs.	0.2	-	140
ACLEDD54-R	4 lbs.	0.4	-	140
ACLEDD72-R	5 lbs.	0.6	-	140
ACPT15-GAA	2 lbs.	0.5	-	145
ACPT18-GAA	2 lbs.	0.5	-	145
ACPWRT	1 lbs.	0.1	-	146
ACTRASH	1 lbs.	1.4	-	148
ACWCB15	6 lbs.	0.7	-	94
ACWCB20	8 lbs.	0.8	-	94
ACWM	1 lbs.	0.6	-	142
BSHAT2142	53 lbs.	5.4	-	102
BSHAT2148	55 lbs.	6.3	-	102
BSHAT2154	57 lbs.	7.1	-	102
BSHAT2160	59 lbs.	7.9	-	102
BSHAT2166	61 lbs.	8.8	-	102
BSHAT2172	63 lbs.	9.6	-	102
BSHAT2748	59 lbs.	7.8	-	102
BSHAT2754	61 lbs.	8.9	-	102
BSHAT2760	63 lbs.	9.9	-	102
BSHAT2766	65 lbs.	10.9	-	102
BSHAT2772	67 lbs.	12.0	-	102
GA2ASF830-W	16 lbs.	0.8	-	138
GA2ASF836-W	17 lbs.	1.0	-	138
GA2ASF842-W	19 lbs.	1.1	-	138
GA2ASF848-W	20 lbs.	1.3	-	138
GA2ASF860-W	22 lbs.	1.6	-	138
GA2ASF866-W	24 lbs.	1.8	-	138
GA2ASF872-W	25 lbs.	1.9	-	138
GA2ASF878-W	26 lbs.	2.1	-	138
GA2ASF884-W	27 lbs.	2.2	-	138
GA2ASF890-W	29 lbs.	2.4	-	138
GA2ASF896-W	30 lbs.	2.5	-	138
GA2ASF8102-W	31 lbs.	2.7	-	138
GA2ASF8108-W	32 lbs.	2.8	-	138
GA2ASF8120-W	35 lbs.	3.1	-	138
GA2ASF8144-W	40 lbs.	3.7	-	138
GA2BKN2H1830-W	126 lbs.	12.3	-	110
GA2BKN2H1836-W	144 lbs.	14.6	-	110
GA2BKN3H1830-W	141 lbs.	17.6	-	110

model number	weight	cubes	#locks	page
GA2BKN3H1836-W	159 lbs.	20.8	-	110
GA2BKN4H1830-W	178 lbs.	22.9	-	110
GA2BKN4H1836-W	201 lbs.	27.1	-	110
GA2BKN5H1830-W	223 lbs.	30.0	-	110
GA2BKN5H1836-W	251 lbs.	35.4	-	110
GA2BKN6H1830-W	251 lbs.	33.2	-	110
GA2BKN6H1836-W	283 lbs.	39.2	-	110
GA2BLRG2466-W	83 lbs.	35.0	-	58
GA2BLRG2472-W	90 lbs.	38.0	-	58
GA2BLRG2478-W	97 lbs.	41.1	-	58
GA2BRG2442A-WW	54 lbs.	22.8	-	58
GA2BRG2442TA-WW	49 lbs.	20.5	-	59
GA2BRG2442T-WW	49 lbs.	20.5	-	59
GA2BRG2442-WW	54 lbs.	22.8	-	58
GA2BRG2448A-WW	60 lbs.	25.8	-	58
GA2BRG2448TA-WW	55 lbs.	23.2	-	59
GA2BRG2448T-WW	55 lbs.	23.2	-	59
GA2BRG2448-WW	60 lbs.	25.8	-	58
GA2BRG2454A-WW	69 lbs.	28.9	-	58
GA2BRG2454TA-WW	61 lbs.	25.9	-	59
GA2BRG2454T-WW	61 lbs.	25.9	-	59
GA2BRG2454-WW	69 lbs.	28.9	-	58
GA2CFS2460T-44WW	335 lbs.	31.4	2	95
GA2CFS2460T-55WW	326 lbs.	31.4	-	95
GA2CFS2472T-44WW	388 lbs.	37.4	2	95
GA2CFS2472T-55WW	380 lbs.	37.4	-	95
GA2CFS2490T-444WW	510 lbs.	46.4	3	96
GA2CFS2490T-454WW	504 lbs.	46.4	2	96
GA2CFS2490T-555WW	492 lbs.	46.4	-	96
GA2CFS24108T-444WW	584 lbs.	55.4	3	96
GA2CFS24108T-454WW	580 lbs.	55.4	2	96
GA2CFS24108T-555WW	572 lbs.	55.4	-	96
GA2CLC5H1818L-WW	174 lbs.	19.9	1	112
GA2CLC5H1818R-WW	174 lbs.	19.9	1	112
GA2CLC5H2418L-WW	217 lbs.	26.7	1	114
GA2CLC5H2418R-WW	217 lbs.	26.7	1	114
GA2CLC6H1818L-WW	207 lbs.	22.0	1	113
GA2CLC6H1818R-WW	197 lbs.	22.0	1	113
GA2CLC6H2418L-WW	248 lbs.	29.6	1	115
GA2CLC6H2418R-WW	248 lbs.	29.6	1	115
GA2CLD5H1818L-WW	220 lbs.	19.9	1	112
GA2CLD5H1818R-WW	220 lbs.	19.9	1	112
GA2CLD5H1824L-WW	254 lbs.	25.6	1	112

**Credentials**

05/22

**WEIGHTS + CUBES**

model number	weight	cubes	#locks	page
GA2CLD5H1824R-WW	254 lbs.	25.6	1	112
GA2CLD5H1830-WW	299 lbs.	31.3	1	112
GA2CLD5H2418L-WW	294 lbs.	26.7	1	114
GA2CLD5H2418R-WW	294 lbs.	26.7	1	114
GA2CLD5H2424L-WW	335 lbs.	34.4	1	114
GA2CLD5H2424R-WW	335 lbs.	34.4	1	114
GA2CLD5H2430-WW	375 lbs.	42.0	1	114
GA2CLD6H1818L-WW	256 lbs.	22.0	1	113
GA2CLD6H1818R-WW	256 lbs.	22.0	1	113
GA2CLD6H1824L-WW	296 lbs.	28.3	1	113
GA2CLD6H1824R-WW	296 lbs.	28.3	1	113
GA2CLD6H2418L-WW	330 lbs.	29.6	1	115
GA2CLD6H2418R-WW	330 lbs.	29.6	1	115
GA2CLD6H2424L-WW	378 lbs.	38.1	1	115
GA2CLD6H2424R-WW	379 lbs.	38.1	1	115
GA2CLFS2490T-B5SHW	398 lbs.	34.8	1	97
GA2CLFS2490T-BBSHW	448 lbs.	34.8	2	97
GA2CLFS2490T-SH5BW	422 lbs.	34.8	1	97
GA2CLFS2490T-SHBBW	471 lbs.	34.8	2	97
GA2CLFS24108T-B5SHW	485 lbs.	41.5	1	97
GA2CLFS24108T-BBSHW	539 lbs.	41.5	2	97
GA2CLFS24108T-SH5BW	485 lbs.	41.5	1	97
GA2CLFS24108T-SHBBW	539 lbs.	41.5	2	97
GA2CLFS24120T-5SH5W	481 lbs.	46.0	-	98
GA2CLFS24120T-B55SHW	542 lbs.	46.0	1	98
GA2CLFS24120T-BSHBW	579 lbs.	46.0	2	98
GA2CLFS24120T-SH55BW	542 lbs.	46.0	1	98
GA2CLS5H1818L-WW	197 lbs.	19.9	1	112
GA2CLS5H1818R-WW	197 lbs.	19.9	1	112
GA2CLS5H1830-WW	285 lbs.	31.3	1	112
GA2CLS5H2418L-WW	251 lbs.	26.7	1	114
GA2CLS5H2418R-WW	251 lbs.	26.7	1	114
GA2CLS5H2430-WW	346 lbs.	42.0	1	114
GA2CLS6H1818L-WW	230 lbs.	22.0	1	113
GA2CLS6H1818R-WW	220 lbs.	22.0	1	113
GA2CLS6H2418L-WW	282 lbs.	29.6	1	115
GA2CLS6H2418R-WW	282 lbs.	29.6	1	115
GA2CWR2460TL-W	72 lbs.	4.4	-	61
GA2CWR2460TR-W	73 lbs.	4.4	-	61
GA2CWR2460T-W	68 lbs.	4.0	-	60
GA2CWR2460-W	76 lbs.	4.4	-	60
GA2CWR2466TL-W	80 lbs.	4.9	-	61
GA2CWR2466TR-W	80 lbs.	4.9	-	61

model number	weight	cubes	#locks	page
GA2CWR2466T-W	74 lbs.	4.4	-	60
GA2CWR2466-W	83 lbs.	4.9	-	60
GA2CWR2472TL-W	87 lbs.	5.3	-	61
GA2CWR2472TR-W	87 lbs.	5.3	-	61
GA2CWR2472T-W	81 lbs.	4.7	-	60
GA2CWR2472-W	90 lbs.	5.3	-	60
GA2CWR2478TL-W	94 lbs.	5.7	-	61
GA2CWR2478TR-W	94 lbs.	5.7	-	61
GA2CWR2478T-W	87 lbs.	5.1	-	60
GA2CWR2478-W	97 lbs.	5.7	-	60
GA2CWR2484TL-W	101 lbs.	6.1	-	61
GA2CWR2484TR-W	101 lbs.	6.1	-	61
GA2CWR2484T-W	93 lbs.	5.5	-	60
GA2CWR2484-W	104 lbs.	6.1	-	60
GA2CWR2490TL-W	108 lbs.	6.5	-	61
GA2CWR2490TR-W	108 lbs.	6.5	-	61
GA2CWR2490T-W	99 lbs.	5.9	-	60
GA2CWR2490-W	111 lbs.	6.5	-	60
GA2CWR2496TL-W	115 lbs.	7.0	-	61
GA2CWR2496TR-W	115 lbs.	7.0	-	61
GA2CWR2496T-W	107 lbs.	6.3	-	60
GA2CWR2496-W	118 lbs.	7.0	-	60
GA2CWR24102TL-W	122 lbs.	7.4	-	61
GA2CWR24102TR-W	122 lbs.	7.4	-	61
GA2CWR24102T-W	112 lbs.	6.6	-	60
GA2CWR24102-W	125 lbs.	7.4	-	60
GA2CWR24108TL-W	129 lbs.	7.8	-	61
GA2CWR24108TR-W	129 lbs.	7.8	-	61
GA2CWR24108T-W	118 lbs.	7.0	-	60
GA2CWR24108-W	132 lbs.	7.8	-	60
GA2CWR24114TL-W	136 lbs.	8.2	-	61
GA2CWR24114TR-W	136 lbs.	8.2	-	61
GA2CWR24114T-W	125 lbs.	7.4	-	60
GA2CWR24114-W	139 lbs.	8.2	-	60
GA2CWR24120TL-W	143 lbs.	8.6	-	61
GA2CWR24120TR-W	143 lbs.	8.6	-	61
GA2CWR24120T-W	131 lbs.	7.8	-	60
GA2CWR24120-W	146 lbs.	8.6	-	60
GA2DMHA48-W	8 lbs.	1.3	-	105
GA2DMHA54-W	9 lbs.	1.4	-	105
GA2DMHA60-W	11 lbs.	1.6	-	105
GA2DMHA66-W	12 lbs.	1.8	-	105
GA2DMHA72-W	13 lbs.	1.9	-	105

# WEIGHTS + CUBES

Credentials

05/22

model number	weight	cubes	#locks	page
GA2DRO3072L-3WW	251 lbs.	46.5	1	42
GA2DRO3072R-3WW	251 lbs.	46.5	1	43
GA2DRO3072TL-3WW	247 lbs.	46.5	1	42
GA2DRO3072TR-3WW	247 lbs.	46.5	1	43
GA2DRO3672-32WW	355 lbs.	54.9	2	41
GA2DRO3672L-3WW	276 lbs.	54.9	1	42
GA2DRO3672R-3WW	276 lbs.	54.9	1	43
GA2DRO3672TL-3WW	267 lbs.	54.9	1	42
GA2DRO3672TR-3WW	267 lbs.	54.9	1	43
GA2DRO3678-32WW	380 lbs.	59.3	2	41
GA2DRO3678L-3WW	286 lbs.	59.3	1	42
GA2DRO3678R-3WW	286 lbs.	59.3	1	43
GA2DRO3678TL-3WW	276 lbs.	59.3	1	42
GA2DRO3678TR-3WW	276 lbs.	59.3	1	43
GA2DRO3684-32WW	405 lbs.	63.7	2	41
GA2DRO3684L-3WW	306 lbs.	63.7	1	42
GA2DRO3684R-3WW	306 lbs.	63.7	1	43
GA2DRO3684TL-3WW	301 lbs.	63.7	1	42
GA2DRO3684TR-3WW	301 lbs.	63.7	1	43
GA2DTRAK3672L-WW	500 lbs.	54.9	-	38
GA2DTRAK3672R-WW	500 lbs.	54.9	-	39
GA2DTRAK3678L-WW	525 lbs.	59.3	-	38
GA2DTRAK3678R-WW	525 lbs.	59.3	-	39
GA2DTRAK3684L-WW	550 lbs.	63.7	-	38
GA2DTRAK3684R-WW	550 lbs.	63.7	-	39
GA2DTRL3072-G	101 lbs.	46.5	-	35
GA2DTRL3072-S	75 lbs.	46.5	-	35
GA2DTRL3072-W	111 lbs.	46.5	-	34
GA2DTRL3672-G	125 lbs.	54.9	-	35
GA2DTRL3672-S	85 lbs.	54.9	-	35
GA2DTRL3672-W	131 lbs.	54.9	-	34
GA2DTRL3678-G	135 lbs.	59.3	-	35
GA2DTRL3678-S	95 lbs.	59.3	-	35
GA2DTRL3678-W	142 lbs.	59.3	-	34
GA2DTRL3684-G	145 lbs.	63.7	-	35
GA2DTRL3684-S	105 lbs.	63.7	-	35
GA2DTRL3684-W	152 lbs.	63.7	-	34
GA2DTRM3672L-3WW	350 lbs.	54.9	1	36
GA2DTRM3672R-3WW	350 lbs.	54.9	1	37
GA2DTRM3678L-3WW	375 lbs.	59.3	1	36
GA2DTRM3678R-3WW	375 lbs.	59.3	1	37
GA2DTRM3684L-3WW	400 lbs.	63.7	1	36
GA2DTRM3684R-3WW	400 lbs.	63.7	1	37
GA2DTRR3672-WW	239 lbs.	54.9	-	40

model number	weight	cubes	#locks	page
GA2DTRR3678-WW	264 lbs.	59.3	-	40
GA2DTRR3684-WW	289 lbs.	63.7	-	40
GA2DWRA2442-W	39 lbs.	3.2	-	103
GA2DWRA2448-W	45 lbs.	3.6	-	103
GA2DWRA2454-W	51 lbs.	4.0	-	103
GA2DWRA2460-W	56 lbs.	4.4	-	103
GA2DWRA2466-W	62 lbs.	4.9	-	103
GA2DWRA2472-W	67 lbs.	5.3	-	103
GA2DWRA3048-W	56 lbs.	4.4	-	104
GA2DWRA3054-W	63 lbs.	4.9	-	104
GA2DWRA3060-W	70 lbs.	5.4	-	104
GA2DWRA3066-W	77 lbs.	5.9	-	104
GA2DWRA3072-W	84 lbs.	6.4	-	104
GA2DWRA3648-W	67 lbs.	5.2	-	104
GA2DWRA3654-W	76 lbs.	5.8	-	104
GA2DWRA3660-W	84 lbs.	6.4	-	104
GA2DWRA3666-W	93 lbs.	7.0	-	104
GA2DWRA3672-W	101 lbs.	7.6	-	104
GA2HDC2H2430T-WW	169 lbs.	17.3	-	111
GA2HDC2H2430-WW	169 lbs.	17.3	-	111
GA2HDC2H2436T-WW	195 lbs.	20.4	-	111
GA2HDC2H2436-WW	195 lbs.	20.4	-	111
GA2HDCLH2430-WW	132 lbs.	13.1	-	111
GA2HDCLH2436-WW	152 lbs.	15.5	-	111
GA2LFS2H2430T-WW	177 lbs.	17.3	1	108
GA2LFS2H2430-WW	188 lbs.	17.3	1	108
GA2LFS2H2436T-WW	196 lbs.	20.4	1	108
GA2LFS2H2436-WW	212 lbs.	20.4	1	108
GA2LFS3H2430-WW	259 lbs.	24.7	1	109
GA2LFS3H2436-WW	297 lbs.	29.2	1	109
GA2LFS4H2430-WW	325 lbs.	32.2	1	109
GA2LFS4H2436-WW	364 lbs.	38.0	1	109
GA2LFS5H2430-WW	410 lbs.	42.0	1	109
GA2LFS5H2436-WW	461 lbs.	49.7	1	109
GA2LFS6H2430-WW	454 lbs.	46.5	1	109
GA2LFS6H2436-WW	512 lbs.	55.0	1	109
GA2LFLSH2430-WW	162 lbs.	13.1	1	108
GA2LFLSH2436-WW	172 lbs.	15.5	1	108
GA2MCA24-W	30 lbs.	4.0	-	90
GA2MCA27-W	32 lbs.	4.4	-	90
GA2MCA30-W	34 lbs.	4.9	-	90
GA2MCA33-W	35 lbs.	5.3	-	90
GA2MCA36-W	37 lbs.	5.8	-	90
GA2MCA39-W	39 lbs.	6.2	-	90



model number	weight	cubes	#locks	page
GA2MCA42-W	41 lbs.	6.7	-	90
GA2MCA45-W	43 lbs.	7.1	-	90
GA2MCA48-W	45 lbs.	7.6	-	90
GA2MCA51-W	46 lbs.	8.0	-	90
GA2MCA54-W	48 lbs.	8.5	-	90
GA2MCA57-W	53 lbs.	8.9	-	90
GA2MCA60-W	54 lbs.	9.3	-	90
GA2MCA63-W	56 lbs.	9.8	-	90
GA2MCA66-W	58 lbs.	10.2	-	90
GA2MCA69-W	60 lbs.	10.7	-	90
GA2MCA72-W	62 lbs.	11.1	-	90
GA2MCF60-W	41 lbs.	4.1	-	88
GA2MCF66-W	45 lbs.	4.5	-	88
GA2MCF72-W	48 lbs.	4.9	-	88
GA2MCF78-W	51 lbs.	5.3	-	88
GA2MCF84-W	54 lbs.	5.7	-	88
GA2MCF90-W	58 lbs.	6.1	-	88
GA2MCF96-W	61 lbs.	6.5	-	88
GA2MCF102-W	64 lbs.	6.9	-	88
GA2MCF108-W	67 lbs.	7.4	-	88
GA2MCF114-W	70 lbs.	7.8	-	88
GA2MCF120-W	73 lbs.	8.2	-	88
GA2MLCF60-W	33 lbs.	3.1	-	89
GA2MLCF66-W	35 lbs.	3.4	-	89
GA2MLCF72-W	37 lbs.	3.7	-	89
GA2MLCF78-W	40 lbs.	4.0	-	89
GA2MLCF84-W	42 lbs.	4.3	-	89
GA2MLCF90-W	44 lbs.	4.6	-	89
GA2MLCF96-W	46 lbs.	4.9	-	89
GA2MLCF102-W	49 lbs.	5.2	-	89
GA2MLCF108-W	51 lbs.	5.5	-	89
GA2MLCF114-W	53 lbs.	5.8	-	89
GA2MLCF120-W	57 lbs.	6.1	-	89
GA2MLPW2415L-AW	75 lbs.	6.7	1	77
GA2MLPW2415L-LW	55 lbs.	6.5	-	76
GA2MLPW2415L-XBW	65 lbs.	6.5	-	76
GA2MLPW2415R-AW	75 lbs.	6.7	1	83
GA2MLPW2415R-LW	55 lbs.	6.5	-	82
GA2MLPW2415R-XBW	65 lbs.	6.5	-	82
GA2MLPW2418L-AW	81 lbs.	7.9	1	77
GA2MLPW2418R-AW	81 lbs.	7.9	1	83
GA2MLPW2430L-5W	89 lbs.	12.3	-	78
GA2MLPW2430L-BW	139 lbs.	12.3	1	78
GA2MLPW2430L-PW	120 lbs.	12.3	1	78

model number	weight	cubes	#locks	page
GA2MLPW2430L-SHW	77 lbs.	12.3	-	78
GA2MLPW2430L-TW	122 lbs.	12.3	1	78
GA2MLPW2430R-5W	89 lbs.	12.3	-	84
GA2MLPW2430R-BW	139 lbs.	12.3	1	84
GA2MLPW2430R-PW	120 lbs.	12.3	1	84
GA2MLPW2430R-SHW	77 lbs.	12.3	-	84
GA2MLPW2430R-TW	122 lbs.	12.3	1	84
GA2MLPW2436L-5W	98 lbs.	14.6	-	79
GA2MLPW2436L-BW	151 lbs.	14.6	1	79
GA2MLPW2436L-PW	130 lbs.	12.3	1	79
GA2MLPW2436L-SHW	87 lbs.	14.6	-	79
GA2MLPW2436L-TW	132 lbs.	12.3	1	79
GA2MLPW2436R-5W	98 lbs.	14.6	-	85
GA2MLPW2436R-BW	151 lbs.	14.6	1	85
GA2MLPW2436R-PW	130 lbs.	12.3	1	85
GA2MLPW2436R-SHW	87 lbs.	14.6	-	85
GA2MLPW2436R-TW	132 lbs.	12.3	1	85
GA2MLPW2445L-5AW	157 lbs.	18.0	1	80
GA2MLPW2445L-BAW	175 lbs.	18.0	2	80
GA2MLPW2445R-A5W	157 lbs.	18.0	1	86
GA2MLPW2445R-ABW	175 lbs.	18.0	2	86
GA2MLPW2454L-5AW	176 lbs.	21.3	1	80
GA2MLPW2454L-BAW	196 lbs.	21.3	2	80
GA2MLPW2454R-A5W	176 lbs.	21.3	1	86
GA2MLPW2454R-ABW	196 lbs.	21.3	2	86
GA2MLPW2460L-55W	173 lbs.	23.6	-	81
GA2MLPW2460L-BBW	209 lbs.	23.6	2	81
GA2MLPW2460R-55W	173 lbs.	23.6	-	87
GA2MLPW2460R-BBW	209 lbs.	23.6	2	87
GA2MLSPT12-W	7 lbs.	0.4	-	93
GA2MLSPT12-W	11 lbs.	1.3	-	93
GA2MPD1818-AW	99 lbs.	7.2	1	99
GA2MPW2415L-2W	90 lbs.	9.0	1	65
GA2MPW2415L-3W	93 lbs.	9.0	1	65
GA2MPW2415L-LW	50 lbs.	8.7	-	64
GA2MPW2415L-XBW	71 lbs.	8.7	-	64
GA2MPW2415L-XEW	71 lbs.	8.7	-	64
GA2MPW2415R-2W	90 lbs.	9.0	1	71
GA2MPW2415R-3W	93 lbs.	9.0	1	71
GA2MPW2415R-LW	50 lbs.	8.7	-	70
GA2MPW2415R-XBW	71 lbs.	8.7	-	70
GA2MPW2415R-XEW	71 lbs.	8.7	-	70
GA2MPW2418L-2W	97 lbs.	10.5	1	65
GA2MPW2418L-3W	101 lbs.	10.5	1	65

# WEIGHTS + CUBES

**Credentials**  
05/22

model number	weight	cubes	#locks	page
GA2MPW2418R-2W	97 lbs.	10.5	1	71
GA2MPW2418R-3W	101 lbs.	10.5	1	71
GA2MPW2430L-4W	135 lbs.	16.5	1	66
GA2MPW2430L-5W	121 lbs.	16.5	-	66
GA2MPW2430L-7W	136 lbs.	16.5	1	66
GA2MPW2430L-23W	172 lbs.	16.5	2	66
GA2MPW2430L-BW	165 lbs.	16.5	1	66
GA2MPW2430L-PW	130 lbs.	16.5	1	66
GA2MPW2430L-SHW	105 lbs.	16.5	-	66
GA2MPW2430L-TW	132 lbs.	16.5	1	66
GA2MPW2430R-4W	135 lbs.	16.5	1	72
GA2MPW2430R-5W	121 lbs.	16.5	-	72
GA2MPW2430R-7W	136 lbs.	16.5	1	72
GA2MPW2430R-32W	172 lbs.	16.5	2	72
GA2MPW2430R-BW	165 lbs.	16.5	1	72
GA2MPW2430R-PW	130 lbs.	16.5	1	72
GA2MPW2430R-SHW	105 lbs.	16.5	-	72
GA2MPW2430R-TW	132 lbs.	16.5	1	72
GA2MPW2436L-4W	142 lbs.	19.5	1	67
GA2MPW2436L-5W	138 lbs.	19.5	-	67
GA2MPW2436L-7W	147 lbs.	19.5	1	67
GA2MPW2436L-23W	187 lbs.	19.5	2	67
GA2MPW2436L-BW	183 lbs.	19.5	1	67
GA2MPW2436L-PW	140 lbs.	19.5	1	67
GA2MPW2436L-SHW	118 lbs.	19.5	-	67
GA2MPW2436L-TW	142 lbs.	19.5	1	67
GA2MPW2436R-4W	142 lbs.	19.5	1	73
GA2MPW2436R-5W	138 lbs.	19.5	-	73
GA2MPW2436R-7W	147 lbs.	19.5	1	73
GA2MPW2436R-32W	187 lbs.	19.5	2	73
GA2MPW2436R-BW	183 lbs.	19.5	1	73
GA2MPW2436R-PW	140 lbs.	19.5	1	73
GA2MPW2436R-SHW	118 lbs.	19.5	-	73
GA2MPW2436R-TW	142 lbs.	19.5	1	73
GA2MPW2445L-43W	203 lbs.	24.0	2	68
GA2MPW2445L-52W	200 lbs.	24.0	1	68
GA2MPW2445L-72W	216 lbs.	24.0	2	68
GA2MPW2445R-25W	200 lbs.	24.0	1	74
GA2MPW2445R-27W	216 lbs.	24.0	2	74
GA2MPW2445R-34W	203 lbs.	24.0	2	74
GA2MPW2454L-43W	232 lbs.	28.4	2	68
GA2MPW2454L-52W	224 lbs.	28.4	1	68
GA2MPW2454L-72W	234 lbs.	28.4	2	68
GA2MPW2454R-25W	224 lbs.	28.4	1	74

model number	weight	cubes	#locks	page
GA2MPW2454R-27W	234 lbs.	28.4	2	74
GA2MPW2454R-34W	232 lbs.	28.4	2	74
GA2MPW2460L-44W	244 lbs.	31.4	2	69
GA2MPW2460L-55W	231 lbs.	31.4	-	69
GA2MPW2460L-BBW	322 lbs.	31.4	2	69
GA2MPW2460R-44W	244 lbs.	31.4	2	75
GA2MPW2460R-55W	231 lbs.	31.4	-	75
GA2MPW2460R-BBW	322 lbs.	31.4	2	75
GA2MRA21-W	28 lbs.	3.6	-	92
GA2MRA24-W	30 lbs.	4.0	-	92
GA2MRA27-W	32 lbs.	4.4	-	92
GA2MRA30-W	34 lbs.	4.9	-	92
GA2MRA33-W	36 lbs.	5.3	-	92
GA2MRA36-W	37 lbs.	5.8	-	92
GA2MRA39-W	39 lbs.	6.2	-	92
GA2MRA42-W	41 lbs.	6.7	-	92
GA2MRA45-W	43 lbs.	7.1	-	92
GA2MRA48-W	45 lbs.	7.6	-	92
GA2MRA51-W	47 lbs.	8.0	-	92
GA2MRA54-W	49 lbs.	8.5	-	92
GA2MRA57-W	51 lbs.	8.9	-	92
GA2MRA60-W	53 lbs.	9.3	-	92
GA2MRF39-W	20 lbs.	2.8	-	91
GA2MRF42-W	22 lbs.	3.0	-	91
GA2MRF45-W	23 lbs.	3.2	-	91
GA2MRF48-W	25 lbs.	3.4	-	91
GA2MRF51-W	26 lbs.	3.6	-	91
GA2MRF54-W	28 lbs.	3.8	-	91
GA2MRF57-W	30 lbs.	4.0	-	91
GA2MRF60-W	32 lbs.	4.2	-	91
GA2MRF63-W	33 lbs.	4.4	-	91
GA2MRF66-W	35 lbs.	4.6	-	91
GA2MRF69-W	36 lbs.	4.8	-	91
GA2MRF72-W	38 lbs.	5.0	-	91
GA2MSP12-W	7 lbs.	0.6	-	93
GA2MSPT12-W	11 lbs.	1.7	-	93
GA2RLRL3072L-W	126 lbs.	46.5	-	52
GA2RLRL3072R-W	126 lbs.	46.5	-	53
GA2RLRL3078L-W	135 lbs.	50.2	-	52
GA2RLRL3078R-W	135 lbs.	50.2	-	53
GA2RLRL3678L-W	160 lbs.	59.3	-	52
GA2RLRL3678R-W	160 lbs.	59.3	-	53
GA2RLRL3684L-W	170 lbs.	63.7	-	52
GA2RLRL3684R-W	170 lbs.	63.7	-	53

**Credentials**

05/22

**WEIGHTS + CUBES**

model number	weight	cubes	#locks	page
GA2RLRO3072L-3W	231 lbs.	46.5	1	56
GA2RLRO3072R-3W	231 lbs.	46.5	1	57
GA2RLRO3078L-3W	241 lbs.	50.2	1	56
GA2RLRO3078R-3W	241 lbs.	50.2	1	57
GA2RLRO3678L-3W	276 lbs.	59.3	1	56
GA2RLRO3678R-3W	276 lbs.	59.3	1	57
GA2RLRO3684L-3W	287 lbs.	63.7	1	56
GA2RLRO3684R-3W	287 lbs.	63.7	1	57
GA2RLRR3072L-W	126 lbs.	46.5	-	54
GA2RLRR3072R-W	126 lbs.	46.5	-	55
GA2RLRR3078L-W	135 lbs.	50.2	-	54
GA2RLRR3078R-W	135 lbs.	50.2	-	55
GA2RLRR3678L-W	160 lbs.	59.3	-	54
GA2RLRR3678R-W	160 lbs.	59.3	-	55
GA2RLRR3684L-W	170 lbs.	63.7	-	54
GA2RLRR3684R-W	170 lbs.	63.7	-	55
GA2RRL3048L-W	76 lbs.	31.6	-	52
GA2RRL3048R-W	76 lbs.	31.6	-	53
GA2RRL3054L-W	85 lbs.	35.3	-	52
GA2RRL3054R-W	85 lbs.	35.3	-	53
GA2RRL3654L-W	101 lbs.	41.7	-	52
GA2RRL3654R-W	101 lbs.	41.7	-	53
GA2RRL3660L-W	110 lbs.	46.1	-	52
GA2RRL3660R-W	110 lbs.	46.1	-	53
GA2RRO3048L-3W	188 lbs.	31.6	1	56
GA2RRO3048R-3W	188 lbs.	31.6	1	57
GA2RRO3054L-3W	198 lbs.	35.3	1	56
GA2RRO3054R-3W	198 lbs.	35.3	1	57
GA2RRO3654L-3W	225 lbs.	41.7	1	56
GA2RRO3654R-3W	225 lbs.	41.7	1	57
GA2RRO3660L-3W	237 lbs.	46.1	1	56
GA2RRO3660R-3W	237 lbs.	46.1	1	57
GA2RRR3048L-W	133 lbs.	31.6	-	54
GA2RRR3048R-W	133 lbs.	31.6	-	55
GA2RRR3054L-W	143 lbs.	35.3	-	54
GA2RRR3054R-W	143 lbs.	35.3	-	55
GA2RRR3654L-W	167 lbs.	41.7	-	54
GA2RRR3654R-W	167 lbs.	41.7	-	55
GA2RRR3660L-W	179 lbs.	46.1	-	54
GA2RRR3660R-W	179 lbs.	46.1	-	55
GA2RWR2442T-W	49 lbs.	2.8	-	63
GA2RWR2442-W	55 lbs.	3.2	-	62
GA2RWR2448T-W	56 lbs.	3.2	-	63
GA2RWR2448-W	62 lbs.	3.6	-	62

model number	weight	cubes	#locks	page
GA2RWR2454T-W	62 lbs.	3.6	-	63
GA2RWR2454-W	69 lbs.	4.0	-	62
GA2RWR2460T-W	68 lbs.	4.0	-	63
GA2RWR2460-W	76 lbs.	4.4	-	62
GA2RWR2466T-W	75 lbs.	4.4	-	63
GA2RWR2466-W	83 lbs.	4.9	-	62
GA2RWR2472T-W	81 lbs.	4.7	-	63
GA2RWR2472-W	90 lbs.	5.3	-	62
GA2SBH5H2418L-WW	284 lbs.	26.7	2	116
GA2SBH5H2418R-WW	284 lbs.	26.7	2	116
GA2SBH5H2430-WW	384 lbs.	42.0	2	116
GA2SBH6H2418L-WW	315 lbs.	29.6	2	116
GA2SBH6H2418R-WW	315 lbs.	29.6	2	116
GA2SBH6H2430-WW	436 lbs.	46.5	2	116
GA2TRD42-W	79 lbs.	5.3	-	139
GA2TRD48-W	100 lbs.	6.8	-	139
GA2TRD54-W	124 lbs.	8.5	-	139
GA2TRD60-W	150 lbs.	10.3	-	139
GA2UTC5H2424L-WW	413 lbs.	34.4	3	117
GA2UTC5H2424R-WW	413 lbs.	34.4	3	117
GA2UTC6H2424L-WW	461 lbs.	38.1	3	117
GA2UTC6H2424R-WW	461 lbs.	38.1	3	117
GA2WCF1H60-WG	212 lbs.	17.2	-	121
GA2WCF1H60-WW	195 lbs.	17.2	-	120
GA2WCF1H72-WG	246 lbs.	20.5	-	121
GA2WCF1H72-WW	225 lbs.	20.5	-	120
GA2WCF1H90-WG	311 lbs.	25.4	-	121
GA2WCF1H90-WW	286 lbs.	25.4	-	120
GA2WCF1H108-WG	360 lbs.	30.4	-	121
GA2WCF1H108-WW	329 lbs.	30.4	-	120
GA2WCH1H30-WG	117 lbs.	9.0	-	119
GA2WCH1H30-WW	104 lbs.	9.0	-	118
GA2WCH1H36-WG	133 lbs.	10.7	-	119
GA2WCH1H36-WW	119 lbs.	10.7	-	118
GA2WCH1H60-WG	219 lbs.	17.2	-	119
GA2WCH1H60-WW	194 lbs.	17.2	-	118
GA2WCH1H66-WW	209 lbs.	18.9	-	118
GA2WCH1H72-WG	251 lbs.	20.5	-	119
GA2WCH1H72-WW	225 lbs.	20.5	-	118
GA2WCH1H78-WW	239 lbs.	22.1	-	118
GA2WCH1H84-WW	270 lbs.	23.8	-	118
GA2WCH1H90-WG	322 lbs.	25.4	-	119
GA2WCH1H90-WW	285 lbs.	25.4	-	118
GA2WCH1H96-WW	301 lbs.	27.1	-	118

# WEIGHTS + CUBES

Credentials

05/22

model number	weight	cubes	#locks	page
GA2WCH1H102-WW	315 lbs.	28.7	-	118
GA2WCH1H108-WG	371 lbs.	30.4	-	119
GA2WCH1H108-WW	330 lbs.	30.4	-	118
GA2WCH2H30-WG	138 lbs.	12.4	-	125
GA2WCH2H30-WW	123 lbs.	12.4	-	124
GA2WCH2H36-WG	156 lbs.	14.7	-	125
GA2WCH2H36-WW	141 lbs.	14.7	-	124
GA2WCH2H60-WG	261 lbs.	23.7	-	125
GA2WCH2H60-WW	231 lbs.	23.7	-	124
GA2WCH2H66-WW	248 lbs.	26.0	-	124
GA2WCH2H72-WG	297 lbs.	28.3	-	125
GA2WCH2H72-WW	266 lbs.	28.3	-	124
GA2WCH2H78-WW	283 lbs.	30.5	-	124
GA2WCH2H84-WW	322 lbs.	32.8	-	124
GA2WCH2H90-WG	385 lbs.	35.0	-	125
GA2WCH2H90-WW	339 lbs.	35.0	-	124
GA2WCS1H60-WG	159 lbs.	17.2	-	123
GA2WCS1H60-WW	164 lbs.	17.2	-	122
GA2WCS1H72-WG	183 lbs.	20.5	-	123
GA2WCS1H72-WW	181 lbs.	20.5	-	122
GA2WCS1H90-WG	223 lbs.	25.4	-	123
GA2WCS1H90-WW	244 lbs.	25.4	-	122
GA2WCS1H108-WG	271 lbs.	30.4	-	123
GA2WCS1H108-WW	275 lbs.	30.4	-	122
GA2WCS2H60-WG	166 lbs.	23.7	-	127
GA2WCS2H60-WW	164 lbs.	23.7	-	126
GA2WCS2H72-WG	190 lbs.	28.3	-	127
GA2WCS2H72-WW	201 lbs.	28.3	-	126
GA2WCS2H90-WG	243 lbs.	35.0	-	127
GA2WCS2H90-WW	259 lbs.	35.0	-	126
GA2XRAK3072L-W	550 lbs.	46.5	-	48
GA2XRAK3072R-W	550 lbs.	46.5	-	49
GA2XRAK3072TL-W	552 lbs.	46.5	-	48
GA2XRAK3072TR-W	552 lbs.	46.5	-	49
GA2XRAK3672L-W	571 lbs.	54.9	-	48
GA2XRAK3672R-W	571 lbs.	54.9	-	49
GA2XRAK3672TL-W	560 lbs.	54.9	-	48
GA2XRAK3672TR-W	560 lbs.	54.9	-	49
GA2XRAK3678L-W	568 lbs.	59.3	-	48
GA2XRAK3678R-W	568 lbs.	59.3	-	49
GA2XRAK3678TL-W	570 lbs.	59.3	-	48
GA2XRAK3678TR-W	570 lbs.	59.3	-	49
GA2XRAK3684L-W	578 lbs.	63.7	-	48
GA2XRAK3684R-W	578 lbs.	63.7	-	49

model number	weight	cubes	#locks	page
GA2XRAK3684TL-W	578 lbs.	63.7	-	48
GA2XRAK3684TR-W	578 lbs.	63.7	-	49
GA2XRL3072L-W	152 lbs.	46.5	-	44
GA2XRL3072R-W	152 lbs.	46.5	-	45
GA2XRL3072TL-W	145 lbs.	46.5	-	44
GA2XRL3072TR-W	145 lbs.	46.5	-	45
GA2XRL3672L-W	181 lbs.	54.9	-	44
GA2XRL3672R-W	181 lbs.	54.9	-	45
GA2XRL3672TL-W	168 lbs.	54.9	-	44
GA2XRL3672TR-W	168 lbs.	54.9	-	45
GA2XRL3678L-W	191 lbs.	59.3	-	44
GA2XRL3678R-W	191 lbs.	59.3	-	45
GA2XRL3678TL-W	178 lbs.	59.3	-	44
GA2XRL3678TR-W	178 lbs.	59.3	-	45
GA2XRL3684L-W	200 lbs.	63.7	-	44
GA2XRL3684R-W	200 lbs.	63.7	-	45
GA2XRL3684TL-W	189 lbs.	63.7	-	44
GA2XRL3684TR-W	189 lbs.	63.7	-	45
GA2XRM3072L-W	220 lbs.	46.5	-	46
GA2XRM3072R-W	220 lbs.	46.5	-	47
GA2XRM3072TL-W	220 lbs.	46.5	-	46
GA2XRM3072TR-W	220 lbs.	46.5	-	47
GA2XRM3672L-W	245 lbs.	54.9	-	46
GA2XRM3672R-W	245 lbs.	54.9	-	47
GA2XRM3672TL-W	245 lbs.	54.9	-	46
GA2XRM3672TR-W	245 lbs.	54.9	-	47
GA2XRM3678L-W	265 lbs.	59.3	-	46
GA2XRM3678R-W	265 lbs.	59.3	-	47
GA2XRM3678TL-W	265 lbs.	59.3	-	46
GA2XRM3678TR-W	265 lbs.	59.3	-	47
GA2XRM3684L-W	285 lbs.	63.7	-	46
GA2XRM3684R-W	285 lbs.	63.7	-	47
GA2XRM3684TL-W	284 lbs.	63.7	-	46
GA2XRM3684TR-W	284 lbs.	63.7	-	47
GA2XRR3072L-W	190 lbs.	46.5	-	50
GA2XRR3072R-W	190 lbs.	46.5	-	51
GA2XRR3072TL-W	196 lbs.	46.5	-	50
GA2XRR3072TR-W	196 lbs.	46.5	-	51
GA2XRR3672L-W	215 lbs.	54.9	-	50
GA2XRR3672R-W	215 lbs.	54.9	-	51
GA2XRR3672TL-W	230 lbs.	54.9	-	50
GA2XRR3672TR-W	230 lbs.	54.9	-	51
GA2XRR3678L-W	235 lbs.	59.3	-	50
GA2XRR3678R-W	235 lbs.	59.3	-	51

model number	weight	cubes	#locks	page
GA2XRR3678TL-W	242 lbs.	59.3	-	50
GA2XRR3678TR-W	242 lbs.	59.3	-	51
GA2XRR3684L-W	255 lbs.	63.7	-	50
GA2XRR3684R-W	255 lbs.	63.7	-	51
GA2XRR3684TL-W	254 lbs.	63.7	-	50
GA2XRR3684TR-W	254 lbs.	63.7	-	51
GAACLPD-CUSH2130T	10 lbs.	2.1	-	100
GAACLPD-CUSH2136T	10 lbs.	2.4	-	100
GAACLPD-CUSH2430	9 lbs.	2.3	-	100
GAACLPD-CUSH2436	9 lbs.	2.7	-	100
GAACORNER	8 lbs.	1.7	-	143
GAADSKPAD	10 lbs.	2.3	-	143
GAAMPD-CUSH1818	6 lbs.	1.2	-	100
GAATGW1H30-GSA	43 lbs.	3.7	-	133
GAATGW1H30-XGSA	48 lbs.	3.7	-	134
GAATGW1H36-GSA	50 lbs.	4.3	-	133
GAATGW1H36-XGSA	55 lbs.	4.3	-	134
GAATGW1H42-GSA	58 lbs.	5.0	-	133
GAATGW1H42-XGSA	63 lbs.	5.0	-	134
GAATGW1H48-GSA	66 lbs.	5.6	-	133
GAATGW1H48-XGSA	71 lbs.	5.6	-	134
GAATGW2H30-GSA	50 lbs.	4.3	-	133
GAATGW2H30-XGSA	55 lbs.	4.3	-	134
GAATGW2H36-GSA	59 lbs.	5.0	-	133
GAATGW2H36-XGSA	64 lbs.	5.0	-	134
GAATGW2H42-GSA	67 lbs.	5.8	-	133
GAATGW2H42-XGSA	72 lbs.	5.8	-	134
GAATGW2H48-GSA	76 lbs.	6.6	-	133
GAATGW2H48-XGSA	81 lbs.	6.6	-	134
GAATGW30-GSA	28 lbs.	2.3	-	132
GAATGW36-GSA	32 lbs.	2.7	-	132
GAATGW60-GSA	50 lbs.	4.3	-	132
GAATGW66-GSA	55 lbs.	4.7	-	132
GAATGW72-GSA	59 lbs.	5.1	-	132
GAATGW78-GSA	64 lbs.	5.5	-	132
GAATGW84-GSA	68 lbs.	5.9	-	132
GAATGW90-GSA	73 lbs.	6.4	-	132
GAATGW96-GSA	77 lbs.	6.8	-	132
GAATGW102-GSA	82 lbs.	7.2	-	132
GAATGW108-GSA	86 lbs.	7.6	-	132
GAATKW1H30	24 lbs.	3.8	-	129
GAATKW1H36	27 lbs.	4.5	-	129
GAATKW1H42	29 lbs.	5.1	-	129
GAATKW1H48	32 lbs.	5.8	-	129

model number	weight	cubes	#locks	page
GAATKW2H30	26 lbs.	4.4	-	129
GAATKW2H36	29 lbs.	5.2	-	129
GAATKW2H42	33 lbs.	6.0	-	129
GAATKW2H48	36 lbs.	6.8	-	129
GAATKW30	18 lbs.	2.3	-	128
GAATKW36	20 lbs.	2.8	-	128
GAATKW60	26 lbs.	4.5	-	128
GAATKW66	28 lbs.	4.9	-	128
GAATKW72	29 lbs.	5.3	-	128
GAATKW78	31 lbs.	5.7	-	128
GAATKW84	33 lbs.	6.1	-	128
GAATKW90	34 lbs.	6.6	-	128
GAATKW96	36 lbs.	7.0	-	128
GAATKW102	37 lbs.	7.4	-	128
GAATKW108	39 lbs.	7.8	-	128
GAATKW120	42 lbs.	8.7	-	128
GAATLKW1H30	26 lbs.	4.3	-	131
GAATLKW1H36	29 lbs.	5.1	-	131
GAATLKW1H42	33 lbs.	5.9	-	131
GAATLKW1H48	36 lbs.	6.7	-	131
GAATLKW2H30	28 lbs.	5.0	-	131
GAATLKW2H36	32 lbs.	5.9	-	131
GAATLKW2H42	36 lbs.	6.8	-	131
GAATLKW2H48	40 lbs.	7.7	-	131
GAATLKW30	20 lbs.	2.9	-	130
GAATLKW36	22 lbs.	3.4	-	130
GAATLKW60	31 lbs.	5.5	-	130
GAATLKW66	33 lbs.	6.1	-	130
GAATLKW72	35 lbs.	6.6	-	130
GAATLKW78	37 lbs.	7.1	-	130
GAATLKW84	39 lbs.	7.7	-	130
GAATLKW90	41 lbs.	8.2	-	130
GAATLKW96	43 lbs.	8.7	-	130
GAATLKW102	45 lbs.	9.2	-	130
GAATLKW108	47 lbs.	9.8	-	130
GAATLKW120	52 lbs.	10.8	-	130
GAATOP1818-W	20 lbs.	1.0	-	149
GAATRAYBOX15	3 lbs.	0.9	-	144
GAATRAYBOX18	4 lbs.	1.0	-	144
GAATRAYBOX30	7 lbs.	1.7	-	144
GAATRAYBOX36	8 lbs.	2.1	-	144
GAATRAYLTR15	3 lbs.	1.0	-	144
GAATRAYLTR18	4 lbs.	1.1	-	144
GAATROUGH30	3 lbs.	0.6	-	101

# WEIGHTS + CUBES

model number	weight	cubes	#locks	page
GAATROUGH36	3 lbs.	0.7	–	101
GAATROUGH42	4 lbs.	0.9	–	101
GAATROUGH48	4 lbs.	1.0	–	101
GAATROUGH54	5 lbs.	1.1	–	101
GAATROUGH60	5 lbs.	1.2	–	101
GAATROUGH66	6 lbs.	1.4	–	101
GAATROUGH72	6 lbs.	1.5	–	101
GAATROUGH78	7 lbs.	1.6	–	101
GAATROUGH84	7 lbs.	1.7	–	101
GAATROUGH90	8 lbs.	1.9	–	101
GAATROUGH96	9 lbs.	2.0	–	101
GAATROUGH102	9 lbs.	2.1	–	101
GAATROUGH108	10 lbs.	2.2	–	101
GAATROUGH114	10 lbs.	2.4	–	101
GAATROUGH120	11 lbs.	2.5	–	101
GAATWD1H30	68 lbs.	3.8	–	136
GAATWD1H30-X	68 lbs.	3.8	–	137
GAATWD1H36	80 lbs.	4.5	–	136
GAATWD1H36-X	80 lbs.	4.5	–	137
GAATWD1H42	91 lbs.	5.1	–	136
GAATWD1H42-X	91 lbs.	5.1	–	137
GAATWD1H48	103 lbs.	5.8	–	136
GAATWD1H48-X	103 lbs.	5.8	–	137
GAATWD2H30	78 lbs.	4.4	–	136
GAATWD2H30-X	78 lbs.	4.4	–	137
GAATWD2H36	92 lbs.	5.2	–	136
GAATWD2H36-X	92 lbs.	5.2	–	137
GAATWD2H42	106 lbs.	6.0	–	136
GAATWD2H42-X	106 lbs.	6.0	–	137
GAATWD2H48	120 lbs.	6.8	–	136
GAATWD2H48-X	120 lbs.	6.8	–	137
GAATWD30	45 lbs.	2.3	–	135
GAATWD36	51 lbs.	2.8	–	135
GAATWD60	79 lbs.	4.5	–	135
GAATWD66	86 lbs.	4.9	–	135
GAATWD72	93 lbs.	5.3	–	135
GAATWD78	100 lbs.	5.7	–	135
GAATWD84	107 lbs.	6.1	–	135
GAATWD90	114 lbs.	6.6	–	135
GAATWD96	121 lbs.	7.0	–	135
GAATWD102	127 lbs.	7.4	–	135
GAATWD108	134 lbs.	7.8	–	135
GAATWD120	148 lbs.	8.7	–	135
GS2CDWSD-W	2 lbs.	13.0	–	145

model number	weight	cubes	#locks	page
MDWLBK24	2 lbs.	1.2	–	94
MDWLBK30	2 lbs.	1.2	–	94
SAMAGNET	1 lbs.	0.1	–	141



---

---

# Gunlocke®

One Gunlocke Drive  
Wayland, NY 14572  
800 828 6300