

PRICING EFFECTIVE MAY 2022

CREDENTIALS™

Price & Specification Guide

PDF updated July 11, 2022

Gunlocke®

VENEER 1 (SELECT)

NATURAL FC CHERRY

A. Cinnamon/Biltmore	NC260
B. Lowell Ash	NC394
C. Medium Red	NC512
D. Light	NC701
E. Shaker	NC774
F. Burnished	NC777

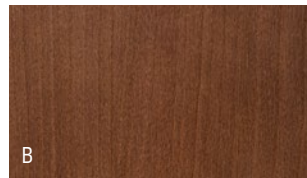

NATURAL FC MAPLE

G. Natural	NE800
H. Harvest	NE856



NATURAL FC WALNUT

I. Florence	NT579
J. Light	NT601
K. Skyline	NT625
L. Nutmeg	NT629
M. Pinnacle	NT679
N. Sumatra	NT693
O. Ebony	NT509
(Use OP TopFin Only)	

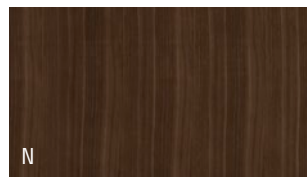
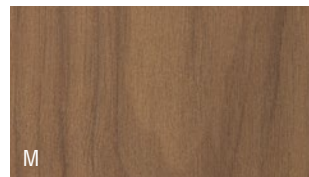
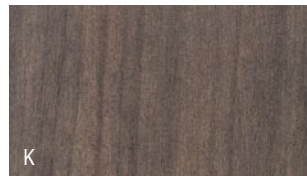
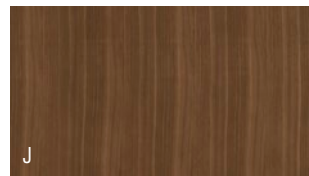
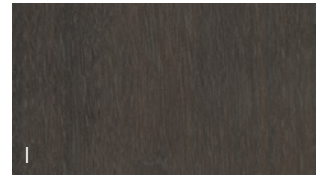
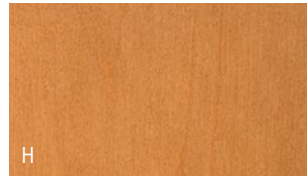

VENEER 2 (PREMIUM)

NATURAL QC WALNUT

A. Florence	QT579
B. Light	QT601
C. Skyline	QT625
D. Nutmeg	QT629
E. Pinnacle	QT679
F. Sumatra	QT693
G. Ebony	QT509
(Use OP TopFin Only)	

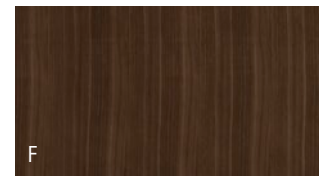
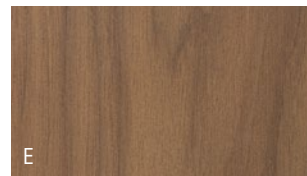
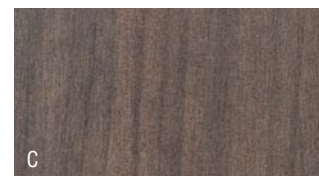
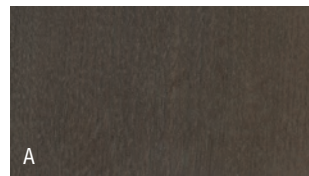

NATURAL RIFT CUT OAK

H. Light	RF301
I. Dark	RF331
J. Phantom Ecu	RF912
(Use OP TopFin Only)	
K. Fawn Cypress	RF108



K

ORDERING OPTION CODES

Credentials
05/22

UV TOP FINISH

Open Pore Low Sheen	OP
Full Fill ClearTech™	FF
Full Fill Top ≤ 120" Length(+\$250)	
Full Fill Top > 120" Length(+\$400)	

PULLS

Metal Pull - Champagne Silver	MPS
Metal Pull - Dark Bronze	MPZ
Integral Wood Pull	FPW

PENCIL LIP COLOR

Pencil Lip - Champagne Silver	PLS
Pencil Lip - Dark Bronze	PLZ

BACK PAINTED GLASS DOORS/TACKZONE

Ice White	WH
Black	BK
Muslin	ML

BACK PAINTED GLASS TOPS

Ice White, Acid Etched	TWH
Black, Acid Etched	TBK
Muslin, Acid Etched	TML

DESKTOP OPTION

Standard Veneer	TVN
Faux Leather Inlay	
White (+\$1,516)	TLW
Black (+\$1,516)	TLB
Chocolate (+\$1,516)	TLC

Back Painted Glass Insert	
Ice White, Acid Etched (+\$2,122)	TGW
Black, Acid Etched (+\$2,122)	TGB
Muslin, Acid Etched (+\$2,122)	TGM

ROUND TOP VENEER PATTERN

Standard Veneer	TVN
Sunburst Veneer (+\$1,819)	TSB

PERSONAL CORNER

LEATHER	
White	CWH
Black	CBL
Chocolate	CCH

VINYL

White	VWH
Black	VBL
Chocolate	VCH

MODESTY PANEL SET #1

No Mod Required (deduct \$771)	MN
Finished Modesty Panel	MY

MODESTY PANEL SET #2 TROUGH BRIDGES

No Mod Required (deduct \$1,266)	MN
Wall Access Panel	AP

LOCKS

Locks Yes	LY
Locks No	LN

KEYING

Field Installed Locks	FL
-----------------------	----

FACTORY-INSTALLED

Random Key Numbers	
Silver	RMS
Black	RMB

Designated Key Numbers

Specify a number between:	
Silver	FT100TAS - FT150TAS
Black	FT100TA - FT150TA

GRAIN DIRECTION

Standard Veneer Direction	VLG
Cross/Short Veneer Direction	VST

MAGNETIC ACCESSORIES PAINT COLOR

White	AWH
Black	ABK
Muslin	AML

OFFICE NUMBER

Specify a number to identify each office	OFC1-OFC199
--	-------------

PULLS

Metal Pull - Champagne Silver



Metal Pull - Dark Bronze



Integral Wood Pull



LEATHER DETAILS

Leather Desk Inlay



Leather Tray for Overhead Cubby



Leather Box Drawer Insert



MISC. DETAILS

Grommet

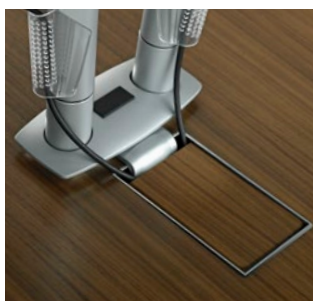

Printer Pedestal



Height Adjustable Desk



General Information	2-6	Overheads	118-146
Conditions of Sale	2	Single Wall Mount Overheads	118-123
GSA Terms & Conditions	3-4	Double High Wall Mount Overheads	124-127
Warranty	5	Tackboards	128-131
Delivery Information	6	Back Painted Glass Whiteboards	132-138
Veneers & Finishes	7	Wood Magnetic Tackzone	139-145
Edge Detail & Pull Options	8	Shelves for Segmented Tackzone	146
Pedestal Legend	9	Miscellaneous	
Filing	10-11	Round Tables & Bases	147-148
Product Reference	13-31	Accessories	149-158
Features + Advantages	14-15	Fabric Grade Pricing	160-163
Technical Specifications	16-18	Weights + Cubes	164-180
Worksurface UV Finishes	19		
Height Reference	20		
Desktop Leather Inlay and Glass Insert Locations	21		
Worksurface Veneer Grain Directions	22-23		
Grommets & Trough Locations	24-25		
Metal Pull Locations	26		
Integral Wood Pull Locations	27		
Specification Tips	28		
Wire Management	29-30		
Product Specifications	31		
Unitized Casegoods	33-105		
Freestanding Table Desks	34-40		
Double Pedestal Desks	41		
Single Pedestal Desks	42-43		
Extensions	44-51		
Runoff Desks	52-57		
Bridges	58-59		
Credenza & Return Components	60-63		
Pedestals	64-75		
Layers Pedestals	76-87		
Modesty / Access / Support Panels	88-93		
Brackets / Storage	94-98		
Mobile Pedestals	99		
Cushions	100		
Trough Inserts	101		
Height Adjustable Desks	102-105		
Storage	107-117		
Lateral Files	108-109		
Bookcases	110		
Hinged Door Cabinets	111		
Closets	112-115		
Storage Box	116		
Utility Cabinets	117		

INTRODUCTION

The Gunlocke Company is dedicated to providing the finest products and service possible. This price list reflects that commitment. Included is a current listing of our casegood models.

Seating and Lounge are presented in a separate price list. Contact your Gunlocke Customer Services Representative for more information, (800) 828-6300.

Designed for easy use, each page of this price list, and the inside front cover fold out provide all information required to order a product correctly. Should additional information be needed, contact your Gunlocke customer service representative.

PRICING

Prices shown cover standard product specifications. Any changes or alterations, other than those listed, will be subject to an additional charge. Prices include cartoning and freight. Authorization and pricing must be secured in advance for orders or contracts calling for large quantities, indefinite quantities, or extended delivery dates. Prices are subject to change without notice; the most current prices are published on <http://www.gunlocke.com>.

ORDERING

To expedite order entry and to assure proper service, email or fax all orders directly to:

The Gunlocke Company

Attn: Order Entry
One Gunlocke Drive
Wayland, New York 14572
585-728-5111
585-728-8350 FAX
800-828-6300
www.gunlocke.com

Gunlocke will not be responsible for duplicate orders if purchase orders are left unmarked.

ACKNOWLEDGMENT

Each order will be acknowledged by Gunlocke. Customers should check each acknowledgment for accuracy and immediately notify Gunlocke of any discrepancies. The printed acknowledgment is the final agreement between The Gunlocke Company and the customer, superseding all previous communications regarding the order.

SPECIFICATION CHANGES

Gunlocke reserves the right to change specifications for the improvement of products at any time, without notice.

ORDER CHANGES

Gunlocke is not required to accept changes in orders after confirmation. Reasonable changes are subject to additional charges for labor, material and administrative costs.

Order changes of acknowledgment may result in re-scheduling of product.

RETURNED MERCHANDISE

No merchandise may be returned without prior authorization.

SHOWROOMS

For all showroom locations and tour information, please reference the showrooms page online at: www.gunlocke.com/inspiration/showrooms

CANCELLATIONS

Cancellation of orders cannot be accepted since every order is manufactured according to customer specifications.

STORAGE

If delivery cannot be made and products are ready, Gunlocke will transfer products to a storage facility and products will be invoiced at that time. The customer is responsible for storage charges and assumes and bears all risks associated with the storage of that product.

TERMS

Net 30 days from date of invoice. A service charge of eighteen percent (18%) per year or .0004931% per day, compounded monthly, will be added to balance due beyond the thirtieth day. Products are shipped FOB factory, freight prepaid and allowed. Title passes to purchaser and Gunlocke's responsibility ceases when shipment is accepted for transportation by a carrier. A full explanation of all payment terms is found on order and invoice forms.

ORDERING INFORMATION

1a. Intended use: The furniture on this schedule is intended for use by Government executives (or equivalent military rank) in the Executive, Judicial and Legislative Branches of the Federal Government. To help customers make a good purchasing decision based on their needs and budget, GSA has established four grades of furniture. Grade (1) includes furniture that tends to be the most expensive on this schedule, grade (2) furniture tends to be more moderately priced and grades (3) and (4) furniture tend to be affordably priced when compared to grades (1) and (2). Some pieces of furniture on this schedule may be significantly higher in price than GSA Traditional and Contemporary Executive Special Order Program furniture. The ordering agency or service is responsible for determining furniture appropriate for use in its offices which will fit within its budget and comply with applicable Federal or internal agency procurement regulations. Please see reverse for GSA terms and conditions.

Grade 1 All exposed solid parts such as top rims, base rails etc. (except decorative accents, inlays and painted parts) shall be the same species as the face veneer. Top and bottom edges of drawer fronts shall be solid wood in the same species as the face veneers. Drawer sides and backs shall be solid wood.

Grade 2 Exposed wood panel trim and trim on tops shall be the same wood species as the face veneer on the top. Some or all other exposed solid parts, such as base rails can be an alternative wood species (such as poplar or gum) different from the face veneers. Exposed, finished engineered wood core material such as MDF is acceptable only for the edges of drawer fronts. Drawer sides shall be solid wood or veneer core plywood/laminated construction. Silea is grade 2.

Grade 3 Most or all exposed solid parts can be an alternative wood species (such as poplar or gum), different from the face veneers. Exposed, finished engineered wood core material such as MDF is acceptable only for the edges of drawer fronts. Drawer sides shall be solid wood or veneer core plywood/laminated construction. Medley, Kennsington, Credentials, and all tables are grade 3.

Grade 4 Most or all exposed solid parts can be an alternative wood species (such as poplar or gum), different from the face veneers. Exposed, finished engineered wood core material such as MDF is acceptable only for the edges of drawer fronts. Drawer sides shall be composite wood material construction such as MDF. Trio is grade 4.

1. **Maximum Order Threshold:**
SIN# 33721 \$250,000
2. **Minimum order:** \$2,000 list
3. **Geographic coverage:**
48 contiguous states and DC (CONUS)
4. **Points of production:**
Wayland, NY, Steuben County, USA
Hickory, NC, Catawba County, USA
5. **Discount Statement:** Discount is applied to List Price.
Structure in List \$:
\$2,000 – \$100,000 list 60.5%
\$100,001 – \$400,000 list 62.7%
\$400,001 – MOT (\$1,428,571 List). 65.0%
Over MOT (\$1,428,572 List). Negotiable
* These discounts apply to single purchase orders, shipping to the same place in the same time period
6. **Quantity Discount:** See above
7. **Payment terms:**
1% 23 days Net 30 days from date of shipment, for product only, for all electronic invoices processed through a Federal payment system, (including, but not limited to, WAWF, IPP, etc.). All other invoice sales are Net 30 days from date of shipment. Prompt payment terms are not applicable to credit card orders.
8. **Government Credit Cards** are accepted above and below the micro-purchase levels.
Written confirmation and authorized signatures are required. Activities may verbally provide card information, but products shall be confirmed in writing.
Use of credit cards shall be at the time of order placement with cards charged at the time of shipment, see GSAR 552-232-80 (C).
There are no additional discounts for using a credit card.
9. **Foreign items:** None
- 10a. **Time of delivery:** 60 days ARO
- 10b. **Expedited delivery:** Contact Gunlocke
- 10c. **Overnight and 2-day delivery:** Contact Gunlocke
- 10d. **Urgent requirements:** Contact Gunlocke
11. **FOB point(s):** F.O.B. Origin, with freight being paid by Gunlocke for all deliveries within CONUS.
12. **Ordering address(es):**
The Gunlocke Company
c/o Authorized Gunlocke GSA Dealer
One Gunlocke Drive
Wayland, NY 14572
Phone: (800) 828-6300
Fax: (585) 728-8350
13. **Payment address(es):**
The Gunlocke Company LLC
13367 Collections Center Drive
Chicago, IL 60693
14. **Warranty provision:** See warranty on page 5
15. **Export packing charges:**
Write for quotation on export packaging.
16. **Terms and conditions of Government commercial credit card acceptance:** Credit Cards are accepted.
17. **Terms and conditions of rental, maintenance, and repair:** Not applicable
18. **Terms and conditions of installation:**
Installation services shall be priced at a rate not to exceed 30% of the net product price, per project. The minimum order charge for installation shall be \$175.00. Projects involving extraordinary circumstances which require installation charges exceeding the proposed installation rates will be submitted to the GSA Contracting Officer for review and approval.
19. **Project Management:**
\$65 Per Hour, inclusive of IFF
20. **Reconfiguration and Relocation Services:**
\$65 Per Hour, inclusive of IFF
21. **Design/Layout Services:**
\$65 Per Hour, inclusive of IFF
22. **Terms and conditions of repair:**
Refer to Gunlocke Customer Support
23. **List of service and distribution:** Points: Not applicable
24. **Participating dealers:** A list of participating dealers will be supplied to any government agency upon request or is available on our website at www.gunlocke.com.
25. **Preventative maintenance:**
Not applicable. Instruction sheets available upon request.
26. **Environmental attributes:** Gunlocke has an active environmental program. Please call (800) 828-6300 for details.
27. **Data universal number system:**
(DUNS) number is 19-993-6550
28. **CCR registration/Cage Code:** The Gunlocke Company is registered in the DoD CCR. Cage Code - 26574
29. **Returns:**
No returns of goods will be accepted without written consent and shipping instructions from Gunlocke, and the Government customer will be required to pay all return freight charges. A restocking fee of 30% net will apply on all authorized returns provided Gunlocke receives goods in the condition in which they left the factory. No credit will be given if goods cannot be reused. Special order items are in no event subject to return. Goods must be returned within 70 days of shipment from factory.
30. **Cancellations:** No charge prior to production. After production has begun (5 days ARO), only the actual costs that the contractor can demonstrate will be billed to the customer if the merchandise cannot be resold within a reasonable period of time (90 days).
31. **Inside Delivery:** Gunlocke rates are for dock-to-dock delivery and do not include inside delivery, un-cartoning or set up. If desired, arrangements for inside delivery must be made and approved when the order is placed and will have a corresponding fee of 7% of list price of the order with a minimum charge of \$75. Requests for un-cartoning and set up will be coordinated with a Gunlocke Dealer with applicable charges applied to the order.
32. **Federal Tax ID # 22-3887942**

12 YEAR WARRANTY

Subject to the limitations set forth below. The Gunlocke Company warrants to the original purchaser all product in this price list to be free from defects in material and workmanship for a twelve year period from the date of shipment. This 12-year warranty applies to all products sold and installed by a Gunlocke authorized agent for normal commercial single shift service. Gunlocke will repair, or at its option, replace defective merchandise, free of charge. The following components not manufactured by Gunlocke have the following warranties:

- **High wear components** such as casters and glides are warranted for five years after date of shipment to original owner.
- **Electrical components** warranted 10 years from date of manufacture with exception of lamps and ballasts which are not warranted. This includes Fluorescent Tasklights.
- **LED tasklights** are warranted for 3 years from date of shipment to original owner.
- **Drawer suspensions** are warranted for lifetime of product after shipment to original owner.
- **Personal corners** including covering (leather) are warranted for three years of single shift and normal use after shipment to original owner.
- **Height adjustable electrical components** are warranted for five years of single shift and normal use after shipment to original owner.

Any non-standard material selected by the customer is not warranted. Neither does this warranty apply to damage resulting from accident, alteration, or misuse, as well as damage from normal wear and tear such as dents, nicks, scratches, fading and improper maintenance. That is, Gunlocke's warranty is only valid if products are given proper use and care. Gunlocke assumes no responsibility for product damages resulting from improper installation or user modification.

WOOD FURNITURE

Wood owes its inherent beauty to variations in color, grain, and texture, and therefore, these variations are not considered defects. There may be minor variations from one piece of furniture to the next even though they are finished at the same time. Exposure to light and the aging process will cause a darkening of natural wood products. Light finishes on wood products do not mask the natural characteristics of wood. The Gunlocke Company does not guarantee the exact matching of grain, pattern, and color.

These finishes do not cover any of the natural characteristics of the wood, including nature's colorations, pitch pockets, and the variations of steambent wood. Merchandise will not be replaced because of these natural variations.

It is expressly understood and agreed that the buyer's sole and exclusive remedy for any and all losses or damages resulting from nonconforming goods, or from any other cause, shall be repair or replacement of defective parts, and that Gunlocke shall not be liable for damages or injury to persons or property, nor for replacement of the entire commercial unit, if repair or replacement of defective parts can reasonably render the unit conforming.

All warranty claims must be made in writing by the original owner. Owner may be required to produce the invoice or other evidence to establish that a claim is within the warranty period. Warranty claims may be submitted on the Gunlocke website.

<https://apps.gunlockeadvantage.com/QualityFeedback/>

As stated and illustrated on the website, serial numbers are required to process a warranty claim. No person, firm or corporation is authorized to assume for Gunlocke any liability in connection with the sale or installation of Gunlocke products except as stated above.

All other warranties, expressed or implied, are excluded. Gunlocke shall not be liable for incidental or consequential damages of any sort.

Within the Continental USA, all orders above \$20,000 list are shipped FOB factory, freight prepaid and allowed. All orders less than \$20,000 list will be subject to a \$200 net freight charge. Products shipped to Alaska and Hawaii FOB factory, freight prepaid and allowed to port of embarkation. Customer is responsible for freight charges from port of embarkation to final destination.

An anticipated shipping date is indicated on the order acknowledgment. Gunlocke cannot accept responsibility for shipping delays caused by outside sources or unforeseen problems. Delay of shipments requested by customers must be approved by Gunlocke. Any resultant storage charges will be charged to the customer.

Gunlocke may await completion of the entire order and ship all at once or may make partial shipments from time to time at its sole discretion unless the customer requests in writing that partial shipments are needed and Gunlocke approves the specific shipping schedule. Additional charges may apply.

Gunlocke is not liable for any delay or failure to deliver or perform due to strikes, lock-outs, or other labor or transportation difficulties, delay of sources or supply, accidents, fires, acts of God, or any other causes of like or unlike nature beyond the control of Gunlocke.

LIABILITY

Gunlocke products and their packaging are tendered to a transportation company only after passing rigid quality control inspection. At that time, title to the product is passed to the purchaser. However the transportation company assumes all liability from acceptance of shipment through its delivery. That is, Gunlocke's liability ceases at the time of shipment.

FILING OF CLAIMS

All claims for damage or loss must be submitted via our website at: <https://apps.gunlockeadvantage.com/QualityFeedback/> within 15 days after receipt of merchandise. Do not return freight damaged merchandise to Gunlocke. Follow the steps below to expedite processing and resolution of claims.

For Visible Damage

1. Make damage notation on delivery receipt and have driver sign. Do not reject or refuse the shipment.
2. Immediately contact Gunlocke Traffic Department at 585-728-8268.
3. Hold damaged carton and all interior packing for carrier's inspection. These materials will be needed to substantiate the claim.

For Concealed Damage

1. Open cartons within 15 days of receipt and inspect.
2. Follow steps 2, and 3 as listed under Visible Damage.
3. Do not remove product from delivered destination.

For Loss

1. Be sure loss notation is made on delivery receipt and have driver sign.
2. Contact Gunlocke Traffic Department at 585-728-8268.

Should transportation company seek to limit its liability on concealed, loss, or damage claims, please contact Gunlocke's traffic department. After a thorough investigation of the claim, the traffic department will provide you with guidance in corresponding with the carrier.

Returned merchandise, regardless of delivery method, will not be accepted unless specifically authorized by Gunlocke.

For Damage or Loss of Parcel Post or UPS Shipment

Notify the Gunlocke traffic department immediately at 585-728-8268.

NORMAL DELIVERY

All normal ground transportation by Gunlocke will be made on a dock-to-dock basis. The Gunlocke traffic department will determine the recommended method of shipment according to the ship to destination. If the delivery on a shipment takes longer than 2 hours to be unloaded, an additional charge will be billed at \$60/hour at 15 minute increments. Gunlocke reserves the absolute right to determine the method of shipping unless special delivery instructions have been previously approved.

Gunlocke will make every effort in honoring delivery requests as stated on orders. However, the Company shall have no liability for failure to deliver, perform or delay in delivery due to any cause outside the control of Gunlocke. The Company assumes no liability for costs incurred due to delayed or late deliveries.

If a guaranteed delivery time is needed please call Gunlocke Traffic Department at 585-728-8268 for a quote as additional charges will apply. Weekend or after hours deliveries are subject to additional charges.

WEEKEND DELIVERY

A \$500 charge will apply on weekend delivery after 3:00 PM Friday through Sunday evenings.

DROP SHIP / JOB SITE DELIVERY

Orders under \$50,000 list will incur a \$125 charge for ship to locations other than a designated dealer warehouse.

INSIDE DELIVERY

Inside delivery must be noted on order. A minimum \$100 charge will apply.

SPECIAL DELIVERY

Please contact the Gunlocke traffic department for special delivery services such as inside delivery, weekend or after hour deliveries, reconsignment or other special needs. These are billable services.

Gunlocke will make every effort in honoring delivery requests as stated on orders. However, the Company shall have no liability for failure to deliver, perform or delay in delivery due to any cause outside the control of Gunlocke. The Company assumes no liability for costs incurred due to delayed or late deliveries.

DOCK RESTRICTIONS

Gunlocke trailers are 53' x 102"; when attached to truck cab the total length is 75'. If delivery dock will not accommodate trucks of this sizes, the Gunlocke traffic department must be contacted prior to shipping. Alternate arrangements can be made; additional charges may apply.

CREDENTIALS CASEGOODS

Credentials is offered in three select veneers and two premium veneers. All exposed surfaces utilize select plain sliced Cherry, Maple or Walnut veneers or premium Quarter Cut Walnut or Rift Cut Oak veneers.

Specialty Finishes:

- Gunlocke so that a finish formulation can be developed to match the special finish and color.
- Review the approval sample provided by Gunlocke.
- Written approval and sign off is required for Gunlocke customer service.
- Once written approval and sign off is received, the special finish order will be acknowledged.

Note: See Gunlocke Advantage website for special finish request forms.

All Casegoods & Tables Purchase Orders:

- 10% list upcharge per wood unit to base veneer option receiving special finish.
- \$250 net formulation fee for special finish.

Note: This procedure and related costs apply to new and previously formulated special finishes. Special finish orders may receive additional lead time.

UV TOP FINISH

Credentials worksurfaces feature two low emitting UV finish options that enhance the beauty of natural wood and ensures the depth, clarity, color consistency and durability throughout the life of the product.

UV finish options

Full-fill Cleartech (upcharge)	FF
Open Pore Low Sheen	OP

CREDENTIALS VENEERS

veneer 1 (select)

Plain Sliced Cherry
Plain Sliced Maple
Plain Sliced Walnut

veneer 2 (premium)

Quarter Cut Walnut
Rift Cut Oak

NOTE: For FSC Certified Product add "FSC" to beginning of finish option code. Example: FSCNC260. A 5% list upcharge will be applied per unit ordered with FSC option.

EDGE DETAILS – square

profiles/cope

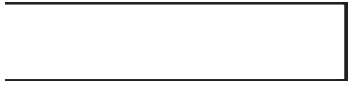

PULL OPTIONS

Credentials is available in a metal pull and an integral wood finger pull.
The metal pull is available in an anodized silver and dark bronze finish.

METAL PULL

Top Mount
-Top of pedestal fronts

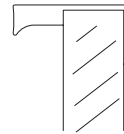
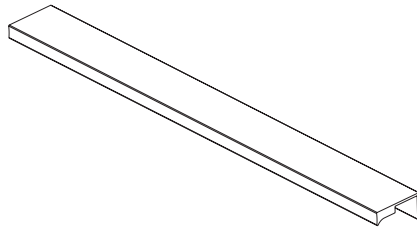

Face Mount
-Face of closet/storage doors

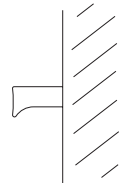
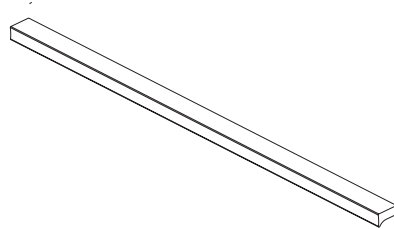

INTEGRAL WOOD PULL

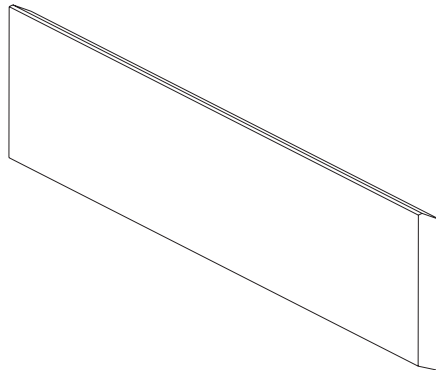

PEDESTAL LEGEND

NOTE: Left hand pedestals shown below.

FULL HEIGHT

[---]= (HIDDEN BOX DRAWER)

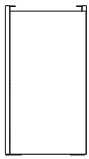

-X
FALSE



-2
FILE

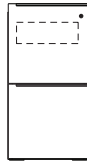

-3
(BOX)
BOX
FILE

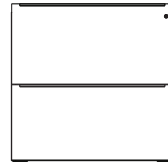

-4
LATERAL
LATERAL

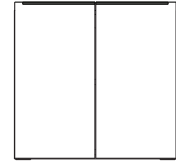

-5
HINGED DOOR

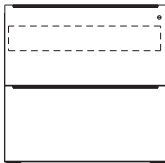

-7
(BOX)
BOX
LATERAL

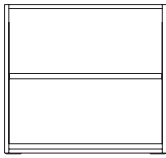

-SH
OPEN SHELF

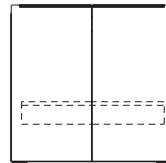

-P
PRINTER PED

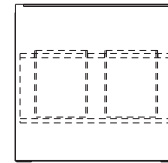

-T
TRASH RECEPTACLE
INCLUDES 2 TRASH CANS

LAYERS HEIGHT

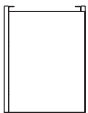

-X
FALSE



-A
(BOX)
FILE

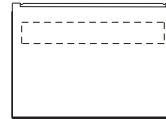

-B
(BOX)



-5
HINGED DOOR

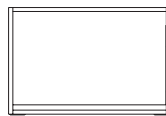

-SH
OPEN SHELF

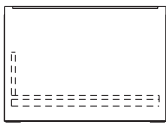

-P
PRINTER PED

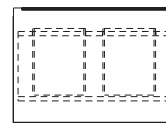

-T
TRASH RECEPTACLE
INCLUDES 2 TRASH CANS

MOBILE PEDESTAL

-Optional Face Lock

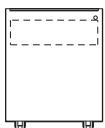

NOTE: LEATHER BOX DRAWER INSERTS MUST BE ORDERED SEPARATELY.

STANDARD FILING OPTIONS
WOOD PEDESTALS

15 wide file drawers

- A. Letter – side to side
- B. Legal – side to side

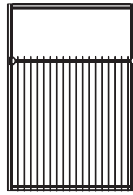

A

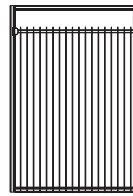

B

18 wide file drawers

- C. Letter – side to side
- D. Legal – side to side
- E. Letter – front to back

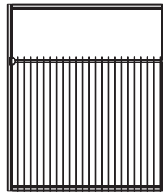

C

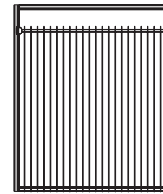

D

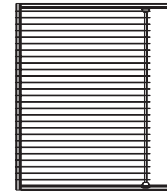

E

30 wide file drawers

- F. Letter – side to side
- G. Legal – side to side
- H. Letter – front to back

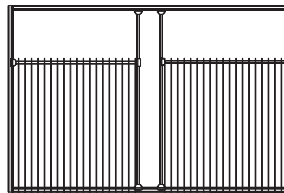

F

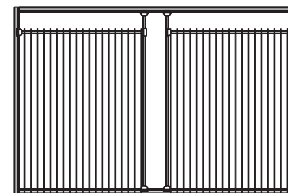

G

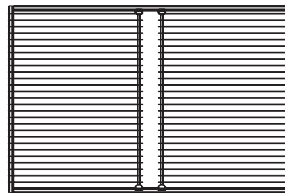

H

36 wide file drawers

- I. Letter – side to side
- J. Legal – side to side
- K. Letter – front to back
- L. Legal – front to back

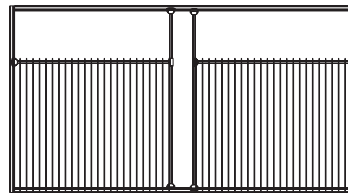

I

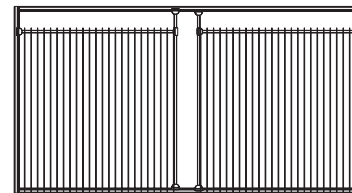

J

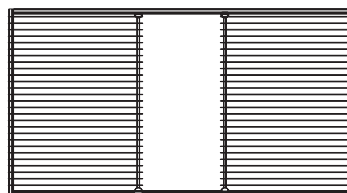

K

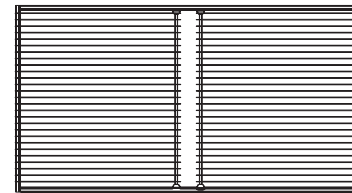

L

INSIDE DRAWER DIMENSIONS

WOOD DRAWERS

Pedestal width	Drawer type	D	W	H
15 letter width	24 box	14 1/16	11 3/8	3 1/4
	24 file	17 1/16	11 3/8	9 1/8
18 letter width	30 box	14 1/16	14 3/8	3 1/4
	30 file	17 1/16	14 3/8	9 1/8
30 width	box	14 1/16	26 3/8	3 1/4
	lateral	17 1/16	26 3/8	9 1/8
36 width	box	14 1/16	32 3/8	3 1/4
	lateral	17 1/16	32 3/8	9 1/8

LOCKS & KEYING

Locks are standard on all below worksurface storage units. Two lock options are available. When the factory installed lock option is selected lock cores are installed at the factory. Note: when the random option is selected some units may be shipped with the same key number. When the field installed lock option is selected each unit is shipped with an empty lock cylinder. Locks are Silver or Black.

factory installed locks option code

Option 1

silver random keys	RMS
black random keys	RMB

Option 2 Specify a number between

SILVER Designated Keys	100TAS - 150TAS
BLACK Designated Keys	100ta - 150TA

Field installed locks are also available. When field installed locks are specified each unit is shipped with an empty lock cylinder. A separate line item must be ordered to receive the numbered lock cores for field installation. Field installed locks are available at an additional charge of \$5 list per lock core.

Field installed lock core set, specify model # and key number (add \$5 list per core):

	model number	Specify a number between
SILVER Designated Keys	ACLCKFLD	100tas - 200TAS
BLACK Designated Keys	ACLCKFLD	100ta - 200TA

Note: Add \$5 list per lock core.

Product Reference 13-31

- Features + Advantages 14-15
- Technical Specifications 16-18
- Worksurface UV Finishes. 19
- Height Reference. 20
- Desktop Leather Inlay and Glass Insert Locations 21
- Worksurface Veneer Grain Directions 22-23
- Grommets & Trough Locations 24-25
- Metal Pull Locations. 26
- Integral Wood Pull Locations. 27
- Specification Tips 28
- Wire Management 29-30
- Product Specifications. 31

ATTRIBUTE	FEATURE	ADVANTAGE
STYLE/DESIGN	Hand selected veneer	<ul style="list-style-type: none"> • Quarter cut walnut and plain sliced cherry, maple, and walnut • Rift cut oak
	Refined aesthetic	<ul style="list-style-type: none"> • Clean, modern design • Layering and various planes • Refined details • Integral wood pull or metal pull • Mitered worksurfaces with waterfall veneer • Optional locking on all units
	High end material selection	<ul style="list-style-type: none"> • Stone • Leather • Back painted glass • Stainless steel desk base • Dark bronze and champagne silver hardware
PLANNING FLEXIBILITY	Large breadth of line	<ul style="list-style-type: none"> • Numerous components can be used together to create a variety of planning requirements for size and storage
FUNCTIONALITY	Accessory track/trough system	<ul style="list-style-type: none"> • Provides sit-to-stand solution in office • Electric driven system with three preset heights • Height range of 29.5"-42" • Integrated in mitered wood base • Charcoal black metal shroud for clean aesthetic in up position
STORAGE	Soft close hardware	<ul style="list-style-type: none"> • Hidden bottom mount suspension on soft close drawers • Soft close hinges on all doors
	Cantilevered worksurfaces	<ul style="list-style-type: none"> • Provides unique aesthetic and conferencing end
	Magnetic tackzone	<ul style="list-style-type: none"> • Backpainted glass and wood tackzone provide magnetic surface for posting papers and magnetic accessories
	Hidden box drawers	<ul style="list-style-type: none"> • Provides clean lines and fewer fronts • Includes veneered front • Optional leather inserts
	Overhead door options	<ul style="list-style-type: none"> • Hinged, soft lift, or sliding door overheads
	Various pedestal options	<ul style="list-style-type: none"> • Drawers, doors, open shelves, printer storage, and trash can

ATTRIBUTE	FEATURE	ADVANTAGE
TECHNOLOGY INTEGRATION	Wire management	<ul style="list-style-type: none"> • Worksurface trough with pencil lip • Flush grommet with door options
	Wall access	<ul style="list-style-type: none"> • Optional hinged wall access panels provide simple, clean wire management
	Lighting	<ul style="list-style-type: none"> • Standard high efficiency LED tasklighting • Recessed into bottom of overhead for clean aesthetic
	Worksurface power	<ul style="list-style-type: none"> • Power unit can be installed beneath grommet, in worksurface trough or in kneespace for easy access
SUSTAINABILITY	Design for the environment	<ul style="list-style-type: none"> • FSC certified products available • LEED IEQ 4.5 compliant finish • High percentage of recycled content: 66% post industrial and 9% post consumer yielding an RC value factor of 42% • Energy Efficient LED task lighting
DURABILITY	Drawer system	<ul style="list-style-type: none"> • Dowel construction—strength • Superior filing capability—extruded file rail integral to drawer • UV finish on drawers—scratch and chemical resistant • 5-sided drawers—can adjust or remove in field without unloading drawers
	Optional full fill or open pore finish	<ul style="list-style-type: none"> • UV cured finish on worksurfaces—durable top coat • Robotic sprayer—uniformity of finish • Depth, clarity, color consistency, and durability
	12-year warranty	<ul style="list-style-type: none"> • Backed by Gunlocke's 12-year warranty

veneers

All exposed wood surfaces utilize select Plain Sliced Cherry, Maple, Walnut veneers or premium Quarter Cut Walnut, or Rift Cut Oak veneers. These veneers are carefully selected and slip matched to assure balance and consistency.

WOOD TOPS

Wood veneer tops feature a balanced 3-ply construction and are 1 1/2" thick. Each top has a 3/32" thick external solid-wood band on all sides.

Standard tops are constructed of 45 lb particleboard.

Tops connect to the chassis with wood screws through the inset top panel of the pedestals and steel angle brackets.

CHASSIS/PEDESTAL CONSTRUCTION

All wood pedestals are made with veneer end panels and fronts which are constructed with 3/4" thick balanced 3-ply panels. End panels are connected with an inset top, back, and bottom panel which is made of 3/4" thick 3-ply particle board. Panels are securely fastened together with cam fasteners in conjunction with solid wood dowels that are securely adhered with PVA (white polyvinyl acetate) glue. A 1 1/16"H x 2 7/16"W 3-ply particle board is mounted to the underside of the inset bottom panel. A threaded steel glide plate is attached to the hardwood stretcher to provide a durable connection between the glide and the bottom of pedestal. The glide plate is 10-gauge or 0.134" thick steel.

Steel glide plates are attached to single end panels with screws. End panels are pre-bored to accept the stem of the glide. The threaded steel glide plate provides a durable connection from glide to bottom of unit end panel.

Each unit is equipped with a minimum of four adjustable glides.

OVERHEAD/STORAGE CONSTRUCTION

All wood panels are constructed with 1" thick balanced 3-ply panels. The top, end, and bottom panels are securely fastened together with wooden dowels that are adhered with PVA (white polyvinyl acetate) glue. This construction method eliminates any visible assembly fasteners.

Wall mount cabinets are mounted to the wall with a spade and "Z" bracket attachment method. Steel barrel nuts and spade brackets are securely mounted through the back of wall mount cabinets. All units ship with a steel Z bracket. This bracket is mounted to the wall by field installers. Installers are responsible for selecting and supplying appropriate fasteners for wall conditions.

Units with hinged doors include 95° soft close hinges. Hinges are fully adjustable.

LAYERS UNITS

All layers runoffs and bridges include a wood box to sit on the low height credenza unit. Layers box includes a protective non-skid strip on bottom edge to protect lower worksurface. Layers units provide 7 3/4" of height difference.

GLIDES

Glides provide 1 1/8" of vertical leveling adjustment. Glide bottom is durable nonrust nylon.

DRAWERS

All drawers are constructed of four sides and a bottom, which are attached to a drawer front with screws for easy removal. Drawer fronts feature matched veneer within each pedestal set.

The drawer side material is vinyl-clad particleboard, finished with a roll-coated 7-level UV cured polyester/acrylic finish that provides a high level of chemical and scratch resistance. The drawers are fastened together at each corner with dowel joinery for maximum drawer

strength. The bottom material is a 3-ply substrate consisting of medium density fiberboard core with a melamine face and backer.

Optional leather organization trays are available for all box drawers.

PULLS

Units are available in a continuous metal pull or an integral wood pull.

The drawer front on credenza and return pedestals overlay the worksurface for an uninterrupted appearance. The drawer front on the desk pedestals are below the worksurface to keep main worksurface clean.

Integral wood pull is on a 35° bevel and provides a seamless wood look to the station.

Continuous metal pull is an anodized aluminum pull available in a dark bronze or champagne silver finish. The metal pull on pedestal fronts aligns with metal pull on 24D closets. The metal pull on overhead doors aligns with metal pull on 18D closets.

SUSPENSIONS

Credentials casegoods utilizes zinc-coated steel, high-grade drawer suspensions which feature an integrated soft close mechanism. The suspensions are bottom mount and are concealed under the drawer body for a cleaner appearance when opening/closing drawers. Box drawer suspensions are 15" depth full extension and are load rated for 100 lb static load, 90 lb dynamic load. File and lateral file drawers are 18" depth full extension and are load rated for 150 lb static load, 135 lb dynamic load. Lateral files include an anti-tip mechanism that prevents more than one drawer from being opened at the same time.

HINGES

Units with hinged doors include 95° soft close hinges. Hinges are fully adjustable.

FILING

The file hanging system is an integral part of the drawer. A highly durable black plastic extrusion is securely fastened into a route on the top of the drawer. The plastic extrusion and steel folder rails allow side to side and front to back filing in file and lateral file drawers. The plastic extrusion was designed to promote optimum filing capacity within the drawer while providing a durable, reliable and maintenance free filing system. (See filing capability section for technical information on drawer dimensions.)

LOCKS

Silver or black face locks are optional on all desks, credenzas, returns, modular pedestals, and storage units. Each pedestal is independently locked. Lock plugs are either factory or field installed.

KEYING

Keying is available either factory or field installed. Factory installed keying offers two options: random or designated. When the random keying option is selected an arbitrary key number will be assigned to the unit. Note: some furniture units may have like key numbers when random keying is selected. When the designated keying option is selected a key number must be specified between 100TAS-150TAS for silver lock core and 100TA-150TA for black lock cores. All keys are solid brass. When the field installed keying option is selected, a lock cylinder will not be included in the furniture unit.

WIRE MANAGEMENT

Wire management capabilities include optional worksurface grommets and worksurface troughs. Chassis include wire cutouts in kneewell for seamless wire management between pedestals and adjoining units.

Trough worksurfaces provide a 1" wire management gap on the back edge of the worksurface. An anodized aluminum pencil lip is included with each trough worksurface. The tackzone sits below the worksurface on the top edge of the pedestal end panels. A trough worksurface is REQUIRED for all tackzone applications.

Under worksurface wire managers (Model #ACWM) are sold separately to conceal wires between pedestals. These units house and manage wire horizontally around a station.

Wall access is accommodated in credenza, bridge and return units. Two options are available. (1) No modesty panel provides direct access to wall. (2) The hinged access panel option provides access to the wall as needed, creates a cavity behind the panel to mount a power strip (not provided) and houses cords behind panel. The panel hinges and clips on and off to provide occasional access as needed.

POWER UNIT

A power unit may be ordered separately to add integrated power to the station. The unit includes 3 power outlets – 2 power outlets on top surface and 1 power outlet on the end. Ships with 6 ft power cord with standard plug. UL listed.

The unit can be mounted in various applications: 1) to bottom of worksurface beneath grommets, 2) to bottom of worksurface in trough opening, 3) as power strip inside wall access panels or kneespace.

TECHNICAL SPECIFICATIONS**GROMMET**

3.250" x 5.875" rectangular grommet. Grommet bezel is inset flush to top of worksurface. Includes a hinged door that is on a dampening hinge for smooth open/close. Door material may be specified as wood veneer or back painted glass.

LIGHTING

Recessed low-profile LED overhead lighting is standard and INCLUDED in all overhead cabinets. They do NOT need to be purchased separately. LED lighting provides high efficiency, low energy lighting with a long life. All LED light strips are encased in a silver aluminum extrusion and include a built-in microswitch to turn the light on/off. Lights are field installed. All units include a 10' cord with a standard plug. Light temperature is 3200K.

MONITOR ARM

Monitor arm is EVO2. Monitor arm is silver finish. Monitor arm can be mounted inside grommet hole, desktop trough, or clamped to edge of desk.

Product specs are listed below:

Vertical range: +/- 5.2" from horizontal

Horizontal range: 18.6"

Rotation: 360° at two joints, 180° from center

Monitor tilt: 90° up, 20° down from center

Monitor pivot: Landscape to portrait

Monitor compatibility: VESA monitor compatible - 75mm & 100mm VESA adapters included

Cable management: Cables are managed beneath arm

Mounting options: Desk clamp, grommet mount, or trough mount

Monitor weight: 7-20lbs

ACCESSORIES

All accessories include imbedded magnets and can be positioned anywhere on wood tackzone and back painted glass tackzone. The accessories provide quick access to files, pencils, and other work utensils. Units are painted standard white, muslin, and black to match glass colors.

PERSONAL CORNER + DESKPADS

Personal corners can be used between two perpendicular worksurfaces to create an ergonomic corner for user. Deskpads are used in-line. All units are wrapped in leather or vinyl. The bottom surface has a felt lining to protect the worksurface. The chassis is made from 10-gauge aluminum. Personal corners are 36"W x 12 1/2"D. Deskpads are 36"W x 18"D. Units are designed to fit over 1 1/2" thick worksurfaces. Desk inlays are Dolce faux leather and are available in three colors.

ORGANIZATIONAL TRAYS

Leather organization trays can be used in box drawers and in cubby of 1H overheads. All units are wrapped in leather. The bottom surface has a protective felt lining.

STAINLESS STEEL BASE

Stainless steel base units include a brushed stainless base. Unit is constructed of 1 1/2" square stainless steel tubing. Units are fully welded for seamless construction.

Three top options are available – 1) wood top, 2) stone top, 3) back painted glass top. Units with a wood top are rabbetted into base with a 1/2" top exposed on all sides. Back painted glass tops and stone tops include a recessed plywood subtop for glass/stone. Stone tops include a template for stone so it can be purchased locally.

TACKBOARDS

Tackboards are constructed of 7/8" thick material comprised of a 1/8" thick hardboard glued in between a layer of 3/8" thick pressboard on each side. The fabric is precisely aligned and fitted to the tackboard and adhered to the rigid hardboard with staples.

A trough worksurface is REQUIRED for all tackzone applications.

BACK PAINTED GLASS

Doors and tackzone back painted glass units are captured by an extruded aluminum mitered frame which is powder coated to match. Frame is 3/4" thick and 1 3/4" high. The frame is low profile allowing only 1/16" visible frame around the perimeter of the glass from the front view. Back painted glass is 4mm thick and is available on doors, and in the "tackzone" of overhead storage. Tackzone glass units are magnetized with a steel backer. These units can also act as a whiteboard with use of dry-erase markers. 6 magnets are included with each magnetized whiteboard.

Worksurfaces and desktop inserts in back painted glass are frameless and are acid etched to eliminate fingerprinting.

A trough worksurface is REQUIRED for all tackzone applications.

CLEANING BACK PAINTED GLASS

All back painted glass should be cleaned with a soft lint free cloth and non-ammonia based cleaner only.

FINISH

Natural veneer is subject to nature's quality control. Each species will exhibit differences in grain pattern and tone. This is to be expected and, in fact, contributes to the beauty and individuality of each product. Flat Cut veneers emphasize the variations of wood by exhibiting cathedrals in the grain pattern. Quarter Cut and Rift Cut veneers are a premium cut that maintains variations in the grain but without cathedral patterns. Stratawood is a natural, FSC®-certified reconstituted veneer that is designed to exhibit a straight-grain pattern, absent of cathedrals or other significant grain and tone variations.

Worksurfaces, desktops, and tabletops are protected by one of the world's most advanced UV cured finish coatings, available in Full Fill ClearTech® or Open Pore low sheen finish, applied by state-of-the-art finishing equipment. Both finishes meet the stringent requirements for VOC emissions and air quality. Cured in a specially designed ultraviolet oven, the finish fuses to the wood, forming a durable shield that provides a high level of scratch, stain, chemical, and heat resistance, plus a high level of clarity.

Chassis, storage, overheads, and veneer bases are finished with a 30 sheen, conversion varnish finish.

All colors and species are not available on all products. Please refer to front cover of price lists for availability of finishes.

For the technical specifications see the Finish System Guide & Technical specifications available at www.gunlocke.com/finishsystem.

CLEANING FINISH

Regular dusting and occasional cleaning are recommended to maintain your wood finish. To clean, dampen a soft cloth with luke warm water and gently wipe the wood in the direction of the grain. A mild solution of Murphy's oil soap and water may also be used. Avoid cleaners with oil, waxes, or silicones as they may create a hazy look.

Credentials worksurfaces feature two low emitting UV finish options that enhance the beauty of natural wood and ensures the depth, clarity, color consistency and durability throughout the life of the product.

OPEN PORE UV FINISH

The Gunlocke Open Pore UV Finish delivers a luxurious look-and-feel, while maintaining a high-level of durability and repairability.



- Open pore finish (natural texture of woodgrain is present)
- 20 sheen
- Solvent based UV cured finish with low emitting qualities
- Open pore finish allows for greater repairability

CLEARTECH™ FULL FILLED UV FINISH

The ClearTech™ finishing system is a full-filled UV finish that provides superior durability with strong water, chemical and heat resistance.



- Full-filled finish (provides exceptional depth and clarity)
- 40 sheen
- Solvent based UV cured finish with low emitting qualities
- Superior durability

STANDARD UNIT HEIGHTS FOR CREDENTIALS:

unit	height
Worksurface	1 1/2
Layers Pedestal	20 3/16
Layers Pedestal + Worksurface	21 11/16
2H Pedestal	27 15/16
2H Pedestal + Worksurface	29 7/16

unit	height
3H Storage	43 7/16
4H Storage	57 7/16
5H Storage	75 15/16
6H Storage	84 7/16
1H Overhead	19 1/2
2H Overhead	28

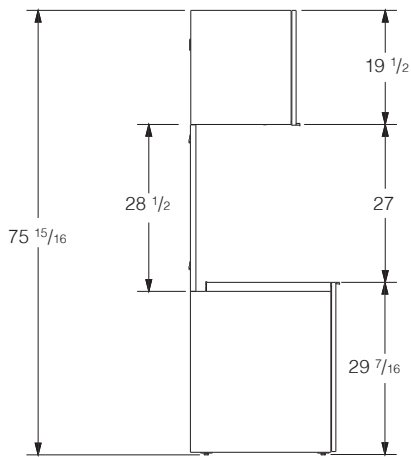

Standard Height Credenza
1 High Overhead

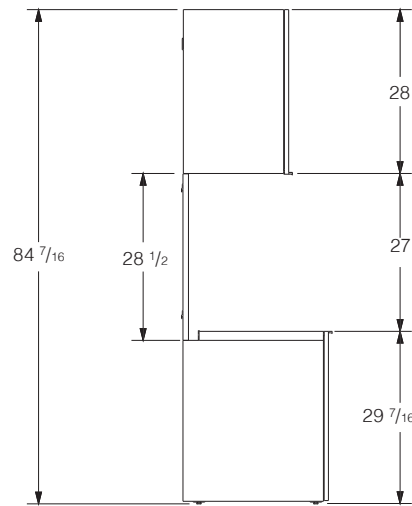

Standard Height Credenza
2 High Overhead

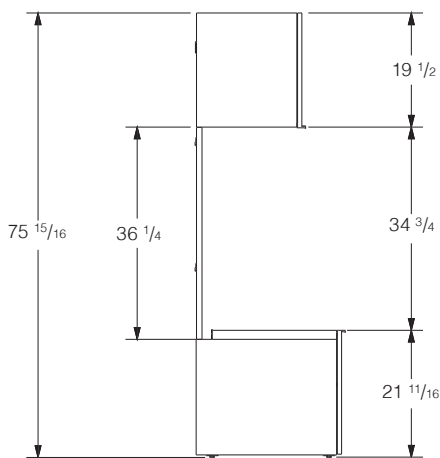

Layers Height Credenza
1 High Overhead

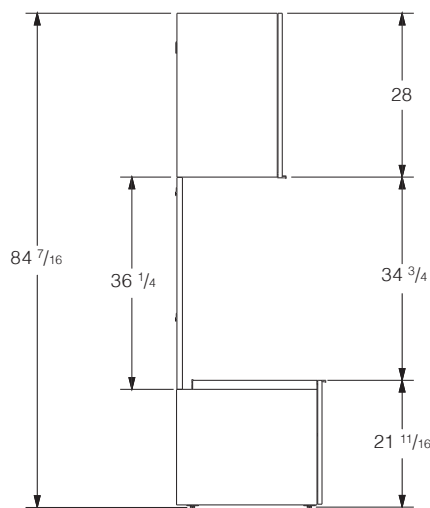

Layers Height Credenza
2 High Overhead

DESKTOP LEATHER INLAY AND GLASS INSERT LOCATIONS

Desks and Extensions are available with a Faux Leather inlay or a back painted glass insert.

option picks

Standard Veneer	TVN
Faux Leather Inlay	
White (+\$1,378)	TLW
Black (+\$1,378)	TLB
Chocolate (+\$1,378)	TLC
Back Painted Glass Insert (Acid Etched)	
Ice White (+\$1,929)	TGW
Black (+\$1,929)	TGB
Muslin (+\$1,929)	TGM

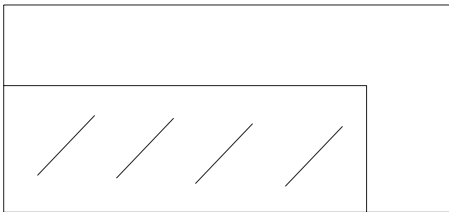

Freestanding Desk with Modesty Panel Base
(LH desk shown)
Ex. GA2DTRM3672L-3WW

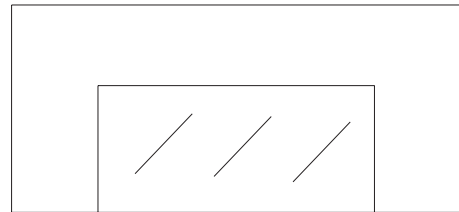

Freestanding Double Pedestal Desks &
Freestanding Miter Base Desk
Ex. GA2DRO3672-32WW
GA2DTRR3672-WW

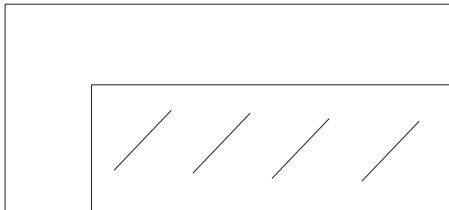

Freestanding Desk with Height Adjustable Base
(LH desk shown)
Ex. GA2DTRA3672L-WW

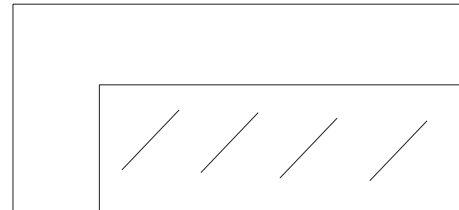

Single Pedestal Desks & All Extension Desks
(LH desk shown)
Ex. GA2DRO3672L-3WW

WORKSURFACE VENEER GRAIN DIRECTIONS:

Note: All vertical faces on chassis and storage are vertical grain.

FREESTANDING DESK

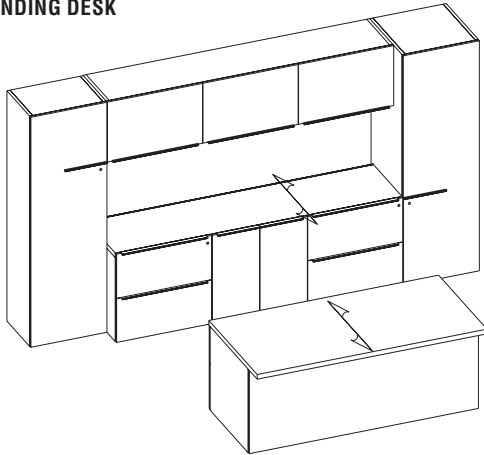

Freestanding Desk – short grain
Full Base Credenza – short grain

L STATION

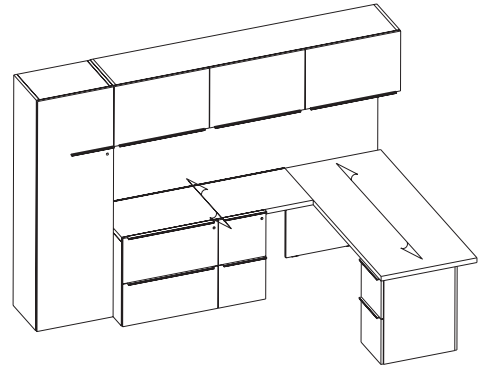

Single Pedestal Desk / Extension – long grain
Modular Return – short grain

U STATION

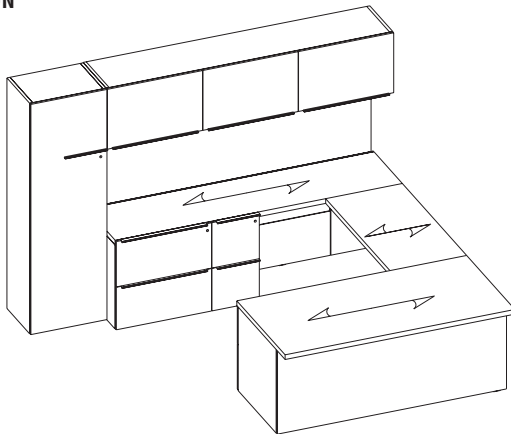

Single Pedestal Desk / Extension – long grain
Bridge –short grain
Modular Credenza –long grain

WORKSURFACE VENEER GRAIN DIRECTIONS:

Note: All vertical faces on chassis and storage are vertical grain.

LAYERS WORKWALL L STATION

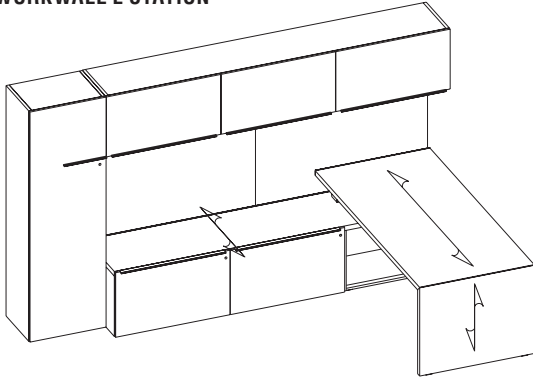

Layers Mitered Runoff Desk – long grain
Layers Full Bank Credenza – short grain

WORKWALL L STATION

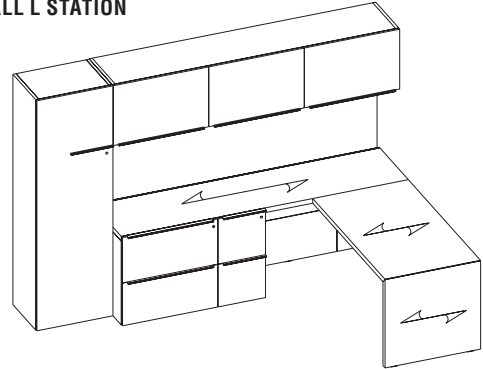

Mitered Runoff Desk – short grain
Modular Credenza – long grain

WORKWALL U STATION

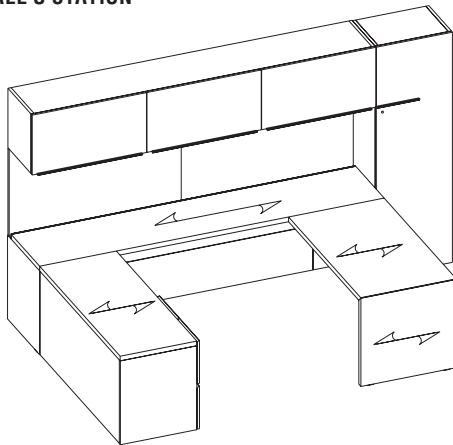

Mitered Runoff Desk –short grain
Modular Credenza – long grain
Modular Return – short grain

Credentials worksurfaces are available with an optional grommet.

- Grommet is recessed into worksurface and includes a dampening mechanism for smooth open / close.
- Grommet door cover is available in veneer or back painted glass.
- A 1" slot is included for cords and/or monitor arm clamps.

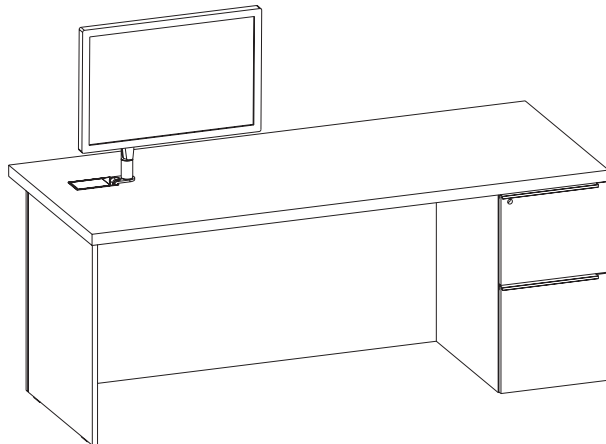

Grommet shown in Single Pedestal Desk with Monitor Arm

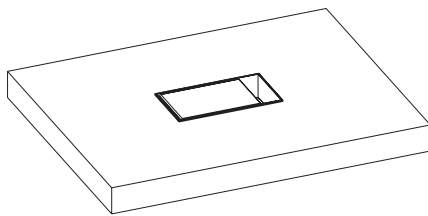

Grommet door closed

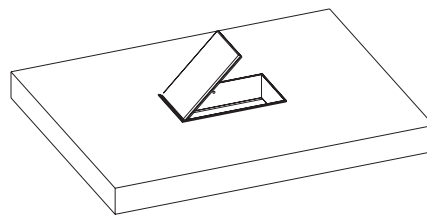

Grommet door open

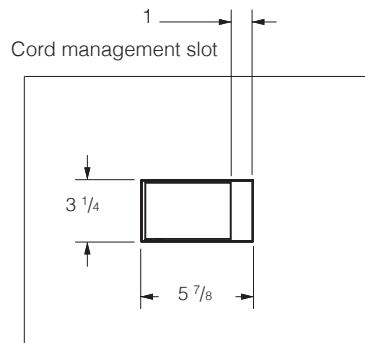

Grommet dimensions

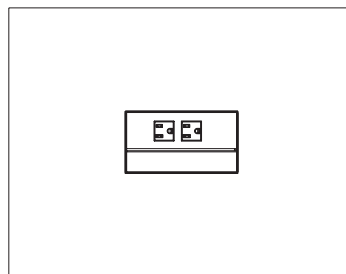

Top view shown with power unit – ACPWRT
ACPWRT must be ordered separately
(shown without door)

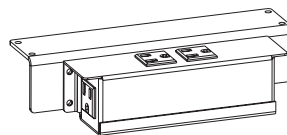

The worksurface trough is integral to the design and configuration of the product.

- The trough provides a 1 11/16" gap for cords, power access, and monitor arm clamping.
- All trough worksurfaces include a metal pencil lip.
- The tackzone is recessed into trough area – below worksurface level and sits on end panel of pedestal/chassis.
- Plastic Trough Insert is required and must be ordered separately across entire length of trough (see page 101 to order).

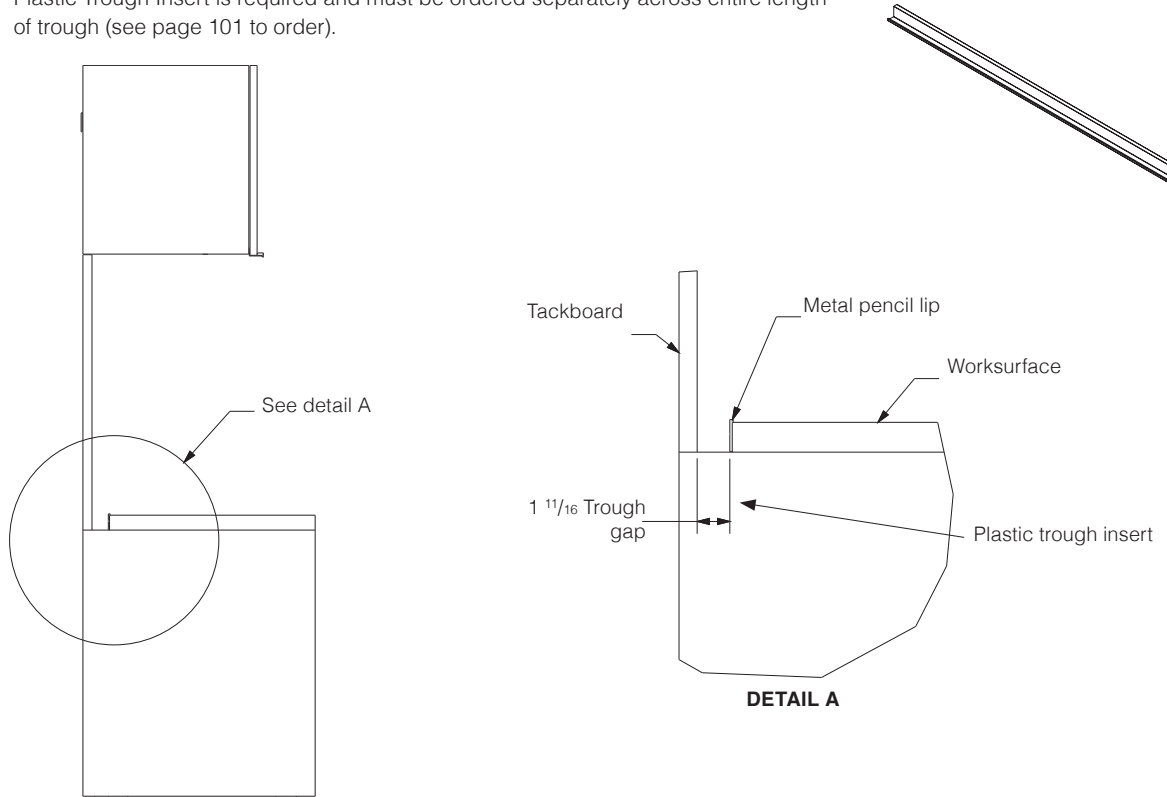

A trough worksurface is REQUIRED in ALL tackzone applications.

- The trough can be on a single worksurface or span across multiple units.
- In situations where the trough spans multiple units, each individual unit MUST be specified with a trough worksurface.

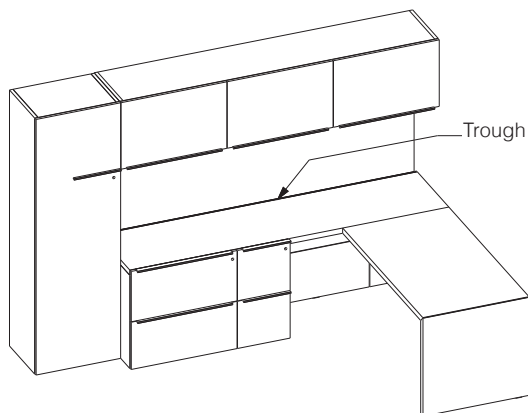

EXAMPLE 1:
Back edge of credenza

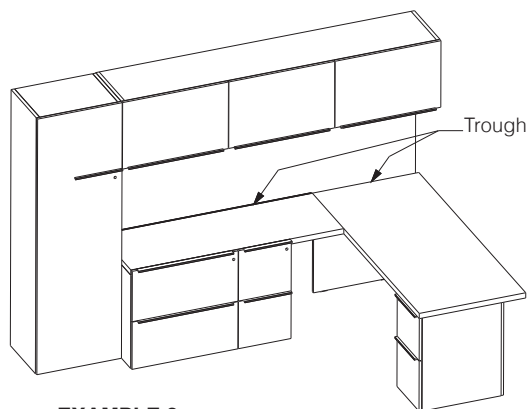

EXAMPLE 2:
Back edge of return
and
Left hand end of desk

METAL PULL LOCATIONS

Metal pull locations are shown below.

Left hand units shown where applicable.

DESK PEDESTALS

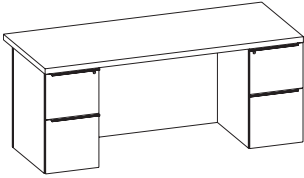

MODULAR PEDESTALS

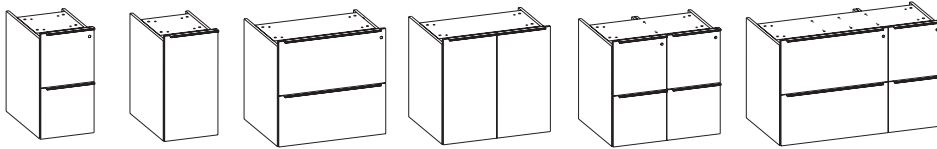

STORAGE

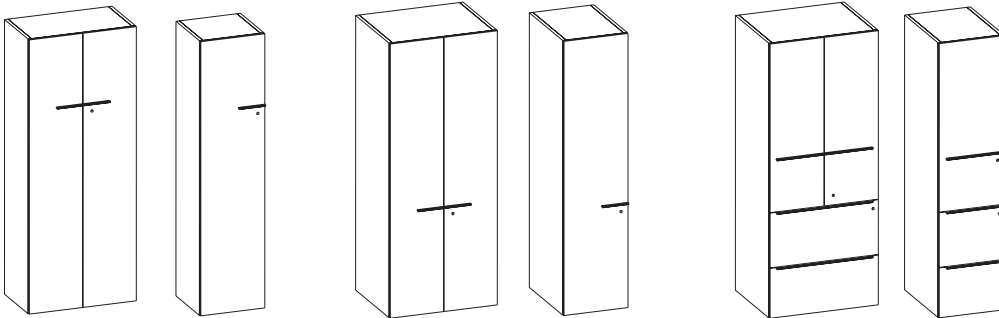

18D CLOSETS

24D CLOSETS

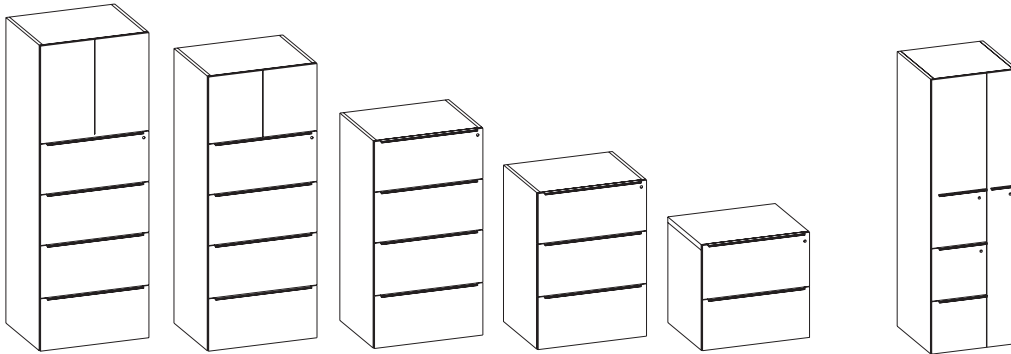

OVERHEADS

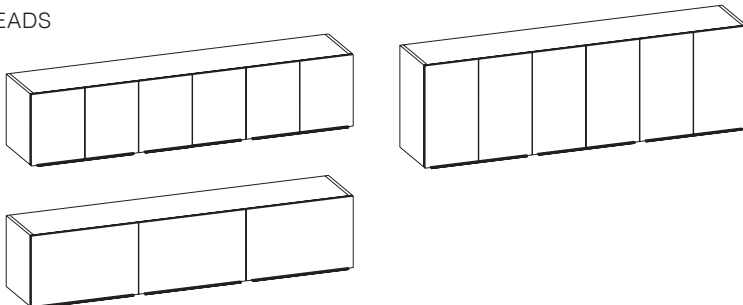

Integral wood pull locations are shown below.

Left hand units shown where applicable.

DESK PEDESTALS

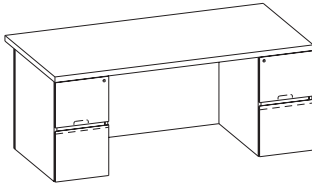

--- dashed line indicates bevel / hidden finger pull

MODULAR PEDESTALS

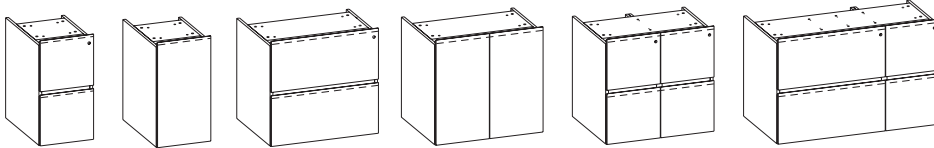

STORAGE

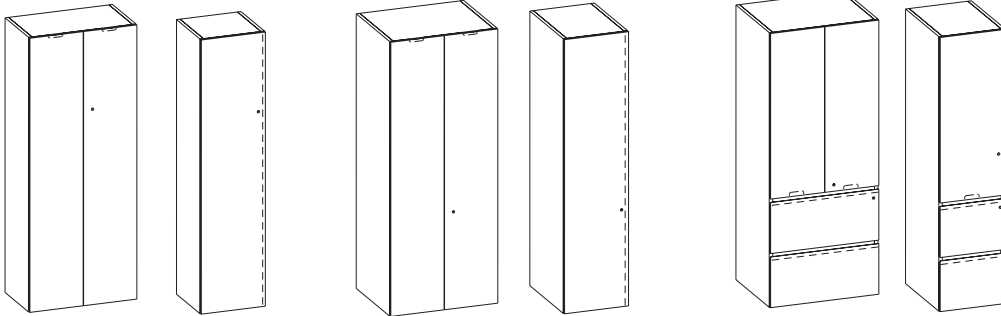

18D CLOSETS

24D CLOSETS

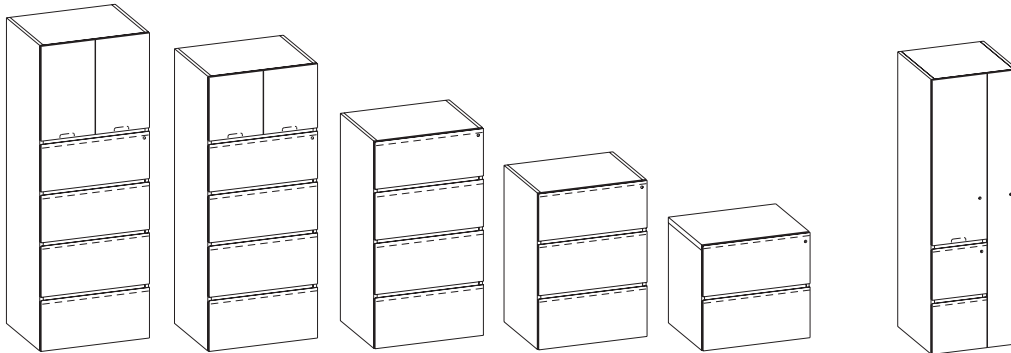

OVERHEADS

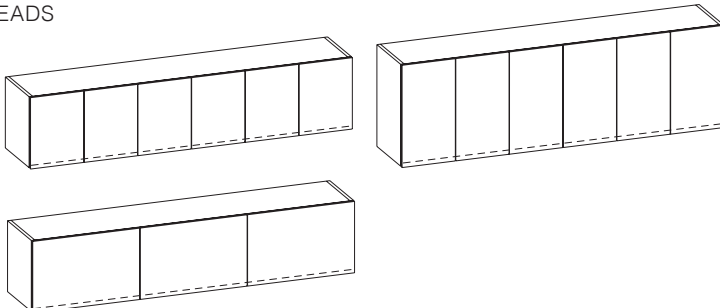

STEP 1: SELECT CONFIGURATION

FREESTANDING DESK

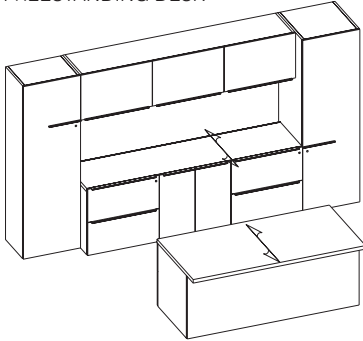

U STATION

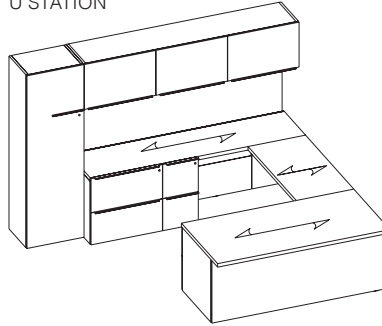

WORKWALL U STATION

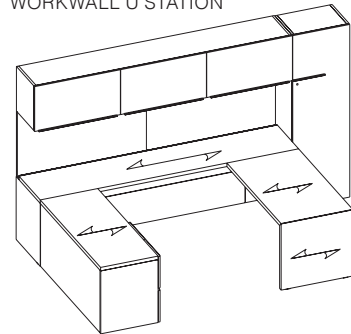

L STATION

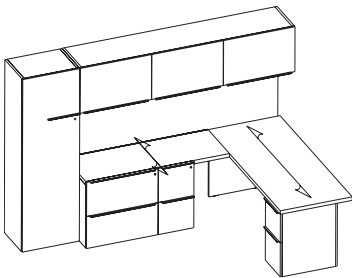

WORKWALL L STATION

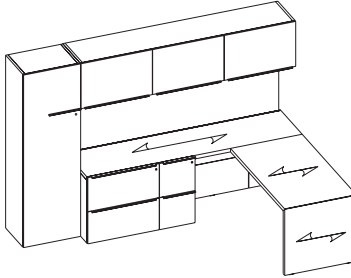

LAYERS WORKWALL L STATION

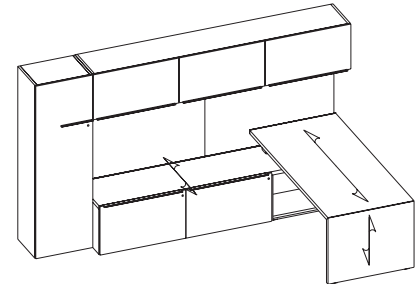

STEP 2: BEGIN WITH DESKING COMPONENTS

- Desk, extensions, runoffs, and full bank credenzas are unitized
- Credenzas and returns are built from modular components which must be specified separately

STEP 3: BE SURE TO SPECIFY TROUGH LOCATIONS ALONG ENTIRE LENGTH OF TACKZONE

- Plastic Trough Insert is REQUIRED and must be ordered separately across entire length of trough

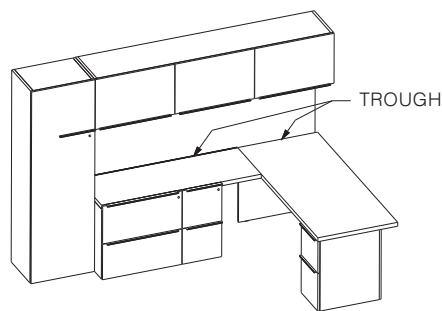
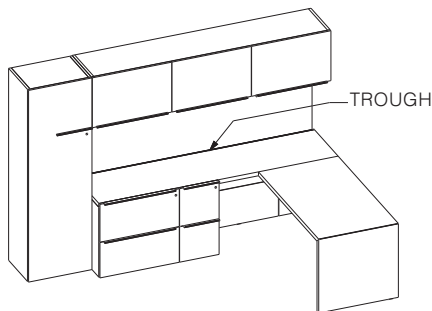

STEP 4: ADD FREESTANDING STORAGE

- Lateral files, bookcases, closets, storage box, and utility cabinets

STEP 5: ADD OVERHEADS AND TACKZONE

- Fabric tackboard, magnetic glass whiteboards, and wood tackzones are available
- Recessed tasklights are INCLUDED with all overhead cabinets

STEP 6: INSERT ACCESSORIES

- Leather box drawer inserts, power units, magnetic accessories, monitor arms, etc.

STEP 7: OFFICE # OPTION

- An office # option is included on all models ("OFC1" through "OFC199")
- Each individual office must be specified with its own unique office #
- All components for each office must be specified with the same office # option

GROMMET SPECIFICATIONS

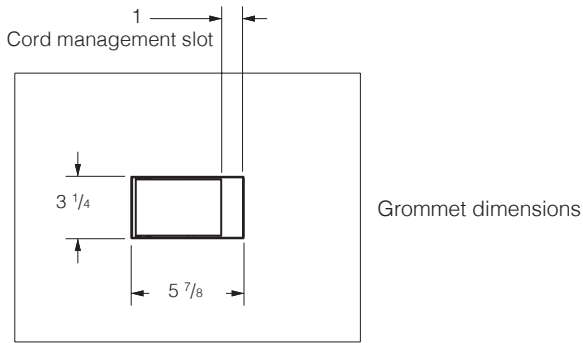

GROMMET LOCATIONS

Credenzas, Returns, Bridges

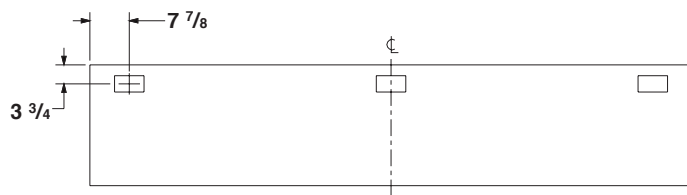

Pedestal Desks and Run-offs; Miter Desks, Extensions, and Run-offs; Slab Base Extensions and Run-offs

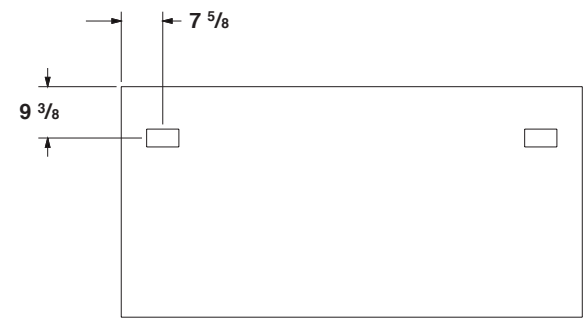

Stainless Metal Base Desks, Extensions, and Runoffs

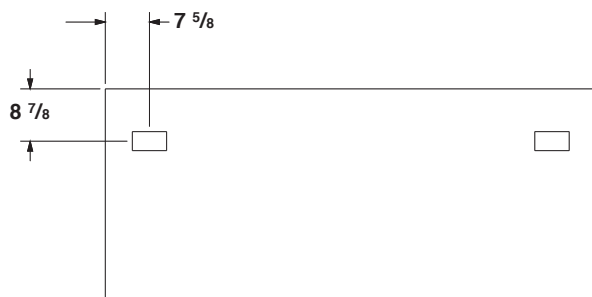

Layers Run-off Tops

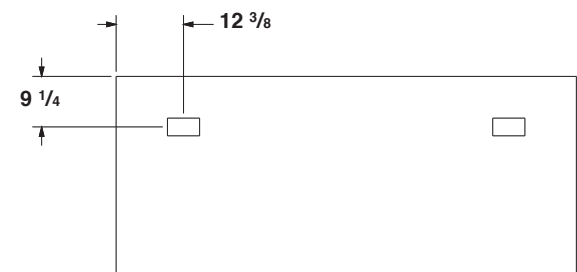

Height Adjustable Desks

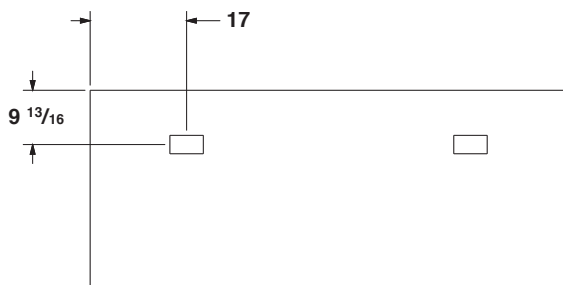

Height Adjustable Extensions

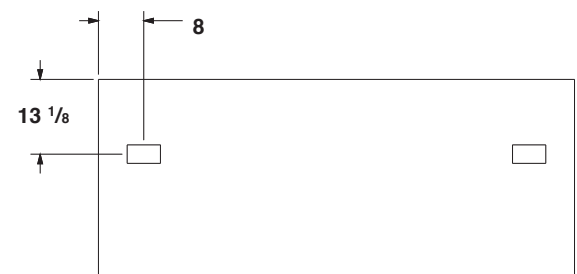

GROMMET LOCATIONS

Modesty Panel Base Desks

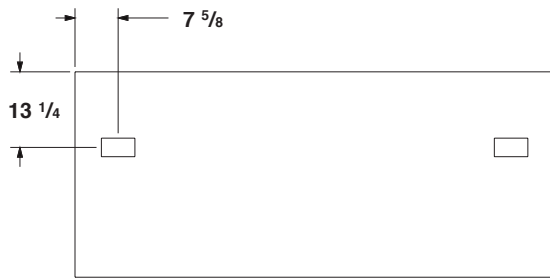

Modesty Panel Base Extensions (No Trough)

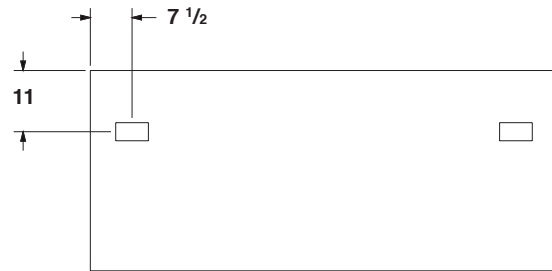

Modesty Panel Base Extensions (Trough End)

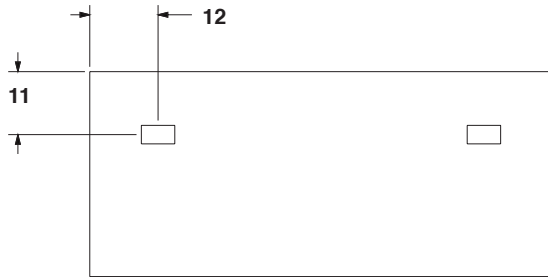

HEIGHT ADJUSTABLE WORKSURFACES

Worksurfaces are actual widths. A 1" clearance gap is required for any height adjustable top on all sides. Moving worksurfaces can collide with other components. It is important to ensure free range of motion prior to operating the table. Please contact Gunlocke's Tailored Solutions department (GUNTS) for special worksurface size requirements if standard models do not provide 1" gaps. Adjacent worksurfaces need to be self supporting. A wall mount bracket may be used.

HEIGHT ADJUSTABLE BASE

Electric height adjustable base unit is available in a 2-Stage lifting column with an offset C-Leg design. The height adjustable base is a compact 2-part lifting column. A lifting column is an electric linear actuator integrated into a stable guide. The sophisticated motor system is completely hidden inside the column. The control box is powered by 110-120V /60Hz. Standby power is 0.1 Watts. Height range is 29" to 45". Lifting columns are rated for 225 lbs. dynamic load per column and are connected to tops using steel support brackets. Pedestals taller than 24 H" when placed under the height adjustable table will limit range in lowest position.

HEIGHT ADJUSTABLE COMPONENTS

Height adjustable components include:

- Qty (2) height adjustable lifting columns
- Qty (1) control box
- Qty (5) keypad options from basic to premium
- Qty (2) cables connecting lifting columns to control box
- Qty (1) standard plug power cable to connect control box to power source

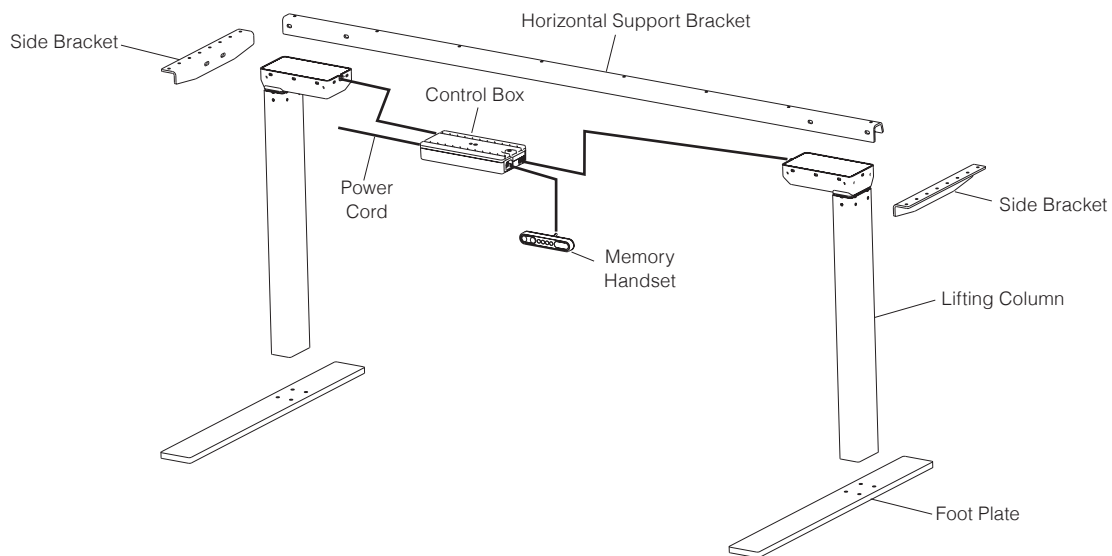

Unitized Casegoods 33-105

- Freestanding Table Desks 34-40
- Double Pedestal Desks 41
- Single Pedestal Desks 42-43
- Extensions 44-51
- Runoff Desks 52-57
- Bridges 58-59
- Credenza & Return Components 60-63
- Pedestals 64-75
- Layers Pedestals 76-87
- Modesty / Access / Support Panels 88-93
- Brackets / Storage 94-98
- Mobile Pedestals 99
- Cushions 100
- Trough Inserts 101
- Height Adjustable Desks 102-105

FREESTANDING TABLE DESKS

Stainless metal base

Credentials

05/22

WOOD TOP

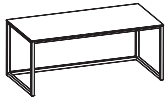

User Side

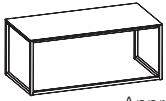

Approach Side

D	W	H	new model number	old model number	veneer 1	veneer 2
30	72	29 7/16	GA2DTRL3072-W	GAADTRL3072-W	9,315	10,247
36	72	29 7/16	GA2DTRL3672-W	GAADTRL3672-W	9,601	10,562
36	78	29 7/16	GA2DTRL3678-W	GAADTRL3678-W	9,890	10,879
36	84	29 7/16	GA2DTRL3684-W	GAADTRL3684-W	10,187	11,206

- Optional 10" height modesty panel with 6" overhang

PRODUCT INFO

Stainless base is 1.5" square stainless tube with brushed finish

Fully welded seamless assembly

1.5" worksurface is rabbeted into stainless base assembly - H" top thickness is visible on all sides

short grain veneer on worksurface

TO ORDER PLEASE SPECIFY THE FOLLOWING:

1.		MODEL NUMBER
2.		FINISH
3.		TOP UV FINISH TYPE
4.		MODESTY
5.		GROMMET
6.		OFFICE #

See inside front cover for required option codes

Example

GA2DTRL3072-W.NC215.FF.MY.GN.OFC1

GA2DTRL3072-W	NC215	FF	MY	GN	OFC1
MODEL NUMBER	FINISH	TOP UV FINISH	MODESTY	GROMMET	OFFICE #

See set 1 below for grommet option codes

No Grommet	GN
Left	GL ___ (Add +\$175)
Right	GR ___ (Add +\$175)
Left & Right	GB ___ (Add +\$350)

___ = add grommet bezel color and door finish to complete option pick.

SV	= silver bezel, veneer door
BV	= black bezel, veneer door
WG	= silver bezel, white glass door
MG	= silver bezel, muslin glass door
BG	= black bezel, black glass door

Example: **GLSV** = left grommet, silver bezel, veneer door

	D	W	H	new model number	old model number	list
GLASS TOP  User Side	30	72	29 7/16	GA2DTRL3072-G	GAADTRL3072-G	15,301
	36	72	29 7/16	GA2DTRL3672-G	GAADTRL3672-G	15,774
	36	78	29 7/16	GA2DTRL3678-G	GAADTRL3678-G	16,248
	36	84	29 7/16	GA2DTRL3684-G	GAADTRL3684-G	16,736

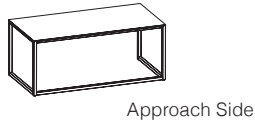

• Back painted glass is 1/2" thick.

STONE TOP
(stone top ordered separately)

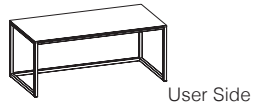

30	72	29 7/16	GA2DTRL3072-S	GAADTRL3072-S	7,463
36	72	29 7/16	GA2DTRL3672-S	GAADTRL3672-S	7,696
36	78	29 7/16	GA2DTRL3678-S	GAADTRL3678-S	7,926
36	84	29 7/16	GA2DTRL3684-S	GAADTRL3684-S	8,165

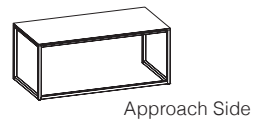

- Gunlocke will provide a template for the stone to be sourced locally. Contact GUNCS for template.
- Template is for 2cm (3/4") thick stone top.

PRODUCT INFO

Stainless base is 1.5" square stainless tube with brushed finish

Fully welded seamless assembly

Includes a 1" plywood subtop

TO ORDER PLEASE SPECIFY THE FOLLOWING:

- MODEL NUMBER**
- BACK PAINTED GLASS COLOR (ONLY FOR GLASS TOPS)**
- OFFICE #**

See inside front cover for required option codes

Example

GA2DTRL3072-G.TWH.OFC1
 GA2DTRL3072-G TWH OFC1
 MODEL NUMBER BACK PAINTED GLASS COLOR OFFICE #

FREESTANDING TABLE DESKS

Credentials

05/22

Modesty panel base

PEDESTAL LEFT

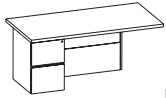

User Side

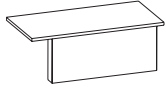

Approach Side

D	W	H	new model number	old model number	veneer 1	veneer 2
36	72	29 7/16	GA2DTRM3672L-3WW	GAADTRM3672L-3WW	8,364	9,201
36	78	29 7/16	GA2DTRM3678L-3WW	GAADTRM3678L-3WW	8,614	9,476
36	84	29 7/16	GA2DTRM3684L-3WW	GAADTRM3684L-3WW	8,874	9,762

- 10" overhang approach side
- 15" overhang on conference end
- Pedestal is 18" width w/ hidden upper box drawer

PRODUCT INFO

Short grain veneer on worksurface

TO ORDER PLEASE SPECIFY THE FOLLOWING:

1.		MODEL NUMBER
2.		FINISH
3.		TOP UV FINISH TYPE
4.		DESKTOP INSERT
5.		PULL
6.		GROMMET
7.		LOCKING
8.		KEYING
9.		OFFICE #

See inside front cover for required option codes

Example

GA2DTRM3672L-3WW.NC215.FF.TVN.MPS.GN.LY.RMS.OFC1

GA2DTRM3672L-3WW	NC215	FF	TVN	MPS	GN	LY	RMS	OFC1
MODEL NUMBER	FINISH	TOP UV FINISH	DESKTOP INSERT	PULL	GROMMET	LOCKING	KEYING	OFFICE #

See set 2 below for grommet option codes

No Grommet **GN**
Left **GL** ___ (Add +\$175)

___ = add grommet bezel color and door finish to complete option pick.

SV = silver bezel, veneer door
BV = black bezel, veneer door
WG = silver bezel, white glass door
MG = silver bezel, muslin glass door
BG = black bezel, black glass door

Example: **GLSV** = left grommet, silver bezel, veneer door

	D	W	H	new model number	old model number	veneer 1	veneer 2
PEDESTAL RIGHT	36	72	29 7/16	GA2DTRM3672R-3WW	GAADTRM3672R-3WW	8,364	9,201
	36	78	29 7/16	GA2DTRM3678R-3WW	GAADTRM3678R-3WW	8,614	9,476
	36	84	29 7/16	GA2DTRM3684R-3WW	GAADTRM3684R-3WW	8,874	9,762

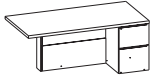

User Side

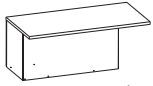

Approach Side

- 10" overhang approach side
- 15" overhang on conference end
- Pedestal is 18" width w/ hidden upper box drawer

PRODUCT INFO

Short grain veneer on worksurface

TO ORDER PLEASE SPECIFY THE FOLLOWING:

1. **MODEL NUMBER**
2. **FINISH**
3. **TOP UV FINISH TYPE**
4. **DESKTOP INSERT**
5. **PULL**
6. **GROMMET**
7. **LOCKING**
8. **KEYING**
9. **OFFICE #**

See inside front cover for required option codes

Example

GA2DTRM3672R-3WW.NC215.FF.TVN.MPS.GN.LY.RMS.OFC1

GA2DTRM3672R-3WW	NC215	FF	TVN	MPS	GN	LY	RMS	OFC1
MODEL NUMBER	FINISH	TOP UV FINISH	DESKTOP INSERT	PULL	GROMMET	LOCKING	KEYING	OFFICE #

See set 3 below for grommet option codes

No Grommet Right **GN**
GR ___ (Add +\$175)

___ = add grommet bezel color and door finish to complete option pick.

- SV** = silver bezel, veneer door
- BV** = black bezel, veneer door
- WG** = silver bezel, white glass door
- MG** = silver bezel, muslin glass door
- BG** = black bezel, black glass door

Example: **GRSV** = right grommet, silver bezel, veneer door

FREESTANDING TABLE DESKS

Credentials
05/22

Height adjustable base

CONFERENCE END LEFT

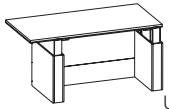

User Side

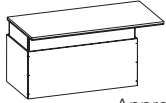

Approach Side

D	W	H	new model number	old model number	veneer 1	veneer 2
36	72	29 7/16	GA2DTRAK3672L-WW	GAADTRAK3672L-WW	13,322	14,655
36	78	29 7/16	GA2DTRAK3678L-WW	GAADTRAK3678L-WW	13,776	15,154
36	84	29 7/16	GA2DTRAK3684L-WW	GAADTRAK3684L-WW	14,241	15,666

- 6" overhang approach side
- 12" overhang on conference end
- Provides sit-to-stand electric height adjustment
- Height adjustable mechanism is integrated into a wood base
- Includes black metal shroud to conceal height adjustable hardware when in raised position
- 29" to 45" height adjustment range

PRODUCT INFO

Short grain veneer on worksurface

TO ORDER PLEASE SPECIFY THE FOLLOWING:

1.	<input type="text"/>	MODEL NUMBER
2.	<input type="text"/>	FINISH
3.	<input type="text"/>	TOP UV FINISH TYPE
4.	<input type="text"/>	DESKTOP INSERT
5.	<input type="text"/>	GROMMET
6.	<input type="text"/>	OFFICE #

See set 3 below for grommet option codes

No Grommet **GN**
Right **GR** ___ (Add +\$175)

___ = add grommet bezel color and door finish to complete option pick.

SV = silver bezel, veneer door
BV = black bezel, veneer door
WG = silver bezel, white glass door
MG = silver bezel, muslin glass door
BG = black bezel, black glass door

Example: **GRSV** = right grommet, silver bezel, veneer door

See inside front cover for required option codes

Example

GA2DTRAK3672L-WW.NC215.FF.TVN.GN.OFC1					
GA2DTRAK3672L-WW	NC215	FF	TVN	GN	OFC1
MODEL NUMBER	FINISH	TOP UV FINISH	DESKTOP INSERT	GROMMET	OFFICE #

CONFERENCE END RIGHT

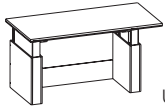

User Side

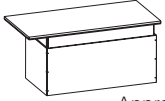

Approach Side

D	W	H	new model number	old model number	veneer 1	veneer 2
36	72	29 7/16	GA2DTRAK3672R-WW	GAADTRAK3672R-WW	13,322	14,655
36	78	29 7/16	GA2DTRAK3678R-WW	GAADTRAK3678R-WW	13,776	15,154
36	84	29 7/16	GA2DTRAK3684R-WW	GAADTRAK3684R-WW	14,241	15,666

- 6" overhang approach side
- 12" overhang on conference end
- Provides sit-to-stand electric height adjustment
- Height adjustable mechanism is integrated into a wood base
- Includes black metal shroud to conceal height adjustable hardware when in raised position
- 29" to 45" height adjustment range

PRODUCT INFO

Short grain veneer on worksurface

TO ORDER PLEASE SPECIFY THE FOLLOWING:

- MODEL NUMBER**
- FINISH**
- TOP UV FINISH TYPE**
- DESKTOP INSERT**
- GROMMET**
- OFFICE #**

See set 2 below for grommet option codes

No Grommet **GN**
Left **GL** ____ (Add +\$175)

____ = add grommet bezel color and door finish to complete option pick.

- SV** = silver bezel, veneer door
- BV** = black bezel, veneer door
- WG** = silver bezel, white glass door
- MG** = silver bezel, muslin glass door
- BG** = black bezel, black glass door

Example: **GLSV** = left grommet, silver bezel, veneer door

See inside front cover for required option codes

Example

GA2DTRAK3672R-WW.NC215.FF.TVN.GN.OFC1					
GA2DTRAK3672R-WW	NC215	FF	TVN	GN	OFC1
MODEL NUMBER	FINISH	TOP UV FINISH	DESKTOP INSERT	GROMMET	OFFICE #

FREESTANDING TABLE DESKS

Credentials

05/22

Miter end panel base

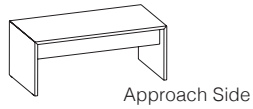
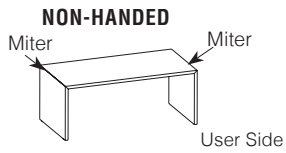

D	W	H	new model number	old model number	veneer 1	veneer 2
36	72	29 7/16	GA2DTRR3672-WW	GAADTRR3672-WW	6,680	7,348
36	78	29 7/16	GA2DTRR3678-WW	GAADTRR3678-WW	6,883	7,572
36	84	29 7/16	GA2DTRR3684-WW	GAADTRR3684-WW	7,089	7,798

- 10" height modesty panel standard with 6" overhang

PRODUCT INFO

Short grain veneer on worksurface

TO ORDER PLEASE SPECIFY THE FOLLOWING:

1. **MODEL NUMBER**
2. **FINISH**
3. **TOP UV FINISH TYPE**
4. **DESKTOP INSERT**
5. **GROMMET**
6. **OFFICE #**

See set 1 below for grommet option codes

No Grommet **GN**
 Left **GL** ___ (Add +\$175)
 Right **GR** ___ (Add +\$175)
 Left & Right **GB** ___ (Add +\$350)

___ = add grommet bezel color and door finish to complete option pick.

SV = silver bezel, veneer door
BV = black bezel, veneer door
WG = silver bezel, white glass door
MG = silver bezel, muslin glass door
BG = black bezel, black glass door

See inside front cover for required option codes

Example: **GLSV** = left grommet, silver bezel,

Example

GA2DTRR3672-WW.NC215.FF.TVN.GN.OFC1

GA2DTRR3672-WW	NC215	FF	TVN	GN	OFC1
MODEL NUMBER	FINISH	TOP UV FINISH	DESKTOP INSERT	GROMMET	OFFICE#

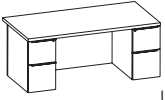
	D	W	H	new model number	old model number	veneer 1	veneer 2
 <p>User Side</p>	36	72	29 7/16	GA2DRO3672-32WW	GAADRO3672-32WW	9,318	10,250
	36	78	29 7/16	GA2DRO3678-32WW	GAADRO3678-32WW	9,598	10,558
	36	84	29 7/16	GA2DRO3684-32WW	GAADRO3684-32WW	9,885	10,874

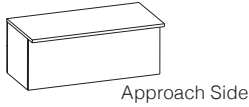

- Full modesty panel with 6" overhang
- -3 pedestals include hidden upper box drawer
- 72" and 78" width units include 15" width pedestal
- 84" width units include 18" width pedestal

PRODUCT INFO

Short grain veneer on worksurface

TO ORDER PLEASE SPECIFY THE FOLLOWING:

1. **MODEL NUMBER**
2. **FINISH**
3. **TOP UV FINISH TYPE**
4. **DESKTOP INSERT**
5. **PULL**
6. **GROMMET**
7. **LOCKING**
8. **KEYING**
9. **OFFICE #**

See inside front cover for required option codes

Example

GA2DRO3672-32WW.NC215.FF.TVN.MPS.GN.LY.RMS.OFC1									
GA2DRO3672-32WW	NC215	FF	TVN	MPS	GN	LY	RMS	OFC1	
MODEL NUMBER	FINISH	TOP UV FINISH	DESKTOP INSERT	PULL	GROMMET	LOCKING	KEYING	OFFICE #	

See set 1 below for grommet option codes

- No Grommet **GN**
- Left **GL** ___ (Add +\$175)
- Right **GR** ___ (Add +\$175)
- Left & Right **GB** ___ (Add +\$350)

___ = add grommet bezel color and door finish to complete option pick.

- SV** = silver bezel, veneer door
- BV** = black bezel, veneer door
- WG** = silver bezel, white glass door
- MG** = silver bezel, muslin glass door
- BG** = black bezel, black glass door

Example: **GLSV** = left grommet, silver bezel, veneer door

SINGLE PEDESTAL DESKS

Credentials
05/22

Left hand

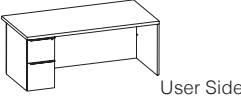
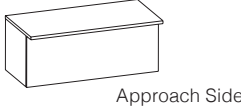
	D	W	H	new model number	old model number	veneer 1	veneer 2
PEDESTAL LEFT NO TROUGH  	30	72	29 7/16	GA2DRO3072L-3WW	GAADRO3072L-3WW	7,559	8,315
	36	72	29 7/16	GA2DRO3672L-3WW	GAADRO3672L-3WW	7,792	8,572
	36	78	29 7/16	GA2DRO3678L-3WW	GAADRO3678L-3WW	8,024	8,827
	36	84	29 7/16	GA2DRO3684L-3WW	GAADRO3684L-3WW	8,268	9,095

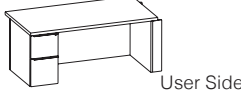
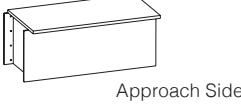
	D	W	H	new model number	old model number	veneer 1	veneer 2
PEDESTAL LEFT TROUGH RIGHT END  	30	72	29 7/16	GA2DRO3072TL-3WW	GAADRO3072TL-3WW	7,559	8,315
	36	72	29 7/16	GA2DRO3672TL-3WW	GAADRO3672TL-3WW	7,792	8,572
	36	78	29 7/16	GA2DRO3678TL-3WW	GAADRO3678TL-3WW	8,024	8,827
	36	84	29 7/16	GA2DRO3684TL-3WW	GAADRO3684TL-3WW	8,268	9,095

- Full modesty panel with 6" overhang
- -3 pedestals include hidden upper box drawer
- 72" and 78" width units include 15" width pedestal
- 84" width units include 18" width pedestal
- Trough end units are required when a tackzone spans over the end of the desk worksurface
- Trough units include a metal pencil lip

NOTE: Plastic Trough Insert is REQUIRED and must be ordered separately across entire length of trough. Single Pedestal desks have 6" overhang, deducting 6" from the overall trough insert length.

PRODUCT INFO

Long grain veneer on worksurface

TO ORDER PLEASE SPECIFY THE FOLLOWING:

- -
 -
 -
 -
 -
 -
 -
 -
 -
- MODEL NUMBER**
FINISH
TOP UV FINISH TYPE
DESKTOP INSERT
PULL
GROMMET
LOCKING
KEYING
PENCIL LIP COLOR (TROUGH ONLY)
OFFICE #

See set 1 below for grommet option codes

No Grommet **GN**
Left **GL** ___ (Add +\$175)
Right **GR** ___ (Add +\$175)
Left & Right **GB** ___ (Add +\$350)

___ = add grommet bezel color and door finish to complete option pick.

SV = silver bezel, veneer door
BV = black bezel, veneer door
WG = silver bezel, white glass door
MG = silver bezel, muslin glass door
BG = black bezel, black glass door

Example: **GLSV** = left grommet, silver bezel, veneer door

See inside front cover for required option codes

Example

GA2DRO3072L-3WW.NC215.FF.TVN.MPS.GN.LY.RMS.OFC1

MODEL NUMBER	FINISH	TOP UV FINISH	DESKTOP INSERT	PULL	GROMMET	LOCKING	KEYING	OFFICE #
GA2DRO3072L-3WW	NC215	FF	TVN	MPS	GN	LY	RMS	OFC1

	D	W	H	new model number	old model number	veneer 1	veneer 2
PEDESTAL RIGHT NO TROUGH	30	72	29 7/16	GA2DRO3072R-3WW	GAADRO3072R-3WW	7,559	8,315
	36	72	29 7/16	GA2DRO3672R-3WW	GAADRO3672R-3WW	7,792	8,572
	36	78	29 7/16	GA2DRO3678R-3WW	GAADRO3678R-3WW	8,024	8,827
	36	84	29 7/16	GA2DRO3684R-3WW	GAADRO3684R-3WW	8,268	9,095

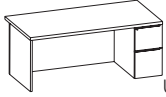

User Side



Approach Side

PEDESTAL RIGHT TROUGH LEFT END

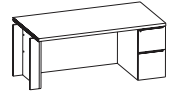

User Side



Approach Side

30	72	29 7/16	GA2DRO3072TR-3WW	GAADRO3072TR-3WW	7,559	8,315
36	72	29 7/16	GA2DRO3672TR-3WW	GAADRO3672TR-3WW	7,792	8,572
36	78	29 7/16	GA2DRO3678TR-3WW	GAADRO3678TR-3WW	8,024	8,827
36	84	29 7/16	GA2DRO3684TR-3WW	GAADRO3684TR-3WW	8,268	9,095

- Full modesty panel with 6" overhang
- -3 pedestals include hidden upper box drawer
- 72" and 78" width units include 15" width pedestal
- 84" width units include 18" width pedestal
- Trough end units are required when a tackzone spans over the end of the desk worksurface
- Trough units include a metal pencil lip

NOTE: Plastic Trough Insert is REQUIRED and must be ordered separately across entire length of trough. Single Pedestal desks have 6" overhang, deducting 6" from the overall trough insert length.

PRODUCT INFO

Long grain veneer on worksurface

TO ORDER PLEASE SPECIFY THE FOLLOWING:

- MODEL NUMBER
- FINISH
- TOP UV FINISH TYPE
- DESKTOP INSERT
- PULL
- GROMMET
- LOCKING
- KEYING
- PENCIL LIP COLOR (TROUGH ONLY)
- OFFICE #

See set 1 below for grommet option codes

- No Grommet **GN**
 Left **GL** ___ (Add +\$175)
 Right **GR** ___ (Add +\$175)
 Left & Right **GB** ___ (Add +\$350)

___ = add grommet bezel color and door finish to complete option pick.

- SV** = silver bezel, veneer door
BV = black bezel, veneer door
WG = silver bezel, white glass door
MG = silver bezel, muslin glass door
BG = black bezel, black glass door

Example: **GLSV** = left grommet, silver bezel, veneer door

See inside front cover for required option codes

Example

GA2DRO3072R-3WW.NC215.FF.TVN.MPS.GN.LY.RMS.OFC1

MODEL NUMBER	FINISH	TOP UV FINISH	DESKTOP INSERT	PULL	GROMMET	LOCKING	KEYING	OFFICE #
GA2DRO3072R-3WW	NC215	FF	TVN	MPS	GN	LY	RMS	OFC1

EXTENSIONS

Left hand | stainless metal base

Credentials
05/22

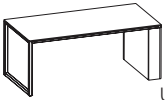
	D	W	H	new model number	old model number	veneer 1	veneer 2
BASE LEFT NO TROUGH							
 User Side	30	72	29 7/16	GA2XRL3072L-W	GAAXRL3072L-W	8,385	9,224
	36	72	29 7/16	GA2XRL3672L-W	GAAXRL3672L-W	8,642	9,507
	36	78	29 7/16	GA2XRL3678L-W	GAAXRL3678L-W	8,901	9,792
	36	84	29 7/16	GA2XRL3684L-W	GAAXRL3684L-W	9,168	10,085

BASE LEFT TROUGH RIGHT END

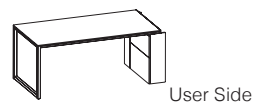

30	72	29 7/16	GA2XRL3072TL-W	GAAXRL3072TL-W	8,385	9,224
36	72	29 7/16	GA2XRL3672TL-W	GAAXRL3672TL-W	8,642	9,507
36	78	29 7/16	GA2XRL3678TL-W	GAAXRL3678TL-W	8,901	9,792
36	84	29 7/16	GA2XRL3684TL-W	GAAXRL3684TL-W	9,168	10,085

- Optional 10" height modesty panel with 6" overhang
- Trough end units are required when a tackzone spans over the end of the desk worksurface.
- Trough units include a metal pencil lip

NOTE: Plastic Trough Insert is REQUIRED and must be ordered separately across entire length of trough.

PRODUCT INFO

Stainless base is 1.5" square stainless tube with brushed finish

1.5" worksurface is rabbeted into stainless base assembly. 1/2" top thickness is visible on all sides

Long grain veneer on worksurface

TO ORDER PLEASE SPECIFY THE FOLLOWING:

1.	<input type="text"/>	MODEL NUMBER
2.	<input type="text"/>	FINISH
3.	<input type="text"/>	TOP UV FINISH TYPE
4.	<input type="text"/>	DESKTOP INSERT
5.	<input type="text"/>	MODESTY
6.	<input type="text"/>	GROMMET
7.	<input type="text"/>	PENCIL LIP COLOR (TROUGH ONLY)
8.	<input type="text"/>	OFFICE #

See set 3 below for grommet option codes

No Grommet **GN**
Right **GR** ___ (Add +\$175)

___ = add grommet bezel color and door finish to complete option pick.

SV = silver bezel, veneer door
BV = black bezel, veneer door
WG = silver bezel, white glass door
MG = silver bezel, muslin glass door
BG = black bezel, black glass door

Example: **GRSV** = right grommet, silver bezel, veneer door

See inside front cover for required option codes

Example

MODEL NUMBER	FINISH	TOP UV FINISH	DESKTOP INSERT	MODESTY	GROMMET	OFFICE #
GA2XRL3072L-W	NC215	FF	TVN	MY	GN	OFC1

**BASE RIGHT
NO TROUGH**

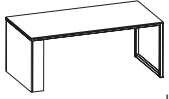

User Side

D	W	H	new model number	old model number	veneer 1	veneer 2
30	72	29 7/16	GA2XRL3072R-W	GAAXRL3072R-W	8,385	9,224
36	72	29 7/16	GA2XRL3672R-W	GAAXRL3672R-W	8,642	9,507
36	78	29 7/16	GA2XRL3678R-W	GAAXRL3678R-W	8,901	9,792
36	84	29 7/16	GA2XRL3684R-W	GAAXRL3684R-W	9,168	10,085

**BASE RIGHT
TROUGH LEFT END**

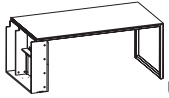

User Side

30	72	29 7/16	GA2XRL3072TR-W	GAAXRL3072TR-W	8,385	9,224
36	72	29 7/16	GA2XRL3672TR-W	GAAXRL3672TR-W	8,642	9,507
36	78	29 7/16	GA2XRL3678TR-W	GAAXRL3678TR-W	8,901	9,792
36	84	29 7/16	GA2XRL3684TR-W	GAAXRL3684TR-W	9,168	10,085

- Optional 10" height modesty panel with 6" overhang
- Trough end units are required when a tackzone spans over the end of the desk worksurface.
- Trough units include a metal pencil lip

NOTE: Plastic Trough Insert is REQUIRED and must be ordered separately across entire length of trough.

PRODUCT INFO

Stainless base is 1.5" square stainless tube with brushed finish

1.5" worksurface is rabbeted into stainless base assembly. 1/2" top thickness is visible on all sides

Long grain veneer on worksurface

TO ORDER PLEASE SPECIFY THE FOLLOWING:

1. **MODEL NUMBER**
2. **FINISH**
3. **TOP UV FINISH TYPE**
4. **DESKTOP INSERT**
5. **MODESTY**
6. **GROMMET**
7. **PENCIL LIP COLOR (TROUGH ONLY)**
8. **OFFICE #**

See set 2 below for grommet option codes

No Grommet **GN**
Left **GL** ____ (Add +\$175)

____ = add grommet bezel color and door finish to complete option pick.

SV = silver bezel, veneer door
BV = black bezel, veneer door
WG = silver bezel, white glass door
MG = silver bezel, muslin glass door
BG = black bezel, black glass door

Example: **GLSV** = left grommet, silver bezel, veneer door

See inside front cover for required option codes

Example

GA2XRL3072R-W.NC215.FF.TVN.MY.GN.OFC1						
GA2XRL3072R-W	NC215	FF	TVN	MY	GN	OFC1
MODEL NUMBER	FINISH	TOP UV FINISH	DESKTOP INSERT	MODESTY	GROMMET	OFFICE #

EXTENSIONS

Left hand | modesty panel base

Credentials
05/22

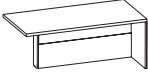
	D	W	H	new model number	old model number	veneer 1	veneer 2
BASE LEFT NO TROUGH  User Side	30	72	29 7/16	GA2XRM3072L-W	GAAXRM3072L-W	6,896	7,586
	36	72	29 7/16	GA2XRM3672L-W	GAAXRM3672L-W	7,109	7,820
	36	78	29 7/16	GA2XRM3678L-W	GAAXRM3678L-W	7,322	8,055
	36	84	29 7/16	GA2XRM3684L-W	GAAXRM3684L-W	7,543	8,298

BASE LEFT TROUGH RIGHT END



User Side

30	72	29 7/16	GA2XRM3072TL-W	GAAXRM3072TL-W	6,896	7,586
36	72	29 7/16	GA2XRM3672TL-W	GAAXRM3672TL-W	7,109	7,820
36	78	29 7/16	GA2XRM3678TL-W	GAAXRM3678TL-W	7,322	8,055
36	84	29 7/16	GA2XRM3684TL-W	GAAXRM3684TL-W	7,543	8,298

- 10" overhang approach side
- 15" overhang on conference end
- Trough end units are required when a tackzone spans over the end of the desk worksurface.
- Trough units include a metal pencil lip

NOTE: Plastic Trough Insert is REQUIRED and must be ordered separately across entire length of trough.

PRODUCT INFO

Long grain veneer on worksurface

TO ORDER PLEASE SPECIFY THE FOLLOWING:

- MODEL NUMBER**
- FINISH**
- TOP UV FINISH TYPE**
- DESKTOP INSERT**
- GROMMET**
- PENCIL LIP COLOR (TROUGH ONLY)**
- OFFICE #**

See set 3 below for grommet option codes

No Grommet **GN**
Right **GR** ___ (Add +\$175)

___ = add grommet bezel color and door finish to complete option pick.

SV = silver bezel, veneer door
BV = black bezel, veneer door
WG = silver bezel, white glass door
MG = silver bezel, muslin glass door
BG = black bezel, black glass door

Example: **GRSV** = right grommet, silver bezel, veneer door

See inside front cover for required option codes

Example

GA2XRM3072L-W.NC215.FF.TVN.GN.OFC1

GA2XRM3072L-W	NC215	FF	TVN	GN	OFC1
MODEL NUMBER	FINISH	TOP UV FINISH	DESKTOP INSERT	GROMMET	OFFICE #

	D	W	H	new model number	old model number	veneer 1	veneer 2
BASE RIGHT NO TROUGH	30	72	29 7/16	GA2XRM3072R-W	GAAXRM3072R-W	6,896	7,586
	36	72	29 7/16	GA2XRM3672R-W	GAAXRM3672R-W	7,109	7,820
	36	78	29 7/16	GA2XRM3678R-W	GAAXRM3678R-W	7,322	8,055
	36	84	29 7/16	GA2XRM3684R-W	GAAXRM3684R-W	7,543	8,298

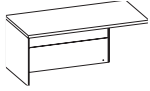

User Side

**BASE RIGHT
TROUGH LEFT END**

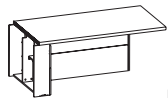

User Side

30	72	29 7/16	GA2XRM3072TR-W	GAAXRM3072TR-W	6,896	7,586
36	72	29 7/16	GA2XRM3672TR-W	GAAXRM3672TR-W	7,109	7,820
36	78	29 7/16	GA2XRM3678TR-W	GAAXRM3678TR-W	7,322	8,055
36	84	29 7/16	GA2XRM3684TR-W	GAAXRM3684TR-W	7,543	8,298

- 10" overhang approach side
- 15" overhang on conference end
- Trough end units are required when a tackzone spans over the end of the desk worksurface.
- Trough units include a metal pencil lip

NOTE: Plastic Trough Insert is REQUIRED and must be ordered separately across entire length of trough.

PRODUCT INFO

Long grain veneer on worksurface

TO ORDER PLEASE SPECIFY THE FOLLOWING:

1. **MODEL NUMBER**
2. **FINISH**
3. **TOP UV FINISH TYPE**
4. **DESKTOP INSERT**
5. **GROMMET**
6. **PENCIL LIP COLOR (TROUGH ONLY)**
7. **OFFICE #**

See set 2 below for grommet option codes

No Grommet **GN**
Left **GL** ___ (Add +\$175)

___ = add grommet bezel color and door finish to complete option pick.

SV = silver bezel, veneer door
BV = black bezel, veneer door
WG = silver bezel, white glass door
MG = silver bezel, muslin glass door
BG = black bezel, black glass door

Example: **GLSV** = left grommet, silver bezel, veneer door

See inside front cover for required option codes

Example

GA2XRM3072R-W.NC215.FF.TVN.GN.OFC1
 GA2XRM3072R-W NC215 FF TVN GN OFC1
MODEL NUMBER **FINISH** **TOP UV FINISH** **DESKTOP INSERT** **GROMMET** **OFFICE #**

EXTENSIONS

Left hand | height adjustable base

	D	W	H	new model number	old model number	veneer 1	veneer 2
CONFERENCE END LEFT NO TROUGH	30	72	29 7/16	GA2XRAK3072L-W	GAAXRAK3072L-W	12,478	13,726
	36	72	29 7/16	GA2XRAK3672L-W	GAAXRAK3672L-W	12,917	14,209
	36	78	29 7/16	GA2XRAK3678L-W	GAAXRAK3678L-W	13,356	14,692
	36	84	29 7/16	GA2XRAK3684L-W	GAAXRAK3684L-W	13,810	15,191

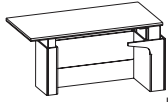

User Side

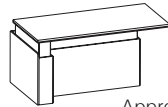

Approach Side

CONFERENCE END LEFT TROUGH RIGHT END

	30	72	29 7/16	GA2XRAK3072TL-W	GAAXRAK3072TL-W	12,478	13,726
	36	72	29 7/16	GA2XRAK3672TL-W	GAAXRAK3672TL-W	12,917	14,209
	36	78	29 7/16	GA2XRAK3678TL-W	GAAXRAK3678TL-W	13,356	14,692
	36	84	29 7/16	GA2XRAK3684TL-W	GAAXRAK3684TL-W	13,810	15,191

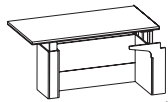

User Side

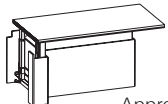

Approach Side

- 10" overhang approach side
- 15" overhang on conference end
- Trough end units are required when a tackzone spans over the end of the desk worksurface.
- Trough units include a metal pencil lip
- Provides sit-to-stand electric height adjustment
- Height adjustable mechanism is integrated into a wood base
- Includes black metal shroud to conceal height adjustable hardware when in raised position
- 29" to 45" height adjustment range
- If attaching to a bridge, specify bridge model for use with height adjustable extensions
- If attaching to a return, a 3" shorter width modesty or wall access panel must be used on return

NOTE: Plastic Trough Insert is REQUIRED and must be ordered separately across entire length of trough.

PRODUCT INFO

Long grain veneer on worksurface

TO ORDER PLEASE SPECIFY THE FOLLOWING:

1.		MODEL NUMBER
2.		FINISH
3.		TOP UV FINISH TYPE
4.		DESKTOP INSERT
5.		GROMMET
6.		PENCIL LIP COLOR (TROUGH ONLY)
7.		OFFICE #

See set 3 below for grommet option codes

No Grommet **GN**
Right **GR** ___ (Add +\$175)

___ = add grommet bezel color and door finish to complete option pick.

SV = silver bezel, veneer door
BV = black bezel, veneer door
WG = silver bezel, white glass door
MG = silver bezel, muslin glass door
BG = black bezel, black glass door

Example: **GRSV** = right grommet, silver bezel, veneer door

See inside front cover for required option codes

Example

GA2XRAK3072L-W.NC215.FF.TVN.GN.OFC1					
GA2XRAK3072L-W	NC215	FF	TVN	GN	OFC1
MODEL NUMBER	FINISH	TOP UV FINISH	DESKTOP INSERT	GROMMET	OFFICE #

	D	W	H	new model number	old model number	veneer 1	veneer 2
CONFERENCE END RIGHT NO TROUGH	30	72	29 7/16	GA2XRAK3072R-W	GAAXRAK3072R-W	12,478	13,726
	36	72	29 7/16	GA2XRAK3672R-W	GAAXRAK3672R-W	12,917	14,209
	36	78	29 7/16	GA2XRAK3678R-W	GAAXRAK3678R-W	13,356	14,692
	36	84	29 7/16	GA2XRAK3684R-W	GAAXRAK3684R-W	13,810	15,191

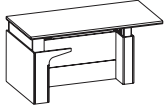

User Side

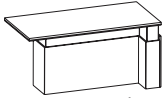

Approach Side

CONFERENCE END RIGHT TROUGH LEFT END

	30	72	29 7/16	GA2XRAK3072TR-W	GAAXRAK3072TR-W	12,478	13,726
	36	72	29 7/16	GA2XRAK3672TR-W	GAAXRAK3672TR-W	12,917	14,209
	36	78	29 7/16	GA2XRAK3678TR-W	GAAXRAK3678TR-W	13,356	14,692
	36	84	29 7/16	GA2XRAK3684TR-W	GAAXRAK3684TR-W	13,810	15,191

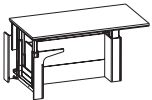

User Side

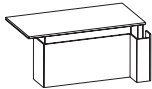

Approach Side

- 10" overhang approach side
- 15" overhang on conference end
- Trough end units are required when a tackzone spans over the end of the desk worksurface.
- Trough units include a metal pencil lip
- Provides sit-to-stand electric height adjustment
- Height adjustable mechanism is integrated into a wood base
- Includes black metal shroud to conceal height adjustable hardware when in raised position
- 29" to 45" height adjustment range
- If attaching to a bridge, specify bridge model for use with height adjustable extensions
- If attaching to a return, a 3" shorter width modesty or wall access panel must be used on return

NOTE: Plastic Trough Insert is REQUIRED and must be ordered separately across entire length of trough.

PRODUCT INFO

Long grain veneer on worksurface

TO ORDER PLEASE SPECIFY THE FOLLOWING:

1. **MODEL NUMBER**
2. **FINISH**
3. **TOP UV FINISH TYPE**
4. **DESKTOP INSERT**
5. **GROMMET**
6. **PENCIL LIP COLOR (TROUGH ONLY)**
7. **OFFICE #**

See set 2 below for grommet option codes

No Grommet **GN**
Left **GL** ___ (Add +\$175)

___ = add grommet bezel color and door finish to complete option pick.

SV = silver bezel, veneer door
BV = black bezel, veneer door
WG = silver bezel, white glass door
MG = silver bezel, muslin glass door
BG = black bezel, black glass door

Example: **GLSV** = left grommet, silver bezel, veneer door

See inside front cover for required option codes

Example

GA2XRAK3072R-W.NC215.FF.TVN.GN.OFC1					
GA2XRAK3072R-W	NC215	FF	TVN	GN	OFC1
MODEL NUMBER	FINISH	TOP UV FINISH	DESKTOP INSERT	GROMMET	OFFICE #

EXTENSIONS

Left hand | miter end panel base

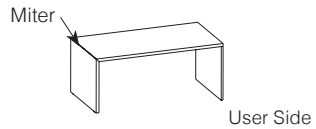
	D	W	H	new model number	old model number	veneer 1	veneer 2
BASE LEFT NO TROUGH	30	72	29 7/16	GA2XRR3072L-W	GAAXRR3072L-W	6,304	6,935
	36	72	29 7/16	GA2XRR3672L-W	GAAXRR3672L-W	6,498	7,148
	36	78	29 7/16	GA2XRR3678L-W	GAAXRR3678L-W	6,694	7,364
	36	84	29 7/16	GA2XRR3684L-W	GAAXRR3684L-W	6,895	7,585

	D	W	H	new model number	old model number	veneer 1	veneer 2
BASE LEFT TROUGH RIGHT END	30	72	29 7/16	GA2XRR3072TL-W	GAAXRR3072TL-W	6,304	6,935
	36	72	29 7/16	GA2XRR3672TL-W	GAAXRR3672TL-W	6,498	7,148
	36	78	29 7/16	GA2XRR3678TL-W	GAAXRR3678TL-W	6,694	7,364
	36	84	29 7/16	GA2XRR3684TL-W	GAAXRR3684TL-W	6,895	7,585

- 6" overhang approach side
- Trough end units are required when a tackzone spans over the end of the desk worksurface.
- Trough units include a metal pencil lip

NOTE: Plastic Trough Insert is REQUIRED and must be ordered separately across entire length of trough.

PRODUCT INFO

Long grain veneer on worksurface

TO ORDER PLEASE SPECIFY THE FOLLOWING:

1. **MODEL NUMBER**
2. **FINISH**
3. **TOP UV FINISH TYPE**
4. **DESKTOP INSERT**
5. **GROMMET**
6. **PENCIL LIP COLOR (TROUGH ONLY)**
7. **OFFICE #**

See set 3 below for grommet option codes

No Grommet **GN**
Right **GR** ___ (Add +\$175)

___ = add grommet bezel color and door finish to complete option pick.

SV = silver bezel, veneer door
BV = black bezel, veneer door
WG = silver bezel, white glass door
MG = silver bezel, muslin glass door
BG = black bezel, black glass door

Example: **GRSV** = right grommet, silver bezel, veneer door

See inside front cover for required option codes

Example

GA2XRR3072L-W.NC215.FF.TVN.GN.OFC1

GA2XRR3072L-W	NC215	FF	TVN	GN	OFC1
MODEL NUMBER	FINISH	TOP UV FINISH	DESKTOP INSERT	GROMMET	OFFICE #

**BASE RIGHT
NO TROUGH**

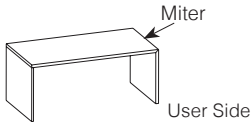

D	W	H	new model number	old model number	veneer 1	veneer 2
30	72	29 7/16	GA2XRR3072R-W	GAAXRR3072R-W	6,304	6,935
36	72	29 7/16	GA2XRR3672R-W	GAAXRR3672R-W	6,498	7,148
36	78	29 7/16	GA2XRR3678R-W	GAAXRR3678R-W	6,694	7,364
36	84	29 7/16	GA2XRR3684R-W	GAAXRR3684R-W	6,895	7,585

**BASE RIGHT
TROUGH LEFT END**

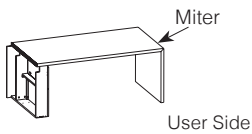

30	72	29 7/16	GA2XRR3072TR-W	GAAXRR3072TR-W	6,304	6,935
36	72	29 7/16	GA2XRR3672TR-W	GAAXRR3672TR-W	6,498	7,148
36	78	29 7/16	GA2XRR3678TR-W	GAAXRR3678TR-W	6,694	7,364
36	84	29 7/16	GA2XRR3684TR-W	GAAXRR3684TR-W	6,895	7,585

- 6" overhang approach side
- Trough end units are required when a tackzone spans over the end of the desk worksurface.
- Trough units include a metal pencil lip

NOTE: Plastic Trough Insert is REQUIRED and must be ordered separately across entire length of trough

PRODUCT INFO

Long grain veneer on worksurface

TO ORDER PLEASE SPECIFY THE FOLLOWING:

1. **MODEL NUMBER**
2. **FINISH**
3. **TOP UV FINISH TYPE**
4. **DESKTOP INSERT**
5. **GROMMET**
6. **PENCIL LIP COLOR (TROUGH ONLY)**
7. **OFFICE #**

See set 2 below for grommet option codes

No Grommet **GN**
Left **GL** ___ (Add +\$175)

___ = add grommet bezel color and door finish to complete option pick.

SV = silver bezel, veneer door
BV = black bezel, veneer door
WG = silver bezel, white glass door
MG = silver bezel, muslin glass door
BG = black bezel, black glass door

Example: **GLSV** = left grommet, silver bezel, veneer door

See inside front cover for required option codes

Example

GA2XRR3072R-W.NC215.FF.TVN.GN.OFC1					
GA2XRR3072R-W	NC215	FF	TVN	GN	OFC1
MODEL NUMBER	FINISH	TOP UV FINISH	DESKTOP INSERT	GROMMET	OFFICE #

RUNOFF DESKS

Left hand | stainless metal base

Credentials

05/22

STANDARD BASE LEFT



User Side

D	W	H	new model number	old model number	veneer 1	veneer 2
30	48	29 7/16	GA2RRL3048L-W	GAARRL3048L-W	7,124	7,837
30	54	29 7/16	GA2RRL3054L-W	GAARRL3054L-W	7,337	8,071
36	54	29 7/16	GA2RRL3654L-W	GAARRL3654L-W	7,559	8,315
36	60	29 7/16	GA2RRL3660L-W	GAARRL3660L-W	7,786	8,565

- Optional 10" height modesty panel with 6" overhang

LAYERS OVERLAPPING BASE LEFT



User Side

30	72	29 7/16	GA2RLRL3072L-W	GAARLRL3072L-W	7,481	8,230
30	78	29 7/16	GA2RLRL3078L-W	GAARLRL3078L-W	7,857	8,643
36	78	29 7/16	GA2RLRL3678L-W	GAARLRL3678L-W	8,249	9,074
36	84	29 7/16	GA2RLRL3684L-W	GAARLRL3684L-W	8,660	9,526

- Optional 10" height modesty panel with 6" overhang
- Layers units overlap low height credenza worksurfaces
- Includes layers box
- Unit is free-floating on lower credenza worksurface
- Includes pencil lip on end of unit

PRODUCT INFO

Stainless base is 1.5" square stainless tube with brushed finish

1.5" worksurface is rabbeted into stainless base assembly - H" top thickness is visible on all sides

Short grain veneer on worksurface

TO ORDER PLEASE SPECIFY THE FOLLOWING:

1.	<input type="text"/>	MODEL NUMBER
2.	<input type="text"/>	FINISH
3.	<input type="text"/>	TOP UV FINISH TYPE
4.	<input type="text"/>	MODESTY
5.	<input type="text"/>	GROMMET
6.	<input type="text"/>	PENCIL LIP COLOR (LAYERS ONLY)
7.	<input type="text"/>	OFFICE #

See set 3 below for grommet option codes

No Grommet **GN**
Right **GR** ___ (Add +\$175)

___ = add grommet bezel color and door finish to complete option pick.

SV = silver bezel, veneer door
BV = black bezel, veneer door
WG = silver bezel, white glass door
MG = silver bezel, muslin glass door
BG = black bezel, black glass door

Example: **GRSV** = right grommet, silver bezel, veneer door

See inside front cover for required option codes

Example

GA2RRL3048L-W.NC215.FF.TVN.MY.GN.PLS.OFC1

GA2RRL3048L-W	NC215	FF	TVN	MY	GN	PLS	OFC1
MODEL NUMBER	FINISH	TOP UV FINISH	DESKTOP INSERT	MODESTY	GROMMET	PENCIL LIP COLOR	OFFICE #

**STANDARD
BASE RIGHT**



User Side

D	W	H	new model number	old model number	veneer 1	veneer 2
30	48	29 7/16	GA2RRL3048R-W	GAARRL3048R-W	7,124	7,837
30	54	29 7/16	GA2RRL3054R-W	GAARRL3054R-W	7,337	8,071
36	54	29 7/16	GA2RRL3654R-W	GAARRL3654R-W	7,559	8,315
36	60	29 7/16	GA2RRL3660R-W	GAARRL3660R-W	7,786	8,565

- Optional 10" height modesty panel with 6" overhang

**LAYERS OVERLAPPING
BASE RIGHT**



User Side

30	72	29 7/16	GA2RLRL3072R-W	GAARLRL3072R-W	7,481	8,230
30	78	29 7/16	GA2RLRL3078R-W	GAARLRL3078R-W	7,857	8,643
36	78	29 7/16	GA2RLRL3678R-W	GAARLRL3678R-W	8,249	9,074
36	84	29 7/16	GA2RLRL3684R-W	GAARLRL3684R-W	8,660	9,526

- Optional 10" height modesty panel with 6" overhang
- Layers units overlap low height credenza worksurfaces
- Includes layers box
- Unit is free-floating on lower credenza worksurface
- Includes pencil lip on end of unit

PRODUCT INFO

Stainless base is 1.5" square stainless tube with brushed finish

1.5" worksurface is rabbeted into stainless base assembly - H" top thickness is visible on all sides

Short grain veneer on worksurface

TO ORDER PLEASE SPECIFY THE FOLLOWING:

- MODEL NUMBER**
- FINISH**
- TOP UV FINISH TYPE**
- MODESTY**
- GROMMET**
- PENCIL LIP COLOR (LAYERS ONLY)**
- OFFICE #**

See set 2 below for grommet option codes

No Grommet **GN**
Left **GL** ____ (Add +\$175)

____ = add grommet bezel color and door finish to complete option pick.

SV = silver bezel, veneer door
BV = black bezel, veneer door
WG = silver bezel, white glass door
MG = silver bezel, muslin glass door
BG = black bezel, black glass door

Example: **GLSV** = left grommet, silver bezel, veneer door

See inside front cover for required option codes

Example

GA2RRL3048R-W.NC215.FF.TVN.MY.GN.PLS.OFC1

GA2RRL3048R-W	NC215	FF	TVN	MY	GN	PLS	OFC1
MODEL NUMBER	FINISH	TOP UV FINISH	DESKTOP INSERT	MODESTY	GROMMET	PENCIL LIP COLOR	OFFICE#

RUNOFF DESKS

Left hand | miter panel base

Credentials
05/22

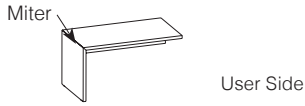
	D	W	H	new model number	old model number	veneer 1	veneer 2
STANDARD BASE LEFT 	30	48	29 7/16	GA2RRR3048L-W	GAARRR3048L-W	5,357	5,893
	30	54	29 7/16	GA2RRR3054L-W	GAARRR3054L-W	5,518	6,070
	36	54	29 7/16	GA2RRR3654L-W	GAARRR3654L-W	5,684	6,253
	36	60	29 7/16	GA2RRR3660L-W	GAARRR3660L-W	5,854	6,440

- 6" overhang approach side

LAYERS OVERLAPPING BASE LEFT

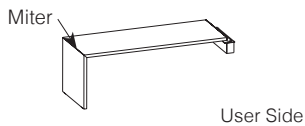

30	72	29 7/16	GA2RLRR3072L-W	GAARLRR3072L-W	5,627	6,190
30	78	29 7/16	GA2RLRR3078L-W	GAARLRR3078L-W	5,907	6,498
36	78	29 7/16	GA2RLRR3678L-W	GAARLRR3678L-W	6,200	6,820
36	84	29 7/16	GA2RLRR3684L-W	GAARLRR3684L-W	6,512	7,164

- 6" overhang approach side
- Layers units overlap low height credenza worksurfaces
- Includes layers box
- Unit is free-floating on lower credenza worksurface
- Includes pencil lip on end of unit

PRODUCT INFO

Short grain veneer on worksurface

TO ORDER PLEASE SPECIFY THE FOLLOWING:

1.	<input type="text"/>	MODEL NUMBER
2.	<input type="text"/>	FINISH
3.	<input type="text"/>	TOP UV FINISH TYPE
4.	<input type="text"/>	GROMMET
5.	<input type="text"/>	PENCIL LIP COLOR (LAYERS ONLY)
6.	<input type="text"/>	OFFICE #

See set 3 below for grommet option codes

No Grommet **GN**
Right **GR** ____ (Add +\$175)

____ = add grommet bezel color and door finish to complete option pick.

SV = silver bezel, veneer door
BV = black bezel, veneer door
WG = silver bezel, white glass door
MG = silver bezel, muslin glass door
BG = black bezel, black glass door

Example: **GRSV** = right grommet, silver bezel, veneer door

See inside front cover for required option codes

Example

GA2RRR3048L-W.NC215.FF.TVN.GNS.PLS.OFC1						
GA2RRR3048L-W	NC215	FF	TVN	GN	PLS	OFC1
MODEL NUMBER	FINISH	TOP UV FINISH	DESKTOP INSERT	GROMMET	PENCIL LIP COLOR	OFFICE #

**STANDARD
BASE RIGHT**

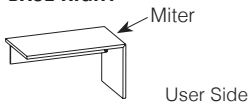

D	W	H	new model number	old model number	veneer 1	veneer 2
30	48	29 7/16	GA2RRR3048R-W	GAARRR3048R-W	5,357	5,893
30	54	29 7/16	GA2RRR3054R-W	GAARRR3054R-W	5,518	6,070
36	54	29 7/16	GA2RRR3654R-W	GAARRR3654R-W	5,684	6,253
36	60	29 7/16	GA2RRR3660R-W	GAARRR3660R-W	5,854	6,440

- 6" overhang approach side

**LAYERS OVERLAPPING
BASE RIGHT**

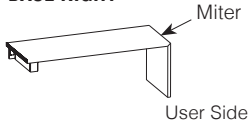

30	72	29 7/16	GA2RLRR3072R-W	GAARLRR3072R-W	5,627	6,190
30	78	29 7/16	GA2RLRR3078R-W	GAARLRR3078R-W	5,907	6,498
36	78	29 7/16	GA2RLRR3678R-W	GAARLRR3678R-W	6,200	6,820
36	84	29 7/16	GA2RLRR3684R-W	GAARLRR3684R-W	6,512	7,164

- 6" overhang approach side
- Layers units overlap low height credenza worksurfaces
- Includes layers box
- Unit is free-floating on lower credenza worksurface
- Includes pencil lip on end of unit

PRODUCT INFO

Short grain veneer on worksurface

TO ORDER PLEASE SPECIFY THE FOLLOWING:

- MODEL NUMBER**
- FINISH**
- TOP UV FINISH TYPE**
- GROMMET**
- PENCIL LIP COLOR (LAYERS ONLY)**
- OFFICE #**

See set 2 below for grommet option codes

No Grommet **GN**
Left **GL** ____ (Add +\$175)

____ = add grommet bezel color and door finish to complete option pick.

SV = silver bezel, veneer door
BV = black bezel, veneer door
WG = silver bezel, white glass door
MG = silver bezel, muslin glass door
BG = black bezel, black glass door

Example: **GLSV** = left grommet, silver bezel, veneer door

See inside front cover for required option codes

Example

GA2RRR3048R-W.NC215.FF.TVN.GN.PLS.OFC1						
GA2RRR3048R-W	NC215	FF	TVN	GN	PLS	OFC1
MODEL NUMBER	FINISH	TOP UV FINISH	DESKTOP INSERT	GROMMET	PENCIL LIP COLOR	OFFICE #

RUNOFF DESKS

Left hand | pedestal

Credentials

05/22

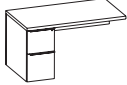
	D	W	H	new model number	old model number	veneer 1	veneer 2
STANDARD PEDESTAL LEFT  User Side	30	48	29 7/16	GA2RRO3048L-3W	GAARRO3048L-3W	6,424	7,067
	30	54	29 7/16	GA2RRO3054L-3W	GAARRO3054L-3W	6,615	7,277
	36	54	29 7/16	GA2RRO3654L-3W	GAARRO3654L-3W	6,812	7,494
	36	60	29 7/16	GA2RRO3660L-3W	GAARRO3660L-3W	7,020	7,722



- 6" overhang approach side
- -3 pedestals include hidden upper box drawer
- All units include 15" width pedestal

LAYERS OVERLAPPING PEDESTAL LEFT

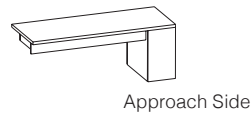
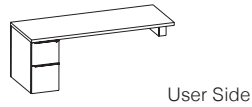

30	72	29 7/16	GA2RLRO3072L-3W	GAARLRO3072L-3W	6,747	7,422
30	78	29 7/16	GA2RLRO3078L-3W	GAARLRO3078L-3W	7,084	7,793
36	78	29 7/16	GA2RLRO3678L-3W	GAARLRO3678L-3W	7,434	8,178
36	84	29 7/16	GA2RLRO3684L-3W	GAARLRO3684L-3W	7,809	8,590

- 6" overhang approach side
- -3 pedestals include hidden upper box drawer
- All units include 15" width pedestal
- Layers units overlap low height credenza worksurfaces
- Includes layers box
- Unit is free-floating on lower credenza worksurface
- Includes pencil lip on end of unit

PRODUCT INFO

Short grain veneer on worksurface

TO ORDER PLEASE SPECIFY THE FOLLOWING:

1.		MODEL NUMBER
2.		FINISH
3.		TOP UV FINISH TYPE
4.		PULL
5.		MODESTY
6.		GROMMET
7.		PENCIL LIP COLOR (LAYERS ONLY)
8.		LOCKING
9.		KEYING
10.		OFFICE #

See set 3 below for grommet option codes

No Grommet **GN**
Right **GR** ___ (Add +\$175)

___ = add grommet bezel color and door finish to complete option pick.

SV = silver bezel, veneer door
BV = black bezel, veneer door
WG = silver bezel, white glass door
MG = silver bezel, muslin glass door
BG = black bezel, black glass door

Example: **GRSV** = right grommet, silver bezel, veneer door

See inside front cover for required option codes

Example

GA2RRO3048L-3W.NC215.FF.TVN.MPS.MY.GN.PLS.LY.RMS.OFC1

GA2RRO3048L-3W	NC215	FF	TVN	MPS	MY	GN	PLS	LY	RMS	OFC1
MODEL NUMBER	FINISH	TOP UV FINISH	DESKTOP INSERT	PULL	MODESTY	GROMMET	PENCIL LIP COLOR	LOCKING	KEYING	OFFICE #

	D	W	H	new model number	old model number	veneer 1	veneer 2
STANDARD PEDESTAL RIGHT	30	48	29 7/16	GA2RRO3048R-3W	GAARRO3048R-3W	6,424	7,067
	30	54	29 7/16	GA2RRO3054R-3W	GAARRO3054R-3W	6,615	7,277
	36	54	29 7/16	GA2RRO3654R-3W	GAARRO3654R-3W	6,812	7,494
	36	60	29 7/16	GA2RRO3660R-3W	GAARRO3660R-3W	7,020	7,722

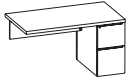

User Side

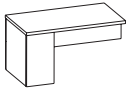

Approach Side

- 6" overhang approach side
- -3 pedestals include hidden upper box drawer
- All units include 15" width pedestal

LAYERS OVERLAPPING PEDESTAL RIGHT

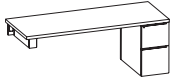

User Side

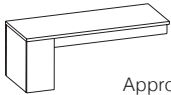

Approach Side

30	72	29 7/16	GA2RLRO3072R-3W	GAARLRO3072R-3W	6,747	7,422
30	78	29 7/16	GA2RLRO3078R-3W	GAARLRO3078R-3W	7,084	7,793
36	78	29 7/16	GA2RLRO3678R-3W	GAARLRO3678R-3W	7,434	8,178
36	84	29 7/16	GA2RLRO3684R-3W	GAARLRO3684R-3W	7,809	8,590

- 6" overhang approach side
- -3 pedestals include hidden upper box drawer
- All units include 15" width pedestal
- Layers units overlap low height credenza worksurfaces
- Includes layers box
- Unit is free-floating on lower credenza worksurface

PRODUCT INFO

Short grain veneer on worksurface

TO ORDER PLEASE SPECIFY THE FOLLOWING:

- MODEL NUMBER
- FINISH
- TOP UV FINISH TYPE
- PULL
- MODESTY
- GROMMET
- PENCIL LIP COLOR (LAYERS ONLY)
- LOCKING
- KEYING
- OFFICE #

See set 2 below for grommet option codes

No Grommet **GN**
Left **GL** ___ (Add +\$175)

___ = add grommet bezel color and door finish to complete option pick.

SV = silver bezel, veneer door
BV = black bezel, veneer door
WG = silver bezel, white glass door
MG = silver bezel, muslin glass door
BG = black bezel, black glass door

Example: **GLSV** = left grommet, silver bezel, veneer door

See inside front cover for required option codes

Example

GA2RRO3048R-3W	NC215	FF	TVN	MPS	MY	GN	PLS	LY	RMS	OFC1
MODEL NUMBER	FINISH	TOP UV FINISH	DESKTOP INSERT	PULL	MODESTY	GROMMET	PENCIL LIP COLOR	LOCKING	KEYING	OFFICE #

BRIDGES

Standard

Credentials

05/22

STANDARD

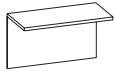

D	W	H	new model number	old model number	veneer 1	veneer 2
24	42	29 7/16	GA2BRG2442-WW	GAABRG2442-WW	2,919	3,211
24	48	29 7/16	GA2BRG2448-WW	GAABRG2448-WW	3,002	3,303
24	54	29 7/16	GA2BRG2454-WW	GAABRG2454-WW	3,088	3,397

- Optional no modesty panel (deduct -\$700) or full height modesty panel

FOR USE WITH HEIGHT ADJUSTABLE EXTENSIONS

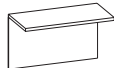

24	42	29 7/16	GA2BRG2442A-WW	GAABRG2442A-WW	2,919	3,211
24	48	29 7/16	GA2BRG2448A-WW	GAABRG2448A-WW	3,002	3,303
24	54	29 7/16	GA2BRG2454A-WW	GAABRG2454A-WW	3,088	3,397

- Optional no modesty panel (deduct -\$700) or full height modesty panel

LAYERS FOR USE WITH STANDARD OR HEIGHT ADJUSTABLE DESKS/EXTENSIONS



24	66	29 7/16	GA2BLRG2466-W	GAABLRG2466-W	3,068	3,375
24	72	29 7/16	GA2BLRG2472-W	GAABLRG2472-W	3,152	3,468
24	78	29 7/16	GA2BLRG2478-W	GAABLRG2478-W	3,243	3,568

- No modesty panel
- Layers units overlap low height credenza worksurfaces
- Includes layers box
- Unit is free-floating on lower credenza worksurface

PRODUCT INFO

Short grain veneer on worksurface

TO ORDER PLEASE SPECIFY THE FOLLOWING:

1.	<input type="text"/>	MODEL NUMBER
2.	<input type="text"/>	FINISH
3.	<input type="text"/>	TOP UV FINISH TYPE
4.	<input type="text"/>	MODESTY
5.	<input type="text"/>	GROMMET
6.	<input type="text"/>	OFFICE #

See set 4 below for grommet option codes

No Grommet **GN**
Center **GC** ___ (Add +\$175)

___ = add grommet bezel color and door finish to complete option pick.

SV = silver bezel, veneer door
BV = black bezel, veneer door
WG = silver bezel, white glass door
MG = silver bezel, muslin glass door
BG = black bezel, black glass door

Example: **GCSV** = center grommet, silver bezel, veneer door

See inside front cover for required option codes

Example

GA2BRG2442-WW.NC215.FF.MY.GN.OFC1

GA2BRG2442-WW	NC215	FF	MY	GN	OFC1
MODEL NUMBER	FINISH	TOP UV FINISH	MODESTY	GROMMET	OFFICE #

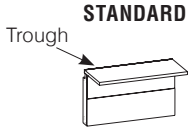

STANDARD

D	W	H	new model number	old model number	veneer 1	veneer 2
21 1/4	42	29 7/16	GA2BRG2442T-WW	GAABRG2442T-WW	3,788	4,167
21 1/4	48	29 7/16	GA2BRG2448T-WW	GAABRG2448T-WW	3,871	4,259
21 1/4	54	29 7/16	GA2BRG2454T-WW	GAABRG2454T-WW	3,959	4,355

- Optional no modesty panel (deduct -\$1,150) or wall access panel
- Trough back units are required when a tackzone spans over the back of the worksurface
- Trough units include a metal pencil lip

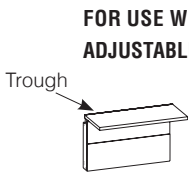

**FOR USE WITH HEIGHT
ADJUSTABLE EXTENSIONS**

21 1/4	42	29 7/16	GA2BRG2442TA-WW	GAABRG2442TA-WW	3,788	4,167
21 1/4	48	29 7/16	GA2BRG2448TA-WW	GAABRG2448TA-WW	3,871	4,259
21 1/4	54	29 7/16	GA2BRG2454TA-WW	GAABRG2454TA-WW	3,959	4,355

- Optional no modesty panel (deduct -\$1,150) or wall access panel
- Trough back units are required when a tackzone spans over the back of the worksurface
- Trough units include a metal pencil lip

NOTE: Plastic Trough Insert is REQUIRED and must be ordered separately across entire length of trough.

PRODUCT INFO

Short grain veneer on worksurface

TO ORDER PLEASE SPECIFY THE FOLLOWING:

- MODEL NUMBER**
- FINISH**
- TOP UV FINISH TYPE**
- MODESTY**
- PENCIL LIP COLOR (TROUGH ONLY)**
- OFFICE #**

See inside front cover for required option codes

Example

GA2BRG2442T-WW.NC215.FF.MY.PLS.OFC1
 GA2BRG2442T-WW NC215 FF MY PLS OFC1
 MODEL NUMBER FINISH TOP UV FINISH MODESTY PENCIL LIP COLOR OFFICE #

CREDENZA WORKSURFACES

Standard & trough back

Credentials
05/22

	D	W	H	new model number	old model number	veneer 1	veneer 2
STANDARD 	24	60	1 1/2	GA2CWR2460-W	GAACWR2460-W	1,829	2,012
	24	66	1 1/2	GA2CWR2466-W	GAACWR2466-W	1,925	2,118
	24	72	1 1/2	GA2CWR2472-W	GAACWR2472-W	2,029	2,232
	24	78	1 1/2	GA2CWR2478-W	GAACWR2478-W	2,129	2,342
	24	84	1 1/2	GA2CWR2484-W	GAACWR2484-W	2,234	2,458
	24	90	1 1/2	GA2CWR2490-W	GAACWR2490-W	2,349	2,584
	24	96	1 1/2	GA2CWR2496-W	GAACWR2496-W	2,463	2,710
	24	102	1 1/2	GA2CWR24102-W	GAACWR24102-W	2,639	2,903
	24	108	1 1/2	GA2CWR24108-W	GAACWR24108-W	2,875	3,163
	24	114	1 1/2	GA2CWR24114-W	GAACWR24114-W	3,133	3,447
	24	120	1 1/2	GA2CWR24120-W	GAACWR24120-W	3,418	3,760

TROUGH BACK

Trough



24	60	1 1/2	GA2CWR2460T-W	GAACWR2460T-W	1,829	2,012
24	66	1 1/2	GA2CWR2466T-W	GAACWR2466T-W	1,925	2,118
24	72	1 1/2	GA2CWR2472T-W	GAACWR2472T-W	2,029	2,232
24	78	1 1/2	GA2CWR2478T-W	GAACWR2478T-W	2,129	2,342
24	84	1 1/2	GA2CWR2484T-W	GAACWR2484T-W	2,234	2,458
24	90	1 1/2	GA2CWR2490T-W	GAACWR2490T-W	2,349	2,584
24	96	1 1/2	GA2CWR2496T-W	GAACWR2496T-W	2,463	2,710
24	102	1 1/2	GA2CWR24102T-W	GAACWR24102T-W	2,639	2,903
24	108	1 1/2	GA2CWR24108T-W	GAACWR24108T-W	2,875	3,163
24	114	1 1/2	GA2CWR24114T-W	GAACWR24114T-W	3,133	3,447
24	120	1 1/2	GA2CWR24120T-W	GAACWR24120T-W	3,418	3,760

- Trough back units are required when a tackzone spans over the back of the worksurface
- Trough units include a metal pencil lip

NOTE: Plastic Trough Insert is REQUIRED and must be ordered separately across entire length of trough.

PRODUCT INFO

Long grain veneer on worksurface

TO ORDER PLEASE SPECIFY THE FOLLOWING:

- -
 -
 -
 -
 -
- MODEL NUMBER**
FINISH
TOP UV FINISH TYPE
GROMMET (STANDARD TOP ONLY)
PENCIL LIP COLOR (TROUGH ONLY)
OFFICE #

See set 5 below for grommet option codes

No Grommet **GN**
Left **GL** ___ (Add +\$175)
Right **GR** ___ (Add +\$175)
Center **GC** ___ (Add +\$175)

___ = add grommet bezel color and door finish to complete option pick.

SV = silver bezel, veneer door
BV = black bezel, veneer door
WG = silver bezel, white glass door
MG = silver bezel, muslin glass door
BG = black bezel, black glass door

Example: **GCSV** = center grommet, silver bezel, veneer door

See inside front cover for required option codes

Example

GA2CWR2460-W.NC215.FF.GN.PLS.OFC1
GA2CWR2460-W NC215 FF GN PLS OFC1
MODEL NUMBER FINISH TOP UV FINISH GROMMET PENCIL LIP COLOR OFFICE #

TROUGH LEFT END



D	W	H	new model number	old model number	veneer 1	veneer 2
24	60	1 1/2	GA2CWR2460TL-W	GAACWR2460TL-W	1,829	2,012
24	66	1 1/2	GA2CWR2466TL-W	GAACWR2466TL-W	1,925	2,118
24	72	1 1/2	GA2CWR2472TL-W	GAACWR2472TL-W	2,029	2,232
24	78	1 1/2	GA2CWR2478TL-W	GAACWR2478TL-W	2,129	2,342
24	84	1 1/2	GA2CWR2484TL-W	GAACWR2484TL-W	2,234	2,458
24	90	1 1/2	GA2CWR2490TL-W	GAACWR2490TL-W	2,349	2,584
24	96	1 1/2	GA2CWR2496TL-W	GAACWR2496TL-W	2,463	2,710
24	102	1 1/2	GA2CWR24102TL-W	GAACWR24102TL-W	2,639	2,903
24	108	1 1/2	GA2CWR24108TL-W	GAACWR24108TL-W	2,875	3,163
24	114	1 1/2	GA2CWR24114TL-W	GAACWR24114TL-W	3,133	3,447
24	120	1 1/2	GA2CWR24120TL-W	GAACWR24120TL-W	3,418	3,760

- Trough left end units are required when a tack zone spans over the left end of the worksurface.
- Trough units include a metal pencil lip

TROUGH RIGHT END

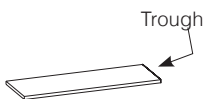

24	60	1 1/2	GA2CWR2460TR-W	GAACWR2460TR-W	1,829	2,012
24	66	1 1/2	GA2CWR2466TR-W	GAACWR2466TR-W	1,925	2,118
24	72	1 1/2	GA2CWR2472TR-W	GAACWR2472TR-W	2,029	2,232
24	78	1 1/2	GA2CWR2478TR-W	GAACWR2478TR-W	2,129	2,342
24	84	1 1/2	GA2CWR2484TR-W	GAACWR2484TR-W	2,234	2,458
24	90	1 1/2	GA2CWR2490TR-W	GAACWR2490TR-W	2,349	2,584
24	96	1 1/2	GA2CWR2496TR-W	GAACWR2496TR-W	2,463	2,710
24	102	1 1/2	GA2CWR24102TR-W	GAACWR24102TR-W	2,639	2,903
24	108	1 1/2	GA2CWR24108TR-W	GAACWR24108TR-W	2,875	3,163
24	114	1 1/2	GA2CWR24114TR-W	GAACWR24114TR-W	3,133	3,447
24	120	1 1/2	GA2CWR24120TR-W	GAACWR24120TR-W	3,418	3,760

- Trough back units are required when a tackzone spans over the back of the worksurface
- Trough units include a metal pencil lip

NOTE: Plastic Trough Insert is REQUIRED and must be ordered separately across entire length of trough.

PRODUCT INFO

Long grain veneer on worksurface

TO ORDER PLEASE SPECIFY THE FOLLOWING:

1. **MODEL NUMBER**
2. **FINISH**
3. **TOP UV FINISH TYPE**
4. **GROMMET**
5. **PENCIL LIP COLOR (TROUGH ONLY)**
6. **OFFICE #**

See set 5 below for grommet option codes

No Grommet **GN**
 Left **GL** ___ (Add +\$175)
 Right **GR** ___ (Add +\$175)
 Center **GC** ___ (Add +\$175)

___ = add grommet bezel color and door finish to complete option pick.

SV = silver bezel, veneer door
BV = black bezel, veneer door
WG = silver bezel, white glass door
MG = silver bezel, muslin glass door
BG = black bezel, black glass door

See inside front cover for required option codes

Example: **GCSV** = center grommet, silver bezel, veneer door

Example

GA2CWR2460TL-W.NC215.FF.GN.PLS.OFC1
 GA2CWR2460TL-W NC215 FF GN PLS OFC1
 MODEL NUMBER FINISH TOP UV FINISH GROMMET PENCIL LIP COLOR OFFICE #

RETURN WORKSURFACES

Standard

Credentials

05/22

STANDARD



D	W	H	new model number	old model number	veneer 1	veneer 2
24	42	1 1/2	GA2RWR2442-W	GAARWR2442-W	1,568	1,725
24	48	1 1/2	GA2RWR2448-W	GAARWR2448-W	1,649	1,814
24	54	1 1/2	GA2RWR2454-W	GAARWR2454-W	1,736	1,910
24	60	1 1/2	GA2RWR2460-W	GAARWR2460-W	1,829	2,012
24	66	1 1/2	GA2RWR2466-W	GAARWR2466-W	1,925	2,118
24	72	1 1/2	GA2RWR2472-W	GAARWR2472-W	2,029	2,232

PRODUCT INFO

Short grain veneer on worksurface

TO ORDER PLEASE SPECIFY THE FOLLOWING:

- 1. **MODEL NUMBER**
- 2. **FINISH**
- 3. **TOP UV FINISH TYPE**
- 4. **GROMMET**
- 5. **OFFICE #**

See set 5 below for grommet option codes

No Grommet **GN**
 Left **GL** ___ (Add +\$175)
 Right **GR** ___ (Add +\$175)
 Center **GC** ___ (Add +\$175)

___ = add grommet bezel color and door finish to complete option pick.

SV = silver bezel, veneer door
BV = black bezel, veneer door
WG = silver bezel, white glass door
MG = silver bezel, muslin glass door
BG = black bezel, black glass door

See inside front cover for required option codes

Example: **GCSV** = center grommet, silver bezel, veneer door

Example

GA2RWR2442-W.NC215.FF.GN.OFC1

GA2RWR2442-W	NC215	FF	GN	OFC1
MODEL NUMBER	FINISH	TOP UV FINISH	GROMMET	OFFICE #

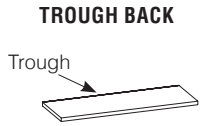

D	W	H	new model number	old model number	veneer 1	veneer 2
24	42	1 1/2	GA2RWR2442T-W	GAARWR2442T-W	1,568	1,725
24	48	1 1/2	GA2RWR2448T-W	GAARWR2448T-W	1,649	1,814
24	54	1 1/2	GA2RWR2454T-W	GAARWR2454T-W	1,736	1,910
24	60	1 1/2	GA2RWR2460T-W	GAARWR2460T-W	1,829	2,012
24	66	1 1/2	GA2RWR2466T-W	GAARWR2466T-W	1,925	2,118
24	72	1 1/2	GA2RWR2472T-W	GAARWR2472T-W	2,029	2,232

- Trough back units are required when a tackzone spans over the back of the worksurface
- Trough units include a metal pencil lip

NOTE: Plastic Trough Insert is REQUIRED and must be ordered separately across entire length of trough.

PRODUCT INFO

short grain veneer on worksurface

TO ORDER PLEASE SPECIFY THE FOLLOWING:

- | | | |
|----|----------------------|---------------------------|
| 1. | <input type="text"/> | MODEL NUMBER |
| 2. | <input type="text"/> | FINISH |
| 3. | <input type="text"/> | TOP UV FINISH TYPE |
| 4. | <input type="text"/> | PENCIL LIP COLOR |
| 5. | <input type="text"/> | OFFICE # |

See inside front cover for required option codes

Example

GA2RWR2442T-W.NC215.FF.PLS.OFC1				
GA2RWR2442T-W	NC215	FF	PLS	OFC1
MODEL NUMBER	FINISH	TOP UV FINISH	PENCIL LIP COLOR	OFFICE #

PEDESTALS

Full height | left hand

Credentials

05/22

	D	W	H	new model number	old model number	veneer 1	veneer 2
15" WIDTH FALSE PEDESTALS	24	15	27 15/16	GA2MPW2415L-LW	GAAMPW2415L-LW	1,302	1,433



- For use with: standard or trough back worksurfaces
no modesty panel applications



	24	15	27 15/16	GA2MPW2415L-XBW	GAAMPW2415L-XBW	1,361	1,498
--	----	----	----------	------------------------	-----------------	-------	-------

- For use with: standard or trough back worksurfaces
wall access panel or full back panel applications



	24	6 1/2	27 15/16	GA2MPW2415L-XEW	GAAMPW2415L-XEW	1,361	1,498
--	----	-------	----------	------------------------	-----------------	-------	-------

- For use with: standard or trough left end worksurfaces
no modesty or full back panel applications
- Aligns with wall access panel on adjoining bridge or return

PRODUCT INFO

TO ORDER PLEASE SPECIFY THE FOLLOWING:

1. **MODEL NUMBER**
2. **FINISH**
3. **OFFICE #**

See inside front cover for required option codes

Example

GA2MPW2415L-LW.NC215.OFC1
 GA2MPW2415L-LW NC215 OFC1
 MODEL NUMBER FINISH OFFICE #

	D	W	H	new model number	old model number	veneer 1	veneer 2
15" WIDTH							
FILE FILE	24 7/8	15	27 15/16	GA2MPW2415L-2W	GAAMPW2415L-2W	3,427	3,770
							
BOX BOX FILE	24 7/8	15	27 15/16	GA2MPW2415L-3W	GAAMPW2415L-3W	3,427	3,770
							
18" WIDTH							
FILE FILE	24 7/8	18	27 15/16	GA2MPW2418L-2W	GAAMPW2418L-2W	3,601	3,962
							
BOX BOX FILE	24 7/8	18	27 15/16	GA2MPW2418L-3W	GAAMPW2418L-3W	3,601	3,962
							

PRODUCT INFO

All pedestals have optional face locks

Hinged door cabinets do not lock

-3 and -7 pedestals include hidden upper box drawer

TO ORDER PLEASE SPECIFY THE FOLLOWING:

- 1. **MODEL NUMBER**
- 2. **FINISH**
- 3. **PULL**
- 4. **LOCKING**
- 5. **KEYING**
- 6. **OFFICE #**

See inside front cover for required option codes

Example









GA2MPW2415L-2W.NC215.MPS.LY.RMS.OFC1					
GA2MPW2415L-2W	NC215	MPS	LY	RMS	OFC1
MODEL NUMBER	FINISH	PULL	LOCKING	KEYING	OFFICE #

PEDESTALS

Full height | left hand

Credentials

05/22

	D	W	H	new model number	old model number	veneer 1	veneer 2
30" WIDTH							
LATERAL FILE 	24 7/8	30	27 15/16	GA2MPW2430L-4W	GAAMPW2430L-4W	3,908	4,299
	• Optional face lock						
BOX BOX LATERAL FILE 	24 7/8	30	27 15/16	GA2MPW2430L-7W	GAAMPW2430L-7W	3,908	4,299
	• Optional face lock						
HINGED DOOR 	24 7/8	30	27 15/16	GA2MPW2430L-5W	GAAMPW2430L-5W	3,427	3,770
OPEN SHELF 	24 7/8	30	27 15/16	GA2MPW2430L-SHW	GAAMPW2430L-SHW	3,070	3,377
	• Optional face lock						
PRINTER 	24 7/8	30	27 15/16	GA2MPW2430L-PW	GAAMPW2430L-PW	3,619	3,981
TRASH RECEPTACLE 	24 7/8	30	27 15/16	GA2MPW2430L-TW	GAAMPW2430L-TW	3,619	3,981
	• Includes quantity (2) brushed satin aluminum trash cans						
FILE FILE + BOX BOX FILE 	24 7/8	30	27 15/16	GA2MPW2430L-23W	GAAMPW2430L-23W	6,170	6,787
	• Optional face lock						
OPEN CUBBY BOX LATERAL FILE 	24 7/8	30	27 15/16	GA2MPW2430L-BW	GAAMPW2430L-BW	3,793	4,173
	• Optional face lock						

PRODUCT INFO

Hinged door cabinets do not lock

-B pedestals include hidden upper box drawer



TO ORDER PLEASE SPECIFY THE FOLLOWING:

1. **MODEL NUMBER**
2. **FINISH**
3. **PULL**
4. **LOCKING**
5. **KEYING**
6. **OFFICE #**

See inside front cover for required option codes

Example

GA2MPW2430L-4W.NC215.MPS.LY.RMS.OFC1
 GA2MPW2430L-4W NC215 MPS LY RMS OFC1
 MODEL NUMBER FINISH PULL LOCKING KEYING OFFICE #

	D	W	H	new model number	old model number	vener 1	vener 2
36" WIDTH							
LATERAL FILE 	24 7/8	36	27 15/16	GA2MPW2436L-4W	GAAMPW2436L-4W	4,381	4,820
	• Optional face lock						
BOX BOX LATERAL FILE 	24 7/8	36	27 15/16	GA2MPW2436L-7W	GAAMPW2436L-7W	4,381	4,820
	• Optional face lock						
HINGED DOOR 	24 7/8	36	27 15/16	GA2MPW2436L-5W	GAAMPW2436L-5W	3,841	4,226
OPEN SHELF 	24 7/8	36	27 15/16	GA2MPW2436L-SHW	GAAMPW2436L-SHW	3,437	3,781
	• Optional face lock						
PRINTER 	24 7/8	36	27 15/16	GA2MPW2436L-PW	GAAMPW2436L-PW	4,055	4,461
TRASH RECEPTACLE 	24 7/8	36	27 15/16	GA2MPW2436L-TW	GAAMPW2436L-TW	4,055	4,461
	• Includes quantity (2) brushed satin aluminum trash cans						
FILE FILE + BOX BOX FILE 	24 7/8	36	27 15/16	GA2MPW2436L-23W	GAAMPW2436L-23W	6,481	7,130
	• Optional face lock						
OPEN CUBBY BOX LATERAL FILE 	24 7/8	36	27 15/16	GA2MPW2436L-BW	GAAMPW2436L-BW	4,248	4,673
	• Optional face lock						

PRODUCT INFO

Hinged door cabinets do not lock

-B pedestals include hidden upper box drawer

TO ORDER PLEASE SPECIFY THE FOLLOWING:

- | | | |
|----|----------------------|---------------------|
| 1. | <input type="text"/> | MODEL NUMBER |
| 2. | <input type="text"/> | FINISH |
| 3. | <input type="text"/> | PULL |
| 4. | <input type="text"/> | LOCKING |
| 5. | <input type="text"/> | KEYING |
| 6. | <input type="text"/> | OFFICE # |

See inside front cover for required option codes

Example



GA2MPW2436L-4W.NC215.MPS.LY.RMS.OFC1
 GA2MPW2436L-4W NC215 MPS LY RMS OFC1
 MODEL NUMBER FINISH PULL LOCKING KEYING OFFICE #

PEDESTALS

Full height | left hand

Credentials

05/22

	D	W	H	new model number	old model number	veneer 1	veneer 2
45" WIDTH							
HINGED DOOR + FILE FILE	24 7/8	45	27 15/16	GA2MPW2445L-52W	GAAMPW2445L-52W	6,170	6,787
							
LATERAL FILE + BOX BOX FILE	24 7/8	45	27 15/16	GA2MPW2445L-43W	GAAMPW2445L-43W	6,605	7,266
							
BOX BOX LATERAL FILE + FILE FILE	24 7/8	45	27 15/16	GA2MPW2445L-72W	GAAMPW2445L-72W	6,605	7,266
							
54" WIDTH							
HINGED DOOR + FILE FILE	24 7/8	54	27 15/16	GA2MPW2454L-52W	GAAMPW2454L-52W	6,696	7,366
							
LATERAL FILE + BOX BOX FILE	24 7/8	54	27 15/16	GA2MPW2454L-43W	GAAMPW2454L-43W	7,183	7,902
							
BOX BOX LATERAL FILE + FILE FILE	24 7/8	54	27 15/16	GA2MPW2454L-72W	GAAMPW2454L-72W	7,183	7,902
							

PRODUCT INFO

All pedestals have optional face locks

Hinged door cabinets do not lock

-3 and -7 pedestals include hidden upper box drawer

TO ORDER PLEASE SPECIFY THE FOLLOWING:

1. **MODEL NUMBER**
2. **FINISH**
3. **PULL**
4. **LOCKING**
5. **KEYING**
6. **OFFICE #**

See inside front cover for required option codes

Example

GA2MPW2445L-52W.NC215.MPS.LY.RMS.OFC1

GA2MPW2445L-52W	NC215	MPS	LY	RMS	OFC1
MODEL NUMBER	FINISH	PULL	LOCKING	KEYING	OFFICE #

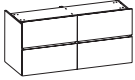
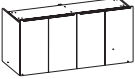
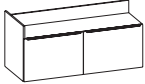
	D	W	H	new model number	old model number	veneer 1	veneer 2
60" WIDTH							
LATERAL FILE 	24 7/8	60	27 15/16	GA2MPW2460L-44W	GAAMPW2460L-44W	7,040	7,744
HINGED DOOR 	24 7/8	60	27 15/16	GA2MPW2460L-55W	GAAMPW2460L-55W	6,170	6,787
OPEN CUBBY BOX LATERAL FILE 	24 7/8	60	27 15/16	GA2MPW2460L-BBW	GAAMPW2460L-BBW	6,828	7,511

PRODUCT INFO

All pedestals have optional face locks

Hinged door cabinets do not lock

-B pedestals include hidden upper box drawer

TO ORDER PLEASE SPECIFY THE FOLLOWING:

- 1. **MODEL NUMBER**
- 2. **FINISH**
- 3. **PULL**
- 4. **LOCKING**
- 5. **KEYING**
- 6. **OFFICE #**

See inside front cover for required option codes

Example

GA2MPW2460L-44W.NC215.MPS.LY.RMS.OFC1
 GA2MPW2460L-44W NC215 MPS LY RMS OFC1
 MODEL NUMBER FINISH PULL LOCKING KEYING OFFICE #

PEDESTALS

Full height | right hand

Credentials

05/22

	D	W	H	new model number	old model number	veneer 1	veneer 2
--	---	---	---	------------------	------------------	----------	----------

**15" WIDTH
FALSE PEDESTALS**

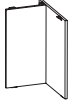

24	15	27 15/16	GA2MPW2415R-LW	GAAMPW2415R-LW	1,302	1,433
----	----	----------	-----------------------	----------------	-------	-------

- For use with: standard or trough back worksurfaces
no modesty panel applications



24	15	27 15/16	GA2MPW2415R-XBW	GAAMPW2415R-XBW	1,361	1,498
----	----	----------	------------------------	-----------------	-------	-------

- For use with: standard or trough back worksurfaces
wall access or full back panel applications

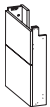

24	6 1/2	27 15/16	GA2MPW2415R-XEW	GAAMPW2415R-XEW	1,361	1,498
----	-------	----------	------------------------	-----------------	-------	-------

- For use with: standard or trough left end worksurfaces
no modesty or full back panel applications
- Aligns with wall access panel on adjoining bridge or return

PRODUCT INFO





TO ORDER PLEASE SPECIFY THE FOLLOWING:

1. **MODEL NUMBER**
2. **FINISH**
3. **OFFICE #**

See inside front cover for required option codes

Example

GA2MPW2415R-LW.NC215.OFC1		
GA2MPW2415R-LW	NC215	OFC1
MODEL NUMBER	FINISH	OFFICE #

	D	W	H	new model number	old model number	veneer 1	veneer 2
15" WIDTH							
FILE FILE	24 7/8	15	27 15/16	GA2MPW2415R-2W	GAAMPW2415R-2W	3,427	3,770
							
BOX BOX FILE	24 7/8	15	27 15/16	GA2MPW2415R-3W	GAAMPW2415R-3W	3,427	3,770
							
18" WIDTH							
FILE FILE	24 7/8	18	27 15/16	GA2MPW2418R-2W	GAAMPW2418R-2W	3,601	3,962
							
BOX BOX FILE	24 7/8	18	27 15/16	GA2MPW2418R-3W	GAAMPW2418R-3W	3,601	3,962
							

PRODUCT INFO

All pedestals have optional face locks

Hinged door cabinets do not lock

-3 and -7 pedestals include hidden upper box drawer

TO ORDER PLEASE SPECIFY THE FOLLOWING:

- 1. **MODEL NUMBER**
- 2. **FINISH**
- 3. **PULL**
- 4. **LOCKING**
- 5. **KEYING**
- 6. **OFFICE #**

See inside front cover for required option codes

Example



GA2MPW2415R-2W.NC215.MPS.LY.RMS.OFC1
 GA2MPW2415R-2W NC215 MPS LY RMS OFC1
 MODEL NUMBER FINISH PULL LOCKING KEYING OFFICE #

PEDESTALS

Full height | right hand

Credentials

05/22

	D	W	H	new model number	old model number	veneer 1	veneer 2
30" WIDTH							
LATERAL FILE 	24 7/8	30	27 15/16	GA2MPW2430R-4W	GAAMPW2430R-4W	3,908	4,299
BOX BOX LATERAL FILE 	24 7/8	30	27 15/16	GA2MPW2430R-7W	GAAMPW2430R-7W	3,908	4,299
HINGED DOOR 	24 7/8	30	27 15/16	GA2MPW2430R-5W	GAAMPW2430R-5W	3,427	3,770
OPEN SHELF 	24 7/8	30	27 15/16	GA2MPW2430R-SHW	GAAMPW2430R-SHW	3,070	3,377
PRINTER 	24 7/8	30	27 15/16	GA2MPW2430R-PW	GAAMPW2430R-PW	3,619	3,981
TRASH RECEPTACLE 	24 7/8	30	27 15/16	GA2MPW2430R-TW	GAAMPW2430R-TW	3,619	3,981
				• Includes quantity (2) brushed satin aluminum trash cans			
FILE FILE + BOX BOX FILE 	24 7/8	30	27 15/16	GA2MPW2430R-32W	GAAMPW2430R-32W	6,170	6,787
OPEN CUBBY BOX LATERAL FILE 	24 7/8	30	27 15/16	GA2MPW2430R-BW	GAAMPW2430R-BW	3,793	4,173

PRODUCT INFO

All pedestals have optional face locks

Hinged door cabinets do not lock

-B pedestals include hidden upper box drawer

TO ORDER PLEASE SPECIFY THE FOLLOWING:

1. **MODEL NUMBER**
2. **FINISH**
3. **PULL**
4. **LOCKING**
5. **KEYING**
6. **OFFICE #**

See inside front cover for required option codes

Example

GA2MPW2430R-4W.NC215.MPS.LY.RMS.OFC1

GA2MPW2430R-4W	NC215	MPS	LY	RMS	OFC1
MODEL NUMBER	FINISH	PULL	LOCKING	KEYING	OFFICE #

	D	W	H	new model number	old model number	veneer 1	veneer 2
36" WIDTH							
LATERAL FILE 	24 7/8	36	27 15/16	GA2MPW2436R-4W	GAAMPW2436R-4W	4,381	4,820
BOX BOX LATERAL FILE 	24 7/8	36	27 15/16	GA2MPW2436R-7W	GAAMPW2436R-7W	4,381	4,820
HINGED DOOR 	24 7/8	36	27 15/16	GA2MPW2436R-5W	GAAMPW2436R-5W	3,841	4,226
OPEN SHELF 	24 7/8	36	27 15/16	GA2MPW2436R-SHW	GAAMPW2436R-SHW	3,437	3,781
PRINTER 	24 7/8	36	27 15/16	GA2MPW2436R-PW	GAAMPW2436R-PW	4,055	4,461
TRASH RECEPTACLE 	24 7/8	36	27 15/16	GA2MPW2436R-TW	GAAMPW2436R-TW	4,055	4,461
	<ul style="list-style-type: none"> • Includes quantity (2) brushed satin aluminum trash cans 						
BOX BOX FILE+ FILE FILE 	24 7/8	36	27 15/16	GA2MPW2436R-32W	GAAMPW2436R-32W	6,481	7,130
OPEN CUBBY BOX LATERAL FILE 	24 7/8	36	27 15/16	GA2MPW2436R-BW	GAAMPW2436R-BW	4,248	4,673

PRODUCT INFO

All pedestals have optional face locks

Hinged door cabinets do not lock

-B pedestals include hidden upper box drawer

TO ORDER PLEASE SPECIFY THE FOLLOWING:

- | | | |
|----|----------------------|---------------------|
| 1. | <input type="text"/> | MODEL NUMBER |
| 2. | <input type="text"/> | FINISH |
| 3. | <input type="text"/> | PULL |
| 4. | <input type="text"/> | LOCKING |
| 5. | <input type="text"/> | KEYING |
| 6. | <input type="text"/> | OFFICE # |

See inside front cover for required option codes

Example



GA2MPW2436R-4W.NC215.MPS.LY.RMS.OFC1					
GA2MPW2436R-4W	NC215	MPS	LY	RMS	OFC1
MODEL NUMBER	FINISH	PULL	LOCKING	KEYING	OFFICE #

PEDESTALS

Full height | right hand

Credentials

05/22

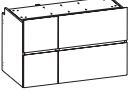
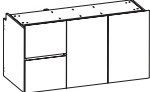
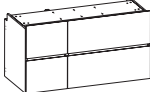
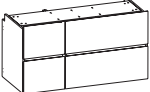
	D	W	H	new model number	old model number	veneer 1	veneer 2
45" WIDTH							
HINGED DOOR + FILE FILE 	24 7/8	45	27 15/16	GA2MPW2445R-25W	GAAMPW2445R-25W	6,170	6,787
LATERAL FILE + BOX BOX FILE 	24 7/8	45	27 15/16	GA2MPW2445R-34W	GAAMPW2445R-34W	6,605	7,266
BOX BOX LATERAL FILE + FILE FILE 	24 7/8	45	27 15/16	GA2MPW2445R-27W	GAAMPW2445R-27W	6,605	7,266
54" WIDTH							
HINGED DOOR + FILE FILE 	24 7/8	54	27 15/16	GA2MPW2454R-25W	GAAMPW2454R-25W	6,696	7,366
LATERAL FILE + BOX BOX FILE 	24 7/8	54	27 15/16	GA2MPW2454R-34W	GAAMPW2454R-34W	7,183	7,902
BOX BOX LATERAL FILE + 	24 7/8	54	27 15/16	GA2MPW2454R-27W	GAAMPW2454R-27W	7,183	7,902

PRODUCT INFO

All pedestals have optional face locks

Hinged door cabinets do not lock

-3 and -7 pedestals include hidden upper box drawer

TO ORDER PLEASE SPECIFY THE FOLLOWING:

1. **MODEL NUMBER**
2. **FINISH**
3. **PULL**
4. **LOCKING**
5. **KEYING**
6. **OFFICE #**

See inside front cover for required option codes

Example

GA2MPW2445R-25W.NC215.MPS.LY.RMS.OFC1
 GA2MPW2445R-25W NC215 MPS LY RMS OFC1
 MODEL NUMBER FINISH PULL LOCKING KEYING OFFICE #

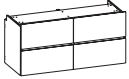
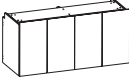
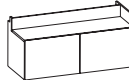
	D	W	H	new model number	old model number	veneer 1	veneer 2
60" WIDTH							
LATERAL FILE 	24 7/8	60	27 15/16	GA2MPW2460R-44W	GAAMPW2460R-44W	7,040	7,744
HINGED DOOR 	24 7/8	60	27 15/16	GA2MPW2460R-55W	GAAMPW2460R-55W	6,170	6,787
OPEN CUBBY BOX LATERAL FILE 	24 7/8	60	27 15/16	GA2MPW2460R-BBW	GAAMPW2460R-BBW	6,828	7,511

PRODUCT INFO

All pedestals have optional face locks

Hinged door cabinets do not lock

-BB pedestals include hidden upper box drawer

TO ORDER PLEASE SPECIFY THE FOLLOWING:

1. **MODEL NUMBER**
2. **FINISH**
3. **PULL**
4. **LOCKING**
5. **KEYING**
6. **OFFICE #**

See inside front cover for required option codes

Example

GA2MPW2460R-44W.NC215.MPS.LY.RMS.OFC1
 GA2MPW2460R-44W NC215 MPS LY RMS OFC1
 MODEL NUMBER FINISH PULL LOCKING KEYING OFFICE #

LAYERS PEDESTALS

Low height | left hand

Credentials

05/22

	D	W	H	new model number	old model number	veneer 1	veneer 2
15" WIDTH							
FALSE PEDESTALS	24	15	20 ³ / ₁₆	GA2MLPW2415L-LW	GAAMPLPW2415L-LW	1,238	1,362



- For use with: standard or trough back worksurfaces
no modesty panel applications



	24	15	20 ³ / ₁₆	GA2MLPW2415L-XBW	GAAMPLPW2415L-XBW	1,293	1,423
--	----	----	---------------------------------	-------------------------	-------------------	-------	-------

- For use with: standard or trough back worksurfaces
wall access panel or full back panel applications

PRODUCT INFO

TO ORDER PLEASE SPECIFY THE FOLLOWING:

- MODEL NUMBER**
- FINISH**
- OFFICE #**

See inside front cover for required option codes

Example

GA2MLPW2415L-LW.NC215.OFC1

GA2MLPW2415L-LW	NC215	OFC1
MODEL NUMBER	FINISH	OFFICE #

	D	W	H	new model number	old model number	veneer 1	veneer 2
15" WIDTH BOX FILE	24 7/8	15	20 3/16	GA2MLPW2415L-AW	GAAMPLPW2415L-AWW	3,255	3,581



18" WIDTH BOX FILE	24 7/8	18	20 3/16	GA2MLPW2418L-AW	GAAMPLPW2418L-AWW	3,421	3,764
--------------------------------	--------	----	---------	------------------------	-------------------	-------	-------



PRODUCT INFO

All pedestals have optional face locks

Hinged door cabinets do not lock

-A and -B pedestals include hidden upper box drawer

TO ORDER PLEASE SPECIFY THE FOLLOWING:

- 1. **MODEL NUMBER**
- 2. **FINISH**
- 3. **PULL**
- 4. **LOCKING**
- 5. **KEYING**
- 6. **OFFICE #**

See inside front cover for required option codes

Example

GA2MLPW2415L-AW.NC215.MPS.LY.RMS.OFC1
 GA2MLPW2415L-AW NC215 MPS LY RMS OFC1
 MODEL NUMBER FINISH PULL LOCKING KEYING OFFICE #

LAYERS PEDESTALS

Low height | left hand

Credentials

05/22

	D	W	H	new model number	old model number	veneer 1	veneer 2
30" WIDTH							
BOX LATERAL FILE	24 7/8	30	20 3/16	GA2MLPW2430L-BW	GAAMLPW2430L-BWW	3,715	4,087
				• Optional face lock			
HINGED DOOR	24 7/8	30	20 3/16	GA2MLPW2430L-5W	GAAMLPW2430L-5WW	3,255	3,581
							
OPEN SHELF	24 7/8	30	20 3/16	GA2MLPW2430L-SHW	GAAMLPW2430L-SHW	2,916	3,208
							
PRINTER	24 7/8	30	20 3/16	GA2MLPW2430L-PW	GAAMLPW2430L-PW	3,437	3,781
							
TRASH RECEPTACLE	24 7/8	30	20 3/16	GA2MLPW2430L-TW	GAAMLPW2430L-TW	5,335	5,869
				• Includes quantity (2) brushed satin aluminum trash cans			

PRODUCT INFO

Hinged door cabinets do not lock

-A and -B pedestals include hidden upper box drawer

TO ORDER PLEASE SPECIFY THE FOLLOWING:

- | | | |
|----|----------------------|---------------------|
| 1. | <input type="text"/> | MODEL NUMBER |
| 2. | <input type="text"/> | FINISH |
| 3. | <input type="text"/> | PULL |
| 4. | <input type="text"/> | LOCKING |
| 5. | <input type="text"/> | KEYING |
| 6. | <input type="text"/> | OFFICE # |

See inside front cover for required option codes

Example

GA2MLPW2430L-BW.NC215.MPS.LY.RMS.OFC1

GA2MLPW2430L-BW	NC215	MPS	LY	RMS	OFC1
MODEL NUMBER	FINISH	PULL	LOCKING	KEYING	OFFICE #

	D	W	H	new model number	old model number	veneer 1	veneer 2
36" WIDTH							
BOX LATERAL FILE 	24 7/8	36	20 3/16	GA2MLPW2436L-BW	GAAMPLPW2436L-BW	4,158	4,574
				• Optional face lock			
HINGED DOOR 	24 7/8	36	20 3/16	GA2MLPW2436L-5W	GAAMPLPW2436L-5W	3,648	4,013
OPEN SHELF 	24 7/8	36	20 3/16	GA2MLPW2436L-SHW	GAAMPLPW2436L-SHW	3,269	3,596
PRINTER 	24 7/8	36	20 3/16	GA2MLPW2436L-PW	GAAMPLPW2436L-PW	3,855	4,241
TRASH RECEPTACLE 	24 7/8	36	20 3/16	GA2MLPW2436L-TW	GAAMPLPW2436L-TW	3,855	4,241
				• Includes quantity (2) brushed satin aluminum trash cans			

PRODUCT INFO

Hinged door cabinets do not lock

-A and -B pedestals include hidden upper box drawer

TO ORDER PLEASE SPECIFY THE FOLLOWING:

- 1. **MODEL NUMBER**
- 2. **FINISH**
- 3. **PULL**
- 4. **LOCKING**
- 5. **KEYING**
- 6. **OFFICE #**

See inside front cover for required option codes

Example

GA2MLPW2436L-BW.NC215.MPS.LY.RMS.OFC1
 GA2MLPW2436L-BW NC215 MPS LY RMS OFC1
 MODEL NUMBER FINISH PULL LOCKING KEYING OFFICE #

LAYERS PEDESTALS

Low height | left hand

Credentials

05/22

	D	W	H	new model number	old model number	veneer 1	veneer 2
45" WIDTH							
HINGED DOOR + BOX FILE	24 7/8	45	20 3/16	GA2MLPW2445L-5AW	GAAMPLPW2445L-5AW	5,860	6,446
							
BOX LATERAL FILE + BOX FILE	24 7/8	45	20 3/16	GA2MLPW2445L-BAW	GAAMPLPW2445L-BAW	6,273	6,901
							
54" WIDTH							
HINGED DOOR + BOX FILE	24 7/8	54	20 3/16	GA2MLPW2454L-5AW	GAAMPLPW2454L-5AW	6,360	6,996
							
BOX LATERAL FILE + BOX FILE	24 7/8	54	20 3/16	GA2MLPW2454L-BAW	GAAMPLPW2454L-BAW	6,822	7,505
							

PRODUCT INFO

All pedestals have optional face locks

Hinged door cabinets do not lock

-A and -B pedestals include hidden upper box drawer

TO ORDER PLEASE SPECIFY THE FOLLOWING:

1. **MODEL NUMBER**
2. **FINISH**
3. **PULL**
4. **LOCKING**
5. **KEYING**
6. **OFFICE #**

See inside front cover for required option codes

Example

GA2MLPW2445L-5AW.NC215.MPS.LY.RMS.OFC1

GA2MLPW2445L-5AW	NC215	MPS	LY	RMS	OFC1
MODEL NUMBER	FINISH	PULL	LOCKING	KEYING	OFFICE #

	D	W	H	new model number	old model number	veneer 1	veneer 2
60" WIDTH							
BOX LATERAL FILE + BOX LATERAL FILE	24 7/8	60	20 3/16	GA2MLPW2460L-BBW	GAAMLPW2460L-BBW	6,690	7,359

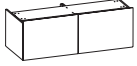

HINGED DOOR + HINGED DOOR	24 7/8	60	20 3/16	GA2MLPW2460L-55W	GAAMLPW2460L-55W	5,860	6,446
------------------------------	--------	----	---------	-------------------------	------------------	-------	-------

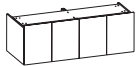

PRODUCT INFO

Hinged door cabinets do not lock

-A and -B pedestals include hidden upper box drawer

TO ORDER PLEASE SPECIFY THE FOLLOWING:

- 1. **MODEL NUMBER**
- 2. **FINISH**
- 3. **PULL**
- 4. **LOCKING**
- 5. **KEYING**
- 6. **OFFICE #**

See inside front cover for required option codes

Example

GA2MLPW2460L-BBW.NC215.MPS.LY.RMS.OFC1

GA2MLPW2460L-BBW	NC215	MPS	LY	RMS	OFC1
MODEL NUMBER	FINISH	PULL	LOCKING	KEYING	OFFICE #

LAYERS PEDESTALS

Low height | right hand

Credentials

05/22

	D	W	H	new model number	old model number	veneer 1	veneer 2
15" WIDTH							
FALSE PEDESTALS	24	15	20 ³ / ₁₆	GA2MLPW2415R-LW	GAAMPLPW2415R-LW	1,238	1,362

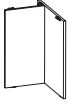

- For use with: standard or trough back worksurfaces
no modesty panel applications



	24	15	20 ³ / ₁₆	GA2MLPW2415R-XBW	GAAMPLPW2415R-XBW	1,293	1,423
--	----	----	---------------------------------	-------------------------	-------------------	-------	-------

- For use with: standard or trough back worksurfaces
wall access panel or full back panel applications

PRODUCT INFO

TO ORDER PLEASE SPECIFY THE FOLLOWING:

1. **MODEL NUMBER**
2. **FINISH**
3. **OFFICE #**

See inside front cover for required option codes

Example

GA2MLPW2415R-LW.NC215.OFC1

GA2MLPW2415R-LW	NC215	OFC1
<small>MODEL NUMBER</small>	<small>FINISH</small>	<small>OFFICE #</small>

	D	W	H	new model number	old model number	veneer 1	veneer 2
15" WIDTH							
BOX FILE	24 7/8	15	20 3/16	GA2MLPW2415R-AW	GAAMLPW2415R-AWW	3,255	3,581



18" WIDTH							
BOX FILE	24 7/8	18	20 3/16	GA2MLPW2418R-AW	GAAMLPW2418R-AWW	3,421	3,764



PRODUCT INFO

All pedestals have optional face locks

Hinged door cabinets do not lock

-A and -B pedestals include hidden upper box drawer

TO ORDER PLEASE SPECIFY THE FOLLOWING:

- 1. **MODEL NUMBER**
- 2. **FINISH**
- 3. **PULL**
- 4. **LOCKING**
- 5. **KEYING**
- 6. **OFFICE #**

See inside front cover for required option codes

Example



GA2MLPW2415R-AW.NC215.MPS.LY.RMS.OFC1
 GA2MLPW2415R-AW NC215 MPS LY RMS OFC1
 MODEL NUMBER FINISH PULL LOCKING KEYING OFFICE #

LAYERS PEDESTALS

Low height | right hand

Credentials

05/22

	D	W	H	new model number	old model number	veneer 1	veneer 2
30" WIDTH							
BOX LATERAL FILE 	24 7/8	30	20 3/16	GA2MLPW2430R-BW	GAAMPLPW2430R-BWW	3,715	4,087
				• Optional face lock			
HINGED DOOR 	24 7/8	30	20 3/16	GA2MLPW2430R-5W	GAAMPLPW2430R-5WW	3,255	3,581
OPEN SHELF 	24 7/8	30	20 3/16	GA2MLPW2430R-SHW	GAAMPLPW2430R-SHW	2,916	3,208
PRINTER 	24 7/8	30	20 3/16	GA2MLPW2430R-PW	GAAMPLPW2430R-PW	3,437	3,781
TRASH RECEPTACLE 	24 7/8	30	20 3/16	GA2MLPW2430R-TW	GAAMPLPW2430R-TW	5,335	5,869
				• Includes quantity (2) brushed satin aluminum trash cans			

PRODUCT INFO

Hinged door cabinets do not lock

-A and -B pedestals include hidden upper box drawer

TO ORDER PLEASE SPECIFY THE FOLLOWING:

- | | | |
|----|----------------------|---------------------|
| 1. | <input type="text"/> | MODEL NUMBER |
| 2. | <input type="text"/> | FINISH |
| 3. | <input type="text"/> | PULL |
| 4. | <input type="text"/> | LOCKING |
| 5. | <input type="text"/> | KEYING |
| 6. | <input type="text"/> | OFFICE # |

See inside front cover for required option codes

Example

GA2MLPW2430R-BW.NC215.MPS.LY.RMS.OFC1

GA2MLPW2430R-BW	NC215	MPS	LY	RMS	OFC1
MODEL NUMBER	FINISH	PULL	LOCKING	KEYING	OFFICE #

	D	W	H	new model number	old model number	veneer 1	veneer 2
36" WIDTH							
BOX LATERAL FILE 	24 7/8	36	20 3/16	GA2MLPW2436R-BW	GAAMPLPW2436R-BWW	4,158	4,574
				• Optional face lock			
HINGED DOOR 	24 7/8	36	20 3/16	GA2MLPW2436R-5W	GAAMPLPW2436R-5WW	3,648	4,013
OPEN SHELF 	24 7/8	36	20 3/16	GA2MLPW2436R-SHW	GAAMPLPW2436R-SHW	3,269	3,596
PRINTER 	24 7/8	36	20 3/16	GA2MLPW2436R-PW	GAAMPLPW2436R-PW	3,855	4,241
TRASH RECEPTACLE 	24 7/8	36	20 3/16	GA2MLPW2436R-TW	GAAMPLPW2436R-TW	3,855	4,241
				• Includes quantity (2) brushed satin aluminum trash cans			

PRODUCT INFO

Hinged door cabinets do not lock

-A and -B pedestals include hidden upper box drawer

TO ORDER PLEASE SPECIFY THE FOLLOWING:

- 1. **MODEL NUMBER**
- 2. **FINISH**
- 3. **PULL**
- 4. **LOCKING**
- 5. **KEYING**
- 6. **OFFICE #**

See inside front cover for required option codes

Example

GA2MLPW2436R-BW.NC215.MPS.LY.RMS.OFC1
 GA2MLPW2436R-BW NC215 MPS LY RMS OFC1
 MODEL NUMBER FINISH PULL LOCKING KEYING OFFICE #

LAYERS PEDESTALS

Low height | right hand

Credentials

05/22

	D	W	H	new model number	old model number	veneer 1	veneer 2
45" WIDTH HINGED DOOR + BOX FILE 	24 7/8	45	20 3/16	GA2MLPW2445R-A5W	GAAMPLPW2445R-A5W	5,860	6,446
BOX LATERAL FILE + BOX FILE 	24 7/8	45	20 3/16	GA2MLPW2445R-ABW	GAAMPLPW2445R-ABW	6,273	6,901
54" WIDTH HINGED DOOR + BOX FILE 	24 7/8	54	20 3/16	GA2MLPW2454R-A5W	GAAMPLPW2454R-A5W	6,360	6,996
BOX LATERAL FILE + BOX FILE 	24 7/8	54	20 3/16	GA2MLPW2454R-ABW	GAAMPLPW2454R-ABW	6,822	7,505

PRODUCT INFO

All pedestals have optional face locks

Hinged door cabinets do not lock

-A and -B pedestals include hidden upper box drawer

TO ORDER PLEASE SPECIFY THE FOLLOWING:

1. **MODEL NUMBER**
2. **FINISH**
3. **PULL**
4. **LOCKING**
5. **KEYING**
6. **OFFICE #**

See inside front cover for required option codes

Example

GA2MLPW2445R-A5W.NC215.MPS.LY.RMS.OFC1

GA2MLPW2445R-A5W	NC215	MPS	LY	RMS	OFC1
MODEL NUMBER	FINISH	PULL	LOCKING	KEYING	OFFICE #

	D	W	H	new model number	old model number	veneer 1	veneer 2
--	---	---	---	------------------	------------------	----------	----------

60" WIDTH

BOX | LATERAL FILE +
BOX | LATERAL FILE

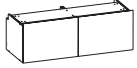

24 7/8	60	20 3/16	GA2MLPW2460R-BBW	GAAMPLPW2460R-BBW	6,690	7,359
--------	----	---------	-------------------------	-------------------	-------	-------

HINGED DOOR +
HINGED DOOR

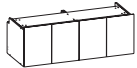

24 7/8	60	20 3/16	GA2MLPW2460R-55W	GAAMPLPW2460R-55W	5,860	6,446
--------	----	---------	-------------------------	-------------------	-------	-------

PRODUCT INFO

All pedestals have optional face locks

Hinged door cabinets do not lock

-A and -B pedestals include hidden upper box drawer

TO ORDER PLEASE SPECIFY THE FOLLOWING:

1. **MODEL NUMBER**
2. **FINISH**
3. **PULL**
4. **LOCKING**
5. **KEYING**
6. **OFFICE #**

See inside front cover for required option codes

Example

GA2MLPW2460R-BBW.NC215.MPS.LY.RMS.OFC1

GA2MLPW2460R-BBW	NC215	MPS	LY	RMS	OFC1
MODEL NUMBER	FINISH	PULL	LOCKING	KEYING	OFFICE #

CREDENZA MODESTY PANELS

Full height

Credentials

05/22

FINISHED BACK PANEL



D	W	H	new model number	old model number	veneer 1	veneer 2
$\frac{3}{4}$	58 $\frac{1}{2}$	27 $\frac{15}{16}$	GA2MCF60-W	GAAMCF60-W	1,417	1,559
$\frac{3}{4}$	64 $\frac{1}{2}$	27 $\frac{15}{16}$	GA2MCF66-W	GAAMCF66-W	1,495	1,645
$\frac{3}{4}$	70 $\frac{1}{2}$	27 $\frac{15}{16}$	GA2MCF72-W	GAAMCF72-W	1,575	1,733
$\frac{3}{4}$	76 $\frac{1}{2}$	27 $\frac{15}{16}$	GA2MCF78-W	GAAMCF78-W	1,650	1,815
$\frac{3}{4}$	82 $\frac{1}{2}$	27 $\frac{15}{16}$	GA2MCF84-W	GAAMCF84-W	1,734	1,908
$\frac{3}{4}$	88 $\frac{1}{2}$	27 $\frac{15}{16}$	GA2MCF90-W	GAAMCF90-W	1,822	2,005
$\frac{3}{4}$	94 $\frac{1}{2}$	27 $\frac{15}{16}$	GA2MCF96-W	GAAMCF96-W	1,916	2,108
$\frac{3}{4}$	100 $\frac{1}{2}$	27 $\frac{15}{16}$	GA2MCF102-W	GAAMCF102-W	2,045	2,250
$\frac{3}{4}$	106 $\frac{1}{2}$	27 $\frac{15}{16}$	GA2MCF108-W	GAAMCF108-W	2,189	2,408
$\frac{3}{4}$	112 $\frac{1}{2}$	27 $\frac{15}{16}$	GA2MCF114-W	GAAMCF114-W	2,347	2,582
$\frac{3}{4}$	118 $\frac{1}{2}$	27 $\frac{15}{16}$	GA2MCF120-W	GAAMCF120-W	2,509	2,760

- Specify width to match worksurface width
- Example: 90" worksurface = 90" finished back panel

PRODUCT INFO

TO ORDER PLEASE SPECIFY THE FOLLOWING:

1. **MODEL NUMBER**
2. **FINISH**
3. **OFFICE #**

See inside front cover for required option codes

Example

GA2MCF60-W.NC215.OFC1
 GA2MCF60-W NC215 OFC1
 MODEL NUMBER FINISH OFFICE #

FINISHED BACK PANEL



D	W	H	new model number	old model number	veneer 1	veneer 2
³ / ₄	58 1/2	20 ³ / ₁₆	GA2MLCF60-W	GAAMLCF60-W	1,350	1,485
³ / ₄	64 1/2	20 ³ / ₁₆	GA2MLCF66-W	GAAMLCF66-W	1,417	1,559
³ / ₄	70 1/2	20 ³ / ₁₆	GA2MLCF72-W	GAAMLCF72-W	1,495	1,645
³ / ₄	76 1/2	20 ³ / ₁₆	GA2MLCF78-W	GAAMLCF78-W	1,571	1,729
³ / ₄	82 1/2	20 ³ / ₁₆	GA2MLCF84-W	GAAMLCF84-W	1,648	1,813
³ / ₄	88 1/2	20 ³ / ₁₆	GA2MLCF90-W	GAAMLCF90-W	1,731	1,905
³ / ₄	94 1/2	20 ³ / ₁₆	GA2MLCF96-W	GAAMLCF96-W	1,817	1,999
³ / ₄	100 1/2	20 ³ / ₁₆	GA2MLCF102-W	GAAMLCF102-W	1,942	2,137
³ / ₄	106 1/2	20 ³ / ₁₆	GA2MLCF108-W	GAAMLCF108-W	2,079	2,287
³ / ₄	112 1/2	20 ³ / ₁₆	GA2MLCF114-W	GAAMLCF114-W	2,226	2,449
³ / ₄	118 1/2	20 ³ / ₁₆	GA2MLCF120-W	GAAMLCF120-W	2,382	2,621

- Specify width to match worksurface width
- Example: 90" worksurface = 90" finished back panel

PRODUCT INFO

TO ORDER PLEASE SPECIFY THE FOLLOWING:

1. **MODEL NUMBER**
2. **FINISH**
3. **OFFICE #**

See inside front cover for required option codes

Example

GA2MLCF60-W.NC215.OFC1
 GA2MLCF60-W NC215 OFC1
 MODEL NUMBER FINISH OFFICE #

CREDENZA WALL ACCESS PANELS

Full height

Credentials

05/22

WALL ACCESS PANEL



D	W	H	new model number	old model number	veneer 1	veneer 2
5 11/16	24	26 1/2	GA2MCA24-W	GAAMCA24-W	1,752	1,928
5 11/16	27	26 1/2	GA2MCA27-W	GAAMCA27-W	1,808	1,989
5 11/16	30	26 1/2	GA2MCA30-W	GAAMCA30-W	1,864	2,051
5 11/16	33	26 1/2	GA2MCA33-W	GAAMCA33-W	1,922	2,115
5 11/16	36	26 1/2	GA2MCA36-W	GAAMCA36-W	1,982	2,181
5 11/16	39	26 1/2	GA2MCA39-W	GAAMCA39-W	2,044	2,249
5 11/16	42	26 1/2	GA2MCA42-W	GAAMCA42-W	2,084	2,293
5 11/16	45	26 1/2	GA2MCA45-W	GAAMCA45-W	2,129	2,342
5 11/16	48	26 1/2	GA2MCA48-W	GAAMCA48-W	2,172	2,390
5 11/16	51	26 1/2	GA2MCA51-W	GAAMCA51-W	2,217	2,439
5 11/16	54	26 1/2	GA2MCA54-W	GAAMCA54-W	2,259	2,485
5 11/16	57	26 1/2	GA2MCA57-W	GAAMCA57-W	2,306	2,537
5 11/16	60	26 1/2	GA2MCA60-W	GAAMCA60-W	2,352	2,588
5 11/16	63	26 1/2	GA2MCA63-W	GAAMCA63-W	2,400	2,640
5 11/16	66	26 1/2	GA2MCA66-W	GAAMCA66-W	2,447	2,692
5 11/16	69	26 1/2	GA2MCA69-W	GAAMCA69-W	2,497	2,747
5 11/16	72	26 1/2	GA2MCA72-W	GAAMCA72-W	2,545	2,800

- Specify width to match kneewell space between pedestals
- Example: (90" worksurface) - (15" LH pedestal) - (15" RH pedestal) = 60" wall access panel

PRODUCT INFO

TO ORDER PLEASE SPECIFY THE FOLLOWING:

1. **MODEL NUMBER**
2. **FINISH**
3. **OFFICE #**

See inside front cover for required option codes

Example

GA2MCA24-W.NC215.OFC1
 GA2MCA24-W NC215 OFC1
 MODEL NUMBER FINISH OFFICE #

FINISHED BACK PANEL



D	W	H	new model number	old model number	veneer 1	veneer 2
3/4	38 1/4	27 15/16	GA2MRF39-W	GAAMRF39-W	1,181	1,300
3/4	41 1/4	27 15/16	GA2MRF42-W	GAAMRF42-W	1,217	1,339
3/4	44 1/4	27 15/16	GA2MRF45-W	GAAMRF45-W	1,253	1,379
3/4	47 1/4	27 15/16	GA2MRF48-W	GAAMRF48-W	1,283	1,412
3/4	50 1/4	27 15/16	GA2MRF51-W	GAAMRF51-W	1,316	1,448
3/4	53 1/4	27 15/16	GA2MRF54-W	GAAMRF54-W	1,350	1,485
3/4	56 1/4	27 15/16	GA2MRF57-W	GAAMRF57-W	1,385	1,524
3/4	59 1/4	27 15/16	GA2MRF60-W	GAAMRF60-W	1,417	1,559
3/4	62 1/4	27 15/16	GA2MRF63-W	GAAMRF63-W	1,456	1,602
3/4	65 1/4	27 15/16	GA2MRF66-W	GAAMRF66-W	1,495	1,645
3/4	68 1/4	27 15/16	GA2MRF69-W	GAAMRF69-W	1,535	1,689
3/4	71 1/4	27 15/16	GA2MRF72-W	GAAMRF72-W	1,575	1,733

- Specify width to match worksurface width
- Example: 60" worksurface = 60" finished back panel

NOTE: A 3" shorter width modesty is required when used with a height adjustable desk.

PRODUCT INFO

TO ORDER PLEASE SPECIFY THE FOLLOWING:

1. **MODEL NUMBER**
2. **FINISH**
3. **OFFICE #**

See inside front cover for required option codes

Example

GA2MRF39-W.NC215.OFC1
 GA2MRF39-W NC215 OFC1
 MODEL NUMBER FINISH OFFICE #

RETURN WALL ACCESS PANELS

Full height

Credentials

05/22

WALL ACCESS PANEL



D	W	H	new model number	old model number	veneer 1	veneer 2
5 11/16	21	26 1/2	GA2MRA21-W	GAAMRA21-W	1,701	1,872
5 11/16	24	26 1/2	GA2MRA24-W	GAAMRA24-W	1,752	1,928
5 11/16	27	26 1/2	GA2MRA27-W	GAAMRA27-W	1,808	1,989
5 11/16	30	26 1/2	GA2MRA30-W	GAAMRA30-W	1,864	2,051
5 11/16	33	26 1/2	GA2MRA33-W	GAAMRA33-W	1,922	2,115
5 11/16	36	26 1/2	GA2MRA36-W	GAAMRA36-W	1,982	2,181
5 11/16	39	26 1/2	GA2MRA39-W	GAAMRA39-W	2,044	2,249
5 11/16	42	26 1/2	GA2MRA42-W	GAAMRA42-W	2,084	2,293
5 11/16	45	26 1/2	GA2MRA45-W	GAAMRA45-W	2,129	2,342
5 11/16	48	26 1/2	GA2MRA48-W	GAAMRA48-W	2,172	2,390
5 11/16	51	26 1/2	GA2MRA51-W	GAAMRA51-W	2,217	2,439
5 11/16	54	26 1/2	GA2MRA54-W	GAAMRA54-W	2,259	2,485
5 11/16	57	26 1/2	GA2MRA57-W	GAAMRA57-W	2,306	2,537
5 11/16	60	26 1/2	GA2MRA60-W	GAAMRA60-W	2,352	2,588

- Specify width to match kneewell space between pedestals
- Example: (60" worksurface) - (15" LH pedestal) = 45" wall access panel

NOTE: A 3" shorter width wall access panel is required when used with a height adjustable desk.

PRODUCT INFO

TO ORDER PLEASE SPECIFY THE FOLLOWING:

1. **MODEL NUMBER**
2. **FINISH**
3. **OFFICE #**

See inside front cover for required option codes

Example

GA2MRA21-W.NC215.OFC1
 GA2MRA21-W NC215 OFC1
 MODEL NUMBER FINISH OFFICE #

	D	W	H	new model number	old model number	veneer 1	veneer 2
FULL HEIGHT							
INTERMEDIATE SUPPORT FOR USE WITH MODESTY PANEL	3/4	14	27 1/2	GA2MSP12-W	GAAMSP12-W	780	858



T-SUPPORT FOR USE WITH NO MODESTY PANEL	8	12	27 1/2	GA2MSPT12-W	GAAMSPT12-W	665	732
---	---	----	--------	--------------------	-------------	-----	-----



LAYERS LOW HEIGHT							
INTERMEDIATE SUPPORT FOR USE WITH MODESTY PANEL	3/4	5 11/16	20 3/16	GA2MLSP12-W	GAAMLSP12-W	347	382



T-SUPPORT FOR USE WITH NO MODESTY PANEL	8	5 11/16	20 3/16	GA2MLSPT12-W	GAAMLSPT12-W	631	695
---	---	---------	---------	---------------------	--------------	-----	-----



PRODUCT INFO

TO ORDER PLEASE SPECIFY THE FOLLOWING:

- 1. **MODEL NUMBER**
- 2. **FINISH**
- 3. **OFFICE #**

See inside front cover for required option codes

Example

GA2MSP12-W.NC215.OFC1

GA2MSP12-W	NC215	OFC1
<small>MODEL NUMBER</small>	<small>FINISH</small>	<small>OFFICE #</small>

WALL MOUNT BRACKET

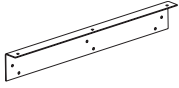

D	W	H	model number	list
2 1/2	19	1 1/4	MDWLBK24	119
2 1/2	25	1 1/4	MDWLBK30	128

WALL MOUNT BRACKET

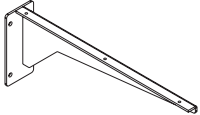

3 1/8	20 3/16	7 1/8	ACWCB20	223
3 1/8	15 3/16	7 1/8	ACWCB15	209

- For use with 24" tops to provide support on an end condition

- For use with 24" tops to provide support on center as an alternative to a T-bracket

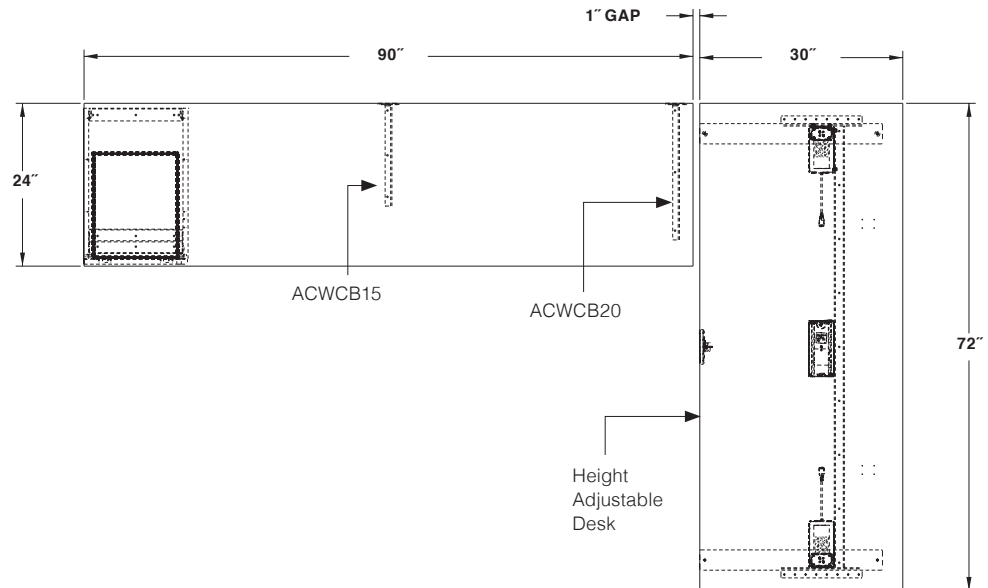

PRODUCT INFO

TO ORDER PLEASE SPECIFY THE FOLLOWING:



1. MODEL NUMBER

NOTE: Office # option not required

See inside front cover for required option codes

Example

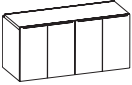
MDWLBK24
MDWLBK24
MODEL NUMBER

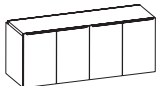
	D	W	H	new model number	old model number	veneer 1	veneer 2
60" WIDTH							
-44	24 7/8	60	27 15/16	GA2CFS2460T-44WW	GAACFS2460T-44WW	8,926	9,819
							
-55	24 7/8	60	27 15/16	GA2CFS2460T-55WW	GAACFS2460T-55WW	8,036	8,840
							
72" WIDTH							
-44	24 7/8	72	27 15/16	GA2CFS2472T-44WW	GAACFS2472T-44WW	9,980	10,978
							
-55	24 7/8	72	27 15/16	GA2CFS2472T-55WW	GAACFS2472T-55WW	8,978	9,876
							

- Trough back units are required when a tackzone spans over the back of the worksurface
- Trough units include a metal pencil lip

NOTE: Plastic Trough Insert is REQUIRED and must be ordered separately across entire length of trough.

PRODUCT INFO

Short grain veneer on worksurface

Doors do not lock

TO ORDER PLEASE SPECIFY THE FOLLOWING:

- | | | |
|----|----------------------|---------------------------------------|
| 1. | <input type="text"/> | MODEL NUMBER |
| 2. | <input type="text"/> | FINISH |
| 3. | <input type="text"/> | TOP UV FINISH TYPE |
| 4. | <input type="text"/> | PULL |
| 5. | <input type="text"/> | MODESTY |
| 6. | <input type="text"/> | LOCKING |
| 7. | <input type="text"/> | KEYING |
| 8. | <input type="text"/> | PENCIL LIP COLOR (TROUGH ONLY) |
| 9. | <input type="text"/> | OFFICE # |

See inside front cover for required option codes

Example

GA2CFS2460T-44WW.NC215.FF.MPS.MY.LY.RMS.PLS.OFC1
 GA2CFS2460T-44WW NC215 FF MPS MY LY RMS PLS OFC1
 MODEL NUMBER FINISH TOP UV FINISH PULL MODESTY LOCKING KEYING PENCIL LIP COLOR OFFICE #

FULL BANK STORAGE CREDENZAS

Credentials
05/22

Trough back

	D	W	H	new model number	old model number	veneer 1	veneer 2
90" WIDTH							
-444	24 7/8	90	27 15/16	GA2CFS2490T-444WW	GAACFS2490T-444WW	13,024	14,327
							
-555	24 7/8	90	27 15/16	GA2CFS2490T-555WW	GAACFS2490T-555WW	11,686	12,855
							
-454	24 7/8	90	27 15/16	GA2CFS2490T-454WW	GAACFS2490T-454WW	12,576	13,834
							
108" WIDTH							
-444	24 7/8	108	27 15/16	GA2CFS24108T-444WW	GAACFS24108T-444WW	14,817	16,299
							
-555	24 7/8	108	27 15/16	GA2CFS24108T-555WW	GAACFS24108T-555WW	13,314	14,646
							
-454	24 7/8	108	27 15/16	GA2CFS24108T-454WW	GAACFS24108T-454WW	14,311	15,743
							

- Trough back units are required when a tackzone spans over the back of the worksurface
- Trough units include a metal pencil lip

NOTE: Plastic Trough Insert is REQUIRED and must be ordered separately across entire length of trough.

PRODUCT INFO

Short grain veneer on worksurface

Doors do not lock

TO ORDER PLEASE SPECIFY THE FOLLOWING:

1. **MODEL NUMBER**
2. **FINISH**
3. **TOP UV FINISH TYPE**
4. **PULL**
5. **MODESTY**
6. **LOCKING**
7. **KEYING**
8. **PENCIL LIP COLOR (TROUGH ONLY)**
9. **OFFICE #**

See inside front cover for required option codes

Example

GA2CFS2490T-444WW.NC125.FF.MPS.MY.LY.RMS.PLS.OFC1

GA2CFS2490T-444WW	NC125	FF	MPS	MY	LY	RMS	PLS	OFC1
<small>MODEL NUMBER</small>	<small>FINISH</small>	<small>TOP UV FINISH</small>	<small>PULL</small>	<small>MODESTY</small>	<small>LOCKING</small>	<small>KEYING</small>	<small>PENCIL LIP COLOR</small>	<small>OFFICE #</small>

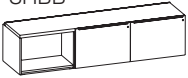
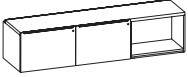
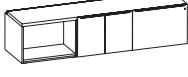
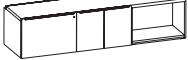
	D	W	H	new model number	old model number	veneer 1	veneer 2
90" WIDTH							
-SHBB 	24 7/8	90	20 3/16	GA2CLFS2490T-SHBBW	GAACLFS2490T-SHBBW	11,741	12,916
-BBSH 	24 7/8	90	20 3/16	GA2CLFS2490T-BBSHW	GAACLFS2490T-BBSHW	11,741	12,916
-SH5B 	24 7/8	90	20 3/16	GA2CLFS2490T-SH5BW	GAACLFS2490T-SH5BW	11,319	12,451
-B5SH 	24 7/8	90	20 3/16	GA2CLFS2490T-B5SHW	GAACLFS2490T-B5SHW	11,319	12,451

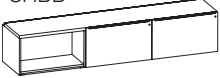
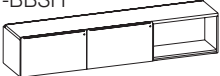
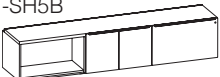
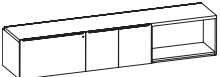
108" WIDTH							
-SHBB 	24 7/8	108	20 3/16	GA2CLFS24108T-SHBBW	GAACLFS24108T-SHBBW	13,381	14,720
-BBSH 	24 7/8	108	20 3/16	GA2CLFS24108T-BBSHW	GAACLFS24108T-BBSHW	13,381	14,720
-SH5B 	24 7/8	108	20 3/16	GA2CLFS24108T-SH5BW	GAACLFS24108T-SH5BW	12,904	14,195
-B5SH 	24 7/8	108	20 3/16	GA2CLFS24108T-B5SHW	GAACLFS24108T-B5SHW	12,904	14,195

- Trough back units are required when a tackzone spans over the back of the worksurface
- Trough units include a metal pencil lip

NOTE: Plastic Trough Insert is REQUIRED and must be ordered separately across entire length of trough.

PRODUCT INFO

Short grain veneer on worksurface

Doors do not lock

TO ORDER PLEASE SPECIFY THE FOLLOWING:

- | | | |
|----|----------------------|---------------------------------------|
| 1. | <input type="text"/> | MODEL NUMBER |
| 2. | <input type="text"/> | FINISH |
| 3. | <input type="text"/> | TOP UV FINISH TYPE |
| 4. | <input type="text"/> | PULL |
| 5. | <input type="text"/> | MODESTY |
| 6. | <input type="text"/> | LOCKING |
| 7. | <input type="text"/> | KEYING |
| 8. | <input type="text"/> | PENCIL LIP COLOR (TROUGH ONLY) |
| 9. | <input type="text"/> | OFFICE # |

See inside front cover for required option codes

Example

GA2CLFS2490T-SHBBW.NC215.FF.MPS.MY.LY.RMS.PLS.OFC1
 GA2CLFS2490T-SHBBW NC215 FF MPS MY LY RMS PLS OFC1
 MODEL NUMBER FINISH TOP UV FINISH PULL MODESTY LOCKING KEYING PENCIL LIP COLOR OFFICE #

LAYERS FULL BANK STORAGE CREDENZAS

Credentials
05/22

Trough back

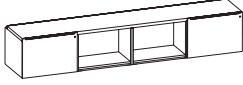
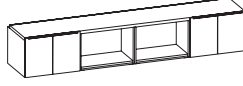
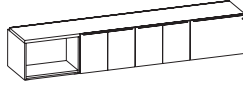
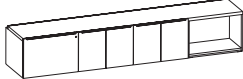
	D	W	H	new model number	old model number	veneer 1	veneer 2
120" WIDTH							
-BSHB	24 7/8	120	20 3/16	GA2CLFS24120T-BSHBW	GAACLFS24120T-BSHBW	15,429	16,972
							
-5SH5	24 7/8	120	20 3/16	GA2CLFS24120T-5SH5W	GAACLFS24120T-5SH5W	15,429	16,972
							
-SH55B	24 7/8	120	20 3/16	GA2CLFS24120T-SH55BW	GAACLFS24120T-SH55BW	15,317	16,849
							
-B55SH	24 7/8	120	20 3/16	GA2CLFS24120T-B55SHW	GAACLFS24120T-B55SHW	15,317	16,849
							

- Trough back units are required when a tackzone spans over the back of the worksurface
- Trough units include a metal pencil lip

NOTE: Plastic Trough Insert is REQUIRED and must be ordered separately across entire length of trough.

PRODUCT INFO

Short grain veneer on worksurface

Doors do not lock

TO ORDER PLEASE SPECIFY THE FOLLOWING:

1. **MODEL NUMBER**
2. **FINISH**
3. **TOP UV FINISH TYPE**
4. **PULL**
5. **MODESTY**
6. **LOCKING**
7. **KEYING**
8. **PENCIL LIP COLOR (TROUGH ONLY)**
9. **OFFICE #**

See inside front cover for required option codes

Example

GA2CLFS24120T-BSHBW.NC215.FF.MPS.MY.LY.RMS.PLS.OFC1

GA2CLFS24120T-BSHBW	NC215	FF	MPS	MY	LY	RMS	PLS	OFC1
MODEL NUMBER	FINISH	TOP UV FINISH	PULL	MODESTY	LOCKING	KEYING	PENCIL LIP COLOR	OFFICE #

	D	W	H	new model number	old model number	veneer 1	veneer 2
18" WIDTH BOX FILE	21 3/8	18	21 15/16	GA2MPD1818-AW	GAAMPD1818-AW	3,762	4,139



PRODUCT INFO

Includes 2 locking casters and 2 non-locking casters

Includes inset top panel

Includes hidden box drawer

TO ORDER PLEASE SPECIFY THE FOLLOWING:

- 1. **MODEL NUMBER**
- 2. **FINISH**
- 3. **PULL**
- 4. **LOCKING**
- 5. **KEYING**
- 6. **OFFICE #**

See inside front cover for required option codes

Example

GA2MPD1818-AW.NC215.MPS.LY.RMS.OFC1

GA2MPD1818-AW	NC215	CPM	LY	RMS	OFC1
MODEL NUMBER	FINISH	PULL	LOCKING	KEYING	OFFICE #

CUSHIONS

Credentials
05/22

	D	W	H	model number	fabric grades			COM/4
					1	2	3	
MOBILE PEDESTAL CUSHIONS								
	19 3/4	17 3/4	1 1/2	GAAMPD-CUSH1818	575	591	613	631

LAYERS CREENZA CUSHIONS FOR STANDARD WORKSURFACE



23 3/4	30	1 1/2	GAACLPD-CUSH2430	647	671	696	723
23 3/4	36	1 1/2	GAACLPD-CUSH2436	699	730	762	795

LAYERS CREENZA CUSHIONS FOR TROUGH BACK WORKSURFACES



21	30	1 1/2	GAACLPD-CUSH2130T	647	671	696	723
21	36	1 1/2	GAACLPD-CUSH2136T	699	730	762	795

PRODUCT INFO

COM Fabric	(yds)
CUSH1818	0.75
CUSH2430	1.00
CUSH2436	1.25
CUSH2430T	1.00
CUSH2436T	1.25

COM Leather	(sq ft)
CUSH1818	12.75
CUSH2430	17.00
CUSH2436	21.25
CUSH2430T	17.00
CUSH2436T	21.25

TO ORDER PLEASE SPECIFY THE FOLLOWING:

1. **MODEL NUMBER**
2. **FABRIC**
3. **FLAMMABILITY**
4. **OFFICE #**

For standard flammability rating, please specify CTB117, for California 133 and Boston fire-code treatment, please specify CTB113

Option Codes:
U = CTB117
U3 = CTB133 (Add +\$125)

See inside front cover for required option codes

Example

GAAMPD-CUSH1818.FABRIC.U.OFC1			
GAAMPD-CUSH1818	FABRIC	U	OFC1
MODEL NUMBER	FABRIC	FLAMMABILITY	OFFICE #

	D	W	H	model number	list
TROUGH INSERT	3	28 1/4	3	GAATROUGH30	157
	3	34 1/4	3	GAATROUGH36	160
	3	40 1/4	3	GAATROUGH42	163
	3	46 1/4	3	GAATROUGH48	168
	3	52 1/4	3	GAATROUGH54	171
	3	58 1/4	3	GAATROUGH60	174
	3	64 1/4	3	GAATROUGH66	247
	3	70 1/4	3	GAATROUGH72	250
	3	76 1/4	3	GAATROUGH78	255
	3	82 1/4	3	GAATROUGH84	257
	3	88 1/4	3	GAATROUGH90	262
	3	94 1/4	3	GAATROUGH96	266
	3	100 1/4	3	GAATROUGH102	270
	3	106 1/4	3	GAATROUGH108	273
	3	112 1/4	3	GAATROUGH114	275
3	118 1/4	3	GAATROUGH120	281	

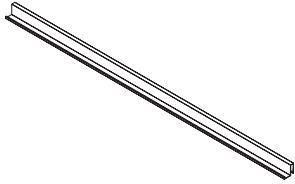

Profile:

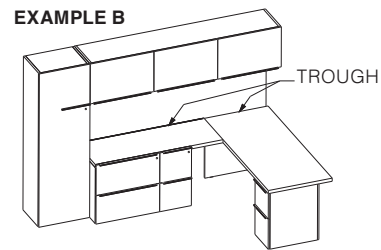
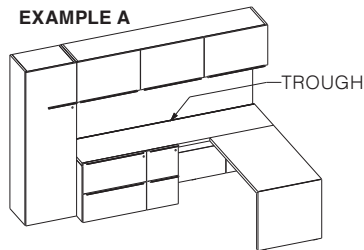
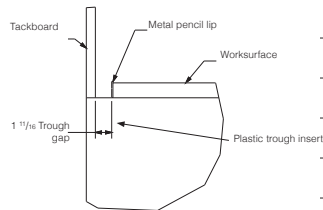

Trough insert is required across the entire length of trough.

EXAMPLE A: 108" back edge of credenza = 108" Trough Insert

EXAMPLE B: (72" back edge of return) + (36" LH end of desk) - (6" Desk overhang) = 102" Trough Insert

NOTE: overhang only needs to be deducted from overall length for single pedestal desks

PRODUCT INFO

Trough insert is black plastic

TO ORDER PLEASE SPECIFY THE FOLLOWING:

1. **MODEL NUMBER**
2. **OFFICE #**

See inside front cover for required option codes

Example

GAATROUGH30.OFC1	
GAATROUGH30	OFC1
MODEL NUMBER	OFFICE #

	for use with top sizes	D	W	H	model number	list
BASES	24 x 42	21	42	26 5/8	BSHAT2142	2,823
	24 x 48	21	48	26 5/8	BSHAT2148	2,836
	24 x 54	21	54	26 5/8	BSHAT2154	2,853
	24 x 60	21	60	26 5/8	BSHAT2160	2,866
	24 x 66	21	66	26 5/8	BSHAT2166	2,882
	24 x 72	21	72	26 5/8	BSHAT2172	2,896

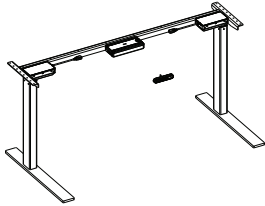

30/36 x 48	27	48	26 5/8	BSHAT2748	2,866
30/36 x 54	27	54	26 5/8	BSHAT2754	2,882
30/36 x 60	27	60	26 5/8	BSHAT2760	2,896
30/36 x 66	27	66	26 5/8	BSHAT2766	2,913
30/36 x 72	27	72	26 5/8	BSHAT2772	2,927



Base at lowest height setting

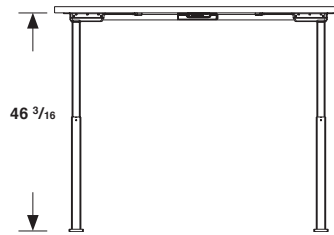

Base at tallest height setting

PRODUCT INFO

TO ORDER PLEASE SPECIFY THE FOLLOWING:

1. **MODEL NUMBER**
2. **BASE COLOR**

BASE COLOR OPTIONS:

- BK** Black
- SV** Silver

See inside front cover for required option codes

Example

BSHAT2760.BK
 BSHAT2760 BK
 MODEL NUMBER BASE COLOR

	D	W	H	new model number	old model number	veneer 1	veneer 2
24" TOPS 	24	42	1 1/2	GA2DWRA2442-W	GAADWRA2442-W	1,568	1,725
	24	48	1 1/2	GA2DWRA2448-W	GAADWRA2448-W	1,649	1,814
	24	54	1 1/2	GA2DWRA2454-W	GAADWRA2454-W	1,736	1,910
	24	60	1 1/2	GA2DWRA2460-W	GAADWRA2460-W	1,829	2,012
	24	66	1 1/2	GA2DWRA2466-W	GAADWRA2466-W	1,925	2,118
	24	72	1 1/2	GA2DWRA2472-W	GAADWRA2472-W	2,029	2,232

PRODUCT INFO

TO ORDER PLEASE SPECIFY THE FOLLOWING:

1.
2.
3.
4.
5.
6.

- MODEL NUMBER**
- FINISH**
- TOP UV FINISH TYPE**
- GRAIN DIRECTION**
- GROMMET**
- OFFICE #**

See set 1 below for grommet option codes

- No Grommet** **GN**
- Left **GL (Add +\$175)**
- Center **GC (Add +\$175)**
- Right **GR (Add +\$175)**
- Both **GB (Add +\$350)**

Add grommet bezel color and door finish to complete option pick.

- SV** = silver bezel, veneer door
- BV** = black bezel, veneer door
- WG** = silver bezel, white glass door
- BG** = black bezel, black glass door
- MG** = silver bezel, muslin glass door

See inside front cover for required option codes

Example: GLSV = left grommet, silver bezel, veneer door

Example

GA2DWRA2442-W.NC215.FF.VLG.GN.OFC1

GA2DWRA2442-W	NC215	FF	VLG	GN	OFC1
MODEL NUMBER	FINISH	TOP UV FINISH	GRAIN DIRECTION	GROMMET	OFFICE #

	D	W	H	new model number	old model number	veneer 1	veneer 2
30" TOPS 	30	48	1 1/2	GA2DWRA3048-W	GAADWRA3048-W	1,919	2,111
	30	54	1 1/2	GA2DWRA3054-W	GAADWRA3054-W	2,033	2,237
	30	60	1 1/2	GA2DWRA3060-W	GAADWRA3060-W	2,194	2,414
	30	66	1 1/2	GA2DWRA3066-W	GAADWRA3066-W	2,334	2,568
	30	72	1 1/2	GA2DWRA3072-W	GAADWRA3072-W	2,400	2,640

36" TOPS 	36	48	1 1/2	GA2DWRA3648-W	GAADWRA3648-W	2,243	2,468
	36	54	1 1/2	GA2DWRA3654-W	GAADWRA3654-W	2,372	2,610
	36	60	1 1/2	GA2DWRA3660-W	GAADWRA3660-W	2,510	2,761
	36	66	1 1/2	GA2DWRA3666-W	GAADWRA3666-W	2,701	2,972
	36	72	1 1/2	GA2DWRA3672-W	GAADWRA3672-W	2,761	3,038

PRODUCT INFO

TO ORDER PLEASE SPECIFY THE FOLLOWING:

1.	
2.	
3.	
4.	
5.	
6.	

MODEL NUMBER
FINISH
TOP UV FINISH TYPE
GRAIN DIRECTION
GROMMET
OFFICE #

See set 1 below for grommet option codes

No Grommet GN
Left **GL (Add +\$175)**
Right **GR (Add +\$175)**
Both **GB (Add +\$350)**

Add grommet bezel color and door finish to complete option pick.

SV = silver bezel, veneer door
BV = black bezel, veneer door
WG = silver bezel, white glass door
BG = black bezel, black glass door
MG = silver bezel, muslin glass door

Example: GLSV = left grommet, silver bezel, veneer door

See inside front cover for required option codes

Example

GA2DWRA3048-W.NC215.FF.VLG.GN.OFC1

GA2DWRA3048-W	NC215	FF	VLG	GN	OFC1
MODEL NUMBER	FINISH	TOP UV FINISH	GRAIN DIRECTION	GROMMET	OFFICE #

HEIGHT ADJUSTABLE MODESTY PANEL

Optional | for use with 30" and 36" Tops

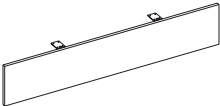
	D	W	H	new model number	old model number	veneer 1	veneer 2
MODESTY PANELS 	3/4	48	10	GA2DMHA48-W	GAADMHA48-W	873	961
	3/4	54	10	GA2DMHA54-W	GAADMHA54-W	921	1,014
	3/4	60	10	GA2DMHA60-W	GAADMHA60-W	971	1,069
	3/4	66	10	GA2DMHA66-W	GAADMHA66-W	1,026	1,129
	3/4	72	10	GA2DMHA72-W	GAADMHA72-W	1,067	1,174

- Optional 10" height modesty panel with 6" overhang

PRODUCT INFO

TO ORDER PLEASE SPECIFY THE FOLLOWING:

- | | | |
|----|----------------------|---------------------|
| 1. | <input type="text"/> | MODEL NUMBER |
| 2. | <input type="text"/> | FINISH |
| 3. | <input type="text"/> | OFFICE # |

See inside front cover for required option codes

Example

GA2DMHA48-W.NC215.OFC1
 GA2DMHA48-W NC215 OFC1
 MODEL NUMBER FINISH OFFICE #

Storage	107-117
Lateral Files	108-109
Bookcases	110
Hinged Door Cabinets	111
Closets	112-115
Storage Box	116
Utility Cabinets	117
Overheads	118-146
Single Wall Mount Overheads	118-123
Double High Wall Mount Overheads	124-127
Tackboards	128-131
Back Painted Glass Whiteboards	132-138
Wood Magnetic Tackzone	139-145
Shelves for Segmented Tackzone	146
Miscellaneous	
Round Tables & Bases	147-148
Accessories	149-158
Fabric Grade Pricing	160-163
Weights + Cubes	164-180

LATERAL FILES

Layers & 2 high

Credentials

05/22

	D	W	H	new model number	old model number	veneer 1	veneer 2
30" WIDTH LAYERS							
STANDARD	24 7/8	30	21 11/16	GA2LFSLH2430-WW	GAALFSLH2430-WW	4,816	5,298



36" WIDTH LAYERS
STANDARD

	24 7/8	36	21 11/16	GA2LFSLH2436-WW	GAALFSLH2436-WW	5,055	5,561
--	--------	----	----------	------------------------	-----------------	-------	-------



30" WIDTH 2 HIGH
STANDARD

	24 7/8	30	29 7/16	GA2LFS2H2430-WW	GAALFS2H2430-WW	5,069	5,576
--	--------	----	---------	------------------------	-----------------	-------	-------



W/ TROUGH BACK

	24 7/8	30	29 7/16	GA2LFS2H2430T-WW	GAALFS2H2430T-WW	5,069	5,576
--	--------	----	---------	-------------------------	------------------	-------	-------



36" WIDTH 2 HIGH
STANDARD

	24 7/8	36	29 7/16	GA2LFS2H2436-WW	GAALFS2H2436-WW	5,321	5,854
--	--------	----	---------	------------------------	-----------------	-------	-------



W/ TROUGH BACK

	24 7/8	36	29 7/16	GA2LFS2H2436T-WW	GAALFS2H2436T-WW	5,321	5,854
--	--------	----	---------	-------------------------	------------------	-------	-------



- Trough back units are required when a tackzone spans over the back of the worksurface
- Trough units include a metal pencil lip

NOTE: Plastic Trough Insert is REQUIRED and must be ordered separately. Freestanding Lateral Files and Hinged Door Cabinets require their own trough insert.

PRODUCT INFO

All units have a finished back

All pedestals have optional face locks

Layers height includes hidden upper box drawer

TO ORDER PLEASE SPECIFY THE FOLLOWING:

1.	<input type="text"/>	MODEL NUMBER
2.	<input type="text"/>	FINISH
3.	<input type="text"/>	TOP UV FINISH TYPE
4.	<input type="text"/>	GRAIN DIRECTION
5.	<input type="text"/>	PULL
6.	<input type="text"/>	LOCKING
7.	<input type="text"/>	KEYING
8.	<input type="text"/>	PENCIL LIP COLOR (TROUGH ONLY)
9.	<input type="text"/>	OFFICE #

Grain Direction: specify grain direction to match that of adjoining unit.





Example:
Specify "VST" short grain if next to:
-Unitized Full Bank Credenza, Desk, or Extension





Specify "VLG" long grain if next to:
-Modular Single Pedestal Credenza, or Return

See inside front cover for required option codes

Example

GA2LFSLH2430-WW.NC215.VLG.MPS.LY.RMS.PLS.OFC1									
GA2LFSLH2430-WW	NC215	FF	VLG	MPS	LY	RMS	PLS	OFC1	
MODEL NUMBER	FINISH	TOP UV FINISH	GRAIN DIRECTION	PULL	LOCKING	KEYING	PENCIL LIP COLOR	OFFICE #	

	D	W	H	new model number	old model number	veneer 1	veneer 2
30" WIDTH							
	24 7/8	30	43 7/16	GA2LFS3H2430-WW	GAALFS3H2430-WW	6,999	7,699
	24 7/8	30	57 7/16	GA2LFS4H2430-WW	GAALFS4H2430-WW	8,594	9,454
	24 7/8	30	75 15/16	GA2LFS5H2430-WW	GAALFS5H2430-WW	11,576	12,734
	24 7/8	30	84 7/16	GA2LFS6H2430-WW	GAALFS6H2430-WW	12,458	13,704

36" WIDTH							
	24 7/8	36	43 7/16	GA2LFS3H2436-WW	GAALFS3H2436-WW	7,348	8,083
	24 7/8	36	57 7/16	GA2LFS4H2436-WW	GAALFS4H2436-WW	9,024	9,927
	24 7/8	36	75 15/16	GA2LFS5H2436-WW	GAALFS5H2436-WW	12,156	13,372
	24 7/8	36	84 7/16	GA2LFS6H2436-WW	GAALFS6H2436-WW	13,082	14,391

NOTE: 5 High and 6 High Lateral Files do not have locks on top doors. These doors are equipped with touch latches and free swing hinges.

PRODUCT INFO

All units have a finished back

All pedestals have optional face locks

5H and 6H Lateral Files do not lock on top doors.

TO ORDER PLEASE SPECIFY THE FOLLOWING:

- | | | |
|----|----------------------|---------------------|
| 1. | <input type="text"/> | MODEL NUMBER |
| 2. | <input type="text"/> | FINISH |
| 3. | <input type="text"/> | PULL |
| 4. | <input type="text"/> | LOCKING |
| 5. | <input type="text"/> | KEYING |
| 6. | <input type="text"/> | OFFICE # |

See inside front cover for required option codes

Example

GA2LFS3H2430-WW.NC215.MPS.LY.RM.OFC1
 GA2LFS3H2430-WW NC215 MPS LY RMS OFC1
 MODEL NUMBER FINISH PULL LOCKING KEYING OFFICE #

BOOKCASES

2 High | 6 high

Credentials

05/22

		D	W	H	new model number	old model number	veneer 1	veneer 2	
30" WIDTH									
	2 HIGH	16 7/8	30	29 7/16	GA2BKN2H1830-W	GAABKN2H1830-W	2,942	3,237	
	3 HIGH	16 7/8	30	43 7/16	GA2BKN3H1830-W	GAABKN3H1830-W	3,532	3,886	
	4 HIGH	16 7/8	30	57 7/16	GA2BKN4H1830-W	GAABKN4H1830-W	4,241	4,666	
	5 HIGH	16 7/8	30	75 15/16	GA2BKN5H1830-W	GAABKN5H1830-W	5,086	5,595	
	6 HIGH	16 7/8	30	84 7/16	GA2BKN6H1830-W	GAABKN6H1830-W	6,105	6,716	
36" WIDTH									
	2 HIGH	16 7/8	36	29 7/16	GA2BKN2H1836-W	GAABKN2H1836-W	3,297	3,627	
	3 HIGH	16 7/8	36	43 7/16	GA2BKN3H1836-W	GAABKN3H1836-W	3,959	4,355	
	4 HIGH	16 7/8	36	57 7/16	GA2BKN4H1836-W	GAABKN4H1836-W	4,748	5,223	
	5 HIGH	16 7/8	36	75 15/16	GA2BKN5H1836-W	GAABKN5H1836-W	5,700	6,270	
	6 HIGH	16 7/8	36	84 7/16	GA2BKN6H1836-W	GAABKN6H1836-W	6,840	7,524	

PRODUCT INFO

All units have a finished back

6-high bookcases must be attached to wall

TO ORDER PLEASE SPECIFY THE FOLLOWING:

1. **MODEL NUMBER**
2. **FINISH**
3. **OFFICE #**

See inside front cover for required option codes

Example

GA2BKN2H1830-W.NC215.OFC1
 GA2BKN2H1830-W NC215 OFC1
 MODEL NUMBER FINISH OFFICE #

	D	W	H	new model number	old model number	veneer 1	veneer 2
30" WIDTH LAYERS							
STANDARD	24 7/8	30	21 11/16	GA2HDCLH2430-WW	GAAHDCLH2430-WW	3,660	4,026



36" WIDTH LAYERS							
STANDARD	24 7/8	36	21 11/16	GA2HDCLH2436-WW	GAAHDCLH2436-WW	4,046	4,451



30" WIDTH 2 HIGH							
STANDARD	24 7/8	30	29 7/16	GA2HDC2H2430-WW	GAAHDC2H2430-WW	3,855	4,241



W/ TROUGH BACK	24 7/8	30	29 7/16	GA2HDC2H2430T-WW	GAAHDC2H2430T-WW	3,855	4,241
----------------	--------	----	---------	-------------------------	------------------	-------	-------



36" WIDTH 2 HIGH							
STANDARD	24 7/8	36	29 7/16	GA2HDC2H2436-WW	GAAHDC2H2436-WW	4,257	4,683



W/ TROUGH BACK	24 7/8	36	29 7/16	GA2HDC2H2436T-WW	GAAHDC2H2436T-WW	4,257	4,683
----------------	--------	----	---------	-------------------------	------------------	-------	-------



- Trough back units are required when a tackzone spans over the back of the worksurface
- Trough units include a metal pencil lip

NOTE: Plastic Trough Insert is REQUIRED and must be ordered separately. Freestanding Lateral Files and Hinged Door Cabinets require their own trough insert.

PRODUCT INFO

All units have a finished back

Units do not lock

TO ORDER PLEASE SPECIFY THE FOLLOWING:

- MODEL NUMBER**
- FINISH**
- TOP UV FINISH**
- GRAIN DIRECTION**
- PULL**
- PENCIL LIP COLOR(TROUGH ONLY)**
- OFFICE #**

Grain Direction: specify grain direction to match that of adjoining unit.

Example:
Specify "VST" short grain if next to:
-Unitized Full Bank Credenza, Desk, or Extension

Specify "VLG" long grain if next to:
-Modular Single Pedestal Credenza, or Return

See inside front cover for required option codes

Example

GA2HDCLH2430-WW.NC215.OP.VLG.MPS.PLS.OFC1						
GA2HDCLH2430-WW	NC215	OP	VLG	MPS	PLS	OFC1
MODEL NUMBER	FINISH	TOP UV FINISH	GRAIN DIRECTION	PULL	PENCIL LIP COLOR	OFFICE #

CLOSETS – 18D

5 High

Credentials

05/22

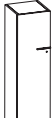
	D	W	H	new model number	old model number	veneer 1	veneer 2
18" WIDTH LEFT HAND 	17 3/4	18	75 15/16	GA2CLC5H1818L-WW	GAACLC5H1818L-WW	5,230	5,753
	17 3/4	18	75 15/16	GA2CLS5H1818L-WW	GAACLS5H1818L-WW	5,827	6,410
	17 3/4	18	75 15/16	GA2CLD5H1818L-WW	GAACLD5H1818L-WW	6,514	7,166

- CLC = Coat hook with (1) adjustable shelf
- CLS = (4) adjustable shelves
- CLD = Coat hook with (1) adjustable shelf | Divider | (4) adjustable shelves

18" WIDTH RIGHT HAND

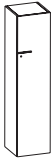

17 3/4	18	75 15/16	GA2CLC5H1818R-WW	GAACLC5H1818R-WW	5,230	5,753
17 3/4	18	75 15/16	GA2CLS5H1818R-WW	GAACLS5H1818R-WW	5,827	6,410
17 3/4	18	75 15/16	GA2CLD5H1818R-WW	GAACLD5H1818R-WW	6,514	7,166

- CLC = Coat hook with (1) adjustable shelf
- CLS = (4) adjustable shelves
- CLD = Coat hook with (1) adjustable shelf | Divider | (4) adjustable shelves

24" WIDTH LEFT HAND

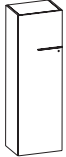

17 3/4	24	75 15/16	GA2CLD5H1824L-WW	GAACLD5H1824L-WW	7,487	8,236
--------	----	----------	-------------------------	------------------	-------	-------

- CLD = Coat hook with (1) adjustable shelf | Divider | (4) adjustable shelves

24" WIDTH RIGHT HAND

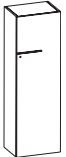

17 3/4	24	75 15/16	GA2CLD5H1824R-WW	GAACLD5H1824R-WW	7,487	8,236
--------	----	----------	-------------------------	------------------	-------	-------

- CLD = Coat hook with (1) adjustable shelf | Divider | (4) adjustable shelves

30" WIDTH

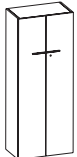

17 3/4	30	75 15/16	GA2CLS5H1830-WW	GAACLS5H1830-WW	8,449	9,294
17 3/4	30	75 15/16	GA2CLD5H1830-WW	GAACLD5H1830-WW	9,119	10,031

- CLS = (4) adjustable shelves
- CLD = Coat hook with (1) adjustable shelf | Divider | (4) adjustable shelves

PRODUCT INFO

All units have a finished back

All units have optional face locks

TO ORDER PLEASE SPECIFY THE FOLLOWING:

1.	<input type="text"/>	MODEL NUMBER
2.	<input type="text"/>	FINISH
3.	<input type="text"/>	PULL
4.	<input type="text"/>	LOCKING
5.	<input type="text"/>	KEYING
6.	<input type="text"/>	OFFICE #

See inside front cover for required option codes

Example

GA2CLC5H1818L-WW.NC215.MPS.LY.RMS.OFC1

GA2CLC5H1818L-WW	NC215	MPS	LY	RMS	OFC1
MODEL NUMBER	FINISH	PULL	LOCKING	KEYING	OFFICE #

D	W	H	new model number	old model number	veneer 1	veneer 2
17 3/4	18	84 7/16	GA2CLC6H1818L-WW	GAACLC6H1818L-WW	5,854	6,440
17 3/4	18	84 7/16	GA2CLS6H1818L-WW	GAACLS6H1818L-WW	6,525	7,178
17 3/4	18	84 7/16	GA2CLD6H1818L-WW	GAACLD6H1818L-WW	7,294	8,024

18" WIDTH LEFT HAND



- CLC = Coat hook with (2) adjustable shelves
- CLS = (5) adjustable shelves
- CLD = Coat hook with (2) adjustable adjustable shelf | Divider | (5) adjustable shelves

18" WIDTH RIGHT HAND



17 3/4	18	84 7/16	GA2CLC6H1818R-WW	GAACLC6H1818R-WW	5,854	6,440
17 3/4	18	84 7/16	GA2CLS6H1818R-WW	GAACLS6H1818R-WW	6,525	7,178
17 3/4	18	84 7/16	GA2CLD6H1818R-WW	GAACLD6H1818R-WW	7,294	8,024

- CLC = Coat hook with (2) adjustable shelves
- CLS = (5) adjustable shelves
- CLD = Coat hook with (2) adjustable adjustable shelf | Divider | (5) adjustable shelves

24" WIDTH LEFT HAND

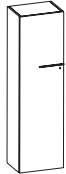

17 3/4	24	84 7/16	GA2CLD6H1824L-WW	GAACLD6H1824L-WW	8,390	9,229
--------	----	---------	-------------------------	------------------	-------	-------

- CLD = Coat hook with (2) adjustable shelves | Divider | (5) adjustable shelves

24" WIDTH RIGHT HAND



17 3/4	24	84 7/16	GA2CLD6H1824R-WW	GAACLD6H1824R-WW	8,390	9,229
--------	----	---------	-------------------------	------------------	-------	-------

- CLD = Coat hook with (2) adjustable shelves | Divider | (5) adjustable shelves

PRODUCT INFO

All units have a finished back

All units have optional face locks

TO ORDER PLEASE SPECIFY THE FOLLOWING:

- | | | |
|----|----------------------|---------------------|
| 1. | <input type="text"/> | MODEL NUMBER |
| 2. | <input type="text"/> | FINISH |
| 3. | <input type="text"/> | PULL |
| 4. | <input type="text"/> | LOCKING |
| 5. | <input type="text"/> | KEYING |
| 6. | <input type="text"/> | OFFICE # |

See inside front cover for required option codes

Example

GA2CLC6H1818L-WW.NC215.MPS.LY.RMS.OFC1
 GA2CLC6H1818L-WW NC215 MPS LY RMS OFC1
 MODEL NUMBER FINISH PULL LOCKING KEYING OFFICE #

CLOSETS – 24D

5 High

Credentials

05/22

D	W	H	new model number	old model number	veneer 1	veneer 2
24 7/8	18	75 15/16	GA2CLC5H2418L-WW	GAACLC5H2418L-WW	5,503	6,054
24 7/8	18	75 15/16	GA2CLS5H2418L-WW	GAACLS5H2418L-WW	6,131	6,745
24 7/8	18	75 15/16	GA2CLD5H2418L-WW	GAACLD5H2418L-WW	6,854	7,540

18" WIDTH LEFT HAND



- CLC = Closet rod with (1) adjustable shelf
- CLS = (4) adjustable shelves
- CLD = Closet rod with (1) adjustable shelf | Divider | (4) adjustable shelves

18" WIDTH RIGHT HAND



24 7/8	18	75 15/16	GA2CLC5H2418R-WW	GAACLC5H2418R-WW	5,503	6,054
24 7/8	18	75 15/16	GA2CLS5H2418R-WW	GAACLS5H2418R-WW	6,131	6,745
24 7/8	18	75 15/16	GA2CLD5H2418R-WW	GAACLD5H2418R-WW	6,854	7,540

- CLC = Closet rod with (1) adjustable shelf
- CLD = Closet rod with (1) adjustable shelf | Divider | (4) adjustable shelves

24" WIDTH LEFT HAND

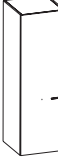

24 7/8	24	75 15/16	GA2CLD5H2424L-WW	GAACLD5H2424L-WW	7,886	8,675
--------	----	----------	-------------------------	------------------	-------	-------

- CLD = Closet rod with (1) adjustable shelf | Divider | (4) adjustable shelves

24" WIDTH RIGHT HAND



24 7/8	24	75 15/16	GA2CLD5H2424R-WW	GAACLD5H2424R-WW	7,886	8,675
--------	----	----------	-------------------------	------------------	-------	-------

- CLD = Closet rod with (1) adjustable shelf | Divider | (4) adjustable shelves

30" WIDTH

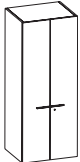

24 7/8	30	75 15/16	GA2CLS5H2430-WW	GAACLS5H2430-WW	8,891	9,781
24 7/8	30	75 15/16	GA2CLD5H2430-WW	GAACLD5H2430-WW	9,598	10,558

- CLS = (4) adjustable shelves
- CLD = Closet rod with (1) adjustable shelf | Divider | (4) adjustable shelves

PRODUCT INFO

All units have a finished back

All units have optional face locks

Metal pull height matches 29H pedestal pulls

TO ORDER PLEASE SPECIFY THE FOLLOWING:

1.	<input type="text"/>	MODEL NUMBER
2.	<input type="text"/>	FINISH
3.	<input type="text"/>	PULL
4.	<input type="text"/>	LOCKING
5.	<input type="text"/>	KEYING
6.	<input type="text"/>	OFFICE #

See inside front cover for required option codes

Example

GA2CLC5H2418L-WW.NC215.MPS.LY.RMS.OFC1

GA2CLC5H2418L-WW	NC215	MPS	LY	RMS	OFC1
MODEL NUMBER	FINISH	PULL	LOCKING	KEYING	OFFICE #

D	W	H	new model number	old model number	veneer 1	veneer 2
24 7/8	18	84 7/16	GA2CLC6H2418L-WW	GAACLC6H2418L-WW	6,166	6,783
24 7/8	18	84 7/16	GA2CLS6H2418L-WW	GAACLS6H2418L-WW	6,869	7,556
24 7/8	18	84 7/16	GA2CLD6H2418L-WW	GAACLD6H2418L-WW	7,677	8,445

18" WIDTH LEFT HAND



- CLC = Closet rod with (2) adjustable shelves
- CLS = (5) adjustable shelves
- CLD = Closet rod with (2) adjustable adjustable shelf | Divider | (5) adjustable shelves

18" WIDTH RIGHT HAND



24 7/8	18	84 7/16	GA2CLC6H2418R-WW	GAACLC6H2418R-WW	6,166	6,783
24 7/8	18	84 7/16	GA2CLS6H2418R-WW	GAACLS6H2418R-WW	6,869	7,556
24 7/8	18	84 7/16	GA2CLD6H2418R-WW	GAACLD6H2418R-WW	7,677	8,445

- CLC = Closet rod with (2) adjustable shelf
- CLS = (5) adjustable shelves
- CLD = Closet rod with (2) adjustable shelf | Divider | (5) adjustable shelves

24" WIDTH LEFT HAND



24 7/8	24	84 7/16	GA2CLD6H2424L-WW	GAACLD6H2424L-WW	8,827	9,710
--------	----	---------	-------------------------	------------------	-------	-------

- CLD = Closet rod with (2) adjustable shelf | Divider | (5) adjustable shelves

24" WIDTH RIGHT HAND



24 7/8	24	84 7/16	GA2CLD6H2424R-WW	GAACLD6H2424R-WW	8,827	9,710
--------	----	---------	-------------------------	------------------	-------	-------

- CLD = Closet rod with (2) adjustable shelf | Divider | (5) adjustable shelves

PRODUCT INFO

All units have a finished back

All units have optional face locks

Metal pull height matches 29H pedestal pulls

TO ORDER PLEASE SPECIFY THE FOLLOWING:

- | | | |
|----|----------------------|---------------------|
| 1. | <input type="text"/> | MODEL NUMBER |
| 2. | <input type="text"/> | FINISH |
| 3. | <input type="text"/> | PULL |
| 4. | <input type="text"/> | LOCKING |
| 5. | <input type="text"/> | KEYING |
| 6. | <input type="text"/> | OFFICE # |

See inside front cover for required option codes

Example

GA2CLC6H2418L-WW.NC215.MPS.LY.RMS.OFC1
 GA2CLC6H2418L-WW NC215 MPS LY RMS OFC1
 MODEL NUMBER FINISH PULL LOCKING KEYING OFFICE #

STORAGE BOX

5 High | 6 high

Credentials

05/22

	D	W	H	new model number	old model number	veneer 1	veneer 2
5 HIGH							
	18" WIDTH LEFT HAND	24 7/8	18	75 15/16	GA2SBH5H2418L-WW	GAASBH5H2418L-WW	6,807 7,488
		<ul style="list-style-type: none"> Includes (2) adjustable shelves behind doors (2) file drawers bottom, door upper 					
	18" WIDTH RIGHT HAND	24 7/8	18	75 15/16	GA2SBH5H2418R-WW	GAASBH5H2418R-WW	6,807 7,488
	<ul style="list-style-type: none"> Includes (2) adjustable shelves behind doors (2) file drawers bottom, door upper 						
	30" WIDTH	24 7/8	30	75 15/16	GA2SBH5H2430-WW	GAASBH5H2430-WW	10,140 11,154
		<ul style="list-style-type: none"> Includes (2) adjustable shelves behind doors (2) file drawers bottom, door upper 					
	6 HIGH						
	18" WIDTH LEFT HAND	24 7/8	18	84 7/16	GA2SBH6H2418L-WW	GAASBH6H2418L-WW	8,101 8,912
		<ul style="list-style-type: none"> Includes (3) adjustable shelves behind door (2) file drawers bottom, door upper 					
	18" WIDTH RIGHT HAND	24 7/8	18	84 7/16	GA2SBH6H2418R-WW	GAASBH6H2418R-WW	8,101 8,912
	<ul style="list-style-type: none"> Includes (3) adjustable shelves behind door (2) file drawers bottom, door upper 						
	30" WIDTH	24 7/8	30	84 7/16	GA2SBH6H2430-WW	GAASBH6H2430-WW	11,686 12,855
		<ul style="list-style-type: none"> Includes (3) adjustable shelves behind door (2) file drawers bottom, door upper 					

PRODUCT INFO

All units have a finished back

All units have optional face locks

TO ORDER PLEASE SPECIFY THE FOLLOWING:

- | | | |
|----|----------------------|---------------------|
| 1. | <input type="text"/> | MODEL NUMBER |
| 2. | <input type="text"/> | FINISH |
| 3. | <input type="text"/> | PULL |
| 4. | <input type="text"/> | LOCKING |
| 5. | <input type="text"/> | KEYING |
| 6. | <input type="text"/> | OFFICE # |

See inside front cover for required option codes

Example

GA2SBH5H2418L-WW.NC215.MPS.LY.RMS.OFC1
 GA2SBH5H2418L-WW NC215 MPS LY RMS OFC1
 MODEL NUMBER FINISH PULL LOCKING KEYING OFFICE #

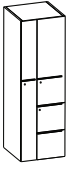
	D	W	H	new model number	old model number	veneer 1	veneer 2
5 HIGH							
	LEFT HAND	24 7/8	24	75 15/16	GA2UTC5H2424L-WW	GAAUTC5H2424L-WW	10,633 11,697
	RIGHT HAND	24 7/8	24	75 15/16	GA2UTC5H2424R-WW	GAAUTC5H2424R-WW	10,633 11,697
6 HIGH							
	LEFT HAND	24 7/8	24	84 7/16	GA2UTC6H2424L-WW	GAAUTC6H2424L-WW	12,196 13,416
	RIGHT HAND	24 7/8	24	84 7/16	GA2UTC6H2424R-WW	GAAUTC6H2424R-WW	12,196 13,416

Note: Tall door hinges off center divider on utility cabinets for side access to integral wood pulls.

PRODUCT INFO

All units have a finished back

All units have optional face locks

TO ORDER PLEASE SPECIFY THE FOLLOWING:

- 1. **MODEL NUMBER**
- 2. **FINISH**
- 3. **PULL**
- 4. **LOCKING**
- 5. **KEYING**
- 6. **OFFICE #**

See inside front cover for required option codes

Example

GA2UTC5H2424L-WW.NC215.MPS.LY.RMS.OFC1
 GA2UTC5H2424L-WW NC215 MPS LY RMS OFC1
 MODEL NUMBER FINISH PULL LOCKING KEYING OFFICE #

WALL MOUNT OVERHEADS

Hinged | wood doors

Credentials

05/22

1 HIGH

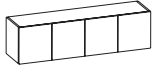

D	W	H	new model number	old model number	veneer 1	veneer 2
18	30	19 1/2	GA2WCH1H30-WW	GAAWCH1H30-WW	4,156	4,572
18	36	19 1/2	GA2WCH1H36-WW	GAAWCH1H36-WW	4,344	4,779
18	60	19 1/2	GA2WCH1H60-WW	GAAWCH1H60-WW	7,285	8,014
18	66	19 1/2	GA2WCH1H66-WW	GAAWCH1H66-WW	7,607	8,368
18	72	19 1/2	GA2WCH1H72-WW	GAAWCH1H72-WW	7,948	8,743
18	78	19 1/2	GA2WCH1H78-WW	GAAWCH1H78-WW	8,611	9,473
18	84	19 1/2	GA2WCH1H84-WW	GAAWCH1H84-WW	8,990	9,889
18	90	19 1/2	GA2WCH1H90-WW	GAAWCH1H90-WW	9,385	10,324
18	96	19 1/2	GA2WCH1H96-WW	GAAWCH1H96-WW	9,785	10,764
18	102	19 1/2	GA2WCH1H102-WW	GAAWCH1H102-WW	10,198	11,218
18	108	19 1/2	GA2WCH1H108-WW	GAAWCH1H108-WW	10,635	11,699

- Units are available in wood integral pull only
- Recessed LED tasklights included

PRODUCT INFO

Doors do not lock

Door widths:

30" = (2) doors

36" = (2) doors

60" = (4) doors

66" = (4) doors

72" = (4) doors

78" = (4) doors

84" = (6) doors

90" = (6) doors

96" = (6) doors

102" = (6) doors

108" = (6) doors

Hidden cubbies behind doors

TO ORDER PLEASE SPECIFY THE FOLLOWING:

1.	<input type="text"/>	MODEL NUMBER
2.	<input type="text"/>	FINISH
3.	<input type="text"/>	PULL
4.	<input type="text"/>	OFFICE #

See inside front cover for required option codes

Example

GA2WCH1H30-WW.NC215.MPS.OFC1

GA2WCH1H30-WW	NC215	MPS	OFC1
MODEL NUMBER	FINISH	PULL	OFFICE #

1 HIGH

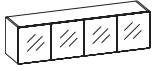

D	W	H	new model number	old model number	veneer 1	veneer 2
18	30	19 1/2	GA2WCH1H30-WG	GAAWCH1H30-WG	4,692	5,162
18	36	19 1/2	GA2WCH1H36-WG	GAAWCH1H36-WG	4,910	5,401
18	60	19 1/2	GA2WCH1H60-WG	GAAWCH1H60-WG	8,203	9,024
18	72	19 1/2	GA2WCH1H72-WG	GAAWCH1H72-WG	8,967	9,864
18	90	19 1/2	GA2WCH1H90-WG	GAAWCH1H90-WG	10,574	11,632
18	108	19 1/2	GA2WCH1H108-WG	GAAWCH1H108-WG	12,009	13,210

- Recessed LED tasklights included

PRODUCT INFO

Doors do not lock

Door widths:

30" = (2) doors

36" = (2) doors

60" = (4) doors

72" = (4) doors

90" = (6) doors

108" = (6) doors

Hidden cubbies behind doors

TO ORDER PLEASE SPECIFY THE FOLLOWING:

1. **MODEL NUMBER**
2. **FINISH**
3. **GLASS COLOR**
4. **OFFICE #**

See inside front cover for required option codes

Example

GA2WCH1H30-WG.NC215.WH.OFC1
 GA2WCH1H30-WG NC215 WH OFC1
 MODEL NUMBER FINISH GLASS COLOR OFFICE #

WALL MOUNT OVERHEADS

Soft lift | wood doors

Credentials

05/22

1 HIGH

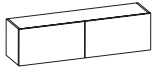

D	W	H	new model number	old model number	veneer 1	veneer 2
18	60	19 1/2	GA2WCF1H60-WW	GAAWCF1H60-WW	7,591	8,351
18	72	19 1/2	GA2WCF1H72-WW	GAAWCF1H72-WW	8,287	9,116
18	90	19 1/2	GA2WCF1H90-WW	GAAWCF1H90-WW	9,785	10,764
18	108	19 1/2	GA2WCF1H108-WW	GAAWCF1H108-WW	11,094	12,204

- Units are available in wood integral pull only
- Recessed LED tasklights included

PRODUCT INFO

Doors do not lock

Door widths:

60" = (2) doors

72" = (2) doors

90" = (3) doors

108" = (3) doors

Hidden cubbies behind doors

TO ORDER PLEASE SPECIFY THE FOLLOWING:

1. **MODEL NUMBER**
2. **FINISH**
3. **PULL**
4. **OFFICE #**

See inside front cover for required option codes

Example

GA2WCF1H60-WW.NC215.MPS.OFC1

GA2WCF1H60-WW	NC215	MPS	OFC1
MODEL NUMBER	FINISH	PULL	OFFICE #

1 HIGH

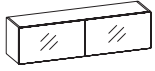

D	W	H	new model number	old model number	veneer 1	veneer 2
18	60	19 1/2	GA2WCF1H60-WG	GAAWCF1H60-WG	8,557	9,413
18	72	19 1/2	GA2WCF1H72-WG	GAAWCF1H72-WG	9,357	10,293
18	90	19 1/2	GA2WCF1H90-WG	GAAWCF1H90-WG	11,030	12,133
18	108	19 1/2	GA2WCF1H108-WG	GAAWCF1H108-WG	12,537	13,791

- Recessed LED tasklights included

PRODUCT INFO

Doors do not lock

Door widths:

60" = (2) doors

72" = (2) doors

90" = (3) doors

108" = (3) doors

Hidden cubbies behind doors

TO ORDER PLEASE SPECIFY THE FOLLOWING:

1. **MODEL NUMBER**
2. **FINISH**
3. **GLASS COLOR**
4. **OFFICE #**

See inside front cover for required option codes

Example

GA2WCF1H60-WG.NC215.WH.OFC1

GA2WCF1H60-WG	NC215	WH	OFC1
<small>MODEL NUMBER</small>	<small>FINISH</small>	<small>GLASS COLOR</small>	<small>OFFICE #</small>

WALL MOUNT OVERHEADS

Sliding | wood doors

Credentials

05/22

1 HIGH

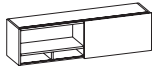

D	W	H	new model number	old model number	veneer 1	veneer 2
18	60	19 1/2	GA2WCS1H60-WW	GAAWCS1H60-WW	7,591	8,351
18	72	19 1/2	GA2WCS1H72-WW	GAAWCS1H72-WW	8,287	9,116
18	90	19 1/2	GA2WCS1H90-WW	GAAWCS1H90-WW	9,785	10,764
18	108	19 1/2	GA2WCS1H108-WW	GAAWCS1H108-WW	11,094	12,204

- No pulls required
- Recessed LED tasklights included

PRODUCT INFO

Doors do not lock

Door widths:

60" = (1) doors

72" = (1) doors

90" = (2) doors

108" = (2) doors

Hidden cubbies behind doors

TO ORDER PLEASE SPECIFY THE FOLLOWING:

1. **MODEL NUMBER**
2. **FINISH**
3. **OFFICE #**

See inside front cover for required option codes

Example

GA2WCS1H60-WW.NC215.OFC1

GA2WCS1H60-WW	NC215	OFC1
MODEL NUMBER	FINISH	OFFICE #

1 HIGH

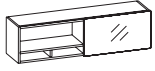

D	W	H	new model number	old model number	veneer 1	veneer 2
18	60	19 1/2	GA2WCS1H60-WG	GAAWCS1H60-WG	8,557	9,413
18	72	19 1/2	GA2WCS1H72-WG	GAAWCS1H72-WG	9,357	10,293
18	90	19 1/2	GA2WCS1H90-WG	GAAWCS1H90-WG	11,030	12,133
18	108	19 1/2	GA2WCS1H108-WG	GAAWCS1H108-WG	12,537	13,791

- Recessed LED tasklights included

PRODUCT INFO

Doors do not lock

Door widths:
60" = (1) doors
72" = (1) doors
90" = (2) doors
108" = (2) doors

Hidden cubbies behind doors

TO ORDER PLEASE SPECIFY THE FOLLOWING:

- MODEL NUMBER**
- FINISH**
- GLASS COLOR**
- OFFICE #**

See inside front cover for required option codes

Example

GA2WCS1H60-WG.NC215.WH.OFC1
 GA2WCS1H60-WG NC215 WH OFC1
 MODEL NUMBER FINISH GLASS COLOR OFFICE #

WALL MOUNT OVERHEADS

Hinged | wood doors

Credentials

05/22

2 HIGH

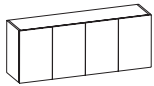

D	W	H	new model number	old model number	veneer 1	veneer 2
18	30	28	GA2WCH2H30-WW	GAAWCH2H30-WW	5,945	6,540
18	36	28	GA2WCH2H36-WW	GAAWCH2H36-WW	6,228	6,851
18	60	28	GA2WCH2H60-WW	GAAWCH2H60-WW	8,853	9,739
18	66	28	GA2WCH2H66-WW	GAAWCH2H66-WW	9,261	10,188
18	72	28	GA2WCH2H72-WW	GAAWCH2H72-WW	9,686	10,655
18	78	28	GA2WCH2H78-WW	GAAWCH2H78-WW	10,443	11,488
18	84	28	GA2WCH2H84-WW	GAAWCH2H84-WW	10,918	12,010
18	90	28	GA2WCH2H90-WW	GAAWCH2H90-WW	11,414	12,556

- Units are available in wood integral pull only
- Recessed LED tasklights included

PRODUCT INFO

Doors do not lock

Door widths:

30" = (2) doors

36" = (2) doors

60" = (4) doors

66" = (4) doors

72" = (4) doors

78" = (4) doors

84" = (6) doors

90" = (6) doors

TO ORDER PLEASE SPECIFY THE FOLLOWING:

- | | | |
|----|----------------------|---------------------|
| 1. | <input type="text"/> | MODEL NUMBER |
| 2. | <input type="text"/> | FINISH |
| 3. | <input type="text"/> | PULL |
| 4. | <input type="text"/> | OFFICE # |

See inside front cover for required option codes

Example

GA2WCH2H30-WW.NC215.MPS.OFC1			
GA2WCH2H30-WW	NC215	MPS	OFC1
MODEL NUMBER	FINISH	PULL	OFFICE #

2 HIGH

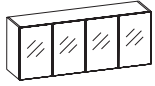

D	W	H	new model number	old model number	veneer 1	veneer 2
18	30	28	GA2WCH2H30-WG	GAAWCH2H30-WG	6,753	7,429
18	36	28	GA2WCH2H36-WG	GAAWCH2H36-WG	7,076	7,784
18	60	28	GA2WCH2H60-WG	GAAWCH2H60-WG	10,009	11,010
18	72	28	GA2WCH2H72-WG	GAAWCH2H72-WG	10,966	12,063
18	90	28	GA2WCH2H90-WG	GAAWCH2H90-WG	12,905	14,196

- Recessed LED tasklights included

PRODUCT INFO

Doors do not lock

Door widths:
 30" = (2) doors
 36" = (2) doors
 60" = (4) doors
 72" = (4) doors
 90" = (6) doors

TO ORDER PLEASE SPECIFY THE FOLLOWING:

1. **MODEL NUMBER**
2. **FINISH**
3. **GLASS COLOR**
4. **OFFICE #**

See inside front cover for required option codes

Example

GA2WCH2H30-WG.NC215.WH.OFC1
 GA2WCH2H30-WG NC215 WH OFC1
MODEL NUMBER FINISH GLASS COLOR OFFICE #

WALL MOUNT OVERHEADS

Sliding | wood doors

Credentials

05/22

2 HIGH

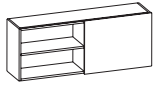

D	W	H	new model number	old model number	veneer 1	veneer 2
18	60	28	GA2WCS2H60-WW	GAAWCS2H60-WW	9,237	10,161
18	72	28	GA2WCS2H72-WW	GAAWCS2H72-WW	10,111	11,123
18	90	28	GA2WCS2H90-WW	GAAWCS2H90-WW	11,911	13,103

- No pulls required
- Recessed LED tasklights included

PRODUCT INFO

Doors do not lock

Door widths:
 60" = (1) doors
 72" = (1) doors
 90" = (2) doors

TO ORDER PLEASE SPECIFY THE FOLLOWING:

1. **MODEL NUMBER**
2. **FINISH**
3. **OFFICE #**

See inside front cover for required option codes

Example

GA2WCS2H60-WW.NC215.OFC1

GA2WCS2H60-WW	NC215	OFC1
MODEL NUMBER	FINISH	OFFICE #

2 HIGH

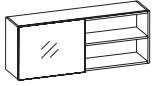

D	W	H	new model number	old model number	veneer 1	veneer 2
18	60	28	GA2WCS2H60-WG	GAAWCS2H60-WG	10,451	11,497
18	72	28	GA2WCS2H72-WG	GAAWCS2H72-WG	11,455	12,601
18	90	28	GA2WCS2H90-WG	GAAWCS2H90-WG	13,479	14,827

- Recessed LED tasklights included

PRODUCT INFO

Doors do not lock

Door widths:
60" = (1) doors
72" = (1) doors
90" = (2) doors

TO ORDER PLEASE SPECIFY THE FOLLOWING:

1. **MODEL NUMBER**
2. **FINISH**
3. **GLASS COLOR**
4. **OFFICE #**

See inside front cover for required option codes

Example

GA2WCS2H60-WG.NC215.WH.OFC1

GA2WCS2H60-WG	NC215	WH	OFC1
<small>MODEL NUMBER</small>	<small>FINISH</small>	<small>GLASS COLOR</small>	<small>OFFICE #</small>

TACKBOARDS

Standard

Credentials
05/22

	D	W	H	yards	model number	fabric grades			COM/4
						1	2	3	
STANDARD									
	7/8	30	28 1/2	1.25	GAATKW30	915	938	963	988
	7/8	36	28 1/2	1.25	GAATKW36	959	988	1,021	1,052
	7/8	60	28 1/2	2.00	GAATKW60	1,114	1,161	1,210	1,261
	7/8	66	28 1/2	2.25	GAATKW66	1,137	1,184	1,233	1,284
	7/8	72	28 1/2	2.50	GAATKW72	1,181	1,233	1,290	1,349
	7/8	78	28 1/2	2.50	GAATKW78	1,216	1,277	1,339	1,403
	7/8	84	28 1/2	2.75	GAATKW84	1,248	1,309	1,371	1,435
	7/8	90	28 1/2	3.00	GAATKW90	1,302	1,366	1,437	1,507
	7/8	96	28 1/2	3.00	GAATKW96	1,357	1,426	1,503	1,579
2-PIECE	7/8	102	28 1/2	3.50	GAATKW102	1,873	1,950	2,032	2,114
2-PIECE	7/8	108	28 1/2	4.00	GAATKW108	1,938	2,023	2,110	2,199
2-PIECE	7/8	120	28 1/2	4.00	GAATKW120	2,231	2,320	2,414	2,509

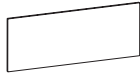

FABRIC

- Dimensioned from full height trough worksurface to bottom of overhead.
- A trough worksurface is required for ALL tackzone.
- Tackboards listed on this page are all standard "railroad".

PRODUCT SPECIFICATIONS:

STANDARD

The fabric on all Gunlocke tackboards is applied in a railroad fashion.

- Tackboard widths less than or equal to 96" are one piece
- Tackboards greater than 96" are two piece and the fabric is pattern matched
- When ordering individual wall mount tackboards to be placed side by side, the fabric pattern will be random matched. If a fabric pattern match is required, contact Gunlocke Bid/Quote for a special quote.

SPECIAL

Fabric applied "up the roll" is a special application. Please see guidelines below and contact Gunlocke Bid/Quote for a special quote.

- Fabrics used on tackboard 48" and under in width can be applied "up the roll"
- Tackboards greater than 48" in width can only be applied railroaded, due to fabric height limitations

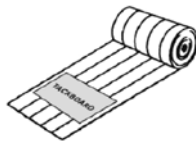
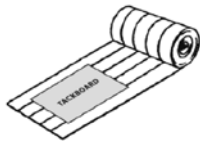

PRODUCT INFO

See yards listed above for COM fabric requirement

102, 108, and 120 wide tackboards are 2-piece

TO ORDER PLEASE SPECIFY THE FOLLOWING:

1.	<input type="text"/>	MODEL NUMBER
2.	<input type="text"/>	FABRIC
3.	<input type="text"/>	FSC TACKBOARD
4.	<input type="text"/>	OFFICE #

FSC Tackboard Options:

FSC = FSC Required (+5% COM upcharge)
NR = FSC Not Required

COM FABRIC REQUIREMENT

All COM must be shipped prepaid to Gunlocke with package side marked with:

- Dealer Name
- Dealer Purchase Order Number
- Gunlocke Pattern Number

See inside front cover for required option codes

Example

GAATKW30.FABRIC.FSC.OFC1
 GAATKW30 FABRIC FSC OFC1
 MODEL NUMBER FABRIC FSC TACKBOARD OFFICE #

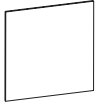
	D	W	H	yards	model number	fabric grades			COM/4
						1	2	3	
 FABRIC	7/8	30	48	1.25	GAATKW1H30	1,114	1,137	1,162	1,187
	7/8	36	48	1.25	GAATKW1H36	1,137	1,166	1,199	1,230
	7/8	42	48	1.50	GAATKW1H42	1,181	1,218	1,254	1,293
	7/8	48	48	1.50	GAATKW1H48	1,216	1,253	1,289	1,328

- Dimensioned from trough worksurface to top of 1 high overhead (or 5 high storage)
- A trough worksurface is required for ALL tackzone.

TOP OF 2 HIGH OVERHEAD

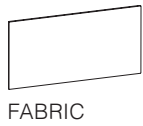

7/8	30	56 1/2	1.75	GAATKW2H30	1,137	1,160	1,185	1,210
7/8	36	56 1/2	1.75	GAATKW2H36	1,181	1,210	1,243	1,274
7/8	42	56 1/2	1.75	GAATKW2H42	1,216	1,253	1,289	1,328
7/8	48	56 1/2	1.75	GAATKW2H48	1,248	1,285	1,321	1,360

- Dimensioned from trough worksurface to top of 2 high overhead (or 6 high storage)
- A trough worksurface is required for ALL tackzone.
- Tackboards to top of 1H overheads are standard "railroad". Tackboards to top of 2H overheads are "up the roll".

PRODUCT SPECIFICATIONS:

STANDARD

The fabric on all Gunlocke tackboards is applied in a railroad fashion.

- Tackboard widths less than or equal to 96" are one piece
- Tackboards greater than 96" are two piece and the fabric is pattern matched
- When ordering individual wall mount tackboards to be placed side by side, the fabric pattern will be random matched. If a fabric pattern match is required, contact Gunlocke Bid/Quote for a special quote.

SPECIAL

Fabric applied "up the roll" is a special application. Please see guidelines below and contact Gunlocke Bid/Quote for a special quote.

- Fabrics used on tackboard 48" and under in width can be applied "up the roll"
- Tackboards greater than 48" in width can only be applied railroaded, due to fabric height limitations

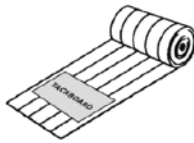
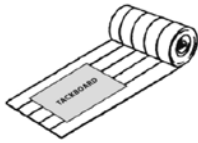

PRODUCT INFO

See yards listed above for COM fabric requirement

TO ORDER PLEASE SPECIFY THE FOLLOWING:

1. **MODEL NUMBER**
2. **FABRIC**
3. **FSC TACKBOARD**
4. **OFFICE #**

FSC Tackboard Options:

FSC = FSC Required (+5% COM upcharge)
NR = FSC Not Required

COM FABRIC REQUIREMENT

All COM must be shipped prepaid to Gunlocke with package side marked with:

- Dealer Name
- Dealer Purchase Order Number
- Gunlocke Pattern Number

See inside front cover for required option codes

Example

GAATKW1H30. FABRIC.FSC.OFC1			
GAATKW1H30	FABRIC	FSC	OFC1
MODEL NUMBER	FABRIC	FSC TACKBOARD	OFFICE #

LAYERS TACKBOARDS

Credentials
05/22

Standard

STANDARD



FABRIC

	D	W	H	yards	model number	fabric grades			COM/4
						1	2	3	
	7/8	30	36 1/4	1.25	GAATLKW30	959	982	1,007	1,032
	7/8	36	36 1/4	1.25	GAATLKW36	1,114	1,143	1,176	1,207
	7/8	60	36 1/4	2.00	GAATLKW60	1,137	1,184	1,233	1,284
	7/8	66	36 1/4	2.25	GAATLKW66	1,181	1,228	1,277	1,328
	7/8	72	36 1/4	2.50	GAATLKW72	1,216	1,268	1,325	1,384
	7/8	78	36 1/4	2.50	GAATLKW78	1,248	1,309	1,371	1,435
	7/8	84	36 1/4	2.75	GAATLKW84	1,302	1,363	1,425	1,489
	7/8	90	36 1/4	3.00	GAATLKW90	1,357	1,421	1,492	1,562
	7/8	96	36 1/4	3.00	GAATLKW96	1,873	1,942	2,019	2,095
2-PIECE	7/8	102	36 1/4	3.50	GAATLKW102	1,938	2,015	2,097	2,179
2-PIECE	7/8	108	36 1/4	4.00	GAATLKW108	2,036	2,121	2,208	2,297
2-PIECE	7/8	120	36 1/4	4.00	GAATLKW120	2,272	2,361	2,455	2,550

- Dimensioned from full height trough worksurface to bottom of overhead.
- A trough worksurface is required for ALL tackzone.
- Tackboards listed on this page are all standard "railroad".

PRODUCT SPECIFICATIONS:

STANDARD

The fabric on all Gunlocke tackboards is applied in a railroad fashion.

- Tackboard widths less than or equal to 96" are one piece
- Tackboards greater than 96" are two piece and the fabric is pattern matched
- When ordering individual wall mount tackboards to be placed side by side, the fabric pattern will be random matched. If a fabric pattern match is required, contact Gunlocke Bid/Quote for a special quote.

SPECIAL

Fabric applied "up the roll" is a special application. Please see guidelines below and contact Gunlocke Bid/Quote for a special quote.

- Fabrics used on tackboard 48" and under in width can be applied "up the roll"
- Tackboards greater than 48" in width can only be applied railroaded, due to fabric height limitations

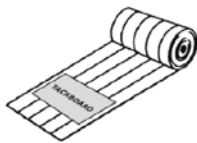
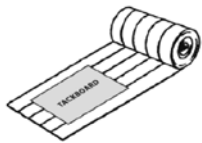

PRODUCT INFO

See yards listed above for COM fabric requirement

102, 108, and 120 wide tackboards are 2-piece

TO ORDER PLEASE SPECIFY THE FOLLOWING:

1. **MODEL NUMBER**
2. **FABRIC**
3. **FSC TACKBOARD**
4. **OFFICE #**

FSC Tackboard Options:

FSC = FSC Required (+5% COM upcharge)
NR = FSC Not Required

COM FABRIC REQUIREMENT

All COM must be shipped prepaid to Gunlocke with package side marked with:

- Dealer Name
- Dealer Purchase Order Number
- Gunlocke Pattern Number

See inside front cover for required option codes

Example

GAATLKW30.FABRIC.FSC.OFC1
 GAATLKW30 FABRIC FSC OFC1
 MODEL NUMBER FABRIC FSC TACKBOARD OFFICE #

	D	W	H	yards	model number	fabric grades			COM/4
						1	2	3	
TOP OF 1 HIGH OVERHEAD	7/8	30	55 3/4	1.75	GAATLKW1H30	1,137	1,160	1,185	1,210
	7/8	36	55 3/4	1.75	GAATLKW1H36	1,181	1,210	1,243	1,274
	7/8	42	55 3/4	1.75	GAATLKW1H42	1,216	1,253	1,289	1,328
	7/8	48	55 3/4	1.75	GAATLKW1H48	1,248	1,285	1,321	1,360



FABRIC

- Dimensioned from trough worksurface to top of 1 high overhead (or 5 high storage)
- A trough worksurface is required for ALL tackzone.

TOP OF 2 HIGH OVERHEAD

TOP OF 2 HIGH OVERHEAD	7/8	30	64 1/4	2.00	GAATLKW2H30	1,181	1,204	1,229	1,254
	7/8	36	64 1/4	2.00	GAATLKW2H36	1,216	1,245	1,278	1,309
	7/8	42	64 1/4	2.00	GAATLKW2H42	1,248	1,285	1,321	1,360
	7/8	48	64 1/4	2.00	GAATLKW2H48	1,302	1,339	1,375	1,414

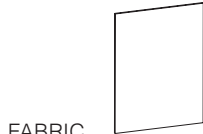

FABRIC

- Dimensioned from trough worksurface to top of 2 high overhead (or 6 high storage)
- A trough worksurface is required for ALL tackzone.
- Layers tackboards to top of 1H and 2H overheads are "up the roll".

PRODUCT SPECIFICATIONS:

STANDARD

The fabric on all Gunlocke tackboards is applied in a railroad fashion.

- Tackboard widths less than or equal to 96" are one piece
- Tackboards greater than 96" are two piece and the fabric is pattern matched
- When ordering individual wall mount tackboards to be placed side by side, the fabric pattern will be random matched. If a fabric pattern match is required, contact Gunlocke Bid/Quote for a special quote.

SPECIAL

Fabric applied "up the roll" is a special application. Please see guidelines below and contact Gunlocke Bid/Quote for a special quote.

- Fabrics used on tackboard 48" and under in width can be applied "up the roll"
- Tackboards greater than 48" in width can only be applied railroaded, due to fabric height limitations

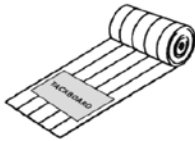
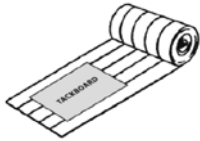

PRODUCT INFO

See yards listed above for COM fabric requirement

TO ORDER PLEASE SPECIFY THE FOLLOWING:

1. **MODEL NUMBER**
2. **FABRIC**
3. **FSC TACKBOARD**
4. **OFFICE #**

FSC Tackboard Options:

FSC = FSC Required (+5% COM upcharge)
NR = FSC Not Required

COM FABRIC REQUIREMENT

All COM must be shipped prepaid to Gunlocke with package side marked with:

- Dealer Name
- Dealer Purchase Order Number
- Gunlocke Pattern Number

See inside front cover for required option codes

Example

GAATLKW30.FABRIC.FSC.OFC1

GAATLKW30	FABRIC	FSC	OFC1
MODEL NUMBER	FABRIC	FSC TACKBOARD	OFFICE #

WHITEBOARDS

Standard

Credentials

05/22

	D	W	H	model number	list
STANDARD	3/4	30	28 1/2	GAATGW30-GSA	1,725
	3/4	36	28 1/2	GAATGW36-GSA	1,960
	3/4	60	28 1/2	GAATGW60-GSA	3,213
MAGNETIC	3/4	66	28 1/2	GAATGW66-GSA	3,677
	3/4	72	28 1/2	GAATGW72-GSA	3,919
	3/4	78	28 1/2	GAATGW78-GSA	4,345
	3/4	84	28 1/2	GAATGW84-GSA	4,936
2-PIECE	3/4	90	28 1/2	GAATGW90-GSA	5,164
2-PIECE	3/4	96	28 1/2	GAATGW96-GSA	5,412
2-PIECE	3/4	102	28 1/2	GAATGW102-GSA	5,641
	3/4	108	28 1/2	GAATGW108-GSA	5,881

- **NOTE:** Quantity 6 magnets are included with each unit 72"W and less. Quantity 12 magnets are included with each unit 84"W and greater. Magnets can also be ordered separately.

PRODUCT INFO

TO ORDER PLEASE SPECIFY THE FOLLOWING:

1. **MODEL NUMBER**
2. **GLASS COLOR**
3. **OFFICE #**

NOTE: Whiteboards are GSA (TAA) compliant standard.

See inside front cover for required option codes

Example

GAATGW30-GSA.WH.OFC1		
GAATGW30-GSA	WH	OFC1
<small>MODEL NUMBER</small>	<small>GLASS COLOR</small>	<small>OFFICE #</small>

TOP OF 1 HIGH OVERHEAD

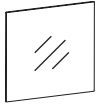

MAGNETIC

D	W	H	model number	select
3/4	30	48	GAATGW1H30-GSA	3,213
3/4	36	48	GAATGW1H36-GSA	3,677
3/4	42	48	GAATGW1H42-GSA	3,919
3/4	48	48	GAATGW1H48-GSA	4,345

- Dimensioned from trough worksurface to top of 1 high overhead (or 5 high storage)
- A trough worksurface is required for ALL tackzone.

TOP OF 2 HIGH OVERHEAD

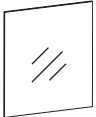

MAGNETIC

3/4	30	56 1/2	GAATGW2H30-GSA	3,677
3/4	36	56 1/2	GAATGW2H36-GSA	3,919
3/4	42	56 1/2	GAATGW2H42-GSA	4,345
3/4	48	56 1/2	GAATGW2H48-GSA	4,936

- Dimensioned from trough worksurface to top of 2 high overhead (or 6 high storage)
- A trough worksurface is required for ALL tackzone.
- **NOTE:** Quantity 6 magnets are included with each unit 72"W and less. Quantity 12 magnets are included with each unit 84"W and greater. Magnets can also be ordered separately.

PRODUCT INFO

TO ORDER PLEASE SPECIFY THE FOLLOWING:

1. **MODEL NUMBER**
2. **GLASS COLOR**
3. **OFFICE #**

NOTE: Whiteboards are GSA (TAA) compliant standard.

See inside front cover for required option codes

Example

GAATGW1H30-GSA.WH.OFC1
 GAATGW1H30-GSA WH OFC1
 MODEL NUMBER GLASS COLOR OFFICE #

LAYERS WHITEBOARDS

Standard

Credentials

05/22

STANDARD



MAGNETIC

	D	W	H	model number	list
	3/4	30	36 1/4	GAATLGW30-GSA	1,960
	3/4	36	36 1/4	GAATLGW36-GSA	3,213
	3/4	60	36 1/4	GAATLGW60-GSA	3,677
	3/4	66	36 1/4	GAATLGW66-GSA	3,919
	3/4	72	36 1/4	GAATLGW72-GSA	4,345
	3/4	78	36 1/4	GAATLGW78-GSA	4,936
	3/4	84	36 1/4	GAATLGW84-GSA	5,164
	3/4	90	36 1/4	GAATLGW90-GSA	5,412
2-PIECE	3/4	96	36 1/4	GAATLGW96-GSA	5,641
2-PIECE	3/4	102	36 1/4	GAATLGW102-GSA	5,881
2-PIECE	3/4	108	36 1/4	GAATLGW108-GSA	6,084

• **NOTE:** Quantity 6 magnets are included with each unit 72"W and less. Quantity 12 magnets are included with each unit 84"W and greater. Magnets can also be ordered separately.

PRODUCT INFO

TO ORDER PLEASE SPECIFY THE FOLLOWING:

1. **MODEL NUMBER**
2. **GLASS COLOR**
3. **OFFICE #**

NOTE: Whiteboards are GSA (TAA) compliant standard.

See inside front cover for required option codes

Example

GAATLGW30-GSA.WH.OFC1
 GAATLGW30-GSA WH OFC1
 MODEL NUMBER GLASS COLOR OFFICE #

TOP OF 1 HIGH OVERHEAD

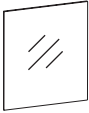

MAGNETIC

D	W	H	model number	list
3/4	30	55 3/4	GAATLGW1H30-GSA	3,677
3/4	36	55 3/4	GAATLGW1H36-GSA	3,919
3/4	42	55 3/4	GAATLGW1H42-GSA	4,345
3/4	48	55 3/4	GAATLGW1H48-GSA	4,936

- Dimensioned from trough worksurface to top of 1 high overhead (or 5 high storage)
- A trough worksurface is required for ALL tackzone.

TOP OF 2 HIGH OVERHEAD

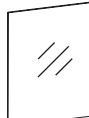

MAGNETIC

3/4	30	64 1/4	GAATLGW2H30-GSA	3,919
3/4	36	64 1/4	GAATLGW2H36-GSA	4,345
3/4	42	64 1/4	GAATLGW2H42-GSA	4,936
3/4	48	64 1/4	GAATLGW2H48-GSA	5,164

- Dimensioned from trough worksurface to top of 2 high overhead (or 6 high storage)
- A trough worksurface is required for ALL tackzone.
- **NOTE:** Quantity 6 magnets are included with each unit 72"W and less. Quantity 12 magnets are included with each unit 84"W and greater. Magnets can also be ordered separately.

PRODUCT INFO

TO ORDER PLEASE SPECIFY THE FOLLOWING:

1. **MODEL NUMBER**
2. **GLASS COLOR**
3. **OFFICE #**

NOTE: Whiteboards are GSA (TAA) compliant standard.

See inside front cover for required option codes

Example

GAATLGW1H30-GSA.WH.OFC1
 GAATLGW1H30-GSA WH OFC
 MODEL NUMBER GLASS COLOR OFFICE #

SEGMENTED WHITEBOARDS

Credentials
05/22

Standard

STANDARD



MAGNETIC

	D	W	H	model number	list
	3/4	30	28 1/2	GAATGW30-LXGSA	1,981
	3/4	36	28 1/2	GAATGW36-LXGSA	2,255
	3/4	60	28 1/2	GAATGW60-LXGSA	3,695
	3/4	66	28 1/2	GAATGW66-LXGSA	4,231
	3/4	72	28 1/2	GAATGW72-LXGSA	4,510
	3/4	78	28 1/2	GAATGW78-LXGSA	5,003
	3/4	84	28 1/2	GAATGW84-LXGSA	5,676
	3/4	90	28 1/2	GAATGW90-LXGSA	5,939
2-PIECE	3/4	96	28 1/2	GAATGW96-LXGSA	6,224
2-PIECE	3/4	102	28 1/2	GAATGW102-LXGSA	6,486
2-PIECE	3/4	108	28 1/2	GAATGW108-LXGSA	6,763

- **NOTE:** Quantity 6 magnets are included with each unit 72"W and less. Quantity 12 magnets are included with each unit 84"W and greater. Magnets can also be ordered separately.
- Shelves must be ordered separately.

PRODUCT INFO

TO ORDER PLEASE SPECIFY THE FOLLOWING:

1. **MODEL NUMBER**
2. **GLASS COLOR**
3. **OFFICE #**

NOTE: Whiteboards are GSA (TAA) compliant standard.

See inside front cover for required option codes

Example

GAATGW30-LXGSA.WH.OFC1
 GAATGW30-LXGSA WH OFC1
 MODEL NUMBER GLASS COLOR OFFICE #

	D	W	H	model number	list
TOP OF 1 HIGH OVERHEAD 	3/4	30	48	GAATGW1H30-XGSA	3,695
	3/4	36	48	GAATGW1H36-XGSA	4,231
	3/4	42	48	GAATGW1H42-XGSA	4,510
	3/4	48	48	GAATGW1H48-XGSA	5,003

MAGNETIC

- Dimensioned from trough worksurface to top of 1 high overhead (or 5 high storage)
- A trough worksurface is required for ALL tackzone.

TOP OF 2 HIGH OVERHEAD

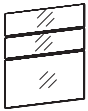

MAGNETIC

3/4	30	56 1/2	GAATGW2H30-XGSA	4,231
3/4	36	56 1/2	GAATGW2H36-XGSA	4,510
3/4	42	56 1/2	GAATGW2H42-XGSA	5,003
3/4	48	56 1/2	GAATGW2H48-XGSA	5,676

- Dimensioned from trough worksurface to top of 2 high overhead (or 6 high storage)
- A trough worksurface is required for ALL tackzone.
- **NOTE:** Quantity 6 magnets are included with each unit 72"W and less. Quantity 12 magnets are included with each unit 84"W and greater. Magnets can also be ordered separately.
- Shelves must be ordered separately.

PRODUCT INFO

TO ORDER PLEASE SPECIFY THE FOLLOWING:

1. **MODEL NUMBER**
2. **GLASS COLOR**
3. **OFFICE #**

NOTE: Whiteboards are GSA (TAA) compliant standard.

See inside front cover for required option codes

Example

GAATGW30-LXGSA.WH.OFC1
 GAATGW30-LXGSA WH OFC1
 MODEL NUMBER GLASS COLOR OFFICE #

LAYERS SEGMENTED WHITEBOARDS

Credentials
05/22

Standard

STANDARD



MAGNETIC

	D	W	H	model number	list
	3/4	30	36 1/4	GAATLGW30-LXGSA	2,255
	3/4	36	36 1/4	GAATLGW36-LXGSA	3,695
	3/4	60	36 1/4	GAATLGW60-LXGSA	4,231
	3/4	66	36 1/4	GAATLGW66-LXGSA	4,510
	3/4	72	36 1/4	GAATLGW72-LXGSA	5,003
	3/4	78	36 1/4	GAATLGW78-LXGSA	5,676
	3/4	84	36 1/4	GAATLGW84-LXGSA	5,939
	3/4	90	36 1/4	GAATLGW90-LXGSA	6,224
2-PIECE	3/4	96	36 1/4	GAATLGW96-LXGSA	6,486
2-PIECE	3/4	102	36 1/4	GAATLGW102-LXGSA	6,763
2-PIECE	3/4	108	36 1/4	GAATLGW108-LXGSA	6,995

- **NOTE:** Quantity 6 magnets are included with each unit 72"W and less. Quantity 12 magnets are included with each unit 84"W and greater. Magnets can also be ordered separately.
- Shelves must be ordered separately.

PRODUCT INFO

TO ORDER PLEASE SPECIFY THE FOLLOWING:

1. **MODEL NUMBER**
2. **GLASS COLOR**
3. **OFFICE #**

NOTE: Whiteboards are GSA (TAA) compliant standard.

See inside front cover for required option codes

Example

GAATLGW30-LXGSA.WH.OFC1
 GAATLGW30-LXGSA WH OFC1
 MODEL NUMBER GLASS COLOR OFFICE #

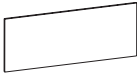
	D	W	H	model number	veneer 1	veneer 2	
STANDARD  MAGNETIC	7/8	30	28 1/2	GAATWD30	1,731	1,904	
	7/8	36	28 1/2	GAATWD36	1,837	2,021	
	7/8	60	28 1/2	GAATWD60	2,483	2,732	
	7/8	66	28 1/2	GAATWD66	2,628	2,891	
	7/8	72	28 1/2	GAATWD72	2,853	3,138	
	7/8	78	28 1/2	GAATWD78	2,942	3,236	
	7/8	84	28 1/2	GAATWD84	3,102	3,411	
	7/8	90	28 1/2	GAATWD90	3,513	3,864	
	2-PIECE	7/8	96	28 1/2	GAATWD96	3,617	3,977
	2-PIECE	7/8	102	28 1/2	GAATWD102	3,723	4,095
	2-PIECE	7/8	108	28 1/2	GAATWD108	3,927	4,319
	2-PIECE	7/8	120	28 1/2	GAATWD120	4,055	4,460

• **NOTE:** Quantity 6 magnets are included with each unit 72"W and less. Quantity 12 magnets are included with each unit 84"W and greater. Magnets can also be ordered separately.

PRODUCT INFO

TO ORDER PLEASE SPECIFY THE FOLLOWING:

1. **MODEL NUMBER**
2. **FINISH**
3. **OFFICE #**

See inside front cover for required option codes

Example

GAATWD30.NC215.OFC1
 GAATWD30 NC215 OFC1
 MODEL NUMBER FINISH OFFICE #

WOOD MAGNETIC TACKZONE

Credentials
05/22

Top of Overhead

	D	W	H	model number	veneer 1	veneer 2
TOP OF 1 HIGH OVERHEAD  MAGNETIC	7/8	30	48	GAATWD1H30	2,483	2,732
	7/8	36	48	GAATWD1H36	2,628	2,891
	7/8	42	48	GAATWD1H42	2,853	3,138
	7/8	48	48	GAATWD1H48	2,942	3,236

- Dimensioned from trough worksurface to top of 1 high overhead (or 5 high storage)
- A trough worksurface is required for ALL tackzone.

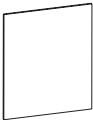
	D	W	H	model number	veneer 1	veneer 2
TOP OF 2 HIGH OVERHEAD  MAGNETIC	7/8	30	56 1/2	GAATWD2H30	2,628	2,891
	7/8	36	56 1/2	GAATWD2H36	2,853	3,138
	7/8	42	56 1/2	GAATWD2H42	2,942	3,236
	7/8	48	56 1/2	GAATWD2H48	3,102	3,411

- Dimensioned from trough worksurface to top of 2 high overhead (or 6 high storage)
- A trough worksurface is required for ALL tackzone.

- **NOTE:** Quantity 6 magnets are included with each unit 72"W and less. Quantity 12 magnets are included with each unit 84"W and greater. Magnets can also be ordered separately.

PRODUCT INFO

TO ORDER PLEASE SPECIFY THE FOLLOWING:

1. **MODEL NUMBER**
2. **FINISH**
3. **OFFICE #**

See inside front cover for required option codes

Example

GAATWD1H30.NC215.OFC1
 GAATWD1H30 NC215 OFC1
 MODEL NUMBER FINISH OFFICE #

STANDARD



MAGNETIC

	D	W	H	model number	veneer 1	veneer 2
	7/8	30	36 1/4	GAATLWD30	1,837	2,021
	7/8	36	36 1/4	GAATLWD36	2,483	2,732
	7/8	60	36 1/4	GAATLWD60	2,628	2,891
	7/8	66	36 1/4	GAATLWD66	2,853	3,138
	7/8	72	36 1/4	GAATLWD72	2,942	3,236
	7/8	78	36 1/4	GAATLWD78	3,102	3,411
	7/8	84	36 1/4	GAATLWD84	3,513	3,864
	7/8	90	36 1/4	GAATLWD90	3,617	3,977
2-PIECE	7/8	96	36 1/4	GAATLWD96	3,723	4,095
2-PIECE	7/8	102	36 1/4	GAATLWD102	3,927	4,319
2-PIECE	7/8	108	36 1/4	GAATLWD108	4,130	4,543
2-PIECE	7/8	120	36 1/4	GAATLWD120	4,332	4,765

• **NOTE:** Quantity 6 magnets are included with each unit 72"W and less. Quantity 12 magnets are included with each unit 84"W and greater. Magnets can also be ordered separately.

PRODUCT INFO

TO ORDER PLEASE SPECIFY THE FOLLOWING:

1. **MODEL NUMBER**
2. **FINISH**
3. **OFFICE #**

See inside front cover for required option codes

Example

GAATLWD30.NC215.OFC1
 GAATLWD30 NC215 OFC1
 MODEL NUMBER FINISH OFFICE #

LAYERS WOOD MAGNETIC TACKZONE

Credentials
05/22

Top of Overhead

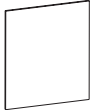
	D	W	H	model number	veneer 1	veneer 2
TOP OF 1 HIGH OVERHEAD  MAGNETIC	7/8	30	55 3/4	GAATLWD1H30	2,628	2,891
	7/8	36	55 3/4	GAATLWD1H36	2,853	3,138
	7/8	42	55 3/4	GAATLWD1H42	2,942	3,236
	7/8	48	55 3/4	GAATLWD1H48	3,102	3,411

- Dimensioned from trough worksurface to top of 1 high overhead (or 5 high storage)
- A trough worksurface is required for ALL tackzone.

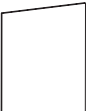
	D	W	H	model number	veneer 1	veneer 2
TOP OF 2 HIGH OVERHEAD  MAGNETIC	7/8	30	64 1/4	GAATLWD2H30	2,853	3,138
	7/8	36	64 1/4	GAATLWD2H36	2,942	3,236
	7/8	42	64 1/4	GAATLWD2H42	3,102	3,411
	7/8	48	64 1/4	GAATLWD2H48	3,513	3,864

- Dimensioned from trough worksurface to top of 2 high overhead (or 6 high storage)
- A trough worksurface is required for ALL tackzone.
- **NOTE:** Quantity 6 magnets are included with each unit 72"W and less. Quantity 12 magnets are included with each unit 84"W and greater. Magnets can also be ordered separately.

PRODUCT INFO

TO ORDER PLEASE SPECIFY THE FOLLOWING:

1. **MODEL NUMBER**
2. **FINISH**
3. **OFFICE #**

See inside front cover for required option codes

Example

GAATLWD1H30.NC215.OFC1
 GAATLWD1H30 NC215 OFC1
 MODEL NUMBER FINISH OFFICE #

	D	W	H	model number	veneer 1	veneer 2	
STANDARD	7/8	30	28 1/2	GAATWD30-LX	1,987	2,186	
	7/8	36	28 1/2	GAATWD36-LX	2,113	2,324	
MAGNETIC	7/8	60	28 1/2	GAATWD60-LX	2,855	3,140	
	7/8	66	28 1/2	GAATWD66-LX	3,025	3,327	
	7/8	72	28 1/2	GAATWD72-LX	3,282	3,610	
	7/8	78	28 1/2	GAATWD78-LX	3,384	3,722	
	7/8	84	28 1/2	GAATWD84-LX	3,569	3,926	
	7/8	90	28 1/2	GAATWD90-LX	4,040	4,444	
	2-PIECE	7/8	96	28 1/2	GAATWD96-LX	4,157	4,573
	2-PIECE	7/8	102	28 1/2	GAATWD102-LX	4,282	4,709
	2-PIECE	7/8	108	28 1/2	GAATWD108-LX	4,515	4,967
	2-PIECE	7/8	120	28 1/2	GAATWD120-LX	4,666	5,133

- **NOTE:** Quantity 6 magnets are included with each unit 72"W and less. Quantity 12 magnets are included with each unit 84"W and greater. Magnets can also be ordered separately.
- Shelves must be ordered separately.

PRODUCT INFO

TO ORDER PLEASE SPECIFY THE FOLLOWING:

1. **MODEL NUMBER**
2. **FINISH**
3. **OFFICE #**

See inside front cover for required option codes

Example

GAATWD30-LX.NC215.OFC1
 GAATWD30-LX NC215 OFC1
 MODEL NUMBER FINISH OFFICE #

SEGMENTED WOOD MAGNETIC TACKZONE

Credentials
05/22

Top of Overhead

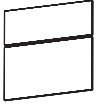
	D	W	H	model number	veneer 1	veneer 2
 MAGNETIC	7/8	30	48	GAATWD1H30-X	2,855	3,140
	7/8	36	48	GAATWD1H36-X	3,025	3,327
	7/8	42	48	GAATWD1H42-X	3,282	3,610
	7/8	48	48	GAATWD1H48-X	3,384	3,722

- Dimensioned from trough worksurface to top of 1 high overhead (or 5 high storage)
- A trough worksurface is required for ALL tackzone

TOP OF 2 HIGH OVERHEAD

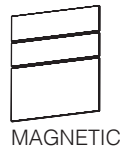

7/8	30	56 1/2	GAATWD2H30-X	3,025	3,327
7/8	36	56 1/2	GAATWD2H36-X	3,282	3,610
7/8	42	56 1/2	GAATWD2H42-X	3,384	3,722
7/8	48	56 1/2	GAATWD2H48-X	3,569	3,926

- Dimensioned from trough worksurface to top of 2 high overhead (or 6 high storage)
- A trough worksurface is required for ALL tackzone.
- **NOTE:** Quantity 6 magnets are included with each unit 72"W and less. Quantity 12 magnets are included with each unit 84"W and greater. Magnets can also be ordered separately.
- Shelves must be ordered separately.

PRODUCT INFO

TO ORDER PLEASE SPECIFY THE FOLLOWING:

1. **MODEL NUMBER**
2. **FINISH**
3. **OFFICE #**

See inside front cover for required option codes

Example

GAADTRM3672L-3WW.NC215.OFC1
 GAADTRM3672L-3WW NC215 OFC1
 MODEL NUMBER FINISH OFFICE #

STANDARD



MAGNETIC

	D	W	H	model number	veneer 1	veneer 2
	7/8	30	36 1/4	GAATLWD30-LX	2,113	2,324
	7/8	36	36 1/4	GAATLWD36-LX	2,855	3,140
	7/8	60	36 1/4	GAATLWD60-LX	3,025	3,327
	7/8	66	36 1/4	GAATLWD66-LX	3,282	3,610
	7/8	72	36 1/4	GAATLWD72-LX	3,384	3,722
	7/8	78	36 1/4	GAATLWD78-LX	3,569	3,926
	7/8	84	36 1/4	GAATLWD84-LX	4,040	4,444
	7/8	90	36 1/4	GAATLWD90-LX	4,157	4,573
2-PIECE	7/8	96	36 1/4	GAATLWD96-LX	4,282	4,709
2-PIECE	7/8	102	36 1/4	GAATLWD102-LX	4,515	4,967
2-PIECE	7/8	108	36 1/4	GAATLWD108-LX	4,747	5,221
2-PIECE	7/8	120	36 1/4	GAATLWD120-LX	4,979	5,477

- **NOTE:** Quantity 6 magnets are included with each unit 72"W and less. Quantity 12 magnets are included with each unit 84"W and greater. Magnets can also be ordered separately.
- Shelves must be ordered separately.

PRODUCT INFO

TO ORDER PLEASE SPECIFY THE FOLLOWING:

1. **MODEL NUMBER**
2. **FINISH**
3. **OFFICE #**

See inside front cover for required option codes

Example

GAATLWD30-LX.NC215.OFC1
 GAATLWD30-LX NC215 OFC1
 MODEL NUMBER FINISH OFFICE #

	D	W	H	new model number	old model number	veneer 1	veneer 2	
WOOD 	8	30	1	GA2ASF830-W	GAAASF830-W	856	942	
	8	36	1	GA2ASF836-W	GAAASF836-W	922	1,015	
	8	42	1	GA2ASF842-W	GAAASF842-W	1,050	1,155	
	8	48	1	GA2ASF848-W	GAAASF848-W	1,172	1,290	
	8	60	1	GA2ASF860-W	GAAASF860-W	1,336	1,470	
	8	66	1	GA2ASF866-W	GAAASF866-W	1,428	1,571	
	8	72	1	GA2ASF872-W	GAAASF872-W	1,509	1,660	
	8	78	1	GA2ASF878-W	GAAASF878-W	1,583	1,742	
	8	84	1	GA2ASF884-W	GAAASF884-W	1,673	1,841	
	8	90	1	GA2ASF890-W	GAAASF890-W	1,872	2,060	
	2-PIECE	8	96	1	GA2ASF896-W	GAAASF896-W	1,937	2,131
	2-PIECE	8	102	1	GA2ASF8102-W	GAAASF8102-W	2,005	2,206
	2-PIECE	8	108	1	GA2ASF8108-W	GAAASF8108-W	2,069	2,276
	2-PIECE	8	120	1	GA2ASF8120-W	GAAASF8120-W	2,673	2,941
2-PIECE	8	144	1	GA2ASF8144-W	GAAASF8144-W	3,022	3,325	

- WHEN PLACING MULTIPLE SHELVES END TO END, PLEASE CONTACT GUNTS FOR A SPECIAL SET OF SHELVES WITH A DOWEL PIN FOR ALIGNMENT SHELF TO SHELF
- STANDARD 2-PIECE SHELVES INCLUDE DOWEL PIN

PRODUCT INFO

TO ORDER PLEASE SPECIFY THE FOLLOWING:

1. MODEL NUMBER
2. FINISH
3. OFFICE #

See inside front cover for required option codes

Example

GA2ASF830-W.NC215.OFC1
 GA2ASF830-W NC215 OFC1
MODEL NUMBER FINISH OFFICE #

	D	W	H	new model number	old model number	veneer 1	veneer 2
 2-PIECE 2-PIECE	42 dia.		1 1/2	GA2TRD42-W	GAATR42-W	4,456	4,902
	48 dia.		1 1/2	GA2TRD48-W	GAATR48-W	5,254	5,780
	54 dia.		1 1/2	GA2TRD54-W	GAATR54-W	6,290	6,919
	60 dia.		1 1/2	GA2TRD60-W	GAATR60-W	6,565	7,222

PRODUCT INFO

TO ORDER PLEASE SPECIFY THE FOLLOWING:



1. **MODEL NUMBER**
2. **FINISH**
3. **TOP UV FINISH TYPE**
4. **OFFICE #**

See inside front cover for required option codes

Example

GA2TRD42-W.NC215.FF.OFC1

GA2TRD42-W	NC215	FF	OFC1
MODEL NUMBER	FINISH	TOP UV FINISH	OFFICE #

	D	W	H	model number	list
X BASE 32 	32	32	27 ¹⁵ / ₁₆	BSXBASE32	4,522
<ul style="list-style-type: none"> • For use with 42" and 48" dia. round tables • 3" dia. column 					
X BASE 40 	40	40	27 ¹⁵ / ₁₆	BSXBASE40	4,645
<ul style="list-style-type: none"> • For use with 54" and 60" dia. round tables • 3" dia. column 					

PRODUCT INFO

Brushed Satin
Nickel Finish

TO ORDER PLEASE SPECIFY THE FOLLOWING:

1. **MODEL NUMBER**

NOTE: Office # option not required

See inside front cover for required option codes

Example

BSXBASE32
BSXBASE32
MODEL NUMBER

	D	W	H	model number	list
RECESSED LED TASKLIGHTS					
	5/8	24	5/8	ACLEDD24-R	722
	5/8	54	5/8	ACLEDD54-R	1,008
	5/8	72	5/8	ACLEDD72-R	1,525

Tasklights are INCLUDED with all overhead cabinets.
They do NOT need to be purchased separately.

- LED lighting provides high efficiency, low energy lighting with a long life.
- All LED light strips are encased in a silver aluminum extrusion and include a built-in microswitch to turn the light on/off.
- Lights are field installed.
- All units include a 10' cord with a standard plug.
- Tasklights are recessed into bottom panel of overhead cabinet.
- Light temperature 3200K

<p>PRODUCT INFO</p> <p>See product specs above</p>	<p>TO ORDER PLEASE SPECIFY THE FOLLOWING:</p> <p>1. <input style="width: 80px; height: 20px;" type="text"/> MODEL NUMBER</p> <p>NOTE: Office # option not required</p> <p>See inside front cover for required option codes</p> <p>Example</p> <hr/> <p>ACLEDD24-R ACLEDD24-R MODEL NUMBER</p>
---	--

MAGNETS



D	W	H	model number	list
$\frac{3}{8}$ dia.		$\frac{1}{2}$	SAMAGNET	90

- **NOTE:** Quantity 6 magnets are included with each unit 72"W and less. Quantity 12 magnets are included with each unit 84"W and greater.
- Magnets are silver

PRODUCT INFO

TO ORDER PLEASE SPECIFY THE FOLLOWING:

1. **MODEL NUMBER**

See inside front cover for required option codes

Example

SAMAGNET
SAMAGNET
MODEL NUMBER

	D	W	H	model number	list
BENEATH WORKSURFACE WIRE MANAGER	3 1/4	30	1	ACWM	101

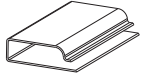

PRODUCT INFO

TO ORDER PLEASE SPECIFY THE FOLLOWING:

1. **MODEL NUMBER**

NOTE: Office # option not required

See inside front cover for required option codes

Example

ACWM
ACWM
MODEL NUMBER

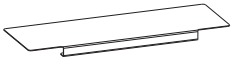
	D	W	H	model number	list
PERSONAL CORNER					
	12 1/2	36	1 7/8	GAACORNER	1,040

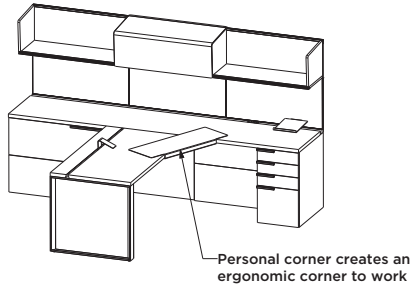

DESKPAD					
	18	36	1 7/8	GAADSKPAD	1,471

PRODUCT INFO

Designed for 1.5" thick worksurfaces.

TO ORDER PLEASE SPECIFY THE FOLLOWING:

1. **MODEL NUMBER**
2. **LEATHER/VINYL COLOR**
3. **OFFICE #**

Leather Color:
CBL = Black
CWH = White
CCH = Chocolate

Vinyl Color:
VBL = Black
VWH = White
VCH = Chocolate

See inside front cover for required option codes







Example

GAACORNER.CWH.OFC1
 GAACORNER CWH OFC1
 MODEL NUMBER LEATHER COLOR OFFICE #

Credentials

05/22
Leather

ORGANIZATION TRAYS

	D	W	H	model number	list
15" BOX DRAWER INSERT 	13 15/16	11 11/16	3	GAATRAYBOX15	815
	<ul style="list-style-type: none"> For use in 15" wide box drawers 				
18" BOX DRAWER INSERT 	13 15/16	14 11/16	3	GAATRAYBOX18	895
	<ul style="list-style-type: none"> For use in 18" wide box drawers 				
30" BOX DRAWER INSERT 	13 15/16	26 11/16	3	GAATRAYBOX30	1,525
	<ul style="list-style-type: none"> For use in 30" wide box drawers 				
36" BOX DRAWER INSERT 	13 15/16	32 11/16	3	GAATRAYBOX36	1,669
	<ul style="list-style-type: none"> For use in 36" wide box drawers 				
15" TRAY FOR OVERHEADS WITH CUBBY  (Sliding & soft lift doors ONLY)	13 15/16	13 1/4	3	GAATRAYLTR15	711
	<ul style="list-style-type: none"> Letter tray for use in 1 high overheads with 15" wide cubbies. For sliding door and soft lift door overhead, with width dimension in 15" increments = 60"w, 90"w, 120"w Not for use with hinged doors. Hinge location prevents leather tray from fitting in opening. 				
18" TRAY FOR OVERHEADS WITH CUBBY  (Sliding & soft lift doors ONLY)	13 15/16	16 1/4	3	GAATRAYLTR18	777
	<ul style="list-style-type: none"> Letter tray for use in 1 high overheads with 18" wide cubbies For sliding door and soft lift door overhead, with width dimension in 18" increments = 72"w, 108"w Not for use with hinged doors. Hinge location prevents leather tray from fitting in opening. 				

PRODUCT INFO

TO ORDER PLEASE SPECIFY THE FOLLOWING:

1. **MODEL NUMBER**
2. **LEATHER COLOR**
3. **OFFICE #**

Leather Color:

- CBL** = Black
- CWH** = White
- CCH** = Chocolate

See inside front cover for required option codes

Example

GAATRAYBOX15.CWH.OFC1
 GAATRAYBOX15 CWH OFC1
 MODEL NUMBER LEATHER COLOR OFFICE #

CENTER DRAWERS

Credentials
05/22

	D	W	H	model number	list
15" PENCIL TRAY	3	11 5/16	1 1/4	ACPT15-GAA	103

18" PENCIL TRAY

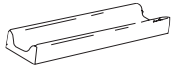

	3	14 5/16	1 1/4	ACPT18-GAA	110
--	---	---------	-------	-------------------	-----

CENTER DRAWER

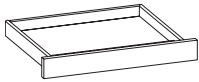

	17 5/8	21 3/4	2 15/16	GS2CDWSD- <input type="text"/>	757	826
--	--------	--------	---------	---------------------------------------	-----	-----

veneer 1 veneer 2

INTERIOR DIMENSIONS

D = 15 1/2
W = 18 1/4
H = 1 3/8

PRODUCT INFO

Center drawer includes pencil tray

TO ORDER PLEASE SPECIFY THE FOLLOWING:

- MODEL NUMBER**
- FINISH** • Finish option not required for pencil trays

NOTE: Office # option not required

See inside front cover for required option codes

Example

ACCD19.NC215	
ACCD19	NC215
<u>MODEL NUMBER</u>	<u>FINISH</u>

	D	W	H	model number	list
POWER UNIT	1 3/4	3	1 3/4	ACPWRT	674

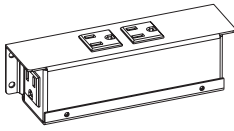

- Includes 3 power outlets - 2 power outlets on top surface and 1 power outlet on end of unit.
- Ships with 6 ft power cord with standard plug
- UL listed
- Mounting bracket included for use installation in the following applications:
 - To bottom of worksurface beneath grommets
 - To bottom of worksurface in trough opening of trough worksurfaces
 - As power strip inside wall access panels or beneath desks

PRODUCT INFO

TO ORDER PLEASE SPECIFY THE FOLLOWING:

1. **MODEL NUMBER**

NOTE: Office # option not required

See inside front cover for required option codes

Example





ACPWRT
ACPWRT
MODEL NUMBER

FILING RAILS

Replacements

Credentials

05/22

	D	W	H	model number	list
FOR USE WITH 15" W FILE DRAWERS 	1/8	15	1	ACFLR15-AA	37
FOR USE WITH 18" W FILE DRAWERS 	1/8	18	1	ACFLR18-AA	38
FOR USE WITH 30" W LATERAL FILES 	1/8	30	1	ACFLR30-AA	42
FOR USE WITH 36" W LATERAL FILES 	1/8	36	1	ACFLR36-AA	46

PRODUCT INFO

TO ORDER PLEASE SPECIFY THE FOLLOWING:

1. MODEL NUMBER

NOTE: Office # option not required

See inside front cover for required option codes

Example

ACFLR15-AA
 ACFLR15-AA
 MODEL NUMBER

TRASH CAN

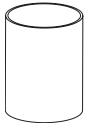

D	W	H	model number	list
9 3/4	9 3/4	12	ACTRASH	823

Quantity 2 trash cans are included with all (-T) pedestals.
They do not need to be purchased separately.

- Satin brushed aluminum finish

PRODUCT INFO

TO ORDER PLEASE SPECIFY THE FOLLOWING:

1. **MODEL NUMBER**

NOTE: Office # option not required

See inside front cover for required option codes

Example

ACTRASH
ACTRASH
MODEL NUMBER

SAMPLE TOP

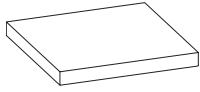

D	W	H	model number	vener 1	vener 2
18	18	1 1/2	GAATOP1818-W	1,255	1,379

PRODUCT INFO

TO ORDER PLEASE SPECIFY THE FOLLOWING:

- 1. **MODEL NUMBER**
- 2. **FINISH**
- 3. **TOP UV FINISH TYPE**
- 4. **OFFICE #**

See inside front cover for required option codes

Example

GAATOP1818-W.NC215.FF.OFC1
 GAADTOP1818 NC215 FF OFC1
 MODEL NUMBER FINISH TOP UV OFFICE #
 FINISH

FABRIC GRADE PRICING

Credentials
05/22

model number	1	2	3	COM/4	5	6	7	8	9	10	11	12	13	14	15	16
GAAMPD-CUSH1818	575	591	613	631	660	683	707	734	758	785	810	836	869	893	924	957
GAACLPD-CUSH2430	647	671	696	723	759	792	822	857	888	924	960	992	1,036	1,067	1,107	1,150
GAACLPD-CUSH2436	699	730	762	795	838	881	919	963	1,003	1,045	1,089	1,130	1,185	1,226	1,277	1,331
GAACLPD-CUSH2130T	647	671	696	723	759	792	822	857	888	924	960	992	1,036	1,067	1,107	1,150
GAACLPD-CUSH2136T	699	730	762	795	838	881	919	963	1,003	1,045	1,089	1,130	1,185	1,226	1,277	1,331
GAATKW30	915	938	963	988	1,022	1,055	1,084	1,115	1,149	1,181	1,218	1,246	1,287	1,321	1,360	1,401
GAATKW36	959	988	1,021	1,052	1,094	1,133	1,172	1,214	1,250	1,292	1,335	1,374	1,427	1,466	1,515	1,567
GAATKW60	1,114	1,161	1,210	1,261	1,329	1,394	1,451	1,520	1,583	1,649	1,715	1,781	1,863	1,926	2,006	2,088
GAATKW66	1,137	1,184	1,233	1,284	1,352	1,417	1,474	1,543	1,606	1,672	1,738	1,804	1,886	1,949	2,029	2,111
GAATKW72	1,181	1,233	1,290	1,349	1,422	1,497	1,561	1,638	1,709	1,782	1,858	1,930	2,023	2,093	2,183	2,277
GAATKW78	1,216	1,277	1,339	1,403	1,486	1,571	1,641	1,726	1,806	1,890	1,974	2,055	2,156	2,234	2,335	2,439
GAATKW84	1,248	1,309	1,371	1,435	1,518	1,603	1,673	1,758	1,838	1,922	2,006	2,087	2,188	2,266	2,367	2,471
GAATKW90	1,302	1,366	1,437	1,507	1,599	1,691	1,770	1,860	1,948	2,041	2,133	2,219	2,334	2,421	2,530	2,645
GAATKW96	1,357	1,426	1,503	1,579	1,681	1,779	1,866	1,965	2,059	2,161	2,261	2,356	2,479	2,574	2,695	2,817
GAATKW102	1,873	1,950	2,032	2,114	2,224	2,331	2,423	2,532	2,635	2,743	2,853	2,954	3,089	3,192	3,320	3,455
GAATKW108	1,938	2,023	2,110	2,199	2,316	2,435	2,532	2,651	2,763	2,880	2,995	3,109	3,253	3,364	3,504	3,648
GAATKW120	2,231	2,320	2,414	2,509	2,636	2,760	2,868	2,993	3,113	3,237	3,362	3,483	3,639	3,757	3,905	4,061
GAATKW1H30	1,114	1,137	1,162	1,187	1,221	1,254	1,283	1,314	1,348	1,380	1,417	1,445	1,486	1,520	1,559	1,600
GAATKW1H36	1,137	1,166	1,199	1,230	1,272	1,311	1,350	1,392	1,428	1,470	1,513	1,552	1,605	1,644	1,693	1,745
GAATKW1H42	1,181	1,218	1,254	1,293	1,343	1,395	1,439	1,488	1,536	1,587	1,638	1,684	1,748	1,797	1,855	1,916
GAATKW1H48	1,216	1,253	1,289	1,328	1,378	1,430	1,474	1,523	1,571	1,622	1,673	1,719	1,783	1,832	1,890	1,951
GAATKW2H30	1,137	1,160	1,185	1,210	1,244	1,277	1,306	1,337	1,371	1,403	1,440	1,468	1,509	1,543	1,582	1,623
GAATKW2H36	1,181	1,210	1,243	1,274	1,316	1,355	1,394	1,436	1,472	1,514	1,557	1,596	1,649	1,688	1,737	1,789
GAATKW2H42	1,216	1,253	1,289	1,328	1,378	1,430	1,474	1,523	1,571	1,622	1,673	1,719	1,783	1,832	1,890	1,951
GAATKW2H48	1,248	1,285	1,321	1,360	1,410	1,462	1,506	1,555	1,603	1,654	1,705	1,751	1,815	1,864	1,922	1,983
GAATLKW30	959	982	1,007	1,032	1,066	1,099	1,128	1,159	1,193	1,225	1,262	1,290	1,331	1,365	1,404	1,445
GAATLKW36	1,114	1,143	1,176	1,207	1,249	1,288	1,327	1,369	1,405	1,447	1,490	1,529	1,582	1,621	1,670	1,722
GAATLKW60	1,137	1,184	1,233	1,284	1,352	1,417	1,474	1,543	1,606	1,672	1,738	1,804	1,886	1,949	2,029	2,111
GAATLKW66	1,181	1,228	1,277	1,328	1,396	1,461	1,518	1,587	1,650	1,716	1,782	1,848	1,930	1,993	2,073	2,155
GAATLKW72	1,216	1,268	1,325	1,384	1,457	1,532	1,596	1,673	1,744	1,817	1,893	1,965	2,058	2,128	2,218	2,312
GAATLKW78	1,248	1,309	1,371	1,435	1,518	1,603	1,673	1,758	1,838	1,922	2,006	2,087	2,188	2,266	2,367	2,471
GAATLKW84	1,302	1,363	1,425	1,489	1,572	1,657	1,727	1,812	1,892	1,976	2,060	2,141	2,242	2,320	2,421	2,525
GAATLKW90	1,357	1,421	1,492	1,562	1,654	1,746	1,825	1,915	2,003	2,096	2,188	2,274	2,389	2,476	2,585	2,700
GAATLKW96	1,873	1,942	2,019	2,095	2,197	2,295	2,382	2,481	2,575	2,677	2,777	2,872	2,995	3,090	3,211	3,333
GAATLKW102	1,938	2,015	2,097	2,179	2,289	2,396	2,488	2,597	2,700	2,808	2,918	3,019	3,154	3,257	3,385	3,520
GAATLKW108	2,036	2,121	2,208	2,297	2,414	2,533	2,630	2,749	2,861	2,978	3,093	3,207	3,351	3,462	3,602	3,746
GAATLKW120	2,272	2,361	2,455	2,550	2,677	2,801	2,909	3,034	3,154	3,278	3,403	3,524	3,680	3,798	3,946	4,102

model number	17	18	19	20	21	22	23	24	25	26	27	col	L1	L2	L3	L4	L5
GAAMPD-CUSH1818	990	1,012	1,045	1,073	1,105	1,136	1,197	1,258	1,324	1,384	1,445	631	826	1,035	1,245	1,457	1,646
GAACLPD-CUSH2430	1,194	1,224	1,264	1,304	1,345	1,384	1,467	1,547	1,631	1,713	1,793	723	983	1,263	1,541	1,821	2,075
GAACLPD-CUSH2436	1,381	1,420	1,471	1,519	1,570	1,621	1,726	1,827	1,928	2,031	2,134	795	1,118	1,470	1,817	2,167	2,483
GAACLPD-CUSH2130T	1,194	1,224	1,264	1,304	1,345	1,384	1,467	1,547	1,631	1,713	1,793	723	983	1,263	1,541	1,821	2,075
GAACLPD-CUSH2136T	1,381	1,420	1,471	1,519	1,570	1,621	1,726	1,827	1,928	2,031	2,134	795	1,118	1,470	1,817	2,167	2,483
GAATKW30	1,442	1,470	1,508	1,547	1,587	1,626	1,705	1,781	1,864	1,942	2,019						
GAATKW36	1,616	1,653	1,701	1,749	1,800	1,849	1,949	2,044	2,144	2,244	2,343						
GAATKW60	2,167	2,224	2,303	2,380	2,458	2,538	2,696	2,852	3,010	3,169	3,326						
GAATKW66	2,190	2,247	2,326	2,403	2,481	2,561	2,719	2,875	3,033	3,192	3,349						
GAATKW72	2,365	2,431	2,520	2,605	2,695	2,782	2,961	3,136	3,315	3,495	3,670						
GAATKW78	2,538	2,610	2,708	2,805	2,904	3,006	3,204	3,398	3,596	3,796	3,989						
GAATKW84	2,570	2,642	2,740	2,837	2,936	3,038	3,236	3,430	3,628	3,828	4,021						
GAATKW90	2,753	2,834	2,943	3,049	3,156	3,266	3,485	3,700	3,920	4,139	4,352						
GAATKW96	2,937	3,023	3,140	3,255	3,374	3,492	3,731	3,966	4,204	4,440	4,674						
GAATKW102	3,584	3,677	3,808	3,930	4,057	4,187	4,445	4,696	4,956	5,216	5,467						
GAATKW108	3,787	3,888	4,028	4,161	4,298	4,438	4,717	4,990	5,269	5,545	5,817						
GAATKW120	4,211	4,317	4,467	4,610	4,759	4,909	5,206	5,499	5,798	6,094	6,387						
GAATKW1H30	1,641	1,669	1,707	1,746	1,786	1,825	1,904	1,980	2,063	2,141	2,218						
GAATKW1H36	1,794	1,831	1,879	1,927	1,978	2,027	2,127	2,222	2,322	2,422	2,521						
GAATKW1H42	1,976	2,021	2,081	2,136	2,195	2,257	2,376	2,495	2,614	2,731	2,851						
GAATKW1H48	2,011	2,056	2,116	2,171	2,230	2,292	2,411	2,530	2,649	2,766	2,886						
GAATKW2H30	1,664	1,692	1,730	1,769	1,809	1,848	1,927	2,003	2,086	2,164	2,241						
GAATKW2H36	1,838	1,875	1,923	1,971	2,022	2,071	2,171	2,266	2,366	2,466	2,565						
GAATKW2H42	2,011	2,056	2,116	2,171	2,230	2,292	2,411	2,530	2,649	2,766	2,886						
GAATKW2H48	2,043	2,088	2,148	2,203	2,262	2,324	2,443	2,562	2,681	2,798	2,918						
GAATLKW30	1,486	1,514	1,552	1,591	1,631	1,670	1,749	1,825	1,908	1,986	2,063						
GAATLKW36	1,771	1,808	1,856	1,904	1,955	2,004	2,104	2,199	2,299	2,399	2,498						
GAATLKW60	2,190	2,247	2,326	2,403	2,481	2,561	2,719	2,875	3,033	3,192	3,349						
GAATLKW66	2,234	2,291	2,370	2,447	2,525	2,605	2,763	2,919	3,077	3,236	3,393						
GAATLKW72	2,400	2,466	2,555	2,640	2,730	2,817	2,996	3,171	3,350	3,530	3,705						
GAATLKW78	2,570	2,642	2,740	2,837	2,936	3,038	3,236	3,430	3,628	3,828	4,021						
GAATLKW84	2,624	2,696	2,794	2,891	2,990	3,092	3,290	3,484	3,682	3,882	4,075						
GAATLKW90	2,808	2,889	2,998	3,104	3,211	3,321	3,540	3,755	3,975	4,194	4,407						
GAATLKW96	3,453	3,539	3,656	3,771	3,890	4,008	4,247	4,482	4,720	4,956	5,190						
GAATLKW102	3,649	3,742	3,873	3,995	4,122	4,252	4,510	4,761	5,021	5,281	5,532						
GAATLKW108	3,885	3,986	4,126	4,259	4,396	4,536	4,815	5,088	5,367	5,643	5,915						
GAATLKW120	4,252	4,358	4,508	4,651	4,800	4,950	5,247	5,540	5,839	6,135	6,428						

FABRIC GRADE PRICING

Credentials
05/22

model number	1	2	3	COM/4	5	6	7	8	9	10	11	12	13	14	15	16
GAATLKW1H30	1,137	1,160	1,185	1,210	1,244	1,277	1,306	1,337	1,371	1,403	1,440	1,468	1,509	1,543	1,582	1,623
GAATLKW1H36	1,181	1,210	1,243	1,274	1,316	1,355	1,394	1,436	1,472	1,514	1,557	1,596	1,649	1,688	1,737	1,789
GAATLKW1H42	1,216	1,253	1,289	1,328	1,378	1,430	1,474	1,523	1,571	1,622	1,673	1,719	1,783	1,832	1,890	1,951
GAATLKW1H48	1,248	1,285	1,321	1,360	1,410	1,462	1,506	1,555	1,603	1,654	1,705	1,751	1,815	1,864	1,922	1,983
GAATLKW2H30	1,181	1,204	1,229	1,254	1,288	1,321	1,350	1,381	1,415	1,447	1,484	1,512	1,553	1,587	1,626	1,667
GAATLKW2H36	1,216	1,245	1,278	1,309	1,351	1,390	1,429	1,471	1,507	1,549	1,592	1,631	1,684	1,723	1,772	1,824
GAATLKW2H42	1,248	1,285	1,321	1,360	1,410	1,462	1,506	1,555	1,603	1,654	1,705	1,751	1,815	1,864	1,922	1,983
GAATLKW2H48	1,302	1,339	1,375	1,414	1,464	1,516	1,560	1,609	1,657	1,708	1,759	1,805	1,869	1,918	1,976	2,037

model number	17	18	19	20	21	22	23	24	25	26	27	col	L1	L2	L3	L4	L5
GAATLKW1H30	1,664	1,692	1,730	1,769	1,809	1,848	1,927	2,003	2,086	2,164	2,241						
GAATLKW1H36	1,838	1,875	1,923	1,971	2,022	2,071	2,171	2,266	2,366	2,466	2,565						
GAATLKW1H42	2,011	2,056	2,116	2,171	2,230	2,292	2,411	2,530	2,649	2,766	2,886						
GAATLKW1H48	2,043	2,088	2,148	2,203	2,262	2,324	2,443	2,562	2,681	2,798	2,918						
GAATLKW2H30	1,708	1,736	1,774	1,813	1,853	1,892	1,971	2,047	2,130	2,208	2,285						
GAATLKW2H36	1,873	1,910	1,958	2,006	2,057	2,106	2,206	2,301	2,401	2,501	2,600						
GAATLKW2H42	2,043	2,088	2,148	2,203	2,262	2,324	2,443	2,562	2,681	2,798	2,918						
GAATLKW2H48	2,097	2,142	2,202	2,257	2,316	2,378	2,497	2,616	2,735	2,852	2,972						

model number	weight	cubes	#locks	page
ACFLR15-AA	1 lbs.	0.1	-	156
ACFLR18-AA	1 lbs.	0.2	-	156
ACFLR30-AA	1 lbs.	0.2	-	156
ACFLR36-AA	1 lbs.	0.3	-	156
ACLED24-R	1 lbs.	0.2	-	149
ACLED54-R	4 lbs.	0.4	-	149
ACLED72-R	5 lbs.	0.6	-	149
ACPT15-GAA	2 lbs.	0.5	-	154
ACPT18-GAA	2 lbs.	0.5	-	154
ACPWRT	1 lbs.	0.1	-	155
ACTRASH	1 lbs.	1.4	-	157
ACWCB15	6 lbs.	0.7	-	94
ACWCB20	8 lbs.	0.8	-	94
ACWM	1 lbs.	0.6	-	151
BSHAT2142	53 lbs.	5.4	-	102
BSHAT2148	55 lbs.	6.3	-	102
BSHAT2154	57 lbs.	7.1	-	102
BSHAT2160	59 lbs.	7.9	-	102
BSHAT2166	61 lbs.	8.8	-	102
BSHAT2172	63 lbs.	9.6	-	102
BSHAT2748	59 lbs.	7.8	-	102
BSHAT2754	61 lbs.	8.9	-	102
BSHAT2760	63 lbs.	9.9	-	102
BSHAT2766	65 lbs.	10.9	-	102
BSHAT2772	67 lbs.	12.0	-	102
BSXBASE32	50 lbs.	21.9	-	148
BSXBASE40	60 lbs.	33.1	-	148
GA2ASF830-W	16 lbs.	0.8	-	146
GA2ASF836-W	17 lbs.	1.0	-	146
GA2ASF842-W	19 lbs.	1.1	-	146
GA2ASF848-W	20 lbs.	1.3	-	146
GA2ASF860-W	22 lbs.	1.6	-	146
GA2ASF866-W	24 lbs.	1.8	-	146
GA2ASF872-W	25 lbs.	1.9	-	146
GA2ASF878-W	26 lbs.	2.1	-	146
GA2ASF884-W	27 lbs.	2.2	-	146
GA2ASF890-W	29 lbs.	2.4	-	146
GA2ASF896-W	30 lbs.	2.5	-	146
GA2ASF8102-W	31 lbs.	2.7	-	146
GA2ASF8108-W	32 lbs.	2.8	-	146
GA2ASF8120-W	35 lbs.	3.1	-	146
GA2ASF8144-W	40 lbs.	3.7	-	146
GA2BKN2H1830-W	126 lbs.	12.3	-	110

model number	weight	cubes	#locks	page
GA2BKN2H1836-W	144 lbs.	14.6	-	110
GA2BKN3H1830-W	141 lbs.	17.6	-	110
GA2BKN3H1836-W	159 lbs.	20.8	-	110
GA2BKN4H1830-W	178 lbs.	22.9	-	110
GA2BKN4H1836-W	201 lbs.	27.1	-	110
GA2BKN5H1830-W	223 lbs.	30.0	-	110
GA2BKN5H1836-W	251 lbs.	35.4	-	110
GA2BKN6H1830-W	251 lbs.	33.2	-	110
GA2BKN6H1836-W	283 lbs.	39.2	-	110
GA2BLRG2466-W	83 lbs.	35.0	-	58
GA2BLRG2472-W	90 lbs.	38.0	-	58
GA2BLRG2478-W	97 lbs.	41.1	-	58
GA2BRG2442A-WW	54 lbs.	22.8	-	58
GA2BRG2442TA-WW	49 lbs.	20.5	-	59
GA2BRG2442T-WW	49 lbs.	20.5	-	59
GA2BRG2442-WW	54 lbs.	22.8	-	58
GA2BRG2448A-WW	60 lbs.	25.8	-	58
GA2BRG2448TA-WW	55 lbs.	23.2	-	59
GA2BRG2448T-WW	55 lbs.	23.2	-	59
GA2BRG2448-WW	60 lbs.	25.8	-	58
GA2BRG2454A-WW	69 lbs.	28.9	-	58
GA2BRG2454TA-WW	61 lbs.	25.9	-	59
GA2BRG2454T-WW	61 lbs.	25.9	-	59
GA2BRG2454-WW	69 lbs.	28.9	-	58
GA2CFS2460T-44WW	335 lbs.	31.4	2	95
GA2CFS2460T-55WW	326 lbs.	31.4	-	95
GA2CFS2472T-44WW	388 lbs.	37.4	2	95
GA2CFS2472T-55WW	380 lbs.	37.4	-	95
GA2CFS2490T-444WW	510 lbs.	46.4	3	96
GA2CFS2490T-454WW	504 lbs.	46.4	2	96
GA2CFS2490T-555WW	492 lbs.	46.4	-	96
GA2CFS24108T-444WW	584 lbs.	55.4	3	96
GA2CFS24108T-454WW	580 lbs.	55.4	2	96
GA2CFS24108T-555WW	572 lbs.	55.4	-	96
GA2CLC5H1818L-WW	174 lbs.	19.9	1	112
GA2CLC5H1818R-WW	174 lbs.	19.9	1	112
GA2CLC5H2418L-WW	217 lbs.	26.7	1	114
GA2CLC5H2418R-WW	217 lbs.	26.7	1	114
GA2CLC6H1818L-WW	207 lbs.	22.0	1	113
GA2CLC6H1818R-WW	197 lbs.	22.0	1	113
GA2CLC6H2418L-WW	248 lbs.	29.6	1	115
GA2CLC6H2418R-WW	248 lbs.	29.6	1	115
GA2CLD5H1818L-WW	220 lbs.	19.9	1	112

Credentials

05/22

WEIGHTS + CUBES

model number	weight	cubes	#locks	page
GA2CLD5H1818R-WW	220 lbs.	19.9	1	112
GA2CLD5H1824L-WW	254 lbs.	25.6	1	112
GA2CLD5H1824R-WW	254 lbs.	25.6	1	112
GA2CLD5H1830-WW	299 lbs.	31.3	1	112
GA2CLD5H2418L-WW	294 lbs.	26.7	1	114
GA2CLD5H2418R-WW	294 lbs.	26.7	1	114
GA2CLD5H2424L-WW	335 lbs.	34.4	1	114
GA2CLD5H2424R-WW	335 lbs.	34.4	1	114
GA2CLD5H2430-WW	375 lbs.	42.0	1	114
GA2CLD6H1818L-WW	256 lbs.	22.0	1	113
GA2CLD6H1818R-WW	256 lbs.	22.0	1	113
GA2CLD6H1824L-WW	296 lbs.	28.3	1	113
GA2CLD6H1824R-WW	296 lbs.	28.3	1	113
GA2CLD6H2418L-WW	330 lbs.	29.6	1	115
GA2CLD6H2418R-WW	330 lbs.	29.6	1	115
GA2CLD6H2424L-WW	378 lbs.	38.1	1	115
GA2CLD6H2424R-WW	379 lbs.	38.1	1	115
GA2CLFS2490T-B5SHW	398 lbs.	34.8	1	97
GA2CLFS2490T-BBSHW	448 lbs.	34.8	2	97
GA2CLFS2490T-SH5BW	422 lbs.	34.8	1	97
GA2CLFS2490T-SHBBW	471 lbs.	34.8	2	97
GA2CLFS24108T-B5SHW	485 lbs.	41.5	1	97
GA2CLFS24108T-BBSHW	539 lbs.	41.5	2	97
GA2CLFS24108T-SH5BW	485 lbs.	41.5	1	97
GA2CLFS24108T-SHBBW	539 lbs.	41.5	2	97
GA2CLFS24120T-5SH5W	481 lbs.	46.0	-	98
GA2CLFS24120T-B55SHW	542 lbs.	46.0	1	98
GA2CLFS24120T-BSHBW	579 lbs.	46.0	2	98
GA2CLFS24120T-SH55BW	542 lbs.	46.0	1	98
GA2CLS5H1818L-WW	197 lbs.	19.9	1	112
GA2CLS5H1818R-WW	197 lbs.	19.9	1	112
GA2CLS5H1830-WW	285 lbs.	31.3	1	112
GA2CLS5H2418L-WW	251 lbs.	26.7	1	114
GA2CLS5H2418R-WW	251 lbs.	26.7	1	114
GA2CLS5H2430-WW	346 lbs.	42.0	1	114
GA2CLS6H1818L-WW	230 lbs.	22.0	1	113
GA2CLS6H1818R-WW	220 lbs.	22.0	1	113
GA2CLS6H2418L-WW	282 lbs.	29.6	1	115
GA2CLS6H2418R-WW	282 lbs.	29.6	1	115
GA2CWR2460TL-W	72 lbs.	4.4	-	61
GA2CWR2460TR-W	73 lbs.	4.4	-	61
GA2CWR2460T-W	68 lbs.	4.0	-	60
GA2CWR2460-W	76 lbs.	4.4	-	60

model number	weight	cubes	#locks	page
GA2CWR2466TL-W	80 lbs.	4.9	-	61
GA2CWR2466TR-W	80 lbs.	4.9	-	61
GA2CWR2466T-W	74 lbs.	4.4	-	60
GA2CWR2466-W	83 lbs.	4.9	-	60
GA2CWR2472TL-W	87 lbs.	5.3	-	61
GA2CWR2472TR-W	87 lbs.	5.3	-	61
GA2CWR2472T-W	81 lbs.	4.7	-	60
GA2CWR2472-W	90 lbs.	5.3	-	60
GA2CWR2478TL-W	94 lbs.	5.7	-	61
GA2CWR2478TR-W	94 lbs.	5.7	-	61
GA2CWR2478T-W	87 lbs.	5.1	-	60
GA2CWR2478-W	97 lbs.	5.7	-	60
GA2CWR2484TL-W	101 lbs.	6.1	-	61
GA2CWR2484TR-W	101 lbs.	6.1	-	61
GA2CWR2484T-W	93 lbs.	5.5	-	60
GA2CWR2484-W	104 lbs.	6.1	-	60
GA2CWR2490TL-W	108 lbs.	6.5	-	61
GA2CWR2490TR-W	108 lbs.	6.5	-	61
GA2CWR2490T-W	99 lbs.	5.9	-	60
GA2CWR2490-W	111 lbs.	6.5	-	60
GA2CWR2496TL-W	115 lbs.	7.0	-	61
GA2CWR2496TR-W	115 lbs.	7.0	-	61
GA2CWR2496T-W	107 lbs.	6.3	-	60
GA2CWR2496-W	118 lbs.	7.0	-	60
GA2CWR24102TL-W	122 lbs.	7.4	-	61
GA2CWR24102TR-W	122 lbs.	7.4	-	61
GA2CWR24102T-W	112 lbs.	6.6	-	60
GA2CWR24102-W	125 lbs.	7.4	-	60
GA2CWR24108TL-W	129 lbs.	7.8	-	61
GA2CWR24108TR-W	129 lbs.	7.8	-	61
GA2CWR24108T-W	118 lbs.	7.0	-	60
GA2CWR24108-W	132 lbs.	7.8	-	60
GA2CWR24114TL-W	136 lbs.	8.2	-	61
GA2CWR24114TR-W	136 lbs.	8.2	-	61
GA2CWR24114T-W	125 lbs.	7.4	-	60
GA2CWR24114-W	139 lbs.	8.2	-	60
GA2CWR24120TL-W	143 lbs.	8.6	-	61
GA2CWR24120TR-W	143 lbs.	8.6	-	61
GA2CWR24120T-W	131 lbs.	7.8	-	60
GA2CWR24120-W	146 lbs.	8.6	-	60
GA2DMHA48-W	8 lbs.	1.3	-	105
GA2DMHA54-W	9 lbs.	1.4	-	105
GA2DMHA60-W	11 lbs.	1.6	-	105

WEIGHTS + CUBES

Credentials

05/22

model number	weight	cubes	#locks	page
GA2DMHA66-W	12 lbs.	1.8	-	105
GA2DMHA72-W	13 lbs.	1.9	-	105
GA2DRO3072L-3WW	251 lbs.	46.5	1	42
GA2DRO3072R-3WW	251 lbs.	46.5	1	43
GA2DRO3072TL-3WW	247 lbs.	46.5	1	42
GA2DRO3072TR-3WW	247 lbs.	46.5	1	43
GA2DRO3672-32WW	355 lbs.	54.9	2	41
GA2DRO3672L-3WW	276 lbs.	54.9	1	42
GA2DRO3672R-3WW	276 lbs.	54.9	1	43
GA2DRO3672TL-3WW	267 lbs.	54.9	1	42
GA2DRO3672TR-3WW	267 lbs.	54.9	1	43
GA2DRO3678-32WW	380 lbs.	59.3	2	41
GA2DRO3678L-3WW	286 lbs.	59.3	1	42
GA2DRO3678R-3WW	286 lbs.	59.3	1	43
GA2DRO3678TL-3WW	276 lbs.	59.3	1	42
GA2DRO3678TR-3WW	276 lbs.	59.3	1	43
GA2DRO3684-32WW	405 lbs.	63.7	2	41
GA2DRO3684L-3WW	306 lbs.	63.7	1	42
GA2DRO3684R-3WW	306 lbs.	63.7	1	43
GA2DRO3684TL-3WW	301 lbs.	63.7	1	42
GA2DRO3684TR-3WW	301 lbs.	63.7	1	43
GA2DTRAK3672L-WW	500 lbs.	54.9	-	38
GA2DTRAK3672R-WW	500 lbs.	54.9	-	39
GA2DTRAK3678L-WW	525 lbs.	59.3	-	38
GA2DTRAK3678R-WW	525 lbs.	59.3	-	39
GA2DTRAK3684L-WW	550 lbs.	63.7	-	38
GA2DTRAK3684R-WW	550 lbs.	63.7	-	39
GA2DTRL3072-G	101 lbs.	46.5	-	35
GA2DTRL3072-S	75 lbs.	46.5	-	35
GA2DTRL3072-W	111 lbs.	46.5	-	34
GA2DTRL3672-G	125 lbs.	54.9	-	35
GA2DTRL3672-S	85 lbs.	54.9	-	35
GA2DTRL3672-W	131 lbs.	54.9	-	34
GA2DTRL3678-G	135 lbs.	59.3	-	35
GA2DTRL3678-S	95 lbs.	59.3	-	35
GA2DTRL3678-W	142 lbs.	59.3	-	34
GA2DTRL3684-G	145 lbs.	63.7	-	35
GA2DTRL3684-S	105 lbs.	63.7	-	35
GA2DTRL3684-W	152 lbs.	63.7	-	34
GA2DTRM3672L-3WW	350 lbs.	54.9	1	36
GA2DTRM3672R-3WW	350 lbs.	54.9	1	37
GA2DTRM3678L-3WW	375 lbs.	59.3	1	36
GA2DTRM3678R-3WW	375 lbs.	59.3	1	37
GA2DTRM3684L-3WW	400 lbs.	63.7	1	36

model number	weight	cubes	#locks	page
GA2DTRM3684R-3WW	400 lbs.	63.7	1	37
GA2DTRR3672-WW	239 lbs.	54.9	-	40
GA2DTRR3678-WW	264 lbs.	59.3	-	40
GA2DTRR3684-WW	289 lbs.	63.7	-	40
GA2DWRA2442-W	39 lbs.	3.2	-	103
GA2DWRA2448-W	45 lbs.	3.6	-	103
GA2DWRA2454-W	51 lbs.	4.0	-	103
GA2DWRA2460-W	56 lbs.	4.4	-	103
GA2DWRA2466-W	62 lbs.	4.9	-	103
GA2DWRA2472-W	67 lbs.	5.3	-	103
GA2DWRA3048-W	56 lbs.	4.4	-	104
GA2DWRA3054-W	63 lbs.	4.9	-	104
GA2DWRA3060-W	70 lbs.	5.4	-	104
GA2DWRA3066-W	77 lbs.	5.9	-	104
GA2DWRA3072-W	84 lbs.	6.4	-	104
GA2DWRA3648-W	67 lbs.	5.2	-	104
GA2DWRA3654-W	76 lbs.	5.8	-	104
GA2DWRA3660-W	84 lbs.	6.4	-	104
GA2DWRA3666-W	93 lbs.	7.0	-	104
GA2DWRA3672-W	101 lbs.	7.6	-	104
GA2HDC2H2430T-WW	169 lbs.	17.3	-	111
GA2HDC2H2430-WW	169 lbs.	17.3	-	111
GA2HDC2H2436T-WW	195 lbs.	20.4	-	111
GA2HDC2H2436-WW	195 lbs.	20.4	-	111
GA2HDCLH2430-WW	132 lbs.	13.1	-	111
GA2HDCLH2436-WW	152 lbs.	15.5	-	111
GA2LFS2H2430T-WW	177 lbs.	17.3	1	108
GA2LFS2H2430-WW	188 lbs.	17.3	1	108
GA2LFS2H2436T-WW	196 lbs.	20.4	1	108
GA2LFS2H2436-WW	212 lbs.	20.4	1	108
GA2LFS3H2430-WW	259 lbs.	24.7	1	109
GA2LFS3H2436-WW	297 lbs.	29.2	1	109
GA2LFS4H2430-WW	325 lbs.	32.2	1	109
GA2LFS4H2436-WW	364 lbs.	38.0	1	109
GA2LFS5H2430-WW	410 lbs.	42.0	1	109
GA2LFS5H2436-WW	461 lbs.	49.7	1	109
GA2LFS6H2430-WW	454 lbs.	46.5	1	109
GA2LFS6H2436-WW	512 lbs.	55.0	1	109
GA2LFSLH2430-WW	162 lbs.	13.1	1	108
GA2LFSLH2436-WW	172 lbs.	15.5	1	108
GA2MCA24-W	30 lbs.	4.0	-	90
GA2MCA27-W	32 lbs.	4.4	-	90
GA2MCA30-W	34 lbs.	4.9	-	90
GA2MCA33-W	35 lbs.	5.3	-	90

Credentials

05/22

WEIGHTS + CUBES

model number	weight	cubes	#locks	page
GA2MCA36-W	37 lbs.	5.8	-	90
GA2MCA39-W	39 lbs.	6.2	-	90
GA2MCA42-W	41 lbs.	6.7	-	90
GA2MCA45-W	43 lbs.	7.1	-	90
GA2MCA48-W	45 lbs.	7.6	-	90
GA2MCA51-W	46 lbs.	8.0	-	90
GA2MCA54-W	48 lbs.	8.5	-	90
GA2MCA57-W	53 lbs.	8.9	-	90
GA2MCA60-W	54 lbs.	9.3	-	90
GA2MCA63-W	56 lbs.	9.8	-	90
GA2MCA66-W	58 lbs.	10.2	-	90
GA2MCA69-W	60 lbs.	10.7	-	90
GA2MCA72-W	62 lbs.	11.1	-	90
GA2MCF60-W	41 lbs.	4.1	-	88
GA2MCF66-W	45 lbs.	4.5	-	88
GA2MCF72-W	48 lbs.	4.9	-	88
GA2MCF78-W	51 lbs.	5.3	-	88
GA2MCF84-W	54 lbs.	5.7	-	88
GA2MCF90-W	58 lbs.	6.1	-	88
GA2MCF96-W	61 lbs.	6.5	-	88
GA2MCF102-W	64 lbs.	6.9	-	88
GA2MCF108-W	67 lbs.	7.4	-	88
GA2MCF114-W	70 lbs.	7.8	-	88
GA2MCF120-W	73 lbs.	8.2	-	88
GA2MLCF60-W	33 lbs.	3.1	-	89
GA2MLCF66-W	35 lbs.	3.4	-	89
GA2MLCF72-W	37 lbs.	3.7	-	89
GA2MLCF78-W	40 lbs.	4.0	-	89
GA2MLCF84-W	42 lbs.	4.3	-	89
GA2MLCF90-W	44 lbs.	4.6	-	89
GA2MLCF96-W	46 lbs.	4.9	-	89
GA2MLCF102-W	49 lbs.	5.2	-	89
GA2MLCF108-W	51 lbs.	5.5	-	89
GA2MLCF114-W	53 lbs.	5.8	-	89
GA2MLCF120-W	57 lbs.	6.1	-	89
GA2MLPW2415L-AW	75 lbs.	6.7	1	77
GA2MLPW2415L-LW	55 lbs.	6.5	-	76
GA2MLPW2415L-XBW	65 lbs.	6.5	-	76
GA2MLPW2415R-AW	75 lbs.	6.7	1	83
GA2MLPW2415R-LW	55 lbs.	6.5	-	82
GA2MLPW2415R-XBW	65 lbs.	6.5	-	82
GA2MLPW2418L-AW	81 lbs.	7.9	1	77
GA2MLPW2418R-AW	81 lbs.	7.9	1	83
GA2MLPW2430L-5W	89 lbs.	12.3	-	78

model number	weight	cubes	#locks	page
GA2MLPW2430L-BW	139 lbs.	12.3	1	78
GA2MLPW2430L-PW	120 lbs.	12.3	1	78
GA2MLPW2430L-SHW	77 lbs.	12.3	-	78
GA2MLPW2430L-TW	122 lbs.	12.3	1	78
GA2MLPW2430R-5W	89 lbs.	12.3	-	84
GA2MLPW2430R-BW	139 lbs.	12.3	1	84
GA2MLPW2430R-PW	120 lbs.	12.3	1	84
GA2MLPW2430R-SHW	77 lbs.	12.3	-	84
GA2MLPW2430R-TW	122 lbs.	12.3	1	84
GA2MLPW2436L-5W	98 lbs.	14.6	-	79
GA2MLPW2436L-BW	151 lbs.	14.6	1	79
GA2MLPW2436L-PW	130 lbs.	12.3	1	79
GA2MLPW2436L-SHW	87 lbs.	14.6	-	79
GA2MLPW2436L-TW	132 lbs.	12.3	1	79
GA2MLPW2436R-5W	98 lbs.	14.6	-	85
GA2MLPW2436R-BW	151 lbs.	14.6	1	85
GA2MLPW2436R-PW	130 lbs.	12.3	1	85
GA2MLPW2436R-SHW	87 lbs.	14.6	-	85
GA2MLPW2436R-TW	132 lbs.	12.3	1	85
GA2MLPW2445L-5AW	157 lbs.	18.0	1	80
GA2MLPW2445L-BAW	175 lbs.	18.0	2	80
GA2MLPW2445R-A5W	157 lbs.	18.0	1	86
GA2MLPW2445R-ABW	175 lbs.	18.0	2	86
GA2MLPW2454L-5AW	176 lbs.	21.3	1	80
GA2MLPW2454L-BAW	196 lbs.	21.3	2	80
GA2MLPW2454R-A5W	176 lbs.	21.3	1	86
GA2MLPW2454R-ABW	196 lbs.	21.3	2	86
GA2MLPW2460L-55W	173 lbs.	23.6	-	81
GA2MLPW2460L-BBW	209 lbs.	23.6	2	81
GA2MLPW2460R-55W	173 lbs.	23.6	-	87
GA2MLPW2460R-BBW	209 lbs.	23.6	2	87
GA2MLSPT12-W	7 lbs.	0.4	-	93
GA2MLSPT12-W	11 lbs.	1.3	-	93
GA2MPD1818-AW	99 lbs.	7.2	1	99
GA2MPW2415L-2W	90 lbs.	9.0	1	65
GA2MPW2415L-3W	93 lbs.	9.0	1	65
GA2MPW2415L-LW	50 lbs.	8.7	-	64
GA2MPW2415L-XBW	71 lbs.	8.7	-	64
GA2MPW2415L-XEW	71 lbs.	8.7	-	64
GA2MPW2415R-2W	90 lbs.	9.0	1	71
GA2MPW2415R-3W	93 lbs.	9.0	1	71
GA2MPW2415R-LW	50 lbs.	8.7	-	70
GA2MPW2415R-XBW	71 lbs.	8.7	-	70
GA2MPW2415R-XEW	71 lbs.	8.7	-	70

WEIGHTS + CUBES

Credentials
05/22

model number	weight	cubes	#locks	page
GA2MPW2418L-2W	97 lbs.	10.5	1	65
GA2MPW2418L-3W	101 lbs.	10.5	1	65
GA2MPW2418R-2W	97 lbs.	10.5	1	71
GA2MPW2418R-3W	101 lbs.	10.5	1	71
GA2MPW2430L-4W	135 lbs.	16.5	1	66
GA2MPW2430L-5W	121 lbs.	16.5	–	66
GA2MPW2430L-7W	136 lbs.	16.5	1	66
GA2MPW2430L-23W	172 lbs.	16.5	2	66
GA2MPW2430L-BW	165 lbs.	16.5	1	66
GA2MPW2430L-PW	130 lbs.	16.5	1	66
GA2MPW2430L-SHW	105 lbs.	16.5	–	66
GA2MPW2430L-TW	132 lbs.	16.5	1	66
GA2MPW2430R-4W	135 lbs.	16.5	1	72
GA2MPW2430R-5W	121 lbs.	16.5	–	72
GA2MPW2430R-7W	136 lbs.	16.5	1	72
GA2MPW2430R-32W	172 lbs.	16.5	2	72
GA2MPW2430R-BW	165 lbs.	16.5	1	72
GA2MPW2430R-PW	130 lbs.	16.5	1	72
GA2MPW2430R-SHW	105 lbs.	16.5	–	72
GA2MPW2430R-TW	132 lbs.	16.5	1	72
GA2MPW2436L-4W	142 lbs.	19.5	1	67
GA2MPW2436L-5W	138 lbs.	19.5	–	67
GA2MPW2436L-7W	147 lbs.	19.5	1	67
GA2MPW2436L-23W	187 lbs.	19.5	2	67
GA2MPW2436L-BW	183 lbs.	19.5	1	67
GA2MPW2436L-PW	140 lbs.	19.5	1	67
GA2MPW2436L-SHW	118 lbs.	19.5	–	67
GA2MPW2436L-TW	142 lbs.	19.5	1	67
GA2MPW2436R-4W	142 lbs.	19.5	1	73
GA2MPW2436R-5W	138 lbs.	19.5	–	73
GA2MPW2436R-7W	147 lbs.	19.5	1	73
GA2MPW2436R-32W	187 lbs.	19.5	2	73
GA2MPW2436R-BW	183 lbs.	19.5	1	73
GA2MPW2436R-PW	140 lbs.	19.5	1	73
GA2MPW2436R-SHW	118 lbs.	19.5	–	73
GA2MPW2436R-TW	142 lbs.	19.5	1	73
GA2MPW2445L-43W	203 lbs.	24.0	2	68
GA2MPW2445L-52W	200 lbs.	24.0	1	68
GA2MPW2445L-72W	216 lbs.	24.0	2	68
GA2MPW2445R-25W	200 lbs.	24.0	1	74
GA2MPW2445R-27W	216 lbs.	24.0	2	74
GA2MPW2445R-34W	203 lbs.	24.0	2	74
GA2MPW2454L-43W	232 lbs.	28.4	2	68
GA2MPW2454L-52W	224 lbs.	28.4	1	68

model number	weight	cubes	#locks	page
GA2MPW2454L-72W	234 lbs.	28.4	2	68
GA2MPW2454R-25W	224 lbs.	28.4	1	74
GA2MPW2454R-27W	234 lbs.	28.4	2	74
GA2MPW2454R-34W	232 lbs.	28.4	2	74
GA2MPW2460L-44W	244 lbs.	31.4	2	69
GA2MPW2460L-55W	231 lbs.	31.4	–	69
GA2MPW2460L-BBW	322 lbs.	31.4	2	69
GA2MPW2460R-44W	244 lbs.	31.4	2	75
GA2MPW2460R-55W	231 lbs.	31.4	–	75
GA2MPW2460R-BBW	322 lbs.	31.4	2	75
GA2MRA21-W	28 lbs.	3.6	–	92
GA2MRA24-W	30 lbs.	4.0	–	92
GA2MRA27-W	32 lbs.	4.4	–	92
GA2MRA30-W	34 lbs.	4.9	–	92
GA2MRA33-W	36 lbs.	5.3	–	92
GA2MRA36-W	37 lbs.	5.8	–	92
GA2MRA39-W	39 lbs.	6.2	–	92
GA2MRA42-W	41 lbs.	6.7	–	92
GA2MRA45-W	43 lbs.	7.1	–	92
GA2MRA48-W	45 lbs.	7.6	–	92
GA2MRA51-W	47 lbs.	8.0	–	92
GA2MRA54-W	49 lbs.	8.5	–	92
GA2MRA57-W	51 lbs.	8.9	–	92
GA2MRA60-W	53 lbs.	9.3	–	92
GA2MRF39-W	20 lbs.	2.8	–	91
GA2MRF42-W	22 lbs.	3.0	–	91
GA2MRF45-W	23 lbs.	3.2	–	91
GA2MRF48-W	25 lbs.	3.4	–	91
GA2MRF51-W	26 lbs.	3.6	–	91
GA2MRF54-W	28 lbs.	3.8	–	91
GA2MRF57-W	30 lbs.	4.0	–	91
GA2MRF60-W	32 lbs.	4.2	–	91
GA2MRF63-W	33 lbs.	4.4	–	91
GA2MRF66-W	35 lbs.	4.6	–	91
GA2MRF69-W	36 lbs.	4.8	–	91
GA2MRF72-W	38 lbs.	5.0	–	91
GA2MSP12-W	7 lbs.	0.6	–	93
GA2MSPT12-W	11 lbs.	1.7	–	93
GA2RLRL3072L-W	126 lbs.	46.5	–	52
GA2RLRL3072R-W	126 lbs.	46.5	–	53
GA2RLRL3078L-W	135 lbs.	50.2	–	52
GA2RLRL3078R-W	135 lbs.	50.2	–	53
GA2RLRL3678L-W	160 lbs.	59.3	–	52
GA2RLRL3678R-W	160 lbs.	59.3	–	53

Credentials

05/22

WEIGHTS + CUBES

model number	weight	cubes	#locks	page
GA2RLRL3684L-W	170 lbs.	63.7	-	52
GA2RLRL3684R-W	170 lbs.	63.7	-	53
GA2RLRO3072L-3W	231 lbs.	46.5	1	56
GA2RLRO3072R-3W	231 lbs.	46.5	1	57
GA2RLRO3078L-3W	241 lbs.	50.2	1	56
GA2RLRO3078R-3W	241 lbs.	50.2	1	57
GA2RLRO3678L-3W	276 lbs.	59.3	1	56
GA2RLRO3678R-3W	276 lbs.	59.3	1	57
GA2RLRO3684L-3W	287 lbs.	63.7	1	56
GA2RLRO3684R-3W	287 lbs.	63.7	1	57
GA2RLRR3072L-W	126 lbs.	46.5	-	54
GA2RLRR3072R-W	126 lbs.	46.5	-	55
GA2RLRR3078L-W	135 lbs.	50.2	-	54
GA2RLRR3078R-W	135 lbs.	50.2	-	55
GA2RLRR3678L-W	160 lbs.	59.3	-	54
GA2RLRR3678R-W	160 lbs.	59.3	-	55
GA2RLRR3684L-W	170 lbs.	63.7	-	54
GA2RLRR3684R-W	170 lbs.	63.7	-	55
GA2RRL3048L-W	76 lbs.	31.6	-	52
GA2RRL3048R-W	76 lbs.	31.6	-	53
GA2RRL3054L-W	85 lbs.	35.3	-	52
GA2RRL3054R-W	85 lbs.	35.3	-	53
GA2RRL3654L-W	101 lbs.	41.7	-	52
GA2RRL3654R-W	101 lbs.	41.7	-	53
GA2RRL3660L-W	110 lbs.	46.1	-	52
GA2RRL3660R-W	110 lbs.	46.1	-	53
GA2RRO3048L-3W	188 lbs.	31.6	1	56
GA2RRO3048R-3W	188 lbs.	31.6	1	57
GA2RRO3054L-3W	198 lbs.	35.3	1	56
GA2RRO3054R-3W	198 lbs.	35.3	1	57
GA2RRO3654L-3W	225 lbs.	41.7	1	56
GA2RRO3654R-3W	225 lbs.	41.7	1	57
GA2RRO3660L-3W	237 lbs.	46.1	1	56
GA2RRO3660R-3W	237 lbs.	46.1	1	57
GA2RRR3048L-W	133 lbs.	31.6	-	54
GA2RRR3048R-W	133 lbs.	31.6	-	55
GA2RRR3054L-W	143 lbs.	35.3	-	54
GA2RRR3054R-W	143 lbs.	35.3	-	55
GA2RRR3654L-W	167 lbs.	41.7	-	54
GA2RRR3654R-W	167 lbs.	41.7	-	55
GA2RRR3660L-W	179 lbs.	46.1	-	54
GA2RRR3660R-W	179 lbs.	46.1	-	55
GA2RWR2442T-W	49 lbs.	2.8	-	63
GA2RWR2442-W	55 lbs.	3.2	-	62

model number	weight	cubes	#locks	page
GA2RWR2448T-W	56 lbs.	3.2	-	63
GA2RWR2448-W	62 lbs.	3.6	-	62
GA2RWR2454T-W	62 lbs.	3.6	-	63
GA2RWR2454-W	69 lbs.	4.0	-	62
GA2RWR2460T-W	68 lbs.	4.0	-	63
GA2RWR2460-W	76 lbs.	4.4	-	62
GA2RWR2466T-W	75 lbs.	4.4	-	63
GA2RWR2466-W	83 lbs.	4.9	-	62
GA2RWR2472T-W	81 lbs.	4.7	-	63
GA2RWR2472-W	90 lbs.	5.3	-	62
GA2SBH5H2418L-WW	284 lbs.	26.7	2	116
GA2SBH5H2418R-WW	284 lbs.	26.7	2	116
GA2SBH5H2430-WW	384 lbs.	42.0	2	116
GA2SBH6H2418L-WW	315 lbs.	29.6	2	116
GA2SBH6H2418R-WW	315 lbs.	29.6	2	116
GA2SBH6H2430-WW	436 lbs.	46.5	2	116
GA2TRD42-W	79 lbs.	5.3	-	147
GA2TRD48-W	100 lbs.	6.8	-	147
GA2TRD54-W	124 lbs.	8.5	-	147
GA2TRD60-W	150 lbs.	10.3	-	147
GA2UTC5H2424L-WW	413 lbs.	34.4	3	117
GA2UTC5H2424R-WW	413 lbs.	34.4	3	117
GA2UTC6H2424L-WW	461 lbs.	38.1	3	117
GA2UTC6H2424R-WW	461 lbs.	38.1	3	117
GA2WCF1H60-WG	212 lbs.	17.2	-	121
GA2WCF1H60-WW	195 lbs.	17.2	-	120
GA2WCF1H72-WG	246 lbs.	20.5	-	121
GA2WCF1H72-WW	225 lbs.	20.5	-	120
GA2WCF1H90-WG	311 lbs.	25.4	-	121
GA2WCF1H90-WW	286 lbs.	25.4	-	120
GA2WCF1H108-WG	360 lbs.	30.4	-	121
GA2WCF1H108-WW	329 lbs.	30.4	-	120
GA2WCH1H30-WG	117 lbs.	9.0	-	119
GA2WCH1H30-WW	104 lbs.	9.0	-	118
GA2WCH1H36-WG	133 lbs.	10.7	-	119
GA2WCH1H36-WW	119 lbs.	10.7	-	118
GA2WCH1H60-WG	219 lbs.	17.2	-	119
GA2WCH1H60-WW	194 lbs.	17.2	-	118
GA2WCH1H66-WW	209 lbs.	18.9	-	118
GA2WCH1H72-WG	251 lbs.	20.5	-	119
GA2WCH1H72-WW	225 lbs.	20.5	-	118
GA2WCH1H78-WW	239 lbs.	22.1	-	118
GA2WCH1H84-WW	270 lbs.	23.8	-	118
GA2WCH1H90-WG	322 lbs.	25.4	-	119

WEIGHTS + CUBES

model number	weight	cubes	#locks	page
GA2WCH1H90-WW	285 lbs.	25.4	-	118
GA2WCH1H96-WW	301 lbs.	27.1	-	118
GA2WCH1H102-WW	315 lbs.	28.7	-	118
GA2WCH1H108-WG	371 lbs.	30.4	-	119
GA2WCH1H108-WW	330 lbs.	30.4	-	118
GA2WCH2H30-WG	138 lbs.	12.4	-	125
GA2WCH2H30-WW	123 lbs.	12.4	-	124
GA2WCH2H36-WG	156 lbs.	14.7	-	125
GA2WCH2H36-WW	141 lbs.	14.7	-	124
GA2WCH2H60-WG	261 lbs.	23.7	-	125
GA2WCH2H60-WW	231 lbs.	23.7	-	124
GA2WCH2H66-WW	248 lbs.	26.0	-	124
GA2WCH2H72-WG	297 lbs.	28.3	-	125
GA2WCH2H72-WW	266 lbs.	28.3	-	124
GA2WCH2H78-WW	283 lbs.	30.5	-	124
GA2WCH2H84-WW	322 lbs.	32.8	-	124
GA2WCH2H90-WG	385 lbs.	35.0	-	125
GA2WCH2H90-WW	339 lbs.	35.0	-	124
GA2WCS1H60-WG	159 lbs.	17.2	-	123
GA2WCS1H60-WW	164 lbs.	17.2	-	122
GA2WCS1H72-WG	183 lbs.	20.5	-	123
GA2WCS1H72-WW	181 lbs.	20.5	-	122
GA2WCS1H90-WG	223 lbs.	25.4	-	123
GA2WCS1H90-WW	244 lbs.	25.4	-	122
GA2WCS1H108-WG	271 lbs.	30.4	-	123
GA2WCS1H108-WW	275 lbs.	30.4	-	122
GA2WCS2H60-WG	166 lbs.	23.7	-	127
GA2WCS2H60-WW	164 lbs.	23.7	-	126
GA2WCS2H72-WG	190 lbs.	28.3	-	127
GA2WCS2H72-WW	201 lbs.	28.3	-	126
GA2WCS2H90-WG	243 lbs.	35.0	-	127
GA2WCS2H90-WW	259 lbs.	35.0	-	126
GA2XRAK3072L-W	550 lbs.	46.5	-	48
GA2XRAK3072R-W	550 lbs.	46.5	-	49
GA2XRAK3072TL-W	552 lbs.	46.5	-	48
GA2XRAK3072TR-W	552 lbs.	46.5	-	49
GA2XRAK3672L-W	571 lbs.	54.9	-	48
GA2XRAK3672R-W	571 lbs.	54.9	-	49
GA2XRAK3672TL-W	560 lbs.	54.9	-	48
GA2XRAK3672TR-W	560 lbs.	54.9	-	49
GA2XRAK3678L-W	568 lbs.	59.3	-	48
GA2XRAK3678R-W	568 lbs.	59.3	-	49
GA2XRAK3678TL-W	570 lbs.	59.3	-	48
GA2XRAK3678TR-W	570 lbs.	59.3	-	49

model number	weight	cubes	#locks	page
GA2XRAK3684L-W	578 lbs.	63.7	-	48
GA2XRAK3684R-W	578 lbs.	63.7	-	49
GA2XRAK3684TL-W	578 lbs.	63.7	-	48
GA2XRAK3684TR-W	578 lbs.	63.7	-	49
GA2XRL3072L-W	152 lbs.	46.5	-	44
GA2XRL3072R-W	152 lbs.	46.5	-	45
GA2XRL3072TL-W	145 lbs.	46.5	-	44
GA2XRL3072TR-W	145 lbs.	46.5	-	45
GA2XRL3672L-W	181 lbs.	54.9	-	44
GA2XRL3672R-W	181 lbs.	54.9	-	45
GA2XRL3672TL-W	168 lbs.	54.9	-	44
GA2XRL3672TR-W	168 lbs.	54.9	-	45
GA2XRL3678L-W	191 lbs.	59.3	-	44
GA2XRL3678R-W	191 lbs.	59.3	-	45
GA2XRL3678TL-W	178 lbs.	59.3	-	44
GA2XRL3678TR-W	178 lbs.	59.3	-	45
GA2XRL3684L-W	200 lbs.	63.7	-	44
GA2XRL3684R-W	200 lbs.	63.7	-	45
GA2XRL3684TL-W	189 lbs.	63.7	-	44
GA2XRL3684TR-W	189 lbs.	63.7	-	45
GA2XRM3072L-W	220 lbs.	46.5	-	46
GA2XRM3072R-W	220 lbs.	46.5	-	47
GA2XRM3072TL-W	220 lbs.	46.5	-	46
GA2XRM3072TR-W	220 lbs.	46.5	-	47
GA2XRM3672L-W	245 lbs.	54.9	-	46
GA2XRM3672R-W	245 lbs.	54.9	-	47
GA2XRM3672TL-W	245 lbs.	54.9	-	46
GA2XRM3672TR-W	245 lbs.	54.9	-	47
GA2XRM3678L-W	265 lbs.	59.3	-	46
GA2XRM3678R-W	265 lbs.	59.3	-	47
GA2XRM3678TL-W	265 lbs.	59.3	-	46
GA2XRM3678TR-W	265 lbs.	59.3	-	47
GA2XRM3684L-W	285 lbs.	63.7	-	46
GA2XRM3684R-W	285 lbs.	63.7	-	47
GA2XRM3684TL-W	284 lbs.	63.7	-	46
GA2XRM3684TR-W	284 lbs.	63.7	-	47
GA2XRR3072L-W	190 lbs.	46.5	-	50
GA2XRR3072R-W	190 lbs.	46.5	-	51
GA2XRR3072TL-W	196 lbs.	46.5	-	50
GA2XRR3072TR-W	196 lbs.	46.5	-	51
GA2XRR3672L-W	215 lbs.	54.9	-	50
GA2XRR3672R-W	215 lbs.	54.9	-	51
GA2XRR3672TL-W	230 lbs.	54.9	-	50
GA2XRR3672TR-W	230 lbs.	54.9	-	51

Credentials

05/22

WEIGHTS + CUBES

model number	weight	cubes	#locks	page
GA2XRR3678L-W	235 lbs.	59.3	-	50
GA2XRR3678R-W	235 lbs.	59.3	-	51
GA2XRR3678TL-W	242 lbs.	59.3	-	50
GA2XRR3678TR-W	242 lbs.	59.3	-	51
GA2XRR3684L-W	255 lbs.	63.7	-	50
GA2XRR3684R-W	255 lbs.	63.7	-	51
GA2XRR3684TL-W	254 lbs.	63.7	-	50
GA2XRR3684TR-W	254 lbs.	63.7	-	51
GAAASF830-W	16 lbs.	0.8	-	146
GAAASF836-W	17 lbs.	1.0	-	146
GAAASF842-W	19 lbs.	1.1	-	146
GAAASF848-W	20 lbs.	1.3	-	146
GAAASF860-W	22 lbs.	1.6	-	146
GAAASF866-W	24 lbs.	1.8	-	146
GAAASF872-W	25 lbs.	1.9	-	146
GAAASF878-W	26 lbs.	2.1	-	146
GAAASF884-W	27 lbs.	2.2	-	146
GAAASF890-W	29 lbs.	2.4	-	146
GAAASF896-W	30 lbs.	2.5	-	146
GAAASF8102-W	31 lbs.	2.7	-	146
GAAASF8108-W	32 lbs.	2.8	-	146
GAAASF8120-W	35 lbs.	3.1	-	146
GAAASF8144-W	40 lbs.	3.7	-	146
GAABKN2H1830-W	126 lbs.	12.3	-	110
GAABKN2H1836-W	144 lbs.	14.6	-	110
GAABKN3H1830-W	141 lbs.	17.6	-	110
GAABKN3H1836-W	159 lbs.	20.8	-	110
GAABKN4H1830-W	178 lbs.	22.9	-	110
GAABKN4H1836-W	201 lbs.	27.1	-	110
GAABKN5H1830-W	223 lbs.	30.0	-	110
GAABKN5H1836-W	251 lbs.	35.4	-	110
GAABKN6H1830-W	251 lbs.	33.2	-	110
GAABKN6H1836-W	283 lbs.	39.2	-	110
GAABLRG2466-W	83 lbs.	35.0	-	58
GAABLRG2472-W	90 lbs.	38.0	-	58
GAABLRG2478-W	97 lbs.	41.1	-	58
GAABRG2442A-WW	54 lbs.	22.8	-	58
GAABRG2442TA-WW	49 lbs.	20.5	-	59
GAABRG2442T-WW	49 lbs.	20.5	-	59
GAABRG2442-WW	54 lbs.	22.8	-	58
GAABRG2448A-WW	60 lbs.	25.8	-	58
GAABRG2448TA-WW	55 lbs.	23.2	-	59
GAABRG2448T-WW	55 lbs.	23.2	-	59
GAABRG2448-WW	60 lbs.	25.8	-	58

model number	weight	cubes	#locks	page
GAABRG2454A-WW	69 lbs.	28.9	-	58
GAABRG2454TA-WW	61 lbs.	25.9	-	59
GAABRG2454T-WW	61 lbs.	25.9	-	59
GAABRG2454-WW	69 lbs.	28.9	-	58
GAACFS2460T-44WW	335 lbs.	31.4	2	95
GAACFS2460T-55WW	326 lbs.	31.4	-	95
GAACFS2472T-44WW	388 lbs.	37.4	2	95
GAACFS2472T-55WW	380 lbs.	37.4	-	95
GAACFS2490T-444WW	510 lbs.	46.4	3	96
GAACFS2490T-454WW	504 lbs.	46.4	2	96
GAACFS2490T-555WW	492 lbs.	46.4	-	96
GAACFS24108T-444WW	584 lbs.	55.4	3	96
GAACFS24108T-454WW	580 lbs.	55.4	2	96
GAACFS24108T-555WW	572 lbs.	55.4	-	96
GAACLC5H1818L-WW	174 lbs.	19.9	1	112
GAACLC5H1818R-WW	174 lbs.	19.9	1	112
GAACLC5H2418L-WW	217 lbs.	26.7	1	114
GAACLC5H2418R-WW	217 lbs.	26.7	1	114
GAACLC6H1818L-WW	207 lbs.	22.0	1	113
GAACLC6H1818R-WW	197 lbs.	22.0	1	113
GAACLC6H2418L-WW	248 lbs.	29.6	1	115
GAACLC6H2418R-WW	248 lbs.	29.6	1	115
GAACLD5H1818L-WW	220 lbs.	19.9	1	112
GAACLD5H1818R-WW	220 lbs.	19.9	1	112
GAACLD5H1824L-WW	254 lbs.	25.6	1	112
GAACLD5H1824R-WW	254 lbs.	25.6	1	112
GAACLD5H1830-WW	299 lbs.	31.3	1	112
GAACLD5H2418L-WW	294 lbs.	26.7	1	114
GAACLD5H2418R-WW	294 lbs.	26.7	1	114
GAACLD5H2424L-WW	335 lbs.	34.4	1	114
GAACLD5H2424R-WW	335 lbs.	34.4	1	114
GAACLD5H2430-WW	375 lbs.	42.0	1	114
GAACLD6H1818L-WW	256 lbs.	22.0	1	113
GAACLD6H1818R-WW	256 lbs.	22.0	1	113
GAACLD6H1824L-WW	296 lbs.	28.3	1	113
GAACLD6H1824R-WW	296 lbs.	28.3	1	113
GAACLD6H2418L-WW	330 lbs.	29.6	1	115
GAACLD6H2418R-WW	330 lbs.	29.6	1	115
GAACLD6H2424L-WW	378 lbs.	38.1	1	115
GAACLD6H2424R-WW	379 lbs.	38.1	1	115
GAACLFS2490T-B5SHW	398 lbs.	34.8	1	97
GAACLFS2490T-BBSHW	448 lbs.	34.8	2	97
GAACLFS2490T-SH5BW	422 lbs.	34.8	1	97
GAACLFS2490T-SHBBW	471 lbs.	34.8	2	97

WEIGHTS + CUBES

Credentials

05/22

model number	weight	cubes	#locks	page
GAACLFS24108T-B5SHW	485 lbs.	41.5	1	97
GAACLFS24108T-BBSHW	539 lbs.	41.5	2	97
GAACLFS24108T-SH5BW	485 lbs.	41.5	1	97
GAACLFS24108T-SHBBW	539 lbs.	41.5	2	97
GAACLFS24120T-5SH5W	481 lbs.	46.0	-	98
GAACLFS24120T-B55SHW	542 lbs.	46.0	1	98
GAACLFS24120T-BSHBW	579 lbs.	46.0	2	98
GAACLFS24120T-SH55BW	542 lbs.	46.0	1	98
GAACLPD-CUSH2130T	10 lbs.	2.1	-	100
GAACLPD-CUSH2136T	10 lbs.	2.4	-	100
GAACLPD-CUSH2430	9 lbs.	2.3	-	100
GAACLPD-CUSH2436	9 lbs.	2.7	-	100
GAACLS5H1818L-WW	197 lbs.	19.9	1	112
GAACLS5H1818R-WW	197 lbs.	19.9	1	112
GAACLS5H1830-WW	285 lbs.	31.3	1	112
GAACLS5H2418L-WW	251 lbs.	26.7	1	114
GAACLS5H2418R-WW	251 lbs.	26.7	1	114
GAACLS5H2430-WW	346 lbs.	42.0	1	114
GAACLS6H1818L-WW	230 lbs.	22.0	1	113
GAACLS6H1818R-WW	220 lbs.	22.0	1	113
GAACLS6H2418L-WW	282 lbs.	29.6	1	115
GAACLS6H2418R-WW	282 lbs.	29.6	1	115
GAACORNER	8 lbs.	1.7	-	152
GAACWR2460TL-W	72 lbs.	4.4	-	61
GAACWR2460TR-W	73 lbs.	4.4	-	61
GAACWR2460T-W	68 lbs.	4.0	-	60
GAACWR2460-W	76 lbs.	4.4	-	60
GAACWR2466TL-W	80 lbs.	4.9	-	61
GAACWR2466TR-W	80 lbs.	4.9	-	61
GAACWR2466T-W	74 lbs.	4.4	-	60
GAACWR2466-W	83 lbs.	4.9	-	60
GAACWR2472TL-W	87 lbs.	5.3	-	61
GAACWR2472TR-W	87 lbs.	5.3	-	61
GAACWR2472T-W	81 lbs.	4.7	-	60
GAACWR2472-W	90 lbs.	5.3	-	60
GAACWR2478TL-W	94 lbs.	5.7	-	61
GAACWR2478TR-W	94 lbs.	5.7	-	61
GAACWR2478T-W	87 lbs.	5.1	-	60
GAACWR2478-W	97 lbs.	5.7	-	60
GAACWR2484TL-W	101 lbs.	6.1	-	61
GAACWR2484TR-W	101 lbs.	6.1	-	61
GAACWR2484T-W	93 lbs.	5.5	-	60
GAACWR2484-W	104 lbs.	6.1	-	60
GAACWR2490TL-W	108 lbs.	6.5	-	61

model number	weight	cubes	#locks	page
GAACWR2490TR-W	108 lbs.	6.5	-	61
GAACWR2490T-W	99 lbs.	5.9	-	60
GAACWR2490-W	111 lbs.	6.5	-	60
GAACWR2496TL-W	115 lbs.	7.0	-	61
GAACWR2496TR-W	115 lbs.	7.0	-	61
GAACWR2496T-W	107 lbs.	6.3	-	60
GAACWR2496-W	118 lbs.	7.0	-	60
GAACWR24102TL-W	122 lbs.	7.4	-	61
GAACWR24102TR-W	122 lbs.	7.4	-	61
GAACWR24102T-W	112 lbs.	6.6	-	60
GAACWR24102-W	125 lbs.	7.4	-	60
GAACWR24108TL-W	129 lbs.	7.8	-	61
GAACWR24108TR-W	129 lbs.	7.8	-	61
GAACWR24108T-W	118 lbs.	7.0	-	60
GAACWR24108-W	132 lbs.	7.8	-	60
GAACWR24114TL-W	136 lbs.	8.2	-	61
GAACWR24114TR-W	136 lbs.	8.2	-	61
GAACWR24114T-W	125 lbs.	7.4	-	60
GAACWR24114-W	139 lbs.	8.2	-	60
GAACWR24120TL-W	143 lbs.	8.6	-	61
GAACWR24120TR-W	143 lbs.	8.6	-	61
GAACWR24120T-W	131 lbs.	7.8	-	60
GAACWR24120-W	146 lbs.	8.6	-	60
GAADMHA48-W	8 lbs.	1.3	-	105
GAADMHA54-W	9 lbs.	1.4	-	105
GAADMHA60-W	11 lbs.	1.6	-	105
GAADMHA66-W	12 lbs.	1.8	-	105
GAADMHA72-W	13 lbs.	1.9	-	105
GAADRO3072L-3WW	251 lbs.	46.5	1	42
GAADRO3072R-3WW	251 lbs.	46.5	1	43
GAADRO3072TL-3WW	247 lbs.	46.5	1	42
GAADRO3072TR-3WW	247 lbs.	46.5	1	43
GAADRO3672-32WW	355 lbs.	54.9	2	41
GAADRO3672L-3WW	276 lbs.	54.9	1	42
GAADRO3672R-3WW	276 lbs.	54.9	1	43
GAADRO3672TL-3WW	267 lbs.	54.9	1	42
GAADRO3672TR-3WW	267 lbs.	54.9	1	43
GAADRO3678-32WW	380 lbs.	59.3	2	41
GAADRO3678L-3WW	286 lbs.	59.3	1	42
GAADRO3678R-3WW	286 lbs.	59.3	1	43
GAADRO3678TL-3WW	276 lbs.	59.3	1	42
GAADRO3678TR-3WW	276 lbs.	59.3	1	43
GAADRO3684-32WW	405 lbs.	63.7	2	41
GAADRO3684L-3WW	306 lbs.	63.7	1	42

Credentials

05/22

WEIGHTS + CUBES

model number	weight	cubes	#locks	page
GAADRO3684R-3WW	306 lbs.	63.7	1	43
GAADRO3684TL-3WW	301 lbs.	63.7	1	42
GAADRO3684TR-3WW	301 lbs.	63.7	1	43
GAADSKPAD	10 lbs.	2.3	-	152
GAADTRAK3672L-WW	500 lbs.	54.9	-	38
GAADTRAK3672R-WW	500 lbs.	54.9	-	39
GAADTRAK3678L-WW	525 lbs.	59.3	-	38
GAADTRAK3678R-WW	525 lbs.	59.3	-	39
GAADTRAK3684L-WW	550 lbs.	63.7	-	38
GAADTRAK3684R-WW	550 lbs.	63.7	-	39
GAADTRL3072-G	101 lbs.	46.5	-	35
GAADTRL3072-S	75 lbs.	46.5	-	35
GAADTRL3072-W	111 lbs.	46.5	-	34
GAADTRL3672-G	125 lbs.	54.9	-	35
GAADTRL3672-S	85 lbs.	54.9	-	35
GAADTRL3672-W	131 lbs.	54.9	-	34
GAADTRL3678-G	135 lbs.	59.3	-	35
GAADTRL3678-S	95 lbs.	59.3	-	35
GAADTRL3678-W	142 lbs.	59.3	-	34
GAADTRL3684-G	145 lbs.	63.7	-	35
GAADTRL3684-S	105 lbs.	63.7	-	35
GAADTRL3684-W	152 lbs.	63.7	-	34
GAADTRM3672L-3WW	350 lbs.	54.9	1	36
GAADTRM3672R-3WW	350 lbs.	54.9	1	37
GAADTRM3678L-3WW	375 lbs.	59.3	1	36
GAADTRM3678R-3WW	375 lbs.	59.3	1	37
GAADTRM3684L-3WW	400 lbs.	63.7	1	36
GAADTRM3684R-3WW	400 lbs.	63.7	1	37
GAADTRR3672-WW	239 lbs.	54.9	-	40
GAADTRR3678-WW	264 lbs.	59.3	-	40
GAADTRR3684-WW	289 lbs.	63.7	-	40
GAADWRA2442-W	39 lbs.	3.2	-	103
GAADWRA2448-W	45 lbs.	3.6	-	103
GAADWRA2454-W	51 lbs.	4.0	-	103
GAADWRA2460-W	56 lbs.	4.4	-	103
GAADWRA2466-W	62 lbs.	4.9	-	103
GAADWRA2472-W	67 lbs.	5.3	-	103
GAADWRA3048-W	56 lbs.	4.4	-	104
GAADWRA3054-W	63 lbs.	4.9	-	104
GAADWRA3060-W	70 lbs.	5.4	-	104
GAADWRA3066-W	77 lbs.	5.9	-	104
GAADWRA3072-W	84 lbs.	6.4	-	104
GAADWRA3648-W	67 lbs.	5.2	-	104
GAADWRA3654-W	76 lbs.	5.8	-	104

model number	weight	cubes	#locks	page
GAADWRA3660-W	84 lbs.	6.4	-	104
GAADWRA3666-W	93 lbs.	7.0	-	104
GAADWRA3672-W	101 lbs.	7.6	-	104
GAAHDC2H2430T-WW	169 lbs.	17.3	-	111
GAAHDC2H2430-WW	169 lbs.	17.3	-	111
GAAHDC2H2436T-WW	195 lbs.	20.4	-	111
GAAHDC2H2436-WW	195 lbs.	20.4	-	111
GAAHDC2H2436T-WW	195 lbs.	20.4	-	111
GAALFS2H2430T-WW	177 lbs.	17.3	1	108
GAALFS2H2430-WW	188 lbs.	17.3	1	108
GAALFS2H2436T-WW	196 lbs.	20.4	1	108
GAALFS2H2436-WW	212 lbs.	20.4	1	108
GAALFS3H2430-WW	259 lbs.	24.7	1	109
GAALFS3H2436-WW	297 lbs.	29.2	1	109
GAALFS4H2430-WW	325 lbs.	32.2	1	109
GAALFS4H2436-WW	364 lbs.	38.0	1	109
GAALFS5H2430-WW	410 lbs.	42.0	1	109
GAALFS5H2436-WW	461 lbs.	49.7	1	109
GAALFS6H2430-WW	454 lbs.	46.5	1	109
GAALFS6H2436-WW	512 lbs.	55.0	1	109
GAALFSLH2430-WW	162 lbs.	13.1	1	108
GAALFSLH2436-WW	172 lbs.	15.5	1	108
GAAMCA24-W	30 lbs.	4.0	-	90
GAAMCA27-W	32 lbs.	4.4	-	90
GAAMCA30-W	34 lbs.	4.9	-	90
GAAMCA33-W	35 lbs.	5.3	-	90
GAAMCA36-W	37 lbs.	5.8	-	90
GAAMCA39-W	39 lbs.	6.2	-	90
GAAMCA42-W	41 lbs.	6.7	-	90
GAAMCA45-W	43 lbs.	7.1	-	90
GAAMCA48-W	45 lbs.	7.6	-	90
GAAMCA51-W	46 lbs.	8.0	-	90
GAAMCA54-W	48 lbs.	8.5	-	90
GAAMCA57-W	53 lbs.	8.9	-	90
GAAMCA60-W	54 lbs.	9.3	-	90
GAAMCA63-W	56 lbs.	9.8	-	90
GAAMCA66-W	58 lbs.	10.2	-	90
GAAMCA69-W	60 lbs.	10.7	-	90
GAAMCA72-W	62 lbs.	11.1	-	90
GAAMCF60-W	41 lbs.	4.1	-	88
GAAMCF66-W	45 lbs.	4.5	-	88
GAAMCF72-W	48 lbs.	4.9	-	88
GAAMCF78-W	51 lbs.	5.3	-	88

WEIGHTS + CUBES

Credentials
05/22

model number	weight	cubes	#locks	page
GAAMCF84-W	54 lbs.	5.7	-	88
GAAMCF90-W	58 lbs.	6.1	-	88
GAAMCF96-W	61 lbs.	6.5	-	88
GAAMCF102-W	64 lbs.	6.9	-	88
GAAMCF108-W	67 lbs.	7.4	-	88
GAAMCF114-W	70 lbs.	7.8	-	88
GAAMCF120-W	73 lbs.	8.2	-	88
GAAMLCF60-W	33 lbs.	3.1	-	89
GAAMLCF66-W	35 lbs.	3.4	-	89
GAAMLCF72-W	37 lbs.	3.7	-	89
GAAMLCF78-W	40 lbs.	4.0	-	89
GAAMLCF84-W	42 lbs.	4.3	-	89
GAAMLCF90-W	44 lbs.	4.6	-	89
GAAMLCF96-W	46 lbs.	4.9	-	89
GAAMLCF102-W	49 lbs.	5.2	-	89
GAAMLCF108-W	51 lbs.	5.5	-	89
GAAMLCF114-W	53 lbs.	5.8	-	89
GAAMLCF120-W	57 lbs.	6.1	-	89
GAAMPLPW2415L-AWW	75 lbs.	6.7	1	77
GAAMPLPW2415L-LW	55 lbs.	6.5	-	76
GAAMPLPW2415L-XBW	65 lbs.	6.5	-	76
GAAMPLPW2415R-AWW	75 lbs.	6.7	1	83
GAAMPLPW2415R-LW	55 lbs.	6.5	-	82
GAAMPLPW2415R-XBW	65 lbs.	6.5	-	82
GAAMPLPW2418L-AWW	81 lbs.	7.9	1	77
GAAMPLPW2418R-AWW	81 lbs.	7.9	1	83
GAAMPLPW2430L-5WW	89 lbs.	12.3	-	78
GAAMPLPW2430L-BWW	139 lbs.	12.3	1	78
GAAMPLPW2430L-PW	120 lbs.	12.3	1	78
GAAMPLPW2430L-SHW	77 lbs.	12.3	-	78
GAAMPLPW2430L-TW	122 lbs.	12.3	1	78
GAAMPLPW2430R-5WW	89 lbs.	12.3	-	84
GAAMPLPW2430R-BWW	139 lbs.	12.3	1	84
GAAMPLPW2430R-PW	120 lbs.	12.3	1	84
GAAMPLPW2430R-SHW	77 lbs.	12.3	-	84
GAAMPLPW2430R-TW	122 lbs.	12.3	1	84
GAAMPLPW2436L-5W	98 lbs.	14.6	-	79
GAAMPLPW2436L-BW	151 lbs.	14.6	1	79
GAAMPLPW2436L-PW	130 lbs.	12.3	1	79
GAAMPLPW2436L-SHW	87 lbs.	14.6	-	79
GAAMPLPW2436L-TW	132 lbs.	12.3	1	79
GAAMPLPW2436R-5WW	98 lbs.	14.6	-	85
GAAMPLPW2436R-BWW	151 lbs.	14.6	1	85
GAAMPLPW2436R-PW	130 lbs.	12.3	1	85

model number	weight	cubes	#locks	page
GAAMPLPW2436R-SHW	87 lbs.	14.6	-	85
GAAMPLPW2436R-TW	132 lbs.	12.3	1	85
GAAMPLPW2445L-5AW	157 lbs.	18.0	1	80
GAAMPLPW2445L-BAW	175 lbs.	18.0	2	80
GAAMPLPW2445R-A5W	157 lbs.	18.0	1	86
GAAMPLPW2445R-ABW	175 lbs.	18.0	2	86
GAAMPLPW2454L-5AW	176 lbs.	21.3	1	80
GAAMPLPW2454L-BAW	196 lbs.	21.3	2	80
GAAMPLPW2454R-A5W	176 lbs.	21.3	1	86
GAAMPLPW2454R-ABW	196 lbs.	21.3	2	86
GAAMPLPW2460L-55W	173 lbs.	23.6	-	81
GAAMPLPW2460L-BBW	209 lbs.	23.6	2	81
GAAMPLPW2460R-55W	173 lbs.	23.6	-	87
GAAMPLPW2460R-BBW	209 lbs.	23.6	2	87
GAAMLSP12-W	7 lbs.	0.4	-	93
GAAMLSPT12-W	11 lbs.	1.3	-	93
GAAMPD1818-AW	99 lbs.	7.2	1	99
GAAMPD-CUSH1818	6 lbs.	1.2	-	100
GAAMPW2415L-2W	90 lbs.	9.0	1	65
GAAMPW2415L-3W	93 lbs.	9.0	1	65
GAAMPW2415L-LW	50 lbs.	8.7	-	64
GAAMPW2415L-XBW	71 lbs.	8.7	-	64
GAAMPW2415L-XEW	71 lbs.	8.7	-	64
GAAMPW2415R-2W	90 lbs.	9.0	1	71
GAAMPW2415R-3W	93 lbs.	9.0	1	71
GAAMPW2415R-LW	50 lbs.	8.7	-	70
GAAMPW2415R-XBW	71 lbs.	8.7	-	70
GAAMPW2415R-XEW	71 lbs.	8.7	-	70
GAAMPW2418L-2W	97 lbs.	10.5	1	65
GAAMPW2418L-3W	101 lbs.	10.5	1	65
GAAMPW2418R-2W	97 lbs.	10.5	1	71
GAAMPW2418R-3W	101 lbs.	10.5	1	71
GAAMPW2430L-4W	135 lbs.	16.5	1	66
GAAMPW2430L-5W	121 lbs.	16.5	-	66
GAAMPW2430L-7W	136 lbs.	16.5	1	66
GAAMPW2430L-23W	172 lbs.	16.5	2	66
GAAMPW2430L-BW	165 lbs.	16.5	1	66
GAAMPW2430L-PW	130 lbs.	16.5	1	66
GAAMPW2430L-SHW	105 lbs.	16.5	-	66
GAAMPW2430L-TW	132 lbs.	16.5	1	66
GAAMPW2430R-4W	135 lbs.	16.5	1	72
GAAMPW2430R-5W	121 lbs.	16.5	-	72
GAAMPW2430R-7W	136 lbs.	16.5	1	72
GAAMPW2430R-32W	172 lbs.	16.5	2	72

Credentials

05/22

WEIGHTS + CUBES

model number	weight	cubes	#locks	page
GAAMPW2430R-BW	165 lbs.	16.5	1	72
GAAMPW2430R-PW	130 lbs.	16.5	1	72
GAAMPW2430R-SHW	105 lbs.	16.5	-	72
GAAMPW2430R-TW	132 lbs.	16.5	1	72
GAAMPW2436L-4W	142 lbs.	19.5	1	67
GAAMPW2436L-5W	138 lbs.	19.5	-	67
GAAMPW2436L-7W	147 lbs.	19.5	1	67
GAAMPW2436L-23W	187 lbs.	19.5	2	67
GAAMPW2436L-BW	183 lbs.	19.5	1	67
GAAMPW2436L-PW	140 lbs.	19.5	1	67
GAAMPW2436L-SHW	118 lbs.	19.5	-	67
GAAMPW2436L-TW	142 lbs.	19.5	1	67
GAAMPW2436R-4W	142 lbs.	19.5	1	73
GAAMPW2436R-5W	138 lbs.	19.5	-	73
GAAMPW2436R-7W	147 lbs.	19.5	1	73
GAAMPW2436R-32W	187 lbs.	19.5	2	73
GAAMPW2436R-BW	183 lbs.	19.5	1	73
GAAMPW2436R-PW	140 lbs.	19.5	1	73
GAAMPW2436R-SHW	118 lbs.	19.5	-	73
GAAMPW2436R-TW	142 lbs.	19.5	1	73
GAAMPW2445L-43W	203 lbs.	24.0	2	68
GAAMPW2445L-52W	200 lbs.	24.0	1	68
GAAMPW2445L-72W	216 lbs.	24.0	2	68
GAAMPW2445R-25W	200 lbs.	24.0	1	74
GAAMPW2445R-27W	216 lbs.	24.0	2	74
GAAMPW2445R-34W	203 lbs.	24.0	2	74
GAAMPW2454L-43W	232 lbs.	28.4	2	68
GAAMPW2454L-52W	224 lbs.	28.4	1	68
GAAMPW2454L-72W	234 lbs.	28.4	2	68
GAAMPW2454R-25W	224 lbs.	28.4	1	74
GAAMPW2454R-27W	234 lbs.	28.4	2	74
GAAMPW2454R-34W	232 lbs.	28.4	2	74
GAAMPW2460L-44W	244 lbs.	31.4	2	69
GAAMPW2460L-55W	231 lbs.	31.4	-	69
GAAMPW2460L-BBW	322 lbs.	31.4	2	69
GAAMPW2460R-44W	244 lbs.	31.4	2	75
GAAMPW2460R-55W	231 lbs.	31.4	-	75
GAAMPW2460R-BBW	322 lbs.	31.4	2	75
GAAMRA21-W	28 lbs.	3.6	-	92
GAAMRA24-W	30 lbs.	4.0	-	92
GAAMRA27-W	32 lbs.	4.4	-	92
GAAMRA30-W	34 lbs.	4.9	-	92
GAAMRA33-W	36 lbs.	5.3	-	92
GAAMRA36-W	37 lbs.	5.8	-	92

model number	weight	cubes	#locks	page
GAAMRA39-W	39 lbs.	6.2	-	92
GAAMRA42-W	41 lbs.	6.7	-	92
GAAMRA45-W	43 lbs.	7.1	-	92
GAAMRA48-W	45 lbs.	7.6	-	92
GAAMRA51-W	47 lbs.	8.0	-	92
GAAMRA54-W	49 lbs.	8.5	-	92
GAAMRA57-W	51 lbs.	8.9	-	92
GAAMRA60-W	53 lbs.	9.3	-	92
GAAMRF39-W	20 lbs.	2.8	-	91
GAAMRF42-W	22 lbs.	3.0	-	91
GAAMRF45-W	23 lbs.	3.2	-	91
GAAMRF48-W	25 lbs.	3.4	-	91
GAAMRF51-W	26 lbs.	3.6	-	91
GAAMRF54-W	28 lbs.	3.8	-	91
GAAMRF57-W	30 lbs.	4.0	-	91
GAAMRF60-W	32 lbs.	4.2	-	91
GAAMRF63-W	33 lbs.	4.4	-	91
GAAMRF66-W	35 lbs.	4.6	-	91
GAAMRF69-W	36 lbs.	4.8	-	91
GAAMRF72-W	38 lbs.	5.0	-	91
GAAMSP12-W	7 lbs.	0.6	-	93
GAAMSPT12-W	11 lbs.	1.7	-	93
GAARLRL3072L-W	126 lbs.	46.5	-	52
GAARLRL3072R-W	126 lbs.	46.5	-	53
GAARLRL3078L-W	135 lbs.	50.2	-	52
GAARLRL3078R-W	135 lbs.	50.2	-	53
GAARLRL3678L-W	160 lbs.	59.3	-	52
GAARLRL3678R-W	160 lbs.	59.3	-	53
GAARLRL3684L-W	170 lbs.	63.7	-	52
GAARLRL3684R-W	170 lbs.	63.7	-	53
GAARLRO3072L-3W	231 lbs.	46.5	1	56
GAARLRO3072R-3W	231 lbs.	46.5	1	57
GAARLRO3078L-3W	241 lbs.	50.2	1	56
GAARLRO3078R-3W	241 lbs.	50.2	1	57
GAARLRO3678L-3W	276 lbs.	59.3	1	56
GAARLRO3678R-3W	276 lbs.	59.3	1	57
GAARLRO3684L-3W	287 lbs.	63.7	1	56
GAARLRO3684R-3W	287 lbs.	63.7	1	57
GAARLRR3072L-W	126 lbs.	46.5	-	54
GAARLRR3072R-W	126 lbs.	46.5	-	55
GAARLRR3078L-W	135 lbs.	50.2	-	54
GAARLRR3078R-W	135 lbs.	50.2	-	55
GAARLRR3678L-W	160 lbs.	59.3	-	54
GAARLRR3678R-W	160 lbs.	59.3	-	55

WEIGHTS + CUBES

Credentials

05/22

model number	weight	cubes	#locks	page
GAARLRR3684L-W	170 lbs.	63.7	-	54
GAARLRR3684R-W	170 lbs.	63.7	-	55
GAARRL3048L-W	76 lbs.	31.6	-	52
GAARRL3048R-W	76 lbs.	31.6	-	53
GAARRL3054L-W	85 lbs.	35.3	-	52
GAARRL3054R-W	85 lbs.	35.3	-	53
GAARRL3654L-W	101 lbs.	41.7	-	52
GAARRL3654R-W	101 lbs.	41.7	-	53
GAARRL3660L-W	110 lbs.	46.1	-	52
GAARRL3660R-W	110 lbs.	46.1	-	53
GAARRO3048L-3W	188 lbs.	31.6	1	56
GAARRO3048R-3W	188 lbs.	31.6	1	57
GAARRO3054L-3W	198 lbs.	35.3	1	56
GAARRO3054R-3W	198 lbs.	35.3	1	57
GAARRO3654L-3W	225 lbs.	41.7	1	56
GAARRO3654R-3W	225 lbs.	41.7	1	57
GAARRO3660L-3W	237 lbs.	46.1	1	56
GAARRO3660R-3W	237 lbs.	46.1	1	57
GAARRR3048L-W	133 lbs.	31.6	-	54
GAARRR3048R-W	133 lbs.	31.6	-	55
GAARRR3054L-W	143 lbs.	35.3	-	54
GAARRR3054R-W	143 lbs.	35.3	-	55
GAARRR3654L-W	167 lbs.	41.7	-	54
GAARRR3654R-W	167 lbs.	41.7	-	55
GAARRR3660L-W	179 lbs.	46.1	-	54
GAARRR3660R-W	179 lbs.	46.1	-	55
GAARWR2442T-W	49 lbs.	2.8	-	63
GAARWR2442-W	55 lbs.	3.2	-	62
GAARWR2448T-W	56 lbs.	3.2	-	63
GAARWR2448-W	62 lbs.	3.6	-	62
GAARWR2454T-W	62 lbs.	3.6	-	63
GAARWR2454-W	69 lbs.	4.0	-	62
GAARWR2460T-W	68 lbs.	4.0	-	63
GAARWR2460-W	76 lbs.	4.4	-	62
GAARWR2466T-W	75 lbs.	4.4	-	63
GAARWR2466-W	83 lbs.	4.9	-	62
GAARWR2472T-W	81 lbs.	4.7	-	63
GAARWR2472-W	90 lbs.	5.3	-	62
GAASBH5H2418L-WW	284 lbs.	26.7	2	116
GAASBH5H2418R-WW	284 lbs.	26.7	2	116
GAASBH5H2430-WW	384 lbs.	42.0	2	116
GAASBH6H2418L-WW	315 lbs.	29.6	2	116
GAASBH6H2418R-WW	315 lbs.	29.6	2	116
GAASBH6H2430-WW	436 lbs.	46.5	2	116

model number	weight	cubes	#locks	page
GAATGW1H30-GSA	43 lbs.	3.7	-	133
GAATGW1H30-XGSA	48 lbs.	3.7	-	137
GAATGW1H36-GSA	50 lbs.	4.3	-	133
GAATGW1H36-XGSA	55 lbs.	4.3	-	137
GAATGW1H42-GSA	58 lbs.	5.0	-	133
GAATGW1H42-XGSA	63 lbs.	5.0	-	137
GAATGW1H48-GSA	66 lbs.	5.6	-	133
GAATGW1H48-XGSA	71 lbs.	5.6	-	137
GAATGW2H30-GSA	50 lbs.	4.3	-	133
GAATGW2H30-XGSA	55 lbs.	4.3	-	137
GAATGW2H36-GSA	59 lbs.	5.0	-	133
GAATGW2H36-XGSA	64 lbs.	5.0	-	137
GAATGW2H42-GSA	67 lbs.	5.8	-	133
GAATGW2H42-XGSA	72 lbs.	5.8	-	137
GAATGW2H48-GSA	76 lbs.	6.6	-	133
GAATGW2H48-XGSA	81 lbs.	6.6	-	137
GAATGW30-GSA	28 lbs.	2.3	-	132
GAATGW30-LXGSA	33 lbs.	2.3	-	136
GAATGW36-GSA	32 lbs.	2.7	-	132
GAATGW36-LXGSA	37 lbs.	2.7	-	136
GAATGW60-GSA	50 lbs.	4.3	-	132
GAATGW60-LXGSA	55 lbs.	4.3	-	136
GAATGW66-GSA	55 lbs.	4.7	-	132
GAATGW66-LXGSA	60 lbs.	4.7	-	136
GAATGW72-GSA	59 lbs.	5.1	-	132
GAATGW72-LXGSA	64 lbs.	5.1	-	136
GAATGW78-GSA	64 lbs.	5.5	-	132
GAATGW78-LXGSA	69 lbs.	5.5	-	136
GAATGW84-GSA	68 lbs.	5.9	-	132
GAATGW84-LXGSA	73 lbs.	5.9	-	136
GAATGW90-GSA	73 lbs.	6.4	-	132
GAATGW90-LXGSA	78 lbs.	6.4	-	136
GAATGW96-GSA	77 lbs.	6.8	-	132
GAATGW96-LXGSA	82 lbs.	6.8	-	136
GAATGW102-GSA	82 lbs.	7.2	-	132
GAATGW102-LXGSA	87 lbs.	7.2	-	136
GAATGW108-GSA	86 lbs.	7.6	-	132
GAATGW108-LXGSA	91 lbs.	7.6	-	136
GAATKW1H30	24 lbs.	3.8	-	129
GAATKW1H36	27 lbs.	4.5	-	129
GAATKW1H42	29 lbs.	5.1	-	129
GAATKW1H48	32 lbs.	5.8	-	129
GAATKW2H30	26 lbs.	4.4	-	129
GAATKW2H36	29 lbs.	5.2	-	129

model number	weight	cubes	#locks	page
GAATKW2H42	33 lbs.	6.0	-	129
GAATKW2H48	36 lbs.	6.8	-	129
GAATKW30	18 lbs.	2.3	-	128
GAATKW36	20 lbs.	2.8	-	128
GAATKW60	26 lbs.	4.5	-	128
GAATKW66	28 lbs.	4.9	-	128
GAATKW72	29 lbs.	5.3	-	128
GAATKW78	31 lbs.	5.7	-	128
GAATKW84	33 lbs.	6.1	-	128
GAATKW90	34 lbs.	6.6	-	128
GAATKW96	36 lbs.	7.0	-	128
GAATKW102	37 lbs.	7.4	-	128
GAATKW108	39 lbs.	7.8	-	128
GAATKW120	42 lbs.	8.7	-	128
GAATLGW1H30-GSA	49 lbs.	4.2	-	135
GAATLGW1H36-GSA	58 lbs.	5.0	-	135
GAATLGW1H42-GSA	67 lbs.	5.7	-	135
GAATLGW1H48-GSA	75 lbs.	6.5	-	135
GAATLGW2H30-GSA	56 lbs.	4.8	-	135
GAATLGW2H36-GSA	66 lbs.	5.7	-	135
GAATLGW2H42-GSA	76 lbs.	6.6	-	135
GAATLGW2H48-GSA	86 lbs.	7.4	-	135
GAATLGW30-GSA	34 lbs.	2.8	-	134
GAATLGW30-LXGSA	39 lbs.	2.9	-	138
GAATLGW36-GSA	39 lbs.	3.3	-	134
GAATLGW36-LXGSA	44 lbs.	3.4	-	138
GAATLGW60-GSA	62 lbs.	5.4	-	134
GAATLGW60-LXGSA	67 lbs.	5.5	-	138
GAATLGW66-GSA	68 lbs.	5.9	-	134
GAATLGW66-LXGSA	73 lbs.	6.1	-	138
GAATLGW72-GSA	74 lbs.	6.4	-	134
GAATLGW72-LXGSA	79 lbs.	6.6	-	138
GAATLGW78-GSA	79 lbs.	6.9	-	134
GAATLGW78-LXGSA	84 lbs.	7.1	-	138
GAATLGW84-GSA	85 lbs.	7.4	-	134
GAATLGW84-LXGSA	90 lbs.	7.7	-	138
GAATLGW90-GSA	91 lbs.	7.9	-	134
GAATLGW90-LXGSA	96 lbs.	8.2	-	138
GAATLGW96-GSA	97 lbs.	8.4	-	134
GAATLGW96-LXGSA	102 lbs.	8.7	-	138
GAATLGW102-GSA	102 lbs.	8.9	-	134
GAATLGW102-LXGSA	107 lbs.	9.2	-	138
GAATLGW108-GSA	108 lbs.	9.5	-	134
GAATLGW108-LXGSA	113 lbs.	9.8	-	138

model number	weight	cubes	#locks	page
GAATLKW1H30	26 lbs.	4.3	-	131
GAATLKW1H36	29 lbs.	5.1	-	131
GAATLKW1H42	33 lbs.	5.9	-	131
GAATLKW1H48	36 lbs.	6.7	-	131
GAATLKW2H30	28 lbs.	5.0	-	131
GAATLKW2H36	32 lbs.	5.9	-	131
GAATLKW2H42	36 lbs.	6.8	-	131
GAATLKW2H48	40 lbs.	7.7	-	131
GAATLKW30	20 lbs.	2.9	-	130
GAATLKW36	22 lbs.	3.4	-	130
GAATLKW60	31 lbs.	5.5	-	130
GAATLKW66	33 lbs.	6.1	-	130
GAATLKW72	35 lbs.	6.6	-	130
GAATLKW78	37 lbs.	7.1	-	130
GAATLKW84	39 lbs.	7.7	-	130
GAATLKW90	41 lbs.	8.2	-	130
GAATLKW96	43 lbs.	8.7	-	130
GAATLKW102	45 lbs.	9.2	-	130
GAATLKW108	47 lbs.	9.8	-	130
GAATLKW120	52 lbs.	10.8	-	130
GAATLWD1H30	78 lbs.	4.3	-	142
GAATLWD1H36	91 lbs.	5.1	-	142
GAATLWD1H42	105 lbs.	5.9	-	142
GAATLWD1H48	118 lbs.	6.7	-	142
GAATLWD2H30	88 lbs.	5.0	-	142
GAATLWD2H36	103 lbs.	5.9	-	142
GAATLWD2H42	119 lbs.	6.8	-	142
GAATLWD2H48	135 lbs.	7.7	-	142
GAATLWD30	54 lbs.	2.9	-	141
GAATLWD30-LX				145
GAATLWD36	63 lbs.	3.4	-	141
GAATLWD36-LX				145
GAATLWD60	98 lbs.	5.5	-	141
GAATLWD60-LX				145
GAATLWD66	107 lbs.	6.1	-	141
GAATLWD66-LX				145
GAATLWD72	115 lbs.	6.6	-	141
GAATLWD72-LX				145
GAATLWD78	124 lbs.	7.1	-	141
GAATLWD78-LX				145
GAATLWD84	133 lbs.	7.7	-	141
GAATLWD84-LX				145
GAATLWD90	142 lbs.	8.2	-	141
GAATLWD90-LX				145

model number	weight	cubes	#locks	page
GAATLWD96	151 lbs.	8.7	–	141
GAATLWD96-LX				145
GAATLWD102	159 lbs.	9.2	–	141
GAATLWD102-LX				145
GAATLWD108	168 lbs.	9.8	–	141
GAATLWD108-LX				145
GAATLWD120	186 lbs.	10.8	–	141
GAATLWD120-LX				145
GAATOP1818-W	20 lbs.	1.0	–	158
GAATRAYBOX15	3 lbs.	0.9	–	153
GAATRAYBOX18	4 lbs.	1.0	–	153
GAATRAYBOX30	7 lbs.	1.7	–	153
GAATRAYBOX36	8 lbs.	2.1	–	153
GAATRAYLTR15	3 lbs.	1.0	–	153
GAATRAYLTR18	4 lbs.	1.1	–	153
GAATRD42-W	79 lbs.	5.3	–	147
GAATRD48-W	100 lbs.	6.8	–	147
GAATRD54-W	124 lbs.	8.5	–	147
GAATRD60-W	150 lbs.	10.3	–	147
GAATROUGH30	3 lbs.	0.6	–	101
GAATROUGH36	3 lbs.	0.7	–	101
GAATROUGH42	4 lbs.	0.9	–	101
GAATROUGH48	4 lbs.	1.0	–	101
GAATROUGH54	5 lbs.	1.1	–	101
GAATROUGH60	5 lbs.	1.2	–	101
GAATROUGH66	6 lbs.	1.4	–	101
GAATROUGH72	6 lbs.	1.5	–	101
GAATROUGH78	7 lbs.	1.6	–	101
GAATROUGH84	7 lbs.	1.7	–	101
GAATROUGH90	8 lbs.	1.9	–	101
GAATROUGH96	9 lbs.	2.0	–	101
GAATROUGH102	9 lbs.	2.1	–	101
GAATROUGH108	10 lbs.	2.2	–	101
GAATROUGH114	10 lbs.	2.4	–	101
GAATROUGH120	11 lbs.	2.5	–	101
GAATWD1H30	68 lbs.	3.8	–	140
GAATWD1H30-X	68 lbs.	3.8	–	144
GAATWD1H36	80 lbs.	4.5	–	140
GAATWD1H36-X	80 lbs.	4.5	–	144
GAATWD1H42	91 lbs.	5.1	–	140
GAATWD1H42-X	91 lbs.	5.1	–	144
GAATWD1H48	103 lbs.	5.8	–	140
GAATWD1H48-X	103 lbs.	5.8	–	144
GAATWD2H30	78 lbs.	4.4	–	140

model number	weight	cubes	#locks	page
GAATWD2H30-X	78 lbs.	4.4	–	144
GAATWD2H36	92 lbs.	5.2	–	140
GAATWD2H36-X	92 lbs.	5.2	–	144
GAATWD2H42	106 lbs.	6.0	–	140
GAATWD2H42-X	106 lbs.	6.0	–	144
GAATWD2H48	120 lbs.	6.8	–	140
GAATWD2H48-X	120 lbs.	6.8	–	144
GAATWD30	45 lbs.	2.3	–	139
GAATWD30-LX	45 lbs.	2.3	–	143
GAATWD36	51 lbs.	2.8	–	139
GAATWD36-LX	51 lbs.	2.8	–	143
GAATWD60	79 lbs.	4.5	–	139
GAATWD60-LX	79 lbs.	4.5	–	143
GAATWD66	86 lbs.	4.9	–	139
GAATWD66-LX	86 lbs.	4.9	–	143
GAATWD72	93 lbs.	5.3	–	139
GAATWD72-LX	93 lbs.	5.3	–	143
GAATWD78	100 lbs.	5.7	–	139
GAATWD78-LX	100 lbs.	5.7	–	143
GAATWD84	107 lbs.	6.1	–	139
GAATWD84-LX	107 lbs.	6.1	–	143
GAATWD90	114 lbs.	6.6	–	139
GAATWD90-LX	114 lbs.	6.6	–	143
GAATWD96	121 lbs.	7.0	–	139
GAATWD96-LX	121 lbs.	7.0	–	143
GAATWD102	127 lbs.	7.4	–	139
GAATWD102-LX	127 lbs.	7.4	–	143
GAATWD108	134 lbs.	7.8	–	139
GAATWD108-LX	134 lbs.	7.8	–	143
GAATWD120	148 lbs.	8.7	–	139
GAATWD120-LX	148 lbs.	8.7	–	143
GAAUTC5H2424L-WW	413 lbs.	34.4	3	117
GAAUTC5H2424R-WW	413 lbs.	34.4	3	117
GAAUTC6H2424L-WW	461 lbs.	38.1	3	117
GAAUTC6H2424R-WW	461 lbs.	38.1	3	117
GAAWCF1H60-WG	212 lbs.	17.2	–	121
GAAWCF1H60-WW	195 lbs.	17.2	–	120
GAAWCF1H72-WG	246 lbs.	20.5	–	121
GAAWCF1H72-WW	225 lbs.	20.5	–	120
GAAWCF1H90-WG	311 lbs.	25.4	–	121
GAAWCF1H90-WW	286 lbs.	25.4	–	120
GAAWCF1H108-WG	360 lbs.	30.4	–	121
GAAWCF1H108-WW	329 lbs.	30.4	–	120
GAAWCH1H30-WG	117 lbs.	9.0	–	119

model number	weight	cubes	#locks	page
GAAWCH1H30-WW	104 lbs.	9.0	-	118
GAAWCH1H36-WG	133 lbs.	10.7	-	119
GAAWCH1H36-WW	119 lbs.	10.7	-	118
GAAWCH1H60-WG	219 lbs.	17.2	-	119
GAAWCH1H60-WW	194 lbs.	17.2	-	118
GAAWCH1H66-WW	209 lbs.	18.9	-	118
GAAWCH1H72-WG	251 lbs.	20.5	-	119
GAAWCH1H72-WW	225 lbs.	20.5	-	118
GAAWCH1H78-WW	239 lbs.	22.1	-	118
GAAWCH1H84-WW	270 lbs.	23.8	-	118
GAAWCH1H90-WG	322 lbs.	25.4	-	119
GAAWCH1H90-WW	285 lbs.	25.4	-	118
GAAWCH1H96-WW	301 lbs.	27.1	-	118
GAAWCH1H102-WW	315 lbs.	28.7	-	118
GAAWCH1H108-WG	371 lbs.	30.4	-	119
GAAWCH1H108-WW	330 lbs.	30.4	-	118
GAAWCH2H30-WG	138 lbs.	12.4	-	125
GAAWCH2H30-WW	123 lbs.	12.4	-	124
GAAWCH2H36-WG	156 lbs.	14.7	-	125
GAAWCH2H36-WW	141 lbs.	14.7	-	124
GAAWCH2H60-WG	261 lbs.	23.7	-	125
GAAWCH2H60-WW	231 lbs.	23.7	-	124
GAAWCH2H66-WW	248 lbs.	26.0	-	124
GAAWCH2H72-WG	297 lbs.	28.3	-	125
GAAWCH2H72-WW	266 lbs.	28.3	-	124
GAAWCH2H78-WW	283 lbs.	30.5	-	124
GAAWCH2H84-WW	322 lbs.	32.8	-	124
GAAWCH2H90-WG	385 lbs.	35.0	-	125
GAAWCH2H90-WW	339 lbs.	35.0	-	124
GAAWCS1H60-WG	159 lbs.	17.2	-	123
GAAWCS1H60-WW	164 lbs.	17.2	-	122
GAAWCS1H72-WG	183 lbs.	20.5	-	123
GAAWCS1H72-WW	181 lbs.	20.5	-	122
GAAWCS1H90-WG	223 lbs.	25.4	-	123
GAAWCS1H90-WW	244 lbs.	25.4	-	122
GAAWCS1H108-WG	271 lbs.	30.4	-	123
GAAWCS1H108-WW	275 lbs.	30.4	-	122
GAAWCS2H60-WG	166 lbs.	23.7	-	127
GAAWCS2H60-WW	164 lbs.	23.7	-	126
GAAWCS2H72-WG	190 lbs.	28.3	-	127
GAAWCS2H72-WW	201 lbs.	28.3	-	126
GAAWCS2H90-WG	243 lbs.	35.0	-	127
GAAWCS2H90-WW	259 lbs.	35.0	-	126
GAAXRAK3072L-W	550 lbs.	46.5	-	48

model number	weight	cubes	#locks	page
GAAXRAK3072R-W	550 lbs.	46.5	-	49
GAAXRAK3072TL-W	552 lbs.	46.5	-	48
GAAXRAK3072TR-W	552 lbs.	46.5	-	49
GAAXRAK3672L-W	571 lbs.	54.9	-	48
GAAXRAK3672R-W	571 lbs.	54.9	-	49
GAAXRAK3672TL-W	560 lbs.	54.9	-	48
GAAXRAK3672TR-W	560 lbs.	54.9	-	49
GAAXRAK3678L-W	568 lbs.	59.3	-	48
GAAXRAK3678R-W	568 lbs.	59.3	-	49
GAAXRAK3678TL-W	570 lbs.	59.3	-	48
GAAXRAK3678TR-W	570 lbs.	59.3	-	49
GAAXRAK3684L-W	578 lbs.	63.7	-	48
GAAXRAK3684R-W	578 lbs.	63.7	-	49
GAAXRAK3684TL-W	578 lbs.	63.7	-	48
GAAXRAK3684TR-W	578 lbs.	63.7	-	49
GAAXRL3072L-W	152 lbs.	46.5	-	44
GAAXRL3072R-W	152 lbs.	46.5	-	45
GAAXRL3072TL-W	145 lbs.	46.5	-	44
GAAXRL3072TR-W	145 lbs.	46.5	-	45
GAAXRL3672L-W	181 lbs.	54.9	-	44
GAAXRL3672R-W	181 lbs.	54.9	-	45
GAAXRL3672TL-W	168 lbs.	54.9	-	44
GAAXRL3672TR-W	168 lbs.	54.9	-	45
GAAXRL3678L-W	191 lbs.	59.3	-	44
GAAXRL3678R-W	191 lbs.	59.3	-	45
GAAXRL3678TL-W	178 lbs.	59.3	-	44
GAAXRL3678TR-W	178 lbs.	59.3	-	45
GAAXRL3684L-W	200 lbs.	63.7	-	44
GAAXRL3684R-W	200 lbs.	63.7	-	45
GAAXRL3684TL-W	189 lbs.	63.7	-	44
GAAXRL3684TR-W	189 lbs.	63.7	-	45
GAAXRM3072L-W	220 lbs.	46.5	-	46
GAAXRM3072R-W	220 lbs.	46.5	-	47
GAAXRM3072TL-W	220 lbs.	46.5	-	46
GAAXRM3072TR-W	220 lbs.	46.5	-	47
GAAXRM3672L-W	245 lbs.	54.9	-	46
GAAXRM3672R-W	245 lbs.	54.9	-	47
GAAXRM3672TL-W	245 lbs.	54.9	-	46
GAAXRM3672TR-W	245 lbs.	54.9	-	47
GAAXRM3678L-W	265 lbs.	59.3	-	46
GAAXRM3678R-W	265 lbs.	59.3	-	47
GAAXRM3678TL-W	265 lbs.	59.3	-	46
GAAXRM3678TR-W	265 lbs.	59.3	-	47
GAAXRM3684L-W	285 lbs.	63.7	-	46

WEIGHTS + CUBES

model number	weight	cubes	#locks	page
GAAXRM3684R-W	285 lbs.	63.7	-	47
GAAXRM3684TL-W	284 lbs.	63.7	-	46
GAAXRM3684TR-W	284 lbs.	63.7	-	47
GAAXRR3072L-W	190 lbs.	46.5	-	50
GAAXRR3072R-W	190 lbs.	46.5	-	51
GAAXRR3072TL-W	196 lbs.	46.5	-	50
GAAXRR3072TR-W	196 lbs.	46.5	-	51
GAAXRR3672L-W	215 lbs.	54.9	-	50
GAAXRR3672R-W	215 lbs.	54.9	-	51
GAAXRR3672TL-W	230 lbs.	54.9	-	50
GAAXRR3672TR-W	230 lbs.	54.9	-	51
GAAXRR3678L-W	235 lbs.	59.3	-	50
GAAXRR3678R-W	235 lbs.	59.3	-	51
GAAXRR3678TL-W	242 lbs.	59.3	-	50
GAAXRR3678TR-W	242 lbs.	59.3	-	51
GAAXRR3684L-W	255 lbs.	63.7	-	50
GAAXRR3684R-W	255 lbs.	63.7	-	51
GAAXRR3684TL-W	254 lbs.	63.7	-	50
GAAXRR3684TR-W	254 lbs.	63.7	-	51
GS2CDWSD-W	2 lbs.	13.0	-	154
MDWLBK24	2 lbs.	1.2	-	94
MDWLBK30	2 lbs.	1.2	-	94
SAMAGNET	1 lbs.	0.1	-	150

Gunlocke®

One Gunlocke Drive
Wayland, NY 14572
800 828 6300