

PRICING EFFECTIVE MARCH 2023

SEATING & OCCASIONAL TABLES

Price & Specification Guide

PDF updated April 17, 2023

Gunlocke®

ORDERING OPTION CODES

MAPLE WOOD FINISHES

- A. Natural/Clear Maple 800
- B. Ebony Maple 555
- C. Harvest Maple 856
- D. Beigewood 878
- E. Field Elm 599
- F. Belair 934

*All Finish options are also available with FSC

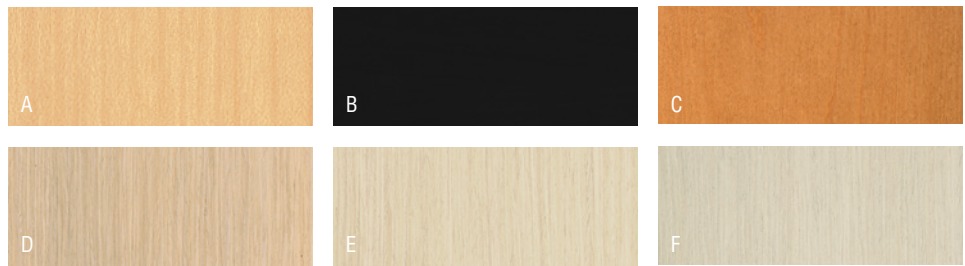

CHERRY WOOD FINISHES

- A. Natural Cherry 222
- B. Light Cherry 701
- C. Cinnamon Cherry 260
- D. Burnished Cherry 777
- E. Medium Red Cherry 512
- F. Lowell Ash 394
- G. Shaker Cherry 774

*All Finish options are also available with FSC



WALNUT WOOD FINISHES

- A. Nutmeg Walnut 629
- B. Light Walnut 601
- C. Sumatra Walnut 693
- D. Skyline Walnut 625
- E. Pinnacle Walnut 679
- F. Florence Walnut 579

*All Finish options are also available with FSC

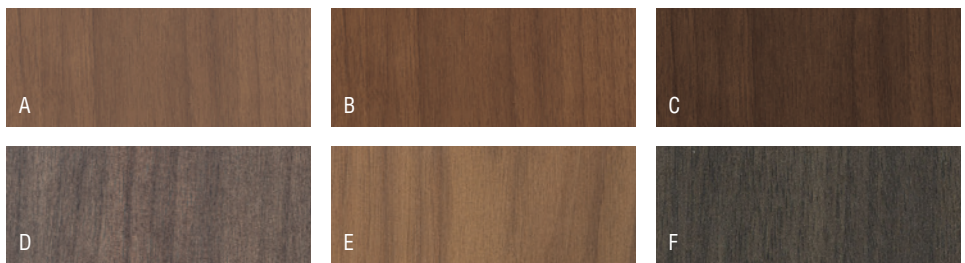

OAK WOOD FINISHES

- A. Natural/Clear Oak 300
- B. Light Rift Oak 301
- C. Dark Rift Oak 331
- D. Phantom Ecru 912
- E. Portico Teak 150
- F. Silver Oak 100
- G. Fawn Cypress 108

*All Finish options are also available with FSC



LAMINATES (AVAILABLE ON LIV SEATING AND CALM OCCASIONAL TABLES)

WOODGRAIN

- | | |
|---------------------|------|
| A. Lowell Ash | LLA1 |
| B. Natural Recon | LNR1 |
| C. Phantom Ecru | LPE1 |
| D. Portico Teak | LPT1 |
| E. Skyline Walnut | LSW1 |
| F. Beigewood | LWBE |
| G. Field Elm | LWFE |
| H. Pinnacle Walnut | PINC |
| I. Fawn Cypress | LFC1 |
| J. Natural Maple | LWD |
| K. Harvest Maple | C |
| L. Shaker Cherry | LW7C |
| M. Biltmore Cherry | COGN |
| N. Florence Walnut | LFW1 |
| O. Kingswood Walnut | LK11 |
| P. NeoWalnut | LNU1 |
| Q. Veranda Teak | LVT1 |

SOLID

- | | |
|-------------------------|------|
| R. Designer White 15051 | LDW1 |
| S. Loft | LM11 |
| T. Flint | LM16 |
| U. Black | P |



PAINT FINISHES

- | | |
|-------------------|-----|
| A. Designer White | PJW |
| B. Chrome | PC |
| C. Silver | PR6 |
| D. Titanium | P8T |
| E. Solar Black | P8X |
| F. Black | P71 |
| G. Pyrite | PJE |
| H. Matte Gold | P8G |
| I. Bullseye | PJF |
| J. Regatta | P8M |

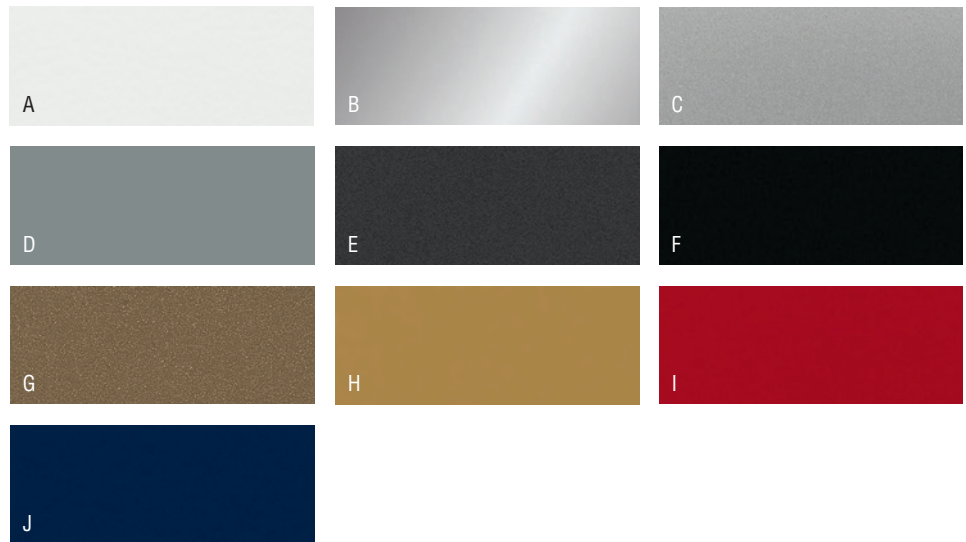

Product Reference
 Products in Numerical Order 2-3
 Abridged Picture Index 4-5

General Information
 GSA Terms And Conditions 6
 Conditions of Sale 7
 Warranty 8
 Shipping Instructions 9

Special Finish and Laser Backs 10

Standard Textile and COM Overview 11-12

COM | COL Guidelines / Ordering 13-14

Cut Yardage | Requirements 15

Flammability | ACT Performance 16

Fabric Matrix 18-21

PRODUCTS

Guest Seating 23-39
 Product Specifications 24-25
 Bank of England™ 26
 Calia 27-28
 Camille 29-30
 Genesee Guest 31-32
 Lily™ 33
 Metta 34-35
 Savor™ 36-37
 Tia™ Guest 38-39

Multipurpose Seating 41-61
 Product Specifications 42
 Convo® Barstool 43-46
 LIV Guest 47-48
 LIV Stool 49-50
 Multi® 51-54
 Multi® Stool 55
 Multi® Bariatric 56-57
 Tia™ Barstool 58-59
 Trillia™ Barstool 60-61

Swivel Seating 63-79
 Swivel Seating Product Specifications 64-67
 Avoca™ 68-69
 Genesee 70-72
 Geneva 73-74
 Olla Executive 75-78
 Washington Series 79

Lounge Seating 81-171
 Product Specifications 82-83
 Calm Lounge Ordering Option Codes 84-85
 Calm 86-104
 Ciji 105-165
 Iris 166-171

Occasional Tables 173-180
 Briefing 174
 Calm 175-177
 Cylinder 178
 Cube 179
 Letchworth 180



PRODUCTS IN NUMERICAL ORDER

Seating
03/23

product	page	product	page	product	page
ACPUNDER-EU Calm	104	GK1105-1W Ciji	109	GK1133 Ciji	163
ACPUNDER-EU-HW Calm	104	GK1105-2A Ciji	118	GK1137 Ciji	163
GABTRT17H2454-WW Letchworth	180	GK1105-2W Ciji	117	GK1139 Ciji	164
GABTRT17H3636-WW Letchworth	180	GK1105-3A Ciji	126	GK1143 Ciji	164
GABTRT17H4242-WW Letchworth	180	GK1105-3W Ciji	125	GK1145R Ciji	164
GABTRT21H2424-WW Letchworth	180	GK1107-1A Ciji	112	GK1155 Ciji	165
GAGB17-198 Calm	104	GK1107-1W Ciji	111	GK1157 Ciji	165
GBGB17-131 Calm	100	GK1107-2A Ciji	120	GK1159 Ciji	165
GBGB17-142 Calm	101	GK1107-2W Ciji	119	GK1161 Ciji	165
GBGB17-153 Calm	102	GK1107-3A Ciji	128	GK1163 Ciji	165
GGCA14-011 Lily	33	GK1107-3W Ciji	127	GK2800 Olla	75
GGCAL17-011 Calia	27	GK1109A Ciji	154	GK2802 Olla	76
GGCAL17-021 Calia	28	GK1109W Ciji	153	GK2804 Olla	75
GGHB17-071 Tia	38	GK1111-1A Ciji	130	GK2806 Olla	76
GGHB17-081 Tia	39	GK1111-1W Ciji	129	GK2808 Olla	77
GGJA14-011 Savor	36	GK1111-2A Ciji	138	GK2810 Olla	78
GGJA14-021 Savor	36	GK1111-2W Ciji	137	GK2812 Olla	77
GGJA14-031 Savor	37	GK1111-3A Ciji	146	GK2814 Olla	78
GGLIV19-011 Liv	47	GK1111-3W Ciji	145	GK3006N Washington	79
GGLIV19-012 Liv	47	GK1113-1A Ciji	132	GK8907 Molti	51
GGLIV19-013 Liv	47	GK1113-1W Ciji	131	GK9901P Molti	52
GGLIV19-014 Liv	47	GK1113-2A Ciji	140	GK9901W Molti	53
GGLIV19-021 Liv	48	GK1113-2W Ciji	139	GK9903N Molti	51
GGLIV19-022 Liv	48	GK1113-3A Ciji	148	GK9905P Molti	54
GGLIV19-023 Liv	48	GK1113-3W Ciji	147	GK9905W Molti	54
GGLIV19-024 Liv	48	GK1115-1A Ciji	134	GK9907N Molti	54
GGLIV19-SVL1 Liv	42	GK1115-1W Ciji	133	GK9923N Molti	55
GGLIV19-SVL2 Liv	42	GK1115-2A Ciji	142	GK9947 BOE	26
GGRA16-111 Genesee	31	GK1115-2W Ciji	141	GK9947US BOE	26
GGRA16-121 Genesee	31	GK1115-3A Ciji	150	GK9961P Molti	56
GGRA16-141 Genesee	32	GK1115-3W Ciji	149	GK9961W Molti	57
GGWA16-011 Metta	34	GK1117-1A Ciji	136	GK21001 Camille	29
GGWA16-021 Metta	35	GK1117-1W Ciji	135	GK21003 Camille	29
GK1101-1A Ciji	106	GK1117-2A Ciji	144	GK21003-021 Camille	30
GK1101-1W Ciji	105	GK1117-2W Ciji	143	GLGB17-011 Calm	86
GK1101-2A Ciji	114	GK1117-3A Ciji	152	GLGB17-021 Calm	87
GK1101-2W Ciji	113	GK1117-3W Ciji	151	GLGB17-031 Calm	88
GK1101-3A Ciji	122	GK1119A Ciji	156	GLGB17-041 Calm	89
GK1101-3W Ciji	121	GK1119W Ciji	155	GLGB17-052 Calm	90
GK1103-1A Ciji	108	GK1121-1A Ciji	158	GLGB17-062 Calm	91
GK1103-1W Ciji	107	GK1121-1W Ciji	157	GLGB17-072 Calm	92
GK1103-2A Ciji	116	GK1121-2A Ciji	160	GLGB17-082 Calm	93
GK1103-2W Ciji	115	GK1121-2W Ciji	159	GLGB17-093 Calm	94
GK1103-3A Ciji	124	GK1121-3A Ciji	162	GLGB17-103 Calm	95
GK1103-3W Ciji	123	GK1121-3W Ciji	161	GLGB17-113 Calm	96
GK1105-1A Ciji	110	GK1131 Ciji	163	GLGB17-123 Calm	97

product	page	product	page	product	page
GLGB17-161 Calm	98	GMQA16-021 Trillia	61	GTGB17-2424H24-S Calm	177
GLGB17-171 Calm	99	GMQA16-041 Trillia	60	GTGB17-2424H24-W Calm	177
GLGB17-181 Calm	103	GMQA16-051 Trillia	61	GTGB17-3225H17-F Calm	175
GLIRS17-011 Iris	166	GMQA16-071 Trillia	60	GTGB17-3225H17-G Calm	175
GLIRS17-021 Iris	167	GMQA16-081 Trillia	61	GTGB17-3225H17-L Calm	175
GLIRS17-031 Iris	166	GNTOCB1824 Tables	179	GTGB17-3225H17-S Calm	175
GLIRS17-041 Iris	168	GNTOCB2420 Tables	179	GTGB17-3225H17-W Calm	175
GLIRS17-051 Iris	169	GNTOCB2424 Tables	179	GTGB17-3232H17-F Calm	175
GLIRS17-061 Iris	170	GNTOCB3616 Tables	179	GTGB17-3232H17-G Calm	175
GLIRS17-071 Iris	169	GNTOCY1820 Tables	178	GTGB17-3232H17-L Calm	175
GLIRS17-081 Iris	171	GNTOCY1824 Tables	178	GTGB17-3232H17-S Calm	175
GM2ETRD18H24-L Briefing	174	GNTOCY2420 Tables	178	GTGB17-3232H17-W Calm	175
GM2ETRD18H24-S Briefing	174	GNTOCY2424 Tables	178	GTGB17-3250H17-F Calm	175
GM2ETRD18H24-W Briefing	174	GNTOCY3616 Tables	178	GTGB17-3250H17-G Calm	175
GM2LTRD18H24-L Briefing	174	GSGNV17-011 Geneva	73	GTGB17-3250H17-L Calm	175
GM2LTRD18H24-S Briefing	174	GSGNV17-031 Geneva	74	GTGB17-3250H17-S Calm	175
GM2LTRD18H24-W Briefing	174	GSGNV17-051 Geneva	73	GTGB17-3250H17-W Calm	175
GM2NTRD18H19-L Briefing	174	GSGNV17-071 Geneva	74		
GM2NTRD18H19-S Briefing	174	GSHA15-011 Avoca	68		
GM2NTRD18H19-W Briefing	174	GSHA15-021 Avoca	68		
GM2NTRD30H15-L Briefing	174	GSHA15-031 Avoca	69		
GM2NTRD30H15-S Briefing	174	GSHA15-041 Avoca	69		
GM2NTRD30H15-W Briefing	174	GSRA16-011 Genesee	70		
GM2NTRS1824H17-L Briefing	174	GSRA16-021 Genesee	70		
GM2NTRS1824H17-S Briefing	174	GSRA16-031 Genesee	71		
GM2NTRS1824H17-W Briefing	174	GSRA16-041 Genesee	71		
GMBTRT17H2454-WW Letchworth	180	GSRA16-051 Genesee	72		
GMBTRT17H3636-WW Letchworth	180	GSRA16-061 Genesee	72		
GMBTRT17H4242-WW Letchworth	180	GTGB17-1218H26-F Calm	177		
GMBTRT21H2424-WW Letchworth	180	GTGB17-1218H26-G Calm	177		
GMBTRT36H2060-WW Letchworth	180	GTGB17-1218H26-L Calm	177		
GMHB17-011 Tia	58	GTGB17-1218H26-S Calm	177		
GMHB17-041 Tia	59	GTGB17-1218H26-W Calm	177		
GMLA15-011 Convo	43	GTGB17-1632H17-F Calm	176		
GMLA15-021 Convo	45	GTGB17-1632H17-G Calm	176		
GMLA15-041 No Match!	44	GTGB17-1632H17-L Calm	176		
GMLA15-051 Convo	46	GTGB17-1632H17-S Calm	176		
GMLIV19-031 Liv	49	GTGB17-1632H17-W Calm	176		
GMLIV19-032 Liv	49	GTGB17-1650H17-F Calm	176		
GMLIV19-033 Liv	49	GTGB17-1650H17-G Calm	176		
GMLIV19-034 Liv	49	GTGB17-1650H17-L Calm	176		
GMLIV19-041 Liv	50	GTGB17-1650H17-S Calm	176		
GMLIV19-042 Liv	50	GTGB17-1650H17-W Calm	176		
GMLIV19-043 Liv	50	GTGB17-2424H24-F Calm	177		
GMLIV19-044 Liv	50	GTGB17-2424H24-G Calm	177		
GMQA16-011 Trillia	60	GTGB17-2424H24-L Calm	177		

GUEST SEATING

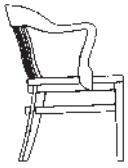

GK9947
Bank of England (pg. 26)

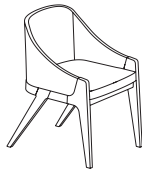

GGCAL17-011
Calia (pg. 27)

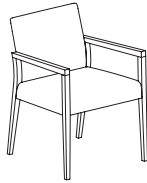

GK21001
Camille (pg. 29)



GGRA16-141
Genesee (pg. 32)

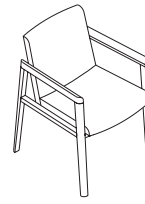

GGCA14-011
Lily (pg. 33)



GGLIV19-023
LIV (pg. 48)



GGWA16-011
Metta (pg. 34)

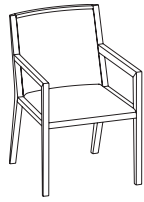

GGJA14-011
Savor (pg. 36)



GGHB17-071
Tia (pg. 38)

MULTIPURPOSE SEATING



GMLA15-011
Convo Barstool
(pg. 43)



GGLIV19-013
LIV Stacker
(pg. 47)



GGLIV19-043
LIV Stool
(pg. 50)



GK9901P
Molti (pg. 52)

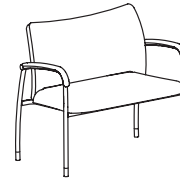

GK9961P
Molti Bariatric
(pg. 56)



GK9923N
Molti Stool (pg. 55)

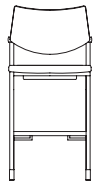

GMHB17-011
Tia Barstool (pg. 58)



GMQA16-011
Trillia Barstool (pg. 60)

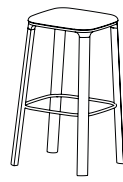

SWIVEL SEATING



GSHA15-031
Avoca (pg. 69)



GSR16-031
Genesee (pg. 71)



GSGNV17-011
Geneva (pg. 73)



GK2800
Olla (pg. 75)



GK3006N
Washington (pg. 79)

LOUNGE SEATING

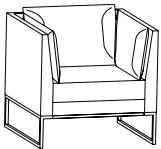

GLGB17-011
Calm (pg. 86)

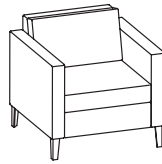

GK1111-1W
Ciji (pg. 129)



GLIRS17-011
Iris (pg. 166)

OCCASIONAL TABLES

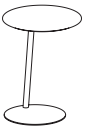

GM2LTRD18H24
Briefing (pg. 174)



GTGB17-3225H17
Calm (pg. 175)



GNTOCY1820
Cylinder (pg. 178)

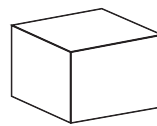

GNTOCB1824
Cube (pg. 179)

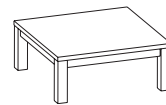

GABTRT21H2424-WW
Letchworth (pg. 180)

1. **Maximum Order Threshold:**
SIN# 33721 \$250,000
2. **Minimum order:** \$2,000 list
3. **Geographic coverage:**
48 contiguous states and DC (CONUS)
4. **Points of production:**
Wayland, NY, Steuben County, USA
Hickory, NC, Catawba County, USA
Muscatine, IA, Muscatine County, USA
5. **Discount Statement: Discount is applied to List Price.**
Structure in List \$:
\$2,000 – \$100,000 list 60.5%
\$100,001 – \$400,000 list 62.7%
\$400,001 – MOT (\$1,428,571 List) 65.0%
Over MOT (\$1,428,572 List) Negotiable
* These discounts apply to single purchase orders, shipping to the same place in the same time period
6. **Quantity Discount:** See above
7. **Payment terms:**
1% 23 days Net 30 days from date of shipment, for product only, for all electronic invoices processed through a Federal payment system, (including, but not limited to, WAWF, IPP, etc.).
All other invoice sales are Net 30 days from date of shipment. Prompt payment terms are not applicable to credit card orders.
8. **Government Credit Cards** are accepted above and below the micro-purchase levels.
Written confirmation and authorized signatures are required. Activities may verbally provide card information, but products shall be confirmed in writing.
Use of credit cards shall be at the time of order placement with cards charged at the time of shipment, see GSAR 552-232-80 (C).
There are no additional discounts for using a credit card.
9. **Foreign items:** None
- 10a. **Time of delivery:** 60 days ARO
- 10b. **Expedited delivery:** Contact Gunlocke
- 10c. **Overnight and 2-day delivery:** Contact Gunlocke
- 10d. **Urgent requirements:** Contact Gunlocke
11. **FOB point(s):** F.O.B. Origin, with freight being paid by Gunlocke for all deliveries within CONUS.
12. **Ordering address(es):**
The Gunlocke Company
c/o Authorized Gunlocke GSA Dealer
One Gunlocke Drive
Wayland, NY 14572
Phone: (800) 828-6300
Fax: (585) 728-8350
13. **Payment address(es):**
The Gunlocke Company LLC
13367 Collections Center Drive
Chicago, IL 60693
14. **Warranty provision:** See warranty on page 8
15. **Export packing charges:**
Write for quotation on export packaging.
16. **Terms and conditions of Government commercial credit card acceptance:** Credit Cards are accepted.
17. **Terms and conditions of rental, maintenance, and repair:**
Not applicable
18. **Terms and conditions of installation:**
Installation services shall be priced at a rate not to exceed 30% of the net product price, per project. The minimum order charge for installation shall be \$175.00. Projects involving extraordinary circumstances which require installation charges exceeding the proposed installation rates will be submitted to the GSA Contracting Officer for review and approval.
19. **Project Management:**
\$65 Per Hour, inclusive of IFF
20. **Reconfiguration and Relocation Services:**
\$65 Per Hour, inclusive of IFF
21. **Design/Layout Services:**
\$65 Per Hour, inclusive of IFF
22. **Terms and conditions of repair:**
Refer to Gunlocke Customer Support
23. **List of service and distribution:** Points: Not applicable
24. **Participating dealers:** A list of participating dealers will be supplied to any government agency upon request or is available on our website at www.gunlocke.com.
25. **Preventative maintenance:**
Not applicable. Instruction sheets available upon request.
26. **Environmental attributes:** Gunlocke has an active environmental program. Please call (800) 828-6300 for details.
27. **Data universal number system:**
(DUNS) number is 19-993-6550
28. **CCR registration/Cage Code:** The Gunlocke Company is registered in the DoD CCR. Cage Code - 26574
29. **Returns:**
No returns of goods will be accepted without written consent and shipping instructions from Gunlocke, and the Government customer will be required to pay all return freight charges. A restocking fee of 30% net will apply on all authorized returns provided Gunlocke receives goods in the condition in which they left the factory. No credit will be given if goods cannot be reused. Special order items are in no event subject to return. Goods must be returned within 70 days of shipment from factory.
30. **Cancellations:** No charge prior to production. After production has begun (5 days ARO), only the actual costs that the contractor can demonstrate will be billed to the customer if the merchandise cannot be resold within a reasonable period of time (90 days).
31. **Inside Delivery:** Gunlocke rates are for dock-to-dock delivery and do not include inside delivery, un-cartoning or set up. If desired, arrangements for inside delivery must be made and approved when the order is placed and will have a corresponding fee of 7% of list price of the order with a minimum charge of \$75. Requests for un-cartoning and set up will be coordinated with a Gunlocke Dealer with applicable charges applied to the order.
32. **Federal Tax ID # 22-3887942**

INTRODUCTION

The Gunlocke Company is dedicated to providing the finest possible products and service. This price list reflects that commitment. Included is a current listing of our seating models.

Casegoods are presented in a separate price lists. Contact your Gunlocke Customer Services Representative for more information. (800) 828-6300

Designed for easy use, each page of this price list provides all information required to order a product correctly. Should additional information be needed, contact your Gunlocke Customer Service representative.

PRICING

Prices shown covers standard products. Any changes or alterations, other than those listed, will be subject to an additional charge. Prices include cartoning and freight. Contact the Gunlocke Tailored Solutions at gunts@gunlocke.com to request custom quotes. Authorization and pricing must be secured in advance for orders or contracts calling for large quantities, indefinite quantities, or extended delivery dates.

ORDERING

Orders submitted electronically will receive priority service and shorter overall lead times. You can submit your orders electronically via traditional EDI (Electronic Data Interchange), by e-commerce at www.gunlockeadvantage.com using your XML and SIF files.

Orders in the amount of \$75,000 list or larger will require a XML or SIF file to be e-mailed to our order entry department at gunlockeoe@gunlocke.com.

Orders under \$75,000 list do not require an XML or SIF file and can be e-mailed to our order entry department at gunlockeoe@gunlocke.com, faxed to 585-728-8350, or mailed to:

The Gunlocke Company
Attn: Order Entry
One Gunlocke Drive
Wayland, New York 14572

ORDER CHANGES

Gunlocke is not required to accept changes in orders after confirmation. Reasonable changes are subject to additional charges for labor, material and administrative costs.

Order changes of acknowledgment may result in re-scheduling of product.

ACKNOWLEDGMENT

Each order will be acknowledged by Gunlocke. Customers should check each acknowledgment for accuracy and immediately notify Gunlocke of any discrepancies.

This printed acknowledgment is the final agreement between The Gunlocke Company and the customer, superseding all previous communications regarding the order.

SPECIFICATION CHANGES

Gunlocke reserves the right to change specifications for the improvement of products at any time, without notice.

RETURNED MERCHANDISE

No merchandise may be returned without prior authorization.

SHOWROOMS

For all showroom locations and tour information, please reference the showrooms page online at: www.gunlocke.com/inspiration/showrooms

CANCELLATIONS

Cancellations of orders cannot be accepted since every order is manufactured according to customer's specifications.

STORAGE

If delivery cannot be made and products are ready, Gunlocke will transfer products to a storage facility of the customers choice and products will be invoiced at this time. The customer is responsible for storage charges as well and assumes and bears all risks associated with the storage of that product.

TERMS

Net 30 days from date of invoice. A service charge of eighteen percent (18%) per year or .0004931 per day, compounded monthly, will be added to balance due beyond the thirtieth day. Products are shipped **FOB factory, freight prepaid and allowed.**

Title passes to purchaser and Gunlocke's responsibility ceases when shipment is accepted for transportation by a carrier. A full explanation of all payment terms is found on order and invoice forms.

12 YEAR WARRANTY

Subject to the limitations set forth below. The Gunlocke Company warrants to the original purchaser all product in this price list to be free from defects in material and workmanship for a twelve year period from the date of shipment.

This **12-year warranty** applies to all products sold and installed by a Gunlocke authorized agent for normal commercial single shift service. Gunlocke will repair, or at its option, replace defective merchandise, free of charge. The following components not manufactured by Gunlocke have the following warranties:

- **High wear components** Such as casters and glides are warranted for five years after date of shipment to original owner.
- **Seating control mechanisms** are warranted for five years after date of shipment to original owner.
- **Fabric and leather** are warranted for three years if single-shift and normal use after shipment to original owner.

Any non-standard material selected by the customer is not warranted. Neither does this warranty apply to damage resulting from accident, alteration, or misuse, as well as damage from normal wear and tear such as dents, nicks, scratches, fading and improper maintenance. That is, Gunlocke's warranty is only valid if products are given proper use and care. Gunlocke assumes no responsibility for product damages resulting from improper installation or user modification.

WOOD FURNITURE

Wood owes its inherent beauty to variations in color, grain, and texture, and therefore, these variations are not considered defects. There may be minor variations from one piece of furniture to the next even though they are finished at the same time. Exposure to light and the aging process will cause a darkening of natural wood products. Light finishes on wood products do not mask the natural characteristics of wood.

The Gunlocke Company does not guarantee the exact matching of grain, pattern, and color. Gunlocke offers 800 a natural maple finish on maple, 222 a natural cherry on maple, 701 a light cherry finish on cherry or maple, 629 nutmeg walnut on walnut or maple, and 601 light walnut on walnut or maple. These finishes do not cover any of the natural characteristics of the wood, including nature's colorations, pitch pockets, and the variations of steambent wood. Merchandise will not be replaced because of these natural variations.

It is expressly understood and agreed that the buyer's sole and exclusive remedy for any and all losses or damages resulting from nonconforming goods, or from any other cause, shall be repair or replacement of defective parts, and that Gunlocke shall not be liable for damages or injury to persons or property, nor for replacement of the entire commercial unit, if repair or replacement of defective parts can reasonably render the unit conforming.

All warranty claims must be submitted in writing by the original owner via our website at <https://apps.gunlockeadvantage.com/QualityFeedback/>.

Owner may be required to produce the invoice or other evidence to establish that a claim is within the warranty period.

As stated and illustrated on the website, serial numbers are required to process a warranty claim. No person, firm, or corporation is authorized to assume for Gunlocke any liability in connection with the sale or installation of Gunlocke products except as stated above.

All other warranties, expressed or implied, are excluded. Gunlocke shall not be liable for incidental or consequential damages of any sort.

*Warranty claims entered at <https://apps.gunlockeadvantage.com/QualityFeedback/>

Within the Continental USA, all orders above \$20,000 list are shipped FOB factory, freight prepaid and allowed. All orders less than \$20,000 list will be subject to a \$200 net freight charge. Products shipped to Alaska and Hawaii FOB factory, freight prepaid and allowed to port of embarkation. Customer is responsible for freight charges from port of embarkation to final destination.

An anticipated shipping date is indicated on the order acknowledgment. Gunlocke cannot accept responsibility for shipping delays caused by outside sources or unforeseen problems. Delay of shipments requested by customers must be approved by Gunlocke. Any resultant storage charges will be charged to the customer.

Gunlocke may await completion of the entire order and ship all at once or may make partial shipments from time to time at its sole discretion unless the customer requests in writing that partial shipments are needed and Gunlocke approves the specific shipping schedule. Additional charges may apply.

Gunlocke is not liable for any delay or failure to deliver or perform due to strikes, lock-outs, or other labor or transportation difficulties, delay of sources or supply, accidents, fires, acts of God, or any other causes of like or unlike nature beyond the control of Gunlocke.

LIABILITY

Gunlocke products and their packaging are tendered to a transportation company only after passing rigid quality control inspection. At that time, title to the product is passed to the purchaser. However the transportation company assumes all liability from acceptance of shipment through its delivery. That is, Gunlocke's liability ceases at the time of shipment.

FILING OF CLAIMS

All claims for damage or loss must be submitted via our website at: <https://apps.gunlockeadvantage.com/QualityFeedback/> within 15 days after receipt of merchandise. Do not return freight damaged merchandise to Gunlocke. Follow the steps below to expedite processing and resolution of claims.

For Visible Damage

1. Make damage notation on delivery receipt and have driver sign. Do not reject or refuse the shipment.
2. Immediately contact Gunlocke Traffic Department at 585-728-8268.
3. Hold damaged carton and all interior packing for carrier's inspection. These materials will be needed to substantiate the claim.

For Concealed Damage

1. Open cartons within 15 days of receipt and inspect.
2. Follow steps 2, and 3 as listed under Visible Damage.
3. Do not remove product from delivered destination.

For Loss

1. Be sure loss notation is made on delivery receipt and have driver sign.
2. Contact Gunlocke Traffic Department at 585-728-8268.

Should transportation company seek to limit its liability on concealed, loss, or damage claims, please contact Gunlocke's traffic department. After a thorough investigation of the claim, the traffic department will provide you with guidance in corresponding with the carrier.

Returned merchandise, regardless of delivery method, will not be accepted unless specifically authorized by Gunlocke.

For Damage or Loss of Parcel Post or UPS Shipment

Notify the Gunlocke traffic department immediately at 585-728-8268.

NORMAL DELIVERY

All normal ground transportation by Gunlocke will be made on a dock-to-dock basis. The Gunlocke traffic department will determine the recommended method of shipment according to the ship to destination. If the delivery on a shipment takes longer than 3 hours to be unloaded, an additional charge will be billed at \$100/hour. Gunlocke reserves the absolute right to determine the method of shipping unless special delivery instructions have been previously approved.

SHIPPING INSTRUCTIONS

Gunlocke will make every effort in honoring delivery requests as stated on orders. However, the Company shall have no liability for failure to deliver, perform or delay in delivery due to any cause outside the control of Gunlocke. The Company assumes no liability for costs incurred due to delayed or late deliveries.

If a guaranteed delivery time is needed please call Gunlocke Traffic Department at 585-728-8268 for a quote as additional charges will apply. Weekend or after hours deliveries are subject to additional charges.

WEEKEND DELIVERY

A \$500 charge will apply on weekend delivery after 3:00 PM Friday through Sunday evenings.

DROP SHIP / JOB SITE DELIVERY

Orders under \$50,000 list will incur a \$125 charge for ship to locations other than a designated dealer warehouse.

INSIDE DELIVERY

Inside delivery must be noted on order. A minimum \$100 charge will apply.

SPECIAL DELIVERY

Please contact the Gunlocke traffic department for special delivery services such as inside delivery, weekend or after hour deliveries, reconsignment or other special needs. These are billable services.

Gunlocke will make every effort in honoring delivery requests as stated on orders. However, the Company shall have no liability for failure to deliver, perform or delay in delivery due to any cause outside the control of Gunlocke. The Company assumes no liability for costs incurred due to delayed or late deliveries.

DOCK RESTRICTIONS

Gunlocke trailers are 53' x 102"; when attached to truck cab the total length is 75'. If delivery dock will not accommodate trucks of this size, the Gunlocke traffic department must be contacted prior to shipping. Alternate arrangements can be made; additional charges may apply.

SPECIAL FINISHES

- Submit a color sample block (minimum size 3" x 3") to Gunlocke Order Entry so that a finish formulation can be developed to match the special finish and color.
- Review the approval sample provided by Gunlocke.
- Written approval and sign off is required for Gunlocke Customer Service.
- Once written approval and sign off is received, the special finish order will be acknowledged.

All seating purchase orders:

- **10% list** upcharge per unit to base model receiving special finish.
- **\$250 net formulation fee** for special finish.

This procedure and cost apply to new and previously formulated special finishes. Special finish orders may receive additional lead time.

FSC OPTION

For FSC Certified Product add "FSC" to beginning of wood finish option code.

Example: FSC260.

Only models that have wood finish option can be ordered as FSC Certified Product.

UPCHARGES

- 5% list upcharge per unit to base model

MULTIPLE FABRICS PRICING

When multiple fabrics per chair are requested, the chair is priced at the highest grade price.

ETCHED AND LASER CUT BACKS

Eligible Models:

All Multi Seating with Wood Backs

Minimum order quantity: 5 Units

There shall be an initial setup fee of **\$250 (NET)** with a **\$100** List up-charge per unit. All standard finishes may be specified with backs. For new designs please submit artwork* to Customer Service for review and approval. Once the artwork is accepted, an actual sample will be produced and sent for approval.

*Please allow 3-5 business days upon receipt of the artwork for the sample to be completed.

All artwork must be clean and sharp image. Gunlocke can only accept mailed original artwork. Artwork must be black and white, bold and have crisp lines to be processed. Contact Order Entry for complete order and approval process. (800) 828-6300.

GUNLOCKE STANDARD TEXTILE OFFERING AND COM PROGRAM OVERVIEW

Customers purchasing Gunlocke seating can choose coverings from the standard fabric/leather offering or fabrics can be specified outside of the Gunlocke standard fabric offering through a simpler, hassle-free COM process.

Standard Fabric/Leather Partnership Program – select from any one of the Gunlocke standard fabrics or leather offerings listed on the website from the following textile partners: HBF, Maharam, Momentum, Ultrafabrics or Camira. For the most current standard fabric and leather offering, please visit the website at www.gunlocke.com.

HBF
TEXTILES

maharam

Ultrafabrics

camira

COM Program – COM coverings can easily be specified and applied your seating products. Gunlocke offers two different processes for the COM program which are outlined below. The Gunlocke To Supply COM process is managed by Gunlocke and Dealer to Supply COM process is managed by the dealer.

- **Gunlocke To Supply (GTS) COM Program** – this is a process for fabrics that are not included in the standard Gunlocke offering. Gunlocke will manage the COM process with the textile supplier and will coordinate with the dealer to approve, grade/price and procure the fabric.

GTS Guidelines:

1. Select the fabric you wish to use and check the Gunlocke COM Tool on www.gunlockeadvantage.com to determine if the fabric you have chosen has already been tested and approved on the product you are interested in. The COM supplier's name, fabric pattern name, and color name will be needed to search for approved fabrics.
 - 2a. If your fabric is listed as an approved fabric, you may place your order directly with Gunlocke Customer Service. Please use the fabric code (e.g., S216426XP) noted in the COM Tool on your order in the place of the standard fabric code.
 - 2b. If the fabric has not previously been tested, you must enter a COM request. Your name, company name and email will be prepopulated fields. The secondary email, project name, and bid/contract number are optional information. However, it's best to include any bid/contract information to ensure the code is set up correctly. The supplier, pattern, and color will show a list by clicking in the box and entering the first letter of the name and these are free form text boxes. Once that information is entered click add. (Multiple series can be added to the same request if they are the same supplier, pattern, and color.) Then click submit. An email will be sent to the to the requestor stating the COM Request was successfully submitted. Up to four emails could be received: Testing materials requested, in testing, and final approval/denial. It's rare actual test yardage is required. Testing is mainly done by reviewing the attributes of the fabric. The testing process takes 24-48 hours.
 3. If approved, the final email will include the GTS fabric option code and price grade. Written COM price quotes hold pricing for 90 days after issue date.
- **Dealer to Supply – COM or COL Program** – this is also a process for fabrics/leathers that are not included in the standard Gunlocke offering. The main difference is that the dealer will manage the COM process themselves and will procure the fabric from textile supplier and send to Gunlocke to upholster on the product.

COM/COL Guidelines:

1. Select the fabric you wish to use and check the Gunlocke COM Tool on www.gunlockeadvantage.com to determine if the fabric you have chosen has already been tested and approved on the product you are interested in. The COM supplier's name, fabric pattern name, and color name will be needed to search for approved fabrics.
2. If your fabric is listed as approved, please reference the upholstery requirements listed in the pricer.
3. If the fabric has not previously been tested, you must enter a COM request. Your name, company name and email will be prepopulated fields. The secondary email, project name, and bid/contract number are optional information. However, it's best to include any bid/contract information to ensure the code is set up correctly. The supplier, pattern, and color will show a list by clicking in the box and entering the first letter of the name and these are free form text boxes. Once that information is entered click add. (Multiple series can be added to the same request if they are the same supplier, pattern, and color.) Then click submit. An email will be sent to the to the requestor stating the COM Request was successfully submitted. Up to four emails could be received: Testing materials requested, in testing, and final approval/denial. It's rare actual test yardage is required. Testing is mainly done by reviewing the attributes of the fabric. The testing process takes 24-48 hours.
4. If approved, the final email will include the Dealer to Supply fabric option code and the COM or COL price grade. Written COM price quotes hold pricing for 90 days after issue date.
5. The dealer is responsible for sending the COM fabric to Gunlocke. Fabric must be marked with "COM – Dealer to Supply", dealer name, order number and seating model #. COM textile should be shipped to the address below the same time as the order submission and reference tracking information on order, to prevent production delays.

HNI Textile Distribution Center - Dealer PO Number
Attn: COM Production Yardage
301 Mulberry Ave.
Dock Doors 20-22
Muscatine, IA 52761
6. All COM "Dealer to Supply" orders will be charged grade 4 pricing. Dealers will pay for the COM fabric separately.
7. All COM fabric must be sent on a fabric roll.
8. Once the COM fabric is received, the order will be scheduled in production and acknowledged with a ship date.

Specific to DTS orders - the customer should send only the amount needed for the order. Fabric should arrive no sooner than 4 weeks in advance of order placement. Excess yardage, or yardage not attached to an order will be disposed of at Gunlocke's discretion.

Any canceled orders are subject to cancellation charges up to the full value of the Gunlocke product canceled. Gunlocke will determine the actual cancellation charge at the time the cancellation is requested.

COM | CUSTOMER'S OWN MATERIAL

1. Gunlocke cannot be held responsible for performance, color accuracy, or weaving of COM materials. All responsibility for COM shipments is between the purchaser and the textile source.
2. Gunlocke assumes no responsibility for the flame retardance of any COM. Customers are solely responsible for making sure that COM shipments comply with all applicable codes and regulations.
3. Gunlocke reserves the right to reject fabrics or leathers we deem unsuitable for upholstery. When this occurs, the customer will be notified in writing with an explanation of the problem. Gunlocke cannot be held responsible for any unsatisfactory results in the application of a COM/COL, and a written release from the customer will be required before the order is processed.
4. Please contact Gunlocke Customer Service if you are planning on having any fabric applied in a non-standard technique. (I.E. using the back side as the face), or have special requirements.
5. Fabric alterations such as laminated backing or fire coding may result in differences in upholstery appearance or stiffness.

YARDAGE REQUIREMENTS

Yardages shown in price list are for non-directional fabric based on 54" wide plain fabric (no repeat pattern). A chart is provided on page 14 to assist in determining the additional COM yardage requirements. Please add the indicated percentage to the yardage shown beside the style number in the price list. This guide will accurately cover most COM orders, but there will be instances due to unusual repeats or designs that additional yardage may be required. **Gunlocke will not be held responsible for any additional COM that may be required. Please contact Customer Service for quotations on fabric requirements.**

SELF-DECK PLATFORMS

Self-covered platforms in COM are available at no upcharge. Allow additional yardage in the following amounts for 54" material:

One seat sofa	1 yd.
Two seat sofa	1.5 yds.
Three seat sofa	2 yds.

FABRIC APPLICATION

Cutting direction is based on the fabric width and the way the fabric is cut from the roll and applied to Gunlocke products. There are two cutting directions: Vertical (cut-right) or Horizontal (railroaded). Gunlocke reserves the right to railroad (or apply the fabric according to the weave) whenever possible to avoid seams in large upholstered areas and/or single cushions units. If a fabric is questionable, a cutting of adequate size allowing full repeats must be sent to Customer Service for approval.

COL | CUSTOMER'S OWN LEATHER

Customer's leather must meet standards set by Gunlocke. All hides must be #1 quality, bear no greater than three defects, and yield a minimum of 45 usable square feet per hide. Imperfections that penetrate the hide, brands, large marks, burns, excessive healed over scars and scratches, and excessive fat wrinkles are considered defects.

COL SPECIFICATIONS

Leather footage requirements listed in the price list refer to usable leather square footage that meet the standards described above. Calf hides must be at least 30 square feet of clean and usable matching hides. When specifying calf hides, add 30% to footage requirements. **Gunlocke will not be held responsible for any additional COL that may be required.**

LEATHER SEAT PUDDLING

Leather is a natural material which has elasticity and will form according to usage. For example as a leather seat "breaks in" (similar to leather shoes) stretching may occur. This is an inherent quality of natural leather and is not considered a defect.

LEATHER LOGOS

Leather is a natural material which has elasticity. The degree of stretching occurring in the upholstery process varies by model and may reduce the visual depth of the logo detail.

EMBROIDERED LOGOS

Certain logo geometry may limit threads per inch on embroidered logos. **Logos on Fabric and Leather have a three year warranty see page 8.**

FOR SAMPLE CONTACT:

gunts@gunlocke.com

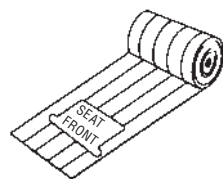

Vertical or Cut-Right

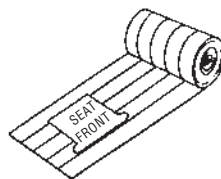

Horizontal or Railroaded

COM | COL ORDERING PROCESS

1. COM material must be approved by Gunlocke for applicability and yardage requirements before acceptance of an order.

Please send large memo sample to COM for approval.

Additional yardage may be required to determine acceptance for upholstery.

2. COM | COL sample must reference the supplier's company name, pattern, color and number order.

3. Application instructions must accompany order. In absence of these instructions, Gunlocke will determine best method of upholstery.

4. All COM | COL must be shipped pre-paid to Gunlocke with package side marked with:

- Dealer Name
- Dealer purchase order number
- Gunlocke seating pattern number

**HNI Textile Distribution Center -
Dealer PO Number
Attn: COM Production Yardage
301 Mulberry Ave.
Dock Doors 20-22
Muscatine, IA 52761**

NOTE

COM and COL orders cannot be scheduled for production or acknowledged as to ship date until COM has been received and approved by Gunlocke. Gunlocke will not warrant application and upholstery technique

PLEASE REFER TO YOUR FABRIC SWATCH CARD FOR HORIZONTAL AND VERTICAL REPEAT REQUIREMENTS.

Fabric Width	Plain Fabric	2"-10" Repeat	11"-20" Repeat	21"-25" Repeat	26"-30" Repeat	31"-37" Repeat	38"-45" Repeat	46"-52" Repeat
54"	0%	10%	15%	20%	25%	30%	35%	40%
52"	15%	20%	25%	30%	35%	40%	45%	50%
50"	25%	30%	35%	40%	45%	50%	55%	60%
48"	35%	40%	45%	50%	55%	60%	65%	70%
45"	45%	50%	55%	60%	65%	70%	75%	80%

Fabric Width	Plain Fabric	2"-10" Repeat	11"-20" Repeat	21"-25" Repeat	26"-30" Repeat	31"-37" Repeat	38"-45" Repeat	46"-52" Repeat
36"	60%	65%	70%	75%	80%	85%	90%	95%

Depending upon the pattern repeat, it may be necessary to cut the fabric vertical (cut-right). This will require 15% additional fabric.

To calculate the correct yardage with repeats (horizontal and vertical), add the horizontal repeat to the vertical repeat for total yardage required.

When calculating repeat, round up to nearest .5 yard.

For example:

A fabric width of 54" with a 8" vertical repeat (requires 10%) + a 20" horizontal repeat (requires 15%) = total additional yardage equals 25%.

Therefore, if the chair requires 2 yards of fabric, multiply 2 by 125% (or 2 x 1.25). Then 2.5 yards will be yardage required.

CUT YARDAGE PROGRAM

All Gunlocke Branded textiles and leathers are available on a cut yardage basis.

PRICING

For pricing information, please contact customer support at guncks@gunlocke.com or call 800-828-6300. Please have fabric pattern and color available. Pricing provided will not include shipping charges, storage or insurance charges, sales and other taxes.

ORDERING

Order all fabrics by name and pattern number. All cut-yardage orders will be cut and shipped to the nearest one-eighth yard. Minimum order quantity is one yard. Leathers are sold by the square foot to the closest whole or half hide. When an exact match is necessary, please submit a cutting with order; slight variations in shade cannot be avoided.

ACKNOWLEDGMENT

All orders will be confirmed by Gunlocke in writing. The order acknowledgment is the final expression of the agreement between the customer and Gunlocke and supersedes all prior verbal and written statements regarding the order. The acknowledgment can be modified only in writing with reconfirmation signed by Gunlocke.

CANCELLATIONS

Orders may not be canceled or returned by the customer without the written consent of The Gunlocke Company and are subject to a cancellation or restocking charge of 35% of the total amount of the order.

CREDIT TERMS FOR CUT YARDAGE PROGRAM

Credit may be established upon Gunlocke's written acceptance of satisfactory references. Gunlocke may cancel or change credit terms at its discretion and may request advance payment at any time. All prepaid orders must include shipping and handling charges and tax where applicable. If local taxes are not applied on prepaid orders, customer must complete a resale certificate indicating their tax I.D. number.

**FLAMMABILITY GUIDELINES
UPHOLSTERY COVERS**

Gunlocke makes every effort to ship high quality product, free of defects in material and workmanship. Great care is taken in selecting only first quality upholstery materials from reputable suppliers.

Upholstery material is warranted for 3 years against unusual wear or deterioration; there is no warranty against fading, normal wear, or customer-induced cuts and tears.

Leather is a natural material. There may be minor variation in markings such as growth wrinkles, healed scars, and grain patterns. Also, subtle variations in the tanning and dyeing process can be seen from one hide to another.

Combinations of Upholstery Covers

Contact Tailored Solutions (gunts@gunlocke.com) for assistance with pricing of fabric, vinyl, leather or upholstery combinations.

SPECIAL TREATMENT/ FLAMMABILITY

Technical Bulletin #133 is a flammability regulation that may be required or requested for certain areas or applications. Most standard Gunlocke fabrics, when used in combination with proper components, can meet the requirements of the composite test for California technical bulletin #133. The composite test requires the use of a full-scale mock-up/sample that in all respects (including fabrics, filling materials, combustible decorative parts and furniture style) reflects the construction of the actual furniture required for a specific area or application.

While Gunlocke has tested several model/upholstery combinations for TB133, not all possible combinations have been tested or certified. Please contact Customer Service to determine if the specific model/upholstery combination you are working with has been tested or if a new test is required. In addition, all COM fabrics must be evaluated on an individual basis and may also require testing. Testing is available as follows:

Specific model & upholstery

- Fire barrier is available as a special treatment. If required, please contact Gunlocke Tailored Solutions to quote as a special: gunts@gunlocke.com.
- Please check with Customer Service to verify testing has been completed with your model and fabric selection.
- Cost of testing a chair is \$850 NET, plus the cost of chair and fabric.
- Additional lead-time for testing for CAL 133.
- Additional lead-time for fire barrier cloth is 3-4 weeks.

*Note that specification of the fire barrier cloth does not in itself provide certification. Testing must be completed and pass for the specific model/upholstery combination to obtain a certificate. Once testing is completed, Gunlocke will provide a certification letter specific to the sample tested for CAL 133.

Special Flammability Code Requirements

Please inquire for pricing and lead time.

ACT PERFORMANCE GUIDELINES

Explanation of ACT Icons

All Gunlocke fabrics conform to the Association of Contract Fabrics Guidelines.

FIRE RETARDANCY

 Flammability testing determines a fabric's resistance to burning.

Application	Passes
Upholstery	California 117-2013
Panels and Upholstered Walls	ASTM E 84 (unadhered method)

COLORFASTNESS TO WET AND DRY CROCKING

 Colorfastness to wet and dry crocking refers to the rubbing off of color from the fabric onto clothing, hands or other materials and can occur under wet or dry conditions.

Application	Passes
Upholstery AATCC 8-1974	Dry Crocking, Class 4 minimum Wet Crocking, Class 3 minimum
Panels and Upholstered Walls	AATCC 8-1974 Class 3 minimum

COLORFASTNESS TO LIGHT

 Colorfastness to light is the degree to which fabric will retain its color when exposed to light.

Application	Passes
Upholstery	AATCC 16-A-1974 or AATCC 16-E-1976 Class 4 minimum at 40 hours
Panels and Upholstered Walls	AATCC 16-A-1974 or AATCC 16-E-1976 Class 4 minimum at 40 hours

PHYSICAL PROPERTIES

 Three physical property tests include: brush pill test to determine a fabric's pilling. Breaking/tensile strength is the ability of a fabric to withstand tension without breaking or tearing. Seam slippage is the pulling apart of fabrics at the seams.

Application	Passes
Upholstery	Brush pill ASTM D3511, 3-4 minimum Breaking strength ASTM DF-D1682-64 (1975) 50 lbs. minimum in warp and weft Seam slippage ASTM D3597-D434-75 25 lbs. minimum in warp and weft

ABRASION

 Abrasion is the ability of a fabric to withstand damage from wear and rubbing. There is a general contract specification as well as a heavy duty specification.

Application	Passes
General Contract Upholstery	ASTM 3597 modified #10 cotton duck) 15,000 double rubs Wyzenbeek Method
Heavy Duty Upholstery	ASTM 3597 modified (#10 cotton duck) 30,000 double rubs Wyzenbeek method or ASTM D4966 (with 21 oz.weight) 40,000 rubs Martindale method

FABRIC MATRIX

Seating
03/23

FABRIC TABLES
Silea Tackboards

• Available upholstery option
RR: railroaded, F/FR: Fire compliant model

Supplier	Pattern Name	Pattern Code	New Grade	FABRIC TABLES Silea Tackboards						
				Tack	Tack A	Tack B	Tack C	Tack D	Tack E	Tack F
HBF Textiles	Blink	1048	4							
HBF Textiles	Look-See	1044	4							
HBF Textiles	Walkabout	1046	4							
HBF Textiles	Against the Grain	SHBFAGG	5	•			•	•	•	
HBF Textiles	Caddy Corner	1016	5							
HBF Textiles	Checkmate	1043	5							
HBF Textiles	Pebbled	SHBFPEB	5							
HBF Textiles	Picnic Plaid	1029	5							
HBF Textiles	Upbeat	1036	5							
HBF Textiles	Zippy	1045	5							
HBF Textiles	Poppy	1047	6							
HBF Textiles	Crew Cut	SHBFCRW	7	•			•	•	•	
HBF Textiles	Happy Camper	1028	7							
HBF Textiles	Honest	SHBFHON	7							
HBF Textiles	Roundabout	1005	7							
HBF Textiles	Dashing	1008	8							
HBF Textiles	Fourfold	SHBFFOU	8	•			•	•	•	
HBF Textiles	Modern Tweed	SHBFMOD	8							
HBF Textiles	Sherpa	1031	8							
HBF Textiles	All Terrain	1027	9							
HBF Textiles	Comfort Zone	905	9							
HBF Textiles	Crafted Felt	1017	9							
HBF Textiles	Curtain Wall	1023	9							
HBF Textiles	Madam Dottie	1001	9							
HBF Textiles	Scribble XS	982	9							
HBF Textiles	Uptown	1039	9							
HBF Textiles	Wabi Sabi	SHBFWAB	9							
HBF Textiles	Color Code	998	10							
HBF Textiles	Digital Bloom 2.0	1050	10							
HBF Textiles	Equation	SHBFEQU	10	•			•	•	•	
HBF Textiles	Folded Lines	973	10							
HBF Textiles	Remember	SHBFREM	10							
HBF Textiles	Roy's Cords	1025	10							
HBF Textiles	Soft Angles 2.0	1051	10							
HBF Textiles	Upscale	1040	10							
HBF Textiles	Air Mail	1006	11							
HBF Textiles	Argyle Boucle	978	11							
HBF Textiles	Brushed Canvas	SHBFBCV	11							
HBF Textiles	Cloud	SHBFCLD	11							
HBF Textiles	Complex	964	12							
HBF Textiles	Abito	SHBFABI	12							
HBF Textiles	Beetle	SHBFABI	12	•			•	•	•	
HBF Textiles	Belgian Meadow	SHBFBLM	12	•			•	•	•	
HBF Textiles	Crosstweed	991	12							
HBF Textiles	Cutout	SHBFCUT	12							
HBF Textiles	Dot Grid	975	12							
HBF Textiles	Dot Structure	SHBFDOT	12							
HBF Textiles	Glint	SHBFGLT	12	•			•	•	•	
HBF Textiles	Grateful Grid	1015	12							
HBF Textiles	Heartfelt	SHBFHTF	12	•	•	•	•	•	•	•
HBF Textiles	Lava Rock	993	12							
HBF Textiles	Merci Boucle	SHBFMER	12							
HBF Textiles	Moving Blanket	SHBFMOV	12							
HBF Textiles	Sable Island	SHBFSAB	12							

FABRIC TABLES
Silea Tackboards

• Available upholstery option
RR: railroaded, F/FR: Fire compliant model

Supplier	Pattern Name	Pattern Code	New Grade	Tackboard Options						
				Tack	Tack A	Tack B	Tack C	Tack D	Tack E	Tack F
HBF Textiles	Sir Stripe A Lot	1004	12							
HBF Textiles	Sweater Weather	1030	12							
HBF Textiles	Twist	SHBFTWS	12							
HBF Textiles	Upstart	1042	12							
HBF Textiles	Cherished Knit	954	13							
HBF Textiles	Enriched Boucle	1021	13							
HBF Textiles	Foundation	SHBFFND	13							
HBF Textiles	Moving Forward	1014	13							
HBF Textiles	Night Earth	1013	13							
HBF Textiles	Pepper Blend	995	13							
HBF Textiles	Quill	1011	13							
HBF Textiles	Scribble XL	983	13							
HBF Textiles	Sister Solid	1003	13							
HBF Textiles	Afghan	SHBFAFG	14	•	•	•	•	•	•	•
HBF Textiles	Smart	SHBFSMT	14							
HBF Textiles	Velvet Mix	977	14							
HBF Textiles	Hipster	SHBFHPT	15	•			•	•	•	
HBF Textiles	Landscape Blur	1024	15							
HBF Textiles	Poodle	1009	16							
HBF Textiles	Sweater	SHBFSWE	16							
HBF Textiles	Woven Memory	1019	16							
HBF Textiles	Crafted Cloud	1018	19							
HBF Textiles	Knitwork	SHBFKNI	21							
HBF Textiles	Bunny	1012	23							
HBF Textiles	Eccentric	966	23							
HBF Textiles	Eccentric	SHBFECC	23							
HBF Textiles	Wild West	717	L2							
HBF Textiles	Aviator	K08	L3							
HBF Textiles	Freeway	K03	L3							
HBF Textiles	Modern Patina	716	L3							
HBF Textiles	Persuede	718	L3							
HBF Textiles	Vivace II	K07	L3							
HBF Textiles	Upper Crust	K05	L5							
HBF Textiles	Voyage	K09	L5							

FABRIC MATRIX

FABRIC TABLES

• Available upholstery option

RR: railroaded, F/FR: Fire compliant model

Supplier	Pattern Name	Pattern Code	New Grade	FABRIC TABLES							Callia
				Liv	Iris	Swivel 2	Lounge 2	Side 1	Side 2		
HBF Textiles	Taylor	TAY	2		•	•	•	•	•	•	
HBF Textiles	Blink	1048	4			•	•	•	•	•	
HBF Textiles	Look-See	1044	4	•	•	•	•	•	•	•	
HBF Textiles	Walkabout	1046	4	•	•	•	•	•	•	•	
HBF Textiles	Against the Grain	SHBFAGG	5	•	•	•	•	•	•	•	
HBF Textiles	Caddy Corner	1016	5	•	•	•	•	•	•	•	
HBF Textiles	Checkmate	1043	5	•	•	•	•	•	•	•	
HBF Textiles	Pebbled	SHBFPEB	5	•	•	•	•	•	•	•	
HBF Textiles	Picnic Plaid	1029	5	•	•	•	•	•	•	•	
HBF Textiles	Upbeat	1036	5	•	•	•	•	•	•	•	
HBF Textiles	Zippy	1045	5	•	•	•	•	•	•	•	
HBF Textiles	Poppy	1047	6	•	•	•	•	•	•	•	
HBF Textiles	Crew Cut	SHBFCRW	7	•	•	•	•	•	•	•	
HBF Textiles	Happy Camper	1028	7	•	•	•	•	•	•	•	
HBF Textiles	Honest	SHBFHON	7	•	•	•	•	•	•	•	
HBF Textiles	Roundabout	1005	7	•	•	•	•	•	•	•	
HBF Textiles	Dashing	1008	8	•	•	•	•	•	•	•	
HBF Textiles	Fourfold	SHBFFOU	8	•	•	•	•	•	•	•	
HBF Textiles	Modern Tweed	SHBFMOD	8	•	•	•	•	•	•	•	
HBF Textiles	Sherpa	1031	8	•	•	•	•	•	•	•	
HBF Textiles	All Terrain	1027	9	•	•	•	•	•	•	•	
HBF Textiles	Comfort Zone	905	9	•	•	•	•	•	•	•	
HBF Textiles	Crafted Felt	1017	9	•	•	•	•	•	•	•	
HBF Textiles	Curtain Wall	1023	9	•	•	•	•	•	•	•	
HBF Textiles	Madam Dottie	1001	9	•	•	•	•	•	•	•	
HBF Textiles	Scribble XS	982	9	•	•	•	•	•	•	•	
HBF Textiles	Uptown	1039	9	•	•	•	•	•	•	•	
HBF Textiles	Wabi Sabi	SHBFWAB	9	•	•	•	•	•	•	•	
HBF Textiles	Color Code	998	10	•	•	•	•	•	•	•	
HBF Textiles	Digital Bloom 2.0	1050	10	•	•	•	•	•	•	•	
HBF Textiles	Equation	SHBFEQU	10	•	•	•	•	•	•	•	
HBF Textiles	Folded Lines	973	10	•	•	•	•	•	•	•	
HBF Textiles	Remember	SHBFREM	10	•	•	•	•	•	•	•	
HBF Textiles	Roy's Cords	1025	10	•	•	•	•	•	•	•	
HBF Textiles	Soft Angles 2.0	1051	10	•	•	•	•	•	•	•	
HBF Textiles	Upscale	1040	10	•	•	•	•	•	•	•	
HBF Textiles	Air Mail	1006	11	•	•	•	•	•	•	•	
HBF Textiles	Argyle Boucle	978	11	•	•	•	•	•	•	•	
HBF Textiles	Brushed Canvas	SHBFBCV	11	•	•	•	•	•	•	•	
HBF Textiles	Cloud	SHBFCLD	11	•	•	•	•	•	•	•	
HBF Textiles	Complex	964	12	•	•	•	•	•	•	•	
HBF Textiles	Abito	SHBFABI	12	•	•	•	•	•	•	•	
HBF Textiles	Beetle	SHBFABI	12	•	•	•	•	•	•	•	
HBF Textiles	Belgian Meadow	SHBFBLM	12	•	•	•	•	•	•	•	
HBF Textiles	Crosstweed	991	12	•	•	•	•	•	•	•	
HBF Textiles	Cutout	SHBFCUT	12	•	•	•	•	•	•	•	
HBF Textiles	Dot Grid	975	12	•	•	•	•	•	•	•	
HBF Textiles	Dot Structure	SHBFDOT	12	•	•	•	•	•	•	•	
HBF Textiles	Glint	SHBFGLT	12	•	•	•	•	•	•	•	
HBF Textiles	Grateful Grid	1015	12	•	•	•	•	•	•	•	
HBF Textiles	Heartfelt	SHBFHTF	12	•	•	•	•	•	•	•	
HBF Textiles	Lava Rock	993	12	•	•	•	•	•	•	•	
HBF Textiles	Merci Boucle	SHBFMER	12	•	•	•	•	•	•	•	
HBF Textiles	Moving Blanket	SHBFMOV	12	•	•	•	•	•	•	•	

FABRIC TABLES

- Available upholstery option
- RR: railroaded, F/FR: Fire compliant model

				Liv	Iris	Avoca, Genesee, Geneva	Olla, Washington	Cilji, Motti Lounge, Calm	Savor	Bank of England, Camille, Convo, Lili, Meta, Motti, Motti Bariatric, Trillia, Side Tandem, Motti Stool, Tia Stool, Silea, Ped Cushions	Callia
Supplier	Pattern Name	Pattern Code	New Grade	Liv	Iris	Swivel 2	Lounge 2	Side 1	Side 2	Callia	
HBF Textiles	Sable Island	SHBFSAB	12	•		•	•	•	•		
HBF Textiles	Sir Stripe A Lot	1004	12	•		•	•	•	•		
HBF Textiles	Sweater Weather	1030	12	•	•	•	•	•	•	•	
HBF Textiles	Twist	SHBFTWS	12		•	•	•	•	•	•	
HBF Textiles	Upstart	1042	12	•	•	•	•	•	•	•	
HBF Textiles	Cherished Knit	954	13	•	•	•	•	•	•	•	
HBF Textiles	Enriched Boucle	1021	13	•	•	•	•	•	•	•	
HBF Textiles	Foundation	SHBFFND	13			•	•		•		
HBF Textiles	Moving Forward	1014	13	•	•	•	•	•	•	•	
HBF Textiles	Night Earth	1013	13	•	•	•	•	•	•	•	
HBF Textiles	Pepper Blend	995	13	•	•	•	•	•	•	•	
HBF Textiles	Quill	1011	13	•	•	•	•	•	•	•	
HBF Textiles	Scribble XL	983	13	•		•	•	•	•		
HBF Textiles	Sister Solid	1003	13	•	•	•	•	•	•	•	
HBF Textiles	Afghan	SHBFAFG	14			•	•	•	•	•	
HBF Textiles	Smart	SHBFSMT	14			•	•	•	•		
HBF Textiles	Velvet Mix	977	14	•		•	•	•	•	•	
HBF Textiles	Hipster	SHBFHPT	15	•	•	•	•	•	•	•	
HBF Textiles	Landscape Blur	1024	15	•		•	•	•	•		
HBF Textiles	Poodle	1009	16	•	•	•	•	•	•	•	
HBF Textiles	Sweater	SHBFSWE	16			•	•	•	•	•	
HBF Textiles	Woven Memory	1019	16	•		•	•	•	•	•	
HBF Textiles	Crafted Cloud	1018	19			•	•	•	•	•	
HBF Textiles	Knitwork	SHBFKNI	21		•	•	•	•	•	•	
HBF Textiles	Bunny	1012	23		•	•	•	•	•	•	
HBF Textiles	Eccentric	966	23		•	•	•	•	•	•	
HBF Textiles	Eccentric	SHBFEC	23								
HBF Textiles	Wild West	717	L2	•		•	•	•	•		
HBF Textiles	Aviator	K08	L3	•	•	•	•	•	•	•	
HBF Textiles	Freeway	K03	L3	•	•	•	•	•	•	•	
HBF Textiles	Modern Patina	716	L3	•		•	•	•	•		
HBF Textiles	Persuede	718	L3	•		•	•	•	•		
HBF Textiles	Vivace II	K07	L3	•	•	•	•	•	•	•	
HBF Textiles	Upper Crust	K05	L5		•	•	•	•	•	•	
HBF Textiles	Voyage	K09	L5	•	•	•	•	•	•	•	

Guest Seating 23-39
 Product Specifications 24-25
 Bank of England™ 26
 Calia 27-28
 Camille 29-30
 Genesee Guest 31-32
 Lily™ 33
 Metta 34-35
 Savor™ 36-37
 Tia™ Guest 38-39

GUEST SEATING

Product Specifications

BANK OF ENGLAND™

Frame:

Construction: Hardwood frame joined by double dowels, corner blocks.

Available hardwoods: Maple

Seat: Foam filled over sheet webbed frame, upholstered.

Back: Steambent hardwood back.

Arm: Steambent hardwood arms.

Glides: Nickel-plated steel.

BIFMA Rating:

Chairs: ANSI/BIFMA X5.1 2011
(253lb Weight Rating)

CALIA

Frame:

Construction: Hardwood frame joined by mortise and tenon, corner blocks. Steambent back rail

Available hardwoods: Maple, Ash

Seat: Foam filled over sheet-webbed seat foundation, upholstered.

Back: High resiliency foam overmolded onto rigid urethane bucket, wrapped in 1/2" foam on inside back.

Glides: Nickel-plated steel

BIFMA Rating:

ANSI/BIFMA X5.1 2017
(275lb Weight Rating)

CAMILLE

Frame:

Construction: Hardwood frame joined by double dowels, mortise and tenon, and corner blocks.

Available hardwoods: Maple

Seat: Foam filled over strip-webbed seat foundation, upholstered.

Back: Foam filled over flexible foundation, upholstered.

Glides: Nickel-plated steel.

BIFMA Rating:

ANSI/BIFMA X5.1 2017
(275lb Weight Rating)

GENESEE

Seat: High resiliency foam overmolded onto rigid urethane bucket, wrapped in 1/2" foam with additional 1/2" high resiliency foam topper.

Back: High resiliency foam overmolded onto rigid urethane bucket, wrapped in 1/2" foam.

Arm:

Polished aluminum: Polished cast aluminum.

Control:

Swivel tilt: Swivel tilt with tilt lockout, polished low-profile control.

Base: Four star, die cast polished aluminum.

Glides: 1 3/4" nylon cap glides.

Upholstery: Top-stitch around edges of bucket.

BIFMA Rating:

ANSI/BIFMA X5.1 2017
(300lb Weight Rating)

LILY™

Frame:

Construction: Hardwood frame joined by mortise and tenon, corner blocks.

Available hardwoods: Maple, Ash

Seat: Foam filled over sheet webbed vent plywood foundation, upholstered.

Back: Foam filled over strip-webbed seat foundation, upholstered.

Glides: Nickel-plated steel.

BIFMA Rating:

ANSI/BIFMA X5.1 2011
(253lb Weight Rating)

METTA

Frame: 3/4" polished chrome steel tubing, with 1/2" solid rod cross members.

Seat & Back:

Fully Upholstered: Rigid fiberglass reinforced urethane with overmolded foam, wrapped in 1/4" dacron. 1/4" upholstery grade plywood outer.

Wood Outers: Rigid fiberglass reinforced urethane with overmolded foam, wrapped in 1/4" dacron. 1/4" qtr cut or rift cut plywood outer.

Arm Cap: 13" flexible vinyl molded piece, undermounted with double-sided tape. Wrapped in J" high density foam.

Glides: Push-fit low density polyethylene; heavy-duty round plastic inserts

Shipping: Product ships 1 to a box. Does not stack.

BIFMA Rating:

ANSI/BIFMA X5.1 2011
(253lb Weight Rating)

SAVOR™

Frame:

Construction: Steambent back posts, hardwood frame joined by mortise and tenon, corner blocks.

Available hardwoods: Maple, Ash

Seat: Foam filled over sheet-webbed plywood seat foundation, upholstered.

Back: Foam filled over strip-webbed seat foundation, upholstered.

Glides: Nickel-plated steel.

BIFMA Rating:

ANSI/BIFMA X5.1 2017
(275lb Weight Rating)

TIA™ GUEST

Frame:

Construction: Hardwood frame joined by mortise and tenon, and corner blocks.

Available hardwoods: Maple, Ash

Seat & Back: ¹³/₁₆" thick plywood bucket, consisting of 13 cross-plyies of ¹/₁₆" thick #3 grade southern hardwood.

Glides: Nickel-plated steel.

BIFMA Rating:

ANSI/BIFMA X5.1 2017
(275lb Weight Rating)

model number	fabric grades								dimensions	W	D	H
GK9947US Arm, upholstered seat	1	5,267	10	5,414	19	5,603	L1	5,423	Overall	23 1/2"	22 3/4"	31 3/8"
	2	5,281	11	5,431	20	5,625	L2	5,560	Seat		16 3/4"	17 3/8"
	3	5,294	12	5,448	21	5,648	L3	5,724	Arm			27 3/4"
	COM/4	5,307	13	5,470	22	5,670	L4	5,860	Between arms	19"		
	5	5,325	14	5,493	23	5,713	L5	5,997	Upholstery Requirements: GK9947US			
	6	5,343	15	5,515	24	5,758			Fabric yards		0.7	
	7	5,360	16	5,537	25	5,802			Leather feet ²		11.9	
	8	5,378	17	5,559	26	5,846			Shipping weight		32 lbs.	
	9	5,396	18	5,581	27	5,890			Cube		13.9	
	GK9947 Wood seat	5,084 All Wood										

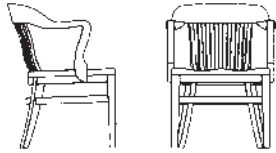

TO ORDER PLEASE SPECIFY THE FOLLOWING:

<input type="text"/>	<input type="text"/>	<input type="text"/>	<input type="text"/>
MODEL NUMBER	FINISH	FLAMMABILITY RATING	UPHOLSTERY (model GK9947US only)
	Cherry finishes on Maple Walnut finishes on Maple Maple finishes on Maple Oak finishes on Maple Please refer to the Bank of England™ product page on www.gunlocke.com for standard finish options.	U CTB117	Please refer to list of available upholstery and leather selections on www.gunlocke.com

Example

GK9947US.215.U.DOL728			
GK9947US	215	U	DOL728
MODEL NUMBER	FINISH	FLAMMABILITY	UPHOLSTERY

model number	fabric grades								dimensions	W	D	H
GGCAL17-011 Single Upholstery	1	2,831	10	3,332	19	3,983	L1	3,366	Overall	21"	24"	31 3/8"
	2	2,877	11	3,392	20	4,058	L2	3,834	Seat	19"	18 3/8"	18"
	3	2,922	12	3,453	21	4,134	L3	4,396	Upholstery Requirements: GGCAL17-011			
	COM/4	2,968	13	3,528	22	4,209	L4	4,863	Fabric yards	2.4		
	5	3,029	14	3,604	23	4,361	L5	5,332	Leather feet ²	40.8		
	6	3,089	15	3,680	24	4,512			Shipping weight	27 lbs.		
	7	3,150	16	3,756	25	4,664			Cube	13.2		
	8	3,210	17	3,831	26	4,815						
	9	3,271	18	3,907	27	4,967						

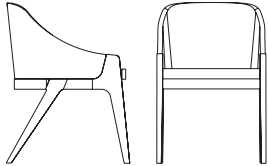

TO ORDER PLEASE SPECIFY THE FOLLOWING:

<input type="text"/>	<input type="text"/>	<input type="text"/>	<input type="text"/>
MODEL NUMBER	SPECIES & FINISH	FLAMMABILITY RATING	UPHOLSTERY

These seating models are available in the following hardwoods:

Maple **NE**
Ash **QA**

Please refer to the Calia product page on www.gunlocke.com for standard finish options.

Cherry finishes on Maple or Ash
Maple finishes on Maple or Ash
Walnut finishes on Maple or Ash
Oak finishes on Maple or Ash

Natural Cherry 222, Natural Maple 800, Honey Maple 873 and Natural Oak 300 not available on Ash.

U CTB117

Please refer to list of available upholstery and leather selections on www.gunlocke.com

Example

GGCAL17-011.NE.U.DOL728

GGCAL17-011	NE	U	DOL728
MODEL NUMBER	SPECIES & FINISH	FLAMMABILITY	UPHOLSTERY

CALIA

Guest | Dual Upholstery

Seating
03/23

model number	fabric grades						dimensions	W	D	H		
GGCAL17-021 Dual upholstery	1	2,881	10	3,445	19	4,177	L1	3,483	Overall	21"	24"	31 3/8"
	2	2,933	11	3,512	20	4,262	L2	4,009	Seat	19"	18 3/8"	18"
	3	2,985	12	3,581	21	4,347	L3	4,641	Upholstery Requirements: GGCAL17-021			
	COM/4	3,036	13	3,665	22	4,433	L4	5,168	Dual Upholstery			
	5	3,103	14	3,751	23	4,603	L5	5,696	Fabric yards	Inner 1.7	Outer 1.0	
	6	3,171	15	3,836	24	4,773			Leather feet ²	Inner 28.9	Outer 17.0	
	7	3,240	16	3,920	25	4,945			Shipping weight			27 lbs.
	8	3,309	17	4,007	26	5,114			Cube			13.2
	9	3,376	18	4,091	27	5,284						

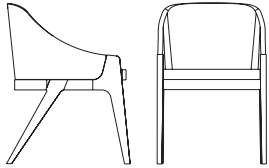

Inner	1	10	355	19	816	L1	379	
	2	33	11	397	20	869	L2	710
	3	65	12	441	21	923	L3	1,108
	COM/4	98	13	494	22	977	L4	1,440
	5	140	14	548	23	1,084	L5	1,772
	6	183	15	601	24	1,191		
	7	226	16	654	25	1,299		
	8	269	17	709	26	1,406		
	9	311	18	762	27	1,513		

Top row of pricing is for units specified with same fabric on Seat and Back. Bottom two rows of pricing required only when two different fabric grades are selected for the Seat and Back.

To calculate price of chair with different grade fabric for Seat and Back; start with Grade 1 price, add appropriate grade price located in second row for Seat, and last add appropriate grade price located in third row for Back to the sum of the Grade 1 and Seat price.

Example: Grade 1 \$2,881 + grade 4 fabric seat \$98 + grade 2 fabric back \$19 = \$2,998

Outer	1	10	209	19	480	L1	223	
	2	19	11	234	20	512	L2	418
	3	39	12	259	21	543	L3	652
	COM/4	57	13	290	22	575	L4	847
	5	82	14	322	23	638	L5	1,043
	6	107	15	354	24	701		
	7	133	16	385	25	765		
	8	159	17	417	26	827		
	9	184	18	448	27	890		

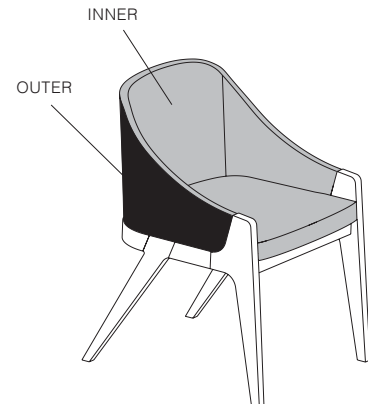

TO ORDER PLEASE SPECIFY THE FOLLOWING:

<input type="text"/>	<input type="text"/>	<input type="text"/>	<input type="text"/>	<input type="text"/>
MODEL NUMBER	SPECIES & FINISH	FLAMMABILITY RATING	INNER UPHOLSTERY	OUTER UPHOLSTERY

These seating models are available in the following hardwoods:

Maple NE
Ash QA

Please refer to the Calia product page on www.gunlocke.com for standard finish options.

Cherry finishes on Maple or Ash
Maple finishes on Maple or Ash
Walnut finishes on Maple or Ash
Oak finishes on Maple or Ash

Natural Cherry 222, Natural Maple 800, Honey Maple 873 and Natural Oak 300 not available on Ash.

U CTB117

Please refer to list of available upholstery and leather selections on www.gunlocke.com

Please refer to list of available upholstery and leather selections on www.gunlocke.com

Example

GGCAL17-021.U.DOL728.DOL728

GGCAL17-021	NE	U	DOL728	SPNN04
MODEL NUMBER	SPECIES & FINISH	FLAMMABILITY UPHOLSTERY	INNER UPHOLSTERY	OUTER UPHOLSTERY

model number	fabric grades								dimensions	W	D	H
GK21001 Open arm, upholstered seat and full back, curved leg	1	1,435	10	1,769	19	2,203	L1	1,792	Overall	22 1/2"	24"	32"
	2	1,466	11	1,809	20	2,253	L2	2,104	Seat		18 1/2"	18 3/4"
	3	1,497	12	1,850	21	2,304	L3	2,479	Arm			25 3/4"
	COM/4	1,526	13	1,900	22	2,354	L4	2,790	Between arms	20"		
	5	1,566	14	1,950	23	2,456	L5	3,102	Upholstery Requirements: GK21001			
	6	1,607	15	2,001	24	2,556			Fabric yards			1.6
	7	1,648	16	2,051	25	2,657			Leather feet ²			27.2
	8	1,688	17	2,101	26	2,758			Shipping weight			23.5 lbs.
	9	1,729	18	2,153	27	2,859			Cube			13.9

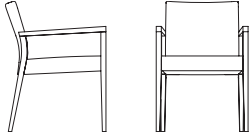

GK21003 Open arm, upholstered seat and half upholstered back, straight leg	1	1,475	10	1,767	19	2,147	L1	1,787	Overall	22 1/2"	25"	30 1/2"
	2	1,502	11	1,802	20	2,192	L2	2,060	Seat		17 3/4"	18 1/2"
	3	1,529	12	1,837	21	2,235	L3	2,388	Arm			25 3/4"
	COM/4	1,555	13	1,882	22	2,280	L4	2,661	Between arms	20"		
	5	1,590	14	1,926	23	2,368	L5	2,934	Upholstery Requirements: GK21003			
	6	1,626	15	1,970	24	2,456			Fabric yards			1.4
	7	1,661	16	2,014	25	2,545			Leather feet ²			23.8
	8	1,697	17	2,059	26	2,633			Shipping weight			23.6 lbs.
	9	1,732	18	2,102	27	2,721			Cube			13.0

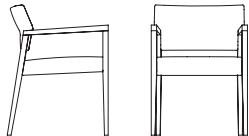

TO ORDER PLEASE SPECIFY THE FOLLOWING:

. . .

MODEL NUMBER	FINISH	FLAMMABILITY RATING	UPHOLSTERY
	Cherry finishes on Maple Walnut finishes on Maple Maple finishes on Maple Oak finishes on Maple Please refer to the Camille product page on www.gunlocke.com for standard finish options.	U CTB117	Please refer to list of available upholstery and leather selections on www.gunlocke.com

Example

GK21001.215.U.DOL728
 GK21001 215 U DOL728
 MODEL NUMBER FINISH FLAMMABILITY UPHOLSTERY

CAMILLE

Guest | Dual Upholstery

Seating
03/23

model number	fabric grades								dimensions	W	D	H
GK21003-021 Open arm, upholstered seat and half upholstered back, straight leg	1	1,503	10	1,817	19	2,223	L1	1,838	Overall	22 1/2"	25"	30 1/2"
	2	1,532	11	1,854	20	2,271	L2	2,131	Seat		17 3/4"	18 1/2"
	3	1,561	12	1,892	21	2,318	L3	2,481	Arm			25 3/4"
	COM/4	1,589	13	1,938	22	2,365	L4	2,773	Between arms	20"		
	5	1,627	14	1,987	23	2,460	L5	3,068	Upholstery Requirements: GK21003-021			
	6	1,664	15	2,034	24	2,554			Dual Upholstery			
	7	1,703	16	2,081	25	2,650			Fabric yards Seat 0.8 Back .5			
	8	1,741	17	2,129	26	2,744			Leather feet ² Seat 13.6 Back 8.5			
	9	1,779	18	2,176	27	2,838			Shipping weight 23.6 lbs.			
								Cube 13.0				

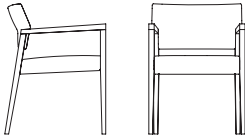

Seat	1	10	209	19	480	L1	223	
	2	19	11	234	20	512	L2	418
	3	39	12	259	21	543	L3	652
	COM/4	57	13	290	22	575	L4	847
	5	82	14	322	23	638	L5	1,043
	6	107	15	354	24	701		
	7	133	16	385	25	765		
	8	159	17	417	26	827		
	9	184	18	448	27	890		

Top row of pricing is for units specified with same fabric on Seat and Back. Bottom two rows of pricing required only when two different fabric grades are selected for the Seat and Back.

To calculate price of chair with different grade fabric for Seat and Back; start with Grade 1 price, add appropriate grade price located in second row for Seat, and last add appropriate grade price located in third row for Back to the sum of the Grade 1 and Seat price.

Example: Grade 1 \$1,503 + grade 4 fabric seat \$57 + grade 2 fabric back \$10 = \$1,570

Back	1	10	105	19	240	L1	112	
	2	10	11	117	20	256	L2	210
	3	19	12	130	21	272	L3	326
	COM/4	29	13	145	22	287	L4	423
	5	42	14	162	23	319	L5	522
	6	54	15	177	24	350		
	7	67	16	193	25	382		
	8	79	17	209	26	414		
	9	92	18	225	27	445		

TO ORDER PLEASE SPECIFY THE FOLLOWING:

<input type="text"/>	<input type="text"/>	<input type="text"/>	<input type="text"/>	<input type="text"/>
MODEL NUMBER	FINISH	FLAMMABILITY RATING	SEAT UPHOLSTERY	BACK UPHOLSTERY
	Cherry finishes on Maple Walnut finishes on Maple Maple finishes on Maple Oak finishes on Maple Please refer to the Camille product page on www.gunlocke.com for standard finish options.	U CTB117	Please refer to list of available upholstery and leather selections on www.gunlocke.com	Please refer to list of available upholstery and leather selections on www.gunlocke.com

Example

GK21003-021.215.U.DOL728.SPNN04				
GK21003-021	215	U	DOL728	SPNN04
MODEL NUMBER	FINISH	FLAMMABILITY	SEAT UPHOLSTERY	BACK UPHOLSTERY

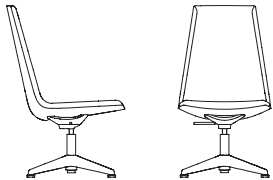
model number	fabric grades							dimensions	W	D	H	
GGRA16-111 Guest, High Back Armless 	1	2,529	10	2,967	19	3,537	L1	2,997	Overall	21 3/4"	28"	39 1/8"
	2	2,569	11	3,020	20	3,603	L2	3,407	Seat	21"	19 1/2"	18"
	3	2,609	12	3,072	21	3,670	L3	3,899	Upholstery Requirements: GGRA16-111			
	COM/4	2,648	13	3,139	22	3,735	L4	4,307	Fabric yards	2.1		
	5	2,702	14	3,205	23	3,868	L5	4,717	Leather feet ²	35.7		
	6	2,755	15	3,272	24	4,001			Shipping weight	44 lbs.		
	7	2,807	16	3,338	25	4,133			Cube	18.3		
	8	2,861	17	3,404	26	4,266						
	9	2,914	18	3,470	27	4,398						

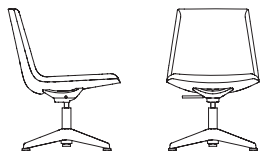
GGRA16-121 Guest, Mid Back Armless 	1	2,378	10	2,733	19	3,194	L1	2,757	Overall	21 3/4"	26 1/2"	32 3/8"
	2	2,411	11	2,775	20	3,247	L2	3,088	Seat		18 5/8"	18"
	3	2,443	12	2,819	21	3,301	L3	3,486	Upholstery Requirements: GGRA16-121			
	COM/4	2,476	13	2,872	22	3,355	L4	3,818	Fabric yards	1.7		
	5	2,518	14	2,926	23	3,462	L5	4,150	Leather feet ²	28.9		
	6	2,561	15	2,979	24	3,569			Shipping weight	42 lbs.		
	7	2,604	16	3,032	25	3,677			Cube	14.5		
	8	2,647	17	3,087	26	3,784						
	9	2,689	18	3,140	27	3,891						

TO ORDER PLEASE SPECIFY THE FOLLOWING:

. .

MODEL NUMBER

FLAMMABILITY RATING

UPHOLSTERY

U CTB117

Please refer to list of available upholstery and leather selections on www.gunlocke.com

NOTE: Genesee Guest comes standard with a 4-star polished aluminum base, return-to-center cylinder, at a fixed seat height of 18", and with 1 3/4" nylon cap glides.

Example

GGRA16-111.U.DOL728

GGRA16-111 U DOL728
MODEL NUMBER FLAMMABILITY UPHOLSTERY

GENESEE GUEST

Polished Arms

Seating
03/23

model number fabric grades dimensions W D H

GGRA16-141
Guest, Mid Back
Polished Arms

1	2,464	10	2,819	19	3,280	L1	2,843
2	2,497	11	2,861	20	3,333	L2	3,174
3	2,529	12	2,905	21	3,387	L3	3,572
COM/4	2,562	13	2,958	22	3,441	L4	3,904
5	2,604	14	3,012	23	3,548	L5	4,236
6	2,647	15	3,065	24	3,655		
7	2,690	16	3,118	25	3,763		
8	2,733	17	3,173	26	3,870		
9	2,775	18	3,226	27	3,977		



Overall	23 1/2"	26 1/2"	32 3/8"
Seat		19 1/4"	18"
Arm			24 1/2"
Between arms	21"		

Upholstery Requirements: GGRA16-141

Fabric yards	1.7
Leather feet ²	28.9
Shipping weight	47 lbs.
Cube	15.6

TO ORDER PLEASE SPECIFY THE FOLLOWING:

. .

MODEL NUMBER

FLAMMABILITY
RATING

UPHOLSTERY

U CTB117

Please refer to list of
available upholstery
and leather selections
on www.gunlocke.com

NOTE: Genesee Guest comes standard with a 4-star polished aluminum base, return-to-center cylinder, at a fixed seat height of 18", and with 1 3/4" nylon cap glides.

Example

GGRA16-141.U.DOL728

GGRA16-141 U DOL728
MODEL NUMBER FLAMMABILITY UPHOLSTERY

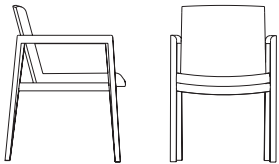
model number	fabric grades								dimensions	W	D	H
GGCA14-011 Open arm, upholstered seat and back 	1	1,929	10	2,263	19	2,697	L1	2,286	Overall	21 1/2"	23 1/2"	33"
	2	1,960	11	2,303	20	2,747	L2	2,598	Seat		18 1/2"	17"
	3	1,991	12	2,344	21	2,798	L3	2,973	Arm			25 3/4"
	COM/4	2,020	13	2,394	22	2,848	L4	3,284	Between arms	19 1/4"		
	5	2,060	14	2,444	23	2,950	L5	3,596	Upholstery Requirements: GGCA14-011			
	6	2,101	15	2,495	24	3,050			Fabric yards			1.6
	7	2,142	16	2,545	25	3,151			Leather feet ²			27.2
	8	2,182	17	2,595	26	3,252			Shipping weight			25 lbs.
	9	2,223	18	2,647	27	3,353			Cube			14.6

TO ORDER PLEASE SPECIFY THE FOLLOWING:

. . . .

MODEL NUMBER **SPECIES & FINISH** **STITCH DETAIL** **FLAMMABILITY RATING** **UPHOLSTERY**

These seating models are available in the following hardwoods:

Maple **NE**
Ash **QA**

Please refer to the Lily™ product page on www.gunlocke.com for standard finish options.

Cherry finishes on Maple
Maple finishes on Maple
Cherry finishes on Ash
Walnut finishes on Ash
Oak finishes on Ash

Natural Oak 300 not available on Ash.

Not required **NR**
Stitch detail
SD +\$88

U CTB117

Please refer to list of available upholstery and leather selections on www.gunlocke.com

Example

GGCA14-011.NE800.SD.U.DOL728

GGCA14-011	NE800	SD	U	DOL728
MODEL NUMBER	SPECIES & FINISH	STITCH DETAIL	FLAMMABILITY	UPHOLSTERY

METTA

Fully Upholstered

model number	fabric grades								dimensions	W	D	H
GGWA16-011 Fully upholstered	1	1,970	10	2,408	19	2,978	L1	2,437	Overall	21 1/8"	25 7/16"	33 9/16"
	2	2,012	11	2,461	20	3,044	L2	2,848	Seat		18 5/8"	18 11/16"
	3	2,051	12	2,515	21	3,110	L3	3,339	Arm			25 3/4"
	COM/4	2,091	13	2,581	22	3,176	L4	3,748	Between arms	18 7/8"		
	5	2,143	14	2,647	23	3,310	L5	4,159				
	6	2,197	15	2,712	24	3,442						
	7	2,249	16	2,780	25	3,574						
	8	2,302	17	2,846	26	3,707						
	9	2,355	18	2,912	27	3,839						

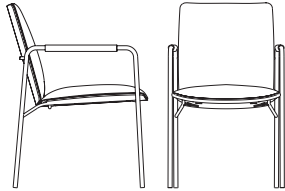

Upholstery Requirements: GGWA16-011

	Dual Upholstery	
Fabric yards	Inners 1.3	Outers .8
Leather feet ²	Inners 22.1	Outers 13.6
Shipping weight	30 lbs.	
Cube	14.4	

Inners and Arms

1	10	271	19	624	L1	289	
2	26	11	304	20	665	L2	543
3	50	12	337	21	706	L3	847
COM/4	75	13	378	22	747	L4	1,101
5	107	14	419	23	829	L5	1,355
6	140	15	459	24	911		
7	173	16	501	25	993		
8	205	17	542	26	1,075		
9	238	18	583	27	1,157		

Top row of pricing is for units specified with same fabric on Seat and Back. Bottom two rows of pricing required only when two different fabric grades are selected for the Seat and Back.

To calculate price of chair with different grade fabric for Seat and Back; start with Grade 1 price, add appropriate grade price located in second row for Seat, and last add appropriate grade price located in third row for Back to the sum of the Grade 1 and Seat price.

Example: Grade 1 \$1,970 + grade 4 fabric seat \$75 + grade 2 fabric back \$16 = \$2,061

Upholstered Inners and Arms

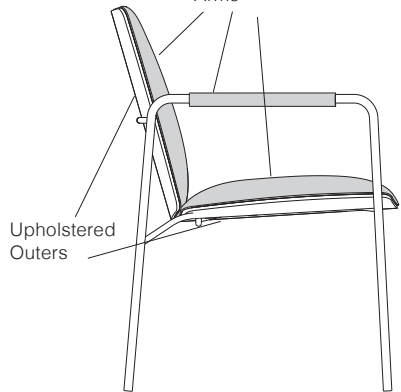

Outers

1	10	167	19	384	L1	178	
2	16	11	187	20	409	L2	335
3	31	12	208	21	434	L3	522
COM/4	46	13	233	22	459	L4	677
5	66	14	258	23	511	L5	834
6	87	15	283	24	561		
7	106	16	309	25	611		
8	127	17	334	26	662		
9	147	18	359	27	712		

TO ORDER PLEASE SPECIFY THE FOLLOWING:

. . .

MODEL NUMBER

FLAMMABILITY RATING

INNERS & ARMS UPHOLSTERY

OUTERS UPHOLSTERY

U CTB117

Please refer to list of available upholstery and leather selections on www.gunlocke.com

Please refer to list of available upholstery and leather selections on www.gunlocke.com

Example

GGWA16-011.U.DOL728.SPNN04

GGWA16-011	U	DOL728	SPNN04
MODEL NUMBER	FLAMMABILITY	INNERS & ARMS UPHOLSTERY	OUTERS UPHOLSTERY

model number	fabric grades								dimensions	W	D	H
GGWA16-021 Wood shell	1	2,245	10	2,516	19	2,869	L1	2,534	Overall	21 1/8"	25 3/4"	33 9/16"
	2	2,271	11	2,549	20	2,910	L2	2,788	Seat		18 5/8"	18 11/16"
	3	2,295	12	2,582	21	2,951	L3	3,092	Arm			25 3/4"
	COM/4	2,320	13	2,623	22	2,992	L4	3,346	Between arms	18 7/8"		
	5	2,352	14	2,664	23	3,074	L5	3,600				
	6	2,385	15	2,704	24	3,156						
	7	2,418	16	2,746	25	3,238						
	8	2,450	17	2,787	26	3,320						
	9	2,483	18	2,828	27	3,402						

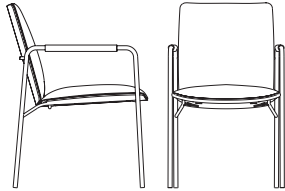

Upholstery Requirements: GGWA16-021

Fabric yards	1.3
Leather feet ²	22.1
Shipping weight	13 lbs.
Cube	14.4

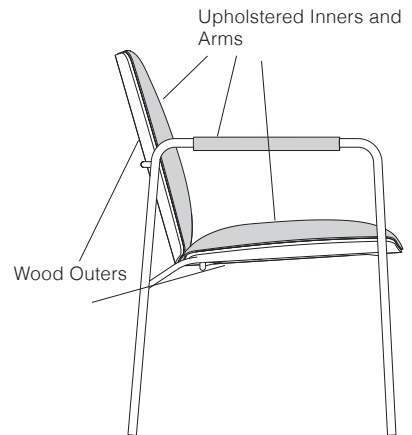

TO ORDER PLEASE SPECIFY THE FOLLOWING:

. . .

MODEL NUMBER	OUTERS FINISH	FLAMMABILITY RATING	INNERS & ARMS UPHOLSTERY
	Walnut finishes on Walnut Cherry finishes on Cherry Maple finishes on Maple Oak finishes on Oak Walnut, Cherry, and Maple shells are quarter cut; Oak shells are rift cut. Please refer to the Metta product page on www.gunlocke.com for standard finish options.	U CTB117	Please refer to list of available upholstery and leather selections on www.gunlocke.com

Example

GGWA16-021.215.U.DOL728

GGWA16-021	215	U	DOL728
MODEL NUMBER	OUTERS FINISH	FLAMMABILITY	INNERS & ARMS UPHOLSTERY

model number	fabric grades								dimensions	W	D	H
GGJA14-011 Open arm, upholstered seat and back wood top rail	1	1,761	10	2,053	19	2,433	L1	2,073	Overall	22 1/2"	23 1/2"	33"
	2	1,788	11	2,088	20	2,478	L2	2,346	Seat	19 1/2"	18"	18 1/2"
	3	1,815	12	2,123	21	2,521	L3	2,674	Arm			25 1/2"
	COM/4	1,841	13	2,168	22	2,566	L4	2,947	Between arms	19 1/2"		
	5	1,876	14	2,212	23	2,654	L5	3,220	Upholstery Requirements: GGJA14-011			
	6	1,912	15	2,256	24	2,742			Fabric yards			1.4
	7	1,947	16	2,300	25	2,831			Leather feet ²			23.8
	8	1,983	17	2,345	26	2,919			Shipping weight			25 lbs.
	9	2,018	18	2,388	27	3,007			Cube			14.6

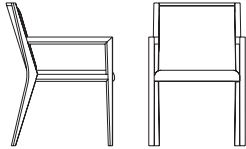

GGJA14-021 Open arm, upholstered seat and back upholstered top rail	1	1,729	10	2,021	19	2,401	L1	2,041
	2	1,756	11	2,056	20	2,446	L2	2,314
	3	1,783	12	2,091	21	2,489	L3	2,642
	COM/4	1,809	13	2,136	22	2,534	L4	2,915
	5	1,844	14	2,180	23	2,622	L5	3,188
	6	1,880	15	2,224	24	2,710		
	7	1,915	16	2,268	25	2,799		
	8	1,951	17	2,313	26	2,887		
	9	1,986	18	2,356	27	2,975		

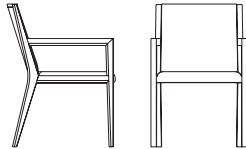

Overall	22 1/2"	23 1/2"	33"
Seat	19 1/2"	18"	18 1/2"
Arm			26"
Between arms	19 1/2"		
Upholstery Requirements: GGJA14-021			
Fabric yards			1.4
Leather feet ²			23.8
Shipping weight			25 lbs.
Cube			14.6

TO ORDER PLEASE SPECIFY THE FOLLOWING:

. . .

MODEL NUMBER **SPECIES & FINISH** **FLAMMABILITY RATING** **UPHOLSTERY**

These seating models are available in the following hardwoods:

Maple **NE**
Ash **QA**

Please refer to the Savor™ product page on www.gunlocke.com for standard finish options.

- Cherry finishes on Maple
- Maple finishes on Maple
- Cherry finishes on Ash
- Walnut finishes on Ash
- Oak finishes on Ash

Natural Oak 300 not available on Ash..

U **CTB117**

Please refer to list of available upholstery and leather selections on www.gunlocke.com

Example

GGJA14-011	NE800	U	DOL728
MODEL NUMBER	SPECIES & FINISH	FLAMMABILITY	UPHOLSTERY

model number	fabric grades						dimensions	W	D	H			
GGJA14-031 Open arm, upholstered seat and back, wood top rail	1	1,794	10	2,170	19	2,658	L1	2,195	Overall	22 1/2"	23 1/2"	33"	
	2	1,829	11	2,215	20	2,715	L2	2,547	Seat	19"	18"	18 1/2"	
	3	1,864	12	2,261	21	2,771	L3	2,968	Arm	25 1/2"			
	COM/4	1,897	13	2,317	22	2,828	L4	3,318	Between arms	19 1/2"			
	5	1,942	14	2,374	23	2,943	L5	3,671	Upholstery Requirements: GGJA14-031				
	6	1,988	15	2,431	24	3,056			Dual Upholstery				
	7	2,033	16	2,488	25	3,170			Fabric yards	Seat 1	Back 0.8		
	8	2,080	17	2,545	26	3,283			Leather feet ²	Seat 17	Back 13.6		
	9	2,125	18	2,601	27	3,396			Shipping weight	25 lbs.			
									Cube	14.6			

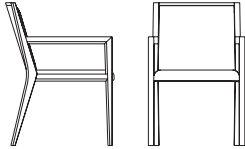

Seat	1	10	209	19	480	L1	223
	2	11	234	20	512	L2	418
	3	12	259	21	543	L3	652
	COM/4	13	290	22	575	L4	847
	5	14	322	23	638	L5	1,043
	6	15	354	24	701		
	7	16	385	25	765		
	8	17	417	26	827		
	9	18	448	27	890		

Top row of pricing is for units specified with same fabric on Seat and Back. Bottom two rows of pricing required only when two different fabric grades are selected for the Seat and Back.

To calculate price of chair with different grade fabric for Seat and Back; start with Grade 1 price, add appropriate grade price located in second row for Seat, and last add appropriate grade price located in third row for Back to the sum of the Grade 1 and Seat price.

Example: Grade 1 \$1,794 + grade 4 fabric seat \$57 + grade 2 fabric back \$16 = \$1,867

Back	1	10	167	19	384	L1	178
	2	11	187	20	409	L2	335
	3	12	208	21	434	L3	522
	COM/4	13	233	22	459	L4	677
	5	14	258	23	511	L5	834
	6	15	283	24	561		
	7	16	309	25	611		
	8	17	334	26	662		
	9	18	359	27	712		

TO ORDER PLEASE SPECIFY THE FOLLOWING:

MODEL NUMBER	SPECIES & FINISH	FLAMMABILITY RATING	SEAT UPHOLSTERY	BACK UPHOLSTERY

These seating models are available in the following hardwoods:

Maple **NE**
Ash **QA**

Please refer to the Savor product page on www.gunlocke.com for standard finish options.

Cherry finishes on Maple
Maple finishes on Maple
Cherry finishes on Ash
Walnut finishes on Ash
Oak finishes on Ash

Natural Oak 300 not available on Ash..

U CTB117

Please refer to list of available upholstery and leather selections on www.gunlocke.com

Please refer to list of available upholstery and leather selections on www.gunlocke.com

Example

GGJA14-031	NE800	U	DOL728	SPNN04
MODEL NUMBER	SPECIES & FINISH	FLAMMABILITY UPHOLSTERY	INNER UPHOLSTERY	OUTER UPHOLSTERY

TIA™ GUEST

Single Upholstery

Seating
03/23

model number	fabric grades								dimensions	W	D	H
GGHB17-071 Single upholstery, armless	1	1,354	10	1,604	19	1,930	L1	1,622	Overall	19"	21 1/2"	32 1/8"
	2	1,377	11	1,635	20	1,968	L2	1,856	Seat	18 1/2"	16 3/4"	18 3/8"
	3	1,400	12	1,665	21	2,005	L3	2,136	Upholstery Requirements: GGH17-071			
	COM/4	1,423	13	1,703	22	2,043	L4	2,370	Fabric yards	1.2		
	5	1,453	14	1,740	23	2,120	L5	2,605	Leather feet ²	20.4		
	6	1,483	15	1,779	24	2,195			Shipping weight	23 lbs.		
	7	1,514	16	1,817	25	2,271			Cube	10.9		
	8	1,544	17	1,855	26	2,346						
	9	1,574	18	1,892	27	2,423						

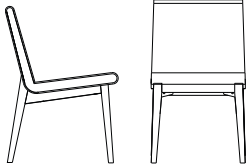

TO ORDER PLEASE SPECIFY THE FOLLOWING:

MODEL NUMBER	FINISH	FLAMMABILITY RATING	UPHOLSTERY

These seating models are available in the following hardwoods:

Maple **NE**
Ash **QA**

Please refer to the Tia product page on www.gunlocke.com for standard finish options.

Cherry finishes on Maple or Ash
Walnut finishes on Maple or Ash
Maple finishes on Maple or Ash
Oak finishes on Maple or Ash

Natural Cherry 222, Natural Maple 800, Honey Maple 873 and Natural Oak 300 not available on Ash.

U CTB117

Please refer to list of available upholstery and leather selections on www.gunlocke.com

Example

GGHB17-071.QA629.U.DOL728

GGHB17-071	QA629	U	DOL728
MODEL NUMBER	FINISH	FLAMMABILITY	UPHOLSTERY

model number	fabric grades						dimensions	W	D	H		
GGHB17-081 Dual upholstery, armless	1	1,379	10	1,858	19	2,483	L1	1,893	Overall	19"	21 1/2"	32 1/8"
	2	1,423	11	1,918	20	2,556	L2	2,340	Seat	18 1/2"	16 3/4"	18 3/8"
	3	1,467	12	1,975	21	2,628	L3	2,879	Upholstery Requirements: GGHB17-081			
	COM/4	1,511	13	2,048	22	2,701	L4	3,327	Dual Upholstery			
	5	1,569	14	2,120	23	2,846	L5	3,776	Fabric yards	Seat 1.1	Back 1.2	
	6	1,626	15	2,194	24	2,991			Leather feet ²	Seat 18.7	Back 20.4	
	7	1,686	16	2,265	25	3,137			Shipping weight	23 lbs.		
	8	1,743	17	2,338	26	3,281			Cube	10.9		
	9	1,801	18	2,410	27	3,427						

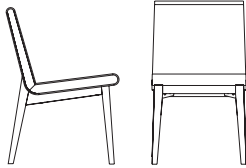

Seat	fabric grades						
1	10	229	19	528	L1	246	
2	21	11	258	20	563	L2	459
3	42	12	285	21	598	L3	718
COM/4	63	13	320	22	633	L4	932
5	91	14	355	23	701	L5	1,146
6	118	15	390	24	771		
7	147	16	423	25	841		
8	174	17	458	26	910		
9	202	18	493	27	979		

Top row of pricing is for units specified with same fabric on Seat and Back. Bottom two rows of pricing required only when two different fabric grades are selected for the Seat and Back.

To calculate price of chair with different grade fabric for Seat and Back; start with Grade 1 price, add appropriate grade price located in second row for Seat, and last add appropriate grade price located in third row for Back to the sum of the Grade 1 and Seat price.

Example: Grade 1 \$1,379 + grade 4 fabric seat \$63 + grade 2 fabric back \$23 = \$1,465

Back	fabric grades						
1	10	250	19	576	L1	268	
2	23	11	281	20	614	L2	502
3	46	12	311	21	651	L3	782
COM/4	69	13	349	22	689	L4	1,016
5	99	14	386	23	766	L5	1,251
6	129	15	425	24	841		
7	160	16	463	25	917		
8	190	17	501	26	992		
9	220	18	538	27	1,069		

Note: When Tia Guest chair is upholstered in multiple fabrics, there is an added angled seam along the side boxings to accommodate seat and back as two choices of upholstery.

TO ORDER PLEASE SPECIFY THE FOLLOWING:

<input type="text"/>	<input type="text"/>	<input type="text"/>	<input type="text"/>	<input type="text"/>
MODEL NUMBER	FINISH	FLAMMABILITY RATING	SEAT UPHOLSTERY	BACK UPHOLSTERY

These seating models are available in the following hardwoods:
Maple **NE**
Ash **QA**
Please refer to the Tia product page on www.gunlocke.com for standard finish options.

Cherry finishes on Maple or Ash
Walnut finishes on Maple or Ash
Maple finishes on Maple or Ash
Oak finishes on Maple or Ash
Natural Cherry 222, Natural Maple 800, Honey Maple 873 and Natural Oak 300 not available on Ash.

U CTB117

Please refer to list of available upholstery and leather selections on www.gunlocke.com

Please refer to list of available upholstery and leather selections on www.gunlocke.com

Example

GGHB17-081.QA629.U.DOL728.SPNN04				
GGHB17-081	QA629	U	DOL728	SPNN04
MODEL NUMBER	FINISH	FLAMMABILITY	SEAT UPHOLSTERY	BACK UPHOLSTERY

Multipurpose Seating 41-61
Product Specifications. 42
Convo® Barstool 43-46
LIV Guest. 47-48
LIV Stool. 49-50
Multi®. 51-54
Multi® Stool 55
Multi® Bariatric. 56-57
Tia™ Barstool. 58-59
Trillia™ Barstool 60-61

MULTIPURPOSE SEATING

Product Specifications

CONVO™

Frame:

Round tubular steel offered in Polished Stainless as well as powder-coats Silver, Black, and Bronze.

Upholstered Seat:

Seat Pan: Rigid fiberglass reinforced urethane pan provides structure to support user load, wrapped in 1/4" dacron.

Top Cushion: High resilient foam overmolded onto rigid fiberglass reinforced urethane pan, wrapped in 1/4" dacron.

Wood Seat:

Consists of 2"x2" solid ash hardwood blocks, glued and contoured to shape.

Glides: Push-fit low density polyethylene; heavy-duty round plastic inserts.

Shipping: Product ships 1 to a box.

BIFMA Rating:

ANSI/BIFMA X5.1 2011
(253lb Weight Rating)

LIV GUEST & STOOL

Frame: Round tubular steel available in 9 powder coat colors (Silver, Black, Designer White, Matte Gold, Pyrite Bronze, Titanium, Solar Black, Regatta Blue, Bullseye Red) or polished chrome.

Laminate Seat: Bent plywood with laminate layer inside and out

Wood Bucket: Bent plywood with quartered cut ash inside and out

Glides: Black Domed Nylon Glide or polished Toggle glide with white nylon and option to purchase nickel or felt caps.

Toggle Glide Caps - 4 pack

Nickel: GGLIV19-SVL1 \$65.00

Felt: GGLIV19-SVL2 \$66.00

Nylon glides are recommended for hard surfaces, commercial carpet and damp environments. Nickel-plated glides are recommended for carpet. Felt glides are recommended for wood, tile or high-sheen floor surfaces.

Stacking: 5 chairs high limit.

See GK8907. Page 51

Shipping: Product ships 1 to a box except armless versions which stacks 2 to a box.

BIFMA Rating:

ANSI/BIFMA X5.1 2017
(275lb Weight Rating)

MULTI GUEST, STOOL & TANDEM

Frame: Round tubular steel.

Seat: Foam filled over contoured plastic, upholstered.

Upholstered Back: PVC Foam filled over plywood, upholstered. Triple stitched.

Wood Back: Bent plywood.

Laser Backs: A laser cut logo or insignia is available on wood back.

LSR: Laser Back Chair. See pg. 10 for directions.

Moderne Arm: Textured polypropylene or RF bent plywood.

Glides: Plastic.

Boot: Flexible textured polyvinyl chloride 2 1/2" high. (glide models only) Black boot on black frame. Grey boot on silver frame.

Casters: 1 1/2" dual wheel hooded; black. Optional.

Shipping: Product ships 2 to a box.

Stacking: 5 chairs high limit or 4 chairs with casters. See GK8907. Page 51

BIFMA Rating:

ANSI/BIFMA X5.1 2017 w/ additional requirements (300lb Weight Rating)

NOTE:

Space required for a stack of chairs 5-high with cart.

W	D	H
26"	38"	51"

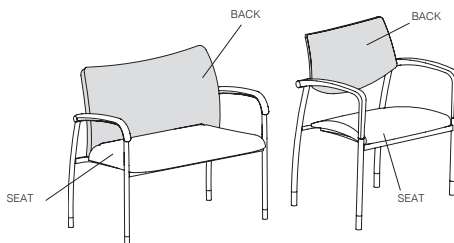

MULTI BARIATRIC

Frame: Round tubular steel.

Seat: Foam filled over reinforced upholstery-grade hardwood seat frame. Sheet webbing Interior for added user comfort. 3 degree seat angle.

Upholstered Back: Foam filled over plywood, upholstered. Triple stitched.

Modern Arms: Textured polypropylene or RF bent plywood.

Glides: Plastic.

Boot: Flexible textured polyvinyl chloride 2 1/2" high (glide models only). Black boot on black frame. Grey boot on silver frame.

Gore Protection: Waterproof moisture barrier, anti-microbial, and stain resistant.

Shipping: Product ships 1 to a box.

BIFMA Rating:

ANSI/BIFMA X5.1 2011 w/ additional requirements (600lb Weight Rating)

TRILLIA™ BARSTOOLS

Wood Seat: Consists of 2" wide solid ash hardwood blocks, glued and contoured to shape.

Upholstered Seat: High resilient foam overmolded onto vacuum-formed ABS plastic. Double needle stitch detail optional.

Legs: Solid ash hardwood.

Footrest: 1/2" solid bar footrest, polished stainless steel.

Glides: Nickel-plated steel.

Shipping: Product ships 1 to a box.

BIFMA Rating:

ANSI/BIFMA X5.1 2011
(253lb Weight Rating)

TIA™ BARSTOOLS

Frame:

Construction: Hardwood frame joined by mortise and tenon, and corner blocks.

Available hardwoods: Maple, Ash

Seat & Back: 13/16" thick plywood bucket, consisting of 13 cross-plyies of 1/16" thick #3 grade southern hardwood.

Footrest: 16 ga steel footrest, available in: polished, brushed, black or white.

Glides: Nickel-plated steel.

Shipping: Product ships 1 to a box.

BIFMA Rating:

ANSI/BIFMA X5.1 2017
(275lb Weight Rating)

model number	fabric grades							dimensions	W	D	H	
GMLA15-011 Upholstered	1	1,337	10	1,631	19	2,009	L1	1,649	Overall	16 1/4"	16"	30 1/2"
	2	1,365	11	1,665	20	2,053	L2	1,923	Seat	16 1/4"	16"	
	3	1,391	12	1,699	21	2,099	L3	2,251	Upholstery Requirements: GMLA15-011			
	COM/4	1,417	13	1,743	22	2,143	L4	2,523	Dual Upholstery			
	5	1,453	14	1,789	23	2,229	L5	2,797	Fabric yards Cushion 0.7 Bottom 0.7			
	6	1,489	15	1,833	24	2,319			Leather feet2 Cushion 11.9 Bottom 11.9			
	7	1,523	16	1,877	25	2,407			Shipping weight 28 lbs.			
	8	1,559	17	1,921	26	2,495			Cube 7.1			
	9	1,595	18	1,965	27	2,583						

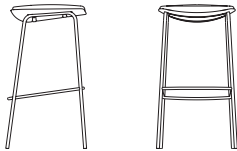

Top Cushion	1	10	147	19	336	L1	156	
	2	14	11	164	20	358	L2	293
	3	27	12	181	21	381	L3	457
	COM/4	40	13	203	22	403	L4	593
	5	58	14	226	23	446	L5	730
	6	76	15	248	24	491		
	7	93	16	270	25	535		
	8	111	17	292	26	579		
	9	129	18	314	27	623		

Top row of pricing is for units specified with same fabric on Seat and Back. Bottom two rows of pricing required only when two different fabric grades are selected for the Seat and Back.

To calculate price of stool with different grade fabric for Top Cushion and Bottom Seat Pan, start with Grade 1 price, add appropriate grade price located in second row for Top Cushion, and last add appropriate grade price located in third row for Bottom Seat Pan to the sum of the Grade 1 and Top Cushion price.

Example: Grade 1 \$1,337 + grade 4 fabric Top Cushion \$40 + grade 2 fabric Bottom Seat Pan \$14 = \$1,391

Bottom Seat Pan	1	10	147	19	336	L1	156	
	2	14	11	164	20	358	L2	293
	3	27	12	181	21	381	L3	457
	COM/4	40	13	203	22	403	L4	593
	5	58	14	226	23	446	L5	730
	6	76	15	248	24	491		
	7	93	16	270	25	535		
	8	111	17	292	26	579		
	9	129	18	314	27	623		

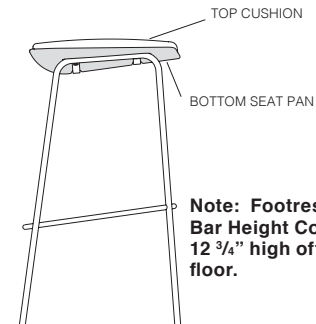

Note: Footrest for Bar Height Convo is 12 3/4" high off the floor.

TO ORDER PLEASE SPECIFY THE FOLLOWING:

<input type="text"/>	<input type="text"/>	<input type="text"/>	<input type="text"/>	<input type="text"/>
MODEL NUMBER	FRAME	FLAMMABILITY RATING	TOP CUSHION UPHOLSTERY	BOTTOM SEAT PAN UPHOLSTERY
	This seating model is available with the following frame options. Please specify by adding suffix to model number. P71 Black PR6 Silver PJE Pyrite	U CTB117	Select upholstery for the top cushion. Please refer to list of available upholstery and leather selections on www.gunlocke.com	Select upholstery for the bottom seat pan. Please refer to list of available upholstery and leather selections on www.gunlocke.com

Example

GMLA15-011.P71.U.DOL728.SPNN04				
GMLA15-011	P71	U	DOL728	SPNN04
MODEL NUMBER	FRAME	FLAMMABILITY RATING	TOP CUSHION UPHOLSTERY	BOTTOM SEAT PAN UPHOLSTERY

CONVO® BARSTOOL

Seating

03/23

Counter Height | Upholstered

model number	fabric grades						dimensions	W	D	H		
GMLA15-041 Upholstered	1	1,337	10	1,631	19	2,009	L1	1,649	Overall	16 1/4"	16"	26 1/4"
	2	1,365	11	1,665	20	2,053	L2	1,923	Seat	16 1/4"	16"	
	3	1,391	12	1,699	21	2,099	L3	2,251	Upholstery Requirements: GMLA15-041			
	COM/4	1,417	13	1,743	22	2,143	L4	2,523	Dual Upholstery			
	5	1,453	14	1,789	23	2,229	L5	2,797	Fabric yards Cushion 0.7 Bottom 0.7			
	6	1,489	15	1,833	24	2,319			Leather feet ² Cushion 11.9 Bottom 11.9			
	7	1,523	16	1,877	25	2,407			Shipping weight 28 lbs.			
	8	1,559	17	1,921	26	2,495			Cube 7.1			
	9	1,595	18	1,965	27	2,583						

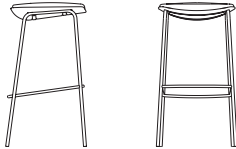

Top Cushion	1	10	19	20	21	22	23	24	25	26	27	L1	L2	L3	L4	L5
		147	336	358	381	403	446	491	535	579	623	156	293	457	593	730
	2	14	11	164	20	358	L2	293								
	3	27	12	181	21	381	L3	457								
	COM/4	40	13	203	22	403	L4	593								
	5	58	14	226	23	446	L5	730								
	6	76	15	248	24	491										
	7	93	16	270	25	535										
	8	111	17	292	26	579										
	9	129	18	314	27	623										

Top row of pricing is for units specified with same fabric on Seat and Back. Bottom two rows of pricing required only when two different fabric grades are selected for the Seat and Back.

To calculate price of stool with different grade fabric for Top Cushion and Bottom Seat Pan, start with Grade 1 price, add appropriate grade price located in second row for Top Cushion, and last add appropriate grade price located in third row for Bottom Seat Pan to the sum of the Grade 1 and Top Cushion price.

Example: Grade 1 \$1,337 + grade 4 fabric Top Cushion \$40 + grade 2 fabric Bottom Seat Pan \$14 = \$1,391

Bottom Seat Pan	1	10	19	20	21	22	23	24	25	26	27	L1	L2	L3	L4	L5
		147	336	358	381	403	446	491	535	579	623	156	293	457	593	730
	2	14	11	164	20	358	L2	293								
	3	27	12	181	21	381	L3	457								
	COM/4	40	13	203	22	403	L4	593								
	5	58	14	226	23	446	L5	730								
	6	76	15	248	24	491										
	7	93	16	270	25	535										
	8	111	17	292	26	579										
	9	129	18	314	27	623										

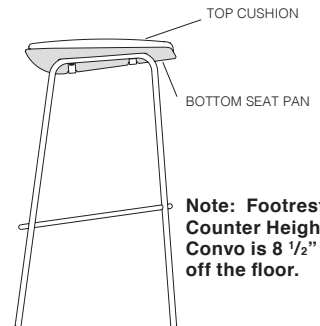

TO ORDER PLEASE SPECIFY THE FOLLOWING:

<input type="text"/>	<input type="text"/>	<input type="text"/>	<input type="text"/>	<input type="text"/>
MODEL NUMBER	FRAME	FLAMMABILITY RATING	TOP CUSHION UPHOLSTERY	BOTTOM SEAT PAN UPHOLSTERY
	This seating model is available with the following frame options. Please specify by adding suffix to model number. P71 Black PR6 Silver PJE Pyrite	U CTB117	Select upholstery for the top cushion. Please refer to list of available upholstery and leather selections on www.gunlocke.com	Select upholstery for the bottom seat pan. Please refer to list of available upholstery and leather selections on www.gunlocke.com

Example

GMLA15-041.P71.U.DOL728.SPNN04				
GMLA15-041	P71	U	DOL728	SPNN04
MODEL NUMBER	FRAME	FLAMMABILITY RATING	TOP CUSHION UPHOLSTERY	BOTTOM SEAT PAN UPHOLSTERY

model number	list		dimensions	W	D	H
GMLA15-021 Solid Ash Wood Seat	2,194	All Wood	Overall	16 1/4"	16"	30 1/2"
			Seat	16 1/4"	16"	

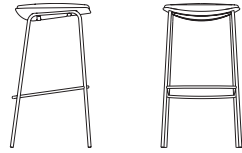

Shipping weight	28 lbs.
Cube	7.1

Note: Footrest for Bar Height Convo is 12 3/4" high off the floor.

TO ORDER PLEASE SPECIFY THE FOLLOWING:

--	--	--	--

MODEL NUMBER **FRAME** **SPECIES & FINISH**

This seating model is available with the following frame options.
Please specify by adding suffix to model number.
P71 Black
PR6 Silver
PJE Pyrite

This seating model is available with the following hardwood option:
Ash QA
Please refer to the Convo™ product page on www.gunlocke.com for standard finish options.
Cherry finishes on Ash
Walnut finishes on Ash
Oak finishes on Ash
Natural Oak 300 not available on Ash.

Example

GMLA15-021.P71.QA601		
GMLA15-021	P71	QA601
MODEL NUMBER	FRAME	SPECIES & FINISH

CONVO® BARSTOOL

Counter Height | Wood Seat

Seating
03/23

model number	list		dimensions	W	D	H
GMLA15-051	2,194	All Wood	Overall	16 1/4"	16"	26 1/8"
Solid Ash Wood Seat			Seat	16 1/4"	16"	

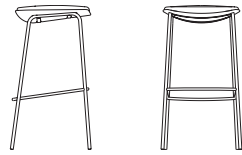

Shipping weight	28 lbs.
Cube	7.1

Note: Footrest for Counter Height Convo is 8 1/2" high off the floor.

TO ORDER PLEASE SPECIFY THE FOLLOWING:

MODEL NUMBER	FRAME	SPECIES & FINISH		

This seating model is available with the following frame options.
Please specify by adding suffix to model number.
P71 Black
PR6 Silver
PJE Pyrite

This seating model is available with the following hardwood option:
Ash QA
Please refer to the Convo™ product page on www.gunlocke.com for standard finish options.
Cherry finishes on Ash
Walnut finishes on Ash
Oak finishes on Ash
Natural Oak 300 not available on Ash.

Example

GMLA15-051.P71.QA601		
GMLA15-051	P71	QA601
MODEL NUMBER	FRAME	SPECIES & FINISH

model number	list	dimensions	W	D	H
GGLIV19-011 Wood Seat	1,281	Overall	21"	22.5"	32.5"
		Seat	19"	17"	17.25"
		Shipping weight			18.5 lbs.
		Cube			12.8

GGLIV19-012
Laminate Seat

895



model number	fabric grades	dimensions	W	D	H
GGLIV19-013 Upholstered Seat	1 1,168 10 1,377 19 1,648 L1 1,391	Overall	21"	22.5"	32.5"
	2 1,187 11 1,402 20 1,680 L2 1,586	Seat	19"	17"	17.25"



Upholstery Requirements: GGLIV19-013

Fabric yards	1
Leather feet ²	17
Shipping weight	19.3 lbs.
Cube	12.8

GGLIV19-014
Upholstered Seat
w/Channel Stitch

1 1,347 10 1,597 19 1,923 L1 1,615
2 1,370 11 1,628 20 1,961 L2 1,849
3 1,393 12 1,658 21 1,998 L3 2,129
COM/4 1,416 13 1,696 22 2,036 L4 2,363
5 1,446 14 1,733 23 2,113 L5 2,598
6 1,476 15 1,772 24 2,188
7 1,507 16 1,810 25 2,264
8 1,537 17 1,848 26 2,339
9 1,567 18 1,885 27 2,416



Overall	21"	22.5"	32.5"
Seat	19"	17"	17.25"

Upholstery Requirements: GGLIV19-014

Fabric yards	1.2
Leather feet ²	20.4
Shipping weight	19.3 lbs.
Cube	12.8

TO ORDER PLEASE SPECIFY THE FOLLOWING:

MODEL NUMBER	FSC	FRAME	GLIDE	GLWOOD	LAMINATE	FABRIC	FLAMMABILITY RATING
	No FSC X FSC Certified F +83	Polished Chrome PC +109 Black P71 Designer White PJW Matte Gold P8G Silver PR6 Pyrite PJE Solar Black P8X Titanium P8T Bullseye PJF Regatta P8M	Standard Black Nylon STD Swivel Glide w/ Nylon SVL0 +18 <i>Toggle Glide Option Pack page 42.</i>	Only on model GGLIV19-011 Cherry finishes on Quartered Ash Walnut finishes on Quartered Ash Maple finishes on Quartered Ash Oak finishes on Quartered Ash	Only on model GGLIV19-012 L1 and L2 Woodgrain Laminates +109	Only on models GGLIV19-013 and GGLIV19-014 Please refer to list of available upholstery and leather selections on www.gunlocke.com	U CTB117

Example

GGLIV19-013.X.PC.STD.DOL728.U

MODEL NUMBER	FSC	FRAME	GLIDE	FABRIC	FLAMMABILITY
GGLIV19-013	X	PC	STD	DOL728	U

LIV
Armed Guest

model number	list	dimensions	W	D	H
GGLIV19-021 Wood Seat	1,484	Overall	20.5"	22.5"	32.5"
		Seat	19"	17"	17.25"
GGLIV19-022 Laminate Seat	1,095	Shipping weight	23.5 lbs.		
		Cube	12.5		

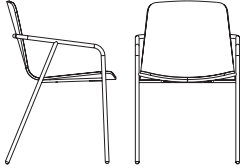

model number	fabric grades								dimensions	W	D	H
GGLIV19-023 Upholstered Seat	1	1,399	10	1,608	19	1,879	L1	1,622	Overall	21"	22.5"	32.5"
	2	1,418	11	1,633	20	1,911	L2	1,817	Seat	19"	17"	17.25"
	3	1,438	12	1,658	21	1,942	L3	2,051	Upholstery Requirements: GGLIV19-023			
	COM/4	1,456	13	1,689	22	1,974	L4	2,246	Fabric yards	1		
	5	1,481	14	1,721	23	2,037	L5	2,442	Leather feet ²	17		
	6	1,506	15	1,753	24	2,100			Shipping weight	24.3 lbs.		
	7	1,532	16	1,784	25	2,164			Cube	12.5		
	8	1,558	17	1,816	26	2,226						
	9	1,583	18	1,847	27	2,289						



GGLIV19-024 Upholstered Seat w/Channel Stitch	1	1,578	10	1,828	19	2,154	L1	1,846
	2	1,601	11	1,859	20	2,192	L2	2,080
	3	1,624	12	1,889	21	2,229	L3	2,360
	COM/4	1,647	13	1,927	22	2,267	L4	2,594
	5	1,677	14	1,964	23	2,344	L5	2,829
	6	1,707	15	2,003	24	2,419		
	7	1,738	16	2,041	25	2,495		
	8	1,768	17	2,079	26	2,570		
	9	1,798	18	2,116	27	2,647		

Overall	21"	22.5"	32.5"
Seat	19"	17"	17.25"
Upholstery Requirements: GGLIV19-024			
Fabric yards	1.2		
Leather feet ²	20.4		
Shipping weight	24.3 lbs.		
Cube	12.5		

TO ORDER PLEASE SPECIFY THE FOLLOWING:

MODEL NUMBER	FSC	FRAME	GLIDE	GLWOOD	LAMINATE	FABRIC	FLAMMABILITY RATING
	No FSC X FSC Certified F +83	Polished Chrome PC +109 Black P71 Designer White PJW Matte Gold P8G Silver PR6 Pyrite PJE Solar Black P8X Titanium P8T Bullseye PJF Regatta P8M	Standard Black Nylon STD Swivel Glide w/ Nylon SVL0 +18 <i>Toggle Glide Option Pack page 42.</i>	Only on model GGLIV19-021 Cherry finishes on Quartered Ash Walnut finishes on Quartered Ash Maple finishes on Quartered Ash Oak finishes on Quartered Ash	Only on model GGLIV19-022 L1 and L2 Woodgrain Laminates +109	Only on models GGLIV19-023 and GGLIV19-024 Please refer to list of available upholstery and leather selections on www.gunlocke.com	U CTB117

Example

GGLIV19-023.X.PC.STD.DOL728.U

MODEL NUMBER	FSC	FRAME	GLIDE	FABRIC	FLAMMABILITY
GGLIV19-023	X	PC	STD	DOL728	U

model number	list	dimensions	W	D	HM
GMLIV19-031 Wood Seat	1,590	Overall	19"	20.5"	32.5"
		Seat	18"	16"	24.5"
GMLIV19-032 Laminate Seat	1,204	Shipping weight	23.6 lbs.		
		Cube	12.5		

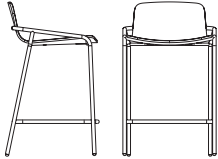

model number	fabric grades						dimensions	W	D	H		
GMLIV19-033 Upholstered Seat	1	1,506	10	1,715	19	1,986	L1	1,729	Overall	19"	20.5"	32.5"
	2	1,525	11	1,740	20	2,018	L2	1,924	Seat	18"	16"	24.5"
	3	1,545	12	1,765	21	2,049	L3	2,158	Upholstery Requirements: GMLIV19-033			
	COM/4	1,563	13	1,796	22	2,081	L4	2,353	Fabric yards	1		
	5	1,588	14	1,828	23	2,144	L5	2,549	Leather feet ²	17		
	6	1,613	15	1,860	24	2,207			Shipping weight	24.4 lbs.		
	7	1,639	16	1,891	25	2,271			Cube	12.5		
	8	1,665	17	1,923	26	2,333						
	9	1,690	18	1,954	27	2,396						

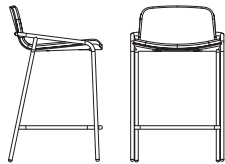

GMLIV19-034 Upholstered Seat w/Channel Stitch	1	1,685	10	1,935	19	2,261	L1	1,953	Overall	19"	20.5"	32.5"
	2	1,708	11	1,966	20	2,299	L2	2,187	Seat	18"	16"	24.5"
	3	1,731	12	1,996	21	2,336	L3	2,467	Upholstery Requirements: GMLIV19-034			
	COM/4	1,754	13	2,034	22	2,374	L4	2,701	Fabric yards	1.2		
	5	1,784	14	2,071	23	2,451	L5	2,936	Leather feet ²	20.4		
	6	1,814	15	2,110	24	2,526			Shipping weight	24.4 lbs.		
	7	1,845	16	2,148	25	2,602			Cube	12.5		
	8	1,875	17	2,186	26	2,677						
	9	1,905	18	2,223	27	2,754						

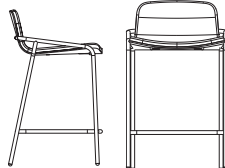

TO ORDER PLEASE SPECIFY THE FOLLOWING:

MODEL NUMBER	FSC	FRAME	GLIDE	GLWOOD	LAMINATE	FABRIC	FLAMMABILITY RATING
	No FSC X FSC Certified F +83	Polished Chrome PC +109 Black P71 Designer White PJW Matte Gold P8G Silver PR6 Pyrite PJE Solar Black P8X Titanium P8T Bullseye PJF Regatta P8M	Standard Black Nylon STD Swivel Glide w/ Nylon SVL0 +18 <i>Toggle Glide Option Pack page 42.</i>	Only on model GGLIV19-031 Cherry finishes on Quartered Ash Walnut finishes on Quartered Ash Maple finishes on Quartered Ash Oak finishes on Quartered Ash	Only on model GGLIV19-032 L1 and L2 Woodgrain Laminates +109	Only on models GGLIV19-033 and GGLIV19-034 Please refer to list of available upholstery and leather selections on www.gunlocke.com	U CTB117

Example

GGLIV19-033.X.PC.STD.DOL728.U

MODEL NUMBER	FSC	FRAME	GLIDE	FABRIC	FLAMMABILITY
GGLIV19-033	X	PC	STD	DOL728	U

LIV

Bar Height Stool

Seating
03/23

model number	list	dimensions	W	D	H
GMLIV19-041 Wood Seat	1,633	Overall	19"	20.5"	37.5"
		Seat	18"	16"	28.5"
GMLIV19-042 Laminate Seat	1,246	Shipping weight	24.6 lbs.		
		Cube	14		

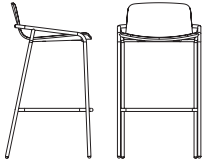

model number	fabric grades					dimensions	W	D	H			
GMLIV19-043 Upholstered Seat	1	1,549	10	1,758	19	2,029	L1	1,772	Overall	19"	20.5"	37.5"
	2	1,568	11	1,783	20	2,061	L2	1,967	Seat	18"	16"	28.5"
	3	1,588	12	1,808	21	2,092	L3	2,201	Upholstery Requirements: GMLIV19-043			
	COM/4	1,606	13	1,839	22	2,124	L4	2,396	Fabric yards	1		
	5	1,631	14	1,871	23	2,187	L5	2,592	Leather feet ²	17		
	6	1,656	15	1,903	24	2,250			Shipping weight	25.4 lbs.		
	7	1,682	16	1,934	25	2,314			Cube	14		
	8	1,708	17	1,966	26	2,376						
	9	1,733	18	1,997	27	2,439						

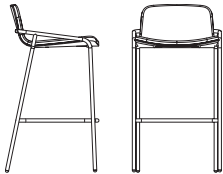

GMLIV19-044 Upholstered Seat w/Channel Stitch	1	1,728	10	1,978	19	2,304	L1	1,996	Overall	19"	20.5"	37.5"
	2	1,751	11	2,009	20	2,342	L2	2,230	Seat	18"	16"	28.5"
	3	1,774	12	2,039	21	2,379	L3	2,510	Upholstery Requirements: GMLIV19-044			
	COM/4	1,797	13	2,077	22	2,417	L4	2,744	Fabric yards	1.2		
	5	1,827	14	2,114	23	2,494	L5	2,979	Leather feet ²	20.4		
	6	1,857	15	2,153	24	2,569			Shipping weight	25.4 lbs.		
	7	1,888	16	2,191	25	2,645			Cube	14		
	8	1,918	17	2,229	26	2,720						
	9	1,948	18	2,266	27	2,797						

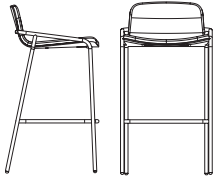

TO ORDER PLEASE SPECIFY THE FOLLOWING:

MODEL NUMBER	FSC	FRAME	GLIDE	GLWOOD	LAMINATE	FABRIC	FLAMMABILITY RATING
	No FSC X FSC Certified F +83	Polished Chrome PC +109 Black P71 Designer White PJW Matte Gold P8G Silver PR6 Pyrite PJE Solar Black P8X Titanium P8T Bullseye PJF Regatta P8M	Standard Black Nylon STD Swivel Glide w/ Nylon SVL0 +18 <i>Toggle Glide Option Pack page 42.</i>	Only on model GGLIV19-041 Cherry finishes on Quartered Ash Walnut finishes on Quartered Ash Maple finishes on Quartered Ash Oak finishes on Quartered Ash	Only on model GGLIV19-042 L1 and L2 Woodgrain Laminates +109	Only on models GGLIV19-043 and GGLIV19-044 Please refer to list of available upholstery and leather selections on www.gunlocke.com	U CTB117

Example

GGLIV19-043.X.PC.STD.DOL728.U						
GGLIV19-043	X	PC	STD	DOL728	U	
MODEL NUMBER	FSC	FRAME	GLIDE	FABRIC	FLAMMABILITY	

model number	fabric grades						dimensions	W	D	H		
GK9903N Armless, upholstered	1	918	10	1,190	19	1,542	L1	1,208	Overall	20 3/4"	23"	33"
	2	944	11	1,222	20	1,583	L2	1,463	Seat		18"	18"
	3	968	12	1,256	21	1,624	L3	1,766	Arm			
	COM/4	993	13	1,296	22	1,664	L4	2,018	Between Arms			
	5	1,026	14	1,338	23	1,748	L5	2,274				
	6	1,059	15	1,378	24	1,829						
	7	1,091	16	1,420	25	1,911						
	8	1,124	17	1,461	26	1,994						
	9	1,157	18	1,502	27	2,075						

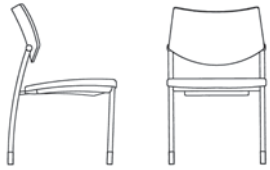

Upholstery Requirements: GK9903N

	Dual Upholstery	
Fabric yards	Seat 0.8	Back 0.5
Leather feet ²	Seat 13.6	Back 8.5
Shipping weight	35 lbs.	
Cube	17.8	

Seat	1	10	167	19	384	L1	178
	2	16	11	187	20	L2	335
	3	31	12	208	21	L3	522
	COM/4	46	13	233	22	L4	677
	5	66	14	258	23	L5	834
	6	87	15	283	24		
	7	106	16	309	25		
	8	127	17	334	26		
	9	147	18	359	27		

Top row of pricing is for units specified with same fabric on Seat and Back. Bottom two rows of pricing required only when two different fabric grades are selected for the Seat and Back.

To calculate price of chair with different grade fabric for Seat and Back; start with Grade 1 price, add appropriate grade price located in second row for Seat, and last add appropriate grade price located in third row for Back to the sum of the Grade 1 and Seat price.

Example: Grade 1 \$918 + grade 4 fabric Seat/Back \$46 + grade 2 fabric Arms \$10 = \$974

Back	1	10	105	19	240	L1	112
	2	10	11	117	20	L2	210
	3	19	12	130	21	L3	326
	COM/4	29	13	145	22	L4	423
	5	42	14	162	23	L5	522
	6	54	15	177	24		
	7	67	16	193	25		
	8	79	17	209	26		
	9	92	18	225	27		

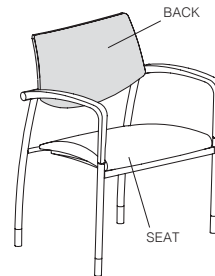

GK8907 Cart	635	Overall	25 3/4"	25 7/8"	7 1/2"
	Holds 5 stacked chairs. Metal cart available in black finish only. (Use with Multi or LIV chairs)	Shipping weight	16 lbs.		
		Cube	20.6		

TO ORDER PLEASE SPECIFY THE FOLLOWING:

<input type="text"/>	<input type="text"/>	<input type="text"/>	<input type="text"/>	<input type="text"/>	<input type="text"/>
MODEL NUMBER	FRAME	GANGING	FLAMMABILITY RATING	SEAT UPHOLSTERY	BACK UPHOLSTERY
This seating model is available with the following frame options. Please specify by adding suffix to model number. NEW FINISHES P71 Black PR6 Silver P71C Black with Casters (+\$180) PR6C Silver with Casters (+\$180)		Ganging device on leg available. Please specify by adding suffix to model number. G Ganging device +\$33 GN No Ganging	U CTB117	Select upholstery for the seat. Please refer to list of available upholstery and leather selections on www.gunlocke.com	Select upholstery for the back. Please refer to list of available upholstery and leather selections on www.gunlocke.com

Example

GK9903N.P71.GN.U.DOL728.SPNN04					
GK9903N	P71	GN	U	DOL728	SPNN04
MODEL NUMBER	FRAME	GANGING	FLAMMABILITY RATING	SEAT UPHOLSTERY	BACK UPHOLSTERY

model number	fabric grades						dimensions	W	D	H		
GK9901P Plastic Moderne Arm, upholstered	1	1,071	10	1,343	19	1,695	L1	1,361	Overall	24 1/2"	23"	33"
	2	1,097	11	1,375	20	1,736	L2	1,616	Seat		18"	18"
	3	1,121	12	1,409	21	1,777	L3	1,919	Arm			26 1/4"
	COM/4	1,146	13	1,449	22	1,817	L4	2,171	Between Arms	20 3/4"		
	5	1,179	14	1,491	23	1,901	L5	2,427				
	6	1,212	15	1,531	24	1,982						
	7	1,244	16	1,573	25	2,064						
	8	1,277	17	1,614	26	2,147						
	9	1,310	18	1,655	27	2,228						



Upholstery Requirements: GK9901P

Dual Upholstery	
Fabric yards	Seat 0.8 Back 0.5
Leather feet ²	Seat 13.6 Back 8.5
Shipping weight	36 lbs.
Cube	17.8

Seat	1	10	19	20	21	22	23	24	25	26	27	L1	L2	L3	L4	L5
		167	384	409	434	459	511	561	611	662	712	178	335	522	677	834
	2	11	187	20	409	L2	335									
	3	12	208	21	434	L3	522									
	COM/4	46	13	233	22	459	L4	677								
	5	66	14	258	23	511	L5	834								
	6	87	15	283	24	561										
	7	106	16	309	25	611										
	8	127	17	334	26	662										
	9	147	18	359	27	712										

Top row of pricing is for units specified with same fabric on Seat and Back. Bottom two rows of pricing required only when two different fabric grades are selected for the Seat and Back.

To calculate price of chair with different grade fabric for Seat and Back; start with Grade 1 price, add appropriate grade price located in second row for Seat, and last add appropriate grade price located in third row for Back to the sum of the Grade 1 and Seat price.

Example: Grade 1 \$1,071 + grade 4 fabric Seat/Back \$46 + grade 2 fabric Arms \$10 = \$1,127

Back	1	10	19	20	21	22	23	24	25	26	27	L1	L2	L3	L4	L5
		105	240	256	272	287	319	350	382	414	445	112	210	326	423	522
	2	10	117	20	256	L2	210									
	3	19	12	130	21	272	L3	326								
	COM/4	29	13	145	22	287	L4	423								
	5	42	14	162	23	319	L5	522								
	6	54	15	177	24	350										
	7	67	16	193	25	382										
	8	79	17	209	26	414										
	9	92	18	225	27	445										

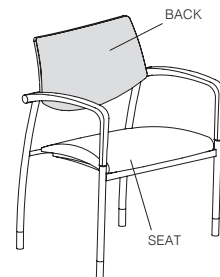

TO ORDER PLEASE SPECIFY THE FOLLOWING:

<input type="text"/>	<input type="text"/>	<input type="text"/>	<input type="text"/>	<input type="text"/>	<input type="text"/>
MODEL NUMBER	FRAME	GANGING	FLAMMABILITY RATING	SEAT UPHOLSTERY	BACK UPHOLSTERY
	This seating model is available with the following frame options. Please specify by adding suffix to model number. NEW FINISHES P71 Black PR6 Silver P71C Black with Casters (+\$180) PR6C Silver with Casters (+\$180)	Ganging device on leg available. Please specify by adding suffix to model number. G Ganging device +\$33 GN No Ganging	U CTB117	Select upholstery for the seat. Please refer to list of available upholstery and leather selections on www.gunlocke.com	Select upholstery for the back. Please refer to list of available upholstery and leather selections on www.gunlocke.com

Example

GK9901P.P71.GN.U.DOL728.SPNN04

GK9901P	P71	GN	U	DOL728	SPNN04
MODEL NUMBER	FRAME	GANGING	FLAMMABILITY RATING	SEAT UPHOLSTERY	BACK UPHOLSTERY

Wood Moderne Arm, Upholstered

model number	fabric grades							
GK9901W Wood Moderne Arm, upholstered	1	1,364	10	1,636	19	1,988	L1	1,654
	2	1,390	11	1,668	20	2,029	L2	1,909
	3	1,414	12	1,702	21	2,070	L3	2,212
	COM/4	1,439	13	1,742	22	2,110	L4	2,464
	5	1,472	14	1,784	23	2,194	L5	2,720
	6	1,505	15	1,824	24	2,275		
	7	1,537	16	1,866	25	2,357		
	8	1,570	17	1,907	26	2,440		
	9	1,603	18	1,948	27	2,521		



dimensions	W	D	H
Overall	24 1/2"	23"	33"
Seat		18"	18"
Arm			26 1/4"
Between Arms	20 3/4"		

Upholstery Requirements: GK9901W

	Dual Upholstery	
Fabric yards	Seat 0.8	Back 0.5
Leather feet ²	Seat 13.6	Back 8.5
Shipping weight	36 lbs.	
Cube	17.8	

Seat	1	10	19	20	21	22	23	24	25	26	27	L1	L2	L3	L4	L5
		167	384									178	335	522	677	834
	2	16	187	409												
	3	31	208	434												
	COM/4	46	233	459												
	5	66	258	511												
	6	87	283	561												
	7	106	309	611												
	8	127	334	662												
	9	147	359	712												

Top row of pricing is for units specified with same fabric on Seat and Back. Bottom two rows of pricing required only when two different fabric grades are selected for the Seat and Back.

To calculate price of chair with different grade fabric for Seat and Back; start with Grade 1 price, add appropriate grade price located in second row for Seat, and last add appropriate grade price located in third row for Back to the sum of the Grade 1 and Seat price.

Example: Grade 1 \$1,364 + grade 4 fabric Seat/Back \$46 + grade 2 fabric Arms \$10 = \$1,420

Back	1	10	19	20	21	22	23	24	25	26	27	L1	L2	L3	L4	L5
		105	240									112	210	326	423	522
	2	10	117	256												
	3	19	130	272												
	COM/4	29	145	287												
	5	42	162	319												
	6	54	177	350												
	7	67	193	382												
	8	79	209	414												
	9	92	225	445												

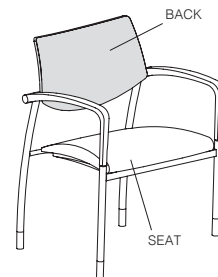

TO ORDER PLEASE SPECIFY THE FOLLOWING:

<input type="text"/>	<input type="text"/>	<input type="text"/>	<input type="text"/>	<input type="text"/>	<input type="text"/>	<input type="text"/>
MODEL NUMBER	FRAME	FINISH	GANGING	FLAMMABILITY RATING	SEAT UPHOLSTERY	BACK UPHOLSTERY
<p>This seating model is available with the following frame options. Please specify by adding suffix to model number.</p> <p>NEW FINISHES</p> <p>P71 Black</p> <p>PR6 Silver</p> <p>P71C Black with Casters (+\$180)</p> <p>PR6C Silver with Casters (+\$180)</p>		<p>Cherry finishes on Maple</p> <p>Walnut finishes on Maple</p> <p>Maple finishes on Maple</p> <p>Oak finishes on Maple</p> <p>Please refer to the Multi® product page on www.gunlocke.com for standard finish options.</p>	<p>Ganging device on leg available. Please specify by adding suffix to model number.</p> <p>G Ganging device +\$33</p> <p>GN No Ganging</p>	<p>U CTB117</p>	<p>Select upholstery for the seat.</p> <p>Please refer to list of available upholstery and leather selections on www.gunlocke.com</p>	<p>Select upholstery for the back.</p> <p>Please refer to list of available upholstery and leather selections on www.gunlocke.com</p>

Example

GK9901W.P71.GN.U.DOL728.SPNN04						
GK9901W	P71	215	GN	U	DOL728	SPNN04
MODEL NUMBER	FRAME	FINISH	GANGING RATING	FLAMMABILITY UPHOLSTERY	SEAT UPHOLSTERY	BACK

MULTI®

Wood Back

Seating
03/23

model number	fabric grades								dimensions	W	D	H
GK9907N Armless, upholstered seat, wood back	1	1,145	10	1,312	19	1,529	L1	1,323	Overall	20 3/4"	23"	33"
	2	1,161	11	1,332	20	1,554	L2	1,480	Seat		18"	18"
	3	1,176	12	1,353	21	1,579	L3	1,667	Upholstery Requirements: GK9907N			
	COM/4	1,191	13	1,378	22	1,604	L4	1,822	Fabric yards	0.8		
	5	1,211	14	1,403	23	1,656	L5	1,979	Leather feet ²	13.6		
	6	1,232	15	1,428	24	1,706			Shipping weight	35 lbs.		
	7	1,251	16	1,454	25	1,756			Cube	17.8		
	8	1,272	17	1,479	26	1,807						
	9	1,292	18	1,504	27	1,857						

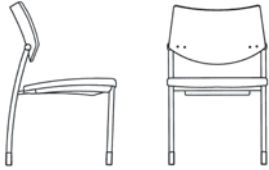

GK9905P Plastic Moderne Arm, upholstered seat, wood back	1	1,299	10	1,466	19	1,683	L1	1,477	Overall	24 1/2"	23"	33"
	2	1,315	11	1,486	20	1,708	L2	1,634	Seat		18"	18"
	3	1,330	12	1,507	21	1,733	L3	1,821	Arm		26 1/4"	
	COM/4	1,345	13	1,532	22	1,758	L4	1,976	Between arms	20 3/4"		
	5	1,365	14	1,557	23	1,810	L5	2,133	Upholstery Requirements: GK9905P			
	6	1,386	15	1,582	24	1,860			Fabric yards	0.8		
	7	1,405	16	1,608	25	1,910			Leather feet ²	13.6		
	8	1,426	17	1,633	26	1,961			Shipping weight	36 lbs.		
	9	1,446	18	1,658	27	2,011			Cube	17.8		

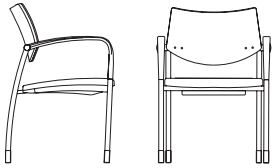

GK9905W Wood Moderne Arm, upholstered seat, wood back	1	1,578	10	1,745	19	1,962	L1	1,756	Overall	24 1/2"	23"	33"
	2	1,594	11	1,765	20	1,987	L2	1,913	Seat		18"	18"
	3	1,609	12	1,786	21	2,012	L3	2,100	Arm		26 1/4"	
	COM/4	1,624	13	1,811	22	2,037	L4	2,255	Between arms	20 3/4"		
	5	1,644	14	1,836	23	2,089	L5	2,412	Upholstery Requirements: GK9905W			
	6	1,665	15	1,861	24	2,139			Fabric yards	0.8		
	7	1,684	16	1,887	25	2,189			Leather feet ²	13.6		
	8	1,705	17	1,912	26	2,240			Shipping weight	36 lbs.		
	9	1,725	18	1,937	27	2,290			Cube	17.8		

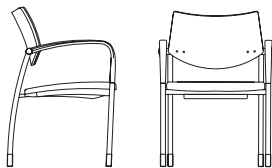

TO ORDER PLEASE SPECIFY THE FOLLOWING:

MODEL NUMBER	FRAME	FINISH	BACK	GANGING	FLAMMABILITY RATING	SEAT UPHOLSTERY
This seating model is available with the following frame options. Please specify by adding suffix to model number.						
NEW FINISHES						
P71 Black						
PR6 Silver						
P71C Black with Casters (+\$180)						
PR6C Silver with Casters (+\$180)						
Cherry finishes on Maple			Back is formed of molded plywood with face veneer in maple.	Ganging device on leg available. Please specify by adding suffix to model number.		Select upholstery for the back.
Walnut finishes on Maple				G Ganging device +\$33		
Maple finishes on Maple				GN No Ganging		
Oak finishes on Maple						
Please refer to the Multi® product page on www.gunlocke.com for standard finish options.			PLN Plain			Please refer to list of available upholstery and leather selections on www.gunlocke.com
			TDP Teardrop +\$109			

Example

GK9905N.P71.215.PLN.GN.U.DOL728

MODEL NUMBER	FRAME	FINISH	BACK	FLAMMABILITY RATING	SEAT UPHOLSTERY
GK9905N	P71	215	PLN	U	DOL728

model number	fabric grades						dimensions	W	D	H		
GK9923N Armless, upholstered	1	1,241	10	1,513	19	1,865	L1	1,531	Overall	24 1/2"	23"	43"
	2	1,267	11	1,545	20	1,906	L2	1,786	Seat		18"	28"
	3	1,291	12	1,579	21	1,947	L3	2,089	Arm			37"
	COM/4	1,316	13	1,619	22	1,987	L4	2,341	Between arms			
	5	1,349	14	1,661	23	2,071	L5	2,597	Seat to Foot Rung			17"
	6	1,382	15	1,701	24	2,152						
	7	1,414	16	1,743	25	2,234						
	8	1,447	17	1,784	26	2,317						
	9	1,480	18	1,825	27	2,398						

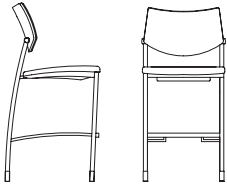

Upholstery Requirements: GK9923N

	Dual Upholstery	
Fabric yards	Seat 0.8	Back 0.5
Leather feet ²	Seat 13.6	Back 8.5
Shipping weight	40 lbs.	
Cube	19.1	

Seat	1	10	167	19	384	L1	178	
	2	16	11	187	20	409	L2	335
	3	31	12	208	21	434	L3	522
	COM/4	46	13	233	22	459	L4	677
	5	66	14	258	23	511	L5	834
	6	87	15	283	24	561		
	7	106	16	309	25	611		
	8	127	17	334	26	662		
	9	147	18	359	27	712		

Top row of pricing is for units specified with same fabric on Seat and Back. Bottom two rows of pricing required only when two different fabric grades are selected for the Seat and Back.

To calculate price of chair with different grade fabric for Seat and Back; start with Grade 1 price, add appropriate grade price located in second row for Seat, and last add appropriate grade price located in third row for Back to the sum of the Grade 1 and Seat price.

Example: Grade 1 \$1,241 + grade 4 fabric Seat/back \$46 + grade 2 fabric Arms \$10 = \$1,297

Back	1	10	105	19	240	L1	112	
	2	10	11	117	20	256	L2	210
	3	19	12	130	21	272	L3	326
	COM/4	29	13	145	22	287	L4	423
	5	42	14	162	23	319	L5	522
	6	54	15	177	24	350		
	7	67	16	193	25	382		
	8	79	17	209	26	414		
	9	92	18	225	27	445		

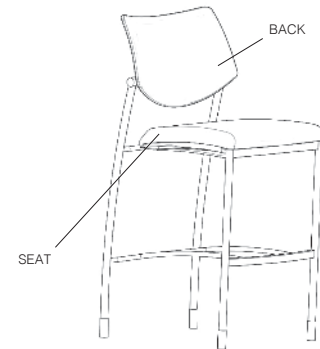

TO ORDER PLEASE SPECIFY THE FOLLOWING:

<input type="text"/>	<input type="text"/>	<input type="text"/>	<input type="text"/>	<input type="text"/>
MODEL NUMBER	FRAME	FLAMMABILITY RATING	SEAT UPHOLSTERY	BACK UPHOLSTERY
	This seating models are available with the following frame options. Please specify by adding suffix to model number. P71 Black PR6 Silver	U CTB117	Select upholstery for the seat. Please refer to list of available upholstery and leather selections on www.gunlocke.com	Select upholstery for the back. Please refer to list of available upholstery and leather selections on www.gunlocke.com

Example

GK9923N	P71	U	DOL728	SPNNO4
MODEL NUMBER	FRAME	FLAMMABILITY RATING	SEAT UPHOLSTERY	BACK UPHOLSTERY

model number	fabric grades						dimensions	W	D	H		
GK9961P Plastic Moderne Arm, upholstered	1	3,361	10	3,820	19	4,417	L1	3,851	Overall	36 1/2"	26 1/4"	33 1/2"
	2	3,405	11	3,876	20	4,486	L2	4,281	Seat		19"	19"
	3	3,445	12	3,932	21	4,556	L3	4,795	Arm			27 1/4"
	COM/4	3,488	13	4,001	22	4,625	L4	5,224	Between arms	33 1/4"		
	5	3,543	14	4,070	23	4,764	L5	5,654				
	6	3,599	15	4,139	24	4,903						
	7	3,653	16	4,209	25	5,041						
	8	3,708	17	4,278	26	5,181						
	9	3,764	18	4,348	27	5,320						

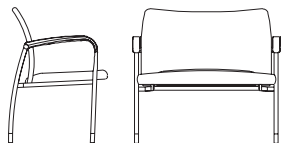

Upholstery Requirements: GK9961P

	Dual Upholstery	
Fabric yards	Seat 0.9	Back 1.3
Leather feet ²	Seat 15.3	Back 22.1
Shipping weight	60 lbs.	
Cube	32.6	

Seat	1	10	19	L1
	188	432	201	
	2	11	211	20
	377			
	3	12	234	21
	489			
	COM/4	52	13	22
	517			
	5	14	290	23
	574			
	6	15	319	24
	631			
	7	16	347	25
	687			
	8	17	375	26
	745			
	9	18	404	27
	802			

Top row of pricing is for units specified with same fabric on Seat and Back. Bottom two rows of pricing required only when two different fabric grades are selected for the Seat and Back.

To calculate price of chair with different grade fabric for Seat and Back; start with Grade 1 price, add appropriate grade price located in second row for Seat, and last add appropriate grade price located in third row for Back to the sum of the Grade 1 and Seat price.

Example: Grade 1 \$3,361 + grade 4 fabric Seat/back \$52 + grade 2 fabric Arms \$26 = \$3,439

Back	1	10	19	L1
	271	624	289	
	2	11	304	20
	665			
	3	12	337	21
	706			
	COM/4	75	13	22
	747			
	5	14	419	23
	829			
	6	15	459	24
	911			
	7	16	501	25
	993			
	8	17	542	26
	1,075			
	9	18	583	27
	1,157			

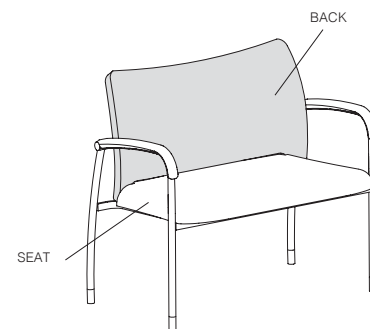

TO ORDER PLEASE SPECIFY THE FOLLOWING:

MODEL NUMBER	FRAME	GANGING	FLAMMABILITY RATING	GORE BARRIER	SEAT UPHOLSTERY	BACK UPHOLSTERY
	P71 Black PR6 Silver	Ganging device on leg available. Please specify by adding suffix to model number. G Ganging device +\$33 GN No Ganging	U CTB117	GBN No Gore	Select upholstery for the seat. Please refer to list of available upholstery and leather selections on www.gunlocke.com	Select upholstery for the back. Please refer to list of available upholstery and leather selections on www.gunlocke.com

Example

GK9961P.P71.GN.U.GBN.DOL728.SPNN04

GK9961P	P71	GN	U	GBN	DOL728	SPNN04
MODEL NUMBER	FRAME	GANGING	FLAMMABILITY RATING	GORE BARRIER	SEAT UPHOLSTERY	BACK UPHOLSTERY

model number	fabric grades							
GK9961W Wood Moderne Arm, upholstered	1	3,653	10	4,112	19	4,709	L1	4,143
	2	3,697	11	4,168	20	4,778	L2	4,573
	3	3,737	12	4,224	21	4,848	L3	5,087
	COM/4	3,780	13	4,293	22	4,917	L4	5,516
	5	3,835	14	4,362	23	5,056	L5	5,946
	6	3,891	15	4,431	24	5,195		
	7	3,945	16	4,501	25	5,333		
	8	4,000	17	4,570	26	5,473		
	9	4,056	18	4,640	27	5,612		

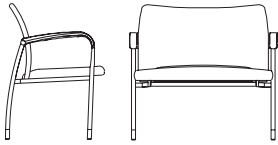

dimensions	W	D	H
Overall	36 1/2"	26 1/4"	33 1/2"
Seat		19"	19"
Arm			27 1/4"
Between arms	33 1/4"		

Upholstery Requirements: GK9961W

	Dual Upholstery	
Fabric yards	Seat 0.9	Back 1.3
Leather feet ²	Seat 15.3	Back 22.1
Shipping weight	60 lbs.	
Cube	32.6	

Seat	1	10	19	20	21	22	23	24	25	26	27	L1	L2	L3	L4	L5
		188	432									201	377	587	762	938
	18	211	460													
	34	234	489													
	52	262	517													
	75	290	574													
	98	319	631													
	119	347	687													
	142	375	745													
	165	404	802													

Top row of pricing is for units specified with same fabric on Seat and Back. Bottom two rows of pricing required only when two different fabric grades are selected for the Seat and Back.

To calculate price of chair with different grade fabric for Seat and Back; start with Grade 1 price, add appropriate grade price located in second row for Seat, and last add appropriate grade price located in third row for Back to the sum of the Grade 1 and Seat price.

Example: Grade 1 \$3,653 + grade 4 fabric Seat/back \$52 + grade 2 fabric Arms \$26 = \$3,731

Back	1	10	19	20	21	22	23	24	25	26	27	L1	L2	L3	L4	L5
		271	624									289	543	847	1,101	1,355
	26	304	665													
	50	337	706													
	75	378	747													
	107	419	829													
	140	459	911													
	173	501	993													
	205	542	1,075													
	238	583	1,157													

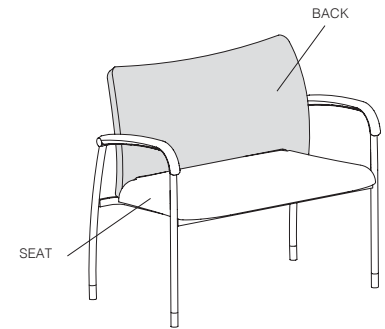

TO ORDER PLEASE SPECIFY THE FOLLOWING:

MODEL NUMBER	FRAME	FINISH	GANGING	FLAMMABILITY RATING	GORE BARRIER	SEAT UPHOLSTERY	BACK UPHOLSTERY
	P71 Black PR6 Silver	Cherry finishes on Maple Walnut finishes on Maple Maple finishes on Maple Oak finishes on Maple Please refer to the Multi® product page on www.gunlocke.com for standard finish options.	Ganging device on leg available. Please specify by adding suffix to model number. G Ganging device +\$33 GN No Ganging	U CTB117	GBN No Gore	Select upholstery for the seat. Please refer to list of available upholstery and leather selections on www.gunlocke.com	Select upholstery for the back. Please refer to list of available upholstery and leather selections on www.gunlocke.com

Example

GK9961W	P71	215	GN	U	GBN	DOL728	SPNNO4
MODEL NUMBER	FRAME	FINISH	GANGING	FLAMMABILITY RATING	GORE BARRIER	SEAT UPHOLSTERY	BACK UPHOLSTERY

TIA™ BARSTOOL

Bar Height | Single Upholstery

Seating
03/23

model number	fabric grades							dimensions	W	D	H	
GMHB17-011 Bar height, single upholstery	1	1,676	10	1,905	19	2,204	L1	1,922	Overall	19"	21 1/2"	40 5/8"
	2	1,697	11	1,934	20	2,239	L2	2,135	Seat	18 1/2"	16 3/4"	30 1/2"
	3	1,718	12	1,961	21	2,274	L3	2,394	Upholstery Requirements: GMHB17-011			
	COM/4	1,739	13	1,996	22	2,309	L4	2,608	Fabric yards	1.1		
	5	1,767	14	2,031	23	2,377	L5	2,822	Leather feet²	18.7		
	6	1,794	15	2,066	24	2,447			Shipping weight	31 lbs.		
	7	1,823	16	2,099	25	2,517			Cube	13.6		
	8	1,850	17	2,134	26	2,586			Note: Footrest for bar height Tia™ is 12 1/8" high off the floor.			
	9	1,878	18	2,169	27	2,655						



TO ORDER PLEASE SPECIFY THE FOLLOWING:

<input type="text"/>	<input type="text"/>	<input type="text"/>	<input type="text"/>	<input type="text"/>
MODEL NUMBER	FOOTREST COLOR	FINISH	FLAMMABILITY RATING	UPHOLSTERY

Polished Stainless **PS +\$60**
 Brushed Stainless **BS +\$60**
 Black Powder Coat **BK**
 White Powder Coat **WH**

These seating models are available in the following hardwoods:
 Maple **NE**
 Ash **QA**
 Please refer to the Tia product page on www.gunlocke.com for standard finish options.

U CTB117

Please refer to list of available upholstery and leather selections on www.gunlocke.com

Cherry finishes on Maple or Ash
Walnut finishes on Maple or Ash
Maple finishes on Maple or Ash
Oak finishes on Maple or Ash
Natural Cherry 222, Natural Maple 800, Honey Maple 873 and Natural Oak 300 not available on Ash.

Example

GMHB17-011.PS.QA629.U.DOL728				
GMHB17-011	PS	QA629	U	DOL728
MODEL NUMBER	FOOTREST COLOR	FINISH	FLAMMABILITY	UPHOLSTERY

model number	fabric grades								dimensions	W	D	H
GMHB17-041 Counter height, single upholstery	1	1,676	10	1,905	19	2,204	L1	1,922	Overall	19"	21 1/2"	36 3/8"
	2	1,697	11	1,934	20	2,239	L2	2,135	Seat	18 1/2"	16 3/4"	26 1/4"
	3	1,718	12	1,961	21	2,274	L3	2,394	Upholstery Requirements: GMHB17-041			
	COM/4	1,739	13	1,996	22	2,309	L4	2,608	Fabric yards	1.1		
	5	1,767	14	2,031	23	2,377	L5	2,822	Leather feet²	18.7		
	6	1,794	15	2,066	24	2,447			Shipping weight	30 lbs.		
	7	1,823	16	2,099	25	2,517			Cube	12.3		
	8	1,850	17	2,134	26	2,586			Note: Footrest for counter height Tia™ is 7 7/8" high off the floor.			
	9	1,878	18	2,169	27	2,655						



TO ORDER PLEASE SPECIFY THE FOLLOWING:

<input type="text"/>	<input type="text"/>	<input type="text"/>	<input type="text"/>	<input type="text"/>
MODEL NUMBER	FOOTREST COLOR	FINISH	FLAMMABILITY RATING	UPHOLSTERY

- Polished Stainless **PS +\$60**
- Brushed Stainless **BS +\$60**
- Black Powder Coat **BK**
- White Powder Coat **WH**

These seating models are available in the following hardwoods:
Maple **NE**
Ash **QA**
Please refer to the Tia product page on www.gunlocke.com for standard finish options.

Cherry finishes on Maple or Ash
Walnut finishes on Maple or Ash
Maple finishes on Maple or Ash
Oak finishes on Maple or Ash
Natural Cherry 222, Natural Maple 800, Honey Maple 873 and Natural Oak 300 not available on Ash.

U CTB117

Please refer to list of available upholstery and leather selections on www.gunlocke.com

Example

GMHB17-041.PS.QA629.U.DOL728				
GMHB17-041	PS	QA629	U	DOL728
MODEL NUMBER	FOOTREST COLOR	FINISH	FLAMMABILITY	UPHOLSTERY

TRILLIA™ BARSTOOL

Upholstered Seat

Seating
03/23

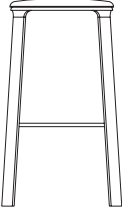
model number	fabric grades							dimensions	W	D	H	
GMQA16-011 Bar height, upholstered seat pad 	1	1,957	10	2,083	19	2,245	L1	2,092	Overall	17 5/8"	17 5/8"	30 H"
	2	1,968	11	2,098	20	2,264	L2	2,208	Seat	17 5/8"	17 5/8"	
	3	1,980	12	2,112	21	2,283	L3	2,349	Upholstery Requirements: GMQA16-011			
	COM/4	1,991	13	2,132	22	2,302	L4	2,465	Fabric yards	Seat pad	0.6	
	5	2,007	14	2,150	23	2,340	L5	2,582	Leather feet ²	Seat pad	10.2	
	6	2,022	15	2,170	24	2,378			Shipping weight	15 lbs.		
	7	2,037	16	2,189	25	2,415			Cube	8.3		
	8	2,052	17	2,207	26	2,453			Note: Footrest for Bar Height Trillia™ is 12" high off the floor.			
	9	2,068	18	2,227	27	2,492						

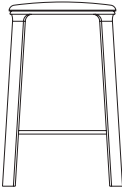
GMQA16-041 Counter height, upholstered seat pad 	1	1,957	10	2,083	19	2,245	L1	2,092	Overall	17 1/8"	17 1/8"	26 H"
	2	1,968	11	2,098	20	2,264	L2	2,208	Seat	17 1/8"	17 1/8"	
	3	1,980	12	2,112	21	2,283	L3	2,349	Upholstery Requirements: GMQA16-041			
	COM/4	1,991	13	2,132	22	2,302	L4	2,465	Fabric yards	Seat pad	0.6	
	5	2,007	14	2,150	23	2,340	L5	2,582	Leather feet ²	Seat pad	10.2	
	6	2,022	15	2,170	24	2,378			Shipping weight	14 lbs.		
	7	2,037	16	2,189	25	2,415			Cube	7.2		
	8	2,052	17	2,207	26	2,453			Note: Footrest for Counter Height Trillia™ is 7 3/4" high off the floor.			
	9	2,068	18	2,227	27	2,492						

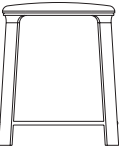
GMQA16-071 Standard height, upholstered seat pad 	1	1,701	10	1,827	19	1,989	L1	1,836	Overall	16 1/4"	16 1/4"	19 3/8"
	2	1,712	11	1,842	20	2,008	L2	1,952	Seat	16 1/4"	16 1/4"	
	3	1,724	12	1,856	21	2,027	L3	2,093	Upholstery Requirements: GMQA16-071			
	COM/4	1,735	13	1,876	22	2,046	L4	2,209	Fabric yards	Seat pad	0.6	
	5	1,751	14	1,894	23	2,084	L5	2,326	Leather feet ²	Seat pad	10.2	
	6	1,766	15	1,914	24	2,122			Shipping weight	14 lbs.		
	7	1,781	16	1,933	25	2,159			Cube	4.8		
	8	1,796	17	1,951	26	2,197			Note: Footrest for Standard Height Trillia™ is 2 1/2" high off the floor.			
	9	1,812	18	1,971	27	2,236						

TO ORDER PLEASE SPECIFY THE FOLLOWING:

<input type="text"/>	<input type="text"/>	<input type="text"/>	<input type="text"/>	<input type="text"/>
MODEL NUMBER	SPECIES & FINISH	STITCH DETAIL	FLAMMABILITY RATING	UPHOLSTERY

These seating models are available in the following hardwoods:
Ash **QA**

Please refer to the Trillia product page on www.gunlocke.com for standard finish options.

Cherry finishes on Ash

Walnut finishes on Ash

Oak finishes on Ash

Natural Oak 300 not available on Ash

Not Required **NR**
Stitch Detail **SD +\$88**

U CTB117

Please refer to list of available upholstery and leather selections on www.gunlocke.com

Example

GMQA16-011.QA601.SD.U.DOL728

GMQA16-011	QA601	SD	U	DOL728
MODEL NUMBER	FINISH	STITCH DETAIL	FLAMMABILITY	UPHOLSTERY

model number	list	dimensions	W	D	H
--------------	------	------------	---	---	---

GMQA16-021
Bar height,
wood seat

1,943

Overall	17 5/8"	17 5/8"	29 5/8"
Seat	17 5/8"	17 5/8"	
Shipping weight	13 lbs.		
Cube	8.1		

Note: Footrest for Bar Height Trillia™ is 12" high off the floor.

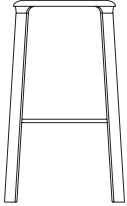

GMQA16-051
Counter height,
wood seat

1,943

Overall	17 1/8"	17 1/8"	25 3/8"
Seat	17 1/8"	17 1/8"	
Shipping weight	12 lbs.		
Cube	7.0		

Note: Footrest for Counter Height Trillia™ is 7 3/4" high off the floor.

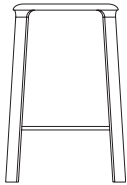

GMQA16-081
Standard height,
wood seat

1,676

Overall	16 1/4"	16 1/4"	18 H"
Seat	16 1/4"	16 1/4"	
Shipping weight	12 lbs.		
Cube	4.6		

Note: Footrest for Standard Height Trillia™ is 2 1/2" high off the floor.

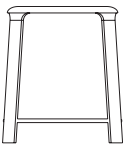

TO ORDER PLEASE SPECIFY THE FOLLOWING:

--	--

MODEL NUMBER **SPECIES & FINISH**

These seating models are available in the following hardwoods:

Ash **QA**

Please refer to the Trillia product page on www.gunlocke.com for standard finish options.

Cherry finishes on Ash

Walnut finishes on Ash

Oak finishes on Ash

Natural Oak 300 not available on Ash

Example

GMQA16-021.QA601

GMQA16-021

QA601

MODEL NUMBER

FINISH

Swivel Seating 63-79
Swivel Seating Product Specifications 64-67
Avoca™ 68-69
Genesee 70-72
Geneva 73-74
Olla Executive 75-78
Washington Series 79

SWIVEL SEATING

Product Specifications

Seating
03/23

AVOCA™

Seat: High resilient foam overmolded onto rigid urethane pan, wrapped in 1/2" foam with additional 1/2" high resiliency foam topper.

Back: High resilient foam overmolded onto rigid urethane pan, wrapped in 1/4" foam with additional 1/2" high resiliency foam topper

Arm:

Full Urethane: Self-skinning urethane foam over steel structure.

Full Polished: Polished cast aluminum.

Polished with Urethane Insert: Polished cast aluminum with self-skinning urethane foam pad.

Control: Swivel-tilt with lockout. Or, premium Synchro-tilt with lockout, tilt tension, pneumatic height adjustment, and 3" range of seat depth adjustment.

Base: Black nylon plastic or die-cast polished aluminum 5 star.

Caster: Soft or Hard. Premium casters with chrome finish are optional.

Upholstery: French-stitch around edges, channel stitching optional.

BIFMA Rating:

ANSI/BIFMA X5.1 2017
(300lb Weight Rating)

GENESEE

Seat: High resiliency foam overmolded onto rigid urethane bucket, wrapped in 1/2" foam with additional 1/2" high resiliency foam topper.

Back: High resiliency foam overmolded onto rigid urethane bucket, wrapped in 1/2" foam.

Arm:

Polished aluminum: Polished cast aluminum.

Upholstered: Polished cast aluminum with routed upholstery groove, covered in J" high density foam, upholstery wrapped with welt cord to cover staples.

Control: Black mid-tilt control, tension adjustment, tilt lockout.

Base: Five-star, die-cast polished aluminum.

Casters: Soft or hard. Premium casters with chrome finish optional.

Upholstery: Top-stitch around edges of bucket.

BIFMA Rating:

ANSI/BIFMA X5.1 2017
(300lb Weight Rating)

GENEVA

Frame: Curved plywood

Seat and Back: Dacron over dual density cut foam.

Arm:

Full Urethane: Self-skinning urethane foam over steel structure

Polished with Urethane Insert: Polished cast aluminum with self-skinning urethane foam pad.

Control: Black mid-tilt control, tension adjustment, tilt lockout.

Base: Black nylon plastic or die-cast polished aluminum star.

Casters: Soft or hard.

BIFMA Rating:

ANSI/BIFMA X5.1 2017
(300lb Weight Rating)

OLLA SWIVEL

Seat and Back: Furniture-grade curved plywood covered with high-resiliency molded foam.

Seat and Back Wood Decor: Maple or Cherry Veneer over molded formed plywood (GK2804/GK2806).

Metal J-Bar Cover: Black, silver or polished aluminum.

Arm:

Adjustable Arm: Arm height range 4", Forward/Back 2", Width Adjustment 1". Arms available in black only.

Upholstered Arm: Cut foam over furniture-grade plywood.

Urethane Arm: Textured urethane.

Control: Synchronized tilt mechanism control, 5-position lock out, tension control and pneumatic height adjustment. The synchronized tilt ratio is 2.3 to 1 degree.

Seat Depth Adjustment: 2" range with 6 evenly spaced lockable positions.

Tilt Lock: 5 incremental positions. Back tilt travel 21 degrees rearward to a fully reclined position.

Base: 5-star base, die-cast aluminum. Available in black, silver and polished aluminum.

Casters: Soft or hard.

Upholstery: The back and seat upholstery is French-stitched.

BIFMA Rating:

ANSI/BIFMA X5.1 2017 w/ additional requirements (300lb Weight Rating, Adjustable Arms test to 275lbs)

WASHINGTON

Frame: Hardwood joined by Double dowels, corner blocked.

Seat: Spring seat platform with foam and cotton filling. Upholstered. Cushion material is fabricated foam and dacron filled. Welted.

Back: Foam, cotton, and dacron filled over spring foundation. Upholstered. Welted.

Arms: Upholstered over dacron and foam.

Swivel base: Five leg, with brass capped detail. Manual lift.

Casters: 2" Bronze Ball.

BIFMA Rating:

ANSI/BIFMA X5.1 2015 w/ additional requirements (400lb Weight Rating)

SWIVEL SEATING

Product Specifications

SWIVEL ERGONOMICS

Dual Point Synchro Tilt

In Synchronous tilt, the backrest and seat pan of a chair reclines at a different ratio (usually 2:1) as you lean back. For every 10 degrees of recline in the backrest for example, the seat pan only tilts back 5 degrees.

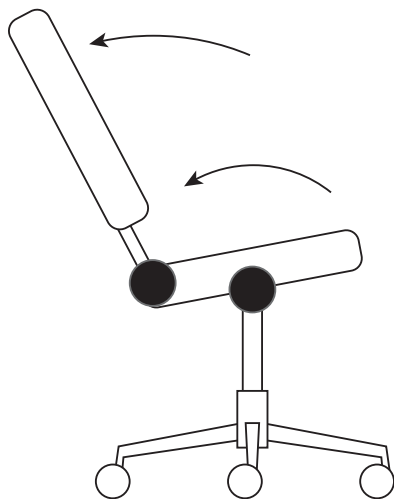

Single Point Mid Tilt

Mid tilt employs a basic tilt mechanism that's located in the center or back of the seat to tilt the seat pan and backrest in tandem. The angle of the front of the seat increases at the same rate as the backrest.

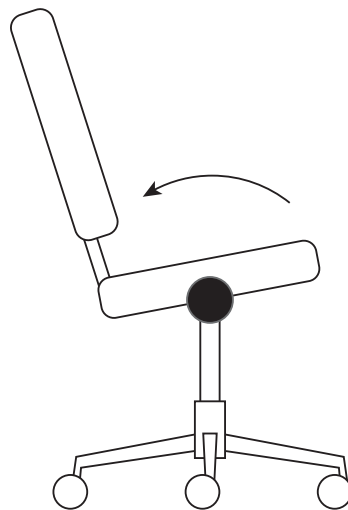

Single Point Knee Tilt

With a Knee tilt, the pivoting point is located near the very front of the seat, resulting in a wide angle tilt that still keeps the front of the seat relatively level. Knee tilt combines some qualities of synchro and mid tilting. With the pivoting point near the front of the seat, your feet remain on the ground even with a larger recline in the seat pan and backrest.

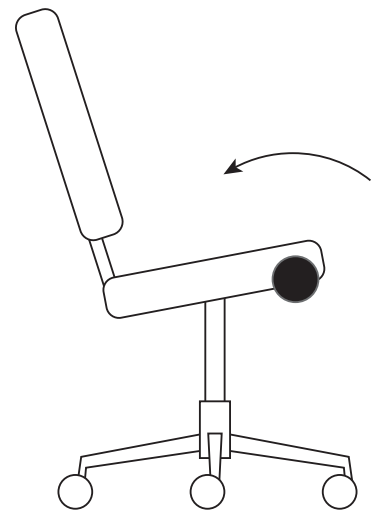

CONTROL HOW TO'S

Mid-Tilt and Knee Tilt Mechanism

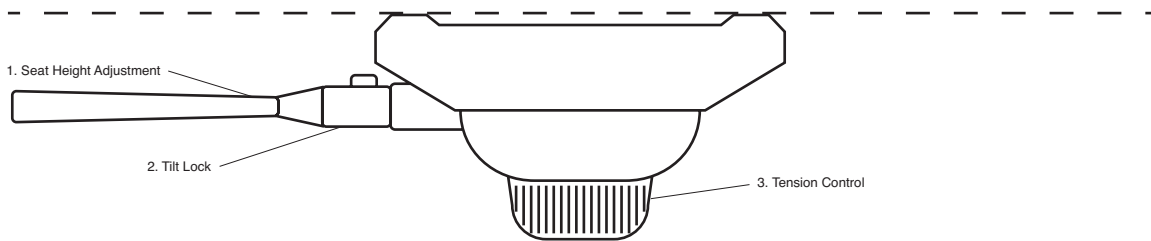

1. SEAT HEIGHT ADJUSTMENT

Slightly lift body weight off seat and pull up on paddle to increase or decrease height. Release lever to lock into desired height.

2. TILT LOCK

Push handle in towards center of control. This will lock the position of the tilt. Pull handle out to allow for free tilting.

3. TENSION CONTROL

Decrease tension by rotating the knob left. Increase tension by rotating the knob right.

Synchro-Tilt Mechanism

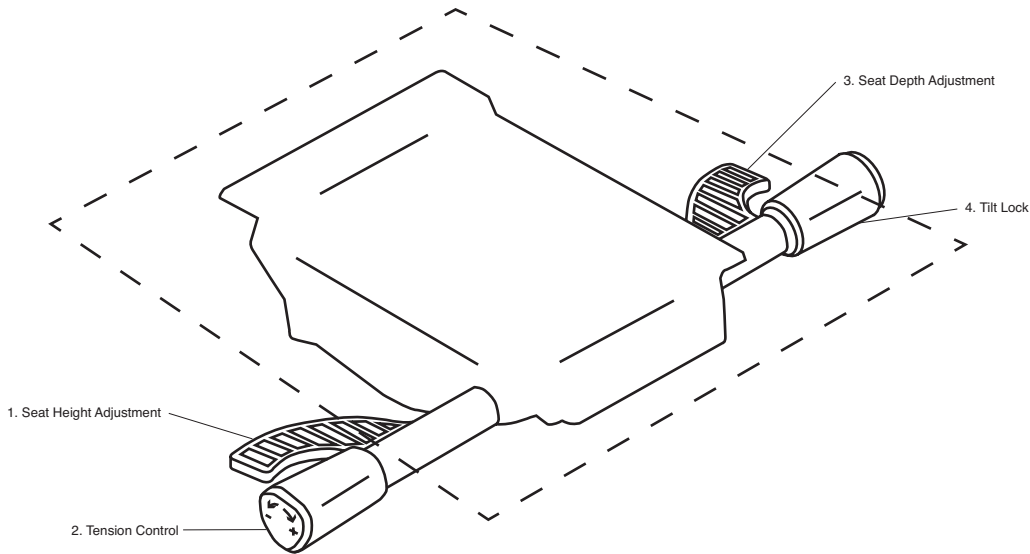

1. SEAT HEIGHT ADJUSTMENT

Slightly lift body weight off seat and pull up on paddle to increase height, or remain seated and pull up on paddle to decrease height. Release paddle to lock into desired height.

2. TENSION CONTROL

Extend Tension Control knob out to adjust. Increase tension by rotating the knob forward. Decrease tension by rotating the knob rearward. Push tension control knob in to original position when finished adjusting tension.

3. SEAT DEPTH ADJUSTMENT

Pull up on lever while seated and slide forward or rearward to desired depth. Release paddle handle to engage.

4. TILT LOCK

Lean back fully back in chair, then rotate handle forward to engage lockout. Rotate handle forward, then lean back into the chair to release the tilt lock feature.

Manual Mechanism

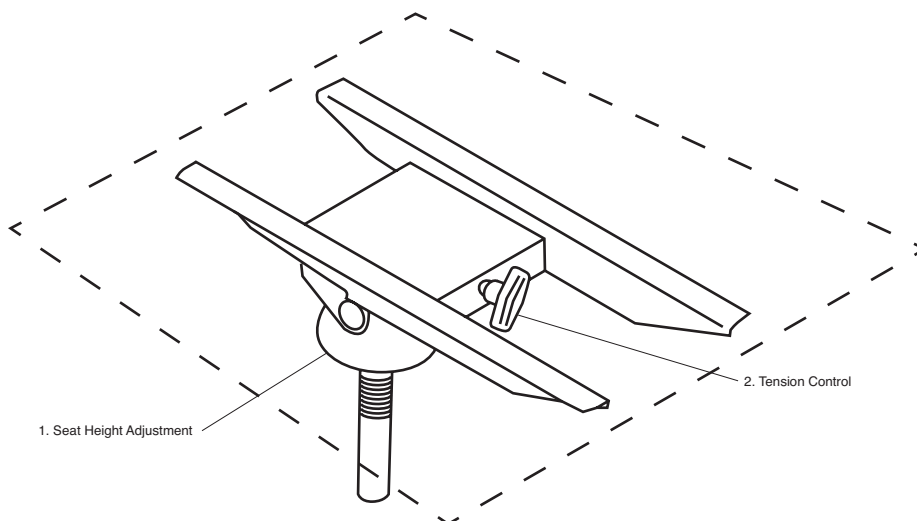

1. SEAT HEIGHT ADJUSTMENT

Slightly lift body weight off seat and rotate bell. Rotating to the right will lower the seat. Rotating to the left will raise seat.

2. TENSION CONTROL

Increase tension by rotating the knob to the right. Decrease tension by rotating the knob left.

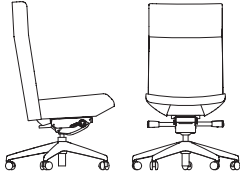
model number	fabric grades							dimensions	W	D	H	
GSHA15-011 High back, armless 	1	2,061	10	2,457	19	2,973	L1	2,484	Overall	26 11/16"	25 3/4"	40 11/16"
	2	2,097	11	2,505	20	3,033	L2	2,855	Seat	19-20"	19"	16 1/2 - 20 1/2"
	3	2,133	12	2,553	21	3,093	L3	3,300	Upholstery Requirements: GSHA15-011			
	COM/4	2,169	13	2,613	22	3,153	L4	3,670	Fabric yards	1.9		
	5	2,217	14	2,673	23	3,272	L5	4,041	Leather feet ²	32.3		
	6	2,265	15	2,733	24	3,392			Shipping weight	52 lbs.		
	7	2,313	16	2,793	25	3,512			Cube	21.6		
	8	2,361	17	2,853	26	3,632						
	9	2,409	18	2,913	27	3,752						

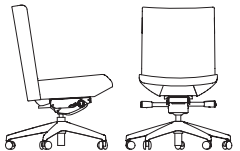
GSHA15-021 Mid back, armless 	1	1,900	10	2,234	19	2,668	L1	2,257	Overall	26 11/16"	25 3/4"	35 11/16"
	2	1,931	11	2,274	20	2,718	L2	2,569	Seat	19-20"	19"	16 1/2 - 20 1/2"
	3	1,962	12	2,315	21	2,769	L3	2,944	Upholstery Requirements: GSHA15-021			
	COM/4	1,991	13	2,365	22	2,819	L4	3,255	Fabric yards	1.6		
	5	2,031	14	2,415	23	2,921	L5	3,567	Leather feet ²	27.2		
	6	2,072	15	2,466	24	3,021			Shipping weight	51 lbs.		
	7	2,113	16	2,516	25	3,122			Cube	19.1		
	8	2,153	17	2,566	26	3,223						
	9	2,194	18	2,618	27	3,324						

Horizontal Channel Stitch Example:



High Back version shown; Mid Back version has channel stitching down entire back.

TO ORDER PLEASE SPECIFY THE FOLLOWING:

MODEL NUMBER	BASE	CASTER	CONTROL	STITCH DETAIL	FLAMMABILITY RATING	UPHOLSTERY
	These seating models are available with the following base option. BBL Black base BAL Polished Aluminum +\$109	CH2 Hard CS2 Soft +\$60 CHC2 Chrome, hard +\$93	P Swivel tilt SKP Synchro-Tilt, seat slider, pneumatic lift with lockout +\$137	NR Not required SD Horizontal Channel Stitch Detail \$137 NOTE: Avoca High Back comes standard with a single horizontal French stitch across the back when the Stitch Not Required (NR) option is chosen.	U CTB117	Please refer to list of available upholstery and leather selections on www.gunlocke.com

Example

GSHA15-011.BBL.CH2.P.NR.U.DOL728						
GSHA15-011	BBL	CH2	P	NR	U	DOL728
MODEL NUMBER	BASE	CASTER	CONTROL	STITCH DETAIL	FLAMMABILITY	UPHOLSTERY

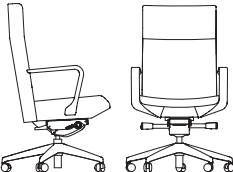
model number	fabric grades						dimensions	W	D	H		
GSHA15-031 High back with arms 	1	2,150	10	2,546	19	3,062	L1	2,573	Overall	26 11/16"	25 3/4"	40 11/16"
	2	2,186	11	2,594	20	3,122	L2	2,944	Seat	19-20"	19"	16 1/2" - 20 1/2"
	3	2,222	12	2,642	21	3,182	L3	3,389	Arm			24 7/8" - 28 7/8"
	COM/4	2,258	13	2,702	22	3,242	L4	3,759	Between arms	19 3/4"		
	5	2,306	14	2,762	23	3,361	L5	4,130	Upholstery Requirements: GSHA15-031			
	6	2,354	15	2,822	24	3,481			Fabric yards		1.9	
	7	2,402	16	2,882	25	3,601			Leather feet²		32.3	
	8	2,450	17	2,942	26	3,721			Shipping weight		56 lbs.	
	9	2,498	18	3,002	27	3,841			Cube		21.6	

GSHA15-041 Mid back with arms 	1	1,986	10	2,320	19	2,754	L1	2,343	Overall	26 11/16"	25 3/4"	35 11/16"
	2	2,017	11	2,360	20	2,804	L2	2,655	Seat	19-20"	19"	16 1/2" - 20 1/2"
	3	2,048	12	2,401	21	2,855	L3	3,030	Arm			24 7/8" - 28 7/8"
	COM/4	2,077	13	2,451	22	2,905	L4	3,341	Between arms	19 3/4"		
	5	2,117	14	2,501	23	3,007	L5	3,653	Upholstery Requirements: GSHA15-041			
	6	2,158	15	2,552	24	3,107			Fabric yards		1.6	
	7	2,199	16	2,602	25	3,208			Leather feet²		27.2	
	8	2,239	17	2,652	26	3,309			Shipping weight		55 lbs.	
	9	2,280	18	2,704	27	3,410			Cube		19.	

Horizontal Channel Stitch Example:



High Back version shown; Mid Back version has channel stitching down entire back.

TO ORDER PLEASE SPECIFY THE FOLLOWING:

MODEL NUMBER	ARM	BASE	CASTER	CONTROL	STITCH DETAIL	FLAMMABILITY RATING	UPHOLSTERY
	These seating models are available with the following arm options. ABL Black Urethane Arm APA Full Polished Aluminum +\$164 API Polished Aluminum with Urethane Arm Cap +\$164	These seating models are available with the following base option. BBL Black base BAL Polished Aluminum +\$109	CH2 Hard CS2 Soft +\$60 CHC2 Chrome, hard +\$93	P Swivel tilt SKP Synchro-Tilt, seat slider, pneumatic lift with lockout +\$137	NR Not required SD Horizontal Channel Stitch Detail \$137 NOTE: Avoca High Back comes standard with a single horizontal French stitch across the back when the Stitch Not Required (NR) option is chosen.	U CTB117	Please refer to list of available upholstery and leather selections on www.gunlocke.com

Example

GSHA15-031.ABL.BBL.CH2.P.NR.U.DOL728

MODEL NUMBER	ARM	BASE	CASTER	CONTROL	STITCH DETAIL	FLAMMABILITY	UPHOLSTERY
GSHA15-031	ABL	BBL	CH2	P	NR	U	DOL728

GENESEE

Armless

Seating
03/23

model number	fabric grades								dimensions	W	D	H
GSRA16-011 Swivel, High Back Armless	1	2,625	10	3,063	19	3,633	L1	3,093	Overall	25 3/4"	28"	38 1/8" - 41 5/8"
	2	2,665	11	3,116	20	3,699	L2	3,503	Seat	21"	19 1/4"	17" - 20 1/2"
	3	2,705	12	3,168	21	3,766	L3	3,995	Upholstery Requirements: GSRA16-011			
	COM/4	2,744	13	3,235	22	3,831	L4	4,403	Fabric yards	2.1		
	5	2,798	14	3,301	23	3,964	L5	4,813	Leather feet ²	35.7		
	6	2,851	15	3,368	24	4,097			Shipping weight	44 lbs.		
	7	2,903	16	3,434	25	4,229			Cube	21.2		
	8	2,957	17	3,500	26	4,362						
	9	3,010	18	3,566	27	4,494						

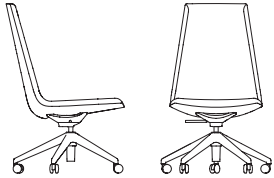

GSRA16-021 Swivel, Mid Back Armless	1	2,468	10	2,823	19	3,284	L1	2,847	Overall	25 3/4"	26 1/2"	31 3/8" - 34 7/8"
	2	2,501	11	2,865	20	3,337	L2	3,178	Seat	21"	19 1/4"	17" - 20 1/2"
	3	2,533	12	2,909	21	3,391	L3	3,576	Upholstery Requirements: GSRA16-021			
	COM/4	2,566	13	2,962	22	3,445	L4	3,908	Fabric yards	2.0		
	5	2,608	14	3,016	23	3,552	L5	4,240	Leather feet ²	28.9		
	6	2,651	15	3,069	24	3,659			Shipping weight	42 lbs.		
	7	2,694	16	3,122	25	3,767			Cube	16.9		
	8	2,737	17	3,177	26	3,874						
	9	2,779	18	3,230	27	3,981						

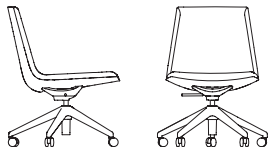



TO ORDER PLEASE SPECIFY THE FOLLOWING:

<input type="text"/>	<input type="text"/>	<input type="text"/>	<input type="text"/>	<input type="text"/>
MODEL NUMBER	CASTER	CONTROL	FLAMMABILITY RATING	UPHOLSTERY
	CH2 Hard CS2 Soft +\$60 CHC2 Chrome, hard +\$93	P Low-profile, polished swivel-tilt, pneumatic lift. MP Black, mid tilt, pneumatic lift with lockout.	U CTB117	Please refer to list of available upholstery and leather selections on www.gunlocke.com

Example

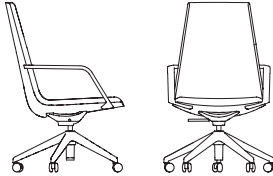
GSRA16-011.CH2.P.U.DOL728
 GSRA16-011 CH2 P U DOL728
 MODEL NUMBER CASTER CONTROL FLAMMABILITY UPHOLSTERY

model number	fabric grades								dimensions	W	D	H
GSRA16-031 Swivel, High Back Polished Arms 	1	2,717	10	3,155	19	3,725	L1	3,185	Overall	27 1/2"	28"	38 1/8" - 41 5/8"
	2	2,757	11	3,208	20	3,791	L2	3,595	Seat	21"	19 1/4"	17" - 20 1/2"
	3	2,797	12	3,260	21	3,858	L3	4,087	Arm			23 1/2" - 27"
	COM/4	2,836	13	3,327	22	3,923	L4	4,495	Between arms	21"		
	5	2,890	14	3,393	23	4,056	L5	4,905	Upholstery Requirements: GSRA16-031			
	6	2,943	15	3,460	24	4,189			Fabric yards			2.1
	7	2,995	16	3,526	25	4,321			Leather feet ²			35.7
	8	3,049	17	3,592	26	4,454			Shipping weight			49 lbs.
	9	3,102	18	3,658	27	4,586			Cube			22.5

GSRA16-041 Swivel, Mid Back Polished Arms 	1	2,559	10	2,914	19	3,375	L1	2,938	Overall	27 1/2"	26 1/2"	31 3/8" - 34 7/8"
	2	2,592	11	2,956	20	3,428	L2	3,269	Seat	21"	19 1/4"	17" - 20 1/2"
	3	2,624	12	3,000	21	3,482	L3	3,667	Arm			23 1/2" - 27"
	COM/4	2,657	13	3,053	22	3,536	L4	3,999	Between arms	21"		
	5	2,699	14	3,107	23	3,643	L5	4,331	Upholstery Requirements: GSRA16-041			
	6	2,742	15	3,160	24	3,750			Fabric yards			2.0
	7	2,785	16	3,213	25	3,858			Leather feet ²			28.9
	8	2,828	17	3,268	26	3,965			Shipping weight			47 lbs.
	9	2,870	18	3,321	27	4,072			Cube			17.9

TO ORDER PLEASE SPECIFY THE FOLLOWING:

<input type="text"/>	<input type="text"/>	<input type="text"/>	<input type="text"/>	<input type="text"/>
MODEL NUMBER	CASTER	CONTROL	FLAMMABILITY RATING	UPHOLSTERY
	CH2 Hard CS2 Soft +\$60 CHC2 Chrome, hard +\$93	P Low-profile, polished swivel-tilt, pneumatic lift. MP Black, mid tilt, pneumatic lift with lockout.	U CTB117	Please refer to list of available upholstery and leather selections on www.gunlocke.com

Example



GSRA16-031.CH2.P.U.DOL728
 GSRA16-031 CH2 P U DOL728
 MODEL NUMBER CASTER CONTROL FLAMMABILITY UPHOLSTERY

GENESEE

Upholstered Arms

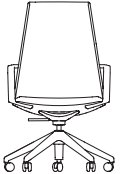
Seating
03/23

model number	fabric grades								dimensions	W	D	H
GSRA16-051 Swivel, High Back Upholstered Arms	1	2,850	10	3,308	19	3,906	L1	3,340	Overall	27 3/4"	28"	38 1/8" - 41 5/8"
	2	2,892	11	3,364	20	3,975	L2	3,769	Seat	21"	19 1/4"	17" - 20 1/2"
	3	2,933	12	3,419	21	4,044	L3	4,284	Arm			23 5/8" - 27 1/8"
	COM/4	2,976	13	3,489	22	4,114	L4	4,713	Between arms	20 3/4"		
	5	3,031	14	3,559	23	4,252	L5	5,143	Upholstery Requirements: GSRA16-051			
	6	3,087	15	3,628	24	4,392			Fabric yards		2.2	
	7	3,142	16	3,697	25	4,530			Leather feet ²		37.4	
	8	3,197	17	3,767	26	4,670			Shipping weight		49 lbs.	
	9	3,253	18	3,836	27	4,808			Cube		22.7	
												

GSRA16-061 Swivel, Mid Back Upholstered Arms	1	2,691	10	3,087	19	3,603	L1	3,114	Overall	27 3/4"	26 1/2"	31 3/8" - 34 7/8"
	2	2,727	11	3,135	20	3,663	L2	3,485	Seat	21"	19 1/4"	17" - 20 1/2"
	3	2,763	12	3,183	21	3,723	L3	3,930	Arm			23 5/8" - 27 1/8"
	COM/4	2,799	13	3,243	22	3,783	L4	4,300	Between arms	20 3/4"		
	5	2,847	14	3,303	23	3,902	L5	4,671	Upholstery Requirements: GSRA16-061			
	6	2,895	15	3,363	24	4,022			Fabric yards		2.0	
	7	2,943	16	3,423	25	4,142			Leather feet ²		32.3	
	8	2,991	17	3,483	26	4,262			Shipping weight		47 lbs.	
	9	3,039	18	3,543	27	4,382			Cube		18	
												

TO ORDER PLEASE SPECIFY THE FOLLOWING:

<input type="text"/>	<input type="text"/>	<input type="text"/>	<input type="text"/>	<input type="text"/>
MODEL NUMBER	CASTER	CONTROL	FLAMMABILITY RATING	UPHOLSTERY
	CH2 Hard CS2 Soft +\$60 CHC2 Chrome, hard +\$93	P Low-profile, polished swivel-tilt, pneumatic lift. MP Black, mid tilt, pneumatic lift with lockout.	U CTB117	Please refer to list of available upholstery and leather selections on www.gunlocke.com

Example

GSRA16-051.CH2.P.215.U.DOL728
 GSRA16-051 CH2 P U DOL728
 MODEL NUMBER CASTER CONTROL FLAMMABILITY UPHOLSTERY

model number	fabric grades						dimensions	W	D	H		
GSGNV17-011 High Back, Pillow Single Uph	1	2,165	10	2,666	19	3,317	L1	2,700	Overall	27 1/4"	27"	42-46"
	2	2,211	11	2,726	20	3,392	L2	3,168	Seat	20"	18"	16 1/2" - 20 1/2"
	3	2,256	12	2,787	21	3,468	L3	3,730	Arm	23" - 27"		
	COM/4	2,302	13	2,862	22	3,543	L4	4,197	Between arms	21"		
	5	2,363	14	2,938	23	3,695	L5	4,666	Upholstery Requirements: GSGNV17-011			
	6	2,423	15	3,014	24	3,846	Fabric yards			2.4		
	7	2,484	16	3,090	25	3,998	Leather feet ²			40.8		
	8	2,544	17	3,165	26	4,149	Shipping weight			45 lbs.		
	9	2,605	18	3,241	27	4,301	Cube			24.6		

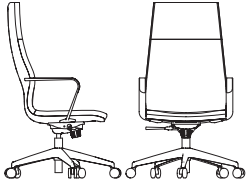

GSGNV17-051 Mid Back, Pillow Single Uph	1	1,986	10	2,403	19	2,946	L1	2,431	Overall	27 1/4"	26 1/2"	33" - 37"
	2	2,025	11	2,453	20	3,009	L2	2,821	Seat	20"	18"	16 1/2" - 20 1/2"
	3	2,062	12	2,504	21	3,072	L3	3,290	Arm	23" - 27"		
	COM/4	2,100	13	2,567	22	3,135	L4	3,680	Between arms	21"		
	5	2,151	14	2,631	23	3,261	L5	4,071	Upholstery Requirements: GSGNV17-051			
	6	2,201	15	2,693	24	3,387	Fabric yards			2		
	7	2,251	16	2,756	25	3,514	Leather feet ²			34		
	8	2,302	17	2,819	26	3,640	Shipping weight			40 lbs.		
	9	2,353	18	2,882	27	3,766	Cube			19.5		



TO ORDER PLEASE SPECIFY THE FOLLOWING:

<input type="text"/>	<input type="text"/>	<input type="text"/>	<input type="text"/>	<input type="text"/>	<input type="text"/>	<input type="text"/>
MODEL NUMBER	ARM	BASE	CONTROL	CASTER	FLAMMABILITY RATING	UPHOLSTERY
	ABL Full Urethane Arms API Polished with urethane insert +\$164	These seating models are available with the following base option. BBL Black base BAL Polished Aluminum +\$109	MP Black, mid tilt, pneumatic lift with lockout.	CH2 Hard CS2 Soft +\$60	U CTB17	Please refer to list of available upholstery and leather selections on www.gunlocke.com

Example

GSGNV17-011.ABL.BBL.MP.CH2.U.DOL728
 GSGNV17-011 ABL BBL MP CH2 U DOL728
 MODEL NUMBER ARM BASE CONTROL CASTER FLAMMABILITY UPHOLSTERY

model number	fabric grades					dimensions	W	D	H			
GSGNV17-031 High Back, Tight Single Uph	1	2,196	10	2,613	19	3,156	L1	2,641	Overall	27 1/4"	27"	42" - 46"
	2	2,235	11	2,663	20	3,219	L2	3,031	Seat	20"	18"	16 1/2" - 20 1/2"
	3	2,272	12	2,714	21	3,282	L3	3,500	Arm	23" - 27"		
	COM/4	2,310	13	2,777	22	3,345	L4	3,890	Between arms	21"		
	5	2,361	14	2,841	23	3,471	L5	4,281	Upholstery Requirements: GSGNV17-031			
	6	2,411	15	2,903	24	3,597			Fabric yards	2		
	7	2,461	16	2,966	25	3,724			Leather feet ²	34		
	8	2,512	17	3,029	26	3,850			Shipping weight	45 lbs.		
	9	2,563	18	3,092	27	3,976			Cube	24.6		

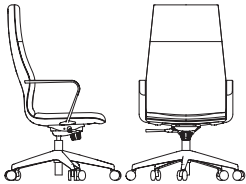

GSGNV17-071 Mid Back, Tight Single Uph	1	2,014	10	2,410	19	2,926	L1	2,437	Overall	27 1/4"	26 1/2"	33" - 37"
	2	2,050	11	2,458	20	2,986	L2	2,808	Seat	20"	18"	16 1/2" - 20 1/2"
	3	2,086	12	2,506	21	3,046	L3	3,253	Arm	23" - 27"		
	COM/4	2,122	13	2,566	22	3,106	L4	3,623	Between arms	21"		
	5	2,170	14	2,626	23	3,225	L5	3,994	Upholstery Requirements: GSGNV17-071			
	6	2,218	15	2,686	24	3,345			Fabric yards	1.9		
	7	2,266	16	2,746	25	3,465			Leather feet ²	32.3		
	8	2,314	17	2,806	26	3,585			Shipping weight	40 lbs.		
	9	2,362	18	2,866	27	3,705			Cube	19.5		



TO ORDER PLEASE SPECIFY THE FOLLOWING:

<input type="text"/>	<input type="text"/>	<input type="text"/>	<input type="text"/>	<input type="text"/>	<input type="text"/>	<input type="text"/>
MODEL NUMBER	ARM	BASE	CONTROL	CASTER	FLAMMABILITY RATING	FABRIC
ABL Full Urethane Arms API Polished with urethane insert +\$164		These seating models are available with the following base option. BBL Black base BAL Polished Aluminum +\$109	MP Black, mid tilt, pneumatic lift with lockout.	CH2 Hard CS2 Soft +\$60	U CTB117	Please refer to list of available upholstery and leather selections on www.gunlocke.com

Example

GSGNV17-031.ABL.BBL.MP.CH2.U.DOL728
 GSGNV17-031 ABL BBL MP CH2 U DOL728
 MODEL NUMBER ARM BASE CONTROL CASTER FLAMMABILITY UPHOLSTERY

model number	fabric grades								dimensions	W	D	H
GK2800 High back, fully upholstered, fixed arms	1	3,463	10	3,901	19	4,471	L1	3,931	Overall	26 1/2"	23 1/2"	43 1/2" - 47 1/2"
	2	3,503	11	3,954	20	4,537	L2	4,341	Seat		18 1/2"	17 3/4" - 21 1/2"
	3	3,543	12	4,006	21	4,604	L3	4,833	Arm			27 15/16"
	COM/4	3,582	13	4,073	22	4,669	L4	5,241	Between arms	19 1/2"		
	5	3,636	14	4,139	23	4,802	L5	5,651	Upholstery Requirements: GK2800			
	6	3,689	15	4,206	24	4,935			Fabric yards		2.1	
	7	3,741	16	4,272	25	5,067			Leather feet ²		35.7	
	8	3,795	17	4,338	26	5,200			Shipping weight		58 lb.	
	9	3,848	18	4,404	27	5,332			Cube		24	



model number	fabric grades								dimensions	W	D	H
GK2804 High back, with Wood Décor, fixed arms	1	4,368	10	4,806	19	5,376	L1	4,836	Overall	26 1/2"	23 1/2"	43 1/2" - 47 1/2"
	2	4,408	11	4,859	20	5,442	L2	5,246	Seat		18"	17 3/4" - 21 3/4"
	3	4,448	12	4,911	21	5,509	L3	5,738	Arm			27 15/16"
	COM/4	4,487	13	4,978	22	5,574	L4	6,146	Between arms	19 1/2"		
	5	4,541	14	5,044	23	5,707	L5	6,556	Upholstery Requirements: GK2804			
	6	4,594	15	5,111	24	5,840			Fabric yards		2.1	
	7	4,646	16	5,177	25	5,972			Leather feet ²		35.7	
	8	4,700	17	5,243	26	6,105			Shipping weight		61 lb.	
	9	4,753	18	5,309	27	6,237			Cube		24	

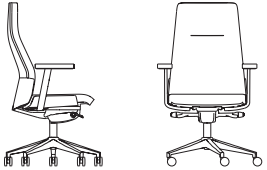

TO ORDER PLEASE SPECIFY THE FOLLOWING:

MODEL NUMBER	METAL FINISH	CASTER	SEAT DEPTH ADJUSTMENT	ARM CAP	WOOD DECOR FINISH	FLAMMABILITY RATING	UPHOLSTERY
	Specified finish applies to Base, and Metal J-bar cover. Metal J-Bar cover located on back of wood décor (models GK2812 and GK2814). Adjustable Arm is available in Black only. BBL Black BSL Silver BAL Polished Aluminum +\$382	CH2 Hard CS2 Soft +\$60	These seating models are available with the following seat depth adjustment option. Please specify by adding suffix to model number. NSDA No Seat Depth-Adjustment SDA Seat Depth Adjustment +\$71	Please specify by adding suffix to model number. ARMUPH Upholstered Arm +\$191 ARMU Urethane Arm	Note: Required for GK2804 only Cherry finishes on Maple Walnut finishes on Maple Maple finishes on Maple Oak finishes on Maple Please refer to the Olla product page on www.gunlocke.com for standard finish options. <i>Natural Cherry 222 not available on Cherry.</i>	U CTB117	Please refer to list of available upholstery and leather selections on www.gunlocke.com

Example

GK2804.BAL.CH2.SDA.ARMUPH.NC701.U.DOL728

MODEL NUMBER	METAL FINISH	CASTER	SEAT DEPTH ADJUSTMENT	ARM CAP	WOOD DECOR FINISH	FLAMMABILITY	UPHOLSTERY
GK2804	BAL	CH2	SDA	ARMUPH	NC701	U	DOL728

OLLA EXECUTIVE

Conference | Fixed Arm | Mid Back

Seating
03/23

model number	fabric grades						dimensions	W	D	H		
GK2802 Mid-back, fully upholstered, fixed arms	1	3,212	10	3,587	19	4,076	L1	3,614	Overall	26 1/2"	23 1/2"	39"- 43"
	2	3,246	11	3,633	20	4,132	L2	3,965	Seat		18"	17 3/4"- 21 3/4"
	3	3,281	12	3,678	21	4,189	L3	4,385	Arm			27 15/16"
	COM/4	3,315	13	3,735	22	4,246	L4	4,736	Between arms	19 1/2"		
	5	3,360	14	3,791	23	4,360	L5	5,087	Upholstery Requirements: GK2802			
	6	3,405	15	3,849	24	4,474			Fabric yards			1.8
	7	3,451	16	3,906	25	4,587			Leather feet ²			30.6
	8	3,497	17	3,962	26	4,700			Shipping weight			57 lb.
	9	3,542	18	4,019	27	4,814			Cube			24



GK2806 Mid-back, with Wood Décor, fixed arms	1	4,049	10	4,424	19	4,913	L1	4,451	Overall	26 1/2"	23 1/2"	39"- 43"
	2	4,083	11	4,470	20	4,969	L2	4,802	Seat		18"	17 3/4"- 21 3/4"
	3	4,118	12	4,515	21	5,026	L3	5,222	Arm			27 15/16"
	COM/4	4,152	13	4,572	22	5,083	L4	5,573	Between arms	19 1/2"		
	5	4,197	14	4,628	23	5,197	L5	5,924	Upholstery Requirements: GK2806			
	6	4,242	15	4,686	24	5,311			Fabric yards			1.8
	7	4,288	16	4,743	25	5,424			Leather feet ²			30.6
	8	4,334	17	4,799	26	5,537			Shipping weight			60 lb.
	9	4,379	18	4,856	27	5,651			Cube			24

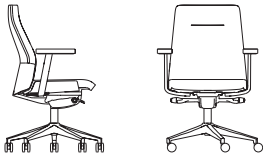

TO ORDER PLEASE SPECIFY THE FOLLOWING:

MODEL NUMBER	METAL FINISH	CASTER	SEAT DEPTH ADJUSTMENT	ARM CAP	WOOD DECOR FINISH	FLAMMABILITY RATING	UPHOLSTERY
	Specified finish applies to Base, and Metal J-bar cover. Metal J-Bar cover located on back of wood décor (models GK2812 and GK2814). Adjustable Arm is available in Black only. BBL Black BSL Silver BAL Polished Aluminum +\$382	CH2 Hard CS2 Soft +\$60	These seating models are available with the following seat depth adjustment option. Please specify by adding suffix to model number. NSDA No Seat Depth-Adjustment SDA Seat Depth Adjustment +\$71	Please specify by adding suffix to model number. ARMUPH Upholstered Arm +\$191 ARMU Urethane Arm	Note: Required for GK2806 only Cherry finishes on Maple Walnut finishes on Maple Maple finishes on Maple Oak finishes on Maple Please refer to the Olla product page on www.gunlocke.com for standard finish options. <i>Natural Cherry 222 not available on Cherry.</i>	U CTB117	Please refer to list of available upholstery and leather selections on www.gunlocke.com

Example

GK2806.BAL.CH2.SDA.ARMUPH.NC701.U.DOL728

MODEL NUMBER	METAL FINISH	CASTER	SEAT DEPTH ADJUSTMENT	ARM CAP	WOOD DECOR FINISH	FLAMMABILITY	UPHOLSTERY
GK2806	BAL	CH2	SDA	ARMUPH	NC701	U	DOL728

model number	fabric grades								dimensions	W	D	H
GK2808 High back, fully upholstered, adjustable arms	1	3,463	10	3,901	19	4,471	L1	3,931	Overall	26 1/2"	23 1/2"	43 1/2" - 47 1/2"
	2	3,503	11	3,954	20	4,537	L2	4,341	Seat		18 1/2"	17 3/4" - 21 3/4"
	3	3,543	12	4,006	21	4,604	L3	4,833	Arm			25 1/2" - 29 1/2"
	COM/4	3,582	13	4,073	22	4,669	L4	5,241	Between arms	19 1/2"		
	5	3,636	14	4,139	23	4,802	L5	5,651	Upholstery Requirements: GK2808			
	6	3,689	15	4,206	24	4,935			Fabric yards			2.1
	7	3,741	16	4,272	25	5,067			Leather feet ²			35.7
	8	3,795	17	4,338	26	5,200			Shipping weight			57 lb.
	9	3,848	18	4,404	27	5,332			Cube			24

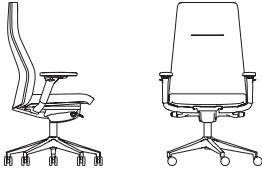

GK2812 High back, with Wood Décor, adjustable arms	1	4,368	10	4,806	19	5,376	L1	4,836	Overall	26 1/2"	23 1/2"	43 1/2" - 47 1/2"
	2	4,408	11	4,859	20	5,442	L2	5,246	Seat		18"	17 3/4" - 21 3/4"
	3	4,448	12	4,911	21	5,509	L3	5,738	Arm			25 1/2" - 29 1/2"
	COM/4	4,487	13	4,978	22	5,574	L4	6,146	Between arms	19 1/2"		
	5	4,541	14	5,044	23	5,707	L5	6,556	Upholstery Requirements: GK2812			
	6	4,594	15	5,111	24	5,840			Fabric yards			2.1
	7	4,646	16	5,177	25	5,972			Leather feet ²			35.7
	8	4,700	17	5,243	26	6,105			Shipping weight			60 lb.
	9	4,753	18	5,309	27	6,237			Cube			24



TO ORDER PLEASE SPECIFY THE FOLLOWING:

MODEL NUMBER	METAL FINISH	CASTER	SEAT DEPTH ADJUSTMENT	ARM CAP	WOOD DECOR FINISH	FLAMMABILITY RATING	UPHOLSTERY
	Specified finish applies to Base, and Metal J-bar cover. Metal J-Bar cover located on back of wood décor (models GK2812 and GK2814). Adjustable Arm is available in Black only. BBL Black BSL Silver BAL Polished Aluminum +\$382	CH2 Hard CS2 Soft +\$60	These seating models are available with the following seat depth adjustment option. Please specify by adding suffix to model number. NSDA No Seat Depth-Adjustment SDA Seat Depth Adjustment +\$71	Please specify by adding suffix to model number. ARMUPH Upholstered Arm +\$191 ARMU Urethane Arm	Note: Required for GK2812 only Cherry finishes on Maple Walnut finishes on Maple Maple finishes on Maple Oak finishes on Maple Please refer to the Olla product page on www.gunlocke.com for standard finish options. <i>Natural Cherry 222 not available on Cherry.</i>	U CTB117	Please refer to list of available upholstery and leather selections on www.gunlocke.com

Example



GK2812.BAL.CH2.SDA.ARMUPH.NC701.U.DOL728

MODEL NUMBER	METAL FINISH	CASTER	SEAT DEPTH ADJUSTMENT	ARM CAP	WOOD DECOR FINISH	FLAMMABILITY	UPHOLSTERY
GK2812	BAL	CH2	SDA	ARMUPH	NC701	U	DOL728

OLLA EXECUTIVE

Manager | Adjustable Arm | Mid Back

Seating
03/23

model number	fabric grades								dimensions	W	D	H
GK2810 Mid-back, fully upholstered, adjustable arms	1	3,212	10	3,587	19	4,076	L1	3,614	Overall	26 1/2"	23 1/2"	39"- 43"
	2	3,246	11	3,633	20	4,132	L2	3,965	Seat		18"	17 3/4"- 21 3/4"
	3	3,281	12	3,678	21	4,189	L3	4,385	Arm			25 1/2"- 29 1/2"
	COM/4	3,315	13	3,735	22	4,246	L4	4,736	Between arms	19 1/2"		
	5	3,360	14	3,791	23	4,360	L5	5,087	Upholstery Requirements: GK2810			
	6	3,405	15	3,849	24	4,474			Fabric yards			1.8
	7	3,451	16	3,906	25	4,587			Leather feet ²			30.6
	8	3,497	17	3,962	26	4,700			Shipping weight			56 lb.
	9	3,542	18	4,019	27	4,814			Cube			24
	 											

GK2814 with Wood Décor, adjustable arms	1	4,049	10	4,424	19	4,913	L1	4,451	Overall	26 1/2"	23 1/2"	39"- 43"
	2	4,083	11	4,470	20	4,969	L2	4,802	Seat		18"	17 3/4"- 21 3/4"
	3	4,118	12	4,515	21	5,026	L3	5,222	Arm			25 1/2"- 29 1/2"
	COM/4	4,152	13	4,572	22	5,083	L4	5,573	Between arms	19 1/2"		
	5	4,197	14	4,628	23	5,197	L5	5,924	Upholstery Requirements: GK2814			
	6	4,242	15	4,686	24	5,311			Fabric yards			1.8
	7	4,288	16	4,743	25	5,424			Leather feet ²			30.6
	8	4,334	17	4,799	26	5,537			Shipping weight			59 lb.
	9	4,379	18	4,856	27	5,651			Cube			24
	 											

TO ORDER PLEASE SPECIFY THE FOLLOWING:

MODEL NUMBER	METAL FINISH	CASTER	SEAT DEPTH ADJUSTMENT	ARM CAP	WOOD DECOR FINISH	FLAMMABILITY RATING	UPHOLSTERY
	Specified finish applies to Base, and Metal J-bar cover. Metal J-Bar cover located on back of wood décor (models GK2812 and GK2814). Adjustable Arm is available in Black only. BBL Black BSL Silver BAL Polished Aluminum +\$382	CH2 Hard CS2 Soft +\$60	These seating models are available with the following seat depth adjustment option. Please specify by adding suffix to model number. NSDA No Seat Depth-Adjustment SDA Seat Depth Adjustment +\$71	Please specify by adding suffix to model number. ARMUPH Upholstered Arm +\$191 ARMU Urethane Arm	Note: Required for GK2814 only Cherry finishes on Maple Walnut finishes on Maple Maple finishes on Maple Oak finishes on Maple Please refer to the Olla product page on www.gunlocke.com for standard finish options. <i>Natural Cherry 222 not available on Cherry.</i>	U CTB117	Please refer to list of available upholstery and leather selections on www.gunlocke.com

Example

GK2814.BAL.CH2.SDA.ARMUPH.NC701.U.DOL728

GK2814	BAL	CH2	SDA	ARMUPH	NC701	U	DOL728
MODEL NUMBER	METAL FINISH	CASTER	SEAT DEPTH ADJUSTMENT	ARM CAP	WOOD DECOR FINISH	FLAMMABILITY	UPHOLSTERY

model number	fabric grades								dimensions	W	D	H
GK3006N Swivel 	1	9,281	10	10,198	19	11,392	L1	10,261	Overall	28"	35"	45" - 47 1/2"
	2	9,364	11	10,309	20	11,530	L2	11,119	Seat		18 1/2"	19 1/2" - 22"
	3	9,448	12	10,419	21	11,670	L3	12,149	Arm			29 1/2" - 32"
	COM/4	9,531	13	10,559	22	11,808	L4	13,007	Between arms	20"		
	5	9,642	14	10,697	23	12,086	L5	13,865	Upholstery Requirements: GK3006N			
	6	9,753	15	10,837	24	12,364			Fabric yards		4.4	
	7	9,865	16	10,975	25	12,641			Leather feet ²		74.8	
	8	9,976	17	11,114	26	12,919			Shipping weight		95 lbs.	
	9	10,087	18	11,253	27	13,197			Cube		38.6	

TO ORDER PLEASE SPECIFY THE FOLLOWING:

. . . .

MODEL NUMBER	NAIL TRIM	FINISH	FLAMMABILITY RATING	UPHOLSTERY
	Standard nail trim is available in two varieties. Please specify by adding suffix to model number. NABR Antique brass	Cherry finishes on Maple Walnut finishes on Maple Oak finishes on Maple Maple finishes on Maple Please refer to the Washington Series product page on www.gunlocke.com for standard finish options.	U CTB117	Please refer to list of available upholstery and leather selections on www.gunlocke.com

Example

GK3006N.NABR.215.U.DOL728

GK3006N	NABR	215	U	DOL728
MODEL NUMBER	NAIL TRIM	FINISH	FLAMMABILITY	UPHOLSTERY

Lounge Seating	81-171
Product Specifications.	82-83
Calm Lounge Ordering Option Codes.	84-85
Calm	86-104
Ciji	105-165
Iris	166-171

LOUNGE SEATING

Product Specifications

CALM

Frame: $\frac{3}{4}$ " x $\frac{3}{4}$ " steel legs with $\frac{3}{4}$ " x 2" cross rails, provides consistent $\frac{3}{4}$ " reveal on all sides.

Deck Frame: Constructed of $\frac{3}{4}$ " upholstery-grade plywood, assembled with box joint joinery using corner blocks, glue and fasteners.

Seat: Plywood seat frame foundation with stretched sheetwebbing suspension, covered with a 1" crown patch, and dual-layer 4 $\frac{1}{4}$ " foam and dacron.

Back: 2"D top surface tapers to 6 $\frac{1}{2}$ "D lumbar thickness for back support structure.

Back Pillows: 5" thick molded foam pillows, with tapered edges, wrapped in dacron. Has black velour panel on lower section of back surface, with HBF Heart-felt back panel used for attachment.

Note: Corner units must be used for modular turns when back support is needed – features two 5" pillows.

Arms: 2"W top surface tapers to 3 $\frac{1}{2}$ "W at bottom of arm.

Arm Pillows: 3" thick molded foam pillows with tapered edges, wrapped in dacron. Has black velour panel at lower section of back surface, with HBF Heart-felt back panel used for attachment.

Ganging Bracket: Black powder coated steel bracket, with slots to mount into 4 t-nuts (order bracket separately).

Glides: $\frac{1}{2}$ " adjustable, threaded steel and nylon leveling glides.

BIFMA Rating:

ANSI/BIFMA X5.4 2020
(275lb Weight Rating)

CIJI

Frame: Upholstery-grade plywood built, box joint construction (using corner blocks, glue and fasteners).

Seat & Back Cushions: Dacron and dual-layer foam over plywood base with flexible foundation, upholstered.

Wood Legs: Tapered, three-sided solid maple. Nickel-plated steel glide $\frac{5}{8}$ " diameter.

Metal Legs: Anodized extruded aluminum. Nickel-plated steel glide $\frac{3}{4}$ " diameter.

Stitch Detail Option: Quilted, single stitch. Available on plain fabrics only.

Ganging Bracket: Plastic male-female alligator clip, 2 pair per unit. (Order separately).

Note: Specify configuration of seating of seating as if you were seated.

Replacement arm can be installed left or right. The replacement seat is for single seat.

Order multiple units for two and three seat lounges and benches.

BIFMA Rating:

ANSI/BIFMA X5.4 2020
(275lb Weight Rating)

IRIS

Lounge Bucket: Fiberglass-reinforced rigid urethane, with overmolded foam and $\frac{1}{2}$ " foam topper, wrapped in dacron. Outside edges wrapped in high-resiliency foam.

Headrest: Fiberglass-reinforced rigid urethane, with overmolded foam, wrapped in dacron. Contains two pocketed steel rods to secure headrest to lounge bucket. Outside edge wrapped in high-resiliency foam.

Wood Legs: Four turned maple or ash hardwood legs, secured into steel assembly with mortise-and-tenon leg attachment. Legs mechanically fastened into steel assembly, inset into rigid urethane bucket. Wood legs taper narrower from top to bottom.

Glides: Nickel-plated steel.

Metal Lounge Base: Four-star metal base, standard with return-to-center cylinder, at a fixed seat height. Comes with low-profile swivel tilt control, with tilt lockout.

Metal Ottoman Base: Four-star metal base, standard with fixed post, at a fixed seat height.

BIFMA Rating:

ANSI/BIFMA X5.4 2020
(275lb Weight Rating)

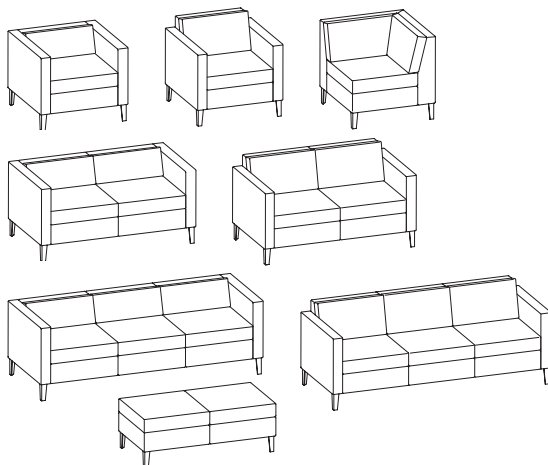

MULTI LOUNGE

Frame: Round tubular steel.

Seat: Foam filled over contoured upholstery, spring foundation webbing.

Back: Foam filled over curved plywood. Upholstered. Triple-stitched.

Arms: Steam-bent hardwood.

Glides: Plastic.

Boot: Flexible textured polyvinyl chloride 2" high (glide model only). Black boot on black frame. Grey boot on silver frame.

Casters: 2" dual wheel (CH).

BIFMA Rating:

ANSI/BIFMA X5.1 2017 w/ additional requirements (300lb Weight Rating)

WOOD FINISH

SELECT VENEERS

NATURAL CHERRY

Cinnamon Cherry	NC260
Lowell Ash	NC394
Medium Red Cherry	NC512
Light Cherry	NC701
Shaker Cherry	NC774
Burnished Cherry	NC777

NATURAL PLAIN SLICED MAPLE

Natural Maple	NE800
Harvest Maple	NE856

NATURAL WALNUT

Light Walnut	NT601
Skyline Walnut	NT625
Nutmeg Walnut	NT629
Pinnacle Walnut	NT679
Sumatra Walnut	NT693
Ebony Walnut	NT555
Florence Walnut	NT579

VENEER 1 (SELECT)

STRATAWOOD CHERRY

Cinnamon/Biltmore	SC260
Lowell Ash	SC394
Clear	SC700
Light	SC701
Shaker	SC774
Burnished	SC777

STRATAWOOD MAPLE

Clear Maple	SE800
Harvest	SE856
Phantom Ecrú	SE912
(Use OP TopFin Only)	
Beigewood	SE878
Field Elm	SE599
Belair	SE934

STRATAWOOD WALNUT

Light	ST601
Skyline	ST625
Pinnacle	ST679
Sumatra	ST693
Florence Walnut	ST579

STRATAWOOD OAK

Clear	SF300
Dark	SF331

STRATAWOOD SILVER OAK

Clear	SB100
Portico Teak	SB150

STRATAWOOD WASHED WALNUT

Clear	SW600
Smoked Onyx	SW697
Smoked Grey	SW612

PREMIER VENEERS

NATURAL QUARTER CUT WALNUT

Light Walnut	QT601
Skyline Walnut	QT625
Nutmeg Walnut	QT629
Pinnacle Walnut	QT679
Sumatra Walnut	QT693
Ebony Walnut	QT555
Florence Walnut	QT579

NATURAL RIFT CUT OAK

Light Rift Cut Oak	RF301
Dark Rift Cut Oak	RF331
Phantom Ecrú	RF912
Fawn Cypress	RF108

UV TOP FINISH

Worksurfaces feature two low emitting UV finish options that enhance the beauty of natural wood and ensures the depth, clarity, color consistency and durability throughout the life of the product

Full-Fill Cleartech (upcharge)	FF
Open Pore Low Sheen	OP

Finish options are subject to change. For new finish information, visit us online www.gunlocke.com/finishsystem

LAMINATE

SELECT LAMINATES

SOLID – Grade 1

Designer White 15051	LDW1
Loft – Grey Cloud	LM11
Charcoal/Flint	LM16

WOODGRAIN – Grade 1

Natural Maple	LWD
Harvest Maple	C
Shaker Cherry	LW7C
Biltmore Cherry	COGN
Pinnacle Walnut	PINC
Florence Walnut	LFW1
Kingswood Walnut	LKI1
Neo Walnut	LNV1

WOODGRAIN – GRADE 2

Fawn Cypress	LFC1
Lowell Ash	LLA1
Natural Recon	LNR1
Phantom Ecu	LPE1
Portico Teak	LPT1
Skyline Walnut	LSW1
Veranda Teak	LVT1

GLASS (12mm soft etched)

Ice White -Designer White	GWH
Black	GBK
Muslin	GML

SOLID SURFACE (12mm solid)

Ebony Skies	SES
Designer White	SDW
Cameo White (Alabaster White)	SAW

Finish options are subject to change. For new finish information, visit us online
www.gunlocke.com/finishsystem

CALM

One Seat Lounge with Arms

Seating
03/23

model number	fabric grades							dimensions	W	D	H	
GLGB17-011 One seat, with arms	1	4,342	10	6,216	19	8,659	L1	7,502	Overall	32"	32"	30"
	2	4,513	11	6,445	20	8,944	L2	10,084	Seat	18"	21"	17"
	3	4,684	12	6,671	21	9,228	L3	13,182	Arm	30"		
	COM/4	4,854	13	6,955	22	9,511	L4	15,764	Between arms	18" - 21"		
	5	5,081	14	7,239	23	10,080	L5	18,345	Upholstery Requirements: GLGB17-011			
	6	5,309	15	7,523	24	10,648			Dual Upholstery			
	7	5,535	16	7,808	25	11,216			Fabric yds Cushion 4 Frame 5			
	8	5,764	17	8,091	26	11,784			Leather ft ² Cushion 100 Frame 125			
	9	5,990	18	8,374	27	12,351			Shipping weight 95 lbs.			
									Cube 23.4			

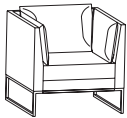

Cushion	1	10	833	19	1,919	L1	1,404	
	2	76	11	935	20	2,045	L2	2,552
	3	152	12	1,035	21	2,172	L3	3,929
	COM/4	227	13	1,161	22	2,297	L4	5,077
	5	329	14	1,288	23	2,550	L5	6,223
	6	430	15	1,414	24	2,803		
	7	530	16	1,541	25	3,055		
	8	632	17	1,666	26	3,308		
	9	733	18	1,792	27	3,559		

Top row of pricing is for units specified with same fabric on cushion and frame. Bottom 2 rows of pricing required only when two different fabric grades are selected for the cushion and frame.

To calculate price of lounge with different grade fabric for cushion and frame; start with Grade 1 price, add appropriate grade price located in second row for cushion, and last add appropriate grade price located in third row for frame to the sum of the Grade 1 and cushion price.

Example: Grade 1 \$4,342 + grade 4 fabric cushion \$227 + grade 2 fabric frame \$95 = \$4,664

Frame	1	10	1,041	19	2,398	L1	1,756	
	2	95	11	1,168	20	2,557	L2	3,190
	3	190	12	1,294	21	2,714	L3	4,911
	COM/4	285	13	1,452	22	2,872	L4	6,345
	5	410	14	1,609	23	3,188	L5	7,780
	6	537	15	1,767	24	3,503		
	7	663	16	1,925	25	3,819		
	8	790	17	2,083	26	4,134		
	9	915	18	2,240	27	4,450		

Select upholstery for everything else other than the seat and back cushions (the outside back, arms, sides, seat frame). You can specify the same fabric as the cushions or select other fabric.

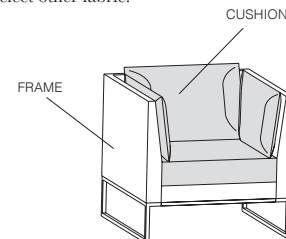

TO ORDER PLEASE SPECIFY THE FOLLOWING:

<input type="text"/>	<input type="text"/>	<input type="text"/>	<input type="text"/>	<input type="text"/>
MODEL NUMBER	FRAME COLOR	FLAMMABILITY RATING	CUSHION UPHOLSTERY	FRAME UPHOLSTERY
	Polished Chrome Brushed Chrome Steel Black Designer White Matte Gold Silver Solar Black Titanium Bullseye Regatta	PC +\$137 BS +\$137 P71 PJW P8G PR6 P8X P8T PJF P8M	U CTB117	Please refer to list of available upholstery and leather selections on www.gunlocke.com
				Please refer to list of available upholstery and leather selections on www.gunlocke.com

Example

GLGB17-011.PC.U.DOL728.SPNN04				
GLGB17-011	PC	U	DOL728	SPNN04
MODEL NUMBER	FRAME COLOR	FLAMMABILITY	CUSHION UPHOLSTERY	FRAME UPHOLSTERY

model number	fabric grades								dimensions	W	D	H
GLGB17-021 One seat, armless	1	3,692	10	4,734	19	6,091	L1	5,449	Overall	25"	32"	30"
	2	3,788	11	4,860	20	6,249	L2	6,883	Seat	25"	21"	17"
	3	3,881	12	4,986	21	6,406	L3	8,604	Upholstery Requirements: GLGB17-021			
	COM/4	3,978	13	5,145	22	6,564	L4	10,038	Dual Upholstery			
	5	4,103	14	5,303	23	6,879	L5	11,472	Fabric yds Cushion 2.2 Frame 2.8			
	6	4,230	15	5,460	24	7,195			Leather ft ² Cushion 55 Frame 70			
	7	4,355	16	5,618	25	7,510			Shipping weight 130 lbs.			
	8	4,481	17	5,776	26	7,828			Cube 18.7			
	9	4,608	18	5,933	27	8,142						



Cushion	1	10	458	19	1,056	L1	773
	2	42	11	514	20	1,125	L2 1,404
	3	83	12	569	21	1,194	L3 2,161
	COM/4	126	13	639	22	1,264	L4 2,792
	5	181	14	709	23	1,402	L5 3,423
	6	237	15	778	24	1,542	
	7	292	16	847	25	1,680	
	8	347	17	917	26	1,820	
	9	403	18	986	27	1,958	

Top row of pricing is for units specified with same fabric on cushion and frame. Bottom 2 rows of pricing required only when two different fabric grades are selected for the cushion and frame.

To calculate price of lounge with different grade fabric for cushion and frame; start with Grade 1 price, add appropriate grade price located in second row for cushion, and last add appropriate grade price located in third row for frame to the sum of the Grade 1 and cushion price.

Example: Grade 1 \$3,692 + grade 4 fabric cushion \$126 + grade 2 fabric frame \$54 = \$3,872

Frame	1	10	584	19	1,343	L1	984
	2	54	11	654	20	1,432	L2 1,787
	3	106	12	725	21	1,520	L3 2,751
	COM/4	160	13	814	22	1,608	L4 3,554
	5	230	14	902	23	1,785	L5 4,357
	6	301	15	990	24	1,961	
	7	371	16	1,079	25	2,138	
	8	442	17	1,167	26	2,316	
	9	513	18	1,255	27	2,492	

Select upholstery for everything else other than the seat and back cushions (the outside back, arms, sides, seat frame). You can specify the same fabric as the cushions or select other fabric.

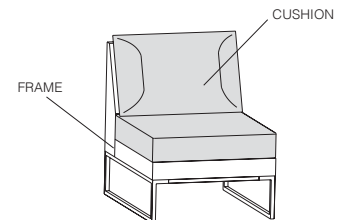

TO ORDER PLEASE SPECIFY THE FOLLOWING:

<input type="text"/>	<input type="text"/>	<input type="text"/>	<input type="text"/>	<input type="text"/>
MODEL NUMBER	FRAME COLOR	FLAMMABILITY RATING	CUSHION UPHOLSTERY	FRAME UPHOLSTERY
	Polished Chrome Brushed Chrome Steel Black Designer White Matte Gold Silver Solar Black Titanium Bullseye Regatta	PC +\$137 BS +\$137 P71 PJW P8G PR6 P8X P8T PJF P8M	U CTB117	Please refer to list of available upholstery and leather selections on www.gunlocke.com
				Please refer to list of available upholstery and leather selections on www.gunlocke.com

Example

GLGB17-021.PC.U.DOL728.SPNN04				
GLGB17-021	PC	U	DOL728	SPNN04
MODEL NUMBER	FRAME COLOR	FLAMMABILITY	CUSHION UPHOLSTERY	FRAME UPHOLSTERY

CALM

One Seat Lounge, Arm Left

model number	fabric grades						dimensions	W	D	H			
GLGB17-031 One seat, arm left	1	4,016	10	5,371	19	7,134	L1	6,298	Overall	28 1/2"	32"	30"	
	2	4,140	11	5,535	20	7,339	L2	8,164	Seat	21 1/2"	21"	17"	
	3	4,263	12	5,699	21	7,545	L3	10,401	Arm	30"			
	COM/4	4,386	13	5,903	22	7,750	L4	12,266	Upholstery Requirements: GLGB17-031				
	5	4,550	14	6,108	23	8,160	L5	14,130	Dual Upholstery				
	6	4,713	15	6,315	24	8,570			Fabric yds	Cushion 3	Frame 3.5		
	7	4,879	16	6,519	25	8,981			Leather ft ²	Cushion 75	Frame 87.5		
	8	5,043	17	6,724	26	9,389			Shipping weight	140 lbs.			
	9	5,207	18	6,929	27	9,801			Cube	21.1			



Cushion	1	10	625	19	1,439	L1	1,053	
	2	57	11	701	20	1,534	L2	1,915
	3	114	12	777	21	1,629	L3	2,947
	COM/4	171	13	871	22	1,724	L4	3,808
	5	247	14	966	23	1,912	L5	4,668
	6	322	15	1,061	24	2,102		
	7	398	16	1,155	25	2,292		
	8	474	17	1,250	26	2,480		
	9	550	18	1,344	27	2,670		

Top row of pricing is for units specified with same fabric on cushion and frame. Bottom 2 rows of pricing required only when two different fabric grades are selected for the cushion and frame.

To calculate price of lounge with different grade fabric for cushion and frame; start with Grade 1 price, add appropriate grade price located in second row for cushion, and last add appropriate grade price located in third row for frame to the sum of the Grade 1 and cushion price.

Example: Grade 1 \$4,016 + grade 4 fabric cushion \$171 + grade 2 fabric frame \$67 = \$4,254

Frame	1	10	730	19	1,679	L1	1,229	
	2	67	11	818	20	1,789	L2	2,233
	3	133	12	906	21	1,900	L3	3,438
	COM/4	199	13	1,016	22	2,010	L4	4,442
	5	287	14	1,126	23	2,232	L5	5,446
	6	375	15	1,238	24	2,452		
	7	465	16	1,348	25	2,673		
	8	553	17	1,458	26	2,893		
	9	641	18	1,569	27	3,115		

Select upholstery for everything else other than the seat and back cushions (the outside back, arms, sides, seat frame). You can specify the same fabric as the cushions or select other fabric.

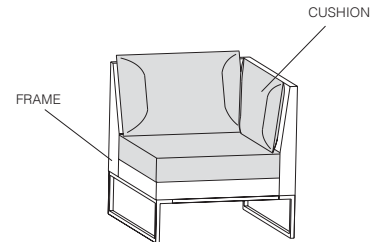

TO ORDER PLEASE SPECIFY THE FOLLOWING:

<input type="text"/>	<input type="text"/>	<input type="text"/>	<input type="text"/>	<input type="text"/>
MODEL NUMBER	FRAME COLOR	FLAMMABILITY RATING	CUSHION UPHOLSTERY	FRAME UPHOLSTERY
	Polished Chrome Brushed Chrome Steel Black Designer White Matte Gold Silver Solar Black Titanium Bullseye Regatta	PC +\$137 BS +\$137 P71 PJW P8G PR6 P8X P8T PJF P8M	U CTB117	Please refer to list of available upholstery and leather selections on www.gunlocke.com
				Please refer to list of available upholstery and leather selections on www.gunlocke.com

Example

GLGB17-031.PC.U.DOL728.SPNN04				
GLGB17-031	PC	U	DOL728	SPNN04
MODEL NUMBER	FRAME COLOR	FLAMMABILITY	CUSHION UPHOLSTERY	FRAME UPHOLSTERY

model number	fabric grades						dimensions	W	D	H			
GLGB17-041 One seat, arm right	1	4,016	10	5,371	19	7,134	L1	6,298	Overall	28 1/2"	32"	30"	
	2	4,140	11	5,535	20	7,339	L2	8,164	Seat	21 1/2"	21"	17"	
	3	4,263	12	5,699	21	7,545	L3	10,401	Arm	30"			
	COM/4	4,386	13	5,903	22	7,750	L4	12,266	Upholstery Requirements: GLGB17-041				
	5	4,550	14	6,108	23	8,160	L5	14,130	Dual Upholstery				
	6	4,713	15	6,315	24	8,570			Fabric yds	Cushion 3	Frame 3.5		
	7	4,879	16	6,519	25	8,981			Leather ft ²	Cushion 75	Frame 87.5		
	8	5,043	17	6,724	26	9,389			Shipping weight	140 lbs.			
	9	5,207	18	6,929	27	9,801			Cube	21.1			



Cushion								
1	10	625	19	1,439	L1	1,053		
2	57	11	701	20	1,534	L2	1,915	
3	114	12	777	21	1,629	L3	2,947	
COM/4	171	13	871	22	1,724	L4	3,808	
5	247	14	966	23	1,912	L5	4,668	
6	322	15	1,061	24	2,102			
7	398	16	1,155	25	2,292			
8	474	17	1,250	26	2,480			
9	550	18	1,344	27	2,670			

Top row of pricing is for units specified with same fabric on cushion and frame. Bottom 2 rows of pricing required only when two different fabric grades are selected for the cushion and frame.

To calculate price of lounge with different grade fabric for cushion and frame; start with Grade 1 price, add appropriate grade price located in second row for cushion, and last add appropriate grade price located in third row for frame to the sum of the Grade 1 and cushion price.

Example: Grade 1 \$4,016 + grade 4 fabric cushion \$171 + grade 2 fabric frame \$67 = \$4,254

Frame								
1	10	730	19	1,679	L1	1,229		
2	67	11	818	20	1,789	L2	2,233	
3	133	12	906	21	1,900	L3	3,438	
COM/4	199	13	1,016	22	2,010	L4	4,442	
5	287	14	1,126	23	2,232	L5	5,446	
6	375	15	1,238	24	2,452			
7	465	16	1,348	25	2,673			
8	553	17	1,458	26	2,893			
9	641	18	1,569	27	3,115			

Select upholstery for everything else other than the seat and back cushions (the outside back, arms, sides, seat frame). You can specify the same fabric as the cushions or select other fabric.

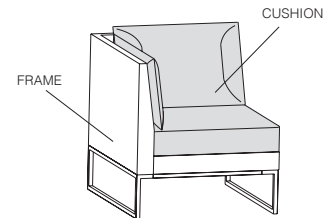

TO ORDER PLEASE SPECIFY THE FOLLOWING:

<input type="text"/>	<input type="text"/>	<input type="text"/>	<input type="text"/>	<input type="text"/>
MODEL NUMBER	FRAME COLOR	FLAMMABILITY RATING	CUSHION UPHOLSTERY	FRAME UPHOLSTERY
	Polished Chrome Brushed Chrome Steel Black Designer White Matte Gold Silver Solar Black Titanium Bullseye Regatta	PC +\$137 BS +\$137 P71 PJW P8G PR6 P8X P8T PJF P8M	U CTB117	Please refer to list of available upholstery and leather selections on www.gunlocke.com
				Please refer to list of available upholstery and leather selections on www.gunlocke.com

Example

GLGB17-041.PC.U.DOL728.SPNN04				
GLGB17-041	PC	U	DOL728	SPNN04
MODEL NUMBER	FRAME COLOR	FLAMMABILITY	CUSHION UPHOLSTERY	FRAME UPHOLSTERY

CALM

Two Seat Lounge with Arms

Seating
03/23

model number	fabric grades						dimensions	W	D	H
GLGB17-052 Two seat, with arms	1	5,950	10	8,554	19	11,946	L1	10,340	Overall	57" 32" 30"
	2	6,188	11	8,869	20	12,341	L2	13,926	Seat	43" 21" 17"
	3	6,424	12	9,185	21	12,734	L3	18,228	Arm	30"
	COM/4	6,662	13	9,579	22	13,129	L4	21,813	Between arms	43" - 46"
	5	6,977	14	9,974	23	13,918	L5	25,399		
	6	7,293	15	10,368	24	14,707				
	7	7,607	16	10,763	25	15,495				
	8	7,923	17	11,158	26	16,285				
	9	8,238	18	11,551	27	17,073				

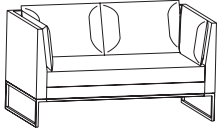

Upholstery Requirements: GLGB17-052

	Dual Upholstery	
Fabric yds	Cushion 6	Frame 6.5
Leather ft ²	Cushion 150	Frame 162.5
Shipping weight	190 lbs.	
Cube	40.1	

Cushion	1	10	19	L1
	1,250	2,878	2,107	
	114	3,068	3,829	
	227	3,256	5,893	
COM/4	342	3,446	7,614	
	493	3,824	9,335	
	645	4,204		
	795	4,582		
	947	4,961		
	1,098	5,339		

Top row of pricing is for units specified with same fabric on cushion and frame. Bottom 2 rows of pricing required only when two different fabric grades are selected for the cushion and frame.

To calculate price of lounge with different grade fabric for cushion and frame; start with Grade 1 price, add appropriate grade price located in second row for cushion, and last add appropriate grade price located in third row for frame to the sum of the Grade 1 and cushion price.

Example: Grade 1 \$5,950 + grade 4 fabric cushion \$342 + grade 2 fabric frame \$124 = \$6,416

Frame	1	10	19	L1
	1,354	3,118	2,283	
	124	3,323	4,147	
	247	3,528	6,385	
COM/4	370	3,733	8,249	
	534	4,144	10,114	
	698	4,553		
	862	4,963		
	1,026	5,374		
	1,190	5,784		

Select upholstery for everything else other than the seat and back cushions (the outside back, arms, sides, seat frame). You can specify the same fabric as the cushions or select other fabric.

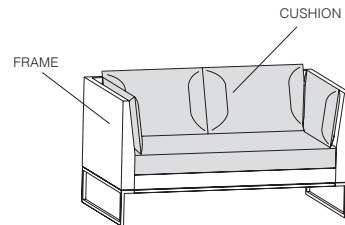

TO ORDER PLEASE SPECIFY THE FOLLOWING:

<input type="text"/>	<input type="text"/>	<input type="text"/>	<input type="text"/>	<input type="text"/>
MODEL NUMBER	FRAME COLOR	FLAMMABILITY RATING	CUSHION UPHOLSTERY	FRAME UPHOLSTERY
	Polished Chrome Brushed Chrome Steel Black Designer White Matte Gold Silver Solar Black Titanium Bullseye Regatta	PC +\$164 BS +\$164 P71 PJW P8G PR6 P8X P8T PJF P8M	U CTB117	Please refer to list of available upholstery and leather selections on www.gunlocke.com

Example

GLGB17-052.PC.U.DOL728.SPNN04

GLGB17-052	PC	U	DOL728	SPNN04
MODEL NUMBER	FRAME COLOR	FLAMMABILITY	CUSHION UPHOLSTERY	FRAME UPHOLSTERY

model number	fabric grades							dimensions	W	D	H	
GLGB17-062 Two seat, armless	1	5,057	10	6,724	19	8,895	L1	7,867	Overall	50"	32"	30"
	2	5,209	11	6,926	20	9,148	L2	10,162	Seat	50"	21"	17"
	3	5,361	12	7,128	21	9,400	L3	12,915	Upholstery Requirements: GLGB17-062			
	COM/4	5,512	13	7,381	22	9,653	L4	15,211	Dual Upholstery			
	5	5,714	14	7,632	23	10,157	L5	17,505	Fabric yds Cushion 4.2 Frame 3.8			
	6	5,916	15	7,885	24	10,661			Leather ft ² Cushion 105 Frame 95			
	7	6,118	16	8,137	25	11,166			Shipping weight 170 lbs.			
	8	6,320	17	8,390	26	11,671			Cube 35.4			
	9	6,522	18	8,642	27	12,177						

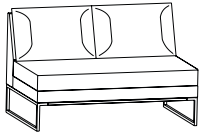

Cushion	1	10	875	19	2,015	L1	1,475	
	2	80	11	981	20	2,148	L2	2,680
	3	160	12	1,087	21	2,280	L3	4,125
	COM/4	239	13	1,220	22	2,413	L4	5,331
	5	345	14	1,352	23	2,678	L5	6,535
	6	451	15	1,485	24	2,942		
	7	557	16	1,617	25	3,207		
	8	663	17	1,750	26	3,472		
	9	769	18	1,882	27	3,738		

Top row of pricing is for units specified with same fabric on cushion and frame. Bottom 2 rows of pricing required only when two different fabric grades are selected for the cushion and frame.

To calculate price of lounge with different grade fabric for cushion and frame; start with Grade 1 price, add appropriate grade price located in second row for cushion, and last add appropriate grade price located in third row for frame to the sum of the Grade 1 and cushion price.

Example: Grade 1 \$5,057 + grade 4 fabric cushion \$239 + grade 2 fabric frame \$72 = \$5,368

Frame	1	10	792	19	1,823	L1	1,335	
	2	72	11	888	20	1,943	L2	2,425
	3	144	12	984	21	2,063	L3	3,733
	COM/4	216	13	1,104	22	2,183	L4	4,823
	5	312	14	1,223	23	2,422	L5	5,913
	6	408	15	1,343	24	2,662		
	7	504	16	1,463	25	2,902		
	8	600	17	1,583	26	3,142		
	9	696	18	1,703	27	3,382		

Select upholstery for everything else other than the seat and back cushions (the outside back, arms, sides, seat frame). You can specify the same fabric as the cushions or select other fabric.

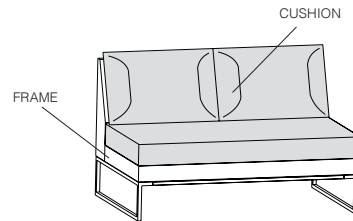

TO ORDER PLEASE SPECIFY THE FOLLOWING:

<input type="text"/>	<input type="text"/>	<input type="text"/>	<input type="text"/>	<input type="text"/>
MODEL NUMBER	FRAME COLOR	FLAMMABILITY RATING	CUSHION UPHOLSTERY	FRAME UPHOLSTERY
	Polished Chrome Brushed Chrome Steel Black Designer White Matte Gold Silver Solar Black Titanium Bullseye Regatta	PC +\$164 BS +\$164 P71 PJW P8G PR6 P8X P8T PJF P8M	U CTB117 Please refer to list of available upholstery and leather selections on www.gunlocke.com	Please refer to list of available upholstery and leather selections on www.gunlocke.com

Example

GLGB17-062.PC.U.DOL728.SPNN04				
GLGB17-062	PC	U	DOL728	SPNN04
MODEL NUMBER	FRAME COLOR	FLAMMABILITY	CUSHION UPHOLSTERY	FRAME UPHOLSTERY

CALM

Two Seat Lounge, Arm Left

model number fabric grades dimensions W D H

GLGB17-072
Two seat, arm left

1	5,504	10	7,545	19	10,205	L1	8,946
2	5,690	11	7,793	20	10,515	L2	11,756
3	5,877	12	8,040	21	10,824	L3	15,130
COM/4	6,062	13	8,350	22	11,133	L4	17,940
5	6,308	14	8,658	23	11,752	L5	20,752
6	6,556	15	8,968	24	12,370		
7	6,804	16	9,277	25	12,989		
8	7,052	17	9,587	26	13,606		
9	7,298	18	9,895	27	14,225		

Overall	53 1/2"	32"	30"
Seat	46 1/2"	19 1/4"	17 "
Arm			30"

Upholstery Requirements: GLGB17-072

	Dual Upholstery	
Fabric yds	Cushion 5	Frame 4.75
Leather ft ²	Cushion 125	Frame 118.8
Shipping weight		180 lbs.
Cube		37.8

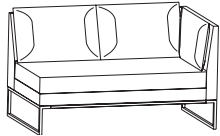

Cushion

1		10	1,041	19	2,398	L1	1,756
2	95	11	1,168	20	2,557	L2	3,190
3	190	12	1,294	21	2,714	L3	4,911
COM/4	285	13	1,452	22	2,872	L4	6,345
5	410	14	1,609	23	3,188	L5	7,780
6	537	15	1,767	24	3,503		
7	663	16	1,925	25	3,819		
8	790	17	2,083	26	4,134		
9	915	18	2,240	27	4,450		

Top row of pricing is for units specified with same fabric on cushion and frame. Bottom 2 rows of pricing required only when two different fabric grades are selected for the cushion and frame.

To calculate price of lounge with different grade fabric for cushion and frame; start with Grade 1 price, add appropriate grade price located in second row for cushion, and last add appropriate grade price located in third row for frame to the sum of the Grade 1 and cushion price.

Example: Grade 1 \$5,504 + grade 4 fabric cushion \$285 + grade 2 fabric frame \$91 = \$5,880

Frame

1		10	1,000	19	2,303	L1	1,686
2	91	11	1,121	20	2,454	L2	3,062
3	183	12	1,242	21	2,606	L3	4,715
COM/4	273	13	1,394	22	2,757	L4	6,091
5	394	14	1,545	23	3,060	L5	7,468
6	515	15	1,697	24	3,363		
7	637	16	1,848	25	3,666		
8	758	17	2,000	26	3,968		
9	879	18	2,151	27	4,271		

Select upholstery for everything else other than the seat and back cushions (the outside back, arms, sides, seat frame). You can specify the same fabric as the cushions or select other fabric.

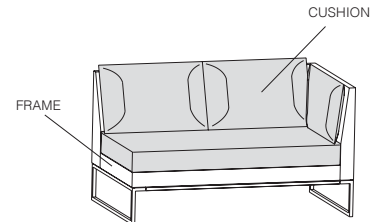

TO ORDER PLEASE SPECIFY THE FOLLOWING:

<input type="text"/>	<input type="text"/>	<input type="text"/>	<input type="text"/>	<input type="text"/>
MODEL NUMBER	FRAME COLOR	FLAMMABILITY RATING	CUSHION UPHOLSTERY	FRAME UPHOLSTERY
	Polished Chrome Brushed Chrome Steel Black Designer White Matte Gold Silver Solar Black Titanium Bullseye Regatta	PC +\$164 BS +\$164 P71 PJW P8G PR6 P8X P8T PJF P8M	U CTB117 Please refer to list of available upholstery and leather selections on www.gunlocke.com	Please refer to list of available upholstery and leather selections on www.gunlocke.com

Example

GLGB17-072.PC.U.DOL728.SPNN04

GLGB17-072	PC	U	DOL728	SPNN04
MODEL NUMBER	FRAME COLOR	FLAMMABILITY	CUSHION UPHOLSTERY	FRAME UPHOLSTERY

model number fabric grades dimensions W D H

GLGB17-082

Two seat, arm right

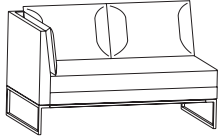

1	5,504	10	7,545	19	10,205	L1	8,946
2	5,690	11	7,793	20	10,515	L2	11,756
3	5,877	12	8,040	21	10,824	L3	15,130
COM/4	6,062	13	8,350	22	11,133	L4	17,940
5	6,308	14	8,658	23	11,752	L5	20,752
6	6,556	15	8,968	24	12,370		
7	6,804	16	9,277	25	12,989		
8	7,052	17	9,587	26	13,606		
9	7,298	18	9,895	27	14,225		

Overall	53 1/2"	32"	30"
Seat	46 1/2"	21"	17"
Arm			30"

Upholstery Requirements: GLGB17-082

	Dual Upholstery	
Fabric yds	Cushion 5	Frame 4.75
Leather ft ²	Cushion 125	Frame 118.75
Shipping weight		180 lbs.
Cube		37.8

Cushion

1		10	1,041	19	2,398	L1	1,756
2	95	11	1,168	20	2,557	L2	3,190
3	190	12	1,294	21	2,714	L3	4,911
COM/4	285	13	1,452	22	2,872	L4	6,345
5	410	14	1,609	23	3,188	L5	7,780
6	537	15	1,767	24	3,503		
7	663	16	1,925	25	3,819		
8	790	17	2,083	26	4,134		
9	915	18	2,240	27	4,450		

Top row of pricing is for units specified with same fabric on cushion and frame. Bottom 2 rows of pricing required only when two different fabric grades are selected for the cushion and frame.

To calculate price of lounge with different grade fabric for cushion and frame; start with Grade 1 price, add appropriate grade price located in second row for cushion, and last add appropriate grade price located in third row for frame to the sum of the Grade 1 and cushion price.

Example: Grade 1 \$5,504 + grade 4 fabric cushion \$285 + grade 2 fabric frame \$91 = \$5,880

Frame

1		10	1,000	19	2,303	L1	1,686
2	91	11	1,121	20	2,454	L2	3,062
3	183	12	1,242	21	2,606	L3	4,715
COM/4	273	13	1,394	22	2,757	L4	6,091
5	394	14	1,545	23	3,060	L5	7,468
6	515	15	1,697	24	3,363		
7	637	16	1,848	25	3,666		
8	758	17	2,000	26	3,968		
9	879	18	2,151	27	4,271		

Select upholstery for everything else other than the seat and back cushions (the outside back, arms, sides, seat frame). You can specify the same fabric as the cushions or select other fabric.

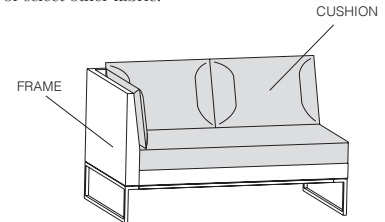

TO ORDER PLEASE SPECIFY THE FOLLOWING:

<input type="text"/>	<input type="text"/>	<input type="text"/>	<input type="text"/>	<input type="text"/>
MODEL NUMBER	FRAME COLOR	FLAMMABILITY RATING	CUSHION UPHOLSTERY	FRAME UPHOLSTERY
	Polished Chrome Brushed Chrome Steel Black Designer White Matte Gold Silver Solar Black Titanium Bullseye Regatta	PC +\$164 BS +\$164 P71 PJW P8G PR6 P8X P8T PJF P8M	U CTB117 Please refer to list of available upholstery and leather selections on www.gunlocke.com	Please refer to list of available upholstery and leather selections on www.gunlocke.com

Example

GLGB17-082.PC.U.DOL728.SPNN04				
GLGB17-082	PC	U	DOL728	SPNN04
MODEL NUMBER	FRAME COLOR	FLAMMABILITY	CUSHION UPHOLSTERY	FRAME UPHOLSTERY

CALM

Three Seat Lounge, with Arms

model number	fabric grades						dimensions	W	D	H
GLGB17-093 Three seat, with arms 	1	7,470	10	10,928	19	15,432	L1	13,298	Overall	82" 32" 30"
	2	7,784	11	11,348	20	15,956	L2	18,062	Seat	68" 21" 17"
	3	8,098	12	11,766	21	16,480	L3	23,776	Arm	30"
	COM/4	8,412	13	12,288	22	17,004	L4	28,536	Between arms	68" - 71"
	5	8,834	14	12,814	23	18,050	L5	33,298	Upholstery Requirements: GLGB17-093	
	6	9,252	15	13,338	24	19,100			Dual Upholstery	
	7	9,670	16	13,860	25	20,146			Fabric yds	Cushion 8.3 Frame 8.3
	8	10,090	17	14,384	26	21,194			Leather ft ²	Cushion 207.5 Frame 207.5
	9	10,510	18	14,910	27	22,240			Shipping weight	300 lbs.
								Cube	56.8	

Cushion	1	10	19	L1	2,914
	157	1,939	2,0	L2	5,296
	314	2,148	21	L3	8,153
COM/4	471	2,409	22	L4	10,533
	682	2,672	23	L5	12,914
	891	2,934	24		
	1,100	3,195	25		
	1,310	3,457	26		
	1,520	3,720	27		

Top row of pricing is for units specified with same fabric on cushion and frame. Bottom 2 rows of pricing required only when two different fabric grades are selected for the cushion and frame.

To calculate price of lounge with different grade fabric for cushion and frame; start with Grade 1 price, add appropriate grade price located in second row for cushion, and last add appropriate grade price located in third row for frame to the sum of the Grade 1 and cushion price.

Example: Grade 1 \$7,470 + grade 4 fabric cushion \$471 + grade 2 fabric frame \$157 = \$8,098

Frame	1	10	19	L1	2,914
	157	1,939	20	L2	5,296
	314	2,148	21	L3	8,153
COM/4	471	2,409	22	L4	10,533
	682	2,672	23	L5	12,914
	891	2,934	24		
	1,100	3,195	25		
	1,310	3,457	26		
	1,520	3,720	27		

Select upholstery for everything else other than the seat and back cushions (the outside back, arms, sides, seat frame). You can specify the same fabric as the cushions or select other fabric.

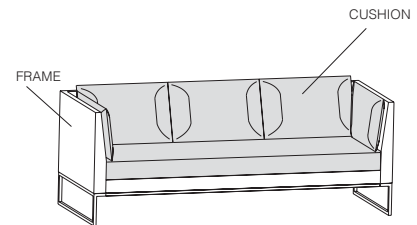

TO ORDER PLEASE SPECIFY THE FOLLOWING:

<input type="text"/>	<input type="text"/>	<input type="text"/>	<input type="text"/>	<input type="text"/>
MODEL NUMBER	FRAME COLOR	FLAMMABILITY RATING	CUSHION UPHOLSTERY	FRAME UPHOLSTERY
	Polished Chrome Brushed Chrome Steel Black Designer White Matte Gold Silver Solar Black Titanium Bullseye Regatta	PC +\$218 BS +\$218 P71 PJW P8G PR6 P8X P8T PJF P8M	U CTB117 Please refer to list of available upholstery and leather selections on www.gunlocke.com	Please refer to list of available upholstery and leather selections on www.gunlocke.com

Example

GLGB17-093.PC.U.DOL728.SPNN04				
GLGB17-093	PC	U	DOL728	SPNN04
MODEL NUMBER	FRAME COLOR	FLAMMABILITY	CUSHION UPHOLSTERY	FRAME UPHOLSTERY

model number	fabric grades							dimensions	W	D	H	
GLGB17-103 Three seat, armless	1	6,350	10	8,768	19	11,914	L1	10,423	Overall	75"	32"	30"
	2	6,570	11	9,060	20	12,279	L2	13,751	Seat	75"	21"	17"
	3	6,790	12	9,352	21	12,647	L3	17,744	Upholstery Requirements: GLGB17-103			
	COM/4	7,009	13	9,718	22	13,012	L4	21,072	Dual Upholstery			
	5	7,302	14	10,084	23	13,744	L5	24,398	Fabric yds	Cushion 6.3	Frame 5.3	
	6	7,595	15	10,450	24	14,477			Leather ft ²	Cushion 156.3	Frame 131.5	
	7	7,887	16	10,817	25	15,209			Shipping weight	280 lbs.		
	8	8,182	17	11,182	26	15,941			Cube	52.1		
	9	8,475	18	11,550	27	16,672						

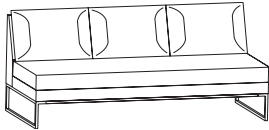

Cushion	1	10	1,313	19	3,022	L1	2,212	
	2	119	11	1,472	20	3,220	L2	4,019
	3	239	12	1,630	21	3,420	L3	6,188
	COM/4	358	13	1,830	22	3,618	L4	7,996
	5	517	14	2,028	23	4,016	L5	9,802
	6	676	15	2,227	24	4,414		
	7	835	16	2,426	25	4,811		
	8	995	17	2,624	26	5,209		
	9	1,154	18	2,824	27	5,606		

Top row of pricing is for units specified with same fabric on cushion and frame. Bottom 2 rows of pricing required only when two different fabric grades are selected for the cushion and frame.

To calculate price of lounge with different grade fabric for cushion and frame; start with Grade 1 price, add appropriate grade price located in second row for cushion, and last add appropriate grade price located in third row for frame to the sum of the Grade 1 and cushion price.

Example: Grade 1 \$6,350 + grade 4 fabric cushion \$358 + grade 2 fabric frame \$101 = \$6,809

Frame	1	10	1,105	19	2,542	L1	1,861	
	2	101	11	1,238	20	2,709	L2	3,382
	3	201	12	1,372	21	2,877	L3	5,206
	COM/4	301	13	1,538	22	3,044	L4	6,726
	5	435	14	1,706	23	3,378	L5	8,246
	6	569	15	1,873	24	3,713		
	7	702	16	2,041	25	4,048		
	8	837	17	2,208	26	4,382		
	9	971	18	2,376	27	4,716		

Select upholstery for everything else other than the seat and back cushions (the outside back, arms, sides, seat frame). You can specify the same fabric as the cushions or select other fabric.

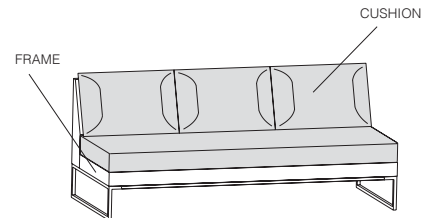

TO ORDER PLEASE SPECIFY THE FOLLOWING:

<input type="text"/>	<input type="text"/>	<input type="text"/>	<input type="text"/>	<input type="text"/>
MODEL NUMBER	FRAME COLOR	FLAMMABILITY RATING	CUSHION UPHOLSTERY	FRAME UPHOLSTERY
	Polished Chrome Brushed Chrome Steel Black Designer White Matte Gold Silver Solar Black Titanium Bullseye Regatta	PC +\$218 BS +\$218 P71 PJW P8G PR6 P8X P8T PJF P8M	U CTB117 Please refer to list of available upholstery and leather selections on www.gunlocke.com	Please refer to list of available upholstery and leather selections on www.gunlocke.com

Example

GLGB17-103.PC.U.DOL728.SPNN04
 GLGB17-103 PC U DOL728 SPNN04
 MODEL NUMBER FRAME COLOR FLAMMABILITY CUSHION UPHOLSTERY FRAME UPHOLSTERY

CALM

Three Seat Lounge, Arm Left

Seating
03/23

model number	fabric grades					dimensions	W	D	H			
GLGB17-113 Three seat, arm left	1	6,908	10	9,782	19	13,528	L1	11,754	Overall	78 1/2"	32"	30"
	2	7,170	11	10,131	20	13,964	L2	15,713	Seat	71 1/2"	21"	17"
	3	7,431	12	10,480	21	14,398	L3	20,462	Arm	30"		
	COM/4	7,692	13	10,914	22	14,834	L4	24,421	Upholstery Requirements: GLGB17-113			
	5	8,042	14	11,351	23	15,704	L5	28,380	Dual Upholstery			
	6	8,390	15	11,786	24	16,575	Fabric yds Cushion 7 Frame 6.75					
	7	8,738	16	12,221	25	17,447	Leather ft ² Cushion 75 Frame 168.8					
	8	9,086	17	12,656	26	18,317	Shipping weight 290 lbs.					
	9	9,434	18	13,091	27	19,188	Cube 54.5					



Cushion	1	10	1,458	19	3,358	L1	2,458	
	2	133	11	1,634	20	3,579	L2	4,466
	3	265	12	1,812	21	3,799	L3	6,875
	COM/4	398	13	2,032	22	4,020	L4	8,883
	5	575	14	2,254	23	4,462	L5	10,892
	6	752	15	2,474	24	4,903		
	7	928	16	2,695	25	5,346		
	8	1,105	17	2,916	26	5,787		
	9	1,281	18	3,136	27	6,229		

Top row of pricing is for units specified with same fabric on cushion and frame. Bottom 2 rows of pricing required only when two different fabric grades are selected for the cushion and frame.

To calculate price of lounge with different grade fabric for cushion and frame; start with Grade 1 price, add appropriate grade price located in second row for cushion, and last add appropriate grade price located in third row for frame to the sum of the Grade 1 and cushion price.

Example: Grade 1 \$6,908 + grade 4 fabric cushion \$398 + grade 2 fabric frame \$129 = \$7,435

Frame	1	10	1,416	19	3,262	L1	2,388	
	2	129	11	1,589	20	3,477	L2	4,339
	3	258	12	1,760	21	3,691	L3	6,679
	COM/4	386	13	1,974	22	3,906	L4	8,630
	5	559	14	2,189	23	4,334	L5	10,580
	6	730	15	2,404	24	4,764		
	7	902	16	2,618	25	5,193		
	8	1,073	17	2,832	26	5,622		
	9	1,245	18	3,047	27	6,051		

Select upholstery for everything else other than the seat and back cushions (the outside back, arms, sides, seat frame). You can specify the same fabric as the cushions or select other fabric.

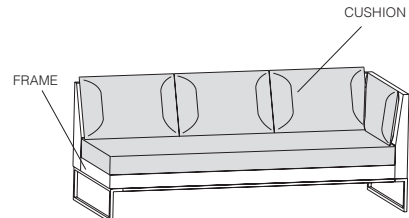

TO ORDER PLEASE SPECIFY THE FOLLOWING:

<input type="text"/>	<input type="text"/>	<input type="text"/>	<input type="text"/>	<input type="text"/>
MODEL NUMBER	FRAME COLOR	FLAMMABILITY RATING	CUSHION UPHOLSTERY	FRAME UPHOLSTERY
	Polished Chrome Brushed Chrome Steel Black Designer White Matte Gold Silver Solar Black Titanium Bullseye Regatta	PC +\$218 BS +\$218 P71 PJW P8G PR6 P8X P8T PJF P8M	U CTB117	Please refer to list of available upholstery and leather selections on www.gunlocke.com
				Please refer to list of available upholstery and leather selections on www.gunlocke.com

Example

GLGB17-113.PC.U.DOL728.SPNN04				
GLGB17-113	PC	U	DOL728	SPNN04
MODEL NUMBER	FRAME COLOR	FLAMMABILITY	CUSHION UPHOLSTERY	FRAME UPHOLSTERY

model number	fabric grades							
GLGB17-123 Three seat, arm right	1	6,908	10	9,782	19	13,528	L1	11,754
	2	7,170	11	10,131	20	13,964	L2	15,713
	3	7,431	12	10,480	21	14,398	L3	20,462
	COM/4	7,692	13	10,914	22	14,834	L4	24,421
	5	8,042	14	11,351	23	15,704	L5	28,380
	6	8,390	15	11,786	24	16,575		
	7	8,738	16	12,221	25	17,447		
	8	9,086	17	12,656	26	18,317		
	9	9,434	18	13,091	27	19,188		

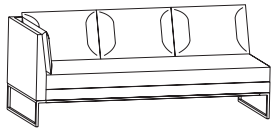

dimensions	W	D	H
Overall	78 1/2"	32"	30"
Seat	71 1/2"	21"	17"
Arm			30"

Upholstery Requirements: GLGB17-123

Dual Upholstery		
Fabric yds	Cushion 7	Frame 6.75
Leather ft ²	Cushion 75	Frame 168.8
Shipping weight	290 lbs.	
Cube	54.5	

Cushion	1	10	1,458	19	3,358	L1	2,458	
	2	133	11	1,634	20	3,579	L2	4,466
	3	265	12	1,812	21	3,799	L3	6,875
	COM/4	398	13	2,032	22	4,020	L4	8,883
	5	575	14	2,254	23	4,462	L5	10,892
	6	752	15	2,474	24	4,903		
	7	928	16	2,695	25	5,346		
	8	1,105	17	2,916	26	5,787		
	9	1,281	18	3,136	27	6,229		

Top row of pricing is for units specified with same fabric on cushion and frame. Bottom 2 rows of pricing required only when two different fabric grades are selected for the cushion and frame.

To calculate price of lounge with different grade fabric for cushion and frame; start with Grade 1 price, add appropriate grade price located in second row for cushion, and last add appropriate grade price located in third row for frame to the sum of the Grade 1 and cushion price.

Example: Grade 1 \$6,908 + grade 4 fabric cushion \$398 + grade 2 fabric frame \$129 = \$7,435

Frame	1	10	1,416	19	3,262	L1	2,388	
	2	129	11	1,589	20	3,477	L2	4,339
	3	258	12	1,760	21	3,691	L3	6,679
	COM/4	386	13	1,974	22	3,906	L4	8,630
	5	559	14	2,189	23	4,334	L5	10,580
	6	730	15	2,404	24	4,764		
	7	902	16	2,618	25	5,193		
	8	1,073	17	2,832	26	5,622		
	9	1,245	18	3,047	27	6,051		

Select upholstery for everything else other than the seat and back cushions (the outside back, arms, sides, seat frame). You can specify the same fabric as the cushions or select other fabric.

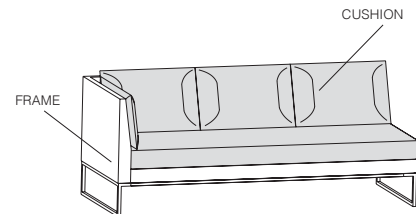

TO ORDER PLEASE SPECIFY THE FOLLOWING:

<input type="text"/>	<input type="text"/>	<input type="text"/>	<input type="text"/>	<input type="text"/>
MODEL NUMBER	FRAME COLOR	FLAMMABILITY RATING	CUSHION UPHOLSTERY	FRAME UPHOLSTERY
	Polished Chrome Brushed Chrome Steel Black Designer White Matte Gold Silver Solar Black Titanium Bullseye Regatta	PC +\$218 BS +\$218 P71 PJW P8G PR6 P8X P8T PJF P8M	U CTB117 Please refer to list of available upholstery and leather selections on www.gunlocke.com	Please refer to list of available upholstery and leather selections on www.gunlocke.com

Example

GLGB17-123.PC.U.DOL728.SPNN04				
GLGB17-123	PC	U	DOL728	SPNN04
MODEL NUMBER	FRAME COLOR	FLAMMABILITY	CUSHION UPHOLSTERY	FRAME UPHOLSTERY

CALM

Left Corner

model number	fabric grades							dimensions	W	D	H	
GLGB17-161 Left corner	1	4,560	10	5,915	19	7,678	L1	6,842	Overall	32"	32"	30"
	2	4,684	11	6,079	20	7,883	L2	8,708	Seat	21"	21"	17"
	3	4,807	12	6,243	21	8,089	L3	10,945	Upholstery Requirements: GLGB17-161			
	COM/4	4,930	13	6,447	22	8,294	L4	12,810	Dual Upholstery			
	5	5,094	14	6,652	23	8,704	L5	14,674	Fabric yds	Cushion 3	Frame 3.5	
	6	5,257	15	6,859	24	9,114			Leather ft2	Cushion 75	Frame 87.5	
	7	5,423	16	7,063	25	9,525			Shipping weight	145 lbs.		
	8	5,587	17	7,268	26	9,933			Cube	23.4		
	9	5,751	18	7,473	27	10,345						



Cushion	1	10	625	19	1,439	L1	1,053	
	2	57	11	701	20	1,534	L2	1,915
	3	114	12	777	21	1,629	L3	2,947
	COM/4	171	13	871	22	1,724	L4	3,808
	5	247	14	966	23	1,912	L5	4,668
	6	322	15	1,061	24	2,102		
	7	398	16	1,155	25	2,292		
	8	474	17	1,250	26	2,480		
	9	550	18	1,344	27	2,670		

Top row of pricing is for units specified with same fabric on cushion and frame. Bottom 2 rows of pricing required only when two different fabric grades are selected for the cushion and frame.

To calculate price of lounge with different grade fabric for cushion and frame; start with Grade 1 price, add appropriate grade price located in second row for cushion, and last add appropriate grade price located in third row for frame to the sum of the Grade 1 and cushion price.

Example: Grade 1 \$4,560 + grade 4 fabric cushion \$171 + grade 2 fabric frame \$67 = \$4,798

Frame	1	10	730	19	1,679	L1	1,229	
	2	67	11	818	20	1,789	L2	2,233
	3	133	12	906	21	1,900	L3	3,438
	COM/4	199	13	1,016	22	2,010	L4	4,442
	5	287	14	1,126	23	2,232	L5	5,446
	6	375	15	1,238	24	2,452		
	7	465	16	1,348	25	2,673		
	8	553	17	1,458	26	2,893		
	9	641	18	1,569	27	3,115		

Select upholstery for everything else other than the seat and back cushions (the outside back, arms, sides, seat frame). You can specify the same fabric as the cushions or select other fabric.

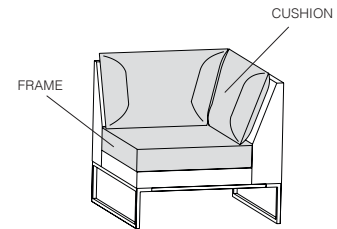

TO ORDER PLEASE SPECIFY THE FOLLOWING:

<input type="text"/>	<input type="text"/>	<input type="text"/>	<input type="text"/>	<input type="text"/>
MODEL NUMBER	FRAME COLOR	FLAMMABILITY RATING	CUSHION UPHOLSTERY	FRAME UPHOLSTERY

- | | | |
|----------------------|------------------|-----------------|
| Polished Chrome | PC +\$137 | U CTB117 |
| Brushed Chrome Steel | BS +\$137 | |
| Black | P71 | |
| Designer White | PJW | |
| Matte Gold | P8G | |
| Silver | PR6 | |
| Solar Black | P8X | |
| Titanium | P8T | |
| Bullseye | PJF | |
| Regatta | P8M | |

Please refer to list of available upholstery and leather selections on www.gunlocke.com

Please refer to list of available upholstery and leather selections on www.gunlocke.com

NOTE: Corner units MUST be used when creating a modular turn where backrests are needed. This aligns the depths between the two "backed" units, and keeps the consistent 5" pillow thickness for the modular turn.

Example

GLGB17-161.PC.U.DOL728.SPNN04				
GLGB17-161	PC	U	DOL728	SPNN04
MODEL NUMBER	FRAME COLOR	FLAMMABILITY	CUSHION UPHOLSTERY	FRAME UPHOLSTERY

model number	fabric grades							dimensions	W	D	H	
GLGB17-171 Right corner	1	4,560	10	5,915	19	7,678	L1	6,842	Overall	32"	32"	30"
	2	4,684	11	6,079	20	7,883	L2	8,708	Seat	21"	21"	17"
	3	4,807	12	6,243	21	8,089	L3	10,945	Upholstery Requirements: GLGB17-171			
	COM/4	4,930	13	6,447	22	8,294	L4	12,810	Dual Upholstery			
	5	5,094	14	6,652	23	8,704	L5	14,674	Fabric yds	Cushion 3	Frame 3.5	
	6	5,257	15	6,859	24	9,114			Leather ft ²	Cushion 75	Frame 87.5	
	7	5,423	16	7,063	25	9,525			Shipping weight	145 lbs.		
	8	5,587	17	7,268	26	9,933			Cube	23.4		
	9	5,751	18	7,473	27	10,345						

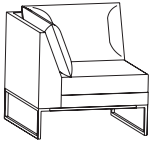

Cushion	1	10	625	19	1,439	L1	1,053	
	2	57	11	701	20	1,534	L2	1,915
	3	114	12	777	21	1,629	L3	2,947
	COM/4	171	13	871	22	1,724	L4	3,808
	5	247	14	966	23	1,912	L5	4,668
	6	322	15	1,061	24	2,102		
	7	398	16	1,155	25	2,292		
	8	474	17	1,250	26	2,480		
	9	550	18	1,344	27	2,670		

Top row of pricing is for units specified with same fabric on cushion and frame. Bottom 2 rows of pricing required only when two different fabric grades are selected for the cushion and frame.

To calculate price of lounge with different grade fabric for cushion and frame; start with Grade 1 price, add appropriate grade price located in second row for cushion, and last add appropriate grade price located in third row for frame to the sum of the Grade 1 and cushion price.

Example: Grade 1 \$4,560 + grade 4 fabric cushion \$171 + grade 2 fabric frame \$67 = \$4,798

Frame	1	10	730	19	1,679	L1	1,229	
	2	67	11	818	20	1,789	L2	2,233
	3	133	12	906	21	1,900	L3	3,438
	COM/4	199	13	1,016	22	2,010	L4	4,442
	5	287	14	1,126	23	2,232	L5	5,446
	6	375	15	1,238	24	2,452		
	7	465	16	1,348	25	2,673		
	8	553	17	1,458	26	2,893		
	9	641	18	1,569	27	3,115		

Select upholstery for everything else other than the seat and back cushions (the outside back, arms, sides, seat frame). You can specify the same fabric as the cushions or select other fabric.

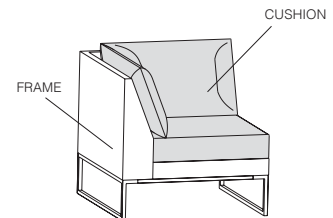

TO ORDER PLEASE SPECIFY THE FOLLOWING:

<input type="text"/>	<input type="text"/>	<input type="text"/>	<input type="text"/>	<input type="text"/>
MODEL NUMBER	FRAME COLOR	FLAMMABILITY RATING	CUSHION UPHOLSTERY	FRAME UPHOLSTERY
	Polished Chrome Brushed Chrome Steel Black Designer White Matte Gold Silver Solar Black Titanium Bullseye Regatta	PC +\$137 BS +\$137 P71 PJW P8G PR6 P8X P8T PJF P8M	U CTB117 Please refer to list of available upholstery and leather selections on www.gunlocke.com	Please refer to list of available upholstery and leather selections on www.gunlocke.com

NOTE: Corner units MUST be used when creating a modular turn where backrests are needed. This aligns the depths between the two "backed" units, and keeps the consistent 5" pillow thickness for the modular turn.

Example

GLGB17-171.PC.U.DOL728.SPNN04				
GLGB17-171	PC	U	DOL728	SPNN04
MODEL NUMBER	FRAME COLOR	FLAMMABILITY	CUSHION UPHOLSTERY	FRAME UPHOLSTERY

CALM

One Seat Bench

Seating
03/23

model number fabric grades dimensions W D H

GBGB17-131
One seat bench

1	2,824	10	3,304	19	3,928	L1	3,632
2	2,869	11	3,362	20	4,001	L2	4,292
3	2,913	12	3,420	21	4,073	L3	5,084
COM/4	2,956	13	3,492	22	4,146	L4	5,743
5	3,013	14	3,565	23	4,291	L5	6,404
6	3,071	15	3,637	24	4,436		
7	3,130	16	3,710	25	4,582		
8	3,188	17	3,783	26	4,726		
9	3,246	18	3,855	27	4,871		

Overall 25" 32" 17"

Upholstery Requirements: GLGB17-131

	Dual Upholstery	
Fabric yds	Cushion 1	Frame 1.3
Leather ft ²	Cushion 25	Frame 32.5
Shipping weight	90 lbs.	
Cube	11.3	

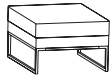

Cushion

1		10	209	19	480	L1	351
2	19	11	234	20	512	L2	638
3	39	12	259	21	543	L3	983
COM/4	57	13	290	22	575	L4	1,269
5	82	14	322	23	638	L5	1,556
6	107	15	354	24	701		
7	133	16	385	25	765		
8	159	17	417	26	827		
9	184	18	448	27	890		

Top row of pricing is for units specified with same fabric on cushion and frame. Bottom 2 rows of pricing required only when two different fabric grades are selected for the cushion and frame.

To calculate price of lounge with different grade fabric for cushion and frame; start with Grade 1 price, add appropriate grade price located in second row for cushion, and last add appropriate grade price located in third row for frame to the sum of the Grade 1 and cushion price.

Example: Grade 1 \$2,824 + grade 4 fabric cushion \$57 + grade 2 fabric frame \$26 = \$2,907

Frame

1		10	271	19	624	L1	457
2	26	11	304	20	665	L2	830
3	50	12	337	21	706	L3	1,277
COM/4	75	13	378	22	747	L4	1,650
5	107	14	419	23	829	L5	2,024
6	140	15	459	24	911		
7	173	16	501	25	993		
8	205	17	542	26	1,075		
9	238	18	583	27	1,157		

Select upholstery for everything else other than the seat and back cushions (the outside back, arms, sides, seat frame). You can specify the same fabric as the cushions or select other fabric.

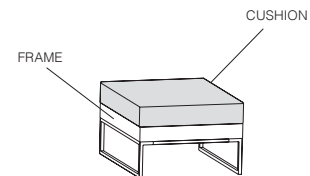

TO ORDER PLEASE SPECIFY THE FOLLOWING:

<input type="text"/>	<input type="text"/>	<input type="text"/>	<input type="text"/>	<input type="text"/>
MODEL NUMBER	FRAME COLOR	FLAMMABILITY RATING	CUSHION UPHOLSTERY	FRAME UPHOLSTERY
	Polished Chrome Brushed Chrome Steel Black Designer White Matte Gold Silver Solar Black Titanium Bullseye Regatta	PC +\$137 BS +\$137 P71 PJW P8G PR6 P8X P8T PJF P8M	U CTB117	Please refer to list of available upholstery and leather selections on www.gunlocke.com

Example

GBGB17-131.PC.U.DOL728.SPNN04
 GBGB17-131 PC U DOL728 SPNN04
 MODEL NUMBER FRAME COLOR FLAMMABILITY CUSHION UPHOLSTERY FRAME UPHOLSTERY

model number	fabric grades							dimensions	W	D	H	
GBGB17-142 Two seat bench	1	3,866	10	4,638	19	5,641	L1	5,166	Overall	50"	32"	17"
	2	3,936	11	4,732	20	5,758	L2	6,227	Upholstery Requirements: GLGB17-142			
	3	4,007	12	4,824	21	5,875	L3	7,501	Dual Upholstery			
	COM/4	4,077	13	4,941	22	5,991	L4	8,562	Fabric yds	Cushion 2.5	Frame 1.2	
	5	4,170	14	5,057	23	6,226	L5	9,624	Leather ft ²	Cushion 62.5	Frame 30	
	6	4,264	15	5,175	24	6,459			Shipping weight	135 lbs.		
	7	4,358	16	5,292	25	6,692			Cube	21.5		
	8	4,451	17	5,408	26	6,925						
	9	4,544	18	5,525	27	7,160						



Cushion	1	10	522	19	1,199	L1	878	
	2	47	11	585	20	1,278	L2	1,595
	3	95	12	647	21	1,358	L3	2,456
	COM/4	142	13	726	22	1,436	L4	3,173
	5	205	14	805	23	1,594	L5	3,890
	6	269	15	884	24	1,752		
	7	332	16	963	25	1,909		
	8	395	17	1,041	26	2,067		
	9	458	18	1,121	27	2,225		

Top row of pricing is for units specified with same fabric on cushion and frame. Bottom 2 rows of pricing required only when two different fabric grades are selected for the cushion and frame.

To calculate price of lounge with different grade fabric for cushion and frame; start with Grade 1 price, add appropriate grade price located in second row for cushion, and last add appropriate grade price located in third row for frame to the sum of the Grade 1 and cushion price.

Example: Grade 1 \$3,866 + grade 4 fabric cushion \$142 + grade 2 fabric frame \$23 = \$4,031

Frame	1	10	250	19	576	L1	422	
	2	23	11	281	20	614	L2	766
	3	46	12	311	21	651	L3	1,179
	COM/4	69	13	349	22	689	L4	1,523
	5	99	14	386	23	766	L5	1,868
	6	129	15	425	24	841		
	7	160	16	463	25	917		
	8	190	17	501	26	992		
	9	220	18	538	27	1,069		

Select upholstery for everything else other than the seat and back cushions (the outside back, arms, sides, seat frame). You can specify the same fabric as the cushions or select other fabric.

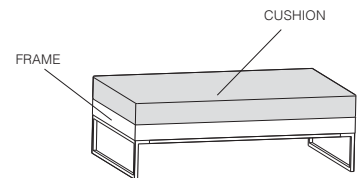

TO ORDER PLEASE SPECIFY THE FOLLOWING:

<input type="text"/>	<input type="text"/>	<input type="text"/>	<input type="text"/>	<input type="text"/>
MODEL NUMBER	FRAME COLOR	FLAMMABILITY RATING	CUSHION UPHOLSTERY	FRAME UPHOLSTERY
	Polished Chrome Brushed Chrome Steel Black Designer White Matte Gold Silver Solar Black Titanium Bullseye Regatta	PC +\$164 BS +\$164 P71 PJW P8G PR6 P8X P8T PJF P8M	U CTB117 Please refer to list of available upholstery and leather selections on www.gunlocke.com	Please refer to list of available upholstery and leather selections on www.gunlocke.com

Example

GLGB17-142.PC.U.DOL728.SPNN04				
GLGB17-142	PC	U	DOL728	SPNN04
MODEL NUMBER	FRAME COLOR	FLAMMABILITY	CUSHION UPHOLSTERY	FRAME UPHOLSTERY

CALM

Three Seat Bench

model number	fabric grades						dimensions	W	D	H
GBGB17-153 Three seat bench	1	4,855	10	6,001	19	7,494	L1	6,786	Overall	75" 32" 17"
	2	4,960	11	6,140	20	7,667	L2	8,365		
	3	5,064	12	6,279	21	7,842	L3	10,258		
	COM/4	5,168	13	6,451	22	8,014	L4	11,836		
	5	5,308	14	6,626	23	8,361	L5	13,412		
	6	5,447	15	6,799	24	8,709				
	7	5,584	16	6,974	25	9,056				
	8	5,724	17	7,146	26	9,404				
	9	5,863	18	7,320	27	9,749				



Upholstery Requirements: GLGB17-153

Dual Upholstery	
Fabric yds	Cushion 4 Frame 1.5
Leather ft ²	Cushion 100 Frame 37.5
Shipping weight	180 lbs.
Cube	31.6

Cushion	1	10	833	19	1,919	L1	1,404	
	2	76	11	935	20	2,045	L2	2,552
	3	152	12	1,035	21	2,172	L3	3,929
	COM/4	227	13	1,161	22	2,297	L4	5,077
	5	329	14	1,288	23	2,550	L5	6,223
	6	430	15	1,414	24	2,803		
	7	530	16	1,541	25	3,055		
	8	632	17	1,666	26	3,308		
	9	733	18	1,792	27	3,559		

Top row of pricing is for units specified with same fabric on cushion and frame. Bottom 2 rows of pricing required only when two different fabric grades are selected for the cushion and frame.

To calculate price of lounge with different grade fabric for cushion and frame; start with Grade 1 price, add appropriate grade price located in second row for cushion, and last add appropriate grade price located in third row for frame to the sum of the Grade 1 and cushion price.

Example: Grade 1 \$4,855 + grade 4 fabric cushion \$227 + grade 2 fabric frame \$29 = \$5,111

Frame	1	10	313	19	720	L1	527	
	2	29	11	350	20	767	L2	958
	3	57	12	389	21	815	L3	1,474
	COM/4	86	13	435	22	862	L4	1,904
	5	124	14	483	23	956	L5	2,334
	6	162	15	530	24	1,051		
	7	199	16	578	25	1,146		
	8	237	17	625	26	1,241		
	9	275	18	673	27	1,335		

Select upholstery for everything else other than the seat and back cushions (the outside back, arms, sides, seat frame). You can specify the same fabric as the cushions or select other fabric.

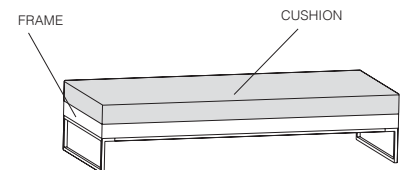

TO ORDER PLEASE SPECIFY THE FOLLOWING:

MODEL NUMBER	FRAME COLOR	FLAMMABILITY RATING	CUSHION UPHOLSTERY	FRAME UPHOLSTERY
<input type="text"/>	<input type="text"/>	<input type="text"/>	<input type="text"/>	<input type="text"/>
	Polished Chrome Brushed Chrome Steel Black Designer White Matte Gold Silver Solar Black Titanium Bullseye Regatta	PC +\$218 BS +\$218 P71 PJW P8G PR6 P8X P8T PJF P8M	U CTB117	Please refer to list of available upholstery and leather selections on www.gunlocke.com

Example

GBGB17-153.PC.U.DOL728.SPNN04

MODEL NUMBER	FRAME COLOR	FLAMMABILITY	CUSHION UPHOLSTERY	FRAME UPHOLSTERY
GBGB17-153	PC	U	DOL728	SPNN04

model number fabric grades dimensions W D H

GLGB17-181 Ottoman	1	2,961	10	3,431	19	4,041	L1	3,752
	2	3,004	11	3,488	20	4,112	L2	4,397
	3	3,047	12	3,544	21	4,182	L3	5,172
	COM/4	3,089	13	3,614	22	4,255	L4	5,816
	5	3,146	14	3,686	23	4,396	L5	6,462
	6	3,203	15	3,757	24	4,538		
	7	3,260	16	3,827	25	4,681		
	8	3,318	17	3,900	26	4,822		
	9	3,374	18	3,970	27	4,963		

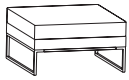

Overall 32" 32" 17"

Upholstery Requirements: GLGB17-181

Dual Upholstery		
Fabric yds	Cushion 1	Frame 1.25
Leather ft ²	Cushion 25	Frame 31.25
Shipping weight	100 lbs.	
Cube	14.2	

Cushion	1	10	209	19	480	L1	351	
	2	19	11	234	20	512	L2	638
	3	39	12	259	21	543	L3	983
	COM/4	57	13	290	22	575	L4	1,269
	5	82	14	322	23	638	L5	1,556
	6	107	15	354	24	701		
	7	133	16	385	25	765		
	8	159	17	417	26	827		
	9	184	18	448	27	890		

Top row of pricing is for units specified with same fabric on cushion and frame. Bottom 2 rows of pricing required only when two different fabric grades are selected for the cushion and frame.

To calculate price of lounge with different grade fabric for cushion and frame; start with Grade 1 price, add appropriate grade price located in second row for cushion, and last add appropriate grade price located in third row for frame to the sum of the Grade 1 and cushion price.

Example: Grade 1 \$2,961 + grade 4 fabric cushion \$57 + grade 2 fabric frame \$24 = \$3,042

Frame	1	10	261	19	600	L1	440	
	2	24	11	293	20	639	L2	798
	3	47	12	324	21	678	L3	1,228
	COM/4	71	13	363	22	719	L4	1,586
	5	103	14	403	23	797	L5	1,945
	6	135	15	442	24	876		
	7	166	16	481	25	955		
	8	198	17	522	26	1,034		
	9	229	18	561	27	1,112		

Select upholstery for everything else other than the seat and back cushions (the outside back, arms, sides, seat frame). You can specify the same fabric as the cushions or select other fabric.

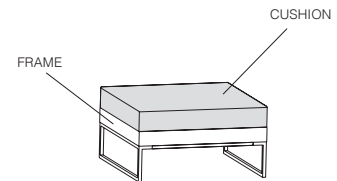

TO ORDER PLEASE SPECIFY THE FOLLOWING:

<input type="text"/>	<input type="text"/>	<input type="text"/>	<input type="text"/>	<input type="text"/>
MODEL NUMBER	FRAME COLOR	FLAMMABILITY RATING	CUSHION UPHOLSTERY	FRAME UPHOLSTERY
	Polished Chrome Brushed Chrome Steel Black Designer White Matte Gold Silver Solar Black Titanium Bullseye Regatta	PC +\$137 BS +\$137 P71 P1JW P8G PR6 P8X P8T P1JF P8M	U CTB117	Please refer to list of available upholstery and leather selections on www.gunlocke.com
				Please refer to list of available upholstery and leather selections on www.gunlocke.com

NOTE: Ottoman to be used in line with lounge units, to create a 32"D x 32"W seating surface..

Example

GLGB17-181.PC.U.DOL728.DOL728
 GLGB17-181 PC U DOL728 SPNN04
 MODEL NUMBER FRAME COLOR FLAMMABILITY CUSHION UPHOLSTERY FRAME UPHOLSTERY

model number	list	dimensions	W	D	H
--------------	------	------------	---	---	---

GAGB17-198
Ganging bracket

161

14.5" 4" 1.5"



- **Note:** No options are selected for ganging bracket model (GAGB17-198).
- One ganging bracket shipped per GAGB17-198 model ordered.
- Lounge units gang together with one ganging bracket per ganged position.

ACPUNDER-EU
Standard Plug

413

5.5" 3" 2"



- **Note:** Power unit mounts at left or right hand side of lounge units only. Positions are predetermined at mounting points into lounge frame (see example below).

ACPUNDER-EU-HW
Hardwired

413

5.5" 3" 2"



- **Note:** Power unit mounts at left or right hand side of lounge units only. Positions are predetermined at mounting points into lounge frame (see example below).

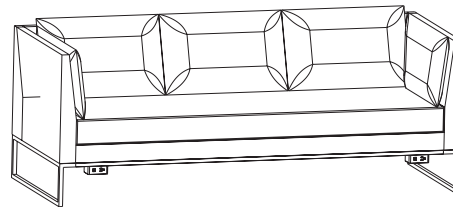
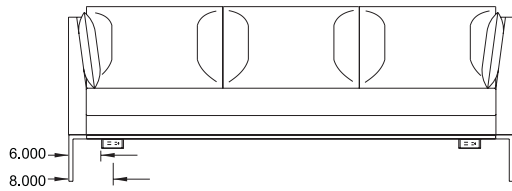

- **Note:** Power unit can be mounted directly into lounge unit frames. Edge of power unit is 6" from outside of lounge, or 8" to center of power unit from outside of lounge. Includes wire clips to attach plug cord to underside of lounge.

TO ORDER PLEASE SPECIFY THE FOLLOWING:

--	--

MODEL NUMBER **POWER COLOR**

Option available for
ACPUNDER-EU and
ACPUNDER-EU-HW models only.

White **WH**
Black **BK**
Silver **SV**

Example

ACPUNDER-EU.WH
ACPUNDER-EU WH
MODEL NUMBER **POWER COLOR**

Seating
03/23

CIJI SINGLE SEAT

Low Back, with Arms, Wood Legs

model number	fabric grades							
GK1101-1W Low back, with arms, Wood legs	1	3,435	10	4,540	19	5,978	L1	5,127
	2	3,536	11	4,673	20	6,145	L2	6,525
	3	3,636	12	4,808	21	6,313	L3	8,204
	COM/4	3,737	13	4,974	22	6,480	L4	9,603
	5	3,871	14	5,141	23	6,813	L5	11,000
	6	4,005	15	5,308	24	7,148		
	7	4,138	16	5,476	25	7,483		
	8	4,272	17	5,643	26	7,818		
	9	4,406	18	5,811	27	8,152		

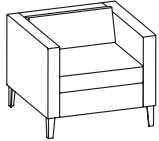

dimensions	W	D	H
Overall	31 3/4"	31 1/2"	27 7/8"
Seat	24"	21"	17 1/4"
Arm			26 7/8"
Between arms	24"		

Upholstery Requirements: GK1101-1W	
	Dual Upholstery
Fabric yds	Cushions 1.5 Frame 3.8
Leather ft ²	Cushions 34.5 Frame 87.4
Shipping weight	97 lbs.
Cube	28.0

Cushion	1	10	19	20	21	22	23	24	25	26	27	L1	L2	L3	L4	L5
		313	720	767	815	862	956	1,051	1,146	1,241	1,335	479	875	1,350	1,746	2,141
	2	29	350	389	435	483	530	578	625	673						
	3	57	389	435	483	530	578	625	673							
	COM/4	86	435	483	530	578	625	673								
	5	124	483	530	578	625	673									
	6	162	530	578	625	673										
	7	199	578	625	673											
	8	237	625	673												
	9	275	673													

Top row of pricing is for units specified with same fabric on cushion and frame. Bottom 2 rows of pricing required only when two different fabric grades are selected for the cushion and frame.

To calculate price of lounge with different grade fabric for cushion and frame; start with Grade 1 price, add appropriate grade price located in second row for cushion, and last add appropriate grade price located in third row for frame to the sum of the Grade 1 and cushion price.

Example: Grade 1 \$3,435 + grade 4 fabric cushion \$86 + grade 2 fabric frame \$72 = \$3,593

Frame	1	10	19	20	21	22	23	24	25	26	27	L1	L2	L3	L4	L5
		792	1,823	1,943	2,063	2,183	2,422	2,662	2,902	3,142	3,382	1,213	2,215	3,419	4,422	5,424
	2	72	888	984	1,104	1,223	1,343	1,463	1,583	1,703						
	3	144	984	1,104	1,223	1,343	1,463	1,583	1,703							
	COM/4	216	1,104	1,223	1,343	1,463	1,583	1,703								
	5	312	1,223	1,343	1,463	1,583										
	6	408	1,343	1,463	1,583											
	7	504	1,463	1,583												
	8	600	1,583													
	9	696	1,703													

Select upholstery for everything else other than the seat and back cushions (the outside back, arms, sides, seat frame). You can specify the same fabric as the cushions or select other fabric.

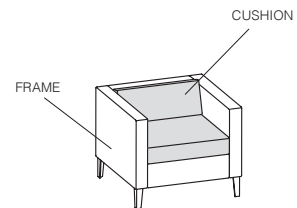

TO ORDER PLEASE SPECIFY THE FOLLOWING:

<input type="text"/>	<input type="text"/>	<input type="text"/>	<input type="text"/>	<input type="text"/>	<input type="text"/>
MODEL NUMBER	WOOD FINISH	STITCH DETAIL	FLAMMABILITY RATING	CUSHION UPHOLSTERY	FRAME UPHOLSTERY
	Cherry finishes on Maple Walnut finishes on Maple Maple finishes on Maple Oak finishes on Maple	None NR Stitch detail SD +\$191	U CTB117	Please refer to list of available upholstery and leather selections on www.gunlocke.com	Please refer to list of available upholstery and leather selections on www.gunlocke.com

Example

GK1101-1W.777.NR.U.DOL728.SPNO4					
GK1101-1W	777	NR	U	DOL728	SPNO4
MODEL NUMBER	WOOD FINISH	STITCH DETAIL	FLAMMABILITY	CUSHION UPHOLSTERY	FRAME UPHOLSTERY

Please refer to the Ciji product page on www.gunlocke.com for standard finish options.

CIJI SINGLE SEAT

Low Back, with Arms, Aluminum Legs

Seating
03/23

model number	fabric grades								dimensions	W	D	H
GK1101-1A Low back, with arms, Aluminum legs	1	3,693	10	4,798	19	6,236	L1	5,385	Overall	31 3/4"	31 1/2"	27 7/8"
	2	3,794	11	4,931	20	6,403	L2	6,783	Seat	24"	21"	17 1/4"
	3	3,894	12	5,066	21	6,571	L3	8,462	Arm	26 7/8"		
	COM/4	3,995	13	5,232	22	6,738	L4	9,861	Between arms	24"		
	5	4,129	14	5,399	23	7,071	L5	11,258	Upholstery Requirements: GK1101-1A			
	6	4,263	15	5,566	24	7,406			Dual Upholstery			
	7	4,396	16	5,734	25	7,741			Fabric yds Cushions 1.5 Frame 3.8			
	8	4,530	17	5,901	26	8,076			Leather ft ² Cushions 34.5 Frame 87.4			
	9	4,664	18	6,069	27	8,410			Shipping weight 97 lbs.			
									Cube 28.0			

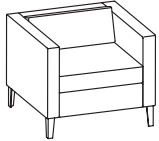

Cushion	1	10	19	20	21	22	23	24	25	26	27	L1	L2	L3	L4	L5
		313	720	479												
	29	350	767	875												
	57	389	815	1,350												
	COM/4	86	435	862	1,746											
	124	483	956	2,141												
	162	530	1,051													
	199	578	1,146													
	237	625	1,241													
	275	673	1,335													

Frame	1	10	19	20	21	22	23	24	25	26	27	L1	L2	L3	L4	L5
		792	1,823	1,213												
	72	888	1,943	2,215												
	144	984	2,063	3,419												
	COM/4	216	1,104	2,183	4,422											
	312	1,223	2,422	5,424												
	408	1,343	2,662													
	504	1,463	2,902													
	600	1,583	3,142													
	696	1,703	3,382													

Top row of pricing is for units specified with same fabric on cushion and frame. Bottom 2 rows of pricing required only when two different fabric grades are selected for the cushion and frame.

To calculate price of lounge with different grade fabric for cushion and frame; start with Grade 1 price, add appropriate grade price located in second row for cushion, and last add appropriate grade price located in third row for frame to the sum of the Grade 1 and cushion price.

Example: Grade 1 \$3,693 + grade 4 fabric cushion \$86 + grade 2 fabric frame \$72 = \$3,851

Select upholstery for everything else other than the seat and back cushions (the outside back, arms, sides, seat frame). You can specify the same fabric as the cushions or select other fabric.

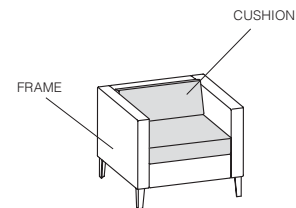

TO ORDER PLEASE SPECIFY THE FOLLOWING:

<input type="text"/>	<input type="text"/>	<input type="text"/>	<input type="text"/>	<input type="text"/>
MODEL NUMBER	STITCH DETAIL	FLAMMABILITY RATING	CUSHION UPHOLSTERY	FRAME UPHOLSTERY
	None NR Stitch detail SD +\$191	U CTB117	Please refer to list of available upholstery and leather selections on www.gunlocke.com	Please refer to list of available upholstery and leather selections on www.gunlocke.com

Example

GK1101-1A.NR.U.DOL728.SPNN04				
GK1101-1A	NR	U	DOL728	SPNN04
MODEL NUMBER	STITCH	FLAMMABILITY DETAIL	CUSHION UPHOLSTERY	FRAME UPHOLSTERY

Please refer to the Ciji product page on www.gunlocke.com for standard finish options.

model number	fabric grades								dimensions	W	D	H
GK1103-1W Low back, armless Wood legs	1	2,633	10	3,259	19	4,073	L1	3,591	Overall	24 5/8"	31 1/2"	27 7/8"
	2	2,691	11	3,333	20	4,167	L2	4,383	Seat	24"	21"	17 1/4"
	3	2,747	12	3,411	21	4,263	L3	5,333	Upholstery Requirements: GK1103-1W			
	COM/4	2,805	13	3,503	22	4,357	L4	6,125		Dual Upholstery		
	5	2,881	14	3,599	23	4,545	L5	6,915	Fabric yds	Cushions 1.5 Frame 1.5		
	6	2,957	15	3,693	24	4,735			Leather ft ²	Cushions 34.5 Frame 34.5		
	7	3,031	16	3,789	25	4,925			Shipping weight	77 lbs.		
	8	3,107	17	3,883	26	5,115			Cube	28.0		
	9	3,183	18	3,979	27	5,303						



Cushion	1	10	313	19	720	L1	479	
	2	29	11	350	20	767	L2	875
	3	57	12	389	21	815	L3	1,350
	COM/4	86	13	435	22	862	L4	1,746
	5	124	14	483	23	956	L5	2,141
	6	162	15	530	24	1,051		
	7	199	16	578	25	1,146		
	8	237	17	625	26	1,241		
	9	275	18	673	27	1,335		

Top row of pricing is for units specified with same fabric on cushion and frame. Bottom 2 rows of pricing required only when two different fabric grades are selected for the cushion and frame.

To calculate price of lounge with different grade fabric for cushion and frame; start with Grade 1 price, add appropriate grade price located in second row for cushion, and last add appropriate grade price located in third row for frame to the sum of the Grade 1 and cushion price.

Example: Grade 1 \$2,633 + grade 4 fabric cushion \$86 + grade 2 fabric frame \$29 = \$2,748

Frame	1	10	313	19	720	L1	479	
	2	29	11	350	20	767	L2	875
	3	57	12	389	21	815	L3	1,350
	COM/4	86	13	435	22	862	L4	1,746
	5	124	14	483	23	956	L5	2,141
	6	162	15	530	24	1,051		
	7	199	16	578	25	1,146		
	8	237	17	625	26	1,241		
	9	275	18	673	27	1,335		

Select upholstery for everything else other than the seat and back cushions (the outside back, arms, sides, seat frame). You can specify the same fabric as the cushions or select other fabric.

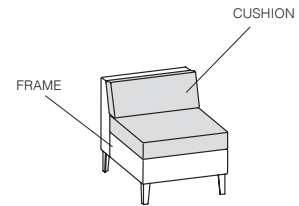

TO ORDER PLEASE SPECIFY THE FOLLOWING:

<input type="text"/>	<input type="text"/>	<input type="text"/>	<input type="text"/>	<input type="text"/>	<input type="text"/>
MODEL NUMBER	WOOD FINISH	STITCH DETAIL	FLAMMABILITY RATING	CUSHION UPHOLSTERY	FRAME UPHOLSTERY
	Cherry finishes on Maple Walnut finishes on Maple Maple finishes on Maple Oak finishes on Maple	None NR Stitch detail SD +\$191	U CTB117	Please refer to list of available upholstery and leather selections on www.gunlocke.com	Please refer to list of available upholstery and leather selections on www.gunlocke.com

Example

GK1103-1W.777.NR.U.DOL728.SPNN04					
GK1103-1W	777	NR	U	DOL728	SPNN04
MODEL NUMBER	WOOD FINISH	STITCH DETAIL	FLAMMABILITY	CUSHION UPHOLSTERY	FRAME UPHOLSTERY

Please refer to the Ciji product page on www.gunlocke.com for standard finish options.

CIJI SINGLE SEAT

Low Back, Armless, Aluminum Legs

Seating
03/23

model number fabric grades dimensions W D H

GK1103-1A

Low back, armless
Aluminum legs



1	2,890	10	3,516	19	4,330	L1	3,848
2	2,948	11	3,590	20	4,424	L2	4,640
3	3,004	12	3,668	21	4,520	L3	5,590
COM/4	3,062	13	3,760	22	4,614	L4	6,382
5	3,138	14	3,856	23	4,802	L5	7,172
6	3,214	15	3,950	24	4,992		
7	3,288	16	4,046	25	5,182		
8	3,364	17	4,140	26	5,372		
9	3,440	18	4,236	27	5,560		

Overall	24 5/8"	31 1/2"	27 7/8"
Seat	24"	21"	17 1/4"

Upholstery Requirements: GK1103-1A

	Dual Upholstery	
Fabric yds	Cushions 1.5	Frame 1.5
Leather ft ²	Cushions 34.5	Frame 34.5
Shipping weight	77 lbs.	
Cube	28.0	

Cushion

1		10	313	19	720	L1	479
2	29	11	350	20	767	L2	875
3	57	12	389	21	815	L3	1,350
COM/4	86	13	435	22	862	L4	1,746
5	124	14	483	23	956	L5	2,141
6	162	15	530	24	1,051		
7	199	16	578	25	1,146		
8	237	17	625	26	1,241		
9	275	18	673	27	1,335		

Top row of pricing is for units specified with same fabric on cushion and frame. Bottom 2 rows of pricing required only when two different fabric grades are selected for the cushion and frame.

To calculate price of lounge with different grade fabric for cushion and frame; start with Grade 1 price, add appropriate grade price located in second row for cushion, and last add appropriate grade price located in third row for frame to the sum of the Grade 1 and cushion price.

Example: Grade 1 \$2,890 + grade 4 fabric cushion \$86 + grade 2 fabric frame \$29 = \$3,005

Frame

1		10	313	19	720	L1	479
2	29	11	350	20	767	L2	875
3	57	12	389	21	815	L3	1,350
COM/4	86	13	435	22	862	L4	1,746
5	124	14	483	23	956	L5	2,141
6	162	15	530	24	1,051		
7	199	16	578	25	1,146		
8	237	17	625	26	1,241		
9	275	18	673	27	1,335		

Select upholstery for everything else other than the seat and back cushions (the outside back, arms, sides, seat frame). You can specify the same fabric as the cushions or select other fabric.

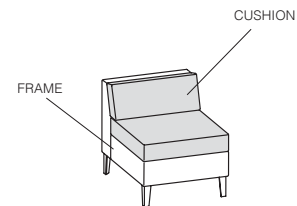

TO ORDER PLEASE SPECIFY THE FOLLOWING:

<input type="text"/>	<input type="text"/>	<input type="text"/>	<input type="text"/>	<input type="text"/>
MODEL NUMBER	STITCH DETAIL	FLAMMABILITY RATING	CUSHION UPHOLSTERY	FRAME UPHOLSTERY
	None NR Stitch detail SD +\$191	U CTB117	Please refer to list of available upholstery and leather selections on www.gunlocke.com	Please refer to list of available upholstery and leather selections on www.gunlocke.com

Example

GK1103-1A.NR.U.DOL728.SPNN04

GK1103-1A	NR	U	DOL728	SPNN04
MODEL NUMBER	STITCH	FLAMMABILITY DETAIL	CUSHION UPHOLSTERY	FRAME UPHOLSTERY

Please refer to the Ciji product page on www.gunlocke.com for standard finish options.

Seating
03/23

CIJI SINGLE SEAT

Low Back, Arm Left, Wood Legs

model number	fabric grades						dimensions	W	D	H		
GK1105-1W Low back, arm left. Wood legs	1	3,237	10	4,134	19	5,300	L1	4,609	Overall	28 1/8"	31 1/2"	27 1/8"
	2	3,320	11	4,241	20	5,436	L2	5,744	Seat	24"	21"	17 1/4"
	3	3,400	12	4,351	21	5,572	L3	7,106	Arm			26 1/8"
	COM/4	3,483	13	4,486	22	5,707	L4	8,242	Between arms			
	5	3,591	14	4,622	23	5,978	L5	9,376	Upholstery Requirements: GK1105-1W			
	6	3,700	15	4,757	24	6,249			Dual Upholstery			
	7	3,807	16	4,894	25	6,521			Fabric yds	Cushions 1.5	Frame 2.8	
	8	3,916	17	5,029	26	6,794			Leather ft ²	Cushions 34.5	Frame 64.4	
	9	4,025	18	5,165	27	7,064			Shipping weight			87 lbs.
								Cube			28.0	



Cushion	1	10	19	20	21	22	23	24	25	26	27
		313	720	L1	479						
	29	350	767	L2	875						
	57	389	815	L3	1,350						
COM/4	86	435	862	L4	1,746						
	124	483	956	L5	2,141						
	162	530	1,051								
	199	578	1,146								
	237	625	1,241								
	275	673	1,335								

Top row of pricing is for units specified with same fabric on cushion and frame. Bottom 2 rows of pricing required only when two different fabric grades are selected for the cushion and frame.

To calculate price of lounge with different grade fabric for cushion and frame; start with Grade 1 price, add appropriate grade price located in second row for cushion, and last add appropriate grade price located in third row for frame to the sum of the Grade 1 and cushion price.

Example: Grade 1 \$3,237 + grade 4 fabric cushion \$86 + grade 2 fabric frame \$54 = \$3,377

Frame	1	10	19	20	21	22	23	24	25	26	27
		584	1,343	L1	893						
	54	654	1,432	L2	1,632						
	106	725	1,520	L3	2,519						
COM/4	160	814	1,608	L4	3,259						
	230	902	1,785	L5	3,998						
	301	990	1,961								
	371	1,079	2,138								
	442	1,167	2,316								
	513	1,255	2,492								

Select upholstery for everything else other than the seat and back cushions (the outside back, arms, sides, seat frame). You can specify the same fabric as the cushions or select other fabric.

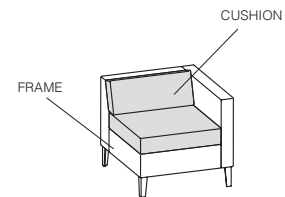

TO ORDER PLEASE SPECIFY THE FOLLOWING:

<input type="text"/>	<input type="text"/>	<input type="text"/>	<input type="text"/>	<input type="text"/>	<input type="text"/>
MODEL NUMBER	WOOD FINISH	STITCH DETAIL	FLAMMABILITY RATING	CUSHION UPHOLSTERY	FRAME UPHOLSTERY
	Cherry finishes on Maple Walnut finishes on Maple Maple finishes on Maple Oak finishes on Maple	None NR Stitch detail SD +\$191	U CTB117	Please refer to list of available upholstery and leather selections on www.gunlocke.com	Please refer to list of available upholstery and leather selections on www.gunlocke.com

Example

GK1105-1W.777.NR.U.DOL728.SPNN04					
GK1105-1W	777	NR	U	DOL728	SPNN04
MODEL NUMBER	WOOD FINISH	STITCH DETAIL	FLAMMABILITY	CUSHION UPHOLSTERY	FRAME UPHOLSTERY

Please refer to the Ciji product page on www.gunlocke.com for standard finish options.

CIJI SINGLE SEAT

Low Back, Arm Left, Aluminum Legs

Seating
03/23

model number fabric grades dimensions W D H

GK1105-1A

Low back, arm left.
Aluminum legs



1	3,494	10	4,391	19	5,557	L1	4,866
2	3,577	11	4,498	20	5,693	L2	6,001
3	3,657	12	4,608	21	5,829	L3	7,363
COM/4	3,740	13	4,743	22	5,964	L4	8,499
5	3,848	14	4,879	23	6,235	L5	9,633
6	3,957	15	5,014	24	6,506		
7	4,064	16	5,151	25	6,778		
8	4,173	17	5,286	26	7,051		
9	4,282	18	5,422	27	7,321		

Overall	28 1/8"	31 1/2"	27 1/8"
Seat	24"	21"	17 1/4"
Arm			26 1/8"
Between arms			

Upholstery Requirements: GK1105-1A

	Dual Upholstery	
Fabric yds	Cushions 1.5	Frame 2.8
Leather ft ²	Cushions 34.5	Frame 64.4
Shipping weight		87 lbs.
Cube		28.0

Cushion

1		10	313	19	720	L1	479
2	29	11	350	20	767	L2	875
3	57	12	389	21	815	L3	1,350
COM/4	86	13	435	22	862	L4	1,746
5	124	14	483	23	956	L5	2,141
6	162	15	530	24	1,051		
7	199	16	578	25	1,146		
8	237	17	625	26	1,241		
9	275	18	673	27	1,335		

Top row of pricing is for units specified with same fabric on cushion and frame. Bottom 2 rows of pricing required only when two different fabric grades are selected for the cushion and frame.

To calculate price of lounge with different grade fabric for cushion and frame; start with Grade 1 price, add appropriate grade price located in second row for cushion, and last add appropriate grade price located in third row for frame to the sum of the Grade 1 and cushion price.

Example: Grade 1 \$3,494 + grade 4 fabric cushion \$86 + grade 2 fabric frame \$54 = \$3,634

Frame

1		10	584	19	1,343	L1	893
2	54	11	654	20	1,432	L2	1,632
3	106	12	725	21	1,520	L3	2,519
COM/4	160	13	814	22	1,608	L4	3,259
5	230	14	902	23	1,785	L5	3,998
6	301	15	990	24	1,961		
7	371	16	1,079	25	2,138		
8	442	17	1,167	26	2,316		
9	513	18	1,255	27	2,492		

Select upholstery for everything else other than the seat and back cushions (the outside back, arms, sides, seat frame). You can specify the same fabric as the cushions or select other fabric.

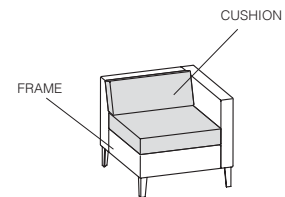

TO ORDER PLEASE SPECIFY THE FOLLOWING:

<input type="text"/>	<input type="text"/>	<input type="text"/>	<input type="text"/>	<input type="text"/>
MODEL NUMBER	STITCH DETAIL	FLAMMABILITY RATING	CUSHION UPHOLSTERY	FRAME UPHOLSTERY
	None NR Stitch detail SD +\$191	U CTB117	Please refer to list of available upholstery and leather selections on www.gunlocke.com	Please refer to list of available upholstery and leather selections on www.gunlocke.com

Example

GK1105-1A.NR.U.DOL728.SPNN04

GK1105-1A	NR	U	DOL728	SPNN04
MODEL NUMBER	STITCH	FLAMMABILITY DETAIL	CUSHION UPHOLSTERY	FRAME UPHOLSTERY

Please refer to the Ciji product page on www.gunlocke.com for standard finish options.

model number	fabric grades							
GK1107-1W Low back, arm right Wood legs	1	3,237	10	4,134	19	5,300	L1	4,609
	2	3,320	11	4,241	20	5,436	L2	5,744
	3	3,400	12	4,351	21	5,572	L3	7,106
	COM/4	3,483	13	4,486	22	5,707	L4	8,242
	5	3,591	14	4,622	23	5,978	L5	9,376
	6	3,700	15	4,757	24	6,249		
	7	3,807	16	4,894	25	6,521		
	8	3,916	17	5,029	26	6,794		
	9	4,025	18	5,165	27	7,064		



dimensions	W	D	H
Overall	28 1/8"	31 1/2"	27 7/8"
Seat	24"	21"	17 1/4"
Arm			26 7/8"
Between arms			

Upholstery Requirements: GK1107-1W

	Dual Upholstery	
Fabric yds	Cushions 1.5	Frame 2.8
Leather ft ²	Cushions 34.5	Frame 64.4
Shipping weight		87 lbs.
Cube		28.0

Cushion	1	10	19	20	21	22	23	24	25	26	27	L1	L2	L3	L4	L5
		313	720	479								479	875	1,350	1,746	2,141
	29	350	767	875								875	1,350	1,746	2,141	
	57	389	815	1,350								1,350	1,746	2,141		
	86	435	862	1,746								1,746	2,141			
	124	483	956	2,141								2,141				
	162	530	1,051													
	199	578	1,146													
	237	625	1,241													
	275	673	1,335													

Top row of pricing is for units specified with same fabric on cushion and frame. Bottom 2 rows of pricing required only when two different fabric grades are selected for the cushion and frame.

To calculate price of lounge with different grade fabric for cushion and frame; start with Grade 1 price, add appropriate grade price located in second row for cushion, and last add appropriate grade price located in third row for frame to the sum of the Grade 1 and cushion price.

Example: Grade 1 \$3,237 + grade 4 fabric cushion \$86 + grade 2 fabric frame \$54 = \$3,377

Frame	1	10	19	20	21	22	23	24	25	26	27	L1	L2	L3	L4	L5
		584	1,343	893								893	1,632	2,519	3,259	3,998
	54	654	1,432	1,632								1,632	2,519	3,259	3,998	
	106	725	1,520	2,519								2,519	3,259	3,998		
	160	814	1,608	3,259								3,259	3,998			
	230	902	1,785	3,998								3,998				
	301	990	1,961													
	371	1,079	2,138													
	442	1,167	2,316													
	513	1,255	2,492													

Select upholstery for everything else other than the seat and back cushions (the outside back, arms, sides, seat frame). You can specify the same fabric as the cushions or select other fabric.

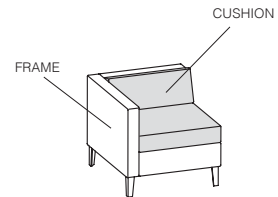

TO ORDER PLEASE SPECIFY THE FOLLOWING:

<input type="text"/>	<input type="text"/>	<input type="text"/>	<input type="text"/>	<input type="text"/>	<input type="text"/>
MODEL NUMBER	WOOD FINISH	STITCH DETAIL	FLAMMABILITY RATING	CUSHION UPHOLSTERY	FRAME UPHOLSTERY
	Cherry finishes on Maple Walnut finishes on Maple Maple finishes on Maple Oak finishes on Maple	None NR Stitch detail SD +\$191	U CTB117	Please refer to list of available upholstery and leather selections on www.gunlocke.com	Please refer to list of available upholstery and leather selections on www.gunlocke.com

Example

GK1107-1W.777.NR.U.DOL728.SPNN04					
GK1107-1W	777	NR	U	DOL728	SPNN04
MODEL NUMBER	WOOD FINISH	STITCH DETAIL	FLAMMABILITY	CUSHION UPHOLSTERY	FRAME UPHOLSTERY

Please refer to the Ciji product page on www.gunlocke.com for standard finish options.

CIJI SINGLE SEAT

Low Back, Arm Right, Aluminum Legs

Seating
03/23

model number	fabric grades						dimensions	W	D	H		
GK1107-1A Low back, arm right Aluminum legs	1	3,494	10	4,391	19	5,557	L1	4,866	Overall	28 1/8"	31 1/2"	27 7/8"
	2	3,577	11	4,498	20	5,693	L2	6,001	Seat	24"	21"	17 1/4"
	3	3,657	12	4,608	21	5,829	L3	7,363	Arm	26 7/8"		
	COM/4	3,740	13	4,743	22	5,964	L4	8,499	Between arms			
	5	3,848	14	4,879	23	6,235	L5	9,633				
	6	3,957	15	5,014	24	6,506						
	7	4,064	16	5,151	25	6,778						
	8	4,173	17	5,286	26	7,051						
	9	4,282	18	5,422	27	7,321						



Upholstery Requirements: GK1107-1A

Dual Upholstery		
Fabric yds	Cushions 1.5	Frame 2.8
Leather ft ²	Cushions 34.5	Frame 64.4
Shipping weight	87 lbs.	
Cube	28.0	

Cushion	1	10	19	20	21	22	23	24	25	26	27	L1	L2	L3	L4	L5
		313	720									479	875	1,350	1,746	2,141
	29	350	767													
	57	389	815													
	86	435	862													
	124	483	956													
	162	530	1,051													
	199	578	1,146													
	237	625	1,241													
	275	673	1,335													

Top row of pricing is for units specified with same fabric on cushion and frame. Bottom 2 rows of pricing required only when two different fabric grades are selected for the cushion and frame.

To calculate price of lounge with different grade fabric for cushion and frame; start with Grade 1 price, add appropriate grade price located in second row for cushion, and last add appropriate grade price located in third row for frame to the sum of the Grade 1 and cushion price.

Example: Grade 1 \$3,494 + grade 4 fabric cushion \$86 + grade 2 fabric frame \$54 = \$3,634

Frame	1	10	19	20	21	22	23	24	25	26	27	L1	L2	L3	L4	L5
		584	1,343									893	1,632	2,519	3,259	3,998
	54	654	1,432													
	106	725	1,520													
	160	814	1,608													
	230	902	1,785													
	301	990	1,961													
	371	1,079	2,138													
	442	1,167	2,316													
	513	1,255	2,492													

Select upholstery for everything else other than the seat and back cushions (the outside back, arms, sides, seat frame). You can specify the same fabric as the cushions or select other fabric.

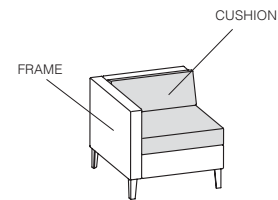

TO ORDER PLEASE SPECIFY THE FOLLOWING:

<input type="text"/>	<input type="text"/>	<input type="text"/>	<input type="text"/>	<input type="text"/>
MODEL NUMBER	STITCH DETAIL	FLAMMABILITY RATING	CUSHION UPHOLSTERY	FRAME UPHOLSTERY
	None NR Stitch detail SD +\$191	U CTB117	Please refer to list of available upholstery and leather selections on www.gunlocke.com	Please refer to list of available upholstery and leather selections on www.gunlocke.com

Example

GK1107-1A.NR.U.DOL728.SPNN04				
GK1107-1A	NR	U	DOL728	SPNN04
MODEL NUMBER	STITCH	FLAMMABILITY DETAIL	CUSHION UPHOLSTERY	FRAME UPHOLSTERY

Please refer to the Ciji product page on www.gunlocke.com for standard finish options.

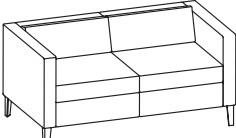
model number	fabric grades						dimensions	W	D	H			
GK1101-2W Low back, with arms Wood legs 	1	4,812	10	6,499	19	8,697	L1	7,397	Overall	56 1/4"	31 1/2"	27 1/8"	
	2	4,966	11	6,704	20	8,954	L2	9,535	Seat	48 1/2"	21"	17 1/4"	
	3	5,121	12	6,908	21	9,209	L3	12,099	Arm	26 1/8"			
	COM/4	5,273	13	7,164	22	9,465	L4	14,236	Between arms	48 1/2"			
	5	5,477	14	7,420	23	9,976	L5	16,373	Upholstery Requirements: GK1101-2W				
	6	5,682	15	7,675	24	10,487			Dual Upholstery				
	7	5,886	16	7,931	25	10,998			Fabric yds	Cushions 2.9	Frame 5.2		
	8	6,091	17	8,186	26	11,508			Leather ft ²	Cushions 66.7	Frame 119.6		
	9	6,295	18	8,442	27	12,021			Shipping weight	119 lbs.			
									Cube	35			

Cushion	1	10	604	19	1,391	L1	926	
	2	55	11	677	20	1,483	L2	1,691
	3	111	12	750	21	1,574	L3	2,609
	COM/4	165	13	842	22	1,666	L4	3,374
	5	238	14	934	23	1,849	L5	4,139
	6	311	15	1,025	24	2,032		
	7	385	16	1,117	25	2,215		
	8	458	17	1,208	26	2,397		
	9	531	18	1,300	27	2,581		

Frame	1	10	1,083	19	2,494	L1	1,659	
	2	99	11	1,215	20	2,659	L2	3,032
	3	198	12	1,346	21	2,823	L3	4,678
	COM/4	296	13	1,510	22	2,987	L4	6,050
	5	427	14	1,674	23	3,315	L5	7,422
	6	559	15	1,838	24	3,643		
	7	689	16	2,002	25	3,971		
	8	821	17	2,166	26	4,299		
	9	952	18	2,330	27	4,628		

Top row of pricing is for units specified with same fabric on cushion and frame. Bottom 2 rows of pricing required only when two different fabric grades are selected for the cushion and frame.

To calculate price of lounge with different grade fabric for cushion and frame; start with Grade 1 price, add appropriate grade price located in second row for cushion, and last add appropriate grade price located in third row for frame to the sum of the Grade 1 and cushion price.

Example: Grade 1 \$4,812 + grade 4 fabric cushion \$165 + grade 2 fabric frame \$99 = \$5,076

Select upholstery for everything else other than the seat and back cushions (the outside back, arms, sides, seat frame). You can specify the same fabric as the cushions or select other fabric.

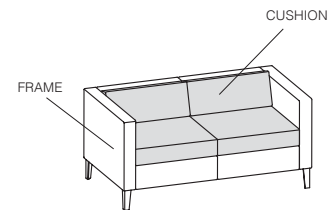

TO ORDER PLEASE SPECIFY THE FOLLOWING:

<input type="text"/>	<input type="text"/>	<input type="text"/>	<input type="text"/>	<input type="text"/>	<input type="text"/>
MODEL NUMBER	WOOD FINISH	STITCH DETAIL	FLAMMABILITY RATING	CUSHION UPHOLSTERY	FRAME UPHOLSTERY
	Cherry finishes on Maple Walnut finishes on Maple Maple finishes on Maple Oak finishes on Maple	None NR Stitch detail SD +\$191	U CTB117	Please refer to list of available upholstery and leather selections on www.gunlocke.com	Please refer to list of available upholstery and leather selections on www.gunlocke.com

Example

GK1101-2W.777.NR.U.DOL728.SPNN04					
GK1101-2W	777	NR	U	DOL728	SPNN04
MODEL NUMBER	WOOD FINISH	STITCH DETAIL	FLAMMABILITY	CUSHION UPHOLSTERY	FRAME UPHOLSTERY

Please refer to the Ciji product page on www.gunlocke.com for standard finish options.

CIJI TWO SEAT

Low Back, with Arms, Aluminum Legs

Seating
03/23

model number	fabric grades							
GK1101-2A Low back, with arms, Aluminum Legs	1	5,070	10	6,757	19	8,955	L1	7,655
	2	5,224	11	6,962	20	9,212	L2	9,793
	3	5,379	12	7,166	21	9,467	L3	12,357
	COM/4	5,531	13	7,422	22	9,723	L4	14,494
	5	5,735	14	7,678	23	10,234	L5	16,631
	6	5,940	15	7,933	24	10,745		
	7	6,144	16	8,189	25	11,256		
	8	6,349	17	8,444	26	11,766		
	9	6,553	18	8,700	27	12,279		

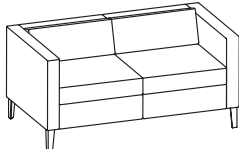

dimensions	W	D	H
Overall	56 1/4"	31 1/2"	27 1/8"
Seat	48 1/2"	21"	17 1/4"
Arm			26 1/8"
Between arms	48 1/2"		

Upholstery Requirements: GK1101-2A	
	Dual Upholstery
Fabric yds	Cushions 2.9 Frame 5.2
Leather ft ²	Cushions 66.7 Frame 119.6
Shipping weight	119 lbs.
Cube	35

Cushion	1	10	19	L1	926			
	2	55	11	677	20	1,483	L2	1,691
	3	111	12	750	21	1,574	L3	2,609
	COM/4	165	13	842	22	1,666	L4	3,374
	5	238	14	934	23	1,849	L5	4,139
	6	311	15	1,025	24	2,032		
	7	385	16	1,117	25	2,215		
	8	458	17	1,208	26	2,397		
	9	531	18	1,300	27	2,581		

Top row of pricing is for units specified with same fabric on cushion and frame. Bottom 2 rows of pricing required only when two different fabric grades are selected for the cushion and frame.

To calculate price of lounge with different grade fabric for cushion and frame; start with Grade 1 price, add appropriate grade price located in second row for cushion, and last add appropriate grade price located in third row for frame to the sum of the Grade 1 and cushion price.

Example: Grade 1 \$5,070 + grade 4 fabric cushion \$165 + grade 2 fabric frame \$99 = \$5,334

Frame	1	10	19	L1	1,659			
	2	99	11	1,215	20	2,659	L2	3,032
	3	198	12	1,346	21	2,823	L3	4,678
	COM/4	296	13	1,510	22	2,987	L4	6,050
	5	427	14	1,674	23	3,315	L5	7,422
	6	559	15	1,838	24	3,643		
	7	689	16	2,002	25	3,971		
	8	821	17	2,166	26	4,299		
	9	952	18	2,330	27	4,628		

Select upholstery for everything else other than the seat and back cushions (the outside back, arms, sides, seat frame). You can specify the same fabric as the cushions or select other fabric.

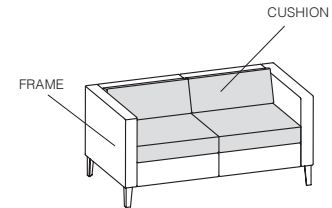

TO ORDER PLEASE SPECIFY THE FOLLOWING:

<input type="text"/>	<input type="text"/>	<input type="text"/>	<input type="text"/>	<input type="text"/>
MODEL NUMBER	STITCH DETAIL	FLAMMABILITY RATING	CUSHION UPHOLSTERY	FRAME UPHOLSTERY
	None NR Stitch detail SD +\$191	U CTB117	Please refer to list of available upholstery and leather selections on www.gunlocke.com	Please refer to list of available upholstery and leather selections on www.gunlocke.com

Example

GK1101-2A.NR.U.DOL728.SPNN04				
GK1101-2A	NR	U	DOL728	SPNN04
MODEL NUMBER	STITCH	FLAMMABILITY DETAIL	CUSHION UPHOLSTERY	FRAME UPHOLSTERY

Please refer to the Ciji product page on www.gunlocke.com for standard finish options.

model number	fabric grades						dimensions	W	D	H		
GK1103-2W Low back, armless, Wood legs	1	3,972	10	5,055	19	6,467	L1	5,632	Overall	49 1/8"	31 1/2"	27 7/8"
	2	4,071	11	5,187	20	6,632	L2	7,004	Seat	48 1/2"	21"	17 1/4"
	3	4,171	12	5,318	21	6,795	L3	8,650	Upholstery Requirements: GK1103-2W			
	COM/4	4,268	13	5,483	22	6,960	L4	10,022	Dual Upholstery			
	5	4,399	14	5,647	23	7,288	L5	11,395	Fabric yds Cushions 2.9 Frame 2.3			
	6	4,530	15	5,811	24	7,616			Leather ft ² Cushions 66.7 Frame 52.9			
	7	4,663	16	5,975	25	7,943			Shipping weight 99 lbs.			
	8	4,793	17	6,139	26	8,270			Cube 35			
	9	4,924	18	6,303	27	8,601						

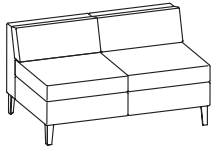

Cushion	1	10	604	19	1,391	L1	926	
	2	55	11	677	20	1,483	L2	1,691
	3	111	12	750	21	1,574	L3	2,609
	COM/4	165	13	842	22	1,666	L4	3,374
	5	238	14	934	23	1,849	L5	4,139
	6	311	15	1,025	24	2,032		
	7	385	16	1,117	25	2,215		
	8	458	17	1,208	26	2,397		
	9	531	18	1,300	27	2,581		

Top row of pricing is for units specified with same fabric on cushion and frame. Bottom 2 rows of pricing required only when two different fabric grades are selected for the cushion and frame.

To calculate price of lounge with different grade fabric for cushion and frame; start with Grade 1 price, add appropriate grade price located in second row for cushion, and last add appropriate grade price located in third row for frame to the sum of the Grade 1 and cushion price.

Example: Grade 1 \$3,972 + grade 4 fabric cushion \$165 + grade 2 fabric frame \$44 = \$4,181

Frame	1	10	479	19	1,104	L1	734	
	2	44	11	538	20	1,177	L2	1,341
	3	88	12	596	21	1,249	L3	2,069
	COM/4	131	13	669	22	1,322	L4	2,676
	5	189	14	741	23	1,467	L5	3,284
	6	247	15	814	24	1,612		
	7	306	16	886	25	1,756		
	8	363	17	959	26	1,901		
	9	421	18	1,031	27	2,048		

Select upholstery for everything else other than the seat and back cushions (the outside back, arms, sides, seat frame). You can specify the same fabric as the cushions or select other fabric.

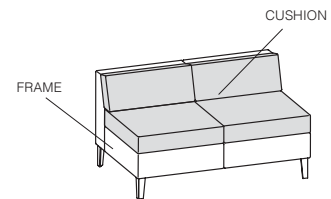

TO ORDER PLEASE SPECIFY THE FOLLOWING:

<input type="text"/>	<input type="text"/>	<input type="text"/>	<input type="text"/>	<input type="text"/>	<input type="text"/>
MODEL NUMBER	WOOD FINISH	STITCH DETAIL	FLAMMABILITY RATING	CUSHION UPHOLSTERY	FRAME UPHOLSTERY
	Cherry finishes on Maple Walnut finishes on Maple Maple finishes on Maple Oak finishes on Maple	None NR Stitch detail SD +\$191	U CTB117	Please refer to list of available upholstery and leather selections on www.gunlocke.com	Please refer to list of available upholstery and leather selections on www.gunlocke.com

Example

GK1103-2W.777.NR.U.DOL728.SPNN04
 GK1103-2W 777 NR U DOL728 SPNN04
 MODEL NUMBER WOOD FINISH STITCH DETAIL FLAMMABILITY CUSHION UPHOLSTERY FRAME UPHOLSTERY

Please refer to the Ciji product page on www.gunlocke.com for standard finish options.

CIJI TWO SEAT

Low Back, Armless, Aluminum Legs

Seating
03/23

model number fabric grades dimensions W D H

GK1103-2A

Low back, armless,
Aluminum legs

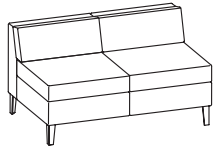

1	4,231	10	5,314	19	6,726	L1	5,891
2	4,330	11	5,446	20	6,891	L2	7,263
3	4,430	12	5,577	21	7,054	L3	8,909
COM/4	4,527	13	5,742	22	7,219	L4	10,281
5	4,658	14	5,906	23	7,547	L5	11,654
6	4,789	15	6,070	24	7,875		
7	4,922	16	6,234	25	8,202		
8	5,052	17	6,398	26	8,529		
9	5,183	18	6,562	27	8,860		

Overall	49 1/8"	31 1/2"	27 7/8"
Seat	48 1/2"	21"	17 1/4"

Upholstery Requirements: GK1103-2A

	Dual Upholstery	
Fabric yds	Cushions 2.9	Frame 2.3
Leather ft ²	Cushions 66.7	
Shipping weight	99 lbs.	
Cube	35	

Top row of pricing is for units specified with same fabric on cushion and frame. Bottom 2 rows of pricing required only when two different fabric grades are selected for the cushion and frame.

To calculate price of lounge with different grade fabric for cushion and frame; start with Grade 1 price, add appropriate grade price located in second row for cushion, and last add appropriate grade price located in third row for frame to the sum of the Grade 1 and cushion price.

Example: Grade 1 \$4,231 + grade 4 fabric cushion \$165 + grade 2 fabric frame \$44 = \$4,440

Cushion

1		10	604	19	1,391	L1	926
2	55	11	677	20	1,483	L2	1,691
3	111	12	750	21	1,574	L3	2,609
COM/4	165	13	842	22	1,666	L4	3,374
5	238	14	934	23	1,849	L5	4,139
6	311	15	1,025	24	2,032		
7	385	16	1,117	25	2,215		
8	458	17	1,208	26	2,397		
9	531	18	1,300	27	2,581		

Frame

1		10	479	19	1,104	L1	734
2	44	11	538	20	1,177	L2	1,341
3	88	12	596	21	1,249	L3	2,069
COM/4	131	13	669	22	1,322	L4	2,676
5	189	14	741	23	1,467	L5	3,284
6	247	15	814	24	1,612		
7	306	16	886	25	1,756		
8	363	17	959	26	1,901		
9	421	18	1,031	27	2,048		

Select upholstery for everything else other than the seat and back cushions (the outside back, arms, sides, seat frame). You can specify the same fabric as the cushions or select other fabric.

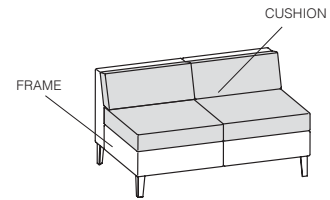

TO ORDER PLEASE SPECIFY THE FOLLOWING:

<input type="text"/>	<input type="text"/>	<input type="text"/>	<input type="text"/>	<input type="text"/>
MODEL NUMBER	STITCH DETAIL	FLAMMABILITY RATING	CUSHION UPHOLSTERY	FRAME UPHOLSTERY
	None NR Stitch detail SD +\$191	U CTB117	Please refer to list of available upholstery and leather selections on www.gunlocke.com	Please refer to list of available upholstery and leather selections on www.gunlocke.com

Example

GK1103-2A.NR.U.DOL728.SPNN04				
GK1103-2A	NR	U	DOL728	SPNN04
MODEL NUMBER	STITCH	FLAMMABILITY DETAIL	CUSHION UPHOLSTERY	FRAME UPHOLSTERY

Please refer to the Ciji product page on www.gunlocke.com for standard finish options.

model number	fabric grades						dimensions	W	D	H		
GK1105-2W Low back, arm left, Wood legs	1	4,614	10	6,010	19	7,828	L1	6,753	Overall	52 5/8"	31 1/2"	27 7/8"
	2	4,741	11	6,179	20	8,040	L2	8,520	Seat	48 1/2"	21"	17 1/4"
	3	4,869	12	6,348	21	8,251	L3	10,642	Arm	26 7/8"		
	COM/4	4,995	13	6,560	22	8,463	L4	12,410	Between arms			
	5	5,164	14	6,771	23	8,885	L5	14,177	Upholstery Requirements: GK1105-2W			
	6	5,333	15	6,982	24	9,308	Dual Upholstery					
	7	5,503	16	7,194	25	9,731	Fabric yds Cushions 2.9 Frame 3.8					
	8	5,672	17	7,405	26	10,153	Leather ft ² Cushions 66.7 Frame 87.4					
	9	5,841	18	7,617	27	10,577	Shipping weight 109 lbs.					
										Cube	35	

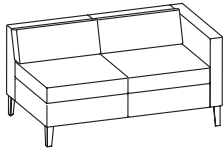

Cushion	1	10	604	19	1,391	L1	926	
	2	55	11	677	20	1,483	L2	1,691
	3	111	12	750	21	1,574	L3	2,609
	COM/4	165	13	842	22	1,666	L4	3,374
	5	238	14	934	23	1,849	L5	4,139
	6	311	15	1,025	24	2,032		
	7	385	16	1,117	25	2,215		
	8	458	17	1,208	26	2,397		
	9	531	18	1,300	27	2,581		

Top row of pricing is for units specified with same fabric on cushion and frame. Bottom 2 rows of pricing required only when two different fabric grades are selected for the cushion and frame.

To calculate price of lounge with different grade fabric for cushion and frame; start with Grade 1 price, add appropriate grade price located in second row for cushion, and last add appropriate grade price located in third row for frame to the sum of the Grade 1 and cushion price.

Example: Grade 1 \$4,614 + grade 4 fabric cushion \$165 + grade 2 fabric frame \$72 = \$4,851

Frame	1	10	792	19	1,823	L1	1,213	
	2	72	11	888	20	1,943	L2	2,215
	3	144	12	984	21	2,063	L3	3,419
	COM/4	216	13	1,104	22	2,183	L4	4,422
	5	312	14	1,223	23	2,422	L5	5,424
	6	408	15	1,343	24	2,662		
	7	504	16	1,463	25	2,902		
	8	600	17	1,583	26	3,142		
	9	696	18	1,703	27	3,382		

Select upholstery for everything else other than the seat and back cushions (the outside back, arms, sides, seat frame). You can specify the same fabric as the cushions or select other fabric.

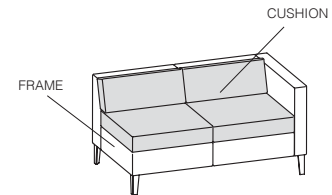

TO ORDER PLEASE SPECIFY THE FOLLOWING:

<input type="text"/>	<input type="text"/>	<input type="text"/>	<input type="text"/>	<input type="text"/>	<input type="text"/>
MODEL NUMBER	WOOD FINISH	STITCH DETAIL	FLAMMABILITY RATING	CUSHION UPHOLSTERY	FRAME UPHOLSTERY
	Cherry finishes on Maple Walnut finishes on Maple Maple finishes on Maple Oak finishes on Maple	None NR Stitch detail SD +\$191	U CTB117	Please refer to list of available upholstery and leather selections on www.gunlocke.com	Please refer to list of available upholstery and leather selections on www.gunlocke.com

Example

GK1105-2W.777.NR.U.DOL728.SPNO4					
GK1105-2W	777	NR	U	DOL728	SPNO4
MODEL NUMBER	WOOD FINISH	STITCH DETAIL	FLAMMABILITY	CUSHION UPHOLSTERY	FRAME UPHOLSTERY

Please refer to the Ciji product page on www.gunlocke.com for standard finish options.

CIJI TWO SEAT

Low Back, Arm Left, Aluminum Legs

Seating
03/23

model number	fabric grades						dimensions	W	D	H		
GK1105-2A Low back, arm left, Aluminum legs	1	4,874	10	6,270	19	8,088	L1	7,013	Overall	52 5/8"	31 1/2"	27 7/8"
	2	5,001	11	6,439	20	8,300	L2	8,780	Seat	48 1/2"	21"	17 1/4"
	3	5,129	12	6,608	21	8,511	L3	10,902	Arm			26 7/8"
	COM/4	5,255	13	6,820	22	8,723	L4	12,670	Between arms			
	5	5,424	14	7,031	23	9,145	L5	14,437				
	6	5,593	15	7,242	24	9,568						
	7	5,763	16	7,454	25	9,991						
	8	5,932	17	7,665	26	10,413						
	9	6,101	18	7,877	27	10,837						
	Upholstery Requirements: GK1105-2A											
Dual Upholstery												
Fabric yds Cushions 2.9 Frame 3.8												
Leather ft ² Cushions 66.7 Frame 87.4												
Shipping weight 109 lbs.												
Cube 35												

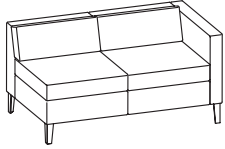

Cushion	1	10	19	L1
	604	1,391	926	
	55	1,483	1,691	
	111	1,574	2,609	
COM/4	165	1,666	3,374	
	238	1,849	4,139	
	311	2,032		
	385	2,215		
	458	2,397		
	531	2,581		

Top row of pricing is for units specified with same fabric on cushion and frame. Bottom 2 rows of pricing required only when two different fabric grades are selected for the cushion and frame.

To calculate price of lounge with different grade fabric for cushion and frame; start with Grade 1 price, add appropriate grade price located in second row for cushion, and last add appropriate grade price located in third row for frame to the sum of the Grade 1 and cushion price.

Example: Grade 1 \$4,874 + grade 4 fabric cushion \$165 + grade 2 fabric frame \$72 = \$5,111

Frame	1	10	19	L1
	792	1,823	1,213	
	72	1,943	2,215	
	144	2,063	3,419	
COM/4	216	2,183	4,422	
	312	2,422	5,424	
	408	2,662		
	504	2,902		
	600	3,142		
	696	3,382		

Select upholstery for everything else other than the seat and back cushions (the outside back, arms, sides, seat frame). You can specify the same fabric as the cushions or select other fabric.

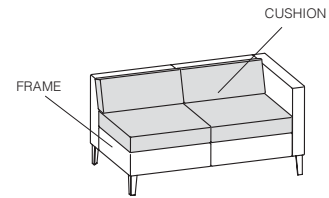

TO ORDER PLEASE SPECIFY THE FOLLOWING:

<input type="text"/>	<input type="text"/>	<input type="text"/>	<input type="text"/>	<input type="text"/>
MODEL NUMBER	STITCH DETAIL	FLAMMABILITY RATING	CUSHION UPHOLSTERY	FRAME UPHOLSTERY
	None NR Stitch detail SD +\$191	U CTB117	Please refer to list of available upholstery and leather selections on www.gunlocke.com	Please refer to list of available upholstery and leather selections on www.gunlocke.com

Example

GK1105-2A.NR.U.DOL728.SPNN04				
GK1105-2A	NR	U	DOL728	SPNN04
MODEL NUMBER	STITCH	FLAMMABILITY DETAIL	CUSHION UPHOLSTERY	FRAME UPHOLSTERY

Please refer to the Ciji product page on www.gunlocke.com for standard finish options.

model number	fabric grades							
GK1107-2W Low back, arm right, Wood legs	1	4,614	10	6,010	19	7,828	L1	6,753
	2	4,741	11	6,179	20	8,040	L2	8,520
	3	4,869	12	6,348	21	8,251	L3	10,642
	COM/4	4,995	13	6,560	22	8,463	L4	12,410
	5	5,164	14	6,771	23	8,885	L5	14,177
	6	5,333	15	6,982	24	9,308		
	7	5,503	16	7,194	25	9,731		
	8	5,672	17	7,405	26	10,153		
	9	5,841	18	7,617	27	10,577		

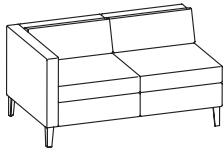

dimensions	W	D	H
Overall	52 5/8"	31 1/2"	27 7/8"
Seat	48 1/2"	21"	17 1/4"
Arm			26 7/8"
Between arms			

Upholstery Requirements: GK1107-2W

	Dual Upholstery	
Fabric yds	Cushions 2.9	Frame 3.8
Leather ft ²	Cushions 66.7	Frame 87.4
Shipping weight	109 lbs.	
Cube	35	

Cushion	1	10	604	19	1,391	L1	926	
	2	55	11	677	20	1,483	L2	1,691
	3	111	12	750	21	1,574	L3	2,609
	COM/4	165	13	842	22	1,666	L4	3,374
	5	238	14	934	23	1,849	L5	4,139
	6	311	15	1,025	24	2,032		
	7	385	16	1,117	25	2,215		
	8	458	17	1,208	26	2,397		
	9	531	18	1,300	27	2,581		

Top row of pricing is for units specified with same fabric on cushion and frame. Bottom 2 rows of pricing required only when two different fabric grades are selected for the cushion and frame.

To calculate price of lounge with different grade fabric for cushion and frame; start with Grade 1 price, add appropriate grade price located in second row for cushion, and last add appropriate grade price located in third row for frame to the sum of the Grade 1 and cushion price.

Example: Grade 1 \$4,614 + grade 4 fabric cushion \$165 + grade 2 fabric frame \$72 = \$4,851

Frame	1	10	792	19	1,823	L1	1,213	
	2	72	11	888	20	1,943	L2	2,215
	3	144	12	984	21	2,063	L3	3,419
	COM/4	216	13	1,104	22	2,183	L4	4,422
	5	312	14	1,223	23	2,422	L5	5,424
	6	408	15	1,343	24	2,662		
	7	504	16	1,463	25	2,902		
	8	600	17	1,583	26	3,142		
	9	696	18	1,703	27	3,382		

Select upholstery for everything else other than the seat and back cushions (the outside back, arms, sides, seat frame). You can specify the same fabric as the cushions or select other fabric.

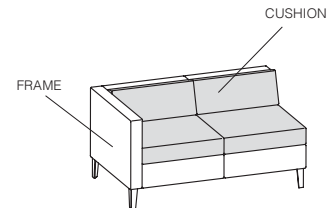

TO ORDER PLEASE SPECIFY THE FOLLOWING:

<input type="text"/>	<input type="text"/>	<input type="text"/>	<input type="text"/>	<input type="text"/>	<input type="text"/>
MODEL NUMBER	WOOD FINISH	STITCH DETAIL	FLAMMABILITY RATING	CUSHION UPHOLSTERY	FRAME UPHOLSTERY
	Cherry finishes on Maple Walnut finishes on Maple Maple finishes on Maple Oak finishes on Maple	None NR Stitch detail SD +\$191	U CTB117	Please refer to list of available upholstery and leather selections on www.gunlocke.com	Please refer to list of available upholstery and leather selections on www.gunlocke.com

Example

GK1107-2W.777.NR.U.DOL728.SPNN04					
GK1107-2W	777	NR	U	DOL728	SPNN04
MODEL NUMBER	WOOD FINISH	STITCH DETAIL	FLAMMABILITY	CUSHION UPHOLSTERY	FRAME UPHOLSTERY

Please refer to the Ciji product page on www.gunlocke.com for standard finish options.

CIJI TWO SEAT

Low Back, Arm Right, Aluminum Legs

model number fabric grades dimensions W D H

GK1107-2A

Low back, arm right
Aluminum legs

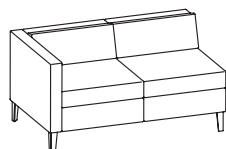

1	4,874	10	6,270	19	8,088	L1	7,013
2	5,001	11	6,439	20	8,300	L2	8,780
3	5,129	12	6,608	21	8,511	L3	10,902
COM/4	5,255	13	6,820	22	8,723	L4	12,670
5	5,424	14	7,031	23	9,145	L5	14,437
6	5,593	15	7,242	24	9,568		
7	5,763	16	7,454	25	9,991		
8	5,932	17	7,665	26	10,413		
9	6,101	18	7,877	27	10,837		

Overall	52 5/8"	31 1/2"	27 7/8"
Seat	48 1/2"	21"	17 1/4"
Arm			26 7/8"
Between arms			

Upholstery Requirements: GK1107-2A

	Dual Upholstery	
Fabric yds	Cushions 2.9	Frame 3.8
Leather ft ²	Cushions 66.7	Frame 87.4
Shipping weight		109 lbs.
Cube		35

Cushion

1		10	604	19	1,391	L1	926
2	55	11	677	20	1,483	L2	1,691
3	111	12	750	21	1,574	L3	2,609
COM/4	165	13	842	22	1,666	L4	3,374
5	238	14	934	23	1,849	L5	4,139
6	311	15	1,025	24	2,032		
7	385	16	1,117	25	2,215		
8	458	17	1,208	26	2,397		
9	531	18	1,300	27	2,581		

Top row of pricing is for units specified with same fabric on cushion and frame. Bottom 2 rows of pricing required only when two different fabric grades are selected for the cushion and frame.

To calculate price of lounge with different grade fabric for cushion and frame; start with Grade 1 price, add appropriate grade price located in second row for cushion, and last add appropriate grade price located in third row for frame to the sum of the Grade 1 and cushion price.

Example: Grade 1 \$4,874 + grade 4 fabric cushion \$165 + grade 2 fabric frame \$72 = \$5,111

Frame

1		10	792	19	1,823	L1	1,213
2	72	11	888	20	1,943	L2	2,215
3	144	12	984	21	2,063	L3	3,419
COM/4	216	13	1,104	22	2,183	L4	4,422
5	312	14	1,223	23	2,422	L5	5,424
6	408	15	1,343	24	2,662		
7	504	16	1,463	25	2,902		
8	600	17	1,583	26	3,142		
9	696	18	1,703	27	3,382		

Select upholstery for everything else other than the seat and back cushions (the outside back, arms, sides, seat frame). You can specify the same fabric as the cushions or select other fabric.

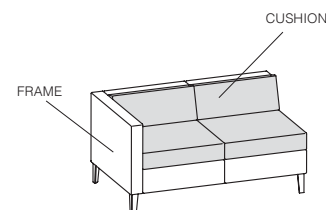

TO ORDER PLEASE SPECIFY THE FOLLOWING:

<input type="text"/>	<input type="text"/>	<input type="text"/>	<input type="text"/>	<input type="text"/>
MODEL NUMBER	STITCH DETAIL	FLAMMABILITY RATING	CUSHION UPHOLSTERY	FRAME UPHOLSTERY
	None NR Stitch detail SD +\$191	U CTB117	Please refer to list of available upholstery and leather selections on www.gunlocke.com	Please refer to list of available upholstery and leather selections on www.gunlocke.com

Example

GK1107-2A	NR	U	DOL728	SPNNO4
MODEL NUMBER	STITCH	FLAMMABILITY DETAIL	CUSHION UPHOLSTERY	FRAME UPHOLSTERY

Please refer to the Ciji product page on www.gunlocke.com for standard finish options.

model number	fabric grades							
GK1101-3W Low back, with arms, Wood legs	1	6,131	10	8,277	19	11,072	L1	9,418
	2	6,326	11	8,537	20	11,397	L2	12,135
	3	6,522	12	8,795	21	11,723	L3	15,397
	COM/4	6,716	13	9,122	22	12,046	L4	18,114
	5	6,976	14	9,446	23	12,697	L5	20,834
	6	7,237	15	9,773	24	13,348		
	7	7,497	16	10,097	25	13,996		
	8	7,757	17	10,421	26	14,647		
	9	8,018	18	10,747	27	15,297		

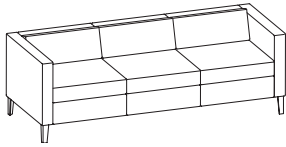

dimensions	W	D	H
Overall	80 3/4"	31 1/2"	27 7/8"
Seat	73"	21"	17 1/4"
Arm			26 7/8"
Between arms	73"		

Upholstery Requirements: GK1101-3W	
	Dual Upholstery
Fabric yds	Cushions 4.4 Frame 5.9
Leather ft²	Cushions 101.2 Frame 135.7
Shipping weight	181 lbs.
Cube	78.5

Cushion	1	10	19	2,111	L1	1,404
	2	83	11	1,028	20	2,249
	3	167	12	1,138	21	2,389
	COM/4	250	13	1,278	22	2,527
	5	361	14	1,416	23	2,805
	6	472	15	1,556	24	3,083
	7	584	16	1,694	25	3,360
	8	695	17	1,833	26	3,638
	9	806	18	1,972	27	3,916

Top row of pricing is for units specified with same fabric on cushion and frame. Bottom 2 rows of pricing required only when two different fabric grades are selected for the cushion and frame.

To calculate price of lounge with different grade fabric for cushion and frame; start with Grade 1 price, add appropriate grade price located in second row for cushion, and last add appropriate grade price located in third row for frame to the sum of the Grade 1 and cushion price.

Example: Grade 1 \$6,131 + grade 4 fabric cushion \$250 + grade 2 fabric frame \$112 = \$6,493

Frame	1	10	19	2,830	L1	1,883
	2	112	11	1,378	20	3,017
	3	224	12	1,526	21	3,203
	COM/4	335	13	1,713	22	3,388
	5	484	14	1,899	23	3,761
	6	634	15	2,086	24	4,134
	7	782	16	2,272	25	4,505
	8	931	17	2,457	26	4,878
	9	1,081	18	2,644	27	5,250

Select upholstery for everything else other than the seat and back cushions (the outside back, arms, sides, seat frame). You can specify the same fabric as the cushions or select other fabric.

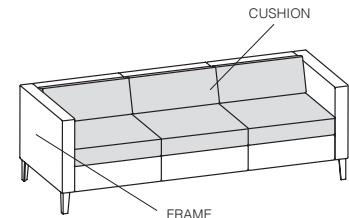

TO ORDER PLEASE SPECIFY THE FOLLOWING:

<input type="text"/>	<input type="text"/>	<input type="text"/>	<input type="text"/>	<input type="text"/>	<input type="text"/>
MODEL NUMBER	WOOD FINISH	STITCH DETAIL	FLAMMABILITY RATING	CUSHION UPHOLSTERY	FRAME UPHOLSTERY
	Cherry finishes on Maple Walnut finishes on Maple Maple finishes on Maple Oak finishes on Maple	None NR Stitch detail SD +\$191	U CTB117	Please refer to list of available upholstery and leather selections on www.gunlocke.com	Please refer to list of available upholstery and leather selections on www.gunlocke.com

Example

GK1101-3W.777.NR.U.DOL728.SPNN04					
GK1101-3W	777	NR	U	DOL728	SPNN04
MODEL NUMBER	WOOD FINISH	STITCH DETAIL	FLAMMABILITY	CUSHION UPHOLSTERY	FRAME UPHOLSTERY

Please refer to the Ciji product page on www.gunlocke.com for standard finish options.

CIJI THREE SEAT

Low Back, with Arms, Aluminum Legs

Seating
03/23

model number	fabric grades							
GK1101-3A Low back, with arms, Aluminum legs	1	6,388	10	8,534	19	11,329	L1	9,675
	2	6,583	11	8,794	20	11,654	L2	12,392
	3	6,779	12	9,052	21	11,980	L3	15,654
	COM/4	6,973	13	9,379	22	12,303	L4	18,371
	5	7,233	14	9,703	23	12,954	L5	21,091
	6	7,494	15	10,030	24	13,605		
	7	7,754	16	10,354	25	14,253		
	8	8,014	17	10,678	26	14,904		
	9	8,275	18	11,004	27	15,554		

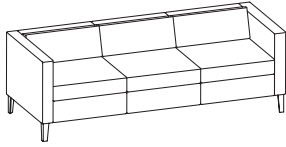

dimensions	W	D	H
Overall	80 3/4"	31 1/2"	27 7/8"
Seat	73"	21"	17 1/4"
Arm			26 7/8"
Between arms	73"		

Upholstery Requirements: GK1101-3A

	Dual Upholstery	
Fabric yds	Cushions 4.4	Frame 5.9
Leather ft ²	Cushions 101.2	Frame 135.7
Shipping weight		181 lbs.
Cube		78.5

Cushion	1	10	19	20	21	22	23	24	25	26	27	L1	L2	L3	L4	L5
		917	2,111	1,404												
	83	1,028	2,249	2,565												
	167	1,138	2,389	3,958												
COM/4	250	1,278	2,527	5,119												
	361	1,416	2,805	6,281												
	472	1,556	3,083													
	584	1,694	3,360													
	695	1,833	3,638													
	806	1,972	3,916													

Top row of pricing is for units specified with same fabric on cushion and frame. Bottom 2 rows of pricing required only when two different fabric grades are selected for the cushion and frame.

To calculate price of lounge with different grade fabric for cushion and frame; start with Grade 1 price, add appropriate grade price located in second row for cushion, and last add appropriate grade price located in third row for frame to the sum of the Grade 1 and cushion price.

Example: Grade 1 \$6,388 + grade 4 fabric cushion \$250 + grade 2 fabric frame \$112 = \$6,750

Frame	1	10	19	20	21	22	23	24	25	26	27	L1	L2	L3	L4	L5
		1,229	2,830	1,883												
	112	1,378	3,017	3,439												
	224	1,526	3,203	5,308												
COM/4	335	1,713	3,388	6,864												
	484	1,899	3,761	8,422												
	634	2,086	4,134													
	782	2,272	4,505													
	931	2,457	4,878													
	1,081	2,644	5,250													

Select upholstery for everything else other than the seat and back cushions (the outside back, arms, sides, seat frame). You can specify the same fabric as the cushions or select other fabric.

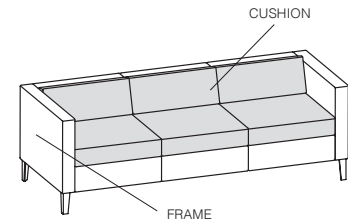

TO ORDER PLEASE SPECIFY THE FOLLOWING:

<input type="text"/>	<input type="text"/>	<input type="text"/>	<input type="text"/>	<input type="text"/>
MODEL NUMBER	STITCH DETAIL	FLAMMABILITY RATING	CUSHION UPHOLSTERY	FRAME UPHOLSTERY
	None NR Stitch detail SD +\$191	U CTB117	Please refer to list of available upholstery and leather selections on www.gunlocke.com	Please refer to list of available upholstery and leather selections on www.gunlocke.com

Example

GK1101-3A.NR.U.DOL728.SPNN04				
GK1101-3A	NR	U	DOL728	SPNN04
MODEL NUMBER	STITCH	FLAMMABILITY DETAIL	CUSHION UPHOLSTERY	FRAME UPHOLSTERY

Please refer to the Ciji product page on www.gunlocke.com for standard finish options.

model number	fabric grades						dimensions	W	D	H		
GK1103-3W Low back, armless, Wood legs	1	5,108	10	6,691	19	8,754	L1	7,533	Overall	73 5/8"	31 1/2"	27 7/8"
	2	5,253	11	6,883	20	8,994	L2	9,538	Seat	73"	21"	17 1/4"
	3	5,396	12	7,075	21	9,234	L3	11,945	Upholstery Requirements: GK1103-3W			
	COM/4	5,541	13	7,315	22	9,473	L4	13,951	Dual Upholstery			
	5	5,732	14	7,555	23	9,953	L5	15,957	Fabric yds	Cushions 4.4	Frame 3.2	
	6	5,924	15	7,795	24	10,433			Leather ft ²	Cushions 101.2	Frame 73.6	
	7	6,117	16	8,034	25	10,912			Shipping weight	161 lbs.		
	8	6,308	17	8,275	26	11,392			Cube	78.5		
	9	6,500	18	8,514	27	11,872						

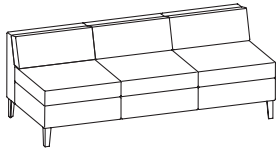

Cushion	1	10	917	19	2,111	L1	1,404	
	2	83	11	1,028	20	2,249	L2	2,565
	3	167	12	1,138	21	2,389	L3	3,958
	COM/4	250	13	1,278	22	2,527	L4	5,119
	5	361	14	1,416	23	2,805	L5	6,281
	6	472	15	1,556	24	3,083		
	7	584	16	1,694	25	3,360		
	8	695	17	1,833	26	3,638		
	9	806	18	1,972	27	3,916		

Top row of pricing is for units specified with same fabric on cushion and frame. Bottom 2 rows of pricing required only when two different fabric grades are selected for the cushion and frame.

To calculate price of lounge with different grade fabric for cushion and frame; start with Grade 1 price, add appropriate grade price located in second row for cushion, and last add appropriate grade price located in third row for frame to the sum of the Grade 1 and cushion price.

Example: Grade 1 \$5,108 + grade 4 fabric cushion \$250 + grade 2 fabric frame \$62 = \$5,420

Frame	1	10	666	19	1,535	L1	1,021	
	2	62	11	747	20	1,637	L2	1,865
	3	121	12	829	21	1,737	L3	2,879
	COM/4	183	13	929	22	1,838	L4	3,724
	5	263	14	1,031	23	2,040	L5	4,568
	6	344	15	1,131	24	2,242		
	7	425	16	1,232	25	2,444		
	8	505	17	1,334	26	2,646		
	9	586	18	1,434	27	2,848		

Select upholstery for everything else other than the seat and back cushions (the outside back, arms, sides, seat frame). You can specify the same fabric as the cushions or select other fabric.

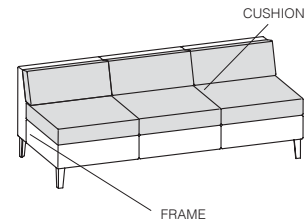

TO ORDER PLEASE SPECIFY THE FOLLOWING:

<input type="text"/>	<input type="text"/>	<input type="text"/>	<input type="text"/>	<input type="text"/>	<input type="text"/>
MODEL NUMBER	WOOD FINISH	STITCH DETAIL	FLAMMABILITY RATING	CUSHION UPHOLSTERY	FRAME UPHOLSTERY
	Cherry finishes on Maple Walnut finishes on Maple Maple finishes on Maple Oak finishes on Maple	None NR Stitch detail SD +\$191	U CTB117	Please refer to list of available upholstery and leather selections on www.gunlocke.com	Please refer to list of available upholstery and leather selections on www.gunlocke.com

Example

GK1103-3W.777.NR.U.DOL728.SPNN04
 GK1103-3W 777 NR U DOL728 SPNN04
 MODEL NUMBER WOOD FINISH STITCH DETAIL FLAMMABILITY CUSHION UPHOLSTERY FRAME UPHOLSTERY

Please refer to the Ciji product page on www.gunlocke.com for standard finish options.

CIJI THREE SEAT

Low Back, Armless, Aluminum Legs

Seating
03/23

model number fabric grades dimensions W D H

GK1103-3A

Low back, armless,
Aluminum legs

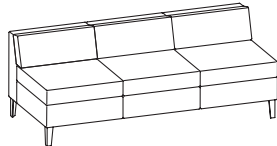

1	5,368	10	6,951	19	9,014	L1	7,793
2	5,513	11	7,143	20	9,254	L2	9,798
3	5,656	12	7,335	21	9,494	L3	12,205
COM/4	5,801	13	7,575	22	9,733	L4	14,211
5	5,992	14	7,815	23	10,213	L5	16,217
6	6,184	15	8,055	24	10,693		
7	6,377	16	8,294	25	11,172		
8	6,568	17	8,535	26	11,652		
9	6,760	18	8,774	27	12,132		

Overall	73 5/8"	31 1/2"	27 7/8"
Seat	73"	21"	17 1/4"

Upholstery Requirements: GK1103-3A

	Dual Upholstery	
Fabric yds	Cushions 4.4	Frame 3.2
Leather ft ²	Cushions 101.2	Frame 73.6
Shipping weight	161 lbs.	
Cube	78.5	

Cushion

1		10	917	19	2,111	L1	1,404
2	83	11	1,028	20	2,249	L2	2,565
3	167	12	1,138	21	2,389	L3	3,958
COM/4	250	13	1,278	22	2,527	L4	5,119
5	361	14	1,416	23	2,805	L5	6,281
6	472	15	1,556	24	3,083		
7	584	16	1,694	25	3,360		
8	695	17	1,833	26	3,638		
9	806	18	1,972	27	3,916		

Top row of pricing is for units specified with same fabric on cushion and frame. Bottom 2 rows of pricing required only when two different fabric grades are selected for the cushion and frame.

To calculate price of lounge with different grade fabric for cushion and frame; start with Grade 1 price, add appropriate grade price located in second row for cushion, and last add appropriate grade price located in third row for frame to the sum of the Grade 1 and cushion price.

Example: Grade 1 \$5,368 + grade 4 fabric cushion \$250 + grade 2 fabric frame \$62 = \$5,680

Frame

1		10	666	19	1,535	L1	1,021
2	62	11	747	20	1,637	L2	1,865
3	121	12	829	21	1,737	L3	2,879
COM/4	183	13	929	22	1,838	L4	3,724
5	263	14	1,031	23	2,040	L5	4,568
6	344	15	1,131	24	2,242		
7	425	16	1,232	25	2,444		
8	505	17	1,334	26	2,646		
9	586	18	1,434	27	2,848		

Select upholstery for everything else other than the seat and back cushions (the outside back, arms, sides, seat frame). You can specify the same fabric as the cushions or select other fabric.

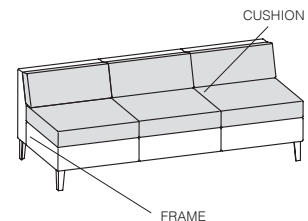

TO ORDER PLEASE SPECIFY THE FOLLOWING:

<input type="text"/>	<input type="text"/>	<input type="text"/>	<input type="text"/>	<input type="text"/>
MODEL NUMBER	STITCH DETAIL	FLAMMABILITY RATING	CUSHION UPHOLSTERY	FRAME UPHOLSTERY
	None NR Stitch detail SD +\$191	U CTB117	Please refer to list of available upholstery and leather selections on www.gunlocke.com	Please refer to list of available upholstery and leather selections on www.gunlocke.com

Example

GK1103-3A.NR.U.DOL728.SPNN04

GK1103-3A	NR	U	DOL728	SPNN04
MODEL NUMBER	STITCH	FLAMMABILITY DETAIL	CUSHION UPHOLSTERY	FRAME UPHOLSTERY

Please refer to the Ciji product page on www.gunlocke.com for standard finish options.

model number	fabric grades							
GK1105-3W Low back, arm left, Wood legs	1	5,910	10	7,910	19	10,515	L1	8,973
	2	6,092	11	8,153	20	10,818	L2	11,507
	3	6,275	12	8,394	21	11,122	L3	14,546
	COM/4	6,456	13	8,698	22	11,424	L4	17,079
	5	6,698	14	9,000	23	12,030	L5	19,613
	6	6,941	15	9,304	24	12,636		
	7	7,183	16	9,606	25	13,241		
	8	7,426	17	9,909	26	13,847		
	9	7,668	18	10,212	27	14,454		

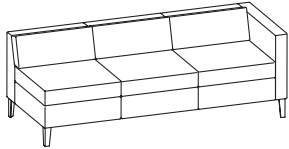

dimensions	W	D	H
Overall	77 1/8"	31 1/2"	27 7/8"
Seat	73"	21"	17 1/4"
Arm			26 7/8"
Between arms			

Upholstery Requirements: GK1105-3W

Dual Upholstery	
Fabric yds	Cushions 4.4 Frame 5.2
Leather ft ²	Cushions 101.2 Frame 119.6
Shipping weight	171 lbs.
Cube	78.5

Cushion	1	10	19	L1	1,404			
	2	83	11	1,028	20	2,249	L2	2,565
	3	167	12	1,138	21	2,389	L3	3,958
	COM/4	250	13	1,278	22	2,527	L4	5,119
	5	361	14	1,416	23	2,805	L5	6,281
	6	472	15	1,556	24	3,083		
	7	584	16	1,694	25	3,360		
	8	695	17	1,833	26	3,638		
	9	806	18	1,972	27	3,916		

Top row of pricing is for units specified with same fabric on cushion and frame. Bottom 2 rows of pricing required only when two different fabric grades are selected for the cushion and frame.

To calculate price of lounge with different grade fabric for cushion and frame; start with Grade 1 price, add appropriate grade price located in second row for cushion, and last add appropriate grade price located in third row for frame to the sum of the Grade 1 and cushion price.

Example: Grade 1 \$5,910 + grade 4 fabric cushion \$250 + grade 2 fabric frame \$99 = \$6,259

Frame	1	10	19	L1	1,659			
	2	99	11	1,215	20	2,659	L2	3,032
	3	198	12	1,346	21	2,823	L3	4,678
	COM/4	296	13	1,510	22	2,987	L4	6,050
	5	427	14	1,674	23	3,315	L5	7,422
	6	559	15	1,838	24	3,643		
	7	689	16	2,002	25	3,971		
	8	821	17	2,166	26	4,299		
	9	952	18	2,330	27	4,628		

Select upholstery for everything else other than the seat and back cushions (the outside back, arms, sides, seat frame). You can specify the same fabric as the cushions or select other fabric.

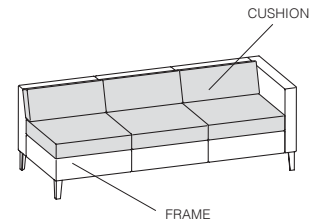

TO ORDER PLEASE SPECIFY THE FOLLOWING:

<input type="text"/>	<input type="text"/>	<input type="text"/>	<input type="text"/>	<input type="text"/>	<input type="text"/>
MODEL NUMBER	WOOD FINISH	STITCH DETAIL	FLAMMABILITY RATING	CUSHION UPHOLSTERY	FRAME UPHOLSTERY
	Cherry finishes on Maple Walnut finishes on Maple Maple finishes on Maple Oak finishes on Maple	None NR Stitch detail SD +\$191	U CTB117	Please refer to list of available upholstery and leather selections on www.gunlocke.com	Please refer to list of available upholstery and leather selections on www.gunlocke.com

Example

GK1105-3W.777.NR.U.DOL728.SPNN04
 GK1105-3W 777 NR U DOL728 SPNN04
 MODEL NUMBER WOOD FINISH STITCH DETAIL FLAMMABILITY CUSHION UPHOLSTERY FRAME UPHOLSTERY

Please refer to the Ciji product page on www.gunlocke.com for standard finish options.

CIJI THREE SEAT

Low Back, Arm Left, Aluminum Legs

Seating
03/23

model number	fabric grades							
GK1105-3A Low back, arm left, Aluminum legs	1	6,169	10	8,169	19	10,774	L1	9,232
	2	6,351	11	8,412	20	11,077	L2	11,766
	3	6,534	12	8,653	21	11,381	L3	14,805
	COM/4	6,715	13	8,957	22	11,683	L4	17,338
	5	6,957	14	9,259	23	12,289	L5	19,872
	6	7,200	15	9,563	24	12,895		
	7	7,442	16	9,865	25	13,500		
	8	7,685	17	10,168	26	14,106		
	9	7,927	18	10,471	27	14,713		

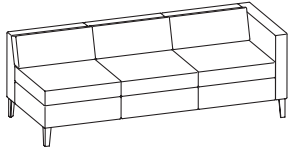

dimensions	W	D	H
Overall	77 1/8"	31 1/2"	27 7/8"
Seat	73"	21"	17 1/4"
Arm			26 7/8"
Between arms			

Upholstery Requirements: GK1105-3A

Dual Upholstery	
Fabric yds	Cushions 4.4 Frame 5.2
Leather ft ²	Cushions 101.2 Frame 119.6
Shipping weight	171 lbs.
Cube	78.5

Cushion	1	10	19	L1	1,404
	83	1,028	2,249	L2	2,565
	167	1,138	2,389	L3	3,958
COM/4	250	1,278	2,527	L4	5,119
	361	1,416	2,805	L5	6,281
	472	1,556	3,083		
	584	1,694	3,360		
	695	1,833	3,638		
	806	1,972	3,916		

Top row of pricing is for units specified with same fabric on cushion and frame. Bottom 2 rows of pricing required only when two different fabric grades are selected for the cushion and frame.

To calculate price of lounge with different grade fabric for cushion and frame; start with Grade 1 price, add appropriate grade price located in second row for cushion, and last add appropriate grade price located in third row for frame to the sum of the Grade 1 and cushion price.

Example: Grade 1 \$6,169 + grade 4 fabric cushion \$250 + grade 2 fabric frame \$99 = \$6,518

Frame	1	10	19	L1	1,659
	99	1,215	2,659	L2	3,032
	198	1,346	2,823	L3	4,678
COM/4	296	1,510	2,987	L4	6,050
	427	1,674	3,315	L5	7,422
	559	1,838	3,643		
	689	2,002	3,971		
	821	2,166	4,299		
	952	2,330	4,628		

Select upholstery for everything else other than the seat and back cushions (the outside back, arms, sides, seat frame). You can specify the same fabric as the cushions or select other fabric.

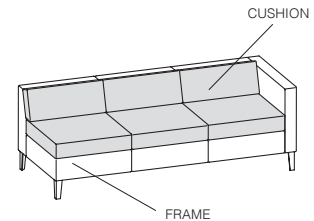

TO ORDER PLEASE SPECIFY THE FOLLOWING:

<input type="text"/>	<input type="text"/>	<input type="text"/>	<input type="text"/>	<input type="text"/>
MODEL NUMBER	STITCH DETAIL	FLAMMABILITY RATING	CUSHION UPHOLSTERY	FRAME UPHOLSTERY
	None NR Stitch detail SD +\$191	U CTB117	Please refer to list of available upholstery and leather selections on www.gunlocke.com	Please refer to list of available upholstery and leather selections on www.gunlocke.com

Example

GK1105-3A.NR.U.DOL728.SPNN04

GK1105-3A	NR	U	DOL728	SPNN04
MODEL NUMBER	STITCH	FLAMMABILITY DETAIL	CUSHION UPHOLSTERY	FRAME UPHOLSTERY

Please refer to the Ciji product page on www.gunlocke.com for standard finish options.

Seating
03/23

CIJI THREE SEAT

Low Back, Arm Right, Wood Legs

model number	fabric grades							
GK1107-3W Low back, arm right, Wood legs	1	5,910	10	7,910	19	10,515	L1	8,973
	2	6,092	11	8,153	20	10,818	L2	11,507
	3	6,275	12	8,394	21	11,122	L3	14,546
	COM/4	6,456	13	8,698	22	11,424	L4	17,079
	5	6,698	14	9,000	23	12,030	L5	19,613
	6	6,941	15	9,304	24	12,636		
	7	7,183	16	9,606	25	13,241		
	8	7,426	17	9,909	26	13,847		
	9	7,668	18	10,212	27	14,454		

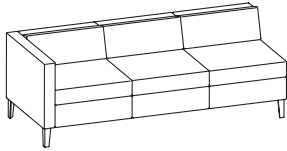

dimensions	W	D	H
Overall	77 1/8"	31 1/2"	27 7/8"
Seat	73"	21"	17 1/4"
Arm			26 7/8"
Between arms			

Upholstery Requirements: GK1107-3W

	Dual Upholstery	
Fabric yds	Cushions 4.4	Frame 5.2
Leather ft ²	Cushions 101.2	Frame 119.6
Shipping weight		171 lbs.
Cube		78.5

Cushion	1	10	19	L1
	917	2,111	1,404	
	83	1,028	2,249	L2
	167	1,138	2,389	L3
COM/4	250	1,278	2,527	L4
	361	1,416	2,805	L5
	472	1,556	3,083	
	584	1,694	3,360	
	695	1,833	3,638	
	806	1,972	3,916	

Top row of pricing is for units specified with same fabric on cushion and frame. Bottom 2 rows of pricing required only when two different fabric grades are selected for the cushion and frame.

To calculate price of lounge with different grade fabric for cushion and frame; start with Grade 1 price, add appropriate grade price located in second row for cushion, and last add appropriate grade price located in third row for frame to the sum of the Grade 1 and cushion price.

Example: Grade 1 \$5,910 + grade 4 fabric cushion \$250 + grade 2 fabric frame \$99 = \$6,259

Frame	1	10	19	L1
	1,083	2,494	1,659	
	99	1,215	2,659	L2
	198	1,346	2,823	L3
COM/4	296	1,510	2,987	L4
	427	1,674	3,315	L5
	559	1,838	3,643	
	689	2,002	3,971	
	821	2,166	4,299	
	952	2,330	4,628	

Select upholstery for everything else other than the seat and back cushions (the outside back, arms, sides, seat frame). You can specify the same fabric as the cushions or select other fabric.

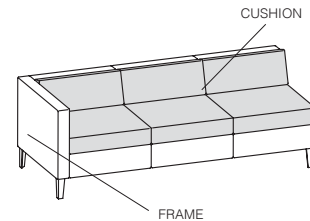

TO ORDER PLEASE SPECIFY THE FOLLOWING:

<input type="text"/>	<input type="text"/>	<input type="text"/>	<input type="text"/>	<input type="text"/>	<input type="text"/>
MODEL NUMBER	WOOD FINISH	STITCH DETAIL	FLAMMABILITY RATING	CUSHION UPHOLSTERY	FRAME UPHOLSTERY
	Cherry finishes on Maple Walnut finishes on Maple Maple finishes on Maple Oak finishes on Maple	None NR Stitch detail SD +\$191	U CTB117	Please refer to list of available upholstery and leather selections on www.gunlocke.com	Please refer to list of available upholstery and leather selections on www.gunlocke.com

Example

GK1107-3W	777	NR	U	DOL728	SPNNO4
MODEL NUMBER	WOOD FINISH	STITCH DETAIL	FLAMMABILITY	CUSHION UPHOLSTERY	FRAME UPHOLSTERY

Please refer to the Ciji product page on www.gunlocke.com for standard finish options.

CIJI THREE SEAT

Low Back, Arm Right, Aluminum Legs

Seating
03/23

model number	fabric grades							
GK1107-3A Low back, arm right, Aluminum legs	1	6,169	10	8,169	19	10,774	L1	9,232
	2	6,351	11	8,412	20	11,077	L2	11,766
	3	6,534	12	8,653	21	11,381	L3	14,805
	COM/4	6,715	13	8,957	22	11,683	L4	17,338
	5	6,957	14	9,259	23	12,289	L5	19,872
	6	7,200	15	9,563	24	12,895		
	7	7,442	16	9,865	25	13,500		
	8	7,685	17	10,168	26	14,106		
	9	7,927	18	10,471	27	14,713		

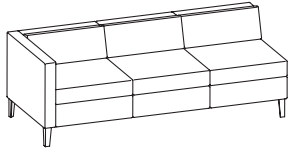

dimensions	W	D	H
Overall	77 1/8"	31 1/2"	27 7/8"
Seat	73"	21"	17 1/4"
Arm			26 7/8"
Between arms			

Upholstery Requirements: GK1107-3A

Dual Upholstery	
Fabric yds	Cushions 4.4 Frame 5.2
Leather ft ²	Cushions 101.2 Frame 119.6
Shipping weight	171 lbs.
Cube	78.5

Cushion	1	10	19	L1	1,404			
	2	83	11	1,028	20	2,249	L2	2,565
	3	167	12	1,138	21	2,389	L3	3,958
	COM/4	250	13	1,278	22	2,527	L4	5,119
	5	361	14	1,416	23	2,805	L5	6,281
	6	472	15	1,556	24	3,083		
	7	584	16	1,694	25	3,360		
	8	695	17	1,833	26	3,638		
	9	806	18	1,972	27	3,916		

Top row of pricing is for units specified with same fabric on cushion and frame. Bottom 2 rows of pricing required only when two different fabric grades are selected for the cushion and frame.

To calculate price of lounge with different grade fabric for cushion and frame; start with Grade 1 price, add appropriate grade price located in second row for cushion, and last add appropriate grade price located in third row for frame to the sum of the Grade 1 and cushion price.

Example: Grade 1 \$6,169 + grade 4 fabric cushion \$250 + grade 2 fabric frame \$99 = \$6,518

Frame	1	10	19	L1	1,659			
	2	99	11	1,215	20	2,659	L2	3,032
	3	198	12	1,346	21	2,823	L3	4,678
	COM/4	296	13	1,510	22	2,987	L4	6,050
	5	427	14	1,674	23	3,315	L5	7,422
	6	559	15	1,838	24	3,643		
	7	689	16	2,002	25	3,971		
	8	821	17	2,166	26	4,299		
	9	952	18	2,330	27	4,628		

Select upholstery for everything else other than the seat and back cushions (the outside back, arms, sides, seat frame). You can specify the same fabric as the cushions or select other fabric.

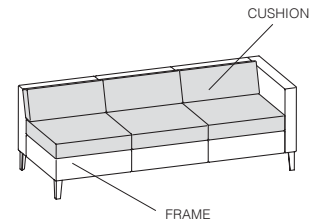

TO ORDER PLEASE SPECIFY THE FOLLOWING:

<input type="text"/>	<input type="text"/>	<input type="text"/>	<input type="text"/>	<input type="text"/>
MODEL NUMBER	STITCH DETAIL	FLAMMABILITY RATING	CUSHION UPHOLSTERY	FRAME UPHOLSTERY
	None NR Stitch detail SD +\$191	U CTB117	Please refer to list of available upholstery and leather selections on www.gunlocke.com	Please refer to list of available upholstery and leather selections on www.gunlocke.com

Example

GK1107-3A.NR.U.DOL728.SPNN04				
GK1107-3A	NR	U	DOL728	SPNN04
MODEL NUMBER	STITCH	FLAMMABILITY DETAIL	CUSHION UPHOLSTERY	FRAME UPHOLSTERY

Please refer to the Ciji product page on www.gunlocke.com for standard finish options.

model number	fabric grades						
GK1111-1W Mid back, with arms, Wood legs	1	3,493	10	4,598	19	6,036	L1 5,185
	2	3,594	11	4,731	20	6,203	L2 6,583
	3	3,694	12	4,866	21	6,371	L3 8,262
	COM/4	3,795	13	5,032	22	6,538	L4 9,661
	5	3,929	14	5,199	23	6,871	L5 11,058
	6	4,063	15	5,366	24	7,206	
	7	4,196	16	5,534	25	7,541	
	8	4,330	17	5,701	26	7,876	
	9	4,464	18	5,869	27	8,210	

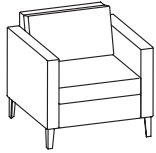

dimensions	W	D	H
Overall	31 3/4"	31 1/2"	32 1/8"
Seat	24"	21"	17 1/4"
Arm			26 7/8"
Between arms	24"		

Upholstery Requirements: GK1111-1W

	Dual Upholstery	
Fabric yds	Cushions 1.5	Frame 3.8
Leather ft ²	Cushions 34.5	Frame 87.4
Shipping weight	102 lbs.	
Cube	28.0	

Cushion	1	10	19	20	21	22	23	24	25	26	27	L1	L2	L3	L4	L5
		313	720	479								479	875	1,350	1,746	2,141
	29	350	767	875								875	1,350	1,746	2,141	
	57	389	815	1,350								1,350	1,746	2,141		
	86	435	862	1,746								1,746	2,141			
	124	483	956	2,141								2,141				
	162	530	1,051													
	199	578	1,146													
	237	625	1,241													
	275	673	1,335													

Top row of pricing is for units specified with same fabric on cushion and frame. Bottom 2 rows of pricing required only when two different fabric grades are selected for the cushion and frame.

To calculate price of lounge with different grade fabric for cushion and frame; start with Grade 1 price, add appropriate grade price located in second row for cushion, and last add appropriate grade price located in third row for frame to the sum of the Grade 1 and cushion price.

Example: Grade 1 \$3,493 + grade 4 fabric cushion \$86 + grade 2 fabric frame \$72 = \$3,651

Frame	1	10	19	20	21	22	23	24	25	26	27	L1	L2	L3	L4	L5
		792	1,823	1,213								1,213	2,215	3,419	4,422	5,424
	72	888	1,943	2,215								2,215	3,419	4,422	5,424	
	144	984	2,063	3,419								3,419	4,422	5,424		
	216	1,104	2,183	4,422								4,422	5,424			
	312	1,223	2,422	5,424								5,424				
	408	1,343	2,662													
	504	1,463	2,902													
	600	1,583	3,142													
	696	1,703	3,382													

Select upholstery for everything else other than the seat and back cushions (the outside back, arms, sides, seat frame). You can specify the same fabric as the cushions or select other fabric.

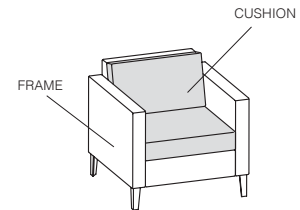

TO ORDER PLEASE SPECIFY THE FOLLOWING:

<input type="text"/>	<input type="text"/>	<input type="text"/>	<input type="text"/>	<input type="text"/>	<input type="text"/>
MODEL NUMBER	WOOD FINISH	STITCH DETAIL	FLAMMABILITY RATING	CUSHION UPHOLSTERY	FRAME UPHOLSTERY
	Cherry finishes on Maple Walnut finishes on Maple Maple finishes on Maple Oak finishes on Maple	None NR Stitch detail SD +\$191	U CTB117	Please refer to list of available upholstery and leather selections on www.gunlocke.com	Please refer to list of available upholstery and leather selections on www.gunlocke.com

Example

GK1111-1W.777.NR.U.DOL728.SPNN04					
GK1111-1W	777	NR	U	DOL728	SPNN04
MODEL NUMBER	WOOD FINISH	STITCH DETAIL	FLAMMABILITY	CUSHION UPHOLSTERY	FRAME UPHOLSTERY

Please refer to the Ciji product page on www.gunlocke.com for standard finish options.

CIJI SINGLE SEAT

Mid Back, with Arms, Aluminum Legs

Seating
03/23

model number	fabric grades							
GK1111-1A Mid back, with arms, Aluminum legs	1	3,750	10	4,855	19	6,293	L1	5,442
	2	3,851	11	4,988	20	6,460	L2	6,840
	3	3,951	12	5,123	21	6,628	L3	8,519
	COM/4	4,052	13	5,289	22	6,795	L4	9,918
	5	4,186	14	5,456	23	7,128	L5	11,315
	6	4,320	15	5,623	24	7,463		
	7	4,453	16	5,791	25	7,798		
	8	4,587	17	5,958	26	8,133		
	9	4,721	18	6,126	27	8,467		

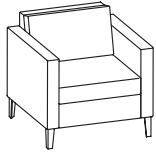

dimensions	W	D	H
Overall	31 3/4"	31 1/2"	32 1/8"
Seat	24"	21"	17 1/4"
Arm			26 7/8"
Between arms	24"		

Upholstery Requirements: GK1111-1A

	Dual Upholstery	
Fabric yds	Cushions 1.5	Frame 3.8
Leather ft ²	Cushions 34.5	Frame 87.4
Shipping weight		102 lbs.
Cube		28.0

Cushion	1	10	19	20	21	22	23	24	25	26	27	L1	L2	L3	L4	L5
		313	720	350	815	862	956	1,051	1,146	1,241	1,335	479	875	1,350	1,746	2,141
	29		767													
	57		815													
	86		862													
	124		956													
	162		1,051													
	199		1,146													
	237		1,241													
	275		1,335													

Top row of pricing is for units specified with same fabric on cushion and frame. Bottom 2 rows of pricing required only when two different fabric grades are selected for the cushion and frame.

To calculate price of lounge with different grade fabric for cushion and frame; start with Grade 1 price, add appropriate grade price located in second row for cushion, and last add appropriate grade price located in third row for frame to the sum of the Grade 1 and cushion price.

Example: Grade 1 \$3,750 + grade 4 fabric cushion \$86 + grade 2 fabric frame \$72 = \$3,908

Frame	1	10	19	20	21	22	23	24	25	26	27	L1	L2	L3	L4	L5
		792	1,823	888	2,063	2,183	2,422	2,662	2,902	3,142	3,382	1,213	2,215	3,419	4,422	5,424
	72		1,943													
	144		2,063													
	216		2,183													
	312		2,422													
	408		2,662													
	504		2,902													
	600		3,142													
	696		3,382													

Select upholstery for everything else other than the seat and back cushions (the outside back, arms, sides, seat frame). You can specify the same fabric as the cushions or select other fabric.

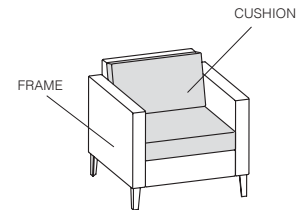

TO ORDER PLEASE SPECIFY THE FOLLOWING:

<input type="text"/>	<input type="text"/>	<input type="text"/>	<input type="text"/>	<input type="text"/>
MODEL NUMBER	STITCH DETAIL	FLAMMABILITY RATING	CUSHION UPHOLSTERY	FRAME UPHOLSTERY
	None NR Stitch detail SD +\$191	U CTB117	Please refer to list of available upholstery and leather selections on www.gunlocke.com	Please refer to list of available upholstery and leather selections on www.gunlocke.com

Example

GK1111-1A.NR.U.DOL728.SPNN04
 GK1111-1A NR U DOL728 SPNN04
 MODEL NUMBER STITCH FLAMMABILITY RATING CUSHION UPHOLSTERY FRAME UPHOLSTERY

Please refer to the Ciji product page on www.gunlocke.com for standard finish options.

model number fabric grades dimensions W D H

GK1113-1W

Mid back, armless,
Wood Legs



1	2,675	10	3,301	19	4,115	L1	3,633
2	2,733	11	3,375	20	4,209	L2	4,425
3	2,789	12	3,453	21	4,305	L3	5,375
COM/4	2,847	13	3,545	22	4,399	L4	6,167
5	2,923	14	3,641	23	4,587	L5	6,957
6	2,999	15	3,735	24	4,777		
7	3,073	16	3,831	25	4,967		
8	3,149	17	3,925	26	5,157		
9	3,225	18	4,021	27	5,345		

Overall	24 5/8"	31 1/2"	32 1/8"
Seat	24"	21"	17 1/4"

Upholstery Requirements: GK1113-1W

	Dual Upholstery	
Fabric yds	Cushions 1.5	Frame 1.5
Leather ft ²	Cushions 34.5	Frame 34.5
Shipping weight	82 lbs.	
Cube	28.0	

Cushion

1		10	313	19	720	L1	479
2	29	11	350	20	767	L2	875
3	57	12	389	21	815	L3	1,350
COM/4	86	13	435	22	862	L4	1,746
5	124	14	483	23	956	L5	2,141
6	162	15	530	24	1,051		
7	199	16	578	25	1,146		
8	237	17	625	26	1,241		
9	275	18	673	27	1,335		

Top row of pricing is for units specified with same fabric on cushion and frame. Bottom 2 rows of pricing required only when two different fabric grades are selected for the cushion and frame.

To calculate price of lounge with different grade fabric for cushion and frame; start with Grade 1 price, add appropriate grade price located in second row for cushion, and last add appropriate grade price located in third row for frame to the sum of the Grade 1 and cushion price.

Example: Grade 1 \$2,675 + grade 4 fabric cushion \$86 + grade 2 fabric frame \$29 = \$2,790

Frame

1		10	313	19	720	L1	479
2	29	11	350	20	767	L2	875
3	57	12	389	21	815	L3	1,350
COM/4	86	13	435	22	862	L4	1,746
5	124	14	483	23	956	L5	2,141
6	162	15	530	24	1,051		
7	199	16	578	25	1,146		
8	237	17	625	26	1,241		
9	275	18	673	27	1,335		

Select upholstery for everything else other than the seat and back cushions (the outside back, arms, sides, seat frame). You can specify the same fabric as the cushions or select other fabric.

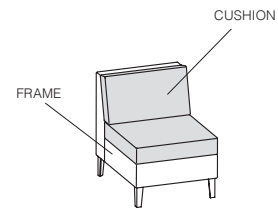

TO ORDER PLEASE SPECIFY THE FOLLOWING:

<input type="text"/>	<input type="text"/>	<input type="text"/>	<input type="text"/>	<input type="text"/>	<input type="text"/>
MODEL NUMBER	WOOD FINISH	STITCH DETAIL	FLAMMABILITY RATING	CUSHION UPHOLSTERY	FRAME UPHOLSTERY
	Cherry finishes on Maple Walnut finishes on Maple Maple finishes on Maple Oak finishes on Maple	None NR Stitch detail SD +\$191	U CTB117	Please refer to list of available upholstery and leather selections on www.gunlocke.com	Please refer to list of available upholstery and leather selections on www.gunlocke.com

Example

GK1113-1W.777.NR.U.DOL728.SPNN04
 GK1113-1W 777 NR U DOL728 SPNN04
 MODEL NUMBER WOOD FINISH STITCH DETAIL FLAMMABILITY CUSHION UPHOLSTERY FRAME UPHOLSTERY

Please refer to the Ciji product page on www.gunlocke.com for standard finish options.

CIJI SINGLE SEAT

Mid Back, Armless, Aluminum Legs

Seating
03/23

model number fabric grades dimensions W D H

GK1113-1A

Mid back, armless,
Aluminum Legs



1	2,935	10	3,561	19	4,375	L1	3,893
2	2,993	11	3,635	20	4,469	L2	4,685
3	3,049	12	3,713	21	4,565	L3	5,635
COM/4	3,107	13	3,805	22	4,659	L4	6,427
5	3,183	14	3,901	23	4,847	L5	7,217
6	3,259	15	3,995	24	5,037		
7	3,333	16	4,091	25	5,227		
8	3,409	17	4,185	26	5,417		
9	3,485	18	4,281	27	5,605		

Overall	24 5/8"	31 1/2"	32 1/8"
Seat	24"	21"	17 1/4"

Upholstery Requirements: GK1113-1A

	Dual Upholstery	
Fabric yds	Cushions 1.5	Frame 1.5
Leather ft ²	Cushions 34.5	Frame 34.5
Shipping weight	82 lbs.	
Cube	28.0	

Cushion

1		10	313	19	720	L1	479
2	29	11	350	20	767	L2	875
3	57	12	389	21	815	L3	1,350
COM/4	86	13	435	22	862	L4	1,746
5	124	14	483	23	956	L5	2,141
6	162	15	530	24	1,051		
7	199	16	578	25	1,146		
8	237	17	625	26	1,241		
9	275	18	673	27	1,335		

Top row of pricing is for units specified with same fabric on cushion and frame. Bottom 2 rows of pricing required only when two different fabric grades are selected for the cushion and frame.

To calculate price of lounge with different grade fabric for cushion and frame; start with Grade 1 price, add appropriate grade price located in second row for cushion, and last add appropriate grade price located in third row for frame to the sum of the Grade 1 and cushion price.

Example: Grade 1 \$2,935 + grade 4 fabric cushion \$86 + grade 2 fabric frame \$29 = \$3,050

Frame

1		10	313	19	720	L1	479
2	29	11	350	20	767	L2	875
3	57	12	389	21	815	L3	1,350
COM/4	86	13	435	22	862	L4	1,746
5	124	14	483	23	956	L5	2,141
6	162	15	530	24	1,051		
7	199	16	578	25	1,146		
8	237	17	625	26	1,241		
9	275	18	673	27	1,335		

Select upholstery for everything else other than the seat and back cushions (the outside back, arms, sides, seat frame). You can specify the same fabric as the cushions or select other fabric.

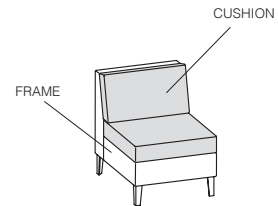

TO ORDER PLEASE SPECIFY THE FOLLOWING:

<input type="text"/>	<input type="text"/>	<input type="text"/>	<input type="text"/>	<input type="text"/>
MODEL NUMBER	STITCH DETAIL	FLAMMABILITY RATING	CUSHION UPHOLSTERY	FRAME UPHOLSTERY
	None NR Stitch detail SD +\$191	U CTB117	Please refer to list of available upholstery and leather selections on www.gunlocke.com	Please refer to list of available upholstery and leather selections on www.gunlocke.com

Example

GK1113-1A.NR.U.DOL728.SPNN04				
GK1113-1A	NR	U	DOL728	SPNN04
MODEL NUMBER	STITCH	FLAMMABILITY DETAIL	CUSHION UPHOLSTERY	FRAME UPHOLSTERY

Please refer to the Ciji product page on www.gunlocke.com for standard finish options.

model number	fabric grades						dimensions	W	D	H		
GK1115-1W Mid back, arm left, Wood legs	1	3,290	10	4,228	19	5,449	L1	4,727	Overall	28 1/8"	31 1/2"	32 1/8"
	2	3,376	11	4,341	20	5,591	L2	5,914	Seat	24"	21"	17 1/4"
	3	3,461	12	4,456	21	5,734	L3	7,339	Arm	26 7/8"		
	COM/4	3,547	13	4,596	22	5,876	L4	8,527	Between arms			
	5	3,661	14	4,739	23	6,158	L5	9,713	Upholstery Requirements: GK1115-1W			
	6	3,774	15	4,881	24	6,443			Dual Upholstery			
	7	3,887	16	5,023	25	6,728			Fabric yds	Cushions 1.5	Frame 3	
	8	4,001	17	5,165	26	7,011			Leather ft ²	Cushions 34.5	Frame 57.5	
	9	4,115	18	5,307	27	7,295			Shipping weight	92 lbs.		
								Cube	28.0			



Cushion	1	10	19	20	21	22	23	24	25	26	27
		313	720	L1	479						
	2	29	11	350	20	767	L2	875			
	3	57	12	389	21	815	L3	1,350			
	COM/4	86	13	435	22	862	L4	1,746			
	5	124	14	483	23	956	L5	2,141			
	6	162	15	530	24	1,051					
	7	199	16	578	25	1,146					
	8	237	17	625	26	1,241					
	9	275	18	673	27	1,335					

Frame	1	10	19	20	21	22	23	24	25	26	27
		625	1,439	L1	958						
	2	57	11	701	20	1,534	L2	1,749			
	3	114	12	777	21	1,629	L3	2,699			
	COM/4	171	13	871	22	1,724	L4	3,491			
	5	247	14	966	23	1,912	L5	4,282			
	6	322	15	1,061	24	2,102					
	7	398	16	1,155	25	2,292					
	8	474	17	1,250	26	2,480					
	9	550	18	1,344	27	2,670					

Top row of pricing is for units specified with same fabric on cushion and frame. Bottom 2 rows of pricing required only when two different fabric grades are selected for the cushion and frame.

To calculate price of lounge with different grade fabric for cushion and frame; start with Grade 1 price, add appropriate grade price located in second row for cushion, and last add appropriate grade price located in third row for frame to the sum of the Grade 1 and cushion price.

Example: Grade 1 \$3,290 + grade 4 fabric cushion \$86 + grade 2 fabric frame \$57 = \$3,433

Select upholstery for everything else other than the seat and back cushions (the outside back, arms, sides, seat frame). You can specify the same fabric as the cushions or select other fabric.

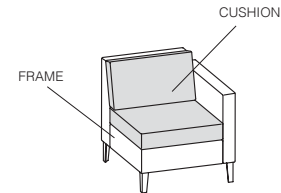

TO ORDER PLEASE SPECIFY THE FOLLOWING:

<input type="text"/>	<input type="text"/>	<input type="text"/>	<input type="text"/>	<input type="text"/>	<input type="text"/>
MODEL NUMBER	WOOD FINISH	STITCH DETAIL	FLAMMABILITY RATING	CUSHION UPHOLSTERY	FRAME UPHOLSTERY
	Cherry finishes on Maple Walnut finishes on Maple Maple finishes on Maple Oak finishes on Maple	None NR Stitch detail SD +\$191	U CTB117	Please refer to list of available upholstery and leather selections on www.gunlocke.com	Please refer to list of available upholstery and leather selections on www.gunlocke.com

Example

GK1115-1W.777.NR.U.DOL728.SPNN04
GK1115-1W 777 NR U DOL728 SPNN04
MODEL NUMBER WOOD FINISH STITCH DETAIL FLAMMABILITY CUSHION UPHOLSTERY FRAME UPHOLSTERY

Please refer to the Ciji product page on www.gunlocke.com for standard finish options.

CIJI SINGLE SEAT

Mid Back, Arm Left, Aluminum Legs

Seating
03/23

model number	fabric grades					dimensions	W	D	H			
GK1115-1A Mid back, arm left, Aluminum legs	1	3,548	10	4,486	19	5,707	L1	4,985	Overall	28 1/8"	31 1/2"	32 1/8"
	2	3,634	11	4,599	20	5,849	L2	6,172	Seat	24"	21"	17 1/4"
	3	3,719	12	4,714	21	5,992	L3	7,597	Arm			26 7/8"
	COM/4	3,805	13	4,854	22	6,134	L4	8,785	Between arms			
	5	3,919	14	4,997	23	6,416	L5	9,971				
	6	4,032	15	5,139	24	6,701						
	7	4,145	16	5,281	25	6,986						
	8	4,259	17	5,423	26	7,269						
	9	4,373	18	5,565	27	7,553						



Upholstery Requirements: GK1115-1A

	Dual Upholstery
Fabric yds	Cushions 1.5 Frame 3
Leather ft ²	Cushions 34.5 Frame 57.5
Shipping weight	92 lbs.
Cube	28.0

Cushion	1	10	19	20	21	22	23	24	25	26	27	L1	L2	L3	L4	L5
		313	720									479	875	1,350	1,746	2,141
	29	350	767													
	57	389	815													
	86	435	862													
	124	483	956													
	162	530	1,051													
	199	578	1,146													
	237	625	1,241													
	275	673	1,335													

Top row of pricing is for units specified with same fabric on cushion and frame. Bottom 2 rows of pricing required only when two different fabric grades are selected for the cushion and frame.

To calculate price of lounge with different grade fabric for cushion and frame; start with Grade 1 price, add appropriate grade price located in second row for cushion, and last add appropriate grade price located in third row for frame to the sum of the Grade 1 and cushion price.

Example: Grade 1 \$3,548 + grade 4 fabric cushion \$86 + grade 2 fabric frame \$57 = \$3,691

Frame	1	10	19	20	21	22	23	24	25	26	27	L1	L2	L3	L4	L5
		625	1,439									958	1,749	2,699	3,491	4,282
	57	701	1,534													
	114	777	1,629													
	171	871	1,724													
	247	966	1,912													
	322	1,061	2,102													
	398	1,155	2,292													
	474	1,250	2,480													
	550	1,344	2,670													

Select upholstery for everything else other than the seat and back cushions (the outside back, arms, sides, seat frame). You can specify the same fabric as the cushions or select other fabric.

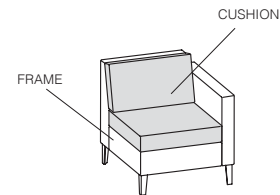

TO ORDER PLEASE SPECIFY THE FOLLOWING:

<input type="text"/>	<input type="text"/>	<input type="text"/>	<input type="text"/>	<input type="text"/>
MODEL NUMBER	STITCH DETAIL	FLAMMABILITY RATING	CUSHION UPHOLSTERY	FRAME UPHOLSTERY
	None NR Stitch detail SD +\$191	U CTB117	Please refer to list of available upholstery and leather selections on www.gunlocke.com	Please refer to list of available upholstery and leather selections on www.gunlocke.com

Example

GK1115-1A.NR.U.DOL728.SPNN04				
GK1115-1A	NR	U	DOL728	SPNN04
MODEL NUMBER	STITCH	FLAMMABILITY DETAIL	CUSHION UPHOLSTERY	FRAME UPHOLSTERY

Please refer to the Ciji product page on www.gunlocke.com for standard finish options.

model number	fabric grades						dimensions	W	D	H		
GK1117-1W Mid back, arm right, Wood legs	1	3,290	10	4,228	19	5,449	L1	4,727	Overall	28 1/8"	31 1/2"	32 1/8"
	2	3,376	11	4,341	20	5,591	L2	5,914	Seat	24"	21"	17 1/4"
	3	3,461	12	4,456	21	5,734	L3	7,339	Arm	26 7/8"		
	COM/4	3,547	13	4,596	22	5,876	L4	8,527	Between arms			
	5	3,661	14	4,739	23	6,158	L5	9,713	Upholstery Requirements: GK1117-1W			
	6	3,774	15	4,881	24	6,443			Dual Upholstery			
	7	3,887	16	5,023	25	6,728			Fabric yds Cushions 1.5 Frame 3			
	8	4,001	17	5,165	26	7,011			Leather ft ² Cushions 34.5 Frame 69			
	9	4,115	18	5,307	27	7,295			Shipping weight 92 lbs.			
								Cube 28.0				



Cushion	1	10	19	20	21	22	23	24	25	26	27	L1	L2	L3	L4	L5
		313	720									479	875	1,350	1,746	2,141
	29	350	767													
	57	389	815													
	86	435	862													
	124	483	956													
	162	530	1,051													
	199	578	1,146													
	237	625	1,241													
	275	673	1,335													

Top row of pricing is for units specified with same fabric on cushion and frame. Bottom 2 rows of pricing required only when two different fabric grades are selected for the cushion and frame.

To calculate price of lounge with different grade fabric for cushion and frame; start with Grade 1 price, add appropriate grade price located in second row for cushion, and last add appropriate grade price located in third row for frame to the sum of the Grade 1 and cushion price.

Example: Grade 1 \$3,290 + grade 4 fabric cushion \$86 + grade 2 fabric frame \$57 = \$3,433

Frame	1	10	19	20	21	22	23	24	25	26	27	L1	L2	L3	L4	L5
		625	1,439									958	1,749	2,699	3,491	4,282
	57	701	1,534													
	114	777	1,629													
	171	871	1,724													
	247	966	1,912													
	322	1,061	2,102													
	398	1,155	2,292													
	474	1,250	2,480													
	550	1,344	2,670													

Select upholstery for everything else other than the seat and back cushions (the outside back, arms, sides, seat frame). You can specify the same fabric as the cushions or select other fabric.

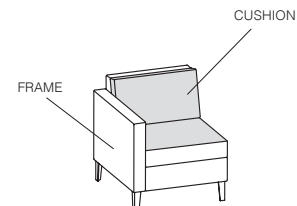

TO ORDER PLEASE SPECIFY THE FOLLOWING:

<input type="text"/>	<input type="text"/>	<input type="text"/>	<input type="text"/>	<input type="text"/>	<input type="text"/>
MODEL NUMBER	WOOD FINISH	STITCH DETAIL	FLAMMABILITY RATING	CUSHION UPHOLSTERY	FRAME UPHOLSTERY
	Cherry finishes on Maple Walnut finishes on Maple Maple finishes on Maple Oak finishes on Maple	None NR Stitch detail SD +\$191	U CTB117	Please refer to list of available upholstery and leather selections on www.gunlocke.com	Please refer to list of available upholstery and leather selections on www.gunlocke.com

Example

GK1117-1W.777.NR.U.DOL728.SPNN04
 GK1117-1W 777 NR U DOL728 SPNN04
 MODEL NUMBER WOOD FINISH STITCH DETAIL FLAMMABILITY CUSHION UPHOLSTERY FRAME UPHOLSTERY

Please refer to the Ciji product page on www.gunlocke.com for standard finish options.

CIJI SINGLE SEAT

Mid Back, Arm Left, Aluminum Legs

Seating
03/23

model number	fabric grades						dimensions	W	D	H		
GK1117-1A Mid back, arm left, Aluminum legs	1	3,548	10	4,486	19	5,707	L1	4,985	Overall	28 1/8"	31 1/2"	32 1/8"
	2	3,634	11	4,599	20	5,849	L2	6,172	Seat	24"	21"	17 1/4"
	3	3,719	12	4,714	21	5,992	L3	7,597	Arm			26 7/8"
	COM/4	3,805	13	4,854	22	6,134	L4	8,785	Between arms			
	5	3,919	14	4,997	23	6,416	L5	9,971				
	6	4,032	15	5,139	24	6,701						
	7	4,145	16	5,281	25	6,986						
	8	4,259	17	5,423	26	7,269						
	9	4,373	18	5,565	27	7,553						



Upholstery Requirements: GK1117-1A

	Dual Upholstery
Fabric yds	Cushions 1.5 Frame 3
Leather ft ²	Cushions 34.5 Frame 57.5
Shipping weight	92 lbs.
Cube	28.0

Cushion	1	10	19	20	21	22	23	24	25	26	27	L1	L2	L3	L4	L5
		313	720									479	875	1,350	1,746	2,141
	29	350	767													
	57	389	815													
	86	435	862													
	124	483	956													
	162	530	1,051													
	199	578	1,146													
	237	625	1,241													
	275	673	1,335													

Top row of pricing is for units specified with same fabric on cushion and frame. Bottom 2 rows of pricing required only when two different fabric grades are selected for the cushion and frame.

To calculate price of lounge with different grade fabric for cushion and frame; start with Grade 1 price, add appropriate grade price located in second row for cushion, and last add appropriate grade price located in third row for frame to the sum of the Grade 1 and cushion price.

Example: Grade 1 \$3,548 + grade 4 fabric cushion \$86 + grade 2 fabric frame \$57 = \$3,691

Frame	1	10	19	20	21	22	23	24	25	26	27	L1	L2	L3	L4	L5
		625	1,439									958	1,749	2,699	3,491	4,282
	57	701	1,534													
	114	777	1,629													
	171	871	1,724													
	247	966	1,912													
	322	1,061	2,102													
	398	1,155	2,292													
	474	1,250	2,480													
	550	1,344	2,670													

Select upholstery for everything else other than the seat and back cushions (the outside back, arms, sides, seat frame). You can specify the same fabric as the cushions or select other fabric.

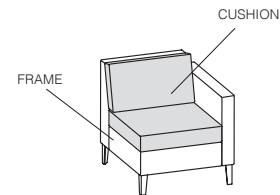

TO ORDER PLEASE SPECIFY THE FOLLOWING:

<input type="text"/>	<input type="text"/>	<input type="text"/>	<input type="text"/>	<input type="text"/>
MODEL NUMBER	STITCH DETAIL	FLAMMABILITY RATING	CUSHION UPHOLSTERY	FRAME UPHOLSTERY
	None NR Stitch detail SD +\$191	U CTB117	Please refer to list of available upholstery and leather selections on www.gunlocke.com	Please refer to list of available upholstery and leather selections on www.gunlocke.com

Example

GK1117-1A.NR.U.DOL728.SPNN04
 GK1117-1A NR U DOL728 SPNN04
 MODEL NUMBER STITCH FLAMMABILITY RATING CUSHION UPHOLSTERY FRAME UPHOLSTERY

Please refer to the Ciji product page on www.gunlocke.com for standard finish options.

model number	fabric grades							
GK1111-2W Mid back, with arms, Wood legs	1	4,894	10	6,603	19	8,827	L1	7,511
	2	5,050	11	6,809	20	9,086	L2	9,675
	3	5,206	12	7,016	21	9,345	L3	12,271
	COM/4	5,360	13	7,274	22	9,604	L4	14,435
	5	5,567	14	7,534	23	10,121	L5	16,598
	6	5,774	15	7,792	24	10,639		
	7	5,981	16	8,052	25	11,157		
	8	6,189	17	8,310	26	11,673		
	9	6,396	18	8,570	27	12,191		

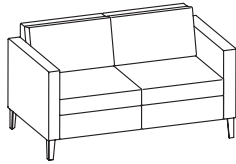

dimensions	W	D	H
Overall	56 1/4"	31 1/2"	32 1/8"
Seat	48 1/2"	21"	17 1/4"
Arm			26 7/8"
Between arms	48 1/2"		

Upholstery Requirements: GK1111-2W		
	Dual Upholstery	
Fabric yds	Cushions 2.9	Frame 5.3
Leather ft ²	Cushions 66.7	Frame 121.9
Shipping weight		127 lbs.
Cube		35

Cushion	1	10	604	19	1,391	L1	926	
	2	55	11	677	20	1,483	L2	1,691
	3	111	12	750	21	1,574	L3	2,609
	COM/4	165	13	842	22	1,666	L4	3,374
	5	238	14	934	23	1,849	L5	4,139
	6	311	15	1,025	24	2,032		
	7	385	16	1,117	25	2,215		
	8	458	17	1,208	26	2,397		
	9	531	18	1,300	27	2,581		

Top row of pricing is for units specified with same fabric on cushion and frame. Bottom 2 rows of pricing required only when two different fabric grades are selected for the cushion and frame.

To calculate price of lounge with different grade fabric for cushion and frame; start with Grade 1 price, add appropriate grade price located in second row for cushion, and last add appropriate grade price located in third row for frame to the sum of the Grade 1 and cushion price.

Example: Grade 1 \$4,894 + grade 4 fabric cushion \$165 + grade 2 fabric frame \$101 = \$5,160

Frame	1	10	1,105	19	2,542	L1	1,691	
	2	101	11	1,238	20	2,709	L2	3,090
	3	201	12	1,372	21	2,877	L3	4,768
	COM/4	301	13	1,538	22	3,044	L4	6,167
	5	435	14	1,706	23	3,378	L5	7,565
	6	569	15	1,873	24	3,713		
	7	702	16	2,041	25	4,048		
	8	837	17	2,208	26	4,382		
	9	971	18	2,376	27	4,716		

Select upholstery for everything else other than the seat and back cushions (the outside back, arms, sides, seat frame). You can specify the same fabric as the cushions or select other fabric.

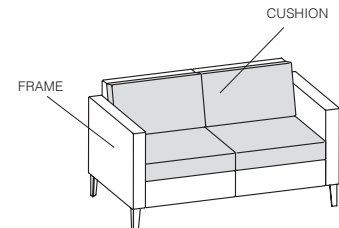

TO ORDER PLEASE SPECIFY THE FOLLOWING:

<input type="text"/>	<input type="text"/>	<input type="text"/>	<input type="text"/>	<input type="text"/>	<input type="text"/>
MODEL NUMBER	WOOD FINISH	STITCH DETAIL	FLAMMABILITY RATING	CUSHION UPHOLSTERY	FRAME UPHOLSTERY
	Cherry finishes on Maple Walnut finishes on Maple Maple finishes on Maple Oak finishes on Maple	None NR Stitch detail SD +\$250	U CTB117	Please refer to list of available upholstery and leather selections on www.gunlocke.com	Please refer to list of available upholstery and leather selections on www.gunlocke.com

Example

GK1111-2W.777.NR.U.DOL728.SPNO4
 GK1111-2W 777 NR U DOL728 SPNO4
 MODEL NUMBER WOOD FINISH STITCH DETAIL FLAMMABILITY UPHOLSTERY CUSHION UPHOLSTERY FRAME REQUEST

Please refer to the Ciji product page on www.gunlocke.com for standard finish options.

CIJI TWO SEAT

Mid Back, with Arms, Aluminum Legs

Seating
03/23

model number	fabric grades						dimensions	W	D	H		
GK1111-2A Mid back, with arms, Aluminum legs	1	5,152	10	6,861	19	9,085	L1	7,769	Overall	56 1/4"	31 1/2"	32 1/8"
	2	5,308	11	7,067	20	9,344	L2	9,933	Seat	48 1/2"	21"	17 1/4"
	3	5,464	12	7,274	21	9,603	L3	12,529	Arm			26 7/8"
	COM/4	5,618	13	7,532	22	9,862	L4	14,693	Between arms	48 1/2"		
	5	5,825	14	7,792	23	10,379	L5	16,856				
	6	6,032	15	8,050	24	10,897						
	7	6,239	16	8,310	25	11,415						
	8	6,447	17	8,568	26	11,931						
	9	6,654	18	8,828	27	12,449						

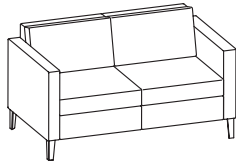

Upholstery Requirements: GK1111-2A

Dual Upholstery	
Fabric yds	Cushions 2.9 Frame 5.3
Leather ft ²	Cushions 66.7 Frame 121.9
Shipping weight	127 lbs.
Cube	35

Cushion	J110	1	10	604	19	1,391	L1	926	
		2	55	11	677	20	1,483	L2	1,691
		3	111	12	750	21	1,574	L3	2,609
		COM/4	165	13	842	22	1,666	L4	3,374
		5	238	14	934	23	1,849	L5	4,139
		6	311	15	1,025	24	2,032		
		7	385	16	1,117	25	2,215		
		8	458	17	1,208	26	2,397		
		9	531	18	1,300	27	2,581		

Top row of pricing is for units specified with same fabric on cushion and frame. Bottom 2 rows of pricing required only when two different fabric grades are selected for the cushion and frame.

To calculate price of lounge with different grade fabric for cushion and frame; start with Grade 1 price, add appropriate grade price located in second row for cushion, and last add appropriate grade price located in third row for frame to the sum of the Grade 1 and cushion price.

Example: Grade 1 \$5,152 + grade 4 fabric cushion \$165 + grade 2 fabric frame \$101 = \$5,418

Frame	1	10	1,105	19	2,542	L1	1,691	
	2	101	11	1,238	20	2,709	L2	3,090
	3	201	12	1,372	21	2,877	L3	4,768
	COM/4	301	13	1,538	22	3,044	L4	6,167
	5	435	14	1,706	23	3,378	L5	7,565
	6	569	15	1,873	24	3,713		
	7	702	16	2,041	25	4,048		
	8	837	17	2,208	26	4,382		
	9	971	18	2,376	27	4,716		

Select upholstery for everything else other than the seat and back cushions (the outside back, arms, sides, seat frame). You can specify the same fabric as the cushions or select other fabric.

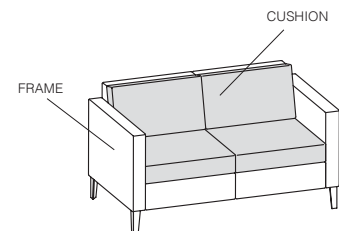

TO ORDER PLEASE SPECIFY THE FOLLOWING:

<input type="text"/>	<input type="text"/>	<input type="text"/>	<input type="text"/>	<input type="text"/>
MODEL NUMBER	STITCH DETAIL	FLAMMABILITY RATING	CUSHION UPHOLSTERY	FRAME UPHOLSTERY
	None NR Stitch detail SD +\$191	U CTB117	Please refer to list of available upholstery and leather selections on www.gunlocke.com	Please refer to list of available upholstery and leather selections on www.gunlocke.com

Example

GK1111-2A.NR.U.DOL728.SPNN04
 GK1111-2A NR U DOL728 SPNN04
 MODEL NUMBER STITCH FLAMMABILITY RATING CUSHION UPHOLSTERY FRAME UPHOLSTERY

Please refer to the Ciji product page on www.gunlocke.com for standard finish options.

model number fabric grades dimensions W D H

GK1113-2W

Mid back, armless,
Wood Legs

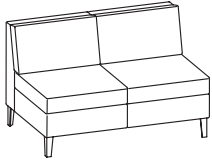

1	4,040	10	5,166	19	6,630	L1	5,764
2	4,142	11	5,302	20	6,801	L2	7,189
3	4,246	12	5,437	21	6,972	L3	8,898
COM/4	4,347	13	5,608	22	7,142	L4	10,323
5	4,483	14	5,779	23	7,483	L5	11,748
6	4,620	15	5,949	24	7,824		
7	4,757	16	6,120	25	8,164		
8	4,893	17	6,289	26	8,504		
9	5,029	18	6,461	27	8,846		

Overall	49 1/8"	31 1/2"	32 1/8"
Seat	48 1/2"	21"	17 1/4"

Upholstery Requirements: GK1113-2W

	Dual Upholstery		
Fabric yds	Cushions 2.9	Frame 2.5	
Leather ft ²	Cushions 66.7	Frame 57.5	
Shipping weight			107 lbs.
Cube			35

Top row of pricing is for units specified with same fabric on cushion and frame. Bottom 2 rows of pricing required only when two different fabric grades are selected for the cushion and frame.

To calculate price of lounge with different grade fabric for cushion and frame; start with Grade 1 price, add appropriate grade price located in second row for cushion, and last add appropriate grade price located in third row for frame to the sum of the Grade 1 and cushion price.

Example: Grade 1 \$4,040 + grade 4 fabric cushion \$165 + grade 2 fabric frame \$47 = \$4,252

Cushion

1		10	604	19	1,391	L1	926
2	55	11	677	20	1,483	L2	1,691
3	111	12	750	21	1,574	L3	2,609
COM/4	165	13	842	22	1,666	L4	3,374
5	238	14	934	23	1,849	L5	4,139
6	311	15	1,025	24	2,032		
7	385	16	1,117	25	2,215		
8	458	17	1,208	26	2,397		
9	531	18	1,300	27	2,581		

Frame

1		10	522	19	1,199	L1	798
2	47	11	585	20	1,278	L2	1,458
3	95	12	647	21	1,358	L3	2,249
COM/4	142	13	726	22	1,436	L4	2,909
5	205	14	805	23	1,594	L5	3,569
6	269	15	884	24	1,752		
7	332	16	963	25	1,909		
8	395	17	1,041	26	2,067		
9	458	18	1,121	27	2,225		

Select upholstery for everything else other than the seat and back cushions (the outside back, arms, sides, seat frame). You can specify the same fabric as the cushions or select other fabric.

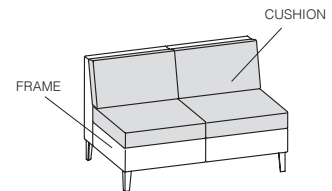

TO ORDER PLEASE SPECIFY THE FOLLOWING:

<input type="text"/>	<input type="text"/>	<input type="text"/>	<input type="text"/>	<input type="text"/>	<input type="text"/>
MODEL NUMBER	WOOD FINISH	STITCH DETAIL	FLAMMABILITY RATING	CUSHION UPHOLSTERY	FRAME UPHOLSTERY
	Cherry finishes on Maple Walnut finishes on Maple Maple finishes on Maple Oak finishes on Maple	None NR Stitch detail SD +\$250	U CTB117	Please refer to list of available upholstery and leather selections on www.gunlocke.com	Please refer to list of available upholstery and leather selections on www.gunlocke.com

Example

GK1113-2W	777	NR	U	DOL728	SPNNO4
MODEL NUMBER	WOOD FINISH	STITCH DETAIL	FLAMMABILITY UPHOLSTERY	CUSHION UPHOLSTERY	FRAME REQUEST

Please refer to the Ciji product page on www.gunlocke.com for standard finish options.

CIJI TWO SEAT

Mid Back, Armless, Aluminum Legs

Seating
03/23

model number	fabric grades						dimensions	W	D	H
GK1113-2A Mid back, armless, Aluminum Legs	1	4,297	10	5,423	19	6,887	L1	6,021	Overall 49 1/8" 31 1/2" 32 1/8"	
	2	4,399	11	5,559	20	7,058	L2	7,446	Seat 48 1/2" 21" 17 1/4"	
	3	4,503	12	5,694	21	7,229	L3	9,155	Upholstery Requirements: GK1113-2A	
	COM/4	4,604	13	5,865	22	7,399	L4	10,580	Dual Upholstery	
	5	4,740	14	6,036	23	7,740	L5	12,005	Fabric yds Cushions 2.9 Frame 2.5	
	6	4,877	15	6,206	24	8,081			Leather ft ² Cushions 66.7 Frame 57.5	
	7	5,014	16	6,377	25	8,421			Shipping weight 107 lbs.	
	8	5,150	17	6,546	26	8,761			Cube 35	
	9	5,286	18	6,718	27	9,103				

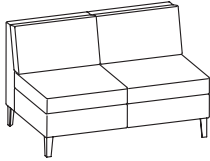

Cushion	1	10	604	19	1,391	L1	926	
	2	55	11	677	20	1,483	L2	1,691
	3	111	12	750	21	1,574	L3	2,609
	COM/4	165	13	842	22	1,666	L4	3,374
	5	238	14	934	23	1,849	L5	4,139
	6	311	15	1,025	24	2,032		
	7	385	16	1,117	25	2,215		
	8	458	17	1,208	26	2,397		
	9	531	18	1,300	27	2,581		

Top row of pricing is for units specified with same fabric on cushion and frame. Bottom 2 rows of pricing required only when two different fabric grades are selected for the cushion and frame.

To calculate price of lounge with different grade fabric for cushion and frame; start with Grade 1 price, add appropriate grade price located in second row for cushion, and last add appropriate grade price located in third row for frame to the sum of the Grade 1 and cushion price.

Example: Grade 1 \$4,297 + grade 4 fabric cushion \$165 + grade 2 fabric frame \$47 = \$4,509

Frame	1	10	522	19	1,199	L1	798	
	2	47	11	585	20	1,278	L2	1,458
	3	95	12	647	21	1,358	L3	2,249
	COM/4	142	13	726	22	1,436	L4	2,909
	5	205	14	805	23	1,594	L5	3,569
	6	269	15	884	24	1,752		
	7	332	16	963	25	1,909		
	8	395	17	1,041	26	2,067		
	9	458	18	1,121	27	2,225		

Select upholstery for everything else other than the seat and back cushions (the outside back, arms, sides, seat frame). You can specify the same fabric as the cushions or select other fabric.

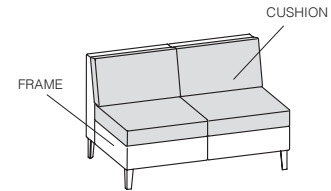

TO ORDER PLEASE SPECIFY THE FOLLOWING:

<input type="text"/>	<input type="text"/>	<input type="text"/>	<input type="text"/>	<input type="text"/>
MODEL NUMBER	STITCH DETAIL	FLAMMABILITY RATING	CUSHION UPHOLSTERY	FRAME UPHOLSTERY
	None NR Stitch detail SD +\$191	U CTB117	Please refer to list of available upholstery and leather selections on www.gunlocke.com	Please refer to list of available upholstery and leather selections on www.gunlocke.com

Example

GK1113-2A.NR.U.DOL728.SPNN04
 GK1113-2A NR U DOL728 SPNN04
 MODEL NUMBER STITCH FLAMMABILITY RATING CUSHION UPHOLSTERY FRAME UPHOLSTERY

Please refer to the Ciji product page on www.gunlocke.com for standard finish options.

model number	fabric grades							
GK1115-2W Mid back, arm left, Wood Legs	1	4,692	10	6,088	19	7,906	L1	6,831
	2	4,819	11	6,257	20	8,118	L2	8,598
	3	4,947	12	6,426	21	8,329	L3	10,720
	COM/4	5,073	13	6,638	22	8,541	L4	12,488
	5	5,242	14	6,849	23	8,963	L5	14,255
	6	5,411	15	7,060	24	9,386		
	7	5,581	16	7,272	25	9,809		
	8	5,750	17	7,483	26	10,231		
	9	5,919	18	7,695	27	10,655		

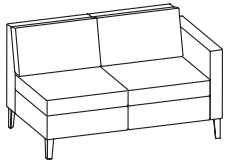

dimensions	W	D	H
Overall	52 5/8"	31 1/2"	32 1/8"
Seat	48 1/2"	21"	17 1/4"
Arm			26 7/8"
Between arms			

Upholstery Requirements: GK1115-2W

	Dual Upholstery	
Fabric yds	Cushions 2.9	Frame 3.8
Leather ft ²	Cushions 66.7	Frame 87.4
Shipping weight		117 lbs.
Cube		35

Cushion	1	10	604	19	1,391	L1	926	
	2	55	11	677	20	1,483	L2	1,691
	3	111	12	750	21	1,574	L3	2,609
	COM/4	165	13	842	22	1,666	L4	3,374
	5	238	14	934	23	1,849	L5	4,139
	6	311	15	1,025	24	2,032		
	7	385	16	1,117	25	2,215		
	8	458	17	1,208	26	2,397		
	9	531	18	1,300	27	2,581		

Top row of pricing is for units specified with same fabric on cushion and frame. Bottom 2 rows of pricing required only when two different fabric grades are selected for the cushion and frame.

To calculate price of lounge with different grade fabric for cushion and frame; start with Grade 1 price, add appropriate grade price located in second row for cushion, and last add appropriate grade price located in third row for frame to the sum of the Grade 1 and cushion price.

Example: Grade 1 \$4,692 + grade 4 fabric cushion \$165 + grade 2 fabric frame \$72 = \$4,929

Frame	1	10	792	19	1,823	L1	1,213	
	2	72	11	888	20	1,943	L2	2,215
	3	144	12	984	21	2,063	L3	3,419
	COM/4	216	13	1,104	22	2,183	L4	4,422
	5	312	14	1,223	23	2,422	L5	5,424
	6	408	15	1,343	24	2,662		
	7	504	16	1,463	25	2,902		
	8	600	17	1,583	26	3,142		
	9	696	18	1,703	27	3,382		

Select upholstery for everything else other than the seat and back cushions (the outside back, arms, sides, seat frame). You can specify the same fabric as the cushions or select other fabric.

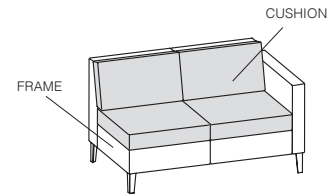

TO ORDER PLEASE SPECIFY THE FOLLOWING:

<input type="text"/>	<input type="text"/>	<input type="text"/>	<input type="text"/>	<input type="text"/>	<input type="text"/>
MODEL NUMBER	WOOD FINISH	STITCH DETAIL	FLAMMABILITY RATING	CUSHION UPHOLSTERY	FRAME UPHOLSTERY
	Cherry finishes on Maple Walnut finishes on Maple Maple finishes on Maple Oak finishes on Maple	None NR Stitch detail SD +\$191	U CTB117	Please refer to list of available upholstery and leather selections on www.gunlocke.com	Please refer to list of available upholstery and leather selections on www.gunlocke.com

Example

GK1115-2W	777	NR	U	DOL728	SPNNO4
MODEL NUMBER	WOOD FINISH	STITCH DETAIL	FLAMMABILITY UPHOLSTERY	CUSHION UPHOLSTERY	FRAME REQUEST

Please refer to the Ciji product page on www.gunlocke.com for standard finish options.

CIJI TWO SEAT

Mid Back, Arm Left, Aluminum Legs

model number	fabric grades							
GK1115-2A Mid back, arm left, Aluminum Legs	1	4,951	10	6,347	19	8,165	L1	7,090
	2	5,078	11	6,516	20	8,377	L2	8,857
	3	5,206	12	6,685	21	8,588	L3	10,979
	COM/4	5,332	13	6,897	22	8,800	L4	12,747
	5	5,501	14	7,108	23	9,222	L5	14,514
	6	5,670	15	7,319	24	9,645		
	7	5,840	16	7,531	25	10,068		
	8	6,009	17	7,742	26	10,490		
	9	6,178	18	7,954	27	10,914		

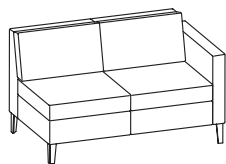

dimensions	W	D	H
Overall	52 5/8"	31 1/2"	32 1/8"
Seat	48 1/2"	21"	17 1/4"
Arm			26 7/8"
Between arms			

Upholstery Requirements: GK1115-2A

	Dual Upholstery	
Fabric yds	Cushions 2.9	Frame 3.8
Leather ft ²	Cushions 66.7	Frame 87.4
Shipping weight		117 lbs.
Cube		35

Cushion	1	10	19	L1	926			
	2	55	11	677	20	1,483	L2	1,691
	3	111	12	750	21	1,574	L3	2,609
	COM/4	165	13	842	22	1,666	L4	3,374
	5	238	14	934	23	1,849	L5	4,139
	6	311	15	1,025	24	2,032		
	7	385	16	1,117	25	2,215		
	8	458	17	1,208	26	2,397		
	9	531	18	1,300	27	2,581		

Top row of pricing is for units specified with same fabric on cushion and frame. Bottom 2 rows of pricing required only when two different fabric grades are selected for the cushion and frame.

To calculate price of lounge with different grade fabric for cushion and frame; start with Grade 1 price, add appropriate grade price located in second row for cushion, and last add appropriate grade price located in third row for frame to the sum of the Grade 1 and cushion price.

Example: Grade 1 \$4,951 + grade 4 fabric cushion \$165 + grade 2 fabric frame \$72 = \$5,188

Frame	1	10	19	L1	1,213			
	2	72	11	888	20	1,943	L2	2,215
	3	144	12	984	21	2,063	L3	3,419
	COM/4	216	13	1,104	22	2,183	L4	4,422
	5	312	14	1,223	23	2,422	L5	5,424
	6	408	15	1,343	24	2,662		
	7	504	16	1,463	25	2,902		
	8	600	17	1,583	26	3,142		
	9	696	18	1,703	27	3,382		

Select upholstery for everything else other than the seat and back cushions (the outside back, arms, sides, seat frame). You can specify the same fabric as the cushions or select other fabric.

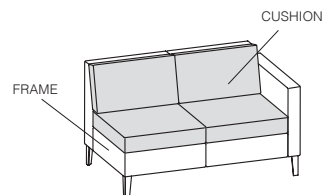

TO ORDER PLEASE SPECIFY THE FOLLOWING:

<input type="text"/>	<input type="text"/>	<input type="text"/>	<input type="text"/>	<input type="text"/>
MODEL NUMBER	STITCH DETAIL	FLAMMABILITY RATING	CUSHION UPHOLSTERY	FRAME UPHOLSTERY
	None NR Stitch detail SD +\$191	U CTB117	Please refer to list of available upholstery and leather selections on www.gunlocke.com	Please refer to list of available upholstery and leather selections on www.gunlocke.com

Example

GK1115-2A.NR.U.DOL728.SPNN04				
GK1115-2A	NR	U	DOL728	SPNN04
MODEL NUMBER	STITCH	FLAMMABILITY DETAIL	CUSHION UPHOLSTERY	FRAME UPHOLSTERY

Please refer to the Ciji product page on www.gunlocke.com for standard finish options.

model number	fabric grades							
GK1117-2W Mid back, arm right, Wood Legs	1	4,692	10	6,088	19	7,906	L1	6,831
	2	4,819	11	6,257	20	8,118	L2	8,598
	3	4,947	12	6,426	21	8,329	L3	10,720
	COM/4	5,073	13	6,638	22	8,541	L4	12,488
	5	5,242	14	6,849	23	8,963	L5	14,255
	6	5,411	15	7,060	24	9,386		
	7	5,581	16	7,272	25	9,809		
	8	5,750	17	7,483	26	10,231		
	9	5,919	18	7,695	27	10,655		

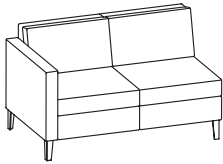

dimensions	W	D	H
Overall	52 5/8"	31 1/2"	32 1/8"
Seat	48 1/2"	21"	17 1/4"
Arm			26 7/8"
Between arms			

Upholstery Requirements: GK1117-2W

Dual Upholstery		
Fabric yds	Cushions 2.9	Frame 3.8
Leather ft ²	Cushions 66.7	Frame 87.4
Shipping weight		117 lbs.
Cube		35

Cushion	1	10	604	19	1,391	L1	926	
	2	55	11	677	20	1,483	L2	1,691
	3	111	12	750	21	1,574	L3	2,609
	COM/4	165	13	842	22	1,666	L4	3,374
	5	238	14	934	23	1,849	L5	4,139
	6	311	15	1,025	24	2,032		
	7	385	16	1,117	25	2,215		
	8	458	17	1,208	26	2,397		
	9	531	18	1,300	27	2,581		

Top row of pricing is for units specified with same fabric on cushion and frame. Bottom 2 rows of pricing required only when two different fabric grades are selected for the cushion and frame.

To calculate price of lounge with different grade fabric for cushion and frame; start with Grade 1 price, add appropriate grade price located in second row for cushion, and last add appropriate grade price located in third row for frame to the sum of the Grade 1 and cushion price.

Example: Grade 1 \$4,692 + grade 4 fabric cushion \$165 + grade 2 fabric frame \$72 = \$4,929

Frame	1	10	792	19	1,823	L1	1,213	
	2	72	11	888	20	1,943	L2	2,215
	3	144	12	984	21	2,063	L3	3,419
	COM/4	216	13	1,104	22	2,183	L4	4,422
	5	312	14	1,223	23	2,422	L5	5,424
	6	408	15	1,343	24	2,662		
	7	504	16	1,463	25	2,902		
	8	600	17	1,583	26	3,142		
	9	696	18	1,703	27	3,382		

Select upholstery for everything else other than the seat and back cushions (the outside back, arms, sides, seat frame). You can specify the same fabric as the cushions or select other fabric.

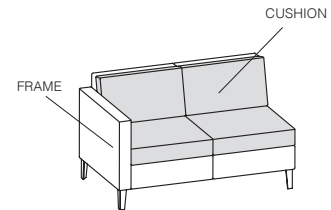

TO ORDER PLEASE SPECIFY THE FOLLOWING:

<input type="text"/>	<input type="text"/>	<input type="text"/>	<input type="text"/>	<input type="text"/>	<input type="text"/>
MODEL NUMBER	WOOD FINISH	STITCH DETAIL	FLAMMABILITY RATING	CUSHION UPHOLSTERY	FRAME UPHOLSTERY
	Cherry finishes on Maple Walnut finishes on Maple Maple finishes on Maple Oak finishes on Maple	None NR Stitch detail SD +\$191	U CTB117	Please refer to list of available upholstery and leather selections on www.gunlocke.com	Please refer to list of available upholstery and leather selections on www.gunlocke.com

Example

GK1117-2W.777.NR.U.DOL728.SPNO4
GK1117-2W 777 NR U DOL728 SPNO4
MODEL NUMBER WOOD FINISH STITCH DETAIL FLAMMABILITY UPHOLSTERY CUSHION UPHOLSTERY FRAME REQUEST

Please refer to the Ciji product page on www.gunlocke.com for standard finish options.

CIJI TWO SEAT

Mid Back, Arm Left, Aluminum Legs

model number	fabric grades							
GK1117-2A Mid back, arm left, Aluminum Legs	1	4,951	10	6,347	19	8,165	L1	7,090
	2	5,078	11	6,516	20	8,377	L2	8,857
	3	5,206	12	6,685	21	8,588	L3	10,979
	COM/4	5,332	13	6,897	22	8,800	L4	12,747
	5	5,501	14	7,108	23	9,222	L5	14,514
	6	5,670	15	7,319	24	9,645		
	7	5,840	16	7,531	25	10,068		
	8	6,009	17	7,742	26	10,490		
	9	6,178	18	7,954	27	10,914		

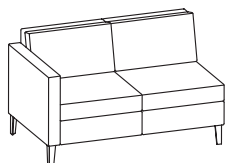

dimensions	W	D	H
Overall	52 5/8"	31 1/2"	32 1/8"
Seat	48 1/2"	21"	17 1/4"
Arm			26 7/8"
Between arms			

Upholstery Requirements: GK1117-2A

	Dual Upholstery	
Fabric yds	Cushions 2.9	Frame 3.8
Leather ft ²	Cushions 66.7	Frame 87.4
Shipping weight		117 lbs.
Cube		35

Cushion	1	10	19	L1	926			
	2	55	11	677	20	1,483	L2	1,691
	3	111	12	750	21	1,574	L3	2,609
	COM/4	165	13	842	22	1,666	L4	3,374
	5	238	14	934	23	1,849	L5	4,139
	6	311	15	1,025	24	2,032		
	7	385	16	1,117	25	2,215		
	8	458	17	1,208	26	2,397		
	9	531	18	1,300	27	2,581		

Top row of pricing is for units specified with same fabric on cushion and frame. Bottom 2 rows of pricing required only when two different fabric grades are selected for the cushion and frame.

To calculate price of lounge with different grade fabric for cushion and frame; start with Grade 1 price, add appropriate grade price located in second row for cushion, and last add appropriate grade price located in third row for frame to the sum of the Grade 1 and cushion price.

Example: Grade 1 \$4,951 + grade 4 fabric cushion \$165 + grade 2 fabric frame \$72 = \$5,188

Frame	1	10	19	L1	1,213			
	2	72	11	888	20	1,943	L2	2,215
	3	144	12	984	21	2,063	L3	3,419
	COM/4	216	13	1,104	22	2,183	L4	4,422
	5	312	14	1,223	23	2,422	L5	5,424
	6	408	15	1,343	24	2,662		
	7	504	16	1,463	25	2,902		
	8	600	17	1,583	26	3,142		
	9	696	18	1,703	27	3,382		

Select upholstery for everything else other than the seat and back cushions (the outside back, arms, sides, seat frame). You can specify the same fabric as the cushions or select other fabric.

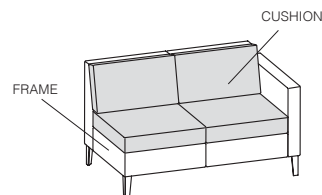

TO ORDER PLEASE SPECIFY THE FOLLOWING:

<input type="text"/>	<input type="text"/>	<input type="text"/>	<input type="text"/>	<input type="text"/>
MODEL NUMBER	STITCH DETAIL	FLAMMABILITY RATING	CUSHION UPHOLSTERY	FRAME UPHOLSTERY
	None NR Stitch detail SD +\$191	U CTB117	Please refer to list of available upholstery and leather selections on www.gunlocke.com	Please refer to list of available upholstery and leather selections on www.gunlocke.com

Example

GK1117-2A.NR.U.DOL728.SPNN04				
GK1117-2A	NR	U	DOL728	SPNN04
MODEL NUMBER	STITCH	FLAMMABILITY DETAIL	CUSHION UPHOLSTERY	FRAME UPHOLSTERY

Please refer to the Ciji product page on www.gunlocke.com for standard finish options.

Seating
03/23

CIJI THREE SEAT

Mid Back, with Arms, Wood Legs

model number	fabric grades							
GK1111-3W Mid back, with arms. Wood legs	1	6,231	10	8,377	19	11,172	L1	9,518
	2	6,426	11	8,637	20	11,497	L2	12,235
	3	6,622	12	8,895	21	11,823	L3	15,497
	COM/4	6,816	13	9,222	22	12,146	L4	18,214
	5	7,076	14	9,546	23	12,797	L5	20,934
	6	7,337	15	9,873	24	13,448		
	7	7,597	16	10,197	25	14,096		
	8	7,857	17	10,521	26	14,747		
	9	8,118	18	10,847	27	15,397		

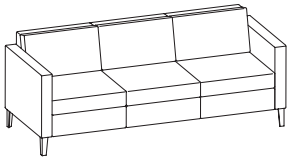

dimensions	W	D	H
Overall	80 3/4"	31 1/2"	32 1/8"
Seat	73"	21"	17 1/4"
Arm			26 7/8"
Between arms	73"		

Upholstery Requirements: GK1111-3W

	Dual Upholstery	
Fabric yds	Cushions 4.4	Frame 5.9
Leather ft ²	Cushions 101.2	Frame 135.7
Shipping weight		188 lbs.
Cube		78.5

Cushion	1	10	19	L1
	917	2,111	1,404	
	2 83	11 1,028	20 2,249	L2 2,565
	3 167	12 1,138	21 2,389	L3 3,958
	COM/4 250	13 1,278	22 2,527	L4 5,119
	5 361	14 1,416	23 2,805	L5 6,281
	6 472	15 1,556	24 3,083	
	7 584	16 1,694	25 3,360	
	8 695	17 1,833	26 3,638	
	9 806	18 1,972	27 3,916	

Top row of pricing is for units specified with same fabric on cushion and frame. Bottom 2 rows of pricing required only when two different fabric grades are selected for the cushion and frame.

To calculate price of lounge with different grade fabric for cushion and frame; start with Grade 1 price, add appropriate grade price located in second row for cushion, and last add appropriate grade price located in third row for frame to the sum of the Grade 1 and cushion price.

Example: Grade 1 \$6,231 + grade 4 fabric cushion \$250 + grade 2 fabric frame \$112 = \$6,593

Frame	1	10	19	L1
	1,229	2,830	1,883	
	2 112	11 1,378	20 3,017	L2 3,439
	3 224	12 1,526	21 3,203	L3 5,308
	COM/4 335	13 1,713	22 3,388	L4 6,864
	5 484	14 1,899	23 3,761	L5 8,422
	6 634	15 2,086	24 4,134	
	7 782	16 2,272	25 4,505	
	8 931	17 2,457	26 4,878	
	9 1,081	18 2,644	27 5,250	

Select upholstery for everything else other than the seat and back cushions (the outside back, arms, sides, seat frame). You can specify the same fabric as the cushions or select other fabric.

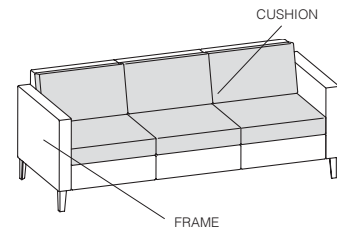

TO ORDER PLEASE SPECIFY THE FOLLOWING:

<input type="text"/>	<input type="text"/>	<input type="text"/>	<input type="text"/>	<input type="text"/>	<input type="text"/>
MODEL NUMBER	WOOD FINISH	STITCH DETAIL	FLAMMABILITY RATING	CUSHION UPHOLSTERY	FRAME UPHOLSTERY
	Cherry finishes on Maple Walnut finishes on Maple Maple finishes on Maple Oak finishes on Maple	None NR Stitch detail SD +\$191	U CTB117	Please refer to list of available upholstery and leather selections on www.gunlocke.com	Please refer to list of available upholstery and leather selections on www.gunlocke.com

Example

GK1111-3W.777.NR.U.DOL728.SPNN04
 GK1111-3W 777 NR U DOL728 SPNN04
 MODEL NUMBER WOOD FINISH STITCH DETAIL FLAMMABILITY UPHOLSTERY CUSHION UPHOLSTERY FRAME REQUEST

Please refer to the Ciji product page on www.gunlocke.com for standard finish options.

CIJI THREE SEAT

Mid Back, with Arms, Aluminum Legs

model number	fabric grades							
GK1111-3A Mid back, with arms, Aluminum legs	1	6,491	10	8,637	19	11,432	L1	9,778
	2	6,686	11	8,897	20	11,757	L2	12,495
	3	6,882	12	9,155	21	12,083	L3	15,757
	COM/4	7,076	13	9,482	22	12,406	L4	18,474
	5	7,336	14	9,806	23	13,057	L5	21,194
	6	7,597	15	10,133	24	13,708		
	7	7,857	16	10,457	25	14,356		
	8	8,117	17	10,781	26	15,007		
	9	8,378	18	11,107	27	15,657		

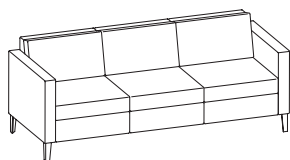

dimensions	W	D	H
Overall	80 3/4"	31 1/2"	32 1/8"
Seat	73"	21"	17 1/4"
Arm			26 7/8"
Between arms	73"		

Upholstery Requirements: GK1111-3A

	Dual Upholstery	
Fabric yds	Cushions 4.4	Frame 5.9
Leather ft ²	Cushions 101.2	Frame 135.7
Shipping weight		188 lbs.
Cube		78.5

Cushion	1	10	19	L1
	917	2,111	1,404	
	83	1,028	2,249	L2
	167	1,138	2,389	L3
COM/4	250	1,278	2,527	L4
	361	1,416	2,805	L5
	472	1,556	3,083	
	584	1,694	3,360	
	695	1,833	3,638	
	806	1,972	3,916	

Top row of pricing is for units specified with same fabric on cushion and frame. Bottom 2 rows of pricing required only when two different fabric grades are selected for the cushion and frame.

To calculate price of lounge with different grade fabric for cushion and frame; start with Grade 1 price, add appropriate grade price located in second row for cushion, and last add appropriate grade price located in third row for frame to the sum of the Grade 1 and cushion price.

Example: Grade 1 \$6,491 + grade 4 fabric cushion \$250 + grade 2 fabric frame \$112 = \$6,853

Frame	1	10	19	L1
	1,229	2,830	1,883	
	112	1,378	3,017	L2
	224	1,526	3,203	L3
COM/4	335	1,713	3,388	L4
	484	1,899	3,761	L5
	634	2,086	4,134	
	782	2,272	4,505	
	931	2,457	4,878	
	1,081	2,644	5,250	

Select upholstery for everything else other than the seat and back cushions (the outside back, arms, sides, seat frame). You can specify the same fabric as the cushions or select other fabric.

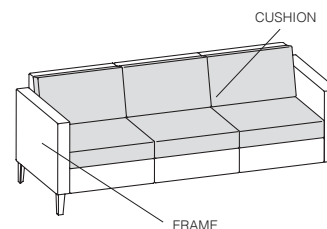

TO ORDER PLEASE SPECIFY THE FOLLOWING:

<input type="text"/>	<input type="text"/>	<input type="text"/>	<input type="text"/>	<input type="text"/>
MODEL NUMBER	STITCH DETAIL	FLAMMABILITY RATING	CUSHION UPHOLSTERY	FRAME UPHOLSTERY
	None NR Stitch detail SD +\$191	U CTB117	Please refer to list of available upholstery and leather selections on www.gunlocke.com	Please refer to list of available upholstery and leather selections on www.gunlocke.com

Example

GK1111-3A.NR.U.DOL728.SPNN04				
GK1111-3A	NR	U	DOL728	SPNN04
MODEL NUMBER	STITCH	FLAMMABILITY DETAIL	CUSHION UPHOLSTERY	FRAME UPHOLSTERY

Please refer to the Ciji product page on www.gunlocke.com for standard finish options.

Seating
03/23

CIJI THREE SEAT
Mid Back, Armless, Wood Legs

model number	fabric grades							
GK1113-3W Mid back, armless, Wood Legs	1	5,197	10	6,801	19	8,891	L1	7,654
	2	5,343	11	6,996	20	9,134	L2	9,686
	3	5,490	12	7,189	21	9,377	L3	12,124
	COM/4	5,635	13	7,434	22	9,620	L4	14,155
	5	5,829	14	7,675	23	10,106	L5	16,188
	6	6,024	15	7,920	24	10,592		
	7	6,219	16	8,161	25	11,078		
	8	6,414	17	8,405	26	11,564		
	9	6,607	18	8,648	27	12,050		

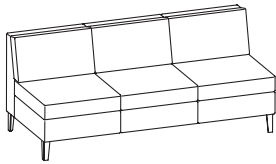

dimensions	W	D	H
Overall	73 5/8"	31 1/2"	32 1/8"
Seat	73"	21"	17 1/4"

Upholstery Requirements: GK1113-3W

Dual Upholstery	
Fabric yds	Cushions 4.4 Frame 3.3
Leather ft ²	Cushions 101.2 Frame 75.9
Shipping weight	168 lbs.
Cube	78.5

Cushion	1	10	19	L1
	917	2,111	1,404	
	83	1,028	2,249	L2
	167	1,138	2,389	L3
COM/4	250	1,278	2,527	L4
	361	1,416	2,805	L5
	472	1,556	3,083	
	584	1,694	3,360	
	695	1,833	3,638	
	806	1,972	3,916	

Top row of pricing is for units specified with same fabric on cushion and frame. Bottom 2 rows of pricing required only when two different fabric grades are selected for the cushion and frame.

To calculate price of lounge with different grade fabric for cushion and frame; start with Grade 1 price, add appropriate grade price located in second row for cushion, and last add appropriate grade price located in third row for frame to the sum of the Grade 1 and cushion price.

Example: Grade 1 \$5,197 + grade 4 fabric cushion \$250 + grade 2 fabric frame \$63 = \$5,510

Frame	1	10	19	L1
	687	1,583	1,053	
	63	771	1,688	L2
	126	854	1,791	L3
COM/4	188	959	1,896	L4
	271	1,062	2,104	L5
	355	1,167	2,312	
	438	1,270	2,521	
	522	1,375	2,729	
	604	1,479	2,937	

Select upholstery for everything else other than the seat and back cushions (the outside back, arms, sides, seat frame). You can specify the same fabric as the cushions or select other fabric.

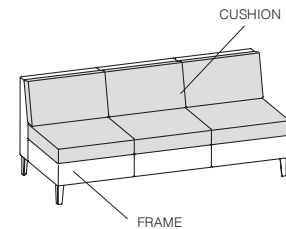

TO ORDER PLEASE SPECIFY THE FOLLOWING:

<input type="text"/>	<input type="text"/>	<input type="text"/>	<input type="text"/>	<input type="text"/>	<input type="text"/>
MODEL NUMBER	WOOD FINISH	STITCH DETAIL	FLAMMABILITY RATING	CUSHION UPHOLSTERY	FRAME UPHOLSTERY
	Cherry finishes on Maple Walnut finishes on Maple Maple finishes on Maple Oak finishes on Maple	None NR Stitch detail SD +\$191	U CTB117	Please refer to list of available upholstery and leather selections on www.gunlocke.com	Please refer to list of available upholstery and leather selections on www.gunlocke.com

Example

GK1113-3W	777	NR	U	DOL728	SPNNO4
MODEL NUMBER	WOOD FINISH	STITCH DETAIL	FLAMMABILITY UPHOLSTERY	CUSHION UPHOLSTERY	FRAME REQUEST

Please refer to the Ciji product page on www.gunlocke.com for standard finish options.

CIJI THREE SEAT

Mid Back, Armless, Aluminum Legs

Seating
03/23

model number fabric grades dimensions W D H

GK1113-3A

Mid back, armless,
Aluminum Legs

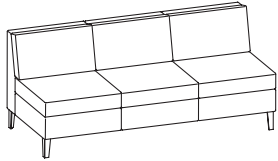

1	5,455	10	7,059	19	9,149	L1	7,912
2	5,601	11	7,254	20	9,392	L2	9,944
3	5,748	12	7,447	21	9,635	L3	12,382
COM/4	5,893	13	7,692	22	9,878	L4	14,413
5	6,087	14	7,933	23	10,364	L5	16,446
6	6,282	15	8,178	24	10,850		
7	6,477	16	8,419	25	11,336		
8	6,672	17	8,663	26	11,822		
9	6,865	18	8,906	27	12,308		

Overall	73 5/8"	31 1/2"	32 1/8"
Seat	73"	21"	17 1/4"

Upholstery Requirements: GK1113-3A

	Dual Upholstery	
Fabric yds	Cushions 4.4	Frame 3.3
Leather ft ²	Cushions 101.2	Frame 75.9
Shipping weight	168 lbs.	
Cube	78.5	

Cushion

1		10	917	19	2,111	L1	1,404
2	83	11	1,028	20	2,249	L2	2,565
3	167	12	1,138	21	2,389	L3	3,958
COM/4	250	13	1,278	22	2,527	L4	5,119
5	361	14	1,416	23	2,805	L5	6,281
6	472	15	1,556	24	3,083		
7	584	16	1,694	25	3,360		
8	695	17	1,833	26	3,638		
9	806	18	1,972	27	3,916		

Top row of pricing is for units specified with same fabric on cushion and frame. Bottom 2 rows of pricing required only when two different fabric grades are selected for the cushion and frame.

To calculate price of lounge with different grade fabric for cushion and frame; start with Grade 1 price, add appropriate grade price located in second row for cushion, and last add appropriate grade price located in third row for frame to the sum of the Grade 1 and cushion price.

Example: Grade 1 \$5,455 + grade 4 fabric cushion \$250 + grade 2 fabric frame \$63 = \$5,768

Frame

1		10	687	19	1,583	L1	1,053
2	63	11	771	20	1,688	L2	1,924
3	126	12	854	21	1,791	L3	2,969
COM/4	188	13	959	22	1,896	L4	3,839
5	271	14	1,062	23	2,104	L5	4,710
6	355	15	1,167	24	2,312		
7	438	16	1,270	25	2,521		
8	522	17	1,375	26	2,729		
9	604	18	1,479	27	2,937		

Select upholstery for everything else other than the seat and back cushions (the outside back, arms, sides, seat frame). You can specify the same fabric as the cushions or select other fabric.

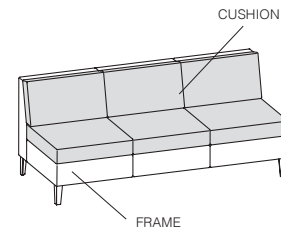

TO ORDER PLEASE SPECIFY THE FOLLOWING:

<input type="text"/>	<input type="text"/>	<input type="text"/>	<input type="text"/>	<input type="text"/>
MODEL NUMBER	STITCH DETAIL	FLAMMABILITY RATING	CUSHION UPHOLSTERY	FRAME UPHOLSTERY
	None NR Stitch detail SD +\$191	U CTB117	Please refer to list of available upholstery and leather selections on www.gunlocke.com	Please refer to list of available upholstery and leather selections on www.gunlocke.com

Example

GK1113-3A.NR.U.DOL728.SPNN04
 GK1111-3A NR U DOL728 SPNN04
 MODEL NUMBER STITCH FLAMMABILITY RATING CUSHION UPHOLSTERY FRAME UPHOLSTERY

Please refer to the Ciji product page on www.gunlocke.com for standard finish options.

Seating
03/23

CIJI THREE SEAT
Mid Back, Arm Left, Wood Legs

model number	fabric grades					dimensions		
GK1115-3W Mid back, arm left, Wood legs	1	6,012	10	8,034	19	10,665	L1	9,107
	2	6,196	11	8,278	20	10,970	L2	11,667
	3	6,380	12	8,522	21	11,278	L3	14,738
	COM/4	6,563	13	8,828	22	11,583	L4	17,298
	5	6,808	14	9,134	23	12,195	L5	19,858
	6	7,053	15	9,441	24	12,808		
	7	7,298	16	9,747	25	13,420		
	8	7,544	17	10,053	26	14,032		
	9	7,789	18	10,360	27	14,644		

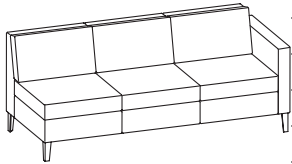

	W	D	H
Overall	77 1/8"	31 1/2"	32 1/8"
Seat	73"	21"	17 1/4"
Arm			26 7/8"
Between arms			

Upholstery Requirements: GK1115-3W

Dual Upholstery	
Fabric yds	Cushions 4.4 Frame 5.3
Leather ft ²	Cushions 101.2 Frame 121.9
Shipping weight	178 lbs.
Cube	78.5

Cushion	1	10	917	19	2,111	L1	1,404	
	2	83	11	1,028	20	2,249	L2	2,565
	3	167	12	1,138	21	2,389	L3	3,958
	COM/4	250	13	1,278	22	2,527	L4	5,119
	5	361	14	1,416	23	2,805	L5	6,281
	6	472	15	1,556	24	3,083		
	7	584	16	1,694	25	3,360		
	8	695	17	1,833	26	3,638		
	9	806	18	1,972	27	3,916		

Top row of pricing is for units specified with same fabric on cushion and frame. Bottom 2 rows of pricing required only when two different fabric grades are selected for the cushion and frame.

To calculate price of lounge with different grade fabric for cushion and frame; start with Grade 1 price, add appropriate grade price located in second row for cushion, and last add appropriate grade price located in third row for frame to the sum of the Grade 1 and cushion price.

Example: Grade 1 \$6,012 + grade 4 fabric cushion \$250 + grade 2 fabric frame \$101 = \$6,363

Frame	1	10	1,105	19	2,542	L1	1,691	
	2	101	11	1,238	20	2,709	L2	3,090
	3	201	12	1,372	21	2,877	L3	4,768
	COM/4	301	13	1,538	22	3,044	L4	6,167
	5	435	14	1,706	23	3,378	L5	7,565
	6	569	15	1,873	24	3,713		
	7	702	16	2,041	25	4,048		
	8	837	17	2,208	26	4,382		
	9	971	18	2,376	27	4,716		

Select upholstery for everything else other than the seat and back cushions (the outside back, arms, sides, seat frame). You can specify the same fabric as the cushions or select other fabric.

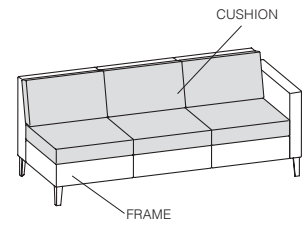

TO ORDER PLEASE SPECIFY THE FOLLOWING:

<input type="text"/>	<input type="text"/>	<input type="text"/>	<input type="text"/>	<input type="text"/>	<input type="text"/>
MODEL NUMBER	WOOD FINISH	STITCH DETAIL	FLAMMABILITY RATING	CUSHION UPHOLSTERY	FRAME UPHOLSTERY
	Cherry finishes on Maple Walnut finishes on Maple Maple finishes on Maple Oak finishes on Maple	None NR Stitch detail SD +\$191	U CTB117	Please refer to list of available upholstery and leather selections on www.gunlocke.com	Please refer to list of available upholstery and leather selections on www.gunlocke.com

Example

GK1115-3W	777	NR	U	DOL728	SPNNO4
MODEL NUMBER	WOOD FINISH	STITCH DETAIL	FLAMMABILITY UPHOLSTERY	CUSHION UPHOLSTERY	FRAME REQUEST

Please refer to the Ciji product page on www.gunlocke.com for standard finish options.

CIJI THREE SEAT

Mid Back, Arm Left, Aluminum Legs

model number	fabric grades							
GK1115-3A Mid back, arm left, Aluminum legs	1	6,271	10	8,293	19	10,924	L1	9,366
	2	6,455	11	8,537	20	11,229	L2	11,926
	3	6,639	12	8,781	21	11,537	L3	14,997
	COM/4	6,822	13	9,087	22	11,842	L4	17,557
	5	7,067	14	9,393	23	12,454	L5	20,117
	6	7,312	15	9,700	24	13,067		
	7	7,557	16	10,006	25	13,679		
	8	7,803	17	10,312	26	14,291		
	9	8,048	18	10,619	27	14,903		

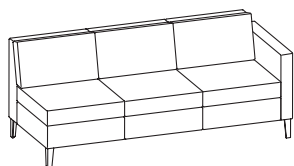

dimensions	W	D	H
Overall	77 1/8"	31 1/2"	32 1/8"
Seat	73"	21"	17 1/4"
Arm			26 7/8"
Between arms			

Upholstery Requirements: GK1115-3A

	Dual Upholstery	
Fabric yds	Cushions 4.4	Frame 5.3
Leather ft ²	Cushions 101.2	Frame 121.9
Shipping weight		178 lbs.
Cube		78.5

Cushion	1	10	19	20	21	22	23	24	25	26	27	L1	L2	L3	L4	L5
		917	2,111	1,404												
	83	1,028	2,249	2,565												
	167	1,138	2,389	3,958												
COM/4	250	1,278	2,527	5,119												
	361	1,416	2,805	6,281												
	472	1,556	3,083													
	584	1,694	3,360													
	695	1,833	3,638													
	806	1,972	3,916													

Top row of pricing is for units specified with same fabric on cushion and frame. Bottom 2 rows of pricing required only when two different fabric grades are selected for the cushion and frame.

To calculate price of lounge with different grade fabric for cushion and frame; start with Grade 1 price, add appropriate grade price located in second row for cushion, and last add appropriate grade price located in third row for frame to the sum of the Grade 1 and cushion price.

Example: Grade 1 \$6,271 + grade 4 fabric cushion \$250 + grade 2 fabric frame \$101 = \$6,622

Frame	1	10	19	20	21	22	23	24	25	26	27	L1	L2	L3	L4	L5
		1,105	2,542	1,691												
	101	1,238	2,709	3,090												
	201	1,372	2,877	4,768												
COM/4	301	1,538	3,044	6,167												
	435	1,706	3,378	7,565												
	569	1,873	3,713													
	702	2,041	4,048													
	837	2,208	4,382													
	971	2,376	4,716													

Select upholstery for everything else other than the seat and back cushions (the outside back, arms, sides, seat frame). You can specify the same fabric as the cushions or select other fabric.

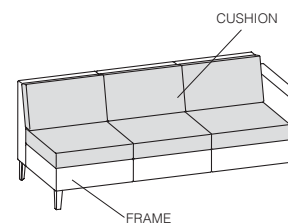

TO ORDER PLEASE SPECIFY THE FOLLOWING:

<input type="text"/>	<input type="text"/>	<input type="text"/>	<input type="text"/>	<input type="text"/>
MODEL NUMBER	STITCH DETAIL	FLAMMABILITY RATING	CUSHION UPHOLSTERY	FRAME UPHOLSTERY
	None NR Stitch detail SD +\$191	U CTB117	Please refer to list of available upholstery and leather selections on www.gunlocke.com	Please refer to list of available upholstery and leather selections on www.gunlocke.com

Example

GK1115-3A.NR.U.DOL728.SPNN04				
GK1115-3A	NR	U	DOL728	SPNN04
MODEL NUMBER	STITCH	FLAMMABILITY DETAIL	CUSHION UPHOLSTERY	FRAME UPHOLSTERY

Please refer to the Ciji product page on www.gunlocke.com for standard finish options.

Seating
03/23

CIJI THREE SEAT

Mid Back, Arm Right, Wood Legs

model number	fabric grades							
GK1117-3W Mid back, arm right, Wood legs	1	6,012	10	8,034	19	10,665	L1	9,107
	2	6,196	11	8,278	20	10,970	L2	11,667
	3	6,380	12	8,522	21	11,278	L3	14,738
	COM/4	6,563	13	8,828	22	11,583	L4	17,298
	5	6,808	14	9,134	23	12,195	L5	19,858
	6	7,053	15	9,441	24	12,808		
	7	7,298	16	9,747	25	13,420		
	8	7,544	17	10,053	26	14,032		
	9	7,789	18	10,360	27	14,644		

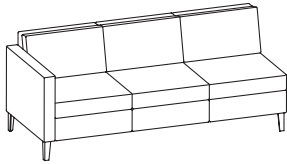

dimensions	W	D	H
Overall	77 1/8"	31 1/2"	32 1/8"
Seat	73"	21"	17 1/4"
Arm			26 7/8"
Between arms			

Upholstery Requirements: GK1117-3W

Dual Upholstery	
Fabric yds	Cushions 4.4 Frame 5.3
Leather ft²	Cushions 101.2 Frame 121.9
Shipping weight	178 lbs.
Cube	78.5

Cushion	1	10	19	20	21	22	L1	L2	L3	L4	L5
		917	2,111	2,249	2,389	2,527	1,404	2,565	3,958	5,119	6,281
	83	1,028	2,249	2,389	2,527	2,665	1,404	2,565	3,958	5,119	6,281
	167	1,138	2,389	2,527	2,665	2,805	1,404	2,565	3,958	5,119	6,281
COM/4	250	1,278	2,527	2,665	2,805	2,943	1,404	2,565	3,958	5,119	6,281
	361	1,416	2,805	2,943	3,083	3,221	1,404	2,565	3,958	5,119	6,281
	472	1,556	3,083	3,221	3,360	3,498	1,404	2,565	3,958	5,119	6,281
	584	1,694	3,360	3,498	3,638	3,776	1,404	2,565	3,958	5,119	6,281
	695	1,833	3,638	3,776	3,916	4,054	1,404	2,565	3,958	5,119	6,281
	806	1,972	3,916	4,054	4,192	4,330	1,404	2,565	3,958	5,119	6,281

Top row of pricing is for units specified with same fabric on cushion and frame. Bottom 2 rows of pricing required only when two different fabric grades are selected for the cushion and frame.

To calculate price of lounge with different grade fabric for cushion and frame; start with Grade 1 price, add appropriate grade price located in second row for cushion, and last add appropriate grade price located in third row for frame to the sum of the Grade 1 and cushion price.

Example: Grade 1 \$6,012 + grade 4 fabric cushion \$250 + grade 2 fabric frame \$101 = \$6,363

Frame	1	10	19	20	21	22	L1	L2	L3	L4	L5
		1,105	2,542	2,709	2,877	3,044	1,691	3,090	4,768	6,167	7,565
	101	1,238	2,709	2,877	3,044	3,211	1,691	3,090	4,768	6,167	7,565
	201	1,372	2,877	3,044	3,211	3,378	1,691	3,090	4,768	6,167	7,565
COM/4	301	1,538	3,044	3,211	3,378	3,545	1,691	3,090	4,768	6,167	7,565
	435	1,706	3,378	3,545	3,713	3,880	1,691	3,090	4,768	6,167	7,565
	569	1,873	3,713	3,880	4,048	4,215	1,691	3,090	4,768	6,167	7,565
	702	2,041	4,048	4,215	4,382	4,549	1,691	3,090	4,768	6,167	7,565
	837	2,208	4,382	4,549	4,716	4,883	1,691	3,090	4,768	6,167	7,565
	971	2,376	4,716	4,883	5,050	5,217	1,691	3,090	4,768	6,167	7,565

Select upholstery for everything else other than the seat and back cushions (the outside back, arms, sides, seat frame). You can specify the same fabric as the cushions or select other fabric.

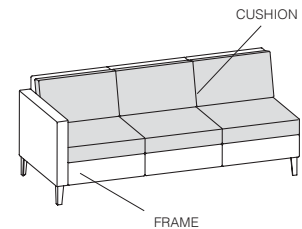

TO ORDER PLEASE SPECIFY THE FOLLOWING:

<input type="text"/>	<input type="text"/>	<input type="text"/>	<input type="text"/>	<input type="text"/>	<input type="text"/>
MODEL NUMBER	WOOD FINISH	STITCH DETAIL	FLAMMABILITY RATING	CUSHION UPHOLSTERY	FRAME UPHOLSTERY
	Cherry finishes on Maple Walnut finishes on Maple Maple finishes on Maple Oak finishes on Maple	None NR Stitch detail SD +\$191	U CTB117	Please refer to list of available upholstery and leather selections on www.gunlocke.com	Please refer to list of available upholstery and leather selections on www.gunlocke.com

Example

GK1117-3W.777.NR.U.DOL728.SPNN04
 GK1117-3W 777 NR U DOL728 SPNN04
 MODEL NUMBER WOOD FINISH STITCH DETAIL FLAMMABILITY UPHOLSTERY CUSHION UPHOLSTERY FRAME REQUEST

Please refer to the Ciji product page on www.gunlocke.com for standard finish options.

CIJI THREE SEAT

Mid Back, Arm Right, Aluminum Legs

Seating
03/23

model number	fabric grades						dimensions	W	D	H		
GK1117-3A Mid back, arm right, Aluminum legs	1	6,271	10	8,293	19	10,924	L1	9,366	Overall	77 1/8"	31 1/2"	32 1/8"
	2	6,455	11	8,537	20	11,229	L2	11,926	Seat	73"	21"	17 1/4"
	3	6,639	12	8,781	21	11,537	L3	14,997	Arm			26 7/8"
	COM/4	6,822	13	9,087	22	11,842	L4	17,557	Between arms			
	5	7,067	14	9,393	23	12,454	L5	20,117				
	6	7,312	15	9,700	24	13,067						
	7	7,557	16	10,006	25	13,679						
	8	7,803	17	10,312	26	14,291						
	9	8,048	18	10,619	27	14,903						

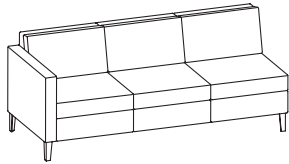

Upholstery Requirements: GK1117-3A

	Dual Upholstery	
Fabric yds	Cushions 4.4	Frame 5.3
Leather ft ²	Cushions 101.2	Frame 121.9
Shipping weight		178 lbs.
Cube		78.5

Cushion	1	10	19	L1
	917	2,111	1,404	
	83	1,028	2,249	L2
	167	1,138	2,389	L3
COM/4	250	1,278	2,527	L4
	361	1,416	2,805	L5
	472	1,556	3,083	
	584	1,694	3,360	
	695	1,833	3,638	
	806	1,972	3,916	

Top row of pricing is for units specified with same fabric on cushion and frame. Bottom 2 rows of pricing required only when two different fabric grades are selected for the cushion and frame.

To calculate price of lounge with different grade fabric for cushion and frame; start with Grade 1 price, add appropriate grade price located in second row for cushion, and last add appropriate grade price located in third row for frame to the sum of the Grade 1 and cushion price.

Example: Grade 1 \$6,271 + grade 4 fabric cushion \$250 + grade 2 fabric frame \$101 = \$6,622

Frame	1	10	19	L1
	1,105	2,542	1,691	
	101	1,238	2,709	L2
	201	1,372	2,877	L3
COM/4	301	1,538	3,044	L4
	435	1,706	3,378	L5
	569	1,873	3,713	
	702	2,041	4,048	
	837	2,208	4,382	
	971	2,376	4,716	

Select upholstery for everything else other than the seat and back cushions (the outside back, arms, sides, seat frame). You can specify the same fabric as the cushions or select other fabric.

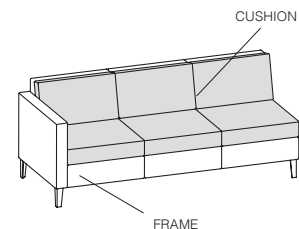

TO ORDER PLEASE SPECIFY THE FOLLOWING:

<input type="text"/>	<input type="text"/>	<input type="text"/>	<input type="text"/>	<input type="text"/>
MODEL NUMBER	STITCH DETAIL	FLAMMABILITY RATING	CUSHION UPHOLSTERY	FRAME UPHOLSTERY
	None NR Stitch detail SD +\$191	U CTB117	Please refer to list of available upholstery and leather selections on www.gunlocke.com	Please refer to list of available upholstery and leather selections on www.gunlocke.com

Example

GK1117-3A.NR.U.DOL728.SPNN04				
GK1117-3A	NR	U	DOL728	SPNN04
MODEL NUMBER	STITCH	FLAMMABILITY DETAIL	CUSHION UPHOLSTERY	FRAME UPHOLSTERY

Please refer to the Ciji product page on www.gunlocke.com for standard finish options.

model number	fabric grades						dimensions	W	D	H		
GK1109W Low back, Wood Legs	1	3,612	10	4,676	19	6,059	L1	5,240	Overall	31 3/4"	31 1/4"	27 7/8"
	2	3,710	11	4,804	20	6,219	L2	6,585	Seat	20 3/4"	20 3/4"	17 1/4"
	3	3,806	12	4,933	21	6,380	L3	8,201	Upholstery Requirements: GK1109W			
	COM/4	3,903	13	5,093	22	6,540	L4	9,547	Dual Upholstery			
	5	4,032	14	5,254	23	6,864	L5	10,893	Fabric yds Cushions 2.7 Frame 2.4			
	6	4,160	15	5,415	24	7,185			Leather ft ² Cushions 62.1 Frame 55.2			
	7	4,289	16	5,577	25	7,507			Shipping weight 93 lbs.			
	8	4,418	17	5,737	26	7,829			Cube 28			
	9	4,546	18	5,898	27	8,151						



Cushion	1	10	563	19	1,295	L1	862	
	2	52	11	631	20	1,380	L2	1,574
	3	103	12	699	21	1,465	L3	2,429
	COM/4	154	13	784	22	1,550	L4	3,142
	5	222	14	869	23	1,722	L5	3,855
	6	290	15	954	24	1,892		
	7	358	16	1,040	25	2,062		
	8	427	17	1,125	26	2,233		
	9	494	18	1,210	27	2,403		

Top row of pricing is for units specified with same fabric on cushion and frame. Bottom 2 rows of pricing required only when two different fabric grades are selected for the cushion and frame.

To calculate price of lounge with different grade fabric for cushion and frame; start with Grade 1 price, add appropriate grade price located in second row for cushion, and last add appropriate grade price located in third row for frame to the sum of the Grade 1 and cushion price.

Example: Grade 1 \$3,612 + grade 4 fabric cushion \$154 + grade 2 fabric frame \$46 = \$3,812

Frame	1	10	501	19	1,152	L1	766	
	2	46	11	561	20	1,227	L2	1,399
	3	91	12	622	21	1,303	L3	2,160
	COM/4	137	13	697	22	1,378	L4	2,793
	5	198	14	773	23	1,530	L5	3,426
	6	258	15	849	24	1,681		
	7	319	16	925	25	1,833		
	8	379	17	1,000	26	1,984		
	9	440	18	1,076	27	2,136		

Select upholstery for everything else other than the seat and back cushions (the outside back, arms, sides, seat frame). You can specify the same fabric as the cushions or select other fabric.

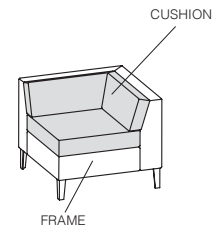

TO ORDER PLEASE SPECIFY THE FOLLOWING:

<input type="text"/>	<input type="text"/>	<input type="text"/>	<input type="text"/>	<input type="text"/>	<input type="text"/>
MODEL NUMBER	WOOD FINISH	STITCH DETAIL	FLAMMABILITY RATING	CUSHION UPHOLSTERY	FRAME UPHOLSTERY
	Cherry finishes on Maple Walnut finishes on Maple Maple finishes on Maple Oak finishes on Maple	None NR Stitch detail SD +\$191	U CTB117	Please refer to list of available upholstery and leather selections on www.gunlocke.com	Please refer to list of available upholstery and leather selections on www.gunlocke.com

Example

GK1109W.777.NR.U.DOL728.SPNN04
 GK1109W 777 NR U DOL728 SPNN04
 MODEL NUMBER WOOD FINISH STITCH DETAIL FLAMMABILITY UPHOLSTERY CUSHION UPHOLSTERY FRAME REQUEST

Please refer to the Ciji product page on www.gunlocke.com for standard finish options.

CIJI CORNER UNIT

Low Back, Aluminum Legs

model number	fabric grades						dimensions	W	D	H		
GK1109A Low back, Aluminum Legs	1	3,870	10	4,934	19	6,317	L1	5,498	Overall	31 3/4"	31 1/4"	27 7/8"
	2	3,968	11	5,062	20	6,477	L2	6,843	Seat	20 3/4"	20 3/4"	17 1/4"
	3	4,064	12	5,191	21	6,638	L3	8,459	Upholstery Requirements: GK1109A			
	COM/4	4,161	13	5,351	22	6,798	L4	9,805	Dual Upholstery			
	5	4,290	14	5,512	23	7,122	L5	11,151	Fabric yds Cushions 2.7 Frame 2.4			
	6	4,418	15	5,673	24	7,443			Leather ft ² Cushions 62.1 Frame 55.2			
	7	4,547	16	5,835	25	7,765			Shipping weight 93 lbs.			
	8	4,676	17	5,995	26	8,087			Cube 28			
	9	4,804	18	6,156	27	8,409						

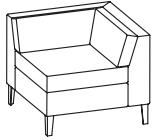

Cushion	1	10	563	19	1,295	L1	862	
	2	52	11	631	20	1,380	L2	1,574
	3	103	12	699	21	1,465	L3	2,429
	COM/4	154	13	784	22	1,550	L4	3,142
	5	222	14	869	23	1,722	L5	3,855
	6	290	15	954	24	1,892		
	7	358	16	1,040	25	2,062		
	8	427	17	1,125	26	2,233		
	9	494	18	1,210	27	2,403		

Top row of pricing is for units specified with same fabric on cushion and frame. Bottom 2 rows of pricing required only when two different fabric grades are selected for the cushion and frame.

To calculate price of lounge with different grade fabric for cushion and frame; start with Grade 1 price, add appropriate grade price located in second row for cushion, and last add appropriate grade price located in third row for frame to the sum of the Grade 1 and cushion price.

Example: Grade 1 \$3,870 + grade 4 fabric cushion \$154 + grade 2 fabric frame \$46 = \$4,070

Frame	1	10	501	19	1,152	L1	766	
	2	46	11	561	20	1,227	L2	1,399
	3	91	12	622	21	1,303	L3	2,160
	COM/4	137	13	697	22	1,378	L4	2,793
	5	198	14	773	23	1,530	L5	3,426
	6	258	15	849	24	1,681		
	7	319	16	925	25	1,833		
	8	379	17	1,000	26	1,984		
	9	440	18	1,076	27	2,136		

Select upholstery for everything else other than the seat and back cushions (the outside back, arms, sides, seat frame). You can specify the same fabric as the cushions or select other fabric.

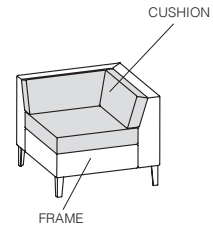

TO ORDER PLEASE SPECIFY THE FOLLOWING:

<input type="text"/>	<input type="text"/>	<input type="text"/>	<input type="text"/>	<input type="text"/>
MODEL NUMBER	STITCH DETAIL	FLAMMABILITY RATING	CUSHION UPHOLSTERY	FRAME UPHOLSTERY
	None NR Stitch detail SD +\$191	U CTB117	Please refer to list of available upholstery and leather selections on www.gunlocke.com	Please refer to list of available upholstery and leather selections on www.gunlocke.com

Example

GK1109A.NR.U.DOL728.SPNN04

GK1109A	NR	U	DOL728	SPNN04
MODEL NUMBER	STITCH	FLAMMABILITY DETAIL	CUSHION UPHOLSTERY	FRAME UPHOLSTERY

Please refer to the Ciji product page on www.gunlocke.com for standard finish options.

model number	fabric grades								dimensions	W	D	H
GK1119W Mid back, Wood legs	1	3,674	10	4,759	19	6,168	L1	5,334	Overall	31 3/4"	31 1/2"	32 1/8"
	2	3,773	11	4,890	20	6,332	L2	6,706	Seat	20 3/4"	20 3/4"	17 1/4"
	3	3,872	12	5,020	21	6,497	L3	8,352	Upholstery Requirements: GK1119W			
	COM/4	3,970	13	5,184	22	6,660	L4	9,725	Dual Upholstery			
	5	4,101	14	5,348	23	6,990	L5	11,098	Fabric yds Cushions 2.7 Frame 2.5			
	6	4,233	15	5,512	24	7,318			Leather ft ² Cushions 62.1 Frame 57.5			
	7	4,364	16	5,677	25	7,645			Shipping weight 97 lbs.			
	8	4,496	17	5,840	26	7,974			Cube 28			
	9	4,626	18	6,005	27	8,302						



Cushion	1	10	563	19	1,295	L1	862	
	2	52	11	631	20	1,380	L2	1,574
	3	103	12	699	21	1,465	L3	2,429
	COM/4	154	13	784	22	1,550	L4	3,142
	5	222	14	869	23	1,722	L5	3,855
	6	290	15	954	24	1,892		
	7	358	16	1,040	25	2,062		
	8	427	17	1,125	26	2,233		
	9	494	18	1,210	27	2,403		

Top row of pricing is for units specified with same fabric on cushion and frame. Bottom 2 rows of pricing required only when two different fabric grades are selected for the cushion and frame.

To calculate price of lounge with different grade fabric for cushion and frame; start with Grade 1 price, add appropriate grade price located in second row for cushion, and last add appropriate grade price located in third row for frame to the sum of the Grade 1 and cushion price.

Example: Grade 1 \$3,674 + grade 4 fabric cushion \$154 + grade 2 fabric frame \$47 = \$3,875

Frame	1	10	522	19	1,199	L1	798	
	2	47	11	585	20	1,278	L2	1,458
	3	95	12	647	21	1,358	L3	2,249
	COM/4	142	13	726	22	1,436	L4	2,909
	5	205	14	805	23	1,594	L5	3,569
	6	269	15	884	24	1,752		
	7	332	16	963	25	1,909		
	8	395	17	1,041	26	2,067		
	9	458	18	1,121	27	2,225		

Select upholstery for everything else other than the seat and back cushions (the outside back, arms, sides, seat frame). You can specify the same fabric as the cushions or select other fabric.

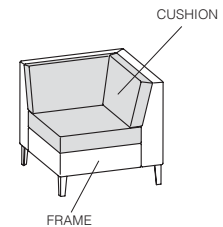

TO ORDER PLEASE SPECIFY THE FOLLOWING:

<input type="text"/>	<input type="text"/>	<input type="text"/>	<input type="text"/>	<input type="text"/>	<input type="text"/>
MODEL NUMBER	WOOD FINISH	STITCH DETAIL	FLAMMABILITY RATING	CUSHION UPHOLSTERY	FRAME UPHOLSTERY
	Cherry finishes on Maple Walnut finishes on Maple Maple finishes on Maple Oak finishes on Maple	None NR Stitch detail SD +\$191	U CTB117	Please refer to list of available upholstery and leather selections on www.gunlocke.com	Please refer to list of available upholstery and leather selections on www.gunlocke.com

Example

GK1119W.777.NR.U.DOL728.SPNN04
 GK1119W 777 NR U DOL728 SPNN04
 MODEL NUMBER WOOD FINISH STITCH DETAIL FLAMMABILITY UPHOLSTERY CUSHION UPHOLSTERY FRAME REQUEST

Please refer to the Ciji product page on www.gunlocke.com for standard finish options.

CIJI CORNER UNIT

Mid Back, Aluminum Legs

Seating
03/23

model number fabric grades dimensions W D H

GK1119A
Mid back,
Aluminum legs



1	3,932	10	5,017	19	6,426	L1	5,592
2	4,031	11	5,148	20	6,590	L2	6,964
3	4,130	12	5,278	21	6,755	L3	8,610
COM/4	4,228	13	5,442	22	6,918	L4	9,983
5	4,359	14	5,606	23	7,248	L5	11,356
6	4,491	15	5,770	24	7,576		
7	4,622	16	5,935	25	7,903		
8	4,754	17	6,098	26	8,232		
9	4,884	18	6,263	27	8,560		

Overall	31 3/4"	31 1/2"	32 1/8"
Seat	20 3/4"	20 3/4"	17 1/4"

Upholstery Requirements: GK1119A

	Dual Upholstery
Fabric yds	Cushions 2.7 Frame 2.5
Leather ft ²	Cushions 62.1 Frame 57.5
Shipping weight	97 lbs.
Cube	28

Cushion

1		10	563	19	1,295	L1	862
2	52	11	631	20	1,380	L2	1,574
3	103	12	699	21	1,465	L3	2,429
COM/4	154	13	784	22	1,550	L4	3,142
5	222	14	869	23	1,722	L5	3,855
6	290	15	954	24	1,892		
7	358	16	1,040	25	2,062		
8	427	17	1,125	26	2,233		
9	494	18	1,210	27	2,403		

Top row of pricing is for units specified with same fabric on cushion and frame. Bottom 2 rows of pricing required only when two different fabric grades are selected for the cushion and frame.

To calculate price of lounge with different grade fabric for cushion and frame; start with Grade 1 price, add appropriate grade price located in second row for cushion, and last add appropriate grade price located in third row for frame to the sum of the Grade 1 and cushion price.

Example: Grade 1 \$3,932 + grade 4 fabric cushion \$154 + grade 2 fabric frame \$47 = \$4,133

Frame

1		10	522	19	1,199	L1	798
2	47	11	585	20	1,278	L2	1,458
3	95	12	647	21	1,358	L3	2,249
COM/4	142	13	726	22	1,436	L4	2,909
5	205	14	805	23	1,594	L5	3,569
6	269	15	884	24	1,752		
7	332	16	963	25	1,909		
8	395	17	1,041	26	2,067		
9	458	18	1,121	27	2,225		

Select upholstery for everything else other than the seat and back cushions (the outside back, arms, sides, seat frame). You can specify the same fabric as the cushions or select other fabric.

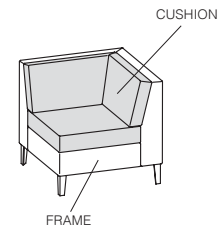

TO ORDER PLEASE SPECIFY THE FOLLOWING:

<input type="text"/>	<input type="text"/>	<input type="text"/>	<input type="text"/>	<input type="text"/>
MODEL NUMBER	STITCH DETAIL	FLAMMABILITY RATING	CUSHION UPHOLSTERY	FRAME UPHOLSTERY
	None NR Stitch detail SD +\$191	U CTB117	Please refer to list of available upholstery and leather selections on www.gunlocke.com	Please refer to list of available upholstery and leather selections on www.gunlocke.com

Example

GK1119A.NR.U.DOL728.SPNN04

GK1119A	NR	U	DOL728	SPNN04
MODEL NUMBER	STITCH	FLAMMABILITY DETAIL	CUSHION UPHOLSTERY	FRAME UPHOLSTERY

Please refer to the Ciji product page on www.gunlocke.com for standard finish options.

model number	fabric grades							
GK1121-1W Single seat, Wood legs	1	1,971	10	2,492	19	3,171	L1	2,769
	2	2,020	11	2,556	20	3,250	L2	3,429
	3	2,067	12	2,619	21	3,328	L3	4,221
	COM/4	2,115	13	2,698	22	3,407	L4	4,881
	5	2,177	14	2,776	23	3,566	L5	5,540
	6	2,240	15	2,855	24	3,723		
	7	2,304	16	2,935	25	3,881		
	8	2,366	17	3,014	26	4,038		
	9	2,429	18	3,092	27	4,197		

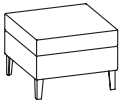

dimensions	W	D	H
Overall	24 5/8"	24 3/4"	17 1/4"
Seat	24 5/8"	24 3/4"	17 1/4"

Upholstery Requirements: GK1121-1W

Dual Upholstery	
Fabric yds	Cushions 1.2 Frame 1.3
Leather ft ²	Cushions 27.6 Frame 29.9
Shipping weight	64 lbs.
Cube	28

Cushion	1	10	250	19	576	L1	383	
	2	23	11	281	20	614	L2	700
	3	46	12	311	21	651	L3	1,080
	COM/4	69	13	349	22	689	L4	1,397
	5	99	14	386	23	766	L5	1,713
	6	129	15	425	24	841		
	7	160	16	463	25	917		
	8	190	17	501	26	992		
	9	220	18	538	27	1,069		

Top row of pricing is for units specified with same fabric on cushion and frame. Bottom 2 rows of pricing required only when two different fabric grades are selected for the cushion and frame.

To calculate price of lounge with different grade fabric for cushion and frame; start with Grade 1 price, add appropriate grade price located in second row for cushion, and last add appropriate grade price located in third row for frame to the sum of the Grade 1 and cushion price.

Example: Grade 1 \$1,971 + grade 4 fabric cushion \$69 + grade 2 fabric frame \$26 = \$2,066

Frame	1	10	271	19	624	L1	415	
	2	26	11	304	20	665	L2	758
	3	50	12	337	21	706	L3	1,170
	COM/4	75	13	378	22	747	L4	1,513
	5	107	14	419	23	829	L5	1,856
	6	140	15	459	24	911		
	7	173	16	501	25	993		
	8	205	17	542	26	1,075		
	9	238	18	583	27	1,157		

Select upholstery for everything else other than the seat and back cushions (the outside back, arms, sides, seat frame). You can specify the same fabric as the cushions or select other fabric.

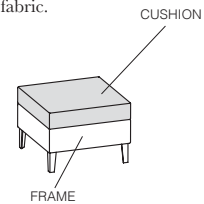

TO ORDER PLEASE SPECIFY THE FOLLOWING:

<input type="text"/>	<input type="text"/>	<input type="text"/>	<input type="text"/>	<input type="text"/>	<input type="text"/>
MODEL NUMBER	WOOD FINISH	STITCH DETAIL	FLAMMABILITY RATING	CUSHION UPHOLSTERY	FRAME UPHOLSTERY
	Cherry finishes on Maple Walnut finishes on Maple Maple finishes on Maple Oak finishes on Maple	None NR Stitch detail SD +\$191	U CTB117	Please refer to list of available upholstery and leather selections on www.gunlocke.com	Please refer to list of available upholstery and leather selections on www.gunlocke.com

Example

GK1121-1W.777.NR.U.DOL728.SPNN04
GK1121-1W 777 NR U DOL728 SPNN04
MODEL NUMBER WOOD FINISH STITCH DETAIL FLAMMABILITY UPHOLSTERY CUSHION UPHOLSTERY FRAME REQUEST

Please refer to the Ciji product page on www.gunlocke.com for standard finish options.

CIJI BENCH

Single Seat, Aluminum Legs

Seating
03/23

model number	fabric grades							
GK1121-1A Single seat, Aluminum legs	1	2,228	10	2,749	19	3,428	L1	3,026
	2	2,277	11	2,813	20	3,507	L2	3,686
	3	2,324	12	2,876	21	3,585	L3	4,478
	COM/4	2,372	13	2,955	22	3,664	L4	5,138
	5	2,434	14	3,033	23	3,823	L5	5,797
	6	2,497	15	3,112	24	3,980		
	7	2,561	16	3,192	25	4,138		
	8	2,623	17	3,271	26	4,295		
	9	2,686	18	3,349	27	4,454		

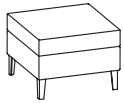

dimensions	W	D	H
Overall	24 5/8"	24 3/4"	17 1/4"
Seat	24 5/8"	24 3/4"	17 1/4"

Upholstery Requirements: GK1121-1A

Dual Upholstery	
Fabric yds	Cushions 1.2 Frame 1.3
Leather ft ²	Cushions 27.6 Frame 29.9
Shipping weight	64 lbs.
Cube	28

Cushion	1	10	19	250	576	L1	383	
	2	23	11	281	20	614	L2	700
	3	46	12	311	21	651	L3	1,080
	COM/4	69	13	349	22	689	L4	1,397
	5	99	14	386	23	766	L5	1,713
	6	129	15	425	24	841		
	7	160	16	463	25	917		
	8	190	17	501	26	992		
	9	220	18	538	27	1,069		

Top row of pricing is for units specified with same fabric on cushion and frame. Bottom 2 rows of pricing required only when two different fabric grades are selected for the cushion and frame.

To calculate price of lounge with different grade fabric for cushion and frame; start with Grade 1 price, add appropriate grade price located in second row for cushion, and last add appropriate grade price located in third row for frame to the sum of the Grade 1 and cushion price.

Example: Grade 1 \$2,228 + grade 4 fabric cushion \$69 + grade 2 fabric frame \$26 = \$2,323

Frame	1	10	19	271	624	L1	415	
	2	26	11	304	20	665	L2	758
	3	50	12	337	21	706	L3	1,170
	COM/4	75	13	378	22	747	L4	1,513
	5	107	14	419	23	829	L5	1,856
	6	140	15	459	24	911		
	7	173	16	501	25	993		
	8	205	17	542	26	1,075		
	9	238	18	583	27	1,157		

Select upholstery for everything else other than the seat and back cushions (the outside back, arms, sides, seat frame). You can specify the same fabric as the cushions or select other fabric.

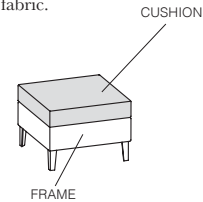

TO ORDER PLEASE SPECIFY THE FOLLOWING:

<input type="text"/>	<input type="text"/>	<input type="text"/>	<input type="text"/>	<input type="text"/>
MODEL NUMBER	STITCH DETAIL	FLAMMABILITY RATING	CUSHION UPHOLSTERY	FRAME UPHOLSTERY
	None NR Stitch detail SD +\$191	U CTB117	Please refer to list of available upholstery and leather selections on www.gunlocke.com	Please refer to list of available upholstery and leather selections on www.gunlocke.com

Example

GK1121-1A.NR.U.DOL728.SPNN04				
GK1121-1A	NR	U	DOL728	SPNN04
MODEL NUMBER	STITCH	FLAMMABILITY DETAIL	CUSHION UPHOLSTERY	FRAME UPHOLSTERY

Please refer to the Ciji product page on www.gunlocke.com for standard finish options.

model number	fabric grades							
GK1121-2W Two seat, Wood legs	1	2,740	10	3,449	19	4,372	L1	3,826
	2	2,805	11	3,534	20	4,479	L2	4,723
	3	2,869	12	3,621	21	4,587	L3	5,800
	COM/4	2,934	13	3,727	22	4,694	L4	6,697
	5	3,020	14	3,835	23	4,907	L5	7,593
	6	3,106	15	3,942	24	5,122		
	7	3,191	16	4,050	25	5,337		
	8	3,277	17	4,157	26	5,552		
	9	3,363	18	4,265	27	5,766		

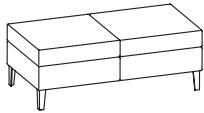

dimensions	W	D	H
Overall	49 1/8"	24 3/4"	17 1/4"
Seat	49 1/8"	24 3/4"	17 1/4"

Upholstery Requirements: GK1121-2W

	Dual Upholstery	
Fabric yds	Cushions 1.5	Frame 1.9
Leather ft ²	Cushions 34.5	Frame 43.7
Shipping weight	74 lbs.	
Cube	35	

Cushion	1	10	19	20	21	22	23	24	25	26	27	L1	L2	L3	L4	L5
		313	720									479	875	1,350	1,746	2,141
	29	350	767													
	57	389	815													
	86	435	862													
	124	483	956													
	162	530	1,051													
	199	578	1,146													
	237	625	1,241													
	275	673	1,335													

Top row of pricing is for units specified with same fabric on cushion and frame. Bottom 2 rows of pricing required only when two different fabric grades are selected for the cushion and frame.

To calculate price of lounge with different grade fabric for cushion and frame; start with Grade 1 price, add appropriate grade price located in second row for cushion, and last add appropriate grade price located in third row for frame to the sum of the Grade 1 and cushion price.

Example: Grade 1 \$2,740 + grade 4 fabric cushion \$86 + grade 2 fabric frame \$36 = \$2,862

Frame	1	10	19	20	21	22	23	24	25	26	27	L1	L2	L3	L4	L5
		396	912									607	1,108	1,710	2,211	2,712
	36	444	972													
	72	492	1,032													
	108	552	1,092													
	156	612	1,211													
	204	672	1,331													
	252	732	1,451													
	300	792	1,571													
	348	852	1,691													

Select upholstery for everything else other than the seat and back cushions (the outside back, arms, sides, seat frame). You can specify the same fabric as the cushions or select other fabric.

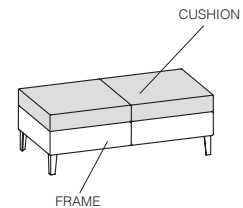

TO ORDER PLEASE SPECIFY THE FOLLOWING:

MODEL NUMBER	WOOD FINISH	STITCH DETAIL	FLAMMABILITY RATING	CUSHION UPHOLSTERY	FRAME UPHOLSTERY
	Cherry finishes on Maple Walnut finishes on Maple Maple finishes on Maple Oak finishes on Maple	None NR Stitch detail SD +\$191	U CTB117	Please refer to list of available upholstery and leather selections on www.gunlocke.com	Please refer to list of available upholstery and leather selections on www.gunlocke.com

Example

GK1121-2W.777.NR.U.DOL728.SPNN04					
GK1121-2W	777	NR	U	DOL728	SPNN04
MODEL NUMBER	WOOD FINISH	STITCH DETAIL	FLAMMABILITY UPHOLSTERY	CUSHION UPHOLSTERY	FRAME REQUEST

Please refer to the Ciji product page on www.gunlocke.com for standard finish options.

CIJI BENCH

Two Seat, Aluminum Legs

Seating
03/23

model number	fabric grades							
GK1121-2A Two seat, Aluminum legs	1	2,997	10	3,706	19	4,629	L1	4,083
	2	3,062	11	3,791	20	4,736	L2	4,980
	3	3,126	12	3,878	21	4,844	L3	6,057
	COM/4	3,191	13	3,984	22	4,951	L4	6,954
	5	3,277	14	4,092	23	5,164	L5	7,850
	6	3,363	15	4,199	24	5,379		
	7	3,448	16	4,307	25	5,594		
	8	3,534	17	4,414	26	5,809		
	9	3,620	18	4,522	27	6,023		

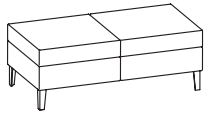

dimensions	W	D	H
Overall	49 1/8"	24 3/4"	17 1/4"
Seat	49 1/8"	24 3/4"	17 1/4"

Upholstery Requirements: GK1121-2A

	Dual Upholstery	
Fabric yds	Cushions 1.5	Frame 1.9
Leather ft ²	Cushions 34.5	Frame 43.7
Shipping weight	74 lbs.	
Cube	35	

Cushion	1	10	19	20	21	22	23	24	25	26	27	L1	L2	L3	L4	L5
		313	720									479	875	1,350	1,746	2,141
	29	350	767													
	57	389	815													
	86	435	862													
	124	483	956													
	162	530	1,051													
	199	578	1,146													
	237	625	1,241													
	275	673	1,335													

Top row of pricing is for units specified with same fabric on cushion and frame. Bottom 2 rows of pricing required only when two different fabric grades are selected for the cushion and frame.

To calculate price of lounge with different grade fabric for cushion and frame; start with Grade 1 price, add appropriate grade price located in second row for cushion, and last add appropriate grade price located in third row for frame to the sum of the Grade 1 and cushion price.

Example: Grade 1 \$2,997 + grade 4 fabric cushion \$86 + grade 2 fabric frame \$36 = \$3,119

Frame	1	10	19	20	21	22	23	24	25	26	27	L1	L2	L3	L4	L5
		396	912									607	1,108	1,710	2,211	2,712
	36	444	972													
	72	492	1,032													
	108	552	1,092													
	156	612	1,211													
	204	672	1,331													
	252	732	1,451													
	300	792	1,571													
	348	852	1,691													

Select upholstery for everything else other than the seat and back cushions (the outside back, arms, sides, seat frame). You can specify the same fabric as the cushions or select other fabric.

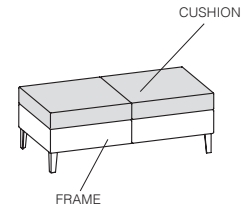

TO ORDER PLEASE SPECIFY THE FOLLOWING:

<input type="text"/>	<input type="text"/>	<input type="text"/>	<input type="text"/>	<input type="text"/>
MODEL NUMBER	STITCH DETAIL	FLAMMABILITY RATING	CUSHION UPHOLSTERY	FRAME UPHOLSTERY
	None NR Stitch detail SD +\$191	U CTB117	Please refer to list of available upholstery and leather selections on www.gunlocke.com	Please refer to list of available upholstery and leather selections on www.gunlocke.com

Example

GK1121-2A.NR.U.DOL728.SPNN04				
GK1121-2A	NR	U	DOL728	SPNN04
MODEL NUMBER	STITCH	FLAMMABILITY DETAIL	CUSHION UPHOLSTERY	FRAME UPHOLSTERY

Please refer to the Ciji product page on www.gunlocke.com for standard finish options.

model number	fabric grades								dimensions	W	D	H
GK1121-3W Three seat, Wood legs	1	3,523	10	4,503	19	5,778	L1	5,023	Overall	73 5/8"	24 3/4"	17 1/4"
	2	3,613	11	4,621	20	5,927	L2	6,263	Seat	73 5/8"	24 3/4"	17 1/4"
	3	3,701	12	4,740	21	6,075	L3	7,752	Upholstery Requirements: GK1121-3W			
	COM/4	3,791	13	4,889	22	6,223	L4	8,993	Dual Upholstery			
	5	3,909	14	5,037	23	6,519	L5	10,233	Fabric yds Cushions 2.8 Frame 1.9			
	6	4,028	15	5,185	24	6,815			Leather ft ² Cushions 64.4 Frame 43.7			
	7	4,146	16	5,334	25	7,112			Shipping weight 125 lbs.			
	8	4,265	17	5,482	26	7,410			Cube 78.5			
	9	4,384	18	5,630	27	7,706						

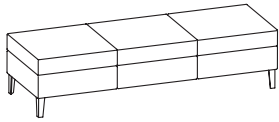

Cushion	1	10	584	19	1,343	L1	893	
	2	54	11	654	20	1,432	L2	1,632
	3	106	12	725	21	1,520	L3	2,519
	COM/4	160	13	814	22	1,608	L4	3,259
	5	230	14	902	23	1,785	L5	3,998
	6	301	15	990	24	1,961		
	7	371	16	1,079	25	2,138		
	8	442	17	1,167	26	2,316		
	9	513	18	1,255	27	2,492		

Frame	1	10	396	19	912	L1	607	
	2	36	11	444	20	972	L2	1,108
	3	72	12	492	21	1,032	L3	1,710
	COM/4	108	13	552	22	1,092	L4	2,211
	5	156	14	612	23	1,211	L5	2,712
	6	204	15	672	24	1,331		
	7	252	16	732	25	1,451		
	8	300	17	792	26	1,571		
	9	348	18	852	27	1,691		

Top row of pricing is for units specified with same fabric on cushion and frame. Bottom 2 rows of pricing required only when two different fabric grades are selected for the cushion and frame.

To calculate price of lounge with different grade fabric for cushion and frame; start with Grade 1 price, add appropriate grade price located in second row for cushion, and last add appropriate grade price located in third row for frame to the sum of the Grade 1 and cushion price.

Example: Grade 1 \$3,523 + grade 4 fabric cushion \$160 + grade 2 fabric frame \$36 = \$3,719

Select upholstery for everything else other than the seat and back cushions (the outside back, arms, sides, seat frame). You can specify the same fabric as the cushions or select other fabric.

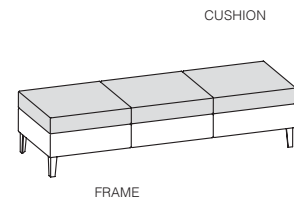

TO ORDER PLEASE SPECIFY THE FOLLOWING:

<input type="text"/>	<input type="text"/>	<input type="text"/>	<input type="text"/>	<input type="text"/>	<input type="text"/>
MODEL NUMBER	WOOD FINISH	STITCH DETAIL	FLAMMABILITY RATING	CUSHION UPHOLSTERY	FRAME UPHOLSTERY
	Cherry finishes on Maple Walnut finishes on Maple Maple finishes on Maple Oak finishes on Maple	None NR Stitch detail SD +\$191	U CTB117	Please refer to list of available upholstery and leather selections on www.gunlocke.com	Please refer to list of available upholstery and leather selections on www.gunlocke.com

Example

GK1121-3W.777.NR.U.DOL728.SPNO4
GK1121-3W 777 NR U DOL728 SPNO4
MODEL NUMBER WOOD FINISH STITCH DETAIL FLAMMABILITY UPHOLSTERY CUSHION UPHOLSTERY FRAME REQUEST

Please refer to the Ciji product page on www.gunlocke.com for standard finish options.

CIJI BENCH

Three Seat, Aluminum Legs

Seating
03/23

model number	fabric grades							
GK1121-3A Three seat, Aluminum legs	1	3,781	10	4,761	19	6,036	L1	5,281
	2	3,871	11	4,879	20	6,185	L2	6,521
	3	3,959	12	4,998	21	6,333	L3	8,010
	COM/4	4,049	13	5,147	22	6,481	L4	9,251
	5	4,167	14	5,295	23	6,777	L5	10,491
	6	4,286	15	5,443	24	7,073		
	7	4,404	16	5,592	25	7,370		
	8	4,523	17	5,740	26	7,668		
	9	4,642	18	5,888	27	7,964		

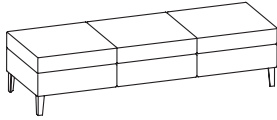

dimensions	W	D	H
Overall	73 5/8"	24 3/4"	17 1/4"
Seat	73 5/8"	24 3/4"	17 1/4"

Upholstery Requirements: GK1121-3A

Dual Upholstery	
Fabric yds	Cushions 2.8 Frame 1.9
Leather ft ²	Cushions 64.4 Frame 43.7
Shipping weight	125 lbs.
Cube	78.5

Cushion	fabric grades						
1		10	584	19	1,343	L1	893
2	54	11	654	20	1,432	L2	1,632
3	106	12	725	21	1,520	L3	2,519
COM/4	160	13	814	22	1,608	L4	3,259
5	230	14	902	23	1,785	L5	3,998
6	301	15	990	24	1,961		
7	371	16	1,079	25	2,138		
8	442	17	1,167	26	2,316		
9	513	18	1,255	27	2,492		

Top row of pricing is for units specified with same fabric on cushion and frame. Bottom 2 rows of pricing required only when two different fabric grades are selected for the cushion and frame.

To calculate price of lounge with different grade fabric for cushion and frame; start with Grade 1 price, add appropriate grade price located in second row for cushion, and last add appropriate grade price located in third row for frame to the sum of the Grade 1 and cushion price.

Example: Grade 1 \$3,781 + grade 4 fabric cushion \$160 + grade 2 fabric frame \$36 = \$3,977

Frame	fabric grades						
1		10	396	19	912	L1	607
2	36	11	444	20	972	L2	1,108
3	72	12	492	21	1,032	L3	1,710
COM/4	108	13	552	22	1,092	L4	2,211
5	156	14	612	23	1,211	L5	2,712
6	204	15	672	24	1,331		
7	252	16	732	25	1,451		
8	300	17	792	26	1,571		
9	348	18	852	27	1,691		

Select upholstery for everything else other than the seat and back cushions (the outside back, arms, sides, seat frame). You can specify the same fabric as the cushions or select other fabric.

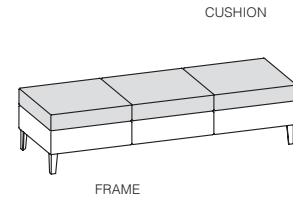

TO ORDER PLEASE SPECIFY THE FOLLOWING:

<input type="text"/>	<input type="text"/>	<input type="text"/>	<input type="text"/>	<input type="text"/>
MODEL NUMBER	STITCH DETAIL	FLAMMABILITY RATING	CUSHION UPHOLSTERY	FRAME UPHOLSTERY
	None NR Stitch detail SD +\$191	U CTB117	Please refer to list of available upholstery and leather selections on www.gunlocke.com	Please refer to list of available upholstery and leather selections on www.gunlocke.com

Example

GK1121-3A.NR.U.DOL728.SPNN04
 GK1121-3A NR U DOL728 SPNN04
 MODEL NUMBER STITCH FLAMMABILITY RATING CUSHION UPHOLSTERY FRAME UPHOLSTERY

Please refer to the Ciji product page on www.gunlocke.com for standard finish options.

model number	fabric grades								dimensions	W	D	H
GK1131 Replacement back cushion for low back lounge	1	530	10	843	19	1,250	L1	1,009	Overall	24 5/8"	4"	11"
	2	559	11	880	20	1,297	L2	1,405	Upholstery Fabric yds			1.5
	3	587	12	919	21	1,345	L3	1,880	Leather ft ²			34.5
	COM/4	616	13	965	22	1,392	L4	2,276				
	5	654	14	1,013	23	1,486	L5	2,671				
	6	692	15	1,060	24	1,581						
	7	729	16	1,108	25	1,676						
	8	767	17	1,155	26	1,771						
	9	805	18	1,203	27	1,865						

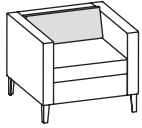

GK1133 Replacement back cushion for low back corner unit	1	992	10	1,305	19	1,712	L1	1,471	Overall	27 1/4"	4"	11"
	2	1,021	11	1,342	20	1,759	L2	1,867	Upholstery Fabric yds			1.5
	3	1,049	12	1,381	21	1,807	L3	2,342	Leather ft ²			34.5
	COM/4	1,078	13	1,427	22	1,854	L4	2,738				
	5	1,116	14	1,475	23	1,948	L5	3,133				
	6	1,154	15	1,522	24	2,043						
	7	1,191	16	1,570	25	2,138						
	8	1,229	17	1,617	26	2,233						
	9	1,267	18	1,665	27	2,327						

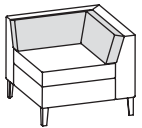

GK1137 Replacement back cushion for mid back lounge	1	530	10	843	19	1,250	L1	1,009	Overall	24 5/8"	4"	15"
	2	559	11	880	20	1,297	L2	1,405	Upholstery Fabric yds			1.5
	3	587	12	919	21	1,345	L3	1,880	Leather ft ²			34.5
	COM/4	616	13	965	22	1,392	L4	2,276				
	5	654	14	1,013	23	1,486	L5	2,671				
	6	692	15	1,060	24	1,581						
	7	729	16	1,108	25	1,676						
	8	767	17	1,155	26	1,771						
	9	805	18	1,203	27	1,865						

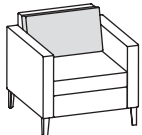

TO ORDER PLEASE SPECIFY THE FOLLOWING:

. . .

MODEL NUMBER

STITCH DETAIL

FLAMMABILITY RATING

CUSHIONS UPHOLSTERY

None **NR**
Stitch detail **SD +\$191**

U CTB117

Please refer to list of available upholstery and leather selections on www.gunlocke.com

Example

GK1131.NR.U.DOL728

GK1131 NR U DOL728
MODEL NUMBER STITCH DETAIL FLAMMABILITY CUSHION UPHOLSTERY

CIJI REPLACEMENT PARTS

Seating
03/23

Cushions and Arms

model number	fabric grades								dimensions	W	D	H
GK1139 Replacement back cushions for mid back corner unit	1	992	10	1,305	19	1,712	L1	1,471	Overall	24 5/8"	4"	15"
	2	1,021	11	1,342	20	1,759	L2	1,867	Upholstery Fabric yds	1.5		
	3	1,049	12	1,381	21	1,807	L3	2,342	Leather ft ²	34.5		
	COM/4	1,078	13	1,427	22	1,854	L4	2,738				
	5	1,116	14	1,475	23	1,948	L5	3,133				
	6	1,154	15	1,522	24	2,043						
	7	1,191	16	1,570	25	2,138						
	8	1,229	17	1,617	26	2,233						
	9	1,267	18	1,665	27	2,327						



GK1143 Replacement seat cushion	1	728	10	1,041	19	1,448	L1	1,207	Overall	24 5/8"	24 5/8"	5"
	2	757	11	1,078	20	1,495	L2	1,603	Upholstery Fabric yds	1.5		
	3	785	12	1,117	21	1,543	L3	2,078	Leather ft ²	34.5		
	COM/4	814	13	1,163	22	1,590	L4	2,474				
	5	852	14	1,211	23	1,684	L5	2,869				
	6	890	15	1,258	24	1,779						
	7	927	16	1,306	25	1,874						
	8	965	17	1,353	26	1,969						
	9	1,003	18	1,401	27	2,063						

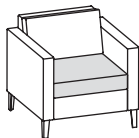

GK1145R Replacement arm right or left	1	792	10	1,271	19	1,896	L1	1,526	Overall	31"	3 1/2"	20 7/8"
	2	836	11	1,330	20	1,969	L2	2,133	Upholstery Fabric yds	2.3		
	3	880	12	1,388	21	2,041	L3	2,861	Leather ft ²	52.9		
	COM/4	923	13	1,461	22	2,114	L4	3,468				
	5	981	14	1,533	23	2,259	L5	4,076				
	6	1,039	15	1,606	24	2,404						
	7	1,098	16	1,678	25	2,548						
	8	1,155	17	1,751	26	2,693						
	9	1,213	18	1,823	27	2,840						

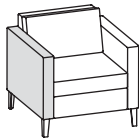

TO ORDER PLEASE SPECIFY THE FOLLOWING:

<input type="text"/>	<input type="text"/>	<input type="text"/>	<input type="text"/>
MODEL NUMBER	STITCH DETAIL	FLAMMABILITY RATING	CUSHIONS UPHOLSTERY
	None NR Stitch detail SD +\$191	U CTB117	Please refer to list of available upholstery and leather selections on www.gunlocke.com
	Option not available for GK1145R or GK1145L		

Example

GK1139.NR.U.DOL728
 GK1139 NR U DOL728
 MODEL NUMBER STITCH DETAIL FLAMMABILITY CUSHION UPHOLSTERY

model number	list	dimensions	W	D	H
--------------	------	------------	---	---	---

GK1155

Replacement wood leg 333

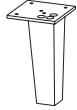

3 1/2 3 1/2 6

GK1157

Replacement aluminum leg 217



3 1/2 3 1/2 6

GK1159

Plate for joining 3 lounge units 135

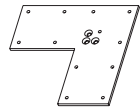

• Used to span the corner formed by the intersection of two armless lounges with a corner unit when assembled in L-shape. This bracket replaces three leg units with one in permanent L-setups

6 3/4" 2 5/8" 2 3/4"

GK1161

Power module 534

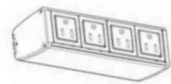

• 15 amp, 72" cord

1 7/8" 5" 5/8"

GK1163

Ganging bracket, set of two 161

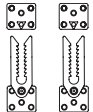

TO ORDER PLEASE SPECIFY THE FOLLOWING:

.

MODEL NUMBER WOOD FINISH

Option available for GK1155 only.

Cherry finishes on Maple

Walnut finishes on Maple

Maple finishes on Maple

Oak finishes on Maple

Please refer to the Ciji product page on www.gunlocke.com for standard finish options.

Example

GK1155.215

GK1155 215

MODEL NUMBER WOOD FINISH

IRIS

Single Upholstery, Metal Base

model number	fabric grades						dimensions	W	D	H		
GLIRS17-011 Single upholstery lounge, return-to-center metal base	1	4,268	10	4,852	19	5,611	L1	4,892	Overall	29 5/8"	27 1/2"	34 3/4"
	2	4,322	11	4,922	20	5,700	L2	5,438	Seat	22"	19 3/4"	17 5/8"
	3	4,374	12	4,993	21	5,788	L3	6,093	Upholstery Requirements: GLIRS17-011			
	COM/4	4,428	13	5,082	22	5,876	L4	6,639	Fabric yards	2.8		
	5	4,498	14	5,170	23	6,053	L5	7,185	Leather feet ²	47.6		
	6	4,569	15	5,258	24	6,229			Shipping weight	45 lbs.		
	7	4,639	16	5,347	25	6,406			Cube	21.7		
	8	4,710	17	5,435	26	6,584			Note: Lounge 4-star metal base comes standard at a fixed height with return-to-center base.			
	9	4,781	18	5,523	27	6,760						



GLIRS17-031 Single upholstery ottoman, fixed metal base	1	1,724	10	1,995	19	2,348	L1	2,013	Overall	21 3/4"	17 3/4"	15 1/4"
	2	1,750	11	2,028	20	2,389	L2	2,267	Upholstery Requirements: GLIRS17-031			
	3	1,774	12	2,061	21	2,430	L3	2,571	Fabric yards	1.3		
	COM/4	1,799	13	2,102	22	2,471	L4	2,825	Leather feet ²	22.1		
	5	1,831	14	2,143	23	2,553	L5	3,079	Shipping weight	20 lbs.		
	6	1,864	15	2,183	24	2,635			Cube	5.4		
	7	1,897	16	2,225	25	2,717			Note: Ottoman metal base comes standard at a fixed height with fixed base.			
	8	1,929	17	2,266	26	2,799						
	9	1,962	18	2,307	27	2,881						



TO ORDER PLEASE SPECIFY THE FOLLOWING:

--	--	--	--

MODEL NUMBER **BASE COLOR** **FLAMMABILITY RATING** **UPHOLSTERY**

Polished Aluminum **BAL**

U CTB117

Please refer to list of available upholstery and leather selections on www.gunlocke.com

Example

GLIRS17-011.BAL.U.DOL728
 GLIRS17-011 BAL U DOL728
 MODEL NUMBER BASE COLOR FLAMMABILITY UPHOLSTERY

Dual Upholstery Lounge, Metal Base

model number	fabric grades							
GLIRS17-021 Dual upholstery lounge, return-to-center metal base	1	4,352	10	4,977	19	5,792	L1	5,022
	2	4,409	11	5,054	20	5,886	L2	5,607
	3	4,467	12	5,129	21	5,980	L3	6,307
	COM/4	4,524	13	5,224	22	6,075	L4	6,892
	5	4,599	14	5,317	23	6,266	L5	7,478
	6	4,674	15	5,414	24	6,455		
	7	4,751	16	5,509	25	6,644		
	8	4,827	17	5,603	26	6,832		
	9	4,902	18	5,697	27	7,023		



dimensions	W	D	H
Overall	29 5/8"	27 1/2"	34 1"
Seat	22"	19 3/4"	17 5/8"

Upholstery Requirements: GLIRS17-021

Dual Upholstery	
Fabric yds	Inside 1.8 Outside 1.2
Leather ft ²	Inside 30.6 Outside 20.4
Shipping weight	45 lbs.
Cube	21.7

Note: Lounge 4-star metal base comes standard at a fixed height with return-to-center base.

Inside	1	10	375	19	864	L1	402	
	2	34	11	421	20	920	L2	753
	3	69	12	466	21	977	L3	1,173
	COM/4	103	13	523	22	1,034	L4	1,524
	5	148	14	579	23	1,148	L5	1,875
	6	193	15	637	24	1,262		
	7	239	16	694	25	1,375		
	8	285	17	750	26	1,488		
	9	330	18	807	27	1,602		

Top row of pricing is for units specified with same fabric on Inside and Outside. Bottom 2 rows of pricing required only when two different fabric grades are selected for the Inside and Outside.

To calculate price of lounge with different grade fabric for Inside and Outside, start with Grade 1 price, add appropriate grade price located in second row for Inside, and last add appropriate grade price located in third row for arms to the sum of the Grade 1 and Inside/Outside price.

Example: Grade 1 \$4,352 + grade 4 fabric Inside \$103 + grade 2 fabric Outside \$23 = \$4,478

Outside	1	10	250	19	576	L1	268	
	2	23	11	281	20	614	L2	502
	3	46	12	311	21	651	L3	782
	COM/4	69	13	349	22	689	L4	1,016
	5	99	14	386	23	766	L5	1,251
	6	129	15	425	24	841		
	7	160	16	463	25	917		
	8	190	17	501	26	992		
	9	220	18	538	27	1,069		

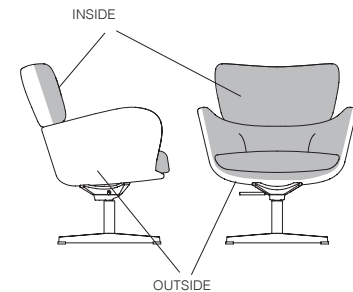

TO ORDER PLEASE SPECIFY THE FOLLOWING:

<input type="text"/>	<input type="text"/>	<input type="text"/>	<input type="text"/>	<input type="text"/>
MODEL NUMBER	BASE COLOR	FLAMMABILITY RATING	INSIDE UPHOLSTERY	OUTSIDE UPHOLSTERY
	Polished Aluminum BAL	U CTB117	Please refer to list of available upholstery and leather selections on www.gunlocke.com	Please refer to list of available upholstery and leather selections on www.gunlocke.com

Example

GLIRS17-021.BAL.U.DOL728.SPNN04

GLIRS17-021	BAL	U	DOL728	SPNN04
MODEL NUMBER	BASE COLOR	FLAMMABILITY	INSIDE UPHOLSTERY	OUTSIDE UPHOLSTERY

IRIS

Dual Upholstery Ottoman, Metal Base

Seating
03/23

model number

fabric grades

dimensions

W

D

H

GLIRS17-041

Dual upholstery ottoman,
fixed metal base



1	1,755	10	2,090	19	2,523	L1	2,113
2	1,785	11	2,130	20	2,574	L2	2,424
3	1,817	12	2,169	21	2,624	L3	2,799
COM/4	1,846	13	2,220	22	2,675	L4	3,110
5	1,887	14	2,270	23	2,776	L5	3,423
6	1,927	15	2,322	24	2,877		
7	1,968	16	2,372	25	2,978		
8	2,009	17	2,422	26	3,078		
9	2,050	18	2,473	27	3,180		

Overall 21 3/4" 17 3/4" 15 1/4"

Upholstery Requirements: GLIRS17-041

	Dual Upholstery	
Fabric yds	Top 0.6	Bottom 1
Leather ft ²	Top 10.2	Bottom 17
Shipping weight	20 lbs.	
Cube	5.4	

Note: Ottoman metal base comes standard at a fixed height with return-to-center base.

Top

1		10	126	19	288	L1	135
2	11	11	141	20	307	L2	251
3	23	12	155	21	326	L3	392
COM/4	34	13	175	22	345	L4	508
5	50	14	193	23	383	L5	625
6	65	15	213	24	421		
7	80	16	232	25	458		
8	95	17	250	26	496		
9	111	18	270	27	535		

Top row of pricing is for units specified with same fabric on Top and Bottom. Bottom 2 rows of pricing required only when two different fabric grades are selected for the Top and Bottom.

To calculate price of lounge with different grade fabric for Inside and Outside, start with Grade 1 price, add appropriate grade price located in second row for Top, and last add appropriate grade price located in third row for Bottom to the sum of the Grade 1, Top/Bottom price.

Example: Grade 1 \$1,755 + grade 4 fabric Top \$34 + grade 2 fabric Bottom \$19 = \$1,808

Bottom

1		10	209	19	480	L1	223
2	19	11	234	20	512	L2	418
3	39	12	259	21	543	L3	652
COM/4	57	13	290	22	575	L4	847
5	82	14	322	23	638	L5	1,043
6	107	15	354	24	701		
7	133	16	385	25	765		
8	159	17	417	26	827		
9	184	18	448	27	890		

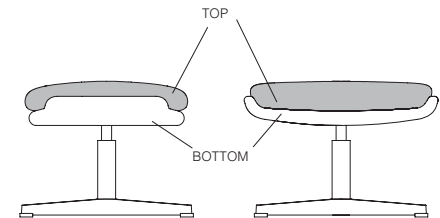

TO ORDER PLEASE SPECIFY THE FOLLOWING:

<input type="text"/>	<input type="text"/>	<input type="text"/>	<input type="text"/>	<input type="text"/>
MODEL NUMBER	BASE COLOR	FLAMMABILITY RATING	TOP UPHOLSTERY	BOTTOM UPHOLSTERY
	Polished Aluminum BAL	U CTB117	Please refer to list of available upholstery and leather selections on www.gunlocke.com	Please refer to list of available upholstery and leather selections on www.gunlocke.com

Example

GLIRS17-041.BAL.U.DOL728.SPNN04

GLIRS17-041	BAL	U	DOL728	SPNN04
MODEL NUMBER	BASE COLOR	FLAMMABILITY	TOP UPHOLSTERY	BOTTOM UPHOLSTERY

model number	fabric grades							dimensions	W	D	H	
GLIRS17-051 Single upholstery lounge, wood legs 	1	4,352	10	4,936	19	5,695	L1	4,976	Overall	29 5/8"	27 1/2"	34 3/4"
	2	4,406	11	5,006	20	5,784	L2	5,522	Seat	22"	19 3/4"	18 3/4"
	3	4,458	12	5,077	21	5,872	L3	6,177	Upholstery Requirements: GLIRS17-051			
	COM/4	4,512	13	5,166	22	5,960	L4	6,723	Fabric yards	2.8		
	5	4,582	14	5,254	23	6,137	L5	7,269	Leather feet ²	47.6		
	6	4,653	15	5,342	24	6,313			Shipping weight	45 lbs.		
	7	4,723	16	5,431	25	6,490			Cube	21.7		
	8	4,794	17	5,519	26	6,668						
	9	4,865	18	5,607	27	6,844						

GLIRS17-071 Single upholstery ottoman, wood legs 	1	1,755	10	2,026	19	2,379	L1	2,044	Overall	21 3/4"	17 3/4"	15 1/4"
	2	1,781	11	2,059	20	2,420	L2	2,298	Upholstery Requirements: GLIRS17-071			
	3	1,805	12	2,092	21	2,461	L3	2,602	Fabric yards	1.3		
	COM/4	1,830	13	2,133	22	2,502	L4	2,856	Leather feet ²	22.1		
	5	1,862	14	2,174	23	2,584	L5	3,110	Shipping weight	20 lbs.		
	6	1,895	15	2,214	24	2,666			Cube	5.4		
	7	1,928	16	2,256	25	2,748						
	8	1,960	17	2,297	26	2,830						
	9	1,993	18	2,338	27	2,912						

TO ORDER PLEASE SPECIFY THE FOLLOWING:

<input type="text"/>	<input type="text"/>	<input type="text"/>	<input type="text"/>
MODEL NUMBER	FINISH	FLAMMABILITY RATING	UPHOLSTERY

These seating models are available in the following hardwoods:

Maple **NE**
Ash **QA**

Please refer to the Tia product page on www.gunlocke.com for standard finish options.

Cherry finishes on Maple or Ash
Walnut finishes on Maple or Ash
Maple finishes on Maple or Ash
Oak finishes on Maple or Ash

Natural Cherry 222, Natural Maple 800, Honey Maple 873 and Natural Oak 300 not available on Ash.

U CTB117

Please refer to list of available upholstery and leather selections on www.gunlocke.com

Example

GLIRS17-051.QA629.U.DOL728
GLIRS17-051 QA629 U DOL728
MODEL NUMBER FINISH FLAMMABILITY UPHOLSTERY

IRIS

Dual Upholstery Lounge, Wood Legs

Seating
03/23

model number

fabric grades

dimensions

W

D

H

GLIRS17-061

Dual upholstery lounge,
wood legs



1	4,435	10	5,060	19	5,875	L 1	5,105
2	4,492	11	5,137	20	5,969	L 2	5,690
3	4,550	12	5,212	21	6,063	L 3	6,390
COM/4	4,607	13	5,307	22	6,158	L 4	6,975
5	4,682	14	5,400	23	6,349	L 5	7,561
6	4,757	15	5,497	24	6,538		
7	4,834	16	5,592	25	6,727		
8	4,910	17	5,686	26	6,915		
9	4,985	18	5,780	27	7,106		

Overall	32"	32"	30"
Seat	22"	19 3/4"	18 3/4"

Upholstery Requirements: GLIRS17-061

	Dual Upholstery	
Fabric yds	Inside 1.8	Outside 1.2
Leather ft ²	Inside 30.6	Outside 20.4
Shipping weight	45 lbs.	
Cube	21.7	

Inside

1		10	375	19	864	L 1	402
2	34	11	421	20	920	L 2	753
3	69	12	466	21	977	L 3	1,173
COM/4	103	13	523	22	1,034	L 4	1,524
5	148	14	579	23	1,148	L 5	1,875
6	193	15	637	24	1,262		
7	239	16	694	25	1,375		
8	285	17	750	26	1,488		
9	330	18	807	27	1,602		

Top row of pricing is for units specified with same fabric on Inside and Outside. Bottom 2 rows of pricing required only when two different fabric grades are selected for the Inside and Outside.

To calculate price of lounge with different grade fabric for Inside and Outside, start with Grade 1 price, add appropriate grade price located in second row for Inside, and last add appropriate grade price located in third row for arms to the sum of the Grade 1 and Inside/Outside price.

Example: Grade 1 \$4,435 + grade 4 fabric Inside \$103 + grade 2 fabric Outside \$23 = \$4,561

Outside

1		10	250	19	576	L 1	268
2	23	11	281	20	614	L 2	502
3	46	12	311	21	651	L 3	782
COM/4	69	13	349	22	689	L 4	1,016
5	99	14	386	23	766	L 5	1,251
6	129	15	425	24	841		
7	160	16	463	25	917		
8	190	17	501	26	992		
9	220	18	538	27	1,069		

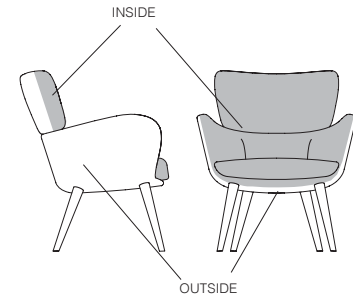

TO ORDER PLEASE SPECIFY THE FOLLOWING:

<input type="text"/>	<input type="text"/>	<input type="text"/>	<input type="text"/>	<input type="text"/>
MODEL NUMBER	FINISH	FLAMMABILITY RATING	INSIDE UPHOLSTERY	OUTSIDE UPHOLSTERY

These seating models are available in the following hardwoods:

Maple **NE**
Ash **QA**

Please refer to the Tia product page on www.gunlocke.com for standard finish options.

Cherry finishes on Maple or Ash
Walnut finishes on Maple or Ash
Maple finishes on Maple or Ash
Oak finishes on Maple or Ash

Natural Cherry 222, Natural Maple 800, Honey Maple 873 and Natural Oak 300 not available on Ash.

U CTB117

Please refer to list of available upholstery and leather selections on www.gunlocke.com

Please refer to list of available upholstery and leather selections on www.gunlocke.com

Example

GLIRS17-061.QA629.U.DOL728.SPNN04

GLIRS17-061	QA629	U	DOL728	SPNN04
MODEL NUMBER	FINISH	FLAMMABILITY	INSIDE UPHOLSTERY	OUTSIDE UPHOLSTERY

model number	fabric grades						dimensions	W	D	H
GLIRS17-081 Dual upholstery ottoman, wood legs	1	1,789	10	2,124	19	2,557	L1	2,147	Overall 21 3/4" 17 3/4" 15 1/4"	
	2	1,819	11	2,164	20	2,608	L2	2,458	Upholstery Requirements: GLIRS17-081	
	3	1,851	12	2,203	21	2,658	L3	2,833	Dual Upholstery	
	COM/4	1,880	13	2,254	22	2,709	L4	3,144	Fabric yds Top 0.6 Bottom 1	
	5	1,921	14	2,304	23	2,810	L5	3,457	Leather ft ² Top 10.2 Bottom 17	
	6	1,961	15	2,356	24	2,911			Shipping weight 20 lbs.	
	7	2,002	16	2,406	25	3,012			Cube 5.4	
	8	2,043	17	2,456	26	3,112				
	9	2,084	18	2,507	27	3,214				



Top	1	10	126	19	288	L1	135	
	2	11	11	141	20	307	L2	251
	3	23	12	155	21	326	L3	392
	COM/4	34	13	175	22	345	L4	508
	5	50	14	193	23	383	L5	625
	6	65	15	213	24	421		
	7	80	16	232	25	458		
	8	95	17	250	26	496		
	9	111	18	270	27	535		

Top row of pricing is for units specified with same fabric on Top and Bottom. Bottom 2 rows of pricing required only when two different fabric grades are selected for the Top and Bottom.

To calculate price of lounge with different grade fabric for Inside and Outside, start with Grade 1 price, add appropriate grade price located in second row for Top, and last add appropriate grade price located in third row for Bottom to the sum of the Grade 1, Top/Bottom price.

Example: Grade 1 \$1,789 + grade 4 fabric Top \$34 + grade 2 fabric Bottom \$19 = \$1,842

Bottom	1	10	209	19	480	L1	223	
	2	19	11	234	20	512	L2	418
	3	39	12	259	21	543	L3	652
	COM/4	57	13	290	22	575	L4	847
	5	82	14	322	23	638	L5	1,043
	6	107	15	354	24	701		
	7	133	16	385	25	765		
	8	159	17	417	26	827		
	9	184	18	448	27	890		

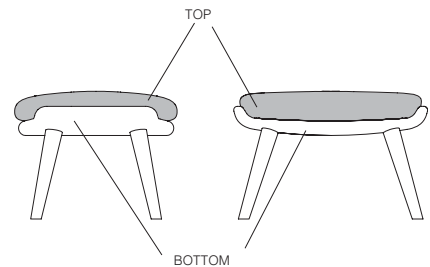

TO ORDER PLEASE SPECIFY THE FOLLOWING:

MODEL NUMBER	FINISH	FLAMMABILITY RATING	TOP UPHOLSTERY	BOTTOM UPHOLSTERY

These seating models are available in the following hardwoods:
Maple **NE**
Ash **QA**

Please refer to the Tia product page on www.gunlocke.com for standard finish options.

Cherry finishes on Maple or Ash
Walnut finishes on Maple or Ash
Maple finishes on Maple or Ash
Oak finishes on Maple or Ash

Natural Cherry 222, Natural Maple 800, Honey Maple 873 and Natural Oak 300 not available on Ash.

U CTB117

Please refer to list of available upholstery and leather selections on www.gunlocke.com

Please refer to list of available upholstery and leather selections on www.gunlocke.com





Example

GLIRS17-081.QA629.U.DOL728.SPNN04				
GLIRS17-081	QA629	U	DOL728	SPNN04
MODEL NUMBER	FINISH	FLAMMABILITY	TOP UPHOLSTERY	BOTTOM UPHOLSTERY

Occasional Tables.....	173-180
Briefing	174
Calm	175-177
Cylinder.....	178
Cube	179
Letchworth	180

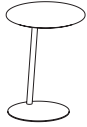
BRIEFING OCCASIONAL TABLES

Seating
03/23

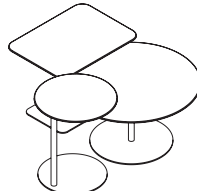
	D	W	H	model number + type	veneer 1	veneer 2	laminated	solid surface
LAPTOP TABLE 24H 	18	18	24 1/2	GM2LTRD18H24- []	2,125	2,338	1,992	2,481
	<ul style="list-style-type: none"> • Top size 18" Dia. • Disc size 14" Dia. 							
END TABLE 24H 	18	18	24 1/2	GM2ETRD18H24- []	2,127	2,340	1,992	2,482
	<ul style="list-style-type: none"> • Top size 18" Dia. • Disc size 14" Dia. 							
NESTING TABLE 19H 	18	18	19 1/2	GM2NTRD18H19- []	2,125	2,338	1,992	2,481
	<ul style="list-style-type: none"> • Top size 18" Dia. • Disc size 14" Dia. 							
NESTING TABLE 17H 	18	24	17 1/2	GM2NTRS1824H17- []	2,659	2,925	2,499	3,013
	<ul style="list-style-type: none"> • Top size 18" x 24" • Disc size 12" x 18" 							
NESTING TABLE 15H 	30	30	15 1/2	GM2NTRD30H15- []	3,013	3,315	2,774	3,369
	<ul style="list-style-type: none"> • Top size 30" Dia. • Disc size 18" Dia. 							
	Nested tables can be grouped together to create a collection with varying heights.							

PRODUCT INFO

Top thickness:

Wood 3/4"

Laminate 3/4"

Glass 1/2"

Solid Surface 1/2"

Top includes inserts for connection to base.

Tops include a knife edge standard.

 Units shipped as separate packages and require field assembly.

TO ORDER PLEASE SPECIFY THE FOLLOWING:

WOOD

1. MODEL NUMBER + W

2. FSC

3. FINISH

4. TOP UV FINISH

5. HARDWARE OPTION

- P71** Black
- PR6** Silver
- P8G** Matte Gold
- PJE** Pyrite
- PJW** Designer White
- P8X** Solar Black
- P8T** Titanium
- PJF** Bullseye
- P8M** Regatta
- PC** Polished Chrome (add \$218)

LAMINATE

1. MODEL NUMBER + L

2. FSC

3. FINISH

4. HARDWARE OPTION

- P71** Black
- PR6** Silver
- P8G** Matte Gold
- PJE** Pyrite
- PJW** Designer White
- P8X** Solar Black
- P8T** Titanium
- PJF** Bullseye
- P8M** Regatta
- PC** Polished Chrome (add \$218)

SOLID SURFACE

1. MODEL NUMBER + S

2. FINISH

3. HARDWARE OPTION

- P71** Black
- PR6** Silver
- P8G** Matte Gold
- PJE** Pyrite
- PJW** Designer White
- P8X** Solar Black
- P8T** Titanium
- PJF** Bullseye
- P8M** Regatta
- PC** Polished Chrome (add \$218)

Example

GM2LTRD18H24-W.X.NC260.OP.P71

GM2LTRD18H24-W	X	NC260	OP	P71
MODEL NUMBER + TYPE	FSC	FINISH	TOP UV FINISH	HARDWARE OPTION

32" Depth Occasional Tables

	D	W	H	model number + type	veneer 1	veneer 2	laminated	solid surface	glass	field-installed top
32"D x 25"W Occasional table 	32	25	17	GTGB17-3225H17- <input type="checkbox"/>	3,232	3,232	2,624	4,621	3,953	2,920
				Shipping wgt	45 lb	45 lb	45 lb	55 lb	55 lb	35 lb
				Cubes	11.3	11.3	11.3	11.3	11.3	11.1

32"D x 32"W Occasional table 	32	32	17	GTGB17-3232H17- <input type="checkbox"/>	3,485	3,485	2,865	5,036	4,312	3,188
				Shipping wgt	50 lb	50 lb	50 lb	60 lb	60 lb	40 lb
				Cubes	14.2	14.2	14.2	14.2	14.2	13.8

32"D x 50"W Occasional table 	32	50	17	GTGB17-3250H17- <input type="checkbox"/>	3,991	3,991	3,323	5,832	4,998	3,696
				Shipping wgt	55 lb	55 lb	55 lb	65 lb	65 lb	45 lb
				Cubes	21.5	21.5	21.5	21.5	21.5	20.9

Note: 32"D occasional tables can be used in-line with lounge units, but are freestanding and do not gang.

TO ORDER PLEASE SPECIFY THE FOLLOWING:

. . .

MODEL NUMBER + TYPE	FRAME COLOR	TOP MATERIAL	TOP UV FINISH (WOOD TOPS ONLY)
Note: Type must be specified as part of model number. Wood Veneer W Laminate L Solid Surface S Glass G Field-Installed Top F	Polished Chrome \$109 - 32x25 \$137 - 32x32 \$164 - 32x50 Brushed Chrome Steel \$109 - 32x25 \$137 - 32x32 \$164 - 32x50 Black Designer White Matte Gold Silver Solar Black Titanium Bullseye Regatta	PC BS	See page 84-85 for required option codes. P71 PJW P8G PR6 P8X P8T PJF P8M

Note: Wood and laminate tops are 1 1/8" thick, rabbeted and inset to leave 1/2" thick edge detail. solid surface and glass tops are 12mm thick, with an inset 3/4" MDF subtop. Field-installed tops receive an inset 3/4" MDF subtop. Wood, laminate, solid surfaces and glass tops all have 1/16" overhang per side.

Example

GTGB17-3225H17-W.PC.NC215.OP

GTGB17-3225H17-W	PC	NC215	OP
MODEL NUMBER	FRAME COLOR	TOP MATERIAL	TOP UV FINISH

CALM

16" Depth Occasional Tables

Seating
03/23

	D	W	H	model number + type	veneer 1	veneer 2	laminare	solid surface	glass	field-installed top
16"D x 32"W Occasional table	16	32	17	GTGB17-1632H17- 	2,978	2,978	2,408	4,233	3,623	2,678
				Shipping wgt	35 lb	35 lb	35 lb	45 lb	45 lb	25 lb
				Cubes	7.7	7.7	7.7	7.7	7.7	7.5

16"D x 50"W Occasional table	16	50	17	GTGB17-1650H17- 	3,232	3,232	2,652	4,649	3,981	2,948
				Shipping wgt	40 lb	40 lb	40 lb	50 lb	50 lb	30 lb
				Cubes	11.7	11.7	11.7	11.7	11.7	11.4

Note: 16"D x 32"W occasional table can be used in-line with lounge units, but are freestanding and do not gang.

TO ORDER PLEASE SPECIFY THE FOLLOWING:

			
MODEL NUMBER + TYPE	FRAME COLOR	TOP MATERIAL	TOP UV FINISH (WOOD TOPS ONLY)

Note:
Type must be specified as part of model number.

Wood Veneer **W**
Laminate **L**
Solid Surface **S**
Glass **G**
Field-Installed Top **F**

Polished Chrome **PC**
\$109 - 16x32
\$137 - 16x50
Brushed Chrome Steel **BS**
\$109 - 16x32
\$137 - 16x50
Black **P71**
Designer White **PJW**
Matte Gold **P8G**
Silver **PR6**
Solar Black **P8X**
Titanium **P8T**
Bullseye **PJF**
Regatta **P8M**

See page 84-85 for required option codes.

Note: Wood and laminate tops are 1 1/8" thick, rabbeted and inset to leave 1/2" thick edge detail. solid surface and glass tops are 12mm thick, with an inset 3/4" MDF subtop. Field-installed tops receive an inset 3/4" MDF subtop. Wood, laminate, solid surfaces and glass tops all have 1/16" overhang per side.

Example

GTGB17-1632H17-W.PC.NC215.OP

GTGB17-1632H17-W	PC	NC215	OP
MODEL NUMBER	FRAME COLOR	TOP MATERIAL	TOP UV FINISH

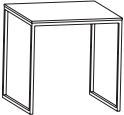
	D	W	H	model number + type	veneer 1	veneer 2	laminate	solid surface	glass	field-installed top
12"D x 18"W Laptop table 	12	18	26	GTGB17-1218H26- <input type="checkbox"/>	2,131	2,131	1,662	2,915	2,499	1,846
				Shipping wgt	15 lb	15 lb	15 lb	20 lb	20 lb	10 lb
				Cubes	5.3	5.3	5.3	5.3	5.3	5.2
24"D x 24"W Side table 	24	24	24	GTGB17-2424H24- <input type="checkbox"/>	3,399	3,399	2,740	4,850	4,146	3,053
				Shipping wgt	25 lb	25 lb	25 lb	30 lb	30 lb	20 lb
				Cubes	11.4	11.4	11.4	11.4	11.4	11.2

TO ORDER PLEASE SPECIFY THE FOLLOWING:

. . .

MODEL NUMBER + TYPE **FRAME COLOR** **TOP MATERIAL** **TOP UV FINISH (WOOD TOPS ONLY)**

Note:

Type must be specified as part of model number.
 Wood Veneer **W**
 Laminate **L**
 Solid Surface **S**
 Glass **G**
 Field-Installed Top **F**

Polished Chrome **PC +\$82**
 Brushed Chrome Steel **BS +\$82**
 Black **P71**
 Designer White **PJW**
 Matte Gold **P8G**
 Silver **PR6**
 Solar Black **P8X**
 Titanium **P8T**
 Bullseye **PJF**
 Regatta **P8M**

See page 84-85 for required option codes.

Note: Wood and laminate tops are 1 1/8" thick, rabbeted and inset to leave 1/2" thick edge detail. solid surface and glass tops are 12mm thick, with an inset 3/4" MDF subtop. Field-installed tops receive an inset 3/4" MDF subtop. Wood, laminate, solid surfaces and glass tops all have 1/16" overhang per side.

Example

GTGB17-1218H26-W.PC.NC215.OP
 GTGB17-1218H26-W PC NC215 OP
 MODEL NUMBER FRAME COLOR TOP MATERIAL TOP UV FINISH

CYLINDER OCCASIONAL TABLES

Seating
03/23

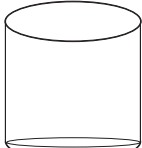
	diameter	H	model number	list
CYLINDER TABLES 	18	20	GNTOCY1820	2,199
	18	24	GNTOCY1824	2,276
	24	20	GNTOCY2420	2,838
	24	24	GNTOCY2424	2,962
	36	16	GNTOCY3616	3,668

SUNBURST PATTERN OPTION

TOP VIEW

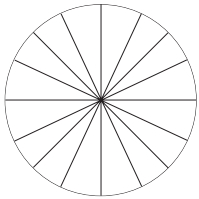

PRODUCT INFO

note
No UV finish.

TO ORDER PLEASE SPECIFY THE FOLLOWING:

. .

MODEL NUMBER **SPECIES & FINISH** **VENEER PATTERN**

Select veneers:

Cherry
Maple

Standard veneer pattern **NP**
Sunburst pattern **SV** **(+\$336)**

Please refer to Gunlocke.com
for standard finish options.

Example

GNTOCY1820.NC260.NP
GNTOCY1820 NC260 NP
MODEL NUMBER FINISH VENEER PATTERN

	D	W	H	model number	list
CUBE TABLES	18	18	24	GNTOCB1824	3,060
	24	24	20	GNTOCB2420	3,197
	24	24	24	GNTOCB2424	3,263
	36	36	16	GNTOCB3616	4,004

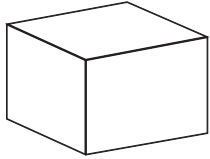

TOP VIEW

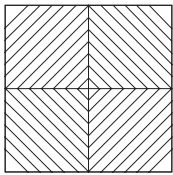

DIAMOND
VENEER OPTION

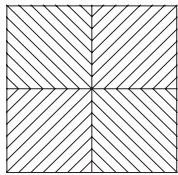

REVERSE
DIAMOND
VENEER OPTION

PRODUCT INFO

note
No UV finish.

TO ORDER PLEASE SPECIFY THE FOLLOWING:

. .

MODEL NUMBER **SPECIES & FINISH** **VENEER PATTERN**

Select veneers:

Cherry
Maple

Standard veneer pattern
Diamond pattern
Reverse diamond

NP
DV (+\$336)
RD (+\$346)

Please refer to Gunlocke.com
for standard finish options.

Example

GNTOCB1824.NC260.NP

GNTOCB1824	NC260	NP
MODEL NUMBER	FINISH	VENEER PATTERN

LETCHWORTH OCCASIONAL TABLES

Seating
03/23

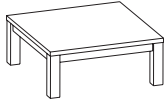
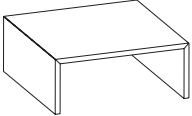
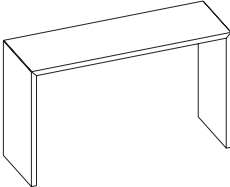
	D	W	H	model number	veneer 1	veneer 2	veneer 3
PARSONS OCCASIONAL 	24	24	21	GABTRT21H2424-WW	2,324	2,558	2,673
	36	36	17	GABTRT17H3636-WW	2,625	2,888	3,020
	42	42	17	GABTRT17H4242-WW	2,926	3,220	3,366
	24	54	17	GABTRT17H2454-WW	2,842	3,127	3,270
MITER OCCASIONAL 	24	24	21	GMBTRT21H2424-WW	6,607	7,269	7,599
	36	36	17	GMBTRT17H3636-WW	2,625	2,888	3,020
	42	42	17	GMBTRT17H4242-WW	2,926	3,220	3,366
	24	54	17	GMBTRT17H2454-WW	2,842	3,127	3,270
MITER CONSOLE 	20	60	36	GMBTRT36H2060-WW	3,273	3,579	3,736

PRODUCT INFO

Tables are shipped in one complete piece and cannot be disassembled. Confirm elevator/doors/hallways for clearance.

TO ORDER PLEASE SPECIFY THE FOLLOWING:

1. MODEL NUMBER
2. FINISH
3. TOP UV FINISH

See inside front cover for required option codes

Example

GABTRT21H2424-WW.NT629.OP
 GABTRT21H2424-WW NT629 OP
 MODEL NUMBER FINISH TOP UV FINISH

THIS PAGE INTENTIONALLY LEFT BLANK

Gunlocke®

One Gunlocke Drive
Wayland, NY 14572
800 828 6300