

PRICING EFFECTIVE MAY 2022

SEATING & OCCASIONAL TABLES

Price & Specification Guide

PDF updated June 13, 2022

Gunlocke®

ORDERING OPTION CODES

MAPLE WOOD FINISHES

- A. Natural/Clear Maple 800
- B. Ebony Maple 555
- C. Harvest Maple 856
- D. Beigewood 878
- E. Field Elm 599
- F. Belair 934

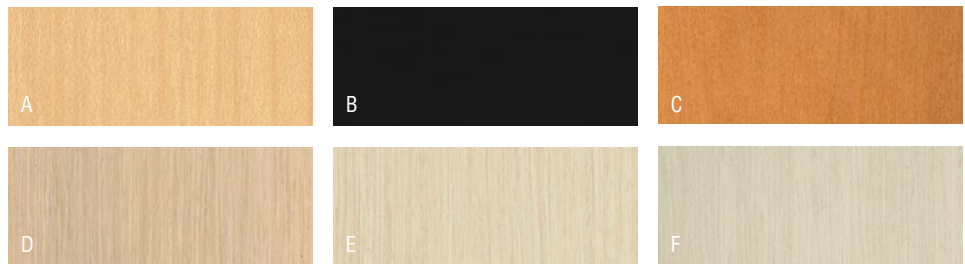

*All Finish options are also available with FSC

CHERRY WOOD FINISHES

- A. Natural Cherry 222
- B. Light Cherry 701
- C. Cinnamon Cherry 260
- D. Burnished Cherry 777
- E. Medium Red Cherry 512
- F. Lowell Ash 394
- G. Shaker Cherry 774



*All Finish options are also available with FSC

WALNUT WOOD FINISHES

- A. Nutmeg Walnut 629
- B. Light Walnut 601
- C. Sumatra Walnut 693
- D. Skyline Walnut 625
- E. Pinnacle Walnut 679

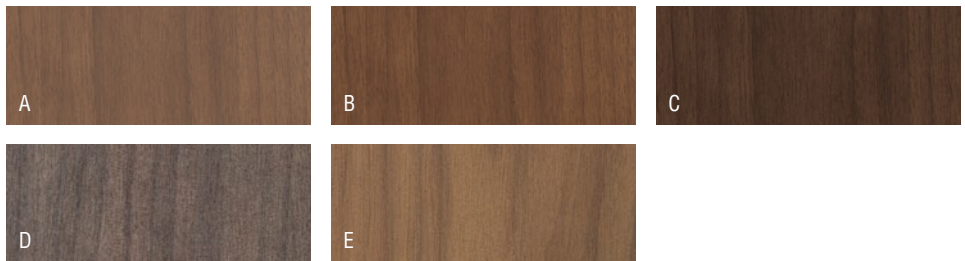

*All Finish options are also available with FSC

OAK WOOD FINISHES

- A. Natural/Clear Oak 300
- B. Light Rift Oak 301
- C. Dark Rift Oak 331
- D. Phantom Ecru 912
- E. Portico Teak 150
- F. Silver Oak 100
- G. Fawn Cypress 108



*All Finish options are also available with FSC

G

LAMINATES (AVAILABLE ON LIV SEATING AND CALM OCCASIONAL TABLES)

WOODGRAIN

- | | |
|---------------------|------|
| A. Lowell Ash | LLA1 |
| B. Natural Recon | LNR1 |
| C. Phantom Ecru | LPE1 |
| D. Portico Teak | LPT1 |
| E. Skyline Walnut | LSW1 |
| F. Pinnacle Walnut | PINC |
| G. Fawn Cypress | LFC1 |
| H. Natural Maple | LWD |
| I. Harvest Maple | C |
| J. Shaker Cherry | LW7C |
| K. Biltmore Cherry | COGN |
| L. Florence Walnut | LFW1 |
| M. Kingswood Walnut | LKI1 |
| N. NeoWalnut | LNU1 |
| O. Veranda Teak | LVT1 |

SOLID

- | | |
|-------------------------|------|
| P. Designer White 15051 | LDW1 |
| Q. Loft | LM11 |
| R. Flint | LM16 |



PAINT FINISHES

- | | |
|-------------------|-----|
| A. Designer White | PJW |
| B. Chrome | PC |
| C. Silver | PR6 |
| D. Titanium | P8T |
| E. Solar Black | P8X |
| F. Black | P71 |
| G. Pyrite | PJE |
| H. Matte Gold | P8G |
| I. Bullseye | PJF |
| J. Regatta | P8M |

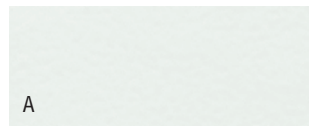

Product Reference
 Products in Numerical Order 2-3
 Abridged Picture Index 4-5

General Information
 GSA Terms And Conditions 6
 Conditions of Sale 7
 Warranty 8
 Shipping Instructions 9

Special Finish, Jury Base and Laser Backs 10

Standard Textile and COM Overview 11-12

COM | COL Guidelines / Ordering 13-14

Cut Yardage | Requirements 15

Flammability | ACT Performance 16

PRODUCTS

Guest Seating 23-43
 Product Specifications 24-25
 Bank of England™ 26
 Calia 27-28
 Camille 29-31
 Genesee Guest 32-34
 Lily™ 35-36
 Metta 37-38
 Savor™ 39-41
 Tia™ Guest 42-43

Multipurpose Seating 45-76
 Product Specifications 46
 Convo® Barstool 47-50
 LIV Guest 51-52
 LIV Stool 53-54
 Multi® 55-58
 Multi® Stool 59-62
 Multi® Bariatric 63-64
 Multi® Side Chair Tandem 65-70
 Tia™ Barstool 71-74
 Trillia™ Barstool 75-76

Swivel Seating 77-106
 Swivel Seating Product Specifications 78-79
 Avoca™ 82-83
 Genesee 84-89
 Geneva 90-101
 Olla Executive 102-105
 Washington Series 106

Lounge Seating 107-198
 Product Specifications 108-109
 Calm Lounge Ordering Option Codes 110-111
 Calm 112-130
 Ciji 131-191
 Iris 192-197
 Multi® Lounge 198

Occasional Tables 205-212
 Briefing 206
 Calm 207-209
 Cylinder 210
 Cube 211
 Letchworth 212



PRODUCTS IN NUMERICAL ORDER

Seating
05/22

product	page	product	page	product	page
ACPUNDER-EU Calm	130	GK1105-2A Ciji	144	GK1159 Ciji	191
ACPUNDER-EU-HW Calm	130	GK1105-2W Ciji	143	GK1161 Ciji	191
GABTRT17H2454-WW Letchworth	212	GK1105-3A Ciji	152	GK1163 Ciji	191
GABTRT17H3636-WW Letchworth	212	GK1105-3W Ciji	151	GK2800 Olla	102
GABTRT17H4242-WW Letchworth	212	GK1107-1A Ciji	138	GK2802 Olla	103
GABTRT21H2424-WW Letchworth	212	GK1107-1W Ciji	137	GK2804 Olla	102
GAGB17-198 Calm	130	GK1107-2A Ciji	146	GK2806 Olla	103
GBGB17-131 Calm	126	GK1107-2W Ciji	145	GK2808 Olla	104
GBGB17-142 Calm	127	GK1107-3A Ciji	154	GK2810 Olla	105
GBGB17-153 Calm	128	GK1107-3W Ciji	153	GK2812 Olla	104
GGCA14-011 Lily	35	GK1109A Ciji	180	GK2814 Olla	105
GGCA14-021 Lily	36	GK1109W Ciji	179	GK3006N Washington	106
GGCAL17-011 Calia	27	GK1111-1A Ciji	156	GK8907 Molti	55
GGCAL17-021 Calia	28	GK1111-1W Ciji	155	GK9901P Molti	56
GGHB17-071 Tia	42	GK1111-2A Ciji	164	GK9901P-SS Molti	65
GGHB17-081 Tia	43	GK1111-2W Ciji	163	GK9901P-SSS Molti	67
GGJA14-011 Savor	39	GK1111-3A Ciji	172	GK9901P-SSSS Molti	69
GGJA14-021 Savor	39	GK1111-3W Ciji	171	GK9901W Molti	57
GGJA14-031 Savor	40	GK1113-1A Ciji	158	GK9901W-SS Molti	66
GGJA14-041 Savor	41	GK1113-1W Ciji	157	GK9901W-SSS Molti	68
GGLIV19-011 Liv	51	GK1113-2A Ciji	166	GK9901W-SSSS Molti	70
GGLIV19-012 Liv	51	GK1113-2W Ciji	165	GK9903N Molti	55
GGLIV19-013 Liv	51	GK1113-3A Ciji	174	GK9905P Molti	58
GGLIV19-014 Liv	51	GK1113-3W Ciji	173	GK9905W Molti	58
GGLIV19-021 Liv	52	GK1115-1A Ciji	160	GK9907N Molti	58
GGLIV19-022 Liv	52	GK1115-1W Ciji	159	GK9921P Molti	60
GGLIV19-023 Liv	52	GK1115-2A Ciji	168	GK9921W Molti	61
GGLIV19-024 Liv	52	GK1115-2W Ciji	167	GK9923N Molti	59
GGLIV19-SVL1	46	GK1115-3A Ciji	176	GK9925P Molti	62
GGLIV19-SVL2	46	GK1115-3W Ciji	175	GK9925W Molti	62
GGRA16-111 Genesee	32	GK1117-1A Ciji	162	GK9927N Molti	62
GGRA16-121 Genesee	32	GK1117-1W Ciji	161	GK9931W Molti	198
GGRA16-131 Genesee	33	GK1117-2A Ciji	170	GK9947 BOE	26
GGRA16-141 Genesee	33	GK1117-2W Ciji	169	GK9947US BOE	26
GGRA16-151 Genesee	34	GK1117-3A Ciji	178	GK9961P Molti	63
GGRA16-161 Genesee	34	GK1117-3W Ciji	177	GK9961W Molti	64
GGWA16-011 Metta	37	GK1119A Ciji	182	GK21001 Camille	29
GGWA16-021 Metta	38	GK1119W Ciji	181	GK21001-021 Camille	30
GK1101-1A Ciji	132	GK1121-1A Ciji	184	GK21003 Camille	29
GK1101-1W Ciji	131	GK1121-1W Ciji	183	GK21003-021 Camille	31
GK1101-2A Ciji	140	GK1121-2A Ciji	186	GLGB17-011 Calm	112
GK1101-2W Ciji	139	GK1121-2W Ciji	185	GLGB17-021 Calm	113
GK1101-3A Ciji	148	GK1121-3A Ciji	188	GLGB17-031 Calm	114
GK1101-3W Ciji	147	GK1121-3W Ciji	187	GLGB17-041 Calm	115
GK1103-1A Ciji	134	GK1131 Ciji	189	GLGB17-052 Calm	116
GK1103-1W Ciji	133	GK1133 Ciji	189	GLGB17-062 Calm	117
GK1103-2A Ciji	142	GK1137 Ciji	189	GLGB17-072 Calm	118
GK1103-2W Ciji	141	GK1139 Ciji	190	GLGB17-082 Calm	119
GK1103-3A Ciji	150	GK1143 Ciji	190	GLGB17-093 Calm	120
GK1103-3W Ciji	149	GK1145R Ciji	190	GLGB17-103 Calm	121
GK1105-1A Ciji	136	GK1155 Ciji	191	GLGB17-113 Calm	122
GK1105-1W Ciji	135	GK1157 Ciji	191	GLGB17-123 Calm	123

product	page	product	page	product	page
GLGB17-161 Calm	124	GMQA16-081 Trillia	76	GTGB17-1632H17-W Calm	208
GLGB17-171 Calm	125	GNTOCB1820 Tables	211	GTGB17-1650H17-F Calm	208
GLGB17-181 Calm	129	GNTOCB1824 Tables	211	GTGB17-1650H17-G Calm	208
GLIRS17-011 Iris	192	GNTOCB2420 Tables	211	GTGB17-1650H17-L Calm	208
GLIRS17-021 Iris	193	GNTOCB2424 Tables	211	GTGB17-1650H17-S Calm	208
GLIRS17-031 Iris	192	GNTOCB3616 Tables	211	GTGB17-1650H17-W Calm	208
GLIRS17-041 Iris	194	GNTOCY1820 Tables	210	GTGB17-2424H24-F Calm	209
GLIRS17-051 Iris	195	GNTOCY1824 Tables	210	GTGB17-2424H24-G Calm	209
GLIRS17-061 Iris	196	GNTOCY2420 Tables	210	GTGB17-2424H24-L Calm	209
GLIRS17-071 Iris	195	GNTOCY2424 Tables	210	GTGB17-2424H24-S Calm	209
GLIRS17-081 Iris	197	GNTOCY3616 Tables	210	GTGB17-2424H24-W Calm	209
GM2ETRD18H24-L Briefing	206	GSGNV17-011 Geneva	90	GTGB17-3225H17-F Calm	207
GM2ETRD18H24-S Briefing	206	GSGNV17-011J Geneva	91	GTGB17-3225H17-G Calm	207
GM2ETRD18H24-W Briefing	206	GSGNV17-021 Geneva	92	GTGB17-3225H17-L Calm	207
GM2LTRD18H24-L Briefing	206	GSGNV17-021J Geneva	93	GTGB17-3225H17-S Calm	207
GM2LTRD18H24-S Briefing	206	GSGNV17-031 Geneva	96	GTGB17-3225H17-W Calm	207
GM2LTRD18H24-W Briefing	206	GSGNV17-031J Geneva	97	GTGB17-3232H17-F Calm	207
GM2NTRD18H19-L Briefing	206	GSGNV17-041 Geneva	98	GTGB17-3232H17-G Calm	207
GM2NTRD18H19-S Briefing	206	GSGNV17-041J Geneva	99	GTGB17-3232H17-L Calm	207
GM2NTRD18H19-W Briefing	206	GSGNV17-051 Geneva	90	GTGB17-3232H17-S Calm	207
GM2NTRD30H15-L Briefing	206	GSGNV17-051J Geneva	91	GTGB17-3232H17-W Calm	207
GM2NTRD30H15-S Briefing	206	GSGNV17-061 Geneva	94	GTGB17-3250H17-F Calm	207
GM2NTRD30H15-W Briefing	206	GSGNV17-061J Geneva	95	GTGB17-3250H17-G Calm	207
GM2NTRS1824H17-L Briefing	206	GSGNV17-071 Geneva	96	GTGB17-3250H17-L Calm	207
GM2NTRS1824H17-S Briefing	206	GSGNV17-071J Geneva	97	GTGB17-3250H17-S Calm	207
GM2NTRS1824H17-W Briefing	206	GSGNV17-081 Geneva	100	GTGB17-3250H17-W Calm	207
GMBTRT17H2454-WW Letchworth	212	GSGNV17-081J Geneva	101		
GMBTRT17H3636-WW Letchworth	212	GSHA15-011 Avoca	82		
GMBTRT17H4242-WW Letchworth	212	GSHA15-021 Avoca	82		
GMBTRT21H2424-WW Letchworth	212	GSHA15-031 Avoca	83		
GMBTRT36H2060-WW Letchworth	212	GSHA15-041 Avoca	83		
GMHB17-011 Tia	71	GSRA16-011 Genesee	84		
GMHB17-021 Tia	72	GSRA16-011J Genesee	85		
GMHB17-041 Tia	73	GSRA16-021 Genesee	84		
GMHB17-051 Tia	74	GSRA16-021J Genesee	85		
GMLA15-011 Convo	47	GSRA16-031 Genesee	86		
GMLA15-021 Convo	48	GSRA16-031J Genesee	87		
GMLA15-041 Convo	49	GSRA16-041 Genesee	86		
GMLA15-051 Convo	50	GSRA16-041J Genesee	87		
GMLIV19-031 Liv	53	GSRA16-051 Genesee	88		
GMLIV19-032 Liv	53	GSRA16-051J Genesee	89		
GMLIV19-033 Liv	53	GSRA16-061 Genesee	88		
GMLIV19-034 Liv	53	GSRA16-061J Genesee	89		
GMLIV19-041 Liv	54	GTGB17-1218H26-F Calm	209		
GMLIV19-042 Liv	54	GTGB17-1218H26-G Calm	209		
GMLIV19-043 Liv	54	GTGB17-1218H26-L Calm	209		
GMLIV19-044 Liv	54	GTGB17-1218H26-S Calm	209		
GMQA16-011 Trillia	75	GTGB17-1218H26-W Calm	209		
GMQA16-021 Trillia	76	GTGB17-1632H17-F Calm	208		
GMQA16-041 Trillia	75	GTGB17-1632H17-G Calm	208		
GMQA16-051 Trillia	76	GTGB17-1632H17-L Calm	208		
GMQA16-071 Trillia	75	GTGB17-1632H17-S Calm	208		

GUEST SEATING

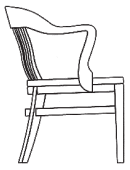

GK9947
Bank of England (pg. 26)

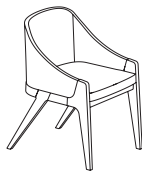

GGCAL17-011
Calia (pg. 27)

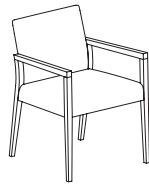

GK21001
Camille (pg. 29)



GGRA16-141
Genesee (pg. 33)

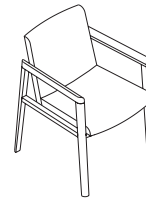

GGCA14-011
Lily (pg. 35)



GGLIV19-023
LIV (pg. 52)



GGWA16-011
Metta (pg. 37)

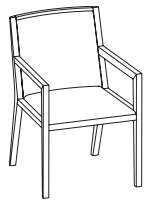

GGJA14-011
Savor (pg. 39)



GGHB17-071
Tia (pg. 42)

JURY/FIXED BASE SEATING



GSRA16-011J
Genesee (pg. 85)



GSGNV17-051J
Geneva (pg. 91)

MULTIPURPOSE SEATING



GMLA15-011
Convo Barstool
(pg. 47)



GGLIV19-013
LIV Stacker
(pg. 51)



GGLIV19-043
LIV Stool
(pg. 54)

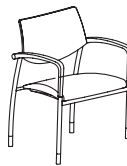

GK9901P
Molti (pg. 56)

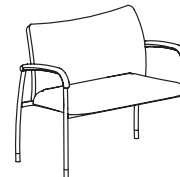

GK9961P
Molti Bariatric
(pg. 63)



GK9921P
Molti Stool (pg. 60)

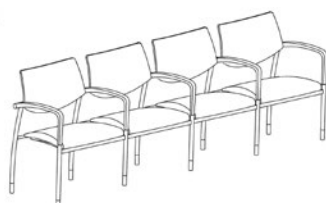

GK9901P-SSSS
Molti Side Chair Tandem (pg. 69)



GMHB17-011
Tia Barstool (pg. 71)

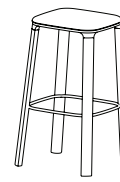

GMQA16-011
Trillia Barstool (pg. 75)

SWIVEL SEATING



GSHA15-031
Avoca (pg. 83)



GSRA16-031
Genesee (pg. 86)



GSGNV17-011
Geneva (pg. 90)



GK2800
Olla (pg. 102)



GK3006N
Washington (pg. 106)

LOUNGE SEATING

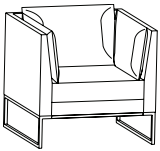

GLGB17-011
Calm (pg. 112)

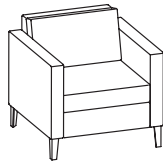

GK1111-1W
Ciji (pg. 155)



GLIRS17-011
Iris (pg. 192)

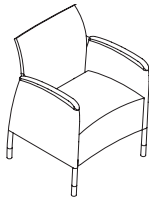

GK9931W
Multi Lounge (pg. 198)

OCCASIONAL TABLES

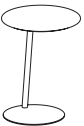

GM2LTRD18H24
Briefing (pg. 206)



GTGB17-3225H17
Calm (pg. 207)

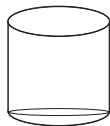

GNTOCY1820
Cylinder (pg. 210)

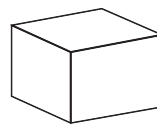

GNTOCB1820
Cube (pg. 211)

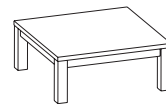

GABTRT21H2424-WW
Letchworth (pg. 212)

1. **Maximum Order Threshold:**
SIN# 33721 \$250,000
2. **Minimum order:** \$2,000 list
3. **Geographic coverage:**
48 contiguous states and DC (CONUS)
4. **Points of production:**
Wayland, NY, Steuben County, USA
Hickory, NC, Catawba County, USA
Muscatine, IA, Muscatine County, USA
5. **Discount Statement: Discount is applied to List Price.**
Structure in List \$:
\$2,000 – \$100,000 list 60.5%
\$100,001 – \$400,000 list 62.7%
\$400,001 – MOT (\$1,428,571 List) 65.0%
Over MOT (\$1,428,572 List) Negotiable
* These discounts apply to single purchase orders, shipping to the same place in the same time period
6. **Quantity Discount:** See above
7. **Payment terms:**
1% 23 days Net 30 days from date of shipment, for product only, for all electronic invoices processed through a Federal payment system, (including, but not limited to, WAWF, IPP, etc.).
All other invoice sales are Net 30 days from date of shipment. Prompt payment terms are not applicable to credit card orders.
8. **Government Credit Cards** are accepted above and below the micro-purchase levels.
Written confirmation and authorized signatures are required. Activities may verbally provide card information, but products shall be confirmed in writing.
Use of credit cards shall be at the time of order placement with cards charged at the time of shipment, see GSAR 552-232-80 (C).
There are no additional discounts for using a credit card.
9. **Foreign items:** None
- 10a. **Time of delivery:** 60 days ARO
- 10b. **Expedited delivery:** Contact Gunlocke
- 10c. **Overnight and 2-day delivery:** Contact Gunlocke
- 10d. **Urgent requirements:** Contact Gunlocke
11. **FOB point(s):** F.O.B. Origin, with freight being paid by Gunlocke for all deliveries within CONUS.
12. **Ordering address(es):**
The Gunlocke Company
c/o Authorized Gunlocke GSA Dealer
One Gunlocke Drive
Wayland, NY 14572
Phone: (800) 828-6300
Fax: (585) 728-8350
13. **Payment address(es):**
The Gunlocke Company LLC
13367 Collections Center Drive
Chicago, IL 60693
14. **Warranty provision:** See warranty on page 8
15. **Export packing charges:**
Write for quotation on export packaging.
16. **Terms and conditions of Government commercial credit card acceptance:** Credit Cards are accepted.
17. **Terms and conditions of rental, maintenance, and repair:**
Not applicable
18. **Terms and conditions of installation:**
Installation services shall be priced at a rate not to exceed 30% of the net product price, per project. The minimum order charge for installation shall be \$175.00. Projects involving extraordinary circumstances which require installation charges exceeding the proposed installation rates will be submitted to the GSA Contracting Officer for review and approval.
19. **Project Management:**
\$65 Per Hour, inclusive of IFF
20. **Reconfiguration and Relocation Services:**
\$65 Per Hour, inclusive of IFF
21. **Design/Layout Services:**
\$65 Per Hour, inclusive of IFF
22. **Terms and conditions of repair:**
Refer to Gunlocke Customer Support
23. **List of service and distribution:** Points: Not applicable
24. **Participating dealers:** A list of participating dealers will be supplied to any government agency upon request or is available on our website at www.gunlocke.com.
25. **Preventative maintenance:**
Not applicable. Instruction sheets available upon request.
26. **Environmental attributes:** Gunlocke has an active environmental program. Please call (800) 828-6300 for details.
27. **Data universal number system:**
(DUNS) number is 19-993-6550
28. **CCR registration/Cage Code:** The Gunlocke Company is registered in the DoD CCR. Cage Code - 26574
29. **Returns:**
No returns of goods will be accepted without written consent and shipping instructions from Gunlocke, and the Government customer will be required to pay all return freight charges. A restocking fee of 30% net will apply on all authorized returns provided Gunlocke receives goods in the condition in which they left the factory. No credit will be given if goods cannot be reused. Special order items are in no event subject to return. Goods must be returned within 70 days of shipment from factory.
30. **Cancellations:** No charge prior to production. After production has begun (5 days ARO), only the actual costs that the contractor can demonstrate will be billed to the customer if the merchandise cannot be resold within a reasonable period of time (90 days).
31. **Inside Delivery:** Gunlocke rates are for dock-to-dock delivery and do not include inside delivery, un-cartoning or set up. If desired, arrangements for inside delivery must be made and approved when the order is placed and will have a corresponding fee of 7% of list price of the order with a minimum charge of \$75. Requests for un-cartoning and set up will be coordinated with a Gunlocke Dealer with applicable charges applied to the order.
32. **Federal Tax ID # 22-3887942**

INTRODUCTION

The Gunlocke Company is dedicated to providing the finest possible products and service. This price list reflects that commitment. Included is a current listing of our seating models.

Casegoods are presented in a separate price lists. Contact your Gunlocke Customer Services Representative for more information. (800) 828-6300

Designed for easy use, each page of this price list provides all information required to order a product correctly. Should additional information be needed, contact your Gunlocke Customer Service representative.

PRICING

Prices shown covers standard products. Any changes or alterations, other than those listed, will be subject to an additional charge. Prices include cartoning and freight. Contact the Gunlocke Tailored Solutions at gunts@gunlocke.com to request custom quotes. Authorization and pricing must be secured in advance for orders or contracts calling for large quantities, indefinite quantities, or extended delivery dates.

ORDERING

Orders submitted electronically will receive priority service and shorter overall lead times. You can submit your orders electronically via traditional EDI (Electronic Data Interchange), by e-commerce at www.gunlockeadvantage.com using your XML and SIF files.

Orders in the amount of \$75,000 list or larger will require a XML or SIF file to be e-mailed to our order entry department at gunlockeoe@gunlocke.com.

Orders under \$75,000 list do not require an XML or SIF file and can be e-mailed to our order entry department at gunlockeoe@gunlocke.com, faxed to 585-728-8350, or mailed to:

The Gunlocke Company
Attn: Order Entry
One Gunlocke Drive
Wayland, New York 14572

ORDER CHANGES

Gunlocke is not required to accept changes in orders after confirmation. Reasonable changes are subject to additional charges for labor, material and administrative costs.

Order changes of acknowledgment may result in re-scheduling of product.

ACKNOWLEDGMENT

Each order will be acknowledged by Gunlocke. Customers should check each acknowledgment for accuracy and immediately notify Gunlocke of any discrepancies.

This printed acknowledgment is the final agreement between The Gunlocke Company and the customer, superseding all previous communications regarding the order.

SPECIFICATION CHANGES

Gunlocke reserves the right to change specifications for the improvement of products at any time, without notice.

RETURNED MERCHANDISE

No merchandise may be returned without prior authorization.

SHOWROOMS

For all showroom locations and tour information, please reference the showrooms page online at: www.gunlocke.com/inspiration/showrooms

CANCELLATIONS

Cancellations of orders cannot be accepted since every order is manufactured according to customer's specifications.

STORAGE

If delivery cannot be made and products are ready, Gunlocke will transfer products to a storage facility of the customers choice and products will be invoiced at this time. The customer is responsible for storage charges as well and assumes and bears all risks associated with the storage of that product.

TERMS

Net 30 days from date of invoice. A service charge of eighteen percent (18%) per year or .0004931 per day, compounded monthly, will be added to balance due beyond the thirtieth day. Products are shipped **FOB factory, freight prepaid and allowed.**

Title passes to purchaser and Gunlocke's responsibility ceases when shipment is accepted for transportation by a carrier. A full explanation of all payment terms is found on order and invoice forms.

12 YEAR WARRANTY

Subject to the limitations set forth below. The Gunlocke Company warrants to the original purchaser all product in this price list to be free from defects in material and workmanship for a twelve year period from the date of shipment.

This **12-year warranty** applies to all products sold and installed by a Gunlocke authorized agent for normal commercial single shift service. Gunlocke will repair, or at its option, replace defective merchandise, free of charge. The following components not manufactured by Gunlocke have the following warranties:

- **High wear components** Such as casters and glides are warranted for five years after date of shipment to original owner.
- **Seating control mechanisms** are warranted for five years after date of shipment to original owner.
- **Fabric and leather** are warranted for three years if single-shift and normal use after shipment to original owner.

Any non-standard material selected by the customer is not warranted. Neither does this warranty apply to damage resulting from accident, alteration, or misuse, as well as damage from normal wear and tear such as dents, nicks, scratches, fading and improper maintenance. That is, Gunlocke's warranty is only valid if products are given proper use and care. Gunlocke assumes no responsibility for product damages resulting from improper installation or user modification.

WOOD FURNITURE

Wood owes its inherent beauty to variations in color, grain, and texture, and therefore, these variations are not considered defects. There may be minor variations from one piece of furniture to the next even though they are finished at the same time. Exposure to light and the aging process will cause a darkening of natural wood products. Light finishes on wood products do not mask the natural characteristics of wood.

The Gunlocke Company does not guarantee the exact matching of grain, pattern, and color. Gunlocke offers 800 a natural maple finish on maple, 222 a natural cherry on maple, 701 a light cherry finish on cherry or maple, 629 nutmeg walnut on walnut or maple, and 601 light walnut on walnut or maple. These finishes do not cover any of the natural characteristics of the wood, including nature's colorations, pitch pockets, and the variations of steambent wood. Merchandise will not be replaced because of these natural variations.

It is expressly understood and agreed that the buyer's sole and exclusive remedy for any and all losses or damages resulting from nonconforming goods, or from any other cause, shall be repair or replacement of defective parts, and that Gunlocke shall not be liable for damages or injury to persons or property, nor for replacement of the entire commercial unit, if repair or replacement of defective parts can reasonably render the unit conforming.

All warranty claims must be submitted in writing by the original owner via our website at <https://apps.gunlockeadvantage.com/QualityFeedback/>.

Owner may be required to produce the invoice or other evidence to establish that a claim is within the warranty period.

As stated and illustrated on the website, serial numbers are required to process a warranty claim. No person, firm, or corporation is authorized to assume for Gunlocke any liability in connection with the sale or installation of Gunlocke products except as stated above.

All other warranties, expressed or implied, are excluded. Gunlocke shall not be liable for incidental or consequential damages of any sort.

*Warranty claims entered at <https://apps.gunlockeadvantage.com/QualityFeedback/>

Within the Continental USA, all orders above \$20,000 list are shipped FOB factory, freight prepaid and allowed. All orders less than \$20,000 list will be subject to a \$200 net freight charge. Products shipped to Alaska and Hawaii FOB factory, freight prepaid and allowed to port of embarkation. Customer is responsible for freight charges from port of embarkation to final destination.

An anticipated shipping date is indicated on the order acknowledgment. Gunlocke cannot accept responsibility for shipping delays caused by outside sources or unforeseen problems. Delay of shipments requested by customers must be approved by Gunlocke. Any resultant storage charges will be charged to the customer.

Gunlocke may await completion of the entire order and ship all at once or may make partial shipments from time to time at its sole discretion unless the customer requests in writing that partial shipments are needed and Gunlocke approves the specific shipping schedule. Additional charges may apply.

Gunlocke is not liable for any delay or failure to deliver or perform due to strikes, lock-outs, or other labor or transportation difficulties, delay of sources or supply, accidents, fires, acts of God, or any other causes of like or unlike nature beyond the control of Gunlocke.

LIABILITY

Gunlocke products and their packaging are tendered to a transportation company only after passing rigid quality control inspection. At that time, title to the product is passed to the purchaser. However the transportation company assumes all liability from acceptance of shipment through its delivery. That is, Gunlocke's liability ceases at the time of shipment.

FILING OF CLAIMS

All claims for damage or loss must be submitted via our website at: <https://apps.gunlockeadvantage.com/QualityFeedback/> within 15 days after receipt of merchandise. Do not return freight damaged merchandise to Gunlocke. Follow the steps below to expedite processing and resolution of claims.

For Visible Damage

1. Make damage notation on delivery receipt and have driver sign. Do not reject or refuse the shipment.
2. Immediately contact Gunlocke Traffic Department at 585-728-8268.
3. Hold damaged carton and all interior packing for carrier's inspection. These materials will be needed to substantiate the claim.

For Concealed Damage

1. Open cartons within 15 days of receipt and inspect.
2. Follow steps 2, and 3 as listed under Visible Damage.
3. Do not remove product from delivered destination.

For Loss

1. Be sure loss notation is made on delivery receipt and have driver sign.
2. Contact Gunlocke Traffic Department at 585-728-8268.

Should transportation company seek to limit its liability on concealed, loss, or damage claims, please contact Gunlocke's traffic department. After a thorough investigation of the claim, the traffic department will provide you with guidance in corresponding with the carrier.

Returned merchandise, regardless of delivery method, will not be accepted unless specifically authorized by Gunlocke.

For Damage or Loss of Parcel Post or UPS Shipment

Notify the Gunlocke traffic department immediately at 585-728-8268.

NORMAL DELIVERY

All normal ground transportation by Gunlocke will be made on a dock-to-dock basis. The Gunlocke traffic department will determine the recommended method of shipment according to the ship to destination. If the delivery on a shipment takes longer than 3 hours to be unloaded, an additional charge will be billed at \$100/hour. Gunlocke reserves the absolute right to determine the method of shipping unless special delivery instructions have been previously approved.

SHIPPING INSTRUCTIONS

Gunlocke will make every effort in honoring delivery requests as stated on orders. However, the Company shall have no liability for failure to deliver, perform or delay in delivery due to any cause outside the control of Gunlocke. The Company assumes no liability for costs incurred due to delayed or late deliveries.

If a guaranteed delivery time is needed please call Gunlocke Traffic Department at 585-728-8268 for a quote as additional charges will apply. Weekend or after hours deliveries are subject to additional charges.

WEEKEND DELIVERY

A \$500 charge will apply on weekend delivery after 3:00 PM Friday through Sunday evenings.

DROP SHIP / JOB SITE DELIVERY

Orders under \$50,000 list will incur a \$125 charge for ship to locations other than a designated dealer warehouse.

INSIDE DELIVERY

Inside delivery must be noted on order. A minimum \$100 charge will apply.

SPECIAL DELIVERY

Please contact the Gunlocke traffic department for special delivery services such as inside delivery, weekend or after hour deliveries, reconsignment or other special needs. These are billable services.

Gunlocke will make every effort in honoring delivery requests as stated on orders. However, the Company shall have no liability for failure to deliver, perform or delay in delivery due to any cause outside the control of Gunlocke. The Company assumes no liability for costs incurred due to delayed or late deliveries.

DOCK RESTRICTIONS

Gunlocke trailers are 53' x 102"; when attached to truck cab the total length is 75'. If delivery dock will not accommodate trucks of this sizes, the Gunlocke traffic department must be contacted prior to shipping. Alternate arrangements can be made; additional charges may apply.

SPECIAL FINISHES

- Submit a color sample block (minimum size 3" x 3") to Gunlocke Order Entry so that a finish formulation can be developed to match the special finish and color.
- Review the approval sample provided by Gunlocke.
- Written approval and sign off is required for Gunlocke Customer Service.
- Once written approval and sign off is received, the special finish order will be acknowledged.

All seating purchase orders:

- **10% list** upcharge per unit to base model receiving special finish.
- **\$250 net formulation fee** for special finish.

This procedure and cost apply to new and previously formulated special finishes. Special finish orders may receive additional lead time.

FSC OPTION

For FSC Certified Product add "FSC" to beginning of wood finish option code.

Example: FSC260.

Only models that have wood finish option can be ordered as FSC Certified Product.

UPCHARGES

- 5% list upcharge per unit to base model

MULTIPLE FABRICS PRICING

When multiple fabrics per chair are requested, the chair is priced at the highest grade price.

ETCHED AND LASER CUT BACKS

Eligible Models:

All Multi Seating with Wood Backs

Minimum order quantity: 5 Units

There shall be an initial setup fee of **\$250 (NET)** with a **\$100** List up-charge per unit. All standard finishes may be specified with backs. For new designs please submit artwork* to Customer Service for review and approval. Once the artwork is accepted, an actual sample will be produced and sent for approval.

*Please allow 3-5 business days upon receipt of the artwork for the sample to be completed.

All artwork must be clean and sharp image. Gunlocke can only accept mailed original artwork. Artwork must be black and white, bold and have crisp lines to be processed. Contact Order Entry for complete order and approval process. (800) 828-6300.

GUNLOCKE STANDARD TEXTILE OFFERING AND COM PROGRAM OVERVIEW

Customers purchasing Gunlocke seating can choose coverings from the standard fabric/leather offering or fabrics can be specified outside of the Gunlocke standard fabric offering through a simpler, hassle-free COM process.

Standard Fabric/Leather Partnership Program – select from any one of the Gunlocke standard fabrics or leather offerings listed on the website from the following textile partners: HBF, Maharam, Momentum, Ultrafabrics or Camira. For the most current standard fabric and leather offering, please visit the website at www.gunlocke.com.

HBF
TEXTILES

maharam

Ultrafabrics

camira

COM Program – COM coverings can easily be specified and applied your seating products. Gunlocke offers two different processes for the COM program which are outlined below. The Gunlocke To Supply COM process is managed by Gunlocke and Dealer to Supply COM process is managed by the dealer.

- **Gunlocke To Supply (GTS) COM Program** – this is a process for fabrics that are not included in the standard Gunlocke offering. Gunlocke will manage the COM process with the textile supplier and will coordinate with the dealer to approve, grade/price and procure the fabric.

GTS Guidelines:

1. Select the fabric you wish to use and check the Gunlocke COM Tool on www.gunlockeadvantage.com to determine if the fabric you have chosen has already been tested and approved on the product you are interested in. The COM supplier's name, fabric pattern name, and color name will be needed to search for approved fabrics.
 - 2a. If your fabric is listed as an approved fabric, you may place your order directly with Gunlocke Customer Service. Please use the fabric code (e.g., S216426XP) noted in the COM Tool on your order in the place of the standard fabric code.
 - 2b. If the fabric has not previously been tested, you must enter a COM request. Your name, company name and email will be prepopulated fields. The secondary email, project name, and bid/contract number are optional information. However, it's best to include any bid/contract information to ensure the code is set up correctly. The supplier, pattern, and color will show a list by clicking in the box and entering the first letter of the name and these are free form text boxes. Once that information is entered click add. (Multiple series can be added to the same request if they are the same supplier, pattern, and color.) Then click submit. An email will be sent to the requestor stating the COM Request was successfully submitted. Up to four emails could be received: Testing materials requested, in testing, and final approval/denial. It's rare actual test yardage is required. Testing is mainly done by reviewing the attributes of the fabric. The testing process takes 24-48 hours.
 3. If approved, the final email will include the GTS fabric option code and price grade. Written COM price quotes hold pricing for 90 days after issue date.
- **Dealer to Supply – COM or COL Program** – this is also a process for fabrics/leathers that are not included in the standard Gunlocke offering. The main difference is that the dealer will manage the COM process themselves and will procure the fabric from textile supplier and send to Gunlocke to upholster on the product.

COM/COL Guidelines:

1. Select the fabric you wish to use and check the Gunlocke COM Tool on www.gunlockeadvantage.com to determine if the fabric you have chosen has already been tested and approved on the product you are interested in. The COM supplier's name, fabric pattern name, and color name will be needed to search for approved fabrics.
2. If your fabric is listed as approved, please reference the upholstery requirements listed in the pricer.
3. If the fabric has not previously been tested, you must enter a COM request. Your name, company name and email will be prepopulated fields. The secondary email, project name, and bid/contract number are optional information. However, it's best to include any bid/contract information to ensure the code is set up correctly. The supplier, pattern, and color will show a list by clicking in the box and entering the first letter of the name and these are free form text boxes. Once that information is entered click add. (Multiple series can be added to the same request if they are the same supplier, pattern, and color.) Then click submit. An email will be sent to the to the requestor stating the COM Request was successfully submitted. Up to four emails could be received: Testing materials requested, in testing, and final approval/denial. It's rare actual test yardage is required. Testing is mainly done by reviewing the attributes of the fabric. The testing process takes 24-48 hours.
4. If approved, the final email will include the Dealer to Supply fabric option code and the COM or COL price grade. Written COM price quotes hold pricing for 90 days after issue date.
5. The dealer is responsible for sending the COM fabric to Gunlocke. Fabric must be marked with "COM – Dealer to Supply", dealer name, order number and seating model #. COM textile should be shipped to the address below the same time as the order submission and reference tracking information on order, to prevent production delays.

HNI Textile Distribution Center - Dealer PO Number
Attn: COM Production Yardage
301 Mulberry Ave.
Dock Doors 20-22
Muscatine, IA 52761

6. All COM "Dealer to Supply" orders will be charged grade 4 pricing. Dealers will pay for the COM fabric separately.
7. All COM fabric must be sent on a fabric roll.
8. Once the COM fabric is received, the order will be scheduled in production and acknowledged with a ship date.

Specific to DTS orders - the customer should send only the amount needed for the order. Fabric should arrive no sooner than 4 weeks in advance of order placement. Excess yardage, or yardage not attached to an order will be disposed of at Gunlocke's discretion.

Any canceled orders are subject to cancellation charges up to the full value of the Gunlocke product canceled. Gunlocke will determine the actual cancellation charge at the time the cancellation is requested.

COM | CUSTOMER'S OWN MATERIAL

1. Gunlocke cannot be held responsible for performance, color accuracy, or weaving of COM materials. All responsibility for COM shipments is between the purchaser and the textile source.
2. Gunlocke assumes no responsibility for the flame retardance of any COM. Customers are solely responsible for making sure that COM shipments comply with all applicable codes and regulations.
3. Gunlocke reserves the right to reject fabrics or leathers we deem unsuitable for upholstery. When this occurs, the customer will be notified in writing with an explanation of the problem. Gunlocke cannot be held responsible for any unsatisfactory results in the application of a COM/COL, and a written release from the customer will be required before the order is processed.
4. Please contact Gunlocke Customer Service if you are planning on having any fabric applied in a non-standard technique. (I.E. using the back side as the face), or have special requirements.
5. Fabric alterations such as laminated backing or fire coding may result in differences in upholstery appearance or stiffness.

YARDAGE REQUIREMENTS

Yardages shown in price list are for non-directional fabric based on 54" wide plain fabric (no repeat pattern). A chart is provided on page 14 to assist in determining the additional COM yardage requirements. Please add the indicated percentage to the yardage shown beside the style number in the price list. This guide will accurately cover most COM orders, but there will be instances due to unusual repeats or designs that additional yardage may be required. **Gunlocke will not be held responsible for any additional COM that may be required. Please contact Customer Service for quotations on fabric requirements.**

SELF-DECK PLATFORMS

Self-covered platforms in COM are available at no upcharge. Allow additional yardage in the following amounts for 54" material:

One seat sofa	1 yd.
Two seat sofa	1.5 yds.
Three seat sofa	2 yds.

FABRIC APPLICATION

Cutting direction is based on the fabric width and the way the fabric is cut from the roll and applied to Gunlocke products. There are two cutting directions: Vertical (cut-right) or Horizontal (railroaded). Gunlocke reserves the right to railroad (or apply the fabric according to the weave) whenever possible to avoid seams in large upholstered areas and/or single cushions units. If a fabric is questionable, a cutting of adequate size allowing full repeats must be sent to Customer Service for approval.

COL | CUSTOMER'S OWN LEATHER

Customer's leather must meet standards set by Gunlocke. All hides must be #1 quality, bear no greater than three defects, and yield a minimum of 45 usable square feet per hide. Imperfections that penetrate the hide, brands, large marks, burns, excessive healed over scars and scratches, and excessive fat wrinkles are considered defects.

COL SPECIFICATIONS

Leather footage requirements listed in the price list refer to usable leather square footage that meet the standards described above. Calf hides must be at least 30 square feet of clean and usable matching hides. When specifying calf hides, add 30% to footage requirements. **Gunlocke will not be held responsible for any additional COL that may be required.**

LEATHER SEAT PUDDLING

Leather is a natural material which has elasticity and will form according to usage. For example as a leather seat "breaks in" (similar to leather shoes) stretching may occur. This is an inherent quality of natural leather and is not considered a defect.

LEATHER LOGOS

Leather is a natural material which has elasticity. The degree of stretching occurring in the upholstery process varies by model and may reduce the visual depth of the logo detail.

EMBROIDERED LOGOS

Certain logo geometry may limit threads per inch on embroidered logos. **Logos on Fabric and Leather have a three year warranty see page 8.**

FOR SAMPLE CONTACT:

gunts@gunlocke.com

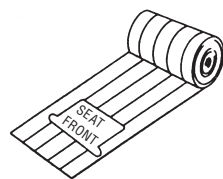

Vertical or Cut-Right

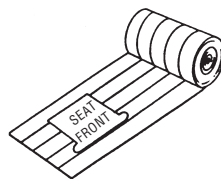

Horizontal or Railroaded

COM | COL ORDERING PROCESS

1. COM material must be approved by Gunlocke for applicability and yardage requirements before acceptance of an order.

Please send large memo sample to COM for approval.

Additional yardage may be required to determine acceptance for upholstery.

2. COM | COL sample must reference the supplier's company name, pattern, color and number order.

3. Application instructions must accompany order. In absence of these instructions, Gunlocke will determine best method of upholstery.

4. All COM | COL must be shipped pre-paid to Gunlocke with package side marked with:

- Dealer Name
- Dealer purchase order number
- Gunlocke seating pattern number

**HNI Textile Distribution Center -
Dealer PO Number
Attn: COM Production Yardage
301 Mulberry Ave.
Dock Doors 20-22
Muscatine, IA 52761**

NOTE

COM and COL orders cannot be scheduled for production or acknowledged as to ship date until COM has been received and approved by Gunlocke. Gunlocke will not warrant application and upholstery technique

PLEASE REFER TO YOUR FABRIC SWATCH CARD FOR HORIZONTAL AND VERTICAL REPEAT REQUIREMENTS.

Fabric Width	Plain Fabric	2"-10" Repeat	11"-20" Repeat	21"-25" Repeat	26"-30" Repeat	31"-37" Repeat	38"-45" Repeat	46"-52" Repeat
54"	0%	10%	15%	20%	25%	30%	35%	40%
52"	15%	20%	25%	30%	35%	40%	45%	50%
50"	25%	30%	35%	40%	45%	50%	55%	60%
48"	35%	40%	45%	50%	55%	60%	65%	70%
45"	45%	50%	55%	60%	65%	70%	75%	80%

Fabric Width	Plain Fabric	2"-10" Repeat	11"-20" Repeat	21"-25" Repeat	26"-30" Repeat	31"-37" Repeat	38"-45" Repeat	46"-52" Repeat
36"	60%	65%	70%	75%	80%	85%	90%	95%

Depending upon the pattern repeat, it may be necessary to cut the fabric vertical (cut-right). This will require 15% additional fabric.

To calculate the correct yardage with repeats (horizontal and vertical), add the horizontal repeat to the vertical repeat for total yardage required.

When calculating repeat, round up to nearest .5 yard.

For example:

A fabric width of 54" with a 8" vertical repeat (requires 10%) + a 20" horizontal repeat (requires 15%) = total additional yardage equals 25%.

Therefore, if the chair requires 2 yards of fabric, multiply 2 by 125% (or 2 x 1.25). Then 2.5 yards will be yardage required.

CUT YARDAGE PROGRAM

All Gunlocke Branded textiles and leathers are available on a cut yardage basis.

PRICING

For pricing information, please contact customer support at guncks@gunlocke.com or call 800-828-6300. Please have fabric pattern and color available. Pricing provided will not include shipping charges, storage or insurance charges, sales and other taxes.

ORDERING

Order all fabrics by name and pattern number. All cut-yardage orders will be cut and shipped to the nearest one-eighth yard. Minimum order quantity is one yard. Leathers are sold by the square foot to the closest whole or half hide. When an exact match is necessary, please submit a cutting with order; slight variations in shade cannot be avoided.

ACKNOWLEDGMENT

All orders will be confirmed by Gunlocke in writing. The order acknowledgment is the final expression of the agreement between the customer and Gunlocke and supersedes all prior verbal and written statements regarding the order. The acknowledgment can be modified only in writing with reconfirmation signed by Gunlocke.

CANCELLATIONS

Orders may not be canceled or returned by the customer without the written consent of The Gunlocke Company and are subject to a cancellation or restocking charge of 35% of the total amount of the order.

CREDIT TERMS FOR CUT YARDAGE PROGRAM

Credit may be established upon Gunlocke's written acceptance of satisfactory references. Gunlocke may cancel or change credit terms at its discretion and may request advance payment at any time. All prepaid orders must include shipping and handling charges and tax where applicable. If local taxes are not applied on prepaid orders, customer must complete a resale certificate indicating their tax I.D. number.

**FLAMMABILITY GUIDELINES
UPHOLSTERY COVERS**

Gunlocke makes every effort to ship high quality product, free of defects in material and workmanship. Great care is taken in selecting only first quality upholstery materials from reputable suppliers.

Upholstery material is warranted for 3 years against unusual wear or deterioration; there is no warranty against fading, normal wear, or customer-induced cuts and tears.

Leather is a natural material. There may be minor variation in markings such as growth wrinkles, healed scars, and grain patterns. Also, subtle variations in the tanning and dyeing process can be seen from one hide to another.

Combinations of Upholstery Covers

Contact Tailored Solutions (gunts@gunlocke.com) for assistance with pricing of fabric, vinyl, leather or upholstery combinations.

SPECIAL TREATMENT/ FLAMMABILITY

Technical Bulletin #133 is a flammability regulation that may be required or requested for certain areas or applications. Most standard Gunlocke fabrics, when used in combination with proper components, can meet the requirements of the composite test for California technical bulletin #133. The composite test requires the use of a full-scale mock-up/sample that in all respects (including fabrics, filling materials, combustible decorative parts and furniture style) reflects the construction of the actual furniture required for a specific area or application.

While Gunlocke has tested several model/upholstery combinations for TB133, not all possible combinations have been tested or certified. Please contact Customer Service to determine if the specific model/upholstery combination you are working with has been tested or if a new test is required. In addition, all COM fabrics must be evaluated on an individual basis and may also require testing. Testing is available as follows:

Specific model & upholstery

- Fire barrier is available as a special treatment. If required, please contact Gunlocke Tailored Solutions to quote as a special: gunts@gunlocke.com.
- Please check with Customer Service to verify testing has been completed with your model and fabric selection.
- Cost of testing a chair is \$850 NET, plus the cost of chair and fabric.
- Additional lead-time for testing for CAL 133.
- Additional lead-time for fire barrier cloth is 3-4 weeks.

*Note that specification of the fire barrier cloth does not in itself provide certification. Testing must be completed and pass for the specific model/upholstery combination to obtain a certificate. Once testing is completed, Gunlocke will provide a certification letter specific to the sample tested for CAL 133.

Special Flammability Code Requirements

Please inquire for pricing and lead time.

ACT PERFORMANCE GUIDELINES

Explanation of ACT Icons

All Gunlocke fabrics conform to the Association of Contract Fabrics Guidelines.

FIRE RETARDANCY



Flammability testing determines a fabric's resistance to burning.

Application	Passes
Upholstery	California 117-2013
Panels and Upholstered Walls	ASTM E 84 (unadhered method)

COLORFASTNESS TO WET AND DRY CROCKING



Colorfastness to wet and dry crocking refers to the rubbing off of color from the fabric onto clothing, hands or other materials and can occur under wet or dry conditions.

Application	Passes
Upholstery AATCC 8-1974	Dry Crocking, Class 4 minimum Wet Crocking, Class 3 minimum
Panels and Upholstered Walls	AATCC 8-1974 Class 3 minimum

COLORFASTNESS TO LIGHT



Colorfastness to light is the degree to which fabric will retain its color when exposed to light.

Application	Passes
Upholstery	AATCC 16-A-1974 or AATCC 16-E-1976 Class 4 minimum at 40 hours
Panels and Upholstered Walls	AATCC 16-A-1974 or AATCC 16-E-1976 Class 4 minimum at 40 hours

PHYSICAL PROPERTIES



Three physical property tests include: brush pill test to determine a fabric's pilling. Breaking/tensile strength is the ability of a fabric to withstand tension without breaking or tearing. Seam slippage is the pulling apart of fabrics at the seams.

Application	Passes
Upholstery	Brush pill ASTM D3511, 3-4 minimum Breaking strength ASTM DF-D1682-64 (1975) 50 lbs. minimum in warp and weft Seam slippage ASTM D3597-D434-75 25 lbs. minimum in warp and weft

ABRASION



Abrasion is the ability of a fabric to withstand damage from wear and rubbing. There is a general contract specification as well as a heavy duty specification.

Application	Passes
General Contract Upholstery	ASTM 3597 modified #10 cotton duck) 15,000 double rubs Wyzenbeek Method
Heavy Duty Upholstery	ASTM 3597 modified (#10 cotton duck) 30,000 double rubs Wyzenbeek method or ASTM D4966 (with 21 oz.weight) 40,000 rubs Martindale method



FABRIC MATRIX

Seating
05/22

FABRIC TABLES
Silea Tackboards

• Available upholstery option
RR: railroaded, F/FR: Fire compliant model

Supplier	Pattern Name	Pattern Code	New Grade	FABRIC TABLES Silea Tackboards						
				Tack	Tack A	Tack B	Tack C	Tack D	Tack E	Tack F
HBF Textiles	Blink	1048	4							
HBF Textiles	Look-See	1044	4							
HBF Textiles	Walkabout	1046	4							
HBF Textiles	Against the Grain	SHBFAGG	5	•			•	•	•	
HBF Textiles	Caddy Corner	1016	5							
HBF Textiles	Checkmate	1043	5							
HBF Textiles	Pebbled	SHBFPEB	5							
HBF Textiles	Picnic Plaid	1029	5							
HBF Textiles	Upbeat	1036	5							
HBF Textiles	Zippy	1045	5							
HBF Textiles	Poppy	1047	6							
HBF Textiles	Crew Cut	SHBFCRW	7	•			•	•	•	
HBF Textiles	Happy Camper	1028	7							
HBF Textiles	Honest	SHBFHON	7							
HBF Textiles	Roundabout	1005	7							
HBF Textiles	Dashing	1008	8							
HBF Textiles	Fourfold	SHBFFOU	8	•			•	•	•	
HBF Textiles	Modern Tweed	SHBFMOD	8							
HBF Textiles	Sherpa	1031	8							
HBF Textiles	All Terrain	1027	9							
HBF Textiles	Comfort Zone	905	9							
HBF Textiles	Crafted Felt	1017	9							
HBF Textiles	Curtain Wall	1023	9							
HBF Textiles	Madam Dottie	1001	9							
HBF Textiles	Scribble XS	982	9							
HBF Textiles	Uptown	1039	9							
HBF Textiles	Wabi Sabi	SHBFWAB	9							
HBF Textiles	Color Code	998	10							
HBF Textiles	Digital Bloom 2.0	1050	10							
HBF Textiles	Equation	SHBFEQU	10	•			•	•	•	
HBF Textiles	Folded Lines	973	10							
HBF Textiles	Remember	SHBFREM	10							
HBF Textiles	Roy's Cords	1025	10							
HBF Textiles	Soft Angles 2.0	1051	10							
HBF Textiles	Upscale	1040	10							
HBF Textiles	Air Mail	1006	11							
HBF Textiles	Argyle Boucle	978	11							
HBF Textiles	Brushed Canvas	SHBFBCV	11							
HBF Textiles	Cloud	SHBFCLD	11							
HBF Textiles	Complex	964	12							
HBF Textiles	Abito	SHBFABI	12							
HBF Textiles	Beetle	SHBFABI	12	•			•	•	•	
HBF Textiles	Belgian Meadow	SHBFBLM	12	•			•	•	•	
HBF Textiles	Crosstweed	991	12							
HBF Textiles	Cutout	SHBFCUT	12							
HBF Textiles	Dot Grid	975	12							
HBF Textiles	Dot Structure	SHBFDOT	12							
HBF Textiles	Glint	SHBFGLT	12	•			•	•	•	
HBF Textiles	Grateful Grid	1015	12							
HBF Textiles	Heartfelt	SHBFHTF	12	•	•	•	•	•	•	•
HBF Textiles	Lava Rock	993	12							
HBF Textiles	Merci Boucle	SHBFMER	12							
HBF Textiles	Moving Blanket	SHBFMOV	12							
HBF Textiles	Sable Island	SHBFSAB	12							

FABRIC TABLES
Silea Tackboards

• Available upholstery option
RR: railroaded, F/FR: Fire compliant model

Supplier	Pattern Name	Pattern Code	New Grade	FABRIC TABLES Silea Tackboards						
				Tack	Tack A	Tack B	Tack C	Tack D	Tack E	Tack F
				No Restriction	66"W & 77"W Railroad Cut Only	77"W Railroad Cut Only	66"W & 77"W Pattern Cut Only	77"W Pattern Cut Only	No Pattern Cut	No Railroad Cut
HBF Textiles	Sir Stripe A Lot	1004	12							
HBF Textiles	Sweater Weather	1030	12							
HBF Textiles	Twist	SHBFTWS	12							
HBF Textiles	Upstart	1042	12							
HBF Textiles	Cherished Knit	954	13							
HBF Textiles	Enriched Boucle	1021	13							
HBF Textiles	Foundation	SHBFFND	13							
HBF Textiles	Moving Forward	1014	13							
HBF Textiles	Night Earth	1013	13							
HBF Textiles	Pepper Blend	995	13							
HBF Textiles	Quill	1011	13							
HBF Textiles	Scribble XL	983	13							
HBF Textiles	Sister Solid	1003	13							
HBF Textiles	Afghan	SHBFAFG	14	•	•	•	•	•	•	•
HBF Textiles	Smart	SHBFSMT	14							
HBF Textiles	Velvet Mix	977	14							
HBF Textiles	Hipster	SHBFHPT	15	•			•	•	•	
HBF Textiles	Landscape Blur	1024	15							
HBF Textiles	Poodle	1009	16							
HBF Textiles	Sweater	SHBFSWE	16							
HBF Textiles	Woven Memory	1019	16							
HBF Textiles	Crafted Cloud	1018	19							
HBF Textiles	Knitwork	SHBFKNI	21							
HBF Textiles	Bunny	1012	23							
HBF Textiles	Eccentric	966	23							
HBF Textiles	Eccentric	SHBFECC	23							
HBF Textiles	Wild West	717	L2							
HBF Textiles	Aviator	K08	L3							
HBF Textiles	Freeway	K03	L3							
HBF Textiles	Modern Patina	716	L3							
HBF Textiles	Persuede	718	L3							
HBF Textiles	Vivace II	K07	L3							
HBF Textiles	Upper Crust	K05	L5							
HBF Textiles	Voyage	K09	L5							

FABRIC MATRIX

FABRIC TABLES

• Available upholstery option

RR: railroaded, F/FR: Fire compliant model

Supplier	Pattern Name	Pattern Code	New Grade	FABRIC TABLES							Callia
				Liv	Iris	Swivel 2	Lounge 2	Side 1	Side 2		
HBF Textiles	Taylor	TAY	2		•	•	•	•	•	•	
HBF Textiles	Blink	1048	4			•	•	•	•	•	
HBF Textiles	Look-See	1044	4	•	•	•	•	•	•	•	
HBF Textiles	Walkabout	1046	4	•	•	•	•	•	•	•	
HBF Textiles	Against the Grain	SHBFAGG	5	•	•	•	•	•	•	•	
HBF Textiles	Caddy Corner	1016	5	•	•	•	•	•	•	•	
HBF Textiles	Checkmate	1043	5	•	•	•	•	•	•	•	
HBF Textiles	Pebbled	SHBFPEB	5	•	•	•	•	•	•	•	
HBF Textiles	Picnic Plaid	1029	5	•	•	•	•	•	•	•	
HBF Textiles	Upbeat	1036	5	•	•	•	•	•	•	•	
HBF Textiles	Zippy	1045	5	•	•	•	•	•	•	•	
HBF Textiles	Poppy	1047	6	•	•	•	•	•	•	•	
HBF Textiles	Crew Cut	SHBFCRW	7	•	•	•	•	•	•	•	
HBF Textiles	Happy Camper	1028	7	•	•	•	•	•	•	•	
HBF Textiles	Honest	SHBFHON	7	•	•	•	•	•	•	•	
HBF Textiles	Roundabout	1005	7	•	•	•	•	•	•	•	
HBF Textiles	Dashing	1008	8	•	•	•	•	•	•	•	
HBF Textiles	Fourfold	SHBFFOU	8	•	•	•	•	•	•	•	
HBF Textiles	Modern Tweed	SHBFMOD	8	•	•	•	•	•	•	•	
HBF Textiles	Sherpa	1031	8	•	•	•	•	•	•	•	
HBF Textiles	All Terrain	1027	9	•	•	•	•	•	•	•	
HBF Textiles	Comfort Zone	905	9	•	•	•	•	•	•	•	
HBF Textiles	Crafted Felt	1017	9	•	•	•	•	•	•	•	
HBF Textiles	Curtain Wall	1023	9	•	•	•	•	•	•	•	
HBF Textiles	Madam Dottie	1001	9	•	•	•	•	•	•	•	
HBF Textiles	Scribble XS	982	9	•	•	•	•	•	•	•	
HBF Textiles	Uptown	1039	9	•	•	•	•	•	•	•	
HBF Textiles	Wabi Sabi	SHBFWAB	9	•	•	•	•	•	•	•	
HBF Textiles	Color Code	998	10	•	•	•	•	•	•	•	
HBF Textiles	Digital Bloom 2.0	1050	10	•	•	•	•	•	•	•	
HBF Textiles	Equation	SHBFEQU	10	•	•	•	•	•	•	•	
HBF Textiles	Folded Lines	973	10	•	•	•	•	•	•	•	
HBF Textiles	Remember	SHBFREM	10	•	•	•	•	•	•	•	
HBF Textiles	Roy's Cords	1025	10	•	•	•	•	•	•	•	
HBF Textiles	Soft Angles 2.0	1051	10	•	•	•	•	•	•	•	
HBF Textiles	Upscale	1040	10	•	•	•	•	•	•	•	
HBF Textiles	Air Mail	1006	11	•	•	•	•	•	•	•	
HBF Textiles	Argyle Boucle	978	11	•	•	•	•	•	•	•	
HBF Textiles	Brushed Canvas	SHBFBCV	11	•	•	•	•	•	•	•	
HBF Textiles	Cloud	SHBFCLD	11	•	•	•	•	•	•	•	
HBF Textiles	Complex	964	12	•	•	•	•	•	•	•	
HBF Textiles	Abito	SHBFABI	12	•	•	•	•	•	•	•	
HBF Textiles	Beetle	SHBFABI	12	•	•	•	•	•	•	•	
HBF Textiles	Belgian Meadow	SHBFBLM	12	•	•	•	•	•	•	•	
HBF Textiles	Crosstweed	991	12	•	•	•	•	•	•	•	
HBF Textiles	Cutout	SHBFCUT	12	•	•	•	•	•	•	•	
HBF Textiles	Dot Grid	975	12	•	•	•	•	•	•	•	
HBF Textiles	Dot Structure	SHBFDOT	12	•	•	•	•	•	•	•	
HBF Textiles	Glint	SHBFGLT	12	•	•	•	•	•	•	•	
HBF Textiles	Grateful Grid	1015	12	•	•	•	•	•	•	•	
HBF Textiles	Heartfelt	SHBFHTF	12	•	•	•	•	•	•	•	
HBF Textiles	Lava Rock	993	12	•	•	•	•	•	•	•	
HBF Textiles	Merci Boucle	SHBFMER	12	•	•	•	•	•	•	•	
HBF Textiles	Moving Blanket	SHBFMOV	12	•	•	•	•	•	•	•	

FABRIC TABLES

- Available upholstery option
- RR: railroaded, F/FR: Fire compliant model

				Liv	Iris	Avoca, Genesee, Olla, Washington, Geneva	Cilji, Motti Lounge, Calm	Savor	Bank of England, Camille, Convo, Lili, Meta, Motti, Motti Bariatric, Trilla, Side Tandem, Motti Stool, Tia Stool, Silea, Ped Cushions	Callia
Supplier	Pattern Name	Pattern Code	New Grade	Liv	Iris	Swivel 2	Lounge 2	Side 1	Side 2	Callia
HBF Textiles	Sable Island	SHBFSAB	12	•		•	•	•	•	
HBF Textiles	Sir Stripe A Lot	1004	12	•		•	•	•	•	
HBF Textiles	Sweater Weather	1030	12	•	•	•	•	•	•	•
HBF Textiles	Twist	SHBFTWS	12		•	•	•	•	•	•
HBF Textiles	Upstart	1042	12	•	•	•	•	•	•	•
HBF Textiles	Cherished Knit	954	13	•	•	•	•	•	•	•
HBF Textiles	Enriched Boucle	1021	13	•	•	•	•	•	•	•
HBF Textiles	Foundation	SHBFFND	13			•	•		•	
HBF Textiles	Moving Forward	1014	13	•	•	•	•	•	•	•
HBF Textiles	Night Earth	1013	13	•	•	•	•	•	•	•
HBF Textiles	Pepper Blend	995	13	•	•	•	•	•	•	•
HBF Textiles	Quill	1011	13	•	•	•	•	•	•	•
HBF Textiles	Scribble XL	983	13	•		•	•	•	•	
HBF Textiles	Sister Solid	1003	13	•	•	•	•	•	•	•
HBF Textiles	Afghan	SHBFAFG	14			•	•	•	•	•
HBF Textiles	Smart	SHBFSMT	14			•	•	•	•	
HBF Textiles	Velvet Mix	977	14	•		•	•	•	•	•
HBF Textiles	Hipster	SHBFHPT	15	•	•	•	•	•	•	•
HBF Textiles	Landscape Blur	1024	15	•		•	•	•	•	
HBF Textiles	Poodle	1009	16	•	•	•	•	•	•	•
HBF Textiles	Sweater	SHBFSWE	16			•	•	•	•	•
HBF Textiles	Woven Memory	1019	16	•		•	•	•	•	•
HBF Textiles	Crafted Cloud	1018	19			•	•	•	•	•
HBF Textiles	Knitwork	SHBFKNI	21		•	•	•	•	•	•
HBF Textiles	Bunny	1012	23		•	•	•	•	•	•
HBF Textiles	Eccentric	966	23		•	•	•	•	•	•
HBF Textiles	Eccentric	SHBFEC	23							
HBF Textiles	Wild West	717	L2	•		•	•	•	•	
HBF Textiles	Aviator	K08	L3	•	•	•	•	•	•	•
HBF Textiles	Freeway	K03	L3	•	•	•	•	•	•	•
HBF Textiles	Modern Patina	716	L3	•		•	•	•	•	
HBF Textiles	Persuede	718	L3	•		•	•	•	•	
HBF Textiles	Vivace II	K07	L3	•	•	•	•	•	•	•
HBF Textiles	Upper Crust	K05	L5		•	•	•	•	•	•
HBF Textiles	Voyage	K09	L5	•	•	•	•	•	•	•

Guest Seating	23-43
Product Specifications	24-25
Bank of England™	26
Calia	27-28
Camille	29-31
Genesee Guest	32-34
Lily™	35-36
Metta	37-38
Savor™	39-41
Tia™ Guest	42-43

GUEST SEATING

Product Specifications

BANK OF ENGLAND™

Frame:

Construction: Hardwood frame joined by double dowels, corner blocks.

Available hardwoods: Maple

Seat: Foam filled over sheet webbed frame, upholstered.

Back: Steambent hardwood back.

Arm: Steambent hardwood arms.

Glides: Nickel-plated steel.

BIFMA Rating:

Chairs: ANSI/BIFMA X5.1 2011
(253lb Weight Rating)

CALIA

Frame:

Construction: Hardwood frame joined by mortise and tenon, corner blocks. Steambent back rail

Available hardwoods: Maple, Ash

Seat: Foam filled over sheet-webbed seat foundation, upholstered.

Back: High resiliency foam overmolded onto rigid urethane bucket, wrapped in 1/2" foam on inside back.

Glides: Nickel-plated steel

BIFMA Rating:

ANSI/BIFMA X5.1 2017
(275lb Weight Rating)

CAMILLE

Frame:

Construction: Hardwood frame joined by double dowels, mortise and tenon, and corner blocks.

Available hardwoods: Maple

Seat: Foam filled over strip-webbed seat foundation, upholstered.

Back: Foam filled over flexible foundation, upholstered.

Glides: Nickel-plated steel.

BIFMA Rating:

ANSI/BIFMA X5.1 2017
(275lb Weight Rating)

GENESEE

Seat: High resiliency foam overmolded onto rigid urethane bucket, wrapped in 1/2" foam with additional 1/2" high resiliency foam topper.

Back: High resiliency foam overmolded onto rigid urethane bucket, wrapped in 1/2" foam.

Arm:

Polished aluminum: Polished cast aluminum.

Upholstered: Polished cast aluminum with routed upholstery groove, covered in 1/2" high density foam, upholstery wrapped with welt cord to cover staples.

Control:

Swivel tilt: Swivel tilt with tilt lockout, polished low-profile control.

Mid tilt: Black mid-tilt control, tension adjustment, tilt lockout.

Base: Four star, die cast polished aluminum.

Caster: Soft or hard. Premium casters with chrome finish optional.

Upholstery: Top-stitch around edges of bucket.

BIFMA Rating:

ANSI/BIFMA X5.1 2017
(300lb Weight Rating)

LILY™

Frame:

Construction: Hardwood frame joined by mortise and tenon, corner blocks.

Available hardwoods: Maple, Ash

Seat: Foam filled over sheet webbed vent plywood foundation, upholstered.

Back: Foam filled over strip-webbed seat foundation, upholstered.

Glides: Nickel-plated steel.

BIFMA Rating:

ANSI/BIFMA X5.1 2011
(253lb Weight Rating)

METTA

Frame: 3/4" polished chrome steel tubing, with 1/2" solid rod cross members.

Seat & Back:

Fully Upholstered: Rigid fiberglass reinforced urethane with overmolded foam, wrapped in 1/4" dacron. 1/4" upholstery grade plywood outer.

Wood Outers: Rigid fiberglass reinforced urethane with overmolded foam, wrapped in 1/4" dacron. 1/4" qtr cut or rift cut plywood outer.

Arm Cap: 13" flexible vinyl molded piece, undermounted with double-sided tape. Wrapped in J" high density foam.

Glides: Push-fit low density polyethylene; heavy-duty round plastic inserts

Shipping: Product ships 1 to a box.

Does not stack.

BIFMA Rating:

ANSI/BIFMA X5.1 2011
(253lb Weight Rating)

SAVOR™

Frame:

Construction: Steambent back posts, hardwood frame joined by mortise and tenon, corner blocks.

Available hardwoods: Maple, Ash

Seat: Foam filled over sheet-webbed plywood seat foundation, upholstered.

Back: Foam filled over strip-webbed seat foundation, upholstered.

Glides: Nickel-plated steel.

BIFMA Rating:

ANSI/BIFMA X5.1 2017
(275lb Weight Rating)

TIA™ GUEST

Frame:

Construction: Hardwood frame joined by mortise and tenon, and corner blocks.

Available hardwoods: Maple, Ash

Seat & Back: ¹³/₁₆" thick plywood bucket, consisting of 13 cross-plyies of ¹/₁₆" thick #3 grade southern hardwood.

Glides: Nickel-plated steel.

BIFMA Rating:

ANSI/BIFMA X5.1 2017
(275lb Weight Rating)

model number	fabric grades								dimensions	W	D	H
GK9947US Arm, upholstered seat	1	4,832	10	4,966	19	5,140	L1	4,975	Overall	23 1/2"	22 3/4"	31 3/8"
	2	4,844	11	4,982	20	5,160	L2	5,100	Seat		16 3/4"	17 3/8"
	3	4,856	12	4,998	21	5,181	L3	5,251	Arm			27 3/4"
	COM/4	4,868	13	5,018	22	5,201	L4	5,376	Between arms	19"		
	5	4,885	14	5,039	23	5,241	L5	5,501	Upholstery Requirements: GK9947US			
	6	4,901	15	5,059	24	5,282			Fabric yards		0.7	
	7	4,917	16	5,079	25	5,322			Leather feet ²		11.9	
	8	4,933	17	5,099	26	5,363			Shipping weight		32 lbs.	
	9	4,950	18	5,120	27	5,403			Cube		13.9	
GK9947 Wood seat	4,897 All Wood											

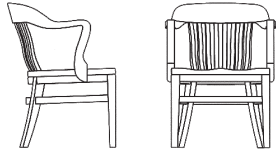

TO ORDER PLEASE SPECIFY THE FOLLOWING:

<input type="text"/>	<input type="text"/>	<input type="text"/>	<input type="text"/>
MODEL NUMBER	FINISH	FLAMMABILITY RATING	UPHOLSTERY (model GK9947US only)
	Cherry finishes on Maple Walnut finishes on Maple Maple finishes on Maple Oak finishes on Maple Please refer to the Bank of England™ product page on www.gunlocke.com for standard finish options.	U CTB117	Please refer to list of available upholstery and leather selections on www.gunlocke.com

Example

GK9947US.215.U.DOL728			
GK9947US	215	U	DOL728
MODEL NUMBER	FINISH	FLAMMABILITY	UPHOLSTERY

model number	fabric grades								dimensions	W	D	H
GGCAL17-011 Single Upholstery	1	2,597	10	3,056	19	3,653	L1	3,087	Overall	21"	24"	31 3/8"
	2	2,639	11	3,111	20	3,722	L2	3,517	Seat	19"	18 3/8"	18"
	3	2,680	12	3,167	21	3,792	L3	4,032	Upholstery Requirements: GGCAL17-011			
	COM/4	2,722	13	3,236	22	3,861	L4	4,461	Fabric yards	2.4		
	5	2,778	14	3,306	23	4,000	L5	4,891	Leather feet ²	40.8		
	6	2,833	15	3,375	24	4,139			Shipping weight	27 lbs.		
	7	2,889	16	3,445	25	4,278			Cube	13.2		
	8	2,944	17	3,514	26	4,417						
	9	3,000	18	3,584	27	4,556						

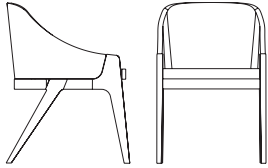

TO ORDER PLEASE SPECIFY THE FOLLOWING:

<input type="text"/>	<input type="text"/>	<input type="text"/>	<input type="text"/>
MODEL NUMBER	SPECIES & FINISH	FLAMMABILITY RATING	UPHOLSTERY

These seating models are available in the following hardwoods: **U CTB117**

Maple **NE**
Ash **QA**

Please refer to the Calia product page on www.gunlocke.com for standard finish options.

Cherry finishes on Maple or Ash
Maple finishes on Maple or Ash
Walnut finishes on Maple or Ash
Oak finishes on Maple or Ash

Natural Cherry 222, Natural Maple 800, Honey Maple 873 and Natural Oak 300 not available on Ash.

Please refer to list of available upholstery and leather selections on www.gunlocke.com

Example

GGCAL17-011.NE.U.DOL728			
GGCAL17-011	NE	U	DOL728
MODEL NUMBER	SPECIES & FINISH	FLAMMABILITY	UPHOLSTERY

CALIA

Guest | Dual Upholstery

Seating
05/22

model number	fabric grades						
GGCAL17-021 Dual upholstery	1	2,643	10	3,159	19	3,831	L1 3,194
	2	2,690	11	3,221	20	3,909	L2 3,677
	3	2,737	12	3,284	21	3,987	L3 4,257
	COM/4	2,784	13	3,362	22	4,066	L4 4,741
	5	2,846	14	3,440	23	4,222	L5 5,224
	6	2,908	15	3,518	24	4,378	
	7	2,972	16	3,596	25	4,535	
	8	3,034	17	3,675	26	4,690	
	9	3,096	18	3,753	27	4,847	

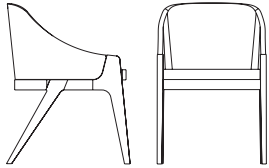

dimensions	W	D	H
Overall	21"	24"	31 3/8"
Seat	19"	18 3/8"	18"

Upholstery Requirements: GGCAL17-021

Dual Upholstery	
Fabric yards	Inner 1.7 Outer 1.0
Leather feet ²	Inner 28.9 Outer 17.0
Shipping weight	27 lbs.
Cube	13.2

Inner	1	10	19	20	21	22	23	24	25	26	27	L1	L2	L3	L4	L5
		325	748	347								347	651	1,016	1,321	1,625
	30	364	797	651												
	59	404	846	1,016												
	89	453	896	1,321												
	128	502	994	1,625												
	167	551	1,092													
	207	600	1,191													
	246	650	1,289													
	285	699	1,388													

Top row of pricing is for units specified with same fabric on Seat and Back. Bottom two rows of pricing required only when two different fabric grades are selected for the Seat and Back.

To calculate price of chair with different grade fabric for Seat and Back; start with Grade 1 price, add appropriate grade price located in second row for Seat, and last add appropriate grade price located in third row for Back to the sum of the Grade 1 and Seat price.

Example: Grade 1 \$2,643 + grade 4 fabric seat \$89 + grade 2 fabric back \$17 = \$2,749

Outer	1	10	19	20	21	22	23	24	25	26	27	L1	L2	L3	L4	L5
		191	440	204								204	383	598	777	956
	17	214	469	383												
	35	237	498	598												
	52	266	527	777												
	75	295	585	956												
	98	324	643													
	122	353	701													
	145	382	758													
	168	411	816													

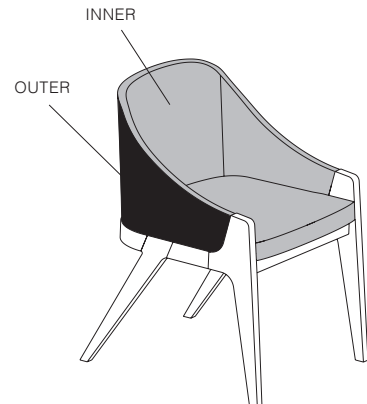

TO ORDER PLEASE SPECIFY THE FOLLOWING:

<input type="text"/>	<input type="text"/>	<input type="text"/>	<input type="text"/>	<input type="text"/>
MODEL NUMBER	SPECIES & FINISH	FLAMMABILITY RATING	INNER UPHOLSTERY	OUTER UPHOLSTERY

These seating models are available in the following hardwoods:

Maple NE
Ash QA

Please refer to the Calia product page on www.gunlocke.com for standard finish options.

Cherry finishes on Maple or Ash
Maple finishes on Maple or Ash
Walnut finishes on Maple or Ash
Oak finishes on Maple or Ash

Natural Cherry 222, Natural Maple 800, Honey Maple 873 and Natural Oak 300 not available on Ash.

U CTB117

Please refer to list of available upholstery and leather selections on www.gunlocke.com

Please refer to list of available upholstery and leather selections on www.gunlocke.com

Example

GGCAL17-021.U.DOL728.DOL728

GGCAL17-021	NE	U	DOL728	SPNN04
MODEL NUMBER	SPECIES & FINISH	FLAMMABILITY UPHOLSTERY	INNER UPHOLSTERY	OUTER UPHOLSTERY

model number	fabric grades								dimensions	W	D	H
GK21001 Open arm, upholstered seat and full back, curved leg	1	1,316	10	1,622	19	2,020	L1	1,643	Overall	22 1/2"	24"	32"
	2	1,344	11	1,659	20	2,066	L2	1,929	Seat		18 1/2"	18 3/4"
	3	1,372	12	1,696	21	2,113	L3	2,273	Arm			25 3/4"
	COM/4	1,399	13	1,742	22	2,159	L4	2,559	Between arms	20"		
	5	1,436	14	1,788	23	2,252	L5	2,845	Upholstery Requirements: GK21001			
	6	1,473	15	1,835	24	2,344			Fabric yards			1.6
	7	1,511	16	1,881	25	2,437			Leather feet ²			27.2
	8	1,548	17	1,927	26	2,529			Shipping weight			23.5 lbs.
	9	1,585	18	1,974	27	2,622			Cube			13.9

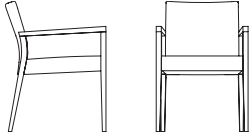

GK21003 Open arm, upholstered seat and half upholstered back, straight leg	1	1,353	10	1,620	19	1,969	L1	1,639	Overall	22 1/2"	25"	30 1/2"
	2	1,377	11	1,653	20	2,010	L2	1,889	Seat		17 3/4"	18 1/2"
	3	1,402	12	1,685	21	2,050	L3	2,190	Arm			25 3/4"
	COM/4	1,426	13	1,726	22	2,091	L4	2,441	Between arms	20"		
	5	1,458	14	1,766	23	2,172	L5	2,691	Upholstery Requirements: GK21003			
	6	1,491	15	1,807	24	2,253			Fabric yards			1.4
	7	1,523	16	1,847	25	2,334			Leather feet ²			23.8
	8	1,556	17	1,888	26	2,415			Shipping weight			23.6 lbs.
	9	1,588	18	1,928	27	2,496			Cube			13.0

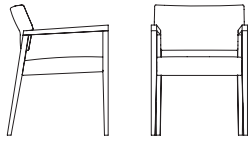

TO ORDER PLEASE SPECIFY THE FOLLOWING:

. . .

MODEL NUMBER	FINISH	FLAMMABILITY RATING	UPHOLSTERY
	Cherry finishes on Maple Walnut finishes on Maple Maple finishes on Maple Oak finishes on Maple Please refer to the Camille product page on www.gunlocke.com for standard finish options.	U CTB117	Please refer to list of available upholstery and leather selections on www.gunlocke.com

Example

GK21001.215.U.DOL728
 GK21001 215 U DOL728
 MODEL NUMBER FINISH FLAMMABILITY UPHOLSTERY

CAMILLE

Guest | Dual Upholstery

Seating
05/22

model number	fabric grades								dimensions	W	D	H
GK21001-021 Open arm, upholstered seat and full back, curved leg	1	1,340	10	1,684	19	2,132	L1	1,707	Overall	22 1/2"	24"	32"
	2	1,371	11	1,725	20	2,184	L2	2,030	Seat		18 1/2"	18 3/4"
	3	1,403	12	1,767	21	2,236	L3	2,416	Arm			25 3/4"
	COM/4	1,434	13	1,819	22	2,288	L4	2,738	Between arms	20"		
	5	1,475	14	1,871	23	2,393	L5	3,061	Upholstery Requirements: GK21001-021			
	6	1,517	15	1,923	24	2,497				Dual Upholstery		
	7	1,559	16	1,976	25	2,601			Fabric yards	Seat 1	Back 0.8	
	8	1,601	17	2,028	26	2,705			Leather feet ²	Seat 17	Back 13.6	
	9	1,642	18	2,080	27	2,809			Shipping weight		23.5 lbs.	
									Cube		13.9	

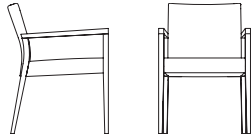

Seat	1	10	19	19	440	L1	204
	2	17	11	214	20	L2	383
	3	35	12	237	21	L3	598
	COM/4	52	13	266	22	L4	777
	5	75	14	295	23	L5	956
	6	98	15	324	24		
	7	122	16	353	25		
	8	145	17	382	26		
	9	168	18	411	27		

Top row of pricing is for units specified with same fabric on Seat and Back. Bottom two rows of pricing required only when two different fabric grades are selected for the Seat and Back.

To calculate price of chair with different grade fabric for Seat and Back; start with Grade 1 price, add appropriate grade price located in second row for Seat, and last add appropriate grade price located in third row for Back to the sum of the Grade 1 and Seat price.

Example: Grade 1 \$1,340 + grade 4 fabric seat \$52 + grade 2 fabric back \$14 = \$1,406

Back	1	10	153	19	352	L1	163
	2	14	11	171	20	L2	307
	3	28	12	190	21	L3	478
	COM/4	42	13	213	22	L4	621
	5	60	14	236	23	L5	765
	6	79	15	259	24		
	7	97	16	283	25		
	8	116	17	306	26		
	9	134	18	329	27		

TO ORDER PLEASE SPECIFY THE FOLLOWING:

<input type="text"/>	<input type="text"/>	<input type="text"/>	<input type="text"/>	<input type="text"/>
MODEL NUMBER	FINISH	FLAMMABILITY RATING	SEAT UPHOLSTERY	BACK UPHOLSTERY
	Cherry finishes on Maple Walnut finishes on Maple Maple finishes on Maple Oak finishes on Maple Please refer to the Camille product page on www.gunlocke.com for standard finish options.	U CTB117	Please refer to list of available upholstery and leather selections on www.gunlocke.com	Please refer to list of available upholstery and leather selections on www.gunlocke.com

Example

GK21001-021.215.U.DOL728.SPNN04				
GK21001-021	215	U	DOL728	SPNN04
MODEL NUMBER	FINISH	FLAMMABILITY	SEAT UPHOLSTERY	BACK UPHOLSTERY

model number	fabric grades							dimensions	W	D	H	
GK21003-021 Open arm, upholstered seat and half upholstered back, straight leg	1	1,378	10	1,665	19	2,038	L1	1,684	Overall	22 1/2"	25"	30 1/2"
	2	1,404	11	1,699	20	2,081	L2	1,953	Seat		17 3/4"	18 1/2"
	3	1,430	12	1,734	21	2,125	L3	2,275	Arm			25 3/4"
	COM/4	1,456	13	1,777	22	2,168	L4	2,543	Between arms	20"		
	5	1,491	14	1,821	23	2,255	L5	2,812	Upholstery Requirements: GK21003-021			
	6	1,525	15	1,864	24	2,342				Dual Upholstery		
	7	1,561	16	1,908	25	2,429			Fabric yards	Seat 0.8	Back .5	
	8	1,595	17	1,951	26	2,515			Leather feet ²	Seat 13.6	Back 8.5	
	9	1,630	18	1,995	27	2,602			Shipping weight			23.6 lbs.
									Cube			13.0

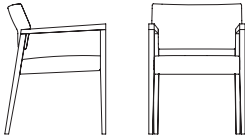

Seat	1	10	191	19	440	L1	204
	2	17	11	214	20	L2	383
	3	35	12	237	21	L3	598
	COM/4	52	13	266	22	L4	777
	5	75	14	295	23	L5	956
	6	98	15	324	24		
	7	122	16	353	25		
	8	145	17	382	26		
	9	168	18	411	27		

Top row of pricing is for units specified with same fabric on Seat and Back. Bottom two rows of pricing required only when two different fabric grades are selected for the Seat and Back.

To calculate price of chair with different grade fabric for Seat and Back; start with Grade 1 price, add appropriate grade price located in second row for Seat, and last add appropriate grade price located in third row for Back to the sum of the Grade 1 and Seat price.

Example: Grade 1 \$1,378 + grade 4 fabric seat \$52 + grade 2 fabric back \$9 = \$1,439

Back	1	10	96	19	220	L1	102
	2	9	11	107	20	L2	192
	3	17	12	119	21	L3	299
	COM/4	26	13	133	22	L4	388
	5	38	14	148	23	L5	478
	6	49	15	162	24		
	7	61	16	177	25		
	8	72	17	191	26		
	9	84	18	206	27		

TO ORDER PLEASE SPECIFY THE FOLLOWING:

<input type="text"/>	<input type="text"/>	<input type="text"/>	<input type="text"/>	<input type="text"/>
MODEL NUMBER	FINISH	FLAMMABILITY RATING	SEAT UPHOLSTERY	BACK UPHOLSTERY
	Cherry finishes on Maple Walnut finishes on Maple Maple finishes on Maple Oak finishes on Maple Please refer to the Camille product page on www.gunlocke.com for standard finish options.	U CTB117	Please refer to list of available upholstery and leather selections on www.gunlocke.com	Please refer to list of available upholstery and leather selections on www.gunlocke.com

Example

GK21003-021.215.U.DOL728.SPNN04				
GK21003-021	215	U	DOL728	SPNN04
MODEL NUMBER	FINISH	FLAMMABILITY	SEAT UPHOLSTERY	BACK UPHOLSTERY

GENESEE GUEST

Armless

Seating
05/22

model number	fabric grades								dimensions	W	D	H
GGRA16-111 Guest, High Back Armless	1	2,320	10	2,721	19	3,244	L1	2,749	Overall	21 3/4"	28"	39 1/8"
	2	2,356	11	2,770	20	3,305	L2	3,125	Seat	21"	19 1/2"	18"
	3	2,393	12	2,818	21	3,366	L3	3,576	Upholstery Requirements: GGRA16-111			
	COM/4	2,429	13	2,879	22	3,426	L4	3,951	Fabric yards	2.1		
	5	2,478	14	2,940	23	3,548	L5	4,327	Leather feet ²	35.7		
	6	2,527	15	3,001	24	3,670			Shipping weight	44 lbs.		
	7	2,575	16	3,062	25	3,791			Cube	18.3		
	8	2,624	17	3,122	26	3,913						
	9	2,673	18	3,183	27	4,034						

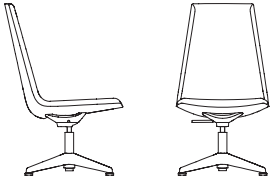

GGRA16-121 Guest, Mid Back Armless	1	2,181	10	2,506	19	2,929	L1	2,528
	2	2,211	11	2,545	20	2,978	L2	2,832
	3	2,240	12	2,585	21	3,027	L3	3,197
	COM/4	2,270	13	2,634	22	3,077	L4	3,502
	5	2,309	14	2,683	23	3,175	L5	3,806
	6	2,348	15	2,732	24	3,273		
	7	2,388	16	2,781	25	3,372		
	8	2,427	17	2,831	26	3,470		
	9	2,466	18	2,880	27	3,569		

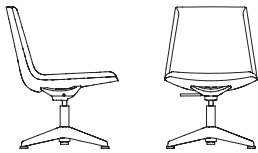

Overall	21 3/4"	26 1/2"	32 3/8"
Seat		18 5/8"	18"
Upholstery Requirements: GGRA16-121			
Fabric yards	1.7		
Leather feet ²	28.9		
Shipping weight	42 lbs.		
Cube	14.5		

TO ORDER PLEASE SPECIFY THE FOLLOWING:

--	--	--

MODEL NUMBER

FLAMMABILITY RATING

UPHOLSTERY

U CTB117

Please refer to list of available upholstery and leather selections on www.gunlocke.com

NOTE: Genesee Guest comes standard with a 4-star polished aluminum base, return-to-center cylinder, at a fixed seat height of 18", and with 1 3/4" nylon cap glides.

Example

GGRA16-111.U.DOL728

GGRA16-111	U	DOL728
MODEL NUMBER	FLAMMABILITY	UPHOLSTERY

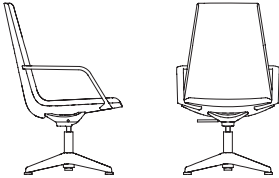
model number	fabric grades								dimensions	W	D	H
GGRA16-131 Guest, High Back Polished Arms 	1	2,401	10	2,802	19	3,325	L1	2,830	Overall	23 1/2"	28"	39 1/2"
	2	2,437	11	2,851	20	3,386	L2	3,206	Seat		19 1/4"	18"
	3	2,474	12	2,899	21	3,447	L3	3,657	Arm			24 1/2"
	COM/4	2,510	13	2,960	22	3,507	L4	4,032	Between arms	21"		
	5	2,559	14	3,021	23	3,629	L5	4,408	Upholstery Requirements: GGRA16-131			
	6	2,608	15	3,082	24	3,751			Fabric yards			2.1
	7	2,656	16	3,143	25	3,872			Leather feet ²			35.7
	8	2,705	17	3,203	26	3,994			Shipping weight			49 lbs.
	9	2,754	18	3,264	27	4,115			Cube			19.6

GGRA16-141 Guest, Mid Back Polished Arms 	1	2,260	10	2,585	19	3,008	L1	2,607	Overall	23 1/2"	26 1/2"	32 3/8"
	2	2,290	11	2,624	20	3,057	L2	2,911	Seat		19 1/4"	18"
	3	2,319	12	2,664	21	3,106	L3	3,276	Arm			24 1/2"
	COM/4	2,349	13	2,713	22	3,156	L4	3,581	Between arms	21"		
	5	2,388	14	2,762	23	3,254	L5	3,885	Upholstery Requirements: GGRA16-141			
	6	2,427	15	2,811	24	3,352			Fabric yards			1.7
	7	2,467	16	2,860	25	3,451			Leather feet ²			28.9
	8	2,506	17	2,910	26	3,549			Shipping weight			47 lbs.
	9	2,545	18	2,959	27	3,648			Cube			15.6

TO ORDER PLEASE SPECIFY THE FOLLOWING:

. .

MODEL NUMBER

FLAMMABILITY RATING

UPHOLSTERY

U CTB117

Please refer to list of available upholstery and leather selections on www.gunlocke.com

NOTE: Genesee Guest comes standard with a 4-star polished aluminum base, return-to-center cylinder, at a fixed seat height of 18", and with 1 3/4" nylon cap glides.

Example

GGRA16-131.U.DOL728

GGRA16-131 U DOL728
MODEL NUMBER FLAMMABILITY UPHOLSTERY

GENESEE GUEST

Upholstered Arms

Seating
05/22

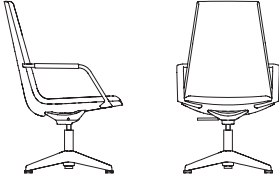
model number	fabric grades								dimensions	W	D	H
GGRA16-151 Guest, High Back Upholstered Arms	1	2,518	10	2,938	19	3,486	L1	2,967	Overall	23 3/4"	28"	39 1/8"
	2	2,556	11	2,989	20	3,550	L2	3,361	Seat	21"	19 1/2"	18"
	3	2,594	12	3,040	21	3,613	L3	3,833	Arm			24 5/8"
	COM/4	2,633	13	3,104	22	3,677	L4	4,227	Between arms	20 3/4"		
	5	2,684	14	3,168	23	3,804	L5	4,621	Upholstery Requirements: GGRA16-151			
	6	2,735	15	3,231	24	3,932			Fabric yards		2.2	
	7	2,785	16	3,295	25	4,059			Leather feet ²		37.4	
	8	2,836	17	3,359	26	4,187			Shipping weight		49 lbs.	
	9	2,887	18	3,422	27	4,314			Cube		19.7	
												

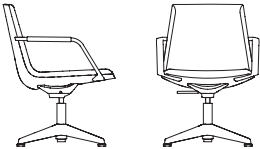
GGRA16-161 Guest, Mid Back Upholstered Arms	1	2,380	10	2,743	19	3,216	L1	2,768	Overall	23 3/4"	26 1/2"	32 3/8"
	2	2,413	11	2,787	20	3,271	L2	3,108	Seat	21"	19 1/2"	18"
	3	2,446	12	2,831	21	3,326	L3	3,516	Arm			24 5/8"
	COM/4	2,479	13	2,886	22	3,381	L4	3,856	Between arms	20 3/4"		
	5	2,523	14	2,941	23	3,491	L5	4,196	Upholstery Requirements: GGRA16-161			
	6	2,567	15	2,996	24	3,601			Fabric yards		1.9	
	7	2,611	16	3,051	25	3,711			Leather feet ²		32.3	
	8	2,655	17	3,106	26	3,821			Shipping weight		47 lbs.	
	9	2,699	18	3,161	27	3,931			Cube		15.7	
												

TO ORDER PLEASE SPECIFY THE FOLLOWING:

. .

MODEL NUMBER

FLAMMABILITY RATING

UPHOLSTERY

U CTB117

Please refer to list of available upholstery and leather selections on www.gunlocke.com

NOTE: Genesee Guest comes standard with a 4-star polished aluminum base, return-to-center cylinder, at a fixed seat height of 18", and with 1 3/4" nylon cap glides.

Example

GGRA16-151.U.DOL728

GGRA16-151

U

DOL728

MODEL NUMBER

FLAMMABILITY

UPHOLSTERY

model number	fabric grades								dimensions	W	D	H
GGCA14-011 Open arm, upholstered seat and back	1	1,769	10	2,075	19	2,473	L1	2,096	Overall	21 1/2"	23 1/2"	33"
	2	1,797	11	2,112	20	2,519	L2	2,382	Seat		18 1/2"	17"
	3	1,825	12	2,149	21	2,566	L3	2,726	Arm			25 3/4"
	COM/4	1,852	13	2,195	22	2,612	L4	3,012	Between arms	19 1/4"		
	5	1,889	14	2,241	23	2,705	L5	3,298	Upholstery Requirements: GGCA14-011			
	6	1,926	15	2,288	24	2,797			Fabric yards			1.6
	7	1,964	16	2,334	25	2,890			Leather feet ²			27.2
	8	2,001	17	2,380	26	2,982			Shipping weight			25 lbs.
	9	2,038	18	2,427	27	3,075			Cube			14.6

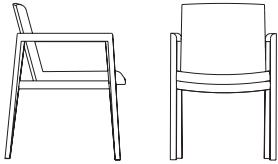

TO ORDER PLEASE SPECIFY THE FOLLOWING:

. . . .

MODEL NUMBER **SPECIES & FINISH** **STITCH DETAIL** **FLAMMABILITY RATING** **UPHOLSTERY**

These seating models are available in the following hardwoods:

Maple **NE**
Ash **QA**

Please refer to the Lily™ product page on www.gunlocke.com for standard finish options.

Cherry finishes on Maple
Maple finishes on Maple
Cherry finishes on Ash
Walnut finishes on Ash
Oak finishes on Ash

Natural Oak 300 not available on Ash.

Not required **NR**
Stitch detail
SD +\$80

U **CTB117**

Please refer to list of available upholstery and leather selections on www.gunlocke.com

Example

GGCA14-011.NE800.SD.U.DOL728

GGCA14-011	NE800	SD	U	DOL728
MODEL NUMBER	SPECIES & FINISH	STITCH DETAIL	FLAMMABILITY	UPHOLSTERY

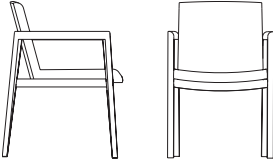
model number	fabric grades								dimensions	W	D	H
GGCA14-021 Open arm, upholstered seat and back 	1	1,800	10	2,106	19	2,504	L1	2,127	Overall	21 1/2"	23 1/2"	33"
	2	1,828	11	2,143	20	2,550	L2	2,413	Seat		18 1/2"	17"
	3	1,855	12	2,180	21	2,597	L3	2,757	Arm			25 3/4"
	COM/4	1,883	13	2,226	22	2,643	L4	3,043	Between arms	19 1/4"		
	5	1,921	14	2,273	23	2,735	L5	3,329	Upholstery Requirements: GGCA14-021			
	6	1,958	15	2,319	24	2,828			Dual Upholstery			
	7	1,994	16	2,365	25	2,920			Fabric yards	Seat .9	Back .7	
	8	2,031	17	2,411	26	3,014			Leather feet ²	Seat 15.3	Back 11.9	Total 27.2
	9	2,069	18	2,458	27	3,106			Shipping weight	25 lbs.		
									Cube	14.6		

Seat	1	10	172	19	396	L1	184	
	2	16	11	193	20	422	L2	345
	3	31	12	214	21	448	L3	538
	COM/4	47	13	240	22	474	L4	699
	5	68	14	266	23	526	L5	860
	6	89	15	292	24	578		
	7	109	16	318	25	630		
	8	130	17	344	26	683		
	9	151	18	370	27	735		

Top row of pricing is for units specified with same fabric on Seat and Back. Bottom two rows of pricing required only when two different fabric grades are selected for the Seat and Back.

To calculate price of chair with different grade fabric for Seat and Back; start with Grade 1 price, add appropriate grade price located in second row for Seat, and last add appropriate grade price located in third row for Back to the sum of the Grade 1 and Seat price.

Example: Grade 1 \$1,800 + grade 4 fabric seat \$47 + grade 2 fabric back \$12 = \$1,859

Back	1	10	134	19	308	L1	143	
	2	12	11	150	20	328	L2	268
	3	24	12	166	21	349	L3	419
	COM/4	36	13	186	22	369	L4	544
	5	53	14	207	23	409	L5	669
	6	69	15	227	24	450		
	7	85	16	247	25	490		
	8	101	17	267	26	531		
	9	118	18	288	27	571		

TO ORDER PLEASE SPECIFY THE FOLLOWING:

<input type="text"/>	<input type="text"/>	<input type="text"/>	<input type="text"/>	<input type="text"/>	<input type="text"/>
MODEL NUMBER	SPECIES & FINISH	STITCH DETAIL	FLAMMABILITY RATING	SEAT UPHOLSTERY	BACK UPHOLSTERY

These seating models are available in the following hardwoods:

Maple **NE**
Ash **QA**

Please refer to the Lily™ product page on www.gunlocke.com for standard finish options.

Cherry finishes on Maple
Maple finishes on Maple
Cherry finishes on Ash
Walnut finishes on Ash
Oak finishes on Ash

Natural Oak 300 not available on Ash.

Not required **NR**
Stitch detail
SD +\$80

U CTB117

Please refer to list of available upholstery and leather selections on www.gunlocke.com

Please refer to list of available upholstery and leather selections on www.gunlocke.com

Example

GGCA14-021.NE800.SD.U.DOL728.SPNN04					
GGCA14-021	NE800	SD	U	DOL728	SPNN04
MODEL NUMBER	SPECIES & FINISH	STITCH DETAIL	FLAMMABILITY	SEAT UPHOLSTERY	BACK UPHOLSTERY

model number	fabric grades							
GGWA16-011 Fully upholstered	1	1,807	10	2,208	19	2,731	L1	2,235
	2	1,844	11	2,256	20	2,792	L2	2,612
	3	1,880	12	2,306	21	2,852	L3	3,062
	COM/4	1,917	13	2,366	22	2,913	L4	3,438
	5	1,965	14	2,427	23	3,035	L5	3,815
	6	2,014	15	2,487	24	3,156		
	7	2,062	16	2,549	25	3,278		
	8	2,111	17	2,610	26	3,400		
	9	2,159	18	2,670	27	3,521		

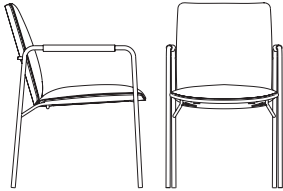

dimensions	W	D	H
Overall	21 1/8"	25 7/16"	33 9/16"
Seat		18 5/8"	18 11/16"
Arm			25 3/4"
Between arms	18 7/8"		

Upholstery Requirements: GGWA16-011	
	Dual Upholstery
Fabric yards	Inners 1.3 Outers .8
Leather feet ²	Inners 22.1 Outers 13.6
Shipping weight	30 lbs.
Cube	14.4

Inners and Arms	1	10	248	19	572	L1	265	
	2	23	11	278	20	610	L2	498
	3	45	12	309	21	647	L3	777
	COM/4	68	13	346	22	685	L4	1,010
	5	98	14	384	23	760	L5	1,243
	6	128	15	421	24	835		
	7	158	16	459	25	911		
	8	188	17	497	26	986		
	9	218	18	534	27	1,061		

Top row of pricing is for units specified with same fabric on Seat and Back. Bottom two rows of pricing required only when two different fabric grades are selected for the Seat and Back.

To calculate price of chair with different grade fabric for Seat and Back; start with Grade 1 price, add appropriate grade price located in second row for Seat, and last add appropriate grade price located in third row for Back to the sum of the Grade 1 and Seat price.

Example: Grade 1 \$1,807 + grade 4 fabric seat \$68 + grade 2 fabric back \$14 = \$1,889

Upholstered Inners and Arms

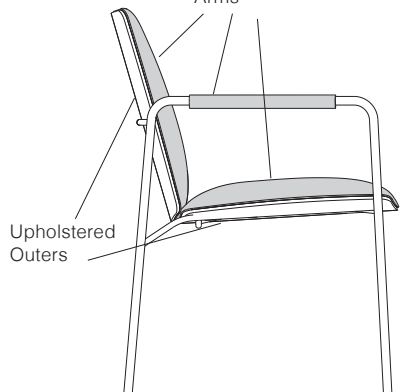

Outers	1	10	153	19	352	L1	163	
	2	14	11	171	20	375	L2	307
	3	28	12	190	21	398	L3	478
	COM/4	42	13	213	22	421	L4	621
	5	60	14	236	23	468	L5	765
	6	79	15	259	24	514		
	7	97	16	283	25	560		
	8	116	17	306	26	607		
	9	134	18	329	27	653		

TO ORDER PLEASE SPECIFY THE FOLLOWING:

. . .

MODEL NUMBER	FLAMMABILITY RATING	INNERS & ARMS UPHOLSTERY	OUTERS UPHOLSTERY
	U CTB117	Please refer to list of available upholstery and leather selections on www.gunlocke.com	Please refer to list of available upholstery and leather selections on www.gunlocke.com

Example

GGWA16-011.U.DOL728.SPNN04			
GGWA16-011	U	DOL728	SPNN04
MODEL NUMBER	FLAMMABILITY	INNERS & ARMS UPHOLSTERY	OUTERS UPHOLSTERY

METTA

Wood Shell

Seating
05/22

model number	fabric grades								dimensions	W	D	H
GGWA16-021 Wood shell	1	2,059	10	2,307	19	2,631	L1	2,324	Overall	21 1/8"	25 3/4"	33 9/16"
	2	2,082	11	2,337	20	2,669	L2	2,557	Seat		18 5/8"	18 11/16"
	3	2,104	12	2,368	21	2,706	L3	2,836	Arm			25 3/4"
	COM/4	2,127	13	2,405	22	2,744	L4	3,069	Between arms	18 7/8"		
	5	2,157	14	2,443	23	2,819	L5	3,302	Upholstery Requirements: GGWA16-021			
	6	2,187	15	2,480	24	2,894			Fabric yards		1.3	
	7	2,217	16	2,518	25	2,970			Leather feet ²		22.1	
	8	2,247	17	2,556	26	3,045			Shipping weight		13 lbs.	
	9	2,277	18	2,593	27	3,120			Cube		14.4	

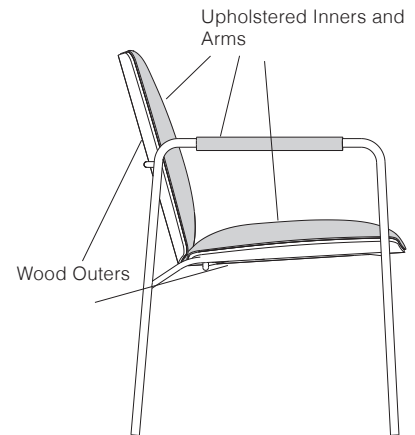
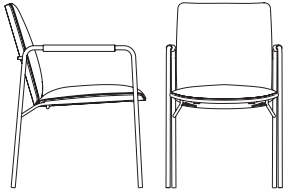

TO ORDER PLEASE SPECIFY THE FOLLOWING:

. . .

MODEL NUMBER	OUTERS FINISH	FLAMMABILITY RATING	INNERS & ARMS UPHOLSTERY
	Walnut finishes on Walnut Cherry finishes on Cherry Maple finishes on Maple Oak finishes on Oak Walnut, Cherry, and Maple shells are quarter cut; Oak shells are rift cut. Please refer to the Metta product page on www.gunlocke.com for standard finish options.	U CTB117	Please refer to list of available upholstery and leather selections on www.gunlocke.com

Example

GGWA16-021.215.U.DOL728

GGWA16-021	215	U	DOL728
MODEL NUMBER	OUTERS FINISH	FLAMMABILITY	INNERS & ARMS UPHOLSTERY

model number	fabric grades								dimensions	W	D	H
GGJA14-011 Open arm, upholstered seat and back wood top rail	1	1,615	10	1,882	19	2,231	L1	1,901	Overall	22 1/2"	23 1/2"	33"
	2	1,639	11	1,915	20	2,272	L2	2,151	Seat	19 1/2"	18"	18 1/2"
	3	1,664	12	1,947	21	2,312	L3	2,452	Arm			25 1/2"
	COM/4	1,688	13	1,988	22	2,353	L4	2,703	Between arms	19 1/2"		
	5	1,720	14	2,028	23	2,434	L5	2,953	Upholstery Requirements: GGJA14-011			
	6	1,753	15	2,069	24	2,515			Fabric yards			1.4
	7	1,785	16	2,109	25	2,596			Leather feet ²			23.8
	8	1,818	17	2,150	26	2,677			Shipping weight			25 lbs.
	9	1,850	18	2,190	27	2,758			Cube			14.6

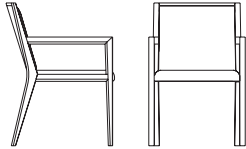

GGJA14-021 Open arm, upholstered seat and back upholstered top rail	1	1,586	10	1,853	19	2,202	L1	1,872
	2	1,610	11	1,886	20	2,243	L2	2,122
	3	1,635	12	1,918	21	2,283	L3	2,423
	COM/4	1,659	13	1,959	22	2,324	L4	2,674
	5	1,691	14	1,999	23	2,405	L5	2,924
	6	1,724	15	2,040	24	2,486		
	7	1,756	16	2,080	25	2,567		
	8	1,789	17	2,121	26	2,648		
	9	1,821	18	2,161	27	2,729		

Overall	22 1/2"	23 1/2"	33"
Seat	19 1/2"	18"	18 1/2"
Arm			26"
Between arms	19 1/2"		
Upholstery Requirements: GGJA14-021			
Fabric yards			1.4
Leather feet ²			23.8
Shipping weight			25 lbs.
Cube			14.6

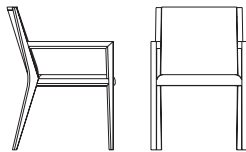

TO ORDER PLEASE SPECIFY THE FOLLOWING:

. . .

MODEL NUMBER

SPECIES & FINISH

FLAMMABILITY RATING

UPHOLSTERY

These seating models are available in the following hardwoods:

Maple **NE**
Ash **QA**

Please refer to the Savor™ product page on www.gunlocke.com for standard finish options.

Cherry finishes on Maple
Maple finishes on Maple
Cherry finishes on Ash
Walnut finishes on Ash
Oak finishes on Ash

Natural Oak 300 not available on Ash..

U CTB117

Please refer to list of available upholstery and leather selections on www.gunlocke.com

Example

GGJA14-011.NE800.U.DOL728

GGJA14-011	NE800	U	DOL728
MODEL NUMBER	SPECIES & FINISH	FLAMMABILITY	UPHOLSTERY

SAVOR™

Guest | Dual Upholstery

model number	fabric grades							dimensions	W	D	H		
GGJA14-031 Open arm, upholstered seat and back, wood top rail	1	1,645	10	1,989	19	2,437	L1	2,012	Overall	22 1/2"	23 1/2"	33"	
	2	1,676	11	2,030	20	2,489	L2	2,335	Seat	19"	18"	18 1/2"	
	3	1,708	12	2,072	21	2,541	L3	2,721	Arm	25 1/2"			
	COM/4	1,739	13	2,124	22	2,593	L4	3,043	Between arms	19 1/2"			
	5	1,780	14	2,176	23	2,698	L5	3,366	Upholstery Requirements: GGJA14-031				
	6	1,822	15	2,228	24	2,802			Dual Upholstery				
	7	1,864	16	2,281	25	2,906			Fabric yards	Seat 1	Back 0.8		
	8	1,906	17	2,333	26	3,010			Leather feet ²	Seat 17	Back 13.6		
	9	1,947	18	2,385	27	3,114			Shipping weight	25 lbs.			
									Cube	14.6			

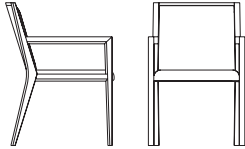

Seat	1	10	191	19	440	L1	204	
	2	17	11	214	20	469	L2	383
	3	35	12	237	21	498	L3	598
	COM/4	52	13	266	22	527	L4	777
	5	75	14	295	23	585	L5	956
	6	98	15	324	24	643		
	7	122	16	353	25	701		
	8	145	17	382	26	758		
	9	168	18	411	27	816		

Top row of pricing is for units specified with same fabric on Seat and Back. Bottom two rows of pricing required only when two different fabric grades are selected for the Seat and Back.

To calculate price of chair with different grade fabric for Seat and Back; start with Grade 1 price, add appropriate grade price located in second row for Seat, and last add appropriate grade price located in third row for Back to the sum of the Grade 1 and Seat price.

Example: Grade 1 \$1,645 + grade 4 fabric seat \$52 + grade 2 fabric back \$14 = \$1,711

Back	1	10	153	19	352	L1	163	
	2	14	11	171	20	375	L2	307
	3	28	12	190	21	398	L3	478
	COM/4	42	13	213	22	421	L4	621
	5	60	14	236	23	468	L5	765
	6	79	15	259	24	514		
	7	97	16	283	25	560		
	8	116	17	306	26	607		
	9	134	18	329	27	653		

TO ORDER PLEASE SPECIFY THE FOLLOWING:

<input type="text"/>	<input type="text"/>	<input type="text"/>	<input type="text"/>	<input type="text"/>
MODEL NUMBER	SPECIES & FINISH	FLAMMABILITY RATING	SEAT UPHOLSTERY	BACK UPHOLSTERY

These seating models are available in the following hardwoods:

Maple	NE
Ash	QA

Please refer to the Savor product page on www.gunlocke.com for standard finish options.

Cherry finishes on Maple
Maple finishes on Maple
Cherry finishes on Ash
Walnut finishes on Ash
Oak finishes on Ash

Natural Oak 300 not available on Ash.

U CTB117

Please refer to list of available upholstery and leather selections on www.gunlocke.com

Please refer to list of available upholstery and leather selections on www.gunlocke.com

Example

GGJA14-031	NE800	U	DOL728	SPNN04
MODEL NUMBER	SPECIES & FINISH	FLAMMABILITY UPHOLSTERY	INNER UPHOLSTERY	OUTER UPHOLSTERY

model number	fabric grades								dimensions	W	D	H
GGJA14-041 Open arm, upholstered seat and back, upholstered top rail	1	1,615	10	1,959	19	2,407	L1	1,982	Overall	22 1/2"	23 1/2"	33"
	2	1,646	11	2,000	20	2,459	L2	2,305	Seat	19"	18"	18 1/2"
	3	1,678	12	2,042	21	2,511	L3	2,691	Arm	26"		
	COM/4	1,709	13	2,094	22	2,563	L4	3,013	Between arms	19 1/2"		
	5	1,750	14	2,146	23	2,668	L5	3,336	Upholstery Requirements: GGJA14-041			
	6	1,792	15	2,198	24	2,772				Dual Upholstery		
	7	1,834	16	2,251	25	2,876			Fabric yards	Seat 1	Back 0.8	
	8	1,876	17	2,303	26	2,980			Leather feet ²	Seat 17	Back 13.6	
	9	1,917	18	2,355	27	3,084			Shipping weight	25 lbs.		
									Cube	14.6		

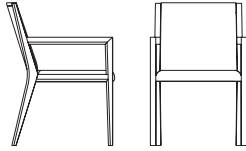

Seat	1	10	191	19	440	L1	204
	2	17	11	214	20	469	L2 383
	3	35	12	237	21	498	L3 598
	COM/4	52	13	266	22	527	L4 777
	5	75	14	295	23	585	L5 956
	6	98	15	324	24	643	
	7	122	16	353	25	701	
	8	145	17	382	26	758	
	9	168	18	411	27	816	

Top row of pricing is for units specified with same fabric on Seat and Back. Bottom two rows of pricing required only when two different fabric grades are selected for the Seat and Back.

To calculate price of chair with different grade fabric for Seat and Back; start with Grade 1 price, add appropriate grade price located in second row for Seat, and last add appropriate grade price located in third row for Back to the sum of the Grade 1 and Seat price.

Example: Grade 1 \$1,615 + grade 4 fabric seat \$52 + grade 2 fabric back \$14 = \$1,681

Back	1	10	153	19	352	L1	163
	2	14	11	171	20	375	L2 307
	3	28	12	190	21	398	L3 478
	COM/4	42	13	213	22	421	L4 621
	5	60	14	236	23	468	L5 765
	6	79	15	259	24	514	
	7	97	16	283	25	560	
	8	116	17	306	26	607	
	9	134	18	329	27	653	

TO ORDER PLEASE SPECIFY THE FOLLOWING:

<input type="text"/>	<input type="text"/>	<input type="text"/>	<input type="text"/>	<input type="text"/>
MODEL NUMBER	SPECIES & FINISH	FLAMMABILITY RATING	SEAT UPHOLSTERY	BACK UPHOLSTERY

These seating models are available in the following hardwoods:

Maple **NE**
Ash **QA**

Please refer to the Savor product page on www.gunlocke.com for standard finish options.

Cherry finishes on Maple
Maple finishes on Maple
Cherry finishes on Ash
Walnut finishes on Ash
Oak finishes on Ash

Natural Oak 300 not available on Ash..

U CTB117

Please refer to list of available upholstery and leather selections on www.gunlocke.com

Please refer to list of available upholstery and leather selections on www.gunlocke.com

Example

GGJA14-041	NE800	U	DOL728	SPNN04
MODEL NUMBER	SPECIES & FINISH	FLAMMABILITY UPHOLSTERY	INNER UPHOLSTERY	OUTER UPHOLSTERY

TIA™ GUEST

Single Upholstery

Seating
05/22

model number	fabric grades								dimensions	W	D	H
GGHB17-071 Single upholstery, armless	1	1,242	10	1,471	19	1,770	L1	1,487	Overall	19"	21 1/2"	32 1/8"
	2	1,263	11	1,499	20	1,805	L2	1,702	Seat	18 1/2"	16 3/4"	18 3/8"
	3	1,284	12	1,527	21	1,839	L3	1,959	Upholstery Requirements: GGHB17-071			
	COM/4	1,305	13	1,562	22	1,874	L4	2,174	Fabric yards	1.2		
	5	1,332	14	1,596	23	1,944	L5	2,389	Leather feet ²	20.4		
	6	1,360	15	1,631	24	2,013			Shipping weight	23 lbs.		
	7	1,388	16	1,666	25	2,083			Cube	10.9		
	8	1,416	17	1,701	26	2,152						
	9	1,443	18	1,735	27	2,222						

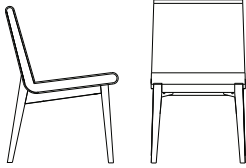

TO ORDER PLEASE SPECIFY THE FOLLOWING:

MODEL NUMBER	FINISH	FLAMMABILITY RATING	UPHOLSTERY

These seating models are available in the following hardwoods:

Maple **NE**
Ash **QA**

Please refer to the Tia product page on www.gunlocke.com for standard finish options.

Cherry finishes on Maple or Ash
Walnut finishes on Maple or Ash
Maple finishes on Maple or Ash
Oak finishes on Maple or Ash

Natural Cherry 222, Natural Maple 800, Honey Maple 873 and Natural Oak 300 not available on Ash.

U CTB117

Please refer to list of available upholstery and leather selections on www.gunlocke.com

Example

GGHB17-071.QA629.U.DOL728			
GGHB17-071	QA629	U	DOL728
MODEL NUMBER	FINISH	FLAMMABILITY	UPHOLSTERY

model number	fabric grades						dimensions	W	D	H		
GGHB17-081 Dual upholstery, armless	1	1,265	10	1,704	19	2,277	L1	1,735	Overall	19"	21 1/2"	32 1/8"
	2	1,305	11	1,758	20	2,344	L2	2,146	Seat	18 1/2"	16 3/4"	18 3/8"
	3	1,345	12	1,811	21	2,410	L3	2,640	Upholstery Requirements: GGHB17-081			
	COM/4	1,385	13	1,878	22	2,477	L4	3,052	Dual Upholstery			
	5	1,438	14	1,944	23	2,610	L5	3,463	Fabric yards	Seat 1.1	Back 1.2	
	6	1,491	15	2,011	24	2,743			Leather feet ²	Seat 18.7	Back 20.4	
	7	1,545	16	2,077	25	2,877			Shipping weight	23 lbs.		
	8	1,598	17	2,144	26	3,009			Cube	10.9		
	9	1,651	18	2,210	27	3,143						

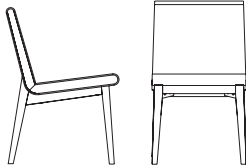

Seat	1	10	210	19	484	L1	225	
	2	19	11	236	20	516	L2	421
	3	38	12	261	21	548	L3	658
	COM/4	57	13	293	22	580	L4	855
	5	83	14	325	23	643	L5	1,051
	6	108	15	357	24	707		
	7	134	16	388	25	771		
	8	159	17	420	26	834		
	9	185	18	452	27	898		

Top row of pricing is for units specified with same fabric on Seat and Back. Bottom two rows of pricing required only when two different fabric grades are selected for the Seat and Back.

To calculate price of chair with different grade fabric for Seat and Back; start with Grade 1 price, add appropriate grade price located in second row for Seat, and last add appropriate grade price located in third row for Back to the sum of the Grade 1 and Seat price.

Example: Grade 1 \$1,265 + grade 4 fabric seat \$57 + grade 2 fabric back \$21 = \$1,343

Back	1	10	229	19	528	L1	245	
	2	21	11	257	20	563	L2	460
	3	42	12	285	21	597	L3	717
	COM/4	63	13	320	22	632	L4	932
	5	90	14	354	23	702	L5	1,147
	6	118	15	389	24	771		
	7	146	16	424	25	841		
	8	174	17	459	26	910		
	9	201	18	493	27	980		

Note: When Tia Guest chair is upholstered in multiple fabrics, there is an added angled seam along the side boxings to accommodate seat and back as two choices of upholstery.

TO ORDER PLEASE SPECIFY THE FOLLOWING:

<input type="text"/>	<input type="text"/>	<input type="text"/>	<input type="text"/>	<input type="text"/>
MODEL NUMBER	FINISH	FLAMMABILITY RATING	SEAT UPHOLSTERY	BACK UPHOLSTERY

These seating models are available in the following hardwoods:
Maple **NE**
Ash **QA**
Please refer to the Tia product page on www.gunlocke.com for standard finish options.

Cherry finishes on Maple or Ash
Walnut finishes on Maple or Ash
Maple finishes on Maple or Ash
Oak finishes on Maple or Ash
Natural Cherry 222, Natural Maple 800, Honey Maple 873 and Natural Oak 300 not available on Ash.

U CTB117

Please refer to list of available upholstery and leather selections on www.gunlocke.com

Please refer to list of available upholstery and leather selections on www.gunlocke.com

Example

GGHB17-081.QA629.U.DOL728.SPNN04				
GGHB17-081	QA629	U	DOL728	SPNN04
MODEL NUMBER	FINISH	FLAMMABILITY	SEAT UPHOLSTERY	BACK UPHOLSTERY

Multipurpose Seating	45-76
Product Specifications.	46
Convo® Barstool	47-50
LIV Guest.	51-52
LIV Stool.	53-54
Multi®.	55-58
Multi® Stool	59-62
Multi® Bariatric.	63-64
Multi® Side Chair Tandem	65-70
Tia™ Barstool.	71-74
Trillia™ Barstool	75-76

MULTIPURPOSE SEATING

Product Specifications

CONVO™

Frame:

Round tubular steel offered in Polished Stainless as well as powder-coats Silver, Black, and Bronze.

Upholstered Seat:

Seat Pan: Rigid fiberglass reinforced urethane pan provides structure to support user load, wrapped in 1/4" dacron.

Top Cushion: High resilient foam overmolded onto rigid fiberglass reinforced urethane pan, wrapped in 1/4" dacron.

Wood Seat:

Consists of 2"x2" solid ash hardwood blocks, glued and contoured to shape.

Glides: Push-fit low density polyethylene; heavy-duty round plastic inserts.

Shipping: Product ships 1 to a box.

BIFMA Rating:

ANSI/BIFMA X5.1 2011
(253lb Weight Rating)

LIV GUEST & STOOL

Frame: Round tubular steel available in 9 powder coat colors (Silver, Black, Designer White, Matte Gold, Pyrite Bronze, Titanium, Solar Black, Regatta Blue, Bullseye Red) or polished chrome.

Laminate Seat: Bent plywood with laminate layer inside and out

Wood Bucket: Bent plywood with quartered cut ash inside and out

Glides: Black Domed Nylon Glide or polished Toggle glide with white nylon and option to purchase nickel or felt caps.

Toggle Glide Caps - 4 pack

Nickel: GGLIV19-SVL1 \$59.00

Felt: GGLIV19-SVL2 \$59.00

Nylon glides are recommended for hard surfaces, commercial carpet and damp environments. Nickel-plated glides are recommended for carpet. Felt glides are recommended for wood, tile or high-sheen floor surfaces.

Stacking: 5 chairs high limit.

See GK8907. Page 55

Shipping: Product ships 1 to a box except armless versions which stacks 2 to a box.

BIFMA Rating:

ANSI/BIFMA X5.1 2017
(275lb Weight Rating)

MULTI GUEST, STOOL & TANDEM

Frame: Round tubular steel.

Seat: Foam filled over contoured plastic, upholstered.

Upholstered Back: PVC Foam filled over plywood, upholstered. Triple stitched.

Wood Back: Bent plywood.

Laser Backs: A laser cut logo or insignia is available on wood back.

LSR: Laser Back Chair. See pg. 10 for directions.

Moderne Arm: Textured polypropylene or RF bent plywood.

Glides: Plastic.

Boot: Flexible textured polyvinyl chloride 2 1/2" high. (glide models only) Black boot on black frame. Grey boot on silver frame.

Casters: 1 1/2" dual wheel hooded; black. Optional.

Shipping: Product ships 2 to a box.

Stacking: 5 chairs high limit or 4 chairs with casters. See GK8907. Page 55

BIFMA Rating:

ANSI/BIFMA X5.1 2017 w/ additional requirements (300lb Weight Rating)

NOTE:

Space required for a stack of chairs 5-high with cart.

W	D	H
26"	38"	51"

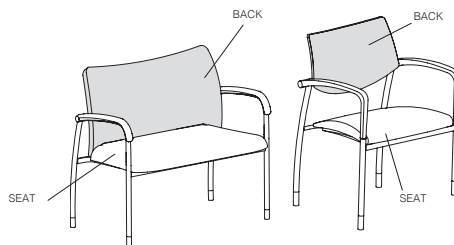

MULTI BARIATRIC

Frame: Round tubular steel.

Seat: Foam filled over reinforced upholstery-grade hardwood seat frame. Sheet webbing Interior for added user comfort. 3 degree seat angle.

Upholstered Back: Foam filled over plywood, upholstered. Triple stitched.

Modern Arms: Textured polypropylene or RF bent plywood.

Glides: Plastic.

Boot: Flexible textured polyvinyl chloride 2 1/2" high (glide models only). Black boot on black frame. Grey boot on silver frame.

Gore Protection: Waterproof moisture barrier, anti-microbial, and stain resistant.

Shipping: Product ships 1 to a box.

BIFMA Rating:

ANSI/BIFMA X5.1 2011 w/ additional requirements (600lb Weight Rating)

TRILLIA™ BARSTOOLS

Wood Seat: Consists of 2" wide solid ash hardwood blocks, glued and contoured to shape.

Upholstered Seat: High resilient foam overmolded onto vacuum-formed ABS plastic. Double needle stitch detail optional.

Legs: Solid ash hardwood.

Footrest: 1/2" solid bar footrest, polished stainless steel.

Glides: Nickel-plated steel.

Shipping: Product ships 1 to a box.

BIFMA Rating:

ANSI/BIFMA X5.1 2011
(253lb Weight Rating)

TIA™ BARSTOOLS

Frame:

Construction: Hardwood frame joined by mortise and tenon, and corner blocks.

Available hardwoods: Maple, Ash

Seat & Back: 13/16" thick plywood bucket, consisting of 13 cross-plyies of 1/16" thick #3 grade southern hardwood.

Footrest: 16 ga steel footrest, available in: polished, brushed, black or white.

Glides: Nickel-plated steel.

Shipping: Product ships 1 to a box.

BIFMA Rating:

ANSI/BIFMA X5.1 2017
(275lb Weight Rating)

model number	fabric grades								dimensions	W	D	H
GMLA15-011 Upholstered	1	1,226	10	1,494	19	1,842	L1	1,512	Overall	16 1/4"	16"	30 1/2"
	2	1,250	11	1,526	20	1,882	L2	1,762	Seat	16 1/4"	16"	
	3	1,274	12	1,558	21	1,924	L3	2,064	Upholstery Requirements: GMLA15-011			
	COM/4	1,298	13	1,598	22	1,964	L4	2,314	Dual Upholstery			
	5	1,332	14	1,640	23	2,044	L5	2,564	Fabric yards Cushion 0.7 Bottom 0.7			
	6	1,364	15	1,680	24	2,126			Leather feet2 Cushion 11.9 Bottom 11.9			
	7	1,396	16	1,720	25	2,206			Shipping weight 28 lbs.			
	8	1,428	17	1,760	26	2,288			Cube 7.1			
	9	1,462	18	1,802	27	2,368						

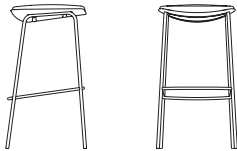

Top Cushion	1	10	134	19	308	L1	143	
	2	12	11	150	20	328	L2	268
	3	24	12	166	21	349	L3	419
	COM/4	36	13	186	22	369	L4	544
	5	53	14	207	23	409	L5	669
	6	69	15	227	24	450		
	7	85	16	247	25	490		
	8	101	17	267	26	531		
	9	118	18	288	27	571		

Top row of pricing is for units specified with same fabric on Seat and Back. Bottom two rows of pricing required only when two different fabric grades are selected for the Seat and Back.

To calculate price of stool with different grade fabric for Top Cushion and Bottom Seat Pan, start with Grade 1 price, add appropriate grade price located in second row for Top Cushion, and last add appropriate grade price located in third row for Bottom Seat Pan to the sum of the Grade 1 and Top Cushion price.

Example: Grade 1 \$1,226 + grade 4 fabric Top Cushion \$36 + grade 2 fabric Bottom Seat Pan \$12 = \$1,274

Bottom Seat Pan	1	10	134	19	308	L1	143	
	2	12	11	150	20	328	L2	268
	3	24	12	166	21	349	L3	419
	COM/4	36	13	186	22	369	L4	544
	5	53	14	207	23	409	L5	669
	6	69	15	227	24	450		
	7	85	16	247	25	490		
	8	101	17	267	26	531		
	9	118	18	288	27	571		

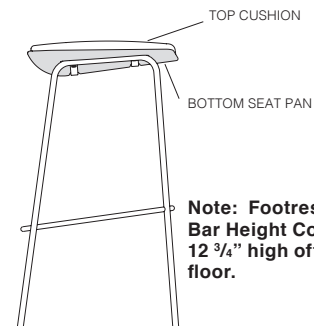

TO ORDER PLEASE SPECIFY THE FOLLOWING:

<input type="text"/>	<input type="text"/>	<input type="text"/>	<input type="text"/>	<input type="text"/>
MODEL NUMBER	FRAME	FLAMMABILITY RATING	TOP CUSHION UPHOLSTERY	BOTTOM SEAT PAN UPHOLSTERY
	This seating model is available with the following frame options. Please specify by adding suffix to model number. P71 Black PR6 Silver PJE Pyrite FPS Polished Stainless +\$100	U CTB117	Select upholstery for the top cushion. Please refer to list of available upholstery and leather selections on www.gunlocke.com	Select upholstery for the bottom seat pan. Please refer to list of available upholstery and leather selections on www.gunlocke.com

Example

GMLA15-011.P71.U.DOL728.SPNN04				
GMLA15-011	P71	U	DOL728	SPNN04
MODEL NUMBER	FRAME	FLAMMABILITY RATING	TOP CUSHION UPHOLSTERY	BOTTOM SEAT PAN UPHOLSTERY

CONVO® BARSTOOL

Bar Height | Wood Seat

Seating
05/22

model number

dimensions W D H

GMLA15-021 List **2,012** All Wood
Solid Ash Wood Seat

Overall	16 1/4"	16"	30 1/2"
Seat	16 1/4"	16"	

Shipping weight	28 lbs.
Cube	7.1

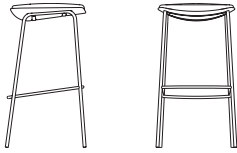

Note: Footrest for Bar Height Convo is 12 3/4" high off the floor.

TO ORDER PLEASE SPECIFY THE FOLLOWING:

MODEL NUMBER	FRAME	SPECIES & FINISH	

This seating model is available with the following frame options.
Please specify by adding suffix to model number.

- P71** Black
- PR6** Silver
- PJE** Pyrite
- FPS** Polished Stainless **+\$100**

This seating model is available with the following hardwood option:
Ash QA
Please refer to the Convo™ product page on www.gunlocke.com for standard finish options.

- Cherry finishes on Ash**
- Walnut finishes on Ash**
- Oak finishes on Ash**
- Natural Oak 300 not available on Ash.*

Example

GMLA15-021.P71.QA601

GMLA15-021	P71	QA601
MODEL NUMBER	FRAME	SPECIES & FINISH

model number fabric grades dimensions W D H

GMLA15-041
Upholstered

1	1,226	10	1,494	19	1,842	L1	1,512
2	1,250	11	1,526	20	1,882	L2	1,762
3	1,274	12	1,558	21	1,924	L3	2,064
COM/4	1,298	13	1,598	22	1,964	L4	2,314
5	1,332	14	1,640	23	2,044	L5	2,564
6	1,364	15	1,680	24	2,126		
7	1,396	16	1,720	25	2,206		
8	1,428	17	1,760	26	2,288		
9	1,462	18	1,802	27	2,368		

Overall	16 1/4"	16"	26 1/4"
Seat	16 1/4"	16"	

Upholstery Requirements: GMLA15-041

	Dual Upholstery	
Fabric yards	Cushion 0.7	Bottom 0.7
Leather feet ²	Cushion 11.9	Bottom 11.9
Shipping weight	28 lbs.	
Cube	7.1	



Top Cushion

1		10	134	19	308	L1	143
2	12	11	150	20	328	L2	268
3	24	12	166	21	349	L3	419
COM/4	36	13	186	22	369	L4	544
5	53	14	207	23	409	L5	669
6	69	15	227	24	450		
7	85	16	247	25	490		
8	101	17	267	26	531		
9	118	18	288	27	571		

Top row of pricing is for units specified with same fabric on Seat and Back. Bottom two rows of pricing required only when two different fabric grades are selected for the Seat and Back.

To calculate price of stool with different grade fabric for Top Cushion and Bottom Seat Pan, start with Grade 1 price, add appropriate grade price located in second row for Top Cushion, and last add appropriate grade price located in third row for Bottom Seat Pan to the sum of the Grade 1 and Top Cushion price.

Example: Grade 1 \$1,226 + grade 4 fabric Top Cushion \$36 + grade 2 fabric Bottom Seat Pan \$12 = \$1,274

Bottom Seat Pan

1		10	134	19	308	L1	143
2	12	11	150	20	328	L2	268
3	24	12	166	21	349	L3	419
COM/4	36	13	186	22	369	L4	544
5	53	14	207	23	409	L5	669
6	69	15	227	24	450		
7	85	16	247	25	490		
8	101	17	267	26	531		
9	118	18	288	27	571		



TO ORDER PLEASE SPECIFY THE FOLLOWING:

<input type="text"/>	<input type="text"/>	<input type="text"/>	<input type="text"/>	<input type="text"/>
MODEL NUMBER	FRAME	FLAMMABILITY RATING	TOP CUSHION UPHOLSTERY	BOTTOM SEAT PAN UPHOLSTERY
	This seating model is available with the following frame options. Please specify by adding suffix to model number. P71 Black PR6 Silver PJE Pyrite FPS Polished Stainless +\$100	U CTB117	Select upholstery for the top cushion. Please refer to list of available upholstery and leather selections on www.gunlocke.com	Select upholstery for the bottom seat pan. Please refer to list of available upholstery and leather selections on www.gunlocke.com

Example

GMLA15-041.P71.U.DOL728.SPNN04				
GMLA15-041	P71	U	DOL728	SPNN04
MODEL NUMBER	FRAME	FLAMMABILITY RATING	TOP CUSHION UPHOLSTERY	BOTTOM SEAT PAN UPHOLSTERY

CONVO® BARSTOOL

Counter Height | Wood Seat

Seating
05/22

model number	list	dimensions	W	D	H
GMLA15-051 Solid Ash Wood Seat	List 2,012 All Wood	Overall	16 1/4"	16"	26 1/8"
		Seat	16 1/4"	16"	

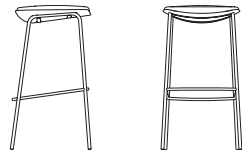

Shipping weight	28 lbs.
Cube	7.1

Note: Footrest for Counter Height Convo is 8 1/2" high off the floor.

TO ORDER PLEASE SPECIFY THE FOLLOWING:

MODEL NUMBER	FRAME	SPECIES & FINISH		

This seating model is available with the following frame options.
Please specify by adding suffix to model number.

- P71** Black
- PR6** Silver
- PJE** Pyrite
- FPS** Polished Stainless **+\$100**

This seating model is available with the following hardwood option:
Ash **QA**
Please refer to the Convo™ product page on www.gunlocke.com for standard finish options.

- Cherry finishes on Ash**
- Walnut finishes on Ash**
- Oak finishes on Ash**

Natural Oak 300 not available on Ash.

Example

GMLA15-051.P71.QA601		
GMLA15-051	P71	QA601
MODEL NUMBER	FRAME	SPECIES & FINISH

model number	list	dimensions	W	D	H
GGLIV19-011 Wood Seat	1,292	Overall	21"	22.5"	32.5"
		Seat	19"	17"	17.25"
		Shipping weight			18.5 lbs.
		Cube			12.8

GGLIV19-012
Laminate Seat

897



model number	fabric grades	dimensions	W	D	H
GGLIV19-013 Upholstered Seat		Overall	21"	22.5"	32.5"
		Seat	19"	17"	17.25



1	1,071	10	1,262	19	1,511	L1	1,275
2	1,088	11	1,285	20	1,540	L2	1,454
3	1,106	12	1,308	21	1,569	L3	1,669
COM/4	1,123	13	1,337	22	1,598	L4	1,848
5	1,146	14	1,366	23	1,656	L5	2,027
6	1,169	15	1,395	24	1,714		
7	1,193	16	1,424	25	1,772		
8	1,216	17	1,453	26	1,829		
9	1,239	18	1,482	27	1,887		

Upholstery Requirements: GGLIV19-013

Fabric yards	1
Leather feet ²	17
Shipping weight	19.3 lbs.
Cube	12.8

GGLIV19-014
Upholstered Seat
w/Channel Stitch

1	1,235	10	1,464	19	1,763	L1	1,480
2	1,256	11	1,492	20	1,798	L2	1,695
3	1,277	12	1,520	21	1,832	L3	1,952
COM/4	1,298	13	1,555	22	1,867	L4	2,167
5	1,325	14	1,589	23	1,937	L5	2,382
6	1,353	15	1,624	24	2,006		
7	1,381	16	1,659	25	2,076		
8	1,409	17	1,694	26	2,145		
9	1,436	18	1,728	27	2,215		

Overall	21"	22.5"	32.5"
Seat	19"	17"	17.25

Upholstery Requirements: GGLIV19-014

Fabric yards	1.2
Leather feet ²	20.4
Shipping weight	19.3 lbs.
Cube	12.8



TO ORDER PLEASE SPECIFY THE FOLLOWING:

MODEL NUMBER	FSC	FRAME	GLIDE	GLWOOD	LAMINATE	FABRIC	FLAMMABILITY RATING
	No FSC X FSC Certified F +60	Polished Chrome PC +100 Black P71 Designer White PJW Matte Gold P8G Silver PR6 Pyrite PJE Solar Black P8X Titanium P8T Bullseye PJF Regatta P8M	Standard Black Nylon STD Swivel Glide w/ Nylon SVL0 +16 <i>Toggle Glide Option Pack page 46.</i>	Only on model GGLIV19-011 Cherry finishes on Quartered Ash Walnut finishes on Quartered Ash Maple finishes on Quartered Ash Oak finishes on Quartered Ash	Only on model GGLIV19-012 L1 and L2 Woodgrain Laminates +100	Only on models GGLIV19-013 and GGLIV19-014 Please refer to list of available upholstery and leather selections on www.gunlocke.com	U CTB117

Example

GGLIV19-013.X.PC.STD.DOL728.U

MODEL NUMBER	FSC	FRAME	GLIDE	FABRIC	FLAMMABILITY
GGLIV19-013	X	PC	STD	DOL728	U

LIV
Armed Guest

Seating
05/22

model number	list	dimensions	W	D	H
GGLIV19-021 Wood Seat	1,497	Overall	20.5"	22.5"	32.5"
		Seat	19"	17"	17.25"
GGLIV19-022 Laminate Seat	1,080	Shipping weight	23.5 lbs.		
		Cube	12.5		

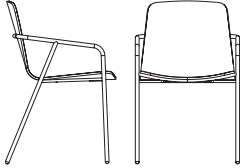

model number	fabric grades						dimensions	W	D	H
GGLIV19-023 Upholstered Seat	1	1,283	10	1,474	19	1,723	Overall	21"	22.5"	32.5"
	2	1,300	11	1,497	20	1,752	Seat	19"	17"	17.25"
	3	1,318	12	1,520	21	1,781	Upholstery Requirements: GGLIV19-023			
	COM/4	1,335	13	1,549	22	1,810	Fabric yards	1		
	5	1,358	14	1,578	23	1,868	Leather feet ²	17		
	6	1,381	15	1,607	24	1,926	Shipping weight	24.3 lbs.		
	7	1,405	16	1,636	25	1,984	Cube	12.5		
	8	1,428	17	1,665	26	2,041				
	9	1,451	18	1,694	27	2,099				



GGLIV19-024 Upholstered Seat w/Channel Stitch	1	1,447	10	1,676	19	1,975	Overall	21"	22.5"	32.5"
	2	1,468	11	1,704	20	2,010	Seat	19"	17"	17.25"
	3	1,489	12	1,732	21	2,044	Upholstery Requirements: GGLIV19-024			
	COM/4	1,510	13	1,767	22	2,079	Fabric yards	1.2		
	5	1,537	14	1,801	23	2,149	Leather feet ²	20.4		
	6	1,565	15	1,836	24	2,218	Shipping weight	24.3 lbs.		
	7	1,593	16	1,871	25	2,288	Cube	12.5		
	8	1,621	17	1,906	26	2,357				
	9	1,648	18	1,940	27	2,427				



TO ORDER PLEASE SPECIFY THE FOLLOWING:

MODEL NUMBER	FSC	FRAME	GLIDE	GLWOOD	LAMINATE	FABRIC	FLAMMABILITY RATING
	No FSC X FSC Certified F +60	Polished Chrome PC +100 Black P71 Designer White PJW Matte Gold P8G Silver PR6 Pyrite PJE Solar Black P8X Titanium P8T Bullseye PJF Regatta P8M	Standard Black Nylon STD Swivel Glide w/ Nylon SVL0 +16 <i>Toggle Glide Option Pack page 46.</i>	Only on model GGLIV19-021 Cherry finishes on Quartered Ash Walnut finishes on Quartered Ash Maple finishes on Quartered Ash Oak finishes on Quartered Ash	Only on model GGLIV19-022 L1 and L2 Woodgrain Laminates +100	Only on models GGLIV19-023 and GGLIV19-024 Please refer to list of available upholstery and leather selections on www.gunlocke.com	U CTB117

Example

GGLIV19-023	X	PC	STD	DOL726	U
MODEL NUMBER	FSC	FRAME	GLIDE	FABRIC	FLAMMABILITY

model number	list	dimensions	W	D	HM
GMLIV19-031 Wood Seat	1,534	Overall	19"	20.5"	32.5"
		Seat	18"	16"	24.5"
GMLIV19-032 Laminate Seat	1,180	Shipping weight	23.6 lbs.		
		Cube	12.5		

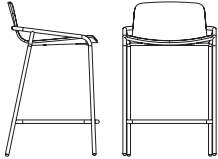

model number	fabric grades						dimensions	W	D	H			
GMLIV19-033 Upholstered Seat	1	1,381	10	1,572	19	1,821	L1	1,585	Overall	19"	20.5"	32.5"	
	2	1,398	11	1,595	20	1,850	L2	1,764	Seat	18"	16"	24.5"	
	3	1,416	12	1,618	21	1,879	L3	1,979	Upholstery Requirements: GMLIV19-033				
	COM/4	1,433	13	1,647	22	1,908	L4	2,158	Fabric yards	1			
	5	1,456	14	1,676	23	1,966	L5	2,337	Leather feet ²	17			
	6	1,479	15	1,705	24	2,024			Shipping weight	24.4 lbs.			
	7	1,503	16	1,734	25	2,082			Cube	12.5			
	8	1,526	17	1,763	26	2,139							
	9	1,549	18	1,792	27	2,197							

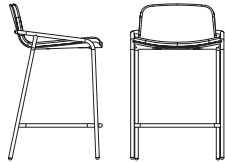

model number	fabric grades						dimensions	W	D	H			
GMLIV19-034 Upholstered Seat w/Channel Stitch	1	1,545	10	1,774	19	2,073	L1	1,790	Overall	19"	20.5"	32.5"	
	2	1,566	11	1,802	20	2,108	L2	2,005	Seat	18"	16"	24.5"	
	3	1,587	12	1,830	21	2,142	L3	2,262	Upholstery Requirements: GMLIV19-034				
	COM/4	1,608	13	1,865	22	2,177	L4	2,477	Fabric yards	1.2			
	5	1,635	14	1,899	23	2,247	L5	2,692	Leather feet ²	20.4			
	6	1,663	15	1,934	24	2,316			Shipping weight	24.4 lbs.			
	7	1,691	16	1,969	25	2,386			Cube	12.5			
	8	1,719	17	2,004	26	2,455							
	9	1,746	18	2,038	27	2,525							

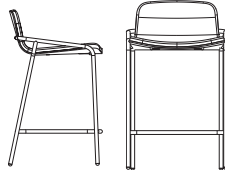

TO ORDER PLEASE SPECIFY THE FOLLOWING:

MODEL NUMBER	FSC	FRAME	GLIDE	GLWOOD	LAMINATE	FABRIC	FLAMMABILITY RATING
	No FSC X FSC Certified F +60	Polished Chrome PC +100 Black P71 Designer White PJW Matte Gold P8G Silver PR6 Pyrite PJE Solar Black P8X Titanium P8T Bullseye PJF Regatta P8M	Standard Black Nylon STD Swivel Glide w/ Nylon SVL0 +16 <i>Toggle Glide Option Pack page 46.</i>	Only on model GGLIV19-031 Cherry finishes on Quartered Ash Walnut finishes on Quartered Ash Maple finishes on Quartered Ash Oak finishes on Quartered Ash	Only on model GGLIV19-032 L1 and L2 Woodgrain Laminates +100	Only on models GGLIV19-033 and GGLIV19-034 Please refer to list of available upholstery and leather selections on www.gunlocke.com	U CTB117

Example

GGLIV19-033.X.PC.STD.DOL728.U

MODEL NUMBER	FSC	FRAME	GLIDE	FABRIC	FLAMMABILITY
GGLIV19-033	X	PC	STD	DOL728	U

LIV

Bar Height Stool

Seating
05/22

model number	list	dimensions	W	D	H
GMLIV19-041 Wood Seat	1,647	Overall	19"	20.5"	37.5"
		Seat	18"	16"	28.5"
GMLIV19-042 Laminate Seat	1,219	Shipping weight	24.6 lbs.		
		Cube	14		

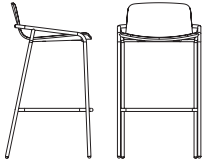

model number	fabric grades						dimensions	W	D	H		
GMLIV19-043 Upholstered Seat	1	1,421	10	1,612	19	1,861	L1	1,625	Overall	19"	20.5"	37.5"
	2	1,438	11	1,635	20	1,890	L2	1,804	Seat	18"	16"	28.5"
	3	1,456	12	1,658	21	1,919	L3	2,019	Upholstery Requirements: GMLIV19-043			
	COM/4	1,473	13	1,687	22	1,948	L4	2,198	Fabric yards	1		
	5	1,496	14	1,716	23	2,006	L5	2,377	Leather feet ²	17		
	6	1,519	15	1,745	24	2,064			Shipping weight	25.4 lbs.		
	7	1,543	16	1,774	25	2,122			Cube	14		
	8	1,566	17	1,803	26	2,179						
	9	1,589	18	1,832	27	2,237						

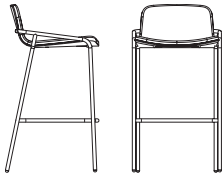

GMLIV19-044 Upholstered Seat w/Channel Stitch	1	1,585	10	1,814	19	2,113	L1	1,830	Overall	19"	20.5"	37.5"
	2	1,606	11	1,842	20	2,148	L2	2,045	Seat	18"	16"	28.5"
	3	1,627	12	1,870	21	2,182	L3	2,302	Upholstery Requirements: GMLIV19-044			
	COM/4	1,648	13	1,905	22	2,217	L4	2,517	Fabric yards	1.2		
	5	1,675	14	1,939	23	2,287	L5	2,732	Leather feet ²	20.4		
	6	1,703	15	1,974	24	2,356			Shipping weight	25.4 lbs.		
	7	1,731	16	2,009	25	2,426			Cube	14		
	8	1,759	17	2,044	26	2,495						
	9	1,786	18	2,078	27	2,565						

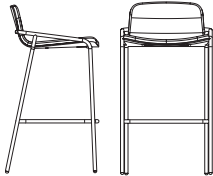

TO ORDER PLEASE SPECIFY THE FOLLOWING:

MODEL NUMBER	FSC	FRAME	GLIDE	GLWOOD	LAMINATE	FABRIC	FLAMMABILITY RATING
	No FSC X FSC Certified F +60	Polished Chrome PC +100 Black P71 Designer White PJW Matte Gold P8G Silver PR6 Pyrite PJE Solar Black P8X Titanium P8T Bullseye PJF Regatta P8M	Standard Black Nylon STD Swivel Glide w/ Nylon SVL0 +16 <i>Toggle Glide Option Pack page 46.</i>	Only on model GGLIV19-041 Cherry finishes on Quartered Ash Walnut finishes on Quartered Ash Maple finishes on Quartered Ash Oak finishes on Quartered Ash	Only on model GGLIV19-042 L1 and L2 Woodgrain Laminates +100	Only on models GGLIV19-043 and GGLIV19-044 Please refer to list of available upholstery and leather selections on www.gunlocke.com	U CTB117

Example

GGLIV19-043.X.PC.STD.DOL728.U						
GGLIV19-043	X	PC	STD	DOL728	U	
MODEL NUMBER	FSC	FRAME	GLIDE	FABRIC	FLAMMABILITY	

model number	fabric grades								dimensions	W	D	H
GK9903N Armless, upholstered	1	842	10	1,091	19	1,414	L1	1,107	Overall	20 3/4"	23"	33"
	2	865	11	1,120	20	1,451	L2	1,341	Seat		18"	18"
	3	887	12	1,151	21	1,489	L3	1,619	Arm			
	COM/4	910	13	1,188	22	1,526	L4	1,851	Between Arms			
	5	940	14	1,226	23	1,602	L5	2,085	Upholstery Requirements: GK9903N			
	6	970	15	1,263	24	1,677			Dual Upholstery			
	7	1,000	16	1,302	25	1,752			Fabric yards	Seat 0.8	Back 0.5	
	8	1,030	17	1,339	26	1,828			Leather feet ²	Seat 13.6	Back 8.5	
	9	1,060	18	1,377	27	1,903			Shipping weight			35 lbs.

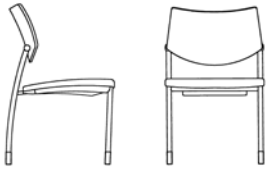

Seat	1	10	153	19	352	L1	163
	2	14	11	171	20	L2	307
	3	28	12	190	21	L3	478
	COM/4	42	13	213	22	L4	621
	5	60	14	236	23	L5	765
	6	79	15	259	24		
	7	97	16	283	25		
	8	116	17	306	26		
	9	134	18	329	27		

Back	1	10	96	19	220	L1	102
	2	9	11	107	20	L2	192
	3	17	12	119	21	L3	299
	COM/4	26	13	133	22	L4	388
	5	38	14	148	23	L5	478
	6	49	15	162	24		
	7	61	16	177	25		
	8	72	17	191	26		
	9	84	18	206	27		

Top row of pricing is for units specified with same fabric on Seat and Back. Bottom two rows of pricing required only when two different fabric grades are selected for the Seat and Back.

To calculate price of chair with different grade fabric for Seat and Back; start with Grade 1 price, add appropriate grade price located in second row for Seat, and last add appropriate grade price located in third row for Back to the sum of the Grade 1 and Seat price.

Example: Grade 1 \$842 + grade 4 fabric Seat/Back \$42 + grade 2 fabric Arms \$9 = \$893

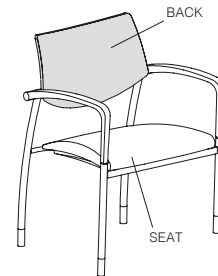

GK8907 Cart	582
Holds 5 stacked chairs. Metal cart available in black finish only. (Use with Multi or LIV chairs)	

Overall	25 3/4"	25 7/8"	7 1/2"
Shipping weight	16 lbs.		
Cube	20.6		

TO ORDER PLEASE SPECIFY THE FOLLOWING:

<input type="text"/>	<input type="text"/>	<input type="text"/>	<input type="text"/>	<input type="text"/>	<input type="text"/>
MODEL NUMBER	FRAME	GANGING	FLAMMABILITY RATING	SEAT UPHOLSTERY	BACK UPHOLSTERY
This seating model is available with the following frame options. Please specify by adding suffix to model number. NEW FINISHES P71 Black PR6 Silver P71C Black with Casters (+\$165) PR6C Silver with Casters (+\$165)		Ganging device on leg available. Please specify by adding suffix to model number. G Ganging device +\$30 GN No Ganging	U CTB117	Select upholstery for the seat. Please refer to list of available upholstery and leather selections on www.gunlocke.com	Select upholstery for the back. Please refer to list of available upholstery and leather selections on www.gunlocke.com

Example

GK9903N.P71.GN.U.DOL728.SPNN04					
GK9903N	P71	GN	U	DOL728	SPNN04
MODEL NUMBER	FRAME	GANGING	FLAMMABILITY RATING	SEAT UPHOLSTERY	BACK UPHOLSTERY

model number

fabric grades

dimensions

W

D

H

GK9901P

Plastic Moderne Arm, upholstered

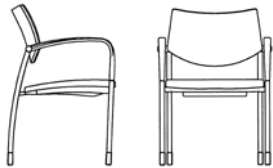

1	982	10	1,231	19	1,554	L1	1,247
2	1,005	11	1,260	20	1,591	L2	1,481
3	1,027	12	1,291	21	1,629	L3	1,759
COM/4	1,050	13	1,328	22	1,666	L4	1,991
5	1,080	14	1,366	23	1,742	L5	2,225
6	1,110	15	1,403	24	1,817		
7	1,140	16	1,442	25	1,892		
8	1,170	17	1,479	26	1,968		
9	1,200	18	1,517	27	2,043		

Overall	24 1/2"	23"	33"
Seat		18"	18"
Arm			26 1/4"
Between Arms	20 3/4"		

Upholstery Requirements: GK9901P

	Dual Upholstery	
Fabric yards	Seat 0.8	Back 0.5
Leather feet ²	Seat 13.6	Back 8.5
Shipping weight		36 lbs.
Cube		17.8

Seat

1	10	153	19	352	L1	163	
2	14	11	171	20	375	L2	307
3	28	12	190	21	398	L3	478
COM/4	42	13	213	22	421	L4	621
5	60	14	236	23	468	L5	765
6	79	15	259	24	514		
7	97	16	283	25	560		
8	116	17	306	26	607		
9	134	18	329	27	653		

Top row of pricing is for units specified with same fabric on Seat and Back. Bottom two rows of pricing required only when two different fabric grades are selected for the Seat and Back.

To calculate price of chair with different grade fabric for Seat and Back; start with Grade 1 price, add appropriate grade price located in second row for Seat, and last add appropriate grade price located in third row for Back to the sum of the Grade 1 and Seat price.

Example: Grade 1 \$982 + grade 4 fabric Seat/Back \$42 + grade 2 fabric Arms \$9 = \$1,033

Back

1	10	96	19	220	L1	102	
2	9	11	107	20	234	L2	192
3	17	12	119	21	249	L3	299
COM/4	26	13	133	22	263	L4	388
5	38	14	148	23	292	L5	478
6	49	15	162	24	321		
7	61	16	177	25	350		
8	72	17	191	26	379		
9	84	18	206	27	408		

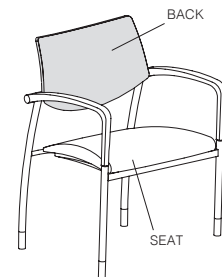

TO ORDER PLEASE SPECIFY THE FOLLOWING:

<input type="text"/>	<input type="text"/>	<input type="text"/>	<input type="text"/>	<input type="text"/>	<input type="text"/>
MODEL NUMBER	FRAME	GANGING	FLAMMABILITY RATING	SEAT UPHOLSTERY	BACK UPHOLSTERY

This seating model is available with the following frame options. Please specify by adding suffix to model number.

NEW FINISHES

- P71** Black
- PR6** Silver
- P71C** Black with Casters (+\$165)
- PR6C** Silver with Casters (+\$165)

Ganging device on leg available. Please specify by adding suffix to model number.

- G** Ganging device +\$30
- GN** No Ganging

U CTB117

Select upholstery for the seat.
Please refer to list of available upholstery and leather selections on www.gunlocke.com

Select upholstery for the back.
Please refer to list of available upholstery and leather selections on www.gunlocke.com

Example

GK9901P.P71.GN.U.DOL728.SPNN04

GK9901P	P71	GN	U	DOL728	SPNN04
MODEL NUMBER	FRAME	GANGING	FLAMMABILITY RATING	SEAT UPHOLSTERY	BACK UPHOLSTERY

Wood Moderne Arm, Upholstered

model number	fabric grades							
GK9901W Wood Moderne Arm, upholstered	1	1,251	10	1,500	19	1,823	L1	1,516
	2	1,274	11	1,529	20	1,860	L2	1,750
	3	1,296	12	1,560	21	1,898	L3	2,028
	COM/4	1,319	13	1,597	22	1,935	L4	2,260
	5	1,349	14	1,635	23	2,011	L5	2,494
	6	1,379	15	1,672	24	2,086		
	7	1,409	16	1,711	25	2,161		
	8	1,439	17	1,748	26	2,237		
	9	1,469	18	1,786	27	2,312		

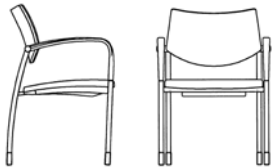

dimensions	W	D	H
Overall	24 1/2"	23"	33"
Seat		18"	18"
Arm			26 1/4"
Between Arms	20 3/4"		

Upholstery Requirements: GK9901W

	Dual Upholstery	
Fabric yards	Seat 0.8	Back 0.5
Leather feet ²	Seat 13.6	Back 8.5
Shipping weight		36 lbs.
Cube		17.8

Seat	1	10	153	19	352	L1	163	
	2	14	11	171	20	375	L2	307
	3	28	12	190	21	398	L3	478
	COM/4	42	13	213	22	421	L4	621
	5	60	14	236	23	468	L5	765
	6	79	15	259	24	514		
	7	97	16	283	25	560		
	8	116	17	306	26	607		
	9	134	18	329	27	653		

Top row of pricing is for units specified with same fabric on Seat and Back; Bottom two rows of pricing required only when two different fabric grades are selected for the Seat and Back.

To calculate price of chair with different grade fabric for Seat and Back; start with Grade 1 price, add appropriate grade price located in second row for Seat, and last add appropriate grade price located in third row for Back to the sum of the Grade 1 and Seat price.

Example: Grade 1 \$1,251 + grade 4 fabric Seat/Back \$42 + grade 2 fabric Arms \$9 = \$1,302

Back	1	10	96	19	220	L1	102	
	2	9	11	107	20	234	L2	192
	3	17	12	119	21	249	L3	299
	COM/4	26	13	133	22	263	L4	388
	5	38	14	148	23	292	L5	478
	6	49	15	162	24	321		
	7	61	16	177	25	350		
	8	72	17	191	26	379		
	9	84	18	206	27	408		

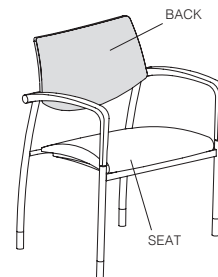

TO ORDER PLEASE SPECIFY THE FOLLOWING:

MODEL NUMBER	FRAME	FINISH	GANGING	FLAMMABILITY RATING	SEAT UPHOLSTERY	BACK UPHOLSTERY
<input type="text"/>	<input type="text"/>	<input type="text"/>	<input type="text"/>	<input type="text"/>	<input type="text"/>	<input type="text"/>
<p>This seating model is available with the following frame options. Please specify by adding suffix to model number.</p> <p>NEW FINISHES</p> <p>P71 Black</p> <p>PR6 Silver</p> <p>P71C Black with Casters (+\$165)</p> <p>PR6C Silver with Casters (+\$165)</p>		<p>Cherry finishes on Maple</p> <p>Walnut finishes on Maple</p> <p>Maple finishes on Maple</p> <p>Oak finishes on Maple</p> <p>Please refer to the Multi® product page on www.gunlocke.com for standard finish options.</p>	<p>Ganging device on leg available. Please specify by adding suffix to model number.</p> <p>G Ganging device +\$30</p> <p>GN No Ganging</p>	<p>U CTB117</p>	<p>Select upholstery for the seat.</p> <p>Please refer to list of available upholstery and leather selections on www.gunlocke.com</p>	<p>Select upholstery for the back.</p> <p>Please refer to list of available upholstery and leather selections on www.gunlocke.com</p>

Example

GK9901W.P71.GN.U.DOL728.SPNN04						
GK9901W	P71	215	GN	U	DOL728	SPNN04
MODEL NUMBER	FRAME	FINISH	GANGING RATING	FLAMMABILITY UPHOLSTERY	SEAT UPHOLSTERY	BACK

model number	fabric grades								dimensions	W	D	H
GK9907N Armless, upholstered seat, wood back	1	1,050	10	1,203	19	1,402	L1	1,213	Overall	20 3/4"	23"	33"
	2	1,064	11	1,221	20	1,425	L2	1,357	Seat		18"	18"
	3	1,078	12	1,240	21	1,448	L3	1,528	Upholstery Requirements: GK9907N			
	COM/4	1,092	13	1,263	22	1,471	L4	1,671	Fabric yards	0.8		
	5	1,110	14	1,286	23	1,518	L5	1,815	Leather feet ²	13.6		
	6	1,129	15	1,309	24	1,564			Shipping weight	35 lbs.		
	7	1,147	16	1,333	25	1,610			Cube	17.8		
	8	1,166	17	1,356	26	1,657						
	9	1,184	18	1,379	27	1,703						

GK9905P Plastic Moderne Arm, upholstered seat, wood back	1	1,191	10	1,344	19	1,543	L1	1,354	Overall	24 1/2"	23"	33"
	2	1,205	11	1,362	20	1,566	L2	1,498	Seat		18"	18"
	3	1,219	12	1,381	21	1,589	L3	1,669	Arm	26 1/4"		
	COM/4	1,233	13	1,404	22	1,612	L4	1,812	Between arms	20 3/4"		
	5	1,251	14	1,427	23	1,659	L5	1,956	Upholstery Requirements: GK9905P			
	6	1,270	15	1,450	24	1,705			Fabric yards	0.8		
	7	1,288	16	1,474	25	1,751			Leather feet ²	13.6		
	8	1,307	17	1,497	26	1,798			Shipping weight	36 lbs.		
	9	1,325	18	1,520	27	1,844			Cube	17.8		

GK9905W Wood Moderne Arm, upholstered seat, wood back	1	1,447	10	1,600	19	1,799	L1	1,610	Overall	24 1/2"	23"	33"
	2	1,461	11	1,618	20	1,822	L2	1,754	Seat		18"	18"
	3	1,475	12	1,637	21	1,845	L3	1,925	Arm	26 1/4"		
	COM/4	1,489	13	1,660	22	1,868	L4	2,068	Between arms	20 3/4"		
	5	1,507	14	1,683	23	1,915	L5	2,212	Upholstery Requirements: GK9905W			
	6	1,526	15	1,706	24	1,961			Fabric yards	0.8		
	7	1,544	16	1,730	25	2,007			Leather feet ²	13.6		
	8	1,563	17	1,753	26	2,054			Shipping weight	36 lbs.		
	9	1,581	18	1,776	27	2,100			Cube	17.8		

TO ORDER PLEASE SPECIFY THE FOLLOWING:

MODEL NUMBER	FRAME	FINISH	BACK	GANGING	FLAMMABILITY RATING	SEAT UPHOLSTERY
	This seating model is available with the following frame options. Please specify by adding suffix to model number. NEW FINISHES P71 Black PR6 Silver P71C Black with Casters (+\$165) PR6C Silver with Casters (+\$165)	Cherry finishes on Maple Walnut finishes on Maple Maple finishes on Maple Oak finishes on Maple Please refer to the Multi® product page on www.gunlocke.com for standard finish options.	Back is formed of molded plywood with face veneer in maple. PLN Plain TDP Teardrop +\$100	Ganging device on leg available. Please specify by adding suffix to model number. G Ganging device +\$30 GN No Ganging	U CTB117	Select upholstery for the back. Please refer to list of available upholstery and leather selections on www.gunlocke.com

Example

GK9905N.P71.215.PLN.GN.U.DOL728

MODEL NUMBER	FRAME	FINISH	BACK	FLAMMABILITY RATING	SEAT UPHOLSTERY
GK9905N	P71	215	PLN	U	DOL728

model number

fabric grades

dimensions

W

D

H

GK9923N
Armless,
upholstered

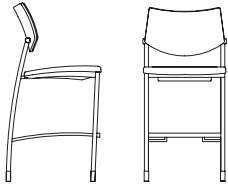

1	1,138	10	1,387	19	1,710	L1	1,403
2	1,161	11	1,416	20	1,747	L2	1,637
3	1,183	12	1,447	21	1,785	L3	1,915
COM/4	1,206	13	1,484	22	1,822	L4	2,147
5	1,236	14	1,522	23	1,898	L5	2,381
6	1,266	15	1,559	24	1,973		
7	1,296	16	1,598	25	2,048		
8	1,326	17	1,635	26	2,124		
9	1,356	18	1,673	27	2,199		

Overall	24 1/2"	23"	43"
Seat		18"	28"
Arm			37"
Between arms			
Seat to Foot Rung			17"

Upholstery Requirements: GK9923N

	Dual Upholstery	
Fabric yards	Seat 0.8	Back 0.5
Leather feet ²	Seat 13.6	Back 8.5
Shipping weight		40 lbs.
Cube		19.1

Seat

1	10	153	19	352	L1	163
2	14	11	171	20	L2	307
3	28	12	190	21	L3	478
COM/4	42	13	213	22	L4	621
5	60	14	236	23	L5	765
6	79	15	259	24		
7	97	16	283	25		
8	116	17	306	26		
9	134	18	329	27		

Top row of pricing is for units specified with same fabric on Seat and Back. Bottom two rows of pricing required only when two different fabric grades are selected for the Seat and Back.

To calculate price of chair with different grade fabric for Seat and Back; start with Grade 1 price, add appropriate grade price located in second row for Seat, and last add appropriate grade price located in third row for Back to the sum of the Grade 1 and Seat price.

Example: Grade 1 \$1,138 + grade 4 fabric Seat/back \$42 + grade 2 fabric Arms \$9 = \$1,189

Back

1	10	96	19	220	L1	102
2	9	11	107	20	L2	192
3	17	12	119	21	L3	299
COM/4	26	13	133	22	L4	388
5	38	14	148	23	L5	478
6	49	15	162	24		
7	61	16	177	25		
8	72	17	191	26		
9	84	18	206	27		

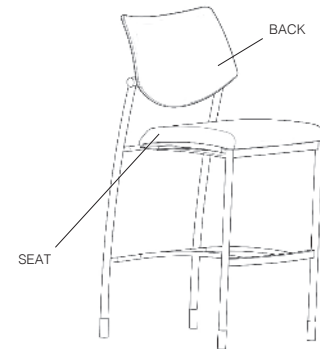

TO ORDER PLEASE SPECIFY THE FOLLOWING:

<input type="text"/>	<input type="text"/>	<input type="text"/>	<input type="text"/>	<input type="text"/>
MODEL NUMBER	FRAME	FLAMMABILITY RATING	SEAT UPHOLSTERY	BACK UPHOLSTERY

This seating models are available with the following frame options. Please specify by adding suffix to model number.

- P71** Black
- PR6** Silver

U CTB117

Select upholstery for the seat.

Please refer to list of available upholstery and leather selections on www.gunlocke.com

Select upholstery for the back.

Please refer to list of available upholstery and leather selections on www.gunlocke.com

Example

GK9923N	P71	U	DOL728	SPNNO4
MODEL NUMBER	FRAME	FLAMMABILITY RATING	SEAT UPHOLSTERY	BACK UPHOLSTERY

MULTI® STOOL

Plastic Moderne Arm, Upholstered

Seating
05/22

model number	fabric grades						dimensions	W	D	H		
GK9921P Plastic Moderne arm, upholstered	1	1,334	10	1,583	19	1,906	L1	1,599	Overall	24 1/2"	23"	43"
	2	1,357	11	1,612	20	1,943	L2	1,833	Seat		18"	28"
	3	1,379	12	1,643	21	1,981	L3	2,111	Arm			37"
	COM/4	1,402	13	1,680	22	2,018	L4	2,343	Between arms	20 3/4"		
	5	1,432	14	1,718	23	2,094	L5	2,577	Seat to Foot Rung			17"
	6	1,462	15	1,755	24	2,169			Upholstery Requirements: GK9921P			
	7	1,492	16	1,794	25	2,244			Dual Upholstery			
	8	1,522	17	1,831	26	2,320			Fabric yards Seat 0.8 Back 0.5			
	9	1,552	18	1,869	27	2,395			Leather feet ² Seat 13.6 Back 8.5			
									Shipping weight 40 lbs.			
								Cube 19.1				

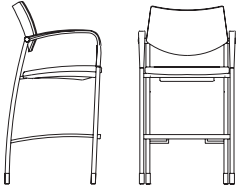

Seat	1	10	153	19	352	L1	163	
	2	14	11	171	20	375	L2	307
	3	28	12	190	21	398	L3	478
	COM/4	42	13	213	22	421	L4	621
	5	60	14	236	23	468	L5	765
	6	79	15	259	24	514		
	7	97	16	283	25	560		
	8	116	17	306	26	607		
	9	134	18	329	27	653		

Top row of pricing is for units specified with same fabric on Seat and Back. Bottom two rows of pricing required only when two different fabric grades are selected for the Seat and Back.

To calculate price of chair with different grade fabric for Seat and Back; start with Grade 1 price, add appropriate grade price located in second row for Seat, and last add appropriate grade price located in third row for Back to the sum of the Grade 1 and Seat price.

Example: Grade 1 \$1,334 + grade 4 fabric Seat/back \$42 + grade 2 fabric Arms \$9 = \$1,385

Back	1	10	96	19	220	L1	102	
	2	9	11	107	20	234	L2	192
	3	17	12	119	21	249	L3	299
	COM/4	26	13	133	22	263	L4	388
	5	38	14	148	23	292	L5	478
	6	49	15	162	24	321		
	7	61	16	177	25	350		
	8	72	17	191	26	379		
	9	84	18	206	27	408		

TO ORDER PLEASE SPECIFY THE FOLLOWING:

<input type="text"/>	<input type="text"/>	<input type="text"/>	<input type="text"/>	<input type="text"/>
MODEL NUMBER	FRAME	FLAMMABILITY RATING	SEAT UPHOLSTERY	BACK UPHOLSTERY
	This seating models are available with the following frame options. Please specify by adding suffix to model number. P71 Black PR6 Silver	U CTB117	Select upholstery for the seat. Please refer to list of available upholstery and leather selections on www.gunlocke.com	Select upholstery for the back. Please refer to list of available upholstery and leather selections on www.gunlocke.com

Example

GK9921P.P71.U.DOL728.SPNN04				
GK9921P	P71	U	DOL728	SPNN04
MODEL NUMBER	FRAME	FLAMMABILITY RATING	SEAT UPHOLSTERY	BACK UPHOLSTERY

model number	fabric grades							dimensions	W	D	H	
GK9921W Wood Moderne arm, upholstered	1	1,602	10	1,851	19	2,174	L1	1,867	Overall	24 1/2"	23"	43"
	2	1,625	11	1,880	20	2,211	L2	2,101	Seat		18"	28"
	3	1,647	12	1,911	21	2,249	L3	2,379	Arm			37"
	COM/4	1,670	13	1,948	22	2,286	L4	2,611	Between arms	20 3/4"		
	5	1,700	14	1,986	23	2,362	L5	2,845	Seat to Foot Rung			17"
	6	1,730	15	2,023	24	2,437						
	7	1,760	16	2,062	25	2,512						
	8	1,790	17	2,099	26	2,588						
	9	1,820	18	2,137	27	2,663						

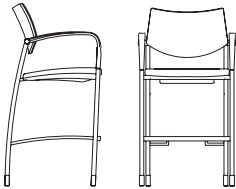

Upholstery Requirements: GK9921W

Dual Upholstery	
Fabric yards	Seat 0.8 Back 0.5
Leather feet ²	Seat 13.6 Back 8.5
Shipping weight	40 lbs.
Cube	19.1

Seat	1	10	153	19	352	L1	163	
	2	14	11	171	20	375	L2	307
	3	28	12	190	21	398	L3	478
	COM/4	42	13	213	22	421	L4	621
	5	60	14	236	23	468	L5	765
	6	79	15	259	24	514		
	7	97	16	283	25	560		
	8	116	17	306	26	607		
	9	134	18	329	27	653		

Top row of pricing is for units specified with same fabric on Seat and Back. Bottom two rows of pricing required only when two different fabric grades are selected for the Seat and Back.

To calculate price of chair with different grade fabric for Seat and Back; start with Grade 1 price, add appropriate grade price located in second row for Seat, and last add appropriate grade price located in third row for Back to the sum of the Grade 1 and Seat price.

Example: Grade 1 \$1,602 + grade 4 fabric Seat/back \$42 + grade 2 fabric Arms \$9 = \$1,653

Back	1	10	96	19	220	L1	102	
	2	9	11	107	20	234	L2	192
	3	17	12	119	21	249	L3	299
	COM/4	26	13	133	22	263	L4	388
	5	38	14	148	23	292	L5	478
	6	49	15	162	24	321		
	7	61	16	177	25	350		
	8	72	17	191	26	379		
	9	84	18	206	27	408		

TO ORDER PLEASE SPECIFY THE FOLLOWING:

<input type="text"/>	<input type="text"/>	<input type="text"/>	<input type="text"/>	<input type="text"/>	<input type="text"/>
MODEL NUMBER	FRAME	FINISH	FLAMMABILITY RATING	SEAT UPHOLSTERY	BACK UPHOLSTERY
	This seating models are available with the following frame options. Please specify by adding suffix to model number. P71 Black PR6 Silver	Cherry finishes on Maple Walnut finishes on Maple Maple finishes on Maple Oak finishes on Maple Please refer to the Multi® product page on www.gunlocke.com for standard finish options.	U CTB117	Select upholstery for the seat. Please refer to list of available upholstery and leather selections on www.gunlocke.com	Select upholstery for the back. Please refer to list of available upholstery and leather selections on www.gunlocke.com

Example

GK9921W.P71.U.DOL728.SPNN04

GK9921W	P71	215	U	DOL728	SPNN04
MODEL NUMBER	FRAME	FINISH	FLAMMABILITY RATING	SEAT UPHOLSTERY	BACK UPHOLSTERY

MULTI® STOOL

Wood Back

Seating
05/22

model number	fabric grades								dimensions	W	D	H	
GK9927N Armless, upholstered seat, wood back	1	1,362	10	1,515	19	1,714	L1	1,525	Overall	24 1/2"	23"	43"	
	2	1,376	11	1,533	20	1,737	L2	1,669	Seat		18"	28"	
	3	1,390	12	1,552	21	1,760	L3	1,840	Arm			37"	
	COM/4	1,404	13	1,575	22	1,783	L4	1,983	Between arms				
	5	1,422	14	1,598	23	1,830	L5	2,127	Seat to Foot Rung			17"	
	6	1,441	15	1,621	24	1,876			Upholstery Requirements: GK9927N				
	7	1,459	16	1,645	25	1,922			Fabric yards			0.8	
	8	1,478	17	1,668	26	1,969			Leather feet ²			13.6	
	9	1,496	18	1,691	27	2,015			Shipping weight			40 lbs.	
									Cube			19.1	

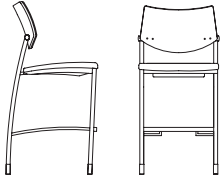

GK9925P Plastic Moderne Arm, upholstered seat, wood back	1	1,543	10	1,696	19	1,895	L1	1,706	Overall	24 1/2"	23"	43"	
	2	1,557	11	1,714	20	1,918	L2	1,850	Seat		18"	28"	
	3	1,571	12	1,733	21	1,941	L3	2,021	Arm			37"	
	COM/4	1,585	13	1,756	22	1,964	L4	2,164	Between arms	20 3/4"			
	5	1,603	14	1,779	23	2,011	L5	2,308	Seat to Foot Rung			17"	
	6	1,622	15	1,802	24	2,057			Upholstery Requirements: GK9925P				
	7	1,640	16	1,826	25	2,103			Fabric yards			0.8	
	8	1,659	17	1,849	26	2,150			Leather feet ²			13.6	
	9	1,677	18	1,872	27	2,196			Shipping weight			40 lbs.	
									Cube			19.1	

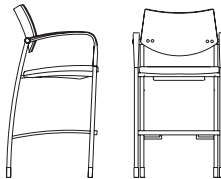

GK9925W Classic arm, upholstered seat, wood back	1	1,811	10	1,964	19	2,163	L1	1,974	Overall	24 1/2"	23"	43"	
	2	1,825	11	1,982	20	2,186	L2	2,118	Seat		18"	28"	
	3	1,839	12	2,001	21	2,209	L3	2,289	Arm			37"	
	COM/4	1,853	13	2,024	22	2,232	L4	2,432	Between arms	20 3/4"			
	5	1,871	14	2,047	23	2,279	L5	2,576	Seat to Foot Rung			17"	
	6	1,890	15	2,070	24	2,325			Upholstery Requirements: GK9925W				
	7	1,908	16	2,094	25	2,371			Fabric yards			0.8	
	8	1,927	17	2,117	26	2,418			Leather feet ²			13.6	
	9	1,945	18	2,140	27	2,464			Shipping weight			40 lbs.	
									Cube			19.1	

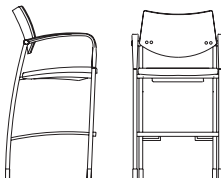

TO ORDER PLEASE SPECIFY THE FOLLOWING:

MODEL NUMBER	FRAME	FINISH	BACK	FLAMMABILITY RATING	SEAT UPHOLSTERY

These seating models are available with the following frame options. Please specify by adding suffix to model number.

P71 Black
PR6 Silver

Cherry finishes on Maple
Walnut finishes on Maple
Maple finishes on Maple
Oak finishes on Maple

Please refer to the Multi® product page on www.gunlocke.com for standard finish options.

Back is formed of molded plywood with face veneer in maple.



U CTB117

Select upholstery for the back.
Please refer to list of available upholstery and leather selections on www.gunlocke.com

Example

GK9925N.P71.215.PLN.U.DOL728

GK9925N	P71	215	PLN	U	DOL728
MODEL NUMBER	FRAME	FINISH	BACK	FLAMMABILITY RATING	SEAT UPHOLSTERY

model number	fabric grades								dimensions	W	D	H
GK9961P Plastic Moderne Arm, upholstered	1	3,083	10	3,503	19	4,051	L1	3,532	Overall	36 1/2"	26 1/4"	33 1/2"
	2	3,122	11	3,554	20	4,115	L2	3,926	Seat		19"	19"
	3	3,159	12	3,606	21	4,178	L3	4,398	Arm			27 1/4"
	COM/4	3,198	13	3,669	22	4,242	L4	4,792	Between arms	33 1/4"		
	5	3,249	14	3,733	23	4,369	L5	5,186	Upholstery Requirements: GK9961P			
	6	3,300	15	3,796	24	4,496			Dual Upholstery			
	7	3,350	16	3,860	25	4,624			Fabric yards	Seat 0.9	Back 1.3	
	8	3,401	17	3,924	26	4,752			Leather feet ²	Seat 15.3	Back 22.1	
	9	3,452	18	3,987	27	4,879			Shipping weight			60 lbs.
								Cube			32.6	

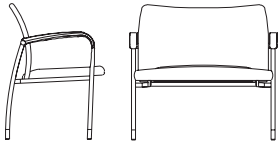

Seat	1	10	172	19	396	L1	184	
	2	16	11	193	20	422	L2	345
	3	31	12	214	21	448	L3	538
	COM/4	47	13	240	22	474	L4	699
	5	68	14	266	23	526	L5	860
	6	89	15	292	24	578		
	7	109	16	318	25	630		
	8	130	17	344	26	683		
	9	151	18	370	27	735		

Top row of pricing is for units specified with same fabric on Seat and Back. Bottom two rows of pricing required only when two different fabric grades are selected for the Seat and Back.

To calculate price of chair with different grade fabric for Seat and Back; start with Grade 1 price, add appropriate grade price located in second row for Seat, and last add appropriate grade price located in third row for Back to the sum of the Grade 1 and Seat price.

Example: Grade 1 \$3,083 + grade 4 fabric Seat/back \$47 + grade 2 fabric Arms \$23 = \$3,153

Back	1	10	248	19	572	L1	265	
	2	23	11	278	20	610	L2	498
	3	45	12	309	21	647	L3	777
	COM/4	68	13	346	22	685	L4	1,010
	5	98	14	384	23	760	L5	1,243
	6	128	15	421	24	835		
	7	158	16	459	25	911		
	8	188	17	497	26	986		
	9	218	18	534	27	1,061		

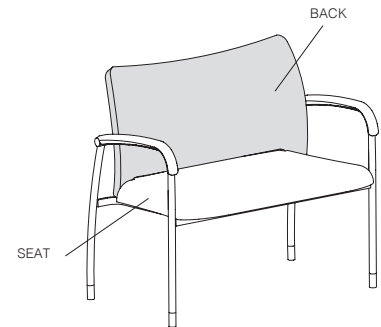

TO ORDER PLEASE SPECIFY THE FOLLOWING:

MODEL NUMBER	FRAME	GANGING	FLAMMABILITY RATING	GORE BARRIER	SEAT UPHOLSTERY	BACK UPHOLSTERY
	P71 Black PR6 Silver	Ganging device on leg available. Please specify by adding suffix to model number. G Ganging device +\$30 GN No Ganging	U CTB117	Minimum order of 2. Two week added leadtime for moisture barrier option. GBY Gore Barrier +\$75 /chair GBN No Gore	Select upholstery for the seat. Please refer to list of available upholstery and leather selections on www.gunlocke.com	Select upholstery for the back. Please refer to list of available upholstery and leather selections on www.gunlocke.com

Example

GK9961P.P71.GN.U.GBN.DOL728.SPNN04

GK9961P	P71	GN	U	GBN	DOL728	SPNN04
MODEL NUMBER	FRAME	GANGING	FLAMMABILITY RATING	GORE BARRIER	SEAT UPHOLSTERY	BACK UPHOLSTERY

model number	fabric grades							dimensions	W	D	H	
GK9961W Wood Moderne Arm, upholstered	1	3,351	10	3,771	19	4,319	L1	3,800	Overall	36 1/2"	26 1/4"	33 1/2"
	2	3,390	11	3,822	20	4,383	L2	4,194	Seat		19"	19"
	3	3,427	12	3,874	21	4,446	L3	4,666	Arm			27 1/4"
	COM/4	3,466	13	3,937	22	4,510	L4	5,060	Between arms	33 1/4"		
	5	3,517	14	4,001	23	4,637	L5	5,454				
	6	3,568	15	4,064	24	4,764						
	7	3,618	16	4,128	25	4,892						
	8	3,669	17	4,192	26	5,020						
	9	3,720	18	4,255	27	5,147						

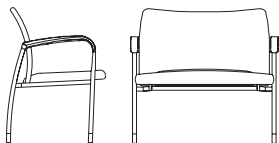

Upholstery Requirements: GK9961W

	Dual Upholstery	
Fabric yards	Seat 0.9	Back 1.3
Leather feet ²	Seat 15.3	Back 22.1
Shipping weight	60 lbs.	
Cube	32.6	

Seat	1	10	172	19	396	L1	184	
	2	16	11	193	20	422	L2	345
	3	31	12	214	21	448	L3	538
	COM/4	47	13	240	22	474	L4	699
	5	68	14	266	23	526	L5	860
	6	89	15	292	24	578		
	7	109	16	318	25	630		
	8	130	17	344	26	683		
	9	151	18	370	27	735		

Top row of pricing is for units specified with same fabric on Seat and Back. Bottom two rows of pricing required only when two different fabric grades are selected for the Seat and Back.

To calculate price of chair with different grade fabric for Seat and Back; start with Grade 1 price, add appropriate grade price located in second row for Seat, and last add appropriate grade price located in third row for Back to the sum of the Grade 1 and Seat price.

Example: Grade 1 \$3,351 + grade 4 fabric Seat/back \$47 + grade 2 fabric Arms \$23 = \$3,421

Back	1	10	248	19	572	L1	265	
	2	23	11	278	20	610	L2	498
	3	45	12	309	21	647	L3	777
	COM/4	68	13	346	22	685	L4	1,010
	5	98	14	384	23	760	L5	1,243
	6	128	15	421	24	835		
	7	158	16	459	25	911		
	8	188	17	497	26	986		
	9	218	18	534	27	1,061		

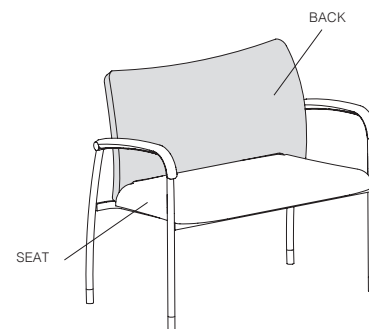

TO ORDER PLEASE SPECIFY THE FOLLOWING:

MODEL NUMBER	FRAME	FINISH	GANGING	FLAMMABILITY RATING	GORE BARRIER	SEAT UPHOLSTERY	BACK UPHOLSTERY
	P71 Black PR6 Silver	Cherry finishes on Maple Walnut finishes on Maple Maple finishes on Maple Oak finishes on Maple Please refer to the Multi® product page on www.gunlocke.com for standard finish options.	Ganging device on leg available. Please specify by adding suffix to model number. G Ganging device +\$30 GN No Ganging	U CTB117	Minimum order of 2. Two week added leadtime for moisture barrier option. GBY Gore Barrier +\$75 /chair GBN No Gore	Select upholstery for the seat. Please refer to list of available upholstery and leather selections on www.gunlocke.com	Select upholstery for the back. Please refer to list of available upholstery and leather selections on www.gunlocke.com

Example

GK9961W.P71.215.GN.U.GBN.DOL728.SPNN04

GK9961W	P71	215	GN	U	GBN	DOL728	SPNN04
MODEL NUMBER	FRAME	FINISH	GANGING	FLAMMABILITY RATING	GORE BARRIER	SEAT UPHOLSTERY	BACK UPHOLSTERY

model number	fabric grades						dimensions	W	D	H		
GK9901P-SS Plastic Moderne Arm, upholstered	1	1,957	10	2,454	19	3,101	L1	2,488	Overall	46"	23"	33"
	2	2,002	11	2,514	20	3,176	L2	2,953	Seat		18"	18"
	3	2,048	12	2,574	21	3,252	L3	3,512	Arm			26 1/4"
	COM/4	2,092	13	2,649	22	3,327	L4	3,977	Between arms	20"		
	5	2,152	14	2,724	23	3,478	L5	4,442				
	6	2,212	15	2,800	24	3,628						
	7	2,274	16	2,875	25	3,779						
	8	2,334	17	2,950	26	3,928						
	9	2,394	18	3,026	27	4,079						

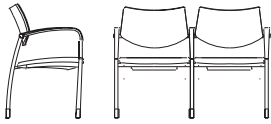

Upholstery Requirements: GK9901P-SS

Dual Upholstery	
Fabric yards	Seat 1.6 Back 1
Leather feet ²	Seat 27.2 Back 17
Shipping weight	64 lbs.
Cube	32.6

Seat	1	10	306	19	704	L1	327	
	2	28	11	343	20	750	L2	613
	3	56	12	380	21	797	L3	957
	COM/4	83	13	426	22	843	L4	1,243
	5	120	14	472	23	936	L5	1,529
	6	157	15	519	24	1,028		
	7	195	16	565	25	1,121		
	8	232	17	611	26	1,213		
	9	269	18	658	27	1,306		

Top row of pricing is for units specified with same fabric on Seat and Back. Bottom two rows of pricing required only when two different fabric grades are selected for the Seat and Back.

To calculate price of chair with different grade fabric for Seat and Back; start with Grade 1 price, add appropriate grade price located in second row for Seat, and last add appropriate grade price located in third row for Back to the sum of the Grade 1 and Seat price.

Example: Grade 1 \$1,957 + grade 4 fabric Seat/back \$83 + grade 2 fabric Arms \$17 = \$2,057

Back	1	10	191	19	440	L1	204	
	2	17	11	214	20	469	L2	383
	3	35	12	237	21	498	L3	598
	COM/4	52	13	266	22	527	L4	777
	5	75	14	295	23	585	L5	956
	6	98	15	324	24	643		
	7	122	16	353	25	701		
	8	145	17	382	26	758		
	9	168	18	411	27	816		

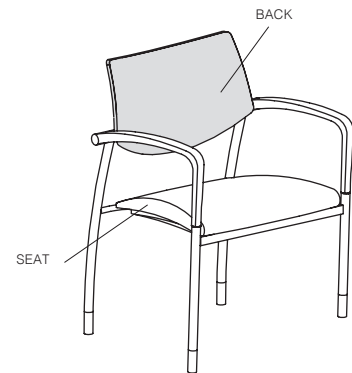

TO ORDER PLEASE SPECIFY THE FOLLOWING:

<input type="text"/>	<input type="text"/>	<input type="text"/>	<input type="text"/>	<input type="text"/>
MODEL NUMBER	FRAME	FLAMMABILITY RATING	SEAT UPHOLSTERY	BACK UPHOLSTERY
	P71 Black PR6 Silver	U CTB117	Select upholstery for the seat. Please refer to list of available upholstery and leather selections on www.gunlocke.com	Select upholstery for the back. Please refer to list of available upholstery and leather selections on www.gunlocke.com

Example

GK9901P-SS.AE.PR6.U.DOL728.SPNN04

GK9901P-SS	PR6	U	DOL728	SPNN04
MODEL NUMBER	FRAME	FLAMMABILITY RATING	SEAT UPHOLSTERY	BACK UPHOLSTERY

MULTI® SIDE CHAIR TANDEM

2 Seats

Seating
05/22

model number

fabric grades

dimensions

W

D

H

GK9901W-SS

Wood Moderne Arm, upholstered

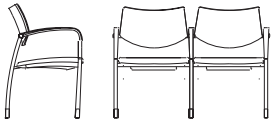

1	2,358	10	2,855	19	3,502	L1	2,889
2	2,403	11	2,915	20	3,577	L2	3,354
3	2,449	12	2,975	21	3,653	L3	3,913
COM/4	2,493	13	3,050	22	3,728	L4	4,378
5	2,553	14	3,125	23	3,879	L5	4,843
6	2,613	15	3,201	24	4,029		
7	2,675	16	3,276	25	4,180		
8	2,735	17	3,351	26	4,329		
9	2,795	18	3,427	27	4,480		

Overall	46"	23"	33"
Seat		18"	18"
Arm			26 1/4"
Between arms	20"		

Upholstery Requirements: GK9901W-SS

	Dual Upholstery	
Fabric yards	Seat 1.6	Back 1
Leather feet ²	Seat 27.2	Back 17
Shipping weight		64 lbs.
Cube		32.6

Seat

1	10	306	19	704	L1	327
2	28	11	343	20	L2	613
3	56	12	380	21	L3	957
COM/4	83	13	426	22	L4	1,243
5	120	14	472	23	L5	1,529
6	157	15	519	24		
7	195	16	565	25		
8	232	17	611	26		
9	269	18	658	27		

Top row of pricing is for units specified with same fabric on Seat and Back. Bottom two rows of pricing required only when two different fabric grades are selected for the Seat and Back.

To calculate price of chair with different grade fabric for Seat and Back; start with Grade 1 price, add appropriate grade price located in second row for Seat, and last add appropriate grade price located in third row for Back to the sum of the Grade 1 and Seat price.

Example: Grade 1 \$2,358 + grade 4 fabric Seat/back \$83 + grade 2 fabric Arms \$17 = \$2,458

Back

1	10	191	19	440	L1	204
2	17	11	214	20	L2	383
3	35	12	237	21	L3	598
COM/4	52	13	266	22	L4	777
5	75	14	295	23	L5	956
6	98	15	324	24		
7	122	16	353	25		
8	145	17	382	26		
9	168	18	411	27		

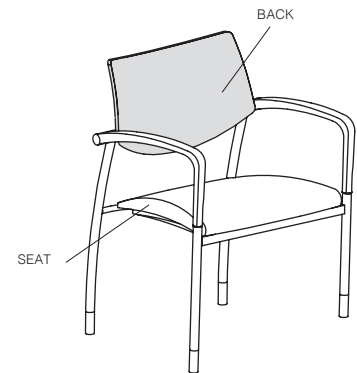

TO ORDER PLEASE SPECIFY THE FOLLOWING:

<input type="text"/>	<input type="text"/>	<input type="text"/>	<input type="text"/>	<input type="text"/>	<input type="text"/>
MODEL NUMBER	FRAME	FINISH	FLAMMABILITY RATING	SEAT UPHOLSTERY	BACK UPHOLSTERY
	P71 Black PR6 Silver	Cherry finishes on Maple Walnut finishes on Maple Maple finishes on Maple Oak finishes on Maple Please refer to the Multi® product page on www.gunlocke.com for standard finish options.	U CTB117	Select upholstery for the seat. Please refer to list of available upholstery and leather selections on www.gunlocke.com	Select upholstery for the back. Please refer to list of available upholstery and leather selections on www.gunlocke.com

Example

GK9901W-SS.PR6.215.U.DOL728.SPNN04					
GK9901W-SS	PR6	215	U	DOL728	SPNN04
MODEL NUMBER	FRAME	FINISH	FLAMMABILITY RATING	SEAT UPHOLSTERY	BACK UPHOLSTERY

model number	fabric grades								
GK9901P-SSS Plastic Moderne Arm, upholstered as shown, with 3 seats	1	2,905	10	3,651	19	4,621	L1	3,701	
	2	2,973	11	3,740	20	4,733	L2	4,400	
	3	3,040	12	3,831	21	4,847	L3	5,237	
	COM/4	3,108	13	3,943	22	4,959	L4	5,934	
	Same as GK9901P-SS with 3 seats	5	3,199	14	4,057	23	5,185	L5	6,633
		6	3,289	15	4,169	24	5,411		
		7	3,379	16	4,283	25	5,637		
		8	3,469	17	4,395	26	5,863		
		9	3,560	18	4,509	27	6,088		

dimensions	W	D	H
Overall	67 1/2"	23"	33"
Seat		18"	18"
Arm			26 1/4"
Between arms	20"		

Upholstery Requirements: GK9901P-SSS

	Dual Upholstery	
Fabric yards	Seat 2.4	Back 1.5
Leather feet ²	Seat 40.8	Back 25.5
Shipping weight	96 lbs.	
Cube	59.5	

Seat	1	10	19	L1
	459	1,056	490	
	42	514	920	
	83	570	1,435	
COM/4	125	639	1,864	
	181	709	2,294	
	236	778		
	292	848		
	347	917		
	403	987		

Top row of pricing is for units specified with same fabric on Seat and Back. Bottom two rows of pricing required only when two different fabric grades are selected for the Seat and Back.

To calculate price of chair with different grade fabric for Seat and Back; start with Grade 1 price, add appropriate grade price located in second row for Seat, and last add appropriate grade price located in third row for Back to the sum of the Grade 1 and Seat price.

Example: Grade 1 \$2,905 + grade 4 fabric Seat/back \$125 + grade 2 fabric Arms \$26 = \$3,056

Back	1	10	19	L1
	287	660	306	
	26	321	575	
	52	356	897	
COM/4	78	399	1,165	
	113	443	1,434	
	148	486		
	182	530		
	217	573		
	252	617		

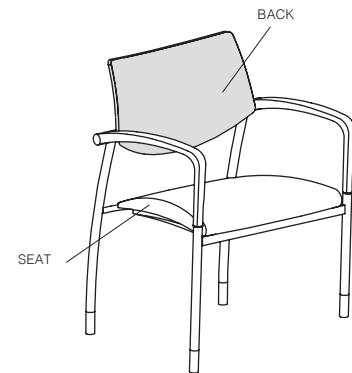

TO ORDER PLEASE SPECIFY THE FOLLOWING:

<input type="text"/>	<input type="text"/>	<input type="text"/>	<input type="text"/>	<input type="text"/>
MODEL NUMBER	FRAME	FLAMMABILITY RATING	SEAT UPHOLSTERY	BACK UPHOLSTERY
	P71 Black PR6 Silver	U CTB117	Select upholstery for the seat. Please refer to list of available upholstery and leather selections on www.gunlocke.com	Select upholstery for the back. Please refer to list of available upholstery and leather selections on www.gunlocke.com

Example

GK9901P-SSS.PR6.U.DOL728.SPNN04

GK9901P-SSS	PR6	U	DOL728	SPNN04
MODEL NUMBER	FRAME	FLAMMABILITY RATING	SEAT UPHOLSTERY	BACK UPHOLSTERY

MULTI® SIDE CHAIR TANDEM

3 Seats

Seating
05/22

model number	fabric grades							
GK9901W-SSS Wood Moderne Arm, upholstered as shown, with 3 seats	1	3,440	10	4,186	19	5,156	L1 4,236	
	2	3,508	11	4,275	20	5,268	L2 4,935	
	3	3,575	12	4,366	21	5,382	L3 5,772	
	COM/4	3,643	13	4,478	22	5,494	L4 6,469	
	Same as GK9901W-SS with 3 seats	5	3,734	14	4,592	23	5,720	L5 7,168
	6	3,824	15	4,704	24	5,946		
	7	3,914	16	4,818	25	6,172		
	8	4,004	17	4,930	26	6,398		
	9	4,095	18	5,044	27	6,623		

dimensions	W	D	H
Overall	67 1/2"	23"	33"
Seat		18"	18"
Arm			26 1/4"
Between arms	20"		

Upholstery Requirements: GK9901W-SSS

	Dual Upholstery	
Fabric yards	Seat 2.4	Back 1.5
Leather feet ²	Seat 40.8	Back 25.5
Shipping weight	96 lbs.	
Cube	59.5	

Seat	1	10	459	19	1,056	L1	490
	2	42	11	514	20	L2	920
	3	83	12	570	21	L3	1,435
	COM/4	125	13	639	22	L4	1,864
	5	181	14	709	23	L5	2,294
	6	236	15	778	24		
	7	292	16	848	25		
	8	347	17	917	26		
	9	403	18	987	27		

Top row of pricing is for units specified with same fabric on Seat and Back. Bottom two rows of pricing required only when two different fabric grades are selected for the Seat and Back.

To calculate price of chair with different grade fabric for Seat and Back; start with Grade 1 price, add appropriate grade price located in second row for Seat, and last add appropriate grade price located in third row for Back to the sum of the Grade 1 and Seat price.

Example: Grade 1 \$3,440 + grade 4 fabric Seat/back \$125 + grade 2 fabric Arms \$26 = \$3,591

Back	1	10	287	19	660	L1	306
	2	26	11	321	20	L2	575
	3	52	12	356	21	L3	897
	COM/4	78	13	399	22	L4	1,165
	5	113	14	443	23	L5	1,434
	6	148	15	486	24		
	7	182	16	530	25		
	8	217	17	573	26		
	9	252	18	617	27		

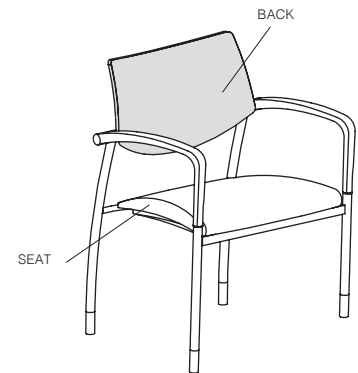

TO ORDER PLEASE SPECIFY THE FOLLOWING:

<input type="text"/>	<input type="text"/>	<input type="text"/>	<input type="text"/>	<input type="text"/>	<input type="text"/>
MODEL NUMBER	FRAME	FINISH	FLAMMABILITY RATING	SEAT UPHOLSTERY	BACK UPHOLSTERY
	P71 Black PR6 Silver	Cherry finishes on Maple Walnut finishes on Maple Maple finishes on Maple Oak finishes on Maple Please refer to the Multi® product page on www.gunlocke.com for standard finish options.	U CTB117	Select upholstery for the seat. Please refer to list of available upholstery and leather selections on www.gunlocke.com	Select upholstery for the back. Please refer to list of available upholstery and leather selections on www.gunlocke.com

Example

GK9901W-SSS.PR6.215.U.DOL728.SPNNO4

GK9901W-SSS	PR6	215	U	DOL728	SPNNO4
MODEL NUMBER	FRAME	FINISH	FLAMMABILITY RATING	SEAT UPHOLSTERY	BACK UPHOLSTERY

model number	fabric grades							
GK9901P-SSSS Plastic Moderne Arm, upholstered as shown, with 4 seats	1	3,848	10	4,841	19	6,136	L1	4,909
	2	3,939	11	4,961	20	6,287	L2	5,840
	3	4,028	12	5,083	21	6,437	L3	6,957
	COM/4	4,119	13	5,233	22	6,588	L4	7,888
	5	4,240	14	5,384	23	6,888	L5	8,819
	6	4,360	15	5,533	24	7,189		
	7	4,480	16	5,684	25	7,491		
	8	4,600	17	5,835	26	7,792		
	9	4,721	18	5,985	27	8,093		

Same as GK9901-SS
with 4 seats

dimensions	W	D	H
Overall	90"	23"	33"
Seat		19"	19"
Arm			26 1/4"
Between arms	20"		

Upholstery Requirements: GK9901P-SSSS

Dual Upholstery	
Fabric yards	Seat 3.2 Back 2
Leather feet ²	Seat 54.4 Back 34
Shipping weight	128 lbs.
Cube	69.4

Seat	1	10	611	19	1,408	L1	653
	2	56	11	685	20	L2	1,226
	3	111	12	760	21	L3	1,913
	COM/4	167	13	852	22	L4	2,486
	5	241	14	945	23	L5	3,059
	6	315	15	1,037	24		
	7	389	16	1,130	25		
	8	463	17	1,223	26		
	9	537	18	1,315	27		

Top row of pricing is for units specified with same fabric on Seat and Back. Bottom two rows of pricing required only when two different fabric grades are selected for the Seat and Back.

To calculate price of chair with different grade fabric for Seat and Back; start with Grade 1 price, add appropriate grade price located in second row for Seat, and last add appropriate grade price located in third row for Back to the sum of the Grade 1 and Seat price.

Example: Grade 1 \$3,848 + grade 4 fabric Seat/back \$167 + grade 2 fabric Arms \$35 = \$4,050

Back	1	10	382	19	880	L1	408
	2	35	11	428	20	L2	766
	3	69	12	475	21	L3	1,196
	COM/4	104	13	533	22	L4	1,554
	5	151	14	591	23	L5	1,912
	6	197	15	648	24		
	7	243	16	706	25		
	8	289	17	764	26		
	9	336	18	822	27		

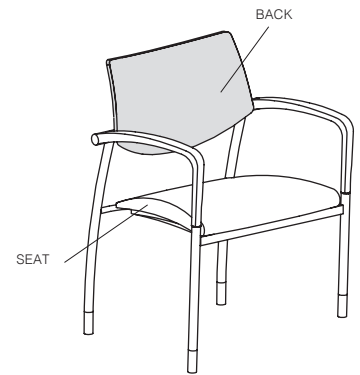

TO ORDER PLEASE SPECIFY THE FOLLOWING:

<input type="text"/>	<input type="text"/>	<input type="text"/>	<input type="text"/>	<input type="text"/>
MODEL NUMBER	FRAME	FLAMMABILITY RATING	SEAT UPHOLSTERY	BACK UPHOLSTERY
	P71 Black PR6 Silver	U CTB117	Select upholstery for the seat. Please refer to list of available upholstery and leather selections on www.gunlocke.com	Select upholstery for the back. Please refer to list of available upholstery and leather selections on www.gunlocke.com

Example

GK9901P-SSSS.PR6.U.DOL728.SPNN04

GK9901P-SSSS	PR6	U	DOL728	SPNN04
MODEL NUMBER	FRAME	FLAMMABILITY RATING	SEAT UPHOLSTERY	BACK UPHOLSTERY

MULTI® SIDE CHAIR TANDEM

4 Seats

Seating
05/22

model number	fabric grades							
GK9901W-SSSS Wood Moderne Arm, upholstered as shown, with 4 seats	1	4,518	10	5,511	19	6,806	L1	5,579
	2	4,609	11	5,631	20	6,957	L2	6,510
	3	4,698	12	5,753	21	7,107	L3	7,627
	COM/4	4,789	13	5,903	22	7,258	L4	8,558
	5	4,910	14	6,054	23	7,558	L5	9,489
	6	5,030	15	6,203	24	7,859		
	7	5,150	16	6,354	25	8,161		
	8	5,270	17	6,505	26	8,462		
	9	5,391	18	6,655	27	8,763		

Same as GK9901-SS
with 4 seats

dimensions	W	D	H
Overall	90"	23"	33"
Seat		19"	19"
Arm			26 1/4"
Between arms	20"		

Upholstery Requirements: GK9901W-SSSS

Dual Upholstery	
Fabric yards	Seat 3.2 Back 2
Leather feet ²	Seat 54.4 Back 34
Shipping weight	128 lbs.
Cube	69.4

Seat	1	10	611	19	1,408	L1	653	
	2	56	11	685	20	1,501	L2	1,226
	3	111	12	760	21	1,593	L3	1,913
	COM/4	167	13	852	22	1,686	L4	2,486
	5	241	14	945	23	1,871	L5	3,059
	6	315	15	1,037	24	2,056		
	7	389	16	1,130	25	2,242		
	8	463	17	1,223	26	2,427		
	9	537	18	1,315	27	2,612		

Top row of pricing is for units specified with same fabric on Seat and Back. Bottom two rows of pricing required only when two different fabric grades are selected for the Seat and Back.

To calculate price of chair with different grade fabric for Seat and Back; start with Grade 1 price, add appropriate grade price located in second row for Seat, and last add appropriate grade price located in third row for Back to the sum of the Grade 1 and Seat price.

Example: Grade 1 \$4,518 + grade 4 fabric Seat/back \$167 + grade 2 fabric Arms \$35 = \$4,720

Back	1	10	382	19	880	L1	408	
	2	35	11	428	20	938	L2	766
	3	69	12	475	21	996	L3	1,196
	COM/4	104	13	533	22	1,054	L4	1,554
	5	151	14	591	23	1,169	L5	1,912
	6	197	15	648	24	1,285		
	7	243	16	706	25	1,401		
	8	289	17	764	26	1,517		
	9	336	18	822	27	1,633		

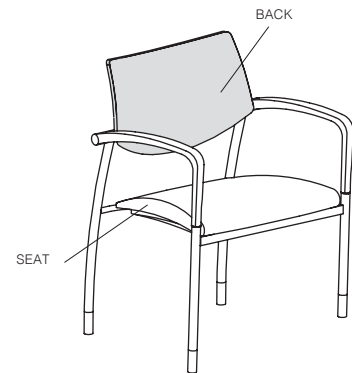

TO ORDER PLEASE SPECIFY THE FOLLOWING:

<input type="text"/>	<input type="text"/>	<input type="text"/>	<input type="text"/>	<input type="text"/>	<input type="text"/>
MODEL NUMBER	FRAME	FINISH	FLAMMABILITY RATING	SEAT UPHOLSTERY	BACK UPHOLSTERY
	P71 Black PR6 Silver	Cherry finishes on Maple Walnut finishes on Maple Maple finishes on Maple Oak finishes on Maple Please refer to the Multi® product page on www.gunlocke.com for standard finish options.	U CTB117	Select upholstery for the seat. Please refer to list of available upholstery and leather selections on www.gunlocke.com	Select upholstery for the back. Please refer to list of available upholstery and leather selections on www.gunlocke.com

Example

GK9901W-SSSS.PR6.215.U.DOL728.SPNN04

GK9901W-SSSS	PR6	215	U	DOL728	SPNN04
MODEL NUMBER	FRAME	FINISH	FLAMMABILITY RATING	SEAT UPHOLSTERY	BACK UPHOLSTERY

model number	fabric grades								dimensions	W	D	H
GMHB17-011 Bar height, single upholstery	1	1,537	10	1,747	19	2,021	L1	1,762	Overall	19"	21 1/2"	40 5/8"
	2	1,556	11	1,773	20	2,053	L2	1,958	Seat	18 1/2"	16 3/4"	30 1/2"
	3	1,575	12	1,798	21	2,085	L3	2,195	Upholstery Requirements: GMHB17-011			
	COM/4	1,594	13	1,830	22	2,117	L4	2,392	Fabric yards	1.1		
	5	1,620	14	1,862	23	2,180	L5	2,588	Leather feet²	18.7		
	6	1,645	15	1,894	24	2,244			Shipping weight	31 lbs.		
	7	1,671	16	1,925	25	2,308			Cube	13.6		
	8	1,696	17	1,957	26	2,371			Note: Footrest for bar height Tia™ is 12 1/8" high off the floor.			
	9	1,722	18	1,989	27	2,435						



TO ORDER PLEASE SPECIFY THE FOLLOWING:

<input type="text"/>	<input type="text"/>	<input type="text"/>	<input type="text"/>	<input type="text"/>
MODEL NUMBER	FOOTREST COLOR	FINISH	FLAMMABILITY RATING	UPHOLSTERY

- Polished Stainless **PS +\$50**
- Brushed Stainless **BS +\$50**
- Black Powder Coat **BK**
- White Powder Coat **WH**

These seating models are available in the following hardwoods:
Maple **NE**
Ash **QA**
Please refer to the Tia product page on www.gunlocke.com for standard finish options.

U CTB117

Please refer to list of available upholstery and leather selections on www.gunlocke.com

Cherry finishes on Maple or Ash
Walnut finishes on Maple or Ash
Maple finishes on Maple or Ash
Oak finishes on Maple or Ash
Natural Cherry 222, Natural Maple 800, Honey Maple 873 and Natural Oak 300 not available on Ash.

Example

GMHB17-011.PS.QA629.U.DOL728				
GMHB17-011	PS	QA629	U	DOL728
MODEL NUMBER	FOOTREST COLOR	FINISH	FLAMMABILITY	UPHOLSTERY

TIA™ BARSTOOL

Bar Height | Dual Upholstery

Seating
05/22

model number

fabric grades

dimensions

W

D

H

GMHB17-021

Bar height,
dual upholstery



1	1,564	10	1,965	19	2,488	L1	1,993
2	1,600	11	2,014	20	2,549	L2	2,368
3	1,637	12	2,062	21	2,610	L3	2,820
COM/4	1,673	13	2,123	22	2,671	L4	3,196
5	1,722	14	2,184	23	2,792	L5	3,571
6	1,770	15	2,245	24	2,914		
7	1,820	16	2,305	25	3,036		
8	1,868	17	2,366	26	3,156		
9	1,917	18	2,427	27	3,278		

Overall	19"	21 1/2"	40 5/8"
Seat	18 1/2"	16 3/4"	30 1/2"

Upholstery Requirements: GMHB17-021

	Dual Upholstery	
Fabric yards	Seat 1.1	Back 1
Leather feet ²	Seat 18.7	Back 17
Shipping weight	31 lbs.	
Cube	13.6	

Note: Footrest for bar height Tia™ is 12 1/8" high off the floor.

Seat

1	10	210	19	484	L1	225
2	19	11	236	20	L2	421
3	38	12	261	21	L3	658
COM/4	57	13	293	22	L4	855
5	83	14	325	23	L5	1,051
6	108	15	357	24		
7	134	16	388	25		
8	159	17	420	26		
9	185	18	452	27		

Top row of pricing is for units specified with same fabric on Seat and Back. Bottom two rows of pricing required only when two different fabric grades are selected for the Seat and Back.

To calculate price of chair with different grade fabric for Seat and Back; start with Grade 1 price, add appropriate grade price located in second row for Seat, and last add appropriate grade price located in third row for Back to the sum of the Grade 1 and Seat price.

Example: Grade 1 \$1,564 + grade 4 fabric seat \$57 + grade 2 fabric back \$17 = \$1,638

Back

1	10	191	19	440	L1	204
2	17	11	214	20	L2	383
3	35	12	237	21	L3	598
COM/4	52	13	266	22	L4	777
5	75	14	295	23	L5	956
6	98	15	324	24		
7	122	16	353	25		
8	145	17	382	26		
9	168	18	411	27		

Note: When Tia Barstool is upholstered in multiple fabrics, there is an added angled seam along the side boxings to accommodate seat and back as two choices of upholstery.

TO ORDER PLEASE SPECIFY THE FOLLOWING:

<input type="text"/>	<input type="text"/>	<input type="text"/>	<input type="text"/>	<input type="text"/>	<input type="text"/>
MODEL NUMBER	FOOTREST COLOR	FINISH	FLAMMABILITY RATING	SEAT UPHOLSTERY	BACK UPHOLSTERY

Polished Stainless **PS +\$50**
 Brushed Stainless **BS +\$50**
 Black Powder Coat **BK**
 White Powder Coat **WH**

These seating models are available in the following hardwoods:
 Maple **NE**
 Ash **QA**
 Please refer to the Tia product page on www.gunlocke.com for standard finish options.

Cherry finishes on Maple or Ash
Walnut finishes on Maple or Ash
Maple finishes on Maple or Ash
Oak finishes on Maple or Ash
Natural Cherry 222, Natural Maple 800, Honey Maple 873 and Natural Oak 300 not available on Ash.

U CTB117

Please refer to list of available upholstery and leather selections on www.gunlocke.com

Please refer to list of available upholstery and leather selections on www.gunlocke.com

Example

GMHB17-021.PS.QA629.U.DOL728.SPNN04

GMHB17-021	PS	QA629	U	DOL728	SPNN04
MODEL NUMBER	FOOTREST COLOR	FINISH	FLAMMABILITY	SEAT UPHOLSTERY	BACK UPHOLSTERY

model number	fabric grades								dimensions	W	D	H
GMHB17-041 Counter height, single upholstery	1	1,537	10	1,747	19	2,021	L1	1,762	Overall	19"	21 1/2"	36 3/8"
	2	1,556	11	1,773	20	2,053	L2	1,958	Seat	18 1/2"	16 3/4"	26 1/4"
	3	1,575	12	1,798	21	2,085	L3	2,195	Upholstery Requirements: GMHB17-041			
	COM/4	1,594	13	1,830	22	2,117	L4	2,392	Fabric yards	1.1		
	5	1,620	14	1,862	23	2,180	L5	2,588	Leather feet²	18.7		
	6	1,645	15	1,894	24	2,244			Shipping weight	30 lbs.		
	7	1,671	16	1,925	25	2,308			Cube	12.3		
	8	1,696	17	1,957	26	2,371			Note: Footrest for counter height Tia™ is 7 7/8" high off the floor.			
	9	1,722	18	1,989	27	2,435						



TO ORDER PLEASE SPECIFY THE FOLLOWING:

<input type="text"/>	<input type="text"/>	<input type="text"/>	<input type="text"/>	<input type="text"/>
MODEL NUMBER	FOOTREST COLOR	FINISH	FLAMMABILITY RATING	UPHOLSTERY

- Polished Stainless **PS +\$50**
- Brushed Stainless **BS +\$50**
- Black Powder Coat **BK**
- White Powder Coat **WH**

These seating models are available in the following hardwoods:
Maple **NE**
Ash **QA**
Please refer to the Tia product page on www.gunlocke.com for standard finish options.

Cherry finishes on Maple or Ash
Walnut finishes on Maple or Ash
Maple finishes on Maple or Ash
Oak finishes on Maple or Ash
Natural Cherry 222, Natural Maple 800, Honey Maple 873 and Natural Oak 300 not available on Ash.

U CTB117

Please refer to list of available upholstery and leather selections on www.gunlocke.com

Example

GMHB17-041.PS.QA629.U.DOL728				
GMHB17-041	PS	QA629	U	DOL728
MODEL NUMBER	FOOTREST COLOR	FINISH	FLAMMABILITY	UPHOLSTERY

TIA™ BARSTOOL

Counter Height | Dual Upholstery

Seating
05/22

model number

fabric grades

dimensions

W

D

H

GMHB17-051

Counter height,
dual upholstery



1	1,564	10	1,965	19	2,488	L1	1,993
2	1,600	11	2,014	20	2,549	L2	2,368
3	1,637	12	2,062	21	2,610	L3	2,820
COM/4	1,673	13	2,123	22	2,671	L4	3,196
5	1,722	14	2,184	23	2,792	L5	3,571
6	1,770	15	2,245	24	2,914		
7	1,820	16	2,305	25	3,036		
8	1,868	17	2,366	26	3,156		
9	1,917	18	2,427	27	3,278		

Overall	19"	21 1/2"	36 3/8"
Seat	18 1/2"	16 3/4"	26 1/4"

Upholstery Requirements: GMHB17-051

	Dual Upholstery	
Fabric yards	Seat 1.1	Back 1
Leather feet ²	Seat 18.7	Back 17
Shipping weight	30 lbs.	
Cube	12.3	

Note: Footrest for counter height Tia™ is 7 7/8" high off the floor.

Seat

1	10	210	19	484	L1	225
2	19	11	236	20	L2	421
3	38	12	261	21	L3	658
COM/4	57	13	293	22	L4	855
5	83	14	325	23	L5	1,051
6	108	15	357	24		
7	134	16	388	25		
8	159	17	420	26		
9	185	18	452	27		

Top row of pricing is for units specified with same fabric on Seat and Back. Bottom two rows of pricing required only when two different fabric grades are selected for the Seat and Back.

To calculate price of chair with different grade fabric for Seat and Back; start with Grade 1 price, add appropriate grade price located in second row for Seat, and last add appropriate grade price located in third row for Back to the sum of the Grade 1 and Seat price.

Example: Grade 1 \$1,564 + grade 4 fabric seat \$57 + grade 2 fabric back \$17 = \$1,638

Back

1	10	191	19	440	L1	204
2	17	11	214	20	L2	383
3	35	12	237	21	L3	598
COM/4	52	13	266	22	L4	777
5	75	14	295	23	L5	956
6	98	15	324	24		
7	122	16	353	25		
8	145	17	382	26		
9	168	18	411	27		

Note: When Tia Barstool is upholstered in multiple fabrics, there is an added angled seam along the side boxings to accommodate seat and back as two choices of upholstery.

TO ORDER PLEASE SPECIFY THE FOLLOWING:

<input type="text"/>	<input type="text"/>	<input type="text"/>	<input type="text"/>	<input type="text"/>	<input type="text"/>
----------------------	----------------------	----------------------	----------------------	----------------------	----------------------

MODEL NUMBER

FOOTREST COLOR

FINISH

FLAMMABILITY RATING

SEAT UPHOLSTERY

BACK UPHOLSTERY

Polished Stainless **PS +\$50**
 Brushed Stainless **BS +\$50**
 Black Powder Coat **BK**
 White Powder Coat **WH**

These seating models are available in the following hardwoods:
 Maple **NE**
 Ash **QA**
 Please refer to the Tia product page on www.gunlocke.com for standard finish options.

Cherry finishes on Maple or Ash
Walnut finishes on Maple or Ash
Maple finishes on Maple or Ash
Oak finishes on Maple or Ash

Natural Cherry 222, Natural Maple 800, Honey Maple 873 and Natural Oak 300 not available on Ash.

U **CTB117**

Please refer to list of available upholstery and leather selections on www.gunlocke.com

Please refer to list of available upholstery and leather selections on www.gunlocke.com

Example

GMHB17-051.PS.QA629.U.DOL728.SPNN04

GMHB17-051	PS	QA629	U	DOL728	SPNN04
MODEL NUMBER	FOOTREST COLOR	FINISH	FLAMMABILITY	SEAT UPHOLSTERY	BACK UPHOLSTERY

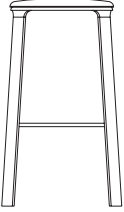
model number	fabric grades								dimensions	W	D	H
GMQA16-011 Bar height, upholstered seat pad 	1	1,795	10	1,910	19	2,059	L1	1,918	Overall	17 5/8"	17 5/8"	30 H"
	2	1,805	11	1,924	20	2,076	L2	2,025	Seat	17 5/8"	17 5/8"	
	3	1,816	12	1,937	21	2,094	L3	2,154	Upholstery Requirements: GMQA16-011			
	COM/4	1,826	13	1,955	22	2,111	L4	2,261	Fabric yards	Seat pad 0.6		
	5	1,840	14	1,972	23	2,146	L5	2,368	Leather feet ²	Seat pad 10.2		
	6	1,854	15	1,990	24	2,181			Shipping weight	15 lbs.		
	7	1,868	16	2,007	25	2,215			Cube	8.3		
	8	1,882	17	2,024	26	2,250			Note: Footrest for Bar Height Trillia™ is 12" high off the floor.			
	9	1,896	18	2,042	27	2,285						

GMQA16-041 Counter height, upholstered seat pad 	1	1,795	10	1,910	19	2,059	L1	1,918	Overall	17 1/8"	17 1/8"	26 H"
	2	1,805	11	1,924	20	2,076	L2	2,025	Seat	17 1/8"	17 1/8"	
	3	1,816	12	1,937	21	2,094	L3	2,154	Upholstery Requirements: GMQA16-041			
	COM/4	1,826	13	1,955	22	2,111	L4	2,261	Fabric yards	Seat pad 0.6		
	5	1,840	14	1,972	23	2,146	L5	2,368	Leather feet ²	Seat pad 10.2		
	6	1,854	15	1,990	24	2,181			Shipping weight	14 lbs.		
	7	1,868	16	2,007	25	2,215			Cube	7.2		
	8	1,882	17	2,024	26	2,250			Note: Footrest for Counter Height Trillia™ is 7 3/4" high off the floor.			
	9	1,896	18	2,042	27	2,285						

GMQA16-071 Standard height, upholstered seat pad 	1	1,560	10	1,675	19	1,824	L1	1,683	Overall	16 1/4"	16 1/4"	19 3/8"
	2	1,570	11	1,689	20	1,841	L2	1,790	Seat	16 1/4"	16 1/4"	
	3	1,581	12	1,702	21	1,859	L3	1,919	Upholstery Requirements: GMQA16-071			
	COM/4	1,591	13	1,720	22	1,876	L4	2,026	Fabric yards	Seat pad 0.6		
	5	1,605	14	1,737	23	1,911	L5	2,133	Leather feet ²	Seat pad 10.2		
	6	1,619	15	1,755	24	1,946			Shipping weight	14 lbs.		
	7	1,633	16	1,772	25	1,980			Cube	4.8		
	8	1,647	17	1,789	26	2,015			Note: Footrest for Standard Height Trillia™ is 2 1/2" high off the floor.			
	9	1,661	18	1,807	27	2,050						

TO ORDER PLEASE SPECIFY THE FOLLOWING:

<input type="text"/>	<input type="text"/>	<input type="text"/>	<input type="text"/>	<input type="text"/>
MODEL NUMBER	SPECIES & FINISH	STITCH DETAIL	FLAMMABILITY RATING	UPHOLSTERY

These seating models are available in the following hardwoods:
Ash **QA**

Please refer to the Trillia product page on www.gunlocke.com for standard finish options.

Cherry finishes on Ash

Walnut finishes on Ash

Oak finishes on Ash

Natural Oak 300 not available on Ash

Not Required **NR**
Stitch Detail **SD +\$80**

U CTB117

Please refer to list of available upholstery and leather selections on www.gunlocke.com

Example

GMQA16-011.QA601.SD.U.DOL728				
GMQA16-011	QA601	SD	U	DOL728
MODEL NUMBER	FINISH	STITCH DETAIL	FLAMMABILITY	UPHOLSTERY

TRILLIA™ BARSTOOL

Wood Seat

Seating
05/22

model number	list	dimensions	W	D	H
GMQA16-021 Bar height, wood seat	1,782	Overall	17 5/8"	17 5/8"	29 5/8"
		Seat	17 5/8"	17 5/8"	
		Shipping weight			13 lbs.
		Cube			8.1
		Note: Footrest for Bar Height Trillia™ is 12" high off the floor.			

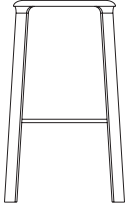

GMQA16-051 Counter height, wood seat	1,782	Overall	17 1/8"	17 1/8"	25 3/8"
		Seat	17 1/8"	17 1/8"	
		Shipping weight			12 lbs.
		Cube			7.0
		Note: Footrest for Counter Height Trillia™ is 7 3/4" high off the floor.			

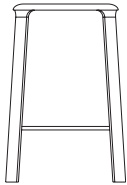

GMQA16-081 Standard height, wood seat	1,537	Overall	16 1/4"	16 1/4"	18 H"
		Seat	16 1/4"	16 1/4"	
		Shipping weight			12 lbs.
		Cube			4.6
		Note: Footrest for Standard Height Trillia™ is 2 1/2" high off the floor.			

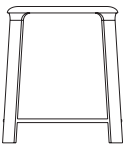

TO ORDER PLEASE SPECIFY THE FOLLOWING:

--	--

MODEL NUMBER **SPECIES & FINISH**

These seating models are available in the following hardwoods:

Ash **QA**

Please refer to the Trillia product page on www.gunlocke.com for standard finish options.

Cherry finishes on Ash

Walnut finishes on Ash

Oak finishes on Ash

Natural Oak 300 not available on Ash

Example

GMQA16-021.QA601

GMQA16-021

QA601

MODEL NUMBER

FINISH

Swivel Seating	77-106
Product Specifications	78-79
Avoca™	82-83
Genesee	84-89
Geneva	90-101
Olla Executive	102-105
Washington Series	106

SWIVEL SEATING

Product Specifications

AVOCA™

Seat: High resilient foam overmolded onto rigid urethane pan, wrapped in 1/2" foam with additional 1/2" high resiliency foam topper.

Back: High resilient foam overmolded onto rigid urethane pan, wrapped in 1/4" foam with additional 1/2" high resiliency foam topper

Arm:

Full Urethane: Self-skinning urethane foam over steel structure.

Full Polished: Polished cast aluminum.

Polished with Urethane Insert: Polished cast aluminum with self-skinning urethane foam pad.

Control: Swivel-tilt with lockout. Or, premium Synchro-tilt with lockout, tilt tension, pneumatic height adjustment, and 3" range of seat depth adjustment.

Base: Black nylon plastic or die-cast polished aluminum 5 star.

Caster: Soft or Hard. Premium casters with chrome finish are optional.

Upholstery: French-stitch around edges, channel stitching optional.

BIFMA Rating:

ANSI/BIFMA X5.1 2017
(300lb Weight Rating)

GENESEE

Seat: High resiliency foam overmolded onto rigid urethane bucket, wrapped in 1/2" foam with additional 1/2" high resiliency foam topper.

Back: High resiliency foam overmolded onto rigid urethane bucket, wrapped in 1/2" foam.

Arm:

Polished aluminum: Polished cast aluminum.

Upholstered: Polished cast aluminum with routed upholstery groove, covered in J" high density foam, upholstery wrapped with welt cord to cover staples.

Control: Black mid-tilt control, tension adjustment, tilt lockout.

Base: Five-star, die-cast polished aluminum.

Casters: Soft or hard. Premium casters with chrome finish optional.

Upholstery: Top-stitch around edges of bucket.

Jury/Fixed Base Available: 360 Return to Center, Return to Height

BIFMA Rating:

ANSI/BIFMA X5.1 2017
(300lb Weight Rating)

GENEVA

Frame: Curved plywood

Seat and Back: Dacron over dual density cut foam.

Arm:

Full Urethane: Self-skinning urethane foam over steel structure

Polished with Urethane Insert: Polished cast aluminum with self-skinning urethane foam pad.

Control: Black mid-tilt control, tension adjustment, tilt lockout.

Base: Black nylon plastic or die-cast polished aluminum star.

Casters: Soft or hard.

Jury/Fixed Base Available: 360 Return to Center, Return to Height

BIFMA Rating:

ANSI/BIFMA X5.1 2017
(300lb Weight Rating)

OLLA SWIVEL

Seat and Back: Furniture-grade curved plywood covered with high-resiliency molded foam.

Seat and Back Wood Decor: Maple or Cherry Veneer over molded formed plywood (GK2804/GK2806).

Metal J-Bar Cover: Black, silver or polished aluminum.

Arm:

Adjustable Arm: Arm height range 4", Forward/Back 2", Width Adjustment 1". Arms available in black only.

Upholstered Arm: Cut foam over furniture-grade plywood.

Urethane Arm: Textured urethane.

Control: Synchronized tilt mechanism control, 5-position lock out, tension control and pneumatic height adjustment. The synchronized tilt ratio is 2.3 to 1 degree.

Seat Depth Adjustment: 2" range with 6 evenly spaced lockable positions.

Tilt Lock: 5 incremental positions. Back tilt travel 21 degrees rearward to a fully reclined position.

Base: 5-star base, die-cast aluminum. Available in black, silver and polished aluminum.

Casters: Soft or hard.

Upholstery: The back and seat upholstery is French-stitched.

BIFMA Rating:

ANSI/BIFMA X5.1 2017 w/ additional requirements (300lb Weight Rating, Adjustable Arms test to 275lbs)

WASHINGTON

Frame: Hardwood joined by Double dowels, corner blocked.

Seat: Spring seat platform with foam and cotton filling. Upholstered. Cushion material is fabricated foam and dacron filled. Welted.

Back: Foam, cotton, and dacron filled over spring foundation. Upholstered. Welted.

Arms: Upholstered over dacron and foam.

Swivel base: Five leg, with brass capped detail. Manual lift.

Casters: 2" Bronze Ball.

BIFMA Rating:

ANSI/BIFMA X5.1 2015 w/ additional requirements (400lb Weight Rating)

SWIVEL SEATING

Product Specifications

SWIVEL ERGONOMICS

Dual Point Synchro Tilt

In Synchronous tilt, the backrest and seat pan of a chair reclines at a different ratio (usually 2:1) as you lean back. For every 10 degrees of recline in the backrest for example, the seat pan only tilts back 5 degrees

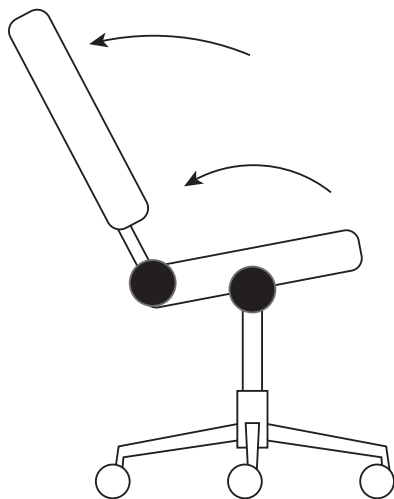

Single Point Mid Tilt

Mid tilt employs a basic tilt mechanism that's located in the center or back of the seat to tilt the seat pan and backrest in tandem. The angle of the front of the seat increases at the same rate as the backrest.

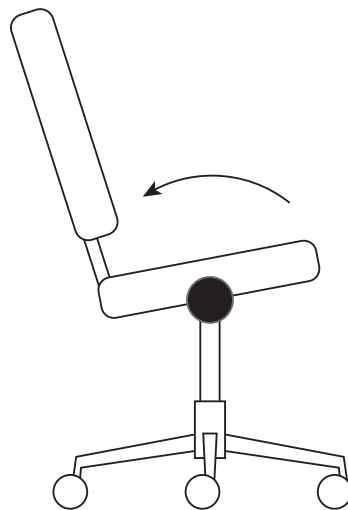

Single Point Knee Tilt

With a Knee tilt, the pivoting point is located near the very front of the seat, resulting in a wide angle tilt that still keeps the front of the seat relatively level. Knee tilt combines some qualities of synchro and mid tilting. With the pivoting point near the front of the seat, your feet remain on the ground even with a larger recline in the seat pan and backrest.

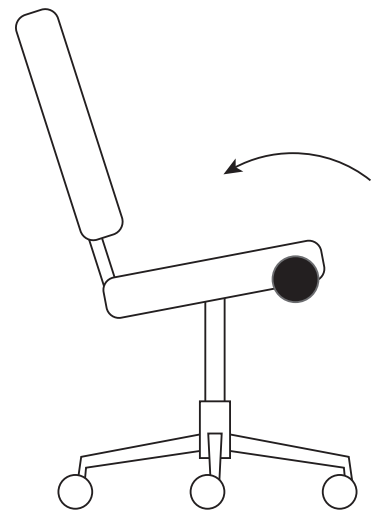

CONTROL HOW TO'S

Mid-Tilt and Knee Tilt Mechanism

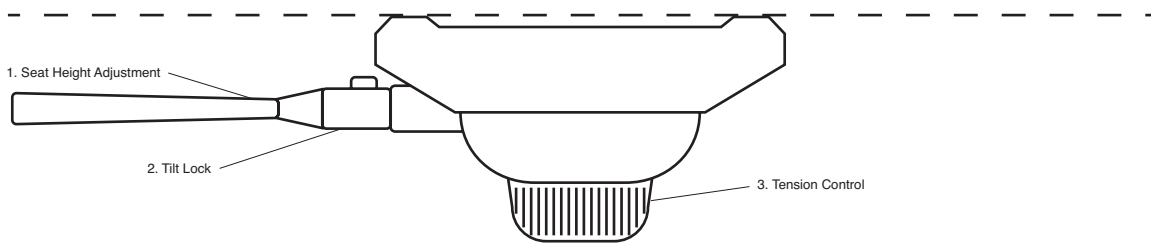

1. SEAT HEIGHT ADJUSTMENT

Slightly lift body weight off seat and pull up on paddle to increase or decrease height. Release lever to lock into desired height.

2. TILT LOCK

Push handle in towards center of control. This will lock the position of the tilt. Pull handle out to allow for free tilting.

3. TENSION CONTROL

Decrease tension by rotating the knob left. Increase tension by rotating the knob right.

Synchro-Tilt Mechanism

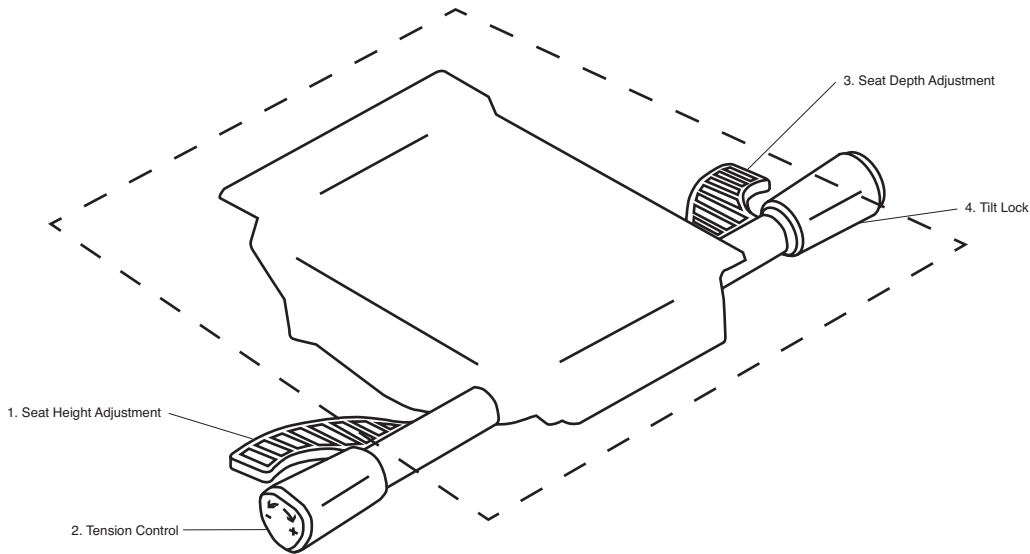

1. SEAT HEIGHT ADJUSTMENT

Slightly lift body weight off seat and pull up on paddle to increase height, or remain seated and pull up on paddle to decrease height. Release paddle to lock into desired height.

2. TENSION CONTROL

Extend Tension Control knob out to adjust. Increase tension by rotating the knob forward. Decrease tension by rotating the knob rearward. Push tension control knob in to original position when finished adjusting tension.

3. SEAT DEPTH ADJUSTMENT

Pull up on lever while seated and slide forward or rearward to desired depth. Release paddle handle to engage.

4. TILT LOCK

Lean back fully back in chair, then rotate handle forward to engage lockout. Rotate handle forward, then lean back into the chair to release the tilt lock feature.

Manual Mechanism

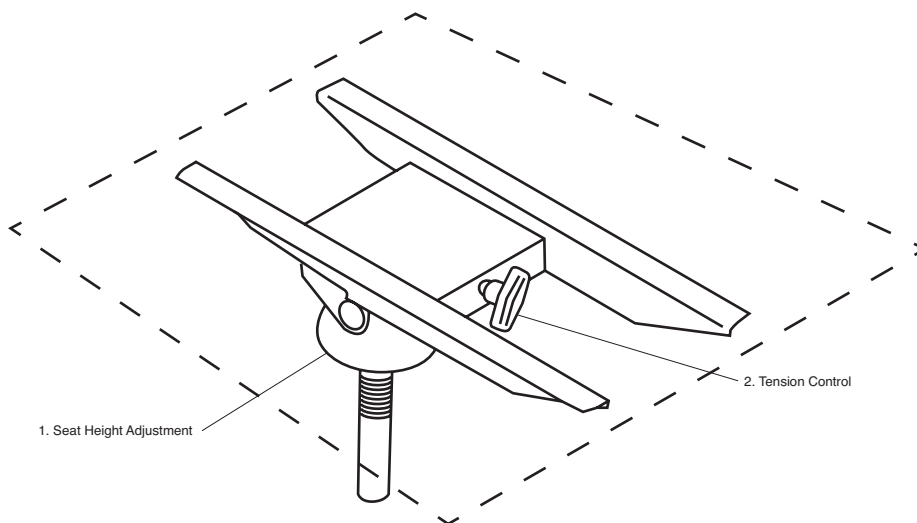

1. SEAT HEIGHT ADJUSTMENT

Slightly lift body weight off seat and rotate bell. Rotating to the right will lower the seat. Rotating to the left will raise seat.

2. TENSION CONTROL

Increase tension by rotating the knob to the right. Decrease tension by rotating the knob left.

model number

fabric grades

dimensions

W

D

H

GSHA15-011

High back, armless

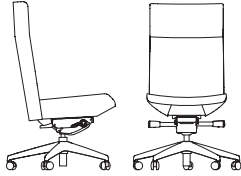

1	1,890	10	2,253	19	2,726	L1	2,278
2	1,923	11	2,297	20	2,781	L2	2,618
3	1,956	12	2,341	21	2,836	L3	3,026
COM/4	1,989	13	2,396	22	2,891	L4	3,366
5	2,033	14	2,451	23	3,001	L5	3,706
6	2,077	15	2,506	24	3,111		
7	2,121	16	2,561	25	3,221		
8	2,165	17	2,616	26	3,331		
9	2,209	18	2,671	27	3,441		

Overall	26 11/16"	25 3/4"	40 11/16"
Seat	19-20"	19"	16 1/2 - 20 1/2"

Upholstery Requirements: GSHA15-011

Fabric yards	1.9
Leather feet ²	32.3
Shipping weight	52 lbs.
Cube	21.6

GSHA15-021

Mid back, armless

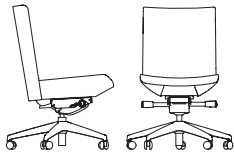

1	1,743	10	2,049	19	2,447	L1	2,070
2	1,771	11	2,086	20	2,493	L2	2,356
3	1,799	12	2,123	21	2,540	L3	2,700
COM/4	1,826	13	2,169	22	2,586	L4	2,986
5	1,863	14	2,215	23	2,679	L5	3,272
6	1,900	15	2,262	24	2,771		
7	1,938	16	2,308	25	2,864		
8	1,975	17	2,354	26	2,956		
9	2,012	18	2,401	27	3,049		

Overall	26 11/16"	25 3/4"	35 11/16"
Seat	19-20"	19"	16 1/2 - 20 1/2"

Upholstery Requirements: GSHA15-021

Fabric yards	1.6
Leather feet ²	27.2
Shipping weight	51 lbs.
Cube	19.1

Horizontal Channel Stitch Example:



High Back version shown;
Mid Back version has
channel stitching down
entire back.

TO ORDER PLEASE SPECIFY THE FOLLOWING:

.

MODEL NUMBER

BASE

CASTER

CONTROL

STITCH DETAIL

FLAMMABILITY RATING

UPHOLSTERY

These seating models are available with the following base option.
BBL Black base
BAL Polished Aluminum **+\$100**

CH2 Hard
CS2 Soft **+\$55**
CHC2 Chrome, hard **+\$85**

P Swivel tilt
SKP Synchro-Tilt, seat slider, pneumatic lift with lockout **+\$125**

NR Not required
SD Horizontal Channel Stitch Detail **\$125**
NOTE: Avoca High Back comes standard with a single horizontal French stitch across the back when the Stitch Not Required (**NR**) option is chosen.

U CTB117

Please refer to list of available upholstery and leather selections on www.gunlocke.com

Example

GSHA15-011.BBL.CH2.P.NR.U.DOL728

GSHA15-011	BBL	CH2	P	NR	U	DOL728
MODEL NUMBER	BASE	CASTER	CONTROL	STITCH DETAIL	FLAMMABILITY	UPHOLSTERY

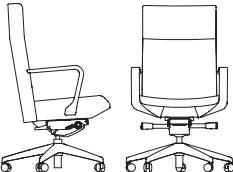
model number	fabric grades							dimensions	W	D	H	
GSHA15-031 High back with arms 	1	1,972	10	2,335	19	2,808	L1	2,360	Overall	26 11/16"	25 3/4"	40 11/16"
	2	2,005	11	2,379	20	2,863	L2	2,700	Seat	19-20"	19"	16 1/2" - 20 1/2"
	3	2,038	12	2,423	21	2,918	L3	3,108	Arm			24 7/8" - 28 7/8"
	COM/4	2,071	13	2,478	22	2,973	L4	3,448	Between arms	19 3/4"		
	5	2,115	14	2,533	23	3,083	L5	3,788	Upholstery Requirements: GSHA15-031			
	6	2,159	15	2,588	24	3,193			Fabric yards		1.9	
	7	2,203	16	2,643	25	3,303			Leather feet²		32.3	
	8	2,247	17	2,698	26	3,413			Shipping weight		56 lbs.	
	9	2,291	18	2,753	27	3,523			Cube		21.6	

GSHA15-041 Mid back with arms 	1	1,822	10	2,128	19	2,526	L1	2,149	Overall	26 11/16"	25 3/4"	35 11/16"
	2	1,850	11	2,165	20	2,572	L2	2,435	Seat	19-20"	19"	16 1/2" - 20 1/2"
	3	1,878	12	2,202	21	2,619	L3	2,779	Arm			24 7/8" - 28 7/8"
	COM/4	1,905	13	2,248	22	2,665	L4	3,065	Between arms	19 3/4"		
	5	1,942	14	2,294	23	2,758	L5	3,351	Upholstery Requirements: GSHA15-041			
	6	1,979	15	2,341	24	2,850			Fabric yards		1.6	
	7	2,017	16	2,387	25	2,943			Leather feet²		27.2	
	8	2,054	17	2,433	26	3,035			Shipping weight		55 lbs.	
	9	2,091	18	2,480	27	3,128			Cube		19.	

Horizontal Channel Stitch Example:



High Back version shown; Mid Back version has channel stitching down entire back.

TO ORDER PLEASE SPECIFY THE FOLLOWING:

MODEL NUMBER	ARM	BASE	CASTER	CONTROL	STITCH DETAIL	FLAMMABILITY RATING	UPHOLSTERY
	These seating models are available with the following arm options. ABL Black Urethane Arm APA Full Polished Aluminum +\$150 API Polished Aluminum with Urethane Arm Cap +\$150	These seating models are available with the following base option. BBL Black base Aluminum +\$100	CH2 Hard CS2 Soft +\$55 CHC2 Chrome, hard +\$85	P Swivel tilt SKP Synchro-Tilt, seat slider, pneumatic lift with lockout +\$125	NR Not required SD Horizontal Channel Stitch Detail \$125 NOTE: Avoca High Back comes standard with a single horizontal French stitch across the back when the Stitch Not Required (NR) option is chosen.	U CTB117	Please refer to list of available upholstery and leather selections on www.gunlocke.com

Example

GSHA15-031.ABL.BBL.CH2.P.NR.U.DOL728							
GSHA15-031	ABL	BBL	CH2	P	NR	U	DOL728
MODEL NUMBER	ARM	BASE	CASTER	CONTROL	STITCH DETAIL	FLAMMABILITY	UPHOLSTERY

GENESEE

Armless

Seating
05/22

model number	fabric grades								dimensions	W	D	H
GSRA16-011 Swivel, High Back Armless	1	2,408	10	2,809	19	3,332	L1	2,837	Overall	25 3/4"	28"	38 1/8" - 41 5/8"
	2	2,444	11	2,858	20	3,393	L2	3,213	Seat	21"	19 1/4"	17" - 20 1/2"
	3	2,481	12	2,906	21	3,454	L3	3,664	Upholstery Requirements: GSRA16-011			
	COM/4	2,517	13	2,967	22	3,514	L4	4,039	Fabric yards	2.1		
	5	2,566	14	3,028	23	3,636	L5	4,415	Leather feet ²	35.7		
	6	2,615	15	3,089	24	3,758			Shipping weight	44 lbs.		
	7	2,663	16	3,150	25	3,879			Cube	21.2		
	8	2,712	17	3,210	26	4,001						
	9	2,761	18	3,271	27	4,122						

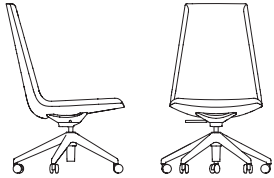

GSRA16-021 Swivel, Mid Back Armless	1	2,264	10	2,589	19	3,012	L1	2,611	Overall	25 3/4"	26 1/2"	31 3/8" - 34 7/8"
	2	2,294	11	2,628	20	3,061	L2	2,915	Seat	21"	19 1/4"	17" - 20 1/2"
	3	2,323	12	2,668	21	3,110	L3	3,280	Upholstery Requirements: GSRA16-021			
	COM/4	2,353	13	2,717	22	3,160	L4	3,585	Fabric yards	2.0		
	5	2,392	14	2,766	23	3,258	L5	3,889	Leather feet ²	28.9		
	6	2,431	15	2,815	24	3,356			Shipping weight	42 lbs.		
	7	2,471	16	2,864	25	3,455			Cube	16.9		
	8	2,510	17	2,914	26	3,553						
	9	2,549	18	2,963	27	3,652						

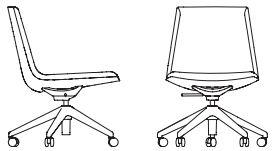

TO ORDER PLEASE SPECIFY THE FOLLOWING:

<input type="text"/>	<input type="text"/>	<input type="text"/>	<input type="text"/>	<input type="text"/>
MODEL NUMBER	CASTER	CONTROL	FLAMMABILITY RATING	UPHOLSTERY
	CH2 Hard CS2 Soft +\$55 CHC2 Chrome, hard +\$85	P Low-profile, polished swivel-tilt, pneumatic lift. MP Black, mid tilt, pneumatic lift with lockout.	U CTB117	Please refer to list of available upholstery and leather selections on www.gunlocke.com

Example

GSRA16-011.CH2.P.U.DOL728
 GSRA16-011 CH2 P U DOL728
 MODEL NUMBER CASTER CONTROL FLAMMABILITY UPHOLSTERY

model number	fabric grades								dimensions	W	D	H
GSRA16-011J Jury/Fixed Base, High Back Armless	1	2,679	10	3,080	19	3,603	L1	3,108	Overall	25 3/4"	28"	38 1/8" - 41 5/8"
	2	2,715	11	3,129	20	3,664	L2	3,484	Seat	21"	19 1/4"	17" - 20 1/2"
	3	2,752	12	3,177	21	3,725	L3	3,935	Upholstery Requirements: GSRA16-011J			
	COM/4	2,788	13	3,238	22	3,785	L4	4,310	Fabric yards	2.1		
	5	2,837	14	3,299	23	3,907	L5	4,686	Leather feet ²	35.7		
	6	2,886	15	3,360	24	4,029			Shipping weight	44 lbs.		
	7	2,934	16	3,421	25	4,150			Cube	21.2		
	8	2,983	17	3,481	26	4,272						
	9	3,032	18	3,542	27	4,393						

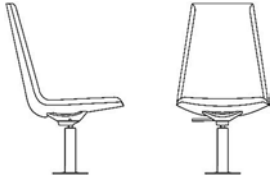

GSRA16-021J Jury/Fixed Base, Mid Back Armless	1	2,534	10	2,859	19	3,282	L1	2,881	Overall	25 3/4"	26 1/2"	31 3/8" - 34 7/8"
	2	2,564	11	2,898	20	3,331	L2	3,185	Seat	21"	19 1/4"	17" - 20 1/2"
	3	2,593	12	2,938	21	3,380	L3	3,550	Upholstery Requirements: GSRA16-021J			
	COM/4	2,623	13	2,987	22	3,430	L4	3,855	Fabric yards	2.0		
	5	2,662	14	3,036	23	3,528	L5	4,159	Leather feet ²	28.9		
	6	2,701	15	3,085	24	3,626			Shipping weight	42 lbs.		
	7	2,741	16	3,134	25	3,725			Cube	16.9		
	8	2,780	17	3,184	26	3,823						
	9	2,819	18	3,233	27	3,922						

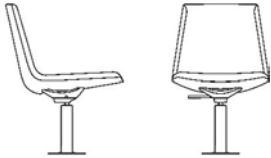

TO ORDER PLEASE SPECIFY THE FOLLOWING:

--	--	--	--

MODEL NUMBER **JURY BASE** **FLAMMABILITY RATING** **UPHOLSTERY**

360RTCH
Return-to-Center
Return-to-Height

U CTB117

Please refer to list of
available upholstery
and leather selections
on www.gunlocke.com

Example

GSRA16-011J.360RTCH.U.DOL728

GSRA16-011J	360RTCH	U	DOL728
MODEL NUMBER	JURY BASE	FLAMMABILITY	UPHOLSTERY

GENESEE

Polished Arms

Seating
05/22

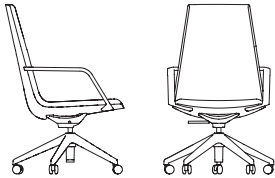
model number	fabric grades								dimensions	W	D	H
GSRA16-031 Swivel, High Back Polished Arms 	1	2,492	10	2,893	19	3,416	L1	2,921	Overall	27 1/2"	28"	38 1/8" - 41 5/8"
	2	2,528	11	2,942	20	3,477	L2	3,297	Seat	21"	19 1/4"	17" - 20 1/2"
	3	2,565	12	2,990	21	3,538	L3	3,748	Arm			23 1/2" - 27"
	COM/4	2,601	13	3,051	22	3,598	L4	4,123	Between arms	21"		
	5	2,650	14	3,112	23	3,720	L5	4,499	Upholstery Requirements: GSRA16-031			
	6	2,699	15	3,173	24	3,842			Fabric yards		2.1	
	7	2,747	16	3,234	25	3,963			Leather feet ²		35.7	
	8	2,796	17	3,294	26	4,085			Shipping weight		49 lbs.	
	9	2,845	18	3,355	27	4,206			Cube		22.5	

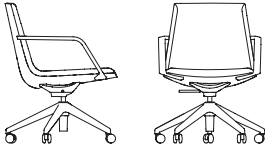
GSRA16-041 Swivel, Mid Back Polished Arms 	1	2,347	10	2,672	19	3,095	L1	2,694	Overall	27 1/2"	26 1/2"	31 3/8" - 34 7/8"
	2	2,377	11	2,711	20	3,144	L2	2,998	Seat	21"	19 1/4"	17" - 20 1/2"
	3	2,406	12	2,751	21	3,193	L3	3,363	Arm			23 1/2" - 27"
	COM/4	2,436	13	2,800	22	3,243	L4	3,668	Between arms	21"		
	5	2,475	14	2,849	23	3,341	L5	3,972	Upholstery Requirements: GSRA16-041			
	6	2,514	15	2,898	24	3,439			Fabric yards		2.0	
	7	2,554	16	2,947	25	3,538			Leather feet ²		28.9	
	8	2,593	17	2,997	26	3,636			Shipping weight		47 lbs.	
	9	2,632	18	3,046	27	3,735			Cube		17.9	

TO ORDER PLEASE SPECIFY THE FOLLOWING:

<input type="text"/>	<input type="text"/>	<input type="text"/>	<input type="text"/>	<input type="text"/>
MODEL NUMBER	CASTER	CONTROL	FLAMMABILITY RATING	UPHOLSTERY
	CH2 Hard CS2 Soft +\$55 CHC2 Chrome, hard +\$85	P Low-profile, polished swivel-tilt, pneumatic lift. MP Black, mid tilt, pneumatic lift with lockout.	U CTB117	Please refer to list of available upholstery and leather selections on www.gunlocke.com

Example

GSRA16-031.CH2.P.U.DOL728
 GSRA16-031 CH2 P U DOL728
 MODEL NUMBER CASTER CONTROL FLAMMABILITY UPHOLSTERY

model number	fabric grades								dimensions	W	D	H
GSRA16-031J Jury/Fixed Base, High Back Polished Arms	1	2,763	10	3,164	19	3,687	L1	3,192	Overall	27 1/2"	28"	38 1/8" - 41 5/8"
	2	2,799	11	3,213	20	3,748	L2	3,568	Seat	21"	19 1/4"	17" - 20 1/2"
	3	2,836	12	3,261	21	3,809	L3	4,019	Arm			23 1/2" - 27"
	COM/4	2,872	13	3,322	22	3,869	L4	4,394	Between arms	21"		
	5	2,921	14	3,383	23	3,991	L5	4,770	Upholstery Requirements: GSRA16-031J			
	6	2,970	15	3,444	24	4,113			Fabric yards			2.1
	7	3,018	16	3,505	25	4,234			Leather feet ²			35.7
	8	3,067	17	3,565	26	4,356			Shipping weight			49 lbs.
	9	3,116	18	3,626	27	4,477			Cube			22.5

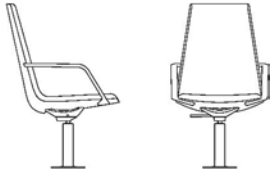

GSRA16-041J Jury/Fixed Base, Mid Back Polished Arms	1	2,617	10	2,942	19	3,365	L1	2,964	Overall	27 1/2"	26 1/2"	31 3/8" - 34 7/8"
	2	2,647	11	2,981	20	3,414	L2	3,268	Seat	21"	19 1/4"	17" - 20 1/2"
	3	2,676	12	3,021	21	3,463	L3	3,633	Arm			23 1/2" - 27"
	COM/4	2,706	13	3,070	22	3,513	L4	3,938	Between arms	21"		
	5	2,745	14	3,119	23	3,611	L5	4,242	Upholstery Requirements: GSRA16-041J			
	6	2,784	15	3,168	24	3,709			Fabric yards			2.0
	7	2,824	16	3,217	25	3,808			Leather feet ²			28.9
	8	2,863	17	3,267	26	3,906			Shipping weight			47 lbs.
	9	2,902	18	3,316	27	4,005			Cube			17.9

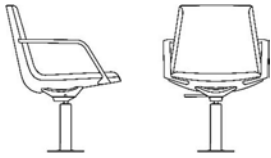

TO ORDER PLEASE SPECIFY THE FOLLOWING:

--	--	--	--

MODEL NUMBER **JURY BASE** **FLAMMABILITY RATING** **UPHOLSTERY**

360RTCH
Return-to-Center
Return-to-Height

U CTB117

Please refer to list of
available upholstery
and leather selections
on www.gunlocke.com

Example

GSRA16-031J.360RTCH.U.DOL728

GSRA16-031J	360RTCH	U	DOL728
MODEL NUMBER	JURY BASE	FLAMMABILITY	UPHOLSTERY

GENESEE

Upholstered Arms

Seating
05/22

model number	fabric grades								dimensions	W	D	H
GSRA16-051 Swivel, High Back Upholstered Arms	1	2,614	10	3,034	19	3,582	L1	3,063	Overall	27 3/4"	28"	38 1/8" - 41 5/8"
	2	2,652	11	3,085	20	3,646	L2	3,457	Seat	21"	19 1/4"	17" - 20 1/2"
	3	2,690	12	3,136	21	3,709	L3	3,929	Arm			23 5/8" - 27 1/8"
	COM/4	2,729	13	3,200	22	3,773	L4	4,323	Between arms	20 3/4"		
	5	2,780	14	3,264	23	3,900	L5	4,717				
	6	2,831	15	3,327	24	4,028						
	7	2,881	16	3,391	25	4,155						
	8	2,932	17	3,455	26	4,283						
	9	2,983	18	3,518	27	4,410						

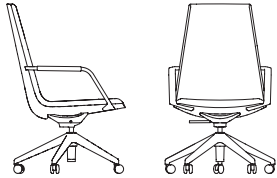

Upholstery Requirements: GSRA16-051

Fabric yards	2.2
Leather feet ²	37.4
Shipping weight	49 lbs.
Cube	22.7

GSRA16-061 Swivel, Mid Back Upholstered Arms	1	2,468	10	2,831	19	3,304	L1	2,856
	2	2,501	11	2,875	20	3,359	L2	3,196
	3	2,534	12	2,919	21	3,414	L3	3,604
	COM/4	2,567	13	2,974	22	3,469	L4	3,944
	5	2,611	14	3,029	23	3,579	L5	4,284
	6	2,655	15	3,084	24	3,689		
	7	2,699	16	3,139	25	3,799		
	8	2,743	17	3,194	26	3,909		
	9	2,787	18	3,249	27	4,019		

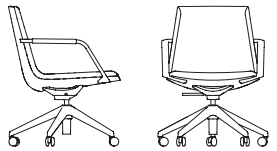

Overall	27 3/4"	26 1/2"	31 3/8" - 34 7/8"
Seat	21"	19 1/4"	17" - 20 1/2"
Arm			23 5/8" - 27 1/8"
Between arms	20 3/4"		

Upholstery Requirements: GSRA16-061

Fabric yards	2.0
Leather feet ²	32.3
Shipping weight	47 lbs.
Cube	18

TO ORDER PLEASE SPECIFY THE FOLLOWING:

<input type="text"/>	<input type="text"/>	<input type="text"/>	<input type="text"/>	<input type="text"/>
MODEL NUMBER	CASTER	CONTROL	FLAMMABILITY RATING	UPHOLSTERY
	CH2 Hard CS2 Soft +\$55 CHC2 Chrome, hard +\$85	P Low-profile, polished swivel-tilt, pneumatic lift. MP Black, mid tilt, pneumatic lift with lockout.	U CTB117	Please refer to list of available upholstery and leather selections on www.gunlocke.com

Example

GSRA16-051.CH2.P.215.U.DOL728				
GSRA16-051	CH2	P	U	DOL728
MODEL NUMBER	CASTER	CONTROL	FLAMMABILITY	UPHOLSTERY

model number	fabric grades								dimensions	W	D	H
GSRA16-051J Jury/Fixed Base, High Back Upholstered Arms	1	2,885	10	3,305	19	3,853	L1	3,334	Overall	27 3/4"	28"	38 1/8" - 41 5/8"
	2	2,923	11	3,356	20	3,917	L2	3,728	Seat	21"	19 1/4"	17" - 20 1/2"
	3	2,961	12	3,407	21	3,980	L3	4,200	Arm	23 5/8" - 27 1/8"		
	COM/4	3,000	13	3,471	22	4,044	L4	4,594	Between arms	20 3/4"		
	5	3,051	14	3,535	23	4,171	L5	4,988	Upholstery Requirements: GSRA16-051J			
	6	3,102	15	3,598	24	4,299			Fabric yards	2.2		
	7	3,152	16	3,662	25	4,426			Leather feet ²	37.4		
	8	3,203	17	3,726	26	4,554			Shipping weight	49 lbs.		
	9	3,254	18	3,789	27	4,681			Cube	22.7		

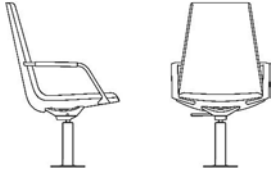

GSRA16-061J Jury/Fixed Base, Mid Back Upholstered Arms	1	2,739	10	3,102	19	3,575	L1	3,127	Overall	27 3/4"	26 1/2"	31 3/8" - 34 7/8"
	2	2,772	11	3,146	20	3,630	L2	3,467	Seat	21"	19 1/4"	17" - 20 1/2"
	3	2,805	12	3,190	21	3,685	L3	3,875	Arm	23 5/8" - 27 1/8"		
	COM/4	2,838	13	3,245	22	3,740	L4	4,215	Between arms	20 3/4"		
	5	2,882	14	3,300	23	3,850	L5	4,555	Upholstery Requirements: GSRA16-061J			
	6	2,926	15	3,355	24	3,960			Fabric yards	2.0		
	7	2,970	16	3,410	25	4,070			Leather feet ²	32.3		
	8	3,014	17	3,465	26	4,180			Shipping weight	47 lbs.		
	9	3,058	18	3,520	27	4,290			Cube	18		

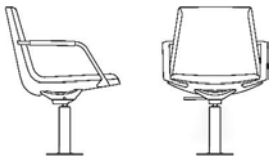

TO ORDER PLEASE SPECIFY THE FOLLOWING:

. . .

MODEL NUMBER **JURY BASE** **FLAMMABILITY RATING** **UPHOLSTERY**

360RTCH
Return-to-Center
Return-to-Height

U **CTB117**

Please refer to list of
available upholstery
and leather selections
on www.gunlocke.com

Example

GSRA16-051J.360RTCH.U.DOL728

GSRA16-051J 360RTCH U DOL728
MODEL NUMBER JURY BASE FLAMMABILITY UPHOLSTERY

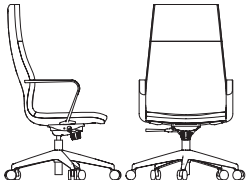
model number	fabric grades								dimensions	W	D	H
GSGNV17-011 High Back, Pillow Single Uph	1	1,986	10	2,445	19	3,042	L1	2,476	Overall	27 1/4"	27"	42-46"
	2	2,028	11	2,500	20	3,111	L2	2,906	Seat	20"	18"	16 1/2" - 20 1/2"
	3	2,069	12	2,556	21	3,181	L3	3,421	Arm	23" - 27"		
	COM/4	2,111	13	2,625	22	3,250	L4	3,850	Between arms	21"		
	5	2,167	14	2,695	23	3,389	L5	4,280	Upholstery Requirements: GSGNV17-011			
	6	2,222	15	2,764	24	3,528			Fabric yards	2.4		
	7	2,278	16	2,834	25	3,667			Leather feet ²	40.8		
	8	2,333	17	2,903	26	3,806			Shipping weight	45 lbs.		
	9	2,389	18	2,973	27	3,945			Cube	24.6		
												

GSGNV17-051 Mid Back, Pillow Single Uph	1	1,822	10	2,204	19	2,702	L1	2,230	Overall	27 1/4"	26 1/2"	33" - 37"
	2	1,857	11	2,250	20	2,760	L2	2,588	Seat	20"	18"	16 1/2" - 20 1/2"
	3	1,891	12	2,297	21	2,818	L3	3,018	Arm	23" - 27"		
	COM/4	1,926	13	2,355	22	2,876	L4	3,376	Between arms	21"		
	5	1,973	14	2,413	23	2,991	L5	3,734	Upholstery Requirements: GSGNV17-051			
	6	2,019	15	2,470	24	3,107			Fabric yards	2		
	7	2,065	16	2,528	25	3,223			Leather feet ²	34		
	8	2,111	17	2,586	26	3,339			Shipping weight	40 lbs.		
	9	2,158	18	2,644	27	3,455			Cube	19.5		
												

TO ORDER PLEASE SPECIFY THE FOLLOWING:

<input type="text"/>	<input type="text"/>	<input type="text"/>	<input type="text"/>	<input type="text"/>	<input type="text"/>	<input type="text"/>
MODEL NUMBER	ARM	BASE	CONTROL	CASTER	FLAMMABILITY RATING	UPHOLSTERY
	ABL Full Urethane Arms API Polished with urethane insert +\$150	These seating models are available with the following base option. BBL Black base BAL Polished Aluminum +\$100	MP Black, mid tilt, pneumatic lift with lockout.	CH2 Hard CS2 Soft +\$55	U CTB17	Please refer to list of available upholstery and leather selections on www.gunlocke.com

Example

GSGNV17-011.ABL.BBL.MP.CH2.U.DOL728

GSGNV17-011	ABL	BBL	MP	CH2	U	DOL728
MODEL NUMBER	ARM	BASE	CONTROL	CASTER	FLAMMABILITY	UPHOLSTERY

model number	fabric grades								dimensions	W	D	H
GSGNV17-011J Jury/Fixed Base, High Back, Pillow Single Uph	1	2,302	10	2,761	19	3,358	L1	2,792	Overall	27 1/4"	27"	42-46"
	2	2,344	11	2,816	20	3,427	L2	3,222	Seat	20"	18"	16 1/2" - 20 1/2"
	3	2,385	12	2,872	21	3,497	L3	3,737	Arm			23" - 27"
	COM/4	2,427	13	2,941	22	3,566	L4	4,166	Between arms	21"		
	5	2,483	14	3,011	23	3,705	L5	4,596	Upholstery Requirements: GSGNV17-011J			
	6	2,538	15	3,080	24	3,844			Fabric yards		2.4	
	7	2,594	16	3,150	25	3,983			Leather feet ²		40.8	
	8	2,649	17	3,219	26	4,122			Shipping weight		45 lbs.	
	9	2,705	18	3,289	27	4,261			Cube		24.6	

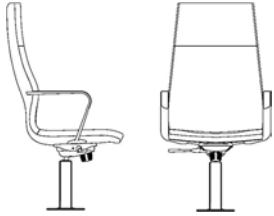

GSGNV17-051J Jury/Fixed Base, Mid Back, Pillow Single Uph	1	2,138	10	2,520	19	3,018	L1	2,546	Overall	27 1/4"	26 1/2"	33" - 37"
	2	2,173	11	2,566	20	3,076	L2	2,904	Seat	20"	18"	16 1/2" - 20 1/2"
	3	2,207	12	2,613	21	3,134	L3	3,334	Arm		23" - 27"	
	COM/4	2,242	13	2,671	22	3,192	L4	3,692	Between arms	21"		
	5	2,289	14	2,729	23	3,307	L5	4,050	Upholstery Requirements: GSGNV17-051J			
	6	2,335	15	2,786	24	3,423			Fabric yards		2	
	7	2,381	16	2,844	25	3,539			Leather feet ²		34	
	8	2,427	17	2,902	26	3,655			Shipping weight		40 lbs.	
	9	2,474	18	2,960	27	3,771			Cube		19.5	

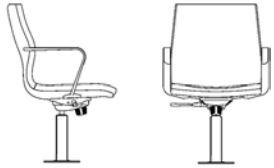

TO ORDER PLEASE SPECIFY THE FOLLOWING:

<input type="text"/>	<input type="text"/>	<input type="text"/>	<input type="text"/>	<input type="text"/>
MODEL NUMBER	ARM	JURY BASE	FLAMMABILITY RATING	UPHOLSTERY
ABL Full Urethane Arms	API Polished with urethane insert +\$150	These seating models are available with the following base option. 360RTCH 360 Return-to-Center Return-to-Height	U CTB117	Please refer to list of available upholstery and leather selections on www.gunlocke.com

Example

GSGNV17-011J.ABL.360RTCH.U.DOL728
 GSGNV17-011J ABL 360RTCH U DOL728
 MODEL NUMBER ARM JURY BASE FLAMMABILITY UPHOLSTERY

model number	fabric grades								dimensions	W	D	H
GSGNV17-021 High Back, Pillow Dual Uph	1	1,996	10	2,722	19	3,668	L1	2,772	Overall	27 1/4"	27"	42" - 46"
	2	2,062	11	2,810	20	3,778	L2	3,452	Seat	20"	18"	16 1/2" - 20 1/2"
	3	2,128	12	2,898	21	3,888	L3	4,268	Arm	23" - 27"		
	COM/4	2,194	13	3,008	22	3,998	L4	4,948	Between arms	21"		
	5	2,282	14	3,118	23	4,218	L5	5,628	Upholstery Requirements: GSGNV17-021			
	6	2,370	15	3,228	24	4,438			Dual Upholstery			
	7	2,458	16	3,338	25	4,658			Fabric yards	Inners 1.8	Outers 1	
	8	2,546	17	3,448	26	4,878			Leather feet ²	Inners 47.6	Outers 17	
	9	2,634	18	3,558	27	5,098			Shipping weight	45 lbs.		
									Cube	24.6		

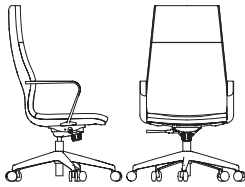

Inner	1	10	535	19	1,232	L1	572	
	2	49	11	600	20	1,313	L2	1,073
	3	97	12	665	21	1,394	L3	1,674
	COM/4	146	13	746	22	1,475	L4	2,175
	5	211	14	827	23	1,637	L5	2,676
	6	276	15	908	24	1,799		
	7	340	16	989	25	1,961		
	8	405	17	1,070	26	2,124		
	9	470	18	1,151	27	2,286		

Outer	1	10	191	19	440	L1	204	
	2	17	11	214	20	469	L2	383
	3	35	12	237	21	498	L3	598
	COM/4	52	13	266	22	527	L4	777
	5	75	14	295	23	585	L5	956
	6	98	15	324	24	643		
	7	122	16	353	25	701		
	8	145	17	382	26	758		
	9	168	18	411	27	816		

Top row of pricing is for units specified with same fabric on Inner and Outer. Bottom two rows of pricing required only when two different fabric grades are selected for the Inner/Outer.

To calculate price of chair with different grade fabric for Inner/Outer; start with Grade 1 price, add appropriate grade price located in second row for Inner; and last add appropriate grade price located in third row for Outer to the sum of the Grade 1 and Inner/Outer price.

Example: Grade 1 \$1,996 + grade 4 fabric Inner \$146 + grade 2 fabric Outer \$17 = \$2,159

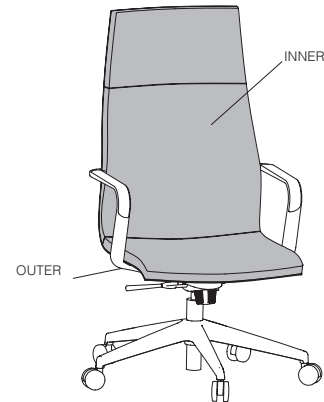

TO ORDER PLEASE SPECIFY THE FOLLOWING:

<input type="text"/>	<input type="text"/>	<input type="text"/>	<input type="text"/>	<input type="text"/>	<input type="text"/>	<input type="text"/>	<input type="text"/>
MODEL NUMBER	ARM	BASE	CONTROL	CASTER	FLAMMABILITY RATING	INNER UPHOLSTERY	OUTER UPHOLSTERY

ABL Full Urethane Arms	These seating models are available with the following base option. BBL Black base BAL Polished Aluminum +\$100	MP Black, mid tilt, pneumatic lift with lockout.	CH2 Hard	U CTB117	Please refer to list of available upholstery and leather selections on www.gunlocke.com	Please refer to list of available upholstery and leather selections on www.gunlocke.com
API Polished with urethane insert +\$150			CS2 Soft +\$55			

Example

GSGNV17-021.ABL.BBL.MP.CH2.U.DOL728.DOL728

GSGNV17-021	ABL	BBL	MP	CH2	U	DOL728	SPNN04
MODEL NUMBER	ARM	BASE	CONTROL	CASTER	FLAMMABILITY	INNER UPHOLSTERY	OUTER UPHOLSTERY

model number	fabric grades								dimensions	W	D	H
GSGNV17-021J Jury/Fixed Base, High Back, Pillow Dual Uph	1	2,313	10	3,039	19	3,985	L1	3,089	Overall	27 1/4"	27"	42" - 46"
	2	2,379	11	3,127	20	4,095	L2	3,769	Seat	20"	18"	16 1/2" - 20 1/2"
	3	2,445	12	3,215	21	4,205	L3	4,585	Arm	23" - 27"		
	COM/4	2,511	13	3,325	22	4,315	L4	5,265	Between arms	21"		
	5	2,599	14	3,435	23	4,535	L5	5,945	Upholstery Requirements: GSGNV17-021J			
	6	2,687	15	3,545	24	4,755			Dual Upholstery			
	7	2,775	16	3,655	25	4,975			Fabric yards	Inners 1.8	Outers 1	
	8	2,863	17	3,765	26	5,195			Leather feet ²	Inners 47.6	Outers 17	
	9	2,951	18	3,875	27	5,415			Shipping weight	45 lbs.		
								Cube	24.6			

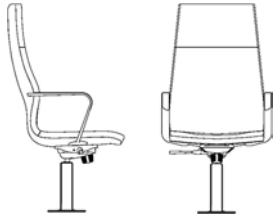

Inner	1	10	535	19	1,232	L1	572	
	2	49	11	600	20	1,313	L2	1,073
	3	97	12	665	21	1,394	L3	1,674
	COM/4	146	13	746	22	1,475	L4	2,175
	5	211	14	827	23	1,637	L5	2,676
	6	276	15	908	24	1,799		
	7	340	16	989	25	1,961		
	8	405	17	1,070	26	2,124		
	9	470	18	1,151	27	2,286		

Top row of pricing is for units specified with same fabric on Inner and Outer. Bottom two rows of pricing required only when two different fabric grades are selected for the Inner/Outer.

To calculate price of chair with different grade fabric for Inner/Outer; start with Grade 1 price, add appropriate grade price located in second row for Inner; and last add appropriate grade price located in third row for Outer to the sum of the Grade 1 and Inner/Outer price.

Example: Grade 1 \$2,313 + grade 4 fabric Inner \$146 + grade 2 fabric Outer \$17 = \$2,476

Outer	1	10	191	19	440	L1	204	
	2	17	11	214	20	469	L2	383
	3	35	12	237	21	498	L3	598
	COM/4	52	13	266	22	527	L4	777
	5	75	14	295	23	585	L5	956
	6	98	15	324	24	643		
	7	122	16	353	25	701		
	8	145	17	382	26	758		
	9	168	18	411	27	816		

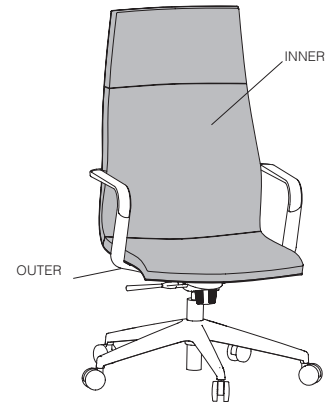

TO ORDER PLEASE SPECIFY THE FOLLOWING:

<input type="text"/>	<input type="text"/>	<input type="text"/>	<input type="text"/>	<input type="text"/>	<input type="text"/>
MODEL NUMBER	ARM	JURY BASE	FLAMMABILITY RATING	INNER UPHOLSTERY	OUTER UPHOLSTERY
	ABL Full Urethane Arms API Polished with urethane insert +\$150	These seating models are available with the following base option. 360RTCH 360 Return-to-Center Return-to-Height	U CTB117	Please refer to list of available upholstery and leather selections on www.gunlocke.com	Please refer to list of available upholstery and leather selections on www.gunlocke.com

Example

GSGNV17-021J.ABL.360RTCH.U.DOL728.DOL728

GSGNV17-021J	ABL	360RTCH	U	DOL728	SPNN04
MODEL NUMBER	ARM	JURY BASE	FLAMMABILITY	INNER UPHOLSTERY	OUTER UPHOLSTERY

model number fabric grades dimensions W D H

GSGNV17-061
Mid Back,
Pillow Dual Uph

1	1,831	10	2,251	19	2,799	L1	2,280
2	1,869	11	2,302	20	2,863	L2	2,674
3	1,908	12	2,353	21	2,926	L3	3,146
COM/4	1,946	13	2,417	22	2,990	L4	3,540
5	1,996	14	2,480	23	3,118	L5	3,934
6	2,048	15	2,544	24	3,245		
7	2,098	16	2,608	25	3,372		
8	2,150	17	2,672	26	3,500		
9	2,200	18	2,735	27	3,627		

Overall	27 1/4"	26 1/2"	33" - 37"
Seat	20"	18"	16 1/2" - 20 1/2"
Arm		23" - 27"	
Between arms	21"		

Upholstery Requirements: GSGNV17-061

	Dual Upholstery	
Fabric yards	Inners 1.4	Outers 0.8
Leather feet ²	Inners 23.8	Outers 13.6
Shipping weight		40 lbs.
Cube		19.5



Inner

1	10	267	19	616	L1	286
2	24	11	300	20	L2	536
3	49	12	332	21	L3	837
COM/4	73	13	373	22	L4	1,088
5	105	14	413	23	L5	1,338
6	138	15	454	24		
7	170	16	494	25		
8	203	17	535	26		
9	235	18	575	27		

Top row of pricing is for units specified with same fabric on Inner and Outer. Bottom two rows of pricing required only when two different fabric grades are selected for the Inner/Outer.

To calculate price of chair with different grade fabric for Inner/Outer; start with Grade 1 price, add appropriate grade price located in second row for Inner; and last add appropriate grade price located in third row for Outer to the sum of the Grade 1 and Inner/Outer price.

Example: Grade 1 \$1,831 + grade 4 fabric Inner \$73 + grade 2 fabric Outer \$14 = \$1,918

Outer

1	10	153	19	352	L1	163
2	14	11	171	20	L2	307
3	28	12	190	21	L3	478
COM/4	42	13	213	22	L4	621
5	60	14	236	23	L5	765
6	79	15	259	24		
7	97	16	283	25		
8	116	17	306	26		
9	134	18	329	27		

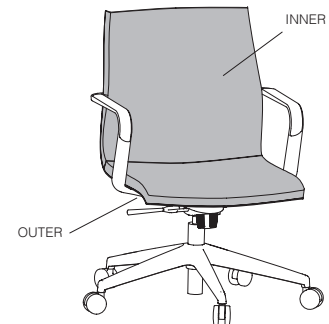

TO ORDER PLEASE SPECIFY THE FOLLOWING:

.

MODEL NUMBER **ARM** **BASE** **CONTROL** **CASTER** **FLAMMABILITY RATING** **INNER UPHOLSTERY** **OUTER UPHOLSTERY**

ABL Full Urethane Arms
API Polished with urethane insert +\$150

These seating models are available with the following base option.
BBL Black base
BAL Polished Aluminum +\$100

MP Black, mid tilt, pneumatic lift with lockout.

CH2 Hard
CS2 Soft +\$55

U CTB117

Please refer to list of available upholstery and leather selections on www.gunlocke.com

Please refer to list of available upholstery and leather selections on www.gunlocke.com

Example

GSGNV17-061.ABL.BBL.MP.CH2.U.DOL728.DOL728

GSGNV17-061	ABL	BBL	MP	CH2	U	DOL728	SPNN04
MODEL NUMBER	ARM	BASE	CONTROL	CASTER	FLAMMABILITY	INNER UPHOLSTERY	OUTER UPHOLSTERY

model number	fabric grades								dimensions	W	D	H	
GSGNV17-061J Jury/Fixed Base, Mid Back, Pillow Dual Uph	1	2,148	10	2,568	19	3,116	L1	2,597	Overall	27 1/4"	26 1/2"	33" - 37"	
	2	2,186	11	2,619	20	3,180	L2	2,991	Seat	20"	18"	16 1/2" - 20 1/2"	
	3	2,225	12	2,670	21	3,243	L3	3,463	Arm	23" - 27"			
	COM/4	2,263	13	2,734	22	3,307	L4	3,857	Between arms	21"			
	5	2,313	14	2,797	23	3,435	L5	4,251	Upholstery Requirements: GSGNV17-061J				
	6	2,365	15	2,861	24	3,562			Dual Upholstery				
	7	2,415	16	2,925	25	3,689			Fabric yards Inners 1.4 Outers 0.8				
	8	2,467	17	2,989	26	3,817			Leather feet ² Inners 23.8 Outers 13.6				
	9	2,517	18	3,052	27	3,944			Shipping weight 40 lbs.				
									Cube 19.5				

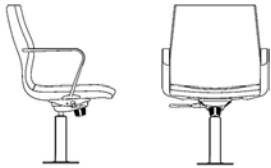

Inner	1	10	267	19	616	L1	286	
	2	24	11	300	20	657	L2	536
	3	49	12	332	21	697	L3	837
	COM/4	73	13	373	22	738	L4	1,088
	5	105	14	413	23	819	L5	1,338
	6	138	15	454	24	900		
	7	170	16	494	25	981		
	8	203	17	535	26	1,062		
	9	235	18	575	27	1,143		

Top row of pricing is for units specified with same fabric on Inner and Outer. Bottom two rows of pricing required only when two different fabric grades are selected for the Inner/Outer.

To calculate price of chair with different grade fabric for Inner/Outer; start with Grade 1 price, add appropriate grade price located in second row for Inner; and last add appropriate grade price located in third row for Outer to the sum of the Grade 1 and Inner/Outer price.

Example: Grade 1 \$2,148 + grade 4 fabric Inner \$73 + grade 2 fabric Outer \$14 = \$2,235

Outer	1	10	153	19	352	L1	163	
	2	14	11	171	20	375	L2	307
	3	28	12	190	21	398	L3	478
	COM/4	42	13	213	22	421	L4	621
	5	60	14	236	23	468	L5	765
	6	79	15	259	24	514		
	7	97	16	283	25	560		
	8	116	17	306	26	607		
	9	134	18	329	27	653		

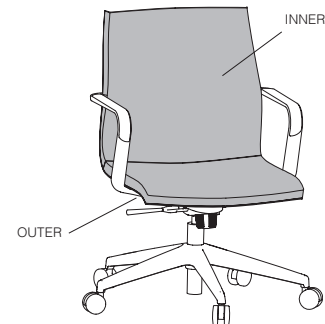

TO ORDER PLEASE SPECIFY THE FOLLOWING:

<input type="text"/>	<input type="text"/>	<input type="text"/>	<input type="text"/>	<input type="text"/>	<input type="text"/>
MODEL NUMBER	ARM	JURY BASE	FLAMMABILITY RATING	INNER UPHOLSTERY	OUTER UPHOLSTERY
	ABL Full Urethane Arms API Polished with urethane insert +\$150	These seating models are available with the following base option. 360RTCH 360 Return-to-Center Return-to-Height	U CTB117	Please refer to list of available upholstery and leather selections on www.gunlocke.com	Please refer to list of available upholstery and leather selections on www.gunlocke.com

Example

GSGNV17-061J.ABL.360RTCH.U.DOL728.DOL728					
GSGNV17-061J	ABL	360RTCH	U	DOL728	SPNN04
MODEL NUMBER	ARM	JURY BASE	FLAMMABILITY	INNER UPHOLSTERY	OUTER UPHOLSTERY

model number	fabric grades							dimensions	W	D	H	
GSGNV17-031 High Back, Tight Single Uph	1	2,014	10	2,396	19	2,894	L1	2,422	Overall	27 1/4"	27"	42" - 46"
	2	2,049	11	2,442	20	2,952	L2	2,780	Seat	20"	18"	16 1/2" - 20 1/2"
	3	2,083	12	2,489	21	3,010	L3	3,210	Arm	23" - 27"		
	COM/4	2,118	13	2,547	22	3,068	L4	3,568	Between arms	21"		
	5	2,165	14	2,605	23	3,183	L5	3,926	Upholstery Requirements: GSGNV17-031			
	6	2,211	15	2,662	24	3,299			Fabric yards	2		
	7	2,257	16	2,720	25	3,415			Leather feet ²	34		
	8	2,303	17	2,778	26	3,531			Shipping weight	45 lbs.		
	9	2,350	18	2,836	27	3,647			Cube	24.6		

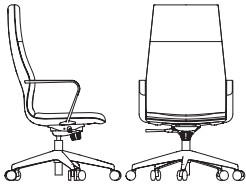

GSGNV17-071 Mid Back, Tight Single Uph	1	1,847	10	2,210	19	2,683	L1	2,235	Overall	27 1/4"	26 1/2"	33" - 37"
	2	1,880	11	2,254	20	2,738	L2	2,575	Seat	20"	18"	16 1/2" - 20 1/2"
	3	1,913	12	2,298	21	2,793	L3	2,983	Arm	23" - 27"		
	COM/4	1,946	13	2,353	22	2,848	L4	3,323	Between arms	21"		
	5	1,990	14	2,408	23	2,958	L5	3,663	Upholstery Requirements: GSGNV17-071			
	6	2,034	15	2,463	24	3,068			Fabric yards	1.9		
	7	2,078	16	2,518	25	3,178			Leather feet ²	32.3		
	8	2,122	17	2,573	26	3,288			Shipping weight	40 lbs.		
	9	2,166	18	2,628	27	3,398			Cube	19.5		



TO ORDER PLEASE SPECIFY THE FOLLOWING:

<input type="text"/>	<input type="text"/>	<input type="text"/>	<input type="text"/>	<input type="text"/>	<input type="text"/>	<input type="text"/>
MODEL NUMBER	ARM	BASE	CONTROL	CASTER	FLAMMABILITY RATING	FABRIC

- | | | | | | |
|---|--|---|-----------------------|-----------------|---|
| ABL Full Urethane Arms | These seating models are available with the following base option. | MP Black, mid tilt, pneumatic lift with lockout. | CH2 Hard | U CTB117 | Please refer to list of available upholstery and leather selections on www.gunlocke.com |
| API Polished with urethane insert +\$150 | | BBL Black base | CS2 Soft +\$55 | | |
| | BAL Polished Aluminum +\$100 | | | | |

Example

GSGNV17-031.ABL.BBL.MP.CH2.U.DOL728

GSGNV17-031	ABL	BBL	MP	CH2	U	DOL728
MODEL NUMBER	ARM	BASE	CONTROL	CASTER	FLAMMABILITY	UPHOLSTERY

model number	fabric grades							dimensions	W	D	H	
GSGNV17-031J Jury/Fixed Base, High Back, Tight Single Uph	1	2,333	10	2,715	19	3,213	L1	2,741	Overall	27 1/4"	27"	42" -46"
	2	2,368	11	2,761	20	3,271	L2	3,099	Seat	20"	18"	16 1/2" - 20 1/2"
	3	2,402	12	2,808	21	3,329	L3	3,529	Arm	23" - 27"		
	COM/4	2,437	13	2,866	22	3,387	L4	3,887	Between arms	21"		
	5	2,484	14	2,924	23	3,502	L5	4,245	Upholstery Requirements: GSGNV17-031J			
	6	2,530	15	2,981	24	3,618			Fabric yards	2		
	7	2,576	16	3,039	25	3,734			Leather feet ²	34		
	8	2,622	17	3,097	26	3,850			Shipping weight	45 lbs.		
	9	2,669	18	3,155	27	3,966			Cube	24.6		

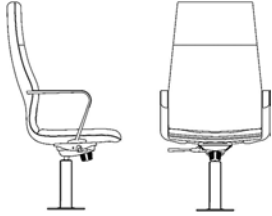

GSGNV17-071J Jury/Fixed Base, Mid Back, Tight Single Uph	1	2,167	10	2,530	19	3,003	L1	2,555	Overall	27 1/4"	26 1/2"	33" - 37"
	2	2,200	11	2,574	20	3,058	L2	2,895	Seat	20"	18"	16 1/2" - 20 1/2"
	3	2,233	12	2,618	21	3,113	L3	3,303	Arm	23" - 27"		
	COM/4	2,266	13	2,673	22	3,168	L4	3,643	Between arms	21"		
	5	2,310	14	2,728	23	3,278	L5	3,983	Upholstery Requirements: GSGNV17-071J			
	6	2,354	15	2,783	24	3,388			Fabric yards	1.9		
	7	2,398	16	2,838	25	3,498			Leather feet ²	32.3		
	8	2,442	17	2,893	26	3,608			Shipping weight	40 lbs.		
	9	2,486	18	2,948	27	3,718			Cube	19.5		

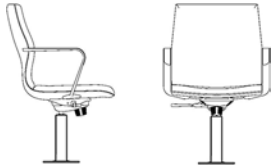

TO ORDER PLEASE SPECIFY THE FOLLOWING:

MODEL NUMBER	ARM	JURY BASE	FLAMMABILITY RATING	FABRIC

ABL Full Urethane Arms
API Polished with urethane insert **+\$150**

These seating models are available with the following base option.
360RTCH
 360 Return-to-Center Return-to-Height

U CTB117

Please refer to list of available upholstery and leather selections on www.gunlocke.com

Example

GSGNV17-031J.ABL.360RTCH.U.DOL728
 GSGNV17-031J ABL 360RTCH U DOL728
 MODEL NUMBER ARM JURY BASE FLAMMABILITY UPHOLSTERY

model number fabric grades dimensions W D H

GSGNV17-041
High Back,
Tight Dual Uph

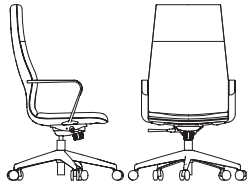

1	2,023	10	2,520	19	3,167	L1	2,554
2	2,068	11	2,580	20	3,242	L2	3,019
3	2,114	12	2,640	21	3,318	L3	3,578
COM/4	2,158	13	2,715	22	3,393	L4	4,043
5	2,218	14	2,790	23	3,544	L5	4,508
6	2,278	15	2,866	24	3,694		
7	2,340	16	2,941	25	3,845		
8	2,400	17	3,016	26	3,994		
9	2,460	18	3,092	27	4,145		

Overall	27 1/4"	27"	42" - 46"
Seat	20"	18"	16 1/2" - 20 1/2"
Arm	23" - 27"		
Between arms	21"		

Upholstery Requirements: GSGNV17-041

	Dual Upholstery	
Fabric yards	Inners 1.6	Outers 1
Leather feet ²	Inners 27.2	Outers 17
Shipping weight	45 lbs.	
Cube	24.6	

Inner

1	10	306	19	704	L1	327
2	28	11	343	20	L2	613
3	56	12	380	21	L3	957
COM/4	83	13	426	22	L4	1,243
5	120	14	472	23	L5	1,529
6	157	15	519	24		1,028
7	195	16	565	25		1,121
8	232	17	611	26		1,213
9	269	18	658	27		1,306

Top row of pricing is for units specified with same fabric on Inner and Outer. Bottom two rows of pricing required only when two different fabric grades are selected for the Inner/Outer.

To calculate price of chair with different grade fabric for Inner/Outer; start with Grade 1 price, add appropriate grade price located in second row for Inner; and last add appropriate grade price located in third row for Outer to the sum of the Grade 1 and Inner/Outer price.

Example: Grade 1 \$2,023 + grade 4 fabric Inner \$83 + grade 2 fabric Outer \$17 = \$2,123

Outer

1	10	191	19	440	L1	204
2	17	11	214	20	L2	383
3	35	12	237	21	L3	598
COM/4	52	13	266	22	L4	777
5	75	14	295	23	L5	956
6	98	15	324	24		643
7	122	16	353	25		701
8	145	17	382	26		758
9	168	18	411	27		816

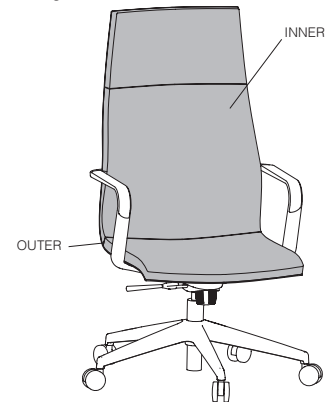

TO ORDER PLEASE SPECIFY THE FOLLOWING:

<input type="text"/>	<input type="text"/>	<input type="text"/>	<input type="text"/>	<input type="text"/>	<input type="text"/>	<input type="text"/>	<input type="text"/>
MODEL NUMBER	ARM	BASE	CONTROL	CASTER	FLAMMABILITY RATING	INNER UPHOLSTERY	OUTER UPHOLSTERY
ABL Full Urethane Arms API Polished with urethane insert +\$150		These seating models are available with the following base option. BBL Black base BAL Polished Aluminum +\$100	MP Black, mid tilt, pneumatic lift with lockout.	CH2 Hard CS2 Soft +\$55	U CTB117	Please refer to list of available upholstery and leather selections on www.gunlocke.com	Please refer to list of available upholstery and leather selections on www.gunlocke.com

Example

GSGNV17-041.ABL.BBL.MP.CH2.U.DOL728.DOL728

GSGNV17-041	ABL	BBL	MP	CH2	U	DOL728	SPNN04
MODEL NUMBER	ARM	BASE	CONTROL	CASTER	FLAMMABILITY	INNER UPHOLSTERY	OUTER UPHOLSTER

model number	fabric grades						dimensions	W	D	H		
GSGNV17-041J Jury/Fixed Base, High Back, Tight Dual Uph	1	2,346	10	2,843	19	3,490	L1	2,877	Overall	27 1/4"	27"	42" - 46"
	2	2,391	11	2,903	20	3,565	L2	3,342	Seat	20"	18"	16 1/2" - 20 1/2"
	3	2,437	12	2,963	21	3,641	L3	3,901	Arm	23" - 27"		
	COM/4	2,481	13	3,038	22	3,716	L4	4,366	Between arms	21"		
	5	2,541	14	3,113	23	3,867	L5	4,831	Upholstery Requirements: GSGNV17-041J			
	6	2,601	15	3,189	24	4,017			Dual Upholstery			
	7	2,663	16	3,264	25	4,168			Fabric yards Inners 1.6 Outers 1			
	8	2,723	17	3,339	26	4,317			Leather feet ² Inners 27.2 Outers 17			
	9	2,783	18	3,415	27	4,468			Shipping weight 45 lbs.			
								Cube 24.6				

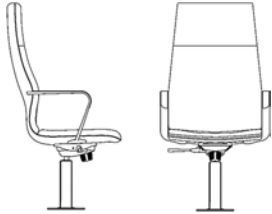

Inner	1	10	306	19	704	L1	327
	2	11	343	20	750	L2	613
	3	12	380	21	797	L3	957
	COM/4	83	426	22	843	L4	1,243
	5	14	472	23	936	L5	1,529
	6	15	519	24	1,028		
	7	16	565	25	1,121		
	8	17	611	26	1,213		
	9	18	658	27	1,306		

Top row of pricing is for units specified with same fabric on Inner and Outer. Bottom two rows of pricing required only when two different fabric grades are selected for the Inner/Outer.

To calculate price of chair with different grade fabric for Inner/Outer; start with Grade 1 price, add appropriate grade price located in second row for Inner; and last add appropriate grade price located in third row for Outer to the sum of the Grade 1 and Inner/Outer price.

Example: Grade 1 \$2,346 + grade 4 fabric Inner \$83 + grade 2 fabric Outer \$17 = \$2,446

Outer	1	10	191	19	440	L1	204
	2	11	214	20	469	L2	383
	3	12	237	21	498	L3	598
	COM/4	52	266	22	527	L4	777
	5	14	295	23	585	L5	956
	6	15	324	24	643		
	7	16	353	25	701		
	8	17	382	26	758		
	9	18	411	27	816		

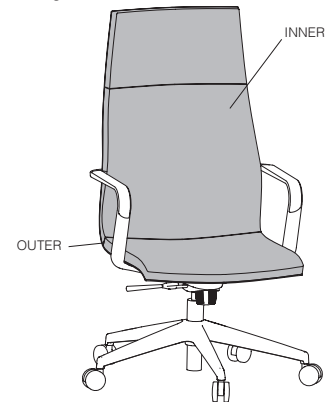

TO ORDER PLEASE SPECIFY THE FOLLOWING:

<input type="text"/>	<input type="text"/>	<input type="text"/>	<input type="text"/>	<input type="text"/>	<input type="text"/>
MODEL NUMBER	ARM	JURY BASE	FLAMMABILITY RATING	INNER UPHOLSTERY	OUTER UPHOLSTERY
	ABL Full Urethane Arms API Polished with urethane insert +\$150	These seating models are available with the following base option. 360RTCH 360 Return-to-Center Return-to-Height	U CTB117	Please refer to list of available upholstery and leather selections on www.gunlocke.com	Please refer to list of available upholstery and leather selections on www.gunlocke.com

Example

GSGNV17-041J.ABL.360RTCH.U.DOL728.DOL728					
GSGNV17-041J	ABL	360RTCH	U	DOL728	SPNN04
MODEL NUMBER	ARM	JURY BASE	FLAMMABILITY	INNER UPHOLSTERY	OUTER UPHOLSTERY

model number

fabric grades

dimensions

W

D

H

GSGNV17-081

Mid Back,
Tight Dual Uph



1	1,856	10	2,276	19	2,824	L1	2,305
2	1,894	11	2,327	20	2,888	L2	2,699
3	1,933	12	2,378	21	2,951	L3	3,171
COM/4	1,971	13	2,442	22	3,015	L4	3,565
5	2,021	14	2,505	23	3,143	L5	3,959
6	2,073	15	2,569	24	3,270		
7	2,123	16	2,633	25	3,397		
8	2,175	17	2,697	26	3,525		
9	2,225	18	2,760	27	3,652		

Overall	27 1/4"	26 1/2"	33" - 37"
Seat	20"	18"	16 1/2" - 20 1/2"
Arm	23" - 27"		
Between arms	21"		

Upholstery Requirements: GSGNV17-081

	Dual Upholstery	
Fabric yards	Inners 1.4	Outers 0.8
Leather feet ²	Inners 23.8	Outers 13.6
Shipping weight	40 lbs.	
Cube	19.5	

Inner

1	10	267	19	616	L1	286
2	24	11	300	20	L2	536
3	49	12	332	21	L3	837
COM/4	73	13	373	22	L4	1,088
5	105	14	413	23	L5	1,338
6	138	15	454	24		
7	170	16	494	25		
8	203	17	535	26		
9	235	18	575	27		

Top row of pricing is for units specified with same fabric on Inner and Outer. Bottom two rows of pricing required only when two different fabric grades are selected for the Inner/Outer

To calculate price of chair with different grade fabric for Inner/Outer; start with Grade 1 price, add appropriate grade price located in second row for Inner, and last add appropriate grade price located in third row for Outer to the sum of the Grade 1 and Inner/Outer price.

Example: Grade 1 \$1,856 + grade 4 fabric Inner \$73 + grade 2 fabric Outer \$14 = \$1,943

Outer

1	10	153	19	352	L1	163
2	14	11	171	20	L2	307
3	28	12	190	21	L3	478
COM/4	42	13	213	22	L4	621
5	60	14	236	23	L5	765
6	79	15	259	24		
7	97	16	283	25		
8	116	17	306	26		
9	134	18	329	27		

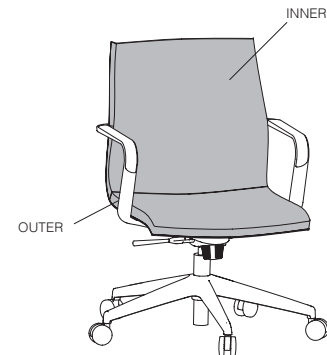

TO ORDER PLEASE SPECIFY THE FOLLOWING:

.

MODEL NUMBER **ARM** **BASE** **CONTROL** **CASTER** **FLAMMABILITY RATING** **INNER UPHOLSTERY** **OUTER UPHOLSTERY**

ABL Full Urethane Arms
API Polished with urethane insert +\$150

These seating models are available with the following base option.
BBL Black base
BAL Polished Aluminum +\$100

MP Black, mid tilt, pneumatic lift with lockout.

CH2 Hard
CS2 Soft +\$55

U CTB117

Please refer to list of available upholstery and leather selections on www.gunlocke.com

Please refer to list of available upholstery and leather selections on www.gunlocke.com

Example

GSGNV17-081.ABL.BBL.MP.CH2.U.DOL728.DOL728

GSGNV17-081	ABL	BBL	MP	CH2	U	DOL728	SPNN04
MODEL NUMBER	ARM	BASE	CONTROL	CASTER	FLAMMABILITY	INNER UPHOLSTERY	OUTER UPHOLSTERY

model number	fabric grades								dimensions	W	D	H
GSGNV17-081J Jury/Fixed Base, Mid Back, Tight Dual Uph	1	2,177	10	2,597	19	3,145	L1	2,626	Overall	27 1/4"	26 1/2"	33" - 37"
	2	2,215	11	2,648	20	3,209	L2	3,020	Seat	20"	18"	16 1/2" - 20 1/2"
	3	2,254	12	2,699	21	3,272	L3	3,492	Arm	23" - 27"		
	COM/4	2,292	13	2,763	22	3,336	L4	3,886	Between arms	21"		
	5	2,342	14	2,826	23	3,464	L5	4,280	Upholstery Requirements: GSGNV17-081J			
	6	2,394	15	2,890	24	3,591				Dual Upholstery		
	7	2,444	16	2,954	25	3,718			Fabric yards	Inners 1.4	Outers 0.8	
	8	2,496	17	3,018	26	3,846			Leather feet ²	Inners 23.8	Outers 13.6	
	9	2,546	18	3,081	27	3,973			Shipping weight	40 lbs.		
								Cube	19.5			

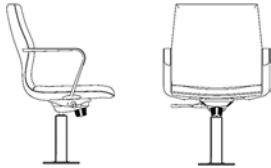

Inner	1	10	267	19	616	L1	286	
	2	24	11	300	20	657	L2	536
	3	49	12	332	21	697	L3	837
	COM/4	73	13	373	22	738	L4	1,088
	5	105	14	413	23	819	L5	1,338
	6	138	15	454	24	900		
	7	170	16	494	25	981		
	8	203	17	535	26	1,062		
	9	235	18	575	27	1,143		

Top row of pricing is for units specified with same fabric on Inner and Outer. Bottom two rows of pricing required only when two different fabric grades are selected for the Inner/Outer.

To calculate price of chair with different grade fabric for Inner/Outer; start with Grade 1 price, add appropriate grade price located in second row for Inner, and last add appropriate grade price located in third row for Outer to the sum of the Grade 1 and Inner/Outer price.

Example: Grade 1 \$2,177 + grade 4 fabric Inner \$73 + grade 2 fabric Outer \$14 = \$2,264

Outer	1	10	153	19	352	L1	163	
	2	14	11	171	20	375	L2	307
	3	28	12	190	21	398	L3	478
	COM/4	42	13	213	22	421	L4	621
	5	60	14	236	23	468	L5	765
	6	79	15	259	24	514		
	7	97	16	283	25	560		
	8	116	17	306	26	607		
	9	134	18	329	27	653		

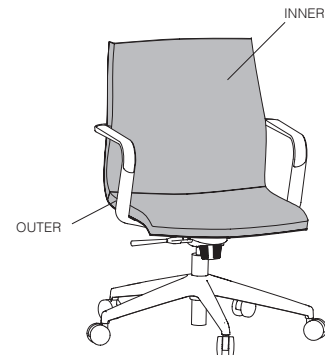

TO ORDER PLEASE SPECIFY THE FOLLOWING:

<input type="text"/>	<input type="text"/>	<input type="text"/>	<input type="text"/>	<input type="text"/>	<input type="text"/>
MODEL NUMBER	ARM	JURY BASE	FLAMMABILITY RATING	INNER UPHOLSTERY	OUTER UPHOLSTERY
	ABL Full Urethane Arms API Polished with urethane insert +\$150	These seating models are available with the following base option. 360RTCH 360 Return-to-Center Return-to-Height	U CTB117	Please refer to list of available upholstery and leather selections on www.gunlocke.com	Please refer to list of available upholstery and leather selections on www.gunlocke.com

Example

GSGNV17-081J.ABL.360RTCH.U.DOL728.DOL728

GSGNV17-081J	ABL	360RTCH	U	DOL728	SPNN04
MODEL NUMBER	ARM	JURY BASE	FLAMMABILITY	INNER UPHOLSTERY	OUTER UPHOLSTERY

OLLA EXECUTIVE

Conference | Fixed Arm | High Back

Seating
05/22

model number	fabric grades							dimensions	W	D	H	
GK2800 High back, fully upholstered, fixed arms	1	3,177	10	3,578	19	4,101	L1	3,606	Overall	26 1/2"	23 1/2"	43 1/2" - 47 1/2"
	2	3,213	11	3,627	20	4,162	L2	3,982	Seat		18 1/2"	17 3/4" - 21 1/2"
	3	3,250	12	3,675	21	4,223	L3	4,433	Arm			27 15/16"
	COM/4	3,286	13	3,736	22	4,283	L4	4,808	Between arms	19 1/2"		
	5	3,335	14	3,797	23	4,405	L5	5,184				
	6	3,384	15	3,858	24	4,527						
	7	3,432	16	3,919	25	4,648						
	8	3,481	17	3,979	26	4,770						
	9	3,530	18	4,040	27	4,891						

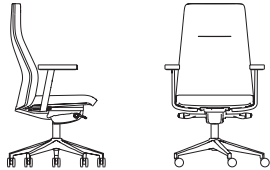

Upholstery Requirements: GK2800

Fabric yards	2.1
Leather feet ²	35.7
Shipping weight	58 lb.
Cube	24

model number	fabric grades							dimensions	W	D	H	
GK2804 High back, with Wood Décor, fixed arms	1	4,007	10	4,408	19	4,931	L1	4,436	Overall	26 1/2"	23 1/2"	43 1/2" - 47 1/2"
	2	4,043	11	4,457	20	4,992	L2	4,812	Seat		18"	17 3/4" - 21 3/4"
	3	4,080	12	4,505	21	5,053	L3	5,263	Arm			27 15/16"
	COM/4	4,116	13	4,566	22	5,113	L4	5,638	Between arms	19 1/2"		
	5	4,165	14	4,627	23	5,235	L5	6,014				
	6	4,214	15	4,688	24	5,357						
	7	4,262	16	4,749	25	5,478						
	8	4,311	17	4,809	26	5,600						
	9	4,360	18	4,870	27	5,721						

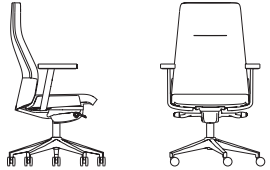

Upholstery Requirements: GK2804

Fabric yards	2.1
Leather feet ²	35.7
Shipping weight	61 lb.
Cube	24

TO ORDER PLEASE SPECIFY THE FOLLOWING:

MODEL NUMBER	METAL FINISH	CASTER	SEAT DEPTH ADJUSTMENT	ARM CAP	WOOD DECOR FINISH	FLAMMABILITY RATING	UPHOLSTERY
	Specified finish applies to Base, and Metal J-bar cover. Metal J-Bar cover located on back of wood décor (models GK2812 and GK2814). Adjustable Arm is available in Black only. BBL Black BSL Silver BAL Polished Aluminum +\$350	CH2 Hard CS2 Soft +\$55	These seating models are available with the following seat depth adjustment option. Please specify by adding suffix to model number. NSDA No Seat Depth-Adjustment SDA Seat Depth Adjustment +\$65	Please specify by adding suffix to model number. ARMUPH Upholstered Arm +\$175 ARMU Urethane Arm	Note: Required for GK2804 only Cherry finishes on Maple Walnut finishes on Maple Maple finishes on Maple Oak finishes on Maple Please refer to the Olla product page on www.gunlocke.com for standard finish options. <i>Natural Cherry 222 not available on Cherry.</i>	U CTB117	Please refer to list of available upholstery and leather selections on www.gunlocke.com

Example

GK2804.BAL.CH2.SDA.ARMUPH.NC701.U.DOL728

GK2804	BAL	CH2	SDA	ARMUPH	NC701	U	DOL728
MODEL NUMBER	METAL FINISH	CASTER	SEAT DEPTH ADJUSTMENT	ARM CAP	WOOD DECOR FINISH	FLAMMABILITY	UPHOLSTERY

model number	fabric grades							dimensions	W	D	H	
GK2802 Mid-back, fully upholstered, fixed arms	1	2,946	10	3,290	19	3,738	L1	3,314	Overall	26 1/2"	23 1/2"	39"- 43"
	2	2,977	11	3,332	20	3,790	L2	3,636	Seat		18"	17 3/4"- 21 3/4"
	3	3,009	12	3,373	21	3,842	L3	4,022	Arm			27 15/16"
	COM/4	3,040	13	3,425	22	3,894	L4	4,344	Between arms	19 1/2"		
	5	3,081	14	3,477	23	3,999	L5	4,666				
	6	3,123	15	3,530	24	4,103						
	7	3,165	16	3,582	25	4,207						
	8	3,207	17	3,634	26	4,311						
	9	3,248	18	3,686	27	4,415						



Upholstery Requirements: GK2802

Fabric yards	1.8
Leather feet ²	30.6
Shipping weight	57 lb.
Cube	24

GK2806 Mid-back, with Wood Décor, fixed arms	1	3,714	10	4,058	19	4,506	L1	4,082
	2	3,745	11	4,100	20	4,558	L2	4,404
	3	3,777	12	4,141	21	4,610	L3	4,790
	COM/4	3,808	13	4,193	22	4,662	L4	5,112
	5	3,849	14	4,245	23	4,767	L5	5,434
	6	3,891	15	4,298	24	4,871		
	7	3,933	16	4,350	25	4,975		
	8	3,975	17	4,402	26	5,079		
	9	4,016	18	4,454	27	5,183		

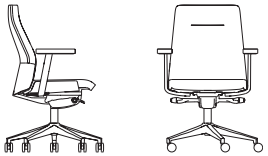

Overall	26 1/2"	23 1/2"	39"- 43"
Seat		18"	17 3/4"- 21 3/4"
Arm			27 15/16"
Between arms	19 1/2"		

Upholstery Requirements: GK2806

Fabric yards	1.8
Leather feet ²	30.6
Shipping weight	60 lb.
Cube	24

TO ORDER PLEASE SPECIFY THE FOLLOWING:

MODEL NUMBER	METAL FINISH	CASTER	SEAT DEPTH ADJUSTMENT	ARM CAP	WOOD DECOR FINISH	FLAMMABILITY RATING	UPHOLSTERY
	Specified finish applies to Base, and Metal J-bar cover. Metal J-Bar cover located on back of wood décor (models GK2812 and GK2814). Adjustable Arm is available in Black only. BBL Black BSL Silver BAL Polished Aluminum +\$350	CH2 Hard CS2 Soft +\$55	These seating models are available with the following seat depth adjustment option. Please specify by adding suffix to model number. NSDA No Seat Depth-Adjustment SDA Seat Depth Adjustment +\$65	Please specify by adding suffix to model number. ARMUPH Upholstered Arm +\$175 ARMU Urethane Arm	Note: Required for GK2806 only Cherry finishes on Maple Walnut finishes on Maple Maple finishes on Maple Oak finishes on Maple Please refer to the Olla product page on www.gunlocke.com for standard finish options. <i>Natural Cherry 222 not available on Cherry.</i>	U CTB117	Please refer to list of available upholstery and leather selections on www.gunlocke.com

Example

GK2806.BAL.CH2.SDA.ARMUPH.NC701.U.DOL728

GK2806	BAL	CH2	SDA	ARMUPH	NC701	U	DOL728
MODEL NUMBER	METAL FINISH	CASTER	SEAT DEPTH ADJUSTMENT	ARM CAP	WOOD DECOR FINISH	FLAMMABILITY	UPHOLSTERY

OLLA EXECUTIVE

Manager | Adjustable Arm | High Back

Seating
05/22

model number	fabric grades							dimensions	W	D	H	
GK2808 High back, fully upholstered, adjustable arms	1	3,177	10	3,578	19	4,101	L1	3,606	Overall	26 1/2"	23 1/2"	43 1/2" - 47 1/2"
	2	3,213	11	3,627	20	4,162	L2	3,982	Seat		18 1/2"	17 3/4" - 21 3/4"
	3	3,250	12	3,675	21	4,223	L3	4,433	Arm			25 1/2" - 29 1/2"
	COM/4	3,286	13	3,736	22	4,283	L4	4,808	Between arms	19 1/2"		
	5	3,335	14	3,797	23	4,405	L5	5,184	Upholstery Requirements: GK2808			
	6	3,384	15	3,858	24	4,527			Fabric yards			2.1
	7	3,432	16	3,919	25	4,648			Leather feet ²			35.7
	8	3,481	17	3,979	26	4,770			Shipping weight			57 lb.
	9	3,530	18	4,040	27	4,891			Cube			24



model number	fabric grades							dimensions	W	D	H	
GK2812 High back, with Wood Décor, adjustable arms	1	4,007	10	4,408	19	4,931	L1	4,436	Overall	26 1/2"	23 1/2"	43 1/2" - 47 1/2"
	2	4,043	11	4,457	20	4,992	L2	4,812	Seat		18"	17 3/4" - 21 3/4"
	3	4,080	12	4,505	21	5,053	L3	5,263	Arm			25 1/2" - 29 1/2"
	COM/4	4,116	13	4,566	22	5,113	L4	5,638	Between arms	19 1/2"		
	5	4,165	14	4,627	23	5,235	L5	6,014	Upholstery Requirements: GK2812			
	6	4,214	15	4,688	24	5,357			Fabric yards			2.1
	7	4,262	16	4,749	25	5,478			Leather feet ²			35.7
	8	4,311	17	4,809	26	5,600			Shipping weight			60 lb.
	9	4,360	18	4,870	27	5,721			Cube			24

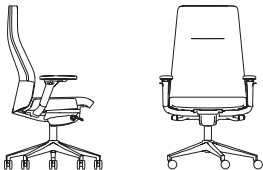





TO ORDER PLEASE SPECIFY THE FOLLOWING:

MODEL NUMBER	METAL FINISH	CASTER	SEAT DEPTH ADJUSTMENT	ARM CAP	WOOD DECOR FINISH	FLAMMABILITY RATING	UPHOLSTERY
<input type="text"/>	<input type="text"/>	<input type="text"/>	<input type="text"/>	<input type="text"/>	<input type="text"/>	<input type="text"/>	<input type="text"/>
Specified finish applies to Base, and Metal J-bar cover. Metal J-Bar cover located on back of wood décor (models GK2812 and GK2814). Adjustable Arm is available in Black only.	CH2 Hard CS2 Soft +\$55	These seating models are available with the following seat depth adjustment option. Please specify by adding suffix to model number. NSDA No Seat Depth-Adjustment SDA Seat Depth Adjustment +\$65	Please specify by adding suffix to model number. ARMUPH Upholstered Arm +\$175 ARMU Urethane Arm	Note: Required for GK2812 only Cherry finishes on Maple Walnut finishes on Maple Maple finishes on Maple Oak finishes on Maple Please refer to the Olla product page on www.gunlocke.com for standard finish options. <i>Natural Cherry 222 not available on Cherry.</i>	U CTB117	Please refer to list of available upholstery and leather selections on www.gunlocke.com	

Example

GK2812	BAL	CH2	SDA	ARMUPH	NC701	U	DOL728
MODEL NUMBER	METAL FINISH	CASTER	SEAT DEPTH ADJUSTMENT	ARM CAP	WOOD DECOR FINISH	FLAMMABILITY	UPHOLSTERY

model number	fabric grades							dimensions	W	D	H	
GK2810 Mid-back, fully upholstered, adjustable arms	1	2,946	10	3,290	19	3,738	L1	3,314	Overall	26 1/2"	23 1/2"	39"- 43"
	2	2,977	11	3,332	20	3,790	L2	3,636	Seat		18"	17 3/4"- 21 3/4"
	3	3,009	12	3,373	21	3,842	L3	4,022	Arm			25 1/2"- 29 1/2"
	COM/4	3,040	13	3,425	22	3,894	L4	4,344	Between arms	19 1/2"		
	5	3,081	14	3,477	23	3,999	L5	4,666	Upholstery Requirements: GK2810			
	6	3,123	15	3,530	24	4,103			Fabric yards			1.8
	7	3,165	16	3,582	25	4,207			Leather feet ²			30.6
	8	3,207	17	3,634	26	4,311			Shipping weight			56 lb.
	9	3,248	18	3,686	27	4,415			Cube			24
												

GK2814 with Wood Décor, adjustable arms	1	3,714	10	4,058	19	4,506	L1	4,082	Overall	26 1/2"	23 1/2"	39"- 43"
	2	3,745	11	4,100	20	4,558	L2	4,404	Seat		18"	17 3/4"- 21 3/4"
	3	3,777	12	4,141	21	4,610	L3	4,790	Arm			25 1/2"- 29 1/2"
	COM/4	3,808	13	4,193	22	4,662	L4	5,112	Between arms	19 1/2"		
	5	3,849	14	4,245	23	4,767	L5	5,434	Upholstery Requirements: GK2814			
	6	3,891	15	4,298	24	4,871			Fabric yards			1.8
	7	3,933	16	4,350	25	4,975			Leather feet ²			30.6
	8	3,975	17	4,402	26	5,079			Shipping weight			59 lb.
	9	4,016	18	4,454	27	5,183			Cube			24
												

TO ORDER PLEASE SPECIFY THE FOLLOWING:

MODEL NUMBER	METAL FINISH	CASTER	SEAT DEPTH ADJUSTMENT	ARM CAP	WOOD DECOR FINISH	FLAMMABILITY RATING	UPHOLSTERY
	Specified finish applies to Base, and Metal J-bar cover. Metal J-Bar cover located on back of wood décor (models GK2812 and GK2814). Adjustable Arm is available in Black only. BBL Black BSL Silver BAL Polished Aluminum +\$350	CH2 Hard CS2 Soft +\$55	These seating models are available with the following seat depth adjustment option. Please specify by adding suffix to model number. NSDA No Seat Depth Adjustment SDA Seat Depth Adjustment +\$65	Please specify by adding suffix to model number. ARMUPH Upholstered Arm +\$175 ARMU Urethane Arm	Note: Required for GK2814 only Cherry finishes on Maple Walnut finishes on Maple Maple finishes on Maple Oak finishes on Maple Please refer to the Olla product page on www.gunlocke.com for standard finish options. <i>Natural Cherry 222 not available on Cherry.</i>	U CTB117	Please refer to list of available upholstery and leather selections on www.gunlocke.com

Example

GK2814.BAL.CH2.SDA.ARMUPH.NC701.U.DOL728

GK2814	BAL	CH2	SDA	ARMUPH	NC701	U	DOL728
MODEL NUMBER	METAL FINISH	CASTER	SEAT DEPTH ADJUSTMENT	ARM CAP	WOOD DECOR FINISH	FLAMMABILITY	UPHOLSTERY

WASHINGTON SERIES

Seating
05/22

model number	fabric grades								dimensions	W	D	H
GK3006N Swivel 	1	8,514	10	9,355	19	10,450	L1	9,413	Overall	28"	35"	45" - 47 1/2"
	2	8,590	11	9,457	20	10,577	L2	10,200	Seat		18 1/2"	19 1/2" - 22"
	3	8,667	12	9,558	21	10,705	L3	11,145	Arm			29 1/2" - 32"
	COM/4	8,743	13	9,686	22	10,832	L4	11,932	Between arms	20"		
	5	8,845	14	9,813	23	11,087	L5	12,719	Upholstery Requirements: GK3006N			
	6	8,947	15	9,941	24	11,342			Fabric yards			4.4
	7	9,049	16	10,068	25	11,596			Leather feet ²			74.8
	8	9,151	17	10,195	26	11,851			Shipping weight			95 lbs.
	9	9,253	18	10,323	27	12,106			Cube			38.6

TO ORDER PLEASE SPECIFY THE FOLLOWING:

. . . .

MODEL NUMBER . **NAIL TRIM** . **FINISH** . **FLAMMABILITY RATING** . **UPHOLSTERY**

Standard nail trim is available in two varieties. Please specify by adding suffix to model number.
NABR
Antique brass

Cherry finishes on Maple
Walnut finishes on Maple
Oak finishes on Maple
Maple finishes on Maple
Please refer to the Washington Series product page on www.gunlocke.com for standard finish options.

U CTB117

Please refer to list of available upholstery and leather selections on www.gunlocke.com

Example

GK3006N.NABR.215.U.DOL728
GK3006N NABR 215 U DOL728
MODEL NUMBER NAIL TRIM FINISH FLAMMABILITY UPHOLSTERY

Lounge Seating	107-198
Product Specifications.	108-109
Calm Lounge Ordering Option Codes.	110-111
Calm	112-130
Ciji	131-191
Iris	192-197
Multi® Lounge	198

LOUNGE SEATING

Product Specifications

CALM

Frame: $\frac{3}{4}$ " x $\frac{3}{4}$ " steel legs with $\frac{3}{4}$ " x 2" cross rails, provides consistent $\frac{3}{4}$ " reveal on all sides.

Deck Frame: Constructed of $\frac{3}{4}$ " upholstery-grade plywood, assembled with box joint joinery using corner blocks, glue and fasteners.

Seat: Plywood seat frame foundation with stretched sheetwebbing suspension, covered with a 1" crown patch, and dual-layer 4 $\frac{1}{4}$ " foam and dacron.

Back: 2"D top surface tapers to 6 $\frac{1}{2}$ "D lumbar thickness for back support structure.

Back Pillows: 5" thick molded foam pillows, with tapered edges, wrapped in dacron. Has black velour panel on lower section of back surface, with HBF Heart-felt back panel used for attachment.

Note: Corner units must be used for modular turns when back support is needed – features two 5" pillows.

Arms: 2"W top surface tapers to 3 $\frac{1}{2}$ "W at bottom of arm.

Arm Pillows: 3" thick molded foam pillows with tapered edges, wrapped in dacron. Has black velour panel at lower section of back surface, with HBF Heart-felt back panel used for attachment.

Ganging Bracket: Black powder coated steel bracket, with slots to mount into 4 t-nuts (order bracket separately).

Glides: $\frac{1}{2}$ " adjustable, threaded steel and nylon leveling glides.

BIFMA Rating:

ANSI/BIFMA X5.4 2020
(275lb Weight Rating)

CIJI

Frame: Upholstery-grade plywood built, box joint construction (using corner blocks, glue and fasteners).

Seat & Back Cushions: Dacron and dual-layer foam over plywood base with flexible foundation, upholstered.

Wood Legs: Tapered, three-sided solid maple. Nickel-plated steel glide $\frac{5}{8}$ " diameter.

Metal Legs: Anodized extruded aluminum. Nickel-plated steel glide $\frac{3}{4}$ " diameter.

Stitch Detail Option: Quilted, single stitch. Available on plain fabrics only.

Ganging Bracket: Plastic male-female alligator clip, 2 pair per unit. (Order separately).

Note: Specify configuration of seating of seating as if you were seated.

Replacement arm can be installed left or right. The replacement seat is for single seat.

Order multiple units for two and three seat lounges and benches.

BIFMA Rating:

ANSI/BIFMA X5.4 2020
(275lb Weight Rating)

IRIS

Lounge Bucket: Fiberglass-reinforced rigid urethane, with overmolded foam and $\frac{1}{2}$ " foam topper, wrapped in dacron. Outside edges wrapped in high-resiliency foam.

Headrest: Fiberglass-reinforced rigid urethane, with overmolded foam, wrapped in dacron. Contains two pocketed steel rods to secure headrest to lounge bucket. Outside edge wrapped in high-resiliency foam.

Wood Legs: Four turned maple or ash hardwood legs, secured into steel assembly with mortise-and-tenon leg attachment. Legs mechanically fastened into steel assembly, inset into rigid urethane bucket. Wood legs taper narrower from top to bottom.

Glides: Nickel-plated steel.

Metal Lounge Base: Four-star metal base, standard with return-to-center cylinder, at a fixed seat height. Comes with low-profile swivel tilt control, with tilt lockout.

Metal Ottoman Base: Four-star metal base, standard with fixed post, at a fixed seat height.

BIFMA Rating:

ANSI/BIFMA X5.4 2020
(275lb Weight Rating)

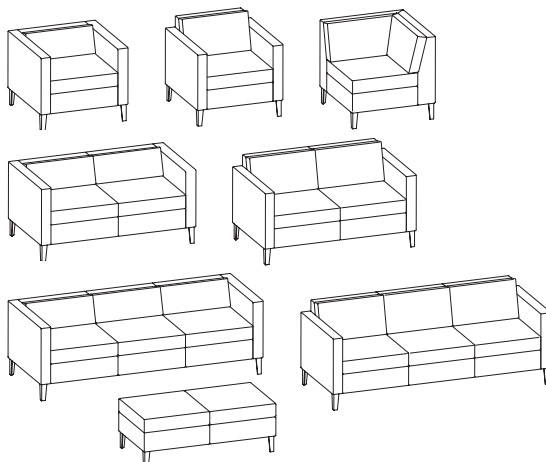

MULTI LOUNGE

Frame: Round tubular steel.

Seat: Foam filled over contoured upholstery, spring foundation webbing.

Back: Foam filled over curved plywood. Upholstered. Triple-stitched.

Arms: Steam-bent hardwood.

Glides: Plastic.

Boot: Flexible textured polyvinyl chloride 2" high (glide model only). Black boot on black frame. Grey boot on silver frame.

Casters: 2" dual wheel (CH).

BIFMA Rating:

ANSI/BIFMA X5.1 2017 w/ additional requirements (300lb Weight Rating)

WOOD FINISH

SELECT VENEERS

NATURAL CHERRY

Cinnamon Cherry	NC260
Lowell Ash	NC394
Medium Red Cherry	NC512
Light Cherry	NC701
Shaker Cherry	NC774
Burnished Cherry	NC777

NATURAL PLAIN SLICED MAPLE

Natural Maple	NE800
Harvest Maple	NE856

NATURAL WALNUT

Light Walnut	NT601
Skyline Walnut	NT625
Nutmeg Walnut	NT629
Pinnacle Walnut	NT679
Sumatra Walnut	NT693
Ebony Walnut	NT555
Florence Walnut	NT579

VENEER 1 (SELECT)

STRATAWOOD CHERRY

Cinnamon/Biltmore	SC260
Lowell Ash	SC394
Clear	SC700
Light	SC701
Shaker	SC774
Burnished	SC777

STRATAWOOD MAPLE

Clear Maple	SE800
Harvest	SE856
Phantom Ecrú	SE912
(Use OP TopFin Only)	
Beigewood	SE878
Field Elm	SE599
Belair	SE934

STRATAWOOD WALNUT

Light	ST601
Skyline	ST625
Pinnacle	ST679
Sumatra	ST693
Florence Walnut	ST579

STRATAWOOD OAK

Clear	SF300
Dark	SF331

STRATAWOOD SILVER OAK

Clear	SB100
Portico Teak	SB150

STRATAWOOD WASHED WALNUT

Clear	SW600
Smoked Onyx	SW697
Smoked Grey	SW612

PREMIER VENEERS

NATURAL QUARTER CUT WALNUT

Light Walnut	QT601
Skyline Walnut	QT625
Nutmeg Walnut	QT629
Pinnacle Walnut	QT679
Sumatra Walnut	QT693
Ebony Walnut	QT555
Florence Walnut	QT579

NATURAL RIFT CUT OAK

Light Rift Cut Oak	RF301
Dark Rift Cut Oak	RF331
Phantom Ecrú	RF912
Fawn Cypress	RF108

UV TOP FINISH

Worksurfaces feature two low emitting UV finish options that enhance the beauty of natural wood and ensures the depth, clarity, color consistency and durability throughout the life of the product

Full-Fill Cleartech (upcharge)	FF
Open Pore Low Sheen	OP

Finish options are subject to change. For new finish information, visit us online www.gunlocke.com/finishsystem

LAMINATE

SELECT LAMINATES

SOLID – Grade 1

Designer White 15051	LDW1
Loft – Grey Cloud	LM11
Charcoal/Flint	LM16

WOODGRAIN – Grade 1

Natural Maple	LWD
Harvest Maple	C
Shaker Cherry	LW7C
Biltmore Cherry	COGN
Pinnacle Walnut	PINC
Florence Walnut	LFW1
Kingswood Walnut	LKI1
Neo Walnut	LNV1

WOODGRAIN – GRADE 2

Fawn Cypress	LFC1
Lowell Ash	LLA1
Natural Recon	LNR1
Phantom Ecu	LPE1
Portico Teak	LPT1
Skyline Walnut	LSW1
Veranda Teak	LVT1

GLASS (12mm soft etched)

Ice White -Designer White	GWH
Black	GBK
Muslin	GML

SOLID SURFACE (12mm solid)

Ebony Skies	SES
Designer White	SDW
Cameo White (Alabaster White)	SAW

Finish options are subject to change. For new finish information, visit us online
www.gunlocke.com/finishsystem

CALM

One Seat Lounge with Arms

Seating
05/22

model number	fabric grades								dimensions	W	D	H
GLGB17-011 One seat, with arms	1	3,983	10	5,702	19	7,943	L1	6,882	Overall	32"	32"	30"
	2	4,139	11	5,911	20	8,204	L2	9,250	Seat	18"	21"	17"
	3	4,296	12	6,119	21	8,464	L3	12,092	Arm			30"
	COM/4	4,452	13	6,380	22	8,724	L4	14,461	Between arms	18" - 21"		
	5	4,660	14	6,640	23	9,246	L5	16,829				
	6	4,869	15	6,901	24	9,767						
	7	5,077	16	7,162	25	10,288						
	8	5,286	17	7,422	26	10,809						
	9	5,494	18	7,682	27	11,330						
	Upholstery Requirements: GLGB17-011											
										Dual Upholstery		
Fabric yds										Cushion 4		Frame 5
Leather ft ²										Cushion 100		Frame 125
Shipping weight										95 lbs.		
Cube										23.4		

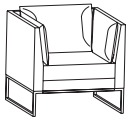

Cushion	1	10	764	19	1,760	L1	1,288
	2	69	11	857	20	L2	2,341
	3	139	12	949	21	L3	3,604
	COM/4	208	13	1,065	22	L4	4,657
	5	301	14	1,181	23	L5	5,709
	6	394	15	1,297	24		
	7	486	16	1,413	25		
	8	579	17	1,528	26		
	9	672	18	1,644	27		

Top row of pricing is for units specified with same fabric on cushion and frame. Bottom 2 rows of pricing required only when two different fabric grades are selected for the cushion and frame.

To calculate price of lounge with different grade fabric for cushion and frame; start with Grade 1 price, add appropriate grade price located in second row for cushion, and last add appropriate grade price located in third row for frame to the sum of the Grade 1 and cushion price.

Example: Grade 1 \$3,983 + grade 4 fabric cushion \$208 + grade 2 fabric frame \$87 = \$4,278

Frame	1	10	955	19	2,200	L1	1,611
	2	87	11	1,071	20	L2	2,926
	3	174	12	1,187	21	L3	4,505
	COM/4	261	13	1,332	22	L4	5,821
	5	376	14	1,476	23	L5	7,137
	6	492	15	1,621	24		
	7	608	16	1,766	25		
	8	724	17	1,911	26		
	9	839	18	2,055	27		

Select upholstery for everything else other than the seat and back cushions (the outside back, arms, sides, seat frame). You can specify the same fabric as the cushions or select other fabric.

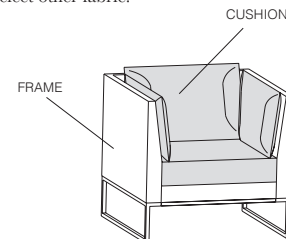

TO ORDER PLEASE SPECIFY THE FOLLOWING:

<input type="text"/>	<input type="text"/>	<input type="text"/>	<input type="text"/>	<input type="text"/>
MODEL NUMBER	FRAME COLOR	FLAMMABILITY RATING	CUSHION UPHOLSTERY	FRAME UPHOLSTERY
	Polished Chrome Brushed Chrome Steel Black Designer White Matte Gold Silver Solar Black Titanium Bullseye Regatta	PC +\$125 BS +\$125 P71 PJW P8G PR6 P8X P8T PJF P8M	U CTB117	Please refer to list of available upholstery and leather selections on www.gunlocke.com
				Please refer to list of available upholstery and leather selections on www.gunlocke.com

Example

GLGB17-011.PC.U.DOL728.SPNN04
 GLGB17-011 PC U DOL728 SPNN04
 MODEL NUMBER FRAME COLOR FLAMMABILITY CUSHION UPHOLSTERY FRAME UPHOLSTERY

model number	fabric grades							dimensions	W	D	H	
GLGB17-021 One seat, armless	1	3,387	10	4,342	19	5,587	L1	4,998	Overall	25"	32"	30"
	2	3,474	11	4,458	20	5,732	L2	6,314	Seat	25"	21"	17"
	3	3,560	12	4,574	21	5,876	L3	7,892	Upholstery Requirements: GLGB17-021			
	COM/4	3,648	13	4,719	22	6,021	L4	9,208	Dual Upholstery			
	5	3,764	14	4,864	23	6,310	L5	10,524	Fabric yds Cushion 2.2 Frame 2.8			
	6	3,880	15	5,008	24	6,600			Leather ft ² Cushion 55 Frame 70			
	7	3,994	16	5,153	25	6,889			Shipping weight 130 lbs.			
	8	4,110	17	5,298	26	7,180			Cube 18.7			
	9	4,226	18	5,442	27	7,469						



Cushion								
1	10	420	19	968	L1	709		
2	38	11	471	20	L2	1,288		
3	76	12	522	21	L3	1,982		
COM/4	115	13	586	22	L4	2,561		
5	166	14	650	23	L5	3,140		
6	217	15	713	24				
7	267	16	777	25				
8	318	17	841	26				
9	369	18	904	27				

Top row of pricing is for units specified with same fabric on cushion and frame. Bottom 2 rows of pricing required only when two different fabric grades are selected for the cushion and frame.

To calculate price of lounge with different grade fabric for cushion and frame; start with Grade 1 price, add appropriate grade price located in second row for cushion, and last add appropriate grade price located in third row for frame to the sum of the Grade 1 and cushion price.

Example: Grade 1 \$3,387 + grade 4 fabric cushion \$115 + grade 2 fabric frame \$49 = \$3,551

Frame								
1	10	535	19	1,232	L1	902		
2	49	11	600	20	L2	1,639		
3	97	12	665	21	L3	2,523		
COM/4	146	13	746	22	L4	3,260		
5	211	14	827	23	L5	3,997		
6	276	15	908	24				
7	340	16	989	25				
8	405	17	1,070	26				
9	470	18	1,151	27				

Select upholstery for everything else other than the seat and back cushions (the outside back, arms, sides, seat frame). You can specify the same fabric as the cushions or select other fabric.

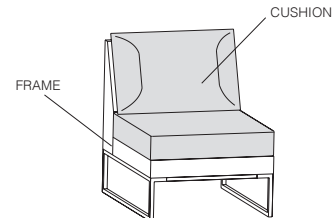

TO ORDER PLEASE SPECIFY THE FOLLOWING:

<input type="text"/>	<input type="text"/>	<input type="text"/>	<input type="text"/>	<input type="text"/>
MODEL NUMBER	FRAME COLOR	FLAMMABILITY RATING	CUSHION UPHOLSTERY	FRAME UPHOLSTERY
	Polished Chrome Brushed Chrome Steel Black Designer White Matte Gold Silver Solar Black Titanium Bullseye Regatta	PC +\$125 BS +\$125 P71 PJW P8G PR6 P8X P8T PJF P8M	U CTB117	Please refer to list of available upholstery and leather selections on www.gunlocke.com
				Please refer to list of available upholstery and leather selections on www.gunlocke.com

Example

GLGB17-021.PC.U.DOL728.SPNN04				
GLGB17-021	PC	U	DOL728	SPNN04
MODEL NUMBER	FRAME COLOR	FLAMMABILITY	CUSHION UPHOLSTERY	FRAME UPHOLSTERY

CALM

One Seat Lounge, Arm Left

Seating
05/22

model number fabric grades dimensions W D H

GLGB17-031
One seat, arm left

1	3,684	10	4,926	19	6,544	L1	5,777
2	3,797	11	5,077	20	6,732	L2	7,488
3	3,910	12	5,227	21	6,921	L3	9,541
COM/4	4,022	13	5,415	22	7,109	L4	11,252
5	4,173	14	5,603	23	7,485	L5	12,962
6	4,323	15	5,792	24	7,861		
7	4,475	16	5,979	25	8,238		
8	4,625	17	6,167	26	8,613		
9	4,776	18	6,356	27	8,990		

Overall	28 1/2"	32"	30"
Seat	21 1/2"	21"	17"
Arm			30"

Upholstery Requirements: GLGB17-031

	Dual Upholstery		
Fabric yds	Cushion 3	Frame 3.5	
Leather ft ²	Cushion 75	Frame 87.5	
Shipping weight	140 lbs.		
Cube	21.1		



Cushion

1		10	573	19	1,320	L1	966
2	52	11	643	20	1,407	L2	1,756
3	104	12	712	21	1,494	L3	2,703
COM/4	156	13	799	22	1,581	L4	3,493
5	226	14	886	23	1,754	L5	4,282
6	295	15	973	24	1,928		
7	365	16	1,059	25	2,102		
8	434	17	1,146	26	2,275		
9	504	18	1,233	27	2,449		

Top row of pricing is for units specified with same fabric on cushion and frame. Bottom 2 rows of pricing required only when two different fabric grades are selected for the cushion and frame.

To calculate price of lounge with different grade fabric for cushion and frame; start with Grade 1 price, add appropriate grade price located in second row for cushion, and last add appropriate grade price located in third row for frame to the sum of the Grade 1 and cushion price.

Example: Grade 1 \$3,684 + grade 4 fabric cushion \$156 + grade 2 fabric frame \$61 = \$3,901

Frame

1		10	669	19	1,540	L1	1,127
2	61	11	750	20	1,641	L2	2,048
3	122	12	831	21	1,743	L3	3,154
COM/4	182	13	932	22	1,844	L4	4,075
5	263	14	1,033	23	2,047	L5	4,996
6	344	15	1,135	24	2,249		
7	426	16	1,236	25	2,452		
8	507	17	1,337	26	2,654		
9	588	18	1,439	27	2,857		

Select upholstery for everything else other than the seat and back cushions (the outside back, arms, sides, seat frame). You can specify the same fabric as the cushions or select other fabric.

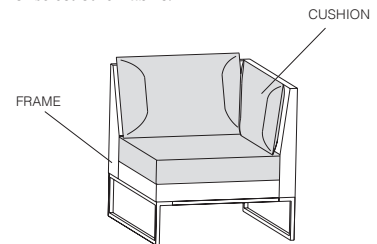

TO ORDER PLEASE SPECIFY THE FOLLOWING:

<input type="text"/>	<input type="text"/>	<input type="text"/>	<input type="text"/>	<input type="text"/>
MODEL NUMBER	FRAME COLOR	FLAMMABILITY RATING	CUSHION UPHOLSTERY	FRAME UPHOLSTERY
	Polished Chrome Brushed Chrome Steel Black Designer White Matte Gold Silver Solar Black Titanium Bullseye Regatta	PC +\$125 BS +\$125 P71 PJW P8G PR6 P8X P8T PJF P8M	U CTB117	Please refer to list of available upholstery and leather selections on www.gunlocke.com

Example

GLGB17-031.PC.U.DOL728.SPNN04				
GLGB17-031	PC	U	DOL728	SPNN04
MODEL NUMBER	FRAME COLOR	FLAMMABILITY	CUSHION UPHOLSTERY	FRAME UPHOLSTERY

model number fabric grades dimensions W D H

GLGB17-041

One seat, arm right



1	3,684	10	4,926	19	6,544	L1	5,777
2	3,797	11	5,077	20	6,732	L2	7,488
3	3,910	12	5,227	21	6,921	L3	9,541
COM/4	4,022	13	5,415	22	7,109	L4	11,252
5	4,173	14	5,603	23	7,485	L5	12,962
6	4,323	15	5,792	24	7,861		
7	4,475	16	5,979	25	8,238		
8	4,625	17	6,167	26	8,613		
9	4,776	18	6,356	27	8,990		

Overall	28 1/2"	32"	30"
Seat	21 1/2"	21"	17"
Arm			30"

Upholstery Requirements: GLGB17-041

	Dual Upholstery		
Fabric yds	Cushion 3	Frame 3.5	
Leather ft ²	Cushion 75	Frame 87.5	
Shipping weight			140 lbs.
Cube			21.1

Cushion

1	10	573	19	1,320	L1	966
2	52	11	643	20	L2	1,756
3	104	12	712	21	L3	2,703
COM/4	156	13	799	22	L4	3,493
5	226	14	886	23	L5	4,282
6	295	15	973	24		
7	365	16	1,059	25		
8	434	17	1,146	26		
9	504	18	1,233	27		

Top row of pricing is for units specified with same fabric on cushion and frame. Bottom 2 rows of pricing required only when two different fabric grades are selected for the cushion and frame.

To calculate price of lounge with different grade fabric for cushion and frame; start with Grade 1 price, add appropriate grade price located in second row for cushion, and last add appropriate grade price located in third row for frame to the sum of the Grade 1 and cushion price.

Example: Grade 1 \$3,684 + grade 4 fabric cushion \$156 + grade 2 fabric frame \$61 = \$3,901

Frame

1	10	669	19	1,540	L1	1,127
2	61	11	750	20	L2	2,048
3	122	12	831	21	L3	3,154
COM/4	182	13	932	22	L4	4,075
5	263	14	1,033	23	L5	4,996
6	344	15	1,135	24		
7	426	16	1,236	25		
8	507	17	1,337	26		
9	588	18	1,439	27		

Select upholstery for everything else other than the seat and back cushions (the outside back, arms, sides, seat frame). You can specify the same fabric as the cushions or select other fabric.

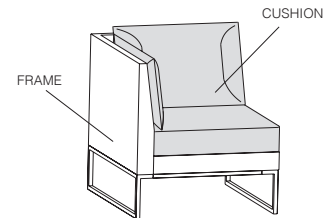

TO ORDER PLEASE SPECIFY THE FOLLOWING:

<input type="text"/>	<input type="text"/>	<input type="text"/>	<input type="text"/>	<input type="text"/>
MODEL NUMBER	FRAME COLOR	FLAMMABILITY RATING	CUSHION UPHOLSTERY	FRAME UPHOLSTERY
	Polished Chrome Brushed Chrome Steel Black Designer White Matte Gold Silver Solar Black Titanium Bullseye Regatta	PC +\$125 BS +\$125 P71 PJW P8G PR6 P8X P8T PJF P8M	U CTB117 Please refer to list of available upholstery and leather selections on www.gunlocke.com	Please refer to list of available upholstery and leather selections on www.gunlocke.com

Example

GLGB17-041.PC.U.DOL728.SPNN04				
GLGB17-041	PC	U	DOL728	SPNN04
MODEL NUMBER	FRAME COLOR	FLAMMABILITY	CUSHION UPHOLSTERY	FRAME UPHOLSTERY

CALM

Two Seat Lounge with Arms

Seating
05/22

model number	fabric grades								dimensions	W	D	H
GLGB17-052 Two seat, with arms	1	5,458	10	7,846	19	10,958	L1	9,485	Overall	57"	32"	30"
	2	5,675	11	8,135	20	11,320	L2	12,774	Seat	43"	21"	17"
	3	5,892	12	8,425	21	11,681	L3	16,721	Arm			30"
	COM/4	6,110	13	8,787	22	12,043	L4	20,010	Between arms	43" - 46"		
	5	6,399	14	9,149	23	12,767	L5	23,300	Upholstery Requirements: GLGB17-052			
	6	6,689	15	9,510	24	13,491			Dual Upholstery			
	7	6,977	16	9,873	25	14,214			Fabric yds Cushion 6 Frame 6.5			
	8	7,267	17	10,235	26	14,939			Leather ft ² Cushion 150 Frame 162.5			
	9	7,556	18	10,596	27	15,662			Shipping weight 190 lbs.			
									Cube 40.1			

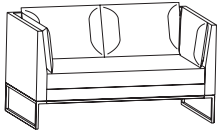

Cushion	1	10	1,146	19	2,640	L1	1,933	
	2	104	11	1,285	20	2,814	L2	3,512
	3	208	12	1,424	21	2,987	L3	5,406
	COM/4	313	13	1,598	22	3,161	L4	6,985
	5	452	14	1,772	23	3,508	L5	8,564
	6	591	15	1,945	24	3,856		
	7	729	16	2,119	25	4,203		
	8	868	17	2,293	26	4,551		
	9	1,007	18	2,466	27	4,898		

Top row of pricing is for units specified with same fabric on cushion and frame. Bottom 2 rows of pricing required only when two different fabric grades are selected for the cushion and frame.

To calculate price of lounge with different grade fabric for cushion and frame; start with Grade 1 price, add appropriate grade price located in second row for cushion, and last add appropriate grade price located in third row for frame to the sum of the Grade 1 and cushion price.

Example: Grade 1 \$5,458 + grade 4 fabric cushion \$313 + grade 2 fabric frame \$113 = \$5,884

Frame	1	10	1,242	19	2,860	L1	2,094	
	2	113	11	1,392	20	3,048	L2	3,804
	3	226	12	1,543	21	3,236	L3	5,857
	COM/4	339	13	1,731	22	3,424	L4	7,567
	5	489	14	1,919	23	3,801	L5	9,278
	6	640	15	2,107	24	4,177		
	7	790	16	2,296	25	4,553		
	8	941	17	2,484	26	4,930		
	9	1,091	18	2,672	27	5,306		

Select upholstery for everything else other than the seat and back cushions (the outside back, arms, sides, seat frame). You can specify the same fabric as the cushions or select other fabric.

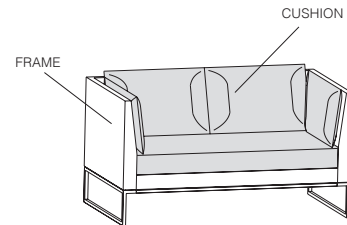

TO ORDER PLEASE SPECIFY THE FOLLOWING:

<input type="text"/>	<input type="text"/>	<input type="text"/>	<input type="text"/>	<input type="text"/>
MODEL NUMBER	FRAME COLOR	FLAMMABILITY RATING	CUSHION UPHOLSTERY	FRAME UPHOLSTERY
	Polished Chrome Brushed Chrome Steel Black Designer White Matte Gold Silver Solar Black Titanium Bullseye Regatta	PC +\$150 BS +\$150 P71 PJW P8G PR6 P8X P8T PJF P8M	U CTB117	Please refer to list of available upholstery and leather selections on www.gunlocke.com

Example

GLGB17-052.PC.U.DOL728.SPNN04				
GLGB17-052	PC	U	DOL728	SPNN04
MODEL NUMBER	FRAME COLOR	FLAMMABILITY	CUSHION UPHOLSTERY	FRAME UPHOLSTERY

model number	fabric grades								dimensions	W	D	H
GLGB17-062 Two seat, armless	1	4,639	10	6,167	19	8,159	L1	7,216	Overall	50"	32"	30"
	2	4,778	11	6,353	20	8,391	L2	9,321	Seat	50"	21"	17"
	3	4,917	12	6,538	21	8,622	L3	11,847	Upholstery Requirements: GLGB17-062			
	COM/4	5,056	13	6,770	22	8,854	L4	13,953	Dual Upholstery			
	5	5,241	14	7,001	23	9,317	L5	16,058	Fabric yds Cushion 4.2 Frame 3.8			
	6	5,426	15	7,233	24	9,780			Leather ft ² Cushion 105 Frame 95			
	7	5,612	16	7,464	25	10,243			Shipping weight 170 lbs.			
	8	5,797	17	7,696	26	10,706			Cube 35.4			
	9	5,982	18	7,927	27	11,170						

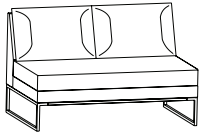

Cushion	1	10	802	19	1,848	L1	1,353	
	2	73	11	900	20	1,970	L2	2,458
	3	146	12	997	21	2,091	L3	3,784
	COM/4	219	13	1,119	22	2,213	L4	4,890
	5	316	14	1,240	23	2,456	L5	5,995
	6	413	15	1,362	24	2,699		
	7	511	16	1,483	25	2,942		
	8	608	17	1,605	26	3,185		
	9	705	18	1,726	27	3,429		

Top row of pricing is for units specified with same fabric on cushion and frame. Bottom 2 rows of pricing required only when two different fabric grades are selected for the cushion and frame.

To calculate price of lounge with different grade fabric for cushion and frame; start with Grade 1 price, add appropriate grade price located in second row for cushion, and last add appropriate grade price located in third row for frame to the sum of the Grade 1 and cushion price.

Example: Grade 1 \$4,639 + grade 4 fabric cushion \$219 + grade 2 fabric frame \$66 = \$4,654

Frame	1	10	726	19	1,672	L1	1,224	
	2	66	11	814	20	1,782	L2	2,224
	3	132	12	902	21	1,892	L3	3,424
	COM/4	198	13	1,012	22	2,002	L4	4,424
	5	286	14	1,122	23	2,222	L5	5,424
	6	374	15	1,232	24	2,442		
	7	462	16	1,342	25	2,662		
	8	550	17	1,452	26	2,882		
	9	638	18	1,562	27	3,102		

Select upholstery for everything else other than the seat and back cushions (the outside back, arms, sides, seat frame). You can specify the same fabric as the cushions or select other fabric.

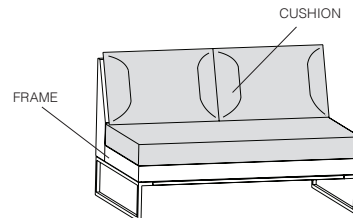

TO ORDER PLEASE SPECIFY THE FOLLOWING:

<input type="text"/>	<input type="text"/>	<input type="text"/>	<input type="text"/>	<input type="text"/>
MODEL NUMBER	FRAME COLOR	FLAMMABILITY RATING	CUSHION UPHOLSTERY	FRAME UPHOLSTERY
	Polished Chrome Brushed Chrome Steel Black Designer White Matte Gold Silver Solar Black Titanium Bullseye Regatta	PC +\$150 BS +\$150 P71 PJW P8G PR6 P8X P8T PJF P8M	U CTB117 Please refer to list of available upholstery and leather selections on www.gunlocke.com	Please refer to list of available upholstery and leather selections on www.gunlocke.com

Example

GLGB17-062.PC.U.DOL728.SPNN04				
GLGB17-062	PC	U	DOL728	SPNN04
MODEL NUMBER	FRAME COLOR	FLAMMABILITY	CUSHION UPHOLSTERY	FRAME UPHOLSTERY

CALM

Two Seat Lounge, Arm Left

Seating
05/22

model number fabric grades dimensions W D H

GLGB17-072
Two seat, arm left

1	5,049	10	6,921	19	9,361	L1	8,206
2	5,219	11	7,148	20	9,645	L2	10,784
3	5,390	12	7,375	21	9,928	L3	13,879
COM/4	5,560	13	7,659	22	10,212	L4	16,458
5	5,786	14	7,942	23	10,780	L5	19,037
6	6,013	15	8,226	24	11,347		
7	6,241	16	8,510	25	11,915		
8	6,468	17	8,794	26	12,481		
9	6,694	18	9,077	27	13,049		

Overall	53 1/2"	32"	30"
Seat	46 1/2"	19 1/4"	17 "
Arm			30"

Upholstery Requirements: GLGB17-072

	Dual Upholstery	
Fabric yds	Cushion 5	Frame 4.75
Leather ft ²	Cushion 125	Frame 118.8
Shipping weight	180 lbs.	
Cube	37.8	

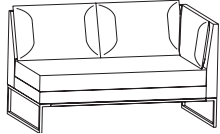

Cushion

1	10	955	19	2,200	L1	1,611
2	87	11	1,071	20	L2	2,926
3	174	12	1,187	21	L3	4,505
COM/4	261	13	1,332	22	L4	5,821
5	376	14	1,476	23	L5	7,137
6	492	15	1,621	24		
7	608	16	1,766	25		
8	724	17	1,911	26		
9	839	18	2,055	27		

Top row of pricing is for units specified with same fabric on cushion and frame. Bottom 2 rows of pricing required only when two different fabric grades are selected for the cushion and frame.

To calculate price of lounge with different grade fabric for cushion and frame; start with Grade 1 price, add appropriate grade price located in second row for cushion, and last add appropriate grade price located in third row for frame to the sum of the Grade 1 and cushion price.

Example: Grade 1 \$5,049 + grade 4 fabric cushion \$261 + grade 2 fabric frame \$83 = \$5,393

Frame

1	10	917	19	2,112	L1	1,546
2	83	11	1,028	20	L2	2,809
3	167	12	1,139	21	L3	4,325
COM/4	250	13	1,278	22	L4	5,588
5	361	14	1,417	23	L5	6,851
6	472	15	1,556	24		
7	584	16	1,695	25		
8	695	17	1,834	26		
9	806	18	1,973	27		

Select upholstery for everything else other than the seat and back cushions (the outside back, arms, sides, seat frame). You can specify the same fabric as the cushions or select other fabric.

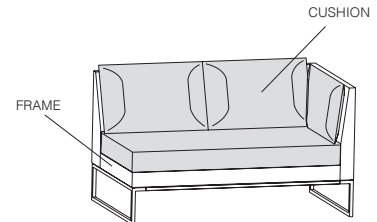

TO ORDER PLEASE SPECIFY THE FOLLOWING:

<input type="text"/>	<input type="text"/>	<input type="text"/>	<input type="text"/>	<input type="text"/>
MODEL NUMBER	FRAME COLOR	FLAMMABILITY RATING	CUSHION UPHOLSTERY	FRAME UPHOLSTERY
	Polished Chrome Brushed Chrome Steel Black Designer White Matte Gold Silver Solar Black Titanium Bullseye Regatta	PC +\$150 BS +\$150 P71 PJW P8G PR6 P8X P8T PJF P8M	U CTB117 Please refer to list of available upholstery and leather selections on www.gunlocke.com	Please refer to list of available upholstery and leather selections on www.gunlocke.com

Example

GLGB17-072.PC.U.DOL728.SPNN04

GLGB17-072	PC	U	DOL728	SPNN04
MODEL NUMBER	FRAME COLOR	FLAMMABILITY	CUSHION UPHOLSTERY	FRAME UPHOLSTERY

model number fabric grades dimensions W D H

GLGB17-082

Two seat, arm right

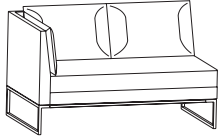

1	5,049	10	6,921	19	9,361	L1	8,206
2	5,219	11	7,148	20	9,645	L2	10,784
3	5,390	12	7,375	21	9,928	L3	13,879
COM/4	5,560	13	7,659	22	10,212	L4	16,458
5	5,786	14	7,942	23	10,780	L5	19,037
6	6,013	15	8,226	24	11,347		
7	6,241	16	8,510	25	11,915		
8	6,468	17	8,794	26	12,481		
9	6,694	18	9,077	27	13,049		

Overall	53 1/2"	32"	30"
Seat	46 1/2"	21"	17"
Arm			30"

Upholstery Requirements: GLGB17-082

	Dual Upholstery	
Fabric yds	Cushion 5	Frame 4.75
Leather ft ²	Cushion 125	Frame 118.75
Shipping weight	180 lbs.	
Cube	37.8	

Cushion

1	10	955	19	2,200	L1	1,611
2	87	11	1,071	20	L2	2,926
3	174	12	1,187	21	L3	4,505
COM/4	261	13	1,332	22	L4	5,821
5	376	14	1,476	23	L5	7,137
6	492	15	1,621	24		
7	608	16	1,766	25		
8	724	17	1,911	26		
9	839	18	2,055	27		

Top row of pricing is for units specified with same fabric on cushion and frame. Bottom 2 rows of pricing required only when two different fabric grades are selected for the cushion and frame.

To calculate price of lounge with different grade fabric for cushion and frame; start with Grade 1 price, add appropriate grade price located in second row for cushion, and last add appropriate grade price located in third row for frame to the sum of the Grade 1 and cushion price.

Example: Grade 1 \$5,049 + grade 4 fabric cushion \$261 + grade 2 fabric frame \$83 = \$5,393

Frame

1	10	917	19	2,112	L1	1,546
2	83	11	1,028	20	L2	2,809
3	167	12	1,139	21	L3	4,325
COM/4	250	13	1,278	22	L4	5,588
5	361	14	1,417	23	L5	6,851
6	472	15	1,556	24		
7	584	16	1,695	25		
8	695	17	1,834	26		
9	806	18	1,973	27		

Select upholstery for everything else other than the seat and back cushions (the outside back, arms, sides, seat frame). You can specify the same fabric as the cushions or select other fabric.

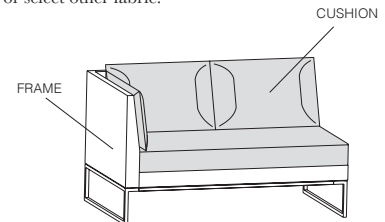

TO ORDER PLEASE SPECIFY THE FOLLOWING:

<input type="text"/>	<input type="text"/>	<input type="text"/>	<input type="text"/>	<input type="text"/>
MODEL NUMBER	FRAME COLOR	FLAMMABILITY RATING	CUSHION UPHOLSTERY	FRAME UPHOLSTERY
	Polished Chrome Brushed Chrome Steel Black Designer White Matte Gold Silver Solar Black Titanium Bullseye Regatta	PC +\$150 BS +\$150 P71 PJW P8G PR6 P8X P8T PJF P8M	U CTB117 Please refer to list of available upholstery and leather selections on www.gunlocke.com	Please refer to list of available upholstery and leather selections on www.gunlocke.com

Example

GLGB17-082.PC.U.DOL728.SPNN04

GLGB17-082	PC	U	DOL728	SPNN04
MODEL NUMBER	FRAME COLOR	FLAMMABILITY	CUSHION UPHOLSTERY	FRAME UPHOLSTERY

CALM

Three Seat Lounge, with Arms

Seating
05/22

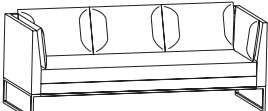
model number	fabric grades								dimensions	W	D	H
GLGB17-093 Three seat, with arms 	1	6,853	10	10,025	19	14,157	L1	12,199	Overall	82"	32"	30"
	2	7,141	11	10,409	20	14,637	L2	16,569	Seat	68"	21"	17"
	3	7,429	12	10,793	21	15,119	L3	21,811	Arm			30"
	COM/4	7,717	13	11,273	22	15,599	L4	26,179	Between arms	68" - 71"		
	5	8,103	14	11,755	23	16,559	L5	30,547	Upholstery Requirements: GLGB17-093			
	6	8,487	15	12,235	24	17,521			Dual Upholstery			
	7	8,871	16	12,715	25	18,481			Fabric yds Cushion 8.3 Frame 8.3			
	8	9,255	17	13,195	26	19,443			Leather ft ² Cushion 207.5 Frame 207.5			
	9	9,641	18	13,677	27	20,403			Shipping weight 300 lbs.			
									Cube 56.8			

Cushion	1	10	1,586	19	3,652	L1	2,673	
	2	144	11	1,778	20	3,892	L2	4,858
	3	288	12	1,970	21	4,133	L3	7,479
	COM/4	432	13	2,210	22	4,373	L4	9,663
	5	625	14	2,451	23	4,853	L5	11,847
	6	817	15	2,691	24	5,334		
	7	1,009	16	2,931	25	5,814		
	8	1,201	17	3,171	26	6,295		
	9	1,394	18	3,412	27	6,775		

Top row of pricing is for units specified with same fabric on cushion and frame. Bottom 2 rows of pricing required only when two different fabric grades are selected for the cushion and frame.

To calculate price of lounge with different grade fabric for cushion and frame; start with Grade 1 price, add appropriate grade price located in second row for cushion, and last add appropriate grade price located in third row for frame to the sum of the Grade 1 and cushion price.

Example: Grade 1 \$6,853 + grade 4 fabric cushion \$432 + grade 2 fabric frame \$144 = \$7,429

Frame	1	10	1,586	19	3,652	L1	2,673	
	2	144	11	1,778	20	3,892	L2	4,858
	3	288	12	1,970	21	4,133	L3	7,479
	COM/4	432	13	2,210	22	4,373	L4	9,663
	5	625	14	2,451	23	4,853	L5	11,847
	6	817	15	2,691	24	5,334		
	7	1,009	16	2,931	25	5,814		
	8	1,201	17	3,171	26	6,295		
	9	1,394	18	3,412	27	6,775		

Select upholstery for everything else other than the seat and back cushions (the outside back, arms, sides, seat frame). You can specify the same fabric as the cushions or select other fabric.

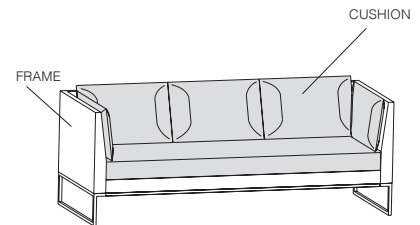

TO ORDER PLEASE SPECIFY THE FOLLOWING:

<input type="text"/>	<input type="text"/>	<input type="text"/>	<input type="text"/>	<input type="text"/>
MODEL NUMBER	FRAME COLOR	FLAMMABILITY RATING	CUSHION UPHOLSTERY	FRAME UPHOLSTERY
	Polished Chrome Brushed Chrome Steel Black Designer White Matte Gold Silver Solar Black Titanium Bullseye Regatta	PC +\$200 BS +\$200 P71 PJW P8G PR6 P8X P8T PJF P8M	U CTB117	Please refer to list of available upholstery and leather selections on www.gunlocke.com
				Please refer to list of available upholstery and leather selections on www.gunlocke.com

Example

GLGB17-093.PC.U.DOL728.SPNN04				
GLGB17-093	PC	U	DOL728	SPNN04
MODEL NUMBER	FRAME COLOR	FLAMMABILITY	CUSHION UPHOLSTERY	FRAME UPHOLSTERY

model number fabric grades dimensions W D H

GLGB17-103

Three seat, armless

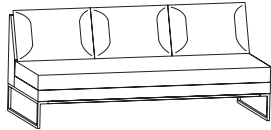

1	5,825	10	8,042	19	10,929	L1	9,561
2	6,026	11	8,310	20	11,264	L2	12,614
3	6,228	12	8,578	21	11,601	L3	16,278
COM/4	6,429	13	8,914	22	11,936	L4	19,330
5	6,698	14	9,250	23	12,608	L5	22,382
6	6,967	15	9,586	24	13,280		
7	7,235	16	9,922	25	13,951		
8	7,504	17	10,257	26	14,623		
9	7,773	18	10,594	27	15,294		

Overall	75"	32"	30"
Seat	75"	21"	17"

Upholstery Requirements: GLGB17-103

Dual Upholstery		
Fabric yds	Cushion 6.3	Frame 5.3
Leather ft ²	Cushion 156.3	Frame 131.5
Shipping weight	280 lbs.	
Cube	52.1	

Cushion

1	10	1,204	19	2,772	L1	2,029
2	109	11	1,350	20	L2	3,687
3	219	12	1,495	21	L3	5,677
COM/4	328	13	1,678	22	L4	7,335
5	474	14	1,860	23	L5	8,992
6	620	15	2,043	24		
7	766	16	2,225	25		
8	912	17	2,407	26		
9	1,058	18	2,590	27		

Top row of pricing is for units specified with same fabric on cushion and frame. Bottom 2 rows of pricing required only when two different fabric grades are selected for the cushion and frame.

To calculate price of lounge with different grade fabric for cushion and frame; start with Grade 1 price, add appropriate grade price located in second row for cushion, and last add appropriate grade price located in third row for frame to the sum of the Grade 1 and cushion price.

Example: Grade 1 \$5,825 + grade 4 fabric cushion \$328 + grade 2 fabric frame \$92 = \$6,245

Frame

1	10	1,013	19	2,332	L1	1,707
2	92	11	1,135	20	L2	3,102
3	184	12	1,258	21	L3	4,776
COM/4	276	13	1,411	22	L4	6,170
5	399	14	1,565	23	L5	7,565
6	522	15	1,718	24		
7	644	16	1,872	25		
8	767	17	2,025	26		
9	890	18	2,179	27		

Select upholstery for everything else other than the seat and back cushions (the outside back, arms, sides, seat frame). You can specify the same fabric as the cushions or select other fabric.

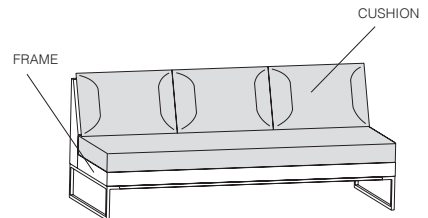

TO ORDER PLEASE SPECIFY THE FOLLOWING:

<input type="text"/>	<input type="text"/>	<input type="text"/>	<input type="text"/>	<input type="text"/>
MODEL NUMBER	FRAME COLOR	FLAMMABILITY RATING	CUSHION UPHOLSTERY	FRAME UPHOLSTERY
	Polished Chrome Brushed Chrome Steel Black Designer White Matte Gold Silver Solar Black Titanium Bullseye Regatta	PC +\$200 BS +\$200 P71 PJW P8G PR6 P8X P8T PJF P8M	U CTB117 Please refer to list of available upholstery and leather selections on www.gunlocke.com	Please refer to list of available upholstery and leather selections on www.gunlocke.com

Example

GLGB17-103.PC.U.DOL728.SPNN04
 GLGB17-103 PC U DOL728 SPNN04
 MODEL NUMBER FRAME COLOR FLAMMABILITY CUSHION UPHOLSTERY FRAME UPHOLSTERY

CALM

Three Seat Lounge, Arm Left

Seating
05/22

model number fabric grades dimensions W D H

GLGB17-113

Three seat, arm left



1	6,337	10	8,973	19	12,409	L1	10,782
2	6,577	11	9,293	20	12,809	L2	14,414
3	6,816	12	9,613	21	13,208	L3	18,771
COM/4	7,056	13	10,012	22	13,608	L4	22,403
5	7,376	14	10,412	23	14,406	L5	26,035
6	7,695	15	10,811	24	15,205		
7	8,015	16	11,210	25	16,005		
8	8,334	17	11,610	26	16,803		
9	8,654	18	12,009	27	17,602		

Overall	78 1/2"	32"	30"
Seat	71 1/2"	21"	17"
Arm			30"

Upholstery Requirements: GLGB17-113

	Dual Upholstery	
Fabric yds	Cushion 7	Frame 6.75
Leather ft ²	Cushion 75	Frame 168.8
Shipping weight	290 lbs.	
Cube	54.5	

Cushion

1	10	1,337	19	3,080	L1	2,255
2	122	11	1,499	20	L2	4,097
3	243	12	1,662	21	L3	6,307
COM/4	365	13	1,864	22	L4	8,149
5	527	14	2,067	23	L5	9,992
6	689	15	2,269	24		
7	851	16	2,472	25		
8	1,013	17	2,675	26		
9	1,175	18	2,877	27		

Top row of pricing is for units specified with same fabric on cushion and frame. Bottom 2 rows of pricing required only when two different fabric grades are selected for the cushion and frame.

To calculate price of lounge with different grade fabric for cushion and frame; start with Grade 1 price, add appropriate grade price located in second row for cushion, and last add appropriate grade price located in third row for frame to the sum of the Grade 1 and cushion price.

Example: Grade 1 \$6,337 + grade 4 fabric cushion \$365 + grade 2 fabric frame \$118 = \$6,820

Frame

1	10	1,299	19	2,992	L1	2,190
2	118	11	1,457	20	L2	3,980
3	236	12	1,614	21	L3	6,127
COM/4	354	13	1,811	22	L4	7,917
5	512	14	2,008	23	L5	9,706
6	669	15	2,205	24		
7	827	16	2,401	25		
8	984	17	2,598	26		
9	1,142	18	2,795	27		

Select upholstery for everything else other than the seat and back cushions (the outside back, arms, sides, seat frame). You can specify the same fabric as the cushions or select other fabric.

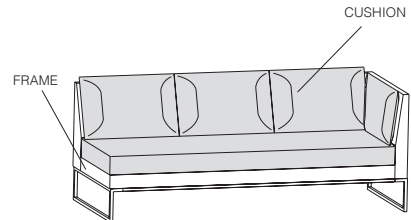

TO ORDER PLEASE SPECIFY THE FOLLOWING:

<input type="text"/>	<input type="text"/>	<input type="text"/>	<input type="text"/>	<input type="text"/>
MODEL NUMBER	FRAME COLOR	FLAMMABILITY RATING	CUSHION UPHOLSTERY	FRAME UPHOLSTERY
	Polished Chrome Brushed Chrome Steel Black Designer White Matte Gold Silver Solar Black Titanium Bullseye Regatta	PC +\$200 BS +\$200 P71 PJW P8G PR6 P8X P8T PJF P8M	U CTB117	Please refer to list of available upholstery and leather selections on www.gunlocke.com

Example

GLGB17-113	PC	U	DOL728	SPNN04
MODEL NUMBER	FRAME COLOR	FLAMMABILITY	CUSHION UPHOLSTERY	FRAME UPHOLSTERY

model number	fabric grades							
GLGB17-123 Three seat, arm right	1	6,337	10	8,973	19	12,409	L1	10,782
	2	6,577	11	9,293	20	12,809	L2	14,414
	3	6,816	12	9,613	21	13,208	L3	18,771
	COM/4	7,056	13	10,012	22	13,608	L4	22,403
	5	7,376	14	10,412	23	14,406	L5	26,035
	6	7,695	15	10,811	24	15,205		
	7	8,015	16	11,210	25	16,005		
	8	8,334	17	11,610	26	16,803		
	9	8,654	18	12,009	27	17,602		

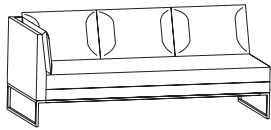

dimensions	W	D	H
Overall	78 1/2"	32"	30"
Seat	71 1/2"	21"	17"
Arm			30"

Upholstery Requirements: GLGB17-123

	Dual Upholstery	
Fabric yds	Cushion 7	Frame 6.75
Leather ft ²	Cushion 75	Frame 168.8
Shipping weight	290 lbs.	
Cube	54.5	

Cushion								
1	10	1,337	19	3,080	L1	2,255		
2	122	11	1,499	20	3,283	L2	4,097	
3	243	12	1,662	21	3,485	L3	6,307	
COM/4	365	13	1,864	22	3,688	L4	8,149	
5	527	14	2,067	23	4,093	L5	9,992	
6	689	15	2,269	24	4,498			
7	851	16	2,472	25	4,904			
8	1,013	17	2,675	26	5,309			
9	1,175	18	2,877	27	5,714			

Top row of pricing is for units specified with same fabric on cushion and frame. Bottom 2 rows of pricing required only when two different fabric grades are selected for the cushion and frame.

To calculate price of lounge with different grade fabric for cushion and frame; start with Grade 1 price, add appropriate grade price located in second row for cushion, and last add appropriate grade price located in third row for frame to the sum of the Grade 1 and cushion price.

Example: Grade 1 \$6,337 + grade 4 fabric cushion \$365 + grade 2 fabric frame \$118 = \$6,820

Frame								
1	10	1,299	19	2,992	L1	2,190		
2	118	11	1,457	20	3,189	L2	3,980	
3	236	12	1,614	21	3,386	L3	6,127	
COM/4	354	13	1,811	22	3,583	L4	7,917	
5	512	14	2,008	23	3,976	L5	9,706	
6	669	15	2,205	24	4,370			
7	827	16	2,401	25	4,764			
8	984	17	2,598	26	5,157			
9	1,142	18	2,795	27	5,551			

Select upholstery for everything else other than the seat and back cushions (the outside back, arms, sides, seat frame). You can specify the same fabric as the cushions or select other fabric.

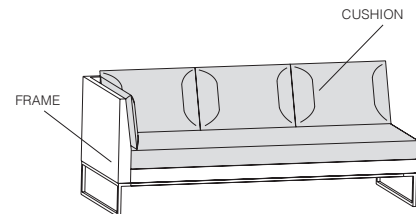

TO ORDER PLEASE SPECIFY THE FOLLOWING:

<input type="text"/>	<input type="text"/>	<input type="text"/>	<input type="text"/>	<input type="text"/>
MODEL NUMBER	FRAME COLOR	FLAMMABILITY RATING	CUSHION UPHOLSTERY	FRAME UPHOLSTERY
	Polished Chrome Brushed Chrome Steel Black Designer White Matte Gold Silver Solar Black Titanium Bullseye Regatta	PC +\$200 BS +\$200 P71 PJW P8G PR6 P8X P8T PJF P8M	U CTB117 Please refer to list of available upholstery and leather selections on www.gunlocke.com	Please refer to list of available upholstery and leather selections on www.gunlocke.com

Example

GLGB17-123.PC.U.DOL728.SPNN04
 GLGB17-123 PC U DOL728 SPNN04
 MODEL NUMBER FRAME COLOR FLAMMABILITY CUSHION UPHOLSTERY FRAME UPHOLSTERY

CALM

Left Corner

model number fabric grades dimensions W D H

GLGB17-161
Left corner

1	4,183	10	5,425	19	7,043	L1	6,276
2	4,296	11	5,576	20	7,231	L2	7,987
3	4,409	12	5,726	21	7,420	L3	10,040
COM/4	4,521	13	5,914	22	7,608	L4	11,751
5	4,672	14	6,102	23	7,984	L5	13,461
6	4,822	15	6,291	24	8,360		
7	4,974	16	6,478	25	8,737		
8	5,124	17	6,666	26	9,112		
9	5,275	18	6,855	27	9,489		

Overall	32"	32"	30"
Seat	21"	21"	17"

Upholstery Requirements: GLGB17-161

	Dual Upholstery	
Fabric yds	Cushion 3	Frame 3.5
Leather ft ²	Cushion 75	Frame 87.5
Shipping weight	145 lbs.	
Cube	23.4	



Cushion

1	10	573	19	1,320	L1	966
2	52	11	643	20	L2	1,756
3	104	12	712	21	L3	2,703
COM/4	156	13	799	22	L4	3,493
5	226	14	886	23	L5	4,282
6	295	15	973	24		
7	365	16	1,059	25		
8	434	17	1,146	26		
9	504	18	1,233	27		

Top row of pricing is for units specified with same fabric on cushion and frame. Bottom 2 rows of pricing required only when two different fabric grades are selected for the cushion and frame.

To calculate price of lounge with different grade fabric for cushion and frame; start with Grade 1 price, add appropriate grade price located in second row for cushion, and last add appropriate grade price located in third row for frame to the sum of the Grade 1 and cushion price.

Example: Grade 1 \$4,183 + grade 4 fabric cushion \$156 + grade 2 fabric frame \$61 = \$4,400

Frame

1	10	669	19	1,540	L1	1,127
2	61	11	750	20	L2	2,048
3	122	12	831	21	L3	3,154
COM/4	182	13	932	22	L4	4,075
5	263	14	1,033	23	L5	4,996
6	344	15	1,135	24		
7	426	16	1,236	25		
8	507	17	1,337	26		
9	588	18	1,439	27		

Select upholstery for everything else other than the seat and back cushions (the outside back, arms, sides, seat frame). You can specify the same fabric as the cushions or select other fabric.

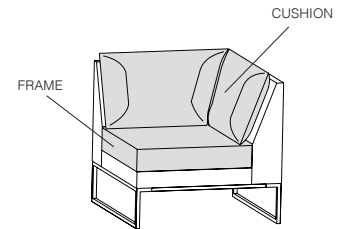

TO ORDER PLEASE SPECIFY THE FOLLOWING:

. . . .
MODEL NUMBER **FRAME COLOR** **FLAMMABILITY RATING** **CUSHION UPHOLSTERY** **FRAME UPHOLSTERY**

- | | | |
|----------------------|------------------|-----------------|
| Polished Chrome | PC +\$125 | U CTB117 |
| Brushed Chrome Steel | BS +\$125 | |
| Black | P71 | |
| Designer White | PJW | |
| Matte Gold | P8G | |
| Silver | PR6 | |
| Solar Black | P8X | |
| Titanium | P8T | |
| Bullseye | PJF | |
| Regatta | P8M | |

Please refer to list of available upholstery and leather selections on www.gunlocke.com

Please refer to list of available upholstery and leather selections on www.gunlocke.com

NOTE: Corner units MUST be used when creating a modular turn where backrests are needed. This aligns the depths between the two "backed" units, and keeps the consistent 5" pillow thickness for the modular turn.

Example

GLGB17-161.PC.U.DOL728.SPNN04

GLGB17-161	PC	U	DOL728	SPNN04
MODEL NUMBER	FRAME COLOR	FLAMMABILITY	CUSHION UPHOLSTERY	FRAME UPHOLSTERY

model number fabric grades dimensions W D H

GLGB17-171
Right corner

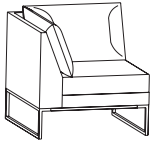

1	4,183	10	5,425	19	7,043	L1	6,276
2	4,296	11	5,576	20	7,231	L2	7,987
3	4,409	12	5,726	21	7,420	L3	10,040
COM/4	4,521	13	5,914	22	7,608	L4	11,751
5	4,672	14	6,102	23	7,984	L5	13,461
6	4,822	15	6,291	24	8,360		
7	4,974	16	6,478	25	8,737		
8	5,124	17	6,666	26	9,112		
9	5,275	18	6,855	27	9,489		

Overall	32"	32"	30"
Seat	21"	21"	17"

Upholstery Requirements: GLGB17-171

	Dual Upholstery	
Fabric yds	Cushion 3	Frame 3.5
Leather ft ²	Cushion 75	Frame 87.5
Shipping weight	145 lbs.	
Cube	23.4	

Cushion

1	10	573	19	1,320	L1	966
2	52	11	643	20	L2	1,756
3	104	12	712	21	L3	2,703
COM/4	156	13	799	22	L4	3,493
5	226	14	886	23	L5	4,282
6	295	15	973	24		
7	365	16	1,059	25		
8	434	17	1,146	26		
9	504	18	1,233	27		

Top row of pricing is for units specified with same fabric on cushion and frame. Bottom 2 rows of pricing required only when two different fabric grades are selected for the cushion and frame.

To calculate price of lounge with different grade fabric for cushion and frame; start with Grade 1 price, add appropriate grade price located in second row for cushion, and last add appropriate grade price located in third row for frame to the sum of the Grade 1 and cushion price.

Example: Grade 1 \$4,183 + grade 4 fabric cushion \$156 + grade 2 fabric frame \$61 = \$4,400

Frame

1	10	669	19	1,540	L1	1,127
2	61	11	750	20	L2	2,048
3	122	12	831	21	L3	3,154
COM/4	182	13	932	22	L4	4,075
5	263	14	1,033	23	L5	4,996
6	344	15	1,135	24		
7	426	16	1,236	25		
8	507	17	1,337	26		
9	588	18	1,439	27		

Select upholstery for everything else other than the seat and back cushions (the outside back, arms, sides, seat frame). You can specify the same fabric as the cushions or select other fabric.

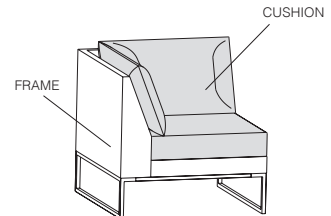

TO ORDER PLEASE SPECIFY THE FOLLOWING:

. . . .
MODEL NUMBER **FRAME COLOR** **FLAMMABILITY RATING** **CUSHION UPHOLSTERY** **FRAME UPHOLSTERY**

- Polished Chrome **PC +\$125** **U** **CTB117**
- Brushed Chrome Steel **BS +\$125**
- Black **P71**
- Designer White **PJW**
- Matte Gold **P8G**
- Silver **PR6**
- Solar Black **P8X**
- Titanium **P8T**
- Bullseye **PJF**
- Regatta **P8M**

Please refer to list of available upholstery and leather selections on www.gunlocke.com

Please refer to list of available upholstery and leather selections on www.gunlocke.com

NOTE: Corner units MUST be used when creating a modular turn where backrests are needed. This aligns the depths between the two "backed" units, and keeps the consistent 5" pillow thickness for the modular turn.

Example

GLGB17-171.PC.U.DOL728.SPNN04

GLGB17-171	PC	U	DOL728	SPNN04
MODEL NUMBER	FRAME COLOR	FLAMMABILITY	CUSHION UPHOLSTERY	FRAME UPHOLSTERY

CALM

One Seat Bench

model number fabric grades dimensions W D H

GBGB17-131
One seat bench

1	2,590	10	3,029	19	3,602	L1	3,331
2	2,630	11	3,082	20	3,669	L2	3,936
3	2,670	12	3,136	21	3,735	L3	4,662
COM/4	2,710	13	3,202	22	3,802	L4	5,267
5	2,763	14	3,269	23	3,935	L5	5,873
6	2,816	15	3,335	24	4,068		
7	2,870	16	3,402	25	4,202		
8	2,923	17	3,469	26	4,334		
9	2,976	18	3,535	27	4,467		

Overall 25" 32" 17"

Upholstery Requirements: GLGB17-131

	Dual Upholstery	
Fabric yds	Cushion 1	Frame 1.3
Leather ft ²	Cushion 25	Frame 32.5
Shipping weight	90 lbs.	
Cube	11.3	



Cushion

1	10	191	19	440	L1	322
2	17	11	214	20	L2	585
3	35	12	237	21	L3	901
COM/4	52	13	266	22	L4	1,164
5	75	14	295	23	L5	1,427
6	98	15	324	24		
7	122	16	353	25		
8	145	17	382	26		
9	168	18	411	27		

Top row of pricing is for units specified with same fabric on cushion and frame. Bottom 2 rows of pricing required only when two different fabric grades are selected for the cushion and frame.

To calculate price of lounge with different grade fabric for cushion and frame; start with Grade 1 price, add appropriate grade price located in second row for cushion, and last add appropriate grade price located in third row for frame to the sum of the Grade 1 and cushion price.

Example: Grade 1 \$2,590 + grade 4 fabric cushion \$52 + grade 2 fabric frame \$23 = \$2,665

Frame

1	10	248	19	572	L1	419
2	23	11	278	20	L2	761
3	45	12	309	21	L3	1,171
COM/4	68	13	346	22	L4	1,513
5	98	14	384	23	L5	1,856
6	128	15	421	24		
7	158	16	459	25		
8	188	17	497	26		
9	218	18	534	27		

Select upholstery for everything else other than the seat and back cushions (the outside back, arms, sides, seat frame). You can specify the same fabric as the cushions or select other fabric.

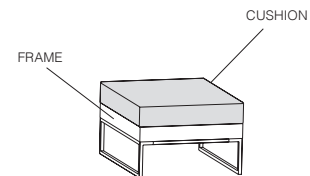

TO ORDER PLEASE SPECIFY THE FOLLOWING:

<input type="text"/>	<input type="text"/>	<input type="text"/>	<input type="text"/>	<input type="text"/>
MODEL NUMBER	FRAME COLOR	FLAMMABILITY RATING	CUSHION UPHOLSTERY	FRAME UPHOLSTERY
	Polished Chrome Brushed Chrome Steel Black Designer White Matte Gold Silver Solar Black Titanium Bullseye Regatta	PC +\$125 BS +\$125 P71 PJW P8G PR6 P8X P8T PJF P8M	U CTB117 Please refer to list of available upholstery and leather selections on www.gunlocke.com	Please refer to list of available upholstery and leather selections on www.gunlocke.com

Example

GBGB17-131.PC.U.DOL728.SPNN04
 GBGB17-131 PC U DOL728 SPNN04
 MODEL NUMBER FRAME COLOR FLAMMABILITY CUSHION UPHOLSTERY FRAME UPHOLSTERY

model number fabric grades dimensions W D H

GBGB17-142
Two seat bench

1	3,546	10	4,253	19	5,174	L1	4,738
2	3,610	11	4,339	20	5,281	L2	5,711
3	3,675	12	4,424	21	5,388	L3	6,880
COM/4	3,739	13	4,532	22	5,495	L4	7,854
5	3,824	14	4,638	23	5,710	L5	8,827
6	3,910	15	4,746	24	5,924		
7	3,996	16	4,853	25	6,138		
8	4,082	17	4,960	26	6,352		
9	4,167	18	5,067	27	6,567		

Overall 50" 32" 17"

Upholstery Requirements: GLGB17-142

	Dual Upholstery	
Fabric yds	Cushion 2.5	Frame 1.2
Leather ft ²	Cushion 62.5	Frame 30
Shipping weight	135 lbs.	
Cube	21.5	



Cushion

1	10	478	19	1,100	L1	805
2	43	11	536	20	L2	1,463
3	87	12	593	21	L3	2,253
COM/4	130	13	666	22	L4	2,911
5	188	14	738	23	L5	3,568
6	246	15	811	24		
7	304	16	883	25		
8	362	17	955	26		
9	420	18	1,028	27		

Top row of pricing is for units specified with same fabric on cushion and frame. Bottom 2 rows of pricing required only when two different fabric grades are selected for the cushion and frame.

To calculate price of lounge with different grade fabric for cushion and frame; start with Grade 1 price, add appropriate grade price located in second row for cushion, and last add appropriate grade price located in third row for frame to the sum of the Grade 1 and cushion price.

Example: Grade 1 \$3,546 + grade 4 fabric cushion \$130 + grade 2 fabric frame \$21 = \$3,697

Frame

1	10	229	19	528	L1	387
2	21	11	257	20	L2	702
3	42	12	285	21	L3	1,081
COM/4	63	13	320	22	L4	1,397
5	90	14	354	23	L5	1,713
6	118	15	389	24		
7	146	16	424	25		
8	174	17	459	26		
9	201	18	493	27		

Select upholstery for everything else other than the seat and back cushions (the outside back, arms, sides, seat frame). You can specify the same fabric as the cushions or select other fabric.

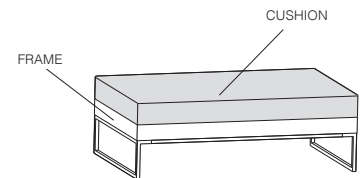

TO ORDER PLEASE SPECIFY THE FOLLOWING:

<input type="text"/>	<input type="text"/>	<input type="text"/>	<input type="text"/>	<input type="text"/>
MODEL NUMBER	FRAME COLOR	FLAMMABILITY RATING	CUSHION UPHOLSTERY	FRAME UPHOLSTERY
	Polished Chrome Brushed Chrome Steel Black Designer White Matte Gold Silver Solar Black Titanium Bullseye Regatta	PC +\$150 BS +\$150 P71 PJW P8G PR6 P8X P8T PJF P8M	U CTB117 Please refer to list of available upholstery and leather selections on www.gunlocke.com	Please refer to list of available upholstery and leather selections on www.gunlocke.com

Example

GLGB17-142.PC.U.DOL728.SPNN04
 GLGB17-142 PC U DOL728 SPNN04
 MODEL NUMBER FRAME COLOR FLAMMABILITY CUSHION UPHOLSTERY FRAME UPHOLSTERY

CALM

Three Seat Bench

Seating
05/22

model number fabric grades dimensions W D H

Model Number	Grade 1 Price	Grade 10 Price	Grade 19 Price	Grade 21 Price	Grade 25 Price	Grade 26 Price	Grade 27 Price
GBGB17-153	1 4,454	10 5,505	19 6,874	L1 6,225			
Three seat bench	2 4,549	11 5,632	20 7,033	L2 7,673			
	3 4,645	12 5,759	21 7,193	L3 9,410			
	COM/4 4,740	13 5,918	22 7,351	L4 10,857			
	5 4,868	14 6,078	23 7,670	L5 12,304			
	6 4,996	15 6,237	24 7,989				
	7 5,122	16 6,397	25 8,307				
	8 5,250	17 6,555	26 8,626				
	9 5,378	18 6,715	27 8,943				



Overall 75" 32" 17"

Upholstery Requirements: GLGB17-153

Dual Upholstery		
Fabric yds	Cushion 4	Frame 1.5
Leather ft ²	Cushion 100	Frame 37.5
Shipping weight		180 lbs.
Cube		31.6

Cushion	Grade 1 Price	Grade 10 Price	Grade 19 Price	Grade 21 Price	Grade 25 Price	Grade 26 Price	Grade 27 Price
	1	10 764	19 1,760	L1 1,288			
	2 69	11 857	20 1,876	L2 2,341			
	3 139	12 949	21 1,992	L3 3,604			
	COM/4 208	13 1,065	22 2,107	L4 4,657			
	5 301	14 1,181	23 2,339	L5 5,709			
	6 394	15 1,297	24 2,571				
	7 486	16 1,413	25 2,802				
	8 579	17 1,528	26 3,034				
	9 672	18 1,644	27 3,265				

Top row of pricing is for units specified with same fabric on cushion and frame. Bottom 2 rows of pricing required only when two different fabric grades are selected for the cushion and frame.

To calculate price of lounge with different grade fabric for cushion and frame; start with Grade 1 price, add appropriate grade price located in second row for cushion, and last add appropriate grade price located in third row for frame to the sum of the Grade 1 and cushion price.

Example: Grade 1 \$4,454 + grade 4 fabric cushion \$208 + grade 2 fabric frame \$26 = \$4,688

Frame	Grade 1 Price	Grade 10 Price	Grade 19 Price	Grade 21 Price	Grade 25 Price	Grade 26 Price	Grade 27 Price
	1	10 287	19 660	L1 483			
	2 26	11 321	20 703	L2 878			
	3 52	12 356	21 747	L3 1,352			
	COM/4 78	13 399	22 790	L4 1,746			
	5 113	14 443	23 877	L5 2,141			
	6 148	15 486	24 964				
	7 182	16 530	25 1,051				
	8 217	17 573	26 1,138				
	9 252	18 617	27 1,224				

Select upholstery for everything else other than the seat and back cushions (the outside back, arms, sides, seat frame). You can specify the same fabric as the cushions or select other fabric.

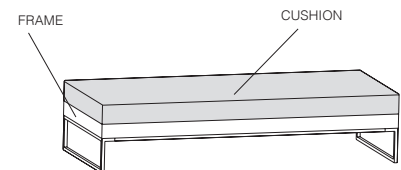

TO ORDER PLEASE SPECIFY THE FOLLOWING:

MODEL NUMBER	FRAME COLOR	FLAMMABILITY RATING	CUSHION UPHOLSTERY	FRAME UPHOLSTERY
<input type="text"/>	<input type="text"/>	<input type="text"/>	<input type="text"/>	<input type="text"/>
Polished Chrome	PC +\$200	U CTB117	Please refer to list of available upholstery and leather selections on www.gunlocke.com	Please refer to list of available upholstery and leather selections on www.gunlocke.com
Brushed Chrome Steel	BS +\$200			
Black	P71			
Designer White	PJW			
Matte Gold	P8G			
Silver	PR6			
Solar Black	P8X			
Titanium	P8T			
Bullseye	PJF			
Regatta	P8M			

Example

GBGB17-153.PC.U.DOL728.SPNN04
 GBGB17-153 PC U DOL728 SPNN04
 MODEL NUMBER FRAME COLOR FLAMMABILITY CUSHION UPHOLSTERY FRAME UPHOLSTERY

model number fabric grades dimensions W D H

GLGB17-181
Ottoman

1	2,716	10	3,146	19	3,706	L1	3,441
2	2,755	11	3,198	20	3,771	L2	4,033
3	2,794	12	3,250	21	3,836	L3	4,743
COM/4	2,833	13	3,315	22	3,902	L4	5,335
5	2,885	14	3,380	23	4,032	L5	5,927
6	2,937	15	3,445	24	4,162		
7	2,990	16	3,510	25	4,293		
8	3,042	17	3,576	26	4,422		
9	3,094	18	3,641	27	4,552		

Overall 32" 32" 17"

Upholstery Requirements: GLGB17-181

	Dual Upholstery	
Fabric yds	Cushion 1	Frame 1.25
Leather ft ²	Cushion 25	Frame 31.25
Shipping weight	100 lbs.	
Cube	14.2	

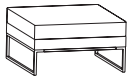

Cushion

1	10	191	19	440	L1	322
2	17	11	214	20	L2	585
3	35	12	237	21	L3	901
COM/4	52	13	266	22	L4	1,164
5	75	14	295	23	L5	1,427
6	98	15	324	24		
7	122	16	353	25		
8	145	17	382	26		
9	168	18	411	27		

Top row of pricing is for units specified with same fabric on cushion and frame. Bottom 2 rows of pricing required only when two different fabric grades are selected for the cushion and frame.

To calculate price of lounge with different grade fabric for cushion and frame; start with Grade 1 price, add appropriate grade price located in second row for cushion, and last add appropriate grade price located in third row for frame to the sum of the Grade 1 and cushion price.

Example: Grade 1 \$2,716 + grade 4 fabric cushion \$52 + grade 2 fabric frame \$22 = \$2,790

Frame

1	10	239	19	550	L1	403
2	22	11	268	20	L2	732
3	43	12	297	21	L3	1,126
COM/4	65	13	333	22	L4	1,455
5	94	14	369	23	L5	1,784
6	123	15	405	24		
7	152	16	441	25		
8	181	17	478	26		
9	210	18	514	27		

Select upholstery for everything else other than the seat and back cushions (the outside back, arms, sides, seat frame). You can specify the same fabric as the cushions or select other fabric.

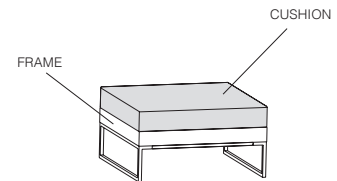

TO ORDER PLEASE SPECIFY THE FOLLOWING:

. . . .
MODEL NUMBER **FRAME COLOR** **FLAMMABILITY RATING** **CUSHION UPHOLSTERY** **FRAME UPHOLSTERY**

- Polished Chrome
- Brushed Chrome Steel
- Black
- Designer White
- Matte Gold
- Silver
- Solar Black
- Titanium
- Bullseye
- Regatta

- PC +\$125**
- BS +\$125**
- P71**
- PJW**
- P8G**
- PR6**
- P8X**
- P8T**
- PJF**
- P8M**

U CTB117

Please refer to list of available upholstery and leather selections on www.gunlocke.com

Please refer to list of available upholstery and leather selections on www.gunlocke.com

NOTE: Ottoman to be used in line with lounge units, to create a 32"D x 32"W seating surface..

Example

GLGB17-181.PC.U.DOL728.DOL728
 GLGB17-181 PC U DOL728 SPNN04
 MODEL NUMBER FRAME COLOR FLAMMABILITY CUSHION UPHOLSTERY FRAME UPHOLSTERY

model number	list	dimensions	W	D	H
--------------	------	------------	---	---	---

GAGB17-198
Gangng bracket

147

14.5" 4" 1.5"



- **Note:** No options are selected for gangng bracket model (GAGB17-198).
- One gangng bracket shipped per GAGB17-198 model ordered.
- Lounge units gang together with one gangng bracket per gangng position.

ACPUNDER-EU
Standard Plug

378

5.5" 3" 2"



- **Note:** Power unit mounts at left or right hand side of lounge units only. Positions are predetermined at mounting points into lounge frame (see example below).

ACPUNDER-EU-HW
Hardwired

378

5.5" 3" 2"



- **Note:** Power unit mounts at left or right hand side of lounge units only. Positions are predetermined at mounting points into lounge frame (see example below).

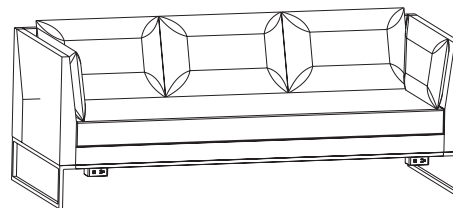
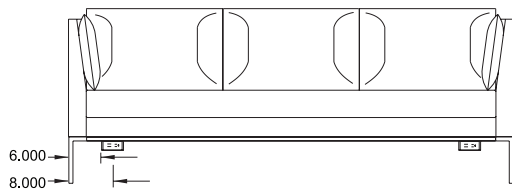

- **Note:** Power unit can be mounted directly into lounge unit frames. Edge of power unit is 6" from outside of lounge, or 8" to center of power unit from outside of lounge. Includes wire clips to attach plug cord to underside of lounge.

TO ORDER PLEASE SPECIFY THE FOLLOWING:

--	--

MODEL NUMBER **POWER COLOR**

Option available for
ACPUNDER-EU and
ACPUNDER-EU-HW models only.

White **WH**
Black **BK**
Silver **SV**

Example

ACPUNDER-EU.WH
ACPUNDER-EU WH
MODEL NUMBER POWER COLOR

Seating
05/22

CIJI SINGLE SEAT

Low Back, with Arms, Wood Legs

model number	fabric grades							
GK1101-1W Low back, with arms, Wood legs	1	3,151	10	4,164	19	5,483	L1	4,702
	2	3,243	11	4,286	20	5,636	L2	5,985
	3	3,335	12	4,409	21	5,790	L3	7,525
	COM/4	3,427	13	4,562	22	5,943	L4	8,808
	5	3,550	14	4,716	23	6,250	L5	10,091
	6	3,673	15	4,869	24	6,557		
	7	3,795	16	5,023	25	6,864		
	8	3,918	17	5,176	26	7,171		
	9	4,041	18	5,330	27	7,477		

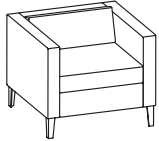

dimensions	W	D	H
Overall	31 3/4"	31 1/2"	27 7/8"
Seat	24"	21"	17 1/4"
Arm			26 7/8"
Between arms	24"		

Upholstery Requirements: GK1101-1W

	Dual Upholstery	
Fabric yds	Cushions 1.5	Frame 3.8
Leather ft ²	Cushions 34.5	Frame 87.4
Shipping weight		97 lbs.
Cube		28.0

Cushion

1	10	287	19	660	L1	439
2	26	11	321	20	L2	802
3	52	12	356	21	L3	1,238
COM/4	78	13	399	22	L4	1,601
5	113	14	443	23	L5	1,964
6	148	15	486	24		
7	182	16	530	25		
8	217	17	573	26		
9	252	18	617	27		

Top row of pricing is for units specified with same fabric on cushion and frame. Bottom 2 rows of pricing required only when two different fabric grades are selected for the cushion and frame.

To calculate price of lounge with different grade fabric for cushion and frame; start with Grade 1 price, add appropriate grade price located in second row for cushion, and last add appropriate grade price located in third row for frame to the sum of the Grade 1 and cushion price.

Example: Grade 1 \$3,151 + grade 4 fabric cushion \$78 + grade 2 fabric frame \$66 = \$3,295

Frame

1	10	726	19	1,672	L1	1,112
2	66	11	814	20	L2	2,032
3	132	12	902	21	L3	3,136
COM/4	198	13	1,012	22	L4	4,056
5	286	14	1,122	23	L5	4,976
6	374	15	1,232	24		
7	462	16	1,342	25		
8	550	17	1,452	26		
9	638	18	1,562	27		

Select upholstery for everything else other than the seat and back cushions (the outside back, arms, sides, seat frame). You can specify the same fabric as the cushions or select other fabric.

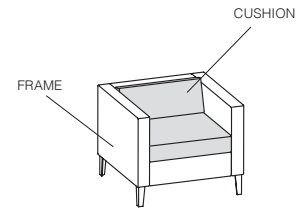

TO ORDER PLEASE SPECIFY THE FOLLOWING:

<input type="text"/>	<input type="text"/>	<input type="text"/>	<input type="text"/>	<input type="text"/>	<input type="text"/>
MODEL NUMBER	WOOD FINISH	STITCH DETAIL	FLAMMABILITY RATING	CUSHION UPHOLSTERY	FRAME UPHOLSTERY
	Cherry finishes on Maple Walnut finishes on Maple Maple finishes on Maple Oak finishes on Maple	None NR Stitch detail SD +\$175	U CTB117	Please refer to list of available upholstery and leather selections on www.gunlocke.com	Please refer to list of available upholstery and leather selections on www.gunlocke.com

Example

GK1101-1W.777.NR.U.DOL728.SPNN04					
GK1101-1W	777	NR	U	DOL728	SPNN04
MODEL NUMBER	WOOD FINISH	STITCH DETAIL	FLAMMABILITY	CUSHION UPHOLSTERY	FRAME UPHOLSTERY

Please refer to the Ciji product page on www.gunlocke.com for standard finish options.

CIJI SINGLE SEAT

Low Back, with Arms, Aluminum Legs

Seating
05/22

model number

fabric grades

dimensions

W

D

H

GK1101-1A

Low back, with arms,
Aluminum legs

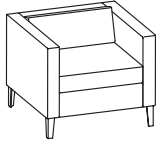

	1	3,388	10	4,401	19	5,720	L1	4,939
	2	3,480	11	4,523	20	5,873	L2	6,222
	3	3,572	12	4,646	21	6,027	L3	7,762
COM/4	3,664	13	4,799	22	6,180	L4	9,045	
	5	3,787	14	4,953	23	6,487	L5	10,328
	6	3,910	15	5,106	24	6,794		
	7	4,032	16	5,260	25	7,101		
	8	4,155	17	5,413	26	7,408		
	9	4,278	18	5,567	27	7,714		

Overall	31 3/4"	31 1/2"	27 7/8"
Seat	24"	21"	17 1/4"
Arm			26 7/8"
Between arms	24"		

Upholstery Requirements: GK1101-1A

	Dual Upholstery		
Fabric yds	Cushions 1.5	Frame 3.8	
Leather ft ²	Cushions 34.5	Frame 87.4	
Shipping weight			97 lbs.
Cube			28.0

Cushion

	1	10	287	19	660	L1	439	
	2	26	11	321	20	703	L2	802
	3	52	12	356	21	747	L3	1,238
COM/4	78	13	399	22	790	L4	1,601	
	5	113	14	443	23	877	L5	1,964
	6	148	15	486	24	964		
	7	182	16	530	25	1,051		
	8	217	17	573	26	1,138		
	9	252	18	617	27	1,224		

Top row of pricing is for units specified with same fabric on cushion and frame. Bottom 2 rows of pricing required only when two different fabric grades are selected for the cushion and frame.

To calculate price of lounge with different grade fabric for cushion and frame; start with Grade 1 price, add appropriate grade price located in second row for cushion, and last add appropriate grade price located in third row for frame to the sum of the Grade 1 and cushion price.

Example: Grade 1 \$3,388 + grade 4 fabric cushion \$78 + grade 2 fabric frame \$66 = \$3,532

Frame

	1	10	726	19	1,672	L1	1,112	
	2	66	11	814	20	1,782	L2	2,032
	3	132	12	902	21	1,892	L3	3,136
COM/4	198	13	1,012	22	2,002	L4	4,056	
	5	286	14	1,122	23	2,222	L5	4,976
	6	374	15	1,232	24	2,442		
	7	462	16	1,342	25	2,662		
	8	550	17	1,452	26	2,882		
	9	638	18	1,562	27	3,102		

Select upholstery for everything else other than the seat and back cushions (the outside back, arms, sides, seat frame). You can specify the same fabric as the cushions or select other fabric.

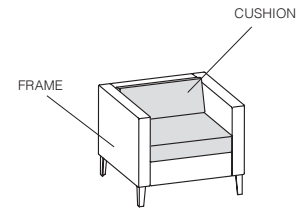

TO ORDER PLEASE SPECIFY THE FOLLOWING:

<input type="text"/>	<input type="text"/>	<input type="text"/>	<input type="text"/>	<input type="text"/>
MODEL NUMBER	STITCH DETAIL	FLAMMABILITY RATING	CUSHION UPHOLSTERY	FRAME UPHOLSTERY
	None NR Stitch detail SD +\$175	U CTB117	Please refer to list of available upholstery and leather selections on www.gunlocke.com	Please refer to list of available upholstery and leather selections on www.gunlocke.com

Example

GK1101-1A.NR.U.DOL728.SPNN04

GK1101-1A	NR	U	DOL728	SPNN04
MODEL NUMBER	STITCH	FLAMMABILITY DETAIL	CUSHION UPHOLSTERY	FRAME UPHOLSTERY

Please refer to the Ciji product page on www.gunlocke.com for standard finish options.

model number	fabric grades							dimensions	W	D	H	
GK1103-1W Low back, armless Wood legs	1	2,415	10	2,989	19	3,735	L1	3,293	Overall	24 5/8"	31 1/2"	27 7/8"
	2	2,467	11	3,057	20	3,821	L2	4,019	Seat	24"	21"	17 1/4"
	3	2,519	12	3,127	21	3,909	L3	4,891	Upholstery Requirements: GK1103-1W			
	COM/4	2,571	13	3,213	22	3,995	L4	5,617	Dual Upholstery			
	5	2,641	14	3,301	23	4,169	L5	6,343	Fabric yds Cushions 1.5 Frame 1.5			
	6	2,711	15	3,387	24	4,343			Leather ft ² Cushions 34.5 Frame 34.5			
	7	2,779	16	3,475	25	4,517			Shipping weight 77 lbs.			
	8	2,849	17	3,561	26	4,691			Cube 28.0			
	9	2,919	18	3,649	27	4,863						



Cushion	1	10	287	19	660	L1	439
	2	26	11	321	20	703	L2 802
	3	52	12	356	21	747	L3 1,238
	COM/4	78	13	399	22	790	L4 1,601
	5	113	14	443	23	877	L5 1,964
	6	148	15	486	24	964	
	7	182	16	530	25	1,051	
	8	217	17	573	26	1,138	
	9	252	18	617	27	1,224	

Top row of pricing is for units specified with same fabric on cushion and frame. Bottom 2 rows of pricing required only when two different fabric grades are selected for the cushion and frame.

To calculate price of lounge with different grade fabric for cushion and frame; start with Grade 1 price, add appropriate grade price located in second row for cushion, and last add appropriate grade price located in third row for frame to the sum of the Grade 1 and cushion price.

Example: Grade 1 \$2,415 + grade 4 fabric cushion \$78 + grade 2 fabric frame \$26 = \$2,519

Frame	1	10	287	19	660	L1	439
	2	26	11	321	20	703	L2 802
	3	52	12	356	21	747	L3 1,238
	COM/4	78	13	399	22	790	L4 1,601
	5	113	14	443	23	877	L5 1,964
	6	148	15	486	24	964	
	7	182	16	530	25	1,051	
	8	217	17	573	26	1,138	
	9	252	18	617	27	1,224	

Select upholstery for everything else other than the seat and back cushions (the outside back, arms, sides, seat frame). You can specify the same fabric as the cushions or select other fabric.

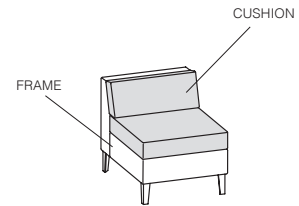

TO ORDER PLEASE SPECIFY THE FOLLOWING:

<input type="text"/>	<input type="text"/>	<input type="text"/>	<input type="text"/>	<input type="text"/>	<input type="text"/>
MODEL NUMBER	WOOD FINISH	STITCH DETAIL	FLAMMABILITY RATING	CUSHION UPHOLSTERY	FRAME UPHOLSTERY
	Cherry finishes on Maple Walnut finishes on Maple Maple finishes on Maple Oak finishes on Maple	None NR Stitch detail SD +\$175	U CTB117	Please refer to list of available upholstery and leather selections on www.gunlocke.com	Please refer to list of available upholstery and leather selections on www.gunlocke.com

Example

GK1103-1W.777.NR.U.DOL728.SPNN04					
GK1103-1W	777	NR	U	DOL728	SPNN04
MODEL NUMBER	WOOD FINISH	STITCH DETAIL	FLAMMABILITY	CUSHION UPHOLSTERY	FRAME UPHOLSTERY

Please refer to the Ciji product page on www.gunlocke.com for standard finish options.

CIJI SINGLE SEAT

Low Back, Armless, Aluminum Legs

model number fabric grades dimensions W D H

GK1103-1A

Low back, armless
Aluminum legs



1	2,651	10	3,225	19	3,971	L1	3,529
2	2,703	11	3,293	20	4,057	L2	4,255
3	2,755	12	3,363	21	4,145	L3	5,127
COM/4	2,807	13	3,449	22	4,231	L4	5,853
5	2,877	14	3,537	23	4,405	L5	6,579
6	2,947	15	3,623	24	4,579		
7	3,015	16	3,711	25	4,753		
8	3,085	17	3,797	26	4,927		
9	3,155	18	3,885	27	5,099		

Overall	24 5/8"	31 1/2"	27 7/8"
Seat	24"	21"	17 1/4"

Upholstery Requirements: GK1103-1A

	Dual Upholstery		
Fabric yds	Cushions 1.5	Frame 1.5	
Leather ft ²	Cushions 34.5	Frame 34.5	
Shipping weight	77 lbs.		
Cube	28.0		

Cushion

1	10	287	19	660	L1	439	
2	26	11	321	20	703	L2	802
3	52	12	356	21	747	L3	1,238
COM/4	78	13	399	22	790	L4	1,601
5	113	14	443	23	877	L5	1,964
6	148	15	486	24	964		
7	182	16	530	25	1,051		
8	217	17	573	26	1,138		
9	252	18	617	27	1,224		

Top row of pricing is for units specified with same fabric on cushion and frame. Bottom 2 rows of pricing required only when two different fabric grades are selected for the cushion and frame.

To calculate price of lounge with different grade fabric for cushion and frame; start with Grade 1 price, add appropriate grade price located in second row for cushion, and last add appropriate grade price located in third row for frame to the sum of the Grade 1 and cushion price.

Example: Grade 1 \$2,651 + grade 4 fabric cushion \$78 + grade 2 fabric frame \$26 = \$2,755

Frame

1	10	287	19	660	L1	439	
2	26	11	321	20	703	L2	802
3	52	12	356	21	747	L3	1,238
COM/4	78	13	399	22	790	L4	1,601
5	113	14	443	23	877	L5	1,964
6	148	15	486	24	964		
7	182	16	530	25	1,051		
8	217	17	573	26	1,138		
9	252	18	617	27	1,224		

Select upholstery for everything else other than the seat and back cushions (the outside back, arms, sides, seat frame). You can specify the same fabric as the cushions or select other fabric.

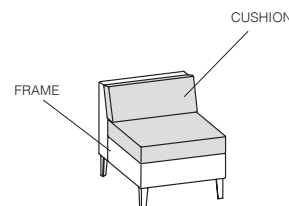

TO ORDER PLEASE SPECIFY THE FOLLOWING:

<input type="text"/>	<input type="text"/>	<input type="text"/>	<input type="text"/>	<input type="text"/>
MODEL NUMBER	STITCH DETAIL	FLAMMABILITY RATING	CUSHION UPHOLSTERY	FRAME UPHOLSTERY
	None NR Stitch detail SD +\$175	U CTB117	Please refer to list of available upholstery and leather selections on www.gunlocke.com	Please refer to list of available upholstery and leather selections on www.gunlocke.com

Example

GK1103-1A.NR.U.DOL728.SPNN04

GK1103-1A	NR	U	DOL728	SPNN04
MODEL NUMBER	STITCH	FLAMMABILITY DETAIL	CUSHION UPHOLSTERY	FRAME UPHOLSTERY

Please refer to the Ciji product page on www.gunlocke.com for standard finish options.

Seating
05/22

CIJI SINGLE SEAT

Low Back, Arm Left, Wood Legs

model number	fabric grades							dimensions	W	D	H		
GK1105-1W Low back, arm left. Wood legs	1	2,969	10	3,791	19	4,861	L1	4,227	Overall	28 1/8"	31 1/2"	27 1/8"	
	2	3,044	11	3,890	20	4,985	L2	5,268	Seat	24"	21"	17 1/4"	
	3	3,118	12	3,990	21	5,110	L3	6,518	Arm			26 1/8"	
	COM/4	3,193	13	4,114	22	5,234	L4	7,559	Between arms				
	5	3,293	14	4,239	23	5,483	L5	8,600	Upholstery Requirements: GK1105-1W				
	6	3,393	15	4,363	24	5,732			Dual Upholstery				
	7	3,491	16	4,488	25	5,981			Fabric yds	Cushions 1.5	Frame 2.8		
	8	3,591	17	4,612	26	6,231			Leather ft ²	Cushions 34.5	Frame 64.4		
	9	3,691	18	4,737	27	6,479			Shipping weight			87 lbs.	
									Cube				28.0



Cushion	1	10	287	19	660	L1	439
	2	26	11	321	20	703	L2 802
	3	52	12	356	21	747	L3 1,238
	COM/4	78	13	399	22	790	L4 1,601
	5	113	14	443	23	877	L5 1,964
	6	148	15	486	24	964	
	7	182	16	530	25	1,051	
	8	217	17	573	26	1,138	
	9	252	18	617	27	1,224	

Top row of pricing is for units specified with same fabric on cushion and frame. Bottom 2 rows of pricing required only when two different fabric grades are selected for the cushion and frame.

To calculate price of lounge with different grade fabric for cushion and frame; start with Grade 1 price, add appropriate grade price located in second row for cushion, and last add appropriate grade price located in third row for frame to the sum of the Grade 1 and cushion price.

Example: Grade 1 \$2,969 + grade 4 fabric cushion \$78 + grade 2 fabric frame \$49 = \$3,096

Frame	1	10	535	19	1,232	L1	819
	2	49	11	600	20	1,313	L2 1,497
	3	97	12	665	21	1,394	L3 2,311
	COM/4	146	13	746	22	1,475	L4 2,989
	5	211	14	827	23	1,637	L5 3,667
	6	276	15	908	24	1,799	
	7	340	16	989	25	1,961	
	8	405	17	1,070	26	2,124	
	9	470	18	1,151	27	2,286	

Select upholstery for everything else other than the seat and back cushions (the outside back, arms, sides, seat frame). You can specify the same fabric as the cushions or select other fabric.

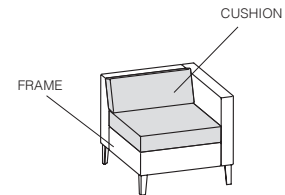

TO ORDER PLEASE SPECIFY THE FOLLOWING:

<input type="text"/>	<input type="text"/>	<input type="text"/>	<input type="text"/>	<input type="text"/>	<input type="text"/>
MODEL NUMBER	WOOD FINISH	STITCH DETAIL	FLAMMABILITY RATING	CUSHION UPHOLSTERY	FRAME UPHOLSTERY
	Cherry finishes on Maple Walnut finishes on Maple Maple finishes on Maple Oak finishes on Maple	None NR Stitch detail SD +\$175	U CTB117	Please refer to list of available upholstery and leather selections on www.gunlocke.com	Please refer to list of available upholstery and leather selections on www.gunlocke.com

Example

GK1105-1W.777.NR.U.DOL728.SPNN04					
GK1105-1W	777	NR	U	DOL728	SPNN04
MODEL NUMBER	WOOD FINISH	STITCH DETAIL	FLAMMABILITY	CUSHION UPHOLSTERY	FRAME UPHOLSTERY

Please refer to the Ciji product page on www.gunlocke.com for standard finish options.

CIJI SINGLE SEAT

Low Back, Arm Left, Aluminum Legs

model number fabric grades dimensions W D H

GK1105-1A

Low back, arm left.
Aluminum legs



1	3,205	10	4,027	19	5,097	L1	4,463
2	3,280	11	4,126	20	5,221	L2	5,504
3	3,354	12	4,226	21	5,346	L3	6,754
COM/4	3,429	13	4,350	22	5,470	L4	7,795
5	3,529	14	4,475	23	5,719	L5	8,836
6	3,629	15	4,599	24	5,968		
7	3,727	16	4,724	25	6,217		
8	3,827	17	4,848	26	6,467		
9	3,927	18	4,973	27	6,715		

Overall	28 1/8"	31 1/2"	27 1/8"
Seat	24"	21"	17 1/4"
Arm			26 1/8"
Between arms			

Upholstery Requirements: GK1105-1A

	Dual Upholstery	
Fabric yds	Cushions 1.5	Frame 2.8
Leather ft ²	Cushions 34.5	Frame 64.4
Shipping weight		87 lbs.
Cube		28.0

Cushion

1		10	287	19	660	L1	439
2	26	11	321	20	703	L2	802
3	52	12	356	21	747	L3	1,238
COM/4	78	13	399	22	790	L4	1,601
5	113	14	443	23	877	L5	1,964
6	148	15	486	24	964		
7	182	16	530	25	1,051		
8	217	17	573	26	1,138		
9	252	18	617	27	1,224		

Top row of pricing is for units specified with same fabric on cushion and frame. Bottom 2 rows of pricing required only when two different fabric grades are selected for the cushion and frame.

To calculate price of lounge with different grade fabric for cushion and frame; start with Grade 1 price, add appropriate grade price located in second row for cushion, and last add appropriate grade price located in third row for frame to the sum of the Grade 1 and cushion price.

Example: Grade 1 \$3,205 + grade 4 fabric cushion \$78 + grade 2 fabric frame \$49 = \$3,332

Frame

1		10	535	19	1,232	L1	819
2	49	11	600	20	1,313	L2	1,497
3	97	12	665	21	1,394	L3	2,311
COM/4	146	13	746	22	1,475	L4	2,989
5	211	14	827	23	1,637	L5	3,667
6	276	15	908	24	1,799		
7	340	16	989	25	1,961		
8	405	17	1,070	26	2,124		
9	470	18	1,151	27	2,286		

Select upholstery for everything else other than the seat and back cushions (the outside back, arms, sides, seat frame). You can specify the same fabric as the cushions or select other fabric.

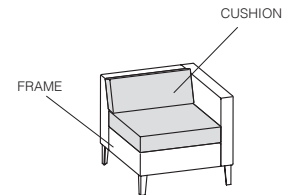

TO ORDER PLEASE SPECIFY THE FOLLOWING:

<input type="text"/>	<input type="text"/>	<input type="text"/>	<input type="text"/>	<input type="text"/>
MODEL NUMBER	STITCH DETAIL	FLAMMABILITY RATING	CUSHION UPHOLSTERY	FRAME UPHOLSTERY
	None NR Stitch detail SD +\$175	U CTB117	Please refer to list of available upholstery and leather selections on www.gunlocke.com	Please refer to list of available upholstery and leather selections on www.gunlocke.com

Example

GK1105-1A.NR.U.DOL728.SPNN04				
GK1105-1A	NR	U	DOL728	SPNN04
MODEL NUMBER	STITCH	FLAMMABILITY DETAIL	CUSHION UPHOLSTERY	FRAME UPHOLSTERY

Please refer to the Ciji product page on www.gunlocke.com for standard finish options.

model number	fabric grades							dimensions	W	D	H	
GK1107-1W Low back, arm right Wood legs	1	2,969	10	3,791	19	4,861	L1	4,227	Overall	28 1/8"	31 1/2"	27 7/8"
	2	3,044	11	3,890	20	4,985	L2	5,268	Seat	24"	21"	17 1/4"
	3	3,118	12	3,990	21	5,110	L3	6,518	Arm	26 7/8"		
	COM/4	3,193	13	4,114	22	5,234	L4	7,559	Between arms			
	5	3,293	14	4,239	23	5,483	L5	8,600	Upholstery Requirements: GK1107-1W			
	6	3,393	15	4,363	24	5,732			Dual Upholstery			
	7	3,491	16	4,488	25	5,981			Fabric yds	Cushions 1.5	Frame 2.8	
	8	3,591	17	4,612	26	6,231			Leather ft ²	Cushions 34.5	Frame 64.4	
	9	3,691	18	4,737	27	6,479			Shipping weight	87 lbs.		
									Cube	28.0		



Cushion	1	10	287	19	660	L1	439
	2	26	11	321	20	703	L2 802
	3	52	12	356	21	747	L3 1,238
	COM/4	78	13	399	22	790	L4 1,601
	5	113	14	443	23	877	L5 1,964
	6	148	15	486	24	964	
	7	182	16	530	25	1,051	
	8	217	17	573	26	1,138	
	9	252	18	617	27	1,224	

Top row of pricing is for units specified with same fabric on cushion and frame. Bottom 2 rows of pricing required only when two different fabric grades are selected for the cushion and frame.

To calculate price of lounge with different grade fabric for cushion and frame; start with Grade 1 price, add appropriate grade price located in second row for cushion, and last add appropriate grade price located in third row for frame to the sum of the Grade 1 and cushion price.

Example: Grade 1 \$2,969 + grade 4 fabric cushion \$78 + grade 2 fabric frame \$49 = \$3,096

Frame	1	10	535	19	1,232	L1	819
	2	49	11	600	20	1,313	L2 1,497
	3	97	12	665	21	1,394	L3 2,311
	COM/4	146	13	746	22	1,475	L4 2,989
	5	211	14	827	23	1,637	L5 3,667
	6	276	15	908	24	1,799	
	7	340	16	989	25	1,961	
	8	405	17	1,070	26	2,124	
	9	470	18	1,151	27	2,286	

Select upholstery for everything else other than the seat and back cushions (the outside back, arms, sides, seat frame). You can specify the same fabric as the cushions or select other fabric.

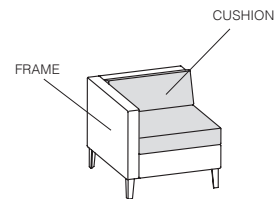

TO ORDER PLEASE SPECIFY THE FOLLOWING:

<input type="text"/>	<input type="text"/>	<input type="text"/>	<input type="text"/>	<input type="text"/>	<input type="text"/>
MODEL NUMBER	WOOD FINISH	STITCH DETAIL	FLAMMABILITY RATING	CUSHION UPHOLSTERY	FRAME UPHOLSTERY
	Cherry finishes on Maple Walnut finishes on Maple Maple finishes on Maple Oak finishes on Maple	None NR Stitch detail SD +\$175	U CTB117	Please refer to list of available upholstery and leather selections on www.gunlocke.com	Please refer to list of available upholstery and leather selections on www.gunlocke.com

Example

GK1107-1W.777.NR.U.DOL728.SPNN04					
GK1107-1W	777	NR	U	DOL728	SPNN04
MODEL NUMBER	WOOD FINISH	STITCH DETAIL	FLAMMABILITY	CUSHION UPHOLSTERY	FRAME UPHOLSTERY

Please refer to the Ciji product page on www.gunlocke.com for standard finish options.

CIJI SINGLE SEAT

Low Back, Arm Right, Aluminum Legs

Seating
05/22

model number	fabric grades								dimensions	W	D	H
GK1107-1A Low back, arm right Aluminum legs	1	3,205	10	4,027	19	5,097	L1	4,463	Overall	28 1/8"	31 1/2"	27 7/8"
	2	3,280	11	4,126	20	5,221	L2	5,504	Seat	24"	21"	17 1/4"
	3	3,354	12	4,226	21	5,346	L3	6,754	Arm	26 7/8"		
	COM/4	3,429	13	4,350	22	5,470	L4	7,795	Between arms			
	5	3,529	14	4,475	23	5,719	L5	8,836	Upholstery Requirements: GK1107-1A			
	6	3,629	15	4,599	24	5,968	Dual Upholstery					
	7	3,727	16	4,724	25	6,217	Fabric yds Cushions 1.5 Frame 2.8					
	8	3,827	17	4,848	26	6,467	Leather ft ² Cushions 34.5 Frame 64.4					
	9	3,927	18	4,973	27	6,715	Shipping weight 87 lbs.					
										Cube 28.0		



Cushion	1	10	19	20	21	22	23	24	25	26	27	L1	L2	L3	L4	L5
		287	660									439	802	1,238	1,601	1,964
	26	321	703													
	52	356	747													
	78	399	790													
	113	443	877													
	148	486	964													
	182	530	1,051													
	217	573	1,138													
	252	617	1,224													

Top row of pricing is for units specified with same fabric on cushion and frame. Bottom 2 rows of pricing required only when two different fabric grades are selected for the cushion and frame.

To calculate price of lounge with different grade fabric for cushion and frame; start with Grade 1 price, add appropriate grade price located in second row for cushion, and last add appropriate grade price located in third row for frame to the sum of the Grade 1 and cushion price.

Example: Grade 1 \$3,205 + grade 4 fabric cushion \$78 + grade 2 fabric frame \$49 = \$3,332

Frame	1	10	19	20	21	22	23	24	25	26	27	L1	L2	L3	L4	L5
		535	1,232									819	1,497	2,311	2,989	3,667
	49	600	1,313													
	97	665	1,394													
	146	746	1,475													
	211	827	1,637													
	276	908	1,799													
	340	989	1,961													
	405	1,070	2,124													
	470	1,151	2,286													

Select upholstery for everything else other than the seat and back cushions (the outside back, arms, sides, seat frame). You can specify the same fabric as the cushions or select other fabric.

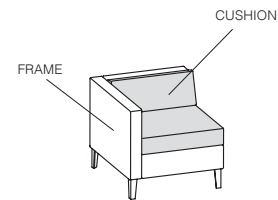

TO ORDER PLEASE SPECIFY THE FOLLOWING:

<input type="text"/>	<input type="text"/>	<input type="text"/>	<input type="text"/>	<input type="text"/>
MODEL NUMBER	STITCH DETAIL	FLAMMABILITY RATING	CUSHION UPHOLSTERY	FRAME UPHOLSTERY
	None NR Stitch detail SD +\$175	U CTB117	Please refer to list of available upholstery and leather selections on www.gunlocke.com	Please refer to list of available upholstery and leather selections on www.gunlocke.com

Example

GK1107-1A.NR.U.DOL728.SPNN04
 GK1107-1A NR U DOL728 SPNN04
 MODEL NUMBER STITCH FLAMMABILITY RATING CUSHION UPHOLSTERY FRAME UPHOLSTERY

Please refer to the Ciji product page on www.gunlocke.com for standard finish options.

Seating
05/22

CIJI TWO SEAT

Low Back, with Arms. Wood Legs

model number fabric grades dimensions W D H

GK1101-2W

Low back, with arms
Wood legs

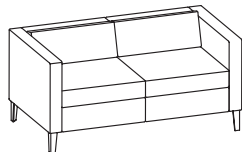

1	4,414	10	5,961	19	7,978	L1	6,785
2	4,554	11	6,149	20	8,213	L2	8,746
3	4,696	12	6,336	21	8,447	L3	11,098
COM/4	4,836	13	6,571	22	8,682	L4	13,059
5	5,023	14	6,805	23	9,151	L5	15,020
6	5,211	15	7,040	24	9,620		
7	5,399	16	7,274	25	10,089		
8	5,587	17	7,509	26	10,557		
9	5,774	18	7,743	27	11,026		

Overall	56 1/4"	31 1/2"	27 1/8"
Seat	48 1/2"	21"	17 1/4"
Arm			26 1/8"
Between arms	48 1/2"		

Upholstery Requirements: GK1101-2W

	Dual Upholstery
Fabric yds	Cushions 2.9 Frame 5.2
Leather ft ²	Cushions 66.7 Frame 119.6
Shipping weight	119 lbs.
Cube	35

Cushion

1	10	554	19	1,276	L1	849
2	50	11	621	20	L2	1,551
3	101	12	688	21	L3	2,393
COM/4	151	13	772	22	L4	3,095
5	218	14	856	23	L5	3,797
6	285	15	940	24		
7	353	16	1,024	25		
8	420	17	1,108	26		
9	487	18	1,192	27		

Top row of pricing is for units specified with same fabric on cushion and frame. Bottom 2 rows of pricing required only when two different fabric grades are selected for the cushion and frame.

To calculate price of lounge with different grade fabric for cushion and frame; start with Grade 1 price, add appropriate grade price located in second row for cushion, and last add appropriate grade price located in third row for frame to the sum of the Grade 1 and cushion price.

Example: Grade 1 \$4,414 + grade 4 fabric cushion \$151 + grade 2 fabric frame \$90 = \$4,655

Frame

1	10	993	19	2,288	L1	1,522
2	90	11	1,114	20	L2	2,781
3	181	12	1,234	21	L3	4,291
COM/4	271	13	1,385	22	L4	5,550
5	391	14	1,535	23	L5	6,809
6	512	15	1,686	24		
7	632	16	1,836	25		
8	753	17	1,987	26		
9	873	18	2,137	27		

Select upholstery for everything else other than the seat and back cushions (the outside back, arms, sides, seat frame). You can specify the same fabric as the cushions or select other fabric.

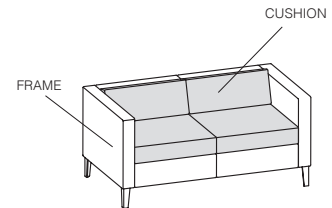

TO ORDER PLEASE SPECIFY THE FOLLOWING:

<input type="text"/>	<input type="text"/>	<input type="text"/>	<input type="text"/>	<input type="text"/>	<input type="text"/>
MODEL NUMBER	WOOD FINISH	STITCH DETAIL	FLAMMABILITY RATING	CUSHION UPHOLSTERY	FRAME UPHOLSTERY
	Cherry finishes on Maple Walnut finishes on Maple Maple finishes on Maple Oak finishes on Maple	None NR Stitch detail SD +\$175	U CTB117	Please refer to list of available upholstery and leather selections on www.gunlocke.com	Please refer to list of available upholstery and leather selections on www.gunlocke.com

Example

GK1101-2W.777.NR.U.DOL728.SPNN04
 GK1101-2W 777 NR U DOL728 SPNN04
 MODEL NUMBER WOOD FINISH STITCH DETAIL FLAMMABILITY CUSHION UPHOLSTERY FRAME UPHOLSTERY

Please refer to the Ciji product page on www.gunlocke.com for standard finish options.

CIJI TWO SEAT

Low Back, with Arms, Aluminum Legs

Seating
05/22

model number	fabric grades							
GK1101-2A Low back, with arms, Aluminum Legs	1	4,651	10	6,198	19	8,215	L1	7,022
	2	4,791	11	6,386	20	8,450	L2	8,983
	3	4,933	12	6,573	21	8,684	L3	11,335
	COM/4	5,073	13	6,808	22	8,919	L4	13,296
	5	5,260	14	7,042	23	9,388	L5	15,257
	6	5,448	15	7,277	24	9,857		
	7	5,636	16	7,511	25	10,326		
	8	5,824	17	7,746	26	10,794		
	9	6,011	18	7,980	27	11,263		

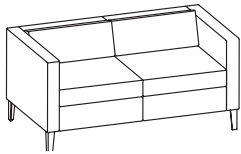

dimensions	W	D	H
Overall	56 1/4"	31 1/2"	27 1/8"
Seat	48 1/2"	21"	17 1/4"
Arm			26 1/8"
Between arms	48 1/2"		

Upholstery Requirements: GK1101-2A	
	Dual Upholstery
Fabric yds	Cushions 2.9 Frame 5.2
Leather ft ²	Cushions 66.7 Frame 119.6
Shipping weight	119 lbs.
Cube	35

Cushion	1	10	554	19	1,276	L1	849
	2	50	11	621	20	L2	1,551
	3	101	12	688	21	L3	2,393
	COM/4	151	13	772	22	L4	3,095
	5	218	14	856	23	L5	3,797
	6	285	15	940	24		
	7	353	16	1,024	25		
	8	420	17	1,108	26		
	9	487	18	1,192	27		

Top row of pricing is for units specified with same fabric on cushion and frame. Bottom 2 rows of pricing required only when two different fabric grades are selected for the cushion and frame.

To calculate price of lounge with different grade fabric for cushion and frame; start with Grade 1 price, add appropriate grade price located in second row for cushion, and last add appropriate grade price located in third row for frame to the sum of the Grade 1 and cushion price.

Example: Grade 1 \$4,651 + grade 4 fabric cushion \$151 + grade 2 fabric frame \$90 = \$4,892

Frame	1	10	993	19	2,288	L1	1,522
	2	90	11	1,114	20	L2	2,781
	3	181	12	1,234	21	L3	4,291
	COM/4	271	13	1,385	22	L4	5,550
	5	391	14	1,535	23	L5	6,809
	6	512	15	1,686	24		
	7	632	16	1,836	25		
	8	753	17	1,987	26		
	9	873	18	2,137	27		

Select upholstery for everything else other than the seat and back cushions (the outside back, arms, sides, seat frame). You can specify the same fabric as the cushions or select other fabric.

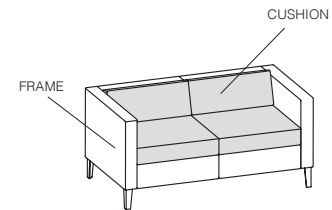

TO ORDER PLEASE SPECIFY THE FOLLOWING:

<input type="text"/>	<input type="text"/>	<input type="text"/>	<input type="text"/>	<input type="text"/>
MODEL NUMBER	STITCH DETAIL	FLAMMABILITY RATING	CUSHION UPHOLSTERY	FRAME UPHOLSTERY
	None NR Stitch detail SD +\$175	U CTB117	Please refer to list of available upholstery and leather selections on www.gunlocke.com	Please refer to list of available upholstery and leather selections on www.gunlocke.com

Example

GK1101-2A.NR.U.DOL728.SPNN04				
GK1101-2A	NR	U	DOL728	SPNN04
MODEL NUMBER	STITCH	FLAMMABILITY DETAIL	CUSHION UPHOLSTERY	FRAME UPHOLSTERY

Please refer to the Ciji product page on www.gunlocke.com for standard finish options.

Seating
05/22

CIJI TWO SEAT

Low Back, Armless, Wood Legs

model number

fabric grades

dimensions

W

D

H

GK1103-2W

Low back, armless,
Wood legs

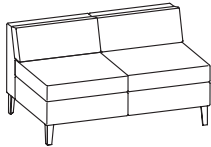

1	3,644	10	4,637	19	5,932	L1	5,166
2	3,734	11	4,758	20	6,083	L2	6,425
3	3,825	12	4,878	21	6,233	L3	7,935
COM/4	3,915	13	5,029	22	6,384	L4	9,194
5	4,035	14	5,179	23	6,685	L5	10,453
6	4,155	15	5,330	24	6,986		
7	4,277	16	5,480	25	7,287		
8	4,397	17	5,631	26	7,587		
9	4,517	18	5,781	27	7,889		

Overall	49 1/8"	31 1/2"	27 7/8"
Seat	48 1/2"	21"	17 1/4"

Upholstery Requirements: GK1103-2W

	Dual Upholstery	
Fabric yds	Cushions 2.9	Frame 2.3
Leather ft ²	Cushions 66.7	Frame 52.9
Shipping weight	99 lbs.	
Cube	35	

Cushion

1	10	554	19	1,276	L1	849
2	50	11	621	20	L2	1,551
3	101	12	688	21	L3	2,393
COM/4	151	13	772	22	L4	3,095
5	218	14	856	23	L5	3,797
6	285	15	940	24		
7	353	16	1,024	25		
8	420	17	1,108	26		
9	487	18	1,192	27		

Top row of pricing is for units specified with same fabric on cushion and frame. Bottom 2 rows of pricing required only when two different fabric grades are selected for the cushion and frame.

To calculate price of lounge with different grade fabric for cushion and frame; start with Grade 1 price, add appropriate grade price located in second row for cushion, and last add appropriate grade price located in third row for frame to the sum of the Grade 1 and cushion price.

Example: Grade 1 \$3,644 + grade 4 fabric cushion \$151 + grade 2 fabric frame \$40 = \$3,835

Frame

1	10	439	19	1,012	L1	673
2	40	11	493	20	L2	1,230
3	80	12	546	21	L3	1,898
COM/4	120	13	613	22	L4	2,455
5	173	14	679	23	L5	3,012
6	226	15	746	24		
7	280	16	812	25		
8	333	17	879	26		
9	386	18	945	27		

Select upholstery for everything else other than the seat and back cushions (the outside back, arms, sides, seat frame). You can specify the same fabric as the cushions or select other fabric.

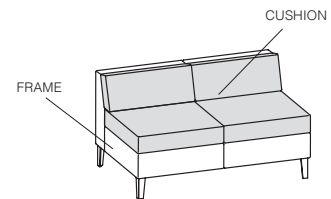

TO ORDER PLEASE SPECIFY THE FOLLOWING:

<input type="text"/>	<input type="text"/>	<input type="text"/>	<input type="text"/>	<input type="text"/>	<input type="text"/>
MODEL NUMBER	WOOD FINISH	STITCH DETAIL	FLAMMABILITY RATING	CUSHION UPHOLSTERY	FRAME UPHOLSTERY
	Cherry finishes on Maple Walnut finishes on Maple Maple finishes on Maple Oak finishes on Maple	None NR Stitch detail SD +\$175	U CTB117	Please refer to list of available upholstery and leather selections on www.gunlocke.com	Please refer to list of available upholstery and leather selections on www.gunlocke.com

Example

GK1103-2W.777.NR.U.DOL728.SPNN04					
GK1103-2W	777	NR	U	DOL728	SPNN04
MODEL NUMBER	WOOD FINISH	STITCH DETAIL	FLAMMABILITY	CUSHION UPHOLSTERY	FRAME UPHOLSTERY

Please refer to the Ciji product page on www.gunlocke.com for standard finish options.

CIJI TWO SEAT

Low Back, Armless, Aluminum Legs

model number

fabric grades

dimensions

W

D

H

GK1103-2A

Low back, armless,
Aluminum legs

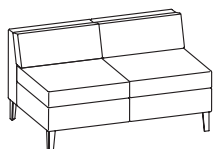

1	3,881	10	4,874	19	6,169	L1	5,403
2	3,971	11	4,995	20	6,320	L2	6,662
3	4,062	12	5,115	21	6,470	L3	8,172
COM/4	4,152	13	5,266	22	6,621	L4	9,431
5	4,272	14	5,416	23	6,922	L5	10,690
6	4,392	15	5,567	24	7,223		
7	4,514	16	5,717	25	7,524		
8	4,634	17	5,868	26	7,824		
9	4,754	18	6,018	27	8,126		

Overall	49 1/8"	31 1/2"	27 7/8"
Seat	48 1/2"	21"	17 1/4"

Upholstery Requirements: GK1103-2A

	Dual Upholstery	
Fabric yds	Cushions 2.9	Frame 2.3
Leather ft ²	Cushions 66.7	Frame 52.9
Shipping weight	99 lbs.	
Cube	35	

Cushion

1		10	554	19	1,276	L1	849
2	50	11	621	20	1,360	L2	1,551
3	101	12	688	21	1,444	L3	2,393
COM/4	151	13	772	22	1,528	L4	3,095
5	218	14	856	23	1,696	L5	3,797
6	285	15	940	24	1,864		
7	353	16	1,024	25	2,032		
8	420	17	1,108	26	2,199		
9	487	18	1,192	27	2,367		

Top row of pricing is for units specified with same fabric on cushion and frame. Bottom 2 rows of pricing required only when two different fabric grades are selected for the cushion and frame.

To calculate price of lounge with different grade fabric for cushion and frame; start with Grade 1 price, add appropriate grade price located in second row for cushion, and last add appropriate grade price located in third row for frame to the sum of the Grade 1 and cushion price.

Example: Grade 1 \$3,881 + grade 4 fabric cushion \$151 + grade 2 fabric frame \$40 = \$4,072

Frame

1		10	439	19	1,012	L1	673
2	40	11	493	20	1,079	L2	1,230
3	80	12	546	21	1,145	L3	1,898
COM/4	120	13	613	22	1,212	L4	2,455
5	173	14	679	23	1,345	L5	3,012
6	226	15	746	24	1,478		
7	280	16	812	25	1,611		
8	333	17	879	26	1,744		
9	386	18	945	27	1,878		

Select upholstery for everything else other than the seat and back cushions (the outside back, arms, sides, seat frame). You can specify the same fabric as the cushions or select other fabric.

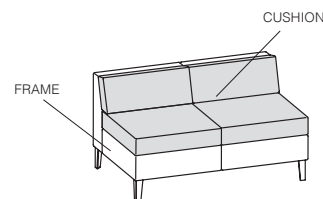

TO ORDER PLEASE SPECIFY THE FOLLOWING:

<input type="text"/>	<input type="text"/>	<input type="text"/>	<input type="text"/>	<input type="text"/>
MODEL NUMBER	STITCH DETAIL	FLAMMABILITY RATING	CUSHION UPHOLSTERY	FRAME UPHOLSTERY
	None NR Stitch detail SD +\$175	U CTB117	Please refer to list of available upholstery and leather selections on www.gunlocke.com	Please refer to list of available upholstery and leather selections on www.gunlocke.com

Example

GK1103-2A.NR.U.DOL728.SPNN04

GK1103-2A	NR	U	DOL728	SPNN04
MODEL NUMBER	STITCH	FLAMMABILITY DETAIL	CUSHION UPHOLSTERY	FRAME UPHOLSTERY

Please refer to the Ciji product page on www.gunlocke.com for standard finish options.

Seating
05/22

CIJI TWO SEAT

Low Back, Arm Left, Wood Legs

model number	fabric grades						dimensions	W	D	H		
GK1105-2W Low back, arm left, Wood legs	1	4,233	10	5,513	19	7,181	L1	6,194	Overall	52 5/8"	31 1/2"	27 7/8"
	2	4,349	11	5,668	20	7,375	L2	7,816	Seat	48 1/2"	21"	17 1/4"
	3	4,466	12	5,823	21	7,569	L3	9,762	Arm	26 7/8"		
	COM/4	4,582	13	6,017	22	7,763	L4	11,384	Between arms			
	5	4,737	14	6,211	23	8,151	L5	13,006	Upholstery Requirements: GK1105-2W			
	6	4,892	15	6,405	24	8,539	Dual Upholstery					
	7	5,048	16	6,599	25	8,927	Fabric yds Cushions 2.9 Frame 3.8					
	8	5,203	17	6,793	26	9,314	Leather ft ² Cushions 66.7 Frame 87.4					
	9	5,358	18	6,987	27	9,702	Shipping weight 109 lbs.					
								Cube 35				

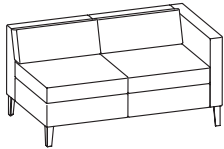

Cushion	1	10	554	19	1,276	L1	849	
	2	50	11	621	20	1,360	L2	1,551
	3	101	12	688	21	1,444	L3	2,393
	COM/4	151	13	772	22	1,528	L4	3,095
	5	218	14	856	23	1,696	L5	3,797
	6	285	15	940	24	1,864		
	7	353	16	1,024	25	2,032		
	8	420	17	1,108	26	2,199		
	9	487	18	1,192	27	2,367		

Top row of pricing is for units specified with same fabric on cushion and frame. Bottom 2 rows of pricing required only when two different fabric grades are selected for the cushion and frame.

To calculate price of lounge with different grade fabric for cushion and frame; start with Grade 1 price, add appropriate grade price located in second row for cushion, and last add appropriate grade price located in third row for frame to the sum of the Grade 1 and cushion price.

Example: Grade 1 \$4,233 + grade 4 fabric cushion \$151 + grade 2 fabric frame \$66 = \$4,450

Frame	1	10	726	19	1,672	L1	1,112	
	2	66	11	814	20	1,782	L2	2,032
	3	132	12	902	21	1,892	L3	3,136
	COM/4	198	13	1,012	22	2,002	L4	4,056
	5	286	14	1,122	23	2,222	L5	4,976
	6	374	15	1,232	24	2,442		
	7	462	16	1,342	25	2,662		
	8	550	17	1,452	26	2,882		
	9	638	18	1,562	27	3,102		

Select upholstery for everything else other than the seat and back cushions (the outside back, arms, sides, seat frame). You can specify the same fabric as the cushions or select other fabric.

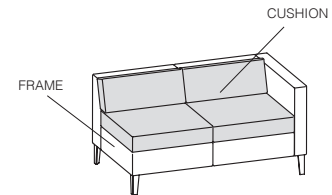

TO ORDER PLEASE SPECIFY THE FOLLOWING:

<input type="text"/>	<input type="text"/>	<input type="text"/>	<input type="text"/>	<input type="text"/>	<input type="text"/>
MODEL NUMBER	WOOD FINISH	STITCH DETAIL	FLAMMABILITY RATING	CUSHION UPHOLSTERY	FRAME UPHOLSTERY
	Cherry finishes on Maple Walnut finishes on Maple Maple finishes on Maple Oak finishes on Maple	None NR Stitch detail SD +\$175	U CTB117	Please refer to list of available upholstery and leather selections on www.gunlocke.com	Please refer to list of available upholstery and leather selections on www.gunlocke.com

Example

GK1105-2W.777.NR.U.DOL728.SPNO4					
GK1105-2W	777	NR	U	DOL728	SPNO4
MODEL NUMBER	WOOD FINISH	STITCH DETAIL	FLAMMABILITY	CUSHION UPHOLSTERY	FRAME UPHOLSTERY

Please refer to the Ciji product page on www.gunlocke.com for standard finish options.

CIJI TWO SEAT

Low Back, Arm Left, Aluminum Legs

model number fabric grades dimensions W D H

GK1105-2A

Low back, arm left,
Aluminum legs

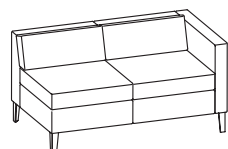

1	4,471	10	5,751	19	7,419	L1	6,432
2	4,587	11	5,906	20	7,613	L2	8,054
3	4,704	12	6,061	21	7,807	L3	10,000
COM/4	4,820	13	6,255	22	8,001	L4	11,622
5	4,975	14	6,449	23	8,389	L5	13,244
6	5,130	15	6,643	24	8,777		
7	5,286	16	6,837	25	9,165		
8	5,441	17	7,031	26	9,552		
9	5,596	18	7,225	27	9,940		

Overall	52 5/8"	31 1/2"	27 7/8"
Seat	48 1/2"	21"	17 1/4"
Arm			26 7/8"
Between arms			

Upholstery Requirements: GK1105-2A

	Dual Upholstery	
Fabric yds	Cushions 2.9	Frame 3.8
Leather ft ²	Cushions 66.7	Frame 87.4
Shipping weight		109 lbs.
Cube		35

Cushion

1	10	554	19	1,276	L1	849
2	50	11	621	20	L2	1,551
3	101	12	688	21	L3	2,393
COM/4	151	13	772	22	L4	3,095
5	218	14	856	23	L5	3,797
6	285	15	940	24		
7	353	16	1,024	25		
8	420	17	1,108	26		
9	487	18	1,192	27		

Top row of pricing is for units specified with same fabric on cushion and frame. Bottom 2 rows of pricing required only when two different fabric grades are selected for the cushion and frame.

To calculate price of lounge with different grade fabric for cushion and frame; start with Grade 1 price, add appropriate grade price located in second row for cushion, and last add appropriate grade price located in third row for frame to the sum of the Grade 1 and cushion price.

Example: Grade 1 \$4,471 + grade 4 fabric cushion \$151 + grade 2 fabric frame \$66 = \$4,688

Frame

1	10	726	19	1,672	L1	1,112
2	66	11	814	20	L2	2,032
3	132	12	902	21	L3	3,136
COM/4	198	13	1,012	22	L4	4,056
5	286	14	1,122	23	L5	4,976
6	374	15	1,232	24		
7	462	16	1,342	25		
8	550	17	1,452	26		
9	638	18	1,562	27		

Select upholstery for everything else other than the seat and back cushions (the outside back, arms, sides, seat frame). You can specify the same fabric as the cushions or select other fabric.

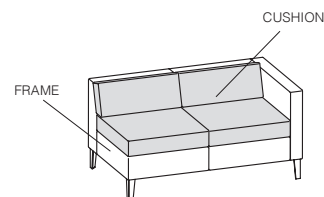

TO ORDER PLEASE SPECIFY THE FOLLOWING:

<input type="text"/>	<input type="text"/>	<input type="text"/>	<input type="text"/>	<input type="text"/>
MODEL NUMBER	STITCH DETAIL	FLAMMABILITY RATING	CUSHION UPHOLSTERY	FRAME UPHOLSTERY
	None NR Stitch detail SD +\$175	U CTB117	Please refer to list of available upholstery and leather selections on www.gunlocke.com	Please refer to list of available upholstery and leather selections on www.gunlocke.com

Example

GK1105-2A.NR.U.DOL728.SPNN04				
GK1105-2A	NR	U	DOL728	SPNN04
MODEL NUMBER	STITCH	FLAMMABILITY DETAIL	CUSHION UPHOLSTERY	FRAME UPHOLSTERY

Please refer to the Ciji product page on www.gunlocke.com for standard finish options.

Seating
05/22

CIJI TWO SEAT

Low Back, Arm Right, Wood Legs

model number	fabric grades							
GK1107-2W Low back, arm right, Wood legs	1	4,233	10	5,513	19	7,181	L1	6,194
	2	4,349	11	5,668	20	7,375	L2	7,816
	3	4,466	12	5,823	21	7,569	L3	9,762
	COM/4	4,582	13	6,017	22	7,763	L4	11,384
	5	4,737	14	6,211	23	8,151	L5	13,006
	6	4,892	15	6,405	24	8,539		
	7	5,048	16	6,599	25	8,927		
	8	5,203	17	6,793	26	9,314		
	9	5,358	18	6,987	27	9,702		

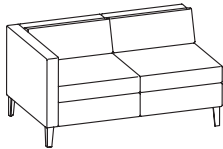

dimensions	W	D	H
Overall	52 5/8"	31 1/2"	27 7/8"
Seat	48 1/2"	21"	17 1/4"
Arm			26 7/8"
Between arms			

Upholstery Requirements: GK1107-2W

	Dual Upholstery	
Fabric yds	Cushions 2.9	Frame 3.8
Leather ft ²	Cushions 66.7	Frame 87.4
Shipping weight		109 lbs.
Cube		35

Cushion	1	10	554	19	1,276	L1	849
	2	50	11	621	20	L2	1,551
	3	101	12	688	21	L3	2,393
	COM/4	151	13	772	22	L4	3,095
	5	218	14	856	23	L5	3,797
	6	285	15	940	24		
	7	353	16	1,024	25		
	8	420	17	1,108	26		
	9	487	18	1,192	27		

Top row of pricing is for units specified with same fabric on cushion and frame. Bottom 2 rows of pricing required only when two different fabric grades are selected for the cushion and frame.

To calculate price of lounge with different grade fabric for cushion and frame; start with Grade 1 price, add appropriate grade price located in second row for cushion, and last add appropriate grade price located in third row for frame to the sum of the Grade 1 and cushion price.

Example: Grade 1 \$4,233 + grade 4 fabric cushion \$151 + grade 2 fabric frame \$66 = \$4,450

Frame	1	10	726	19	1,672	L1	1,112
	2	66	11	814	20	L2	2,032
	3	132	12	902	21	L3	3,136
	COM/4	198	13	1,012	22	L4	4,056
	5	286	14	1,122	23	L5	4,976
	6	374	15	1,232	24		
	7	462	16	1,342	25		
	8	550	17	1,452	26		
	9	638	18	1,562	27		

Select upholstery for everything else other than the seat and back cushions (the outside back, arms, sides, seat frame). You can specify the same fabric as the cushions or select other fabric.

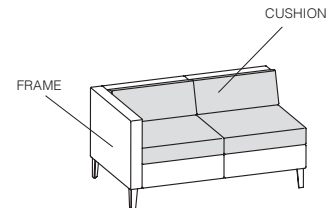

TO ORDER PLEASE SPECIFY THE FOLLOWING:

<input type="text"/>	<input type="text"/>	<input type="text"/>	<input type="text"/>	<input type="text"/>	<input type="text"/>
MODEL NUMBER	WOOD FINISH	STITCH DETAIL	FLAMMABILITY RATING	CUSHION UPHOLSTERY	FRAME UPHOLSTERY
	Cherry finishes on Maple Walnut finishes on Maple Maple finishes on Maple Oak finishes on Maple	None NR Stitch detail SD +\$175	U CTB117	Please refer to list of available upholstery and leather selections on www.gunlocke.com	Please refer to list of available upholstery and leather selections on www.gunlocke.com

Example

GK1107-2W.777.NR.U.DOL728.SPNN04					
GK1107-2W	777	NR	U	DOL728	SPNN04
MODEL NUMBER	WOOD FINISH	STITCH DETAIL	FLAMMABILITY	CUSHION UPHOLSTERY	FRAME UPHOLSTERY

Please refer to the Ciji product page on www.gunlocke.com for standard finish options.

CIJI TWO SEAT

Low Back, Arm Right, Aluminum Legs

model number fabric grades dimensions W D H

GK1107-2A

Low back, arm right
Aluminum legs

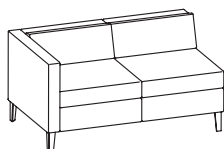

1	4,471	10	5,751	19	7,419	L1	6,432
2	4,587	11	5,906	20	7,613	L2	8,054
3	4,704	12	6,061	21	7,807	L3	10,000
COM/4	4,820	13	6,255	22	8,001	L4	11,622
5	4,975	14	6,449	23	8,389	L5	13,244
6	5,130	15	6,643	24	8,777		
7	5,286	16	6,837	25	9,165		
8	5,441	17	7,031	26	9,552		
9	5,596	18	7,225	27	9,940		

Overall	52 5/8"	31 1/2"	27 7/8"
Seat	48 1/2"	21"	17 1/4"
Arm			26 7/8"
Between arms			

Upholstery Requirements: GK1107-2A

	Dual Upholstery	
Fabric yds	Cushions 2.9	Frame 3.8
Leather ft ²	Cushions 66.7	Frame 87.4
Shipping weight		109 lbs.
Cube		35

Cushion

1	10	554	19	1,276	L1	849
2	50	11	621	20	L2	1,551
3	101	12	688	21	L3	2,393
COM/4	151	13	772	22	L4	3,095
5	218	14	856	23	L5	3,797
6	285	15	940	24		
7	353	16	1,024	25		
8	420	17	1,108	26		
9	487	18	1,192	27		

Top row of pricing is for units specified with same fabric on cushion and frame. Bottom 2 rows of pricing required only when two different fabric grades are selected for the cushion and frame.

To calculate price of lounge with different grade fabric for cushion and frame; start with Grade 1 price, add appropriate grade price located in second row for cushion, and last add appropriate grade price located in third row for frame to the sum of the Grade 1 and cushion price.

Example: Grade 1 \$4,471 + grade 4 fabric cushion \$151 + grade 2 fabric frame \$66 = \$4,688

Frame

1	10	726	19	1,672	L1	1,112
2	66	11	814	20	L2	2,032
3	132	12	902	21	L3	3,136
COM/4	198	13	1,012	22	L4	4,056
5	286	14	1,122	23	L5	4,976
6	374	15	1,232	24		
7	462	16	1,342	25		
8	550	17	1,452	26		
9	638	18	1,562	27		

Select upholstery for everything else other than the seat and back cushions (the outside back, arms, sides, seat frame). You can specify the same fabric as the cushions or select other fabric.

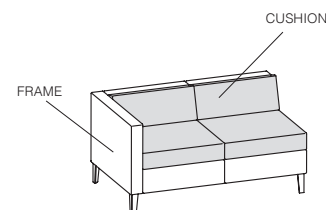

TO ORDER PLEASE SPECIFY THE FOLLOWING:

<input type="text"/>	<input type="text"/>	<input type="text"/>	<input type="text"/>	<input type="text"/>
MODEL NUMBER	STITCH DETAIL	FLAMMABILITY RATING	CUSHION UPHOLSTERY	FRAME UPHOLSTERY
	None NR Stitch detail SD +\$175	U CTB117	Please refer to list of available upholstery and leather selections on www.gunlocke.com	Please refer to list of available upholstery and leather selections on www.gunlocke.com

Example

GK1107-2A.NR.U.DOL728.SPNN04
 GK1107-2A NR U DOL728 SPNN04
 MODEL NUMBER STITCH FLAMMABILITY RATING CUSHION UPHOLSTERY FRAME UPHOLSTERY

Please refer to the Ciji product page on www.gunlocke.com for standard finish options.

Seating
05/22

CIJI THREE SEAT

Low Back, with Arms, Wood Legs

model number	fabric grades							
GK1101-3W Low back, with arms, Wood legs	1	5,624	10	7,592	19	10,156	L1	8,639
	2	5,802	11	7,831	20	10,454	L2	11,132
	3	5,982	12	8,068	21	10,753	L3	14,124
	COM/4	6,160	13	8,367	22	11,050	L4	16,617
	5	6,399	14	8,665	23	11,647	L5	19,112
	6	6,638	15	8,964	24	12,244		
	7	6,876	16	9,262	25	12,839		
	8	7,115	17	9,559	26	13,436		
	9	7,354	18	9,858	27	14,032		

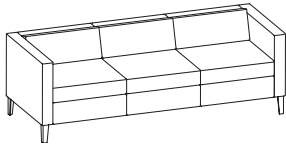

dimensions	W	D	H
Overall	80 3/4"	31 1/2"	27 7/8"
Seat	73"	21"	17 1/4"
Arm			26 7/8"
Between arms	73"		

Upholstery Requirements: GK1101-3W	
	Dual Upholstery
Fabric yds	Cushions 4.4 Frame 5.9
Leather ft²	Cushions 101.2 Frame 135.7
Shipping weight	181 lbs.
Cube	78.5

Cushion	1	10	841	19	1,936	L1	1,288
	2	76	11	943	20	2,063	L2 2,353
	3	153	12	1,044	21	2,191	L3 3,631
	COM/4	229	13	1,172	22	2,318	L4 4,696
	5	331	14	1,299	23	2,573	L5 5,762
	6	433	15	1,427	24	2,828	
	7	535	16	1,554	25	3,082	
	8	637	17	1,681	26	3,337	
	9	739	18	1,809	27	3,592	

Top row of pricing is for units specified with same fabric on cushion and frame. Bottom 2 rows of pricing required only when two different fabric grades are selected for the cushion and frame.

To calculate price of lounge with different grade fabric for cushion and frame; start with Grade 1 price, add appropriate grade price located in second row for cushion, and last add appropriate grade price located in third row for frame to the sum of the Grade 1 and cushion price.

Example: Grade 1 \$5,624 + grade 4 fabric cushion \$229 + grade 2 fabric frame \$102 = \$5,955

Frame	1	10	1,127	19	2,596	L1	1,727
	2	102	11	1,264	20	2,767	L2 3,155
	3	205	12	1,400	21	2,938	L3 4,869
	COM/4	307	13	1,571	22	3,108	L4 6,297
	5	444	14	1,742	23	3,450	L5 7,726
	6	581	15	1,913	24	3,792	
	7	717	16	2,084	25	4,133	
	8	854	17	2,254	26	4,475	
	9	991	18	2,425	27	4,816	

Select upholstery for everything else other than the seat and back cushions (the outside back, arms, sides, seat frame). You can specify the same fabric as the cushions or select other fabric.

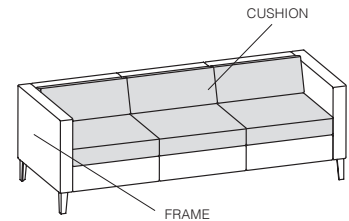

TO ORDER PLEASE SPECIFY THE FOLLOWING:

<input type="text"/>	<input type="text"/>	<input type="text"/>	<input type="text"/>	<input type="text"/>	<input type="text"/>
MODEL NUMBER	WOOD FINISH	STITCH DETAIL	FLAMMABILITY RATING	CUSHION UPHOLSTERY	FRAME UPHOLSTERY
	Cherry finishes on Maple Walnut finishes on Maple Maple finishes on Maple Oak finishes on Maple	None NR Stitch detail SD +\$175	U CTB117	Please refer to list of available upholstery and leather selections on www.gunlocke.com	Please refer to list of available upholstery and leather selections on www.gunlocke.com

Example

GK1101-3W.777.NR.U.DOL728.SPNN04
 GK1101-3W 777 NR U DOL728 SPNN04
 MODEL NUMBER WOOD FINISH STITCH DETAIL FLAMMABILITY CUSHION UPHOLSTERY FRAME UPHOLSTERY

Please refer to the Ciji product page on www.gunlocke.com for standard finish options.

CIJI THREE SEAT

Low Back, with Arms, Aluminum Legs

Seating
05/22

model number	fabric grades							
GK1101-3A Low back, with arms, Aluminum legs	1	5,860	10	7,828	19	10,392	L1	8,875
	2	6,038	11	8,067	20	10,690	L2	11,368
	3	6,218	12	8,304	21	10,989	L3	14,360
	COM/4	6,396	13	8,603	22	11,286	L4	16,853
	5	6,635	14	8,901	23	11,883	L5	19,348
	6	6,874	15	9,200	24	12,480		
	7	7,112	16	9,498	25	13,075		
	8	7,351	17	9,795	26	13,672		
	9	7,590	18	10,094	27	14,268		

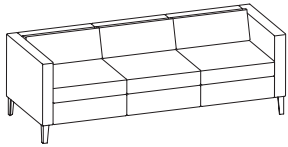

dimensions	W	D	H
Overall	80 3/4"	31 1/2"	27 7/8"
Seat	73"	21"	17 1/4"
Arm			26 7/8"
Between arms	73"		

Upholstery Requirements: GK1101-3A

	Dual Upholstery	
Fabric yds	Cushions 4.4	Frame 5.9
Leather ft ²	Cushions 101.2	Frame 135.7
Shipping weight		181 lbs.
Cube		78.5

Cushion	1	10	841	19	1,936	L1	1,288
	2	76	11	943	20	L2	2,353
	3	153	12	1,044	21	L3	3,631
	COM/4	229	13	1,172	22	L4	4,696
	5	331	14	1,299	23	L5	5,762
	6	433	15	1,427	24		
	7	535	16	1,554	25		
	8	637	17	1,681	26		
	9	739	18	1,809	27		

Top row of pricing is for units specified with same fabric on cushion and frame. Bottom 2 rows of pricing required only when two different fabric grades are selected for the cushion and frame.

To calculate price of lounge with different grade fabric for cushion and frame; start with Grade 1 price, add appropriate grade price located in second row for cushion, and last add appropriate grade price located in third row for frame to the sum of the Grade 1 and cushion price.

Example: Grade 1 \$5,860 + grade 4 fabric cushion \$229 + grade 2 fabric frame \$102 = \$6,191

Frame	1	10	1,127	19	2,596	L1	1,727
	2	102	11	1,264	20	L2	3,155
	3	205	12	1,400	21	L3	4,869
	COM/4	307	13	1,571	22	L4	6,297
	5	444	14	1,742	23	L5	7,726
	6	581	15	1,913	24		
	7	717	16	2,084	25		
	8	854	17	2,254	26		
	9	991	18	2,425	27		

Select upholstery for everything else other than the seat and back cushions (the outside back, arms, sides, seat frame). You can specify the same fabric as the cushions or select other fabric.

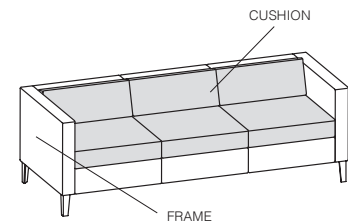

TO ORDER PLEASE SPECIFY THE FOLLOWING:

<input type="text"/>	<input type="text"/>	<input type="text"/>	<input type="text"/>	<input type="text"/>
MODEL NUMBER	STITCH DETAIL	FLAMMABILITY RATING	CUSHION UPHOLSTERY	FRAME UPHOLSTERY
	None NR Stitch detail SD +\$175	U CTB117	Please refer to list of available upholstery and leather selections on www.gunlocke.com	Please refer to list of available upholstery and leather selections on www.gunlocke.com

Example

GK1101-3A.NR.U.DOL728.SPNN04				
GK1101-3A	NR	U	DOL728	SPNN04
MODEL NUMBER	STITCH	FLAMMABILITY DETAIL	CUSHION UPHOLSTERY	FRAME UPHOLSTERY

Please refer to the Ciji product page on www.gunlocke.com for standard finish options.

Seating
05/22

CIJI THREE SEAT

Low Back, Armless, Wood Legs

model number fabric grades dimensions W D H

GK1103-3W

Low back, armless,
Wood legs

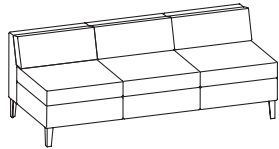

1	4,686	10	6,138	19	8,030	L1	6,910
2	4,818	11	6,314	20	8,250	L2	8,750
3	4,950	12	6,490	21	8,470	L3	10,958
COM/4	5,082	13	6,710	22	8,690	L4	12,798
5	5,258	14	6,930	23	9,130	L5	14,638
6	5,434	15	7,150	24	9,570		
7	5,610	16	7,370	25	10,010		
8	5,786	17	7,590	26	10,450		
9	5,962	18	7,810	27	10,890		

Overall	73 5/8"	31 1/2"	27 7/8"
Seat	73"	21"	17 1/4"

Upholstery Requirements: GK1103-3W

	Dual Upholstery	
Fabric yds	Cushions 4.4	Frame 3.2
Leather ft ²	Cushions 101.2	Frame 73.6
Shipping weight	161 lbs.	
Cube	78.5	

Cushion

1	10	841	19	1,936	L1	1,288
2	76	11	943	20	L2	2,353
3	153	12	1,044	21	L3	3,631
COM/4	229	13	1,172	22	L4	4,696
5	331	14	1,299	23	L5	5,762
6	433	15	1,427	24		
7	535	16	1,554	25		
8	637	17	1,681	26		
9	739	18	1,809	27		

Top row of pricing is for units specified with same fabric on cushion and frame. Bottom 2 rows of pricing required only when two different fabric grades are selected for the cushion and frame.

To calculate price of lounge with different grade fabric for cushion and frame; start with Grade 1 price, add appropriate grade price located in second row for cushion, and last add appropriate grade price located in third row for frame to the sum of the Grade 1 and cushion price.

Example: Grade 1 \$4,686 + grade 4 fabric cushion \$229 + grade 2 fabric frame \$56 = \$4,971

Frame

1	10	611	19	1,408	L1	936
2	56	11	685	20	L2	1,711
3	111	12	760	21	L3	2,641
COM/4	167	13	852	22	L4	3,416
5	241	14	945	23	L5	4,190
6	315	15	1,037	24		
7	389	16	1,130	25		
8	463	17	1,223	26		
9	537	18	1,315	27		

Select upholstery for everything else other than the seat and back cushions (the outside back, arms, sides, seat frame). You can specify the same fabric as the cushions or select other fabric.

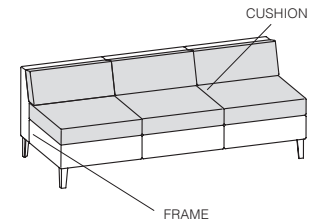

TO ORDER PLEASE SPECIFY THE FOLLOWING:

<input type="text"/>	<input type="text"/>	<input type="text"/>	<input type="text"/>	<input type="text"/>	<input type="text"/>
MODEL NUMBER	WOOD FINISH	STITCH DETAIL	FLAMMABILITY RATING	CUSHION UPHOLSTERY	FRAME UPHOLSTERY
	Cherry finishes on Maple Walnut finishes on Maple Maple finishes on Maple Oak finishes on Maple	None NR Stitch detail SD +\$175	U CTB117	Please refer to list of available upholstery and leather selections on www.gunlocke.com	Please refer to list of available upholstery and leather selections on www.gunlocke.com

Example

GK1103-3W	777	NR	U	DOL728	SPNNO4
MODEL NUMBER	WOOD FINISH	STITCH DETAIL	FLAMMABILITY	CUSHION UPHOLSTERY	FRAME UPHOLSTERY

Please refer to the Ciji product page on www.gunlocke.com for standard finish options.

CIJI THREE SEAT

Low Back, Armless, Aluminum Legs

model number	fabric grades							
GK1103-3A Low back, armless, Aluminum legs	1	4,924	10	6,376	19	8,268	L1	7,148
	2	5,056	11	6,552	20	8,488	L2	8,988
	3	5,188	12	6,728	21	8,708	L3	11,196
	COM/4	5,320	13	6,948	22	8,928	L4	13,036
	5	5,496	14	7,168	23	9,368	L5	14,876
	6	5,672	15	7,388	24	9,808		
	7	5,848	16	7,608	25	10,248		
	8	6,024	17	7,828	26	10,688		
	9	6,200	18	8,048	27	11,128		

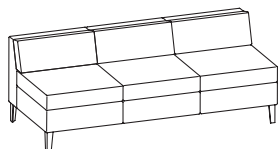

dimensions	W	D	H
Overall	73 5/8"	31 1/2"	27 7/8"
Seat	73"	21"	17 1/4"

Upholstery Requirements: GK1103-3A

Dual Upholstery	
Fabric yds	Cushions 4.4 Frame 3.2
Leather ft ²	Cushions 101.2 Frame 73.6
Shipping weight	161 lbs.
Cube	78.5

Cushion	1	10	841	19	1,936	L1	1,288
	2	76	11	943	20	L2	2,353
	3	153	12	1,044	21	L3	3,631
	COM/4	229	13	1,172	22	L4	4,696
	5	331	14	1,299	23	L5	5,762
	6	433	15	1,427	24		
	7	535	16	1,554	25		
	8	637	17	1,681	26		
	9	739	18	1,809	27		

Top row of pricing is for units specified with same fabric on cushion and frame. Bottom 2 rows of pricing required only when two different fabric grades are selected for the cushion and frame.

To calculate price of lounge with different grade fabric for cushion and frame; start with Grade 1 price, add appropriate grade price located in second row for cushion, and last add appropriate grade price located in third row for frame to the sum of the Grade 1 and cushion price.

Example: Grade 1 \$4,924 + grade 4 fabric cushion \$229 + grade 2 fabric frame \$56 = \$5,209

Frame	1	10	611	19	1,408	L1	936
	2	56	11	685	20	L2	1,711
	3	111	12	760	21	L3	2,641
	COM/4	167	13	852	22	L4	3,416
	5	241	14	945	23	L5	4,190
	6	315	15	1,037	24		
	7	389	16	1,130	25		
	8	463	17	1,223	26		
	9	537	18	1,315	27		

Select upholstery for everything else other than the seat and back cushions (the outside back, arms, sides, seat frame). You can specify the same fabric as the cushions or select other fabric.

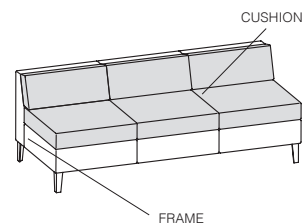

TO ORDER PLEASE SPECIFY THE FOLLOWING:

<input type="text"/>	<input type="text"/>	<input type="text"/>	<input type="text"/>	<input type="text"/>
MODEL NUMBER	STITCH DETAIL	FLAMMABILITY RATING	CUSHION UPHOLSTERY	FRAME UPHOLSTERY
	None NR Stitch detail SD +\$175	U CTB117	Please refer to list of available upholstery and leather selections on www.gunlocke.com	Please refer to list of available upholstery and leather selections on www.gunlocke.com

Example

GK1103-3A.NR.U.DOL728.SPNN04				
GK1103-3A	NR	U	DOL728	SPNN04
MODEL NUMBER	STITCH	FLAMMABILITY DETAIL	CUSHION UPHOLSTERY	FRAME UPHOLSTERY

Please refer to the Ciji product page on www.gunlocke.com for standard finish options.

Seating
05/22

CIJI THREE SEAT

Low Back, Arm Left, Wood Legs

model number	fabric grades							
GK1105-3W Low back, arm left, Wood legs	1	5,422	10	7,256	19	9,646	L1	8,232
	2	5,588	11	7,479	20	9,924	L2	10,556
	3	5,756	12	7,700	21	10,202	L3	13,344
	COM/4	5,922	13	7,979	22	10,480	L4	15,668
	5	6,144	14	8,256	23	11,036	L5	17,993
	6	6,367	15	8,535	24	11,592		
	7	6,589	16	8,812	25	12,147		
	8	6,812	17	9,090	26	12,703		
	9	7,034	18	9,368	27	13,259		

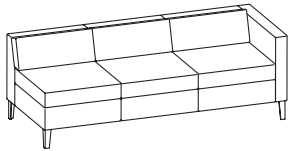

dimensions	W	D	H
Overall	77 1/8"	31 1/2"	27 7/8"
Seat	73"	21"	17 1/4"
Arm			26 7/8"
Between arms			

Upholstery Requirements: GK1105-3W

Dual Upholstery	
Fabric yds	Cushions 4.4 Frame 5.2
Leather ft²	Cushions 101.2 Frame 119.6
Shipping weight	171 lbs.
Cube	78.5

Cushion	1	10	841	19	1,936	L1	1,288	
	2	76	11	943	20	2,063	L2	2,353
	3	153	12	1,044	21	2,191	L3	3,631
	COM/4	229	13	1,172	22	2,318	L4	4,696
	5	331	14	1,299	23	2,573	L5	5,762
	6	433	15	1,427	24	2,828		
	7	535	16	1,554	25	3,082		
	8	637	17	1,681	26	3,337		
	9	739	18	1,809	27	3,592		

Top row of pricing is for units specified with same fabric on cushion and frame. Bottom 2 rows of pricing required only when two different fabric grades are selected for the cushion and frame.

To calculate price of lounge with different grade fabric for cushion and frame; start with Grade 1 price, add appropriate grade price located in second row for cushion, and last add appropriate grade price located in third row for frame to the sum of the Grade 1 and cushion price.

Example: Grade 1 \$5,422 + grade 4 fabric cushion \$229 + grade 2 fabric frame \$90 = \$5,741

Frame	1	10	993	19	2,288	L1	1,522	
	2	90	11	1,114	20	2,439	L2	2,781
	3	181	12	1,234	21	2,589	L3	4,291
	COM/4	271	13	1,385	22	2,740	L4	5,550
	5	391	14	1,535	23	3,041	L5	6,809
	6	512	15	1,686	24	3,342		
	7	632	16	1,836	25	3,643		
	8	753	17	1,987	26	3,944		
	9	873	18	2,137	27	4,245		

Select upholstery for everything else other than the seat and back cushions (the outside back, arms, sides, seat frame). You can specify the same fabric as the cushions or select other fabric.

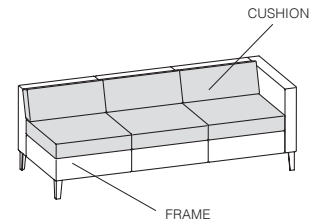

TO ORDER PLEASE SPECIFY THE FOLLOWING:

<input type="text"/>	<input type="text"/>	<input type="text"/>	<input type="text"/>	<input type="text"/>	<input type="text"/>
MODEL NUMBER	WOOD FINISH	STITCH DETAIL	FLAMMABILITY RATING	CUSHION UPHOLSTERY	FRAME UPHOLSTERY
	Cherry finishes on Maple Walnut finishes on Maple Maple finishes on Maple Oak finishes on Maple	None NR Stitch detail SD +\$175	U CTB117	Please refer to list of available upholstery and leather selections on www.gunlocke.com	Please refer to list of available upholstery and leather selections on www.gunlocke.com

Example

GK1105-3W.777.NR.U.DOL728.SPNN04
 GK1105-3W 777 NR U DOL728 SPNN04
 MODEL NUMBER WOOD FINISH STITCH DETAIL FLAMMABILITY CUSHION UPHOLSTERY FRAME UPHOLSTERY

Please refer to the Ciji product page on www.gunlocke.com for standard finish options.

CIJI THREE SEAT

Low Back, Arm Left, Aluminum Legs

Seating
05/22

model number	fabric grades							
GK1105-3A Low back, arm left, Aluminum legs	1	5,659	10	7,493	19	9,883	L1	8,469
	2	5,825	11	7,716	20	10,161	L2	10,793
	3	5,993	12	7,937	21	10,439	L3	13,581
	COM/4	6,159	13	8,216	22	10,717	L4	15,905
	5	6,381	14	8,493	23	11,273	L5	18,230
	6	6,604	15	8,772	24	11,829		
	7	6,826	16	9,049	25	12,384		
	8	7,049	17	9,327	26	12,940		
	9	7,271	18	9,605	27	13,496		

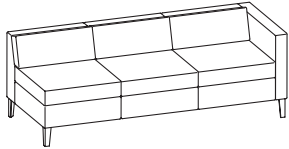

dimensions	W	D	H
Overall	77 1/8"	31 1/2"	27 7/8"
Seat	73"	21"	17 1/4"
Arm			26 7/8"
Between arms			

Upholstery Requirements: GK1105-3A

Dual Upholstery	
Fabric yds	Cushions 4.4 Frame 5.2
Leather ft ²	Cushions 101.2 Frame 119.6
Shipping weight	171 lbs.
Cube	78.5

Cushion	1	10	841	19	1,936	L1	1,288	
	2	76	11	943	20	2,063	L2	2,353
	3	153	12	1,044	21	2,191	L3	3,631
	COM/4	229	13	1,172	22	2,318	L4	4,696
	5	331	14	1,299	23	2,573	L5	5,762
	6	433	15	1,427	24	2,828		
	7	535	16	1,554	25	3,082		
	8	637	17	1,681	26	3,337		
	9	739	18	1,809	27	3,592		

Top row of pricing is for units specified with same fabric on cushion and frame. Bottom 2 rows of pricing required only when two different fabric grades are selected for the cushion and frame.

To calculate price of lounge with different grade fabric for cushion and frame; start with Grade 1 price, add appropriate grade price located in second row for cushion, and last add appropriate grade price located in third row for frame to the sum of the Grade 1 and cushion price.

Example: Grade 1 \$5,659 + grade 4 fabric cushion \$229 + grade 2 fabric frame \$90 = \$5,978

Frame	1	10	993	19	2,288	L1	1,522	
	2	90	11	1,114	20	2,439	L2	2,781
	3	181	12	1,234	21	2,589	L3	4,291
	COM/4	271	13	1,385	22	2,740	L4	5,550
	5	391	14	1,535	23	3,041	L5	6,809
	6	512	15	1,686	24	3,342		
	7	632	16	1,836	25	3,643		
	8	753	17	1,987	26	3,944		
	9	873	18	2,137	27	4,245		

Select upholstery for everything else other than the seat and back cushions (the outside back, arms, sides, seat frame). You can specify the same fabric as the cushions or select other fabric.

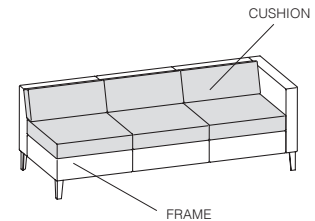

TO ORDER PLEASE SPECIFY THE FOLLOWING:

<input type="text"/>	<input type="text"/>	<input type="text"/>	<input type="text"/>	<input type="text"/>
MODEL NUMBER	STITCH DETAIL	FLAMMABILITY RATING	CUSHION UPHOLSTERY	FRAME UPHOLSTERY
	None NR Stitch detail SD +\$175	U CTB117	Please refer to list of available upholstery and leather selections on www.gunlocke.com	Please refer to list of available upholstery and leather selections on www.gunlocke.com

Example

GK1105-3A.NR.U.DOL728.SPNN04				
GK1105-3A	NR	U	DOL728	SPNN04
MODEL NUMBER	STITCH	FLAMMABILITY DETAIL	CUSHION UPHOLSTERY	FRAME UPHOLSTERY

Please refer to the Ciji product page on www.gunlocke.com for standard finish options.

Seating
05/22

CIJI THREE SEAT

Low Back, Arm Right, Wood Legs

model number

fabric grades

dimensions

W

D

H

GK1107-3W

Low back, arm right,
Wood legs

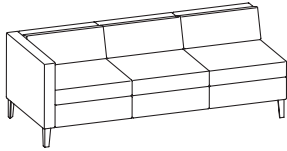

1	5,422	10	7,256	19	9,646	L1	8,232
2	5,588	11	7,479	20	9,924	L2	10,556
3	5,756	12	7,700	21	10,202	L3	13,344
COM/4	5,922	13	7,979	22	10,480	L4	15,668
5	6,144	14	8,256	23	11,036	L5	17,993
6	6,367	15	8,535	24	11,592		
7	6,589	16	8,812	25	12,147		
8	6,812	17	9,090	26	12,703		
9	7,034	18	9,368	27	13,259		

Overall	77 1/8"	31 1/2"	27 7/8"
Seat	73"	21"	17 1/4"
Arm			26 7/8"
Between arms			

Upholstery Requirements: GK1107-3W

	Dual Upholstery	
Fabric yds	Cushions 4.4	Frame 5.2
Leather ft²	Cushions 101.2	Frame 119.6
Shipping weight		171 lbs.
Cube		78.5

Cushion

1	10	841	19	1,936	L1	1,288
2	76	11	943	20	L2	2,353
3	153	12	1,044	21	L3	3,631
COM/4	229	13	1,172	22	L4	4,696
5	331	14	1,299	23	L5	5,762
6	433	15	1,427	24		
7	535	16	1,554	25		
8	637	17	1,681	26		
9	739	18	1,809	27		

Top row of pricing is for units specified with same fabric on cushion and frame. Bottom 2 rows of pricing required only when two different fabric grades are selected for the cushion and frame.

To calculate price of lounge with different grade fabric for cushion and frame; start with Grade 1 price, add appropriate grade price located in second row for cushion, and last add appropriate grade price located in third row for frame to the sum of the Grade 1 and cushion price.

Example: Grade 1 \$5,422 + grade 4 fabric cushion \$229 + grade 2 fabric frame \$90 = \$5,741

Frame

1	10	993	19	2,288	L1	1,522
2	90	11	1,114	20	L2	2,781
3	181	12	1,234	21	L3	4,291
COM/4	271	13	1,385	22	L4	5,550
5	391	14	1,535	23	L5	6,809
6	512	15	1,686	24		
7	632	16	1,836	25		
8	753	17	1,987	26		
9	873	18	2,137	27		

Select upholstery for everything else other than the seat and back cushions (the outside back, arms, sides, seat frame). You can specify the same fabric as the cushions or select other fabric.

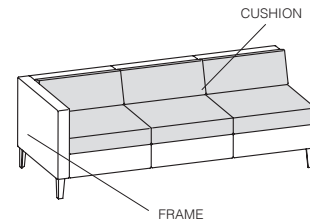

TO ORDER PLEASE SPECIFY THE FOLLOWING:

<input type="text"/>	<input type="text"/>	<input type="text"/>	<input type="text"/>	<input type="text"/>	<input type="text"/>
MODEL NUMBER	WOOD FINISH	STITCH DETAIL	FLAMMABILITY RATING	CUSHION UPHOLSTERY	FRAME UPHOLSTERY
	Cherry finishes on Maple Walnut finishes on Maple Maple finishes on Maple Oak finishes on Maple	None NR Stitch detail SD +\$175	U CTB117	Please refer to list of available upholstery and leather selections on www.gunlocke.com	Please refer to list of available upholstery and leather selections on www.gunlocke.com

Example

GK1107-3W	777	NR	U	DOL728	SPNNO4
MODEL NUMBER	WOOD FINISH	STITCH DETAIL	FLAMMABILITY	CUSHION UPHOLSTERY	FRAME UPHOLSTERY

Please refer to the Ciji product page on www.gunlocke.com for standard finish options.

CIJI THREE SEAT

Low Back, Arm Right, Aluminum Legs

Seating
05/22

model number	fabric grades							
GK1107-3A Low back, arm right, Aluminum legs	1	5,659	10	7,493	19	9,883	L1	8,469
	2	5,825	11	7,716	20	10,161	L2	10,793
	3	5,993	12	7,937	21	10,439	L3	13,581
	COM/4	6,159	13	8,216	22	10,717	L4	15,905
	5	6,381	14	8,493	23	11,273	L5	18,230
	6	6,604	15	8,772	24	11,829		
	7	6,826	16	9,049	25	12,384		
	8	7,049	17	9,327	26	12,940		
	9	7,271	18	9,605	27	13,496		

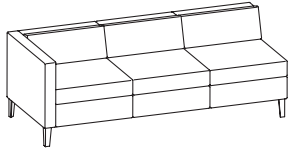

dimensions	W	D	H
Overall	77 1/8"	31 1/2"	27 7/8"
Seat	73"	21"	17 1/4"
Arm			26 7/8"
Between arms			

Upholstery Requirements: GK1107-3A

Dual Upholstery	
Fabric yds	Cushions 4.4 Frame 5.2
Leather ft ²	Cushions 101.2 Frame 119.6
Shipping weight	171 lbs.
Cube	78.5

Cushion	1	10	841	19	1,936	L1	1,288	
	2	76	11	943	20	2,063	L2	2,353
	3	153	12	1,044	21	2,191	L3	3,631
	COM/4	229	13	1,172	22	2,318	L4	4,696
	5	331	14	1,299	23	2,573	L5	5,762
	6	433	15	1,427	24	2,828		
	7	535	16	1,554	25	3,082		
	8	637	17	1,681	26	3,337		
	9	739	18	1,809	27	3,592		

Top row of pricing is for units specified with same fabric on cushion and frame. Bottom 2 rows of pricing required only when two different fabric grades are selected for the cushion and frame.

To calculate price of lounge with different grade fabric for cushion and frame; start with Grade 1 price, add appropriate grade price located in second row for cushion, and last add appropriate grade price located in third row for frame to the sum of the Grade 1 and cushion price.

Example: Grade 1 \$5,659 + grade 4 fabric cushion \$229 + grade 2 fabric frame \$90 = \$5,978

Frame	1	10	993	19	2,288	L1	1,522	
	2	90	11	1,114	20	2,439	L2	2,781
	3	181	12	1,234	21	2,589	L3	4,291
	COM/4	271	13	1,385	22	2,740	L4	5,550
	5	391	14	1,535	23	3,041	L5	6,809
	6	512	15	1,686	24	3,342		
	7	632	16	1,836	25	3,643		
	8	753	17	1,987	26	3,944		
	9	873	18	2,137	27	4,245		

Select upholstery for everything else other than the seat and back cushions (the outside back, arms, sides, seat frame). You can specify the same fabric as the cushions or select other fabric.

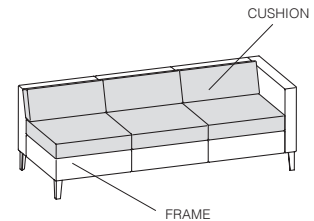

TO ORDER PLEASE SPECIFY THE FOLLOWING:

<input type="text"/>	<input type="text"/>	<input type="text"/>	<input type="text"/>	<input type="text"/>
MODEL NUMBER	STITCH DETAIL	FLAMMABILITY RATING	CUSHION UPHOLSTERY	FRAME UPHOLSTERY
	None NR Stitch detail SD +\$175	U CTB117	Please refer to list of available upholstery and leather selections on www.gunlocke.com	Please refer to list of available upholstery and leather selections on www.gunlocke.com

Example

GK1107-3A.NR.U.DOL728.SPNN04				
GK1107-3A	NR	U	DOL728	SPNN04
MODEL NUMBER	STITCH	FLAMMABILITY DETAIL	CUSHION UPHOLSTERY	FRAME UPHOLSTERY

Please refer to the Ciji product page on www.gunlocke.com for standard finish options.

Seating
05/22

CIJI SINGLE SEAT

Mid Back, with Arms, Wood Legs

model number	fabric grades							
GK1111-1W Mid back, with arms, Wood legs	1	3,204	10	4,217	19	5,536	L1	4,755
	2	3,296	11	4,339	20	5,689	L2	6,038
	3	3,388	12	4,462	21	5,843	L3	7,578
	COM/4	3,480	13	4,615	22	5,996	L4	8,861
	5	3,603	14	4,769	23	6,303	L5	10,144
	6	3,726	15	4,922	24	6,610		
	7	3,848	16	5,076	25	6,917		
	8	3,971	17	5,229	26	7,224		
	9	4,094	18	5,383	27	7,530		

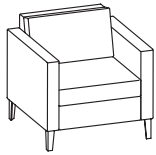

dimensions	W	D	H
Overall	31 3/4"	31 1/2"	32 1/8"
Seat	24"	21"	17 1/4"
Arm			26 7/8"
Between arms	24"		

Upholstery Requirements: GK1111-1W

Dual Upholstery	
Fabric yds	Cushions 1.5 Frame 3.8
Leather ft²	Cushions 34.5 Frame 87.4
Shipping weight	102 lbs.
Cube	28.0

Cushion	1	10	287	19	660	L1	439
	2	26	11	321	20	L2	802
	3	52	12	356	21	L3	1,238
	COM/4	78	13	399	22	L4	1,601
	5	113	14	443	23	L5	1,964
	6	148	15	486	24		
	7	182	16	530	25		
	8	217	17	573	26		
	9	252	18	617	27		

Top row of pricing is for units specified with same fabric on cushion and frame. Bottom 2 rows of pricing required only when two different fabric grades are selected for the cushion and frame.

To calculate price of lounge with different grade fabric for cushion and frame; start with Grade 1 price, add appropriate grade price located in second row for cushion, and last add appropriate grade price located in third row for frame to the sum of the Grade 1 and cushion price.

Example: Grade 1 \$3,204 + grade 4 fabric cushion \$78 + grade 2 fabric frame \$66 = \$3,348

Frame	1	10	726	19	1,672	L1	1,112
	2	66	11	814	20	L2	2,032
	3	132	12	902	21	L3	3,136
	COM/4	198	13	1,012	22	L4	4,056
	5	286	14	1,122	23	L5	4,976
	6	374	15	1,232	24		
	7	462	16	1,342	25		
	8	550	17	1,452	26		
	9	638	18	1,562	27		

Select upholstery for everything else other than the seat and back cushions (the outside back, arms, sides, seat frame). You can specify the same fabric as the cushions or select other fabric.

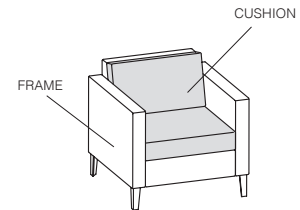

TO ORDER PLEASE SPECIFY THE FOLLOWING:

<input type="text"/>	<input type="text"/>	<input type="text"/>	<input type="text"/>	<input type="text"/>	<input type="text"/>
MODEL NUMBER	WOOD FINISH	STITCH DETAIL	FLAMMABILITY RATING	CUSHION UPHOLSTERY	FRAME UPHOLSTERY
	Cherry finishes on Maple Walnut finishes on Maple Maple finishes on Maple Oak finishes on Maple	None NR Stitch detail SD +\$175	U CTB117	Please refer to list of available upholstery and leather selections on www.gunlocke.com	Please refer to list of available upholstery and leather selections on www.gunlocke.com

Example

GK1111-1W.777.NR.U.DOL728.SPNN04
 GK1111-1W 777 NR U DOL728 SPNN04
 MODEL NUMBER WOOD FINISH STITCH DETAIL FLAMMABILITY CUSHION UPHOLSTERY FRAME UPHOLSTERY

Please refer to the Ciji product page on www.gunlocke.com for standard finish options.

CIJI SINGLE SEAT

Mid Back, with Arms, Aluminum Legs

Seating
05/22

model number	fabric grades								dimensions	W	D	H
GK1111-1A Mid back, with arms, Aluminum legs	1	3,440	10	4,453	19	5,772	L1	4,991	Overall	31 3/4"	31 1/2"	32 1/8"
	2	3,532	11	4,575	20	5,925	L2	6,274	Seat	24"	21"	17 1/4"
	3	3,624	12	4,698	21	6,079	L3	7,814	Arm	26 7/8"		
	COM/4	3,716	13	4,851	22	6,232	L4	9,097	Between arms	24"		
	5	3,839	14	5,005	23	6,539	L5	10,380	Upholstery Requirements: GK1111-1A			
	6	3,962	15	5,158	24	6,846			Dual Upholstery			
	7	4,084	16	5,312	25	7,153			Fabric yds Cushions 1.5 Frame 3.8			
	8	4,207	17	5,465	26	7,460			Leather ft ² Cushions 34.5 Frame 87.4			
	9	4,330	18	5,619	27	7,766			Shipping weight 102 lbs.			
									Cube 28.0			

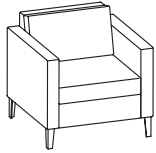

Cushion	1	10	287	19	660	L1	439	
	2	26	11	321	20	703	L2	802
	3	52	12	356	21	747	L3	1,238
	COM/4	78	13	399	22	790	L4	1,601
	5	113	14	443	23	877	L5	1,964
	6	148	15	486	24	964		
	7	182	16	530	25	1,051		
	8	217	17	573	26	1,138		
	9	252	18	617	27	1,224		

Frame	1	10	726	19	1,672	L1	1,112	
	2	66	11	814	20	1,782	L2	2,032
	3	132	12	902	21	1,892	L3	3,136
	COM/4	198	13	1,012	22	2,002	L4	4,056
	5	286	14	1,122	23	2,222	L5	4,976
	6	374	15	1,232	24	2,442		
	7	462	16	1,342	25	2,662		
	8	550	17	1,452	26	2,882		
	9	638	18	1,562	27	3,102		

Top row of pricing is for units specified with same fabric on cushion and frame. Bottom 2 rows of pricing required only when two different fabric grades are selected for the cushion and frame.

To calculate price of lounge with different grade fabric for cushion and frame; start with Grade 1 price, add appropriate grade price located in second row for cushion, and last add appropriate grade price located in third row for frame to the sum of the Grade 1 and cushion price.

Example: Grade 1 \$3,440 + grade 4 fabric cushion \$78 + grade 2 fabric frame \$66 = \$3,584

Select upholstery for everything else other than the seat and back cushions (the outside back, arms, sides, seat frame). You can specify the same fabric as the cushions or select other fabric.

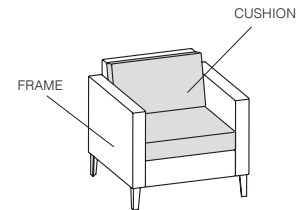

TO ORDER PLEASE SPECIFY THE FOLLOWING:

<input type="text"/>	<input type="text"/>	<input type="text"/>	<input type="text"/>	<input type="text"/>
MODEL NUMBER	STITCH DETAIL	FLAMMABILITY RATING	CUSHION UPHOLSTERY	FRAME UPHOLSTERY
	None NR Stitch detail SD +\$175	U CTB117	Please refer to list of available upholstery and leather selections on www.gunlocke.com	Please refer to list of available upholstery and leather selections on www.gunlocke.com

Example

GK1111-1A.NR.U.DOL728.SPNN04
 GK1111-1A NR U DOL728 SPNN04
 MODEL NUMBER STITCH FLAMMABILITY RATING CUSHION UPHOLSTERY FRAME UPHOLSTERY

Please refer to the Ciji product page on www.gunlocke.com for standard finish options.

Seating
05/22

CIJI SINGLE SEAT

Mid Back, Armless, Wood Legs

model number fabric grades dimensions W D H

GK1113-1W

Mid back, armless,
Wood Legs



1	2,454	10	3,028	19	3,774	L1	3,332
2	2,506	11	3,096	20	3,860	L2	4,058
3	2,558	12	3,166	21	3,948	L3	4,930
COM/4	2,610	13	3,252	22	4,034	L4	5,656
5	2,680	14	3,340	23	4,208	L5	6,382
6	2,750	15	3,426	24	4,382		
7	2,818	16	3,514	25	4,556		
8	2,888	17	3,600	26	4,730		
9	2,958	18	3,688	27	4,902		

Overall	24 5/8"	31 1/2"	32 1/8"
Seat	24"	21"	17 1/4"

Upholstery Requirements: GK1113-1W

	Dual Upholstery	
Fabric yds	Cushions 1.5	Frame 1.5
Leather ft ²	Cushions 34.5	Frame 34.5
Shipping weight	82 lbs.	
Cube	28.0	

Top row of pricing is for units specified with same fabric on cushion and frame. Bottom 2 rows of pricing required only when two different fabric grades are selected for the cushion and frame.

To calculate price of lounge with different grade fabric for cushion and frame; start with Grade 1 price, add appropriate grade price located in second row for cushion, and last add appropriate grade price located in third row for frame to the sum of the Grade 1 and cushion price.

Example: Grade 1 \$2,454 + grade 4 fabric cushion \$78 + grade 2 fabric frame \$26 = \$2,558

Cushion

1	10	287	19	660	L1	439
2	26	11	321	20	L2	802
3	52	12	356	21	L3	1,238
COM/4	78	13	399	22	L4	1,601
5	113	14	443	23	L5	1,964
6	148	15	486	24		
7	182	16	530	25		
8	217	17	573	26		
9	252	18	617	27		

Frame

1	10	287	19	660	L1	439
2	26	11	321	20	L2	802
3	52	12	356	21	L3	1,238
COM/4	78	13	399	22	L4	1,601
5	113	14	443	23	L5	1,964
6	148	15	486	24		
7	182	16	530	25		
8	217	17	573	26		
9	252	18	617	27		

Select upholstery for everything else other than the seat and back cushions (the outside back, arms, sides, seat frame). You can specify the same fabric as the cushions or select other fabric.

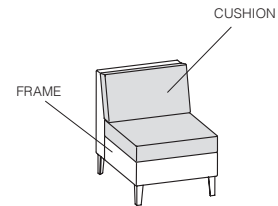

TO ORDER PLEASE SPECIFY THE FOLLOWING:

<input type="text"/>	<input type="text"/>	<input type="text"/>	<input type="text"/>	<input type="text"/>	<input type="text"/>
MODEL NUMBER	WOOD FINISH	STITCH DETAIL	FLAMMABILITY RATING	CUSHION UPHOLSTERY	FRAME UPHOLSTERY
	Cherry finishes on Maple Walnut finishes on Maple Maple finishes on Maple Oak finishes on Maple	None NR Stitch detail SD +\$175	U CTB117	Please refer to list of available upholstery and leather selections on www.gunlocke.com	Please refer to list of available upholstery and leather selections on www.gunlocke.com

Example

GK1113-1W.777.NR.U.DOL728.SPNN04
 GK1113-1W 777 NR U DOL728 SPNN04
 MODEL NUMBER WOOD FINISH STITCH DETAIL FLAMMABILITY CUSHION UPHOLSTERY FRAME UPHOLSTERY

Please refer to the Ciji product page on www.gunlocke.com for standard finish options.

CIJI SINGLE SEAT

Mid Back, Armless, Aluminum Legs

Seating
05/22

model number fabric grades dimensions W D H

GK1113-1A

Mid back, armless,
Aluminum Legs



1	2,692	10	3,266	19	4,012	L1	3,570
2	2,744	11	3,334	20	4,098	L2	4,296
3	2,796	12	3,404	21	4,186	L3	5,168
COM/4	2,848	13	3,490	22	4,272	L4	5,894
5	2,918	14	3,578	23	4,446	L5	6,620
6	2,988	15	3,664	24	4,620		
7	3,056	16	3,752	25	4,794		
8	3,126	17	3,838	26	4,968		
9	3,196	18	3,926	27	5,140		

Overall	24 5/8"	31 1/2"	32 1/8"
Seat	24"	21"	17 1/4"

Upholstery Requirements: GK1113-1A

	Dual Upholstery	
Fabric yds	Cushions 1.5	Frame 1.5
Leather ft ²	Cushions 34.5	Frame 34.5
Shipping weight	82 lbs.	
Cube	28.0	

Cushion

1		10	287	19	660	L1	439
2	26	11	321	20	703	L2	802
3	52	12	356	21	747	L3	1,238
COM/4	78	13	399	22	790	L4	1,601
5	113	14	443	23	877	L5	1,964
6	148	15	486	24	964		
7	182	16	530	25	1,051		
8	217	17	573	26	1,138		
9	252	18	617	27	1,224		

Top row of pricing is for units specified with same fabric on cushion and frame. Bottom 2 rows of pricing required only when two different fabric grades are selected for the cushion and frame.

To calculate price of lounge with different grade fabric for cushion and frame; start with Grade 1 price, add appropriate grade price located in second row for cushion, and last add appropriate grade price located in third row for frame to the sum of the Grade 1 and cushion price.

Example: Grade 1 \$2,692 + grade 4 fabric cushion \$78 + grade 2 fabric frame \$26 = \$2,796

Frame

1		10	287	19	660	L1	439
2	26	11	321	20	703	L2	802
3	52	12	356	21	747	L3	1,238
COM/4	78	13	399	22	790	L4	1,601
5	113	14	443	23	877	L5	1,964
6	148	15	486	24	964		
7	182	16	530	25	1,051		
8	217	17	573	26	1,138		
9	252	18	617	27	1,224		

Select upholstery for everything else other than the seat and back cushions (the outside back, arms, sides, seat frame). You can specify the same fabric as the cushions or select other fabric.

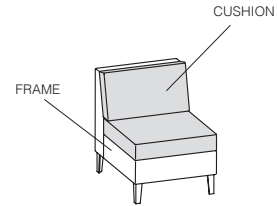

TO ORDER PLEASE SPECIFY THE FOLLOWING:

<input type="text"/>	<input type="text"/>	<input type="text"/>	<input type="text"/>	<input type="text"/>
MODEL NUMBER	STITCH DETAIL	FLAMMABILITY RATING	CUSHION UPHOLSTERY	FRAME UPHOLSTERY
	None NR Stitch detail SD +\$175	U CTB117	Please refer to list of available upholstery and leather selections on www.gunlocke.com	Please refer to list of available upholstery and leather selections on www.gunlocke.com

Example

GK1113-1A.NR.U.DOL728.SPNN04

GK1113-1A	NR	U	DOL728	SPNN04
MODEL NUMBER	STITCH	FLAMMABILITY DETAIL	CUSHION UPHOLSTERY	FRAME UPHOLSTERY

Please refer to the Ciji product page on www.gunlocke.com for standard finish options.

model number fabric grades dimensions W D H

GK1115-1W

Mid back, arm left,
Wood legs



1	3,018	10	3,878	19	4,998	L1	4,335
2	3,096	11	3,982	20	5,128	L2	5,424
3	3,174	12	4,086	21	5,259	L3	6,732
COM/4	3,252	13	4,216	22	5,389	L4	7,821
5	3,357	14	4,347	23	5,649	L5	8,910
6	3,461	15	4,477	24	5,910		
7	3,565	16	4,607	25	6,171		
8	3,669	17	4,737	26	6,431		
9	3,774	18	4,868	27	6,691		

Overall	28 1/8"	31 1/2"	32 1/8"
Seat	24"	21"	17 1/4"
Arm			26 7/8"
Between arms			

Upholstery Requirements: GK1115-1W

	Dual Upholstery	
Fabric yds	Cushions 1.5	Frame 3
Leather ft ²	Cushions 34.5	Frame 57.5
Shipping weight		92 lbs.
Cube		28.0

Cushion

1	10	287	19	660	L1	439
2	26	11	321	20	L2	802
3	52	12	356	21	L3	1,238
COM/4	78	13	399	22	L4	1,601
5	113	14	443	23	L5	1,964
6	148	15	486	24		
7	182	16	530	25		
8	217	17	573	26		
9	252	18	617	27		

Top row of pricing is for units specified with same fabric on cushion and frame. Bottom 2 rows of pricing required only when two different fabric grades are selected for the cushion and frame.

To calculate price of lounge with different grade fabric for cushion and frame; start with Grade 1 price, add appropriate grade price located in second row for cushion, and last add appropriate grade price located in third row for frame to the sum of the Grade 1 and cushion price.

Example: Grade 1 \$3,018 + grade 4 fabric cushion \$78 + grade 2 fabric frame \$52 = \$3,148

Frame

1	10	573	19	1,320	L1	878
2	52	11	643	20	L2	1,604
3	104	12	712	21	L3	2,476
COM/4	156	13	799	22	L4	3,202
5	226	14	886	23	L5	3,928
6	295	15	973	24		
7	365	16	1,059	25		
8	434	17	1,146	26		
9	504	18	1,233	27		

Select upholstery for everything else other than the seat and back cushions (the outside back, arms, sides, seat frame). You can specify the same fabric as the cushions or select other fabric.

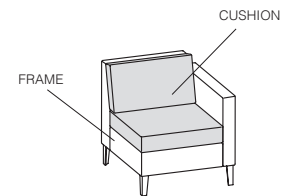

TO ORDER PLEASE SPECIFY THE FOLLOWING:

<input type="text"/>	<input type="text"/>	<input type="text"/>	<input type="text"/>	<input type="text"/>	<input type="text"/>
MODEL NUMBER	WOOD FINISH	STITCH DETAIL	FLAMMABILITY RATING	CUSHION UPHOLSTERY	FRAME UPHOLSTERY
	Cherry finishes on Maple Walnut finishes on Maple Maple finishes on Maple Oak finishes on Maple	None NR Stitch detail SD +\$175	U CTB117	Please refer to list of available upholstery and leather selections on www.gunlocke.com	Please refer to list of available upholstery and leather selections on www.gunlocke.com

Example

GK1115-1W.777.NR.U.DOL728.SPNN04
 GK1115-1W 777 NR U DOL728 SPNN04
 MODEL NUMBER WOOD FINISH STITCH DETAIL FLAMMABILITY CUSHION UPHOLSTERY FRAME UPHOLSTERY

Please refer to the Ciji product page on www.gunlocke.com for standard finish options.

CIJI SINGLE SEAT

Mid Back, Arm Left, Aluminum Legs

Seating
05/22

model number fabric grades dimensions W D H

GK1115-1A

Mid back, arm left,
Aluminum legs



1	3,255	10	4,115	19	5,235	L1	4,572
2	3,333	11	4,219	20	5,365	L2	5,661
3	3,411	12	4,323	21	5,496	L3	6,969
COM/4	3,489	13	4,453	22	5,626	L4	8,058
5	3,594	14	4,584	23	5,886	L5	9,147
6	3,698	15	4,714	24	6,147		
7	3,802	16	4,844	25	6,408		
8	3,906	17	4,974	26	6,668		
9	4,011	18	5,105	27	6,928		

Overall	28 1/8"	31 1/2"	32 1/8"
Seat	24"	21"	17 1/4"
Arm			26 7/8"
Between arms			

Upholstery Requirements: GK1115-1A

	Dual Upholstery	
Fabric yds	Cushions 1.5	Frame 3
Leather ft ²	Cushions 34.5	Frame 57.5
Shipping weight		92 lbs.
Cube		28.0

Cushion

1	10	287	19	660	L1	439
2	26	11	321	20	L2	802
3	52	12	356	21	L3	1,238
COM/4	78	13	399	22	L4	1,601
5	113	14	443	23	L5	1,964
6	148	15	486	24		
7	182	16	530	25		
8	217	17	573	26		
9	252	18	617	27		

Top row of pricing is for units specified with same fabric on cushion and frame. Bottom 2 rows of pricing required only when two different fabric grades are selected for the cushion and frame.

To calculate price of lounge with different grade fabric for cushion and frame; start with Grade 1 price, add appropriate grade price located in second row for cushion, and last add appropriate grade price located in third row for frame to the sum of the Grade 1 and cushion price.

Example: Grade 1 \$3,255 + grade 4 fabric cushion \$78 + grade 2 fabric frame \$52 = \$3,385

Frame

1	10	573	19	1,320	L1	878
2	52	11	643	20	L2	1,604
3	104	12	712	21	L3	2,476
COM/4	156	13	799	22	L4	3,202
5	226	14	886	23	L5	3,928
6	295	15	973	24		
7	365	16	1,059	25		
8	434	17	1,146	26		
9	504	18	1,233	27		

Select upholstery for everything else other than the seat and back cushions (the outside back, arms, sides, seat frame). You can specify the same fabric as the cushions or select other fabric.

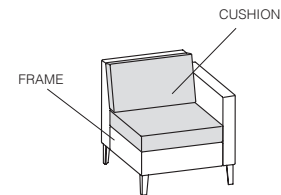

TO ORDER PLEASE SPECIFY THE FOLLOWING:

<input type="text"/>	<input type="text"/>	<input type="text"/>	<input type="text"/>	<input type="text"/>
MODEL NUMBER	STITCH DETAIL	FLAMMABILITY RATING	CUSHION UPHOLSTERY	FRAME UPHOLSTERY
	None NR Stitch detail SD +\$175	U CTB117	Please refer to list of available upholstery and leather selections on www.gunlocke.com	Please refer to list of available upholstery and leather selections on www.gunlocke.com

Example

GK1115-1A.NR.U.DOL728.SPNN04

GK1115-1A	NR	U	DOL728	SPNN04
MODEL NUMBER	STITCH	FLAMMABILITY DETAIL	CUSHION UPHOLSTERY	FRAME UPHOLSTERY

Please refer to the Ciji product page on www.gunlocke.com for standard finish options.

Seating
05/22

CIJI SINGLE SEAT

Mid Back, Arm Right, Wood Legs

model number

fabric grades

dimensions

W

D

H

GK1117-1W

Mid back, arm right,
Wood legs



1	3,018	10	3,878	19	4,998	L1	4,335
2	3,096	11	3,982	20	5,128	L2	5,424
3	3,174	12	4,086	21	5,259	L3	6,732
COM/4	3,252	13	4,216	22	5,389	L4	7,821
5	3,357	14	4,347	23	5,649	L5	8,910
6	3,461	15	4,477	24	5,910		
7	3,565	16	4,607	25	6,171		
8	3,669	17	4,737	26	6,431		
9	3,774	18	4,868	27	6,691		

Overall	28 1/8"	31 1/2"	32 1/8"
Seat	24"	21"	17 1/4"
Arm			26 7/8"
Between arms			

Upholstery Requirements: GK1117-1W

	Dual Upholstery	
Fabric yds	Cushions 1.5	Frame 3
Leather ft ²	Cushions 34.5	Frame 69
Shipping weight		92 lbs.
Cube		28.0

Cushion

1		10	287	19	660	L1	439
2	26	11	321	20	703	L2	802
3	52	12	356	21	747	L3	1,238
COM/4	78	13	399	22	790	L4	1,601
5	113	14	443	23	877	L5	1,964
6	148	15	486	24	964		
7	182	16	530	25	1,051		
8	217	17	573	26	1,138		
9	252	18	617	27	1,224		

Top row of pricing is for units specified with same fabric on cushion and frame. Bottom 2 rows of pricing required only when two different fabric grades are selected for the cushion and frame.

To calculate price of lounge with different grade fabric for cushion and frame; start with Grade 1 price, add appropriate grade price located in second row for cushion, and last add appropriate grade price located in third row for frame to the sum of the Grade 1 and cushion price.

Example: Grade 1 \$3,018 + grade 4 fabric cushion \$78 + grade 2 fabric frame \$52 = \$3,148

Frame

1		10	573	19	1,320	L1	878
2	52	11	643	20	1,407	L2	1,604
3	104	12	712	21	1,494	L3	2,476
COM/4	156	13	799	22	1,581	L4	3,202
5	226	14	886	23	1,754	L5	3,928
6	295	15	973	24	1,928		
7	365	16	1,059	25	2,102		
8	434	17	1,146	26	2,275		
9	504	18	1,233	27	2,449		

Select upholstery for everything else other than the seat and back cushions (the outside back, arms, sides, seat frame). You can specify the same fabric as the cushions or select other fabric.

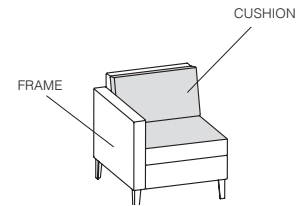

TO ORDER PLEASE SPECIFY THE FOLLOWING:

<input type="text"/>	<input type="text"/>	<input type="text"/>	<input type="text"/>	<input type="text"/>	<input type="text"/>
MODEL NUMBER	WOOD FINISH	STITCH DETAIL	FLAMMABILITY RATING	CUSHION UPHOLSTERY	FRAME UPHOLSTERY
	Cherry finishes on Maple Walnut finishes on Maple Maple finishes on Maple Oak finishes on Maple	None NR Stitch detail SD +\$175	U CTB117	Please refer to list of available upholstery and leather selections on www.gunlocke.com	Please refer to list of available upholstery and leather selections on www.gunlocke.com

Example

GK1117-1W.777.NR.U.DOL728.SPNN04					
GK1117-1W	777	NR	U	DOL728	SPNN04
MODEL NUMBER	WOOD FINISH	STITCH DETAIL	FLAMMABILITY	CUSHION UPHOLSTERY	FRAME UPHOLSTERY

Please refer to the Ciji product page on www.gunlocke.com for standard finish options.

CIJI SINGLE SEAT

Mid Back, Arm Left, Aluminum Legs

Seating
05/22

model number fabric grades dimensions W D H

GK1117-1A

Mid back, arm left,
Aluminum legs

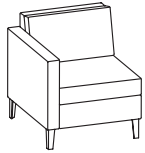

1	3,255	10	4,115	19	5,235	L1	4,572
2	3,333	11	4,219	20	5,365	L2	5,661
3	3,411	12	4,323	21	5,496	L3	6,969
COM/4	3,489	13	4,453	22	5,626	L4	8,058
5	3,594	14	4,584	23	5,886	L5	9,147
6	3,698	15	4,714	24	6,147		
7	3,802	16	4,844	25	6,408		
8	3,906	17	4,974	26	6,668		
9	4,011	18	5,105	27	6,928		

Overall	28 1/8"	31 1/2"	32 1/8"
Seat	24"	21"	17 1/4"
Arm			26 7/8"
Between arms			

Upholstery Requirements: GK1117-1A

	Dual Upholstery	
Fabric yds	Cushions 1.5	Frame 3
Leather ft ²	Cushions 34.5	Frame 57.5
Shipping weight		92 lbs.
Cube		28.0

Top row of pricing is for units specified with same fabric on cushion and frame. Bottom 2 rows of pricing required only when two different fabric grades are selected for the cushion and frame.

To calculate price of lounge with different grade fabric for cushion and frame; start with Grade 1 price, add appropriate grade price located in second row for cushion, and last add appropriate grade price located in third row for frame to the sum of the Grade 1 and cushion price.

Example: Grade 1 \$3,255 + grade 4 fabric cushion \$78 + grade 2 fabric frame \$52 = \$3,385

Cushion

1		10	287	19	660	L1	439
2	26	11	321	20	703	L2	802
3	52	12	356	21	747	L3	1,238
COM/4	78	13	399	22	790	L4	1,601
5	113	14	443	23	877	L5	1,964
6	148	15	486	24	964		
7	182	16	530	25	1,051		
8	217	17	573	26	1,138		
9	252	18	617	27	1,224		

Frame

1		10	573	19	1,320	L1	878
2	52	11	643	20	1,407	L2	1,604
3	104	12	712	21	1,494	L3	2,476
COM/4	156	13	799	22	1,581	L4	3,202
5	226	14	886	23	1,754	L5	3,928
6	295	15	973	24	1,928		
7	365	16	1,059	25	2,102		
8	434	17	1,146	26	2,275		
9	504	18	1,233	27	2,449		

Select upholstery for everything else other than the seat and back cushions (the outside back, arms, sides, seat frame). You can specify the same fabric as the cushions or select other fabric.

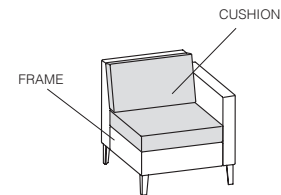

TO ORDER PLEASE SPECIFY THE FOLLOWING:

<input type="text"/>	<input type="text"/>	<input type="text"/>	<input type="text"/>	<input type="text"/>
MODEL NUMBER	STITCH DETAIL	FLAMMABILITY RATING	CUSHION UPHOLSTERY	FRAME UPHOLSTERY
	None NR Stitch detail SD +\$175	U CTB117	Please refer to list of available upholstery and leather selections on www.gunlocke.com	Please refer to list of available upholstery and leather selections on www.gunlocke.com

Example

GK1117-1A.NR.U.DOL728.SPNN04

GK1117-1A	NR	U	DOL728	SPNN04
MODEL NUMBER	STITCH	FLAMMABILITY DETAIL	CUSHION UPHOLSTERY	FRAME UPHOLSTERY

Please refer to the Ciji product page on www.gunlocke.com for standard finish options.

Seating
05/22

CIJI TWO SEAT

Mid Back, with Arms, Wood Legs

model number	fabric grades							
GK1111-2W Mid back, with arms, Wood legs	1	4,489	10	6,056	19	8,097	L1	6,889
	2	4,631	11	6,245	20	8,334	L2	8,874
	3	4,774	12	6,435	21	8,572	L3	11,256
	COM/4	4,916	13	6,672	22	8,809	L4	13,241
	5	5,106	14	6,910	23	9,284	L5	15,226
	6	5,296	15	7,147	24	9,759		
	7	5,486	16	7,385	25	10,234		
	8	5,676	17	7,622	26	10,708		
	9	5,866	18	7,860	27	11,182		

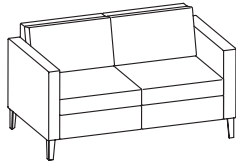

dimensions	W	D	H
Overall	56 1/4"	31 1/2"	32 1/8"
Seat	48 1/2"	21"	17 1/4"
Arm			26 7/8"
Between arms	48 1/2"		

Upholstery Requirements: GK1111-2W

	Dual Upholstery
Fabric yds	Cushions 2.9 Frame 5.3
Leather ft ²	Cushions 66.7 Frame 121.9
Shipping weight	127 lbs.
Cube	35

Cushion	1	10	554	19	1,276	L1	849
	2	50	11	621	20	L2	1,551
	3	101	12	688	21	L3	2,393
	COM/4	151	13	772	22	L4	3,095
	5	218	14	856	23	L5	3,797
	6	285	15	940	24		
	7	353	16	1,024	25		
	8	420	17	1,108	26		
	9	487	18	1,192	27		

Top row of pricing is for units specified with same fabric on cushion and frame. Bottom 2 rows of pricing required only when two different fabric grades are selected for the cushion and frame.

To calculate price of lounge with different grade fabric for cushion and frame; start with Grade 1 price, add appropriate grade price located in second row for cushion, and last add appropriate grade price located in third row for frame to the sum of the Grade 1 and cushion price.

Example: Grade 1 \$4,489 + grade 4 fabric cushion \$151 + grade 2 fabric frame \$92 = \$4,732

Frame	1	10	1,013	19	2,332	L1	1,551
	2	92	11	1,135	20	L2	2,834
	3	184	12	1,258	21	L3	4,374
	COM/4	276	13	1,411	22	L4	5,657
	5	399	14	1,565	23	L5	6,940
	6	522	15	1,718	24		
	7	644	16	1,872	25		
	8	767	17	2,025	26		
	9	890	18	2,179	27		

Select upholstery for everything else other than the seat and back cushions (the outside back, arms, sides, seat frame). You can specify the same fabric as the cushions or select other fabric.

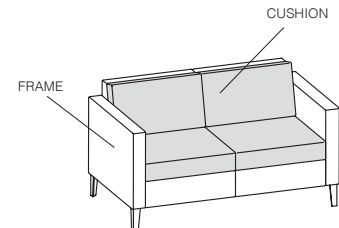

TO ORDER PLEASE SPECIFY THE FOLLOWING:

<input type="text"/>	<input type="text"/>	<input type="text"/>	<input type="text"/>	<input type="text"/>	<input type="text"/>
MODEL NUMBER	WOOD FINISH	STITCH DETAIL	FLAMMABILITY RATING	CUSHION UPHOLSTERY	FRAME UPHOLSTERY
	Cherry finishes on Maple Walnut finishes on Maple Maple finishes on Maple Oak finishes on Maple	None NR Stitch detail SD +\$250	U CTB117	Please refer to list of available upholstery and leather selections on www.gunlocke.com	Please refer to list of available upholstery and leather selections on www.gunlocke.com

Example

GK1111-2W.777.NR.U.DOL728.SPNO4
 GK1111-2W 777 NR U DOL728 SPNO4
 MODEL NUMBER WOOD FINISH STITCH DETAIL FLAMMABILITY UPHOLSTERY CUSHION UPHOLSTERY FRAME REQUEST

Please refer to the Ciji product page on www.gunlocke.com for standard finish options.

CIJI TWO SEAT

Mid Back, with Arms, Aluminum Legs

model number fabric grades dimensions W D H

GK1111-2A

Mid back, with arms,
Aluminum legs

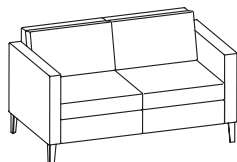

1	4,726	10	6,293	19	8,334	L1	7,126
2	4,868	11	6,482	20	8,571	L2	9,111
3	5,011	12	6,672	21	8,809	L3	11,493
COM/4	5,153	13	6,909	22	9,046	L4	13,478
5	5,343	14	7,147	23	9,521	L5	15,463
6	5,533	15	7,384	24	9,996		
7	5,723	16	7,622	25	10,471		
8	5,913	17	7,859	26	10,945		
9	6,103	18	8,097	27	11,419		

Overall	56 1/4"	31 1/2"	32 1/8"
Seat	48 1/2"	21"	17 1/4"
Arm			26 7/8"
Between arms	48 1/2"		

Upholstery Requirements: GK1111-2A

	Dual Upholstery	
Fabric yds	Cushions 2.9	Frame 5.3
Leather ft ²	Cushions 66.7	Frame 121.9
Shipping weight		127 lbs.
Cube		35

CushionJ110

1		10	554	19	1,276	L1	849
2	50	11	621	20	1,360	L2	1,551
3	101	12	688	21	1,444	L3	2,393
COM/4	151	13	772	22	1,528	L4	3,095
5	218	14	856	23	1,696	L5	3,797
6	285	15	940	24	1,864		
7	353	16	1,024	25	2,032		
8	420	17	1,108	26	2,199		
9	487	18	1,192	27	2,367		

Top row of pricing is for units specified with same fabric on cushion and frame. Bottom 2 rows of pricing required only when two different fabric grades are selected for the cushion and frame.

To calculate price of lounge with different grade fabric for cushion and frame; start with Grade 1 price, add appropriate grade price located in second row for cushion, and last add appropriate grade price located in third row for frame to the sum of the Grade 1 and cushion price.

Example: Grade 1 \$4,726 + grade 4 fabric cushion \$151 + grade 2 fabric frame \$92 = \$4,969

Frame

1		10	1,013	19	2,332	L1	1,551
2	92	11	1,135	20	2,485	L2	2,834
3	184	12	1,258	21	2,639	L3	4,374
COM/4	276	13	1,411	22	2,792	L4	5,657
5	399	14	1,565	23	3,099	L5	6,940
6	522	15	1,718	24	3,406		
7	644	16	1,872	25	3,713		
8	767	17	2,025	26	4,020		
9	890	18	2,179	27	4,326		

Select upholstery for everything else other than the seat and back cushions (the outside back, arms, sides, seat frame). You can specify the same fabric as the cushions or select other fabric.

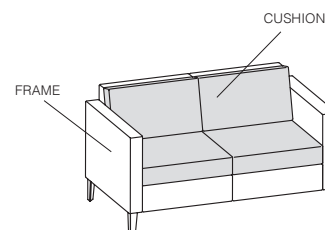

TO ORDER PLEASE SPECIFY THE FOLLOWING:

<input type="text"/>	<input type="text"/>	<input type="text"/>	<input type="text"/>	<input type="text"/>
MODEL NUMBER	STITCH DETAIL	FLAMMABILITY RATING	CUSHION UPHOLSTERY	FRAME UPHOLSTERY
	None NR Stitch detail SD +\$175	U CTB117	Please refer to list of available upholstery and leather selections on www.gunlocke.com	Please refer to list of available upholstery and leather selections on www.gunlocke.com

Example

GK1111-2A.NR.U.DOL728.SPNN04

GK1111-2A	NR	U	DOL728	SPNN04
MODEL NUMBER	STITCH	FLAMMABILITY DETAIL	CUSHION UPHOLSTERY	FRAME UPHOLSTERY

Please refer to the Ciji product page on www.gunlocke.com for standard finish options.

Seating
05/22

CIJI TWO SEAT

Mid Back, Armless, Wood Legs

model number	fabric grades							
GK1113-2W Mid back, armless, Wood Legs	1	3,706	10	4,738	19	6,082	L1	5,287
	2	3,799	11	4,863	20	6,238	L2	6,594
	3	3,894	12	4,987	21	6,395	L3	8,162
	COM/4	3,987	13	5,144	22	6,551	L4	9,469
	5	4,112	14	5,300	23	6,864	L5	10,777
	6	4,237	15	5,457	24	7,177		
	7	4,363	16	5,613	25	7,489		
	8	4,488	17	5,769	26	7,801		
	9	4,613	18	5,926	27	8,114		

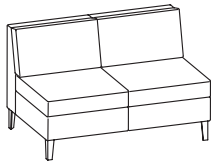

dimensions	W	D	H
Overall	49 1/8"	31 1/2"	32 1/8"
Seat	48 1/2"	21"	17 1/4"

Upholstery Requirements: GK1113-2W

Dual Upholstery		
Fabric yds	Cushions 2.9	Frame 2.5
Leather ft ²	Cushions 66.7	Frame 57.5
Shipping weight	107 lbs.	
Cube	35	

Cushion	1	10	554	19	1,276	L1	849	
	2	50	11	621	20	1,360	L2	1,551
	3	101	12	688	21	1,444	L3	2,393
	COM/4	151	13	772	22	1,528	L4	3,095
	5	218	14	856	23	1,696	L5	3,797
	6	285	15	940	24	1,864		
	7	353	16	1,024	25	2,032		
	8	420	17	1,108	26	2,199		
	9	487	18	1,192	27	2,367		

Top row of pricing is for units specified with same fabric on cushion and frame. Bottom 2 rows of pricing required only when two different fabric grades are selected for the cushion and frame.

To calculate price of lounge with different grade fabric for cushion and frame; start with Grade 1 price, add appropriate grade price located in second row for cushion, and last add appropriate grade price located in third row for frame to the sum of the Grade 1 and cushion price.

Example: Grade 1 \$3,706 + grade 4 fabric cushion \$151 + grade 2 fabric frame \$43 = \$3,900

Frame	1	10	478	19	1,100	L1	732	
	2	43	11	536	20	1,172	L2	1,337
	3	87	12	593	21	1,245	L3	2,063
	COM/4	130	13	666	22	1,317	L4	2,668
	5	188	14	738	23	1,462	L5	3,274
	6	246	15	811	24	1,607		
	7	304	16	883	25	1,751		
	8	362	17	955	26	1,896		
	9	420	18	1,028	27	2,041		

Select upholstery for everything else other than the seat and back cushions (the outside back, arms, sides, seat frame). You can specify the same fabric as the cushions or select other fabric.

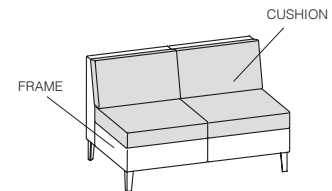

TO ORDER PLEASE SPECIFY THE FOLLOWING:

<input type="text"/>	<input type="text"/>	<input type="text"/>	<input type="text"/>	<input type="text"/>	<input type="text"/>
MODEL NUMBER	WOOD FINISH	STITCH DETAIL	FLAMMABILITY RATING	CUSHION UPHOLSTERY	FRAME UPHOLSTERY
	Cherry finishes on Maple Walnut finishes on Maple Maple finishes on Maple Oak finishes on Maple	None NR Stitch detail SD +\$250	U CTB117	Please refer to list of available upholstery and leather selections on www.gunlocke.com	Please refer to list of available upholstery and leather selections on www.gunlocke.com

Example

GK1113-2W.777.NR.U.DOL728.SPNN04					
GK1113-2W	777	NR	U	DOL728	SPNN04
MODEL NUMBER	WOOD FINISH	STITCH DETAIL	FLAMMABILITY UPHOLSTERY	CUSHION UPHOLSTERY	FRAME REQUEST

Please refer to the Ciji product page on www.gunlocke.com for standard finish options.

CIJI TWO SEAT

Mid Back, Armless, Aluminum Legs

Seating
05/22

model number fabric grades dimensions W D H

GK1113-2A

Mid back, armless,
Aluminum Legs

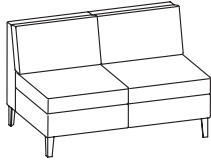

1	3,942	10	4,974	19	6,318	L1	5,523
2	4,035	11	5,099	20	6,474	L2	6,830
3	4,130	12	5,223	21	6,631	L3	8,398
COM/4	4,223	13	5,380	22	6,787	L4	9,705
5	4,348	14	5,536	23	7,100	L5	11,013
6	4,473	15	5,693	24	7,413		
7	4,599	16	5,849	25	7,725		
8	4,724	17	6,005	26	8,037		
9	4,849	18	6,162	27	8,350		

Overall	49 1/8"	31 1/2"	32 1/8"
Seat	48 1/2"	21"	17 1/4"

Upholstery Requirements: GK1113-2A

	Dual Upholstery	
Fabric yds	Cushions 2.9	Frame 2.5
Leather ft ²	Cushions 66.7	Frame 57.5
Shipping weight	107 lbs.	
Cube	35	

Cushion

1	10	554	19	1,276	L1	849
2	50	11	621	20	L2	1,551
3	101	12	688	21	L3	2,393
COM/4	151	13	772	22	L4	3,095
5	218	14	856	23	L5	3,797
6	285	15	940	24		
7	353	16	1,024	25		
8	420	17	1,108	26		
9	487	18	1,192	27		

Top row of pricing is for units specified with same fabric on cushion and frame. Bottom 2 rows of pricing required only when two different fabric grades are selected for the cushion and frame.

To calculate price of lounge with different grade fabric for cushion and frame; start with Grade 1 price, add appropriate grade price located in second row for cushion, and last add appropriate grade price located in third row for frame to the sum of the Grade 1 and cushion price.

Example: Grade 1 \$3,942 + grade 4 fabric cushion \$151 + grade 2 fabric frame \$43 = \$4,136

Frame

1	10	478	19	1,100	L1	732
2	43	11	536	20	L2	1,337
3	87	12	593	21	L3	2,063
COM/4	130	13	666	22	L4	2,668
5	188	14	738	23	L5	3,274
6	246	15	811	24		
7	304	16	883	25		
8	362	17	955	26		
9	420	18	1,028	27		

Select upholstery for everything else other than the seat and back cushions (the outside back, arms, sides, seat frame). You can specify the same fabric as the cushions or select other fabric.

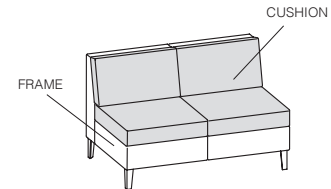

TO ORDER PLEASE SPECIFY THE FOLLOWING:

<input type="text"/>	<input type="text"/>	<input type="text"/>	<input type="text"/>	<input type="text"/>
MODEL NUMBER	STITCH DETAIL	FLAMMABILITY RATING	CUSHION UPHOLSTERY	FRAME UPHOLSTERY
	None NR Stitch detail SD +\$175	U CTB117	Please refer to list of available upholstery and leather selections on www.gunlocke.com	Please refer to list of available upholstery and leather selections on www.gunlocke.com

Example

GK1113-2A	NR	U	DOL728	SPNNO4
MODEL NUMBER	STITCH	FLAMMABILITY DETAIL	CUSHION UPHOLSTERY	FRAME UPHOLSTERY

Please refer to the Ciji product page on www.gunlocke.com for standard finish options.

model number	fabric grades							
GK1115-2W Mid back, arm left, Wood Legs	1	4,304	10	5,584	19	7,252	L1	6,265
	2	4,420	11	5,739	20	7,446	L2	7,887
	3	4,537	12	5,894	21	7,640	L3	9,833
	COM/4	4,653	13	6,088	22	7,834	L4	11,455
	5	4,808	14	6,282	23	8,222	L5	13,077
	6	4,963	15	6,476	24	8,610		
	7	5,119	16	6,670	25	8,998		
	8	5,274	17	6,864	26	9,385		
	9	5,429	18	7,058	27	9,773		

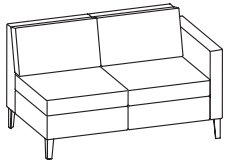

dimensions	W	D	H
Overall	52 5/8"	31 1/2"	32 1/8"
Seat	48 1/2"	21"	17 1/4"
Arm			26 7/8"
Between arms			

Upholstery Requirements: GK1115-2W

	Dual Upholstery	
Fabric yds	Cushions 2.9	Frame 3.8
Leather ft ²	Cushions 66.7	Frame 87.4
Shipping weight		117 lbs.
Cube		35

Cushion	1	10	554	19	1,276	L1	849	
	2	50	11	621	20	1,360	L2	1,551
	3	101	12	688	21	1,444	L3	2,393
	COM/4	151	13	772	22	1,528	L4	3,095
	5	218	14	856	23	1,696	L5	3,797
	6	285	15	940	24	1,864		
	7	353	16	1,024	25	2,032		
	8	420	17	1,108	26	2,199		
	9	487	18	1,192	27	2,367		

Top row of pricing is for units specified with same fabric on cushion and frame. Bottom 2 rows of pricing required only when two different fabric grades are selected for the cushion and frame.

To calculate price of lounge with different grade fabric for cushion and frame; start with Grade 1 price, add appropriate grade price located in second row for cushion, and last add appropriate grade price located in third row for frame to the sum of the Grade 1 and cushion price.

Example: Grade 1 \$4,304 + grade 4 fabric cushion \$151 + grade 2 fabric frame \$66 = \$4,521

Frame	1	10	726	19	1,672	L1	1,112	
	2	66	11	814	20	1,782	L2	2,032
	3	132	12	902	21	1,892	L3	3,136
	COM/4	198	13	1,012	22	2,002	L4	4,056
	5	286	14	1,122	23	2,222	L5	4,976
	6	374	15	1,232	24	2,442		
	7	462	16	1,342	25	2,662		
	8	550	17	1,452	26	2,882		
	9	638	18	1,562	27	3,102		

Select upholstery for everything else other than the seat and back cushions (the outside back, arms, sides, seat frame). You can specify the same fabric as the cushions or select other fabric.

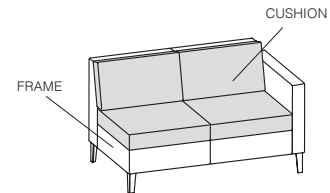

TO ORDER PLEASE SPECIFY THE FOLLOWING:

<input type="text"/>	<input type="text"/>	<input type="text"/>	<input type="text"/>	<input type="text"/>	<input type="text"/>
MODEL NUMBER	WOOD FINISH	STITCH DETAIL	FLAMMABILITY RATING	CUSHION UPHOLSTERY	FRAME UPHOLSTERY
	Cherry finishes on Maple Walnut finishes on Maple Maple finishes on Maple Oak finishes on Maple	None NR Stitch detail SD +\$250	U CTB117	Please refer to list of available upholstery and leather selections on www.gunlocke.com	Please refer to list of available upholstery and leather selections on www.gunlocke.com

Example

GK1115-2W.777.NR.U.DOL728.SPNN04					
GK1115-2W	777	NR	U	DOL728	SPNN04
MODEL NUMBER	WOOD FINISH	STITCH DETAIL	FLAMMABILITY UPHOLSTERY	CUSHION UPHOLSTERY	FRAME REQUEST

Please refer to the Ciji product page on www.gunlocke.com for standard finish options.

CIJI TWO SEAT

Mid Back, Arm Left, Aluminum Legs

model number	fabric grades							
GK1115-2A Mid back, arm left, Aluminum Legs	1	4,542	10	5,822	19	7,490	L1	6,503
	2	4,658	11	5,977	20	7,684	L2	8,125
	3	4,775	12	6,132	21	7,878	L3	10,071
	COM/4	4,891	13	6,326	22	8,072	L4	11,693
	5	5,046	14	6,520	23	8,460	L5	13,315
	6	5,201	15	6,714	24	8,848		
	7	5,357	16	6,908	25	9,236		
	8	5,512	17	7,102	26	9,623		
	9	5,667	18	7,296	27	10,011		

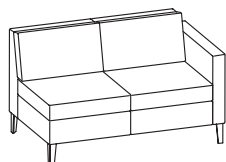

dimensions	W	D	H
Overall	52 5/8"	31 1/2"	32 1/8"
Seat	48 1/2"	21"	17 1/4"
Arm			26 7/8"
Between arms			

Upholstery Requirements: GK1115-2A

	Dual Upholstery	
Fabric yds	Cushions 2.9	Frame 3.8
Leather ft ²	Cushions 66.7	Frame 87.4
Shipping weight		117 lbs.
Cube		35

Cushion	1	10	554	19	1,276	L1	849
	2	50	11	621	20	L2	1,551
	3	101	12	688	21	L3	2,393
	COM/4	151	13	772	22	L4	3,095
	5	218	14	856	23	L5	3,797
	6	285	15	940	24		
	7	353	16	1,024	25		
	8	420	17	1,108	26		
	9	487	18	1,192	27		

Top row of pricing is for units specified with same fabric on cushion and frame. Bottom 2 rows of pricing required only when two different fabric grades are selected for the cushion and frame.

To calculate price of lounge with different grade fabric for cushion and frame; start with Grade 1 price, add appropriate grade price located in second row for cushion, and last add appropriate grade price located in third row for frame to the sum of the Grade 1 and cushion price.

Example: Grade 1 \$4,542 + grade 4 fabric cushion \$151 + grade 2 fabric frame \$66 = \$4,759

Frame	1	10	726	19	1,672	L1	1,112
	2	66	11	814	20	L2	2,032
	3	132	12	902	21	L3	3,136
	COM/4	198	13	1,012	22	L4	4,056
	5	286	14	1,122	23	L5	4,976
	6	374	15	1,232	24		
	7	462	16	1,342	25		
	8	550	17	1,452	26		
	9	638	18	1,562	27		

Select upholstery for everything else other than the seat and back cushions (the outside back, arms, sides, seat frame). You can specify the same fabric as the cushions or select other fabric.

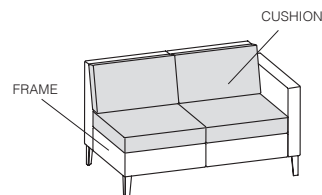

TO ORDER PLEASE SPECIFY THE FOLLOWING:

<input type="text"/>	<input type="text"/>	<input type="text"/>	<input type="text"/>	<input type="text"/>
MODEL NUMBER	STITCH DETAIL	FLAMMABILITY RATING	CUSHION UPHOLSTERY	FRAME UPHOLSTERY
	None NR Stitch detail SD +\$175	U CTB117	Please refer to list of available upholstery and leather selections on www.gunlocke.com	Please refer to list of available upholstery and leather selections on www.gunlocke.com

Example

GK1115-2A.NR.U.DOL728.SPNN04				
GK1115-2A	NR	U	DOL728	SPNN04
MODEL NUMBER	STITCH	FLAMMABILITY DETAIL	CUSHION UPHOLSTERY	FRAME UPHOLSTERY

Please refer to the Ciji product page on www.gunlocke.com for standard finish options.

Seating
05/22

CIJI TWO SEAT

Mid Back, Arm Right, Wood Legs

model number

fabric grades

dimensions

W

D

H

GK1117-2W

Mid back, arm right,
Wood Legs

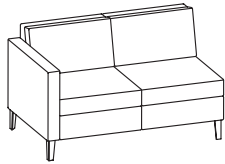

1	4,304	10	5,584	19	7,252	L1	6,265
2	4,420	11	5,739	20	7,446	L2	7,887
3	4,537	12	5,894	21	7,640	L3	9,833
COM/4	4,653	13	6,088	22	7,834	L4	11,455
5	4,808	14	6,282	23	8,222	L5	13,077
6	4,963	15	6,476	24	8,610		
7	5,119	16	6,670	25	8,998		
8	5,274	17	6,864	26	9,385		
9	5,429	18	7,058	27	9,773		

Overall	52 5/8"	31 1/2"	32 1/8"
Seat	48 1/2"	21"	17 1/4"
Arm			26 7/8"
Between arms			

Upholstery Requirements: GK1117-2W

	Dual Upholstery	
Fabric yds	Cushions 2.9	Frame 3.8
Leather ft ²	Cushions 66.7	Frame 87.4
Shipping weight		117 lbs.
Cube		35

Cushion

1		10	554	19	1,276	L1	849
2	50	11	621	20	1,360	L2	1,551
3	101	12	688	21	1,444	L3	2,393
COM/4	151	13	772	22	1,528	L4	3,095
5	218	14	856	23	1,696	L5	3,797
6	285	15	940	24	1,864		
7	353	16	1,024	25	2,032		
8	420	17	1,108	26	2,199		
9	487	18	1,192	27	2,367		

Top row of pricing is for units specified with same fabric on cushion and frame. Bottom 2 rows of pricing required only when two different fabric grades are selected for the cushion and frame.

To calculate price of lounge with different grade fabric for cushion and frame; start with Grade 1 price, add appropriate grade price located in second row for cushion, and last add appropriate grade price located in third row for frame to the sum of the Grade 1 and cushion price.

Example: Grade 1 \$4,304 + grade 4 fabric cushion \$151 + grade 2 fabric frame \$66 = \$4,521

Frame

1		10	726	19	1,672	L1	1,112
2	66	11	814	20	1,782	L2	2,032
3	132	12	902	21	1,892	L3	3,136
COM/4	198	13	1,012	22	2,002	L4	4,056
5	286	14	1,122	23	2,222	L5	4,976
6	374	15	1,232	24	2,442		
7	462	16	1,342	25	2,662		
8	550	17	1,452	26	2,882		
9	638	18	1,562	27	3,102		

Select upholstery for everything else other than the seat and back cushions (the outside back, arms, sides, seat frame). You can specify the same fabric as the cushions or select other fabric.

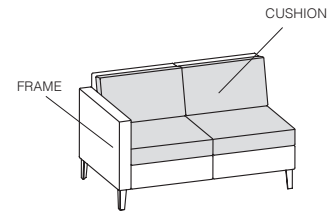

TO ORDER PLEASE SPECIFY THE FOLLOWING:

<input type="text"/>	<input type="text"/>	<input type="text"/>	<input type="text"/>	<input type="text"/>	<input type="text"/>
MODEL NUMBER	WOOD FINISH	STITCH DETAIL	FLAMMABILITY RATING	CUSHION UPHOLSTERY	FRAME UPHOLSTERY
	Cherry finishes on Maple Walnut finishes on Maple Maple finishes on Maple Oak finishes on Maple	None NR Stitch detail SD +\$250	U CTB117	Please refer to list of available upholstery and leather selections on www.gunlocke.com	Please refer to list of available upholstery and leather selections on www.gunlocke.com

Example

GK1117-2W.777.NR.U.DOL728.SPNO4
GK1117-2W 777 NR U DOL728 SPNO4
MODEL NUMBER WOOD FINISH STITCH DETAIL FLAMMABILITY UPHOLSTERY CUSHION UPHOLSTERY FRAME REQUEST

Please refer to the Ciji product page on www.gunlocke.com for standard finish options.

CIJI TWO SEAT

Mid Back, Arm Left, Aluminum Legs

model number	fabric grades							
GK1117-2A Mid back, arm left, Aluminum Legs	1	4,542	10	5,822	19	7,490	L1	6,503
	2	4,658	11	5,977	20	7,684	L2	8,125
	3	4,775	12	6,132	21	7,878	L3	10,071
	COM/4	4,891	13	6,326	22	8,072	L4	11,693
	5	5,046	14	6,520	23	8,460	L5	13,315
	6	5,201	15	6,714	24	8,848		
	7	5,357	16	6,908	25	9,236		
	8	5,512	17	7,102	26	9,623		
	9	5,667	18	7,296	27	10,011		

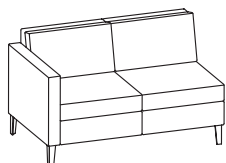

dimensions	W	D	H
Overall	52 5/8"	31 1/2"	32 1/8"
Seat	48 1/2"	21"	17 1/4"
Arm			26 7/8"
Between arms			

Upholstery Requirements: GK1117-2A

	Dual Upholstery	
Fabric yds	Cushions 2.9	Frame 3.8
Leather ft ²	Cushions 66.7	Frame 87.4
Shipping weight		117 lbs.
Cube		35

Cushion	1	10	554	19	1,276	L1	849
	2	50	11	621	20	L2	1,551
	3	101	12	688	21	L3	2,393
	COM/4	151	13	772	22	L4	3,095
	5	218	14	856	23	L5	3,797
	6	285	15	940	24		
	7	353	16	1,024	25		
	8	420	17	1,108	26		
	9	487	18	1,192	27		

Top row of pricing is for units specified with same fabric on cushion and frame. Bottom 2 rows of pricing required only when two different fabric grades are selected for the cushion and frame.

To calculate price of lounge with different grade fabric for cushion and frame; start with Grade 1 price, add appropriate grade price located in second row for cushion, and last add appropriate grade price located in third row for frame to the sum of the Grade 1 and cushion price.

Example: Grade 1 \$4,542 + grade 4 fabric cushion \$151 + grade 2 fabric frame \$66 = \$4,759

Frame	1	10	726	19	1,672	L1	1,112
	2	66	11	814	20	L2	2,032
	3	132	12	902	21	L3	3,136
	COM/4	198	13	1,012	22	L4	4,056
	5	286	14	1,122	23	L5	4,976
	6	374	15	1,232	24		
	7	462	16	1,342	25		
	8	550	17	1,452	26		
	9	638	18	1,562	27		

Select upholstery for everything else other than the seat and back cushions (the outside back, arms, sides, seat frame). You can specify the same fabric as the cushions or select other fabric.

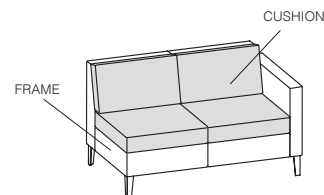

TO ORDER PLEASE SPECIFY THE FOLLOWING:

<input type="text"/>	<input type="text"/>	<input type="text"/>	<input type="text"/>	<input type="text"/>
MODEL NUMBER	STITCH DETAIL	FLAMMABILITY RATING	CUSHION UPHOLSTERY	FRAME UPHOLSTERY
	None NR Stitch detail SD +\$175	U CTB117	Please refer to list of available upholstery and leather selections on www.gunlocke.com	Please refer to list of available upholstery and leather selections on www.gunlocke.com

Example

GK1117-2A.NR.U.DOL728.SPNN04				
GK1117-2A	NR	U	DOL728	SPNN04
MODEL NUMBER	STITCH	FLAMMABILITY DETAIL	CUSHION UPHOLSTERY	FRAME UPHOLSTERY

Please refer to the Ciji product page on www.gunlocke.com for standard finish options.

Seating
05/22

CIJI THREE SEAT

Mid Back, with Arms, Wood Legs

model number	fabric grades							
GK1111-3W Mid back, with arms. Wood legs	1	5,716	10	7,684	19	10,248	L1	8,731
	2	5,894	11	7,923	20	10,546	L2	11,224
	3	6,074	12	8,160	21	10,845	L3	14,216
	COM/4	6,252	13	8,459	22	11,142	L4	16,709
	5	6,491	14	8,757	23	11,739	L5	19,204
	6	6,730	15	9,056	24	12,336		
	7	6,968	16	9,354	25	12,931		
	8	7,207	17	9,651	26	13,528		
	9	7,446	18	9,950	27	14,124		

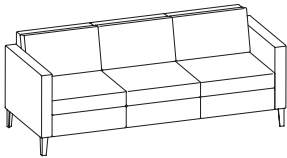

dimensions	W	D	H
Overall	80 3/4"	31 1/2"	32 1/8"
Seat	73"	21"	17 1/4"
Arm			26 7/8"
Between arms	73"		

Upholstery Requirements: GK1111-3W

	Dual Upholstery	
Fabric yds	Cushions 4.4	Frame 5.9
Leather ft ²	Cushions 101.2	Frame 135.7
Shipping weight		188 lbs.
Cube		78.5

Cushion	1	10	841	19	1,936	L1	1,288	
	2	76	11	943	20	2,063	L2	2,353
	3	153	12	1,044	21	2,191	L3	3,631
	COM/4	229	13	1,172	22	2,318	L4	4,696
	5	331	14	1,299	23	2,573	L5	5,762
	6	433	15	1,427	24	2,828		
	7	535	16	1,554	25	3,082		
	8	637	17	1,681	26	3,337		
	9	739	18	1,809	27	3,592		

Top row of pricing is for units specified with same fabric on cushion and frame. Bottom 2 rows of pricing required only when two different fabric grades are selected for the cushion and frame.

To calculate price of lounge with different grade fabric for cushion and frame; start with Grade 1 price, add appropriate grade price located in second row for cushion, and last add appropriate grade price located in third row for frame to the sum of the Grade 1 and cushion price.

Example: Grade 1 \$5,716 + grade 4 fabric cushion \$229 + grade 2 fabric frame \$102 = \$6,047

Frame	1	10	1,127	19	2,596	L1	1,727	
	2	102	11	1,264	20	2,767	L2	3,155
	3	205	12	1,400	21	2,938	L3	4,869
	COM/4	307	13	1,571	22	3,108	L4	6,297
	5	444	14	1,742	23	3,450	L5	7,726
	6	581	15	1,913	24	3,792		
	7	717	16	2,084	25	4,133		
	8	854	17	2,254	26	4,475		
	9	991	18	2,425	27	4,816		

Select upholstery for everything else other than the seat and back cushions (the outside back, arms, sides, seat frame). You can specify the same fabric as the cushions or select other fabric.

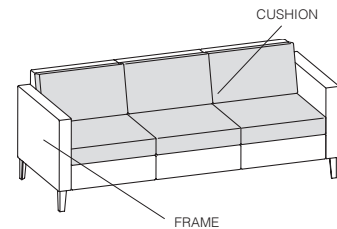

TO ORDER PLEASE SPECIFY THE FOLLOWING:

<input type="text"/>	<input type="text"/>	<input type="text"/>	<input type="text"/>	<input type="text"/>	<input type="text"/>
MODEL NUMBER	WOOD FINISH	STITCH DETAIL	FLAMMABILITY RATING	CUSHION UPHOLSTERY	FRAME UPHOLSTERY
	Cherry finishes on Maple Walnut finishes on Maple Maple finishes on Maple Oak finishes on Maple	None NR Stitch detail SD +\$250	U CTB117	Please refer to list of available upholstery and leather selections on www.gunlocke.com	Please refer to list of available upholstery and leather selections on www.gunlocke.com

Example

GK1111-3W.777.NR.U.DOL728.SPNN04
 GK1111-3W 777 NR U DOL728 SPNN04
 MODEL NUMBER WOOD FINISH STITCH DETAIL FLAMMABILITY UPHOLSTERY CUSHION UPHOLSTERY FRAME REQUEST

Please refer to the Ciji product page on www.gunlocke.com for standard finish options.

CIJI THREE SEAT

Mid Back, with Arms, Aluminum Legs

model number	fabric grades							
GK1111-3A Mid back, with arms, Aluminum legs	1	5,955	10	7,923	19	10,487	L1	8,970
	2	6,133	11	8,162	20	10,785	L2	11,463
	3	6,313	12	8,399	21	11,084	L3	14,455
	COM/4	6,491	13	8,698	22	11,381	L4	16,948
	5	6,730	14	8,996	23	11,978	L5	19,443
	6	6,969	15	9,295	24	12,575		
	7	7,207	16	9,593	25	13,170		
	8	7,446	17	9,890	26	13,767		
	9	7,685	18	10,189	27	14,363		

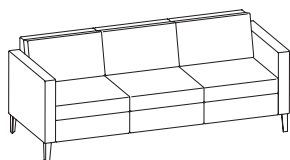

dimensions	W	D	H
Overall	80 3/4"	31 1/2"	32 1/8"
Seat	73"	21"	17 1/4"
Arm			26 7/8"
Between arms	73"		

Upholstery Requirements: GK1111-3A

	Dual Upholstery	
Fabric yds	Cushions 4.4	Frame 5.9
Leather ft ²	Cushions 101.2	Frame 135.7
Shipping weight		188 lbs.
Cube		78.5

Cushion	1	10	841	19	1,936	L1	1,288
	2	76	11	943	20	L2	2,353
	3	153	12	1,044	21	L3	3,631
	COM/4	229	13	1,172	22	L4	4,696
	5	331	14	1,299	23	L5	5,762
	6	433	15	1,427	24		
	7	535	16	1,554	25		
	8	637	17	1,681	26		
	9	739	18	1,809	27		

Top row of pricing is for units specified with same fabric on cushion and frame. Bottom 2 rows of pricing required only when two different fabric grades are selected for the cushion and frame.

To calculate price of lounge with different grade fabric for cushion and frame; start with Grade 1 price, add appropriate grade price located in second row for cushion, and last add appropriate grade price located in third row for frame to the sum of the Grade 1 and cushion price.

Example: Grade 1 \$5,955 + grade 4 fabric cushion \$229 + grade 2 fabric frame \$102 = \$6,286

Frame	1	10	1,127	19	2,596	L1	1,727
	2	102	11	1,264	20	L2	3,155
	3	205	12	1,400	21	L3	4,869
	COM/4	307	13	1,571	22	L4	6,297
	5	444	14	1,742	23	L5	7,726
	6	581	15	1,913	24		
	7	717	16	2,084	25		
	8	854	17	2,254	26		
	9	991	18	2,425	27		

Select upholstery for everything else other than the seat and back cushions (the outside back, arms, sides, seat frame). You can specify the same fabric as the cushions or select other fabric.

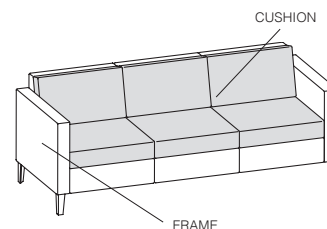

TO ORDER PLEASE SPECIFY THE FOLLOWING:

<input type="text"/>	<input type="text"/>	<input type="text"/>	<input type="text"/>	<input type="text"/>
MODEL NUMBER	STITCH DETAIL	FLAMMABILITY RATING	CUSHION UPHOLSTERY	FRAME UPHOLSTERY
	None NR Stitch detail SD +\$175	U CTB117	Please refer to list of available upholstery and leather selections on www.gunlocke.com	Please refer to list of available upholstery and leather selections on www.gunlocke.com

Example

GK1111-3A.NR.U.DOL728.SPNN04				
GK1111-3A	NR	U	DOL728	SPNN04
MODEL NUMBER	STITCH	FLAMMABILITY DETAIL	CUSHION UPHOLSTERY	FRAME UPHOLSTERY

Please refer to the Ciji product page on www.gunlocke.com for standard finish options.

Seating
05/22

CIJI THREE SEAT
Mid Back, Armless, Wood Legs

model number	fabric grades							
GK1113-3W Mid back, armless, Wood Legs	1	4,767	10	6,238	19	8,155	L1	7,021
	2	4,900	11	6,417	20	8,378	L2	8,885
	3	5,035	12	6,594	21	8,601	L3	11,121
	COM/4	5,168	13	6,818	22	8,824	L4	12,985
	5	5,346	14	7,040	23	9,270	L5	14,850
	6	5,525	15	7,264	24	9,716		
	7	5,703	16	7,486	25	10,161		
	8	5,882	17	7,709	26	10,607		
	9	6,060	18	7,932	27	11,053		

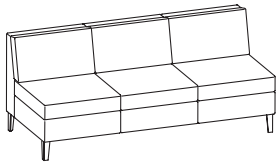

dimensions	W	D	H
Overall	73 5/8"	31 1/2"	32 1/8"
Seat	73"	21"	17 1/4"

Upholstery Requirements: GK1113-3W

Dual Upholstery	
Fabric yds	Cushions 4.4 Frame 3.3
Leather ft ²	Cushions 101.2 Frame 75.9
Shipping weight	168 lbs.
Cube	78.5

Cushion	1	10	841	19	1,936	L1	1,288	
	2	76	11	943	20	2,063	L2	2,353
	3	153	12	1,044	21	2,191	L3	3,631
	COM/4	229	13	1,172	22	2,318	L4	4,696
	5	331	14	1,299	23	2,573	L5	5,762
	6	433	15	1,427	24	2,828		
	7	535	16	1,554	25	3,082		
	8	637	17	1,681	26	3,337		
	9	739	18	1,809	27	3,592		

Top row of pricing is for units specified with same fabric on cushion and frame. Bottom 2 rows of pricing required only when two different fabric grades are selected for the cushion and frame.

To calculate price of lounge with different grade fabric for cushion and frame; start with Grade 1 price, add appropriate grade price located in second row for cushion, and last add appropriate grade price located in third row for frame to the sum of the Grade 1 and cushion price.

Example: Grade 1 \$4,767 + grade 4 fabric cushion \$229 + grade 2 fabric frame \$57 = \$5,053

Frame	1	10	630	19	1,452	L1	966	
	2	57	11	707	20	1,548	L2	1,765
	3	115	12	783	21	1,643	L3	2,723
	COM/4	172	13	879	22	1,739	L4	3,522
	5	248	14	974	23	1,930	L5	4,321
	6	325	15	1,070	24	2,121		
	7	401	16	1,165	25	2,312		
	8	478	17	1,261	26	2,503		
	9	554	18	1,356	27	2,694		

Select upholstery for everything else other than the seat and back cushions (the outside back, arms, sides, seat frame). You can specify the same fabric as the cushions or select other fabric.

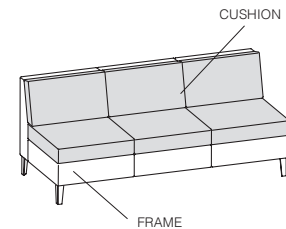

TO ORDER PLEASE SPECIFY THE FOLLOWING:

<input type="text"/>	<input type="text"/>	<input type="text"/>	<input type="text"/>	<input type="text"/>	<input type="text"/>
MODEL NUMBER	WOOD FINISH	STITCH DETAIL	FLAMMABILITY RATING	CUSHION UPHOLSTERY	FRAME UPHOLSTERY
	Cherry finishes on Maple Walnut finishes on Maple Maple finishes on Maple Oak finishes on Maple	None NR Stitch detail SD +\$250	U CTB117	Please refer to list of available upholstery and leather selections on www.gunlocke.com	Please refer to list of available upholstery and leather selections on www.gunlocke.com

Example

GK1113-3W.777.NR.U.DOL728.SPNO4					
GK1113-3W	777	NR	U	DOL728	SPNO4
MODEL NUMBER	WOOD FINISH	STITCH DETAIL	FLAMMABILITY UPHOLSTERY	CUSHION UPHOLSTERY	FRAME REQUEST

Please refer to the Ciji product page on www.gunlocke.com for standard finish options.

CIJI THREE SEAT

Mid Back, Armless, Aluminum Legs

Seating
05/22

model number fabric grades dimensions W D H

GK1113-3A

Mid back, armless,
Aluminum Legs

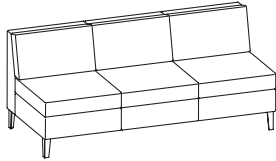

1	5,004	10	6,475	19	8,392	L1	7,258
2	5,137	11	6,654	20	8,615	L2	9,122
3	5,272	12	6,831	21	8,838	L3	11,358
COM/4	5,405	13	7,055	22	9,061	L4	13,222
5	5,583	14	7,277	23	9,507	L5	15,087
6	5,762	15	7,501	24	9,953		
7	5,940	16	7,723	25	10,398		
8	6,119	17	7,946	26	10,844		
9	6,297	18	8,169	27	11,290		

Overall	73 5/8"	31 1/2"	32 1/8"
Seat	73"	21"	17 1/4"

Upholstery Requirements: GK1113-3A

	Dual Upholstery	
Fabric yds	Cushions 4.4	Frame 3.3
Leather ft ²	Cushions 101.2	Frame 75.9
Shipping weight	168 lbs.	
Cube	78.5	

Cushion

1	10	841	19	1,936	L1	1,288
2	76	11	943	20	L2	2,353
3	153	12	1,044	21	L3	3,631
COM/4	229	13	1,172	22	L4	4,696
5	331	14	1,299	23	L5	5,762
6	433	15	1,427	24		
7	535	16	1,554	25		
8	637	17	1,681	26		
9	739	18	1,809	27		

Top row of pricing is for units specified with same fabric on cushion and frame. Bottom 2 rows of pricing required only when two different fabric grades are selected for the cushion and frame.

To calculate price of lounge with different grade fabric for cushion and frame; start with Grade 1 price, add appropriate grade price located in second row for cushion, and last add appropriate grade price located in third row for frame to the sum of the Grade 1 and cushion price.

Example: Grade 1 \$5,004 + grade 4 fabric cushion \$229 + grade 2 fabric frame \$57 = \$5,290

Frame

1	10	630	19	1,452	L1	966
2	57	11	707	20	L2	1,765
3	115	12	783	21	L3	2,723
COM/4	172	13	879	22	L4	3,522
5	248	14	974	23	L5	4,321
6	325	15	1,070	24		
7	401	16	1,165	25		
8	478	17	1,261	26		
9	554	18	1,356	27		

Select upholstery for everything else other than the seat and back cushions (the outside back, arms, sides, seat frame). You can specify the same fabric as the cushions or select other fabric.

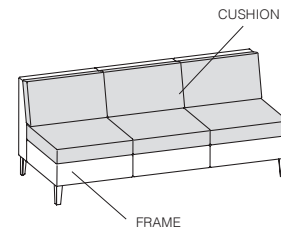

TO ORDER PLEASE SPECIFY THE FOLLOWING:

<input type="text"/>	<input type="text"/>	<input type="text"/>	<input type="text"/>	<input type="text"/>
MODEL NUMBER	STITCH DETAIL	FLAMMABILITY RATING	CUSHION UPHOLSTERY	FRAME UPHOLSTERY
	None NR Stitch detail SD +\$175	U CTB117	Please refer to list of available upholstery and leather selections on www.gunlocke.com	Please refer to list of available upholstery and leather selections on www.gunlocke.com

Example

GK1113-3A.NR.U.DOL728.SPNN04
 GK1111-3A NR U DOL728 SPNN04
 MODEL NUMBER STITCH FLAMMABILITY RATING CUSHION UPHOLSTERY FRAME UPHOLSTERY

Please refer to the Ciji product page on www.gunlocke.com for standard finish options.

Seating
05/22

CIJI THREE SEAT

Mid Back, Arm Left, Wood Legs

model number	fabric grades							
GK1115-3W Mid back, arm left, Wood legs	1	5,515	10	7,369	19	9,783	L1	8,354
	2	5,683	11	7,593	20	10,063	L2	10,702
	3	5,852	12	7,817	21	10,345	L3	13,520
	COM/4	6,020	13	8,098	22	10,625	L4	15,868
	5	6,245	14	8,379	23	11,187	L5	18,217
	6	6,470	15	8,660	24	11,749		
	7	6,694	16	8,941	25	12,310		
	8	6,919	17	9,221	26	12,872		
	9	7,144	18	9,503	27	13,433		

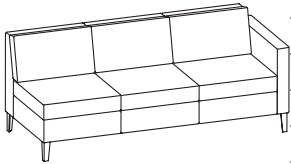

dimensions	W	D	H
Overall	77 1/8"	31 1/2"	32 1/8"
Seat	73"	21"	17 1/4"
Arm			26 7/8"
Between arms			

Upholstery Requirements: GK1115-3W

Dual Upholstery	
Fabric yds	Cushions 4.4 Frame 5.3
Leather ft ²	Cushions 101.2 Frame 121.9
Shipping weight	178 lbs.
Cube	78.5

Cushion	1	10	841	19	1,936	L1	1,288	
	2	76	11	943	20	2,063	L2	2,353
	3	153	12	1,044	21	2,191	L3	3,631
	COM/4	229	13	1,172	22	2,318	L4	4,696
	5	331	14	1,299	23	2,573	L5	5,762
	6	433	15	1,427	24	2,828		
	7	535	16	1,554	25	3,082		
	8	637	17	1,681	26	3,337		
	9	739	18	1,809	27	3,592		

Top row of pricing is for units specified with same fabric on cushion and frame. Bottom 2 rows of pricing required only when two different fabric grades are selected for the cushion and frame.

To calculate price of lounge with different grade fabric for cushion and frame; start with Grade 1 price, add appropriate grade price located in second row for cushion, and last add appropriate grade price located in third row for frame to the sum of the Grade 1 and cushion price.

Example: Grade 1 \$5,515 + grade 4 fabric cushion \$229 + grade 2 fabric frame \$92 = \$5,836

Frame	1	10	1,013	19	2,332	L1	1,551	
	2	92	11	1,135	20	2,485	L2	2,834
	3	184	12	1,258	21	2,639	L3	4,374
	COM/4	276	13	1,411	22	2,792	L4	5,657
	5	399	14	1,565	23	3,099	L5	6,940
	6	522	15	1,718	24	3,406		
	7	644	16	1,872	25	3,713		
	8	767	17	2,025	26	4,020		
	9	890	18	2,179	27	4,326		

Select upholstery for everything else other than the seat and back cushions (the outside back, arms, sides, seat frame). You can specify the same fabric as the cushions or select other fabric.

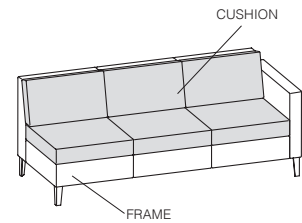

TO ORDER PLEASE SPECIFY THE FOLLOWING:

<input type="text"/>	<input type="text"/>	<input type="text"/>	<input type="text"/>	<input type="text"/>	<input type="text"/>
MODEL NUMBER	WOOD FINISH	STITCH DETAIL	FLAMMABILITY RATING	CUSHION UPHOLSTERY	FRAME UPHOLSTERY
	Cherry finishes on Maple Walnut finishes on Maple Maple finishes on Maple Oak finishes on Maple	None NR Stitch detail SD +\$250	U CTB117	Please refer to list of available upholstery and leather selections on www.gunlocke.com	Please refer to list of available upholstery and leather selections on www.gunlocke.com

Example

GK1115-3W	777	NR	U	DOL728	SPNNO4
MODEL NUMBER	WOOD FINISH	STITCH DETAIL	FLAMMABILITY UPHOLSTERY	CUSHION UPHOLSTERY	FRAME REQUEST

Please refer to the Ciji product page on www.gunlocke.com for standard finish options.

CIJI THREE SEAT

Mid Back, Arm Left, Aluminum Legs

model number	fabric grades							
GK1115-3A Mid back, arm left, Aluminum legs	1	5,753	10	7,607	19	10,021	L1	8,592
	2	5,921	11	7,831	20	10,301	L2	10,940
	3	6,090	12	8,055	21	10,583	L3	13,758
	COM/4	6,258	13	8,336	22	10,863	L4	16,106
	5	6,483	14	8,617	23	11,425	L5	18,455
	6	6,708	15	8,898	24	11,987		
	7	6,932	16	9,179	25	12,548		
	8	7,157	17	9,459	26	13,110		
	9	7,382	18	9,741	27	13,671		

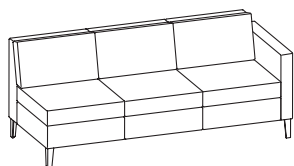

dimensions	W	D	H
Overall	77 1/8"	31 1/2"	32 1/8"
Seat	73"	21"	17 1/4"
Arm			26 7/8"
Between arms			

Upholstery Requirements: GK1115-3A

	Dual Upholstery	
Fabric yds	Cushions 4.4	Frame 5.3
Leather ft ²	Cushions 101.2	Frame 121.9
Shipping weight		178 lbs.
Cube		78.5

Cushion	1	10	841	19	1,936	L1	1,288	
	2	76	11	943	20	2,063	L2	2,353
	3	153	12	1,044	21	2,191	L3	3,631
	COM/4	229	13	1,172	22	2,318	L4	4,696
	5	331	14	1,299	23	2,573	L5	5,762
	6	433	15	1,427	24	2,828		
	7	535	16	1,554	25	3,082		
	8	637	17	1,681	26	3,337		
	9	739	18	1,809	27	3,592		

Top row of pricing is for units specified with same fabric on cushion and frame. Bottom 2 rows of pricing required only when two different fabric grades are selected for the cushion and frame.

To calculate price of lounge with different grade fabric for cushion and frame; start with Grade 1 price, add appropriate grade price located in second row for cushion, and last add appropriate grade price located in third row for frame to the sum of the Grade 1 and cushion price.

Example: Grade 1 \$5,753 + grade 4 fabric cushion \$229 + grade 2 fabric frame \$92 = \$6,074

Frame	1	10	1,013	19	2,332	L1	1,551	
	2	92	11	1,135	20	2,485	L2	2,834
	3	184	12	1,258	21	2,639	L3	4,374
	COM/4	276	13	1,411	22	2,792	L4	5,657
	5	399	14	1,565	23	3,099	L5	6,940
	6	522	15	1,718	24	3,406		
	7	644	16	1,872	25	3,713		
	8	767	17	2,025	26	4,020		
	9	890	18	2,179	27	4,326		

Select upholstery for everything else other than the seat and back cushions (the outside back, arms, sides, seat frame). You can specify the same fabric as the cushions or select other fabric.

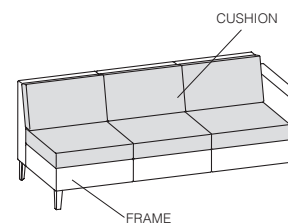

TO ORDER PLEASE SPECIFY THE FOLLOWING:

<input type="text"/>	<input type="text"/>	<input type="text"/>	<input type="text"/>	<input type="text"/>
MODEL NUMBER	STITCH DETAIL	FLAMMABILITY RATING	CUSHION UPHOLSTERY	FRAME UPHOLSTERY
	None NR Stitch detail SD +\$175	U CTB117	Please refer to list of available upholstery and leather selections on www.gunlocke.com	Please refer to list of available upholstery and leather selections on www.gunlocke.com

Example

GK1115-3A.NR.U.DOL728.SPNN04
 GK1115-3A NR U DOL728 SPNN04
 MODEL NUMBER STITCH FLAMMABILITY RATING CUSHION UPHOLSTERY FRAME UPHOLSTERY

Please refer to the Ciji product page on www.gunlocke.com for standard finish options.

Seating
05/22

CIJI THREE SEAT

Mid Back, Arm Right, Wood Legs

model number	fabric grades							
GK1117-3W Mid back, arm right, Wood legs	1	5,515	10	7,369	19	9,783	L1	8,354
	2	5,683	11	7,593	20	10,063	L2	10,702
	3	5,852	12	7,817	21	10,345	L3	13,520
	COM/4	6,020	13	8,098	22	10,625	L4	15,868
	5	6,245	14	8,379	23	11,187	L5	18,217
	6	6,470	15	8,660	24	11,749		
	7	6,694	16	8,941	25	12,310		
	8	6,919	17	9,221	26	12,872		
	9	7,144	18	9,503	27	13,433		

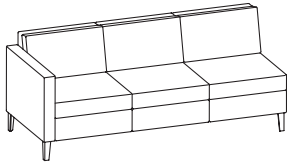

dimensions	W	D	H
Overall	77 1/8"	31 1/2"	32 1/8"
Seat	73"	21"	17 1/4"
Arm			26 7/8"
Between arms			

Upholstery Requirements: GK1117-3W

Dual Upholstery	
Fabric yds	Cushions 4.4 Frame 5.3
Leather ft ²	Cushions 101.2 Frame 121.9
Shipping weight	178 lbs.
Cube	78.5

Cushion	1	10	841	19	1,936	L1	1,288	
	2	76	11	943	20	2,063	L2	2,353
	3	153	12	1,044	21	2,191	L3	3,631
	COM/4	229	13	1,172	22	2,318	L4	4,696
	5	331	14	1,299	23	2,573	L5	5,762
	6	433	15	1,427	24	2,828		
	7	535	16	1,554	25	3,082		
	8	637	17	1,681	26	3,337		
	9	739	18	1,809	27	3,592		

Top row of pricing is for units specified with same fabric on cushion and frame. Bottom 2 rows of pricing required only when two different fabric grades are selected for the cushion and frame.

To calculate price of lounge with different grade fabric for cushion and frame; start with Grade 1 price, add appropriate grade price located in second row for cushion, and last add appropriate grade price located in third row for frame to the sum of the Grade 1 and cushion price.

Example: Grade 1 \$5,515 + grade 4 fabric cushion \$229 + grade 2 fabric frame \$92 = \$5,836

Frame	1	10	1,013	19	2,332	L1	1,551	
	2	92	11	1,135	20	2,485	L2	2,834
	3	184	12	1,258	21	2,639	L3	4,374
	COM/4	276	13	1,411	22	2,792	L4	5,657
	5	399	14	1,565	23	3,099	L5	6,940
	6	522	15	1,718	24	3,406		
	7	644	16	1,872	25	3,713		
	8	767	17	2,025	26	4,020		
	9	890	18	2,179	27	4,326		

Select upholstery for everything else other than the seat and back cushions (the outside back, arms, sides, seat frame). You can specify the same fabric as the cushions or select other fabric.

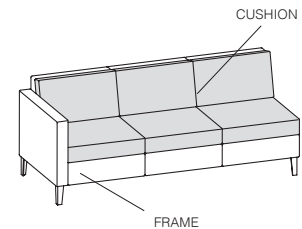

TO ORDER PLEASE SPECIFY THE FOLLOWING:

<input type="text"/>	<input type="text"/>	<input type="text"/>	<input type="text"/>	<input type="text"/>	<input type="text"/>
MODEL NUMBER	WOOD FINISH	STITCH DETAIL	FLAMMABILITY RATING	CUSHION UPHOLSTERY	FRAME UPHOLSTERY
	Cherry finishes on Maple Walnut finishes on Maple Maple finishes on Maple Oak finishes on Maple	None NR Stitch detail SD +\$250	U CTB117	Please refer to list of available upholstery and leather selections on www.gunlocke.com	Please refer to list of available upholstery and leather selections on www.gunlocke.com

Example

GK1117-3W.777.NR.U.DOL728.SPNN04
 GK1117-3W 777 NR U DOL728 SPNN04
 MODEL NUMBER WOOD FINISH STITCH DETAIL FLAMMABILITY UPHOLSTERY CUSHION UPHOLSTERY FRAME REQUEST

Please refer to the Ciji product page on www.gunlocke.com for standard finish options.

CIJI THREE SEAT

Mid Back, Arm Right, Aluminum Legs

Seating
05/22

model number	fabric grades							
GK1117-3A Mid back, arm right, Aluminum legs	1	5,753	10	7,607	19	10,021	L1	8,592
	2	5,921	11	7,831	20	10,301	L2	10,940
	3	6,090	12	8,055	21	10,583	L3	13,758
	COM/4	6,258	13	8,336	22	10,863	L4	16,106
	5	6,483	14	8,617	23	11,425	L5	18,455
	6	6,708	15	8,898	24	11,987		
	7	6,932	16	9,179	25	12,548		
	8	7,157	17	9,459	26	13,110		
	9	7,382	18	9,741	27	13,671		

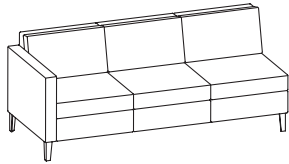

dimensions	W	D	H
Overall	77 1/8"	31 1/2"	32 1/8"
Seat	73"	21"	17 1/4"
Arm			26 7/8"
Between arms			

Upholstery Requirements: GK1117-3A

	Dual Upholstery	
Fabric yds	Cushions 4.4	Frame 5.3
Leather ft ²	Cushions 101.2	Frame 121.9
Shipping weight		178 lbs.
Cube		78.5

Cushion	1	10	841	19	1,936	L1	1,288
	2	76	11	943	20	L2	2,353
	3	153	12	1,044	21	L3	3,631
	COM/4	229	13	1,172	22	L4	4,696
	5	331	14	1,299	23	L5	5,762
	6	433	15	1,427	24		
	7	535	16	1,554	25		
	8	637	17	1,681	26		
	9	739	18	1,809	27		

Top row of pricing is for units specified with same fabric on cushion and frame. Bottom 2 rows of pricing required only when two different fabric grades are selected for the cushion and frame.

To calculate price of lounge with different grade fabric for cushion and frame; start with Grade 1 price, add appropriate grade price located in second row for cushion, and last add appropriate grade price located in third row for frame to the sum of the Grade 1 and cushion price.

Example: Grade 1 \$5,753 + grade 4 fabric cushion \$229 + grade 2 fabric frame \$92 = \$6,074

Frame	1	10	1,013	19	2,332	L1	1,551
	2	92	11	1,135	20	L2	2,834
	3	184	12	1,258	21	L3	4,374
	COM/4	276	13	1,411	22	L4	5,657
	5	399	14	1,565	23	L5	6,940
	6	522	15	1,718	24		
	7	644	16	1,872	25		
	8	767	17	2,025	26		
	9	890	18	2,179	27		

Select upholstery for everything else other than the seat and back cushions (the outside back, arms, sides, seat frame). You can specify the same fabric as the cushions or select other fabric.

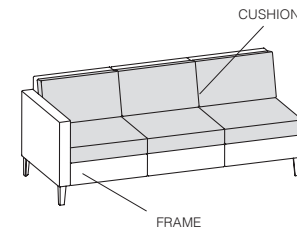

TO ORDER PLEASE SPECIFY THE FOLLOWING:

<input type="text"/>	<input type="text"/>	<input type="text"/>	<input type="text"/>	<input type="text"/>
MODEL NUMBER	STITCH DETAIL	FLAMMABILITY RATING	CUSHION UPHOLSTERY	FRAME UPHOLSTERY
	None NR Stitch detail SD +\$175	U CTB117	Please refer to list of available upholstery and leather selections on www.gunlocke.com	Please refer to list of available upholstery and leather selections on www.gunlocke.com

Example

GK1117-3A.NR.U.DOL728.SPNN04				
GK1117-3A	NR	U	DOL728	SPNN04
MODEL NUMBER	STITCH	FLAMMABILITY DETAIL	CUSHION UPHOLSTERY	FRAME UPHOLSTERY

Please refer to the Ciji product page on www.gunlocke.com for standard finish options.

model number

fabric grades

dimensions

W

D

H

GK1109W

Low back,
Wood Legs



1	3,313	10	4,288	19	5,557	L1	4,805
2	3,402	11	4,405	20	5,704	L2	6,040
3	3,490	12	4,524	21	5,852	L3	7,522
COM/4	3,579	13	4,671	22	5,999	L4	8,757
5	3,697	14	4,819	23	6,295	L5	9,992
6	3,815	15	4,966	24	6,590		
7	3,933	16	5,115	25	6,885		
8	4,051	17	5,262	26	7,181		
9	4,169	18	5,410	27	7,476		

Overall	31 3/4"	31 1/4"	27 7/8"
Seat	20 3/4"	20 3/4"	17 1/4"

Upholstery Requirements: GK1109W

	Dual Upholstery	
Fabric yds	Cushions 2.7	Frame 2.4
Leather ft ²	Cushions 62.1	Frame 55.2
Shipping weight	93 lbs.	
Cube	28	

Cushion

1	10	516	19	1,188	L1	790
2	47	11	578	20	L2	1,444
3	94	12	641	21	L3	2,228
COM/4	141	13	719	22	L4	2,882
5	203	14	797	23	L5	3,536
6	266	15	875	24		
7	328	16	954	25		
8	391	17	1,032	26		
9	453	18	1,110	27		

Top row of pricing is for units specified with same fabric on cushion and frame. Bottom 2 rows of pricing required only when two different fabric grades are selected for the cushion and frame.

To calculate price of lounge with different grade fabric for cushion and frame; start with Grade 1 price, add appropriate grade price located in second row for cushion, and last add appropriate grade price located in third row for frame to the sum of the Grade 1 and cushion price.

Example: Grade 1 \$3,313 + grade 4 fabric cushion \$141 + grade 2 fabric frame \$42 = \$3,496

Frame

1	10	459	19	1,056	L1	702
2	42	11	514	20	L2	1,283
3	83	12	570	21	L3	1,981
COM/4	125	13	639	22	L4	2,562
5	181	14	709	23	L5	3,143
6	236	15	778	24		
7	292	16	848	25		
8	347	17	917	26		
9	403	18	987	27		

Select upholstery for everything else other than the seat and back cushions (the outside back, arms, sides, seat frame). You can specify the same fabric as the cushions or select other fabric.

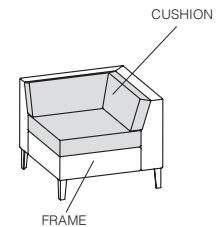

TO ORDER PLEASE SPECIFY THE FOLLOWING:

<input type="text"/>	<input type="text"/>	<input type="text"/>	<input type="text"/>	<input type="text"/>	<input type="text"/>
MODEL NUMBER	WOOD FINISH	STITCH DETAIL	FLAMMABILITY RATING	CUSHION UPHOLSTERY	FRAME UPHOLSTERY
	Cherry finishes on Maple Walnut finishes on Maple Maple finishes on Maple Oak finishes on Maple	None NR Stitch detail SD +\$250	U CTB117	Please refer to list of available upholstery and leather selections on www.gunlocke.com	Please refer to list of available upholstery and leather selections on www.gunlocke.com

Example

GK1109W.777.NR.U.DOL728.SPNN04					
GK1109W	777	NR	U	DOL728	SPNN04
MODEL NUMBER	WOOD FINISH	STITCH DETAIL	FLAMMABILITY UPHOLSTERY	CUSHION UPHOLSTERY	FRAME REQUEST

Please refer to the Ciji product page on www.gunlocke.com for standard finish options.

CIJI CORNER UNIT

Low Back, Aluminum Legs

Seating
05/22

model number fabric grades dimensions W D H

GK1109A
Low back,
Aluminum Legs

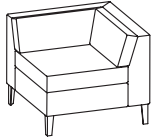

1	3,550	10	4,525	19	5,794	L1	5,042
2	3,639	11	4,642	20	5,941	L2	6,277
3	3,727	12	4,761	21	6,089	L3	7,759
COM/4	3,816	13	4,908	22	6,236	L4	8,994
5	3,934	14	5,056	23	6,532	L5	10,229
6	4,052	15	5,203	24	6,827		
7	4,170	16	5,352	25	7,122		
8	4,288	17	5,499	26	7,418		
9	4,406	18	5,647	27	7,713		

Overall	31 3/4"	31 1/4"	27 7/8"
Seat	20 3/4"	20 3/4"	17 1/4"

Upholstery Requirements: GK1109A

	Dual Upholstery	
Fabric yds	Cushions 2.7	Frame 2.4
Leather ft²	Cushions 62.1	Frame 55.2
Shipping weight	93 lbs.	
Cube	28	

Cushion

1	10	516	19	1,188	L1	790
2	47	11	578	20	L2	1,444
3	94	12	641	21	L3	2,228
COM/4	141	13	719	22	L4	2,882
5	203	14	797	23	L5	3,536
6	266	15	875	24		
7	328	16	954	25		
8	391	17	1,032	26		
9	453	18	1,110	27		

Top row of pricing is for units specified with same fabric on cushion and frame. Bottom 2 rows of pricing required only when two different fabric grades are selected for the cushion and frame.

To calculate price of lounge with different grade fabric for cushion and frame; start with Grade 1 price, add appropriate grade price located in second row for cushion, and last add appropriate grade price located in third row for frame to the sum of the Grade 1 and cushion price.

Example: Grade 1 \$3,550 + grade 4 fabric cushion \$141 + grade 2 fabric frame \$42 = \$3,733

Frame

1	10	459	19	1,056	L1	702
2	42	11	514	20	L2	1,283
3	83	12	570	21	L3	1,981
COM/4	125	13	639	22	L4	2,562
5	181	14	709	23	L5	3,143
6	236	15	778	24		
7	292	16	848	25		
8	347	17	917	26		
9	403	18	987	27		

Select upholstery for everything else other than the seat and back cushions (the outside back, arms, sides, seat frame). You can specify the same fabric as the cushions or select other fabric.

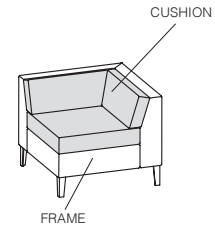

TO ORDER PLEASE SPECIFY THE FOLLOWING:

<input type="text"/>	<input type="text"/>	<input type="text"/>	<input type="text"/>	<input type="text"/>
MODEL NUMBER	STITCH DETAIL	FLAMMABILITY RATING	CUSHION UPHOLSTERY	FRAME UPHOLSTERY
	None NR Stitch detail SD +\$175	U CTB117	Please refer to list of available upholstery and leather selections on www.gunlocke.com	Please refer to list of available upholstery and leather selections on www.gunlocke.com

Example

GK1109A.NR.U.DOL728.SPNN04				
GK1109A	NR	U	DOL728	SPNN04
MODEL NUMBER	STITCH	FLAMMABILITY DETAIL	CUSHION UPHOLSTERY	FRAME UPHOLSTERY

Please refer to the Ciji product page on www.gunlocke.com for standard finish options.

model number fabric grades dimensions W D H

GK1119W
Mid back,
Wood legs



1	3,370	10	4,364	19	5,658	L1	4,892
2	3,460	11	4,484	20	5,808	L2	6,151
3	3,551	12	4,604	21	5,959	L3	7,661
COM/4	3,641	13	4,755	22	6,109	L4	8,920
5	3,761	14	4,905	23	6,411	L5	10,180
6	3,882	15	5,056	24	6,712		
7	4,002	16	5,207	25	7,012		
8	4,123	17	5,357	26	7,314		
9	4,243	18	5,508	27	7,615		

Overall	31 3/4"	31 1/2"	32 1/8"
Seat	20 3/4"	20 3/4"	17 1/4"

Upholstery Requirements: GK1119W

	Dual Upholstery	
Fabric yds	Cushions 2.7	Frame 2.5
Leather ft ²	Cushions 62.1	Frame 57.5
Shipping weight	97 lbs.	
Cube	28	

Top row of pricing is for units specified with same fabric on cushion and frame. Bottom 2 rows of pricing required only when two different fabric grades are selected for the cushion and frame.

To calculate price of lounge with different grade fabric for cushion and frame; start with Grade 1 price, add appropriate grade price located in second row for cushion, and last add appropriate grade price located in third row for frame to the sum of the Grade 1 and cushion price.

Example: Grade 1 \$3,370 + grade 4 fabric cushion \$141 + grade 2 fabric frame \$43 = \$3,554

Cushion

1	10	516	19	1,188	L1	790	
2	47	11	578	20	1,266	L2	1,444
3	94	12	641	21	1,344	L3	2,228
COM/4	141	13	719	22	1,422	L4	2,882
5	203	14	797	23	1,579	L5	3,536
6	266	15	875	24	1,735		
7	328	16	954	25	1,891		
8	391	17	1,032	26	2,048		
9	453	18	1,110	27	2,204		

Frame

1	10	478	19	1,100	L1	732	
2	43	11	536	20	1,172	L2	1,337
3	87	12	593	21	1,245	L3	2,063
COM/4	130	13	666	22	1,317	L4	2,668
5	188	14	738	23	1,462	L5	3,274
6	246	15	811	24	1,607		
7	304	16	883	25	1,751		
8	362	17	955	26	1,896		
9	420	18	1,028	27	2,041		

Select upholstery for everything else other than the seat and back cushions (the outside back, arms, sides, seat frame). You can specify the same fabric as the cushions or select other fabric.

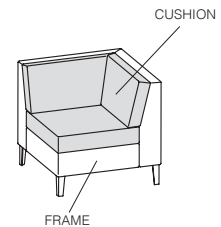

TO ORDER PLEASE SPECIFY THE FOLLOWING:

<input type="text"/>	<input type="text"/>	<input type="text"/>	<input type="text"/>	<input type="text"/>	<input type="text"/>
MODEL NUMBER	WOOD FINISH	STITCH DETAIL	FLAMMABILITY RATING	CUSHION UPHOLSTERY	FRAME UPHOLSTERY
	Cherry finishes on Maple Walnut finishes on Maple Maple finishes on Maple Oak finishes on Maple	None NR Stitch detail SD +\$250	U CTB117	Please refer to list of available upholstery and leather selections on www.gunlocke.com	Please refer to list of available upholstery and leather selections on www.gunlocke.com

Example

GK1119W	777	NR	U	DOL728	SPNNO4
MODEL NUMBER	WOOD FINISH	STITCH DETAIL	FLAMMABILITY UPHOLSTERY	CUSHION UPHOLSTERY	FRAME REQUEST

Please refer to the Ciji product page on www.gunlocke.com for standard finish options.

CIJI CORNER UNIT

Mid Back, Aluminum Legs

model number fabric grades dimensions W D H

GK1119A
Mid back,
Aluminum legs

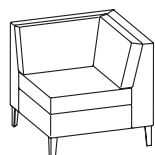

1	3,607	10	4,601	19	5,895	L1	5,129
2	3,697	11	4,721	20	6,045	L2	6,388
3	3,788	12	4,841	21	6,196	L3	7,898
COM/4	3,878	13	4,992	22	6,346	L4	9,157
5	3,998	14	5,142	23	6,648	L5	10,417
6	4,119	15	5,293	24	6,949		
7	4,239	16	5,444	25	7,249		
8	4,360	17	5,594	26	7,551		
9	4,480	18	5,745	27	7,852		

Overall	31 3/4"	31 1/2"	32 1/8"
Seat	20 3/4"	20 3/4"	17 1/4"

Upholstery Requirements: GK1119A

	Dual Upholstery		
Fabric yds	Cushions 2.7	Frame 2.5	
Leather ft ²	Cushions 62.1	Frame 57.5	
Shipping weight			97 lbs.
Cube			28

Cushion

1		10	516	19	1,188	L1	790
2	47	11	578	20	1,266	L2	1,444
3	94	12	641	21	1,344	L3	2,228
COM/4	141	13	719	22	1,422	L4	2,882
5	203	14	797	23	1,579	L5	3,536
6	266	15	875	24	1,735		
7	328	16	954	25	1,891		
8	391	17	1,032	26	2,048		
9	453	18	1,110	27	2,204		

Top row of pricing is for units specified with same fabric on cushion and frame. Bottom 2 rows of pricing required only when two different fabric grades are selected for the cushion and frame.

To calculate price of lounge with different grade fabric for cushion and frame; start with Grade 1 price, add appropriate grade price located in second row for cushion, and last add appropriate grade price located in third row for frame to the sum of the Grade 1 and cushion price.

Example: Grade 1 \$3,607 + grade 4 fabric cushion \$141 + grade 2 fabric frame \$43 = \$3,791

Frame

1		10	478	19	1,100	L1	732
2	43	11	536	20	1,172	L2	1,337
3	87	12	593	21	1,245	L3	2,063
COM/4	130	13	666	22	1,317	L4	2,668
5	188	14	738	23	1,462	L5	3,274
6	246	15	811	24	1,607		
7	304	16	883	25	1,751		
8	362	17	955	26	1,896		
9	420	18	1,028	27	2,041		

Select upholstery for everything else other than the seat and back cushions (the outside back, arms, sides, seat frame). You can specify the same fabric as the cushions or select other fabric.

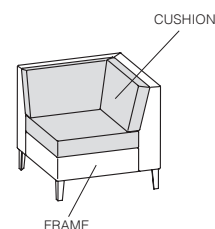

TO ORDER PLEASE SPECIFY THE FOLLOWING:

<input type="text"/>	<input type="text"/>	<input type="text"/>	<input type="text"/>	<input type="text"/>
MODEL NUMBER	STITCH DETAIL	FLAMMABILITY RATING	CUSHION UPHOLSTERY	FRAME UPHOLSTERY
	None NR Stitch detail SD +\$175	U CTB117	Please refer to list of available upholstery and leather selections on www.gunlocke.com	Please refer to list of available upholstery and leather selections on www.gunlocke.com

Example

GK1119A.NR.U.DOL728.SPNN04				
GK1119A	NR	U	DOL728	SPNN04
MODEL NUMBER	STITCH	FLAMMABILITY DETAIL	CUSHION UPHOLSTERY	FRAME UPHOLSTERY

Please refer to the Ciji product page on www.gunlocke.com for standard finish options.

model number	fabric grades							
GK1121-1W Single seat, Wood legs	1	1,808	10	2,285	19	2,908	L1	2,539
	2	1,852	11	2,343	20	2,981	L2	3,145
	3	1,895	12	2,402	21	3,052	L3	3,871
	COM/4	1,939	13	2,474	22	3,125	L4	4,477
	5	1,996	14	2,546	23	3,270	L5	5,081
	6	2,054	15	2,618	24	3,414		
	7	2,112	16	2,691	25	3,560		
	8	2,170	17	2,764	26	3,704		
	9	2,227	18	2,835	27	3,849		

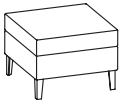

dimensions	W	D	H
Overall	24 5/8"	24 3/4"	17 1/4"
Seat	24 5/8"	24 3/4"	17 1/4"

Upholstery Requirements: GK1121-1W

Dual Upholstery	
Fabric yds	Cushions 1.2 Frame 1.3
Leather ft ²	Cushions 27.6 Frame 29.9
Shipping weight	64 lbs.
Cube	28

Cushion	1	10	229	19	528	L1	351
	2	21	11	257	20	L2	642
	3	42	12	285	21	L3	990
	COM/4	63	13	320	22	L4	1,281
	5	90	14	354	23	L5	1,571
	6	118	15	389	24		
	7	146	16	424	25		
	8	174	17	459	26		
	9	201	18	493	27		

Top row of pricing is for units specified with same fabric on cushion and frame. Bottom 2 rows of pricing required only when two different fabric grades are selected for the cushion and frame.

To calculate price of lounge with different grade fabric for cushion and frame; start with Grade 1 price, add appropriate grade price located in second row for cushion, and last add appropriate grade price located in third row for frame to the sum of the Grade 1 and cushion price.

Example: Grade 1 \$1,808 + grade 4 fabric cushion \$63 + grade 2 fabric frame \$23 = \$1,894

Frame	1	10	248	19	572	L1	380
	2	23	11	278	20	L2	695
	3	45	12	309	21	L3	1,073
	COM/4	68	13	346	22	L4	1,388
	5	98	14	384	23	L5	1,702
	6	128	15	421	24		
	7	158	16	459	25		
	8	188	17	497	26		
	9	218	18	534	27		

Select upholstery for everything else other than the seat and back cushions (the outside back, arms, sides, seat frame). You can specify the same fabric as the cushions or select other fabric.

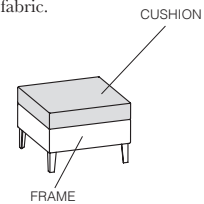

TO ORDER PLEASE SPECIFY THE FOLLOWING:

<input type="text"/>	<input type="text"/>	<input type="text"/>	<input type="text"/>	<input type="text"/>	<input type="text"/>
MODEL NUMBER	WOOD FINISH	STITCH DETAIL	FLAMMABILITY RATING	CUSHION UPHOLSTERY	FRAME UPHOLSTERY
	Cherry finishes on Maple Walnut finishes on Maple Maple finishes on Maple Oak finishes on Maple	None NR Stitch detail SD +\$250	U CTB117	Please refer to list of available upholstery and leather selections on www.gunlocke.com	Please refer to list of available upholstery and leather selections on www.gunlocke.com

Example

GK1121-1W.777.NR.U.DOL728.SPNN04
GK1121-1W 777 NR U DOL728 SPNN04
MODEL NUMBER WOOD FINISH STITCH DETAIL FLAMMABILITY UPHOLSTERY CUSHION UPHOLSTERY FRAME REQUEST

Please refer to the Ciji product page on www.gunlocke.com for standard finish options.

CIJI BENCH

Single Seat, Aluminum Legs

Seating
05/22

model number	fabric grades							
GK1121-1A Single seat, Aluminum legs	1	2,044	10	2,521	19	3,144	L1	2,775
	2	2,088	11	2,579	20	3,217	L2	3,381
	3	2,131	12	2,638	21	3,288	L3	4,107
	COM/4	2,175	13	2,710	22	3,361	L4	4,713
	5	2,232	14	2,782	23	3,506	L5	5,317
	6	2,290	15	2,854	24	3,650		
	7	2,348	16	2,927	25	3,796		
	8	2,406	17	3,000	26	3,940		
	9	2,463	18	3,071	27	4,085		

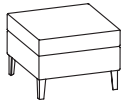

dimensions	W	D	H
Overall	24 5/8"	24 3/4"	17 1/4"
Seat	24 5/8"	24 3/4"	17 1/4"

Upholstery Requirements: GK1121-1A

Dual Upholstery	
Fabric yds	Cushions 1.2 Frame 1.3
Leather ft ²	Cushions 27.6 Frame 29.9
Shipping weight	64 lbs.
Cube	28

Cushion	1	10	229	19	528	L1	351
	2	21	11	257	20	L2	642
	3	42	12	285	21	L3	990
	COM/4	63	13	320	22	L4	1,281
	5	90	14	354	23	L5	1,571
	6	118	15	389	24		
	7	146	16	424	25		
	8	174	17	459	26		
	9	201	18	493	27		

Top row of pricing is for units specified with same fabric on cushion and frame. Bottom 2 rows of pricing required only when two different fabric grades are selected for the cushion and frame.

To calculate price of lounge with different grade fabric for cushion and frame; start with Grade 1 price, add appropriate grade price located in second row for cushion, and last add appropriate grade price located in third row for frame to the sum of the Grade 1 and cushion price.

Example: Grade 1 \$2,044 + grade 4 fabric cushion \$63 + grade 2 fabric frame \$23 = \$2,130

Frame	1	10	248	19	572	L1	380
	2	23	11	278	20	L2	695
	3	45	12	309	21	L3	1,073
	COM/4	68	13	346	22	L4	1,388
	5	98	14	384	23	L5	1,702
	6	128	15	421	24		
	7	158	16	459	25		
	8	188	17	497	26		
	9	218	18	534	27		

Select upholstery for everything else other than the seat and back cushions (the outside back, arms, sides, seat frame). You can specify the same fabric as the cushions or select other fabric.

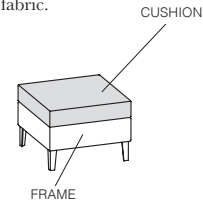

TO ORDER PLEASE SPECIFY THE FOLLOWING:

<input type="text"/>	<input type="text"/>	<input type="text"/>	<input type="text"/>	<input type="text"/>
MODEL NUMBER	STITCH DETAIL	FLAMMABILITY RATING	CUSHION UPHOLSTERY	FRAME UPHOLSTERY
	None NR Stitch detail SD +\$175	U CTB117	Please refer to list of available upholstery and leather selections on www.gunlocke.com	Please refer to list of available upholstery and leather selections on www.gunlocke.com

Example

GK1121-1A.NR.U.DOL728.SPNN04				
GK1121-1A	NR	U	DOL728	SPNN04
MODEL NUMBER	STITCH	FLAMMABILITY DETAIL	CUSHION UPHOLSTERY	FRAME UPHOLSTERY

Please refer to the Ciji product page on www.gunlocke.com for standard finish options.

model number	fabric grades							
GK1121-2W Two seat, Wood legs	1	2,513	10	3,163	19	4,009	L1	3,508
	2	2,572	11	3,241	20	4,107	L2	4,331
	3	2,631	12	3,320	21	4,206	L3	5,319
	COM/4	2,690	13	3,418	22	4,304	L4	6,142
	5	2,769	14	3,517	23	4,501	L5	6,965
	6	2,848	15	3,615	24	4,698		
	7	2,926	16	3,714	25	4,895		
	8	3,005	17	3,812	26	5,092		
	9	3,084	18	3,911	27	5,288		

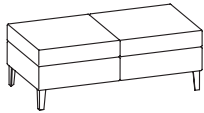

dimensions	W	D	H
Overall	49 1/8"	24 3/4"	17 1/4"
Seat	49 1/8"	24 3/4"	17 1/4"

Upholstery Requirements: GK1121-2W

	Dual Upholstery	
Fabric yds	Cushions 1.5	Frame 1.9
Leather ft ²	Cushions 34.5	Frame 43.7
Shipping weight	74 lbs.	
Cube	35	

Cushion	1	10	287	19	660	L1	439
	2	26	11	321	20	L2	802
	3	52	12	356	21	L3	1,238
	COM/4	78	13	399	22	L4	1,601
	5	113	14	443	23	L5	1,964
	6	148	15	486	24		
	7	182	16	530	25		
	8	217	17	573	26		
	9	252	18	617	27		

Top row of pricing is for units specified with same fabric on cushion and frame. Bottom 2 rows of pricing required only when two different fabric grades are selected for the cushion and frame.

To calculate price of lounge with different grade fabric for cushion and frame; start with Grade 1 price, add appropriate grade price located in second row for cushion, and last add appropriate grade price located in third row for frame to the sum of the Grade 1 and cushion price.

Example: Grade 1 \$2,513 + grade 4 fabric cushion \$78 + grade 2 fabric frame \$33 = \$2,624

Frame	1	10	363	19	836	L1	556
	2	33	11	407	20	L2	1,016
	3	66	12	451	21	L3	1,568
	COM/4	99	13	506	22	L4	2,028
	5	143	14	561	23	L5	2,488
	6	187	15	616	24		
	7	231	16	671	25		
	8	275	17	726	26		
	9	319	18	781	27		

Select upholstery for everything else other than the seat and back cushions (the outside back, arms, sides, seat frame). You can specify the same fabric as the cushions or select other fabric.

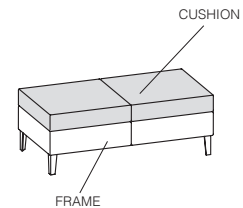

TO ORDER PLEASE SPECIFY THE FOLLOWING:

<input type="text"/>	<input type="text"/>	<input type="text"/>	<input type="text"/>	<input type="text"/>	<input type="text"/>
MODEL NUMBER	WOOD FINISH	STITCH DETAIL	FLAMMABILITY RATING	CUSHION UPHOLSTERY	FRAME UPHOLSTERY
	Cherry finishes on Maple Walnut finishes on Maple Maple finishes on Maple Oak finishes on Maple	None NR Stitch detail SD +\$250	U CTB117	Please refer to list of available upholstery and leather selections on www.gunlocke.com	Please refer to list of available upholstery and leather selections on www.gunlocke.com

Example

GK1121-2W	777	NR	U	DOL728	SPNNO4
MODEL NUMBER	WOOD FINISH	STITCH DETAIL	FLAMMABILITY UPHOLSTERY	CUSHION UPHOLSTERY	FRAME REQUEST

Please refer to the Ciji product page on www.gunlocke.com for standard finish options.

CIJI BENCH

Two Seat, Aluminum Legs

Seating
05/22

model number	fabric grades							
GK1121-2A Two seat, Aluminum legs	1	2,749	10	3,399	19	4,245	L1	3,744
	2	2,808	11	3,477	20	4,343	L2	4,567
	3	2,867	12	3,556	21	4,442	L3	5,555
	COM/4	2,926	13	3,654	22	4,540	L4	6,378
	5	3,005	14	3,753	23	4,737	L5	7,201
	6	3,084	15	3,851	24	4,934		
	7	3,162	16	3,950	25	5,131		
	8	3,241	17	4,048	26	5,328		
	9	3,320	18	4,147	27	5,524		

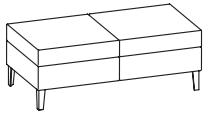

dimensions	W	D	H
Overall	49 1/8"	24 3/4"	17 1/4"
Seat	49 1/8"	24 3/4"	17 1/4"

Upholstery Requirements: GK1121-2A

Dual Upholstery	
Fabric yds	Cushions 1.5 Frame 1.9
Leather ft ²	Cushions 34.5 Frame 43.7
Shipping weight	74 lbs.
Cube	35

Cushion	1	10	287	19	660	L1	439
	2	26	11	321	20	L2	802
	3	52	12	356	21	L3	1,238
	COM/4	78	13	399	22	L4	1,601
	5	113	14	443	23	L5	1,964
	6	148	15	486	24		
	7	182	16	530	25		
	8	217	17	573	26		
	9	252	18	617	27		

Top row of pricing is for units specified with same fabric on cushion and frame. Bottom 2 rows of pricing required only when two different fabric grades are selected for the cushion and frame.

To calculate price of lounge with different grade fabric for cushion and frame; start with Grade 1 price, add appropriate grade price located in second row for cushion, and last add appropriate grade price located in third row for frame to the sum of the Grade 1 and cushion price.

Example: Grade 1 \$2,749 + grade 4 fabric cushion \$78 + grade 2 fabric frame \$33 = \$2,860

Frame	1	10	363	19	836	L1	556
	2	33	11	407	20	L2	1,016
	3	66	12	451	21	L3	1,568
	COM/4	99	13	506	22	L4	2,028
	5	143	14	561	23	L5	2,488
	6	187	15	616	24		
	7	231	16	671	25		
	8	275	17	726	26		
	9	319	18	781	27		

Select upholstery for everything else other than the seat and back cushions (the outside back, arms, sides, seat frame). You can specify the same fabric as the cushions or select other fabric.

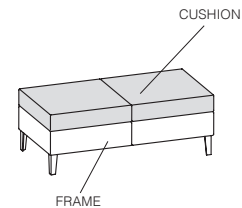

TO ORDER PLEASE SPECIFY THE FOLLOWING:

<input type="text"/>	<input type="text"/>	<input type="text"/>	<input type="text"/>	<input type="text"/>
MODEL NUMBER	STITCH DETAIL	FLAMMABILITY RATING	CUSHION UPHOLSTERY	FRAME UPHOLSTERY
	None NR Stitch detail SD +\$175	U CTB117	Please refer to list of available upholstery and leather selections on www.gunlocke.com	Please refer to list of available upholstery and leather selections on www.gunlocke.com

Example

GK1121-2A.NR.U.DOL728.SPNN04

GK1121-2A	NR	U	DOL728	SPNN04
MODEL NUMBER	STITCH	FLAMMABILITY DETAIL	CUSHION UPHOLSTERY	FRAME UPHOLSTERY

Please refer to the Ciji product page on www.gunlocke.com for standard finish options.

model number	fabric grades								dimensions	W	D	H
GK1121-3W Three seat, Wood legs	1	3,232	10	4,130	19	5,300	L1	4,607	Overall	73 5/8"	24 3/4"	17 1/4"
	2	3,314	11	4,239	20	5,436	L2	5,745	Seat	73 5/8"	24 3/4"	17 1/4"
	3	3,395	12	4,348	21	5,572	L3	7,111	Upholstery Requirements: GK1121-3W			
	COM/4	3,477	13	4,484	22	5,708	L4	8,249	Dual Upholstery			
	5	3,586	14	4,620	23	5,980	L5	9,387	Fabric yds Cushions 2.8 Frame 1.9			
	6	3,695	15	4,756	24	6,252			Leather ft ² Cushions 64.4 Frame 43.7			
	7	3,803	16	4,892	25	6,524			Shipping weight 125 lbs.			
	8	3,912	17	5,028	26	6,797			Cube 78.5			
	9	4,021	18	5,164	27	7,069						

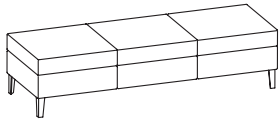

Cushion	1	10	535	19	1,232	L1	819	
	2	49	11	600	20	1,313	L2	1,497
	3	97	12	665	21	1,394	L3	2,311
	COM/4	146	13	746	22	1,475	L4	2,989
	5	211	14	827	23	1,637	L5	3,667
	6	276	15	908	24	1,799		
	7	340	16	989	25	1,961		
	8	405	17	1,070	26	2,124		
	9	470	18	1,151	27	2,286		

Frame	1	10	363	19	836	L1	556	
	2	33	11	407	20	891	L2	1,016
	3	66	12	451	21	946	L3	1,568
	COM/4	99	13	506	22	1,001	L4	2,028
	5	143	14	561	23	1,111	L5	2,488
	6	187	15	616	24	1,221		
	7	231	16	671	25	1,331		
	8	275	17	726	26	1,441		
	9	319	18	781	27	1,551		

Top row of pricing is for units specified with same fabric on cushion and frame. Bottom 2 rows of pricing required only when two different fabric grades are selected for the cushion and frame.

To calculate price of lounge with different grade fabric for cushion and frame; start with Grade 1 price, add appropriate grade price located in second row for cushion, and last add appropriate grade price located in third row for frame to the sum of the Grade 1 and cushion price.

Example: Grade 1 \$3,232 + grade 4 fabric cushion \$146 + grade 2 fabric frame \$33 = \$3,411

Select upholstery for everything else other than the seat and back cushions (the outside back, arms, sides, seat frame). You can specify the same fabric as the cushions or select other fabric.

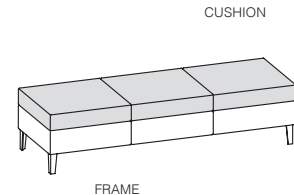

TO ORDER PLEASE SPECIFY THE FOLLOWING:

<input type="text"/>	<input type="text"/>	<input type="text"/>	<input type="text"/>	<input type="text"/>	<input type="text"/>
MODEL NUMBER	WOOD FINISH	STITCH DETAIL	FLAMMABILITY RATING	CUSHION UPHOLSTERY	FRAME UPHOLSTERY
	Cherry finishes on Maple Walnut finishes on Maple Maple finishes on Maple Oak finishes on Maple	None NR Stitch detail SD +\$250	U CTB117	Please refer to list of available upholstery and leather selections on www.gunlocke.com	Please refer to list of available upholstery and leather selections on www.gunlocke.com

Example

GK1121-3W.777.NR.U.DOL728.SPNO4
 GK1121-3W 777 NR U DOL728 SPNO4
 MODEL NUMBER WOOD FINISH STITCH DETAIL FLAMMABILITY UPHOLSTERY CUSHION UPHOLSTERY FRAME REQUEST

Please refer to the Ciji product page on www.gunlocke.com for standard finish options.

CIJI BENCH

Three Seat, Aluminum Legs

Seating
05/22

model number	fabric grades							
GK1121-3A Three seat, Aluminum legs	1	3,468	10	4,366	19	5,536	L1	4,843
	2	3,550	11	4,475	20	5,672	L2	5,981
	3	3,631	12	4,584	21	5,808	L3	7,347
	COM/4	3,713	13	4,720	22	5,944	L4	8,485
	5	3,822	14	4,856	23	6,216	L5	9,623
	6	3,931	15	4,992	24	6,488		
	7	4,039	16	5,128	25	6,760		
	8	4,148	17	5,264	26	7,033		
	9	4,257	18	5,400	27	7,305		

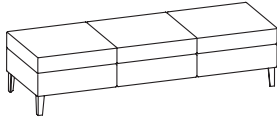

dimensions	W	D	H
Overall	73 5/8"	24 3/4"	17 1/4"
Seat	73 5/8"	24 3/4"	17 1/4"

Upholstery Requirements: GK1121-3A

Dual Upholstery		
Fabric yds	Cushions 2.8	Frame 1.9
Leather ft ²	Cushions 64.4	Frame 43.7
Shipping weight	125 lbs.	
Cube	78.5	

Cushion	1	10	535	19	1,232	L1	819
	2	49	11	600	20	L2	1,497
	3	97	12	665	21	L3	2,311
	COM/4	146	13	746	22	L4	2,989
	5	211	14	827	23	L5	3,667
	6	276	15	908	24		
	7	340	16	989	25		
	8	405	17	1,070	26		
	9	470	18	1,151	27		

Top row of pricing is for units specified with same fabric on cushion and frame. Bottom 2 rows of pricing required only when two different fabric grades are selected for the cushion and frame.

To calculate price of lounge with different grade fabric for cushion and frame; start with Grade 1 price, add appropriate grade price located in second row for cushion, and last add appropriate grade price located in third row for frame to the sum of the Grade 1 and cushion price.

Example: Grade 1 \$3,468 + grade 4 fabric cushion \$146 + grade 2 fabric frame \$33 = \$3,647

Frame	1	10	363	19	836	L1	556
	2	33	11	407	20	L2	1,016
	3	66	12	451	21	L3	1,568
	COM/4	99	13	506	22	L4	2,028
	5	143	14	561	23	L5	2,488
	6	187	15	616	24		
	7	231	16	671	25		
	8	275	17	726	26		
	9	319	18	781	27		

Select upholstery for everything else other than the seat and back cushions (the outside back, arms, sides, seat frame). You can specify the same fabric as the cushions or select other fabric.

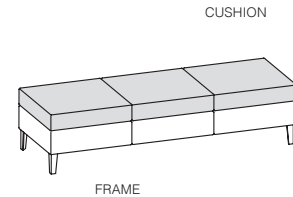

TO ORDER PLEASE SPECIFY THE FOLLOWING:

<input type="text"/>	<input type="text"/>	<input type="text"/>	<input type="text"/>	<input type="text"/>
MODEL NUMBER	STITCH DETAIL	FLAMMABILITY RATING	CUSHION UPHOLSTERY	FRAME UPHOLSTERY
	None NR Stitch detail SD +\$175	U CTB117	Please refer to list of available upholstery and leather selections on www.gunlocke.com	Please refer to list of available upholstery and leather selections on www.gunlocke.com

Example

GK1121-3A.NR.U.DOL728.SPNN04
 GK1121-3A NR U DOL728 SPNN04
 MODEL NUMBER STITCH FLAMMABILITY RATING CUSHION UPHOLSTERY FRAME UPHOLSTERY

Please refer to the Ciji product page on www.gunlocke.com for standard finish options.

Seating
05/22

CIJI REPLACEMENT PARTS

Back Cushions

model number fabric grades dimensions W D H

GK1131
Replacement back cushion
for low back lounge

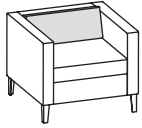

1	486	10	773	19	1,146	L1	925
2	512	11	807	20	1,189	L2	1,288
3	538	12	842	21	1,233	L3	1,724
COM/4	564	13	885	22	1,276	L4	2,087
5	599	14	929	23	1,363	L5	2,450
6	634	15	972	24	1,450		
7	668	16	1,016	25	1,537		
8	703	17	1,059	26	1,624		
9	738	18	1,103	27	1,710		

Overall	24 5/8"	4"	11"
Upholstery Fabric yds	1.5		
Leather ft ²	34.5		

GK1133
Replacement back cushion
for low back corner unit

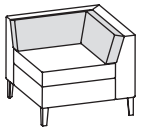

1	910	10	1,197	19	1,570	L1	1,349
2	936	11	1,231	20	1,613	L2	1,712
3	962	12	1,266	21	1,657	L3	2,148
COM/4	988	13	1,309	22	1,700	L4	2,511
5	1,023	14	1,353	23	1,787	L5	2,874
6	1,058	15	1,396	24	1,874		
7	1,092	16	1,440	25	1,961		
8	1,127	17	1,483	26	2,048		
9	1,162	18	1,527	27	2,134		

Overall	27 1/4"	4"	11"
Upholstery Fabric yds	1.5		
Leather ft ²	34.5		

GK1137
Replacement back cushion
for mid back lounge

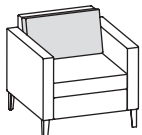

1	486	10	773	19	1,146	L1	925
2	512	11	807	20	1,189	L2	1,288
3	538	12	842	21	1,233	L3	1,724
COM/4	564	13	885	22	1,276	L4	2,087
5	599	14	929	23	1,363	L5	2,450
6	634	15	972	24	1,450		
7	668	16	1,016	25	1,537		
8	703	17	1,059	26	1,624		
9	738	18	1,103	27	1,710		

Overall	24 5/8"	4"	15"
Upholstery Fabric yds	1.5		
Leather ft ²	34.5		

TO ORDER PLEASE SPECIFY THE FOLLOWING:

. . .

MODEL NUMBER **STITCH DETAIL** **FLAMMABILITY RATING** **CUSHIONS UPHOLSTERY**

None **NR**
Stitch detail **SD +\$175**

U CTB117

Please refer to list of
available upholstery
and leather selections
on www.gunlocke.com

Example

GK1131.NR.U.DOL728
GK1131 NR U DOL728
MODEL NUMBER STITCH DETAIL FLAMMABILITY CUSHION UPHOLSTERY

CIJI REPLACEMENT PARTS

Seating
05/22

Cushions and Arms

model number	fabric grades							dimensions	W	D	H	
GK1139 Replacement back cushions for mid back corner unit	1	910	10	1,197	19	1,570	L1	1,349	Overall	24 5/8"	4"	15"
	2	936	11	1,231	20	1,613	L2	1,712	Upholstery Fabric yds	1.5		
	3	962	12	1,266	21	1,657	L3	2,148	Leather ft ²	34.5		
	COM/4	988	13	1,309	22	1,700	L4	2,511				
	5	1,023	14	1,353	23	1,787	L5	2,874				
	6	1,058	15	1,396	24	1,874						
	7	1,092	16	1,440	25	1,961						
	8	1,127	17	1,483	26	2,048						
	9	1,162	18	1,527	27	2,134						



GK1143 Replacement seat cushion	1	667	10	954	19	1,327	L1	1,106	Overall	24 5/8"	24 5/8"	5"
	2	693	11	988	20	1,370	L2	1,469	Upholstery Fabric yds	1.5		
	3	719	12	1,023	21	1,414	L3	1,905	Leather ft ²	34.5		
	COM/4	745	13	1,066	22	1,457	L4	2,268				
	5	780	14	1,110	23	1,544	L5	2,631				
	6	815	15	1,153	24	1,631						
	7	849	16	1,197	25	1,718						
	8	884	17	1,240	26	1,805						
	9	919	18	1,284	27	1,891						

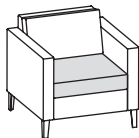

GK1145R Replacement arm right or left	1	726	10	1,165	19	1,738	L1	1,399	Overall	31"	3 1/2"	20 7/8"
	2	766	11	1,219	20	1,805	L2	1,956	Upholstery Fabric yds	2.3		
	3	806	12	1,272	21	1,871	L3	2,624	Leather ft ²	52.9		
	COM/4	846	13	1,339	22	1,938	L4	3,181				
	5	899	14	1,405	23	2,071	L5	3,738				
	6	952	15	1,472	24	2,204						
	7	1,006	16	1,538	25	2,337						
	8	1,059	17	1,605	26	2,470						
	9	1,112	18	1,671	27	2,604						

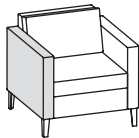

TO ORDER PLEASE SPECIFY THE FOLLOWING:

--	--	--	--

MODEL NUMBER	STITCH DETAIL	FLAMMABILITY RATING	CUSHIONS UPHOLSTERY
---------------------	----------------------	----------------------------	----------------------------

None **NR**
Stitch detail **SD +\$175**

U CTB117

Please refer to list of
available upholstery
and leather selections
on www.gunlocke.com

Option not available for
GK1145R or
GK1145L

Example

GK1139.NR.U.DOL728

GK1139	NR	U	DOL728
MODEL NUMBER	STITCH DETAIL	FLAMMABILITY	CUSHION UPHOLSTERY

model number	list	dimensions	W	D	H
--------------	------	------------	---	---	---

GK1155 Replacement wood leg	319		3 1/2	3 1/2	6
---------------------------------------	-----	--	-------	-------	---



GK1157 Replacement aluminum leg	199		3 1/2	3 1/2	6
---	-----	--	-------	-------	---



GK1159 Plate for joining 3 lounge units	123		6 3/4"	2 5/8"	2 3/4"
---	-----	--	--------	--------	--------

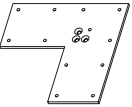

• Used to span the corner formed by the intersection of two armless lounges with a corner unit when assembled in L-shape. This bracket replaces three leg units with one in permanent L-setups

GK1161 Power module	489		1 7/8"	5"	5/8"
-------------------------------	-----	--	--------	----	------



• 15 amp, 72" cord

GK1163 Ganging bracket, set of two	147				
--	-----	--	--	--	--



TO ORDER PLEASE SPECIFY THE FOLLOWING:

.

MODEL NUMBER WOOD FINISH

Option available for GK1155 only.
Cherry finishes on Maple
Walnut finishes on Maple
Maple finishes on Maple
Oak finishes on Maple
 Please refer to the Ciji product page on www.gunlocke.com for standard finish options.

Example

GK1155.215
 GK1155 215
 MODEL NUMBER WOOD FINISH

IRIS

Single Upholstery, Metal Base

model number	fabric grades							dimensions	W	D	H	
GLIRS17-011 Single upholstery lounge, return-to-center metal base	1	3,915	10	4,450	19	5,147	L1	4,487	Overall	29 5/8"	27 1/2"	34 3/4"
	2	3,964	11	4,515	20	5,228	L2	4,988	Seat	22"	19 3/4"	17 5/8"
	3	4,012	12	4,580	21	5,309	L3	5,589	Upholstery Requirements: GLIRS17-011			
	COM/4	4,061	13	4,661	22	5,390	L4	6,090	Fabric yards	2.8		
	5	4,126	14	4,742	23	5,552	L5	6,591	Leather feet ²	47.6		
	6	4,191	15	4,823	24	5,714			Shipping weight	45 lbs.		
	7	4,255	16	4,904	25	5,876			Cube	21.7		
	8	4,320	17	4,985	26	6,039			Note: Lounge 4-star metal base comes standard at a fixed height with return-to-center base.			
	9	4,385	18	5,066	27	6,201						



GLIRS17-031 Single upholstery ottoman, fixed metal base	1	1,581	10	1,829	19	2,153	L1	1,846	Overall	21 3/4"	17 3/4"	15 1/4"
	2	1,604	11	1,859	20	2,191	L2	2,079	Upholstery Requirements: GLIRS17-031			
	3	1,626	12	1,890	21	2,228	L3	2,358	Fabric yards	1.3		
	COM/4	1,649	13	1,927	22	2,266	L4	2,591	Leather feet ²	22.1		
	5	1,679	14	1,965	23	2,341	L5	2,824	Shipping weight	20 lbs.		
	6	1,709	15	2,002	24	2,416			Cube	5.4		
	7	1,739	16	2,040	25	2,492			Note: Ottoman metal base comes standard at a fixed height with fixed base.			
	8	1,769	17	2,078	26	2,567						
	9	1,799	18	2,115	27	2,642						



TO ORDER PLEASE SPECIFY THE FOLLOWING:

. . .

MODEL NUMBER **BASE COLOR** **FLAMMABILITY RATING** **UPHOLSTERY**

Polished Aluminum **BAL** **U** **CTB117** Please refer to list of available upholstery and leather selections on www.gunlocke.com

Example

GLIRS17-011.BAL.U.DOL728

GLIRS17-011 BAL U DOL728

MODEL NUMBER BASE COLOR FLAMMABILITY UPHOLSTERY

model number

fabric grades

dimensions

W

D

H

GLIRS17-021

Dual upholstery lounge,
return-to-center metal base



1	3,992	10	4,565	19	5,312	L1	4,605
2	4,044	11	4,635	20	5,399	L2	5,142
3	4,097	12	4,704	21	5,485	L3	5,785
COM/4	4,149	13	4,791	22	5,572	L4	6,322
5	4,217	14	4,877	23	5,747	L5	6,859
6	4,287	15	4,965	24	5,920		
7	4,357	16	5,052	25	6,094		
8	4,427	17	5,139	26	6,267		
9	4,495	18	5,225	27	6,441		

Overall	29 5/8"	27 1/2"	34 1"
Seat	22"	19 3/4"	17 5/8"

Upholstery Requirements: GLIRS17-021

	Dual Upholstery	
Fabric yds	Inside 1.8	Outside 1.2
Leather ft ²	Inside 30.6	Outside 20.4
Shipping weight	45 lbs.	
Cube	21.7	

Note: Lounge 4-star metal base comes standard at a fixed height with return-to-center base.

Inside

1	10	344	19	792	L1	368
2	31	11	386	20	L2	690
3	63	12	427	21	L3	1,076
COM/4	94	13	479	22	L4	1,398
5	135	14	531	23	L5	1,720
6	177	15	584	24		
7	219	16	636	25		
8	261	17	688	26		
9	302	18	740	27		

Top row of pricing is for units specified with same fabric on Inside and Outside. Bottom 2 rows of pricing required only when two different fabric grades are selected for the Inside and Outside.

To calculate price of lounge with different grade fabric for Inside and Outside, start with Grade 1 price, add appropriate grade price located in second row for Inside, and last add appropriate grade price located in third row for arms to the sum of the Grade 1 and Inside/Outside price.

Example: Grade 1 \$3,992 + grade 4 fabric Inside \$94 + grade 2 fabric Outside \$21 = \$4,107

Outside

1	10	229	19	528	L1	245
2	21	11	257	20	L2	460
3	42	12	285	21	L3	717
COM/4	63	13	320	22	L4	932
5	90	14	354	23	L5	1,147
6	118	15	389	24		
7	146	16	424	25		
8	174	17	459	26		
9	201	18	493	27		

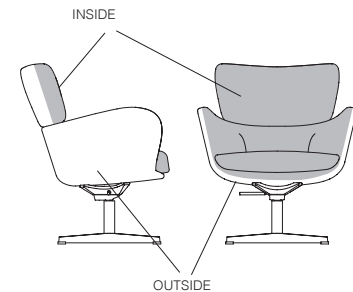

TO ORDER PLEASE SPECIFY THE FOLLOWING:

<input type="text"/>	<input type="text"/>	<input type="text"/>	<input type="text"/>	<input type="text"/>
MODEL NUMBER	BASE COLOR	FLAMMABILITY RATING	INSIDE UPHOLSTERY	OUTSIDE UPHOLSTERY
	Polished Aluminum BAL	U CTB117	Please refer to list of available upholstery and leather selections on www.gunlocke.com	Please refer to list of available upholstery and leather selections on www.gunlocke.com

Example

GLIRS17-021.BAL.U.DOL728.SPNN04

GLIRS17-021	BAL	U	DOL728	SPNN04
MODEL NUMBER	BASE COLOR	FLAMMABILITY	INSIDE UPHOLSTERY	OUTSIDE UPHOLSTERY

IRIS

Dual Upholstery Ottoman, Metal Base

Seating
05/22

model number	fabric grades							
GLIRS17-041 Dual upholstery ottoman, fixed metal base	1	1,610	10	1,916	19	2,314	L1	1,937
	2	1,637	11	1,953	20	2,360	L2	2,223
	3	1,666	12	1,989	21	2,407	L3	2,567
	COM/4	1,693	13	2,036	22	2,453	L4	2,853
	5	1,730	14	2,082	23	2,546	L5	3,139
	6	1,767	15	2,129	24	2,639		
	7	1,805	16	2,175	25	2,731		
	8	1,842	17	2,221	26	2,823		
	9	1,879	18	2,268	27	2,916		



dimensions	W	D	H
Overall	21 3/4"	17 3/4"	15 1/4"

Upholstery Requirements: GLIRS17-041		
Dual Upholstery		
Fabric yds	Top 0.6	Bottom 1
Leather ft ²	Top 10.2	Bottom 17
Shipping weight	20 lbs.	
Cube	5.4	

Note: Ottoman metal base comes standard at a fixed height with return-to-center base.

Top	1	10	115	19	264	L1	123
	2	10	11	129	20	L2	230
	3	21	12	142	21	L3	359
	COM/4	31	13	160	22	L4	466
	5	45	14	177	23	L5	573
	6	59	15	195	24		
	7	73	16	212	25		
	8	87	17	229	26		
	9	101	18	247	27		

Top row of pricing is for units specified with same fabric on Top and Bottom. Bottom 2 rows of pricing required only when two different fabric grades are selected for the Top and Bottom.

To calculate price of lounge with different grade fabric for Inside and Outside, start with Grade 1 price, add appropriate grade price located in second row for Top, and last add appropriate grade price located in third row for Bottom to the sum of the Grade 1, Top/Bottom price.

Example: Grade 1 \$1,610 + grade 4 fabric Top \$31 + grade 2 fabric Bottom \$17 = \$1,658

Bottom	1	10	191	19	440	L1	204
	2	17	11	214	20	L2	383
	3	35	12	237	21	L3	598
	COM/4	52	13	266	22	L4	777
	5	75	14	295	23	L5	956
	6	98	15	324	24		
	7	122	16	353	25		
	8	145	17	382	26		
	9	168	18	411	27		

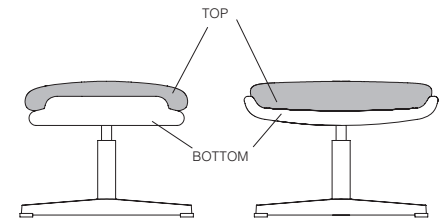



TO ORDER PLEASE SPECIFY THE FOLLOWING:

<input type="text"/>	<input type="text"/>	<input type="text"/>	<input type="text"/>	<input type="text"/>
MODEL NUMBER	BASE COLOR	FLAMMABILITY RATING	TOP UPHOLSTERY	BOTTOM UPHOLSTERY
	Polished Aluminum BAL	U CTB117	Please refer to list of available upholstery and leather selections on www.gunlocke.com	Please refer to list of available upholstery and leather selections on www.gunlocke.com

Example

GLIRS17-041.BAL.U.DOL728.SPNN04				
MODEL NUMBER	BASE COLOR	FLAMMABILITY	TOP UPHOLSTERY	BOTTOM UPHOLSTERY
GLIRS17-041	BAL	U	DOL728	SPNN04

model number	fabric grades								dimensions	W	D	H
GLIRS17-051 Single upholstery lounge, wood legs 	1	3,992	10	4,527	19	5,224	L1	4,564	Overall	29 5/8"	27 1/2"	34 3/4"
	2	4,041	11	4,592	20	5,305	L2	5,065	Seat	22"	19 3/4"	18 3/4"
	3	4,089	12	4,657	21	5,386	L3	5,666	Upholstery Requirements: GLIRS17-051			
	COM/4	4,138	13	4,738	22	5,467	L4	6,167	Fabric yards	2.8		
	5	4,203	14	4,819	23	5,629	L5	6,668	Leather feet ²	47.6		
	6	4,268	15	4,900	24	5,791			Shipping weight	45 lbs.		
	7	4,332	16	4,981	25	5,953			Cube	21.7		
	8	4,397	17	5,062	26	6,116						
	9	4,462	18	5,143	27	6,278						

GLIRS17-071 Single upholstery ottoman, wood legs 	1	1,610	10	1,858	19	2,182	L1	1,875	Overall	21 3/4"	17 3/4"	15 1/4"
	2	1,633	11	1,888	20	2,220	L2	2,108	Upholstery Requirements: GLIRS17-071			
	3	1,655	12	1,919	21	2,257	L3	2,387	Fabric yards	1.3		
	COM/4	1,678	13	1,956	22	2,295	L4	2,620	Leather feet ²	22.1		
	5	1,708	14	1,994	23	2,370	L5	2,853	Shipping weight	20 lbs.		
	6	1,738	15	2,031	24	2,445			Cube	5.4		
	7	1,768	16	2,069	25	2,521						
	8	1,798	17	2,107	26	2,596						
	9	1,828	18	2,144	27	2,671						

TO ORDER PLEASE SPECIFY THE FOLLOWING:

<input type="text"/>	<input type="text"/>	<input type="text"/>	<input type="text"/>
MODEL NUMBER	FINISH	FLAMMABILITY RATING	UPHOLSTERY

These seating models are available in the following hardwoods:

Maple **NE**
Ash **QA**

Please refer to the Tia product page on www.gunlocke.com for standard finish options.

Cherry finishes on Maple or Ash
Walnut finishes on Maple or Ash
Maple finishes on Maple or Ash
Oak finishes on Maple or Ash

Natural Cherry 222, Natural Maple 800, Honey Maple 873 and Natural Oak 300 not available on Ash.

U CTB117

Please refer to list of available upholstery and leather selections on www.gunlocke.com

Example

GLIRS17-051.QA629.U.DOL728
GLIRS17-051 QA629 U DOL728
MODEL NUMBER FINISH FLAMMABILITY UPHOLSTERY

IRIS

Dual Upholstery Lounge, Wood Legs

Seating
05/22

model number

fabric grades

dimensions

W

D

H

GLIRS17-061

Dual upholstery lounge,
wood legs



1	4,068	10	4,641	19	5,388	L1	4,681
2	4,120	11	4,711	20	5,475	L2	5,218
3	4,173	12	4,780	21	5,561	L3	5,861
COM/4	4,225	13	4,867	22	5,648	L4	6,398
5	4,293	14	4,953	23	5,823	L5	6,935
6	4,363	15	5,041	24	5,996		
7	4,433	16	5,128	25	6,170		
8	4,503	17	5,215	26	6,343		
9	4,571	18	5,301	27	6,517		

Overall	32"	32"	30"
Seat	22"	19 3/4"	18 3/4"

Upholstery Requirements: GLIRS17-061

	Dual Upholstery	
Fabric yds	Inside 1.8	Outside 1.2
Leather ft ²	Inside 30.6	Outside 20.4
Shipping weight	45 lbs.	
Cube	21.7	

Inside

1	10	344	19	792	L1	368
2	31	11	386	20	L2	690
3	63	12	427	21	L3	1,076
COM/4	94	13	479	22	L4	1,398
5	135	14	531	23	L5	1,720
6	177	15	584	24		
7	219	16	636	25		
8	261	17	688	26		
9	302	18	740	27		

Top row of pricing is for units specified with same fabric on Inside and Outside. Bottom 2 rows of pricing required only when two different fabric grades are selected for the Inside and Outside.

To calculate price of lounge with different grade fabric for Inside and Outside, start with Grade 1 price, add appropriate grade price located in second row for Inside, and last add appropriate grade price located in third row for arms to the sum of the Grade 1 and Inside/Outside price.

Example: Grade 1 \$4,068 + grade 4 fabric Inside \$94 + grade 2 fabric Outside \$21 = \$4,183

Outside

1	10	229	19	528	L1	245
2	21	11	257	20	L2	460
3	42	12	285	21	L3	717
COM/4	63	13	320	22	L4	932
5	90	14	354	23	L5	1,147
6	118	15	389	24		
7	146	16	424	25		
8	174	17	459	26		
9	201	18	493	27		

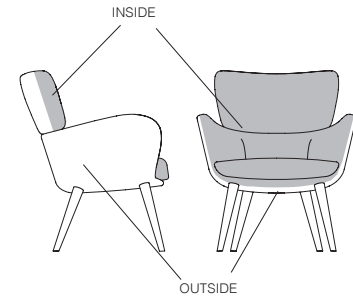

TO ORDER PLEASE SPECIFY THE FOLLOWING:

<input type="text"/>	<input type="text"/>	<input type="text"/>	<input type="text"/>	<input type="text"/>
MODEL NUMBER	FINISH	FLAMMABILITY RATING	INSIDE UPHOLSTERY	OUTSIDE UPHOLSTERY

These seating models are available in the following hardwoods:

Maple **NE**
Ash **QA**

Please refer to the Tia product page on www.gunlocke.com for standard finish options.

Cherry finishes on Maple or Ash
Walnut finishes on Maple or Ash
Maple finishes on Maple or Ash
Oak finishes on Maple or Ash

Natural Cherry 222, Natural Maple 800, Honey Maple 873 and Natural Oak 300 not available on Ash.

U CTB117

Please refer to list of available upholstery and leather selections on www.gunlocke.com

Please refer to list of available upholstery and leather selections on www.gunlocke.com

Example

GLIRS17-061.QA629.U.DOL728.SPNN04

GLIRS17-061	QA629	U	DOL728	SPNN04
MODEL NUMBER	FINISH	FLAMMABILITY	INSIDE UPHOLSTERY	OUTSIDE UPHOLSTERY

model number	fabric grades								dimensions	W	D	H
GLIRS17-081 Dual upholstery ottoman, wood legs	1	1,641	10	1,947	19	2,345	L1	1,968	Overall	21 3/4"	17 3/4"	15 1/4"
	2	1,668	11	1,984	20	2,391	L2	2,254	Upholstery Requirements: GLIRS17-081			
	3	1,697	12	2,020	21	2,438	L3	2,598	Dual Upholstery			
	COM/4	1,724	13	2,067	22	2,484	L4	2,884	Fabric yds Top 0.6 Bottom 1			
	5	1,761	14	2,113	23	2,577	L5	3,170	Leather ft ² Top 10.2 Bottom 17			
	6	1,798	15	2,160	24	2,670			Shipping weight 20 lbs.			
	7	1,836	16	2,206	25	2,762			Cube 5.4			
	8	1,873	17	2,252	26	2,854						
	9	1,910	18	2,299	27	2,947						



Top	1	10	115	19	264	L1	123	
	2	10	11	129	20	281	L2	230
	3	21	12	142	21	299	L3	359
	COM/4	31	13	160	22	316	L4	466
	5	45	14	177	23	351	L5	573
	6	59	15	195	24	386		
	7	73	16	212	25	420		
	8	87	17	229	26	455		
	9	101	18	247	27	490		

Top row of pricing is for units specified with same fabric on Top and Bottom. Bottom 2 rows of pricing required only when two different fabric grades are selected for the Top and Bottom.

To calculate price of lounge with different grade fabric for Inside and Outside, start with Grade 1 price, add appropriate grade price located in second row for Top, and last add appropriate grade price located in third row for Bottom to the sum of the Grade 1, Top/Bottom price.

Example: Grade 1 \$1,641 + grade 4 fabric Top \$31 + grade 2 fabric Bottom \$17 = \$1,689

Bottom	1	10	191	19	440	L1	204	
	2	17	11	214	20	469	L2	383
	3	35	12	237	21	498	L3	598
	COM/4	52	13	266	22	527	L4	777
	5	75	14	295	23	585	L5	956
	6	98	15	324	24	643		
	7	122	16	353	25	701		
	8	145	17	382	26	758		
	9	168	18	411	27	816		

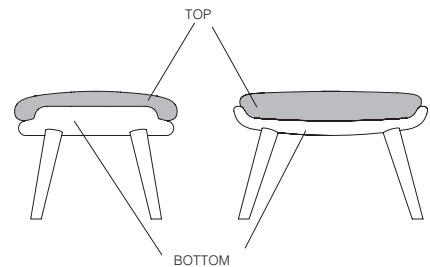

TO ORDER PLEASE SPECIFY THE FOLLOWING:

MODEL NUMBER	FINISH	FLAMMABILITY RATING	TOP UPHOLSTERY	BOTTOM UPHOLSTERY

These seating models are available in the following hardwoods:
Maple **NE**
Ash **QA**

Please refer to the Tia product page on www.gunlocke.com for standard finish options.

Cherry finishes on Maple or Ash
Walnut finishes on Maple or Ash
Maple finishes on Maple or Ash
Oak finishes on Maple or Ash

Natural Cherry 222, Natural Maple 800, Honey Maple 873 and Natural Oak 300 not available on Ash.

U CTB117

Please refer to list of available upholstery and leather selections on www.gunlocke.com

Please refer to list of available upholstery and leather selections on www.gunlocke.com

Example

GLIRS17-081.QA629.U.DOL728.SPNN04				
GLIRS17-081	QA629	U	DOL728	SPNN04
MODEL NUMBER	FINISH	FLAMMABILITY	TOP UPHOLSTERY	BOTTOM UPHOLSTERY

model number	fabric grades							dimensions	W	D	H	
GK9931W Moderne wood arm cap	1	2,272	10	2,807	19	3,504	L1	2,843	Overall	24"	25"	31 1/2"
	2	2,321	11	2,871	20	3,585	L2	3,345	Seat		19 1/2"	19"
	3	2,369	12	2,937	21	3,666	L3	3,946	Arm			26 1/2"
	COM/4	2,418	13	3,017	22	3,747	L4	4,447	Between arms	20 1/4"		
	5	2,483	14	3,099	23	3,909	L5	4,949	Upholstery Requirements: GK9931W			
	6	2,548	15	3,179	24	4,071			Dual Upholstery			
	7	2,612	16	3,261	25	4,234			Fabric yds Seat/Back 1.5 Arms 1.3			
	8	2,677	17	3,342	26	4,396			Leather ft² Seat/Back 25.5 Arms 22.1			
	9	2,742	18	3,423	27	4,557			Shipping weight 64 lbs.			
									Cube 17.6			

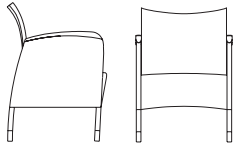

Seat/Back	1	10	287	19	660	L1	306	
	2	26	11	321	20	703	L2	575
	3	52	12	356	21	747	L3	897
	COM/4	78	13	399	22	790	L4	1,165
	5	113	14	443	23	877	L5	1,434
	6	148	15	486	24	964		
	7	182	16	530	25	1,051		
	8	217	17	573	26	1,138		
	9	252	18	617	27	1,224		

Arms	1	10	248	19	572	L1	265	
	2	23	11	278	20	610	L2	498
	3	45	12	309	21	647	L3	777
	COM/4	68	13	346	22	685	L4	1,010
	5	98	14	384	23	760	L5	1,243
	6	128	15	421	24	835		
	7	158	16	459	25	911		
	8	188	17	497	26	986		
	9	218	18	534	27	1,061		

Top row of pricing is for units specified with same fabric on Seat/Back and Arms. Bottom 2 rows of pricing required only when two different fabric grades are selected for the Seat/Back and Arms.

To calculate price of lounge with different grade fabric for Seat/Back and Arms, start with Grade 1 price, add appropriate grade price located in second row for Seat/Back, and last add appropriate grade price located in third row for Arms to the sum of the Grade 1 and Seat/Back

Example: Grade 1 \$2,272 + grade 4 fabric Seat/Back \$78 + grade 2 fabric Arms \$23 = \$2,373

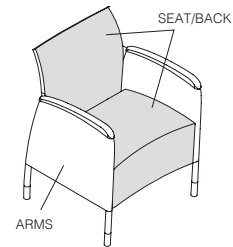

GK9931 model is Certified SCS Indoor Advantage™ to meet USGBC LEED EQ4.5 and California CHPS 1350 Indoor Air Quality Requirements.

TO ORDER PLEASE SPECIFY THE FOLLOWING:

<input type="text"/>	<input type="text"/>	<input type="text"/>	<input type="text"/>	<input type="text"/>	<input type="text"/>
MODEL NUMBER	FRAME	FINISH	FLAMMABILITY RATING	SEAT/BACK UPHOLSTERY	ARMS UPHOLSTERY

This seating model is available with the following frame options. Please specify by adding suffix to model number.

NEW FINISHES

- P71 Black
- PR6 Silver
- P71C Black with Casters (+\$165)
- PR6C Silver with Casters (+\$165)

- Cherry finishes on Maple
- Walnut finishes on Maple
- Maple finishes on Maple
- Oak finishes on Maple

Please refer to the Multi® product page on www.gunlocke.com for standard finish options.

U CTB117

Select upholstery for the Seat/Back.

Please refer to list of available upholstery and leather selections on www.gunlocke.com

Select upholstery for the Arms.

Please refer to list of available upholstery and leather selections on www.gunlocke.com

Example





GK9931W.FBL.215.U.DOL728.SPNN04					
GK9931W	FBL	215	U	DOL728	SPNN04
MODEL NUMBER	FRAME	FINISH	FLAMMABILITY RATING	SEAT/BACK UPHOLSTERY	ARM UPHOLSTERY

OCCASIONAL TABLES

- Occasional Tables..... 205-212
 - Briefing 206
 - Calm 207-209
 - Cylinder..... 210
 - Cube 211
 - Letchworth 212

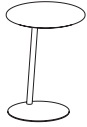
BRIEFING OCCASIONAL TABLES

Seating
05/22

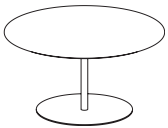
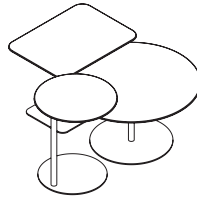
	D	W	H	model number + type	veneer 1	veneer 2	laminated	solid surface
LAPTOP TABLE 24H 	18	18	24 1/2	GM2LTRD18H24- []	1,948	2,131	1,827	2,275
<ul style="list-style-type: none"> • Top size 18" Dia. • Disc size 14" Dia. 								
END TABLE 24H 	18	18	24 1/2	GM2ETRD18H24- []	1,949	2,132	1,827	2,275
<ul style="list-style-type: none"> • Top size 18" Dia. • Disc size 14" Dia. 								
NESTING TABLE 19H 	18	18	19 1/2	GM2NTRD18H19- []	1,948	2,131	1,827	2,275
<ul style="list-style-type: none"> • Top size 18" Dia. • Disc size 14" Dia. 								
NESTING TABLE 17H 	18	24	17 1/2	GM2NTRS1824H17- []	2,438	2,666	2,291	2,763
<ul style="list-style-type: none"> • Top size 18" x 24" • Disc size 12" x 18" 								
NESTING TABLE 15H 	30	30	15 1/2	GM2NTRD30H15- []	2,763	3,022	2,544	3,090
<ul style="list-style-type: none"> • Top size 30" Dia. • Disc size 18" Dia. 								
				Nested tables can be grouped together to create a collection with varying heights. 				

PRODUCT INFO

Top thickness:

Wood 3/4"

Laminated 3/4"

Glass 1/2"

Solid Surface 1/2"

Top includes inserts for connection to base.

Tops include a knife edge standard.

 Units shipped as separate packages and require field assembly.

TO ORDER PLEASE SPECIFY THE FOLLOWING:

WOOD

1. MODEL NUMBER + W

2. FSC

3. FINISH

4. TOP UV FINISH

5. HARDWARE OPTION

- P71** Black
- PR6** Silver
- P8G** Matte Gold
- PJE** Pyrite
- PJW** Designer White
- P8X** Solar Black
- P8T** Titanium
- PJF** Bullseye
- P8M** Regatta
- PC** Polished Chrome (add \$200)

LAMINATE

1. MODEL NUMBER + L

2. FSC

3. FINISH

4. HARDWARE OPTION

- P71** Black
- PR6** Silver
- P8G** Matte Gold
- PJE** Pyrite
- PJW** Designer White
- P8X** Solar Black
- P8T** Titanium
- PJF** Bullseye
- P8M** Regatta
- PC** Polished Chrome (add \$200)

SOLID SURFACE

1. MODEL NUMBER + S

2. FINISH

3. HARDWARE OPTION

- P71** Black
- PR6** Silver
- P8G** Matte Gold
- PJE** Pyrite
- PJW** Designer White
- P8X** Solar Black
- P8T** Titanium
- PJF** Bullseye
- P8M** Regatta
- PC** Polished Chrome (add \$200)

Example

GM2LTRD18H24-W.X.NC260.OP.P71

GM2LTRD18H24-W	X	NC260	OP	P71
MODEL NUMBER + TYPE	FSC	FINISH	TOP UV FINISH	HARDWARE OPTION

32" Depth Occasional Tables

	D	W	H	model number + type	veneer 1	veneer 2	laminated	solid surface	glass	field-installed top
32"D x 25"W Occasional table	32	25	17	GTGB17-3225H17- <input type="checkbox"/>	2,849	2,849	2,512	4,139	3,526	2,578
				Shipping wgt	45 lb	45 lb	45 lb	55 lb	55 lb	35 lb
				Cubes	11.3	11.3	11.3	11.3	11.3	11.1



32"D x 32"W Occasional table	32	32	17	GTGB17-3232H17- <input type="checkbox"/>	3,092	3,092	2,725	4,494	3,830	2,799
				Shipping wgt	50 lb	50 lb	50 lb	60 lb	60 lb	40 lb
				Cubes	14.2	14.2	14.2	14.2	14.2	13.8



32"D x 50"W Occasional table	32	50	17	GTGB17-3250H17- <input type="checkbox"/>	3,581	3,581	3,155	5,200	4,434	3,240
				Shipping wgt	55 lb	55 lb	55 lb	65 lb	65 lb	45 lb
				Cubes	21.5	21.5	21.5	21.5	21.5	20.9



Note: 32"D occasional tables can be used in-line with lounge units, but are freestanding and do not gang.

TO ORDER PLEASE SPECIFY THE FOLLOWING:

. . .

MODEL NUMBER + TYPE	FRAME COLOR	TOP MATERIAL	TOP UV FINISH (WOOD TOPS ONLY)
Note: Type must be specified as part of model number. Wood Veneer W Laminate L Solid Surface S Glass G Field-Installed Top F	Polished Chrome \$100 - 32x25 \$125 - 32x32 \$150 - 32x50 Brushed Chrome Steel \$100 - 32x25 \$125 - 32x32 \$150 - 32x50 Black Designer White Matte Gold Silver Solar Black Titanium Bullseye Regatta	PC BS P71 PJW P8G PR6 P8X P8T PJF P8M	See page 110-111 for required option codes.

Note: Wood and laminate tops are 1 1/8" thick, rabbeted and inset to leave 1/2" thick edge detail. Solid surface and glass tops are 12mm thick, with an inset 3/4" MDF subtop. Field-installed tops receive an inset 3/4" MDF subtop. Wood, laminate, solid surfaces and glass tops all have 1/16" overhang per side.

Example

GTGB17-3225H17-W.PC.NC215.OP

GTGB17-3225H17-W	PC	NC215	OP
MODEL NUMBER	FRAME COLOR	TOP MATERIAL	TOP UV FINISH

CALM

16" Depth Occasional Tables

Seating
05/22

	D	W	H	model number + type	veneer 1	veneer 2	laminata	solid surface	glass	field-installed top
16"D x 32"W Occasional table	16	32	17	GTGB17-1632H17- 	2,604	2,604	2,296	3,783	3,223	2,356
				Shipping wgt	35 lb	35 lb	35 lb	45 lb	45 lb	25 lb
				Cubes	7.7	7.7	7.7	7.7	7.7	7.5



16"D x 50"W Occasional table	16	50	17	GTGB17-1650H17- 	2,849	2,849	2,512	4,139	3,526	2,578
				Shipping wgt	40 lb	40 lb	40 lb	50 lb	50 lb	30 lb
				Cubes	11.7	11.7	11.7	11.7	11.7	11.4



Note: 16"D x 32"W occasional table can be used in-line with lounge units, but are freestanding and do not gang.

TO ORDER PLEASE SPECIFY THE FOLLOWING:

MODEL NUMBER + TYPE

FRAME COLOR

TOP MATERIAL

**TOP UV FINISH
(WOOD TOPS ONLY)**

Note:

Type must be specified as part of model number.

Wood Veneer **W**
Laminate **L**
Solid Surface **S**
Glass **G**
Field-Installed Top **F**

Polished Chrome **PC**
\$100 - 16x32
\$125 - 16x50
Brushed Chrome Steel **BS**
\$100 - 16x32
\$125 - 16x50
Black **P71**
Designer White **PJW**
Matte Gold **P8G**
Silver **PR6**
Solar Black **P8X**
Titanium **P8T**
Bullseye **PJF**
Regatta **P8M**

See page 110-111 for required option codes.

Note: Wood and laminate tops are 1 1/8" thick, rabbeted and inset to leave 1/2" thick edge detail. solid surface and glass tops are 12mm thick, with an inset 3/4" MDF subtop. Field-installed tops receive an inset 3/4" MDF subtop. Wood, laminate, solid surfaces and glass tops all have 1/16" overhang per side.

Example

GTGB17-1632H17-W.PC.NC215.OP

GTGB17-1632H17-W	PC	NC215	OP
MODEL NUMBER	FRAME COLOR	TOP MATERIAL	TOP UV FINISH

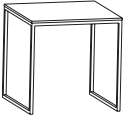
	D	W	H	model number + type	veneer 1	veneer 2	laminate	solid surface	glass	field-installed top
12"D x 18"W Laptop table	12	18	26	GTGB17-1218H26- <input type="checkbox"/>	1,789	1,789	1,579	2,599	2,217	1,618
				Shipping wgt	15 lb	15 lb	15 lb	20 lb	20 lb	10 lb
				Cubes	5.3	5.3	5.3	5.3	5.3	5.2
24"D x 24"W Side table	24	24	24	GTGB17-2424H24- <input type="checkbox"/>	3,009	3,009	2,655	4,374	3,728	2,725
				Shipping wgt	25 lb	25 lb	25 lb	30 lb	30 lb	20 lb
				Cubes	11.4	11.4	11.4	11.4	11.4	11.2

TO ORDER PLEASE SPECIFY THE FOLLOWING:

. . .

MODEL NUMBER + TYPE	FRAME COLOR	TOP MATERIAL	TOP UV FINISH (WOOD TOPS ONLY)
Note: Type must be specified as part of model number.	Polished Chrome	PC +\$75	Note: Wood and laminate tops are 1 1/8" thick, rabbeted and inset to leave 1/2" thick edge detail. solid surface and glass tops are 12mm thick, with an inset 3/4" MDF subtop. Field-installed tops receive an inset 3/4" MDF subtop. Wood, laminate, solid surfaces and glass tops all have 1/16" overhang per side.
Wood Veneer W	Brushed Chrome Steel	BS +\$75	
Laminate L	Black	P71	
Solid Surface S	Designer White	PJW	
Glass G	Matte Gold	P8G	
Field-Installed Top F	Silver	PR6	
	Solar Black	P8X	
	Titanium	P8T	
	Bullseye	PJF	
	Regatta	P8M	
			See page 110-111 for required option codes.

Example

GTGB17-1218H26-W.PC.NC215.OP

GTGB17-1218H26-W	PC	NC215	OP
MODEL NUMBER	FRAME COLOR	TOP MATERIAL	TOP UV FINISH

CYLINDER OCCASIONAL TABLES

Seating
05/22

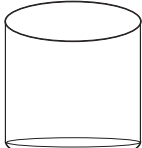
	diameter	H	model number	list
CYLINDER TABLES 	18	20	GNTOCY1820	2,118
	18	24	GNTOCY1824	2,192
	24	20	GNTOCY2420	2,838
	24	24	GNTOCY2424	2,852
	36	16	GNTOCY3616	3,533

SUNBURST PATTERN OPTION

TOP VIEW

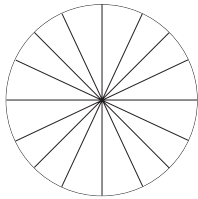

PRODUCT INFO

note
No UV finish.

TO ORDER PLEASE SPECIFY THE FOLLOWING:

. .

MODEL NUMBER **SPECIES & FINISH** **VENEER PATTERN**

Select veneers:

Cherry
Maple

Standard veneer pattern **NP**
Sunburst pattern **SV** **(+\$308)**

Please refer to Gunlocke.com
for standard finish options.

Example

GNTOCY1820.NC260.NP
GNTOCY1820 NC260 NP
MODEL NUMBER FINISH VENEER PATTERN

LETCHWORTH OCCASIONAL TABLES

Seating
05/22

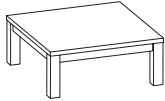
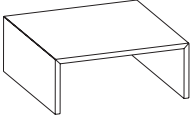
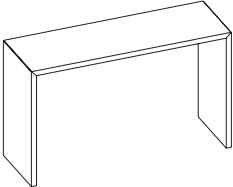
	D	W	H	model number	veneer 1	veneer 2	veneer 3
PARSONS OCCASIONAL 	24	24	21	GABTRT21H2424-WW	2,132	2,279	2,382
	36	36	17	GABTRT17H3636-WW	2,408	2,575	2,691
	42	42	17	GABTRT17H4242-WW	2,684	2,873	3,000
	24	54	17	GABTRT17H2454-WW	2,607	2,790	2,912
MITER OCCASIONAL 	24	24	21	GMBTRT21H2424-WW	6,061	6,629	6,919
	36	36	17	GMBTRT17H3636-WW	2,408	2,635	2,747
	42	42	17	GMBTRT17H4242-WW	2,684	2,935	3,062
	24	54	17	GMBTRT17H2454-WW	2,607	2,852	2,973
MITER CONSOLE 	20	60	36	GMBTRT36H2060-WW	3,002	3,282	3,426

PRODUCT INFO

Tables are shipped in one complete piece and cannot be disassembled. Confirm elevator/doors/hallways for clearance.

TO ORDER PLEASE SPECIFY THE FOLLOWING:

1. MODEL NUMBER
2. FINISH
3. TOP UV FINISH

See inside front cover for required option codes

Example

GABTRT21H2424-WW.NT629.OP

GABTRT21H2424-WW	NT629	OP
MODEL NUMBER	FINISH	TOP UV FINISH

THIS PAGE INTENTIONALLY LEFT BLANK

Gunlocke®

One Gunlocke Drive
Wayland, NY 14572
800 828 6300