

PRICING EFFECTIVE MARCH 2023

SILEA

Price & Specification Guide

PDF updated November 1, 2023

Gunlocke®

veneER 1 (SELECT)

NATURAL FC CHERRY

- A. Cinnamon/Biltmore NC260
- B. Lowell Ash NC394
- C. Medium Red NC512
- D. Light NC701
- E. Shaker NC774
- F. Burnished NC777



NATURAL FC MAPLE

- G. Natural NE800
- H. Harvest NE856



NATURAL FC WALNUT

- I. Florence NT579
 - J. Light NT601
 - K. Skyline NT625
 - L. Nutmeg NT629
 - M. Pinnacle NT679
 - N. Sumatra NT693
 - O. Ebony NT509
- (Use OP TopFin Only)

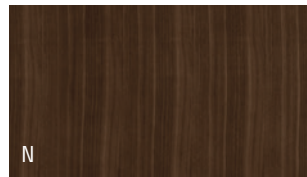
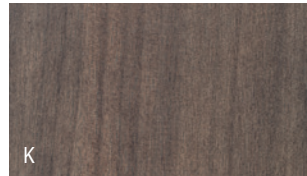
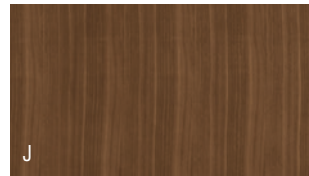

VENEER 1 (SELECT)

STRATAWOOD CHERRY	Vertical	Horizontal
A. Cinnamon/Biltmore	SC260	HSC260
B. Lowell Ash	SC394	HSC394
C. Clear	SC700	HSC700
D. Light	SC701	HSC701
E. Shaker	SC774	HSC774
F. Burnished	SC777	HSC777

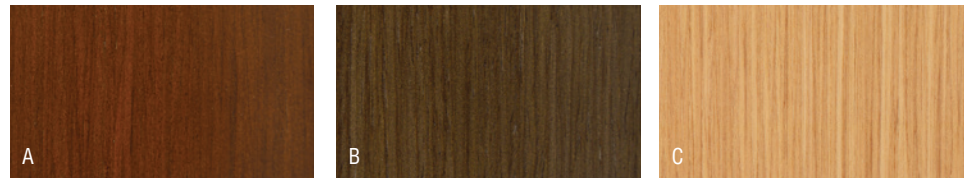

STRATAWOOD MAPLE		
G. Belair	SE934	HSE934
H. Beigewood	SE878	HSE878
I. Field Elm	SE599	HSE599
J. Clear Maple	SE800	HSE800
K. Harvest	SE856	HSE856
L. Phantom Ecrú (Use OP TopFin Only)	SE912	HSE912



STRATAWOOD WALNUT		
M. Florence	ST579	HST579
N. Light	ST601	HST601
O. Skyline	ST625	HST625
P. Pinnacle	ST679	HST679
Q. Sumatra	ST693	HST693



STRATAWOOD OAK		
R. Clear	SF300	HSF300
S. Dark	SF331	HSF331



STRATAWOOD SILVER OAK		
T. Clear	SB100	HSB100
U. Portico Teak	SB150	HSB150



STRATAWOOD WASHED WALNUT		
V. Clear	SW600	
W. Smoked Onyx	SW697	
X. Smoked Grey	SW612	

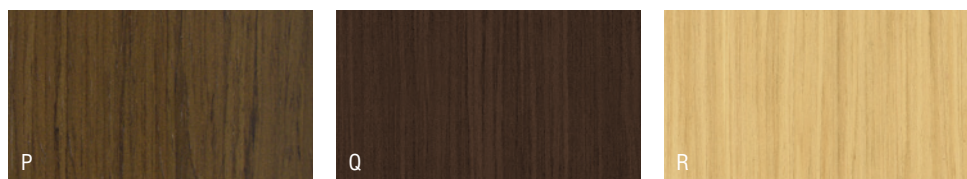

VENEER 2 (PREMIUM)

NATURAL QC WALNUT

A. Florence	QT579
B. Light	QT601
C. Skyline	QT625
D. Nutmeg	QT629
E. Pinnacle	QT679
F. Sumatra	QT693
G. Ebony	QT509
(Use OP TopFin Only)	

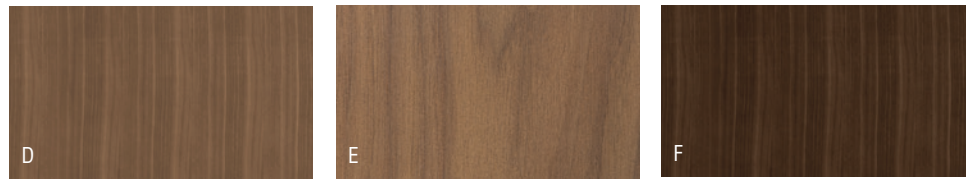
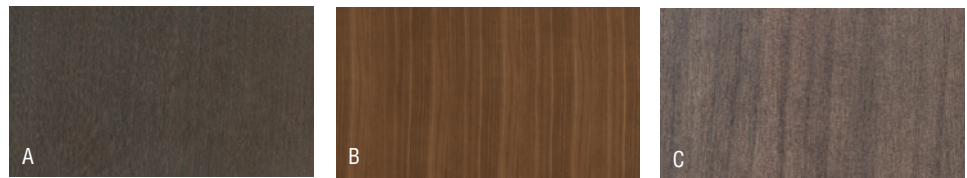

NATURAL RIFT CUT OAK

H. Light	RF301
I. Dark	RF331
J. Phantom Ecrú	RF912
(Use OP TopFin Only)	
K. Fawn Cypress	RF108



LAMINATES

WOODGRAIN

A. Lowell Ash	LLA1
B. Natural Recon	LNR1
C. Phantom Ecrú	LPE1
D. Portico Teak	LPT1
E. Skyline Walnut	LSW1
F. Beigewood	LWBE
G. Field Elm	LWFE
H. Pinnacle Walnut	PINC
I. Fawn Cypress	LFC1
J. Natural Maple	LWD
K. Harvest Maple	C
L. Shaker Cherry	LW7C
M. Biltmore Cherry	COGN
N. Florence Walnut	LFW1
O. Kingswood Walnut	LK11
P. NeoWalnut	LNU1
Q. Veranda Teak	LVT1

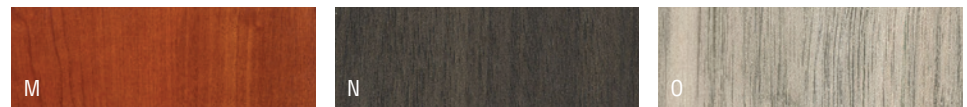

SOLID

R. Designer White 15051	LDW1
S. Loft	LM11
T. Flint	LM16
U. Black	P



GLASS

- | | |
|--|------|
| A. Ice White | GWH2 |
| B. Black | GBK2 |
| C. Muslin | GML2 |
| D. Flint | GFL2 |
| E. Loft | GLO2 |
| F. Beige | GBG2 |
| G. Clear Ribbed Glass
(For Panel Legs Only) | RB |

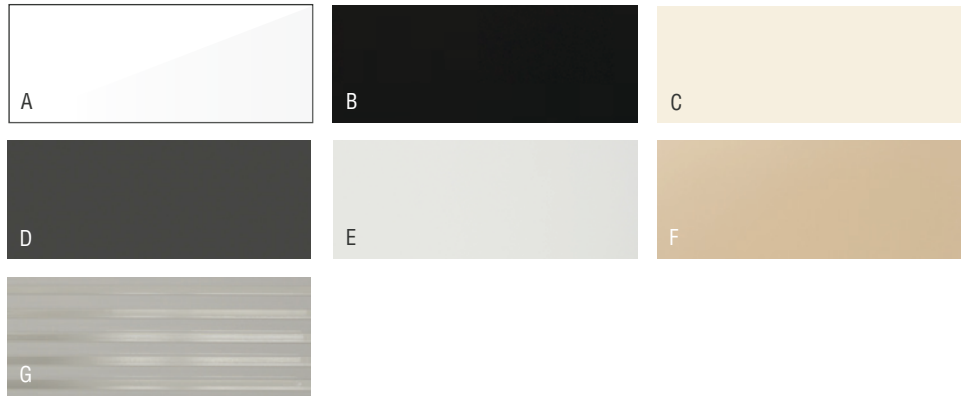

SOLID SURFACE

- | | |
|---------------------|------|
| A. Designer White | SDW4 |
| B. Frosty White | SFW3 |
| C. Night Stars | SNS5 |
| D. Masoned Concrete | SMC2 |
| E. Monte Amiata | SMA1 |

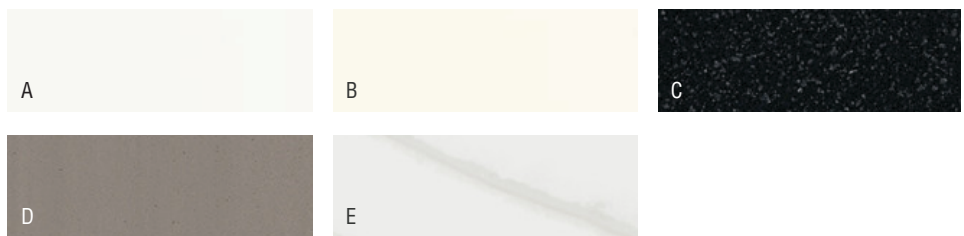

METAL

- | | |
|-------------------|-----|
| A. Black | P71 |
| B. Silver | PR6 |
| C. Matte Gold | P8G |
| D. Pyrite | PJE |
| E. Designer White | PJW |

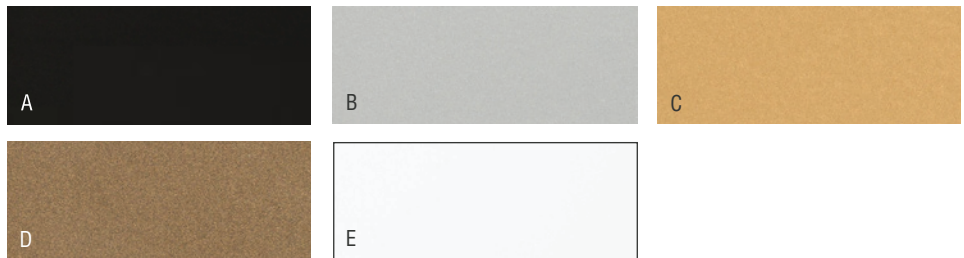

General Information		Modular Casegoods	149-220
Conditions of Sale	2	Desk Worksurface	150-153
GSA Terms & Conditions	3-4	Desk Pedestals	154-155
Warranty	5	Desk Legs	156-160
Delivery Information	6	Desk Runoff Modesty Panel	161-166
Reference	7-9	24 & 30 Depth Worksurfaces	167-170
Pulls Pull Locations	10-11	24 & 30 Depth Pedestals	171-200
Locks & Keying	12-13	Modular End Panel	201
Product Reference	15-49	Modular L Supports	202
Statement of Line	16-23	Support & Ped Backs	203-213
Features + Advantages	24-25	Layers W/ Laptop Drawer	214
Technical Specs	26-28	Round Tops	215
Filing Reference	29-30	Guitar Pick Top	216
Height Reference	31	Layers Box & Brackets	217-219
Wire Management	32	Modular Pedestal Cushion	220
Grommets	33	Cantilever Height Adjustable Desks and	
Details	34	Smart Storage	221-235
Height Adjustability	35	Cantilever Height Adjustable Desks	222-225
Storage	36	Smart Pedestals	226-227
Surface Mount Cabinets	37	Accessory Trays and Bins For Smart Pedestals	228
Dimensions	38-47	False Pedestals	229
Worksurface Finish Specifications	48	Smart Closets	230-231
Grain Direction Specification	49	Smart Lockers	232-233
Unitized Casegoods	51-78	Smart Pedestal Power Units For Grommet Cutout	234
Double Pedestal Desk	52	Solidwood Desktop Accessories	235
Single Pedestal Desk	53-54	Storage	237-267
Runoff Desks	55	Bookcases	238
Layers Runoff W/ Layers Box / Laptop Drawer	56-57	Bookcase / Coat Hook / Closet	239
Double Pedestal Credenza	58	Lateral Files	240-241
Single Pedestal Credenza	59	Closets	242-246
Full Bank Credenza	60-61	Storage Box / Utility Cabinet	247-259
Returns	62	Side Access Storage Locker	260-263
Rectangular Table Desk	63-65	Mobile Pedestal	264-265
Runoffs	66	Storage External Tops	266-267
Rectangular Runoff	67	Wall Mount	269-304
Layers Rectangular Runoff W/ Layers Box /		Cabinets	270-279
Laptop Drawer	68-69	Wall Mount Wall Overhead	280-281
Ellipse Table Desk	70	Tackboard in Tackzone	282-285
Layers Ellipse Runoff W/ Layers Box	71	Tackboard to Top of Overhead	286-291
Arc Boat Table Desk	72	Glass Whiteboard from Floor	292
Layers Arc Boat Runoff W/Layers Box	73	Wall Mount Wall in Tackzone	293-296
Sightline Runoff	74	Magnetic Wood to Top of Overhead	297-301
Layers Sightline Runoff W/ Layers Box /		Shelving for Wall Mount Wall	302-303
Laptop Drawer	75-76	Floating Shelves	304
Layers Cockpit Runoff W/ Layers Box	77	Surface Mount	305-318
Media Top	78	Cabinets	306-310
Height Adjustable	79-123	Towers	311-316
Height Adjustable Split-Top Desks	80-83	Tackboard	317
Freestanding Desk / Extension	84-89	External Tops	318
Credenza	90-93	Workwall	319-324
Bridge	94-95	Workwalls	320-321
Return	96-99	Workwall Tackboard	322
L Shape Height Adjustable Spec Tips	100	Lounge Level Media Unit	323-324
L Shape Height Adjustable	101-116	Accessories	325-340
Shroud for T-Base	117	LED Tasklighting	326
Layers Bookcase	118	Trough Accessories	327-328
Height Adjustable Base	119	Personal Corner	329
Height Adjustable Tops	120	Drawer Filing Rails & Reinforcement Bars	330
Wall Mount Cantilever Bracket	121	Magnets	331
Mixed Material Telescoping Height Adjustable	122	Counterweights	332
Replacement Height Adjustable Keypads	123	Wire Manager	333
Welcome Desk	125-148	Center Drawer	334
Working with Welcome Desks	702-705	Pencil Tray	335
Welcome Desk Typical	706-707	Grommet	336
Advanced Height Adjustable Welcome Desk	132-135	Power Unit	337-339
Advanced Fixed Height Welcome Desk	136-137	3" Dia Field Installed Grommet	340
Fixed Height Welcome Desk	138-139	Grade Fabric Pricing	342-345
Welcome Desk Shell	140-141	Weights + Cubes	346-384
Welcome Desk Bridge	142		
Welcome Desk Returns	143		
Welcome Desk Credenzas	144		
Waterfall Transaction Tops	145		
Transaction Tops	146		
Welcome Desk Tackboard	147		
In/Out Storage Unit	148		

INTRODUCTION

The Gunlocke Company is dedicated to providing the finest products and service possible. This price list reflects that commitment. Included is a current listing of our casegood models.

Seating and Lounge are presented in a separate price list. Contact your Gunlocke Customer Services Representative for more information, (800) 828-6300.

Designed for easy use, each page of this price list, and the inside front cover fold out provide all information required to order a product correctly. Should additional information be needed, contact your Gunlocke customer service representative.

PRICING

Prices shown cover standard product specifications. Any changes or alterations, other than those listed, will be subject to an additional charge. Prices include cartoning and freight. Authorization and pricing must be secured in advance for orders or contracts calling for large quantities, indefinite quantities, or extended delivery dates. Prices are subject to change without notice; the most current prices are published on <http://www.gunlocke.com>.

ACKNOWLEDGEMENT

Each order will be acknowledged by Gunlocke. Customers should check each acknowledgment for accuracy and immediately notify Gunlocke of any discrepancies. The printed acknowledgment is the final agreement between The Gunlocke Company and the customer, superseding all previous communications regarding the order.

SPECIFICATION CHANGES

Gunlocke reserves the right to change specifications for the improvement of products at any time, without notice.

ORDER CHANGES

Gunlocke is not required to accept changes in orders after confirmation. Reasonable changes are subject to additional charges for labor, material and administrative costs.

Order changes of acknowledgment may result in re-scheduling of product.

RETURNED MERCHANDISE

No merchandise may be returned without prior authorization.

SHOWROOMS

For all showroom locations and tour information, please reference the showrooms page online at: www.gunlocke.com/inspiration/showrooms

CANCELLATIONS

Cancellation of orders cannot be accepted since every order is manufactured according to customer specifications.

STORAGE

If delivery cannot be made and products are ready, Gunlocke will transfer products to a storage facility and products will be invoiced at that time. The customer is responsible for storage charges and assumes and bears all risks associated with the storage of that product.

TERMS

Net 30 days from date of invoice. A service charge of eighteen percent (18%) per year or .0004931% per day, compounded monthly, will be added to balance due beyond the thirtieth day. Products are shipped FOB factory, freight prepaid and allowed. Title passes to purchaser and Gunlocke's responsibility ceases when shipment is accepted for transportation by a carrier. A full explanation of all payment terms is found on order and invoice forms.

ORDERING

To expedite order entry and to assure proper service, email or fax all orders directly to:

The Gunlocke Company

Attn: Order Entry
One Gunlocke Drive
Wayland, New York 14572

585-728-5111
585-728-8350 FAX
800-828-6300
www.gunlocke.com

Gunlocke will not be responsible for duplicate orders if purchase orders are left unmarked.

ORDERING INFORMATION

1a. Intended use: The furniture on this schedule is intended for use by Government executives (or equivalent military rank) in the Executive, Judicial and Legislative Branches of the Federal Government. To help customers make a good purchasing decision based on their needs and budget, GSA has established four grades of furniture. Grade (1) includes furniture that tends to be the most expensive on this schedule, grade (2) furniture tends to be more moderately priced and grades (3) and (4) furniture tend to be affordably priced when compared to grades (1) and (2). Some pieces of furniture on this schedule may be significantly higher in price than GSA Traditional and Contemporary Executive Special Order Program furniture. The ordering agency or service is responsible for determining furniture appropriate for use in its offices which will fit within its budget and comply with applicable Federal or internal agency procurement regulations. Please see reverse for GSA terms and conditions.

Grade 1 All exposed solid parts such as top rims, base rails etc. (except decorative accents and inlays) shall be the same species as the face veneer. Top and bottom edges of drawer fronts shall be solid wood in the same species as the face veneers. Drawer sides and backs shall be solid wood.

Grade 2 Exposed wood panel trim and trim on tops shall be the same wood species as the face veneer on the top. Some or all other exposed solid parts, such as base rails can be an alternative wood species (such as poplar or gum) different from the face veneers. Exposed, finished engineered wood core material such as MDF is acceptable only for the edges of drawer fronts. Drawer sides shall be solid wood or veneer core plywood/laminated construction. Silea is grade 2.

Grade 3 Most or all exposed solid parts can be an alternative wood species (such as poplar or gum), different from the face veneers. Exposed, finished engineered wood core material such as MDF is acceptable only for the edges of drawer fronts. Drawer sides shall be solid wood or veneer core plywood/laminated construction. Credentials, and all tables are grade 3.

Grade 4 Most or all exposed solid parts can be an alternative wood species (such as poplar or gum), different from the face veneers. Exposed, finished engineered wood core material such as MDF is acceptable only for the edges of drawer fronts. Drawer sides shall be composite wood material construction such as MDF. Trio is grade 4.

1. **Maximum Order Threshold:**
SIN# 33721 \$250,000
2. **Minimum order:** \$2,000 list
3. **Geographic coverage:**
48 contiguous states and DC (CONUS)
4. **Points of production:**
Wayland, NY, Steuben County, USA
Muscatine, IA, Muscatine County, USA
5. **Discount Statement: Discount is applied to List Price.**
Structure in List \$:
\$2,000 – \$100,000 list 60.5%
\$100,001 – \$400,000 list 62.7%
\$400,001 – MOT (\$1,428,571 List). 65.0%
Over MOT (\$1,428,572 List). Negotiable
* These discounts apply to single purchase orders, shipping to the same place in the same time period
6. **Quantity Discount:** See above
7. **Payment terms:**
1% 23 days Net 30 days from date of shipment, for product only, for all electronic invoices processed through a Federal payment system (including, but not limited to, WAWF, IPP, etc.).

All other invoice sales are Net 30 days from date of shipment. Prompt payment terms are not applicable to credit card orders.
8. **Government Credit Cards** are accepted above and below the micro-purchase levels.

Written confirmation and authorized signatures are required. Activities may verbally provide card information, but products shall be confirmed in writing.

Use of credit cards shall be at the time of order placement with cards charged at the time of shipment, see GSAR 552-232-80 (C).

There are no additional discounts for using a credit card.
9. **Foreign items:** None
- 10a. **Time of delivery:** 60 days ARO
- 10b. **Expedited delivery:** Contact Gunlocke
- 10c. **Overnight and 2-day delivery:** Contact Gunlocke
- 10d. **Urgent requirements:** Contact Gunlocke
11. **FOB point(s):** F.O.B. Origin, with freight being paid by Gunlocke for all deliveries within CONUS.
12. **Ordering address(es):**
The Gunlocke Company
c/o Authorized Gunlocke GSA Dealer
One Gunlocke Drive
Wayland, NY 14572
Phone: (800) 828-6300
Fax: (585) 728-8350
13. **Payment address(es):**
The Gunlocke Company LLC
13367 Collections Center Drive
Chicago, IL 60693
14. **Warranty provision:** See warranty on page 5
15. **Export packing charges:**
Write for quotation on export packaging.
16. **Terms and conditions of Government commercial credit card acceptance:** Credit Cards are accepted.
17. **Terms and conditions of rental, maintenance, and repair:** Not applicable
18. **Terms and conditions of installation:**
Installation services shall be priced at a rate not to exceed 30% of the net product price, per project. The minimum order charge for installation shall be \$175.00. Projects involving extraordinary circumstances which require installation charges exceeding the proposed installation rates will be submitted to the GSA Contracting Officer for review and approval.
19. **Project Management:**
\$65 Per Hour, inclusive of IFF
20. **Reconfiguration and Relocation Services:**
\$65 Per Hour, inclusive of IFF
21. **Design/Layout Services:**
\$65 Per Hour, inclusive of IFF
22. **Terms and conditions of repair:**
Refer to Gunlocke Customer Support
23. **List of service and distribution:** Points: Not applicable
24. **Participating dealers:** A list of participating dealers will be supplied to any government agency upon request or is available on our website at www.gunlocke.com.
25. **Preventative maintenance:**
Not applicable. Instruction sheets available upon request.
26. **Environmental attributes:** Gunlocke has an active environmental program. Please call (800) 828-6300 for details.
27. **Data universal number system:**
(DUNS) number is 19-993-6550
28. **CCR registration/Cage Code:** The Gunlocke Company is registered in the DoD CCR. Cage Code - 26574
29. **Returns:**
No returns of goods will be accepted without written consent and shipping instructions from Gunlocke, and the Government customer will be required to pay all return freight charges. A restocking fee of 30% net will apply on all authorized returns provided Gunlocke receives goods in the condition in which they left the factory. No credit will be given if goods cannot be reused. Special order items are in no event subject to return. Goods must be returned within 70 days of shipment from factory.
30. **Cancellations:** No charge prior to production. After production has begun (5 days ARO), only the actual costs that the contractor can demonstrate will be billed to the customer if the merchandise cannot be resold within a reasonable period of time (90 days).
31. **Inside Delivery:** Gunlocke rates are for dock-to-dock delivery and do not include inside delivery, un-cartoning or set up. If desired, arrangements for inside delivery must be made and approved when the order is placed and will have a corresponding fee of 7% of list price of the order with a minimum charge of \$75. Requests for un-cartoning and set up will be coordinated with a Gunlocke Dealer with applicable charges applied to the order.
32. **Federal Tax ID # 22-3887942**

12 YEAR WARRANTY

Subject to the limitations set forth below. The Gunlocke Company warrants to the original purchaser all product in this price list to be free from defects in material and workmanship for a twelve year period from the date of shipment. This 12-year warranty applies to all products sold and installed by a Gunlocke authorized agent for normal commercial single shift service. Gunlocke will repair, or at its option, replace defective merchandise, free of charge. The following components not manufactured by Gunlocke have the following warranties:

- **High wear components** such as casters and glides are warranted for five years after date of shipment to original owner.
- **Electrical components** are warranted 10 years from date of manufacture with exception of lamps and ballasts which are not warranted. This includes Fluorescent Tasklights.
- **LED tasklights** are warranted for 3 years from date of shipment to original owner.
- **Drawer suspensions** are warranted for lifetime of product after shipment to original owner.
- **Personal corners** including covering (leather) are warranted for three years of single shift and normal use after shipment to original owner.
- **Height adjustable electrical components** are warranted for 7 years of single shift and normal use after shipment to original owner.

Any non-standard material selected by the customer is not warranted. Neither does this warranty apply to damage resulting from accident, alteration, or misuse, as well as damage from normal wear and tear such as dents, nicks, scratches, fading and improper maintenance. That is, Gunlocke's warranty is only valid if products are given proper use and care. Gunlocke assumes no responsibility for product damages resulting from improper installation or user modification.

WOOD FURNITURE

Wood owes its inherent beauty to variations in color, grain, and texture, and therefore, these variations are not considered defects. There may be minor variations from one piece of furniture to the next even though they are finished at the same time. Exposure to light and the aging process will cause a darkening of natural wood products. Light finishes on wood products do not mask the natural characteristics of wood. The Gunlocke Company does not guarantee the exact matching of grain, pattern, and color.

These finishes do not cover any of the natural characteristics of the wood, including nature's colorations, pitch pockets, and the variations of steam-bent wood. Merchandise will not be replaced because of these natural variations.

It is expressly understood and agreed that the buyer's sole and exclusive remedy for any and all losses or damages resulting from nonconforming goods, or from any other cause, shall be repair or replacement of defective parts, and that Gunlocke shall not be liable for damages or injury to persons or property, nor for replacement of the entire commercial unit, if repair or replacement of defective parts can reasonably render the unit conforming.

All warranty claims must be made in writing by the original owner. Owner may be required to produce the invoice or other evidence to establish that a claim is within the warranty period. Warranty claims may be submitted on the Gunlocke website. <https://apps.gunlockeadvantage.com/QualityFeedback/>

As stated and illustrated on the website, serial numbers are required to process a warranty claim. No person, firm or corporation is authorized to assume for Gunlocke any liability in connection with the sale or installation of Gunlocke products except as stated above.

All other warranties, expressed or implied, are excluded. Gunlocke shall not be liable for incidental or consequential damages of any sort.

Within the Continental USA, all orders above \$20,000 list are shipped FOB factory, freight prepaid and allowed. All orders less than \$20,000 list will be subject to a \$200 net freight charge. Products shipped to Alaska and Hawaii FOB factory, freight prepaid and allowed to port of embarkation. Customer is responsible for freight charges from port of embarkation to final destination.

An anticipated shipping date is indicated on the order acknowledgment. Gunlocke cannot accept responsibility for shipping delays caused by outside sources or unforeseen problems. Delay of shipments requested by customers must be approved by Gunlocke. Any resultant storage charges will be charged to the customer.

Gunlocke may await completion of the entire order and ship all at once or may make partial shipments from time to time at its sole discretion unless the customer requests in writing that partial shipments are needed and Gunlocke approves the specific shipping schedule. Additional charges may apply.

Gunlocke is not liable for any delay or failure to deliver or perform due to strikes, lock-outs, or other labor or transportation difficulties, delay of sources or supply, accidents, fires, acts of God, or any other causes of like or unlike nature beyond the control of Gunlocke.

LIABILITY

Gunlocke products and their packaging are tendered to a transportation company only after passing rigid quality control inspection. At that time, title to the product is passed to the purchaser. However the transportation company assumes all liability from acceptance of shipment through its delivery. That is, Gunlocke's liability ceases at the time of shipment.

FILING OF CLAIMS

All claims for damage or loss must be submitted via our website at: <https://apps.gunlockeadvantage.com/QualityFeedback/> within 15 days after receipt of merchandise. Do not return freight damaged merchandise to Gunlocke. Follow the steps below to expedite processing and resolution of claims.

For Visible Damage

1. Make damage notation on delivery receipt and have driver sign. Do not reject or refuse the shipment.
2. Immediately contact Gunlocke Traffic Department at 585-728-8268.
3. Hold damaged carton and all interior packing for carrier's inspection. These materials will be needed to substantiate the claim.

For Concealed Damage

1. Open cartons within 15 days of receipt and inspect.
2. Follow steps 2, and 3 as listed under Visible Damage.
3. Do not remove product from delivered destination.

For Loss

1. Be sure loss notation is made on delivery receipt and have driver sign.
2. Contact Gunlocke Distribution at 585-728-8268.

Should transportation company seek to limit its liability on concealed, loss, or damage claims, please contact Gunlocke's traffic department. After a thorough investigation of the claim, the traffic department will provide you with guidance in corresponding with the carrier.

Returned merchandise, regardless of delivery method, will not be accepted unless specifically authorized by Gunlocke.

For Damage or Loss of Parcel Post or UPS Shipment

Notify Gunlocke distribution immediately at 585-728-8268.

NORMAL DELIVERY

All normal ground transportation by Gunlocke will be made on a dock-to-dock basis. The Gunlocke traffic department will determine the recommended method of shipment according to the ship to destination. If the delivery on a shipment takes longer than 2 hours to be unloaded, an additional charge will be billed at \$60/hour at 15 minute increments. Gunlocke reserves the absolute right to determine the method of shipping unless special delivery instructions have been previously approved.

Gunlocke will make every effort in honoring delivery requests as stated on orders. However, the Company shall have no liability for failure to deliver, perform or delay in delivery due to any cause outside the control of Gunlocke. The Company assumes no liability for costs incurred due to delayed or late deliveries.

If a guaranteed delivery time is needed please call Gunlocke Traffic Department at 585-728-8268 for a quote as additional charges will apply. Weekend or after hours deliveries are subject to additional charges.

WEEKEND DELIVERY

A \$500 charge will apply on weekend delivery after 3:00 PM Friday through Sunday evenings.

DROP SHIP / JOB SITE DELIVERY

Orders under \$50,000 list will incur a \$125 charge for ship to locations other than a designated dealer warehouse.

INSIDE DELIVERY

Inside delivery must be noted on order. A minimum \$100 charge will apply.

SPECIAL DELIVERY

Please contact the Gunlocke traffic department for special delivery services such as inside delivery, weekend or after hour deliveries, reconsignment or other special needs. These are billable services.

Gunlocke will make every effort in honoring delivery requests as stated on orders. However, the Company shall have no liability for failure to deliver, perform or delay in delivery due to any cause outside the control of Gunlocke. The Company assumes no liability for costs incurred due to delayed or late deliveries.

DOCK RESTRICTIONS

Gunlocke trailers are 53' x 102"; when attached to truck cab the total length is 75'. If delivery dock will not accommodate trucks of this sizes, the Gunlocke traffic department must be contacted prior to shipping. Alternate arrangements can be made; additional charges may apply.

VENEERS

Available in 8 select veneers and 2 premium veneers. All exposed wood surfaces utilize select flat cut Cherry, Maple, Walnut veneers, Stratawood (FSC reconstituted veneer), premium quarter cut Walnut, or Rift Oak veneers. Stratawood veneer is made from rapidly renewable wood veneer, which provides a repeatable, consistent straight grain pattern. Stratawood veneers are available in Cherry, Maple, Walnut, or Oak at veneer 1 pricing in vertical or horizontal orientation. All veneers are carefully selected and matched to assure balance and consistency.

SPECIALTY FINISHES

- Submit a color sample block (minimum size 3" x 3") to Gunlocke so that a finish formulation can be developed to match the special finish and color.
- Review the approval sample provided by Gunlocke.
- Written approval and sign off is required for Gunlocke Customer Service.
- Once written approval and sign off is received, the special finish order will be acknowledged.

Note: See Gunlocke Advantage website for special finish request forms.

All Casegoods & Tables Purchase Orders:

- 10% list upcharge per wood unit to specified veneer option receiving special finish.
- \$250 net formulation fee for special finish.

veneer 1 (select)

- Natural Flat Cut Cherry**
- Natural Flat Cut Maple**
- Natural Flat Cut Walnut**
- Stratawood Cherry**
- Stratawood Maple**
- Stratawood Walnut**
- Stratawood Oak**
- Stratawood Silver Oak**
- Stratawood Washed Walnut**

veneer 2 (premium)

- Natural Quarter Cut Walnut**
- Natural Rift Cut Oak**

UV TOP FINISH

Worksurfaces feature two low emitting UV finish options that enhance the beauty of natural wood and ensures depth, clarity, color consistency, and durability throughout the life of the product.

Open Pore Low Sheen	OP
Full-Fill Cleartech (upcharge)	FF

Full Fill Top ≤ 120" Length (+\$273)
Full Fill Top ≥ 120" Length (+\$475)

Note: FSC options can be chosen as option pick for each model.

REFERENCE

Materials & finishes

Silea

03/23

The plastic laminate offering includes 11 woodgrain and 3 solid laminate options from Wilsonart. Laminate tops are high-pressure laminate (HPL), and chassis/storage components are thermally fused laminate (TFL). Laminate edgebands are 2mm thick and are color matched to the laminate option chosen.

Laminates	Description	Option Code	Supplier Name	Supplier Code	Edgeband	Gunlocke Finish Match*
WOODGRAIN	Lowell Ash	LLA1	Wilsonart	7994-12	ABS	NC394
	Natural Recon	LNR1	Wilsonart	7996-12	ABS	RF301
	Phantom Ecru	LPE1	Wilsonart	8212-12	ABS	RF912
	Portico Teak	LPT1	Wilsonart	8210K-12	ABS	SB150
	Skyline Walnut	LSW1	Wilsonart	7964K-12	ABS	QT625
	Field Elm	LWFE	Wilsonart	7999-38	ABS	SE599
	Beigewood	LWBE	Wilsonart	7850-60	ABS	SE878
	Pinnacle Walnut	PINC	Wilsonart	7992-38	ABS	NT679
	Fawn Cypress	LFC1	Wilsonart	8208K-12	ABS	N/A
	Natural Maple	LWD	Wilsonart	11021-38	ABS	NE800
	Harvest Maple	C	Wilsonart	7953-38	ABS	NE856
	Shaker Cherry	LW7C	Wilsonart	7935K-07	ABS	NC774
	Biltmore Cherry	COGN	Wilsonart	7924K-07	ABS	NC260
	Veranda Teak	LVT1	Wilsonart	8209K-12	ABS	SB100
	Kingswood Walnut	LK11	Wilsonart	8218-38	ABS	N/A
	Florence Walnut	LFW1	Wilsonart	7993-38	ABS	N/A
Neo Walnut	LNU1	Wilsonart	7991-38	ABS	N/A	
SOLID	Designer White 15051	LDW1	Wilsonart	15051-60	ABS	WPSW
	Loft	LM11	Wilsonart	15034-60	ABS	WPLF
	Flint	LM16	Wilsonart	10592-38	ABS	WPFT
	Black	P	Wilsonart	1595-60	ABS	N/A
GLASS	Ice White	GWH2				
	Black	GBK2				
	Muslin	GML2				
	Flint	GFL2				
	Loft	GLO2				
	Beige	GBG2				
	Clear Ribbed Glass (For Panel Legs Only)	RB				
SOLID SURFACE	Designer White	SDW4				
	Frosty White	SFW3				
	Night Stars	SNS5				
	Masoned Concrete	SMC2				
	Monte Amiata	SMA1				

* See cross reference above for Gunlocke wood finish match. Although these are good matches, they are not exact matches due to grain pattern and sheen variation from laminate to veneer. They coordinate throughout a floorplate, but we recommend they not be utilized in the same office.

Note: Gunlocke does not guarantee an exact finish match to the plastic laminates listed above.

EDGE DETAIL

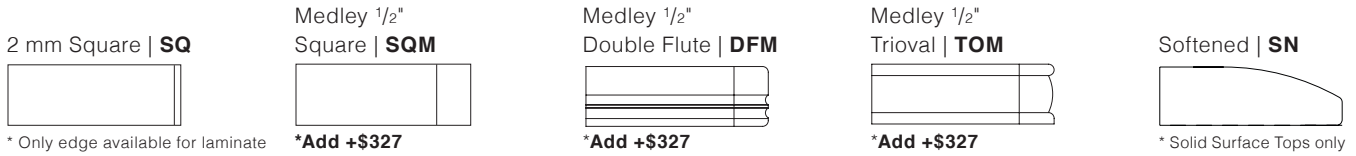

FSC CERTIFIED

Standard - No FSC	X
FSC Certified (5% upcharge)	F

FSC TACKBOARD

FSC Mixed Credit (Upcharge – See Tack & Cushion Pricing)	FSC
FSC Not Required	NR

TOP GRAIN DIRECTION

Long Grain	VLG
Short Grain	VST

• Laminate tops optional grain up to 60", above 60" tops are long grain standard.

DRAWERS

Vinyl Wrapped, with Soft Close suspension	VW
---	-----------

BACK PANEL

No Back Panel	BN
Back Panel Included	BY

POWER UNIT COLOR

Black	BK
Silver	SV
White	WH

POWER UNIT COLOR (For Lounge Level Media)

Black Std Plug	BKSP
Black Hardwire	BKHW
Silver Std Plug	SVSP
Silver Hardwire	SVHW
White Std Plug	WHSP
White Hardwire	WHHW

GLASS COLOR

Ice White	GWH2
Black	GBK2
Muslin	GML2
Flint	GFL2
Loft	GLO2
Beige	GBG2
Clear Ribbed (panel leg insert only)	RB

LOCKS

Locks Yes, Random Matte Silver Keying (Factory Installed)	LYSTD (Add +\$153)
Locks Yes, Omit Lock Core (Field Installed)	LYOMT (Add +\$153)
Locks No	LN

KEYING

Random Matte Silver Keying (Factory Installed)	STD
Omit Lock Core (Field Installed)	OMT

HARDWARE COLOR

Black	P71
Silver	PR6
Matte Gold	P8G
Pyrite	PJE
Designer White	PJW

HEIGHT ADJUSTABLE BASE COLOR (METAL T BASES)

Black (P71)	BK
Silver (PR6)	SV
Designer White (PJW)	PJW

MAGNETIC ACCESSORY

White	AWH
Black	ABK
Muslin	AML

PERSONAL CORNER

Leather	White	CWH
	Black	CBL
	Chocolate	CCH
Vinyl	White	VWH
	Black	VBL
	Chocolate	VCH

CUSHION UPHOLSTERY

Fabric	COM-G27
Leather	COL-L5



TASKLIGHT CORD GROMMET (For Surface Mount Cabinets)

Grommet Included	WY
Grommet No	WN

MODESTY PANEL

Modesty No	MN
Modesty Yes	MY

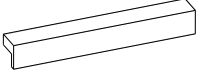
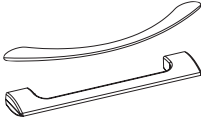
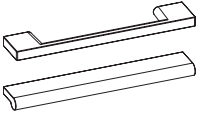
METAL PULL

Silea Black (P71)	PP71		SILEA
Silea Silver (PR6)	PPR6		
Silea Matte Gold (P8G)	PP8G		
Silea Pyrite (PJE)	PPJE		
Silea Designer White (PJW)	PPJW		
Medley Arch Black (P71)	HARB		MEDLEY ARCH
Medley Arch Silver (PR6)	HARS		MEDLEY ARETTE
Medley Arette Black (P71)	HATB		
Medley Arette Silver (PR6)	HATS		
Trio Linear Black (P71)	HLEB		TRIO LINEAR
Trio Linear Silver (PR6)	HLES		TRIO BAR
Trio Bar Black (P71)	HBRB		
Trio Bar Silver (PR6)	HBRS		
Modern Black (P71)	MP71		MODERN
Modern Silver (PR6)	MPR6		
Modern Matte Gold (P8G)	MP8G		
Modern Pyrite (PJE)	MPJE		
Modern Designer White (PJW)	MPJW		

Integral pulls are available as a standard option in wood only.

INTEGRAL PULL

Integral Pull /Touch Latch Doors **FPW**
(add \$218 per unit)

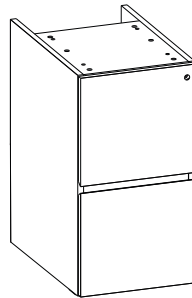

The Silea style metal pull is available in 5 metal finish colors - Silver, Black, Pyrite, Matte Gold, and Designer White. Pulls have the ability to be placed left, right or center with the same drawer front and pull hardware. Pulls are 6" less than the drawer front size with the exception of a 9" pedestal which comes with a 9" pull. Note: This applies to the Silea style pull only. This does not apply to the Arch, Arette, Linear, Bar, or Modern pulls.

CENTERED

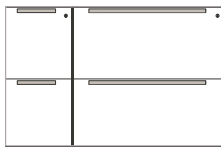

CONTINUOUS

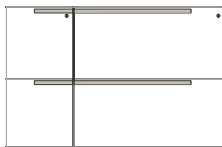

LEFT ALIGNED

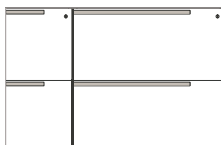

RIGHT ALIGNED

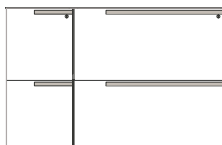

Choice.

The Silea pull enables you to select drawer pull orientation at the time of installation. Maximum flexibility.

CLOSET LOCATIONS

PEDESTAL LOCATIONS

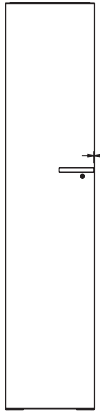

SILEA

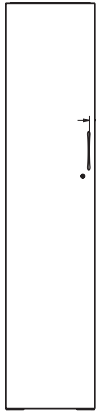

ARCH

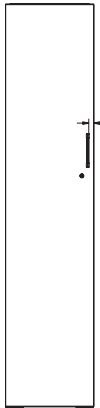

ARETTE

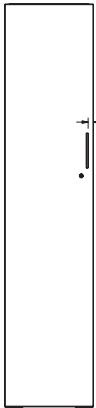

LINEAR

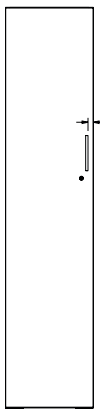

BAR

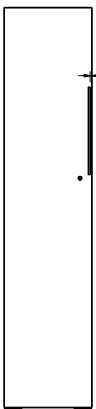

MODERN

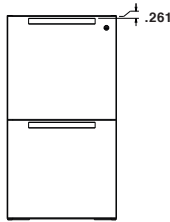

SILEA

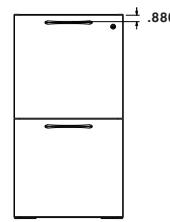

ARCH

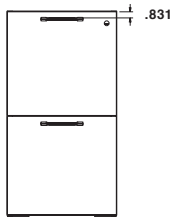

ARETTE

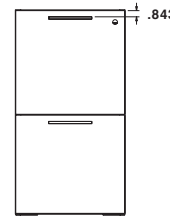

LINEAR

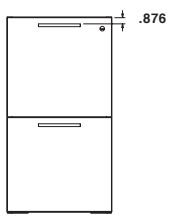

BAR

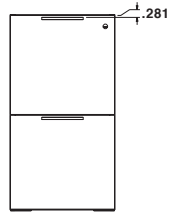

MODERN

Locks are standard on all below worksurface storage units. Closets and overhead storage are optional locking.

STANDARD OPTIONS

- **Random Keying:** Key(s) arbitrarily assigned and installed at the factory. Factory installed locks are silver.

Note: When the random option is selected, some units may be shipped with the same key number.

- **Omit Lock Core:** The factory will omit lock cores. Removable lock core kits with specific key numbers must be ordered to facilitate keying alike in the field. A lock program must be specified. Field installed locks are available in Matte Silver, Black, Pyrite, Matte Gold, and Designer White.

KEYING

Random Matte Silver Keying (Factory Installed)	STD	
Omit Lock Core (Field Installed)	OMT	(If option is chosen, a field installed lock program must be specified)

LOCK PROGRAM (FIELD INSTALLED ONLY)

Random Keying	X
Specified Keying	X101 - X225
Sequential Keying	SEQ/101 - SEQ/225

KEYING COLOR (FIELD INSTALLED ONLY)

Matte Silver	MTS
Black	BLK
Matte Gold	MGD
Pyrite	PYT
Designer White	PJW

REPLACING LOCK CORES

- Lock must be in the unlocked position.
- Insert core removal key and pull core straight out.
- Insert new core with core removable key, hold core into lock and withdraw core removal key.
- Retain original core for future use.

For field installed locks, the "Omit Lock Core" option must be chosen. Then, specify lock model based on total quantity of lock cores within each office. To ensure ease of ordering for a variety of situations, lock cores can be specified in 3 ways – Random, Specified or Sequential.

LOCKING MODELS	DESCRIPTION	LIST
GLKFE1	1 core, 2 keys	\$16
GLKFE2	2 core, 2 keys	\$21
GLKFE3	3 core, 2 keys	\$26
GLKFE4	4 core, 2 keys	\$30
GLKFE5	5 core, 2 keys	\$34
GLKFE6 <i>(de-emphasized)</i>	6 core, 2 keys	\$42
GLKFE7 <i>(de-emphasized)</i>	7 core, 2 keys	\$48
GLKFE8 <i>(de-emphasized)</i>	8 core, 2 keys	\$56
GLKFE9 <i>(de-emphasized)</i>	9 core, 2 keys	\$63
GLKFE10 <i>(de-emphasized)</i>	10 core, 2 keys	\$69
GLKFE11 <i>(de-emphasized)</i>	11 core, 2 keys	\$77
GLKFE12 <i>(de-emphasized)</i>	12 core, 2 keys	\$83
GLKFE13 <i>(de-emphasized)</i>	13 core, 2 keys	\$91
GLKFE14 <i>(de-emphasized)</i>	14 core, 2 keys	\$98
GLKFE15 <i>(de-emphasized)</i>	15 core, 2 keys	\$104

RANDOM KEYING (FIELD INSTALLED)

The Random Keying option is provided for instances where there are multiple orders or phases to a project and the offices need to be keyed alike but the key numbering is not required. With the random keying option, key numbers are not specified. However, the core kits will be in sequential order from a random starting point.

SPECIFIED KEYING (FIELD INSTALLED)

The Specified Keying option is provided for instances where there is a specific key number desired for all of the cores ordered.

SEQUENTIAL KEYING (FIELD INSTALLED)

The Sequential Keying option is provided for instances when there are multiple orders or phases to a project and it is imperative that key numbers are not duplicated..

Note: One core removal key minimum per order. One additional core removal key per 25 lock cores will be shipped.

MASTER KEY

One key available to authorized dealers **GLKMSTR \$9**

KEY NUMBERS 101-225 ARE AVAILABLE.

Orders without key numbers will be specified at random.

RANDOM KEYING EXAMPLE

- There are 18 offices which have 3 black locks that need to be keyed alike, but the key number is not important.

Model String:

GLKFE3. BLK. X. 18
Model Color Program # of Offices

SPECIFIED KEYING EXAMPLE

- There are 6 offices which have 2 silver locks that need to be keyed alike with the key number 202.

Model String:

GLKFE2. MTS. X202. 6
Model Color Program # of Offices

SEQUENTIAL KEYING EXAMPLE

- A multiple phase project has 100 offices - 60 in the first phase with 4 locks, 40 in the second phase with 3 locks. No key number can be duplicated.

Model String (First Phase):

GLKFE4. PYT. SEQ/101. 60

Model String (Second Phase):

GLKFE3. PYT. SEQ/161. 40
Model Color Program # of Offices

Product Reference... 15-49
Statement of Line... 16-23
Features + Advantages... 24-25
Technical Specs... 26-28
Filing Reference... 29-30
Height Reference... 31
Wire Management... 32
Grommets... 33
Details... 34
Height Adjustability... 35
Storage... 36
Surface Mount Cabinets... 37
Dimensions... 38-47
Worksurface Finish Specifications... 48
Grain Direction Specification... 49

STATEMENT OF LINE

Unitized

Silea

03/23

DOUBLE PEDESTAL DESK
9" ped

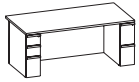

15" ped

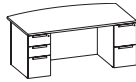
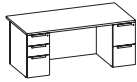

SINGLE PEDESTAL DESK
15" ped

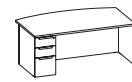
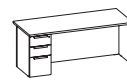
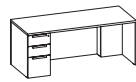

SINGLE PEDESTAL CREDENZA
9" ped

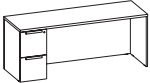

30" ped

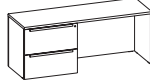

DOUBLE PEDESTAL CREDENZA

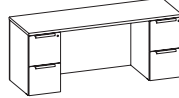

RETURNS

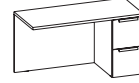

RUNOFF DESK
15" ped (LH & RH)

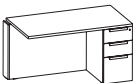

RUNOFF DESK
9" ped (LH & RH)

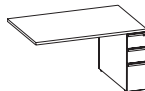

LAYERS RUNOFF DESK
9" ped (LH & RH)

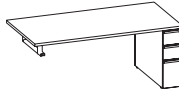

**LAYERS RUNOFF DESK W/
LAPTOP DRAWER (LH & RH)**

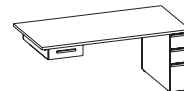

**RECTANGULAR TABLE
DESK**

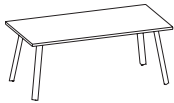

**RECTANGULAR EXTENSION
(LH & RH)**

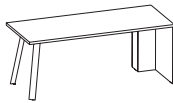

**RACETRACK EXTENSION
(LH & RH)**

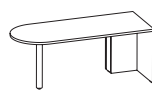

d SHAPE EXTENSION



b SHAPE EXTENSION

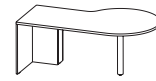

**LAYERS RECTANGULAR
RUNOFF**

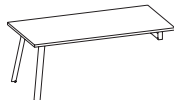

**LAYERS RECTANGULAR RUNOFF
W/LAPTOP DRAWER (LH & RH)**

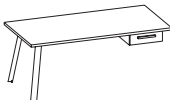

SIGHTLINE RUNOFF

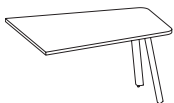

LAYERS SIGHTLINE RUNOFF

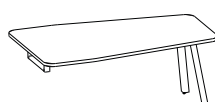

**LAYERS SIGHTLINE RUNOFF
W/LAPTOP DRAWER (LH & RH)**

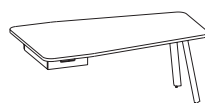

**LAYERS COCKPIT RUNOFF
(LH & RH)**

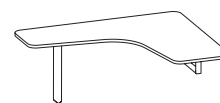

MEDIA TOP

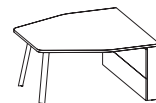

ELLIPSE TABLE DESK

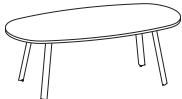

LAYERS ELLIPSE RUNOFF

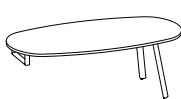

ARC BOAT TABLE DESK

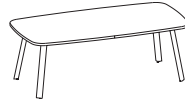

LAYERS ARC BOAT RUNOFF

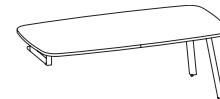

FULL BANK CREDENZA

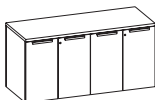
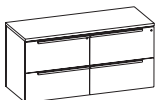

HEIGHT ADJUSTABLE

CREDENZA W/ END PANELS

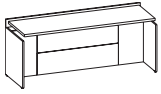

CREDENZA DOUBLE PEDESTAL

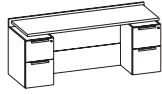

CREDENZA SINGLE PEDESTAL (LH & RH)

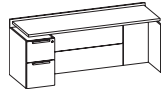

BRIDGE W/ WALL ACCESS PANEL

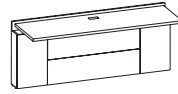

RETURN W/ END PANEL (LH & RH)

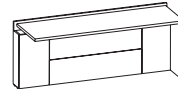

RETURN W/ PEDESTAL (LH & RH)

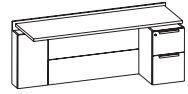

FREESTANDING DESK W/ FULL MODESTY

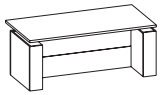

EXT DESK W/ FULL MODESTY (LH & RH)

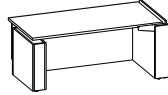

EXT DSK W/ TELESCOPING BASE (LH & RH)

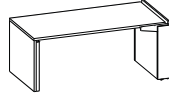

FREESTANDING DESK W/ HALF MODESTY

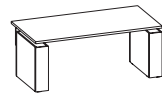

EXT DESK W/ HALF MODESTY (LH & RH)

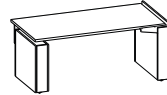

WORKSURFACE FOR T-BASE



SHROUD FOR T-BASE

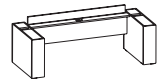

LAYERS BOOKCASE FOR T-BASE



T-BASE



WORKWALL

WALL MOUNTED WORKWALL (3H) (LH & RH)
(Wood only)

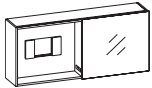

FREESTANDING WORKWALL (5 1/2 H) (LH & RH)
(Wood only)

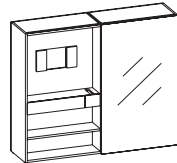

LOUNGE LEVEL MEDIA UNIT
(Wood only)

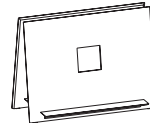

LOUNGE LEVEL MEDIA UNIT
Whiteboard

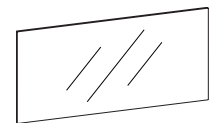

STATEMENT OF LINE

Modular

Silea

03/23

DESK & RUNOFF WORKSURFACE

30 & 36D

Rectangular



Bow



Racetrack



b shape



d shape



24D TOP

Standard or Trough



DOUBLE PEDESTAL FULL MODESTY

9" peds

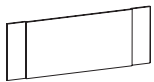

15" peds

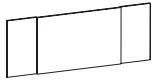

SINGLE PEDESTAL FULL MODESTY

(LH & RH)

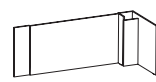

DESK MODESTY PANEL

10" Height



DESK MODESTY PANEL

Full Height



PEDESTALS 24D Standard Height, Standard or Trough Top



(LH & RH)



(LH & RH))



PEDESTALS 24D Standard or Trough Top



(LH & RH)



DESK PEDESTALS

9" ped



(LH & RH)



END PANEL

(Full back, no trough)



L SUPPORTS

(LH & RH)



SUPPORT PANELS

Standard & Layers

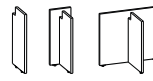

PEDESTAL BACKS

Standard & Layers

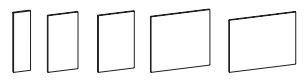

MODESTY & WALL ACCESS PANEL

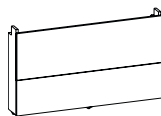

ROUND TOP



GUITAR PICK TOP



CANTILEVER HEIGHT ADJUSTABLE RECTANGULAR DESKS

LEFT & RIGHT HAND

36" Depth - Left Hand

42" Depth - Left Hand

36" Depth - Right Hand

42" Depth - Right Hand

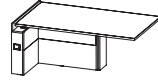
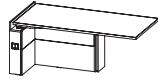
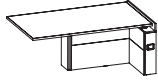
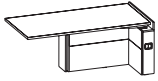

CANTILEVER HEIGHT ADJUSTABLE SIGHTLINE DESKS

42" Depth - Left Hand

42" Depth - Right Hand

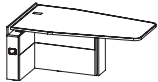
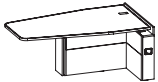

SMART PEDESTALS

Single Unit

Double Unit

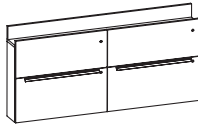

SMART PEDESTAL ACCESSORY TRAYS AND BINS

Large Tray

Large Bin

Small Tray

Small Bin

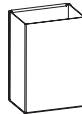
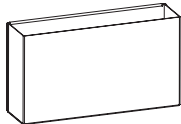

FALSE PEDESTALS

For Fixed Desk or Fixed Return

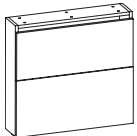

SMART CLOSETS

18" Wide

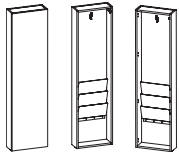

30" Wide Side Access

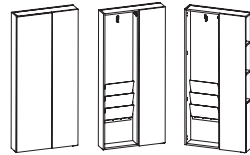

18" Wide w/ Glass Doors

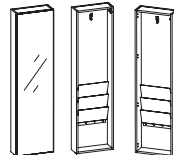

30" Wide Side Access w/ Glass Doors

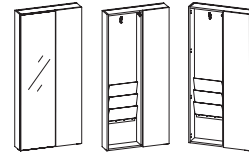

SMART LOCKERS

24" Wide

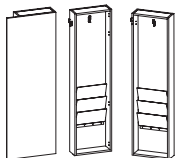

36" Wide Side Access

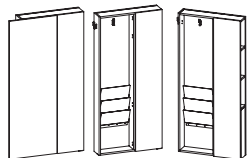

24" Wide w/ Glass Doors

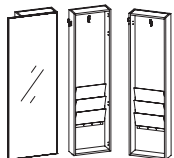

36" Wide Side Access w/ Glass Doors

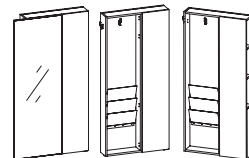

SMART PEDESTAL GROMMET ACCESSORIES

HQ Power w/ Wireless Charging

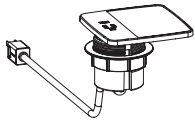

Bezel Mount Power

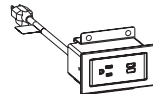

SOLIDWOOD DESKTOP ACCESSORIES

Pencil Tray



Pencil Cup

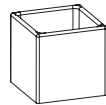

REPLACEMENT HEIGHT ADJUSTABLE KEYPAD ACCESSORIES

Basic Up/Down Keypad



Memory Preset Keypad



Paddle Keypad



Foot Control Keypad



Bluetooth App Control



BOOKCASE - 2H, 3H, 4H, 5H, 6H

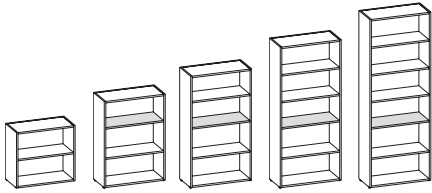

BOOKCASE W/ COAT HOOK
BACK (LH & RH)

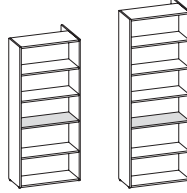

1/2 OPEN BOOKCASE
1/2 CLOSET W/ DOOR
(LH & RH)

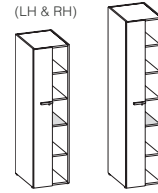

LATERAL FILE - 2H WITH TOP
3H, 4H, 5H, 6H

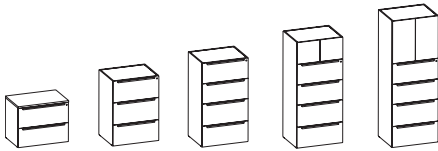

CLOSET
5H & 6H

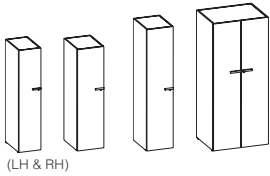

CLOSET W/ GLASS
DOOR (LH & RH)
5H & 6H

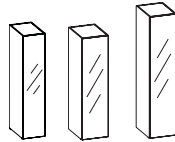

STORAGE BOX
5H & 6H

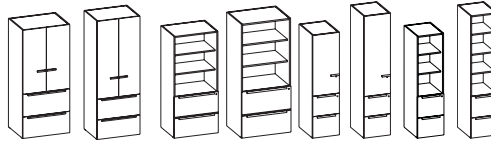

STORAGE CABINET



UTILITY CABINET
(LH & RH) 5H & 6H

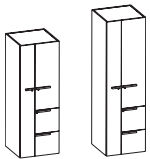

SIDE ACCESS
STORAGE LOCKER
Standard & Layers Height
(LH & RH)



SIDE ACCESS STORAGE
LOCKER W/GLASS DOOR
Standard & Layers Height
(LH & RH)



EXTERNAL STORAGE TOP



MOBILE PEDESTAL
W/ TOP



STATEMENT OF LINE

Wall Mount

Silea

03/23

CABINET W/ HINGED DOORS
(1H)

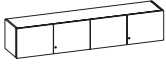

CABINET W/ HINGED GLASS DOORS
(1H)
(Wood only)

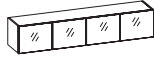

CABINET W/ NO DOORS
(1H)

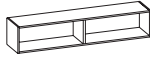

CABINET W/ HINGED DOORS
(2H)

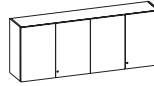

CABINET W/ HINGED GLASS DOORS
(2H)
(Wood only)

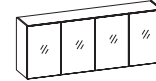

CABINET W/ NO DOORS
(2H)

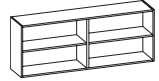

CABINET W/ SLIDING DOORS (1H)



CABINET W/ SLIDING GLASS DOORS (1H)
(Wood only)



CABINET W/ SLIDING DOORS (2H)

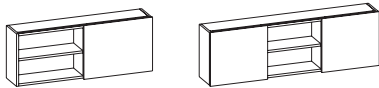

CABINET W/ SLIDING GLASS DOORS (2H)
(Wood only)

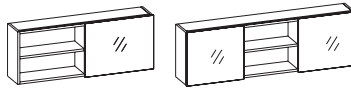

WALL OVERHEAD SHELF TRACK BOTTOM
(1H)



WALL OVERHEAD SHELF TRACK BOTTOM & CENTER
(2H)



TACK ZONE W/ CENTER TRACK
(1H)



LAYERS TACK ZONE W/ CENTER TRACK



TACK ZONE
(Wood, Glass & Fabric)

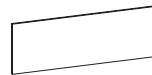

8D & 12D SHELF CLIP INTO WALL W/TRACK



FLOATING SHELF



EXTERNAL TOP



CABINET W/ HINGED DOORS (1H)

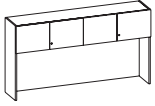

CABINET W/ HINGED GLASS DOORS (1H)
(Wood only)

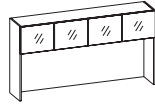

CABINET W/ NO DOORS (1H)

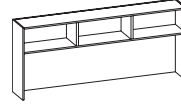

CABINET W/ HINGED DOORS (2H)
(Wood only)

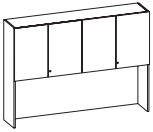

CABINET W/ HINGED GLASS DOORS (2H)
(Wood only)

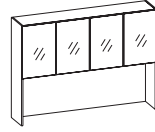

TOWER W/ HINGED DOORS (1H)

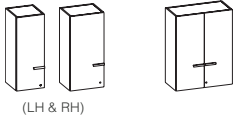

TOWER W/ HINGED DOORS (2H)

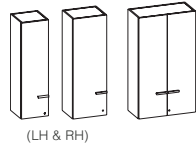

TOWER W/ NO DOORS (1H)

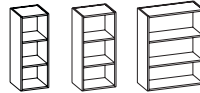

TOWER W/ NO DOORS (2H)

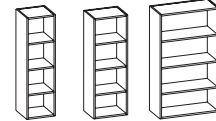

TOWER W/ GLASS DOORS (1H)
(Wood only)

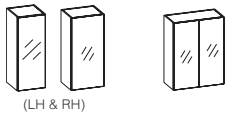

TOWER W/ GLASS DOORS (2H)
(Wood only)

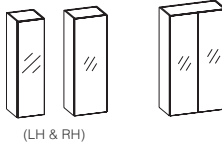

EXTERNAL SURFACE MOUNT
TOP



ATTRIBUTE	FEATURE	ADVANTAGE
STYLE/DESIGN	Refined Aesthetic Range	<ul style="list-style-type: none"> • Application solutions for solo, team and community spaces • Empowers design choice through a flexible aesthetic range • Complete integration of components and functionality options • Curated and compatible materials and finish options embrace diverse styling options • Attention to detail • High level of space customization & functionality • Variety of metal pull options, along with integral pull on wood • Interchangeability of materials provide design flexibility
	Hand Selected Veneer	<ul style="list-style-type: none"> • Quarter cut walnut • Flat cut cherry, maple and walnut • Rift cut oak • Stratawood veneer (horizontal or vertical orientation)
	Mixed Material Solutions	<ul style="list-style-type: none"> • 11 woodgrain laminates • 3 solid laminates • 6 back painted glass options • 5 solid surface options • 5 metal finish colors
SCALABILITY	Size & Scale	<ul style="list-style-type: none"> • Flexibility in material options and components allow for a variety of product planning solutions to meet customer requirements • Standard height and layers height • Application versatility from enclosed spaces to team collaborative settings to community gathering areas
	Aesthetic Cost	
FUNCTIONALITY	Unlimited Outcomes	<ul style="list-style-type: none"> • High-performance workplaces driven by integration, agility, choice, and aesthetic options.
	Integrated Height Adjustability Solutions	<ul style="list-style-type: none"> • Mixed material, full modesty and half modesty desks & extensions • Sit to stand bridges, returns and credenzas • Shrouded height adjustable t-bases • Layers application sit to stand solutions
	Soft Close Suspensions & Hardware	<ul style="list-style-type: none"> • Soft close drawers and hinges on all materials
	Magnetic Tack zone	<ul style="list-style-type: none"> • Back painted glass, wood tack zones provide a magnetic surface for posting papers and magnetic accessories
	Personal Corner	<ul style="list-style-type: none"> • Creates an ergonomic corner for use
	Collaborative Worksurface Shapes	<ul style="list-style-type: none"> • Media, sightline and guitar pick tops provide collaborative solutions in the private office or open areas • Integration of private office components that enable effective meeting spaces
	Workwall Solutions	<ul style="list-style-type: none"> • Progressive meeting office option that allows for collaboration and personalized space • Fits in private office applications or can be pulled into open areas
TECHNOLOGY INTEGRATION	Wire Management Trough	<ul style="list-style-type: none"> • Continuous trough with non-handed pedestals • Easy access to power and data • Clean, simple wire management • Use of clip-in accessories
	Grommets	<ul style="list-style-type: none"> • Rectangular grommets in desks and credenzas • Three grommet positions - closed, small opening for cords, larger opening for monitor arms • Cutout can utilize a power unit to bring technology to the surface
	Wall Access Panels	<ul style="list-style-type: none"> • Hinged wall access panels provide simple, clean wire management and access to cords

ATTRIBUTE	FEATURE	ADVANTAGE
TECHNOLOGY INTEGRATION	Laptop Drawer	<ul style="list-style-type: none"> Incorporated into layers applications under runoff worksurfaces to provide technology storage and power to the user and guest
	Lighting	<ul style="list-style-type: none"> Optional high-efficiency LED task lighting Low energy usage
	Wire Management Trough	<ul style="list-style-type: none"> Continuous trough with non-handed pedestals Easy access to power and data Clean, simple wire management Use of clip-in accessories
	Grommets	<ul style="list-style-type: none"> Rectangular grommets in desks and credenzas Three grommet positions - closed, small opening for cords, larger opening for monitor arm Cutout can utilize a power unit to bring power to the surface
	Wall Access Panels	<ul style="list-style-type: none"> Hinged wall access panels provide simple, clean wire management and access to cords
	Laptop Tray	<ul style="list-style-type: none"> Incorporated into layers applications under runoff worksurfaces to provide technology storage and power to the user and guest
STORAGE	Lighting	<ul style="list-style-type: none"> Optional high-efficiency LED task lighting Low energy usage
	Storage Locker	<ul style="list-style-type: none"> Provides side access shelving for easy access for the user Hidden coat hook and personal storage Door available in wood and laminate Back Painted Glass doors serve as a whiteboard with a kickstand for collaborative meetings
	Wall Mount and Surface Mount Overheads	<ul style="list-style-type: none"> Hinged and sliding doors Wood models have back painted glass door option Mix of open and closed storage
SUSTAINABILITY	Hidden Accessory Drawers	<ul style="list-style-type: none"> Provides clean lines and fewer fronts Maximize space usage in drawers
	Designed for the Environment	<ul style="list-style-type: none"> FSC certified products available FSC reconstituted veneer SCS Indoor Advantage™ Gold Certification High percentage of recycled content - greater than 43% BIFMA level® 3 certified Contribution to LEED V4 and WELL V1 Energy Efficient LED Task lighting
DURABILITY	ClearTech™ Finish	<ul style="list-style-type: none"> Cured finish on worksurfaces - durable top coat Chemical, heat, scratch, and mar resistant Open pore or full-filled finish option, smooth to touch Robotic sprayer - uniformity of finish Depth, clarity, color consistency, and durability
	Gunlocke Craftsmanship	<ul style="list-style-type: none"> Backed by Gunlocke's 12-year warranty High attention to detail, fit, finish and refinement across all material options
PRICE/VALUE	Budget Flexibility	<ul style="list-style-type: none"> Range of basic to premium options and materiality choice provides a broad price range to accommodate solutions without sacrificing design or functionality
	Value	<ul style="list-style-type: none"> 12-year warranty Quality/value built into product throughout the manufacturing process

VENEERS

Available in 8 select veneers and 2 premium veneers. All exposed wood surfaces utilize select flat cut Cherry, Maple, Walnut veneers, Stratawood – FSC reconstituted veneer, premium quarter cut Walnut, or Rift Cut Oak veneers. Stratawood veneer is made from rapidly renewable wood veneer, which provides a repeatable, consistent straight grain pattern. Stratawood veneers are available in Cherry, Maple, Walnut, or Oak at veneer 1 pricing in vertical or horizontal orientation. All veneers are carefully selected and matched to assure balance and consistency.

VENEER TOPS

Wood veneer tops feature 3-ply construction and are comprised of a premium 1.125" thick substrate. Tops are available with a square edge profile and are constructed of 45 lb. density particleboard. Tops are faced with premium veneer and backed with a polymer resin impregnated moisture resistant material. Rectangular tops utilize 2mm solid wood edgebands that are species matched except for Rift Cut Oak which is paired with solid ash hardwoods. Non-rectangular tops utilize matching 1mm edgebands that are doubled up for added durability, creating a total thickness of 2mm.

LAMINATE

The standard laminate offering includes solid and woodgrain laminates from Wilsonart. Laminate tops feature a high pressure laminate (HPL), a balanced 3-ply construction and are comprised of a 1.125" thick substrate. Tops are available with a square edge and are made with 45 lb. density particleboard. Laminate tops have a 2mm matching vinyl edgeband on all sides. Chassis and storage components feature a thermally fused laminate (TFL).

For complete technical specifications, visit www.wilsonart.com.

SOLID SURFACE TOPS

Solid surface tops with plywood subtops are a total of 1.25" thick. Tops are constructed with 0.5" solid surface material applied to premium 0.75" plywood with a built up softened edge detail. Solid surface has a matte finish.

BACK PAINTED GLASS

Back painted glass is captured by an extruded aluminum mitered frame. The frame is low profile, allowing only a 0.063" visible frame around the perimeter of the glass from the front view. Aluminum frames are powder coated to match the color of the glass option chosen. Back painted glass is 4mm thick and whiteboard applications include a steel backer for use with magnets – 6 magnets are included with each whiteboard. Back painted glass has a clear glossy finish for use as a writable surface and can be used with dry-erase markers. Whiteboards are mounted to the wall with a z-bracket connection.

CHASSIS & PEDESTAL CONSTRUCTION

All chassis are constructed with a mixture of 3/4" thick balanced 3-ply panels and 3/4" thick panels. Panels are securely fastened together using cam-lock fasteners and dowels. Steel glide plates are attached to single end panels with screws. End panels are pre-bored to accept the stem of the glide. The threaded steel glide plate provides a durable connection from glide to end panel.

Each unit is equipped with a minimum of four adjustable glides.

OVERHEAD CABINET CONSTRUCTION

All cabinets are constructed with a mixture of 0.75" thick balanced 3-ply panels and 0.75" thick MDF panels. Wood panels are securely attached with hidden fasteners and dowels, and are securely adhered with PVAc-dispersion adhesive. All laminate panels are securely fastened together

using cam-lock fasteners and dowels.

All surface mount cabinets connect to worksurface with double-sided adhesive tape.

Wall mount cabinets are mounted to the wall with a spade and "z" bracket attachment method. Spade brackets are securely mounted through the back of wall mount cabinets. All units ship with a steel z bracket. This bracket is mounted to the wall by field installers. Installers are responsible for selecting and supplying appropriate fasteners for wall conditions.

GLIDES

Glides provide 1.125" of vertical leveling adjustment. Glide bottom is durable non-rust nylon.

TACKBOARDS

Tackboards are constructed of 0.875" thick material comprised of a 0.125" thick hardboard glued in between a layer of 0.375" thick pressboard on each side. The fabric is precisely aligned and fitted to the tackboard and adhered to the rigid hardboard with staples.

DRAWERS

All drawers are constructed of four sides and a bottom, which are attached to a drawer front with screws for easy removal. Drawer fronts feature matched veneer within each pedestal set. The drawer side material is 3-ply 12mm vinyl wrapped particleboard and are miterfold construction. The bottom material is a 3-ply substrate consisting of vinyl wrapped high density fiberboard core.

SUSPENSIONS

Suspensions utilize cold rolled steel, zinc plated, high-grade drawer suspensions. Box drawers are full extension, featuring precision steel ball bearings for a smoother, quieter range of motion and are load rated for 120 lbs. File drawers are full extension, featuring precision steel ball bearings

for increased weight capacity and are load rated for 120 lbs. Lateral file suspensions are load rated for 150 lbs. and include an anti-tip mechanism that prevents both drawers from being opened at the same time. All suspensions are soft close and are warranted for the lifetime of the product.

HINGES

Doors with metal pulls include a 105° hinge with an integrated soft-close mechanism. Doors with touch latch utilize a 110° hinge. Hinges are fully adjustable.

FILING

The file hanging system is an integral part of the drawer. A highly durable black plastic extrusion is securely fastened into a rout on the top of the drawer. The plastic extrusion was designed to promote optimum filing capacity within the drawer while providing a durable, reliable and maintenance free filing system. (See filing capability section for technical information on drawer dimensions).

LOCKS

Locks are standard on all desks, credenzas, returns, modular pedestals, and storage units. Locks are optional on closets and overhead cabinets. Each pedestal is independently locked.

Keying is available either random (factory installed), or omit (field installed).

When "Random Keying" is chosen, the factory will assign key(s) arbitrarily. Factory installed lock cores will be matte silver.

When "Omit Lock Core" is chosen, the factory will omit lock cores and locks will be field installed. A keying program must be chosen - Random, Specified, or Sequential - to specify keys. Field installed locks will be available in matte silver, black, pyrite, and matte gold.

WIRE MANAGEMENT

Wire management capabilities include optional worksurface grommets that can house cords, a monitor arm, or be replaced with a power unit to bring technology to the worksurface. Cavities in the back of pedestals, removable panels, and wall access panels can be used for cord concealment and management.

Under worksurface wire managers (Model # ACWM) are sold separately to conceal wires between pedestals. These units house and manage wires horizontally around a station.

Continuous aluminum wire management troughs provide seamless integration of technology in the credenza. Modular trough tops come with 2 end caps to close off the open-end condition. Clip-in wire management accessories are provided to assist with technology ease and organization. Troughs, end caps and clip-in accessories are available in 5 metal finish colors – silver, black, pyrite, matte gold, and designer white.

POWER

Power units are available in three sizes and are offered as surface mount, under worksurface mount, and clamp mount units. Available in black, white or silver, power units incorporate a combination of power, USB power, and data integration. Each enclosure is rated for 15 amp, 125 volt. Units can be specified with 10' standard plug or 6' hardwire conduit option. Unit is field installed. UL Listed. USB charging ports are 2.1 amps per port. For information on each model, reference the "Power Units" page in the price book.

MAGNETIC ACCESSORIES

Magnetic accessories include imbedded magnets and can be positioned anywhere on magnetic tackzones and back painted glass tackzones/whiteboards. The accessories provide quick access to files, pencils, and other work utensils.

PERSONAL CORNER & DESKPADS

Personal corners can be used between two perpendicular worksurfaces to create an ergonomic corner for user. Deskpads are used in-line. All units are wrapped in leather or vinyl. The bottom surface has a felt lining to protect the worksurface. The chassis is made from 10-gauge aluminum. Personal corners are 36W x 12.5D. Deskpads are 36W x 18D. Units are designed to fit over 1 1/8" worksurfaces.

LIGHTING

LED lighting provides high efficiency, low energy lighting with a long life. All LED lights are encased in a silver aluminum extrusion and include a built-in switch to turn the light on/off with a dimming feature. Lights are field installed. All units include a standard plug.

- Low profile strip light 0.625"H x 0.75"D
- Power: 2.92W / Foot
- LED's per meter: 120
- Color Temp: 3000K
- Certification: UL Listed
- GSA and TAA compliant

HEIGHT ADJUSTABLE

Height adjustable components include:

- Qty (2) height adjustable lifting columns
- Qty (1) control box
- Qty (5) keypad options from basic to premium
- Qty (2) cables connecting lifting columns to control box
- Qty (1) standard plug power cable to connect control box to power source

Lifting columns are rated for 225 lbs. dynamic load per column and are connected to tops using steel support brackets. Height range is 29" to 42.5". Each control box is powered by 120V / 60Hz. 2 lifting columns may draw approximately 1.5 amps total maximum under full load. Standby power is 0.1W.

WORKWALLS

WorkWalls include wall mounted, wall mounted with wall access panels, stack on, and freestanding versions. Incorporating both a collaborative side and personal side, WorkWalls utilize a back painted glass sliding door that can serve as a whiteboard and be secured with a digital lock. The digital lock incorporates a keypad and smartphone app, along with 2 standard USB ports for emergency power jump and battery charging.

WOOD FINISH

Natural veneer is subject to nature's quality control. Each species will exhibit differences in grain pattern and tone. This is to be expected and, in fact, contributes to the beauty and individuality of each product. Flat Cut veneers emphasize the variations of wood by exhibiting cathedrals in the grain pattern. Quarter Cut and Rift Cut veneers are a premium cut that maintains variations in the grain but without cathedral patterns. Stratawood is a natural, FSC® - certified reconstituted veneer that is designed to exhibit a straight-grain pattern, absent of cathedrals or other significant grain and tone variations.

Worksurfaces are protected by one of the world's most advanced UV cured finish coatings, available in Full Fill ClearTech® or Open Pore low sheen finish, applied by state-of-the-art finishing equipment. Both finishes meet the EPA's stringent requirements for VOC emissions and air quality. Cured in a specially designed ultraviolet oven, the finish fuses to the wood, forming a durable shield that provides a high level of scratch, stain, chemical, and heat resistance, along with a high level of clarity.

Chassis, storage, overheads and veneer bases are finished with a 30 sheen. For the Finish System Guide & Technical specifications, visit www.gunlocke.com.

CLEANING CLEARTECH™ FINISH

Dust with a damp cloth. Remove fingerprints or soiling with mild solution; 3 parts water with small amount of mild dish detergent. Apply solution with spray bottle, wipe clean and dry with soft cloth. Note: Do not use furniture polishes containing oil, wax, or silicone, which can produce an oily film or haze.

CLEANING LAMINATE

Dust with a damp cloth. Remove fingerprints or soiling with mild solution; 3 parts water with small amount of mild dish detergent. Apply solution with spray bottle, wipe clean and dry with soft cloth. Note: Do not use furniture polishes containing oil, wax, or silicone, which can produce an oily film or haze.

For specific cleaning instructions on Wilsonart laminates, please visit www.wilsonart.com.

CLEANING GLASS

Dust with a damp cloth. Remove fingerprints or soiling with mild solution; 3 parts water with small amount of mild dish detergent. Apply solution with spray bottle, wipe clean and dry with soft cloth.

CLEANING SOLID SURFACE

Using a damp sponge or cloth, use warm soapy water, an ammonia-based household cleaner, or a dedicated countertop cleaner to clean solid surface. Rub over area using small circular motions, from the front to the back, then side to side, overlapping the circles until the entire area has been cleaned. Rinse the top thoroughly with clean water and wipe surface completely dry.

**STANDARD FILING OPTIONS
FOR PEDESTALS**

9 wide x 30 and 36 deep pedestal

File rails included: 2 per drawer

- A.** 2 rows of letter side to side with 2 file rails
- B.** 1 row of legal side to side

Replacement File Rail Kit Model #ACFLR9-P

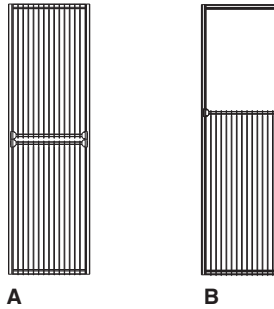

15 wide x 30 and 36 deep pedestal

File rails included: 2 per drawer

- C.** 2 rows of letter side to side with 2 file rails
- D.** 1 row of legal-side to side,

Replacement File Rail Kit Model #ACFLR15-P

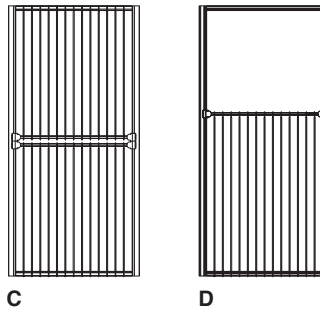

15 wide x 24 deep pedestal

File rails included: 1 per drawer

- E.** Legal-side to side
- F.** 1 row letter side to side,
Model #ACFLR15
Ships w/pedestal.
1 per file drawer.

Replacement File Rail Kit Model #ACFLR15-P

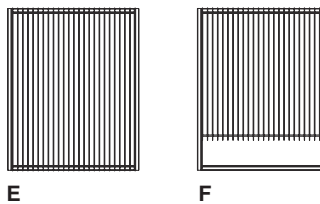

18 wide x 24 deep pedestal

File rails included: 1 per drawer

- G.** Letter-front to back with file rail
- H.** Legal-side to side

Replacement File Rail Kit Model #ACFLR18-P

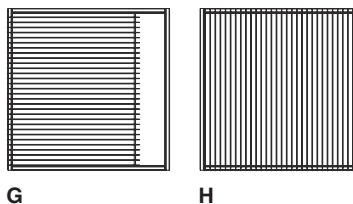

STANDARD FILING OPTIONS

(continued)

Lateral 30 wide x 24 deep pedestal

File rails included: 1 kit per drawer

- I.** Legal-side to side
- J.** Letter-side to side
- K.** 2 rows letter front to back

Replacement File Rail Kit Model #ACFLR30-P

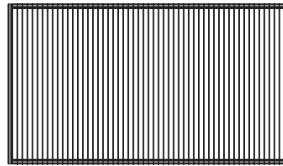

I

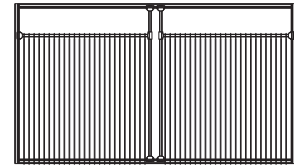

J

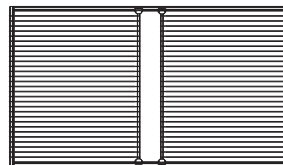

K

Lateral 36 wide x 24 deep pedestal

File rails included: 1 kit per drawer

- L.** Letter-side to side
- M.** 2 rows letter front to back
- N.** Legal-side to side
- O.** 2 rows legal front to back

Replacement File Rail Kit Model #ACFLR36-P

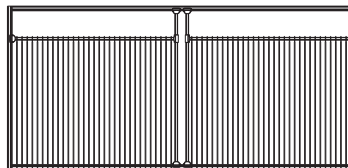

L

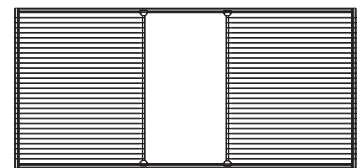

M

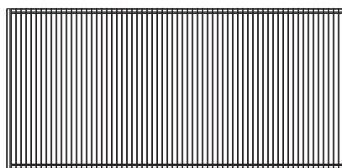

N

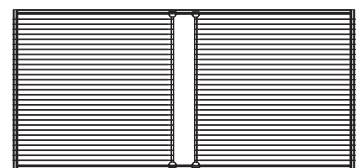

O

HEIGHT REFERENCE

Standard Height

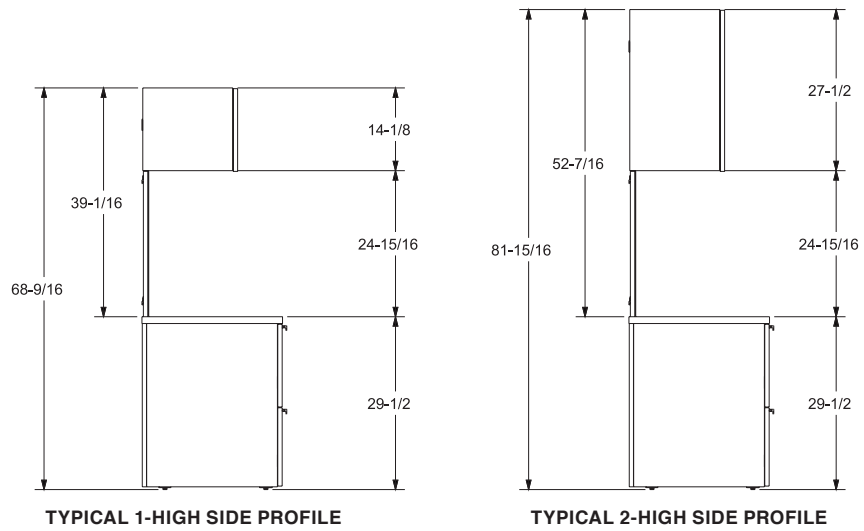

Layers Height

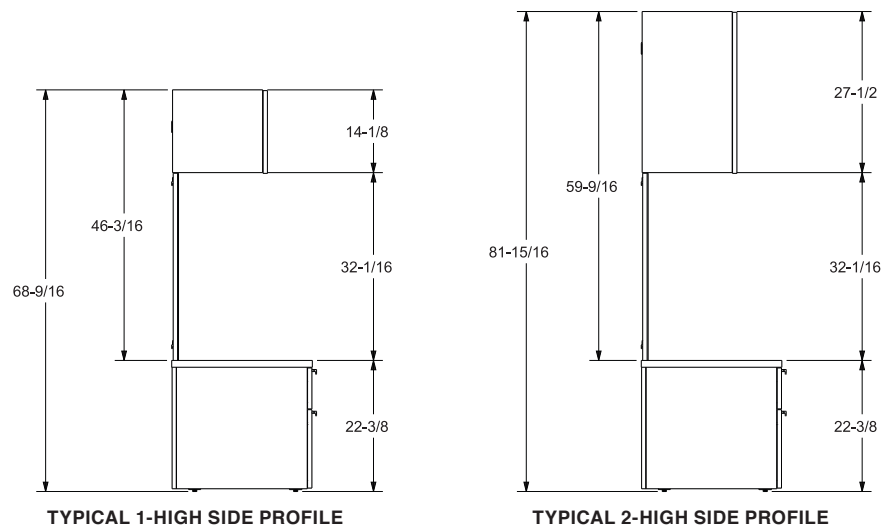

Pedestal

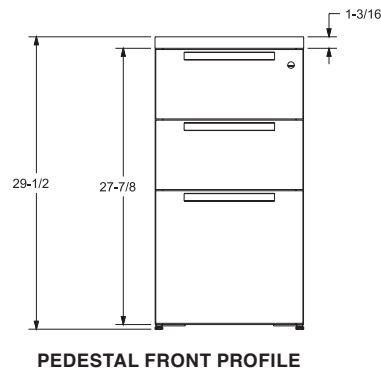

Thoughtfully channel and conceal wires and cables using a streamlined trough feature. Easy wall access and conveniently placed grommets deliver your power and data.

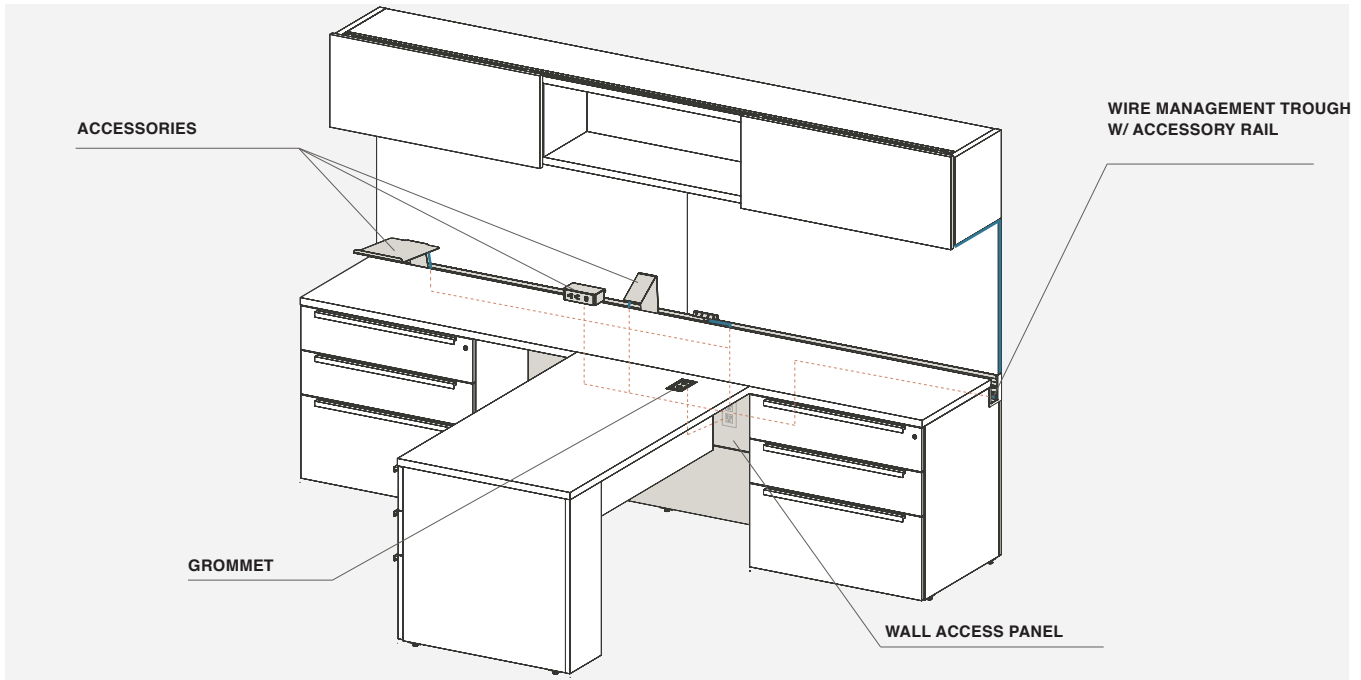

WALL ACCESS PANEL

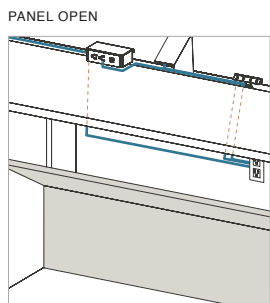

GROMMET

CLOSED

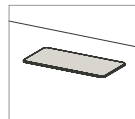

SMALL CORDS

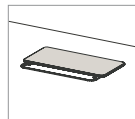

POWER

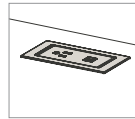

MONITOR ARM

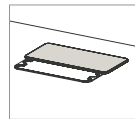

TROUGH

WIRE ROUTE

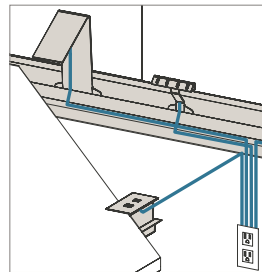

ACCESSORIES

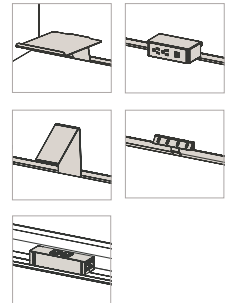

TROUGH INFORMATION

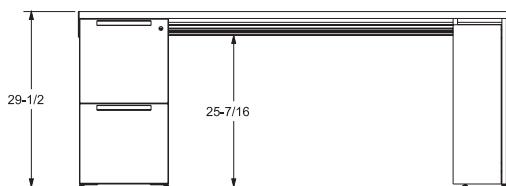

Standard Height

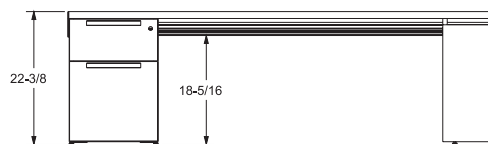

Layers Height

GROMMET LOCATIONS

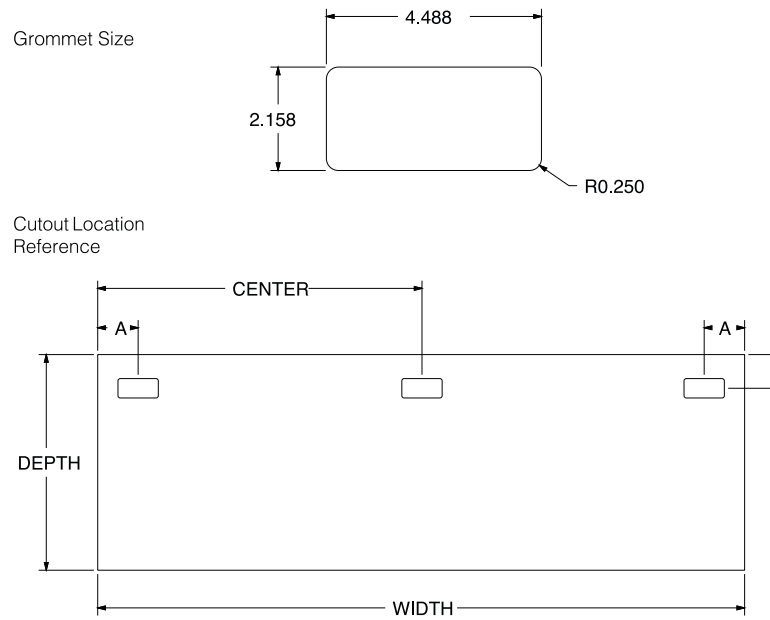

GROMMET CUTOUT LOCATIONS

UNIT	A	CENTER	B
24D Rectangular Tops	12	CENTER	4.25
30D Rectangular Tops	12	-	9.500
36D Rectangular Tops	12	-	9.500
Media Tops	-	CENTER	3.750
Round Tops	-	CENTER	-
Guitar Pick Tops	-	CENTER	-
22D Height Adjustable Tops	10	CENTER	3.5
28D & 34D Height Adjustable Tops	10	CENTER	4
30D Telescoping Height Adjustable Tops	12.500	-	6.125
36D Telescoping Height Adjustable Tops	12.500	-	9.125
30D Half/Full Modesty Height Adjustable Tops	12.500	-	4.500
36D Half/Full Modesty Height Adjustable Tops	12.500	-	7.500
24D Height Adjustable Units	-	CENTER	5.11

• Add \$77 per grommet based on chosen grommet configuration

Gunlocke provides versatile storage features, including convenient options for pull orientation and drawer configuration. The accessory drawer includes convenient internal compartments crafted with Gunlocke quality.

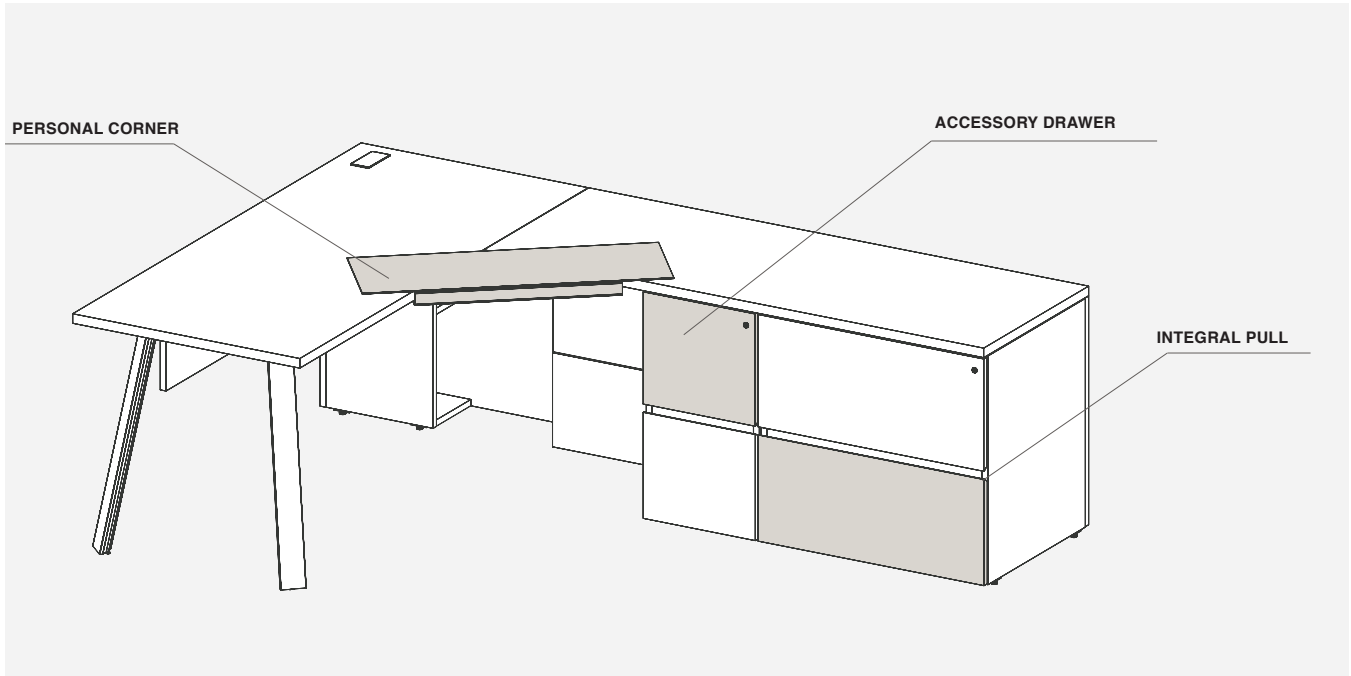

Silea pull orientation

INTEGRAL

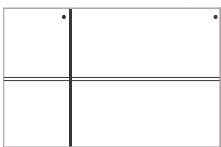

CENTERED

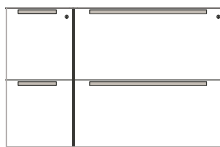

CONTINUOUS

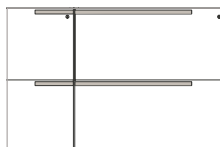

LEFT ALIGNED

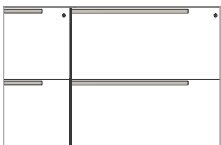

RIGHT ALIGNED

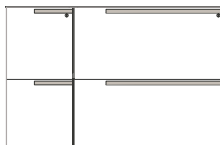

Choice.

Silea enables you to select drawer pull orientation at the time of installation. Maximum flexibility.

ACCESSORY DRAWER

ACCESSORY DRAWER (OPEN)

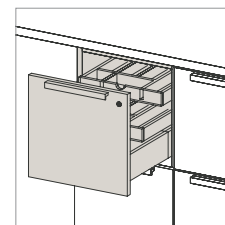

Integrated height adjustability enables the healthful rotation of working posture. The virtually concealed electric mechanism supports the quiet and easy transition to standing. Sit-to-stand, concentrate, collaborate. With height adjustability, a desk is more than a desk. It's a way of wellbeing, adjusting the worksurface to the working position that fits best.

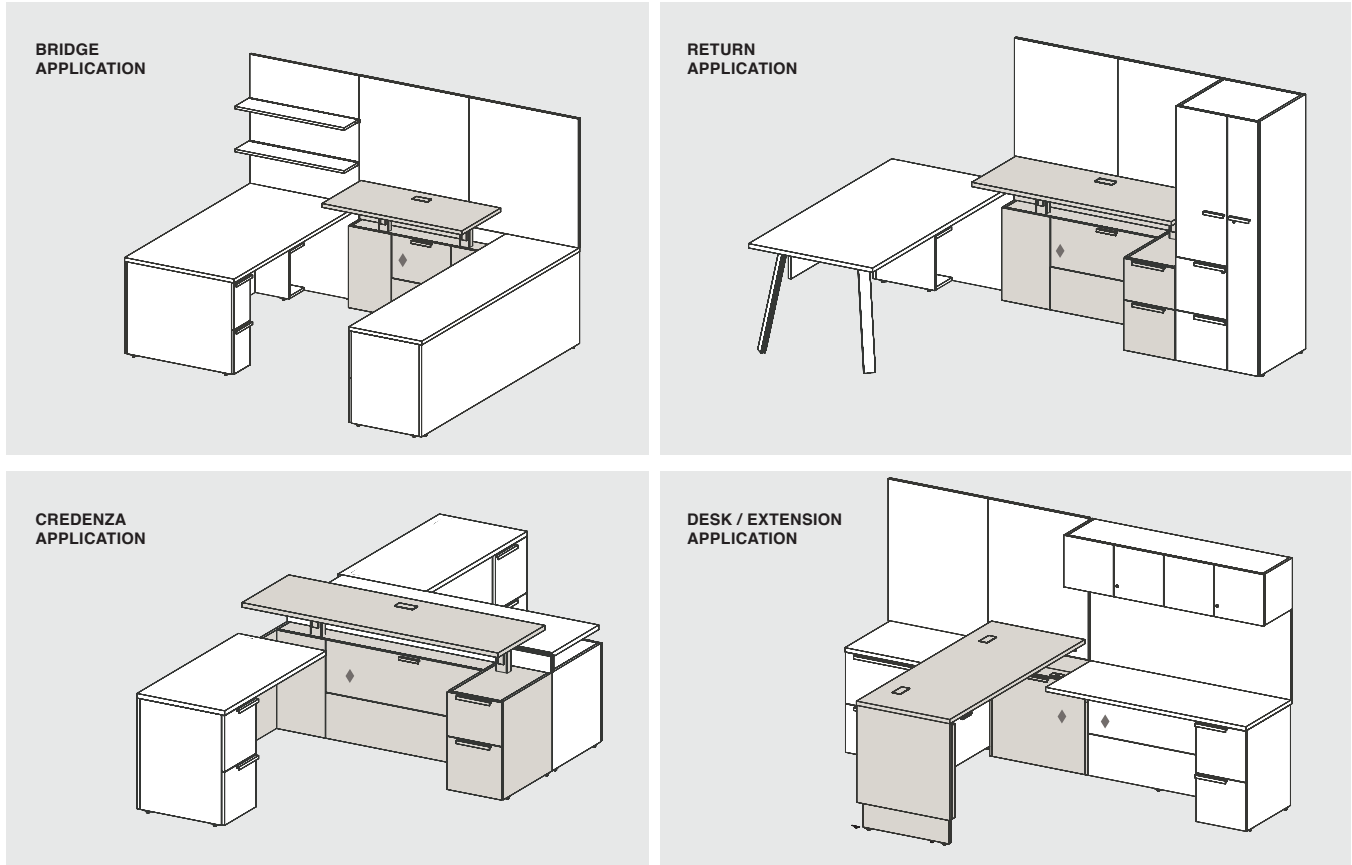

◆ WALL ACCESS PANEL

IMPORTANT SPEC TIP: HEIGHT ADJUSTABILITY WITH MONITOR ARMS

- Monitor arms should **ALWAYS** be installed in grommets on Silea HAT units. Please ensure a grommet location is specified on the top. This allows for bolt mount or clamp mount install of monitor arm.
- Monitor arms should **NOT** be clamped to back edge of top where chassis interference can occur.
- The dimension from top of chassis to bottom of top on many HAT units allows for only approximately 2.250" clearance. Many monitor arm clamps, including Allsteel Pivot Monitor arms, have a taller clamp mount that will crash into the chassis during operation resulting in damage and/or loss of operation.

Example 1: Allsteel Pivot Monitor Arm Clamped to back edge of Silea HAT Bridge Top.

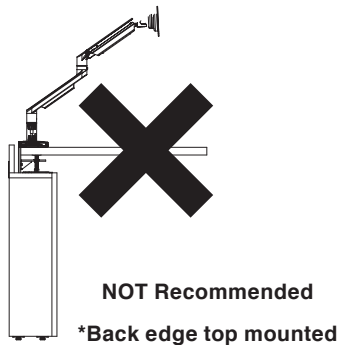

Example 2: Allsteel Pivot Monitor Arm Clamped in grommet of Silea HAT Bridge Top.

NOTE: ensure proper depth of top specified to provide adequate user space from top to monitors.

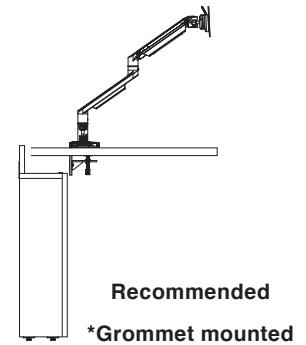

Storage options feature a nested laptop drawer, thoughtfully placed power access, and a multi-functional storage locker.

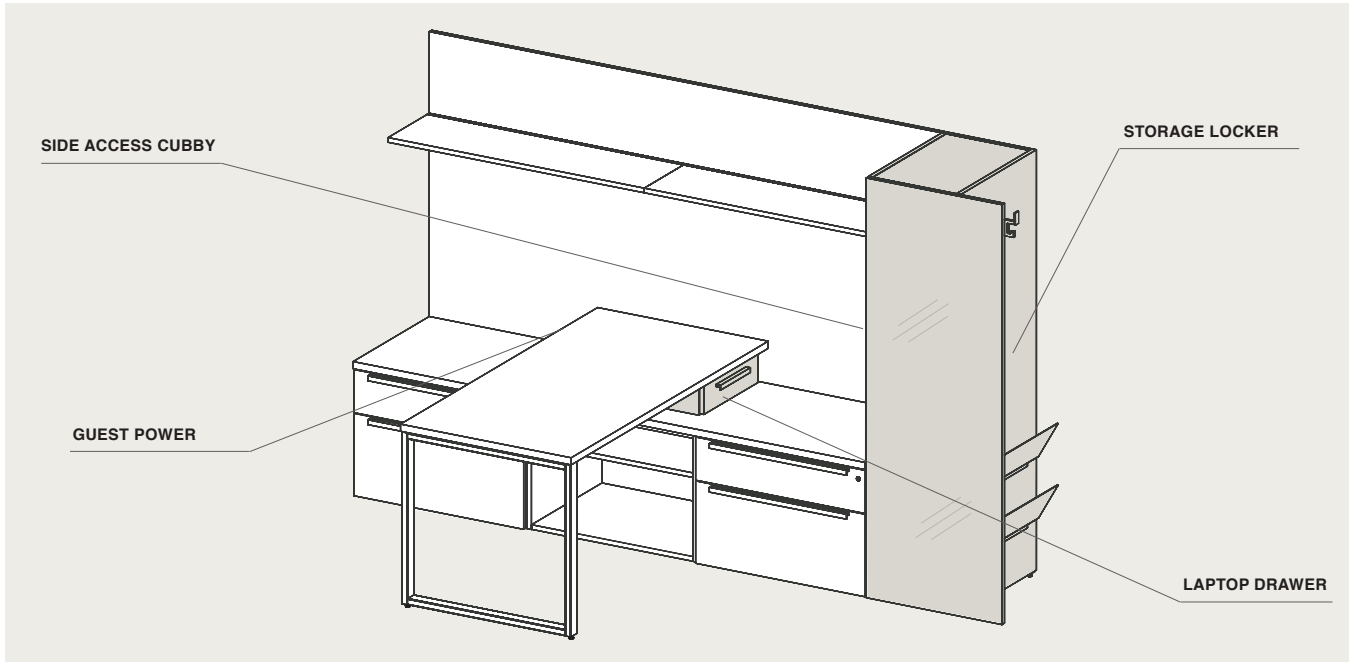

Laptop Drawer

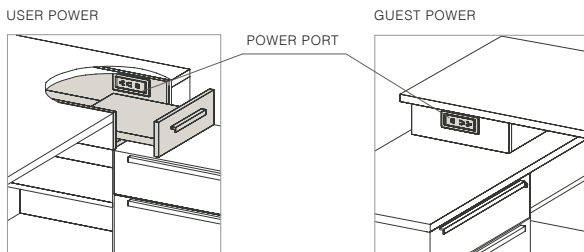

Storage Drawer

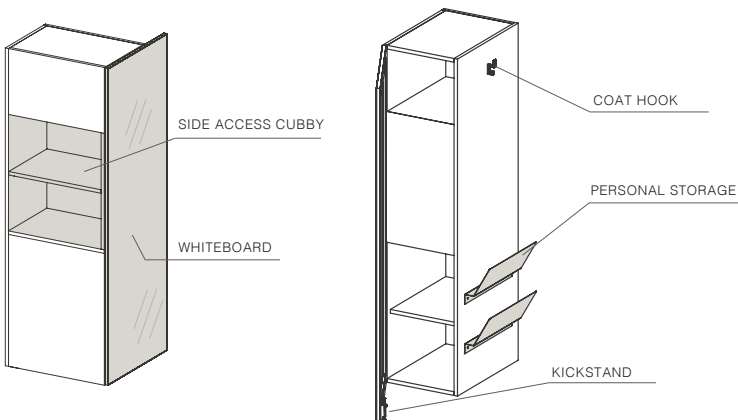

SURFACE MOUNT CABINETS

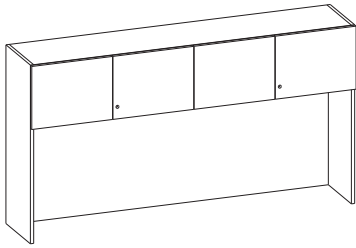

39 High

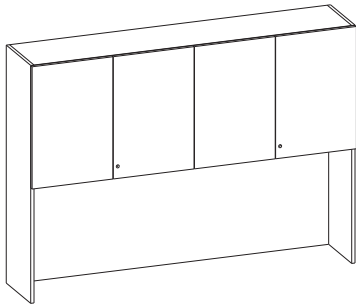

52 High

Technology information & wire management:

- Tasklight cord grommet optional.
- Located in upper right-hand corner, provides task light cord access to wall outlets.

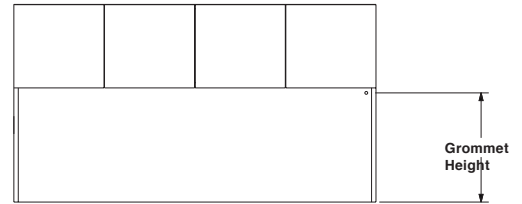

Grommet Height 39H and 52H = 24

Surface mount overhead cabinets must be supported with adequate pedestal or panel support on ends. In addition, the location where the surface mount cabinet and tower meet the worksurface using intermediate supports.

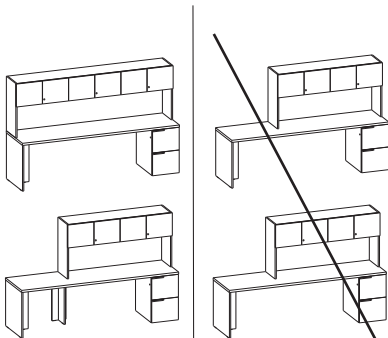

Recommended Support Examples

Inadequate Support Examples

When specifying surface mount storage across multiple units, careful considerations must be used to ensure the correct overall length. An end or back panel of a supporting unit must support the end panel of an overhead cabinet.

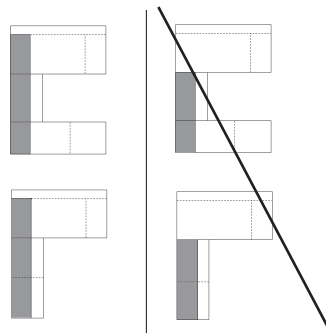

Recommended Support Examples

Inadequate Support Examples

DIMENSIONS

Silea
03/23

DESCRIPTION	STYLE	EXTERNAL DIMENSIONS			LOCATION	INTERNAL DIMENSIONS		
		width	depth	height		width	depth	height
Desk Pedestals 30" Deep	9" Wide Box Box File	9 2/5	29.13	27.88	Box Drawer	5.84	15.02	2.91
					File Drawer	5.84	25.22	9.17
	Acc. Box File	9 2/5	29.13	27.88	Acc. Drawer	5.93	14.92	1.50
					Box Drawer	5.84	15.02	2.91
					File Drawer	5.84	25.22	9.17
File File	9 2/5	29.13	27.88	File Drawer	5.84	25.22	9.17	
Desk Pedestals 36" Deep	9" Wide Box Box File	9 2/5	35.13	27.88	Box Drawer	5.84	15.02	2.91
					File Drawer	5.84	25.22	9.17
	Acc. Box File	9 2/5	35.13	27.88	Acc. Drawer	5.93	14.92	1.50
					Box Drawer	5.84	15.02	2.91
					File Drawer	5.84	25.22	9.17
File File	9 2/5	35.13	27.88	File Drawer	5.84	25.22	9.17	
Desk Pedestals 15" Wide 30" Deep	Box Box File	15	29.13	27.88	Box Drawer	11.40	15.02	2.91
					File Drawer	11.40	25.22	9.20
	File File	15	29.13	27.88	File Drawer	11.40	25.22	9.20
Desk Pedestals 15" Wide 36" Deep	Box Box File	15	35.13	27.88	Box Drawer	11.40	15.02	2.91
					File Drawer	11.40	25.22	9.20
	File File	15	35.13	27.88	File Drawer	11.40	25.22	9.20
Standard Height Modular Pedestals 15"W	Box Box File	15	23.13	27.88	Box Drawer	11.40	15.02	2.91
					File Drawer	11.40	15.02	9.17
	Acc. Box File	15	23.13	27.88	Acc. Drawer	11.50	14.92	1.50
					Box Drawer	11.40	15.02	2.91
					File Drawer	11.40	15.02	9.17
File File	15	23.13	27.88	File Drawer	11.40	15.02	9.17	
Standard Height Modular Pedestals 18"W	Box Box File	18	23.13	27.88	Box Drawer	14.40	15.02	2.91
					File Drawer	14.40	15.02	9.17
	Acc. Box File	18	23.13	27.88	Acc. Drawer	14.49	14.92	1.56
					Box Drawer	14.40	15.02	2.91
					File Drawer	14.40	15.02	9.17
File File	18	23.13	27.88	File Drawer	14.40	15.02	9.17	
Standard Height Modular Pedestals 30"W	File File	30	23.13	27.88	File Drawer	25.90	15.02	9.25
	Box Box File	30	23.13	27.88	Box Drawer	26.40	13.09	2.91
					File Drawer	25.90	15.02	9.25
	Hinged Door	30	23.13	27.88	Total	28.47	13.55	26.38
					Above Shelf	28.47	13.45	12.78
					Below Shelf	28.47	13.55	12.85
	Bookcase	30	22.32	27.88	Total	28.47	13.55	26.38
					Above Shelf	28.47	13.45	12.78
Below Shelf					28.47	13.55	12.85	
Standard Height Modular Pedestals 36"W	File File	36	23.13	27.88	File Drawer	31.90	15.02	9.25
	Box Box File	36	23.13	27.88	Box Drawer	32.40	13.09	2.91
					File Drawer	31.90	15.02	9.25
	Hinged Door	36	23.13	27.88	Total	34.47	13.55	26.44
					Above Shelf	34.47	13.45	12.74
					Below Shelf	34.47	13.55	12.89

DESCRIPTION	STYLE	EXTERNAL DIMENSIONS			LOCATION	INTERNAL DIMENSIONS		
		width	depth	height		width	depth	height
	Bookcase	36	22.32	27.88	Total	34.47	13.55	26.36
					Above Shelf	34.47	13.45	12.70
					Below Shelf	34.47	13.55	12.85
Layers Height Modular Pedestals 15"W	Box File	15	23.13	20.75	Box Drawer	11.40	15.02	2.91
					File Drawer	11.40	15.02	9.17
Layers Height Modular Pedestals 18"W	Box File	18	23.13	20.75	Box Drawer	14.40	15.02	2.91
					File Drawer	14.40	15.02	9.17
Layers Height Modular Pedestals 30"W	Box File	30	23.13	20.75	Box Drawer	26.40	13.09	2.91
					File Drawer	25.90	15.02	9.25
	Hinged Door	30	23.13	20.75	Total	28.47	13.45	19.25
					Above Shelf	28.47	13.45	5.66
					Below Shelf	28.47	13.45	12.85
	Bookcase	30	22.32	20.75	Total	28.47	13.45	19.25
					Above Shelf	28.47	13.45	5.66
					Below Shelf	28.47	13.45	12.85
	Side Access	30	23.13	20.75	Total	28.47	25.59	19.25
					Box Drawer	25.44	15.25	5.12
Layers Height Modular Pedestals 36"W	Box File	36	23.13	20.75	Box Drawer	32.40	13.09	2.91
					File Drawer	31.90	15.02	9.25
	Hinged Door	36	23.13	20.75	Total	34.47	13.55	19.23
					Above Shelf	34.47	13.45	5.58
					Below Shelf	34.47	13.55	12.85
	Bookcase	36	22.32	20.75	Total	34.47	13.55	19.23
					Above Shelf	34.47	13.45	5.58
					Below Shelf	34.47	13.55	12.85
	Side Access	36	23.13	20.75	Total	34.47	25.59	19.23
					Box Drawer	31.44	15.25	5.12
Mobile Pedestal	Mobile pedestal	15	21.80	22.63	Box Drawer	11.40	15.02	2.91
					File Drawer	11.40	15.02	9.17
Bookcases	2H	30	14.88	27.88	2H Top Shelf	28.47	13.91	12.76
					2H Bottom Shelf	28.47	14.07	12.85
	3H	30	14.88	41.77	3H Top Shelf	28.47	13.91	11.98
					3H Middle Shelf	28.47	13.91	13.93
					3H Bottom Shelf	28.47	14.07	12.85
	4H	30	14.88	54.00	4H Top Shelf	28.47	13.91	11.48
					4H 2nd Shelf	28.47	13.91	11.98
					4H 3rd Shelf	28.47	13.91	13.93
					4H Bottom Shelf	28.47	14.07	12.85
	5H	30	14.88	68.13	5H Top Shelf	28.47	13.91	12.61
					5H 2nd Shelf	28.47	13.91	12.25
					5H 3rd Shelf	28.47	13.91	11.98
					5H 4th Shelf	28.47	13.91	13.93
	6H	30	14.88	81.50	6H Top Shelf	28.47	13.91	12.62
6H 2nd Shelf					28.47	13.91	12.61	

DIMENSIONS

Silea
03/23

DESCRIPTION	STYLE	EXTERNAL DIMENSIONS			LOCATION	INTERNAL DIMENSIONS		
		width	depth	height		width	depth	height
					6H 3rd Shelf	28.47	13.91	12.25
					6H 4th Shelf	28.47	13.91	11.98
					6H 5th Shelf	28.47	13.91	13.93
					6H Bottom Shelf	28.47	14.07	12.85
Bookcase / Closet	5H	18	23.88	68.13	5H Top Shelf	7.86	21.10	12.61
					5H 2nd Shelf	7.86	21.10	12.25
					5H 3rd Shelf	7.86	21.10	11.98
					5H 4th Shelf	7.86	21.10	13.93
					5H Bottom Shelf	7.86	22.26	12.85
					Closet	7.86	22.26	66.61
	6H	18	23.88	81.50	6H Top Shelf	7.86	21.10	12.62
					6H 2nd Shelf	7.86	21.10	12.61
					6H 3rd Shelf	7.86	21.10	12.25
					6H 4th Shelf	7.86	21.10	11.98
					6H 5th Shelf	7.86	21.10	13.93
					6H Bottom Shelf	7.86	22.26	12.85
					Closet Above Shelf	7.86	21.10	12.62
					Closet Below Shelf	7.86	22.26	66.61
Lateral Files	2H	30"	23.88	29.04	File Drawer	25.90	15.02	9.25
		36"	23.88	29.04	File Drawer	31.90	15.02	9.25
	3H	30"	23.88	41.77	File Drawer	25.90	15.02	9.25
		36"	23.88	41.77	File Drawer	31.90	15.02	9.25
	4H	30"	23.88	54.00	File Drawer	25.90	15.02	9.25
		36"	23.88	54.00	File Drawer	31.90	15.02	9.25
	5H	30"	23.88	68.13	File Drawer	25.90	15.02	9.25
					Hinged Door	28.47	22.26	13.37
		36"	23.88	68.13	File Drawer	31.90	15.02	9.25
					Hinged Door	34.47	22.26	13.37
	6H	30"	23.88	81.50	File Drawer	25.90	15.02	9.25
					Hinged Door Above Shelf	28.47	21.45	13.00
					Hinged Door Below Shelf	28.47	22.26	13.00
		36"	23.88	81.50	File Drawer	31.90	15.02	9.25
					Hinged Door Above Shelf	34.47	21.45	13.00
					Hinged Door Below Shelf	34.47	22.26	13.00
Closets	15"	15	23.88	68.13	Total	13.47	22.26	66.61
	18"	18	23.88	68.13	Total	16.47	22.26	66.61
	18" 6H	18	23.88	81.50	Above Shelf	16.47	21.10	12.62
					Below Shelf	16.47	22.26	66.61
	5H - D	30	23.88	68.13	Top Shelf	13.86	21.10	12.61
					2nd Shelf	13.86	21.10	12.25
					3rd Shelf	13.86	21.10	11.98
					4th Shelf	13.86	21.10	13.93
					Bottom Shelf	13.86	22.26	12.85
					Coat Rod Section	13.86	22.26	66.61
	5H - S	30	23.88	68.13	Top Shelf	28.47	21.10	12.61

DESCRIPTION	STYLE	EXTERNAL DIMENSIONS			LOCATION	INTERNAL DIMENSIONS		
		width	depth	height		width	depth	height
					2nd Shelf	28.47	21.10	12.25
					3rd Shelf	28.47	21.10	11.98
					4th Shelf	28.47	21.10	13.93
					Bottom Shelf	28.47	22.26	12.85
	6H - D	30	23.88	81.50	Top Shelf	13.86	21.10	12.62
					2nd Shelf	13.86	21.10	12.61
					3rd Shelf	13.86	21.10	12.25
					4th Shelf	13.86	21.10	11.98
					5th Shelf	13.86	21.10	13.93
					Bottom Shelf	13.86	22.26	12.85
					Coat Rod Section Above Top Shelf	13.86	21.10	12.62
					Coat Rod Section Bellow Top Shelf	13.86	22.25	66.61
	6H - S	30	23.88	81.50	Top Shelf	28.47	21.10	12.62
					2nd Shelf	28.47	21.10	12.61
					3rd Shelf	28.47	21.10	12.25
					4th Shelf	28.47	21.10	11.98
					5th Shelf	28.47	21.10	13.93
					Bottom Shelf	28.47	22.26	12.85
Storage Box	5H	30	23.88	68.13	File Drawer	25.90	15.02	9.25
					Total Hinged Door	28.47	22.26	39.50
					Top Shelf	28.47	19.45	12.61
					Middle Shelf	28.47	19.45	12.10
					Bottom Shelf	28.47	22.26	13.29
	6H	30	23.88	81.50	File Drawer	25.90	15.02	9.25
					Total Hinged Door	28.47	22.26	52.87
					Top Shelf	28.47	19.45	12.62
					2nd Shelf	28.47	19.45	12.61
					3rd Shelf	28.47	19.45	12.10
					Bottom Shelf	28.47	22.26	13.29
Storage Box 18" Wide	5H	18	23.88	68.13	File Drawer	14.40	15.02	9.17
					Total Hinged Door	16.47	22.26	39.50
					Top Shelf	16.47	19.45	12.61
					Middle Shelf	16.47	19.45	12.10
					Bottom Shelf	16.47	22.26	13.29
	6H	18	23.88	81.50	File Drawer	14.40	15.02	9.17
					Total Hinged Door	16.47	22.26	52.87
					Top Shelf	16.47	19.45	12.62
					2nd Shelf	16.47	19.45	12.61
					3rd Shelf	16.47	19.45	12.10
					Bottom Shelf	16.47	22.26	13.29
Storage Box 18" Wide No Door	5H	18	23.88	68.13	File Drawer	14.40	15.02	9.17
					Total Shelf	16.47	22.26	39.50
					Top Shelf	16.47	19.45	12.61
					Middle Shelf	16.47	19.45	12.10
					Bottom Shelf	16.47	22.26	13.29

DIMENSIONS

Silea
03/23

DESCRIPTION	STYLE	EXTERNAL DIMENSIONS			LOCATION	INTERNAL DIMENSIONS		
		width	depth	height		width	depth	height
	6H	18	23.88	81.50	File Drawer	14.40	15.02	9.17
					Total Shelf	16.47	22.26	52.87
					Top Shelf	16.47	19.45	12.62
					2nd Shelf	16.47	19.45	12.61
					3rd Shelf	16.47	19.45	12.10
					Bottom Shelf	16.47	22.26	13.29
Utility Cabinet	5H	24	23.88	68.13	Closet	7.84	22.26	66.60
					File Drawer	11.40	15.02	9.17
					Total Hinged Door	13.47	22.32	39.53
					Top Shelf	13.47	19.45	12.61
					Middle Shelf	13.47	19.45	12.10
	6H	24	23.88	81.50	Closet Above Top Shelf	7.84	19.45	12.62
					Closet Below Top Shelf	7.84	22.26	66.61
					File Drawer	11.40	15.02	9.17
					Total Hinged Door	13.47	22.32	52.91
					Top Shelf	13.47	19.45	12.62
					2nd Shelf	13.47	19.45	12.61
					3rd Shelf	13.47	19.45	12.10
					Bottom Shelf	13.47	22.32	13.33
					Storage Cabinet	30"W	30	23.88
Top Shelf	28.47	21.45	12.78					
Bottom Shelf	28.47	22.26	12.85					
36"W	36	23.88	29.04	Total		34.47	22.26	26.38
				Top Shelf		34.47	21.45	12.72
				Bottom Shelf		34.47	22.26	12.85
Standard & Layers Side Access Storage Locker	5H w/ door	23 7/8	23.90	68.13	Inside Top Shelf	14.70	22.32	12.61
					Inside Bottom Shelf	14.70	22.32	12.85
					Top Side Access Shelf	21.55	15.41	12.25
					Bottom Side Access Shelf	21.55	15.47	11.97
	6H w/ door	23 7/8	23.90	81.50	Inside Shelf	14.70	21.12	12.62
					Inside Bottom Shelf	14.70	21.12	13.94
					Top Side Access Shelf	21.55	15.41	12.25
					Bottom Side Access Shelf	21.55	15.47	11.97
1H Wall Mount Cabinets – Hinged Door & Open Shelf	1H Hinged Door (16 1/5"D)	30"	See depth dimensions by style	14.13	Shelf	28.50	14.08	12.59
	1H Glass Door (16 1/4"D)	36"		14.13	Shelf	34.50	14.08	12.59
	1H Open (15 3/8"D)	42"		14.13	Left Shelf	19.67	14.08	12.59
					Right Shelf	19.67	14.08	12.59
				48"	Left Shelf	22.67	14.08	12.59
					Right Shelf	22.67	14.08	12.59
				54"	Left Shelf	25.67	14.08	12.59
					Right Shelf	25.67	14.08	12.59
				60"	Left Shelf	28.67	14.08	12.59
					Right Shelf	28.67	14.08	12.59
			66"	Left Shelf	31.67	14.08	12.59	

DESCRIPTION	STYLE	EXTERNAL DIMENSIONS			LOCATION	INTERNAL DIMENSIONS		
		width	depth	height		width	depth	height
					Right Shelf	31.67	14.08	12.59
		72"		14.13	Left Shelf	34.67	14.08	12.59
					Right Shelf	34.67	14.08	12.59
		78"		14.13	Left Shelf	37.67	14.08	12.59
					Right Shelf	37.67	14.08	12.59
		84"		14.13	Left Shelf	26.67	14.08	12.59
					Middle Shelf	26.84	14.08	12.59
					Right Shelf	26.67	14.08	12.59
		90"		14.13	Left Shelf	28.67	14.08	12.59
					Middle Shelf	28.84	14.08	12.59
					Right Shelf	28.67	14.08	12.59
		96"		14.13	Left Shelf	30.67	14.08	12.59
					Middle Shelf	30.84	14.08	12.59
					Right Shelf	30.67	14.08	12.59
		102"		14.13	Left Shelf	32.67	14.08	12.59
					Middle Shelf	32.84	14.08	12.59
					Right Shelf	32.67	14.08	12.59
		108"		14.13	Left Shelf	34.67	14.08	12.59
					Middle Shelf	34.84	14.08	12.59
					Right Shelf	34.67	14.08	12.59
1H Wall Mount Cabinets – Sliding Doors	1H	60"	16.20	14.13	Left Shelf	28.67	14.08	12.59
					Right Shelf	28.67	14.08	12.59
		72"	16.20	14.13	Left Shelf	34.67	14.08	12.59
					Right Shelf	34.67	14.08	12.59
		90"	16.20	14.13	Left Shelf	28.66	14.08	12.59
					Middle Shelf	28.86	14.08	12.59
					Right Shelf	28.66	14.08	12.59
		108"	16.20	14.13	Left Shelf	34.66	14.08	12.59
					Middle Shelf	34.86	14.08	12.59
					Right Shelf	34.66	14.08	12.59
2H Wall Mount Cabinets – Hinged Door & Open Shelf	2H Hinged Door (16 1/5"D)	30"	See depth dimensions by style	27.50	Top Shelf	28.50	13.95	12.61
	2H Glass Door (16 1/4"D)				Bottom Shelf	28.50	13.95	12.61
	2H Open (15 3/8"D)	36"		27.50	Top Shelf	34.50	13.95	12.61
					Bottom Shelf	34.50	13.95	12.61
		42"		27.50	Top Shelf Left	19.67	13.95	12.61
					Top Shelf Right	19.67	13.95	12.61
					Bottom Shelf Left	19.67	13.95	12.61
					Bottom Shelf Right	19.67	13.95	12.61
		48"		27.50	Top Shelf Left	22.67	13.95	12.61
					Top Shelf Right	22.67	13.95	12.61
					Bottom Shelf Left	22.67	13.95	12.61
					Bottom Shelf Right	22.67	13.95	12.61
		54"		27.50	Top Shelf Left	25.67	13.95	12.61
					Top Shelf Right	25.67	13.95	12.61
					Bottom Shelf Left	25.67	13.95	12.61

DIMENSIONS

Silea
03/23

DESCRIPTION	STYLE	EXTERNAL DIMENSIONS			LOCATION	INTERNAL DIMENSIONS		
		width	depth	height		width	depth	height
					Bottom Shelf Right	25.67	13.95	12.61
		60"		27.50	Top Shelf Left	28.67	13.95	12.61
					Top Shelf Right	28.67	13.95	12.61
					Bottom Shelf Left	28.67	13.95	12.61
					Bottom Shelf Right	28.67	13.95	12.61
		66"		27.50	Top Shelf Left	31.67	13.95	12.58
					Top Shelf Right	31.67	13.95	12.58
					Bottom Shelf Left	31.67	13.95	12.58
					Bottom Shelf Right	31.67	13.95	12.58
		72"		27.50	Top Shelf Left	34.67	13.95	12.58
					Top Shelf Right	34.67	13.95	12.58
					Bottom Shelf Left	34.67	13.95	12.58
					Bottom Shelf Right	34.67	13.95	12.58
		78"		27.50	Top Shelf Left	37.67	13.95	12.58
					Top Shelf Right	37.67	13.95	12.58
					Bottom Shelf Left	37.67	13.95	12.58
					Bottom Shelf Right	37.67	13.95	12.58
		84"		27.50	Top Shelf Left	26.67	13.95	12.61
					Top Shelf Middle	26.84	13.95	12.61
					Top Shelf Right	12.67	13.95	12.61
					Bottom Shelf Left	26.67	14.08	12.61
					Bottom Shelf Middle	26.84	14.08	12.61
					Bottom Shelf Right	26.67	14.08	12.61
		90"		27.50	Top Shelf Left	28.67	13.95	12.61
					Top Shelf Middle	28.84	13.95	12.61
					Top Shelf Right	28.67	13.95	12.61
					Bottom Shelf Left	28.67	14.08	12.61
					Bottom Shelf Middle	28.84	14.08	12.61
					Bottom Shelf Right	28.67	14.08	12.61
2H Wall Mount Cabinets – Sliding Doors	2H	60"	16.20	27.50	Top Shelf Left	28.67	12.89	12.61
					Top Shelf Right	28.67	12.89	12.61
					Bottom Shelf Left	28.67	13.41	12.61
					Bottom Shelf Right	28.67	13.41	12.61
		72"	16.20	27.50	Top Shelf Left	34.67	12.89	12.58
					Top Shelf Right	34.67	12.89	12.58
					Bottom Shelf Left	34.67	13.41	12.58
					Bottom Shelf Right	34.67	13.41	12.58
		90"	16.20	27.50	Top Shelf Left	28.66	12.89	12.61
					Top Shelf Middle	28.86	12.89	12.61
					Top Shelf Right	28.66	12.89	12.61
					Bottom Shelf Left	28.66	13.41	12.61
					Bottom Shelf Middle	28.86	13.41	12.61
					Bottom Shelf Right	28.66	13.41	12.61

DESCRIPTION	STYLE	EXTERNAL DIMENSIONS			LOCATION	INTERNAL DIMENSIONS		
		width	depth	height		width	depth	height
1H Surface Mount Cabinets – Hinged Door & Open Shelf	1H Hinged Door (15 2/3"D)	60"	See depth dimensions by style	39.09	Cabinet Left	28.67	14.11	12.61
	1H Glass Door (15 3/4"D)				Cabinet Right	28.67	14.11	12.61
	1H Open (14 7/8"D)				Tackzone	58.50	14.25	24.97
		66"		39.09	Cabinet Left	31.67	14.11	12.61
					Cabinet Right	31.67	14.11	12.61
					Tackzone	64.50	14.25	24.97
		72"		39.09	Cabinet Left	34.67	14.11	12.61
					Cabinet Right	34.67	14.11	12.61
					Tackzone	70.50	14.25	24.97
		78"		39.09	Cabinet Left	37.67	14.11	12.61
					Cabinet Right	37.67	14.11	12.61
					Tackzone	76.50	14.25	24.97
		84"		39.09	Cabinet Left	26.67	14.11	12.61
					Cabinet Middle	26.84	14.11	12.61
					Cabinet Right	26.67	14.11	12.61
					Tackzone	82.50	14.25	24.97
		90"		39.09	Cabinet Left	28.67	14.11	12.61
					Cabinet Middle	28.84	14.11	12.61
					Cabinet Right	28.67	14.11	12.61
					Tackzone	88.50	14.25	24.97
		96"		39.09	Cabinet Left	30.67	14.11	12.61
					Cabinet Middle	30.84	14.11	12.61
					Cabinet Right	30.67	14.11	12.61
					Tackzone	94.50	14.25	24.97
	102"		39.09	Cabinet Left	32.67	14.11	12.61	
				Cabinet Middle	32.84	14.11	12.61	
				Cabinet Right	32.67	14.11	12.61	
				Tackzone	100.50	14.25	24.97	
	108"		39.09	Cabinet Left	34.67	14.11	12.61	
				Cabinet Middle	34.84	14.11	12.61	
				Cabinet Right	34.67	14.11	12.61	
				Tackzone	106.50	14.13	24.97	
2H Surface Mount Cabinets – Hinged Door & Open Shelf	2H Hinged Door (15 2/3"D)	60"	See depth dimensions by style	52.47	Top Shelf Left	28.67	13.98	12.61
	2H Glass Door (15 3/4"D)				Top Shelf Right	28.67	13.98	12.61
	2H Open (14 7/8"D)				Bottom Shelf Left	28.67	14.11	12.63
					Bottom Shelf Right	28.67	14.11	12.63
					Tackzone	58.50	14.25	24.97
		66"		52.47	Top Shelf Left	31.67	13.98	15.58
					Top Shelf Right	31.67	13.98	15.58
					Bottom Shelf Left	31.67	14.11	12.60
					Bottom Shelf Right	31.67	14.11	12.60
					Tackzone	64.50	14.25	24.97
		72"		52.47	Top Shelf Left	31.67	13.98	12.58
					Top Shelf Right	31.67	13.98	12.58
				Bottom Shelf Left	31.67	14.11	12.60	

DIMENSIONS

Silea
03/23

DESCRIPTION	STYLE	EXTERNAL DIMENSIONS			LOCATION	INTERNAL DIMENSIONS			
		width	depth	height		width	depth	height	
					Bottom Shelf Right	31.67	14.11	12.60	
					Tackzone	64.50	14.25	24.97	
		78"		52.47	Top Shelf Left	37.67	13.98	12.58	
					Top Shelf Right	37.67	13.98	12.58	
					Bottom Shelf Left	37.67	14.11	12.60	
					Bottom Shelf Right	37.67	14.11	12.60	
					Tackzone	76.50	14.25	24.97	
		84"		52.47	Top Shelf Left	26.67	13.98	12.61	
					Top Shelf Middle	26.84	13.98	12.61	
					Top Shelf Right	26.67	13.98	12.61	
					Bottom Shelf Left	26.67	14.11	12.63	
					Bottom Shelf Middle	26.84	14.11	12.63	
					Bottom Shelf Right	26.67	14.11	12.63	
					Tackzone	82.50	14.25	24.97	
		90"		52.47	Top Shelf Left	28.67	13.98	12.61	
					Top Shelf Middle	28.84	13.98	12.61	
					Top Shelf Right	28.67	13.98	12.61	
					Bottom Shelf Left	28.67	14.11	12.63	
					Bottom Shelf Middle	28.84	14.11	12.63	
					Bottom Shelf Right	28.67	14.11	12.63	
					Tackzone	88.50	14.25	24.97	
1H Surface Mount Towers – Hinged Door & Open Shelf	1H Hinged Door (15 3/4"D)	15"	See depth dimensions by style	39.09	Top Shelf	13.50	13.91	12.61	
	1H Glass Door (15 4/5"D)				Middle Shelf	13.50	13.91	12.17	
	1H Open (14 7/8"D)				Bottom Shelf	13.50	14.07	11.30	
			18"		39.09	Top Shelf	16.50	13.91	12.61
						Middle Shelf	16.50	13.91	12.17
						Bottom Shelf	16.50	14.07	11.30
			30"		39.09	Top Shelf	28.50	13.91	12.61
						Middle Shelf	28.50	13.91	12.17
						Bottom Shelf	28.50	14.07	11.30
			36"		39.09	Top Shelf	34.50	13.91	12.55
						Middle Shelf	34.50	13.91	12.11
						Bottom Shelf	34.50	14.07	11.30
2H Surface Mount Towers - Hinged Door & Open Shelf	2H Hinged Door (15 3/4"D)	15"	See depth dimensions by style	52.47	Top Shelf	13.50	13.91	12.61	
	2H Glass Door (15 4/5"D)				2nd Shelf	13.50	13.91	12.63	
	2H Open (14 7/8"D)				3rd Shelf	13.50	13.91	12.17	
						Bottom Shelf	13.50	14.07	11.30
			18"		52.47	Top Shelf	16.50	13.91	12.61
						2nd Shelf	16.50	13.91	12.63
						3rd Shelf	16.50	13.91	12.17
						Bottom Shelf	16.50	14.07	11.30
			30"		52.47	Top Shelf	28.50	13.91	12.61
						2nd Shelf	28.50	13.91	12.63
						3rd Shelf	28.50	13.91	12.17
						Bottom Shelf	28.50	14.07	11.30

DESCRIPTION	STYLE	EXTERNAL DIMENSIONS			LOCATION	INTERNAL DIMENSIONS			
		width	depth	height		width	depth	height	
		36"		52.47	Top Shelf	34.50	13.91	12.55	
					2nd Shelf	34.50	13.91	12.57	
					3rd Shelf	34.50	13.91	12.11	
					Bottom Shelf	34.50	14.07	11.30	
WorkWall	Wall Mount	72"	19.69	39.09	Collaboration Side Tackzone	34.26	11.55	36.73	
					Personal Side Tackzone	34.26	16.30	25.13	
					Personal Side Drawer	26.40	13.09	2.91	
		90°	19.69	39.09	Collaboration Side Tackzone	43.26	11.55	36.73	
	Personal Side Tackzone				43.26	16.30	25.13		
	Personal Side Drawer				32.40	13.09	2.91		
	Wall Mount w/ Wall	72"	19.69	68.13	Collaboration Side Tackzone	34.26	11.55	36.73	
	Access Panel				Personal Side Tackzone	34.26	16.27	25.13	
					Personal Side Drawer	26.40	13.09	2.91	
		90°	19.69	68.13	Wall Access Panel	34.50	6.49	29.06	
	Collaboration Side Tackzone				43.26	11.55	36.73		
	Personal Side Tackzone				43.26	16.27	25.13		
					Personal Side Drawer	32.40	13.09	2.91	
					Wall Access Panel	43.50	6.48	29.06	
	Stack On	72"	19.69	39.09	Collaboration Side Tackzone	34.26	10.38	36.41	
					Personal Side Tackzone	34.26	17.30	36.41	
					Personal Side Shelf	34.26	12.70	11.81	
			90°	19.69	39.09	Collaboration Side Tackzone	43.26	10.38	36.41
		Personal Side Tackzone				43.26	17.30	36.41	
		Personal Side Shelf				43.26	12.70	11.81	
	Freestanding	72"	23.74	75.50	Collaboration Side Tackzone	34.47	10.95	39.49	
					Collaboration Side Drawer	26.40	13.09	2.91	
					Collaboration Side Top Shelf	34.47	12.20	13.33	
					Collaboration Side Bottom Shelf	34.47	12.26	12.10	
Personal Side Tackzone					34.47	16.29	32.35		
Personal Side Drawer Top					32.40	13.09	2.91		
Personal Side Drawer 2nd					31.90	15.02	9.25		
Personal Side Drawer Bottom					31.90	15.02	9.25		
					90°	23.74	75.50	Collaboration Side Tackzone	43.48
Collaboration Side Drawer		32.40	13.09	2.91					
Collaboration Side Top Shelf		43.48	12.20	13.33					
Collaboration Side Bottom Shelf		43.48	12.26	12.10					
Personal Side Tackzone		34.47	16.29	32.35					
Personal Side Drawer Top		32.40	13.09	2.91					
Personal Side Drawer 2nd		31.90	15.02	9.25					
Personal Side Drawer Bottom		31.90	15.02	9.25					
Closet above the Shelf		7.85	17.22	59.80					
Closet below the Shelf		7.85	17.29	12.10					
				Personal Side Drawer Bottom	31 ⁸ / ₉	15	9 ¹ / ₄		
				Closet above the Shelf	7 ⁶ / ₇	17 ² / ₉	59 ⁴ / ₅		
				Closet below the Shelf	7 ⁶ / ₇	17 ² / ₇	12		

Gunlocke worksurfaces feature two low emitting UV finish options that enhance the beauty of natural wood and ensures the depth, clarity, color consistency and durability throughout the life of the product.

OPEN PORE UV FINISH

The Gunlocke Open Pore UV Finish delivers a luxurious look-and-feel, while maintaining a high-level of durability and repairability.



- Open pore finish (natural texture of woodgrain is present)
- 20 sheen
- Water based UV cured finish with low emitting qualities
- Open pore finish allows for greater repairability

CLEARTECH® FULL FILL UV FINISH

The ClearTech® finishing system is a full fill UV finish that provides superior durability with strong water, chemical and heat resistance.



- Full fill finish (provides exceptional depth and clarity)
- 40 sheen
- Water based UV cured finish with low emitting qualities
- Superior durability
- Upcharge applies. See Price List & Specification Guide for details

The typicals shown below include best practices for specifying grain direction on worksurfaces.



LONG GRAIN:
Grain runs width of top



SHORT GRAIN:
Grain runs depth of top

RECOMMENDATIONS

- Grain should run parallel to one another when crossing over worksurface segments
- Avoid running the grain end-to-end when crossing over worksurface segments

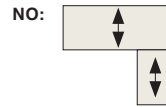

LAMINATE GUIDELINES

- **Laminate worksurfaces:** Optional grain direction is available on worksurfaces up to 60". For worksurfaces above 60", long grain is standard.
- **Laminate modesty and wall access panels:** Grain direction is not optional. Grain runs vertically on panels up to and including 60". Grain runs horizontally on panels over 60".

FREESTANDING

Desk: Long Grain
Credenza: Long Grain

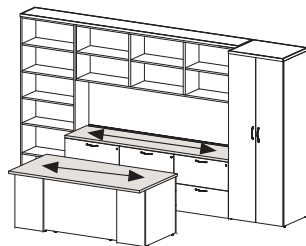

U-STATION

Desk: Long Grain
Bridge: Short Grain
Credenza: Long Grain

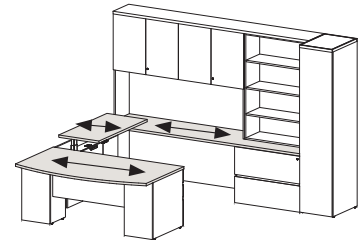

T-STATION

Desk: Long Grain
Return: Short Grain
Hinged Door Cabinet: Short Grain

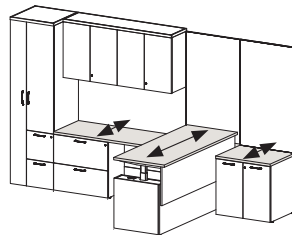

T-STATION WITH LAYERS

Desk: Long Grain
Layers Credenza: Short Grain

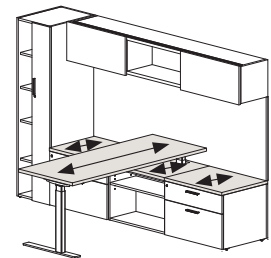

L-STATION

Desk: Long Grain
Return: Short Grain

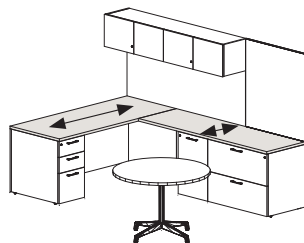

L-STATION

Runoff Desk: Short Grain
Credenza: Long Grain

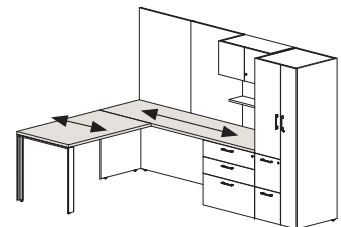



Unitized Casegoods 51-78

- Double Pedestal Desk 52
- Single Pedestal Desk 53-54
- Runoff Desks 55
- Layers Runoff W/ Layers Box / Laptop Drawer 56-57
- Double Pedestal Credenza 58
- Single Pedestal Credenza 59
- Full Bank Credenza 60-61
- Returns 62
- Rectangular Table Desk 63-65
- Runoffs 66
- Rectangular Runoff 67
- Layers Rectangular Runoff W/ Layers Box /
Laptop Drawer 68-69
- Ellipse Table Desk 70
- Layers Ellipse Runoff W/ Layers Box 71
- Arc Boat Table Desk 72
- Layers Arc Boat Runoff W/Layers Box 73
- Sightline Runoff 74
- Layers Sightline Runoff W/ Layers Box /
Laptop Drawer 75-76
- Layers Cockpit Runoff W/ Layers Box 77
- Media Top 78

DOUBLE PEDESTAL DESK

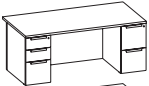
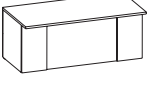
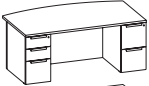
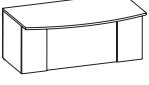
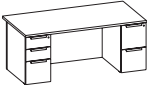
Silea
03/23

	D	W	H	model number + type	laminata	veneer 1	veneer 2
 	36	72	29 1/2	GS2DROB3672-32 []	5,715	8,407	9,281
				<ul style="list-style-type: none"> • 15" wide pedestals • 30" depth pedestals • 3/4" breakfront modesty • 6" overhang 			
 	42	72	29 1/2	GS2DBOB4272-32 []	6,183	9,139	10,089
Bow front				<ul style="list-style-type: none"> • 15" wide pedestals • 30" depth pedestals • 3/4" breakfront modesty • 6" overhang • 12" overhang at center 			
 	36	72	29 1/2	GS2DROF3672-32 []	5,410	7,967	8,795
				<ul style="list-style-type: none"> • 15" wide pedestals • 30" depth pedestals • Flush front modesty • 6" overhang 			

PRODUCT INFO

Wood tops optional grain.

Laminate tops long grain standard.

 Units shipped as separate packages and require field assembly.

Grommet Location (Add \$77 per grommet)

No Grommet **GN**
 Left **GL**
 Right **GR**
 Left & Right **GB**

Specify location first, then select grommet color or "Empty Cutout" option. When "Empty Cutout" option is selected, a grommet or power unit must be ordered separately for each cutout.







TO ORDER PLEASE SPECIFY THE FOLLOWING:

WOOD TOP, WOOD CHASSIS

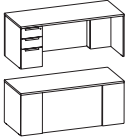
1. **MODEL NUMBER + WW**
2. **FSC**
3. **TOP WOOD FINISH + EDGE**
4. **CHASSIS WOOD FINISH**
5. **TOP UV FINISH**
6. **GRAIN DIRECTION**
7. **PULL**
8. **DRAWERS**
9. **GROMMET**
10. **KEYING**

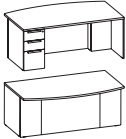
LAM TOP, LAM CHASSIS

1. **MODEL NUMBER + LL**
2. **FSC**
3. **TOP LAM**
4. **CHASSIS LAM**
5. **FRONT LAM**
6. **EDGE DETAIL**
7. **PULL**
8. **DRAWERS**
9. **GROMMET**
10. **KEYING**

	D	W	H	model number + type	laminate	veneer 1	veneer 2
LEFT HAND 	30	60	29 1/2	GS2DRFB3060L-3 <input type="checkbox"/>	4,068	6,002	6,626
	30	66	29 1/2	GS2DRFB3066L-3 <input type="checkbox"/>	4,190	6,185	6,828
	30	72	29 1/2	GS2DRFB3072L-3 <input type="checkbox"/>	4,319	6,377	7,040
	• 3/4" breakfront modesty						
	36	72	29 1/2	GS2DROB3672L-3 <input type="checkbox"/>	4,396	6,501	7,176
	36	78	29 1/2	GS2DROB3678L-3 <input type="checkbox"/>	4,556	6,739	7,439
	• 3/4" breakfront modesty • 6" overhang						
	42	72	29 1/2	GS2DBOB4272L-3 <input type="checkbox"/>	4,864	7,233	7,985
	• 3/4" breakfront modesty • 6" overhang • 12" overhang at center						
RIGHT HAND 	30	60	29 1/2	GS2DRFB3060R-3 <input type="checkbox"/>	4,068	6,002	6,626
	30	66	29 1/2	GS2DRFB3066R-3 <input type="checkbox"/>	4,190	6,185	6,828
	30	72	29 1/2	GS2DRFB3072R-3 <input type="checkbox"/>	4,319	6,377	7,040
	• 3/4" breakfront modesty						
	36	72	29 1/2	GS2DROB3672R-3 <input type="checkbox"/>	4,396	6,501	7,176
	36	78	29 1/2	GS2DROB3678R-3 <input type="checkbox"/>	4,556	6,739	7,439
	• 3/4" breakfront modesty • 6" overhang						
	42	72	29 1/2	GS2DBOB4272R-3 <input type="checkbox"/>	4,864	7,233	7,985
	• 3/4" breakfront modesty • 6" overhang • 12" overhang at center						

PRODUCT INFO

Wood tops optional grain.
Laminate tops optional grain up to 60", over 60" long grain standard.
 Units shipped as separate packages and require field assembly.

Grommet Location
(Add \$77 per grommet)

No Grommet **GN**
Left **GL**
Right **GR**
Left & Right **GB**

Specify location first, then select grommet color or "Empty Cutout" option.
When "Empty Cutout" option is selected, a grommet or power unit must be ordered separately for each cutout.

TO ORDER PLEASE SPECIFY THE FOLLOWING:

WOOD TOP, WOOD CHASSIS



LAM TOP, LAM CHASSIS

- | | |
|----------------------------------|---|
| 1. MODEL NUMBER + WW | 1. MODEL NUMBER + LL |
| 2. FSC | 2. FSC |
| 3. TOP WOOD FINISH + EDGE | 3. TOP LAM |
| 4. CHASSIS WOOD FINISH | 4. CHASSIS LAM |
| 5. TOP UV FINISH | 5. FRONT LAM |
| 6. GRAIN DIRECTION | 6. GRAIN DIRECTION (60W models only) |
| 7. PULL | 7. EDGE DETAIL |
| 8. DRAWERS | 9. PULL |
| 9. GROMMET | 10. DRAWERS |
| 10. KEYING | 11. GROMMET |
| | 12. KEYING |

SINGLE PEDESTAL DESK

15" Pedestals | Flush Front Modesty

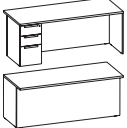
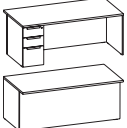
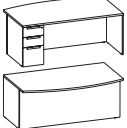
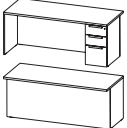
Silea
03/23

	D	W	H	model number + type	laminates	veneer 1	veneer 2
LEFT HAND 	30	60	29 1/2	GS2DROF3060L-3 []	3,854	5,924	6,539
	30	66	29 1/2	GS2DROF3066L-3 []	3,969	6,098	6,732
	30	72	29 1/2	GS2DROF3072L-3 []	4,089	6,277	6,929
	• 6" overhang						
	36	72	29 1/2	GS2DROF3672L-3 []	4,259	6,360	7,021
	36	78	29 1/2	GS2DROF3678L-3 []	4,406	6,582	7,266
	• 6" overhang						
 Bow front	42	72	29 1/2	GS2DBOF4272L-3 []	4,727	7,092	7,829
	• 6" overhang						
	• 12" overhang at center						
RIGHT HAND 	30	60	29 1/2	GS2DROF3060R-3 []	3,854	5,924	6,539
	30	66	29 1/2	GS2DROF3066R-3 []	3,969	6,098	6,732
	30	72	29 1/2	GS2DROF3072R-3 []	4,089	6,277	6,929
	• 6" overhang						
	36	72	29 1/2	GS2DROF3672R-3 []	4,259	6,360	7,021
	36	78	29 1/2	GS2DROF3678R-3 []	4,406	6,582	7,266
	• 6" overhang						
 Bow front	42	72	29 1/2	GS2DBOF4272R-3 []	4,727	7,092	7,829
	• 6" overhang						
	• 12" overhang at center						

PRODUCT INFO

Wood tops optional grain.

Laminate tops long grain standard.

 Units shipped as separate packages and require field assembly.

Grommet Location

(Add \$77 per grommet)

No Grommet **GN**
 Left **GL**
 Right **GR**
 Left & Right **GB**

Specify location first, then select grommet color or "Empty Cutout" option. When "Empty Cutout" option is selected, a grommet or power unit must be ordered separately for each cutout.

TO ORDER PLEASE SPECIFY THE FOLLOWING:

WOOD TOP, WOOD CHASSIS

1. **MODEL NUMBER + WW**
2. **FSC**
3. **TOP WOOD FINISH + EDGE**
4. **CHASSIS WOOD FINISH**
5. **TOP UV FINISH**
6. **GRAIN DIRECTION**
7. **PULL**
8. **DRAWERS**
9. **GROMMET**
10. **KEYING**

LAM TOP, LAM CHASSIS

1. **MODEL NUMBER + LL**
2. **FSC**
3. **TOP LAM**
4. **CHASSIS LAM**
5. **FRONT LAM**
6. **GRAIN DIRECTION (60W models only)**
7. **EDGE DETAIL**
8. **PULL**
9. **DRAWERS**
10. **GROMMET**
11. **KEYING**

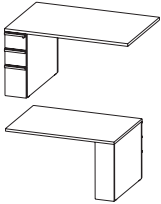
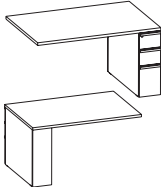
	D	W	H	model number + type	laminata	veneera 1	veneera 2
LEFT HAND 	30	48	29 1/2	GS2RRO3048L-3 []	3,018	4,663	5,147
	30	54	29 1/2	GS2RRO3054L-3 []	3,029	4,683	5,170
	36	54	29 1/2	GS2RRO3654L-3 []	3,202	4,940	5,454
	36	60	29 1/2	GS2RRO3660L-3 []	3,223	4,972	5,489
<ul style="list-style-type: none"> • Flat brackets ordered separately (model #MDWBRK) 							
RIGHT HAND 	30	48	29 1/2	GS2RRO3048R-3 []	3,018	4,663	5,147
	30	54	29 1/2	GS2RRO3054R-3 []	3,029	4,683	5,170
	36	54	29 1/2	GS2RRO3654R-3 []	3,202	4,940	5,454
	36	60	29 1/2	GS2RRO3660R-3 []	3,223	4,972	5,489
<ul style="list-style-type: none"> • Narrow 9 7/16" width pedestal • Flat brackets ordered separately (model #MDWBRK) 							

PRODUCT INFO

Specify pedestal location from user seated position.

All tops optional grain.

 Units shipped as separate packages and require field assembly.

Modesty panel ordered separately.

Grommet Location
(Add \$77 per grommet)

No Grommet **GN**
 Left **GL**
 Right **GR**
 Left & Right **GB**

Specify location first, then select grommet color or "Empty Cutout" option. When "Empty Cutout" option is selected, a grommet or power unit must be ordered separately for each cutout.

TO ORDER PLEASE SPECIFY THE FOLLOWING:

WOOD TOP, WOOD CHASSIS

- MODEL NUMBER + WW**
- FSC**
- TOP WOOD FINISH + EDGE**
- CHASSIS WOOD FINISH**
- TOP UV FINISH**
- GRAIN DIRECTION**
- PULL**
- DRAWERS**
- GROMMET**
- KEYING**

LAM TOP, LAM CHASSIS

- MODEL NUMBER + LL**
- FSC**
- TOP LAM**
- CHASSIS LAM**
- FRONT LAM**
- GRAIN DIRECTION (60W models only)**
- EDGE DETAIL**
- PULL**
- DRAWERS**
- GROMMET**
- KEYING**

LAYERS RUNOFF DESKS W/LAYERS BOX

Left and Right Hand | BBF Pedestal

Silea

03/23

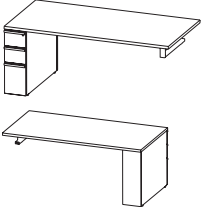
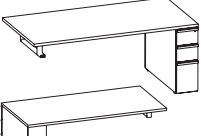
	D	W	H	model number + type	laminate	veneer 1	veneer 2
LEFT HAND 	30	66	29 1/2	GS2RLO3066L-3 []	3,612	5,296	5,847
	30	72	29 1/2	GS2RLO3072L-3 []	3,668	5,381	5,941
	36	72	29 1/2	GS2RLO3672L-3 []	3,897	5,711	6,304
	36	78	29 1/2	GS2RLO3678L-3 []	3,981	5,840	6,447
RIGHT HAND 	30	66	29 1/2	GS2RLO3066R-3 []	3,612	5,296	5,847
	30	72	29 1/2	GS2RLO3072R-3 []	3,668	5,381	5,941
	36	72	29 1/2	GS2RLO3672R-3 []	3,897	5,711	6,304
	36	78	29 1/2	GS2RLO3678R-3 []	3,981	5,840	6,447

- Box | Box | File pedestal
- Narrow 9 7/16" width pedestal

Layers Box

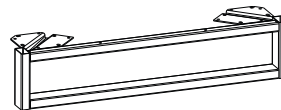

Side view

PRODUCT INFO

Specify pedestal location from user seated position.

All tops long grain standard.

 Units shipped as separate packages and require field assembly.

Grommet Location (Add \$77 per grommet)

No Grommet **GN**
 Left **GL**
 Right **GR**
 Left & Right **GB**

Specify location first, then select grommet color or "Empty Cutout" option. When "Empty Cutout" option is selected, a grommet or power unit must be ordered separately for each cutout.

TO ORDER PLEASE SPECIFY THE FOLLOWING:

WOOD TOP, WOOD CHASSIS

1. **MODEL NUMBER + WW**
2. **FSC**
3. **TOP WOOD FINISH + EDGE**
4. **CHASSIS WOOD FINISH**
5. **TOP UV FINISH**
6. **PULL**
7. **HARDWARE COLOR (Layers Box)**
8. **DRAWERS**
9. **GROMMET**
10. **KEYING**

LAM TOP, LAM CHASSIS

1. **MODEL NUMBER + LL**
2. **FSC**
3. **TOP LAM**
4. **CHASSIS LAM**
5. **FRONT LAM**
6. **EDGE DETAIL**
7. **PULL**
8. **HARDWARE COLOR (Layers Box)**
9. **DRAWERS**
10. **GROMMET**
11. **KEYING**

LAYERS RUNOFF DESKS W/ LAPTOP DRAWER

Left and Right Hand | BBF Pedestal

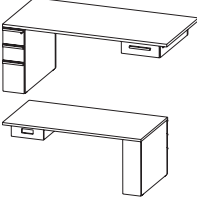
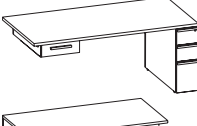
	D	W	H	model number + type	laminata	veneer 1	veneer 2
LEFT HAND 	30	66	29 1/2	GS2RLOS3066L-3 []	4,018	6,137	6,773
	30	72	29 1/2	GS2RLOS3072L-3 []	4,073	6,221	6,866
	36	72	29 1/2	GS2RLOS3672L-3 []	4,325	6,538	7,215
	36	78	29 1/2	GS2RLOS3678L-3 []	4,408	6,666	7,358
RIGHT HAND 	30	66	29 1/2	GS2RLOS3066R-3 []	4,018	6,137	6,773
	30	72	29 1/2	GS2RLOS3072R-3 []	4,073	6,221	6,866
	36	72	29 1/2	GS2RLOS3672R-3 []	4,325	6,538	7,215
	36	78	29 1/2	GS2RLOS3678R-3 []	4,408	6,666	7,358

- Box | Box | File pedestal
- Narrow 9 7/16" width pedestal

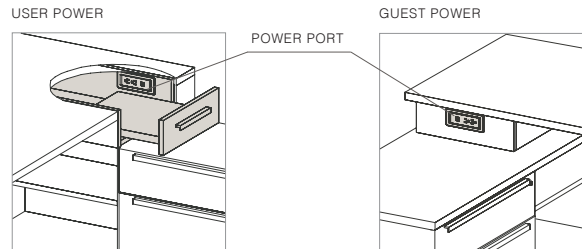

PRODUCT INFO

Specify pedestal location from user seated position.

All tops long grain standard.

 Units shipped as separate packages and require field assembly.

Power units included
(2 USB, 2 power)

Grommet Location
(Add \$77 per grommet)

No Grommet **GN**
Left **GL**
Right **GR**
Left & Right **GB**

Specify location first, then select grommet color or "Empty Cutout" option. When "Empty Cutout" option is selected, a grommet or power unit must be ordered separately for each cutout.

TO ORDER PLEASE SPECIFY THE FOLLOWING:

WOOD TOP, WOOD CHASSIS

1. **MODEL NUMBER + WW**
2. **FSC**
3. **TOP WOOD FINISH + EDGE**
4. **CHASSIS WOOD FINISH**
5. **TOP UV FINISH**
6. **PULL – PEDESTAL**
7. **PULL – LAPTOP DRAWER**
8. **DRAWERS**
9. **GROMMET**
10. **KEYING**
11. **POWER UNIT**

LAM TOP, LAM CHASSIS

1. **MODEL NUMBER + LL**
2. **FSC**
3. **TOP LAM**
4. **CHASSIS LAM**
5. **FRONT LAM**
6. **EDGE DETAIL**
7. **PULL**
8. **DRAWERS**
9. **GROMMET**
10. **KEYING**
11. **POWER UNIT**

DOUBLE PEDESTAL CREDENZA

15" Pedestals

Silea
03/23

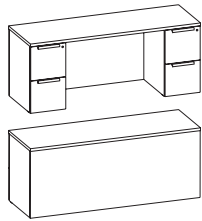

D	W	H	model number + type	laminate	veneer 1	veneer 2
24	72	29 1/2	GS2DPC2472-22 []	5,241	8,174	9,024

- File | File pedestal

PRODUCT INFO

Wood tops optional grain.

Laminate tops long grain standard.

 Units shipped as separate packages and require field assembly.

Grommet Location (Add \$77 per grommet)

No Grommet **GN**
Left **GL**
Right **GR**
Left & Right **GB**

Specify location first, then select grommet color or "Empty Cutout" option. When "Empty Cutout" option is selected, a grommet or power unit must be ordered separately for each cutout.

TO ORDER PLEASE SPECIFY THE FOLLOWING:

WOOD TOP, WOOD CHASSIS

- MODEL NUMBER + WW**
- FSC**
- TOP WOOD FINISH + EDGE**
- CHASSIS WOOD FINISH**
- TOP UV FINISH**
- GRAIN DIRECTION**
- PULL**
- DRAWERS**
- GROMMET**
- MODESTY**
- KEYING**

LAM TOP, LAM CHASSIS

- MODEL NUMBER + LL**
- FSC**
- TOP LAM**
- CHASSIS LAM**
- FRONT LAM**
- EDGE DETAIL**
- PULL**
- DRAWER**
- GROMMET**
- MODESTY**
- KEYING**

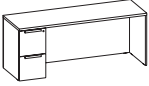
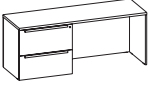
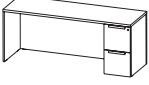
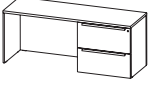
	D	W	H	model number + type	laminata	veneer 1	veneer 2
LEFT HAND 	24	66	29 1/2	GS2SPC2466L-2 []	3,336	5,198	5,738
	24	72	29 1/2	GS2SPC2472L-2 []	3,455	5,389	5,949
	• 15" W pedestal						
	24	72	29 1/2	GS2SPC2472L-4 []	3,891	6,072	6,704
	24	78	29 1/2	GS2SPC2478L-4 []	3,961	6,178	6,821
	24	84	29 1/2	GS2SPC2484L-4 []	4,027	6,284	6,937
	24	90	29 1/2	GS2SPC2490L-4 []	4,214	6,573	7,256
	24	96	29 1/2	GS2SPC2496L-4 []	4,362	6,807	7,515
	• 30" W pedestal						
RIGHT HAND 	24	66	29 1/2	GS2SPC2466R-2 []	3,336	5,198	5,738
	24	72	29 1/2	GS2SPC2472R-2 []	3,455	5,389	5,949
	• 15" W pedestal						
	24	72	29 1/2	GS2SPC2472R-4 []	3,891	6,072	6,704
	24	78	29 1/2	GS2SPC2478R-4 []	3,961	6,178	6,821
	24	84	29 1/2	GS2SPC2484R-4 []	4,027	6,284	6,937
	24	90	29 1/2	GS2SPC2490R-4 []	4,214	6,573	7,256
	24	96	29 1/2	GS2SPC2496R-4 []	4,362	6,807	7,515
	• 30" W pedestal						

PRODUCT INFO

Wood tops optional grain.

Laminate tops long grain standard.

 Units shipped as separate packages and require field assembly.

Grommet Location

(Add \$77 per grommet)

No Grommet **GN**
Left **GL**
Right **GR**
Left & Right **GB**

Specify location first, then select grommet color or "Empty Cutout" option. When "Empty Cutout" option is selected, a grommet or power unit must be ordered separately for each cutout.

TO ORDER PLEASE SPECIFY THE FOLLOWING:

WOOD TOP, WOOD CHASSIS

- MODEL NUMBER + WW**
- FSC**
- TOP WOOD FINISH + EDGE**
- CHASSIS WOOD FINISH**
- TOP UV FINISH**
- GRAIN DIRECTION**
- PULL**
- DRAWERS**
- GROMMET**
- MODESTY**
- KEYING**

LAM TOP, LAM CHASSIS



- MODEL NUMBER + LL**
- FSC**
- TOP LAM**
- CHASSIS LAM**
- FRONT LAM**
- EDGE DETAIL**
- PULL**
- DRAWER**
- GROMMET**
- MODESTY**
- KEYING**

FULL BANK CREDENZA

Lateral File

Silea

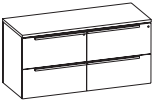
03/23

	D	W	H	model number + type	laminare	veneer 1	veneer 2
	24	60	29 1/2	GS2FSC2460-44 []	5,203	8,111	8,954
	24	72	29 1/2	GS2FSC2472-44 []	5,542	8,639	9,537

PRODUCT INFO

All tops long grain standard.
Ships assembled.

TO ORDER PLEASE SPECIFY THE FOLLOWING:

WOOD TOP, WOOD CHASSIS

1. **MODEL NUMBER + WW**
2. **FSC**
3. **TOP WOOD FINISH + EDGE**
4. **CHASSIS WOOD FINISH**
5. **TOP UV FINISH**
6. **PULL**
7. **DRAWERS**
8. **KEYING**

LAM TOP, LAM CHASSIS

1. **MODEL NUMBER + LL**
2. **FSC**
3. **TOP LAM**
4. **CHASSIS LAM**
5. **FRONT LAM**
6. **EDGE DETAIL**
7. **PULL**
8. **DRAWERS**
9. **KEYING**

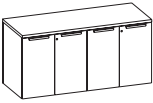
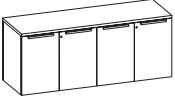
	D	W	H	model number + type	laminata	veneer 1	veneer 2
	24	60	29 1/2	GS2FSC2460-55 []	4,778	7,453	8,227
	24	72	29 1/2	GS2FSC2472-55 []	5,130	7,997	8,828

PRODUCT INFO

All tops long grain standard.
Ships assembled.
(1) Adjustable shelf behind each door set.

TO ORDER PLEASE SPECIFY THE FOLLOWING:

WOOD TOP, WOOD CHASSIS

1. **MODEL NUMBER + WW**
2. **FSC**
3. **TOP WOOD FINISH + EDGE**
4. **CHASSIS WOOD FINISH**
5. **TOP UV FINISH**
6. **PULL**
7. **KEYING**

LAM TOP, LAM CHASSIS

1. **MODEL NUMBER + LL**
2. **FSC**
3. **TOP LAM**
4. **CHASSIS LAM**
5. **FRONT LAM**
6. **EDGE DETAIL**
7. **PULL**
8. **KEYING**

RETURNS

15" Pedestals | Full Modesty

Silea

03/23

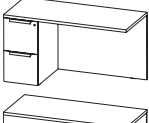
	D	W	H	model number + type	laminate	vener 1	vener 2
LEFT HAND 	24	42	29 1/2	GS2RTN2442L-2 <input type="checkbox"/>	3,084	4,728	5,220
	24	48	29 1/2	GS2RTN2448L-2 <input type="checkbox"/>	3,170	4,863	5,368
	24	54	29 1/2	GS2RTN2454L-2 <input type="checkbox"/>	3,235	4,963	5,479
	24	60	29 1/2	GS2RTN2460L-2 <input type="checkbox"/>	3,331	5,107	5,638

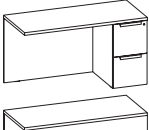
RIGHT HAND 	24	42	29 1/2	GS2RTN2442R-2 <input type="checkbox"/>	3,084	4,728	5,220
	24	48	29 1/2	GS2RTN2448R-2 <input type="checkbox"/>	3,170	4,863	5,368
	24	54	29 1/2	GS2RTN2454R-2 <input type="checkbox"/>	3,235	4,963	5,479
	24	60	29 1/2	GS2RTN2460R-2 <input type="checkbox"/>	3,331	5,107	5,638

- Flat brackets ordered separately (model #MDWBRK)

PRODUCT INFO

Specify pedestal location from user seated position.

All tops optional grain.

 Units shipped as separate packages and require field assembly.

Grommet Location

(Add \$77 per grommet)

No Grommet **GN**
Left **GL**
Right **GR**
Left & Right **GB**

Specify location first, then select grommet color or "Empty Cutout" option. When "Empty Cutout" option is selected, a grommet or power unit must be ordered separately for each cutout.

TO ORDER PLEASE SPECIFY THE FOLLOWING:

WOOD TOP, WOOD CHASSIS

- MODEL NUMBER + WW**
- FSC**
- TOP WOOD FINISH + EDGE**
- CHASSIS WOOD FINISH**
- TOP UV FINISH**
- GRAIN DIRECTION**
- PULL**
- DRAWERS**
- GROMMET**
- KEYING**

LAM TOP, LAM CHASSIS

- MODEL NUMBER + LL**
- FSC**
- TOP LAM**
- CHASSIS LAM**
- FRONT LAM**
- GRAIN DIRECTION**
- EDGE DETAIL**
- PULL**
- DRAWER**
- GROMMET**
- KEYING**

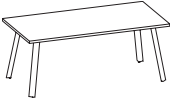
	D	W	H	model number + type	laminata	vener 1	vener 2
	30	66	29 1/2	GS2TRL3066- []	2,200	2,779	3,068
	30	72	29 1/2	GS2TRL3072- []	2,256	2,864	3,162
	36	72	29 1/2	GS2TRL3672- []	2,333	2,988	3,299
	36	78	29 1/2	GS2TRL3678- []	2,417	3,117	3,441

PRODUCT INFO

All tops long grain standard.
 Units shipped as separate packages and require field assembly.

Grommet Location
 (Add \$77 per grommet)

- No Grommet **GN**
- Left **GL**
- Right **GR**
- Left & Right **GB**

Specify location first, then select grommet color or "Empty Cutout" option. When "Empty Cutout" option is selected, a grommet or power unit must be ordered separately for each cutout.

TO ORDER PLEASE SPECIFY THE FOLLOWING:

WOOD TOP

1. **MODEL NUMBER + W**
2. **FSC**
3. **TOP WOOD FINISH + EDGE**
4. **TOP UV FINISH**
5. **HARDWARE COLOR**
6. **GROMMET**

LAM TOP

1. **MODEL NUMBER + L**
2. **FSC**
3. **TOP LAM**
4. **EDGE DETAIL**
5. **HARDWARE COLOR**
6. **GROMMET**

RECTANGULAR EXTENSION

Left and Right Hand

Silea

03/23

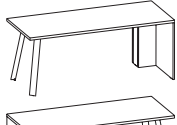
	D	W	H	model number + type	laminata	veneer 1	veneer 2
LEFT HAND 	30	66	29 1/2	GS2XRL3066L- []	2,419	3,412	3,767
	30	72	29 1/2	GS2XRL3072L- []	2,475	3,497	3,860
	36	72	29 1/2	GS2XRL3672L- []	2,592	3,677	4,059
	36	78	29 1/2	GS2XRL3678L- []	2,676	3,806	4,202

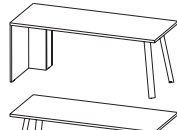
RIGHT HAND 	30	66	29 1/2	GS2XRL3066R- []	2,419	3,412	3,767
	30	72	29 1/2	GS2XRL3072R- []	2,475	3,497	3,860
	36	72	29 1/2	GS2XRL3672R- []	2,592	3,677	4,059
	36	78	29 1/2	GS2XRL3678R- []	2,676	3,806	4,202

- Extensions not for use as a freestanding unit, must attach to adjoining unit.

PRODUCT INFO

Specify legs from user seated position.

All tops long grain standard.

 Units shipped as separate packages and require field assembly.

Modesty panel ordered separately.

Grommet Location

(Add \$77 per grommet)

No Grommet **GN**
Left **GL**
Right **GR**
Left & Right **GB**

Specify location first, then select grommet color or "Empty Cutout" option. When "Empty Cutout" option is selected, a grommet or power unit must be ordered separately for each cutout.



TO ORDER PLEASE SPECIFY THE FOLLOWING:

WOOD TOP, WOOD CHASSIS

1. **MODEL NUMBER + WW**
2. **FSC**
3. **TOP WOOD FINISH + EDGE**
4. **CHASSIS WOOD FINISH**
5. **TOP UV FINISH**
6. **HARDWARE COLOR**
7. **GROMMET**

LAM TOP, LAM CHASSIS

1. **MODEL NUMBER + LL**
2. **FSC**
3. **TOP LAM**
4. **CHASSIS LAM**
5. **EDGE DETAIL**
6. **HARDWARE COLOR**
7. **GROMMET**

	D	W	H	model number + type	laminata	veneer 1	veneer 2
LEFT HAND 	30	66	29 1/2	GS2XRT3066L- []	2,753	4,499	4,967
	30	72	29 1/2	GS2XRT3072L- []	2,820	4,605	5,084
RIGHT HAND 	30	66	29 1/2	GS2XRT3066R- []	2,753	4,499	4,967
	30	72	29 1/2	GS2XRT3072R- []	2,820	4,605	5,084
LEFT HAND 	42	42	29 1/2	GS2XDT4272- []	3,691	5,968	6,589
	42	48	29 1/2	GS2XBT4272- []	3,691	5,968	6,589

• Extensions not for use as a freestanding unit, must attach to adjoining unit.

PRODUCT INFO

Specify column from user seated position.

Wood tops optional grain.

Laminate tops long grain standard.

 Units shipped as separate packages and require field assembly.

Grommet Location

(Add \$77 per grommet)

No Grommet **GN**
 Left **GL**
 Right **GR**
 Left & Right **GB**

Specify location first, then select grommet color or "Empty Cutout" option. When "Empty Cutout" option is selected, a grommet or power unit must be ordered separately for each cutout.

TO ORDER PLEASE SPECIFY THE FOLLOWING:

WOOD TOP, WOOD CHASSIS

- MODEL NUMBER + WW**
- FSC**
- TOP WOOD FINISH + EDGE**
- CHASSIS WOOD FINISH**
- TOP UV FINISH**
- GRAIN DIRECTION**
- HARDWARE COLOR**
- GROMMET**

LAM TOP, LAM CHASSIS

- MODEL NUMBER + LL**
- FSC**
- TOP LAM**
- CHASSIS LAM**
- EDGE DETAIL**
- HARDWARE COLOR**
- GROMMET**

RUNOFFS

15" Pedestal | Full Modesty

Silea

03/23

	D	W	H	model number + type	laminate	veneer 1	veneer 2
LEFT HAND	30	48	29 1/2	GS2RROF3048L-3 <input type="checkbox"/>	3,351	5,145	5,680
	30	54	29 1/2	GS2RROF3054L-3 <input type="checkbox"/>	3,384	5,200	5,741
	36	54	29 1/2	GS2RROF3654L-3 <input type="checkbox"/>	3,445	5,107	5,638
	36	60	29 1/2	GS2RROF3660L-3 <input type="checkbox"/>	3,491	5,170	5,708

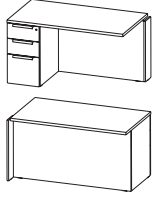

RIGHT HAND	30	48	29 1/2	GS2RROF3048R-3 <input type="checkbox"/>	3,351	5,145	5,680
	30	54	29 1/2	GS2RROF3054R-3 <input type="checkbox"/>	3,384	5,200	5,741
	36	54	29 1/2	GS2RROF3654R-3 <input type="checkbox"/>	3,445	5,107	5,638
	36	60	29 1/2	GS2RROF3660R-3 <input type="checkbox"/>	3,491	5,170	5,708

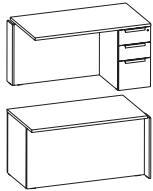

• Flat brackets ordered separately (model #MDWBRK)

PRODUCT INFO

Specify pedestal from user seated position.

Wood tops optional grain.

Laminate tops long grain standard.

 Units shipped as separate packages and require field assembly.

Grommet Location

(Add \$77 per grommet)

No Grommet	GN
Left	GL
Right	GR
Left & Right	GB

Specify location first, then select grommet color or "Empty Cutout" option. When "Empty Cutout" option is selected, a grommet or power unit must be ordered separately for each cutout.

TO ORDER PLEASE SPECIFY THE FOLLOWING:

WOOD TOP, WOOD CHASSIS

1. **MODEL NUMBER + WW**
2. **FSC**
3. **TOP WOOD FINISH + EDGE**
4. **CHASSIS WOOD FINISH**
5. **TOP UV FINISH**
6. **GRAIN DIRECTION**
7. **PULL**
8. **DRAWERS**
9. **GROMMET**
10. **KEYING**

LAM TOP, LAM CHASSIS

1. **MODEL NUMBER + LL**
2. **FSC**
3. **TOP LAM**
4. **CHASSIS LAM**
5. **FRONT LAM**
6. **GRAIN DIRECTION**
7. **EDGE DETAIL**
8. **PULL**
9. **DRAWER**
10. **GROMMET**
11. **KEYING**

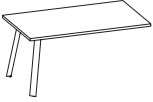
	D	W	H	model number + type	laminate	vener 1	vener 2
	30	48	29 1/2	GS2RRL3048- []	1,355	1,896	2,094
	30	54	29 1/2	GS2RRL3054- []	1,439	1,988	2,196
	36	54	29 1/2	GS2RRL3654- []	1,498	2,077	2,293
	36	60	29 1/2	GS2RRL3660- []	1,518	2,110	2,330

- Flat brackets ordered separately (model #MDWBRK)

PRODUCT INFO

All tops short grain standard.

 Units shipped as separate packages and require field assembly.

Grommet Location
(Add \$77 per grommet)

No Grommet **GN**
Left **GL**
Right **GR**
Left & Right **GB**

Specify location first, then select grommet color or "Empty Cutout" option. When "Empty Cutout" option is selected, a grommet or power unit must be ordered separately for each cutout.

TO ORDER PLEASE SPECIFY THE FOLLOWING:

WOOD TOP

- 1. MODEL NUMBER + W**
- 2. FSC**
- 3. TOP WOOD FINISH + EDGE**
- 4. TOP UV FINISH**
- 5. HARDWARE COLOR**
- 6. GROMMET**

LAM TOP

- 1. MODEL NUMBER + L**
- 2. FSC**
- 3. TOP LAM**
- 4. EDGE DETAIL**
- 5. HARDWARE COLOR**
- 6. GROMMET**

LAYERS RECTANGULAR RUNOFF W/ LAYERS BOX

Left and Right Hand

Silea
03/23

	D	W	H	model number + type	laminate	veneer 1	veneer 2
LEFT HAND 	30	66	29 1/2	GS2RLRL3066L- []	1,950	2,529	2,792
	30	72	29 1/2	GS2RLRL3072L- []	2,006	2,614	2,886
	36	72	29 1/2	GS2RLRL3672L- []	2,121	2,776	3,065
	36	78	29 1/2	GS2RLRL3678L- []	2,205	2,905	3,207

RIGHT HAND 	30	66	29 1/2	GS2RLRL3066R- []	1,950	2,529	2,792
	30	72	29 1/2	GS2RLRL3072R- []	2,006	2,614	2,886
	36	72	29 1/2	GS2RLRL3672R- []	2,121	2,776	3,065
	36	78	29 1/2	GS2RLRL3678R- []	2,205	2,905	3,207

Layers Box

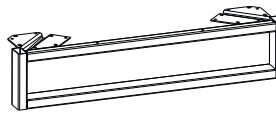

Side view

PRODUCT INFO

Specify legs from user seated position.

All tops long grain standard.

 Units shipped as separate packages and require field assembly.

Grommet Location
(Add \$77 per grommet)

No Grommet **GN**
Left **GL**
Right **GR**
Left & Right **GB**

Specify location first, then select grommet color or "Empty Cutout" option. When "Empty Cutout" option is selected, a grommet or power unit must be ordered separately for each cutout.

TO ORDER PLEASE SPECIFY THE FOLLOWING:

WOOD TOP



1. MODEL NUMBER + W
2. FSC
3. TOP WOOD FINISH + EDGE
4. TOP UV FINISH
5. HARDWARE COLOR (LEG)
6. HARDWARE COLOR (LAYERS BOX)
7. GROMMET

LAM TOP

1. MODEL NUMBER + L
2. FSC
3. TOP LAM
4. EDGE DETAIL
5. HARDWARE COLOR (LEG)
6. HARDWARE COLOR (LAYERS BOX)
9. GROMMET

LAYERS RECTANGULAR RUNOFF W/ LAPTOP DRAWER

Left and Right Hand

	D	W	H	model number + type	laminata	venerer 1	venerer 2
LEFT HAND 	30	66	29 1/2	GS2RLRLS3066L- []	2,356	3,370	3,719
	30	72	29 1/2	GS2RLRLS3072L- []	2,411	3,454	3,812
	36	72	29 1/2	GS2RLRLS3672L- []	2,549	3,603	3,976
	36	78	29 1/2	GS2RLRLS3678L- []	2,632	3,731	4,117
RIGHT HAND 	30	66	29 1/2	GS2RLRLS3066R- []	2,356	3,370	3,719
	30	72	29 1/2	GS2RLRLS3072R- []	2,411	3,454	3,812
	36	72	29 1/2	GS2RLRLS3672R- []	2,549	3,603	3,976
	36	78	29 1/2	GS2RLRLS3678R- []	2,632	3,731	4,117

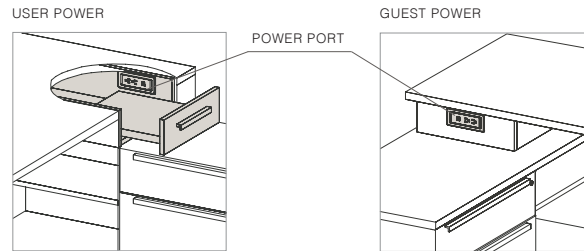

PRODUCT INFO

Specify legs from user seated position.

All tops long grain standard.

 Units shipped as separate packages and require field assembly.

Power units included
(2 USB, 2 power)

Grommet Location
(Add \$77 per grommet)

No Grommet **GN**
Left **GL**
Right **GR**
Left & Right **GB**

Specify location first, then select grommet color or "Empty Cutout" option. When "Empty Cutout" option is selected, a grommet or power unit must be ordered separately for each cutout.

TO ORDER PLEASE SPECIFY THE FOLLOWING:

WOOD TOP

1. **MODEL NUMBER + W**
2. **FSC**
3. **TOP WOOD FINISH + EDGE**
4. **CHASSIS WOOD FINISH**
5. **TOP UV FINISH**
6. **PULL**
7. **HARDWARE COLOR**
8. **GROMMET**
9. **POWER UNIT**

LAM TOP

1. **MODEL NUMBER + L**
2. **FSC**
3. **TOP LAM**
4. **CHASSIS LAM**
5. **EDGE DETAIL**
6. **HARDWARE COLOR**
7. **GROMMET**
8. **POWER UNIT**

ELLIPSE TABLE DESK

Silea
03/23



D	W	H	model number + type	laminata	veneer 1	veneer 2	solid surface
36	72	29 1/2	GS2TEL3672- []	2,889	4,185	4,620	10,098
42	84	29 1/2	GS2TEL4284- []	4,211	6,212	6,858	16,981

PRODUCT INFO

All tops long grain standard.
 Units shipped as separate packages and require field assembly.

TO ORDER PLEASE SPECIFY THE FOLLOWING:

WOOD TOP

1. **MODEL NUMBER + W**
2. **FSC**
3. **TOP WOOD FINISH + EDGE**
4. **TOP UV FINISH**
5. **HARDWARE COLOR**

LAM TOP

1. **MODEL NUMBER + L**
2. **FSC**
3. **TOP LAM**
4. **EDGE DETAIL**
5. **HARDWARE COLOR**

SOLID SURFACE TOP

1. **MODEL NUMBER + S**
2. **SOLID SURFACE**
3. **EDGE DETAIL**
4. **HARDWARE COLOR**

LAYERS ELLIPSE RUNOFF W/ LAYERS BOX



D	W	H	model number + type	laminate	veneer 1	veneer 2	solid surface
36	72	29 1/2	GS2RLEL3672- []	2,751	4,047	4,468	10,602
42	84	29 1/2	GS2RLEL4284- []	4,042	6,039	6,666	17,827

Layers Box

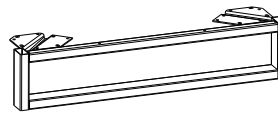

Side view

PRODUCT INFO

All tops long grain standard.

 Units shipped as separate packages and require field assembly.

TO ORDER PLEASE SPECIFY THE FOLLOWING:

WOOD TOP

1. **MODEL NUMBER + W**
2. **FSC**
3. **TOP WOOD FINISH + EDGE**
4. **TOP UV FINISH**
5. **HARDWARE COLOR (Leg)**
6. **HARDWARE COLOR (Layers Box)**

LAM TOP

1. **MODEL NUMBER + L**
2. **FSC**
3. **TOP LAM**
4. **EDGE DETAIL**
5. **HARDWARE COLOR (Leg)**
6. **HARDWARE COLOR (Layers Box)**

SOLID SURFACE TOP

1. **MODEL NUMBER + S**
2. **SOLID SURFACE**
3. **EDGE DETAIL**
4. **HARDWARE COLOR (Leg)**
5. **HARDWARE COLOR (Layers Box)**

ARC BOAT TABLE DESK

Silea
03/23

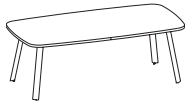

D	W	H	model number + type	laminata	veneer 1	veneer 2	solid surface
36	72	29 1/2	GS2TFL3672- []	2,963	4,259	4,702	10,100
42	84	29 1/2	GS2TFL4284- []	4,215	6,212	6,858	16,981

PRODUCT INFO

All tops long grain standard.
 Units shipped as separate packages and require field assembly.

TO ORDER PLEASE SPECIFY THE FOLLOWING:

WOOD TOP

1. **MODEL NUMBER + W**
2. **FSC**
3. **TOP WOOD FINISH + EDGE**
4. **TOP UV FINISH**
5. **HARDWARE COLOR**

LAM TOP

1. **MODEL NUMBER + L**
2. **FSC**
3. **TOP LAM**
4. **EDGE DETAIL**
5. **HARDWARE COLOR**

SOLID SURFACE TOP

1. **MODEL NUMBER + S**
2. **SOLID SURFACE**
3. **EDGE DETAIL**
4. **HARDWARE COLOR**

LAYERS ARC BOAT RUNOFF W/LAYERS BOX

	D	W	H	model number + type	laminate	veneer 1	veneer 2	solid surface
	36	72	29 1/2	GS2RLFL3672- []	2,751	4,047	4,468	10,602
	42	84	29 1/2	GS2RLFL4284- []	4,042	6,039	6,666	17,827

Layers Box

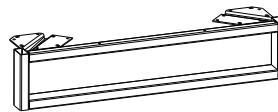

Side view

PRODUCT INFO

All tops long grain standard

 Units shipped as separate packages and require field assembly.

TO ORDER PLEASE SPECIFY THE FOLLOWING:

WOOD TOP

1. **MODEL NUMBER + W**
2. **FSC**
3. **TOP WOOD FINISH + EDGE**
4. **TOP UV FINISH**
5. **HARDWARE COLOR (Leg)**
6. **HARDWARE COLOR (Layers Box)**

LAM TOP

1. **MODEL NUMBER + L**
2. **FSC**
3. **TOP LAM**
4. **EDGE DETAIL**
5. **HARDWARE COLOR (Leg)**
6. **HARDWARE COLOR (Layers Box)**

SOLID SURFACE TOP

1. **MODEL NUMBER + S**
2. **SOLID SURFACE**
3. **EDGE DETAIL**
4. **HARDWARE COLOR (Leg)**
5. **HARDWARE COLOR (Layers Box)**

SIGHTLINE RUNOFF

Silea
03/23

	D	W	H	model number + type	laminata	veneer 1	veneer 2
	42	54	29 1/2	GS2RSL304254- []	1,951	2,818	3,112
	48	66	29 1/2	GS2RSL364866- []	2,126	2,966	3,275

- Flat brackets ordered separately (model #MDWBRK)

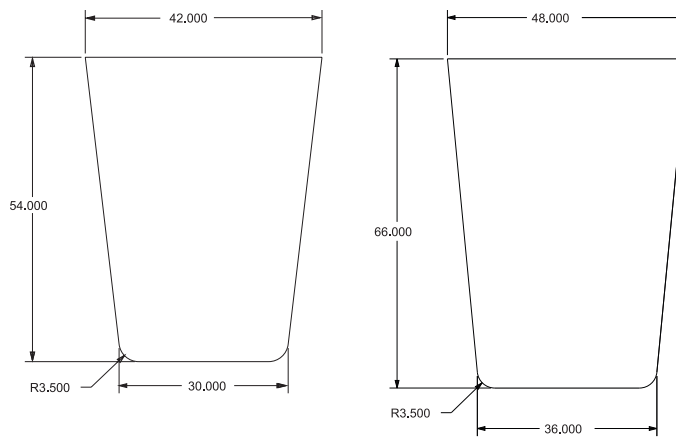

PRODUCT INFO

All tops short grain standard.

 Units shipped as separate packages and require field assembly.

TO ORDER PLEASE SPECIFY THE FOLLOWING:

WOOD TOP

1. **MODEL NUMBER + W**
2. **FSC**
3. **TOP WOOD FINISH + EDGE**
4. **TOP UV FINISH**
5. **HARDWARE COLOR**

LAM TOP

1. **MODEL NUMBER + L**
2. **FSC**
3. **TOP LAM**
4. **EDGE DETAIL**
5. **HARDWARE COLOR**

LAYERS SIGHTLINE RUNOFF W/ LAYERS BOX

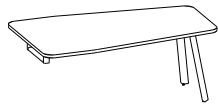

D	W	H	model number + type	laminate	veneer 1	veneer 2	solid surface
42	72	29 1/2	GS2RLSL304272- []	3,044	4,392	4,849	10,602
48	84	29 1/2	GS2RLSL364884- []	4,511	6,518	7,195	17,828

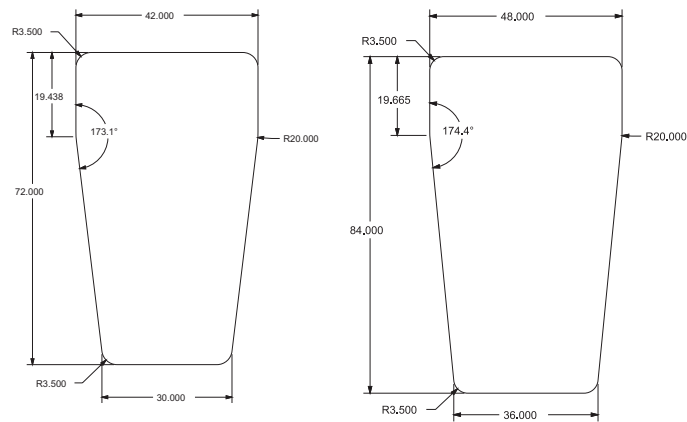

Layers Box

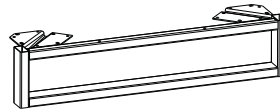

Side view

PRODUCT INFO

All tops long grain standard.

 Units shipped as separate packages and require field assembly.

TO ORDER PLEASE SPECIFY THE FOLLOWING:

WOOD TOP

1. MODEL NUMBER + W
2. FSC
3. TOP WOOD FINISH + EDGE
4. TOP UV FINISH
5. HARDWARE COLOR (Leg)
6. HARDWARE COLOR (Layers Box)

LAM TOP

1. MODEL NUMBER + L
2. FSC
3. TOP LAM
4. EDGE DETAIL
5. HARDWARE COLOR (Leg)
6. HARDWARE COLOR (Layers Box)

SOLID SURFACE TOP



1. MODEL NUMBER + S
2. SOLID SURFACE
3. EDGE DETAIL
4. HARDWARE COLOR (Leg)
5. HARDWARE COLOR (Layers Box)

LAYERS SIGHTLINE RUNOFF W/ LAPTOP DRAWER

Left and Right Hand

Silea

03/23

	D	W	H	model number + type	laminate	veneer 1	veneer 2
LEFT HAND 	42	72	29 1/2	GS2RLSLS304272L- []	3,372	5,155	5,690
	48	84	29 1/2	GS2RLSLS364884L- []	4,934	7,340	8,101
RIGHT HAND 	42	72	29 1/2	GS2RLSLS304272R- []	3,372	5,155	5,690
	48	84	29 1/2	GS2RLSLS364884R- []	4,934	7,340	8,101

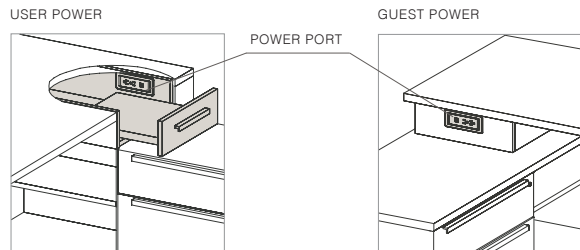

PRODUCT INFO

Specify legs from user seated position.

All tops long grain standard.

 Units shipped as separate packages and require field assembly.

Power units included (2 USB, 2 power)

TO ORDER PLEASE SPECIFY THE FOLLOWING:

WOOD TOP, WOOD CHASSIS

1. **MODEL NUMBER + W**
2. **FSC**
3. **TOP WOOD FINISH + EDGE**
4. **CHASSIS WOOD FINISH**
5. **TOP UV FINISH**
6. **PULL**
7. **HARDWARE COLOR**
8. **POWER UNIT**

LAM TOP, LAM CHASSIS

1. **MODEL NUMBER + L**
2. **FSC**
3. **TOP LAM**
4. **CHASSIS LAM**
5. **EDGE DETAIL**
6. **PULL**
7. **HARDWARE COLOR**
8. **POWER UNIT**

LAYERS COCKPIT RUNOFF W/ LAYERS BOX

Left and Right Hand

	D	W	H	model number + type	laminata	veneer 1	veneer 2	solid surface
LEFT HAND 	60	72	29 1/2	GS2RLC6072L- []	3,924	4,553	5,027	11,861
	60	84	29 1/2	GS2RLC6084L- []	5,466	6,785	7,490	19,448

RIGHT HAND 	60	72	29 1/2	GS2RLC6072R- []	3,924	4,553	5,027	11,861
	60	84	29 1/2	GS2RLC6084R- []	5,466	6,785	7,490	19,448

• All tops are 1 piece.

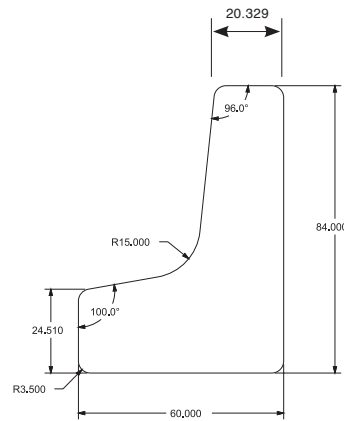
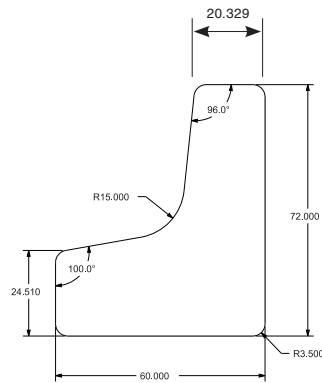

Layers Box



Side view

PRODUCT INFO

Specify legs from user seated position.

All tops long grain standard.

 Units shipped as separate packages and require field assembly.

TO ORDER PLEASE SPECIFY THE FOLLOWING:

WOOD TOP

1. MODEL NUMBER + W
2. FSC
3. TOP WOOD FINISH + EDGE
4. TOP UV FINISH*
5. HARDWARE COLOR

LAM TOP

1. MODEL NUMBER + L
2. FSC
3. TOP LAM
4. EDGE DETAIL
5. HARDWARE COLOR

SOLID SURFACE TOP

1. MODEL NUMBER + S
2. SOLID SURFACE
3. EDGE DETAIL
4. HARDWARE COLOR

• Only available in
OP open pore top
UV finish option

MEDIA TOP

w/ Wall Access Panel

Silea
03/23



D	W	H	model number + type	laminata	veneer 1	veneer 2
60	60	29 1/2	GS2XML366060- []	3,794	5,186	5,725
72	60	29 1/2	GS2XML487260- []	4,782	6,614	7,301

NOTE: UNIT MUST BE WALL MOUNTED

- Wood tops are 2 piece on both models (seam shown in drawing below)

- Laminate and solid surface tops are 1 piece.

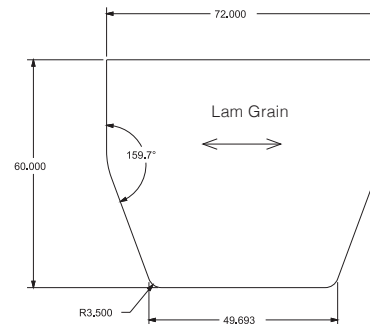
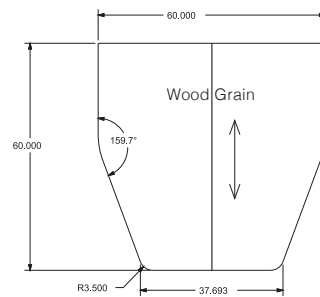

Arrows indicate grain direction.

PRODUCT INFO

All tops long grain standard.
 Units shipped as separate packages and require field assembly.

Grommet Location

(Add \$77 per grommet)

No Grommet **GN**
 Left **GL**
 Right **GR**
 Left & Right **GB**

Specify location first, then select grommet color or "Empty Cutout" option. When "Empty Cutout" option is selected, a grommet or power unit must be ordered separately for each cutout.

TO ORDER PLEASE SPECIFY THE FOLLOWING:

WOOD TOP, WOOD CHASSIS

1. **MODEL NUMBER + WW**
2. **FSC**
3. **TOP WOOD FINISH + EDGE**
4. **CHASSIS WOOD FINISH**
5. **TOP UV FINISH**
6. **HARDWARE COLOR**
7. **GROMMET**

LAM TOP, LAM CHASSIS

1. **MODEL NUMBER + LL**
2. **FSC**
3. **TOP LAM**
4. **CHASSIS LAM**
5. **EDGE DETAIL**
6. **HARDWARE COLOR**
7. **GROMMET**

Height Adjustable 79-123

- Height Adjustable Split-Top Desks 80-83
- Freestanding Desk / Extension 84-89
- Credenza 90-93
- Bridge 94-95
- Return 96-99
- L Shape Height Adjustable Spec Tips. 100
- L Shape Height Adjustable 101-116
- Shroud for T-Base 117
- Layers Bookcase 118
- Height Adjustable Base 119
- Height Adjustable Tops 120
- Wall Mount Cantilever Bracket 121
- Mixed Material Telescoping Height Adjustable 122
- Replacement Height Adjustable Keypads 123

HEIGHT ADJUSTABLE SPLIT-TOP DESKS

Silea

03/23

Left Hand Desk

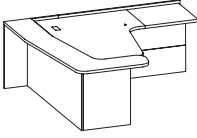
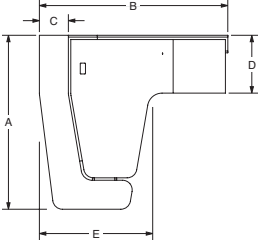
	D	W	H	model number + type	laminata	veneer 1	veneer 2
LEFT HAND DESK	72	78	29 1/2	GS3STAT7278L- []	13,154	18,617	20,550
	A = 72" wide desk B = 78" wide total workwall C = 12" fixed guest overhang D = 24" return depth E = 48" depth total sightline top						
	72	84	29 1/2	GS3STAT7284L- []	13,470	19,111	21,095
	A = 72" wide desk B = 84" wide total workwall C = 12" fixed guest overhang D = 24" return depth E = 48" depth total sightline top						
	78	90	29 1/2	GS3STAT7890L- []	13,743	19,538	21,567
	A = 78" wide desk B = 90" wide total workwall C = 18" fixed guest overhang D = 24" return depth E = 54" depth total sightline top						
	78	96	29 1/2	GS3STAT7896L- []	14,130	20,142	22,233
	A = 78" wide desk B = 96" wide total workwall C = 18" fixed guest overhang D = 24" return depth E = 54" depth total sightline top						

PRODUCT INFO

Unit must be wall mounted.

Metal shroud modesty panel raises up and down with height adjustable top.

29.5" to 42.5" height adjustment range.

 All units shipped as separate packages and require field assembly.

Grommet Location

(Add \$77 per grommet)

No Grommet **GN**
Center **GC**

Specify location first, then select grommet color or "Empty Cutout" option. When "Empty Cutout" option is selected, a grommet or power unit must be ordered separately for each cutout.

TO ORDER PLEASE SPECIFY THE FOLLOWING:

WOOD TOP, WOOD CHASSIS

1. MODEL NUMBER + WW
2. FSC
3. TOP WOOD FINISH + EDGE
4. CHASSIS WOOD FINISH
5. TOP UV FINISH
6. HARDWARE COLOR
7. HAT KEYPAD & BASE COLOR
8. GROMMET

LAM TOP, LAM CHASSIS

1. MODEL NUMBER + LL
2. FSC
3. TOP LAM
4. CHASSIS LAM
5. EDGE DETAIL
6. HARDWARE COLOR
7. HAT KEYPAD & BASE COLOR
8. GROMMET



Optional height adjustable keypads available

HAT KEYPAD & BASE COLOR

Basic Up/Down Keypad, Black P71 Column
Memory Preset Keypad, Black P71 Column
Paddle Keypad, Black P71 Column

UDP71
MEMP71
PDLP71

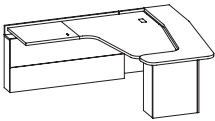
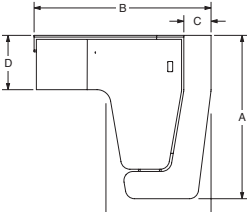
NOTE: Wood Tops only available with Square SQ Edge Detail option. Edge Details SQM, DFM, and TOM with 1/2" band are NOT available.

	D	W	H	model number + type	laminat	veneer 1	veneer 2
RIGHT HAND DESK 	72	78	29 1/2	GS3STAT7278R- []	13,154	18,617	20,550
	A = 72" wide desk B = 78" wide total workwall C = 12" fixed guest overhang D = 24" return depth E = 48" depth total sightline top						
	72	84	29 1/2	GS3STAT7284R- []	13,470	19,111	21,095
	A = 72" wide desk B = 84" wide total workwall C = 12" fixed guest overhang D = 24" return depth E = 48" depth total sightline top						
	78	90	29 1/2	GS3STAT7890R- []	13,743	19,538	21,567
	A = 78" wide desk B = 90" wide total workwall C = 18" fixed guest overhang D = 24" return depth E = 54" depth total sightline top						
	78	96	29 1/2	GS3STAT7896R- []	14,130	20,142	22,233
	A = 78" wide desk B = 96" wide total workwall C = 18" fixed guest overhang D = 24" return depth E = 54" depth total sightline top						

PRODUCT INFO

Unit must be wall mounted.

Metal shroud modesty panel raises up and down with height adjustable top.

29.5" to 42.5" height adjustment range.

 All units shipped as separate packages and require field assembly.

Grommet Location

(Add \$77 per grommet)

No Grommet **GN**
Center **GC**

Specify location first, then select grommet color or "Empty Cutout" option. When "Empty Cutout" option is selected, a grommet or power unit must be ordered separately for each cutout.

TO ORDER PLEASE SPECIFY THE FOLLOWING:

WOOD TOP, WOOD CHASSIS

1. MODEL NUMBER + WW
2. FSC
3. TOP WOOD FINISH + EDGE
4. CHASSIS WOOD FINISH
5. TOP UV FINISH
6. HARDWARE COLOR
7. HAT KEYPAD & BASE COLOR
8. GROMMET

LAM TOP, LAM CHASSIS

1. MODEL NUMBER + LL
2. FSC
3. TOP LAM
4. CHASSIS LAM
5. EDGE DETAIL
6. HARDWARE COLOR
7. HAT KEYPAD & BASE COLOR
8. GROMMET

Optional height adjustable keypads available

HAT KEYPAD & BASE COLOR

Basic Up/Down Keypad, Black P71 Column
Memory Preset Keypad, Black P71 Column
Paddle Keypad, Black P71 Column

UDP71
MEMP71
PDLP71

NOTE: Wood Tops only available with Square SQ Edge Detail option. Edge Details SQM, DFM, and TOM with 1/2" band are NOT available.

HEIGHT ADJUSTABLE SPLIT-TOP DESKS

Silea

03/23

Left Hand Desk, Return With Pedestal

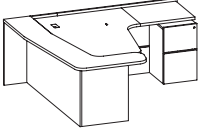
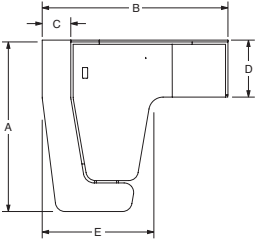
	D	W	H	model number + type	laminates	veneers 1	veneers 2
LEFT HAND DESK RETURN WITH PEDESTAL	72	78	29 1/2	GS3STAT7278L-A []	14,587	21,032	23,216
	A = 72" wide desk B = 78" wide total workwall C = 12" fixed guest overhang D = 24" return depth E = 48" depth total sightline top Note: Return includes 15" wide Accessory/Box/File pedestal						
	72	84	29 1/2	GS3STAT7284L-A []	14,908	21,527	23,762
	A = 72" wide desk B = 84" wide total workwall C = 12" fixed guest overhang D = 24" return depth E = 48" depth total sightline top Note: Return includes 15" wide Accessory/Box/File pedestal						
	78	90	29 1/2	GS3STAT7890L-A []	15,181	21,954	24,234
	A = 78" wide desk B = 90" wide total workwall C = 18" fixed guest overhang D = 24" return depth E = 54" depth total sightline top Note: Return includes 15" wide Accessory/Box/File pedestal						
	78	96	29 1/2	GS3STAT7896L-A []	15,566	22,557	24,899
	A = 78" wide desk B = 96" wide total workwall C = 18" fixed guest overhang D = 24" return depth E = 54" depth total sightline top Note: Return includes 15" wide Accessory/Box/File pedestal						

PRODUCT INFO

Unit must be wall mounted.

Metal shroud modesty panel raises up and down with height adjustable top.

29.5" to 42.5" height adjustment range.

 All units shipped as separate packages and require field assembly.

Grommet Location (Add \$77 per grommet)

No Grommet **GN**
Center **GC**

Specify location first, then select grommet color or "Empty Cutout" option. When "Empty Cutout" option is selected, a grommet or power unit must be ordered separately for each cutout.

NOTE: Monitor arms should **ALWAYS** be installed in grommets on Silea height adjustable units. Please ensure a grommet location is specified on the top. This allows for bolt mount or clamp mount install of monitor arm. See page 35 for details.

TO ORDER PLEASE SPECIFY THE FOLLOWING:

WOOD TOP, WOOD CHASSIS

LAM TOP, LAM CHASSIS

- | | |
|---------------------------------------|---------------------------------------|
| 1. MODEL NUMBER + WW | 1. MODEL NUMBER + LL |
| 2. FSC | 2. FSC |
| 3. TOP WOOD FINISH + EDGE | 3. TOP LAM |
| 4. CHASSIS WOOD FINISH | 4. CHASSIS LAM |
| 5. TOP UV FINISH | 5. FRONT LAM |
| 6. PULL | 6. EDGE DETAIL |
| 7. HARDWARE COLOR | 7. PULL |
| 8. HAT KEYPAD & BASE COLOR | 8. HARDWARE COLOR |
| 9. GROMMET | 9. HAT KEYPAD & BASE COLOR |
| 10. KEYING | 10. GROMMET |
| | 11. KEYING |

Optional height adjustable keypads available

HAT KEYPAD & BASE COLOR

Basic Up/Down Keypad, Black P71 Column	UDP71
Memory Preset Keypad, Black P71 Column	MEMP71
Paddle Keypad, Black P71 Column	PDLP71

NOTE: Wood Tops only available with Square SQ Edge Detail option. Edge Details SQM, DFM, and TOM with 1/2" band are NOT available.

HEIGHT ADJUSTABLE SPLIT-TOP DESKS

Right Hand Desk, Return With Pedestal

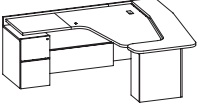
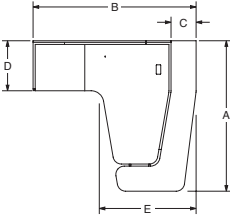
	D	W	H	model number + type	laminata	veneer 1	veneer 2
RIGHT HAND DESK RETURN WITH PEDESTAL	72	78	29 1/2	GS3STAT7278R-A []	14,587	21,032	23,216
	A = 72" wide desk B = 78" wide total workwall C = 12" fixed guest overhang D = 24" return depth E = 48" depth total sightline top Note: Return includes 15" wide Accessory/Box/File pedestal						
	72	84	29 1/2	GS3STAT7284R-A []	14,908	21,527	23,762
	A = 72" wide desk B = 84" wide total workwall C = 12" fixed guest overhang D = 24" return depth E = 48" depth total sightline top Note: Return includes 15" wide Accessory/Box/File pedestal						
	78	90	29 1/2	GS3STAT7890R-A []	15,181	21,954	24,234
	A = 78" wide desk B = 90" wide total workwall C = 18" fixed guest overhang D = 24" return depth E = 54" depth total sightline top Note: Return includes 15" wide Accessory/Box/File pedestal						
	78	96	29 1/2	GS3STAT7896R-A []	15,566	22,557	24,899
	A = 78" wide desk B = 96" wide total workwall C = 18" fixed guest overhang D = 24" return depth E = 54" depth total sightline top Note: Return includes 15" wide Accessory/Box/File pedestal						

PRODUCT INFO

Unit must be wall mounted.

Metal shroud modesty panel raises up and down with height adjustable top.

29.5" to 42.5" height adjustment range.

 All units shipped as separate packages and require field assembly.

Grommet Location (Add \$77 per grommet)

No Grommet **GN**
Center **GC**

Specify location first, then select grommet color or "Empty Cutout" option. When "Empty Cutout" option is selected, a grommet or power unit must be ordered separately for each cutout.

NOTE: Monitor arms should **ALWAYS** be installed in grommets on Silea height adjustable units. Please ensure a grommet location is specified on the top. This allows for bolt mount or clamp mount install of monitor arm. See page 35 for details.

TO ORDER PLEASE SPECIFY THE FOLLOWING:

WOOD TOP, WOOD CHASSIS

LAM TOP, LAM CHASSIS

- | | |
|---------------------------------------|---------------------------------------|
| 1. MODEL NUMBER + WW | 1. MODEL NUMBER + LL |
| 2. FSC | 2. FSC |
| 3. TOP WOOD FINISH + EDGE | 3. TOP LAM |
| 4. CHASSIS WOOD FINISH | 4. CHASSIS LAM |
| 5. TOP UV FINISH | 5. FRONT LAM |
| 6. PULL | 6. EDGE DETAIL |
| 7. HARDWARE COLOR | 7. PULL |
| 8. HAT KEYPAD & BASE COLOR | 8. HARDWARE COLOR |
| 9. GROMMET | 9. HAT KEYPAD & BASE COLOR |
| 10. KEYING | 10. GROMMET |
| | 11. KEYING |

Optional height adjustable keypads available

HAT KEYPAD & BASE COLOR

Basic Up/Down Keypad, Black P71 Column	UDP71
Memory Preset Keypad, Black P71 Column	MEMP71
Paddle Keypad, Black P71 Column	PDLP71



NOTE: Wood Tops only available with Square SQ Edge Detail option. Edge Details SQM, DFM, and TOM with 1/2" band are NOT available.

HEIGHT ADJUSTABLE FREESTANDING DESK

Full Modesty

Silea

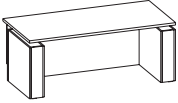
03/23

	D	W	H	model number + type	laminate	veneer 1	veneer 2
	30	66	29 1/2	GS3DFAK3066- []	5,868	10,995	12,138
	30	72	29 1/2	GS3DFAK3072- []	5,962	11,219	12,385
	36	72	29 1/2	GS3DFAK3672- []	6,271	11,448	12,638
	36	78	29 1/2	GS3DFAK3678- []	6,392	11,675	12,888

- Provides sit to stand electric height adjustment
- 29.5" to 42.5" height adjustment range

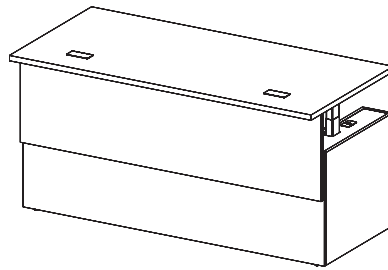

PRODUCT INFO

All tops long grain standard.
Wood models ship assembled.
 Laminate units shipped as separate packages and require field assembly.

Grommet Location (Add \$77 per grommet)

No Grommet **GN**
Left **GL**
Right **GR**
Left & Right **GB**

Specify location first, then select grommet color or "Empty Cutout" option. When "Empty Cutout" option is selected, a grommet or power unit must be ordered separately for each cutout.

NOTE: Monitor arms should **ALWAYS** be installed in grommets on Silea height adjustable units. Please ensure a grommet location is specified on the top. This allows for bolt mount or clamp mount install of monitor arm. See page 35 for details.

TO ORDER PLEASE SPECIFY THE FOLLOWING:

WOOD TOP, WOOD CHASSIS

- MODEL NUMBER + WW**
- FSC**
- TOP WOOD FINISH + EDGE**
- CHASSIS WOOD FINISH**
- TOP UV FINISH**
- HAT KEYPAD & BASE COLOR**
- GROMMET**

LAM TOP, LAM CHASSIS

- MODEL NUMBER + LL**
- FSC**
- TOP LAM**
- CHASSIS LAM**
- EDGE DETAIL**
- HAT KEYPAD & BASE COLOR**
- GROMMET**

Optional height adjustable keypads available

HAT KEYPAD & BASE COLOR

Basic Up/Down Keypad, Black P71 Column
Memory Preset Keypad, Black P71 Column
Paddle Keypad, Black P71 Column

UDP71
MEMP71
PDLP71

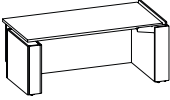
	D	W	H	model number + type	laminate	veneer 1	veneer 2
LEFT HAND 	30	66	29 1/2	GS3XFAK3066L- <input type="checkbox"/>	6,244	10,995	12,138
	30	72	29 1/2	GS3XFAK3072L- <input type="checkbox"/>	6,338	11,219	12,385
	36	72	29 1/2	GS3XFAK3672L- <input type="checkbox"/>	6,607	11,448	12,638
	36	78	29 1/2	GS3XFAK3678L- <input type="checkbox"/>	6,728	11,675	12,888

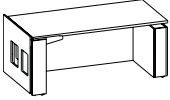
RIGHT HAND 	30	66	29 1/2	GS3XFAK3066R- <input type="checkbox"/>	6,244	10,995	12,138
	30	72	29 1/2	GS3XFAK3072R- <input type="checkbox"/>	6,338	11,219	12,385
	36	72	29 1/2	GS3XFAK3672R- <input type="checkbox"/>	6,607	11,448	12,638
	36	78	29 1/2	GS3XFAK3678R- <input type="checkbox"/>	6,728	11,675	12,888

- Provides sit to stand electric height adjustment
- 29.5" to 42.5" height adjustment range
- Cantilever extends 3" to support adjoining worksurface

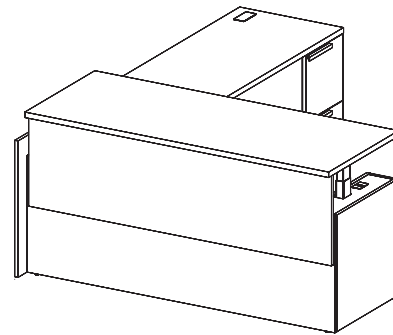

NOTE: If attaching to a return or bridge, a 3" shorter modesty or wall access panel must be used.

PRODUCT INFO

Specify base from user seated position.

All tops long grain standard.

Wood models ship assembled.

 Laminate units shipped as separate packages and require field assembly.

Grommet Location (Add \$77 per grommet)

No Grommet **GN**
Left **GL**
Right **GR**
Left & Right **GB**

Specify location first, then select grommet color or "Empty Cutout" option. When "Empty Cutout" option is selected, a grommet or power unit must be ordered separately for each cutout.

NOTE: Monitor arms should **ALWAYS** be installed in grommets on Silea height adjustable units. Please ensure a grommet location is specified on the top. This allows for bolt mount or clamp mount install of monitor arm. See page 35 for details.

TO ORDER PLEASE SPECIFY THE FOLLOWING:

WOOD TOP, WOOD CHASSIS

- MODEL NUMBER + WW**
- FSC**
- TOP WOOD FINISH + EDGE**
- CHASSIS WOOD FINISH**
- TOP UV FINISH**
- HAT KEYPAD & BASE COLOR**
- GROMMET**

LAM TOP, LAM CHASSIS

- MODEL NUMBER + LL**
- FSC**
- TOP LAM**
- CHASSIS LAM**
- EDGE DETAIL**
- HAT KEYPAD & BASE COLOR**
- GROMMET**

Optional height adjustable keypads available

HAT KEYPAD & BASE COLOR

Basic Up/Down Keypad, Black P71 Column
Memory Preset Keypad, Black P71 Column
Paddle Keypad, Black P71 Column

UDP71
MEMP71
PDL71

HEIGHT ADJUSTABLE EXTENSION DESK

Full Modesty | Left and Right Hand, with Pedestal

Silea

03/23

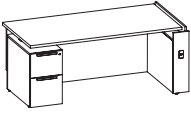
	D	W	H	model number + type	laminate	veneer 1	veneer 2
LEFT HAND 	30	66	29 1/2	GS3XFAK3066L-A <input type="checkbox"/>	6,826	12,092	13,348
	30	72	29 1/2	GS3XFAK3072L-A <input type="checkbox"/>	6,920	12,340	13,622
	36	72	29 1/2	GS3XFAK3672L-A <input type="checkbox"/>	7,160	12,591	13,899
	36	78	29 1/2	GS3XFAK3678L-A <input type="checkbox"/>	7,281	12,844	14,179

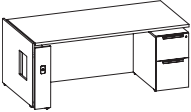
RIGHT HAND 	30	66	29 1/2	GS3XFAK3066R-A <input type="checkbox"/>	6,826	12,092	13,348
	30	72	29 1/2	GS3XFAK3072R-A <input type="checkbox"/>	6,920	12,340	13,622
	36	72	29 1/2	GS3XFAK3672R-A <input type="checkbox"/>	7,160	12,591	13,899
	36	78	29 1/2	GS3XFAK3678R-A <input type="checkbox"/>	7,281	12,844	14,179

- Provides sit to stand electric height adjustment
- 29.5" to 42.5" height adjustment range
- Cantilever extends 3" to support adjoining worksurface

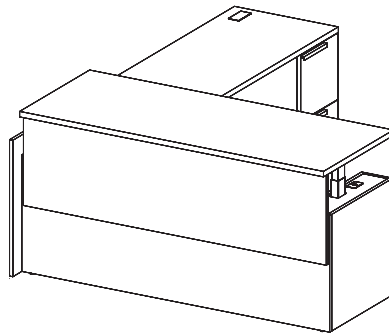

NOTE: If attaching to a return or bridge, a 3" shorter modesty or wall access panel must be used.

PRODUCT INFO

Specify pedestal from user seated position.

All tops long grain standard.

Wood models ship assembled.

 Laminate units shipped as separate packages and require field assembly.

Grommet Location (Add \$77 per grommet)

No Grommet **GN**
 Left **GL**
 Right **GR**
 Left & Right **GB**

Specify location first, then select grommet color or "Empty Cutout" option. When "Empty Cutout" option is selected, a grommet or power unit must be ordered separately for each cutout.

NOTE: Monitor arms should **ALWAYS** be installed in grommets on Silea height adjustable units. Please ensure a grommet location is specified on the top. This allows for bolt mount or clamp mount install of monitor arm. See page 35 for details.

TO ORDER PLEASE SPECIFY THE FOLLOWING:

WOOD TOP, WOOD CHASSIS

1. **MODEL NUMBER + WW**
2. **FSC**
3. **TOP WOOD FINISH + EDGE**
4. **CHASSIS WOOD FINISH**
5. **TOP UV FINISH**
6. **PULL**
7. **HAT KEYPAD & BASE COLOR**
8. **GROMMET**
9. **KEYING**

LAM TOP, LAM CHASSIS

1. **MODEL NUMBER + LL**
2. **FSC**
3. **TOP LAM**
4. **CHASSIS LAM**
5. **FRONT LAM**
6. **EDGE DETAIL**
7. **PULL**
8. **HAT KEYPAD & BASE COLOR**
9. **GROMMET**
10. **KEYING**

Optional height adjustable keypads available

HAT KEYPAD & BASE COLOR

Basic Up/Down Keypad, Black P71 Column
 Memory Preset Keypad, Black P71 Column
 Paddle Keypad, Black P71 Column

UDP71
MEMP71
PDLP71

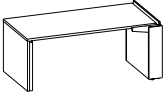
	D	W	H	model number + type	laminata	veneer 1	veneer 2
LEFT HAND 	30	66	29 1/2	GS3XMAK3066L- <input type="checkbox"/>	6,580	10,421	11,504
	30	72	29 1/2	GS3XMAK3072L- <input type="checkbox"/>	6,635	10,568	11,666
	36	72	29 1/2	GS3XMAK3672L- <input type="checkbox"/>	6,904	10,803	11,925
	36	78	29 1/2	GS3XMAK3678L- <input type="checkbox"/>	6,987	10,997	12,140

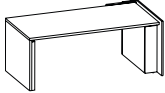
RIGHT HAND 	30	66	29 1/2	GS3XMAK3066R- <input type="checkbox"/>	6,580	10,421	11,504
	30	72	29 1/2	GS3XMAK3072R- <input type="checkbox"/>	6,635	10,568	11,666
	36	72	29 1/2	GS3XMAK3672R- <input type="checkbox"/>	6,904	10,803	11,925
	36	78	29 1/2	GS3XMAK3678R- <input type="checkbox"/>	6,987	10,997	12,140

- Provides sit to stand electric height adjustment
- 29.5" to 42.5" height adjustment range
- Cantilever extends 3" to support adjoining worksurface

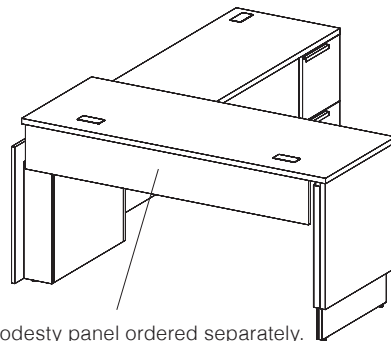

Modesty panel ordered separately.

NOTE: If attaching to a return or bridge, a 3" shorter modesty or wall access panel must be used.

PRODUCT INFO

Specify base from user seated position.

All tops long grain standard. Wood models ship assembled.

 Laminate units shipped as separate packages and require field assembly.

Modesty panel ordered separately.

Grommet Location

(Add \$77 per grommet)

No Grommet **GN**
Left **GL**
Right **GR**
Left & Right **GB**

Specify location first, then select grommet color or "Empty Cutout" option. When "Empty Cutout" option is selected, a grommet or power unit must be ordered separately for each cutout.

NOTE: Monitor arms should **ALWAYS** be installed in grommets on Silea height adjustable units. Please ensure a grommet location is specified on the top. This allows for bolt mount or clamp mount install of monitor arm. See page 35 for details.

TO ORDER PLEASE SPECIFY THE FOLLOWING:

WOOD TOP, WOOD CHASSIS

1. **MODEL NUMBER + WW**
2. **FSC**
3. **TOP WOOD FINISH + EDGE**
4. **CHASSIS WOOD FINISH**
5. **TOP UV FINISH**
6. **HARDWARE COLOR**
7. **HAT KEYPAD & BASE COLOR**
8. **GROMMET**

LAM TOP, LAM CHASSIS

1. **MODEL NUMBER + LL**
2. **FSC**
3. **TOP LAM**
4. **CHASSIS LAM**
5. **EDGE DETAIL**
6. **HARDWARE COLOR**
7. **HAT KEYPAD & BASE COLOR**
8. **GROMMET**

Optional height adjustable keypads available

HAT KEYPAD & BASE COLOR

Basic Up/Down Keypad, Black P71 Column
Memory Preset Keypad, Black P71 Column
Paddle Keypad, Black P71 Column



UDP71
MEMP71
PDLP71

HEIGHT ADJUSTABLE FREESTANDING DESK

Half Modesty

Silea

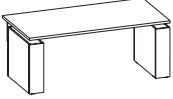
03/23

	D	W	H	model number + type	laminata	veneer 1	veneer 2
	30	66	29 1/2	GS3DHAK3066- []	5,705	9,345	10,316
	30	72	29 1/2	GS3DHAK3072- []	5,822	9,537	10,528
	36	72	29 1/2	GS3DHAK3672- []	6,131	9,730	10,741
	36	78	29 1/2	GS3DHAK3678- []	6,275	9,925	10,957

- Provides sit to stand electric height adjustment
- 29.5" to 42.5" height adjustment range

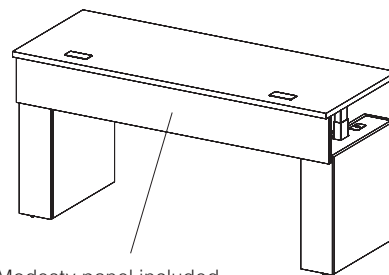

Modesty panel included.

PRODUCT INFO

All tops long grain standard.
Wood models ship assembled.

 Laminata units shipped as separate packages and require field assembly..

Grommet Location (Add \$77 per grommet)

No Grommet **GN**
Left **GL**
Right **GR**
Left & Right **GB**

Specify location first, then select grommet color or "Empty Cutout" option. When "Empty Cutout" option is selected, a grommet or power unit must be ordered separately for each cutout.

NOTE: Monitor arms should **ALWAYS** be installed in grommets on Silea height adjustable units. Please ensure a grommet location is specified on the top. This allows for bolt mount or clamp mount install of monitor arm. See page 35 for details.

TO ORDER PLEASE SPECIFY THE FOLLOWING:

WOOD TOP, WOOD CHASSIS

- MODEL NUMBER + WW**
- FSC**
- TOP WOOD FINISH + EDGE**
- CHASSIS WOOD FINISH**
- TOP UV FINISH**
- HAT KEYPAD & BASE COLOR**
- GROMMET**

LAM TOP, LAM CHASSIS

- MODEL NUMBER + LL**
- FSC**
- TOP LAM**
- CHASSIS LAM**
- EDGE DETAIL**
- HAT KEYPAD & BASE COLOR**
- GROMMET**

Optional height adjustable keypads available

HAT KEYPAD & BASE COLOR

Basic Up/Down Keypad, Black P71 Column
Memory Preset Keypad, Black P71 Column
Paddle Keypad, Black P71 Column

UDP71
MEMP71
PDLP71

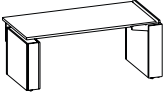
	D	W	H	model number + type	laminata	veneer 1	veneer 2
LEFT HAND 	30	66	29 1/2	GS3XHAK3066L- []	6,081	9,345	10,316
	30	72	29 1/2	GS3XHAK3072L- []	6,198	9,537	10,528
	36	72	29 1/2	GS3XHAK3672L- []	6,467	9,730	10,741
	36	78	29 1/2	GS3XHAK3678L- []	6,611	9,925	10,957

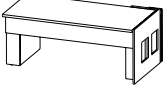
RIGHT HAND 	30	66	29 1/2	GS3XHAK3066R- []	6,081	9,345	10,316
	30	72	29 1/2	GS3XHAK3072R- []	6,198	9,537	10,528
	36	72	29 1/2	GS3XHAK3672R- []	6,467	9,730	10,741
	36	78	29 1/2	GS3XHAK3678R- []	6,611	9,925	10,957

- Provides sit to stand electric height adjustment
- 29.5" to 42.5" height adjustment range
- Cantilever extends 3" to support adjoining worksurface

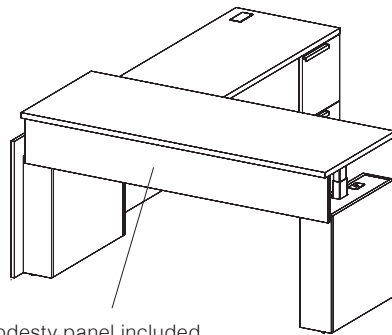

Modesty panel included.

NOTE: If attaching to a return or bridge, a 3" shorter modesty or wall access panel must be used.

PRODUCT INFO

Specify base from user seated position.

All tops long grain standard.

Wood models ship assembled.

 Laminate units shipped as separate packages and require field assembly.

Grommet Location (Add \$77 per grommet)

No Grommet **GN**
 Left **GL**
 Right **GR**
 Left & Right **GB**

Specify location first, then select grommet color or "Empty Cutout" option. When "Empty Cutout" option is selected, a grommet or power unit must be ordered separately for each cutout.

NOTE: Monitor arms should **ALWAYS** be installed in grommets on Silea height adjustable units. Please ensure a grommet location is specified on the top. This allows for bolt mount or clamp mount install of monitor arm. See page 35 for details.

TO ORDER PLEASE SPECIFY THE FOLLOWING:

WOOD TOP, WOOD CHASSIS

- MODEL NUMBER + WW**
- FSC**
- TOP WOOD FINISH + EDGE**
- CHASSIS WOOD FINISH**
- TOP UV FINISH**
- HAT KEYPAD & BASE COLOR**
- GROMMET**

LAM TOP, LAM CHASSIS

- MODEL NUMBER + LL**
- FSC**
- TOP LAM**
- CHASSIS LAM**
- EDGE DETAIL**
- HAT KEYPAD & BASE COLOR**
- GROMMET**

Optional height adjustable keypads available

HAT KEYPAD & BASE COLOR

Basic Up/Down Keypad, Black P71 Column
 Memory Preset Keypad, Black P71 Column
 Paddle Keypad, Black P71 Column

UDP71
MEMP71
PDLP71

HEIGHT ADJUSTABLE CREDENZA 24D

w/ Wall Access and End Panels

Silea

03/23

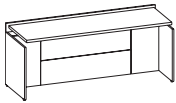
	D	W	H	model number + type	laminate	veneer 1	veneer 2
	24	42	29 1/2	GS3CAK2442- []	4,723	7,395	8,164
	24	48	29 1/2	GS3CAK2448- []	4,835	7,569	8,355
	24	54	29 1/2	GS3CAK2454- []	4,923	7,710	8,512
	24	60	29 1/2	GS3CAK2460- []	5,036	7,887	8,707
	24	66	29 1/2	GS3CAK2466- []	5,144	8,052	8,889
	24	72	29 1/2	GS3CAK2472- []	5,295	8,299	9,162

- Provides sit to stand electric height adjustment
- 29.5" to 42.5" height adjustment range

PRODUCT INFO

Wood tops optional grain standard. Lam tops optional grain up to 60", over 60" long grain standard.

Wood models ship assembled.

 Laminate units shipped as separate packages and require field assembly.

Grommet Location

(Add \$77 per grommet)

No Grommet **GN**
Center **GC**

Specify location first, then select grommet color or "Empty Cutout" option. When "Empty Cutout" option is selected, a grommet or power unit must be ordered separately for each cutout.

NOTE: Monitor arms should **ALWAYS** be installed in grommets on Silea height adjustable units. Please ensure a grommet location is specified on the top. This allows for bolt mount or clamp mount install of monitor arm. See page 35 for details.

TO ORDER PLEASE SPECIFY THE FOLLOWING:

WOOD TOP, WOOD CHASSIS

1. **MODEL NUMBER + WW**
2. **FSC**
3. **TOP WOOD FINISH + EDGE**
4. **CHASSIS WOOD FINISH**
5. **TOP UV FINISH**
6. **GRAIN DIRECTION**
7. **HAT KEYPAD & BASE COLOR**
8. **GROMMET**

LAM TOP, LAM CHASSIS

1. **MODEL NUMBER + LL**
2. **FSC**
3. **TOP LAM**
4. **CHASSIS LAM**
5. **GRAIN DIRECTION (up to 60")**
6. **EDGE DETAIL**
7. **HAT KEYPAD & BASE COLOR**
8. **GROMMET**

Optional height adjustable keypads available

HAT KEYPAD & BASE COLOR

Basic Up/Down Keypad, Black P71 Column
Memory Preset Keypad, Black P71 Column
Paddle Keypad, Black P71 Column

UDP71
MEMP71
PDLP71

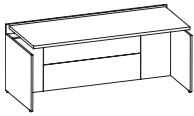
	D	W	H	model number + type	laminate	veneer 1	veneer 2
	30	42	29 1/2	GS3CAK3042- []	5,143	8,134	8,979
	30	48	29 1/2	GS3CAK3048- []	5,243	8,326	9,191
	30	54	29 1/2	GS3CAK3054- []	5,301	8,479	9,360
	30	60	29 1/2	GS3CAK3060- []	5,359	8,676	9,578
	30	66	29 1/2	GS3CAK3066- []	5,462	8,857	9,777
	30	72	29 1/2	GS3CAK3072- []	5,560	9,127	10,076

- Provides sit to stand electric height adjustment
- 29.5" to 42.5" height adjustment range

PRODUCT INFO

Wood tops optional grain standard. Lam tops optional grain up to 60", over 60" long grain standard.

Wood models ship assembled.

 Laminate units shipped as separate packages and require field assembly.

Grommet Location
(Add \$77 per grommet)

No Grommet **GN**
Center **GC**

Specify location first, then select grommet color or "Empty Cutout" option. When "Empty Cutout" option is selected, a grommet or power unit must be ordered separately for each cutout.

NOTE: Monitor arms should **ALWAYS** be installed in grommets on Silea height adjustable units. Please ensure a grommet location is specified on the top. This allows for bolt mount or clamp mount install of monitor arm. See page 35 for details.

TO ORDER PLEASE SPECIFY THE FOLLOWING:

WOOD TOP, WOOD CHASSIS

- MODEL NUMBER + WW**
- FSC**
- TOP WOOD FINISH + EDGE**
- CHASSIS WOOD FINISH**
- TOP UV FINISH**
- GRAIN DIRECTION**
- HAT KEYPAD & BASE COLOR**
- GROMMET**

LAM TOP, LAM CHASSIS

- MODEL NUMBER + LL**
- FSC**
- TOP LAM**
- CHASSIS LAM**
- GRAIN DIRECTION (up to 60")**
- EDGE DETAIL**
- HAT KEYPAD & BASE COLOR**
- GROMMET**

Optional height adjustable keypads available

HAT KEYPAD & BASE COLOR

Basic Up/Down Keypad, Black P71 Column
Memory Preset Keypad, Black P71 Column
Paddle Keypad, Black P71 Column

UDP71
MEMP71
PDLP71

HEIGHT ADJUSTABLE CREDENZA 24D

w/ Hidden Accessory | Box | File Pedestals

Silea

03/23

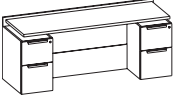
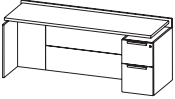
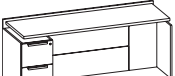
	D	W	H	model number + type	laminata	veneer 1	veneer 2
	24	66	29 1/2	GS3CAK2466-AA []	6,705	11,444	12,633
	24	72	29 1/2	GS3CAK2472-AA []	6,860	11,693	12,908
RIGHT HAND							
	24	66	29 1/2	GS3CAK2466R-A []	5,313	9,572	10,567
	24	72	29 1/2	GS3CAK2472R-A []	5,469	9,821	10,842
LEFT HAND							
	24	66	29 1/2	GS3CAK2466L-A []	5,313	9,572	10,567
	24	72	29 1/2	GS3CAK2472L-A []	5,469	9,821	10,842

- Provides sit to stand electric height adjustment
- 29.5" to 42.5" height adjustment range

PRODUCT INFO

Specify pedestal from user seated position.

Wood tops optional grain standard. Lam tops long grain standard.

Wood models ship assembled.

 Laminate units shipped as separate packages and require field assembly.

Grommet Location

(Add \$77 per grommet)

No Grommet **GN**
Center **GC**

Specify location first, then select grommet color or "Empty Cutout" option. When "Empty Cutout" option is selected, a grommet or power unit must be ordered separately for each cutout.

NOTE: Monitor arms should **ALWAYS** be installed in grommets on Silea height adjustable units. Please ensure a grommet location is specified on the top. This allows for bolt mount or clamp mount install of monitor arm. See page 35 for details.

TO ORDER PLEASE SPECIFY THE FOLLOWING:

WOOD TOP, WOOD CHASSIS

1. **MODEL NUMBER + WW**
2. **FSC**
3. **TOP WOOD FINISH + EDGE**
4. **CHASSIS WOOD FINISH**
5. **TOP UV FINISH**
6. **GRAIN DIRECTION**
7. **PULL**
8. **HAT KEYPAD & BASE COLOR**
9. **GROMMET**
10. **KEYING**

LAM TOP, LAM CHASSIS

1. **MODEL NUMBER + LL**
2. **FSC**
3. **TOP LAM**
4. **CHASSIS LAM**
5. **FRONT LAM**
6. **EDGE DETAIL**
7. **PULL**
8. **HAT KEYPAD & BASE COLOR**
9. **GROMMET**
10. **KEYING**

Optional height adjustable keypads available

HAT KEYPAD & BASE COLOR

Basic Up/Down Keypad, Black P71 Column
Memory Preset Keypad, Black P71 Column
Paddle Keypad, Black P71 Column

UDP71
MEMP71
PDLP71

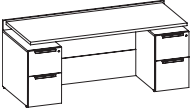
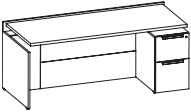
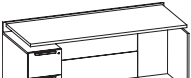
	D	W	H	model number + type	laminata	vener 1	vener 2
	30	66	29 1/2	GS3CAK3066-AA []	6,951	12,589	13,896
	30	72	29 1/2	GS3CAK3072-AA []	7,051	12,862	14,198
RIGHT HAND							
	30	66	29 1/2	GS3CAK3066R-A []	5,565	10,529	11,623
	30	72	29 1/2	GS3CAK3072R-A []	5,669	10,803	11,925
LEFT HAND							
	30	66	29 1/2	GS3CAK3066L-A []	5,565	10,529	11,623
	30	72	29 1/2	GS3CAK3072L-A []	5,669	10,803	11,925

- Provides sit to stand electric height adjustment
- 29.5" to 42.5" height adjustment range

PRODUCT INFO

Wood tops optional grain standard. Lam tops optional grain up to 60", over 60" long grain standard.

Wood models ship assembled.

 Laminate units shipped as separate packages and require field assembly.

Grommet Location
(Add \$77 per grommet)

No Grommet **GN**
Center **GC**

Specify location first, then select grommet color or "Empty Cutout" option. When "Empty Cutout" option is selected, a grommet or power unit must be ordered separately for each cutout.

NOTE: Monitor arms should **ALWAYS** be installed in grommets on Silea height adjustable units. Please ensure a grommet location is specified on the top. This allows for bolt mount or clamp mount install of monitor arm. See page 35 for details.

TO ORDER PLEASE SPECIFY THE FOLLOWING:

WOOD TOP, WOOD CHASSIS

- MODEL NUMBER + WW**
- FSC**
- TOP WOOD FINISH + EDGE**
- CHASSIS WOOD FINISH**
- TOP UV FINISH**
- GRAIN DIRECTION**
- PULL**
- HAT KEYPAD & BASE COLOR**
- GROMMET**
- KEYING**

LAM TOP, LAM CHASSIS

- MODEL NUMBER + LL**
- FSC**
- TOP LAM**
- CHASSIS LAM**
- FRONT LAM**
- EDGE DETAIL**
- PULL**
- HAT KEYPAD & BASE COLOR**
- GROMMET**
- KEYING**

Optional height adjustable keypads available

HAT KEYPAD & BASE COLOR

Basic Up/Down Keypad, Black P71 Column
Memory Preset Keypad, Black P71 Column
Paddle Keypad, Black P71 Column

UDP71
MEMP71
PDLP71

HEIGHT ADJUSTABLE BRIDGE 24D

w/ Wall Access

Silea

03/23

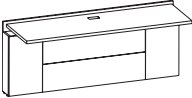
	D	W	H	model number + type	laminate	veneer 1	veneer 2
	24	42	29 1/2	GS3BAK2442- []	3,798	5,951	6,570
	24	48	29 1/2	GS3BAK2448- []	3,909	6,126	6,763
	24	54	29 1/2	GS3BAK2454- []	3,997	6,265	6,916
	24	60	29 1/2	GS3BAK2460- []	4,111	6,442	7,112
	24	66	29 1/2	GS3BAK2466- []	4,218	6,609	7,296
	24	72	29 1/2	GS3BAK2472- []	4,371	6,855	7,567

- **Unit must be wall mounted.**
- Provides sit to stand electric height adjustment
- 29.5" to 42.5" height adjustment range

PRODUCT INFO

Wood tops optional grain standard. Lam tops opt grain up to 60". over 60" long grain standard.

Wood models shipped assembled.

 Laminate units shipped as separate packages and require field assembly.

Grommet Location

(Add \$77 per grommet)

No Grommet **GN**
Center **GC**

Specify location first, then select grommet color or "Empty Cutout" option. When "Empty Cutout" option is selected, a grommet or power unit must be ordered separately for each cutout.

NOTE: Monitor arms should **ALWAYS** be installed in grommets on Silea height adjustable units. Please ensure a grommet location is specified on the top. This allows for bolt mount or clamp mount install of monitor arm. See page 35 for details.

TO ORDER PLEASE SPECIFY THE FOLLOWING:

WOOD TOP, WOOD CHASSIS

- MODEL NUMBER + WW**
- FSC**
- TOP WOOD FINISH + EDGE**
- CHASSIS WOOD FINISH**
- TOP UV FINISH**
- GRAIN DIRECTION**
- HAT KEYPAD & BASE COLOR**
- GROMMET**

LAM TOP, LAM CHASSIS

- MODEL NUMBER + LL**
- FSC**
- TOP LAM**
- CHASSIS LAM**
- GRAIN DIRECTION (up to 60")**
- EDGE DETAIL**
- HAT KEYPAD & BASE COLOR**
- GROMMET**

Optional height adjustable keypads available

HAT KEYPAD & BASE COLOR

Basic Up/Down Keypad, Black P71 Column
Memory Preset Keypad, Black P71 Column
Paddle Keypad, Black P71 Column

UDP71
MEMP71
PDLP71

	D	W	H	model number + type	laminate	veneer 1	veneer 2
	30	42	29 1/2	GS3BAK3042- []	3,996	6,248	6,897
	30	48	29 1/2	GS3BAK3048- []	4,090	6,433	7,102
	30	54	29 1/2	GS3BAK3054- []	4,146	6,578	7,262
	30	60	29 1/2	GS3BAK3060- []	4,202	6,765	7,469
	30	66	29 1/2	GS3BAK3066- []	4,298	6,941	7,662
	30	72	29 1/2	GS3BAK3072- []	4,396	7,197	7,945

- **Unit must be wall mounted.**
- Provides sit to stand electric height adjustment
- 29.5" to 42.5" height adjustment range

PRODUCT INFO

Wood tops optional grain standard. Lam tops optional grain up to 60", over 60" long grain standard.

Wood models shipped assembled.

Laminate units shipped as separate packages and require field assembly.

Grommet Location

(Add \$77 per grommet)

No Grommet **GN**
Center **GC**

Specify location first, then select grommet color or "Empty Cutout" option. When "Empty Cutout" option is selected, a grommet or power unit must be ordered separately for each cutout.

NOTE: Monitor arms should **ALWAYS** be installed in grommets on Silea height adjustable units. Please ensure a grommet location is specified on the top. This allows for bolt mount or clamp mount install of monitor arm. See page 35 for details.

TO ORDER PLEASE SPECIFY THE FOLLOWING:

WOOD TOP, WOOD CHASSIS

- MODEL NUMBER + WW**
- FSC**
- TOP WOOD FINISH + EDGE**
- CHASSIS WOOD FINISH**
- TOP UV FINISH**
- GRAIN DIRECTION**
- HAT KEYPAD & BASE COLOR**
- GROMMET**

LAM TOP, LAM CHASSIS

- MODEL NUMBER + LL**
- FSC**
- TOP LAM**
- CHASSIS LAM**
- GRAIN DIRECTION (up to 60")**
- EDGE DETAIL**
- HAT KEYPAD & BASE COLOR**
- GROMMET**

Optional height adjustable keypads available

HAT KEYPAD & BASE COLOR

Basic Up/Down Keypad, Black P71 Column
Memory Preset Keypad, Black P71 Column
Paddle Keypad, Black P71 Column

UDP71
MEMP71
PDLP71

HEIGHT ADJUSTABLE RETURN 24D

w/ End Panel | Left and Right Hand

Silea

03/23

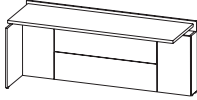
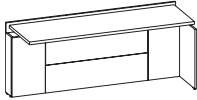
	D	W	H	model number + type	laminate	veneer 1	veneer 2
LEFT HAND 	24	42	29 1/2	GS3RAK2442L- <input type="checkbox"/>	4,260	6,672	7,366
	24	48	29 1/2	GS3RAK2448L- <input type="checkbox"/>	4,373	6,848	7,560
	24	54	29 1/2	GS3RAK2454L- <input type="checkbox"/>	4,460	6,987	7,713
	24	60	29 1/2	GS3RAK2460L- <input type="checkbox"/>	4,574	7,164	7,909
	24	66	29 1/2	GS3RAK2466L- <input type="checkbox"/>	4,679	7,331	8,093
	24	72	29 1/2	GS3RAK2472L- <input type="checkbox"/>	4,832	7,576	8,363
RIGHT HAND 	24	42	29 1/2	GS3RAK2442R- <input type="checkbox"/>	4,260	6,672	7,366
	24	48	29 1/2	GS3RAK2448R- <input type="checkbox"/>	4,373	6,848	7,560
	24	54	29 1/2	GS3RAK2454R- <input type="checkbox"/>	4,460	6,987	7,713
	24	60	29 1/2	GS3RAK2460R- <input type="checkbox"/>	4,574	7,164	7,909
	24	66	29 1/2	GS3RAK2466R- <input type="checkbox"/>	4,679	7,331	8,093
	24	72	29 1/2	GS3RAK2472R- <input type="checkbox"/>	4,832	7,576	8,363

- **Unit must be wall mounted.**
- Provides sit to stand electric height adjustment
- 29.5" to 42.5" height adjustment range

PRODUCT INFO

Wood tops optional grain standard. Lam tops optional grain up to 60", over 60" long grain standard.

Wood models ship assembled.

 Laminate units shipped as separate packages and require field assembly.

Grommet Location

(Add \$77 per grommet)

No Grommet **GN**
Center **GC**

Specify location first, then select grommet color or "Empty Cutout" option. When "Empty Cutout" option is selected, a grommet or power unit must be ordered separately for each cutout.

NOTE: Monitor arms should **ALWAYS** be installed in grommets on Silea height adjustable units. Please ensure a grommet location is specified on the top. This allows for bolt mount or clamp mount install of monitor arm. See page 35 for details.

TO ORDER PLEASE SPECIFY THE FOLLOWING:

WOOD TOP, WOOD CHASSIS

LAM TOP, LAM CHASSIS

- | | |
|---------------------------------------|---------------------------------------|
| 1. MODEL NUMBER + WW | 1. MODEL NUMBER + LL |
| 2. FSC | 2. FSC |
| 3. TOP WOOD FINISH + EDGE | 3. TOP LAM |
| 4. CHASSIS WOOD FINISH | 4. CHASSIS LAM |
| 5. TOP UV FINISH | 5. GRAIN DIRECTION (up to 60") |
| 6. GRAIN DIRECTION | 6. EDGE DETAIL |
| 7. HAT KEYPAD & BASE COLOR | 7. HAT KEYPAD & BASE COLOR |
| 8. GROMMET | 8. GROMMET |

Optional height adjustable keypads available

HAT KEYPAD & BASE COLOR

Basic Up/Down Keypad, Black P71 Column
Memory Preset Keypad, Black P71 Column
Paddle Keypad, Black P71 Column

UDP71
MEMP71
PDLP71

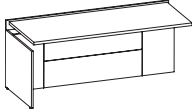
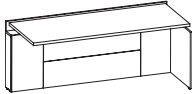
	D	W	H	model number + type	laminata	veneer 1	veneer 2
LEFT HAND 	30	42	29 1/2	GS3RAK3042L- <input type="checkbox"/>	4,635	7,340	8,102
	30	48	29 1/2	GS3RAK3048L- <input type="checkbox"/>	4,733	7,533	8,316
	30	54	29 1/2	GS3RAK3054L- <input type="checkbox"/>	4,792	7,685	8,483
	30	60	29 1/2	GS3RAK3060L- <input type="checkbox"/>	4,851	7,880	8,699
	30	66	29 1/2	GS3RAK3066L- <input type="checkbox"/>	4,950	8,063	8,901
	30	72	29 1/2	GS3RAK3072L- <input type="checkbox"/>	5,053	8,333	9,199
RIGHT HAND 	30	42	29 1/2	GS3RAK3042R- <input type="checkbox"/>	4,635	7,340	8,102
	30	48	29 1/2	GS3RAK3048R- <input type="checkbox"/>	4,733	7,533	8,316
	30	54	29 1/2	GS3RAK3054R- <input type="checkbox"/>	4,792	7,685	8,483
	30	60	29 1/2	GS3RAK3060R- <input type="checkbox"/>	4,851	7,880	8,699
	30	66	29 1/2	GS3RAK3066R- <input type="checkbox"/>	4,950	8,063	8,901
	30	72	29 1/2	GS3RAK3072R- <input type="checkbox"/>	5,053	8,333	9,199

- **Unit must be wall mounted.**
- Provides sit to stand electric height adjustment
- 29.5" to 42.5" height adjustment range

PRODUCT INFO

Wood tops optional grain standard. Lam tops optional grain up to 60", over 60" long grain standard.

Wood models ship assembled.

 Laminate units shipped as separate packages and require field assembly.

Grommet Location
(Add \$77 per grommet)

No Grommet **GN**
Center **GC**

Specify location first, then select grommet color or "Empty Cutout" option. When "Empty Cutout" option is selected, a grommet or power unit must be ordered separately for each cutout.

NOTE: Monitor arms should **ALWAYS** be installed in grommets on Silea height adjustable units. Please ensure a grommet location is specified on the top. This allows for bolt mount or clamp mount install of monitor arm. See page 35 for details.

TO ORDER PLEASE SPECIFY THE FOLLOWING:

WOOD TOP, WOOD CHASSIS

- MODEL NUMBER + WW**
- FSC**
- TOP WOOD FINISH + EDGE**
- CHASSIS WOOD FINISH**
- TOP UV FINISH**
- GRAIN DIRECTION**
- HAT KEYPAD & BASE COLOR**
- GROMMET**

LAM TOP, LAM CHASSIS

- MODEL NUMBER + LL**
- FSC**
- TOP LAM**
- CHASSIS LAM**
- GRAIN DIRECTION (up to 60")**
- EDGE DETAIL**
- HAT KEYPAD & BASE COLOR**
- GROMMET**

Optional height adjustable keypads available

HAT KEYPAD & BASE COLOR

Basic Up/Down Keypad, Black P71 Column
Memory Preset Keypad, Black P71 Column
Paddle Keypad, Black P71 Column

UDP71
MEMP71
PDLP71

HEIGHT ADJUSTABLE RETURN 24D

w/ Hidden Accessory | Box | File | Pedestals

Silea
03/23

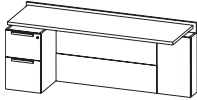
	D	W	H	model number + type	laminare	veneer 1	veneer 2
LEFT HAND 	24	42	29 1/2	GS3RAK2442L-A []	4,737	8,366	9,235
	24	48	29 1/2	GS3RAK2448L-A []	4,847	8,546	9,434
	24	54	29 1/2	GS3RAK2454L-A []	4,936	8,681	9,583
	24	60	29 1/2	GS3RAK2460L-A []	5,052	8,864	9,786
	24	66	29 1/2	GS3RAK2466L-A []	5,236	9,028	9,966
	24	72	29 1/2	GS3RAK2472L-A []	5,394	9,273	10,237

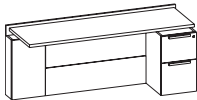
RIGHT HAND 	24	42	29 1/2	GS3RAK2442R-A []	4,737	8,366	9,235
	24	48	29 1/2	GS3RAK2448R-A []	4,847	8,546	9,434
	24	54	29 1/2	GS3RAK2454R-A []	4,936	8,681	9,583
	24	60	29 1/2	GS3RAK2460R-A []	5,052	8,864	9,786
	24	66	29 1/2	GS3RAK2466R-A []	5,236	9,028	9,966
	24	72	29 1/2	GS3RAK2472R-A []	5,394	9,273	10,237

- **Unit must be wall mounted.**
- Provides sit to stand electric height adjustment
- 29.5" to 42.5" height adjustment range

PRODUCT INFO

Wood tops optional grain standard. Lam tops optional grain up to 60", over 60" long grain standard.

If integral pull is chosen, the wall access panel will have a black knob.

Wood models ship assembled.

 Laminate units shipped as separate packages and require field assembly.

Grommet Location
(Add \$77 per grommet)

No Grommet **GN**
Center **GC**

Specify location first, then select grommet color or "Empty Cutout" option. When "Empty Cutout" option is selected, a grommet or power unit must be ordered separately for each cutout.

NOTE: Monitor arms should **ALWAYS** be installed in grommets on Silea height adjustable units. Please ensure a grommet location is specified on the top. This allows for bolt mount or clamp mount install of monitor arm. See page 35 for details.

TO ORDER PLEASE SPECIFY THE FOLLOWING:

WOOD TOP, WOOD CHASSIS

- MODEL NUMBER + WW**
- FSC**
- TOP WOOD FINISH + EDGE**
- CHASSIS WOOD FINISH**
- TOP UV FINISH**
- GRAIN DIRECTION**
- PULL**
- HAT KEYPAD & BASE COLOR**
- GROMMET**
- KEYING**

LAM TOP, LAM CHASSIS

- MODEL NUMBER + LL**
- FSC**
- TOP LAM**
- CHASSIS LAM**
- FRONT LAM**
- GRAIN DIRECTION (up to 60")**
- PULL**
- HAT KEYPAD & BASE COLOR**
- GROMMET**
- KEYING**

Optional height adjustable keypads available

HAT KEYPAD & BASE COLOR

Basic Up/Down Keypad, Black P71 Column
Memory Preset Keypad, Black P71 Column
Paddle Keypad, Black P71 Column

UDP71
MEMP71
PPLP71

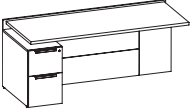
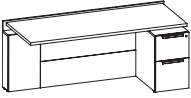
	D	W	H	model number + type	laminata	vener 1	vener 2
LEFT HAND 	30	42	29 1/2	GS3RAK3042L-A []	5,018	9,202	10,158
	30	48	29 1/2	GS3RAK3048L-A []	5,111	9,402	10,379
	30	54	29 1/2	GS3RAK3054L-A []	5,168	9,548	10,540
	30	60	29 1/2	GS3RAK3060L-A []	5,226	9,749	10,762
	30	66	29 1/2	GS3RAK3066L-A []	5,399	9,932	10,964
	30	72	29 1/2	GS3RAK3072L-A []	5,502	10,200	11,260
RIGHT HAND 	30	42	29 1/2	GS3RAK3042R-A []	5,018	9,202	10,158
	30	48	29 1/2	GS3RAK3048R-A []	5,111	9,402	10,379
	30	54	29 1/2	GS3RAK3054R-A []	5,168	9,548	10,540
	30	60	29 1/2	GS3RAK3060R-A []	5,226	9,749	10,762
	30	66	29 1/2	GS3RAK3066R-A []	5,399	9,932	10,964
	30	72	29 1/2	GS3RAK3072R-A []	5,502	10,200	11,260

- Unit must be wall mounted.
- Provides sit to stand electric height adjustment
- 29.5" to 42.5" height adjustment range

PRODUCT INFO

Wood tops optional grain standard. Lam tops optional grain up to 60", over 60" long grain standard. Wood models ship assembled.  Laminata units shipped as separate packages and require field assembly.

Grommet Location

(Add \$77 per grommet)

No Grommet **GN**
Center **GC**
Specify location first, then select grommet color or "Empty Cutout" option. When "Empty Cutout" option is selected, a grommet or power unit must be ordered separately for each cutout.

NOTE: Monitor arms should **ALWAYS** be installed in grommets on Silea height adjustable units. Please ensure a grommet location is specified on the top. This allows for bolt mount or clamp mount install of monitor arm. See page 35 for details.

TO ORDER PLEASE SPECIFY THE FOLLOWING:

WOOD TOP, WOOD CHASSIS

1. **MODEL NUMBER + WW**
2. **FSC**
3. **TOP WOOD FINISH + EDGE**
4. **CHASSIS WOOD FINISH**
5. **TOP UV FINISH**
6. **GRAIN DIRECTION**
7. **PULL**
8. **HAT KEYPAD & BASE COLOR**
9. **GROMMET**
10. **KEYING**

LAM TOP, LAM CHASSIS

1. **MODEL NUMBER + LL**
2. **FSC**
3. **TOP LAM**
4. **CHASSIS LAM**
5. **FRONT LAM**
6. **GRAIN DIRECTION (up to 60")**
7. **EDGE DETAIL**
8. **PULL**
9. **HAT KEYPAD & BASE COLOR**
10. **GROMMET**
11. **KEYING**

Optional height adjustable keypads available

HAT KEYPAD & BASE COLOR

Basic Up/Down Keypad, Black P71 Column
Memory Preset Keypad, Black P71 Column
Paddle Keypad, Black P71 Column

UDP71
MEMP71
PDLP71

Step 1: Select workwall chassis configuration and total width.



Bridge w/o Pedestals
(non-handed)

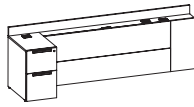

Return w/ Pedestal
Left Hand



Return w/ Pedestal
Right Hand

Step 2: Select desk chassis style and size.

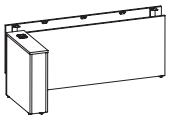

Full modesty,
shroud pedestal
(left hand shown)

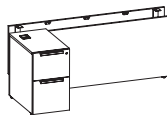

Full modesty,
pedestal
(left hand shown)

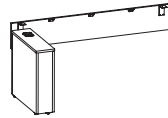

Half modesty,
shroud pedestal
(left hand shown)



Half modesty,
pedestal
(left hand shown)

Step 3. Order desk and return rectangular tops OR a 2-piece cockpit shape top.



Desk
30" or 36" Depth



Return
24" or 30" Depth

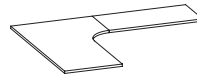

Cockpit Shape
2-piece
(left hand shown)

Note: for rectangular tops, flat brackets must be ordered separately.

Step 4. Order height adjustable hardware and bracketry kit. Select appropriate 3 motor or 4 motor kit based on total workwall length in Step 1.

Total Workwall Width	# Motors	Model # to Order
Workwall 72"	3	GS4LALNKDPD-3
Workwall 78"	3	GS4LALNKDPD-3
Workwall 84"	3	GS4LALNKDPD-3
Workwall 90"	3	GS4LALNKDPD-3
Workwall 96"	3	GS4LALNKDPD-3
Workwall 102"	4	GS4LALNKDPD-4
Workwall 108"	4	GS4LALNKDPD-4

NOTE: Monitor arms should **ALWAYS** be installed in grommets on Silea height adjustable units. Please ensure a grommet location is specified on the top. This allows for bolt mount or clamp mount install of monitor arm. See page 35 for details.

	D	W	H	model number + type	laminate	veneer 1	veneer 2
	7 1/4	72	27 7/8	GS4PLWFP72- []	1,820	3,399	3,753
	7 1/4	78	27 7/8	GS4PLWFP78- []	1,965	3,668	4,050
	7 1/4	84	27 7/8	GS4PLWFP84- []	2,041	3,820	4,217
	7 1/4	90	27 7/8	GS4PLWFP90- []	2,145	4,209	4,647
	7 1/4	96	27 7/8	GS4PLWFP96- []	2,133	4,125	4,554
	7 1/4	102	27 7/8	GS4PLWFP102- []	N/A	4,330	4,781
	7 1/4	108	27 7/8	GS4PLWFP108- []	N/A	4,539	5,011

PRODUCT INFO

Unit must be wall mounted.

Non-handed

 All units shipped as separate packages and require field assembly.

NOTE: Monitor arms should **ALWAYS** be installed in grommets on Silea height adjustable units. Please ensure a grommet location is specified on the top. This allows for bolt mount or clamp mount install of monitor arm. See page 35 for details.

TO ORDER PLEASE SPECIFY THE FOLLOWING:

WOOD CHASSIS

1. **MODEL NUMBER + W**
2. **FSC**
3. **CHASSIS WOOD FINISH**

LAM CHASSIS

1. **MODEL NUMBER + L**
2. **FSC**
3. **CHASSIS LAM**

L SHAPE HEIGHT ADJUSTABLE

Workwall, Left Hand Pedestal

Silea

03/23

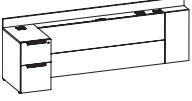
	D	W	H	model number + type	laminate	veneer 1	veneer 2
24" DEPTH PEDESTAL 	24	72	27 7/8	GS4PLWFP2472L-A []	3,351	5,950	6,569
	24	78	27 7/8	GS4PLWFP2478L-A []	3,414	6,083	6,716
	24	84	27 7/8	GS4PLWFP2484L-A []	3,490	6,236	6,884
	24	90	27 7/8	GS4PLWFP2490L-A []	3,665	6,742	7,442
	24	96	27 7/8	GS4PLWFP2496L-A []	3,696	6,730	7,429
	24	102	27 7/8	GS4PLWFP24102L-A []	N/A	6,860	7,573
	24	108	27 7/8	GS4PLWFP24108L-A []	N/A	7,006	7,735
30" DEPTH PEDESTAL	30	72	27 7/8	GS4PLWFP3072L-A []	3,434	6,087	6,720
	30	78	27 7/8	GS4PLWFP3078L-A []	3,497	6,220	6,867
	30	84	27 7/8	GS4PLWFP3084L-A []	3,573	6,373	7,035
	30	90	27 7/8	GS4PLWFP3090L-A []	3,748	6,879	7,593
	30	96	27 7/8	GS4PLWFP3096L-A []	3,779	6,867	7,580
	30	102	27 7/8	GS4PLWFP30102L-A []	N/A	6,997	7,725
	30	108	27 7/8	GS4PLWFP30108L-A []	N/A	7,143	7,886

PRODUCT INFO

Unit must be wall mounted.

 All units shipped as separate packages and require field assembly.

TO ORDER PLEASE SPECIFY THE FOLLOWING:

WOOD CHASSIS

1. **MODEL NUMBER + W**
2. **FSC**
3. **CHASSIS WOOD FINISH**
4. **PULL**
5. **KEYING**

LAM CHASSIS

1. **MODEL NUMBER + L**
2. **FSC**
3. **CHASSIS LAM**
4. **FRONT LAM**
5. **PULL**
6. **KEYING**

	D	W	H	model number + type	laminate	vener 1	vener 2
24" DEPTH PEDESTAL 	24	72	27 7/8	GS4PLWFP2472R-A []	3,351	5,950	6,569
	24	78	27 7/8	GS4PLWFP2478R-A []	3,414	6,083	6,716
	24	84	27 7/8	GS4PLWFP2484R-A []	3,490	6,236	6,884
	24	90	27 7/8	GS4PLWFP2490R-A []	3,665	6,742	7,442
	24	96	27 7/8	GS4PLWFP2496R-A []	3,696	6,730	7,429
	24	102	27 7/8	GS4PLWFP24102R-A []	N/A	6,860	7,573
	24	108	27 7/8	GS4PLWFP24108R-A []	N/A	7,006	7,735
30" DEPTH PEDESTAL	30	72	27 7/8	GS4PLWFP3072R-A []	3,434	6,087	6,720
	30	78	27 7/8	GS4PLWFP3078R-A []	3,497	6,220	6,867
	30	84	27 7/8	GS4PLWFP3084R-A []	3,573	6,373	7,035
	30	90	27 7/8	GS4PLWFP3090R-A []	3,748	6,879	7,593
	30	96	27 7/8	GS4PLWFP3096R-A []	3,779	6,867	7,580
	30	102	27 7/8	GS4PLWFP30102R-A []	N/A	6,997	7,725
	30	108	27 7/8	GS4PLWFP30108R-A []	N/A	7,143	7,886

PRODUCT INFO

Unit must be wall mounted.

 All units shipped as separate packages and require field assembly.

TO ORDER PLEASE SPECIFY THE FOLLOWING:

WOOD CHASSIS

1. **MODEL NUMBER + W**
2. **FSC**
3. **CHASSIS WOOD FINISH**
4. **PULL**
5. **KEYING**

LAM CHASSIS

1. **MODEL NUMBER + L**
2. **FSC**
3. **CHASSIS LAM**
4. **FRONT LAM**
5. **PULL**
6. **KEYING**

L SHAPE HEIGHT ADJUSTABLE

Desk Full Modesty, Left Hand Shroud

Silea

03/23

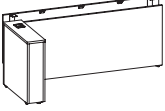
	D	W	H	model number + type	laminate	veneer 1	veneer 2
30" DEPTH SHROUD 	30	66	27 7/8	GS4PLDMF3066L- []	2,034	3,591	3,964
	30	72	27 7/8	GS4PLDMF3072L- []	2,103	3,736	4,125
	30	78	27 7/8	GS4PLDMF3078L- []	2,171	3,876	4,279
	30	84	27 7/8	GS4PLDMF3084L- []	2,315	4,093	4,519
	30	90	27 7/8	GS4PLDMF3090L- []	2,386	4,237	4,678
	30	96	27 7/8	GS4PLDMF3096L- []	2,455	4,381	4,837
36" DEPTH SHROUD	36	66	27 7/8	GS4PLDMF3666L- []	2,150	3,770	4,162
	36	72	27 7/8	GS4PLDMF3672L- []	2,219	3,915	4,322
	36	78	27 7/8	GS4PLDMF3678L- []	2,287	4,055	4,477
	36	84	27 7/8	GS4PLDMF3684L- []	2,431	4,272	4,716
	36	90	27 7/8	GS4PLDMF3690L- []	2,502	4,416	4,875
	36	96	27 7/8	GS4PLDMF3696L- []	2,571	4,560	5,035

PRODUCT INFO

 All units shipped as separate packages and require field assembly.

TO ORDER PLEASE SPECIFY THE FOLLOWING:

WOOD CHASSIS

1. **MODEL NUMBER + W**
2. **FSC**
3. **CHASSIS WOOD FINISH**

LAM CHASSIS

1. **MODEL NUMBER + L**
2. **FSC**
3. **CHASSIS LAM**

	D	W	H	model number + type	laminate	veneer 1	veneer 2
30" DEPTH SHROUD 	30	66	27 7/8	GS4PLDMF3066R- <input type="checkbox"/>	2,034	3,591	3,964
	30	72	27 7/8	GS4PLDMF3072R- <input type="checkbox"/>	2,103	3,736	4,125
	30	78	27 7/8	GS4PLDMF3078R- <input type="checkbox"/>	2,171	3,876	4,279
	30	84	27 7/8	GS4PLDMF3084R- <input type="checkbox"/>	2,315	4,093	4,519
	30	90	27 7/8	GS4PLDMF3090R- <input type="checkbox"/>	2,386	4,237	4,678
	30	96	27 7/8	GS4PLDMF3096R- <input type="checkbox"/>	2,455	4,381	4,837
36" DEPTH SHROUD	36	66	27 7/8	GS4PLDMF3666R- <input type="checkbox"/>	2,150	3,770	4,162
	36	72	27 7/8	GS4PLDMF3672R- <input type="checkbox"/>	2,219	3,915	4,322
	36	78	27 7/8	GS4PLDMF3678R- <input type="checkbox"/>	2,287	4,055	4,477
	36	84	27 7/8	GS4PLDMF3684R- <input type="checkbox"/>	2,431	4,272	4,716
	36	90	27 7/8	GS4PLDMF3690R- <input type="checkbox"/>	2,502	4,416	4,875
	36	96	27 7/8	GS4PLDMF3696R- <input type="checkbox"/>	2,571	4,560	5,035

PRODUCT INFO

 All units shipped as separate packages and require field assembly.

TO ORDER PLEASE SPECIFY THE FOLLOWING:

WOOD CHASSIS

1. **MODEL NUMBER + W**
2. **FSC**
3. **CHASSIS WOOD FINISH**

LAM CHASSIS

1. **MODEL NUMBER + L**
2. **FSC**
3. **CHASSIS LAM**

L SHAPE HEIGHT ADJUSTABLE

Desk Full Modesty, Left Hand Pedestal

Silea

03/23

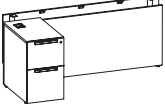
	D	W	H	model number + type	laminata	vener 1	vener 2
30" DEPTH PEDESTAL 	30	66	27 7/8	GS4PLDMF3066L-A <input type="checkbox"/>	2,616	4,709	5,199
	30	72	27 7/8	GS4PLDMF3072L-A <input type="checkbox"/>	2,685	4,854	5,359
	30	78	27 7/8	GS4PLDMF3078L-A <input type="checkbox"/>	2,753	4,994	5,513
	30	84	27 7/8	GS4PLDMF3084L-A <input type="checkbox"/>	2,897	5,211	5,753
	30	90	27 7/8	GS4PLDMF3090L-A <input type="checkbox"/>	2,968	5,355	5,911
	30	96	27 7/8	GS4PLDMF3096L-A <input type="checkbox"/>	3,037	5,499	6,071
36" DEPTH PEDESTAL	36	66	27 7/8	GS4PLDMF3666L-A <input type="checkbox"/>	2,703	4,856	5,361
	36	72	27 7/8	GS4PLDMF3672L-A <input type="checkbox"/>	2,772	5,001	5,521
	36	78	27 7/8	GS4PLDMF3678L-A <input type="checkbox"/>	2,840	5,141	5,676
	36	84	27 7/8	GS4PLDMF3684L-A <input type="checkbox"/>	2,984	5,358	5,915
	36	90	27 7/8	GS4PLDMF3690L-A <input type="checkbox"/>	3,055	5,502	6,074
	36	96	27 7/8	GS4PLDMF3696L-A <input type="checkbox"/>	3,124	5,646	6,233

PRODUCT INFO

 All units shipped as separate packages and require field assembly.

TO ORDER PLEASE SPECIFY THE FOLLOWING:

WOOD CHASSIS

1. **MODEL NUMBER + W**
2. **FSC**
3. **CHASSIS WOOD FINISH**
4. **PULL**
5. **KEYING**

LAM CHASSIS

1. **MODEL NUMBER + L**
2. **FSC**
3. **CHASSIS LAM**
4. **FRONT LAM**
5. **PULL**
6. **KEYING**

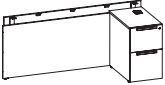
	D	W	H	model number + type	laminate	veneer 1	veneer 2
30" DEPTH PEDESTAL 	30	66	27 7/8	GS4PLDMF3066R-A []	2,616	4,709	5,199
	30	72	27 7/8	GS4PLDMF3072R-A []	2,685	4,854	5,359
	30	78	27 7/8	GS4PLDMF3078R-A []	2,753	4,994	5,513
	30	84	27 7/8	GS4PLDMF3084R-A []	2,897	5,211	5,753
	30	90	27 7/8	GS4PLDMF3090R-A []	2,968	5,355	5,911
	30	96	27 7/8	GS4PLDMF3096R-A []	3,037	5,499	6,071
36" DEPTH PEDESTAL	36	66	27 7/8	GS4PLDMF3666R-A []	2,703	4,856	5,361
	36	72	27 7/8	GS4PLDMF3672R-A []	2,772	5,001	5,521
	36	78	27 7/8	GS4PLDMF3678R-A []	2,840	5,141	5,676
	36	84	27 7/8	GS4PLDMF3684R-A []	2,984	5,358	5,915
	36	90	27 7/8	GS4PLDMF3690R-A []	3,055	5,502	6,074
	36	96	27 7/8	GS4PLDMF3696R-A []	3,124	5,646	6,233

PRODUCT INFO

 All units shipped as separate packages and require field assembly.

TO ORDER PLEASE SPECIFY THE FOLLOWING:

WOOD CHASSIS

1. **MODEL NUMBER + W**
2. **FSC**
3. **CHASSIS WOOD FINISH**
4. **PULL**
5. **KEYING**

LAM CHASSIS

1. **MODEL NUMBER + L**
2. **FSC**
3. **CHASSIS LAM**
4. **FRONT LAM**
5. **PULL**
6. **KEYING**

L SHAPE HEIGHT ADJUSTABLE

Desk Half Modesty, Left Hand Shroud

Silea

03/23

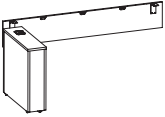
	D	W	H	model number + type	laminate	veneer 1	veneer 2
30" DEPTH SHROUD 	30	66	27 7/8	GS4PLDMH3066L- <input type="checkbox"/>	2,148	3,047	3,365
	30	72	27 7/8	GS4PLDMH3072L- <input type="checkbox"/>	2,205	3,128	3,453
	30	78	27 7/8	GS4PLDMH3078L- <input type="checkbox"/>	2,239	3,176	3,507
	30	84	27 7/8	GS4PLDMH3084L- <input type="checkbox"/>	2,348	3,301	3,645
	30	90	27 7/8	GS4PLDMH3090L- <input type="checkbox"/>	2,385	3,355	3,704
	30	96	27 7/8	GS4PLDMH3096L- <input type="checkbox"/>	2,426	3,411	3,766
36" DEPTH SHROUD	36	66	27 7/8	GS4PLDMH3666L- <input type="checkbox"/>	2,264	3,226	3,562
	36	72	27 7/8	GS4PLDMH3672L- <input type="checkbox"/>	2,321	3,307	3,651
	36	78	27 7/8	GS4PLDMH3678L- <input type="checkbox"/>	2,355	3,355	3,704
	36	84	27 7/8	GS4PLDMH3684L- <input type="checkbox"/>	2,464	3,480	3,842
	36	90	27 7/8	GS4PLDMH3690L- <input type="checkbox"/>	2,501	3,534	3,902
	36	96	27 7/8	GS4PLDMH3696L- <input type="checkbox"/>	2,542	3,590	3,963

PRODUCT INFO

 All units shipped as separate packages and require field assembly.

TO ORDER PLEASE SPECIFY THE FOLLOWING:

WOOD CHASSIS

1. **MODEL NUMBER + W**
2. **FSC**
3. **CHASSIS WOOD FINISH**

LAM CHASSIS

1. **MODEL NUMBER + L**
2. **FSC**
3. **CHASSIS LAM**

	D	W	H	model number + type	laminate	veneer 1	veneer 2
30" DEPTH SHROUD 	30	66	27 7/8	GS4PLDMH3066R- <input type="checkbox"/>	2,148	3,047	3,365
	30	72	27 7/8	GS4PLDMH3072R- <input type="checkbox"/>	2,205	3,128	3,453
	30	78	27 7/8	GS4PLDMH3078R- <input type="checkbox"/>	2,239	3,176	3,507
	30	84	27 7/8	GS4PLDMH3084R- <input type="checkbox"/>	2,348	3,301	3,645
	30	90	27 7/8	GS4PLDMH3090R- <input type="checkbox"/>	2,385	3,355	3,704
	30	96	27 7/8	GS4PLDMH3096R- <input type="checkbox"/>	2,426	3,411	3,766
36" DEPTH SHROUD	36	66	27 7/8	GS4PLDMH3666R- <input type="checkbox"/>	2,264	3,226	3,562
	36	72	27 7/8	GS4PLDMH3672R- <input type="checkbox"/>	2,321	3,307	3,651
	36	78	27 7/8	GS4PLDMH3678R- <input type="checkbox"/>	2,355	3,355	3,704
	36	84	27 7/8	GS4PLDMH3684R- <input type="checkbox"/>	2,464	3,480	3,842
	36	90	27 7/8	GS4PLDMH3690R- <input type="checkbox"/>	2,501	3,534	3,902
	36	96	27 7/8	GS4PLDMH3696R- <input type="checkbox"/>	2,542	3,590	3,963

PRODUCT INFO

 All units shipped as separate packages and require field assembly.

TO ORDER PLEASE SPECIFY THE FOLLOWING:

WOOD CHASSIS

1. **MODEL NUMBER + W**
2. **FSC**
3. **CHASSIS WOOD FINISH**

LAM CHASSIS

1. **MODEL NUMBER + L**
2. **FSC**
3. **CHASSIS LAM**

L SHAPE HEIGHT ADJUSTABLE

Desk Half Modesty, Left Hand Pedestal

Silea

03/23

	D	W	H	model number + type	laminate	veneer 1	veneer 2
30" DEPTH PEDESTAL	30	66	27 7/8	GS4PLDMH3066L-A <input type="checkbox"/>	2,742	4,345	4,797
	30	72	27 7/8	GS4PLDMH3072L-A <input type="checkbox"/>	2,799	4,426	4,886
	30	78	27 7/8	GS4PLDMH3078L-A <input type="checkbox"/>	2,833	4,474	4,939
	30	84	27 7/8	GS4PLDMH3084L-A <input type="checkbox"/>	2,942	4,599	5,077
	30	90	27 7/8	GS4PLDMH3090L-A <input type="checkbox"/>	2,979	4,653	5,136
	30	96	27 7/8	GS4PLDMH3096L-A <input type="checkbox"/>	3,020	4,709	5,199
36" DEPTH PEDESTAL	36	66	27 7/8	GS4PLDMH3666L-A <input type="checkbox"/>	2,829	4,492	4,959
	36	72	27 7/8	GS4PLDMH3672L-A <input type="checkbox"/>	2,886	4,573	5,049
	36	78	27 7/8	GS4PLDMH3678L-A <input type="checkbox"/>	2,920	4,621	5,101
	36	84	27 7/8	GS4PLDMH3684L-A <input type="checkbox"/>	3,029	4,746	5,239
	36	90	27 7/8	GS4PLDMH3690L-A <input type="checkbox"/>	3,066	4,800	5,299
	36	96	27 7/8	GS4PLDMH3696L-A <input type="checkbox"/>	3,107	4,856	5,361

30" DEPTH PEDESTAL

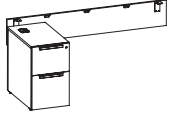

PRODUCT INFO

 All units shipped as separate packages and require field assembly.

TO ORDER PLEASE SPECIFY THE FOLLOWING:

WOOD CHASSIS

1. **MODEL NUMBER + W**
2. **FSC**
3. **CHASSIS WOOD FINISH**
4. **PULL**
5. **KEYING**

LAM CHASSIS

1. **MODEL NUMBER + L**
2. **FSC**
3. **CHASSIS LAM**
4. **FRONT LAM**
5. **PULL**
6. **KEYING**

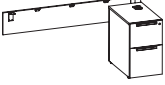
	D	W	H	model number + type	laminate	veneer 1	veneer 2
30" DEPTH PEDESTAL 	30	66	27 7/8	GS4PLDMH3066R-A <input type="checkbox"/>	2,742	4,345	4,797
	30	72	27 7/8	GS4PLDMH3072R-A <input type="checkbox"/>	2,799	4,426	4,886
	30	78	27 7/8	GS4PLDMH3078R-A <input type="checkbox"/>	2,833	4,474	4,939
	30	84	27 7/8	GS4PLDMH3084R-A <input type="checkbox"/>	2,942	4,599	5,077
	30	90	27 7/8	GS4PLDMH3090R-A <input type="checkbox"/>	2,979	4,653	5,136
	30	96	27 7/8	GS4PLDMH3096R-A <input type="checkbox"/>	3,020	4,709	5,199
36" DEPTH PEDESTAL	36	66	27 7/8	GS4PLDMH3666R-A <input type="checkbox"/>	2,829	4,492	4,959
	36	72	27 7/8	GS4PLDMH3672R-A <input type="checkbox"/>	2,886	4,573	5,049
	36	78	27 7/8	GS4PLDMH3678R-A <input type="checkbox"/>	2,920	4,621	5,101
	36	84	27 7/8	GS4PLDMH3684R-A <input type="checkbox"/>	3,029	4,746	5,239
	36	90	27 7/8	GS4PLDMH3690R-A <input type="checkbox"/>	3,066	4,800	5,299
	36	96	27 7/8	GS4PLDMH3696R-A <input type="checkbox"/>	3,107	4,856	5,361

PRODUCT INFO

 All units shipped as separate packages and require field assembly.

TO ORDER PLEASE SPECIFY THE FOLLOWING:

WOOD CHASSIS

1. **MODEL NUMBER + W**
2. **FSC**
3. **CHASSIS WOOD FINISH**
4. **PULL**
5. **KEYING**

LAM CHASSIS

1. **MODEL NUMBER + L**
2. **FSC**
3. **CHASSIS LAM**
4. **FRONT LAM**
5. **PULL**
6. **KEYING**

L SHAPE HEIGHT ADJUSTABLE

30D & 36D Desk Worksurfaces Rectangular

Silea
03/23

	D	W	H	model number + type	laminate	veneer 1	veneer 2
	30	66	1 3/16	GS4LADWR3066- <input type="checkbox"/>	1,036	1,615	1,783
	30	72	1 3/16	GS4LADWR3072- <input type="checkbox"/>	1,091	1,699	1,876
	30	78	1 3/16	GS4LADWR3078- <input type="checkbox"/>	1,166	1,819	2,009
	30	84	1 3/16	GS4LADWR3084- <input type="checkbox"/>	1,248	1,948	2,151
	30	90	1 3/16	GS4LADWR3090- <input type="checkbox"/>	1,330	2,046	2,259
	30	96	1 3/16	GS4LADWR3096- <input type="checkbox"/>	1,396	2,148	2,372
	36	66	1 3/16	GS4LADWR3666- <input type="checkbox"/>	1,109	1,731	1,911
	36	72	1 3/16	GS4LADWR3672- <input type="checkbox"/>	1,168	1,823	2,013
	36	78	1 3/16	GS4LADWR3678- <input type="checkbox"/>	1,251	1,951	2,154
	36	84	1 3/16	GS4LADWR3684- <input type="checkbox"/>	1,338	2,089	2,306
	36	90	1 3/16	GS4LADWR3690- <input type="checkbox"/>	1,425	2,193	2,421
	36	96	1 3/16	GS4LADWR3696- <input type="checkbox"/>	1,497	2,303	2,543

- Flat brackets ordered separately (model #MDWBRK)

PRODUCT INFO

All tops long grain standard.
Tops are undersized to allow for pinch points.

Grommet Location (Add \$77 per grommet)

No Grommet **GN**
Left **GL**
Right **GR**
Left & Right **GB**

Specify location first, then select grommet color or "Empty Cutout" option. When "Empty Cutout" option is selected, a grommet or power unit must be ordered separately for each cutout.

TO ORDER PLEASE SPECIFY THE FOLLOWING:

WOOD TOP

1. **MODEL NUMBER + W**
2. **FSC**
3. **TOP WOOD FINISH + EDGE**
4. **TOP UV FINISH**
5. **GROMMET**

LAM TOP

1. **MODEL NUMBER + L**
2. **FSC**
3. **TOP LAM**
4. **EDGE DETAIL**
5. **GROMMET**

L SHAPE HEIGHT ADJUSTABLE

24D & 30D Return Worksurfaces Rectangular

	D	W	H	model number + type	laminate	veneer 1	veneer 2
	24	42	1 3/16	GS4LACWR2442- <input type="checkbox"/>	719	1,119	1,236
	24	48	1 3/16	GS4LACWR2448- <input type="checkbox"/>	785	1,225	1,353
	24	54	1 3/16	GS4LACWR2454- <input type="checkbox"/>	828	1,289	1,424
	24	60	1 3/16	GS4LACWR2460- <input type="checkbox"/>	899	1,402	1,549
	24	66	1 3/16	GS4LACWR2466- <input type="checkbox"/>	956	1,488	1,643
	24	72	1 3/16	GS4LACWR2472- <input type="checkbox"/>	1,066	1,665	1,839
	30	42	1 3/16	GS4LACWR3042- <input type="checkbox"/>	917	1,432	1,582
	30	48	1 3/16	GS4LACWR3048- <input type="checkbox"/>	966	1,506	1,663
	30	54	1 3/16	GS4LACWR3054- <input type="checkbox"/>	977	1,526	1,686
	30	60	1 3/16	GS4LACWR3060- <input type="checkbox"/>	990	1,543	1,704
	30	66	1 3/16	GS4LACWR3066- <input type="checkbox"/>	1,036	1,615	1,783
	30	72	1 3/16	GS4LACWR3072- <input type="checkbox"/>	1,091	1,699	1,876

• Flat brackets ordered separately (model #MDWBRK)

PRODUCT INFO

Wood tops are short grain standard. Lam tops are short grain up to 60", over 60" are long grain standard.

Tops are undersized to allow for pinch points.

Grommet Location
(Add \$77 per grommet)

No Grommet **GN**
Center **GC**

Specify location first, then select grommet color or "Empty Cutout" option. When "Empty Cutout" option is selected, a grommet or power unit must be ordered separately for each cutout.

TO ORDER PLEASE SPECIFY THE FOLLOWING:

WOOD TOP

- MODEL NUMBER + W**
- FSC**
- TOP WOOD FINISH + EDGE**
- TOP UV FINISH**
- GROMMET**

LAM TOP

- MODEL NUMBER + L**
- FSC**
- TOP LAM**
- EDGE DETAIL**
- GROMMET**

L SHAPE HEIGHT ADJUSTABLE

Cockpit Top Shape, For Left Hand Desk

Silea

03/23

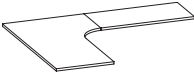
Desk Depth	Desk Width	Return Depth	Return Width	Total Workwall Width	model number + type	laminat	veneer 1	veneer 2	
	30	72	24	42	72	GS4LATOP30722442L- <input type="checkbox"/>	1,991	3,101	3,424
	30	72	24	48	78	GS4LATOP30722448L- <input type="checkbox"/>	2,064	3,215	3,550
	30	72	24	54	84	GS4LATOP30722454L- <input type="checkbox"/>	2,109	3,289	3,632
	30	72	24	60	90	GS4LATOP30722460L- <input type="checkbox"/>	2,191	3,412	3,767
	30	72	24	66	96	GS4LATOP30722466L- <input type="checkbox"/>	2,252	3,507	3,872
	30	72	24	72	102	GS4LATOP30722472L- <input type="checkbox"/>	N/A	3,701	4,086
30	84	24	42	72	GS4LATOP30842442L- <input type="checkbox"/>	2,165	3,374	3,725	
30	84	24	48	78	GS4LATOP30842448L- <input type="checkbox"/>	2,237	3,490	3,853	
30	84	24	54	84	GS4LATOP30842454L- <input type="checkbox"/>	2,283	3,561	3,932	
30	84	24	60	90	GS4LATOP30842460L- <input type="checkbox"/>	2,362	3,685	4,068	
30	84	24	66	96	GS4LATOP30842466L- <input type="checkbox"/>	2,423	3,779	4,172	
30	84	24	72	102	GS4LATOP30842472L- <input type="checkbox"/>	N/A	3,976	4,390	
36	72	24	42	78	GS4LATOP36722442L- <input type="checkbox"/>	1,991	3,239	3,576	
36	72	24	48	84	GS4LATOP36722448L- <input type="checkbox"/>	2,064	3,353	3,702	
36	72	24	54	90	GS4LATOP36722454L- <input type="checkbox"/>	2,109	3,426	3,783	
36	72	24	60	96	GS4LATOP36722460L- <input type="checkbox"/>	2,191	3,549	3,918	
36	72	24	66	102	GS4LATOP36722466L- <input type="checkbox"/>	N/A	3,644	4,023	
36	72	24	72	108	GS4LATOP36722472L- <input type="checkbox"/>	N/A	3,839	4,238	
36	84	24	42	78	GS4LATOP36842442L- <input type="checkbox"/>	2,165	3,528	3,895	
36	84	24	48	84	GS4LATOP36842448L- <input type="checkbox"/>	2,237	3,643	4,022	
36	84	24	54	90	GS4LATOP36842454L- <input type="checkbox"/>	2,283	3,715	4,101	
36	84	24	60	96	GS4LATOP36842460L- <input type="checkbox"/>	2,362	3,840	4,239	
36	84	24	66	102	GS4LATOP36842466L- <input type="checkbox"/>	N/A	3,935	4,344	
36	84	24	72	108	GS4LATOP36842472L- <input type="checkbox"/>	N/A	4,128	4,558	

PRODUCT INFO

Desk top portion is long grain standard, return short grain.

Tops are undersized to allow for pinch points.

Grommet Location

(Add \$77 per grommet)

No Grommet **GN**
 Left **GL**
 Right **GR**
 Left & Right **GB**

Specify location first, then select grommet color or "Empty Cutout" option. When "Empty Cutout" option is selected, a grommet or power unit must be ordered separately for each cutout.

NOTE: Monitor arms should **ALWAYS** be installed in grommets on Silea height adjustable units. Please ensure a grommet location is specified on the top. This allows for bolt mount or clamp mount install of monitor arm. See page 35 for details.

TO ORDER PLEASE SPECIFY THE FOLLOWING:

WOOD TOP

- MODEL NUMBER + W**
- FSC**
- TOP WOOD FINISH + EDGE**
- TOP UV FINISH**
- DESK GROMMET**

LAM TOP

- MODEL NUMBER + L**
- FSC**
- TOP LAM**
- EDGE DETAIL**
- DESK GROMMET**

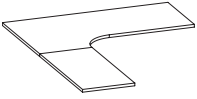

Desk Depth	Desk Width	Return Depth	Return Width	Total Workwall Width	model number + type	laminate	veneer 1	veneer 2
30	72	24	42	72	GS4LATOP30722442R- []	1,991	3,101	3,424
30	72	24	48	78	GS4LATOP30722448R- []	2,064	3,215	3,550
30	72	24	54	84	GS4LATOP30722454R- []	2,109	3,289	3,632
30	72	24	60	90	GS4LATOP30722460R- []	2,191	3,412	3,767
30	72	24	66	96	GS4LATOP30722466R- []	2,252	3,507	3,872
30	72	24	72	102	GS4LATOP30722472R- []	N/A	3,701	4,086
30	84	24	42	72	GS4LATOP30842442R- []	2,165	3,374	3,725
30	84	24	48	78	GS4LATOP30842448R- []	2,237	3,490	3,853
30	84	24	54	84	GS4LATOP30842454R- []	2,283	3,561	3,932
30	84	24	60	90	GS4LATOP30842460R- []	2,362	3,685	4,068
30	84	24	66	96	GS4LATOP30842466R- []	2,423	3,779	4,172
30	84	24	72	102	GS4LATOP30842472R- []	N/A	3,976	4,390
36	72	24	42	78	GS4LATOP36722442R- []	1,991	3,239	3,576
36	72	24	48	84	GS4LATOP36722448R- []	2,064	3,353	3,702
36	72	24	54	90	GS4LATOP36722454R- []	2,109	3,426	3,783
36	72	24	60	96	GS4LATOP36722460R- []	2,191	3,549	3,918
36	72	24	66	102	GS4LATOP36722466R- []	N/A	3,644	4,023
36	72	24	72	108	GS4LATOP36722472R- []	N/A	3,839	4,238
36	84	24	42	78	GS4LATOP36842442R- []	2,165	3,528	3,895
36	84	24	48	84	GS4LATOP36842448R- []	2,237	3,643	4,022
36	84	24	54	90	GS4LATOP36842454R- []	2,283	3,715	4,101
36	84	24	60	96	GS4LATOP36842460R- []	2,362	3,840	4,239
36	84	24	66	102	GS4LATOP36842466R- []	N/A	3,935	4,344
36	84	24	72	108	GS4LATOP36842472R- []	N/A	4,128	4,558

PRODUCT INFO

Desk top portion is long grain standard, return short grain.
Tops are undersized to allow for pinch points.

Grommet Location
(Add \$77 per grommet)

No Grommet **GN**
Left **GL**
Right **GR**
Left & Right **GB**

Specify location first, then select grommet color or "Empty Cutout" option. When "Empty Cutout" option is selected, a grommet or power unit must be ordered separately for each cutout.

NOTE: Monitor arms should **ALWAYS** be installed in grommets on Silea height adjustable units. Please ensure a grommet location is specified on the top. This allows for bolt mount or clamp mount install of monitor arm. See page 35 for details.

TO ORDER PLEASE SPECIFY THE FOLLOWING:

WOOD TOP

- MODEL NUMBER + W**
- FSC**
- TOP WOOD FINISH + EDGE**
- TOP UV FINISH**
- DESK GROMMET**

LAM TOP

- MODEL NUMBER + L**
- FSC**
- TOP LAM**
- EDGE DETAIL**
- DESK GROMMET**

L SHAPE HEIGHT ADJUSTABLE

Hardware & Bracketry Kit

Silea

03/23

D	W	H	model number	part #
3 MOTOR KIT			GS4LALNKDPD-3	2,213
4 MOTOR KIT			GS4LALNKDPD-4	2,748

Total Workwall Width	# Motors	Model # to Order
Workwall 72"	3	GS4LALNKDPD-3
Workwall 78"	3	GS4LALNKDPD-3
Workwall 84"	3	GS4LALNKDPD-3
Workwall 90"	3	GS4LALNKDPD-3
Workwall 96"	3	GS4LALNKDPD-3
Workwall 102"	4	GS4LALNKDPD-4
Workwall 108"	4	GS4LALNKDPD-4

PRODUCT INFO

L shape units require field assembly

NOTE: Monitor arms should **ALWAYS** be installed in grommets on Silea height adjustable units. Please ensure a grommet location is specified on the top. This allows for bolt mount or clamp mount install of monitor arm. See page 35 for details.

TO ORDER PLEASE SPECIFY THE FOLLOWING:

LIST

- MODEL NUMBER**
- HAT KEYPAD & BASE COLOR**

Optional height adjustable keypads available

HAT KEYPAD & BASE COLOR

Basic Up/Down Keypad, Black P71 Column
 Memory Preset Keypad, Black P71 Column
 Paddle Keypad, Black P71 Column

UDP71
MEMP71
PDLP71

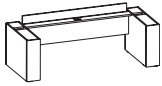
	D	W	H	model number + type	laminate	veneer 1	veneer 2
	24	42	22 1/2	GS3HASHRD2442- []	2,424	3,513	3,879
	24	48	22 1/2	GS3HASHRD2448- []	2,455	3,557	3,927
	24	54	22 1/2	GS3HASHRD2454- []	2,485	3,601	3,975
	24	60	22 1/2	GS3HASHRD2460- []	2,515	3,643	4,022
	24	66	22 1/2	GS3HASHRD2466- []	2,545	3,688	4,072
	24	72	22 1/2	GS3HASHRD2472- []	2,575	3,731	4,120
	30	42	22 1/2	GS3HASHRD3042- []	2,500	3,621	3,998
	30	48	22 1/2	GS3HASHRD3048- []	2,531	3,664	4,045
	30	54	22 1/2	GS3HASHRD3054- []	2,561	3,709	4,095
	30	60	22 1/2	GS3HASHRD3060- []	2,591	3,754	4,145
	30	66	22 1/2	GS3HASHRD3066- []	2,621	3,797	4,192
	30	72	22 1/2	GS3HASHRD3072- []	2,651	3,842	4,241
	36	42	22 1/2	GS3HASHRD3642- []	2,574	3,731	4,120
	36	48	22 1/2	GS3HASHRD3648- []	2,605	3,775	4,168
	36	54	22 1/2	GS3HASHRD3654- []	2,635	3,818	4,215
	36	60	22 1/2	GS3HASHRD3660- []	2,665	3,863	4,265
	36	66	22 1/2	GS3HASHRD3666- []	2,695	3,909	4,316
	36	72	22 1/2	GS3HASHRD3672- []	2,725	3,951	4,362

PRODUCT INFO

Top and t-base ordered separately.

Wood models ship assembled.

 Laminate units shipped as separate packages and require field assembly.

NOTE: Monitor arms should **ALWAYS** be installed in grommets on Silea height adjustable units. Please ensure a grommet location is specified on the top. This allows for bolt mount or clamp mount install of monitor arm. See page 35 for details.

TO ORDER PLEASE SPECIFY THE FOLLOWING:

WOOD CHASSIS

1. **MODEL NUMBER + W**
2. **FSC**
3. **CHASSIS WOOD FINISH**

LAM CHASSIS

1. **MODEL NUMBER + L**
2. **FSC**
3. **CHASSIS LAM**

LAYERS BOOKCASE

w/ top for T-Base

Silea

03/23

	D	W	H	model number + type	laminare	vener 1	vener 2
	23 1/8	24	22 3/8	GS2LHAPD2424L- []	1,688	2,635	2,909
	23 1/8	30	22 3/8	GS2LHAPD2430L- []	1,804	2,817	3,111
	23 1/8	36	22 3/8	GS2LHAPD2436L- []	1,922	3,000	3,312

	23 1/8	24	22 3/8	GS2LHAPD2424R- []	1,688	2,635	2,909
	23 1/8	30	22 3/8	GS2LHAPD2430R- []	1,804	2,817	3,111
	23 1/8	36	22 3/8	GS2LHAPD2436R- []	1,922	3,000	3,312

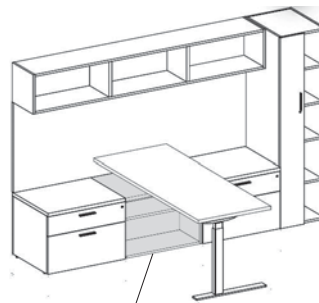

Layers Bookcase
(right hand shown)

PRODUCT INFO

T-base height adjustable not included.

TO ORDER PLEASE SPECIFY THE FOLLOWING:

WOOD TOP, WOOD CHASSIS

1. **MODEL NUMBER + WW**
2. **FSC**
3. **TOP WOOD FINISH + EDGE**
4. **CHASSIS WOOD FINISH**
5. **TOP UV FINISH**
6. **GRAIN DIRECTION**

LAM TOP, LAM CHASSIS

1. **MODEL NUMBER + LL**
2. **FSC**
3. **TOP LAM**
4. **CHASSIS LAM**
5. **GRAIN DIRECTION**

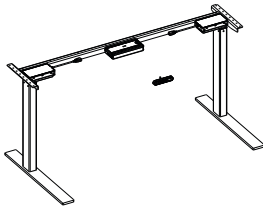
	for use with top sizes	D	W	H	model number	list
	22 x 40	21	36	26	BSHAT2142	3,078
	22 x 46	21	42	26	BSHAT2148	3,092
	22 x 52	21	48	26	BSHAT2154	3,110
	22 x 58	21	54	26	BSHAT2160	3,124
	22 x 64	21	60	26	BSHAT2166	3,142
	22 x 70	21	66	26	BSHAT2172	3,157

28/34 x 46	27	42	26	BSHAT2748	3,124
28/34 x 52	27	48	26	BSHAT2754	3,142
28/34 x 58	27	54	26	BSHAT2760	3,157
28/34 x 64	27	60	26	BSHAT2766	3,176
28/34 x 70	27	66	26	BSHAT2772	3,191



Base at lowest height setting

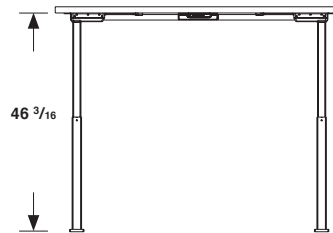

Base at tallest height setting

PRODUCT INFO

Tops and modesty panel ordered separately in modular tab.

TO ORDER PLEASE SPECIFY THE FOLLOWING:

LIST

1. **MODEL NUMBER**
2. **BASE COLOR**

HEIGHT ADJUSTABLE TOPS

22D, 28D & 34D

Silea

03/23

	D	W	H	model number + type	laminate	vener 1	vener 2
	22	40	1 3/16	GS2CWA2240- <input type="checkbox"/>	719	1,119	1,236
	22	46	1 3/16	GS2CWA2246- <input type="checkbox"/>	785	1,225	1,353
	22	52	1 3/16	GS2CWA2252- <input type="checkbox"/>	828	1,289	1,424
	22	58	1 3/16	GS2CWA2258- <input type="checkbox"/>	899	1,402	1,549
	22	64	1 3/16	GS2CWA2264- <input type="checkbox"/>	956	1,488	1,643
	22	70	1 3/16	GS2CWA2270- <input type="checkbox"/>	1,066	1,665	1,839
	28	40	1 3/16	GS2CWA2840- <input type="checkbox"/>	917	1,432	1,582
	28	46	1 3/16	GS2CWA2846- <input type="checkbox"/>	966	1,506	1,663
	28	52	1 3/16	GS2CWA2852- <input type="checkbox"/>	977	1,526	1,686
	28	58	1 3/16	GS2CWA2858- <input type="checkbox"/>	990	1,543	1,704
	28	64	1 3/16	GS2CWA2864- <input type="checkbox"/>	1,036	1,615	1,783
	28	70	1 3/16	GS2CWA2870- <input type="checkbox"/>	1,091	1,699	1,876
	34	40	1 3/16	GS2CWA3440- <input type="checkbox"/>	962	1,503	1,660
	34	46	1 3/16	GS2CWA3446- <input type="checkbox"/>	1,014	1,583	1,748
	34	52	1 3/16	GS2CWA3452- <input type="checkbox"/>	1,036	1,615	1,783
	34	58	1 3/16	GS2CWA3458- <input type="checkbox"/>	1,057	1,647	1,819
	34	64	1 3/16	GS2CWA3464- <input type="checkbox"/>	1,109	1,731	1,911
	34	70	1 3/16	GS2CWA3470- <input type="checkbox"/>	1,168	1,823	2,013

PRODUCT INFO

Depth & width shortened two inches for height adjustable pinch points.

Wood tops optional grain standard.

Lam tops optional grain up to 60", over 60" long grain standard.

Grommet Location (Add \$77 per grommet)

No Grommet **GN**
 Left **GL**
 Center **GC**
 Right **GR**
 Left & Right **GB**
 All **GA**

Specify location first, then select grommet color or "Empty Cutout" option. When "Empty Cutout" option is selected, a grommet or power unit must be ordered separately for each cutout.

TO ORDER PLEASE SPECIFY THE FOLLOWING:

WOOD TOP

- MODEL NUMBER + W**
- FSC**
- TOP WOOD FINISH + EDGE**
- TOP UV FINISH**
- GRAIN DIRECTION**
- GROMMET**

LAM TOP

- MODEL NUMBER + L**
- FSC**
- TOP LAM**
- GRAIN DIRECTION (up to 60")**
- GROMMET**

D	W	H	model number	sin#
3 1/8	15 3/16	7 1/8	ACWCB15	228
<ul style="list-style-type: none"> For use with 24" tops to provide support on center as an alternative to a T-bracket. 				
3 1/8	20 3/16	7 1/8	ACWCB20	244
<ul style="list-style-type: none"> For use with 24" tops to provide support on an end condition. 				

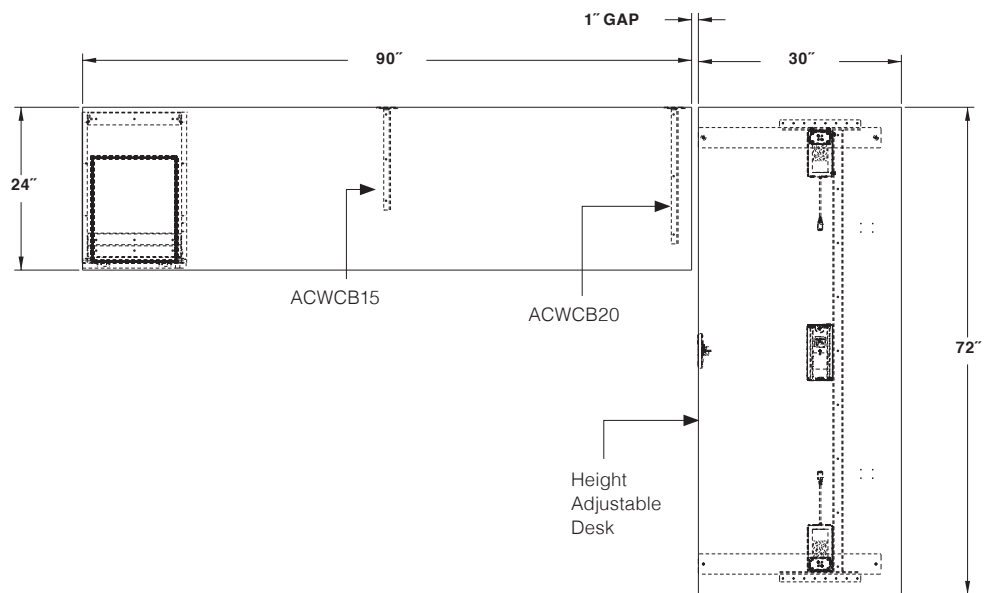
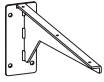

PRODUCT INFO

TO ORDER PLEASE SPECIFY THE FOLLOWING:

LIST

- MODEL NUMBER**

MIXED MATERIAL TELESCOPING HEIGHT ADJUSTABLE

Modesty Panels

Silea

03/23

	D	W	H	model number + type	laminate	veneer 1	veneer 2	metal
	3/4	58	10	GS2XMAMOD66- []	646	939	1,038	657
	3/4	64	10	GS2XMAMOD72- []	708	1,025	1,132	718
	3/4	70	10	GS2XMAMOD78- []	769	1,069	1,181	782

- For use with Telescoping Height Adjustable Extensions

PRODUCT INFO

Grain Direction:

- Natural veneer:
Vertical
- Stratawood veneer:
Optional
- Laminate:
Horizontal

TO ORDER PLEASE SPECIFY THE FOLLOWING:

WOOD MODESTY





1. **MODEL NUMBER + W**
2. **FSC**
3. **CHASSIS WOOD FINISH**

LAM MODESTY

1. **MODEL NUMBER + L**
2. **FSC**
3. **CHASSIS LAM**

METAL MODESTY

1. **MODEL NUMBER + M**
2. **HARDWARE COLOR**

	D	W	H	model number	list
BASIC UP/DOWN KEYPAD 				ACHAT-UD	74
				<ul style="list-style-type: none"> • Basic Up/Down control. 	
MEMORY PRESET KEYPAD 				ACHAT-MEM	93
				<ul style="list-style-type: none"> • 4 memory pre-set options allow the user to adjust their height to their preferred heights. 	
PADDLE KEYPAD 				ACHAT-PDL	137
				<ul style="list-style-type: none"> • Simple, aesthetic control with 1 memory pre-set option and reminder mode. 	
BLUETOOTH APP CONTROL 				ACHAT-BLUETOOTH	109
				<ul style="list-style-type: none"> • Bluetooth receiver can be paired with phone app to operate desk. • Can be used in combination with hand controller for multi-control option. 	

PRODUCT INFO

**ONLY FOR USE WITH
CANTILEVER HEIGHT
ADJUSTABLE DESKS AT THIS
TIME**

TO ORDER PLEASE SPECIFY THE FOLLOWING:

LIST

- 1. MODEL NUMBER**

Welcome Desk 125-148
Working with Welcome Desks 702-705
Welcome Desk Typical. 706-707
Advanced Height Adjustable Welcome Desk 132-135
Advanced Fixed Height Welcome Desk 136-137
Fixed Height Welcome Desk 138-139
Welcome Desk Shell 140-141
Welcome Desk Bridge. 142
Welcome Desk Returns 143
Welcome Desk Credenzas 144
Waterfall Transaction Tops. 145
Transaction Tops 146
Welcome Desk Tackboard. 147
In/Out Storage Unit 148

GALLERY PANELS

- Gallery Panels are constructed of 1 1/8" particleboard with 2mm edgebanding.
- All laminate gallery panels are made using HPL laminate. All panels greater than 60" in width will run horizontal grain.
- All veneer gallery panels are made using an engineered reconstituted (recon) veneer to provide a consistent matching grain pattern and color across adjoining gallery panels. The 2 types of recon veneer used are:
 - 1) A Recon veneer chosen as a close match to natural veneers which are used on tops/chassis. See below for recon to natural finish cross-reference:
 - Gallery panels with finish options starting with "EC" for Recon Cherry to be used with "NC" Natural Cherry tops/chassis.
 - Gallery panels with finish options starting with "ET" for Recon Walnut to be used with "NT" Natural Walnut tops/chassis.
 - Gallery panels with finish options starting with "EF" for Recon Rift Oak to be used with "RF" Natural Rift Oak tops/chassis.
 - 2) Stratawood veneer is also a reconstituted veneer in a straight grain pattern. Stratawood veneer is available on both gallery panels and tops/chassis so the same finish option can be carried through the entire office spec.
 - Stratawood is available in "SC" Cherry, "SE" Maple, "ST" Walnut, and "SF" Oak, "SB" Silver Oak, "SW" Washed Walnut veneers and finishes.

FINISH MATRIX SUMMARY

Gallery Panel Finish Code	Tops/Chassis Finish Code
EC Recon Cherry	NC Natural Cherry
ET Recon Walnut	NT Natural Walnut
EF Recon Rift Oak	RF Natural Rift Oak
SC Stratawood Cherry	SC Stratawood Cherry
SE Stratawood Maple	SE Stratawood Maple
ST Stratawood Walnut	ST Stratawood Walnut
SF Stratawood Oak	SF Stratawood Oak
SB Stratawood Silver Oak	SB Stratawood Silver Oak
SW Stratawood Washed Walnut	SW Stratawood Washed Walnut

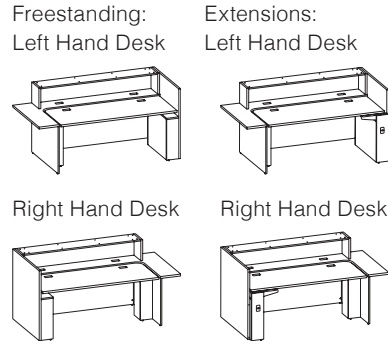

ADVANCED HEIGHT ADJUSTABLE WELCOME DESK

- Split top design provides matching grain on fixed and HAT desk surface.
- For use with waterfall transaction tops only. A waterfall transaction top must be ordered separately and is required (waterfall transaction top substructure included with desk is unfinished).
- Available as Extension Desks or Freestanding Desks.
- Extension desks not for freestanding applications. Must connect to adjoining fixed Welcome bridge or return. Gallery end panel includes boring for connecting to adjoining gallery panels. Includes integrated cantilever support panel for supporting bridge or return top. Must only be used with Welcome bridge or returns with gallery panels.
- Freestanding desks not for use in extension applications with bridges/returns.
- Fixed portion of top always includes left & right grommets. HAT portion of top has optional grommets.
- Available with shroud or 15W desk depth pedestal on conference end.
- Monitor arms should be mounted in HAT top grommets.
- Connecting end shroud includes removable access panel for wire management.

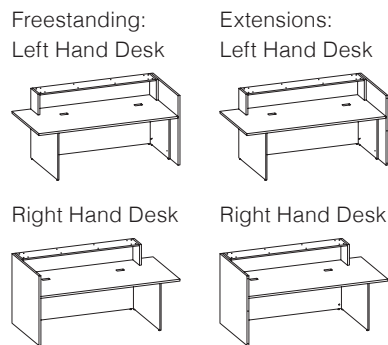

ADVANCED FIXED HEIGHT WELCOME DESK

- For use with waterfall transaction tops only. A waterfall transaction top must be ordered separately and is required (waterfall transaction top substructure included with desk is unfinished).
- Available as Extension Desks or Freestanding Desks.
- Extension desks not for freestanding applications. Must connect to adjoining fixed bridge or return. Gallery end panel includes boring for connecting to adjoining gallery panels. Must only be used with Welcome bridge or returns with gallery panels.
- Freestanding desks not for use in extension applications with bridges/returns.
- Grommets are optional.
- Available with end panel or 15W desk depth pedestal on conference end.



WELCOME DESK SHELL

- Available as Extension Desks or Freestanding Desks.
- Extension desks not for freestanding applications. Must connect to adjoining fixed bridge or return. Gallery end panel includes boring for connecting to adjoining gallery panels. Must only be used with Welcome bridge or returns with gallery panels.
- Freestanding desks not for use in extension applications with bridges/returns.
- Double desk configurations follow the same rules as extension vs. freestanding desks.
- Shell design allows for 30D/36D modular pedestals to be added.
- Specify appropriate desk for transaction top type to be used.
- Grommets are optional.

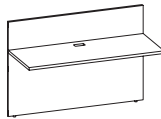
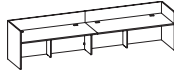

WELCOME DESK BRIDGE

- Connects to adjoining Welcome Desk and Welcome Credenzas with gallery panels.
- Worksurface-to-worksurface flat brackets included.
- Grommets are optional.

Left Hand



WELCOME DESK RETURNS

- Connects to adjoining Welcome Desk with gallery panels.
- Worksurface-to-worksurface flat brackets included.
- Shell design allows for 24D modular pedestals to be added.
- Grommets are optional.

Right Hand

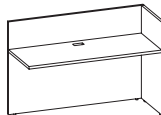

WORKING WITH SILEA WELCOME DESKS

Left Hand



Right Hand



WELCOME DESK CREDENZAS

- Connects to adjoining Welcome Bridge with gallery panels.
- Not for freestanding applications. Gallery end panel includes boring for connecting to adjoining gallery panels.
- Shell design allows for 24D modular pedestals to be added.
- Grommets are optional.

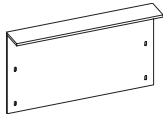

WATERFALL TRANSACTION TOPS

- Mitered assembly.
- For use with Advanced Desks and Desk Shells that are for use with Waterfall Transaction Tops.



TRANSACTION TOPS

- Spans across 2 gallery panels.
- 3" guest overhang.
- Attaches to gallery panels with 9" black angle brackets, must be supported by gallery panels on each and across front.

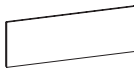

WELCOME DESK TACKBOARD

- Height designed to sit below transaction top attachment brackets.
- To be set on worksurface and attached gallery panels using velcro.

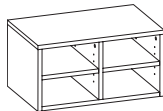

IN/OUT STORAGE UNIT

- 3/4" panel construction.
- Center shelf adjustable on 5 hole pattern.
- Single sided access with full back panel.
- Set on worksurface with protective felt tape allows for easy relocation.

SILEA WELCOME DESK TYPICALS

Silea
03/23

TYPICAL 1 — FREESTANDING DESK

Item	Model	Description	Quantity
A	GS2CPD2415-3W	GUN Mod Ped 24D x 15W-3 Wd	1
B	GS6GDR3072-WW	GUN Freestanding Desk Shell 30x72 Wd	1
C	GS6GDTT72-W	GUN Desk Transaction Top 15X72 Wd	1



TYPICAL 2 — L STATION

Item	Model	Description	Quantity
A	GS6GRT2448L-WW	GUN Return Shell LH 24x48 Wd	1
B	GS2CPD2430L-MFW	GUN Mod Ped 24D x 30W MF LH Wd	1
C	GS6GDR3072R-WW	GUN Handed Desk Shell RH 30x72 Wd	1
D	GS6GDTT72-W	GUN Desk Transaction Top 15X72 Wd	1



TYPICAL 3 — U STATION

Item	Model	Description	Quantity
A	S6GCR2472L-WW	GUN Credenza Shell LH 24x72 Wd	1
B	ACMWS41	GUN Acc Steel Wksf Support 41W	1
C	GS2CPD2415-2W	GUN Mod Ped 24D x 15W-2 Wd	1
D	GS2CPD2436-4W	GUN Mod Ped 24D x 36W-4 Wd	1
E	GS6GBG2454-WW	GUN Bridge Shell 24x54 Wd	1
F	GS6GDR3072R-WW	GUN Handed Desk Shell RH 30x72 Wd	1
G	GS6GDTT72-W	GUN Desk Transaction Top 15X72 Wd	1



TYPICAL 4 — DOUBLE FREESTANDING DESK

Item	Model	Description	Quantity
A	GS2CPD2415-2W	GUN Mod Ped 24D x 15W-2 Wd	1
B	GS2CPD2415-3W	GUN Mod Ped 24D x 15W-3 Wd	1
C	GS6GDR36144-WW	GUN Freestanding Desk Shell 36x144 Wd	1
D	GS6GDTT144-W	GUN Desk Transaction Top 15X144 Wd	1



TYPICAL 5 — ADVANCED FREESTANDING HAT DESK

Item	Model	Description	Quantity
A	GS6GDFA42102L-AWW	Advanced Freestnd Dsk HAT 42102 w/ -A Ped LH Wood	1
B	GS6GDXMT72-W	GUN Desk Transaction Waterfall 72 Wd	1

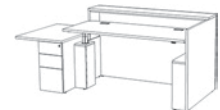

TYPICAL 6 — DOUBLE ADVANCED FIXED DESK

Item	Model	Description	Quantity
A	GS6GDF42102L-AWW	Advanced FreestndDsk Fixed 42102 w/ -A Ped LH Wd	1
B	GS6GDF42102R-AWW	Advanced FreestndDsk Fixed 42102 w/ -A Ped RH Wd	1
C	GS6GDXMT72-W	GUN Desk Transaction Waterfall 72 Wd	2



ADVANCED HEIGHT ADJUSTABLE WELCOME DESK

Silea

03/23

Extension

	D	W	H	model number + type	laminata	vener 1	vener 2
LEFT HAND DESK	45	85	41	GS6GDXA4284L- []	8,102	12,253	13,526

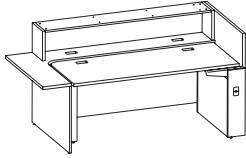

A = 69.86"
B = 28"
C = 11.25"
D = 12.32"
E = 12.13"

RIGHT HAND DESK

	45	85	41	GS6GDXA4284R- []	8,102	12,253	13,526
--	----	----	----	--------------------------	-------	--------	--------

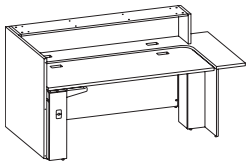

A = 69.86"
B = 28"
C = 11.25"
D = 12.32"
E = 12.13"

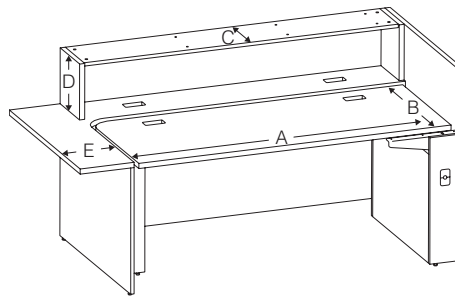

PRODUCT INFO

Separate countertop must be specified.

29.5" to 42.5" height adjustment range.

 All units shipped as separate packages and require field assembly.

Grommet Location

Specify location first, then select grommet color or "Empty Cutout" option. When "Empty Cutout" option is selected, a grommet or power unit must be ordered separately for each cutout.

No upcharge for "Empty Cutout" option.

(Add +\$229 per additional grommet)

Fixed Top always has Left & Right grommets.

Left	GL
Right	GR
Left & Right	GB

NOTE: Monitor arms should **ALWAYS** be installed in grommets on Silea height adjustable units. Please ensure a grommet location is specified on the top. This allows for bolt mount or clamp mount install of monitor arm. See page 35 for details.

TO ORDER PLEASE SPECIFY THE FOLLOWING:

WOOD TOP, WOOD CHASSIS

- MODEL NUMBER + WW**
- FSC**
- TOP WOOD FINISH + EDGE**
- CHASSIS WOOD FINISH**
- GALLERY PANEL WOOD FINISH**
- TOP UV FINISH**
- HAT KEYPAD & BASE COLOR**
- GROMMET**

Optional height adjustable keypads available

HAT KEYPAD & BASE COLOR

Basic Up/Down Keypad, Black P71 Column
Memory Preset Keypad, Black P71 Column
Paddle Keypad, Black P71 Column

LAM TOP, LAM CHASSIS

- MODEL NUMBER + LL**
- FSC**
- TOP LAM**
- CHASSIS LAM**
- EDGE DETAIL**
- HAT KEYPAD & BASE COLOR**
- GROMMET**

UDP71
MEMP71
PDL71

NOTE: Wood Tops only available with Square SQ Edge Detail option. Edge Details SQM, DFM, and TOM with 1/2" band are NOT available.

	D	W	H	model number + type	laminate	veneer 1	veneer 2
--	---	---	---	---------------------	----------	----------	----------

LEFT HAND DESK

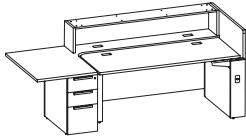

45	103	41	GS6GDXA42102L-A []	10,516	16,073	17,724
----	-----	----	----------------------------	--------	--------	--------

A = 69.84"
B = 28"
C = 11.24"
D = 12.32"
E = 30.13"

RIGHT HAND DESK

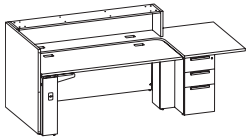

45	103	41	GS6GDXA42102R-A []	10,516	16,073	17,724
----	-----	----	----------------------------	--------	--------	--------

A = 69.84"
B = 28"
C = 11.24"
D = 12.32"
E = 30.13"

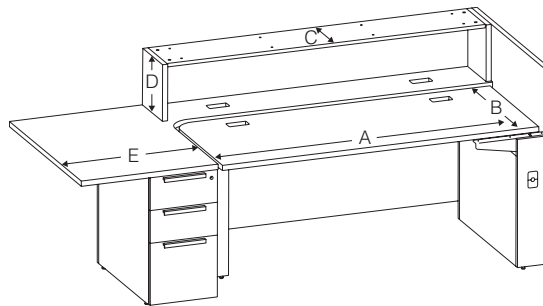

PRODUCT INFO

Separate countertop must be specified.

29.5" to 42.5" height adjustment range.

 All units shipped as separate packages and require field assembly.

Grommet Location

Specify location first, then select grommet color or "Empty Cutout" option. When "Empty Cutout" option is selected, a grommet or power unit must be ordered separately for each cutout.

No upcharge for "Empty Cutout" option.

(Add +\$229 per additional grommet)

Fixed Top always has Left & Right grommets.

Left	GL
Right	GR
Left & Right	GB

NOTE: Monitor arms should **ALWAYS** be installed in grommets on Silea height adjustable units. Please ensure a grommet location is specified on the top. This allows for bolt mount or clamp mount install of monitor arm. See page 35 for details.

TO ORDER PLEASE SPECIFY THE FOLLOWING:

WOOD TOP, WOOD CHASSIS

1. **MODEL NUMBER + WW**
2. **FSC**
3. **TOP WOOD FINISH + EDGE**
4. **CHASSIS WOOD FINISH**
5. **GALLERY PANEL WOOD FINISH**
6. **TOP UV FINISH**
7. **PULL**
8. **DRAWERS**
9. **HAT KEYPAD & BASE COLOR**
10. **GROMMET**
11. **KEYING**

Optional height adjustable keypads available

HAT KEYPAD & BASE COLOR

Basic Up/Down Keypad, Black P71 Column
Memory Preset Keypad, Black P71 Column
Paddle Keypad, Black P71 Column

LAM TOP, LAM CHASSIS

1. **MODEL NUMBER + LL**
2. **FSC**
3. **TOP LAM**
4. **CHASSIS LAM**
5. **EDGE DETAIL**
6. **PULL**
7. **DRAWERS**
8. **HAT KEYPAD & BASE COLOR**
9. **GROMMET**
10. **KEYING**

UDP71
MEMP71
PDLP71

NOTE: Wood Tops only available with Square SQ Edge Detail option. Edge Details SQM, DFM, and TOM with 1/2" band are NOT available.

ADVANCED HEIGHT ADJUSTABLE WELCOME DESK

Freestanding

Silea

03/23

	D	W	H	model number + type	laminata	vener 1	vener 2
LEFT HAND DESK	41	85	41	GS6G DFA4284L- []	8,100	12,012	13,259

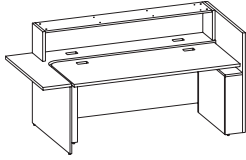

A = 69.84"
 B = 28"
 C = 11.24"
 D = 12.32"
 E = 12.13"

RIGHT HAND DESK

	41	85	41	GS6G DFA4284R- []	8,100	12,012	13,259
--	----	----	----	---------------------------	-------	--------	--------

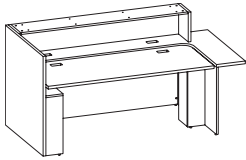

A = 69.84"
 B = 28"
 C = 11.24"
 D = 12.32"
 E = 12.13"

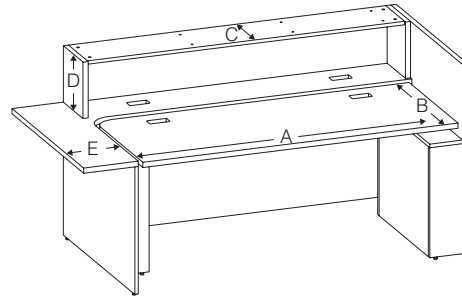

PRODUCT INFO

Separate countertop must be specified.

29.5" to 42.5" height adjustment range.

All units shipped as separate packages and require field assembly.

Grommet Location

Specify location first, then select grommet color or "Empty Cutout" option. When "Empty Cutout" option is selected, a grommet or power unit must be ordered separately for each cutout.

No upcharge for "Empty Cutout" option.

(Add +\$229 per additional grommet)

Fixed Top always has Left & Right grommets.

Left	GL
Right	GR
Left & Right	GB

NOTE: Monitor arms should **ALWAYS** be installed in grommets on Silea height adjustable units. Please ensure a grommet location is specified on the top. This allows for bolt mount or clamp mount install of monitor arm. See page 35 for details.

TO ORDER PLEASE SPECIFY THE FOLLOWING:

WOOD TOP, WOOD CHASSIS

- MODEL NUMBER + WW**
- FSC**
- TOP WOOD FINISH + EDGE**
- CHASSIS WOOD FINISH**
- GALLERY PANEL WOOD FINISH**
- TOP UV FINISH**
- PULL**
- DRAWERS**
- HAT KEYPAD & BASE COLOR**
- GROMMET**
- KEYING**

LAM TOP, LAM CHASSIS

- MODEL NUMBER + LL**
- FSC**
- TOP LAM**
- CHASSIS LAM**
- EDGE DETAIL**
- PULL**
- DRAWERS**
- HAT KEYPAD & BASE COLOR**
- GROMMET**
- KEYING**

Optional height adjustable keypads available

HAT KEYPAD & BASE COLOR

Basic Up/Down Keypad, Black P71 Column
 Memory Preset Keypad, Black P71 Column
 Paddle Keypad, Black P71 Column

UDP71
MEMP71
PDLP71

NOTE: Wood Tops only available with Square SQ Edge Detail option. Edge Details SQM, DFM, and TOM with 1/2" band are NOT available.

ADVANCED HEIGHT ADJUSTABLE WELCOME DESK

Freestanding with Pedestal

	D	W	H	model number + type	laminate	veneer 1	veneer 2
--	---	---	---	---------------------	----------	----------	----------

LEFT HAND DESK

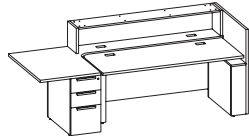

41	103	41	GS6GDFA42102L-A []	10,514	15,832	17,458
----	-----	----	----------------------------	--------	--------	--------

A = 69.84"
B = 28"
C = 11.24"
D = 12.32"
E = 30.13"

RIGHT HAND DESK

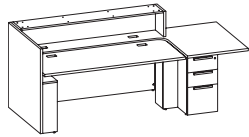

41	103	41	GS6GDFA42102R-A []	10,514	15,832	17,458
----	-----	----	----------------------------	--------	--------	--------

A = 69.84"
B = 28"
C = 11.24"
D = 12.32"
E = 30.13"

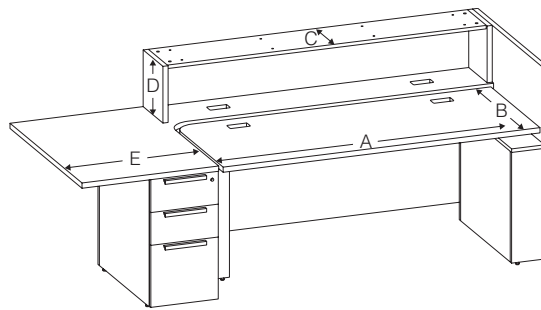

PRODUCT INFO

Separate countertop must be specified.

29.5" to 42.5" height adjustment range.

 All units shipped as separate packages and require field assembly.

Grommet Location

Specify location first, then select grommet color or "Empty Cutout" option. When "Empty Cutout" option is selected, a grommet or power unit must be ordered separately for each cutout.

No upcharge for "Empty Cutout" option.

(Add +\$229 per additional grommet)

Fixed Top always has Left & Right grommets.

Left	GL
Right	GR
Left & Right	GB

NOTE: Monitor arms should **ALWAYS** be installed in grommets on Silea height adjustable units. Please ensure a grommet location is specified on the top. This allows for bolt mount or clamp mount install of monitor arm. See page 35 for details.

TO ORDER PLEASE SPECIFY THE FOLLOWING:

WOOD TOP, WOOD CHASSIS

- MODEL NUMBER + WW**
- FSC**
- TOP WOOD FINISH + EDGE**
- CHASSIS WOOD FINISH**
- GALLERY PANEL WOOD FINISH**
- TOP UV FINISH**
- HAT KEYPAD & BASE COLOR**
- GROMMET**

Optional height adjustable keypads available

HAT KEYPAD & BASE COLOR

Basic Up/Down Keypad, Black P71 Column
Memory Preset Keypad, Black P71 Column
Paddle Keypad, Black P71 Column

LAM TOP, LAM CHASSIS

- MODEL NUMBER + LL**
- FSC**
- TOP LAM**
- CHASSIS LAM**
- EDGE DETAIL**
- HAT KEYPAD & BASE COLOR**
- GROMMET**

UDP71
MEMP71
PDLP71

NOTE: Wood Tops only available with Square SQ Edge Detail option. Edge Details SQM, DFM, and TOM with 1/2" band are NOT available.

ADVANCED FIXED HEIGHT WELCOME DESK

Extension

Silea
03/23

	D	W	H	model number + type	laminata	vener 1	vener 2
LEFT HAND DESK	42	85	41	GS6GDXF4284L- []	4,996	7,715	8,517

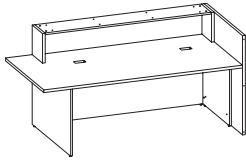

A = 84"
B = 42"
C = 11.25"
D = 12.32"

RIGHT HAND DESK	42	85	41	GS6GDXF4284R- []	4,996	7,715	8,517
------------------------	----	----	----	--------------------------	-------	-------	-------

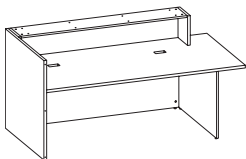

A = 84"
B = 42"
C = 11.25"
D = 12.32"

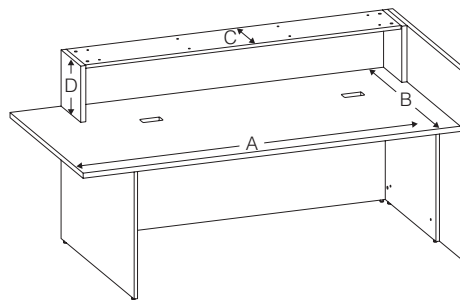

PRODUCT INFO

Separate countertop must be specified.

Grommet Location

(Add \$77 per grommet)

No Grommet **GN**
Left **GL**
Right **GR**
Left & Right **GB**

Specify location first, then select grommet color or "Empty Cutout" option. When "Empty Cutout" option is selected, a grommet or power unit must be ordered separately for each cutout.

TO ORDER PLEASE SPECIFY THE FOLLOWING:

WOOD TOP, WOOD CHASSIS

1. MODEL NUMBER + WW
2. FSC
3. TOP WOOD FINISH + EDGE
4. CHASSIS WOOD FINISH
5. GALLERY PANEL WOOD FINISH
6. TOP UV FINISH
7. GROMMET

LAM TOP, LAM CHASSIS

1. MODEL NUMBER + LL
2. FSC
3. TOP LAM
4. CHASSIS LAM
5. EDGE DETAIL
6. GROMMET

NOTE: Wood Tops only available with Square SQ Edge Detail option. Edge Details SQM, DFM, and TOM with 1/2" band are NOT available.

	D	W	H	model number + type	laminata	veneer 1	veneer 2
LEFT HAND DESK	42	103	41	GS6GDXF42102L-A []	7,410	11,759	12,962

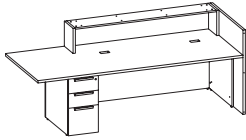

A = 102"
B = 42"
C = 11.25"
D = 12.32"

RIGHT HAND DESK	42	103	41	GS6GDXF42102R-A []	7,410	11,759	12,962
------------------------	----	-----	----	----------------------------	-------	--------	--------

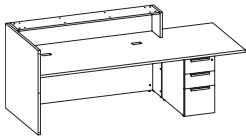

A = 102"
B = 42"
C = 11.25"
D = 12.32"

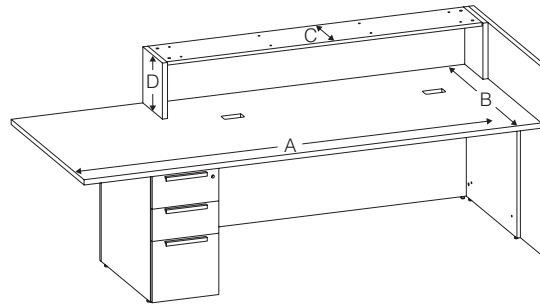

PRODUCT INFO

Separate countertop must be specified.

Grommet Location
(Add \$77 per grommet)

- No Grommet **GN**
- Left **GL**
- Right **GR**
- Left & Right **GB**

Specify location first, then select grommet color or "Empty Cutout" option. When "Empty Cutout" option is selected, a grommet or power unit must be ordered separately for each cutout.

TO ORDER PLEASE SPECIFY THE FOLLOWING:

WOOD TOP, WOOD CHASSIS

1. **MODEL NUMBER + WW**
2. **FSC**
3. **TOP WOOD FINISH + EDGE**
4. **CHASSIS WOOD FINISH**
5. **GALLERY PANEL WOOD FINISH**
6. **TOP UV FINISH**
7. **PULL**
8. **DRAWERS**
9. **GROMMET**
10. **KEYING**

LAM TOP, LAM CHASSIS

1. **MODEL NUMBER + LL**
2. **FSC**
3. **TOP LAM**
4. **CHASSIS LAM**
5. **EDGE DETAIL**
6. **PULL**
7. **DRAWERS**
8. **GROMMET**
9. **KEYING**

NOTE: Wood Tops only available with Square SQ Edge Detail option. Edge Details SQM, DFM, and TOM with 1/2" band are NOT available.

FIXED HEIGHT WELCOME DESK

Freestanding

Silea

03/23

	D	W	H	model number + type	laminata	veneer 1	veneer 2
LEFT HAND DESK	42	85	41	GS6GDFF4284L- []]	4,996	7,715	8,517

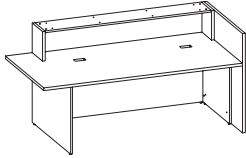

A = 84"
B = 42"
C = 11.25"
D = 12.32"

RIGHT HAND DESK	42	85	41	GS6GDFF4284R- []]	4,996	7,715	8,517
------------------------	----	----	----	----------------------------	-------	-------	-------

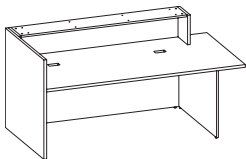

A = 84"
B = 42"
C = 11.25"
D = 12.32"

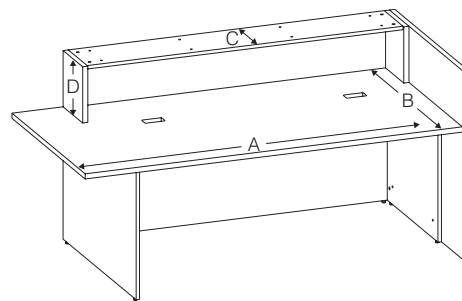

PRODUCT INFO

Separate countertop must be specified.

Grommet Location

(Add \$77 per grommet)

No Grommet **GN**
Left **GL**
Right **GR**
Left & Right **GB**

Specify location first, then select grommet color or "Empty Cutout" option. When "Empty Cutout" option is selected, a grommet or power unit must be ordered separately for each cutout.

TO ORDER PLEASE SPECIFY THE FOLLOWING:

WOOD TOP, WOOD CHASSIS

- MODEL NUMBER + WW**
- FSC**
- TOP WOOD FINISH + EDGE**
- CHASSIS WOOD FINISH**
- GALLERY PANEL WOOD FINISH**
- TOP UV FINISH**
- GROMMET**

LAM TOP, LAM CHASSIS

- MODEL NUMBER + LL**
- FSC**
- TOP LAM**
- CHASSIS LAM**
- EDGE DETAIL**
- GROMMET**

NOTE: Wood Tops only available with Square SQ Edge Detail option. Edge Details SQM, DFM, and TOM with 1/2" band are NOT available.

	D	W	H	model number + type	laminata	veneer 1	veneer 2
LEFT HAND DESK	42	103	41	GS6GDFF42102L-A []	7,410	11,759	12,962

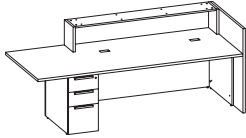

A = 102"
B = 42"
C = 11.25"
D = 12.32"

RIGHT HAND DESK	42	103	41	GS6GDFF42102R-A []	7,410	11,759	12,962
------------------------	----	-----	----	----------------------------	-------	--------	--------

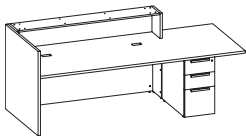

A = 102"
B = 42"
C = 11.25"
D = 12.32"

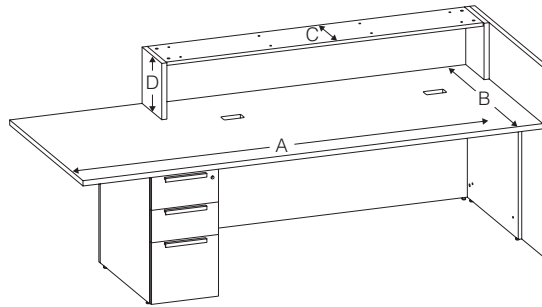

PRODUCT INFO

Separate countertop must be specified.

Grommet Location
(Add \$77 per grommet)

No Grommet **GN**
Left **GL**
Right **GR**
Left & Right **GB**

Specify location first, then select grommet color or "Empty Cutout" option. When "Empty Cutout" option is selected, a grommet or power unit must be ordered separately for each cutout.

TO ORDER PLEASE SPECIFY THE FOLLOWING:

WOOD TOP, WOOD CHASSIS

1. MODEL NUMBER + WW
2. FSC
3. TOP WOOD FINISH + EDGE
4. CHASSIS WOOD FINISH
5. GALLERY PANEL WOOD FINISH
6. TOP UV FINISH
7. PULL
8. GROMMET
9. KEYING

LAM TOP, LAM CHASSIS

1. MODEL NUMBER + LL
2. FSC
3. TOP LAM
4. CHASSIS LAM
5. EDGE DETAIL
6. PULL
7. GROMMET
8. KEYING

NOTE: Wood Tops only available with Square SQ Edge Detail option. Edge Details SQM, DFM, and TOM with 1/2" band are NOT available.

WELCOME DESK SHELL

Freestanding

Silea

03/23

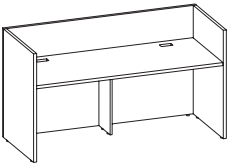
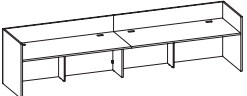
	D	W	H	model number + type	laminate	veneer 1	veneer 2
 GS6GDR3072	31 1/4	74 1/2	41 1/4	GS6GDR3072- []	4,138	6,313	6,969
	37 1/4	74 1/2	41 1/4	GS6GDR3672- []	4,380	6,669	7,362
	37 1/4	86 1/2	41 1/4	GS6GDR3684- []	4,967	7,516	8,297
	31 1/4	146 1/2	41 1/4	GS6GDR30144- []	6,947	11,078	12,145
	37 1/4	146 1/2	41 1/4	GS6GDR36144- []	7,251	11,535	12,649
	37 1/4	170 1/2	41 1/4	GS6GDR36168- []	8,389	13,176	14,461
 GS6GDR36168	• For use with standard transaction tops or with no transaction top. NOT for use with waterfall transaction tops.						
	31 1/4	74 1/2	41 1/4	GS6GDTR3072- []	4,138	6,313	6,969
	37 1/4	74 1/2	41 1/4	GS6GDTR3672- []	4,380	6,669	7,362

• For use with Waterfall Transaction Top only.

PRODUCT INFO

Wood tops long grain.
Laminate tops long grain standard.

 Units shipped as separate packages and require field assembly.

Grommet Location
(Add \$77 per grommet for widths 72"-84", \$153 per grommet for widths 144"-168")

No Grommet **GN**
Center **GC**
Left & Right **GB**

Specify location first, then select grommet color or "Empty Cutout" option. When "Empty Cutout" option is selected, a grommet or power unit must be ordered separately for each cutout.

TO ORDER PLEASE SPECIFY THE FOLLOWING:

WOOD TOP, WOOD CHASSIS

- MODEL NUMBER + WW**
- FSC**
- TOP WOOD FINISH + EDGE**
- CHASSIS WOOD FINISH**
- GALLERY PANEL WOOD FINISH**
- TOP UV FINISH**
- GROMMET**

LAM TOP, LAM CHASSIS

- MODEL NUMBER + LL**
- FSC**
- TOP LAM**
- CHASSIS LAM**
- EDGE DETAIL**
- GROMMET**

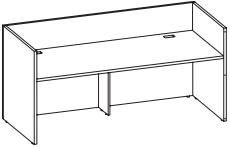
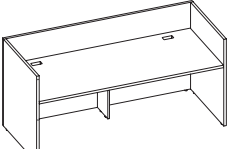
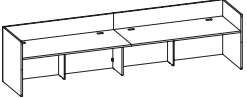
	D	W	H	model number + type	laminate	vener 1	vener 2	
LEFT HAND 	31 1/4	74 1/2	41 1/4	GS6GDR3072L- []	4,138	6,313	6,969	
	37 1/4	74 1/2	41 1/4	GS6GDR3672L- []	4,380	6,669	7,362	
	37 1/4	86 1/2	41 1/4	GS6GDR3684L- []	4,967	7,516	8,297	
	<ul style="list-style-type: none"> • For use with standard transaction tops or with no transaction top. NOT for use with waterfall transaction tops. 							
	31 1/4	74 1/2	41 1/4	GS6GDTR3072L- []	4,138	6,313	6,969	
	37 1/4	74 1/2	41 1/4	GS6GDTR3672L- []	4,380	6,669	7,362	
<ul style="list-style-type: none"> • For use with Waterfall Transaction Top only. 								
RIGHT HAND 	31 1/4	74 1/2	41 1/4	GS6GDR3072R- []	4,138	6,313	6,969	
	37 1/4	74 1/2	41 1/4	GS6GDR3672R- []	4,380	6,669	7,362	
	37 1/4	86 1/2	41 1/4	GS6GDR3684R- []	4,967	7,516	8,297	
	<ul style="list-style-type: none"> • For use with standard transaction tops or with no transaction top. NOT for use with waterfall transaction tops. 							
	31 1/4	74 1/2	41 1/4	GS6GDTR3072R- []	4,138	6,313	6,969	
	37 1/4	74 1/2	41 1/4	GS6GDTR3672R- []	4,380	6,669	7,362	
<ul style="list-style-type: none"> • For use with Waterfall Transaction Top only. 								
LEFT AND RIGHT HAND 	31 1/4	146 1/2	41 1/4	GS6GDR30144LR- []	6,947	11,078	12,145	
	37 1/4	146 1/2	41 1/4	GS6GDR36144LR- []	7,251	11,535	12,649	
	37 1/4	170 1/2	41 1/4	GS6GDR36168LR- []	8,389	13,176	14,461	
	<ul style="list-style-type: none"> • For use with standard transaction tops or with no transaction top. NOT for use with waterfall transaction tops. 							

PRODUCT INFO

Wood tops long grain.
Laminate tops long grain standard.

 Units shipped as separate packages and require field assembly.

Grommet Location
(Add \$77 per grommet for widths 72"-84", \$153 per grommet for widths 144"-168")

No Grommet **GN**
Center **GC**
Left & Right **GB**

Specify location first, then select grommet color or "Empty Cutout" option. When "Empty Cutout" option is selected, a grommet or power unit must be ordered separately for each cutout.

TO ORDER PLEASE SPECIFY THE FOLLOWING:

WOOD TOP, WOOD CHASSIS

1. MODEL NUMBER + WW
2. FSC
3. TOP WOOD FINISH + EDGE
4. CHASSIS WOOD FINISH
5. GALLERY PANEL WOOD FINISH
6. TOP UV FINISH
7. GROMMET

LAM TOP, LAM CHASSIS

1. MODEL NUMBER + LL
2. FSC
3. TOP LAM
4. CHASSIS LAM
5. EDGE DETAIL
6. GROMMET

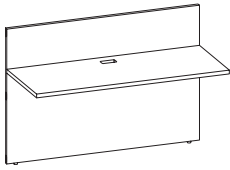

D	W	H	model number + type	laminata	veneer 1	veneer 2
25	48	41 1/4	GS6GBG2448- []	1,806	2,576	2,844
25	54	41 1/4	GS6GBG2454- []	2,057	2,771	3,059
25	60	41 1/4	GS6GBG2460- []	2,195	2,975	3,284

PRODUCT INFO

Wood tops short grain standard. Lam tops short grain standard.

 Units shipped as separate packages and require field assembly.

Grommet Location
(Add \$77 per grommet)

No Grommet **GN**
Center **GC**

Specify location first, then select grommet color or "Empty Cutout" option. When "Empty Cutout" option is selected, a grommet or power unit must be ordered separately for each cutout.

TO ORDER PLEASE SPECIFY THE FOLLOWING:

WOOD TOP, WOOD CHASSIS

1. **MODEL NUMBER + WW**
2. **FSC**
3. **TOP WOOD FINISH + EDGE**
4. **GALLERY PANEL WOOD FINISH**
5. **TOP UV FINISH**
6. **GROMMET**

LAM TOP, LAM CHASSIS

1. **MODEL NUMBER + LL**
2. **FSC**
3. **TOP LAM**
4. **CHASSIS LAM**
5. **EDGE DETAIL**
6. **GROMMET**

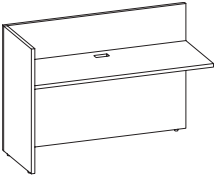
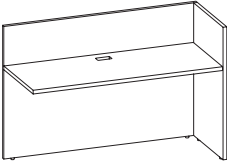
	D	W	H	model number + type	laminata	veneer 1	veneer 2
LEFT HAND 	25 1/4	49 1/4	41 1/4	GS6GRT2448L- []	2,708	3,993	4,408
	25 1/4	55 1/4	41 1/4	GS6GRT2454L- []	2,842	4,190	4,625
	25 1/4	61 1/4	41 1/4	GS6GRT2460L- []	2,982	4,398	4,855
RIGHT HAND 	25 1/4	49 1/4	41 1/4	GS6GRT2448R- []	2,708	3,993	4,408
	25 1/4	55 1/4	41 1/4	GS6GRT2454R- []	2,842	4,190	4,625
	25 1/4	61 1/4	41 1/4	GS6GRT2460R- []	2,982	4,398	4,855

PRODUCT INFO

Wood tops short grain standard. Lam tops short grain standard.

 Units shipped as separate packages and require field assembly.

Grommet Location
(Add \$77 per grommet)

No Grommet **GN**
Center **GC**

Specify location first, then select grommet color or "Empty Cutout" option. When "Empty Cutout" option is selected, a grommet or power unit must be ordered separately for each cutout.

TO ORDER PLEASE SPECIFY THE FOLLOWING:

WOOD TOP, WOOD CHASSIS

- MODEL NUMBER + WW**
- FSC**
- TOP WOOD FINISH + EDGE**
- GALLERY PANEL WOOD FINISH**
- TOP UV FINISH**
- GROMMET**

LAM TOP, LAM CHASSIS

- MODEL NUMBER + LL**
- FSC**
- TOP LAM**
- CHASSIS LAM**
- EDGE DETAIL**
- GROMMET**

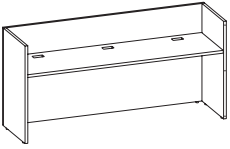
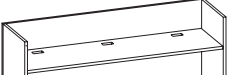
	H	W	D	model number + type	laminare	vener 1	vener 2
LEFT HAND 	25 1/4	74 1/2	41 1/4	GS6GCR2472L- []	4,096	6,027	6,653
	25 1/4	80 1/2	41 1/4	GS6GCR2478L- []	4,269	6,279	6,931
	25 1/4	86 1/2	41 1/4	GS6GCR2484L- []	4,439	6,530	7,208
RIGHT HAND 	25 1/4	74 1/2	41 1/4	GS6GCR2472R- []	4,096	6,027	6,653
	25 1/4	80 1/2	41 1/4	GS6GCR2478R- []	4,269	6,279	6,931
	25 1/4	86 1/2	41 1/4	GS6GCR2484R- []	4,439	6,530	7,208

• Flat brackets ordered separately (model #MDWBRK)

PRODUCT INFO

All tops long grain.

 Units shipped as separate packages and require field assembly.

Grommet Location
(Add \$77 per grommet)

- No Grommet **GN**
- Left **GL**
- Right **GR**
- Left & Right **GB**
- Center **GC**

Specify location first, then select grommet color or "Empty Cutout" option. When "Empty Cutout" option is selected, a grommet or power unit must be ordered separately for each cutout.

TO ORDER PLEASE SPECIFY THE FOLLOWING:

WOOD TOP, WOOD CHASSIS

1. **MODEL NUMBER + WW**
2. **FSC**
3. **TOP WOOD FINISH + EDGE**
4. **TOP UV FINISH**
5. **GROMMET**

LAM TOP, LAM CHASSIS

1. **MODEL NUMBER + LL**
2. **FSC**
3. **TOP LAM**
4. **CHASSIS LAM**
5. **EDGE DETAIL**
6. **GROMMET**

D	W	H	model number + type	laminate	veneer 1	veneer 2	solid surface
12 1/2	74	41 1/2	GS6GDXMT72- []	1,307	1,865	2,052	11,585

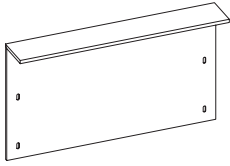

- For use with:
Advanced HAT Welcome Desk
Advanced Fixed Welcome Desk
Welcome Desk Shell
Welcome Desk Extension

PRODUCT INFO

Top thickness:
Wood 1 3/16"
Laminate 1 3/16"
Solid Surface 1 1/4"
Top includes inserts for connection to base.

TO ORDER PLEASE SPECIFY THE FOLLOWING:

WOOD TOP

- 1. MODEL NUMBER + W**
- 2. FSC**
- 3. FINISH**
- 4. TOP UV FINISH**

LAM TOP

- 1. MODEL NUMBER + L**
- 2. FSC**
- 3. FINISH**

SOLID SURFACE TOP



- 1. MODEL NUMBER + S**
- 2. FINISH**

Example

GS6GDXMT72-W.X.NC260.OP
 GS6GDXMT72-W X NC260 OP
 MODEL NUMBER + TYPE FSC FINISH TOP UV FINISH

TRANSACTION TOPS

Silea
03/23

	D	W	H	model number + type	laminata	veneer 1	veneer 2	solid surface
 GS6GDTT72	15	74 3/4	1	GS6GDTT72- []	677	1,456	1,608	4,358
	15	86 3/4	1	GS6GDTT84- []	695	1,300	1,436	4,812
 GS6GDTT144	15	146 3/4	1	GS6GDTT144- []	872	1,679	1,854	7,572
	15	170 3/4	1	GS6GDTT168- []	918	1,896	2,094	8,676

PRODUCT INFO

Top thickness:
Wood 1 3/16"
Laminata 1 3/16"
Solid Surface 1 1/4"
Top includes inserts for connection to base.

TO ORDER PLEASE SPECIFY THE FOLLOWING:

WOOD TOP

1. **MODEL NUMBER + W**
2. **FSC**
3. **FINISH**
4. **TOP UV FINISH**

LAM TOP

1. **MODEL NUMBER + L**
2. **FSC**
3. **FINISH**

SOLID SURFACE TOP

1. **MODEL NUMBER + S**
2. **FINISH**

Example

GS6GDTT72-W.X.NC260.OP
 GS6GDTT72-W X NC260 OP
 MODEL NUMBER + TYPE FSC FINISH TOP UV FINISH

fabric grades

COM/4

	D	W	H	yards	model number	1	2	3	COM/4
ADVANCED DESK APPLICATION	1	70	11 3/8		GS6GXTK72	966	1,012	1,058	1,105

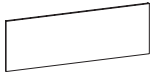

DESK OR CREDENZA APPLICATION



1	72	12		GS6GTK72	966	1,012	1,058	1,105
1	78	12		GS6GTK78	995	1,047	1,098	1,149
1	84	12		GS6GTK84	1,024	1,081	1,137	1,193
1	144	12		GS6GTK144	1,824	1,916	2,009	2,100
1	168	12		GS6GTK168	1,941	2,054	2,166	2,278

RETURN APPLICATION

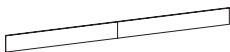

1	71	12		GS6GTK71R	966	1,012	1,058	1,105
1	77	12		GS6GTK77R	995	1,047	1,098	1,149
1	83	12		GS6GTK83R	1,024	1,081	1,137	1,193
1	89	12		GS6GTK89R	1,053	1,110	1,166	1,222
1	94	12		GS6GTK94R	1,079	1,141	1,203	1,264
1	95	12		GS6GTK95R	1,079	1,141	1,203	1,264
1	100	12		GS6GTK100R	1,512	1,579	1,645	1,712
1	106	12		GS6GTK106R	1,572	1,644	1,715	1,787
1	112	12		GS6GTK112R	1,630	1,705	1,778	1,852
1	118	12		GS6GTK118R	1,689	1,771	1,853	1,935
1	124	12		GS6GTK124R	1,747	1,835	1,921	2,008
1	130	12		GS6GTK130R	1,806	1,898	1,991	2,082

PRODUCT INFO

100"-130" wide tackboards are 2 piece.

For use with Silea Welcome Desks.

70" wide tackboard for use within Advanced Desk cubby space.

TO ORDER PLEASE SPECIFY THE FOLLOWING:

LIST

1. **MODEL NUMBER**
2. **FABRIC**
3. **FSC TACKBOARDS**

FSC Tackboard Options

FSC = FSC Required (5% COM upcharge)

NR = FSC Not Required

IN/OUT STORAGE

Silea
03/23

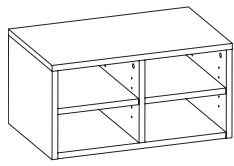

D	W	H	model number + type	laminata	veneer 1	veneer 2	solid surface/ veneer 1	solid surface/ veneer 2
15	23 3/4	12 5/16	GS6MB24SS- []	1,038	1,453	1,598	2,324	2,557

PRODUCT INFO

TO ORDER PLEASE SPECIFY THE FOLLOWING:

WOOD TOP

1. **MODEL NUMBER + W**
2. **FSC**
3. **FINISH**
4. **TOP UV FINISH**

LAM TOP

1. **MODEL NUMBER + L**
2. **FSC**
3. **FINISH**

SOLID SURFACE TOP

1. **MODEL NUMBER + WS**
2. **FSC**
3. **WOOD FINISH**
4. **SOLID SURFACE FINISH**

Example

GS6MBS24SS-W.X.NC260.OP

GS6MBS24SS-W	X	NC260	OP
MODEL NUMBER + TYPE	FSC	FINISH	TOP UV FINISH

Modular Caseworks149-220
Desk Worksurface 150-153
Desk Pedestals 154-155
Desk Legs 156-160
Desk | Runoff Modesty Panel. 161-166
24 & 30 Depth Worksurfaces.167-170
24 & 30 Depth Pedestals 171-200
Modular End Panel201
Modular L Supports202
Support & Ped Backs 203-213
Layers W/ Laptop Drawer 214
Round Tops 215
Guitar Pick Top 216
Layers Box & Brackets.217-219
Modular Pedestal Cushion.220

MODULAR DESK WORKSURFACE

Rectangular

Silea

03/23

	D	W	H	model number + type	laminata	vener 1	vener 2
	30	42	1 3/16	GS2DWRR3042- <input type="checkbox"/>	917	1,432	1,582
	30	48	1 3/16	GS2DWRR3048- <input type="checkbox"/>	966	1,506	1,663
	30	54	1 3/16	GS2DWRR3054- <input type="checkbox"/>	977	1,526	1,686
	30	60	1 3/16	GS2DWRR3060- <input type="checkbox"/>	990	1,543	1,704
	30	66	1 3/16	GS2DWRR3066- <input type="checkbox"/>	1,036	1,615	1,783
	30	72	1 3/16	GS2DWRR3072- <input type="checkbox"/>	1,091	1,699	1,876
	30	78	1 3/16	GS2DWRR3078- <input type="checkbox"/>	1,166	1,819	2,009
	30	84	1 3/16	GS2DWRR3084- <input type="checkbox"/>	1,248	1,948	2,151
	30	90	1 3/16	GS2DWRR3090- <input type="checkbox"/>	1,330	2,046	2,259
	30	96	1 3/16	GS2DWRR3096- <input type="checkbox"/>	1,396	2,148	2,372

• Flat brackets ordered separately (model #MDWBRK)

	36	42	1 3/16	GS2DWRR3642- <input type="checkbox"/>	962	1,503	1,660
	36	48	1 3/16	GS2DWRR3648- <input type="checkbox"/>	1,014	1,583	1,748
	36	54	1 3/16	GS2DWRR3654- <input type="checkbox"/>	1,036	1,615	1,783
	36	60	1 3/16	GS2DWRR3660- <input type="checkbox"/>	1,057	1,647	1,819
	36	66	1 3/16	GS2DWRR3666- <input type="checkbox"/>	1,109	1,731	1,911
	36	72	1 3/16	GS2DWRR3672- <input type="checkbox"/>	1,168	1,823	2,013
	36	78	1 3/16	GS2DWRR3678- <input type="checkbox"/>	1,251	1,951	2,154
	36	84	1 3/16	GS2DWRR3684- <input type="checkbox"/>	1,338	2,089	2,306
	36	90	1 3/16	GS2DWRR3690- <input type="checkbox"/>	1,425	2,193	2,421
	36	96	1 3/16	GS2DWRR3696- <input type="checkbox"/>	1,497	2,303	2,543

• Flat brackets ordered separately (model #MDWBRK)

NOTE: Desks and Extensions without a full modesty panel and an unsupported area of 48" and greater require a steel worksurface support.

PRODUCT INFO

Wood tops optional grain direction.

Lam tops optional grain up to 60", above 60" long grain standard.

Grommet Location

(Add \$77 per grommet)

No Grommet **GN**
 Left **GL**
 Right **GR**
 Left & Right **GB**

Specify location first, then select grommet color or "Empty Cutout" option. When "Empty Cutout" option is selected, a grommet or power unit must be ordered separately for each cutout.

TO ORDER PLEASE SPECIFY THE FOLLOWING:

WOOD TOP

- MODEL NUMBER + W**
- FSC**
- TOP WOOD FINISH + EDGE**
- TOP UV FINISH**
- GRAIN DIRECTION**
- GROMMET**

LAM TOP

- MODEL NUMBER + L**
- FSC**
- TOP LAM**
- GRAIN DIRECTION (up to 60")**
- EDGE DETAIL**
- GROMMET**



D	W	H	model number + type	laminate	veneer 1	veneer 2
36	72	1 3/16	GS2DWA3672- []	1,461	2,282	2,520
36	84	1 3/16	GS2DWA3684- []	1,673	2,612	2,884

• Flat brackets ordered separately (model #MDWBRK)

42	72	1 3/16	GS2DWA4272- []	1,636	2,555	2,821
42	84	1 3/16	GS2DWA4284- []	1,873	2,925	3,230

• Flat brackets ordered separately (model #MDWBRK)

NOTE: Desks and Extensions without a full modesty panel and an unsupported area of 48" and greater require a steel worksurface support.

PRODUCT INFO

Wood tops optional grain direction.

Lam tops long grain standard.

Grommet Location

(Add \$77 per grommet)

- No Grommet **GN**
- Left **GL**
- Right **GR**
- Left & Right **GB**

Specify location first, then select grommet color or "Empty Cutout" option. When "Empty Cutout" option is selected, a grommet or power unit must be ordered separately for each cutout.

TO ORDER PLEASE SPECIFY THE FOLLOWING:

WOOD TOP

1. **MODEL NUMBER + W**
2. **FSC**
3. **TOP WOOD FINISH + EDGE**
4. **TOP UV FINISH**
5. **GRAIN DIRECTION**
6. **GROMMET**

LAM TOP

1. **MODEL NUMBER + L**
2. **FSC**
3. **TOP LAM**
4. **GROMMET**

MODULAR DESK WORKSURFACE

Racetrack

Silea

03/23



D	W	H	model number + type	laminata	vener 1	vener 2
30	66	1 3/16	GS2DWRT3066L- []	1,295	2,020	2,231
30	72	1 3/16	GS2DWRT3072L- []	1,362	2,126	2,348

• Flat brackets ordered separately (model #MDWBRK)

30	66	1 3/16	GS2DWRT3066R- []	1,295	2,020	2,231
30	72	1 3/16	GS2DWRT3072R- []	1,362	2,126	2,348

• Flat brackets ordered separately (model #MDWBRK)

NOTE: Desks and Extensions without a full modesty panel and an unsupported area of 48" and greater require a steel worksurface support.

PRODUCT INFO

Wood tops optional grain direction.

Lam tops optional grain up to 60", above 60" long grain standard.

Grommet Location (Add \$77 per grommet)

No Grommet **GN**
 Left **GL**
 Right **GR**
 Left & Right **GB**

Specify location first, then select grommet color or "Empty Cutout" option. When "Empty Cutout" option is selected, a grommet or power unit must be ordered separately for each cutout.

TO ORDER PLEASE SPECIFY THE FOLLOWING:

WOOD TOP

1. **MODEL NUMBER + W**
2. **FSC**
3. **TOP WOOD FINISH + EDGE**
4. **TOP UV FINISH**
5. **GRAIN DIRECTION**
6. **GROMMET**

LAM TOP

1. **MODEL NUMBER + L**
2. **FSC**
3. **TOP LAM**
4. **GRAIN DIRECTION (up to 60")**
5. **GROMMET**

	D	W	H	model number + type	laminate	veneer 1	veneer 2
b SHAPE	42	72	1 3/16	GS2DWB4272- []	2,233	3,489	3,852



- Flat brackets ordered separately (model #MDWBRK)

d SHAPE	42	72	1 3/16	GS2DWD4272- []	2,233	3,489	3,852
----------------	----	----	--------	------------------------	-------	-------	-------



- Flat brackets ordered separately (model #MDWBRK)

NOTE: Desks and Extensions without a full modesty panel and an unsupported area of 48" and greater require a steel worksurface support.

PRODUCT INFO

Wood tops optional grain direction.
Lam tops long grain standard.

Grommet Location
(Add \$77 per grommet)

No Grommet	GN
Left	GL
Right	GR
Left & Right	GB

Specify location first, then select grommet color or "Empty Cutout" option. When "Empty Cutout" option is selected, a grommet or power unit must be ordered separately for each cutout.

TO ORDER PLEASE SPECIFY THE FOLLOWING:









- | | |
|----------------------------------|----------------------------|
| WOOD TOP | LAM TOP |
| 1. MODEL NUMBER + W | 1. MODEL NUMBER + L |
| 2. FSC | 2. FSC |
| 3. TOP WOOD FINISH + EDGE | 3. TOP LAM |
| 4. TOP UV FINISH | 4. GROMMET |
| 5. GRAIN DIRECTION | |
| 6. GROMMET | |

MODULAR DESK PEDESTALS

30" & 36"D | Left and Right Hand | w/o Back Panel

Silea

03/23

	D	W	H	model number + type	laminata	vener 1	vener 2
30" DEPTH 9" WIDTH							
 Box/Box/File	29 7/8	9 7/16	27 7/8	GS2DPD309-3S <input type="checkbox"/>	1,674	2,423	2,675
 File/File	29 7/8	9 7/16	27 7/8	GS2DPD309-2S <input type="checkbox"/>	1,674	2,423	2,675
30" DEPTH 15" WIDTH							
	29 7/8	15	27 7/8	GS2DPD3015-3 <input type="checkbox"/>	1,674	2,424	2,676
	29 7/8	15	27 7/8	GS2DPD3015-2 <input type="checkbox"/>	1,674	2,424	2,676
36" DEPTH 9" WIDTH							
 Box/Box/File	35 7/8	9 7/16	27 7/8	GS2DPD369-3S <input type="checkbox"/>	1,788	2,591	2,861
 File/File	35 7/8	9 7/16	27 7/8	GS2DPD369-2S <input type="checkbox"/>	1,788	2,591	2,861
36" DEPTH 15" WIDTH							
	35 7/8	15	27 7/8	GS2DPD3615-3 <input type="checkbox"/>	1,978	2,866	3,164
	35 7/8	15	27 7/8	GS2DPD3615-2 <input type="checkbox"/>	1,978	2,866	3,164

• -3A pedestal has hidden accessory drawer behind top drawer front.

PRODUCT INFO

No kneewell cutout.
No pedestal back included.



TO ORDER PLEASE SPECIFY THE FOLLOWING:

WOOD CHASSIS

1. **MODEL NUMBER + W**
2. **FSC**
3. **CHASSIS WOOD FINISH**
4. **PULL**
5. **DRAWERS**
6. **KEYING**

LAM CHASSIS

1. **MODEL NUMBER + L**
2. **FSC**
3. **CHASSIS LAM**
4. **FRONT LAM**
5. **PULL**
6. **DRAWERS**
7. **KEYING**



	D	W	H	model number + type	laminate	veneer 1	veneer 2
30" DEPTH  Left hand	29 7/8	9 7/16	27 7/8	GS2DPD309L-XN []	920	1,334	1,473
	29 7/8	9 7/16	27 7/8	GS2DPD309R-XN []	920	1,334	1,473
	29 7/8	15	27 7/8	GS2DPD3015L-XN []	968	1,989	2,197
	29 7/8	15	27 7/8	GS2DPD3015R-XN []	968	1,989	2,197
36" DEPTH  Right hand	35 7/8	9 7/16	27 7/8	GS2DPD369L-XN []	960	1,390	1,535
	35 7/8	9 7/16	27 7/8	GS2DPD369R-XN []	960	1,390	1,535
	35 7/8	15	27 7/8	GS2DPD3615L-XN []	1,040	1,504	1,661
	35 7/8	15	27 7/8	GS2DPD3615R-XN []	1,040	1,504	1,661

PRODUCT INFO	TO ORDER PLEASE SPECIFY THE FOLLOWING:								
Removable back panel included.	<table border="0"> <tr> <td>WOOD CHASSIS</td> <td>LAM CHASSIS</td> </tr> <tr> <td>1. MODEL NUMBER + W</td> <td>1. MODEL NUMBER + L</td> </tr> <tr> <td>2. FSC</td> <td>2. FSC</td> </tr> <tr> <td>3. CHASSIS WOOD FINISH</td> <td>3. CHASSIS LAM</td> </tr> </table>	WOOD CHASSIS	LAM CHASSIS	1. MODEL NUMBER + W	1. MODEL NUMBER + L	2. FSC	2. FSC	3. CHASSIS WOOD FINISH	3. CHASSIS LAM
WOOD CHASSIS	LAM CHASSIS								
1. MODEL NUMBER + W	1. MODEL NUMBER + L								
2. FSC	2. FSC								
3. CHASSIS WOOD FINISH	3. CHASSIS LAM								

MODULAR DESK PANEL LEGS

Post | Post w/ Casters | Hoop

Silea
03/23

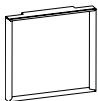
	D	W	H	model number	price
 Post	23 7/8	3	27 7/8	GS2DSL24-N	1,149
	29 7/8	3	27 7/8	GS2DSL30-N	1,186
	35 7/8	3	27 7/8	GS2DSL36-N	1,222
 Post w/casters	23 7/8	3	27 7/8	GS2DSL24-NST	1,403
	29 7/8	3	27 7/8	GS2DSL30-NST	1,442
	35 7/8	3	27 7/8	GS2DSL36-NST	1,477
 Hoop	23 7/8	3	27 7/8	GS2DSL24-H	1,279
	29 7/8	3	27 7/8	GS2DSL30-H	1,317
	35 7/8	3	27 7/8	GS2DSL36-H	1,356

PRODUCT INFO

24" depth panel legs to be used with 24" depth worksurfaces only.

30" depth panel legs to be used with 30" depth worksurfaces only.

36" depth panel legs to be used with 36" depth worksurfaces only.

Legs made out of aluminum.

TO ORDER PLEASE SPECIFY THE FOLLOWING:

LIST

1. **MODEL NUMBER**
2. **HARDWARE COLOR**

	D	W	H	model number	list
 Hoop w/glass insert	23 7/8	3	27 7/8	GS2DSL24-G	2,305
	29 7/8	3	27 7/8	GS2DSL30-G	2,674
	35 7/8	3	27 7/8	GS2DSL36-G	2,957



PRODUCT INFO

24" depth panel legs to be used with 24" depth worksurfaces only.

30" depth panel legs to be used with 30" depth worksurfaces only.

36" depth panel legs to be used with 36" depth worksurfaces only.

TO ORDER PLEASE SPECIFY THE FOLLOWING:

GLASS INSERT

1. **MODEL NUMBER**
2. **HARDWARE COLOR**
3. **GLASS COLOR**

MODULAR DESK PANEL LEGS

Steel Hoop | Open

Silea

03/23

	D	W	H	model number	ISI
 Steel hoop	23 7/8	3	27 7/8	GS2DHL24-H	687
	29 7/8	3	27 7/8	GS2DHL30-H	743
	35 7/8	3	27 7/8	GS2DHL36-H	800



PRODUCT INFO

24" depth panel legs to be used with 24" depth worksurfaces only.

30" depth panel legs to be used with 30" depth worksurfaces only.





36" depth panel legs to be used with 36" depth worksurfaces only.

Leg made out of steel.

TO ORDER PLEASE SPECIFY THE FOLLOWING:

LIST

1. **MODEL NUMBER**
2. **HARDWARE COLOR**

	D	W	H	model number	sq
 Angled	3	3	27 7/8	GS2ALEG-A	420
 Vertical	3	3	27 7/8	GS2VLEG-A	420
 Trapezoid Column	5	3	27 7/8	GS2COLUMN	1,118
 Round Column	3	3	27 7/8	GS2RNDCOLUMN	490



Angled leg



Vertical



Trapezoid Column

PRODUCT INFO

Each model is qty 1.
Column leg cannot be used in freestanding applications. It must be used in adjoining units.

TO ORDER PLEASE SPECIFY THE FOLLOWING:

LIST

1. **MODEL NUMBER**
2. **HARDWARE COLOR**



D	W	H	model number	ISI
3	3	27 7/8	GS2SRNCLEG-W	984



PRODUCT INFO

Only for use on 30" and 36" deep tops.
 Not for use on 24" deep tops.
 Not for use with grommet specified over leg.
 Model is qty 1.

TO ORDER PLEASE SPECIFY THE FOLLOWING:

LIST

1. **MODEL NUMBER**
2. **FSC**
3. **WOOD FINISH**

MODULAR DESK | RUNOFF MODESTY PANEL

10" high for 9" Pedestals and Panel Legs

	D	W	H	model number + type	laminate	veneer 1	veneer 2
	3/4	38	10	GS2DMPH39- <input type="checkbox"/>	410	591	654
	3/4	41	10	GS2DMPH42- <input type="checkbox"/>	424	614	679
	3/4	44	10	GS2DMPH45- <input type="checkbox"/>	441	637	704
	3/4	47	10	GS2DMPH48- <input type="checkbox"/>	488	705	780
	3/4	50	10	GS2DMPH51- <input type="checkbox"/>	506	729	806
	3/4	53	10	GS2DMPH54- <input type="checkbox"/>	518	751	830
	3/4	56	10	GS2DMPH57- <input type="checkbox"/>	537	774	855
	3/4	59	10	GS2DMPH60- <input type="checkbox"/>	574	832	920
	3/4	62	10	GS2DMPH63- <input type="checkbox"/>	591	856	946
	3/4	65	10	GS2DMPH66- <input type="checkbox"/>	606	879	971
	3/4	68	10	GS2DMPH69- <input type="checkbox"/>	637	924	1,020
	3/4	71	10	GS2DMPH72- <input type="checkbox"/>	663	960	1,061

NOTE: For modesty width calculation, subtract pedestal width or 3" for panel legs from the width of the worksurface.

PRODUCT INFO

TO ORDER PLEASE SPECIFY THE FOLLOWING:

WOOD CHASSIS

1. **MODEL NUMBER + W**
2. **FSC**
3. **CHASSIS WOOD FINISH**

LAM CHASSIS

1. **MODEL NUMBER + L**
2. **FSC**
3. **CHASSIS LAM**

MODULAR DESK | RUNOFF MODESTY PANEL

10" high for 15" Pedestals

Silea

03/23

	D	W	H	model number + type	laminata	veneer 1	veneer 2
	3/4	24	10	GS2DMPA24- []	369	533	589
	3/4	27	10	GS2DMPA27- []	376	545	602
	3/4	30	10	GS2DMPA30- []	383	557	615
	3/4	33	10	GS2DMPA33- []	391	774	855
	3/4	36	10	GS2DMPA36- []	398	823	910
	3/4	39	10	GS2DMPA39- []	408	781	863
	3/4	42	10	GS2DMPA42- []	424	614	679
	3/4	45	10	GS2DMPA45- []	439	637	704
	3/4	48	10	GS2DMPA48- []	488	705	780
	3/4	51	10	GS2DMPA51- []	503	729	806
	3/4	54	10	GS2DMPA54- []	521	751	830
	3/4	57	10	GS2DMPA57- []	535	774	855
	3/4	60	10	GS2DMPA60- []	574	832	920
	3/4	63	10	GS2DMPA63- []	591	856	946
	3/4	66	10	GS2DMPA66- []	607	879	971
	3/4	69	10	GS2DMPA69- []	637	924	1,020
	3/4	72	10	GS2DMPA72- []	662	960	1,061

PRODUCT INFO

TO ORDER PLEASE SPECIFY THE FOLLOWING:

WOOD CHASSIS

1. **MODEL NUMBER + W**
2. **FSC**
3. **CHASSIS WOOD FINISH**

LAM CHASSIS

1. **MODEL NUMBER + L**
2. **FSC**
3. **CHASSIS LAM**

DOUBLE PED BREAKFRONT MODESTY

For 9" and 15" Pedestals

	D	W	H	model number + type	laminata	veneer 1	veneer 2
FOR 9" PED 	3/4	90	27 7/8	GS2DDMF990- <input type="checkbox"/>	1,416	2,023	2,234
	3/4	96	27 7/8	GS2DDMF996- <input type="checkbox"/>	1,486	2,124	2,346

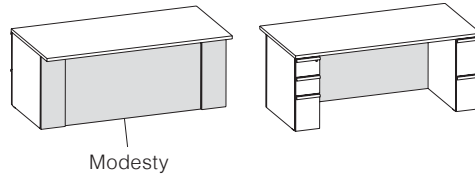

FOR 15" PED

3/4	60	27 7/8	GS2DDMF1560- <input type="checkbox"/>	1,043	1,510	1,667
3/4	66	27 7/8	GS2DDMF1566- <input type="checkbox"/>	1,121	1,624	1,793
3/4	72	27 7/8	GS2DDMF1572- <input type="checkbox"/>	1,199	1,736	1,917
3/4	78	27 7/8	GS2DDMF1578- <input type="checkbox"/>	1,278	1,852	2,045
3/4	84	27 7/8	GS2DDMF1584- <input type="checkbox"/>	1,353	1,963	2,167
3/4	90	27 7/8	GS2DDMF1590- <input type="checkbox"/>	1,442	2,060	2,275
3/4	96	27 7/8	GS2DDMF1596- <input type="checkbox"/>	1,516	2,163	2,388

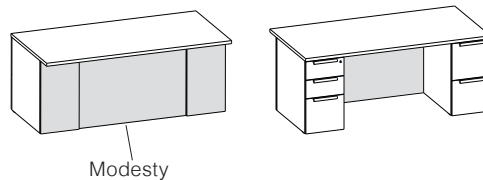

PRODUCT INFO

TO ORDER PLEASE SPECIFY THE FOLLOWING:

WOOD CHASSIS

1. **MODEL NUMBER + W**
2. **FSC**
3. **CHASSIS WOOD FINISH**

LAM CHASSIS





1. **MODEL NUMBER + L**
2. **FSC**
3. **CHASSIS LAM**

SINGLE PED BREAKFRONT MODESTY

For 9" and 15" Pedestals

Silea

03/23

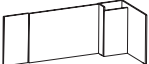
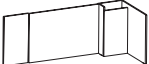
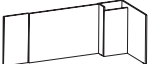
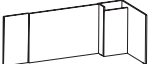
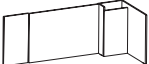
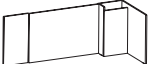
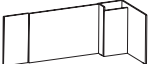
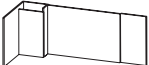
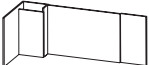
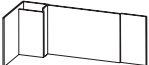
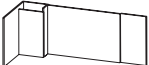
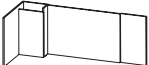
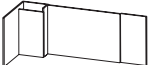
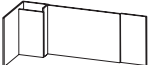
	D	W	H	model number + type	laminate	veneer 1	veneer 2
FOR 30D X 9" PED	29 7/8	90	27 7/8	GS2SDMF990L- 	1,777	2,537	2,801
	29 7/8	96	27 7/8	GS2SDMF996L- 	1,866	2,665	2,942
Left hand	29 7/8	90	27 7/8	GS2SDMF990R- 	1,777	2,537	2,801
	29 7/8	96	27 7/8	GS2SDMF996R- 	1,866	2,665	2,942
Right hand	29 7/8	60	27 7/8	GS2SDMF1560L- 	1,404	2,035	2,247
	29 7/8	66	27 7/8	GS2SDMF1566L- 	1,480	2,146	2,370
FOR 30D X 15" PED	29 7/8	72	27 7/8	GS2SDMF1572L- 	1,554	2,254	2,489
	29 7/8	78	27 7/8	GS2SDMF1578L- 	1,631	2,364	2,611
Left hand	29 7/8	84	27 7/8	GS2SDMF1584L- 	1,708	2,474	2,732
	29 7/8	90	27 7/8	GS2SDMF1590L- 	1,819	2,598	2,869
Right hand	29 7/8	96	27 7/8	GS2SDMF1596L- 	1,911	2,727	3,011
	29 7/8	60	27 7/8	GS2SDMF1560R- 	1,404	2,035	2,247
Right hand	29 7/8	66	27 7/8	GS2SDMF1566R- 	1,480	2,146	2,370
	29 7/8	72	27 7/8	GS2SDMF1572R- 	1,554	2,254	2,489
Left hand	29 7/8	78	27 7/8	GS2SDMF1578R- 	1,631	2,364	2,611
	29 7/8	84	27 7/8	GS2SDMF1584R- 	1,708	2,474	2,732
Right hand	29 7/8	90	27 7/8	GS2SDMF1590R- 	1,819	2,598	2,869
	29 7/8	96	27 7/8	GS2SDMF1596R- 	1,911	2,727	3,011

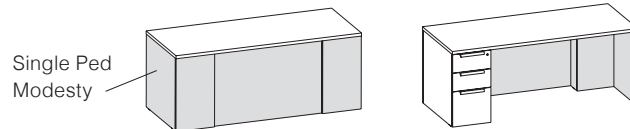

PRODUCT INFO

TO ORDER PLEASE SPECIFY THE FOLLOWING:

WOOD CHASSIS

1. **MODEL NUMBER + W**
2. **FSC**
3. **CHASSIS WOOD FINISH**

LAM CHASSIS

1. **MODEL NUMBER + L**
2. **FSC**
3. **CHASSIS LAM**

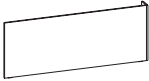
	D	W	H	model number + type	laminate	veneer 1	veneer 2
 Left hand	3/4	42	27 7/8	GS2RRMF42L- []	693	1,006	1,111
	3/4	48	27 7/8	GS2RRMF48L- []	713	1,033	1,141
	3/4	54	27 7/8	GS2RRMF54L- []	735	1,068	1,180
	3/4	60	27 7/8	GS2RRMF60L- []	760	1,099	1,214
	3/4	66	27 7/8	GS2RRMF66L- []	833	1,211	1,338
	3/4	72	27 7/8	GS2RRMF72L- []	1,101	1,595	1,761

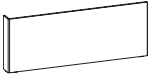
 Right hand	3/4	42	27 7/8	GS2RRMF42R- []	693	1,006	1,111
	3/4	48	27 7/8	GS2RRMF48R- []	713	1,033	1,141
	3/4	54	27 7/8	GS2RRMF54R- []	735	1,068	1,180
	3/4	60	27 7/8	GS2RRMF60R- []	760	1,099	1,214
	3/4	66	27 7/8	GS2RRMF66R- []	833	1,211	1,338
	3/4	72	27 7/8	GS2RRMF72R- []	1,101	1,595	1,761

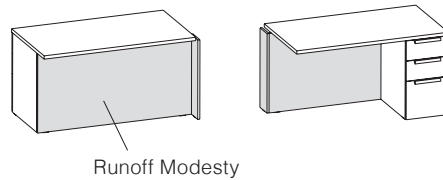

PRODUCT INFO

TO ORDER PLEASE SPECIFY THE FOLLOWING:

WOOD CHASSIS

1. **MODEL NUMBER + W**
2. **FSC**
3. **CHASSIS WOOD FINISH**



LAM CHASSIS

1. **MODEL NUMBER + L**
2. **FSC**
3. **CHASSIS LAM**

EXTENSION FULL MODESTY

For use with Racetrack Tops with Column Base

Silea
03/23

	D	W	H	model number + type	laminata	veneer 1	veneer 2
 Left hand	$\frac{3}{4}$	36	$27 \frac{7}{8}$	GS2XMF36L- []	667	966	1,067
	$\frac{3}{4}$	42	$27 \frac{7}{8}$	GS2XMF42L- []	693	1,006	1,111
 Right hand	$\frac{3}{4}$	36	$27 \frac{7}{8}$	GS2XMF36R- []	667	966	1,067
	$\frac{3}{4}$	42	$27 \frac{7}{8}$	GS2XMF42R- []	693	1,006	1,111

PRODUCT INFO

Not for use with b and d shape tops

TO ORDER PLEASE SPECIFY THE FOLLOWING:

WOOD CHASSIS

1. **MODEL NUMBER + W**
2. **FSC**
3. **CHASSIS WOOD FINISH**

LAM CHASSIS

1. **MODEL NUMBER + L**
2. **FSC**
3. **CHASSIS LAM**

	D	W	H	model number + type	laminata	veneer 1	veneer 2
	24	15	1 3/16	GS2CWR2415- []	529	814	900
	24	18	1 3/16	GS2CWR2418- []	543	834	922
	24	24	1 3/16	GS2CWR2424- []	557	856	946
	24	30	1 3/16	GS2CWR2430- []	563	877	969
	24	36	1 3/16	GS2CWR2436- []	630	983	1,086
	24	42	1 3/16	GS2CWR2442- []	719	1,119	1,236
	24	48	1 3/16	GS2CWR2448- []	785	1,225	1,353
	24	54	1 3/16	GS2CWR2454- []	828	1,289	1,424
	24	60	1 3/16	GS2CWR2460- []	899	1,402	1,549
	24	66	1 3/16	GS2CWR2466- []	956	1,488	1,643
	24	72	1 3/16	GS2CWR2472- []	1,066	1,665	1,839
	24	78	1 3/16	GS2CWR2478- []	1,110	1,731	1,911
	24	84	1 3/16	GS2CWR2484- []	1,154	1,800	1,988
	24	90	1 3/16	GS2CWR2490- []	1,317	2,053	2,267
	24	96	1 3/16	GS2CWR2496- []	1,442	2,251	2,486
	24	102	1 3/16	GS2CWR24102- []	1,571	2,451	2,707
	24	108	1 3/16	GS2CWR24108- []	1,661	2,589	2,859
	24	114	1 3/16	GS2CWR24114- []	1,724	2,690	2,971
	24	120	1 3/16	GS2CWR24120- []	1,841	2,873	3,172

• Flat brackets ordered separately (model #MDWBRK)

NOTE: Credenzas, returns, and bridges with no back panel and an unsupported area of 48" and greater require an intermediate T support.

PRODUCT INFO

Wood tops optional grain direction.
Lam tops optional grain up to 60", over 60" long grain standard.
30" and 36" wide worksurface only has GN or GC for grommet option choice.

Grommet Location
(Add \$77 per grommet)

No Grommet **GN**
Left **GL**
Center **GC**
Right **GR**
Left & Right **GB**
All **GA**

Specify location first, then select grommet color or "Empty Cutout" option. When "Empty Cutout" option is selected, a grommet or power unit must be ordered separately for each cutout.

TO ORDER PLEASE SPECIFY THE FOLLOWING:

WOOD TOP

1. MODEL NUMBER + W
2. FSC
3. TOP WOOD FINISH + EDGE
4. TOP UV FINISH
5. GRAIN DIRECTION
6. GROMMET

LAM TOP

1. MODEL NUMBER + L
2. FSC
3. TOP LAM
4. GRAIN DIRECTION (up to 60")
5. EDGE DETAIL
6. GROMMET

MODULAR 30D TOPS

For Credenzas, Returns, and Bridges

Silea

03/23

	D	W	H	model number + type	laminata	veneer 1	veneer 2
	30	15	1 3/16	GS2CWR3015- <input type="checkbox"/>	581	895	989
	30	18	1 3/16	GS2CWR3018- <input type="checkbox"/>	596	918	1,014
	30	24	1 3/16	GS2CWR3024- <input type="checkbox"/>	612	941	1,040
	30	30	1 3/16	GS2CWR3030- <input type="checkbox"/>	628	966	1,067
	30	36	1 3/16	GS2CWR3036- <input type="checkbox"/>	702	1,080	1,193
	30	42	1 3/16	GS2CWR3042- <input type="checkbox"/>	917	1,432	1,582
	30	48	1 3/16	GS2CWR3048- <input type="checkbox"/>	966	1,506	1,663
	30	54	1 3/16	GS2CWR3054- <input type="checkbox"/>	977	1,526	1,686
	30	60	1 3/16	GS2CWR3060- <input type="checkbox"/>	990	1,543	1,704
	30	66	1 3/16	GS2CWR3066- <input type="checkbox"/>	1,036	1,615	1,783
	30	72	1 3/16	GS2CWR3072- <input type="checkbox"/>	1,091	1,699	1,876
	30	78	1 3/16	GS2CWR3078- <input type="checkbox"/>	1,166	1,819	2,009
	30	84	1 3/16	GS2CWR3084- <input type="checkbox"/>	1,248	1,948	2,151
	30	90	1 3/16	GS2CWR3090- <input type="checkbox"/>	1,330	2,046	2,259
	30	96	1 3/16	GS2CWR3096- <input type="checkbox"/>	1,396	2,148	2,372
	30	102	1 3/16	GS2CWR30102- <input type="checkbox"/>	1,650	2,572	2,840
	30	108	1 3/16	GS2CWR30108- <input type="checkbox"/>	1,743	2,718	3,001
	30	114	1 3/16	GS2CWR30114- <input type="checkbox"/>	1,811	2,824	3,118
	30	120	1 3/16	GS2CWR30120- <input type="checkbox"/>	1,935	3,018	3,332

• Flat brackets ordered separately (model #MDWBRK)

NOTE: Credenzas, returns, and bridges with no back panel and an unsupported area of 48" and greater require an intermediate T support.

PRODUCT INFO

Wood tops optional grain standard.

Lam tops optional grain up to 60", over 60" long grain standard.

15" - 36" wide worksurfaces only have GN or GC for grommet option choice.

Grommet Location (Add \$77 per grommet)

No Grommet	GN
Left	GL
Center	GC
Right	GR
Left & Right	GB
All	GA

Specify location first, then select grommet color or "Empty Cutout" option. When "Empty Cutout" option is selected, a grommet or power unit must be ordered separately for each cutout.













TO ORDER PLEASE SPECIFY THE FOLLOWING:

WOOD TOP

- MODEL NUMBER + W**
- FSC**
- TOP WOOD FINISH + EDGE**
- TOP UV FINISH**
- GRAIN DIRECTION**
- GROMMET**

LAM TOP

- MODEL NUMBER + L**
- FSC**
- TOP LAM**
- GRAIN DIRECTION (up to 60")**
- EDGE DETAIL**
- GROMMET**

	D	W	H	model number + type	laminare	veneer 1	veneer 2
	21	60	1 3/16	GS2CWR2460T- 	1,477	2,225	2,457
	21	66	1 3/16	GS2CWR2466T- 	1,566	2,359	2,605
	21	72	1 3/16	GS2CWR2472T- 	1,732	2,621	2,894
	21	78	1 3/16	GS2CWR2478T- 	1,795	2,719	3,002
	21	84	1 3/16	GS2CWR2484T- 	1,863	2,823	3,117
	21	90	1 3/16	GS2CWR2490T- 	2,110	3,206	3,540
	21	96	1 3/16	GS2CWR2496T- 	2,409	3,536	3,904
	21	102	1 3/16	GS2CWR24102T- 	2,609	3,842	4,241
	21	108	1 3/16	GS2CWR24108T- 	2,749	4,049	4,470
	21	114	1 3/16	GS2CWR24114T- 	2,852	4,201	4,637
	21	120	1 3/16	GS2CWR24120T- 	3,037	4,479	4,945

NOTE: Credenzas, returns, and bridges with no back panel and an unsupported area of 48" and greater require an intermediate T support.

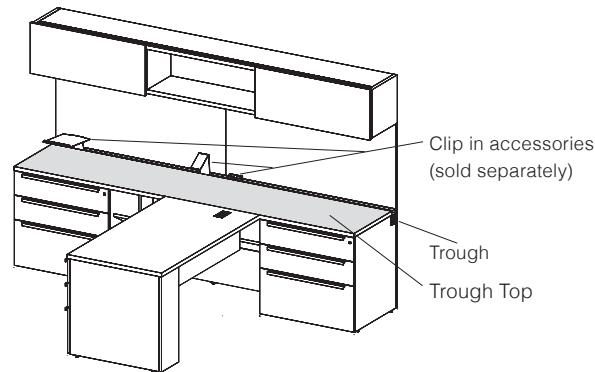

PRODUCT INFO

Wood tops optional grain direction.
Lam tops long grain standard.
 Units shipped as separate packages and require field assembly.
Trough tops require filler strips or back panels, ordered separately.
Do not use 2H surface mount towers on trough tops.

TO ORDER PLEASE SPECIFY THE FOLLOWING:

WOOD TOP

1. **MODEL NUMBER + W**
2. **FSC**
3. **TOP WOOD FINISH**
4. **TOP UV FINISH**
5. **TROUGH COLOR**
6. **GROMMET**













LAM TOP

1. **MODEL NUMBER + L**
2. **FSC**
3. **TOP LAM**
4. **EDGE DETAIL**
5. **TROUGH COLOR**
6. **GROMMET**

MODULAR 30D TOPS WITH TROUGHS

For Credenzas | w/ 2 End Caps

Silea
03/23

	D	W	H	model number + type	laminat	veneer 1	veneer 2
	30	60	1 3/16	GS2CWR3060T- 	1,522	2,308	2,548
	30	66	1 3/16	GS2CWR3066T- 	1,613	2,446	2,700
	30	72	1 3/16	GS2CWR3072T- 	1,787	2,718	3,001
	30	78	1 3/16	GS2CWR3078T- 	1,850	2,821	3,115
	30	84	1 3/16	GS2CWR3084T- 	1,921	2,928	3,233
	30	90	1 3/16	GS2CWR3090T- 	2,176	3,327	3,673
	30	96	1 3/16	GS2CWR3096T- 	2,483	3,669	4,051
	30	102	1 3/16	GS2CWR30102T- 	2,692	3,984	4,399
	30	108	1 3/16	GS2CWR30108T- 	2,838	4,200	4,636
	30	114	1 3/16	GS2CWR30114T- 	2,942	4,360	4,814
	30	120	1 3/16	GS2CWR30120T- 	3,132	4,648	5,131

NOTE: Credenzas, returns, and bridges with no back panel and an unsupported area of 48" and greater require an intermediate T support.

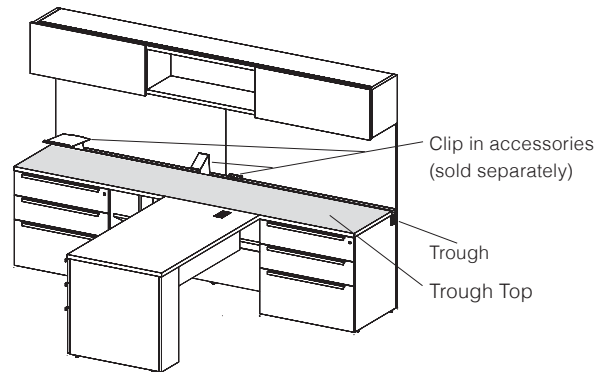

PRODUCT INFO

Wood tops optional grain direction.

Lam tops long grain standard.

 Units shipped as separate packages and require field assembly.

Trough tops require filler strips or back panels, ordered separately.

Do not use 2H surface mount towers on trough tops.



TO ORDER PLEASE SPECIFY THE FOLLOWING:

WOOD TOP

- MODEL NUMBER + W**
- FSC**
- TOP WOOD FINISH + EDGE**
- TOP UV FINISH**
- GRAIN DIRECTION**
- TROUGH COLOR**

LAM TOP

- MODEL NUMBER + L**
- FSC**
- TOP LAM**
- EDGE DETAIL**
- TROUGH COLOR**

	D	W	H	model number + type	laminate	veneer 1	veneer 2
9" WIDTH	23 1/8	9	27 7/8	GS2CPD249L-X []	832	1,300	1,436
 False Pedestal							
 Left	23 1/8	9	27 7/8	GS2CPD249R-X []	832	1,300	1,436
 Right							

PRODUCT INFO

All units have an unfinished back.

Units with an exposed end require a filler strip.

TO ORDER PLEASE SPECIFY THE FOLLOWING:

WOOD

1. **MODEL NUMBER + W**
2. **FSC**
3. **CHASSIS WOOD FINISH**

LAM







1. **MODEL NUMBER + L**
2. **FSC**
3. **CHASSIS LAM**

MODULAR PEDS 24D

Standard Height | 15" and 18"W

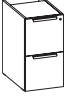
Silea

03/23

	D	W	H	model number + type	laminate	veneer 1	veneer 2
15" WIDTH							
 Box Box File	23 1/8	15	27 7/8	GS2CPD2415-3 []	1,672	2,606	2,878
 Hidden Accessory Hidden Accessory Box File	23 1/8	15	27 7/8	GS2CPD2415-3A []	1,672	2,606	2,878
 File File	23 1/8	15	27 7/8	GS2CPD2415-2 []	1,672	2,606	2,878
18" WIDTH							
 Box Box File	23 1/8	18	27 7/8	GS2CPD2418-3 []	1,788	2,791	3,081
 Hidden Accessory Hidden Accessory Box File	23 1/8	18	27 7/8	GS2CPD2418-3A []	1,788	2,791	3,081
 File File	23 1/8	18	27 7/8	GS2CPD2418-2 []	1,788	2,791	3,081

PRODUCT INFO

All units have an unfinished back.

All pedestals with an exposed side require a filler strip or pedestal back.







TO ORDER PLEASE SPECIFY THE FOLLOWING:

WOOD

1. **MODEL NUMBER + W**
2. **FSC**
3. **CHASSIS WOOD FINISH**
4. **PULL**
5. **DRAWERS**
6. **KEYING**

LAM

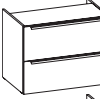
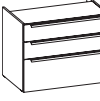
1. **MODEL NUMBER + L**
2. **FSC**
3. **CHASSIS LAM**
4. **FRONT LAM**
5. **PULL**
6. **DRAWERS**
7. **KEYING**

	D	W	H	model number + type	laminate	veneer 1	veneer 2
30" WIDTH							
 File File	23 1/8	30	27 7/8	GS2CPD2430-4 <input type="checkbox"/>	2,097	3,271	3,612
 Box Box File	23 1/8	30	27 7/8	GS2CPD2430-7 <input type="checkbox"/>	2,138	3,336	3,683
 Multi-File Left	23 1/8	30	27 7/8	GS2CPD2430L-MF <input type="checkbox"/>	2,232	3,434	3,791
 Multi-File Right	23 1/8	30	27 7/8	GS2CPD2430R-MF <input type="checkbox"/>	2,232	3,434	3,791
36" WIDTH							
 File File	23 1/8	36	27 7/8	GS2CPD2436-4 <input type="checkbox"/>	2,307	3,598	3,972
 Box Box File	23 1/8	36	27 7/8	GS2CPD2436-7 <input type="checkbox"/>	2,352	3,669	4,051
 Multi-File Left	23 1/8	36	27 7/8	GS2CPD2436L-MF <input type="checkbox"/>	2,455	3,777	4,170
 Multi-File Right	23 1/8	36	27 7/8	GS2CPD2436R-MF <input type="checkbox"/>	2,455	3,777	4,170

PRODUCT INFO

All units have an unfinished back.
All pedestals with an exposed side require a filler strip or pedestal back.

TO ORDER PLEASE SPECIFY THE FOLLOWING:

WOOD

1. **MODEL NUMBER + W**
2. **FSC**
3. **CHASSIS WOOD FINISH**
4. **PULL**
5. **DRAWERS**
6. **KEYING**







LAM

1. **MODEL NUMBER + L**
2. **FSC**
3. **CHASSIS LAM**
4. **FRONT LAM**
5. **PULL**
6. **DRAWERS**
7. **KEYING**

MODULAR PEDS 24D

Standard Height | Hinged Door Cabinets

Silea
03/23

	D	W	H	model number + type	laminate	veneer 1	veneer 2
15" WIDTH							
 Left Hand	23 1/8	15	27 7/8	GS2CPD2415L-5 <input type="checkbox"/>	1,438	2,213	2,443
Right Hand	23 1/8	15	27 7/8	GS2CPD2415R-5 <input type="checkbox"/>	1,438	2,213	2,443
18" WIDTH							
 Left Hand	23 1/8	18	27 7/8	GS2CPD2418L-5 <input type="checkbox"/>	1,509	2,322	2,564
Right Hand	23 1/8	18	27 7/8	GS2CPD2418R-5 <input type="checkbox"/>	1,509	2,322	2,564
24" WIDTH							
 Double Door	23 1/8	24	27 7/8	GS2CPD2424-5 <input type="checkbox"/>	1,722	2,650	2,926
30" WIDTH							
 Double Door	23 1/8	30	27 7/8	GS2CPD2430-5 <input type="checkbox"/>	1,887	2,945	3,252
 With Printer Drawer	23 1/8	30	27 7/8	GS2CPD2430-P <input type="checkbox"/>	2,011	3,093	3,415
36" WIDTH							
 Double Door	23 1/8	36	27 7/8	GS2CPD2436-5 <input type="checkbox"/>	2,074	3,239	3,576
 With Printer Drawer	23 1/8	36	27 7/8	GS2CPD2436-P <input type="checkbox"/>	2,210	3,400	3,754

PRODUCT INFO

All units have an unfinished back.

If integral pull is chosen, doors will be touch latch.

All pedestals with an exposed side require a filler strip or pedestal back.

Includes one adjustable shelf.



TO ORDER PLEASE SPECIFY THE FOLLOWING:

WOOD

1. **MODEL NUMBER + W**
2. **FSC**
3. **CHASSIS WOOD FINISH**
4. **PULL**
5. **KEYING**

LAM

1. **MODEL NUMBER + L**
2. **FSC**
3. **CHASSIS LAM**
4. **FRONT LAM**
5. **PULL**
6. **KEYING**

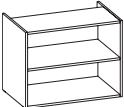
	D	W	H	model number + type	laminata	veneer 1	veneer 2
15" WIDTH 	23 1/8	15	27 7/8	GS2CPD2415-SH []	1,294	1,990	2,198
18" WIDTH 	23 1/8	18	27 7/8	GS2CPD2418-SH []	1,358	2,090	2,307
24" WIDTH 	23 1/8	24	27 7/8	GS2CPD2424-SH []	1,557	2,396	2,646
30" WIDTH 	23 1/8	30	27 7/8	GS2CPD2430-SH []	1,706	2,661	2,938
36" WIDTH 	23 1/8	36	27 7/8	GS2CPD2436-SH []	1,880	2,929	3,234

PRODUCT INFO

All units have an unfinished back.
 All pedestals with an exposed side require a filler strip or pedestal back.
 Adjustable shelf.

TO ORDER PLEASE SPECIFY THE FOLLOWING:

WOOD

1. **MODEL NUMBER + W**
2. **FSC**
3. **CHASSIS WOOD FINISH**

LAM



1. **MODEL NUMBER + L**
2. **FSC**
3. **CHASSIS LAM**

TROUGH MODULAR PEDS 24D

Standard Height | 9"W | Trough Cutouts

Silea

03/23

	D	W	H	model number + type	laminate	veneer 1	veneer 2
9" WIDTH	23 1/8	9	27 7/8	GS2CPD249TL-X []	832	1,300	1,436
 False Pedestal							
 Left	23 1/8	9	27 7/8	GS2CPD249TR-X []	832	1,300	1,436
 Right							

PRODUCT INFO

Pedestals to be used with a modular trough top.

All units have an unfinished back.

All trough pedestals require a filler strip or pedestal back.







TO ORDER PLEASE SPECIFY THE FOLLOWING:

WOOD

1. **MODEL NUMBER + W**
2. **FSC**
3. **CHASSIS WOOD FINISH**

LAM

1. **MODEL NUMBER + L**
2. **FSC**
3. **CHASSIS LAM**

	D	W	H	model number + type	laminate	veneer 1	veneer 2
15" WIDTH							
 Box Box File	23 1/8	15	27 7/8	GS2CPD2415T-3 []	1,672	2,606	2,878
 Hidden Accessory Hidden Accessory Box File	23 1/8	15	27 7/8	GS2CPD2415T-3A []	1,672	2,606	2,878
 File File	23 1/8	15	27 7/8	GS2CPD2415T-2 []	1,672	2,606	2,878
18" WIDTH							
 Box Box File	23 1/8	18	27 7/8	GS2CPD2418T-3 []	1,788	2,791	3,081
 Hidden Accessory Hidden Accessory Box File	23 1/8	18	27 7/8	GS2CPD2418T-3A []	1,788	2,791	3,081
 File File	23 1/8	18	27 7/8	GS2CPD2418T-2 []	1,788	2,791	3,081

PRODUCT INFO

All units have an unfinished back.
Pedestals to be used with a modular trough top.
All trough pedestals require a filler strip or pedestal back.

TO ORDER PLEASE SPECIFY THE FOLLOWING:

WOOD

1. **MODEL NUMBER + W**
2. **FSC**
3. **CHASSIS WOOD FINISH**
4. **PULL**
5. **DRAWERS**
6. **KEYING**





LAM

1. **MODEL NUMBER + L**
2. **FSC**
3. **CHASSIS LAM**
4. **FRONT LAM**
5. **PULL**
6. **DRAWERS**
7. **KEYING**

TROUGH MODULAR PEDS 24D

Standard Height | 30" and 36"W | Trough Cutouts

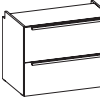
Silea
03/23

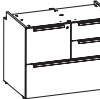
		D	W	H	model number + type	laminate	veneer 1	veneer 2	
30" WIDTH									
	File File	23 1/8	30	27 7/8	GS2CPD2430T-4 <input type="checkbox"/>	2,097	3,271	3,612	
	Box Box File	23 1/8	30	27 7/8	GS2CPD2430T-7 <input type="checkbox"/>	2,138	3,336	3,683	
	Multi-File Left	23 1/8	30	27 7/8	GS2CPD2430TL-MF <input type="checkbox"/>	2,232	3,434	3,791	
	Multi-File Right	23 1/8	30	27 7/8	GS2CPD2430TR-MF <input type="checkbox"/>	2,232	3,434	3,791	
36" WIDTH									
	File File	23 1/8	36	27 7/8	GS2CPD2436T-4 <input type="checkbox"/>	2,307	3,598	3,972	
	Box Box File	23 1/8	36	27 7/8	GS2CPD2436T-7 <input type="checkbox"/>	2,352	3,669	4,051	
	Multi-File Left	23 1/8	36	27 7/8	GS2CPD2436TL-MF <input type="checkbox"/>	2,455	3,777	4,170	
	Multi-File Right	23 1/8	36	27 7/8	GS2CPD2436TR-MF <input type="checkbox"/>	2,455	3,777	4,170	

PRODUCT INFO

All units have an unfinished back.

Pedestals to be used with a modular trough top.

All trough pedestals require a filler strip or pedestal back.







TO ORDER PLEASE SPECIFY THE FOLLOWING:

WOOD

1. **MODEL NUMBER + W**
2. **FSC**
3. **CHASSIS WOOD FINISH**
4. **PULL**
5. **DRAWERS**
6. **KEYING**

LAM

1. **MODEL NUMBER + L**
2. **FSC**
3. **CHASSIS LAM**
4. **FRONT LAM**
5. **PULL**
6. **DRAWERS**
7. **KEYING**

	D	W	H	model number + type	laminata	veneer 1	veneer 2
15" WIDTH							
 Left Hand	23 1/8	15	27 7/8	GS2CPD2415TL-5 <input type="checkbox"/>	1,438	2,213	2,443
Right Hand	23 1/8	15	27 7/8	GS2CPD2415TR-5 <input type="checkbox"/>	1,438	2,213	2,443
18" WIDTH							
 Left Hand	23 1/8	18	27 7/8	GS2CPD2418TL-5 <input type="checkbox"/>	1,509	2,322	2,564
Right Hand	23 1/8	18	27 7/8	GS2CPD2418TR-5 <input type="checkbox"/>	1,509	2,322	2,564
24" WIDTH							
 Double Door	23 1/8	24	27 7/8	GS2CPD2424T-5 <input type="checkbox"/>	1,722	2,650	2,926
30" WIDTH							
 Double Door	23 1/8	30	27 7/8	GS2CPD2430T-5 <input type="checkbox"/>	1,887	2,945	3,252
 With Printer Drawer	23 1/8	30	27 7/8	GS2CPD2430T-P <input type="checkbox"/>	2,011	3,093	3,415
36" WIDTH							
 Double Door	23 1/8	36	27 7/8	GS2CPD2436T-5 <input type="checkbox"/>	2,074	3,239	3,576
 With Printer Drawer	23 1/8	36	27 7/8	GS2CPD2436T-P <input type="checkbox"/>	2,210	3,400	3,754

PRODUCT INFO

All units have an unfinished back.
 Pedestals to be used with a modular trough top.
 If integral pull is chosen, doors will be touch latch.
 All trough pedestals require a filler strip or pedestal back.
 Includes one adjustable shelf.

TO ORDER PLEASE SPECIFY THE FOLLOWING:

WOOD

1. **MODEL NUMBER + W**
2. **FSC**
3. **CHASSIS WOOD FINISH**
4. **PULL**
5. **KEYING**





LAM

1. **MODEL NUMBER + L**
2. **FSC**
3. **CHASSIS LAM**
4. **FRONT LAM**
5. **PULL**
6. **KEYING**

TROUGH MODULAR PEDS 24D

Standard Height | Open Shelf | Trough Cutouts

Silea
03/23

	D	W	H	model number + type	laminata	veneer 1	veneer 2
15" WIDTH 	23 1/8	15	27 7/8	GS2CPD2415T-SH []	1,294	1,990	2,198
18" WIDTH 	23 1/8	18	27 7/8	GS2CPD2418T-SH []	1,358	2,090	2,307
24" WIDTH 	23 1/8	24	27 7/8	GS2CPD2424T-SH []	1,557	2,396	2,646
30" WIDTH 	23 1/8	30	27 7/8	GS2CPD2430T-SH []	1,706	2,661	2,938
36" WIDTH 	23 1/8	36	27 7/8	GS2CPD2436T-SH []	1,880	2,929	3,234

PRODUCT INFO

All units have an unfinished back.

Pedestals to be used with a modular trough top.

All trough pedestals require a filler strip or pedestal back.

Adjustable shelf.



TO ORDER PLEASE SPECIFY THE FOLLOWING:

WOOD

- MODEL NUMBER + W**
- FSC**
- CHASSIS WOOD FINISH**

LAM

- MODEL NUMBER + L**
- FSC**
- CHASSIS LAM**

	D	W	H	model number + type	laminata	veneer 1	veneer 2
9" WIDTH	23 1/8	9	20 3/4	GS2CLPD249L-X []	794	1,234	1,363
 False Pedestal							
 Left	23 1/8	9	20 3/4	GS2CLPD249R-X []	794	1,234	1,363
 Right							

PRODUCT INFO

All units have an unfinished back.

Units with an exposed end require a filler strip.

TO ORDER PLEASE SPECIFY THE FOLLOWING:

WOOD

1. **MODEL NUMBER + W**
2. **FSC**
3. **CHASSIS WOOD FINISH**



LAM

1. **MODEL NUMBER + L**
2. **FSC**
3. **CHASSIS LAM**

MODULAR PEDS 24D

Layers Height | 15" and 18"W

Silea
03/23

	D	W	H	model number + type	laminate	veneer 1	veneer 2
15" WIDTH	23 1/8	15	20 3/4	GS2CLPD2415-A []	1,588	2,475	2,733
 Box/File							
18" WIDTH	23 1/8	18	20 3/4	GS2CLPD2418-A []	1,698	2,654	2,930
 Box/File							

PRODUCT INFO

All units have an unfinished back.

All pedestals with an exposed side require a filler strip or pedestal back.

Layers pedestals may be used with feet or on glides to the floor.

Glides must be removed at install for feet applications.

TO ORDER PLEASE SPECIFY THE FOLLOWING:

WOOD

1. **MODEL NUMBER + W**
2. **FSC**
3. **CHASSIS WOOD FINISH**
4. **PULL**
5. **DRAWERS**
6. **KEYING**

LAM

1. **MODEL NUMBER + L**
2. **FSC**
3. **CHASSIS LAM**
4. **FRONT LAM**
5. **PULL**
6. **DRAWERS**
7. **KEYING**

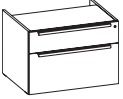
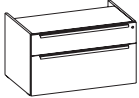
	D	W	H	model number + type	laminate	veneer 1	veneer 2
30" WIDTH	23 1/8	30	20 3/4	GS2CLPD2430-B <input type="checkbox"/>	1,992	3,107	3,430
 Box/File							
36" WIDTH	23 1/8	36	20 3/4	GS2CLPD2436-B <input type="checkbox"/>	2,192	3,418	3,774
 Box/File							

PRODUCT INFO

All units have an unfinished back.
 All pedestals with an exposed side require a filler strip or pedestal back.
 Layers pedestals may be used with feet or on glides to the floor.
 Glides must be removed at install for feet applications.

TO ORDER PLEASE SPECIFY THE FOLLOWING:

WOOD

1. **MODEL NUMBER + W**
2. **FSC**
3. **CHASSIS WOOD FINISH**
4. **PULL**
5. **DRAWERS**
6. **KEYING**

LAM

1. **MODEL NUMBER + L**
2. **FSC**
3. **CHASSIS LAM**
4. **FRONT LAM**
5. **PULL**
6. **DRAWERS**
7. **KEYING**

MODULAR PEDS 24D

Layers Height | 30" and 36"W

Silea
03/23

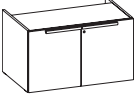
	D	W	H	model number + type	laminata	veneer 1	veneer 2
30" WIDTH	23 1/8	30	20 3/4	GS2CLPD2430-5 []	1,792	2,797	3,089
 Hinged door							
36" WIDTH	23 1/8	36	20 3/4	GS2CLPD2436-5 []	1,972	3,076	3,396
 Hinged door							

PRODUCT INFO

All units have an unfinished back.

If integral pull is chosen, doors will be touch latch.

All pedestals with an exposed side require a filler strip or pedestal back.

Includes one adjustable shelf.

Layers pedestals may be used with feet or on glides to the floor.

Glides must be removed at install for feet applications.

TO ORDER PLEASE SPECIFY THE FOLLOWING:

WOOD

- MODEL NUMBER + W**
- FSC**
- CHASSIS WOOD FINISH**
- PULL**
- KEYING**

LAM

- MODEL NUMBER + L**
- FSC**
- CHASSIS LAM**
- FRONT LAM**
- PULL**
- KEYING**

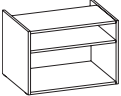
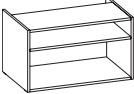
	D	W	H	model number + type	laminate	veneer 1	veneer 2
30" WIDTH  Bookcase	23 1/8	30	20 3/4	GS2CLPD2430-SH []	1,623	2,529	2,792
36" WIDTH  Bookcase	23 1/8	36	20 3/4	GS2CLPD2436-SH []	1,784	2,782	3,071

PRODUCT INFO

All units have an unfinished back.
 All pedestals with an exposed side require a filler strip or pedestal back.
 Adjustable shelf.
 Layers pedestals may be used with feet or on glides to the floor.
 Glides must be removed at install for feet applications.

TO ORDER PLEASE SPECIFY THE FOLLOWING:





- | | |
|-------------------------------|----------------------------|
| WOOD | LAM |
| 1. MODEL NUMBER + W | 1. MODEL NUMBER + L |
| 2. FSC | 2. FSC |
| 3. CHASSIS WOOD FINISH | 3. CHASSIS LAM |

TROUGH MODULAR PEDS 24D

Layers Height | 9"W | Trough Cutouts

Silea

03/23

	D	W	H	model number + type	laminate	veneer 1	veneer 2
9" WIDTH	23 1/8	9	20 3/4	GS2CLPD249TL-X 	794	1,234	1,363
 False Pedestal							
 Left	23 1/8	9	20 3/4	GS2CLPD249TR-X 	794	1,234	1,363
 Right							

PRODUCT INFO

Pedestals is to be used with a modular trough top.

All units have an unfinished back.

All trough pedestals require a filler strip or pedestal back.



TO ORDER PLEASE SPECIFY THE FOLLOWING:

WOOD

- MODEL NUMBER + W**
- FSC**
- CHASSIS WOOD FINISH**

LAM

- MODEL NUMBER + L**
- FSC**
- CHASSIS LAM**

	D	W	H	model number + type	laminiate	veneer 1	veneer 2
15" WIDTH	23 1/8	15	20 3/4	GS2CLPD2415T-A []	1,588	2,475	2,733
 Box/File							
18" WIDTH	23 1/8	18	20 3/4	GS2CLPD2418T-A []	1,698	2,654	2,930
 Box/File							

PRODUCT INFO

All units have an unfinished back.
 Pedestals to be used with a modular trough top.
 All trough pedestals require a filler strip or pedestal back.
 Layers pedestals may be used with feet or on glides to the floor.
 Glides must be removed at install for feet applications.

TO ORDER PLEASE SPECIFY THE FOLLOWING:

WOOD

1. **MODEL NUMBER + W**
2. **FSC**
3. **CHASSIS WOOD FINISH**
4. **PULL**
5. **DRAWERS**
6. **KEYING**

LAM

1. **MODEL NUMBER + L**
2. **FSC**
3. **CHASSIS LAM**
4. **FRONT LAM**
5. **PULL**
6. **DRAWERS**
7. **KEYING**

TROUGH MODULAR PEDS 24D

Layers Height | 30" and 36"W | Trough Cutouts

Silea
03/23

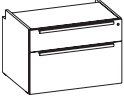
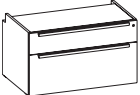
	D	W	H	model number + type	laminate	vener 1	vener 2
30" WIDTH  Box/File	23 1/8	30	20 3/4	GS2CLPD2430T-B []	1,992	3,107	3,430
36" WIDTH  Box/File	23 1/8	36	20 3/4	GS2CLPD2436T-B []	2,192	3,418	3,774

PRODUCT INFO

All units have an unfinished back.

Pedestals to be used with a modular trough top.

All trough pedestals require a filler strip or pedestal back.

Layers pedestals may be used with feet or on glides to the floor.

Glides must be removed at install for feet applications.



TO ORDER PLEASE SPECIFY THE FOLLOWING:

WOOD

1. **MODEL NUMBER + W**
2. **FSC**
3. **CHASSIS WOOD FINISH**
4. **PULL**
5. **DRAWERS**
6. **KEYING**

LAM

1. **MODEL NUMBER + L**
2. **FSC**
3. **CHASSIS LAM**
4. **FRONT LAM**
5. **PULL**
6. **DRAWERS**
7. **KEYING**

	D	W	H	model number + type	laminate	veneer 1	veneer 2
30" WIDTH	23 1/8	30	20 3/4	GS2CLPD2430T-5 []	1,792	2,797	3,089
 Hinged door							
36" WIDTH	23 1/8	36	20 3/4	GS2CLPD2436T-5 []	1,972	3,076	3,396
 Hinged door							

PRODUCT INFO

All units have an unfinished back.
 Pedestals to be used with a modular trough top.
 If integral pull is chosen, doors will be touch latch.
 All trough pedestals require a filler strip or pedestal back.
 Includes one adjustable shelf.
 Layers pedestals may be used with feet or on glides to the floor.
 Glides must be removed at install for feet applications.

TO ORDER PLEASE SPECIFY THE FOLLOWING:

WOOD

1. **MODEL NUMBER + W**
2. **FSC**
3. **CHASSIS WOOD FINISH**
4. **PULL**
5. **KEYING**

LAM

1. **MODEL NUMBER + L**
2. **FSC**
3. **CHASSIS LAM**
4. **FRONT LAM**
5. **PULL**
6. **KEYING**

TROUGH MODULAR PEDS 24D

Layers Height | 30" and 36"W | Trough Cutouts

Silea
03/23

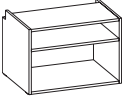
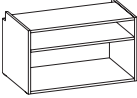
	D	W	H	model number + type	laminate	veneer 1	veneer 2
30" WIDTH	23 1/8	30	20 3/4	GS2CLPD2430T-SH []	1,623	2,529	2,792
 Bookcase							
36" WIDTH	23 1/8	36	20 3/4	GS2CLPD2436T-SH []	1,784	2,782	3,071
 Bookcase							

PRODUCT INFO

All units have an unfinished back.

Pedestals to be used with a modular trough top.

All trough pedestals require a filler strip or pedestal back.

Adjustable shelf.

Layers pedestals may be used with feet or on glides to the floor.

Glides must be removed at install for feet applications.



TO ORDER PLEASE SPECIFY THE FOLLOWING:

WOOD

1. **MODEL NUMBER + W**
2. **FSC**
3. **CHASSIS WOOD FINISH**

LAM

1. **MODEL NUMBER + L**
2. **FSC**
3. **CHASSIS LAM**

	D	W	H	model number + type	laminate	veneer 1	veneer 2
9" WIDTH	29 1/8	9	27 7/8	GS2CPD309L-X []	916	1,431	1,581
 False Pedestal							
 Left	29 1/8	9	27 7/8	GS2CPD309R-X []	916	1,431	1,581
 Right							

PRODUCT INFO

All units have an unfinished back.

Units with an exposed end require a filler strip.

TO ORDER PLEASE SPECIFY THE FOLLOWING:

WOOD CHASSIS

1. **MODEL NUMBER + W**
2. **FSC**
3. **CHASSIS WOOD FINISH**

LAM CHASSIS





1. **MODEL NUMBER + L**
2. **FSC**
3. **CHASSIS LAM**

MODULAR PEDS 30D

Standard Height | 15" and 18"W

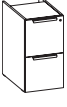
Silea

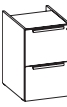
03/23

	D	W	H	model number + type	laminate	veneer 1	veneer 2
15" WIDTH							
 Box Box File	29 1/8	15	27 7/8	GS2CPD3015-3 []	1,838	2,866	3,164
 Hidden Accessory Hidden Accessory Box File	29 1/8	15	27 7/8	GS2CPD3015-3A []	1,838	2,866	3,164
 File File	29 1/8	15	27 7/8	GS2CPD3015-2 []	1,838	2,866	3,164
18" WIDTH							
 Box Box File	29 1/8	18	27 7/8	GS2CPD3018-3 []	1,967	3,071	3,391
 Hidden Accessory Hidden Accessory Box File	29 1/8	18	27 7/8	GS2CPD3018-3A []	1,967	3,071	3,391
 File File	29 1/8	18	27 7/8	GS2CPD3018-2 []	1,967	3,071	3,391

PRODUCT INFO

All units have an unfinished back.

Units with an exposed end require a filler strip.









TO ORDER PLEASE SPECIFY THE FOLLOWING:

WOOD CHASSIS

1. **MODEL NUMBER + W**
2. **FSC**
3. **CHASSIS WOOD FINISH**
4. **PULL**
5. **DRAWERS**
6. **KEYING**

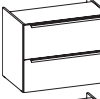
LAM CHASSIS

1. **MODEL NUMBER + L**
2. **FSC**
3. **CHASSIS LAM**
4. **FRONT LAM**
5. **PULL**
6. **DRAWERS**
7. **KEYING**

	D	W	H	model number + type	laminate	veneer 1	veneer 2
30" WIDTH							
 File File	29 1/8	30	27 7/8	GS2CPD3030-4 <input type="checkbox"/>	2,308	3,598	3,972
 Box Box File	29 1/8	30	27 7/8	GS2CPD3030-7 <input type="checkbox"/>	2,352	3,671	4,053
 Multi-File Left	29 1/8	30	27 7/8	GS2CPD3030L-MF <input type="checkbox"/>	2,455	3,777	4,170
 Multi-File Right	29 1/8	30	27 7/8	GS2CPD3030R-MF <input type="checkbox"/>	2,455	3,777	4,170
36" WIDTH							
 File File	29 1/8	36	27 7/8	GS2CPD3036-4 <input type="checkbox"/>	2,537	3,957	4,368
 Box Box File	29 1/8	36	27 7/8	GS2CPD3036-7 <input type="checkbox"/>	2,589	4,036	4,456
 Multi-File Left	29 1/8	36	27 7/8	GS2CPD3036L-MF <input type="checkbox"/>	2,701	4,156	4,588
 Multi-File Right	29 1/8	36	27 7/8	GS2CPD3036R-MF <input type="checkbox"/>	2,701	4,156	4,588

PRODUCT INFO

All units have an unfinished back.

Units with an exposed end require a filler strip.

TO ORDER PLEASE SPECIFY THE FOLLOWING:

WOOD CHASSIS

1. **MODEL NUMBER + W**
2. **FSC**
3. **CHASSIS WOOD FINISH**
4. **PULL**
5. **DRAWERS**
6. **KEYING**







LAM CHASSIS

1. **MODEL NUMBER + L**
2. **FSC**
3. **CHASSIS LAM**
4. **FRONT LAM**
5. **PULL**
6. **DRAWERS**
7. **KEYING**

MODULAR PEDS 30D

Standard Height | Hinged Door Cabinets

Silea
03/23

	D	W	H	model number + type	laminata	veneer 1	veneer 2
15" WIDTH							
 Left Hand	29 1/8	15	27 7/8	GS2CPD3015L-5 <input type="checkbox"/>	1,582	2,433	2,686
Right Hand	29 1/8	15	27 7/8	GS2CPD3015R-5 <input type="checkbox"/>	1,582	2,433	2,686
18" WIDTH							
 Left Hand	29 1/8	18	27 7/8	GS2CPD3018L-5 <input type="checkbox"/>	1,662	2,555	2,821
Right Hand	29 1/8	18	27 7/8	GS2CPD3018R-5 <input type="checkbox"/>	1,662	2,555	2,821
24" WIDTH							
 Double Door	29 1/8	24	27 7/8	GS2CPD3024-5 <input type="checkbox"/>	1,896	2,916	3,220
30" WIDTH							
 Double Door	29 1/8	30	27 7/8	GS2CPD3030-5 <input type="checkbox"/>	2,075	3,241	3,578
 With Printer Drawer	29 1/8	30	27 7/8	GS2CPD3030-P <input type="checkbox"/>	2,213	3,402	3,756
36" WIDTH							
 Double Door	29 1/8	36	27 7/8	GS2CPD3036-5 <input type="checkbox"/>	2,283	3,563	3,934
 With Printer Drawer	29 1/8	36	27 7/8	GS2CPD3036-P <input type="checkbox"/>	2,432	3,741	4,131

PRODUCT INFO

All units have an unfinished back.

Units with an exposed end require a filler strip.

If integral pull is chosen, doors will be touch latch.

-5 pedestal includes one adjustable shelf.

Printer pedestal includes printer drawer.





TO ORDER PLEASE SPECIFY THE FOLLOWING:

WOOD CHASSIS

- MODEL NUMBER + W**
- FSC**
- CHASSIS WOOD FINISH**
- PULL**
- KEYING**

LAM CHASSIS

- MODEL NUMBER + L**
- FSC**
- CHASSIS LAM**
- FRONT LAM**
- PULL**
- KEYING**

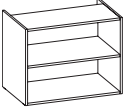
	D	W	H	model number + type	laminate	veneer 1	veneer 2
15" WIDTH 	29 1/8	15	27 7/8	GS2CPD3015-SH []	1,423	2,191	2,419
18" WIDTH 	29 1/8	18	27 7/8	GS2CPD3018-SH []	1,495	2,299	2,538
24" WIDTH 	29 1/8	24	27 7/8	GS2CPD3024-SH []	1,713	2,636	2,910
30" WIDTH 	29 1/8	30	27 7/8	GS2CPD3030-SH []	1,875	2,929	3,234
36" WIDTH 	29 1/8	36	27 7/8	GS2CPD3036-SH []	2,068	3,223	3,558

PRODUCT INFO

All units have an unfinished back.
 Units with an exposed end require a filler strip.
 Includes one adjustable shelf.

TO ORDER PLEASE SPECIFY THE FOLLOWING:

WOOD CHASSIS

1. **MODEL NUMBER + W**
2. **FSC**
3. **CHASSIS WOOD FINISH**

LAM CHASSIS



1. **MODEL NUMBER + L**
2. **FSC**
3. **CHASSIS LAM**

TROUGH MODULAR PEDS 30D

Standard Height | 9"W | Trough Cutouts

Silea

03/23

	D	W	H	model number + type	laminate	veneer 1	veneer 2
9" WIDTH	29 1/8	9	27 7/8	GS2CPD309TL-X []	916	1,431	1,581
 False Pedestal							
 Left	29 1/8	9	27 7/8	GS2CPD309TR-X []	916	1,431	1,581
 Right							

PRODUCT INFO

Pedestals to be used with a modular trough top.

All units have an unfinished back.

All trough pedestals require a filler strip or pedestal back.







TO ORDER PLEASE SPECIFY THE FOLLOWING:

WOOD CHASSIS

1. **MODEL NUMBER + W**
2. **FSC**
3. **CHASSIS WOOD FINISH**

LAM CHASSIS

1. **MODEL NUMBER + L**
2. **FSC**
3. **CHASSIS LAM**

	D	W	H	model number + type	laminate	veneer 1	veneer 2
15" WIDTH							
 Box Box File	29 1/8	15	27 7/8	GS2CPD3015T-3 []	1,838	2,866	3,164
 Hidden Accessory Hidden Accessory Box File	29 1/8	15	27 7/8	GS2CPD3015T-3A []	1,838	2,866	3,164
 File File	29 1/8	15	27 7/8	GS2CPD3015T-2 []	1,838	2,866	3,164
18" WIDTH							
 Box Box File	29 1/8	18	27 7/8	GS2CPD3018T-3 []	1,967	3,071	3,391
 Hidden Accessory Hidden Accessory Box File	29 1/8	18	27 7/8	GS2CPD3018T-3A []	1,967	3,071	3,391
 File File	29 1/8	18	27 7/8	GS2CPD3018T-2 []	1,967	3,071	3,391

PRODUCT INFO

All units have an unfinished back.
Pedestals to be used with a modular trough top.
All trough pedestals require a filler strip or pedestal back.

TO ORDER PLEASE SPECIFY THE FOLLOWING:

WOOD CHASSIS

1. **MODEL NUMBER + W**
2. **FSC**
3. **CHASSIS WOOD FINISH**
4. **PULL**
5. **DRAWERS**
6. **KEYING**







LAM CHASSIS

1. **MODEL NUMBER + L**
2. **FSC**
3. **CHASSIS LAM**
4. **FRONT LAM**
5. **PULL**
6. **DRAWERS**
7. **KEYING**

TROUGH MODULAR PEDS 30D

Standard Height | 30" and 36"W | Trough Cutouts

Silea
03/23

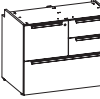
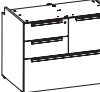
	D	W	H	model number + type	laminate	veneer 1	veneer 2
30" WIDTH							
 File File	29 1/8	30	27 7/8	GS2CPD3030T-4 <input type="checkbox"/>	2,308	3,598	3,972
 Box Box File	29 1/8	30	27 7/8	GS2CPD3030T-7 <input type="checkbox"/>	2,352	3,671	4,053
 Multi-File Left	29 1/8	30	27 7/8	GS2CPD3030TL-MF <input type="checkbox"/>	2,455	3,777	4,170
 Multi-File Right	29 1/8	30	27 7/8	GS2CPD3030TR-MF <input type="checkbox"/>	2,455	3,777	4,170
36" WIDTH							
 File File	29 1/8	36	27 7/8	GS2CPD3036T-4 <input type="checkbox"/>	2,537	3,957	4,368
 Box Box File	29 1/8	36	27 7/8	GS2CPD3036T-7 <input type="checkbox"/>	2,589	4,036	4,456
 Multi-File Left	29 1/8	36	27 7/8	GS2CPD3036TL-MF <input type="checkbox"/>	2,701	4,156	4,588
 Multi-File Right	29 1/8	36	27 7/8	GS2CPD3036TR-MF <input type="checkbox"/>	2,701	4,156	4,588

PRODUCT INFO

All units have an unfinished back.

Pedestals to be used with a modular trough top.

All trough pedestals require a filler strip or pedestal back.





TO ORDER PLEASE SPECIFY THE FOLLOWING:

WOOD CHASSIS

1. **MODEL NUMBER + W**
2. **FSC**
3. **CHASSIS WOOD FINISH**
4. **PULL**
5. **DRAWERS**
6. **KEYING**

LAM CHASSIS

1. **MODEL NUMBER + L**
2. **FSC**
3. **CHASSIS LAM**
4. **FRONT LAM**
5. **PULL**
6. **DRAWERS**
7. **KEYING**

	D	W	H	model number + type	laminate	veneer 1	veneer 2
15" WIDTH							
							
Left Hand	29 1/8	15	27 7/8	GS2CPD3015TL-5 <input type="checkbox"/>	1,582	2,433	2,686
Right Hand	29 1/8	15	27 7/8	GS2CPD3015TR-5 <input type="checkbox"/>	1,582	2,433	2,686
18" WIDTH							
							
Left Hand	29 1/8	18	27 7/8	GS2CPD3018TL-5 <input type="checkbox"/>	1,662	2,555	2,821
Right Hand	29 1/8	18	27 7/8	GS2CPD3018TR-5 <input type="checkbox"/>	1,662	2,555	2,821
24" WIDTH							
							
Double Door	29 1/8	24	27 7/8	GS2CPD3024T-5 <input type="checkbox"/>	1,896	2,916	3,220
30" WIDTH							
							
Double Door	29 1/8	30	27 7/8	GS2CPD3030T-5 <input type="checkbox"/>	2,075	3,241	3,578
With Printer Drawer	29 1/8	30	27 7/8	GS2CPD3030T-P <input type="checkbox"/>	2,213	3,402	3,756
36" WIDTH							
							
Double Door	29 1/8	36	27 7/8	GS2CPD3036T-5 <input type="checkbox"/>	2,283	3,563	3,934
With Printer Drawer	29 1/8	36	27 7/8	GS2CPD3036T-P <input type="checkbox"/>	2,432	3,741	4,131

PRODUCT INFO

All units have an unfinished back.
 Pedestals to be used with a modular trough top.
 All trough pedestals require a filler strip or pedestal back.
 If integral pull is chosen, doors will be touch latch.
 -5 pedestal includes one adjustable shelf.
 Printer pedestal includes printer drawer.

TO ORDER PLEASE SPECIFY THE FOLLOWING:

WOOD CHASSIS

1. **MODEL NUMBER + W**
2. **FSC**
3. **CHASSIS WOOD FINISH**
4. **PULL**
5. **KEYING**





LAM CHASSIS

1. **MODEL NUMBER + L**
2. **FSC**
3. **CHASSIS LAM**
4. **FRONT LAM**
5. **PULL**
6. **KEYING**

TROUGH MODULAR PEDS 30D

Standard Height | Open Shelf | Trough Cutouts

Silea
03/23

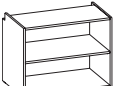
	D	W	H	model number + type	laminate	veneer 1	veneer 2
15" WIDTH 	29 1/8	15	27 7/8	GS2CPD3015T-SH <input type="checkbox"/>	1,423	2,191	2,419
18" WIDTH 	29 1/8	18	27 7/8	GS2CPD3018T-SH <input type="checkbox"/>	1,495	2,299	2,538
24" WIDTH 	29 1/8	24	27 7/8	GS2CPD3024T-SH <input type="checkbox"/>	1,713	2,636	2,910
30" WIDTH 	29 1/8	30	27 7/8	GS2CPD3030T-SH <input type="checkbox"/>	1,875	2,929	3,234
36" WIDTH 	29 1/8	36	27 7/8	GS2CPD3036T-SH <input type="checkbox"/>	2,068	3,223	3,558

PRODUCT INFO

All units have an unfinished back.

Pedestals to be used with a modular trough top.

All trough pedestals require a filler strip or pedestal back.

Adjustable shelf.

TO ORDER PLEASE SPECIFY THE FOLLOWING:

WOOD CHASSIS

- MODEL NUMBER + W**
- FSC**
- CHASSIS WOOD FINISH**

LAM CHASSIS

- MODEL NUMBER + L**
- FSC**
- CHASSIS LAM**



D	W	H	model number + type	laminate	vener 1	vener 2
23 1/8	3/4	27 7/8	GS2MEP24L- []	432	676	747
23 1/8	3/4	27 7/8	GS2MEP24R- []	432	676	747
29 1/8	3/4	27 7/8	GS2MEP30L- []	523	817	903
29 1/8	3/4	27 7/8	GS2MEP30R- []	523	817	903
35 1/8	3/4	27 7/8	GS2MEP36L- []	560	872	963
35 1/8	3/4	27 7/8	GS2MEP36R- []	560	872	963

• Layers version

PRODUCT INFO

End panels require the use of a modular full back modesty panel to complete application.

TO ORDER PLEASE SPECIFY THE FOLLOWING:

WOOD

1. **MODEL NUMBER + W**
2. **FSC**
3. **CHASSIS WOOD FINISH**

LAM

1. **MODEL NUMBER + L**
2. **FSC**
3. **CHASSIS LAM**

MODULAR L SUPPORTS

No Back | No Trough | No Wall Access Panel

Silea

03/23

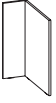
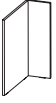
	D	W	H	model number + type	laminate	veneer 1	veneer 2
 Right hand	23 1/8	9	27 7/8	GS2MLS24L- []	738	1,150	1,270
	23 1/8	9	27 7/8	GS2MLS24R- []	738	1,150	1,270
 Left hand	29 7/8	9	27 7/8	GS2MLS30L- []	785	1,227	1,355
	29 7/8	9	27 7/8	GS2MLS30R- []	785	1,227	1,355

• Layers version

PRODUCT INFO

Do not use 2 L supports to create a desk.





TO ORDER PLEASE SPECIFY THE FOLLOWING:

WOOD

1. **MODEL NUMBER + W**
2. **FSC**
3. **CHASSIS WOOD FINISH**

LAM

1. **MODEL NUMBER + L**
2. **FSC**
3. **CHASSIS LAM**

	D	W	H	model number + type	laminata	veneer 1	veneer 2
INTERMEDIATE SUPPORT 	14	3/4	27 7/8	GS2MSP- []	324	802	886
T SUPPORT 	14 3/4	12	27 7/8	GS2MSPT- []	390	1,069	1,181
WORKSURFACE JUNCTION SUPPORT 	14 3/4	24	27 7/8	GS2MSJ24- []	742	1,155	1,275
FILLER STRIP 	3/4	9	27 7/8	GS2MPF- []	378	763	843
PEDESTAL BACKS 	3/4	9	27 7/8	GS2MPB9- []	378	734	811
	3/4	15	27 7/8	GS2MPB15- []	390	865	956
	3/4	18	27 7/8	GS2MPB18- []	445	637	704
	3/4	30	27 7/8	GS2MPB30- []	501	717	793
	3/4	36	27 7/8	GS2MPB36- []	524	749	828

NOTE: Credenzas, returns, and bridges with no back panel and an unsupported area of 48" and greater require an intermediate T support.

PRODUCT INFO

Panels for use with standard or trough tops.
All pedestals with an exposed side require a filler strip or pedestal back.

TO ORDER PLEASE SPECIFY THE FOLLOWING:

WOOD

1. **MODEL NUMBER + W**
2. **FSC**
3. **CHASSIS WOOD FINISH**

LAM





1. **MODEL NUMBER + L**
2. **FSC**
3. **CHASSIS LAM**

MODULAR SUPPORT PANELS & PED BACKS

Silea

03/23

Layers Height

	D	W	H	model number + type	laminat	vener 1	vener 2
INTERMEDIATE SUPPORT 	14	3/4	20 3/4	GS2MLSP- []	324	499	552
T SUPPORT 	14 3/4	12	20 3/4	GS2MLSPT- []	390	599	662
WORKSURFACE JUNCTION SUPPORT 	14 3/4	24	20 3/4	GS2MLSJ24- []	742	1,155	1,275
FILLER STRIP 	3/4	9	20 3/4	GS2MLPF- []	378	763	843
PEDESTAL BACKS 	3/4	15	20 3/4	GS2MLPB15- []	390	558	617
	3/4	18	20 3/4	GS2MLPB18- []	445	637	704
	3/4	30	20 3/4	GS2MLPB30- []	501	717	793
	3/4	36	20 3/4	GS2MLPB36- []	524	749	828

NOTE: Credenzas, returns, and bridges with no back panel and an unsupported area of 48" and greater require an intermediate T support.

PRODUCT INFO

Panels for use with standard or trough tops.
All pedestals with exposed side require a filler strip or pedestal back.

TO ORDER PLEASE SPECIFY THE FOLLOWING:

WOOD

1. **MODEL NUMBER + W**
2. **FSC**
3. **CHASSIS WOOD FINISH**

LAM

1. **MODEL NUMBER + L**
2. **FSC**
3. **CHASSIS LAM**

	D	W	H	model number + type	laminata	veneer 1	veneer 2
	3/4	60	27 7/8	GS2CMF60- []	760	1,099	1,214
	3/4	66	27 7/8	GS2CMF66- []	829	1,201	1,327
	3/4	72	27 7/8	GS2CMF72- []	894	1,296	1,432
	3/4	78	27 7/8	GS2CMF78- []	958	1,390	1,535
	3/4	84	27 7/8	GS2CMF84- []	1,024	1,485	1,640
	3/4	90	27 7/8	GS2CMF90- []	1,091	1,581	1,746
	3/4	96	27 7/8	GS2CMF96- []	1,158	1,676	1,851
	3/4	102	27 7/8	GS2CMF102- []	N/A	1,770	1,955
	3/4	108	27 7/8	GS2CMF108- []	N/A	1,865	2,060
	3/4	114	27 7/8	GS2CMF114- []	N/A	1,959	2,163
	3/4	120	27 7/8	GS2CMF120- []	N/A	2,055	2,269

PRODUCT INFO

Grain Direction

- Natural Veneer: Vertical
- Stratawood Veneer: Optional
- Laminate : Horizontal

TO ORDER PLEASE SPECIFY THE FOLLOWING:

WOOD

- 1. MODEL NUMBER + W**
- 2. FSC**
- 3. CHASSIS WOOD FINISH**

LAM

- 1. MODEL NUMBER + L**
- 2. FSC**
- 3. CHASSIS LAM**

MODULAR CREDENZA FULL MODESTY PANEL

Layers Height

Silea

03/23

	D	W	H	model number + type	laminate	veneer 1	veneer 2
	3/4	45	20 3/4	GS2CLMF45- []	701	1,013	1,119
	3/4	48	20 3/4	GS2CLMF48- []	713	1,032	1,140
	3/4	51	20 3/4	GS2CLMF51- []	726	1,052	1,163
	3/4	54	20 3/4	GS2CLMF54- []	735	1,068	1,180
	3/4	60	20 3/4	GS2CLMF60- []	760	1,099	1,214
	3/4	66	20 3/4	GS2CLMF66- []	829	1,201	1,327
	3/4	72	20 3/4	GS2CLMF72- []	894	1,296	1,432
	3/4	78	20 3/4	GS2CLMF78- []	958	1,390	1,535
	3/4	84	20 3/4	GS2CLMF84- []	1,024	1,485	1,640
	3/4	90	20 3/4	GS2CLMF90- []	1,091	1,581	1,746
	3/4	96	20 3/4	GS2CLMF96- []	1,158	1,676	1,851
	3/4	102	20 3/4	GS2CLMF102- []	N/A	1,770	1,955
	3/4	108	20 3/4	GS2CLMF108- []	N/A	1,865	2,060
	3/4	114	20 3/4	GS2CLMF114- []	N/A	1,959	2,163
3/4	120	20 3/4	GS2CLMF120- []	N/A	2,055	2,269	

PRODUCT INFO

Grain Direction

- Natural Veneer: Vertical
- Stratawood Veneer: Optional
- Laminate : Horizontal

TO ORDER PLEASE SPECIFY THE FOLLOWING:

WOOD

1. **MODEL NUMBER + W**
2. **FSC**
3. **CHASSIS WOOD FINISH**

LAM

1. **MODEL NUMBER + L**
2. **FSC**
3. **CHASSIS LAM**

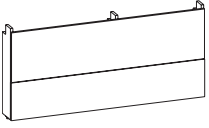
	D	W	H	model number + type	laminate	veneer 1	veneer 2
	7 1/4	21	27 7/8	GS2CMA21- []	893	1,390	1,535
	7 1/4	24	27 7/8	GS2CMA24- []	912	1,426	1,575
	7 1/4	27	27 7/8	GS2CMA27- []	934	1,457	1,609
	7 1/4	30	27 7/8	GS2CMA30- []	956	1,493	1,649
	7 1/4	33	27 7/8	GS2CMA33- []	978	1,527	1,687
	7 1/4	36	27 7/8	GS2CMA36- []	1,001	1,560	1,723
	7 1/4	39	27 7/8	GS2CMA39- []	1,021	1,593	1,759
	7 1/4	42	27 7/8	GS2CMA42- []	1,045	1,629	1,800
	7 1/4	45	27 7/8	GS2CMA45- []	1,065	1,661	1,835
	7 1/4	48	27 7/8	GS2CMA48- []	1,090	1,697	1,874
	7 1/4	51	27 7/8	GS2CMA51- []	1,189	1,732	1,912
	7 1/4	54	27 7/8	GS2CMA54- []	1,210	1,764	1,948
	7 1/4	57	27 7/8	GS2CMA57- []	1,234	1,798	1,986
	7 1/4	60	27 7/8	GS2CMA60- []	1,252	1,830	2,021
	7 1/4	63	27 7/8	GS2CMA63- []	1,281	1,865	2,060
	7 1/4	66	27 7/8	GS2CMA66- []	1,302	1,901	2,099
	7 1/4	69	27 7/8	GS2CMA69- []	1,328	1,932	2,133
7 1/4	72	27 7/8	GS2CMA72- []	1,349	1,967	2,172	

PRODUCT INFO

Grain Direction

- Natural Veneer: Vertical
- Stratawood Veneer: Optional
- Laminate: Vertical up to and including 60"W. Horizontal greater than 60"W.

TO ORDER PLEASE SPECIFY THE FOLLOWING:

WOOD

- 1. MODEL NUMBER + W**
- 2. FSC**
- 3. CHASSIS WOOD FINISH**

LAM

- 1. MODEL NUMBER + L**
- 2. FSC**
- 3. CHASSIS LAM**

MODULAR CREDENZA WALL ACCESS PANEL

Layers Height

Silea

03/23

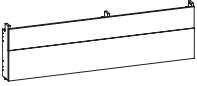
	D	W	H	model number + type	laminate	veneer 1	veneer 2
	7 1/4	21	20 3/4	GS2CLMA21- []	893	1,390	1,535
	7 1/4	24	20 3/4	GS2CLMA24- []	912	1,426	1,575
	7 1/4	27	20 3/4	GS2CLMA27- []	934	1,457	1,609
	7 1/4	30	20 3/4	GS2CLMA30- []	956	1,493	1,649
	7 1/4	33	20 3/4	GS2CLMA33- []	978	1,527	1,687
	7 1/4	36	20 3/4	GS2CLMA36- []	1,001	1,560	1,723
	7 1/4	39	20 3/4	GS2CLMA39- []	1,021	1,593	1,759
	7 1/4	42	20 3/4	GS2CLMA42- []	1,045	1,629	1,800
	7 1/4	45	20 3/4	GS2CLMA45- []	1,065	1,661	1,835
	7 1/4	48	20 3/4	GS2CLMA48- []	1,090	1,697	1,874
	7 1/4	51	20 3/4	GS2CLMA51- []	1,189	1,732	1,912
	7 1/4	54	20 3/4	GS2CLMA54- []	1,210	1,764	1,948
	7 1/4	57	20 3/4	GS2CLMA57- []	1,234	1,798	1,986
	7 1/4	60	20 3/4	GS2CLMA60- []	1,252	1,830	2,021
	7 1/4	63	20 3/4	GS2CLMA63- []	1,281	1,865	2,060
	7 1/4	66	20 3/4	GS2CLMA66- []	1,302	1,901	2,099
	7 1/4	69	20 3/4	GS2CLMA69- []	1,328	1,932	2,133
	7 1/4	72	20 3/4	GS2CLMA72- []	1,349	1,967	2,172

PRODUCT INFO

Grain Direction

- Natural Veneer: Vertical
- Stratawood Veneer: Optional
- Laminate: Vertical up to and including 60"W. Horizontal greater than 60"W.

TO ORDER PLEASE SPECIFY THE FOLLOWING:

WOOD

- MODEL NUMBER + W**
- FSC**
- CHASSIS WOOD FINISH**

LAM

- MODEL NUMBER + L**
- FSC**
- CHASSIS LAM**

	D	W	H	model number + type	laminate	veneer 1	veneer 2
LEFT HAND 	3/4	39	27 7/8	GS2RMF39L- <input type="checkbox"/>	682	987	1,090
	3/4	42	27 7/8	GS2RMF42L- <input type="checkbox"/>	693	1,003	1,108
	3/4	45	27 7/8	GS2RMF45L- <input type="checkbox"/>	701	1,013	1,119
	3/4	48	27 7/8	GS2RMF48L- <input type="checkbox"/>	713	1,032	1,140
	3/4	51	27 7/8	GS2RMF51L- <input type="checkbox"/>	726	1,052	1,163
	3/4	54	27 7/8	GS2RMF54L- <input type="checkbox"/>	735	1,068	1,180
	3/4	57	27 7/8	GS2RMF57L- <input type="checkbox"/>	749	1,081	1,194
	3/4	60	27 7/8	GS2RMF60L- <input type="checkbox"/>	760	1,099	1,214
	3/4	63	27 7/8	GS2RMF63L- <input type="checkbox"/>	794	1,149	1,269
	3/4	66	27 7/8	GS2RMF66L- <input type="checkbox"/>	829	1,201	1,327
	3/4	69	27 7/8	GS2RMF69L- <input type="checkbox"/>	863	1,249	1,379
	3/4	72	27 7/8	GS2RMF72L- <input type="checkbox"/>	894	1,296	1,432
	3/4	75	27 7/8	GS2RMF75L- <input type="checkbox"/>	927	1,344	1,484
	3/4	78	27 7/8	GS2RMF78L- <input type="checkbox"/>	958	1,390	1,535
	3/4	81	27 7/8	GS2RMF81L- <input type="checkbox"/>	992	1,438	1,588
	3/4	84	27 7/8	GS2RMF84L- <input type="checkbox"/>	1,024	1,485	1,640
3/4	87	27 7/8	GS2RMF87L- <input type="checkbox"/>	1,058	1,533	1,693	
3/4	90	27 7/8	GS2RMF90L- <input type="checkbox"/>	1,091	1,581	1,746	

NOTE: If attaching to a height adjustable extension desk, a 3" shorter modesty panel must be used

PRODUCT INFO	TO ORDER PLEASE SPECIFY THE FOLLOWING:								
<p>Handed units due to hole pattern.</p> <p>For use to build full modesty returns and to attach to end panels.</p> <p>Grain Direction</p> <ul style="list-style-type: none"> Natural Veneer: Vertical Stratawood Veneer: Optional Laminate: Vertical up to and including 60"W. Horizontal greater than 60"W. 	<table border="0"> <tr> <td>WOOD</td> <td>LAM</td> </tr> <tr> <td>1. MODEL NUMBER + W</td> <td>1. MODEL NUMBER + L</td> </tr> <tr> <td>2. FSC</td> <td>2. FSC</td> </tr> <tr> <td>3. CHASSIS WOOD FINISH</td> <td>3. CHASSIS LAM</td> </tr> </table>	WOOD	LAM	1. MODEL NUMBER + W	1. MODEL NUMBER + L	2. FSC	2. FSC	3. CHASSIS WOOD FINISH	3. CHASSIS LAM
WOOD	LAM								
1. MODEL NUMBER + W	1. MODEL NUMBER + L								
2. FSC	2. FSC								
3. CHASSIS WOOD FINISH	3. CHASSIS LAM								

MODULAR RETURN FULL MODESTY PANEL

Silea
03/23

	D	W	H	model number + type	laminate	veneer 1	veneer 2
RIGHT HAND 	3/4	39	27 7/8	GS2RMF39R- []	682	987	1,090
	3/4	42	27 7/8	GS2RMF42R- []	693	1,003	1,108
	3/4	45	27 7/8	GS2RMF45R- []	701	1,013	1,119
	3/4	48	27 7/8	GS2RMF48R- []	713	1,032	1,140
	3/4	51	27 7/8	GS2RMF51R- []	726	1,052	1,163
	3/4	54	27 7/8	GS2RMF54R- []	735	1,068	1,180
	3/4	57	27 7/8	GS2RMF57R- []	749	1,081	1,194
	3/4	60	27 7/8	GS2RMF60R- []	760	1,099	1,214
	3/4	63	27 7/8	GS2RMF63R- []	794	1,149	1,269
	3/4	66	27 7/8	GS2RMF66R- []	829	1,201	1,327
	3/4	69	27 7/8	GS2RMF69R- []	863	1,249	1,379
	3/4	72	27 7/8	GS2RMF72R- []	894	1,296	1,432
	3/4	75	27 7/8	GS2RMF75R- []	927	1,344	1,484
	3/4	78	27 7/8	GS2RMF78R- []	958	1,390	1,535
	3/4	81	27 7/8	GS2RMF81R- []	992	1,438	1,588
	3/4	84	27 7/8	GS2RMF84R- []	1,024	1,485	1,640
3/4	87	27 7/8	GS2RMF87R- []	1,058	1,533	1,693	
3/4	90	27 7/8	GS2RMF90R- []	1,091	1,581	1,746	

NOTE: If attaching to a height adjustable extension desk, a 3" shorter modesty panel must be used

PRODUCT INFO

Handed units due to hole pattern.

For use to build full modesty returns and to attach to end panels.

Grain Direction

- Natural Veneer: Vertical
- Stratawood Veneer: Optional
- Laminate: Vertical up to and including 60"W. Horizontal greater than 60"W.

TO ORDER PLEASE SPECIFY THE FOLLOWING:

WOOD

1. **MODEL NUMBER + W**
2. **FSC**
3. **CHASSIS WOOD FINISH**

LAM

1. **MODEL NUMBER + L**
2. **FSC**
3. **CHASSIS LAM**



D	W	H	model number + type	laminate	veneer 1	veneer 2
7 1/4	21	27 7/8	GS2RMA21- []	893	1,390	1,535
7 1/4	24	27 7/8	GS2RMA24- []	912	1,426	1,575
7 1/4	27	27 7/8	GS2RMA27- []	934	1,457	1,609
7 1/4	30	27 7/8	GS2RMA30- []	956	1,493	1,649
7 1/4	33	27 7/8	GS2RMA33- []	978	1,527	1,687
7 1/4	36	27 7/8	GS2RMA36- []	1,001	1,560	1,723
7 1/4	39	27 7/8	GS2RMA39- []	1,021	1,593	1,759
7 1/4	42	27 7/8	GS2RMA42- []	1,045	1,629	1,800
7 1/4	45	27 7/8	GS2RMA45- []	1,065	1,661	1,835
7 1/4	48	27 7/8	GS2RMA48- []	1,090	1,697	1,874
7 1/4	51	27 7/8	GS2RMA51- []	1,189	1,732	1,912
7 1/4	54	27 7/8	GS2RMA54- []	1,210	1,764	1,948
7 1/4	57	27 7/8	GS2RMA57- []	1,234	1,798	1,986
7 1/4	60	27 7/8	GS2RMA60- []	1,252	1,830	2,021
7 1/4	63	27 7/8	GS2RMA63- []	1,281	1,865	2,060
7 1/4	66	27 7/8	GS2RMA66- []	1,302	1,901	2,099
7 1/4	69	27 7/8	GS2RMA69- []	1,328	1,932	2,133
7 1/4	72	27 7/8	GS2RMA72- []	1,349	1,967	2,172

NOTE: If attaching to a height adjustable extension desk, a 3" shorter wall access panel must be used

PRODUCT INFO

Grain Direction

- Natural Veneer: Vertical
- Stratawood Veneer: Optional
- Laminate: Vertical up to and including 60"W. Horizontal greater than 60"W.

TO ORDER PLEASE SPECIFY THE FOLLOWING:

WOOD

- 1. MODEL NUMBER + W**
- 2. FSC**
- 3. CHASSIS WOOD FINISH**

LAM

- 1. MODEL NUMBER + L**
- 2. FSC**
- 3. CHASSIS LAM**

BRIDGE FULL MODESTY PANEL

Silea
03/23

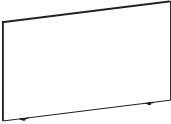
	D	W	H	model number + type	laminate	veneer 1	veneer 2
	3/4	39	27 7/8	GS2BMF39- []	682	987	1,090
	3/4	42	27 7/8	GS2BMF42- []	693	1,003	1,108
	3/4	45	27 7/8	GS2BMF45- []	705	1,013	1,119
	3/4	48	27 7/8	GS2BMF48- []	712	1,032	1,140
	3/4	51	27 7/8	GS2BMF51- []	727	1,052	1,163
	3/4	54	27 7/8	GS2BMF54- []	738	1,068	1,180
	3/4	57	27 7/8	GS2BMF57- []	750	1,081	1,194
	3/4	60	27 7/8	GS2BMF60- []	760	1,099	1,214

NOTE: If attaching to a height adjustable extension desk, a 3" shorter modesty panel must be used

PRODUCT INFO

Grain Direction

- Natural Veneer: Vertical
- Stratawood Veneer: Optional
- Laminate: Vertical up to and including 60"W. Horizontal greater than 60"W.

TO ORDER PLEASE SPECIFY THE FOLLOWING:

WOOD

1. **MODEL NUMBER + W**
2. **FSC**
3. **CHASSIS WOOD FINISH**

LAM

1. **MODEL NUMBER + L**
2. **FSC**
3. **CHASSIS LAM**



D	W	H	model number + type	laminate	veneer 1	veneer 2
7 1/4	39	27 7/8	GS2BMA39- []	1,021	1,593	1,759
7 1/4	42	27 7/8	GS2BMA42- []	1,045	1,629	1,800
7 1/4	45	27 7/8	GS2BMA45- []	1,065	1,661	1,835
7 1/4	48	27 7/8	GS2BMA48- []	1,090	1,697	1,874
7 1/4	51	27 7/8	GS2BMA51- []	1,189	1,732	1,912
7 1/4	54	27 7/8	GS2BMA54- []	1,210	1,764	1,948
7 1/4	57	27 7/8	GS2BMA57- []	1,234	1,798	1,986
7 1/4	60	27 7/8	GS2BMA60- []	1,252	1,830	2,021

NOTE: If attaching to a height adjustable extension desk, a 3" shorter wall access panel must be used

PRODUCT INFO	TO ORDER PLEASE SPECIFY THE FOLLOWING:								
<p>Grain Direction</p> <ul style="list-style-type: none"> • Natural Veneer: Vertical • Stratawood Veneer: Optional • Laminate: Vertical up to and including 60"W. Horizontal greater than 60"W. 	<table border="0"> <tr> <td>WOOD</td> <td>LAM</td> </tr> <tr> <td>1. MODEL NUMBER + W</td> <td>1. MODEL NUMBER + L</td> </tr> <tr> <td>2. FSC</td> <td>2. FSC</td> </tr> <tr> <td>3. CHASSIS WOOD FINISH</td> <td>3. CHASSIS LAM</td> </tr> </table>	WOOD	LAM	1. MODEL NUMBER + W	1. MODEL NUMBER + L	2. FSC	2. FSC	3. CHASSIS WOOD FINISH	3. CHASSIS LAM
WOOD	LAM								
1. MODEL NUMBER + W	1. MODEL NUMBER + L								
2. FSC	2. FSC								
3. CHASSIS WOOD FINISH	3. CHASSIS LAM								

LAYERS W/ LAPTOP DRAWER

For 30" and 36"D Runoff

Silea
03/23

	D	W	H	model number + type	laminate	vener 1	vener 2
	16 3/4	26 1/2	5 15/16	GS2MLB30SL- []	930	1,365	1,506
	16 3/4	26 1/2	5 15/16	GS2MLB30SR- []	930	1,365	1,506

• For use with a 30" deep runoff.

	16 3/4	32 1/2	5 15/16	GS2MLB36SL- []	991	1,390	1,533
	16 3/4	32 1/2	5 15/16	GS2MLB36SR- []	991	1,390	1,533

• For use with a 36" deep runoff.

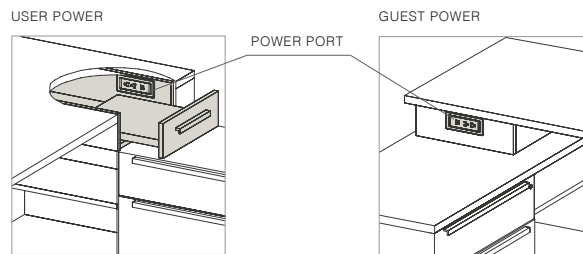

PRODUCT INFO

Unit comes with 2 power units.
Color specified in option pick.

 Units shipped as separate packages and require field assembly.

TO ORDER PLEASE SPECIFY THE FOLLOWING:

WOOD

1. **MODEL NUMBER + W**
2. **FSC**
3. **CHASSIS WOOD FINISH**
4. **PULL**
5. **POWER UNIT**

LAM

1. **MODEL NUMBER + L**
2. **FSC**
3. **CHASSIS LAM**
4. **PULL**
5. **POWER UNIT**

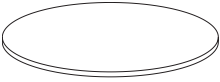
	Dia	H	model number + type	laminata	veneer 1	veneer 2	solid surface
	36	1 3/16	GS2TRD36- []	1,338	2,612	2,884	7,410
	42	1 3/16	GS2TRD42- []	1,453	2,837	3,133	8,055
	48	1 3/16	GS2TRD48- []	1,903	3,710	4,096	10,535
	54	1 3/16	GS2TRD54- []	2,324	4,535	5,006	12,875
	60	1 3/16	GS2TRD60- []	2,828	5,520	6,094	15,644

PRODUCT INFO

Solid surface tops have a softened edge.

54" and 60" wood tops are 2-piece. If top ordered with 4 legs, metal stiffeners must be ordered separately (ACMWS30, qty. 2).

Grommet Location
(Add \$77 per grommet)

No Grommet **GN**
Center **GC**

Specify location first, then select grommet color or "Empty Cutout" option. When "Empty Cutout" option is selected, a grommet or power unit must be ordered separately for each cutout.

TO ORDER PLEASE SPECIFY THE FOLLOWING:

WOOD TOP

1. **MODEL NUMBER + W**
2. **FSC**
3. **TOP WOOD FINISH + EDGE**
4. **TOP UV FINISH**
5. **GROMMET**

LAM TOP

1. **MODEL NUMBER + L**
2. **FSC**
3. **TOP LAM**
4. **EDGE DETAIL**
5. **GROMMET**

SOLID SURFACE TOP

1. **MODEL NUMBER + S**
2. **SOLID SURFACE FINISH**
3. **EDGE DETAIL**
4. **GROMMET**

GUITAR PICK TOP

Silea
03/23

	D	W	H	model number + type	laminate	veneer 1	veneer 2	solid surface
	36	36	1 3/16	GS2TSTG36- <input type="text"/>	1,338	2,612	2,884	7,410
	42	42	1 3/16	GS2TSTG42- <input type="text"/>	1,453	2,837	3,133	8,055
	48	48	1 3/16	GS2TSTG48- <input type="text"/>	1,903	3,710	4,096	10,535

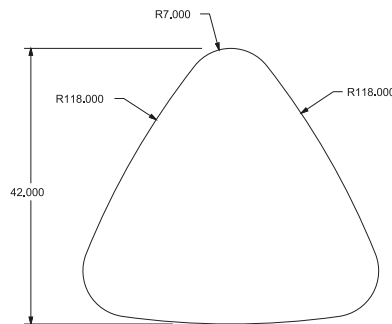

PRODUCT INFO

Solid surface tops have a softened edge.

Grommet Location

(Add \$77 per grommet)

No Grommet **GN**
Center **GC**

Specify location first, then select grommet color or "Empty Cutout" option. When "Empty Cutout" option is selected, a grommet or power unit must be ordered separately for each cutout.

TO ORDER PLEASE SPECIFY THE FOLLOWING:

WOOD TOP

1. **MODEL NUMBER + W**
2. **FSC**
3. **TOP WOOD FINISH + EDGE**
4. **TOP UV FINISH**
5. **GROMMET**

LAM TOP

1. **MODEL NUMBER + L**
2. **FSC**
3. **TOP LAM**
4. **EDGE DETAIL**
5. **GROMMET**

SOLID SURFACE TOP

1. **MODEL NUMBER + S**
2. **SOLID SURFACE FINISH**
3. **EDGE DETAIL**
4. **GROMMET**

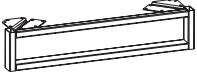
	for use with top sizes	D	W	H	model number	list
	24D/30D	1 1/2	18	5 15/16	GS2MLB18	451
	36D	1 1/2	24	5 15/16	GS2MLB24	489
	42D	1 1/2	30	5 15/16	GS2MLB30	528
	48D	1 1/2	36	5 15/16	GS2MLB36	567

PRODUCT INFO

To be used to support
worksurface in layers
applications.

TO ORDER PLEASE SPECIFY THE FOLLOWING:

LIST

1. **MODEL NUMBER**
2. **HARDWARE COLOR**



D	W	H	model number	in
1 1/2	1 1/2	30	ACMWS30	67
1 1/2	1 1/2	36	ACMWS36	72
1 1/2	1 1/2	41	ACMWS41	73
1 1/2	1 1/2	47	ACMWS47	74
1 1/2	1 1/2	53	ACMWS53	75
1 1/2	1 1/2	59	ACMWS59	76
1 1/2	1 1/2	65	ACMWS65	77
1 1/2	1 1/2	71	ACMWS71	78
1 1/2	1 1/2	83	ACMWS83	117

PRODUCT INFO

Use supports on worksurfaces that span 48" unsupported without a full modesty panel. Calculate total distance between kneewell panels or bases and subtract 6". Use closest available model size.

TO ORDER PLEASE SPECIFY THE FOLLOWING:

LIST

- 1. MODEL NUMBER**

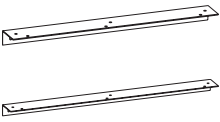
	D	W	H	model number	part #
FLAT BRACKET 	3	6 1/2	1/8	MDWBRK	127
	• For worksurface connections				
WALL MOUNT BRACKETS 	2 1/2	19	1 1/4	MDWLBK24	130
	• For use with 24"D worksurface.				
	2 1/2	25	1 1/4	MDWLBK30	140
	• For use with 30" and 36"D worksurface.				

PRODUCT INFO

TO ORDER PLEASE SPECIFY THE FOLLOWING:

LIST

- 1. MODEL NUMBER**

MODULAR PEDESTAL CUSHION

Standard and Trough Tops

Silea

03/23

	D	W	H	model number + type	fabric grades			COM/4
					1	2	3	
	20 ¹¹ / ₁₆	29 ³ / ₄	1	GS2CLPD-CUSH2130T	595	618	642	667
	20 ¹¹ / ₁₆	35 ³ / ₄	1	GS2CLPD-CUSH2136T	642	671	702	734

PRODUCT INFO

To be used with standard and trough tops.

COM fabric 1.25 yds for both models.

TO ORDER PLEASE SPECIFY THE FOLLOWING:

LIST

1. **MODEL NUMBER**
2. **FABRIC**
3. **FLAMMABILITY**

Flammability Option Codes:
U = CTB 117

For standard flammability rating, please specify CTB 117.

CANTILEVER HEIGHT ADJUSTABLE DESKS AND SMART STORAGE

Cantilever Height Adjustable Desks and Smart Storage	221-235
Cantilever Height Adjustable Desks	222-225
Smart Pedestals	226-227
Accessory Trays and Bins For Smart Pedestals	228
False Pedestals	229
Smart Closets	230-231
Smart Lockers	232-233
Smart Pedestal Power Units For Grommet Cutout	234
Solidwood Desktop Accessories	235

CANTILEVER HEIGHT ADJUSTABLE DESKS - RECTANGULAR

Silea

03/23

Left Hand Desk

	D	W	H	model number + type	laminata	veneer 1	veneer 2	
36" DEPTH 	36	66	29 1/2	GS5CVATR3666L- []	8,422	13,034	14,388	
	• 22 1/2" end overhang, 6" guest overhang							
	36	72	29 1/2	GS5CVATR3672L- []	8,481	13,126	14,489	
	• 28 1/2" end overhang, 6" guest overhang							
	36	78	29 1/2	GS5CVATR3678L- []	8,890	13,580	14,991	
• 34 1/2" end overhang, 6" guest overhang								
• 40 1/2" end overhang, 6" guest overhang								
42" DEPTH 	42	66	29 1/2	GS5CVATR4266L- []	8,962	13,991	15,444	
	• 22 1/2" end overhang, 9" guest overhang							
	42	72	29 1/2	GS5CVATR4272L- []	9,038	14,109	15,574	
	• 28 1/2" end overhang, 9" guest overhang							
	42	78	29 1/2	GS5CVATR4278L- []	9,468	14,595	16,111	
• 34 1/2" end overhang, 9" guest overhang								
• 40 1/2" end overhang, 9" guest overhang								

PRODUCT INFO

Unit must be wall mounted.

Top depth 1" shallower than chassis on user and guest sides to accommodate pinch points of adjoining units

29.5" to 42.5" height adjustment range

 All units shipped as separate packages and require field assembly.

Grommet Location (Add \$77 per grommet)

No Grommet **GN**
 Right **GR**
 Specify location first, then select grommet color or "Empty Cutout" option. When "Empty Cutout" option is selected, a grommet or power unit must be ordered separately for each cutout.

NOTE: Monitor arms should **ALWAYS** be installed in grommets on Silea height adjustable units. Please ensure a grommet location is specified on the top. This allows for bolt mount or clamp mount install of monitor arm. See page 35 for details.

TO ORDER PLEASE SPECIFY THE FOLLOWING:

WOOD TOP, WOOD CHASSIS

- MODEL NUMBER + WW**
- FSC**
- TOP WOOD FINISH + EDGE**
- CHASSIS WOOD FINISH**
- TOP UV FINISH**
- HAT KEYPAD & BASE COLOR**
- GROMMET**

LAM TOP, LAM CHASSIS

- MODEL NUMBER + LL**
- FSC**
- TOP LAM**
- CHASSIS LAM**
- EDGE DETAIL**
- HAT KEYPAD & BASE COLOR**
- GROMMET**

Optional height adjustable keypads available

HAT KEYPAD & BASE COLOR

Basic Up/Down Keypad, Black P71 Column
 Memory Preset Keypad, Black P71 Column
 Paddle Keypad, Black P71 Column

UDP71
MEMP71
PDLP71

CANTILEVER HEIGHT ADJUSTABLE DESKS - RECTANGULAR

Right Hand Desk

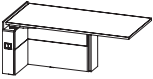
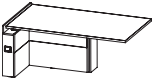
	D	W	H	model number + type	laminata	veneer 1	veneer 2	
36" DEPTH 	36	66	29 1/2	GS5CVATR3666R- []	8,422	13,034	14,388	
	• 22 1/2" end overhang, 6" guest overhang							
	36	72	29 1/2	GS5CVATR3672R- []	8,481	13,126	14,489	
	• 28 1/2" end overhang, 6" guest overhang							
	36	78	29 1/2	GS5CVATR3678R- []	8,890	13,580	14,991	
	• 34 1/2" end overhang, 6" guest overhang							
42" DEPTH 	42	66	29 1/2	GS5CVATR4266R- []	8,962	13,991	15,444	
	• 22 1/2" end overhang, 9" guest overhang							
	42	72	29 1/2	GS5CVATR4272R- []	9,038	14,109	15,574	
	• 28 1/2" end overhang, 9" guest overhang							
	42	78	29 1/2	GS5CVATR4278R- []	9,468	14,595	16,111	
	• 34 1/2" end overhang, 9" guest overhang							
	42	84	29 1/2	GS5CVATR4284R- []	9,576	14,765	16,298	
• 40 1/2" end overhang, 9" guest overhang								

PRODUCT INFO

Unit must be wall mounted.

Top depth 1" shallower than chassis on user and guest sides to accommodate pinch points of adjoining units

29.5" to 42.5" height adjustment range

 All units shipped as separate packages and require field assembly.

Grommet Location

(Add \$77 per grommet)

No Grommet **GN**
Left **GL**

Specify location first, then select grommet color or "Empty Cutout" option. When "Empty Cutout" option is selected, a grommet or power unit must be ordered separately for each cutout.

NOTE: Monitor arms should **ALWAYS** be installed in grommets on Silea height adjustable units. Please ensure a grommet location is specified on the top. This allows for bolt mount or clamp mount install of monitor arm. See page 35 for details.

TO ORDER PLEASE SPECIFY THE FOLLOWING:

WOOD TOP, WOOD CHASSIS

- MODEL NUMBER + WW**
- FSC**
- TOP WOOD FINISH + EDGE**
- CHASSIS WOOD FINISH**
- TOP UV FINISH**
- HAT KEYPAD & BASE COLOR**
- GROMMET**

LAM TOP, LAM CHASSIS

- MODEL NUMBER + LL**
- FSC**
- TOP LAM**
- CHASSIS LAM**
- EDGE DETAIL**
- HAT KEYPAD & BASE COLOR**
- GROMMET**

Optional height adjustable keypads available

HAT KEYPAD & BASE COLOR

Basic Up/Down Keypad, Black P71 Column
Memory Preset Keypad, Black P71 Column
Paddle Keypad, Black P71 Column

UDP71
MEMP71
PDLP71

CANTILEVER HEIGHT ADJUSTABLE DESKS - SIGHTLINE

Silea
03/23

Left Hand Desk

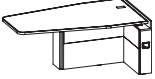
	D	W	H	model number + type	laminate	veneer 1	veneer 2
42" DEPTH 	30-42	66	29 1/2	GS5CVATS304266L- []	9,129	14,251	15,731
	<ul style="list-style-type: none"> • 22 1/2" end overhang, 9" tapered guest overhang 						
	30-42	72	29 1/2	GS5CVATS304272L- []	9,213	14,383	15,877
	<ul style="list-style-type: none"> • 28 1/2" end overhang, 9" tapered guest overhang 						
	30-42	78	29 1/2	GS5CVATS304278L- []	9,655	14,889	16,435
<ul style="list-style-type: none"> • 34 1/2" end overhang, 9" tapered guest overhang 							
	30-42	84	29 1/2	GS5CVATS304284L- []	9,776	15,079	16,645
<ul style="list-style-type: none"> • 40 1/2" end overhang, 9" tapered guest overhang 							

PRODUCT INFO

Unit must be wall mounted.

Top depth 1" shallower than chassis on user and guest sides to accommodate pinch points of adjoining units

29.5" to 42.5" height adjustment range

 All units shipped as separate packages and require field assembly.

Grommet Location (Add \$77 per grommet)

No Grommet **GN**
Right **GR**

Specify location first, then select grommet color or "Empty Cutout" option. When "Empty Cutout" option is selected, a grommet or power unit must be ordered separately for each cutout.

NOTE: Monitor arms should **ALWAYS** be installed in grommets on Silea height adjustable units. Please ensure a grommet location is specified on the top. This allows for bolt mount or clamp mount install of monitor arm. See page 35 for details.

TO ORDER PLEASE SPECIFY THE FOLLOWING:

WOOD TOP, WOOD CHASSIS

- MODEL NUMBER + WW**
- FSC**
- TOP WOOD FINISH + EDGE**
- CHASSIS WOOD FINISH**
- TOP UV FINISH**
- HAT KEYPAD & BASE COLOR**
- GROMMET**

LAM TOP, LAM CHASSIS

- MODEL NUMBER + LL**
- FSC**
- TOP LAM**
- CHASSIS LAM**
- EDGE DETAIL**
- HAT KEYPAD & BASE COLOR**
- GROMMET**

Optional height adjustable keypads available

HAT KEYPAD & BASE COLOR

Basic Up/Down Keypad, Black P71 Column
Memory Preset Keypad, Black P71 Column
Paddle Keypad, Black P71 Column

UDP71
MEMP71
PDLP71

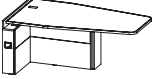
	D	W	H	model number + type	laminate	veneer 1	veneer 2	
42" DEPTH 	30-42	66	29 1/2	GS5CVATS304266R- []	9,129	14,251	15,731	
	• 22 1/2" end overhang, 9" tapered guest overhang							
	30-42	72	29 1/2	GS5CVATS304272R- []	9,213	14,383	15,877	
	• 28 1/2" end overhang, 9" tapered guest overhang							
	30-42	78	29 1/2	GS5CVATS304278R- []	9,655	14,889	16,435	
• 34 1/2" end overhang, 9" tapered guest overhang								
	30-42	84	29 1/2	GS5CVATS304284R- []	9,776	15,079	16,645	
• 40 1/2" end overhang, 9" tapered guest overhang								

PRODUCT INFO

Unit must be wall mounted.

Top depth 1" shallower than chassis on user and guest sides to accommodate pinch points of adjoining units

29.5" to 42.5" height adjustment range

 All units shipped as separate packages and require field assembly.

Grommet Location (Add \$77 per grommet)

No Grommet **GN**
Left **GL**

Specify location first, then select grommet color or "Empty Cutout" option. When "Empty Cutout" option is selected, a grommet or power unit must be ordered separately for each cutout.

NOTE: Monitor arms should **ALWAYS** be installed in grommets on Silea height adjustable units. Please ensure a grommet location is specified on the top. This allows for bolt mount or clamp mount install of monitor arm. See page 35 for details.

TO ORDER PLEASE SPECIFY THE FOLLOWING:

WOOD TOP, WOOD CHASSIS

- MODEL NUMBER + WW**
- FSC**
- TOP WOOD FINISH + EDGE**
- CHASSIS WOOD FINISH**
- TOP UV FINISH**
- HAT KEYPAD & BASE COLOR**
- GROMMET**

LAM TOP, LAM CHASSIS

- MODEL NUMBER + LL**
- FSC**
- TOP LAM**
- CHASSIS LAM**
- EDGE DETAIL**
- HAT KEYPAD & BASE COLOR**
- GROMMET**

Optional height adjustable keypads available

HAT KEYPAD & BASE COLOR

Basic Up/Down Keypad, Black P71 Column
Memory Preset Keypad, Black P71 Column
Paddle Keypad, Black P71 Column

UDP71
MEMP71
PDLP71

SMART PEDESTALS

7 1/4 Depth

Silea

03/23

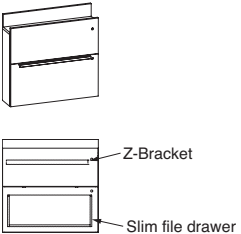
	D	W	H	model number + type	laminates	veneer 1	veneer 2				
 <p>SINGLE UNIT</p>	7 1/4	30	29 1/2	GS5CPD730-S []	1,978	2,866	3,164				
	<ul style="list-style-type: none"> • Bottom Door: 30" Slim File Drawer included. • Top Door: Includes z-bracket for clip-in accessory Bins and Trays. <u>Bins and trays must be ordered separately.</u> 				7 1/4	36	29 1/2	GS5CPD736-S []	2,174	3,154	3,483
	<ul style="list-style-type: none"> • Bottom Door: 36" Slim File Drawer included. • Top Door: Includes z-bracket for clip-in accessory Bins and Trays. <u>Bins and trays must be ordered separately.</u> 				7 1/4	42	29 1/2	GS5CPD742-S []	2,391	3,468	3,829
	<ul style="list-style-type: none"> • Bottom Door: 36" Slim File Drawer included. • Top Door: Includes z-bracket for clip-in accessory Bins and Trays. <u>Bins and trays must be ordered separately.</u> 				7 1/4	48	29 1/2	GS5CPD748-S []	2,745	3,979	4,393
	<ul style="list-style-type: none"> • Bottom Door: 30" Slim File Drawer + 15" Slim File Drawer included. • Top Door: Includes z-bracket for clip-in accessory Bins and Trays. <u>Bins and trays must be ordered separately.</u> 				7 1/4	54	29 1/2	GS5CPD754-S []	2,883	4,177	4,611
<ul style="list-style-type: none"> • Bottom Door: 36" Slim File Drawer + 15" Slim File Drawer included. • Top Door: Includes z-bracket for clip-in accessory Bins and Trays. <u>Bins and trays must be ordered separately.</u> 											

PRODUCT INFO

Unit must be wall mounted.

Grommet Location

(Add \$77 per grommet)

No Grommet **GN**
 Left **GL**
 Right **GR**

Specify location first, then select grommet color or "Empty Cutout" option. When "Empty Cutout" option is selected, a grommet or power unit must be ordered separately for each cutout.

"E" grommet cutout option for rect. grommet or bezel mount power unit model # ACUNOBZL-EU

"3E" grommet cutout option is 3" dia and to be used with HQ power w/ wireless charging model # ACPHQ3QI

TO ORDER PLEASE SPECIFY THE FOLLOWING:

WOOD

- MODEL NUMBER + W**
- FSC**
- CHASSIS WOOD FINISH**
- PULL FOR BOTTOM DOOR**
- GROMMET**
- SIDE WIRE MGT GROMMET**
- LOCKS**

LAM

- MODEL NUMBER + L**
- FSC**
- CHASSIS LAM**
- FRONT LAM**
- PULL FOR BOTTOM DOOR**
- GROMMET**
- SIDE WIRE MGT GROMMET**
- LOCKS**

Pull Option: Bottom door available with standard metal pulls or leather pull. (note: top door is taller than chassis to provide a finger pull to open door)

Leather pull available in 3 colors: Black Bridle **LP12**
 Medium Brown Bridle **LP13**
 Grey Bridle **LP14**

Side Wire Management Grommet Option: A rectangular cutout may be added to end panels to provide horizontal wire management within a station.

No Side Wire Management Grommets **WN**
 Side Wire Management Grommet Left **WL**
 Side Wire Management Grommet Right **WR**
 Side Wire Management Grommet Left & Right **WB**

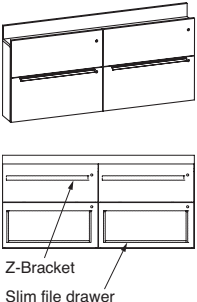
	D	W	H	model number + type	laminare	vener 1	vener 2	
 <p>DOUBLE UNIT</p> <p>Z-Bracket Slim file drawer</p>	7 1/4	60	29 1/2	GS5CPD760-S []	3,187	4,618	5,098	
	<ul style="list-style-type: none"> Bottom Door: 30" Slim File Drawer + 30" Slim File Drawer included. Top Door: Includes z-bracket for clip-in accessory Bins and Trays. <u>Bins and trays must be ordered separately.</u> 							
	7 1/4	66	29 1/2	GS5CPD766-S []	3,346	4,848	5,352	
<ul style="list-style-type: none"> Bottom Door: 30" Slim File Drawer + 36" Slim File Drawer included. Top Door: Includes z-bracket for clip-in accessory Bins and Trays. <u>Bins and trays must be ordered separately.</u> 								
7 1/4	72	29 1/2	GS5CPD772-S []	3,513	5,090	5,619		
<ul style="list-style-type: none"> Bottom Door: 36" Slim File Drawer + 36" Slim File Drawer included. Top Door: Includes z-bracket for clip-in accessory Bins and Trays. <u>Bins and trays must be ordered separately.</u> 								

PRODUCT INFO

Unit must be wall mounted.

Grommet Location

(Add \$77 per grommet)

No Grommet **GN**
Left **GL**
Right **GR**

Specify location first, then select grommet color or "Empty Cutout" option. When "Empty Cutout" option is selected, a grommet or power unit must be ordered separately for each cutout.

"E" grommet cutout option for rect. grommet or bezel mount power unit model # ACUNOBZL-EU

"3E" grommet cutout option is 3" dia and to be used with HQ power w/ wireless charging model # ACPHQ3QI

TO ORDER PLEASE SPECIFY THE FOLLOWING:

WOOD

- MODEL NUMBER + W**
- FSC**
- CHASSIS WOOD FINISH**
- PULL FOR BOTTOM DOOR**
- GROMMET**
- SIDE WIRE MGT GROMMET**
- LOCKS**

LAM

- MODEL NUMBER + L**
- FSC**
- CHASSIS LAM**
- FRONT LAM**
- PULL FOR BOTTOM DOOR**
- GROMMET**
- SIDE WIRE MGT GROMMET**
- LOCKS**

Pull Option: Bottom door available with standard metal pulls or leather pull. (note: top door is taller than chassis to provide a finger pull to open door)



Leather pull available in 3 colors: Black Bridle **LP12**
Medium Brown Bridle **LP13**
Grey Bridle **LP14**

Side Wire Management Grommet Option: A rectangular cutout may be added to end panels to provide horizontal wire management within a station.

No Side Wire Management Grommets **WN**
Side Wire Management Grommet Left **WL**
Side Wire Management Grommet Right **WR**
Side Wire Management Grommet Left & Right **WB**

SMART PEDESTAL ACCESSORY TRAYS AND BINS

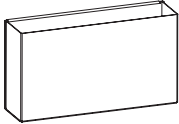
Silea
03/23

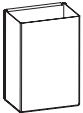
	D	W	H	model number	list
LARGE TRAY 	3	11 1/4	1 1/2	GS5TRAY-LG	92
LARGE BIN 	3	11 1/4	6 1/4	GS5BIN-LG	98
SMALL TRAY 	3	4 1/4	1 1/2	GS5TRAY-SM	84
SMALL BIN 	3	4 1/4	6 1/4	GS5BIN-SM	92

The below matrix recommendation provides a quick reference for ordering Trays and Bins to clip-in upper door of smart pedestals.

Smart Pedestal Model	Usable Inside Width	Recommended Accessories
	For Accessories	Large Tray/Bin + Small Tray/Bin
GS5CPD730-S	20.25	qty 1 + qty 2
GS5CPD736-S	26.25	qty 2 + -
GS5CPD742-S	32.25	qty 2 + qty 2
GS5CPD748-S	38.25	qty 3 + qty 1
GS5CPD754-S	44.25	qty 3 + qty 2
GS5CPD760-S	equivalent to qty (2) 30" smart pedestals	
GS5CPD766-S	equivalent to qty (1) 30" + qty (1) 36" smart pedestal	
GS5CPD772-S	equivalent to qty (2) 36" smart pedestals	

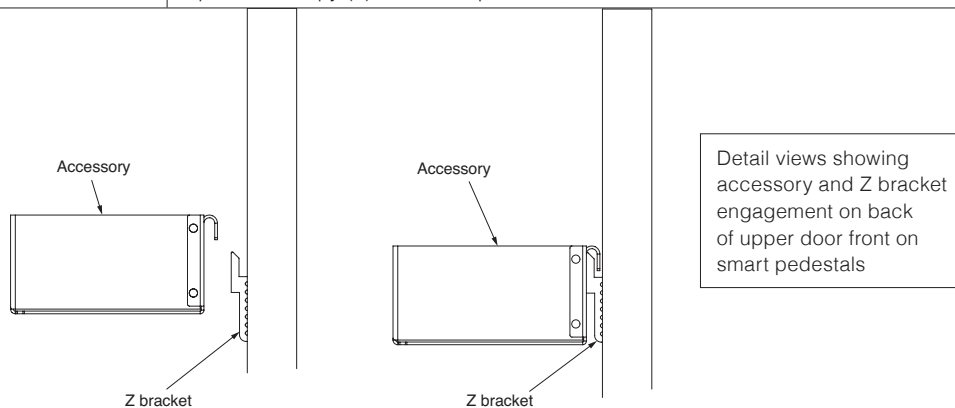

PRODUCT INFO

Accessories clip into Z bracket included on top door of smart pedestals.

Inside bottom of unit is lined with felt.

TO ORDER PLEASE SPECIFY THE FOLLOWING:

LIST

- 1. MODEL NUMBER**
- 2. HARDWARE COLOR**

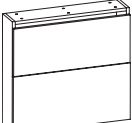
	D	W	H	model number + type	laminate	veneer 1	veneer 2
FALSE PEDESTALS FOR FIXED DESK OR FIXED RETURN 	7 1/4	24	27 7/8	GS5CPD724-X []	1,006	1,568	1,732
	7 1/4	30	27 7/8	GS5CPD730-X []	1,052	1,641	1,813
	7 1/4	36	27 7/8	GS5CPD736-X []	1,099	1,716	1,895
	7 1/4	42	27 7/8	GS5CPD742-X []	1,147	1,792	1,979

Notes:

- Top door hinged for wall access.
- Door split height matches smart pedestals.
- Must be wall mounted.

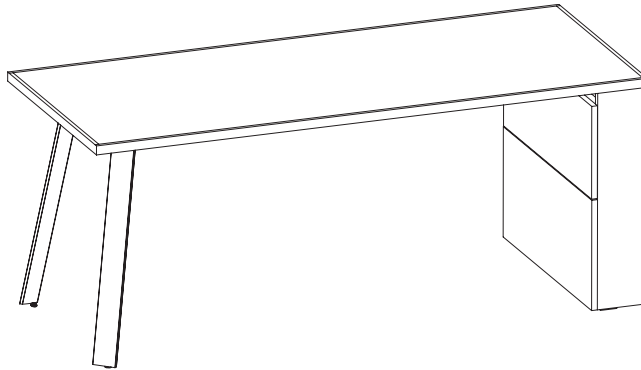

Example: False pedestal shown in application to support a fixed desk or return.

GS5CPD730-XW (false pedestal)
GS2DWRR3072-W (desk worksurface)
GS2ALEG-A (angled legs)

PRODUCT INFO

Unit must be wall mounted.

TO ORDER PLEASE SPECIFY THE FOLLOWING:

WOOD

1. **MODEL NUMBER + W**
2. **FSC**
3. **CHASSIS WOOD FINISH**
4. **SIDE WIRE MGT GROMMET**

LAM

1. **MODEL NUMBER + L**
2. **FSC**
3. **CHASSIS LAM**
4. **FRONT LAM**
5. **SIDE WIRE MGT GROMMET**

Side Wire Management Grommet Option: A rectangular cutout may be added to end panels to provide horizontal wire management within a station.

- | | |
|---|-----------|
| No Side Wire Management Grommets | WN |
| Side Wire Management Grommet Left | WL |
| Side Wire Management Grommet Right | WR |
| Side Wire Management Grommet Left & Right | WB |

SMART CLOSETS

7 1/4 Depth

Silea
03/23

	D	W	H	model number + type	laminare	veneer 1	veneer 2
18" WIDE CLOSET 	7 1/4	18	68 9/16	GS5CLS5H718L- []	2,851	4,132	4,562
	7 1/4	18	68 9/16	GS5CLS5H718R- []	2,851	4,132	4,562

- Behind Door - Coat hook top, 3 Metal trays bottom

Left hand shown
Inside cabinet views shown
without door

30" WIDE SIDE ACCESS CLOSET (18" WIDE CLOSET + 12" SIDE ACCESS)

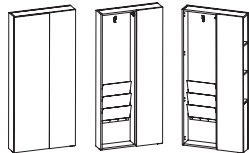

Left hand shown
Inside cabinet views shown
without door

7 1/4	30	68 9/16	GS5CLS5H730L- []	3,696	5,359	5,916
7 1/4	30	68 9/16	GS5CLS5H730R- []	3,696	5,359	5,916

- Behind Door - Coat hook top, 3 Metal trays bottom
- Side Access - Fixed front does not open. 12.5" inside width x 5.75" inside depth. Includes 2 adjustable shelves on 5 hole pattern.

PRODUCT INFO

Unit must be wall mounted.

Coat hook and metal trays are black.

TO ORDER PLEASE SPECIFY THE FOLLOWING:

WOOD

1. **MODEL NUMBER + WW**
2. **FSC**
3. **CHASSIS WOOD FINISH**
4. **LOCKS**

LAM

1. **MODEL NUMBER + LL**
2. **FSC**
3. **CHASSIS LAM**
4. **FRONT LAM**
5. **LOCKS**

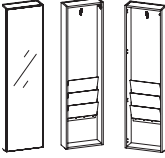
	D	W	H	model number + type	laminata	veneer 1	veneer 2
	7 1/4	18	68 9/16	GS5CLS5H718L- []	N/A	4,959	5,475
	7 1/4	18	68 9/16	GS5CLS5H718R- []	N/A	4,959	5,475

- Behind Door - Coat hook top, 3 Metal trays bottom

Left hand shown
Inside cabinet views shown
without door

**30" WIDE SIDE ACCESS
CLOSET (18" WIDE CLOSET
+ 12" SIDE ACCESS)**

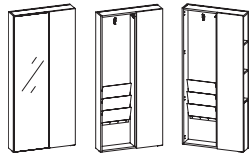

Left hand shown
Inside cabinet views shown
without door

	7 1/4	30	68 9/16	GS5CLS5H730L- []	N/A	6,430	7,099
	7 1/4	30	68 9/16	GS5CLS5H730R- []	N/A	6,430	7,099

- Behind Door - Coat hook top, 3 Metal trays bottom
- Side Access - Fixed front does not open. 12.5" inside width x 5.75" inside depth. Includes 2 adjustable shelves on 5 hole pattern.
- Glass door over closet portion only. Side access fixed front matches chassis finish.

PRODUCT INFO

Unit must be wall mounted.

Glass doors do NOT lock.

Coat hook and metal trays are black.

TO ORDER PLEASE SPECIFY THE FOLLOWING:

WOOD CHASSIS, GLASS DOOR

- 1. MODEL NUMBER + WG**
- 2. FSC**
- 3. CHASSIS WOOD FINISH**
- 4. GLASS**

SMART LOCKERS

7 1/4 Depth

Silea
03/23

	D	W	H	model number + type	laminare	veneer 1	veneer 2
24" WIDE LOCKER 	7 1/4	24	68 9/16	GS5LKR5H724L- []	3,135	4,545	5,017
	7 1/4	24	68 9/16	GS5LKR5H724R- []	3,135	4,545	5,017

Left hand shown
Inside cabinet views shown
without door

- Behind Door - Coat hook top, 3 Metal trays bottom
- Door overhangs chassis by 6". Additional coat hook on end panel.

36" WIDE SIDE ACCESS LOCKER (24" WIDE LOCKER + 12" SIDE ACCESS)

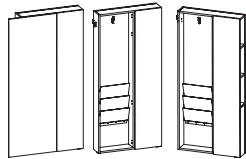

Left hand shown
Inside cabinet views shown
without door

7 1/4	36	68 9/16	GS5LKR5H736L- []	4,066	5,894	6,507
7 1/4	36	68 9/16	GS5LKR5H736R- []	4,066	5,894	6,507

- Behind Door - Coat hook top, 3 Metal trays bottom
- Door overhangs chassis by 6". Additional coat hook on end panel.
- Side Access - Fixed front does not open. 12.5" inside width x 5.75" inside depth. Includes 2 adjustable shelves on 5 hole pattern.

PRODUCT INFO

Unit must be wall mounted.

Doors do NOT lock.

Coat hook and metal trays are black.

 Laminate units shipped as separate packages and require field assembly.

TO ORDER PLEASE SPECIFY THE FOLLOWING:

WOOD

1. **MODEL NUMBER + WW**
2. **FSC**
3. **CHASSIS WOOD FINISH**

LAM

1. **MODEL NUMBER + LL**
2. **FSC**
3. **CHASSIS LAM**
4. **FRONT LAM**

	D	W	H	model number + type	laminata	veneer 1	veneer 2
24" WIDE LOCKER	7 1/4	24	68 9/16	GS5LKR5H724L- []	4,106	5,453	6,020
	7 1/4	24	68 9/16	GS5LKR5H724R- []	4,106	5,453	6,020

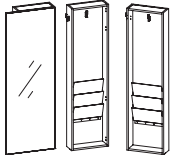

Left hand shown
Inside cabinet views shown
without door

- Behind Door - Coat hook top, 3 Metal trays bottom
- Door overhangs chassis by 6". Additional coat hook on end panel.

**36" WIDE SIDE ACCESS
LOCKER (24" WIDE LOCKER
+ 12" SIDE ACCESS)**

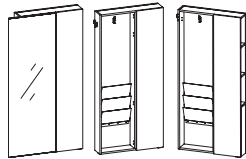

Left hand shown
Inside cabinet views shown
without door

	7 1/4	36	68 9/16	GS5LKR5H736L- []	5,037	7,073	7,808
	7 1/4	36	68 9/16	GS5LKR5H736R- []	5,037	7,073	7,808

- Behind Door - Coat hook top, 3 Metal trays bottom
- Door overhangs chassis by 6". Additional coat hook on end panel.
- Side Access - Fixed front does not open. 12.5" inside width x 5.75" inside depth. Includes 2 adjustable shelves on 5 hole pattern.

PRODUCT INFO

Unit must be wall mounted.

Doors do NOT lock.

Coat hook and metal trays are black.

 Laminate units shipped as separate packages and require field assembly.

TO ORDER PLEASE SPECIFY THE FOLLOWING:

WOOD CHASSIS, GLASS DOOR

1. **MODEL NUMBER + WG**
2. **FSC**
3. **CHASSIS WOOD FINISH**
4. **GLASS**

LAM CHASSIS, GLASS DOOR

1. **MODEL NUMBER + LG**
2. **FSC**
3. **CHASSIS LAM**
4. **GLASS**

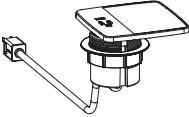
	D	W	H	model number	in
HQ POWER W/ WIRELESS CHARGING TO BE USED IN 3" DIA GROMMET CUTOUT 	3	11 1/4	1 1/2	ACPHQ3QI-B	458
	<ul style="list-style-type: none"> • Black • Fits 3" Dia Cutout option in smart pedestals • 1 Power / 1 USB Charger / 1 Charging Pad • 10ft standard plug cord 				
	3	11 1/4	6 1/4	ACPHQ3QI-S	458
<ul style="list-style-type: none"> • Silver • Fits 3" Dia Cutout option in smart pedestals • 1 Power / 1 USB Charger / 1 Charging Pad • 10ft standard plug cord 					

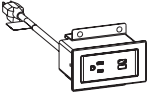
BEZEL MOUNT POWER TO BE USED IN RECTANGULAR GROMMET CUTOUT  <p>Can be used in grommet cutout</p>	2 7/8	4	1 3/4	ACUNOBZL-EU	431
	<ul style="list-style-type: none"> • Optional color • Fits Rectangular Grommet Cutout option in smart pedestals • 1 Power / 2 USB Charger • 10ft standard plug cord 				
	2 7/8	4	1 3/4	ACUNOBZL-EU-HW	431
<ul style="list-style-type: none"> • Optional color • Fits Rectangular Grommet Cutout option in smart pedestals • 1 Power / 2 USB Charger • 6ft hardwire cord 					

PRODUCT INFO

TO ORDER PLEASE SPECIFY THE FOLLOWING:

LIST

1. **MODEL NUMBER**
2. **BEZEL MOUNT POWER COLOR**

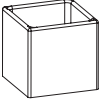
	D	W	H	model number	list
PENCIL TRAY 	3 15/16	11 5/16	1 1/4	GS5PNCLTRAY-WLNT	210
	<ul style="list-style-type: none"> • Walnut, clear finish • Fits in 15" box drawer 				
	3 15/16	11 5/16	1 1/4	GS5PNCLTRAY-MPLE	210
	<ul style="list-style-type: none"> • Maple, clear finish • Fits in 15" box drawer 				
PENCIL CUP 	3 15/16	3 15/16	3 3/4	GS5PNCLCUP-WLNT	210
	<ul style="list-style-type: none"> • Walnut, clear finish 				
	3 15/16	3 15/16	3 3/4	GS5PNCLCUP-MPLE	210
	<ul style="list-style-type: none"> • Maple, clear finish 				

PRODUCT INFO

Solidwood accessories include rubber bumpers on bottom to protect worksurfaces

TO ORDER PLEASE SPECIFY THE FOLLOWING:

LIST

- 1. MODEL NUMBER**



Storage	237-267
Bookcases	238
Bookcase / Coat Hook / Closet	239
Lateral Files	240-241
Closets	242-246
Storage Box / Utility Cabinet	247-259
Side Access Storage Locker	260-263
Mobile Pedestal	264-265
Storage External Tops	266-267

BOOKCASES

2 high – 6 high | 30" & 36"W

Silea

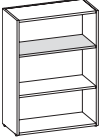
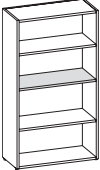
03/23

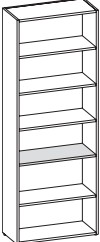
	D	W	H	model number + type	laminated	veneer 1	veneer 2
30" & 36 WIDTH							
 28 High	14 7/8	30	27 7/8	GS2BKN2H30N- []	1,464	2,121	2,342
	14 7/8	36	27 7/8	GS2BKN2H36N- []	1,561	2,260	2,496
 42 High	14 7/8	30	42 3/16	GS2BKN3H30- []	1,917	2,778	3,067
	14 7/8	36	42 3/16	GS2BKN3H36- []	2,205	3,197	3,530
 55 High	14 7/8	30	54 7/16	GS2BKN4H30- []	2,162	3,131	3,457
	14 7/8	36	54 7/16	GS2BKN4H36- []	2,921	4,234	4,675
 68 High	14 7/8	30	68 9/16	GS2BKN5H30- []	2,866	4,148	4,579
	14 7/8	36	68 9/16	GS2BKN5H36- []	3,429	4,968	5,485
 82 High	14 7/8	30	81 5/16	GS2BKN6H30- []	3,363	4,867	5,373
	14 7/8	36	81 5/16	GS2BKN6H36- []	3,509	5,086	5,615

PRODUCT INFO

Units have a finished back.
 Each unit has one fixed shelf, shaded above.
 Top not included.
 To add storage tops, specify external tops.
 6H bookcase to be attached to the wall.

TO ORDER PLEASE SPECIFY THE FOLLOWING:

WOOD

- MODEL NUMBER + WN**
- FSC**
- CHASSIS WOOD FINISH**

LAM

- MODEL NUMBER + LN**
- FSC**
- CHASSIS LAM**

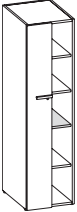
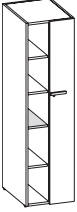
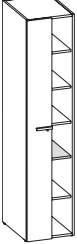
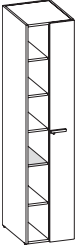
	D	W	H	model number + type	laminate	veneer 1	veneer 2
 <p>LEFT HAND 68 High</p>	24	18	68 ⁹ / ₁₆	GS2BCL5H18L- []	4,421	6,896	7,613
 <p>RIGHT HAND 68 High</p>	24	18	68 ⁹ / ₁₆	GS2BCL5H18R- []	4,421	6,896	7,613
 <p>LEFT HAND 82 High</p>	24	18	81 ¹⁵ / ₁₆	GS2BCL6H18L- []	5,050	7,872	8,690
 <p>RIGHT HAND 82 High</p>	24	18	81 ¹⁵ / ₁₆	GS2BCL6H18R- []	5,050	7,872	8,690

PRODUCT INFO

All units have a finished back.
5H units include (1) closet rod behind door.
6H units include (1) closet rod and (1) adjustable shelf.
Each unit has (1) fixed shelf, highlighted above.

TO ORDER PLEASE SPECIFY THE FOLLOWING:

WOOD

1. **MODEL NUMBER + WW**
2. **FSC**
3. **CHASSIS WOOD FINISH**
4. **PULL**
5. **LOCKS**
6. **KEYING**

LAM

1. **MODEL NUMBER + LL**
2. **FSC**
3. **CHASSIS LAM**
4. **FRONT LAM**
5. **PULL**
6. **LOCKS**
7. **KEYING**

LATERAL FILES 24D

2 high w/top

Silea

03/23

	D	W	H	model number + type	laminate	veneer 1	veneer 2
30" WIDTH	24	30	29 1/2	GS2LFS2H30- []	2,811	4,384	4,840



36" WIDTH	24	36	29 1/2	GS2LFS2H36- []	2,971	4,632	5,114
------------------	----	----	--------	------------------------	-------	-------	-------

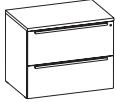

PRODUCT INFO

2H lateral file comes with a top.
All units have a finished back.

TO ORDER PLEASE SPECIFY THE FOLLOWING:

WOOD TOP, WOOD CHASSIS

1. **MODEL NUMBER + WW**
2. **FSC**
3. **TOP WOOD FINISH + EDGE**
4. **CHASSIS WOOD FINISH**
5. **TOP UV FINISH**
6. **PULL**
7. **DRAWERS**
8. **KEYING**

LAM TOP, LAM CHASSIS

1. **MODEL NUMBER + LL**
2. **FSC**
3. **TOP LAM**
4. **CHASSIS LAM**
5. **FRONT LAM**
6. **EDGE DETAIL**
7. **PULL**
8. **DRAWERS**
9. **KEYING**

	D	W	H	model number + type	laminiate	veneer 1	veneer 2
30" WIDTH	24	30	42 ^{3/16}	GS2LFS3H30- []	3,740	5,828	6,433
							
	24	30	54 ^{7/16}	GS2LFS4H30- []	4,662	7,273	8,029
	24	30	68 ^{9/16}	GS2LFS5H30- []	6,010	9,370	10,344
	24	30	81 ^{15/16}	GS2LFS6H30- []	6,954	10,841	11,967
36" WIDTH	24	36	42 ^{3/16}	GS2LFS3H36- []	3,866	6,029	6,656
							
	24	36	54 ^{7/16}	GS2LFS4H36- []	4,797	7,475	8,252
	24	36	68 ^{9/16}	GS2LFS5H36- []	6,326	9,861	10,886
	24	36	81 ^{15/16}	GS2LFS6H36- []	7,097	11,067	12,216

PRODUCT INFO

All units have a finished back.
If integral pull is chosen for wood, doors will be touch latch.
6 high units include (1) adjustable shelf behind doors.
5 and 6 high doors do not lock.

TO ORDER PLEASE SPECIFY THE FOLLOWING:

WOOD CHASSIS

1. **MODEL NUMBER + WW**
2. **FSC**
3. **CHASSIS WOOD FINISH**
4. **PULL**
5. **DRAWERS**
6. **KEYING**

LAM CHASSIS



1. **MODEL NUMBER + LL**
2. **FSC**
3. **CHASSIS LAM**
4. **FRONT LAM**
5. **PULL**
6. **DRAWERS**
7. **KEYING**

CLOSETS 24D

5 high – 6 high

Silea

03/23

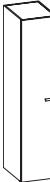
	D	W	H	model number + type	laminate	veneer 1	veneer 2
15" WIDTH							
	24	15	68 ⁹ / ₁₆	GS2CLS5H15L- []	2,789	4,349	4,802
Door hinged left 68 High	24	15	68 ⁹ / ₁₆	GS2CLS5H15R- []	2,789	4,349	4,802
	24	15	81 ¹⁵ / ₁₆	GS2CLS6H15L- []	3,060	4,772	5,268
Door hinged left 82 High	24	15	81 ¹⁵ / ₁₆	GS2CLS6H15R- []	3,060	4,772	5,268
• 6H x 15W units must be attached to wall for stability. Wall attach hardware not provided.							
18" WIDTH							
	24	18	68 ⁹ / ₁₆	GS2CLS5H18L- []	2,929	4,566	5,041
Door hinged left 68 High	24	18	68 ⁹ / ₁₆	GS2CLS5H18R- []	2,929	4,566	5,041
	24	18	81 ¹⁵ / ₁₆	GS2CLS6H18L- []	3,222	5,023	5,546
Door hinged left 82 High	24	18	81 ¹⁵ / ₁₆	GS2CLS6H18R- []	3,222	5,023	5,546

PRODUCT INFO

All units have a finished back.

If integral pull is chosen for wood, doors will be touch latch.

Units include (1) closet rod and (1) fixed shelf at bottom.

TO ORDER PLEASE SPECIFY THE FOLLOWING:

WOOD CHASSIS

1. **MODEL NUMBER + WW**
2. **FSC**
3. **CHASSIS WOOD FINISH**
4. **PULL**
5. **LOCKS**
6. **KEYING**

LAM CHASSIS

1. **MODEL NUMBER + LL**
2. **FSC**
3. **CHASSIS LAM**
4. **FRONT LAM**
5. **PULL**
6. **LOCKS**
7. **KEYING**

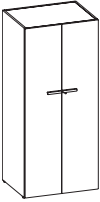
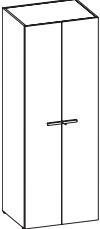
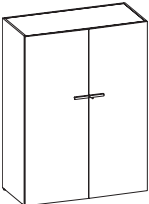
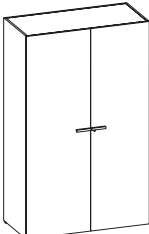
	D	W	H	model number + type	laminata	veneer 1	veneer 2
30" WIDTH  68 High	24	30	68 9/16	GS2CLD5H30-D []	5,285	7,653	8,448
	24	30	68 9/16	GS2CLD5H30-S []	4,930	7,135	7,877
 82 High	24	30	81 15/16	GS2CLD6H30-D []	6,170	8,934	9,862
	24	30	81 15/16	GS2CLD6H30-S []	5,802	8,399	9,271
36" WIDTH  68 High	24	36	68 9/16	GS2CLD5H36-D []	5,812	8,419	9,294
	24	36	68 9/16	GS2CLD5H36-S []	5,424	7,849	8,665
 82 High	24	36	81 15/16	GS2CLD6H36-D []	6,788	9,826	10,847
	24	36	81 15/16	GS2CLD6H36-S []	6,380	9,238	10,198

PRODUCT INFO

All units have a finished back.

Closet codes for 68 high units:

D = (4) 1/2 shelves/
1/2 coat rod

S = (4) full width shelves

Closet codes for 82 high units:

D = (5) 1/2 shelves/
1/2 coat rod

S = (5) full width shelves

If integral pull is chosen for wood, doors will be touch latch.

TO ORDER PLEASE SPECIFY THE FOLLOWING:

WOOD CHASSIS

1. **MODEL NUMBER + WW**
2. **FSC**
3. **CHASSIS WOOD FINISH**
4. **PULL**
5. **LOCKS**
6. **KEYING**

LAM CHASSIS



1. **MODEL NUMBER + LL**
2. **FSC**
3. **CHASSIS LAM**
4. **FRONT LAM**
5. **PULL**
6. **LOCKS**
7. **KEYING**

CLOSETS WITH GLASS DOORS 24D

5 high – 6 high | 15" & 18"W

Silea

03/23

	D	W	H	model number + type	veneer 1 chassis glass door	veneer 2 chassis glass door
15" WIDTH  68 High	24	15	68 ⁹ / ₁₆	GS2CLS5H15L- <input type="checkbox"/>	5,219	5,761
	24	15	68 ⁹ / ₁₆	GS2CLS5H15R- <input type="checkbox"/>	5,219	5,761
	24	15	81 ¹⁵ / ₁₆	GS2CLS6H15L- <input type="checkbox"/>	5,725	6,321
	24	15	81 ¹⁵ / ₁₆	GS2CLS6H15R- <input type="checkbox"/>	5,725	6,321
• 6H x 15W units must be attached to wall for stability. Wall attach hardware not provided.						
18" WIDTH  68 High	24	18	68 ⁹ / ₁₆	GS2CLS5H18L- <input type="checkbox"/>	5,480	6,049
	24	18	68 ⁹ / ₁₆	GS2CLS5H18R- <input type="checkbox"/>	5,480	6,049
	24	18	81 ¹⁵ / ₁₆	GS2CLS6H18L- <input type="checkbox"/>	6,027	6,653
	24	18	81 ¹⁵ / ₁₆	GS2CLS6H18R- <input type="checkbox"/>	6,027	6,653

PRODUCT INFO

All units have a finished back.
 Glass doors do not lock.
 Units include (1) closet rod and
 (1) fixed shelf at bottom.

TO ORDER PLEASE SPECIFY THE FOLLOWING:

WOOD CHASSIS, GLASS DOOR

1. **MODEL NUMBER + WG**
2. **FSC**
3. **CHASSIS WOOD FINISH**
4. **GLASS**

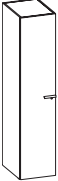
	D	W	H	model number + type	laminat	veneer 1	veneer 2
18" WIDTH  Door hinged left 68 High	30	18	68 ⁹ / ₁₆	GS2CLS5H30D18L- <input type="checkbox"/>	3,223	5,023	5,546
	30	18	68 ⁹ / ₁₆	GS2CLS5H30D18R- <input type="checkbox"/>	3,223	5,023	5,546
 Door hinged left 82 High	30	18	81 ¹⁵ / ₁₆	GS2CLS6H30D18L- <input type="checkbox"/>	3,542	5,526	6,101
	30	18	81 ¹⁵ / ₁₆	GS2CLS6H30D18R- <input type="checkbox"/>	3,542	5,526	6,101

PRODUCT INFO

If integral pull is chosen for wood, doors will be touch latch.
Units include (1) closet rod and (1) fixed shelf at bottom.
All units have a finished back.
30D Laminate units have fasteners on backside with cam covers.

TO ORDER PLEASE SPECIFY THE FOLLOWING:

WOOD CHASSIS

1. **MODEL NUMBER + WW**
2. **FSC**
3. **CHASSIS WOOD FINISH**
4. **PULL**
5. **LOCKS**
6. **KEYING**

LAM CHASSIS

1. **MODEL NUMBER + LL**
2. **FSC**
3. **CHASSIS LAM**
4. **FRONT LAM**
5. **PULL**
6. **LOCKS**
7. **KEYING**

CLOSETS WITH GLASS DOORS 30D

5 high – 6 high

Silea

03/23

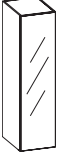
	D	W	H	model number + type	veneer 1 chassis glass door	veneer 2 chassis glass door
18" WIDTH  68 High	30	18	68 ⁹ / ₁₆	GS2CLS5H30D18L- []	6,029	6,656
	30	18	68 ⁹ / ₁₆	GS2CLS5H30D18R- []	6,029	6,656
	30	18	81 ¹⁵ / ₁₆	GS2CLS6H30D18L- []	6,630	7,319
	30	18	81 ¹⁵ / ₁₆	GS2CLS6H30D18R- []	6,630	7,319



PRODUCT INFO

All units have a finished back.
 Glass doors do not lock.
 Units include (1) closet rod and
 (1) fixed shelf at bottom.
 All units have a finished back.
 30D Laminate units have
 fasteners on backside with cam
 covers.

TO ORDER PLEASE SPECIFY THE FOLLOWING:

WOOD CHASSIS, GLASS DOOR

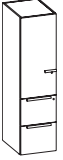
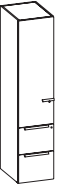
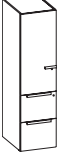
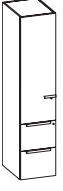
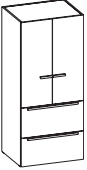
1. **MODEL NUMBER + WG**
2. **FSC**
3. **CHASSIS WOOD FINISH**
4. **GLASS**

	D	W	H	model number + type	laminated	veneer 1	veneer 2
15" WIDTH							
 Hinged door left 68 High	24	15	68 ⁹ / ₁₆	GS2SBD5H15L- []	3,162	4,935	5,448
	24	15	68 ⁹ / ₁₆	GS2SBD5H15R- []	3,162	4,935	5,448
 Hinged door left 82 High	24	15	81 ¹⁵ / ₁₆	GS2SBD6H15L- []	3,478	5,430	5,995
	24	15	81 ¹⁵ / ₁₆	GS2SBD6H15R- []	3,478	5,430	5,995
• 6H x 15W units must be attached to wall for stability. Wall attach hardware not provided.							
18" WIDTH							
 Hinged door left 68 High	24	18	68 ⁹ / ₁₆	GS2SBD5H18L- []	3,328	5,196	5,736
	24	18	68 ⁹ / ₁₆	GS2SBD5H18R- []	3,328	5,196	5,736
 Hinged door left 82 High	24	18	81 ¹⁵ / ₁₆	GS2SBD6H18L- []	3,661	5,716	6,311
	24	18	81 ¹⁵ / ₁₆	GS2SBD6H18R- []	3,661	5,716	6,311
30" WIDTH							
 68 High	24	30	68 ⁹ / ₁₆	GS2SBD5H30- []	5,710	8,906	9,832
 82 High	24	30	81 ¹⁵ / ₁₆	GS2SBD6H30- []	6,034	9,410	10,388

PRODUCT INFO

All units have a finished back.
If integral pull is chosen for wood, doors will be touch latch.
5H units include (2) adjustable shelves behind doors.
6H units include (3) adjustable shelves behind doors.

TO ORDER PLEASE SPECIFY THE FOLLOWING:

WOOD CHASSIS

- MODEL NUMBER + WW**
- FSC**
- CHASSIS WOOD FINISH**
- PULL**
- DRAWERS**
- KEYING**





LAM CHASSIS

- MODEL NUMBER + LL**
- FSC**
- CHASSIS LAM**
- FRONT LAM**
- PULL**
- DRAWERS**
- KEYING**

STORAGE BOX 24D

5 high – 6 high | 15" & 18"W | Box / Box / File

Silea
03/23

	D	W	H	model number + type	laminate	veneer 1	veneer 2
15" WIDTH							
	24	15	68 ⁹ / ₁₆	GS2SBD5H15L-3 []	3,321	5,183	5,722
 Box/Box/File Left 68 High	24	15	68 ⁹ / ₁₆	GS2SBD5H15R-3 []	3,321	5,183	5,722
15" WIDTH							
	24	15	81 ¹⁵ / ₁₆	GS2SBD6H15L-3 []	3,651	5,701	6,293
 Box/Box/File Left 82 High	24	15	81 ¹⁵ / ₁₆	GS2SBD6H15R-3 []	3,651	5,701	6,293
• 6H x 15W units must be attached to wall for stability. Wall attach hardware not provided.							
18" WIDTH							
	24	18	68 ⁹ / ₁₆	GS2SBD5H18L-3 []	3,495	5,456	6,023
 Box/Box/File Left 68 High	24	18	68 ⁹ / ₁₆	GS2SBD5H18R-3 []	3,495	5,456	6,023
18" WIDTH							
	24	18	81 ¹⁵ / ₁₆	GS2SBD6H18L-3 []	3,845	6,000	6,624
 Box/Box/File Left 82 High	24	18	81 ¹⁵ / ₁₆	GS2SBD6H18R-3 []	3,845	6,000	6,624

PRODUCT INFO

If integral pull is chosen for wood, doors will be touch latch.

5H units include (2) adjustable shelves behind doors.

6H units include (3) adjustable shelves behind doors.





TO ORDER PLEASE SPECIFY THE FOLLOWING:

WOOD CHASSIS

1. **MODEL NUMBER + WW**
2. **FSC**
3. **CHASSIS WOOD FINISH**
4. **PULL**
5. **DRAWERS**
6. **KEYING**

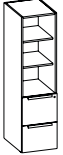
LAM CHASSIS

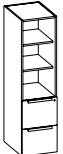
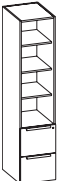
1. **MODEL NUMBER + LL**
2. **FSC**
3. **CHASSIS LAM**
4. **FRONT LAM**
5. **PULL**
6. **DRAWERS**
7. **KEYING**

	D	W	H	model number + type	laminata	veneer 1	veneer 2
15" WIDTH  68 High  82 High	24	15	68 ⁹ / ₁₆	GS2SBD5H15- []	2,924	4,565	5,040
	24	15	81 ¹⁵ / ₁₆	GS2SBD6H15- []	3,219	5,021	5,544
• 6H x 15W units must be attached to wall for stability. Wall attach hardware not provided.							
18" WIDTH  68 High  82 High	24	18	68 ⁹ / ₁₆	GS2SBD5H18- []	3,077	4,804	5,304
	24	18	81 ¹⁵ / ₁₆	GS2SBD6H18- []	3,387	5,286	5,836
30" WIDTH  68 High  82 High	24	30	68 ⁹ / ₁₆	GS2SBD5H30- []	5,282	8,243	9,099
	24	30	81 ¹⁵ / ₁₆	GS2SBD6H30- []	5,282	8,243	9,099

PRODUCT INFO

All units have a finished back.
 If integral pull is chosen for wood, doors will be touch latch.
 Adjustable shelves.

TO ORDER PLEASE SPECIFY THE FOLLOWING:

WOOD CHASSIS

1. **MODEL NUMBER + WN**
2. **FSC**
3. **CHASSIS WOOD FINISH**
4. **PULL**
5. **DRAWERS**
6. **KEYING**





LAM CHASSIS

1. **MODEL NUMBER + LN**
2. **FSC**
3. **CHASSIS LAM**
4. **FRONT LAM**
5. **PULL**
6. **DRAWERS**
7. **KEYING**

STORAGE BOX 24D

5 high – 6 high | 15" & 18"W | Box / Box / File

Silea
03/23

	D	W	H	model number + type	laminata	veneer 1	veneer 2
15" WIDTH	24	15	68 ⁹ / ₁₆	GS2SBD5H15-3 []	3,071	4,793	5,292
 Box/Box/File 68 High							
 Box/Box/File 82 High	24	15	81 ¹⁵ / ₁₆	GS2SBD6H15-3 []	3,378	5,273	5,822
				• 6H x 15W units must be attached to wall for stability. Wall attach hardware not provided.			
18" WIDTH	24	18	68 ⁹ / ₁₆	GS2SBD5H18-3 []	3,231	5,046	5,571
 Box/Box/File 68 High							
 Box/Box/File 82 High	24	18	81 ¹⁵ / ₁₆	GS2SBD6H18-3 []	3,556	5,550	6,127

PRODUCT INFO

All units have a finished back.
If integral pull is chosen for wood, doors will be touch latch.
Adjustable shelves.

TO ORDER PLEASE SPECIFY THE FOLLOWING:

WOOD CHASSIS

1. **MODEL NUMBER + WN**
2. **FSC**
3. **CHASSIS WOOD FINISH**
4. **PULL**
5. **DRAWERS**
6. **KEYING**

LAM CHASSIS

1. **MODEL NUMBER + LN**
2. **FSC**
3. **CHASSIS LAM**
4. **FRONT LAM**
5. **PULL**
6. **DRAWERS**
7. **KEYING**

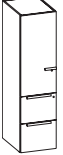
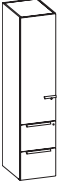
	D	W	H	model number + type	laminate	veneer 1	veneer 2
18" WIDTH	30	18	68 ⁹ / ₁₆	GS2SBD5H30D18L- []	3,661	5,717	6,312
 Hinged door left 68 High	30	18	68 ⁹ / ₁₆	GS2SBD5H30D18R- []	3,661	5,717	6,312
 Hinged door left 82 High	30	18	81 ¹⁵ / ₁₆	GS2SBD6H30D18L- []	4,026	6,287	6,940
	30	18	81 ¹⁵ / ₁₆	GS2SBD6H30D18R- []	4,026	6,287	6,940

PRODUCT INFO

If integral pull is chosen for wood, doors will be touch latch.

5H units include (2) adjustable shelves behind doors.

6H units include (3) adjustable shelves behind doors.

All units have a finished back. 30D Laminate units have fasteners on backside with cam covers.

TO ORDER PLEASE SPECIFY THE FOLLOWING:

WOOD CHASSIS

1. **MODEL NUMBER + WW**
2. **FSC**
3. **CHASSIS WOOD FINISH**
4. **PULL**
5. **DRAWERS**
6. **KEYING**

LAM CHASSIS

1. **MODEL NUMBER + LL**
2. **FSC**
3. **CHASSIS LAM**
4. **FRONT LAM**
5. **PULL**
6. **DRAWERS**
7. **KEYING**

STORAGE BOX 30D

5 high – 6 high | 18"W | File / File

Silea

03/23

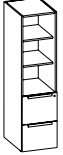
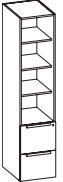
	D	W	H	model number + type	laminate	veneer 1	veneer 2
18" WIDTH  68 High	30	18	68 ⁹ / ₁₆	GS2SBD5H30D18- []	3,387	5,285	5,835
 82 High	30	18	81 ¹⁵ / ₁₆	GS2SBD6H30D18- []	3,726	5,813	6,417

PRODUCT INFO

5H units include (2) adjustable shelves behind doors.

6H units include (3) adjustable shelves behind doors.

All units have a finished back.
30D Laminate units have fasteners on backside with cam covers.



TO ORDER PLEASE SPECIFY THE FOLLOWING:

WOOD CHASSIS

1. **MODEL NUMBER + WN**
2. **FSC**
3. **CHASSIS WOOD FINISH**
4. **PULL**
5. **DRAWERS**
6. **KEYING**

LAM CHASSIS

1. **MODEL NUMBER + LN**
2. **FSC**
3. **CHASSIS LAM**
4. **FRONT LAM**
5. **PULL**
6. **DRAWERS**
7. **KEYING**

	D	W	H	model number + type	laminate	veneer 1	veneer 2
18" WIDTH	30	18	68 ⁹ / ₁₆	GS2SBD5H30D18L-3 []	3,845	6,001	6,625
 Box/Box/File Left 68 High	30	18	68 ⁹ / ₁₆	GS2SBD5H30D18R-3 []	3,845	6,001	6,625
 Box/Box/File Left 82 High	30	18	81 ¹⁵ / ₁₆	GS2SBD6H30D18L-3 []	4,228	6,600	7,286
	30	18	81 ¹⁵ / ₁₆	GS2SBD6H30D18R-3 []	4,228	6,600	7,286

PRODUCT INFO

If integral pull is chosen for wood, doors will be touch latch.
 5H units include (2) adjustable shelves behind doors.
 6H units include (3) adjustable shelves behind doors.
 All units have a finished back.
 30D Laminate units have fasteners on backside with cam covers.

TO ORDER PLEASE SPECIFY THE FOLLOWING:

WOOD CHASSIS

1. **MODEL NUMBER + WW**
2. **FSC**
3. **CHASSIS WOOD FINISH**
4. **PULL**
5. **DRAWERS**
6. **KEYING**

LAM CHASSIS

1. **MODEL NUMBER + LL**
2. **FSC**
3. **CHASSIS LAM**
4. **FRONT LAM**
5. **PULL**
6. **DRAWERS**
7. **KEYING**

STORAGE BOX 30D

5 high – 6 high | 18"W | Box / Box / File

Silea
03/23

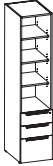
	D	W	H	model number + type	laminated	veneer 1	veneer 2
18" WIDTH	30	18	68 ⁹ / ₁₆	GS2SBD5H30D18-3 []	3,556	5,550	6,127
 Box/Box/File 68 High							
 Box/Box/File 82 High	30	18	81 ¹⁵ / ₁₆	GS2SBD6H30D18-3 []	3,912	6,104	6,739

PRODUCT INFO

5H units include (2) adjustable shelves behind doors.

6H units include (3) adjustable shelves behind doors.

All units have a finished back.
30D Laminate units have fasteners on backside with cam covers.



TO ORDER PLEASE SPECIFY THE FOLLOWING:

WOOD CHASSIS

1. **MODEL NUMBER + WN**
2. **FSC**
3. **CHASSIS WOOD FINISH**
4. **PULL**
5. **DRAWERS**
6. **KEYING**

LAM CHASSIS

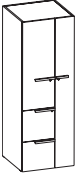
1. **MODEL NUMBER + LN**
2. **FSC**
3. **CHASSIS LAM**
4. **FRONT LAM**
5. **PULL**
6. **DRAWERS**
7. **KEYING**

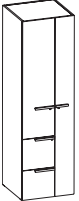
	D	W	H	model number + type	laminata	veneer 1	veneer 2
68 HIGH	24	24	68 ⁹ / ₁₆	GS2UTC5H24L- []	5,669	8,838	9,756
 Left hand							
	24	24	68 ⁹ / ₁₆	GS2UTC5H24R- []	5,669	8,838	9,756
 Right hand							
82 HIGH	24	24	81 ¹⁵ / ₁₆	GS2UTC6H24L- []	6,497	10,132	11,184
 Left hand							
	24	24	81 ¹⁵ / ₁₆	GS2UTC6H24R- []	6,497	10,132	11,184
 Right hand							

PRODUCT INFO

All units have a finished back.
 If integral pull is chosen for wood, door will be touch latch.
 Units include (1) closet rod behind full length door.
 5H units include (2) adjustable shelves behind door above file drawers.
 6H units include (4) adjustable shelves behind door above file drawers.

TO ORDER PLEASE SPECIFY THE FOLLOWING:

WOOD CHASSIS

1. **MODEL NUMBER + WW**
2. **FSC**
3. **CHASSIS WOOD FINISH**
4. **PULL**
5. **DRAWERS**
6. **KEYING**



LAM CHASSIS

1. **MODEL NUMBER + LL**
2. **FSC**
3. **CHASSIS LAM**
4. **FRONT LAM**
5. **PULL**
6. **DRAWERS**
7. **KEYING**

UTILITY CABINET 24D

5 high – 6 high | 24"W | Box / Box / File

Silea
03/23

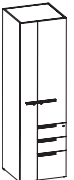
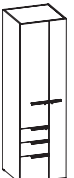
	D	W	H	model number + type	laminate	veneer 1	veneer 2
68" HIGH	24	24	68 ⁹ / ₁₆	GS2UTC5H24L-3 []	5,952	9,280	10,244
 Left hand							
 Right hand	24	24	68 ⁹ / ₁₆	GS2UTC5H24R-3 []	5,952	9,280	10,244
82" HIGH	24	24	81 ¹⁵ / ₁₆	GS2UTC6H24L-3 []	6,822	10,639	11,745
 Left hand							
 Right hand	24	24	81 ¹⁵ / ₁₆	GS2UTC6H24R-3 []	6,822	10,639	11,745

PRODUCT INFO

All units have a finished back.
If integral pull is chosen for wood, door will be touch latch.
Units include (1) closet rod behind full length door.
5H units include (2) adjustable shelves behind door above drawers.
6H units include (4) adjustable shelves behind door above drawers.



TO ORDER PLEASE SPECIFY THE FOLLOWING:

WOOD CHASSIS

1. **MODEL NUMBER + WW**
2. **FSC**
3. **CHASSIS WOOD FINISH**
4. **PULL**
5. **DRAWERS**
6. **KEYING**

LAM CHASSIS

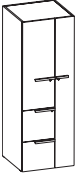
1. **MODEL NUMBER + LL**
2. **FSC**
3. **CHASSIS LAM**
4. **FRONT LAM**
5. **PULL**
6. **DRAWERS**
7. **KEYING**

	D	W	H	model number + type	laminata	veneer 1	veneer 2
68 HIGH	24	30	68 ⁹ / ₁₆	GS2UTC5H30L- <input type="checkbox"/>	6,236	9,722	10,732
 Left hand							
	24	30	68 ⁹ / ₁₆	GS2UTC5H30R- <input type="checkbox"/>	6,236	9,722	10,732
 Right hand							
82 HIGH	24	30	81 ¹⁵ / ₁₆	GS2UTC6H30L- <input type="checkbox"/>	7,148	11,146	12,304
 Left hand							
	24	30	81 ¹⁵ / ₁₆	GS2UTC6H30R- <input type="checkbox"/>	7,148	11,146	12,304
 Right hand							

PRODUCT INFO

All units have a finished back.
 If integral pull is chosen for wood, door will be touch latch.
 Units include (1) closet rod behind full length door.
 5H units include (2) adjustable shelves behind door above drawers.
 6H units include (4) adjustable shelves behind door above drawers.

TO ORDER PLEASE SPECIFY THE FOLLOWING:

WOOD CHASSIS

1. **MODEL NUMBER + WW**
2. **FSC**
3. **CHASSIS WOOD FINISH**
4. **PULL**
5. **DRAWERS**
6. **KEYING**



LAM CHASSIS

1. **MODEL NUMBER + LL**
2. **FSC**
3. **CHASSIS LAM**
4. **FRONT LAM**
5. **PULL**
6. **DRAWERS**
7. **KEYING**

UTILITY CABINET 24D

5 high – 6 high | 30"W | Box / Box / File

Silea
03/23

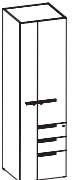
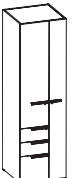
	D	W	H	model number + type	laminate	veneer 1	veneer 2
68" HIGH	24	30	68 ⁹ / ₁₆	GS2UTC5H30L-3 []	6,547	10,209	11,270
 Left hand							
 Right hand	24	30	68 ⁹ / ₁₆	GS2UTC5H30R-3 []	6,547	10,209	11,270
82" HIGH	24	30	81 ¹⁵ / ₁₆	GS2UTC6H30L-3 []	7,504	11,705	12,921
 Left hand							
 Right hand	24	30	81 ¹⁵ / ₁₆	GS2UTC6H30R-3 []	7,504	11,705	12,921

PRODUCT INFO

All units have a finished back.
If integral pull is chosen for wood, door will be touch latch.
Units include (1) closet rod behind full length door.
5H units include (2) adjustable shelves behind door above drawers.
6H units include (4) adjustable shelves behind door above drawers.

TO ORDER PLEASE SPECIFY THE FOLLOWING:

WOOD CHASSIS

1. **MODEL NUMBER + WW**
2. **FSC**
3. **CHASSIS WOOD FINISH**
4. **PULL**
5. **DRAWERS**
6. **KEYING**

LAM CHASSIS

1. **MODEL NUMBER + LL**
2. **FSC**
3. **CHASSIS LAM**
4. **FRONT LAM**
5. **PULL**
6. **DRAWERS**
7. **KEYING**



D	W	H	model number + type	laminata	veneer 1	veneer 2
24	30	29 1/2	GS2SCF2H30-5 []	2,075	3,237	3,574
24	36	29 1/2	GS2SCF2H36-5 []	2,308	3,596	3,970

PRODUCT INFO

Top included.
All units have a finished back.
If integral pull is chosen for wood, door will be touch latch.
(1) adjustable shelf behind doors.

TO ORDER PLEASE SPECIFY THE FOLLOWING:



- | | |
|----------------------------------|-----------------------------|
| WOOD TOP, WOOD CHASSIS | LAM TOP, LAM CHASSIS |
| 1. MODEL NUMBER + WW | 1. MODEL NUMBER + LL |
| 2. FSC | 2. FSC |
| 3. TOP WOOD FINISH + EDGE | 3. TOP LAM |
| 4. CHASSIS WOOD FINISH | 4. CHASSIS LAM |
| 5. TOP UV FINISH | 5. FRONT LAM |
| 6. PULL | 6. TOP UV FINISH |
| 7. KEYING | 7. EDGE DETAIL |
| | 8. PULL |
| | 9. KEYING |

SIDE ACCESS STORAGE LOCKER 24D

5 high – 6 high

Silea

03/23

	D	W	H	model number + type	laminate	veneer 1	veneer 2
24" WIDTH  Left hand unit 68 High	24	24	68 ⁹ / ₁₆	GS2LKR5H24L- []	3,890	5,640	6,227
	24	24	68 ⁹ / ₁₆	GS2LKR5H24R- []	3,890	5,640	6,227
 Right hand unit 82 High	24	24	81 ¹⁵ / ₁₆	GS2LKR6H24L- []	4,799	6,954	7,677
	24	24	81 ¹⁵ / ₁₆	GS2LKR6H24R- []	4,799	6,954	7,677

• Note: door overhangs chassis by 6"

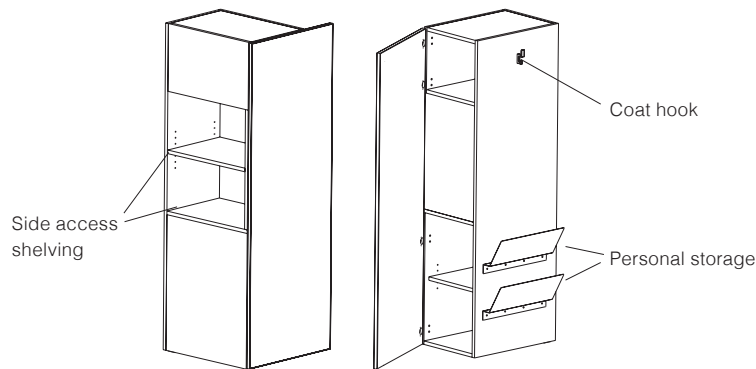

PRODUCT INFO

All units have a finished back.

Unit does not lock.

 Laminate units shipped as separate packages and require field assembly.

Coat hook and metal personal storage shelves are black.

TO ORDER PLEASE SPECIFY THE FOLLOWING:

WOOD CHASSIS



1. **MODEL NUMBER + WW**
2. **FSC**
3. **CHASSIS WOOD FINISH**

LAM CHASSIS

1. **MODEL NUMBER + LL**
2. **FSC**
3. **CHASSIS LAM**
4. **FRONT LAM**

SIDE ACCESS STORAGE LOCKER 24D

Glass Door | 5 high – 6 high

	D	W	H	model number + type	laminate	veneer 1	veneer 2
24" WIDTH  Left hand unit 68 High	24	24	68 ⁹ / ₁₆	GS2LKR5H24L- []	4,861	7,050	7,783
	24	24	68 ⁹ / ₁₆	GS2LKR5H24R- []	4,861	7,050	7,783
 Right hand unit 82 High	24	24	81 ¹⁵ / ₁₆	GS2LKR6H24L- []	5,996	8,693	9,596
	24	24	81 ¹⁵ / ₁₆	GS2LKR6H24R- []	5,996	8,693	9,596

• Note: door overhangs chassis by 6"

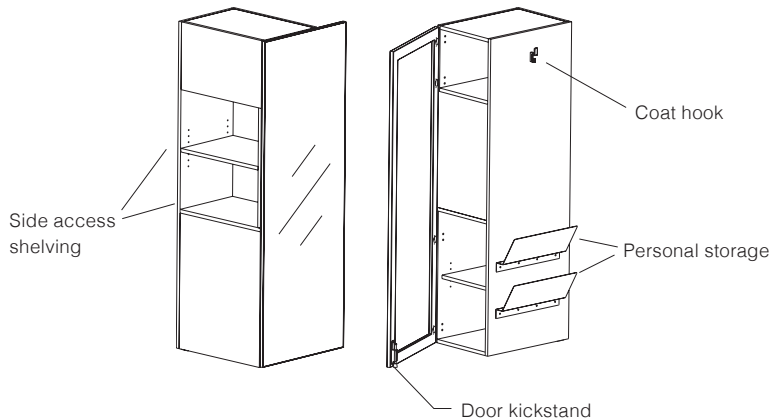

PRODUCT INFO

All units have a finished back.
Door does not lock.

 Laminate units shipped as separate packages and require field assembly.

Coat hook and metal personal storage shelves are black.

TO ORDER PLEASE SPECIFY THE FOLLOWING:

WOOD CHASSIS, GLASS DOOR

1. **MODEL NUMBER + WG**
2. **FSC**
3. **CHASSIS WOOD FINISH**
4. **GLASS**

LAM CHASSIS, GLASS DOOR



1. **MODEL NUMBER + LG**
2. **FSC**
3. **CHASSIS LAM**
4. **GLASS**

SIDE ACCESS STORAGE LOCKER LAYERS HEIGHT 24D

Silea

03/23

5 high – 6 high

	D	W	H	model number + type	laminate	veneer 1	veneer 2
24" WIDTH  Left hand unit 68 High	24	24	68 ^{9/16}	GS2LLKR5H24L- []	3,890	5,640	6,227
	24	24	68 ^{9/16}	GS2LLKR5H24R- []	3,890	5,640	6,227
 Right hand unit 82 High	24	24	81 ^{15/16}	GS2LLKR6H24L- []	4,799	6,954	7,677
	24	24	81 ^{15/16}	GS2LLKR6H24R- []	4,799	6,954	7,677

• Note: door overhangs chassis by 6"

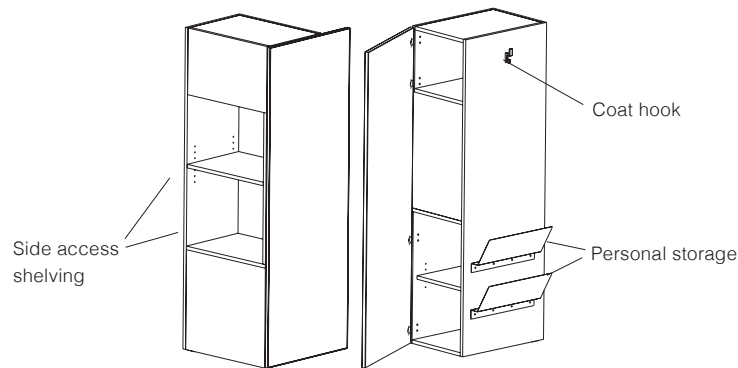

PRODUCT INFO

All units have a finished back.

Doors do not lock.

 Laminate units shipped as separate packages and require field assembly.

Coat hook and metal personal storage shelves are black.

TO ORDER PLEASE SPECIFY THE FOLLOWING:

WOOD CHASSIS

1. **MODEL NUMBER + WW**
2. **FSC**
3. **CHASSIS WOOD FINISH**

LAM CHASSIS

1. **MODEL NUMBER + LL**
2. **FSC**
3. **CHASSIS LAM**
4. **FRONT LAM**

SIDE ACCESS STORAGE LOCKER LAYERS HEIGHT 24D

Glass Door | 5 high – 6 high

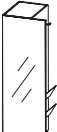
	D	W	H	model number + type	laminate	veneer 1	veneer 2
24" WIDTH  Left hand unit 68 High	24	24	68 ⁹ / ₁₆	GS2LLKR5H24L- []	4,861	7,050	7,783
	24	24	68 ⁹ / ₁₆	GS2LLKR5H24R- []	4,861	7,050	7,783
 Right hand unit 82 High	24	24	81 ¹⁵ / ₁₆	GS2LLKR6H24L- []	5,996	8,693	9,596
	24	24	81 ¹⁵ / ₁₆	GS2LLKR6H24R- []	5,996	8,693	9,596

• Note: door overhangs chassis by 6"

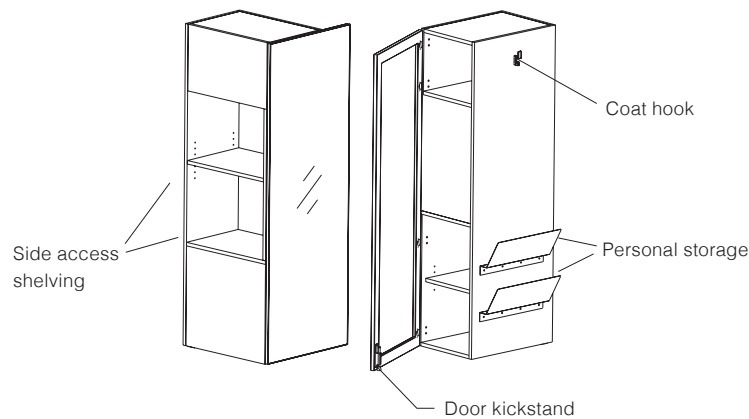

PRODUCT INFO

All units have a finished back.
Doors do not lock.
 Laminate units shipped as separate packages and require field assembly.
Coat hook and metal personal storage shelves are black.

TO ORDER PLEASE SPECIFY THE FOLLOWING:

WOOD CHASSIS, GLASS DOOR



1. **MODEL NUMBER + WG**
2. **FSC**
3. **CHASSIS WOOD FINISH**
4. **GLASS**

LAM CHASSIS, GLASS DOOR

1. **MODEL NUMBER + LG**
2. **FSC**
3. **CHASSIS LAM**
4. **GLASS**

MOBILE PEDESTAL

Silea
03/23

	D	W	H	model number + type	laminata	veneer 1	veneer 2
	21 15/16	15 3/16	21 1/2	GS2MPD-6 []	1,848	2,885	3,185
	23 15/16	15 3/16	27 5/8	GS2MPD-3 []	2,034	3,174	3,505
	23 15/16	15 3/16	27 5/8	GS2MPD-2 []	2,034	3,174	3,505

• Taller Box/Box/File and File/File mobile pedestals with a cushion will NOT fit under a standard height desk. These taller mobile pedestals are not recommended for use with a cushion due to height.

PRODUCT INFO

Top included.
Pedestal on casters.

TO ORDER PLEASE SPECIFY THE FOLLOWING:

WOOD TOP, WOOD CHASSIS

1. **MODEL NUMBER + WW**
2. **FSC**
3. **CHASSIS WOOD FINISH**
4. **PULL**
5. **DRAWERS**
6. **KEYING**

LAM TOP, LAM CHASSIS

1. **MODEL NUMBER + LL**
2. **FSC**
3. **TOP LAM**
4. **CHASSIS LAM**
5. **FRONT LAM**
6. **PULL**
7. **DRAWERS**
8. **KEYING**

	D	W	H	model number	fabric grades			COM/4
					1	2	3	
	21 11/16	14 7/8	1	GS2MPD-CUSH2215	528	545	564	582

PRODUCT INFO
For use with mobile pedestals.
COM Fabric 1.25 yds

TO ORDER PLEASE SPECIFY THE FOLLOWING:

- LIST
1. **MODEL NUMBER**
 2. **FABRIC**
 3. **FLAMMABILITY**

Flammability Option Codes:
U = CT B117
For standard flammability rating,
please specify CTB 117.

STORAGE EXTERNAL TOPS

For Units with Doors

Silea

03/23

	D	W	H	model number + type	laminata	veneer 1	veneer 2
	30	18	1 3/16	GS2SGTOPD3018- <input type="checkbox"/>	555	865	956



PRODUCT INFO

TO ORDER PLEASE SPECIFY THE FOLLOWING:

WOOD TOP

1. **MODEL NUMBER + W**
2. **FSC**
3. **TOP WOOD FINISH + EDGE**
4. **TOP FINISH**

Top Finish Option:

Non-UV Open Pore Finish
Full Fill UV Top Finish

LAM TOP

1. **MODEL NUMBER + L**
2. **FSC**
3. **TOP LAM**

NR
FF (+\$273)

STORAGE EXTERNAL TOPS

For units without doors

D	W	H	model number + type	laminata	vener 1	vener 2
29 1/8	18	1 3/16	GS2SGTOPN3018- []	555	865	956
• For use w/ 24D and 30D storage						
14 7/8	30	1 3/16	GS2SMTOPN30- []	401	1,060	1,171
14 7/8	36	1 3/16	GS2SMTOPN36- []	455	710	785
14 7/8	60	1 3/16	GS2SMTOPN60- []	684	1,069	1,181
14 7/8	72	1 3/16	GS2SMTOPN72- []	786	1,228	1,356
14 7/8	90	1 3/16	GS2SMTOPN90- []	943	1,472	1,626
14 7/8	114	1 3/16	GS2SMTOPN108- []	1,098	1,714	1,893

• For use w/ bookcases

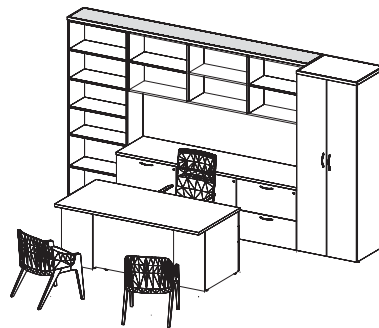

PRODUCT INFO

TO ORDER PLEASE SPECIFY THE FOLLOWING:

WOOD TOP

1. **MODEL NUMBER + W**
2. **FSC**
3. **TOP WOOD FINISH + EDGE**
4. **TOP FINISH**

Top Finish Option:

Non-UV Open Pore Finish
Full Fill UV Top Finish

LAM TOP

1. **MODEL NUMBER + L**
2. **FSC**
3. **TOP LAM**

NR
FF (+\$273)

Wall Mount	269-304
Cabinets	270-279
Wall Mount Wall Overhead	280-281
Tackboard in Tackzone	282-285
Tackboard to Top of Overhead	286-291
Glass Whiteboard from Floor	292
Wall Mount Wall in Tackzone	293-296
Magnetic Wood to Top of Overhead	297-301
Shelving for Wall Mount Wall	302-303
Floating Shelves	304

WALL MOUNT CABINETS

w/ Hinged Doors | 1H

Silea

03/23

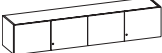
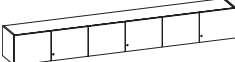
	D	W	H	model number + type	laminate	veneer 1	veneer 2
	16 1/4	30	14 1/8	GS2WMC1H30- []	1,989	3,105	3,428
	16 1/4	36	14 1/8	GS2WMC1H36- []	2,158	3,358	3,707
	16 1/4	42	14 1/8	GS2WMC1H42- []	2,706	4,226	4,666
	16 1/4	48	14 1/8	GS2WMC1H48- []	2,853	4,455	4,919
	16 1/4	54	14 1/8	GS2WMC1H54- []	3,003	4,687	5,175
	16 1/4	60	14 1/8	GS2WMC1H60- []	3,121	4,865	5,371
	16 1/4	66	14 1/8	GS2WMC1H66- []	3,333	5,196	5,736
	16 1/4	72	14 1/8	GS2WMC1H72- []	3,525	5,498	6,070
	16 1/4	78	14 1/8	GS2WMC1H78- []	3,743	5,837	6,444
	16 1/4	84	14 1/8	GS2WMC1H84- []	4,007	6,253	6,903
	16 1/4	90	14 1/8	GS2WMC1H90- []	4,246	6,621	7,309
	16 1/4	96	14 1/8	GS2WMC1H96- []	4,395	6,855	7,567
	16 1/4	102	14 1/8	GS2WMC1H102- []	N/A	7,090	7,827
	16 1/4	108	14 1/8	GS2WMC1H108- []	N/A	7,332	8,094

PRODUCT INFO

of doors:
 30" and 36" = 2 doors
 42" through 78" = 4 doors
 84" through 108" = 6 doors

TO ORDER PLEASE SPECIFY THE FOLLOWING:

WOOD CHASSIS, WOOD DOOR

1. **MODEL NUMBER + WW**
2. **FSC**
3. **CHASSIS WOOD FINISH**
4. **LOCKS**
5. **KEYING**

LAM CHASSIS, LAM DOOR

1. **MODEL NUMBER + LL**
2. **FSC**
3. **CHASSIS LAM**
4. **FRONT LAM**
5. **LOCKS**
6. **KEYING**

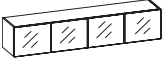
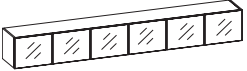
	D	W	H	model number + type	veneer 1	veneer 2
	16 1/4	30	14 1/8	GS2WMC1H30- []	3,658	4,039
	16 1/4	36	14 1/8	GS2WMC1H36- []	3,957	4,368
	16 1/4	60	14 1/8	GS2WMC1H60- []	5,837	6,444
	16 1/4	72	14 1/8	GS2WMC1H72- []	6,596	7,282
	16 1/4	90	14 1/8	GS2WMC1H90- []	8,174	9,024
	16 1/4	108	14 1/8	GS2WMC1H108- []	9,051	9,991

PRODUCT INFO

Type must be specified as part # of doors:
 30" and 36" = 2 doors
 60" through 72" = 4 doors
 90" through 108" = 6 doors
 Glass doors do not lock.

TO ORDER PLEASE SPECIFY THE FOLLOWING:

WOOD CHASSIS, GLASS DOOR

1. **MODEL NUMBER + WG**
2. **FSC**
3. **CHASSIS WOOD FINISH**
4. **GLASS**

WALL MOUNT CABINETS

No Doors | 1H

Silea

03/23

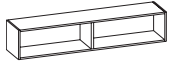

D	W	H	model number + type	laminate	veneer 1	veneer 2
15 3/8	30	14 1/8	GS2WMC1H30- []	1,694	2,642	2,917
15 3/8	36	14 1/8	GS2WMC1H36- []	1,833	2,860	3,158
15 3/8	42	14 1/8	GS2WMC1H42- []	2,300	3,591	3,964
15 3/8	48	14 1/8	GS2WMC1H48- []	2,424	3,788	4,182
15 3/8	54	14 1/8	GS2WMC1H54- []	2,552	3,983	4,398
15 3/8	60	14 1/8	GS2WMC1H60- []	2,654	4,140	4,571
15 3/8	66	14 1/8	GS2WMC1H66- []	2,834	4,421	4,880
15 3/8	72	14 1/8	GS2WMC1H72- []	2,997	4,678	5,165
15 3/8	78	14 1/8	GS2WMC1H78- []	3,180	4,963	5,479
15 3/8	84	14 1/8	GS2WMC1H84- []	3,406	5,318	5,871
15 3/8	90	14 1/8	GS2WMC1H90- []	3,607	5,631	6,217
15 3/8	96	14 1/8	GS2WMC1H96- []	3,735	5,828	6,433
15 3/8	102	14 1/8	GS2WMC1H102- []	N/A	6,029	6,656
15 3/8	108	14 1/8	GS2WMC1H108- []	N/A	6,235	6,883

PRODUCT INFO

TO ORDER PLEASE SPECIFY THE FOLLOWING:

WOOD

1. **MODEL NUMBER + WN**
2. **FSC**
3. **CHASSIS WOOD FINISH**

LAM

1. **MODEL NUMBER + LN**
2. **FSC**
3. **CHASSIS LAM**

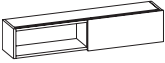
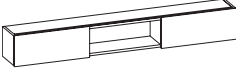
	D	W	H	model number + type	laminate	veneer 1	veneer 2
	16 1/4	60	14 1/8	GS2WMC1H60- []	3,122	4,870	5,376
	16 1/4	66	14 1/8	GS2WMC1H66- []	3,325	5,187	5,726
	16 1/4	72	14 1/8	GS2WMC1H72- []	3,525	5,504	6,077
	16 1/4	78	14 1/8	GS2WMC1H78- []	3,808	5,942	6,559
	16 1/4	84	14 1/8	GS2WMC1H84- []	4,089	6,381	7,044
	16 1/4	90	14 1/8	GS2WMC1H90- []	4,370	6,821	7,530
	16 1/4	96	14 1/8	GS2WMC1H96- []	4,637	7,090	7,827
	16 1/4	102	14 1/8	GS2WMC1H102- []	N/A	7,357	8,122
	16 1/4	108	14 1/8	GS2WMC1H108- []	N/A	7,551	8,336

PRODUCT INFO

of doors:
60" - 78" = 1 door
84" - 108" = 2 doors
Doors do not lock.

TO ORDER PLEASE SPECIFY THE FOLLOWING:

WOOD CHASSIS, WOOD DOOR

1. **MODEL NUMBER + WSW**
2. **FSC**
3. **CHASSIS WOOD FINISH**

LAM CHASSIS, LAM DOOR

1. **MODEL NUMBER + LSL**
2. **FSC**
3. **CHASSIS LAM**
4. **FRONT LAM**

WALL MOUNT CABINETS

w/ Sliding Glass Doors | 1H

Silea

03/23

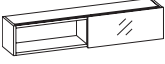
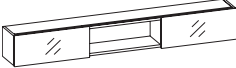
	D	W	H	model number + type	veneer 1	veneer 2
	16 1/4	60	14 1/8	GS2WMC1H60- []	6,129	6,766
	16 1/4	72	14 1/8	GS2WMC1H72- []	6,925	7,645
	16 1/4	90	14 1/8	GS2WMC1H90- []	8,581	9,473
	16 1/4	108	14 1/8	GS2WMC1H108- []	9,503	10,490

PRODUCT INFO

of doors:

60" and 72" = 1 door

90" and 108" = 2 doors

Glass doors do not lock.

TO ORDER PLEASE SPECIFY THE FOLLOWING:

WOOD CHASSIS, GLASS DOOR

1. **MODEL NUMBER + WSG**
2. **FSC**
3. **CHASSIS WOOD FINISH**
4. **GLASS**

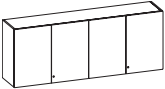
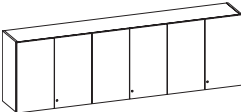
	D	W	H	model number + type	laminata	veneer 1	veneer 2
	16 1/4	30	27 1/2	GS2WMC2H30- []	2,816	4,382	4,838
	16 1/4	36	27 1/2	GS2WMC2H36- []	3,072	4,784	5,282
	16 1/4	42	27 1/2	GS2WMC2H42- []	3,165	4,942	5,456
	16 1/4	48	27 1/2	GS2WMC2H48- []	3,406	5,316	5,869
	16 1/4	54	27 1/2	GS2WMC2H54- []	3,646	5,689	6,280
	16 1/4	60	27 1/2	GS2WMC2H60- []	4,057	6,321	6,978
	16 1/4	66	27 1/2	GS2WMC2H66- []	4,342	6,767	7,471
	16 1/4	72	27 1/2	GS2WMC2H72- []	4,937	7,145	7,888
	16 1/4	78	27 1/2	GS2WMC2H78- []	5,035	7,292	8,050
	16 1/4	84	27 1/2	GS2WMC2H84- []	5,268	7,631	8,424
	16 1/4	90	27 1/2	GS2WMC2H90- []	5,543	8,029	8,863

PRODUCT INFO

of doors:
30" and 36" = 2 doors
60" through 78" = 4 doors
84" and 90" = 6 doors

TO ORDER PLEASE SPECIFY THE FOLLOWING:

WOOD CHASSIS, WOOD DOOR

1. **MODEL NUMBER + WW**
2. **FSC**
3. **CHASSIS WOOD FINISH**
4. **LOCKS**
5. **KEYING**

LAM CHASSIS, LAM DOOR

1. **MODEL NUMBER + LL**
2. **FSC**
3. **CHASSIS LAM**
4. **FRONT LAM**
5. **LOCKS**
6. **KEYING**

WALL MOUNT CABINETS

w/ Hinged Glass Doors | 2H

Silea

03/23

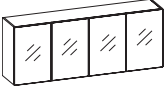
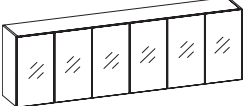
	D	W	H	model number + type	veneer 1	veneer 2
	16 1/4	30	27 1/2	GS2WMC2H30- []	5,161	5,698
	16 1/4	36	27 1/2	GS2WMC2H36- []	5,637	6,223
	16 1/4	60	27 1/2	GS2WMC2H60- []	7,585	8,374
	16 1/4	72	27 1/2	GS2WMC2H72- []	8,574	9,465
	16 1/4	90	27 1/2	GS2WMC2H90- []	9,911	10,940

PRODUCT INFO

of doors:

30" and 36" = 2 doors

60" and 72" = 4 doors

90" = 6 doors

Glass doors do not lock.

TO ORDER PLEASE SPECIFY THE FOLLOWING:

WOOD CHASSIS, GLASS DOOR

1. **MODEL NUMBER + WG**
2. **FSC**
3. **CHASSIS WOOD FINISH**
4. **GLASS**

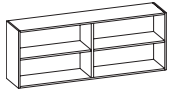

D	W	H	model number + type	laminate	veneer 1	veneer 2
16 1/4	30	27 1/2	GS2WMC2H30- []	2,390	3,731	4,120
16 1/4	36	27 1/2	GS2WMC2H36- []	2,610	4,074	4,497
16 1/4	42	27 1/2	GS2WMC2H42- []	2,692	4,202	4,640
16 1/4	48	27 1/2	GS2WMC2H48- []	2,895	4,518	4,988
16 1/4	54	27 1/2	GS2WMC2H54- []	3,097	4,835	5,338
16 1/4	60	27 1/2	GS2WMC2H60- []	3,447	5,380	5,940
16 1/4	66	27 1/2	GS2WMC2H66- []	3,691	5,760	6,359
16 1/4	72	27 1/2	GS2WMC2H72- []	4,195	6,080	6,712
16 1/4	78	27 1/2	GS2WMC2H78- []	4,280	6,202	6,847
16 1/4	84	27 1/2	GS2WMC2H84- []	4,478	6,491	7,166
16 1/4	90	27 1/2	GS2WMC2H90- []	4,712	6,828	7,538

PRODUCT INFO

TO ORDER PLEASE SPECIFY THE FOLLOWING:

WOOD CHASSIS

1. **MODEL NUMBER + WN**
2. **FSC**
3. **CHASSIS WOOD FINISH**

LAM CHASSIS

1. **MODEL NUMBER + LN**
2. **FSC**
3. **CHASSIS LAM**

WALL MOUNT CABINETS

w/ Sliding Doors | 2H

Silea

03/23

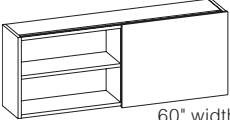
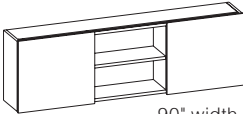
	D	W	H	model number + type	laminata	veneer 1	veneer 2
 <p>60" width</p>	16 1/4	60	27 1/2	GS2WMC2H60- []	4,056	6,329	6,987
	16 1/4	66	27 1/2	GS2WMC2H66- []	4,497	6,743	7,444
	16 1/4	72	27 1/2	GS2WMC2H72- []	4,937	7,153	7,897
	16 1/4	78	27 1/2	GS2WMC2H78- []	5,299	7,516	8,297
	16 1/4	84	27 1/2	GS2WMC2H84- []	5,568	7,879	8,698
 <p>90" width</p>	16 1/4	90	27 1/2	GS2WMC2H90- []	5,706	8,269	9,128

PRODUCT INFO

of doors:
 60" - 78" = 1 door
 84" - 90" = 2 doors
 Doors do not lock.

TO ORDER PLEASE SPECIFY THE FOLLOWING:

WOOD CHASSIS, WOOD DOOR

1. **MODEL NUMBER + WSW**
2. **FSC**
3. **CHASSIS WOOD FINISH**

LAM CHASSIS, LAM DOOR

1. **MODEL NUMBER + LSL**
2. **FSC**
3. **CHASSIS LAM**
4. **FRONT LAM**

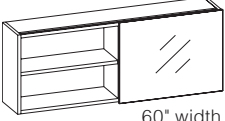
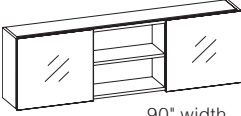
	D	W	H	model number + type	veneer 1	veneer 2
 60" width	16 1/4	60	27 1/2	GS2WMC2H60- []	7,964	8,792
	16 1/4	72	27 1/2	GS2WMC2H72- []	8,251	9,108
 90" width	16 1/4	90	27 1/2	GS2WMC2H90- []	10,222	11,284

PRODUCT INFO

of doors:
60" and 72" = 1 door
90" = 2 doors
Glass doors do not lock.

TO ORDER PLEASE SPECIFY THE FOLLOWING:

WOOD CHASSIS, GLASS DOOR

1. **MODEL NUMBER + WSG**
2. **FSC**
3. **CHASSIS WOOD FINISH**
4. **GLASS**

WALL MOUNT WALL OVERHEAD

Shelf Track Bottom | 1H

Silea

03/23

	D	W	H	model number + type	laminate	veneer 1	veneer 2
	3/4	30	14 1/8	GS2WMW1H30- <input type="checkbox"/>	786	1,142	1,261
	3/4	36	14 1/8	GS2WMW1H36- <input type="checkbox"/>	852	1,234	1,363
	3/4	42	14 1/8	GS2WMW1H42- <input type="checkbox"/>	919	1,334	1,473
	3/4	48	14 1/8	GS2WMW1H48- <input type="checkbox"/>	1,013	1,469	1,622
	3/4	54	14 1/8	GS2WMW1H54- <input type="checkbox"/>	1,107	1,604	1,771
	3/4	60	14 1/8	GS2WMW1H60- <input type="checkbox"/>	1,235	1,788	1,975
	3/4	66	14 1/8	GS2WMW1H66- <input type="checkbox"/>	1,318	1,911	2,110
	3/4	72	14 1/8	GS2WMW1H72- <input type="checkbox"/>	1,393	2,018	2,229
	3/4	78	14 1/8	GS2WMW1H78- <input type="checkbox"/>	1,470	2,126	2,348
	3/4	84	14 1/8	GS2WMW1H84- <input type="checkbox"/>	1,542	2,235	2,468
	3/4	90	14 1/8	GS2WMW1H90- <input type="checkbox"/>	1,728	2,501	2,762
	3/4	96	14 1/8	GS2WMW1H96- <input type="checkbox"/>	1,788	2,590	2,860
	3/4	102	14 1/8	GS2WMW1H102- <input type="checkbox"/>	1,850	2,681	2,961
	3/4	108	14 1/8	GS2WMW1H108- <input type="checkbox"/>	1,916	2,775	3,064

PRODUCT INFO

Shelving can be mounted to bottom aluminum track.
Shelving ordered separately.

TO ORDER PLEASE SPECIFY THE FOLLOWING:

WOOD

1. **MODEL NUMBER + W**
2. **FSC**
3. **CHASSIS WOOD FINISH**
4. **EXTRUSION COLOR**

LAM

1. **MODEL NUMBER + L**
2. **FSC**
3. **CHASSIS LAM**
4. **EXTRUSION COLOR**

	D	W	H	model number + type	laminate	veneer 1	veneer 2
	3/4	30	27 1/2	GS2WMW2H30- <input type="checkbox"/>	935	1,355	1,496
	3/4	36	27 1/2	GS2WMW2H36- <input type="checkbox"/>	1,010	1,462	1,615
	3/4	42	27 1/2	GS2WMW2H42- <input type="checkbox"/>	1,081	1,568	1,732
	3/4	48	27 1/2	GS2WMW2H48- <input type="checkbox"/>	1,209	1,751	1,934
	3/4	54	27 1/2	GS2WMW2H54- <input type="checkbox"/>	1,334	1,935	2,137
	3/4	60	27 1/2	GS2WMW2H60- <input type="checkbox"/>	1,461	2,116	2,337
	3/4	66	27 1/2	GS2WMW2H66- <input type="checkbox"/>	1,565	2,265	2,501
	3/4	72	27 1/2	GS2WMW2H72- <input type="checkbox"/>	1,650	2,389	2,638
	3/4	78	27 1/2	GS2WMW2H78- <input type="checkbox"/>	1,736	2,518	2,780
	3/4	84	27 1/2	GS2WMW2H84- <input type="checkbox"/>	1,825	2,643	2,918
3/4	90	27 1/2	GS2WMW2H90- <input type="checkbox"/>	2,046	2,963	3,272	

PRODUCT INFO

Shelving can be mounted to bottom and center aluminum track.
Shelving ordered separately.

TO ORDER PLEASE SPECIFY THE FOLLOWING:

WOOD

1. **MODEL NUMBER + W**
2. **FSC**
3. **CHASSIS WOOD FINISH**
4. **EXTRUSION COLOR**

LAM

1. **MODEL NUMBER + L**
2. **FSC**
3. **CHASSIS LAM**
4. **EXTRUSION COLOR**

WALL MOUNT TACKBOARD IN TACKZONE

For Standard Height Credenzas

Silea
03/23

fabric grades

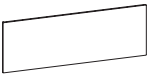
	D	W	H	yards	model number	1	2	3	COM/4
	7/8	24	24 13/16	1.00	GS2TKW24	777	797	820	844
	7/8	30	24 13/16	1.00	GS2TKW30	817	838	863	887
	7/8	36	24 13/16	1.25	GS2TKW36	856	884	914	946
	7/8	42	24 13/16	1.25	GS2TKW42	887	916	946	979
	7/8	48	24 13/16	1.25	GS2TKW48	918	948	980	1,012
	7/8	54	24 13/16	1.25	GS2TKW54	952	984	1,015	1,050
	7/8	60	24 13/16	2.00	GS2TKW60	997	1,042	1,090	1,138
	7/8	66	24 13/16	2.25	GS2TKW66	1,013	1,058	1,106	1,154
	7/8	72	24 13/16	2.25	GS2TKW72	1,054	1,105	1,159	1,214
	7/8	78	24 13/16	2.50	GS2TKW78	1,082	1,138	1,199	1,260
	7/8	84	24 13/16	2.75	GS2TKW84	1,113	1,169	1,230	1,291
	7/8	90	24 13/16	2.75	GS2TKW90	1,164	1,226	1,292	1,357
	7/8	96	24 13/16	3.00	GS2TKW96	1,212	1,280	1,352	1,425
	7/8	102	24 13/16	3.25	GS2TKW102	1,672	1,744	1,824	1,904
	7/8	108	24 13/16	3.50	GS2TKW108	1,733	1,812	1,897	1,982

Product Specifications:

STANDARD

The fabric on all Gunlocke tackboards is applied in a railroad fashion.

- Tackboard widths less than or equal to 96" are one piece
- Tackboards greater than 96" are two piece and the fabric is pattern matched
- When ordering individual wall mount tackboards to be placed side by side, the fabric pattern will be random matched. If a fabric pattern match is required, contact Gunlocke Bid/Quote for a special quote.

SPECIAL

Fabric applied "up the roll" is a special application. Please see guidelines below and contact Gunlocke Bid/Quote for a special quote.

- Fabrics used on tackboard 48" and under in width can be applied "up the roll"
- Tackboards greater than 48" in width can only be applied railroaded, due to fabric height limitations

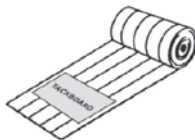
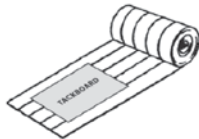

PRODUCT INFO

102" and 108" wide tackboards are 2 piece.

See yards listed above for COM fabric requirements.

TO ORDER PLEASE SPECIFY THE FOLLOWING:

LIST

1. **MODEL NUMBER**
2. **FABRIC**
3. **FSC TACKBOARDS**

FSC Tackboard Options

FSC = FSC Required (5% COM upcharge)

NR = FSC Not Required

WALL MOUNT GLASS WHITEBOARD IN TACKZONE

For Standard Height Credenzas

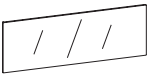
	D	W	H	model number	glass
	7/8	24	24 13/16	GS2TGW24-GSA	1,552
	7/8	30	24 13/16	GS2TGW30-GSA	1,633
	7/8	36	24 13/16	GS2TGW36-GSA	1,857
	7/8	42	24 13/16	GS2TGW42-GSA	2,147
	7/8	48	24 13/16	GS2TGW48-GSA	2,434
	7/8	54	24 13/16	GS2TGW54-GSA	2,724
	7/8	60	24 13/16	GS2TGW60-GSA	3,044
	7/8	66	24 13/16	GS2TGW66-GSA	3,485
	7/8	72	24 13/16	GS2TGW72-GSA	3,713
	7/8	78	24 13/16	GS2TGW78-GSA	4,116
	7/8	84	24 13/16	GS2TGW84-GSA	4,676
	7/8	90	24 13/16	GS2TGW90-GSA	4,891
	7/8	96	24 13/16	GS2TGW96-GSA	5,126
	7/8	102	24 13/16	GS2TGW102-GSA	5,344
7/8	108	24 13/16	GS2TGW108-GSA	5,571	

PRODUCT INFO

96", 102" and 108" wide whiteboards are 2 piece.
Whiteboard frames match glass color.
Whiteboard is magnetic.

TO ORDER PLEASE SPECIFY THE FOLLOWING:

GLASS

1. **MODEL NUMBER**
2. **GLASS**

LAYERS WALL MOUNT TACKBOARD IN TACKZONE

For Layers Height Credenzas

Silea
03/23

fabric grades

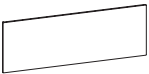
	D	W	H	yards	model number	1	2	3	COM/4
	7/8	24	31 15/16	1.00	GS2TLKW24	815	836	861	885
	7/8	30	31 15/16	1.00	GS2TLKW30	858	881	908	932
	7/8	36	31 15/16	1.25	GS2TLKW36	898	927	960	992
	7/8	42	31 15/16	1.25	GS2TLKW42	931	963	994	1,031
	7/8	48	31 15/16	1.25	GS2TLKW48	963	995	1,028	1,064
	7/8	54	31 15/16	1.25	GS2TLKW54	997	1,032	1,065	1,102
	7/8	60	31 15/16	2.00	GS2TLKW60	1,046	1,093	1,144	1,195
	7/8	66	31 15/16	2.25	GS2TLKW66	1,065	1,111	1,163	1,214
	7/8	72	31 15/16	2.25	GS2TLKW72	1,107	1,160	1,219	1,274
	7/8	78	31 15/16	2.50	GS2TLKW78	1,138	1,197	1,261	1,326
	7/8	84	31 15/16	2.75	GS2TLKW84	1,169	1,228	1,292	1,357
	7/8	90	31 15/16	2.75	GS2TLKW90	1,222	1,287	1,358	1,425
	7/8	96	31 15/16	3.00	GS2TLKW96	1,271	1,342	1,419	1,495
	7/8	102	31 15/16	3.25	GS2TLKW102	1,755	1,830	1,915	1,997
	7/8	108	31 15/16	3.50	GS2TLKW108	1,820	1,903	1,991	2,081

Product Specifications:

STANDARD

The fabric on all Gunlocke tackboards is applied in a railroad fashion.

- Tackboard widths less than or equal to 96" are one piece
- Tackboards greater than 96" are two piece and the fabric is pattern matched
- When ordering individual wall mount tackboards to be placed side by side, the fabric pattern will be random matched. If a fabric pattern match is required, contact Gunlocke Bid/Quote for a special quote.

SPECIAL

Fabric applied "up the roll" is a special application. Please see guidelines below and contact Gunlocke Bid/Quote for a special quote.

- Fabrics used on tackboard 48" and under in width can be applied "up the roll"
- Tackboards greater than 48" in width can only be applied railroaded, due to fabric height limitations

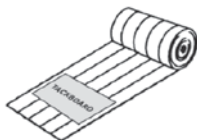
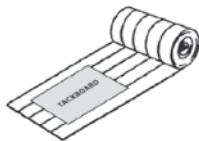

PRODUCT INFO

102" and 108" wide tackboards are 2 piece.

See yards listed above for COM fabric requirements.

TO ORDER PLEASE SPECIFY THE FOLLOWING:

LIST

1. **MODEL NUMBER**
2. **FABRIC**
3. **FSC TACKBOARDS**

FSC Tackboard Options

FSC = FSC Required (5% COM upcharge)

NR = FSC Not Required

LAYERS WALL MOUNT GLASS WHITEBOARD IN TACKZONE

For Layers Height Credenzas

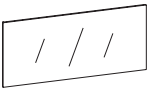
	D	W	H	model number	glass
	7/8	24	31 15/16	GS2TLGW24-GSA	1,629
	7/8	30	31 15/16	GS2TLGW30-GSA	1,714
	7/8	36	31 15/16	GS2TLGW36-GSA	1,951
	7/8	42	31 15/16	GS2TLGW42-GSA	2,264
	7/8	48	31 15/16	GS2TLGW48-GSA	2,576
	7/8	54	31 15/16	GS2TLGW54-GSA	2,890
	7/8	60	31 15/16	GS2TLGW60-GSA	3,198
	7/8	66	31 15/16	GS2TLGW66-GSA	3,660
	7/8	72	31 15/16	GS2TLGW72-GSA	3,898
	7/8	78	31 15/16	GS2TLGW78-GSA	4,321
	7/8	84	31 15/16	GS2TLGW84-GSA	4,908
	7/8	90	31 15/16	GS2TLGW90-GSA	5,136
	7/8	96	31 15/16	GS2TLGW96-GSA	5,384
	7/8	102	31 15/16	GS2TLGW102-GSA	5,613
7/8	108	31 15/16	GS2TLGW108-GSA	5,852	

PRODUCT INFO

96", 102" and 108" wide whiteboards are 2 piece.
Whiteboard frames match glass color.
Whiteboard is magnetic.

TO ORDER PLEASE SPECIFY THE FOLLOWING:

GLASS

1. **MODEL NUMBER**
2. **GLASS**

TACKBOARD TO TOP OF OVERHEAD

1H and 2H | for Standard Height Credenzas

Silea

03/23

fabric grades

	D	W	H	yards	model number	1	2	3	COM/4
	7/8	24	39 1/16	1.25	GS2TKW1H24	975	995	1,018	1,042
	7/8	30	39 1/16	1.25	GS2TKW1H30	1,025	1,046	1,071	1,095
	7/8	36	39 1/16	1.25	GS2TKW1H36	1,044	1,072	1,102	1,134
	7/8	42	39 1/16	1.50	GS2TKW1H42	1,084	1,119	1,154	1,190
	7/8	48	39 1/16	1.50	GS2TKW1H48	1,118	1,153	1,188	1,224
	7/8	24	52 7/16	1.75	GS2TKW2H24	992	1,012	1,035	1,059
	7/8	30	52 7/16	1.75	GS2TKW2H30	1,044	1,065	1,090	1,114
	7/8	36	52 7/16	1.75	GS2TKW2H36	1,084	1,112	1,142	1,174
	7/8	42	52 7/16	1.75	GS2TKW2H42	1,118	1,153	1,188	1,224
	7/8	48	52 7/16	1.75	GS2TKW2H48	1,146	1,181	1,216	1,252

Product Specifications:

STANDARD

The fabric on all Gunlocke tackboards is applied in a railroad fashion.

- Tackboard widths less than or equal to 96" are one piece
- Tackboards greater than 96" are two piece and the fabric is pattern matched
- When ordering individual wall mount tackboards to be placed side by side, the fabric pattern will be random matched. If a fabric pattern match is required, contact Gunlocke Bid/Quote for a special quote.

SPECIAL

Fabric applied "up the roll" is a special application. Please see guidelines below and contact Gunlocke Bid/Quote for a special quote.

- Fabrics used on tackboard 48" and under in width can be applied "up the roll"
- Tackboards greater than 48" in width can only be applied railroaded, due to fabric height limitations

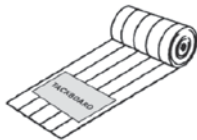
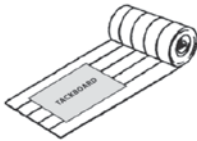

PRODUCT INFO

See yards listed above for COM fabric requirements.

TO ORDER PLEASE SPECIFY THE FOLLOWING:

LIST

1. **MODEL NUMBER**
2. **FABRIC**
3. **FSC TACKBOARDS**

FSC Tackboard Options

FSC = FSC Required (5% COM upcharge)

NR = FSC Not Required

GLASS WHITEBOARD TO TOP OF OVERHEAD

1H and 2H | for Standard Height Credenzas

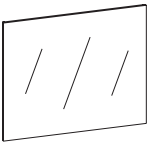
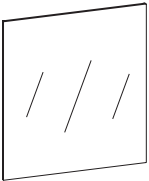
	D	W	H	model number	glass
	7/8	24	39 1/16	GS2TGW1H24-GSA	2,893
	7/8	30	39 1/16	GS2TGW1H30-GSA	3,044
	7/8	36	39 1/16	GS2TGW1H36-GSA	3,485
	7/8	42	39 1/16	GS2TGW1H42-GSA	3,713
	7/8	48	39 1/16	GS2TGW1H48-GSA	4,116
	7/8	24	52 7/16	GS2TGW2H24-GSA	3,311
	7/8	30	52 7/16	GS2TGW2H30-GSA	3,485
	7/8	36	52 7/16	GS2TGW2H36-GSA	3,713
	7/8	42	52 7/16	GS2TGW2H42-GSA	4,116
	7/8	48	52 7/16	GS2TGW2H48-GSA	4,676

PRODUCT INFO

Whiteboard frames match glass color.
Whiteboard is magnetic.

TO ORDER PLEASE SPECIFY THE FOLLOWING:

GLASS

1. **MODEL NUMBER**
2. **GLASS**

LAYERS TACKBOARD TO TOP OF OVERHEAD

1H and 2H | for Layers Height Credenzas

Silea
03/23

fabric grades

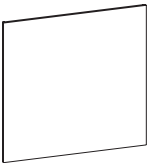
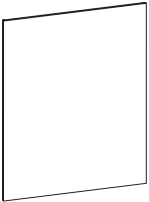
	D	W	H	yards	model number	1	2	3	COM/4
	7/8	24	46 3/16	1.50	GS2TLKW1H24	992	1,012	1,035	1,059
	7/8	30	46 3/16	1.50	GS2TLKW1H30	1,044	1,065	1,090	1,114
	7/8	36	46 3/16	1.50	GS2TLKW1H36	1,084	1,112	1,142	1,174
	7/8	42	46 3/16	1.50	GS2TLKW1H42	1,118	1,153	1,188	1,224
	7/8	48	46 3/16	1.50	GS2TLKW1H48	1,146	1,181	1,216	1,252
	7/8	24	59 9/16	2.00	GS2TLKW2H24	1,031	1,051	1,074	1,098
	7/8	30	59 9/16	2.00	GS2TLKW2H30	1,084	1,105	1,130	1,154
	7/8	36	59 9/16	2.00	GS2TLKW2H36	1,118	1,146	1,176	1,208
	7/8	42	59 9/16	2.00	GS2TLKW2H42	1,146	1,181	1,216	1,252
	7/8	48	59 9/16	2.00	GS2TLKW2H48	1,197	1,232	1,267	1,303

Product Specifications:

STANDARD

The fabric on all Gunlocke tackboards is applied in a railroad fashion.

- Tackboard widths less than or equal to 96" are one piece
- Tackboards greater than 96" are two piece and the fabric is pattern matched
- When ordering individual wall mount tackboards to be placed side by side, the fabric pattern will be random matched. If a fabric pattern match is required, contact Gunlocke Bid/Quote for a special quote.

SPECIAL

Fabric applied "up the roll" is a special application. Please see guidelines below and contact Gunlocke Bid/Quote for a special quote.

- Fabrics used on tackboard 48" and under in width can be applied "up the roll"
- Tackboards greater than 48" in width can only be applied railroaded, due to fabric height limitations

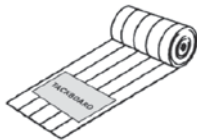
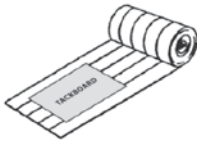

PRODUCT INFO

See yards listed above for COM fabric requirements.

TO ORDER PLEASE SPECIFY THE FOLLOWING:

LIST

1. **MODEL NUMBER**
2. **FABRIC**
3. **FSC TACKBOARDS**

FSC Tackboard Options

FSC = FSC Required (5% COM upcharge)

NR = FSC Not Required

LAYERS GLASS WHITEBOARD TO TOP OF OVERHEAD

1H and 2H | for Layers Height Credenzas

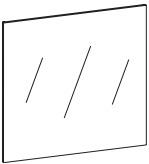
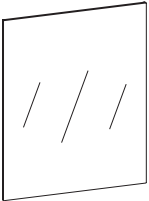
	D	W	H	model number	glass
	7/8	24	46 3/16	GS2TLGW1H24-GSA	3,039
	7/8	30	46 3/16	GS2TLGW1H30-GSA	3,198
	7/8	36	46 3/16	GS2TLGW1H36-GSA	3,660
	7/8	42	46 3/16	GS2TLGW1H42-GSA	3,898
	7/8	48	46 3/16	GS2TLGW1H48-GSA	4,321
	7/8	24	59 9/16	GS2TLGW2H24-GSA	3,478
	7/8	30	59 9/16	GS2TLGW2H30-GSA	3,660
	7/8	36	59 9/16	GS2TLGW2H36-GSA	3,898
	7/8	42	59 9/16	GS2TLGW2H42-GSA	4,321
	7/8	48	59 9/16	GS2TLGW2H48-GSA	4,908

PRODUCT INFO

Whiteboard frames match glass color.
Whiteboard is magnetic.

TO ORDER PLEASE SPECIFY THE FOLLOWING:

GLASS

1. **MODEL NUMBER**
2. **GLASS**

TACKBOARDS FOR MOUNTING 1H OVERHEADS AT 6H HEIGHT

For Standard Height Credenzas

Silea
03/23

fabric grades

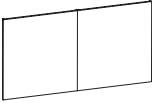
	D	W	H	yards	model number	1	2	3	COM/4
	7/8	24	38 1/4	1.00	GS2TTKW24	973	999	1,029	1,056
	7/8	30	38 1/4	1.00	GS2TTKW30	1,023	1,050	1,081	1,110
	7/8	36	38 1/4	1.25	GS2TTKW36	1,070	1,105	1,142	1,182
	7/8	42	38 1/4	1.50	GS2TTKW42	1,110	1,146	1,184	1,225
	7/8	48	38 1/4	1.50	GS2TTKW48	1,147	1,186	1,225	1,266
	7/8	54	38 1/4	2.00	GS2TTKW54	1,427	1,477	1,522	1,575
	7/8	60	38 1/4	2.00	GS2TTKW60	1,496	1,565	1,636	1,710
	7/8	66	38 1/4	2.25	GS2TTKW66	1,520	1,589	1,660	1,734
	7/8	72	38 1/4	2.50	GS2TTKW72	1,581	1,657	1,740	1,821
	7/8	78	38 1/4	2.50	GS2TTKW78	1,624	1,708	1,799	1,893
	7/8	84	38 1/4	2.75	GS2TTKW84	1,672	1,755	1,847	1,940
	7/8	90	38 1/4	3.00	GS2TTKW90	1,746	1,839	1,939	2,038
	7/8	96	38 1/4	3.00	GS2TTKW96	1,818	1,920	2,029	2,138
	7/8	102	38 1/4	3.50	GS2TTKW102	2,508	2,616	2,736	2,854
7/8	108	38 1/4	3.50	GS2TTKW108	2,601	2,719	2,848	2,973	

- Can be used in height adjustable applications with overheads to create clearance for desk and monitors. Monitor height should be verified.

Product Specifications:

STANDARD

The fabric on all Gunlocke tackboards is applied in a railroad fashion.

- Tackboard widths less than or equal to 96" are one piece
- Tackboards greater than 96" are two piece and the fabric is pattern matched
- When ordering individual wall mount tackboards to be placed side by side, the fabric pattern will be random matched. If a fabric pattern match is required, contact Gunlocke Bid/Quote for a special quote.

SPECIAL

Fabric applied "up the roll" is a special application. Please see guidelines below and contact Gunlocke Bid/Quote for a special quote.

- Fabrics used on tackboard 48" and under in width can be applied "up the roll"
- Tackboards greater than 48" in width can only be applied railroaded, due to fabric height limitations

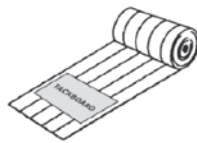
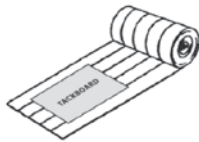

PRODUCT INFO

54"-96" wide tackboards are 2 piece.

102"-108" wide tackboards are 3 piece.

See yards listed above for COM fabric requirements.

TO ORDER PLEASE SPECIFY THE FOLLOWING:

LIST

1. **MODEL NUMBER**
2. **FABRIC**
3. **FSC TACKBOARDS**

FSC Tackboard Options

FSC = FSC Required (5% COM upcharge)

NR = FSC Not Required

GLASS WHITEBOARDS FOR MOUNTING 1H OVERHEADS AT 6H HEIGHT

For Standard Height Credenzas

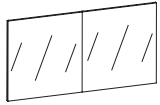

D	W	H	model number	glass
7/8	24	38 1/4	GS2TTGW24-GSA	2,741
7/8	30	38 1/4	GS2TTGW30-GSA	3,044
7/8	36	38 1/4	GS2TTGW36-GSA	3,485
7/8	42	38 1/4	GS2TTGW42-GSA	3,713
7/8	48	38 1/4	GS2TTGW48-GSA	4,116
7/8	54	38 1/4	GS2TTGW54-GSA	4,735
7/8	60	38 1/4	GS2TTGW60-GSA	5,483
7/8	66	38 1/4	GS2TTGW66-GSA	5,877
7/8	72	38 1/4	GS2TTGW72-GSA	6,273
7/8	78	38 1/4	GS2TTGW78-GSA	6,479
7/8	84	38 1/4	GS2TTGW84-GSA	6,684
7/8	90	38 1/4	GS2TTGW90-GSA	7,047
7/8	96	38 1/4	GS2TTGW96-GSA	7,410
7/8	102	38 1/4	GS2TTGW102-GSA	9,015
7/8	108	38 1/4	GS2TTGW108-GSA	9,410

- Can be used in height adjustable applications with overheads to create clearance for desk and monitors. Monitor height should be verified.

PRODUCT INFO

54"-96" wide whiteboards are 2 piece.

102"-108" wide whiteboards are 3 piece.

Whiteboard frames match glass color.

Whiteboard is magnetic.

TO ORDER PLEASE SPECIFY THE FOLLOWING:

LIST

- 1. MODEL NUMBER**
- 2. GLASS**

GLASS WHITEBOARD FROM FLOOR

To Top of 4H, 5H and 6H

Silea
03/23

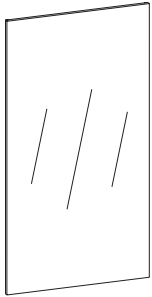

D	W	H	model number	glass
7/8	36	68 1/8	GS2WGW5H36	3,898
7/8	36	81 1/2	GS2WGW6H36	4,908

PRODUCT INFO

Whiteboard frames match glass color.

Whiteboard is magnetic.

TO ORDER PLEASE SPECIFY THE FOLLOWING:

GLASS

1. **MODEL NUMBER**
2. **GLASS**

WALL MOUNT WALL IN TACKZONE

w/ Center Track | 1H | for Standard Height Credenzas

	D	W	H	model number + type	laminate	veneer 1	veneer 2
	3/4	30	24 13/16	GS2TWD30-X []	838	1,213	1,340
	3/4	36	24 13/16	GS2TWD36-X []	900	1,305	1,442
	3/4	42	24 13/16	GS2TWD42-X []	1,003	1,449	1,600
	3/4	48	24 13/16	GS2TWD48-X []	1,107	1,593	1,759
	3/4	54	24 13/16	GS2TWD54-X []	1,207	1,735	1,916
	3/4	60	24 13/16	GS2TWD60-X []	1,308	1,892	2,090
	3/4	66	24 13/16	GS2TWD66-X []	1,398	2,025	2,236
	3/4	72	24 13/16	GS2TWD72-X []	1,479	2,140	2,363
	3/4	78	24 13/16	GS2TWD78-X []	1,557	2,256	2,491
	3/4	84	24 13/16	GS2TWD84-X []	1,634	2,368	2,615
	3/4	90	24 13/16	GS2TWD90-X []	1,831	2,650	2,926
	3/4	96	24 13/16	GS2TWD96-X []	1,895	2,744	3,030
	3/4	102	24 13/16	GS2TWD102-X []	1,965	2,842	3,138
	3/4	108	24 13/16	GS2TWD108-X []	2,028	2,937	3,243

PRODUCT INFO

Shelving can be mounted to center aluminum track.
Shelving ordered separately.

TO ORDER PLEASE SPECIFY THE FOLLOWING:

WOOD

1. **MODEL NUMBER + W**
2. **FSC**
3. **CHASSIS WOOD FINISH**
4. **EXTRUSION COLOR**

LAM

1. **MODEL NUMBER + L**
2. **FSC**
3. **CHASSIS LAM**
4. **EXTRUSION COLOR**

MAGNETIC WALL MOUNT WALL IN TACKZONE

w/ Steel Backer | 1H | for Standard Height Credenzas

Silea

03/23

	D	W	H	model number + type	veneer 1	veneer 2
	3/4	24	24 13/16	GS2TWD24- <input type="checkbox"/>	1,629	1,800
	3/4	30	24 13/16	GS2TWD30- <input type="checkbox"/>	1,669	1,843
	3/4	36	24 13/16	GS2TWD36- <input type="checkbox"/>	1,770	1,955
	3/4	42	24 13/16	GS2TWD42- <input type="checkbox"/>	1,927	2,128
	3/4	48	24 13/16	GS2TWD48- <input type="checkbox"/>	2,085	2,302
	3/4	54	24 13/16	GS2TWD54- <input type="checkbox"/>	2,240	2,474
	3/4	60	24 13/16	GS2TWD60- <input type="checkbox"/>	2,396	2,646
	3/4	66	24 13/16	GS2TWD66- <input type="checkbox"/>	2,536	2,800
	3/4	72	24 13/16	GS2TWD72- <input type="checkbox"/>	2,753	3,040
	3/4	78	24 13/16	GS2TWD78- <input type="checkbox"/>	2,842	3,138
	3/4	84	24 13/16	GS2TWD84- <input type="checkbox"/>	2,995	3,307
	3/4	90	24 13/16	GS2TWD90- <input type="checkbox"/>	3,391	3,744
	3/4	96	24 13/16	GS2TWD96- <input type="checkbox"/>	3,490	3,853
	3/4	102	24 13/16	GS2TWD102- <input type="checkbox"/>	3,594	3,968
3/4	108	24 13/16	GS2TWD108- <input type="checkbox"/>	3,785	4,179	

PRODUCT INFO

Tackzone is magnetic.
It is not recommended to stack wood units side by side due to grain variation. Contact Tailored Solutions for a matched set.

TO ORDER PLEASE SPECIFY THE FOLLOWING:

WOOD

1. **MODEL NUMBER + W**
2. **FSC**
3. **CHASSIS WOOD FINISH**

LAYERS WALL MOUNT WALL IN TACKZONE

w/ Center Track | for Layers Height Credenzas

	D	W	H	model number + type	laminate	veneer 1	veneer 2
	3/4	30	31 15/16	GS2TLWD30-X []	880	1,275	1,408
	3/4	36	31 15/16	GS2TLWD36-X []	945	1,371	1,514
	3/4	42	31 15/16	GS2TLWD42-X []	1,081	1,566	1,730
	3/4	48	31 15/16	GS2TLWD48-X []	1,189	1,720	1,899
	3/4	54	31 15/16	GS2TLWD54-X []	1,295	1,878	2,074
	3/4	60	31 15/16	GS2TLWD60-X []	1,374	1,991	2,199
	3/4	66	31 15/16	GS2TLWD66-X []	1,470	2,127	2,349
	3/4	72	31 15/16	GS2TLWD72-X []	1,551	2,251	2,486
	3/4	78	31 15/16	GS2TLWD78-X []	1,634	2,371	2,618
	3/4	84	31 15/16	GS2TLWD84-X []	1,718	2,489	2,748
	3/4	90	31 15/16	GS2TLWD90-X []	1,921	2,785	3,075
	3/4	96	31 15/16	GS2TLWD96-X []	1,989	2,885	3,185
	3/4	102	31 15/16	GS2TLWD102-X []	2,062	2,987	3,298
3/4	108	31 15/16	GS2TLWD108-X []	2,129	3,086	3,407	

PRODUCT INFO

Shelving can be mounted to center aluminum track.
Shelving ordered separately.

TO ORDER PLEASE SPECIFY THE FOLLOWING:

WOOD

1. **MODEL NUMBER + W**
2. **FSC**
3. **CHASSIS WOOD FINISH**
4. **EXTRUSION COLOR**

LAM

1. **MODEL NUMBER + L**
2. **FSC**
3. **CHASSIS LAM**
4. **EXTRUSION COLOR**

MAGNETIC WALL MOUNT WALL IN TACKZONE

w/ Steel Backer | for Layers Height Credenzas

Silea

03/23

	D	W	H	model number + type	veneer 1	veneer 2
	3/4	24	31 15/16	GS2TLWD24- <input type="checkbox"/>	1,711	1,889
	3/4	30	31 15/16	GS2TLWD30- <input type="checkbox"/>	1,754	1,937
	3/4	36	31 15/16	GS2TLWD36- <input type="checkbox"/>	1,858	2,051
	3/4	42	31 15/16	GS2TLWD42- <input type="checkbox"/>	2,024	2,235
	3/4	48	31 15/16	GS2TLWD48- <input type="checkbox"/>	2,188	2,416
	3/4	54	31 15/16	GS2TLWD54- <input type="checkbox"/>	2,352	2,597
	3/4	60	31 15/16	GS2TLWD60- <input type="checkbox"/>	2,515	2,777
	3/4	66	31 15/16	GS2TLWD66- <input type="checkbox"/>	2,661	2,938
	3/4	72	31 15/16	GS2TLWD72- <input type="checkbox"/>	2,892	3,193
	3/4	78	31 15/16	GS2TLWD78- <input type="checkbox"/>	2,985	3,296
	3/4	84	31 15/16	GS2TLWD84- <input type="checkbox"/>	3,143	3,470
	3/4	90	31 15/16	GS2TLWD90- <input type="checkbox"/>	3,559	3,929
	3/4	96	31 15/16	GS2TLWD96- <input type="checkbox"/>	3,663	4,044
	3/4	102	31 15/16	GS2TLWD102- <input type="checkbox"/>	3,775	4,168
	3/4	108	31 15/16	GS2TLWD108- <input type="checkbox"/>	3,976	4,390

PRODUCT INFO

Tackzone is magnetic.
It is not recommended to stack wood units side by side due to grain variation. Contact Tailored Solutions for a matched set.

TO ORDER PLEASE SPECIFY THE FOLLOWING:

WOOD

1. **MODEL NUMBER + W**
2. **FSC**
3. **CHASSIS WOOD FINISH**

	D	W	H	model number + type	veneer 1	veneer 2
	3/4	24	39 1/16	GS2TWD1H24- []	2,335	2,579
	3/4	30	39 1/16	GS2TWD1H30- []	2,396	2,646
	3/4	36	39 1/16	GS2TWD1H36- []	2,536	2,800
	3/4	42	39 1/16	GS2TWD1H42- []	2,753	3,040
	3/4	48	39 1/16	GS2TWD1H48- []	2,842	3,138
	3/4	54	39 1/16	GS2TWD1H54- []	2,985	3,296
	3/4	60	39 1/16	GS2TWD1H60- []	3,132	3,458
	3/4	66	39 1/16	GS2TWD1H66- []	3,290	3,633
	3/4	72	39 1/16	GS2TWD1H72- []	3,455	3,814
	3/4	78	39 1/16	GS2TWD1H78- []	3,627	4,005
	3/4	84	39 1/16	GS2TWD1H84- []	3,809	4,205
	3/4	90	39 1/16	GS2TWD1H90- []	3,999	4,415
	3/4	96	39 1/16	GS2TWD1H96- []	4,199	4,635
	3/4	102	39 1/16	GS2TWD1H102- []	4,409	4,867
3/4	108	39 1/16	GS2TWD1H108- []	4,630	5,111	

PRODUCT INFO

Tackzone is magnetic.
It is not recommended to stack wood units side by side due to grain variation. Contact Tailored Solutions for a matched set.
24" - 48" = 1 piece
54" - 102" = 2 piece
108" = 3 piece

TO ORDER PLEASE SPECIFY THE FOLLOWING:

WOOD

1. **MODEL NUMBER + W**
2. **FSC**
3. **CHASSIS WOOD FINISH**

MAGNETIC WOOD TO TOP OF OVERHEAD

2H | for Standard Height Credenzas

Silea

03/23

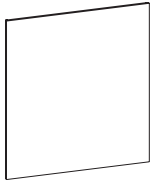

D	W	H	model number + type	veneer 1	veneer 2
3/4	24	52 7/16	GS2TWD2H24- []	2,473	2,731
3/4	30	52 7/16	GS2TWD2H30- []	2,536	2,800
3/4	36	52 7/16	GS2TWD2H36- []	2,753	3,040
3/4	42	52 7/16	GS2TWD2H42- []	2,842	3,138
3/4	48	52 7/16	GS2TWD2H48- []	2,995	3,307
3/4	54	52 7/16	GS2TWD2H54- []	3,144	3,471
3/4	60	52 7/16	GS2TWD2H60- []	3,302	3,646
3/4	66	52 7/16	GS2TWD2H66- []	3,467	3,828
3/4	72	52 7/16	GS2TWD2H72- []	3,640	4,019
3/4	78	52 7/16	GS2TWD2H78- []	3,822	4,219
3/4	84	52 7/16	GS2TWD2H84- []	4,014	4,432
3/4	90	52 7/16	GS2TWD2H90- []	4,213	4,652
3/4	96	52 7/16	GS2TWD2H96- []	4,426	4,886
3/4	102	52 7/16	GS2TWD2H102- []	4,647	5,130
3/4	108	52 7/16	GS2TWD2H108- []	4,879	5,386

PRODUCT INFO

Tackzone is magnetic.
It is not recommended to stack wood units side by side due to grain variation. Contact Tailored Solutions for a matched set.

24" - 48" = 1 piece
54" - 102" = 2 piece
108" = 3 piece

TO ORDER PLEASE SPECIFY THE FOLLOWING:

WOOD

1. **MODEL NUMBER + W**
2. **FSC**
3. **CHASSIS WOOD FINISH**

LAYERS MAGNETIC WOOD TO TOP OF OVERHEAD

1H | for Layers Height Credenzas

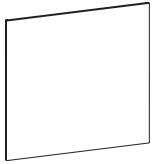

D	W	H	model number	veneer 1	veneer 2
3/4	24	46 3/16	GS2TLWD1H24- []	2,452	2,708
3/4	30	46 3/16	GS2TLWD1H30- []	2,515	2,777
3/4	36	46 3/16	GS2TLWD1H36- []	2,661	2,938
3/4	42	46 3/16	GS2TLWD1H42- []	2,892	3,193
3/4	48	46 3/16	GS2TLWD1H48- []	2,985	3,296
3/4	54	46 3/16	GS2TLWD1H54- []	3,132	3,458
3/4	60	46 3/16	GS2TLWD1H60- []	3,290	3,633
3/4	66	46 3/16	GS2TLWD1H66- []	3,455	3,814
3/4	72	46 3/16	GS2TLWD1H72- []	3,627	4,005
3/4	78	46 3/16	GS2TLWD1H78- []	3,809	4,205
3/4	84	46 3/16	GS2TLWD1H84- []	3,999	4,415
3/4	90	46 3/16	GS2TLWD1H90- []	4,199	4,635
3/4	96	46 3/16	GS2TLWD1H96- []	4,409	4,867
3/4	102	46 3/16	GS2TLWD1H102- []	4,630	5,111
3/4	108	46 3/16	GS2TLWD1H108- []	4,861	5,366

PRODUCT INFO

Tackzone is magnetic.
It is not recommended to stack wood units side by side due to grain variation. Contact Tailored Solutions for a matched set.

24" - 48" = 1 piece
54" - 102" = 2 piece
108" = 3 piece

TO ORDER PLEASE SPECIFY THE FOLLOWING:

WOOD

1. **MODEL NUMBER + W**
2. **FSC**
3. **CHASSIS WOOD FINISH**

LAYERS MAGNETIC WOOD TO TOP OF OVERHEAD

2H | for Layers Height Credenzas

Silea

03/23

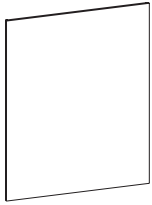

D	W	H	model number	veneer 1	veneer 2
3/4	24	59 9/16	GS2TLWD2H24- []	2,596	2,867
3/4	30	59 9/16	GS2TLWD2H30- []	2,661	2,938
3/4	36	59 9/16	GS2TLWD2H36- []	2,892	3,193
3/4	42	59 9/16	GS2TLWD2H42- []	2,985	3,296
3/4	48	59 9/16	GS2TLWD2H48- []	3,143	3,470
3/4	54	59 9/16	GS2TLWD2H54- []	3,302	3,646
3/4	60	59 9/16	GS2TLWD2H60- []	3,467	3,828
3/4	66	59 9/16	GS2TLWD2H66- []	3,640	4,019
3/4	72	59 9/16	GS2TLWD2H72- []	3,822	4,219
3/4	78	59 9/16	GS2TLWD2H78- []	4,014	4,432
3/4	84	59 9/16	GS2TLWD2H84- []	4,213	4,652
3/4	90	59 9/16	GS2TLWD2H90- []	4,426	4,886
3/4	96	59 9/16	GS2TLWD2H96- []	4,647	5,130
3/4	102	59 9/16	GS2TLWD2H102- []	4,879	5,386
3/4	108	59 9/16	GS2TLWD2H108- []	5,121	5,653

PRODUCT INFO

Tackzone is magnetic.

It is not recommended to stack wood units side by side due to grain variation. Contact Tailored Solutions for a matched set.

24" - 48" = 1 piece

54" - 102" = 2 piece

108" = 3 piece

TO ORDER PLEASE SPECIFY THE FOLLOWING:

WOOD

1. **MODEL NUMBER + W**
2. **FSC**
3. **CHASSIS WOOD FINISH**

MAGNETIC WOOD TACKZONE FOR MOUNTING 1H OVERHEADS AT 6H HEIGHT

for Standard Height Credenzas

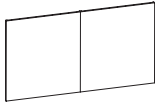

D	W	H	model number + type	veneer 1	veneer 2
7/8	24	38 1/4	GS2TTWD24- []	2,335	2,579
7/8	30	38 1/4	GS2TTWD30- []	2,396	2,646
7/8	36	38 1/4	GS2TTWD36- []	2,536	2,800
7/8	42	38 1/4	GS2TTWD42- []	2,753	3,040
7/8	48	38 1/4	GS2TTWD48- []	2,842	3,138
7/8	54	38 1/4	GS2TTWD54- []	2,985	3,296
7/8	60	38 1/4	GS2TTWD60- []	3,132	3,458
7/8	66	38 1/4	GS2TTWD66- []	3,290	3,633
7/8	72	38 1/4	GS2TTWD72- []	3,455	3,814
7/8	78	38 1/4	GS2TTWD78- []	3,627	4,005
7/8	84	38 1/4	GS2TTWD84- []	3,809	4,205
7/8	90	38 1/4	GS2TTWD90- []	3,999	4,415
7/8	96	38 1/4	GS2TTWD96- []	4,199	4,635
7/8	102	38 1/4	GS2TTWD102- []	4,409	4,867
7/8	108	38 1/4	GS2TTWD108- []	4,630	5,111

- Can be used in height adjustable applications with overheads to create clearance for desk and monitors. Monitor height should be verified.

PRODUCT INFO

Tackzone is magnetic.
It is not recommended to stack wood units side by side due to grain variation. Contact Tailored Solutions for a matched set.
54"-96" models are 2-piece.
102"-108" models are 3-piece.

TO ORDER PLEASE SPECIFY THE FOLLOWING:

WOOD

- 1. MODEL NUMBER + W**
- 2. FSC**
- 3. CHASSIS WOOD FINISH**

SHELVING FOR WALL MOUNT WALL

8 1/2" depth

Silea
03/23

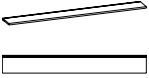
	D	W	H	model number + type	laminate	aluminum	veneer 1	veneer 2	
ALUMINUM  Side view	8 1/2	30	3/4	GS2ASF830- <input type="checkbox"/>	616	806	893	986	
	8 1/2	36	3/4	GS2ASF836- <input type="checkbox"/>	667	870	965	1,066	
	8 1/2	42	3/4	GS2ASF842- <input type="checkbox"/>	742	952	1,077	1,190	
	8 1/2	48	3/4	GS2ASF848- <input type="checkbox"/>	817	1,045	1,184	1,308	
	8 1/2	54	3/4	GS2ASF854- <input type="checkbox"/>	893	1,140	1,294	1,430	
	8 1/2	60	3/4	GS2ASF860- <input type="checkbox"/>	966	1,259	1,396	1,541	
	8 1/2	66	3/4	GS2ASF866- <input type="checkbox"/>	1,032	1,344	1,495	1,651	
	8 1/2	72	3/4	GS2ASF872- <input type="checkbox"/>	1,090	1,417	1,577	1,742	
	LAM / WOOD  Side view	8 1/2	78	3/4	GS2ASF878- <input type="checkbox"/>	1,147	1,496	1,664	1,838
		8 1/2	84	3/4	GS2ASF884- <input type="checkbox"/>	1,209	1,571	1,747	1,930
8 1/2		90	3/4	GS2ASF890- <input type="checkbox"/>	1,350	1,758	1,956	2,160	
8 1/2		96	3/4	GS2ASF896- <input type="checkbox"/>	1,401	1,820	2,024	2,235	
8 1/2		102	3/4	GS2ASF8102- <input type="checkbox"/>	1,448	1,884	2,093	2,311	
8 1/2		108	3/4	GS2ASF8108- <input type="checkbox"/>	1,497	1,948	2,165	2,391	
8 1/2		114	3/4	GS2ASF8114- <input type="checkbox"/>	1,787	2,171	2,590	2,860	
8 1/2		120	3/4	GS2ASF8120- <input type="checkbox"/>	1,932	2,515	2,795	3,087	
8 1/2		132	3/4	GS2ASF8132- <input type="checkbox"/>	2,069	N/A	2,996	3,308	
8 1/2		144	3/4	GS2ASF8144- <input type="checkbox"/>	2,181	N/A	3,161	3,490	

• Note: Weight capacity for 8 1/2" depth shelves is 1.75 lbs per linear inch of shelf width. Load should be evenly distributed.

PRODUCT INFO

Aluminum shelf is powder coated.

An aluminum rail is mounted to back of shelf.

Laminate shelves (2) piece above 96".

All aluminum shelves are (1) piece.

Wood shelves (2) piece above 120".

Light ordered separately:
 30" and 36" = (1) 24" light
 60" = (1) 48" light
 66" through 108" = (1) 60" light
 120" = (2) 48" lights

TO ORDER PLEASE SPECIFY THE FOLLOWING:

WOOD



- MODEL NUMBER + W**
- FSC**
- CHASSIS WOOD FINISH**
- EXTRUSION COLOR**

ALUMINUM

- MODEL NUMBER + A**
- EXTRUSION COLOR**

LAM

- MODEL NUMBER + L**
- FSC**
- CHASSIS LAM**
- EXTRUSION COLOR**

	D	W	H	model number + type	laminate	aluminum	veneer 1	veneer 2	
ALUMINUM  Side view	12 1/2	30	3/4	GS2ASF1230- <input type="checkbox"/>	685	895	995	1,099	
	12 1/2	36	3/4	GS2ASF1236- <input type="checkbox"/>	740	966	1,074	1,187	
	12 1/2	42	3/4	GS2ASF1242- <input type="checkbox"/>	825	1,057	1,195	1,320	
	12 1/2	48	3/4	GS2ASF1248- <input type="checkbox"/>	909	1,161	1,316	1,454	
	12 1/2	54	3/4	GS2ASF1254- <input type="checkbox"/>	992	1,264	1,437	1,587	
	12 1/2	60	3/4	GS2ASF1260- <input type="checkbox"/>	1,074	1,396	1,552	1,714	
	12 1/2	66	3/4	GS2ASF1266- <input type="checkbox"/>	1,147	1,495	1,661	1,835	
	12 1/2	72	3/4	GS2ASF1272- <input type="checkbox"/>	1,211	1,612	1,751	1,934	
	LAM / WOOD  Side view	12 1/2	78	3/4	GS2ASF1278- <input type="checkbox"/>	1,278	1,697	1,847	2,039
		12 1/2	84	3/4	GS2ASF1284- <input type="checkbox"/>	1,344	1,785	1,942	2,144
12 1/2		90	3/4	GS2ASF1290- <input type="checkbox"/>	1,501	1,955	2,172	2,398	
12 1/2		96	3/4	GS2ASF1296- <input type="checkbox"/>	1,552	2,023	2,249	2,484	
12 1/2		102	3/4	GS2ASF12102- <input type="checkbox"/>	1,607	2,093	2,327	2,569	
12 1/2		108	3/4	GS2ASF12108- <input type="checkbox"/>	1,663	2,213	2,405	2,655	
12 1/2		114	3/4	GS2ASF12114- <input type="checkbox"/>	1,925	2,417	2,791	3,081	
12 1/2		120	3/4	GS2ASF12120- <input type="checkbox"/>	2,147	2,797	3,107	3,430	
12 1/2		132	3/4	GS2ASF12132- <input type="checkbox"/>	2,298	N/A	3,328	3,674	
12 1/2		144	3/4	GS2ASF12144- <input type="checkbox"/>	2,423	N/A	3,514	3,880	

• Note: Weight capacity for 12 1/2" depth shelves is 2.50 lbs per linear inch of shelf width. Load should be evenly distributed.

PRODUCT INFO

Aluminum shelf is powder coated.

An aluminum rail is mounted to back of shelf.

Laminate shelves (2) piece above 96".

All aluminum shelves are (1) piece.

Wood shelves (2) piece above 120".

Light ordered separately:
 30" and 36" = (1) 24" light
 60" = (1) 48" light
 66" through 108" = (1) 60" light
 120" = (2) 48" lights

TO ORDER PLEASE SPECIFY THE FOLLOWING:

WOOD

- MODEL NUMBER + W**
- FSC**
- CHASSIS WOOD FINISH**
- EXTRUSION COLOR**

ALUMINUM

- MODEL NUMBER + A**
- EXTRUSION COLOR**

LAM

- MODEL NUMBER + L**
- FSC**
- CHASSIS LAM**
- EXTRUSION COLOR**

FLOATING SHELVES

Silea
03/23

	D	W	H	model number + type	laminate	veneer 1	veneer 2
	8	30	1 3/16	GS2FSF830- <input type="checkbox"/>	629	911	1,006
	8	36	1 3/16	GS2FSF836- <input type="checkbox"/>	681	985	1,088
	8	42	1 3/16	GS2FSF842- <input type="checkbox"/>	801	1,161	1,282
	8	48	1 3/16	GS2FSF848- <input type="checkbox"/>	900	1,305	1,442
	8	54	1 3/16	GS2FSF854- <input type="checkbox"/>	944	1,368	1,511
	8	60	1 3/16	GS2FSF860- <input type="checkbox"/>	984	1,427	1,576
	8	66	1 3/16	GS2FSF866- <input type="checkbox"/>	1,036	1,501	1,657
	8	72	1 3/16	GS2FSF872- <input type="checkbox"/>	1,111	1,611	1,779

NOTE: For display purposes only.
5 lb. weight restriction per linear foot.

PRODUCT INFO	TO ORDER PLEASE SPECIFY THE FOLLOWING:		
	<table style="width: 100%; border: none;"> <tr> <td style="width: 50%; vertical-align: top;"> <p>WOOD</p> <ol style="list-style-type: none"> 1. MODEL NUMBER + W 2. FSC 3. CHASSIS WOOD FINISH </td> <td style="width: 50%; vertical-align: top;"> <p>LAM</p> <ol style="list-style-type: none"> 1. MODEL NUMBER + L 2. FSC 3. CHASSIS LAM </td> </tr> </table>	<p>WOOD</p> <ol style="list-style-type: none"> 1. MODEL NUMBER + W 2. FSC 3. CHASSIS WOOD FINISH 	<p>LAM</p> <ol style="list-style-type: none"> 1. MODEL NUMBER + L 2. FSC 3. CHASSIS LAM
<p>WOOD</p> <ol style="list-style-type: none"> 1. MODEL NUMBER + W 2. FSC 3. CHASSIS WOOD FINISH 	<p>LAM</p> <ol style="list-style-type: none"> 1. MODEL NUMBER + L 2. FSC 3. CHASSIS LAM 		

Surface Mount	305-318
Cabinets	306-310
Towers	311-316
Tackboard	317
External Tops	318

SURFACE MOUNT CABINETS

w/ Hinged Doors | 1H

Silea

03/23

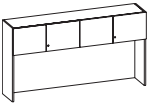
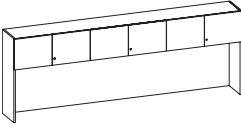
	D	W	H	model number + type	laminate	veneer 1	veneer 2
	15 3/4	59 7/8	39 1/16	GS2SMC1H60- []	4,065	5,883	6,495
	15 3/4	65 7/8	39 1/16	GS2SMC1H66- []	4,215	6,100	6,734
	15 3/4	71 7/8	39 1/16	GS2SMC1H72- []	4,566	6,605	7,291
	15 3/4	77 7/8	39 1/16	GS2SMC1H78- []	4,654	6,734	7,434
	15 3/4	83 7/8	39 1/16	GS2SMC1H84- []	4,889	7,074	7,809
	15 3/4	89 7/8	39 1/16	GS2SMC1H90- []	5,151	7,451	8,225
	15 3/4	95 7/8	39 1/16	GS2SMC1H96- []	5,414	7,835	8,650
	15 3/4	101 7/8	39 1/16	GS2SMC1H102- []	N/A	8,550	9,439
	15 3/4	107 7/8	39 1/16	GS2SMC1H108- []	N/A	9,105	10,052

PRODUCT INFO

of doors:
 60" through 78" = 4 doors
 84" through 108" = 6 doors
 All units have a finished back.
 If tasklight cord grommet is chosen (WY), a 1 1/4" hole is included in back panel.

TO ORDER PLEASE SPECIFY THE FOLLOWING:

- | | |
|----------------------------------|----------------------------------|
| WOOD CHASSIS, WOOD DOOR | LAM CHASSIS, LAM DOOR |
| 1. MODEL NUMBER + WW | 1. MODEL NUMBER + LL |
| 2. FSC | 2. FSC |
| 3. CHASSIS WOOD FINISH | 3. CHASSIS LAM |
| 4. TASKLIGHT CORD GROMMET | 4. FRONT LAM |
| 5. LOCKS | 5. TASKLIGHT CORD GROMMET |
| 6. KEYING | 6. LOCKS |
| | 7. KEYING |

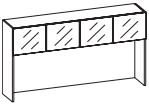
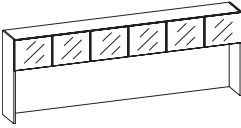
	D	W	H	model number + type	veneer 1	veneer 2
 	15 3/4	59 7/8	39 1/16	GS2SMC1H60- []	7,187	7,934
	15 3/4	71 7/8	39 1/16	GS2SMC1H72- []	8,074	8,913
	15 3/4	89 7/8	39 1/16	GS2SMC1H90- []	9,109	10,056
	15 3/4	107 7/8	39 1/16	GS2SMC1H108- []	11,127	12,283

PRODUCT INFO

of doors:

60" and 72" = 4 doors
90" and 108" = 6 doors

All units have a finished back.

Glass doors do not lock.

Door frames match glass color.

If tasklight cord grommet is chosen (WY), a 1 1/4" hole is included in back panel.

TO ORDER PLEASE SPECIFY THE FOLLOWING:

WOOD CHASSIS, GLASS DOOR

1. **MODEL NUMBER + WG**
2. **FSC**
3. **CHASSIS WOOD FINISH**
4. **GLASS**
5. **TASKLIGHT CORD GROMMET**

SURFACE MOUNT CABINETS

No Doors | 1H

Silea

03/23

	D	W	H	model number + type	laminat	veneer 1	veneer 2
	14 7/8	59 7/8	39 1/16	GS2SMC1H60- []	3,456	5,006	5,526
	14 7/8	65 7/8	39 1/16	GS2SMC1H66- []	3,584	5,192	5,732
	14 7/8	71 7/8	39 1/16	GS2SMC1H72- []	3,879	5,622	6,207
	14 7/8	77 7/8	39 1/16	GS2SMC1H78- []	3,956	5,735	6,332
	14 7/8	83 7/8	39 1/16	GS2SMC1H84- []	4,154	6,021	6,647
	14 7/8	89 7/8	39 1/16	GS2SMC1H90- []	4,377	6,341	7,000
	14 7/8	95 7/8	39 1/16	GS2SMC1H96- []	4,602	6,670	7,364
	14 7/8	101 7/8	39 1/16	GS2SMC1H102- []	N/A	7,276	8,032
	14 7/8	107 7/8	39 1/16	GS2SMC1H108- []	N/A	7,749	8,554

PRODUCT INFO

of doors:
 60" through 78" = 4 doors
 84" and 90" = 6 doors
 All units have a finished back.
 If tasklight cord grommet is chosen (WY), a 1 1/4" hole is included in back panel.

TO ORDER PLEASE SPECIFY THE FOLLOWING:

WOOD CHASSIS

1. **MODEL NUMBER + WN**
2. **FSC**
3. **CHASSIS WOOD FINISH**
4. **TASKLIGHT CORD GROMMET**

LAM CHASSIS

1. **MODEL NUMBER + LN**
2. **FSC**
3. **CHASSIS LAM**
4. **TASKLIGHT CORD GROMMET**

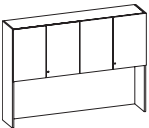
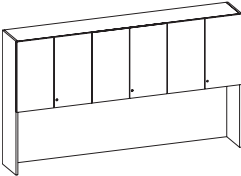
	D	W	H	model number + type	veneer 1	veneer 2
	15 3/4	59 7/8	52 7/16	GS2SMC2H60- []	7,131	7,873
	15 3/4	65 7/8	52 7/16	GS2SMC2H66- []	7,315	8,075
	15 3/4	71 7/8	52 7/16	GS2SMC2H72- []	7,613	8,404
	15 3/4	77 7/8	52 7/16	GS2SMC2H78- []	8,052	8,889
	15 3/4	83 7/8	52 7/16	GS2SMC2H84- []	8,456	9,335
	15 3/4	89 7/8	52 7/16	GS2SMC2H90- []	8,860	9,780

• Not for use w/ credenza trough top.

PRODUCT INFO

of doors:
60" through 78" = 4 doors
84" and 90" = 6 doors
All units have a finished back.
If tasklight cord grommet is chosen (WY), a 1 1/4" hole is included in back panel.

TO ORDER PLEASE SPECIFY THE FOLLOWING:

WOOD CHASSIS, WOOD DOOR

1. **MODEL NUMBER + WW**
2. **FSC**
3. **CHASSIS WOOD FINISH**
4. **TASKLIGHT CORD GROMMET**
5. **LOCKS**
6. **KEYING**

SURFACE MOUNT CABINETS

w/ Hinged Glass Doors | 2H

Silea

03/23

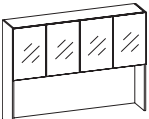
	D	W	H	model number + type	veneer 1	veneer 2
	15 3/4	59 7/8	52 7/16	GS2SMC2H60- []	8,718	9,624
	15 3/4	71 7/8	52 7/16	GS2SMC2H72- []	9,305	10,272
	15 3/4	89 7/8	52 7/16	GS2SMC2H90- []	10,830	11,955

• Not for use w/ credenza trough top.

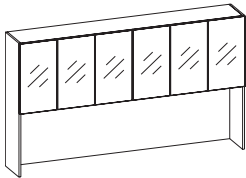

PRODUCT INFO

of doors:

60" and 72" = 4 doors

90" = 6 doors

Glass doors do not lock.

All units have a finished back.





Door frames match glass color.

If tasklight cord grommet is chosen (WY), a 1 1/4" hole is included in back panel.

TO ORDER PLEASE SPECIFY THE FOLLOWING:

WOOD CHASSIS, GLASS DOOR

1. **MODEL NUMBER + WG**
2. **FSC**
3. **CHASSIS WOOD FINISH**
4. **GLASS**
5. **TASKLIGHT CORD GROMMET**

		D	W	H	model number + type	laminate	veneer 1	veneer 2
15" WIDTH								
 1 door Door hinged left	LEFT	15 3/4	15	39 1/16	GS2STF1H15L- <input type="checkbox"/>	1,201	1,522	1,681
	RIGHT	15 3/4	15	39 1/16	GS2STF1H15R- <input type="checkbox"/>	1,201	1,522	1,681
18" WIDTH								
 1 door Door hinged left	LEFT	15 3/4	18	39 1/16	GS2STF1H18L- <input type="checkbox"/>	1,501	1,901	2,099
	RIGHT	15 3/4	18	39 1/16	GS2STF1H18R- <input type="checkbox"/>	1,501	1,901	2,099
30" WIDTH								
 2 doors		15 3/4	30	39 1/16	GS2STF1H30- <input type="checkbox"/>	2,431	3,076	3,396
36" WIDTH								
 2 doors		15 3/4	36	39 1/16	GS2STF1H36- <input type="checkbox"/>	2,735	3,465	3,825

PRODUCT INFO

All units have a finished back.
If integral pull is chosen for wood, doors will be touch latch.

TO ORDER PLEASE SPECIFY THE FOLLOWING:





- | | |
|-------------------------------|-----------------------------|
| WOOD CHASSIS, WOOD DOOR | LAM CHASSIS, LAM DOOR |
| 1. MODEL NUMBER + WW | 1. MODEL NUMBER + LL |
| 2. FSC | 2. FSC |
| 3. CHASSIS WOOD FINISH | 3. CHASSIS LAM |
| 4. PULLS | 4. FRONT LAM |
| 5. LOCKS | 5. PULLS |
| 6. KEYING | 6. LOCKS |
| | 7. KEYING |

SURFACE MOUNT TOWERS

w/ Hinged Glass Doors | 1H

Silea

03/23

	D	W	H	model number + type	veneer 1	veneer 2
15" WIDTH						
 1 door	LEFT	15 3/4	15	39 1/16	GS2STF1H15L- []	1,858 2,051
	RIGHT	15 3/4	15	39 1/16	GS2STF1H15R- []	1,858 2,051
18" WIDTH						
 1 door	LEFT	15 3/4	18	39 1/16	GS2STF1H18L- []	2,324 2,566
	RIGHT	15 3/4	18	39 1/16	GS2STF1H18R- []	2,324 2,566
30" WIDTH						
 2 doors		15 3/4	30	39 1/16	GS2STF1H30- []	3,762 4,154
36" WIDTH						
 2 doors		15 3/4	36	39 1/16	GS2STF1H36- []	4,234 4,675





PRODUCT INFO

All units have a finished back.
 Door frames match glass color.
 Glass doors do not lock and are touch latch.

TO ORDER PLEASE SPECIFY THE FOLLOWING:

WOOD CHASSIS, GLASS DOOR

1. **MODEL NUMBER + WG**
2. **FSC**
3. **CHASSIS WOOD FINISH**
4. **GLASS**

	D	W	H	model number + type	laminata	veneer 1	veneer 2
15" WIDTH 	14 7/8	15	39 1/16	GS2STN1H15- []	1,069	1,355	1,496
18" WIDTH 	14 7/8	18	39 1/16	GS2STN1H18- []	1,335	1,691	1,867
30" WIDTH 	14 7/8	30	39 1/16	GS2STN1H30- []	2,182	2,762	3,049
36" WIDTH 	14 7/8	36	39 1/16	GS2STN1H36- []	2,454	3,110	3,434

PRODUCT INFO

All units have a finished back.

TO ORDER PLEASE SPECIFY THE FOLLOWING:

WOOD CHASSIS

- MODEL NUMBER + WN**
- FSC**
- CHASSIS WOOD FINISH**

LAM CHASSIS



- MODEL NUMBER + LN**
- FSC**
- CHASSIS LAM**

SURFACE MOUNT TOWERS

w/ Hinged Doors | 2H

Silea

03/23

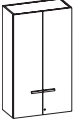
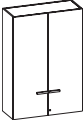
	D	W	H	model number + type	laminate	veneer 1	veneer 2	
15" WIDTH								
 1 door	LEFT	15 3/4	15	52 7/16	GS2STF2H15L- []	2,033	2,576	2,845
	RIGHT	15 3/4	15	52 7/16	GS2STF2H15R- []	2,033	2,576	2,845
18" WIDTH								
 1 door	LEFT	15 3/4	18	52 7/16	GS2STF2H18L- []	2,541	3,219	3,554
	RIGHT	15 3/4	18	52 7/16	GS2STF2H18R- []	2,541	3,219	3,554
30" WIDTH								
 2 doors		15 3/4	30	52 7/16	GS2STF2H30- []	2,797	3,544	3,913
36" WIDTH								
 2 doors		15 3/4	36	52 7/16	GS2STF2H36- []	3,128	3,964	4,377

• Not for use w/ credenza trough top.

PRODUCT INFO

Type must be specified as part
All units have a finished back.
If integral pull is chosen for
wood, doors will be touch
latch.

TO ORDER PLEASE SPECIFY THE FOLLOWING:

WOOD CHASSIS, WOOD DOOR

1. **MODEL NUMBER + WW**
2. **FSC**
3. **CHASSIS WOOD FINISH**
4. **PULLS**
5. **LOCKS**
6. **KEYING**

LAM CHASSIS, LAM DOOR

1. **MODEL NUMBER + LL**
2. **FSC**
3. **CHASSIS LAM**
4. **FRONT LAM**
5. **PULLS**
6. **LOCKS**
7. **KEYING**

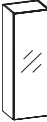
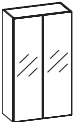
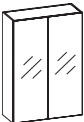
	D	W	H	model number + type	veneer 1	veneer 2
15" WIDTH						
 1 door	LEFT	15 3/4	15	52 7/16	GS2STF2H15L- []	3,144 3,471
	RIGHT	15 3/4	15	52 7/16	GS2STF2H15R- []	3,144 3,471
18" WIDTH						
 1 door	LEFT	15 3/4	18	52 7/16	GS2STF2H18L- []	3,933 4,342
	RIGHT	15 3/4	18	52 7/16	GS2STF2H18R- []	3,933 4,342
30" WIDTH						
 2 doors		15 3/4	30	52 7/16	GS2STF2H30- []	4,331 4,782
36" WIDTH						
 2 doors		15 3/4	36	52 7/16	GS2STF2H36- []	4,845 5,349

• Not for use w/ credenza trough top.

PRODUCT INFO

All units have a finished back.
Door frames match glass color.
Glass doors do not lock and are touch latch.

TO ORDER PLEASE SPECIFY THE FOLLOWING:

WOOD CHASSIS, GLASS DOOR



1. **MODEL NUMBER + WG**
2. **FSC**
3. **CHASSIS WOOD FINISH**
4. **GLASS**

SURFACE MOUNT TOWERS

w/ No Doors, 2H

Silea

03/23

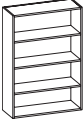
	D	W	H	model number + type	laminate	veneer 1	veneer 2
15" WIDTH 	14 7/8	15	52 7/16	GS2STN2H15- []	1,104	1,402	1,549
18" WIDTH 	14 7/8	18	52 7/16	GS2STN2H18- []	1,384	1,749	1,932
30" WIDTH 	14 7/8	30	52 7/16	GS2STN2H30- []	2,424	3,072	3,392
36" WIDTH 	14 7/8	36	52 7/16	GS2STN2H36- []	2,705	3,427	3,784

• Not for use w/ credenza trough top.

PRODUCT INFO

All units have a finished back.

TO ORDER PLEASE SPECIFY THE FOLLOWING:

WOOD CHASSIS

- MODEL NUMBER + WN**
- FSC**
- CHASSIS WOOD FINISH**

LAM CHASSIS

- MODEL NUMBER + LN**
- FSC**
- CHASSIS LAM**

fabric grades

COM/4



D	W	H	yards	model number	1	2	3	COM/4
7/8	58	23 7/8	1.00	GS2TKS60	997	1,042	1,090	1,138
7/8	64	23 7/8	1.00	GS2TKS66	1,013	1,058	1,106	1,154
7/8	70	23 7/8	1.25	GS2TKS72	1,054	1,105	1,159	1,214
7/8	76	23 7/8	1.25	GS2TKS78	1,082	1,138	1,199	1,260
7/8	82	23 7/8	1.25	GS2TKS84	1,113	1,169	1,230	1,291
7/8	88	23 7/8	1.50	GS2TKS90	1,164	1,226	1,292	1,357
7/8	94	23 7/8	1.50	GS2TKS96	1,212	1,280	1,352	1,425
7/8	100	23 7/8	1.75	GS2TKS102	1,672	1,744	1,824	1,904
7/8	106	23 7/8	1.75	GS2TKS108	1,733	1,812	1,897	1,982

PRODUCT INFO

102" and 108" wide tackboards are 2 piece.

For use with 1H and 2H surface mount cabinets.

See yards listed above for COM fabric requirements.

TO ORDER PLEASE SPECIFY THE FOLLOWING:

LIST

- 1. MODEL NUMBER**
- 2. FABRIC**
- 3. FSC TACKBOARDS**

FSC Tackboard Options

FSC = FSC Required (5% COM upcharge)

NR = FSC Not Required

SURFACE MOUNT EXTERNAL TOPS

For Units Without Doors

Silea

03/23

D	W	H	model number	laminate	veneer 1	veneer 2
14 7/8	30	1 3/16	GS2SMTOPN30- <input type="checkbox"/>	401	1,060	1,171
14 7/8	36	1 3/16	GS2SMTOPN36- <input type="checkbox"/>	455	710	785
14 7/8	60	1 3/16	GS2SMTOPN60- <input type="checkbox"/>	684	1,069	1,181
14 7/8	72	1 3/16	GS2SMTOPN72- <input type="checkbox"/>	786	1,228	1,356
14 7/8	90	1 3/16	GS2SMTOPN90- <input type="checkbox"/>	943	1,472	1,626
14 7/8	108	1 3/16	GS2SMTOPN108- <input type="checkbox"/>	1,098	1,714	1,893

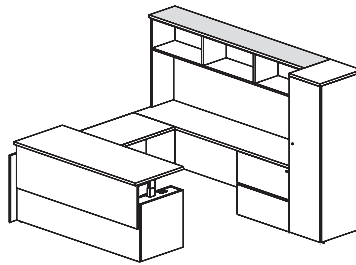

PRODUCT INFO

TO ORDER PLEASE SPECIFY THE FOLLOWING:

WOOD TOP

1. **MODEL NUMBER + W**
2. **FSC**
3. **TOP WOOD FINISH + EDGE**
4. **TOP FINISH**

Top Finish Option:

Non-UV Open Pore Finish

Full Fill UV Top Finish

NR

FF (+\$273)

LAM TOP

1. **MODEL NUMBER + L**
2. **FSC**
3. **TOP LAM**

Workwall	319-324
Workwalls.	320-321
Workwall Tackboard	322
Lounge Level Media Unit	323-324

WORKWALL

Wall Mount

Silea

03/23

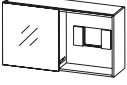
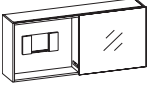
	D	W	H	model number + type	veneer 1	veneer 2
72" WIDTH  Left hand shown	19 1/2	72	39 1/16	GS2WSB3H72L- []	12,016	13,265
	19 1/2	72	39 1/16	GS2WSB3H72R- []	12,016	13,265
90" WIDTH  Right hand shown	19 1/2	90	39 1/16	GS2WSB3H90L- []	13,878	15,319
	19 1/2	90	39 1/16	GS2WSB3H90R- []	13,878	15,319

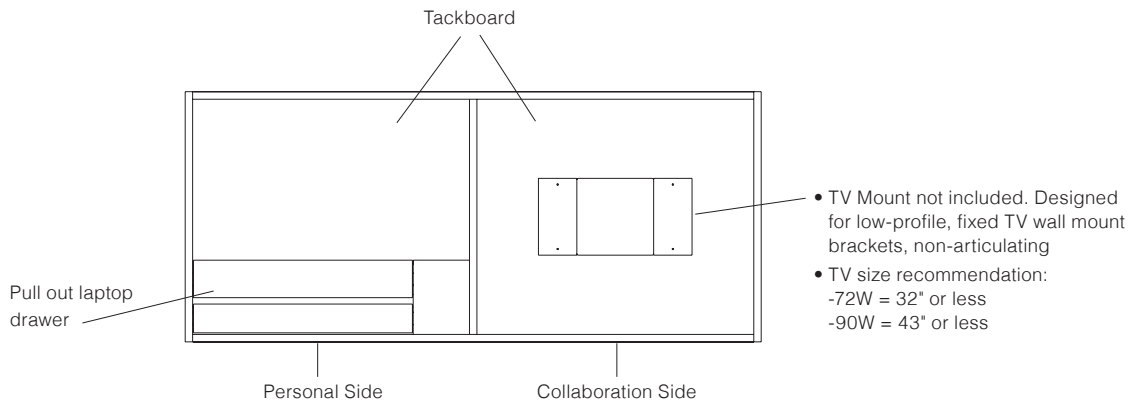

• Shown above with door removed.

PRODUCT INFO

Must order tackboard separately.
 2 power units included.
 Sliding glass door frame matches glass color.
 Whiteboard sliding door is non-magnetic.

TO ORDER PLEASE SPECIFY THE FOLLOWING:

WOOD CHASSIS, GLASS DOOR

1. **MODEL NUMBER + WSG**
2. **FSC**
3. **CHASSIS WOOD FINISH**
4. **GLASS**
5. **DRAWERS**
6. **POWER UNIT COLOR**

	D	W	H	model number + type	veneer 1	veneer 2
90" WIDTH	23 3/4	90	76	GS2FBX75H90L- []	23,664	26,121
	23 3/4	90	76	GS2FBX75H90R- []	23,664	26,121

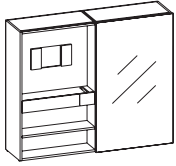

Right hand shown

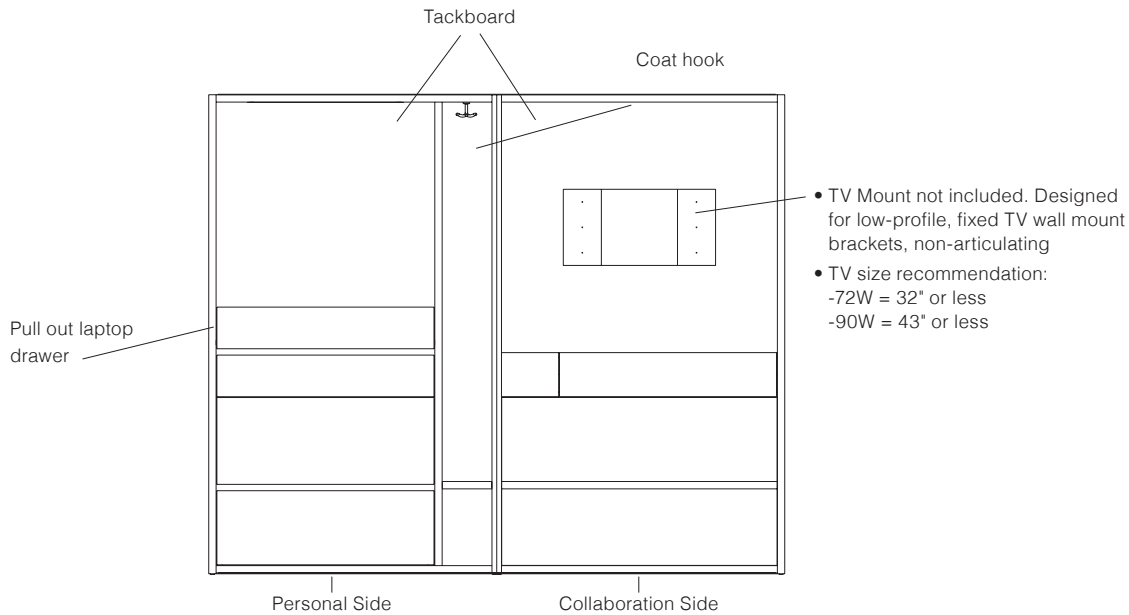

• 90" wide, shown above with door removed. 72" W does not have a closet.

PRODUCT INFO

Must order tackboard separately.
2 power units included.
Sliding glass door frame matches glass color.
Back panel optional.
Whiteboard sliding door is non-magnetic.

TO ORDER PLEASE SPECIFY THE FOLLOWING:

WOOD CHASSIS, GLASS DOOR

1. **MODEL NUMBER + WSG**
2. **FSC**
3. **CHASSIS WOOD FINISH**
4. **GLASS**
5. **BACK PANEL**
6. **DRAWERS**
7. **POWER UNIT COLOR**

						fabric grades			
D	W	H	yds	model number	1	2	3	COM/4	
	7/8	33 1/2	36 1/2	2.25	GS2TKWSB72	1,107	1,160	1,219	1,274
	7/8	42 1/2	36 1/2	2.75	GS2TKWSB90	1,222	1,287	1,358	1,425
• For use with Wall Mounted Workwalls, 2 pc									
	7/8	33 1/2	36 1/2	1.25	GS2TKWSB36	898	927	960	992
	7/8	42 1/2	36 1/2	1.50	GS2TKWSB45	942	984	1,031	1,075
• For use with Stack On Workwalls, 1 pc (Personal Side only)									
	7/8	33 1/2	36 1/2	2.25	GS2TKFBX72	1,107	1,160	1,219	1,274
	7/8	42 1/2	36 1/2	2.50	GS2TKFBX90	1,222	1,287	1,358	1,425
• For use with Freestanding Workwalls, 2 pc									

PRODUCT INFO

102" and 108" wide tackboards are 2 piece.

TO ORDER PLEASE SPECIFY THE FOLLOWING:

LIST

1. **MODEL NUMBER**
2. **FABRIC**
3. **FSC TACKBOARDS**

FSC Tackboard Options

FSC = FSC Required (5% COM upcharge)

NR = FSC Not Required

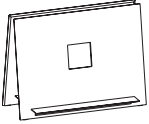
	D	W	H	model number + type	veneer 1	veneer 2
	30 1/4	66	49 1/2	GLLM48H66-WW	8,376	9,246

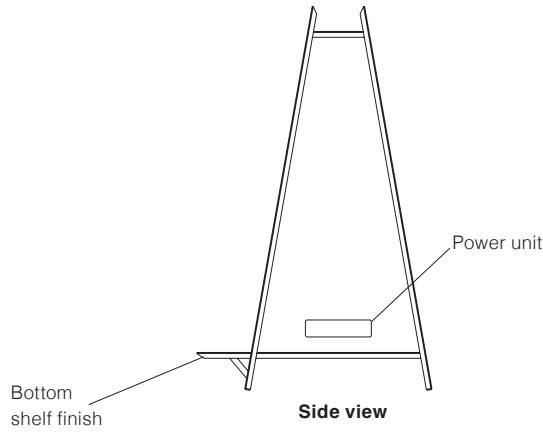

PRODUCT INFO

Wood models only.
 Bottom shelf can match chassis color, or be Ebony Walnut.
 2 power units included.
 TV mount not included.
 Designed for low-profile, fixed TV wall mount brackets, non-articulating. TV size recommendation is 66" or less.

TO ORDER PLEASE SPECIFY THE FOLLOWING:

WOOD

1. **MODEL NUMBER + WW**
2. **FSC**
3. **CHASSIS WOOD FINISH**
4. **BOTTOM SHELF FINISH**
5. **POWER UNIT COLOR**

LOUNGE LEVEL MEDIA UNIT

Whiteboard

Silea
03/23

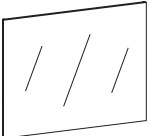
	D	W	H	model number	list
	1/2	58	36	GLLMTGW36H58W-GSA	3,643

PRODUCT INFO

Whiteboard frame matches
glass color.
Whiteboard is magnetic.

TO ORDER PLEASE SPECIFY THE FOLLOWING:

LIST

1. **MODEL NUMBER**
2. **GLASS COLOR**

Accessories	325-340
LED Tasklighting	326
Trough Accessories	327-328
Personal Corner	329
Drawer Filing Rails & Reinforcement Bars	330
Magnets	331
Counterweights	332
Wire Manager	333
Center Drawer	334
Pencil Tray	335
Grommet	336
Power Unit	337-339
3" Dia Field Installed Grommet	340
Grade Fabric Pricing	342-345
Weights + Cubes	346-384

	D	W	H	model number	lum
	3/4	23	5/8	ACTLED24	494
	3/4	35	5/8	ACTLED36	535
	3/4	47	5/8	ACTLED48	577
	3/4	59	5/8	ACTLED60	617

Product Specifications:

LED lighting provides high efficiency, low energy lighting with a long life. All LED lights are encased in a silver aluminum extrusion and include a built-in switch to turn the light on/off with a dimming feature. Lights are field installed. All units include a standard plug.

- Low profile strip light 5/8" H x 3/4" D
- Power: 2.92W / Foot
- LED's per meter: 120
- Color Temp: 3000K
- Certification: UL Listed
- GSA and TAA compliant

Size	Voltage	Wattage (W)	Luminous Flux (Lm)
24"	12 Volt DC	5.9	497
36"	12 Volt DC	8.8	746
48"	12 Volt DC	11.8	994
60"	12 Volt DC	14.6	1242





PRODUCT INFO

See product specs above.

TO ORDER PLEASE SPECIFY THE FOLLOWING:

LIST

- 1. MODEL NUMBER**

	D	W	H	model number	part
PAPER TRAY 	12	8 1/2	6	GS2AT-PAPER	196
PDA HOLDER 	6	3	6	GS2AT-PDA	155
• Note: Includes black non-slip surface to hold device on angled surface.					
PENCIL TRAY 	5	8	5	GS2AT-PNCL	155
PLUG HOLDER 	1	4	3	GS2AT-PLUG	155
SHELF 	6	8	6	GS2AT-SHELF	196

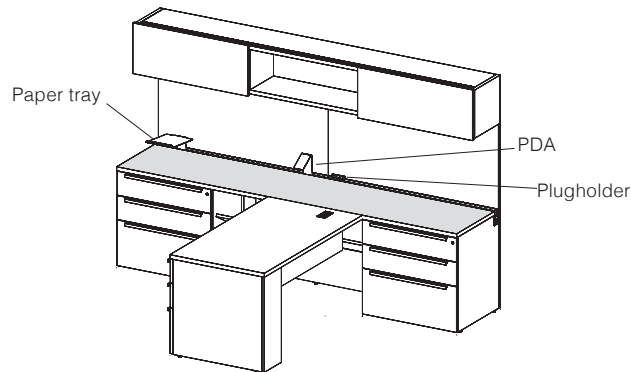

PRODUCT INFO

To be used with trough worksurface.
Available in 5 metal finish colors.

TO ORDER PLEASE SPECIFY THE FOLLOWING:

LIST

1. **MODEL NUMBER**
2. **HARDWARE COLOR**

TROUGH ACCESSORIES

Silea

03/23

Power Unit

	D	W	H	model number	sin#
	1 3/4	3	1 3/4	ACPWRT	735

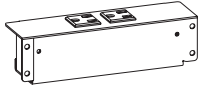

End of unit

- Includes 3 power outlets - 2 power outlets on top surface and 1 power outlet on end of unit.
- Ships with 6 ft power cord with standard plug
- UL listed
- Mounting bracket included for use installation in the following applications:
 - To bottom of worksurface beneath grommets
 - To bottom of worksurface in trough opening of trough worksurfaces
 - As power strip inside wall access panels or beneath desks

PRODUCT INFO

To be mounted in trough opening.

TO ORDER PLEASE SPECIFY THE FOLLOWING:

LIST

1. **MODEL NUMBER**

	D	W	H	model number	
	12 1/2	36	1 11/16	SACORNER	974

	18	36	1 11/16	SADSKPAD	1,379
---	----	----	---------	-----------------	-------

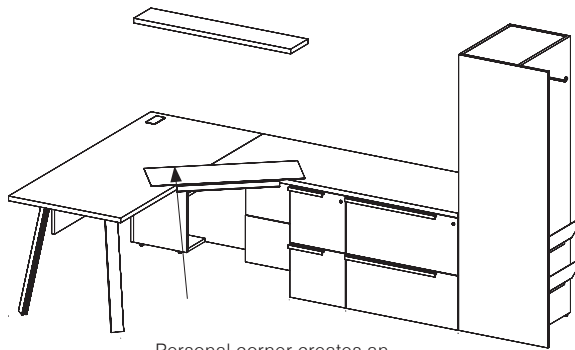

Personal corner creates an ergonomic corner to work.

PRODUCT INFO

LEATHER COLORS

Black **CBL**
White **CWH**
Chocolate **CCH**

VINYL COLORS

Black **VBL**
White **VWH**
Chocolate **VCH**







TO ORDER PLEASE SPECIFY THE FOLLOWING:

LIST

1. **MODEL NUMBER**
2. **COLOR**

DRAWER FILING RAILS & REINFORCEMENT BARS

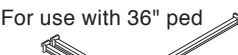
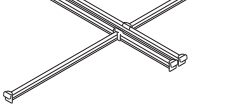
Silea
03/23

	D	W	H	model number	$\frac{1}{8}$
For use with smart pedestals 	$\frac{1}{8}$	5	1	ACFLR5-P	31
For use with 9" ped 	$\frac{1}{8}$	9	1	ACFLR9-P	34
For use with 15" ped 	$\frac{1}{8}$	15	1	ACFLR15-P	39
For use with 18" ped 	$\frac{1}{8}$	18	1	ACFLR18-P	41
For use with 30" ped 	$\frac{1}{8}$	18	1	ACFLR30-P	45
For use with 36" ped 	$\frac{1}{8}$	18	1	ACFLR36-P	50
Optional Lateral File Drawer Reinforcement Bar 	$1 \frac{1}{2}$	$1 \frac{9}{16}$	15	ACDRB-LAT	66

• **Note:** Lateral file drawer reinforcement bars are OPTIONAL, and are only required when excessive stacking of paper occurs in bottom of drawers. Reinforcement bars are oriented front-to-back on file drawers and front-to-back on lateral file drawers.

PRODUCT INFO

TO ORDER PLEASE SPECIFY THE FOLLOWING:

LIST

- MODEL NUMBER**

	Dia	H	model number	list
	$\frac{3}{8}$	$\frac{1}{2}$	SAMAGNET	99

QUANTITY 6

Note: Quantity 6 magnets included with each whiteboard 72" W and less.
Quantity 12 magnets included with each whiteboard 84"W and greater.

PRODUCT INFO

Magnets are silver.

TO ORDER PLEASE SPECIFY THE FOLLOWING:

LIST

- 1. MODEL NUMBER**

D	W	H	model number	list
$\frac{3}{16}$	12	15	ACCNTRWGT15	290
$\frac{1}{2}$	$8 \frac{5}{8}$	25	ACCNTRWGT30	326
$\frac{1}{2}$	$8 \frac{5}{8}$	28	ACCNTRWGT36	362

- For use when a 15" or 18" modular pedestal with drawers is used as a freestanding unit.

- For use when a 30" or 36" modular pedestal with drawers has a top and is a freestanding unit.

Examples:

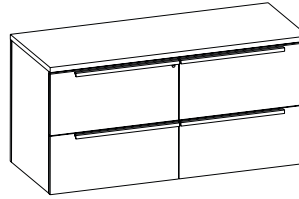
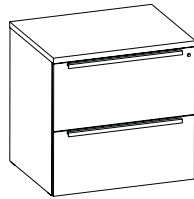

PRODUCT INFO

TO ORDER PLEASE SPECIFY THE FOLLOWING:

LIST

1. **MODEL NUMBER**

	Dia	H	model number	list
WIRE MANAGER	3 1/2	30	1 ACWM	111

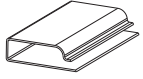

PRODUCT INFO

TO ORDER PLEASE SPECIFY THE FOLLOWING:

LIST

1. **MODEL NUMBER**

CENTER DRAWER

Silea
03/23

	D	W	H	model number + type	veneer 1	veneer 2
CENTER DRAWER	17 ⁵ / ₈	21 ³ / ₄	2 ¹⁵ / ₁₆	GS2CDWSD- []	795	878



INTERIOR DIMENSIONS

D = 15 ¹/₂
 W = 18 ¹/₄
 H = 1 ³/₈

- **Note:** Not available with a laminate drawer front.

PRODUCT INFO

Includes pencil tray.

TO ORDER PLEASE SPECIFY THE FOLLOWING:

WOOD

- 1. MODEL NUMBER + W**
- 2. CHASSIS WOOD FINISH**

	Dia	W	H	model number	sin
PENCIL TRAYS 	3	11 5/16	1 1/4	ACPT15-GAA	113
	3	14 5/16	1 1/4	ACPT18-GAA	120

PRODUCT INFO

TO ORDER PLEASE SPECIFY THE FOLLOWING:

LIST

- 1. MODEL NUMBER**

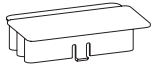

D	W	H	model number	list
2 1/2	5	1	GS2GMT	178

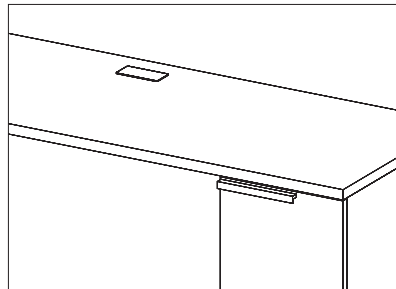

Closed

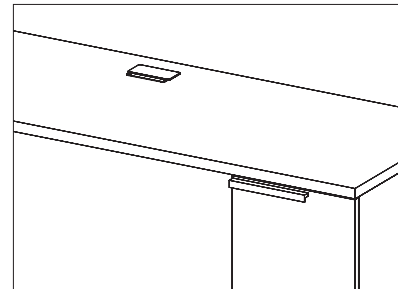

Small opening for cords

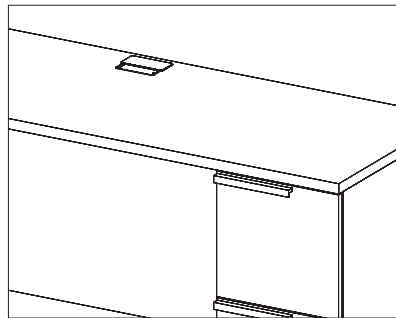

Large opening for monitor arms

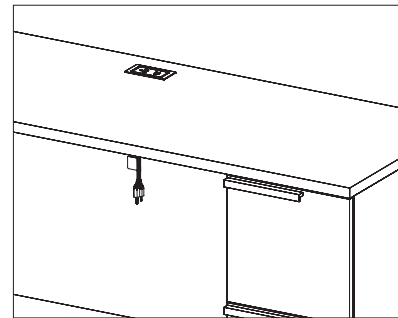

Grommet can be switched for ACUNOBZL-EU and ACUNOBZL-EU-HW power units

PRODUCT INFO

Available in 5 metal finish colors.
Do not place grommets over laptop drawer.

TO ORDER PLEASE SPECIFY THE FOLLOWING:

LIST

1. **MODEL NUMBER**
2. **HARDWARE COLOR**

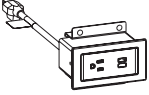
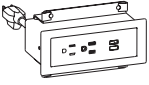
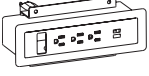
	D	W	H	model number	list
 <p>Can be used in grommet cutout</p>	2 7/8	4	1 3/4	ACUNOBZL-EU	431
	<ul style="list-style-type: none"> Includes 1 power, 2 USB - standard plug 				
	2 7/8	4	1 3/4	ACUNOBZL-EU-HW	431
<ul style="list-style-type: none"> Includes 1 power, 2 USB - hardwired 					
	2 7/8	5 1/2	1 3/4	ACDUOBZL-EEU	511
	<ul style="list-style-type: none"> Includes 2 USB, 2 power - standard plug 				
	2 7/8	5 1/2	1 3/4	ACDUOBZL-EEU-HW	511
<ul style="list-style-type: none"> Includes 2 USB, 2 power - hardwired 					
	2 7/8	8 1/16	1 3/4	ACTRIOBZL-EEEUD	588
	<ul style="list-style-type: none"> Includes 2 USB, 3 power, 1 data - standard plug 				
	2 7/8	8 1/16	1 3/4	ACTRIOBZL-EEEUD-HW	588
<ul style="list-style-type: none"> Includes 2 USB, 3 power, 1 data - hardwired 					

Data Port Kit included where applicable.

Insert options include:

- VGA
- Commscope
- Cable retainer
- Sieman
- Ortronics
- Belden EZ MDVO
- Mini-com
- Blank
- Keystone

PRODUCT INFO

ACUNOBZL-EU and ACUNOBZL-EU-HW models can be used in grommet cutout location.

10' standard plug or 6' hardwire power source.

TO ORDER PLEASE SPECIFY THE FOLLOWING:

LIST



1. **MODEL NUMBER**
2. **POWER UNIT COLOR**

POWER UNIT

Clamp mount

Silea

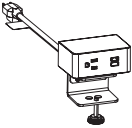
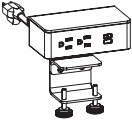
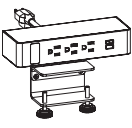
03/23

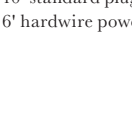
	D	W	H	model number	list
	2 7/8	4	1 3/4	ACUNOCLMP-EU	431
	<ul style="list-style-type: none"> Includes 1 power, 2 USB - standard plug 				
	2 7/8	4	1 3/4	ACUNOCLMP-EU-HW	431
	<ul style="list-style-type: none"> Includes 1 power, 2 USB - hardwired 				
	2 7/8	5 1/2	1 3/4	ACDUOCLMP-EEU	511
	<ul style="list-style-type: none"> Includes 2 USB, 2 power - standard plug 				
	2 7/8	5 1/2	1 3/4	ACDUOCLMP-EEU-HW	511
	<ul style="list-style-type: none"> Includes 2 USB, 2 power - hardwired 				
	2 7/8	8 1/16	1 3/4	ACTRIOCLMP-EEEUD	588
	<ul style="list-style-type: none"> Includes 2 USB, 3 power, 1 data - standard plug 				
	2 7/8	8 1/16	1 3/4	ACTRIOCLMP-EEEUD-HW	588
	<ul style="list-style-type: none"> Includes 2 USB, 3 power, 1 data - hardwired 				

Data Port Kit included where applicable.

Insert options include:

- VGA
- Commscope
- Cable retainer
- Sieman
- Ortronics
- Belden EZ MDVO
- Mini-com
- Blank
- Keystone

PRODUCT INFO

To be mounted on edge of worksurfaces.



Not to be used on height adjustable credenzas, returns or bridges on back edge of top or in grommet.

10' standard plug or 6' hardwire power source.

TO ORDER PLEASE SPECIFY THE FOLLOWING:

LIST

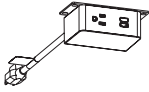
1. **MODEL NUMBER**
2. **POWER UNIT COLOR**

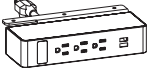
	D	W	H	model number	list
	2 7/8	4	1 3/4	ACPUNDER-EU	413
	• Includes 1 power, 2 USB - standard plug				
	2 7/8	4	1 3/4	ACPUNDER-EU-HW	413
• Includes 1 power, 2 USB - hardwired					
	2 7/8	5 1/2	1 3/4	GDAPPM-EEU	499
	• Includes 2 USB, 2 power - standard plug				
	2 7/8	5 1/2	1 3/4	GDAPPM-EEU-HW	499
• Includes 2 USB, 2 power - hardwired					
	2 7/8	8 1/16	1 3/4	ACTRIOUNDER-EEEUD	555
	• Includes 2 USB, 3 power, 1 data - standard plug				
	2 7/8	8 1/16	1 3/4	ACTRIOUNDER-EEEUD-HW	555
• Includes 2 USB, 3 power, 1 data - hardwired					

Data Port Kit included where applicable.

Insert options include:

- VGA
- Sieman
- Mini-com
- Commscope
- Ortronics
- Blank
- Cable retainer
- Belden EZ MDVO
- Keystone

PRODUCT INFO

10' Standard plug or 6' hardwire power source.

TO ORDER PLEASE SPECIFY THE FOLLOWING:

LIST

1. **MODEL NUMBER**
2. **POWER UNIT COLOR**

3" DIA FIELD INSTALLED GROMMET

Silea
03/23

	Dia	H	model number	list
FIELD INSTALL GROMMET	3	1	ACGRMTFLD	74



- 2 piece design - sleeve plus cover
- Fits standard 3" diameter cutout
- Plastic

PRODUCT INFO

TO ORDER PLEASE SPECIFY THE FOLLOWING:

LIST

- 1. MODEL NUMBER**
- 2. FIELD INSTALL GROMMET COLOR**
 - Black **BK**
 - Silver **SV**
 - White **WH**

GRADE FABRIC PRICING

Silea
03/23

model number	1	2	3	COM/4	5	6	7	8	9	10	11	12	13	14	15	16
--------------	---	---	---	-------	---	---	---	---	---	----	----	----	----	----	----	----

Cushions

GS2MPD-CUSH2215	528	545	564	582	607	633	653	680	703	729	753	777	808	832	861	894
GS2CLPD-CUSH2130T	595	618	642	667	701	734	762	796	827	858	894	924	964	996	1,034	1,076
GS2CLPD-CUSH2136T	642	671	702	734	777	815	852	893	932	973	1,012	1,053	1,105	1,144	1,193	1,244

Tackboards

GS2TKW30	817	838	863	887	919	953	978	1,009	1,040	1,071	1,104	1,134	1,173	1,204	1,239	1,281
GS2TKW36	856	884	914	946	984	1,023	1,058	1,098	1,136	1,174	1,215	1,251	1,301	1,340	1,387	1,436
GS2TKW42	887	916	946	979	1,020	1,060	1,095	1,136	1,176	1,216	1,257	1,297	1,350	1,388	1,436	1,488
GS2TKW48	918	948	980	1,012	1,056	1,098	1,134	1,176	1,218	1,257	1,301	1,343	1,396	1,437	1,486	1,541
GS2TKW54	952	984	1,015	1,050	1,093	1,137	1,176	1,221	1,264	1,305	1,347	1,390	1,445	1,488	1,541	1,597
GS2TKW60	997	1,042	1,090	1,138	1,201	1,266	1,319	1,384	1,443	1,508	1,571	1,632	1,709	1,771	1,848	1,924
GS2TKW66	1,013	1,058	1,106	1,154	1,217	1,282	1,335	1,400	1,459	1,524	1,587	1,648	1,725	1,787	1,864	1,940
GS2TKW72	1,054	1,105	1,159	1,214	1,286	1,355	1,419	1,489	1,557	1,628	1,699	1,766	1,858	1,925	2,008	2,100
GS2TKW78	1,082	1,138	1,199	1,260	1,340	1,420	1,488	1,569	1,644	1,725	1,804	1,880	1,978	2,054	2,150	2,249
GS2TKW84	1,113	1,169	1,230	1,291	1,371	1,451	1,519	1,600	1,675	1,756	1,835	1,911	2,009	2,085	2,181	2,280
GS2TKW90	1,164	1,226	1,292	1,357	1,447	1,533	1,609	1,698	1,779	1,870	1,955	2,039	2,149	2,232	2,335	2,443
GS2TKW96	1,212	1,280	1,352	1,425	1,519	1,616	1,698	1,792	1,882	1,977	2,073	2,164	2,282	2,372	2,486	2,604
GS2TKW102	1,672	1,744	1,824	1,904	2,007	2,108	2,197	2,300	2,400	2,501	2,604	2,703	2,830	2,928	3,051	3,181
GS2TKW108	1,733	1,812	1,897	1,982	2,094	2,203	2,300	2,414	2,519	2,632	2,742	2,849	2,985	3,093	3,226	3,363

Layers Tackboards

GS2TLKW30	858	881	908	932	965	999	1,027	1,061	1,093	1,127	1,159	1,191	1,230	1,264	1,303	1,345
GS2TLKW36	898	927	960	992	1,035	1,073	1,111	1,152	1,193	1,233	1,275	1,314	1,366	1,408	1,457	1,508
GS2TLKW42	931	963	994	1,031	1,072	1,114	1,153	1,197	1,236	1,277	1,321	1,363	1,418	1,458	1,510	1,563
GS2TLKW48	963	995	1,028	1,064	1,107	1,151	1,191	1,236	1,279	1,322	1,365	1,408	1,466	1,508	1,562	1,617
GS2TLKW54	997	1,032	1,065	1,102	1,148	1,190	1,232	1,279	1,323	1,367	1,414	1,460	1,517	1,561	1,618	1,673
GS2TLKW60	1,046	1,093	1,144	1,195	1,261	1,328	1,384	1,452	1,514	1,582	1,648	1,712	1,793	1,856	1,938	2,020
GS2TLKW66	1,065	1,111	1,163	1,214	1,280	1,347	1,403	1,471	1,533	1,600	1,666	1,730	1,812	1,875	1,957	2,038
GS2TLKW72	1,107	1,160	1,219	1,274	1,351	1,424	1,489	1,565	1,636	1,709	1,784	1,854	1,948	2,022	2,111	2,205
GS2TLKW78	1,138	1,197	1,261	1,326	1,409	1,494	1,564	1,650	1,728	1,813	1,896	1,976	2,080	2,158	2,258	2,508
GS2TLKW84	1,169	1,228	1,292	1,357	1,440	1,525	1,595	1,681	1,759	1,844	1,927	2,007	2,111	2,189	2,289	2,539
GS2TLKW90	1,222	1,287	1,358	1,425	1,518	1,609	1,689	1,782	1,868	1,962	2,053	2,140	2,255	2,342	2,451	2,565
GS2TLKW96	1,271	1,342	1,419	1,495	1,594	1,693	1,782	1,881	1,977	2,076	2,176	2,271	2,395	2,490	2,610	2,733
GS2TLKW102	1,755	1,830	1,915	1,997	2,104	2,213	2,306	2,414	2,516	2,626	2,732	2,837	2,972	3,073	3,203	3,340
GS2TLKW108	1,820	1,903	1,991	2,081	2,198	2,314	2,416	2,533	2,646	2,762	2,879	2,991	3,135	3,246	3,386	3,530

Tack to Top Overhead | 1H

GS2TKW1H30	1,025	1,046	1,071	1,095	1,127	1,161	1,186	1,217	1,248	1,279	1,312	1,342	1,381	1,412	1,447	1,489
GS2TKW1H36	1,044	1,072	1,102	1,134	1,172	1,211	1,246	1,286	1,324	1,362	1,403	1,439	1,489	1,528	1,575	1,624
GS2TKW1H42	1,084	1,119	1,154	1,190	1,239	1,287	1,330	1,378	1,422	1,471	1,519	1,565	1,624	1,669	1,727	1,784
GS2TKW1H48	1,118	1,153	1,188	1,224	1,273	1,321	1,364	1,412	1,456	1,505	1,553	1,599	1,658	1,703	1,761	1,818

model number 17 18 19 20 21 22 23 24 25 26 27 COL L1 L2 L3 L4 L5

Cushions

GS2MPD-CUSH2215	923	944	974	1,004	1,032	1,062	1,123	1,179	1,240	1,300	1,358	582	767	967	1,168	1,368	1,548
GS2CLPD-CUSH2130T	1,115	1,144	1,184	1,220	1,260	1,297	1,377	1,452	1,534	1,611	1,688	667	915	1,181	1,448	1,715	1,955
GS2CLPD-CUSH2136T	1,292	1,329	1,377	1,424	1,473	1,521	1,619	1,717	1,814	1,913	2,009	734	1,041	1,375	1,707	2,043	2,344

Tackboards

GS2TKW30	1,319	1,347	1,383	1,419	1,458	1,494	1,572	1,645	1,721	1,794	1,870						
GS2TKW36	1,482	1,518	1,565	1,611	1,658	1,706	1,799	1,892	1,986	2,082	2,173						
GS2TKW42	1,535	1,571	1,619	1,667	1,716	1,764	1,863	1,960	2,057	2,156	2,252						
GS2TKW48	1,590	1,627	1,678	1,726	1,775	1,826	1,928	2,028	2,128	2,232	2,331						
GS2TKW54	1,647	1,685	1,738	1,790	1,841	1,893	1,999	2,101	2,204	2,312	2,413						
GS2TKW60	2,001	2,055	2,131	2,202	2,278	2,356	2,506	2,654	2,805	2,957	3,104						
GS2TKW66	2,017	2,071	2,147	2,218	2,294	2,372	2,522	2,670	2,821	2,973	3,120						
GS2TKW72	2,183	2,247	2,329	2,413	2,498	2,579	2,753	2,918	3,087	3,261	3,426						
GS2TKW78	2,344	2,410	2,506	2,597	2,692	2,788	2,977	3,162	3,351	3,542	3,726						
GS2TKW84	2,375	2,441	2,537	2,628	2,723	2,819	3,008	3,193	3,382	3,573	3,757						
GS2TKW90	2,548	2,624	2,729	2,828	2,932	3,037	3,245	3,448	3,658	3,868	4,073						
GS2TKW96	2,718	2,801	2,914	3,021	3,134	3,248	3,475	3,699	3,926	4,150	4,373						
GS2TKW102	3,303	3,393	3,515	3,633	3,754	3,879	4,124	4,364	4,610	4,857	5,097						
GS2TKW108	3,495	3,591	3,723	3,851	3,984	4,115	4,382	4,643	4,908	5,171	5,431						

Layers Tackboards

GS2TLKW30	1,385	1,414	1,453	1,491	1,532	1,569	1,649	1,728	1,808	1,887	1,964						
GS2TLKW36	1,557	1,593	1,642	1,689	1,739	1,788	1,890	1,987	2,084	2,186	2,282						
GS2TLKW42	1,614	1,652	1,703	1,752	1,803	1,854	1,960	2,060	2,161	2,265	2,365						
GS2TLKW48	1,670	1,708	1,761	1,814	1,866	1,916	2,026	2,131	2,234	2,342	2,445						
GS2TLKW54	1,728	1,768	1,824	1,874	1,933	1,985	2,098	2,203	2,317	2,424	2,533						
GS2TLKW60	2,099	2,156	2,239	2,313	2,392	2,471	2,632	2,786	2,945	3,104	3,259						
GS2TLKW66	2,118	2,175	2,256	2,332	2,409	2,490	2,650	2,804	2,963	3,120	3,278						
GS2TLKW72	2,290	2,358	2,446	2,532	2,622	2,710	2,891	3,064	3,243	3,423	3,598						
GS2TLKW78	2,462	2,532	2,633	2,729	2,828	2,928	3,127	3,322	3,519	3,721	3,913						
GS2TLKW84	2,493	2,563	2,664	2,760	2,859	2,959	3,158	3,353	3,550	3,752	3,944						
GS2TLKW90	2,674	2,754	2,864	2,968	3,078	3,187	3,407	3,622	3,843	4,061	4,274						
GS2TLKW96	2,853	2,938	3,057	3,171	3,291	3,409	3,648	3,881	4,119	4,356	4,592						
GS2TLKW102	3,466	3,561	3,689	3,813	3,940	4,071	4,330	4,581	4,840	5,100	5,352						
GS2TLKW108	3,671	3,772	3,911	4,044	4,183	4,322	4,603	4,875	5,152	5,431	5,702						

Tack to Top Overhead I 1H

GS2TKW1H30	1,527	1,555	1,591	1,627	1,666	1,702	1,780	1,853	1,929	2,002	2,078						
GS2TKW1H36	1,670	1,706	1,753	1,799	1,846	1,894	1,987	2,080	2,174	2,270	2,361						
GS2TKW1H42	1,842	1,885	1,940	1,994	2,054	2,109	2,224	2,335	2,449	2,561	2,675						
GS2TKW1H48	1,876	1,919	1,974	2,028	2,088	2,143	2,258	2,369	2,483	2,595	2,709						

GRADE FABRIC PRICING

Silea
03/23

model number	1	2	3	COM/4	5	6	7	8	9	10	11	12	13	14	15	16
Tack to Top Overhead I 2H																
GS2TKW2H30	1,044	1,065	1,090	1,114	1,146	1,180	1,205	1,236	1,267	1,298	1,331	1,361	1,400	1,431	1,466	1,508
GS2TKW2H36	1,084	1,112	1,142	1,174	1,212	1,251	1,286	1,326	1,364	1,402	1,443	1,479	1,529	1,568	1,615	1,664
GS2TKW2H42	1,118	1,153	1,188	1,224	1,273	1,321	1,364	1,412	1,456	1,505	1,553	1,599	1,658	1,703	1,761	1,818
GS2TKW2H48	1,146	1,181	1,216	1,252	1,301	1,349	1,392	1,440	1,484	1,533	1,581	1,627	1,686	1,731	1,789	1,846
Layers Tack to Top Overhead I 1H																
GS2TLKW1H30	1,044	1,065	1,090	1,114	1,146	1,180	1,205	1,236	1,267	1,298	1,331	1,361	1,400	1,431	1,466	1,508
GS2TLKW1H36	1,084	1,112	1,142	1,174	1,212	1,251	1,286	1,326	1,364	1,402	1,443	1,479	1,529	1,568	1,615	1,664
GS2TLKW1H42	1,118	1,153	1,188	1,224	1,273	1,321	1,364	1,412	1,456	1,505	1,553	1,599	1,658	1,703	1,761	1,818
GS2TLKW1H48	1,146	1,181	1,216	1,252	1,301	1,349	1,392	1,440	1,484	1,533	1,581	1,627	1,686	1,731	1,789	1,846
Layers Tack to Top Overhead I 2H																
GS2TLKW2H30	1,084	1,105	1,130	1,154	1,186	1,220	1,245	1,276	1,307	1,338	1,371	1,401	1,440	1,471	1,506	1,548
GS2TLKW2H36	1,118	1,146	1,176	1,208	1,246	1,285	1,320	1,360	1,398	1,436	1,477	1,513	1,563	1,602	1,649	1,698
GS2TLKW2H42	1,146	1,181	1,216	1,252	1,301	1,349	1,392	1,440	1,484	1,533	1,581	1,627	1,686	1,731	1,789	1,846
GS2TLKW2H48	1,197	1,232	1,267	1,303	1,352	1,400	1,443	1,491	1,535	1,584	1,632	1,678	1,737	1,782	1,840	1,897
Surface Mount Tackboards																
GS2TKS60	997	1,042	1,090	1,138	1,201	1,266	1,319	1,384	1,443	1,508	1,571	1,632	1,709	1,771	1,848	1,924
GS2TKS66	1,013	1,058	1,106	1,154	1,217	1,282	1,335	1,400	1,459	1,524	1,587	1,648	1,725	1,787	1,864	1,940
GS2TKS72	1,054	1,105	1,159	1,214	1,286	1,355	1,419	1,489	1,557	1,628	1,699	1,766	1,858	1,925	2,008	2,100
GS2TKS78	1,082	1,138	1,199	1,260	1,340	1,420	1,488	1,569	1,644	1,725	1,804	1,880	1,978	2,054	2,150	2,249
GS2TKS84	1,113	1,169	1,230	1,291	1,371	1,451	1,519	1,600	1,675	1,756	1,835	1,911	2,009	2,085	2,181	2,280
GS2TKS90	1,164	1,226	1,292	1,357	1,447	1,533	1,609	1,698	1,779	1,870	1,955	2,039	2,149	2,232	2,335	2,443
GS2TKS96	1,212	1,280	1,352	1,425	1,519	1,616	1,698	1,792	1,882	1,977	2,073	2,164	2,282	2,372	2,486	2,604
GS2TKS102	1,672	1,744	1,824	1,904	2,007	2,108	2,197	2,300	2,400	2,501	2,604	2,703	2,830	2,928	3,051	3,181
GS2TKS108	1,733	1,812	1,897	1,982	2,094	2,203	2,300	2,414	2,519	2,632	2,742	2,849	2,985	3,093	3,226	3,363
WorkWall Tackboards																
GS2TKWSB72	1,107	1,160	1,219	1,274	1,351	1,424	1,489	1,565	1,636	1,709	1,784	1,854	1,948	2,022	2,111	2,205
GS2TKWSB90	1,222	1,287	1,358	1,425	1,518	1,609	1,689	1,782	1,868	1,962	2,053	2,140	2,255	2,342	2,451	2,565
GS2TKWSB36	898	927	960	992	1,035	1,073	1,111	1,152	1,193	1,233	1,275	1,314	1,366	1,408	1,457	1,508
GS2TKWSB45	942	984	1,031	1,075	1,134	1,193	1,244	1,308	1,363	1,424	1,483	1,542	1,616	1,672	1,746	1,818
GS2TKFBX72	1,107	1,160	1,219	1,274	1,351	1,424	1,489	1,565	1,636	1,709	1,784	1,854	1,948	2,022	2,111	2,205
GS2TKFBX90	1,222	1,287	1,358	1,425	1,518	1,609	1,689	1,782	1,868	1,962	2,053	2,140	2,255	2,342	2,451	2,565

model number 17 18 19 20 21 22 23 24 25 26 27 COL L1 L2 L3 L4 L5

Tack to Top Overhead I 2H

GS2TKW2H30	1,546	1,574	1,610	1,646	1,685	1,721	1,799	1,872	1,948	2,021	2,097						
GS2TKW2H36	1,710	1,746	1,793	1,839	1,886	1,934	2,027	2,120	2,214	2,310	2,401						
GS2TKW2H42	1,876	1,919	1,974	2,028	2,088	2,143	2,258	2,369	2,483	2,595	2,709						
GS2TKW2H48	1,904	1,947	2,002	2,056	2,116	2,171	2,286	2,397	2,511	2,623	2,737						

Layers Tack to Top Overhead I 1H

GS2TLKW1H30	1,546	1,574	1,610	1,646	1,685	1,721	1,799	1,872	1,948	2,021	2,097						
GS2TLKW1H36	1,710	1,746	1,793	1,839	1,886	1,934	2,027	2,120	2,214	2,310	2,401						
GS2TLKW1H42	1,876	1,919	1,974	2,028	2,088	2,143	2,258	2,369	2,483	2,595	2,709						
GS2TLKW1H48	1,904	1,947	2,002	2,056	2,116	2,171	2,286	2,397	2,511	2,623	2,737						

Layers Tack to Top Overhead I 2H

GS2TLKW2H30	1,586	1,614	1,650	1,686	1,725	1,761	1,839	1,912	1,988	2,061	2,137						
GS2TLKW2H36	1,744	1,780	1,827	1,873	1,920	1,968	2,061	2,154	2,248	2,344	2,435						
GS2TLKW2H42	1,904	1,947	2,002	2,056	2,116	2,171	2,286	2,397	2,511	2,623	2,737						
GS2TLKW2H48	1,955	1,998	2,053	2,107	2,167	2,222	2,337	2,448	2,562	2,674	2,788						

Surface Mount Tackboards

GS2TKS60	2,001	2,055	2,131	2,202	2,278	2,356	2,506	2,654	2,805	2,957	3,104						
GS2TKS66	2,017	2,071	2,147	2,218	2,294	2,372	2,522	2,670	2,821	2,973	3,120						
GS2TKS72	2,183	2,247	2,329	2,413	2,498	2,579	2,753	2,918	3,087	3,261	3,426						
GS2TKS78	2,344	2,410	2,506	2,597	2,692	2,788	2,977	3,162	3,351	3,542	3,726						
GS2TKS84	2,375	2,441	2,537	2,628	2,723	2,819	3,008	3,193	3,382	3,573	3,757						
GS2TKS90	2,548	2,624	2,729	2,828	2,932	3,037	3,245	3,448	3,658	3,868	4,073						
GS2TKS96	2,718	2,801	2,914	3,021	3,134	3,248	3,475	3,699	3,926	4,150	4,373						
GS2TKS102	3,303	3,393	3,515	3,633	3,754	3,879	4,124	4,364	4,610	4,857	5,097						
GS2TKS108	3,495	3,591	3,723	3,851	3,984	4,115	4,382	4,643	4,908	5,171	5,431						

WorkWall Tackboards

GS2TKWSB72	2,290	2,358	2,446	2,532	2,622	2,710	2,891	3,064	3,243	3,423	3,598						
GS2TKWSB90	2,674	2,754	2,864	2,968	3,078	3,187	3,407	3,622	3,843	4,061	4,274						
GS2TKWSB36	1,557	1,593	1,642	1,689	1,739	1,788	1,890	1,987	2,084	2,186	2,282						
GS2TKWSB45	1,891	1,941	2,013	2,080	2,155	2,223	2,368	2,508	2,651	2,793	2,932						
GS2TKFBX72	2,290	2,358	2,446	2,532	2,622	2,710	2,891	3,064	3,243	3,423	3,598						
GS2TKFBX90	2,674	2,754	2,864	2,968	3,078	3,187	3,407	3,622	3,843	4,061	4,274						

WEIGHTS + CUBES

Silea
03/23

model number	weight	cubes	#locks	page
ACCNTRWGT15	20	0.5	-	332
ACCNTRWGT30	30	1	-	332
ACCNTRWGT36	35	1	-	332
ACDRB-LAT	2	0.5	-	330
ACDUOBZL-EEU	3	0.2	-	337
ACDUOBZL-EEU-HW	3	0.2	-	337
ACDUOCLMP-EEU	3	0.2	-	338
ACDUOCLMP-EEU-HW	3	0.2	-	338
ACFLR5-P	1	0.1	-	330
ACFLR9-P	1	0.1	-	330
ACFLR15-P	1	0.1	-	330
ACFLR18-P	1	0.2	-	330
ACFLR30-P	1	0.3	-	330
ACFLR36-P	1	0.3	-	330
ACGRMTFLD	1	0.1	-	340
ACHAT-BLUETOOTH	1	0.1	-	123
ACHAT-MEM	1	0.1	-	123
ACHAT-PDL	1	0.1	-	123
ACHAT-UD	1	0.1	-	123
ACMWS30	3	0.4	-	218
ACMWS36	4	0.5	-	218
ACMWS41	4	0.5	-	218
ACMWS47	5	0.6	-	218
ACMWS53	5	0.7	-	218
ACMWS59	6	0.7	-	218
ACMWS65	7	0.8	-	218
ACMWS71	7	0.9	-	218
ACMWS83	8	1	-	218
ACPHQ3QI-B	3	0.3	-	234
ACPHQ3QI-S	3	0.3	-	234
ACPT15-GAA	2	0.5	-	335
ACPT18-GAA	2	0.5	-	335
ACPUNDER-EU	2	0.2	-	339
ACPUNDER-EU-HW	2	0.2	-	339
ACPWRT	2	0.2	-	328
ACTLED24	2	0.1	-	326
ACTLED36	3	0.2	-	326
ACTLED48	4	0.3	-	326
ACTLED60	5	0.3	-	326
ACTRIOBZL-EEEUD	4	0.3	-	337
ACTRIOBZL-EEEUD-HW	4	0.3	-	337
ACTRIOCLMP-EEEUD	4	0.3	-	338
ACTRIOCLMP-EEEUD-HW	4	0.3	-	338
ACTRIOUNDER-EEEUD	4	0.3	-	339

model number	weight	cubes	#locks	page
ACTRIOUNDER-EEEUD-HW	4	0.3	-	339
ACUNOBZL-EU	2	0.2	-	234, 337
ACUNOBZL-EU-HW	2	0.2	-	234, 337
ACUNOCLMP-EU	2	0.2	-	338
ACUNOCLMP-EU-HW	2	0.2	-	338
ACWCB15	6	0.7	-	121
ACWCB20	8	0.8	-	121
ACWM	2	0.1	-	333
BSHAT2142	53	5.4	-	119
BSHAT2148	55	6.3	-	119
BSHAT2154	57	7.1	-	119
BSHAT2160	59	7.9	-	119
BSHAT2166	61	8.8	-	119
BSHAT2172	63	9.6	-	119
BSHAT2748	59	7.8	-	119
BSHAT2754	61	8.9	-	119
BSHAT2760	63	9.9	-	119
BSHAT2766	65	10.9	-	119
BSHAT2772	67	12	-	119
GDAPPM-EEU	3	0.1	-	339
GDAPPM-EEU-HW	3	0.1	-	339
GLLM48H66-WW	225	69.7	-	323
GLLMTGW36H58W-GSA	59	4.8	-	324
GS2ALEG-A	8	0.6	-	159
GS2ASF830-A	10	0.8	-	302
GS2ASF830-L	7	0.3	-	302
GS2ASF830-W	8	0.8	-	302
GS2ASF836-A	12	1	-	302
GS2ASF836-L	9	0.3	-	302
GS2ASF836-W	10	1	-	302
GS2ASF842-A	14	1.1	-	302
GS2ASF842-L	11	1.1	-	302
GS2ASF842-W	11	1.1	-	302
GS2ASF848-A	15	1.3	-	302
GS2ASF848-L	12	1.3	-	302
GS2ASF848-W	12	1.3	-	302
GS2ASF854-A	17	1.4	-	302
GS2ASF854-L	14	1.4	-	302
GS2ASF854-W	14	1.4	-	302
GS2ASF860-A	19	1.6	-	302
GS2ASF860-L	15	0.5	-	302
GS2ASF860-W	16	1.6	-	302
GS2ASF866-A	21	1.7	-	302
GS2ASF866-L	16	0.6	-	302

model number	weight	cubes	#locks	page
GS2ASF866-W	17	1.7	-	302
GS2ASF872-A	23	1.9	-	302
GS2ASF872-L	18	0.7	-	302
GS2ASF872-W	19	1.9	-	302
GS2ASF878-A	25	2	-	302
GS2ASF878-L	19	0.7	-	302
GS2ASF878-W	20	2	-	302
GS2ASF884-A	27	1.1	-	302
GS2ASF884-L	21	0.8	-	302
GS2ASF884-W	22	1.1	-	302
GS2ASF890-A	29	1.2	-	302
GS2ASF890-L	22	0.8	-	302
GS2ASF890-W	24	1.2	-	302
GS2ASF896-A	31	1.3	-	302
GS2ASF896-L	24	0.9	-	302
GS2ASF896-W	26	1.3	-	302
GS2ASF1230-A	14	1.1	-	303
GS2ASF1230-L	10	0.3	-	303
GS2ASF1230-W	11	1.1	-	303
GS2ASF1236-A	16	1.3	-	303
GS2ASF1236-L	12	0.3	-	303
GS2ASF1236-W	13	1.3	-	303
GS2ASF1242-A	18	1.5	-	303
GS2ASF1242-L	15	1.5	-	303
GS2ASF1242-W	15	1.5	-	303
GS2ASF1248-A	21	1.7	-	303
GS2ASF1248-L	18	1.7	-	303
GS2ASF1248-W	18	1.7	-	303
GS2ASF1254-A	24	1.9	-	303
GS2ASF1254-L	20	1.9	-	303
GS2ASF1254-W	20	1.9	-	303
GS2ASF1260-A	27	2.1	-	303
GS2ASF1260-L	20	0.5	-	303
GS2ASF1260-W	22	2.1	-	303
GS2ASF1266-A	30	2.3	-	303
GS2ASF1266-L	22	0.6	-	303
GS2ASF1266-W	24	2.3	-	303
GS2ASF1272-A	33	2.5	-	303
GS2ASF1272-L	24	0.7	-	303
GS2ASF1272-W	26	2.5	-	303
GS2ASF1278-A	35	2.7	-	303
GS2ASF1278-L	26	0.7	-	303
GS2ASF1278-W	28	2.7	-	303
GS2ASF1284-A	38	1.5	-	303

model number	weight	cubes	#locks	page
GS2ASF1284-L	27	0.8	-	303
GS2ASF1284-W	31	1.5	-	303
GS2ASF1290-A	41	1.6	-	303
GS2ASF1290-L	29	0.8	-	303
GS2ASF1290-W	33	1.6	-	303
GS2ASF1296-A	44	1.7	-	303
GS2ASF1296-L	31	0.9	-	303
GS2ASF1296-W	35	1.7	-	303
GS2ASF8102-A	33	1.3	-	302
GS2ASF8102-L	25	0.5	-	302
GS2ASF8102-W	27	1.3	-	302
GS2ASF8108-A	35	1.4	-	302
GS2ASF8108-L	27	0.5	-	302
GS2ASF8108-W	28	1.4	-	302
GS2ASF8114-A	37	1.4	-	302
GS2ASF8114-L	30	2.9	-	302
GS2ASF8114-W	30	2.9	-	302
GS2ASF8120-A	39	1.6	-	302
GS2ASF8120-L	30	0.5	-	302
GS2ASF8120-W	32	1.6	-	302
GS2ASF8132-A	34	2.8	-	302
GS2ASF8132-L	34	2.8	-	302
GS2ASF8132-W	34	2.8	-	302
GS2ASF8144-A	38	3	-	302
GS2ASF8144-L	38	3	-	302
GS2ASF8144-W	38	3	-	302
GS2ASF12102-A	46	1.8	-	303
GS2ASF12102-L	33	0.5	-	303
GS2ASF12102-W	37	1.8	-	303
GS2ASF12108-A	49	1.9	-	303
GS2ASF12108-L	35	0.5	-	303
GS2ASF12108-W	39	1.9	-	303
GS2ASF12114-A	51	2	-	303
GS2ASF12114-L	41	3.9	-	303
GS2ASF12114-W	41	3.9	-	303
GS2ASF12120-A	54	2.1	-	303
GS2ASF12120-L	39	0.5	-	303
GS2ASF12120-W	44	2.1	-	303
GS2ASF12132-A	48	2.3	-	303
GS2ASF12132-L	48	2.3	-	303
GS2ASF12132-W	48	2.3	-	303
GS2ASF12144-A	52	2.5	-	303
GS2ASF12144-L	52	2.5	-	303
GS2ASF12144-W	52	2.5	-	303

WEIGHTS + CUBES

Silea
03/23

model number	weight	cubes	#locks	page
GS2AT-PAPER	2	0.9	-	327
GS2AT-PDA	1	0.3	-	327
GS2AT-PLUG	1	0.1	-	327
GS2AT-PNCL	1	0.4	-	327
GS2AT-SHELF	2	0.5	-	327
GS2BCL5H18L-LL	210	23.5	1	239
GS2BCL5H18L-WW	210	23.5	1	239
GS2BCL5H18R-LL	210	23.5	1	239
GS2BCL5H18R-WW	210	23.5	1	239
GS2BCL6H18L-LL	250	27.9	1	239
GS2BCL6H18L-WW	250	27.9	1	239
GS2BCL6H18R-LL	250	27.9	1	239
GS2BCL6H18R-WW	250	27.9	1	239
GS2BKN2H30N-LN	65	10.5	-	238
GS2BKN2H30N-WN	65	10.5	-	238
GS2BKN2H36N-LN	80	12.5	-	238
GS2BKN2H36N-WN	80	12.5	-	238
GS2BKN3H30-LN	100	14.7	-	238
GS2BKN3H30-WN	100	14.7	-	238
GS2BKN3H36-LN	115	18.2	-	238
GS2BKN3H36-WN	115	18.2	-	238
GS2BKN4H30-LN	127	18.6	-	238
GS2BKN4H30-WN	127	18.6	-	238
GS2BKN4H36-LN	142	23.2	-	238
GS2BKN4H36-WN	142	23.2	-	238
GS2BKN5H30-LN	152	23.2	-	238
GS2BKN5H30-WN	152	23.2	-	238
GS2BKN5H36-LN	167	28.9	-	238
GS2BKN5H36-WN	167	28.9	-	238
GS2BKN6H30-LN	213	27.6	-	238
GS2BKN6H30-WN	213	27.6	-	238
GS2BKN6H36-LN	228	34.3	-	238
GS2BKN6H36-WN	228	34.3	-	238
GS2BMA39-L	35	6.8	-	213
GS2BMA39-W	35	6.8	-	213
GS2BMA42-L	37	7.2	-	213
GS2BMA42-W	37	7.2	-	213
GS2BMA45-L	39	7.7	-	213
GS2BMA45-W	39	7.7	-	213
GS2BMA48-L	41	8.2	-	213
GS2BMA48-W	41	8.2	-	213
GS2BMA51-L	43	8.7	-	213
GS2BMA51-W	43	8.7	-	213
GS2BMA54-L	45	9.2	-	213

model number	weight	cubes	#locks	page
GS2BMA54-W	45	9.2	-	213
GS2BMA57-L	47	9.6	-	213
GS2BMA57-W	47	9.6	-	213
GS2BMA60-L	49	10.1	-	213
GS2BMA60-W	49	10.1	-	213
GS2BMF39-L	19	2.9	-	212
GS2BMF39-W	19	2.9	-	212
GS2BMF42-L	20	3.1	-	212
GS2BMF42-W	20	3.1	-	212
GS2BMF45-L	21	3.3	-	212
GS2BMF45-W	21	3.3	-	212
GS2BMF48-L	23	3.5	-	212
GS2BMF48-W	23	3.5	-	212
GS2BMF51-L	24	3.7	-	212
GS2BMF51-W	24	3.7	-	212
GS2BMF54-L	26	3.9	-	212
GS2BMF54-W	26	3.9	-	212
GS2BMF57-L	27	4.1	-	212
GS2BMF57-W	27	4.1	-	212
GS2BMF60-L	29	4.3	-	212
GS2BMF60-W	29	4.3	-	212
GS2CDWSD-W	2	13	-	334
GS2CLD5H30-DLL	286	36.9	1	243
GS2CLD5H30-DWW	286	36.9	1	243
GS2CLD5H30-SLL	265	36.9	1	243
GS2CLD5H30-SWW	265	36.9	1	243
GS2CLD5H36-DLL	306	55.7	-	243
GS2CLD5H36-DWW	306	55.7	-	243
GS2CLD5H36-SLL	285	55.7	-	243
GS2CLD5H36-SWW	285	55.7	-	243
GS2CLD6H30-DLL	342	43.8	1	243
GS2CLD6H30-DWW	342	43.8	1	243
GS2CLD6H30-SLL	311	43.8	1	243
GS2CLD6H30-SWW	311	43.8	1	243
GS2CLD6H36-DLL	362	55.7	-	243
GS2CLD6H36-DWW	362	55.7	-	243
GS2CLD6H36-SLL	331	55.7	-	243
GS2CLD6H36-SWW	331	55.7	-	243
GS2CLMA21-L	20	3.8	-	208
GS2CLMA21-W	20	3.8	-	208
GS2CLMA24-L	22	4.3	-	208
GS2CLMA24-W	22	4.3	-	208
GS2CLMA27-L	24	4.7	-	208
GS2CLMA27-W	24	4.7	-	208

model number	weight	cubes	#locks	page
GS2CLMA30-L	26	5.2	-	208
GS2CLMA30-W	26	5.2	-	208
GS2CLMA33-L	28	5.6	-	208
GS2CLMA33-W	28	5.6	-	208
GS2CLMA36-L	30	6.1	-	208
GS2CLMA36-W	30	6.1	-	208
GS2CLMA39-L	32	6.5	-	208
GS2CLMA39-W	32	6.5	-	208
GS2CLMA42-L	34	7	-	208
GS2CLMA42-W	34	7	-	208
GS2CLMA45-L	36	7.4	-	208
GS2CLMA45-W	36	7.4	-	208
GS2CLMA48-L	38	7.9	-	208
GS2CLMA48-W	38	7.9	-	208
GS2CLMA51-L	40	8.4	-	208
GS2CLMA51-W	40	8.4	-	208
GS2CLMA54-L	42	8.8	-	208
GS2CLMA54-W	42	8.8	-	208
GS2CLMA57-L	44	9.3	-	208
GS2CLMA57-W	44	9.3	-	208
GS2CLMA60-L	46	9.7	-	208
GS2CLMA60-W	46	9.7	-	208
GS2CLMA63-L	48	10.2	-	208
GS2CLMA63-W	48	10.2	-	208
GS2CLMA66-L	50	10.6	-	208
GS2CLMA66-W	50	10.6	-	208
GS2CLMA69-L	52	11.1	-	208
GS2CLMA69-W	52	11.1	-	208
GS2CLMA72-L	54	11.5	-	208
GS2CLMA72-W	54	11.5	-	208
GS2CLMF45-L	18	2.5	-	206
GS2CLMF45-W	18	2.5	-	206
GS2CLMF48-L	19	2.6	-	206
GS2CLMF48-W	19	2.6	-	206
GS2CLMF51-L	21	2.8	-	206
GS2CLMF51-W	21	2.8	-	206
GS2CLMF54-L	22	2.9	-	206
GS2CLMF54-W	22	2.9	-	206
GS2CLMF60-L	27	3.3	-	206
GS2CLMF60-W	27	3.3	-	206
GS2CLMF66-L	30	3.6	-	206
GS2CLMF66-W	30	3.6	-	206
GS2CLMF72-L	33	3.9	-	206
GS2CLMF72-W	33	3.9	-	206

model number	weight	cubes	#locks	page
GS2CLMF78-L	36	4.2	-	206
GS2CLMF78-W	36	4.2	-	206
GS2CLMF84-L	39	4.5	-	206
GS2CLMF84-W	39	4.5	-	206
GS2CLMF90-L	42	4.9	-	206
GS2CLMF90-W	42	4.9	-	206
GS2CLMF96-L	45	5.2	-	206
GS2CLMF96-W	45	5.2	-	206
GS2CLMF102-L	48	5.5	-	206
GS2CLMF102-W	48	5.5	-	206
GS2CLMF108-L	51	5.8	-	206
GS2CLMF108-W	51	5.8	-	206
GS2CLMF114-L	54	6.1	-	206
GS2CLMF114-W	54	6.1	-	206
GS2CLMF120-L	57	6.4	-	206
GS2CLMF120-W	57	6.4	-	206
GS2CLPD249L-XL	32	4.3	-	181
GS2CLPD249L-XW	32	4.3	-	181
GS2CLPD249R-XL	32	4.3	-	181
GS2CLPD249R-XW	32	4.3	-	181
GS2CLPD249TL-XL	32	4.3	-	186
GS2CLPD249TL-XW	32	4.3	-	186
GS2CLPD249TR-XL	32	4.3	-	186
GS2CLPD249TR-XW	32	4.3	-	186
GS2CLPD2415-AL	79	6.5	1	182
GS2CLPD2415-AW	79	6.5	1	182
GS2CLPD2415T-AL	79	6.5	1	187
GS2CLPD2415T-AW	79	6.5	1	187
GS2CLPD2418-AL	86	7.5	1	182
GS2CLPD2418-AW	86	7.5	1	182
GS2CLPD2418T-AL	86	7.5	1	187
GS2CLPD2418T-AW	86	7.5	1	187
GS2CLPD2430-5L	106	11.8	1	184
GS2CLPD2430-5W	106	11.8	1	184
GS2CLPD2430-BL	111	11.8	1	183
GS2CLPD2430-BW	111	11.8	1	183
GS2CLPD2430-SHL	96	11.8	-	185
GS2CLPD2430-SHW	96	11.8	-	185
GS2CLPD2430T-5L	106	11.8	1	189
GS2CLPD2430T-5W	106	11.8	1	189
GS2CLPD2430T-BL	111	11.8	1	188
GS2CLPD2430T-BW	111	11.8	1	188
GS2CLPD2430T-SHL	96	11.8	-	190
GS2CLPD2430T-SHW	96	11.8	-	190

WEIGHTS + CUBES

Silea
03/23

model number	weight	cubes	#locks	page
GS2CLPD2436-5L	124	14	1	184
GS2CLPD2436-5W	124	14	1	184
GS2CLPD2436-BL	125	14	1	183
GS2CLPD2436-BW	125	14	1	183
GS2CLPD2436-SHL	114	14	-	185
GS2CLPD2436-SHW	114	14	-	185
GS2CLPD2436T-5L	124	14	1	189
GS2CLPD2436T-5W	124	14	1	189
GS2CLPD2436T-BL	125	14	1	188
GS2CLPD2436T-BW	125	14	1	188
GS2CLPD2436T-SHL	114	14	-	190
GS2CLPD2436T-SHW	114	14	-	190
GS2CLPD-CUSH2130T	10	1.8	-	220
GS2CLPD-CUSH2136T	11	2.1	-	220
GS2CLS5H15L-LL	146	20.1	1	242
GS2CLS5H15L-WG	146	20.1	-	244
GS2CLS5H15L-WW	146	20.1	1	242
GS2CLS5H15R-LL	146	20.1	1	242
GS2CLS5H15R-WG	146	20.1	-	244
GS2CLS5H15R-WW	146	20.1	1	242
GS2CLS5H18L-LL	166	23.5	1	242
GS2CLS5H18L-WG	166	23.5	-	244
GS2CLS5H18L-WW	166	23.5	1	242
GS2CLS5H18R-LL	166	23.5	1	242
GS2CLS5H18R-WG	166	23.5	-	244
GS2CLS5H18R-WW	166	23.5	1	242
GS2CLS5H30D18L-LL	181	31.6	-	245
GS2CLS5H30D18L-WG	181	31.6	-	246
GS2CLS5H30D18L-WW	181	31.6	-	245
GS2CLS5H30D18R-LL	181	31.6	-	245
GS2CLS5H30D18R-WG	181	31.6	-	246
GS2CLS5H30D18R-WW	181	31.6	-	245
GS2CLS6H15L-LL	181	26.5	-	242
GS2CLS6H15L-WG	181	26.5	-	244
GS2CLS6H15L-WW	181	26.5	-	242
GS2CLS6H15R-LL	181	26.5	-	242
GS2CLS6H15R-WG	181	26.5	-	244
GS2CLS6H15R-WW	181	26.5	-	242
GS2CLS6H18L-LL	191	27.9	1	242
GS2CLS6H18L-WG	191	27.9	-	244
GS2CLS6H18L-WW	191	27.9	1	242
GS2CLS6H18R-LL	191	27.9	1	242
GS2CLS6H18R-WG	191	27.9	-	244
GS2CLS6H18R-WW	191	27.9	1	242

model number	weight	cubes	#locks	page
GS2CLS6H30D18L-LL	205	31.6	-	245
GS2CLS6H30D18L-WG	205	31.6	-	246
GS2CLS6H30D18L-WW	205	31.6	-	245
GS2CLS6H30D18R-LL	205	31.6	-	245
GS2CLS6H30D18R-WG	205	31.6	-	246
GS2CLS6H30D18R-WW	205	31.6	-	245
GS2CMA21-L	23	3.9	-	207
GS2CMA21-W	23	3.9	-	207
GS2CMA24-L	25	4.3	-	207
GS2CMA24-W	25	4.3	-	207
GS2CMA27-L	27	4.8	-	207
GS2CMA27-W	27	4.8	-	207
GS2CMA30-L	29	5.3	-	207
GS2CMA30-W	29	5.3	-	207
GS2CMA33-L	31	5.8	-	207
GS2CMA33-W	31	5.8	-	207
GS2CMA36-L	33	6.3	-	207
GS2CMA36-W	33	6.3	-	207
GS2CMA39-L	35	6.8	-	207
GS2CMA39-W	35	6.8	-	207
GS2CMA42-L	37	7.2	-	207
GS2CMA42-W	37	7.2	-	207
GS2CMA45-L	39	7.7	-	207
GS2CMA45-W	39	7.7	-	207
GS2CMA48-L	41	8.2	-	207
GS2CMA48-W	41	8.2	-	207
GS2CMA51-L	43	8.7	-	207
GS2CMA51-W	43	8.7	-	207
GS2CMA54-L	45	9.2	-	207
GS2CMA54-W	45	9.2	-	207
GS2CMA57-L	47	9.6	-	207
GS2CMA57-W	47	9.6	-	207
GS2CMA60-L	49	10.1	-	207
GS2CMA60-W	49	10.1	-	207
GS2CMA63-L	51	10.6	-	207
GS2CMA63-W	51	10.6	-	207
GS2CMA66-L	53	11.1	-	207
GS2CMA66-W	53	11.1	-	207
GS2CMA69-L	55	11.6	-	207
GS2CMA69-W	55	11.6	-	207
GS2CMA72-L	57	12.1	-	207
GS2CMA72-W	57	12.1	-	207
GS2CMF60-L	29	4.3	-	205
GS2CMF60-W	29	4.3	-	205

model number	weight	cubes	#locks	page
GS2CMF66-L	32	4.7	-	205
GS2CMF66-W	32	4.7	-	205
GS2CMF72-L	35	5.1	-	205
GS2CMF72-W	35	5.1	-	205
GS2CMF78-L	38	5.5	-	205
GS2CMF78-W	38	5.5	-	205
GS2CMF84-L	41	5.9	-	205
GS2CMF84-W	41	5.9	-	205
GS2CMF90-L	44	6.3	-	205
GS2CMF90-W	44	6.3	-	205
GS2CMF96-L	47	6.7	-	205
GS2CMF96-W	47	6.7	-	205
GS2CMF102-L	50	7.1	-	205
GS2CMF102-W	50	7.1	-	205
GS2CMF108-L	53	7.5	-	205
GS2CMF108-W	53	7.5	-	205
GS2CMF114-L	56	7.9	-	205
GS2CMF114-W	56	7.9	-	205
GS2CMF120-L	59	8.4	-	205
GS2CMF120-W	59	8.4	-	205
GS2COLUMN	10	0.9	-	159
GS2CPD249L-XL	37	5.6	-	171
GS2CPD249L-XW	37	5.6	-	171
GS2CPD249R-XL	37	5.6	-	171
GS2CPD249R-XW	37	5.6	-	171
GS2CPD249TL-XL	37	5.6	-	176
GS2CPD249TL-XW	37	5.6	-	176
GS2CPD249TR-XL	37	5.6	-	176
GS2CPD249TR-XW	37	5.6	-	176
GS2CPD309L-XL	40	8.7	-	191
GS2CPD309L-XW	40	8.7	-	191
GS2CPD309R-XL	40	8.7	-	191
GS2CPD309R-XW	40	8.7	-	191
GS2CPD309TL-XL	40	8.7	-	196
GS2CPD309TL-XW	40	8.7	-	196
GS2CPD309TR-XL	40	8.7	-	196
GS2CPD309TR-XW	40	8.7	-	196
GS2CPD2415-2L	84	8.4	1	172
GS2CPD2415-2W	84	8.4	1	172
GS2CPD2415-3AL	84	8.4	1	172
GS2CPD2415-3AW	84	8.4	1	172
GS2CPD2415-3L	84	8.4	1	172
GS2CPD2415-3W	84	8.4	1	172
GS2CPD2415L-5L	70	10.5	1	174

model number	weight	cubes	#locks	page
GS2CPD2415L-5W	70	10.5	1	174
GS2CPD2415R-5L	70	10.5	1	174
GS2CPD2415R-5W	70	10.5	1	174
GS2CPD2415-SHL	65	10.5	-	175
GS2CPD2415-SHW	65	10.5	-	175
GS2CPD2415T-2L	84	8.4	1	177
GS2CPD2415T-2W	84	8.4	1	177
GS2CPD2415T-3AL	84	8.4	1	177
GS2CPD2415T-3AW	84	8.4	1	177
GS2CPD2415T-3L	84	8.4	1	177
GS2CPD2415T-3W	84	8.4	1	177
GS2CPD2415TL-5L	70	10.5	1	179
GS2CPD2415TL-5W	70	10.5	1	179
GS2CPD2415TR-5L	70	10.5	1	179
GS2CPD2415TR-5W	70	10.5	1	179
GS2CPD2415T-SHL	65	10.5	-	180
GS2CPD2415T-SHW	65	10.5	-	180
GS2CPD2418-2L	91	9.8	1	172
GS2CPD2418-2W	91	9.8	1	172
GS2CPD2418-3AL	91	9.8	1	172
GS2CPD2418-3AW	91	9.8	1	172
GS2CPD2418-3L	91	9.8	1	172
GS2CPD2418-3W	91	9.8	1	172
GS2CPD2418L-5L	75	12.1	1	174
GS2CPD2418L-5W	75	12.1	1	174
GS2CPD2418R-5L	75	12.1	1	174
GS2CPD2418R-5W	75	12.1	1	174
GS2CPD2418-SHL	75	12.1	-	175
GS2CPD2418-SHW	75	12.1	-	175
GS2CPD2418T-2L	91	9.8	1	177
GS2CPD2418T-2W	91	9.8	1	177
GS2CPD2418T-3AL	91	9.8	1	177
GS2CPD2418T-3AW	91	9.8	1	177
GS2CPD2418T-3L	91	9.8	1	177
GS2CPD2418T-3W	91	9.8	1	177
GS2CPD2418TL-5L	75	12.1	1	179
GS2CPD2418TL-5W	75	12.1	1	179
GS2CPD2418TR-5L	75	12.1	1	179
GS2CPD2418TR-5W	75	12.1	1	179
GS2CPD2418T-SHL	75	12.1	-	180
GS2CPD2418T-SHW	75	12.1	-	180
GS2CPD2424-5L	85	15.4	1	174
GS2CPD2424-5W	85	15.4	1	174
GS2CPD2424-SHL	80	15.4	-	175

WEIGHTS + CUBES

Silea
03/23

model number	weight	cubes	#locks	page
GS2CPD2424-SHW	80	15.4	-	175
GS2CPD2424T-5L	85	15.4	1	179
GS2CPD2424T-5W	85	15.4	1	179
GS2CPD2424T-SHL	80	15.4	-	180
GS2CPD2424T-SHW	80	15.4	-	180
GS2CPD2430-4L	116	15.4	1	173
GS2CPD2430-4W	116	15.4	1	173
GS2CPD2430-5L	111	15.4	1	174
GS2CPD2430-5W	111	15.4	1	174
GS2CPD2430-7L	118	15.4	1	173
GS2CPD2430-7W	118	15.4	1	173
GS2CPD2430L-MFL	136	18.7	1	173
GS2CPD2430L-MFW	136	18.7	1	173
GS2CPD2430-PL	135	18.7	1	174
GS2CPD2430-PW	135	18.7	1	174
GS2CPD2430R-MFL	136	18.7	1	173
GS2CPD2430R-MFW	136	18.7	1	173
GS2CPD2430-SHL	101	15.4	-	175
GS2CPD2430-SHW	101	15.4	-	175
GS2CPD2430T-4L	116	15.4	1	178
GS2CPD2430T-4W	116	15.4	1	178
GS2CPD2430T-5L	111	15.4	1	179
GS2CPD2430T-5W	111	15.4	1	179
GS2CPD2430T-7L	118	15.4	1	178
GS2CPD2430T-7W	118	15.4	1	178
GS2CPD2430TL-MFL	136	18.7	1	178
GS2CPD2430TL-MFW	136	18.7	1	178
GS2CPD2430T-PL	135	18.7	1	179
GS2CPD2430T-PW	135	18.7	1	179
GS2CPD2430TR-MFL	136	18.7	1	178
GS2CPD2430TR-MFW	136	18.7	1	178
GS2CPD2430T-SHL	101	15.4	-	180
GS2CPD2430T-SHW	101	15.4	-	180
GS2CPD2436-4L	130	18.2	1	173
GS2CPD2436-4W	130	18.2	1	173
GS2CPD2436-5L	129	18.2	1	174
GS2CPD2436-5W	129	18.2	1	174
GS2CPD2436-7L	133	18.2	1	173
GS2CPD2436-7W	133	18.2	1	173
GS2CPD2436L-MFL	150	22	1	173
GS2CPD2436L-MFW	150	22	1	173
GS2CPD2436-PL	140	22	1	174
GS2CPD2436-PW	140	22	1	174
GS2CPD2436R-MFL	150	22	1	173

model number	weight	cubes	#locks	page
GS2CPD2436R-MFW	150	22	1	173
GS2CPD2436-SHL	119	18.2	-	175
GS2CPD2436-SHW	119	18.2	-	175
GS2CPD2436T-4L	130	18.2	1	178
GS2CPD2436T-4W	130	18.2	1	178
GS2CPD2436T-5L	129	18.2	1	179
GS2CPD2436T-5W	129	18.2	1	179
GS2CPD2436T-7L	133	18.2	1	178
GS2CPD2436T-7W	133	18.2	1	178
GS2CPD2436TL-MFL	150	22	1	178
GS2CPD2436TL-MFW	150	22	1	178
GS2CPD2436T-PL	140	22	1	179
GS2CPD2436T-PW	140	22	1	179
GS2CPD2436TR-MFL	150	22	1	178
GS2CPD2436TR-MFW	150	22	1	178
GS2CPD2436T-SHL	119	18.2	-	180
GS2CPD2436T-SHW	119	18.2	-	180
GS2CPD3015-2L	89	12.7	1	192
GS2CPD3015-2W	89	12.7	1	192
GS2CPD3015-3AL	89	12.7	1	192
GS2CPD3015-3AW	89	12.7	1	192
GS2CPD3015-3L	89	12.7	1	192
GS2CPD3015-3W	89	12.7	1	192
GS2CPD3015L-5L	75	12.7	1	194
GS2CPD3015L-5W	75	12.7	1	194
GS2CPD3015R-5L	75	12.7	1	194
GS2CPD3015R-5W	75	12.7	1	194
GS2CPD3015-SHL	70	12.7	-	195
GS2CPD3015-SHW	70	12.7	-	195
GS2CPD3015T-2L	88	12.7	1	197
GS2CPD3015T-2W	88	12.7	1	197
GS2CPD3015T-3AL	88	12.7	1	197
GS2CPD3015T-3AW	88	12.7	1	197
GS2CPD3015T-3L	88	12.7	1	197
GS2CPD3015T-3W	88	12.7	1	197
GS2CPD3015TL-5L	75	12.7	1	199
GS2CPD3015TL-5W	75	12.7	1	199
GS2CPD3015TR-5L	75	12.7	1	199
GS2CPD3015TR-5W	75	12.7	1	199
GS2CPD3015T-SHL	70	12.7	-	200
GS2CPD3015T-SHW	70	12.7	-	200
GS2CPD3018-2L	96	14.7	1	192
GS2CPD3018-2W	96	14.7	1	192
GS2CPD3018-3AL	96	14.7	1	192

model number	weight	cubes	#locks	page
GS2CPD3018-3AW	96	14.7	1	192
GS2CPD3018-3L	96	14.7	1	192
GS2CPD3018-3W	96	14.7	1	192
GS2CPD3018L-5L	80	14.7	1	194
GS2CPD3018L-5W	80	14.7	1	194
GS2CPD3018R-5L	80	14.7	1	194
GS2CPD3018R-5W	80	14.7	1	194
GS2CPD3018-SHL	80	14.7	-	195
GS2CPD3018-SHW	80	14.7	-	195
GS2CPD3018T-2L	95	14.7	1	197
GS2CPD3018T-2W	95	14.7	1	197
GS2CPD3018T-3AL	95	14.7	1	197
GS2CPD3018T-3AW	95	14.7	1	197
GS2CPD3018T-3L	95	14.7	1	197
GS2CPD3018T-3W	95	14.7	1	197
GS2CPD3018TL-5L	80	14.7	1	199
GS2CPD3018TL-5W	80	14.7	1	199
GS2CPD3018TR-5L	80	14.7	1	199
GS2CPD3018TR-5W	80	14.7	1	199
GS2CPD3018T-SHL	80	14.7	-	200
GS2CPD3018T-SHW	80	14.7	-	200
GS2CPD3024-5L	90	18.7	1	194
GS2CPD3024-5W	90	18.7	1	194
GS2CPD3024-SHL	85	18.7	-	195
GS2CPD3024-SHW	85	18.7	-	195
GS2CPD3024T-5L	90	18.7	1	199
GS2CPD3024T-5W	90	18.7	1	199
GS2CPD3024T-SHL	85	18.7	-	200
GS2CPD3024T-SHW	85	18.7	-	200
GS2CPD3030-4L	120	22.7	1	193
GS2CPD3030-4W	120	22.7	1	193
GS2CPD3030-5L	114	22.7	1	194
GS2CPD3030-5W	114	22.7	1	194
GS2CPD3030-7L	125	22.7	1	193
GS2CPD3030-7W	125	22.7	1	193
GS2CPD3030L-MFL	148	22.7	1	193
GS2CPD3030L-MFW	148	22.7	1	193
GS2CPD3030-PL	140	22.7	1	194
GS2CPD3030-PW	140	22.7	1	194
GS2CPD3030R-MFL	148	22.7	1	193
GS2CPD3030R-MFW	148	22.7	1	193
GS2CPD3030-SHL	105	22.7	-	195
GS2CPD3030-SHW	105	22.7	-	195
GS2CPD3030T-4L	125	22.7	1	198

model number	weight	cubes	#locks	page
GS2CPD3030T-4W	125	22.7	1	198
GS2CPD3030T-5L	119	22.7	1	199
GS2CPD3030T-5W	119	22.7	1	199
GS2CPD3030T-7L	127	22.7	1	198
GS2CPD3030T-7W	127	22.7	1	198
GS2CPD3030TL-MFL	148	22.7	1	198
GS2CPD3030TL-MFW	148	22.7	1	198
GS2CPD3030T-PL	140	22.7	1	199
GS2CPD3030T-PW	140	22.7	1	199
GS2CPD3030TR-MFL	148	22.7	1	198
GS2CPD3030TR-MFW	148	22.7	1	198
GS2CPD3030T-SHL	108	22.7	-	200
GS2CPD3030T-SHW	108	22.7	-	200
GS2CPD3036-4L	128	26.8	1	193
GS2CPD3036-4W	128	26.8	1	193
GS2CPD3036-5L	122	26.8	1	194
GS2CPD3036-5W	122	26.8	1	194
GS2CPD3036-7L	132	26.8	1	193
GS2CPD3036-7W	132	26.8	1	193
GS2CPD3036L-MFL	162	26.8	1	193
GS2CPD3036L-MFW	162	26.8	1	193
GS2CPD3036-PL	145	26.8	1	194
GS2CPD3036-PW	145	26.8	1	194
GS2CPD3036R-MFL	162	26.8	1	193
GS2CPD3036R-MFW	162	26.8	1	193
GS2CPD3036-SHL	113	26.8	-	195
GS2CPD3036-SHW	113	26.8	-	195
GS2CPD3036T-4L	140	26.8	1	198
GS2CPD3036T-4W	140	26.8	1	198
GS2CPD3036T-5L	135	26.8	1	199
GS2CPD3036T-5W	135	26.8	1	199
GS2CPD3036T-7L	143	26.8	1	198
GS2CPD3036T-7W	143	26.8	1	198
GS2CPD3036TL-MFL	162	26.8	1	198
GS2CPD3036TL-MFW	162	26.8	1	198
GS2CPD3036T-PL	145	26.8	1	199
GS2CPD3036T-PW	145	26.8	1	199
GS2CPD3036TR-MFL	162	26.8	1	198
GS2CPD3036TR-MFW	162	26.8	1	198
GS2CPD3036T-SHL	124	26.8	-	200
GS2CPD3036T-SHW	124	26.8	-	200
GS2CWA2240-L	27	2.6	-	120
GS2CWA2240-W	27	2.6	-	120
GS2CWA2246-L	31	3	-	120

WEIGHTS + CUBES

Silea
03/23

model number	weight	cubes	#locks	page
GS2CWA2246-W	31	3	-	120
GS2CWA2252-L	35	3.3	-	120
GS2CWA2252-W	35	3.3	-	120
GS2CWA2258-L	39	3.7	-	120
GS2CWA2258-W	39	3.7	-	120
GS2CWA2264-L	43	4.1	-	120
GS2CWA2264-W	43	4.1	-	120
GS2CWA2270-L	48	4.4	-	120
GS2CWA2270-W	48	4.4	-	120
GS2CWA2840-L	35	3.2	-	120
GS2CWA2840-W	35	3.2	-	120
GS2CWA2846-L	40	3.7	-	120
GS2CWA2846-W	40	3.7	-	120
GS2CWA2852-L	45	4.1	-	120
GS2CWA2852-W	45	4.1	-	120
GS2CWA2858-L	50	4.6	-	120
GS2CWA2858-W	50	4.6	-	120
GS2CWA2864-L	55	5	-	120
GS2CWA2864-W	55	5	-	120
GS2CWA2870-L	61	5.5	-	120
GS2CWA2870-W	61	5.5	-	120
GS2CWA3440-L	42	3.9	-	120
GS2CWA3440-W	42	3.9	-	120
GS2CWA3446-L	48	4.4	-	120
GS2CWA3446-W	48	4.4	-	120
GS2CWA3452-L	55	4.9	-	120
GS2CWA3452-W	55	4.9	-	120
GS2CWA3458-L	61	5.5	-	120
GS2CWA3458-W	61	5.5	-	120
GS2CWA3464-L	67	6	-	120
GS2CWA3464-W	67	6	-	120
GS2CWA3470-L	73	6.5	-	120
GS2CWA3470-W	73	6.5	-	120
GS2CWR2415-L	11	1.3	-	167
GS2CWR2415-W	11	1.3	-	167
GS2CWR2418-L	13	1.5	-	167
GS2CWR2418-W	13	1.5	-	167
GS2CWR2424-L	18	1.9	-	167
GS2CWR2424-W	18	1.9	-	167
GS2CWR2430-L	27	2.2	-	167
GS2CWR2430-W	27	2.2	-	167
GS2CWR2436-L	32	2.6	-	167
GS2CWR2436-W	32	2.6	-	167
GS2CWR2442-L	36	2.9	-	167

model number	weight	cubes	#locks	page
GS2CWR2442-W	36	2.9	-	167
GS2CWR2448-L	41	3.3	-	167
GS2CWR2448-W	41	3.3	-	167
GS2CWR2454-L	45	3.7	-	167
GS2CWR2454-W	45	3.7	-	167
GS2CWR2460-L	49	4.1	-	167
GS2CWR2460T-L	49	5.3	-	169
GS2CWR2460T-W	59	5.3	-	169
GS2CWR2460-W	49	4.1	-	167
GS2CWR2466-L	54	4.5	-	167
GS2CWR2466T-L	53	5.8	-	169
GS2CWR2466T-W	65	5.8	-	169
GS2CWR2466-W	54	4.5	-	167
GS2CWR2472-L	58	4.9	-	167
GS2CWR2472T-L	58	6.3	-	169
GS2CWR2472T-W	71	6.3	-	169
GS2CWR2472-W	58	4.9	-	167
GS2CWR2478-L	63	5.3	-	167
GS2CWR2478T-L	63	6.8	-	169
GS2CWR2478T-W	76	6.9	-	169
GS2CWR2478-W	63	5.3	-	167
GS2CWR2484-L	67	5.7	-	167
GS2CWR2484T-L	68	7.3	-	169
GS2CWR2484T-W	81	7.4	-	169
GS2CWR2484-W	67	5.7	-	167
GS2CWR2490-L	72	6.1	-	167
GS2CWR2490T-L	72	7.8	-	169
GS2CWR2490T-W	87	7.9	-	169
GS2CWR2490-W	72	6.1	-	167
GS2CWR2496-L	76	6.5	-	167
GS2CWR2496T-L	77	8.3	-	169
GS2CWR2496T-W	93	8.4	-	169
GS2CWR2496-W	76	6.5	-	167
GS2CWR3015-L	14	1.6	-	168
GS2CWR3015-W	14	1.6	-	168
GS2CWR3018-L	16	1.8	-	168
GS2CWR3018-W	16	1.8	-	168
GS2CWR3024-L	22	2.3	-	168
GS2CWR3024-W	22	2.3	-	168
GS2CWR3030-L	28	2.8	-	168
GS2CWR3030-W	28	2.8	-	168
GS2CWR3036-L	32	3.3	-	168
GS2CWR3036-W	32	3.3	-	168
GS2CWR3042-L	38	3.8	-	168

model number	weight	cubes	#locks	page
GS2CWR3042-W	38	3.8	-	168
GS2CWR3048-L	45	4.3	-	168
GS2CWR3048-W	45	4.3	-	168
GS2CWR3054-L	50	4.8	-	168
GS2CWR3054-W	50	4.8	-	168
GS2CWR3060-L	55	5.3	-	168
GS2CWR3060T-L	55	6.5	-	170
GS2CWR3060T-W	55	6.5	-	170
GS2CWR3060-W	55	5.3	-	168
GS2CWR3066-L	60	5.8	-	168
GS2CWR3066T-L	61	7.1	-	170
GS2CWR3066T-W	61	7.1	-	170
GS2CWR3066-W	60	5.8	-	168
GS2CWR3072-L	65	6.3	-	168
GS2CWR3072T-L	67	7.7	-	170
GS2CWR3072T-W	67	7.7	-	170
GS2CWR3072-W	65	6.3	-	168
GS2CWR3078-L	70	6.8	-	168
GS2CWR3078T-L	72	8.3	-	170
GS2CWR3078T-W	72	8.3	-	170
GS2CWR3078-W	70	6.8	-	168
GS2CWR3084-L	75	7.3	-	168
GS2CWR3084T-L	78	8.9	-	170
GS2CWR3084T-W	78	8.9	-	170
GS2CWR3084-W	75	7.3	-	168
GS2CWR3090-L	80	7.8	-	168
GS2CWR3090T-L	84	9.5	-	170
GS2CWR3090T-W	84	9.5	-	170
GS2CWR3090-W	80	7.8	-	168
GS2CWR3096-L	85	8.3	-	168
GS2CWR3096T-L	90	10.1	-	170
GS2CWR3096T-W	90	10.1	-	170
GS2CWR3096-W	85	8.3	-	168
GS2CWR24102-L	81	6.9	-	167
GS2CWR24102T-L	82	8.8	-	169
GS2CWR24102T-W	99	8.9	-	169
GS2CWR24102-W	81	6.9	-	167
GS2CWR24108-L	85	7.3	-	167
GS2CWR24108T-L	87	9.3	-	169
GS2CWR24108T-W	105	9.4	-	169
GS2CWR24108-W	85	7.3	-	167
GS2CWR24114-L	89	7.7	-	167
GS2CWR24114T-L	92	9.8	-	169
GS2CWR24114T-W	111	9.9	-	169

model number	weight	cubes	#locks	page
GS2CWR24114-W	89	7.7	-	167
GS2CWR24120-L	94	8	-	167
GS2CWR24120T-L	96	10.3	-	169
GS2CWR24120T-W	117	10.4	-	169
GS2CWR24120-W	94	8	-	167
GS2CWR30102-L	90	8.8	-	168
GS2CWR30102T-L	96	10.7	-	170
GS2CWR30102T-W	96	10.7	-	170
GS2CWR30102-W	90	8.8	-	168
GS2CWR30108-L	95	9.3	-	168
GS2CWR30108T-L	102	11.3	-	170
GS2CWR30108T-W	102	11.3	-	170
GS2CWR30108-W	95	9.3	-	168
GS2CWR30114-L	100	9.8	-	168
GS2CWR30114T-L	108	12	-	170
GS2CWR30114T-W	108	12	-	170
GS2CWR30114-W	100	9.8	-	168
GS2CWR30120-L	105	10.2	-	168
GS2CWR30120T-L	114	12.6	-	170
GS2CWR30120T-W	114	12.6	-	170
GS2CWR30120-W	105	10.2	-	168
GS2DBOB4272-32LL	342	33.8	2	52
GS2DBOB4272-32WW	342	33.8	2	52
GS2DBOB4272L-3LL	266	23.3	1	53
GS2DBOB4272L-3WW	266	23.3	1	53
GS2DBOB4272R-3LL	266	23.3	1	53
GS2DBOB4272R-3WW	266	23.3	1	53
GS2DBOF4272L-3LL	247	26	1	54
GS2DBOF4272L-3WW	247	26	1	54
GS2DBOF4272R-3LL	247	26	1	54
GS2DBOF4272R-3WW	247	26	1	54
GS2DDMF990-L	49	5.6	-	163
GS2DDMF990-W	49	5.8	-	163
GS2DDMF996-L	52	6	-	163
GS2DDMF996-W	52	6.3	-	163
GS2DDMF1560-L	33	3.2	-	163
GS2DDMF1560-W	33	3.2	-	163
GS2DDMF1566-L	36	3.9	-	163
GS2DDMF1566-W	36	3.9	-	163
GS2DDMF1572-L	39	4.5	-	163
GS2DDMF1572-W	39	4.5	-	163
GS2DDMF1578-L	42	5.1	-	163
GS2DDMF1578-W	42	5.1	-	163
GS2DDMF1584-L	46	5.8	-	163

WEIGHTS + CUBES

Silea
03/23

model number	weight	cubes	#locks	page
GS2DDMF1584-W	46	5.8	-	163
GS2DDMF1590-L	49	5	-	163
GS2DDMF1590-W	49	5	-	163
GS2DDMF1596-L	52	5.4	-	163
GS2DDMF1596-W	52	5.4	-	163
GS2DHL24-H	18	2.9	-	158
GS2DHL30-H	21	3.5	-	158
GS2DHL36-H	23	4.2	-	158
GS2DMPA24-L	7	0.8	-	162
GS2DMPA24-W	7	0.8	-	162
GS2DMPA27-L	7	0.9	-	162
GS2DMPA27-W	7	0.9	-	162
GS2DMPA30-L	7	0.9	-	162
GS2DMPA30-W	7	0.9	-	162
GS2DMPA33-L	7	1	-	162
GS2DMPA33-W	7	1	-	162
GS2DMPA36-L	7	1.1	-	162
GS2DMPA36-W	7	1.1	-	162
GS2DMPA39-L	7	1.2	-	162
GS2DMPA39-W	7	1.2	-	162
GS2DMPA42-L	8	1.3	-	162
GS2DMPA42-W	8	1.3	-	162
GS2DMPA45-L	8	1.4	-	162
GS2DMPA45-W	8	1.4	-	162
GS2DMPA48-L	9	1.5	-	162
GS2DMPA48-W	9	1.5	-	162
GS2DMPA51-L	9	1.5	-	162
GS2DMPA51-W	9	1.5	-	162
GS2DMPA54-L	10	1.6	-	162
GS2DMPA54-W	10	1.6	-	162
GS2DMPA57-L	10	1.7	-	162
GS2DMPA57-W	10	1.7	-	162
GS2DMPA60-L	11	1.8	-	162
GS2DMPA60-W	11	1.8	-	162
GS2DMPA63-L	11	1.9	-	162
GS2DMPA63-W	11	1.9	-	162
GS2DMPA66-L	12	2	-	162
GS2DMPA66-W	12	2	-	162
GS2DMPA69-L	12	2.1	-	162
GS2DMPA69-W	12	2.1	-	162
GS2DMPA72-L	13	2.1	-	162
GS2DMPA72-W	13	2.1	-	162
GS2DMPH39-G	7	1.2	-	161
GS2DMPH39-L	7	1.2	-	161

model number	weight	cubes	#locks	page
GS2DMPH39-W	7	1.2	-	161
GS2DMPH42-G	8	1.3	-	161
GS2DMPH42-L	8	1.3	-	161
GS2DMPH42-W	8	1.3	-	161
GS2DMPH45-G	8	1.3	-	161
GS2DMPH45-L	8	1.3	-	161
GS2DMPH45-W	8	1.3	-	161
GS2DMPH48-G	9	1.4	-	161
GS2DMPH48-L	9	1.4	-	161
GS2DMPH48-W	9	1.4	-	161
GS2DMPH51-G	9	1.5	-	161
GS2DMPH51-L	9	1.5	-	161
GS2DMPH51-W	9	1.5	-	161
GS2DMPH54-G	10	1.6	-	161
GS2DMPH54-L	10	1.6	-	161
GS2DMPH54-W	10	1.6	-	161
GS2DMPH57-G	10	1.7	-	161
GS2DMPH57-L	10	1.7	-	161
GS2DMPH57-W	10	1.7	-	161
GS2DMPH60-G	11	1.8	-	161
GS2DMPH60-L	11	1.8	-	161
GS2DMPH60-W	11	1.8	-	161
GS2DMPH63-G	11	1.9	-	161
GS2DMPH63-L	11	1.9	-	161
GS2DMPH63-W	11	1.9	-	161
GS2DMPH66-G	12	1.9	-	161
GS2DMPH66-L	12	1.9	-	161
GS2DMPH66-W	12	1.9	-	161
GS2DMPH69-G	12	2	-	161
GS2DMPH69-L	12	2	-	161
GS2DMPH69-W	12	2	-	161
GS2DMPH72-G	13	2.1	-	161
GS2DMPH72-L	13	2.1	-	161
GS2DMPH72-W	13	2.1	-	161
GS2DPC2472-22LL	265	26.8	1	58
GS2DPC2472-22WW	265	26.8	1	58
GS2DPD309-2SL	85	7.3	1	154
GS2DPD309-2SW	85	7.3	1	154
GS2DPD309-3SL	85	7.3	1	154
GS2DPD309-3SW	85	7.3	1	154
GS2DPD309L-XNL	45	7.3	-	155
GS2DPD309L-XNW	45	7.3	-	155
GS2DPD309R-XNL	45	7.3	-	155
GS2DPD309R-XNW	45	7.3	-	155

model number	weight	cubes	#locks	page
GS2DPD369-2SL	92	8.6	1	154
GS2DPD369-2SW	92	8.6	1	154
GS2DPD369-3SL	92	8.6	1	154
GS2DPD369-3SW	92	8.6	1	154
GS2DPD369L-XNL	52	8.6	-	155
GS2DPD369L-XNW	52	8.6	-	155
GS2DPD369R-XNL	52	8.6	-	155
GS2DPD369R-XNW	52	8.6	-	155
GS2DPD3015-2L	105	10.6	1	154
GS2DPD3015-2W	105	10.6	1	154
GS2DPD3015-3L	105	10.6	1	154
GS2DPD3015-3W	105	10.6	1	154
GS2DPD3015L-XNL	51	10.6	-	155
GS2DPD3015L-XNW	51	10.6	-	155
GS2DPD3015R-XNL	51	10.6	-	155
GS2DPD3015R-XNW	51	10.6	-	155
GS2DPD3615-2L	112	12.5	1	154
GS2DPD3615-2W	112	12.5	1	154
GS2DPD3615-3L	112	12.5	1	154
GS2DPD3615-3W	112	12.5	1	154
GS2DPD3615L-XNL	58	12.5	-	155
GS2DPD3615L-XNW	58	12.5	-	155
GS2DPD3615R-XNL	58	12.5	-	155
GS2DPD3615R-XNW	58	12.5	-	155
GS2DRFB3060L-3LL	218	18.8	1	53
GS2DRFB3060L-3WW	218	18.8	1	53
GS2DRFB3060R-3LL	218	18.8	1	53
GS2DRFB3060R-3WW	218	18.8	1	53
GS2DRFB3066L-3LL	229	20	1	53
GS2DRFB3066L-3WW	229	20	1	53
GS2DRFB3066R-3LL	229	20	1	53
GS2DRFB3066R-3WW	229	20	1	53
GS2DRFB3072L-3LL	240	21.1	1	53
GS2DRFB3072L-3WW	240	21.1	1	53
GS2DRFB3072R-3LL	240	21.1	1	53
GS2DRFB3072R-3WW	240	21.1	1	53
GS2DROB3672-32LL	329	32.7	2	52
GS2DROB3672-32WW	329	32.7	2	52
GS2DROB3672L-3LL	253	22.2	1	53
GS2DROB3672L-3WW	253	22.2	1	53
GS2DROB3672R-3LL	253	22.2	1	53
GS2DROB3672R-3WW	253	22.2	1	53
GS2DROB3678L-3LL	266	23.4	1	53
GS2DROB3678L-3WW	266	23.4	1	53

model number	weight	cubes	#locks	page
GS2DROB3678R-3LL	266	23.4	1	53
GS2DROB3678R-3WW	266	23.4	1	53
GS2DROF3060L-3LL	180	19.5	1	54
GS2DROF3060L-3WW	180	19.5	1	54
GS2DROF3060R-3LL	180	19.5	1	54
GS2DROF3060R-3WW	180	19.5	1	54
GS2DROF3066L-3LL	188	20.4	1	54
GS2DROF3066L-3WW	188	20.4	1	54
GS2DROF3066R-3LL	188	20.4	1	54
GS2DROF3066R-3WW	188	20.4	1	54
GS2DROF3072L-3LL	197	21.2	1	54
GS2DROF3072L-3WW	197	21.2	1	54
GS2DROF3072R-3LL	197	21.2	1	54
GS2DROF3072R-3WW	197	21.2	1	54
GS2DROF3672-32LL	325	33.3	2	52
GS2DROF3672-32WW	325	33.3	2	52
GS2DROF3672L-3LL	234	24.9	1	54
GS2DROF3672L-3WW	234	24.9	1	54
GS2DROF3672R-3LL	234	24.9	1	54
GS2DROF3672R-3WW	234	24.9	1	54
GS2DROF3678L-3LL	244	25.9	1	54
GS2DROF3678L-3WW	244	25.9	1	54
GS2DROF3678R-3LL	244	25.9	1	54
GS2DROF3678R-3WW	244	25.9	1	54
GS2DSL24-G	26	2.9	-	157
GS2DSL24-H	20	2.9	-	156
GS2DSL24-N	17	2.9	-	156
GS2DSL24-NST	18	2.9	-	156
GS2DSL30-G	29	3.5	-	157
GS2DSL30-H	23	3.5	-	156
GS2DSL30-N	20	3.5	-	156
GS2DSL30-NST	21	3.5	-	156
GS2DSL36-G	31	4.2	-	157
GS2DSL36-H	25	4.2	-	156
GS2DSL36-N	22	4.2	-	156
GS2DSL36-NST	23	4.2	-	156
GS2DWA3672-L	80	7.1	-	151
GS2DWA3672-W	80	7.1	-	151
GS2DWA3684-L	93	8.2	-	151
GS2DWA3684-W	93	8.2	-	151
GS2DWA4272-L	93	8.2	-	151
GS2DWA4272-W	93	8.2	-	151
GS2DWA4284-L	109	9.5	-	151
GS2DWA4284-W	109	9.5	-	151

WEIGHTS + CUBES

Silea
03/23

model number	weight	cubes	#locks	page
GS2DWB4272-L	93	8.2	-	153
GS2DWB4272-W	93	8.2	-	153
GS2DWD4272-L	93	8.2	-	153
GS2DWD4272-W	93	8.2	-	153
GS2DWRR3042-L	39	3.6	-	150
GS2DWRR3042-W	39	3.6	-	150
GS2DWRR3048-L	44	4.1	-	150
GS2DWRR3048-W	44	4.1	-	150
GS2DWRR3054-L	50	4.6	-	150
GS2DWRR3054-W	50	4.6	-	150
GS2DWRR3060-L	56	5	-	150
GS2DWRR3060-W	56	5	-	150
GS2DWRR3066-L	61	5.5	-	150
GS2DWRR3066-W	61	5.5	-	150
GS2DWRR3072-L	67	6	-	150
GS2DWRR3072-W	67	6	-	150
GS2DWRR3078-L	72	6.5	-	150
GS2DWRR3078-W	72	6.5	-	150
GS2DWRR3084-L	78	7	-	150
GS2DWRR3084-W	78	7	-	150
GS2DWRR3090-L	84	7.4	-	150
GS2DWRR3090-W	80	7.8	-	150
GS2DWRR3096-L	90	7.9	-	150
GS2DWRR3096-W	85	8.3	-	150
GS2DWRR3642-L	47	4.3	-	150
GS2DWRR3642-W	47	4.3	-	150
GS2DWRR3648-L	53	4.8	-	150
GS2DWRR3648-W	53	4.8	-	150
GS2DWRR3654-L	60	5.4	-	150
GS2DWRR3654-W	60	5.4	-	150
GS2DWRR3660-L	67	6	-	150
GS2DWRR3660-W	67	6	-	150
GS2DWRR3666-L	73	6.5	-	150
GS2DWRR3666-W	73	6.5	-	150
GS2DWRR3672-L	80	7.1	-	150
GS2DWRR3672-W	80	7.1	-	150
GS2DWRR3678-L	87	7.7	-	150
GS2DWRR3678-W	87	7.7	-	150
GS2DWRR3684-L	93	8.2	-	150
GS2DWRR3684-W	93	8.2	-	150
GS2DWRR3690-L	100	8.7	-	150
GS2DWRR3690-W	96	9.1	-	150
GS2DWRR3696-L	106	9.3	-	150
GS2DWRR3696-W	102	9.7	-	150

model number	weight	cubes	#locks	page
GS2DWRT3066L-L	61	5.5	-	152
GS2DWRT3066L-W	61	5.5	-	152
GS2DWRT3066R-L	61	5.5	-	152
GS2DWRT3066R-W	61	5.5	-	152
GS2DWRT3072L-L	67	6	-	152
GS2DWRT3072L-W	67	6	-	152
GS2DWRT3072R-L	67	6	-	152
GS2DWRT3072R-W	67	6	-	152
GS2FBX75H90L-WSG	775	103	-	321
GS2FBX75H90R-WSG	775	103	-	321
GS2FSC2460-44LL	240	32	2	60
GS2FSC2460-55LL	210	32	2	61
GS2FSC2460-55WW	210	32	2	61
GS2FSC2472-44LL	310	38.1	2	60
GS2FSC2472-44WW	310	38.1	2	60
GS2FSC2472-55LL	280	38.1	2	61
GS2FSC2472-55WW	280	38.1	2	61
GS2FSF830-L	10	0.9	-	304
GS2FSF830-W	10	0.9	-	304
GS2FSF836-L	12	1	-	304
GS2FSF836-W	12	1	-	304
GS2FSF842-L	14	1.2	-	304
GS2FSF842-W	14	1.2	-	304
GS2FSF848-L	16	1.4	-	304
GS2FSF848-W	16	1.4	-	304
GS2FSF854-L	18	1.5	-	304
GS2FSF854-W	18	1.5	-	304
GS2FSF860-L	20	1.7	-	304
GS2FSF860-W	20	1.7	-	304
GS2FSF866-L	22	1.8	-	304
GS2FSF866-W	22	1.8	-	304
GS2FSF872-L	24	2	-	304
GS2FSF872-W	24	2	-	304
GS2GMT	1	0.1	-	336
GS2LFS2H30-LL	156	16.8	1	240
GS2LFS2H30-WW	156	16.8	1	240
GS2LFS2H36-LL	179	19.8	1	240
GS2LFS2H36-WW	179	19.8	1	240
GS2LFS3H30-LL	201	23.3	1	241
GS2LFS3H30-WW	201	23.3	1	241
GS2LFS3H36-LL	230	27.5	1	241
GS2LFS3H36-WW	230	27.5	1	241
GS2LFS4H30-LL	246	29.6	1	241
GS2LFS4H30-WW	246	29.6	1	241

model number	weight	cubes	#locks	page
GS2LFS4H36-LL	281	35	1	241
GS2LFS4H36-WW	281	35	1	241
GS2LFS5H30-LL	291	36.9	1	241
GS2LFS5H30-WW	291	36.9	1	241
GS2LFS5H36-LL	332	43.6	1	241
GS2LFS5H36-WW	332	43.6	1	241
GS2LFS6H30-LL	337	43.8	1	241
GS2LFS6H30-WW	337	43.8	1	241
GS2LFS6H36-LL	386	51.8	1	241
GS2LFS6H36-WW	386	51.8	1	241
GS2LHAPD2424L-LL	88	10.4	-	118
GS2LHAPD2424L-WW	88	10.4	-	118
GS2LHAPD2424R-LL	88	10.4	-	118
GS2LHAPD2424R-WW	88	10.4	-	118
GS2LHAPD2430L-LL	96	12.7	-	118
GS2LHAPD2430L-WW	96	12.7	-	118
GS2LHAPD2430R-LL	96	12.7	-	118
GS2LHAPD2430R-WW	96	12.7	-	118
GS2LHAPD2436L-LL	114	15	-	118
GS2LHAPD2436L-WW	114	15	-	118
GS2LHAPD2436R-LL	114	15	-	118
GS2LHAPD2436R-WW	114	15	-	118
GS2LKR5H24L-LG	175	28.8	-	261
GS2LKR5H24L-LL	175	28.8	-	260
GS2LKR5H24L-WG	175	30.2	-	261
GS2LKR5H24L-WW	175	30.2	-	260
GS2LKR5H24R-LG	175	28.8	-	261
GS2LKR5H24R-LL	175	28.8	-	260
GS2LKR5H24R-WG	175	30.2	-	261
GS2LKR5H24R-WW	175	30.2	-	260
GS2LKR6H24L-LG	230	34	-	261
GS2LKR6H24L-LL	230	33.9	-	260
GS2LKR6H24L-WG	230	35.8	-	261
GS2LKR6H24L-WW	230	35.8	-	260
GS2LKR6H24R-LG	230	34	-	261
GS2LKR6H24R-LL	230	33.9	-	260
GS2LKR6H24R-WG	230	35.8	-	261
GS2LKR6H24R-WW	230	35.8	-	260
GS2LLKR5H24L-LG	175	28.8	-	263
GS2LLKR5H24L-LL	175	28.8	-	262
GS2LLKR5H24L-WG	175	30.2	-	263
GS2LLKR5H24L-WW	175	30.2	-	262
GS2LLKR5H24R-LG	175	28.8	-	263
GS2LLKR5H24R-LL	175	28.8	-	262

model number	weight	cubes	#locks	page
GS2LLKR5H24R-WG	175	30.2	-	263
GS2LLKR5H24R-WW	175	30.2	-	262
GS2LLKR6H24L-LG	230	34	-	263
GS2LLKR6H24L-LL	230	33.9	-	262
GS2LLKR6H24L-WG	230	35.8	-	263
GS2LLKR6H24L-WW	230	35.8	-	262
GS2LLKR6H24R-LG	230	34	-	263
GS2LLKR6H24R-LL	230	33.9	-	262
GS2LLKR6H24R-WG	230	35.8	-	263
GS2LLKR6H24R-WW	230	35.8	-	262
GS2MEP24L-L	11	1.8	-	201
GS2MEP24L-W	11	1.8	-	201
GS2MEP24R-L	11	1.8	-	201
GS2MEP24R-W	11	1.8	-	201
GS2MEP30L-L	14	2.2	-	201
GS2MEP30L-W	14	2.2	-	201
GS2MEP30R-L	14	2.2	-	201
GS2MEP30R-W	14	2.2	-	201
GS2MEP36L-L	17	2.6	-	201
GS2MEP36L-W	17	2.6	-	201
GS2MEP36R-L	17	2.6	-	201
GS2MEP36R-W	17	2.6	-	201
GS2MLB18	5	0.4	-	217
GS2MLB24	7	0.5	-	217
GS2MLB30	9	0.6	-	217
GS2MLB30SL-L	45	3	-	214
GS2MLB30SL-W	45	3.2	-	214
GS2MLB30SR-L	45	3	-	214
GS2MLB30SR-W	45	3.2	-	214
GS2MLB36	11	0.8	-	217
GS2MLB36SL-L	51	3.6	-	214
GS2MLB36SL-W	51	3.8	-	214
GS2MLB36SR-L	51	3.6	-	214
GS2MLB36SR-W	51	3.8	-	214
GS2MLPB15-L	7	0.9	-	204
GS2MLPB15-W	7	0.9	-	204
GS2MLPB18-L	11	1.1	-	204
GS2MLPB18-W	11	1.1	-	204
GS2MLPB30-L	14	1.7	-	204
GS2MLPB30-W	14	1.7	-	204
GS2MLPB36-L	17	2	-	204
GS2MLPB36-W	17	2	-	204
GS2MLPF-L	2	0.5	-	204
GS2MLPF-W	2	0.5	-	204

WEIGHTS + CUBES

Silea
03/23

model number	weight	cubes	#locks	page
GS2MLS24L-L	25	2.9	-	202
GS2MLS24L-W	25	2.9	-	202
GS2MLS24R-L	25	2.9	-	202
GS2MLS24R-W	25	2.9	-	202
GS2MLS30L-L	28	3.5	-	202
GS2MLS30L-W	28	3.5	-	202
GS2MLS30R-L	28	3.5	-	202
GS2MLS30R-W	28	3.5	-	202
GS2MLSJ24-L	20	1.5	-	204
GS2MLSJ24-W	20	1.5	-	204
GS2MLSP-L	9	0.9	-	204
GS2MLSPT-L	13	1.5	-	204
GS2MLSPT-W	13	1.5	-	204
GS2MLSP-W	9	0.9	-	204
GS2MPB9-L	5	0.8	-	203
GS2MPB9-W	5	0.8	-	203
GS2MPB15-L	7	1.2	-	203
GS2MPB15-W	7	1.2	-	203
GS2MPB18-L	11	1.4	-	203
GS2MPB18-W	11	1.4	-	203
GS2MPB30-L	14	2.2	-	203
GS2MPB30-W	14	2.2	-	203
GS2MPB36-L	17	2.6	-	203
GS2MPB36-W	17	2.6	-	203
GS2MPD-2LL	84	9.1	1	264
GS2MPD-2WW	84	9.1	1	264
GS2MPD-3LL	84	9.1	1	264
GS2MPD-3WW	84	9.1	1	264
GS2MPD-6LL	91	6.4	1	264
GS2MPD-6WW	91	6.4	1	264
GS2MPD-CUSH2215	7	1	-	265
GS2MPF-L	2	0.6	-	203
GS2MPF-W	2	0.6	-	203
GS2MSJ24-L	20	1.9	-	203
GS2MSJ24-W	20	1.9	-	203
GS2MSP-L	9	1.2	-	203
GS2MSPT-L	13	1.9	-	203
GS2MSPT-W	13	1.9	-	203
GS2MSP-W	9	1.2	-	203
GS2RLC6072L-L	149	18.4	-	77
GS2RLC6072L-S	163	18.4	-	77
GS2RLC6072L-W	156	13.5	-	77
GS2RLC6072R-L	149	18.4	-	77
GS2RLC6072R-S	163	18.4	-	77

model number	weight	cubes	#locks	page
GS2RLC6072R-W	156	13.5	-	77
GS2RLC6084L-L	171	21.1	-	77
GS2RLC6084L-S	183	21.1	-	77
GS2RLC6084L-W	180	15.4	-	77
GS2RLC6084R-L	171	21.1	-	77
GS2RLC6084R-S	183	21.1	-	77
GS2RLC6084R-W	180	15.4	-	77
GS2RLEL3672-L	104	13.3	-	71
GS2RLEL3672-S	175	13.3	-	71
GS2RLEL3672-W	108	10.2	-	71
GS2RLEL4284-L	133	16.9	-	71
GS2RLEL4284-S	190	16.9	-	71
GS2RLEL4284-W	139	12.8	-	71
GS2RLFL3672-L	104	13.3	-	73
GS2RLFL3672-S	175	13.3	-	73
GS2RLFL3672-W	108	10.2	-	73
GS2RLFL4284-L	133	16.9	-	73
GS2RLFL4284-S	190	16.9	-	73
GS2RLFL4284-W	139	12.8	-	73
GS2RLO3066L-3LL	160	13.7	1	56
GS2RLO3066L-3WW	160	13.7	1	56
GS2RLO3066R-3LL	160	13.7	1	56
GS2RLO3066R-3WW	160	13.7	1	56
GS2RLO3072L-3LL	167	14.3	1	56
GS2RLO3072L-3WW	167	14.3	1	56
GS2RLO3072R-3LL	167	14.3	1	56
GS2RLO3072R-3WW	167	14.3	1	56
GS2RLO3672L-3LL	189	16.8	1	56
GS2RLO3672L-3WW	189	16.8	1	56
GS2RLO3672R-3LL	189	16.8	1	56
GS2RLO3672R-3WW	189	16.8	1	56
GS2RLO3678L-3LL	196	17.5	1	56
GS2RLO3678L-3WW	196	17.5	1	56
GS2RLO3678R-3LL	196	17.5	1	56
GS2RLO3678R-3WW	196	17.5	1	56
GS2RLOS3066L-3LL	270	42.8	1	57
GS2RLOS3066L-3WW	196	16	1	57
GS2RLOS3066R-3LL	270	42.8	1	57
GS2RLOS3066R-3WW	196	16	1	57
GS2RLOS3072L-3LL	280	46.5	1	57
GS2RLOS3072L-3WW	202	16.5	1	57
GS2RLOS3072R-3LL	280	46.5	1	57
GS2RLOS3072R-3WW	202	16.5	1	57
GS2RLOS3672L-3LL	290	55	1	57

model number	weight	cubes	#locks	page
GS2RLOS3672L-3WW	228	19.5	1	57
GS2RLOS3672R-3LL	290	55	1	57
GS2RLOS3672R-3WW	228	19.5	1	57
GS2RLOS3678L-3LL	300	59.4	1	57
GS2RLOS3678L-3WW	235	20.1	1	57
GS2RLOS3678R-3LL	300	59.4	1	57
GS2RLOS3678R-3WW	235	20.1	1	57
GS2RLRL3066L-L	91	8.4	-	68
GS2RLRL3066L-W	91	8.4	-	68
GS2RLRL3066R-L	91	8.4	-	68
GS2RLRL3066R-W	91	8.4	-	68
GS2RLRL3072L-L	98	9	-	68
GS2RLRL3072L-W	98	9	-	68
GS2RLRL3072R-L	98	9	-	68
GS2RLRL3072R-W	98	9	-	68
GS2RLRL3672L-L	113	10.2	-	68
GS2RLRL3672L-W	113	10.2	-	68
GS2RLRL3672R-L	113	10.2	-	68
GS2RLRL3672R-W	113	10.2	-	68
GS2RLRL3678L-L	120	10.9	-	68
GS2RLRL3678L-W	120	10.9	-	68
GS2RLRL3678R-L	120	10.9	-	68
GS2RLRL3678R-W	120	10.9	-	68
GS2RLRLS3066L-L	127	10.5	-	69
GS2RLRLS3066L-W	127	10.7	-	69
GS2RLRLS3066R-L	127	10.5	-	69
GS2RLRLS3066R-W	127	10.7	-	69
GS2RLRLS3072L-L	133	11	-	69
GS2RLRLS3072L-W	133	11.2	-	69
GS2RLRLS3072R-L	133	11	-	69
GS2RLRLS3072R-W	133	11.2	-	69
GS2RLRLS3672L-L	152	12.7	-	69
GS2RLRLS3672L-W	152	12.9	-	69
GS2RLRLS3672R-L	152	12.7	-	69
GS2RLRLS3672R-W	152	12.9	-	69
GS2RLRLS3678L-L	159	13.3	-	69
GS2RLRLS3678L-W	159	13.5	-	69
GS2RLRLS3678R-L	159	13.3	-	69
GS2RLRLS3678R-W	159	13.5	-	69
GS2RLSL304272L-L	118	14.9	-	75
GS2RLSL304272L-S	189	14.9	-	75
GS2RLSL304272L-W	123	11.4	-	75
GS2RLSL364884L-L	148	18.7	-	75
GS2RLSL364884L-S	235	18.7	-	75

model number	weight	cubes	#locks	page
GS2RLSL364884-W	154	14.1	-	75
GS2RLSLS304272L-L	149	16.7	-	76
GS2RLSLS304272L-W	154	13.4	-	76
GS2RLSLS304272R-L	149	16.7	-	76
GS2RLSLS304272R-W	154	13.4	-	76
GS2RLSLS364884L-L	190	21.6	-	76
GS2RLSLS364884L-W	196	17.2	-	76
GS2RLSLS364884R-L	190	21.6	-	76
GS2RLSLS364884R-W	196	17.2	-	76
GS2RMA21-L	23	3.9	-	211
GS2RMA21-W	23	3.9	-	211
GS2RMA24-L	25	4.3	-	211
GS2RMA24-W	25	4.3	-	211
GS2RMA27-L	27	4.8	-	211
GS2RMA27-W	27	4.8	-	211
GS2RMA30-L	29	5.3	-	211
GS2RMA30-W	29	5.3	-	211
GS2RMA33-L	31	5.8	-	211
GS2RMA33-W	31	5.8	-	211
GS2RMA36-L	33	6.3	-	211
GS2RMA36-W	33	6.3	-	211
GS2RMA39-L	35	6.8	-	211
GS2RMA39-W	35	6.8	-	211
GS2RMA42-L	37	7.2	-	211
GS2RMA42-W	37	7.2	-	211
GS2RMA45-L	39	7.7	-	211
GS2RMA45-W	39	7.7	-	211
GS2RMA48-L	41	8.2	-	211
GS2RMA48-W	41	8.2	-	211
GS2RMA51-L	43	8.7	-	211
GS2RMA51-W	43	8.7	-	211
GS2RMA54-L	45	11.3	-	211
GS2RMA54-W	45	11.3	-	211
GS2RMA57-L	47	11.9	-	211
GS2RMA57-W	47	11.9	-	211
GS2RMA60-L	49	12.4	-	211
GS2RMA60-W	49	12.4	-	211
GS2RMA63-L	51	13	-	211
GS2RMA63-W	51	13	-	211
GS2RMA66-L	53	13.6	-	211
GS2RMA66-W	53	13.6	-	211
GS2RMA69-L	55	14.2	-	211
GS2RMA69-W	55	14.2	-	211
GS2RMA72-L	57	14.8	-	211

WEIGHTS + CUBES

Silea
03/23

model number	weight	cubes	#locks	page
GS2RMA72-W	57	14.8	-	211
GS2RMF39L-L	19	2.9	-	209
GS2RMF39L-W	19	2.9	-	209
GS2RMF39R-L	19	2.9	-	210
GS2RMF39R-W	19	2.9	-	210
GS2RMF42L-L	20	3.1	-	209
GS2RMF42L-W	20	3.1	-	209
GS2RMF42R-L	20	3.1	-	210
GS2RMF42R-W	20	3.1	-	210
GS2RMF45L-L	21	3.3	-	209
GS2RMF45L-W	21	3.3	-	209
GS2RMF45R-L	21	3.3	-	210
GS2RMF45R-W	21	3.3	-	210
GS2RMF48L-L	23	3.5	-	209
GS2RMF48L-W	23	3.5	-	209
GS2RMF48R-L	23	3.5	-	210
GS2RMF48R-W	23	3.5	-	210
GS2RMF51L-L	24	3.7	-	209
GS2RMF51L-W	24	3.7	-	209
GS2RMF51R-L	24	3.7	-	210
GS2RMF51R-W	24	3.7	-	210
GS2RMF54L-L	26	3.9	-	209
GS2RMF54L-W	26	3.9	-	209
GS2RMF54R-L	26	3.9	-	210
GS2RMF54R-W	26	3.9	-	210
GS2RMF57L-L	27	4.1	-	209
GS2RMF57L-W	27	4.1	-	209
GS2RMF57R-L	27	4.1	-	210
GS2RMF57R-W	27	4.1	-	210
GS2RMF60L-L	29	4.3	-	209
GS2RMF60L-W	29	4.3	-	209
GS2RMF60R-L	29	4.3	-	210
GS2RMF60R-W	29	4.3	-	210
GS2RMF63L-L	31	3.7	-	209
GS2RMF63L-W	31	3.7	-	209
GS2RMF63R-L	31	3.7	-	210
GS2RMF63R-W	31	3.7	-	210
GS2RMF66L-L	33	3.9	-	209
GS2RMF66L-W	33	3.9	-	209
GS2RMF66R-L	33	3.9	-	210
GS2RMF66R-W	33	3.9	-	210
GS2RMF69L-L	35	4.1	-	209
GS2RMF69L-W	35	4.1	-	209
GS2RMF69R-L	35	4.1	-	210

model number	weight	cubes	#locks	page
GS2RMF69R-W	35	4.1	-	210
GS2RMF72L-L	37	4.2	-	209
GS2RMF72L-W	37	4.2	-	209
GS2RMF72R-L	37	4.2	-	210
GS2RMF72R-W	37	4.2	-	210
GS2RMF75L-L	39	4.4	-	209
GS2RMF75L-W	39	4.4	-	209
GS2RMF75R-L	39	4.4	-	210
GS2RMF75R-W	39	4.4	-	210
GS2RMF78L-L	41	4.6	-	209
GS2RMF78L-W	41	4.6	-	209
GS2RMF78R-L	41	4.6	-	210
GS2RMF78R-W	41	4.6	-	210
GS2RMF81L-L	43	4.7	-	209
GS2RMF81L-W	43	4.7	-	209
GS2RMF81R-L	43	4.7	-	210
GS2RMF81R-W	43	4.7	-	210
GS2RMF84L-L	45	4.9	-	209
GS2RMF84L-W	45	4.9	-	209
GS2RMF84R-L	45	4.9	-	210
GS2RMF84R-W	45	4.9	-	210
GS2RMF87L-L	47	5.1	-	209
GS2RMF87L-W	47	5.1	-	209
GS2RMF87R-L	47	5.1	-	210
GS2RMF87R-W	47	5.1	-	210
GS2RMF90L-L	49	5.2	-	209
GS2RMF90L-W	49	5.2	-	209
GS2RMF90R-L	49	5.2	-	210
GS2RMF90R-W	49	5.2	-	210
GS2RNDCOLUMN	10	0.6	-	159
GS2RRL3048-L	65	6.1	-	67
GS2RRL3048-W	65	6.1	-	67
GS2RRL3054-L	71	6.6	-	67
GS2RRL3054-W	75	7.1	-	67
GS2RRL3654-L	81	7.4	-	67
GS2RRL3654-W	85	7.9	-	67
GS2RRL3660-L	88	8	-	67
GS2RRL3660-W	92	8.5	-	67
GS2RRMF42L-L	23	4.5	-	165
GS2RRMF42L-W	23	4.5	-	165
GS2RRMF42R-L	23	4.5	-	165
GS2RRMF42R-W	23	4.5	-	165
GS2RRMF48L-L	26	5.1	-	165
GS2RRMF48L-W	26	5.1	-	165

model number	weight	cubes	#locks	page
GS2RRMF48R-L	26	5.1	-	165
GS2RRMF48R-W	26	5.1	-	165
GS2RRMF54L-L	29	5.8	-	165
GS2RRMF54L-W	29	5.8	-	165
GS2RRMF54R-L	29	5.8	-	165
GS2RRMF54R-W	29	5.8	-	165
GS2RRMF60L-L	33	6.4	-	165
GS2RRMF60L-W	33	6.4	-	165
GS2RRMF60R-L	33	6.4	-	165
GS2RRMF60R-W	33	6.4	-	165
GS2RRMF66L-L	36	7.1	-	165
GS2RRMF66L-W	36	7.1	-	165
GS2RRMF66R-L	36	7.1	-	165
GS2RRMF66R-W	36	7.1	-	165
GS2RRMF72L-L	39	7.7	-	165
GS2RRMF72L-W	39	7.7	-	165
GS2RRMF72R-L	39	7.7	-	165
GS2RRMF72R-W	39	7.7	-	165
GS2RRO3048L-3LL	136	12.6	1	55
GS2RRO3048L-3WW	141	12.6	1	55
GS2RRO3048R-3LL	136	12.6	1	55
GS2RRO3048R-3WW	141	12.6	1	55
GS2RRO3054L-3LL	143	13.2	1	55
GS2RRO3054L-3WW	148	13.2	1	55
GS2RRO3054R-3LL	143	13.2	1	55
GS2RRO3054R-3WW	148	13.2	1	55
GS2RRO3654L-3LL	160	15.3	1	55
GS2RRO3654L-3WW	165	15.4	1	55
GS2RRO3654R-3LL	160	15.3	1	55
GS2RRO3654R-3WW	165	15.4	1	55
GS2RRO3660L-3LL	168	16.1	1	55
GS2RRO3660L-3WW	173	16.1	1	55
GS2RRO3660R-3LL	168	16.1	1	55
GS2RRO3660R-3WW	173	16.1	1	55
GS2RROF3048L-3LL	154	17.6	-	66
GS2RROF3048L-3WW	154	17.6	-	66
GS2RROF3048R-3LL	154	17.6	-	66
GS2RROF3048R-3WW	154	17.6	-	66
GS2RROF3054L-3LL	163	18.7	-	66
GS2RROF3054L-3WW	163	18.7	-	66
GS2RROF3054R-3LL	163	18.7	-	66
GS2RROF3054R-3WW	163	18.7	-	66
GS2RROF3654L-3LL	194	21.7	-	66
GS2RROF3654L-3WW	194	21.7	-	66

model number	weight	cubes	#locks	page
GS2RROF3654R-3LL	194	21.7	-	66
GS2RROF3654R-3WW	194	21.7	-	66
GS2RROF3660L-3LL	205	23	-	66
GS2RROF3660L-3WW	205	23	-	66
GS2RROF3660R-3LL	205	23	-	66
GS2RROF3660R-3WW	205	23	-	66
GS2RSL304254-L	82	10.9	-	74
GS2RSL304254-W	86	8.2	-	74
GS2RSL364866-L	113	14.7	-	74
GS2RSL364866-W	118	11	-	74
GS2RTN2442L-2LL	140	14.4	2	62
GS2RTN2442L-2WW	140	14.4	2	62
GS2RTN2442R-2LL	140	14.4	2	62
GS2RTN2442R-2WW	140	14.4	2	62
GS2RTN2448L-2LL	148	15.2	2	62
GS2RTN2448L-2WW	148	15.2	2	62
GS2RTN2448R-2LL	148	15.2	2	62
GS2RTN2448R-2WW	148	15.2	2	62
GS2RTN2454L-2LL	155	16	2	62
GS2RTN2454L-2WW	155	16	2	62
GS2RTN2454R-2LL	155	16	2	62
GS2RTN2454R-2WW	155	16	2	62
GS2RTN2460L-2LL	162	16.8	2	62
GS2RTN2460L-2WW	162	16.8	2	62
GS2RTN2460R-2LL	162	16.8	2	62
GS2RTN2460R-2WW	162	16.8	2	62
GS2SBD5H15-3LN	160	22.5	1	250
GS2SBD5H15-3WN	160	22.5	1	250
GS2SBD5H15L-3LL	167	22.5	2	248
GS2SBD5H15L-3WW	167	22.5	2	248
GS2SBD5H15L-LL	167	22.5	2	247
GS2SBD5H15-LN	160	22.5	1	249
GS2SBD5H15L-WW	167	22.5	2	247
GS2SBD5H15R-3LL	167	22.5	2	248
GS2SBD5H15R-3WW	167	22.5	2	248
GS2SBD5H15R-LL	167	22.5	2	247
GS2SBD5H15R-WW	167	22.5	2	247
GS2SBD5H15-WN	160	22.5	1	249
GS2SBD5H18-3LN	170	26	1	250
GS2SBD5H18-3WN	170	26	1	250
GS2SBD5H18L-3LL	175	26	2	248
GS2SBD5H18L-3WW	175	26	2	248
GS2SBD5H18L-LL	175	23.5	1	247
GS2SBD5H18-LN	165	23.5	-	249

WEIGHTS + CUBES

Silea
03/23

model number	weight	cubes	#locks	page
GS2SBD5H18L-WW	175	23.5	1	247
GS2SBD5H18R-3LL	175	26	2	248
GS2SBD5H18R-3WW	175	26	2	248
GS2SBD5H18R-LL	175	23.5	1	247
GS2SBD5H18R-WW	175	23.5	1	247
GS2SBD5H18-WN	165	23.5	-	249
GS2SBD5H30D18-3LN	180	31.6	1	254
GS2SBD5H30D18-3WN	180	31.6	1	254
GS2SBD5H30D18L-3LL	185	31.6	2	253
GS2SBD5H30D18L-3WW	185	31.6	2	253
GS2SBD5H30D18L-LL	185	31.6	2	251
GS2SBD5H30D18-LN	180	31.6	1	252
GS2SBD5H30D18L-WW	185	31.6	2	251
GS2SBD5H30D18R-3LL	185	31.6	2	253
GS2SBD5H30D18R-3WW	185	31.6	2	253
GS2SBD5H30D18R-LL	185	31.6	2	251
GS2SBD5H30D18R-WW	185	31.6	2	251
GS2SBD5H30D18-WN	180	31.6	1	252
GS2SBD5H30-LL	297	36.9	2	247
GS2SBD5H30-LN	282	36.9	-	249
GS2SBD5H30-WN	282	36.9	-	249
GS2SBD5H30-WW	297	36.9	2	247
GS2SBD6H15-3LN	190	26.5	1	250
GS2SBD6H15-3WN	190	26.5	1	250
GS2SBD6H15L-3LL	197	26.5	2	248
GS2SBD6H15L-3WW	197	26.5	2	248
GS2SBD6H15L-LL	197	26.5	2	247
GS2SBD6H15-LN	190	26.5	1	249
GS2SBD6H15L-WW	197	26.5	2	247
GS2SBD6H15R-3WW	197	26.5	2	248
GS2SBD6H15R-LL	197	26.5	2	247
GS2SBD6H15R-WW	197	26.5	2	247
GS2SBD6H15-WN	190	26.5	1	249
GS2SBD6H18-3LN	200	30.7	1	250
GS2SBD6H18-3WN	200	30.7	1	250
GS2SBD6H18L-3LL	205	30.7	2	248
GS2SBD6H18L-3WW	205	30.7	2	248
GS2SBD6H18L-LL	205	27.9	1	247
GS2SBD6H18-LN	195	27.9	-	249
GS2SBD6H18L-WW	205	27.9	1	247
GS2SBD6H18R-3LL	205	30.7	2	248
GS2SBD6H18R-3WW	205	30.7	2	248
GS2SBD6H18R-LL	205	27.9	1	247

model number	weight	cubes	#locks	page
GS2SBD6H18R-WW	205	27.9	1	247
GS2SBD6H18-WN	195	27.9	-	249
GS2SBD6H30D18-3LN	210	37.2	1	254
GS2SBD6H30D18-3WN	210	37.2	1	254
GS2SBD6H30D18L-3LL	215	37.2	2	253
GS2SBD6H30D18L-3WW	215	37.2	2	253
GS2SBD6H30D18L-LL	215	37.2	2	251
GS2SBD6H30D18-LN	210	37.2	1	252
GS2SBD6H30D18L-WW	215	37.2	2	251
GS2SBD6H30D18R-3LL	215	37.2	2	253
GS2SBD6H30D18R-3WW	215	37.2	2	253
GS2SBD6H30D18R-LL	215	37.2	2	251
GS2SBD6H30D18R-WW	215	37.2	2	251
GS2SBD6H30D18-WN	210	37.2	1	252
GS2SBD6H30-LL	343	43.8	2	247
GS2SBD6H30-LN	328	43.8	-	249
GS2SBD6H30-WN	328	43.8	-	249
GS2SBD6H30-WW	343	43.8	2	247
GS2SCF2H30-5LL	123	16.8	1	259
GS2SCF2H30-5WW	123	16.8	1	259
GS2SCF2H36-5LL	143	19.8	1	259
GS2SCF2H36-5WW	143	19.8	1	259
GS2SDMF990L-L	71	5.8	-	164
GS2SDMF990L-W	71	5.8	-	164
GS2SDMF990R-L	71	5.6	-	164
GS2SDMF990R-W	71	5.8	-	164
GS2SDMF996L-L	74	6.1	-	164
GS2SDMF996L-W	74	6.3	-	164
GS2SDMF996R-L	74	6.1	-	164
GS2SDMF996R-W	74	6.3	-	164
GS2SDMF1560L-L	57	3.2	-	164
GS2SDMF1560L-W	57	3.2	-	164
GS2SDMF1560R-L	57	3.2	-	164
GS2SDMF1560R-W	57	3.2	-	164
GS2SDMF1566L-L	63	3.9	-	164
GS2SDMF1566L-W	63	3.9	-	164
GS2SDMF1566R-L	63	3.9	-	164
GS2SDMF1566R-W	63	3.9	-	164
GS2SDMF1572L-L	68	4.5	-	164
GS2SDMF1572L-W	68	4.5	-	164
GS2SDMF1572R-L	68	4.5	-	164
GS2SDMF1572R-W	68	4.5	-	164
GS2SDMF1578L-L	74	5.1	-	164

model number	weight	cubes	#locks	page
GS2SDMF1578L-W	74	5.1	-	164
GS2SDMF1578R-L	74	5.1	-	164
GS2SDMF1578R-W	74	5.1	-	164
GS2SDMF1584L-L	80	5.8	-	164
GS2SDMF1584L-W	80	5.8	-	164
GS2SDMF1584R-L	80	5.8	-	164
GS2SDMF1584R-W	80	5.8	-	164
GS2SDMF1590L-L	74	4.7	-	164
GS2SDMF1590L-W	74	5	-	164
GS2SDMF1590R-L	74	4.7	-	164
GS2SDMF1590R-W	74	5	-	164
GS2SDMF1596L-L	77	5.2	-	164
GS2SDMF1596L-W	77	5.4	-	164
GS2SDMF1596R-L	77	5.2	-	164
GS2SDMF1596R-W	77	5.4	-	164
GS2SGTOPD3018-L	16	1.8	-	266
GS2SGTOPD3018-W	16	1.8	-	266
GS2SGTOPN3018-L	16	1.8	-	267
GS2SGTOPN3018-W	16	1.8	-	267
GS2SMC1H60-LL	120	27.3	2	306
GS2SMC1H60-LN	110	27.4	-	308
GS2SMC1H60-WG	120	27.3	-	307
GS2SMC1H60-WN	110	27.4	-	308
GS2SMC1H60-WW	120	27.3	2	306
GS2SMC1H66-LL	130	29.9	2	306
GS2SMC1H66-LN	120	30	-	308
GS2SMC1H66-WN	120	30	-	308
GS2SMC1H66-WW	130	29.9	2	306
GS2SMC1H72-LL	140	32.5	2	306
GS2SMC1H72-LN	130	32.6	-	308
GS2SMC1H72-WG	140	32.5	-	307
GS2SMC1H72-WN	130	32.6	-	308
GS2SMC1H72-WW	140	32.5	2	306
GS2SMC1H78-LL	148	35.1	2	306
GS2SMC1H78-LN	138	35.2	-	308
GS2SMC1H78-WN	138	35.2	-	308
GS2SMC1H78-WW	148	35.1	2	306
GS2SMC1H84-LL	167	37.7	3	306
GS2SMC1H84-LN	157	37.8	-	308
GS2SMC1H84-WN	157	37.8	-	308
GS2SMC1H84-WW	167	37.7	3	306
GS2SMC1H90-LL	175	40.3	3	306
GS2SMC1H90-LN	165	40.4	-	308
GS2SMC1H90-WG	175	40.3	-	307

model number	weight	cubes	#locks	page
GS2SMC1H90-WN	165	40.4	-	308
GS2SMC1H90-WW	175	40.3	3	306
GS2SMC1H96-LL	183	42.9	3	306
GS2SMC1H96-LN	173	43	-	308
GS2SMC1H96-WN	173	43	-	308
GS2SMC1H96-WW	183	42.9	3	306
GS2SMC1H102-LL	191	47.9	3	306
GS2SMC1H102-LN	181	45.6	-	308
GS2SMC1H102-WN	181	45.6	-	308
GS2SMC1H102-WW	191	45.5	3	306
GS2SMC1H108-LL	200	50.6	3	306
GS2SMC1H108-LN	190	48.2	-	308
GS2SMC1H108-WG	200	48.1	-	307
GS2SMC1H108-WN	190	48.2	-	308
GS2SMC1H108-WW	200	48.1	3	306
GS2SMC2H60-WG	180	35.9	-	310
GS2SMC2H60-WW	180	35.9	2	309
GS2SMC2H66-WW	195	39.4	2	309
GS2SMC2H72-WG	210	42.8	2	310
GS2SMC2H72-WW	210	42.8	-	309
GS2SMC2H78-WW	225	46.2	2	309
GS2SMC2H84-WW	245	49.6	3	309
GS2SMC2H90-WG	265	53.1	-	310
GS2SMC2H90-WW	265	53.1	3	309
GS2SMTOPN30-L	14	1.4	-	267, 318
GS2SMTOPN30-W	14	1.4	-	267, 318
GS2SMTOPN36-L	17	1.7	-	267, 318
GS2SMTOPN36-W	17	1.7	-	267, 318
GS2SMTOPN60-L	28	2.7	-	267, 318
GS2SMTOPN60-W	28	2.7	-	267, 318
GS2SMTOPN72-L	33	3.2	-	267, 318
GS2SMTOPN72-W	33	3.2	-	267, 318
GS2SMTOPN90-L	41	4	-	267, 318
GS2SMTOPN90-W	41	4	-	267, 318
GS2SMTOPN108-L	50	4.8	-	267, 318
GS2SMTOPN108-W	50	4.8	-	267, 318
GS2SPC2466L-2LL	174	17.6	1	59
GS2SPC2466L-2WW	174	17.6	1	59
GS2SPC2466R-2LL	174	17.6	1	59
GS2SPC2466R-2WW	174	17.6	1	59
GS2SPC2472L-2LL	181	18.4	1	59
GS2SPC2472L-2WW	181	18.4	1	59
GS2SPC2472L-4LL	213	25.4	1	59
GS2SPC2472L-4WW	213	25.4	1	59

WEIGHTS + CUBES

Silea
03/23

model number	weight	cubes	#locks	page
GS2SPC2472R-2LL	181	18.4	1	59
GS2SPC2472R-2WW	181	18.4	1	59
GS2SPC2472R-4LL	213	25.4	1	59
GS2SPC2472R-4WW	213	25.4	1	59
GS2SPC2478L-4LL	221	26.2	1	59
GS2SPC2478L-4WW	221	26.2	1	59
GS2SPC2478R-4LL	221	26.2	1	59
GS2SPC2478R-4WW	221	26.2	1	59
GS2SPC2484L-4LL	229	27	1	59
GS2SPC2484L-4WW	229	27	1	59
GS2SPC2484R-4LL	229	27	1	59
GS2SPC2484R-4WW	229	27	1	59
GS2SPC2490L-4LL	237	27.8	1	59
GS2SPC2490L-4WW	237	27.8	1	59
GS2SPC2490R-4LL	237	27.8	1	59
GS2SPC2490R-4WW	237	27.8	1	59
GS2SPC2496L-4LL	244	28.6	1	59
GS2SPC2496L-4WW	244	28.6	1	59
GS2SPC2496R-4LL	244	28.6	1	59
GS2SPC2496R-4WW	244	28.6	1	59
GS2SRNCLEG-W	20	0.6	-	160
GS2STF1H15L-LL	58	8.2	1	311
GS2STF1H15L-WG	58	8.2	-	312
GS2STF1H15L-WW	58	8.2	1	311
GS2STF1H15R-LL	58	8.2	1	311
GS2STF1H15R-WG	58	8.2	-	312
GS2STF1H15R-WW	58	8.2	1	311
GS2STF1H18L-LL	65	9.1	1	311
GS2STF1H18L-WG	65	9.1	-	312
GS2STF1H18L-WW	65	9.1	1	311
GS2STF1H18R-LL	65	9.1	1	311
GS2STF1H18R-WG	65	9.1	-	312
GS2STF1H18R-WW	65	9.1	1	311
GS2STF1H30-LL	100	14.3	1	311
GS2STF1H30-WG	100	14.3	-	312
GS2STF1H30-WW	100	14.3	1	311
GS2STF1H36-LL	115	16.9	1	311
GS2STF1H36-WG	115	16.9	-	312
GS2STF1H36-WW	115	16.9	1	311
GS2STF2H15L-LL	83	10.8	1	314
GS2STF2H15L-WG	83	10.8	-	315
GS2STF2H15L-WW	83	10.8	1	314
GS2STF2H15R-LL	83	10.8	1	314
GS2STF2H15R-WG	83	10.8	-	315

model number	weight	cubes	#locks	page
GS2STF2H15R-WW	83	10.8	1	314
GS2STF2H18L-LL	90	12	1	314
GS2STF2H18L-WG	90	12	-	315
GS2STF2H18L-WW	90	12	1	314
GS2STF2H18R-LL	90	12	1	314
GS2STF2H18R-WG	90	12	-	315
GS2STF2H18R-WW	90	12	1	314
GS2STF2H30-LL	125	18.9	1	314
GS2STF2H30-WG	125	18.9	-	315
GS2STF2H30-WW	125	18.9	1	314
GS2STF2H36-LL	150	22.3	1	314
GS2STF2H36-WG	150	22.3	-	315
GS2STF2H36-WW	150	22.3	1	314
GS2STN1H15-LN	50	7.8	-	313
GS2STN1H15-WN	50	7.8	-	313
GS2STN1H18-LN	55	9.1	-	313
GS2STN1H18-WN	55	9.1	-	313
GS2STN1H30-LN	90	9.1	-	313
GS2STN1H30-WN	90	14.3	-	313
GS2STN1H36-LN	100	14.3	-	313
GS2STN1H36-WN	100	16.9	-	313
GS2STN2H15-LN	60	10.3	-	316
GS2STN2H15-WN	60	10.3	-	316
GS2STN2H18-LN	65	12	-	316
GS2STN2H18-WN	65	12	-	316
GS2STN2H30-LN	100	12	-	316
GS2STN2H30-WN	100	12	-	316
GS2STN2H36-LN	110	18.9	-	316
GS2STN2H36-WN	110	18.9	-	316
GS2TEL3672-L	108	14.2	-	70
GS2TEL3672-S	179	14.2	-	70
GS2TEL3672-W	112	11.1	-	70
GS2TEL4284-L	135	17.6	-	70
GS2TEL4284-S	197	18.3	-	70
GS2TEL4284-W	146	14.2	-	70
GS2TFL3672-L	113	14.8	-	72
GS2TFL3672-S	184	14.8	-	72
GS2TFL3672-W	117	11.7	-	72
GS2TFL4284-L	140	18.3	-	72
GS2TFL4284-S	197	18.3	-	72
GS2TFL4284-W	146	14.2	-	72
GS2TGW1H24-GSA	35	2.1	-	287
GS2TGW1H30-GSA	43	3.2	-	287
GS2TGW1H36-GSA	50	3.8	-	287

model number	weight	cubes	#locks	page
GS2TGW1H42-GSA	58	4.3	-	287
GS2TGW1H48-GSA	66	4.9	-	287
GS2TGW2H24-GSA	41	2.8	-	287
GS2TGW2H30-GSA	50	4.1	-	287
GS2TGW2H36-GSA	59	4.8	-	287
GS2TGW2H42-GSA	67	5.6	-	287
GS2TGW2H48-GSA	76	6.3	-	287
GS2TGW24-GSA	24	1.4	-	283
GS2TGW30-GSA	28	2.1	-	283
GS2TGW36-GSA	32	2.4	-	283
GS2TGW42-GSA	36	2.8	-	283
GS2TGW48-GSA	40	3.2	-	283
GS2TGW54-GSA	45	3.6	-	283
GS2TGW60-GSA	50	3.9	-	283
GS2TGW66-GSA	55	4.3	-	283
GS2TGW72-GSA	59	4.7	-	283
GS2TGW78-GSA	64	5.1	-	283
GS2TGW84-GSA	68	5.4	-	283
GS2TGW90-GSA	73	5.8	-	283
GS2TGW96-GSA	77	3.2	-	283
GS2TGW102-GSA	82	3.4	-	283
GS2TGW108-GSA	86	3.6	-	283
GS2TKFBX72	28	5	-	322
GS2TKFBX90	35	6.2	-	322
GS2TKS60	26	3.7	-	317
GS2TKS66	28	4	-	317
GS2TKS72	29	4.4	-	317
GS2TKS78	31	4.8	-	317
GS2TKS84	33	5.1	-	317
GS2TKS90	34	5.5	-	317
GS2TKS96	36	5.8	-	317
GS2TKS102	37	3.3	-	317
GS2TKS108	39	3.4	-	317
GS2TKW1H24	20	2.1	-	286
GS2TKW1H30	24	3.2	-	286
GS2TKW1H36	27	3.8	-	286
GS2TKW1H42	29	4.3	-	286
GS2TKW1H48	32	4.9	-	286
GS2TKW2H24	23	2.8	-	286
GS2TKW2H30	26	4.1	-	286
GS2TKW2H36	29	4.8	-	286
GS2TKW2H42	33	5.6	-	286
GS2TKW2H48	36	6.3	-	286
GS2TKW24	16	1.4	-	282

model number	weight	cubes	#locks	page
GS2TKW30	18	2.1	-	282
GS2TKW36	20	2.4	-	282
GS2TKW42	21	2.8	-	282
GS2TKW48	22	3.2	-	282
GS2TKW54	24	3.6	-	282
GS2TKW60	26	3.9	-	282
GS2TKW66	28	4.3	-	282
GS2TKW72	29	4.7	-	282
GS2TKW78	31	5.1	-	282
GS2TKW84	33	5.4	-	282
GS2TKW90	34	5.8	-	282
GS2TKW96	36	6.2	-	282
GS2TKW102	37	3.4	-	282
GS2TKW108	39	3.6	-	282
GS2TKWSB36	14	3.2	-	322
GS2TKWSB45	17	4	-	322
GS2TKWSB72	28	5	-	322
GS2TKWSB90	35	6.2	-	322
GS2TLGW1H24-GSA	40	2.5	-	289
GS2TLGW1H30-GSA	49	3.6	-	289
GS2TLGW1H36-GSA	58	4.3	-	289
GS2TLGW1H42-GSA	67	5	-	289
GS2TLGW1H48-GSA	75	5.6	-	289
GS2TLGW2H24-GSA	46	3.1	-	289
GS2TLGW2H30-GSA	56	4.6	-	289
GS2TLGW2H36-GSA	66	5.5	-	289
GS2TLGW2H42-GSA	76	6.3	-	289
GS2TLGW2H48-GSA	86	7.2	-	289
GS2TLGW24-GSA	29	1.8	-	285
GS2TLGW30-GSA	34	2.6	-	285
GS2TLGW36-GSA	39	3.1	-	285
GS2TLGW42-GSA	45	3.5	-	285
GS2TLGW48-GSA	50	4	-	285
GS2TLGW54-GSA	56	4.5	-	285
GS2TLGW60-GSA	62	4.9	-	285
GS2TLGW66-GSA	68	5.4	-	285
GS2TLGW72-GSA	74	5.9	-	285
GS2TLGW78-GSA	79	6.3	-	285
GS2TLGW84-GSA	85	6.8	-	285
GS2TLGW90-GSA	91	7.3	-	285
GS2TLGW96-GSA	97	4	-	285
GS2TLGW102-GSA	102	4.2	-	285
GS2TLGW108-GSA	108	4.5	-	285
GS2TLKW1H24	23	2.5	-	288

WEIGHTS + CUBES

Silea
03/23

model number	weight	cubes	#locks	page
GS2TLKW1H30	26	3.6	-	288
GS2TLKW1H36	29	4.3	-	288
GS2TLKW1H42	33	5	-	288
GS2TLKW1H48	36	5.6	-	288
GS2TLKW2H24	24	3.1	-	288
GS2TLKW2H30	28	4.6	-	288
GS2TLKW2H36	32	5.5	-	288
GS2TLKW2H42	36	6.3	-	288
GS2TLKW2H48	40	7.2	-	288
GS2TLKW24	18	1.8	-	284
GS2TLKW30	20	2.6	-	284
GS2TLKW36	22	3.1	-	284
GS2TLKW42	24	3.5	-	284
GS2TLKW48	26	4	-	284
GS2TLKW54	28	4.5	-	284
GS2TLKW60	31	4.9	-	284
GS2TLKW66	33	5.4	-	284
GS2TLKW72	35	5.9	-	284
GS2TLKW78	37	6.3	-	284
GS2TLKW84	39	6.8	-	284
GS2TLKW90	41	7.3	-	284
GS2TLKW96	43	7.8	-	284
GS2TLKW102	45	4.2	-	284
GS2TLKW108	47	4.5	-	284
GS2TLWD1H24-W	60	3.4	-	299
GS2TLWD1H30-W	73	3.5	-	299
GS2TLWD1H36-W	85	4.2	-	299
GS2TLWD1H42-W	96	4.8	-	299
GS2TLWD1H48-W	108	5.4	-	299
GS2TLWD1H54-W	130	5.4	-	299
GS2TLWD1H60-W	140	6	-	299
GS2TLWD1H66-W	150	6.5	-	299
GS2TLWD1H72-W	175	7	-	299
GS2TLWD1H78-W	190	7.5	-	299
GS2TLWD1H84-W	205	8.1	-	299
GS2TLWD1H90-W	215	8.6	-	299
GS2TLWD1H96-W	225	9.1	-	299
GS2TLWD1H102-W	240	9.6	-	299
GS2TLWD1H108-W	270	9.4	-	299
GS2TLWD2H24-W	70	4.4	-	300
GS2TLWD2H30-W	73	4.5	-	300
GS2TLWD2H36-W	85	5.3	-	300
GS2TLWD2H42-W	96	6.1	-	300
GS2TLWD2H48-W	108	6.9	-	300

model number	weight	cubes	#locks	page
GS2TLWD2H54-W	150	6.9	-	300
GS2TLWD2H60-W	160	7.6	-	300
GS2TLWD2H66-W	170	8.2	-	300
GS2TLWD2H72-W	195	8.9	-	300
GS2TLWD2H78-W	210	9.6	-	300
GS2TLWD2H84-W	225	10.2	-	300
GS2TLWD2H90-W	240	10.9	-	300
GS2TLWD2H96-W	255	11.6	-	300
GS2TLWD2H102-W	270	12.2	-	300
GS2TLWD2H108-W	295	11.9	-	300
GS2TLWD24-W	23	2.5	-	296
GS2TLWD30-W	26	2.5	-	296
GS2TLWD30-XL	21	2.7	-	295
GS2TLWD30-XW	26	2.5	-	295
GS2TLWD36-W	29	3	-	296
GS2TLWD36-XL	25	3.2	-	295
GS2TLWD36-XW	29	3	-	295
GS2TLWD42-W	33	3.4	-	296
GS2TLWD42-XL	33	3.4	-	295
GS2TLWD42-XW	33	3.4	-	295
GS2TLWD48-W	36	3.9	-	296
GS2TLWD48-XL	36	3.9	-	295
GS2TLWD48-XW	36	3.9	-	295
GS2TLWD54-W	39	4.3	-	296
GS2TLWD54-XL	39	4.3	-	295
GS2TLWD54-XW	39	4.3	-	295
GS2TLWD60-W	42	4.8	-	296
GS2TLWD60-XL	41	5.1	-	295
GS2TLWD60-XW	42	4.8	-	295
GS2TLWD66-W	45	5.2	-	296
GS2TLWD66-XL	45	5.6	-	295
GS2TLWD66-XW	45	5.2	-	295
GS2TLWD72-W	48	5.7	-	296
GS2TLWD72-XL	49	6.1	-	295
GS2TLWD72-XW	48	5.7	-	295
GS2TLWD78-W	51	6.1	-	296
GS2TLWD78-XL	54	6.6	-	295
GS2TLWD78-XW	51	6.1	-	295
GS2TLWD84-W	54	6.6	-	296
GS2TLWD84-XL	58	7	-	295
GS2TLWD84-XW	54	6.6	-	295
GS2TLWD90-W	57	7.1	-	296
GS2TLWD90-XL	62	7.5	-	295
GS2TLWD90-XW	57	7.1	-	295

model number	weight	cubes	#locks	page
GS2TLWD96-W	60	7.5	-	296
GS2TLWD96-XL	66	8	-	295
GS2TLWD96-XW	60	7.5	-	295
GS2TLWD102-W	63	8	-	296
GS2TLWD102-XL	70	4.2	-	295
GS2TLWD102-XW	63	8	-	295
GS2TLWD108-W	67	8.4	-	296
GS2TLWD108-XL	74	4.5	-	295
GS2TLWD108-XW	67	8.4	-	295
GS2TRD36-L	45	3.7	-	215
GS2TRD36-S	68	3.7	-	215
GS2TRD36-W	45	3.7	-	215
GS2TRD42-L	59	4.9	-	215
GS2TRD42-S	89	4.9	-	215
GS2TRD42-W	59	4.9	-	215
GS2TRD48-L	76	6.3	-	215
GS2TRD48-S	114	6.3	-	215
GS2TRD48-W	76	6.3	-	215
GS2TRD54-L	95	7.9	-	215
GS2TRD54-S	143	7.9	-	215
GS2TRD54-W	95	7.9	-	215
GS2TRD60-L	116	9.6	-	215
GS2TRD60-S	174	9.6	-	215
GS2TRD60-W	116	9.6	-	215
GS2TRL3066-L	102	10	-	63
GS2TRL3066-W	102	10	-	63
GS2TRL3072-L	109	10.6	-	63
GS2TRL3072-W	109	10.6	-	63
GS2TRL3672-L	122	11.7	-	63
GS2TRL3672-W	122	11.7	-	63
GS2TRL3678-L	129	12.4	-	63
GS2TRL3678-W	129	12.4	-	63
GS2TSTG36-L	45	3.7	-	216
GS2TSTG36-S	68	3.7	-	216
GS2TSTG36-W	45	3.7	-	216
GS2TSTG42-L	59	4.9	-	216
GS2TSTG42-S	89	4.9	-	216
GS2TSTG42-W	59	4.9	-	216
GS2TSTG48-L	76	6.3	-	216
GS2TSTG48-S	114	6.3	-	216
GS2TSTG48-W	76	6.3	-	216
GS2TTGW24-GSA	35	2.1	-	291
GS2TTGW30-GSA	43	2.5	-	291
GS2TTGW36-GSA	50	3	-	291

model number	weight	cubes	#locks	page
GS2TTGW42-GSA	58	3.4	-	291
GS2TTGW48-GSA	66	3.9	-	291
GS2TTGW54-GSA	82	3.9	-	291
GS2TTGW60-GSA	90	4.2	-	291
GS2TTGW66-GSA	98	4.6	-	291
GS2TTGW72-GSA	106	5	-	291
GS2TTGW78-GSA	114	5.4	-	291
GS2TTGW84-GSA	122	5.7	-	291
GS2TTGW90-GSA	130	6.1	-	291
GS2TTGW96-GSA	138	6.5	-	291
GS2TTGW102-GSA	150	7.6	-	291
GS2TTGW108-GSA	158	8	-	291
GS2TTKW24	19	2.1	-	290
GS2TTKW30	21	2.5	-	290
GS2TTKW36	23	3	-	290
GS2TTKW42	25	3.4	-	290
GS2TTKW48	27	3.9	-	290
GS2TTKW54	30	3.9	-	290
GS2TTKW60	32	4.2	-	290
GS2TTKW66	34	4.6	-	290
GS2TTKW72	36	5	-	290
GS2TTKW78	38	5.4	-	290
GS2TTKW84	40	5.7	-	290
GS2TTKW90	42	6.1	-	290
GS2TTKW96	44	6.5	-	290
GS2TTKW102	47	7.6	-	290
GS2TTKW108	50	8	-	290
GS2TTWD24-W	52	2.9	-	301
GS2TTWD30-W	60	3.6	-	301
GS2TTWD36-W	70	4.2	-	301
GS2TTWD42-W	80	4.8	-	301
GS2TTWD48-W	100	5.4	-	301
GS2TTWD54-W	120	4.6	-	301
GS2TTWD60-W	140	5.1	-	301
GS2TTWD66-W	150	5.5	-	301
GS2TTWD72-W	160	6	-	301
GS2TTWD78-W	170	6.4	-	301
GS2TTWD84-W	180	6.9	-	301
GS2TTWD90-W	190	7.3	-	301
GS2TTWD96-W	200	7.8	-	301
GS2TTWD102-W	210	8.2	-	301
GS2TTWD108-W	240	8	-	301
GS2TWD1H24-W	52	2.9	-	297
GS2TWD1H30-W	68	3	-	297

WEIGHTS + CUBES

Silea
03/23

model number	weight	cubes	#locks	page
GS2TWD1H36-W	80	3.6	-	297
GS2TWD1H42-W	91	4.1	-	297
GS2TWD1H48-W	103	4.7	-	297
GS2TWD1H54-W	120	4.6	-	297
GS2TWD1H60-W	140	5.1	-	297
GS2TWD1H66-W	150	5.5	-	297
GS2TWD1H72-W	160	6	-	297
GS2TWD1H78-W	170	6.4	-	297
GS2TWD1H84-W	180	6.9	-	297
GS2TWD1H90-W	190	7.3	-	297
GS2TWD1H96-W	200	7.8	-	297
GS2TWD1H102-W	210	8.2	-	297
GS2TWD1H108-W	240	8	-	297
GS2TWD2H24-W	64	3.8	-	298
GS2TWD2H30-W	78	4	-	298
GS2TWD2H36-W	92	4.7	-	298
GS2TWD2H42-W	106	5.4	-	298
GS2TWD2H48-W	120	6.1	-	298
GS2TWD2H54-W	140	6.1	-	298
GS2TWD2H60-W	150	6.7	-	298
GS2TWD2H66-W	160	7.3	-	298
GS2TWD2H72-W	185	7.8	-	298
GS2TWD2H78-W	200	8.4	-	298
GS2TWD2H84-W	215	9	-	298
GS2TWD2H90-W	230	9.6	-	298
GS2TWD2H96-W	245	10.2	-	298
GS2TWD2H102-W	260	10.8	-	298
GS2TWD2H108-W	280	10.5	-	298
GS2TWD24-W	18	2	-	294
GS2TWD30-W	21	2	-	294
GS2TWD30-XL	16	2.1	-	293
GS2TWD30-XW	21	2	-	293
GS2TWD36-W	24	2.4	-	294
GS2TWD36-XL	20	2.5	-	293
GS2TWD36-XW	24	2.4	-	293
GS2TWD42-W	27	2.7	-	294
GS2TWD42-XL	27	2.7	-	293
GS2TWD42-XW	27	2.7	-	293
GS2TWD48-W	30	3.1	-	294
GS2TWD48-XL	30	3.1	-	293
GS2TWD48-XW	30	3.1	-	293
GS2TWD54-W	33	3.4	-	294
GS2TWD54-XL	33	3.4	-	293
GS2TWD54-XW	33	3.4	-	293

model number	weight	cubes	#locks	page
GS2TWD60-W	37	3.8	-	294
GS2TWD60-XL	33	4.1	-	293
GS2TWD60-XW	37	3.8	-	293
GS2TWD66-W	40	4.2	-	294
GS2TWD66-XL	36	4.4	-	293
GS2TWD66-XW	40	4.2	-	293
GS2TWD72-W	43	4.5	-	294
GS2TWD72-XL	39	4.8	-	293
GS2TWD72-XW	43	4.5	-	293
GS2TWD78-W	46	4.9	-	294
GS2TWD78-XL	43	5.2	-	293
GS2TWD78-XW	46	4.9	-	293
GS2TWD84-W	49	5.3	-	294
GS2TWD84-XL	46	5.6	-	293
GS2TWD84-XW	49	5.3	-	293
GS2TWD90-W	52	5.6	-	294
GS2TWD90-XL	49	6	-	293
GS2TWD90-XW	52	5.6	-	293
GS2TWD96-W	55	6	-	294
GS2TWD96-XL	53	6.4	-	293
GS2TWD96-XW	55	6	-	293
GS2TWD102-W	58	6.3	-	294
GS2TWD102-XL	56	3.4	-	293
GS2TWD102-XW	58	6.3	-	293
GS2TWD108-W	62	6.7	-	294
GS2TWD108-XL	59	3.6	-	293
GS2TWD108-XW	62	6.7	-	293
GS2UTC5H24L-3LL	269	33.1	3	256
GS2UTC5H24L-3WW	269	33.1	3	256
GS2UTC5H24L-LL	269	30.2	3	255
GS2UTC5H24L-WW	269	30.2	3	255
GS2UTC5H24R-3LL	269	33.1	3	256
GS2UTC5H24R-3WW	269	33.1	3	256
GS2UTC5H24R-LL	269	30.2	3	255
GS2UTC5H24R-WW	269	30.2	3	255
GS2UTC5H30L-3LL	285	40.2	3	258
GS2UTC5H30L-3WW	285	40.2	3	258
GS2UTC5H30L-LL	285	40.2	3	257
GS2UTC5H30L-WW	285	40.2	3	257
GS2UTC5H30R-3LL	285	40.2	3	258
GS2UTC5H30R-3WW	285	40.2	3	258
GS2UTC5H30R-LL	285	40.2	3	257
GS2UTC5H30R-WW	285	40.2	3	257
GS2UTC6H24L-3LL	317	39	3	256

model number	weight	cubes	#locks	page
GS2UTC6H24L-3WW	317	39	3	256
GS2UTC6H24L-LL	317	35.8	3	255
GS2UTC6H24L-WW	317	35.8	3	255
GS2UTC6H24R-3LL	317	39	3	256
GS2UTC6H24R-3WW	317	39	3	256
GS2UTC6H24R-LL	317	35.8	3	255
GS2UTC6H24R-WW	317	35.8	3	255
GS2UTC6H30L-3LL	330	47.4	3	258
GS2UTC6H30L-3WW	330	47.4	3	258
GS2UTC6H30L-LL	330	47.4	3	257
GS2UTC6H30L-WW	330	47.4	3	257
GS2UTC6H30R-3LL	330	47.4	3	258
GS2UTC6H30R-3WW	330	47.4	3	258
GS2UTC6H30R-LL	330	47.4	3	257
GS2UTC6H30R-WW	330	47.4	3	257
GS2VLEG-A	8	0.6	-	159
GS2WGW5H36	74	6.2	-	292
GS2WGW6H36	85	7.4	-	292
GS2WMC1H30-LL	45	5.8	1	270
GS2WMC1H30-LN	40	6	-	272
GS2WMC1H30-WG	45	5.8	-	271
GS2WMC1H30-WN	40	6	-	272
GS2WMC1H30-WW	45	5.8	1	270
GS2WMC1H36-LL	52	6.9	1	270
GS2WMC1H36-LN	47	7.1	-	272
GS2WMC1H36-WG	52	6.9	-	271
GS2WMC1H36-WN	47	7.1	-	272
GS2WMC1H36-WW	52	6.9	1	270
GS2WMC1H42-LL	60	8.6	2	270
GS2WMC1H42-LN	50	8.2	-	272
GS2WMC1H42-WN	50	8.2	-	272
GS2WMC1H42-WW	60	8.6	2	270
GS2WMC1H48-LL	69	9.7	2	270
GS2WMC1H48-LN	59	9.3	-	272
GS2WMC1H48-WN	59	9.3	-	272
GS2WMC1H48-WW	69	9.7	2	270
GS2WMC1H54-LL	78	10.9	2	270
GS2WMC1H54-LN	68	10.4	-	272
GS2WMC1H54-WN	68	10.4	-	272
GS2WMC1H54-WW	78	10.9	2	270
GS2WMC1H60-LL	85	11.1	2	270
GS2WMC1H60-LN	75	11.5	-	272
GS2WMC1H60-LSL	85	11.1	-	273
GS2WMC1H60-WG	85	11.1	-	271

model number	weight	cubes	#locks	page
GS2WMC1H60-WN	75	11.5	-	272
GS2WMC1H60-WSG	85	11.1	-	274
GS2WMC1H60-WSW	85	11.1	-	273
GS2WMC1H60-WW	85	11.1	2	270
GS2WMC1H66-LL	94	12.2	2	270
GS2WMC1H66-LN	84	12.6	-	272
GS2WMC1H66-LSL	95	15	-	273
GS2WMC1H66-WN	84	12.6	-	272
GS2WMC1H66-WSW	95	15	-	273
GS2WMC1H66-WW	94	12.2	2	270
GS2WMC1H72-LL	105	13.2	2	270
GS2WMC1H72-LN	95	13.7	-	272
GS2WMC1H72-LSL	105	13.2	-	273
GS2WMC1H72-WG	105	13.2	-	271
GS2WMC1H72-WN	95	13.7	-	272
GS2WMC1H72-WSG	105	13.2	-	274
GS2WMC1H72-WSW	105	13.2	-	273
GS2WMC1H72-WW	105	13.2	2	270
GS2WMC1H78-LL	115	14.3	2	270
GS2WMC1H78-LN	105	14.8	-	272
GS2WMC1H78-LSL	115	17.6	-	273
GS2WMC1H78-WN	105	14.8	-	272
GS2WMC1H78-WSW	115	17.6	-	273
GS2WMC1H78-WW	115	14.3	2	270
GS2WMC1H84-LL	125	15.4	3	270
GS2WMC1H84-LN	115	15.8	-	272
GS2WMC1H84-LSL	125	18.8	-	273
GS2WMC1H84-WN	115	15.8	-	272
GS2WMC1H84-WSW	125	18.8	-	273
GS2WMC1H84-WW	125	15.4	3	270
GS2WMC1H90-LL	135	16.4	3	270
GS2WMC1H90-LN	125	16.9	-	272
GS2WMC1H90-LSL	135	16.4	-	273
GS2WMC1H90-WG	135	16.4	-	271
GS2WMC1H90-WN	125	16.9	-	272
GS2WMC1H90-WSG	135	16.4	-	274
GS2WMC1H90-WSW	135	16.4	-	273
GS2WMC1H90-WW	135	16.4	3	270
GS2WMC1H96-LL	142	17.5	3	270
GS2WMC1H96-LN	132	18	-	272
GS2WMC1H96-LSL	145	21.4	-	273
GS2WMC1H96-WN	132	18	-	272
GS2WMC1H96-WSW	145	21.4	-	273
GS2WMC1H96-WW	142	17.5	3	270

WEIGHTS + CUBES

Silea
03/23

model number	weight	cubes	#locks	page
GS2WMC1H102-LL	149	20	3	270
GS2WMC1H102-LN	139	19.1	-	272
GS2WMC1H102-WN	139	19.1	-	272
GS2WMC1H102-WSW	155	22.7	-	273
GS2WMC1H102-WW	149	18.5	3	270
GS2WMC1H108-LL	158	21.2	3	270
GS2WMC1H108-LN	148	20.2	-	272
GS2WMC1H108-WG	158	19.6	-	271
GS2WMC1H108-WN	148	20.2	-	272
GS2WMC1H108-WSG	158	19.6	-	274
GS2WMC1H108-WSW	158	19.6	-	273
GS2WMC1H108-WW	158	19.6	3	270
GS2WMC2H30-LL	85	10.4	1	275
GS2WMC2H30-LN	80	10.7	-	277
GS2WMC2H30-WG	85	10.4	-	276
GS2WMC2H30-WN	80	10.7	-	277
GS2WMC2H30-WW	85	10.4	1	275
GS2WMC2H36-LL	93	12.3	1	275
GS2WMC2H36-LN	88	12.6	-	277
GS2WMC2H36-WG	93	12.3	-	276
GS2WMC2H36-WN	88	12.6	-	277
GS2WMC2H36-WW	93	12.3	1	275
GS2WMC2H42-LL	108	15.3	2	275
GS2WMC2H42-LN	98	14.6	-	277
GS2WMC2H42-WN	98	14.6	-	277
GS2WMC2H42-WW	108	15.3	2	275
GS2WMC2H48-LL	122	17.3	2	275
GS2WMC2H48-LN	112	16.5	-	277
GS2WMC2H48-WN	112	16.5	-	277
GS2WMC2H48-WW	122	17.3	2	275
GS2WMC2H54-LL	136	19.4	2	275
GS2WMC2H54-LN	126	18.5	-	277
GS2WMC2H54-WN	126	18.5	-	277
GS2WMC2H54-WW	136	19.4	2	275
GS2WMC2H60-LL	150	19.8	2	275
GS2WMC2H60-LN	140	20.4	-	277
GS2WMC2H60-LSL	150	19.8	-	278
GS2WMC2H60-WG	150	19.8	-	276
GS2WMC2H60-WN	140	20.4	-	277
GS2WMC2H60-WSG	150	19.8	-	279
GS2WMC2H60-WSW	150	19.8	-	278
GS2WMC2H60-WW	150	19.8	2	275
GS2WMC2H66-LL	167	21.7	2	275
GS2WMC2H66-LN	157	22.4	-	277

model number	weight	cubes	#locks	page
GS2WMC2H66-LSL	168	25.9	-	278
GS2WMC2H66-WN	157	22.4	-	277
GS2WMC2H66-WSW	168	25.9	-	278
GS2WMC2H66-WW	167	21.7	2	275
GS2WMC2H72-LL	186	23.6	2	275
GS2WMC2H72-LN	176	24.3	-	277
GS2WMC2H72-LSL	186	23.6	-	278
GS2WMC2H72-WG	186	23.6	-	276
GS2WMC2H72-WN	176	24.3	-	277
GS2WMC2H72-WSG	186	23.6	-	279
GS2WMC2H72-WSW	186	23.6	-	278
GS2WMC2H72-WW	186	23.6	2	275
GS2WMC2H78-LL	201	25.5	2	275
GS2WMC2H78-LN	191	26.3	-	277
GS2WMC2H78-LSL	204	30.4	-	278
GS2WMC2H78-WN	191	26.3	-	277
GS2WMC2H78-WSW	204	30.4	-	278
GS2WMC2H78-WW	201	25.5	2	275
GS2WMC2H84-LL	218	27.4	3	275
GS2WMC2H84-LN	208	28.2	-	277
GS2WMC2H84-LSL	220	32.6	-	278
GS2WMC2H84-WN	208	28.2	-	277
GS2WMC2H84-WSW	220	32.6	-	278
GS2WMC2H84-WW	218	27.4	3	275
GS2WMC2H90-LL	237	29.2	3	275
GS2WMC2H90-LN	227	30.2	-	277
GS2WMC2H90-LSL	237	29.2	-	278
GS2WMC2H90-WG	237	29.2	-	276
GS2WMC2H90-WN	227	30.2	-	277
GS2WMC2H90-WSG	237	29.2	-	279
GS2WMC2H90-WSW	237	29.2	-	278
GS2WMC2H90-WW	237	29.2	3	275
GS2WMW1H30-L	10	1.3	-	280
GS2WMW1H30-W	10	1.3	-	280
GS2WMW1H36-L	12	1.5	-	280
GS2WMW1H36-W	12	1.5	-	280
GS2WMW1H42-L	14	1.8	-	280
GS2WMW1H42-W	14	1.8	-	280
GS2WMW1H48-L	16	2	-	280
GS2WMW1H48-W	16	2	-	280
GS2WMW1H54-L	18	2.3	-	280
GS2WMW1H54-W	18	2.3	-	280
GS2WMW1H60-L	20	2.5	-	280
GS2WMW1H60-W	20	2.5	-	280

model number	weight	cubes	#locks	page
GS2WMW1H66-L	22	2.7	-	280
GS2WMW1H66-W	22	2.7	-	280
GS2WMW1H72-L	24	3	-	280
GS2WMW1H72-W	25	3	-	280
GS2WMW1H78-L	26	3.2	-	280
GS2WMW1H78-W	27	3.2	-	280
GS2WMW1H84-L	28	3.4	-	280
GS2WMW1H84-W	29	3.4	-	280
GS2WMW1H90-L	31	3.7	-	280
GS2WMW1H90-W	32	3.7	-	280
GS2WMW1H96-L	33	3.9	-	280
GS2WMW1H96-W	4	3.9	-	280
GS2WMW1H102-L	35	2.1	-	280
GS2WMW1H102-W	35	4.2	-	280
GS2WMW1H108-L	37	2.2	-	280
GS2WMW1H108-W	39	4.4	-	280
GS2WMW2H30-L	19	2.3	-	281
GS2WMW2H30-W	21	2.3	-	281
GS2WMW2H36-L	22	2.8	-	281
GS2WMW2H36-W	25	2.8	-	281
GS2WMW2H42-L	29	3.2	-	281
GS2WMW2H42-W	29	3.2	-	281
GS2WMW2H48-L	34	3.6	-	281
GS2WMW2H48-W	34	3.6	-	281
GS2WMW2H54-L	38	4	-	281
GS2WMW2H54-W	38	4	-	281
GS2WMW2H60-L	37	4.4	-	281
GS2WMW2H60-W	42	4.4	-	281
GS2WMW2H66-L	41	4.9	-	281
GS2WMW2H66-W	46	4.9	-	281
GS2WMW2H72-L	45	5.3	-	281
GS2WMW2H72-W	51	5.3	-	281
GS2WMW2H78-L	49	5.7	-	281
GS2WMW2H78-W	56	5.7	-	281
GS2WMW2H84-L	52	6.1	-	281
GS2WMW2H84-W	60	6.1	-	281
GS2WMW2H90-L	56	6.6	-	281
GS2WMW2H90-W	67	6.6	-	281
GS2WSB3H72L-WSG	300	41.1	-	320
GS2WSB3H72R-WSG	300	41.1	-	320
GS2WSB3H90L-WSG	375	50.9	-	320
GS2WSB3H90R-WSG	375	50.9	-	320
GS2XBT4272-LL	154	19.6	-	65
GS2XBT4272-WW	154	19.6	-	65

model number	weight	cubes	#locks	page
GS2XDT4272-LL	154	19.6	-	65
GS2XDT4272-WW	154	19.6	-	65
GS2XMAMOD66-L	12	1.7	-	122
GS2XMAMOD66-M	12	1.7	-	122
GS2XMAMOD66-W	12	1.9	-	122
GS2XMAMOD72-L	12	1.9	-	122
GS2XMAMOD72-M	12	1.9	-	122
GS2XMAMOD72-W	13	1.9	-	122
GS2XMAMOD78-L	12	2.1	-	122
GS2XMAMOD78-M	12	2.1	-	122
GS2XMAMOD78-W	12	2.1	-	122
GS2XMF36L-L	20	3.9	-	166
GS2XMF36L-W	20	3.9	-	166
GS2XMF36R-L	20	3.9	-	166
GS2XMF36R-W	20	3.9	-	166
GS2XMF42L-L	23	4.5	-	166
GS2XMF42L-W	23	4.5	-	166
GS2XMF42R-L	23	4.5	-	166
GS2XMF42R-W	23	4.5	-	166
GS2XML366060-LL	173	26.3	-	78
GS2XML366060-WW	179	22.1	-	78
GS2XML487260-LL	202	30.9	-	78
GS2XML487260-WW	209	25.9	-	78
GS2XRL3066L-LL	143	17.3	-	64
GS2XRL3066L-WW	143	17.3	-	64
GS2XRL3066R-LL	143	17.3	-	64
GS2XRL3066R-WW	143	17.3	-	64
GS2XRL3072L-LL	151	18	-	64
GS2XRL3072L-WW	151	18	-	64
GS2XRL3072R-LL	151	18	-	64
GS2XRL3072R-WW	151	18	-	64
GS2XRL3672L-LL	171	20.4	-	64
GS2XRL3672L-WW	171	20.4	-	64
GS2XRL3672R-LL	171	20.4	-	64
GS2XRL3672R-WW	171	20.4	-	64
GS2XRL3678L-LL	180	21.3	-	64
GS2XRL3678L-WW	178	21.3	-	64
GS2XRL3678R-LL	180	21.3	-	64
GS2XRL3678R-WW	178	21.3	-	64
GS2XRT3066L-LL	122	16.9	-	65
GS2XRT3066L-WW	122	16.9	-	65
GS2XRT3066R-LL	122	16.9	-	65
GS2XRT3066R-WW	122	16.9	-	65
GS2XRT3072L-LL	128	17.4	-	65

WEIGHTS + CUBES

Silea
03/23

model number	weight	cubes	#locks	page
GS2XRT3072L-WW	128	17.4	-	65
GS2XRT3072R-LL	128	17.4	-	65
GS2XRT3072R-WW	128	17.4	-	65
GS3BAK2442-LL	80	11.7	-	94
GS3BAK2442-WW	80	10.2	-	94
GS3BAK2448-LL	90	13.4	-	94
GS3BAK2448-WW	90	11.5	-	94
GS3BAK2454-LL	100	15	-	94
GS3BAK2454-WW	100	12.9	-	94
GS3BAK2460-LL	110	16.6	-	94
GS3BAK2460-WW	110	14.2	-	94
GS3BAK2466-LL	120	18.3	-	94
GS3BAK2466-WW	120	15.6	-	94
GS3BAK2472-LL	130	19.9	-	94
GS3BAK2472-WW	130	16.9	-	94
GS3BAK3042-LL	216	19.2	-	95
GS3BAK3042-WW	130	30.5	-	95
GS3BAK3048-LL	227	20.8	-	95
GS3BAK3048-WW	140	34.5	-	95
GS3BAK3054-LL	239	22.4	-	95
GS3BAK3054-WW	149	38.5	-	95
GS3BAK3060-LL	256	24	-	95
GS3BAK3060-WW	157	42.5	-	95
GS3BAK3066-LL	274	25.6	-	95
GS3BAK3066-WW	165	46.5	-	95
GS3BAK3072-LL	286	51.4	-	95
GS3BAK3072-WW	176	50.4	-	95
GS3CAK2442-LL	229	63	-	90
GS3CAK2442-WW	167	30.5	-	90
GS3CAK2448-LL	240	35.9	-	90
GS3CAK2448-WW	175	34.5	-	90
GS3CAK2454-LL	250	39.2	-	90
GS3CAK2454-WW	183	38.5	-	90
GS3CAK2460-LL	265	42.5	-	90
GS3CAK2460-WW	190	42.5	-	90
GS3CAK2466-AALL	349	37.5	2	92
GS3CAK2466-AAWW	295	46.5	2	92
GS3CAK2466L-ALL	328	47.7	1	92
GS3CAK2466L-AWW	260	46.5	1	92
GS3CAK2466-LL	283	45.8	-	90
GS3CAK2466R-ALL	328	47.7	1	92
GS3CAK2466R-AWW	255	46.5	1	92
GS3CAK2466-WW	197	46.5	-	90
GS3CAK2472-AALL	358	39	2	92

model number	weight	cubes	#locks	page
GS3CAK2472-AAWW	305	50.4	2	92
GS3CAK2472L-ALL	338	51	1	92
GS3CAK2472L-AWW	275	50.4	1	92
GS3CAK2472-LL	293	49.1	-	90
GS3CAK2472R-ALL	338	51	1	92
GS3CAK2472R-AWW	265	50.4	1	92
GS3CAK2472-WW	207	50.4	-	90
GS3CAK3042-LL	238	37.8	-	91
GS3CAK3042-WW	151	30.5	-	91
GS3CAK3048-LL	249	41.8	-	91
GS3CAK3048-WW	160	34.5	-	91
GS3CAK3054-LL	261	45.8	-	91
GS3CAK3054-WW	169	38.5	-	91
GS3CAK3060-LL	278	49.8	-	91
GS3CAK3060-WW	177	42.5	-	91
GS3CAK3066-AALL	386	42.2	1	93
GS3CAK3066-AAWW	304	46.5	1	93
GS3CAK3066L-ALL	356	56.1	1	93
GS3CAK3066L-AWW	251	46.5	1	93
GS3CAK3066-LL	296	53.8	-	91
GS3CAK3066R-ALL	356	56.1	1	93
GS3CAK3066R-AWW	251	46.5	1	93
GS3CAK3066-WW	185	46.5	-	91
GS3CAK3072-AALL	397	43.8	1	93
GS3CAK3072-AAWW	315	50.4	1	93
GS3CAK3072L-ALL	368	60.1	1	93
GS3CAK3072L-AWW	261	50.4	1	93
GS3CAK3072-LL	308	57.8	-	91
GS3CAK3072R-ALL	368	60.1	1	93
GS3CAK3072R-AWW	261	50.4	1	93
GS3CAK3072-WW	196	50.4	-	91
GS3DFAK3066-LL	339	30.9	-	84
GS3DFAK3066-WW	308	46.5	-	84
GS3DFAK3072-LL	354	32.7	-	84
GS3DFAK3072-WW	318	50.4	-	84
GS3DFAK3672-WW	328	60.2	-	84
GS3DFAK3678-LL	385	35.7	-	84
GS3DFAK3678-WW	338	65	-	84
GS3DHAK3066-LL	296	25.4	-	88
GS3DHAK3066-WW	266	46.5	-	88
GS3DHAK3072-LL	307	26.7	-	88
GS3DHAK3072-WW	276	50.4	-	88
GS3DHAK3672-LL	325	28.3	-	88
GS3DHAK3672-WW	286	60.2	-	88

model number	weight	cubes	#locks	page
GS3DHAK3678-LL	334	29.5	-	88
GS3DHAK3678-WW	296	65	-	88
GS3HASHRD2442-L	124	13.3	-	117
GS3HASHRD2442-W	76	9.4	-	117
GS3HASHRD2448-L	128	14.4	-	117
GS3HASHRD2448-W	80	9.4	-	117
GS3HASHRD2454-L	132	14.9	-	117
GS3HASHRD2454-W	84	9.4	-	117
GS3HASHRD2460-L	136	15.6	-	117
GS3HASHRD2460-W	86	9.4	-	117
GS3HASHRD2466-L	140	16.4	-	117
GS3HASHRD2466-W	90	9.4	-	117
GS3HASHRD2472-L	144	17.2	-	117
GS3HASHRD2472-W	94	10.8	-	117
GS3HASHRD3042-L	138	15.3	-	117
GS3HASHRD3042-W	84	11.6	-	117
GS3HASHRD3048-L	142	16.3	-	117
GS3HASHRD3048-W	88	11.6	-	117
GS3HASHRD3054-L	146	16.9	-	117
GS3HASHRD3054-W	92	11.6	-	117
GS3HASHRD3060-L	150	17.6	-	117
GS3HASHRD3060-W	96	11.6	-	117
GS3HASHRD3066-L	154	18.4	-	117
GS3HASHRD3066-W	100	11.6	-	117
GS3HASHRD3072-L	158	19.1	-	117
GS3HASHRD3072-W	104	11.6	-	117
GS3HASHRD3642-L	150	17.3	-	117
GS3HASHRD3642-W	98	14.1	-	117
GS3HASHRD3648-L	154	18.3	-	117
GS3HASHRD3648-W	102	14.1	-	117
GS3HASHRD3654-L	158	18.8	-	117
GS3HASHRD3654-W	106	14.1	-	117
GS3HASHRD3660-L	162	19.6	-	117
GS3HASHRD3660-W	110	14.1	-	117
GS3HASHRD3666-L	166	20.4	-	117
GS3HASHRD3666-W	114	14.1	-	117
GS3HASHRD3672-L	170	21.1	-	117
GS3HASHRD3672-W	118	14.1	-	117
GS3RAK2442L-ALL	283	25.5	1	98
GS3RAK2442L-AWW	228	30.5	1	98
GS3RAK2442L-LL	221	33.3	-	96
GS3RAK2442L-WW	160	30.5	-	96
GS3RAK2442R-ALL	153	18	1	98
GS3RAK2442R-AWW	228	30.5	1	98

model number	weight	cubes	#locks	page
GS3RAK2442R-LL	221	33.3	-	96
GS3RAK2442R-WW	160	30.5	-	96
GS3RAK2448L-ALL	294	27.2	1	98
GS3RAK2448L-AWW	233	34.5	1	98
GS3RAK2448L-LL	232	36.8	-	96
GS3RAK2448L-WW	168	34.5	-	96
GS3RAK2448R-ALL	162	19.6	1	98
GS3RAK2448R-AWW	170	25.9	1	98
GS3RAK2448R-LL	232	36.8	-	96
GS3RAK2448R-WW	168	34.5	-	96
GS3RAK2454L-ALL	304	28.8	1	98
GS3RAK2454L-AWW	237	38.5	1	98
GS3RAK2454L-LL	242	40.2	-	96
GS3RAK2454L-WW	176	38.5	-	96
GS3RAK2454R-ALL	170	21.2	1	98
GS3RAK2454R-AWW	180	28.9	1	98
GS3RAK2454R-LL	242	40.2	-	96
GS3RAK2454R-WW	176	38.5	-	96
GS3RAK2460L-ALL	319	30.4	1	98
GS3RAK2460L-AWW	242	42.5	1	98
GS3RAK2460L-LL	257	43.6	-	96
GS3RAK2460L-WW	183	42.5	-	96
GS3RAK2460R-ALL	178	22.9	1	98
GS3RAK2460R-AWW	190	32	1	98
GS3RAK2460R-LL	257	43.6	-	96
GS3RAK2460R-WW	183	42.5	-	96
GS3RAK2466L-ALL	337	32	1	98
GS3RAK2466L-AWW	248	46.5	1	98
GS3RAK2466L-LL	275	47	-	96
GS3RAK2466L-WW	190	46.5	-	96
GS3RAK2466R-ALL	187	24.5	1	98
GS3RAK2466R-AWW	200	35	1	98
GS3RAK2466R-LL	275	47	-	96
GS3RAK2466R-WW	190	46.5	-	96
GS3RAK2472L-ALL	347	33.6	1	98
GS3RAK2472L-AWW	258	50.4	-	98
GS3RAK2472L-LL	285	50.4	-	96
GS3RAK2472L-WW	200	50.4	-	96
GS3RAK2472R-ALL	195	26.2	1	98
GS3RAK2472R-AWW	210	38.1	1	98
GS3RAK2472R-LL	285	50.4	-	96
GS3RAK2472R-WW	200	50.4	-	96
GS3RAK3042L-ALL	301	28.1	1	99
GS3RAK3042L-AWW	215	30.5	1	99

WEIGHTS + CUBES

Silea
03/23

model number	weight	cubes	#locks	page
GS3RAK3042L-LL	227	37.8	-	97
GS3RAK3042L-WW	141	30.5	-	97
GS3RAK3042R-ALL	301	28.1	1	99
GS3RAK3042R-AWW	215	30.5	1	99
GS3RAK3042R-LL	227	37.8	-	97
GS3RAK3042R-WW	141	30.5	-	97
GS3RAK3048L-ALL	312	29.8	1	99
GS3RAK3048L-AWW	221	34.5	1	99
GS3RAK3048L-LL	238	41.8	-	97
GS3RAK3048L-WW	150	34.5	-	97
GS3RAK3048R-ALL	312	29.8	1	99
GS3RAK3048R-AWW	221	34.5	1	99
GS3RAK3048R-LL	238	41.8	-	97
GS3RAK3048R-WW	150	34.5	-	97
GS3RAK3054L-ALL	324	31.5	1	99
GS3RAK3054L-AWW	226	38.5	1	99
GS3RAK3054L-LL	250	45.8	-	97
GS3RAK3054L-WW	159	38.5	-	97
GS3RAK3054R-ALL	324	31.5	1	99
GS3RAK3054R-AWW	226	38.5	1	99
GS3RAK3054R-LL	250	45.8	-	97
GS3RAK3054R-WW	159	38.5	-	97
GS3RAK3060L-ALL	341	33.1	1	99
GS3RAK3060L-AWW	232	42.5	1	99
GS3RAK3060L-LL	267	49.8	-	97
GS3RAK3060L-WW	167	42.5	-	97
GS3RAK3060R-ALL	341	33.1	1	99
GS3RAK3060R-AWW	232	42.5	1	99
GS3RAK3060R-LL	267	49.8	-	97
GS3RAK3060R-WW	167	42.5	-	97
GS3RAK3066L-ALL	359	34.8	1	99
GS3RAK3066L-AWW	239	46.5	1	99
GS3RAK3066L-LL	285	53.8	-	97
GS3RAK3066L-WW	175	46.5	-	97
GS3RAK3066R-ALL	359	34.8	1	99
GS3RAK3066R-AWW	239	46.5	1	99
GS3RAK3066R-LL	285	53.8	-	97
GS3RAK3066R-WW	175	46.5	-	97
GS3RAK3072L-ALL	371	36.5	1	99
GS3RAK3072L-AWW	250	50.4	1	99
GS3RAK3072L-LL	297	57.8	-	97
GS3RAK3072L-WW	186	50.4	-	97
GS3RAK3072R-ALL	371	36.5	1	99
GS3RAK3072R-AWW	250	50.4	1	99

model number	weight	cubes	#locks	page
GS3RAK3072R-LL	297	57.8	-	97
GS3RAK3072R-WW	186	50.4	-	97
GS3STAT7278L-ALL	505	68.1	1	82
GS3STAT7278L-AWW	505	68.1	1	82
GS3STAT7278L-LL	450	62	-	80
GS3STAT7278L-WW	450	62	-	80
GS3STAT7278R-ALL	505	68.1	1	83
GS3STAT7278R-AWW	505	68.1	1	83
GS3STAT7278R-LL	450	62	-	81
GS3STAT7278R-WW	450	62	-	81
GS3STAT7284L-ALL	519	69.3	1	82
GS3STAT7284L-AWW	519	69.3	1	82
GS3STAT7284L-LL	464	63.2	-	80
GS3STAT7284L-WW	464	63.2	-	80
GS3STAT7284R-ALL	519	69.3	1	83
GS3STAT7284R-AWW	519	69.3	1	83
GS3STAT7284R-LL	464	63.2	-	81
GS3STAT7284R-WW	464	63.2	-	81
GS3STAT7890L-ALL	547	71.9	1	82
GS3STAT7890L-AWW	547	71.9	1	82
GS3STAT7890L-LL	492	65.7	-	80
GS3STAT7890L-WW	492	65.7	-	80
GS3STAT7890R-ALL	547	71.9	1	83
GS3STAT7890R-AWW	547	71.9	1	83
GS3STAT7890R-LL	492	65.7	-	81
GS3STAT7890R-WW	492	65.7	-	81
GS3STAT7896L-ALL	560	73.1	1	82
GS3STAT7896L-AWW	560	73.1	1	82
GS3STAT7896L-LL	451	60.6	-	80
GS3STAT7896L-WW	451	60.6	-	80
GS3STAT7896R-ALL	560	73.1	1	83
GS3STAT7896R-AWW	560	73.1	1	83
GS3STAT7896R-LL	505	66.9	-	81
GS3STAT7896R-WW	505	66.9	-	81
GS3XFAK3066L-ALL	370	34.4	1	86
GS3XFAK3066L-AWW	340	56.2	1	86
GS3XFAK3066L-LL	322	31.7	-	85
GS3XFAK3066L-WW	323	56.2	-	85
GS3XFAK3066R-ALL	370	36.3	1	86
GS3XFAK3066R-AWW	340	56.2	1	86
GS3XFAK3066R-LL	322	31.7	-	85
GS3XFAK3066R-WW	323	56.2	-	85
GS3XFAK3072L-ALL	384	35.9	1	86
GS3XFAK3072L-AWW	360	61	1	86

model number	weight	cubes	#locks	page
GS3XFAK3072L-LL	336	33.3	-	85
GS3XFAK3072L-WW	333	61	-	85
GS3XFAK3072R-ALL	384	37.8	1	86
GS3XFAK3072R-AWW	360	61	1	86
GS3XFAK3072R-LL	336	33.3	-	85
GS3XFAK3072R-WW	333	61	-	85
GS3XFAK3672L-ALL	412	38.2	1	86
GS3XFAK3672L-AWW	380	80.8	1	86
GS3XFAK3672L-LL	359	36.4	-	85
GS3XFAK3672L-WW	343	80.8	-	85
GS3XFAK3672R-ALL	412	40.1	1	86
GS3XFAK3672R-AWW	380	80.8	1	86
GS3XFAK3672R-LL	359	36.4	-	85
GS3XFAK3672R-WW	343	80.8	-	85
GS3XFAK3678L-ALL	427	38.5	1	86
GS3XFAK3678L-AWW	400	87.1	1	86
GS3XFAK3678L-LL	374	37	-	85
GS3XFAK3678L-WW	353	87.1	-	85
GS3XFAK3678R-ALL	427	40.4	1	86
GS3XFAK3678R-AWW	400	87.1	1	86
GS3XFAK3678R-LL	374	37	-	85
GS3XFAK3678R-WW	353	87.1	-	85
GS3XHAK3066L-LL	279	29.4	-	89
GS3XHAK3066L-WW	281	56.2	-	89
GS3XHAK3066R-LL	279	29.4	-	89
GS3XHAK3066R-WW	281	56.2	-	89
GS3XHAK3072L-LL	289	30.6	-	89
GS3XHAK3072L-WW	291	61	-	89
GS3XHAK3072R-LL	289	30.6	-	89
GS3XHAK3072R-WW	291	61	-	89
GS3XHAK3672L-LL	312	33.7	-	89
GS3XHAK3672L-WW	301	61	-	89
GS3XHAK3672R-LL	312	33.7	-	89
GS3XHAK3672R-WW	301	61	-	89
GS3XHAK3678L-LL	323	33.9	-	89
GS3XHAK3678L-WW	311	65.8	-	89
GS3XHAK3678R-LL	323	33.9	-	89
GS3XHAK3678R-WW	311	65.8	-	89
GS3XMAK3066L-LL	288	35.1	-	87
GS3XMAK3066L-WW	301	55.5	-	87
GS3XMAK3066R-LL	288	35.1	-	87
GS3XMAK3066R-WW	301	55.5	-	87
GS3XMAK3072L-LL	297	36.4	-	87
GS3XMAK3072L-WW	310	60.2	-	87

model number	weight	cubes	#locks	page
GS3XMAK3072R-LL	297	36.4	-	87
GS3XMAK3072R-WW	310	60.2	-	87
GS3XMAK3672L-LL	325	40.5	-	87
GS3XMAK3672L-WW	319	60.2	-	87
GS3XMAK3672R-LL	325	40.5	-	87
GS3XMAK3672R-WW	319	79.7	-	87
GS3XMAK3678L-LL	335	41.8	-	87
GS3XMAK3678L-WW	328	65	-	87
GS3XMAK3678R-LL	335	41.8	-	87
GS3XMAK3678R-WW	328	86	-	87
GS4LACWR2442-L	36	2.8	-	113
GS4LACWR2442-W	36	2.8	-	113
GS4LACWR2448-L	41	3.2	-	113
GS4LACWR2448-W	41	3.2	-	113
GS4LACWR2454-L	45	3.6	-	113
GS4LACWR2454-W	45	3.6	-	113
GS4LACWR2460-L	49	4	-	113
GS4LACWR2460-W	49	4	-	113
GS4LACWR2466-L	54	4.4	-	113
GS4LACWR2466-W	54	4.4	-	113
GS4LACWR2472-L	58	4.7	-	113
GS4LACWR2472-W	58	4.7	-	113
GS4LACWR3042-L	41	3.6	-	113
GS4LACWR3042-W	41	3.6	-	113
GS4LACWR3048-L	47	4.1	-	113
GS4LACWR3048-W	47	4.1	-	113
GS4LACWR3054-L	52	4.6	-	113
GS4LACWR3054-W	52	4.6	-	113
GS4LACWR3060-L	56	7.2	-	113
GS4LACWR3060-W	56	5.1	-	113
GS4LACWR3066-L	62	7.9	-	113
GS4LACWR3066-W	62	5.5	-	113
GS4LACWR3072-L	66	8.6	-	113
GS4LACWR3072-W	66	8.6	-	113
GS4LADWR3066-L	61	5.2	-	112
GS4LADWR3066-W	61	5.5	-	112
GS4LADWR3072-L	67	5.7	-	112
GS4LADWR3072-W	67	6	-	112
GS4LADWR3078-L	72	6.1	-	112
GS4LADWR3078-W	72	6.5	-	112
GS4LADWR3084-L	78	6.6	-	112
GS4LADWR3084-W	78	7	-	112
GS4LADWR3090-L	84	7.1	-	112
GS4LADWR3090-W	84	7.5	-	112

WEIGHTS + CUBES

Silea
03/23

model number	weight	cubes	#locks	page
GS4LADWR3096-L	90	7.5	-	112
GS4LADWR3096-W	90	7.9	-	112
GS4LADWR3666-L	70	6.2	-	112
GS4LADWR3666-W	70	6.5	-	112
GS4LADWR3672-L	75	6.7	-	112
GS4LADWR3672-W	75	7.1	-	112
GS4LADWR3678-L	81	7.3	-	112
GS4LADWR3678-W	81	7.7	-	112
GS4LADWR3684-L	88	7.8	-	112
GS4LADWR3684-W	88	8.2	-	112
GS4LADWR3690-L	94	8.4	-	112
GS4LADWR3690-W	94	8.8	-	112
GS4LADWR3696-L	101	8.9	-	112
GS4LADWR3696-W	101	9.4	-	112
GS4LALNKDPD-3	85	9.5	-	116
GS4LALNKDPD-4	105	9.5	-	116
GS4LATOP30722442L-L	102	11.7	-	114
GS4LATOP30722442L-W	102	11.7	-	114
GS4LATOP30722442R-L	102	11.7	-	115
GS4LATOP30722442R-W	102	11.7	-	115
GS4LATOP30722448L-L	106	11.7	-	114
GS4LATOP30722448L-W	106	11.7	-	114
GS4LATOP30722448R-L	106	11.7	-	115
GS4LATOP30722448R-W	106	11.7	-	115
GS4LATOP30722454L-L	110	11.7	-	114
GS4LATOP30722454L-W	110	11.7	-	114
GS4LATOP30722454R-L	110	11.7	-	115
GS4LATOP30722454R-W	110	11.7	-	115
GS4LATOP30722460L-L	114	11.7	-	114
GS4LATOP30722460L-W	114	11.7	-	114
GS4LATOP30722460R-L	114	11.7	-	115
GS4LATOP30722460R-W	114	11.7	-	115
GS4LATOP30722466L-L	118	11.7	-	114
GS4LATOP30722466L-W	118	11.7	-	114
GS4LATOP30722466R-L	118	11.7	-	115
GS4LATOP30722466R-W	118	11.7	-	115
GS4LATOP30722472L-W	122	11.7	-	114
GS4LATOP30722472R-W	122	11.7	-	115
GS4LATOP30842442L-L	110	13.6	-	114
GS4LATOP30842442L-W	110	13.6	-	114
GS4LATOP30842442R-L	110	13.6	-	115
GS4LATOP30842442R-W	110	13.6	-	115
GS4LATOP30842448L-L	114	13.6	-	114
GS4LATOP30842448L-W	114	13.6	-	114

model number	weight	cubes	#locks	page
GS4LATOP30842448R-L	114	13.6	-	115
GS4LATOP30842448R-W	114	13.6	-	115
GS4LATOP30842454L-L	118	13.6	-	114
GS4LATOP30842454L-W	118	13.6	-	114
GS4LATOP30842454R-L	118	13.6	-	115
GS4LATOP30842454R-W	118	13.6	-	115
GS4LATOP30842460L-L	122	13.6	-	114
GS4LATOP30842460L-W	122	13.6	-	114
GS4LATOP30842460R-L	122	13.6	-	115
GS4LATOP30842460R-W	122	13.6	-	115
GS4LATOP30842466L-L	126	13.6	-	114
GS4LATOP30842466L-W	126	13.6	-	114
GS4LATOP30842466R-L	126	13.6	-	115
GS4LATOP30842466R-W	126	13.6	-	115
GS4LATOP30842472L-W	130	13.6	-	114
GS4LATOP30842472R-W	130	13.6	-	115
GS4LATOP36722442L-L	118	13.3	-	114
GS4LATOP36722442L-W	118	13.3	-	114
GS4LATOP36722442R-L	118	13.3	-	115
GS4LATOP36722442R-W	118	13.3	-	115
GS4LATOP36722448L-L	122	13.3	-	114
GS4LATOP36722448L-W	122	13.3	-	114
GS4LATOP36722448R-L	122	13.3	-	115
GS4LATOP36722448R-W	122	13.3	-	115
GS4LATOP36722454L-L	126	13.3	-	114
GS4LATOP36722454L-W	126	13.3	-	114
GS4LATOP36722454R-L	126	13.3	-	115
GS4LATOP36722454R-W	126	13.3	-	115
GS4LATOP36722460L-L	130	13.3	-	114
GS4LATOP36722460L-W	130	13.3	-	114
GS4LATOP36722460R-L	130	13.3	-	115
GS4LATOP36722460R-W	130	13.3	-	115
GS4LATOP36722466L-W	134	13.3	-	114
GS4LATOP36722466R-W	134	13.3	-	115
GS4LATOP36722472L-W	138	13.3	-	114
GS4LATOP36722472R-W	138	13.3	-	115
GS4LATOP36842442L-L	121	15.4	-	114
GS4LATOP36842442L-W	121	15.4	-	114
GS4LATOP36842442R-L	121	15.4	-	115
GS4LATOP36842442R-W	121	15.4	-	115
GS4LATOP36842448L-L	125	15.4	-	114
GS4LATOP36842448L-W	125	15.4	-	114
GS4LATOP36842448R-L	125	15.4	-	115
GS4LATOP36842448R-W	125	15.4	-	115

model number	weight	cubes	#locks	page
GS4LATOP36842454L-L	129	15.4	-	114
GS4LATOP36842454L-W	129	15.4	-	114
GS4LATOP36842454R-L	129	15.4	-	115
GS4LATOP36842454R-W	129	15.4	-	115
GS4LATOP36842460L-L	133	15.4	-	114
GS4LATOP36842460L-W	133	15.4	-	114
GS4LATOP36842460R-L	133	15.4	-	115
GS4LATOP36842460R-W	133	15.4	-	115
GS4LATOP36842466L-W	137	15.4	-	114
GS4LATOP36842466R-W	137	15.4	-	115
GS4LATOP36842472L-W	141	15.4	-	114
GS4LATOP36842472R-W	141	15.4	-	115
GS4PLDMF3066L-AL	161	13.3	1	106
GS4PLDMF3066L-AW	161	15.1	1	106
GS4PLDMF3066L-L	135	9.5	-	104
GS4PLDMF3066L-W	135	9.7	-	104
GS4PLDMF3066R-AL	161	13.5	1	107
GS4PLDMF3066R-AW	161	15.1	1	107
GS4PLDMF3066R-L	135	9.8	-	105
GS4PLDMF3066R-W	135	9.7	-	105
GS4PLDMF3072L-AL	164	13.9	1	106
GS4PLDMF3072L-AW	164	15.5	1	106
GS4PLDMF3072L-L	138	10.1	-	104
GS4PLDMF3072L-W	138	10.1	-	104
GS4PLDMF3072R-AL	164	13.9	1	107
GS4PLDMF3072R-AW	164	15.5	1	107
GS4PLDMF3072R-L	138	10.1	-	105
GS4PLDMF3072R-W	138	10.1	-	105
GS4PLDMF3078L-AL	166	14.3	1	106
GS4PLDMF3078L-AW	166	15.9	1	106
GS4PLDMF3078L-L	140	10.5	-	104
GS4PLDMF3078L-W	140	10.5	-	104
GS4PLDMF3078R-AL	166	14.3	1	107
GS4PLDMF3078R-AW	166	15.9	1	107
GS4PLDMF3078R-L	140	10.5	-	105
GS4PLDMF3078R-W	140	10.5	-	105
GS4PLDMF3084L-AL	176	15.3	1	106
GS4PLDMF3084L-AW	176	16.9	1	106
GS4PLDMF3084L-L	150	11.6	-	104
GS4PLDMF3084L-W	150	11.5	-	104
GS4PLDMF3084R-AL	176	15.3	1	107
GS4PLDMF3084R-AW	176	16.9	1	107
GS4PLDMF3084R-L	150	11.6	-	105
GS4PLDMF3084R-W	150	11.5	-	105

model number	weight	cubes	#locks	page
GS4PLDMF3090L-AL	179	15.8	1	106
GS4PLDMF3090L-AW	179	17.4	1	106
GS4PLDMF3090L-L	153	12	-	104
GS4PLDMF3090L-W	153	12	-	104
GS4PLDMF3090R-AL	179	15.8	1	107
GS4PLDMF3090R-AW	179	17.4	1	107
GS4PLDMF3090R-L	153	12	-	105
GS4PLDMF3090R-W	153	12	-	105
GS4PLDMF3096L-AL	183	16.3	1	106
GS4PLDMF3096L-AW	183	17.9	1	106
GS4PLDMF3096L-L	157	12.5	-	104
GS4PLDMF3096L-W	157	12.5	-	104
GS4PLDMF3096R-AL	183	16.3	1	107
GS4PLDMF3096R-AW	183	17.9	1	107
GS4PLDMF3096R-L	157	12.5	-	105
GS4PLDMF3096R-W	157	12.5	-	105
GS4PLDMF3666L-AL	173	14.5	1	106
GS4PLDMF3666L-AW	173	15.1	1	106
GS4PLDMF3666L-L	140	10.2	-	104
GS4PLDMF3666L-W	140	10.2	-	104
GS4PLDMF3666R-AL	173	14.8	1	107
GS4PLDMF3666R-AW	173	15.1	1	107
GS4PLDMF3666R-L	140	10.5	-	105
GS4PLDMF3666R-W	140	10.2	-	105
GS4PLDMF3672L-AL	176	15.2	1	106
GS4PLDMF3672L-AW	176	15.5	1	106
GS4PLDMF3672L-L	143	10.9	-	104
GS4PLDMF3672L-W	143	10.6	-	104
GS4PLDMF3672R-AL	176	15.2	1	107
GS4PLDMF3672R-AW	176	15.5	1	107
GS4PLDMF3672R-L	143	10.9	-	105
GS4PLDMF3672R-W	143	10.6	-	105
GS4PLDMF3678L-AL	178	15.6	1	106
GS4PLDMF3678L-AW	178	15.9	1	106
GS4PLDMF3678L-L	145	11.3	-	104
GS4PLDMF3678L-W	145	11	-	104
GS4PLDMF3678R-AL	178	15.6	1	107
GS4PLDMF3678R-AW	178	15.9	1	107
GS4PLDMF3678R-L	145	11.3	-	105
GS4PLDMF3678R-W	145	11	-	105
GS4PLDMF3684L-AL	188	16.6	1	106
GS4PLDMF3684L-AW	188	16.9	1	106
GS4PLDMF3684L-L	155	12.3	-	104
GS4PLDMF3684L-W	155	12.1	-	104

WEIGHTS + CUBES

Silea
03/23

model number	weight	cubes	#locks	page
GS4PLDMF3684R-AL	188	16.6	1	107
GS4PLDMF3684R-AW	188	16.9	1	107
GS4PLDMF3684R-L	155	12.3	-	105
GS4PLDMF3684R-W	155	12.1	-	105
GS4PLDMF3690L-AL	191	17.1	1	106
GS4PLDMF3690L-AW	191	17.4	1	106
GS4PLDMF3690L-L	158	12.8	-	104
GS4PLDMF3690L-W	158	12.6	-	104
GS4PLDMF3690R-AL	191	17.1	1	107
GS4PLDMF3690R-AW	191	17.4	1	107
GS4PLDMF3690R-L	158	12.8	-	105
GS4PLDMF3690R-W	158	12.6	-	105
GS4PLDMF3696L-AL	195	17.5	1	106
GS4PLDMF3696L-AW	195	17.9	1	106
GS4PLDMF3696L-L	162	13.2	-	104
GS4PLDMF3696L-W	162	13	-	104
GS4PLDMF3696R-AL	195	17.5	1	107
GS4PLDMF3696R-AW	195	17.9	1	107
GS4PLDMF3696R-L	162	13.2	-	105
GS4PLDMF3696R-W	162	13	-	105
GS4PLDMH3066L-AL	120	12.5	1	110
GS4PLDMH3066L-AW	120	14.1	1	110
GS4PLDMH3066L-L	90	8.2	-	108
GS4PLDMH3066L-W	90	8.2	-	108
GS4PLDMH3066R-AL	120	12.5	1	111
GS4PLDMH3066R-AW	120	14.1	1	111
GS4PLDMH3066R-L	90	8.2	-	109
GS4PLDMH3066R-W	90	8.2	-	109
GS4PLDMH3072L-AL	121	13	1	110
GS4PLDMH3072L-AW	121	14.3	1	110
GS4PLDMH3072L-L	91	8.7	-	108
GS4PLDMH3072L-W	91	8.4	-	108
GS4PLDMH3072R-AL	121	13	1	111
GS4PLDMH3072R-AW	121	14.3	1	111
GS4PLDMH3072R-L	91	8.7	-	109
GS4PLDMH3072R-W	91	8.4	-	109
GS4PLDMH3078L-AL	122	12.9	1	110
GS4PLDMH3078L-AW	122	14.5	1	110
GS4PLDMH3078L-L	92	8.6	-	108
GS4PLDMH3078L-W	92	8.6	-	108
GS4PLDMH3078R-AL	122	12.9	1	111
GS4PLDMH3078R-AW	122	14.5	1	111
GS4PLDMH3078R-L	92	8.6	-	109
GS4PLDMH3078R-W	92	8.6	-	109
GS4PLDMH3084L-AL	128	13.7	1	110

model number	weight	cubes	#locks	page
GS4PLDMH3084L-AW	128	15.4	1	110
GS4PLDMH3084L-L	98	9.4	-	108
GS4PLDMH3084L-W	98	9.4	-	108
GS4PLDMH3084R-AL	128	13.7	1	111
GS4PLDMH3084R-AW	128	15.4	1	111
GS4PLDMH3084R-L	98	9.4	-	109
GS4PLDMH3084R-W	98	9.4	-	109
GS4PLDMH3090L-AL	130	14	1	110
GS4PLDMH3090L-AW	130	15.6	1	110
GS4PLDMH3090L-L	100	9.7	-	108
GS4PLDMH3090L-W	100	9.7	-	108
GS4PLDMH3090R-AL	130	14	1	111
GS4PLDMH3090R-AW	130	15.6	1	111
GS4PLDMH3090R-L	100	9.7	-	109
GS4PLDMH3090R-W	100	9.7	-	109
GS4PLDMH3096L-AL	132	14.3	1	110
GS4PLDMH3096L-AW	132	15.9	1	110
GS4PLDMH3096L-L	102	10	-	108
GS4PLDMH3096L-W	102	10	-	108
GS4PLDMH3096R-AL	132	14.3	1	111
GS4PLDMH3096R-AW	132	15.9	1	111
GS4PLDMH3096R-L	102	10	-	109
GS4PLDMH3096R-W	102	10	-	109
GS4PLDMH3666L-AL	132	13.8	1	110
GS4PLDMH3666L-AW	132	14.1	1	110
GS4PLDMH3666L-L	95	9	-	108
GS4PLDMH3666L-W	95	8.8	-	108
GS4PLDMH3666R-AL	132	13.8	1	111
GS4PLDMH3666R-AW	132	14.1	1	111
GS4PLDMH3666R-L	95	9	-	109
GS4PLDMH3666R-W	95	8.8	-	109
GS4PLDMH3672L-AL	133	14.3	1	110
GS4PLDMH3672L-AW	133	14.3	1	110
GS4PLDMH3672L-L	96	9.5	-	108
GS4PLDMH3672L-W	96	9	-	108
GS4PLDMH3672R-AL	133	14.3	1	111
GS4PLDMH3672R-AW	133	14.3	1	111
GS4PLDMH3672R-L	96	9.5	-	109
GS4PLDMH3672R-W	96	9	-	109
GS4PLDMH3678L-AL	134	14.2	1	110
GS4PLDMH3678L-AW	134	14.5	1	110
GS4PLDMH3678L-L	97	9.3	-	108
GS4PLDMH3678L-W	97	9.2	-	108
GS4PLDMH3678R-AL	134	14.2	1	111
GS4PLDMH3678R-AW	134	14.5	1	111

model number	weight	cubes	#locks	page
GS4PLDMH3678R-L	97	9.3	-	109
GS4PLDMH3678R-W	97	9.2	-	109
GS4PLDMH3684L-AL	140	15	1	110
GS4PLDMH3684L-AW	140	15.4	1	110
GS4PLDMH3684L-L	103	10.2	-	108
GS4PLDMH3684L-W	103	10	-	108
GS4PLDMH3684R-AL	140	15	1	111
GS4PLDMH3684R-AW	140	15.4	1	111
GS4PLDMH3684R-L	103	10.2	-	109
GS4PLDMH3684R-W	103	10	-	109
GS4PLDMH3690L-AL	142	15.3	1	110
GS4PLDMH3690L-AW	142	15.6	1	110
GS4PLDMH3690L-L	105	10.5	-	108
GS4PLDMH3690L-W	105	10.3	-	108
GS4PLDMH3690R-AL	142	15.3	1	111
GS4PLDMH3690R-AW	142	15.6	1	111
GS4PLDMH3690R-L	105	10.5	-	109
GS4PLDMH3690R-W	105	10.3	-	109
GS4PLDMH3696L-AL	144	15.5	1	110
GS4PLDMH3696L-AW	144	15.9	1	110
GS4PLDMH3696L-L	107	10.7	-	108
GS4PLDMH3696L-W	107	10.5	-	108
GS4PLDMH3696R-AL	144	15.5	1	111
GS4PLDMH3696R-AW	144	15.9	1	111
GS4PLDMH3696R-L	107	10.7	-	109
GS4PLDMH3696R-W	107	10.5	-	109
GS4PLWFP72-L	127	15.4	-	101
GS4PLWFP72-W	127	15.4	-	101
GS4PLWFP78-L	135	16.7	-	101
GS4PLWFP78-W	135	16.7	-	101
GS4PLWFP84-L	142	17.9	-	101
GS4PLWFP84-W	142	17.9	-	101
GS4PLWFP90-L	149	19.1	-	101
GS4PLWFP90-W	149	19.1	-	101
GS4PLWFP96-L	156	20.3	-	101
GS4PLWFP96-W	156	20.3	-	101
GS4PLWFP102-W	164	21.5	-	101
GS4PLWFP108-W	170	22.8	-	101
GS4PLWFP2472L-AL	166	21.6	1	102
GS4PLWFP2472L-AW	166	21.6	1	102
GS4PLWFP2472R-AL	166	21.6	1	103
GS4PLWFP2472R-AW	166	21.6	1	103
GS4PLWFP2478L-AL	174	22.8	1	102
GS4PLWFP2478L-AW	174	22.8	1	102
GS4PLWFP2478R-AL	174	22.8	1	103

model number	weight	cubes	#locks	page
GS4PLWFP2478R-AW	174	22.8	1	103
GS4PLWFP2484L-AL	181	24	1	102
GS4PLWFP2484L-AW	181	24	1	102
GS4PLWFP2484R-AL	181	24	1	103
GS4PLWFP2484R-AW	181	24	1	103
GS4PLWFP2490L-AL	189	25.3	1	102
GS4PLWFP2490L-AW	189	25.3	1	102
GS4PLWFP2490R-AL	189	25.3	1	103
GS4PLWFP2490R-AW	189	25.3	1	103
GS4PLWFP2496L-AL	196	26.5	1	102
GS4PLWFP2496L-AW	196	26.5	1	102
GS4PLWFP2496R-AL	196	26.5	1	103
GS4PLWFP2496R-AW	196	26.5	1	103
GS4PLWFP3072L-AL	174	23.5	1	102
GS4PLWFP3072L-AW	174	23.5	1	102
GS4PLWFP3072R-AL	174	23.5	1	103
GS4PLWFP3072R-AW	174	23.5	1	103
GS4PLWFP3078L-AL	182	24.7	1	102
GS4PLWFP3078L-AW	182	24.7	1	102
GS4PLWFP3078R-AL	182	24.7	1	103
GS4PLWFP3078R-AW	182	24.7	1	103
GS4PLWFP3084L-AL	189	25.9	1	102
GS4PLWFP3084L-AW	189	25.9	1	102
GS4PLWFP3084R-AL	189	25.9	1	103
GS4PLWFP3084R-AW	189	25.9	1	103
GS4PLWFP3090L-AL	197	27.2	1	102
GS4PLWFP3090L-AW	197	27.2	1	102
GS4PLWFP3090R-AL	197	27.2	1	103
GS4PLWFP3090R-AW	197	27.2	1	103
GS4PLWFP3096L-AL	204	28.4	1	102
GS4PLWFP3096L-AW	204	28.4	1	102
GS4PLWFP3096R-AL	204	28.4	1	103
GS4PLWFP3096R-AW	204	28.4	1	103
GS4PLWFP24102L-AW	204	27.7	1	102
GS4PLWFP24102R-AW	204	27.7	1	103
GS4PLWFP24108L-AW	210	28.9	1	102
GS4PLWFP24108R-AW	210	28.9	1	103
GS4PLWFP30102L-AW	212	29.6	1	102
GS4PLWFP30102R-AW	212	29.6	1	103
GS4PLWFP30108L-AW	218	30.8	1	102
GS4PLWFP30108R-AW	218	30.8	1	103
GS5BIN-LG	1	0.5	-	228
GS5BIN-SM	1	0.2	-	228
GS5CLS5H718L-LL	105	9.1	1	230
GS5CLS5H718L-WG	105	9.1	-	231

WEIGHTS + CUBES

Silea
03/23

model number	weight	cubes	#locks	page
GS5CLS5H718L-WW	105	9.1	1	230
GS5CLS5H718R-LL	105	9.1	1	230
GS5CLS5H718R-WG	105	9.1	-	231
GS5CLS5H718R-WW	105	9.1	1	230
GS5CLS5H730L-LL	180	9.1	1	230
GS5CLS5H730L-WG	180	14.3	-	231
GS5CLS5H730L-WW	180	14.3	1	230
GS5CLS5H730R-LL	180	9.1	1	230
GS5CLS5H730R-WG	180	14.3	-	231
GS5CLS5H730R-WW	180	14.3	1	230
GS5CPD724-XL	48	4.9	-	229
GS5CPD724-XW	48	4.9	-	229
GS5CPD730-SL	60	6	2	226
GS5CPD730-SW	60	6	2	226
GS5CPD730-XL	55	6	-	229
GS5CPD730-XW	55	6	-	229
GS5CPD736-SL	72	7.1	2	226
GS5CPD736-SW	72	7.1	2	226
GS5CPD736-XL	62	7.1	-	229
GS5CPD736-XW	62	7.1	-	229
GS5CPD742-SL	84	8.2	2	226
GS5CPD742-SW	84	8.2	2	226
GS5CPD742-XL	69	8.2	-	229
GS5CPD742-XW	69	8.2	-	229
GS5CPD748-SL	96	9.3	2	226
GS5CPD748-SW	96	9.3	2	226
GS5CPD754-SL	108	10.4	2	226
GS5CPD754-SW	108	10.4	2	226
GS5CPD760-SL	120	11.5	4	227
GS5CPD760-SW	120	11.5	4	227
GS5CPD766-SL	132	12.6	4	227
GS5CPD766-SW	132	12.6	4	227
GS5CPD772-SL	144	13.7	4	227
GS5CPD772-SW	144	13.7	4	227
GS5CVATR3666L-LL	382	40.6	-	222
GS5CVATR3666L-WW	382	40.6	-	222
GS5CVATR3666R-LL	382	40.6	-	223
GS5CVATR3666R-WW	382	40.6	-	223
GS5CVATR3672L-LL	389	41.1	-	222
GS5CVATR3672L-WW	389	41.1	-	222
GS5CVATR3672R-LL	389	41.1	-	223
GS5CVATR3672R-WW	389	41.1	-	223
GS5CVATR3678L-LL	406	42.2	-	222
GS5CVATR3678L-WW	406	42.2	-	222
GS5CVATR3678R-LL	396	42.2	-	223

model number	weight	cubes	#locks	page
GS5CVATR3678R-WW	396	42.2	-	223
GS5CVATR3684L-LL	412	42.8	-	222
GS5CVATR3684L-WW	412	42.8	-	222
GS5CVATR3684R-LL	402	42.8	-	223
GS5CVATR3684R-WW	402	42.8	-	223
GS5CVATR4266L-LL	411	46	-	222
GS5CVATR4266L-WW	411	46	-	222
GS5CVATR4266R-LL	411	46	-	223
GS5CVATR4266R-WW	411	46	-	223
GS5CVATR4272L-LL	418	46.7	-	222
GS5CVATR4272L-WW	418	46.7	-	222
GS5CVATR4272R-LL	418	46.7	-	223
GS5CVATR4272R-WW	418	46.7	-	223
GS5CVATR4278L-LL	436	47.8	-	222
GS5CVATR4278L-WW	436	47.8	-	222
GS5CVATR4278R-LL	426	47.8	-	223
GS5CVATR4278R-WW	426	47.8	-	223
GS5CVATR4284L-LL	444	48.5	-	222
GS5CVATR4284L-WW	444	48.5	-	222
GS5CVATR4284R-LL	434	48.5	-	223
GS5CVATR4284R-WW	434	48.5	-	223
GS5CVATS304266L-LL	411	46	-	224
GS5CVATS304266L-WW	411	46	-	224
GS5CVATS304266R-LL	411	46	-	225
GS5CVATS304266R-WW	411	46	-	225
GS5CVATS304272L-LL	418	46.7	-	224
GS5CVATS304272L-WW	418	46.7	-	224
GS5CVATS304272R-LL	418	46.7	-	225
GS5CVATS304272R-WW	418	46.7	-	225
GS5CVATS304278L-LL	436	47.8	-	224
GS5CVATS304278L-WW	436	47.8	-	224
GS5CVATS304278R-LL	426	47.8	-	225
GS5CVATS304278R-WW	426	47.8	-	225
GS5CVATS304284L-LL	444	48.5	-	224
GS5CVATS304284L-WW	444	48.5	-	224
GS5CVATS304284R-LL	434	48.5	-	225
GS5CVATS304284R-WW	434	48.5	-	225
GS5LKR5H724L-LG	155	21.2	-	233
GS5LKR5H724L-LL	155	21.2	-	232
GS5LKR5H724L-WG	155	11.7	-	233
GS5LKR5H724L-WW	155	11.7	-	232
GS5LKR5H724R-LG	155	21.2	-	233
GS5LKR5H724R-LL	155	21.2	-	232
GS5LKR5H724R-WG	155	11.7	-	233
GS5LKR5H724R-WW	155	11.7	-	232

model number	weight	cubes	#locks	page
GS5LKR5H736L-LG	195	21.2	-	233
GS5LKR5H736L-LL	195	21.2	-	232
GS5LKR5H736L-WG	195	16.9	-	233
GS5LKR5H736L-WW	195	16.9	-	232
GS5LKR5H736R-LG	195	21.2	-	233
GS5LKR5H736R-LL	195	21.2	-	232
GS5LKR5H736R-WG	195	16.9	-	233
GS5LKR5H736R-WW	195	16.9	-	232
GS5PNCLCUP-MPLE	1	0.2	-	235
GS5PNCLCUP-WLNT	1	0.2	-	235
GS5PNCLTRAY-MPLE	2	0.2	-	235
GS5PNCLTRAY-WLNT	2	0.2	-	235
GS5TRAY-LG	1	0.2	-	228
GS5TRAY-SM	1	0.1	-	228
GS6GBG2448-LL	111	28.9	-	142
GS6GBG2448-WW	111	28.9	-	142
GS6GBG2454-LL	123	32.5	-	142
GS6GBG2454-WW	123	32.5	-	142
GS6GBG2460-LL	36.1	135	-	142
GS6GBG2460-WW	36.1	135	-	142
GS6GCR2472L-LL	236	45	-	144
GS6GCR2472L-WW	236	45	-	144
GS6GCR2472R-LL	236	45	-	144
GS6GCR2472R-WW	236	45	-	144
GS6GCR2478L-LL	249	48.6	-	144
GS6GCR2478L-WW	249	48.6	-	144
GS6GCR2478R-LL	249	48.6	-	144
GS6GCR2478R-WW	249	48.6	-	144
GS6GCR2484L-LL	261	52.3	-	144
GS6GCR2484L-WW	261	52.3	-	144
GS6GCR2484R-LL	261	52.3	-	144
GS6GCR2484R-WW	261	52.3	-	144
GS6G DFA4284L-LL	491	83.7	-	134
GS6G DFA4284L-WW	491	83.7	-	134
GS6G DFA4284R-LL	491	83.7	-	134
GS6G DFA4284R-WW	491	83.7	-	134
GS6G DFA42102L-ALL	599	101.4	1	135
GS6G DFA42102L-AWW	599	101.3	1	135
GS6G DFA42102R-ALL	599	101.4	1	135
GS6G DFA42102R-AWW	599	101.3	1	135
GS6G DFF4284L-LL	316	85.7	-	138
GS6G DFF4284L-WW	316	85.7	-	138
GS6G DFF4284R-LL	316	85.7	-	138
GS6G DFF4284R-WW	316	85.7	-	138
GS6G DFF42102L-ALL	424	103.8	1	139

model number	weight	cubes	#locks	page
GS6G DFF42102L-AWW	424	103.8	1	139
GS6G DFF42102R-ALL	424	103.8	1	139
GS6G DFF42102R-AWW	424	103.8	1	139
GS6G DR3072L-LL	269	55.7	-	140
GS6G DR3072L-LL	269	55.7	-	141
GS6G DR3072L-WW	269	55.7	-	141
GS6G DR3072R-LL	269	55.7	-	141
GS6G DR3072R-WW	269	55.7	-	141
GS6G DR3072-WW	269	55.7	-	140
GS6G DR3672L-LL	299	66.4	-	140
GS6G DR3672L-LL	299	66.4	-	141
GS6G DR3672L-WW	299	66.4	-	141
GS6G DR3672R-LL	299	66.4	-	141
GS6G DR3672R-WW	299	66.4	-	141
GS6G DR3672-WW	299	66.4	-	140
GS6G DR3684L-LL	327	77.1	-	140
GS6G DR3684L-LL	327	77.1	-	141
GS6G DR3684L-WW	327	77.1	-	141
GS6G DR3684R-LL	327	77.1	-	141
GS6G DR3684R-WW	327	77.1	-	141
GS6G DR3684-WW	327	77.1	-	140
GS6G DR30144L-LL	458	109.5	-	140
GS6G DR30144LR-LL	458	109.5	-	141
GS6G DR30144LR-WW	458	109.5	-	141
GS6G DR30144-WW	458	109.5	-	140
GS6G DR36144L-LL	503	130.5	-	140
GS6G DR36144LR-LL	503	130.5	-	141
GS6G DR36144LR-WW	503	130.5	-	141
GS6G DR36144-WW	503	130.5	-	140
GS6G DR36168L-LL	559	151.9	-	140
GS6G DR36168LR-LL	559	151.9	-	141
GS6G DR36168LR-WW	559	151.9	-	141
GS6G DR36168-WW	559	151.9	-	140
GS6G DTR3072L-LL	269	55.7	-	140
GS6G DTR3072L-LL	269	55.7	-	141
GS6G DTR3072L-WW	269	55.7	-	141
GS6G DTR3072R-LL	269	55.7	-	141
GS6G DTR3072R-WW	269	55.7	-	141
GS6G DTR3072-WW	269	55.7	-	140
GS6G DTR3672L-LL	299	66.4	-	140
GS6G DTR3672L-LL	299	66.4	-	141
GS6G DTR3672L-WW	299	66.4	-	141
GS6G DTR3672R-LL	299	66.4	-	141
GS6G DTR3672R-WW	299	66.4	-	141
GS6G DTR3672-WW	299	66.4	-	140

WEIGHTS + CUBES

Silea
03/23

model number	weight	cubes	#locks	page
GS6GDTT72-L	36	4.3	-	146
GS6GDTT72-S	39	5.2	-	146
GS6GDTT72-W	36	4.3	-	146
GS6GDTT84-L	42	5	-	146
GS6GDTT84-S	46	6	-	146
GS6GDTT84-W	42	5	-	146
GS6GDTT144-L	72	6	-	146
GS6GDTT144-S	78	6.9	-	146
GS6GDTT144-W	72	6	-	146
GS6GDTT168-L	84	6.9	-	146
GS6GDTT168-S	92	7.9	-	146
GS6GDTT168-W	84	6.9	-	146
GS6GDXA4284L-LL	494	91.7	-	132
GS6GDXA4284L-WW	494	91.7	-	132
GS6GDXA4284R-LL	494	91.7	-	132
GS6GDXA4284R-WW	494	91.7	-	132
GS6GDXA42102L-ALL	602	111	1	133
GS6GDXA42102L-AWW	602	111	1	133
GS6GDXA42102R-ALL	602	111	1	133
GS6GDXA42102R-AWW	602	111	1	133
GS6GDXF4284L-LL	316	85.6	-	136
GS6GDXF4284L-WW	316	85.6	-	136
GS6GDXF4284R-LL	316	85.6	-	136
GS6GDXF4284R-WW	316	85.6	-	136
GS6GDXF42102L-ALL	424	103.6	1	137
GS6GDXF42102L-AWW	424	103.6	1	137
GS6GDXF42102R-ALL	424	103.6	1	137
GS6GDXF42102R-AWW	424	103.6	1	137
GS6GDXMT72-L	174	14.5	-	145
GS6GDXMT72-S	240	54.3	-	145
GS6GDXMT72-W	174	14.5	-	145
GS6GRT2448L-LL	151	29.8	-	143
GS6GRT2448L-WW	151	29.8	-	143
GS6GRT2448R-LL	151	29.8	-	143
GS6GRT2448R-WW	151	29.8	-	143
GS6GRT2454L-LL	163	33.4	-	143
GS6GRT2454L-WW	163	33.4	-	143
GS6GRT2454R-LL	163	33.4	-	143
GS6GRT2454R-WW	163	33.4	-	143
GS6GRT2460L-LL	175	37	-	143
GS6GRT2460L-WW	175	37	-	143
GS6GRT2460R-LL	175	37	-	143
GS6GRT2460R-WW	175	37	-	143
GS6GTK71R	14	3.6	-	147
GS6GTK72	14	3.6	-	147

model number	weight	cubes	#locks	page
GS6GTK77R	15	3.8	-	147
GS6GTK78	15	3.8	-	147
GS6GTK83R	16	4.1	-	147
GS6GTK84	16	4.1	-	147
GS6GTK89R	17	4.4	-	147
GS6GTK94R	19	3.6	-	147
GS6GTK95R	18	4.6	-	147
GS6GTK100R	22	3.1	-	147
GS6GTK106R	24	3.2	-	147
GS6GTK112R	26	3.4	-	147
GS6GTK118R	28	3.6	-	147
GS6GTK124R	30	3.4	-	147
GS6GTK130R	32	3.6	-	147
GS6GTK144	30	4.3	-	147
GS6GTK168	32	4.9	-	147
GS6GXTK72	13	3.5	-	147
GS6MB24SS-L	30	5.3	-	148
GS6MB24SS-W	30	5.2	-	148
GS6MB24SS-WS	50	5.2	-	148
MDWBRK	1	0.4	-	219
MDWLBK24	2	0.3	-	219
MDWLBK30	2	0.4	-	219
SACORNER	8	1.7	-	329
SADSKPAD	10	2.3	-	329
SAMAGNET	1	0.1	-	331

Gunlocke®

One Gunlocke Drive
Wayland, NY 14572
800 828 6300