

PRICING EFFECTIVE MAY 2022

# SILEA

---

*Price & Specification Guide*

---

PDF updated August 4, 2022

Gunlocke®

# veneER 1 (SELECT)

## NATURAL FC CHERRY

- A. Cinnamon/Biltmore NC260
- B. Lowell Ash NC394
- C. Medium Red NC512
- D. Light NC701
- E. Shaker NC774
- F. Burnished NC777

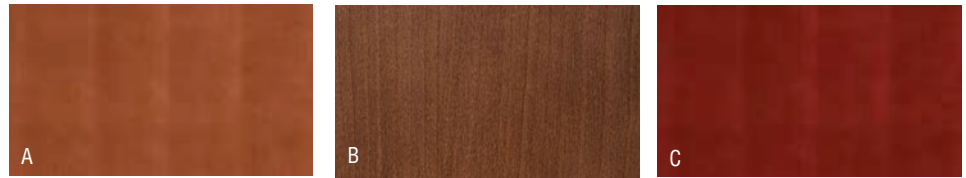

## NATURAL FC MAPLE

- G. Natural NE800
- H. Harvest NE856



## NATURAL FC WALNUT

- I. Florence NT579
  - J. Light NT601
  - K. Skyline NT625
  - L. Nutmeg NT629
  - M. Pinnacle NT679
  - N. Sumatra NT693
  - O. Ebony NT509
- (Use OP TopFin Only)



## veneER 1 (SELECT)

STRATAWOOD CHERRY	Vertical	Horizontal
A. Cinnamon/Biltmore	SC260	HSC260
B. Lowell Ash	SC394	HSC394
C. Clear	SC700	HSC700
D. Light	SC701	HSC701
E. Shaker	SC774	HSC774
F. Burnished	SC777	HSC777



STRATAWOOD MAPLE	Vertical	Horizontal
G. Belair	SE934	HSE934
H. Beigewood	SE878	HSE878
I. Field Elm	SE599	HSE599
J. Clear Maple	SE800	HSE800
K. Harvest	SE856	HSE856
L. Phantom Ecru (Use OP TopFin Only)	SE912	HSE912

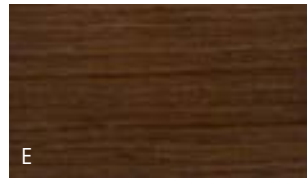

STRATAWOOD WALNUT	Vertical	Horizontal
M. Florence	ST579	HST579
N. Light	ST601	HST601
O. Skyline	ST625	HST625
P. Pinnacle	ST679	HST679
Q. Sumatra	ST693	HST693



STRATAWOOD OAK	Vertical	Horizontal
R. Clear	SF300	HSF300
S. Dark	SF331	HSF331



STRATAWOOD SILVER OAK	Vertical	Horizontal
T. Clear	SB100	HSB100
U. Portico Teak	SB150	HSB150

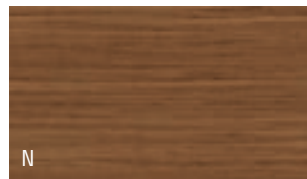

STRATAWOOD WASHED WALNUT	Vertical	Horizontal
V. Clear	SW600	
W. Smoked Onyx	SW697	
X. Smoked Grey	SW612	

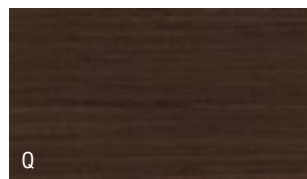

## VENEER 2 (PREMIUM)

### NATURAL QC WALNUT

A. Florence	QT579
B. Light	QT601
C. Skyline	QT625
D. Nutmeg	QT629
E. Pinnacle	QT679
F. Sumatra	QT693
G. Ebony	QT509
(Use OP TopFin Only)	



### NATURAL RIFT CUT OAK

H. Light	RF301
I. Dark	RF331
J. Phantom Ecrú	RF912
(Use OP TopFin Only)	
K. Fawn Cypress	RF108



## LAMINATES

### WOODGRAIN

A. Lowell Ash	LLA1
B. Natural Recon	LNR1
C. Phantom Ecrú	LPE1
D. Portico Teak	LPT1
E. Skyline Walnut	LSW1
F. Pinnacle Walnut	PINC
G. Fawn Cypress	LFC1
H. Natural Maple	LWD
I. Harvest Maple	C
J. Shaker Cherry	LW7C
K. Biltmore Cherry	COGN
L. Florence Walnut	LFW1
M. Kingswood Walnut	LK11
N. NeoWalnut	LNU1
O. Veranda Teak	LVT1

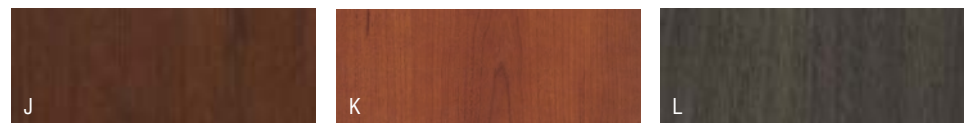

### SOLID

P. Designer White 15051	LDW1
Q. Loft	LM11
R. Flint	LM16

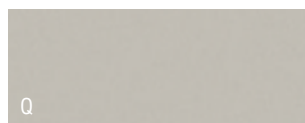

## GLASS

- |  |      |
|--|------|
| A. Ice White                                   | GWH2 |
| B. Black                                       | GBK2 |
| C. Muslin                                      | GML2 |
| D. Flint                                       | GFL2 |
| E. Loft  | GLO2 |
| F. Beige                                       | GBG2 |
| G. Clear Ribbed Glass<br>(For Panel Legs Only) | RB   |

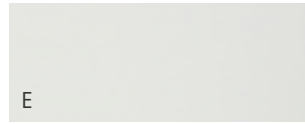
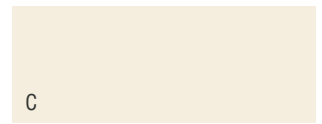

## SOLID SURFACE

- |                   |     |
|-------------------|-----|
| A. Deep Night Sky | SES |
| B. Designer White | SDW |
| C. Cameo White    | SAW |

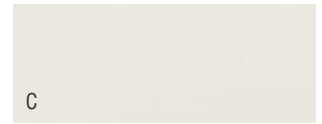

## METAL

- |                   |     |
|-------------------|-----|
| A. Black          | P71 |
| B. Silver         | PR6 |
| C. Matte Gold     | P8G |
| D. Pyrite         | PJE |
| E. Designer White | PJW |

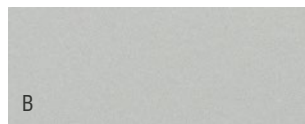
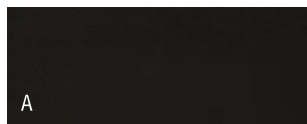



General Information		Modular Casegoods	127-202
Conditions of Sale...	2	Desk Worksurface	128-132
GSA Terms & Conditions...	3-4	Desk Pedestals	133-134
Warranty...	5	Desk Legs	135-140
Delivery Information...	6	Desk   Runoff Modesty Panel	141-146
Reference	7-9	24 & 30 Depth Worksurfaces	147-150
Pulls   Pull Locations	10-11	24 & 30 Depth Pedestals	151-182
Locks & Keying	12-13	Modular End Panel	183
Product Reference	15-49	Modular L Supports	184
Statement of Line	16-23	Support & Ped Backs	185-195
Features + Advantages	24-25	Layers W/ Laptop Drawer	196
Technical Specs	26-28	Round Tops	197
Filing Reference	29-30	Guitar Pick Top	198
Height Reference	31	Layers Box & Brackets	199-201
Wire Management	32	Modular Pedestal Cushion	202
Grommets	33	Cantilever Height Adjustable Desks and	
Details	34	Smart Storage	203-217
Height Adjustability	35	Cantilever Height Adjustable Desks	204-207
Storage	36	Smart Pedestals	208-209
Surface Mount Cabinets	37	Accessory Trays and Bins For Smart Pedestals	210
Dimensions	38-47	False Pedestals	211
Worksurface Finish Specifications	48	Smart Closets	212-213
Grain Direction Specification	49	Smart Lockers	214-215
Unitized Casegoods	51-79	Smart Pedestal Power Units For Grommet Cutout	216
Double Pedestal Desk	52	Solidwood Desktop Accessories	217
Single Pedestal Desk	53-55	Footed	219-244
Runoff Desks	56	Reference	220-221
Layers Runoff W/ Layers Box / Laptop Drawer	57-58	Footed	222-224
Double Pedestal Credenza	59	1H Peds	225-228
Single Pedestal Credenza	60	Layers Pedestals	229-240
Full Bank Credenza	61-62	Storage	241-244
Returns	63	Storage	245-276
Rectangular Table Desk	64-66	Bookcases	246
Runoffs	67	Bookcase / Coat Hook / Closet	247-248
Rectangular Runoff	68	Lateral Files	249-250
Layers Rectangular Runoff W/ Layers Box /		Closets	251-255
Laptop Drawer	69-70	Storage Box / Utility Cabinet	256-268
Ellipse Table Desk	71	Side Access Storage Locker	269-272
Layers Ellipse Runoff W/ Layers Box	72	Mobile Pedestal	273-274
Arc Boat Table Desk	73	Storage External Tops	275-276
Layers Arc Boat Runoff W/Layers Box	74	Wall Mount	277-317
Sightline Runoff	75	Cabinets	278-287
Layers Sightline Runoff W/ Layers Box /		Wall Mount Wall Overhead	288-289
Laptop Drawer	76-77	Tackboard in Tackzone	290-293
Layers Cockpit Runoff W/ Layers Box	78	Tackboard to Top of Overhead	294-299
Media Top	79	Tackboard / Glass Whiteboard from Floor	300-301
Height Adjustable	81-125	Wall Mount Wall in Tackzone	302-305
Height Adjustable Split-Top Desks	82-85	Magnetic Wood to Top of Overhead	306-310
Freestanding Desk / Extension	86-91	Wood Tack from Floor	311
Credenza	92-95	Shelving for Wall Mount Wall	312-314
Bridge	96-97	Floating Shelves	315
Return	98-101	Wall Mount External Tops	316-317
L Shape Height Adjustable Spec Tips	102	Surface Mount	319-334
L Shape Height Adjustable	103-118	Cabinets	320-324
Shroud for T-Base	119	Towers	325-330
Layers Bookcase	120	Tackboard / Glass Whiteboard	331-332
Height Adjustable Base	121	External Tops	333-334
Height Adjustable Tops	122	Workwall	335-342
Wall Mount Cantilever Bracket	123	Workwalls	336-339
Mixed Material Telescoping Height Adjustable	124	Workwall Tackboard	340
Replacement Height Adjustable Keypads	125	Lounge Level Media Unit	341-342
Welcome Desk	126.1-126.18	Accessories	343-358
Advanced Height Adjustable Welcome Desk	126.2-126.5	LED Tasklighting	344
Advanced Fixed Height Welcome Desk	126.6-126.7	Trough Accessories	345-346
Fixed Height Welcome Desk	126.8-126.9	Personal Corner	347
Welcome Desk Shell	126.10-126.11	Drawer Filing Rails & Reinforcement Bars	348
Welcome Desk Bridge	126.12	Magnets	349
Welcome Desk Returns	126.13	Counterweights	350
Welcome Desk Credenzas	126.14	Wire Manager	351
Waterfall Transaction Tops	126.15	Center Drawer	352
Transaction Tops	126.16	Pencil Tray	353
Welcome Desk Tackboard	126.17	Grommet	354
In/Out Storage Unit	126.18	Power Unit	355-357
		3" Dia Field Installed Grommet	358
		Grade Fabric Pricing	360-363
		Weights + Cubes	364-407

**INTRODUCTION**

The Gunlocke Company is dedicated to providing the finest products and service possible. This price list reflects that commitment. Included is a current listing of our casegood models.

Seating and Lounge are presented in a separate price list. Contact your Gunlocke Customer Services Representative for more information, (800) 828-6300.

Designed for easy use, each page of this price list, and the inside front cover fold out provide all information required to order a product correctly. Should additional information be needed, contact your Gunlocke customer service representative.

**PRICING**

Prices shown cover standard product specifications. Any changes or alterations, other than those listed, will be subject to an additional charge. Prices include cartoning and freight. Authorization and pricing must be secured in advance for orders or contracts calling for large quantities, indefinite quantities, or extended delivery dates. Prices are subject to change without notice; the most current prices are published on <http://www.gunlocke.com>.

**ACKNOWLEDGEMENT**

Each order will be acknowledged by Gunlocke. Customers should check each acknowledgment for accuracy and immediately notify Gunlocke of any discrepancies. The printed acknowledgment is the final agreement between The Gunlocke Company and the customer, superseding all previous communications regarding the order.

**SPECIFICATION CHANGES**

Gunlocke reserves the right to change specifications for the improvement of products at any time, without notice.

**ORDER CHANGES**

Gunlocke is not required to accept changes in orders after confirmation. Reasonable changes are subject to additional charges for labor, material and administrative costs.

Order changes of acknowledgment may result in re-scheduling of product.

**RETURNED MERCHANDISE**

No merchandise may be returned without prior authorization.

**SHOWROOMS**

For all showroom locations and tour information, please reference the showrooms page online at: [www.gunlocke.com/inspiration/showrooms](http://www.gunlocke.com/inspiration/showrooms)

**CANCELLATIONS**

Cancellation of orders cannot be accepted since every order is manufactured according to customer specifications.

**STORAGE**

If delivery cannot be made and products are ready, Gunlocke will transfer products to a storage facility and products will be invoiced at that time. The customer is responsible for storage charges and assumes and bears all risks associated with the storage of that product.

**TERMS**

Net 30 days from date of invoice. A service charge of eighteen percent (18%) per year or .0004931% per day, compounded monthly, will be added to balance due beyond the thirtieth day. Products are shipped FOB factory, freight prepaid and allowed. Title passes to purchaser and Gunlocke's responsibility ceases when shipment is accepted for transportation by a carrier. A full explanation of all payment terms is found on order and invoice forms.

**ORDERING**

To expedite order entry and to assure proper service, email or fax all orders directly to:

**The Gunlocke Company**

Attn: Order Entry  
One Gunlocke Drive  
Wayland, New York 14572

585-728-5111  
585-728-8350 FAX  
800-828-6300  
[www.gunlocke.com](http://www.gunlocke.com)

Gunlocke will not be responsible for duplicate orders if purchase orders are left unmarked.



## ORDERING INFORMATION

**1a. Intended use:** The furniture on this schedule is intended for use by Government executives (or equivalent military rank) in the Executive, Judicial and Legislative Branches of the Federal Government. To help customers make a good purchasing decision based on their needs and budget, GSA has established four grades of furniture. Grade (1) includes furniture that tends to be the most expensive on this schedule, grade (2) furniture tends to be more moderately priced and grades (3) and (4) furniture tend to be affordably priced when compared to grades (1) and (2). Some pieces of furniture on this schedule may be significantly higher in price than GSA Traditional and Contemporary Executive Special Order Program furniture. The ordering agency or service is responsible for determining furniture appropriate for use in its offices which will fit within its budget and comply with applicable Federal or internal agency procurement regulations. Please see reverse for GSA terms and conditions.

**Grade 1** All exposed solid parts such as top rims, base rails etc. (except decorative accents and inlays) shall be the same species as the face veneer. Top and bottom edges of drawer fronts shall be solid wood in the same species as the face veneers. Drawer sides and backs shall be solid wood.

**Grade 2** Exposed wood panel trim and trim on tops shall be the same wood species as the face veneer on the top. Some or all other exposed solid parts, such as base rails can be an alternative wood species (such as poplar or gum) different from the face veneers. Exposed, finished engineered wood core material such as MDF is acceptable only for the edges of drawer fronts. Drawer sides shall be solid wood or veneer core plywood/laminated construction. Silea is grade 2.

**Grade 3** Most or all exposed solid parts can be an alternative wood species (such as poplar or gum), different from the face veneers. Exposed, finished engineered wood core material such as MDF is acceptable only for the edges of drawer fronts. Drawer sides shall be solid wood or veneer core plywood/laminated construction. Credentials, and all tables are grade 3.

**Grade 4** Most or all exposed solid parts can be an alternative wood species (such as poplar or gum), different from the face veneers. Exposed, finished engineered wood core material such as MDF is acceptable only for the edges of drawer fronts. Drawer sides shall be composite wood material construction such as MDF. Trio is grade 4.

1. **Maximum Order Threshold:**  
SIN# 33721 . . . . . \$250,000
2. **Minimum order:** \$2,000 list
3. **Geographic coverage:**  
48 contiguous states and DC (CONUS)
4. **Points of production:**  
Wayland, NY, Steuben County, USA  
Muscatine, IA, Muscatine County, USA
5. **Discount Statement: Discount is applied to List Price.**  
**Structure in List \$:**  
\$2,000 – \$100,000 list . . . . . 60.5%  
\$100,001 – \$400,000 list . . . . . 62.7%  
\$400,001 – MOT (\$1,428,571 List). . . . . 65.0%  
Over MOT (\$1,428,572 List). . . . . Negotiable  
\* These discounts apply to single purchase orders, shipping to the same place in the same time period
6. **Quantity Discount:** See above
7. **Payment terms:**  
1% 23 days Net 30 days from date of shipment, for product only, for all electronic invoices processed through a Federal payment system (including, but not limited to, WAWF, IPP, etc.).  
  
All other invoice sales are Net 30 days from date of shipment. Prompt payment terms are not applicable to credit card orders.
8. **Government Credit Cards** are accepted above and below the micro-purchase levels.  
  
Written confirmation and authorized signatures are required. Activities may verbally provide card information, but products shall be confirmed in writing.  
  
Use of credit cards shall be at the time of order placement with cards charged at the time of shipment, see GSAR 552-232-80 (C).  
  
There are no additional discounts for using a credit card.
9. **Foreign items:** None
- 10a. **Time of delivery:** 60 days ARO
- 10b. **Expedited delivery:** Contact Gunlocke
- 10c. **Overnight and 2-day delivery:** Contact Gunlocke
- 10d. **Urgent requirements:** Contact Gunlocke
11. **FOB point(s):** F.O.B. Origin, with freight being paid by Gunlocke for all deliveries within CONUS.
12. **Ordering address(es):**  
The Gunlocke Company  
c/o Authorized Gunlocke GSA Dealer  
One Gunlocke Drive  
Wayland, NY 14572  
Phone: (800) 828-6300  
Fax: (585) 728-8350
13. **Payment address(es):**  
The Gunlocke Company LLC  
13367 Collections Center Drive  
Chicago, IL 60693
14. **Warranty provision:** See warranty on page 5
15. **Export packing charges:**  
Write for quotation on export packaging.
16. **Terms and conditions of Government commercial credit card acceptance:** Credit Cards are accepted.
17. **Terms and conditions of rental, maintenance, and repair:** Not applicable
18. **Terms and conditions of installation:**  
Installation services shall be priced at a rate not to exceed 30% of the net product price, per project. The minimum order charge for installation shall be \$175.00. Projects involving extraordinary circumstances which require installation charges exceeding the proposed installation rates will be submitted to the GSA Contracting Officer for review and approval.
19. **Project Management:**  
\$65 Per Hour, inclusive of IFF
20. **Reconfiguration and Relocation Services:**  
\$65 Per Hour, inclusive of IFF
21. **Design/Layout Services:**  
\$65 Per Hour, inclusive of IFF
22. **Terms and conditions of repair:**  
Refer to Gunlocke Customer Support
23. **List of service and distribution:** Points: Not applicable
24. **Participating dealers:** A list of participating dealers will be supplied to any government agency upon request or is available on our website at [www.gunlocke.com](http://www.gunlocke.com).
25. **Preventative maintenance:**  
Not applicable. Instruction sheets available upon request.
26. **Environmental attributes:** Gunlocke has an active environmental program. Please call (800) 828-6300 for details.
27. **Data universal number system:**  
(DUNS) number is 19-993-6550
28. **CCR registration/Cage Code:** The Gunlocke Company is registered in the DoD CCR. Cage Code - 26574
29. **Returns:**  
No returns of goods will be accepted without written consent and shipping instructions from Gunlocke, and the Government customer will be required to pay all return freight charges. A restocking fee of 30% net will apply on all authorized returns provided Gunlocke receives goods in the condition in which they left the factory. No credit will be given if goods cannot be reused. Special order items are in no event subject to return. Goods must be returned within 70 days of shipment from factory.
30. **Cancellations:** No charge prior to production. After production has begun (5 days ARO), only the actual costs that the contractor can demonstrate will be billed to the customer if the merchandise cannot be resold within a reasonable period of time (90 days).
31. **Inside Delivery:** Gunlocke rates are for dock-to-dock delivery and do not include inside delivery, un-cartoning or set up. If desired, arrangements for inside delivery must be made and approved when the order is placed and will have a corresponding fee of 7% of list price of the order with a minimum charge of \$75. Requests for un-cartoning and set up will be coordinated with a Gunlocke Dealer with applicable charges applied to the order.
32. **Federal Tax ID # 22-3887942**

## 12 YEAR WARRANTY

Subject to the limitations set forth below. The Gunlocke Company warrants to the original purchaser all product in this price list to be free from defects in material and workmanship for a twelve year period from the date of shipment. This 12-year warranty applies to all products sold and installed by a Gunlocke authorized agent for normal commercial single shift service. Gunlocke will repair, or at its option, replace defective merchandise, free of charge. The following components not manufactured by Gunlocke have the following warranties:

- **High wear components** such as casters and glides are warranted for five years after date of shipment to original owner.
- **Electrical components** are warranted 10 years from date of manufacture with exception of lamps and ballasts which are not warranted. This includes Fluorescent Tasklights.
- **LED tasklights** are warranted for 3 years from date of shipment to original owner.
- **Drawer suspensions** are warranted for lifetime of product after shipment to original owner.
- **Personal corners** including covering (leather) are warranted for three years of single shift and normal use after shipment to original owner.
- **Height adjustable electrical components** are warranted for 7 years of single shift and normal use after shipment to original owner.

Any non-standard material selected by the customer is not warranted. Neither does this warranty apply to damage resulting from accident, alteration, or misuse, as well as damage from normal wear and tear such as dents, nicks, scratches, fading and improper maintenance. That is, Gunlocke's warranty is only valid if products are given proper use and care. Gunlocke assumes no responsibility for product damages resulting from improper installation or user modification.

## WOOD FURNITURE

Wood owes its inherent beauty to variations in color, grain, and texture, and therefore, these variations are not considered defects. There may be minor variations from one piece of furniture to the next even though they are finished at the same time. Exposure to light and the aging process will cause a darkening of natural wood products. Light finishes on wood products do not mask the natural characteristics of wood. The Gunlocke Company does not guarantee the exact matching of grain, pattern, and color.

These finishes do not cover any of the natural characteristics of the wood, including nature's colorations, pitch pockets, and the variations of steam-bent wood. Merchandise will not be replaced because of these natural variations.

It is expressly understood and agreed that the buyer's sole and exclusive remedy for any and all losses or damages resulting from nonconforming goods, or from any other cause, shall be repair or replacement of defective parts, and that Gunlocke shall not be liable for damages or injury to persons or property, nor for replacement of the entire commercial unit, if repair or replacement of defective parts can reasonably render the unit conforming.

All warranty claims must be made in writing by the original owner. Owner may be required to produce the invoice or other evidence to establish that a claim is within the warranty period. Warranty claims may be submitted on the Gunlocke website.

<https://apps.gunlockeadvantage.com/QualityFeedback/>

As stated and illustrated on the website, serial numbers are required to process a warranty claim. No person, firm or corporation is authorized to assume for Gunlocke any liability in connection with the sale or installation of Gunlocke products except as stated above.

All other warranties, expressed or implied, are excluded. Gunlocke shall not be liable for incidental or consequential damages of any sort.

Within the Continental USA, all orders above \$20,000 list are shipped FOB factory, freight prepaid and allowed. All orders less than \$20,000 list will be subject to a \$200 net freight charge. Products shipped to Alaska and Hawaii FOB factory, freight prepaid and allowed to port of embarkation. Customer is responsible for freight charges from port of embarkation to final destination.

An anticipated shipping date is indicated on the order acknowledgment. Gunlocke cannot accept responsibility for shipping delays caused by outside sources or unforeseen problems. Delay of shipments requested by customers must be approved by Gunlocke. Any resultant storage charges will be charged to the customer.

Gunlocke may await completion of the entire order and ship all at once or may make partial shipments from time to time at its sole discretion unless the customer requests in writing that partial shipments are needed and Gunlocke approves the specific shipping schedule. Additional charges may apply.

Gunlocke is not liable for any delay or failure to deliver or perform due to strikes, lock-outs, or other labor or transportation difficulties, delay of sources or supply, accidents, fires, acts of God, or any other causes of like or unlike nature beyond the control of Gunlocke.

**LIABILITY**

Gunlocke products and their packaging are tendered to a transportation company only after passing rigid quality control inspection. At that time, title to the product is passed to the purchaser. However the transportation company assumes all liability from acceptance of shipment through its delivery. That is, Gunlocke's liability ceases at the time of shipment.

**FILING OF CLAIMS**

All claims for damage or loss must be submitted via our website at: <https://apps.gunlockeadvantage.com/QualityFeedback/> within 15 days after receipt of merchandise. Do not return freight damaged merchandise to Gunlocke. Follow the steps below to expedite processing and resolution of claims.

**For Visible Damage**

1. Make damage notation on delivery receipt and have driver sign. Do not reject or refuse the shipment.
2. Immediately contact Gunlocke Traffic Department at 585-728-8268.
3. Hold damaged carton and all interior packing for carrier's inspection. These materials will be needed to substantiate the claim.

**For Concealed Damage**

1. Open cartons within 15 days of receipt and inspect.
2. Follow steps 2, and 3 as listed under Visible Damage.
3. Do not remove product from delivered destination.

**For Loss**

1. Be sure loss notation is made on delivery receipt and have driver sign.
2. Contact Gunlocke Distribution at 585-728-8268.

Should transportation company seek to limit its liability on concealed, loss, or damage claims, please contact Gunlocke's traffic department. After a thorough investigation of the claim, the traffic department will provide you with guidance in corresponding with the carrier.

Returned merchandise, regardless of delivery method, will not be accepted unless specifically authorized by Gunlocke.

**For Damage or Loss of Parcel Post or UPS Shipment**

Notify Gunlocke distribution immediately at 585-728-8268.

**NORMAL DELIVERY**

All normal ground transportation by Gunlocke will be made on a dock-to-dock basis. The Gunlocke traffic department will determine the recommended method of shipment according to the ship to destination. If the delivery on a shipment takes longer than 2 hours to be unloaded, an additional charge will be billed at \$60/hour at 15 minute increments. Gunlocke reserves the absolute right to determine the method of shipping unless special delivery instructions have been previously approved.

**Gunlocke will make every effort in honoring delivery requests as stated on orders. However, the Company shall have no liability for failure to deliver, perform or delay in delivery due to any cause outside the control of Gunlocke. The Company assumes no liability for costs incurred due to delayed or late deliveries.**

If a guaranteed delivery time is needed please call Gunlocke Traffic Department at 585-728-8268 for a quote as additional charges will apply. Weekend or after hours deliveries are subject to additional charges.

**WEEKEND DELIVERY**

A \$500 charge will apply on weekend delivery after 3:00 PM Friday through Sunday evenings.

**DROP SHIP / JOB SITE DELIVERY**

Orders under \$50,000 list will incur a \$125 charge for ship to locations other than a designated dealer warehouse.

**INSIDE DELIVERY**

Inside delivery must be noted on order. A minimum \$100 charge will apply.

**SPECIAL DELIVERY**

Please contact the Gunlocke traffic department for special delivery services such as inside delivery, weekend or after hour deliveries, reconsignment or other special needs. These are billable services.

**Gunlocke will make every effort in honoring delivery requests as stated on orders. However, the Company shall have no liability for failure to deliver, perform or delay in delivery due to any cause outside the control of Gunlocke. The Company assumes no liability for costs incurred due to delayed or late deliveries.**

**DOCK RESTRICTIONS**

Gunlocke trailers are 53' x 102"; when attached to truck cab the total length is 75'. If delivery dock will not accommodate trucks of this sizes, the Gunlocke traffic department must be contacted prior to shipping. Alternate arrangements can be made; additional charges may apply.

**VENEERS**

Available in 8 select veneers and 2 premium veneers. All exposed wood surfaces utilize select flat cut Cherry, Maple, Walnut veneers, Stratawood (FSC reconstituted veneer), premium quarter cut Walnut, or Rift Oak veneers. Stratawood veneer is made from rapidly renewable wood veneer, which provides a repeatable, consistent straight grain pattern. Stratawood veneers are available in Cherry, Maple, Walnut, or Oak at veneer 1 pricing in vertical or horizontal orientation. All veneers are carefully selected and matched to assure balance and consistency.

**SPECIALTY FINISHES**

- Submit a color sample block (minimum size 3" x 3") to Gunlocke so that a finish formulation can be developed to match the special finish and color.
- Review the approval sample provided by Gunlocke.
- Written approval and sign off is required for Gunlocke Customer Service.
- Once written approval and sign off is received, the special finish order will be acknowledged.

**Note:** See Gunlocke Advantage website for special finish request forms.

**All Casegoods & Tables Purchase Orders:**

- 10% list upcharge per wood unit to specified veneer option receiving special finish.
- \$250 net formulation fee for special finish.

veneer 1 (select)

- Natural Flat Cut Cherry**
- Natural Flat Cut Maple**
- Natural Flat Cut Walnut**
- Stratawood Cherry**
- Stratawood Maple**
- Stratawood Walnut**
- Stratawood Oak**
- Stratawood Silver Oak**
- Stratawood Washed Walnut**

veneer 2 (premium)

- Natural Quarter Cut Walnut**
- Natural Rift Cut Oak**

**UV TOP FINISH**

Worksurfaces feature two low emitting UV finish options that enhance the beauty of natural wood and ensures depth, clarity, color consistency, and durability throughout the life of the product.

<b>Open Pore Low Sheen</b>	<b>OP</b>
<b>Full-Fill Cleartech (upcharge)</b>	<b>FF</b>

Full Fill Top ≤ 120" Length (+\$250)  
Full Fill Top ≥ 120" Length (+\$400)

**Note:** FSC options can be chosen as option pick for each model.

# REFERENCE

## Materials & finishes

Silea

05/22

The plastic laminate offering includes 11 woodgrain and 3 solid laminate options from Wilsonart. Laminate tops are high-pressure laminate (HPL), and chassis/storage components are thermally fused laminate (TFL). Laminate edgebands are 2mm thick and are color matched to the laminate option chosen.

Laminates	Description	Option Code	Supplier Name	Supplier Code	Edgeband (ABS, PVC)	Gunlocke Finish Match*
<b>WOODGRAIN</b>	Lowell Ash	<b>LLA1</b>	Wilsonart	7994-12	ABS	NC394
	Natural Recon	<b>LNR1</b>	Wilsonart	7996-12	ABS	RF301
	Phantom Ecu	<b>LPE1</b>	Wilsonart	8212-12	ABS	RF912
	Portico Teak	<b>LPT1</b>	Wilsonart	8210K-12	ABS	SB150
	Skyline Walnut	<b>LSW1</b>	Wilsonart	7964K-12	ABS	QT625
	Pinnacle Walnut	<b>PINC</b>	Wilsonart	7992-38	PVC	NT679
	Fawn Cypress	<b>LFC1</b>	Wilsonart	8208K-12	ABS	N/A
	Natural Maple	<b>LWD</b>	Wilsonart	11021-38	PVC	NE800
	Harvest Maple	<b>C</b>	Wilsonart	7953-38	PVC	NE856
	Shaker Cherry	<b>LW7C</b>	Wilsonart	7935K-07	PVC	NC774
	Biltmore Cherry	<b>COGN</b>	Wilsonart	7924K-07	PVC	NC260
	Veranda Teak	<b>LVT1</b>	Wilsonart	8209K-12	ABS	SB100
	Kingswood Walnut	<b>LKI1</b>	Wilsonart	8218-38	ABS	N/A
	Florence Walnut	<b>LFW1</b>	Wilsonart	7993-38	ABS	N/A
	Neo Walnut	<b>LNU1</b>	Wilsonart	7991-38	ABS	N/A
<b>SOLID</b>	Designer White 15051	<b>LDW1</b>	Wilsonart	15051-60	ABS	WPSW
	Loft – Grey Cloud	<b>LM11</b>	Wilsonart	15034-60	ABS	WPLF
	Charcoal/Flint	<b>LM16</b>	Wilsonart	10592-38	PVC	WPFT
<b>GLASS</b>	Ice White	<b>GWH2</b>				
	Black	<b>GBK2</b>				
	Muslin	<b>GML2</b>				
	Flint	<b>GFL2</b>				
	Loft	<b>GLO2</b>				
	Beige	<b>GBG2</b>				
	Clear Ribbed Glass (For Panel Legs Only)	<b>RB</b>				
<b>SOLID SURFACE</b>	Deep Night Sky	<b>SES</b>				
	Designer White	<b>SDW</b>				
	Cameo White	<b>SAW</b>				

\* See cross reference above for Gunlocke wood finish match. Although these are good matches, they are not exact matches due to grain pattern and sheen variation from laminate to veneer. They coordinate throughout a floorplate, but we recommend they not be utilized in the same office.

**Note:** Gunlocke does not guarantee an exact finish match to the plastic laminates listed above.

**EDGE DETAIL**

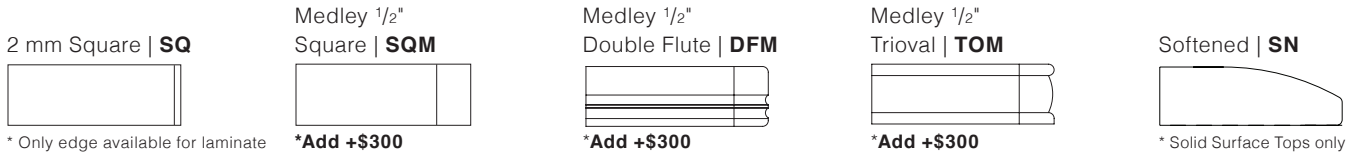

**FSC CERTIFIED**

Standard - No FSC	<b>X</b>
FSC Certified (5% upcharge)	<b>F</b>

**FSC TACKBOARD**

FSC Mixed Credit (Upcharge – See Tack & Cushion Pricing)	<b>FSC</b>
FSC Not Required	<b>NR</b>

**TOP GRAIN DIRECTION**

Long Grain	<b>VLG</b>
Short Grain	<b>VST</b>

• Laminate tops optional grain up to 60", above 60" tops are long grain standard.

**DRAWERS**

Vinyl Wrapped, with Soft Close suspension	<b>VW</b>
---	-----------

**BACK PANEL**

No Back Panel	<b>BN</b>
Back Panel Included	<b>BY</b>

**POWER UNIT COLOR**

Black	<b>BK</b>
Silver	<b>SV</b>
White	<b>WH</b>

**POWER UNIT COLOR (For Lounge Level Media)**

Black Std Plug	<b>BKSP</b>
Black Hardwire	<b>BKHW</b>
Silver Std Plug	<b>SVSP</b>
Silver Hardwire	<b>SVHW</b>
White Std Plug	<b>WHSP</b>
White Hardwire	<b>WHHW</b>

**GLASS COLOR**

Ice White	<b>GWH2</b>
Black	<b>GBK2</b>
Muslin	<b>GML2</b>
Flint	<b>GFL2</b>
Loft	<b>GLO2</b>
Beige	<b>GBG2</b>
Clear Ribbed (panel leg insert only)	<b>RB</b>

**LOCKS**

Locks Yes, Random Matte Silver Keying (Factory Installed)	<b>LYSTD</b> (Add +\$140)
Locks Yes, Omit Lock Core (Field Installed)	<b>LYOMT</b> (Add +\$140)
Locks No	<b>LN</b>

**KEYING**

Random Matte Silver Keying (Factory Installed)	<b>STD</b>
Omit Lock Core (Field Installed)	<b>OMT</b>

**HARDWARE COLOR**

Black	<b>P71</b>
Silver	<b>PR6</b>
Matte Gold	<b>P8G</b>
Pyrite	<b>PJE</b>
Designer White	<b>PJW</b>

**HEIGHT ADJUSTABLE BASE COLOR (METAL T BASES)**

Black (P71)	<b>BK</b>
Silver (PR6)	<b>SV</b>
Designer White (PJW)	<b>PJW</b>

**MAGNETIC ACCESSORY**

White	<b>AWH</b>
Black	<b>ABK</b>
Muslin	<b>AML</b>

**PERSONAL CORNER**

Leather	White	<b>CWH</b>
	Black	<b>CBL</b>
	Chocolate	<b>CCH</b>
Vinyl	White	<b>VWH</b>
	Black	<b>VBL</b>
	Chocolate	<b>VCH</b>

**CUSHION UPHOLSTERY**

Fabric	<b>COM-G27</b>
Leather	<b>COL-L5</b>

**TASKLIGHT CORD GROMMET (For Surface Mount Cabinets)**

Grommet Included	<b>WY</b>
Grommet No	<b>WN</b>

**MODESTY PANEL**

Modesty No	<b>MN</b>
Modesty Yes	<b>MY</b>

**METAL PULL**

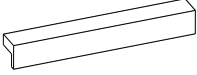
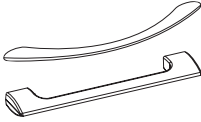
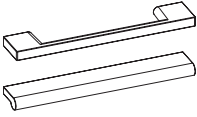
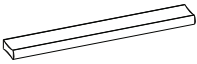
Silea Black (P71)	<b>PP71</b>		<b>SILEA</b>
Silea Silver (PR6)	<b>PPR6</b>		
Silea Matte Gold (P8G)	<b>PP8G</b>		
Silea Pyrite (PJE)	<b>PPJE</b>		
Silea Designer White (PJW)	<b>PPJW</b>		
Medley Arch Black (P71)	<b>HARB</b>		<b>MEDLEY ARCH</b>
Medley Arch Silver (PR6)	<b>HARS</b>		<b>MEDLEY ARETTE</b>
Medley Arette Black (P71)	<b>HATB</b>		
Medley Arette Silver (PR6)	<b>HATS</b>		
Trio Linear Black (P71)	<b>HLEB</b>		<b>TRIO LINEAR</b>
Trio Linear Silver (PR6)	<b>HLES</b>		<b>TRIO BAR</b>
Trio Bar Black (P71)	<b>HBRB</b>		
Trio Bar Silver (PR6)	<b>HBRS</b>		
Modern Black (P71)	<b>MP71</b>		<b>MODERN</b>
Modern Silver (PR6)	<b>MPR6</b>		
Modern Matte (P8G)	<b>MP8G</b>		
Modern Pyrite (PJE)	<b>MPJE</b>		
Modern Designer White (PJW)	<b>MPJW</b>		

Integral pulls are available as a standard option in wood only.

**INTEGRAL PULL**

Integral Pull /Touch Latch Doors **FPW**  
(add \$200 per unit)

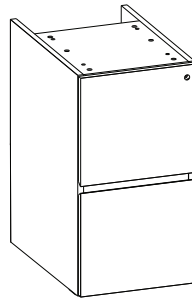

The Silea style metal pull is available in 5 metal finish colors - Silver, Black, Pyrite, Matte Gold, and Designer White. Pulls have the ability to be placed left, right or center with the same drawer front and pull hardware. Pulls are 6" less than the drawer front size with the exception of a 9" pedestal which comes with a 9" pull. Note: This applies to the Silea style pull only. This does not apply to the Arch, Arette, Linear, Bar, or Modern pulls.

CENTERED

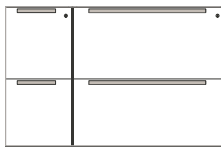

CONTINUOUS

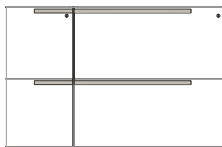

LEFT ALIGNED

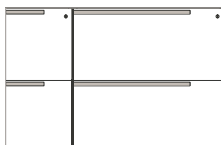

RIGHT ALIGNED

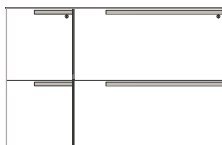

**Choice.**

The Silea pull enables you to select drawer pull orientation at the time of installation. Maximum flexibility.



CLOSET LOCATIONS

PEDESTAL LOCATIONS

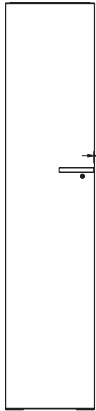

SILEA

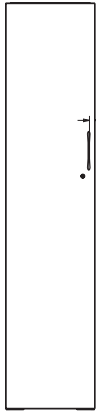

ARCH

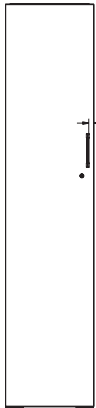

ARETTE

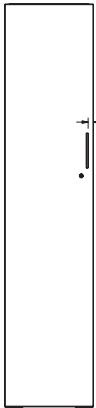

LINEAR

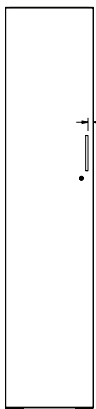

BAR

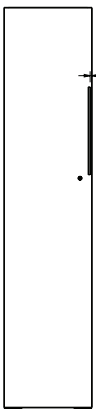

MODERN

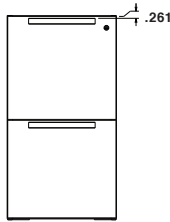

SILEA

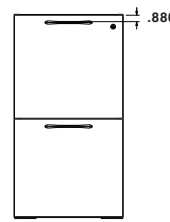

ARCH

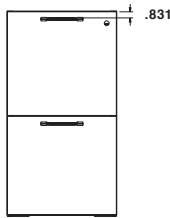

ARETTE

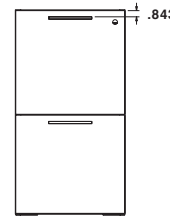

LINEAR

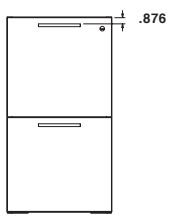

BAR

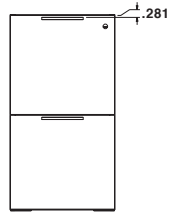

MODERN

Locks are standard on all below worksurface storage units. Closets and overhead storage are optional locking.

## STANDARD OPTIONS

---

- **Random Keying:** Key(s) arbitrarily assigned and installed at the factory. Factory installed locks are silver.

**Note:** When the random option is selected, some units may be shipped with the same key number.

- **Omit Lock Core:** The factory will omit lock cores. Removable lock core kits with specific key numbers must be ordered to facilitate keying alike in the field. A lock program must be specified. Field installed locks are available in Matte Silver, Black, Pyrite, Matte Gold, and Designer White.

## KEYING

---

Random Matte Silver Keying (Factory Installed)	<b>STD</b>	
Omit Lock Core (Field Installed)	<b>OMT</b>	(If option is chosen, a field installed lock program must be specified)

## LOCK PROGRAM (FIELD INSTALLED ONLY)

---

Random Keying	<b>X</b>
Specified Keying	<b>X101 - X225</b>
Sequential Keying	<b>SEQ/101 - SEQ/225</b>

## KEYING COLOR (FIELD INSTALLED ONLY)

---

Matte Silver	<b>MTS</b>
Black	<b>BLK</b>
Matte Gold	<b>MGD</b>
Pyrite	<b>PYT</b>
Designer White	<b>PJW</b>

### REPLACING LOCK CORES

- Lock must be in the unlocked position.
- Insert core removal key and pull core straight out.
- Insert new core with core removable key, hold core into lock and withdraw core removal key.
- Retain original core for future use.

For field installed locks, the "Omit Lock Core" option must be chosen. Then, specify lock model based on total quantity of lock cores within each office. To ensure ease of ordering for a variety of situations, lock cores can be specified in 3 ways – Random, Specified or Sequential.

LOCKING MODELS	DESCRIPTION	LIST
GLKFE1	1 core, 2 keys	\$13
GLKFE2	2 core, 2 keys	\$17
GLKFE3	3 core, 2 keys	\$21
GLKFE4	4 core, 2 keys	\$25
GLKFE5	5 core, 2 keys	\$29
GLKFE6	6 core, 2 keys	\$35
GLKFE7	7 core, 2 keys	\$41
GLKFE8	8 core, 2 keys	\$47
GLKFE9	9 core, 2 keys	\$53
GLKFE10	10 core, 2 keys	\$59
GLKFE11	11 core, 2 keys	\$65
GLKFE12	12 core, 2 keys	\$71
GLKFE13	13 core, 2 keys	\$77
GLKFE14	14 core, 2 keys	\$83
GLKFE15	15 core, 2 keys	\$89

**Note:** One core removal key minimum per order. One additional core removal key per 25 lock cores will be shipped.

### MASTER KEY

One key available to authorized dealers **GLKMSTR \$7**

**KEY NUMBERS 101-225 ARE AVAILABLE.**  
Orders without key numbers will be specified at random.

### RANDOM KEYING (FIELD INSTALLED)

The Random Keying option is provided for instances where there are multiple orders or phases to a project and the offices need to be keyed alike but the key numbering is not required. With the random keying option, key numbers are not specified. However, the core kits will be in sequential order from a random starting point.

### SPECIFIED KEYING (FIELD INSTALLED)

The Specified Keying option is provided for instances where there is a specific key number desired for all of the cores ordered.

### SEQUENTIAL KEYING (FIELD INSTALLED)

The Sequential Keying option is provided for instances when there are multiple orders or phases to a project and it is imperative that key numbers are not duplicated..

### RANDOM KEYING EXAMPLE

- There are 18 offices which have 3 black locks that need to be keyed alike, but the key number is not important.

Model String:

**GLKFE3. BLK. X. 18**  
*Model Color Program # of Offices*

### SPECIFIED KEYING EXAMPLE

- There are 6 offices which have 2 silver locks that need to be keyed alike with the key number 202.

Model String:

**GLKFE2. MTS. X202. 6**  
*Model Color Program # of Offices*

### SEQUENTIAL KEYING EXAMPLE

- A multiple phase project has 100 offices - 60 in the first phase with 4 locks, 40 in the second phase with 3 locks. No key number can be duplicated.

Model String (First Phase):

**GLKFE4. PYT. SEQ/101. 60**

Model String (Second Phase):

**GLKFE3. PYT. SEQ/161. 40**  
*Model Color Program # of Offices*



Product Reference... 15-49  
Statement of Line... 16-23  
Features + Advantages... 24-25  
Technical Specs... 26-28  
Filing Reference... 29-30  
Height Reference... 31  
Wire Management... 32  
Grommets... 33  
Details... 34  
Height Adjustability... 35  
Storage... 36  
Surface Mount Cabinets... 37  
Dimensions... 38-47  
Worksurface Finish Specifications... 48  
Grain Direction Specification... 49

# STATEMENT OF LINE

Unitized

Silea

05/22

**DOUBLE PEDESTAL DESK**  
9" ped

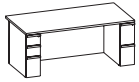

15" ped

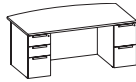
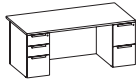

**SINGLE PEDESTAL DESK**  
9" ped

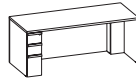

15" ped

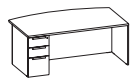
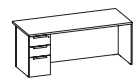
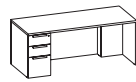

**SINGLE PEDESTAL CREDENZA**  
9" ped

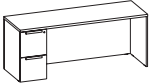

30" ped

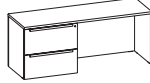

**DOUBLE PEDESTAL CREDENZA**

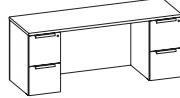

**RETURNS**

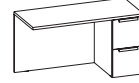

**RUNOFF DESK**  
15" ped (LH & RH)

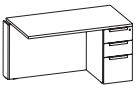

**RUNOFF DESK**  
9" ped (LH & RH)

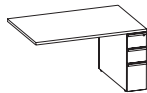

**LAYERS RUNOFF DESK**  
9" ped (LH & RH)

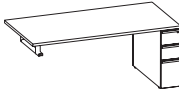

**LAYERS RUNOFF DESK W/  
LAPTOP DRAWER (LH & RH)**

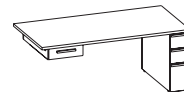

**RECTANGULAR TABLE DESK**

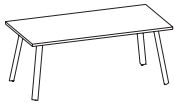

**RECTANGULAR EXTENSION**  
(LH & RH)

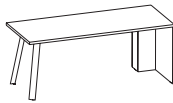

**RACETRACK EXTENSION**  
(LH & RH)



**d SHAPE EXTENSION**



**b SHAPE EXTENSION**

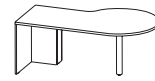

**LAYERS RECTANGULAR RUNOFF**

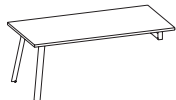

**LAYERS RECTANGULAR RUNOFF W/LAPTOP DRAWER (LH & RH)**

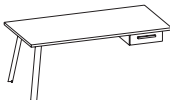

**SIGHTLINE RUNOFF**

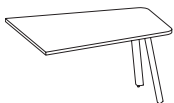

**LAYERS SIGHTLINE RUNOFF**

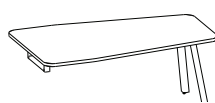

**LAYERS SIGHTLINE RUNOFF W/LAPTOP DRAWER (LH & RH)**

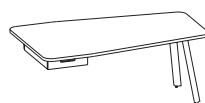

**LAYERS COCKPIT RUNOFF (LH & RH)**

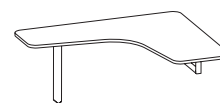

**MEDIA TOP**



**ELLIPSE TABLE DESK**

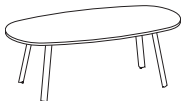

**LAYERS ELLIPSE RUNOFF**

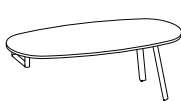

**ARC BOAT TABLE DESK**

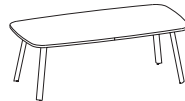

**LAYERS ARC BOAT RUNOFF**

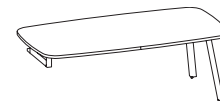

**FULL BANK CREDENZA**

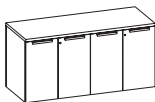
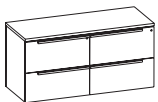

HEIGHT ADJUSTABLE

CREDENZA W/ END PANELS

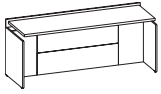

CREDENZA DOUBLE PEDESTAL

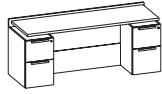

CREDENZA SINGLE PEDESTAL (LH & RH)

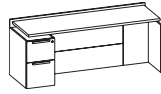

BRIDGE W/ WALL ACCESS PANEL

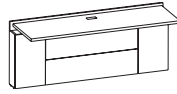

RETURN W/ END PANEL (LH & RH)

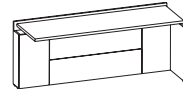

RETURN W/ PEDESTAL (LH & RH)

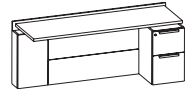

FREESTANDING DESK W/ FULL MODESTY

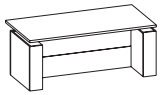

EXT DESK W/ FULL MODESTY (LH & RH)

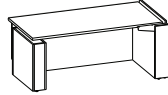

FREESTANDING DESK W/ TELESCOPING BASE

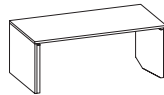

EXT DSK W/ TELESCOPING BASE (LH & RH)

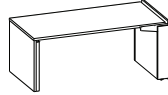

FREESTANDING DESK W/ HALF MODESTY

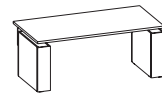

EXT DESK W/ HALF MODESTY (LH & RH)

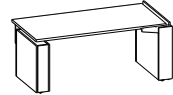

WORKSURFACE FOR T-BASE



SHROUD FOR T-BASE

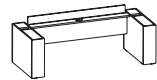

LAYERS BOOKCASE FOR T-BASE



T-BASE



WORKWALL

WALL MOUNTED WORKWALL (3H) (LH & RH)  
(Wood only)

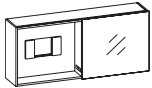

FREESTANDING WORKWALL (5 1/2 H) (LH & RH)  
(Wood only)

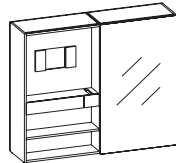

LOUNGE LEVEL MEDIA UNIT  
(Wood only)

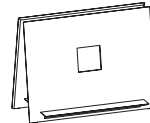

LOUNGE LEVEL MEDIA UNIT  
Whiteboard

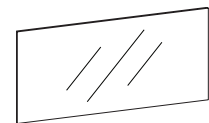

# STATEMENT OF LINE

Modular

Silea

05/22

## DESK & RUNOFF WORKSURFACE

30 & 36D

Rectangular

Bow

Racetrack

b shape

d shape

j shape

24D TOP

Standard or Trough



## DOUBLE PEDESTAL FULL MODESTY

9" peds

15" peds

## SINGLE PEDESTAL FULL MODESTY

(LH & RH)

## DESK MODESTY PANEL

10" Height

## DESK MODESTY PANEL

Full Height



## PEDESTALS 24D Standard Height, Standard or Trough Top



## PEDESTALS 24D Layers Height, Standard or Trough Top

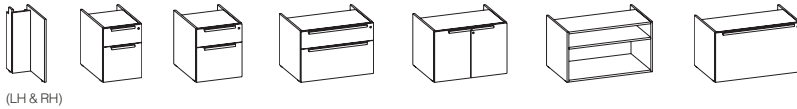

## DESK PEDESTALS

9" ped

## END PANEL

(Full back, no trough)

## L SUPPORTS

(LH & RH)

## SUPPORT PANELS

Standard & Layers

## PEDESTAL BACKS

Standard & Layers



## MODESTY & WALL ACCESS PANEL

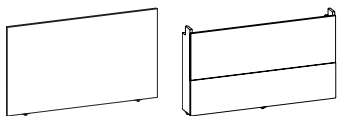

## ROUND TOP



## GUITAR PICK TOP





---

**CANTILEVER HEIGHT ADJUSTABLE RECTANGULAR DESKS**

**LEFT & RIGHT HAND**

36" Depth - Left Hand

42" Depth - Left Hand

36" Depth - Right Hand

42" Depth - Right Hand

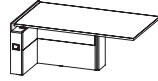
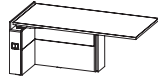
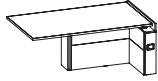
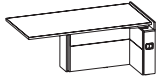

---

**CANTILEVER HEIGHT ADJUSTABLE SIGHTLINE DESKS**

42" Depth - Left Hand

42" Depth - Right Hand

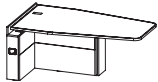
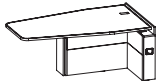

---

**SMART PEDESTALS**

Single Unit

Double Unit

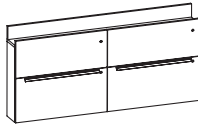

---

**SMART PEDESTAL ACCESSORY TRAYS AND BINS**

Large Tray

Large Bin

Small Tray

Small Bin

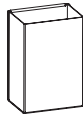
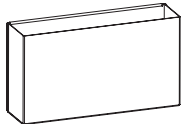

---

**FALSE PEDESTALS**

For Fixed Desk or Fixed Return

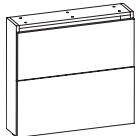

**SMART CLOSETS**  
18" Wide

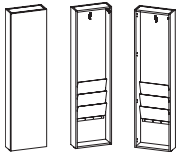

30" Wide Side Access

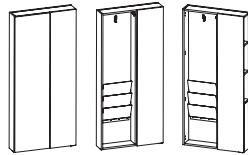

18" Wide w/ Glass Doors



30" Wide Side Access w/ Glass Doors

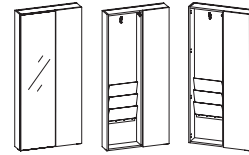

**SMART LOCKERS**  
24" Wide

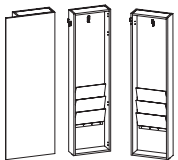

36" Wide Side Access

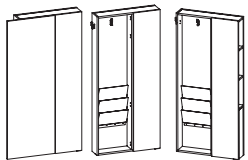

24" Wide w/ Glass Doors

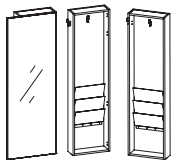

36" Wide Side Access w/ Glass Doors

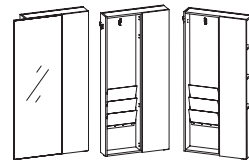

**SMART PEDESTAL GROMMET ACCESSORIES**  
HQ Power w/ Wireless Charging

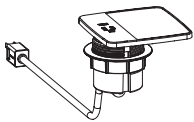

Bezel Mount Power

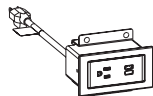

**SOLIDWOOD DESKTOP ACCESSORIES**

Pencil Tray



Pencil Cup

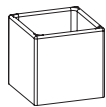

**REPLACEMENT HEIGHT ADJUSTABLE KEYPAD ACCESSORIES**

Basic Up/Down Keypad



Memory Preset Keypad



Paddle Keypad



Foot Control Keypad



Bluetooth App Control



BOOKCASE - 2H, 3H, 4H, 5H, 6H

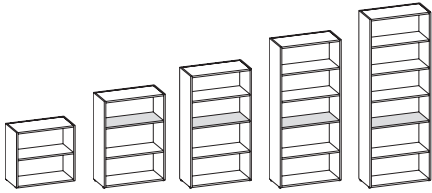

BOOKCASE W/ COAT HOOK  
BACK (LH & RH)

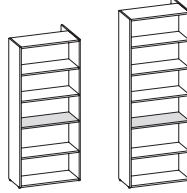

1/2 OPEN BOOKCASE  
1/2 CLOSET W/ DOOR  
(LH & RH)

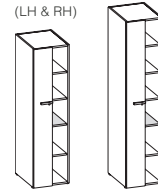

LATERAL FILE - 2H WITH TOP  
3H, 4H, 5H, 6H

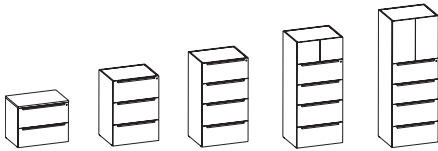

CLOSET  
5H & 6H

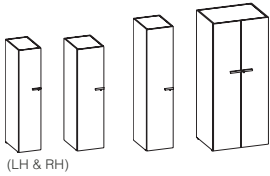

CLOSET W/ GLASS  
DOOR (LH & RH)  
5H & 6H

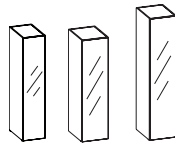

STORAGE BOX  
5H & 6H

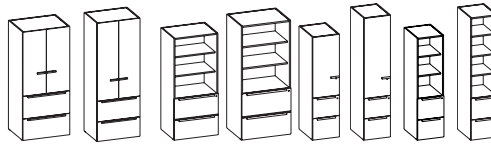

STORAGE CABINET



UTILITY CABINET  
(LH & RH) 5H & 6H

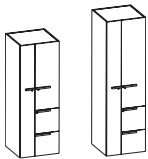

SIDE ACCESS  
STORAGE LOCKER  
Standard & Layers Height  
(LH & RH)



SIDE ACCESS STORAGE  
LOCKER W/GLASS DOOR  
Standard & Layers Height  
(LH & RH)



EXTERNAL STORAGE TOP



MOBILE PEDESTAL  
W/ TOP



# STATEMENT OF LINE

Wall Mount

Silea

05/22

**CABINET W/ HINGED DOORS**  
(1H)

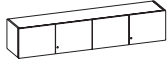

**CABINET W/ HINGED GLASS DOORS**  
(1H)  
(Wood only)

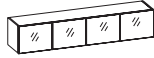

**CABINET W/ NO DOORS**  
(1H)

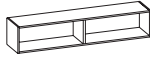

**CABINET W/ HINGED DOORS**  
(2H)

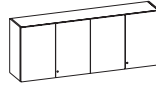

**CABINET W/ HINGED GLASS DOORS**  
(2H)  
(Wood only)

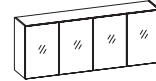

**CABINET W/ NO DOORS**  
(2H)

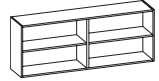

**CABINET W/ SLIDING DOORS** (1H)



**CABINET W/ SLIDING GLASS DOORS** (1H)  
(Wood only)



**CABINET W/ SLIDING DOORS** (2H)

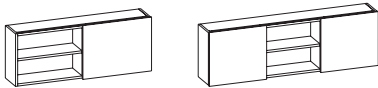

**CABINET W/ SLIDING GLASS DOORS** (2H)  
(Wood only)

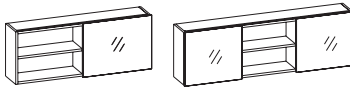

**WALL OVERHEAD SHELF TRACK BOTTOM**  
(1H)



**WALL OVERHEAD SHELF TRACK BOTTOM & CENTER**  
(2H)



**TACK ZONE W/ CENTER TRACK**  
(1H)



**LAYERS TACK ZONE W/ CENTER TRACK**



**TACK ZONE**  
(Wood, Glass & Fabric)

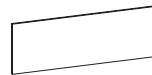

**8D & 12D SHELF CLIP INTO WALL W/TRACK**



**FLOATING SHELF**



**EXTERNAL TOP**



CABINET W/ HINGED DOORS (1H)

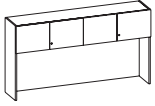

CABINET W/ HINGED GLASS DOORS (1H)  
(Wood only)

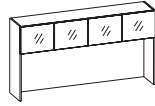

CABINET W/ NO DOORS (1H)

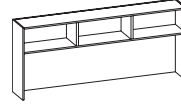

CABINET W/ HINGED DOORS (2H)  
(Wood only)

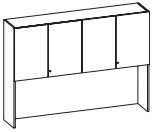

CABINET W/ HINGED GLASS DOORS (2H)  
(Wood only)

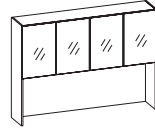

TOWER W/ HINGED DOORS (1H)

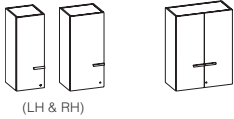

TOWER W/ HINGED DOORS (2H)

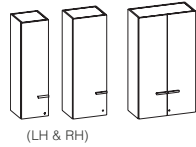

TOWER W/ NO DOORS (1H)

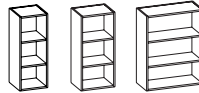

TOWER W/ NO DOORS (2H)

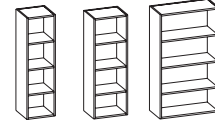

TOWER W/ GLASS DOORS (1H)  
(Wood only)

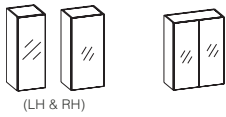

TOWER W/ GLASS DOORS (2H)  
(Wood only)

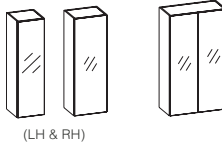

EXTERNAL SURFACE MOUNT  
TOP



ATTRIBUTE	FEATURE	ADVANTAGE
<b>STYLE/DESIGN</b>	Refined Aesthetic Range	<ul style="list-style-type: none"> <li>• Application solutions for solo, team and community spaces</li> <li>• Empowers design choice through a flexible aesthetic range</li> <li>• Complete integration of components and functionality options</li> <li>• Curated and compatible materials and finish options embrace diverse styling options</li> <li>• Attention to detail</li> <li>• High level of space customization &amp; functionality</li> <li>• Variety of metal pull options, along with integral pull on wood</li> <li>• Interchangeability of materials provide design flexibility</li> </ul>
	Hand Selected Veneer	<ul style="list-style-type: none"> <li>• Quarter cut walnut</li> <li>• Flat cut cherry, maple and walnut</li> <li>• Rift cut oak</li> <li>• Stratawood veneer (horizontal or vertical orientation)</li> </ul>
	Mixed Material Solutions	<ul style="list-style-type: none"> <li>• 11 woodgrain laminates</li> <li>• 3 solid laminates</li> <li>• 6 back painted glass options</li> <li>• 3 Corian options</li> <li>• 5 metal finish colors</li> </ul>
<b>SCALABILITY</b>	Size & Scale	<ul style="list-style-type: none"> <li>• Flexibility in material options and components allow for a variety of product planning solutions to meet customer requirements</li> <li>• Standard height and layers height</li> <li>• Application versatility from enclosed spaces to team collaborative settings to community gathering areas</li> </ul>
	Aesthetic Cost	
<b>FUNCTIONALITY</b>	Unlimited Outcomes	<ul style="list-style-type: none"> <li>• High-performance workplaces driven by integration, agility, choice, and aesthetic options.</li> </ul>
	Integrated Height Adjustability Solutions	<ul style="list-style-type: none"> <li>• Mixed material, full modesty and half modesty desks &amp; extensions</li> <li>• Sit to stand bridges, returns and credenzas</li> <li>• Shrouded height adjustable t-bases</li> <li>• Layers application sit to stand solutions</li> </ul>
	Soft Close Suspensions & Hardware	<ul style="list-style-type: none"> <li>• Soft close drawers and hinges on all materials</li> </ul>
	Magnetic Tack zone	<ul style="list-style-type: none"> <li>• Back painted glass, wood tack zones provide a magnetic surface for posting papers and magnetic accessories</li> </ul>
	Personal Corner	<ul style="list-style-type: none"> <li>• Creates an ergonomic corner for use</li> </ul>
	Collaborative Worksurface Shapes	<ul style="list-style-type: none"> <li>• Media, sightline and guitar pick tops provide collaborative solutions in the private office or open areas</li> <li>• Integration of private office components that enable effective meeting spaces</li> </ul>
	Workwall Solutions	<ul style="list-style-type: none"> <li>• Progressive meeting office option that allows for collaboration and personalized space</li> <li>• Fits in private office applications or can be pulled into open areas</li> </ul>
<b>TECHNOLOGY INTEGRATION</b>	Wire Management Trough	<ul style="list-style-type: none"> <li>• Continuous trough with non-handed pedestals</li> <li>• Easy access to power and data</li> <li>• Clean, simple wire management</li> <li>• Use of clip-in accessories</li> </ul>
	Grommets	<ul style="list-style-type: none"> <li>• Rectangular grommets in desks and credenzas</li> <li>• Three grommet positions - closed, small opening for cords, larger opening for monitor arms</li> <li>• Cutout can utilize a power unit to bring technology to the surface</li> </ul>
	Wall Access Panels	<ul style="list-style-type: none"> <li>• Hinged wall access panels provide simple, clean wire management and access to cords</li> </ul>

ATTRIBUTE	FEATURE	ADVANTAGE
<b>TECHNOLOGY INTEGRATION</b>	Laptop Drawer	<ul style="list-style-type: none"> <li>Incorporated into layers applications under runoff worksurfaces to provide technology storage and power to the user and guest</li> </ul>
	Lighting	<ul style="list-style-type: none"> <li>Optional high-efficiency LED task lighting</li> <li>Low energy usage</li> </ul>
	Wire Management Trough	<ul style="list-style-type: none"> <li>Continuous trough with non-handed pedestals</li> <li>Easy access to power and data</li> <li>Clean, simple wire management</li> <li>Use of clip-in accessories</li> </ul>
	Grommets	<ul style="list-style-type: none"> <li>Rectangular grommets in desks and credenzas</li> <li>Three grommet positions - closed, small opening for cords, larger opening for monitor arm</li> <li>Cutout can utilize a power unit to bring power to the surface</li> </ul>
	Wall Access Panels	<ul style="list-style-type: none"> <li>Hinged wall access panels provide simple, clean wire management and access to cords</li> </ul>
	Laptop Tray	<ul style="list-style-type: none"> <li>Incorporated into layers applications under runoff worksurfaces to provide technology storage and power to the user and guest</li> </ul>
<b>STORAGE</b>	Lighting	<ul style="list-style-type: none"> <li>Optional high-efficiency LED task lighting</li> <li>Low energy usage</li> </ul>
	Storage Locker	<ul style="list-style-type: none"> <li>Provides side access shelving for easy access for the user</li> <li>Hidden coat hook and personal storage</li> <li>Door available in wood and laminate</li> <li>Back Painted Glass doors serve as a whiteboard with a kickstand for collaborative meetings</li> </ul>
	Wall Mount and Surface Mount Overheads	<ul style="list-style-type: none"> <li>Hinged and sliding doors</li> <li>Wood models have back painted glass door option</li> <li>Mix of open and closed storage</li> </ul>
<b>SUSTAINABILITY</b>	Hidden Accessory Drawers	<ul style="list-style-type: none"> <li>Provides clean lines and fewer fronts</li> <li>Maximize space usage in drawers</li> </ul>
	Designed for the Environment	<ul style="list-style-type: none"> <li>FSC certified products available</li> <li>FSC reconstituted veneer</li> <li>SCS Indoor Advantage™ Gold Certification</li> <li>High percentage of recycled content - greater than 43%</li> <li>BIFMA level® 3 certified</li> <li>Contribution to LEED V4 and WELL V1</li> <li>Energy Efficient LED Task lighting</li> </ul>
<b>DURABILITY</b>	ClearTech™ Finish	<ul style="list-style-type: none"> <li>Cured finish on worksurfaces - durable top coat</li> <li>Chemical, heat, scratch, and mar resistant</li> <li>Open pore or full-filled finish option, smooth to touch</li> <li>Robotic sprayer - uniformity of finish</li> <li>Depth, clarity, color consistency, and durability</li> </ul>
	Gunlocke Craftsmanship	<ul style="list-style-type: none"> <li>Backed by Gunlocke's 12-year warranty</li> <li>High attention to detail, fit, finish and refinement across all material options</li> </ul>
<b>PRICE/VALUE</b>	Budget Flexibility	<ul style="list-style-type: none"> <li>Range of basic to premium options and materiality choice provides a broad price range to accommodate solutions without sacrificing design or functionality</li> </ul>
	Value	<ul style="list-style-type: none"> <li>12-year warranty</li> <li>Quality/value built into product throughout the manufacturing process</li> </ul>

### veneers

Available in 8 select veneers and 2 premium veneers. All exposed wood surfaces utilize select flat cut Cherry, Maple, Walnut veneers, Stratawood – FSC reconstituted veneer, premium quarter cut Walnut, or Rift Cut Oak veneers. Stratawood veneer is made from rapidly renewable wood veneer, which provides a repeatable, consistent straight grain pattern. Stratawood veneers are available in Cherry, Maple, Walnut, or Oak at veneer 1 pricing in vertical or horizontal orientation. All veneers are carefully selected and matched to assure balance and consistency.

### veneER TOPS

Wood veneer tops feature 3-ply construction and are comprised of a premium 1.125" thick substrate. Tops are available with a square edge profile and are constructed of 45 lb. density particleboard. Tops are faced with premium veneer and backed with a polymer resin impregnated moisture resistant material. Rectangular tops utilize 2mm solid wood edgebands that are species matched except for Rift Cut Oak which is paired with solid ash hardwoods. Non-rectangular tops utilize matching 1mm edgebands that are doubled up for added durability, creating a total thickness of 2mm.

### LAMINATE

The standard laminate offering includes solid and woodgrain laminates from Wilsonart. Laminate tops feature a high pressure laminate (HPL), a balanced 3-ply construction and are comprised of a 1.125" thick substrate. Tops are available with a square edge and are made with 45 lb. density particleboard. Laminate tops have a 2mm matching vinyl edgeband on all sides. Chassis and storage components feature a thermally fused laminate (TFL).

For complete technical specifications, visit [www.wilsonart.com](http://www.wilsonart.com).

### SOLID SURFACE TOPS

Solid surface tops with plywood subtops are a total of 1.25" thick. Tops are constructed with 0.5" Corian solid surface material applied to premium 0.75" plywood with a built up softened edge detail. Corian has a matte finish.

### BACK PAINTED GLASS

Back painted glass is captured by an extruded aluminum mitered frame. The frame is low profile, allowing only a 0.063" visible frame around the perimeter of the glass from the front view. Aluminum frames are powder coated to match the color of the glass option chosen. Back painted glass is 4mm thick and whiteboard applications include a steel backer for use with magnets – 6 magnets are included with each whiteboard. Back painted glass has a clear glossy finish for use as a writable surface and can be used with dry-erase markers. Whiteboards are mounted to the wall with a z-bracket connection.

### CHASSIS & PEDESTAL CONSTRUCTION

All chassis are constructed with a mixture of 3/4" thick balanced 3-ply panels and 3/4" thick panels. Panels are securely fastened together using cam-lock fasteners and dowels. Steel glide plates are attached to single end panels with screws. End panels are pre-bored to accept the stem of the glide. The threaded steel glide plate provides a durable connection from glide to end panel.

Each unit is equipped with a minimum of four adjustable glides.

### OVERHEAD CABINET CONSTRUCTION

All cabinets are constructed with a mixture of 0.75" thick balanced 3-ply panels and 0.75" thick MDF panels. Wood panels are securely attached with hidden fasteners and dowels, and are securely adhered with PVAc-dispersion adhesive. All laminate panels are securely fastened together

using cam-lock fasteners and dowels.

All surface mount cabinets connect to worksurface with double-sided adhesive tape.

Wall mount cabinets are mounted to the wall with a spade and "z" bracket attachment method. Spade brackets are securely mounted through the back of wall mount cabinets. All units ship with a steel z bracket. This bracket is mounted to the wall by field installers. Installers are responsible for selecting and supplying appropriate fasteners for wall conditions.

### GLIDES

Glides provide 1.125" of vertical leveling adjustment. Glide bottom is durable non-rust nylon.

### TACKBOARDS

Tackboards are constructed of 0.875" thick material comprised of a 0.125" thick hardboard glued in between a layer of 0.375" thick pressboard on each side. The fabric is precisely aligned and fitted to the tackboard and adhered to the rigid hardboard with staples.

### DRAWERS

All drawers are constructed of four sides and a bottom, which are attached to a drawer front with screws for easy removal. Drawer fronts feature matched veneer within each pedestal set. The drawer side material is 3-ply 12mm vinyl wrapped particleboard and are miterfold construction. The bottom material is a 3-ply substrate consisting of vinyl wrapped high density fiberboard core.

### SUSPENSIONS

Suspensions utilize cold rolled steel, zinc plated, high-grade drawer suspensions. Box drawers are full extension, featuring precision steel ball bearings for a smoother, quieter range of motion and are load rated for 120 lbs. File drawers are full extension, featuring precision steel ball bearings



for increased weight capacity and are load rated for 120 lbs. Lateral file suspensions are load rated for 150 lbs. and include an anti-tip mechanism that prevents both drawers from being opened at the same time. All suspensions are soft close and are warranted for the lifetime of the product.

### HINGES

Doors with metal pulls include a 105° hinge with an integrated soft-close mechanism. Doors with touch latch utilize a 110° hinge. Hinges are fully adjustable.

### FILING

The file hanging system is an integral part of the drawer. A highly durable black plastic extrusion is securely fastened into a rout on the top of the drawer. The plastic extrusion was designed to promote optimum filing capacity within the drawer while providing a durable, reliable and maintenance free filing system. (See filing capability section for technical information on drawer dimensions).

### LOCKS

Locks are standard on all desks, credenzas, returns, modular pedestals, and storage units. Locks are optional on closets and overhead cabinets. Each pedestal is independently locked.

Keying is available either random (factory installed), or omit (field installed).

When "Random Keying" is chosen, the factory will assign key(s) arbitrarily. Factory installed lock cores will be matte silver.

When "Omit Lock Core" is chosen, the factory will omit lock cores and locks will be field installed. A keying program must be chosen - Random, Specified, or Sequential - to specify keys. Field installed locks will be available in matte silver, black, pyrite, and matte gold.

### WIRE MANAGEMENT

Wire management capabilities include optional worksurface grommets that can house cords, a monitor arm, or be replaced with a power unit to bring technology to the worksurface. Cavities in the back of pedestals, removable panels, and wall access panels can be used for cord concealment and management.

Under worksurface wire managers (Model # ACWM) are sold separately to conceal wires between pedestals. These units house and manage wires horizontally around a station.

Continuous aluminum wire management troughs provide seamless integration of technology in the credenza. Modular trough tops come with 2 end caps to close off the open-end condition. Clip-in wire management accessories are provided to assist with technology ease and organization. Troughs, end caps and clip-in accessories are available in 5 metal finish colors – silver, black, pyrite, matte gold, and designer white.

### POWER

Power units are available in three sizes and are offered as surface mount, under worksurface mount, and clamp mount units. Available in black, white or silver, power units incorporate a combination of power, USB power, and data integration. Each enclosure is rated for 15 amp, 125 volt. Units can be specified with 10' standard plug or 6' hardwire conduit option. Unit is field installed. UL Listed. USB charging ports are 2.1 amps per port. For information on each model, reference the "Power Units" page in the price book.

### MAGNETIC ACCESSORIES

Magnetic accessories include imbedded magnets and can be positioned anywhere on magnetic tackzones and back painted glass tackzones/whiteboards. The accessories provide quick access to files, pencils, and other work utensils.

### PERSONAL CORNER & DESKPADS

Personal corners can be used between two perpendicular worksurfaces to create an ergonomic corner for user. Deskpads are used in-line. All units are wrapped in leather or vinyl. The bottom surface has a felt lining to protect the worksurface. The chassis is made from 10-gauge aluminum. Personal corners are 36W x 12.5D. Deskpads are 36W x 18D. Units are designed to fit over 1 1/8" worksurfaces.

### LIGHTING

LED lighting provides high efficiency, low energy lighting with a long life. All LED lights are encased in a silver aluminum extrusion and include a built-in switch to turn the light on/off with a dimming feature. Lights are field installed. All units include a standard plug.

- Low profile strip light 0.625"H x 0.75"D
- Power: 2.92W / Foot
- LED's per meter: 120
- Color Temp: 3000K
- Certification: UL Listed
- GSA and TAA compliant

### HEIGHT ADJUSTABLE

Height adjustable components include:

- Qty (2) height adjustable lifting columns
- Qty (1) control box
- Qty (5) keypad options from basic to premium
- Qty (2) cables connecting lifting columns to control box
- Qty (1) standard plug power cable to connect control box to power source

Lifting columns are rated for 225 lbs. dynamic load per column and are connected to tops using steel support brackets. Height range is 29" to 42.5". Each control box is powered by 120V / 60Hz. 2 lifting columns may draw approximately 1.5 amps total maximum under full load. Standby power is 0.1W.

### WORKWALLS

WorkWalls include wall mounted, wall mounted with wall access panels, stack on, and freestanding versions. Incorporating both a collaborative side and personal side, WorkWalls utilize a back painted glass sliding door that can serve as a whiteboard and be secured with a digital lock. The digital lock incorporates a keypad and smartphone app, along with 2 standard USB ports for emergency power jump and battery charging.

### WOOD FINISH

Natural veneer is subject to nature's quality control. Each species will exhibit differences in grain pattern and tone. This is to be expected and, in fact, contributes to the beauty and individuality of each product. Flat Cut veneers emphasize the variations of wood by exhibiting cathedrals in the grain pattern. Quarter Cut and Rift Cut veneers are a premium cut that maintains variations in the grain but without cathedral patterns. Stratawood is a natural, FSC® - certified reconstituted veneer that is designed to exhibit a straight-grain pattern, absent of cathedrals or other significant grain and tone variations.

Worksurfaces are protected by one of the world's most advanced UV cured finish coatings, available in Full Fill ClearTech® or Open Pore low sheen finish, applied by state-of-the-art finishing equipment. Both finishes meet the EPA's stringent requirements for VOC emissions and air quality. Cured in a specially designed ultraviolet oven, the finish fuses to the wood, forming a durable shield that provides a high level of scratch, stain, chemical, and heat resistance, along with a high level of clarity.

Chassis, storage, overheads and veneer bases are finished with a 30 sheen. For the Finish System Guide & Technical specifications, visit [www.gunlocke.com](http://www.gunlocke.com).

### CLEANING CLEARTECH™ FINISH

Dust with a damp cloth. Remove fingerprints or soiling with mild solution; 3 parts water with small amount of mild dish detergent. Apply solution with spray bottle, wipe clean and dry with soft cloth. Note: Do not use furniture polishes containing oil, wax, or silicone, which can produce an oily film or haze.

### CLEANING LAMINATE

Dust with a damp cloth. Remove fingerprints or soiling with mild solution; 3 parts water with small amount of mild dish detergent. Apply solution with spray bottle, wipe clean and dry with soft cloth. Note: Do not use furniture polishes containing oil, wax, or silicone, which can produce an oily film or haze.

For specific cleaning instructions on Wilsonart laminates, please visit [www.wilsonart.com](http://www.wilsonart.com).

### CLEANING GLASS

Dust with a damp cloth. Remove fingerprints or soiling with mild solution; 3 parts water with small amount of mild dish detergent. Apply solution with spray bottle, wipe clean and dry with soft cloth.

### CLEANING SOLID SURFACE CORIAN

Using a damp sponge or cloth, use warm soapy water, an ammonia-based household cleaner, or a dedicated countertop cleaner to clean Corian solid surface. Rub over area using small circular motions, from the front to the back, then side to side, overlapping the circles until the entire area has been cleaned. Rinse the top thoroughly with clean water and wipe surface completely dry.

**STANDARD FILING OPTIONS  
FOR PEDESTALS**

**9 wide x 30 and 36 deep pedestal**

File rails included: 2 per drawer

- A.** 2 rows of letter side to side with 2 file rails
- B.** 1 row of legal side to side

Replacement File Rail Kit Model #ACFLR9-P

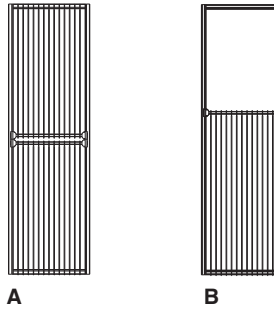

**15 wide x 30 and 36 deep pedestal**

File rails included: 2 per drawer

- C.** 2 rows of letter side to side with 2 file rails
- D.** 1 row of legal-side to side,

Replacement File Rail Kit Model #ACFLR15-P

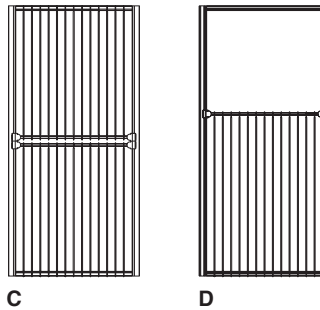

**15 wide x 24 deep pedestal**

File rails included: 1 per drawer

- E.** Legal-side to side
- F.** 1 row letter side to side,  
Model #ACFLR15  
Ships w/pedestal.  
1 per file drawer.

Replacement File Rail Kit Model #ACFLR15-P

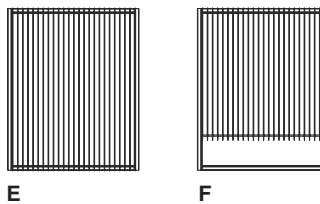

**18 wide x 24 deep pedestal**

File rails included: 1 per drawer

- G.** Letter-front to back with file rail
- H.** Legal-side to side

Replacement File Rail Kit Model #ACFLR18-P

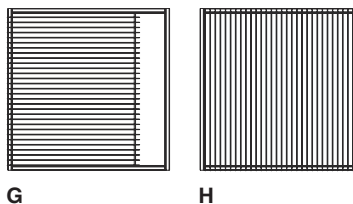

**STANDARD FILING OPTIONS**

(continued)

**Lateral 30 wide x 24 deep pedestal**

File rails included: 1 kit per drawer

- I.** Legal-side to side
- J.** Letter-side to side
- K.** 2 rows letter front to back

Replacement File Rail Kit Model #ACFLR30-P

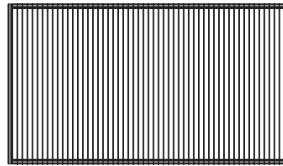

**I**

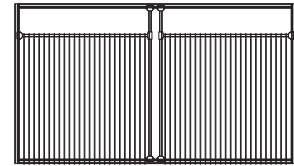

**J**

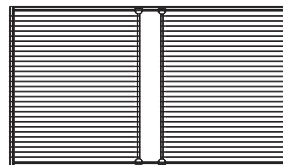

**K**

**Lateral 36 wide x 24 deep pedestal**

File rails included: 1 kit per drawer

- L.** Letter-side to side
- M.** 2 rows letter front to back
- N.** Legal-side to side
- O.** 2 rows legal front to back

Replacement File Rail Kit Model #ACFLR36-P

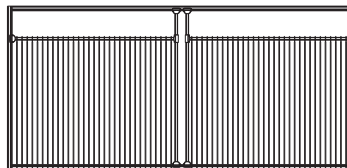

**L**

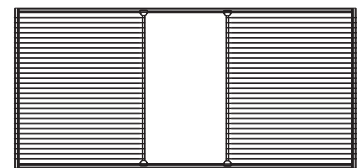

**M**

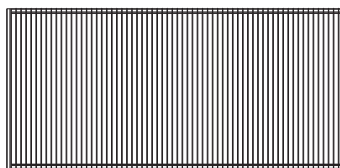

**N**

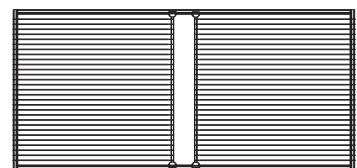

**O**

## HEIGHT REFERENCE

### Standard Height

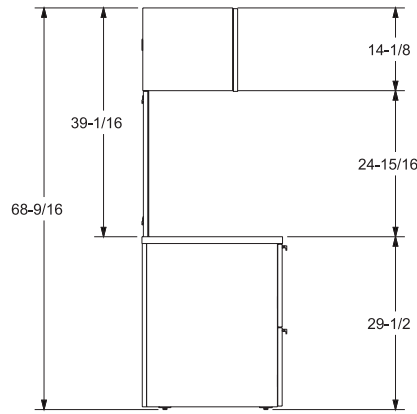

TYPICAL 1-HIGH SIDE PROFILE

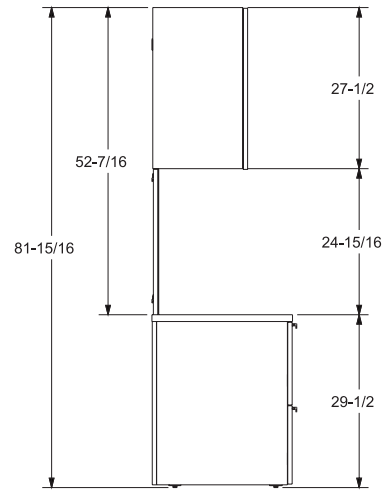

TYPICAL 2-HIGH SIDE PROFILE

### Layers Height

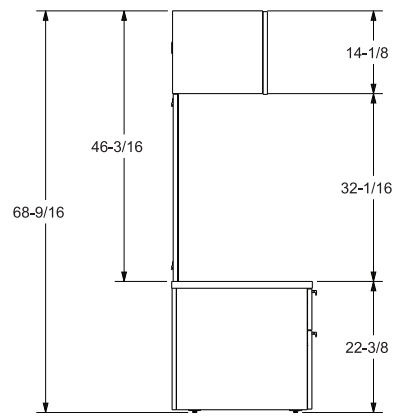

TYPICAL 1-HIGH SIDE PROFILE

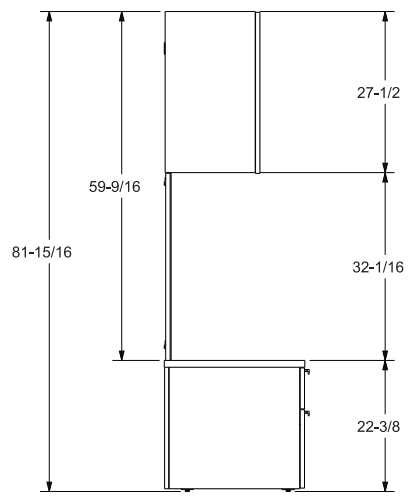

TYPICAL 2-HIGH SIDE PROFILE

### Pedestal

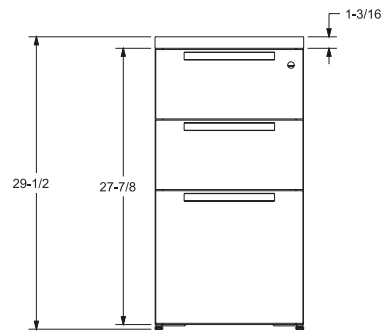

PEDESTAL FRONT PROFILE

Thoughtfully channel and conceal wires and cables using a streamlined trough feature. Easy wall access and conveniently placed grommets deliver your power and data.

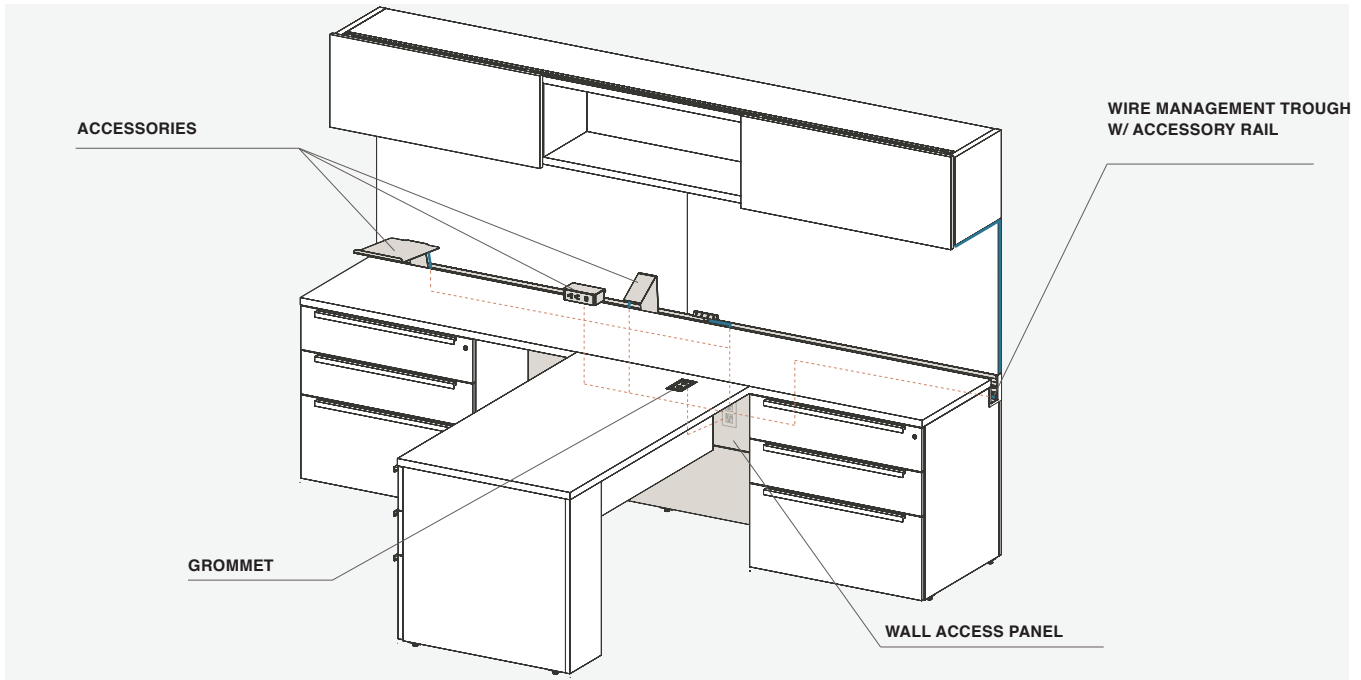

## WALL ACCESS PANEL

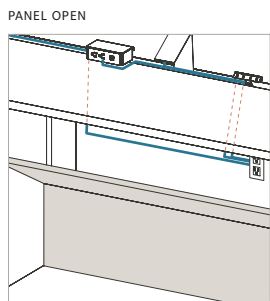

## GROMMET

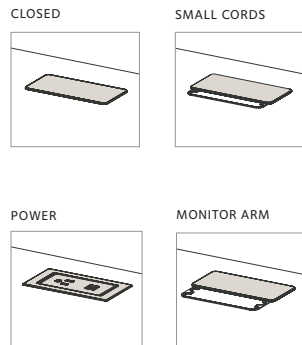

## TROUGH

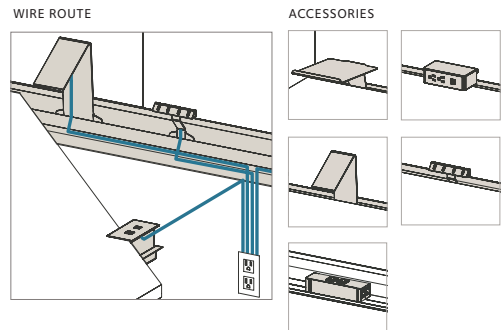

## TROUGH INFORMATION

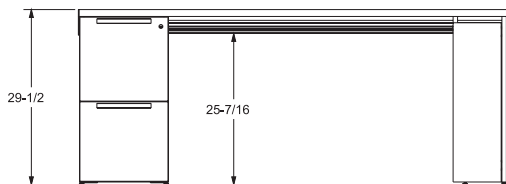

Standard Height

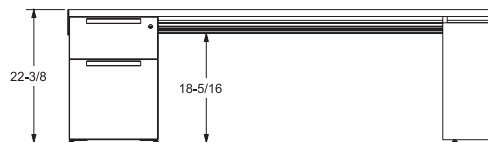

Layers Height

**GROMMET LOCATIONS**

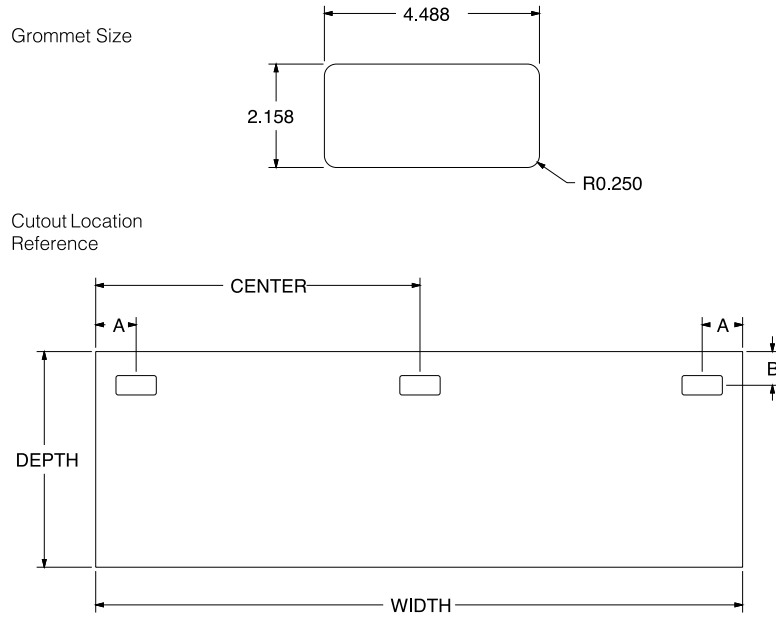

**GROMMET CUTOUT LOCATIONS**

UNIT	A	CENTER	B
24D Rectangular Tops	12	CENTER	4.25
30D Rectangular Tops	12	-	9.500
36D Rectangular Tops	12	-	9.500
Media Tops	-	CENTER	3.750
Round Tops	-	CENTER	-
Guitar Pick Tops	-	CENTER	-
22D Height Adjustable Tops	10	CENTER	3.5
28D & 34D Height Adjustable Tops	10	CENTER	4
30D Telescoping Height Adjustable Tops	12.500	-	6.125
36D Telescoping Height Adjustable Tops	12.500	-	9.125
30D Half/Full Modesty Height Adjustable Tops	12.500	-	4.500
36D Half/Full Modesty Height Adjustable Tops	12.500	-	7.500
24D Height Adjustable Units	-	CENTER	5.11

• Add \$70 per grommet based on chosen grommet configuration

Gunlocke provides versatile storage features, including convenient options for pull orientation and drawer configuration. The accessory drawer includes convenient internal compartments crafted with Gunlocke quality.

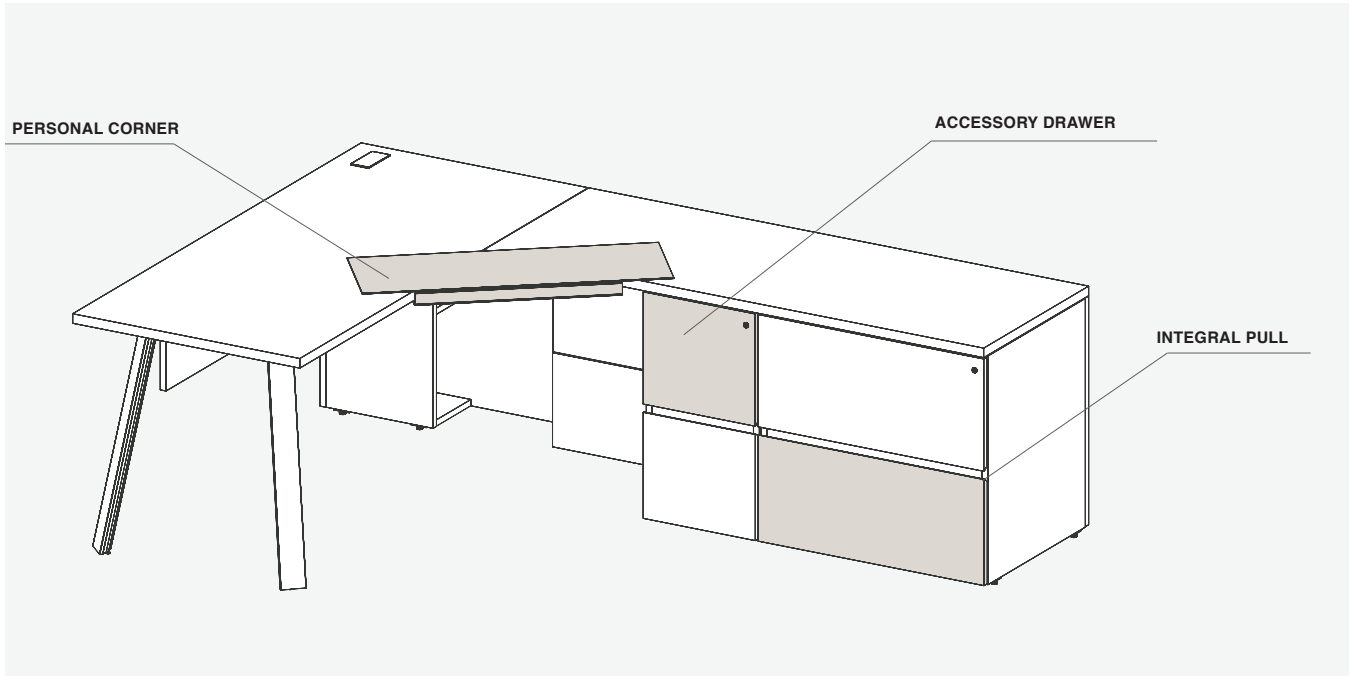

## Silea pull orientation

INTEGRAL

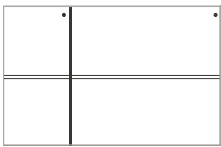

CENTERED

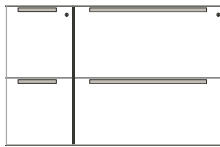

CONTINUOUS

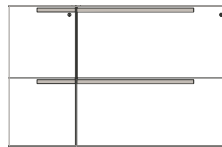

LEFT ALIGNED

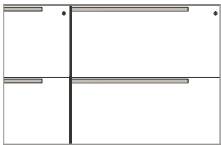

RIGHT ALIGNED

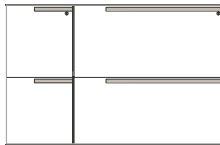

### Choice.

Silea enables you to select drawer pull orientation at the time of installation. Maximum flexibility.

## ACCESSORY DRAWER

ACCESSORY DRAWER (OPEN)

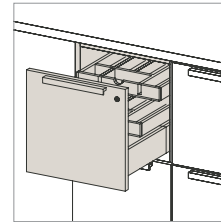



Integrated height adjustability enables the healthful rotation of working posture. The virtually concealed electric mechanism supports the quiet and easy transition to standing. Sit-to-stand, concentrate, collaborate. With height adjustability, a desk is more than a desk. It's a way of wellbeing, adjusting the worksurface to the working position that fits best.

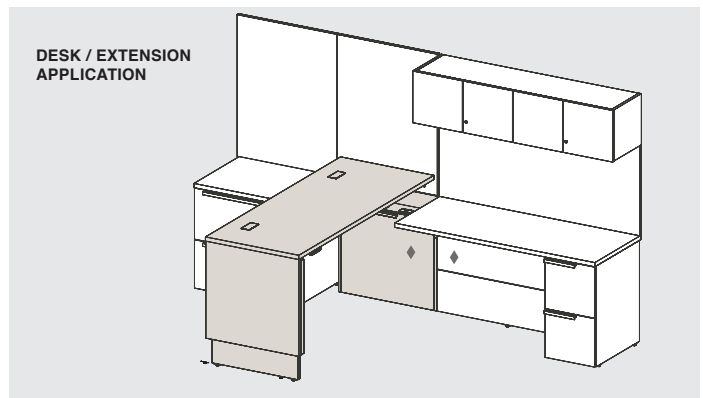
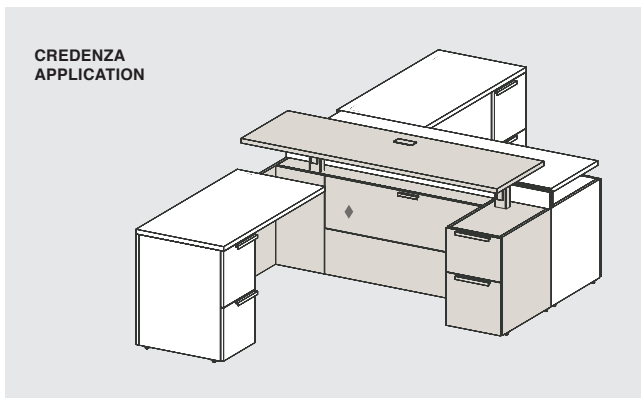
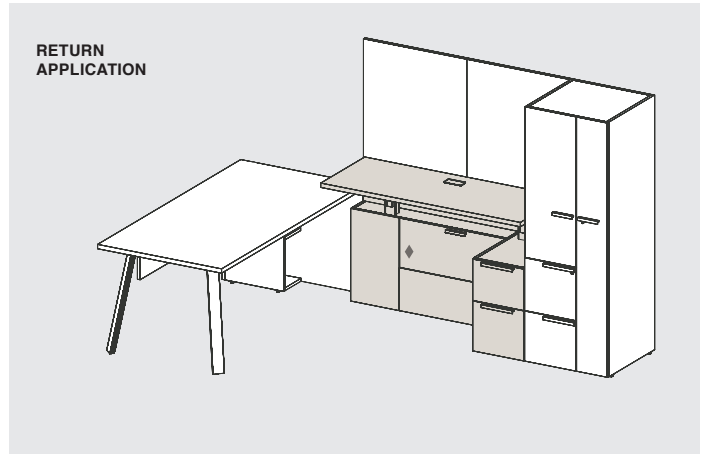
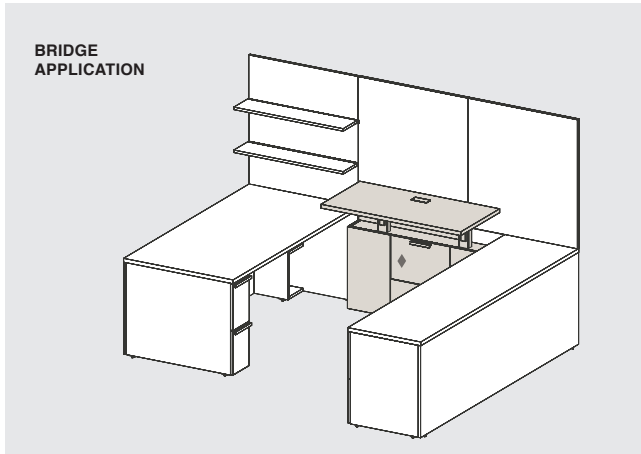

◆ WALL ACCESS PANEL

**TELESCOPING**

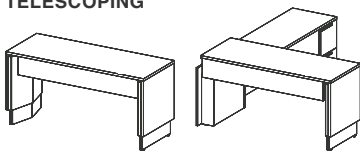

**HALF**

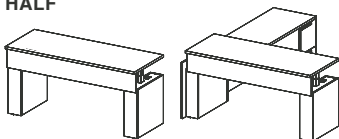

**FULL**

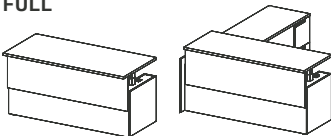

**CHASSIS TO TOP DIMENSION**

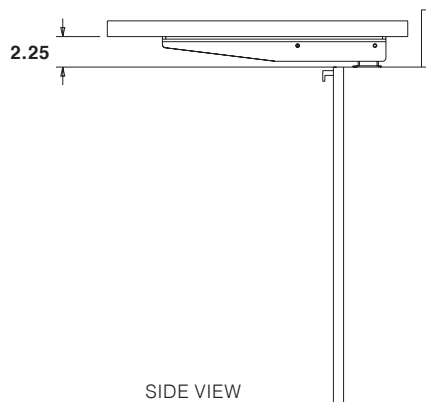

Storage options feature a nested laptop drawer, thoughtfully placed power access, and a multi-functional storage locker.

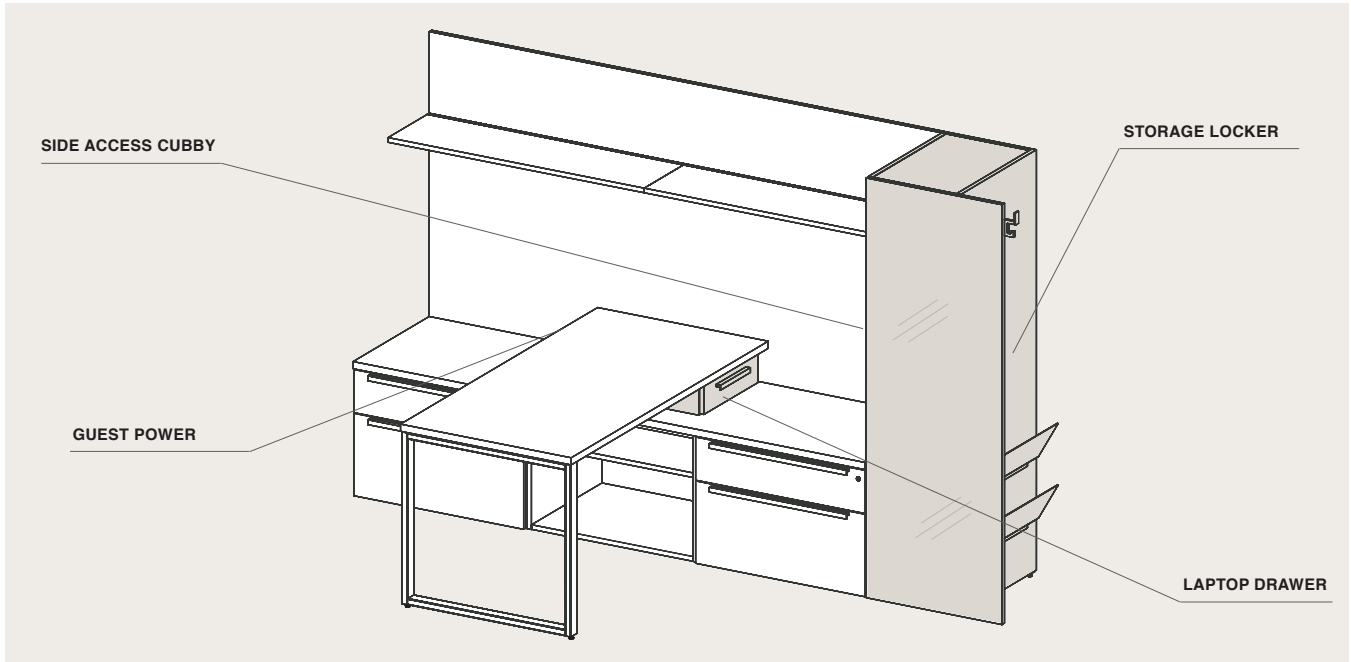

## Laptop Drawer

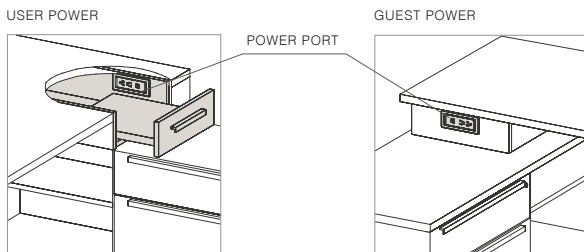

## Storage Drawer

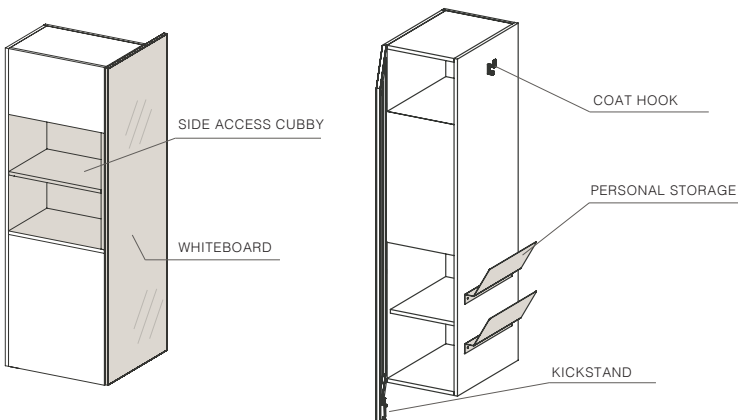

## SURFACE MOUNT CABINETS

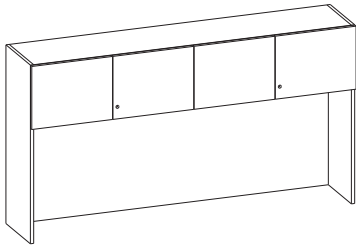

39 High

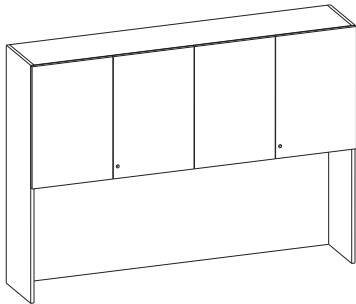

52 High

### Technology information & wire management:

- Tasklight cord grommet optional.
- Located in upper right-hand corner, provides task light cord access to wall outlets.

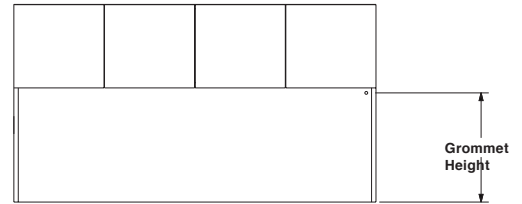

**Grommet Height** 39H and 52H = 24

Surface mount overhead cabinets must be supported with adequate pedestal or panel support on ends. In addition, the location where the surface mount cabinet and tower meet the worksurface using intermediate supports.

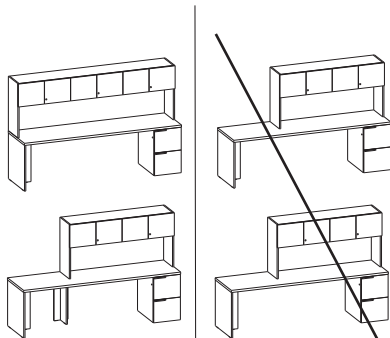

**Recommended Support Examples**

**Inadequate Support Examples**

When specifying surface mount storage across multiple units, careful considerations must be used to ensure the correct overall length. An end or back panel of a supporting unit must support the end panel of an overhead cabinet.

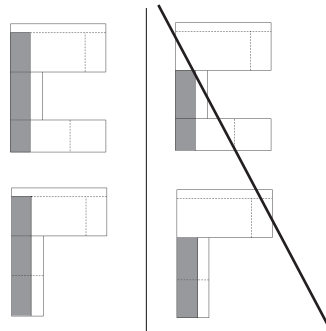

**Recommended Support Examples**

**Inadequate Support Examples**

# DIMENSIONS

Silea  
05/22

DESCRIPTION	STYLE	EXTERNAL DIMENSIONS			LOCATION	INTERNAL DIMENSIONS		
		width	depth	height		width	depth	height
Desk Pedestals 30" Deep	9" Wide Box   Box   File	9 2/5	29.13	27.88	Box Drawer	5.84	15.02	2.91
					File Drawer	5.84	25.22	9.17
	Acc.   Box   File	9 2/5	29.13	27.88	Acc. Drawer	5.93	14.92	1.50
					Box Drawer	5.84	15.02	2.91
					File Drawer	5.84	25.22	9.17
File   File	9 2/5	29.13	27.88	File Drawer	5.84	25.22	9.17	
Desk Pedestals 36" Deep	9" Wide Box   Box   File	9 2/5	35.13	27.88	Box Drawer	5.84	15.02	2.91
					File Drawer	5.84	25.22	9.17
	Acc.   Box   File	9 2/5	35.13	27.88	Acc. Drawer	5.93	14.92	1.50
					Box Drawer	5.84	15.02	2.91
					File Drawer	5.84	25.22	9.17
File   File	9 2/5	35.13	27.88	File Drawer	5.84	25.22	9.17	
Desk Pedestals 15" Wide 30" Deep	Box   Box   File	15	29.13	27.88	Box Drawer	11.40	15.02	2.91
					File Drawer	11.40	25.22	9.20
	File   File	15	29.13	27.88	File Drawer	11.40	25.22	9.20
Desk Pedestals 15" Wide 36" Deep	Box   Box   File	15	35.13	27.88	Box Drawer	11.40	15.02	2.91
					File Drawer	11.40	25.22	9.20
	File   File	15	35.13	27.88	File Drawer	11.40	25.22	9.20
Standard Height Modular Pedestals 15"W	Box   Box   File	15	23.13	27.88	Box Drawer	11.40	15.02	2.91
					File Drawer	11.40	15.02	9.17
	Acc.   Box   File	15	23.13	27.88	Acc. Drawer	11.50	14.92	1.50
					Box Drawer	11.40	15.02	2.91
					File Drawer	11.40	15.02	9.17
File   File	15	23.13	27.88	File Drawer	11.40	15.02	9.17	
Standard Height Modular Pedestals 18"W	Box   Box   File	18	23.13	27.88	Box Drawer	14.40	15.02	2.91
					File Drawer	14.40	15.02	9.17
	Acc.   Box   File	18	23.13	27.88	Acc. Drawer	14.49	14.92	1.56
					Box Drawer	14.40	15.02	2.91
					File Drawer	14.40	15.02	9.17
File   File	18	23.13	27.88	File Drawer	14.40	15.02	9.17	
Standard Height Modular Pedestals 30"W	File   File	30	23.13	27.88	File Drawer	25.90	15.02	9.25
					Box   Box   File	30	23.13	27.88
	Hinged Door	30	23.13	27.88	File Drawer	25.90	15.02	9.25
					Total	28.47	13.55	26.38
					Above Shelf	28.47	13.45	12.78
	Bookcase	30	22.32	27.88	Below Shelf	28.47	13.55	12.85
					Total	28.47	13.55	26.38
					Above Shelf	28.47	13.45	12.78
	Hinged Door	30	23.13	27.88	Below Shelf	28.47	13.55	12.85
Total					31.90	15.02	9.25	
Above Shelf					34.47	13.45	12.74	
Standard Height Modular Pedestals 36"W	File   File	36	23.13	27.88	Box Drawer	32.40	13.09	2.91
					File Drawer	31.90	15.02	9.25
	Hinged Door	36	23.13	27.88	Total	34.47	13.55	26.44
					Above Shelf	34.47	13.45	12.74
					Below Shelf	34.47	13.55	12.89

DESCRIPTION	STYLE	EXTERNAL DIMENSIONS			LOCATION	INTERNAL DIMENSIONS		
		width	depth	height		width	depth	height
	Bookcase	36	22.32	27.88	Total	34.47	13.55	26.36
					Above Shelf	34.47	13.45	12.70
					Below Shelf	34.47	13.55	12.85
Layers Height Modular Pedestals 15"W	Box   File	15	23.13	20.75	Box Drawer	11.40	15.02	2.91
					File Drawer	11.40	15.02	9.17
Layers Height Modular Pedestals 18"W	Box   File	18	23.13	20.75	Box Drawer	14.40	15.02	2.91
					File Drawer	14.40	15.02	9.17
Layers Height Modular Pedestals 30"W	Box   File	30	23.13	20.75	Box Drawer	26.40	13.09	2.91
					File Drawer	25.90	15.02	9.25
	Hinged Door	30	23.13	20.75	Total	28.47	13.45	19.25
					Above Shelf	28.47	13.45	5.66
					Below Shelf	28.47	13.45	12.85
	Bookcase	30	22.32	20.75	Total	28.47	13.45	19.25
					Above Shelf	28.47	13.45	5.66
					Below Shelf	28.47	13.45	12.85
	Side Access	30	23.13	20.75	Total	28.47	25.59	19.25
					Box Drawer	25.44	15.25	5.12
Layers Height Modular Pedestals 36"W	Box   File	36	23.13	20.75	Box Drawer	32.40	13.09	2.91
					File Drawer	31.90	15.02	9.25
	Hinged Door	36	23.13	20.75	Total	34.47	13.55	19.23
					Above Shelf	34.47	13.45	5.58
					Below Shelf	34.47	13.55	12.85
	Bookcase	36	22.32	20.75	Total	34.47	13.55	19.23
					Above Shelf	34.47	13.45	5.58
					Below Shelf	34.47	13.55	12.85
	Side Access	36	23.13	20.75	Total	34.47	25.59	19.23
					Box Drawer	31.44	15.25	5.12
Mobile Pedestal	Mobile pedestal	15	21.80	22.63	Box Drawer	11.40	15.02	2.91
					File Drawer	11.40	15.02	9.17
Bookcases	2H	30	14.88	27.88	2H Top Shelf	28.47	13.91	12.76
					2H Bottom Shelf	28.47	14.07	12.85
	3H	30	14.88	41.77	3H Top Shelf	28.47	13.91	11.98
					3H Middle Shelf	28.47	13.91	13.93
					3H Bottom Shelf	28.47	14.07	12.85
	4H	30	14.88	54.00	4H Top Shelf	28.47	13.91	11.48
					4H 2nd Shelf	28.47	13.91	11.98
					4H 3rd Shelf	28.47	13.91	13.93
					4H Bottom Shelf	28.47	14.07	12.85
	5H	30	14.88	68.13	5H Top Shelf	28.47	13.91	12.61
					5H 2nd Shelf	28.47	13.91	12.25
					5H 3rd Shelf	28.47	13.91	11.98
					5H 4th Shelf	28.47	13.91	13.93
	6H	30	14.88	81.50	6H Top Shelf	28.47	13.91	12.62
6H 2nd Shelf					28.47	13.91	12.61	

# DIMENSIONS

Silea  
05/22

DESCRIPTION	STYLE	EXTERNAL DIMENSIONS			LOCATION	INTERNAL DIMENSIONS		
		width	depth	height		width	depth	height
					6H 3rd Shelf	28.47	13.91	12.25
					6H 4th Shelf	28.47	13.91	11.98
					6H 5th Shelf	28.47	13.91	13.93
					6H Bottom Shelf	28.47	14.07	12.85
<b>Bookcase / Closet</b>	5H	18	23.88	68.13	5H Top Shelf	7.86	21.10	12.61
					5H 2nd Shelf	7.86	21.10	12.25
					5H 3rd Shelf	7.86	21.10	11.98
					5H 4th Shelf	7.86	21.10	13.93
					5H Bottom Shelf	7.86	22.26	12.85
					Closet	7.86	22.26	66.61
	6H	18	23.88	81.50	6H Top Shelf	7.86	21.10	12.62
					6H 2nd Shelf	7.86	21.10	12.61
					6H 3rd Shelf	7.86	21.10	12.25
					6H 4th Shelf	7.86	21.10	11.98
					6H 5th Shelf	7.86	21.10	13.93
					6H Bottom Shelf	7.86	22.26	12.85
					Closet Above Shelf	7.86	21.10	12.62
					Closet Below Shelf	7.86	22.26	66.61
<b>Lateral Files</b>	2H	30"	23.88	29.04	File Drawer	25.90	15.02	9.25
		36"	23.88	29.04	File Drawer	31.90	15.02	9.25
	3H	30"	23.88	41.77	File Drawer	25.90	15.02	9.25
		36"	23.88	41.77	File Drawer	31.90	15.02	9.25
	4H	30"	23.88	54.00	File Drawer	25.90	15.02	9.25
		36"	23.88	54.00	File Drawer	31.90	15.02	9.25
	5H	30"	23.88	68.13	File Drawer	25.90	15.02	9.25
					Hinged Door	28.47	22.26	13.37
		36"	23.88	68.13	File Drawer	31.90	15.02	9.25
					Hinged Door	34.47	22.26	13.37
	6H	30"	23.88	81.50	File Drawer	25.90	15.02	9.25
					Hinged Door Above Shelf	28.47	21.45	13.00
					Hinged Door Below Shelf	28.47	22.26	13.00
		36"	23.88	81.50	File Drawer	31.90	15.02	9.25
					Hinged Door Above Shelf	34.47	21.45	13.00
					Hinged Door Below Shelf	34.47	22.26	13.00
<b>Closets</b>	15"	15	23.88	68.13	Total	13.47	22.26	66.61
	18"	18	23.88	68.13	Total	16.47	22.26	66.61
	18" 6H	18	23.88	81.50	Above Shelf	16.47	21.10	12.62
					Below Shelf	16.47	22.26	66.61
	5H - D	30	23.88	68.13	Top Shelf	13.86	21.10	12.61
					2nd Shelf	13.86	21.10	12.25
					3rd Shelf	13.86	21.10	11.98
					4th Shelf	13.86	21.10	13.93
					Bottom Shelf	13.86	22.26	12.85
					Coat Rod Section	13.86	22.26	66.61
	5H - S	30	23.88	68.13	Top Shelf	28.47	21.10	12.61

DESCRIPTION	STYLE	EXTERNAL DIMENSIONS			LOCATION	INTERNAL DIMENSIONS		
		width	depth	height		width	depth	height
					2nd Shelf	28.47	21.10	12.25
					3rd Shelf	28.47	21.10	11.98
					4th Shelf	28.47	21.10	13.93
					Bottom Shelf	28.47	22.26	12.85
	6H - D	30	23.88	81.50	Top Shelf	13.86	21.10	12.62
					2nd Shelf	13.86	21.10	12.61
					3rd Shelf	13.86	21.10	12.25
					4th Shelf	13.86	21.10	11.98
					5th Shelf	13.86	21.10	13.93
					Bottom Shelf	13.86	22.26	12.85
					Coat Rod Section Above Top Shelf	13.86	21.10	12.62
					Coat Rod Section Bellow Top Shelf	13.86	22.25	66.61
	6H - S	30	23.88	81.50	Top Shelf	28.47	21.10	12.62
					2nd Shelf	28.47	21.10	12.61
					3rd Shelf	28.47	21.10	12.25
					4th Shelf	28.47	21.10	11.98
					5th Shelf	28.47	21.10	13.93
					Bottom Shelf	28.47	22.26	12.85
Storage Box	5H	30	23.88	68.13	File Drawer	25.90	15.02	9.25
					Total Hinged Door	28.47	22.26	39.50
					Top Shelf	28.47	19.45	12.61
					Middle Shelf	28.47	19.45	12.10
					Bottom Shelf	28.47	22.26	13.29
	6H	30	23.88	81.50	File Drawer	25.90	15.02	9.25
					Total Hinged Door	28.47	22.26	52.87
					Top Shelf	28.47	19.45	12.62
					2nd Shelf	28.47	19.45	12.61
					3rd Shelf	28.47	19.45	12.10
					Bottom Shelf	28.47	22.26	13.29
Storage Box 18" Wide	5H	18	23.88	68.13	File Drawer	14.40	15.02	9.17
					Total Hinged Door	16.47	22.26	39.50
					Top Shelf	16.47	19.45	12.61
					Middle Shelf	16.47	19.45	12.10
					Bottom Shelf	16.47	22.26	13.29
	6H	18	23.88	81.50	File Drawer	14.40	15.02	9.17
					Total Hinged Door	16.47	22.26	52.87
					Top Shelf	16.47	19.45	12.62
					2nd Shelf	16.47	19.45	12.61
					3rd Shelf	16.47	19.45	12.10
					Bottom Shelf	16.47	22.26	13.29
Storage Box 18" Wide No Door	5H	18	23.88	68.13	File Drawer	14.40	15.02	9.17
					Total Shelf	16.47	22.26	39.50
					Top Shelf	16.47	19.45	12.61
					Middle Shelf	16.47	19.45	12.10
					Bottom Shelf	16.47	22.26	13.29

# DIMENSIONS

Silea  
05/22

DESCRIPTION	STYLE	EXTERNAL DIMENSIONS			LOCATION	INTERNAL DIMENSIONS		
		width	depth	height		width	depth	height
	6H	18	23.88	81.50	File Drawer	14.40	15.02	9.17
					Total Shelf	16.47	22.26	52.87
					Top Shelf	16.47	19.45	12.62
					2nd Shelf	16.47	19.45	12.61
					3rd Shelf	16.47	19.45	12.10
					Bottom Shelf	16.47	22.26	13.29
Utility Cabinet	5H	24	23.88	68.13	Closet	7.84	22.26	66.60
					File Drawer	11.40	15.02	9.17
					Total Hinged Door	13.47	22.32	39.53
					Top Shelf	13.47	19.45	12.61
					Middle Shelf	13.47	19.45	12.10
	6H	24	23.88	81.50	Closet Above Top Shelf	7.84	19.45	12.62
					Closet Below Top Shelf	7.84	22.26	66.61
					File Drawer	11.40	15.02	9.17
					Total Hinged Door	13.47	22.32	52.91
					Top Shelf	13.47	19.45	12.62
					2nd Shelf	13.47	19.45	12.61
					3rd Shelf	13.47	19.45	12.10
					Bottom Shelf	13.47	22.32	13.33
					Storage Cabinet	30"W	30	23.88
Top Shelf	28.47	21.45	12.78					
Bottom Shelf	28.47	22.26	12.85					
36"W	36	23.88	29.04	Total		34.47	22.26	26.38
				Top Shelf		34.47	21.45	12.72
				Bottom Shelf		34.47	22.26	12.85
Standard & Layers Side Access Storage Locker	5H w/ door	23 7/8	23.90	68.13	Inside Top Shelf	14.70	22.32	12.61
					Inside Bottom Shelf	14.70	22.32	12.85
					Top Side Access Shelf	21.55	15.41	12.25
					Bottom Side Access Shelf	21.55	15.47	11.97
	6H w/ door	23 7/8	23.90	81.50	Inside Shelf	14.70	21.12	12.62
					Inside Bottom Shelf	14.70	21.12	13.94
					Top Side Access Shelf	21.55	15.41	12.25
					Bottom Side Access Shelf	21.55	15.47	11.97
1H Wall Mount Cabinets – Hinged Door & Open Shelf	1H Hinged Door (16 1/5"D)	30"	See depth dimensions by style	14.13	Shelf	28.50	14.08	12.59
	1H Glass Door (16 1/4"D)	36"		14.13	Shelf	34.50	14.08	12.59
	1H Open (15 3/8"D)	42"		14.13	Left Shelf	19.67	14.08	12.59
					Right Shelf	19.67	14.08	12.59
				48"	Left Shelf	22.67	14.08	12.59
					Right Shelf	22.67	14.08	12.59
				54"	Left Shelf	25.67	14.08	12.59
					Right Shelf	25.67	14.08	12.59
				60"	Left Shelf	28.67	14.08	12.59
					Right Shelf	28.67	14.08	12.59
			66"	Left Shelf	31.67	14.08	12.59	



DESCRIPTION	STYLE	EXTERNAL DIMENSIONS			LOCATION	INTERNAL DIMENSIONS		
		width	depth	height		width	depth	height
					Right Shelf	31.67	14.08	12.59
		72"		14.13	Left Shelf	34.67	14.08	12.59
					Right Shelf	34.67	14.08	12.59
		78"		14.13	Left Shelf	37.67	14.08	12.59
					Right Shelf	37.67	14.08	12.59
		84"		14.13	Left Shelf	26.67	14.08	12.59
					Middle Shelf	26.84	14.08	12.59
					Right Shelf	26.67	14.08	12.59
		90"		14.13	Left Shelf	28.67	14.08	12.59
					Middle Shelf	28.84	14.08	12.59
					Right Shelf	28.67	14.08	12.59
		96"		14.13	Left Shelf	30.67	14.08	12.59
					Middle Shelf	30.84	14.08	12.59
					Right Shelf	30.67	14.08	12.59
		102"		14.13	Left Shelf	32.67	14.08	12.59
					Middle Shelf	32.84	14.08	12.59
					Right Shelf	32.67	14.08	12.59
		108"		14.13	Left Shelf	34.67	14.08	12.59
					Middle Shelf	34.84	14.08	12.59
					Right Shelf	34.67	14.08	12.59
1H Wall Mount Cabinets – Sliding Doors	1H	60"	16.20	14.13	Left Shelf	28.67	14.08	12.59
					Right Shelf	28.67	14.08	12.59
		72"	16.20	14.13	Left Shelf	34.67	14.08	12.59
					Right Shelf	34.67	14.08	12.59
		90"	16.20	14.13	Left Shelf	28.66	14.08	12.59
					Middle Shelf	28.86	14.08	12.59
					Right Shelf	28.66	14.08	12.59
		108"	16.20	14.13	Left Shelf	34.66	14.08	12.59
					Middle Shelf	34.86	14.08	12.59
					Right Shelf	34.66	14.08	12.59
2H Wall Mount Cabinets – Hinged Door & Open Shelf	2H Hinged Door (16 1/5"D)	30"	See depth dimensions by style	27.50	Top Shelf	28.50	13.95	12.61
	2H Glass Door (16 1/4"D)				Bottom Shelf	28.50	13.95	12.61
	2H Open (15 3/8"D)	36"		27.50	Top Shelf	34.50	13.95	12.61
					Bottom Shelf	34.50	13.95	12.61
		42"		27.50	Top Shelf Left	19.67	13.95	12.61
					Top Shelf Right	19.67	13.95	12.61
					Bottom Shelf Left	19.67	13.95	12.61
					Bottom Shelf Right	19.67	13.95	12.61
		48"		27.50	Top Shelf Left	22.67	13.95	12.61
					Top Shelf Right	22.67	13.95	12.61
					Bottom Shelf Left	22.67	13.95	12.61
					Bottom Shelf Right	22.67	13.95	12.61
		54"		27.50	Top Shelf Left	25.67	13.95	12.61
					Top Shelf Right	25.67	13.95	12.61
					Bottom Shelf Left	25.67	13.95	12.61

# DIMENSIONS

Silea  
05/22

DESCRIPTION	STYLE	EXTERNAL DIMENSIONS			LOCATION	INTERNAL DIMENSIONS		
		width	depth	height		width	depth	height
					Bottom Shelf Right	25.67	13.95	12.61
		60"		27.50	Top Shelf Left	28.67	13.95	12.61
					Top Shelf Right	28.67	13.95	12.61
					Bottom Shelf Left	28.67	13.95	12.61
					Bottom Shelf Right	28.67	13.95	12.61
		66"		27.50	Top Shelf Left	31.67	13.95	12.58
					Top Shelf Right	31.67	13.95	12.58
					Bottom Shelf Left	31.67	13.95	12.58
					Bottom Shelf Right	31.67	13.95	12.58
		72"		27.50	Top Shelf Left	34.67	13.95	12.58
					Top Shelf Right	34.67	13.95	12.58
					Bottom Shelf Left	34.67	13.95	12.58
					Bottom Shelf Right	34.67	13.95	12.58
		78"		27.50	Top Shelf Left	37.67	13.95	12.58
					Top Shelf Right	37.67	13.95	12.58
					Bottom Shelf Left	37.67	13.95	12.58
					Bottom Shelf Right	37.67	13.95	12.58
		84"		27.50	Top Shelf Left	26.67	13.95	12.61
					Top Shelf Middle	26.84	13.95	12.61
					Top Shelf Right	12.67	13.95	12.61
					Bottom Shelf Left	26.67	14.08	12.61
					Bottom Shelf Middle	26.84	14.08	12.61
					Bottom Shelf Right	26.67	14.08	12.61
		90"		27.50	Top Shelf Left	28.67	13.95	12.61
					Top Shelf Middle	28.84	13.95	12.61
					Top Shelf Right	28.67	13.95	12.61
					Bottom Shelf Left	28.67	14.08	12.61
					Bottom Shelf Middle	28.84	14.08	12.61
					Bottom Shelf Right	28.67	14.08	12.61
2H Wall Mount Cabinets – Sliding Doors	2H	60"	16.20	27.50	Top Shelf Left	28.67	12.89	12.61
					Top Shelf Right	28.67	12.89	12.61
					Bottom Shelf Left	28.67	13.41	12.61
					Bottom Shelf Right	28.67	13.41	12.61
		72"	16.20	27.50	Top Shelf Left	34.67	12.89	12.58
					Top Shelf Right	34.67	12.89	12.58
					Bottom Shelf Left	34.67	13.41	12.58
					Bottom Shelf Right	34.67	13.41	12.58
		90"	16.20	27.50	Top Shelf Left	28.66	12.89	12.61
					Top Shelf Middle	28.86	12.89	12.61
					Top Shelf Right	28.66	12.89	12.61
					Bottom Shelf Left	28.66	13.41	12.61
					Bottom Shelf Middle	28.86	13.41	12.61
					Bottom Shelf Right	28.66	13.41	12.61

DESCRIPTION	STYLE	EXTERNAL DIMENSIONS			LOCATION	INTERNAL DIMENSIONS		
		width	depth	height		width	depth	height
1H Surface Mount Cabinets – Hinged Door & Open Shelf	1H Hinged Door (15 2/3"D)	60"	See depth dimensions by style	39.09	Cabinet Left	28.67	14.11	12.61
	1H Glass Door (15 3/4"D)				Cabinet Right	28.67	14.11	12.61
	1H Open (14 7/8"D)				Tackzone	58.50	14.25	24.97
		66"		39.09	Cabinet Left	31.67	14.11	12.61
					Cabinet Right	31.67	14.11	12.61
					Tackzone	64.50	14.25	24.97
		72"		39.09	Cabinet Left	34.67	14.11	12.61
					Cabinet Right	34.67	14.11	12.61
					Tackzone	70.50	14.25	24.97
		78"		39.09	Cabinet Left	37.67	14.11	12.61
					Cabinet Right	37.67	14.11	12.61
					Tackzone	76.50	14.25	24.97
		84"		39.09	Cabinet Left	26.67	14.11	12.61
					Cabinet Middle	26.84	14.11	12.61
					Cabinet Right	26.67	14.11	12.61
					Tackzone	82.50	14.25	24.97
		90"		39.09	Cabinet Left	28.67	14.11	12.61
					Cabinet Middle	28.84	14.11	12.61
					Cabinet Right	28.67	14.11	12.61
					Tackzone	88.50	14.25	24.97
		96"		39.09	Cabinet Left	30.67	14.11	12.61
					Cabinet Middle	30.84	14.11	12.61
					Cabinet Right	30.67	14.11	12.61
					Tackzone	94.50	14.25	24.97
	102"		39.09	Cabinet Left	32.67	14.11	12.61	
				Cabinet Middle	32.84	14.11	12.61	
				Cabinet Right	32.67	14.11	12.61	
				Tackzone	100.50	14.25	24.97	
	108"		39.09	Cabinet Left	34.67	14.11	12.61	
				Cabinet Middle	34.84	14.11	12.61	
				Cabinet Right	34.67	14.11	12.61	
				Tackzone	106.50	14.13	24.97	
2H Surface Mount Cabinets – Hinged Door & Open Shelf	2H Hinged Door (15 2/3"D)	60"	See depth dimensions by style	52.47	Top Shelf Left	28.67	13.98	12.61
	2H Glass Door (15 3/4"D)				Top Shelf Right	28.67	13.98	12.61
	2H Open (14 7/8"D)				Bottom Shelf Left	28.67	14.11	12.63
					Bottom Shelf Right	28.67	14.11	12.63
					Tackzone	58.50	14.25	24.97
		66"		52.47	Top Shelf Left	31.67	13.98	15.58
					Top Shelf Right	31.67	13.98	15.58
					Bottom Shelf Left	31.67	14.11	12.60
					Bottom Shelf Right	31.67	14.11	12.60
					Tackzone	64.50	14.25	24.97
		72"		52.47	Top Shelf Left	31.67	13.98	12.58
					Top Shelf Right	31.67	13.98	12.58
				Bottom Shelf Left	31.67	14.11	12.60	

# DIMENSIONS

Silea  
05/22

DESCRIPTION	STYLE	EXTERNAL DIMENSIONS			LOCATION	INTERNAL DIMENSIONS			
		width	depth	height		width	depth	height	
					Bottom Shelf Right	31.67	14.11	12.60	
					Tackzone	64.50	14.25	24.97	
		78"		52.47	Top Shelf Left	37.67	13.98	12.58	
					Top Shelf Right	37.67	13.98	12.58	
					Bottom Shelf Left	37.67	14.11	12.60	
					Bottom Shelf Right	37.67	14.11	12.60	
					Tackzone	76.50	14.25	24.97	
		84"		52.47	Top Shelf Left	26.67	13.98	12.61	
					Top Shelf Middle	26.84	13.98	12.61	
					Top Shelf Right	26.67	13.98	12.61	
					Bottom Shelf Left	26.67	14.11	12.63	
					Bottom Shelf Middle	26.84	14.11	12.63	
					Bottom Shelf Right	26.67	14.11	12.63	
					Tackzone	82.50	14.25	24.97	
		90"		52.47	Top Shelf Left	28.67	13.98	12.61	
					Top Shelf Middle	28.84	13.98	12.61	
					Top Shelf Right	28.67	13.98	12.61	
					Bottom Shelf Left	28.67	14.11	12.63	
					Bottom Shelf Middle	28.84	14.11	12.63	
					Bottom Shelf Right	28.67	14.11	12.63	
					Tackzone	88.50	14.25	24.97	
1H Surface Mount Towers – Hinged Door & Open Shelf	1H Hinged Door (15 3/4"D)	15"	See depth dimensions by style	39.09	Top Shelf	13.50	13.91	12.61	
	1H Glass Door (15 4/5"D)				Middle Shelf	13.50	13.91	12.17	
	1H Open (14 7/8"D)				Bottom Shelf	13.50	14.07	11.30	
			18"		39.09	Top Shelf	16.50	13.91	12.61
						Middle Shelf	16.50	13.91	12.17
						Bottom Shelf	16.50	14.07	11.30
			30"		39.09	Top Shelf	28.50	13.91	12.61
						Middle Shelf	28.50	13.91	12.17
						Bottom Shelf	28.50	14.07	11.30
			36"		39.09	Top Shelf	34.50	13.91	12.55
						Middle Shelf	34.50	13.91	12.11
						Bottom Shelf	34.50	14.07	11.30
2H Surface Mount Towers - Hinged Door & Open Shelf	2H Hinged Door (15 3/4"D)	15"	See depth dimensions by style	52.47	Top Shelf	13.50	13.91	12.61	
	2H Glass Door (15 4/5"D)				2nd Shelf	13.50	13.91	12.63	
	2H Open (14 7/8"D)				3rd Shelf	13.50	13.91	12.17	
						Bottom Shelf	13.50	14.07	11.30
			18"		52.47	Top Shelf	16.50	13.91	12.61
						2nd Shelf	16.50	13.91	12.63
						3rd Shelf	16.50	13.91	12.17
						Bottom Shelf	16.50	14.07	11.30
			30"		52.47	Top Shelf	28.50	13.91	12.61
						2nd Shelf	28.50	13.91	12.63
						3rd Shelf	28.50	13.91	12.17
						Bottom Shelf	28.50	14.07	11.30

DESCRIPTION	STYLE	EXTERNAL DIMENSIONS			LOCATION	INTERNAL DIMENSIONS			
		width	depth	height		width	depth	height	
		36"		52.47	Top Shelf	34.50	13.91	12.55	
					2nd Shelf	34.50	13.91	12.57	
					3rd Shelf	34.50	13.91	12.11	
					Bottom Shelf	34.50	14.07	11.30	
WorkWall	Wall Mount	72"	19.69	39.09	Collaboration Side Tackzone	34.26	11.55	36.73	
					Personal Side Tackzone	34.26	16.30	25.13	
					Personal Side Drawer	26.40	13.09	2.91	
		90°	19.69	39.09	Collaboration Side Tackzone	43.26	11.55	36.73	
	Personal Side Tackzone				43.26	16.30	25.13		
	Personal Side Drawer				32.40	13.09	2.91		
	Wall Mount w/ Wall	72"	19.69	68.13	Collaboration Side Tackzone	34.26	11.55	36.73	
	Access Panel				Personal Side Tackzone	34.26	16.27	25.13	
					Personal Side Drawer	26.40	13.09	2.91	
		90°	19.69	68.13	Wall Access Panel	34.50	6.49	29.06	
					Collaboration Side Tackzone	43.26	11.55	36.73	
					Personal Side Tackzone	43.26	16.27	25.13	
					Personal Side Drawer	32.40	13.09	2.91	
					Wall Access Panel	43.50	6.48	29.06	
	Stack On	72"	19.69	39.09	Collaboration Side Tackzone	34.26	10.38	36.41	
					Personal Side Tackzone	34.26	17.30	36.41	
					Personal Side Shelf	34.26	12.70	11.81	
			90°	19.69	39.09	Collaboration Side Tackzone	43.26	10.38	36.41
		Personal Side Tackzone				43.26	17.30	36.41	
		Personal Side Shelf				43.26	12.70	11.81	
	Freestanding	72"	23.74	75.50	Collaboration Side Tackzone	34.47	10.95	39.49	
					Collaboration Side Drawer	26.40	13.09	2.91	
					Collaboration Side Top Shelf	34.47	12.20	13.33	
					Collaboration Side Bottom Shelf	34.47	12.26	12.10	
Personal Side Tackzone					34.47	16.29	32.35		
Personal Side Drawer Top					32.40	13.09	2.91		
Personal Side Drawer 2nd					31.90	15.02	9.25		
Personal Side Drawer Bottom					31.90	15.02	9.25		
					90°	23.74	75.50	Collaboration Side Tackzone	43.48
Collaboration Side Drawer		32.40	13.09	2.91					
Collaboration Side Top Shelf		43.48	12.20	13.33					
Collaboration Side Bottom Shelf		43.48	12.26	12.10					
Personal Side Tackzone		34.47	16.29	32.35					
Personal Side Drawer Top		32.40	13.09	2.91					
Personal Side Drawer 2nd		31.90	15.02	9.25					
Personal Side Drawer Bottom		31.90	15.02	9.25					
Closet above the Shelf		7.85	17.22	59.80					
Closet below the Shelf		7.85	17.29	12.10					
Personal Side Drawer Bottom	31 <sup>8</sup> / <sub>9</sub>	15	9 <sup>1</sup> / <sub>4</sub>						
Closet above the Shelf	7 <sup>6</sup> / <sub>7</sub>	17 <sup>2</sup> / <sub>9</sub>	59 <sup>4</sup> / <sub>5</sub>						
Closet below the Shelf	7 <sup>6</sup> / <sub>7</sub>	17 <sup>2</sup> / <sub>7</sub>	12						

**Gunlocke worksurfaces feature two low emitting UV finish options that enhance the beauty of natural wood and ensures the depth, clarity, color consistency and durability throughout the life of the product.**

## OPEN PORE UV FINISH

The Gunlocke Open Pore UV Finish delivers a luxurious look-and-feel, while maintaining a high-level of durability and repairability.



- Open pore finish (natural texture of woodgrain is present)
- 20 sheen
- Water based UV cured finish with low emitting qualities
- Open pore finish allows for greater repairability

## CLEARTECH® FULL FILL UV FINISH

The ClearTech® finishing system is a full fill UV finish that provides superior durability with strong water, chemical and heat resistance.

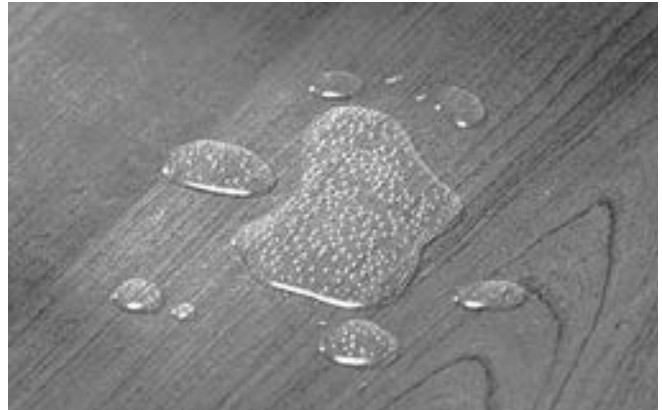

- Full fill finish (provides exceptional depth and clarity)
- 40 sheen
- Water based UV cured finish with low emitting qualities
- Superior durability
- Upcharge applies. See Price List & Specification Guide for details

The typicals shown below include best practices for specifying grain direction on worksurfaces.



**LONG GRAIN:**  
Grain runs width of top



**SHORT GRAIN:**  
Grain runs depth of top

## RECOMMENDATIONS

- Grain should run parallel to one another when crossing over worksurface segments
- Avoid running the grain end-to-end when crossing over worksurface segments

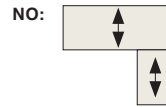

## LAMINATE GUIDELINES

- **Laminate worksurfaces:** Optional grain direction is available on worksurfaces up to 60". For worksurfaces above 60", long grain is standard.
- **Laminate modesty and wall access panels:** Grain direction is not optional. Grain runs vertically on panels up to and including 60". Grain runs horizontally on panels over 60".

### FREESTANDING

Desk: Long Grain  
Credenza: Long Grain

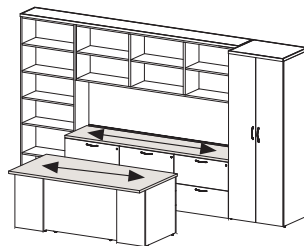

### U-STATION

Desk: Long Grain  
Bridge: Short Grain  
Credenza: Long Grain

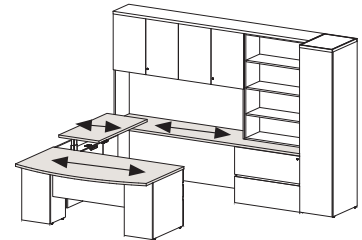

### T-STATION

Desk: Long Grain  
Return: Short Grain  
Hinged Door Cabinet: Short Grain

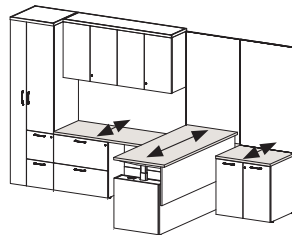

### T-STATION WITH LAYERS

Desk: Long Grain  
Layers Credenza: Short Grain

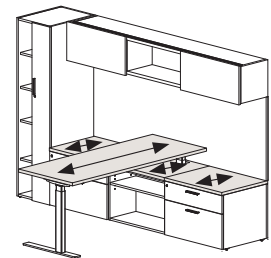

### L-STATION

Desk: Long Grain  
Return: Short Grain

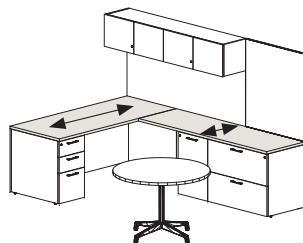

### L-STATION

Runoff Desk: Short Grain  
Credenza: Long Grain

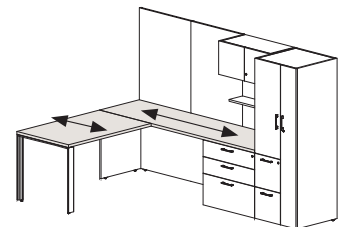





Unitized Casegoods . . . . . 51-79

- Double Pedestal Desk . . . . . 52
- Single Pedestal Desk . . . . . 53-55
- Runoff Desks . . . . . 56
- Layers Runoff W/ Layers Box / Laptop Drawer . . . . . 57-58
- Double Pedestal Credenza . . . . . 59
- Single Pedestal Credenza . . . . . 60
- Full Bank Credenza . . . . . 61-62
- Returns . . . . . 63
- Rectangular Table Desk . . . . . 64-66
- Runoffs . . . . . 67
- Rectangular Runoff . . . . . 68
- Layers Rectangular Runoff W/ Layers Box /  
Laptop Drawer . . . . . 69-70
- Ellipse Table Desk . . . . . 71
- Layers Ellipse Runoff W/ Layers Box . . . . . 72
- Arc Boat Table Desk . . . . . 73
- Layers Arc Boat Runoff W/Layers Box . . . . . 74
- Sightline Runoff . . . . . 75
- Layers Sightline Runoff W/ Layers Box /  
Laptop Drawer . . . . . 76-77
- Layers Cockpit Runoff W/ Layers Box . . . . . 78
- Media Top . . . . . 79

# DOUBLE PEDESTAL DESK

Silea  
05/22

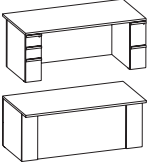
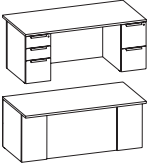
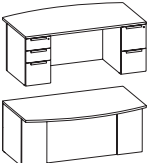
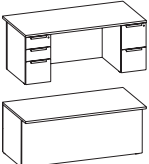
	D	W	H	model number + type	laminata	veneer 1	veneer 2
	36	72	29 1/2	<b>GS2DROB3672-32S</b> [ ]	5,414	7,968	8,765
				<ul style="list-style-type: none"> <li>• Narrow 9 7/16" width pedestals</li> <li>• 30" depth pedestals</li> <li>• 3/4" breakfront modesty</li> <li>• 6" overhang</li> </ul>			
	36	72	29 1/2	<b>GS2DROB3672-32</b> [ ]	5,441	8,005	8,806
				<ul style="list-style-type: none"> <li>• 15" wide pedestals</li> <li>• 30" depth pedestals</li> <li>• 3/4" breakfront modesty</li> <li>• 6" overhang</li> </ul>			
	42	72	29 1/2	<b>GS2DBOB4272-32</b> [ ]	5,887	8,702	9,573
Bow front				<ul style="list-style-type: none"> <li>• 15" wide pedestals</li> <li>• 30" depth pedestals</li> <li>• 3/4" breakfront modesty</li> <li>• 6" overhang</li> <li>• 12" overhang at center</li> </ul>			
	36	72	29 1/2	<b>GS2DROF3672-32</b> [ ]	5,151	7,586	8,345
				<ul style="list-style-type: none"> <li>• 15" wide pedestals</li> <li>• 30" depth pedestals</li> <li>• Flush front modesty</li> <li>• 6" overhang</li> </ul>			

## PRODUCT INFO

Wood tops optional grain.

Laminate tops long grain standard.

 Units shipped as separate packages and require field assembly.

### Grommet Location (Add \$70 per grommet)

No Grommet **GN**  
Left **GL**  
Right **GR**  
Left & Right **GB**

Specify location first, then select grommet color or "Empty Cutout" option. When "Empty Cutout" option is selected, a grommet or power unit must be ordered separately for each cutout.

## TO ORDER PLEASE SPECIFY THE FOLLOWING:

### WOOD TOP, WOOD CHASSIS

1. **MODEL NUMBER + WW**
2. **FSC**
3. **TOP WOOD FINISH + EDGE**
4. **CHASSIS WOOD FINISH**
5. **TOP UV FINISH**
6. **GRAIN DIRECTION**
7. **PULL**
8. **DRAWERS**
9. **GROMMET**
10. **KEYING**

### LAM TOP, LAM CHASSIS

1. **MODEL NUMBER + LL**
2. **FSC**
3. **TOP LAM**
4. **CHASSIS LAM**
5. **FRONT LAM**
6. **EDGE DETAIL**
7. **PULL**
8. **DRAWERS**
9. **GROMMET**
10. **KEYING**

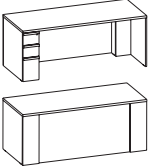
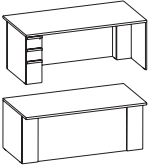
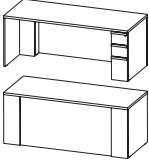
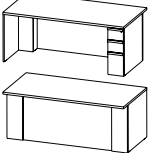
	D	W	H	model number + type	laminates	veneer 1	veneer 2
<b>LEFT HAND</b> 	30	60	29 1/2	<b>GS2DRFB3060L-3S</b> <input type="checkbox"/>	3,834	5,659	6,225
	30	66	29 1/2	<b>GS2DRFB3066L-3S</b> <input type="checkbox"/>	3,950	5,832	6,416
	30	72	29 1/2	<b>GS2DRFB3072L-3S</b> <input type="checkbox"/>	4,077	6,016	6,618
	• 3/4" breakfront modesty						
	36	72	29 1/2	<b>GS2DROB3672L-3S</b> <input type="checkbox"/>	4,150	6,134	6,748
	36	78	29 1/2	<b>GS2DROB3678L-3S</b> <input type="checkbox"/>	4,299	6,360	6,996
	<ul style="list-style-type: none"> <li>• 3/4" breakfront modesty</li> <li>• 6" overhang</li> </ul>						
<b>RIGHT HAND</b> 	30	60	29 1/2	<b>GS2DRFB3060R-3S</b> <input type="checkbox"/>	3,834	5,659	6,225
	30	66	29 1/2	<b>GS2DRFB3066R-3S</b> <input type="checkbox"/>	3,950	5,832	6,416
	30	72	29 1/2	<b>GS2DRFB3072R-3S</b> <input type="checkbox"/>	4,077	6,016	6,618
	• 3/4" breakfront modesty						
	36	72	29 1/2	<b>GS2DROB3672R-3S</b> <input type="checkbox"/>	4,150	6,134	6,748
	36	78	29 1/2	<b>GS2DROB3678R-3S</b> <input type="checkbox"/>	4,299	6,360	6,996
	<ul style="list-style-type: none"> <li>• 3/4" breakfront modesty</li> <li>• 6" overhang</li> </ul>						

**PRODUCT INFO**

Wood tops optional grain.  
Laminate tops long grain standard.  
 Units shipped as separate packages and require field assembly.

**Grommet Location**  
(Add \$70 per grommet)

No Grommet **GN**  
Left **GL**  
Right **GR**  
Left & Right **GB**

Specify location first, then select grommet color or "Empty Cutout" option. When "Empty Cutout" option is selected, a grommet or power unit must be ordered separately for each cutout.

**TO ORDER PLEASE SPECIFY THE FOLLOWING:**

- |                                  |   |
|----------------------------------|---|
| WOOD TOP, WOOD CHASSIS           | LAM TOP, LAM CHASSIS                        |
| 1. <b>MODEL NUMBER + WW</b>      | 1. <b>MODEL NUMBER + LL</b>                 |
| 2. <b>FSC</b>                    | 2. <b>FSC</b>                               |
| 3. <b>TOP WOOD FINISH + EDGE</b> | 3. <b>TOP LAM</b>                           |
| 4. <b>CHASSIS WOOD FINISH</b>    | 4. <b>CHASSIS LAM</b>                       |
| 5. <b>TOP UV FINISH</b>          | 5. <b>FRONT LAM</b>                         |
| 6. <b>GRAIN DIRECTION</b>        | 6. <b>GRAIN DIRECTION (60W models only)</b> |
| 7. <b>PULL</b>                   | 7. <b>EDGE DETAIL</b>                       |
| 8. <b>DRAWERS</b>                | 8. <b>PULL</b>                              |
| 9. <b>GROMMET</b>                | 9. <b>DRAWERS</b>                           |
| 10. <b>KEYING</b>                | 10. <b>GROMMET</b>                          |
|                                  | 11. <b>KEYING</b>                           |

# SINGLE PEDESTAL DESK

15" Pedestals | Breakfront Modesty

Silea  
05/22

	D	W	H	model number + type	laminate	veneer 1	veneer 2
<b>LEFT HAND</b> 	30	60	29 1/2	<b>GS2DRFB3060L-3</b> <input type="checkbox"/>	3,873	5,715	6,287
	30	66	29 1/2	<b>GS2DRFB3066L-3</b> <input type="checkbox"/>	3,989	5,889	6,478
	30	72	29 1/2	<b>GS2DRFB3072L-3</b> <input type="checkbox"/>	4,113	6,072	6,680
	• 3/4" breakfront modesty						
	36	72	29 1/2	<b>GS2DROB3672L-3</b> <input type="checkbox"/>	4,186	6,190	6,809
	36	78	29 1/2	<b>GS2DROB3678L-3</b> <input type="checkbox"/>	4,338	6,417	7,059
	• 3/4" breakfront modesty • 6" overhang						
	42	72	29 1/2	<b>GS2DBOB4272L-3</b> <input type="checkbox"/>	4,632	6,887	7,576
	• 3/4" breakfront modesty • 6" overhang • 12" overhang at center						
<b>RIGHT HAND</b> 	30	60	29 1/2	<b>GS2DRFB3060R-3</b> <input type="checkbox"/>	3,873	5,715	6,287
	30	66	29 1/2	<b>GS2DRFB3066R-3</b> <input type="checkbox"/>	3,989	5,889	6,478
	30	72	29 1/2	<b>GS2DRFB3072R-3</b> <input type="checkbox"/>	4,113	6,072	6,680
	• 3/4" breakfront modesty						
	36	72	29 1/2	<b>GS2DROB3672R-3</b> <input type="checkbox"/>	4,186	6,190	6,809
	36	78	29 1/2	<b>GS2DROB3678R-3</b> <input type="checkbox"/>	4,338	6,417	7,059
	• 3/4" breakfront modesty • 6" overhang						
	42	72	29 1/2	<b>GS2DBOB4272R-3</b> <input type="checkbox"/>	4,632	6,887	7,576
	• 3/4" breakfront modesty • 6" overhang • 12" overhang at center						

## PRODUCT INFO

Wood tops optional grain.  
Laminate tops optional grain up to 60", over 60" long grain standard.

Units shipped as separate packages and require field assembly.

### Grommet Location (Add \$70 per grommet)

No Grommet **GN**  
Left **GL**  
Right **GR**  
Left & Right **GB**

Specify location first, then select grommet color or "Empty Cutout" option.  
When "Empty Cutout" option is selected, a grommet or power unit must be ordered separately for each cutout.



## TO ORDER PLEASE SPECIFY THE FOLLOWING:

WOOD TOP, WOOD CHASSIS

1. MODEL NUMBER + WW
2. FSC
3. TOP WOOD FINISH + EDGE
4. CHASSIS WOOD FINISH
5. TOP UV FINISH
6. GRAIN DIRECTION
7. PULL
8. DRAWERS
9. GROMMET
10. KEYING

LAM TOP, LAM CHASSIS

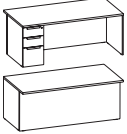
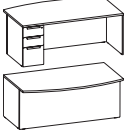
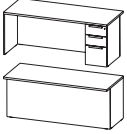
1. MODEL NUMBER + LL
2. FSC
3. TOP LAM
4. CHASSIS LAM
5. FRONT LAM
6. GRAIN DIRECTION (60W models only)
7. EDGE DETAIL
9. PULL
10. DRAWERS
11. GROMMET
12. KEYING

	D	W	H	model number + type	laminiate	veneer 1	veneer 2
<b>LEFT HAND</b> 	30	60	29 1/2	<b>GS2DROF3060L-3</b> <input type="checkbox"/>	3,668	5,639	6,203
	30	66	29 1/2	<b>GS2DROF3066L-3</b> <input type="checkbox"/>	3,778	5,805	6,386
	30	72	29 1/2	<b>GS2DROF3072L-3</b> <input type="checkbox"/>	3,893	5,976	6,574
	• 6" overhang						
	36	72	29 1/2	<b>GS2DROF3672L-3</b> <input type="checkbox"/>	4,055	6,056	6,662
	36	78	29 1/2	<b>GS2DROF3678L-3</b> <input type="checkbox"/>	4,195	6,267	6,894
	• 6" overhang						
 Bow front	42	72	29 1/2	<b>GS2DBOF4272L-3</b> <input type="checkbox"/>	4,501	6,753	7,429
	• 6" overhang						
	• 12" overhang at center						
<b>RIGHT HAND</b> 	30	60	29 1/2	<b>GS2DROF3060R-3</b> <input type="checkbox"/>	3,668	5,639	6,203
	30	66	29 1/2	<b>GS2DROF3066R-3</b> <input type="checkbox"/>	3,778	5,805	6,386
	30	72	29 1/2	<b>GS2DROF3072R-3</b> <input type="checkbox"/>	3,893	5,976	6,574
	• 6" overhang						
	36	72	29 1/2	<b>GS2DROF3672R-3</b> <input type="checkbox"/>	4,055	6,056	6,662
	36	78	29 1/2	<b>GS2DROF3678R-3</b> <input type="checkbox"/>	4,195	6,267	6,894
	• 6" overhang						
 Bow front	42	72	29 1/2	<b>GS2DBOF4272R-3</b> <input type="checkbox"/>	4,501	6,753	7,429
	• 6" overhang						
	• 12" overhang at center						

**PRODUCT INFO**

Wood tops optional grain.  
Laminate tops long grain standard.  
 Units shipped as separate packages and require field assembly.

**Grommet Location**  
(Add \$70 per grommet)

No Grommet **GN**  
Left **GL**  
Right **GR**  
Left & Right **GB**

Specify location first, then select grommet color or "Empty Cutout" option. When "Empty Cutout" option is selected, a grommet or power unit must be ordered separately for each cutout.

**TO ORDER PLEASE SPECIFY THE FOLLOWING:**

WOOD TOP, WOOD CHASSIS

- MODEL NUMBER + WW**
- FSC**
- TOP WOOD FINISH + EDGE**
- CHASSIS WOOD FINISH**
- TOP UV FINISH**
- GRAIN DIRECTION**
- PULL**
- DRAWERS**
- GROMMET**
- KEYING**

LAM TOP, LAM CHASSIS

- MODEL NUMBER + LL**
- FSC**
- TOP LAM**
- CHASSIS LAM**
- FRONT LAM**
- GRAIN DIRECTION (60W models only)**
- EDGE DETAIL**
- PULL**
- DRAWERS**
- GROMMET**
- KEYING**

# RUNOFF DESKS

Left and Right Hand | BBF Pedestal

Silea

05/22

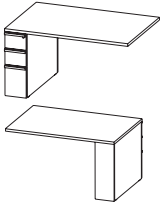
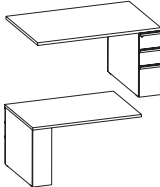
	D	W	H	model number + type	laminata	veneera 1	veneera 2
<b>LEFT HAND</b> 	30	48	29 1/2	<b>GS2RRO3048L-3</b> [ ]	2,874	4,440	4,884
	30	54	29 1/2	<b>GS2RRO3054L-3</b> [ ]	2,884	4,459	4,905
	36	54	29 1/2	<b>GS2RRO3654L-3</b> [ ]	3,048	4,704	5,175
	36	60	29 1/2	<b>GS2RRO3660L-3</b> [ ]	3,068	4,734	5,208
<ul style="list-style-type: none"> <li>• Flat brackets ordered separately (model #MDWBRK)</li> </ul>							
<b>RIGHT HAND</b> 	30	48	29 1/2	<b>GS2RRO3048R-3</b> [ ]	2,874	4,440	4,884
	30	54	29 1/2	<b>GS2RRO3054R-3</b> [ ]	2,884	4,459	4,905
	36	54	29 1/2	<b>GS2RRO3654R-3</b> [ ]	3,048	4,704	5,175
	36	60	29 1/2	<b>GS2RRO3660R-3</b> [ ]	3,068	4,734	5,208
<ul style="list-style-type: none"> <li>• Narrow 9 7/16" width pedestal</li> <li>• Flat brackets ordered separately (model #MDWBRK)</li> </ul>							

## PRODUCT INFO

Specify pedestal location from user seated position.

All tops optional grain.

 Units shipped as separate packages and require field assembly.

Modesty panel ordered separately.

### Grommet Location (Add \$70 per grommet)

No Grommet **GN**  
 Left **GL**  
 Right **GR**  
 Left & Right **GB**

Specify location first, then select grommet color or "Empty Cutout" option. When "Empty Cutout" option is selected, a grommet or power unit must be ordered separately for each cutout.

## TO ORDER PLEASE SPECIFY THE FOLLOWING:

WOOD TOP, WOOD CHASSIS

1. **MODEL NUMBER + WW**
2. **FSC**
3. **TOP WOOD FINISH + EDGE**
4. **CHASSIS WOOD FINISH**
5. **TOP UV FINISH**
6. **GRAIN DIRECTION**
7. **PULL**
8. **DRAWERS**
9. **GROMMET**
10. **KEYING**

LAM TOP, LAM CHASSIS

1. **MODEL NUMBER + LL**
2. **FSC**
3. **TOP LAM**
4. **CHASSIS LAM**
5. **FRONT LAM**
6. **GRAIN DIRECTION (60W models only)**
7. **EDGE DETAIL**
8. **PULL**
9. **DRAWERS**
10. **GROMMET**
11. **KEYING**

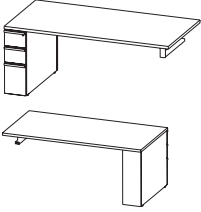
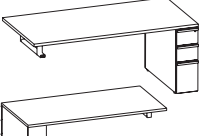
	D	W	H	model number + type	laminiate	veneer 1	veneer 2
<b>LEFT HAND</b> 	30	66	29 1/2	<b>GS2RLO3066L-3</b> [ ]	3,438	5,042	5,547
	30	72	29 1/2	<b>GS2RLO3072L-3</b> [ ]	3,492	5,123	5,636
	36	72	29 1/2	<b>GS2RLO3672L-3</b> [ ]	3,709	5,437	5,981
	36	78	29 1/2	<b>GS2RLO3678L-3</b> [ ]	3,789	5,560	6,116
<b>RIGHT HAND</b> 	30	66	29 1/2	<b>GS2RLO3066R-3</b> [ ]	3,438	5,042	5,547
	30	72	29 1/2	<b>GS2RLO3072R-3</b> [ ]	3,492	5,123	5,636
	36	72	29 1/2	<b>GS2RLO3672R-3</b> [ ]	3,709	5,437	5,981
	36	78	29 1/2	<b>GS2RLO3678R-3</b> [ ]	3,789	5,560	6,116

- Box | Box | File pedestal
- Narrow 9 7/16" width pedestal

### Layers Box

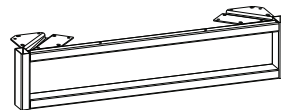

Side view

### PRODUCT INFO

Specify pedestal location from user seated position.

All tops long grain standard.

 Units shipped as separate packages and require field assembly.

#### Grommet Location (Add \$70 per grommet)

No Grommet    **GN**  
 Left            **GL**  
 Right          **GR**  
 Left & Right   **GB**

Specify location first, then select grommet color or "Empty Cutout" option. When "Empty Cutout" option is selected, a grommet or power unit must be ordered separately for each cutout.

### TO ORDER PLEASE SPECIFY THE FOLLOWING:

#### WOOD TOP, WOOD CHASSIS

- MODEL NUMBER + WW**
- FSC**
- TOP WOOD FINISH + EDGE**
- CHASSIS WOOD FINISH**
- TOP UV FINISH**
- PULL**
- HARDWARE COLOR (Layers Box)**
- DRAWERS**
- GROMMET**
- KEYING**

#### LAM TOP, LAM CHASSIS

- MODEL NUMBER + LL**
- FSC**
- TOP LAM**
- CHASSIS LAM**
- FRONT LAM**
- EDGE DETAIL**
- PULL**
- HARDWARE COLOR (Layers Box)**
- DRAWERS**
- GROMMET**
- KEYING**

# LAYERS RUNOFF DESKS W/ LAPTOP DRAWER

Left and Right Hand | BBF Pedestal

Silea

05/22

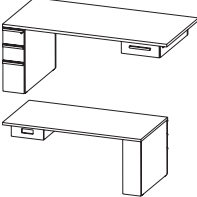
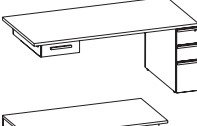
	D	W	H	model number + type	laminata	veneer 1	veneer 2
<b>LEFT HAND</b> 	30	66	29 1/2	<b>GS2RLOS3066L-3</b> [ ]	3,810	5,828	6,411
	30	72	29 1/2	<b>GS2RLOS3072L-3</b> [ ]	3,863	5,908	6,499
	36	72	29 1/2	<b>GS2RLOS3672L-3</b> [ ]	4,102	6,210	6,831
	36	78	29 1/2	<b>GS2RLOS3678L-3</b> [ ]	4,181	6,332	6,966
<b>RIGHT HAND</b> 	30	66	29 1/2	<b>GS2RLOS3066R-3</b> [ ]	3,810	5,828	6,411
	30	72	29 1/2	<b>GS2RLOS3072R-3</b> [ ]	3,863	5,908	6,499
	36	72	29 1/2	<b>GS2RLOS3672R-3</b> [ ]	4,102	6,210	6,831
	36	78	29 1/2	<b>GS2RLOS3678R-3</b> [ ]	4,181	6,332	6,966

- Box | Box | File pedestal
- Narrow 9 7/16" width pedestal

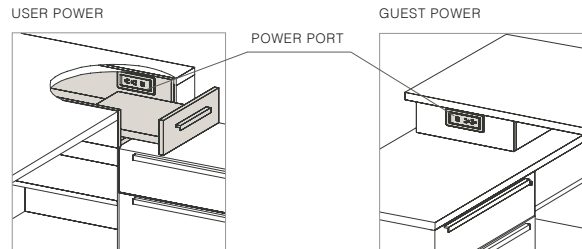

## PRODUCT INFO

Specify pedestal location from user seated position.

All tops long grain standard.

 Units shipped as separate packages and require field assembly.

Power units included  
(2 USB, 2 power)

### Grommet Location

(Add \$70 per grommet)

No Grommet **GN**  
 Left **GL**  
 Right **GR**  
 Left & Right **GB**

Specify location first, then select grommet color or "Empty Cutout" option. When "Empty Cutout" option is selected, a grommet or power unit must be ordered separately for each cutout.

## TO ORDER PLEASE SPECIFY THE FOLLOWING:

WOOD TOP, WOOD CHASSIS

1. **MODEL NUMBER + WW**
2. **FSC**
3. **TOP WOOD FINISH + EDGE**
4. **CHASSIS WOOD FINISH**
5. **TOP UV FINISH**
6. **PULL – PEDESTAL**
7. **PULL – LAPTOP DRAWER**
8. **DRAWERS**
9. **GROMMET**
10. **KEYING**
11. **POWER UNIT**

LAM TOP, LAM CHASSIS

1. **MODEL NUMBER + LL**
2. **FSC**
3. **TOP LAM**
4. **CHASSIS LAM**
5. **FRONT LAM**
6. **EDGE DETAIL**
7. **PULL**
8. **DRAWERS**
9. **GROMMET**
10. **KEYING**
11. **POWER UNIT**



D	W	H	model number + type	laminate	veneer 1	veneer 2
24	72	29 1/2	<b>GS2DPC2472-22</b> [ ]	4,990	7,782	8,561

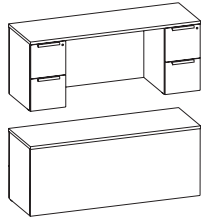

- File | File pedestal

**PRODUCT INFO**

Wood tops optional grain.

Laminate tops long grain standard.

 Units shipped as separate packages and require field assembly.

**Grommet Location**  
(Add \$70 per grommet)

No Grommet **GN**  
Left **GL**  
Right **GR**  
Left & Right **GB**

Specify location first, then select grommet color or "Empty Cutout" option. When "Empty Cutout" option is selected, a grommet or power unit must be ordered separately for each cutout.

**TO ORDER PLEASE SPECIFY THE FOLLOWING:**

WOOD TOP, WOOD CHASSIS

- MODEL NUMBER + WW**
- FSC**
- TOP WOOD FINISH + EDGE**
- CHASSIS WOOD FINISH**
- TOP UV FINISH**
- GRAIN DIRECTION**
- PULL**
- DRAWERS**
- GROMMET**
- MODESTY**
- KEYING**

LAM TOP, LAM CHASSIS

- MODEL NUMBER + LL**
- FSC**
- TOP LAM**
- CHASSIS LAM**
- FRONT LAM**
- EDGE DETAIL**
- PULL**
- DRAWER**
- GROMMET**
- MODESTY**
- KEYING**

# SINGLE PEDESTAL CREDENZA

15" or 30" Pedestals | Full Modesty

Silea

05/22

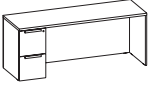
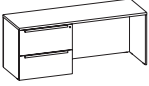
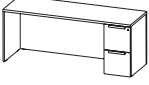
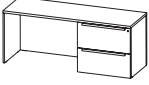
	D	W	H	model number + type	laminare	veneer 1	veneer 2
<b>LEFT HAND</b> 	24	66	29 1/2	<b>GS2SPC2466L-2</b> <input type="checkbox"/>	3,176	4,949	5,444
	24	72	29 1/2	<b>GS2SPC2472L-2</b> <input type="checkbox"/>	3,289	5,130	5,643
	• 15" W pedestal						
	24	72	29 1/2	<b>GS2SPC2472L-4</b> <input type="checkbox"/>	3,705	5,781	6,360
	24	78	29 1/2	<b>GS2SPC2478L-4</b> <input type="checkbox"/>	3,772	5,883	6,472
	24	84	29 1/2	<b>GS2SPC2484L-4</b> <input type="checkbox"/>	3,835	5,984	6,583
	24	90	29 1/2	<b>GS2SPC2490L-4</b> <input type="checkbox"/>	4,012	6,259	6,885
	24	96	29 1/2	<b>GS2SPC2496L-4</b> <input type="checkbox"/>	4,153	6,481	7,130
	• 30" W pedestal						
<b>RIGHT HAND</b> 	24	66	29 1/2	<b>GS2SPC2466R-2</b> <input type="checkbox"/>	3,176	4,949	5,444
	24	72	29 1/2	<b>GS2SPC2472R-2</b> <input type="checkbox"/>	3,289	5,130	5,643
	• 15" W pedestal						
	24	72	29 1/2	<b>GS2SPC2472R-4</b> <input type="checkbox"/>	3,705	5,781	6,360
	24	78	29 1/2	<b>GS2SPC2478R-4</b> <input type="checkbox"/>	3,772	5,883	6,472
	24	84	29 1/2	<b>GS2SPC2484R-4</b> <input type="checkbox"/>	3,835	5,984	6,583
	24	90	29 1/2	<b>GS2SPC2490R-4</b> <input type="checkbox"/>	4,012	6,259	6,885
	24	96	29 1/2	<b>GS2SPC2496R-4</b> <input type="checkbox"/>	4,153	6,481	7,130
	• 30" W pedestal						

## PRODUCT INFO

Wood tops optional grain.

Laminate tops long grain standard.

 Units shipped as separate packages and require field assembly.

### Grommet Location

(Add \$70 per grommet)

No Grommet **GN**  
 Left **GL**  
 Right **GR**  
 Left & Right **GB**

Specify location first, then select grommet color or "Empty Cutout" option. When "Empty Cutout" option is selected, a grommet or power unit must be ordered separately for each cutout.



## TO ORDER PLEASE SPECIFY THE FOLLOWING:

WOOD TOP, WOOD CHASSIS

1. MODEL NUMBER + WW
2. FSC
3. TOP WOOD FINISH + EDGE
4. CHASSIS WOOD FINISH
5. TOP UV FINISH
6. GRAIN DIRECTION
7. PULL
8. DRAWERS
9. GROMMET
10. MODESTY
11. KEYING

LAM TOP, LAM CHASSIS

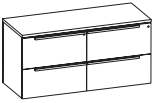
1. MODEL NUMBER + LL
2. FSC
3. TOP LAM
4. CHASSIS LAM
5. FRONT LAM
6. EDGE DETAIL
7. PULL
8. DRAWER
9. GROMMET
10. MODESTY
11. KEYING

	D	W	H	model number + type	laminata	veneer 1	veneer 2
	24	60	29 1/2	<b>GS2FSC2460-44</b> [ ]	4,955	7,724	8,497
	24	72	29 1/2	<b>GS2FSC2472-44</b> [ ]	5,278	8,227	9,050

**PRODUCT INFO**

All tops long grain standard.  
Ships assembled.

**TO ORDER PLEASE SPECIFY THE FOLLOWING:**

WOOD TOP, WOOD CHASSIS

1. **MODEL NUMBER + WW**
2. **FSC**
3. **TOP WOOD FINISH + EDGE**
4. **CHASSIS WOOD FINISH**
5. **TOP UV FINISH**
6. **PULL**
7. **DRAWERS**
8. **KEYING**

LAM TOP, LAM CHASSIS

1. **MODEL NUMBER + LL**
2. **FSC**
3. **TOP LAM**
4. **CHASSIS LAM**
5. **FRONT LAM**
6. **EDGE DETAIL**
7. **PULL**
8. **DRAWERS**
9. **KEYING**

# FULL BANK CREDENZA

Hinged Door

Silea

05/22

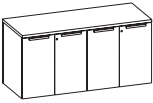
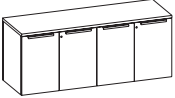
	D	W	H	model number + type	laminata	veneer 1	veneer 2
	24	60	29 1/2	<b>GS2FSC2460-55</b> [ ]	4,550	7,098	7,808
	24	72	29 1/2	<b>GS2FSC2472-55</b> [ ]	4,885	7,616	8,378

## PRODUCT INFO

All tops long grain standard.  
Ships assembled.  
(1) Adjustable shelf behind each door set.

## TO ORDER PLEASE SPECIFY THE FOLLOWING:

WOOD TOP, WOOD CHASSIS

1. **MODEL NUMBER + WW**
2. **FSC**
3. **TOP WOOD FINISH + EDGE**
4. **CHASSIS WOOD FINISH**
5. **TOP UV FINISH**
6. **PULL**
7. **KEYING**

LAM TOP, LAM CHASSIS

1. **MODEL NUMBER + LL**
2. **FSC**
3. **TOP LAM**
4. **CHASSIS LAM**
5. **FRONT LAM**
6. **EDGE DETAIL**
7. **PULL**
8. **KEYING**

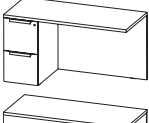
	D	W	H	model number + type	laminate	veneer 1	veneer 2
<b>LEFT HAND</b> 	24	42	29 1/2	<b>GS2RTN2442L-2</b> [ ]	2,936	4,501	4,952
	24	48	29 1/2	<b>GS2RTN2448L-2</b> [ ]	3,018	4,629	5,092
	24	54	29 1/2	<b>GS2RTN2454L-2</b> [ ]	3,080	4,725	5,198
	24	60	29 1/2	<b>GS2RTN2460L-2</b> [ ]	3,171	4,862	5,349

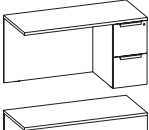
<b>RIGHT HAND</b> 	24	42	29 1/2	<b>GS2RTN2442R-2</b> [ ]	2,936	4,501	4,952
	24	48	29 1/2	<b>GS2RTN2448R-2</b> [ ]	3,018	4,629	5,092
	24	54	29 1/2	<b>GS2RTN2454R-2</b> [ ]	3,080	4,725	5,198
	24	60	29 1/2	<b>GS2RTN2460R-2</b> [ ]	3,171	4,862	5,349

• Flat brackets ordered separately (model #MDWBRK)

**PRODUCT INFO**

Specify pedestal location from user seated position.

All tops optional grain.

 Units shipped as separate packages and require field assembly.

**Grommet Location**  
(Add \$70 per grommet)

No Grommet **GN**  
Left **GL**  
Right **GR**  
Left & Right **GB**

Specify location first, then select grommet color or "Empty Cutout" option. When "Empty Cutout" option is selected, a grommet or power unit must be ordered separately for each cutout.

**TO ORDER PLEASE SPECIFY THE FOLLOWING:**

WOOD TOP, WOOD CHASSIS

1. **MODEL NUMBER + WW**
2. **FSC**
3. **TOP WOOD FINISH + EDGE**
4. **CHASSIS WOOD FINISH**
5. **TOP UV FINISH**
6. **GRAIN DIRECTION**
7. **PULL**
8. **DRAWERS**
9. **GROMMET**
10. **KEYING**

LAM TOP, LAM CHASSIS

1. **MODEL NUMBER + LL**
2. **FSC**
3. **TOP LAM**
4. **CHASSIS LAM**
5. **FRONT LAM**
6. **GRAIN DIRECTION**
7. **EDGE DETAIL**
8. **PULL**
9. **DRAWER**
10. **GROMMET**
11. **KEYING**

# RECTANGULAR TABLE DESK

Silea  
05/22

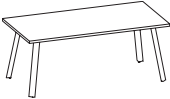
	D	W	H	model number + type	laminata	vener 1	vener 2
	30	66	29 1/2	<b>GS2TRL3066-</b> [ ]	2,094	2,646	2,911
	30	72	29 1/2	<b>GS2TRL3072-</b> [ ]	2,148	2,727	3,000
	36	72	29 1/2	<b>GS2TRL3672-</b> [ ]	2,221	2,845	3,130
	36	78	29 1/2	<b>GS2TRL3678-</b> [ ]	2,301	2,968	3,265

## PRODUCT INFO

All tops long grain standard.

 Units shipped as separate packages and require field assembly.

### Grommet Location (Add \$70 per grommet)

No Grommet **GN**  
Left **GL**  
Right **GR**  
Left & Right **GB**

Specify location first, then select grommet color or "Empty Cutout" option. When "Empty Cutout" option is selected, a grommet or power unit must be ordered separately for each cutout.

## TO ORDER PLEASE SPECIFY THE FOLLOWING:

### WOOD TOP

1. **MODEL NUMBER + W**
2. **FSC**
3. **TOP WOOD FINISH + EDGE**
4. **TOP UV FINISH**
5. **HARDWARE COLOR**
6. **GROMMET**

### LAM TOP

1. **MODEL NUMBER + L**
2. **FSC**
3. **TOP LAM**
4. **EDGE DETAIL**
5. **HARDWARE COLOR**
6. **GROMMET**

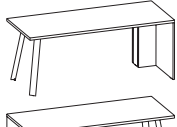
	D	W	H	model number + type	laminata	vener 1	vener 2
<b>LEFT HAND</b> 	30	66	29 1/2	<b>GS2XRL3066L-</b> [ ]	2,302	3,248	3,573
	30	72	29 1/2	<b>GS2XRL3072L-</b> [ ]	2,356	3,329	3,662
	36	72	29 1/2	<b>GS2XRL3672L-</b> [ ]	2,467	3,500	3,850
	36	78	29 1/2	<b>GS2XRL3678L-</b> [ ]	2,547	3,623	3,986

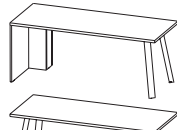
<b>RIGHT HAND</b> 	30	66	29 1/2	<b>GS2XRL3066R-</b> [ ]	2,302	3,248	3,573
	30	72	29 1/2	<b>GS2XRL3072R-</b> [ ]	2,356	3,329	3,662
	36	72	29 1/2	<b>GS2XRL3672R-</b> [ ]	2,467	3,500	3,850
	36	78	29 1/2	<b>GS2XRL3678R-</b> [ ]	2,547	3,623	3,986

• Extensions not for use as a freestanding unit, must attach to adjoining unit.

**PRODUCT INFO**

Specify legs from user seated position.

All tops long grain standard.

 Units shipped as separate packages and require field assembly.

Modesty panel ordered separately.

**Grommet Location**

(Add \$70 per grommet)

No Grommet **GN**  
Left **GL**  
Right **GR**  
Left & Right **GB**

Specify location first, then select grommet color or "Empty Cutout" option. When "Empty Cutout" option is selected, a grommet or power unit must be ordered separately for each cutout.

**TO ORDER PLEASE SPECIFY THE FOLLOWING:**

WOOD TOP, WOOD CHASSIS

- MODEL NUMBER + WW**
- FSC**
- TOP WOOD FINISH + EDGE**
- CHASSIS WOOD FINISH**
- TOP UV FINISH**
- HARDWARE COLOR**
- GROMMET**

LAM TOP, LAM CHASSIS



- MODEL NUMBER + LL**
- FSC**
- TOP LAM**
- CHASSIS LAM**
- EDGE DETAIL**
- HARDWARE COLOR**
- GROMMET**

# EXTENSIONS

Racetrack, d & b Shape

Silea

05/22

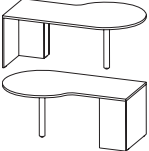
	D	W	H	model number + type	laminate	veneer 1	veneer 2
<b>LEFT HAND</b> 	30	66	29 1/2	<b>GS2XRT3066L-</b> [ ]	2,620	4,283	4,712
	30	72	29 1/2	<b>GS2XRT3072L-</b> [ ]	2,684	4,384	4,823
<b>RIGHT HAND</b> 	30	66	29 1/2	<b>GS2XRT3066R-</b> [ ]	2,620	4,283	4,712
	30	72	29 1/2	<b>GS2XRT3072R-</b> [ ]	2,684	4,384	4,823
<b>LEFT HAND</b> 	42	42	29 1/2	<b>GS2XDT4272-</b> [ ]	3,513	5,682	6,251
<b>RIGHT HAND</b> 	42	48	29 1/2	<b>GS2XBT4272-</b> [ ]	3,513	5,682	6,251

• Extensions not for use as a freestanding unit, must attach to adjoining unit.

## PRODUCT INFO

Specify column from user seated position.

Wood tops optional grain.

Laminate tops long grain standard.

 Units shipped as separate packages and require field assembly.

### Grommet Location

(Add \$70 per grommet)

No Grommet **GN**  
 Left **GL**  
 Right **GR**  
 Left & Right **GB**

Specify location first, then select grommet color or "Empty Cutout" option. When "Empty Cutout" option is selected, a grommet or power unit must be ordered separately for each cutout.

## TO ORDER PLEASE SPECIFY THE FOLLOWING:

WOOD TOP, WOOD CHASSIS

1. **MODEL NUMBER + WW**
2. **FSC**
3. **TOP WOOD FINISH + EDGE**
4. **CHASSIS WOOD FINISH**
5. **TOP UV FINISH**
6. **GRAIN DIRECTION**
7. **HARDWARE COLOR**
8. **GROMMET**

LAM TOP, LAM CHASSIS

1. **MODEL NUMBER + LL**
2. **FSC**
3. **TOP LAM**
4. **CHASSIS LAM**
5. **EDGE DETAIL**
6. **HARDWARE COLOR**
7. **GROMMET**

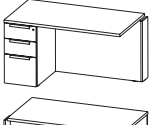

	D	W	H	model number + type	laminate	veneer 1	veneer 2
<b>LEFT HAND</b> 	30	48	29 1/2	<b>GS2RROF3048L-3</b> [ ]	3,191	4,898	5,388
	30	54	29 1/2	<b>GS2RROF3054L-3</b> [ ]	3,222	4,951	5,447
	36	54	29 1/2	<b>GS2RROF3654L-3</b> [ ]	3,280	4,863	5,350
	36	60	29 1/2	<b>GS2RROF3660L-3</b> [ ]	3,323	4,922	5,415

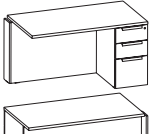
<b>RIGHT HAND</b> 	30	48	29 1/2	<b>GS2RROF3048R-3</b> [ ]	3,191	4,898	5,388
	30	54	29 1/2	<b>GS2RROF3054R-3</b> [ ]	3,222	4,951	5,447
	36	54	29 1/2	<b>GS2RROF3654R-3</b> [ ]	3,280	4,863	5,350
	36	60	29 1/2	<b>GS2RROF3660R-3</b> [ ]	3,323	4,922	5,415

• Flat brackets ordered separately (model #MDWBRK)

**PRODUCT INFO**

Specify pedestal from user seated position.

Wood tops optional grain.

Laminate tops long grain standard.

 Units shipped as separate packages and require field assembly.

**Grommet Location**  
(Add \$70 per grommet)

No Grommet **GN**  
Left **GL**  
Right **GR**  
Left & Right **GB**

Specify location first, then select grommet color or "Empty Cutout" option. When "Empty Cutout" option is selected, a grommet or power unit must be ordered separately for each cutout.

**TO ORDER PLEASE SPECIFY THE FOLLOWING:**

WOOD TOP, WOOD CHASSIS

1. **MODEL NUMBER + WW**
2. **FSC**
3. **TOP WOOD FINISH + EDGE**
4. **CHASSIS WOOD FINISH**
5. **TOP UV FINISH**
6. **GRAIN DIRECTION**
7. **PULL**
8. **DRAWERS**
9. **GROMMET**
10. **KEYING**

LAM TOP, LAM CHASSIS

1. **MODEL NUMBER + LL**
2. **FSC**
3. **TOP LAM**
4. **CHASSIS LAM**
5. **FRONT LAM**
6. **GRAIN DIRECTION**
7. **EDGE DETAIL**
8. **PULL**
9. **DRAWER**
10. **GROMMET**
11. **KEYING**

# RECTANGULAR RUNOFF

Silea  
05/22

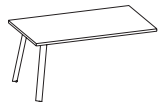

D	W	H	model number + type	laminate	veneer 1	veneer 2
30	48	29 1/2	<b>GS2RRL3048-</b> [ ]	1,290	1,805	1,986
30	54	29 1/2	<b>GS2RRL3054-</b> [ ]	1,369	1,892	2,082
36	54	29 1/2	<b>GS2RRL3654-</b> [ ]	1,425	1,977	2,175
36	60	29 1/2	<b>GS2RRL3660-</b> [ ]	1,444	2,008	2,209

- Flat brackets ordered separately (model #MDWBRK)

## PRODUCT INFO

All tops short grain standard.

 Units shipped as separate packages and require field assembly.

### Grommet Location (Add \$70 per grommet)

No Grommet **GN**  
Left **GL**  
Right **GR**  
Left & Right **GB**

Specify location first, then select grommet color or "Empty Cutout" option. When "Empty Cutout" option is selected, a grommet or power unit must be ordered separately for each cutout.

## TO ORDER PLEASE SPECIFY THE FOLLOWING:

### WOOD TOP

1. **MODEL NUMBER + W**
2. **FSC**
3. **TOP WOOD FINISH + EDGE**
4. **TOP UV FINISH**
5. **HARDWARE COLOR**
6. **GROMMET**

### LAM TOP

1. **MODEL NUMBER + L**
2. **FSC**
3. **TOP LAM**
4. **EDGE DETAIL**
5. **HARDWARE COLOR**
6. **GROMMET**

# LAYERS RECTANGULAR RUNOFF W/ LAYERS BOX

Left and Right Hand

	D	W	H	model number + type	laminata	veneer 1	veneer 2
<b>LEFT HAND</b> 	30	66	29 1/2	<b>GS2RLRL3066L-</b> [ ]	1,855	2,407	2,648
	30	72	29 1/2	<b>GS2RLRL3072L-</b> [ ]	1,909	2,488	2,737
	36	72	29 1/2	<b>GS2RLRL3672L-</b> [ ]	2,018	2,642	2,907
	36	78	29 1/2	<b>GS2RLRL3678L-</b> [ ]	2,098	2,765	3,042

<b>RIGHT HAND</b> 	30	66	29 1/2	<b>GS2RLRL3066R-</b> [ ]	1,855	2,407	2,648
	30	72	29 1/2	<b>GS2RLRL3072R-</b> [ ]	1,909	2,488	2,737
	36	72	29 1/2	<b>GS2RLRL3672R-</b> [ ]	2,018	2,642	2,907
	36	78	29 1/2	<b>GS2RLRL3678R-</b> [ ]	2,098	2,765	3,042

**Layers Box**

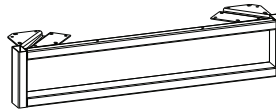

Side view

**PRODUCT INFO**

Specify legs from user seated position.

All tops long grain standard.

 Units shipped as separate packages and require field assembly.

**Grommet Location**  
(Add \$70 per grommet)

No Grommet **GN**  
Left **GL**  
Right **GR**  
Left & Right **GB**

Specify location first, then select grommet color or "Empty Cutout" option. When "Empty Cutout" option is selected, a grommet or power unit must be ordered separately for each cutout.

**TO ORDER PLEASE SPECIFY THE FOLLOWING:**

**WOOD TOP**

1. **MODEL NUMBER + W**
2. **FSC**
3. **TOP WOOD FINISH + EDGE**
4. **TOP UV FINISH**
5. **HARDWARE COLOR (LEG)**
6. **HARDWARE COLOR (LAYERS BOX)**
7. **GROMMET**

**LAM TOP**

1. **MODEL NUMBER + L**
2. **FSC**
3. **TOP LAM**
4. **EDGE DETAIL**
5. **HARDWARE COLOR (LEG)**
6. **HARDWARE COLOR (LAYERS BOX)**
9. **GROMMET**

# LAYERS RECTANGULAR RUNOFF W/ LAPTOP DRAWER

Left and Right Hand

Silea  
05/22

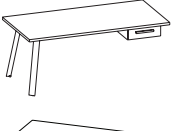
	D	W	H	model number + type	laminate	veneer 1	veneer 2
	30	66	29 1/2	<b>GS2RLRLS3066L-</b> [ ]	2,227	3,193	3,513
	30	72	29 1/2	<b>GS2RLRLS3072L-</b> [ ]	2,280	3,273	3,601
	36	72	29 1/2	<b>GS2RLRLS3672L-</b> [ ]	2,411	3,415	3,757
	36	78	29 1/2	<b>GS2RLRLS3678L-</b> [ ]	2,490	3,537	3,891

## RIGHT HAND

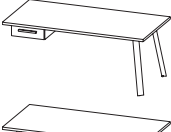
	30	66	29 1/2	<b>GS2RLRLS3066R-</b> [ ]	2,227	3,193	3,513
	30	72	29 1/2	<b>GS2RLRLS3072R-</b> [ ]	2,280	3,273	3,601
	36	72	29 1/2	<b>GS2RLRLS3672R-</b> [ ]	2,411	3,415	3,757
	36	78	29 1/2	<b>GS2RLRLS3678R-</b> [ ]	2,490	3,537	3,891

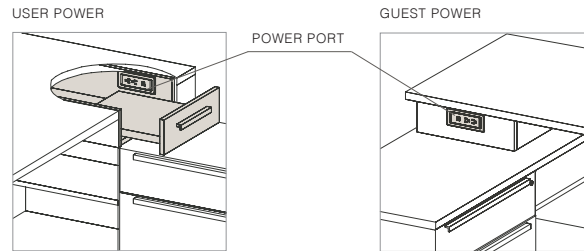

## PRODUCT INFO

Specify legs from user seated position.

All tops long grain standard.

 Units shipped as separate packages and require field assembly.

Power units included  
(2 USB, 2 power)

**Grommet Location**  
(Add \$70 per grommet)

No Grommet **GN**  
Left **GL**  
Right **GR**  
Left & Right **GB**

Specify location first, then select grommet color or "Empty Cutout" option. When "Empty Cutout" option is selected, a grommet or power unit must be ordered separately for each cutout.

## TO ORDER PLEASE SPECIFY THE FOLLOWING:

### WOOD TOP

- MODEL NUMBER + W**
- FSC**
- TOP WOOD FINISH + EDGE**
- CHASSIS WOOD FINISH**
- TOP UV FINISH**
- PULL**
- HARDWARE COLOR**
- GROMMET**
- POWER UNIT**

### LAM TOP

- MODEL NUMBER + L**
- FSC**
- TOP LAM**
- CHASSIS LAM**
- EDGE DETAIL**
- HARDWARE COLOR**
- GROMMET**
- POWER UNIT**

	D	W	H	model number + type	laminata	veneer 1	veneer 2	solid surface
	36	72	29 1/2	<b>GS2TEL3672-</b> [ ]	2,751	3,985	4,384	9,617
	42	84	29 1/2	<b>GS2TEL4284-</b> [ ]	4,010	5,915	6,507	16,171

**PRODUCT INFO**

All tops long grain standard.  
 Units shipped as separate packages and require field assembly.

**TO ORDER PLEASE SPECIFY THE FOLLOWING:**

**WOOD TOP**

1. **MODEL NUMBER + W**
2. **FSC**
3. **TOP WOOD FINISH + EDGE**
4. **TOP UV FINISH**
5. **HARDWARE COLOR**

**LAM TOP**

1. **MODEL NUMBER + L**
2. **FSC**
3. **TOP LAM**
4. **EDGE DETAIL**
5. **HARDWARE COLOR**

**SOLID SURFACE TOP**

1. **MODEL NUMBER + S**
2. **SOLID SURFACE**
3. **EDGE DETAIL**
4. **HARDWARE COLOR**

# LAYERS ELLIPSE RUNOFF W/ LAYERS BOX

Silea  
05/22



D	W	H	model number + type	laminate	veneer 1	veneer 2	solid surface
36	72	29 1/2	<b>GS2RLEL3672-</b> [ ]	2,618	3,852	4,238	10,095
42	84	29 1/2	<b>GS2RLEL4284-</b> [ ]	3,847	5,749	6,324	16,976

## Layers Box

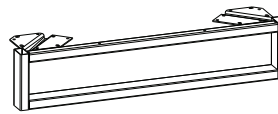

Side view

### PRODUCT INFO

All tops long grain standard.

 Units shipped as separate packages and require field assembly.

### TO ORDER PLEASE SPECIFY THE FOLLOWING:

#### WOOD TOP

1. **MODEL NUMBER + W**
2. **FSC**
3. **TOP WOOD FINISH + EDGE**
4. **TOP UV FINISH**
5. **HARDWARE COLOR (Leg)**
6. **HARDWARE COLOR (Layers Box)**

#### LAM TOP

1. **MODEL NUMBER + L**
2. **FSC**
3. **TOP LAM**
4. **EDGE DETAIL**
5. **HARDWARE COLOR (Leg)**
6. **HARDWARE COLOR (Layers Box)**

#### SOLID SURFACE TOP

1. **MODEL NUMBER + S**
2. **SOLID SURFACE**
3. **EDGE DETAIL**
4. **HARDWARE COLOR (Leg)**
5. **HARDWARE COLOR (Layers Box)**

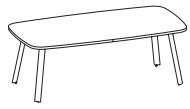

D	W	H	model number + type	laminata	veneer 1	veneer 2	solid surface
36	72	29 1/2	<b>GS2TFL3672-</b> [ ]	2,821	4,055	4,461	9,618
42	84	29 1/2	<b>GS2TFL4284-</b> [ ]	4,013	5,915	6,507	16,171

**PRODUCT INFO**

All tops long grain standard.  
 Units shipped as separate packages and require field assembly.

**TO ORDER PLEASE SPECIFY THE FOLLOWING:**

**WOOD TOP**

1. **MODEL NUMBER + W**
2. **FSC**
3. **TOP WOOD FINISH + EDGE**
4. **TOP UV FINISH**
5. **HARDWARE COLOR**

**LAM TOP**

1. **MODEL NUMBER + L**
2. **FSC**
3. **TOP LAM**
4. **EDGE DETAIL**
5. **HARDWARE COLOR**

**SOLID SURFACE TOP**

1. **MODEL NUMBER + S**
2. **SOLID SURFACE**
3. **EDGE DETAIL**
4. **HARDWARE COLOR**

# LAYERS ARC BOAT RUNOFF W/LAYERS BOX

Silea  
05/22

	D	W	H	model number + type	laminata	veneer 1	veneer 2	solid surface
	36	72	29 1/2	<b>GS2RLFL3672-</b> [ ]	2,618	3,852	4,238	10,095
	42	84	29 1/2	<b>GS2RLFL4284-</b> [ ]	3,847	5,749	6,324	16,976

Layers Box

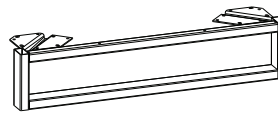

Side view

## PRODUCT INFO

All tops long grain standard

 Units shipped as separate packages and require field assembly.

## TO ORDER PLEASE SPECIFY THE FOLLOWING:

### WOOD TOP

1. MODEL NUMBER + W
2. FSC
3. TOP WOOD FINISH + EDGE
4. TOP UV FINISH
5. HARDWARE COLOR (Leg)
6. HARDWARE COLOR (Layers Box)

### LAM TOP

1. MODEL NUMBER + L
2. FSC
3. TOP LAM
4. EDGE DETAIL
5. HARDWARE COLOR (Leg)
6. HARDWARE COLOR (Layers Box)

### SOLID SURFACE TOP

1. MODEL NUMBER + S
2. SOLID SURFACE
3. EDGE DETAIL
4. HARDWARE COLOR (Leg)
5. HARDWARE COLOR (Layers Box)



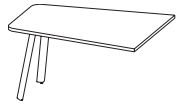

D	W	H	model number + type	laminare	veneer 1	veneer 2
42	54	29 1/2	<b>GS2RSL304254-</b> [ ]	1,857	2,683	2,952
48	66	29 1/2	<b>GS2RSL364866-</b> [ ]	2,023	2,823	3,106

• Flat brackets ordered separately (model #MDWBRK)

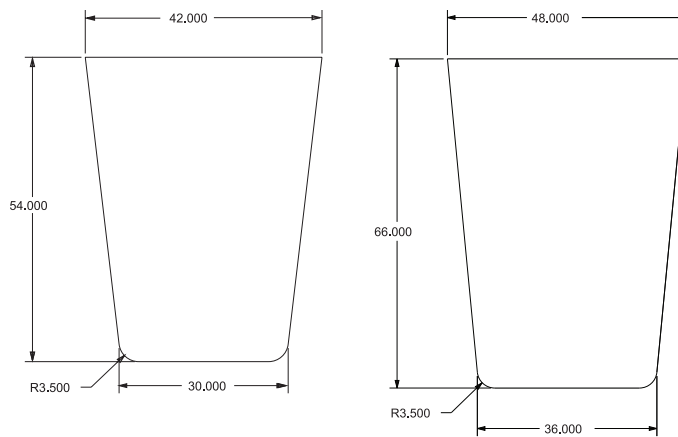

**PRODUCT INFO**

All tops short grain standard.  
 Units shipped as separate packages and require field assembly.

**TO ORDER PLEASE SPECIFY THE FOLLOWING:**

**WOOD TOP**

1. **MODEL NUMBER + W**
2. **FSC**
3. **TOP WOOD FINISH + EDGE**
4. **TOP UV FINISH**
5. **HARDWARE COLOR**

**LAM TOP**

1. **MODEL NUMBER + L**
2. **FSC**
3. **TOP LAM**
4. **EDGE DETAIL**
5. **HARDWARE COLOR**

# LAYERS SIGHTLINE RUNOFF W/ LAYERS BOX

Silea  
05/22

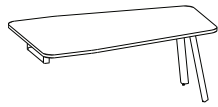

D	W	H	model number + type	laminata	veneer 1	veneer 2	solid surface
36	72	29 1/2	<b>GS2RLSL304272-</b> [ ]	2,897	4,181	4,600	10,095
42	84	29 1/2	<b>GS2RLSL364884-</b> [ ]	4,295	6,206	6,827	16,978

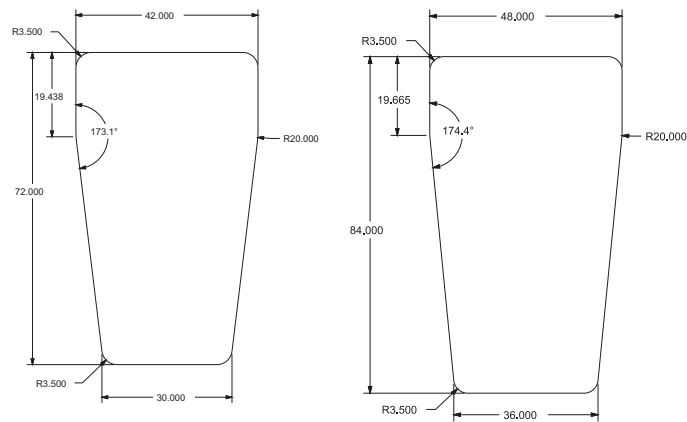

Layers Box

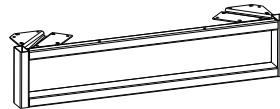

Side view

## PRODUCT INFO

All tops long grain standard.

 Units shipped as separate packages and require field assembly.

## TO ORDER PLEASE SPECIFY THE FOLLOWING:

### WOOD TOP

1. MODEL NUMBER + W
2. FSC
3. TOP WOOD FINISH + EDGE
4. TOP UV FINISH
5. HARDWARE COLOR (Leg)
6. HARDWARE COLOR (Layers Box)

### LAM TOP

1. MODEL NUMBER + L
2. FSC
3. TOP LAM
4. EDGE DETAIL
5. HARDWARE COLOR (Leg)
6. HARDWARE COLOR (Layers Box)

### SOLID SURFACE TOP

1. MODEL NUMBER + S
2. SOLID SURFACE
3. EDGE DETAIL
4. HARDWARE COLOR (Leg)
5. HARDWARE COLOR (Layers Box)

# LAYERS SIGHTLINE RUNOFF W/ LAPTOP DRAWER

Left and Right Hand

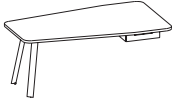
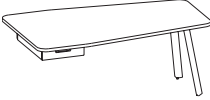
	D	W	H	model number + type	laminate	veneer 1	veneer 2
<b>LEFT HAND</b> 	42	72	29 1/2	<b>GS2RLSLS304272L-</b> [ ]	3,195	4,893	5,383
	48	84	29 1/2	<b>GS2RLSLS364884L-</b> [ ]	4,682	6,973	7,671
<b>RIGHT HAND</b> 	42	72	29 1/2	<b>GS2RLSLS304272R-</b> [ ]	3,195	4,893	5,383
	48	84	29 1/2	<b>GS2RLSLS364884R-</b> [ ]	4,682	6,973	7,671

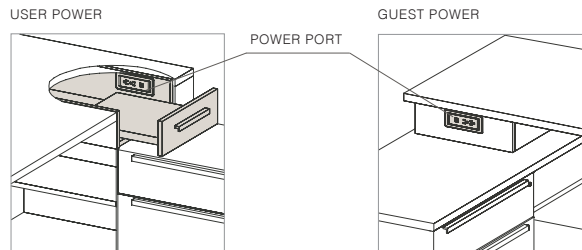

## PRODUCT INFO

Specify legs from user seated position.

All tops long grain standard.

 Units shipped as separate packages and require field assembly.

Power units included (2 USB, 2 power)

## TO ORDER PLEASE SPECIFY THE FOLLOWING:

WOOD TOP, WOOD CHASSIS

1. **MODEL NUMBER + W**
2. **FSC**
3. **TOP WOOD FINISH + EDGE**
4. **CHASSIS WOOD FINISH**
5. **TOP UV FINISH**
6. **PULL**
7. **HARDWARE COLOR**
8. **POWER UNIT**

LAM TOP, LAM CHASSIS

1. **MODEL NUMBER + L**
2. **FSC**
3. **TOP LAM**
4. **CHASSIS LAM**
5. **EDGE DETAIL**
6. **PULL**
7. **HARDWARE COLOR**
8. **POWER UNIT**

# LAYERS COCKPIT RUNOFF W/ LAYERS BOX

Left and Right Hand

Silea  
05/22

	D	W	H	model number + type	laminata	veneer 1	veneer 2	solid surface
<b>LEFT HAND</b> 	60	72	29 1/2	<b>GS2RLC6072L-</b> [ ]	3,735	4,334	4,768	11,294
	60	84	29 1/2	<b>GS2RLC6084L-</b> [ ]	5,204	6,460	7,106	18,520

<b>RIGHT HAND</b> 	60	72	29 1/2	<b>GS2RLC6072R-</b> [ ]	3,735	4,334	4,768	11,294
	60	84	29 1/2	<b>GS2RLC6084R-</b> [ ]	5,204	6,460	7,106	18,520

• All tops are 1 piece.

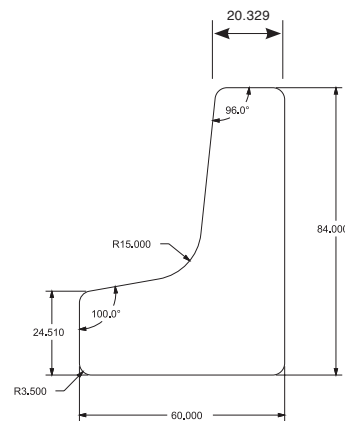
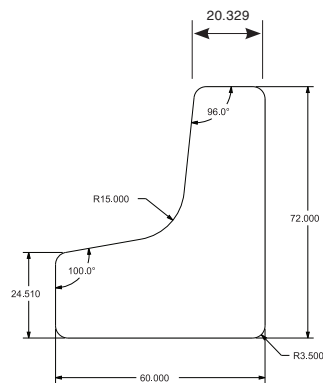

### Layers Box

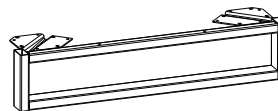

Side view

### PRODUCT INFO

Specify legs from user seated position.

All tops long grain standard.

 Units shipped as separate packages and require field assembly.

### TO ORDER PLEASE SPECIFY THE FOLLOWING:

#### WOOD TOP

1. MODEL NUMBER + W
2. FSC
3. TOP WOOD FINISH + EDGE
4. TOP UV FINISH\*
5. HARDWARE COLOR

#### LAM TOP

1. MODEL NUMBER + L
2. FSC
3. TOP LAM
4. EDGE DETAIL
5. HARDWARE COLOR

#### SOLID SURFACE TOP

1. MODEL NUMBER + S
2. SOLID SURFACE
3. EDGE DETAIL
4. HARDWARE COLOR

• Only available in  
**OP** open pore top  
UV finish option



D	W	H	model number + type	laminated	veneer 1	veneer 2
60	60	29 1/2	<b>GS2XML366060-</b> [ ]	3,609	4,935	5,429
72	60	29 1/2	<b>GS2XML487260-</b> [ ]	4,550	6,294	6,924

**NOTE: UNIT MUST BE WALL MOUNTED**

- Wood tops are 2 piece on both models (seam shown in drawing below)

- Laminate and solid surface tops are 1 piece.

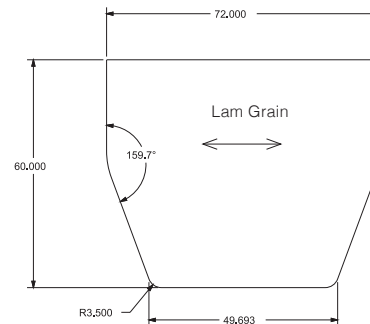
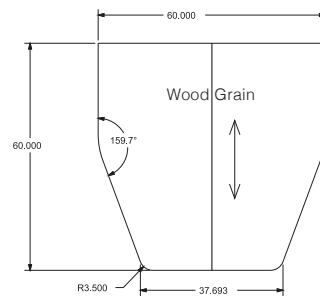

Arrows indicate grain direction.

**PRODUCT INFO**

All tops long grain standard.  
Units shipped as separate packages and require field assembly.

**Grommet Location**  
(Add \$70 per grommet)

- No Grommet **GN**
- Left **GL**
- Right **GR**
- Left & Right **GB**

Specify location first, then select grommet color or "Empty Cutout" option. When "Empty Cutout" option is selected, a grommet or power unit must be ordered separately for each cutout.

**TO ORDER PLEASE SPECIFY THE FOLLOWING:**

WOOD TOP, WOOD CHASSIS

1. **MODEL NUMBER + WW**
2. **FSC**
3. **TOP WOOD FINISH + EDGE**
4. **CHASSIS WOOD FINISH**
5. **TOP UV FINISH**
6. **HARDWARE COLOR**
7. **GROMMET**

LAM TOP, LAM CHASSIS

1. **MODEL NUMBER + LL**
2. **FSC**
3. **TOP LAM**
4. **CHASSIS LAM**
5. **EDGE DETAIL**
6. **HARDWARE COLOR**
7. **GROMMET**



Height Adjustable . . . . . 81-125

- Height Adjustable Split-Top Desks . . . . . 82-85
- Freestanding Desk / Extension . . . . . 86-91
- Credenza . . . . . 92-95
- Bridge . . . . . 96-97
- Return . . . . . 98-101
- L Shape Height Adjustable Spec Tips. . . . . 102
- L Shape Height Adjustable . . . . . 103-118
- Shroud for T-Base . . . . . 119
- Layers Bookcase . . . . . 120
- Height Adjustable Base . . . . . 121
- Height Adjustable Tops . . . . . 122
- Wall Mount Cantilever Bracket . . . . . 123
- Mixed Material Telescoping Height Adjustable . . . . . 124
- Replacement Height Adjustable Keypads . . . . . 125

# HEIGHT ADJUSTABLE SPLIT-TOP DESKS

## Left Hand Desk

Silea

05/22

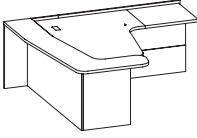
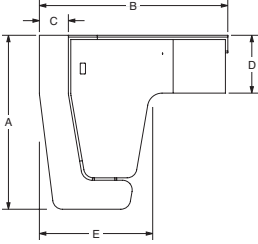
	D	W	H	model number + type	laminata	veneer 1	veneer 2
<b>LEFT HAND DESK</b>	72	78	29 1/2	<b>GS3STAT7278L-</b> [ ]	12,525	17,727	19,500
	A = 72" wide desk B = 78" wide total workwall C = 12" fixed guest overhang D = 24" return depth E = 48" depth total sightline top						
	72	84	29 1/2	<b>GS3STAT7284L-</b> [ ]	12,826	18,198	20,018
	A = 72" wide desk B = 84" wide total workwall C = 12" fixed guest overhang D = 24" return depth E = 48" depth total sightline top						
	78	90	29 1/2	<b>GS3STAT7890L-</b> [ ]	13,086	18,604	20,465
	A = 78" wide desk B = 90" wide total workwall C = 18" fixed guest overhang D = 24" return depth E = 54" depth total sightline top						
	78	96	29 1/2	<b>GS3STAT7896L-</b> [ ]	13,454	19,180	21,098
	A = 78" wide desk B = 96" wide total workwall C = 18" fixed guest overhang D = 24" return depth E = 54" depth total sightline top						

### PRODUCT INFO

#### Unit must be wall mounted.

Metal shroud modesty panel raises up and down with height adjustable top.

29.5" to 42.5" height adjustment range.

 All units shipped as separate packages and require field assembly.

#### Grommet Location

(Add \$70 per grommet)

No Grommet **GN**  
Center **GC**

Specify location first, then select grommet color or "Empty Cutout" option. When "Empty Cutout" option is selected, a grommet or power unit must be ordered separately for each cutout.

### TO ORDER PLEASE SPECIFY THE FOLLOWING:

WOOD TOP, WOOD CHASSIS

LAM TOP, LAM CHASSIS

- |                                       |                                       |
|---------------------------------------|---------------------------------------|
| <b>1. MODEL NUMBER + WW</b>           | <b>1. MODEL NUMBER + LL</b>           |
| <b>2. FSC</b>                         | <b>2. FSC</b>                         |
| <b>3. TOP WOOD FINISH + EDGE</b>      | <b>3. TOP LAM</b>                     |
| <b>4. CHASSIS WOOD FINISH</b>         | <b>4. CHASSIS LAM</b>                 |
| <b>5. TOP UV FINISH</b>               | <b>5. EDGE DETAIL</b>                 |
| <b>6. HARDWARE COLOR</b>              | <b>6. HARDWARE COLOR</b>              |
| <b>7. HAT KEYPAD &amp; BASE COLOR</b> | <b>7. HAT KEYPAD &amp; BASE COLOR</b> |
| <b>8. GROMMET</b>                     | <b>8. GROMMET</b>                     |

Optional height adjustable keypads available

#### HAT KEYPAD & BASE COLOR

Basic Up/Down Keypad, Black P71 Column

Memory Preset Keypad, Black P71 Column

Paddle Keypad, Black P71 Column

Foot Control Keypad, Black P71 Column

**UDP71**

**MEMP71**

**PDLP71**

**FPDP71** Add \$240



NOTE: Foot control keypad is bluetooth controlled and may be used in conjunction with other keypads attached to worksurface.

For these situations order standard keypad for worksurface separately.

Foot control requires qty (2) AAA batteries needed. Batteries not included.

**NOTE:** Wood Tops only available with Square SQ Edge Detail option. Edge Details SQM, DFM, and TOM with 1/2" band are NOT available.

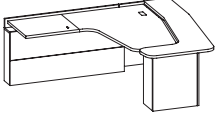
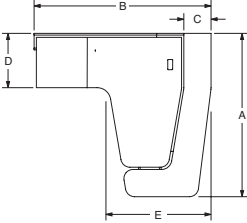
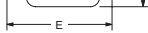

	D	W	H	model number + type	laminata	veneera 1	veneera 2
<b>RIGHT HAND DESK</b> 	72	78	29 1/2	<b>GS3STAT7278R-</b> [ ]	12,525	17,727	19,500
	A = 72" wide desk B = 78" wide total workwall C = 12" fixed guest overhang D = 24" return depth E = 48" depth total sightline top						
	72	84	29 1/2	<b>GS3STAT7284R-</b> [ ]	12,826	18,198	20,018
	A = 72" wide desk B = 84" wide total workwall C = 12" fixed guest overhang D = 24" return depth E = 48" depth total sightline top						
	78	90	29 1/2	<b>GS3STAT7890R-</b> [ ]	13,086	18,604	20,465
	A = 78" wide desk B = 90" wide total workwall C = 18" fixed guest overhang D = 24" return depth E = 54" depth total sightline top						
	78	96	29 1/2	<b>GS3STAT7896R-</b> [ ]	13,454	19,180	21,098
	A = 78" wide desk B = 96" wide total workwall C = 18" fixed guest overhang D = 24" return depth E = 54" depth total sightline top						

**PRODUCT INFO**

**Unit must be wall mounted.**

Metal shroud modesty panel raises up and down with height adjustable top.

29.5" to 42.5" height adjustment range.

 All units shipped as separate packages and require field assembly.

**Grommet Location**

(Add \$70 per grommet)

No Grommet **GN**  
Center **GC**

Specify location first, then select grommet color or "Empty Cutout" option. When "Empty Cutout" option is selected, a grommet or power unit must be ordered separately for each cutout.

**TO ORDER PLEASE SPECIFY THE FOLLOWING:**

WOOD TOP, WOOD CHASSIS

LAM TOP, LAM CHASSIS

- |                                       |                                       |
|---------------------------------------|---------------------------------------|
| <b>1. MODEL NUMBER + WW</b>           | <b>1. MODEL NUMBER + LL</b>           |
| <b>2. FSC</b>                         | <b>2. FSC</b>                         |
| <b>3. TOP WOOD FINISH + EDGE</b>      | <b>3. TOP LAM</b>                     |
| <b>4. CHASSIS WOOD FINISH</b>         | <b>4. CHASSIS LAM</b>                 |
| <b>5. TOP UV FINISH</b>               | <b>5. EDGE DETAIL</b>                 |
| <b>6. HARDWARE COLOR</b>              | <b>6. HARDWARE COLOR</b>              |
| <b>7. HAT KEYPAD &amp; BASE COLOR</b> | <b>7. HAT KEYPAD &amp; BASE COLOR</b> |
| <b>8. GROMMET</b>                     | <b>8. GROMMET</b>                     |

Optional height adjustable keypads available

**HAT KEYPAD & BASE COLOR**

Basic Up/Down Keypad, Black P71 Column  
 Memory Preset Keypad, Black P71 Column  
 Paddle Keypad, Black P71 Column  
 Foot Control Keypad, Black P71 Column

**UDP71**  
**MEMP71**  
**PDLP71**  
**FPDP71** Add \$240

NOTE: Foot control keypad is bluetooth controlled and may be used in conjunction with other keypads attached to worksurface. For these situations order standard keypad for worksurface separately. Foot control requires qty (2) AAA batteries needed. Batteries not included.

**NOTE:** Wood Tops only available with Square SQ Edge Detail option. Edge Details SQM, DFM, and TOM with 1/2" band are NOT available.

# HEIGHT ADJUSTABLE SPLIT-TOP DESKS

Left Hand Desk, Return With Pedestal

Silea

05/22

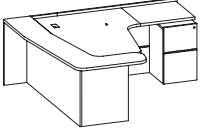
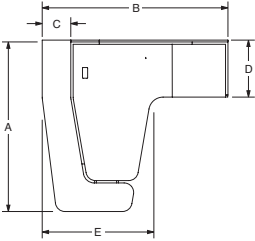
	D	W	H	model number + type	laminates	veneer 1	veneer 2
<b>LEFT HAND DESK RETURN WITH PEDESTAL</b>	72	78	29 1/2	<b>GS3STAT7278L-A</b> [ ]	13,889	20,027	22,030
	A = 72" wide desk B = 78" wide total workwall C = 12" fixed guest overhang D = 24" return depth E = 48" depth total sightline top Note: Return includes 15" wide Accessory/Box/File pedestal						
	72	84	29 1/2	<b>GS3STAT7284L-A</b> [ ]	14,194	20,499	22,549
	A = 72" wide desk B = 84" wide total workwall C = 12" fixed guest overhang D = 24" return depth E = 48" depth total sightline top Note: Return includes 15" wide Accessory/Box/File pedestal						
	78	90	29 1/2	<b>GS3STAT7890L-A</b> [ ]	14,454	20,905	22,996
	A = 78" wide desk B = 90" wide total workwall C = 18" fixed guest overhang D = 24" return depth E = 54" depth total sightline top Note: Return includes 15" wide Accessory/Box/File pedestal						
	78	96	29 1/2	<b>GS3STAT7896L-A</b> [ ]	14,821	21,480	23,628
	A = 78" wide desk B = 96" wide total workwall C = 18" fixed guest overhang D = 24" return depth E = 54" depth total sightline top Note: Return includes 15" wide Accessory/Box/File pedestal						

## PRODUCT INFO

### Unit must be wall mounted.

Metal shroud modesty panel raises up and down with height adjustable top.

29.5" to 42.5" height adjustment range.

 All units shipped as separate packages and require field assembly.

### Grommet Location (Add \$70 per grommet)

No Grommet **GN**  
Center **GC**

Specify location first, then select grommet color or "Empty Cutout" option. When "Empty Cutout" option is selected, a grommet or power unit must be ordered separately for each cutout.

## TO ORDER PLEASE SPECIFY THE FOLLOWING:

WOOD TOP, WOOD CHASSIS

LAM TOP, LAM CHASSIS

- |                                       |                                       |
|---------------------------------------|---------------------------------------|
| 1. <b>MODEL NUMBER + WW</b>           | 1. <b>MODEL NUMBER + LL</b>           |
| 2. <b>FSC</b>                         | 2. <b>FSC</b>                         |
| 3. <b>TOP WOOD FINISH + EDGE</b>      | 3. <b>TOP LAM</b>                     |
| 4. <b>CHASSIS WOOD FINISH</b>         | 4. <b>CHASSIS LAM</b>                 |
| 5. <b>TOP UV FINISH</b>               | 5. <b>FRONT LAM</b>                   |
| 6. <b>PULL</b>                        | 6. <b>EDGE DETAIL</b>                 |
| 7. <b>HARDWARE COLOR</b>              | 7. <b>PULL</b>                        |
| 8. <b>HAT KEYPAD &amp; BASE COLOR</b> | 8. <b>HARDWARE COLOR</b>              |
| 9. <b>GROMMET</b>                     | 9. <b>HAT KEYPAD &amp; BASE COLOR</b> |
| 10. <b>KEYING</b>                     | 10. <b>GROMMET</b>                    |
|                                       | 11. <b>KEYING</b>                     |

Optional height adjustable keypads available

### HAT KEYPAD & BASE COLOR

Basic Up/Down Keypad, Black P71 Column	<b>UDP71</b>
Memory Preset Keypad, Black P71 Column	<b>MEMP71</b>
Paddle Keypad, Black P71 Column	<b>PDLP71</b>
Foot Control Keypad, Black P71 Column	<b>FPDP71</b> Add \$240

NOTE: Foot control keypad is bluetooth controlled and may be used in conjunction with other keypads attached to worksurface. For these situations order standard keypad for worksurface separately. Foot control requires qty (2) AAA batteries needed. Batteries not included.

**NOTE:** Wood Tops only available with Square SQ Edge Detail option. Edge Details SQM, DFM, and TOM with 1/2" band are NOT available.

# HEIGHT ADJUSTABLE SPLIT-TOP DESKS

Right Hand Desk, Return With Pedestal

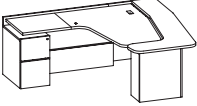
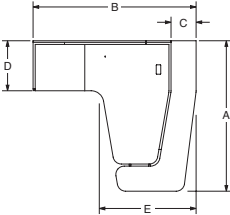
	D	W	H	model number + type	laminiate	veneer 1	veneer 2
<b>RIGHT HAND DESK RETURN WITH PEDESTAL</b>	72	78	29 1/2	<b>GS3STAT7278R-A</b> [ ]	13,889	20,027	22,030
	A = 72" wide desk B = 78" wide total workwall C = 12" fixed guest overhang D = 24" return depth E = 48" depth total sightline top Note: Return includes 15" wide Accessory/Box/File pedestal						
	72	84	29 1/2	<b>GS3STAT7284R-A</b> [ ]	14,194	20,499	22,549
	A = 72" wide desk B = 84" wide total workwall C = 12" fixed guest overhang D = 24" return depth E = 48" depth total sightline top Note: Return includes 15" wide Accessory/Box/File pedestal						
	78	90	29 1/2	<b>GS3STAT7890R-A</b> [ ]	14,454	20,905	22,996
	A = 78" wide desk B = 90" wide total workwall C = 18" fixed guest overhang D = 24" return depth E = 54" depth total sightline top Note: Return includes 15" wide Accessory/Box/File pedestal						
	78	96	29 1/2	<b>GS3STAT7896R-A</b> [ ]	14,821	21,480	23,628
	A = 78" wide desk B = 96" wide total workwall C = 18" fixed guest overhang D = 24" return depth E = 54" depth total sightline top Note: Return includes 15" wide Accessory/Box/File pedestal						

## PRODUCT INFO

### Unit must be wall mounted.

Metal shroud modesty panel raises up and down with height adjustable top.

29.5" to 42.5" height adjustment range.

 All units shipped as separate packages and require field assembly.

### Grommet Location (Add \$70 per grommet)

No Grommet **GN**  
Center **GC**

Specify location first, then select grommet color or "Empty Cutout" option. When "Empty Cutout" option is selected, a grommet or power unit must be ordered separately for each cutout.

## TO ORDER PLEASE SPECIFY THE FOLLOWING:

WOOD TOP, WOOD CHASSIS

LAM TOP, LAM CHASSIS

- |                                       |                                       |
|---------------------------------------|---------------------------------------|
| 1. <b>MODEL NUMBER + WW</b>           | 1. <b>MODEL NUMBER + LL</b>           |
| 2. <b>FSC</b>                         | 2. <b>FSC</b>                         |
| 3. <b>TOP WOOD FINISH + EDGE</b>      | 3. <b>TOP LAM</b>                     |
| 4. <b>CHASSIS WOOD FINISH</b>         | 4. <b>CHASSIS LAM</b>                 |
| 5. <b>TOP UV FINISH</b>               | 5. <b>FRONT LAM</b>                   |
| 6. <b>PULL</b>                        | 6. <b>EDGE DETAIL</b>                 |
| 7. <b>HARDWARE COLOR</b>              | 7. <b>PULL</b>                        |
| 8. <b>HAT KEYPAD &amp; BASE COLOR</b> | 8. <b>HARDWARE COLOR</b>              |
| 9. <b>GROMMET</b>                     | 9. <b>HAT KEYPAD &amp; BASE COLOR</b> |
| 10. <b>KEYING</b>                     | 10. <b>GROMMET</b>                    |
|                                       | 11. <b>KEYING</b>                     |

Optional height adjustable keypads available

### HAT KEYPAD & BASE COLOR

Basic Up/Down Keypad, Black P71 Column	<b>UDP71</b>
Memory Preset Keypad, Black P71 Column	<b>MEMP71</b>
Paddle Keypad, Black P71 Column	<b>PDLP71</b>
Foot Control Keypad, Black P71 Column	<b>FPDP71</b> Add \$240

NOTE: Foot control keypad is bluetooth controlled and may be used in conjunction with other keypads attached to worksurface. For these situations order standard keypad for worksurface separately. Foot control requires qty (2) AAA batteries needed. Batteries not included.



**NOTE:** Wood Tops only available with Square SQ Edge Detail option. Edge Details SQM, DFM, and TOM with 1/2" band are NOT available.

# HEIGHT ADJUSTABLE FREESTANDING DESK

Full Modesty

Silea

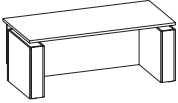
05/22

	D	W	H	model number + type	laminate	veneer 1	veneer 2
	30	66	29 1/2	<b>GS3DFAK3066-</b> [ ]	5,586	10,471	11,519
	30	72	29 1/2	<b>GS3DFAK3072-</b> [ ]	5,676	10,684	11,753
	36	72	29 1/2	<b>GS3DFAK3672-</b> [ ]	5,971	10,902	11,993
	36	78	29 1/2	<b>GS3DFAK3678-</b> [ ]	6,086	11,119	12,231

- Provides sit to stand electric height adjustment
- 29.5" to 42.5" height adjustment range

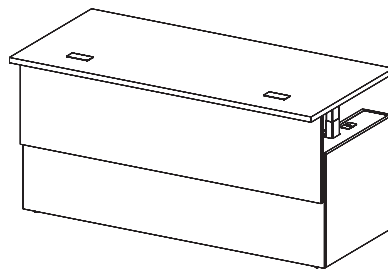

## PRODUCT INFO

All tops long grain standard.  
Wood models ship assembled.  
 Laminate units shipped as separate packages and require field assembly.

### Grommet Location (Add \$70 per grommet)

No Grommet **GN**  
Left **GL**  
Right **GR**  
Left & Right **GB**

Specify location first, then select grommet color or "Empty Cutout" option. When "Empty Cutout" option is selected, a grommet or power unit must be ordered separately for each cutout.

## TO ORDER PLEASE SPECIFY THE FOLLOWING:

### WOOD TOP, WOOD CHASSIS

- MODEL NUMBER + WW**
- FSC**
- TOP WOOD FINISH + EDGE**
- CHASSIS WOOD FINISH**
- TOP UV FINISH**
- HAT KEYPAD & BASE COLOR**
- GROMMET**

### LAM TOP, LAM CHASSIS

- MODEL NUMBER + LL**
- FSC**
- TOP LAM**
- CHASSIS LAM**
- EDGE DETAIL**
- HAT KEYPAD & BASE COLOR**
- GROMMET**

Optional height adjustable keypads available

### HAT KEYPAD & BASE COLOR

Basic Up/Down Keypad, Black P71 Column  
Memory Preset Keypad, Black P71 Column  
Paddle Keypad, Black P71 Column  
Foot Control Keypad, Black P71 Column

**UDP71**  
**MEMP71**  
**PDLP71**  
**FPDP71** Add \$240

NOTE: Foot control keypad is bluetooth controlled and may be used in conjunction with other keypads attached to worksurface. For these situations order standard keypad for worksurface separately. Foot control requires qty (2) AAA batteries needed. Batteries not included.

# HEIGHT ADJUSTABLE EXTENSION DESK

Full Modesty | Left and Right Hand

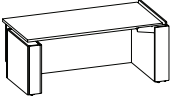
	D	W	H	model number + type	laminata	vener 1	vener 2
<b>LEFT HAND</b> 	30	66	29 1/2	<b>GS3XFAK3066L-</b> [ ]	5,944	10,471	11,519
	30	72	29 1/2	<b>GS3XFAK3072L-</b> [ ]	6,034	10,684	11,753
	36	72	29 1/2	<b>GS3XFAK3672L-</b> [ ]	6,291	10,902	11,993
	36	78	29 1/2	<b>GS3XFAK3678L-</b> [ ]	6,406	11,119	12,231

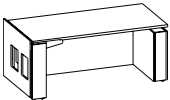
<b>RIGHT HAND</b> 	30	66	29 1/2	<b>GS3XFAK3066R-</b> [ ]	5,944	10,471	11,519
	30	72	29 1/2	<b>GS3XFAK3072R-</b> [ ]	6,034	10,684	11,753
	36	72	29 1/2	<b>GS3XFAK3672R-</b> [ ]	6,291	10,902	11,993
	36	78	29 1/2	<b>GS3XFAK3678R-</b> [ ]	6,406	11,119	12,231

- Provides sit to stand electric height adjustment
- 29.5" to 42.5" height adjustment range
- Cantilever extends 3" to support adjoining worksurface

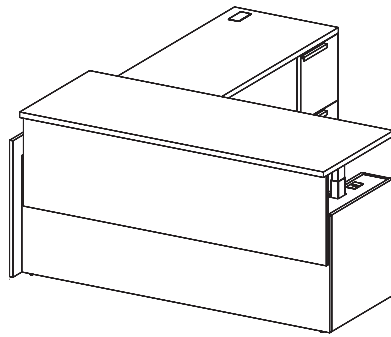

NOTE: If attaching to a return or bridge, a 3" shorter modesty or wall access panel must be used.

## PRODUCT INFO

Specify base from user seated position.

All tops long grain standard.

Wood models ship assembled.

 Laminata units shipped as separate packages and require field assembly.

**Grommet Location**  
(Add \$70 per grommet)

No Grommet **GN**  
Left **GL**  
Right **GR**  
Left & Right **GB**

Specify location first, then select grommet color or "Empty Cutout" option. When "Empty Cutout" option is selected, a grommet or power unit must be ordered separately for each cutout.

## TO ORDER PLEASE SPECIFY THE FOLLOWING:

WOOD TOP, WOOD CHASSIS

1. **MODEL NUMBER + WW**
2. **FSC**
3. **TOP WOOD FINISH + EDGE**
4. **CHASSIS WOOD FINISH**
5. **TOP UV FINISH**
6. **HAT KEYPAD & BASE COLOR**
7. **GROMMET**

LAM TOP, LAM CHASSIS

1. **MODEL NUMBER + LL**
2. **FSC**
3. **TOP LAM**
4. **CHASSIS LAM**
5. **EDGE DETAIL**
6. **HAT KEYPAD & BASE COLOR**
7. **GROMMET**

Optional height adjustable keypads available

### HAT KEYPAD & BASE COLOR

Basic Up/Down Keypad, Black P71 Column	<b>UDP71</b>
Memory Preset Keypad, Black P71 Column	<b>MEMP71</b>
Paddle Keypad, Black P71 Column	<b>PDLP71</b>
Foot Control Keypad, Black P71 Column	<b>FPDP71</b> Add \$240

NOTE: Foot control keypad is bluetooth controlled and may be used in conjunction with other keypads attached to worksurface. For these situations order standard keypad for worksurface separately. Foot control requires qty (2) AAA batteries needed. Batteries not included.

# HEIGHT ADJUSTABLE EXTENSION DESK

Full Modesty | Left and Right Hand, with Pedestal

Silea

05/22

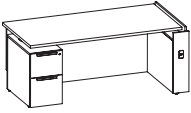
	D	W	H	model number + type	laminate	veneer 1	veneer 2
<b>LEFT HAND</b> 	30	66	29 1/2	<b>GS3XFAK3066L-A</b> [ ]	6,498	11,516	12,668
	30	72	29 1/2	<b>GS3XFAK3072L-A</b> [ ]	6,588	11,752	12,928
	36	72	29 1/2	<b>GS3XFAK3672L-A</b> [ ]	6,817	11,991	13,191
	36	78	29 1/2	<b>GS3XFAK3678L-A</b> [ ]	6,932	12,232	13,456

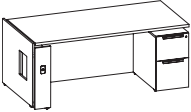
<b>RIGHT HAND</b> 	30	66	29 1/2	<b>GS3XFAK3066R-A</b> [ ]	6,498	11,516	12,668
	30	72	29 1/2	<b>GS3XFAK3072R-A</b> [ ]	6,588	11,752	12,928
	36	72	29 1/2	<b>GS3XFAK3672R-A</b> [ ]	6,817	11,991	13,191
	36	78	29 1/2	<b>GS3XFAK3678R-A</b> [ ]	6,932	12,232	13,456

- Provides sit to stand electric height adjustment
- 29.5" to 42.5" height adjustment range
- Cantilever extends 3" to support adjoining worksurface

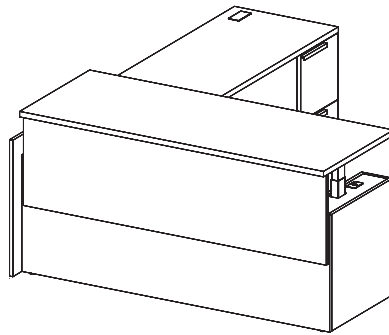

NOTE: If attaching to a return or bridge, a 3" shorter modesty or wall access panel must be used.

## PRODUCT INFO

Specify pedestal from user seated position.

All tops long grain standard.

Wood models ship assembled.

 Laminate units shipped as separate packages and require field assembly.

### Grommet Location (Add \$70 per grommet)

No Grommet **GN**  
 Left **GL**  
 Right **GR**  
 Left & Right **GB**

Specify location first, then select grommet color or "Empty Cutout" option. When "Empty Cutout" option is selected, a grommet or power unit must be ordered separately for each cutout.

## TO ORDER PLEASE SPECIFY THE FOLLOWING:

### WOOD TOP, WOOD CHASSIS

1. MODEL NUMBER + WW
2. FSC
3. TOP WOOD FINISH + EDGE
4. CHASSIS WOOD FINISH
5. TOP UV FINISH
6. PULL
7. HAT KEYPAD & BASE COLOR
8. GROMMET
9. KEYING

### LAM TOP, LAM CHASSIS

1. MODEL NUMBER + LL
2. FSC
3. TOP LAM
4. CHASSIS LAM
5. FRONT LAM
6. EDGE DETAIL
7. PULL
8. HAT KEYPAD & BASE COLOR
9. GROMMET
10. KEYING

Optional height adjustable keypads available

### HAT KEYPAD & BASE COLOR

Basic Up/Down Keypad, Black P71 Column  
 Memory Preset Keypad, Black P71 Column  
 Paddle Keypad, Black P71 Column  
 =Foot Control Keypad, Black P71 Column

**UDP71**  
**MEMP71**  
**PDLP71**  
**FPDP71** Add \$240

NOTE: Foot control keypad is bluetooth controlled and may be used in conjunction with other keypads attached to worksurface. For these situations order standard keypad for worksurface separately. Foot control requires qty (2) AAA batteries needed. Batteries not included.

	D	W	H	model number + type	laminata	veneer 1	veneer 2
<b>LEFT HAND</b> 	30	66	29 1/2	<b>GS3XMAK3066L-</b> <input type="checkbox"/>	6,264	9,924	10,917
	30	72	29 1/2	<b>GS3XMAK3072L-</b> <input type="checkbox"/>	6,317	10,064	11,071
	36	72	29 1/2	<b>GS3XMAK3672L-</b> <input type="checkbox"/>	6,574	10,288	11,317
	36	78	29 1/2	<b>GS3XMAK3678L-</b> <input type="checkbox"/>	6,653	10,473	11,521

<b>RIGHT HAND</b> 	30	66	29 1/2	<b>GS3XMAK3066R-</b> <input type="checkbox"/>	6,264	9,924	10,917
	30	72	29 1/2	<b>GS3XMAK3072R-</b> <input type="checkbox"/>	6,317	10,064	11,071
	36	72	29 1/2	<b>GS3XMAK3672R-</b> <input type="checkbox"/>	6,574	10,288	11,317
	36	78	29 1/2	<b>GS3XMAK3678R-</b> <input type="checkbox"/>	6,653	10,473	11,521

- Provides sit to stand electric height adjustment
- 29.5" to 42.5" height adjustment range
- Cantilever extends 3" to support adjoining worksurface

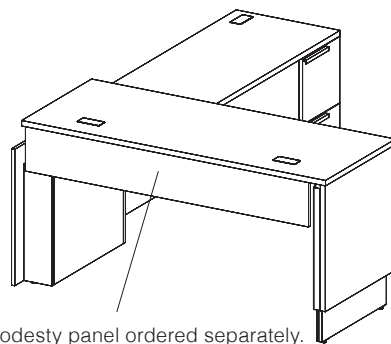

Modesty panel ordered separately.

NOTE: If attaching to a return or bridge, a 3" shorter modesty or wall access panel must be used.

## PRODUCT INFO

Specify base from user seated position.

All tops long grain standard.

Wood models ship assembled.

 Laminata units shipped as separate packages and require field assembly.

Modesty panel ordered separately.

### Grommet Location

(Add \$70 per grommet)

No Grommet **GN**  
Left **GL**  
Right **GR**  
Left & Right **GB**

Specify location first, then select grommet color or "Empty Cutout" option. When "Empty Cutout" option is selected, a grommet or power unit must be ordered separately for each cutout.

## TO ORDER PLEASE SPECIFY THE FOLLOWING:

### WOOD TOP, WOOD CHASSIS

- MODEL NUMBER + WW**
- FSC**
- TOP WOOD FINISH + EDGE**
- CHASSIS WOOD FINISH**
- TOP UV FINISH**
- HARDWARE COLOR**
- HAT KEYPAD & BASE COLOR**
- GROMMET**

### LAM TOP, LAM CHASSIS

- MODEL NUMBER + LL**
- FSC**
- TOP LAM**
- CHASSIS LAM**
- EDGE DETAIL**
- HARDWARE COLOR**
- HAT KEYPAD & BASE COLOR**
- GROMMET**

Optional height adjustable keypads available

### HAT KEYPAD & BASE COLOR

Basic Up/Down Keypad, Black P71 Column **UDP71**  
Memory Preset Keypad, Black P71 Column **MEMP71**  
Paddle Keypad, Black P71 Column **PDLP71**  
Foot Control Keypad, Black P71 Column **FPDP71** Add \$240

NOTE: Foot control keypad is bluetooth controlled and may be used in conjunction with other keypads attached to worksurface.

For these situations order standard keypad for worksurface separately.



Foot control requires qty (2) AAA batteries needed. Batteries not included.

# HEIGHT ADJUSTABLE FREESTANDING DESK

Half Modesty

Silea

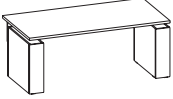
05/22

	D	W	H	model number + type	laminate	veneer 1	veneer 2
	30	66	29 1/2	<b>GS3DHAK3066-</b> [ ]	5,431	8,900	9,790
	30	72	29 1/2	<b>GS3DHAK3072-</b> [ ]	5,543	9,082	9,991
	36	72	29 1/2	<b>GS3DHAK3672-</b> [ ]	5,838	9,266	10,193
	36	78	29 1/2	<b>GS3DHAK3678-</b> [ ]	5,975	9,452	10,398

- Provides sit to stand electric height adjustment
- 29.5" to 42.5" height adjustment range

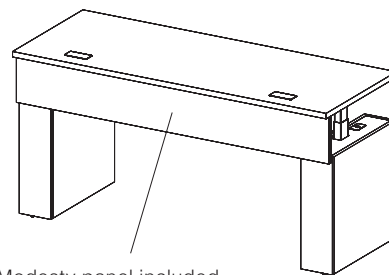

Modesty panel included.

## PRODUCT INFO

All tops long grain standard.  
Wood models ship assembled.

 Laminate units shipped as separate packages and require field assembly..

**Grommet Location**  
(Add \$70 per grommet)

No Grommet **GN**  
Left **GL**  
Right **GR**  
Left & Right **GB**

Specify location first, then select grommet color or "Empty Cutout" option. When "Empty Cutout" option is selected, a grommet or power unit must be ordered separately for each cutout.

## TO ORDER PLEASE SPECIFY THE FOLLOWING:

WOOD TOP, WOOD CHASSIS

1. **MODEL NUMBER + WW**
2. **FSC**
3. **TOP WOOD FINISH + EDGE**
4. **CHASSIS WOOD FINISH**
5. **TOP UV FINISH**
6. **HAT KEYPAD & BASE COLOR**
7. **GROMMET**

LAM TOP, LAM CHASSIS

1. **MODEL NUMBER + LL**
2. **FSC**
3. **TOP LAM**
4. **CHASSIS LAM**
5. **EDGE DETAIL**
6. **HAT KEYPAD & BASE COLOR**
7. **GROMMET**

Optional height adjustable keypads available

### HAT KEYPAD & BASE COLOR

Basic Up/Down Keypad, Black P71 Column	<b>UDP71</b>
Memory Preset Keypad, Black P71 Column	<b>MEMP71</b>
Paddle Keypad, Black P71 Column	<b>PDLP71</b>
Foot Control Keypad, Black P71 Column	<b>FPDP71</b> Add \$240

NOTE: Foot control keypad is bluetooth controlled and may be used in conjunction with other keypads attached to worksurface.

For these situations order standard keypad for worksurface separately.  
Foot control requires qty (2) AAA batteries needed. Batteries not included.



# HEIGHT ADJUSTABLE EXTENSION DESK

Half Modesty | Left and Right Hand

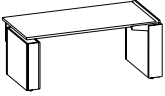
	D	W	H	model number + type	laminata	veneer 1	veneer 2
<b>LEFT HAND</b> 	30	66	29 1/2	<b>GS3XHAK3066L-</b> [ ]	5,789	8,900	9,790
	30	72	29 1/2	<b>GS3XHAK3072L-</b> [ ]	5,901	9,082	9,991
	36	72	29 1/2	<b>GS3XHAK3672L-</b> [ ]	6,158	9,266	10,193
	36	78	29 1/2	<b>GS3XHAK3678L-</b> [ ]	6,295	9,452	10,398

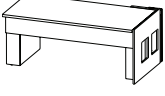
<b>RIGHT HAND</b> 	30	66	29 1/2	<b>GS3XHAK3066R-</b> [ ]	5,789	8,900	9,790
	30	72	29 1/2	<b>GS3XHAK3072R-</b> [ ]	5,901	9,082	9,991
	36	72	29 1/2	<b>GS3XHAK3672R-</b> [ ]	6,158	9,266	10,193
	36	78	29 1/2	<b>GS3XHAK3678R-</b> [ ]	6,295	9,452	10,398

- Provides sit to stand electric height adjustment
- 29.5" to 42.5" height adjustment range
- Cantilever extends 3" to support adjoining worksurface

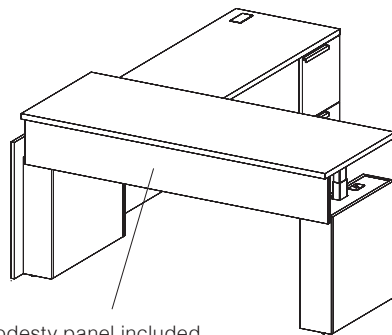

Modesty panel included.

NOTE: If attaching to a return or bridge, a 3" shorter modesty or wall access panel must be used.

## PRODUCT INFO

Specify base from user seated position.

All tops long grain standard.

Wood models ship assembled.

 Laminata units shipped as separate packages and require field assembly.

**Grommet Location**  
(Add \$70 per grommet)

No Grommet **GN**  
Left **GL**  
Right **GR**  
Left & Right **GB**

Specify location first, then select grommet color or "Empty Cutout" option. When "Empty Cutout" option is selected, a grommet or power unit must be ordered separately for each cutout.

## TO ORDER PLEASE SPECIFY THE FOLLOWING:

WOOD TOP, WOOD CHASSIS

1. **MODEL NUMBER + WW**
2. **FSC**
3. **TOP WOOD FINISH + EDGE**
4. **CHASSIS WOOD FINISH**
5. **TOP UV FINISH**
6. **HAT KEYPAD & BASE COLOR**
7. **GROMMET**

LAM TOP, LAM CHASSIS

1. **MODEL NUMBER + LL**
2. **FSC**
3. **TOP LAM**
4. **CHASSIS LAM**
5. **EDGE DETAIL**
6. **HAT KEYPAD & BASE COLOR**
7. **GROMMET**

Optional height adjustable keypads available

### HAT KEYPAD & BASE COLOR

Basic Up/Down Keypad, Black P71 Column	<b>UDP71</b>
Memory Preset Keypad, Black P71 Column	<b>MEMP71</b>
Paddle Keypad, Black P71 Column	<b>PDLP71</b>
Foot Control Keypad, Black P71 Column	<b>FPDP71</b> Add \$240

NOTE: Foot control keypad is bluetooth controlled and may be used in conjunction with other keypads attached to worksurface.

For these situations order standard keypad for worksurface separately.  
Foot control requires qty (2) AAA batteries needed. Batteries not included.

# HEIGHT ADJUSTABLE CREDENZA 24D

w/ Wall Access and End Panels

Silea  
05/22

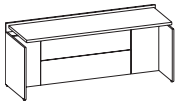
	D	W	H	model number + type	laminate	veneer 1	veneer 2
	24	42	29 1/2	<b>GS3CAK2442-</b> [ ]	4,497	7,042	7,747
	24	48	29 1/2	<b>GS3CAK2448-</b> [ ]	4,603	7,208	7,929
	24	54	29 1/2	<b>GS3CAK2454-</b> [ ]	4,687	7,342	8,077
	24	60	29 1/2	<b>GS3CAK2460-</b> [ ]	4,795	7,511	8,263
	24	66	29 1/2	<b>GS3CAK2466-</b> [ ]	4,898	7,668	8,435
	24	72	29 1/2	<b>GS3CAK2472-</b> [ ]	5,042	7,903	8,694

- Provides sit to stand electric height adjustment
- 29.5" to 42.5" height adjustment range

## PRODUCT INFO

Wood tops optional grain standard. Lam tops optional grain up to 60", over 60" long grain standard.

Wood models ship assembled.

 Laminate units shipped as separate packages and require field assembly.

### Grommet Location (Add \$70 per grommet)

No Grommet **GN**  
Center **GC**

Specify location first, then select grommet color or "Empty Cutout" option. When "Empty Cutout" option is selected, a grommet or power unit must be ordered separately for each cutout.

## TO ORDER PLEASE SPECIFY THE FOLLOWING:

### WOOD TOP, WOOD CHASSIS

1. **MODEL NUMBER + WW**
2. **FSC**
3. **TOP WOOD FINISH + EDGE**
4. **CHASSIS WOOD FINISH**
5. **TOP UV FINISH**
6. **GRAIN DIRECTION**
7. **HAT KEYPAD & BASE COLOR**
8. **GROMMET**

### LAM TOP, LAM CHASSIS

1. **MODEL NUMBER + LL**
2. **FSC**
3. **TOP LAM**
4. **CHASSIS LAM**
5. **GRAIN DIRECTION (up to 60")**
6. **EDGE DETAIL**
7. **HAT KEYPAD & BASE COLOR**
8. **GROMMET**

Optional height adjustable keypads available

### HAT KEYPAD & BASE COLOR

Basic Up/Down Keypad, Black P71 Column  
Memory Preset Keypad, Black P71 Column  
Paddle Keypad, Black P71 Column  
Foot Control Keypad, Black P71 Column

**UDP71**  
**MEMP71**  
**PDLP71**  
**FPDP71** Add \$240

NOTE: Foot control keypad is bluetooth controlled and may be used in conjunction with other keypads attached to worksurface. For these situations order standard keypad for worksurface separately. Foot control requires qty (2) AAA batteries needed. Batteries not included.

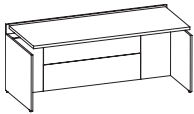
	D	W	H	model number + type	laminate	veneer 1	veneer 2
	30	42	29 1/2	<b>GS3CAK3042-</b> [ ]	4,897	7,746	8,521
	30	48	29 1/2	<b>GS3CAK3048-</b> [ ]	4,992	7,929	8,722
	30	54	29 1/2	<b>GS3CAK3054-</b> [ ]	5,047	8,075	8,883
	30	60	29 1/2	<b>GS3CAK3060-</b> [ ]	5,102	8,262	9,089
	30	66	29 1/2	<b>GS3CAK3066-</b> [ ]	5,200	8,435	9,279
	30	72	29 1/2	<b>GS3CAK3072-</b> [ ]	5,295	8,692	9,562

- Provides sit to stand electric height adjustment
- 29.5" to 42.5" height adjustment range

## PRODUCT INFO

Wood tops optional grain standard. Lam tops optional grain up to 60", over 60" long grain standard.

Wood models ship assembled.

 Laminate units shipped as separate packages and require field assembly.

### Grommet Location

(Add \$70 per grommet)

No Grommet    **GN**  
Center         **GC**

Specify location first, then select grommet color or "Empty Cutout" option. When "Empty Cutout" option is selected, a grommet or power unit must be ordered separately for each cutout.

## TO ORDER PLEASE SPECIFY THE FOLLOWING:

### WOOD TOP, WOOD CHASSIS

- MODEL NUMBER + WW**
- FSC**
- TOP WOOD FINISH + EDGE**
- CHASSIS WOOD FINISH**
- TOP UV FINISH**
- GRAIN DIRECTION**
- HAT KEYPAD & BASE COLOR**
- GROMMET**

### LAM TOP, LAM CHASSIS

- MODEL NUMBER + LL**
- FSC**
- TOP LAM**
- CHASSIS LAM**
- GRAIN DIRECTION (up to 60")**
- EDGE DETAIL**
- HAT KEYPAD & BASE COLOR**
- GROMMET**

Optional height adjustable keypads available

### HAT KEYPAD & BASE COLOR

Basic Up/Down Keypad, Black P71 Column  
Memory Preset Keypad, Black P71 Column  
Paddle Keypad, Black P71 Column  
Foot Control Keypad, Black P71 Column

**UDP71**  
**MEMP71**  
**PDLP71**  
**FPDP71** Add \$240

NOTE: Foot control keypad is bluetooth controlled and may be used in conjunction with other keypads attached to worksurface. For these situations order standard keypad for worksurface separately. Foot control requires qty (2) AAA batteries needed. Batteries not included.

# HEIGHT ADJUSTABLE CREDENZA 24D

w/ Hidden Accessory | Box | File Pedestals

Silea  
05/22

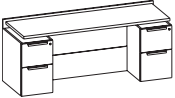
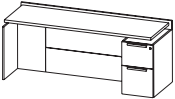
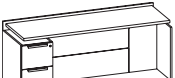
	D	W	H	model number + type	laminare	vener 1	vener 2
	24	66	29 1/2	<b>GS3CAK2466-AA</b> [ ]	6,383	10,899	11,989
	24	72	29 1/2	<b>GS3CAK2472-AA</b> [ ]	6,531	11,136	12,250
<b>RIGHT HAND</b>							
	24	66	29 1/2	<b>GS3CAK2466R-A</b> [ ]	5,058	9,116	10,028
	24	72	29 1/2	<b>GS3CAK2472R-A</b> [ ]	5,207	9,353	10,289
<b>LEFT HAND</b>							
	24	66	29 1/2	<b>GS3CAK2466L-A</b> [ ]	5,058	9,116	10,028
	24	72	29 1/2	<b>GS3CAK2472L-A</b> [ ]	5,207	9,353	10,289

- Provides sit to stand electric height adjustment
- 29.5" to 42.5" height adjustment range

## PRODUCT INFO

Specify pedestal from user seated position.

Wood tops optional grain standard. Lam tops long grain standard.

Wood models ship assembled.

 Laminate units shipped as separate packages and require field assembly.

### Grommet Location

(Add \$70 per grommet)

No Grommet **GN**  
Center **GC**

Specify location first, then select grommet color or "Empty Cutout" option. When "Empty Cutout" option is selected, a grommet or power unit must be ordered separately for each cutout.

## TO ORDER PLEASE SPECIFY THE FOLLOWING:

### WOOD TOP, WOOD CHASSIS

- MODEL NUMBER + WW**
- FSC**
- TOP WOOD FINISH + EDGE**
- CHASSIS WOOD FINISH**
- TOP UV FINISH**
- GRAIN DIRECTION**
- PULL**
- HAT KEYPAD & BASE COLOR**
- GROMMET**
- KEYING**

### LAM TOP, LAM CHASSIS

- MODEL NUMBER + LL**
- FSC**
- TOP LAM**
- CHASSIS LAM**
- FRONT LAM**
- EDGE DETAIL**
- PULL**
- HAT KEYPAD & BASE COLOR**
- GROMMET**
- KEYING**

Optional height adjustable keypads available

### HAT KEYPAD & BASE COLOR

Basic Up/Down Keypad, Black P71 Column	<b>UDP71</b>
Memory Preset Keypad, Black P71 Column	<b>MEMP71</b>
Paddle Keypad, Black P71 Column	<b>PDLP71</b>
Foot Control Keypad, Black P71 Column	<b>FPDP71</b> Add \$240

NOTE: Foot control keypad is bluetooth controlled and may be used in conjunction with other keypads attached to worksurface. For these situations order standard keypad for worksurface separately. Foot control requires qty (2) AAA batteries needed. Batteries not included.

# HEIGHT ADJUSTABLE CREDENZA 30D

w/ Hidden Accessory | Box | File Pedestals

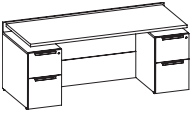
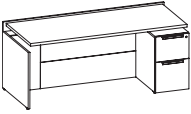
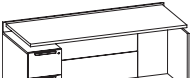
	D	W	H	model number + type	laminata	vener 1	vener 2
	30	66	29 1/2	<b>GS3CAK3066-AA</b> [ ]	6,617	11,989	13,188
	30	72	29 1/2	<b>GS3CAK3072-AA</b> [ ]	6,713	12,249	13,474
<b>RIGHT HAND</b>							
	30	66	29 1/2	<b>GS3CAK3066R-A</b> [ ]	5,298	10,027	11,030
	30	72	29 1/2	<b>GS3CAK3072R-A</b> [ ]	5,398	10,288	11,317
<b>LEFT HAND</b>							
	30	66	29 1/2	<b>GS3CAK3066L-A</b> [ ]	5,298	10,027	11,030
	30	72	29 1/2	<b>GS3CAK3072L-A</b> [ ]	5,398	10,288	11,317

- Provides sit to stand electric height adjustment
- 29.5" to 42.5" height adjustment range

## PRODUCT INFO

Wood tops optional grain standard. Lam tops optional grain up to 60", over 60" long grain standard.

Wood models ship assembled.

 Laminate units shipped as separate packages and require field assembly.

### Grommet Location (Add \$70 per grommet)

No Grommet    **GN**  
Center         **GC**

Specify location first, then select grommet color or "Empty Cutout" option. When "Empty Cutout" option is selected, a grommet or power unit must be ordered separately for each cutout.

## TO ORDER PLEASE SPECIFY THE FOLLOWING:

### WOOD TOP, WOOD CHASSIS

- MODEL NUMBER + WW**
- FSC**
- TOP WOOD FINISH + EDGE**
- CHASSIS WOOD FINISH**
- TOP UV FINISH**
- GRAIN DIRECTION**
- PULL**
- HAT KEYPAD & BASE COLOR**
- GROMMET**
- KEYING**

### LAM TOP, LAM CHASSIS

- MODEL NUMBER + LL**
- FSC**
- TOP LAM**
- CHASSIS LAM**
- FRONT LAM**
- EDGE DETAIL**
- PULL**
- HAT KEYPAD & BASE COLOR**
- GROMMET**
- KEYING**

Optional height adjustable keypads available

### HAT KEYPAD & BASE COLOR

Basic Up/Down Keypad, Black P71 Column	<b>UDP71</b>
Memory Preset Keypad, Black P71 Column	<b>MEMP71</b>
Paddle Keypad, Black P71 Column	<b>PDLP71</b>
Foot Control Keypad, Black P71 Column	<b>FPDP71</b> Add \$240

NOTE: Foot control keypad is bluetooth controlled and may be used in conjunction with other keypads attached to worksurface. For these situations order standard keypad for worksurface separately. Foot control requires qty (2) AAA batteries needed. Batteries not included.

# HEIGHT ADJUSTABLE BRIDGE 24D

w/ Wall Access

Silea  
05/22

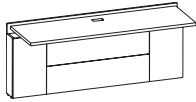

D	W	H	model number + type	laminate	veneer 1	veneer 2
24	42	29 1/2	<b>GS3BAK2442-</b> [ ]	3,616	5,667	6,234
24	48	29 1/2	<b>GS3BAK2448-</b> [ ]	3,721	5,834	6,418
24	54	29 1/2	<b>GS3BAK2454-</b> [ ]	3,805	5,966	6,563
24	60	29 1/2	<b>GS3BAK2460-</b> [ ]	3,914	6,135	6,749
24	66	29 1/2	<b>GS3BAK2466-</b> [ ]	4,016	6,294	6,924
24	72	29 1/2	<b>GS3BAK2472-</b> [ ]	4,162	6,528	7,181

- **Unit must be wall mounted.**
- Provides sit to stand electric height adjustment
- 29.5" to 42.5" height adjustment range

## PRODUCT INFO

Wood tops optional grain standard. Lam tops opt grain up to 60". over 60" long grain standard.

Wood models shipped assembled.

 Laminate units shipped as separate packages and require field assembly.

**Grommet Location**  
(Add \$70 per grommet)

No Grommet **GN**  
Center **GC**

Specify location first, then select grommet color or "Empty Cutout" option. When "Empty Cutout" option is selected, a grommet or power unit must be ordered separately for each cutout.

## TO ORDER PLEASE SPECIFY THE FOLLOWING:

### WOOD TOP, WOOD CHASSIS

- MODEL NUMBER + WW**
- FSC**
- TOP WOOD FINISH + EDGE**
- CHASSIS WOOD FINISH**
- TOP UV FINISH**
- GRAIN DIRECTION**
- HAT KEYPAD & BASE COLOR**
- GROMMET**

### LAM TOP, LAM CHASSIS

- MODEL NUMBER + LL**
- FSC**
- TOP LAM**
- CHASSIS LAM**
- GRAIN DIRECTION (up to 60")**
- EDGE DETAIL**
- HAT KEYPAD & BASE COLOR**
- GROMMET**

Optional height adjustable keypads available

#### HAT KEYPAD & BASE COLOR

Basic Up/Down Keypad, Black P71 Column  
Memory Preset Keypad, Black P71 Column  
Paddle Keypad, Black P71 Column  
Foot Control Keypad, Black P71 Column

**UDP71**  
**MEMP71**  
**PDLP71**  
**FPDP71** Add \$240

NOTE: Foot control keypad is bluetooth controlled and may be used in conjunction with other keypads attached to worksurface. For these situations order standard keypad for worksurface separately. Foot control requires qty (2) AAA batteries needed. Batteries not included.

D	W	H	model number + type	laminate	veneer 1	veneer 2
30	42	29 1/2	<b>GS3BAK3042-</b> [ ]	3,805	5,950	6,545
30	48	29 1/2	<b>GS3BAK3048-</b> [ ]	3,894	6,126	6,739
30	54	29 1/2	<b>GS3BAK3054-</b> [ ]	3,947	6,264	6,891
30	60	29 1/2	<b>GS3BAK3060-</b> [ ]	4,000	6,442	7,087
30	66	29 1/2	<b>GS3BAK3066-</b> [ ]	4,092	6,610	7,271
30	72	29 1/2	<b>GS3BAK3072-</b> [ ]	4,186	6,854	7,540

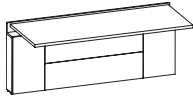

- **Unit must be wall mounted.**
- Provides sit to stand electric height adjustment
- 29.5" to 42.5" height adjustment range

**PRODUCT INFO**

Wood tops optional grain standard. Lam tops optional grain up to 60", over 60" long grain standard.

Wood models shipped assembled.

 Laminate units shipped as separate packages and require field assembly.

**Grommet Location**  
(Add \$70 per grommet)

No Grommet **GN**  
Center **GC**

Specify location first, then select grommet color or "Empty Cutout" option. When "Empty Cutout" option is selected, a grommet or power unit must be ordered separately for each cutout.

**TO ORDER PLEASE SPECIFY THE FOLLOWING:**

WOOD TOP, WOOD CHASSIS

- MODEL NUMBER + WW**
- FSC**
- TOP WOOD FINISH + EDGE**
- CHASSIS WOOD FINISH**
- TOP UV FINISH**
- GRAIN DIRECTION**
- HAT KEYPAD & BASE COLOR**
- GROMMET**

LAM TOP, LAM CHASSIS

- MODEL NUMBER + LL**
- FSC**
- TOP LAM**
- CHASSIS LAM**
- GRAIN DIRECTION (up to 60")**
- EDGE DETAIL**
- HAT KEYPAD & BASE COLOR**
- GROMMET**

Optional height adjustable keypads available

**HAT KEYPAD & BASE COLOR**

Basic Up/Down Keypad, Black P71 Column	<b>UDP71</b>
Memory Preset Keypad, Black P71 Column	<b>MEMP71</b>
Paddle Keypad, Black P71 Column	<b>PDLP71</b>
Foot Control Keypad, Black P71 Column	<b>FPDP71</b> Add \$240

NOTE: Foot control keypad is bluetooth controlled and may be used in conjunction with other keypads attached to worksurface. For these situations order standard keypad for worksurface separately. Foot control requires qty (2) AAA batteries needed. Batteries not included.

# HEIGHT ADJUSTABLE RETURN 24D

w/ End Panel | Left and Right Hand

Silea

05/22

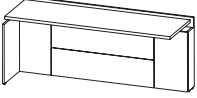
	D	W	H	model number + type	laminata	veneer 1	veneer 2
<b>LEFT HAND</b> 	24	42	29 1/2	<b>GS3RAK2442L-</b> <input type="checkbox"/>	4,056	6,354	6,990
	24	48	29 1/2	<b>GS3RAK2448L-</b> <input type="checkbox"/>	4,163	6,521	7,174
	24	54	29 1/2	<b>GS3RAK2454L-</b> <input type="checkbox"/>	4,246	6,654	7,320
	24	60	29 1/2	<b>GS3RAK2460L-</b> <input type="checkbox"/>	4,355	6,822	7,505
	24	66	29 1/2	<b>GS3RAK2466L-</b> <input type="checkbox"/>	4,455	6,981	7,680
	24	72	29 1/2	<b>GS3RAK2472L-</b> <input type="checkbox"/>	4,601	7,215	7,937

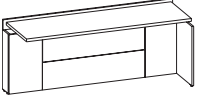
<b>RIGHT HAND</b> 	24	42	29 1/2	<b>GS3RAK2442R-</b> <input type="checkbox"/>	4,056	6,354	6,990
	24	48	29 1/2	<b>GS3RAK2448R-</b> <input type="checkbox"/>	4,163	6,521	7,174
	24	54	29 1/2	<b>GS3RAK2454R-</b> <input type="checkbox"/>	4,246	6,654	7,320
	24	60	29 1/2	<b>GS3RAK2460R-</b> <input type="checkbox"/>	4,355	6,822	7,505
	24	66	29 1/2	<b>GS3RAK2466R-</b> <input type="checkbox"/>	4,455	6,981	7,680
	24	72	29 1/2	<b>GS3RAK2472R-</b> <input type="checkbox"/>	4,601	7,215	7,937

- **Unit must be wall mounted.**
- Provides sit to stand electric height adjustment
- 29.5" to 42.5" height adjustment range

## PRODUCT INFO

Wood tops optional grain standard. Lam tops optional grain up to 60", over 60" long grain standard.

Wood models ship assembled.

 Laminate units shipped as separate packages and require field assembly.

**Grommet Location**  
(Add \$70 per grommet)

No Grommet **GN**  
Center **GC**

Specify location first, then select grommet color or "Empty Cutout" option. When "Empty Cutout" option is selected, a grommet or power unit must be ordered separately for each cutout.

## TO ORDER PLEASE SPECIFY THE FOLLOWING:

WOOD TOP, WOOD CHASSIS

LAM TOP, LAM CHASSIS

- |                                       |                                       |
|---------------------------------------|---------------------------------------|
| 1. <b>MODEL NUMBER + WW</b>           | 1. <b>MODEL NUMBER + LL</b>           |
| 2. <b>FSC</b>                         | 2. <b>FSC</b>                         |
| 3. <b>TOP WOOD FINISH + EDGE</b>      | 3. <b>TOP LAM</b>                     |
| 4. <b>CHASSIS WOOD FINISH</b>         | 4. <b>CHASSIS LAM</b>                 |
| 5. <b>TOP UV FINISH</b>               | 5. <b>GRAIN DIRECTION (up to 60")</b> |
| 6. <b>GRAIN DIRECTION</b>             | 6. <b>EDGE DETAIL</b>                 |
| 7. <b>HAT KEYPAD &amp; BASE COLOR</b> | 7. <b>HAT KEYPAD &amp; BASE COLOR</b> |
| 8. <b>GROMMET</b>                     | 8. <b>GROMMET</b>                     |

Optional height adjustable keypads available

### HAT KEYPAD & BASE COLOR

Basic Up/Down Keypad, Black P71 Column

**UDP71**

Memory Preset Keypad, Black P71 Column

**MEMP71**

Paddle Keypad, Black P71 Column

**PDLP71**

Foot Control Keypad, Black P71 Column

**FPDP71** Add \$240

NOTE: Foot control keypad is bluetooth controlled and may be used in conjunction with other keypads attached to worksurface. For these situations order standard keypad for worksurface separately. Foot control requires qty (2) AAA batteries needed. Batteries not included.



# HEIGHT ADJUSTABLE RETURN 30D

w/ End Panel | Left and Right Hand

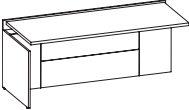
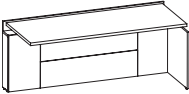
	D	W	H	model number + type	laminata	veneer 1	veneer 2
<b>LEFT HAND</b> 	30	42	29 1/2	<b>GS3RAK3042L-</b> <input type="checkbox"/>	4,413	6,990	7,689
	30	48	29 1/2	<b>GS3RAK3048L-</b> <input type="checkbox"/>	4,506	7,174	7,892
	30	54	29 1/2	<b>GS3RAK3054L-</b> <input type="checkbox"/>	4,563	7,319	8,051
	30	60	29 1/2	<b>GS3RAK3060L-</b> <input type="checkbox"/>	4,618	7,504	8,255
	30	66	29 1/2	<b>GS3RAK3066L-</b> <input type="checkbox"/>	4,713	7,679	8,447
	30	72	29 1/2	<b>GS3RAK3072L-</b> <input type="checkbox"/>	4,812	7,936	8,730
<b>RIGHT HAND</b> 	30	42	29 1/2	<b>GS3RAK3042R-</b> <input type="checkbox"/>	4,413	6,990	7,689
	30	48	29 1/2	<b>GS3RAK3048R-</b> <input type="checkbox"/>	4,506	7,174	7,892
	30	54	29 1/2	<b>GS3RAK3054R-</b> <input type="checkbox"/>	4,563	7,319	8,051
	30	60	29 1/2	<b>GS3RAK3060R-</b> <input type="checkbox"/>	4,618	7,504	8,255
	30	66	29 1/2	<b>GS3RAK3066R-</b> <input type="checkbox"/>	4,713	7,679	8,447
	30	72	29 1/2	<b>GS3RAK3072R-</b> <input type="checkbox"/>	4,812	7,936	8,730

- **Unit must be wall mounted.**
- Provides sit to stand electric height adjustment
- 29.5" to 42.5" height adjustment range

## PRODUCT INFO

Wood tops optional grain standard. Lam tops optional grain up to 60", over 60" long grain standard.

Wood models ship assembled.

 Laminate units shipped as separate packages and require field assembly.

**Grommet Location**  
(Add \$70 per grommet)

No Grommet **GN**  
Center **GC**

Specify location first, then select grommet color or "Empty Cutout" option. When "Empty Cutout" option is selected, a grommet or power unit must be ordered separately for each cutout.

## TO ORDER PLEASE SPECIFY THE FOLLOWING:

WOOD TOP, WOOD CHASSIS

- MODEL NUMBER + WW**
- FSC**
- TOP WOOD FINISH + EDGE**
- CHASSIS WOOD FINISH**
- TOP UV FINISH**
- GRAIN DIRECTION**
- HAT KEYPAD & BASE COLOR**
- GROMMET**

LAM TOP, LAM CHASSIS

- MODEL NUMBER + LL**
- FSC**
- TOP LAM**
- CHASSIS LAM**
- GRAIN DIRECTION (up to 60")**
- EDGE DETAIL**
- HAT KEYPAD & BASE COLOR**
- GROMMET**

Optional height adjustable keypads available

### HAT KEYPAD & BASE COLOR

Basic Up/Down Keypad, Black P71 Column	<b>UDP71</b>
Memory Preset Keypad, Black P71 Column	<b>MEMP71</b>
Paddle Keypad, Black P71 Column	<b>PDLP71</b>
Foot Control Keypad, Black P71 Column	<b>FPDP71</b> Add \$240

NOTE: Foot control keypad is bluetooth controlled and may be used in conjunction with other keypads attached to worksurface. For these situations order standard keypad for worksurface separately. Foot control requires qty (2) AAA batteries needed. Batteries not included.

# HEIGHT ADJUSTABLE RETURN 24D

w/ Hidden Accessory | Box | File | Pedestals

Silea

05/22

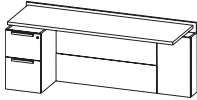
	D	W	H	model number + type	laminare	veneer 1	veneer 2
<b>LEFT HAND</b> 	24	42	29 1/2	<b>GS3RAK2442L-A</b> [ ]	4,509	7,967	8,764
	24	48	29 1/2	<b>GS3RAK2448L-A</b> [ ]	4,614	8,139	8,953
	24	54	29 1/2	<b>GS3RAK2454L-A</b> [ ]	4,699	8,267	9,094
	24	60	29 1/2	<b>GS3RAK2460L-A</b> [ ]	4,809	8,441	9,286
	24	66	29 1/2	<b>GS3RAK2466L-A</b> [ ]	4,984	8,598	9,458
	24	72	29 1/2	<b>GS3RAK2472L-A</b> [ ]	5,136	8,831	9,715

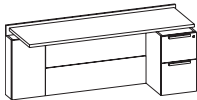
<b>RIGHT HAND</b> 	24	42	29 1/2	<b>GS3RAK2442R-A</b> [ ]	4,509	7,967	8,764
	24	48	29 1/2	<b>GS3RAK2448R-A</b> [ ]	4,614	8,139	8,953
	24	54	29 1/2	<b>GS3RAK2454R-A</b> [ ]	4,699	8,267	9,094
	24	60	29 1/2	<b>GS3RAK2460R-A</b> [ ]	4,809	8,441	9,286
	24	66	29 1/2	<b>GS3RAK2466R-A</b> [ ]	4,984	8,598	9,458
	24	72	29 1/2	<b>GS3RAK2472R-A</b> [ ]	5,136	8,831	9,715

- **Unit must be wall mounted.**
- Provides sit to stand electric height adjustment
- 29.5" to 42.5" height adjustment range

## PRODUCT INFO

Wood tops optional grain standard. Lam tops optional grain up to 60", over 60" long grain standard.

If integral pull is chosen, the wall access panel will have a black knob.

Wood models ship assembled.

 Laminate units shipped as separate packages and require field assembly.

**Grommet Location**  
(Add \$70 per grommet)

No Grommet **GN**  
Center **GC**

Specify location first, then select grommet color or "Empty Cutout" option. When "Empty Cutout" option is selected, a grommet or power unit must be ordered separately for each cutout.

## TO ORDER PLEASE SPECIFY THE FOLLOWING:

### WOOD TOP, WOOD CHASSIS

- MODEL NUMBER + WW**
- FSC**
- TOP WOOD FINISH + EDGE**
- CHASSIS WOOD FINISH**
- TOP UV FINISH**
- GRAIN DIRECTION**
- PULL**
- HAT KEYPAD & BASE COLOR**
- GROMMET**
- KEYING**

### LAM TOP, LAM CHASSIS

- MODEL NUMBER + LL**
- FSC**
- TOP LAM**
- CHASSIS LAM**
- FRONT LAM**
- GRAIN DIRECTION (up to 60")**
- PULL**
- HAT KEYPAD & BASE COLOR**
- GROMMET**
- KEYING**

Optional height adjustable keypads available

#### HAT KEYPAD & BASE COLOR

Basic Up/Down Keypad, Black P71 Column	<b>UDP71</b>
Memory Preset Keypad, Black P71 Column	<b>MEMP71</b>
Paddle Keypad, Black P71 Column	<b>PDLP71</b>
Foot Control Keypad, Black P71 Column	<b>FPDP71</b> Add \$240

NOTE: Foot control keypad is bluetooth controlled and may be used in conjunction with other keypads attached to worksurface. For these situations order standard keypad for worksurface separately. Foot control requires qty (2) AAA batteries needed. Batteries not included.

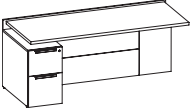
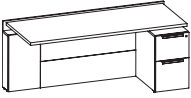
	D	W	H	model number + type	laminat	vener 1	vener 2
<b>LEFT HAND</b> 	30	42	29 1/2	<b>GS3RAK3042L-A</b> [ ]	4,777	8,763	9,640
	30	48	29 1/2	<b>GS3RAK3048L-A</b> [ ]	4,866	8,954	9,850
	30	54	29 1/2	<b>GS3RAK3054L-A</b> [ ]	4,920	9,093	10,003
	30	60	29 1/2	<b>GS3RAK3060L-A</b> [ ]	4,974	9,284	10,213
	30	66	29 1/2	<b>GS3RAK3066L-A</b> [ ]	5,139	9,459	10,405
	30	72	29 1/2	<b>GS3RAK3072L-A</b> [ ]	5,239	9,714	10,686
<b>RIGHT HAND</b> 	30	42	29 1/2	<b>GS3RAK3042R-A</b> [ ]	4,777	8,763	9,640
	30	48	29 1/2	<b>GS3RAK3048R-A</b> [ ]	4,866	8,954	9,850
	30	54	29 1/2	<b>GS3RAK3054R-A</b> [ ]	4,920	9,093	10,003
	30	60	29 1/2	<b>GS3RAK3060R-A</b> [ ]	4,974	9,284	10,213
	30	66	29 1/2	<b>GS3RAK3066R-A</b> [ ]	5,139	9,459	10,405
	30	72	29 1/2	<b>GS3RAK3072R-A</b> [ ]	5,239	9,714	10,686

- Unit must be wall mounted.
- Provides sit to stand electric height adjustment
- 29.5" to 42.5" height adjustment range

**PRODUCT INFO**

Wood tops optional grain standard. Lam tops optional grain up to 60", over 60" long grain standard. Wood models ship assembled.  Laminate units shipped as separate packages and require field assembly.

**Grommet Location**  
(Add \$70 per grommet)

No Grommet **GN**  
Center **GC**  
Specify location first, then select grommet color or "Empty Cutout" option. When "Empty Cutout" option is selected, a grommet or power unit must be ordered separately for each cutout.

**TO ORDER PLEASE SPECIFY THE FOLLOWING:**

- |                                       |                                       |
|---------------------------------------|---------------------------------------|
| <b>WOOD TOP, WOOD CHASSIS</b>         | <b>LAM TOP, LAM CHASSIS</b>           |
| <b>1. MODEL NUMBER + WW</b>           | <b>1. MODEL NUMBER + LL</b>           |
| <b>2. FSC</b>                         | <b>2. FSC</b>                         |
| <b>3. TOP WOOD FINISH + EDGE</b>      | <b>3. TOP LAM</b>                     |
| <b>4. CHASSIS WOOD FINISH</b>         | <b>4. CHASSIS LAM</b>                 |
| <b>5. TOP UV FINISH</b>               | <b>5. FRONT LAM</b>                   |
| <b>6. GRAIN DIRECTION</b>             | <b>6. GRAIN DIRECTION (up to 60")</b> |
| <b>7. PULL</b>                        | <b>7. EDGE DETAIL</b>                 |
| <b>8. HAT KEYPAD &amp; BASE COLOR</b> | <b>8. PULL</b>                        |
| <b>9. GROMMET</b>                     | <b>9. HAT KEYPAD &amp; BASE COLOR</b> |
| <b>10. KEYING</b>                     | <b>10. GROMMET</b>                    |
|                                       | <b>11. KEYING</b>                     |

Optional height adjustable keypads available

**HAT KEYPAD & BASE COLOR**

Basic Up/Down Keypad, Black P71 Column	<b>UDP71</b>
Memory Preset Keypad, Black P71 Column	<b>MEMP71</b>
Paddle Keypad, Black P71 Column	<b>PDLP71</b>
Foot Control Keypad, Black P71 Column	<b>FPDP71 Add \$240</b>

NOTE: Foot control keypad is bluetooth controlled and may be used in conjunction with other keypads attached to worksurface. For these situations order standard keypad for worksurface separately. Foot control requires qty (2) AAA batteries needed. Batteries not included.

**Step 1: Select workwall chassis configuration and total width.**



Bridge w/o Pedestals  
(non-handed)

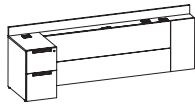

Return w/ Pedestal  
Left Hand



Return w/ Pedestal  
Right Hand

**Step 2: Select desk chassis style and size.**

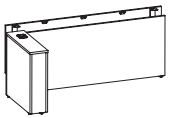

Full modesty,  
shroud pedestal  
(left hand shown)

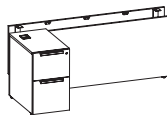

Full modesty,  
pedestal  
(left hand shown)

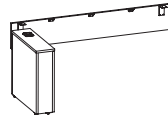

Half modesty,  
shroud pedestal  
(left hand shown)



Half modesty,  
pedestal  
(left hand shown)

**Step 3. Order desk and return rectangular tops OR a 2-piece cockpit shape top.**



Desk  
30" or 36" Depth



Return  
24" or 30" Depth

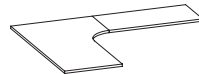

Cockpit Shape  
2-piece  
(left hand shown)

**Note:** for rectangular tops, flat brackets must be ordered separately.

**Step 4. Order height adjustable hardware and bracketry kit. Select appropriate 3 motor or 4 motor kit based on total workwall length in Step 1.**

Total Workwall Width	# Motors	Model # to Order
Workwall 72"	3	GS4LALNKDPD-3
Workwall 78"	3	GS4LALNKDPD-3
Workwall 84"	3	GS4LALNKDPD-3
Workwall 90"	3	GS4LALNKDPD-3
Workwall 96"	3	GS4LALNKDPD-3
Workwall 102"	4	GS4LALNKDPD-4
Workwall 108"	4	GS4LALNKDPD-4

	D	W	H	model number + type	laminate	veneer 1	veneer 2
	7 1/4	72	27 7/8	<b>GS4PLWFP72-</b> [ ]	1,733	3,236	3,560
	7 1/4	78	27 7/8	<b>GS4PLWFP78-</b> [ ]	1,870	3,492	3,842
	7 1/4	84	27 7/8	<b>GS4PLWFP84-</b> [ ]	1,942	3,637	4,001
	7 1/4	90	27 7/8	<b>GS4PLWFP90-</b> [ ]	2,042	4,007	4,408
	7 1/4	96	27 7/8	<b>GS4PLWFP96-</b> [ ]	2,030	3,928	4,321
	7 1/4	102	27 7/8	<b>GS4PLWFP102-</b> [ ]	N/A	4,123	4,536
	7 1/4	108	27 7/8	<b>GS4PLWFP108-</b> [ ]	N/A	4,322	4,755

## PRODUCT INFO

**Unit must be wall mounted.**

Non-handed

 All units shipped as separate packages and require field assembly.

## TO ORDER PLEASE SPECIFY THE FOLLOWING:

### WOOD CHASSIS

1. **MODEL NUMBER + W**
2. **FSC**
3. **CHASSIS WOOD FINISH**

### LAM CHASSIS

1. **MODEL NUMBER + L**
2. **FSC**
3. **CHASSIS LAM**

# L SHAPE HEIGHT ADJUSTABLE

Workwall, Left Hand Pedestal

Silea

05/22

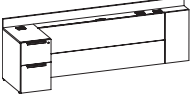
	D	W	H	model number + type	laminate	veneer 1	veneer 2
<b>24" DEPTH PEDESTAL</b> 	24	72	27 7/8	<b>GS4PLWFP2472L-A</b> [ ]	3,190	5,666	6,233
	24	78	27 7/8	<b>GS4PLWFP2478L-A</b> [ ]	3,250	5,792	6,372
	24	84	27 7/8	<b>GS4PLWFP2484L-A</b> [ ]	3,322	5,938	6,532
	24	90	27 7/8	<b>GS4PLWFP2490L-A</b> [ ]	3,489	6,420	7,062
	24	96	27 7/8	<b>GS4PLWFP2496L-A</b> [ ]	3,518	6,409	7,050
	24	102	27 7/8	<b>GS4PLWFP24102L-A</b> [ ]	N/A	6,532	7,186
	24	108	27 7/8	<b>GS4PLWFP24108L-A</b> [ ]	N/A	6,672	7,340
<b>30" DEPTH PEDESTAL</b>	30	72	27 7/8	<b>GS4PLWFP3072L-A</b> [ ]	3,269	5,796	6,376
	30	78	27 7/8	<b>GS4PLWFP3078L-A</b> [ ]	3,329	5,922	6,515
	30	84	27 7/8	<b>GS4PLWFP3084L-A</b> [ ]	3,401	6,068	6,675
	30	90	27 7/8	<b>GS4PLWFP3090L-A</b> [ ]	3,568	6,550	7,205
	30	96	27 7/8	<b>GS4PLWFP3096L-A</b> [ ]	3,597	6,539	7,193
	30	102	27 7/8	<b>GS4PLWFP30102L-A</b> [ ]	N/A	6,662	7,329
	30	108	27 7/8	<b>GS4PLWFP30108L-A</b> [ ]	N/A	6,802	7,483

## PRODUCT INFO

**Unit must be wall mounted.**

 All units shipped as separate packages and require field assembly.

## TO ORDER PLEASE SPECIFY THE FOLLOWING:

### WOOD CHASSIS

1. **MODEL NUMBER + W**
2. **FSC**
3. **CHASSIS WOOD FINISH**
4. **PULL**
5. **KEYING**

### LAM CHASSIS

1. **MODEL NUMBER + L**
2. **FSC**
3. **CHASSIS LAM**
4. **FRONT LAM**
5. **PULL**
6. **KEYING**

	D	W	H	model number + type	laminate	veneer 1	veneer 2
<b>24" DEPTH PEDESTAL</b> 	24	72	27 7/8	<b>GS4PLWFP2472R-A</b> [ ]	3,190	5,666	6,233
	24	78	27 7/8	<b>GS4PLWFP2478R-A</b> [ ]	3,250	5,792	6,372
	24	84	27 7/8	<b>GS4PLWFP2484R-A</b> [ ]	3,322	5,938	6,532
	24	90	27 7/8	<b>GS4PLWFP2490R-A</b> [ ]	3,489	6,420	7,062
	24	96	27 7/8	<b>GS4PLWFP2496R-A</b> [ ]	3,518	6,409	7,050
	24	102	27 7/8	<b>GS4PLWFP24102R-A</b> [ ]	N/A	6,532	7,186
	24	108	27 7/8	<b>GS4PLWFP24108R-A</b> [ ]	N/A	6,672	7,340
<b>30" DEPTH PEDESTAL</b>	30	72	27 7/8	<b>GS4PLWFP3072R-A</b> [ ]	3,269	5,796	6,376
	30	78	27 7/8	<b>GS4PLWFP3078R-A</b> [ ]	3,329	5,922	6,515
	30	84	27 7/8	<b>GS4PLWFP3084R-A</b> [ ]	3,401	6,068	6,675
	30	90	27 7/8	<b>GS4PLWFP3090R-A</b> [ ]	3,568	6,550	7,205
	30	96	27 7/8	<b>GS4PLWFP3096R-A</b> [ ]	3,597	6,539	7,193
	30	102	27 7/8	<b>GS4PLWFP30102R-A</b> [ ]	N/A	6,662	7,329
	30	108	27 7/8	<b>GS4PLWFP30108R-A</b> [ ]	N/A	6,802	7,483

**PRODUCT INFO**

**Unit must be wall mounted.**

 All units shipped as separate packages and require field assembly.

**TO ORDER PLEASE SPECIFY THE FOLLOWING:**

WOOD CHASSIS

1. **MODEL NUMBER + W**
2. **FSC**
3. **CHASSIS WOOD FINISH**
4. **PULL**
5. **KEYING**

LAM CHASSIS

1. **MODEL NUMBER + L**
2. **FSC**
3. **CHASSIS LAM**
4. **FRONT LAM**
5. **PULL**
6. **KEYING**

# L SHAPE HEIGHT ADJUSTABLE

Desk Full Modesty, Left Hand Shroud

Silea

05/22

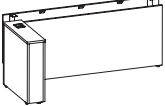
	D	W	H	model number + type	laminate	veneer 1	veneer 2
<b>30" DEPTH SHROUD</b> 	30	66	27 7/8	<b>GS4PLDMF3066L-</b> [ ]	1,936	3,419	3,761
	30	72	27 7/8	<b>GS4PLDMF3072L-</b> [ ]	2,002	3,557	3,913
	30	78	27 7/8	<b>GS4PLDMF3078L-</b> [ ]	2,067	3,690	4,059
	30	84	27 7/8	<b>GS4PLDMF3084L-</b> [ ]	2,203	3,896	4,286
	30	90	27 7/8	<b>GS4PLDMF3090L-</b> [ ]	2,271	4,034	4,438
	30	96	27 7/8	<b>GS4PLDMF3096L-</b> [ ]	2,337	4,171	4,589
<b>36" DEPTH SHROUD</b>	36	66	27 7/8	<b>GS4PLDMF3666L-</b> [ ]	2,047	3,590	3,949
	36	72	27 7/8	<b>GS4PLDMF3672L-</b> [ ]	2,113	3,728	4,101
	36	78	27 7/8	<b>GS4PLDMF3678L-</b> [ ]	2,178	3,861	4,248
	36	84	27 7/8	<b>GS4PLDMF3684L-</b> [ ]	2,314	4,067	4,474
	36	90	27 7/8	<b>GS4PLDMF3690L-</b> [ ]	2,382	4,205	4,626
	36	96	27 7/8	<b>GS4PLDMF3696L-</b> [ ]	2,448	4,342	4,777

## PRODUCT INFO

 All units shipped as separate packages and require field assembly.

## TO ORDER PLEASE SPECIFY THE FOLLOWING:

### WOOD CHASSIS

1. **MODEL NUMBER + W**
2. **FSC**
3. **CHASSIS WOOD FINISH**

### LAM CHASSIS

1. **MODEL NUMBER + L**
2. **FSC**
3. **CHASSIS LAM**



	D	W	H	model number + type	laminate	veneer 1	veneer 2
<b>30" DEPTH SHROUD</b> 	30	66	27 7/8	<b>GS4PLDMF3066R-</b> <input type="checkbox"/>	1,936	3,419	3,761
	30	72	27 7/8	<b>GS4PLDMF3072R-</b> <input type="checkbox"/>	2,002	3,557	3,913
	30	78	27 7/8	<b>GS4PLDMF3078R-</b> <input type="checkbox"/>	2,067	3,690	4,059
	30	84	27 7/8	<b>GS4PLDMF3084R-</b> <input type="checkbox"/>	2,203	3,896	4,286
	30	90	27 7/8	<b>GS4PLDMF3090R-</b> <input type="checkbox"/>	2,271	4,034	4,438
	30	96	27 7/8	<b>GS4PLDMF3096R-</b> <input type="checkbox"/>	2,337	4,171	4,589
<b>36" DEPTH SHROUD</b>	36	66	27 7/8	<b>GS4PLDMF3666R-</b> <input type="checkbox"/>	2,047	3,590	3,949
	36	72	27 7/8	<b>GS4PLDMF3672R-</b> <input type="checkbox"/>	2,113	3,728	4,101
	36	78	27 7/8	<b>GS4PLDMF3678R-</b> <input type="checkbox"/>	2,178	3,861	4,248
	36	84	27 7/8	<b>GS4PLDMF3684R-</b> <input type="checkbox"/>	2,314	4,067	4,474
	36	90	27 7/8	<b>GS4PLDMF3690R-</b> <input type="checkbox"/>	2,382	4,205	4,626
	36	96	27 7/8	<b>GS4PLDMF3696R-</b> <input type="checkbox"/>	2,448	4,342	4,777

**PRODUCT INFO**

 All units shipped as separate packages and require field assembly.

**TO ORDER PLEASE SPECIFY THE FOLLOWING:**

WOOD CHASSIS

1. **MODEL NUMBER + W**
2. **FSC**
3. **CHASSIS WOOD FINISH**

LAM CHASSIS

1. **MODEL NUMBER + L**
2. **FSC**
3. **CHASSIS LAM**

# L SHAPE HEIGHT ADJUSTABLE

Desk Full Modesty, Left Hand Pedestal

Silea

05/22

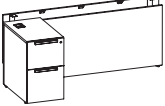
	D	W	H	model number + type	laminate	veneer 1	veneer 2
<b>30" DEPTH PEDESTAL</b> 	30	66	27 7/8	<b>GS4PLDMF3066L-A</b> <input type="checkbox"/>	2,490	4,484	4,933
	30	72	27 7/8	<b>GS4PLDMF3072L-A</b> <input type="checkbox"/>	2,556	4,622	5,085
	30	78	27 7/8	<b>GS4PLDMF3078L-A</b> <input type="checkbox"/>	2,621	4,755	5,231
	30	84	27 7/8	<b>GS4PLDMF3084L-A</b> <input type="checkbox"/>	2,757	4,961	5,458
	30	90	27 7/8	<b>GS4PLDMF3090L-A</b> <input type="checkbox"/>	2,825	5,099	5,609
	30	96	27 7/8	<b>GS4PLDMF3096L-A</b> <input type="checkbox"/>	2,891	5,236	5,760
<b>36" DEPTH PEDESTAL</b>	36	66	27 7/8	<b>GS4PLDMF3666L-A</b> <input type="checkbox"/>	2,573	4,624	5,087
	36	72	27 7/8	<b>GS4PLDMF3672L-A</b> <input type="checkbox"/>	2,639	4,762	5,239
	36	78	27 7/8	<b>GS4PLDMF3678L-A</b> <input type="checkbox"/>	2,704	4,895	5,385
	36	84	27 7/8	<b>GS4PLDMF3684L-A</b> <input type="checkbox"/>	2,840	5,101	5,612
	36	90	27 7/8	<b>GS4PLDMF3690L-A</b> <input type="checkbox"/>	2,908	5,239	5,763
	36	96	27 7/8	<b>GS4PLDMF3696L-A</b> <input type="checkbox"/>	2,974	5,376	5,914

## PRODUCT INFO

 All units shipped as separate packages and require field assembly.

## TO ORDER PLEASE SPECIFY THE FOLLOWING:

### WOOD CHASSIS

1. **MODEL NUMBER + W**
2. **FSC**
3. **CHASSIS WOOD FINISH**
4. **PULL**
5. **KEYING**

### LAM CHASSIS

1. **MODEL NUMBER + L**
2. **FSC**
3. **CHASSIS LAM**
4. **FRONT LAM**
5. **PULL**
6. **KEYING**

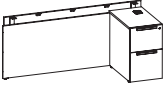
	D	W	H	model number + type	laminate	veneer 1	veneer 2
<b>30" DEPTH PEDESTAL</b> 	30	66	27 7/8	<b>GS4PLDMF3066R-A</b> <input type="checkbox"/>	2,490	4,484	4,933
	30	72	27 7/8	<b>GS4PLDMF3072R-A</b> <input type="checkbox"/>	2,556	4,622	5,085
	30	78	27 7/8	<b>GS4PLDMF3078R-A</b> <input type="checkbox"/>	2,621	4,755	5,231
	30	84	27 7/8	<b>GS4PLDMF3084R-A</b> <input type="checkbox"/>	2,757	4,961	5,458
	30	90	27 7/8	<b>GS4PLDMF3090R-A</b> <input type="checkbox"/>	2,825	5,099	5,609
	30	96	27 7/8	<b>GS4PLDMF3096R-A</b> <input type="checkbox"/>	2,891	5,236	5,760
<b>36" DEPTH PEDESTAL</b>	36	66	27 7/8	<b>GS4PLDMF3666R-A</b> <input type="checkbox"/>	2,573	4,624	5,087
	36	72	27 7/8	<b>GS4PLDMF3672R-A</b> <input type="checkbox"/>	2,639	4,762	5,239
	36	78	27 7/8	<b>GS4PLDMF3678R-A</b> <input type="checkbox"/>	2,704	4,895	5,385
	36	84	27 7/8	<b>GS4PLDMF3684R-A</b> <input type="checkbox"/>	2,840	5,101	5,612
	36	90	27 7/8	<b>GS4PLDMF3690R-A</b> <input type="checkbox"/>	2,908	5,239	5,763
	36	96	27 7/8	<b>GS4PLDMF3696R-A</b> <input type="checkbox"/>	2,974	5,376	5,914

**PRODUCT INFO**

 All units shipped as separate packages and require field assembly.

**TO ORDER PLEASE SPECIFY THE FOLLOWING:**

WOOD CHASSIS

1. **MODEL NUMBER + W**
2. **FSC**
3. **CHASSIS WOOD FINISH**
4. **PULL**
5. **KEYING**

LAM CHASSIS

1. **MODEL NUMBER + L**
2. **FSC**
3. **CHASSIS LAM**
4. **FRONT LAM**
5. **PULL**
6. **KEYING**

# L SHAPE HEIGHT ADJUSTABLE

Desk Half Modesty, Left Hand Shroud

Silea

05/22

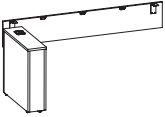
	D	W	H	model number + type	laminate	veneer 1	veneer 2
<b>30" DEPTH SHROUD</b> 	30	66	27 7/8	<b>GS4PLDMH3066L-</b> <input type="checkbox"/>	2,045	2,901	3,192
	30	72	27 7/8	<b>GS4PLDMH3072L-</b> <input type="checkbox"/>	2,099	2,978	3,276
	30	78	27 7/8	<b>GS4PLDMH3078L-</b> <input type="checkbox"/>	2,131	3,024	3,327
	30	84	27 7/8	<b>GS4PLDMH3084L-</b> <input type="checkbox"/>	2,235	3,142	3,457
	30	90	27 7/8	<b>GS4PLDMH3090L-</b> <input type="checkbox"/>	2,270	3,194	3,514
	30	96	27 7/8	<b>GS4PLDMH3096L-</b> <input type="checkbox"/>	2,309	3,247	3,572
<b>36" DEPTH SHROUD</b>	36	66	27 7/8	<b>GS4PLDMH3666L-</b> <input type="checkbox"/>	2,156	3,072	3,380
	36	72	27 7/8	<b>GS4PLDMH3672L-</b> <input type="checkbox"/>	2,210	3,149	3,464
	36	78	27 7/8	<b>GS4PLDMH3678L-</b> <input type="checkbox"/>	2,242	3,195	3,515
	36	84	27 7/8	<b>GS4PLDMH3684L-</b> <input type="checkbox"/>	2,346	3,313	3,645
	36	90	27 7/8	<b>GS4PLDMH3690L-</b> <input type="checkbox"/>	2,381	3,365	3,702
	36	96	27 7/8	<b>GS4PLDMH3696L-</b> <input type="checkbox"/>	2,420	3,418	3,760

## PRODUCT INFO

 All units shipped as separate packages and require field assembly.

## TO ORDER PLEASE SPECIFY THE FOLLOWING:

### WOOD CHASSIS

1. **MODEL NUMBER + W**
2. **FSC**
3. **CHASSIS WOOD FINISH**

### LAM CHASSIS

1. **MODEL NUMBER + L**
2. **FSC**
3. **CHASSIS LAM**

	D	W	H	model number + type	laminate	veneer 1	veneer 2
<b>30" DEPTH SHROUD</b> 	30	66	27 7/8	<b>GS4PLDMH3066R-</b> <input type="checkbox"/>	2,045	2,901	3,192
	30	72	27 7/8	<b>GS4PLDMH3072R-</b> <input type="checkbox"/>	2,099	2,978	3,276
	30	78	27 7/8	<b>GS4PLDMH3078R-</b> <input type="checkbox"/>	2,131	3,024	3,327
	30	84	27 7/8	<b>GS4PLDMH3084R-</b> <input type="checkbox"/>	2,235	3,142	3,457
	30	90	27 7/8	<b>GS4PLDMH3090R-</b> <input type="checkbox"/>	2,270	3,194	3,514
	30	96	27 7/8	<b>GS4PLDMH3096R-</b> <input type="checkbox"/>	2,309	3,247	3,572
<b>36" DEPTH SHROUD</b>	36	66	27 7/8	<b>GS4PLDMH3666R-</b> <input type="checkbox"/>	2,156	3,072	3,380
	36	72	27 7/8	<b>GS4PLDMH3672R-</b> <input type="checkbox"/>	2,210	3,149	3,464
	36	78	27 7/8	<b>GS4PLDMH3678R-</b> <input type="checkbox"/>	2,242	3,195	3,515
	36	84	27 7/8	<b>GS4PLDMH3684R-</b> <input type="checkbox"/>	2,346	3,313	3,645
	36	90	27 7/8	<b>GS4PLDMH3690R-</b> <input type="checkbox"/>	2,381	3,365	3,702
	36	96	27 7/8	<b>GS4PLDMH3696R-</b> <input type="checkbox"/>	2,420	3,418	3,760

**PRODUCT INFO**

 All units shipped as separate packages and require field assembly.

**TO ORDER PLEASE SPECIFY THE FOLLOWING:**

WOOD CHASSIS

1. **MODEL NUMBER + W**
2. **FSC**
3. **CHASSIS WOOD FINISH**

LAM CHASSIS

1. **MODEL NUMBER + L**
2. **FSC**
3. **CHASSIS LAM**

# L SHAPE HEIGHT ADJUSTABLE

Desk Half Modesty, Left Hand Pedestal

Silea

05/22

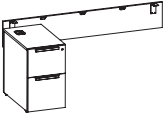
	D	W	H	model number + type	laminate	veneer 1	veneer 2
<b>30" DEPTH PEDESTAL</b> 	30	66	27 7/8	<b>GS4PLDMH3066L-A</b> <input type="checkbox"/>	2,610	4,137	4,551
	30	72	27 7/8	<b>GS4PLDMH3072L-A</b> <input type="checkbox"/>	2,664	4,214	4,636
	30	78	27 7/8	<b>GS4PLDMH3078L-A</b> <input type="checkbox"/>	2,696	4,260	4,686
	30	84	27 7/8	<b>GS4PLDMH3084L-A</b> <input type="checkbox"/>	2,800	4,378	4,816
	30	90	27 7/8	<b>GS4PLDMH3090L-A</b> <input type="checkbox"/>	2,835	4,430	4,873
	30	96	27 7/8	<b>GS4PLDMH3096L-A</b> <input type="checkbox"/>	2,874	4,483	4,932
<b>36" DEPTH PEDESTAL</b>	36	66	27 7/8	<b>GS4PLDMH3666L-A</b> <input type="checkbox"/>	2,693	4,277	4,705
	36	72	27 7/8	<b>GS4PLDMH3672L-A</b> <input type="checkbox"/>	2,747	4,354	4,790
	36	78	27 7/8	<b>GS4PLDMH3678L-A</b> <input type="checkbox"/>	2,779	4,400	4,840
	36	84	27 7/8	<b>GS4PLDMH3684L-A</b> <input type="checkbox"/>	2,883	4,518	4,970
	36	90	27 7/8	<b>GS4PLDMH3690L-A</b> <input type="checkbox"/>	2,918	4,570	5,027
	36	96	27 7/8	<b>GS4PLDMH3696L-A</b> <input type="checkbox"/>	2,957	4,623	5,086

## PRODUCT INFO

 All units shipped as separate packages and require field assembly.

## TO ORDER PLEASE SPECIFY THE FOLLOWING:

### WOOD CHASSIS

1. **MODEL NUMBER + W**
2. **FSC**
3. **CHASSIS WOOD FINISH**
4. **PULL**
5. **KEYING**

### LAM CHASSIS

1. **MODEL NUMBER + L**
2. **FSC**
3. **CHASSIS LAM**
4. **FRONT LAM**
5. **PULL**
6. **KEYING**

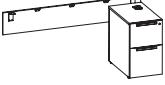
	D	W	H	model number + type	laminate	veneer 1	veneer 2
<b>30" DEPTH PEDESTAL</b> 	30	66	27 7/8	<b>GS4PLDMH3066R-A</b> <input type="checkbox"/>	2,610	4,137	4,551
	30	72	27 7/8	<b>GS4PLDMH3072R-A</b> <input type="checkbox"/>	2,664	4,214	4,636
	30	78	27 7/8	<b>GS4PLDMH3078R-A</b> <input type="checkbox"/>	2,696	4,260	4,686
	30	84	27 7/8	<b>GS4PLDMH3084R-A</b> <input type="checkbox"/>	2,800	4,378	4,816
	30	90	27 7/8	<b>GS4PLDMH3090R-A</b> <input type="checkbox"/>	2,835	4,430	4,873
	30	96	27 7/8	<b>GS4PLDMH3096R-A</b> <input type="checkbox"/>	2,874	4,483	4,932
<b>36" DEPTH PEDESTAL</b>	36	66	27 7/8	<b>GS4PLDMH3666R-A</b> <input type="checkbox"/>	2,693	4,277	4,705
	36	72	27 7/8	<b>GS4PLDMH3672R-A</b> <input type="checkbox"/>	2,747	4,354	4,790
	36	78	27 7/8	<b>GS4PLDMH3678R-A</b> <input type="checkbox"/>	2,779	4,400	4,840
	36	84	27 7/8	<b>GS4PLDMH3684R-A</b> <input type="checkbox"/>	2,883	4,518	4,970
	36	90	27 7/8	<b>GS4PLDMH3690R-A</b> <input type="checkbox"/>	2,918	4,570	5,027
	36	96	27 7/8	<b>GS4PLDMH3696R-A</b> <input type="checkbox"/>	2,957	4,623	5,086

**PRODUCT INFO**

 All units shipped as separate packages and require field assembly.

**TO ORDER PLEASE SPECIFY THE FOLLOWING:**

WOOD CHASSIS

1. **MODEL NUMBER + W**
2. **FSC**
3. **CHASSIS WOOD FINISH**
4. **PULL**
5. **KEYING**

LAM CHASSIS

1. **MODEL NUMBER + L**
2. **FSC**
3. **CHASSIS LAM**
4. **FRONT LAM**
5. **PULL**
6. **KEYING**

# L SHAPE HEIGHT ADJUSTABLE

## 30D & 36D Desk Worksurfaces Rectangular

Silea  
05/22

	D	W	H	model number + type	laminata	veneer 1	veneer 2
	30	66	1 3/16	<b>GS4LADWR3066-</b> <input type="checkbox"/>	986	1,538	1,692
	30	72	1 3/16	<b>GS4LADWR3072-</b> <input type="checkbox"/>	1,039	1,618	1,780
	30	78	1 3/16	<b>GS4LADWR3078-</b> <input type="checkbox"/>	1,110	1,732	1,906
	30	84	1 3/16	<b>GS4LADWR3084-</b> <input type="checkbox"/>	1,188	1,855	2,041
	30	90	1 3/16	<b>GS4LADWR3090-</b> <input type="checkbox"/>	1,266	1,948	2,143
	30	96	1 3/16	<b>GS4LADWR3096-</b> <input type="checkbox"/>	1,329	2,045	2,250
	36	66	1 3/16	<b>GS4LADWR3666-</b> <input type="checkbox"/>	1,056	1,648	1,813
	36	72	1 3/16	<b>GS4LADWR3672-</b> <input type="checkbox"/>	1,112	1,736	1,910
	36	78	1 3/16	<b>GS4LADWR3678-</b> <input type="checkbox"/>	1,191	1,858	2,044
	36	84	1 3/16	<b>GS4LADWR3684-</b> <input type="checkbox"/>	1,274	1,989	2,188
	36	90	1 3/16	<b>GS4LADWR3690-</b> <input type="checkbox"/>	1,357	2,088	2,297
	36	96	1 3/16	<b>GS4LADWR3696-</b> <input type="checkbox"/>	1,425	2,193	2,413

- Flat brackets ordered separately (model #MDWBRK)

### PRODUCT INFO

All tops long grain standard.  
Tops are undersized to allow for pinch points.

#### Grommet Location (Add \$70 per grommet)

No Grommet **GN**  
Left **GL**  
Right **GR**  
Left & Right **GB**

Specify location first, then select grommet color or "Empty Cutout" option. When "Empty Cutout" option is selected, a grommet or power unit must be ordered separately for each cutout.

### TO ORDER PLEASE SPECIFY THE FOLLOWING:

#### WOOD TOP

1. **MODEL NUMBER + W**
2. **FSC**
3. **TOP WOOD FINISH + EDGE**
4. **TOP UV FINISH**
5. **GROMMET**

#### LAM TOP

1. **MODEL NUMBER + L**
2. **FSC**
3. **TOP LAM**
4. **EDGE DETAIL**
5. **GROMMET**



# L SHAPE HEIGHT ADJUSTABLE

## 24D & 30D Return Worksurfaces Rectangular

	D	W	H	model number + type	laminate	veneer 1	veneer 2
	24	42	1 3/16	<b>GS4LACWR2442-</b> <input type="checkbox"/>	684	1,065	1,172
	24	48	1 3/16	<b>GS4LACWR2448-</b> <input type="checkbox"/>	747	1,166	1,283
	24	54	1 3/16	<b>GS4LACWR2454-</b> <input type="checkbox"/>	788	1,227	1,350
	24	60	1 3/16	<b>GS4LACWR2460-</b> <input type="checkbox"/>	856	1,335	1,469
	24	66	1 3/16	<b>GS4LACWR2466-</b> <input type="checkbox"/>	910	1,417	1,559
	24	72	1 3/16	<b>GS4LACWR2472-</b> <input type="checkbox"/>	1,015	1,585	1,744
	30	42	1 3/16	<b>GS4LACWR3042-</b> <input type="checkbox"/>	873	1,363	1,500
	30	48	1 3/16	<b>GS4LACWR3048-</b> <input type="checkbox"/>	920	1,434	1,578
	30	54	1 3/16	<b>GS4LACWR3054-</b> <input type="checkbox"/>	930	1,453	1,599
	30	60	1 3/16	<b>GS4LACWR3060-</b> <input type="checkbox"/>	942	1,469	1,616
	30	66	1 3/16	<b>GS4LACWR3066-</b> <input type="checkbox"/>	986	1,538	1,692
	30	72	1 3/16	<b>GS4LACWR3072-</b> <input type="checkbox"/>	1,039	1,618	1,780

• Flat brackets ordered separately (model #MDWBRK)

### PRODUCT INFO

Wood tops are short grain standard. Lam tops are short grain up to 60", over 60" are long grain standard.

Tops are undersized to allow for pinch points.

#### Grommet Location (Add \$70 per grommet)

No Grommet **GN**  
Center **GC**

Specify location first, then select grommet color or "Empty Cutout" option. When "Empty Cutout" option is selected, a grommet or power unit must be ordered separately for each cutout.

### TO ORDER PLEASE SPECIFY THE FOLLOWING:

#### WOOD TOP

- MODEL NUMBER + W**
- FSC**
- TOP WOOD FINISH + EDGE**
- TOP UV FINISH**
- GROMMET**

#### LAM TOP

- MODEL NUMBER + L**
- FSC**
- TOP LAM**
- EDGE DETAIL**
- GROMMET**

# L SHAPE HEIGHT ADJUSTABLE

Cockpit Top Shape, For Left Hand Desk

Silea

05/22

Desk Depth	Desk Width	Return Depth	Return Width	Total Workwall Width	model number + type	laminate	veneer 1	veneer 2
30	72	24	42	72	GS4LATOP30722442L- [ ]	1,896	2,953	3,249
30	72	24	48	78	GS4LATOP30722448L- [ ]	1,965	3,061	3,368
30	72	24	54	84	GS4LATOP30722454L- [ ]	2,008	3,132	3,446
30	72	24	60	90	GS4LATOP30722460L- [ ]	2,086	3,249	3,574
30	72	24	66	96	GS4LATOP30722466L- [ ]	2,144	3,340	3,674
30	72	24	72	102	GS4LATOP30722472L- [ ]	N/A	3,524	3,877
30	84	24	42	72	GS4LATOP30842442L- [ ]	2,061	3,213	3,535
30	84	24	48	78	GS4LATOP30842448L- [ ]	2,130	3,323	3,656
30	84	24	54	84	GS4LATOP30842454L- [ ]	2,174	3,391	3,731
30	84	24	60	90	GS4LATOP30842460L- [ ]	2,249	3,509	3,860
30	84	24	66	96	GS4LATOP30842466L- [ ]	2,307	3,599	3,959
30	84	24	72	102	GS4LATOP30842472L- [ ]	N/A	3,786	4,165
36	72	24	42	78	GS4LATOP36722442L- [ ]	1,896	3,084	3,393
36	72	24	48	84	GS4LATOP36722448L- [ ]	1,965	3,193	3,513
36	72	24	54	90	GS4LATOP36722454L- [ ]	2,008	3,262	3,589
36	72	24	60	96	GS4LATOP36722460L- [ ]	2,086	3,380	3,718
36	72	24	66	102	GS4LATOP36722466L- [ ]	N/A	3,470	3,817
36	72	24	72	108	GS4LATOP36722472L- [ ]	N/A	3,656	4,022
36	84	24	42	78	GS4LATOP36842442L- [ ]	2,061	3,360	3,696
36	84	24	48	84	GS4LATOP36842448L- [ ]	2,130	3,469	3,816
36	84	24	54	90	GS4LATOP36842454L- [ ]	2,174	3,538	3,892
36	84	24	60	96	GS4LATOP36842460L- [ ]	2,249	3,657	4,023
36	84	24	66	102	GS4LATOP36842466L- [ ]	N/A	3,747	4,122
36	84	24	72	108	GS4LATOP36842472L- [ ]	N/A	3,931	4,325

## PRODUCT INFO

Desk top portion is long grain standard, return short grain.

Tops are undersized to allow for pinch points.

**Grommet Location**  
(Add \$70 per grommet)

No Grommet    **GN**  
Left            **GL**  
Right          **GR**  
Left & Right   **GB**

Specify location first, then select grommet color or "Empty Cutout" option. When "Empty Cutout" option is selected, a grommet or power unit must be ordered separately for each cutout.

## TO ORDER PLEASE SPECIFY THE FOLLOWING:

### WOOD TOP

- MODEL NUMBER + W**
- FSC**
- TOP WOOD FINISH + EDGE**
- TOP UV FINISH**
- DESK GROMMET**

### LAM TOP

- MODEL NUMBER + L**
- FSC**
- TOP LAM**
- EDGE DETAIL**
- DESK GROMMET**

# L SHAPE HEIGHT ADJUSTABLE

Cockpit Top Shape, For Right Hand Desk

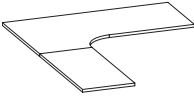
Desk Depth	Desk Width	Return Depth	Return Width	Total Workwall Width	model number + type	laminate	veneer 1	veneer 2	
	30	72	24	42	72	<b>GS4LATOP30722442R-</b> <input type="checkbox"/>	1,896	2,953	3,249
	30	72	24	48	78	<b>GS4LATOP30722448R-</b> <input type="checkbox"/>	1,965	3,061	3,368
	30	72	24	54	84	<b>GS4LATOP30722454R-</b> <input type="checkbox"/>	2,008	3,132	3,446
	30	72	24	60	90	<b>GS4LATOP30722460R-</b> <input type="checkbox"/>	2,086	3,249	3,574
	30	72	24	66	96	<b>GS4LATOP30722466R-</b> <input type="checkbox"/>	2,144	3,340	3,674
	30	72	24	72	102	<b>GS4LATOP30722472R-</b> <input type="checkbox"/>	N/A	3,524	3,877
30	84	24	42	72	<b>GS4LATOP30842442R-</b> <input type="checkbox"/>	2,061	3,213	3,535	
30	84	24	48	78	<b>GS4LATOP30842448R-</b> <input type="checkbox"/>	2,130	3,323	3,656	
30	84	24	54	84	<b>GS4LATOP30842454R-</b> <input type="checkbox"/>	2,174	3,391	3,731	
30	84	24	60	90	<b>GS4LATOP30842460R-</b> <input type="checkbox"/>	2,249	3,509	3,860	
30	84	24	66	96	<b>GS4LATOP30842466R-</b> <input type="checkbox"/>	2,307	3,599	3,959	
30	84	24	72	102	<b>GS4LATOP30842472R-</b> <input type="checkbox"/>	N/A	3,786	4,165	
36	72	24	42	78	<b>GS4LATOP36722442R-</b> <input type="checkbox"/>	1,896	3,084	3,393	
36	72	24	48	84	<b>GS4LATOP36722448R-</b> <input type="checkbox"/>	1,965	3,193	3,513	
36	72	24	54	90	<b>GS4LATOP36722454R-</b> <input type="checkbox"/>	2,008	3,262	3,589	
36	72	24	60	96	<b>GS4LATOP36722460R-</b> <input type="checkbox"/>	2,086	3,380	3,718	
36	72	24	66	102	<b>GS4LATOP36722466R-</b> <input type="checkbox"/>	N/A	3,470	3,817	
36	72	24	72	108	<b>GS4LATOP36722472R-</b> <input type="checkbox"/>	N/A	3,656	4,022	
36	84	24	42	78	<b>GS4LATOP36842442R-</b> <input type="checkbox"/>	2,061	3,360	3,696	
36	84	24	48	84	<b>GS4LATOP36842448R-</b> <input type="checkbox"/>	2,130	3,469	3,816	
36	84	24	54	90	<b>GS4LATOP36842454R-</b> <input type="checkbox"/>	2,174	3,538	3,892	
36	84	24	60	96	<b>GS4LATOP36842460R-</b> <input type="checkbox"/>	2,249	3,657	4,023	
36	84	24	66	102	<b>GS4LATOP36842466R-</b> <input type="checkbox"/>	N/A	3,747	4,122	
36	84	24	72	108	<b>GS4LATOP36842472R-</b> <input type="checkbox"/>	N/A	3,931	4,325	

### PRODUCT INFO

Desk top portion is long grain standard, return short grain.

Tops are undersized to allow for pinch points.

#### Grommet Location (Add \$70 per grommet)

No Grommet **GN**  
Left **GL**  
Right **GR**  
Left & Right **GB**

Specify location first, then select grommet color or "Empty Cutout" option. When "Empty Cutout" option is selected, a grommet or power unit must be ordered separately for each cutout.

### TO ORDER PLEASE SPECIFY THE FOLLOWING:

#### WOOD TOP

- MODEL NUMBER + W**
- FSC**
- TOP WOOD FINISH + EDGE**
- TOP UV FINISH**
- DESK GROMMET**

#### LAM TOP

- MODEL NUMBER + L**
- FSC**
- TOP LAM**
- EDGE DETAIL**
- DESK GROMMET**

# L SHAPE HEIGHT ADJUSTABLE

Hardware & Bracketry Kit

Silea

05/22

D	W	H	model number	Qty
<b>3 MOTOR KIT</b>			<b>GS4LALNKDPD-3</b>	2,107
<b>4 MOTOR KIT</b>			<b>GS4LALNKDPD-4</b>	2,617

Total Workwall Width	# Motors	Model # to Order
Workwall 72"	3	GS4LALNKDPD-3
Workwall 78"	3	GS4LALNKDPD-3
Workwall 84"	3	GS4LALNKDPD-3
Workwall 90"	3	GS4LALNKDPD-3
Workwall 96"	3	GS4LALNKDPD-3
Workwall 102"	4	GS4LALNKDPD-4
Workwall 108"	4	GS4LALNKDPD-4

## PRODUCT INFO

L shape units require field assembly

## TO ORDER PLEASE SPECIFY THE FOLLOWING:

### LIST

- MODEL NUMBER**
- HAT KEYPAD & BASE COLOR**

Optional height adjustable keypads available

#### HAT KEYPAD & BASE COLOR

Basic Up/Down Keypad, Black P71 Column	<b>UDP71</b>
Memory Preset Keypad, Black P71 Column	<b>MEMP71</b>
Paddle Keypad, Black P71 Column	<b>PDLP71</b>
Foot Control Keypad, Black P71 Column	<b>FPDP71</b> Add \$240

NOTE: Foot control keypad is bluetooth controlled and may be used in conjunction with other keypads attached to worksurface. For these situations order standard keypad for worksurface separately. Foot control requires qty (2) AAA batteries needed. Batteries not included.

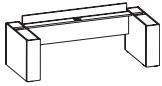
	D	W	H	model number + type	laminata	venera 1	venera 2
	24	42	22 1/2	GS3HASHRD2442- [ ]	2,308	3,345	3,680
	24	48	22 1/2	GS3HASHRD2448- [ ]	2,337	3,387	3,726
	24	54	22 1/2	GS3HASHRD2454- [ ]	2,366	3,429	3,772
	24	60	22 1/2	GS3HASHRD2460- [ ]	2,395	3,469	3,816
	24	66	22 1/2	GS3HASHRD2466- [ ]	2,423	3,512	3,864
	24	72	22 1/2	GS3HASHRD2472- [ ]	2,452	3,553	3,909
	30	42	22 1/2	GS3HASHRD3042- [ ]	2,380	3,448	3,793
	30	48	22 1/2	GS3HASHRD3048- [ ]	2,409	3,489	3,838
	30	54	22 1/2	GS3HASHRD3054- [ ]	2,438	3,532	3,886
	30	60	22 1/2	GS3HASHRD3060- [ ]	2,467	3,575	3,933
	30	66	22 1/2	GS3HASHRD3066- [ ]	2,495	3,616	3,978
	30	72	22 1/2	GS3HASHRD3072- [ ]	2,524	3,659	4,025
	36	42	22 1/2	GS3HASHRD3642- [ ]	2,450	3,553	3,909
	36	48	22 1/2	GS3HASHRD3648- [ ]	2,479	3,595	3,955
	36	54	22 1/2	GS3HASHRD3654- [ ]	2,508	3,636	4,000
	36	60	22 1/2	GS3HASHRD3660- [ ]	2,537	3,679	4,047
	36	66	22 1/2	GS3HASHRD3666- [ ]	2,565	3,722	4,095
	36	72	22 1/2	GS3HASHRD3672- [ ]	2,594	3,762	4,139

**PRODUCT INFO**

Top and t-base ordered separately.

Wood models ship assembled.

 Laminate units shipped as separate packages and require field assembly.

**TO ORDER PLEASE SPECIFY THE FOLLOWING:**

WOOD CHASSIS

1. **MODEL NUMBER + W**
2. **FSC**
3. **CHASSIS WOOD FINISH**

LAM CHASSIS

1. **MODEL NUMBER + L**
2. **FSC**
3. **CHASSIS LAM**

# LAYERS BOOKCASE

w/ top for T-Base

Silea

05/22

	D	W	H	model number + type	laminare	vener 1	vener 2
	23 1/8	24	22 3/8	<b>GS2LHAPD2424L-</b> [ ]	1,607	2,509	2,760
	23 1/8	30	22 3/8	<b>GS2LHAPD2430L-</b> [ ]	1,718	2,682	2,951
	23 1/8	36	22 3/8	<b>GS2LHAPD2436L-</b> [ ]	1,830	2,857	3,143

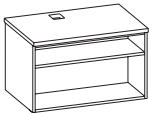
	23 1/8	24	22 3/8	<b>GS2LHAPD2424R-</b> [ ]	1,607	2,509	2,760
	23 1/8	30	22 3/8	<b>GS2LHAPD2430R-</b> [ ]	1,718	2,682	2,951
	23 1/8	36	22 3/8	<b>GS2LHAPD2436R-</b> [ ]	1,830	2,857	3,143



Layers Bookcase  
(right hand shown)

## PRODUCT INFO

T-base height adjustable not included.

## TO ORDER PLEASE SPECIFY THE FOLLOWING:

WOOD TOP, WOOD CHASSIS

1. **MODEL NUMBER + WW**
2. **FSC**
3. **TOP WOOD FINISH + EDGE**
4. **CHASSIS WOOD FINISH**
5. **TOP UV FINISH**
6. **GRAIN DIRECTION**

LAM TOP, LAM CHASSIS

1. **MODEL NUMBER + LL**
2. **FSC**
3. **TOP LAM**
4. **CHASSIS LAM**
5. **GRAIN DIRECTION**

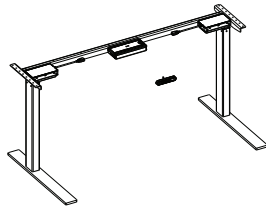
for use with top sizes	D	W	H	model number	list	
	22 x 40	21	36	26	<b>BSHAT2142</b>	2,823
	22 x 46	21	42	26	<b>BSHAT2148</b>	2,836
	22 x 52	21	48	26	<b>BSHAT2154</b>	2,853
	22 x 58	21	54	26	<b>BSHAT2160</b>	2,866
	22 x 64	21	60	26	<b>BSHAT2166</b>	2,882
	22 x 70	21	66	26	<b>BSHAT2172</b>	2,896

28/34 x 46	27	42	26	<b>BSHAT2748</b>	2,866
28/34 x 52	27	48	26	<b>BSHAT2754</b>	2,882
28/34 x 58	27	54	26	<b>BSHAT2760</b>	2,896
28/34 x 64	27	60	26	<b>BSHAT2766</b>	2,913
28/34 x 70	27	66	26	<b>BSHAT2772</b>	2,927

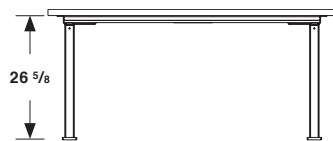

Base at lowest height setting

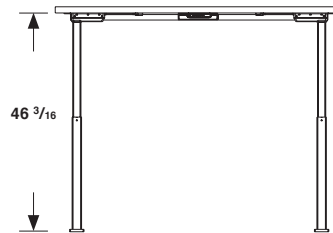

Base at tallest height setting

**PRODUCT INFO**

Tops and modesty panel ordered separately in modular tab.

**TO ORDER PLEASE SPECIFY THE FOLLOWING:**

LIST

1. **MODEL NUMBER**
2. **BASE COLOR**

# HEIGHT ADJUSTABLE TOPS

22D, 28D & 34D

Silea

05/22

	D	W	H	model number + type	laminata	veneer 1	veneer 2
	22	40	1 3/16	<b>GS2CWA2240-</b> <input type="checkbox"/>	684	1,065	1,172
	22	46	1 3/16	<b>GS2CWA2246-</b> <input type="checkbox"/>	747	1,166	1,283
	22	52	1 3/16	<b>GS2CWA2252-</b> <input type="checkbox"/>	788	1,227	1,350
	22	58	1 3/16	<b>GS2CWA2258-</b> <input type="checkbox"/>	856	1,335	1,469
	22	64	1 3/16	<b>GS2CWA2264-</b> <input type="checkbox"/>	910	1,417	1,559
	22	70	1 3/16	<b>GS2CWA2270-</b> <input type="checkbox"/>	1,015	1,585	1,744
	28	40	1 3/16	<b>GS2CWA2840-</b> <input type="checkbox"/>	873	1,363	1,500
	28	46	1 3/16	<b>GS2CWA2846-</b> <input type="checkbox"/>	920	1,434	1,578
	28	52	1 3/16	<b>GS2CWA2852-</b> <input type="checkbox"/>	930	1,453	1,599
	28	58	1 3/16	<b>GS2CWA2858-</b> <input type="checkbox"/>	942	1,469	1,616
	28	64	1 3/16	<b>GS2CWA2864-</b> <input type="checkbox"/>	986	1,538	1,692
	28	70	1 3/16	<b>GS2CWA2870-</b> <input type="checkbox"/>	1,039	1,618	1,780
	34	40	1 3/16	<b>GS2CWA3440-</b> <input type="checkbox"/>	916	1,431	1,575
	34	46	1 3/16	<b>GS2CWA3446-</b> <input type="checkbox"/>	965	1,507	1,658
	34	52	1 3/16	<b>GS2CWA3452-</b> <input type="checkbox"/>	986	1,538	1,692
	34	58	1 3/16	<b>GS2CWA3458-</b> <input type="checkbox"/>	1,006	1,568	1,725
	34	64	1 3/16	<b>GS2CWA3464-</b> <input type="checkbox"/>	1,056	1,648	1,813
	34	70	1 3/16	<b>GS2CWA3470-</b> <input type="checkbox"/>	1,112	1,736	1,910

## PRODUCT INFO

Depth & width shortened two inches for height adjustable pinch points.

Wood tops optional grain standard.

Lam tops optional grain up to 60", over 60" long grain standard.

### Grommet Location (Add \$70 per grommet)

No Grommet **GN**  
 Left **GL**  
 Center **GC**  
 Right **GR**  
 Left & Right **GB**  
 All **GA**

Specify location first, then select grommet color or "Empty Cutout" option. When "Empty Cutout" option is selected, a grommet or power unit must be ordered separately for each cutout.

## TO ORDER PLEASE SPECIFY THE FOLLOWING:

### WOOD TOP

- MODEL NUMBER + W**
- FSC**
- TOP WOOD FINISH + EDGE**
- TOP UV FINISH**
- GRAIN DIRECTION**
- GROMMET**

### LAM TOP

- MODEL NUMBER + L**
- FSC**
- TOP LAM**
- GRAIN DIRECTION (up to 60")**
- GROMMET**



D	W	H	model number	list
3 1/8	15 3/16	7 1/8	<b>ACWCB15</b>	209
<ul style="list-style-type: none"> <li>For use with 24" tops to provide support on center as an alternative to a T-bracket.</li> </ul>				
3 1/8	20 3/16	7 1/8	<b>ACWCB20</b>	223
<ul style="list-style-type: none"> <li>For use with 24" tops to provide support on an end condition.</li> </ul>				

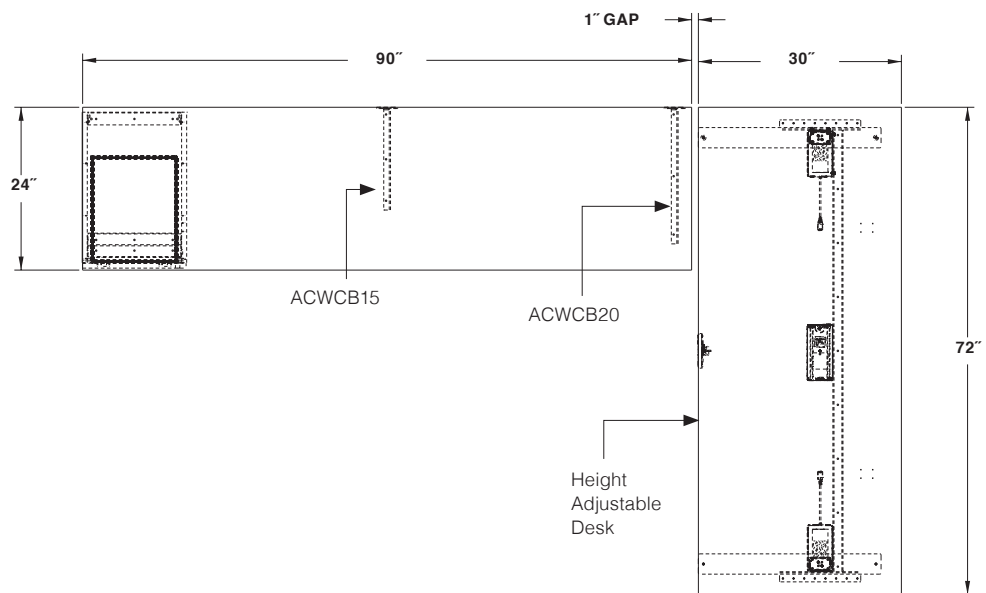
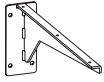

**PRODUCT INFO**

TO ORDER PLEASE SPECIFY THE FOLLOWING:

LIST

- MODEL NUMBER**

# MIXED MATERIAL TELESCOPING HEIGHT ADJUSTABLE

Modesty Panels

Silea

05/22

	D	W	H	model number + type	laminate	veneer 1	veneer 2	metal
	3/4	58	10	<b>GS2DMAMOD66-</b> [ ]	615	894	984	625
	3/4	64	10	<b>GS2DMAMOD72-</b> [ ]	674	976	1,074	683
	3/4	70	10	<b>GS2DMAMOD78-</b> [ ]	732	1,018	1,120	744

- For use with Telescoping Height Adjustable Desks

3/4	58	10	<b>GS2XMAMOD66-</b> [ ]	615	894	984	625
3/4	64	10	<b>GS2XMAMOD72-</b> [ ]	674	976	1,074	683
3/4	70	10	<b>GS2XMAMOD78-</b> [ ]	732	1,018	1,120	744

- For use with Telescoping Height Adjustable Extensions

## PRODUCT INFO

### Grain Direction:

- Natural veneer:  
Vertical
- Stratawood veneer:  
Optional
- Laminate:  
Horizontal

## TO ORDER PLEASE SPECIFY THE FOLLOWING:

### WOOD MODESTY

- MODEL NUMBER + W**
- FSC**
- CHASSIS WOOD FINISH**





### LAM MODESTY

- MODEL NUMBER + L**
- FSC**
- CHASSIS LAM**

### METAL MODESTY

- MODEL NUMBER + M**
- HARDWARE COLOR**

# REPLACEMENT HEIGHT ADJUSTABLE KEYPAD ACCESSORIES

	D	W	H	model number	list
<b>BASIC UP/DOWN KEYPAD</b> 				<b>ACHAT-UD</b>	67
				<ul style="list-style-type: none"> <li>• Basic Up/Down control.</li> </ul>	
<b>MEMORY PRESET KEYPAD</b> 				<b>ACHAT-MEM</b>	85
				<ul style="list-style-type: none"> <li>• 4 memory pre-set options allow the user to adjust their height to their preferred heights.</li> </ul>	
<b>PADDLE KEYPAD</b> 				<b>ACHAT-PDL</b>	125
				<ul style="list-style-type: none"> <li>• Simple, aesthetic control with 1 memory pre-set option and reminder mode.</li> </ul>	
<b>FOOT CONTROL KEYPAD</b> 				<b>ACHAT-FPD</b>	319
				<ul style="list-style-type: none"> <li>• Wireless, hands free control.</li> <li>• Bluetooth receiver included.</li> <li>• Can be used in combination with hand controller for multi-control option.</li> <li>• 2 AAA batteries needed. Batteries not included.</li> </ul>	
<b>BLUETOOTH APP CONTROL</b> 				<b>ACHAT-BLUETOOTH</b>	100
				<ul style="list-style-type: none"> <li>• Bluetooth receiver can be paired with phone app to operate desk.</li> <li>• Can be used in combination with hand controller for multi-control option.</li> </ul>	

## PRODUCT INFO

\*\*ONLY FOR USE WITH  
CANTILEVER HEIGHT  
ADJUSTABLE DESKS AT THIS  
TIME\*\*

## TO ORDER PLEASE SPECIFY THE FOLLOWING:

LIST

### 1. MODEL NUMBER



Welcome Desk . . . . .	126.1-126.18
Advanced Height Adjustable Welcome Desk . . . . .	126.2-126.5
Advanced Fixed Height Welcome Desk . . . . .	126.6-126.7
Fixed Height Welcome Desk . . . . .	126.8-126.9
Welcome Desk Shell . . . . .	126.10-126.11
Welcome Desk Bridge . . . . .	126.12
Welcome Desk Returns . . . . .	126.13
Welcome Desk Credenzas . . . . .	126.14
Waterfall Transaction Tops . . . . .	126.15
Transaction Tops . . . . .	126.16
Welcome Desk Tackboard . . . . .	126.17
In/Out Storage Unit . . . . .	126.18

# ADVANCED HEIGHT ADJUSTABLE WELCOME DESK

Silea

05/22

Extension

	D	W	H	model number + type	laminate	veneer 1	veneer 2
<b>LEFT HAND DESK</b>	45	85	41	<b>GS6GDXA4284L- [ ]</b>	7,714	11,666	12,833

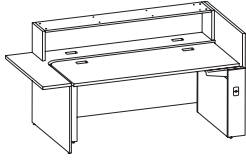

A = 69.86"  
B = 28"  
C = 11.25"  
D = 12.32"  
E = 12.13"

## RIGHT HAND DESK

	45	85	41	<b>GS6GDXA4284R- [ ]</b>	7,714	11,666	12,833
--	----	----	----	--------------------------	-------	--------	--------

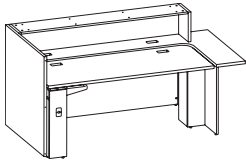

A = 69.86"  
B = 28"  
C = 11.25"  
D = 12.32"  
E = 12.13"

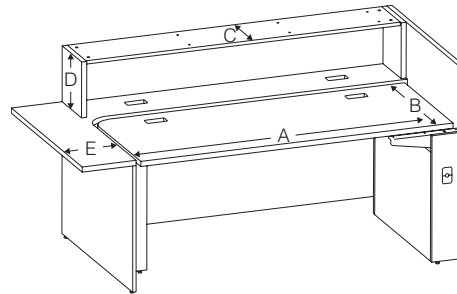

## PRODUCT INFO

Separate countertop must be specified.

29.5" to 42.5" height adjustment range.

All units shipped as separate packages and require field assembly.

### Grommet Location

Specify location first, then select grommet color or "Empty Cutout" option. When "Empty Cutout" option is selected, a grommet or power unit must be ordered separately for each cutout.

No upcharge for "Empty Cutout" option.

(Add +\$210 per additional grommet)

Fixed Top always has Left & Right grommets.

Left	<b>GL</b>
Right	<b>GR</b>
Left & Right	<b>GB</b>

## TO ORDER PLEASE SPECIFY THE FOLLOWING:

### WOOD TOP, WOOD CHASSIS

- MODEL NUMBER + WW**
- FSC**
- TOP WOOD FINISH + EDGE**
- CHASSIS WOOD FINISH**
- GALLERY PANEL WOOD FINISH**
- TOP UV FINISH**
- HAT KEYPAD & BASE COLOR**
- GROMMET**

### LAM TOP, LAM CHASSIS

- MODEL NUMBER + LL**
- FSC**
- TOP LAM**
- CHASSIS LAM**
- EDGE DETAIL**
- HAT KEYPAD & BASE COLOR**
- GROMMET**

Optional height adjustable keypads available

### HAT KEYPAD & BASE COLOR

Basic Up/Down Keypad, Black P71 Column  
Memory Preset Keypad, Black P71 Column  
Paddle Keypad, Black P71 Column  
Foot Control Keypad, Black P71 Column

**UDP71**  
**MEMP71**  
**PDLP71**  
**FPDP71** Add \$240

NOTE: Foot control keypad is bluetooth controlled and may be used in conjunction with other keypads attached to worksurface. For these situations order standard keypad for worksurface separately. Foot control requires qty (2) AAA batteries needed. Batteries not included.

**NOTE:** Wood Tops only available with Square SQ Edge Detail option. Edge Details SQM, DFM, and TOM with 1/2" band are NOT available.

# ADVANCED HEIGHT ADJUSTABLE WELCOME DESK

Extension with Pedestal

	D	W	H	model number + type	laminare	vener 1	vener 2
--	---	---	---	---------------------	----------	---------	---------

**LEFT HAND DESK**

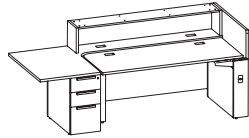

45	103	41	<b>GS6GDXA42102L-A</b> [ ]	9,905	15,137	16,651
----	-----	----	----------------------------	-------	--------	--------

A = 69.84"  
B = 28"  
C = 11.24"  
D = 12.32"  
E = 30.13"

**RIGHT HAND DESK**

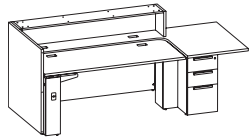

45	103	41	<b>GS6GDXA42102R-A</b> [ ]	9,905	15,137	16,651
----	-----	----	----------------------------	-------	--------	--------

A = 69.84"  
B = 28"  
C = 11.24"  
D = 12.32"  
E = 30.13"

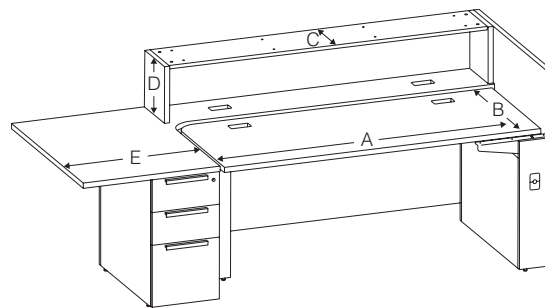

**PRODUCT INFO**

Separate countertop must be specified.

29.5" to 42.5" height adjustment range.

All units shipped as separate packages and require field assembly.

**Grommet Location**

Specify location first, then select grommet color or "Empty Cutout" option. When "Empty Cutout" option is selected, a grommet or power unit must be ordered separately for each cutout.

No upcharge for "Empty Cutout" option.

(Add +\$210 per additional grommet)

Fixed Top always has Left & Right grommets.

Left **GL**  
Right **GR**  
Left & Right **GB**

**TO ORDER PLEASE SPECIFY THE FOLLOWING:**

WOOD TOP, WOOD CHASSIS

- MODEL NUMBER + WW
- FSC
- TOP WOOD FINISH + EDGE
- CHASSIS WOOD FINISH
- GALLERY PANEL WOOD FINISH
- TOP UV FINISH
- PULL
- DRAWERS
- HAT KEYPAD & BASE COLOR
- GROMMET
- KEYING

LAM TOP, LAM CHASSIS

- MODEL NUMBER + LL
- FSC
- TOP LAM
- CHASSIS LAM
- EDGE DETAIL
- PULL
- DRAWERS
- HAT KEYPAD & BASE COLOR
- GROMMET
- KEYING

Optional height adjustable keypads available

**HAT KEYPAD & BASE COLOR**

Basic Up/Down Keypad, Black P71 Column	<b>UDP71</b>
Memory Preset Keypad, Black P71 Column	<b>MEMP71</b>
Paddle Keypad, Black P71 Column	<b>PDLP71</b>
Foot Control Keypad, Black P71 Column	<b>FPDP71</b> Add \$240

NOTE: Foot control keypad is bluetooth controlled and may be used in conjunction with other keypads attached to worksurface. For these situations order standard keypad for worksurface separately. Foot control requires qty (2) AAA batteries needed. Batteries not included.

NOTE: Wood Tops only available with Square SQ Edge Detail option. Edge Details SQM, DFM, and TOM with 1/2" band are NOT available.

# ADVANCED HEIGHT ADJUSTABLE WELCOME DESK

Freestanding

Silea

05/22

	D	W	H	model number + type	laminates	veneers 1	veneers 2
--	---	---	---	---------------------	-----------	-----------	-----------

## LEFT HAND DESK

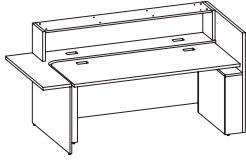

41	85	41	<b>GS6GDFA4284L-</b> [ ]	7,712	11,437	12,581
----	----	----	--------------------------	-------	--------	--------

A = 69.84"  
B = 28"  
C = 11.24"  
D = 12.32"  
E = 12.13"

## RIGHT HAND DESK

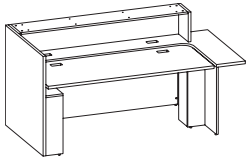

41	85	41	<b>GS6GDFA4284R-</b> [ ]	7,712	11,437	12,581
----	----	----	--------------------------	-------	--------	--------

A = 69.84"  
B = 28"  
C = 11.24"  
D = 12.32"  
E = 12.13"

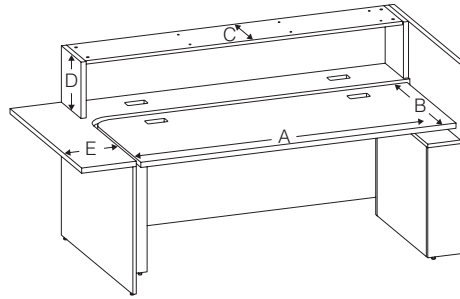

## PRODUCT INFO

Separate countertop must be specified.

29.5" to 42.5" height adjustment range.

All units shipped as separate packages and require field assembly.

### Grommet Location

Specify location first, then select grommet color or "Empty Cutout" option. When "Empty Cutout" option is selected, a grommet or power unit must be ordered separately for each cutout.

No upcharge for "Empty Cutout" option.

(Add +\$210 per additional grommet)

Fixed Top always has Left & Right grommets.

Left	<b>GL</b>
Right	<b>GR</b>
Left & Right	<b>GB</b>

## TO ORDER PLEASE SPECIFY THE FOLLOWING:

### WOOD TOP, WOOD CHASSIS

- MODEL NUMBER + WW**
- FSC**
- TOP WOOD FINISH + EDGE**
- CHASSIS WOOD FINISH**
- GALLERY PANEL WOOD FINISH**
- TOP UV FINISH**
- PULL**
- DRAWERS**
- HAT KEYPAD & BASE COLOR**
- GROMMET**
- KEYING**

### LAM TOP, LAM CHASSIS

- MODEL NUMBER + LL**
- FSC**
- TOP LAM**
- CHASSIS LAM**
- EDGE DETAIL**
- PULL**
- DRAWERS**
- HAT KEYPAD & BASE COLOR**
- GROMMET**
- KEYING**

Optional height adjustable keypads available

### HAT KEYPAD & BASE COLOR

Basic Up/Down Keypad, Black P71 Column	<b>UDP71</b>
Memory Preset Keypad, Black P71 Column	<b>MEMP71</b>
Paddle Keypad, Black P71 Column	<b>PDLP71</b>
Foot Control Keypad, Black P71 Column	<b>FPDP71</b> Add \$240

NOTE: Foot control keypad is bluetooth controlled and may be used in conjunction with other keypads attached to worksurface. For these situations order standard keypad for worksurface separately. Foot control requires qty (2) AAA batteries needed. Batteries not included.

**NOTE:** Wood Tops only available with Square SQ Edge Detail option. Edge Details SQM, DFM, and TOM with 1/2" band are NOT available.



# ADVANCED HEIGHT ADJUSTABLE WELCOME DESK

Freestanding with Pedestal

	D	W	H	model number + type	laminata	vener 1	vener 2
--	---	---	---	---------------------	----------	---------	---------

**LEFT HAND DESK**

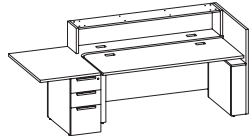

41	103	41	<b>GS6GDFA42102L-A</b> [ ]	9,903	14,908	16,399
----	-----	----	----------------------------	-------	--------	--------

A = 69.84"  
B = 28"  
C = 11.24"  
D = 12.32"  
E = 30.13"

**RIGHT HAND DESK**

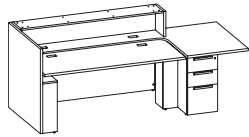

41	103	41	<b>GS6GDFA42102R-A</b> [ ]	9,903	14,908	16,399
----	-----	----	----------------------------	-------	--------	--------

A = 69.84"  
B = 28"  
C = 11.24"  
D = 12.32"  
E = 30.13"

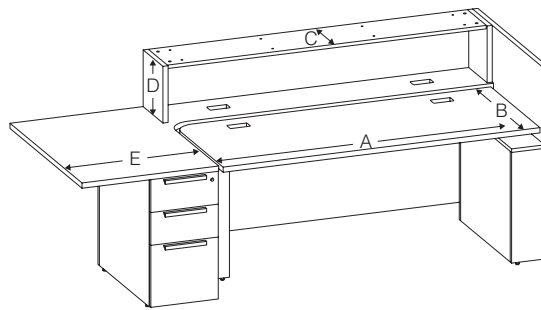

**PRODUCT INFO**

Separate countertop must be specified.

29.5" to 42.5" height adjustment range.

 All units shipped as separate packages and require field assembly.

**Grommet Location**

Specify location first, then select grommet color or "Empty Cutout" option. When "Empty Cutout" option is selected, a grommet or power unit must be ordered separately for each cutout.

No upcharge for "Empty Cutout" option.

(Add +\$210 per additional grommet)

Fixed Top always has Left & Right grommets.

Left **GL**  
Right **GR**  
Left & Right **GB**

**TO ORDER PLEASE SPECIFY THE FOLLOWING:**

**WOOD TOP, WOOD CHASSIS**

- MODEL NUMBER + WW**
- FSC**
- TOP WOOD FINISH + EDGE**
- CHASSIS WOOD FINISH**
- GALLERY PANEL WOOD FINISH**
- TOP UV FINISH**
- HAT KEYPAD & BASE COLOR**
- GROMMET**

**LAM TOP, LAM CHASSIS**

- MODEL NUMBER + LL**
- FSC**
- TOP LAM**
- CHASSIS LAM**
- EDGE DETAIL**
- HAT KEYPAD & BASE COLOR**
- GROMMET**

Optional height adjustable keypads available

**HAT KEYPAD & BASE COLOR**

Basic Up/Down Keypad, Black P71 Column  
Memory Preset Keypad, Black P71 Column  
Paddle Keypad, Black P71 Column  
Foot Control Keypad, Black P71 Column

**UDP71**  
**MEMP71**  
**PDLP71**  
**FPDP71** Add \$240

**NOTE:** Foot control keypad is bluetooth controlled and may be used in conjunction with other keypads attached to worksurface. For these situations order standard keypad for worksurface separately. Foot control requires qty (2) AAA batteries needed. Batteries not included.

**NOTE:** Wood Tops only available with Square SQ Edge Detail option. Edge Details SQM, DFM, and TOM with 1/2" band are NOT available.

# ADVANCED FIXED HEIGHT WELCOME DESK

Silea

05/22

Extension

	D	W	H	model number + type	laminata	vener 1	vener 2
<b>LEFT HAND DESK</b>	42	85	41	<b>GS6GDXF4284L-</b> [ ] ]	4,757	7,346	8,081

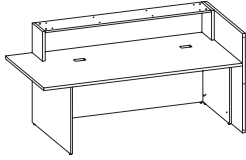

A = 84"  
B = 42"  
C = 11.25"  
D = 12.32"

<b>RIGHT HAND DESK</b>	42	85	41	<b>GS6GDXF4284R-</b> [ ] ]	4,757	7,346	8,081
------------------------	----	----	----	----------------------------	-------	-------	-------

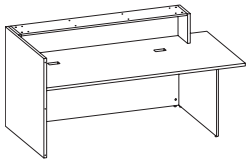

A = 84"  
B = 42"  
C = 11.25"  
D = 12.32"

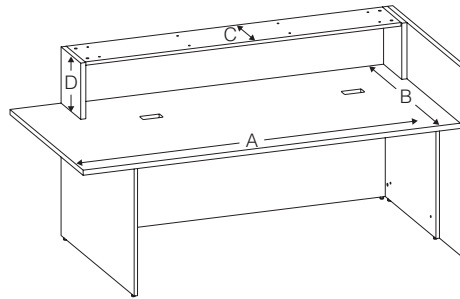

## PRODUCT INFO

Separate countertop must be specified.

### Grommet Location

(Add \$70 per grommet)

No Grommet **GN**  
Left **GL**  
Right **GR**  
Left & Right **GB**

Specify location first, then select grommet color or "Empty Cutout" option. When "Empty Cutout" option is selected, a grommet or power unit must be ordered separately for each cutout.

## TO ORDER PLEASE SPECIFY THE FOLLOWING:

### WOOD TOP, WOOD CHASSIS

- MODEL NUMBER + WW**
- FSC**
- TOP WOOD FINISH + EDGE**
- CHASSIS WOOD FINISH**
- GALLERY PANEL WOOD FINISH**
- TOP UV FINISH**
- GROMMET**

### LAM TOP, LAM CHASSIS

- MODEL NUMBER + LL**
- FSC**
- TOP LAM**
- CHASSIS LAM**
- EDGE DETAIL**
- GROMMET**

**NOTE:** Wood Tops only available with Square SQ Edge Detail option. Edge Details SQM, DFM, and TOM with 1/2" band are NOT available.

	D	W	H	model number + type	laminata	vener 1	vener 2
<b>LEFT HAND DESK</b>	42	103	41	<b>GS6GDXF42102L-A</b> [ ]	6,948	11,030	12,133

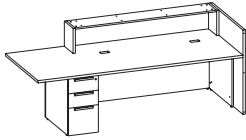

A = 102"  
B = 42"  
C = 11.25"  
D = 12.32"

<b>RIGHT HAND DESK</b>	42	103	41	<b>GS6GDXF42102R-A</b> [ ]	6,948	11,030	12,133
------------------------	----	-----	----	----------------------------	-------	--------	--------

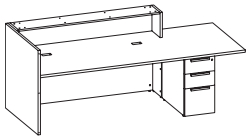

A = 102"  
B = 42"  
C = 11.25"  
D = 12.32"

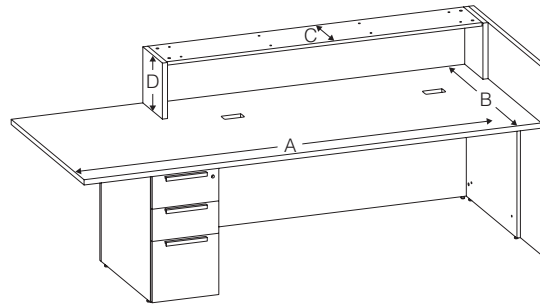

**PRODUCT INFO**

Separate countertop must be specified.

**Grommet Location**  
(Add \$70 per grommet)

- No Grommet **GN**
- Left **GL**
- Right **GR**
- Left & Right **GB**

Specify location first, then select grommet color or "Empty Cutout" option. When "Empty Cutout" option is selected, a grommet or power unit must be ordered separately for each cutout.

**TO ORDER PLEASE SPECIFY THE FOLLOWING:**

WOOD TOP, WOOD CHASSIS

1. **MODEL NUMBER + WW**
2. **FSC**
3. **TOP WOOD FINISH + EDGE**
4. **CHASSIS WOOD FINISH**
5. **GALLERY PANEL WOOD FINISH**
6. **TOP UV FINISH**
7. **PULL**
8. **DRAWERS**
9. **GROMMET**
10. **KEYING**

LAM TOP, LAM CHASSIS

1. **MODEL NUMBER + LL**
2. **FSC**
3. **TOP LAM**
4. **CHASSIS LAM**
5. **EDGE DETAIL**
6. **PULL**
7. **DRAWERS**
8. **GROMMET**
9. **KEYING**

**NOTE:** Wood Tops only available with Square SQ Edge Detail option. Edge Details SQM, DFM, and TOM with 1/2" band are NOT available.

# FIXED HEIGHT WELCOME DESK

Freestanding

Silea

05/22

	D	W	H	model number + type	laminata	vener 1	vener 2
<b>LEFT HAND DESK</b>	42	85	41	<b>GS6GDFF4284L- [ ]</b>	4,757	7,346	8,081

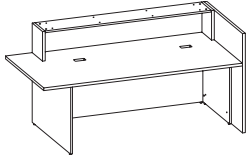

A = 84"  
B = 42"  
C = 11.25"  
D = 12.32"

<b>RIGHT HAND DESK</b>	42	85	41	<b>GS6GDFF4284R- [ ]</b>	4,757	7,346	8,081
------------------------	----	----	----	--------------------------	-------	-------	-------

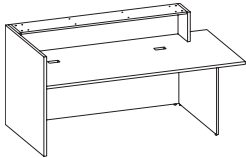

A = 84"  
B = 42"  
C = 11.25"  
D = 12.32"

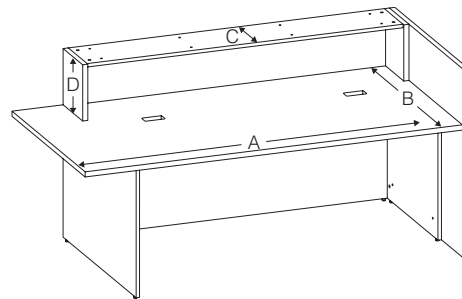

## PRODUCT INFO

Separate countertop must be specified.

### Grommet Location

(Add \$70 per grommet)

No Grommet **GN**  
Left **GL**  
Right **GR**  
Left & Right **GB**

Specify location first, then select grommet color or "Empty Cutout" option. When "Empty Cutout" option is selected, a grommet or power unit must be ordered separately for each cutout.

## TO ORDER PLEASE SPECIFY THE FOLLOWING:

### WOOD TOP, WOOD CHASSIS

- MODEL NUMBER + WW**
- FSC**
- TOP WOOD FINISH + EDGE**
- CHASSIS WOOD FINISH**
- GALLERY PANEL WOOD FINISH**
- TOP UV FINISH**
- GROMMET**

### LAM TOP, LAM CHASSIS

- MODEL NUMBER + LL**
- FSC**
- TOP LAM**
- CHASSIS LAM**
- EDGE DETAIL**
- GROMMET**

**NOTE:** Wood Tops only available with Square SQ Edge Detail option. Edge Details SQM, DFM, and TOM with 1/2" band are NOT available.

	D	W	H	model number + type	laminata	vener 1	vener 2
<b>LEFT HAND DESK</b>	42	103	41	<b>GS6GDFF42102L-A</b> [ ]	6,948	11,030	12,133

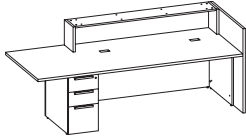

A = 102"  
B = 42"  
C = 11.25"  
D = 12.32"

<b>RIGHT HAND DESK</b>	42	103	41	<b>GS6GDFF42102R-A</b> [ ]	6,948	11,030	12,133
------------------------	----	-----	----	----------------------------	-------	--------	--------

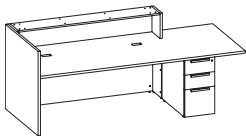

A = 102"  
B = 42"  
C = 11.25"  
D = 12.32"

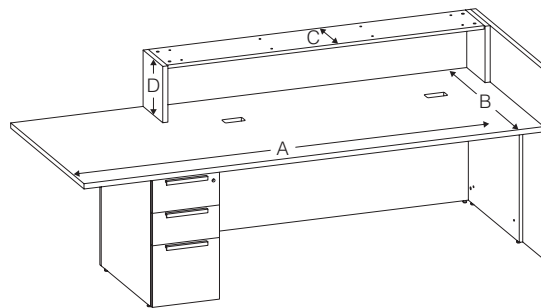

**PRODUCT INFO**

Separate countertop must be specified.

**Grommet Location**  
(Add \$70 per grommet)

No Grommet **GN**  
Left **GL**  
Right **GR**  
Left & Right **GB**

Specify location first, then select grommet color or "Empty Cutout" option. When "Empty Cutout" option is selected, a grommet or power unit must be ordered separately for each cutout.

**TO ORDER PLEASE SPECIFY THE FOLLOWING:**

WOOD TOP, WOOD CHASSIS

1. MODEL NUMBER + WW
2. FSC
3. TOP WOOD FINISH + EDGE
4. CHASSIS WOOD FINISH
5. GALLERY PANEL WOOD FINISH
6. TOP UV FINISH
7. PULL
8. GROMMET
9. KEYING

LAM TOP, LAM CHASSIS

1. MODEL NUMBER + LL
2. FSC
3. TOP LAM
4. CHASSIS LAM
5. EDGE DETAIL
6. PULL
7. GROMMET
8. KEYING

**NOTE:** Wood Tops only available with Square SQ Edge Detail option. Edge Details SQM, DFM, and TOM with 1/2" band are NOT available.

# WELCOME DESK SHELL

Freestanding

Silea

05/22

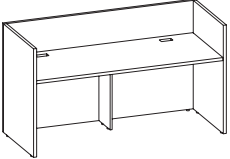
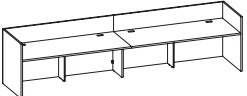
	D	W	H	model number + type	laminata	veneer 1	veneer 2
 GS6GDR3072	31 1/4	74 1/2	41 1/4	<b>GS6GDR3072-</b> [ ]	3,940	6,011	6,612
	37 1/4	74 1/2	41 1/4	<b>GS6GDR3672-</b> [ ]	4,170	6,350	6,985
	37 1/4	86 1/2	41 1/4	<b>GS6GDR3684-</b> [ ]	4,729	7,156	7,872
	31 1/4	146 1/2	41 1/4	<b>GS6GDR30144-</b> [ ]	6,306	9,784	10,762
	37 1/4	146 1/2	41 1/4	<b>GS6GDR36144-</b> [ ]	6,595	10,219	11,241
 GS6GDR36168	37 1/4	170 1/2	41 1/4	<b>GS6GDR36168-</b> [ ]	7,679	11,782	12,960
	31 1/4	74 1/2	41 1/4	<b>GS6GDTR3072-</b> [ ]	3,940	6,011	6,612
	37 1/4	74 1/2	41 1/4	<b>GS6GDTR3672-</b> [ ]	4,170	6,350	6,985

• For use with Waterfall Transaction Top

## PRODUCT INFO

Wood tops long grain.  
Laminate tops long grain standard.

 Units shipped as separate packages and require field assembly.

### Grommet Location

(Add \$70 per grommet for widths 72"-84", \$140 per grommet for widths 144"-168")

No Grommet **GN**  
Center **GC**  
Left & Right **GB**

Specify location first, then select grommet color or "Empty Cutout" option. When "Empty Cutout" option is selected, a grommet or power unit must be ordered separately for each cutout.

## TO ORDER PLEASE SPECIFY THE FOLLOWING:

### WOOD TOP, WOOD CHASSIS

- MODEL NUMBER + WW**
- FSC**
- TOP WOOD FINISH + EDGE**
- CHASSIS WOOD FINISH**
- GALLERY PANEL WOOD FINISH**
- TOP UV FINISH**
- GROMMET**

### LAM TOP, LAM CHASSIS

- MODEL NUMBER + LL**
- FSC**
- TOP LAM**
- CHASSIS LAM**
- EDGE DETAIL**
- GROMMET**

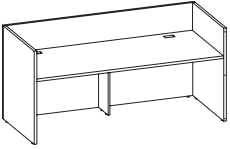
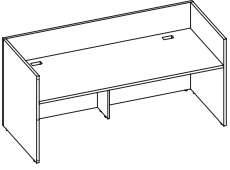
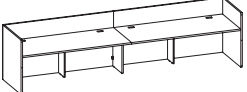
	D	W	H	model number + type	laminate	veneer 1	veneer 2	
<b>LEFT HAND</b> 	31 1/4	74 1/2	41 1/4	<b>GS6GDR3072L-</b> [ ]	3,940	6,011	6,612	
	37 1/4	74 1/2	41 1/4	<b>GS6GDR3672L-</b> [ ]	4,170	6,350	6,985	
	37 1/4	86 1/2	41 1/4	<b>GS6GDR3684L-</b> [ ]	4,729	7,156	7,872	
	• 3/4" breakfront modesty							
	31 1/4	74 1/2	41 1/4	<b>GS6GDTR3072L-</b> [ ]	3,940	6,011	6,612	
	37 1/4	74 1/2	41 1/4	<b>GS6GDTR3672L-</b> [ ]	4,170	6,350	6,985	
• For use with Waterfall Transaction Top								
<b>RIGHT HAND</b> 	31 1/4	74 1/2	41 1/4	<b>GS6GDR3072R-</b> [ ]	3,940	6,011	6,612	
	37 1/4	74 1/2	41 1/4	<b>GS6GDR3672R-</b> [ ]	4,170	6,350	6,985	
	37 1/4	86 1/2	41 1/4	<b>GS6GDR3684R-</b> [ ]	4,729	7,156	7,872	
	31 1/4	74 1/2	41 1/4	<b>GS6GDTR3072R-</b> [ ]	3,940	6,011	6,612	
	37 1/4	74 1/2	41 1/4	<b>GS6GDTR3672R-</b> [ ]	4,170	6,350	6,985	
	• For use with Waterfall Transaction Top							
<b>LEFT AND RIGHT HAND</b> 	31 1/4	146 1/2	41 1/4	<b>GS6GDR30144LR-</b> [ ]	6,306	9,784	10,762	
	37 1/4	146 1/2	41 1/4	<b>GS6GDR36144LR-</b> [ ]	6,595	10,219	11,241	
	37 1/4	170 1/2	41 1/4	<b>GS6GDR36168LR-</b> [ ]	7,679	11,782	12,960	

**PRODUCT INFO**

Wood tops long grain.  
Laminate tops long grain standard.

 Units shipped as separate packages and require field assembly.

**Grommet Location**  
(Add \$70 per grommet for widths 72"-84", \$140 per grommet for widths 144"-168")

No Grommet **GN**  
Center **GC**  
Left & Right **GB**

Specify location first, then select grommet color or "Empty Cutout" option. When "Empty Cutout" option is selected, a grommet or power unit must be ordered separately for each cutout.

**TO ORDER PLEASE SPECIFY THE FOLLOWING:**

WOOD TOP, WOOD CHASSIS

1. MODEL NUMBER + WW
2. FSC
3. TOP WOOD FINISH + EDGE
4. CHASSIS WOOD FINISH
5. GALLERY PANEL WOOD FINISH
6. TOP UV FINISH
7. GROMMET

LAM TOP, LAM CHASSIS

1. MODEL NUMBER + LL
2. FSC
3. TOP LAM
4. CHASSIS LAM
5. EDGE DETAIL
6. GROMMET

# WELCOME DESK BRIDGE

Silea  
05/22

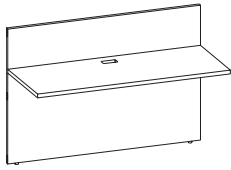

D	W	H	model number + type	laminata	veneer 1	veneer 2
25	48	41 1/4	<b>GS6GBG2448-</b> [ ]	1,719	2,452	2,697
25	54	41 1/4	<b>GS6GBG2454-</b> [ ]	1,958	2,638	2,902
25	60	41 1/4	<b>GS6GBG2460-</b> [ ]	2,090	2,833	3,116

## PRODUCT INFO

Wood tops long grain standard. Lam tops long grain standard.

 Units shipped as separate packages and require field assembly.

### Grommet Location (Add \$70 per grommet)

No Grommet **GN**  
Center **GC**

Specify location first, then select grommet color or "Empty Cutout" option. When "Empty Cutout" option is selected, a grommet or power unit must be ordered separately for each cutout.

## TO ORDER PLEASE SPECIFY THE FOLLOWING:

### WOOD TOP, WOOD CHASSIS

1. **MODEL NUMBER + WW**
2. **FSC**
3. **TOP WOOD FINISH + EDGE**
4. **GALLERY PANEL WOOD FINISH**
5. **TOP UV FINISH**
6. **GROMMET**

### LAM TOP, LAM CHASSIS

1. **MODEL NUMBER + LL**
2. **FSC**
3. **TOP LAM**
4. **CHASSIS LAM**
5. **EDGE DETAIL**
6. **GROMMET**

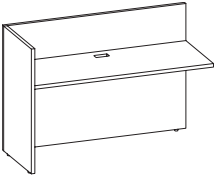
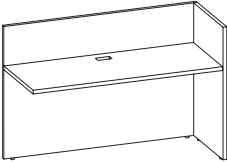

	D	W	H	model number + type	laminata	vener 1	vener 2
<b>LEFT HAND</b> 	25 1/4	49 1/4	41 1/4	<b>GS6GRT2448L-</b> [ ]	2,578	3,802	4,182
	25 1/4	55 1/4	41 1/4	<b>GS6GRT2454L-</b> [ ]	2,706	3,989	4,388
	25 1/4	61 1/4	41 1/4	<b>GS6GRT2460L-</b> [ ]	2,839	4,188	4,607
<b>RIGHT HAND</b> 	25 1/4	49 1/4	41 1/4	<b>GS6GRT2448R-</b> [ ]	2,578	3,802	4,182
	25 1/4	55 1/4	41 1/4	<b>GS6GRT2454R-</b> [ ]	2,706	3,989	4,388
	25 1/4	61 1/4	41 1/4	<b>GS6GRT2460R-</b> [ ]	2,839	4,188	4,607

**PRODUCT INFO**

Wood tops long grain standard. Lam tops long grain standard.

 Units shipped as separate packages and require field assembly.

**Grommet Location**  
(Add \$70 per grommet)

No Grommet **GN**  
Center **GC**

Specify location first, then select grommet color or "Empty Cutout" option. When "Empty Cutout" option is selected, a grommet or power unit must be ordered separately for each cutout.

**TO ORDER PLEASE SPECIFY THE FOLLOWING:**

WOOD TOP, WOOD CHASSIS

1. **MODEL NUMBER + WW**
2. **FSC**
3. **TOP WOOD FINISH + EDGE**
4. **GALLERY PANEL WOOD FINISH**
5. **TOP UV FINISH**
6. **GROMMET**

LAM TOP, LAM CHASSIS

1. **MODEL NUMBER + LL**
2. **FSC**
3. **TOP LAM**
4. **CHASSIS LAM**
5. **EDGE DETAIL**
6. **GROMMET**

# WELCOME DESK CREDENZAS

Silea  
05/22

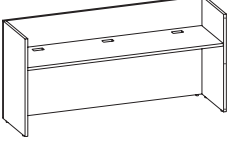
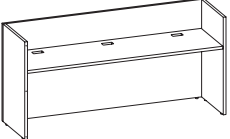
	H	W	D	model number + type	laminata	vener 1	vener 2
<b>LEFT HAND</b> 	25 1/4	74 1/2	41 1/4	<b>GS6GCR2472L-</b> [ ]	3,900	5,739	6,313
	25 1/4	80 1/2	41 1/4	<b>GS6GCR2478L-</b> [ ]	4,065	5,979	6,577
	25 1/4	86 1/2	41 1/4	<b>GS6GCR2484L-</b> [ ]	4,227	6,218	6,840
<b>RIGHT HAND</b> 	25 1/4	74 1/2	41 1/4	<b>GS6GCR2472R-</b> [ ]	3,900	5,739	6,313
	25 1/4	80 1/2	41 1/4	<b>GS6GCR2478R-</b> [ ]	4,065	5,979	6,577
	25 1/4	86 1/2	41 1/4	<b>GS6GCR2484R-</b> [ ]	4,227	6,218	6,840

• Flat brackets ordered separately (model #MDWBRK)

## PRODUCT INFO

All tops long grain.

 Units shipped as separate packages and require field assembly.

### Grommet Location (Add \$70 per grommet)

No Grommet **GN**  
 Left **GL**  
 Right **GR**  
 Left & Right **GB**  
 Center **GC**

Specify location first, then select grommet color or "Empty Cutout" option. When "Empty Cutout" option is selected, a grommet or power unit must be ordered separately for each cutout.

## TO ORDER PLEASE SPECIFY THE FOLLOWING:

WOOD TOP, WOOD CHASSIS

- MODEL NUMBER + WW**
- FSC**
- TOP WOOD FINISH + EDGE**
- TOP UV FINISH**
- GROMMET**

LAM TOP, LAM CHASSIS

- MODEL NUMBER + LL**
- FSC**
- TOP LAM**
- CHASSIS LAM**
- EDGE DETAIL**
- GROMMET**

D	W	H	model number + type	laminate	veneer 1	veneer 2	solid surface
12 1/2	74	41 1/2	<b>GS6GDXMT72- [ ]</b>	1,244	1,776	1,954	11,033

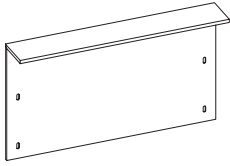

- For use with:  
Advanced HAT Welcome Desk  
Advanced Fixed Welcome Desk  
Welcome Desk Shell  
Welcome Desk Extension

**PRODUCT INFO**

Top thickness:  
Wood 3/4"  
Laminate 3/4"  
Solid Surface 1/2"  
Top includes inserts for connection to base.

**TO ORDER PLEASE SPECIFY THE FOLLOWING:**

WOOD TOP

1. **MODEL NUMBER + W**
2. **FSC**
3. **FINISH**
4. **TOP UV FINISH**

LAM TOP

1. **MODEL NUMBER + L**
2. **FSC**
3. **FINISH**

SOLID SURFACE TOP



1. **MODEL NUMBER + S**
2. **FINISH**

Example

GS6GDXMT72-W.X.NC260.OP  
 GS6GDXMT72-W X NC260 OP  
 MODEL NUMBER + TYPE FSC FINISH TOP UV FINISH

# TRANSACTION TOPS

Silea  
05/22

	D	W	H	model number + type	laminate	veneer 1	veneer 2	solid surface
 GS6GDTT72	15	74 <sup>3</sup> / <sub>4</sub>	1	<b>GS6GDTT72-</b> [ ]	644	1,386	1,525	4,150
	15	86 <sup>3</sup> / <sub>4</sub>	1	<b>GS6GDTT84-</b> [ ]	661	1,238	1,362	4,582
 GS6GDTT144	15	146 <sup>3</sup> / <sub>4</sub>	1	<b>GS6GDTT144-</b> [ ]	830	1,599	1,759	7,211
	15	170 <sup>3</sup> / <sub>4</sub>	1	<b>GS6GDTT168-</b> [ ]	874	1,805	1,986	8,262

## PRODUCT INFO

Top thickness:  
Wood <sup>3</sup>/<sub>4</sub>"  
Laminate <sup>3</sup>/<sub>4</sub>"  
Solid Surface <sup>1</sup>/<sub>2</sub>"  
Top includes inserts for  
connection to base.

## TO ORDER PLEASE SPECIFY THE FOLLOWING:

### WOOD TOP

1. **MODEL NUMBER + W**
2. **FSC**
3. **FINISH**
4. **TOP UV FINISH**

### LAM TOP

1. **MODEL NUMBER + L**
2. **FSC**
3. **FINISH**



### SOLID SURFACE TOP

1. **MODEL NUMBER + S**
2. **FINISH**

### Example

GS6GDTT72-W.X.NC260.OP  
 GS6GDTT72-W      X      NC260      OP  
 MODEL NUMBER + TYPE      FSC      FINISH      TOP UV FINISH

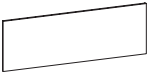
fabric grades

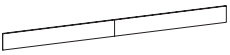
	D	W	H	yards	model number	1	2	3	COM/4
<b>ADVANCED DESK APPLICATION</b>	1	70	11 3/8		<b>GS6GXTK72</b>	920	962	1,004	1,047
									
<b>DESK OR CREDENZA APPLICATION</b>	1	72	12		<b>GS6GTK72</b>	920	962	1,004	1,047
	1	78	12		<b>GS6GTK78</b>	947	994	1,041	1,088
	1	84	12		<b>GS6GTK84</b>	975	1,027	1,078	1,130
	1	144	12		<b>GS6GTK144</b>	1,737	1,821	1,906	1,990
	1	168	12		<b>GS6GTK168</b>	1,848	1,951	2,054	2,157
<b>RETURN APPLICATION</b>	1	71	12		<b>GS6GTK71R</b>	920	962	1,004	1,047
	1	77	12		<b>GS6GTK77R</b>	947	994	1,041	1,088
	1	83	12		<b>GS6GTK83R</b>	975	1,027	1,078	1,130
	1	89	12		<b>GS6GTK89R</b>	1,002	1,054	1,105	1,157
	1	94	12		<b>GS6GTK94R</b>	1,027	1,083	1,140	1,196
	1	95	12		<b>GS6GTK95R</b>	1,027	1,083	1,140	1,196
	1	100	12		<b>GS6GTK100R</b>	1,440	1,501	1,562	1,623
	1	106	12		<b>GS6GTK106R</b>	1,497	1,563	1,628	1,694
	1	112	12		<b>GS6GTK112R</b>	1,552	1,620	1,687	1,755
	1	118	12		<b>GS6GTK118R</b>	1,608	1,683	1,758	1,833
	1	124	12		<b>GS6GTK124R</b>	1,663	1,743	1,822	1,902
	1	130	12		<b>GS6GTK130R</b>	1,720	1,804	1,889	1,973

**PRODUCT INFO**

100"-130" wide tackboards are 2 piece.

For use with Silea Welcome Desks.

70" wide tackboard for use within Advanced Desk cubby space.

**TO ORDER PLEASE SPECIFY THE FOLLOWING:**

LIST

1. **MODEL NUMBER**
2. **FABRIC**
3. **FSC TACKBOARDS**

**FSC Tackboard Options**

**FSC** = FSC Required (5% COM upcharge)

**NR** = FSC Not Required

# IN/OUT STORAGE

Silea  
05/22

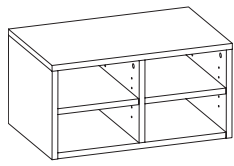

D	W	H	model number + type	laminata	veneer 1	veneer 2	solid surface/ veneer 1	solid surface/ veneer 2
15	23 3/4	12 5/16	<b>GS6MB24SS-</b> [ ]	952	1,333	1,466	2,132	2,345

## PRODUCT INFO

Top thickness:  
Wood 3/4"  
Laminate 3/4"  
Solid Surface 1/2"  
Top includes inserts for  
connection to base.

## TO ORDER PLEASE SPECIFY THE FOLLOWING:

### WOOD TOP

1. **MODEL NUMBER + W**
2. **FSC**
3. **FINISH**
4. **TOP UV FINISH**

### LAM TOP

1. **MODEL NUMBER + L**
2. **FSC**
3. **FINISH**

### SOLID SURFACE TOP

1. **MODEL NUMBER + WS**
2. **FSC**
3. **WOOD FINISH**
4. **SOLID SURFACE FINISH**

### Example

GS6MBS24SS-W.X.NC260.OP

GS6MBS24SS-W	X	NC260	OP
MODEL NUMBER + TYPE	FSC	FINISH	TOP UV FINISH

Modular Caseloads	127-202
Desk Worksurface	128-132
Desk Pedestals	133-134
Desk Legs	135-140
Desk   Runoff Modesty Panel	141-146
24 & 30 Depth Worksurfaces	147-150
24 & 30 Depth Pedestals	151-182
Modular End Panel	183
Modular L Supports	184
Support & Ped Backs	185-195
Layers W/ Laptop Drawer	196
Round Tops	197
Guitar Pick Top	198
Layers Box & Brackets	199-201
Modular Pedestal Cushion	202

# MODULAR DESK WORKSURFACE

Rectangular

Silea

05/22

	D	W	H	model number + type	laminata	vener 1	vener 2
	30	42	1 3/16	<b>GS2DWRR3042-</b> <input type="checkbox"/>	873	1,363	1,500
	30	48	1 3/16	<b>GS2DWRR3048-</b> <input type="checkbox"/>	920	1,434	1,578
	30	54	1 3/16	<b>GS2DWRR3054-</b> <input type="checkbox"/>	930	1,453	1,599
	30	60	1 3/16	<b>GS2DWRR3060-</b> <input type="checkbox"/>	942	1,469	1,616
	30	66	1 3/16	<b>GS2DWRR3066-</b> <input type="checkbox"/>	986	1,538	1,692
	30	72	1 3/16	<b>GS2DWRR3072-</b> <input type="checkbox"/>	1,039	1,618	1,780
	30	78	1 3/16	<b>GS2DWRR3078-</b> <input type="checkbox"/>	1,110	1,732	1,906
	30	84	1 3/16	<b>GS2DWRR3084-</b> <input type="checkbox"/>	1,188	1,855	2,041
	30	90	1 3/16	<b>GS2DWRR3090-</b> <input type="checkbox"/>	1,266	1,948	2,143
	30	96	1 3/16	<b>GS2DWRR3096-</b> <input type="checkbox"/>	1,329	2,045	2,250

• Flat brackets ordered separately (model #MDWBRK)

	36	42	1 3/16	<b>GS2DWRR3642-</b> <input type="checkbox"/>	916	1,431	1,575
	36	48	1 3/16	<b>GS2DWRR3648-</b> <input type="checkbox"/>	965	1,507	1,658
	36	54	1 3/16	<b>GS2DWRR3654-</b> <input type="checkbox"/>	986	1,538	1,692
	36	60	1 3/16	<b>GS2DWRR3660-</b> <input type="checkbox"/>	1,006	1,568	1,725
	36	66	1 3/16	<b>GS2DWRR3666-</b> <input type="checkbox"/>	1,056	1,648	1,813
	36	72	1 3/16	<b>GS2DWRR3672-</b> <input type="checkbox"/>	1,112	1,736	1,910
	36	78	1 3/16	<b>GS2DWRR3678-</b> <input type="checkbox"/>	1,191	1,858	2,044
	36	84	1 3/16	<b>GS2DWRR3684-</b> <input type="checkbox"/>	1,274	1,989	2,188
	36	90	1 3/16	<b>GS2DWRR3690-</b> <input type="checkbox"/>	1,357	2,088	2,297
	36	96	1 3/16	<b>GS2DWRR3696-</b> <input type="checkbox"/>	1,425	2,193	2,413

• Flat brackets ordered separately (model #MDWBRK)

**NOTE:** Desks and Extensions without a full modesty panel and an unsupported area of 48" and greater require a steel worksurface support.

## PRODUCT INFO

Wood tops optional grain direction.

Lam tops optional grain up to 60", above 60" long grain standard.

### Grommet Location

(Add \$70 per grommet)

No Grommet **GN**  
 Left **GL**  
 Right **GR**  
 Left & Right **GB**

Specify location first, then select grommet color or "Empty Cutout" option. When "Empty Cutout" option is selected, a grommet or power unit must be ordered separately for each cutout.

## TO ORDER PLEASE SPECIFY THE FOLLOWING:

### WOOD TOP

1. **MODEL NUMBER + W**
2. **FSC**
3. **TOP WOOD FINISH + EDGE**
4. **TOP UV FINISH**
5. **GRAIN DIRECTION**
6. **GROMMET**

### LAM TOP

1. **MODEL NUMBER + L**
2. **FSC**
3. **TOP LAM**
4. **GRAIN DIRECTION (up to 60")**
5. **EDGE DETAIL**
6. **GROMMET**



	D	W	H	model number + type	laminate	veneer 1	veneer 2
	36	66	1 3/16	<b>GS2DWA3666-</b> <input type="checkbox"/>	1,319	2,060	2,266
	36	72	1 3/16	<b>GS2DWA3672-</b> <input type="checkbox"/>	1,391	2,173	2,391
	36	78	1 3/16	<b>GS2DWA3678-</b> <input type="checkbox"/>	1,490	2,325	2,558
	36	84	1 3/16	<b>GS2DWA3684-</b> <input type="checkbox"/>	1,593	2,487	2,736

- Flat brackets ordered separately (model #MDWBRK)

	42	66	1 3/16	<b>GS2DWA4266-</b> <input type="checkbox"/>	1,478	2,307	2,538
	42	72	1 3/16	<b>GS2DWA4272-</b> <input type="checkbox"/>	1,558	2,433	2,677
	42	78	1 3/16	<b>GS2DWA4278-</b> <input type="checkbox"/>	1,668	2,604	2,865
	42	84	1 3/16	<b>GS2DWA4284-</b> <input type="checkbox"/>	1,783	2,785	3,064

- Flat brackets ordered separately (model #MDWBRK)

**NOTE:** Desks and Extensions without a full modesty panel and an unsupported area of 48" and greater require a steel worksurface support.

**PRODUCT INFO**

Wood tops optional grain direction.  
Lam tops long grain standard.

**Grommet Location**

(Add \$70 per grommet)

No Grommet **GN**  
Left **GL**  
Right **GR**  
Left & Right **GB**

Specify location first, then select grommet color or "Empty Cutout" option. When "Empty Cutout" option is selected, a grommet or power unit must be ordered separately for each cutout.

**TO ORDER PLEASE SPECIFY THE FOLLOWING:**

WOOD TOP

- MODEL NUMBER + W**
- FSC**
- TOP WOOD FINISH + EDGE**
- TOP UV FINISH**
- GRAIN DIRECTION**
- GROMMET**

LAM TOP

- MODEL NUMBER + L**
- FSC**
- TOP LAM**
- GROMMET**

# MODULAR DESK WORKSURFACE

Racetrack

Silea

05/22



D	W	H	model number + type	laminate	veneer 1	veneer 2
30	48	1 3/16	<b>GS2DWRT3048L-</b> <input type="checkbox"/>	1,149	1,793	1,973
30	54	1 3/16	<b>GS2DWRT3054L-</b> <input type="checkbox"/>	1,163	1,815	1,997
30	60	1 3/16	<b>GS2DWRT3060L-</b> <input type="checkbox"/>	1,176	1,837	2,021
30	66	1 3/16	<b>GS2DWRT3066L-</b> <input type="checkbox"/>	1,233	1,923	2,116
30	72	1 3/16	<b>GS2DWRT3072L-</b> <input type="checkbox"/>	1,297	2,024	2,227
30	78	1 3/16	<b>GS2DWRT3078L-</b> <input type="checkbox"/>	1,387	2,167	2,384
30	84	1 3/16	<b>GS2DWRT3084L-</b> <input type="checkbox"/>	1,582	2,467	2,714

• Flat brackets ordered separately (model #MDWBRK)

30	48	1 3/16	<b>GS2DWRT3048R-</b> <input type="checkbox"/>	1,149	1,793	1,973
30	54	1 3/16	<b>GS2DWRT3054R-</b> <input type="checkbox"/>	1,163	1,815	1,997
30	60	1 3/16	<b>GS2DWRT3060R-</b> <input type="checkbox"/>	1,176	1,837	2,021
30	66	1 3/16	<b>GS2DWRT3066R-</b> <input type="checkbox"/>	1,233	1,923	2,116
30	72	1 3/16	<b>GS2DWRT3072R-</b> <input type="checkbox"/>	1,297	2,024	2,227
30	78	1 3/16	<b>GS2DWRT3078R-</b> <input type="checkbox"/>	1,387	2,167	2,384
30	84	1 3/16	<b>GS2DWRT3084R-</b> <input type="checkbox"/>	1,582	2,467	2,714

• Flat brackets ordered separately (model #MDWBRK)

**NOTE:** Desks and Extensions without a full modesty panel and an unsupported area of 48" and greater require a steel worksurface support.

## PRODUCT INFO

Wood tops optional grain direction.

Lam tops optional grain up to 60", above 60" long grain standard.

### Grommet Location (Add \$70 per grommet)

No Grommet **GN**  
 Left **GL**  
 Right **GR**  
 Left & Right **GB**

Specify location first, then select grommet color or "Empty Cutout" option. When "Empty Cutout" option is selected, a grommet or power unit must be ordered separately for each cutout.

## TO ORDER PLEASE SPECIFY THE FOLLOWING:

### WOOD TOP

1. **MODEL NUMBER + W**
2. **FSC**
3. **TOP WOOD FINISH + EDGE**
4. **TOP UV FINISH**
5. **GRAIN DIRECTION**
6. **GROMMET**

### LAM TOP

1. **MODEL NUMBER + L**
2. **FSC**
3. **TOP LAM**
4. **GRAIN DIRECTION (up to 60")**
5. **GROMMET**

	D	W	H	model number + type	laminata	veneer 1	veneer 2
<b>b SHAPE</b> 	42	72	1 3/16	<b>GS2DWB4272-</b> <input type="checkbox"/>	2,126	3,322	3,655
	42	78	1 3/16	<b>GS2DWB4278-</b> <input type="checkbox"/>	2,264	3,534	3,888
	42	84	1 3/16	<b>GS2DWB4284-</b> <input type="checkbox"/>	2,411	3,760	4,136

• Flat brackets ordered separately (model #MDWBRK)

<b>d SHAPE</b> 	42	72	1 3/16	<b>GS2DWD4272-</b> <input type="checkbox"/>	2,126	3,322	3,655
	42	78	1 3/16	<b>GS2DWD4278-</b> <input type="checkbox"/>	2,264	3,534	3,888
	42	84	1 3/16	<b>GS2DWD4284-</b> <input type="checkbox"/>	2,411	3,760	4,136

• Flat brackets ordered separately (model #MDWBRK)

**NOTE:** Desks and Extensions without a full modesty panel and an unsupported area of 48" and greater require a steel worksurface support.

**PRODUCT INFO**

Wood tops optional grain direction.

Lam tops long grain standard.

**Grommet Location**

(Add \$70 per grommet)

- No Grommet **GN**
- Left **GL**
- Right **GR**
- Left & Right **GB**

Specify location first, then select grommet color or "Empty Cutout" option. When "Empty Cutout" option is selected, a grommet or power unit must be ordered separately for each cutout.

**TO ORDER PLEASE SPECIFY THE FOLLOWING:**

WOOD TOP

1. **MODEL NUMBER + W**
2. **FSC**
3. **TOP WOOD FINISH + EDGE**
4. **TOP UV FINISH**
5. **GRAIN DIRECTION**
6. **GROMMET**

LAM TOP

1. **MODEL NUMBER + L**
2. **FSC**
3. **TOP LAM**
4. **GROMMET**

# MODULAR DESK WORKSURFACE

j Shape

Silea

05/22

	D	W	H	model number + type	laminate	veneer 1	veneer 2
<b>LEFT HAND</b> 	30	48	1 3/16	<b>GS2DWJ3048L-</b> <input type="checkbox"/>	1,149	1,793	1,973
	30	54	1 3/16	<b>GS2DWJ3054L-</b> <input type="checkbox"/>	1,163	1,815	1,997
	30	60	1 3/16	<b>GS2DWJ3060L-</b> <input type="checkbox"/>	1,176	1,837	2,021
	30	66	1 3/16	<b>GS2DWJ3066L-</b> <input type="checkbox"/>	1,233	1,923	2,116
	30	72	1 3/16	<b>GS2DWJ3072L-</b> <input type="checkbox"/>	1,297	2,024	2,227
	30	78	1 3/16	<b>GS2DWJ3078L-</b> <input type="checkbox"/>	1,387	2,167	2,384
	30	84	1 3/16	<b>GS2DWJ3084L-</b> <input type="checkbox"/>	1,582	2,467	2,714

• Flat brackets ordered separately (model #MDWBRK)

## RIGHT HAND



30	48	1 3/16	<b>GS2DWJ3048R-</b> <input type="checkbox"/>	1,149	1,793	1,973
30	54	1 3/16	<b>GS2DWJ3054R-</b> <input type="checkbox"/>	1,163	1,815	1,997
30	60	1 3/16	<b>GS2DWJ3060R-</b> <input type="checkbox"/>	1,176	1,837	2,021
30	66	1 3/16	<b>GS2DWJ3066R-</b> <input type="checkbox"/>	1,233	1,923	2,116
30	72	1 3/16	<b>GS2DWJ3072R-</b> <input type="checkbox"/>	1,297	2,024	2,227
30	78	1 3/16	<b>GS2DWJ3078R-</b> <input type="checkbox"/>	1,387	2,167	2,384
30	84	1 3/16	<b>GS2DWJ3084R-</b> <input type="checkbox"/>	1,582	2,467	2,714

• Flat brackets ordered separately (model #MDWBRK)

**NOTE:** Desks and Extensions without a full modesty panel and an unsupported area of 48" and greater require a steel worksurface support.

## PRODUCT INFO

Wood tops optional grain direction.

Lam tops optional grain up to 60", above 60" long grain standard.

### Grommet Location (Add \$70 per grommet)

No Grommet **GN**  
 Left **GL**  
 Right **GR**  
 Left & Right **GB**

Specify location first, then select grommet color or "Empty Cutout" option. When "Empty Cutout" option is selected, a grommet or power unit must be ordered separately for each cutout.











## TO ORDER PLEASE SPECIFY THE FOLLOWING:

### WOOD TOP

1. **MODEL NUMBER + W**
2. **FSC**
3. **TOP WOOD FINISH + EDGE**
4. **TOP UV FINISH**
5. **GRAIN DIRECTION**
6. **GROMMET**

### LAM TOP

1. **MODEL NUMBER + L**
2. **FSC**
3. **TOP LAM**
4. **GRAIN DIRECTION (up to 60")**
5. **GROMMET**

	D	W	H	model number + type	laminata	veneer 1	veneer 2
<b>30" DEPTH   9" WIDTH</b>							
 Box/Box/File	29 7/8	9 7/16	27 7/8	<b>GS2DPD309-3S</b> <input type="checkbox"/>	1,594	2,307	2,538
 Hidden Accessory   Hidden Accessory   Box   File	29 7/8	9 7/16	27 7/8	<b>GS2DPD309-3SA</b> <input type="checkbox"/>	1,669	2,419	2,661
 File/File	29 7/8	9 7/16	27 7/8	<b>GS2DPD309-2S</b> <input type="checkbox"/>	1,594	2,307	2,538
<b>30" DEPTH   15" WIDTH</b>							
	29 7/8	15	27 7/8	<b>GS2DPD3015-3</b> <input type="checkbox"/>	1,594	2,308	2,539
	29 7/8	15	27 7/8	<b>GS2DPD3015-2</b> <input type="checkbox"/>	1,594	2,308	2,539
<b>36" DEPTH   9" WIDTH</b>							
 Box/Box/File	35 7/8	9 7/16	27 7/8	<b>GS2DPD369-3S</b> <input type="checkbox"/>	1,702	2,467	2,714
 Hidden Accessory   Hidden Accessory   Box   File	35 7/8	9 7/16	27 7/8	<b>GS2DPD369-3SA</b> <input type="checkbox"/>	1,820	2,636	2,900
 File/File	35 7/8	9 7/16	27 7/8	<b>GS2DPD369-2S</b> <input type="checkbox"/>	1,702	2,467	2,714
<b>36" DEPTH   15" WIDTH</b>							
	35 7/8	15	27 7/8	<b>GS2DPD3615-3</b> <input type="checkbox"/>	1,883	2,729	3,002
	35 7/8	15	27 7/8	<b>GS2DPD3615-2</b> <input type="checkbox"/>	1,883	2,729	3,002

• -3A pedestal has hidden accessory drawer behind top drawer front.

**PRODUCT INFO**

No kneewell cutout.  
No pedestal back included.

**TO ORDER PLEASE SPECIFY THE FOLLOWING:**

WOOD CHASSIS

1. MODEL NUMBER + W
2. FSC
3. CHASSIS WOOD FINISH
4. PULL
5. DRAWERS
6. KEYING

LAM CHASSIS



1. MODEL NUMBER + L
2. FSC
3. CHASSIS LAM
4. FRONT LAM
5. PULL
6. DRAWERS
7. KEYING

# MODULAR DESK PEDESTALS

30D & 36D | Left and Right Hand | w/Back Panel

Silea

05/22

	D	W	H	model number + type	laminate	veneer 1	veneer 2
<b>30" DEPTH</b>  Left hand	29 7/8	9 7/16	27 7/8	<b>GS2DPD309L-XN</b> [ ]	876	1,270	1,397
	29 7/8	9 7/16	27 7/8	<b>GS2DPD309R-XN</b> [ ]	876	1,270	1,397
	29 7/8	15	27 7/8	<b>GS2DPD3015L-XN</b> [ ]	921	1,894	2,084
	29 7/8	15	27 7/8	<b>GS2DPD3015R-XN</b> [ ]	921	1,894	2,084
<b>36" DEPTH</b>  Right hand	35 7/8	9 7/16	27 7/8	<b>GS2DPD369L-XN</b> [ ]	914	1,323	1,456
	35 7/8	9 7/16	27 7/8	<b>GS2DPD369R-XN</b> [ ]	914	1,323	1,456
	35 7/8	15	27 7/8	<b>GS2DPD3615L-XN</b> [ ]	990	1,432	1,576
	35 7/8	15	27 7/8	<b>GS2DPD3615R-XN</b> [ ]	990	1,432	1,576

## PRODUCT INFO

Removable back panel included.



## TO ORDER PLEASE SPECIFY THE FOLLOWING:

### WOOD CHASSIS

1. **MODEL NUMBER + W**
2. **FSC**
3. **CHASSIS WOOD FINISH**

### LAM CHASSIS

1. **MODEL NUMBER + L**
2. **FSC**
3. **CHASSIS LAM**

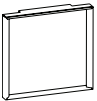
	D	W	H	model number	sq
 Post	23 7/8	3	27 7/8	<b>GS2DSL24-N</b>	1,094
	29 7/8	3	27 7/8	<b>GS2DSL30-N</b>	1,129
	35 7/8	3	27 7/8	<b>GS2DSL36-N</b>	1,163
 Post w/casters	23 7/8	3	27 7/8	<b>GS2DSL24-NST</b>	1,336
	29 7/8	3	27 7/8	<b>GS2DSL30-NST</b>	1,373
	35 7/8	3	27 7/8	<b>GS2DSL36-NST</b>	1,406
 Hoop	23 7/8	3	27 7/8	<b>GS2DSL24-H</b>	1,218
	29 7/8	3	27 7/8	<b>GS2DSL30-H</b>	1,254
	35 7/8	3	27 7/8	<b>GS2DSL36-H</b>	1,291

**PRODUCT INFO**

24" depth panel legs to be used with 24" depth worksurfaces only.

30" depth panel legs to be used with 30" depth worksurfaces only.

36" depth panel legs to be used with 36" depth worksurfaces only.

Legs made out of aluminum.

**TO ORDER PLEASE SPECIFY THE FOLLOWING:**

LIST

1. **MODEL NUMBER**
2. **HARDWARE COLOR**

# MODULAR DESK PANEL LEGS

Wood Insert

Silea

05/22

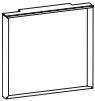
	D	W	H	model number	veneer 1	veneer 2
 <p>Hoop w/wood insert</p>	23 7/8	3	27 7/8	<b>GS2DSL24-W</b>	1,793	1,973
	29 7/8	3	27 7/8	<b>GS2DSL30-W</b>	1,887	2,076
	35 7/8	3	27 7/8	<b>GS2DSL36-W</b>	1,942	2,137



## PRODUCT INFO

24" depth panel legs to be used with 24" depth worksurfaces only.

30" depth panel legs to be used with 30" depth worksurfaces only.

36" depth panel legs to be used with 36" depth worksurfaces only.

## TO ORDER PLEASE SPECIFY THE FOLLOWING:

### WOOD INSERT

1. **MODEL NUMBER**
2. **FSC**
3. **CHASSIS WOOD FINISH**
4. **HARDWARE COLOR**



	D	W	H	model number	list
 <p>Hoop w/glass insert</p>	23 7/8	3	27 7/8	<b>GS2DSL24-G</b>	2,195
	29 7/8	3	27 7/8	<b>GS2DSL30-G</b>	2,546
	35 7/8	3	27 7/8	<b>GS2DSL36-G</b>	2,816



**PRODUCT INFO**

24" depth panel legs to be used with 24" depth worksurfaces only.

30" depth panel legs to be used with 30" depth worksurfaces only.

36" depth panel legs to be used with 36" depth worksurfaces only.

**TO ORDER PLEASE SPECIFY THE FOLLOWING:**

GLASS INSERT

1. **MODEL NUMBER**
2. **HARDWARE COLOR**
3. **GLASS COLOR**

# MODULAR DESK PANEL LEGS

Steel Hoop | Open

Silea

05/22

	D	W	H	model number	part
 Steel hoop	23 7/8	3	27 7/8	<b>GS2DHL24-H</b>	654
	29 7/8	3	27 7/8	<b>GS2DHL30-H</b>	707
	35 7/8	3	27 7/8	<b>GS2DHL36-H</b>	761



## PRODUCT INFO

24" depth panel legs to be used with 24" depth worksurfaces only.

30" depth panel legs to be used with 30" depth worksurfaces only.





36" depth panel legs to be used with 36" depth worksurfaces only.

Leg made out of steel.

## TO ORDER PLEASE SPECIFY THE FOLLOWING:

### LIST

1. **MODEL NUMBER**
2. **HARDWARE COLOR**

	D	W	H	model number	lbs
 Angled	3	3	27 7/8	<b>GS2ALEG-A</b>	400
 Vertical	3	3	27 7/8	<b>GS2VLEG-A</b>	400
 Trapezoid Column	5	3	27 7/8	<b>GS2COLUMN</b>	1,064
 Round Column	3	3	27 7/8	<b>GS2RNDCOLUMN</b>	466



**PRODUCT INFO**

Each model is qty 1.  
Column leg cannot be used in freestanding applications. It must be used in adjoining units.

**TO ORDER PLEASE SPECIFY THE FOLLOWING:**

LIST

1. **MODEL NUMBER**
2. **HARDWARE COLOR**



D	W	H	model number	ISI
3	3	27 7/8	<b>GS2SRNCLEG-W</b>	937



## PRODUCT INFO

Only for use on 30" and 36" deep tops.  
 Not for use on 24" deep tops.  
 Not for use with grommet specified over leg.  
 Model is qty 1.

## TO ORDER PLEASE SPECIFY THE FOLLOWING:

### LIST

1. **MODEL NUMBER**
2. **FSC**
3. **WOOD FINISH**

# MODULAR DESK | RUNOFF MODESTY PANEL

10" high for 9" Pedestals and Panel Legs

	D	W	H	model number + type	laminate	veneer 1	veneer 2	glass
	3/4	38	10	<b>GS2DMPH39-</b> <input type="checkbox"/>	390	562	619	1,259
	3/4	41	10	<b>GS2DMPH42-</b> <input type="checkbox"/>	403	584	643	1,379
	3/4	44	10	<b>GS2DMPH45-</b> <input type="checkbox"/>	420	606	667	1,496
	3/4	47	10	<b>GS2DMPH48-</b> <input type="checkbox"/>	464	671	739	1,613
	3/4	50	10	<b>GS2DMPH51-</b> <input type="checkbox"/>	481	694	764	1,728
	3/4	53	10	<b>GS2DMPH54-</b> <input type="checkbox"/>	493	715	787	1,845
	3/4	56	10	<b>GS2DMPH57-</b> <input type="checkbox"/>	511	737	811	1,964
	3/4	59	10	<b>GS2DMPH60-</b> <input type="checkbox"/>	546	792	872	2,067
	3/4	62	10	<b>GS2DMPH63-</b> <input type="checkbox"/>	562	815	897	2,242
	3/4	65	10	<b>GS2DMPH66-</b> <input type="checkbox"/>	577	837	921	2,366
	3/4	68	10	<b>GS2DMPH69-</b> <input type="checkbox"/>	606	880	968	2,445
	3/4	71	10	<b>GS2DMPH72-</b> <input type="checkbox"/>	631	914	1,006	2,522

**NOTE:** For modesty width calculation, subtract pedestal width or 3" for panel legs from the width of the worksurface.

## PRODUCT INFO

### TO ORDER PLEASE SPECIFY THE FOLLOWING:

#### WOOD CHASSIS

1. **MODEL NUMBER + W**
2. **FSC**
3. **CHASSIS WOOD FINISH**

#### LAM CHASSIS

1. **MODEL NUMBER + L**
2. **FSC**
3. **CHASSIS LAM**

#### GLASS

1. **MODEL NUMBER + G**
2. **GLASS COLOR**

# MODULAR DESK | RUNOFF MODESTY PANEL

10" high for 15" Pedestals

Silea

05/22

	D	W	H	model number + type	laminate	veneer 1	veneer 2
	3/4	24	10	<b>GS2DMPA24-</b> <input type="checkbox"/>	351	507	558
	3/4	27	10	<b>GS2DMPA27-</b> <input type="checkbox"/>	358	519	571
	3/4	30	10	<b>GS2DMPA30-</b> <input type="checkbox"/>	364	530	583
	3/4	33	10	<b>GS2DMPA33-</b> <input type="checkbox"/>	372	737	811
	3/4	36	10	<b>GS2DMPA36-</b> <input type="checkbox"/>	379	783	862
	3/4	39	10	<b>GS2DMPA39-</b> <input type="checkbox"/>	388	743	818
	3/4	42	10	<b>GS2DMPA42-</b> <input type="checkbox"/>	403	584	643
	3/4	45	10	<b>GS2DMPA45-</b> <input type="checkbox"/>	418	606	667
	3/4	48	10	<b>GS2DMPA48-</b> <input type="checkbox"/>	464	671	739
	3/4	51	10	<b>GS2DMPA51-</b> <input type="checkbox"/>	479	694	764
	3/4	54	10	<b>GS2DMPA54-</b> <input type="checkbox"/>	496	715	787
	3/4	57	10	<b>GS2DMPA57-</b> <input type="checkbox"/>	509	737	811
	3/4	60	10	<b>GS2DMPA60-</b> <input type="checkbox"/>	546	792	872
	3/4	63	10	<b>GS2DMPA63-</b> <input type="checkbox"/>	562	815	897
	3/4	66	10	<b>GS2DMPA66-</b> <input type="checkbox"/>	578	837	921
	3/4	69	10	<b>GS2DMPA69-</b> <input type="checkbox"/>	606	880	968
	3/4	72	10	<b>GS2DMPA72-</b> <input type="checkbox"/>	630	914	1,006

## PRODUCT INFO

### TO ORDER PLEASE SPECIFY THE FOLLOWING:

#### WOOD CHASSIS







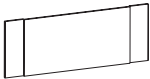

1. **MODEL NUMBER + W**
2. **FSC**
3. **CHASSIS WOOD FINISH**

#### LAM CHASSIS

1. **MODEL NUMBER + L**
2. **FSC**
3. **CHASSIS LAM**





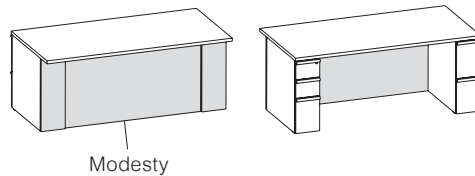

# DOUBLE PED BREAKFRONT MODESTY

For 9" and 15" Pedestals

	D	W	H	model number + type	laminata	veneer 1	veneer 2
<b>FOR 9" PED</b> 	3/4	60	27 7/8	<b>GS2DDMF960-</b> 	966	1,404	1,545
	3/4	66	27 7/8	<b>GS2DDMF966-</b> 	1,043	1,511	1,663
	3/4	72	27 7/8	<b>GS2DDMF972-</b> 	1,114	1,618	1,780
	3/4	78	27 7/8	<b>GS2DDMF978-</b> 	1,190	1,726	1,899
	3/4	84	27 7/8	<b>GS2DDMF984-</b> 	1,265	1,833	2,017
	3/4	90	27 7/8	<b>GS2DDMF990-</b> 	1,348	1,926	2,119
	3/4	96	27 7/8	<b>GS2DDMF996-</b> 	1,415	2,022	2,225



<b>FOR 15" PED</b> 
--

3/4	60	27 7/8	<b>GS2DDMF1560-</b> 	993	1,438	1,582
3/4	66	27 7/8	<b>GS2DDMF1566-</b> 	1,067	1,546	1,701
3/4	72	27 7/8	<b>GS2DDMF1572-</b> 	1,141	1,653	1,819
3/4	78	27 7/8	<b>GS2DDMF1578-</b> 	1,217	1,763	1,940
3/4	84	27 7/8	<b>GS2DDMF1584-</b> 	1,288	1,869	2,056
3/4	90	27 7/8	<b>GS2DDMF1590-</b> 	1,373	1,961	2,158
3/4	96	27 7/8	<b>GS2DDMF1596-</b> 	1,443	2,060	2,266

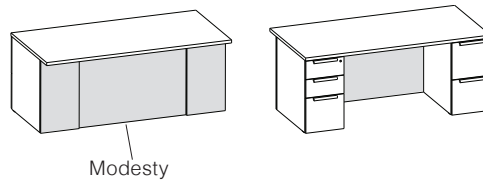

## PRODUCT INFO

### TO ORDER PLEASE SPECIFY THE FOLLOWING:

#### WOOD CHASSIS

1. **MODEL NUMBER + W**
2. **FSC**
3. **CHASSIS WOOD FINISH**

#### LAM CHASSIS



1. **MODEL NUMBER + L**
2. **FSC**
3. **CHASSIS LAM**

# SINGLE PED BREAKFRONT MODESTY

For 9" and 15" Pedestals

Silea

05/22

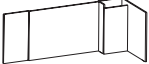
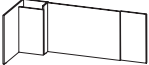
	D	W	H	model number + type	laminata	veneer 1	veneer 2
<b>FOR 30D X 9" PED</b>  Left hand	29 7/8	60	27 7/8	<b>GS2SDMF960L-</b> <input type="checkbox"/>	1,298	1,883	2,072
	29 7/8	66	27 7/8	<b>GS2SDMF966L-</b> <input type="checkbox"/>	1,370	1,987	2,186
	29 7/8	72	27 7/8	<b>GS2SDMF972L-</b> <input type="checkbox"/>	1,444	2,091	2,301
	29 7/8	78	27 7/8	<b>GS2SDMF978L-</b> <input type="checkbox"/>	1,514	2,195	2,415
	29 7/8	84	27 7/8	<b>GS2SDMF984L-</b> <input type="checkbox"/>	1,587	2,302	2,533
	29 7/8	90	27 7/8	<b>GS2SDMF990L-</b> <input type="checkbox"/>	1,692	2,416	2,658
	29 7/8	96	27 7/8	<b>GS2SDMF996L-</b> <input type="checkbox"/>	1,777	2,538	2,792
 Right hand	29 7/8	60	27 7/8	<b>GS2SDMF960R-</b> <input type="checkbox"/>	1,298	1,883	2,072
	29 7/8	66	27 7/8	<b>GS2SDMF966R-</b> <input type="checkbox"/>	1,370	1,987	2,186
	29 7/8	72	27 7/8	<b>GS2SDMF972R-</b> <input type="checkbox"/>	1,444	2,091	2,301
	29 7/8	78	27 7/8	<b>GS2SDMF978R-</b> <input type="checkbox"/>	1,514	2,195	2,415
	29 7/8	84	27 7/8	<b>GS2SDMF984R-</b> <input type="checkbox"/>	1,587	2,302	2,533
	29 7/8	90	27 7/8	<b>GS2SDMF990R-</b> <input type="checkbox"/>	1,692	2,416	2,658
	29 7/8	96	27 7/8	<b>GS2SDMF996R-</b> <input type="checkbox"/>	1,777	2,538	2,792
<b>FOR 30D X 15" PED</b>  Left hand	29 7/8	60	27 7/8	<b>GS2SDMF1560L-</b> <input type="checkbox"/>	1,337	1,938	2,132
	29 7/8	66	27 7/8	<b>GS2SDMF1566L-</b> <input type="checkbox"/>	1,409	2,043	2,248
	29 7/8	72	27 7/8	<b>GS2SDMF1572L-</b> <input type="checkbox"/>	1,480	2,146	2,361
	29 7/8	78	27 7/8	<b>GS2SDMF1578L-</b> <input type="checkbox"/>	1,553	2,251	2,477
	29 7/8	84	27 7/8	<b>GS2SDMF1584L-</b> <input type="checkbox"/>	1,626	2,356	2,592
	29 7/8	90	27 7/8	<b>GS2SDMF1590L-</b> <input type="checkbox"/>	1,732	2,474	2,722
	29 7/8	96	27 7/8	<b>GS2SDMF1596L-</b> <input type="checkbox"/>	1,820	2,597	2,857
 Right hand	29 7/8	60	27 7/8	<b>GS2SDMF1560R-</b> <input type="checkbox"/>	1,337	1,938	2,132
	29 7/8	66	27 7/8	<b>GS2SDMF1566R-</b> <input type="checkbox"/>	1,409	2,043	2,248
	29 7/8	72	27 7/8	<b>GS2SDMF1572R-</b> <input type="checkbox"/>	1,480	2,146	2,361
	29 7/8	78	27 7/8	<b>GS2SDMF1578R-</b> <input type="checkbox"/>	1,553	2,251	2,477
	29 7/8	84	27 7/8	<b>GS2SDMF1584R-</b> <input type="checkbox"/>	1,626	2,356	2,592
	29 7/8	90	27 7/8	<b>GS2SDMF1590R-</b> <input type="checkbox"/>	1,732	2,474	2,722
	29 7/8	96	27 7/8	<b>GS2SDMF1596R-</b> <input type="checkbox"/>	1,820	2,597	2,857

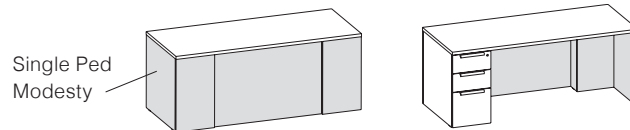

## PRODUCT INFO

### TO ORDER PLEASE SPECIFY THE FOLLOWING:

#### WOOD CHASSIS

1. **MODEL NUMBER + W**
2. **FSC**
3. **CHASSIS WOOD FINISH**

#### LAM CHASSIS

1. **MODEL NUMBER + L**
2. **FSC**
3. **CHASSIS LAM**

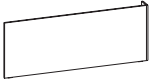

	D	W	H	model number + type	laminate	veneer 1	veneer 2
 Left hand	3/4	42	27 7/8	<b>GS2RRMF42L-</b> [ ]	660	958	1,054
	3/4	48	27 7/8	<b>GS2RRMF48L-</b> [ ]	679	983	1,082
	3/4	54	27 7/8	<b>GS2RRMF54L-</b> [ ]	700	1,017	1,119
	3/4	60	27 7/8	<b>GS2RRMF60L-</b> [ ]	723	1,046	1,151
	3/4	66	27 7/8	<b>GS2RRMF66L-</b> [ ]	793	1,153	1,269
	3/4	72	27 7/8	<b>GS2RRMF72L-</b> [ ]	1,048	1,519	1,671

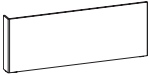
 Right hand	3/4	42	27 7/8	<b>GS2RRMF42R-</b> [ ]	660	958	1,054
	3/4	48	27 7/8	<b>GS2RRMF48R-</b> [ ]	679	983	1,082
	3/4	54	27 7/8	<b>GS2RRMF54R-</b> [ ]	700	1,017	1,119
	3/4	60	27 7/8	<b>GS2RRMF60R-</b> [ ]	723	1,046	1,151
	3/4	66	27 7/8	<b>GS2RRMF66R-</b> [ ]	793	1,153	1,269
	3/4	72	27 7/8	<b>GS2RRMF72R-</b> [ ]	1,048	1,519	1,671

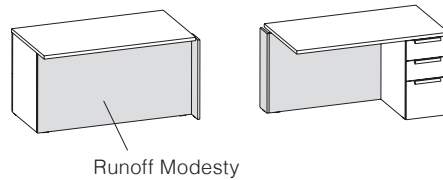

**PRODUCT INFO**

**TO ORDER PLEASE SPECIFY THE FOLLOWING:**

WOOD CHASSIS

1. **MODEL NUMBER + W**
2. **FSC**
3. **CHASSIS WOOD FINISH**

LAM CHASSIS

1. **MODEL NUMBER + L**
2. **FSC**
3. **CHASSIS LAM**

# EXTENSION FULL MODESTY

For use with Racetrack Tops with Column Base

Silea

05/22

	D	W	H	model number + type	laminata	veneer 1	veneer 2
 Left hand	3/4	36	27 7/8	<b>GS2XMF36L-</b> [ ]	635	920	1,012
	3/4	39	27 7/8	<b>GS2XMF39L-</b> [ ]	648	939	1,033
	3/4	42	27 7/8	<b>GS2XMF42L-</b> [ ]	660	958	1,054
	3/4	45	27 7/8	<b>GS2XMF45L-</b> [ ]	670	971	1,069
	3/4	48	27 7/8	<b>GS2XMF48L-</b> [ ]	679	983	1,082
	3/4	51	27 7/8	<b>GS2XMF51L-</b> [ ]	691	1,002	1,103
	3/4	54	27 7/8	<b>GS2XMF54L-</b> [ ]	700	1,017	1,119
3/4	57	27 7/8	<b>GS2XMF57L-</b> [ ]	716	1,038	1,142	

 Right hand	3/4	36	27 7/8	<b>GS2XMF36R-</b> [ ]	635	920	1,012
	3/4	39	27 7/8	<b>GS2XMF39R-</b> [ ]	648	939	1,033
	3/4	42	27 7/8	<b>GS2XMF42R-</b> [ ]	660	958	1,054
	3/4	45	27 7/8	<b>GS2XMF45R-</b> [ ]	670	971	1,069
	3/4	48	27 7/8	<b>GS2XMF48R-</b> [ ]	679	983	1,082
	3/4	51	27 7/8	<b>GS2XMF51R-</b> [ ]	691	1,002	1,103
	3/4	54	27 7/8	<b>GS2XMF54R-</b> [ ]	700	1,017	1,119
3/4	57	27 7/8	<b>GS2XMF57R-</b> [ ]	716	1,038	1,142	

## PRODUCT INFO

Not for use with b and d shape tops

## TO ORDER PLEASE SPECIFY THE FOLLOWING:

### WOOD CHASSIS

1. **MODEL NUMBER + W**
2. **FSC**
3. **CHASSIS WOOD FINISH**

### LAM CHASSIS

1. **MODEL NUMBER + L**
2. **FSC**
3. **CHASSIS LAM**

	D	W	H	model number + type	laminata	veneer 1	veneer 2
	24	15	1 3/16	GS2CWR2415- [ ]	503	775	853
	24	18	1 3/16	GS2CWR2418- [ ]	517	794	874
	24	24	1 3/16	GS2CWR2424- [ ]	530	815	897
	24	30	1 3/16	GS2CWR2430- [ ]	536	835	919
	24	36	1 3/16	GS2CWR2436- [ ]	600	936	1,030
	24	42	1 3/16	GS2CWR2442- [ ]	684	1,065	1,172
	24	48	1 3/16	GS2CWR2448- [ ]	747	1,166	1,283
	24	54	1 3/16	GS2CWR2454- [ ]	788	1,227	1,350
	24	60	1 3/16	GS2CWR2460- [ ]	856	1,335	1,469
	24	66	1 3/16	GS2CWR2466- [ ]	910	1,417	1,559
	24	72	1 3/16	GS2CWR2472- [ ]	1,015	1,585	1,744
	24	78	1 3/16	GS2CWR2478- [ ]	1,057	1,648	1,813
	24	84	1 3/16	GS2CWR2484- [ ]	1,099	1,714	1,886
	24	90	1 3/16	GS2CWR2490- [ ]	1,254	1,955	2,151
	24	96	1 3/16	GS2CWR2496- [ ]	1,373	2,143	2,358
	24	102	1 3/16	GS2CWR24102- [ ]	1,496	2,334	2,568
	24	108	1 3/16	GS2CWR24108- [ ]	1,581	2,465	2,712
	24	114	1 3/16	GS2CWR24114- [ ]	1,641	2,561	2,818
	24	120	1 3/16	GS2CWR24120- [ ]	1,753	2,736	3,010

• Flat brackets ordered separately (model #MDWBRK)

**NOTE:** Credenzas, returns, and bridges with no back panel and an unsupported area of 48" and greater require an intermediate T support.

**PRODUCT INFO**

Wood tops optional grain direction.  
Lam tops optional grain up to 60", over 60" long grain standard.  
30" and 36" wide worksurface only has GN or GC for grommet option choice.

**Grommet Location**  
(Add \$70 per grommet)

No Grommet **GN**  
Left **GL**  
Center **GC**  
Right **GR**  
Left & Right **GB**  
All **GA**

Specify location first, then select grommet color or "Empty Cutout" option. When "Empty Cutout" option is selected, a grommet or power unit must be ordered separately for each cutout.

**TO ORDER PLEASE SPECIFY THE FOLLOWING:**

WOOD TOP

1. MODEL NUMBER + W
2. FSC
3. TOP WOOD FINISH + EDGE
4. TOP UV FINISH
5. GRAIN DIRECTION
6. GROMMET

LAM TOP

1. MODEL NUMBER + L
2. FSC
3. TOP LAM
4. GRAIN DIRECTION (up to 60")
5. EDGE DETAIL
6. GROMMET

# MODULAR 30D TOPS

For Credenzas, Returns, and Bridges

Silea

05/22

	D	W	H	model number + type	laminata	veneer 1	veneer 2
	30	15	1 3/16	<b>GS2CWR3015-</b> <input type="checkbox"/>	553	852	938
	30	18	1 3/16	<b>GS2CWR3018-</b> <input type="checkbox"/>	567	874	962
	30	24	1 3/16	<b>GS2CWR3024-</b> <input type="checkbox"/>	582	896	986
	30	30	1 3/16	<b>GS2CWR3030-</b> <input type="checkbox"/>	598	920	1,012
	30	36	1 3/16	<b>GS2CWR3036-</b> <input type="checkbox"/>	668	1,028	1,131
	30	42	1 3/16	<b>GS2CWR3042-</b> <input type="checkbox"/>	873	1,363	1,500
	30	48	1 3/16	<b>GS2CWR3048-</b> <input type="checkbox"/>	920	1,434	1,578
	30	54	1 3/16	<b>GS2CWR3054-</b> <input type="checkbox"/>	930	1,453	1,599
	30	60	1 3/16	<b>GS2CWR3060-</b> <input type="checkbox"/>	942	1,469	1,616
	30	66	1 3/16	<b>GS2CWR3066-</b> <input type="checkbox"/>	986	1,538	1,692
	30	72	1 3/16	<b>GS2CWR3072-</b> <input type="checkbox"/>	1,039	1,618	1,780
	30	78	1 3/16	<b>GS2CWR3078-</b> <input type="checkbox"/>	1,110	1,732	1,906
	30	84	1 3/16	<b>GS2CWR3084-</b> <input type="checkbox"/>	1,188	1,855	2,041
	30	90	1 3/16	<b>GS2CWR3090-</b> <input type="checkbox"/>	1,266	1,948	2,143
	30	96	1 3/16	<b>GS2CWR3096-</b> <input type="checkbox"/>	1,329	2,045	2,250
	30	102	1 3/16	<b>GS2CWR30102-</b> <input type="checkbox"/>	1,571	2,449	2,694
	30	108	1 3/16	<b>GS2CWR30108-</b> <input type="checkbox"/>	1,660	2,588	2,847
	30	114	1 3/16	<b>GS2CWR30114-</b> <input type="checkbox"/>	1,724	2,689	2,958
	30	120	1 3/16	<b>GS2CWR30120-</b> <input type="checkbox"/>	1,842	2,874	3,162

• Flat brackets ordered separately (model #MDWBRK)

**NOTE:** Credenzas, returns, and bridges with no back panel and an unsupported area of 48" and greater require an intermediate T support.

## PRODUCT INFO

Wood tops optional grain standard.  
Lam tops optional grain up to 60", over 60" long grain standard.  
15" - 36" wide worksurfaces only have GN or GC for grommet option choice.

### Grommet Location (Add \$70 per grommet)

No Grommet **GN**  
Left **GL**  
Center **GC**  
Right **GR**  
Left & Right **GB**  
All **GA**

Specify location first, then select grommet color or "Empty Cutout" option. When "Empty Cutout" option is selected, a grommet or power unit must be ordered separately for each cutout.













## TO ORDER PLEASE SPECIFY THE FOLLOWING:

### WOOD TOP

1. **MODEL NUMBER + W**
2. **FSC**
3. **TOP WOOD FINISH + EDGE**
4. **TOP UV FINISH**
5. **GRAIN DIRECTION**
6. **GROMMET**

### LAM TOP

1. **MODEL NUMBER + L**
2. **FSC**
3. **TOP LAM**
4. **GRAIN DIRECTION (up to 60")**
5. **EDGE DETAIL**
6. **GROMMET**

	D	W	H	model number + type	laminata	veneer 1	veneer 2
	21	60	1 3/16	<b>GS2CWR2460T-</b> 	1,406	2,118	2,330
	21	66	1 3/16	<b>GS2CWR2466T-</b> 	1,490	2,245	2,470
	21	72	1 3/16	<b>GS2CWR2472T-</b> 	1,648	2,494	2,744
	21	78	1 3/16	<b>GS2CWR2478T-</b> 	1,709	2,589	2,848
	21	84	1 3/16	<b>GS2CWR2484T-</b> 	1,773	2,687	2,956
	21	90	1 3/16	<b>GS2CWR2490T-</b> 	2,008	3,052	3,358
	21	96	1 3/16	<b>GS2CWR2496T-</b> 	2,293	3,367	3,704
	21	102	1 3/16	<b>GS2CWR24102T-</b> 	2,483	3,657	4,023
	21	108	1 3/16	<b>GS2CWR24108T-</b> 	2,617	3,855	4,241
	21	114	1 3/16	<b>GS2CWR24114T-</b> 	2,715	4,000	4,400
	21	120	1 3/16	<b>GS2CWR24120T-</b> 	2,891	4,265	4,692

**NOTE:** Credenzas, returns, and bridges with no back panel and an unsupported area of 48" and greater require an intermediate T support.

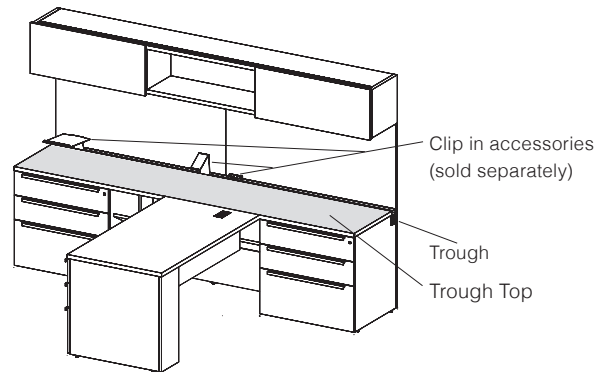

**PRODUCT INFO**

Wood tops optional grain direction.

Lam tops long grain standard.

 Units shipped as separate packages and require field assembly.

Trough tops require filler strips or back panels, ordered separately.

Do not use 2H surface mount towers on trough tops.

**TO ORDER PLEASE SPECIFY THE FOLLOWING:**

WOOD TOP

1. **MODEL NUMBER + W**
2. **FSC**
3. **TOP WOOD FINISH**
4. **TOP UV FINISH**
5. **TROUGH COLOR**
6. **GROMMET**













LAM TOP

1. **MODEL NUMBER + L**
2. **FSC**
3. **TOP LAM**
4. **EDGE DETAIL**
5. **TROUGH COLOR**
6. **GROMMET**

# MODULAR 30D TOPS WITH TROUGHS

For Credenzas | w/ 2 End Caps

Silea  
05/22

	D	W	H	model number + type	laminat	veneer 1	veneer 2
	30	60	1 3/16	<b>GS2CWR3060T-</b> 	1,449	2,197	2,417
	30	66	1 3/16	<b>GS2CWR3066T-</b> 	1,535	2,328	2,561
	30	72	1 3/16	<b>GS2CWR3072T-</b> 	1,700	2,587	2,846
	30	78	1 3/16	<b>GS2CWR3078T-</b> 	1,761	2,686	2,955
	30	84	1 3/16	<b>GS2CWR3084T-</b> 	1,828	2,787	3,066
	30	90	1 3/16	<b>GS2CWR3090T-</b> 	2,071	3,167	3,484
	30	96	1 3/16	<b>GS2CWR3096T-</b> 	2,364	3,493	3,843
	30	102	1 3/16	<b>GS2CWR30102T-</b> 	2,562	3,793	4,173
	30	108	1 3/16	<b>GS2CWR30108T-</b> 	2,701	3,999	4,399
	30	114	1 3/16	<b>GS2CWR30114T-</b> 	2,801	4,151	4,567
	30	120	1 3/16	<b>GS2CWR30120T-</b> 	2,982	4,426	4,869

**NOTE:** Credenzas, returns, and bridges with no back panel and an unsupported area of 48" and greater require an intermediate T support.

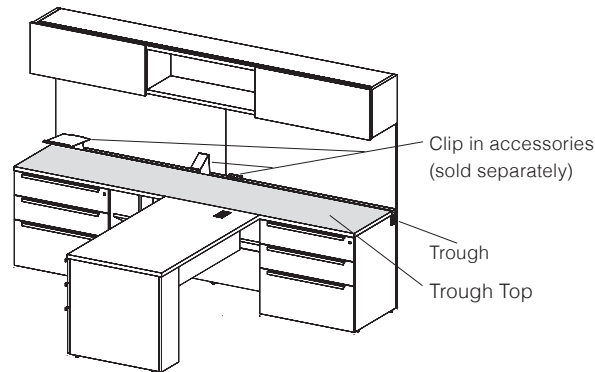

## PRODUCT INFO

Wood tops optional grain direction.

Lam tops long grain standard.

 Units shipped as separate packages and require field assembly.

Trough tops require filler strips or back panels, ordered separately.

Do not use 2H surface mount towers on trough tops.







## TO ORDER PLEASE SPECIFY THE FOLLOWING:

### WOOD TOP

1. **MODEL NUMBER + W**
2. **FSC**
3. **TOP WOOD FINISH + EDGE**
4. **TOP UV FINISH**
5. **GRAIN DIRECTION**
6. **TROUGH COLOR**

### LAM TOP

1. **MODEL NUMBER + L**
2. **FSC**
3. **TOP LAM**
4. **EDGE DETAIL**
5. **TROUGH COLOR**

	D	W	H	model number + type	laminata	vener 1	vener 2
<b>9" WIDTH</b>	23 1/8	9	27 7/8	<b>GS2CPD249L-X</b> [ ]	792	1,238	1,362
 False Pedestal							
 Left	23 1/8	9	27 7/8	<b>GS2CPD249R-X</b> [ ]	792	1,238	1,362
 Right							
<b>18" WIDTH</b>	23 1/8	18	27 7/8	<b>GS2CPD2418L-X</b> [ ]	872	1,362	1,499
 False Pedestal							
 Left	23 1/8	18	27 7/8	<b>GS2CPD2418R-X</b> [ ]	872	1,362	1,499
 Right							

**PRODUCT INFO**

All units have an unfinished back.

Units with an exposed end require a filler strip.

**TO ORDER PLEASE SPECIFY THE FOLLOWING:**

**WOOD**

1. **MODEL NUMBER + W**
2. **FSC**
3. **CHASSIS WOOD FINISH**

**LAM**







1. **MODEL NUMBER + L**
2. **FSC**
3. **CHASSIS LAM**

# MODULAR PEDS 24D

Standard Height | 15" and 18"W

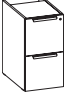
Silea

05/22

	D	W	H	model number + type	laminate	veneer 1	veneer 2
<b>15" WIDTH</b>							
 Box   Box   File	23 1/8	15	27 7/8	<b>GS2CPD2415-3</b> [ ]	1,592	2,481	2,730
 Hidden Accessory   Hidden Accessory   Box   File	23 1/8	15	27 7/8	<b>GS2CPD2415-3A</b> [ ]	1,592	2,481	2,730
 File   File	23 1/8	15	27 7/8	<b>GS2CPD2415-2</b> [ ]	1,592	2,481	2,730
<b>18" WIDTH</b>							
 Box   Box   File	23 1/8	18	27 7/8	<b>GS2CPD2418-3</b> [ ]	1,702	2,658	2,924
 Hidden Accessory   Hidden Accessory   Box   File	23 1/8	18	27 7/8	<b>GS2CPD2418-3A</b> [ ]	1,702	2,658	2,924
 File   File	23 1/8	18	27 7/8	<b>GS2CPD2418-2</b> [ ]	1,702	2,658	2,924

## PRODUCT INFO

All units have an unfinished back.

All pedestals with an exposed side require a filler strip or pedestal back.

## TO ORDER PLEASE SPECIFY THE FOLLOWING:







### WOOD

1. **MODEL NUMBER + W**
2. **FSC**
3. **CHASSIS WOOD FINISH**
4. **PULL**
5. **DRAWERS**
6. **KEYING**

### LAM

1. **MODEL NUMBER + L**
2. **FSC**
3. **CHASSIS LAM**
4. **FRONT LAM**
5. **PULL**
6. **DRAWERS**
7. **KEYING**

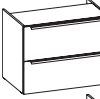
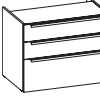

	D	W	H	model number + type	laminate	veneer 1	veneer 2
<b>30" WIDTH</b>							
 File   File	23 1/8	30	27 7/8	<b>GS2CPD2430-4</b> <input type="checkbox"/>	1,997	3,115	3,427
 Box   Box   File	23 1/8	30	27 7/8	<b>GS2CPD2430-7</b> <input type="checkbox"/>	2,036	3,177	3,495
 Multi-File Left	23 1/8	30	27 7/8	<b>GS2CPD2430L-MF</b> <input type="checkbox"/>	2,125	3,270	3,597
 Multi-File Right	23 1/8	30	27 7/8	<b>GS2CPD2430R-MF</b> <input type="checkbox"/>	2,125	3,270	3,597
<b>36" WIDTH</b>							
 File   File	23 1/8	36	27 7/8	<b>GS2CPD2436-4</b> <input type="checkbox"/>	2,197	3,426	3,769
 Box   Box   File	23 1/8	36	27 7/8	<b>GS2CPD2436-7</b> <input type="checkbox"/>	2,240	3,494	3,844
 Multi-File Left	23 1/8	36	27 7/8	<b>GS2CPD2436L-MF</b> <input type="checkbox"/>	2,338	3,597	3,957
 Multi-File Right	23 1/8	36	27 7/8	<b>GS2CPD2436R-MF</b> <input type="checkbox"/>	2,338	3,597	3,957

**PRODUCT INFO**

All units have an unfinished back.  
All pedestals with an exposed side require a filler strip or pedestal back.

**TO ORDER PLEASE SPECIFY THE FOLLOWING:**

WOOD

1. **MODEL NUMBER + W**
2. **FSC**
3. **CHASSIS WOOD FINISH**
4. **PULL**
5. **DRAWERS**
6. **KEYING**







LAM

1. **MODEL NUMBER + L**
2. **FSC**
3. **CHASSIS LAM**
4. **FRONT LAM**
5. **PULL**
6. **DRAWERS**
7. **KEYING**

# MODULAR PEDS 24D

Standard Height | Hinged Door Cabinets

Silea  
05/22

	D	W	H	model number + type	laminata	veneer 1	veneer 2
<b>15" WIDTH</b>							
 Left Hand	23 1/8	15	27 7/8	<b>GS2CPD2415L-5</b> <input type="checkbox"/>	1,369	2,107	2,318
Right Hand	23 1/8	15	27 7/8	<b>GS2CPD2415R-5</b> <input type="checkbox"/>	1,369	2,107	2,318
<b>18" WIDTH</b>							
 Left Hand	23 1/8	18	27 7/8	<b>GS2CPD2418L-5</b> <input type="checkbox"/>	1,437	2,211	2,433
Right Hand	23 1/8	18	27 7/8	<b>GS2CPD2418R-5</b> <input type="checkbox"/>	1,437	2,211	2,433
<b>24" WIDTH</b>							
 Double Door	23 1/8	24	27 7/8	<b>GS2CPD2424-5</b> <input type="checkbox"/>	1,640	2,523	2,776
<b>30" WIDTH</b>							
 Double Door	23 1/8	30	27 7/8	<b>GS2CPD2430-5</b> <input type="checkbox"/>	1,797	2,804	3,085
 With Printer Drawer	23 1/8	30	27 7/8	<b>GS2CPD2430-P</b> <input type="checkbox"/>	1,915	2,945	3,240
<b>36" WIDTH</b>							
 Double Door	23 1/8	36	27 7/8	<b>GS2CPD2436-5</b> <input type="checkbox"/>	1,975	3,084	3,393
 With Printer Drawer	23 1/8	36	27 7/8	<b>GS2CPD2436-P</b> <input type="checkbox"/>	2,104	3,238	3,562

## PRODUCT INFO

All units have an unfinished back.

If integral pull is chosen, doors will be touch latch.

All pedestals with an exposed side require a filler strip or pedestal back.

Includes one adjustable shelf.



## TO ORDER PLEASE SPECIFY THE FOLLOWING:

### WOOD

1. **MODEL NUMBER + W**
2. **FSC**
3. **CHASSIS WOOD FINISH**
4. **PULL**
5. **KEYING**

### LAM

1. **MODEL NUMBER + L**
2. **FSC**
3. **CHASSIS LAM**
4. **FRONT LAM**
5. **PULL**
6. **KEYING**

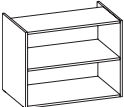
	D	W	H	model number + type	laminata	vener 1	vener 2
<b>15" WIDTH</b> 	23 1/8	15	27 7/8	<b>GS2CPD2415-SH</b> [ ]	1,232	1,895	2,085
<b>18" WIDTH</b> 	23 1/8	18	27 7/8	<b>GS2CPD2418-SH</b> [ ]	1,293	1,990	2,189
<b>24" WIDTH</b> 	23 1/8	24	27 7/8	<b>GS2CPD2424-SH</b> [ ]	1,482	2,281	2,510
<b>30" WIDTH</b> 	23 1/8	30	27 7/8	<b>GS2CPD2430-SH</b> [ ]	1,624	2,534	2,788
<b>36" WIDTH</b> 	23 1/8	36	27 7/8	<b>GS2CPD2436-SH</b> [ ]	1,790	2,789	3,068

**PRODUCT INFO**

All units have an unfinished back.  
 All pedestals with an exposed side require a filler strip or pedestal back.  
 Adjustable shelf.

**TO ORDER PLEASE SPECIFY THE FOLLOWING:**

WOOD

1. **MODEL NUMBER + W**
2. **FSC**
3. **CHASSIS WOOD FINISH**







LAM

1. **MODEL NUMBER + L**
2. **FSC**
3. **CHASSIS LAM**

# TROUGH MODULAR PEDS 24D

Standard Height | 9" and 18"W | Trough Cutouts

Silea  
05/22

	D	W	H	model number + type	laminate	veneer 1	veneer 2
<b>9" WIDTH</b>	23 1/8	9	27 7/8	<b>GS2CPD249TL-X</b> [ ]	792	1,238	1,362
 False Pedestal							
 Left	23 1/8	9	27 7/8	<b>GS2CPD249TR-X</b> [ ]	792	1,238	1,362
 Right							
<b>18" WIDTH</b>	23 1/8	18	27 7/8	<b>GS2CPD2418TL-X</b> [ ]	872	1,362	1,499
 False Pedestal							
 Left	23 1/8	18	27 7/8	<b>GS2CPD2418TR-X</b> [ ]	872	1,362	1,499
 Right							

## PRODUCT INFO

Pedestals to be used with a modular trough top.  
All units have an unfinished back.  
All trough pedestals require a filler strip or pedestal back.







## TO ORDER PLEASE SPECIFY THE FOLLOWING:

### WOOD

1. **MODEL NUMBER + W**
2. **FSC**
3. **CHASSIS WOOD FINISH**

### LAM

1. **MODEL NUMBER + L**
2. **FSC**
3. **CHASSIS LAM**

	D	W	H	model number + type	laminata	veneer 1	veneer 2
<b>15" WIDTH</b>							
 Box   Box   File	23 1/8	15	27 7/8	<b>GS2CPD2415T-3</b> [ ]	1,592	2,481	2,730
 Hidden Accessory   Hidden Accessory   Box   File	23 1/8	15	27 7/8	<b>GS2CPD2415T-3A</b> [ ]	1,592	2,481	2,730
 File   File	23 1/8	15	27 7/8	<b>GS2CPD2415T-2</b> [ ]	1,592	2,481	2,730
<b>18" WIDTH</b>							
 Box   Box   File	23 1/8	18	27 7/8	<b>GS2CPD2418T-3</b> [ ]	1,702	2,658	2,924
 Hidden Accessory   Hidden Accessory   Box   File	23 1/8	18	27 7/8	<b>GS2CPD2418T-3A</b> [ ]	1,702	2,658	2,924
 File   File	23 1/8	18	27 7/8	<b>GS2CPD2418T-2</b> [ ]	1,702	2,658	2,924

**PRODUCT INFO**

All units have an unfinished back.  
Pedestals to be used with a modular trough top.  
All trough pedestals require a filler strip or pedestal back.

**TO ORDER PLEASE SPECIFY THE FOLLOWING:**

WOOD

1. **MODEL NUMBER + W**
2. **FSC**
3. **CHASSIS WOOD FINISH**
4. **PULL**
5. **DRAWERS**
6. **KEYING**





LAM

1. **MODEL NUMBER + L**
2. **FSC**
3. **CHASSIS LAM**
4. **FRONT LAM**
5. **PULL**
6. **DRAWERS**
7. **KEYING**

# TROUGH MODULAR PEDS 24D

Standard Height | 30" and 36"W | Trough Cutouts

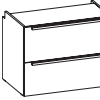
Silea  
05/22

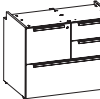
		D	W	H	model number + type	laminate	veneer 1	veneer 2	
<b>30" WIDTH</b>									
	File   File	23 1/8	30	27 7/8	<b>GS2CPD2430T-4</b> <input type="checkbox"/>	1,997	3,115	3,427	
	Box   Box   File	23 1/8	30	27 7/8	<b>GS2CPD2430T-7</b> <input type="checkbox"/>	2,036	3,177	3,495	
	Multi-File Left	23 1/8	30	27 7/8	<b>GS2CPD2430TL-MF</b> <input type="checkbox"/>	2,125	3,270	3,597	
	Multi-File Right	23 1/8	30	27 7/8	<b>GS2CPD2430TR-MF</b> <input type="checkbox"/>	2,125	3,270	3,597	
<b>36" WIDTH</b>									
	File   File	23 1/8	36	27 7/8	<b>GS2CPD2436T-4</b> <input type="checkbox"/>	2,197	3,426	3,769	
	Box   Box   File	23 1/8	36	27 7/8	<b>GS2CPD2436T-7</b> <input type="checkbox"/>	2,240	3,494	3,844	
	Multi-File Left	23 1/8	36	27 7/8	<b>GS2CPD2436TL-MF</b> <input type="checkbox"/>	2,338	3,597	3,957	
	Multi-File Right	23 1/8	36	27 7/8	<b>GS2CPD2436TR-MF</b> <input type="checkbox"/>	2,338	3,597	3,957	

## PRODUCT INFO

All units have an unfinished back.

Pedestals to be used with a modular trough top.

All trough pedestals require a filler strip or pedestal back.







## TO ORDER PLEASE SPECIFY THE FOLLOWING:

### WOOD

1. **MODEL NUMBER + W**
2. **FSC**
3. **CHASSIS WOOD FINISH**
4. **PULL**
5. **DRAWERS**
6. **KEYING**

### LAM

1. **MODEL NUMBER + L**
2. **FSC**
3. **CHASSIS LAM**
4. **FRONT LAM**
5. **PULL**
6. **DRAWERS**
7. **KEYING**

	D	W	H	model number + type	laminata	veneer 1	veneer 2
<b>15" WIDTH</b>							
 Left Hand	23 1/8	15	27 7/8	<b>GS2CPD2415TL-5</b> <input type="checkbox"/>	1,369	2,107	2,318
Right Hand	23 1/8	15	27 7/8	<b>GS2CPD2415TR-5</b> <input type="checkbox"/>	1,369	2,107	2,318
<b>18" WIDTH</b>							
 Left Hand	23 1/8	18	27 7/8	<b>GS2CPD2418TL-5</b> <input type="checkbox"/>	1,437	2,211	2,433
Right Hand	23 1/8	18	27 7/8	<b>GS2CPD2418TR-5</b> <input type="checkbox"/>	1,437	2,211	2,433
<b>24" WIDTH</b>							
 Double Door	23 1/8	24	27 7/8	<b>GS2CPD2424T-5</b> <input type="checkbox"/>	1,640	2,523	2,776
<b>30" WIDTH</b>							
 Double Door	23 1/8	30	27 7/8	<b>GS2CPD2430T-5</b> <input type="checkbox"/>	1,797	2,804	3,085
 With Printer Drawer	23 1/8	30	27 7/8	<b>GS2CPD2430T-P</b> <input type="checkbox"/>	1,915	2,945	3,240
<b>36" WIDTH</b>							
 Double Door	23 1/8	36	27 7/8	<b>GS2CPD2436T-5</b> <input type="checkbox"/>	1,975	3,084	3,393
 With Printer Drawer	23 1/8	36	27 7/8	<b>GS2CPD2436T-P</b> <input type="checkbox"/>	2,104	3,238	3,562

**PRODUCT INFO**

All units have an unfinished back.  
 Pedestals to be used with a modular trough top.  
 If integral pull is chosen, doors will be touch latch.  
 All trough pedestals require a filler strip or pedestal back.  
 Includes one adjustable shelf.

**TO ORDER PLEASE SPECIFY THE FOLLOWING:**

WOOD

1. **MODEL NUMBER + W**
2. **FSC**
3. **CHASSIS WOOD FINISH**
4. **PULL**
5. **KEYING**





LAM

1. **MODEL NUMBER + L**
2. **FSC**
3. **CHASSIS LAM**
4. **FRONT LAM**
5. **PULL**
6. **KEYING**

# TROUGH MODULAR PEDS 24D

Standard Height | Open Shelf | Trough Cutouts

Silea  
05/22

	D	W	H	model number + type	laminata	veneer 1	veneer 2
<b>15" WIDTH</b> 	23 1/8	15	27 7/8	<b>GS2CPD2415T-SH</b> [ ]	1,232	1,895	2,085
<b>18" WIDTH</b> 	23 1/8	18	27 7/8	<b>GS2CPD2418T-SH</b> [ ]	1,293	1,990	2,189
<b>24" WIDTH</b> 	23 1/8	24	27 7/8	<b>GS2CPD2424T-SH</b> [ ]	1,482	2,281	2,510
<b>30" WIDTH</b> 	23 1/8	30	27 7/8	<b>GS2CPD2430T-SH</b> [ ]	1,624	2,534	2,788
<b>36" WIDTH</b> 	23 1/8	36	27 7/8	<b>GS2CPD2436T-SH</b> [ ]	1,790	2,789	3,068

## PRODUCT INFO

All units have an unfinished back.

Pedestals to be used with a modular trough top.

All trough pedestals require a filler strip or pedestal back.

Adjustable shelf.

## TO ORDER PLEASE SPECIFY THE FOLLOWING:







### WOOD

- MODEL NUMBER + W**
- FSC**
- CHASSIS WOOD FINISH**

### LAM

- MODEL NUMBER + L**
- FSC**
- CHASSIS LAM**



	D	W	H	model number + type	laminate	veneer 1	veneer 2
<b>9" WIDTH</b>	23 1/8	9	20 3/4	<b>GS2CLPD249L-X</b> [ ]	756	1,175	1,293
 False Pedestal							
 Left	23 1/8	9	20 3/4	<b>GS2CLPD249R-X</b> [ ]	756	1,175	1,293
 Right							
<b>18" WIDTH</b>	23 1/8	18	20 3/4	<b>GS2CLPD2418L-X</b> [ ]	828	1,294	1,424
 False Pedestal							
 Left	23 1/8	18	20 3/4	<b>GS2CLPD2418R-X</b> [ ]	828	1,294	1,424
 Right							

**PRODUCT INFO**

All units have an unfinished back.

Units with an exposed end require a filler strip.

**TO ORDER PLEASE SPECIFY THE FOLLOWING:**

WOOD

1. **MODEL NUMBER + W**
2. **FSC**
3. **CHASSIS WOOD FINISH**



LAM

1. **MODEL NUMBER + L**
2. **FSC**
3. **CHASSIS LAM**

# MODULAR PEDS 24D

Layers Height | 15" and 18"W

Silea  
05/22

	D	W	H	model number + type	laminate	veneer 1	veneer 2
<b>15" WIDTH</b>	23 1/8	15	20 3/4	<b>GS2CLPD2415-A</b> [ ]	1,512	2,357	2,593
 Box/File							
<b>18" WIDTH</b>	23 1/8	18	20 3/4	<b>GS2CLPD2418-A</b> [ ]	1,617	2,527	2,780
 Box/File							

## PRODUCT INFO

All units have an unfinished back.

All pedestals with an exposed side require a filler strip or pedestal back.

Layers pedestals may be used with feet or on glides to the floor.

Glides must be removed at install for feet applications.

## TO ORDER PLEASE SPECIFY THE FOLLOWING:

### WOOD

1. **MODEL NUMBER + W**
2. **FSC**
3. **CHASSIS WOOD FINISH**
4. **PULL**
5. **DRAWERS**
6. **KEYING**

### LAM

1. **MODEL NUMBER + L**
2. **FSC**
3. **CHASSIS LAM**
4. **FRONT LAM**
5. **PULL**
6. **DRAWERS**
7. **KEYING**

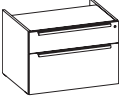
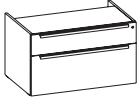
	D	W	H	model number + type	laminate	veneer 1	veneer 2
<b>30" WIDTH</b>	23 1/8	30	20 3/4	<b>GS2CLPD2430-B</b> <input type="checkbox"/>	1,897	2,959	3,255
 Box/File							
<b>36" WIDTH</b>	23 1/8	36	20 3/4	<b>GS2CLPD2436-B</b> <input type="checkbox"/>	2,087	3,255	3,581
 Box/File							

**PRODUCT INFO**

All units have an unfinished back.  
 All pedestals with an exposed side require a filler strip or pedestal back.  
 Layers pedestals may be used with feet or on glides to the floor.  
 Glides must be removed at install for feet applications.

**TO ORDER PLEASE SPECIFY THE FOLLOWING:**

WOOD

1. **MODEL NUMBER + W**
2. **FSC**
3. **CHASSIS WOOD FINISH**
4. **PULL**
5. **DRAWERS**
6. **KEYING**

LAM

1. **MODEL NUMBER + L**
2. **FSC**
3. **CHASSIS LAM**
4. **FRONT LAM**
5. **PULL**
6. **DRAWERS**
7. **KEYING**

# MODULAR PEDS 24D

Layers Height | 30" and 36"W

Silea  
05/22

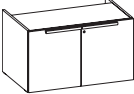
	D	W	H	model number + type	laminate	veneer 1	veneer 2
<b>30" WIDTH</b>	23 1/8	30	20 3/4	<b>GS2CLPD2430-5</b> [ ]	1,706	2,663	2,930
 Hinged door							
<b>36" WIDTH</b>	23 1/8	36	20 3/4	<b>GS2CLPD2436-5</b> [ ]	1,878	2,929	3,222
 Hinged door							

## PRODUCT INFO

All units have an unfinished back.

If integral pull is chosen, doors will be touch latch.

All pedestals with an exposed side require a filler strip or pedestal back.

Includes one adjustable shelf.

Layers pedestals may be used with feet or on glides to the floor.

Glides must be removed at install for feet applications.

## TO ORDER PLEASE SPECIFY THE FOLLOWING:

### WOOD

- 1. MODEL NUMBER + W**
- 2. FSC**
- 3. CHASSIS WOOD FINISH**
- 4. PULL**
- 5. KEYING**

### LAM

- 1. MODEL NUMBER + L**
- 2. FSC**
- 3. CHASSIS LAM**
- 4. FRONT LAM**
- 5. PULL**
- 6. KEYING**

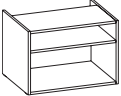
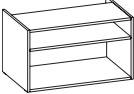
	D	W	H	model number + type	laminat	vener 1	vener 2
<b>30" WIDTH</b>  Bookcase	23 1/8	30	20 3/4	<b>GS2CLPD2430-SH</b> [ ]	1,545	2,408	2,649
<b>36" WIDTH</b>  Bookcase	23 1/8	36	20 3/4	<b>GS2CLPD2436-SH</b> [ ]	1,699	2,649	2,914

**PRODUCT INFO**

All units have an unfinished back.  
 All pedestals with an exposed side require a filler strip or pedestal back.  
 Adjustable shelf.  
 Layers pedestals may be used with feet or on glides to the floor.  
 Glides must be removed at install for feet applications.

**TO ORDER PLEASE SPECIFY THE FOLLOWING:**

- |                               |                            |
|-------------------------------|----------------------------|
| WOOD                          | LAM                        |
| 1. <b>MODEL NUMBER + W</b>    | 1. <b>MODEL NUMBER + L</b> |
| 2. <b>FSC</b>                 | 2. <b>FSC</b>              |
| 3. <b>CHASSIS WOOD FINISH</b> | 3. <b>CHASSIS LAM</b>      |

# MODULAR PEDS 24D

Layers Height | 30" and 36"W | Side Access

Silea

05/22

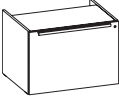
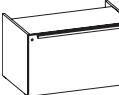
	D	W	H	model number + type	laminata	veneer 1	veneer 2
<b>30" WIDTH</b>	23 1/8	30	20 3/4	<b>GS2CLPD2430L-SD</b> [ ]	1,793	2,797	3,077
 Side access Left hand	23 1/8	30	20 3/4	<b>GS2CLPD2430R-SD</b> [ ]	1,793	2,797	3,077
<b>36" WIDTH</b>	23 1/8	36	20 3/4	<b>GS2CLPD2436L-SD</b> [ ]	1,972	3,076	3,384
 Side access Right hand	23 1/8	36	20 3/4	<b>GS2CLPD2436R-SD</b> [ ]	1,972	3,076	3,384



Right hand unit shown above

## PRODUCT INFO

Units are handed based on lock location.

All units have an unfinished back.

All pedestals with an exposed side require a filler strip or pedestal back.

Layers pedestals may be used with feet or on glides to the floor.

Glides must be removed at install for feet applications.











## TO ORDER PLEASE SPECIFY THE FOLLOWING:

### WOOD

1. **MODEL NUMBER + W**
2. **FSC**
3. **CHASSIS WOOD FINISH**
4. **PULL**
5. **KEYING**

### LAM

1. **MODEL NUMBER + L**
2. **FSC**
3. **CHASSIS LAM**
4. **FRONT LAM**
5. **PULL**
6. **KEYING**

	D	W	H	model number + type	laminate	veneer 1	veneer 2
<b>9" WIDTH</b>	23 1/8	9	20 3/4	<b>GS2CLPD249TL-X</b> 	756	1,175	1,293
 False Pedestal							
 Left	23 1/8	9	20 3/4	<b>GS2CLPD249TR-X</b> 	756	1,175	1,293
 Right							
<b>18" WIDTH</b>	23 1/8	18	20 3/4	<b>GS2CLPD2418TL-X</b> 	828	1,294	1,424
 False Pedestal							
 Left	23 1/8	18	20 3/4	<b>GS2CLPD2418TR-X</b> 	828	1,294	1,424
 Right							

**PRODUCT INFO**

Pedestals is to be used with a modular trough top.  
All units have an unfinished back.  
All trough pedestals require a filler strip or pedestal back.

**TO ORDER PLEASE SPECIFY THE FOLLOWING:**

**WOOD**

1. **MODEL NUMBER + W**
2. **FSC**
3. **CHASSIS WOOD FINISH**



**LAM**

1. **MODEL NUMBER + L**
2. **FSC**
3. **CHASSIS LAM**

# TROUGH MODULAR PEDS 24D

Layers Height | 15" and 18"W | Trough Cutouts

Silea  
05/22

	D	W	H	model number + type	laminiate	veneer 1	veneer 2
<b>15" WIDTH</b>  Box/File	23 1/8	15	20 3/4	<b>GS2CLPD2415T-A</b> [ ]	1,512	2,357	2,593
<b>18" WIDTH</b>  Box/File	23 1/8	18	20 3/4	<b>GS2CLPD2418T-A</b> [ ]	1,617	2,527	2,780

## PRODUCT INFO

All units have an unfinished back.

Pedestals to be used with a modular trough top.

All trough pedestals require a filler strip or pedestal back.

Layers pedestals may be used with feet or on glides to the floor.

Glides must be removed at install for feet applications.

## TO ORDER PLEASE SPECIFY THE FOLLOWING:

### WOOD

1. **MODEL NUMBER + W**
2. **FSC**
3. **CHASSIS WOOD FINISH**
4. **PULL**
5. **DRAWERS**
6. **KEYING**

### LAM

1. **MODEL NUMBER + L**
2. **FSC**
3. **CHASSIS LAM**
4. **FRONT LAM**
5. **PULL**
6. **DRAWERS**
7. **KEYING**

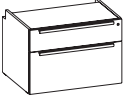
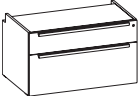

	D	W	H	model number + type	laminate	veneer 1	veneer 2
<b>30" WIDTH</b>  Box/File	23 1/8	30	20 3/4	<b>GS2CLPD2430T-B</b> [ ]	1,897	2,959	3,255
<b>36" WIDTH</b>  Box/File	23 1/8	36	20 3/4	<b>GS2CLPD2436T-B</b> [ ]	2,087	3,255	3,581

**PRODUCT INFO**

All units have an unfinished back.  
 Pedestals to be used with a modular trough top.  
 All trough pedestals require a filler strip or pedestal back.  
 Layers pedestals may be used with feet or on glides to the floor.  
 Glides must be removed at install for feet applications.

**TO ORDER PLEASE SPECIFY THE FOLLOWING:**

WOOD

1. **MODEL NUMBER + W**
2. **FSC**
3. **CHASSIS WOOD FINISH**
4. **PULL**
5. **DRAWERS**
6. **KEYING**



LAM

1. **MODEL NUMBER + L**
2. **FSC**
3. **CHASSIS LAM**
4. **FRONT LAM**
5. **PULL**
6. **DRAWERS**
7. **KEYING**

# TROUGH MODULAR PEDS 24D

Layers Height | 30" and 36"W | Trough Cutouts

Silea  
05/22

	D	W	H	model number + type	laminate	veneer 1	veneer 2
<b>30" WIDTH</b>	23 1/8	30	20 3/4	<b>GS2CLPD2430T-5</b> [ ]	1,706	2,663	2,930
 Hinged door							
<b>36" WIDTH</b>	23 1/8	36	20 3/4	<b>GS2CLPD2436T-5</b> [ ]	1,878	2,929	3,222
 Hinged door							

## PRODUCT INFO

All units have an unfinished back.

Pedestals to be used with a modular trough top.

If integral pull is chosen, doors will be touch latch.

All trough pedestals require a filler strip or pedestal back.

Includes one adjustable shelf.

Layers pedestals may be used with feet or on glides to the floor.

Glides must be removed at install for feet applications.

## TO ORDER PLEASE SPECIFY THE FOLLOWING:

### WOOD

1. **MODEL NUMBER + W**
2. **FSC**
3. **CHASSIS WOOD FINISH**
4. **PULL**
5. **KEYING**

### LAM

1. **MODEL NUMBER + L**
2. **FSC**
3. **CHASSIS LAM**
4. **FRONT LAM**
5. **PULL**
6. **KEYING**

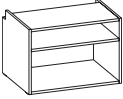
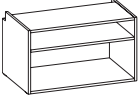
	D	W	H	model number + type	laminate	vener 1	vener 2
<b>30" WIDTH</b>	23 1/8	30	20 3/4	<b>GS2CLPD2430T-SH</b> [ ]	1,545	2,408	2,649
 Bookcase							
<b>36" WIDTH</b>	23 1/8	36	20 3/4	<b>GS2CLPD2436T-SH</b> [ ]	1,699	2,649	2,914
 Bookcase							

**PRODUCT INFO**

All units have an unfinished back.  
 Pedestals to be used with a modular trough top.  
 All trough pedestals require a filler strip or pedestal back.  
 Adjustable shelf.  
 Layers pedestals may be used with feet or on glides to the floor.  
 Glides must be removed at install for feet applications.

**TO ORDER PLEASE SPECIFY THE FOLLOWING:**

WOOD

1. **MODEL NUMBER + W**
2. **FSC**
3. **CHASSIS WOOD FINISH**

LAM

1. **MODEL NUMBER + L**
2. **FSC**
3. **CHASSIS LAM**

# TROUGH MODULAR PEDS 24D

Layers Height | 30" and 36"W | Side Access w/ Trough Cutouts

Silea  
05/22

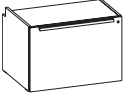
	D	W	H	model number + type	laminate	veneer 1	veneer 2
<b>30" WIDTH</b>	23 1/8	30	20 3/4	<b>GS2CLPD2430TL-SD</b> <input type="checkbox"/>	1,793	2,797	3,077
 Side access Left hand	23 1/8	30	20 3/4	<b>GS2CLPD2430TR-SD</b> <input type="checkbox"/>	1,793	2,797	3,077
<b>36" WIDTH</b>	23 1/8	36	20 3/4	<b>GS2CLPD2436TL-SD</b> <input type="checkbox"/>	1,972	3,076	3,384
 Side access Right hand	23 1/8	36	20 3/4	<b>GS2CLPD2436TR-SD</b> <input type="checkbox"/>	1,972	3,076	3,384



Right hand unit shown above.

## PRODUCT INFO

Units are handed based on lock location.

All units have an unfinished back.

Pedestals to be used with a modular trough top.

All trough pedestals require a filler strip or pedestal back.

Layers pedestals may be used with feet or on glides to the floor.

Glides must be removed at install for feet applications.











## TO ORDER PLEASE SPECIFY THE FOLLOWING:

### WOOD

1. **MODEL NUMBER + W**
2. **FSC**
3. **CHASSIS WOOD FINISH**
4. **PULL**
5. **KEYING**

### LAM

1. **MODEL NUMBER + L**
2. **FSC**
3. **CHASSIS LAM**
4. **FRONT LAM**
5. **PULL**
6. **KEYING**

	D	W	H	model number + type	laminata	vener 1	vener 2
<b>9" WIDTH</b>	29 1/8	9	27 7/8	<b>GS2CPD309L-X</b> 	872	1,362	1,499
 False Pedestal							
 Left	29 1/8	9	27 7/8	<b>GS2CPD309R-X</b> 	872	1,362	1,499
 Right							
<b>18" WIDTH</b>	29 1/8	18	27 7/8	<b>GS2CPD3018L-X</b> 	959	1,498	1,648
 False Pedestal							
 Left	29 1/8	18	27 7/8	<b>GS2CPD3018R-X</b> 	959	1,498	1,648
 Right							

**PRODUCT INFO**

All units have an unfinished back.

Units with an exposed end require a filler strip.

**TO ORDER PLEASE SPECIFY THE FOLLOWING:**

WOOD CHASSIS

- MODEL NUMBER + W**
- FSC**
- CHASSIS WOOD FINISH**

LAM CHASSIS





- MODEL NUMBER + L**
- FSC**
- CHASSIS LAM**

# MODULAR PEDS 30D

Standard Height | 15" and 18"W

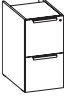
Silea

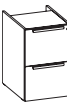
05/22

	D	W	H	model number + type	laminate	veneer 1	veneer 2
<b>15" WIDTH</b>							
 Box   Box   File	29 1/8	15	27 7/8	<b>GS2CPD3015-3</b> [ ]	1,750	2,729	3,002
 Hidden Accessory   Hidden Accessory   Box   File	29 1/8	15	27 7/8	<b>GS2CPD3015-3A</b> [ ]	1,750	2,729	3,002
 File   File	29 1/8	15	27 7/8	<b>GS2CPD3015-2</b> [ ]	1,750	2,729	3,002
<b>18" WIDTH</b>							
 Box   Box   File	29 1/8	18	27 7/8	<b>GS2CPD3018-3</b> [ ]	1,873	2,924	3,217
 Hidden Accessory   Hidden Accessory   Box   File	29 1/8	18	27 7/8	<b>GS2CPD3018-3A</b> [ ]	1,873	2,924	3,217
 File   File	29 1/8	18	27 7/8	<b>GS2CPD3018-2</b> [ ]	1,873	2,924	3,217

## PRODUCT INFO

All units have an unfinished back.

Units with an exposed end require a filler strip.









## TO ORDER PLEASE SPECIFY THE FOLLOWING:

### WOOD CHASSIS

1. **MODEL NUMBER + W**
2. **FSC**
3. **CHASSIS WOOD FINISH**
4. **PULL**
5. **DRAWERS**
6. **KEYING**

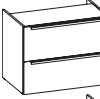
### LAM CHASSIS

1. **MODEL NUMBER + L**
2. **FSC**
3. **CHASSIS LAM**
4. **FRONT LAM**
5. **PULL**
6. **DRAWERS**
7. **KEYING**

	D	W	H	model number + type	laminata	veneer 1	veneer 2
<b>30" WIDTH</b>							
 File   File	29 1/8	30	27 7/8	<b>GS2CPD3030-4</b> <input type="checkbox"/>	2,198	3,426	3,769
 Box   Box   File	29 1/8	30	27 7/8	<b>GS2CPD3030-7</b> <input type="checkbox"/>	2,240	3,496	3,846
 Multi-File Left	29 1/8	30	27 7/8	<b>GS2CPD3030L-MF</b> <input type="checkbox"/>	2,338	3,597	3,957
 Multi-File Right	29 1/8	30	27 7/8	<b>GS2CPD3030R-MF</b> <input type="checkbox"/>	2,338	3,597	3,957
<b>36" WIDTH</b>							
 File   File	29 1/8	36	27 7/8	<b>GS2CPD3036-4</b> <input type="checkbox"/>	2,416	3,768	4,145
 Box   Box   File	29 1/8	36	27 7/8	<b>GS2CPD3036-7</b> <input type="checkbox"/>	2,465	3,843	4,228
 Multi-File Left	29 1/8	36	27 7/8	<b>GS2CPD3036L-MF</b> <input type="checkbox"/>	2,572	3,958	4,354
 Multi-File Right	29 1/8	36	27 7/8	<b>GS2CPD3036R-MF</b> <input type="checkbox"/>	2,572	3,958	4,354

**PRODUCT INFO**

All units have an unfinished back.

Units with an exposed end require a filler strip.

**TO ORDER PLEASE SPECIFY THE FOLLOWING:**

WOOD CHASSIS

1. **MODEL NUMBER + W**
2. **FSC**
3. **CHASSIS WOOD FINISH**
4. **PULL**
5. **DRAWERS**
6. **KEYING**







LAM CHASSIS

1. **MODEL NUMBER + L**
2. **FSC**
3. **CHASSIS LAM**
4. **FRONT LAM**
5. **PULL**
6. **DRAWERS**
7. **KEYING**

# MODULAR PEDS 30D

Standard Height | Hinged Door Cabinets

Silea  
05/22

	D	W	H	model number + type	laminata	veneer 1	veneer 2
<b>15" WIDTH</b>							
 Left Hand	29 1/8	15	27 7/8	<b>GS2CPD3015L-5</b> <input type="checkbox"/>	1,506	2,317	2,549
Right Hand	29 1/8	15	27 7/8	<b>GS2CPD3015R-5</b> <input type="checkbox"/>	1,506	2,317	2,549
<b>18" WIDTH</b>							
 Left Hand	29 1/8	18	27 7/8	<b>GS2CPD3018L-5</b> <input type="checkbox"/>	1,582	2,433	2,677
Right Hand	29 1/8	18	27 7/8	<b>GS2CPD3018R-5</b> <input type="checkbox"/>	1,582	2,433	2,677
<b>24" WIDTH</b>							
 Double Door	29 1/8	24	27 7/8	<b>GS2CPD3024-5</b> <input type="checkbox"/>	1,805	2,777	3,055
<b>30" WIDTH</b>							
 Double Door	29 1/8	30	27 7/8	<b>GS2CPD3030-5</b> <input type="checkbox"/>	1,976	3,086	3,395
 With Printer Drawer	29 1/8	30	27 7/8	<b>GS2CPD3030-P</b> <input type="checkbox"/>	2,107	3,240	3,564
<b>36" WIDTH</b>							
 Double Door	29 1/8	36	27 7/8	<b>GS2CPD3036-5</b> <input type="checkbox"/>	2,174	3,393	3,733
 With Printer Drawer	29 1/8	36	27 7/8	<b>GS2CPD3036-P</b> <input type="checkbox"/>	2,316	3,562	3,919

## PRODUCT INFO

All units have an unfinished back.

Units with an exposed end require a filler strip.

If integral pull is chosen, doors will be touch latch.

-5 pedestal includes one adjustable shelf.

Printer pedestal includes printer drawer.

## TO ORDER PLEASE SPECIFY THE FOLLOWING:





### WOOD CHASSIS

1. **MODEL NUMBER + W**
2. **FSC**
3. **CHASSIS WOOD FINISH**
4. **PULL**
5. **KEYING**

### LAM CHASSIS

1. **MODEL NUMBER + L**
2. **FSC**
3. **CHASSIS LAM**
4. **FRONT LAM**
5. **PULL**
6. **KEYING**



	D	W	H	model number + type	laminat	veneer 1	veneer 2
<b>15" WIDTH</b> 	29 1/8	15	27 7/8	<b>GS2CPD3015-SH</b> [ ]	1,355	2,086	2,295
<b>18" WIDTH</b> 	29 1/8	18	27 7/8	<b>GS2CPD3018-SH</b> [ ]	1,423	2,189	2,408
<b>24" WIDTH</b> 	29 1/8	24	27 7/8	<b>GS2CPD3024-SH</b> [ ]	1,631	2,510	2,761
<b>30" WIDTH</b> 	29 1/8	30	27 7/8	<b>GS2CPD3030-SH</b> [ ]	1,785	2,789	3,068
<b>36" WIDTH</b> 	29 1/8	36	27 7/8	<b>GS2CPD3036-SH</b> [ ]	1,969	3,069	3,376

**PRODUCT INFO**

All units have an unfinished back.  
 Units with an exposed end require a filler strip.  
 Includes one adjustable shelf.

**TO ORDER PLEASE SPECIFY THE FOLLOWING:**

WOOD CHASSIS

1. **MODEL NUMBER + W**
2. **FSC**
3. **CHASSIS WOOD FINISH**







LAM CHASSIS

1. **MODEL NUMBER + L**
2. **FSC**
3. **CHASSIS LAM**

# TROUGH MODULAR PEDS 30D

Standard Height | 9" and 18"W | Trough Cutouts

Silea  
05/22

	D	W	H	model number + type	laminat	veneer 1	veneer 2
<b>9" WIDTH</b>	29 1/8	9	27 7/8	<b>GS2CPD309TL-X</b> [ ]	872	1,362	1,499
 False Pedestal							
 Left	29 1/8	9	27 7/8	<b>GS2CPD309TR-X</b> [ ]	872	1,362	1,499
 Right							
<b>18" WIDTH</b>	29 1/8	18	27 7/8	<b>GS2CPD3018TL-X</b> [ ]	959	1,498	1,648
 False Pedestal							
 Left	29 1/8	18	27 7/8	<b>GS2CPD3018TR-X</b> [ ]	959	1,498	1,648
 Right							

## PRODUCT INFO

Pedestals to be used with a modular trough top.  
All units have an unfinished back.  
All trough pedestals require a filler strip or pedestal back.







## TO ORDER PLEASE SPECIFY THE FOLLOWING:

### WOOD CHASSIS

- MODEL NUMBER + W**
- FSC**
- CHASSIS WOOD FINISH**

### LAM CHASSIS

- MODEL NUMBER + L**
- FSC**
- CHASSIS LAM**

	D	W	H	model number + type	laminate	veneer 1	veneer 2
<b>15" WIDTH</b>							
 Box   Box   File	29 1/8	15	27 7/8	<b>GS2CPD3015T-3</b> [ ]	1,750	2,729	3,002
 Hidden Accessory   Hidden Accessory   Box   File	29 1/8	15	27 7/8	<b>GS2CPD3015T-3A</b> [ ]	1,750	2,729	3,002
 File   File	29 1/8	15	27 7/8	<b>GS2CPD3015T-2</b> [ ]	1,750	2,729	3,002
<b>18" WIDTH</b>							
 Box   Box   File	29 1/8	18	27 7/8	<b>GS2CPD3018T-3</b> [ ]	1,873	2,924	3,217
 Hidden Accessory   Hidden Accessory   Box   File	29 1/8	18	27 7/8	<b>GS2CPD3018T-3A</b> [ ]	1,873	2,924	3,217
 File   File	29 1/8	18	27 7/8	<b>GS2CPD3018T-2</b> [ ]	1,873	2,924	3,217

**PRODUCT INFO**

All units have an unfinished back.  
Pedestals to be used with a modular trough top.  
All trough pedestals require a filler strip or pedestal back.

**TO ORDER PLEASE SPECIFY THE FOLLOWING:**

WOOD CHASSIS

1. **MODEL NUMBER + W**
2. **FSC**
3. **CHASSIS WOOD FINISH**
4. **PULL**
5. **DRAWERS**
6. **KEYING**







LAM CHASSIS

1. **MODEL NUMBER + L**
2. **FSC**
3. **CHASSIS LAM**
4. **FRONT LAM**
5. **PULL**
6. **DRAWERS**
7. **KEYING**

# TROUGH MODULAR PEDS 30D

Standard Height | 30" and 36"W | Trough Cutouts

Silea  
05/22

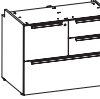
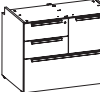
	D	W	H	model number + type	laminata	veneer 1	veneer 2
<b>30" WIDTH</b>							
 File   File	29 1/8	30	27 7/8	<b>GS2CPD3030T-4</b> <input type="checkbox"/>	2,198	3,426	3,769
 Box   Box   File	29 1/8	30	27 7/8	<b>GS2CPD3030T-7</b> <input type="checkbox"/>	2,240	3,496	3,846
 Multi-File Left	29 1/8	30	27 7/8	<b>GS2CPD3030TL-MF</b> <input type="checkbox"/>	2,338	3,597	3,957
 Multi-File Right	29 1/8	30	27 7/8	<b>GS2CPD3030TR-MF</b> <input type="checkbox"/>	2,338	3,597	3,957
<b>36" WIDTH</b>							
 File   File	29 1/8	36	27 7/8	<b>GS2CPD3036T-4</b> <input type="checkbox"/>	2,416	3,768	4,145
 Box   Box   File	29 1/8	36	27 7/8	<b>GS2CPD3036T-7</b> <input type="checkbox"/>	2,465	3,843	4,228
 Multi-File Left	29 1/8	36	27 7/8	<b>GS2CPD3036TL-MF</b> <input type="checkbox"/>	2,572	3,958	4,354
 Multi-File Right	29 1/8	36	27 7/8	<b>GS2CPD3036TR-MF</b> <input type="checkbox"/>	2,572	3,958	4,354

## PRODUCT INFO

All units have an unfinished back.

Pedestals to be used with a modular trough top.

All trough pedestals require a filler strip or pedestal back.





## TO ORDER PLEASE SPECIFY THE FOLLOWING:

### WOOD CHASSIS

1. **MODEL NUMBER + W**
2. **FSC**
3. **CHASSIS WOOD FINISH**
4. **PULL**
5. **DRAWERS**
6. **KEYING**

### LAM CHASSIS

1. **MODEL NUMBER + L**
2. **FSC**
3. **CHASSIS LAM**
4. **FRONT LAM**
5. **PULL**
6. **DRAWERS**
7. **KEYING**

	D	W	H	model number + type	laminate	veneer 1	veneer 2
<b>15" WIDTH</b>							
 Left Hand	29 1/8	15	27 7/8	<b>GS2CPD3015TL-5</b> <input type="checkbox"/>	1,506	2,317	2,549
Right Hand	29 1/8	15	27 7/8	<b>GS2CPD3015TR-5</b> <input type="checkbox"/>	1,506	2,317	2,549
<b>18" WIDTH</b>							
 Left Hand	29 1/8	18	27 7/8	<b>GS2CPD3018TL-5</b> <input type="checkbox"/>	1,582	2,433	2,677
Right Hand	29 1/8	18	27 7/8	<b>GS2CPD3018TR-5</b> <input type="checkbox"/>	1,582	2,433	2,677
<b>24" WIDTH</b>							
 Double Door	29 1/8	24	27 7/8	<b>GS2CPD3024T-5</b> <input type="checkbox"/>	1,805	2,777	3,055
<b>30" WIDTH</b>							
 Double Door	29 1/8	30	27 7/8	<b>GS2CPD3030T-5</b> <input type="checkbox"/>	1,976	3,086	3,395
With Printer Drawer	29 1/8	30	27 7/8	<b>GS2CPD3030T-P</b> <input type="checkbox"/>	2,107	3,240	3,564
<b>36" WIDTH</b>							
 Double Door	29 1/8	36	27 7/8	<b>GS2CPD3036T-5</b> <input type="checkbox"/>	2,174	3,393	3,733
With Printer Drawer	29 1/8	36	27 7/8	<b>GS2CPD3036T-P</b> <input type="checkbox"/>	2,316	3,562	3,919

**PRODUCT INFO**

All units have an unfinished back.  
 Pedestals to be used with a modular trough top.  
 All trough pedestals require a filler strip or pedestal back.  
 If integral pull is chosen, doors will be touch latch.  
 -5 pedestal includes one adjustable shelf.  
 Printer pedestal includes printer drawer.

**TO ORDER PLEASE SPECIFY THE FOLLOWING:**

WOOD CHASSIS

1. **MODEL NUMBER + W**
2. **FSC**
3. **CHASSIS WOOD FINISH**
4. **PULL**
5. **KEYING**





LAM CHASSIS

1. **MODEL NUMBER + L**
2. **FSC**
3. **CHASSIS LAM**
4. **FRONT LAM**
5. **PULL**
6. **KEYING**

# TROUGH MODULAR PEDS 30D

Standard Height | Open Shelf | Trough Cutouts

Silea  
05/22

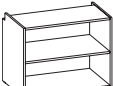
	D	W	H	model number + type	laminate	veneer 1	veneer 2
<b>15" WIDTH</b> 	29 1/8	15	27 7/8	<b>GS2CPD3015T-SH</b> <input type="checkbox"/>	1,355	2,086	2,295
<b>18" WIDTH</b> 	29 1/8	18	27 7/8	<b>GS2CPD3018T-SH</b> <input type="checkbox"/>	1,423	2,189	2,408
<b>24" WIDTH</b> 	29 1/8	24	27 7/8	<b>GS2CPD3024T-SH</b> <input type="checkbox"/>	1,631	2,510	2,761
<b>30" WIDTH</b> 	29 1/8	30	27 7/8	<b>GS2CPD3030T-SH</b> <input type="checkbox"/>	1,785	2,789	3,068
<b>36" WIDTH</b> 	29 1/8	36	27 7/8	<b>GS2CPD3036T-SH</b> <input type="checkbox"/>	1,969	3,069	3,376

## PRODUCT INFO

All units have an unfinished back.

Pedestals to be used with a modular trough top.

All trough pedestals require a filler strip or pedestal back.

Adjustable shelf.

## TO ORDER PLEASE SPECIFY THE FOLLOWING:

### WOOD CHASSIS

- MODEL NUMBER + W**
- FSC**
- CHASSIS WOOD FINISH**

### LAM CHASSIS

- MODEL NUMBER + L**
- FSC**
- CHASSIS LAM**

	D	W	H	model number + type	laminate	vener 1	vener 2
	23 1/8	3/4	27 7/8	<b>GS2MEP24L-</b> [ ]	411	643	708
	23 1/8	3/4	27 7/8	<b>GS2MEP24R-</b> [ ]	411	643	708
	29 1/8	3/4	27 7/8	<b>GS2MEP30L-</b> [ ]	498	778	856
	29 1/8	3/4	27 7/8	<b>GS2MEP30R-</b> [ ]	498	778	856
	35 1/8	3/4	27 7/8	<b>GS2MEP36L-</b> [ ]	533	830	913
	35 1/8	3/4	27 7/8	<b>GS2MEP36R-</b> [ ]	533	830	913
	23 1/8	3/4	20 3/4	<b>GS2MLEP24L-</b> [ ]	365	571	629
	23 1/8	3/4	20 3/4	<b>GS2MLEP24R-</b> [ ]	365	571	629

• Layers version

**PRODUCT INFO**

End panels require the use of a modular full back modesty panel to complete application.

**TO ORDER PLEASE SPECIFY THE FOLLOWING:**

WOOD

1. **MODEL NUMBER + W**
2. **FSC**
3. **CHASSIS WOOD FINISH**

LAM



1. **MODEL NUMBER + L**
2. **FSC**
3. **CHASSIS LAM**

# MODULAR L SUPPORTS

No Back | No Trough | No Wall Access Panel

Silea

05/22

	D	W	H	model number + type	laminata	veneer 1	veneer 2
 Right hand	23 1/8	9	27 7/8	<b>GS2MLS24L-</b> [ ]	702	1,095	1,205
	23 1/8	9	27 7/8	<b>GS2MLS24R-</b> [ ]	702	1,095	1,205
 Left hand	29 7/8	9	27 7/8	<b>GS2MLS30L-</b> [ ]	747	1,168	1,285
	29 7/8	9	27 7/8	<b>GS2MLS30R-</b> [ ]	747	1,168	1,285
	35 7/8	9	27 7/8	<b>GS2MLS36L-</b> [ ]	825	1,290	1,419
	35 7/8	9	27 7/8	<b>GS2MLS36R-</b> [ ]	825	1,290	1,419
	23 1/8	9	20 3/4	<b>GS2MLLS24L-</b> [ ]	627	976	1,074
	23 1/8	9	20 3/4	<b>GS2MLLS24R-</b> [ ]	627	976	1,074

• Layers version

## PRODUCT INFO

Do not use 2 L supports to create a desk.

## TO ORDER PLEASE SPECIFY THE FOLLOWING:





### WOOD

1. **MODEL NUMBER + W**
2. **FSC**
3. **CHASSIS WOOD FINISH**

### LAM

1. **MODEL NUMBER + L**
2. **FSC**
3. **CHASSIS LAM**



	D	W	H	model number + type	laminata	veneer 1	veneer 2
<b>INTERMEDIATE SUPPORT</b> 	14	3/4	27 7/8	<b>GS2MSP-</b> [ ]	308	763	840
<b>T SUPPORT</b> 	14 3/4	12	27 7/8	<b>GS2MSPT-</b> [ ]	371	1,018	1,120
<b>WORKSURFACE JUNCTION SUPPORT</b> 	14 3/4	24	27 7/8	<b>GS2MSJ24-</b> [ ]	706	1,100	1,210
<b>FILLER STRIP</b> 	3/4	9	27 7/8	<b>GS2MPF-</b> [ ]	360	726	799
<b>PEDESTAL BACKS</b> 	3/4	9	27 7/8	<b>GS2MPB9-</b> [ ]	360	699	769
	3/4	15	27 7/8	<b>GS2MPB15-</b> [ ]	371	823	906
	3/4	18	27 7/8	<b>GS2MPB18-</b> [ ]	423	606	667
	3/4	30	27 7/8	<b>GS2MPB30-</b> [ ]	477	682	751
	3/4	36	27 7/8	<b>GS2MPB36-</b> [ ]	499	713	785

**NOTE:** Credenzas, returns, and bridges with no back panel and an unsupported area of 48" and greater require an intermediate T support.

**PRODUCT INFO**

Panels for use with standard or trough tops.  
All pedestals with an exposed side require a filler strip or pedestal back.

**TO ORDER PLEASE SPECIFY THE FOLLOWING:**

**WOOD**

1. **MODEL NUMBER + W**
2. **FSC**
3. **CHASSIS WOOD FINISH**

**LAM**





1. **MODEL NUMBER + L**
2. **FSC**
3. **CHASSIS LAM**

# MODULAR SUPPORT PANELS & PED BACKS

Silea

05/22

Layers Height

	D	W	H	model number + type	laminat	vener 1	vener 2
<b>INTERMEDIATE SUPPORT</b> 	14	3/4	20 3/4	<b>GS2MLSP-</b> [ ]	308	475	523
<b>T SUPPORT</b> 	14 3/4	12	20 3/4	<b>GS2MLSPT-</b> [ ]	371	570	627
<b>WORKSURFACE JUNCTION SUPPORT</b> 	14 3/4	24	20 3/4	<b>GS2MLSJ24-</b> [ ]	706	1,100	1,210
<b>FILLER STRIP</b> 	3/4	9	20 3/4	<b>GS2MLPF-</b> [ ]	360	726	799
<b>PEDESTAL BACKS</b> 	3/4	15	20 3/4	<b>GS2MLPB15-</b> [ ]	371	531	585
	3/4	18	20 3/4	<b>GS2MLPB18-</b> [ ]	423	606	667
	3/4	30	20 3/4	<b>GS2MLPB30-</b> [ ]	477	682	751
	3/4	36	20 3/4	<b>GS2MLPB36-</b> [ ]	499	713	785

**NOTE:** Credenzas, returns, and bridges with no back panel and an unsupported area of 48" and greater require an intermediate T support.

## PRODUCT INFO

Panels for use with standard or trough tops.  
All pedestals with exposed side require a filler strip or pedestal back.

## TO ORDER PLEASE SPECIFY THE FOLLOWING:

### WOOD

- MODEL NUMBER + W**
- FSC**
- CHASSIS WOOD FINISH**

### LAM

- MODEL NUMBER + L**
- FSC**
- CHASSIS LAM**

	D	W	H	model number + type	laminate	vener 1	vener 2
	3/4	60	27 7/8	<b>GS2CMF60-</b> [ ]	723	1,046	1,151
	3/4	66	27 7/8	<b>GS2CMF66-</b> [ ]	789	1,143	1,258
	3/4	72	27 7/8	<b>GS2CMF72-</b> [ ]	851	1,234	1,358
	3/4	78	27 7/8	<b>GS2CMF78-</b> [ ]	912	1,323	1,456
	3/4	84	27 7/8	<b>GS2CMF84-</b> [ ]	975	1,414	1,556
	3/4	90	27 7/8	<b>GS2CMF90-</b> [ ]	1,039	1,505	1,656
	3/4	96	27 7/8	<b>GS2CMF96-</b> [ ]	1,102	1,596	1,756
	3/4	102	27 7/8	<b>GS2CMF102-</b> [ ]	N/A	1,685	1,854
	3/4	108	27 7/8	<b>GS2CMF108-</b> [ ]	N/A	1,776	1,954
	3/4	114	27 7/8	<b>GS2CMF114-</b> [ ]	N/A	1,865	2,052
3/4	120	27 7/8	<b>GS2CMF120-</b> [ ]	N/A	1,957	2,153	

**PRODUCT INFO**

**Grain Direction**

- Natural Vener: Vertical
- Stratawood Vener: Optional
- Laminate : Horizontal

**TO ORDER PLEASE SPECIFY THE FOLLOWING:**

WOOD

- 1. MODEL NUMBER + W**
- 2. FSC**
- 3. CHASSIS WOOD FINISH**

LAM

- 1. MODEL NUMBER + L**
- 2. FSC**
- 3. CHASSIS LAM**

# MODULAR CREDENZA FULL MODESTY PANEL

Layers Height

Silea

05/22

	D	W	H	model number + type	laminate	vener 1	vener 2
	3/4	45	20 3/4	<b>GS2CLMF45-</b> [ ]	667	964	1,061
	3/4	48	20 3/4	<b>GS2CLMF48-</b> [ ]	679	982	1,081
	3/4	51	20 3/4	<b>GS2CLMF51-</b> [ ]	691	1,001	1,102
	3/4	54	20 3/4	<b>GS2CLMF54-</b> [ ]	700	1,017	1,119
	3/4	60	20 3/4	<b>GS2CLMF60-</b> [ ]	723	1,046	1,151
	3/4	66	20 3/4	<b>GS2CLMF66-</b> [ ]	789	1,143	1,258
	3/4	72	20 3/4	<b>GS2CLMF72-</b> [ ]	851	1,234	1,358
	3/4	78	20 3/4	<b>GS2CLMF78-</b> [ ]	912	1,323	1,456
	3/4	84	20 3/4	<b>GS2CLMF84-</b> [ ]	975	1,414	1,556
	3/4	90	20 3/4	<b>GS2CLMF90-</b> [ ]	1,039	1,505	1,656
	3/4	96	20 3/4	<b>GS2CLMF96-</b> [ ]	1,102	1,596	1,756
	3/4	102	20 3/4	<b>GS2CLMF102-</b> [ ]	N/A	1,685	1,854
	3/4	108	20 3/4	<b>GS2CLMF108-</b> [ ]	N/A	1,776	1,954
	3/4	114	20 3/4	<b>GS2CLMF114-</b> [ ]	N/A	1,865	2,052
3/4	120	20 3/4	<b>GS2CLMF120-</b> [ ]	N/A	1,957	2,153	

## PRODUCT INFO

### Grain Direction

- Natural Veneer: Vertical
- Stratawood Veneer: Optional
- Laminate : Horizontal

## TO ORDER PLEASE SPECIFY THE FOLLOWING:

### WOOD

1. **MODEL NUMBER + W**
2. **FSC**
3. **CHASSIS WOOD FINISH**

### LAM

1. **MODEL NUMBER + L**
2. **FSC**
3. **CHASSIS LAM**

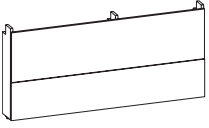
	D	W	H	model number + type	laminate	veneer 1	veneer 2
	7 1/4	21	27 7/8	<b>GS2CMA21-</b> [ ]	850	1,323	1,456
	7 1/4	24	27 7/8	<b>GS2CMA24-</b> [ ]	868	1,358	1,494
	7 1/4	27	27 7/8	<b>GS2CMA27-</b> [ ]	889	1,387	1,526
	7 1/4	30	27 7/8	<b>GS2CMA30-</b> [ ]	910	1,421	1,564
	7 1/4	33	27 7/8	<b>GS2CMA33-</b> [ ]	931	1,454	1,600
	7 1/4	36	27 7/8	<b>GS2CMA36-</b> [ ]	953	1,485	1,634
	7 1/4	39	27 7/8	<b>GS2CMA39-</b> [ ]	972	1,517	1,669
	7 1/4	42	27 7/8	<b>GS2CMA42-</b> [ ]	995	1,551	1,707
	7 1/4	45	27 7/8	<b>GS2CMA45-</b> [ ]	1,014	1,581	1,740
	7 1/4	48	27 7/8	<b>GS2CMA48-</b> [ ]	1,038	1,616	1,778
	7 1/4	51	27 7/8	<b>GS2CMA51-</b> [ ]	1,132	1,649	1,814
	7 1/4	54	27 7/8	<b>GS2CMA54-</b> [ ]	1,152	1,680	1,848
	7 1/4	57	27 7/8	<b>GS2CMA57-</b> [ ]	1,175	1,712	1,884
	7 1/4	60	27 7/8	<b>GS2CMA60-</b> [ ]	1,192	1,742	1,917
	7 1/4	63	27 7/8	<b>GS2CMA63-</b> [ ]	1,220	1,776	1,954
	7 1/4	66	27 7/8	<b>GS2CMA66-</b> [ ]	1,240	1,810	1,991
	7 1/4	69	27 7/8	<b>GS2CMA69-</b> [ ]	1,264	1,840	2,024
7 1/4	72	27 7/8	<b>GS2CMA72-</b> [ ]	1,284	1,873	2,061	

**PRODUCT INFO**

**Grain Direction**

- Natural Veneer: Vertical
- Stratawood Veneer: Optional
- Laminate: Vertical up to and including 60"W. Horizontal greater than 60"W.

**TO ORDER PLEASE SPECIFY THE FOLLOWING:**

WOOD

- MODEL NUMBER + W**
- FSC**
- CHASSIS WOOD FINISH**

LAM

- MODEL NUMBER + L**
- FSC**
- CHASSIS LAM**

# MODULAR CREDENZA WALL ACCESS PANEL

Layers Height

Silea

05/22

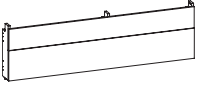
	D	W	H	model number + type	laminate	veneer 1	veneer 2
	7 1/4	21	20 3/4	<b>GS2CLMA21-</b> [ ]	850	1,323	1,456
	7 1/4	24	20 3/4	<b>GS2CLMA24-</b> [ ]	868	1,358	1,494
	7 1/4	27	20 3/4	<b>GS2CLMA27-</b> [ ]	889	1,387	1,526
	7 1/4	30	20 3/4	<b>GS2CLMA30-</b> [ ]	910	1,421	1,564
	7 1/4	33	20 3/4	<b>GS2CLMA33-</b> [ ]	931	1,454	1,600
	7 1/4	36	20 3/4	<b>GS2CLMA36-</b> [ ]	953	1,485	1,634
	7 1/4	39	20 3/4	<b>GS2CLMA39-</b> [ ]	972	1,517	1,669
	7 1/4	42	20 3/4	<b>GS2CLMA42-</b> [ ]	995	1,551	1,707
	7 1/4	45	20 3/4	<b>GS2CLMA45-</b> [ ]	1,014	1,581	1,740
	7 1/4	48	20 3/4	<b>GS2CLMA48-</b> [ ]	1,038	1,616	1,778
	7 1/4	51	20 3/4	<b>GS2CLMA51-</b> [ ]	1,132	1,649	1,814
	7 1/4	54	20 3/4	<b>GS2CLMA54-</b> [ ]	1,152	1,680	1,848
	7 1/4	57	20 3/4	<b>GS2CLMA57-</b> [ ]	1,175	1,712	1,884
	7 1/4	60	20 3/4	<b>GS2CLMA60-</b> [ ]	1,192	1,742	1,917
	7 1/4	63	20 3/4	<b>GS2CLMA63-</b> [ ]	1,220	1,776	1,954
	7 1/4	66	20 3/4	<b>GS2CLMA66-</b> [ ]	1,240	1,810	1,991
	7 1/4	69	20 3/4	<b>GS2CLMA69-</b> [ ]	1,264	1,840	2,024
7 1/4	72	20 3/4	<b>GS2CLMA72-</b> [ ]	1,284	1,873	2,061	

## PRODUCT INFO

### Grain Direction

- Natural Veneer: Vertical
- Stratawood Veneer: Optional
- Laminate: Vertical up to and including 60"W. Horizontal greater than 60"W.

## TO ORDER PLEASE SPECIFY THE FOLLOWING:

### WOOD

- MODEL NUMBER + W**
- FSC**
- CHASSIS WOOD FINISH**

### LAM

- MODEL NUMBER + L**
- FSC**
- CHASSIS LAM**

	D	W	H	model number + type	laminate	veneer 1	veneer 2
<b>LEFT HAND</b> 	3/4	39	27 7/8	<b>GS2RMF39L-</b> [ ]	649	940	1,034
	3/4	42	27 7/8	<b>GS2RMF42L-</b> [ ]	660	955	1,051
	3/4	45	27 7/8	<b>GS2RMF45L-</b> [ ]	667	964	1,061
	3/4	48	27 7/8	<b>GS2RMF48L-</b> [ ]	679	982	1,081
	3/4	51	27 7/8	<b>GS2RMF51L-</b> [ ]	691	1,001	1,102
	3/4	54	27 7/8	<b>GS2RMF54L-</b> [ ]	700	1,017	1,119
	3/4	57	27 7/8	<b>GS2RMF57L-</b> [ ]	713	1,029	1,132
	3/4	60	27 7/8	<b>GS2RMF60L-</b> [ ]	723	1,046	1,151
	3/4	63	27 7/8	<b>GS2RMF63L-</b> [ ]	756	1,094	1,204
	3/4	66	27 7/8	<b>GS2RMF66L-</b> [ ]	789	1,143	1,258
	3/4	69	27 7/8	<b>GS2RMF69L-</b> [ ]	821	1,189	1,308
	3/4	72	27 7/8	<b>GS2RMF72L-</b> [ ]	851	1,234	1,358
	3/4	75	27 7/8	<b>GS2RMF75L-</b> [ ]	882	1,280	1,408
	3/4	78	27 7/8	<b>GS2RMF78L-</b> [ ]	912	1,323	1,456
	3/4	81	27 7/8	<b>GS2RMF81L-</b> [ ]	944	1,369	1,506
	3/4	84	27 7/8	<b>GS2RMF84L-</b> [ ]	975	1,414	1,556
3/4	87	27 7/8	<b>GS2RMF87L-</b> [ ]	1,007	1,460	1,606	
3/4	90	27 7/8	<b>GS2RMF90L-</b> [ ]	1,039	1,505	1,656	

**NOTE:** If attaching to a height adjustable extension desk, a 3" shorter modesty panel must be used

PRODUCT INFO	TO ORDER PLEASE SPECIFY THE FOLLOWING:								
<p>Handed units due to hole pattern.</p> <p>For use to build full modesty returns and to attach to end panels.</p> <p><b>Grain Direction</b></p> <ul style="list-style-type: none"> <li>• Natural Veneer: Vertical</li> <li>• Stratawood Veneer: Optional</li> <li>• Laminate: Vertical</li> </ul>	<table border="0"> <tr> <td>WOOD</td> <td>LAM</td> </tr> <tr> <td>1. MODEL NUMBER + W</td> <td>1. MODEL NUMBER + L</td> </tr> <tr> <td>2. FSC</td> <td>2. FSC</td> </tr> <tr> <td>3. CHASSIS WOOD FINISH</td> <td>3. CHASSIS LAM</td> </tr> </table>	WOOD	LAM	1. MODEL NUMBER + W	1. MODEL NUMBER + L	2. FSC	2. FSC	3. CHASSIS WOOD FINISH	3. CHASSIS LAM
WOOD	LAM								
1. MODEL NUMBER + W	1. MODEL NUMBER + L								
2. FSC	2. FSC								
3. CHASSIS WOOD FINISH	3. CHASSIS LAM								

# MODULAR RETURN FULL MODESTY PANEL

Silea  
05/22

	D	W	H	model number + type	laminate	veneer 1	veneer 2
<b>RIGHT HAND</b> 	3/4	39	27 7/8	<b>GS2RMF39R-</b> [ ]	649	940	1,034
	3/4	42	27 7/8	<b>GS2RMF42R-</b> [ ]	660	955	1,051
	3/4	45	27 7/8	<b>GS2RMF45R-</b> [ ]	667	964	1,061
	3/4	48	27 7/8	<b>GS2RMF48R-</b> [ ]	679	982	1,081
	3/4	51	27 7/8	<b>GS2RMF51R-</b> [ ]	691	1,001	1,102
	3/4	54	27 7/8	<b>GS2RMF54R-</b> [ ]	700	1,017	1,119
	3/4	57	27 7/8	<b>GS2RMF57R-</b> [ ]	713	1,029	1,132
	3/4	60	27 7/8	<b>GS2RMF60R-</b> [ ]	723	1,046	1,151
	3/4	63	27 7/8	<b>GS2RMF63R-</b> [ ]	756	1,094	1,204
	3/4	66	27 7/8	<b>GS2RMF66R-</b> [ ]	789	1,143	1,258
	3/4	69	27 7/8	<b>GS2RMF69R-</b> [ ]	821	1,189	1,308
	3/4	72	27 7/8	<b>GS2RMF72R-</b> [ ]	851	1,234	1,358
	3/4	75	27 7/8	<b>GS2RMF75R-</b> [ ]	882	1,280	1,408
	3/4	78	27 7/8	<b>GS2RMF78R-</b> [ ]	912	1,323	1,456
	3/4	81	27 7/8	<b>GS2RMF81R-</b> [ ]	944	1,369	1,506
	3/4	84	27 7/8	<b>GS2RMF84R-</b> [ ]	975	1,414	1,556
3/4	87	27 7/8	<b>GS2RMF87R-</b> [ ]	1,007	1,460	1,606	
3/4	90	27 7/8	<b>GS2RMF90R-</b> [ ]	1,039	1,505	1,656	

**NOTE:** If attaching to a height adjustable extension desk, a 3" shorter modesty panel must be used

## PRODUCT INFO

Handed units due to hole pattern.

For use to build full modesty returns and to attach to end panels.

### Grain Direction

- Natural Veneer: Vertical
- Stratawood Veneer: Optional
- Laminate: Vertical

## TO ORDER PLEASE SPECIFY THE FOLLOWING:

### WOOD

1. **MODEL NUMBER + W**
2. **FSC**
3. **CHASSIS WOOD FINISH**

### LAM

1. **MODEL NUMBER + L**
2. **FSC**
3. **CHASSIS LAM**



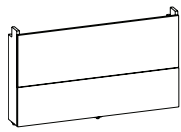

D	W	H	model number + type	laminate	veneer 1	veneer 2
7 1/4	21	27 7/8	<b>GS2RMA21-</b> [ ]	850	1,323	1,456
7 1/4	24	27 7/8	<b>GS2RMA24-</b> [ ]	868	1,358	1,494
7 1/4	27	27 7/8	<b>GS2RMA27-</b> [ ]	889	1,387	1,526
7 1/4	30	27 7/8	<b>GS2RMA30-</b> [ ]	910	1,421	1,564
7 1/4	33	27 7/8	<b>GS2RMA33-</b> [ ]	931	1,454	1,600
7 1/4	36	27 7/8	<b>GS2RMA36-</b> [ ]	953	1,485	1,634
7 1/4	39	27 7/8	<b>GS2RMA39-</b> [ ]	972	1,517	1,669
7 1/4	42	27 7/8	<b>GS2RMA42-</b> [ ]	995	1,551	1,707
7 1/4	45	27 7/8	<b>GS2RMA45-</b> [ ]	1,014	1,581	1,740
7 1/4	48	27 7/8	<b>GS2RMA48-</b> [ ]	1,038	1,616	1,778
7 1/4	51	27 7/8	<b>GS2RMA51-</b> [ ]	1,132	1,649	1,814
7 1/4	54	27 7/8	<b>GS2RMA54-</b> [ ]	1,152	1,680	1,848
7 1/4	57	27 7/8	<b>GS2RMA57-</b> [ ]	1,175	1,712	1,884
7 1/4	60	27 7/8	<b>GS2RMA60-</b> [ ]	1,192	1,742	1,917
7 1/4	63	27 7/8	<b>GS2RMA63-</b> [ ]	1,220	1,776	1,954
7 1/4	66	27 7/8	<b>GS2RMA66-</b> [ ]	1,240	1,810	1,991
7 1/4	69	27 7/8	<b>GS2RMA69-</b> [ ]	1,264	1,840	2,024
7 1/4	72	27 7/8	<b>GS2RMA72-</b> [ ]	1,284	1,873	2,061

**NOTE:** If attaching to a height adjustable extension desk, a 3" shorter wall access panel must be used

**PRODUCT INFO**

**Grain Direction**

- Natural Veneer: Vertical
- Stratawood Veneer: Optional
- Laminate : Vertical

**TO ORDER PLEASE SPECIFY THE FOLLOWING:**

WOOD

- 1. MODEL NUMBER + W**
- 2. FSC**
- 3. CHASSIS WOOD FINISH**

LAM

- 1. MODEL NUMBER + L**
- 2. FSC**
- 3. CHASSIS LAM**

# BRIDGE FULL MODESTY PANEL

Silea  
05/22

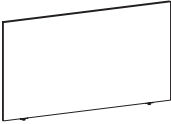
	D	W	H	model number + type	laminate	veneer 1	veneer 2
	3/4	39	27 7/8	<b>GS2BMF39-</b> [ ]	649	940	1,034
	3/4	42	27 7/8	<b>GS2BMF42-</b> [ ]	660	955	1,051
	3/4	45	27 7/8	<b>GS2BMF45-</b> [ ]	671	964	1,061
	3/4	48	27 7/8	<b>GS2BMF48-</b> [ ]	678	982	1,081
	3/4	51	27 7/8	<b>GS2BMF51-</b> [ ]	692	1,001	1,102
	3/4	54	27 7/8	<b>GS2BMF54-</b> [ ]	702	1,017	1,119
	3/4	57	27 7/8	<b>GS2BMF57-</b> [ ]	714	1,029	1,132
	3/4	60	27 7/8	<b>GS2BMF60-</b> [ ]	723	1,046	1,151

**NOTE:** If attaching to a height adjustable extension desk, a 3" shorter modesty panel must be used

## PRODUCT INFO

### Grain Direction

- Natural Veneer: Vertical
- Stratawood Veneer: Optional
- Laminate : Vertical

## TO ORDER PLEASE SPECIFY THE FOLLOWING:

### WOOD

1. **MODEL NUMBER + W**
2. **FSC**
3. **CHASSIS WOOD FINISH**

### LAM

1. **MODEL NUMBER + L**
2. **FSC**
3. **CHASSIS LAM**



D	W	H	model number + type	laminate	veneer 1	veneer 2
7 1/4	39	27 7/8	<b>GS2BMA39-</b> [ ]	972	1,517	1,669
7 1/4	42	27 7/8	<b>GS2BMA42-</b> [ ]	995	1,551	1,707
7 1/4	45	27 7/8	<b>GS2BMA45-</b> [ ]	1,014	1,581	1,740
7 1/4	48	27 7/8	<b>GS2BMA48-</b> [ ]	1,038	1,616	1,778
7 1/4	51	27 7/8	<b>GS2BMA51-</b> [ ]	1,132	1,649	1,814
7 1/4	54	27 7/8	<b>GS2BMA54-</b> [ ]	1,152	1,680	1,848
7 1/4	57	27 7/8	<b>GS2BMA57-</b> [ ]	1,175	1,712	1,884
7 1/4	60	27 7/8	<b>GS2BMA60-</b> [ ]	1,192	1,742	1,917

**NOTE:** If attaching to a height adjustable extension desk, a 3" shorter wall access panel must be used

PRODUCT INFO	TO ORDER PLEASE SPECIFY THE FOLLOWING:								
<p><b>Grain Direction</b></p> <ul style="list-style-type: none"> <li>• Natural Veneer: Vertical</li> <li>• Stratawood Veneer: Optional</li> <li>• Laminate : Vertical</li> </ul>	<table border="0"> <tr> <td>WOOD</td> <td>LAM</td> </tr> <tr> <td>1. MODEL NUMBER + W</td> <td>1. MODEL NUMBER + L</td> </tr> <tr> <td>2. FSC</td> <td>2. FSC</td> </tr> <tr> <td>3. CHASSIS WOOD FINISH</td> <td>3. CHASSIS LAM</td> </tr> </table>	WOOD	LAM	1. MODEL NUMBER + W	1. MODEL NUMBER + L	2. FSC	2. FSC	3. CHASSIS WOOD FINISH	3. CHASSIS LAM
WOOD	LAM								
1. MODEL NUMBER + W	1. MODEL NUMBER + L								
2. FSC	2. FSC								
3. CHASSIS WOOD FINISH	3. CHASSIS LAM								

# LAYERS W/ LAPTOP DRAWER

For 30" and 36"D Runoff

Silea

05/22

	D	W	H	model number + type	laminate	veneer 1	veneer 2
	16 3/4	26 1/2	5 15/16	<b>GS2MLB30SL-</b> [ ]	870	1,284	1,413
	16 3/4	26 1/2	5 15/16	<b>GS2MLB30SR-</b> [ ]	870	1,284	1,413

• For use with a 30" deep runoff.

	16 3/4	32 1/2	5 15/16	<b>GS2MLB36SL-</b> [ ]	928	1,308	1,439
	16 3/4	32 1/2	5 15/16	<b>GS2MLB36SR-</b> [ ]	928	1,308	1,439

• For use with a 36" deep runoff.

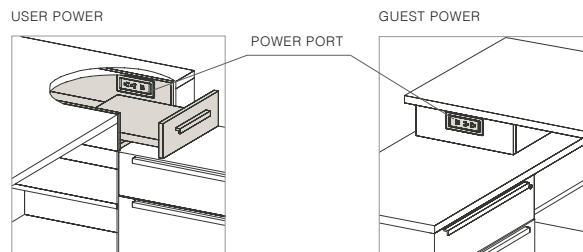

## PRODUCT INFO

Unit comes with 2 power units. Color specified in option pick.

 Units shipped as separate packages and require field assembly.

## TO ORDER PLEASE SPECIFY THE FOLLOWING:

### WOOD

1. **MODEL NUMBER + W**
2. **FSC**
3. **CHASSIS WOOD FINISH**
4. **PULL**
5. **POWER UNIT**

### LAM

1. **MODEL NUMBER + L**
2. **FSC**
3. **CHASSIS LAM**
4. **PULL**
5. **POWER UNIT**

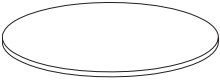
	Dia	H	model number + type	laminate	veneer 1	veneer 2	solid surface
	36	1 3/16	<b>GS2TRD36-</b> [ ]	1,274	2,487	2,736	
	42	1 3/16	<b>GS2TRD42-</b> [ ]	1,383	2,701	2,972	
	48	1 3/16	<b>GS2TRD48-</b> [ ]	1,812	3,533	3,887	
	54	1 3/16	<b>GS2TRD54-</b> [ ]	2,213	4,319	4,751	
	60	1 3/16	<b>GS2TRD60-</b> [ ]	2,693	5,257	5,783	

**PRODUCT INFO**

Solid surface tops have a softened edge.

54" and 60" wood tops are 2-piece. If top ordered with 4 legs, metal stiffeners must be ordered separately (ACMWS30, qty. 2).

**Grommet Location**  
(Add \$70 per grommet)

No Grommet **GN**  
Center **GC**

Specify location first, then select grommet color or "Empty Cutout" option. When "Empty Cutout" option is selected, a grommet or power unit must be ordered separately for each cutout.

**TO ORDER PLEASE SPECIFY THE FOLLOWING:**

**WOOD TOP**

1. **MODEL NUMBER + W**
2. **FSC**
3. **TOP WOOD FINISH + EDGE**
4. **TOP UV FINISH**
5. **GROMMET**

**LAM TOP**

1. **MODEL NUMBER + L**
2. **FSC**
3. **TOP LAM**
4. **EDGE DETAIL**
5. **GROMMET**

**SOLID SURFACE TOP**

1. **MODEL NUMBER + S**
2. **SOLID SURFACE FINISH**
3. **EDGE DETAIL**
4. **GROMMET**

# GUITAR PICK TOP

Silea  
05/22

	D	W	H	model number + type	laminate	veneer 1	veneer 2	solid surface
	36	36	1 3/16	<b>GS2TSTG36-</b> <input type="checkbox"/>	1,274	2,487	2,736	
	42	42	1 3/16	<b>GS2TSTG42-</b> <input type="checkbox"/>	1,383	2,701	2,972	
	48	48	1 3/16	<b>GS2TSTG48-</b> <input type="checkbox"/>	1,812	3,533	3,887	

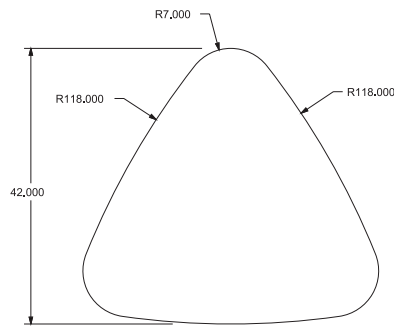

## PRODUCT INFO

Solid surface tops have a softened edge.

### Grommet Location

(Add \$70 per grommet)

No Grommet **GN**  
Center **GC**

Specify location first, then select grommet color or "Empty Cutout" option. When "Empty Cutout" option is selected, a grommet or power unit must be ordered separately for each cutout.

## TO ORDER PLEASE SPECIFY THE FOLLOWING:

### WOOD TOP

1. **MODEL NUMBER + W**
2. **FSC**
3. **TOP WOOD FINISH + EDGE**
4. **TOP UV FINISH**
5. **GROMMET**

### LAM TOP

1. **MODEL NUMBER + L**
2. **FSC**
3. **TOP LAM**
4. **EDGE DETAIL**
5. **GROMMET**

### SOLID SURFACE TOP

1. **MODEL NUMBER + S**
2. **SOLID SURFACE FINISH**
3. **EDGE DETAIL**
4. **GROMMET**

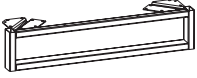
	for use with top sizes	D	W	H	model number	list
	24D/30D	1 1/2	18	5 15/16	<b>GS2MLB18</b>	429
	36D	1 1/2	24	5 15/16	<b>GS2MLB24</b>	465
	42D	1 1/2	30	5 15/16	<b>GS2MLB30</b>	502
	48D	1 1/2	36	5 15/16	<b>GS2MLB36</b>	540

**PRODUCT INFO**

To be used to support  
worksurface in layers  
applications.

**TO ORDER PLEASE SPECIFY THE FOLLOWING:**

LIST

1. **MODEL NUMBER**
2. **HARDWARE COLOR**

# STEEL WORKSURFACE SUPPORT

Silea  
05/22

	D	W	H	model number	list
	1 1/2	1 1/2	30	<b>ACMWS30</b>	63
	1 1/2	1 1/2	36	<b>ACMWS36</b>	68
	1 1/2	1 1/2	41	<b>ACMWS41</b>	69
	1 1/2	1 1/2	47	<b>ACMWS47</b>	70
	1 1/2	1 1/2	53	<b>ACMWS53</b>	71
	1 1/2	1 1/2	59	<b>ACMWS59</b>	72
	1 1/2	1 1/2	65	<b>ACMWS65</b>	73
	1 1/2	1 1/2	71	<b>ACMWS71</b>	74
	1 1/2	1 1/2	83	<b>ACMWS83</b>	111

## PRODUCT INFO

Use supports on worksurfaces that span 48" unsupported without a full modesty panel. Calculate total distance between kneewell panels or bases and subtract 6". Use closest available model size.

## TO ORDER PLEASE SPECIFY THE FOLLOWING:

LIST

- MODEL NUMBER**

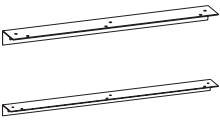

	D	W	H	model number	part
<b>FLAT BRACKET</b> 	7 3/4	16 1/2	1/8	<b>MDWBRK</b>	116
	• For worksurface connections				
<b>WALL MOUNT BRACKETS</b> 	2 1/2	19	1 1/4	<b>MDWLBK24</b>	119
	• For use with 24"D worksurface.				
	2 1/2	25	1 1/4	<b>MDWLBK30</b>	128
	• For use with 30" and 36"D worksurface.				

**PRODUCT INFO**

TO ORDER PLEASE SPECIFY THE FOLLOWING:

LIST

- 1. MODEL NUMBER**

# MODULAR PEDESTAL CUSHION

Standard and Trough Tops

Silea

05/22

	D	W	H	model number + type	fabric grades			COM/4
					1	2	3	
	20 11/16	29 3/4	1	<b>GS2CLPD-CUSH2130T</b>	566	587	609	632
	20 11/16	35 3/4	1	<b>GS2CLPD-CUSH2136T</b>	611	637	666	695

## PRODUCT INFO

To be used with standard and trough tops.

**COM fabric 1.25 yds for both models.**

## TO ORDER PLEASE SPECIFY THE FOLLOWING:

### LIST

1. **MODEL NUMBER**
2. **FABRIC**
3. **FLAMMABILITY**

**Flammability Option Codes:**  
**U = CTB 117**

For standard flammability rating, please specify CTB 117.

# CANTILEVER HEIGHT ADJUSTABLE DESKS AND SMART STORAGE

Cantilever Height Adjustable Desks and Smart Storage . . . . .	203-217
Cantilever Height Adjustable Desks . . . . .	204-207
Smart Pedestals. . . . .	208-209
Accessory Trays and Bins For Smart Pedestals . . . . .	210
False Pedestals . . . . .	211
Smart Closets . . . . .	212-213
Smart Lockers . . . . .	214-215
Smart Pedestal Power Units For Grommet Cutout. . . . .	216
Solidwood Desktop Accessories. . . . .	217

# CANTILEVER HEIGHT ADJUSTABLE DESKS - RECTANGULAR

Silea

05/22

Left Hand Desk

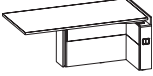
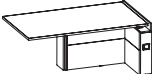
	D	W	H	model number + type	laminate	vener 1	vener 2	
<b>36" DEPTH</b> 	36	66	29 1/2	<b>GS5CVATR3666L-</b> [ ]	8,019	12,411	13,653	
	• 22 1/2" end overhang, 6" guest overhang							
	36	72	29 1/2	<b>GS5CVATR3672L-</b> [ ]	8,075	12,499	13,749	
	• 28 1/2" end overhang, 6" guest overhang							
	36	78	29 1/2	<b>GS5CVATR3678L-</b> [ ]	8,464	12,931	14,225	
• 34 1/2" end overhang, 6" guest overhang								
	36	84	29 1/2	<b>GS5CVATR3684L-</b> [ ]	8,547	13,062	14,369	
• 40 1/2" end overhang, 6" guest overhang								
<b>42" DEPTH</b> 	42	66	29 1/2	<b>GS5CVATR4266L-</b> [ ]	8,533	13,322	14,655	
	• 22 1/2" end overhang, 9" guest overhang							
	42	72	29 1/2	<b>GS5CVATR4272L-</b> [ ]	8,605	13,434	14,778	
	• 28 1/2" end overhang, 9" guest overhang							
	42	78	29 1/2	<b>GS5CVATR4278L-</b> [ ]	9,014	13,896	15,286	
• 34 1/2" end overhang, 9" guest overhang								
	42	84	29 1/2	<b>GS5CVATR4284L-</b> [ ]	9,117	14,058	15,464	
• 40 1/2" end overhang, 9" guest overhang								

## PRODUCT INFO

**Unit must be wall mounted.**

Top depth 1" shallower than chassis on user and guest sides to accommodate pinch points of adjoining units

29.5" to 42.5" height adjustment range

 All units shipped as separate packages and require field assembly.

**Grommet Location**  
(Add \$70 per grommet)

No Grommet **GN**  
Right **GR**

Specify location first, then select grommet color or "Empty Cutout" option. When "Empty Cutout" option is selected, a grommet or power unit must be ordered separately for each cutout.

## TO ORDER PLEASE SPECIFY THE FOLLOWING:

WOOD TOP, WOOD CHASSIS

- MODEL NUMBER + WW**
- FSC**
- TOP WOOD FINISH + EDGE**
- CHASSIS WOOD FINISH**
- TOP UV FINISH**
- HAT KEYPAD & BASE COLOR**
- GROMMET**

LAM TOP, LAM CHASSIS

- MODEL NUMBER + LL**
- FSC**
- TOP LAM**
- CHASSIS LAM**
- EDGE DETAIL**
- HAT KEYPAD & BASE COLOR**
- GROMMET**

Optional height adjustable keypads available

### HAT KEYPAD & BASE COLOR

Basic Up/Down Keypad, Black P71 Column  
Memory Preset Keypad, Black P71 Column  
Paddle Keypad, Black P71 Column  
Foot Control Keypad, Black P71 Column

**UDP71**  
**MEMP71**  
**PDLP71**  
**FPDP71** Add \$240

NOTE: Foot control keypad is bluetooth controlled and may be used in conjunction with other keypads attached to worksurface. For these situations order standard keypad for worksurface separately. Foot control requires qty (2) AAA batteries needed. Batteries not included.

# CANTILEVER HEIGHT ADJUSTABLE DESKS - RECTANGULAR

Right Hand Desk

	D	W	H	model number + type	laminate	veneer 1	veneer 2	
<b>36" DEPTH</b> 	36	66	29 1/2	<b>GS5CVATR3666R-</b> [ ]	8,019	12,411	13,653	
	• 22 1/2" end overhang, 6" guest overhang							
	36	72	29 1/2	<b>GS5CVATR3672R-</b> [ ]	8,075	12,499	13,749	
	• 28 1/2" end overhang, 6" guest overhang							
	36	78	29 1/2	<b>GS5CVATR3678R-</b> [ ]	8,464	12,931	14,225	
• 34 1/2" end overhang, 6" guest overhang								
	36	84	29 1/2	<b>GS5CVATR3684R-</b> [ ]	8,547	13,062	14,369	
• 40 1/2" end overhang, 6" guest overhang								
<b>42" DEPTH</b> 	42	66	29 1/2	<b>GS5CVATR4266R-</b> [ ]	8,533	13,322	14,655	
	• 22 1/2" end overhang, 9" guest overhang							
	42	72	29 1/2	<b>GS5CVATR4272R-</b> [ ]	8,605	13,434	14,778	
	• 28 1/2" end overhang, 9" guest overhang							
	42	78	29 1/2	<b>GS5CVATR4278R-</b> [ ]	9,014	13,896	15,286	
• 34 1/2" end overhang, 9" guest overhang								
	42	84	29 1/2	<b>GS5CVATR4284R-</b> [ ]	9,117	14,058	15,464	
• 40 1/2" end overhang, 9" guest overhang								

## PRODUCT INFO

### Unit must be wall mounted.

Top depth 1" shallower than chassis on user and guest sides to accommodate pinch points of adjoining units

29.5" to 42.5" height adjustment range

 All units shipped as separate packages and require field assembly.

### Grommet Location

(Add \$70 per grommet)

No Grommet **GN**

Left **GL**

Specify location first, then select grommet color or "Empty Cutout" option. When "Empty Cutout" option is selected, a grommet or power unit must be ordered separately for each cutout.

## TO ORDER PLEASE SPECIFY THE FOLLOWING:

WOOD TOP, WOOD CHASSIS

- MODEL NUMBER + WW**
- FSC**
- TOP WOOD FINISH + EDGE**
- CHASSIS WOOD FINISH**
- TOP UV FINISH**
- HAT KEYPAD & BASE COLOR**
- GROMMET**

LAM TOP, LAM CHASSIS

- MODEL NUMBER + LL**
- FSC**
- TOP LAM**
- CHASSIS LAM**
- EDGE DETAIL**
- HAT KEYPAD & BASE COLOR**
- GROMMET**

Optional height adjustable keypads available

### HAT KEYPAD & BASE COLOR

Basic Up/Down Keypad, Black P71 Column  
Memory Preset Keypad, Black P71 Column  
Paddle Keypad, Black P71 Column  
Foot Control Keypad, Black P71 Column

**UDP71**  
**MEMP71**  
**PDL71**  
**FPDP71** Add \$240

NOTE: Foot control keypad is bluetooth controlled and may be used in conjunction with other keypads attached to worksurface. For these situations order standard keypad for worksurface separately. Foot control requires qty (2) AAA batteries needed. Batteries not included.

# CANTILEVER HEIGHT ADJUSTABLE DESKS - SIGHTLINE

Silea  
05/22

Left Hand Desk

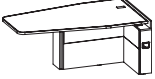
	D	W	H	model number + type	laminate	veneer 1	veneer 2
<b>42" DEPTH</b> 	30-42	66	29 1/2	<b>GS5CVATS304266L-</b> [ ]	8,692	13,569	14,926
	<ul style="list-style-type: none"> <li>• 22 1/2" end overhang, 9" tapered guest overhang</li> </ul>						
	30-42	72	29 1/2	<b>GS5CVATS304272L-</b> [ ]	8,772	13,695	15,065
	<ul style="list-style-type: none"> <li>• 28 1/2" end overhang, 9" tapered guest overhang</li> </ul>						
	30-42	78	29 1/2	<b>GS5CVATS304278L-</b> [ ]	9,192	14,176	15,594
<ul style="list-style-type: none"> <li>• 34 1/2" end overhang, 9" tapered guest overhang</li> </ul>							
	30-42	84	29 1/2	<b>GS5CVATS304284L-</b> [ ]	9,307	14,357	15,793
<ul style="list-style-type: none"> <li>• 40 1/2" end overhang, 9" tapered guest overhang</li> </ul>							

## PRODUCT INFO

### Unit must be wall mounted.

Top depth 1" shallower than chassis on user and guest sides to accommodate pinch points of adjoining units

29.5" to 42.5" height adjustment range

 All units shipped as separate packages and require field assembly.

### Grommet Location

(Add \$70 per grommet)

No Grommet **GN**

Right **GR**

Specify location first, then select grommet color or "Empty Cutout" option. When "Empty Cutout" option is selected, a grommet or power unit must be ordered separately for each cutout.

## TO ORDER PLEASE SPECIFY THE FOLLOWING:

### WOOD TOP, WOOD CHASSIS

- MODEL NUMBER + WW**
- FSC**
- TOP WOOD FINISH + EDGE**
- CHASSIS WOOD FINISH**
- TOP UV FINISH**
- HAT KEYPAD & BASE COLOR**
- GROMMET**

### LAM TOP, LAM CHASSIS

- MODEL NUMBER + LL**
- FSC**
- TOP LAM**
- CHASSIS LAM**
- EDGE DETAIL**
- HAT KEYPAD & BASE COLOR**
- GROMMET**

Optional height adjustable keypads available

### HAT KEYPAD & BASE COLOR

Basic Up/Down Keypad, Black P71 Column

Memory Preset Keypad, Black P71 Column

Paddle Keypad, Black P71 Column

Foot Control Keypad, Black P71 Column

**UDP71**

**MEMP71**

**PDLP71**

**FPDP71** Add \$240

NOTE: Foot control keypad is bluetooth controlled and may be used in conjunction with other keypads attached to worksurface. For these situations order standard keypad for worksurface separately. Foot control requires qty (2) AAA batteries needed. Batteries not included.

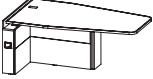
	D	W	H	model number + type	laminata	vener 1	vener 2
<b>42" DEPTH</b> 	30-42	66	29 1/2	<b>GS5CVATS304266R-</b> [ ]	8,692	13,569	14,926
	<ul style="list-style-type: none"> <li>• 22 1/2" end overhang, 9" tapered guest overhang</li> </ul>						
	30-42	72	29 1/2	<b>GS5CVATS304272R-</b> [ ]	8,772	13,695	15,065
	<ul style="list-style-type: none"> <li>• 28 1/2" end overhang, 9" tapered guest overhang</li> </ul>						
	30-42	78	29 1/2	<b>GS5CVATS304278R-</b> [ ]	9,192	14,176	15,594
<ul style="list-style-type: none"> <li>• 34 1/2" end overhang, 9" tapered guest overhang</li> </ul>							
	30-42	84	29 1/2	<b>GS5CVATS304284R-</b> [ ]	9,307	14,357	15,793
<ul style="list-style-type: none"> <li>• 40 1/2" end overhang, 9" tapered guest overhang</li> </ul>							

## PRODUCT INFO

### Unit must be wall mounted.

Top depth 1" shallower than chassis on user and guest sides to accommodate pinch points of adjoining units

29.5" to 42.5" height adjustment range

 All units shipped as separate packages and require field assembly.

### Grommet Location

(Add \$70 per grommet)

No Grommet **GN**  
Left **GL**

Specify location first, then select grommet color or "Empty Cutout" option. When "Empty Cutout" option is selected, a grommet or power unit must be ordered separately for each cutout.

## TO ORDER PLEASE SPECIFY THE FOLLOWING:

### WOOD TOP, WOOD CHASSIS

- MODEL NUMBER + WW**
- FSC**
- TOP WOOD FINISH + EDGE**
- CHASSIS WOOD FINISH**
- TOP UV FINISH**
- HAT KEYPAD & BASE COLOR**
- GROMMET**

### LAM TOP, LAM CHASSIS

- MODEL NUMBER + LL**
- FSC**
- TOP LAM**
- CHASSIS LAM**
- EDGE DETAIL**
- HAT KEYPAD & BASE COLOR**
- GROMMET**

Optional height adjustable keypads available

### HAT KEYPAD & BASE COLOR

Basic Up/Down Keypad, Black P71 Column  
Memory Preset Keypad, Black P71 Column  
Paddle Keypad, Black P71 Column  
Foot Control Keypad, Black P71 Column

**UDP71**  
**MEMP71**  
**PDL71**  
**FPDP71** Add \$240

NOTE: Foot control keypad is bluetooth controlled and may be used in conjunction with other keypads attached to worksurface. For these situations order standard keypad for worksurface separately. Foot control requires qty (2) AAA batteries needed. Batteries not included.

# SMART PEDESTALS

7 1/4 Depth

Silea

05/22

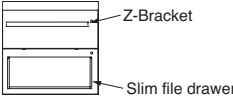
	D	W	H	model number + type	laminate	veneer 1	veneer 2
<b>SINGLE UNIT</b>  	7 1/4	30	29 1/2	<b>GS5CPD730-S</b> [ ]	1,883	2,729	3,002
	<ul style="list-style-type: none"> <li>Bottom Door: 30" Slim File Drawer included.</li> <li>Top Door: Includes z-bracket for clip-in accessory Bins and Trays. <u>Bins and trays must be ordered separately.</u></li> </ul>						
	7 1/4	36	29 1/2	<b>GS5CPD736-S</b> [ ]	2,070	3,003	3,304
	<ul style="list-style-type: none"> <li>Bottom Door: 36" Slim File Drawer included.</li> <li>Top Door: Includes z-bracket for clip-in accessory Bins and Trays. <u>Bins and trays must be ordered separately.</u></li> </ul>						
	7 1/4	42	29 1/2	<b>GS5CPD742-S</b> [ ]	2,277	3,302	3,633
<ul style="list-style-type: none"> <li>Bottom Door: 36" Slim File Drawer included.</li> <li>Top Door: Includes z-bracket for clip-in accessory Bins and Trays. <u>Bins and trays must be ordered separately.</u></li> </ul>							
7 1/4	48	29 1/2	<b>GS5CPD748-S</b> [ ]	2,614	3,789	4,168	
<ul style="list-style-type: none"> <li>Bottom Door: 30" Slim File Drawer + 15" Slim File Drawer included.</li> <li>Top Door: Includes z-bracket for clip-in accessory Bins and Trays. <u>Bins and trays must be ordered separately.</u></li> </ul>							
7 1/4	54	29 1/2	<b>GS5CPD754-S</b> [ ]	2,745	3,978	4,376	
<ul style="list-style-type: none"> <li>Bottom Door: 36" Slim File Drawer + 15" Slim File Drawer included.</li> <li>Top Door: Includes z-bracket for clip-in accessory Bins and Trays. <u>Bins and trays must be ordered separately.</u></li> </ul>							

## PRODUCT INFO

**Unit must be wall mounted.**

### Grommet Location

(Add \$70 per grommet)

No Grommet **GN**  
 Left **GL**  
 Right **GR**

Specify location first, then select grommet color or "Empty Cutout" option. When "Empty Cutout" option is selected, a grommet or power unit must be ordered separately for each cutout.

"E" grommet cutout option for rect. grommet or bezel mount power unit model # ACUNOBZL-EU

"3E" grommet cutout option is 3" dia and to be used with HQ power w/ wireless charging model # ACPHQ3QI

## TO ORDER PLEASE SPECIFY THE FOLLOWING:

### WOOD

- MODEL NUMBER + W**
- FSC**
- CHASSIS WOOD FINISH**
- PULL FOR BOTTOM DOOR**
- GROMMET**
- SIDE WIRE MGT GROMMET**
- LOCKS**

### LAM

- MODEL NUMBER + L**
- FSC**
- CHASSIS LAM**
- FRONT LAM**
- PULL FOR BOTTOM DOOR**
- GROMMET**
- SIDE WIRE MGT GROMMET**
- LOCKS**

**Pull Option:** Bottom door available with standard metal pulls or leather pull. (note: top door is taller than chassis to provide a finger pull to open door)

Leather pull available in 3 colors: Black Bridle **LP12**  
 Medium Brown Bridle **LP13**  
 Grey Bridle **LP14**

**Side Wire Management Grommet Option:** A rectangular cutout may be added to end panels to provide horizontal wire management within a station.

No Side Wire Management Grommets **WN**  
 Side Wire Management Grommet Left **WL**  
 Side Wire Management Grommet Right **WR**  
 Side Wire Management Grommet Left & Right **WB**

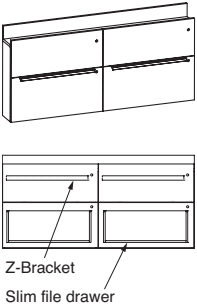

	D	W	H	model number + type	laminata	vener 1	vener 2	
 <p><b>DOUBLE UNIT</b></p> <p>Z-Bracket Slim file drawer</p>	7 1/4	60	29 1/2	<b>GS5CPD760-S</b> [ ]	3,035	4,398	4,838	
	<ul style="list-style-type: none"> <li>• Bottom Door: 30" Slim File Drawer + 30" Slim File Drawer included.</li> <li>• Top Door: Includes z-bracket for clip-in accessory Bins and Trays. <u>Bins and trays must be ordered separately.</u></li> </ul>							
	7 1/4	66	29 1/2	<b>GS5CPD766-S</b> [ ]	3,186	4,617	5,079	
<ul style="list-style-type: none"> <li>• Bottom Door: 30" Slim File Drawer + 36" Slim File Drawer included.</li> <li>• Top Door: Includes z-bracket for clip-in accessory Bins and Trays. <u>Bins and trays must be ordered separately.</u></li> </ul>								
7 1/4	72	29 1/2	<b>GS5CPD772-S</b> [ ]	3,345	4,847	5,332		
<ul style="list-style-type: none"> <li>• Bottom Door: 36" Slim File Drawer + 36" Slim File Drawer included.</li> <li>• Top Door: Includes z-bracket for clip-in accessory Bins and Trays. <u>Bins and trays must be ordered separately.</u></li> </ul>								

**PRODUCT INFO**

**Unit must be wall mounted.**

**Grommet Location**

(Add \$70 per grommet)

No Grommet **GN**  
Left **GL**  
Right **GR**

Specify location first, then select grommet color or "Empty Cutout" option. When "Empty Cutout" option is selected, a grommet or power unit must be ordered separately for each cutout.

"E" grommet cutout option for rect. grommet or bezel mount power unit model # ACUNOBZL-EU

"3E" grommet cutout option is 3" dia and to be used with HQ power w/ wireless charging model # ACPHQ3QI

**TO ORDER PLEASE SPECIFY THE FOLLOWING:**

WOOD

- MODEL NUMBER + W**
- FSC**
- CHASSIS WOOD FINISH**
- PULL FOR BOTTOM DOOR**
- GROMMET**
- SIDE WIRE MGT GROMMET**
- LOCKS**

LAM

- MODEL NUMBER + L**
- FSC**
- CHASSIS LAM**
- FRONT LAM**
- PULL FOR BOTTOM DOOR**
- GROMMET**
- SIDE WIRE MGT GROMMET**
- LOCKS**

**Pull Option:** Bottom door available with standard metal pulls or leather pull. (note: top door is taller than chassis to provide a finger pull to open door)



Leather pull available in 3 colors: Black Bridle **LP12**  
Medium Brown Bridle **LP13**  
Grey Bridle **LP14**

**Side Wire Management Grommet Option:** A rectangular cutout may be added to end panels to provide horizontal wire management within a station.

No Side Wire Management Grommets **WN**  
Side Wire Management Grommet Left **WL**  
Side Wire Management Grommet Right **WR**  
Side Wire Management Grommet Left & Right **WB**

# SMART PEDESTAL ACCESSORY TRAYS AND BINS

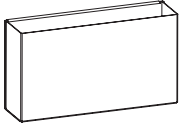
Silea  
05/22

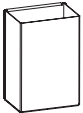
	D	W	H	model number	list
<b>LARGE TRAY</b> 	3	11 1/4	1 1/2	<b>GS5TRAY-LG</b>	87
<b>LARGE BIN</b> 	3	11 1/4	6 1/4	<b>GS5BIN-LG</b>	93
<b>SMALL TRAY</b> 	3	4 1/4	1 1/2	<b>GS5TRAY-SM</b>	80
<b>SMALL BIN</b> 	3	4 1/4	6 1/4	<b>GS5BIN-SM</b>	87

The below matrix recommendation provides a quick reference for ordering Trays and Bins to clip-in upper door of smart pedestals.

Smart Pedestal Model	Usable Inside Width	Recommended Accessories
	For Accessories	Large Tray/Bin + Small Tray/Bin
<b>GS5CPD730-S</b>	20.25	qty 1 + qty 2
<b>GS5CPD736-S</b>	26.25	qty 2 + -
<b>GS5CPD742-S</b>	32.25	qty 2 + qty 2
<b>GS5CPD748-S</b>	38.25	qty 3 + qty 1
<b>GS5CPD754-S</b>	44.25	qty 3 + qty 2
<b>GS5CPD760-S</b>	equivalent to qty (2) 30" smart pedestals	
<b>GS5CPD766-S</b>	equivalent to qty (1) 30" + qty (1) 36" smart pedestal	
<b>GS5CPD772-S</b>	equivalent to qty (2) 36" smart pedestals	

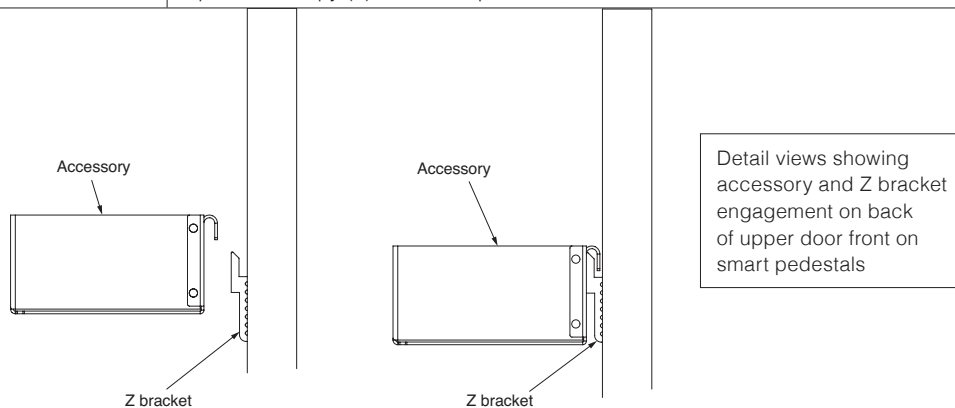

## PRODUCT INFO

Accessories clip into Z bracket included on top door of smart pedestals.

Inside bottom of unit is lined with felt.

## TO ORDER PLEASE SPECIFY THE FOLLOWING:

### LIST

- 1. MODEL NUMBER**
- 2. HARDWARE COLOR**

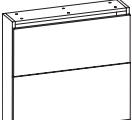
	D	W	H	model number + type	laminata	vener 1	vener 2
<b>FALSE PEDESTALS FOR FIXED DESK OR FIXED RETURN</b>  	7 1/4	24	27 7/8	<b>GS5CPD724-X</b> [ ]	958	1,493	1,643
	7 1/4	30	27 7/8	<b>GS5CPD730-X</b> [ ]	1,001	1,562	1,719
	7 1/4	36	27 7/8	<b>GS5CPD736-X</b> [ ]	1,046	1,634	1,798
	7 1/4	42	27 7/8	<b>GS5CPD742-X</b> [ ]	1,092	1,706	1,877

**Notes:**

- Top door hinged for wall access.
- Door split height matches smart pedestals.
- Must be wall mounted.

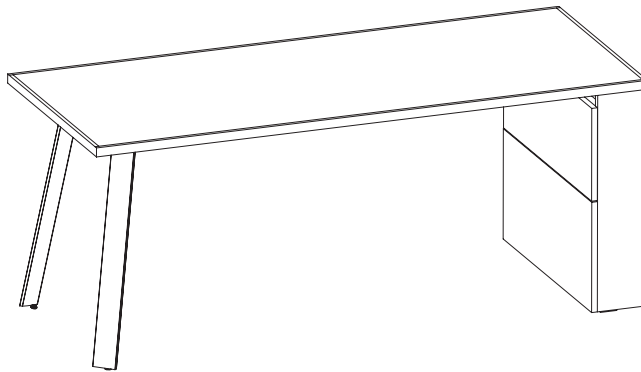

Example: False pedestal shown in application to support a fixed desk or return.

GS5CPD730-XW (false pedestal)  
GS2DWRR3072-W (desk worksurface)  
GS2ALEG-A (angled legs)

**PRODUCT INFO**

Unit must be wall mounted.

**TO ORDER PLEASE SPECIFY THE FOLLOWING:**

WOOD

1. **MODEL NUMBER + W**
2. **FSC**
3. **CHASSIS WOOD FINISH**
4. **SIDE WIRE MGT GROMMET**

LAM

1. **MODEL NUMBER + L**
2. **FSC**
3. **CHASSIS LAM**
4. **FRONT LAM**
5. **SIDE WIRE MGT GROMMET**

**Side Wire Management Grommet Option:** A rectangular cutout may be added to end panels to provide horizontal wire management within a station.

No Side Wire Management Grommets	<b>WN</b>
Side Wire Management Grommet Left	<b>WL</b>
Side Wire Management Grommet Right	<b>WR</b>
Side Wire Management Grommet Left & Right	<b>WB</b>

# SMART CLOSETS

7 1/4 Depth

Silea

05/22

	D	W	H	model number + type	laminare	veneer 1	veneer 2
<b>18" WIDE CLOSET</b>	7 1/4	18	68 9/16	<b>GS5CLS5H718L-</b> [ ]	2,715	3,935	4,329
	7 1/4	18	68 9/16	<b>GS5CLS5H718R-</b> [ ]	2,715	3,935	4,329

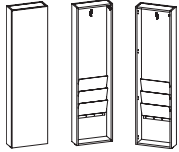

Left hand shown  
Inside cabinet views shown  
without door

- Behind Door - Coat hook top, 3 Metal trays bottom

## 30" WIDE SIDE ACCESS CLOSET (18" WIDE CLOSET + 12" SIDE ACCESS)

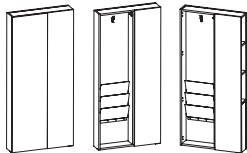

Left hand shown  
Inside cabinet views shown  
without door

	7 1/4	30	68 9/16	<b>GS5CLS5H730L-</b> [ ]	3,520	5,103	5,614
	7 1/4	30	68 9/16	<b>GS5CLS5H730R-</b> [ ]	3,520	5,103	5,614

- Behind Door - Coat hook top, 3 Metal trays bottom
- Side Access - Fixed front does not open. 12.5" inside width x 5.75" inside depth. Includes 2 adjustable shelves on 5 hole pattern.

### PRODUCT INFO

**Unit must be wall mounted.**

Coat hook and metal trays are black.

### TO ORDER PLEASE SPECIFY THE FOLLOWING:

#### WOOD

1. **MODEL NUMBER + WW**
2. **FSC**
3. **CHASSIS WOOD FINISH**
4. **LOCKS**

#### LAM

1. **MODEL NUMBER + LL**
2. **FSC**
3. **CHASSIS LAM**
4. **FRONT LAM**
5. **LOCKS**

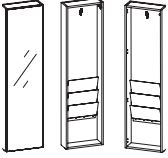
	D	W	H	model number + type	laminata	veneer 1	veneer 2
	7 1/4	18	68 9/16	<b>GS5CLS5H718L-</b> [ ]	N/A	4,722	5,195
	7 1/4	18	68 9/16	<b>GS5CLS5H718R-</b> [ ]	N/A	4,722	5,195

- Behind Door - Coat hook top, 3 Metal trays bottom

Left hand shown  
Inside cabinet views shown  
without door

**30" WIDE SIDE ACCESS  
CLOSET (18" WIDE CLOSET  
+ 12" SIDE ACCESS)**

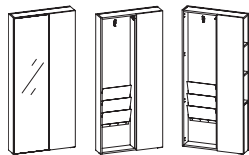

Left hand shown  
Inside cabinet views shown  
without door

	7 1/4	30	68 9/16	<b>GS5CLS5H730L-</b> [ ]	N/A	6,123	6,736
	7 1/4	30	68 9/16	<b>GS5CLS5H730R-</b> [ ]	N/A	6,123	6,736

- Behind Door - Coat hook top, 3 Metal trays bottom
- Side Access - Fixed front does not open. 12.5" inside width x 5.75" inside depth. Includes 2 adjustable shelves on 5 hole pattern.
- Glass door over closet portion only. Side access fixed front matches chassis finish.

**PRODUCT INFO**

**Unit must be wall mounted.**

Glass doors do NOT lock.

Coat hook and metal trays are black.

**TO ORDER PLEASE SPECIFY THE FOLLOWING:**

WOOD CHASSIS, GLASS DOOR

- 1. MODEL NUMBER + WG**
- 2. FSC**
- 3. CHASSIS WOOD FINISH**
- 4. GLASS**

# SMART LOCKERS

7 1/4 Depth

Silea  
05/22

	D	W	H	model number + type	laminate	veneer 1	veneer 2
<b>24" WIDE LOCKER</b> 	7 1/4	24	68 9/16	<b>GS5LKR5H724L-</b> [ ]	2,984	4,328	4,761
	7 1/4	24	68 9/16	<b>GS5LKR5H724R-</b> [ ]	2,984	4,328	4,761

- Behind Door - Coat hook top, 3 Metal trays bottom
- Door overhangs chassis by 6". Additional coat hook on end panel.

Left hand shown  
Inside cabinet views shown  
without door

## 36" WIDE SIDE ACCESS LOCKER (24" WIDE LOCKER + 12" SIDE ACCESS)

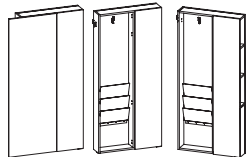

Left hand shown  
Inside cabinet views shown  
without door

7 1/4	36	68 9/16	<b>GS5LKR5H736L-</b> [ ]	3,871	5,613	6,175
7 1/4	36	68 9/16	<b>GS5LKR5H736R-</b> [ ]	3,871	5,613	6,175

- Behind Door - Coat hook top, 3 Metal trays bottom
- Door overhangs chassis by 6". Additional coat hook on end panel.
- Side Access - Fixed front does not open. 12.5" inside width x 5.75" inside depth. Includes 2 adjustable shelves on 5 hole pattern.

### PRODUCT INFO

#### Unit must be wall mounted.

Doors do NOT lock.

Coat hook and metal trays are black.

 Laminate units shipped as separate packages and require field assembly.

### TO ORDER PLEASE SPECIFY THE FOLLOWING:

#### WOOD

1. **MODEL NUMBER + WW**
2. **FSC**
3. **CHASSIS WOOD FINISH**

#### LAM

1. **MODEL NUMBER + LL**
2. **FSC**
3. **CHASSIS LAM**
4. **FRONT LAM**

	D	W	H	model number + type	laminate	veneer 1	veneer 2
<b>24" WIDE LOCKER</b>	7 1/4	24	68 9/16	<b>GS5LKR5H724L-</b> [ ]	3,909	5,193	5,713
	7 1/4	24	68 9/16	<b>GS5LKR5H724R-</b> [ ]	3,909	5,193	5,713

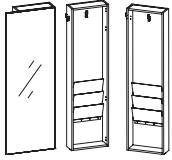

Left hand shown  
Inside cabinet views shown  
without door

- Behind Door - Coat hook top, 3 Metal trays bottom
- Door overhangs chassis by 6". Additional coat hook on end panel.

**36" WIDE SIDE ACCESS  
LOCKER (24" WIDE LOCKER  
+ 12" SIDE ACCESS)**

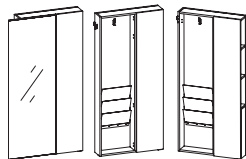

Left hand shown  
Inside cabinet views shown  
without door

	7 1/4	36	68 9/16	<b>GS5LKR5H736L-</b> [ ]	4,796	6,736	7,410
	7 1/4	36	68 9/16	<b>GS5LKR5H736R-</b> [ ]	4,796	6,736	7,410

- Behind Door - Coat hook top, 3 Metal trays bottom
- Door overhangs chassis by 6". Additional coat hook on end panel.
- Side Access - Fixed front does not open. 12.5" inside width x 5.75" inside depth. Includes 2 adjustable shelves on 5 hole pattern.

**PRODUCT INFO**

**Unit must be wall mounted.**

Doors do NOT lock.

Coat hook and metal trays are black.

 Laminate units shipped as separate packages and require field assembly.

**TO ORDER PLEASE SPECIFY THE FOLLOWING:**

WOOD CHASSIS, GLASS DOOR

1. **MODEL NUMBER + WG**
2. **FSC**
3. **CHASSIS WOOD FINISH**
4. **GLASS**

LAM CHASSIS, GLASS DOOR

1. **MODEL NUMBER + LG**
2. **FSC**
3. **CHASSIS LAM**
4. **GLASS**

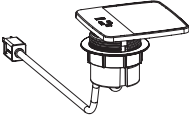
	D	W	H	model number	in
<b>HQ POWER W/ WIRELESS CHARGING TO BE USED IN 3" DIA GROMMET CUTOUT</b> 	3	11 1/4	1 1/2	<b>ACPHQ3QI-B</b>	420
				<ul style="list-style-type: none"> <li>• Black</li> <li>• Fits 3" Dia Cutout option in smart pedestals</li> <li>• 1 Power / 1 USB Charger / 1 Charging Pad</li> <li>• 10ft standard plug cord</li> </ul>	
	3	11 1/4	6 1/4	<b>ACPHQ3QI-S</b>	420
				<ul style="list-style-type: none"> <li>• Silver</li> <li>• Fits 3" Dia Cutout option in smart pedestals</li> <li>• 1 Power / 1 USB Charger / 1 Charging Pad</li> <li>• 10ft standard plug cord</li> </ul>	

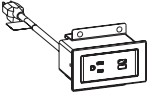
<b>BEZEL MOUNT POWER TO BE USED IN RECTANGULAR GROMMET CUTOUT</b>  <p>Can be used in grommet cutout</p>	2 7/8	4	1 3/4	<b>ACUNOBZL-EU</b>	395
				<ul style="list-style-type: none"> <li>• Optional color</li> <li>• Fits Rectangular Grommet Cutout option in smart pedestals</li> <li>• 1 Power / 2 USB Charger</li> <li>• 10ft standard plug cord</li> </ul>	
	2 7/8	4	1 3/4	<b>ACUNOBZL-EU-HW</b>	395
				<ul style="list-style-type: none"> <li>• Optional color</li> <li>• Fits Rectangular Grommet Cutout option in smart pedestals</li> <li>• 1 Power / 2 USB Charger</li> <li>• 6ft hardwire cord</li> </ul>	

## PRODUCT INFO

## TO ORDER PLEASE SPECIFY THE FOLLOWING:

LIST

1. **MODEL NUMBER**
2. **BEZEL MOUNT POWER COLOR**

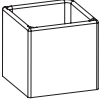

	D	W	H	model number	list
<b>PENCIL TRAY</b> 	3 15/16	11 5/16	1 1/4	<b>GS5PNCLTRAY-WLNT</b>	192
	<ul style="list-style-type: none"> <li>• Walnut, clear finish</li> <li>• Fits in 15" box drawer</li> </ul>				
	3 15/16	11 5/16	1 1/4	<b>GS5PNCLTRAY-MPLE</b>	192
	<ul style="list-style-type: none"> <li>• Maple, clear finish</li> <li>• Fits in 15" box drawer</li> </ul>				
<b>PENCIL CUP</b> 	3 15/16	3 15/16	3 3/4	<b>GS5PNCLCUP-WLNT</b>	192
	<ul style="list-style-type: none"> <li>• Walnut, clear finish</li> </ul>				
	3 15/16	3 15/16	3 3/4	<b>GS5PNCLCUP-MPLE</b>	192
	<ul style="list-style-type: none"> <li>• Maple, clear finish</li> </ul>				

**PRODUCT INFO**

Solidwood accessories include rubber bumpers on bottom to protect worksurfaces

**TO ORDER PLEASE SPECIFY THE FOLLOWING:**

LIST

- 1. MODEL NUMBER**



Footed . . . . .	219-244
Reference . . . . .	220-221
Footed . . . . .	222-224
1H Peds . . . . .	225-228
Layers Pedestals . . . . .	229-240
Storage . . . . .	241-244

Feet can be added to the product to provide a light scale, modern aesthetic. Feet are ordered separately for field installation.

**Option 1:** vertical steel foot



Feet are 7 1/8" height

Feet can be added to layers pedestals, 1H pedestals, and storage units. Layers pedestals ship with glides which must be removed for feet applications. 1H pedestals and storage units for use with feet are only designed for footed applications. All other standard specification rules apply.

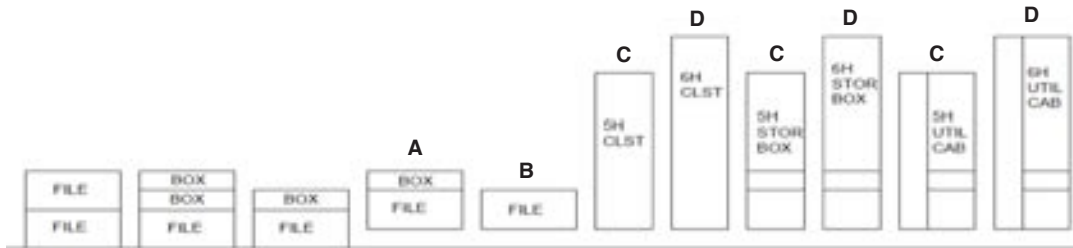

- Feet added to layers pedestals to equal standard height. See example "A".
- Feet added to 1H pedestals to equal layers height. See example "B".
- Feet added to 61 7/16" high storage units to equal 5H (68 9/16" high). See example "C".
- Feet added to 74 13/16" high storage units to equal 6H (81 15/16" high). See example "D".

**Storage ordering rules**

- 4 individual corner feet are required on all tall freestanding storage units



**Credenza ordering rules**

- Feet are for use in creating full bank credenzas or NO MODESTY credenzas and returns.  
(not for use in desking applications or creating credenzas and returns with full modesty panels or wall access panels)

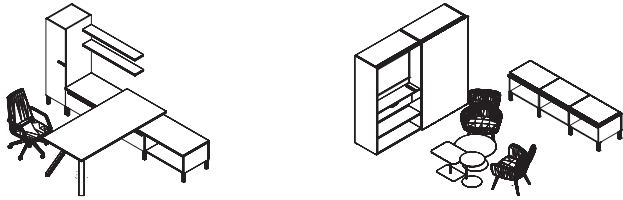

- Order corner feet for 4 outside corners and inline feet for each seam of adjoining pedestals.



- When qty (2) 15" and 18" Layers Pedestals are side by side a pedestal ganging kit may be used. Order **GS2FT-GANGKIT**.



**Freestanding Credenza Counterweight rules**

- Counterweights must be added to each drawer unit in freestanding applications or the credenza assembly must be wall mounted using the wall mount kit **GS2FT-WMKIT**. Units attached to adjoining units and units with layers runoffs attached do NOT require counterweights. Counterweights and wall mount kit must be ordered separately.

1H Pedestals	Counterweight Model	Qty
<b>GS2CPF1H2430-4</b>	<b>ACCNTRWGT30</b>	1
<b>GS2CPF1H2436-4</b>	<b>ACCNTRWGT36</b>	1
<b>GS2CPF1H2430T-4</b>	<b>ACCNTRWGT30</b>	1
<b>GS2CPF1H2436T-4</b>	<b>ACCNTRWGT36</b>	1

Layers Pedestals	Counterweight Model	Qty
<b>GS2CLPD2430-B</b>	<b>ACCNTRWGT30</b>	2
<b>GS2CLPD2436-B</b>	<b>ACCNTRWGT36</b>	2
<b>GS2CLPD2430T-B</b>	<b>ACCNTRWGT30</b>	2
<b>GS2CLPD2436T-B</b>	<b>ACCNTRWGT36</b>	2
<b>GS2CLPD2415-A</b>	<b>ACCNTRWGT15</b>	1
<b>GS2CLPD2418-A</b>	<b>ACCNTRWGT15</b>	1

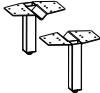
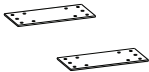
	D	W	H	model number	part
<b>Corner Foot Kit (Qty 4)</b> 	1 1/2	1 1/2	7 1/8	<b>GS2FT-CNR4</b>	480
	<ul style="list-style-type: none"> <li>Includes qty (4) corner feet</li> </ul>				
<b>Inline Foot Kit (Qty 2)</b> 	1 1/2	1 1/2	7 1/8	<b>GS2FT-INL2</b>	212
	<ul style="list-style-type: none"> <li>Includes qty (2) inline feet to be positioned at the front and back of the case. A pair of inline feet must be used at each seam of adjoining pedestals. (Inline Feet NOT for use with tall storage units)</li> </ul>				
<b>Pedestal Ganging Kit</b> 	3	6 1/2	1/8	<b>GS2FT-GANGKIT</b>	135
	<ul style="list-style-type: none"> <li>Includes flat brackets for ganging qty (2) 15" / 18" layers pedestals to reduce the qty of inline feet. (Ganging Kit NOT for use with 30" and 36" pedestals)</li> </ul>				

**PRODUCT INFO**

**TO ORDER PLEASE SPECIFY THE FOLLOWING:**

LIST

1. **MODEL NUMBER**
2. **HARDWARE COLOR**

Note: hardware color option applies to Corner and Inline Foot models only.

D	W	H	model number	list
$\frac{3}{16}$	12	15	<b>ACCNTRWGT15</b>	266
<ul style="list-style-type: none"> <li>For use when a 15" or 18" modular pedestal with drawers is used as a freestanding unit.</li> </ul>				
$\frac{1}{2}$	8 $\frac{5}{8}$	25	<b>ACCNTRWGT30</b>	299
$\frac{1}{2}$	8 $\frac{5}{8}$	28	<b>ACCNTRWGT36</b>	332

- For use when a 30" or 36" modular pedestal with drawers has a top and is a freestanding unit.

Examples:

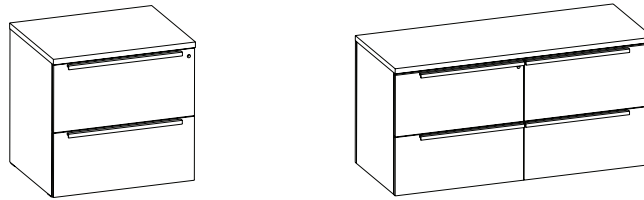

See matrix and rules on Pg. 221

**PRODUCT INFO**

**TO ORDER PLEASE SPECIFY THE FOLLOWING:**

LIST

- MODEL NUMBER**

# WALL MOUNT KIT

Silea  
05/22

	D	W	H	model number	list
<b>Wall Mount Kit</b>	2 5/16	3	1 3/8	<b>GS2FT-WMKIT</b>	135
 • Includes qty (4) wall mount brackets for freestanding credenza applications. Counterweights may be used as alternative.					

## PRODUCT INFO

TO ORDER PLEASE SPECIFY THE FOLLOWING:

LIST

1. **MODEL NUMBER**



	D	W	H	model number + type	laminate	veneer 1	veneer 2
--	---	---	---	---------------------	----------	----------	----------

**STANDARD**

30" width

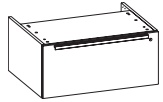

23 1/8	30	13 5/8	<b>GS2CPF1H2430-4</b> [ ]	1,597	2,653	2,919
--------	----	--------	---------------------------	-------	-------	-------

36" width

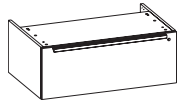

23 1/8	36	13 5/8	<b>GS2CPF1H2436-4</b> [ ]	1,788	2,949	3,244
--------	----	--------	---------------------------	-------	-------	-------

**TROUGH CUTOUTS**

30" width

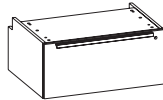

23 1/8	30	13 5/8	<b>GS2CPF1H2430T-4</b> [ ]	1,597	2,653	2,919
--------	----	--------	----------------------------	-------	-------	-------

36" width

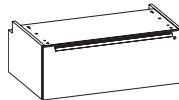

23 1/8	36	13 5/8	<b>GS2CPF1H2436T-4</b> [ ]	1,788	2,949	3,244
--------	----	--------	----------------------------	-------	-------	-------

**PRODUCT INFO**

All units have an unfinished back.  
Trough pedestals to be used with a modular trough top.  
All trough pedestals require a fillerstrip or pedestal back.

**TO ORDER PLEASE SPECIFY THE FOLLOWING:**

**WOOD**

1. **MODEL NUMBER + W**
2. **FSC**
3. **CHASSIS WOOD FINISH**
4. **PULL**
5. **DRAWERS**
6. **KEYING**

**LAM**

1. **MODEL NUMBER + L**
2. **FSC**
3. **CHASSIS LAM**
4. **FRONT LAM**
5. **PULL**
6. **DRAWERS**
7. **KEYING**

Note: Integral pull option NOT available on these units.

# MODULAR 1H PEDS 24D

for use with feet

Silea

05/22

	D	W	H	model number + type	laminate	veneer 1	veneer 2
--	---	---	---	---------------------	----------	----------	----------

## STANDARD

30" width

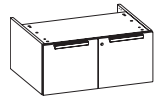

23 1/8	30	13 5/8	<b>GS2CPF1H2430-5</b> [ ]	1,406	2,358	2,594
--------	----	--------	---------------------------	-------	-------	-------

36" width

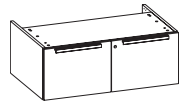

23 1/8	36	13 5/8	<b>GS2CPF1H2436-5</b> [ ]	1,578	2,626	2,889
--------	----	--------	---------------------------	-------	-------	-------

## TROUGH CUTOUTS

30" width

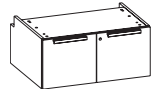

23 1/8	30	13 5/8	<b>GS2CPF1H2430T-5</b> [ ]	1,406	2,358	2,594
--------	----	--------	----------------------------	-------	-------	-------

36" width

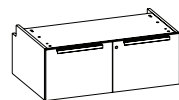

23 1/8	36	13 5/8	<b>GS2CPF1H2436T-5</b> [ ]	1,578	2,626	2,889
--------	----	--------	----------------------------	-------	-------	-------

## PRODUCT INFO

All units have an unfinished back.

Trough pedestals to be used with a modular trough top.

All trough pedestals require a fillerstrip or pedestal back.

## TO ORDER PLEASE SPECIFY THE FOLLOWING:

### WOOD

1. **MODEL NUMBER + W**
2. **FSC**
3. **CHASSIS WOOD FINISH**
4. **PULL**
5. **KEYING**

### LAM

1. **MODEL NUMBER + L**
2. **FSC**
3. **CHASSIS LAM**
4. **FRONT LAM**
5. **PULL**
6. **KEYING**

	D	W	H	model number + type	laminate	veneer 1	veneer 2
--	---	---	---	---------------------	----------	----------	----------

**STANDARD**

30" width

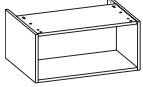

23 1/8	30	13 5/8	<b>GS2CPF1H2430-SH</b> [ ]	1,245	2,104	2,315
--------	----	--------	----------------------------	-------	-------	-------

36" width

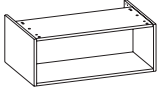

23 1/8	36	13 5/8	<b>GS2CPF1H2436-SH</b> [ ]	1,399	2,343	2,578
--------	----	--------	----------------------------	-------	-------	-------

**TROUGH CUTOUTS**

30" width

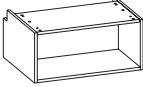

23 1/8	30	13 5/8	<b>GS2CPF1H2430T-SH</b> [ ]	1,245	2,104	2,315
--------	----	--------	-----------------------------	-------	-------	-------

36" width

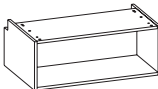

23 1/8	36	13 5/8	<b>GS2CPF1H2436T-SH</b> [ ]	1,399	2,343	2,578
--------	----	--------	-----------------------------	-------	-------	-------

**PRODUCT INFO**

All units have an unfinished back.  
Trough pedestals to be used with a modular trough top.  
All trough pedestals require a fillerstrip or pedestal back.

**TO ORDER PLEASE SPECIFY THE FOLLOWING:**

WOOD

1. **MODEL NUMBER + W**
2. **FSC**
3. **CHASSIS WOOD FINISH**

LAM

1. **MODEL NUMBER + L**
2. **FSC**
3. **CHASSIS LAM**

# MODULAR 1H FILLER STRIP AND PED BACKS

for use with 1H pedestals

Silea

05/22

	D	W	H	model number + type	laminate	veneer 1	veneer 2
<b>FILLER STRIP</b>	$\frac{3}{4}$	9	$13 \frac{5}{8}$	<b>GS2MPF1H-</b> <input type="text"/>	360	360	396



## PEDESTAL BACKS

$\frac{3}{4}$	30	$13 \frac{5}{8}$	<b>GS2MPB1H30-</b> <input type="text"/>	454	648	713
$\frac{3}{4}$	36	$13 \frac{5}{8}$	<b>GS2MPB1H36-</b> <input type="text"/>	473	678	746
$\frac{3}{4}$	60	$13 \frac{5}{8}$	<b>GS2MPB1H60-</b> <input type="text"/>	686	994	1,094
$\frac{3}{4}$	66	$13 \frac{5}{8}$	<b>GS2MPB1H66-</b> <input type="text"/>	748	1,088	1,197
$\frac{3}{4}$	72	$13 \frac{5}{8}$	<b>GS2MPB1H72-</b> <input type="text"/>	809	1,173	1,291



### PRODUCT INFO

Panels for use with standard or trough tops

All trough pedestals require a filler strip or pedestal back.

### TO ORDER PLEASE SPECIFY THE FOLLOWING:

#### WOOD

- MODEL NUMBER + W**
- FSC**
- CHASSIS WOOD FINISH**

#### LAM

- MODEL NUMBER + L**
- FSC**
- CHASSIS LAM**

	D	W	H	model number + type	laminate	veneer 1	veneer 2
<b>15" WIDTH</b>	23 1/8	15	20 3/4	<b>GS2CLPD2415-A</b> [ ]	1,512	2,357	2,593



Box/File

<b>18" WIDTH</b>	23 1/8	18	20 3/4	<b>GS2CLPD2418-A</b> [ ]	1,617	2,527	2,780
------------------	--------	----	--------	--------------------------	-------	-------	-------



Box/File

**PRODUCT INFO**

All units have an unfinished back.  
 All pedestals with an exposed side require a filler strip or pedestal back.  
 Layers pedestals may be used with feet or on glides to the floor.  
 Glides must be removed at install for feet applications.

**TO ORDER PLEASE SPECIFY THE FOLLOWING:**

WOOD

1. **MODEL NUMBER + W**
2. **FSC**
3. **CHASSIS WOOD FINISH**
4. **PULL**
5. **DRAWERS**
6. **KEYING**

LAM

1. **MODEL NUMBER + L**
2. **FSC**
3. **CHASSIS LAM**
4. **FRONT LAM**
5. **PULL**
6. **DRAWERS**
7. **KEYING**

# MODULAR PEDS 24D

Layers Height | 30" and 36"W

Silea  
05/22

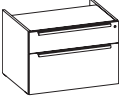
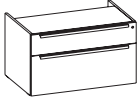
	D	W	H	model number + type	laminat	vener 1	vener 2
<b>30" WIDTH</b>	23 1/8	30	20 3/4	<b>GS2CLPD2430-B</b> <input type="checkbox"/>	1,897	2,959	3,255
 Box/File							
<b>36" WIDTH</b>	23 1/8	36	20 3/4	<b>GS2CLPD2436-B</b> <input type="checkbox"/>	2,087	3,255	3,581
 Box/File							

## PRODUCT INFO

All units have an unfinished back.

All pedestals with an exposed side require a filler strip or pedestal back.

Layers pedestals may be used with feet or on glides to the floor.

Glides must be removed at install for feet applications.

## TO ORDER PLEASE SPECIFY THE FOLLOWING:

### WOOD

1. **MODEL NUMBER + W**
2. **FSC**
3. **CHASSIS WOOD FINISH**
4. **PULL**
5. **DRAWERS**
6. **KEYING**

### LAM

1. **MODEL NUMBER + L**
2. **FSC**
3. **CHASSIS LAM**
4. **FRONT LAM**
5. **PULL**
6. **DRAWERS**
7. **KEYING**

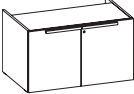
	D	W	H	model number + type	laminate	veneer 1	veneer 2
<b>30" WIDTH</b>	23 1/8	30	20 3/4	<b>GS2CLPD2430-5</b> [ ]	1,706	2,663	2,930
 Hinged door							
<b>36" WIDTH</b>	23 1/8	36	20 3/4	<b>GS2CLPD2436-5</b> [ ]	1,878	2,929	3,222
 Hinged door							

**PRODUCT INFO**

All units have an unfinished back.  
 If integral pull is chosen, doors will be touch latch.  
 All pedestals with an exposed side require a filler strip or pedestal back.  
 Includes one adjustable shelf.  
 Layers pedestals may be used with feet or on glides to the floor.  
 Glides must be removed at install for feet applications.

**TO ORDER PLEASE SPECIFY THE FOLLOWING:**

WOOD

1. **MODEL NUMBER + W**
2. **FSC**
3. **CHASSIS WOOD FINISH**
4. **PULL**
5. **KEYING**

LAM

1. **MODEL NUMBER + L**
2. **FSC**
3. **CHASSIS LAM**
4. **FRONT LAM**
5. **PULL**
6. **KEYING**

# MODULAR PEDS 24D

Layers Height | 30" and 36"W

Silea  
05/22

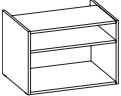
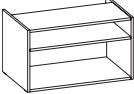
	D	W	H	model number + type	laminat	vener 1	vener 2
<b>30" WIDTH</b>  Bookcase	23 1/8	30	20 3/4	<b>GS2CLPD2430-SH</b> [ ]	1,545	2,408	2,649
<b>36" WIDTH</b>  Bookcase	23 1/8	36	20 3/4	<b>GS2CLPD2436-SH</b> [ ]	1,699	2,649	2,914

## PRODUCT INFO

All units have an unfinished back.  
 All pedestals with an exposed side require a filler strip or pedestal back.  
 Adjustable shelf.  
 Layers pedestals may be used with feet or on glides to the floor.  
 Glides must be removed at install for feet applications.

## TO ORDER PLEASE SPECIFY THE FOLLOWING:



### WOOD

- MODEL NUMBER + W**
- FSC**
- CHASSIS WOOD FINISH**

### LAM

- MODEL NUMBER + L**
- FSC**
- CHASSIS LAM**

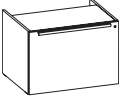

	D	W	H	model number + type	laminate	veneer 1	veneer 2
<b>30" WIDTH</b>	23 1/8	30	20 3/4	<b>GS2CLPD2430L-SD</b> [ ]	1,793	2,797	3,077
 Side access Left hand	23 1/8	30	20 3/4	<b>GS2CLPD2430R-SD</b> [ ]	1,793	2,797	3,077
<b>36" WIDTH</b>	23 1/8	36	20 3/4	<b>GS2CLPD2436L-SD</b> [ ]	1,972	3,076	3,384
 Side access Right hand	23 1/8	36	20 3/4	<b>GS2CLPD2436R-SD</b> [ ]	1,972	3,076	3,384



Right hand unit shown above

**PRODUCT INFO**

Units are handed based on lock location.  
All units have an unfinished back.  
All pedestals with an exposed side require a filler strip or pedestal back.  
Layers pedestals may be used with feet or on glides to the floor.  
Glides must be removed at install for feet applications.

**TO ORDER PLEASE SPECIFY THE FOLLOWING:**

WOOD

1. **MODEL NUMBER + W**
2. **FSC**
3. **CHASSIS WOOD FINISH**
4. **PULL**
5. **KEYING**



LAM

1. **MODEL NUMBER + L**
2. **FSC**
3. **CHASSIS LAM**
4. **FRONT LAM**
5. **PULL**
6. **KEYING**

# TROUGH MODULAR PEDS 24D

Layers Height | 15" and 18"W | Trough Cutouts

Silea  
05/22

	D	W	H	model number + type	laminate	veneer 1	veneer 2
<b>15" WIDTH</b>  Box/File	23 1/8	15	20 3/4	<b>GS2CLPD2415T-A</b> [ ]	1,512	2,357	2,593
<b>18" WIDTH</b>  Box/File	23 1/8	18	20 3/4	<b>GS2CLPD2418T-A</b> [ ]	1,617	2,527	2,780

## PRODUCT INFO

All units have an unfinished back.

Pedestals to be used with a modular trough top.

All trough pedestals require a filler strip or pedestal back.

Layers pedestals may be used with feet or on glides to the floor.

Glides must be removed at install for feet applications.

## TO ORDER PLEASE SPECIFY THE FOLLOWING:

### WOOD

1. **MODEL NUMBER + W**
2. **FSC**
3. **CHASSIS WOOD FINISH**
4. **PULL**
5. **DRAWERS**
6. **KEYING**

### LAM

1. **MODEL NUMBER + L**
2. **FSC**
3. **CHASSIS LAM**
4. **FRONT LAM**
5. **PULL**
6. **DRAWERS**
7. **KEYING**

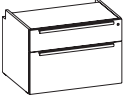
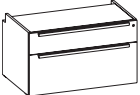
	D	W	H	model number + type	laminate	veneer 1	veneer 2
<b>30" WIDTH</b>  Box/File	23 1/8	30	20 3/4	<b>GS2CLPD2430T-B</b> [ ]	1,897	2,959	3,255
<b>36" WIDTH</b>  Box/File	23 1/8	36	20 3/4	<b>GS2CLPD2436T-B</b> [ ]	2,087	3,255	3,581

**PRODUCT INFO**

All units have an unfinished back.  
 Pedestals to be used with a modular trough top.  
 All trough pedestals require a filler strip or pedestal back.  
 Layers pedestals may be used with feet or on glides to the floor.  
 Glides must be removed at install for feet applications.

**TO ORDER PLEASE SPECIFY THE FOLLOWING:**

WOOD

1. **MODEL NUMBER + W**
2. **FSC**
3. **CHASSIS WOOD FINISH**
4. **PULL**
5. **DRAWERS**
6. **KEYING**



LAM

1. **MODEL NUMBER + L**
2. **FSC**
3. **CHASSIS LAM**
4. **FRONT LAM**
5. **PULL**
6. **DRAWERS**
7. **KEYING**

# TROUGH MODULAR PEDS 24D

Layers Height | 30" and 36"W | Trough Cutouts

Silea  
05/22

	D	W	H	model number + type	laminate	veneer 1	veneer 2
<b>30" WIDTH</b>	23 1/8	30	20 3/4	<b>GS2CLPD2430T-5</b> [ ]	1,706	2,663	2,930
 Hinged door							
<b>36" WIDTH</b>	23 1/8	36	20 3/4	<b>GS2CLPD2436T-5</b> [ ]	1,878	2,929	3,222
 Hinged door							

## PRODUCT INFO

All units have an unfinished back.

Pedestals to be used with a modular trough top.

If integral pull is chosen, doors will be touch latch.

All trough pedestals require a filler strip or pedestal back.

Includes one adjustable shelf.

Layers pedestals may be used with feet or on glides to the floor.

Glides must be removed at install for feet applications.

## TO ORDER PLEASE SPECIFY THE FOLLOWING:

### WOOD

- MODEL NUMBER + W**
- FSC**
- CHASSIS WOOD FINISH**
- PULL**
- KEYING**

### LAM

- MODEL NUMBER + L**
- FSC**
- CHASSIS LAM**
- FRONT LAM**
- PULL**
- KEYING**

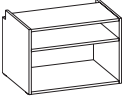
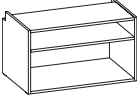
	D	W	H	model number + type	laminate	vener 1	vener 2
<b>30" WIDTH</b>	23 1/8	30	20 3/4	<b>GS2CLPD2430T-SH</b> [ ]	1,545	2,408	2,649
 Bookcase							
<b>36" WIDTH</b>	23 1/8	36	20 3/4	<b>GS2CLPD2436T-SH</b> [ ]	1,699	2,649	2,914
 Bookcase							

**PRODUCT INFO**

All units have an unfinished back.  
 Pedestals to be used with a modular trough top.  
 All trough pedestals require a filler strip or pedestal back.  
 Adjustable shelf.  
 Layers pedestals may be used with feet or on glides to the floor.  
 Glides must be removed at install for feet applications.



**TO ORDER PLEASE SPECIFY THE FOLLOWING:**

- |                               |                            |
|-------------------------------|----------------------------|
| <b>WOOD</b>                   | <b>LAM</b>                 |
| 1. <b>MODEL NUMBER + W</b>    | 1. <b>MODEL NUMBER + L</b> |
| 2. <b>FSC</b>                 | 2. <b>FSC</b>              |
| 3. <b>CHASSIS WOOD FINISH</b> | 3. <b>CHASSIS LAM</b>      |

# TROUGH MODULAR PEDS 24D

Layers Height | 30" and 36"W | Side Access w/ Trough Cutouts

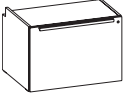
Silea  
05/22

	D	W	H	model number + type	laminate	veneer 1	veneer 2
<b>30" WIDTH</b>	23 1/8	30	20 3/4	<b>GS2CLPD2430TL-SD</b> <input type="checkbox"/>	1,793	2,797	3,077
 Side access Left hand	23 1/8	30	20 3/4	<b>GS2CLPD2430TR-SD</b> <input type="checkbox"/>	1,793	2,797	3,077
<b>36" WIDTH</b>	23 1/8	36	20 3/4	<b>GS2CLPD2436TL-SD</b> <input type="checkbox"/>	1,972	3,076	3,384
 Side access Right hand	23 1/8	36	20 3/4	<b>GS2CLPD2436TR-SD</b> <input type="checkbox"/>	1,972	3,076	3,384



Right hand unit shown above.

## PRODUCT INFO

Units are handed based on lock location.

All units have an unfinished back.

Pedestals to be used with a modular trough top.

All trough pedestals require a filler strip or pedestal back.

Layers pedestals may be used with feet or on glides to the floor.

Glides must be removed at install for feet applications.



## TO ORDER PLEASE SPECIFY THE FOLLOWING:

### WOOD

1. **MODEL NUMBER + W**
2. **FSC**
3. **CHASSIS WOOD FINISH**
4. **PULL**
5. **KEYING**

### LAM

1. **MODEL NUMBER + L**
2. **FSC**
3. **CHASSIS LAM**
4. **FRONT LAM**
5. **PULL**
6. **KEYING**

	D	W	H	model number + type	laminate	vener 1	vener 2
<b>FILLER STRIP</b> 	3/4	9	20 3/4	<b>GS2MLPF-</b> [ ]	360	726	799
<b>PEDESTAL BACKS</b> 	3/4	15	20 3/4	<b>GS2MLPB15-</b> [ ]	371	531	585
	3/4	18	20 3/4	<b>GS2MLPB18-</b> [ ]	423	606	667
	3/4	30	20 3/4	<b>GS2MLPB30-</b> [ ]	477	682	751
	3/4	36	20 3/4	<b>GS2MLPB36-</b> [ ]	499	713	785

**PRODUCT INFO**

Panels for use with standard or trough tops.  
All pedestals with exposed side require a filler strip or pedestal back.

**TO ORDER PLEASE SPECIFY THE FOLLOWING:**

WOOD

1. **MODEL NUMBER + W**
2. **FSC**
3. **CHASSIS WOOD FINISH**

LAM

1. **MODEL NUMBER + L**
2. **FSC**
3. **CHASSIS LAM**

# MODULAR CREDENZA FULL MODESTY PANEL

Layers Height

Silea  
05/22

	D	W	H	model number + type	laminare	veneer 1	veneer 2
	3/4	45	20 3/4	<b>GS2CLMF45-</b> [ ]	667	964	1,061
	3/4	48	20 3/4	<b>GS2CLMF48-</b> [ ]	679	982	1,081
	3/4	51	20 3/4	<b>GS2CLMF51-</b> [ ]	691	1,001	1,102
	3/4	54	20 3/4	<b>GS2CLMF54-</b> [ ]	700	1,017	1,119
	3/4	60	20 3/4	<b>GS2CLMF60-</b> [ ]	723	1,046	1,151
	3/4	66	20 3/4	<b>GS2CLMF66-</b> [ ]	789	1,143	1,258
	3/4	72	20 3/4	<b>GS2CLMF72-</b> [ ]	851	1,234	1,358
	3/4	78	20 3/4	<b>GS2CLMF78-</b> [ ]	912	1,323	1,456
	3/4	84	20 3/4	<b>GS2CLMF84-</b> [ ]	975	1,414	1,556
	3/4	90	20 3/4	<b>GS2CLMF90-</b> [ ]	1,039	1,505	1,656
	3/4	96	20 3/4	<b>GS2CLMF96-</b> [ ]	1,102	1,596	1,756
	3/4	102	20 3/4	<b>GS2CLMF102-</b> [ ]	N/A	1,685	1,854
	3/4	108	20 3/4	<b>GS2CLMF108-</b> [ ]	N/A	1,776	1,954
	3/4	114	20 3/4	<b>GS2CLMF114-</b> [ ]	N/A	1,865	2,052
3/4	120	20 3/4	<b>GS2CLMF120-</b> [ ]	N/A	1,957	2,153	

## PRODUCT INFO

### Grain Direction

- Natural Veneer: Vertical
- Stratawood Veneer: Optional
- Laminate : Vertical ≤60  
Horizontal >60

## TO ORDER PLEASE SPECIFY THE FOLLOWING:



### WOOD

1. **MODEL NUMBER + W**
2. **FSC**
3. **CHASSIS WOOD FINISH**

### LAM

1. **MODEL NUMBER + L**
2. **FSC**
3. **CHASSIS LAM**



	D	W	H	model number + type	laminata	veneer 1	veneer 2
<b>18" WIDTH</b>							
 <p>Door hinged left 68 High</p>	24	18	61 7/16	<b>GS2CLS5H18L-F</b> <input type="checkbox"/>	2,307	3,862	4,249
	24	18	61 7/16	<b>GS2CLS5H18R-F</b> <input type="checkbox"/>	2,307	3,862	4,249
 <p>Door hinged left 82 High</p>	24	18	74 13/16	<b>GS2CLS6H18L-F</b> <input type="checkbox"/>	2,587	4,296	4,726
	24	18	74 13/16	<b>GS2CLS6H18R-F</b> <input type="checkbox"/>	2,587	4,296	4,726

• Quantity 4 individual corner feet required and must be ordered separately.

**PRODUCT INFO**

All units have a finished back.  
If integral pull is chosen for wood, doors will be touch latch.  
Units include (1) closet rod and (1) fixed shelf at bottom of cabinet.

**TO ORDER PLEASE SPECIFY THE FOLLOWING:**

WOOD CHASSIS

1. **MODEL NUMBER + WW**
2. **FSC**
3. **CHASSIS WOOD FINISH**
4. **PULL**
5. **LOCKS**
6. **KEYING**

LAM CHASSIS







1. **MODEL NUMBER + LL**
2. **FSC**
3. **CHASSIS LAM**
4. **FRONT LAM**
5. **PULL**
6. **LOCKS**
7. **KEYING**

# STORAGE BOX

For use with feet

Silea

05/22

	D	W	H	model number + type	laminate	veneer 1	veneer 2
<b>18" WIDTH</b>							
 <p>Hinged door left 68 High</p>	24	18	61 7/16	<b>GS2SBD5H18L-F</b> 	2,690	4,461	4,908
	24	18	61 7/16	<b>GS2SBD5H18R-F</b> 	2,690	4,461	4,908
 <p>Hinged door left 82 High</p>	24	18	74 13/16	<b>GS2SBD6H18L-F</b> 	3,006	4,955	5,451
	24	18	74 13/16	<b>GS2SBD6H18R-F</b> 	3,006	4,955	5,451

- Quantity 4 individual corner feet required and must be ordered separately.

## PRODUCT INFO

All units have a finished back.  
If integral pull is chosen for wood, doors will be touch latch.

5H units include (2) adjustable shelves behind doors.

6H units include (3) adjustable shelves behind doors.

Includes Box / File drawers.

## TO ORDER PLEASE SPECIFY THE FOLLOWING:

### WOOD CHASSIS

- MODEL NUMBER + WW**
- FSC**
- CHASSIS WOOD FINISH**
- PULL**
- DRAWERS**
- KEYING**

### LAM CHASSIS

- MODEL NUMBER + LL**
- FSC**
- CHASSIS LAM**
- FRONT LAM**
- PULL**
- DRAWERS**
- KEYING**

	D	W	H	model number + type	laminata	veneer 1	veneer 2
--	---	---	---	---------------------	----------	----------	----------

**18" WIDTH**



68 High

24	18	61 <sup>7</sup> / <sub>16</sub>	<b>GS2SBD5H18-F</b> <input type="checkbox"/>	2,451	4,089	4,498
----	----	---------------------------------	--	-------	-------	-------



82 High

24	18	74 <sup>13</sup> / <sub>16</sub>	<b>GS2SBD6H18-F</b> <input type="checkbox"/>	2,745	4,545	5,000
----	----	----------------------------------	--	-------	-------	-------

- Quantity 4 individual corner feet required and must be ordered separately.

**PRODUCT INFO**

All units have a finished back.  
If integral pull is chosen for wood, doors will be touch latch.  
Adjustable shelves.  
Includes Box / File drawers.

**TO ORDER PLEASE SPECIFY THE FOLLOWING:**

WOOD CHASSIS

1. **MODEL NUMBER + WN**
2. **FSC**
3. **CHASSIS WOOD FINISH**
4. **PULL**
5. **DRAWERS**
6. **KEYING**

LAM CHASSIS









1. **MODEL NUMBER + LN**
2. **FSC**
3. **CHASSIS LAM**
4. **FRONT LAM**
5. **PULL**
6. **DRAWERS**
7. **KEYING**

# UTILITY CABINET

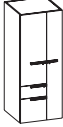
For use with feet

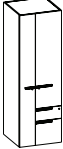
Silea

05/22

	D	W	H	model number + type	laminate	veneer 1	veneer 2
<b>68 HIGH</b>							
 Left hand	24	24	61 <sup>7</sup> / <sub>16</sub>	<b>GS2UTC5H24L-F</b> 	4,918	7,928	8,721
 Right hand	24	24	61 <sup>7</sup> / <sub>16</sub>	<b>GS2UTC5H24R-F</b> 	4,918	7,928	8,721
<b>82 HIGH</b>							
 Left hand	24	24	74 <sup>13</sup> / <sub>16</sub>	<b>GS2UTC6H24L-F</b> 	5,708	9,164	10,081
 Right hand	24	24	74 <sup>13</sup> / <sub>16</sub>	<b>GS2UTC6H24R-F</b> 	5,708	9,164	10,081

• Quantity 4 individual corner feet required and must be ordered separately.

## PRODUCT INFO

All units have a finished back.  
 If integral pull is chosen for wood, door will be touch latch.  
 Units include (1) closet rod behind full length door.  
 5H units include (2) adjustable shelves behind door above file drawers.  
 6H units include (4) adjustable shelves behind door above file drawers.  
 Includes Box / File drawers.

## TO ORDER PLEASE SPECIFY THE FOLLOWING:

### WOOD CHASSIS

1. **MODEL NUMBER + WW**
2. **FSC**
3. **CHASSIS WOOD FINISH**
4. **PULL**
5. **DRAWERS**
6. **KEYING**

### LAM CHASSIS

1. **MODEL NUMBER + LL**
2. **FSC**
3. **CHASSIS LAM**
4. **FRONT LAM**
5. **PULL**
6. **DRAWERS**
7. **KEYING**



Storage . . . . .	245-276
Bookcases . . . . .	246
Bookcase / Coat Hook / Closet . . . . .	247-248
Lateral Files . . . . .	249-250
Closets . . . . .	251-255
Storage Box / Utility Cabinet . . . . .	256-268
Side Access Storage Locker . . . . .	269-272
Mobile Pedestal . . . . .	273-274
Storage External Tops . . . . .	275-276

# BOOKCASES

2 high – 6 high | 30" & 36"W

Silea

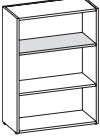
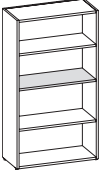
05/22

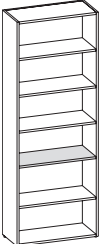
	D	W	H	model number + type	laminated	veneer 1	veneer 2
<b>30" &amp; 36" WIDTH</b>							
 28 High	14 7/8	30	27 7/8	<b>GS2BKN2H30N-</b> [ ]	1,394	2,020	2,222
	14 7/8	36	27 7/8	<b>GS2BKN2H36N-</b> [ ]	1,486	2,152	2,368
 42 High	14 7/8	30	42 3/16	<b>GS2BKN3H30-</b> [ ]	1,825	2,645	2,910
	14 7/8	36	42 3/16	<b>GS2BKN3H36-</b> [ ]	2,100	3,044	3,349
 55 High	14 7/8	30	54 7/16	<b>GS2BKN4H30-</b> [ ]	2,059	2,981	3,280
	14 7/8	36	54 7/16	<b>GS2BKN4H36-</b> [ ]	2,781	4,032	4,436
 68 High	14 7/8	30	68 9/16	<b>GS2BKN5H30-</b> [ ]	2,729	3,950	4,345
	14 7/8	36	68 9/16	<b>GS2BKN5H36-</b> [ ]	3,265	4,731	5,205
 82 High	14 7/8	30	81 5/16	<b>GS2BKN6H30-</b> [ ]	3,202	4,635	5,099
	14 7/8	36	81 5/16	<b>GS2BKN6H36-</b> [ ]	3,341	4,843	5,328

## PRODUCT INFO

Units have a finished back.  
 Each unit has one fixed shelf, shaded above.  
 Top not included.  
 To add storage tops, specify external tops.  
 6H bookcase to be attached to the wall.



## TO ORDER PLEASE SPECIFY THE FOLLOWING:

### WOOD

- MODEL NUMBER + WN**
- FSC**
- CHASSIS WOOD FINISH**

### LAM

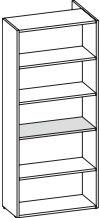
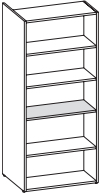
- MODEL NUMBER + LN**
- FSC**
- CHASSIS LAM**

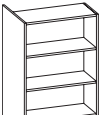
	D	W	H	model number + type	laminata	veneer 1	veneer 2
 <b>LEFT HAND</b> 68 High	24	30	68 <sup>9</sup> / <sub>16</sub>	<b>GS2BSC5H30L-</b> [ ]	3,275	4,744	5,219
 <b>RIGHT HAND</b> 68 High	24	30	68 <sup>9</sup> / <sub>16</sub>	<b>GS2BSC5H30R-</b> [ ]	3,275	4,744	5,219
 <b>LEFT HAND</b> 82 High	24	30	81 <sup>15</sup> / <sub>16</sub>	<b>GS2BSC6H30L-</b> [ ]	3,839	5,561	6,118
 <b>RIGHT HAND</b> 82 High	24	30	81 <sup>15</sup> / <sub>16</sub>	<b>GS2BSC6H30R-</b> [ ]	3,839	5,561	6,118

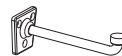
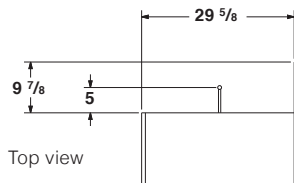

COAT HOOK

**PRODUCT INFO**

Unit has a finished back.  
A coat hook is mounted to back of bookcase.  
Each unit has one fixed shelf, shaded above.

**TO ORDER PLEASE SPECIFY THE FOLLOWING:**

WOOD

1. **MODEL NUMBER + WN**
2. **FSC**
3. **CHASSIS WOOD FINISH**

LAM

1. **MODEL NUMBER + LN**
2. **FSC**
3. **CHASSIS LAM**

# BOOKCASE / CLOSET 24D

5 high – 6 high

Silea

05/22

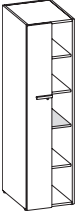
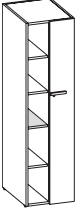
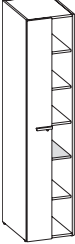
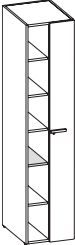
	D	W	H	model number + type	laminate	veneer 1	veneer 2
 <p><b>LEFT HAND</b> 68 High</p>	24	18	68 <sup>9</sup> / <sub>16</sub>	<b>GS2BCL5H18L-</b> [ ]	4,210	6,567	7,224
 <p><b>RIGHT HAND</b> 68 High</p>	24	18	68 <sup>9</sup> / <sub>16</sub>	<b>GS2BCL5H18R-</b> [ ]	4,210	6,567	7,224
 <p><b>LEFT HAND</b> 82 High</p>	24	18	81 <sup>15</sup> / <sub>16</sub>	<b>GS2BCL6H18L-</b> [ ]	4,809	7,497	8,247
 <p><b>RIGHT HAND</b> 82 High</p>	24	18	81 <sup>15</sup> / <sub>16</sub>	<b>GS2BCL6H18R-</b> [ ]	4,809	7,497	8,247

## PRODUCT INFO

All units have a finished back.  
5H units include (1) closet rod behind door.  
6H units include (1) closet rod and (1) adjustable shelf.  
Each unit has (1) fixed shelf, highlighted above.

## TO ORDER PLEASE SPECIFY THE FOLLOWING:



### WOOD

1. **MODEL NUMBER + WW**
2. **FSC**
3. **CHASSIS WOOD FINISH**
4. **PULL**
5. **LOCKS**
6. **KEYING**

### LAM

1. **MODEL NUMBER + LL**
2. **FSC**
3. **CHASSIS LAM**
4. **FRONT LAM**
5. **PULL**
6. **LOCKS**
7. **KEYING**



	D	W	H	model number + type	laminate	veneer 1	veneer 2
<b>30" WIDTH</b>	24	30	29 1/2	<b>GS2LFS2H30-</b> [ ]	2,677	4,175	4,593
							
<b>36" WIDTH</b>	24	36	29 1/2	<b>GS2LFS2H36-</b> [ ]	2,829	4,411	4,853
							

**PRODUCT INFO**

2H lateral file comes with a top.  
All units have a finished back.

**TO ORDER PLEASE SPECIFY THE FOLLOWING:**

- |                                  |                             |
|----------------------------------|-----------------------------|
| WOOD TOP, WOOD CHASSIS           | LAM TOP, LAM CHASSIS        |
| 1. <b>MODEL NUMBER + WW</b>      | 1. <b>MODEL NUMBER + LL</b> |
| 2. <b>FSC</b>                    | 2. <b>FSC</b>               |
| 3. <b>TOP WOOD FINISH + EDGE</b> | 3. <b>TOP LAM</b>           |
| 4. <b>CHASSIS WOOD FINISH</b>    | 4. <b>CHASSIS LAM</b>       |
| 5. <b>TOP UV FINISH</b>          | 5. <b>FRONT LAM</b>         |
| 6. <b>PULL</b>                   | 6. <b>EDGE DETAIL</b>       |
| 7. <b>DRAWERS</b>                | 7. <b>PULL</b>              |
| 8. <b>KEYING</b>                 | 8. <b>DRAWERS</b>           |
|                                  | 9. <b>KEYING</b>            |

# LATERAL FILES 24D

3 high – 6 high

Silea

05/22

	D	W	H	model number + type	laminata	veneer 1	veneer 2
<b>30" WIDTH</b>	24	30	42 <sup>3/16</sup>	<b>GS2LFS3H30-</b> [ ]	3,561	5,550	6,105
							
	24	30	54 <sup>7/16</sup>	<b>GS2LFS4H30-</b> [ ]	4,440	6,926	7,619
	24	30	68 <sup>9/16</sup>	<b>GS2LFS5H30-</b> [ ]	5,723	8,923	9,816
	24	30	81 <sup>15/16</sup>	<b>GS2LFS6H30-</b> [ ]	6,622	10,324	11,357
<b>36" WIDTH</b>	24	36	42 <sup>3/16</sup>	<b>GS2LFS3H36-</b> [ ]	3,681	5,741	6,316
							
	24	36	54 <sup>7/16</sup>	<b>GS2LFS4H36-</b> [ ]	4,568	7,119	7,831
	24	36	68 <sup>9/16</sup>	<b>GS2LFS5H36-</b> [ ]	6,024	9,391	10,331
	24	36	81 <sup>15/16</sup>	<b>GS2LFS6H36-</b> [ ]	6,759	10,540	11,594

## PRODUCT INFO

All units have a finished back.  
 If integral pull is chosen for wood, doors will be touch latch.  
 6 high units include (1) adjustable shelf behind doors.  
 5 and 6 high doors do not lock.



## TO ORDER PLEASE SPECIFY THE FOLLOWING:

### WOOD CHASSIS

1. **MODEL NUMBER + WW**
2. **FSC**
3. **CHASSIS WOOD FINISH**
4. **PULL**
5. **DRAWERS**
6. **KEYING**

### LAM CHASSIS

1. **MODEL NUMBER + LL**
2. **FSC**
3. **CHASSIS LAM**
4. **FRONT LAM**
5. **PULL**
6. **DRAWERS**
7. **KEYING**

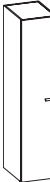
	D	W	H	model number + type	laminate	veneer 1	veneer 2
<b>15" WIDTH</b>	24	15	68 <sup>9</sup> / <sub>16</sub>	<b>GS2CLS5H15L-</b> [ ]	2,656	4,141	4,556
 Door hinged left 68 High	24	15	68 <sup>9</sup> / <sub>16</sub>	<b>GS2CLS5H15R-</b> [ ]	2,656	4,141	4,556
 Door hinged left 82 High	24	15	81 <sup>15</sup> / <sub>16</sub>	<b>GS2CLS6H15L-</b> [ ]	2,914	4,544	4,999
	24	15	81 <sup>15</sup> / <sub>16</sub>	<b>GS2CLS6H15R-</b> [ ]	2,914	4,544	4,999
• 6H x 15W units must be attached to wall for stability. Wall attach hardware not provided.							
<b>18" WIDTH</b>	24	18	68 <sup>9</sup> / <sub>16</sub>	<b>GS2CLS5H18L-</b> [ ]	2,789	4,348	4,783
 Door hinged left 68 High	24	18	68 <sup>9</sup> / <sub>16</sub>	<b>GS2CLS5H18R-</b> [ ]	2,789	4,348	4,783
 Door hinged left 82 High	24	18	81 <sup>15</sup> / <sub>16</sub>	<b>GS2CLS6H18L-</b> [ ]	3,068	4,783	5,262
	24	18	81 <sup>15</sup> / <sub>16</sub>	<b>GS2CLS6H18R-</b> [ ]	3,068	4,783	5,262

**PRODUCT INFO**

All units have a finished back.  
If integral pull is chosen for wood, doors will be touch latch.  
Units include (1) closet rod and (1) fixed shelf at bottom.

**TO ORDER PLEASE SPECIFY THE FOLLOWING:**

WOOD CHASSIS

1. **MODEL NUMBER + WW**
2. **FSC**
3. **CHASSIS WOOD FINISH**
4. **PULL**
5. **LOCKS**
6. **KEYING**

LAM CHASSIS

1. **MODEL NUMBER + LL**
2. **FSC**
3. **CHASSIS LAM**
4. **FRONT LAM**
5. **PULL**
6. **LOCKS**
7. **KEYING**

# CLOSETS 24D

5 high – 6 high

Silea

05/22

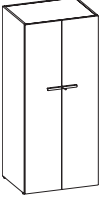
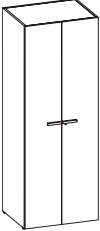
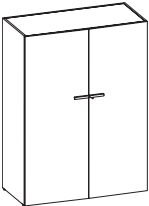
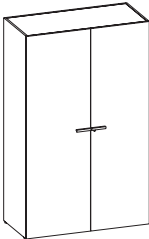
	D	W	H	model number + type	laminata	veneer 1	veneer 2
<b>30" WIDTH</b>  68 High	24	30	68 <sup>9</sup> / <sub>16</sub>	<b>GS2CLD5H30-D</b> [ ]	5,033	7,288	8,017
	24	30	68 <sup>9</sup> / <sub>16</sub>	<b>GS2CLD5H30-S</b> [ ]	4,695	6,795	7,475
 82 High	24	30	81 <sup>15</sup> / <sub>16</sub>	<b>GS2CLD6H30-D</b> [ ]	5,876	8,508	9,359
	24	30	81 <sup>15</sup> / <sub>16</sub>	<b>GS2CLD6H30-S</b> [ ]	5,525	7,999	8,799
<b>36" WIDTH</b>  68 High	24	36	68 <sup>9</sup> / <sub>16</sub>	<b>GS2CLD5H36-D</b> [ ]	5,535	8,018	8,820
	24	36	68 <sup>9</sup> / <sub>16</sub>	<b>GS2CLD5H36-S</b> [ ]	5,165	7,475	8,223
 82 High	24	36	81 <sup>15</sup> / <sub>16</sub>	<b>GS2CLD6H36-D</b> [ ]	6,464	9,358	10,294
	24	36	81 <sup>15</sup> / <sub>16</sub>	<b>GS2CLD6H36-S</b> [ ]	6,076	8,798	9,678

## PRODUCT INFO

All units have a finished back.

Closet codes for 68 high units:

D = (4) 1/2 shelves/  
1/2 coat rod

S = (4) full width shelves

Closet codes for 82 high units:

D = (5) 1/2 shelves/  
1/2 coat rod

S = (5) full width shelves

If integral pull is chosen for wood, doors will be touch latch.

## TO ORDER PLEASE SPECIFY THE FOLLOWING:

### WOOD CHASSIS

1. **MODEL NUMBER + WW**
2. **FSC**
3. **CHASSIS WOOD FINISH**
4. **PULL**
5. **LOCKS**
6. **KEYING**

### LAM CHASSIS

1. **MODEL NUMBER + LL**
2. **FSC**
3. **CHASSIS LAM**
4. **FRONT LAM**
5. **PULL**
6. **LOCKS**
7. **KEYING**

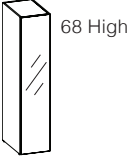
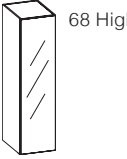
	D	W	H	model number + type	veneer 1 chassis glass door	veneer 2 chassis glass door
<b>15" WIDTH</b> 	24	15	68 <sup>9</sup> / <sub>16</sub>	<b>GS2CLS5H15L-</b> <input type="checkbox"/>	4,970	5,467
	24	15	68 <sup>9</sup> / <sub>16</sub>	<b>GS2CLS5H15R-</b> <input type="checkbox"/>	4,970	5,467
	24	15	81 <sup>15</sup> / <sub>16</sub>	<b>GS2CLS6H15L-</b> <input type="checkbox"/>	5,452	5,998
	24	15	81 <sup>15</sup> / <sub>16</sub>	<b>GS2CLS6H15R-</b> <input type="checkbox"/>	5,452	5,998
<ul style="list-style-type: none"> <li>• 6H x 15W units must be attached to wall for stability. Wall attach hardware not provided.</li> </ul>						
<b>18" WIDTH</b> 	24	18	68 <sup>9</sup> / <sub>16</sub>	<b>GS2CLS5H18L-</b> <input type="checkbox"/>	5,219	5,741
	24	18	68 <sup>9</sup> / <sub>16</sub>	<b>GS2CLS5H18R-</b> <input type="checkbox"/>	5,219	5,741
	24	18	81 <sup>15</sup> / <sub>16</sub>	<b>GS2CLS6H18L-</b> <input type="checkbox"/>	5,740	6,314
	24	18	81 <sup>15</sup> / <sub>16</sub>	<b>GS2CLS6H18R-</b> <input type="checkbox"/>	5,740	6,314

**PRODUCT INFO**

All units have a finished back.  
 Glass doors do not lock.  
 Units include (1) closet rod and  
 (1) fixed shelf at bottom.

**TO ORDER PLEASE SPECIFY THE FOLLOWING:**

WOOD CHASSIS, GLASS DOOR

- 1. MODEL NUMBER + WG**
- 2. FSC**
- 3. CHASSIS WOOD FINISH**
- 4. GLASS**

# CLOSETS 30D

5 high – 6 high

Silea

05/22

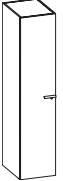
	D	W	H	model number + type	laminare	veneer 1	veneer 2
<b>18" WIDTH</b>  Door hinged left 68 High	30	18	68 <sup>9</sup> / <sub>16</sub>	<b>GS2CLS5H30D18L-</b> [ ]	3,069	4,783	5,262
	30	18	68 <sup>9</sup> / <sub>16</sub>	<b>GS2CLS5H30D18R-</b> [ ]	3,069	4,783	5,262
 Door hinged left 82 High	30	18	81 <sup>15</sup> / <sub>16</sub>	<b>GS2CLS6H30D18L-</b> [ ]	3,373	5,262	5,789
	30	18	81 <sup>15</sup> / <sub>16</sub>	<b>GS2CLS6H30D18R-</b> [ ]	3,373	5,262	5,789

## PRODUCT INFO

If integral pull is chosen for wood, doors will be touch latch.

Units include (1) closet rod and (1) fixed shelf at bottom.

All units have a finished back. 30D Laminate units have fasteners on backside with cam covers.

## TO ORDER PLEASE SPECIFY THE FOLLOWING:

### WOOD CHASSIS

1. **MODEL NUMBER + WW**
2. **FSC**
3. **CHASSIS WOOD FINISH**
4. **PULL**
5. **LOCKS**
6. **KEYING**

### LAM CHASSIS

1. **MODEL NUMBER + LL**
2. **FSC**
3. **CHASSIS LAM**
4. **FRONT LAM**
5. **PULL**
6. **LOCKS**
7. **KEYING**

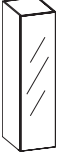
	D	W	H	model number + type	veneer 1 chassis glass door	veneer 2 chassis glass door
<b>18" WIDTH</b>  68 High	30	18	68 <sup>9</sup> / <sub>16</sub>	<b>GS2CLS5H30D18L-</b> [ ]	5,741	6,316
	30	18	68 <sup>9</sup> / <sub>16</sub>	<b>GS2CLS5H30D18R-</b> [ ]	5,741	6,316
	30	18	81 <sup>15</sup> / <sub>16</sub>	<b>GS2CLS6H30D18L-</b> [ ]	6,314	6,946
	30	18	81 <sup>15</sup> / <sub>16</sub>	<b>GS2CLS6H30D18R-</b> [ ]	6,314	6,946

**PRODUCT INFO**

All units have a finished back.  
 Glass doors do not lock.  
 Units include (1) closet rod and  
 (1) fixed shelf at bottom.  
 All units have a finished back.  
 30D Laminate units have  
 fasteners on backside with cam  
 covers.

**TO ORDER PLEASE SPECIFY THE FOLLOWING:**

WOOD CHASSIS, GLASS DOOR





1. **MODEL NUMBER + WG**
2. **FSC**
3. **CHASSIS WOOD FINISH**
4. **GLASS**

# STORAGE BOX 24D

5 high – 6 high | 15", 18", & 30"W

Silea

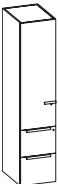
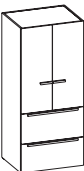
05/22

	D	W	H	model number + type	laminate	veneer 1	veneer 2
<b>15" WIDTH</b>							
 Hinged door left 68 High	24	15	68 <sup>9</sup> / <sub>16</sub>	<b>GS2SBD5H15L-</b> <input type="checkbox"/>	3,011	4,700	5,170
	24	15	68 <sup>9</sup> / <sub>16</sub>	<b>GS2SBD5H15R-</b> <input type="checkbox"/>	3,011	4,700	5,170
 Hinged door left 82 High	24	15	81 <sup>15</sup> / <sub>16</sub>	<b>GS2SBD6H15L-</b> <input type="checkbox"/>	3,312	5,171	5,689
	24	15	81 <sup>15</sup> / <sub>16</sub>	<b>GS2SBD6H15R-</b> <input type="checkbox"/>	3,312	5,171	5,689
• 6H x 15W units must be attached to wall for stability. Wall attach hardware not provided.							
<b>18" WIDTH</b>							
 Hinged door left 68 High	24	18	68 <sup>9</sup> / <sub>16</sub>	<b>GS2SBD5H18L-</b> <input type="checkbox"/>	3,169	4,948	5,443
	24	18	68 <sup>9</sup> / <sub>16</sub>	<b>GS2SBD5H18R-</b> <input type="checkbox"/>	3,169	4,948	5,443
 Hinged door left 82 High	24	18	81 <sup>15</sup> / <sub>16</sub>	<b>GS2SBD6H18L-</b> <input type="checkbox"/>	3,486	5,443	5,988
	24	18	81 <sup>15</sup> / <sub>16</sub>	<b>GS2SBD6H18R-</b> <input type="checkbox"/>	3,486	5,443	5,988
<b>30" WIDTH</b>							
 68 High	24	30	68 <sup>9</sup> / <sub>16</sub>	<b>GS2SBD5H30-</b> <input type="checkbox"/>	5,438	8,481	9,330
 82 High	24	30	81 <sup>15</sup> / <sub>16</sub>	<b>GS2SBD6H30-</b> <input type="checkbox"/>	5,746	8,961	9,858

## PRODUCT INFO

All units have a finished back.  
If integral pull is chosen for wood, doors will be touch latch.

5H units include (2) adjustable shelves behind doors.

6H units include (3) adjustable shelves behind doors.

## TO ORDER PLEASE SPECIFY THE FOLLOWING:





### WOOD CHASSIS

1. **MODEL NUMBER + WW**
2. **FSC**
3. **CHASSIS WOOD FINISH**
4. **PULL**
5. **DRAWERS**
6. **KEYING**

### LAM CHASSIS

1. **MODEL NUMBER + LL**
2. **FSC**
3. **CHASSIS LAM**
4. **FRONT LAM**
5. **PULL**
6. **DRAWERS**
7. **KEYING**



	D	W	H	model number + type	laminate	veneer 1	veneer 2
<b>15" WIDTH</b>							
	24	15	68 <sup>9</sup> / <sub>16</sub>	<b>GS2SBD5H15L-3</b> [ ]	3,162	4,936	5,430
 Box/Box/File Left 68 High	24	15	68 <sup>9</sup> / <sub>16</sub>	<b>GS2SBD5H15R-3</b> [ ]	3,162	4,936	5,430
<b>15" WIDTH</b>							
	24	15	81 <sup>15</sup> / <sub>16</sub>	<b>GS2SBD6H15L-3</b> [ ]	3,477	5,429	5,972
 Box/Box/File Left 82 High	24	15	81 <sup>15</sup> / <sub>16</sub>	<b>GS2SBD6H15R-3</b> [ ]	3,477	5,429	5,972
• 6H x 15W units must be attached to wall for stability. Wall attach hardware not provided.							
<b>18" WIDTH</b>							
	24	18	68 <sup>9</sup> / <sub>16</sub>	<b>GS2SBD5H18L-3</b> [ ]	3,328	5,196	5,716
 Box/Box/File Left 68 High	24	18	68 <sup>9</sup> / <sub>16</sub>	<b>GS2SBD5H18R-3</b> [ ]	3,328	5,196	5,716
<b>18" WIDTH</b>							
	24	18	81 <sup>15</sup> / <sub>16</sub>	<b>GS2SBD6H18L-3</b> [ ]	3,661	5,714	6,286
 Box/Box/File Left 82 High	24	18	81 <sup>15</sup> / <sub>16</sub>	<b>GS2SBD6H18R-3</b> [ ]	3,661	5,714	6,286

**PRODUCT INFO**

If integral pull is chosen for wood, doors will be touch latch.

5H units include (2) adjustable shelves behind doors.

6H units include (3) adjustable shelves behind doors.

**TO ORDER PLEASE SPECIFY THE FOLLOWING:**

WOOD CHASSIS

1. **MODEL NUMBER + WW**
2. **FSC**
3. **CHASSIS WOOD FINISH**
4. **PULL**
5. **DRAWERS**
6. **KEYING**

LAM CHASSIS



1. **MODEL NUMBER + LL**
2. **FSC**
3. **CHASSIS LAM**
4. **FRONT LAM**
5. **PULL**
6. **DRAWERS**
7. **KEYING**

# STORAGE BOX 24D

5 high – 6 high | 15", 18", & 30"W

Silea

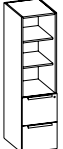
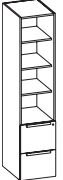
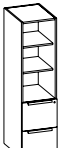
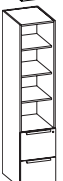
05/22

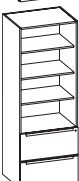
	D	W	H	model number + type	laminata	veneer 1	veneer 2
<b>15" WIDTH</b>  68 High  82 High	24	15	68 <sup>9</sup> / <sub>16</sub>	<b>GS2SBD5H15-</b> [ ]	2,784	4,347	4,782
	24	15	81 <sup>15</sup> / <sub>16</sub>	<b>GS2SBD6H15-</b> [ ]	3,065	4,781	5,260
• 6H x 15W units must be attached to wall for stability. Wall attach hardware not provided.							
<b>18" WIDTH</b>  68 High  82 High	24	18	68 <sup>9</sup> / <sub>16</sub>	<b>GS2SBD5H18-</b> [ ]	2,930	4,575	5,033
	24	18	81 <sup>15</sup> / <sub>16</sub>	<b>GS2SBD6H18-</b> [ ]	3,225	5,034	5,538
<b>30" WIDTH</b>  68 High  82 High	24	30	68 <sup>9</sup> / <sub>16</sub>	<b>GS2SBD5H30-</b> [ ]	5,030	7,850	8,635
	24	30	81 <sup>15</sup> / <sub>16</sub>	<b>GS2SBD6H30-</b> [ ]	5,030	7,850	8,635

## PRODUCT INFO

All units have a finished back.  
 If integral pull is chosen for wood, doors will be touch latch.  
 Adjustable shelves.





## TO ORDER PLEASE SPECIFY THE FOLLOWING:

### WOOD CHASSIS

1. **MODEL NUMBER + WN**
2. **FSC**
3. **CHASSIS WOOD FINISH**
4. **PULL**
5. **DRAWERS**
6. **KEYING**

### LAM CHASSIS

1. **MODEL NUMBER + LN**
2. **FSC**
3. **CHASSIS LAM**
4. **FRONT LAM**
5. **PULL**
6. **DRAWERS**
7. **KEYING**

	D	W	H	model number + type	laminata	veneer 1	veneer 2
<b>15" WIDTH</b>	24	15	68 <sup>9</sup> / <sub>16</sub>	<b>GS2SBD5H15-3</b> [ ]	2,924	4,564	5,021
 Box/Box/File 68 High							
 Box/Box/File 82 High	24	15	81 <sup>15</sup> / <sub>16</sub>	<b>GS2SBD6H15-3</b> [ ]	3,217	5,021	5,524
				• 6H x 15W units must be attached to wall for stability. Wall attach hardware not provided.			
<b>18" WIDTH</b>	24	18	68 <sup>9</sup> / <sub>16</sub>	<b>GS2SBD5H18-3</b> [ ]	3,077	4,805	5,286
 Box/Box/File 68 High							
 Box/Box/File 82 High	24	18	81 <sup>15</sup> / <sub>16</sub>	<b>GS2SBD6H18-3</b> [ ]	3,386	5,285	5,814

**PRODUCT INFO**

All units have a finished back.  
If integral pull is chosen for wood, doors will be touch latch.  
Adjustable shelves.

**TO ORDER PLEASE SPECIFY THE FOLLOWING:**

WOOD CHASSIS

1. **MODEL NUMBER + WN**
2. **FSC**
3. **CHASSIS WOOD FINISH**
4. **PULL**
5. **DRAWERS**
6. **KEYING**

LAM CHASSIS

1. **MODEL NUMBER + LN**
2. **FSC**
3. **CHASSIS LAM**
4. **FRONT LAM**
5. **PULL**
6. **DRAWERS**
7. **KEYING**

# STORAGE BOX 30D

5 high – 6 high | 18"W | File / File

Silea

05/22

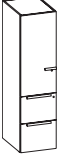
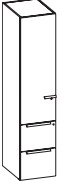
	D	W	H	model number + type	laminate	veneer 1	veneer 2
<b>18" WIDTH</b>	30	18	68 <sup>9</sup> / <sub>16</sub>	<b>GS2SBD5H30D18L-</b> [ ]	3,486	5,444	5,989
 Hinged door left 68 High	30	18	68 <sup>9</sup> / <sub>16</sub>	<b>GS2SBD5H30D18R-</b> [ ]	3,486	5,444	5,989
 Hinged door left 82 High	30	18	81 <sup>15</sup> / <sub>16</sub>	<b>GS2SBD6H30D18L-</b> [ ]	3,834	5,987	6,586
	30	18	81 <sup>15</sup> / <sub>16</sub>	<b>GS2SBD6H30D18R-</b> [ ]	3,834	5,987	6,586

## PRODUCT INFO

If integral pull is chosen for wood, doors will be touch latch.

5H units include (2) adjustable shelves behind doors.

6H units include (3) adjustable shelves behind doors.

All units have a finished back. 30D Laminate units have fasteners on backside with cam covers.

## TO ORDER PLEASE SPECIFY THE FOLLOWING:

### WOOD CHASSIS

1. **MODEL NUMBER + WW**
2. **FSC**
3. **CHASSIS WOOD FINISH**
4. **PULL**
5. **DRAWERS**
6. **KEYING**

### LAM CHASSIS

1. **MODEL NUMBER + LL**
2. **FSC**
3. **CHASSIS LAM**
4. **FRONT LAM**
5. **PULL**
6. **DRAWERS**
7. **KEYING**

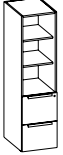
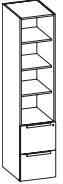
	D	W	H	model number + type	laminat	veneer 1	veneer 2
<b>18" WIDTH</b>	30	18	68 <sup>9</sup> / <sub>16</sub>	<b>GS2SBD5H30D18-</b> [ ]	3,225	5,033	5,537
 68 High							
 82 High	30	18	81 <sup>15</sup> / <sub>16</sub>	<b>GS2SBD6H30D18-</b> [ ]	3,548	5,536	6,090

**PRODUCT INFO**

5H units include (2) adjustable shelves behind doors.  
 6H units include (3) adjustable shelves behind doors.  
 All units have a finished back.  
 30D Laminate units have fasteners on backside with cam covers.

**TO ORDER PLEASE SPECIFY THE FOLLOWING:**

WOOD CHASSIS

1. **MODEL NUMBER + WN**
2. **FSC**
3. **CHASSIS WOOD FINISH**
4. **PULL**
5. **DRAWERS**
6. **KEYING**

LAM CHASSIS



1. **MODEL NUMBER + LN**
2. **FSC**
3. **CHASSIS LAM**
4. **FRONT LAM**
5. **PULL**
6. **DRAWERS**
7. **KEYING**

# STORAGE BOX 30D

5 high – 6 high | 18"W | Box / Box / File

Silea

05/22

	D	W	H	model number + type	laminate	veneer 1	veneer 2
<b>18" WIDTH</b>	30	18	68 <sup>9</sup> / <sub>16</sub>	<b>GS2SBD5H30D18L-3</b> [ ]	3,661	5,715	6,287
 Box/Box/File Left 68 High	30	18	68 <sup>9</sup> / <sub>16</sub>	<b>GS2SBD5H30D18R-3</b> [ ]	3,661	5,715	6,287
 Box/Box/File Left 82 High	30	18	81 <sup>15</sup> / <sub>16</sub>	<b>GS2SBD6H30D18L-3</b> [ ]	4,026	6,285	6,914
	30	18	81 <sup>15</sup> / <sub>16</sub>	<b>GS2SBD6H30D18R-3</b> [ ]	4,026	6,285	6,914

## PRODUCT INFO

If integral pull is chosen for wood, doors will be touch latch.

5H units include (2) adjustable shelves behind doors.

6H units include (3) adjustable shelves behind doors.

All units have a finished back. 30D Laminate units have fasteners on backside with cam covers.

## TO ORDER PLEASE SPECIFY THE FOLLOWING:

### WOOD CHASSIS

1. **MODEL NUMBER + WW**
2. **FSC**
3. **CHASSIS WOOD FINISH**
4. **PULL**
5. **DRAWERS**
6. **KEYING**

### LAM CHASSIS

1. **MODEL NUMBER + LL**
2. **FSC**
3. **CHASSIS LAM**
4. **FRONT LAM**
5. **PULL**
6. **DRAWERS**
7. **KEYING**

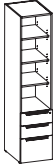
	D	W	H	model number + type	laminate	veneer 1	veneer 2
<b>18" WIDTH</b>	30	18	68 <sup>9</sup> / <sub>16</sub>	<b>GS2SBD5H30D18-3</b> [ ]	3,386	5,285	5,814
 Box/Box/File 68 High							
 Box/Box/File 82 High	30	18	81 <sup>15</sup> / <sub>16</sub>	<b>GS2SBD6H30D18-3</b> [ ]	3,725	5,813	6,395

**PRODUCT INFO**

5H units include (2) adjustable shelves behind doors.  
6H units include (3) adjustable shelves behind doors.  
All units have a finished back.  
30D Laminate units have fasteners on backside with cam covers.

**TO ORDER PLEASE SPECIFY THE FOLLOWING:**

WOOD CHASSIS

1. **MODEL NUMBER + WN**
2. **FSC**
3. **CHASSIS WOOD FINISH**
4. **PULL**
5. **DRAWERS**
6. **KEYING**

LAM CHASSIS



1. **MODEL NUMBER + LN**
2. **FSC**
3. **CHASSIS LAM**
4. **FRONT LAM**
5. **PULL**
6. **DRAWERS**
7. **KEYING**

# UTILITY CABINET 24D

5 high – 6 high

Silea

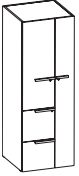
05/22

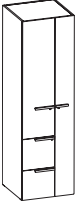
	D	W	H	model number + type	laminata	veneer 1	veneer 2
<b>68 HIGH</b>	24	24	68 <sup>9</sup> / <sub>16</sub>	<b>GS2UTC5H24L-</b> [ ]	5,399	8,417	9,259
 Left hand							
	24	24	68 <sup>9</sup> / <sub>16</sub>	<b>GS2UTC5H24R-</b> [ ]	5,399	8,417	9,259
 Right hand							
<b>82 HIGH</b>	24	24	81 <sup>15</sup> / <sub>16</sub>	<b>GS2UTC6H24L-</b> [ ]	6,187	9,649	10,614
 Left hand							
	24	24	81 <sup>15</sup> / <sub>16</sub>	<b>GS2UTC6H24R-</b> [ ]	6,187	9,649	10,614
 Right hand							

## PRODUCT INFO

All units have a finished back.  
 If integral pull is chosen for wood, door will be touch latch.  
 Units include (1) closet rod behind full length door.  
 5H units include (2) adjustable shelves behind door above file drawers.  
 6H units include (4) adjustable shelves behind door above file drawers.

## TO ORDER PLEASE SPECIFY THE FOLLOWING:

### WOOD CHASSIS

1. **MODEL NUMBER + WW**
2. **FSC**
3. **CHASSIS WOOD FINISH**
4. **PULL**
5. **DRAWERS**
6. **KEYING**

### LAM CHASSIS

1. **MODEL NUMBER + LL**
2. **FSC**
3. **CHASSIS LAM**
4. **FRONT LAM**
5. **PULL**
6. **DRAWERS**
7. **KEYING**



	D	W	H	model number + type	laminate	veneer 1	veneer 2
--	---	---	---	---------------------	----------	----------	----------

**68" HIGH**

24	24	68 <sup>9</sup> / <sub>16</sub>	<b>GS2UTC5H24L-3</b> [ ]	5,668	8,838	9,722
----	----	---------------------------------	--------------------------	-------	-------	-------



Left hand

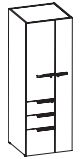

Right hand

24	24	68 <sup>9</sup> / <sub>16</sub>	<b>GS2UTC5H24R-3</b> [ ]	5,668	8,838	9,722
----	----	---------------------------------	--------------------------	-------	-------	-------

**82" HIGH**

24	24	81 <sup>15</sup> / <sub>16</sub>	<b>GS2UTC6H24L-3</b> [ ]	6,497	10,132	11,146
----	----	----------------------------------	--------------------------	-------	--------	--------

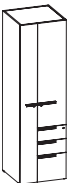

Left hand

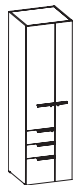

Right hand

24	24	81 <sup>15</sup> / <sub>16</sub>	<b>GS2UTC6H24R-3</b> [ ]	6,497	10,132	11,146
----	----	----------------------------------	--------------------------	-------	--------	--------

**PRODUCT INFO**

All units have a finished back.  
If integral pull is chosen for wood, door will be touch latch.  
Units include (1) closet rod behind full length door.  
5H units include (2) adjustable shelves behind door above drawers.  
6H units include (4) adjustable shelves behind door above drawers.

**TO ORDER PLEASE SPECIFY THE FOLLOWING:**

WOOD CHASSIS

1. **MODEL NUMBER + WW**
2. **FSC**
3. **CHASSIS WOOD FINISH**
4. **PULL**
5. **DRAWERS**
6. **KEYING**



LAM CHASSIS

1. **MODEL NUMBER + LL**
2. **FSC**
3. **CHASSIS LAM**
4. **FRONT LAM**
5. **PULL**
6. **DRAWERS**
7. **KEYING**

# UTILITY CABINET 24D

5 high – 6 high | 30"W | File / File

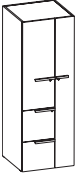
Silea  
05/22

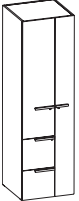
	D	W	H	model number + type	laminata	veneer 1	veneer 2
<b>68 HIGH</b>	24	30	68 <sup>9</sup> / <sub>16</sub>	<b>GS2UTC5H30L-</b> [ ]	5,939	9,259	10,185
 Left hand							
	24	30	68 <sup>9</sup> / <sub>16</sub>	<b>GS2UTC5H30R-</b> [ ]	5,939	9,259	10,185
 Right hand							
<b>82 HIGH</b>	24	30	81 <sup>15</sup> / <sub>16</sub>	<b>GS2UTC6H30L-</b> [ ]	6,807	10,615	11,677
 Left hand							
	24	30	81 <sup>15</sup> / <sub>16</sub>	<b>GS2UTC6H30R-</b> [ ]	6,807	10,615	11,677
 Right hand							

## PRODUCT INFO

All units have a finished back.  
If integral pull is chosen for wood, door will be touch latch.  
Units include (1) closet rod behind full length door.  
5H units include (2) adjustable shelves behind door above drawers.  
6H units include (4) adjustable shelves behind door above drawers.

## TO ORDER PLEASE SPECIFY THE FOLLOWING:

### WOOD CHASSIS

1. **MODEL NUMBER + WW**
2. **FSC**
3. **CHASSIS WOOD FINISH**
4. **PULL**
5. **DRAWERS**
6. **KEYING**

### LAM CHASSIS

1. **MODEL NUMBER + LL**
2. **FSC**
3. **CHASSIS LAM**
4. **FRONT LAM**
5. **PULL**
6. **DRAWERS**
7. **KEYING**

	D	W	H	model number + type	laminata	veneer 1	veneer 2
<b>68" HIGH</b>	24	30	68 <sup>9</sup> / <sub>16</sub>	<b>GS2UTC5H30L-3</b> [ ]	6,235	9,722	10,695



Left hand

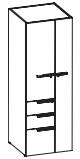

Right hand

	24	30	68 <sup>9</sup> / <sub>16</sub>	<b>GS2UTC5H30R-3</b> [ ]	6,235	9,722	10,695
--	----	----	---------------------------------	--------------------------	-------	-------	--------

**82" HIGH**

	24	30	81 <sup>15</sup> / <sub>16</sub>	<b>GS2UTC6H30L-3</b> [ ]	7,146	11,147	12,262
--	----	----	----------------------------------	--------------------------	-------	--------	--------

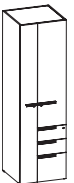

Left hand

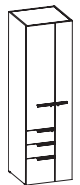

Right hand

	24	30	81 <sup>15</sup> / <sub>16</sub>	<b>GS2UTC6H30R-3</b> [ ]	7,146	11,147	12,262
--	----	----	----------------------------------	--------------------------	-------	--------	--------

**PRODUCT INFO**

All units have a finished back.  
If integral pull is chosen for wood, door will be touch latch.  
Units include (1) closet rod behind full length door.  
5H units include (2) adjustable shelves behind door above drawers.  
6H units include (4) adjustable shelves behind door above drawers.

**TO ORDER PLEASE SPECIFY THE FOLLOWING:**

WOOD CHASSIS

1. **MODEL NUMBER + WW**
2. **FSC**
3. **CHASSIS WOOD FINISH**
4. **PULL**
5. **DRAWERS**
6. **KEYING**

LAM CHASSIS

1. **MODEL NUMBER + LL**
2. **FSC**
3. **CHASSIS LAM**
4. **FRONT LAM**
5. **PULL**
6. **DRAWERS**
7. **KEYING**

# STORAGE CABINET 24D

2 high w/top

Silea

05/22



D	W	H	model number + type	laminata	veneer 1	veneer 2
24	30	29 1/2	<b>GS2SCF2H30-5</b> [ ]	1,976	3,082	3,391
24	36	29 1/2	<b>GS2SCF2H36-5</b> [ ]	2,198	3,424	3,767

## PRODUCT INFO

Top included.

All units have a finished back.

If integral pull is chosen for wood, door will be touch latch.

(1) adjustable shelf behind doors.



## TO ORDER PLEASE SPECIFY THE FOLLOWING:

WOOD TOP, WOOD CHASSIS

1. **MODEL NUMBER + WW**
2. **FSC**
3. **TOP WOOD FINISH + EDGE**
4. **CHASSIS WOOD FINISH**
5. **TOP UV FINISH**
6. **PULL**
7. **KEYING**

LAM TOP, LAM CHASSIS

1. **MODEL NUMBER + LL**
2. **FSC**
3. **TOP LAM**
4. **CHASSIS LAM**
5. **FRONT LAM**
6. **TOP UV FINISH**
7. **EDGE DETAIL**
8. **PULL**
9. **KEYING**

	D	W	H	model number + type	laminated	veneer 1	veneer 2
<b>24" WIDTH</b>  Left hand unit 68 High	24	24	68 <sup>9/16</sup>	<b>GS2LKR5H24L-</b> [ ]	3,703	5,371	5,909
	24	24	68 <sup>9/16</sup>	<b>GS2LKR5H24R-</b> [ ]	3,703	5,371	5,909
 Right hand unit 82 High	24	24	81 <sup>15/16</sup>	<b>GS2LKR6H24L-</b> [ ]	4,569	6,622	7,285
	24	24	81 <sup>15/16</sup>	<b>GS2LKR6H24R-</b> [ ]	4,569	6,622	7,285

• Note: door overhangs chassis by 6"

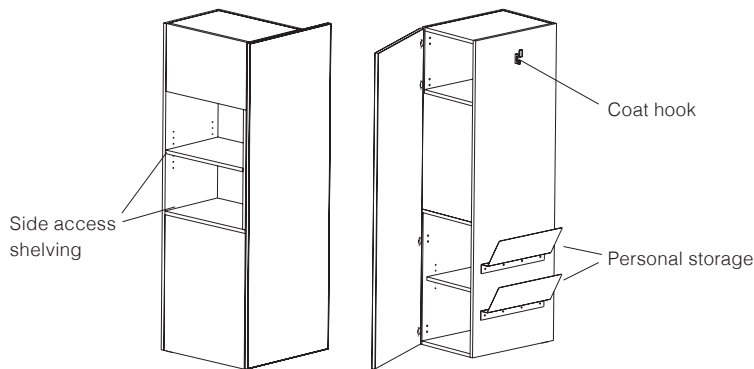

**PRODUCT INFO**

All units have a finished back.  
 Unit does not lock.  
 Laminate units shipped as separate packages and require field assembly.  
 Coat hook and metal personal storage shelves are black.

**TO ORDER PLEASE SPECIFY THE FOLLOWING:**

WOOD CHASSIS

1. **MODEL NUMBER + WW**
2. **FSC**
3. **CHASSIS WOOD FINISH**

LAM CHASSIS



1. **MODEL NUMBER + LL**
2. **FSC**
3. **CHASSIS LAM**
4. **FRONT LAM**

# SIDE ACCESS STORAGE LOCKER 24D

Glass Door | 5 high – 6 high

Silea

05/22

	D	W	H	model number + type	laminate	veneer 1	veneer 2
<b>24" WIDTH</b>  Left hand unit 68 High	24	24	68 <sup>9</sup> / <sub>16</sub>	<b>GS2LKR5H24L-</b> [ ]	4,628	6,714	7,386
	24	24	68 <sup>9</sup> / <sub>16</sub>	<b>GS2LKR5H24R-</b> [ ]	4,628	6,714	7,386
 Right hand unit 82 High	24	24	81 <sup>15</sup> / <sub>16</sub>	<b>GS2LKR6H24L-</b> [ ]	5,709	8,279	9,107
	24	24	81 <sup>15</sup> / <sub>16</sub>	<b>GS2LKR6H24R-</b> [ ]	5,709	8,279	9,107

• Note: door overhangs chassis by 6"

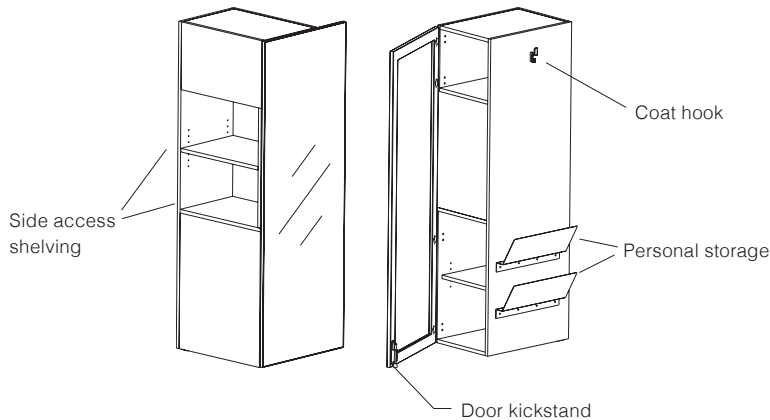

## PRODUCT INFO

All units have a finished back.  
 Door does not lock.

 Laminate units shipped as separate packages and require field assembly.

Coat hook and metal personal storage shelves are black.

## TO ORDER PLEASE SPECIFY THE FOLLOWING:

WOOD CHASSIS, GLASS DOOR



1. **MODEL NUMBER + WG**
2. **FSC**
3. **CHASSIS WOOD FINISH**
4. **GLASS**

LAM CHASSIS, GLASS DOOR

1. **MODEL NUMBER + LG**
2. **FSC**
3. **CHASSIS LAM**
4. **GLASS**

# SIDE ACCESS STORAGE LOCKER LAYERS HEIGHT 24D

5 high – 6 high

	D	W	H	model number + type	laminated	veneer 1	veneer 2
<b>24" WIDTH</b>  Left hand unit 68 High	24	24	68 <sup>9</sup> / <sub>16</sub>	<b>GS2LLKR5H24L-</b> [ ]	3,703	5,371	5,909
	24	24	68 <sup>9</sup> / <sub>16</sub>	<b>GS2LLKR5H24R-</b> [ ]	3,703	5,371	5,909
 Right hand unit 82 High	24	24	81 <sup>15</sup> / <sub>16</sub>	<b>GS2LLKR6H24L-</b> [ ]	4,569	6,622	7,285
	24	24	81 <sup>15</sup> / <sub>16</sub>	<b>GS2LLKR6H24R-</b> [ ]	4,569	6,622	7,285

• Note: door overhangs chassis by 6"

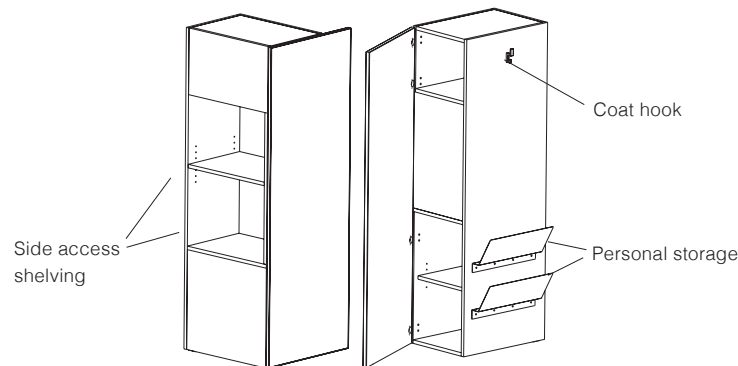

## PRODUCT INFO

All units have a finished back.  
Doors do not lock.

 Laminate units shipped as separate packages and require field assembly.

Coat hook and metal personal storage shelves are black.

## TO ORDER PLEASE SPECIFY THE FOLLOWING:

### WOOD CHASSIS

1. **MODEL NUMBER + WW**
2. **FSC**
3. **CHASSIS WOOD FINISH**

### LAM CHASSIS

1. **MODEL NUMBER + LL**
2. **FSC**
3. **CHASSIS LAM**
4. **FRONT LAM**

# SIDE ACCESS STORAGE LOCKER LAYERS HEIGHT 24D

Glass Door | 5 high – 6 high

Silea  
05/22

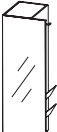
	D	W	H	model number + type	laminate	veneer 1	veneer 2
<b>24" WIDTH</b>  Left hand unit 68 High	24	24	68 <sup>9</sup> / <sub>16</sub>	<b>GS2LLKR5H24L-</b> [ ]	4,628	6,714	7,386
	24	24	68 <sup>9</sup> / <sub>16</sub>	<b>GS2LLKR5H24R-</b> [ ]	4,628	6,714	7,386
 Right hand unit 82 High	24	24	81 <sup>15</sup> / <sub>16</sub>	<b>GS2LLKR6H24L-</b> [ ]	5,709	8,279	9,107
	24	24	81 <sup>15</sup> / <sub>16</sub>	<b>GS2LLKR6H24R-</b> [ ]	5,709	8,279	9,107

• Note: door overhangs chassis by 6"

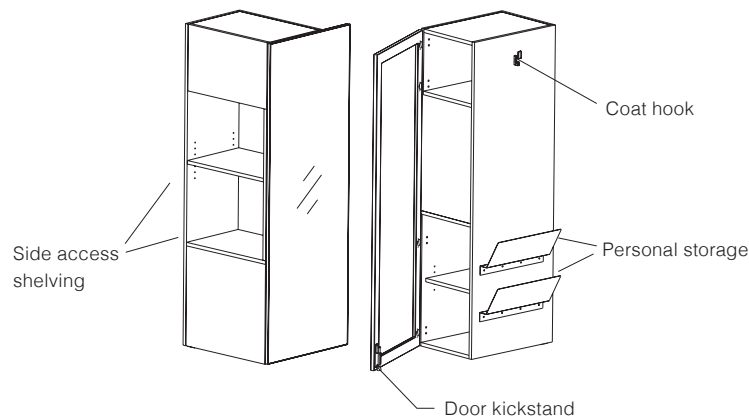

## PRODUCT INFO

All units have a finished back.  
Doors do not lock.

 Laminate units shipped as separate packages and require field assembly.

Coat hook and metal personal storage shelves are black.

## TO ORDER PLEASE SPECIFY THE FOLLOWING:



WOOD CHASSIS, GLASS DOOR

- MODEL NUMBER + WG**
- FSC**
- CHASSIS WOOD FINISH**
- GLASS**

LAM CHASSIS, GLASS DOOR

- MODEL NUMBER + LG**
- FSC**
- CHASSIS LAM**
- GLASS**

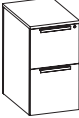

	D	W	H	model number + type	laminata	veneer 1	veneer 2
	21 15/16	15 3/16	21 1/2	<b>GS2MPD-6</b> [ ]	1,760	2,747	3,022
	23 15/16	15 3/16	27 5/8	<b>GS2MPD-3</b> [ ]	1,937	3,022	3,325
	23 15/16	15 3/16	27 5/8	<b>GS2MPD-2</b> [ ]	1,937	3,022	3,325

• Taller Box/Box/File and File/File mobile pedestals with a cushion will NOT fit under a standard height desk. These taller mobile pedestals are not recommended for use with a cushion due to height.

**PRODUCT INFO**

Top included.  
Pedestal on casters.

**TO ORDER PLEASE SPECIFY THE FOLLOWING:**

WOOD TOP, WOOD CHASSIS

1. **MODEL NUMBER + WW**
2. **FSC**
3. **CHASSIS WOOD FINISH**
4. **PULL**
5. **DRAWERS**
6. **KEYING**

LAM TOP, LAM CHASSIS

1. **MODEL NUMBER + LL**
2. **FSC**
3. **TOP LAM**
4. **CHASSIS LAM**
5. **FRONT LAM**
6. **PULL**
7. **DRAWERS**
8. **KEYING**

# MOBILE PEDESTAL CUSHION

Silea  
05/22

	D	W	H	model number	fabric grades			COM/4
					1	2	3	
	21 11/16	14 7/8	1	<b>GS2MPD-CUSH2215</b>	502	517	535	551

## PRODUCT INFO

For use with mobile pedestals.

**COM Fabric 1.25 yds**

## TO ORDER PLEASE SPECIFY THE FOLLOWING:

LIST

1. **MODEL NUMBER**
2. **FABRIC**
3. **FLAMMABILITY**

**Flammability Option Codes:**  
**U** = CTB117  
 For standard flammability rating,  
 please specify CTB 117.

	D	W	H	model number + type	laminate	veneer 1	veneer 2
	24	15	1 3/16	<b>GS2SGTOPD2415-</b> [ ]	493	770	847
	24	18	1 3/16	<b>GS2SGTOPD2418-</b> [ ]	501	783	862
	24	24	1 3/16	<b>GS2SGTOPD2424-</b> [ ]	512	1,048	1,153
	24	30	1 3/16	<b>GS2SGTOPD2430-</b> [ ]	535	835	919
	24	36	1 3/16	<b>GS2SGTOPD2436-</b> [ ]	599	936	1,030
	30	18	1 3/16	<b>GS2SGTOPD3018-</b> [ ]	528	823	906



**PRODUCT INFO**

**TO ORDER PLEASE SPECIFY THE FOLLOWING:**

WOOD TOP

1. **MODEL NUMBER + W**
2. **FSC**
3. **TOP WOOD FINISH + EDGE**
4. **TOP FINISH**

**Top Finish Option:**

Non-UV Open Pore Finish  
Full Fill UV Top Finish

LAM TOP

1. **MODEL NUMBER + L**
2. **FSC**
3. **TOP LAM**

**NR**  
**FF (+\$250)**

# STORAGE EXTERNAL TOPS

For units without doors

Silea

05/22

D	W	H	model number + type	laminata	veneer 1	veneer 2
23 1/8	15	1 3/16	<b>GS2SGTOPN2415-</b> [ ]	493	770	847
23 1/8	18	1 3/16	<b>GS2SGTOPN2418-</b> [ ]	501	783	862
23 1/8	24	1 3/16	<b>GS2SGTOPN2424-</b> [ ]	512	798	878
23 1/8	30	1 3/16	<b>GS2SGTOPN2430-</b> [ ]	535	835	919
23 1/8	36	1 3/16	<b>GS2SGTOPN2436-</b> [ ]	599	936	1,030
29 1/8	18	1 3/16	<b>GS2SGTOPN3018-</b> [ ]	528	823	906
• For use w/ 24D and 30D storage						
14 7/8	30	1 3/16	<b>GS2SMTOPN30-</b> [ ]	381	1,009	1,110
14 7/8	36	1 3/16	<b>GS2SMTOPN36-</b> [ ]	433	676	744
14 7/8	60	1 3/16	<b>GS2SMTOPN60-</b> [ ]	651	1,018	1,120
14 7/8	66	1 3/16	<b>GS2SMTOPN66-</b> [ ]	697	1,090	1,199
14 7/8	72	1 3/16	<b>GS2SMTOPN72-</b> [ ]	748	1,169	1,286
14 7/8	90	1 3/16	<b>GS2SMTOPN90-</b> [ ]	898	1,401	1,542
14 7/8	96	1 3/16	<b>GS2SMTOPN96-</b> [ ]	949	1,480	1,628
14 7/8	102	1 3/16	<b>GS2SMTOPN102-</b> [ ]	994	1,552	1,708
14 7/8	114	1 3/16	<b>GS2SMTOPN108-</b> [ ]	1,045	1,632	1,796
14 7/8	120	1 3/16	<b>GS2SMTOPN120-</b> [ ]	1,157	1,808	1,989

• For use w/ bookcases

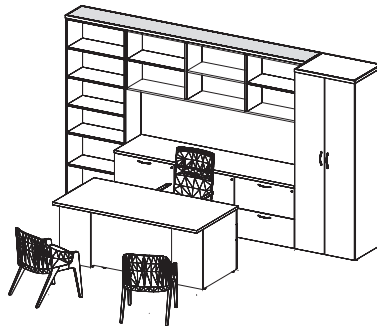

## PRODUCT INFO

## TO ORDER PLEASE SPECIFY THE FOLLOWING:

### WOOD TOP

1. **MODEL NUMBER + W**
2. **FSC**
3. **TOP WOOD FINISH + EDGE**
4. **TOP FINISH**

#### Top Finish Option:

Non-UV Open Pore Finish  
Full Fill UV Top Finish

### LAM TOP

1. **MODEL NUMBER + L**
2. **FSC**
3. **TOP LAM**

**NR**  
**FF (+\$250)**

Wall Mount . . . . .	277-317
Cabinets . . . . .	278-287
Wall Mount Wall Overhead . . . . .	288-289
Tackboard in Tackzone . . . . .	290-293
Tackboard to Top of Overhead . . . . .	294-299
Tackboard / Glass Whiteboard from Floor . . . . .	300-301
Wall Mount Wall in Tackzone . . . . .	302-305
Magnetic Wood to Top of Overhead . . . . .	306-310
Wood Tack from Floor . . . . .	311
Shelving for Wall Mount Wall . . . . .	312-314
Floating Shelves . . . . .	315
Wall Mount External Tops . . . . .	316-317

# WALL MOUNT CABINETS

w/ Hinged Doors | 1H

Silea

05/22

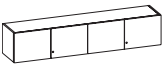
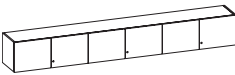
	D	W	H	model number + type	laminate	veneer 1	veneer 2
	16 1/4	30	14 1/8	<b>GS2WMC1H30-</b> [ ]	1,894	2,957	3,253
	16 1/4	36	14 1/8	<b>GS2WMC1H36-</b> [ ]	2,055	3,198	3,518
	16 1/4	42	14 1/8	<b>GS2WMC1H42-</b> [ ]	2,577	4,024	4,427
	16 1/4	48	14 1/8	<b>GS2WMC1H48-</b> [ ]	2,717	4,242	4,667
	16 1/4	54	14 1/8	<b>GS2WMC1H54-</b> [ ]	2,860	4,463	4,910
	16 1/4	60	14 1/8	<b>GS2WMC1H60-</b> [ ]	2,972	4,633	5,097
	16 1/4	66	14 1/8	<b>GS2WMC1H66-</b> [ ]	3,174	4,948	5,443
	16 1/4	72	14 1/8	<b>GS2WMC1H72-</b> [ ]	3,357	5,236	5,760
	16 1/4	78	14 1/8	<b>GS2WMC1H78-</b> [ ]	3,564	5,559	6,115
	16 1/4	84	14 1/8	<b>GS2WMC1H84-</b> [ ]	3,816	5,955	6,551
	16 1/4	90	14 1/8	<b>GS2WMC1H90-</b> [ ]	4,043	6,305	6,936
	16 1/4	96	14 1/8	<b>GS2WMC1H96-</b> [ ]	4,185	6,528	7,181
	16 1/4	102	14 1/8	<b>GS2WMC1H102-</b> [ ]	N/A	6,752	7,428
	16 1/4	108	14 1/8	<b>GS2WMC1H108-</b> [ ]	N/A	6,982	7,681

## PRODUCT INFO

# of doors:  
 30" and 36" = 2 doors  
 42" through 78" = 4 doors  
 84" through 108" = 6 doors

## TO ORDER PLEASE SPECIFY THE FOLLOWING:

WOOD CHASSIS, WOOD DOOR

1. **MODEL NUMBER + WW**
2. **FSC**
3. **CHASSIS WOOD FINISH**
4. **LOCKS**
5. **KEYING**

LAM CHASSIS, LAM DOOR

1. **MODEL NUMBER + LL**
2. **FSC**
3. **CHASSIS LAM**
4. **FRONT LAM**
5. **LOCKS**
6. **KEYING**

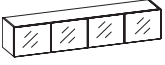
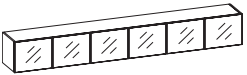
	D	W	H	model number + type	veneer 1	veneer 2
	16 1/4	30	14 1/8	<b>GS2WMC1H30-</b> [ ]	3,483	3,832
	16 1/4	36	14 1/8	<b>GS2WMC1H36-</b> [ ]	3,768	4,145
	16 1/4	60	14 1/8	<b>GS2WMC1H60-</b> [ ]	5,559	6,115
	16 1/4	72	14 1/8	<b>GS2WMC1H72-</b> [ ]	6,281	6,910
	16 1/4	90	14 1/8	<b>GS2WMC1H90-</b> [ ]	7,784	8,563
	16 1/4	108	14 1/8	<b>GS2WMC1H108-</b> [ ]	8,620	9,482

**PRODUCT INFO**

Type must be specified as part # of doors:  
 30" and 36" = 2 doors  
 60" through 72" = 4 doors  
 90" through 108" = 6 doors  
 Glass doors do not lock.

**TO ORDER PLEASE SPECIFY THE FOLLOWING:**

WOOD CHASSIS, GLASS DOOR

1. **MODEL NUMBER + WG**
2. **FSC**
3. **CHASSIS WOOD FINISH**
4. **GLASS**

# WALL MOUNT CABINETS

No Doors | 1H

Silea

05/22

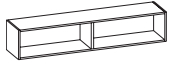

D	W	H	model number + type	laminate	veneer 1	veneer 2
15 3/8	30	14 1/8	<b>GS2WMC1H30-</b> [ ]	1,613	2,516	2,768
15 3/8	36	14 1/8	<b>GS2WMC1H36-</b> [ ]	1,745	2,723	2,996
15 3/8	42	14 1/8	<b>GS2WMC1H42-</b> [ ]	2,190	3,420	3,762
15 3/8	48	14 1/8	<b>GS2WMC1H48-</b> [ ]	2,308	3,607	3,968
15 3/8	54	14 1/8	<b>GS2WMC1H54-</b> [ ]	2,430	3,793	4,173
15 3/8	60	14 1/8	<b>GS2WMC1H60-</b> [ ]	2,527	3,942	4,337
15 3/8	66	14 1/8	<b>GS2WMC1H66-</b> [ ]	2,699	4,210	4,631
15 3/8	72	14 1/8	<b>GS2WMC1H72-</b> [ ]	2,854	4,455	4,901
15 3/8	78	14 1/8	<b>GS2WMC1H78-</b> [ ]	3,028	4,726	5,199
15 3/8	84	14 1/8	<b>GS2WMC1H84-</b> [ ]	3,243	5,064	5,571
15 3/8	90	14 1/8	<b>GS2WMC1H90-</b> [ ]	3,435	5,362	5,899
15 3/8	96	14 1/8	<b>GS2WMC1H96-</b> [ ]	3,557	5,550	6,105
15 3/8	102	14 1/8	<b>GS2WMC1H102-</b> [ ]	N/A	5,741	6,316
15 3/8	108	14 1/8	<b>GS2WMC1H108-</b> [ ]	N/A	5,938	6,532

## PRODUCT INFO

### TO ORDER PLEASE SPECIFY THE FOLLOWING:

#### WOOD

1. **MODEL NUMBER + WN**
2. **FSC**
3. **CHASSIS WOOD FINISH**

#### LAM

1. **MODEL NUMBER + LN**
2. **FSC**
3. **CHASSIS LAM**

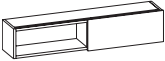
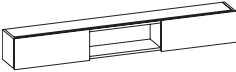

	D	W	H	model number + type	laminata	veneer 1	veneer 2
	16 1/4	60	14 1/8	<b>GS2WMC1H60-</b> [ ]	2,973	4,638	5,102
	16 1/4	66	14 1/8	<b>GS2WMC1H66-</b> [ ]	3,166	4,940	5,434
	16 1/4	72	14 1/8	<b>GS2WMC1H72-</b> [ ]	3,357	5,241	5,766
	16 1/4	78	14 1/8	<b>GS2WMC1H78-</b> [ ]	3,626	5,659	6,225
	16 1/4	84	14 1/8	<b>GS2WMC1H84-</b> [ ]	3,894	6,077	6,685
	16 1/4	90	14 1/8	<b>GS2WMC1H90-</b> [ ]	4,161	6,496	7,146
	16 1/4	96	14 1/8	<b>GS2WMC1H96-</b> [ ]	4,416	6,752	7,428
	16 1/4	102	14 1/8	<b>GS2WMC1H102-</b> [ ]	N/A	7,006	7,707
	16 1/4	108	14 1/8	<b>GS2WMC1H108-</b> [ ]	N/A	7,191	7,911

**PRODUCT INFO**

# of doors:  
60" - 78" = 1 door  
84" - 108" = 2 doors  
Doors do not lock.

**TO ORDER PLEASE SPECIFY THE FOLLOWING:**

WOOD CHASSIS, WOOD DOOR

1. **MODEL NUMBER + WSW**
2. **FSC**
3. **CHASSIS WOOD FINISH**

LAM CHASSIS, LAM DOOR

1. **MODEL NUMBER + LSL**
2. **FSC**
3. **CHASSIS LAM**
4. **FRONT LAM**

# WALL MOUNT CABINETS

w/ Sliding Glass Doors | 1H

Silea

05/22

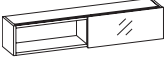
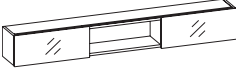
	D	W	H	model number + type	veneer 1	veneer 2
	16 1/4	60	14 1/8	<b>GS2WMC1H60-</b> [ ]	5,837	6,421
	16 1/4	72	14 1/8	<b>GS2WMC1H72-</b> [ ]	6,595	7,255
	16 1/4	90	14 1/8	<b>GS2WMC1H90-</b> [ ]	8,172	8,990
	16 1/4	108	14 1/8	<b>GS2WMC1H108-</b> [ ]	9,050	9,955

## PRODUCT INFO

# of doors:

60" and 72" = 1 door

90" and 108" = 2 doors

Glass doors do not lock.

## TO ORDER PLEASE SPECIFY THE FOLLOWING:

WOOD CHASSIS, GLASS DOOR

1. **MODEL NUMBER + WSG**
2. **FSC**
3. **CHASSIS WOOD FINISH**
4. **GLASS**

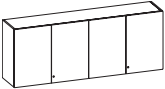
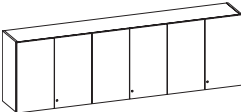
	D	W	H	model number + type	laminata	veneer 1	veneer 2
	16 1/4	30	27 1/2	<b>GS2WMC2H30-</b> [ ]	2,681	4,173	4,591
	16 1/4	36	27 1/2	<b>GS2WMC2H36-</b> [ ]	2,925	4,556	5,012
	16 1/4	42	27 1/2	<b>GS2WMC2H42-</b> [ ]	3,014	4,706	5,177
	16 1/4	48	27 1/2	<b>GS2WMC2H48-</b> [ ]	3,243	5,062	5,569
	16 1/4	54	27 1/2	<b>GS2WMC2H54-</b> [ ]	3,472	5,418	5,960
	16 1/4	60	27 1/2	<b>GS2WMC2H60-</b> [ ]	3,863	6,020	6,622
	16 1/4	66	27 1/2	<b>GS2WMC2H66-</b> [ ]	4,135	6,444	7,089
	16 1/4	72	27 1/2	<b>GS2WMC2H72-</b> [ ]	4,701	6,804	7,485
	16 1/4	78	27 1/2	<b>GS2WMC2H78-</b> [ ]	4,795	6,944	7,639
	16 1/4	84	27 1/2	<b>GS2WMC2H84-</b> [ ]	5,017	7,267	7,994
	16 1/4	90	27 1/2	<b>GS2WMC2H90-</b> [ ]	5,279	7,646	8,411

**PRODUCT INFO**

# of doors:  
30" and 36" = 2 doors  
60" through 78" = 4 doors  
84" and 90" = 6 doors

**TO ORDER PLEASE SPECIFY THE FOLLOWING:**

WOOD CHASSIS, WOOD DOOR

1. **MODEL NUMBER + WW**
2. **FSC**
3. **CHASSIS WOOD FINISH**
4. **LOCKS**
5. **KEYING**

LAM CHASSIS, LAM DOOR

1. **MODEL NUMBER + LL**
2. **FSC**
3. **CHASSIS LAM**
4. **FRONT LAM**
5. **LOCKS**
6. **KEYING**

# WALL MOUNT CABINETS

w/ Hinged Glass Doors | 2H

Silea

05/22

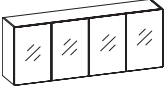
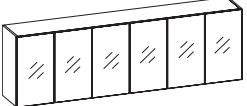
	D	W	H	model number + type	veneer 1	veneer 2
	16 1/4	30	27 1/2	<b>GS2WMC2H30-</b> [ ]	4,915	5,407
	16 1/4	36	27 1/2	<b>GS2WMC2H36-</b> [ ]	5,368	5,905
	16 1/4	60	27 1/2	<b>GS2WMC2H60-</b> [ ]	7,223	7,946
	16 1/4	72	27 1/2	<b>GS2WMC2H72-</b> [ ]	8,165	8,982
	16 1/4	90	27 1/2	<b>GS2WMC2H90-</b> [ ]	9,439	10,383

## PRODUCT INFO

# of doors:

30" and 36" = 2 doors

60" and 72" = 4 doors

90" = 6 doors

Glass doors do not lock.

## TO ORDER PLEASE SPECIFY THE FOLLOWING:

WOOD CHASSIS, GLASS DOOR

1. **MODEL NUMBER + WG**
2. **FSC**
3. **CHASSIS WOOD FINISH**
4. **GLASS**

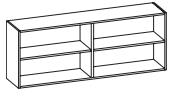

D	W	H	model number + type	laminate	veneer 1	veneer 2
16 1/4	30	27 1/2	<b>GS2WMC2H30-</b> [ ]	2,276	3,553	3,909
16 1/4	36	27 1/2	<b>GS2WMC2H36-</b> [ ]	2,485	3,880	4,268
16 1/4	42	27 1/2	<b>GS2WMC2H42-</b> [ ]	2,563	4,001	4,402
16 1/4	48	27 1/2	<b>GS2WMC2H48-</b> [ ]	2,757	4,302	4,733
16 1/4	54	27 1/2	<b>GS2WMC2H54-</b> [ ]	2,949	4,604	5,065
16 1/4	60	27 1/2	<b>GS2WMC2H60-</b> [ ]	3,282	5,123	5,636
16 1/4	66	27 1/2	<b>GS2WMC2H66-</b> [ ]	3,515	5,485	6,034
16 1/4	72	27 1/2	<b>GS2WMC2H72-</b> [ ]	3,995	5,790	6,369
16 1/4	78	27 1/2	<b>GS2WMC2H78-</b> [ ]	4,076	5,906	6,497
16 1/4	84	27 1/2	<b>GS2WMC2H84-</b> [ ]	4,264	6,181	6,800
16 1/4	90	27 1/2	<b>GS2WMC2H90-</b> [ ]	4,487	6,502	7,153

**PRODUCT INFO**

**TO ORDER PLEASE SPECIFY THE FOLLOWING:**

WOOD CHASSIS

1. **MODEL NUMBER + WN**
2. **FSC**
3. **CHASSIS WOOD FINISH**

LAM CHASSIS

1. **MODEL NUMBER + LN**
2. **FSC**
3. **CHASSIS LAM**

# WALL MOUNT CABINETS

w/ Sliding Doors | 2H

Silea

05/22

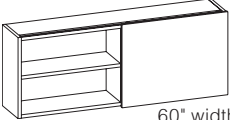
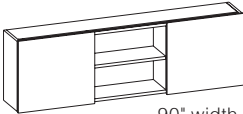
	D	W	H	model number + type	laminata	veneer 1	veneer 2
 <p>60" width</p>	16 1/4	60	27 1/2	<b>GS2WMC2H60-</b> [ ]	3,862	6,027	6,630
	16 1/4	66	27 1/2	<b>GS2WMC2H66-</b> [ ]	4,282	6,421	7,064
	16 1/4	72	27 1/2	<b>GS2WMC2H72-</b> [ ]	4,701	6,812	7,494
	16 1/4	78	27 1/2	<b>GS2WMC2H78-</b> [ ]	5,046	7,158	7,874
	16 1/4	84	27 1/2	<b>GS2WMC2H84-</b> [ ]	5,302	7,503	8,254
 <p>90" width</p>	16 1/4	90	27 1/2	<b>GS2WMC2H90-</b> [ ]	5,434	7,875	8,663

## PRODUCT INFO

# of doors:  
 60" - 78" = 1 door  
 84" - 90" = 2 doors  
 Doors do not lock.

## TO ORDER PLEASE SPECIFY THE FOLLOWING:

WOOD CHASSIS, WOOD DOOR

1. **MODEL NUMBER + WSW**
2. **FSC**
3. **CHASSIS WOOD FINISH**

LAM CHASSIS, LAM DOOR

1. **MODEL NUMBER + LSL**
2. **FSC**
3. **CHASSIS LAM**
4. **FRONT LAM**

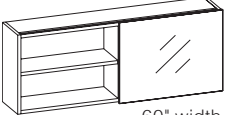
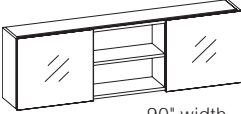
	D	W	H	model number + type	veneer 1	veneer 2
	16 1/4	60	27 1/2	<b>GS2WMC2H60-</b> [ ]	7,584	8,343
60" width	16 1/4	72	27 1/2	<b>GS2WMC2H72-</b> [ ]	7,858	8,644
	16 1/4	90	27 1/2	<b>GS2WMC2H90-</b> [ ]	9,735	10,709
90" width						

**PRODUCT INFO**

# of doors:  
60" and 72" = 1 door  
90" = 2 doors  
Glass doors do not lock.

**TO ORDER PLEASE SPECIFY THE FOLLOWING:**

WOOD CHASSIS, GLASS DOOR

1. **MODEL NUMBER + WSG**
2. **FSC**
3. **CHASSIS WOOD FINISH**
4. **GLASS**

# WALL MOUNT WALL OVERHEAD

Shelf Track Bottom | 1H

Silea

05/22

	D	W	H	model number + type	laminate	veneer 1	veneer 2
	3/4	30	14 1/8	<b>GS2WMW1H30-</b> <input type="checkbox"/>	748	1,087	1,196
	3/4	36	14 1/8	<b>GS2WMW1H36-</b> <input type="checkbox"/>	811	1,175	1,293
	3/4	42	14 1/8	<b>GS2WMW1H42-</b> <input type="checkbox"/>	875	1,270	1,397
	3/4	48	14 1/8	<b>GS2WMW1H48-</b> <input type="checkbox"/>	964	1,399	1,539
	3/4	54	14 1/8	<b>GS2WMW1H54-</b> <input type="checkbox"/>	1,054	1,527	1,680
	3/4	60	14 1/8	<b>GS2WMW1H60-</b> <input type="checkbox"/>	1,176	1,702	1,873
	3/4	66	14 1/8	<b>GS2WMW1H66-</b> <input type="checkbox"/>	1,255	1,820	2,002
	3/4	72	14 1/8	<b>GS2WMW1H72-</b> <input type="checkbox"/>	1,326	1,921	2,114
	3/4	78	14 1/8	<b>GS2WMW1H78-</b> <input type="checkbox"/>	1,400	2,024	2,227
	3/4	84	14 1/8	<b>GS2WMW1H84-</b> <input type="checkbox"/>	1,468	2,128	2,341
	3/4	90	14 1/8	<b>GS2WMW1H90-</b> <input type="checkbox"/>	1,645	2,381	2,620
	3/4	96	14 1/8	<b>GS2WMW1H96-</b> <input type="checkbox"/>	1,702	2,466	2,713
	3/4	102	14 1/8	<b>GS2WMW1H102-</b> <input type="checkbox"/>	1,761	2,553	2,809
	3/4	108	14 1/8	<b>GS2WMW1H108-</b> <input type="checkbox"/>	1,824	2,642	2,907

## PRODUCT INFO

Shelving can be mounted to bottom aluminum track.

Shelving ordered separately.

End trim sold separately to cover sides (GS2ENDTRIM14).

## TO ORDER PLEASE SPECIFY THE FOLLOWING:

### WOOD

- MODEL NUMBER + W**
- FSC**
- CHASSIS WOOD FINISH**
- EXTRUSION COLOR**

### LAM

- MODEL NUMBER + L**
- FSC**
- CHASSIS LAM**
- EXTRUSION COLOR**



	D	W	H	model number + type	laminate	veneer 1	veneer 2
	3/4	30	27 1/2	<b>GS2WMW2H30-</b> <input type="checkbox"/>	890	1,290	1,419
	3/4	36	27 1/2	<b>GS2WMW2H36-</b> <input type="checkbox"/>	961	1,392	1,532
	3/4	42	27 1/2	<b>GS2WMW2H42-</b> <input type="checkbox"/>	1,029	1,493	1,643
	3/4	48	27 1/2	<b>GS2WMW2H48-</b> <input type="checkbox"/>	1,151	1,667	1,834
	3/4	54	27 1/2	<b>GS2WMW2H54-</b> <input type="checkbox"/>	1,270	1,842	2,027
	3/4	60	27 1/2	<b>GS2WMW2H60-</b> <input type="checkbox"/>	1,391	2,015	2,217
	3/4	66	27 1/2	<b>GS2WMW2H66-</b> <input type="checkbox"/>	1,490	2,157	2,373
	3/4	72	27 1/2	<b>GS2WMW2H72-</b> <input type="checkbox"/>	1,571	2,275	2,503
	3/4	78	27 1/2	<b>GS2WMW2H78-</b> <input type="checkbox"/>	1,653	2,398	2,638
	3/4	84	27 1/2	<b>GS2WMW2H84-</b> <input type="checkbox"/>	1,738	2,517	2,769
3/4	90	27 1/2	<b>GS2WMW2H90-</b> <input type="checkbox"/>	1,948	2,821	3,104	

**PRODUCT INFO**

Shelving can be mounted to bottom and center aluminum track.

Shelving ordered separately.

End trim sold separately to cover sides (GS2ENDTRIM28).

**TO ORDER PLEASE SPECIFY THE FOLLOWING:**

WOOD

1. **MODEL NUMBER + W**
2. **FSC**
3. **CHASSIS WOOD FINISH**
4. **EXTRUSION COLOR**

LAM

1. **MODEL NUMBER + L**
2. **FSC**
3. **CHASSIS LAM**
4. **EXTRUSION COLOR**

# WALL MOUNT TACKBOARD IN TACKZONE

For Standard Height Credenzas

Silea

05/22

fabric grades

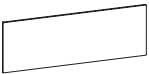
	D	W	H	yards	model number	1	2	3	COM/4
	7/8	24	24 13/16	1.00	<b>GS2TKW24</b>	740	758	779	801
	7/8	30	24 13/16	1.00	<b>GS2TKW30</b>	778	797	820	842
	7/8	36	24 13/16	1.25	<b>GS2TKW36</b>	815	840	868	897
	7/8	42	24 13/16	1.25	<b>GS2TKW42</b>	844	870	898	928
	7/8	48	24 13/16	1.25	<b>GS2TKW48</b>	874	901	930	960
	7/8	54	24 13/16	1.25	<b>GS2TKW54</b>	906	935	963	995
	7/8	60	24 13/16	2.00	<b>GS2TKW60</b>	949	990	1,034	1,078
	7/8	66	24 13/16	2.25	<b>GS2TKW66</b>	964	1,005	1,049	1,093
	7/8	72	24 13/16	2.25	<b>GS2TKW72</b>	1,003	1,049	1,099	1,149
	7/8	78	24 13/16	2.50	<b>GS2TKW78</b>	1,030	1,081	1,137	1,193
	7/8	84	24 13/16	2.75	<b>GS2TKW84</b>	1,060	1,111	1,167	1,223
	7/8	90	24 13/16	2.75	<b>GS2TKW90</b>	1,108	1,164	1,225	1,285
	7/8	96	24 13/16	3.00	<b>GS2TKW96</b>	1,154	1,216	1,282	1,349
	7/8	102	24 13/16	3.25	<b>GS2TKW102</b>	1,592	1,658	1,731	1,804
	7/8	108	24 13/16	3.50	<b>GS2TKW108</b>	1,650	1,722	1,800	1,878

Product Specifications:

### STANDARD

The fabric on all Gunlocke tackboards is applied in a railroad fashion.

- Tackboard widths less than or equal to 96" are one piece
- Tackboards greater than 96" are two piece and the fabric is pattern matched
- When ordering individual wall mount tackboards to be placed side by side, the fabric pattern will be random matched. If a fabric pattern match is required, contact Gunlocke Bid/Quote for a special quote.

### SPECIAL

Fabric applied "up the roll" is a special application. Please see guidelines below and contact Gunlocke Bid/Quote for a special quote.

- Fabrics used on tackboard 48" and under in width can be applied "up the roll"
- Tackboards greater than 48" in width can only be applied railroaded, due to fabric height limitations

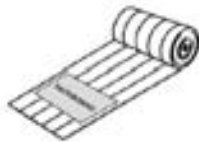

### PRODUCT INFO

102" and 108" wide tackboards are 2 piece.

See yards listed above for COM fabric requirements.

### TO ORDER PLEASE SPECIFY THE FOLLOWING:

LIST

1. **MODEL NUMBER**
2. **FABRIC**
3. **FSC TACKBOARDS**

#### FSC Tackboard Options

**FSC** = FSC Required (5% COM upcharge)

**NR** = FSC Not Required

# WALL MOUNT GLASS WHITEBOARD IN TACKZONE

For Standard Height Credenzas

	D	W	H	model number	glass
	7/8	24	24 13/16	<b>GS2TGW24-GSA</b>	1,478
	7/8	30	24 13/16	<b>GS2TGW30-GSA</b>	1,555
	7/8	36	24 13/16	<b>GS2TGW36-GSA</b>	1,768
	7/8	42	24 13/16	<b>GS2TGW42-GSA</b>	2,044
	7/8	48	24 13/16	<b>GS2TGW48-GSA</b>	2,318
	7/8	54	24 13/16	<b>GS2TGW54-GSA</b>	2,594
	7/8	60	24 13/16	<b>GS2TGW60-GSA</b>	2,899
	7/8	66	24 13/16	<b>GS2TGW66-GSA</b>	3,319
	7/8	72	24 13/16	<b>GS2TGW72-GSA</b>	3,536
	7/8	78	24 13/16	<b>GS2TGW78-GSA</b>	3,920
	7/8	84	24 13/16	<b>GS2TGW84-GSA</b>	4,453
	7/8	90	24 13/16	<b>GS2TGW90-GSA</b>	4,658
	7/8	96	24 13/16	<b>GS2TGW96-GSA</b>	4,881
	7/8	102	24 13/16	<b>GS2TGW102-GSA</b>	5,089
7/8	108	24 13/16	<b>GS2TGW108-GSA</b>	5,305	

## PRODUCT INFO

96", 102" and 108" wide whiteboards are 2 piece.  
Whiteboard frames match glass color.  
Whiteboard is magnetic.

## TO ORDER PLEASE SPECIFY THE FOLLOWING:

GLASS

1. **MODEL NUMBER**
2. **GLASS**

# LAYERS WALL MOUNT TACKBOARD IN TACKZONE

For Layers Height Credenzas

Silea

05/22

fabric grades

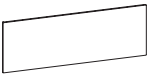
	D	W	H	yards	model number	1	2	3	COM/4
	7/8	24	31 15/16	1.00	<b>GS2TLKW24</b>	776	795	818	840
	7/8	30	31 15/16	1.00	<b>GS2TLKW30</b>	817	838	862	884
	7/8	36	31 15/16	1.25	<b>GS2TLKW36</b>	855	881	911	941
	7/8	42	31 15/16	1.25	<b>GS2TLKW42</b>	886	915	943	977
	7/8	48	31 15/16	1.25	<b>GS2TLKW48</b>	917	946	976	1,009
	7/8	54	31 15/16	1.25	<b>GS2TLKW54</b>	949	981	1,011	1,045
	7/8	60	31 15/16	2.00	<b>GS2TLKW60</b>	996	1,039	1,085	1,132
	7/8	66	31 15/16	2.25	<b>GS2TLKW66</b>	1,014	1,056	1,103	1,150
	7/8	72	31 15/16	2.25	<b>GS2TLKW72</b>	1,054	1,102	1,156	1,207
	7/8	78	31 15/16	2.50	<b>GS2TLKW78</b>	1,083	1,137	1,195	1,255
	7/8	84	31 15/16	2.75	<b>GS2TLKW84</b>	1,113	1,167	1,225	1,285
	7/8	90	31 15/16	2.75	<b>GS2TLKW90</b>	1,163	1,222	1,287	1,349
	7/8	96	31 15/16	3.00	<b>GS2TLKW96</b>	1,210	1,275	1,345	1,415
	7/8	102	31 15/16	3.25	<b>GS2TLKW102</b>	1,671	1,739	1,817	1,893
	7/8	108	31 15/16	3.50	<b>GS2TLKW108</b>	1,733	1,809	1,889	1,972

Product Specifications:

### STANDARD

The fabric on all Gunlocke tackboards is applied in a railroad fashion.

- Tackboard widths less than or equal to 96" are one piece
- Tackboards greater than 96" are two piece and the fabric is pattern matched
- When ordering individual wall mount tackboards to be placed side by side, the fabric pattern will be random matched. If a fabric pattern match is required, contact Gunlocke Bid/Quote for a special quote.

### SPECIAL

Fabric applied "up the roll" is a special application. Please see guidelines below and contact Gunlocke Bid/Quote for a special quote.

- Fabrics used on tackboard 48" and under in width can be applied "up the roll"
- Tackboards greater than 48" in width can only be applied railroaded, due to fabric height limitations



## PRODUCT INFO

102" and 108" wide tackboards are 2 piece.

See yards listed above for COM fabric requirements.

## TO ORDER PLEASE SPECIFY THE FOLLOWING:

LIST

1. **MODEL NUMBER**
2. **FABRIC**
3. **FSC TACKBOARDS**

### FSC Tackboard Options

**FSC** = FSC Required (5% COM upcharge)

**NR** = FSC Not Required

# LAYERS WALL MOUNT GLASS WHITEBOARD IN TACKZONE

For Layers Height Credenzas

	D	W	H	model number	glass
	7/8	24	31 15/16	<b>GS2TLGW24-GSA</b>	1,551
	7/8	30	31 15/16	<b>GS2TLGW30-GSA</b>	1,632
	7/8	36	31 15/16	<b>GS2TLGW36-GSA</b>	1,858
	7/8	42	31 15/16	<b>GS2TLGW42-GSA</b>	2,156
	7/8	48	31 15/16	<b>GS2TLGW48-GSA</b>	2,453
	7/8	54	31 15/16	<b>GS2TLGW54-GSA</b>	2,752
	7/8	60	31 15/16	<b>GS2TLGW60-GSA</b>	3,045
	7/8	66	31 15/16	<b>GS2TLGW66-GSA</b>	3,485
	7/8	72	31 15/16	<b>GS2TLGW72-GSA</b>	3,712
	7/8	78	31 15/16	<b>GS2TLGW78-GSA</b>	4,115
	7/8	84	31 15/16	<b>GS2TLGW84-GSA</b>	4,674
	7/8	90	31 15/16	<b>GS2TLGW90-GSA</b>	4,891
	7/8	96	31 15/16	<b>GS2TLGW96-GSA</b>	5,127
	7/8	102	31 15/16	<b>GS2TLGW102-GSA</b>	5,345
7/8	108	31 15/16	<b>GS2TLGW108-GSA</b>	5,573	

## PRODUCT INFO

96", 102" and 108" wide whiteboards are 2 piece.  
Whiteboard frames match glass color.  
Whiteboard is magnetic.

## TO ORDER PLEASE SPECIFY THE FOLLOWING:

GLASS

1. **MODEL NUMBER**
2. **GLASS**

# TACKBOARD TO TOP OF OVERHEAD

1H and 2H | for Standard Height Credenzas

Silea  
05/22

fabric grades

	D	W	H	yards	model number	1	2	3	COM/4
	7/8	24	39 1/16	1.25	<b>GS2TKW1H24</b>	928	946	967	989
	7/8	30	39 1/16	1.25	<b>GS2TKW1H30</b>	976	995	1,018	1,040
	7/8	36	39 1/16	1.25	<b>GS2TKW1H36</b>	994	1,019	1,047	1,076
	7/8	42	39 1/16	1.50	<b>GS2TKW1H42</b>	1,032	1,064	1,096	1,129
	7/8	48	39 1/16	1.50	<b>GS2TKW1H48</b>	1,064	1,096	1,128	1,161
	7/8	24	52 7/16	1.75	<b>GS2TKW2H24</b>	944	962	983	1,005
	7/8	30	52 7/16	1.75	<b>GS2TKW2H30</b>	994	1,013	1,036	1,058
	7/8	36	52 7/16	1.75	<b>GS2TKW2H36</b>	1,032	1,057	1,085	1,114
	7/8	42	52 7/16	1.75	<b>GS2TKW2H42</b>	1,064	1,096	1,128	1,161
	7/8	48	52 7/16	1.75	<b>GS2TKW2H48</b>	1,091	1,123	1,155	1,188

Product Specifications:

### STANDARD

The fabric on all Gunlocke tackboards is applied in a railroad fashion.

- Tackboard widths less than or equal to 96" are one piece
- Tackboards greater than 96" are two piece and the fabric is pattern matched
- When ordering individual wall mount tackboards to be placed side by side, the fabric pattern will be random matched. If a fabric pattern match is required, contact Gunlocke Bid/Quote for a special quote.

### SPECIAL

Fabric applied "up the roll" is a special application. Please see guidelines below and contact Gunlocke Bid/Quote for a special quote.

- Fabrics used on tackboard 48" and under in width can be applied "up the roll"
- Tackboards greater than 48" in width can only be applied railroaded, due to fabric height limitations



## PRODUCT INFO

See yards listed above for COM fabric requirements.

## TO ORDER PLEASE SPECIFY THE FOLLOWING:

LIST

1. **MODEL NUMBER**
2. **FABRIC**
3. **FSC TACKBOARDS**

#### FSC Tackboard Options

**FSC** = FSC Required (5% COM upcharge)

**NR** = FSC Not Required

# GLASS WHITEBOARD TO TOP OF OVERHEAD

1H and 2H | for Standard Height Credenzas

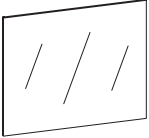
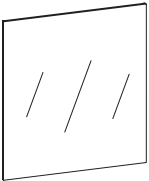
	D	W	H	model number	glass
	7/8	24	39 1/16	<b>GS2TGW1H24-GSA</b>	2,755
	7/8	30	39 1/16	<b>GS2TGW1H30-GSA</b>	2,899
	7/8	36	39 1/16	<b>GS2TGW1H36-GSA</b>	3,319
	7/8	42	39 1/16	<b>GS2TGW1H42-GSA</b>	3,536
	7/8	48	39 1/16	<b>GS2TGW1H48-GSA</b>	3,920
	7/8	24	52 7/16	<b>GS2TGW2H24-GSA</b>	3,153
	7/8	30	52 7/16	<b>GS2TGW2H30-GSA</b>	3,319
	7/8	36	52 7/16	<b>GS2TGW2H36-GSA</b>	3,536
	7/8	42	52 7/16	<b>GS2TGW2H42-GSA</b>	3,920
	7/8	48	52 7/16	<b>GS2TGW2H48-GSA</b>	4,453

## PRODUCT INFO

Whiteboard frames match glass color.

Whiteboard is magnetic.

## TO ORDER PLEASE SPECIFY THE FOLLOWING:

GLASS

1. **MODEL NUMBER**
2. **GLASS**

# LAYERS TACKBOARD TO TOP OF OVERHEAD

1H and 2H | for Layers Height Credenzas

Silea  
05/22

fabric grades

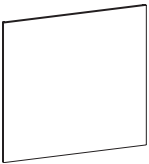
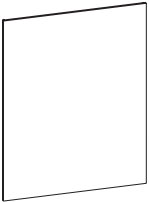
	D	W	H	yards	model number	1	2	3	COM/4
	7/8	24	46 3/16	1.50	<b>GS2TLKW1H24</b>	944	962	983	1,005
	7/8	30	46 3/16	1.50	<b>GS2TLKW1H30</b>	994	1,013	1,036	1,058
	7/8	36	46 3/16	1.50	<b>GS2TLKW1H36</b>	1,032	1,057	1,085	1,114
	7/8	42	46 3/16	1.50	<b>GS2TLKW1H42</b>	1,064	1,096	1,128	1,161
	7/8	48	46 3/16	1.50	<b>GS2TLKW1H48</b>	1,091	1,123	1,155	1,188
	7/8	24	59 9/16	2.00	<b>GS2TLKW2H24</b>	981	999	1,020	1,042
	7/8	30	59 9/16	2.00	<b>GS2TLKW2H30</b>	1,032	1,051	1,074	1,096
	7/8	36	59 9/16	2.00	<b>GS2TLKW2H36</b>	1,064	1,089	1,117	1,146
	7/8	42	59 9/16	2.00	<b>GS2TLKW2H42</b>	1,091	1,123	1,155	1,188
	7/8	48	59 9/16	2.00	<b>GS2TLKW2H48</b>	1,140	1,172	1,204	1,237

Product Specifications:

### STANDARD

The fabric on all Gunlocke tackboards is applied in a railroad fashion.

- Tackboard widths less than or equal to 96" are one piece
- Tackboards greater than 96" are two piece and the fabric is pattern matched
- When ordering individual wall mount tackboards to be placed side by side, the fabric pattern will be random matched. If a fabric pattern match is required, contact Gunlocke Bid/Quote for a special quote.

### SPECIAL

Fabric applied "up the roll" is a special application. Please see guidelines below and contact Gunlocke Bid/Quote for a special quote.

- Fabrics used on tackboard 48" and under in width can be applied "up the roll"
- Tackboards greater than 48" in width can only be applied railroaded, due to fabric height limitations



## PRODUCT INFO

See yards listed above for COM fabric requirements.

## TO ORDER PLEASE SPECIFY THE FOLLOWING:

LIST

1. **MODEL NUMBER**
2. **FABRIC**
3. **FSC TACKBOARDS**

#### FSC Tackboard Options

**FSC** = FSC Required (5% COM upcharge)

**NR** = FSC Not Required



# LAYERS GLASS WHITEBOARD TO TOP OF OVERHEAD

1H and 2H | for Layers Height Credenzas

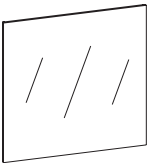
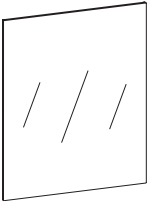
	D	W	H	model number	glass
	7/8	24	46 3/16	<b>GS2TLGW1H24-GSA</b>	2,894
	7/8	30	46 3/16	<b>GS2TLGW1H30-GSA</b>	3,045
	7/8	36	46 3/16	<b>GS2TLGW1H36-GSA</b>	3,485
	7/8	42	46 3/16	<b>GS2TLGW1H42-GSA</b>	3,712
	7/8	48	46 3/16	<b>GS2TLGW1H48-GSA</b>	4,115
	7/8	24	59 9/16	<b>GS2TLGW2H24-GSA</b>	3,312
	7/8	30	59 9/16	<b>GS2TLGW2H30-GSA</b>	3,485
	7/8	36	59 9/16	<b>GS2TLGW2H36-GSA</b>	3,712
	7/8	42	59 9/16	<b>GS2TLGW2H42-GSA</b>	4,115
	7/8	48	59 9/16	<b>GS2TLGW2H48-GSA</b>	4,674

## PRODUCT INFO

Whiteboard frames match glass color.  
Whiteboard is magnetic.

## TO ORDER PLEASE SPECIFY THE FOLLOWING:

GLASS

1. **MODEL NUMBER**
2. **GLASS**

# TACKBOARDS FOR MOUNTING 1H OVERHEADS AT 6H HEIGHT

For Standard Height Credenzas

Silea  
05/22

fabric grades

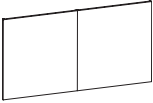
	D	W	H	yards	model number	1	2	3	COM/4
	7/8	24	38 1/4	1.00	<b>GS2TTKW24</b>	926	949	977	1,002
	7/8	30	38 1/4	1.00	<b>GS2TTKW30</b>	974	998	1,027	1,053
	7/8	36	38 1/4	1.25	<b>GS2TTKW36</b>	1,019	1,051	1,085	1,121
	7/8	42	38 1/4	1.50	<b>GS2TTKW42</b>	1,057	1,090	1,124	1,162
	7/8	48	38 1/4	1.50	<b>GS2TTKW48</b>	1,092	1,127	1,163	1,201
	7/8	54	38 1/4	2.00	<b>GS2TTKW54</b>	1,359	1,404	1,446	1,494
	7/8	60	38 1/4	2.00	<b>GS2TTKW60</b>	1,424	1,487	1,552	1,620
	7/8	66	38 1/4	2.25	<b>GS2TTKW66</b>	1,447	1,510	1,575	1,643
	7/8	72	38 1/4	2.50	<b>GS2TTKW72</b>	1,505	1,574	1,650	1,725
	7/8	78	38 1/4	2.50	<b>GS2TTKW78</b>	1,546	1,623	1,706	1,792
	7/8	84	38 1/4	2.75	<b>GS2TTKW84</b>	1,592	1,668	1,752	1,837
	7/8	90	38 1/4	3.00	<b>GS2TTKW90</b>	1,662	1,747	1,839	1,929
	7/8	96	38 1/4	3.00	<b>GS2TTKW96</b>	1,731	1,824	1,924	2,024
	7/8	102	38 1/4	3.50	<b>GS2TTKW102</b>	2,388	2,487	2,597	2,705
7/8	108	38 1/4	3.50	<b>GS2TTKW108</b>	2,477	2,585	2,703	2,818	

- Can be used in height adjustable applications with overheads to create clearance for desk and monitors. Monitor height should be verified.

Product Specifications:

### STANDARD

The fabric on all Gunlocke tackboards is applied in a railroad fashion.

- Tackboard widths less than or equal to 96" are one piece
- Tackboards greater than 96" are two piece and the fabric is pattern matched
- When ordering individual wall mount tackboards to be placed side by side, the fabric pattern will be random matched. If a fabric pattern match is required, contact Gunlocke Bid/Quote for a special quote.

### SPECIAL

Fabric applied "up the roll" is a special application. Please see guidelines below and contact Gunlocke Bid/Quote for a special quote.

- Fabrics used on tackboard 48" and under in width can be applied "up the roll"
- Tackboards greater than 48" in width can only be applied railroaded, due to fabric height limitations

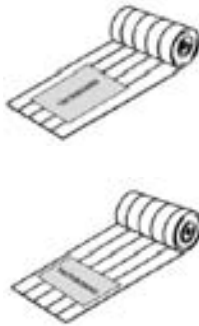

## PRODUCT INFO

54"-96" wide tackboards are 2 piece.

102"-108" wide tackboards are 3 piece.

See yards listed above for COM fabric requirements.

## TO ORDER PLEASE SPECIFY THE FOLLOWING:

LIST

1. **MODEL NUMBER**
2. **FABRIC**
3. **FSC TACKBOARDS**

### FSC Tackboard Options

**FSC** = FSC Required (5% COM upcharge)

**NR** = FSC Not Required

# GLASS WHITEBOARDS FOR MOUNTING 1H OVERHEADS AT 6H HEIGHT

For Standard Height Credenzas

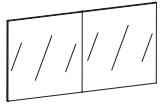

D	W	H	model number	glass
7/8	24	38 1/4	<b>GS2TTGW24-GSA</b>	2,610
7/8	30	38 1/4	<b>GS2TTGW30-GSA</b>	2,899
7/8	36	38 1/4	<b>GS2TTGW36-GSA</b>	3,319
7/8	42	38 1/4	<b>GS2TTGW42-GSA</b>	3,536
7/8	48	38 1/4	<b>GS2TTGW48-GSA</b>	3,920
7/8	54	38 1/4	<b>GS2TTGW54-GSA</b>	4,509
7/8	60	38 1/4	<b>GS2TTGW60-GSA</b>	5,221
7/8	66	38 1/4	<b>GS2TTGW66-GSA</b>	5,597
7/8	72	38 1/4	<b>GS2TTGW72-GSA</b>	5,974
7/8	78	38 1/4	<b>GS2TTGW78-GSA</b>	6,170
7/8	84	38 1/4	<b>GS2TTGW84-GSA</b>	6,365
7/8	90	38 1/4	<b>GS2TTGW90-GSA</b>	6,711
7/8	96	38 1/4	<b>GS2TTGW96-GSA</b>	7,057
7/8	102	38 1/4	<b>GS2TTGW102-GSA</b>	8,585
7/8	108	38 1/4	<b>GS2TTGW108-GSA</b>	8,961

- Can be used in height adjustable applications with overheads to create clearance for desk and monitors. Monitor height should be verified.

## PRODUCT INFO

54"-96" wide whiteboards are 2 piece.  
102"-108" wide whiteboards are 3 piece.  
Whiteboard frames match glass color.  
Whiteboard is magnetic.

## TO ORDER PLEASE SPECIFY THE FOLLOWING:

LIST

- 1. MODEL NUMBER**
- 2. GLASS**

# TACKBOARD FROM FLOOR

To Top of 4H, 5H and 6H

Silea

05/22

fabric grades

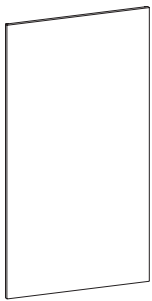

D	W	H	yards	model number	1	2	3	COM/4
7/8	36	54	1.75	<b>GS2WKW4H36</b>	996	1,039	1,085	1,132
7/8	36	68 1/8	2.25	<b>GS2WKW5H36</b>	1,054	1,102	1,156	1,207
7/8	36	81 1/2	2.50	<b>GS2WKW6H36</b>	1,113	1,167	1,225	1,285

## PRODUCT INFO

See yards listed above for COM fabric requirements.

## TO ORDER PLEASE SPECIFY THE FOLLOWING:

LIST

1. **MODEL NUMBER**
2. **FABRIC**
3. **FSC TACKBOARDS**

### FSC Tackboard Options

**FSC** = FSC Required (5% COM upcharge)

**NR** = FSC Not Required

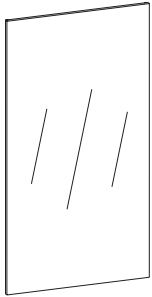

D	W	H	model number	glass
7/8	36	54	<b>GS2WGW4H36</b>	3,045
7/8	36	68 1/8	<b>GS2WGW5H36</b>	3,712
7/8	36	81 1/2	<b>GS2WGW6H36</b>	4,674

**PRODUCT INFO**

Whiteboard frames match glass color.  
Whiteboard is magnetic.

**TO ORDER PLEASE SPECIFY THE FOLLOWING:**

GLASS

1. **MODEL NUMBER**
2. **GLASS**

# WALL MOUNT WALL IN TACKZONE

w/ Center Track | 1H | for Standard Height Credenzas

Silea

05/22

	D	W	H	model number + type	laminate	veneer 1	veneer 2
	3/4	30	24 13/16	<b>GS2TWD30-X</b> [ ]	798	1,155	1,271
	3/4	36	24 13/16	<b>GS2TWD36-X</b> [ ]	857	1,242	1,367
	3/4	42	24 13/16	<b>GS2TWD42-X</b> [ ]	955	1,380	1,518
	3/4	48	24 13/16	<b>GS2TWD48-X</b> [ ]	1,054	1,517	1,669
	3/4	54	24 13/16	<b>GS2TWD54-X</b> [ ]	1,149	1,652	1,818
	3/4	60	24 13/16	<b>GS2TWD60-X</b> [ ]	1,245	1,801	1,982
	3/4	66	24 13/16	<b>GS2TWD66-X</b> [ ]	1,331	1,928	2,121
	3/4	72	24 13/16	<b>GS2TWD72-X</b> [ ]	1,408	2,038	2,242
	3/4	78	24 13/16	<b>GS2TWD78-X</b> [ ]	1,482	2,148	2,363
	3/4	84	24 13/16	<b>GS2TWD84-X</b> [ ]	1,556	2,255	2,481
	3/4	90	24 13/16	<b>GS2TWD90-X</b> [ ]	1,743	2,523	2,776
	3/4	96	24 13/16	<b>GS2TWD96-X</b> [ ]	1,804	2,613	2,875
	3/4	102	24 13/16	<b>GS2TWD102-X</b> [ ]	1,871	2,706	2,977
	3/4	108	24 13/16	<b>GS2TWD108-X</b> [ ]	1,931	2,797	3,077

## PRODUCT INFO

Shelving can be mounted to center aluminum track.  
Shelving ordered separately.  
End trim sold separately to cover sides (GS2ENDTRIM25).

## TO ORDER PLEASE SPECIFY THE FOLLOWING:

### WOOD

- MODEL NUMBER + W**
- FSC**
- CHASSIS WOOD FINISH**
- EXTRUSION COLOR**

### LAM

- MODEL NUMBER + L**
- FSC**
- CHASSIS LAM**
- EXTRUSION COLOR**

# MAGNETIC WALL MOUNT WALL IN TACKZONE

w/ Steel Backer | 1H | for Standard Height Credenzas

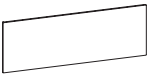
	D	W	H	model number + type	veneer 1	veneer 2
	3/4	24	24 13/16	<b>GS2TWD24-</b> <input type="checkbox"/>	1,551	1,707
	3/4	30	24 13/16	<b>GS2TWD30-</b> <input type="checkbox"/>	1,589	1,748
	3/4	36	24 13/16	<b>GS2TWD36-</b> <input type="checkbox"/>	1,685	1,854
	3/4	42	24 13/16	<b>GS2TWD42-</b> <input type="checkbox"/>	1,835	2,019
	3/4	48	24 13/16	<b>GS2TWD48-</b> <input type="checkbox"/>	1,985	2,184
	3/4	54	24 13/16	<b>GS2TWD54-</b> <input type="checkbox"/>	2,133	2,347
	3/4	60	24 13/16	<b>GS2TWD60-</b> <input type="checkbox"/>	2,281	2,510
	3/4	66	24 13/16	<b>GS2TWD66-</b> <input type="checkbox"/>	2,415	2,657
	3/4	72	24 13/16	<b>GS2TWD72-</b> <input type="checkbox"/>	2,621	2,884
	3/4	78	24 13/16	<b>GS2TWD78-</b> <input type="checkbox"/>	2,706	2,977
	3/4	84	24 13/16	<b>GS2TWD84-</b> <input type="checkbox"/>	2,852	3,138
	3/4	90	24 13/16	<b>GS2TWD90-</b> <input type="checkbox"/>	3,229	3,552
	3/4	96	24 13/16	<b>GS2TWD96-</b> <input type="checkbox"/>	3,323	3,656
	3/4	102	24 13/16	<b>GS2TWD102-</b> <input type="checkbox"/>	3,422	3,765
3/4	108	24 13/16	<b>GS2TWD108-</b> <input type="checkbox"/>	3,604	3,965	

## PRODUCT INFO

Tackzone is magnetic.

End trim sold separately to cover sides (GS2ENDTRIM25).

It is not recommended to stack wood units side by side due to grain variation. Contact Tailored Solutions for a matched set.

## TO ORDER PLEASE SPECIFY THE FOLLOWING:

### WOOD

1. **MODEL NUMBER + W**
2. **FSC**
3. **CHASSIS WOOD FINISH**

# LAYERS WALL MOUNT WALL IN TACKZONE

w/ Center Track | for Layers Height Credenzas

Silea

05/22

	D	W	H	model number + type	laminate	veneer 1	veneer 2
	3/4	30	31 15/16	<b>GS2TLWD30-X</b> [ ]	838	1,214	1,336
	3/4	36	31 15/16	<b>GS2TLWD36-X</b> [ ]	900	1,305	1,436
	3/4	42	31 15/16	<b>GS2TLWD42-X</b> [ ]	1,029	1,491	1,641
	3/4	48	31 15/16	<b>GS2TLWD48-X</b> [ ]	1,132	1,638	1,802
	3/4	54	31 15/16	<b>GS2TLWD54-X</b> [ ]	1,233	1,788	1,967
	3/4	60	31 15/16	<b>GS2TLWD60-X</b> [ ]	1,308	1,896	2,086
	3/4	66	31 15/16	<b>GS2TLWD66-X</b> [ ]	1,400	2,025	2,228
	3/4	72	31 15/16	<b>GS2TLWD72-X</b> [ ]	1,477	2,143	2,358
	3/4	78	31 15/16	<b>GS2TLWD78-X</b> [ ]	1,556	2,258	2,484
	3/4	84	31 15/16	<b>GS2TLWD84-X</b> [ ]	1,636	2,370	2,607
	3/4	90	31 15/16	<b>GS2TLWD90-X</b> [ ]	1,829	2,652	2,918
	3/4	96	31 15/16	<b>GS2TLWD96-X</b> [ ]	1,894	2,747	3,022
	3/4	102	31 15/16	<b>GS2TLWD102-X</b> [ ]	1,963	2,844	3,129
3/4	108	31 15/16	<b>GS2TLWD108-X</b> [ ]	2,027	2,939	3,233	

## PRODUCT INFO

Shelving can be mounted to center aluminum track.  
Shelving ordered separately.  
End trim sold separately to cover sides (GS2ENDTRIM32).

## TO ORDER PLEASE SPECIFY THE FOLLOWING:

### WOOD

1. **MODEL NUMBER + W**
2. **FSC**
3. **CHASSIS WOOD FINISH**
4. **EXTRUSION COLOR**

### LAM

1. **MODEL NUMBER + L**
2. **FSC**
3. **CHASSIS LAM**
4. **EXTRUSION COLOR**



# MAGNETIC WALL MOUNT WALL IN TACKZONE

w/ Steel Backer | for Layers Height Credenzas

	D	W	H	model number + type	veneer 1	veneer 2
	3/4	24	31 15/16	<b>GS2TLWD24-</b> [ ]	1,629	1,792
	3/4	30	31 15/16	<b>GS2TLWD30-</b> [ ]	1,670	1,837
	3/4	36	31 15/16	<b>GS2TLWD36-</b> [ ]	1,769	1,946
	3/4	42	31 15/16	<b>GS2TLWD42-</b> [ ]	1,927	2,120
	3/4	48	31 15/16	<b>GS2TLWD48-</b> [ ]	2,083	2,292
	3/4	54	31 15/16	<b>GS2TLWD54-</b> [ ]	2,240	2,464
	3/4	60	31 15/16	<b>GS2TLWD60-</b> [ ]	2,395	2,635
	3/4	66	31 15/16	<b>GS2TLWD66-</b> [ ]	2,534	2,788
	3/4	72	31 15/16	<b>GS2TLWD72-</b> [ ]	2,754	3,030
	3/4	78	31 15/16	<b>GS2TLWD78-</b> [ ]	2,842	3,127
	3/4	84	31 15/16	<b>GS2TLWD84-</b> [ ]	2,993	3,293
	3/4	90	31 15/16	<b>GS2TLWD90-</b> [ ]	3,389	3,728
	3/4	96	31 15/16	<b>GS2TLWD96-</b> [ ]	3,488	3,837
	3/4	102	31 15/16	<b>GS2TLWD102-</b> [ ]	3,595	3,955
3/4	108	31 15/16	<b>GS2TLWD108-</b> [ ]	3,786	4,165	

## PRODUCT INFO

Tackzone is magnetic.

End trim sold separately to cover sides (GS2ENDTRIM32).

It is not recommended to stack wood units side by side due to grain variation. Contact Tailored Solutions for a matched set.

## TO ORDER PLEASE SPECIFY THE FOLLOWING:

WOOD

1. **MODEL NUMBER + W**
2. **FSC**
3. **CHASSIS WOOD FINISH**

# MAGNETIC WOOD TO TOP OF OVERHEAD

1H | for Standard Height Credenzas

Silea

05/22

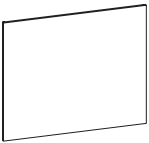
	D	W	H	model number + type	veneer 1	veneer 2
	3/4	24	39 1/16	<b>GS2TWD1H24-</b> <input type="checkbox"/>	2,223	2,446
	3/4	30	39 1/16	<b>GS2TWD1H30-</b> <input type="checkbox"/>	2,281	2,510
	3/4	36	39 1/16	<b>GS2TWD1H36-</b> <input type="checkbox"/>	2,415	2,657
	3/4	42	39 1/16	<b>GS2TWD1H42-</b> <input type="checkbox"/>	2,621	2,884
	3/4	48	39 1/16	<b>GS2TWD1H48-</b> <input type="checkbox"/>	2,706	2,977
	3/4	54	39 1/16	<b>GS2TWD1H54-</b> <input type="checkbox"/>	2,842	3,127
	3/4	60	39 1/16	<b>GS2TWD1H60-</b> <input type="checkbox"/>	2,982	3,281
	3/4	66	39 1/16	<b>GS2TWD1H66-</b> <input type="checkbox"/>	3,133	3,447
	3/4	72	39 1/16	<b>GS2TWD1H72-</b> <input type="checkbox"/>	3,290	3,619
	3/4	78	39 1/16	<b>GS2TWD1H78-</b> <input type="checkbox"/>	3,454	3,800
	3/4	84	39 1/16	<b>GS2TWD1H84-</b> <input type="checkbox"/>	3,627	3,990
	3/4	90	39 1/16	<b>GS2TWD1H90-</b> <input type="checkbox"/>	3,808	4,189
	3/4	96	39 1/16	<b>GS2TWD1H96-</b> <input type="checkbox"/>	3,999	4,399
	3/4	102	39 1/16	<b>GS2TWD1H102-</b> <input type="checkbox"/>	4,199	4,619
3/4	108	39 1/16	<b>GS2TWD1H108-</b> <input type="checkbox"/>	4,409	4,850	

## PRODUCT INFO

Tackzone is magnetic.

End trim sold separately to cover sides (GS2ENDTRIM39 and GS2ENDTRIM53).

It is not recommended to stack wood units side by side due to grain variation. Contact Tailored Solutions for a matched set.

24" - 48" = 1 piece

54" - 102" = 2 piece

108" = 3 piece

## TO ORDER PLEASE SPECIFY THE FOLLOWING:

### WOOD

1. **MODEL NUMBER + W**
2. **FSC**
3. **CHASSIS WOOD FINISH**

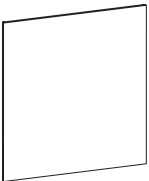
	D	W	H	model number + type	veneer 1	veneer 2
	3/4	24	52 7/16	GS2TWD2H24- [ ]	2,355	2,591
	3/4	30	52 7/16	GS2TWD2H30- [ ]	2,415	2,657
	3/4	36	52 7/16	GS2TWD2H36- [ ]	2,621	2,884
	3/4	42	52 7/16	GS2TWD2H42- [ ]	2,706	2,977
	3/4	48	52 7/16	GS2TWD2H48- [ ]	2,852	3,138
	3/4	54	52 7/16	GS2TWD2H54- [ ]	2,994	3,294
	3/4	60	52 7/16	GS2TWD2H60- [ ]	3,144	3,459
	3/4	66	52 7/16	GS2TWD2H66- [ ]	3,301	3,632
	3/4	72	52 7/16	GS2TWD2H72- [ ]	3,466	3,813
	3/4	78	52 7/16	GS2TWD2H78- [ ]	3,640	4,004
	3/4	84	52 7/16	GS2TWD2H84- [ ]	3,822	4,205
	3/4	90	52 7/16	GS2TWD2H90- [ ]	4,012	4,414
	3/4	96	52 7/16	GS2TWD2H96- [ ]	4,215	4,637
	3/4	102	52 7/16	GS2TWD2H102- [ ]	4,425	4,868
3/4	108	52 7/16	GS2TWD2H108- [ ]	4,646	5,111	

**PRODUCT INFO**

Tackzone is magnetic.  
End trim sold separately to cover sides (GS2ENDTRIM39 and GS2ENDTRIM53).  
It is not recommended to stack wood units side by side due to grain variation. Contact Tailored Solutions for a matched set.  
24" - 48" = 1 piece  
54" - 102" = 2 piece  
108" = 3 piece

**TO ORDER PLEASE SPECIFY THE FOLLOWING:**

WOOD

1. **MODEL NUMBER + W**
2. **FSC**
3. **CHASSIS WOOD FINISH**

# LAYERS MAGNETIC WOOD TO TOP OF OVERHEAD

1H | for Layers Height Credenzas

Silea

05/22

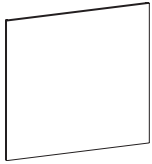

D	W	H	model number	veneer 1	veneer 2
3/4	24	46 3/16	<b>GS2TLWD1H24-</b> <input type="checkbox"/>	2,335	2,569
3/4	30	46 3/16	<b>GS2TLWD1H30-</b> <input type="checkbox"/>	2,395	2,635
3/4	36	46 3/16	<b>GS2TLWD1H36-</b> <input type="checkbox"/>	2,534	2,788
3/4	42	46 3/16	<b>GS2TLWD1H42-</b> <input type="checkbox"/>	2,754	3,030
3/4	48	46 3/16	<b>GS2TLWD1H48-</b> <input type="checkbox"/>	2,842	3,127
3/4	54	46 3/16	<b>GS2TLWD1H54-</b> <input type="checkbox"/>	2,982	3,281
3/4	60	46 3/16	<b>GS2TLWD1H60-</b> <input type="checkbox"/>	3,133	3,447
3/4	66	46 3/16	<b>GS2TLWD1H66-</b> <input type="checkbox"/>	3,290	3,619
3/4	72	46 3/16	<b>GS2TLWD1H72-</b> <input type="checkbox"/>	3,454	3,800
3/4	78	46 3/16	<b>GS2TLWD1H78-</b> <input type="checkbox"/>	3,627	3,990
3/4	84	46 3/16	<b>GS2TLWD1H84-</b> <input type="checkbox"/>	3,808	4,189
3/4	90	46 3/16	<b>GS2TLWD1H90-</b> <input type="checkbox"/>	3,999	4,399
3/4	96	46 3/16	<b>GS2TLWD1H96-</b> <input type="checkbox"/>	4,199	4,619
3/4	102	46 3/16	<b>GS2TLWD1H102-</b> <input type="checkbox"/>	4,409	4,850
3/4	108	46 3/16	<b>GS2TLWD1H108-</b> <input type="checkbox"/>	4,629	5,092

## PRODUCT INFO

Tackzone is magnetic.

End trim sold separately to cover sides (GS2ENDTRIM46 and GS2ENDTRIM60).

It is not recommended to stack wood units side by side due to grain variation. Contact Tailored Solutions for a matched set.

24" - 48" = 1 piece

54" - 102" = 2 piece

108" = 3 piece

## TO ORDER PLEASE SPECIFY THE FOLLOWING:

### WOOD

1. **MODEL NUMBER + W**
2. **FSC**
3. **CHASSIS WOOD FINISH**

# LAYERS MAGNETIC WOOD TO TOP OF OVERHEAD

2H | for Layers Height Credenzas

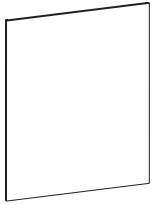

D	W	H	model number	veneer 1	veneer 2
3/4	24	59 9/16	<b>GS2TLWD2H24-</b> [ ]	2,472	2,720
3/4	30	59 9/16	<b>GS2TLWD2H30-</b> [ ]	2,534	2,788
3/4	36	59 9/16	<b>GS2TLWD2H36-</b> [ ]	2,754	3,030
3/4	42	59 9/16	<b>GS2TLWD2H42-</b> [ ]	2,842	3,127
3/4	48	59 9/16	<b>GS2TLWD2H48-</b> [ ]	2,993	3,293
3/4	54	59 9/16	<b>GS2TLWD2H54-</b> [ ]	3,144	3,459
3/4	60	59 9/16	<b>GS2TLWD2H60-</b> [ ]	3,301	3,632
3/4	66	59 9/16	<b>GS2TLWD2H66-</b> [ ]	3,466	3,813
3/4	72	59 9/16	<b>GS2TLWD2H72-</b> [ ]	3,640	4,004
3/4	78	59 9/16	<b>GS2TLWD2H78-</b> [ ]	3,822	4,205
3/4	84	59 9/16	<b>GS2TLWD2H84-</b> [ ]	4,012	4,414
3/4	90	59 9/16	<b>GS2TLWD2H90-</b> [ ]	4,215	4,637
3/4	96	59 9/16	<b>GS2TLWD2H96-</b> [ ]	4,425	4,868
3/4	102	59 9/16	<b>GS2TLWD2H102-</b> [ ]	4,646	5,111
3/4	108	59 9/16	<b>GS2TLWD2H108-</b> [ ]	4,877	5,365

## PRODUCT INFO

Tackzone is magnetic.

End trim sold separately to cover sides (GS2ENDTRIM46 and GS2ENDTRIM60).

It is not recommended to stack wood units side by side due to grain variation. Contact Tailored Solutions for a matched set.

24" - 48" = 1 piece

54" - 102" = 2 piece

108" = 3 piece

## TO ORDER PLEASE SPECIFY THE FOLLOWING:

### WOOD

1. **MODEL NUMBER + W**
2. **FSC**
3. **CHASSIS WOOD FINISH**

# MAGNETIC WOOD TACKZONE FOR MOUNTING 1H OVERHEADS AT 6H HEIGHT

for Standard Height Credenzas

Silea  
05/22

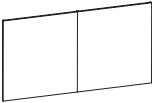
	D	W	H	model number + type	veneer 1	veneer 2
	7/8	24	38 1/4	<b>GS2TTWD24-</b> [ ]	2,223	2,446
	7/8	30	38 1/4	<b>GS2TTWD30-</b> [ ]	2,281	2,510
	7/8	36	38 1/4	<b>GS2TTWD36-</b> [ ]	2,415	2,657
	7/8	42	38 1/4	<b>GS2TTWD42-</b> [ ]	2,621	2,884
	7/8	48	38 1/4	<b>GS2TTWD48-</b> [ ]	2,706	2,977
	7/8	54	38 1/4	<b>GS2TTWD54-</b> [ ]	2,842	3,127
	7/8	60	38 1/4	<b>GS2TTWD60-</b> [ ]	2,982	3,281
	7/8	66	38 1/4	<b>GS2TTWD66-</b> [ ]	3,133	3,447
	7/8	72	38 1/4	<b>GS2TTWD72-</b> [ ]	3,290	3,619
	7/8	78	38 1/4	<b>GS2TTWD78-</b> [ ]	3,454	3,800
	7/8	84	38 1/4	<b>GS2TTWD84-</b> [ ]	3,627	3,990
	7/8	90	38 1/4	<b>GS2TTWD90-</b> [ ]	3,808	4,189
	7/8	96	38 1/4	<b>GS2TTWD96-</b> [ ]	3,999	4,399
	7/8	102	38 1/4	<b>GS2TTWD102-</b> [ ]	4,199	4,619
7/8	108	38 1/4	<b>GS2TTWD108-</b> [ ]	4,409	4,850	

- Can be used in height adjustable applications with overheads to create clearance for desk and monitors. Monitor height should be verified.

## PRODUCT INFO

Tackzone is magnetic.

It is not recommended to stack wood units side by side due to grain variation. Contact Tailored Solutions for a matched set.

54"-96" models are 2-piece.

102"-108" models are 3-piece.

## TO ORDER PLEASE SPECIFY THE FOLLOWING:

WOOD

1. **MODEL NUMBER + W**
2. **FSC**
3. **CHASSIS WOOD FINISH**

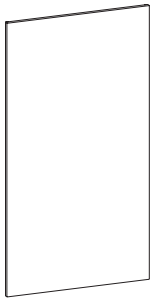

D	W	H	model number + type	veneer 1	veneer 2
3/4	36	54	GS2WWD4H36- [ ]	2,281	2,510
3/4	36	68 1/8	GS2WWD5H36- [ ]	2,621	2,884
3/4	36	81 1/2	GS2WWD6H36- [ ]	2,852	3,138

**PRODUCT INFO**

Tackzone is magnetic. It is not recommended to stack wood units side by side due to grain variation. Contact Tailored Solutions for a matched set.

**TO ORDER PLEASE SPECIFY THE FOLLOWING:**



WOOD

1. **MODEL NUMBER + W**
2. **FSC**
3. **CHASSIS WOOD FINISH**

# SHELVING FOR WALL MOUNT WALL

8 1/2" depth

Silea  
05/22

	D	W	H	model number + type	laminate	aluminum	veneer 1	veneer 2
<b>ALUMINUM</b>  Side view	8 1/2	30	3/4	<b>GS2ASF830-</b> [ ]	586	767	850	935
	8 1/2	36	3/4	<b>GS2ASF836-</b> [ ]	635	828	919	1,011
	8 1/2	42	3/4	<b>GS2ASF842-</b> [ ]	706	906	1,025	1,128
	8 1/2	48	3/4	<b>GS2ASF848-</b> [ ]	778	995	1,127	1,240
	8 1/2	54	3/4	<b>GS2ASF854-</b> [ ]	850	1,085	1,232	1,356
	8 1/2	60	3/4	<b>GS2ASF860-</b> [ ]	920	1,199	1,329	1,462
	8 1/2	66	3/4	<b>GS2ASF866-</b> [ ]	982	1,280	1,423	1,566
	8 1/2	72	3/4	<b>GS2ASF872-</b> [ ]	1,038	1,349	1,501	1,652
	8 1/2	78	3/4	<b>GS2ASF878-</b> [ ]	1,092	1,424	1,584	1,743
	8 1/2	84	3/4	<b>GS2ASF884-</b> [ ]	1,151	1,496	1,663	1,830
<b>LAM / WOOD</b>  Side view	8 1/2	90	3/4	<b>GS2ASF890-</b> [ ]	1,285	1,674	1,862	2,049
	8 1/2	96	3/4	<b>GS2ASF896-</b> [ ]	1,334	1,733	1,927	2,120
	8 1/2	102	3/4	<b>GS2ASF8102-</b> [ ]	1,379	1,794	1,993	2,193
	8 1/2	108	3/4	<b>GS2ASF8108-</b> [ ]	1,425	1,855	2,061	2,268
	8 1/2	114	3/4	<b>GS2ASF8114-</b> [ ]	1,701	2,067	2,466	2,713
	8 1/2	120	3/4	<b>GS2ASF8120-</b> [ ]	1,840	2,395	2,661	2,928
	8 1/2	132	3/4	<b>GS2ASF8132-</b> [ ]	1,970	N/A	2,853	3,139
	8 1/2	144	3/4	<b>GS2ASF8144-</b> [ ]	2,077	N/A	3,010	3,311

• Note: Weight capacity for 8 1/2" depth shelves is 1.75 lbs per linear inch of shelf width. Load should be evenly distributed.

## PRODUCT INFO

Aluminum shelf is powder coated.

An aluminum rail is mounted to back of shelf.

Laminate shelves (2) piece above 96".

All aluminum shelves are (1) piece.

Wood shelves (2) piece above 120".

Light ordered separately:  
 30" and 36" = (1) 24" light  
 60" = (1) 48" light  
 66" through 108" = (1) 60" light  
 120" = (2) 48" lights

## TO ORDER PLEASE SPECIFY THE FOLLOWING:

### WOOD

- MODEL NUMBER + W**
- FSC**
- CHASSIS WOOD FINISH**
- EXTRUSION COLOR**























### ALUMINUM

- MODEL NUMBER + A**
- EXTRUSION COLOR**

### LAM

- MODEL NUMBER + L**
- FSC**
- CHASSIS LAM**
- EXTRUSION COLOR**



	D	W	H	model number + type	laminate	aluminum	veneer 1	veneer 2	
<b>ALUMINUM</b>   Side view	12 1/2	30	3/4	<b>GS2ASF1230-</b> 	652	852	947	1,042	
	12 1/2	36	3/4	<b>GS2ASF1236-</b> 	704	920	1,022	1,125	
	12 1/2	42	3/4	<b>GS2ASF1242-</b> 	785	1,006	1,138	1,252	
	12 1/2	48	3/4	<b>GS2ASF1248-</b> 	865	1,105	1,253	1,379	
	12 1/2	54	3/4	<b>GS2ASF1254-</b> 	944	1,203	1,368	1,505	
	12 1/2	60	3/4	<b>GS2ASF1260-</b> 	1,022	1,329	1,478	1,626	
	12 1/2	66	3/4	<b>GS2ASF1266-</b> 	1,092	1,423	1,581	1,740	
	12 1/2	72	3/4	<b>GS2ASF1272-</b> 	1,153	1,535	1,667	1,834	
	<b>LAM / WOOD</b>   Side view	12 1/2	78	3/4	<b>GS2ASF1278-</b> 	1,217	1,616	1,759	1,935
		12 1/2	84	3/4	<b>GS2ASF1284-</b> 	1,280	1,700	1,849	2,034
12 1/2		90	3/4	<b>GS2ASF1290-</b> 	1,429	1,861	2,068	2,275	
12 1/2		96	3/4	<b>GS2ASF1296-</b> 	1,478	1,926	2,141	2,356	
12 1/2		102	3/4	<b>GS2ASF12102-</b> 	1,530	1,993	2,216	2,438	
12 1/2		108	3/4	<b>GS2ASF12108-</b> 	1,583	2,107	2,290	2,519	
12 1/2		114	3/4	<b>GS2ASF12114-</b> 	1,833	2,301	2,658	2,924	
12 1/2		120	3/4	<b>GS2ASF12120-</b> 	2,044	2,663	2,959	3,255	
12 1/2		132	3/4	<b>GS2ASF12132-</b> 	2,188	N/A	3,169	3,486	
12 1/2		144	3/4	<b>GS2ASF12144-</b> 	2,307	N/A	3,346	3,681	

• Note: Weight capacity for 12 1/2" depth shelves is 2.50 lbs per linear inch of shelf width. Load should be evenly distributed.

**PRODUCT INFO**

Aluminum shelf is powder coated.

An aluminum rail is mounted to back of shelf.

Laminate shelves (2) piece above 96".

All aluminum shelves are (1) piece.

Wood shelves (2) piece above 120".

Light ordered separately:  
 30" and 36" = (1) 24" light  
 60" = (1) 48" light  
 66" through 108" = (1) 60" light  
 120" = (2) 48" lights

**TO ORDER PLEASE SPECIFY THE FOLLOWING:**

**WOOD**

- MODEL NUMBER + W**
- FSC**
- CHASSIS WOOD FINISH**
- EXTRUSION COLOR**

**ALUMINUM**

- MODEL NUMBER + A**
- EXTRUSION COLOR**

**LAM**

- MODEL NUMBER + L**
- FSC**
- CHASSIS LAM**
- EXTRUSION COLOR**

D	W	H	model number	in
1/8	1	24 13/16	<b>GS2ENDTRIM25</b>	98
• For Standard tack only				
1/8	1	31 15/16	<b>GS2ENDTRIM32</b>	71
• For Layers tack only				
1/8	1	14 1/8	<b>GS2ENDTRIM14</b>	100
• For 1H overhead only				
1/8	1	27 1/2	<b>GS2ENDTRIM28</b>	69
• For 2H overhead only				
1/8	1	39 1/16	<b>GS2ENDTRIM39</b>	122
• For Standard tack and 1H overhead				
1/8	1	52 7/16	<b>GS2ENDTRIM53</b>	124
• For Standard tack and 2H overhead				
1/8	1	46 3/16	<b>GS2ENDTRIM46</b>	77
• For Layers tack and 1H overhead				
1/8	1	59 9/16	<b>GS2ENDTRIM60</b>	80
• For Layers tack and 2H overhead				

## PRODUCT INFO

End trim to be used on the side of wall mount walls.

## TO ORDER PLEASE SPECIFY THE FOLLOWING:

LIST

1. **MODEL NUMBER**
2. **HARDWARE COLOR**

	D	W	H	model number + type	laminata	veneer 1	veneer 2
	8	30	1 3/16	<b>GS2FSF830-</b> <input type="checkbox"/>	599	867	954
	8	36	1 3/16	<b>GS2FSF836-</b> <input type="checkbox"/>	648	938	1,032
	8	42	1 3/16	<b>GS2FSF842-</b> <input type="checkbox"/>	762	1,105	1,216
	8	48	1 3/16	<b>GS2FSF848-</b> <input type="checkbox"/>	857	1,242	1,367
	8	54	1 3/16	<b>GS2FSF854-</b> <input type="checkbox"/>	899	1,302	1,433
	8	60	1 3/16	<b>GS2FSF860-</b> <input type="checkbox"/>	937	1,359	1,495
	8	66	1 3/16	<b>GS2FSF866-</b> <input type="checkbox"/>	986	1,429	1,572
	8	72	1 3/16	<b>GS2FSF872-</b> <input type="checkbox"/>	1,058	1,534	1,688

**NOTE:** For display purposes only.  
5 lb. weight restriction per linear foot.

PRODUCT INFO	TO ORDER PLEASE SPECIFY THE FOLLOWING:		
	<table style="width: 100%; border: none;"> <tr> <td style="width: 50%; vertical-align: top;"> <p>WOOD</p> <ol style="list-style-type: none"> <li>1. <b>MODEL NUMBER + W</b></li> <li>2. <b>FSC</b></li> <li>3. <b>CHASSIS WOOD FINISH</b></li> </ol> </td> <td style="width: 50%; vertical-align: top;"> <p>LAM</p> <ol style="list-style-type: none"> <li>1. <b>MODEL NUMBER + L</b></li> <li>2. <b>FSC</b></li> <li>3. <b>CHASSIS LAM</b></li> </ol> </td> </tr> </table>	<p>WOOD</p> <ol style="list-style-type: none"> <li>1. <b>MODEL NUMBER + W</b></li> <li>2. <b>FSC</b></li> <li>3. <b>CHASSIS WOOD FINISH</b></li> </ol>	<p>LAM</p> <ol style="list-style-type: none"> <li>1. <b>MODEL NUMBER + L</b></li> <li>2. <b>FSC</b></li> <li>3. <b>CHASSIS LAM</b></li> </ol>
<p>WOOD</p> <ol style="list-style-type: none"> <li>1. <b>MODEL NUMBER + W</b></li> <li>2. <b>FSC</b></li> <li>3. <b>CHASSIS WOOD FINISH</b></li> </ol>	<p>LAM</p> <ol style="list-style-type: none"> <li>1. <b>MODEL NUMBER + L</b></li> <li>2. <b>FSC</b></li> <li>3. <b>CHASSIS LAM</b></li> </ol>		

# WALL MOUNT EXTERNAL TOPS

For Units with Doors

Silea

05/22

D	W	H	model number + type	laminata	veneer 1	veneer 2
16 1/4	30	1 3/16	<b>GS2OHTOPD30-</b> <input type="checkbox"/>	381	1,086	1,195
16 1/4	36	1 3/16	<b>GS2OHTOPD36-</b> <input type="checkbox"/>	433	1,079	1,187
16 1/4	42	1 3/16	<b>GS2OHTOPD42-</b> <input type="checkbox"/>	479	747	822
16 1/4	48	1 3/16	<b>GS2OHTOPD48-</b> <input type="checkbox"/>	540	843	928
16 1/4	54	1 3/16	<b>GS2OHTOPD54-</b> <input type="checkbox"/>	592	922	1,015
16 1/4	60	1 3/16	<b>GS2OHTOPD60-</b> <input type="checkbox"/>	651	1,018	1,120
16 1/4	66	1 3/16	<b>GS2OHTOPD66-</b> <input type="checkbox"/>	697	1,090	1,199
16 1/4	72	1 3/16	<b>GS2OHTOPD72-</b> <input type="checkbox"/>	748	1,169	1,286
16 1/4	78	1 3/16	<b>GS2OHTOPD78-</b> <input type="checkbox"/>	800	1,250	1,375
16 1/4	84	1 3/16	<b>GS2OHTOPD84-</b> <input type="checkbox"/>	847	1,320	1,452
16 1/4	90	1 3/16	<b>GS2OHTOPD90-</b> <input type="checkbox"/>	898	1,401	1,542
16 1/4	96	1 3/16	<b>GS2OHTOPD96-</b> <input type="checkbox"/>	949	1,480	1,628
16 1/4	102	1 3/16	<b>GS2OHTOPD102-</b> <input type="checkbox"/>	994	1,552	1,708
16 1/4	108	1 3/16	<b>GS2OHTOPD108-</b> <input type="checkbox"/>	1,045	1,632	1,796
16 1/4	114	1 3/16	<b>GS2OHTOPD114-</b> <input type="checkbox"/>	1,106	1,727	1,900
16 1/4	120	1 3/16	<b>GS2OHTOPD120-</b> <input type="checkbox"/>	1,157	1,808	1,989

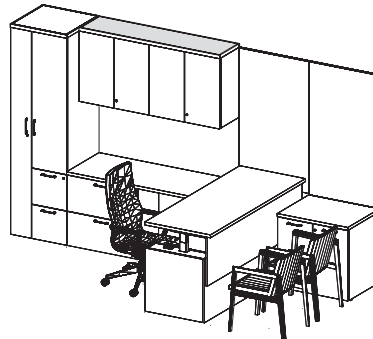

## PRODUCT INFO

## TO ORDER PLEASE SPECIFY THE FOLLOWING:

### WOOD TOP

1. **MODEL NUMBER + W**
2. **FSC**
3. **TOP WOOD FINISH + EDGE**
4. **TOP FINISH**

#### Top Finish Option:

Non-UV Open Pore Finish  
Full Fill UV Top Finish

### LAM TOP

1. **MODEL NUMBER + L**
2. **FSC**
3. **TOP LAM**

**NR**  
**FF (+\$250)**

	D	W	H	model number + type	laminata	veneer 1	veneer 2
	15 3/8	30	1 3/16	<b>GS2OHTOPN30-</b> <input type="checkbox"/>	381	596	656
	15 3/8	36	1 3/16	<b>GS2OHTOPN36-</b> <input type="checkbox"/>	433	1,039	1,143
	15 3/8	42	1 3/16	<b>GS2OHTOPN42-</b> <input type="checkbox"/>	479	747	822
	15 3/8	48	1 3/16	<b>GS2OHTOPN48-</b> <input type="checkbox"/>	540	843	928
	15 3/8	54	1 3/16	<b>GS2OHTOPN54-</b> <input type="checkbox"/>	592	922	1,015
	15 3/8	60	1 3/16	<b>GS2OHTOPN60-</b> <input type="checkbox"/>	651	1,018	1,120
	15 3/8	66	1 3/16	<b>GS2OHTOPN66-</b> <input type="checkbox"/>	697	1,090	1,199
	15 3/8	72	1 3/16	<b>GS2OHTOPN72-</b> <input type="checkbox"/>	748	1,169	1,286
	15 3/8	78	1 3/16	<b>GS2OHTOPN78-</b> <input type="checkbox"/>	800	1,250	1,375
	15 3/8	84	1 3/16	<b>GS2OHTOPN84-</b> <input type="checkbox"/>	847	1,320	1,452
	15 3/8	90	1 3/16	<b>GS2OHTOPN90-</b> <input type="checkbox"/>	898	1,401	1,542
	15 3/8	96	1 3/16	<b>GS2OHTOPN96-</b> <input type="checkbox"/>	949	1,480	1,628
	15 3/8	102	1 3/16	<b>GS2OHTOPN102-</b> <input type="checkbox"/>	994	1,552	1,708
	15 3/8	108	1 3/16	<b>GS2OHTOPN108-</b> <input type="checkbox"/>	1,045	1,632	1,796
	15 3/8	114	1 3/16	<b>GS2OHTOPN114-</b> <input type="checkbox"/>	1,106	1,727	1,900
	15 3/8	120	1 3/16	<b>GS2OHTOPN120-</b> <input type="checkbox"/>	1,157	1,808	1,989

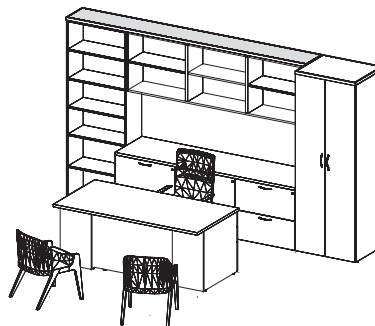

**PRODUCT INFO**

**TO ORDER PLEASE SPECIFY THE FOLLOWING:**

WOOD TOP

1. **MODEL NUMBER + W**
2. **FSC**
3. **TOP WOOD FINISH + EDGE**
4. **TOP FINISH**

**Top Finish Option:**  
 Non-UV Open Pore Finish  
 Full Fill UV Top Finish

LAM TOP

1. **MODEL NUMBER + L**
2. **FSC**
3. **TOP LAM**

**NR**  
**FF (+\$250)**



Surface Mount . . . . .	319-334
Cabinets . . . . .	320-324
Towers . . . . .	325-330
Tackboard / Glass Whiteboard . . . . .	331-332
External Tops . . . . .	333-334

# SURFACE MOUNT CABINETS

w/ Hinged Doors | 1H

Silea

05/22

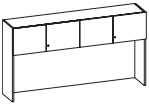
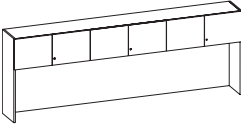
	D	W	H	model number + type	laminate	veneer 1	veneer 2
	15 3/4	59 7/8	39 1/16	<b>GS2SMC1H60-</b> [ ]	3,871	5,602	6,163
	15 3/4	65 7/8	39 1/16	<b>GS2SMC1H66-</b> [ ]	4,014	5,809	6,390
	15 3/4	71 7/8	39 1/16	<b>GS2SMC1H72-</b> [ ]	4,348	6,290	6,919
	15 3/4	77 7/8	39 1/16	<b>GS2SMC1H78-</b> [ ]	4,432	6,413	7,055
	15 3/4	83 7/8	39 1/16	<b>GS2SMC1H84-</b> [ ]	4,656	6,737	7,411
	15 3/4	89 7/8	39 1/16	<b>GS2SMC1H90-</b> [ ]	4,905	7,096	7,806
	15 3/4	95 7/8	39 1/16	<b>GS2SMC1H96-</b> [ ]	5,156	7,461	8,208
	15 3/4	101 7/8	39 1/16	<b>GS2SMC1H102-</b> [ ]	N/A	8,142	8,957
	15 3/4	107 7/8	39 1/16	<b>GS2SMC1H108-</b> [ ]	N/A	8,671	9,539

## PRODUCT INFO

# of doors:  
 60" through 78" = 4 doors  
 84" through 108" = 6 doors  
 All units have a finished back.  
 If tasklight cord grommet is chosen (WY), a 1 1/4" hole is included in back panel.

## TO ORDER PLEASE SPECIFY THE FOLLOWING:

- |                                  |                                  |
|----------------------------------|----------------------------------|
| WOOD CHASSIS, WOOD DOOR          | LAM CHASSIS, LAM DOOR            |
| 1. <b>MODEL NUMBER + WW</b>      | 1. <b>MODEL NUMBER + LL</b>      |
| 2. <b>FSC</b>                    | 2. <b>FSC</b>                    |
| 3. <b>CHASSIS WOOD FINISH</b>    | 3. <b>CHASSIS LAM</b>            |
| 4. <b>TASKLIGHT CORD GROMMET</b> | 4. <b>FRONT LAM</b>              |
| 5. <b>LOCKS</b>                  | 5. <b>TASKLIGHT CORD GROMMET</b> |
| 6. <b>KEYING</b>                 | 6. <b>LOCKS</b>                  |
|                                  | 7. <b>KEYING</b>                 |

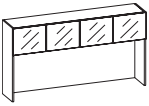
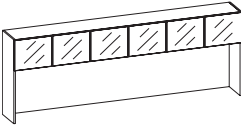

	D	W	H	model number + type	veneer 1	veneer 2
  	15 3/4	59 7/8	39 1/16	<b>GS2SMC1H60-</b> [ ]	6,844	7,529
	15 3/4	71 7/8	39 1/16	<b>GS2SMC1H72-</b> [ ]	7,689	8,458
	15 3/4	89 7/8	39 1/16	<b>GS2SMC1H90-</b> [ ]	8,675	9,543
	15 3/4	107 7/8	39 1/16	<b>GS2SMC1H108-</b> [ ]	10,597	11,657

**PRODUCT INFO**

# of doors:  
60" and 72" = 4 doors  
90" and 108" = 6 doors  
All units have a finished back.  
Glass doors do not lock.  
Door frames match glass color.  
If tasklight cord grommet is chosen (WY), a 1 1/4" hole is included in back panel.

**TO ORDER PLEASE SPECIFY THE FOLLOWING:**

- WOOD CHASSIS, GLASS DOOR
1. **MODEL NUMBER + WG**
  2. **FSC**
  3. **CHASSIS WOOD FINISH**
  4. **GLASS**
  5. **TASKLIGHT CORD GROMMET**

# SURFACE MOUNT CABINETS

No Doors | 1H

Silea

05/22

	D	W	H	model number + type	laminata	veneer 1	veneer 2
	14 7/8	59 7/8	39 1/16	<b>GS2SMC1H60-</b> [ ]	3,291	4,767	5,244
	14 7/8	65 7/8	39 1/16	<b>GS2SMC1H66-</b> [ ]	3,413	4,944	5,439
	14 7/8	71 7/8	39 1/16	<b>GS2SMC1H72-</b> [ ]	3,694	5,354	5,890
	14 7/8	77 7/8	39 1/16	<b>GS2SMC1H78-</b> [ ]	3,767	5,461	6,008
	14 7/8	83 7/8	39 1/16	<b>GS2SMC1H84-</b> [ ]	3,956	5,734	6,308
	14 7/8	89 7/8	39 1/16	<b>GS2SMC1H90-</b> [ ]	4,168	6,039	6,643
	14 7/8	95 7/8	39 1/16	<b>GS2SMC1H96-</b> [ ]	4,382	6,352	6,988
	14 7/8	101 7/8	39 1/16	<b>GS2SMC1H102-</b> [ ]	N/A	6,929	7,622
	14 7/8	107 7/8	39 1/16	<b>GS2SMC1H108-</b> [ ]	N/A	7,380	8,118

## PRODUCT INFO

# of doors:

60" through 78" = 4 doors

84" and 90" = 6 doors

All units have a finished back.

If tasklight cord grommet is chosen (WY), a 1 1/4" hole is included in back panel.

## TO ORDER PLEASE SPECIFY THE FOLLOWING:

WOOD CHASSIS

1. **MODEL NUMBER + WN**
2. **FSC**
3. **CHASSIS WOOD FINISH**
4. **TASKLIGHT CORD GROMMET**

LAM CHASSIS

1. **MODEL NUMBER + LN**
2. **FSC**
3. **CHASSIS LAM**
4. **TASKLIGHT CORD GROMMET**

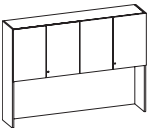
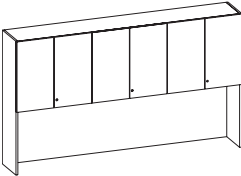
	D	W	H	model number + type	veneer 1	veneer 2
	15 3/4	59 7/8	52 7/16	<b>GS2SMC2H60-</b> [ ]	6,791	7,471
	15 3/4	65 7/8	52 7/16	<b>GS2SMC2H66-</b> [ ]	6,966	7,663
	15 3/4	71 7/8	52 7/16	<b>GS2SMC2H72-</b> [ ]	7,250	7,975
	15 3/4	77 7/8	52 7/16	<b>GS2SMC2H78-</b> [ ]	7,668	8,435
	15 3/4	83 7/8	52 7/16	<b>GS2SMC2H84-</b> [ ]	8,053	8,859
	15 3/4	89 7/8	52 7/16	<b>GS2SMC2H90-</b> [ ]	8,438	9,282

• Not for use w/ credenza trough top.

**PRODUCT INFO**

# of doors:  
60" through 78" = 4 doors  
84" and 90" = 6 doors  
All units have a finished back.  
If tasklight cord grommet is chosen (WY), a 1 1/4" hole is included in back panel.

**TO ORDER PLEASE SPECIFY THE FOLLOWING:**

- WOOD CHASSIS, WOOD DOOR
- 1. MODEL NUMBER + WW**
  - 2. FSC**
  - 3. CHASSIS WOOD FINISH**
  - 4. TASKLIGHT CORD GROMMET**
  - 5. LOCKS**
  - 6. KEYING**

# SURFACE MOUNT CABINETS

w/ Hinged Glass Doors | 2H

Silea

05/22

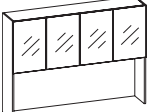
	D	W	H	model number + type	veneer 1	veneer 2
	15 3/4	59 7/8	52 7/16	<b>GS2SMC2H60-</b> [ ]	8,302	9,133
	15 3/4	71 7/8	52 7/16	<b>GS2SMC2H72-</b> [ ]	8,861	9,748
	15 3/4	89 7/8	52 7/16	<b>GS2SMC2H90-</b> [ ]	10,314	11,346

• Not for use w/ credenza trough top.

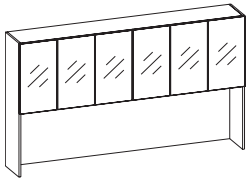

## PRODUCT INFO

# of doors:

60" and 72" = 4 doors

90" = 6 doors

Glass doors do not lock.

All units have a finished back.





Door frames match glass color.

If tasklight cord grommet is chosen (WY), a 1 1/4" hole is included in back panel.

## TO ORDER PLEASE SPECIFY THE FOLLOWING:

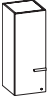
WOOD CHASSIS, GLASS DOOR

1. **MODEL NUMBER + WG**
2. **FSC**
3. **CHASSIS WOOD FINISH**
4. **GLASS**
5. **TASKLIGHT CORD GROMMET**

		D	W	H	model number + type	laminate	veneer 1	veneer 2	
<b>15" WIDTH</b>									
	1 door Door hinged left	LEFT	15 3/4	15	39 1/16	<b>GS2STF1H15L-</b> <input type="checkbox"/>	1,143	1,449	1,594
		RIGHT	15 3/4	15	39 1/16	<b>GS2STF1H15R-</b> <input type="checkbox"/>	1,143	1,449	1,594
<b>18" WIDTH</b>									
	1 door Door hinged left	LEFT	15 3/4	18	39 1/16	<b>GS2STF1H18L-</b> <input type="checkbox"/>	1,429	1,810	1,991
		RIGHT	15 3/4	18	39 1/16	<b>GS2STF1H18R-</b> <input type="checkbox"/>	1,429	1,810	1,991
<b>30" WIDTH</b>									
	2 doors		15 3/4	30	39 1/16	<b>GS2STF1H30-</b> <input type="checkbox"/>	2,315	2,929	3,222
<b>36" WIDTH</b>									
	2 doors		15 3/4	36	39 1/16	<b>GS2STF1H36-</b> <input type="checkbox"/>	2,604	3,300	3,630

**PRODUCT INFO**

All units have a finished back.  
If integral pull is chosen for wood, doors will be touch latch.

**TO ORDER PLEASE SPECIFY THE FOLLOWING:**

WOOD CHASSIS, WOOD DOOR

1. **MODEL NUMBER + WW**
2. **FSC**
3. **CHASSIS WOOD FINISH**
4. **PULLS**
5. **LOCKS**
6. **KEYING**

LAM CHASSIS, LAM DOOR





1. **MODEL NUMBER + LL**
2. **FSC**
3. **CHASSIS LAM**
4. **FRONT LAM**
5. **PULLS**
6. **LOCKS**
7. **KEYING**

# SURFACE MOUNT TOWERS

w/ Hinged Glass Doors | 1H

Silea

05/22

	D	W	H	model number + type	veneer 1	veneer 2	
<b>15" WIDTH</b>							
 1 door	LEFT	15 3/4	15	39 1/16	<b>GS2STF1H15L-</b> [ ]	1,769	1,946
	RIGHT	15 3/4	15	39 1/16	<b>GS2STF1H15R-</b> [ ]	1,769	1,946
<b>18" WIDTH</b>							
 1 door	LEFT	15 3/4	18	39 1/16	<b>GS2STF1H18L-</b> [ ]	2,213	2,435
	RIGHT	15 3/4	18	39 1/16	<b>GS2STF1H18R-</b> [ ]	2,213	2,435
<b>30" WIDTH</b>							
 2 doors		15 3/4	30	39 1/16	<b>GS2STF1H30-</b> [ ]	3,582	3,941
<b>36" WIDTH</b>							
 2 doors		15 3/4	36	39 1/16	<b>GS2STF1H36-</b> [ ]	4,032	4,436





## PRODUCT INFO

All units have a finished back.  
 Door frames match glass color.  
 Glass doors do not lock and are touch latch.

## TO ORDER PLEASE SPECIFY THE FOLLOWING:

WOOD CHASSIS, GLASS DOOR

1. **MODEL NUMBER + WG**
2. **FSC**
3. **CHASSIS WOOD FINISH**
4. **GLASS**

	D	W	H	model number + type	laminata	veneer 1	veneer 2
<b>15" WIDTH</b> 	14 7/8	15	39 1/16	<b>GS2STN1H15-</b> [ ]	1,018	1,290	1,419
<b>18" WIDTH</b> 	14 7/8	18	39 1/16	<b>GS2STN1H18-</b> [ ]	1,271	1,610	1,771
<b>30" WIDTH</b> 	14 7/8	30	39 1/16	<b>GS2STN1H30-</b> [ ]	2,078	2,630	2,893
<b>36" WIDTH</b> 	14 7/8	36	39 1/16	<b>GS2STN1H36-</b> [ ]	2,337	2,961	3,258

**PRODUCT INFO**

All units have a finished back.

**TO ORDER PLEASE SPECIFY THE FOLLOWING:**

WOOD CHASSIS

1. **MODEL NUMBER + WN**
2. **FSC**
3. **CHASSIS WOOD FINISH**

LAM CHASSIS



1. **MODEL NUMBER + LN**
2. **FSC**
3. **CHASSIS LAM**

# SURFACE MOUNT TOWERS

w/ Hinged Doors | 2H

Silea

05/22

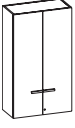
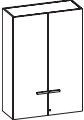
	D	W	H	model number + type	laminate	veneer 1	veneer 2	
<b>15" WIDTH</b>								
 1 door	LEFT	15 3/4	15	52 7/16	<b>GS2STF2H15L-</b> [ ]	1,936	2,453	2,699
	RIGHT	15 3/4	15	52 7/16	<b>GS2STF2H15R-</b> [ ]	1,936	2,453	2,699
<b>18" WIDTH</b>								
 1 door	LEFT	15 3/4	18	52 7/16	<b>GS2STF2H18L-</b> [ ]	2,420	3,065	3,372
	RIGHT	15 3/4	18	52 7/16	<b>GS2STF2H18R-</b> [ ]	2,420	3,065	3,372
<b>30" WIDTH</b>								
 2 doors		15 3/4	30	52 7/16	<b>GS2STF2H30-</b> [ ]	2,663	3,375	3,713
<b>36" WIDTH</b>								
 2 doors		15 3/4	36	52 7/16	<b>GS2STF2H36-</b> [ ]	2,979	3,775	4,153

• Not for use w/ credenza trough top.

## PRODUCT INFO

Type must be specified as part  
All units have a finished back.  
If integral pull is chosen for  
wood, doors will be touch  
latch.

## TO ORDER PLEASE SPECIFY THE FOLLOWING:

WOOD CHASSIS, WOOD DOOR

1. **MODEL NUMBER + WW**
2. **FSC**
3. **CHASSIS WOOD FINISH**
4. **PULLS**
5. **LOCKS**
6. **KEYING**

LAM CHASSIS, LAM DOOR

1. **MODEL NUMBER + LL**
2. **FSC**
3. **CHASSIS LAM**
4. **FRONT LAM**
5. **PULLS**
6. **LOCKS**
7. **KEYING**

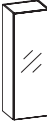
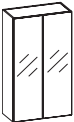
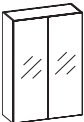

	D	W	H	model number + type	veneer 1	veneer 2
<b>15" WIDTH</b>						
 1 door	LEFT	15 3/4	15	52 7/16	<b>GS2STF2H15L-</b> [ ]	2,994 3,294
	RIGHT	15 3/4	15	52 7/16	<b>GS2STF2H15R-</b> [ ]	2,994 3,294
<b>18" WIDTH</b>						
 1 door	LEFT	15 3/4	18	52 7/16	<b>GS2STF2H18L-</b> [ ]	3,745 4,120
	RIGHT	15 3/4	18	52 7/16	<b>GS2STF2H18R-</b> [ ]	3,745 4,120
<b>30" WIDTH</b>						
 2 doors		15 3/4	30	52 7/16	<b>GS2STF2H30-</b> [ ]	4,124 4,537
<b>36" WIDTH</b>						
 2 doors		15 3/4	36	52 7/16	<b>GS2STF2H36-</b> [ ]	4,614 5,076

• Not for use w/ credenza trough top.

**PRODUCT INFO**

All units have a finished back.  
Door frames match glass color.  
Glass doors do not lock and are touch latch.

**TO ORDER PLEASE SPECIFY THE FOLLOWING:**

WOOD CHASSIS, GLASS DOOR



1. **MODEL NUMBER + WG**
2. **FSC**
3. **CHASSIS WOOD FINISH**
4. **GLASS**

# SURFACE MOUNT TOWERS

w/ No Doors, 2H

Silea

05/22

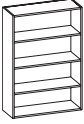
	D	W	H	model number + type	laminata	veneer 1	veneer 2
<b>15" WIDTH</b> 	14 7/8	15	52 7/16	<b>GS2STN2H15-</b> [ ]	1,051	1,335	1,469
<b>18" WIDTH</b> 	14 7/8	18	52 7/16	<b>GS2STN2H18-</b> [ ]	1,318	1,665	1,832
<b>30" WIDTH</b> 	14 7/8	30	52 7/16	<b>GS2STN2H30-</b> [ ]	2,308	2,925	3,218
<b>36" WIDTH</b> 	14 7/8	36	52 7/16	<b>GS2STN2H36-</b> [ ]	2,576	3,263	3,590

• Not for use w/ credenza trough top.

## PRODUCT INFO

All units have a finished back.

## TO ORDER PLEASE SPECIFY THE FOLLOWING:

### WOOD CHASSIS

- MODEL NUMBER + WN**
- FSC**
- CHASSIS WOOD FINISH**

### LAM CHASSIS

- MODEL NUMBER + LN**
- FSC**
- CHASSIS LAM**

# SURFACE MOUNT TACKBOARD

fabric grades

COM/4



D	W	H	yards	model number	1	2	3	COM/4
7/8	58	23 7/8	1.00	<b>GS2TKS60</b>	949	990	1,034	1,078
7/8	64	23 7/8	1.00	<b>GS2TKS66</b>	964	1,005	1,049	1,093
7/8	70	23 7/8	1.25	<b>GS2TKS72</b>	1,003	1,049	1,099	1,149
7/8	76	23 7/8	1.25	<b>GS2TKS78</b>	1,030	1,081	1,137	1,193
7/8	82	23 7/8	1.25	<b>GS2TKS84</b>	1,060	1,111	1,167	1,223
7/8	88	23 7/8	1.50	<b>GS2TKS90</b>	1,108	1,164	1,225	1,285
7/8	94	23 7/8	1.50	<b>GS2TKS96</b>	1,154	1,216	1,282	1,349
7/8	100	23 7/8	1.75	<b>GS2TKS102</b>	1,592	1,658	1,731	1,804
7/8	106	23 7/8	1.75	<b>GS2TKS108</b>	1,650	1,722	1,800	1,878

## PRODUCT INFO

102" and 108" wide tackboards are 2 piece.

For use with 1H and 2H surface mount cabinets.

See yards listed above for COM fabric requirements.

## TO ORDER PLEASE SPECIFY THE FOLLOWING:

LIST

1. **MODEL NUMBER**
2. **FABRIC**
3. **FSC TACKBOARDS**

### FSC Tackboard Options

**FSC** = FSC Required (5% COM upcharge)

**NR** = FSC Not Required

# SURFACE MOUNT GLASS WHITEBOARD

Silea  
05/22

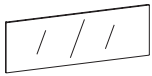

D	W	H	model number	Glass
7/8	58	23 7/8	<b>GS2TGS60-GSA</b>	2,899
7/8	64	23 7/8	<b>GS2TGS66-GSA</b>	3,319
7/8	70	23 7/8	<b>GS2TGS72-GSA</b>	3,536
7/8	76	23 7/8	<b>GS2TGS78-GSA</b>	3,920
7/8	82	23 7/8	<b>GS2TGS84-GSA</b>	4,453
7/8	88	23 7/8	<b>GS2TGS90-GSA</b>	4,658
7/8	94	23 7/8	<b>GS2TGS96-GSA</b>	4,881
7/8	100	23 7/8	<b>GS2TGS102-GSA</b>	5,089
7/8	106	23 7/8	<b>GS2TGS108-GSA</b>	5,305

## PRODUCT INFO

96", 102" and 108" wide whiteboards are 2 piece.  
Whiteboard frames match glass color.  
Whiteboard is magnetic.

## TO ORDER PLEASE SPECIFY THE FOLLOWING:

GLASS

1. **MODEL NUMBER**
2. **GLASS**

	D	W	H	model number + type	lamine	veneer 1	veneer 2
	15 3/4	15	1 3/16	GS2SMTOPD15- <input type="checkbox"/>	368	575	633
	15 3/4	18	1 3/16	GS2SMTOPD18- <input type="checkbox"/>	375	587	646
	15 3/4	30	1 3/16	GS2SMTOPD30- <input type="checkbox"/>	381	1,009	1,110
	15 3/4	36	1 3/16	GS2SMTOPD36- <input type="checkbox"/>	433	676	744
	15 3/4	42	1 3/16	GS2SMTOPD42- <input type="checkbox"/>	479	747	822
	15 3/4	48	1 3/16	GS2SMTOPD48- <input type="checkbox"/>	540	843	928
	15 3/4	54	1 3/16	GS2SMTOPD54- <input type="checkbox"/>	592	922	1,015
	15 3/4	60	1 3/16	GS2SMTOPD60- <input type="checkbox"/>	651	1,018	1,120
	15 3/4	66	1 3/16	GS2SMTOPD66- <input type="checkbox"/>	697	1,090	1,199
	15 3/4	72	1 3/16	GS2SMTOPD72- <input type="checkbox"/>	748	1,169	1,286
	15 3/4	78	1 3/16	GS2SMTOPD78- <input type="checkbox"/>	800	1,250	1,375
	15 3/4	84	1 3/16	GS2SMTOPD84- <input type="checkbox"/>	847	1,320	1,452
	15 3/4	90	1 3/16	GS2SMTOPD90- <input type="checkbox"/>	898	1,401	1,542
	15 3/4	96	1 3/16	GS2SMTOPD96- <input type="checkbox"/>	949	1,480	1,628
	15 3/4	102	1 3/16	GS2SMTOPD102- <input type="checkbox"/>	994	1,552	1,708
	15 3/4	108	1 3/16	GS2SMTOPD108- <input type="checkbox"/>	1,045	1,632	1,796
	15 3/4	114	1 3/16	GS2SMTOPD114- <input type="checkbox"/>	1,106	1,727	1,900
	15 3/4	120	1 3/16	GS2SMTOPD120- <input type="checkbox"/>	1,157	1,808	1,989

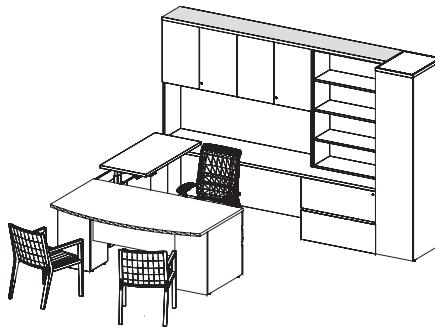

PRODUCT INFO

TO ORDER PLEASE SPECIFY THE FOLLOWING:

WOOD TOP

1. MODEL NUMBER + W
2. FSC
3. TOP WOOD FINISH + EDGE
4. TOP FINISH

Top Finish Option:

Non-UV Open Pore Finish  
Full Fill UV Top Finish

LAM TOP

1. MODEL NUMBER + L
2. FSC
3. TOP LAM

NR  
FF (+\$250)

# SURFACE MOUNT EXTERNAL TOPS

For Units Without Doors

Silea

05/22

D	W	H	model number	laminate	veneer 1	veneer 2
14 7/8	15	1 3/16	<b>GS2SMTOPN15-</b> <input type="checkbox"/>	368	575	633
14 7/8	18	1 3/16	<b>GS2SMTOPN18-</b> <input type="checkbox"/>	375	587	646
14 7/8	30	1 3/16	<b>GS2SMTOPN30-</b> <input type="checkbox"/>	381	1,009	1,110
14 7/8	36	1 3/16	<b>GS2SMTOPN36-</b> <input type="checkbox"/>	433	676	744
14 7/8	42	1 3/16	<b>GS2SMTOPN42-</b> <input type="checkbox"/>	479	747	822
14 7/8	48	1 3/16	<b>GS2SMTOPN48-</b> <input type="checkbox"/>	540	843	928
14 7/8	54	1 3/16	<b>GS2SMTOPN54-</b> <input type="checkbox"/>	592	922	1,015
14 7/8	60	1 3/16	<b>GS2SMTOPN60-</b> <input type="checkbox"/>	651	1,018	1,120
14 7/8	66	1 3/16	<b>GS2SMTOPN66-</b> <input type="checkbox"/>	697	1,090	1,199
14 7/8	72	1 3/16	<b>GS2SMTOPN72-</b> <input type="checkbox"/>	748	1,169	1,286
14 7/8	78	1 3/16	<b>GS2SMTOPN78-</b> <input type="checkbox"/>	800	1,250	1,375
14 7/8	84	1 3/16	<b>GS2SMTOPN84-</b> <input type="checkbox"/>	847	1,320	1,452
14 7/8	90	1 3/16	<b>GS2SMTOPN90-</b> <input type="checkbox"/>	898	1,401	1,542
14 7/8	96	1 3/16	<b>GS2SMTOPN96-</b> <input type="checkbox"/>	949	1,480	1,628
14 7/8	102	1 3/16	<b>GS2SMTOPN102-</b> <input type="checkbox"/>	994	1,552	1,708
14 7/8	108	1 3/16	<b>GS2SMTOPN108-</b> <input type="checkbox"/>	1,045	1,632	1,796
14 7/8	114	1 3/16	<b>GS2SMTOPN114-</b> <input type="checkbox"/>	1,106	1,727	1,900
14 7/8	120	1 3/16	<b>GS2SMTOPN120-</b> <input type="checkbox"/>	1,157	1,808	1,989

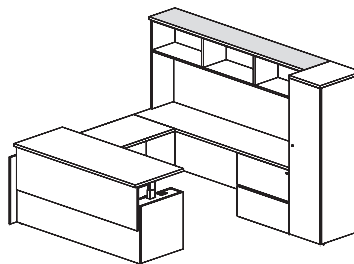

## PRODUCT INFO

### TO ORDER PLEASE SPECIFY THE FOLLOWING:

#### WOOD TOP

1. **MODEL NUMBER + W**
2. **FSC**
3. **TOP WOOD FINISH + EDGE**
4. **TOP FINISH**

#### Top Finish Option:

Non-UV Open Pore Finish

Full Fill UV Top Finish

#### LAM TOP

1. **MODEL NUMBER + L**
2. **FSC**
3. **TOP LAM**

**NR**

**FF (+\$250)**

Workwall . . . . .	335-342
Workwalls. . . . .	336-339
Workwall Tackboard . . . . .	340
Lounge Level Media Unit . . . . .	341-342

# WORKWALL

Wall Mount

Silea

05/22

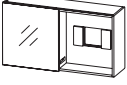
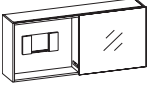
	D	W	H	model number + type	veneer 1	veneer 2
<b>72" WIDTH</b>  Left hand shown	19 1/2	72	39 1/16	<b>GS2WSB3H72L-</b> [ ]	11,443	12,588
	19 1/2	72	39 1/16	<b>GS2WSB3H72R-</b> [ ]	11,443	12,588
<b>90" WIDTH</b>  Right hand shown	19 1/2	90	39 1/16	<b>GS2WSB3H90L-</b> [ ]	13,217	14,539
	19 1/2	90	39 1/16	<b>GS2WSB3H90R-</b> [ ]	13,217	14,539

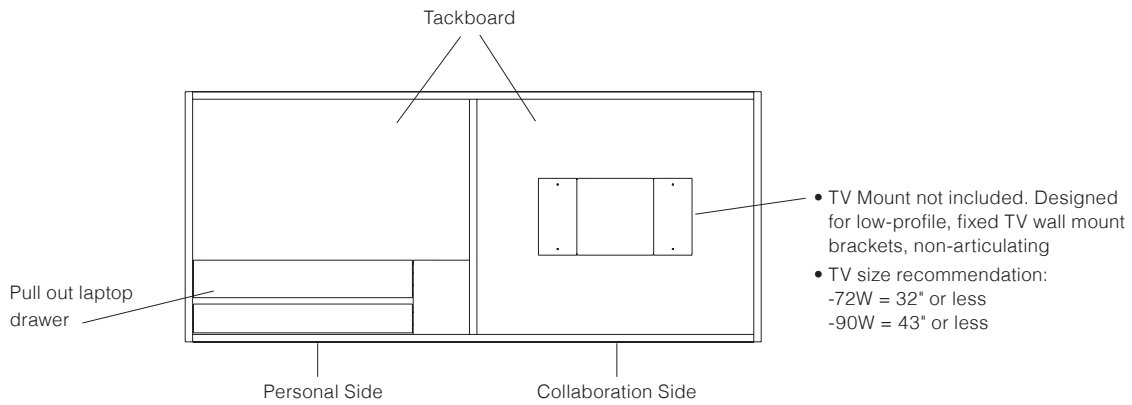

• Shown above with door removed.

## PRODUCT INFO

Must order tackboard separately.  
 2 power units included.  
 Sliding glass door frame matches glass color.  
 Whiteboard sliding door is non-magnetic.

## TO ORDER PLEASE SPECIFY THE FOLLOWING:

WOOD CHASSIS, GLASS DOOR

1. **MODEL NUMBER + WSG**
2. **FSC**
3. **CHASSIS WOOD FINISH**
4. **GLASS**
5. **DRAWERS**
6. **POWER UNIT COLOR**

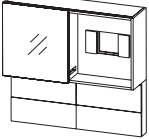
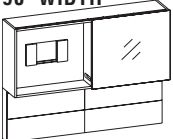

	D	W	H	model number + type	veneer 1	veneer 2
<b>72" WIDTH</b>  <p>Left hand shown</p>	19 1/2	72	68 9/16	<b>GS2WSBA3H72L-</b> [ ]	13,385	14,724
	19 1/2	72	68 9/16	<b>GS2WSBA3H72R-</b> [ ]	13,385	14,724
<b>90" WIDTH</b>  <p>Right hand shown</p>	19 1/2	90	68 9/16	<b>GS2WSBA3H90L-</b> [ ]	15,462	17,009
	19 1/2	90	68 9/16	<b>GS2WSBA3H90R-</b> [ ]	15,462	17,009

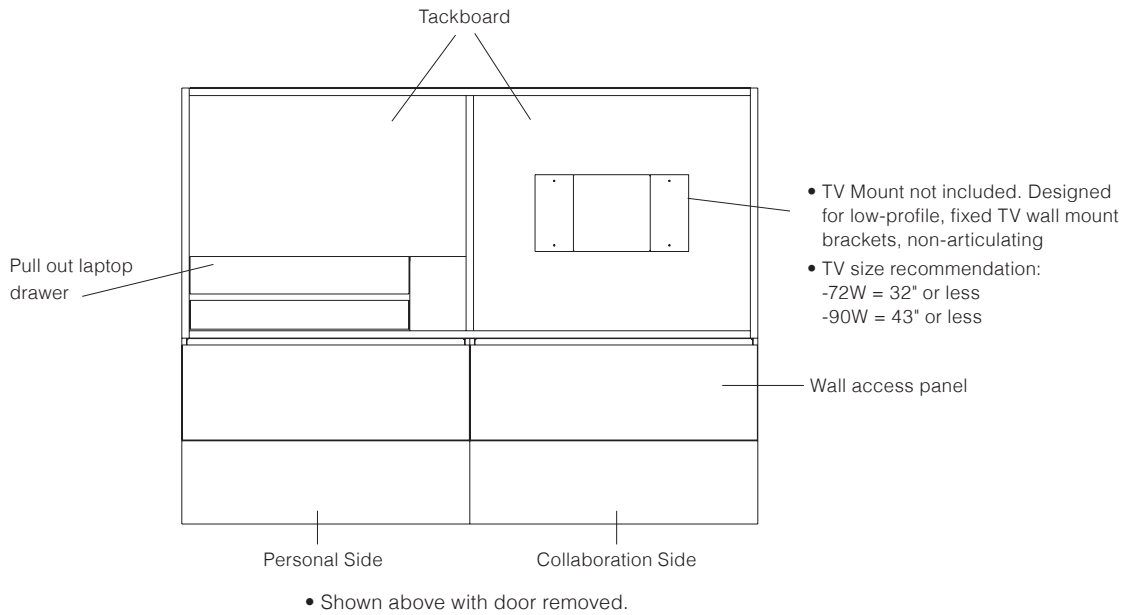

**PRODUCT INFO**

Must order tackboard separately.  
2 power units included.  
Sliding glass door frame matches glass color.  
Whiteboard sliding door is non-magnetic.

**TO ORDER PLEASE SPECIFY THE FOLLOWING:**

WOOD CHASSIS, GLASS DOOR

1. **MODEL NUMBER + WSG**
2. **FSC**
3. **CHASSIS WOOD FINISH**
4. **GLASS**
5. **DRAWERS**
6. **POWER UNIT COLOR**

# WORKWALL

Stack On

Silea

05/22

	D	W	H	model number + type	veneer 1	veneer 2
<b>72" WIDTH</b>	19 1/2	72	39 1/16	<b>GS2WSBS3H72L-</b> [ ]	9,881	10,870
	19 1/2	72	39 1/16	<b>GS2WSBS3H72R-</b> [ ]	9,881	10,870
<b>90" WIDTH</b>	19 1/2	90	39 1/16	<b>GS2WSBS3H90L-</b> [ ]	11,411	12,553
	19 1/2	90	39 1/16	<b>GS2WSBS3H90R-</b> [ ]	11,411	12,553

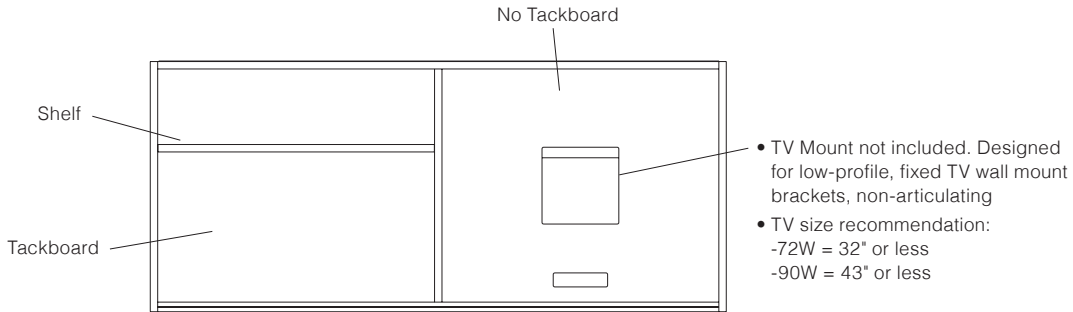
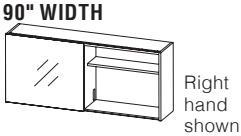

• Shown above with door removed.

## PRODUCT INFO

Must order tackboard separately.  
 2 power units included.  
 Sliding glass door frame matches glass color.  
 To be used with a credenza unit underneath.  
 Whiteboard sliding door is non-magnetic.

## TO ORDER PLEASE SPECIFY THE FOLLOWING:

WOOD CHASSIS, GLASS DOOR

- 1. MODEL NUMBER + WSG**
- 2. FSC**
- 3. CHASSIS WOOD FINISH**
- 4. GLASS**
- 5. DRAWERS**
- 6. POWER UNIT COLOR**

	D	W	H	model number + type	veneer 1	veneer 2
<b>72" WIDTH</b>	23 3/4	72	76	<b>GS2FBX75H72L-</b> [ ]	19,512	21,464
	23 3/4	72	76	<b>GS2FBX75H72R-</b> [ ]	19,512	21,464

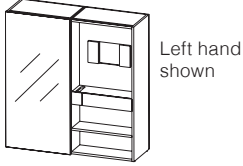

<b>90" WIDTH</b>	23 3/4	90	76	<b>GS2FBX75H90L-</b> [ ]	22,537	24,791
	23 3/4	90	76	<b>GS2FBX75H90R-</b> [ ]	22,537	24,791

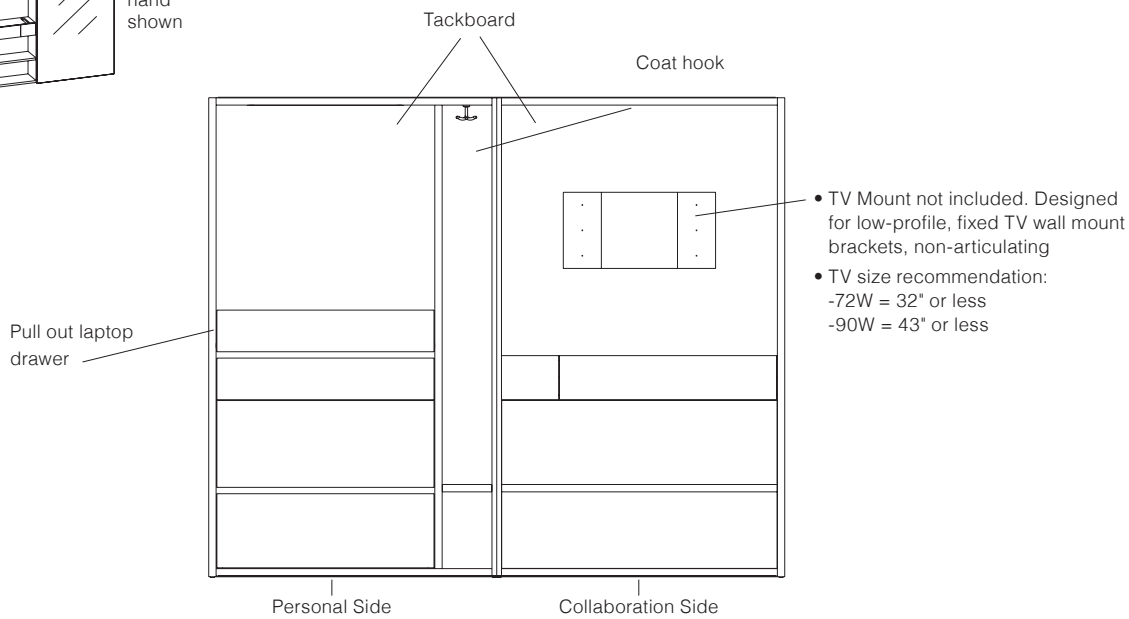
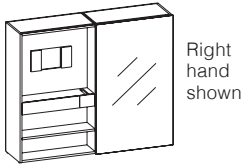

• 90" wide, shown above with door removed. 72" W does not have a closet.

**PRODUCT INFO**

Must order tackboard separately.  
2 power units included.  
Sliding glass door frame matches glass color.  
Back panel optional.  
Whiteboard sliding door is non-magnetic.

**TO ORDER PLEASE SPECIFY THE FOLLOWING:**

WOOD CHASSIS, GLASS DOOR

- 1. MODEL NUMBER + WSG**
- 2. FSC**
- 3. CHASSIS WOOD FINISH**
- 4. GLASS**
- 5. BACK PANEL**
- 6. DRAWERS**
- 7. POWER UNIT COLOR**

						fabric grades			COM#
D	W	H	yds	model number	1	2	3		
	7/8	33 1/2	36 1/2	2.25	<b>GS2TKWSB72</b>	1,054	1,102	1,156	1,207
	7/8	42 1/2	36 1/2	2.75	<b>GS2TKWSB90</b>	1,163	1,222	1,287	1,349
• For use with Wall Mounted Workwalls, 2 pc									
	7/8	33 1/2	36 1/2	1.25	<b>GS2TKWSB36</b>	855	881	911	941
	7/8	42 1/2	36 1/2	1.50	<b>GS2TKWSB45</b>	897	935	978	1,019
• For use with Stack On Workwalls, 1 pc (Personal Side only)									
	7/8	33 1/2	36 1/2	2.25	<b>GS2TKFBX72</b>	1,054	1,102	1,156	1,207
	7/8	42 1/2	36 1/2	2.50	<b>GS2TKFBX90</b>	1,163	1,222	1,287	1,349
• For use with Freestanding Workwalls, 2 pc									

## PRODUCT INFO

102" and 108" wide tackboards are 2 piece.

## TO ORDER PLEASE SPECIFY THE FOLLOWING:

### LIST

1. **MODEL NUMBER**
2. **FABRIC**
3. **FSC TACKBOARDS**

#### FSC Tackboard Options

**FSC** = FSC Required (5% COM upcharge)

**NR** = FSC Not Required

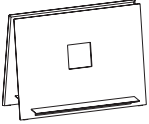
	D	W	H	model number + type	veneer 1	veneer 2
	30 1/4	66	49 1/2	<b>GLLM48H66-WW</b>	7,977	8,775

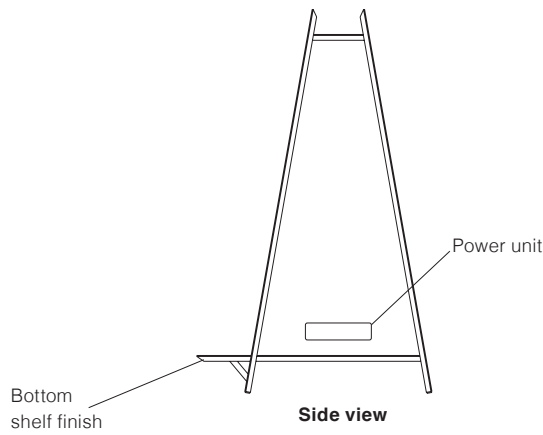

**PRODUCT INFO**

Wood models only.  
 Bottom shelf can match chassis color, or be Ebony Walnut.  
 2 power units included.  
 TV mount not included.  
 Designed for low-profile, fixed TV wall mount brackets, non-articulating. TV size recommendation is 66" or less.

**TO ORDER PLEASE SPECIFY THE FOLLOWING:**

WOOD

1. **MODEL NUMBER + WW**
2. **FSC**
3. **CHASSIS WOOD FINISH**
4. **BOTTOM SHELF FINISH**
5. **POWER UNIT COLOR**

# LOUNGE LEVEL MEDIA UNIT

Whiteboard

Silea  
05/22

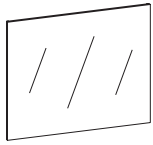

D	W	H	model number	list
1/2	58	36	<b>GLLMTGW36H58W-GSA</b>	3,469

## PRODUCT INFO

Whiteboard frame matches  
glass color.  
Whiteboard is magnetic.

## TO ORDER PLEASE SPECIFY THE FOLLOWING:

LIST

1. **MODEL NUMBER**
2. **GLASS COLOR**

Accessories . . . . .	343-358
LED Tasklighting . . . . .	344
Trough Accessories . . . . .	345-346
Personal Corner . . . . .	347
Drawer Filing Rails & Reinforcement Bars . . . . .	348
Magnets . . . . .	349
Counterweights . . . . .	350
Wire Manager . . . . .	351
Center Drawer . . . . .	352
Pencil Tray . . . . .	353
Grommet . . . . .	354
Power Unit . . . . .	355-357
3" Dia Field Installed Grommet . . . . .	358
Grade Fabric Pricing . . . . .	360-363
Weights + Cubes . . . . .	364-407

	D	W	H	model number	lum
	3/4	23	5/8	<b>ACTLED24</b>	453
	3/4	35	5/8	<b>ACTLED36</b>	490
	3/4	47	5/8	<b>ACTLED48</b>	529
	3/4	59	5/8	<b>ACTLED60</b>	566

**Product Specifications:**

LED lighting provides high efficiency, low energy lighting with a long life. All LED lights are encased in a silver aluminum extrusion and include a built-in switch to turn the light on/off with a dimming feature. Lights are field installed. All units include a standard plug.

- Low profile strip light 5/8" H x 3/4" D
- Power: 2.92W / Foot
- LED's per meter: 120
- Color Temp: 3000K
- Certification: UL Listed
- GSA and TAA compliant

Size	Voltage	Wattage (W)	Luminous Flux (Lm)
24"	12 Volt DC	5.9	497
36"	12 Volt DC	8.8	746
48"	12 Volt DC	11.8	994
60"	12 Volt DC	14.6	1242

**PRODUCT INFO**





See product specs above.

**TO ORDER PLEASE SPECIFY THE FOLLOWING:**

LIST

- 1. MODEL NUMBER**



	D	W	H	model number	186
<b>PAPER TRAY</b> 	12	8 1/2	6	<b>GS2AT-PAPER</b>	186
<b>PDA HOLDER</b> 	6	3	6	<b>GS2AT-PDA</b>	147
• Note: Includes black non-slip surface to hold device on angled surface.					
<b>PENCIL TRAY</b> 	5	8	5	<b>GS2AT-PNCL</b>	147
<b>PLUG HOLDER</b> 	1	4	3	<b>GS2AT-PLUG</b>	147
<b>SHELF</b> 	6	8	6	<b>GS2AT-SHELF</b>	186

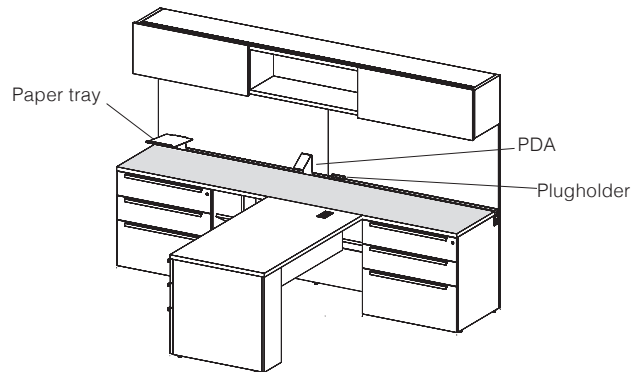

**PRODUCT INFO**

To be used with trough worksurface.  
Available in 5 metal finish colors.

**TO ORDER PLEASE SPECIFY THE FOLLOWING:**

LIST

1. **MODEL NUMBER**
2. **HARDWARE COLOR**

# TROUGH ACCESSORIES

Silea

05/22

Power Unit

	D	W	H	model number	sin#
	1 3/4	3	1 3/4	<b>ACPWRT</b>	674

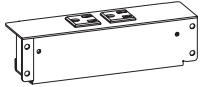

End of unit

- Includes 3 power outlets - 2 power outlets on top surface and 1 power outlet on end of unit.
- Ships with 6 ft power cord with standard plug
- UL listed
- Mounting bracket included for use installation in the following applications:
  - To bottom of worksurface beneath grommets
  - To bottom of worksurface in trough opening of trough worksurfaces
  - As power strip inside wall access panels or beneath desks

## PRODUCT INFO

To be mounted in trough opening.

## TO ORDER PLEASE SPECIFY THE FOLLOWING:

LIST

1. **MODEL NUMBER**

	D	W	H	model number	list
	12 1/2	36	1 11/16	<b>SACORNER</b>	927

	18	36	1 11/16	<b>SADSKPAD</b>	1,313
---	----	----	---------	-----------------	-------

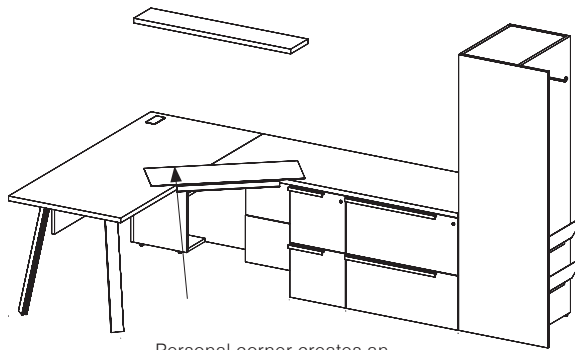

Personal corner creates an ergonomic corner to work.

**PRODUCT INFO**

**LEATHER COLORS**

Black **CBL**  
White **CWH**  
Chocolate **CCH**

**VINYL COLORS**

Black **VBL**  
White **VWH**  
Chocolate **VCH**







**TO ORDER PLEASE SPECIFY THE FOLLOWING:**

LIST

1. **MODEL NUMBER**
2. **COLOR**

# DRAWER FILING RAILS & REINFORCEMENT BARS

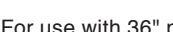
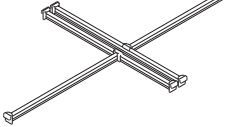
Silea  
05/22

	D	W	H	model number	$\frac{3}{8}$
For use with smart pedestals 	$\frac{1}{8}$	5	1	<b>ACFLR5-P</b>	28
For use with 9" ped 	$\frac{1}{8}$	9	1	<b>ACFLR9-P</b>	31
For use with 15" ped 	$\frac{1}{8}$	15	1	<b>ACFLR15-P</b>	35
For use with 18" ped 	$\frac{1}{8}$	18	1	<b>ACFLR18-P</b>	37
For use with 30" ped 	$\frac{1}{8}$	18	1	<b>ACFLR30-P</b>	41
For use with 36" ped 	$\frac{1}{8}$	18	1	<b>ACFLR36-P</b>	45
Optional Lateral File Drawer Reinforcement Bar 	$1 \frac{1}{2}$	$1 \frac{9}{16}$	15	<b>ACDRB-LAT</b>	60

• **Note:** Lateral file drawer reinforcement bars are OPTIONAL, and are only required when excessive stacking of paper occurs in bottom of drawers. Reinforcement bars are oriented front-to-back on file drawers and front-to-back on lateral file drawers.

## PRODUCT INFO

## TO ORDER PLEASE SPECIFY THE FOLLOWING:

LIST

### 1. MODEL NUMBER

	Dia	H	model number	list
	$\frac{3}{8}$	$\frac{1}{2}$	<b>SAMAGNET</b>	90

**QUANTITY 6**

**Note:** Quantity 6 magnets included with each whiteboard 72" W and less.  
Quantity 12 magnets included with each whiteboard 84"W and greater.

**PRODUCT INFO**

Magnets are silver.

**TO ORDER PLEASE SPECIFY THE FOLLOWING:**

LIST

- 1. MODEL NUMBER**

D	W	H	model number	list
$\frac{3}{16}$	12	15	<b>ACCNTRWGT15</b>	266
<ul style="list-style-type: none"> <li>For use when a 15" or 18" modular pedestal with drawers is used as a freestanding unit.</li> </ul>				
$\frac{1}{2}$	$8 \frac{5}{8}$	25	<b>ACCNTRWGT30</b>	299
$\frac{1}{2}$	$8 \frac{5}{8}$	28	<b>ACCNTRWGT36</b>	332

- For use when a 30" or 36" modular pedestal with drawers has a top and is a freestanding unit.

Examples:

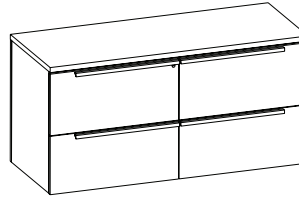
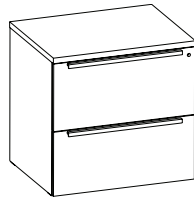

## PRODUCT INFO

TO ORDER PLEASE SPECIFY THE FOLLOWING:

LIST

- MODEL NUMBER**

	Dia	H	model number	list
<b>WIRE MANAGER</b>	3 1/2	30	1 <b>ACWM</b>	101

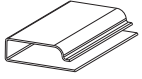

**PRODUCT INFO**

TO ORDER PLEASE SPECIFY THE FOLLOWING:

LIST

1. **MODEL NUMBER**

# CENTER DRAWER

Silea  
05/22

	D	W	H	model number + type	veneer 1	veneer 2
<b>CENTER DRAWER</b>	17 <sup>5</sup> / <sub>8</sub>	21 <sup>3</sup> / <sub>4</sub>	2 <sup>15</sup> / <sub>16</sub>	<b>GS2CDWSD-</b> [ ]	757	833



**INTERIOR DIMENSIONS**

D = 15 <sup>1</sup>/<sub>2</sub>  
 W = 18 <sup>1</sup>/<sub>4</sub>  
 H = 1 <sup>3</sup>/<sub>8</sub>

- **Note:** Not available with a laminate drawer front.

**PRODUCT INFO**

Includes pencil tray.

**TO ORDER PLEASE SPECIFY THE FOLLOWING:**

WOOD

- 1. MODEL NUMBER + W**
- 2. CHASSIS WOOD FINISH**



	Dia	W	H	model number	list
<b>PENCIL TRAYS</b>	3	11 <sup>5</sup> / <sub>16</sub>	1 <sup>1</sup> / <sub>4</sub>	<b>ACPT15-GAA</b>	103
	3	14 <sup>5</sup> / <sub>16</sub>	1 <sup>1</sup> / <sub>4</sub>	<b>ACPT18-GAA</b>	110

**PRODUCT INFO**

TO ORDER PLEASE SPECIFY THE FOLLOWING:

LIST

- 1. MODEL NUMBER**

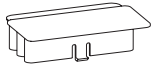

D	W	H	model number	list
2 1/2	5	1	<b>GS2GMT</b>	169

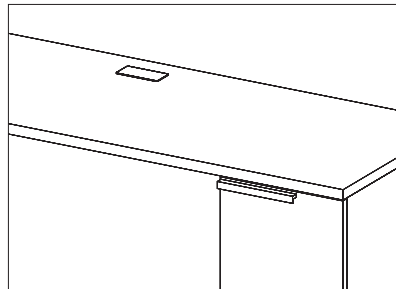

Closed

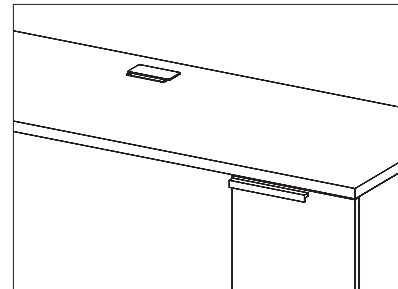

Small opening for cords

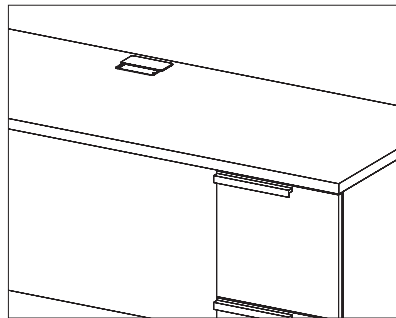

Large opening for monitor arms

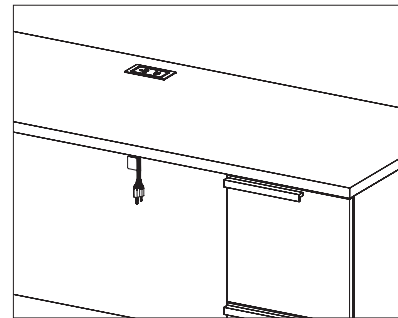

Grommet can be switched for ACUNOBZL-EU and ACUNOBZL-EU-HW power units

## PRODUCT INFO

Available in 5 metal finish colors.  
Do not place grommets over laptop drawer.

## TO ORDER PLEASE SPECIFY THE FOLLOWING:

LIST

1. **MODEL NUMBER**
2. **HARDWARE COLOR**

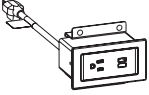
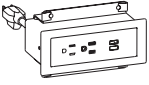
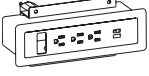
	D	W	H	model number	list
 <p>Can be used in grommet cutout</p>	2 7/8	4	1 3/4	<b>ACUNOBZL-EU</b>	395
	<ul style="list-style-type: none"> <li>Includes 1 power, 2 USB - standard plug</li> </ul>				
	2 7/8	4	1 3/4	<b>ACUNOBZL-EU-HW</b>	395
<ul style="list-style-type: none"> <li>Includes 1 power, 2 USB - hardwired</li> </ul>					
	2 7/8	5 1/2	1 3/4	<b>ACDUOBZL-EEU</b>	468
	<ul style="list-style-type: none"> <li>Includes 2 USB, 2 power - standard plug</li> </ul>				
	2 7/8	5 1/2	1 3/4	<b>ACDUOBZL-EEU-HW</b>	468
<ul style="list-style-type: none"> <li>Includes 2 USB, 2 power - hardwired</li> </ul>					
	2 7/8	8 1/16	1 3/4	<b>ACTRIOBZL-EEEUD</b>	539
	<ul style="list-style-type: none"> <li>Includes 2 USB, 3 power, 1 data - standard plug</li> </ul>				
	2 7/8	8 1/16	1 3/4	<b>ACTRIOBZL-EEEUD-HW</b>	539
<ul style="list-style-type: none"> <li>Includes 2 USB, 3 power, 1 data - hardwired</li> </ul>					

Data Port Kit included where applicable.

Insert options include:

- VGA
- Sieman
- Mini-com
- Commscope
- Ortronics
- Blank
- Cable retainer
- Belden EZ MDVO
- Keystone

**PRODUCT INFO**

ACUNOBZL-EU and ACUNOBZL-EU-HW models can be used in grommet cutout location.

10' standard plug or 6' hardwire power source.

**TO ORDER PLEASE SPECIFY THE FOLLOWING:**

LIST



1. **MODEL NUMBER**
2. **POWER UNIT COLOR**

# POWER UNIT

Clamp mount

Silea

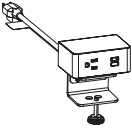
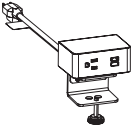
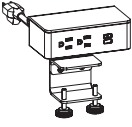
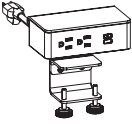
05/22

	D	W	H	model number	list
	2 7/8	4	1 3/4	<b>ACUNOCLMP-EU</b>	395
	<ul style="list-style-type: none"> <li>Includes 1 power, 2 USB - standard plug</li> </ul>				
	2 7/8	4	1 3/4	<b>ACUNOCLMP-EU-HW</b>	395
	<ul style="list-style-type: none"> <li>Includes 1 power, 2 USB - hardwired</li> </ul>				
	2 7/8	5 1/2	1 3/4	<b>ACDUOCLMP-EEU</b>	468
	<ul style="list-style-type: none"> <li>Includes 2 USB, 2 power - standard plug</li> </ul>				
	2 7/8	5 1/2	1 3/4	<b>ACDUOCLMP-EEU-HW</b>	468
	<ul style="list-style-type: none"> <li>Includes 2 USB, 2 power - hardwired</li> </ul>				
	2 7/8	8 1/16	1 3/4	<b>ACTRIOCLMP-EEEUD</b>	539
	<ul style="list-style-type: none"> <li>Includes 2 USB, 3 power, 1 data - standard plug</li> </ul>				
	2 7/8	8 1/16	1 3/4	<b>ACTRIOCLMP-EEEUD-HW</b>	539
	<ul style="list-style-type: none"> <li>Includes 2 USB, 3 power, 1 data - hardwired</li> </ul>				

Data Port Kit included where applicable.

Insert options include:

- VGA
- Sieman
- Mini-com
- Commscope
- Ortronics
- Blank
- Cable retainer
- Belden EZ MDVO
- Keystone

## PRODUCT INFO

To be mounted on edge of worksurfaces.



Not to be used on height adjustable credenzas, returns or bridges on back edge of top or in grommet.

10' standard plug or 6' hardwire power source.

## TO ORDER PLEASE SPECIFY THE FOLLOWING:

LIST

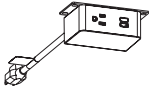
1. **MODEL NUMBER**
2. **POWER UNIT COLOR**

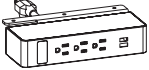
	D	W	H	model number	list
	2 7/8	4	1 3/4	<b>ACPUNDER-EU</b>	378
	• Includes 1 power, 2 USB - standard plug				
	2 7/8	4	1 3/4	<b>ACPUNDER-EU-HW</b>	378
	• Includes 1 power, 2 USB - hardwired				
	2 7/8	5 1/2	1 3/4	<b>GDAPPM-EEU</b>	457
	• Includes 2 USB, 2 power - standard plug				
	2 7/8	5 1/2	1 3/4	<b>GDAPPM-EEU-HW</b>	457
	• Includes 2 USB, 2 power - hardwired				
	2 7/8	8 1/16	1 3/4	<b>ACTRIOUNDER-EEEUD</b>	509
	• Includes 2 USB, 3 power, 1 data - standard plug				
	2 7/8	8 1/16	1 3/4	<b>ACTRIOUNDER-EEEUD-HW</b>	509
	• Includes 2 USB, 3 power, 1 data - hardwired				

Data Port Kit included where applicable.

Insert options include:

- VGA
- Commscope
- Cable retainer
- Sieman
- Ortronics
- Belden EZ MDVO
- Mini-com
- Blank
- Keystone

**PRODUCT INFO**

10' Standard plug or 6' hardwire power source.

**TO ORDER PLEASE SPECIFY THE FOLLOWING:**

LIST

- 1. MODEL NUMBER**
- 2. POWER UNIT COLOR**

# 3" DIA FIELD INSTALLED GROMMET

Silea  
05/22

	Dia	H	model number	list
<b>FIELD INSTALL GROMMET</b>	3	1	<b>ACGRMTFLD</b>	67



- 2 piece design - sleeve plus cover
- Fits standard 3" diameter cutout
- Plastic

## PRODUCT INFO

### TO ORDER PLEASE SPECIFY THE FOLLOWING:

#### LIST

- 1. MODEL NUMBER**
- 2. FIELD INSTALL GROMMET COLOR**
  - Black **BK**
  - Silver **SV**
  - White **WH**



# GRADE FABRIC PRICING

Silea  
05/22

model number	1	2	3	COM/4	5	6	7	8	9	10	11	12	13	14	15	16
--------------	---	---	---	-------	---	---	---	---	---	----	----	----	----	----	----	----

## Cushions

GS2MPD-CUSH2215	502	517	535	551	574	598	616	641	662	686	708	730	758	780	807	837
GS2CLPD-CUSH2130T	566	587	609	632	663	693	719	750	778	807	840	867	904	933	968	1,007
GS2CLPD-CUSH2136T	611	637	666	695	734	769	803	841	877	914	950	988	1,035	1,071	1,116	1,163

## Tackboards

GS2TKW30	778	797	820	842	871	902	925	954	982	1,011	1,041	1,068	1,104	1,133	1,165	1,203
GS2TKW36	815	840	868	897	932	968	1,000	1,037	1,071	1,106	1,144	1,177	1,223	1,259	1,302	1,347
GS2TKW42	844	870	898	928	966	1,002	1,034	1,072	1,109	1,145	1,183	1,220	1,268	1,303	1,347	1,395
GS2TKW48	874	901	930	960	1,000	1,039	1,072	1,110	1,149	1,185	1,225	1,263	1,312	1,350	1,395	1,445
GS2TKW54	906	935	963	995	1,035	1,075	1,111	1,152	1,192	1,229	1,268	1,307	1,358	1,397	1,446	1,497
GS2TKW60	949	990	1,034	1,078	1,136	1,195	1,244	1,304	1,358	1,417	1,475	1,531	1,602	1,659	1,729	1,799
GS2TKW66	964	1,005	1,049	1,093	1,151	1,210	1,259	1,319	1,373	1,432	1,490	1,546	1,617	1,674	1,744	1,814
GS2TKW72	1,003	1,049	1,099	1,149	1,215	1,279	1,337	1,402	1,464	1,529	1,594	1,656	1,740	1,802	1,878	1,962
GS2TKW78	1,030	1,081	1,137	1,193	1,266	1,340	1,402	1,476	1,545	1,619	1,692	1,762	1,852	1,921	2,009	2,100
GS2TKW84	1,060	1,111	1,167	1,223	1,296	1,370	1,432	1,506	1,575	1,649	1,722	1,792	1,882	1,951	2,039	2,130
GS2TKW90	1,108	1,164	1,225	1,285	1,367	1,446	1,516	1,597	1,672	1,755	1,833	1,910	2,011	2,087	2,182	2,281
GS2TKW96	1,154	1,216	1,282	1,349	1,435	1,524	1,599	1,686	1,768	1,855	1,943	2,027	2,135	2,218	2,322	2,431
GS2TKW102	1,592	1,658	1,731	1,804	1,899	1,992	2,073	2,168	2,259	2,352	2,447	2,537	2,654	2,744	2,857	2,976
GS2TKW108	1,650	1,722	1,800	1,878	1,981	2,081	2,170	2,274	2,371	2,474	2,575	2,673	2,798	2,897	3,019	3,145

## Layers Tackboards

GS2TLKW30	817	838	862	884	915	946	972	1,003	1,032	1,063	1,093	1,122	1,158	1,189	1,225	1,263
GS2TLKW36	855	881	911	941	980	1,015	1,050	1,088	1,125	1,162	1,200	1,236	1,284	1,322	1,367	1,414
GS2TLKW42	886	915	943	977	1,015	1,053	1,089	1,130	1,165	1,203	1,243	1,282	1,332	1,369	1,417	1,465
GS2TLKW48	917	946	976	1,009	1,049	1,089	1,126	1,167	1,206	1,246	1,285	1,325	1,378	1,417	1,466	1,517
GS2TLKW54	949	981	1,011	1,045	1,087	1,126	1,164	1,207	1,248	1,288	1,331	1,373	1,426	1,466	1,518	1,569
GS2TLKW60	996	1,039	1,085	1,132	1,193	1,254	1,306	1,368	1,425	1,487	1,548	1,607	1,681	1,739	1,814	1,889
GS2TLKW66	1,014	1,056	1,103	1,150	1,211	1,272	1,324	1,386	1,443	1,504	1,565	1,624	1,699	1,757	1,832	1,906
GS2TLKW72	1,054	1,102	1,156	1,207	1,277	1,344	1,404	1,474	1,539	1,606	1,675	1,739	1,825	1,893	1,975	2,061
GS2TLKW78	1,083	1,137	1,195	1,255	1,331	1,409	1,473	1,552	1,624	1,702	1,778	1,851	1,947	2,018	2,110	2,339
GS2TLKW84	1,113	1,167	1,225	1,285	1,361	1,439	1,503	1,582	1,654	1,732	1,808	1,881	1,977	2,048	2,140	2,369
GS2TLKW90	1,163	1,222	1,287	1,349	1,434	1,518	1,591	1,676	1,755	1,841	1,925	2,005	2,110	2,190	2,290	2,395
GS2TLKW96	1,210	1,275	1,345	1,415	1,506	1,597	1,678	1,769	1,857	1,948	2,040	2,127	2,241	2,328	2,438	2,551
GS2TLKW102	1,671	1,739	1,817	1,893	1,991	2,091	2,176	2,275	2,369	2,470	2,567	2,663	2,787	2,880	2,999	3,125
GS2TLKW108	1,733	1,809	1,889	1,972	2,079	2,186	2,279	2,387	2,490	2,597	2,704	2,807	2,939	3,041	3,169	3,301

## Tack to Top Overhead | 1H

GS2TKW1H30	976	995	1,018	1,040	1,069	1,100	1,123	1,152	1,180	1,209	1,239	1,266	1,302	1,331	1,363	1,401
GS2TKW1H36	994	1,019	1,047	1,076	1,111	1,147	1,179	1,216	1,250	1,285	1,323	1,356	1,402	1,438	1,481	1,526
GS2TKW1H42	1,032	1,064	1,096	1,129	1,174	1,218	1,257	1,301	1,342	1,387	1,431	1,473	1,527	1,568	1,621	1,674
GS2TKW1H48	1,064	1,096	1,128	1,161	1,206	1,250	1,289	1,333	1,374	1,419	1,463	1,505	1,559	1,600	1,653	1,706



model number      17    18    19    20    21    22    23    24    25    26    27    COL    L1    L2    L3    L4    L5

**Cushions**

GS2MPD-CUSH2215	864	883	911	938	964	991	1,047	1,099	1,155	1,210	1,263	551	721	904	1,089	1,272	1,437
GS2CLPD-CUSH2130T	1,043	1,069	1,106	1,139	1,176	1,210	1,283	1,352	1,427	1,498	1,568	632	859	1,103	1,348	1,593	1,813
GS2CLPD-CUSH2136T	1,207	1,241	1,285	1,328	1,373	1,417	1,507	1,597	1,686	1,777	1,865	695	977	1,283	1,588	1,896	2,172

**Tackboards**

GS2TKW30	1,238	1,264	1,297	1,330	1,366	1,399	1,470	1,537	1,607	1,674	1,744						
GS2TKW36	1,389	1,422	1,465	1,507	1,550	1,594	1,680	1,765	1,851	1,939	2,023						
GS2TKW42	1,438	1,471	1,515	1,559	1,604	1,648	1,739	1,828	1,917	2,008	2,096						
GS2TKW48	1,490	1,524	1,571	1,615	1,660	1,707	1,800	1,892	1,984	2,079	2,170						
GS2TKW54	1,543	1,578	1,627	1,674	1,721	1,769	1,866	1,960	2,054	2,153	2,246						
GS2TKW60	1,870	1,919	1,989	2,054	2,124	2,195	2,333	2,469	2,607	2,747	2,882						
GS2TKW66	1,885	1,934	2,004	2,069	2,139	2,210	2,348	2,484	2,622	2,762	2,897						
GS2TKW72	2,038	2,097	2,172	2,249	2,327	2,402	2,561	2,713	2,868	3,027	3,179						
GS2TKW78	2,187	2,248	2,336	2,419	2,507	2,595	2,768	2,938	3,111	3,286	3,455						
GS2TKW84	2,217	2,278	2,366	2,449	2,537	2,625	2,798	2,968	3,141	3,316	3,485						
GS2TKW90	2,377	2,447	2,543	2,634	2,730	2,826	3,017	3,203	3,396	3,588	3,776						
GS2TKW96	2,535	2,611	2,715	2,813	2,917	3,021	3,230	3,435	3,643	3,849	4,054						
GS2TKW102	3,088	3,170	3,282	3,391	3,502	3,616	3,841	4,061	4,287	4,514	4,734						
GS2TKW108	3,266	3,354	3,475	3,593	3,715	3,835	4,080	4,319	4,562	4,804	5,042						

**Layers Tackboards**

GS2TLKW30	1,300	1,327	1,362	1,397	1,435	1,469	1,542	1,615	1,688	1,761	1,831						
GS2TLKW36	1,459	1,492	1,537	1,580	1,626	1,671	1,765	1,854	1,943	2,036	2,124						
GS2TLKW42	1,512	1,547	1,594	1,639	1,686	1,732	1,830	1,921	2,014	2,109	2,201						
GS2TLKW48	1,565	1,600	1,649	1,697	1,745	1,791	1,892	1,988	2,083	2,182	2,276						
GS2TLKW54	1,619	1,656	1,707	1,753	1,807	1,855	1,959	2,055	2,160	2,258	2,358						
GS2TLKW60	1,962	2,014	2,090	2,158	2,230	2,303	2,451	2,592	2,738	2,884	3,026						
GS2TLKW66	1,980	2,032	2,106	2,176	2,247	2,321	2,468	2,609	2,755	2,899	3,044						
GS2TLKW72	2,139	2,201	2,282	2,361	2,443	2,524	2,690	2,849	3,013	3,178	3,339						
GS2TLKW78	2,297	2,361	2,454	2,542	2,633	2,725	2,907	3,086	3,267	3,452	3,628						
GS2TLKW84	2,327	2,391	2,484	2,572	2,663	2,755	2,937	3,116	3,297	3,482	3,658						
GS2TLKW90	2,495	2,568	2,669	2,764	2,865	2,965	3,167	3,364	3,567	3,767	3,963						
GS2TLKW96	2,661	2,739	2,848	2,953	3,063	3,171	3,390	3,604	3,822	4,040	4,256						
GS2TLKW102	3,240	3,327	3,445	3,559	3,675	3,795	4,033	4,263	4,501	4,739	4,971						
GS2TLKW108	3,431	3,523	3,651	3,773	3,900	4,028	4,286	4,535	4,789	5,045	5,294						

**Tack to Top Overhead I 1H**

GS2TKW1H30	1,436	1,462	1,495	1,528	1,564	1,597	1,668	1,735	1,805	1,872	1,942						
GS2TKW1H36	1,568	1,601	1,644	1,686	1,729	1,773	1,859	1,944	2,030	2,118	2,202						
GS2TKW1H42	1,727	1,766	1,817	1,866	1,921	1,972	2,077	2,179	2,284	2,387	2,491						
GS2TKW1H48	1,759	1,798	1,849	1,898	1,953	2,004	2,109	2,211	2,316	2,419	2,523						

# GRADE FABRIC PRICING

Silea  
05/22

model number	1	2	3	COM/4	5	6	7	8	9	10	11	12	13	14	15	16
--------------	---	---	---	-------	---	---	---	---	---	----	----	----	----	----	----	----

## Tack to Top Overhead I 2H

GS2TKW2H30	994	1,013	1,036	1,058	1,087	1,118	1,141	1,170	1,198	1,227	1,257	1,284	1,320	1,349	1,381	1,419
GS2TKW2H36	1,032	1,057	1,085	1,114	1,149	1,185	1,217	1,254	1,288	1,323	1,361	1,394	1,440	1,476	1,519	1,564
GS2TKW2H42	1,064	1,096	1,128	1,161	1,206	1,250	1,289	1,333	1,374	1,419	1,463	1,505	1,559	1,600	1,653	1,706
GS2TKW2H48	1,091	1,123	1,155	1,188	1,233	1,277	1,316	1,360	1,401	1,446	1,490	1,532	1,586	1,627	1,680	1,733

## Layers Tack to Top Overhead I 1H

GS2TLKW1H30	994	1,013	1,036	1,058	1,087	1,118	1,141	1,170	1,198	1,227	1,257	1,284	1,320	1,349	1,381	1,419
GS2TLKW1H36	1,032	1,057	1,085	1,114	1,149	1,185	1,217	1,254	1,288	1,323	1,361	1,394	1,440	1,476	1,519	1,564
GS2TLKW1H42	1,064	1,096	1,128	1,161	1,206	1,250	1,289	1,333	1,374	1,419	1,463	1,505	1,559	1,600	1,653	1,706
GS2TLKW1H48	1,091	1,123	1,155	1,188	1,233	1,277	1,316	1,360	1,401	1,446	1,490	1,532	1,586	1,627	1,680	1,733

## Layers Tack to Top Overhead I 2H

GS2TLKW2H30	1,032	1,051	1,074	1,096	1,125	1,156	1,179	1,208	1,236	1,265	1,295	1,322	1,358	1,387	1,419	1,457
GS2TLKW2H36	1,064	1,089	1,117	1,146	1,181	1,217	1,249	1,286	1,320	1,355	1,393	1,426	1,472	1,508	1,551	1,596
GS2TLKW2H42	1,091	1,123	1,155	1,188	1,233	1,277	1,316	1,360	1,401	1,446	1,490	1,532	1,586	1,627	1,680	1,733
GS2TLKW2H48	1,140	1,172	1,204	1,237	1,282	1,326	1,365	1,409	1,450	1,495	1,539	1,581	1,635	1,676	1,729	1,782

## Tackboard from Floor

GS2WKW4H36	996	1,039	1,085	1,132	1,193	1,254	1,306	1,368	1,425	1,487	1,548	1,607	1,681	1,739	1,814	1,889
GS2WKW5H36	1,054	1,102	1,156	1,207	1,277	1,344	1,404	1,474	1,539	1,606	1,675	1,739	1,825	1,893	1,975	2,061
GS2WKW6H36	1,113	1,167	1,225	1,285	1,361	1,439	1,503	1,582	1,654	1,732	1,808	1,881	1,977	2,048	2,140	2,235

## Surface Mount Tackboards

GS2TKS60	949	990	1,034	1,078	1,136	1,195	1,244	1,304	1,358	1,417	1,475	1,531	1,602	1,659	1,729	1,799
GS2TKS66	964	1,005	1,049	1,093	1,151	1,210	1,259	1,319	1,373	1,432	1,490	1,546	1,617	1,674	1,744	1,814
GS2TKS72	1,003	1,049	1,099	1,149	1,215	1,279	1,337	1,402	1,464	1,529	1,594	1,656	1,740	1,802	1,878	1,962
GS2TKS78	1,030	1,081	1,137	1,193	1,266	1,340	1,402	1,476	1,545	1,619	1,692	1,762	1,852	1,921	2,009	2,100
GS2TKS84	1,060	1,111	1,167	1,223	1,296	1,370	1,432	1,506	1,575	1,649	1,722	1,792	1,882	1,951	2,039	2,130
GS2TKS90	1,108	1,164	1,225	1,285	1,367	1,446	1,516	1,597	1,672	1,755	1,833	1,910	2,011	2,087	2,182	2,281
GS2TKS96	1,154	1,216	1,282	1,349	1,435	1,524	1,599	1,686	1,768	1,855	1,943	2,027	2,135	2,218	2,322	2,431
GS2TKS102	1,592	1,658	1,731	1,804	1,899	1,992	2,073	2,168	2,259	2,352	2,447	2,537	2,654	2,744	2,857	2,976
GS2TKS108	1,650	1,722	1,800	1,878	1,981	2,081	2,170	2,274	2,371	2,474	2,575	2,673	2,798	2,897	3,019	3,145

## WorkWall Tackboards

GS2TKWSB72	1,054	1,102	1,156	1,207	1,277	1,344	1,404	1,474	1,539	1,606	1,675	1,739	1,825	1,893	1,975	2,061
GS2TKWSB90	1,163	1,222	1,287	1,349	1,434	1,518	1,591	1,676	1,755	1,841	1,925	2,005	2,110	2,190	2,290	2,395
GS2TKWSB36	855	881	911	941	980	1,015	1,050	1,088	1,125	1,162	1,200	1,236	1,284	1,322	1,367	1,414
GS2TKWSB45	897	935	978	1,019	1,073	1,127	1,174	1,232	1,283	1,339	1,393	1,447	1,515	1,566	1,634	1,700
GS2TKFBX72	1,054	1,102	1,156	1,207	1,277	1,344	1,404	1,474	1,539	1,606	1,675	1,739	1,825	1,893	1,975	2,061
GS2TKFBX90	1,163	1,222	1,287	1,349	1,434	1,518	1,591	1,676	1,755	1,841	1,925	2,005	2,110	2,190	2,290	2,395

model number      17    18    19    20    21    22    23    24    25    26    27    COL   L1   L2   L3   L4   L5

**Tack to Top Overhead I 2H**

GS2TKW2H30	1,454	1,480	1,513	1,546	1,582	1,615	1,686	1,753	1,823	1,890	1,960						
GS2TKW2H36	1,606	1,639	1,682	1,724	1,767	1,811	1,897	1,982	2,068	2,156	2,240						
GS2TKW2H42	1,759	1,798	1,849	1,898	1,953	2,004	2,109	2,211	2,316	2,419	2,523						
GS2TKW2H48	1,786	1,825	1,876	1,925	1,980	2,031	2,136	2,238	2,343	2,446	2,550						

**Layers Tack to Top Overhead I 1H**

GS2TLKW1H30	1,454	1,480	1,513	1,546	1,582	1,615	1,686	1,753	1,823	1,890	1,960						
GS2TLKW1H36	1,606	1,639	1,682	1,724	1,767	1,811	1,897	1,982	2,068	2,156	2,240						
GS2TLKW1H42	1,759	1,798	1,849	1,898	1,953	2,004	2,109	2,211	2,316	2,419	2,523						
GS2TLKW1H48	1,786	1,825	1,876	1,925	1,980	2,031	2,136	2,238	2,343	2,446	2,550						

**Layers Tack to Top Overhead I 2H**

GS2TLKW2H30	1,492	1,518	1,551	1,584	1,620	1,653	1,724	1,791	1,861	1,928	1,998						
GS2TLKW2H36	1,638	1,671	1,714	1,756	1,799	1,843	1,929	2,014	2,100	2,188	2,272						
GS2TLKW2H42	1,786	1,825	1,876	1,925	1,980	2,031	2,136	2,238	2,343	2,446	2,550						
GS2TLKW2H48	1,835	1,874	1,925	1,974	2,029	2,080	2,185	2,287	2,392	2,495	2,599						

**Tackboard from Floor**

GS2WKW4H36	1,962	2,014	2,090	2,158	2,230	2,303	2,451	2,592	2,738	2,884	3,026						
GS2WKW5H36	2,139	2,201	2,282	2,361	2,443	2,524	2,690	2,849	3,013	3,178	3,339						
GS2WKW6H36	2,327	2,391	2,484	2,572	2,663	2,755	2,937	3,116	3,297	3,482	3,658						

**Surface Mount Tackboards**

GS2TKS60	1,870	1,919	1,989	2,054	2,124	2,195	2,333	2,469	2,607	2,747	2,882						
GS2TKS66	1,885	1,934	2,004	2,069	2,139	2,210	2,348	2,484	2,622	2,762	2,897						
GS2TKS72	2,038	2,097	2,172	2,249	2,327	2,402	2,561	2,713	2,868	3,027	3,179						
GS2TKS78	2,187	2,248	2,336	2,419	2,507	2,595	2,768	2,938	3,111	3,286	3,455						
GS2TKS84	2,217	2,278	2,366	2,449	2,537	2,625	2,798	2,968	3,141	3,316	3,485						
GS2TKS90	2,377	2,447	2,543	2,634	2,730	2,826	3,017	3,203	3,396	3,588	3,776						
GS2TKS96	2,535	2,611	2,715	2,813	2,917	3,021	3,230	3,435	3,643	3,849	4,054						
GS2TKS102	3,088	3,170	3,282	3,391	3,502	3,616	3,841	4,061	4,287	4,514	4,734						
GS2TKS108	3,266	3,354	3,475	3,593	3,715	3,835	4,080	4,319	4,562	4,804	5,042						

**WorkWall Tackboards**

GS2TKWSB72	2,139	2,201	2,282	2,361	2,443	2,524	2,690	2,849	3,013	3,178	3,339						
GS2TKWSB90	2,495	2,568	2,669	2,764	2,865	2,965	3,167	3,364	3,567	3,767	3,963						
GS2TKWSB36	1,459	1,492	1,537	1,580	1,626	1,671	1,765	1,854	1,943	2,036	2,124						
GS2TKWSB45	1,767	1,813	1,879	1,941	2,009	2,072	2,205	2,333	2,464	2,595	2,722						
GS2TKFBX72	2,139	2,201	2,282	2,361	2,443	2,524	2,690	2,849	3,013	3,178	3,339						
GS2TKFBX90	2,495	2,568	2,669	2,764	2,865	2,965	3,167	3,364	3,567	3,767	3,963						

# WEIGHTS + CUBES

Silea  
05/22

model number	weight	cubes	#locks	page
ACCNTRWGT15	20	0.5	-	223, 350
ACCNTRWGT30	30	1.0	-	223, 350
ACCNTRWGT36	35	1.0	-	223, 350
ACDRB-LAT	2	0.5	-	348
ACDUOBZL-EEU	3	0.2	-	355
ACDUOBZL-EEU-HW	3	0.2	-	355
ACDUOCLMP-EEU	3	0.2	-	356
ACDUOCLMP-EEU-HW	3	0.2	-	356
ACFLR5-P	1	0.1	-	348
ACFLR9-P	1	0.1	-	348
ACFLR15-P	1	0.1	-	348
ACFLR18-P	1	0.2	-	348
ACFLR30-P	1	0.3	-	348
ACFLR36-P	1	0.3	-	348
ACGRMTFLD	1	0.1	-	358
ACHAT-BLUETOOTH	1	0.1	-	125
ACHAT-FPD	1	0.1	-	125
ACHAT-MEM	1	0.1	-	125
ACHAT-PDL	1	0.1	-	125
ACHAT-UD	1	0.1	-	125
ACMWS30	3	0.4	-	200
ACMWS36	4	0.5	-	200
ACMWS41	4	0.5	-	200
ACMWS47	5	0.6	-	200
ACMWS53	5	0.7	-	200
ACMWS59	6	0.7	-	200
ACMWS65	7	0.8	-	200
ACMWS71	7	0.9	-	200
ACMWS83	8	1.0	-	200
ACPHQ3QI-B	3	0.3	-	216
ACPHQ3QI-S	3	0.3	-	216
ACPT15-GAA	2	0.5	-	353
ACPT18-GAA	2	0.5	-	353
ACPUNDER-EU	2	0.2	-	357
ACPUNDER-EU-HW	2	0.2	-	357
ACPWRT	2	0.2	-	346
ACTLED24	2	0.1	-	344
ACTLED36	3	0.2	-	344
ACTLED48	4	0.3	-	344
ACTLED60	5	0.3	-	344
ACTRIOBZL-EEEUD	4	0.3	-	355
ACTRIOBZL-EEEUD-HW	4	0.3	-	355
ACTRIOCLMP-EEEUD	4	0.3	-	356
ACTRIOCLMP-EEEUD-HW	4	0.3	-	356

model number	weight	cubes	#locks	page
ACTRIOUNDER-EEEUD	4	0.3	-	357
ACTRIOUNDER-EEEUD-HW	4	0.3	-	357
ACUNOBZL-EU	2	0.2	-	216, 355
ACUNOBZL-EU-HW	2	0.2	-	216, 355
ACUNOCLMP-EU	2	0.2	-	356
ACUNOCLMP-EU-HW	2	0.2	-	356
ACWCB15	6	0.7	-	123
ACWCB20	8	0.8	-	123
ACWM	2	0.1	-	351
BSHAT2142	53	5.4	-	121
BSHAT2148	55	6.3	-	121
BSHAT2154	57	7.1	-	121
BSHAT2160	59	7.9	-	121
BSHAT2166	61	8.8	-	121
BSHAT2172	63	9.6	-	121
BSHAT2748	59	7.8	-	121
BSHAT2754	61	8.9	-	121
BSHAT2760	63	9.9	-	121
BSHAT2766	65	10.9	-	121
BSHAT2772	67	12.0	-	121
GDAPPM-EEU	3	0.1	-	357
GDAPPM-EEU-HW	3	0.1	-	357
GLLM48H66-WW	225	69.7	-	341
GLLMTGW36H58W-GSA	59	4.8	-	342
GS2ALEG-A	8	0.6	-	139
GS2ASF830-A	10	0.8	-	312
GS2ASF830-L	7	0.3	-	312
GS2ASF830-W	8	0.8	-	312
GS2ASF836-A	12	1.0	-	312
GS2ASF836-L	9	0.3	-	312
GS2ASF836-W	10	1.0	-	312
GS2ASF842-A	14	1.1	-	312
GS2ASF842-L	11	1.1	-	312
GS2ASF842-W	11	1.1	-	312
GS2ASF848-A	15	1.3	-	312
GS2ASF848-L	12	1.3	-	312
GS2ASF848-W	12	1.3	-	312
GS2ASF854-A	17	1.4	-	312
GS2ASF854-L	14	1.4	-	312
GS2ASF854-W	14	1.4	-	312
GS2ASF860-A	19	1.6	-	312
GS2ASF860-L	15	0.5	-	312
GS2ASF860-W	16	1.6	-	312
GS2ASF866-A	21	1.7	-	312

model number	weight	cubes	#locks	page
GS2ASF866-L	16	0.6	-	312
GS2ASF866-W	17	1.7	-	312
GS2ASF872-A	23	1.9	-	312
GS2ASF872-L	18	0.7	-	312
GS2ASF872-W	19	1.9	-	312
GS2ASF878-A	25	2.0	-	312
GS2ASF878-L	19	0.7	-	312
GS2ASF878-W	20	2.0	-	312
GS2ASF884-A	27	1.1	-	312
GS2ASF884-L	21	0.8	-	312
GS2ASF884-W	22	1.1	-	312
GS2ASF890-A	29	1.2	-	312
GS2ASF890-L	22	0.8	-	312
GS2ASF890-W	24	1.2	-	312
GS2ASF896-A	31	1.3	-	312
GS2ASF896-L	24	0.9	-	312
GS2ASF896-W	26	1.3	-	312
GS2ASF1230-A	14	1.1	-	313
GS2ASF1230-L	10	0.3	-	313
GS2ASF1230-W	11	1.1	-	313
GS2ASF1236-A	16	1.3	-	313
GS2ASF1236-L	12	0.3	-	313
GS2ASF1236-W	13	1.3	-	313
GS2ASF1242-A	18	1.5	-	313
GS2ASF1242-L	15	1.5	-	313
GS2ASF1242-W	15	1.5	-	313
GS2ASF1248-A	21	1.7	-	313
GS2ASF1248-L	18	1.7	-	313
GS2ASF1248-W	18	1.7	-	313
GS2ASF1254-A	24	1.9	-	313
GS2ASF1254-L	20	1.9	-	313
GS2ASF1254-W	20	1.9	-	313
GS2ASF1260-A	27	2.1	-	313
GS2ASF1260-L	20	0.5	-	313
GS2ASF1260-W	22	2.1	-	313
GS2ASF1266-A	30	2.3	-	313
GS2ASF1266-L	22	0.6	-	313
GS2ASF1266-W	24	2.3	-	313
GS2ASF1272-A	33	2.5	-	313
GS2ASF1272-L	24	0.7	-	313
GS2ASF1272-W	26	2.5	-	313
GS2ASF1278-A	35	2.7	-	313
GS2ASF1278-L	26	0.7	-	313
GS2ASF1278-W	28	2.7	-	313

model number	weight	cubes	#locks	page
GS2ASF1284-A	38	1.5	-	313
GS2ASF1284-L	27	0.8	-	313
GS2ASF1284-W	31	1.5	-	313
GS2ASF1290-A	41	1.6	-	313
GS2ASF1290-L	29	0.8	-	313
GS2ASF1290-W	33	1.6	-	313
GS2ASF1296-A	44	1.7	-	313
GS2ASF1296-L	31	0.9	-	313
GS2ASF1296-W	35	1.7	-	313
GS2ASF8102-A	33	1.3	-	312
GS2ASF8102-L	25	0.5	-	312
GS2ASF8102-W	27	1.3	-	312
GS2ASF8108-A	35	1.4	-	312
GS2ASF8108-L	27	0.5	-	312
GS2ASF8108-W	28	1.4	-	312
GS2ASF8114-A	37	1.4	-	312
GS2ASF8114-L	30	2.9	-	312
GS2ASF8114-W	30	2.9	-	312
GS2ASF8120-A	39	1.6	-	312
GS2ASF8120-L	30	0.5	-	312
GS2ASF8120-W	32	1.6	-	312
GS2ASF8132-A	34	2.8	-	312
GS2ASF8132-L	34	2.8	-	312
GS2ASF8132-W	34	2.8	-	312
GS2ASF8144-A	38	3.0	-	312
GS2ASF8144-L	38	3.0	-	312
GS2ASF8144-W	38	3.0	-	312
GS2ASF12102-A	46	1.8	-	313
GS2ASF12102-L	33	0.5	-	313
GS2ASF12102-W	37	1.8	-	313
GS2ASF12108-A	49	1.9	-	313
GS2ASF12108-L	35	0.5	-	313
GS2ASF12108-W	39	1.9	-	313
GS2ASF12114-A	51	2.0	-	313
GS2ASF12114-L	41	3.9	-	313
GS2ASF12114-W	41	3.9	-	313
GS2ASF12120-A	54	2.1	-	313
GS2ASF12120-L	39	0.5	-	313
GS2ASF12120-W	44	2.1	-	313
GS2ASF12132-A	48	2.3	-	313
GS2ASF12132-L	48	2.3	-	313
GS2ASF12132-W	48	2.3	-	313
GS2ASF12144-A	52	2.5	-	313
GS2ASF12144-L	52	2.5	-	313

# WEIGHTS + CUBES

Silea  
05/22

model number	weight	cubes	#locks	page
GS2ASF12144-W	52	2.5	-	313
GS2AT-PAPER	2	0.9	-	345
GS2AT-PDA	1	0.3	-	345
GS2AT-PLUG	1	0.1	-	345
GS2AT-PNCL	1	0.4	-	345
GS2AT-SHELF	2	0.5	-	345
GS2BCL5H18L-LL	210	23.5	1	248
GS2BCL5H18L-WW	210	23.5	1	248
GS2BCL5H18R-LL	210	23.5	1	248
GS2BCL5H18R-WW	210	23.5	1	248
GS2BCL6H18L-LL	250	27.9	1	248
GS2BCL6H18L-WW	250	27.9	1	248
GS2BCL6H18R-LL	250	27.9	1	248
GS2BCL6H18R-WW	250	27.9	1	248
GS2BKN2H30N-LN	65	10.5	-	246
GS2BKN2H30N-WN	65	10.5	-	246
GS2BKN2H36N-LN	80	12.5	-	246
GS2BKN2H36N-WN	80	12.5	-	246
GS2BKN3H30-LN	100	14.7	-	246
GS2BKN3H30-WN	100	14.7	-	246
GS2BKN3H36-LN	115	18.2	-	246
GS2BKN3H36-WN	115	18.2	-	246
GS2BKN4H30-LN	127	18.6	-	246
GS2BKN4H30-WN	127	18.6	-	246
GS2BKN4H36-LN	142	23.2	-	246
GS2BKN4H36-WN	142	23.2	-	246
GS2BKN5H30-LN	152	23.2	-	246
GS2BKN5H30-WN	152	23.2	-	246
GS2BKN5H36-LN	167	28.9	-	246
GS2BKN5H36-WN	167	28.9	-	246
GS2BKN6H30-LN	213	27.6	-	246
GS2BKN6H30-WN	213	27.6	-	246
GS2BKN6H36-LN	228	34.3	-	246
GS2BKN6H36-WN	228	34.3	-	246
GS2BMA39-L	35	6.8	-	195
GS2BMA39-W	35	6.8	-	195
GS2BMA42-L	37	7.2	-	195
GS2BMA42-W	37	7.2	-	195
GS2BMA45-L	39	7.7	-	195
GS2BMA45-W	39	7.7	-	195
GS2BMA48-L	41	8.2	-	195
GS2BMA48-W	41	8.2	-	195
GS2BMA51-L	43	8.7	-	195
GS2BMA51-W	43	8.7	-	195

model number	weight	cubes	#locks	page
GS2BMA54-L	45	9.2	-	195
GS2BMA54-W	45	9.2	-	195
GS2BMA57-L	47	9.6	-	195
GS2BMA57-W	47	9.6	-	195
GS2BMA60-L	49	10.1	-	195
GS2BMA60-W	49	10.1	-	195
GS2BMF39-L	19	2.9	-	194
GS2BMF39-W	19	2.9	-	194
GS2BMF42-L	20	3.1	-	194
GS2BMF42-W	20	3.1	-	194
GS2BMF45-L	21	3.3	-	194
GS2BMF45-W	21	3.3	-	194
GS2BMF48-L	23	3.5	-	194
GS2BMF48-W	23	3.5	-	194
GS2BMF51-L	24	3.7	-	194
GS2BMF51-W	24	3.7	-	194
GS2BMF54-L	26	3.9	-	194
GS2BMF54-W	26	3.9	-	194
GS2BMF57-L	27	4.1	-	194
GS2BMF57-W	27	4.1	-	194
GS2BMF60-L	29	4.3	-	194
GS2BMF60-W	29	4.3	-	194
GS2BSC5H30L-LN	167	36.9	-	247
GS2BSC5H30L-WN	167	36.9	-	247
GS2BSC5H30R-LN	167	36.9	-	247
GS2BSC5H30R-WN	167	36.9	-	247
GS2BSC6H30L-LN	195	43.8	-	247
GS2BSC6H30L-WN	195	43.8	-	247
GS2BSC6H30R-LN	195	43.8	-	247
GS2BSC6H30R-WN	195	43.8	-	247
GS2CDWSD-W	2	13.0	-	352
GS2CLD5H30-DLL	286	36.9	1	252
GS2CLD5H30-DWW	286	36.9	1	252
GS2CLD5H30-SLL	265	36.9	1	252
GS2CLD5H30-SWW	265	36.9	1	252
GS2CLD5H36-DLL	306	55.7	-	252
GS2CLD5H36-DWW	306	55.7	-	252
GS2CLD5H36-SLL	285	55.7	-	252
GS2CLD5H36-SWW	285	55.7	-	252
GS2CLD6H30-DLL	342	43.8	1	252
GS2CLD6H30-DWW	342	43.8	1	252
GS2CLD6H30-SLL	311	43.8	1	252
GS2CLD6H30-SWW	311	43.8	1	252
GS2CLD6H36-DLL	362	55.7	-	252

model number	weight	cubes	#locks	page
GS2CLD6H36-DWW	362	55.7	-	252
GS2CLD6H36-SLL	331	55.7	-	252
GS2CLD6H36-SWW	331	55.7	-	252
GS2CLMA21-L	20	3.8	-	190
GS2CLMA21-W	20	3.8	-	190
GS2CLMA24-L	22	4.3	-	190
GS2CLMA24-W	22	4.3	-	190
GS2CLMA27-L	24	4.7	-	190
GS2CLMA27-W	24	4.7	-	190
GS2CLMA30-L	26	5.2	-	190
GS2CLMA30-W	26	5.2	-	190
GS2CLMA33-L	28	5.6	-	190
GS2CLMA33-W	28	5.6	-	190
GS2CLMA36-L	30	6.1	-	190
GS2CLMA36-W	30	6.1	-	190
GS2CLMA39-L	32	6.5	-	190
GS2CLMA39-W	32	6.5	-	190
GS2CLMA42-L	34	7.0	-	190
GS2CLMA42-W	34	7.0	-	190
GS2CLMA45-L	36	7.4	-	190
GS2CLMA45-W	36	7.4	-	190
GS2CLMA48-L	38	7.9	-	190
GS2CLMA48-W	38	7.9	-	190
GS2CLMA51-L	40	8.4	-	190
GS2CLMA51-W	40	8.4	-	190
GS2CLMA54-L	42	8.8	-	190
GS2CLMA54-W	42	8.8	-	190
GS2CLMA57-L	44	9.3	-	190
GS2CLMA57-W	44	9.3	-	190
GS2CLMA60-L	46	9.7	-	190
GS2CLMA60-W	46	9.7	-	190
GS2CLMA63-L	48	10.2	-	190
GS2CLMA63-W	48	10.2	-	190
GS2CLMA66-L	50	10.6	-	190
GS2CLMA66-W	50	10.6	-	190
GS2CLMA69-L	52	11.1	-	190
GS2CLMA69-W	52	11.1	-	190
GS2CLMA72-L	54	11.5	-	190
GS2CLMA72-W	54	11.5	-	190
GS2CLMF45-L	18	2.5	-	188, 240
GS2CLMF45-W	18	2.5	-	188, 240
GS2CLMF48-L	19	2.6	-	188, 240
GS2CLMF48-W	19	2.6	-	188, 240
GS2CLMF51-L	21	2.8	-	188, 240

model number	weight	cubes	#locks	page
GS2CLMF51-W	21	2.8	-	188, 240
GS2CLMF54-L	22	2.9	-	188, 240
GS2CLMF54-W	22	2.9	-	188, 240
GS2CLMF60-L	27	3.3	-	188, 240
GS2CLMF60-W	27	3.3	-	188, 240
GS2CLMF66-L	30	3.6	-	188, 240
GS2CLMF66-W	30	3.6	-	188, 240
GS2CLMF72-L	33	3.9	-	188, 240
GS2CLMF72-W	33	3.9	-	188, 240
GS2CLMF78-L	36	4.2	-	188, 240
GS2CLMF78-W	36	4.2	-	188, 240
GS2CLMF84-L	39	4.5	-	188, 240
GS2CLMF84-W	39	4.5	-	188, 240
GS2CLMF90-L	42	4.9	-	188, 240
GS2CLMF90-W	42	4.9	-	188, 240
GS2CLMF96-L	45	5.2	-	188, 240
GS2CLMF96-W	45	5.2	-	188, 240
GS2CLMF102-L	48	5.5	-	188, 240
GS2CLMF102-W	48	5.5	-	188, 240
GS2CLMF108-L	51	5.8	-	188, 240
GS2CLMF108-W	51	5.8	-	188, 240
GS2CLMF114-L	54	6.1	-	188, 240
GS2CLMF114-W	54	6.1	-	188, 240
GS2CLMF120-L	57	6.4	-	188, 240
GS2CLMF120-W	57	6.4	-	188, 240
GS2CLPD249L-XL	32	4.3	-	161
GS2CLPD249L-XW	32	4.3	-	161
GS2CLPD249R-XL	32	4.3	-	161
GS2CLPD249R-XW	32	4.3	-	161
GS2CLPD249TL-XL	32	4.3	-	167
GS2CLPD249TL-XW	32	4.3	-	167
GS2CLPD249TR-XL	32	4.3	-	167
GS2CLPD249TR-XW	32	4.3	-	167
GS2CLPD2415-AL	79	6.5	1	162, 229
GS2CLPD2415-AW	79	6.5	1	162, 229
GS2CLPD2415T-AL	79	6.5	1	168, 234
GS2CLPD2415T-AW	79	6.5	1	168, 234
GS2CLPD2418-AL	86	7.5	1	162, 229
GS2CLPD2418-AW	86	7.5	1	162, 229
GS2CLPD2418L-XL	66	7.5	-	161
GS2CLPD2418L-XW	66	7.5	-	161
GS2CLPD2418R-XL	66	7.5	-	161
GS2CLPD2418R-XW	66	7.5	-	161
GS2CLPD2418T-AL	86	7.5	1	168, 234

# WEIGHTS + CUBES

Silea  
05/22

model number	weight	cubes	#locks	page
GS2CLPD2418T-AW	86	7.5	1	168, 234
GS2CLPD2418TL-XL	66	4.3	-	167
GS2CLPD2418TL-XW	66	4.3	-	167
GS2CLPD2418TR-XL	66	4.3	-	167
GS2CLPD2418TR-XW	66	4.3	-	167
GS2CLPD2430-5L	106	11.8	1	164, 231
GS2CLPD2430-5W	106	11.8	1	164, 231
GS2CLPD2430-BL	111	11.8	1	163, 230
GS2CLPD2430-BW	111	11.8	1	163, 230
GS2CLPD2430L-SDL	110	11.8	1	166, 233
GS2CLPD2430L-SDW	110	11.8	1	166, 233
GS2CLPD2430R-SDL	110	11.8	1	166, 233
GS2CLPD2430R-SDW	110	11.8	1	166, 233
GS2CLPD2430-SHL	96	11.8	-	165, 232
GS2CLPD2430-SHW	96	11.8	-	165, 232
GS2CLPD2430T-5L	106	11.8	1	170, 236
GS2CLPD2430T-5W	106	11.8	1	170, 236
GS2CLPD2430T-BL	111	11.8	1	169, 235
GS2CLPD2430T-BW	111	11.8	1	169, 235
GS2CLPD2430TL-SDL	110	11.8	1	172, 238
GS2CLPD2430TL-SDW	110	11.8	1	172, 238
GS2CLPD2430TR-SDL	110	11.8	1	172, 238
GS2CLPD2430TR-SDW	110	11.8	1	172, 238
GS2CLPD2430T-SHL	96	11.8	-	171, 237
GS2CLPD2430T-SHW	96	11.8	-	171, 237
GS2CLPD2436-5L	124	14.0	1	164, 231
GS2CLPD2436-5W	124	14.0	1	164, 231
GS2CLPD2436-BL	125	14.0	1	163, 230
GS2CLPD2436-BW	125	14.0	1	163, 230
GS2CLPD2436L-SDL	125	14.0	1	166, 233
GS2CLPD2436L-SDW	125	14.0	1	166, 233
GS2CLPD2436R-SDL	125	14.0	1	166, 233
GS2CLPD2436R-SDW	125	14.0	1	166, 233
GS2CLPD2436-SHL	114	14.0	-	165, 232
GS2CLPD2436-SHW	114	14.0	-	165, 232
GS2CLPD2436T-5L	124	14.0	1	170, 236
GS2CLPD2436T-5W	124	14.0	1	170, 236
GS2CLPD2436T-BL	125	14.0	1	169, 235
GS2CLPD2436T-BW	125	14.0	1	169, 235
GS2CLPD2436TL-SDL	125	14.0	1	172, 238
GS2CLPD2436TL-SDW	125	14.0	1	172, 238
GS2CLPD2436TR-SDL	125	14.0	1	172, 238
GS2CLPD2436TR-SDW	125	14.0	1	172, 238
GS2CLPD2436T-SHL	114	14.0	-	171, 237

model number	weight	cubes	#locks	page
GS2CLPD2436T-SHW	114	14.0	-	171, 237
GS2CLPD-CUSH2130T	10	1.8	-	202
GS2CLPD-CUSH2136T	11	2.1	-	202
GS2CLS5H15L-LL	146	20.1	1	251
GS2CLS5H15L-WG	146	20.1	-	253
GS2CLS5H15L-WW	146	20.1	1	251
GS2CLS5H15R-LL	146	20.1	1	251
GS2CLS5H15R-WG	146	20.1	-	253
GS2CLS5H15R-WW	146	20.1	1	251
GS2CLS5H18L-FLL	176	21.1	1	241
GS2CLS5H18L-FWW	176	21.1	1	241
GS2CLS5H18L-LL	166	23.5	1	251
GS2CLS5H18L-WG	166	23.5	-	253
GS2CLS5H18L-WW	166	23.5	1	251
GS2CLS5H18R-FLL	176	21.1	1	241
GS2CLS5H18R-FWW	176	21.1	1	241
GS2CLS5H18R-LL	166	23.5	1	251
GS2CLS5H18R-WG	166	23.5	-	253
GS2CLS5H18R-WW	166	23.5	1	251
GS2CLS5H30D18L-LL	181	31.6	-	254
GS2CLS5H30D18L-WG	181	31.6	-	255
GS2CLS5H30D18L-WW	181	31.6	-	254
GS2CLS5H30D18R-LL	181	31.6	-	254
GS2CLS5H30D18R-WG	181	31.6	-	255
GS2CLS5H30D18R-WW	181	31.6	-	254
GS2CLS6H15L-LL	181	26.5	-	251
GS2CLS6H15L-WG	181	26.5	-	253
GS2CLS6H15L-WW	181	26.5	-	251
GS2CLS6H15R-LL	181	26.5	-	251
GS2CLS6H15R-WG	181	26.5	-	253
GS2CLS6H15R-WW	181	26.5	-	251
GS2CLS6H18L-FLL	201	25.5	1	241
GS2CLS6H18L-FWW	201	25.5	1	241
GS2CLS6H18L-LL	191	27.9	1	251
GS2CLS6H18L-WG	191	27.9	-	253
GS2CLS6H18L-WW	191	27.9	1	251
GS2CLS6H18R-FLL	201	25.5	1	241
GS2CLS6H18R-FWW	201	25.5	1	241
GS2CLS6H18R-LL	191	27.9	1	251
GS2CLS6H18R-WG	191	27.9	-	253
GS2CLS6H18R-WW	191	27.9	1	251
GS2CLS6H30D18L-LL	205	31.6	-	254
GS2CLS6H30D18L-WG	205	31.6	-	255
GS2CLS6H30D18L-WW	205	31.6	-	254



model number	weight	cubes	#locks	page
GS2CLS6H30D18R-LL	205	31.6	-	254
GS2CLS6H30D18R-WG	205	31.6	-	255
GS2CLS6H30D18R-WW	205	31.6	-	254
GS2CMA21-L	23	3.9	-	189
GS2CMA21-W	23	3.9	-	189
GS2CMA24-L	25	4.3	-	189
GS2CMA24-W	25	4.3	-	189
GS2CMA27-L	27	4.8	-	189
GS2CMA27-W	27	4.8	-	189
GS2CMA30-L	29	5.3	-	189
GS2CMA30-W	29	5.3	-	189
GS2CMA33-L	31	5.8	-	189
GS2CMA33-W	31	5.8	-	189
GS2CMA36-L	33	6.3	-	189
GS2CMA36-W	33	6.3	-	189
GS2CMA39-L	35	6.8	-	189
GS2CMA39-W	35	6.8	-	189
GS2CMA42-L	37	7.2	-	189
GS2CMA42-W	37	7.2	-	189
GS2CMA45-L	39	7.7	-	189
GS2CMA45-W	39	7.7	-	189
GS2CMA48-L	41	8.2	-	189
GS2CMA48-W	41	8.2	-	189
GS2CMA51-L	43	8.7	-	189
GS2CMA51-W	43	8.7	-	189
GS2CMA54-L	45	9.2	-	189
GS2CMA54-W	45	9.2	-	189
GS2CMA57-L	47	9.6	-	189
GS2CMA57-W	47	9.6	-	189
GS2CMA60-L	49	10.1	-	189
GS2CMA60-W	49	10.1	-	189
GS2CMA63-L	51	10.6	-	189
GS2CMA63-W	51	10.6	-	189
GS2CMA66-L	53	11.1	-	189
GS2CMA66-W	53	11.1	-	189
GS2CMA69-L	55	11.6	-	189
GS2CMA69-W	55	11.6	-	189
GS2CMA72-L	57	12.1	-	189
GS2CMA72-W	57	12.1	-	189
GS2CMF60-L	29	4.3	-	187
GS2CMF60-W	29	4.3	-	187
GS2CMF66-L	32	4.7	-	187
GS2CMF66-W	32	4.7	-	187
GS2CMF72-L	35	5.1	-	187

model number	weight	cubes	#locks	page
GS2CMF72-W	35	5.1	-	187
GS2CMF78-L	38	5.5	-	187
GS2CMF78-W	38	5.5	-	187
GS2CMF84-L	41	5.9	-	187
GS2CMF84-W	41	5.9	-	187
GS2CMF90-L	44	6.3	-	187
GS2CMF90-W	44	6.3	-	187
GS2CMF96-L	47	6.7	-	187
GS2CMF96-W	47	6.7	-	187
GS2CMF102-L	50	7.1	-	187
GS2CMF102-W	50	7.1	-	187
GS2CMF108-L	53	7.5	-	187
GS2CMF108-W	53	7.5	-	187
GS2CMF114-L	56	7.9	-	187
GS2CMF114-W	56	7.9	-	187
GS2CMF120-L	59	8.4	-	187
GS2CMF120-W	59	8.4	-	187
GS2COLUMN	10	0.9	-	139
GS2CPD249L-XL	37	5.6	-	151
GS2CPD249L-XW	37	5.6	-	151
GS2CPD249R-XL	37	5.6	-	151
GS2CPD249R-XW	37	5.6	-	151
GS2CPD249TL-XL	37	5.6	-	156
GS2CPD249TL-XW	37	5.6	-	156
GS2CPD249TR-XL	37	5.6	-	156
GS2CPD249TR-XW	37	5.6	-	156
GS2CPD309L-XL	40	8.7	-	173
GS2CPD309L-XW	40	8.7	-	173
GS2CPD309R-XL	40	8.7	-	173
GS2CPD309R-XW	40	8.7	-	173
GS2CPD309TL-XL	40	8.7	-	178
GS2CPD309TL-XW	40	8.7	-	178
GS2CPD309TR-XL	40	8.7	-	178
GS2CPD309TR-XW	40	8.7	-	178
GS2CPD2415-2L	84	8.4	1	152
GS2CPD2415-2W	84	8.4	1	152
GS2CPD2415-3AL	84	8.4	1	152
GS2CPD2415-3AW	84	8.4	1	152
GS2CPD2415-3L	84	8.4	1	152
GS2CPD2415-3W	84	8.4	1	152
GS2CPD2415L-5L	70	10.5	1	154
GS2CPD2415L-5W	70	10.5	1	154
GS2CPD2415R-5L	70	10.5	1	154
GS2CPD2415R-5W	70	10.5	1	154

# WEIGHTS + CUBES

Silea  
05/22

model number	weight	cubes	#locks	page
GS2CPD2415-SHL	65	10.5	-	155
GS2CPD2415-SHW	65	10.5	-	155
GS2CPD2415T-2L	84	8.4	1	157
GS2CPD2415T-2W	84	8.4	1	157
GS2CPD2415T-3AL	84	8.4	1	157
GS2CPD2415T-3AW	84	8.4	1	157
GS2CPD2415T-3L	84	8.4	1	157
GS2CPD2415T-3W	84	8.4	1	157
GS2CPD2415TL-5L	70	10.5	1	159
GS2CPD2415TL-5W	70	10.5	1	159
GS2CPD2415TR-5L	70	10.5	1	159
GS2CPD2415TR-5W	70	10.5	1	159
GS2CPD2415T-SHL	65	10.5	-	160
GS2CPD2415T-SHW	65	10.5	-	160
GS2CPD2418-2L	91	9.8	1	152
GS2CPD2418-2W	91	9.8	1	152
GS2CPD2418-3AL	91	9.8	1	152
GS2CPD2418-3AW	91	9.8	1	152
GS2CPD2418-3L	91	9.8	1	152
GS2CPD2418-3W	91	9.8	1	152
GS2CPD2418L-5L	75	12.1	1	154
GS2CPD2418L-5W	75	12.1	1	154
GS2CPD2418L-XL	71	9.8	-	151
GS2CPD2418L-XW	71	9.8	-	151
GS2CPD2418R-5L	75	12.1	1	154
GS2CPD2418R-5W	75	12.1	1	154
GS2CPD2418R-XL	71	9.8	-	151
GS2CPD2418R-XW	71	9.8	-	151
GS2CPD2418-SHL	75	12.1	-	155
GS2CPD2418-SHW	75	12.1	-	155
GS2CPD2418T-2L	91	9.8	1	157
GS2CPD2418T-2W	91	9.8	1	157
GS2CPD2418T-3AL	91	9.8	1	157
GS2CPD2418T-3AW	91	9.8	1	157
GS2CPD2418T-3L	91	9.8	1	157
GS2CPD2418T-3W	91	9.8	1	157
GS2CPD2418TL-5L	75	12.1	1	159
GS2CPD2418TL-5W	75	12.1	1	159
GS2CPD2418TL-XL	71	9.8	-	156
GS2CPD2418TL-XW	71	9.8	-	156
GS2CPD2418TR-5L	75	12.1	1	159
GS2CPD2418TR-5W	75	12.1	1	159
GS2CPD2418TR-XL	71	9.8	-	156
GS2CPD2418TR-XW	71	9.8	-	156

model number	weight	cubes	#locks	page
GS2CPD2418T-SHL	75	12.1	-	160
GS2CPD2418T-SHW	75	12.1	-	160
GS2CPD2424-5L	85	15.4	1	154
GS2CPD2424-5W	85	15.4	1	154
GS2CPD2424-SHL	80	15.4	-	155
GS2CPD2424-SHW	80	15.4	-	155
GS2CPD2424T-5L	85	15.4	1	159
GS2CPD2424T-5W	85	15.4	1	159
GS2CPD2424T-SHL	80	15.4	-	160
GS2CPD2424T-SHW	80	15.4	-	160
GS2CPD2430-4L	116	15.4	1	153
GS2CPD2430-4W	116	15.4	1	153
GS2CPD2430-5L	111	15.4	1	154
GS2CPD2430-5W	111	15.4	1	154
GS2CPD2430-7L	118	15.4	1	153
GS2CPD2430-7W	118	15.4	1	153
GS2CPD2430L-MFL	136	18.7	1	153
GS2CPD2430L-MFW	136	18.7	1	153
GS2CPD2430-PL	135	18.7	1	154
GS2CPD2430-PW	135	18.7	1	154
GS2CPD2430R-MFL	136	18.7	1	153
GS2CPD2430R-MFW	136	18.7	1	153
GS2CPD2430-SHL	101	15.4	-	155
GS2CPD2430-SHW	101	15.4	-	155
GS2CPD2430T-4L	116	15.4	1	158
GS2CPD2430T-4W	116	15.4	1	158
GS2CPD2430T-5L	111	15.4	1	159
GS2CPD2430T-5W	111	15.4	1	159
GS2CPD2430T-7L	118	15.4	1	158
GS2CPD2430T-7W	118	15.4	1	158
GS2CPD2430TL-MFL	136	18.7	1	158
GS2CPD2430TL-MFW	136	18.7	1	158
GS2CPD2430T-PL	135	18.7	1	159
GS2CPD2430T-PW	135	18.7	1	159
GS2CPD2430TR-MFL	136	18.7	1	158
GS2CPD2430TR-MFW	136	18.7	1	158
GS2CPD2430T-SHL	101	15.4	-	160
GS2CPD2430T-SHW	101	15.4	-	160
GS2CPD2436-4L	130	18.2	1	153
GS2CPD2436-4W	130	18.2	1	153
GS2CPD2436-5L	129	18.2	1	154
GS2CPD2436-5W	129	18.2	1	154
GS2CPD2436-7L	133	18.2	1	153
GS2CPD2436-7W	133	18.2	1	153

model number	weight	cubes	#locks	page
GS2CPD2436L-MFL	150	22.0	1	153
GS2CPD2436L-MFW	150	22.0	1	153
GS2CPD2436-PL	140	22.0	1	154
GS2CPD2436-PW	140	22.0	1	154
GS2CPD2436R-MFL	150	22.0	1	153
GS2CPD2436R-MFW	150	22.0	1	153
GS2CPD2436-SHL	119	18.2	-	155
GS2CPD2436-SHW	119	18.2	-	155
GS2CPD2436T-4L	130	18.2	1	158
GS2CPD2436T-4W	130	18.2	1	158
GS2CPD2436T-5L	129	18.2	1	159
GS2CPD2436T-5W	129	18.2	1	159
GS2CPD2436T-7L	133	18.2	1	158
GS2CPD2436T-7W	133	18.2	1	158
GS2CPD2436TL-MFL	150	22.0	1	158
GS2CPD2436TL-MFW	150	22.0	1	158
GS2CPD2436T-PL	140	22.0	1	159
GS2CPD2436T-PW	140	22.0	1	159
GS2CPD2436TR-MFL	150	22.0	1	158
GS2CPD2436TR-MFW	150	22.0	1	158
GS2CPD2436T-SHL	119	18.2	-	160
GS2CPD2436T-SHW	119	18.2	-	160
GS2CPD3015-2L	89	12.7	1	174
GS2CPD3015-2W	89	12.7	1	174
GS2CPD3015-3AL	89	12.7	1	174
GS2CPD3015-3AW	89	12.7	1	174
GS2CPD3015-3L	89	12.7	1	174
GS2CPD3015-3W	89	12.7	1	174
GS2CPD3015L-5L	75	12.7	1	176
GS2CPD3015L-5W	75	12.7	1	176
GS2CPD3015R-5L	75	12.7	1	176
GS2CPD3015R-5W	75	12.7	1	176
GS2CPD3015-SHL	70	12.7	-	177
GS2CPD3015-SHW	70	12.7	-	177
GS2CPD3015T-2L	88	12.7	1	179
GS2CPD3015T-2W	88	12.7	1	179
GS2CPD3015T-3AL	88	12.7	1	179
GS2CPD3015T-3AW	88	12.7	1	179
GS2CPD3015T-3L	88	12.7	1	179
GS2CPD3015T-3W	88	12.7	1	179
GS2CPD3015TL-5L	75	12.7	1	181
GS2CPD3015TL-5W	75	12.7	1	181
GS2CPD3015TR-5L	75	12.7	1	181
GS2CPD3015TR-5W	75	12.7	1	181

model number	weight	cubes	#locks	page
GS2CPD3015T-SHL	70	12.7	-	182
GS2CPD3015T-SHW	70	12.7	-	182
GS2CPD3018-2L	96	14.7	1	174
GS2CPD3018-2W	96	14.7	1	174
GS2CPD3018-3AL	96	14.7	1	174
GS2CPD3018-3AW	96	14.7	1	174
GS2CPD3018-3L	96	14.7	1	174
GS2CPD3018-3W	96	14.7	1	174
GS2CPD3018L-5L	80	14.7	1	176
GS2CPD3018L-5W	80	14.7	1	176
GS2CPD3018L-XL	45	14.7	-	173
GS2CPD3018L-XW	45	14.7	-	173
GS2CPD3018R-5L	80	14.7	1	176
GS2CPD3018R-5W	80	14.7	1	176
GS2CPD3018R-XL	45	14.7	-	173
GS2CPD3018R-XW	45	14.7	-	173
GS2CPD3018-SHL	80	14.7	-	177
GS2CPD3018-SHW	80	14.7	-	177
GS2CPD3018T-2L	95	14.7	1	179
GS2CPD3018T-2W	95	14.7	1	179
GS2CPD3018T-3AL	95	14.7	1	179
GS2CPD3018T-3AW	95	14.7	1	179
GS2CPD3018T-3L	95	14.7	1	179
GS2CPD3018T-3W	95	14.7	1	179
GS2CPD3018TL-5L	80	14.7	1	181
GS2CPD3018TL-5W	80	14.7	1	181
GS2CPD3018TL-XL	45	14.7	-	178
GS2CPD3018TL-XW	45	14.7	-	178
GS2CPD3018TR-5L	80	14.7	1	181
GS2CPD3018TR-5W	80	14.7	1	181
GS2CPD3018TR-XL	45	14.7	-	178
GS2CPD3018TR-XW	45	14.7	-	178
GS2CPD3018T-SHL	80	14.7	-	182
GS2CPD3018T-SHW	80	14.7	-	182
GS2CPD3024-5L	90	18.7	1	176
GS2CPD3024-5W	90	18.7	1	176
GS2CPD3024-SHL	85	18.7	-	177
GS2CPD3024-SHW	85	18.7	-	177
GS2CPD3024T-5L	90	18.7	1	181
GS2CPD3024T-5W	90	18.7	1	181
GS2CPD3024T-SHL	85	18.7	-	182
GS2CPD3024T-SHW	85	18.7	-	182
GS2CPD3030-4L	120	22.7	1	175
GS2CPD3030-4W	120	22.7	1	175

# WEIGHTS + CUBES

Silea  
05/22

model number	weight	cubes	#locks	page
GS2CPD3030-5L	114	22.7	1	176
GS2CPD3030-5W	114	22.7	1	176
GS2CPD3030-7L	125	22.7	1	175
GS2CPD3030-7W	125	22.7	1	175
GS2CPD3030L-MFL	148	22.7	1	175
GS2CPD3030L-MFW	148	22.7	1	175
GS2CPD3030-PL	140	22.7	1	176
GS2CPD3030-PW	140	22.7	1	176
GS2CPD3030R-MFL	148	22.7	1	175
GS2CPD3030R-MFW	148	22.7	1	175
GS2CPD3030-SHL	105	22.7	-	177
GS2CPD3030-SHW	105	22.7	-	177
GS2CPD3030T-4L	125	22.7	1	180
GS2CPD3030T-4W	125	22.7	1	180
GS2CPD3030T-5L	119	22.7	1	181
GS2CPD3030T-5W	119	22.7	1	181
GS2CPD3030T-7L	127	22.7	1	180
GS2CPD3030T-7W	127	22.7	1	180
GS2CPD3030TL-MFL	148	22.7	1	180
GS2CPD3030TL-MFW	148	22.7	1	180
GS2CPD3030T-PL	140	22.7	1	181
GS2CPD3030T-PW	140	22.7	1	181
GS2CPD3030TR-MFL	148	22.7	1	180
GS2CPD3030TR-MFW	148	22.7	1	180
GS2CPD3030T-SHL	108	22.7	-	182
GS2CPD3030T-SHW	108	22.7	-	182
GS2CPD3036-4L	128	26.8	1	175
GS2CPD3036-4W	128	26.8	1	175
GS2CPD3036-5L	122	26.8	1	176
GS2CPD3036-5W	122	26.8	1	176
GS2CPD3036-7L	132	26.8	1	175
GS2CPD3036-7W	132	26.8	1	175
GS2CPD3036L-MFL	162	26.8	1	175
GS2CPD3036L-MFW	162	26.8	1	175
GS2CPD3036-PL	145	26.8	1	176
GS2CPD3036-PW	145	26.8	1	176
GS2CPD3036R-MFL	162	26.8	1	175
GS2CPD3036R-MFW	162	26.8	1	175
GS2CPD3036-SHL	113	26.8	-	177
GS2CPD3036-SHW	113	26.8	-	177
GS2CPD3036T-4L	140	26.8	1	180
GS2CPD3036T-4W	140	26.8	1	180
GS2CPD3036T-5L	135	26.8	1	181
GS2CPD3036T-5W	135	26.8	1	181

model number	weight	cubes	#locks	page
GS2CPD3036T-7L	143	26.8	1	180
GS2CPD3036T-7W	143	26.8	1	180
GS2CPD3036TL-MFL	162	26.8	1	180
GS2CPD3036TL-MFW	162	26.8	1	180
GS2CPD3036T-PL	145	26.8	1	181
GS2CPD3036T-PW	145	26.8	1	181
GS2CPD3036TR-MFL	162	26.8	1	180
GS2CPD3036TR-MFW	162	26.8	1	180
GS2CPD3036T-SHL	124	26.8	-	182
GS2CPD3036T-SHW	124	26.8	-	182
GS2CPF1H2430-4L	60	8.3	1	225
GS2CPF1H2430-4W	60	8.3	1	225
GS2CPF1H2430-5L	56	8.3	1	226
GS2CPF1H2430-5W	56	8.3	1	226
GS2CPF1H2430-SHL	50	8.3	-	227
GS2CPF1H2430-SHW	50	8.3	-	227
GS2CPF1H2430T-4L	116	15.4	1	225
GS2CPF1H2430T-4W	116	15.4	1	225
GS2CPF1H2430T-5L	56	8.3	1	226
GS2CPF1H2430T-5W	56	8.3	1	226
GS2CPF1H2430T-SHL	50	8.3	-	227
GS2CPF1H2430T-SHW	50	8.3	-	227
GS2CPF1H2436-4L	60	9.8	1	225
GS2CPF1H2436-4W	60	9.8	1	225
GS2CPF1H2436-5L	56	9.8	1	226
GS2CPF1H2436-5W	56	9.8	1	226
GS2CPF1H2436-SHL	50	9.8	-	227
GS2CPF1H2436-SHW	50	9.8	-	227
GS2CPF1H2436T-4L	130	18.2	1	225
GS2CPF1H2436T-4W	130	18.2	1	225
GS2CPF1H2436T-5L	56	9.8	1	226
GS2CPF1H2436T-5W	56	9.8	1	226
GS2CPF1H2436T-SHL	50	9.8	-	227
GS2CPF1H2436T-SHW	50	9.8	-	227
GS2CWA2240-L	27	2.6	-	122
GS2CWA2240-W	27	2.6	-	122
GS2CWA2246-L	31	3.0	-	122
GS2CWA2246-W	31	3.0	-	122
GS2CWA2252-L	35	3.3	-	122
GS2CWA2252-W	35	3.3	-	122
GS2CWA2258-L	39	3.7	-	122
GS2CWA2258-W	39	3.7	-	122
GS2CWA2264-L	43	4.1	-	122
GS2CWA2264-W	43	4.1	-	122

model number	weight	cubes	#locks	page
GS2CWA2270-L	48	4.4	-	122
GS2CWA2270-W	48	4.4	-	122
GS2CWA2840-L	35	3.2	-	122
GS2CWA2840-W	35	3.2	-	122
GS2CWA2846-L	40	3.7	-	122
GS2CWA2846-W	40	3.7	-	122
GS2CWA2852-L	45	4.1	-	122
GS2CWA2852-W	45	4.1	-	122
GS2CWA2858-L	50	4.6	-	122
GS2CWA2858-W	50	4.6	-	122
GS2CWA2864-L	55	5.0	-	122
GS2CWA2864-W	55	5.0	-	122
GS2CWA2870-L	61	5.5	-	122
GS2CWA2870-W	61	5.5	-	122
GS2CWA3440-L	42	3.9	-	122
GS2CWA3440-W	42	3.9	-	122
GS2CWA3446-L	48	4.4	-	122
GS2CWA3446-W	48	4.4	-	122
GS2CWA3452-L	55	4.9	-	122
GS2CWA3452-W	55	4.9	-	122
GS2CWA3458-L	61	5.5	-	122
GS2CWA3458-W	61	5.5	-	122
GS2CWA3464-L	67	6.0	-	122
GS2CWA3464-W	67	6.0	-	122
GS2CWA3470-L	73	6.5	-	122
GS2CWA3470-W	73	6.5	-	122
GS2CWR2415-L	11	1.3	-	147
GS2CWR2415-W	11	1.3	-	147
GS2CWR2418-L	13	1.5	-	147
GS2CWR2418-W	13	1.5	-	147
GS2CWR2424-L	18	1.9	-	147
GS2CWR2424-W	18	1.9	-	147
GS2CWR2430-L	27	2.2	-	147
GS2CWR2430-W	27	2.2	-	147
GS2CWR2436-L	32	2.6	-	147
GS2CWR2436-W	32	2.6	-	147
GS2CWR2442-L	36	2.9	-	147
GS2CWR2442-W	36	2.9	-	147
GS2CWR2448-L	41	3.3	-	147
GS2CWR2448-W	41	3.3	-	147
GS2CWR2454-L	45	3.7	-	147
GS2CWR2454-W	45	3.7	-	147
GS2CWR2460-L	49	4.1	-	147
GS2CWR2460T-L	49	5.3	-	149

model number	weight	cubes	#locks	page
GS2CWR2460T-W	59	5.3	-	149
GS2CWR2460-W	49	4.1	-	147
GS2CWR2466-L	54	4.5	-	147
GS2CWR2466T-L	53	5.8	-	149
GS2CWR2466T-W	65	5.8	-	149
GS2CWR2466-W	54	4.5	-	147
GS2CWR2472-L	58	4.9	-	147
GS2CWR2472T-L	58	6.3	-	149
GS2CWR2472T-W	71	6.3	-	149
GS2CWR2472-W	58	4.9	-	147
GS2CWR2478-L	63	5.3	-	147
GS2CWR2478T-L	63	6.8	-	149
GS2CWR2478T-W	76	6.9	-	149
GS2CWR2478-W	63	5.3	-	147
GS2CWR2484-L	67	5.7	-	147
GS2CWR2484T-L	68	7.3	-	149
GS2CWR2484T-W	81	7.4	-	149
GS2CWR2484-W	67	5.7	-	147
GS2CWR2490-L	72	6.1	-	147
GS2CWR2490T-L	72	7.8	-	149
GS2CWR2490T-W	87	7.9	-	149
GS2CWR2490-W	72	6.1	-	147
GS2CWR2496-L	76	6.5	-	147
GS2CWR2496T-L	77	8.3	-	149
GS2CWR2496T-W	93	8.4	-	149
GS2CWR2496-W	76	6.5	-	147
GS2CWR3015-L	14	1.6	-	148
GS2CWR3015-W	14	1.6	-	148
GS2CWR3018-L	16	1.8	-	148
GS2CWR3018-W	16	1.8	-	148
GS2CWR3024-L	22	2.3	-	148
GS2CWR3024-W	22	2.3	-	148
GS2CWR3030-L	28	2.8	-	148
GS2CWR3030-W	28	2.8	-	148
GS2CWR3036-L	32	3.3	-	148
GS2CWR3036-W	32	3.3	-	148
GS2CWR3042-L	38	3.8	-	148
GS2CWR3042-W	38	3.8	-	148
GS2CWR3048-L	45	4.3	-	148
GS2CWR3048-W	45	4.3	-	148
GS2CWR3054-L	50	4.8	-	148
GS2CWR3054-W	50	4.8	-	148
GS2CWR3060-L	55	5.3	-	148
GS2CWR3060T-L	55	6.5	-	150

# WEIGHTS + CUBES

Silea  
05/22

model number	weight	cubes	#locks	page
GS2CWR3060T-W	55	6.5	-	150
GS2CWR3060-W	55	5.3	-	148
GS2CWR3066-L	60	5.8	-	148
GS2CWR3066T-L	61	7.1	-	150
GS2CWR3066T-W	61	7.1	-	150
GS2CWR3066-W	60	5.8	-	148
GS2CWR3072-L	65	6.3	-	148
GS2CWR3072T-L	67	7.7	-	150
GS2CWR3072T-W	67	7.7	-	150
GS2CWR3072-W	65	6.3	-	148
GS2CWR3078-L	70	6.8	-	148
GS2CWR3078T-L	72	8.3	-	150
GS2CWR3078T-W	72	8.3	-	150
GS2CWR3078-W	70	6.8	-	148
GS2CWR3084-L	75	7.3	-	148
GS2CWR3084T-L	78	8.9	-	150
GS2CWR3084T-W	78	8.9	-	150
GS2CWR3084-W	75	7.3	-	148
GS2CWR3090-L	80	7.8	-	148
GS2CWR3090T-L	84	9.5	-	150
GS2CWR3090T-W	84	9.5	-	150
GS2CWR3090-W	80	7.8	-	148
GS2CWR3096-L	85	8.3	-	148
GS2CWR3096T-L	90	10.1	-	150
GS2CWR3096T-W	90	10.1	-	150
GS2CWR3096-W	85	8.3	-	148
GS2CWR24102-L	81	6.9	-	147
GS2CWR24102T-L	82	8.8	-	149
GS2CWR24102T-W	99	8.9	-	149
GS2CWR24102-W	81	6.9	-	147
GS2CWR24108-L	85	7.3	-	147
GS2CWR24108T-L	87	9.3	-	149
GS2CWR24108T-W	105	9.4	-	149
GS2CWR24108-W	85	7.3	-	147
GS2CWR24114-L	89	7.7	-	147
GS2CWR24114T-L	92	9.8	-	149
GS2CWR24114T-W	111	9.9	-	149
GS2CWR24114-W	89	7.7	-	147
GS2CWR24120-L	94	8.0	-	147
GS2CWR24120T-L	96	10.3	-	149
GS2CWR24120T-W	117	10.4	-	149
GS2CWR24120-W	94	8.0	-	147
GS2CWR30102-L	90	8.8	-	148
GS2CWR30102T-L	96	10.7	-	150

model number	weight	cubes	#locks	page
GS2CWR30102T-W	96	10.7	-	150
GS2CWR30102-W	90	8.8	-	148
GS2CWR30108-L	95	9.3	-	148
GS2CWR30108T-L	102	11.3	-	150
GS2CWR30108T-W	102	11.3	-	150
GS2CWR30108-W	95	9.3	-	148
GS2CWR30114-L	100	9.8	-	148
GS2CWR30114T-L	108	12.0	-	150
GS2CWR30114T-W	108	12.0	-	150
GS2CWR30114-W	100	9.8	-	148
GS2CWR30120-L	105	10.2	-	148
GS2CWR30120T-L	114	12.6	-	150
GS2CWR30120T-W	114	12.6	-	150
GS2CWR30120-W	105	10.2	-	148
GS2DBOB4272-32LL	342	33.8	2	52
GS2DBOB4272-32WW	342	33.8	2	52
GS2DBOB4272L-3LL	266	23.3	1	54
GS2DBOB4272L-3WW	266	23.3	1	54
GS2DBOB4272R-3LL	266	23.3	1	54
GS2DBOB4272R-3WW	266	23.3	1	54
GS2DBOF4272L-3LL	247	26.0	1	55
GS2DBOF4272L-3WW	247	26.0	1	55
GS2DBOF4272R-3LL	247	26.0	1	55
GS2DBOF4272R-3WW	247	26.0	1	55
GS2DDMF960-L	33	4.5	-	143
GS2DDMF960-W	33	4.5	-	143
GS2DDMF966-L	36	5.1	-	143
GS2DDMF966-W	36	5.1	-	143
GS2DDMF972-L	39	5.8	-	143
GS2DDMF972-W	39	5.8	-	143
GS2DDMF978-L	42	6.4	-	143
GS2DDMF978-W	42	6.4	-	143
GS2DDMF984-L	46	7.1	-	143
GS2DDMF984-W	46	7.1	-	143
GS2DDMF990-L	49	5.6	-	143
GS2DDMF990-W	49	5.8	-	143
GS2DDMF996-L	52	6.0	-	143
GS2DDMF996-W	52	6.3	-	143
GS2DDMF1560-L	33	3.2	-	143
GS2DDMF1560-W	33	3.2	-	143
GS2DDMF1566-L	36	3.9	-	143
GS2DDMF1566-W	36	3.9	-	143
GS2DDMF1572-L	39	4.5	-	143
GS2DDMF1572-W	39	4.5	-	143

model number	weight	cubes	#locks	page
GS2DDMF1578-L	42	5.1	-	143
GS2DDMF1578-W	42	5.1	-	143
GS2DDMF1584-L	46	5.8	-	143
GS2DDMF1584-W	46	5.8	-	143
GS2DDMF1590-L	49	5.0	-	143
GS2DDMF1590-W	49	5.0	-	143
GS2DDMF1596-L	52	5.4	-	143
GS2DDMF1596-W	52	5.4	-	143
GS2DHL24-H	18	2.9	-	138
GS2DHL30-H	21	3.5	-	138
GS2DHL36-H	23	4.2	-	138
GS2DMAMOD66-L	12	1.7	-	124
GS2DMAMOD66-M	12	1.7	-	124
GS2DMAMOD66-W	12	1.9	-	124
GS2DMAMOD72-L	12	1.9	-	124
GS2DMAMOD72-M	12	1.9	-	124
GS2DMAMOD72-W	13	1.9	-	124
GS2DMAMOD78-L	12	2.1	-	124
GS2DMAMOD78-M	12	2.1	-	124
GS2DMAMOD78-W	12	2.1	-	124
GS2DMPA24-L	7	0.8	-	142
GS2DMPA24-W	7	0.8	-	142
GS2DMPA27-L	7	0.9	-	142
GS2DMPA27-W	7	0.9	-	142
GS2DMPA30-L	7	0.9	-	142
GS2DMPA30-W	7	0.9	-	142
GS2DMPA33-L	7	1.0	-	142
GS2DMPA33-W	7	1.0	-	142
GS2DMPA36-L	7	1.1	-	142
GS2DMPA36-W	7	1.1	-	142
GS2DMPA39-L	7	1.2	-	142
GS2DMPA39-W	7	1.2	-	142
GS2DMPA42-L	8	1.3	-	142
GS2DMPA42-W	8	1.3	-	142
GS2DMPA45-L	8	1.4	-	142
GS2DMPA45-W	8	1.4	-	142
GS2DMPA48-L	9	1.5	-	142
GS2DMPA48-W	9	1.5	-	142
GS2DMPA51-L	9	1.5	-	142
GS2DMPA51-W	9	1.5	-	142
GS2DMPA54-L	10	1.6	-	142
GS2DMPA54-W	10	1.6	-	142
GS2DMPA57-L	10	1.7	-	142
GS2DMPA57-W	10	1.7	-	142

model number	weight	cubes	#locks	page
GS2DMPA60-L	11	1.8	-	142
GS2DMPA60-W	11	1.8	-	142
GS2DMPA63-L	11	1.9	-	142
GS2DMPA63-W	11	1.9	-	142
GS2DMPA66-L	12	2.0	-	142
GS2DMPA66-W	12	2.0	-	142
GS2DMPA69-L	12	2.1	-	142
GS2DMPA69-W	12	2.1	-	142
GS2DMPA72-L	13	2.1	-	142
GS2DMPA72-W	13	2.1	-	142
GS2DMPH39-G	7	1.2	-	141
GS2DMPH39-L	7	1.2	-	141
GS2DMPH39-W	7	1.2	-	141
GS2DMPH42-G	8	1.3	-	141
GS2DMPH42-L	8	1.3	-	141
GS2DMPH42-W	8	1.3	-	141
GS2DMPH45-G	8	1.3	-	141
GS2DMPH45-L	8	1.3	-	141
GS2DMPH45-W	8	1.3	-	141
GS2DMPH48-G	9	1.4	-	141
GS2DMPH48-L	9	1.4	-	141
GS2DMPH48-W	9	1.4	-	141
GS2DMPH51-G	9	1.5	-	141
GS2DMPH51-L	9	1.5	-	141
GS2DMPH51-W	9	1.5	-	141
GS2DMPH54-G	10	1.6	-	141
GS2DMPH54-L	10	1.6	-	141
GS2DMPH54-W	10	1.6	-	141
GS2DMPH57-G	10	1.7	-	141
GS2DMPH57-L	10	1.7	-	141
GS2DMPH57-W	10	1.7	-	141
GS2DMPH60-G	11	1.8	-	141
GS2DMPH60-L	11	1.8	-	141
GS2DMPH60-W	11	1.8	-	141
GS2DMPH63-G	11	1.9	-	141
GS2DMPH63-L	11	1.9	-	141
GS2DMPH63-W	11	1.9	-	141
GS2DMPH66-G	12	1.9	-	141
GS2DMPH66-L	12	1.9	-	141
GS2DMPH66-W	12	1.9	-	141
GS2DMPH69-G	12	2.0	-	141
GS2DMPH69-L	12	2.0	-	141
GS2DMPH69-W	12	2.0	-	141
GS2DMPH72-G	13	2.1	-	141

# WEIGHTS + CUBES

Silea  
05/22

model number	weight	cubes	#locks	page
GS2DMPH72-L	13	2.1	-	141
GS2DMPH72-W	13	2.1	-	141
GS2DPC2472-22LL	265	26.8	1	59
GS2DPC2472-22WW	265	26.8	1	59
GS2DPD309-2SL	85	7.3	1	133
GS2DPD309-2SW	85	7.3	1	133
GS2DPD309-3SAL	85	7.3	1	133
GS2DPD309-3SAW	85	7.3	1	133
GS2DPD309-3SL	85	7.3	1	133
GS2DPD309-3SW	85	7.3	1	133
GS2DPD309L-XNL	45	7.3	-	134
GS2DPD309L-XNW	45	7.3	-	134
GS2DPD309R-XNL	45	7.3	-	134
GS2DPD309R-XNW	45	7.3	-	134
GS2DPD369-2SL	92	8.6	1	133
GS2DPD369-2SW	92	8.6	1	133
GS2DPD369-3SAL	92	8.6	1	133
GS2DPD369-3SAW	92	8.6	1	133
GS2DPD369-3SL	92	8.6	1	133
GS2DPD369-3SW	92	8.6	1	133
GS2DPD369L-XNL	52	8.6	-	134
GS2DPD369L-XNW	52	8.6	-	134
GS2DPD369R-XNL	52	8.6	-	134
GS2DPD369R-XNW	52	8.6	-	134
GS2DPD3015-2L	105	10.6	1	133
GS2DPD3015-2W	105	10.6	1	133
GS2DPD3015-3L	105	10.6	1	133
GS2DPD3015-3W	105	10.6	1	133
GS2DPD3015L-XNL	51	10.6	-	134
GS2DPD3015L-XNW	51	10.6	-	134
GS2DPD3015R-XNL	51	10.6	-	134
GS2DPD3015R-XNW	51	10.6	-	134
GS2DPD3615-2L	112	12.5	1	133
GS2DPD3615-2W	112	12.5	1	133
GS2DPD3615-3L	112	12.5	1	133
GS2DPD3615-3W	112	12.5	1	133
GS2DPD3615L-XNL	58	12.5	-	134
GS2DPD3615L-XNW	58	12.5	-	134
GS2DPD3615R-XNL	58	12.5	-	134
GS2DPD3615R-XNW	58	12.5	-	134
GS2DRFB3060L-3LL	218	18.8	1	54
GS2DRFB3060L-3SLL	198	16.8	1	53
GS2DRFB3060L-3SWW	198	16.8	1	53
GS2DRFB3060L-3WW	218	18.8	1	54

model number	weight	cubes	#locks	page
GS2DRFB3060R-3LL	218	18.8	1	54
GS2DRFB3060R-3SLL	198	16.8	1	53
GS2DRFB3060R-3SWW	198	16.8	1	53
GS2DRFB3060R-3WW	218	18.8	1	54
GS2DRFB3066L-3LL	229	20.0	1	54
GS2DRFB3066L-3SLL	209	18.0	1	53
GS2DRFB3066L-3SWW	209	18.0	1	53
GS2DRFB3066L-3WW	229	20.0	1	54
GS2DRFB3066R-3LL	229	20.0	1	54
GS2DRFB3066R-3SLL	209	18.0	1	53
GS2DRFB3066R-3SWW	209	18.0	1	53
GS2DRFB3066R-3WW	229	20.0	1	54
GS2DRFB3072L-3LL	240	21.1	1	54
GS2DRFB3072L-3SLL	220	19.1	1	53
GS2DRFB3072L-3SWW	220	19.1	1	53
GS2DRFB3072L-3WW	240	21.1	1	54
GS2DRFB3072R-3LL	240	21.1	1	54
GS2DRFB3072R-3SLL	220	19.1	1	53
GS2DRFB3072R-3SWW	220	19.1	1	53
GS2DRFB3072R-3WW	240	21.1	1	54
GS2DROB3672-32LL	329	32.7	2	52
GS2DROB3672-32SLL	289	27.5	2	52
GS2DROB3672-32SWW	289	27.5	2	52
GS2DROB3672-32WW	329	32.7	2	52
GS2DROB3672L-3LL	253	22.2	1	54
GS2DROB3672L-3SLL	233	20.2	1	53
GS2DROB3672L-3SWW	233	20.2	1	53
GS2DROB3672L-3WW	253	22.2	1	54
GS2DROB3672R-3LL	253	22.2	1	54
GS2DROB3672R-3SLL	233	20.2	1	53
GS2DROB3672R-3SWW	233	20.2	1	53
GS2DROB3672R-3WW	253	22.2	1	54
GS2DROB3678L-3LL	266	23.4	1	54
GS2DROB3678L-3SLL	246	21.4	1	53
GS2DROB3678L-3SWW	246	21.4	1	53
GS2DROB3678L-3WW	266	23.4	1	54
GS2DROB3678R-3LL	266	23.4	1	54
GS2DROB3678R-3SLL	246	21.4	1	53
GS2DROB3678R-3SWW	246	21.4	1	53
GS2DROB3678R-3WW	266	23.4	1	54
GS2DROF3060L-3LL	180	19.5	1	55
GS2DROF3060L-3WW	180	19.5	1	55
GS2DROF3060R-3LL	180	19.5	1	55
GS2DROF3060R-3WW	180	19.5	1	55



model number	weight	cubes	#locks	page
GS2DROF3066L-3LL	188	20.4	1	55
GS2DROF3066L-3WW	188	20.4	1	55
GS2DROF3066R-3LL	188	20.4	1	55
GS2DROF3066R-3WW	188	20.4	1	55
GS2DROF3072L-3LL	197	21.2	1	55
GS2DROF3072L-3WW	197	21.2	1	55
GS2DROF3072R-3LL	197	21.2	1	55
GS2DROF3072R-3WW	197	21.2	1	55
GS2DROF3672-32LL	325	33.3	2	52
GS2DROF3672-32WW	325	33.3	2	52
GS2DROF3672L-3LL	234	24.9	1	55
GS2DROF3672L-3WW	234	24.9	1	55
GS2DROF3672R-3LL	234	24.9	1	55
GS2DROF3672R-3WW	234	24.9	1	55
GS2DROF3678L-3LL	244	25.9	1	55
GS2DROF3678L-3WW	244	25.9	1	55
GS2DROF3678R-3LL	244	25.9	1	55
GS2DROF3678R-3WW	244	25.9	1	55
GS2DSL24-G	26	2.9	-	137
GS2DSL24-H	20	2.9	-	135
GS2DSL24-N	17	2.9	-	135
GS2DSL24-NST	18	2.9	-	135
GS2DSL24-W	26	2.9	-	136
GS2DSL30-G	29	3.5	-	137
GS2DSL30-H	23	3.5	-	135
GS2DSL30-N	20	3.5	-	135
GS2DSL30-NST	21	3.5	-	135
GS2DSL30-W	29	3.5	-	136
GS2DSL36-G	31	4.2	-	137
GS2DSL36-H	25	4.2	-	135
GS2DSL36-N	22	4.2	-	135
GS2DSL36-NST	23	4.2	-	135
GS2DSL36-W	31	4.2	-	136
GS2DWA3666-L	73	6.5	-	129
GS2DWA3666-W	73	6.5	-	129
GS2DWA3672-L	80	7.1	-	129
GS2DWA3672-W	80	7.1	-	129
GS2DWA3678-L	87	7.7	-	129
GS2DWA3678-W	87	7.7	-	129
GS2DWA3684-L	93	8.2	-	129
GS2DWA3684-W	93	8.2	-	129
GS2DWA4266-L	86	7.5	-	129
GS2DWA4266-W	86	7.5	-	129
GS2DWA4272-L	93	8.2	-	129

model number	weight	cubes	#locks	page
GS2DWA4272-W	93	8.2	-	129
GS2DWA4278-L	101	8.8	-	129
GS2DWA4278-W	101	8.8	-	129
GS2DWA4284-L	109	9.5	-	129
GS2DWA4284-W	109	9.5	-	129
GS2DWB4272-L	93	8.2	-	131
GS2DWB4272-W	93	8.2	-	131
GS2DWB4278-L	101	8.8	-	131
GS2DWB4278-W	101	8.8	-	131
GS2DWB4284-L	109	9.5	-	131
GS2DWB4284-W	109	9.5	-	131
GS2DWD4272-L	93	8.2	-	131
GS2DWD4272-W	93	8.2	-	131
GS2DWD4278-L	101	8.8	-	131
GS2DWD4278-W	101	8.8	-	131
GS2DWD4284-L	109	9.5	-	131
GS2DWD4284-W	109	9.5	-	131
GS2DWJ3048L-L	44	4.1	-	132
GS2DWJ3048L-W	44	4.1	-	132
GS2DWJ3048R-L	53	4.8	-	132
GS2DWJ3048R-W	53	4.8	-	132
GS2DWJ3054L-L	50	4.6	-	132
GS2DWJ3054L-W	50	4.6	-	132
GS2DWJ3054R-L	60	5.4	-	132
GS2DWJ3054R-W	60	5.4	-	132
GS2DWJ3060L-L	56	5.0	-	132
GS2DWJ3060L-W	56	5.0	-	132
GS2DWJ3060R-L	67	6.0	-	132
GS2DWJ3060R-W	67	6.0	-	132
GS2DWJ3066L-L	61	5.5	-	132
GS2DWJ3066L-W	61	5.5	-	132
GS2DWJ3066R-L	73	6.5	-	132
GS2DWJ3066R-W	73	6.5	-	132
GS2DWJ3072L-L	67	6.0	-	132
GS2DWJ3072L-W	67	6.0	-	132
GS2DWJ3072R-L	80	7.1	-	132
GS2DWJ3072R-W	80	7.1	-	132
GS2DWJ3078L-L	72	6.5	-	132
GS2DWJ3078L-W	72	6.5	-	132
GS2DWJ3078R-L	87	7.7	-	132
GS2DWJ3078R-W	87	7.7	-	132
GS2DWJ3084L-L	78	7.0	-	132
GS2DWJ3084L-W	78	7.0	-	132
GS2DWJ3084R-L	93	8.2	-	132

# WEIGHTS + CUBES

Silea  
05/22

model number	weight	cubes	#locks	page
GS2DWJ3084R-W	93	8.2	-	132
GS2DWRR3042-L	39	3.6	-	128
GS2DWRR3042-W	39	3.6	-	128
GS2DWRR3048-L	44	4.1	-	128
GS2DWRR3048-W	44	4.1	-	128
GS2DWRR3054-L	50	4.6	-	128
GS2DWRR3054-W	50	4.6	-	128
GS2DWRR3060-L	56	5.0	-	128
GS2DWRR3060-W	56	5.0	-	128
GS2DWRR3066-L	61	5.5	-	128
GS2DWRR3066-W	61	5.5	-	128
GS2DWRR3072-L	67	6.0	-	128
GS2DWRR3072-W	67	6.0	-	128
GS2DWRR3078-L	72	6.5	-	128
GS2DWRR3078-W	72	6.5	-	128
GS2DWRR3084-L	78	7.0	-	128
GS2DWRR3084-W	78	7.0	-	128
GS2DWRR3090-L	84	7.4	-	128
GS2DWRR3090-W	80	7.8	-	128
GS2DWRR3096-L	90	7.9	-	128
GS2DWRR3096-W	85	8.3	-	128
GS2DWRR3642-L	47	4.3	-	128
GS2DWRR3642-W	47	4.3	-	128
GS2DWRR3648-L	53	4.8	-	128
GS2DWRR3648-W	53	4.8	-	128
GS2DWRR3654-L	60	5.4	-	128
GS2DWRR3654-W	60	5.4	-	128
GS2DWRR3660-L	67	6.0	-	128
GS2DWRR3660-W	67	6.0	-	128
GS2DWRR3666-L	73	6.5	-	128
GS2DWRR3666-W	73	6.5	-	128
GS2DWRR3672-L	80	7.1	-	128
GS2DWRR3672-W	80	7.1	-	128
GS2DWRR3678-L	87	7.7	-	128
GS2DWRR3678-W	87	7.7	-	128
GS2DWRR3684-L	93	8.2	-	128
GS2DWRR3684-W	93	8.2	-	128
GS2DWRR3690-L	100	8.7	-	128
GS2DWRR3690-W	96	9.1	-	128
GS2DWRR3696-L	106	9.3	-	128
GS2DWRR3696-W	102	9.7	-	128
GS2DWRT3048L-L	44	4.1	-	130
GS2DWRT3048L-W	44	4.1	-	130
GS2DWRT3048R-L	44	4.1	-	130

model number	weight	cubes	#locks	page
GS2DWRT3048R-W	44	4.1	-	130
GS2DWRT3054L-L	50	4.6	-	130
GS2DWRT3054L-W	50	4.6	-	130
GS2DWRT3054R-L	50	4.6	-	130
GS2DWRT3054R-W	50	4.6	-	130
GS2DWRT3060L-L	56	5.0	-	130
GS2DWRT3060L-W	56	5.0	-	130
GS2DWRT3060R-L	56	5.0	-	130
GS2DWRT3060R-W	56	5.0	-	130
GS2DWRT3066L-L	61	5.5	-	130
GS2DWRT3066L-W	61	5.5	-	130
GS2DWRT3066R-L	61	5.5	-	130
GS2DWRT3066R-W	61	5.5	-	130
GS2DWRT3072L-L	67	6.0	-	130
GS2DWRT3072L-W	67	6.0	-	130
GS2DWRT3072R-L	67	6.0	-	130
GS2DWRT3072R-W	67	6.0	-	130
GS2DWRT3078L-L	72	6.5	-	130
GS2DWRT3078L-W	72	6.5	-	130
GS2DWRT3078R-L	72	6.5	-	130
GS2DWRT3078R-W	72	6.5	-	130
GS2DWRT3084L-L	78	7.0	-	130
GS2DWRT3084L-W	78	7.0	-	130
GS2DWRT3084R-L	78	7.0	-	130
GS2DWRT3084R-W	78	7.0	-	130
GS2ENDTRIM14	1	0.1	-	314
GS2ENDTRIM25	1	0.2	-	314
GS2ENDTRIM28	1	0.2	-	314
GS2ENDTRIM32	1	0.3	-	314
GS2ENDTRIM39	1	0.3	-	314
GS2ENDTRIM46	2	0.4	-	314
GS2ENDTRIM53	2	0.4	-	314
GS2ENDTRIM60	2	0.5	-	314
GS2FBX75H72L-WSG	625	83.1	-	339
GS2FBX75H72R-WSG	625	83.1	-	339
GS2FBX75H90L-WSG	775	103.0	-	339
GS2FBX75H90R-WSG	775	103.0	-	339
GS2FSC2460-44LL	240	32.0	2	61
GS2FSC2460-55LL	210	32.0	2	62
GS2FSC2460-55WW	210	32.0	2	62
GS2FSC2472-44LL	310	38.1	2	61
GS2FSC2472-44WW	310	38.1	2	61
GS2FSC2472-55LL	280	38.1	2	62
GS2FSC2472-55WW	280	38.1	2	62

model number	weight	cubes	#locks	page
GS2FSF830-L	10	0.9	-	315
GS2FSF830-W	10	0.9	-	315
GS2FSF836-L	12	1.0	-	315
GS2FSF836-W	12	1.0	-	315
GS2FSF842-L	14	1.2	-	315
GS2FSF842-W	14	1.2	-	315
GS2FSF848-L	16	1.4	-	315
GS2FSF848-W	16	1.4	-	315
GS2FSF854-L	18	1.5	-	315
GS2FSF854-W	18	1.5	-	315
GS2FSF860-L	20	1.7	-	315
GS2FSF860-W	20	1.7	-	315
GS2FSF866-L	22	1.8	-	315
GS2FSF866-W	22	1.8	-	315
GS2FSF872-L	24	2.0	-	315
GS2FSF872-W	24	2.0	-	315
GS2FT-CNR4	16	0.5	-	222
GS2FT-GANGKIT	2	0.1	-	222
GS2FT-INL2	8	0.5	-	222
GS2FT-WMKIT	2	0.1	-	224
GS2GMT	1	0.1	-	354
GS2LFS2H30-LL	156	16.8	1	249
GS2LFS2H30-WW	156	16.8	1	249
GS2LFS2H36-LL	179	19.8	1	249
GS2LFS2H36-WW	179	19.8	1	249
GS2LFS3H30-LL	201	23.3	1	250
GS2LFS3H30-WW	201	23.3	1	250
GS2LFS3H36-LL	230	27.5	1	250
GS2LFS3H36-WW	230	27.5	1	250
GS2LFS4H30-LL	246	29.6	1	250
GS2LFS4H30-WW	246	29.6	1	250
GS2LFS4H36-LL	281	35.0	1	250
GS2LFS4H36-WW	281	35.0	1	250
GS2LFS5H30-LL	291	36.9	1	250
GS2LFS5H30-WW	291	36.9	1	250
GS2LFS5H36-LL	332	43.6	1	250
GS2LFS5H36-WW	332	43.6	1	250
GS2LFS6H30-LL	337	43.8	1	250
GS2LFS6H30-WW	337	43.8	1	250
GS2LFS6H36-LL	386	51.8	1	250
GS2LFS6H36-WW	386	51.8	1	250
GS2LHAPD2424L-LL	88	10.4	-	120
GS2LHAPD2424L-WW	88	10.4	-	120
GS2LHAPD2424R-LL	88	10.4	-	120

model number	weight	cubes	#locks	page
GS2LHAPD2424R-WW	88	10.4	-	120
GS2LHAPD2430L-LL	96	12.7	-	120
GS2LHAPD2430L-WW	96	12.7	-	120
GS2LHAPD2430R-LL	96	12.7	-	120
GS2LHAPD2430R-WW	96	12.7	-	120
GS2LHAPD2436L-LL	114	15.0	-	120
GS2LHAPD2436L-WW	114	15.0	-	120
GS2LHAPD2436R-LL	114	15.0	-	120
GS2LHAPD2436R-WW	114	15.0	-	120
GS2LKR5H24L-LG	175	28.8	-	270
GS2LKR5H24L-LL	175	28.8	-	269
GS2LKR5H24L-WG	175	30.2	-	270
GS2LKR5H24L-WW	175	30.2	-	269
GS2LKR5H24R-LG	175	28.8	-	270
GS2LKR5H24R-LL	175	28.8	-	269
GS2LKR5H24R-WG	175	30.2	-	270
GS2LKR5H24R-WW	175	30.2	-	269
GS2LKR6H24L-LG	230	34.0	-	270
GS2LKR6H24L-LL	230	33.9	-	269
GS2LKR6H24L-WG	230	35.8	-	270
GS2LKR6H24L-WW	230	35.8	-	269
GS2LKR6H24R-LG	230	34.0	-	270
GS2LKR6H24R-LL	230	33.9	-	269
GS2LKR6H24R-WG	230	35.8	-	270
GS2LKR6H24R-WW	230	35.8	-	269
GS2LLKR5H24L-LG	175	28.8	-	272
GS2LLKR5H24L-LL	175	28.8	-	271
GS2LLKR5H24L-WG	175	30.2	-	272
GS2LLKR5H24L-WW	175	30.2	-	271
GS2LLKR5H24R-LG	175	28.8	-	272
GS2LLKR5H24R-LL	175	28.8	-	271
GS2LLKR5H24R-WG	175	30.2	-	272
GS2LLKR5H24R-WW	175	30.2	-	271
GS2LLKR6H24L-LG	230	34.0	-	272
GS2LLKR6H24L-LL	230	33.9	-	271
GS2LLKR6H24L-WG	230	35.8	-	272
GS2LLKR6H24L-WW	230	35.8	-	271
GS2LLKR6H24R-LG	230	34.0	-	272
GS2LLKR6H24R-LL	230	33.9	-	271
GS2LLKR6H24R-WG	230	35.8	-	272
GS2LLKR6H24R-WW	230	35.8	-	271
GS2MEP24L-L	11	1.8	-	183
GS2MEP24L-W	11	1.8	-	183
GS2MEP24R-L	11	1.8	-	183

# WEIGHTS + CUBES

Silea  
05/22

model number	weight	cubes	#locks	page
GS2MEP24R-W	11	1.8	-	183
GS2MEP30L-L	14	2.2	-	183
GS2MEP30L-W	14	2.2	-	183
GS2MEP30R-L	14	2.2	-	183
GS2MEP30R-W	14	2.2	-	183
GS2MEP36L-L	17	2.6	-	183
GS2MEP36L-W	17	2.6	-	183
GS2MEP36R-L	17	2.6	-	183
GS2MEP36R-W	17	2.6	-	183
GS2MLB18	5	0.4	-	199
GS2MLB24	7	0.5	-	199
GS2MLB30	9	0.6	-	199
GS2MLB30SL-L	45	3.0	-	196
GS2MLB30SL-W	45	3.2	-	196
GS2MLB30SR-L	45	3.0	-	196
GS2MLB30SR-W	45	3.2	-	196
GS2MLB36	11	0.8	-	199
GS2MLB36SL-L	51	3.6	-	196
GS2MLB36SL-W	51	3.8	-	196
GS2MLB36SR-L	51	3.6	-	196
GS2MLB36SR-W	51	3.8	-	196
GS2MLEP24L-L	11	1.3	-	183
GS2MLEP24L-W	11	1.3	-	183
GS2MLEP24R-L	11	1.3	-	183
GS2MLEP24R-W	11	1.3	-	183
GS2MLLS24L-L	25	2.2	-	184
GS2MLLS24L-W	25	2.2	-	184
GS2MLLS24R-L	25	2.2	-	184
GS2MLLS24R-W	25	2.2	-	184
GS2MLPB15-L	7	0.9	-	186, 239
GS2MLPB15-W	7	0.9	-	186, 239
GS2MLPB18-L	11	1.1	-	186, 239
GS2MLPB18-W	11	1.1	-	186, 239
GS2MLPB30-L	14	1.7	-	186, 239
GS2MLPB30-W	14	1.7	-	186, 239
GS2MLPB36-L	17	2.0	-	186, 239
GS2MLPB36-W	17	2.0	-	186, 239
GS2MLPF-L	2	0.5	-	186, 239
GS2MLPF-W	2	0.5	-	186, 239
GS2MLS24L-L	25	2.9	-	184
GS2MLS24L-W	25	2.9	-	184
GS2MLS24R-L	25	2.9	-	184
GS2MLS24R-W	25	2.9	-	184
GS2MLS30L-L	28	3.5	-	184

model number	weight	cubes	#locks	page
GS2MLS30L-W	28	3.5	-	184
GS2MLS30R-L	28	3.5	-	184
GS2MLS30R-W	28	3.5	-	184
GS2MLS36L-L	31	4.2	-	184
GS2MLS36L-W	31	4.2	-	184
GS2MLS36R-L	31	4.2	-	184
GS2MLS36R-W	31	4.2	-	184
GS2MLSJ24-L	20	1.5	-	186
GS2MLSJ24-W	20	1.5	-	186
GS2MLSP-L	9	0.9	-	186
GS2MLSP-L	13	1.5	-	186
GS2MLSP-W	13	1.5	-	186
GS2MLSP-W	9	0.9	-	186
GS2MPB1H30-L	8	1.2	-	228
GS2MPB1H30-W	8	1.2	-	228
GS2MPB1H36-L	10	1.4	-	228
GS2MPB1H36-W	10	1.4	-	228
GS2MPB1H60-L	16	2.3	-	228
GS2MPB1H60-W	16	2.3	-	228
GS2MPB1H66-L	18	2.5	-	228
GS2MPB1H66-W	18	2.5	-	228
GS2MPB1H72-L	19	2.7	-	228
GS2MPB1H72-W	19	2.7	-	228
GS2MPB9-L	5	0.8	-	185
GS2MPB9-W	5	0.8	-	185
GS2MPB15-L	7	1.2	-	185
GS2MPB15-W	7	1.2	-	185
GS2MPB18-L	11	1.4	-	185
GS2MPB18-W	11	1.4	-	185
GS2MPB30-L	14	2.2	-	185
GS2MPB30-W	14	2.2	-	185
GS2MPB36-L	17	2.6	-	185
GS2MPB36-W	17	2.6	-	185
GS2MPD-2LL	84	9.1	1	273
GS2MPD-2WW	84	9.1	1	273
GS2MPD-3LL	84	9.1	1	273
GS2MPD-3WW	84	9.1	1	273
GS2MPD-6LL	91	6.4	1	273
GS2MPD-6WW	91	6.4	1	273
GS2MPD-CUSH2215	7	1.0	-	274
GS2MPF1H-L	2	0.3	-	228
GS2MPF1H-W	2	0.3	-	228
GS2MPF-L	2	0.6	-	185
GS2MPF-W	2	0.6	-	185

model number	weight	cubes	#locks	page
GS2MSJ24-L	20	1.9	-	185
GS2MSJ24-W	20	1.9	-	185
GS2MSP-L	9	1.2	-	185
GS2MSPT-L	13	1.9	-	185
GS2MSPT-W	13	1.9	-	185
GS2MSP-W	9	1.2	-	185
GS2OHTOPD30-L	15	1.5	-	316
GS2OHTOPD30-W	15	1.5	-	316
GS2OHTOPD36-L	18	1.8	-	316
GS2OHTOPD36-W	18	1.8	-	316
GS2OHTOPD42-L	21	2.1	-	316
GS2OHTOPD42-W	21	2.1	-	316
GS2OHTOPD48-L	24	2.4	-	316
GS2OHTOPD48-W	24	2.4	-	316
GS2OHTOPD54-L	27	2.7	-	316
GS2OHTOPD54-W	27	2.7	-	316
GS2OHTOPD60-L	30	2.9	-	316
GS2OHTOPD60-W	30	2.9	-	316
GS2OHTOPD66-L	33	3.2	-	316
GS2OHTOPD66-W	33	3.2	-	316
GS2OHTOPD72-L	36	3.5	-	316
GS2OHTOPD72-W	36	3.5	-	316
GS2OHTOPD78-L	39	3.8	-	316
GS2OHTOPD78-W	39	3.8	-	316
GS2OHTOPD84-L	42	4.1	-	316
GS2OHTOPD84-W	42	4.1	-	316
GS2OHTOPD90-L	45	4.3	-	316
GS2OHTOPD90-W	45	4.3	-	316
GS2OHTOPD96-L	48	4.6	-	316
GS2OHTOPD96-W	48	4.6	-	316
GS2OHTOPD102-L	51	4.9	-	316
GS2OHTOPD102-W	51	4.9	-	316
GS2OHTOPD108-L	54	5.2	-	316
GS2OHTOPD108-W	54	5.2	-	316
GS2OHTOPD114-L	57	5.5	-	316
GS2OHTOPD114-W	57	5.5	-	316
GS2OHTOPD120-L	60	5.7	-	316
GS2OHTOPD120-W	60	5.7	-	316
GS2OHTOPN30-L	14	1.5	-	317
GS2OHTOPN30-W	14	1.5	-	317
GS2OHTOPN36-L	17	1.7	-	317
GS2OHTOPN36-W	17	1.7	-	317
GS2OHTOPN42-L	20	2.0	-	317
GS2OHTOPN42-W	20	2.0	-	317

model number	weight	cubes	#locks	page
GS2OHTOPN48-L	23	2.3	-	317
GS2OHTOPN48-W	23	2.3	-	317
GS2OHTOPN54-L	26	2.5	-	317
GS2OHTOPN54-W	26	2.5	-	317
GS2OHTOPN60-L	28	2.8	-	317
GS2OHTOPN60-W	28	2.8	-	317
GS2OHTOPN66-L	31	3.1	-	317
GS2OHTOPN66-W	31	3.1	-	317
GS2OHTOPN72-L	34	3.3	-	317
GS2OHTOPN72-W	34	3.3	-	317
GS2OHTOPN78-L	37	3.6	-	317
GS2OHTOPN78-W	37	3.6	-	317
GS2OHTOPN84-L	40	3.9	-	317
GS2OHTOPN84-W	40	3.9	-	317
GS2OHTOPN90-L	43	4.1	-	317
GS2OHTOPN90-W	43	4.1	-	317
GS2OHTOPN96-L	46	4.4	-	317
GS2OHTOPN96-W	46	4.4	-	317
GS2OHTOPN102-L	48	4.7	-	317
GS2OHTOPN102-W	48	4.7	-	317
GS2OHTOPN108-L	51	4.9	-	317
GS2OHTOPN108-W	51	4.9	-	317
GS2OHTOPN114-L	54	5.2	-	317
GS2OHTOPN114-W	54	5.2	-	317
GS2OHTOPN120-L	57	5.5	-	317
GS2OHTOPN120-W	57	5.5	-	317
GS2RLC6072L-L	149	18.4	-	78
GS2RLC6072L-S	163	18.4	-	78
GS2RLC6072L-W	156	13.5	-	78
GS2RLC6072R-L	149	18.4	-	78
GS2RLC6072R-S	163	18.4	-	78
GS2RLC6072R-W	156	13.5	-	78
GS2RLC6084L-L	171	21.1	-	78
GS2RLC6084L-S	183	21.1	-	78
GS2RLC6084L-W	180	15.4	-	78
GS2RLC6084R-L	171	21.1	-	78
GS2RLC6084R-S	183	21.1	-	78
GS2RLC6084R-W	180	15.4	-	78
GS2RLEL3672-L	104	13.3	-	72
GS2RLEL3672-S	175	13.3	-	72
GS2RLEL3672-W	108	10.2	-	72
GS2RLEL4284-L	133	16.9	-	72
GS2RLEL4284-S	190	16.9	-	72
GS2RLEL4284-W	139	12.8	-	72

# WEIGHTS + CUBES

Silea  
05/22

model number	weight	cubes	#locks	page
GS2RLFL3672-L	104	13.3	-	74
GS2RLFL3672-S	175	13.3	-	74
GS2RLFL3672-W	108	10.2	-	74
GS2RLFL4284-L	133	16.9	-	74
GS2RLFL4284-S	190	16.9	-	74
GS2RLFL4284-W	139	12.8	-	74
GS2RLO3066L-3LL	160	13.7	1	57
GS2RLO3066L-3WW	160	13.7	1	57
GS2RLO3066R-3LL	160	13.7	1	57
GS2RLO3066R-3WW	160	13.7	1	57
GS2RLO3072L-3LL	167	14.3	1	57
GS2RLO3072L-3WW	167	14.3	1	57
GS2RLO3072R-3LL	167	14.3	1	57
GS2RLO3072R-3WW	167	14.3	1	57
GS2RLO3672L-3LL	189	16.8	1	57
GS2RLO3672L-3WW	189	16.8	1	57
GS2RLO3672R-3LL	189	16.8	1	57
GS2RLO3672R-3WW	189	16.8	1	57
GS2RLO3678L-3LL	196	17.5	1	57
GS2RLO3678L-3WW	196	17.5	1	57
GS2RLO3678R-3LL	196	17.5	1	57
GS2RLO3678R-3WW	196	17.5	1	57
GS2RLOS3066L-3LL	270	42.8	1	58
GS2RLOS3066L-3WW	196	16.0	1	58
GS2RLOS3066R-3LL	270	42.8	1	58
GS2RLOS3066R-3WW	196	16.0	1	58
GS2RLOS3072L-3LL	280	46.5	1	58
GS2RLOS3072L-3WW	202	16.5	1	58
GS2RLOS3072R-3LL	280	46.5	1	58
GS2RLOS3072R-3WW	202	16.5	1	58
GS2RLOS3672L-3LL	290	55.0	1	58
GS2RLOS3672L-3WW	228	19.5	1	58
GS2RLOS3672R-3LL	290	55.0	1	58
GS2RLOS3672R-3WW	228	19.5	1	58
GS2RLOS3678L-3LL	300	59.4	1	58
GS2RLOS3678L-3WW	235	20.1	1	58
GS2RLOS3678R-3LL	300	59.4	1	58
GS2RLOS3678R-3WW	235	20.1	1	58
GS2RLRL3066L-L	91	8.4	-	69
GS2RLRL3066L-W	91	8.4	-	69
GS2RLRL3066R-L	91	8.4	-	69
GS2RLRL3066R-W	91	8.4	-	69
GS2RLRL3072L-L	98	9.0	-	69

model number	weight	cubes	#locks	page
GS2RLRL3072L-W	98	9.0	-	69
GS2RLRL3072R-L	98	9.0	-	69
GS2RLRL3072R-W	98	9.0	-	69
GS2RLRL3672L-L	113	10.2	-	69
GS2RLRL3672L-W	113	10.2	-	69
GS2RLRL3672R-L	113	10.2	-	69
GS2RLRL3672R-W	113	10.2	-	69
GS2RLRL3678L-L	120	10.9	-	69
GS2RLRL3678L-W	120	10.9	-	69
GS2RLRL3678R-L	120	10.9	-	69
GS2RLRL3678R-W	120	10.9	-	69
GS2RLRLS3066L-L	127	10.5	-	70
GS2RLRLS3066L-W	127	10.7	-	70
GS2RLRLS3066R-L	127	10.5	-	70
GS2RLRLS3066R-W	127	10.7	-	70
GS2RLRLS3072L-L	133	11.0	-	70
GS2RLRLS3072L-W	133	11.2	-	70
GS2RLRLS3072R-L	133	11.0	-	70
GS2RLRLS3072R-W	133	11.2	-	70
GS2RLRLS3672L-L	152	12.7	-	70
GS2RLRLS3672L-W	152	12.9	-	70
GS2RLRLS3672R-L	152	12.7	-	70
GS2RLRLS3672R-W	152	12.9	-	70
GS2RLRLS3678L-L	159	13.3	-	70
GS2RLRLS3678L-W	159	13.5	-	70
GS2RLRLS3678R-L	159	13.3	-	70
GS2RLRLS3678R-W	159	13.5	-	70
GS2RLSL304272-L	118	14.9	-	76
GS2RLSL304272-S	189	14.9	-	76
GS2RLSL304272-W	123	11.4	-	76
GS2RLSL364884-L	148	18.7	-	76
GS2RLSL364884-S	235	18.7	-	76
GS2RLSL364884-W	154	14.1	-	76
GS2RLSLS304272L-L	149	16.7	-	77
GS2RLSLS304272L-W	154	13.4	-	77
GS2RLSLS304272R-L	149	16.7	-	77
GS2RLSLS304272R-W	154	13.4	-	77
GS2RLSLS364884L-L	190	21.6	-	77
GS2RLSLS364884L-W	196	17.2	-	77
GS2RLSLS364884R-L	190	21.6	-	77
GS2RLSLS364884R-W	196	17.2	-	77
GS2RMA21-L	23	3.9	-	193
GS2RMA21-W	23	3.9	-	193

model number	weight	cubes	#locks	page
GS2RMA24-L	25	4.3	-	193
GS2RMA24-W	25	4.3	-	193
GS2RMA27-L	27	4.8	-	193
GS2RMA27-W	27	4.8	-	193
GS2RMA30-L	29	5.3	-	193
GS2RMA30-W	29	5.3	-	193
GS2RMA33-L	31	5.8	-	193
GS2RMA33-W	31	5.8	-	193
GS2RMA36-L	33	6.3	-	193
GS2RMA36-W	33	6.3	-	193
GS2RMA39-L	35	6.8	-	193
GS2RMA39-W	35	6.8	-	193
GS2RMA42-L	37	7.2	-	193
GS2RMA42-W	37	7.2	-	193
GS2RMA45-L	39	7.7	-	193
GS2RMA45-W	39	7.7	-	193
GS2RMA48-L	41	8.2	-	193
GS2RMA48-W	41	8.2	-	193
GS2RMA51-L	43	8.7	-	193
GS2RMA51-W	43	8.7	-	193
GS2RMA54-L	45	11.3	-	193
GS2RMA54-W	45	11.3	-	193
GS2RMA57-L	47	11.9	-	193
GS2RMA57-W	47	11.9	-	193
GS2RMA60-L	49	12.4	-	193
GS2RMA60-W	49	12.4	-	193
GS2RMA63-L	51	13.0	-	193
GS2RMA63-W	51	13.0	-	193
GS2RMA66-L	53	13.6	-	193
GS2RMA66-W	53	13.6	-	193
GS2RMA69-L	55	14.2	-	193
GS2RMA69-W	55	14.2	-	193
GS2RMA72-L	57	14.8	-	193
GS2RMA72-W	57	14.8	-	193
GS2RMF39L-L	19	2.9	-	191
GS2RMF39L-W	19	2.9	-	191
GS2RMF39R-L	19	2.9	-	192
GS2RMF39R-W	19	2.9	-	192
GS2RMF42L-L	20	3.1	-	191
GS2RMF42L-W	20	3.1	-	191
GS2RMF42R-L	20	3.1	-	192
GS2RMF42R-W	20	3.1	-	192
GS2RMF45L-L	21	3.3	-	191
GS2RMF45L-W	21	3.3	-	191

model number	weight	cubes	#locks	page
GS2RMF45R-L	21	3.3	-	192
GS2RMF45R-W	21	3.3	-	192
GS2RMF48L-L	23	3.5	-	191
GS2RMF48L-W	23	3.5	-	191
GS2RMF48R-L	23	3.5	-	192
GS2RMF48R-W	23	3.5	-	192
GS2RMF51L-L	24	3.7	-	191
GS2RMF51L-W	24	3.7	-	191
GS2RMF51R-L	24	3.7	-	192
GS2RMF51R-W	24	3.7	-	192
GS2RMF54L-L	26	3.9	-	191
GS2RMF54L-W	26	3.9	-	191
GS2RMF54R-L	26	3.9	-	192
GS2RMF54R-W	26	3.9	-	192
GS2RMF57L-L	27	4.1	-	191
GS2RMF57L-W	27	4.1	-	191
GS2RMF57R-L	27	4.1	-	192
GS2RMF57R-W	27	4.1	-	192
GS2RMF60L-L	29	4.3	-	191
GS2RMF60L-W	29	4.3	-	191
GS2RMF60R-L	29	4.3	-	192
GS2RMF60R-W	29	4.3	-	192
GS2RMF63L-L	31	3.7	-	191
GS2RMF63L-W	31	3.7	-	191
GS2RMF63R-L	31	3.7	-	192
GS2RMF63R-W	31	3.7	-	192
GS2RMF66L-L	33	3.9	-	191
GS2RMF66L-W	33	3.9	-	191
GS2RMF66R-L	33	3.9	-	192
GS2RMF66R-W	33	3.9	-	192
GS2RMF69L-L	35	4.1	-	191
GS2RMF69L-W	35	4.1	-	191
GS2RMF69R-L	35	4.1	-	192
GS2RMF69R-W	35	4.1	-	192
GS2RMF72L-L	37	4.2	-	191
GS2RMF72L-W	37	4.2	-	191
GS2RMF72R-L	37	4.2	-	192
GS2RMF72R-W	37	4.2	-	192
GS2RMF75L-L	39	4.4	-	191
GS2RMF75L-W	39	4.4	-	191
GS2RMF75R-L	39	4.4	-	192
GS2RMF75R-W	39	4.4	-	192
GS2RMF78L-L	41	4.6	-	191
GS2RMF78L-W	41	4.6	-	191

# WEIGHTS + CUBES

Silea  
05/22

model number	weight	cubes	#locks	page
GS2RMF78R-L	41	4.6	-	192
GS2RMF78R-W	41	4.6	-	192
GS2RMF81L-L	43	4.7	-	191
GS2RMF81L-W	43	4.7	-	191
GS2RMF81R-L	43	4.7	-	192
GS2RMF81R-W	43	4.7	-	192
GS2RMF84L-L	45	4.9	-	191
GS2RMF84L-W	45	4.9	-	191
GS2RMF84R-L	45	4.9	-	192
GS2RMF84R-W	45	4.9	-	192
GS2RMF87L-L	47	5.1	-	191
GS2RMF87L-W	47	5.1	-	191
GS2RMF87R-L	47	5.1	-	192
GS2RMF87R-W	47	5.1	-	192
GS2RMF90L-L	49	5.2	-	191
GS2RMF90L-W	49	5.2	-	191
GS2RMF90R-L	49	5.2	-	192
GS2RMF90R-W	49	5.2	-	192
GS2RNDCOLUMN	10	0.6	-	139
GS2RRL3048-L	65	6.1	-	68
GS2RRL3048-W	65	6.1	-	68
GS2RRL3054-L	71	6.6	-	68
GS2RRL3054-W	75	7.1	-	68
GS2RRL3654-L	81	7.4	-	68
GS2RRL3654-W	85	7.9	-	68
GS2RRL3660-L	88	8.0	-	68
GS2RRL3660-W	92	8.5	-	68
GS2RRMF42L-L	23	4.5	-	145
GS2RRMF42L-W	23	4.5	-	145
GS2RRMF42R-L	23	4.5	-	145
GS2RRMF42R-W	23	4.5	-	145
GS2RRMF48L-L	26	5.1	-	145
GS2RRMF48L-W	26	5.1	-	145
GS2RRMF48R-L	26	5.1	-	145
GS2RRMF48R-W	26	5.1	-	145
GS2RRMF54L-L	29	5.8	-	145
GS2RRMF54L-W	29	5.8	-	145
GS2RRMF54R-L	29	5.8	-	145
GS2RRMF54R-W	29	5.8	-	145
GS2RRMF60L-L	33	6.4	-	145
GS2RRMF60L-W	33	6.4	-	145
GS2RRMF60R-L	33	6.4	-	145
GS2RRMF60R-W	33	6.4	-	145
GS2RRMF66L-L	36	7.1	-	145

model number	weight	cubes	#locks	page
GS2RRMF66L-W	36	7.1	-	145
GS2RRMF66R-L	36	7.1	-	145
GS2RRMF66R-W	36	7.1	-	145
GS2RRMF72L-L	39	7.7	-	145
GS2RRMF72L-W	39	7.7	-	145
GS2RRMF72R-L	39	7.7	-	145
GS2RRMF72R-W	39	7.7	-	145
GS2RRO3048L-3LL	136	12.6	1	56
GS2RRO3048L-3WW	141	12.6	1	56
GS2RRO3048R-3LL	136	12.6	1	56
GS2RRO3048R-3WW	141	12.6	1	56
GS2RRO3054L-3LL	143	13.2	1	56
GS2RRO3054L-3WW	148	13.2	1	56
GS2RRO3054R-3LL	143	13.2	1	56
GS2RRO3054R-3WW	148	13.2	1	56
GS2RRO3654L-3LL	160	15.3	1	56
GS2RRO3654L-3WW	165	15.4	1	56
GS2RRO3654R-3LL	160	15.3	1	56
GS2RRO3654R-3WW	165	15.4	1	56
GS2RRO3660L-3LL	168	16.1	1	56
GS2RRO3660L-3WW	173	16.1	1	56
GS2RRO3660R-3LL	168	16.1	1	56
GS2RRO3660R-3WW	173	16.1	1	56
GS2RROF3048L-3LL	154	17.6	-	67
GS2RROF3048L-3WW	154	17.6	-	67
GS2RROF3048R-3LL	154	17.6	-	67
GS2RROF3048R-3WW	154	17.6	-	67
GS2RROF3054L-3LL	163	18.7	-	67
GS2RROF3054L-3WW	163	18.7	-	67
GS2RROF3054R-3LL	163	18.7	-	67
GS2RROF3054R-3WW	163	18.7	-	67
GS2RROF3654L-3LL	194	21.7	-	67
GS2RROF3654L-3WW	194	21.7	-	67
GS2RROF3654R-3LL	194	21.7	-	67
GS2RROF3654R-3WW	194	21.7	-	67
GS2RROF3660L-3LL	205	23.0	-	67
GS2RROF3660L-3WW	205	23.0	-	67
GS2RROF3660R-3LL	205	23.0	-	67
GS2RROF3660R-3WW	205	23.0	-	67
GS2RSL304254-L	82	10.9	-	75
GS2RSL304254-W	86	8.2	-	75
GS2RSL364866-L	113	14.7	-	75
GS2RSL364866-W	118	11.0	-	75
GS2RTN2442L-2LL	140	14.4	2	63



model number	weight	cubes	#locks	page
GS2RTN2442L-2WW	140	14.4	2	63
GS2RTN2442R-2LL	140	14.4	2	63
GS2RTN2442R-2WW	140	14.4	2	63
GS2RTN2448L-2LL	148	15.2	2	63
GS2RTN2448L-2WW	148	15.2	2	63
GS2RTN2448R-2LL	148	15.2	2	63
GS2RTN2448R-2WW	148	15.2	2	63
GS2RTN2454L-2LL	155	16.0	2	63
GS2RTN2454L-2WW	155	16.0	2	63
GS2RTN2454R-2LL	155	16.0	2	63
GS2RTN2454R-2WW	155	16.0	2	63
GS2RTN2460L-2LL	162	16.8	2	63
GS2RTN2460L-2WW	162	16.8	2	63
GS2RTN2460R-2LL	162	16.8	2	63
GS2RTN2460R-2WW	162	16.8	2	63
GS2SBD5H15-3LN	160	22.5	1	259
GS2SBD5H15-3WN	160	22.5	1	259
GS2SBD5H15L-3LL	167	22.5	2	257
GS2SBD5H15L-3WW	167	22.5	2	257
GS2SBD5H15L-LL	167	22.5	2	256
GS2SBD5H15-LN	160	22.5	1	258
GS2SBD5H15L-WW	167	22.5	2	256
GS2SBD5H15R-3LL	167	22.5	2	257
GS2SBD5H15R-3WW	167	22.5	2	257
GS2SBD5H15R-LL	167	22.5	2	256
GS2SBD5H15R-WW	167	22.5	2	256
GS2SBD5H15-WN	160	22.5	1	258
GS2SBD5H18-3LN	170	26.0	1	259
GS2SBD5H18-3WN	170	26.0	1	259
GS2SBD5H18-FLN	175	21.1	2	243
GS2SBD5H18-FWN	175	21.1	2	243
GS2SBD5H18L-3LL	175	26.0	2	257
GS2SBD5H18L-3WW	175	26.0	2	257
GS2SBD5H18L-FLL	185	21.1	2	242
GS2SBD5H18L-FWW	185	21.1	2	242
GS2SBD5H18L-LL	175	23.5	1	256
GS2SBD5H18-LN	165	23.5	-	258
GS2SBD5H18L-WW	175	23.5	1	256
GS2SBD5H18R-3LL	175	26.0	2	257
GS2SBD5H18R-3WW	175	26.0	2	257
GS2SBD5H18R-FLL	185	21.1	2	242
GS2SBD5H18R-FWW	185	21.1	2	242
GS2SBD5H18R-LL	175	23.5	1	256
GS2SBD5H18R-WW	175	23.5	1	256

model number	weight	cubes	#locks	page
GS2SBD5H18-WN	165	23.5	-	258
GS2SBD5H30D18-3LN	180	31.6	1	263
GS2SBD5H30D18-3WN	180	31.6	1	263
GS2SBD5H30D18L-3LL	185	31.6	2	262
GS2SBD5H30D18L-3WW	185	31.6	2	262
GS2SBD5H30D18L-LL	185	31.6	2	260
GS2SBD5H30D18-LN	180	31.6	1	261
GS2SBD5H30D18L-WW	185	31.6	2	260
GS2SBD5H30D18R-3LL	185	31.6	2	262
GS2SBD5H30D18R-3WW	185	31.6	2	262
GS2SBD5H30D18R-LL	185	31.6	2	260
GS2SBD5H30D18R-WW	185	31.6	2	260
GS2SBD5H30D18-WN	180	31.6	1	261
GS2SBD5H30-LL	297	36.9	2	256
GS2SBD5H30-LN	282	36.9	-	258
GS2SBD5H30-WN	282	36.9	-	258
GS2SBD5H30-WW	297	36.9	2	256
GS2SBD6H15-3LN	190	26.5	1	259
GS2SBD6H15-3WN	190	26.5	1	259
GS2SBD6H15L-3LL	197	26.5	2	257
GS2SBD6H15L-3WW	197	26.5	2	257
GS2SBD6H15L-LL	197	26.5	2	256
GS2SBD6H15-LN	190	26.5	1	258
GS2SBD6H15L-WW	197	26.5	2	256
GS2SBD6H15R-3WW	197	26.5	2	257
GS2SBD6H15R-LL	197	26.5	2	256
GS2SBD6H15R-WW	197	26.5	2	256
GS2SBD6H15-WN	190	26.5	1	258
GS2SBD6H18-3LN	200	30.7	1	259
GS2SBD6H18-3WN	200	30.7	1	259
GS2SBD6H18-FLN	205	25.5	2	243
GS2SBD6H18-FWN	205	25.5	2	243
GS2SBD6H18L-3LL	205	30.7	2	257
GS2SBD6H18L-3WW	205	30.7	2	257
GS2SBD6H18L-FLL	215	25.5	2	242
GS2SBD6H18L-FWW	215	25.5	2	242
GS2SBD6H18L-LL	205	27.9	1	256
GS2SBD6H18-LN	195	27.9	-	258
GS2SBD6H18L-WW	205	27.9	1	256
GS2SBD6H18R-3LL	205	30.7	2	257
GS2SBD6H18R-3WW	205	30.7	2	257
GS2SBD6H18R-FLL	215	25.5	2	242
GS2SBD6H18R-FWW	215	25.5	2	242
GS2SBD6H18R-LL	205	27.9	1	256

# WEIGHTS + CUBES

Silea  
05/22

model number	weight	cubes	#locks	page
GS2SBD6H18R-WW	205	27.9	1	256
GS2SBD6H18-WN	195	27.9	-	258
GS2SBD6H30D18-3LN	210	37.2	1	263
GS2SBD6H30D18-3WN	210	37.2	1	263
GS2SBD6H30D18L-3LL	215	37.2	2	262
GS2SBD6H30D18L-3WW	215	37.2	2	262
GS2SBD6H30D18L-LL	215	37.2	2	260
GS2SBD6H30D18-LN	210	37.2	1	261
GS2SBD6H30D18L-WW	215	37.2	2	260
GS2SBD6H30D18R-3LL	215	37.2	2	262
GS2SBD6H30D18R-3WW	215	37.2	2	262
GS2SBD6H30D18R-LL	215	37.2	2	260
GS2SBD6H30D18R-WW	215	37.2	2	260
GS2SBD6H30D18-WN	210	37.2	1	261
GS2SBD6H30-LL	343	43.8	2	256
GS2SBD6H30-LN	328	43.8	-	258
GS2SBD6H30-WN	328	43.8	-	258
GS2SBD6H30-WW	343	43.8	2	256
GS2SCF2H30-5LL	123	16.8	1	268
GS2SCF2H30-5WW	123	16.8	1	268
GS2SCF2H36-5LL	143	19.8	1	268
GS2SCF2H36-5WW	143	19.8	1	268
GS2SDMF960L-L	57	4.5	-	144
GS2SDMF960L-W	57	4.5	-	144
GS2SDMF960R-L	57	4.5	-	144
GS2SDMF960R-W	57	4.5	-	144
GS2SDMF966L-L	63	5.1	-	144
GS2SDMF966L-W	63	5.1	-	144
GS2SDMF966R-L	63	5.1	-	144
GS2SDMF966R-W	63	5.1	-	144
GS2SDMF972L-L	68	5.8	-	144
GS2SDMF972L-W	68	5.8	-	144
GS2SDMF972R-L	68	5.8	-	144
GS2SDMF972R-W	68	5.8	-	144
GS2SDMF978L-L	74	6.4	-	144
GS2SDMF978L-W	74	6.4	-	144
GS2SDMF978R-L	74	6.4	-	144
GS2SDMF978R-W	74	6.4	-	144
GS2SDMF984L-L	80	7.1	-	144
GS2SDMF984L-W	80	7.1	-	144
GS2SDMF984R-L	80	7.1	-	144
GS2SDMF984R-W	80	7.1	-	144
GS2SDMF990L-L	71	5.8	-	144
GS2SDMF990L-W	71	5.8	-	144

model number	weight	cubes	#locks	page
GS2SDMF990R-L	71	5.6	-	144
GS2SDMF990R-W	71	5.8	-	144
GS2SDMF996L-L	74	6.1	-	144
GS2SDMF996L-W	74	6.3	-	144
GS2SDMF996R-L	74	6.1	-	144
GS2SDMF996R-W	74	6.3	-	144
GS2SDMF1560L-L	57	3.2	-	144
GS2SDMF1560L-W	57	3.2	-	144
GS2SDMF1560R-L	57	3.2	-	144
GS2SDMF1560R-W	57	3.2	-	144
GS2SDMF1566L-L	63	3.9	-	144
GS2SDMF1566L-W	63	3.9	-	144
GS2SDMF1566R-L	63	3.9	-	144
GS2SDMF1566R-W	63	3.9	-	144
GS2SDMF1572L-L	68	4.5	-	144
GS2SDMF1572L-W	68	4.5	-	144
GS2SDMF1572R-L	68	4.5	-	144
GS2SDMF1572R-W	68	4.5	-	144
GS2SDMF1578L-L	74	5.1	-	144
GS2SDMF1578L-W	74	5.1	-	144
GS2SDMF1578R-L	74	5.1	-	144
GS2SDMF1578R-W	74	5.1	-	144
GS2SDMF1584L-L	80	5.8	-	144
GS2SDMF1584L-W	80	5.8	-	144
GS2SDMF1584R-L	80	5.8	-	144
GS2SDMF1584R-W	80	5.8	-	144
GS2SDMF1590L-L	74	4.7	-	144
GS2SDMF1590L-W	74	5.0	-	144
GS2SDMF1590R-L	74	4.7	-	144
GS2SDMF1590R-W	74	5.0	-	144
GS2SDMF1596L-L	77	5.2	-	144
GS2SDMF1596L-W	77	5.4	-	144
GS2SDMF1596R-L	77	5.2	-	144
GS2SDMF1596R-W	77	5.4	-	144
GS2SGTOPD2415-L	11	1.2	-	275
GS2SGTOPD2415-W	11	1.2	-	275
GS2SGTOPD2418-L	13	1.4	-	275
GS2SGTOPD2418-W	13	1.4	-	275
GS2SGTOPD2424-L	18	1.8	-	275
GS2SGTOPD2424-W	18	1.8	-	275
GS2SGTOPD2430-L	22	2.2	-	275
GS2SGTOPD2430-W	22	2.2	-	275
GS2SGTOPD2436-L	27	2.6	-	275
GS2SGTOPD2436-W	27	2.6	-	275

model number	weight	cubes	#locks	page
GS2SGTOPD3018-L	16	1.8	-	275
GS2SGTOPD3018-W	16	1.8	-	275
GS2SGTOPN2415-L	11	1.1	-	276
GS2SGTOPN2415-W	11	1.1	-	276
GS2SGTOPN2418-L	13	1.3	-	276
GS2SGTOPN2418-W	13	1.3	-	276
GS2SGTOPN2424-L	17	1.7	-	276
GS2SGTOPN2424-W	17	1.7	-	276
GS2SGTOPN2430-L	21	2.1	-	276
GS2SGTOPN2430-W	21	2.1	-	276
GS2SGTOPN2436-L	26	2.5	-	276
GS2SGTOPN2436-W	26	2.5	-	276
GS2SGTOPN3018-L	16	1.8	-	276
GS2SGTOPN3018-W	16	1.8	-	276
GS2SMC1H60-LL	120	27.3	2	320
GS2SMC1H60-LN	110	27.4	-	322
GS2SMC1H60-WG	120	27.3	-	321
GS2SMC1H60-WN	110	27.4	-	322
GS2SMC1H60-WW	120	27.3	2	320
GS2SMC1H66-LL	130	29.9	2	320
GS2SMC1H66-LN	120	30.0	-	322
GS2SMC1H66-WN	120	30.0	-	322
GS2SMC1H66-WW	130	29.9	2	320
GS2SMC1H72-LL	140	32.5	2	320
GS2SMC1H72-LN	130	32.6	-	322
GS2SMC1H72-WG	140	32.5	-	321
GS2SMC1H72-WN	130	32.6	-	322
GS2SMC1H72-WW	140	32.5	2	320
GS2SMC1H78-LL	148	35.1	2	320
GS2SMC1H78-LN	138	35.2	-	322
GS2SMC1H78-WN	138	35.2	-	322
GS2SMC1H78-WW	148	35.1	2	320
GS2SMC1H84-LL	167	37.7	3	320
GS2SMC1H84-LN	157	37.8	-	322
GS2SMC1H84-WN	157	37.8	-	322
GS2SMC1H84-WW	167	37.7	3	320
GS2SMC1H90-LL	175	40.3	3	320
GS2SMC1H90-LN	165	40.4	-	322
GS2SMC1H90-WG	175	40.3	-	321
GS2SMC1H90-WN	165	40.4	-	322
GS2SMC1H90-WW	175	40.3	3	320
GS2SMC1H96-LL	183	42.9	3	320
GS2SMC1H96-LN	173	43.0	-	322
GS2SMC1H96-WN	173	43.0	-	322

model number	weight	cubes	#locks	page
GS2SMC1H96-WW	183	42.9	3	320
GS2SMC1H102-LL	191	47.9	3	320
GS2SMC1H102-LN	181	45.6	-	322
GS2SMC1H102-WN	181	45.6	-	322
GS2SMC1H102-WW	191	45.5	3	320
GS2SMC1H108-LL	200	50.6	3	320
GS2SMC1H108-LN	190	48.2	-	322
GS2SMC1H108-WG	200	48.1	-	321
GS2SMC1H108-WN	190	48.2	-	322
GS2SMC1H108-WW	200	48.1	3	320
GS2SMC2H60-WG	180	35.9	-	324
GS2SMC2H60-WW	180	35.9	2	323
GS2SMC2H66-WW	195	39.4	2	323
GS2SMC2H72-WG	210	42.8	2	324
GS2SMC2H72-WW	210	42.8	-	323
GS2SMC2H78-WW	225	46.2	2	323
GS2SMC2H84-WW	245	49.6	3	323
GS2SMC2H90-WG	265	53.1	-	324
GS2SMC2H90-WW	265	53.1	3	323
GS2SMTOPD15-L	7	0.8	-	333
GS2SMTOPD15-W	7	0.8	-	333
GS2SMTOPD18-L	9	1.0	-	333
GS2SMTOPD18-W	9	1.0	-	333
GS2SMTOPD30-L	15	1.5	-	333
GS2SMTOPD30-W	15	1.5	-	333
GS2SMTOPD36-W	18	1.8	-	333
GS2SMTOPD42-L	20	2.0	-	333
GS2SMTOPD42-W	20	2.0	-	333
GS2SMTOPD48-L	23	2.3	-	333
GS2SMTOPD48-W	23	2.3	-	333
GS2SMTOPD54-L	26	2.6	-	333
GS2SMTOPD54-W	26	2.6	-	333
GS2SMTOPD60-L	29	2.9	-	333
GS2SMTOPD60-W	29	2.9	-	333
GS2SMTOPD66-L	32	3.1	-	333
GS2SMTOPD66-W	32	3.1	-	333
GS2SMTOPD72-L	35	3.4	-	333
GS2SMTOPD72-W	35	3.4	-	333
GS2SMTOPD78-L	38	3.7	-	333
GS2SMTOPD78-W	38	3.7	-	333
GS2SMTOPD84-L	41	4.0	-	333
GS2SMTOPD84-W	41	4.0	-	333
GS2SMTOPD90-L	44	4.2	-	333
GS2SMTOPD90-W	44	4.2	-	333

# WEIGHTS + CUBES

Silea  
05/22

model number	weight	cubes	#locks	page
GS2SMTOPD96-L	47	4.5	-	333
GS2SMTOPD96-W	47	4.5	-	333
GS2SMTOPD102-L	50	4.8	-	333
GS2SMTOPD102-W	50	4.8	-	333
GS2SMTOPD108-L	53	5.0	-	333
GS2SMTOPD108-W	53	5.0	-	333
GS2SMTOPD114-L	55	5.3	-	333
GS2SMTOPD114-W	55	5.3	-	333
GS2SMTOPD120-L	58	5.6	-	333
GS2SMTOPD120-W	58	5.6	-	333
GS2SMTOPN15-L	7	0.8	-	334
GS2SMTOPN15-W	7	0.8	-	334
GS2SMTOPN18-L	8	0.9	-	334
GS2SMTOPN18-W	8	0.9	-	334
GS2SMTOPN30-L	14	1.4	-	276, 334
GS2SMTOPN30-W	14	1.4	-	276, 334
GS2SMTOPN36-L	17	1.7	-	276, 334
GS2SMTOPN36-W	17	1.7	-	276, 334
GS2SMTOPN42-L	19	1.9	-	334
GS2SMTOPN42-W	19	1.9	-	334
GS2SMTOPN48-L	22	2.2	-	334
GS2SMTOPN48-W	22	2.2	-	334
GS2SMTOPN54-L	25	2.5	-	334
GS2SMTOPN54-W	25	2.5	-	334
GS2SMTOPN60-L	28	2.7	-	276, 334
GS2SMTOPN60-W	28	2.7	-	276, 334
GS2SMTOPN66-L	30	3.0	-	276, 334
GS2SMTOPN66-W	30	3.0	-	276, 334
GS2SMTOPN72-L	33	3.2	-	276, 334
GS2SMTOPN72-W	33	3.2	-	276, 334
GS2SMTOPN78-L	36	3.5	-	334
GS2SMTOPN78-W	36	3.5	-	334
GS2SMTOPN84-L	39	3.8	-	334
GS2SMTOPN84-W	39	3.8	-	334
GS2SMTOPN90-L	41	4.0	-	276, 334
GS2SMTOPN90-W	41	4.0	-	276, 334
GS2SMTOPN96-L	44	4.3	-	276, 334
GS2SMTOPN96-W	44	4.3	-	276, 334
GS2SMTOPN102-L	47	4.5	-	276, 334
GS2SMTOPN102-W	47	4.5	-	276, 334
GS2SMTOPN108-L	50	4.8	-	276, 334
GS2SMTOPN108-W	50	4.8	-	276, 334
GS2SMTOPN114-L	52	5.1	-	334
GS2SMTOPN114-W	52	5.1	-	334

model number	weight	cubes	#locks	page
GS2SMTOPN120-L	55	5.3	-	276, 334
GS2SMTOPN120-W	55	5.3	-	276, 334
GS2SPC2466L-2LL	174	17.6	1	60
GS2SPC2466L-2WW	174	17.6	1	60
GS2SPC2466R-2LL	174	17.6	1	60
GS2SPC2466R-2WW	174	17.6	1	60
GS2SPC2472L-2LL	181	18.4	1	60
GS2SPC2472L-2WW	181	18.4	1	60
GS2SPC2472L-4LL	213	25.4	1	60
GS2SPC2472L-4WW	213	25.4	1	60
GS2SPC2472R-2LL	181	18.4	1	60
GS2SPC2472R-2WW	181	18.4	1	60
GS2SPC2472R-4LL	213	25.4	1	60
GS2SPC2472R-4WW	213	25.4	1	60
GS2SPC2478L-4LL	221	26.2	1	60
GS2SPC2478L-4WW	221	26.2	1	60
GS2SPC2478R-4LL	221	26.2	1	60
GS2SPC2478R-4WW	221	26.2	1	60
GS2SPC2484L-4LL	229	27.0	1	60
GS2SPC2484L-4WW	229	27.0	1	60
GS2SPC2484R-4LL	229	27.0	1	60
GS2SPC2484R-4WW	229	27.0	1	60
GS2SPC2490L-4LL	237	27.8	1	60
GS2SPC2490L-4WW	237	27.8	1	60
GS2SPC2490R-4LL	237	27.8	1	60
GS2SPC2490R-4WW	237	27.8	1	60
GS2SPC2496L-4LL	244	28.6	1	60
GS2SPC2496L-4WW	244	28.6	1	60
GS2SPC2496R-4LL	244	28.6	1	60
GS2SPC2496R-4WW	244	28.6	1	60
GS2SRNCLEG-W	20	0.6	-	140
GS2STF1H15L-LL	58	8.2	1	325
GS2STF1H15L-WG	58	8.2	-	326
GS2STF1H15L-WW	58	8.2	1	325
GS2STF1H15R-LL	58	8.2	1	325
GS2STF1H15R-WG	58	8.2	-	326
GS2STF1H15R-WW	58	8.2	1	325
GS2STF1H18L-LL	65	9.1	1	325
GS2STF1H18L-WG	65	9.1	-	326
GS2STF1H18L-WW	65	9.1	1	325
GS2STF1H18R-LL	65	9.1	1	325
GS2STF1H18R-WG	65	9.1	-	326
GS2STF1H18R-WW	65	9.1	1	325
GS2STF1H30-LL	100	14.3	1	325

model number	weight	cubes	#locks	page
GS2STF1H30-WG	100	14.3	-	326
GS2STF1H30-WW	100	14.3	1	325
GS2STF1H36-LL	115	16.9	1	325
GS2STF1H36-WG	115	16.9	-	326
GS2STF1H36-WW	115	16.9	1	325
GS2STF2H15L-LL	83	10.8	1	328
GS2STF2H15L-WG	83	10.8	-	329
GS2STF2H15L-WW	83	10.8	1	328
GS2STF2H15R-LL	83	10.8	1	328
GS2STF2H15R-WG	83	10.8	-	329
GS2STF2H15R-WW	83	10.8	1	328
GS2STF2H18L-LL	90	12.0	1	328
GS2STF2H18L-WG	90	12.0	-	329
GS2STF2H18L-WW	90	12.0	1	328
GS2STF2H18R-LL	90	12.0	1	328
GS2STF2H18R-WG	90	12.0	-	329
GS2STF2H18R-WW	90	12.0	1	328
GS2STF2H30-LL	125	18.9	1	328
GS2STF2H30-WG	125	18.9	-	329
GS2STF2H30-WW	125	18.9	1	328
GS2STF2H36-LL	150	22.3	1	328
GS2STF2H36-WG	150	22.3	-	329
GS2STF2H36-WW	150	22.3	1	328
GS2STN1H15-LN	50	7.8	-	327
GS2STN1H15-WN	50	7.8	-	327
GS2STN1H18-LN	55	9.1	-	327
GS2STN1H18-WN	55	9.1	-	327
GS2STN1H30-LN	90	9.1	-	327
GS2STN1H30-WN	90	14.3	-	327
GS2STN1H36-LN	100	14.3	-	327
GS2STN1H36-WN	100	16.9	-	327
GS2STN2H15-LN	60	10.3	-	330
GS2STN2H15-WN	60	10.3	-	330
GS2STN2H18-LN	65	12.0	-	330
GS2STN2H18-WN	65	12.0	-	330
GS2STN2H30-LN	100	12.0	-	330
GS2STN2H30-WN	100	12.0	-	330
GS2STN2H36-LN	110	18.9	-	330
GS2STN2H36-WN	110	18.9	-	330
GS2TEL3672-L	108	14.2	-	71
GS2TEL3672-S	179	14.2	-	71
GS2TEL3672-W	112	11.1	-	71
GS2TEL4284-L	135	17.6	-	71
GS2TEL4284-S	197	18.3	-	71

model number	weight	cubes	#locks	page
GS2TEL4284-W	146	14.2	-	71
GS2TFL3672-L	113	14.8	-	73
GS2TFL3672-S	184	14.8	-	73
GS2TFL3672-W	117	11.7	-	73
GS2TFL4284-L	140	18.3	-	73
GS2TFL4284-S	197	18.3	-	73
GS2TFL4284-W	146	14.2	-	73
GS2TGS60-GSA	50	3.7	-	332
GS2TGS66-GSA	55	4.0	-	332
GS2TGS72-GSA	59	4.4	-	332
GS2TGS78-GSA	64	4.8	-	332
GS2TGS84-GSA	68	5.1	-	332
GS2TGS90-GSA	73	5.5	-	332
GS2TGS96-GSA	77	3.1	-	332
GS2TGS102-GSA	82	3.3	-	332
GS2TGS108-GSA	86	3.4	-	332
GS2TGW1H24-GSA	35	2.1	-	295
GS2TGW1H30-GSA	43	3.2	-	295
GS2TGW1H36-GSA	50	3.8	-	295
GS2TGW1H42-GSA	58	4.3	-	295
GS2TGW1H48-GSA	66	4.9	-	295
GS2TGW2H24-GSA	41	2.8	-	295
GS2TGW2H30-GSA	50	4.1	-	295
GS2TGW2H36-GSA	59	4.8	-	295
GS2TGW2H42-GSA	67	5.6	-	295
GS2TGW2H48-GSA	76	6.3	-	295
GS2TGW24-GSA	24	1.4	-	291
GS2TGW30-GSA	28	2.1	-	291
GS2TGW36-GSA	32	2.4	-	291
GS2TGW42-GSA	36	2.8	-	291
GS2TGW48-GSA	40	3.2	-	291
GS2TGW54-GSA	45	3.6	-	291
GS2TGW60-GSA	50	3.9	-	291
GS2TGW66-GSA	55	4.3	-	291
GS2TGW72-GSA	59	4.7	-	291
GS2TGW78-GSA	64	5.1	-	291
GS2TGW84-GSA	68	5.4	-	291
GS2TGW90-GSA	73	5.8	-	291
GS2TGW96-GSA	77	3.2	-	291
GS2TGW102-GSA	82	3.4	-	291
GS2TGW108-GSA	86	3.6	-	291
GS2TKFBX72	28	5.0	-	340
GS2TKFBX90	35	6.2	-	340
GS2TKS60	26	3.7	-	331

# WEIGHTS + CUBES

Silea  
05/22

model number	weight	cubes	#locks	page
GS2TKS66	28	4.0	-	331
GS2TKS72	29	4.4	-	331
GS2TKS78	31	4.8	-	331
GS2TKS84	33	5.1	-	331
GS2TKS90	34	5.5	-	331
GS2TKS96	36	5.8	-	331
GS2TKS102	37	3.3	-	331
GS2TKS108	39	3.4	-	331
GS2TKW1H24	20	2.1	-	294
GS2TKW1H30	24	3.2	-	294
GS2TKW1H36	27	3.8	-	294
GS2TKW1H42	29	4.3	-	294
GS2TKW1H48	32	4.9	-	294
GS2TKW2H24	23	2.8	-	294
GS2TKW2H30	26	4.1	-	294
GS2TKW2H36	29	4.8	-	294
GS2TKW2H42	33	5.6	-	294
GS2TKW2H48	36	6.3	-	294
GS2TKW24	16	1.4	-	290
GS2TKW30	18	2.1	-	290
GS2TKW36	20	2.4	-	290
GS2TKW42	21	2.8	-	290
GS2TKW48	22	3.2	-	290
GS2TKW54	24	3.6	-	290
GS2TKW60	26	3.9	-	290
GS2TKW66	28	4.3	-	290
GS2TKW72	29	4.7	-	290
GS2TKW78	31	5.1	-	290
GS2TKW84	33	5.4	-	290
GS2TKW90	34	5.8	-	290
GS2TKW96	36	6.2	-	290
GS2TKW102	37	3.4	-	290
GS2TKW108	39	3.6	-	290
GS2TKWSB36	14	3.2	-	340
GS2TKWSB45	17	4.0	-	340
GS2TKWSB72	28	5.0	-	340
GS2TKWSB90	35	6.2	-	340
GS2TLGW1H24-GSA	40	2.5	-	297
GS2TLGW1H30-GSA	49	3.6	-	297
GS2TLGW1H36-GSA	58	4.3	-	297
GS2TLGW1H42-GSA	67	5.0	-	297
GS2TLGW1H48-GSA	75	5.6	-	297
GS2TLGW2H24-GSA	46	3.1	-	297
GS2TLGW2H30-GSA	56	4.6	-	297

model number	weight	cubes	#locks	page
GS2TLGW2H36-GSA	66	5.5	-	297
GS2TLGW2H42-GSA	76	6.3	-	297
GS2TLGW2H48-GSA	86	7.2	-	297
GS2TLGW24-GSA	29	1.8	-	293
GS2TLGW30-GSA	34	2.6	-	293
GS2TLGW36-GSA	39	3.1	-	293
GS2TLGW42-GSA	45	3.5	-	293
GS2TLGW48-GSA	50	4.0	-	293
GS2TLGW54-GSA	56	4.5	-	293
GS2TLGW60-GSA	62	4.9	-	293
GS2TLGW66-GSA	68	5.4	-	293
GS2TLGW72-GSA	74	5.9	-	293
GS2TLGW78-GSA	79	6.3	-	293
GS2TLGW84-GSA	85	6.8	-	293
GS2TLGW90-GSA	91	7.3	-	293
GS2TLGW96-GSA	97	4.0	-	293
GS2TLGW102-GSA	102	4.2	-	293
GS2TLGW108-GSA	108	4.5	-	293
GS2TLKW1H24	23	2.5	-	296
GS2TLKW1H30	26	3.6	-	296
GS2TLKW1H36	29	4.3	-	296
GS2TLKW1H42	33	5.0	-	296
GS2TLKW1H48	36	5.6	-	296
GS2TLKW2H24	24	3.1	-	296
GS2TLKW2H30	28	4.6	-	296
GS2TLKW2H36	32	5.5	-	296
GS2TLKW2H42	36	6.3	-	296
GS2TLKW2H48	40	7.2	-	296
GS2TLKW24	18	1.8	-	292
GS2TLKW30	20	2.6	-	292
GS2TLKW36	22	3.1	-	292
GS2TLKW42	24	3.5	-	292
GS2TLKW48	26	4.0	-	292
GS2TLKW54	28	4.5	-	292
GS2TLKW60	31	4.9	-	292
GS2TLKW66	33	5.4	-	292
GS2TLKW72	35	5.9	-	292
GS2TLKW78	37	6.3	-	292
GS2TLKW84	39	6.8	-	292
GS2TLKW90	41	7.3	-	292
GS2TLKW96	43	7.8	-	292
GS2TLKW102	45	4.2	-	292
GS2TLKW108	47	4.5	-	292
GS2TLWD1H24-W	60	3.4	-	308

model number	weight	cubes	#locks	page
GS2TLWD1H30-W	73	3.5	-	308
GS2TLWD1H36-W	85	4.2	-	308
GS2TLWD1H42-W	96	4.8	-	308
GS2TLWD1H48-W	108	5.4	-	308
GS2TLWD1H54-W	130	5.4	-	308
GS2TLWD1H60-W	140	6.0	-	308
GS2TLWD1H66-W	150	6.5	-	308
GS2TLWD1H72-W	175	7.0	-	308
GS2TLWD1H78-W	190	7.5	-	308
GS2TLWD1H84-W	205	8.1	-	308
GS2TLWD1H90-W	215	8.6	-	308
GS2TLWD1H96-W	225	9.1	-	308
GS2TLWD1H102-W	240	9.6	-	308
GS2TLWD1H108-W	270	9.4	-	308
GS2TLWD2H24-W	70	4.4	-	309
GS2TLWD2H30-W	73	4.5	-	309
GS2TLWD2H36-W	85	5.3	-	309
GS2TLWD2H42-W	96	6.1	-	309
GS2TLWD2H48-W	108	6.9	-	309
GS2TLWD2H54-W	150	6.9	-	309
GS2TLWD2H60-W	160	7.6	-	309
GS2TLWD2H66-W	170	8.2	-	309
GS2TLWD2H72-W	195	8.9	-	309
GS2TLWD2H78-W	210	9.6	-	309
GS2TLWD2H84-W	225	10.2	-	309
GS2TLWD2H90-W	240	10.9	-	309
GS2TLWD2H96-W	255	11.6	-	309
GS2TLWD2H102-W	270	12.2	-	309
GS2TLWD2H108-W	295	11.9	-	309
GS2TLWD24-W	23	2.5	-	305
GS2TLWD30-W	26	2.5	-	305
GS2TLWD30-XL	21	2.7	-	304
GS2TLWD30-XW	26	2.5	-	304
GS2TLWD36-W	29	3.0	-	305
GS2TLWD36-XL	25	3.2	-	304
GS2TLWD36-XW	29	3.0	-	304
GS2TLWD42-W	33	3.4	-	305
GS2TLWD42-XL	33	3.4	-	304
GS2TLWD42-XW	33	3.4	-	304
GS2TLWD48-W	36	3.9	-	305
GS2TLWD48-XL	36	3.9	-	304
GS2TLWD48-XW	36	3.9	-	304
GS2TLWD54-W	39	4.3	-	305
GS2TLWD54-XL	39	4.3	-	304

model number	weight	cubes	#locks	page
GS2TLWD54-XW	39	4.3	-	304
GS2TLWD60-W	42	4.8	-	305
GS2TLWD60-XL	41	5.1	-	304
GS2TLWD60-XW	42	4.8	-	304
GS2TLWD66-W	45	5.2	-	305
GS2TLWD66-XL	45	5.6	-	304
GS2TLWD66-XW	45	5.2	-	304
GS2TLWD72-W	48	5.7	-	305
GS2TLWD72-XL	49	6.1	-	304
GS2TLWD72-XW	48	5.7	-	304
GS2TLWD78-W	51	6.1	-	305
GS2TLWD78-XL	54	6.6	-	304
GS2TLWD78-XW	51	6.1	-	304
GS2TLWD84-W	54	6.6	-	305
GS2TLWD84-XL	58	7.0	-	304
GS2TLWD84-XW	54	6.6	-	304
GS2TLWD90-W	57	7.1	-	305
GS2TLWD90-XL	62	7.5	-	304
GS2TLWD90-XW	57	7.1	-	304
GS2TLWD96-W	60	7.5	-	305
GS2TLWD96-XL	66	8.0	-	304
GS2TLWD96-XW	60	7.5	-	304
GS2TLWD102-W	63	8.0	-	305
GS2TLWD102-XL	70	4.2	-	304
GS2TLWD102-XW	63	8.0	-	304
GS2TLWD108-W	67	8.4	-	305
GS2TLWD108-XL	74	4.5	-	304
GS2TLWD108-XW	67	8.4	-	304
GS2TRD36-L	45	3.7	-	197
GS2TRD36-S	68	3.7	-	197
GS2TRD36-W	45	3.7	-	197
GS2TRD42-L	59	4.9	-	197
GS2TRD42-S	89	4.9	-	197
GS2TRD42-W	59	4.9	-	197
GS2TRD48-L	76	6.3	-	197
GS2TRD48-S	114	6.3	-	197
GS2TRD48-W	76	6.3	-	197
GS2TRD54-L	95	7.9	-	197
GS2TRD54-S	143	7.9	-	197
GS2TRD54-W	95	7.9	-	197
GS2TRD60-L	116	9.6	-	197
GS2TRD60-S	174	9.6	-	197
GS2TRD60-W	116	9.6	-	197
GS2TRL3066-L	102	10.0	-	64

# WEIGHTS + CUBES

Silea  
05/22

model number	weight	cubes	#locks	page
GS2TRL3066-W	102	10.0	-	64
GS2TRL3072-L	109	10.6	-	64
GS2TRL3072-W	109	10.6	-	64
GS2TRL3672-L	122	11.7	-	64
GS2TRL3672-W	122	11.7	-	64
GS2TRL3678-L	129	12.4	-	64
GS2TRL3678-W	129	12.4	-	64
GS2TSTG36-L	45	3.7	-	198
GS2TSTG36-S	68	3.7	-	198
GS2TSTG36-W	45	3.7	-	198
GS2TSTG42-L	59	4.9	-	198
GS2TSTG42-S	89	4.9	-	198
GS2TSTG42-W	59	4.9	-	198
GS2TSTG48-L	76	6.3	-	198
GS2TSTG48-S	114	6.3	-	198
GS2TSTG48-W	76	6.3	-	198
GS2TTGW24-GSA	35	2.1	-	299
GS2TTGW30-GSA	43	2.5	-	299
GS2TTGW36-GSA	50	3.0	-	299
GS2TTGW42-GSA	58	3.4	-	299
GS2TTGW48-GSA	66	3.9	-	299
GS2TTGW54-GSA	82	3.9	-	299
GS2TTGW60-GSA	90	4.2	-	299
GS2TTGW66-GSA	98	4.6	-	299
GS2TTGW72-GSA	106	5.0	-	299
GS2TTGW78-GSA	114	5.4	-	299
GS2TTGW84-GSA	122	5.7	-	299
GS2TTGW90-GSA	130	6.1	-	299
GS2TTGW96-GSA	138	6.5	-	299
GS2TTGW102-GSA	150	7.6	-	299
GS2TTGW108-GSA	158	8.0	-	299
GS2TTKW24	19	2.1	-	298
GS2TTKW30	21	2.5	-	298
GS2TTKW36	23	3.0	-	298
GS2TTKW42	25	3.4	-	298
GS2TTKW48	27	3.9	-	298
GS2TTKW54	30	3.9	-	298
GS2TTKW60	32	4.2	-	298
GS2TTKW66	34	4.6	-	298
GS2TTKW72	36	5.0	-	298
GS2TTKW78	38	5.4	-	298
GS2TTKW84	40	5.7	-	298
GS2TTKW90	42	6.1	-	298
GS2TTKW96	44	6.5	-	298

model number	weight	cubes	#locks	page
GS2TTKW102	47	7.6	-	298
GS2TTKW108	50	8.0	-	298
GS2TTWD24-W	52	2.9	-	310
GS2TTWD30-W	60	3.6	-	310
GS2TTWD36-W	70	4.2	-	310
GS2TTWD42-W	80	4.8	-	310
GS2TTWD48-W	100	5.4	-	310
GS2TTWD54-W	120	4.6	-	310
GS2TTWD60-W	140	5.1	-	310
GS2TTWD66-W	150	5.5	-	310
GS2TTWD72-W	160	6.0	-	310
GS2TTWD78-W	170	6.4	-	310
GS2TTWD84-W	180	6.9	-	310
GS2TTWD90-W	190	7.3	-	310
GS2TTWD96-W	200	7.8	-	310
GS2TTWD102-W	210	8.2	-	310
GS2TTWD108-W	240	8.0	-	310
GS2TWD1H24-W	52	2.9	-	306
GS2TWD1H30-W	68	3.0	-	306
GS2TWD1H36-W	80	3.6	-	306
GS2TWD1H42-W	91	4.1	-	306
GS2TWD1H48-W	103	4.7	-	306
GS2TWD1H54-W	120	4.6	-	306
GS2TWD1H60-W	140	5.1	-	306
GS2TWD1H66-W	150	5.5	-	306
GS2TWD1H72-W	160	6.0	-	306
GS2TWD1H78-W	170	6.4	-	306
GS2TWD1H84-W	180	6.9	-	306
GS2TWD1H90-W	190	7.3	-	306
GS2TWD1H96-W	200	7.8	-	306
GS2TWD1H102-W	210	8.2	-	306
GS2TWD1H108-W	240	8.0	-	306
GS2TWD2H24-W	64	3.8	-	307
GS2TWD2H30-W	78	4.0	-	307
GS2TWD2H36-W	92	4.7	-	307
GS2TWD2H42-W	106	5.4	-	307
GS2TWD2H48-W	120	6.1	-	307
GS2TWD2H54-W	140	6.1	-	307
GS2TWD2H60-W	150	6.7	-	307
GS2TWD2H66-W	160	7.3	-	307
GS2TWD2H72-W	185	7.8	-	307
GS2TWD2H78-W	200	8.4	-	307
GS2TWD2H84-W	215	9.0	-	307
GS2TWD2H90-W	230	9.6	-	307



model number	weight	cubes	#locks	page
GS2TWD2H96-W	245	10.2	-	307
GS2TWD2H102-W	260	10.8	-	307
GS2TWD2H108-W	280	10.5	-	307
GS2TWD24-W	18	2.0	-	303
GS2TWD30-W	21	2.0	-	303
GS2TWD30-XL	16	2.1	-	302
GS2TWD30-XW	21	2.0	-	302
GS2TWD36-W	24	2.4	-	303
GS2TWD36-XL	20	2.5	-	302
GS2TWD36-XW	24	2.4	-	302
GS2TWD42-W	27	2.7	-	303
GS2TWD42-XL	27	2.7	-	302
GS2TWD42-XW	27	2.7	-	302
GS2TWD48-W	30	3.1	-	303
GS2TWD48-XL	30	3.1	-	302
GS2TWD48-XW	30	3.1	-	302
GS2TWD54-W	33	3.4	-	303
GS2TWD54-XL	33	3.4	-	302
GS2TWD54-XW	33	3.4	-	302
GS2TWD60-W	37	3.8	-	303
GS2TWD60-XL	33	4.1	-	302
GS2TWD60-XW	37	3.8	-	302
GS2TWD66-W	40	4.2	-	303
GS2TWD66-XL	36	4.4	-	302
GS2TWD66-XW	40	4.2	-	302
GS2TWD72-W	43	4.5	-	303
GS2TWD72-XL	39	4.8	-	302
GS2TWD72-XW	43	4.5	-	302
GS2TWD78-W	46	4.9	-	303
GS2TWD78-XL	43	5.2	-	302
GS2TWD78-XW	46	4.9	-	302
GS2TWD84-W	49	5.3	-	303
GS2TWD84-XL	46	5.6	-	302
GS2TWD84-XW	49	5.3	-	302
GS2TWD90-W	52	5.6	-	303
GS2TWD90-XL	49	6.0	-	302
GS2TWD90-XW	52	5.6	-	302
GS2TWD96-W	55	6.0	-	303
GS2TWD96-XL	53	6.4	-	302
GS2TWD96-XW	55	6.0	-	302
GS2TWD102-W	58	6.3	-	303
GS2TWD102-XL	56	3.4	-	302
GS2TWD102-XW	58	6.3	-	302
GS2TWD108-W	62	6.7	-	303

model number	weight	cubes	#locks	page
GS2TWD108-XL	59	3.6	-	302
GS2TWD108-XW	62	6.7	-	302
GS2UTC5H24L-3LL	269	33.1	3	265
GS2UTC5H24L-3WW	269	33.1	3	265
GS2UTC5H24L-FLL	269	27.2	3	244
GS2UTC5H24L-FWW	269	27.2	3	244
GS2UTC5H24L-LL	269	30.2	3	264
GS2UTC5H24L-WW	269	30.2	3	264
GS2UTC5H24R-3LL	269	33.1	3	265
GS2UTC5H24R-3WW	269	33.1	3	265
GS2UTC5H24R-FLL	269	27.2	3	244
GS2UTC5H24R-FWW	269	27.2	3	244
GS2UTC5H24R-LL	269	30.2	3	264
GS2UTC5H24R-WW	269	30.2	3	264
GS2UTC5H30L-3LL	285	40.2	3	267
GS2UTC5H30L-3WW	285	40.2	3	267
GS2UTC5H30L-LL	285	40.2	3	266
GS2UTC5H30L-WW	285	40.2	3	266
GS2UTC5H30R-3LL	285	40.2	3	267
GS2UTC5H30R-3WW	285	40.2	3	267
GS2UTC5H30R-LL	285	40.2	3	266
GS2UTC5H30R-WW	285	40.2	3	266
GS2UTC6H24L-3LL	317	39.0	3	265
GS2UTC6H24L-3WW	317	39.0	3	265
GS2UTC6H24L-FLL	317	32.8	3	244
GS2UTC6H24L-FWW	317	32.8	3	244
GS2UTC6H24L-LL	317	35.8	3	264
GS2UTC6H24L-WW	317	35.8	3	264
GS2UTC6H24R-3LL	317	39.0	3	265
GS2UTC6H24R-3WW	317	39.0	3	265
GS2UTC6H24R-FLL	317	32.8	3	244
GS2UTC6H24R-FWW	317	32.8	3	244
GS2UTC6H24R-LL	317	35.8	3	264
GS2UTC6H24R-WW	317	35.8	3	264
GS2UTC6H30L-3LL	330	47.4	3	267
GS2UTC6H30L-3WW	330	47.4	3	267
GS2UTC6H30L-LL	330	47.4	3	266
GS2UTC6H30L-WW	330	47.4	3	266
GS2UTC6H30R-3LL	330	47.4	3	267
GS2UTC6H30R-3WW	330	47.4	3	267
GS2UTC6H30R-LL	330	47.4	3	266
GS2UTC6H30R-WW	330	47.4	3	266
GS2VLEG-A	8	0.6	-	139
GS2WGW4H36	62	5.0	-	301

# WEIGHTS + CUBES

Silea  
05/22

model number	weight	cubes	#locks	page
GS2WGW5H36	74	6.2	-	301
GS2WGW6H36	85	7.4	-	301
GS2WKW4H36	31	5.0	-	300
GS2WKW5H36	35	6.2	-	300
GS2WKW6H36	39	7.4	-	300
GS2WMC1H30-LL	45	5.8	1	278
GS2WMC1H30-LN	40	6.0	-	280
GS2WMC1H30-WG	45	5.8	-	279
GS2WMC1H30-WN	40	6.0	-	280
GS2WMC1H30-WW	45	5.8	1	278
GS2WMC1H36-LL	52	6.9	1	278
GS2WMC1H36-LN	47	7.1	-	280
GS2WMC1H36-WG	52	6.9	-	279
GS2WMC1H36-WN	47	7.1	-	280
GS2WMC1H36-WW	52	6.9	1	278
GS2WMC1H42-LL	60	8.6	2	278
GS2WMC1H42-LN	50	8.2	-	280
GS2WMC1H42-WN	50	8.2	-	280
GS2WMC1H42-WW	60	8.6	2	278
GS2WMC1H48-LL	69	9.7	2	278
GS2WMC1H48-LN	59	9.3	-	280
GS2WMC1H48-WN	59	9.3	-	280
GS2WMC1H48-WW	69	9.7	2	278
GS2WMC1H54-LL	78	10.9	2	278
GS2WMC1H54-LN	68	10.4	-	280
GS2WMC1H54-WN	68	10.4	-	280
GS2WMC1H54-WW	78	10.9	2	278
GS2WMC1H60-LL	85	11.1	2	278
GS2WMC1H60-LN	75	11.5	-	280
GS2WMC1H60-LSL	85	11.1	-	281
GS2WMC1H60-WG	85	11.1	-	279
GS2WMC1H60-WN	75	11.5	-	280
GS2WMC1H60-WSG	85	11.1	-	282
GS2WMC1H60-WSW	85	11.1	-	281
GS2WMC1H60-WW	85	11.1	2	278
GS2WMC1H66-LL	94	12.2	2	278
GS2WMC1H66-LN	84	12.6	-	280
GS2WMC1H66-LSL	95	15.0	-	281
GS2WMC1H66-WN	84	12.6	-	280
GS2WMC1H66-WSW	95	15.0	-	281
GS2WMC1H66-WW	94	12.2	2	278
GS2WMC1H72-LL	105	13.2	2	278
GS2WMC1H72-LN	95	13.7	-	280
GS2WMC1H72-LSL	105	13.2	-	281

model number	weight	cubes	#locks	page
GS2WMC1H72-WG	105	13.2	-	279
GS2WMC1H72-WN	95	13.7	-	280
GS2WMC1H72-WSG	105	13.2	-	282
GS2WMC1H72-WSW	105	13.2	-	281
GS2WMC1H72-WW	105	13.2	2	278
GS2WMC1H78-LL	115	14.3	2	278
GS2WMC1H78-LN	105	14.8	-	280
GS2WMC1H78-LSL	115	17.6	-	281
GS2WMC1H78-WN	105	14.8	-	280
GS2WMC1H78-WSW	115	17.6	-	281
GS2WMC1H78-WW	115	14.3	2	278
GS2WMC1H84-LL	125	15.4	3	278
GS2WMC1H84-LN	115	15.8	-	280
GS2WMC1H84-LSL	125	18.8	-	281
GS2WMC1H84-WN	115	15.8	-	280
GS2WMC1H84-WSW	125	18.8	-	281
GS2WMC1H84-WW	125	15.4	3	278
GS2WMC1H90-LL	135	16.4	3	278
GS2WMC1H90-LN	125	16.9	-	280
GS2WMC1H90-LSL	135	16.4	-	281
GS2WMC1H90-WG	135	16.4	-	279
GS2WMC1H90-WN	125	16.9	-	280
GS2WMC1H90-WSG	135	16.4	-	282
GS2WMC1H90-WSW	135	16.4	-	281
GS2WMC1H90-WW	135	16.4	3	278
GS2WMC1H96-LL	142	17.5	3	278
GS2WMC1H96-LN	132	18.0	-	280
GS2WMC1H96-LSL	145	21.4	-	281
GS2WMC1H96-WN	132	18.0	-	280
GS2WMC1H96-WSW	145	21.4	-	281
GS2WMC1H96-WW	142	17.5	3	278
GS2WMC1H102-LL	149	20.0	3	278
GS2WMC1H102-LN	139	19.1	-	280
GS2WMC1H102-WN	139	19.1	-	280
GS2WMC1H102-WSW	155	22.7	-	281
GS2WMC1H102-WW	149	18.5	3	278
GS2WMC1H108-LL	158	21.2	3	278
GS2WMC1H108-LN	148	20.2	-	280
GS2WMC1H108-WG	158	19.6	-	279
GS2WMC1H108-WN	148	20.2	-	280
GS2WMC1H108-WSG	158	19.6	-	282
GS2WMC1H108-WSW	158	19.6	-	281
GS2WMC1H108-WW	158	19.6	3	278
GS2WMC2H30-LL	85	10.4	1	283

model number	weight	cubes	#locks	page
GS2WMC2H30-LN	80	10.7	-	285
GS2WMC2H30-WG	85	10.4	-	284
GS2WMC2H30-WN	80	10.7	-	285
GS2WMC2H30-WW	85	10.4	1	283
GS2WMC2H36-LL	93	12.3	1	283
GS2WMC2H36-LN	88	12.6	-	285
GS2WMC2H36-WG	93	12.3	-	284
GS2WMC2H36-WN	88	12.6	-	285
GS2WMC2H36-WW	93	12.3	1	283
GS2WMC2H42-LL	108	15.3	2	283
GS2WMC2H42-LN	98	14.6	-	285
GS2WMC2H42-WN	98	14.6	-	285
GS2WMC2H42-WW	108	15.3	2	283
GS2WMC2H48-LL	122	17.3	2	283
GS2WMC2H48-LN	112	16.5	-	285
GS2WMC2H48-WN	112	16.5	-	285
GS2WMC2H48-WW	122	17.3	2	283
GS2WMC2H54-LL	136	19.4	2	283
GS2WMC2H54-LN	126	18.5	-	285
GS2WMC2H54-WN	126	18.5	-	285
GS2WMC2H54-WW	136	19.4	2	283
GS2WMC2H60-LL	150	19.8	2	283
GS2WMC2H60-LN	140	20.4	-	285
GS2WMC2H60-LSL	150	19.8	-	286
GS2WMC2H60-WG	150	19.8	-	284
GS2WMC2H60-WN	140	20.4	-	285
GS2WMC2H60-WSG	150	19.8	-	287
GS2WMC2H60-WSW	150	19.8	-	286
GS2WMC2H60-WW	150	19.8	2	283
GS2WMC2H66-LL	167	21.7	2	283
GS2WMC2H66-LN	157	22.4	-	285
GS2WMC2H66-LSL	168	25.9	-	286
GS2WMC2H66-WN	157	22.4	-	285
GS2WMC2H66-WSW	168	25.9	-	286
GS2WMC2H66-WW	167	21.7	2	283
GS2WMC2H72-LL	186	23.6	2	283
GS2WMC2H72-LN	176	24.3	-	285
GS2WMC2H72-LSL	186	23.6	-	286
GS2WMC2H72-WG	186	23.6	-	284
GS2WMC2H72-WN	176	24.3	-	285
GS2WMC2H72-WSG	186	23.6	-	287
GS2WMC2H72-WSW	186	23.6	-	286
GS2WMC2H72-WW	186	23.6	2	283
GS2WMC2H78-LL	201	25.5	2	283

model number	weight	cubes	#locks	page
GS2WMC2H78-LN	191	26.3	-	285
GS2WMC2H78-LSL	204	30.4	-	286
GS2WMC2H78-WN	191	26.3	-	285
GS2WMC2H78-WSW	204	30.4	-	286
GS2WMC2H78-WW	201	25.5	2	283
GS2WMC2H84-LL	218	27.4	3	283
GS2WMC2H84-LN	208	28.2	-	285
GS2WMC2H84-LSL	220	32.6	-	286
GS2WMC2H84-WN	208	28.2	-	285
GS2WMC2H84-WSW	220	32.6	-	286
GS2WMC2H84-WW	218	27.4	3	283
GS2WMC2H90-LL	237	29.2	3	283
GS2WMC2H90-LN	227	30.2	-	285
GS2WMC2H90-LSL	237	29.2	-	286
GS2WMC2H90-WG	237	29.2	-	284
GS2WMC2H90-WN	227	30.2	-	285
GS2WMC2H90-WSG	237	29.2	-	287
GS2WMC2H90-WSW	237	29.2	-	286
GS2WMC2H90-WW	237	29.2	3	283
GS2WMW1H30-L	10	1.3	-	288
GS2WMW1H30-W	10	1.3	-	288
GS2WMW1H36-L	12	1.5	-	288
GS2WMW1H36-W	12	1.5	-	288
GS2WMW1H42-L	14	1.8	-	288
GS2WMW1H42-W	14	1.8	-	288
GS2WMW1H48-L	16	2.0	-	288
GS2WMW1H48-W	16	2.0	-	288
GS2WMW1H54-L	18	2.3	-	288
GS2WMW1H54-W	18	2.3	-	288
GS2WMW1H60-L	20	2.5	-	288
GS2WMW1H60-W	20	2.5	-	288
GS2WMW1H66-L	22	2.7	-	288
GS2WMW1H66-W	22	2.7	-	288
GS2WMW1H72-L	24	3.0	-	288
GS2WMW1H72-W	25	3.0	-	288
GS2WMW1H78-L	26	3.2	-	288
GS2WMW1H78-W	27	3.2	-	288
GS2WMW1H84-L	28	3.4	-	288
GS2WMW1H84-W	29	3.4	-	288
GS2WMW1H90-L	31	3.7	-	288
GS2WMW1H90-W	32	3.7	-	288
GS2WMW1H96-L	33	3.9	-	288
GS2WMW1H96-W	4	3.9	-	288
GS2WMW1H102-L	35	2.1	-	288

# WEIGHTS + CUBES

Silea  
05/22

model number	weight	cubes	#locks	page
GS2WMW1H102-W	35	4.2	-	288
GS2WMW1H108-L	37	2.2	-	288
GS2WMW1H108-W	39	4.4	-	288
GS2WMW2H30-L	19	2.3	-	289
GS2WMW2H30-W	21	2.3	-	289
GS2WMW2H36-L	22	2.8	-	289
GS2WMW2H36-W	25	2.8	-	289
GS2WMW2H42-L	29	3.2	-	289
GS2WMW2H42-W	29	3.2	-	289
GS2WMW2H48-L	34	3.6	-	289
GS2WMW2H48-W	34	3.6	-	289
GS2WMW2H54-L	38	4.0	-	289
GS2WMW2H54-W	38	4.0	-	289
GS2WMW2H60-L	37	4.4	-	289
GS2WMW2H60-W	42	4.4	-	289
GS2WMW2H66-L	41	4.9	-	289
GS2WMW2H66-W	46	4.9	-	289
GS2WMW2H72-L	45	5.3	-	289
GS2WMW2H72-W	51	5.3	-	289
GS2WMW2H78-L	49	5.7	-	289
GS2WMW2H78-W	56	5.7	-	289
GS2WMW2H84-L	52	6.1	-	289
GS2WMW2H84-W	60	6.1	-	289
GS2WMW2H90-L	56	6.6	-	289
GS2WMW2H90-W	67	6.6	-	289
GS2WSB3H72L-WSG	300	41.1	-	336
GS2WSB3H72R-WSG	300	41.1	-	336
GS2WSB3H90L-WSG	375	50.9	-	336
GS2WSB3H90R-WSG	375	50.9	-	336
GS2WSBA3H72L-WSG	375	54.8	-	337
GS2WSBA3H72R-WSG	375	54.8	-	337
GS2WSBA3H90L-WSG	465	67.9	-	337
GS2WSBA3H90R-WSG	465	67.9	-	337
GS2WSBS3H72L-WSG	300	41.1	-	338
GS2WSBS3H72R-WSG	300	41.1	-	338
GS2WSBS3H90L-WSG	375	50.9	-	338
GS2WSBS3H90R-WSG	375	50.9	-	338
GS2WWD4H36-W	65	3.8	-	311
GS2WWD5H36-W	70	4.9	-	311
GS2WWD6H36-W	75	6.1	-	311
GS2XBT4272-LL	154	19.6	-	66
GS2XBT4272-WW	154	19.6	-	66
GS2XDT4272-LL	154	19.6	-	66
GS2XDT4272-WW	154	19.6	-	66

model number	weight	cubes	#locks	page
GS2XMAMOD66-L	12	1.7	-	124
GS2XMAMOD66-M	12	1.7	-	124
GS2XMAMOD66-W	12	1.9	-	124
GS2XMAMOD72-L	12	1.9	-	124
GS2XMAMOD72-M	12	1.9	-	124
GS2XMAMOD72-W	13	1.9	-	124
GS2XMAMOD78-L	12	2.1	-	124
GS2XMAMOD78-M	12	2.1	-	124
GS2XMAMOD78-W	12	2.1	-	124
GS2XMF36L-L	20	3.9	-	146
GS2XMF36L-W	20	3.9	-	146
GS2XMF36R-L	20	3.9	-	146
GS2XMF36R-W	20	3.9	-	146
GS2XMF39L-L	21	4.2	-	146
GS2XMF39L-W	21	4.2	-	146
GS2XMF39R-L	21	4.2	-	146
GS2XMF39R-W	21	4.2	-	146
GS2XMF42L-L	23	4.5	-	146
GS2XMF42L-W	23	4.5	-	146
GS2XMF42R-L	23	4.5	-	146
GS2XMF42R-W	23	4.5	-	146
GS2XMF45L-L	24	4.8	-	146
GS2XMF45L-W	24	4.8	-	146
GS2XMF45R-L	24	4.8	-	146
GS2XMF45R-W	24	4.8	-	146
GS2XMF48L-L	26	5.1	-	146
GS2XMF48L-W	26	5.1	-	146
GS2XMF48R-L	26	5.1	-	146
GS2XMF48R-W	26	5.1	-	146
GS2XMF51L-L	28	5.5	-	146
GS2XMF51L-W	28	5.5	-	146
GS2XMF51R-L	28	5.5	-	146
GS2XMF51R-W	28	5.5	-	146
GS2XMF54L-L	29	5.8	-	146
GS2XMF54L-W	29	5.8	-	146
GS2XMF54R-L	29	5.8	-	146
GS2XMF54R-W	29	5.8	-	146
GS2XMF57L-L	31	6.1	-	146
GS2XMF57L-W	31	6.1	-	146
GS2XMF57R-L	31	6.1	-	146
GS2XMF57R-W	31	6.1	-	146
GS2XML366060-LL	173	26.3	-	79
GS2XML366060-WW	179	22.1	-	79
GS2XML487260-LL	202	30.9	-	79

model number	weight	cubes	#locks	page
GS2XML487260-WW	209	25.9	-	79
GS2XRL3066L-LL	143	17.3	-	65
GS2XRL3066L-WW	143	17.3	-	65
GS2XRL3066R-LL	143	17.3	-	65
GS2XRL3066R-WW	143	17.3	-	65
GS2XRL3072L-LL	151	18.0	-	65
GS2XRL3072L-WW	151	18.0	-	65
GS2XRL3072R-LL	151	18.0	-	65
GS2XRL3072R-WW	151	18.0	-	65
GS2XRL3672L-LL	171	20.4	-	65
GS2XRL3672L-WW	171	20.4	-	65
GS2XRL3672R-LL	171	20.4	-	65
GS2XRL3672R-WW	171	20.4	-	65
GS2XRL3678L-LL	180	21.3	-	65
GS2XRL3678L-WW	178	21.3	-	65
GS2XRL3678R-LL	180	21.3	-	65
GS2XRL3678R-WW	178	21.3	-	65
GS2XRT3066L-LL	122	16.9	-	66
GS2XRT3066L-WW	122	16.9	-	66
GS2XRT3066R-LL	122	16.9	-	66
GS2XRT3066R-WW	122	16.9	-	66
GS2XRT3072L-LL	128	17.4	-	66
GS2XRT3072L-WW	128	17.4	-	66
GS2XRT3072R-LL	128	17.4	-	66
GS2XRT3072R-WW	128	17.4	-	66
GS3BAK2442-LL	80	11.7	-	96
GS3BAK2442-WW	80	10.2	-	96
GS3BAK2448-LL	90	13.4	-	96
GS3BAK2448-WW	90	11.5	-	96
GS3BAK2454-LL	100	15.0	-	96
GS3BAK2454-WW	100	12.9	-	96
GS3BAK2460-LL	110	16.6	-	96
GS3BAK2460-WW	110	14.2	-	96
GS3BAK2466-LL	120	18.3	-	96
GS3BAK2466-WW	120	15.6	-	96
GS3BAK2472-LL	130	19.9	-	96
GS3BAK2472-WW	130	16.9	-	96
GS3BAK3042-LL	216	19.2	-	97
GS3BAK3042-WW	130	30.5	-	97
GS3BAK3048-LL	227	20.8	-	97
GS3BAK3048-WW	140	34.5	-	97
GS3BAK3054-LL	239	22.4	-	97
GS3BAK3054-WW	149	38.5	-	97
GS3BAK3060-LL	256	24.0	-	97

model number	weight	cubes	#locks	page
GS3BAK3060-WW	157	42.5	-	97
GS3BAK3066-LL	274	25.6	-	97
GS3BAK3066-WW	165	46.5	-	97
GS3BAK3072-LL	286	51.4	-	97
GS3BAK3072-WW	176	50.4	-	97
GS3CAK2442-LL	229	63.0	-	92
GS3CAK2442-WW	167	30.5	-	92
GS3CAK2448-LL	240	35.9	-	92
GS3CAK2448-WW	175	34.5	-	92
GS3CAK2454-LL	250	39.2	-	92
GS3CAK2454-WW	183	38.5	-	92
GS3CAK2460-LL	265	42.5	-	92
GS3CAK2460-WW	190	42.5	-	92
GS3CAK2466-AALL	349	37.5	2	94
GS3CAK2466-AAWW	295	46.5	2	94
GS3CAK2466L-ALL	328	47.7	1	94
GS3CAK2466L-AWW	260	46.5	1	94
GS3CAK2466-LL	283	45.8	-	92
GS3CAK2466R-ALL	328	47.7	1	94
GS3CAK2466R-AWW	255	46.5	1	94
GS3CAK2466-WW	197	46.5	-	92
GS3CAK2472-AALL	358	39.0	2	94
GS3CAK2472-AAWW	305	50.4	2	94
GS3CAK2472L-ALL	338	51.0	1	94
GS3CAK2472L-AWW	275	50.4	1	94
GS3CAK2472-LL	293	49.1	-	92
GS3CAK2472R-ALL	338	51.0	1	94
GS3CAK2472R-AWW	265	50.4	1	94
GS3CAK2472-WW	207	50.4	-	92
GS3CAK3042-LL	238	37.8	-	93
GS3CAK3042-WW	151	30.5	-	93
GS3CAK3048-LL	249	41.8	-	93
GS3CAK3048-WW	160	34.5	-	93
GS3CAK3054-LL	261	45.8	-	93
GS3CAK3054-WW	169	38.5	-	93
GS3CAK3060-LL	278	49.8	-	93
GS3CAK3060-WW	177	42.5	-	93
GS3CAK3066-AALL	386	42.2	1	95
GS3CAK3066-AAWW	304	46.5	1	95
GS3CAK3066L-ALL	356	56.1	1	95
GS3CAK3066L-AWW	251	46.5	1	95
GS3CAK3066-LL	296	53.8	-	93
GS3CAK3066R-ALL	356	56.1	1	95
GS3CAK3066R-AWW	251	46.5	1	95

# WEIGHTS + CUBES

Silea  
05/22

model number	weight	cubes	#locks	page
GS3CAK3066-WW	185	46.5	-	93
GS3CAK3072-AALL	397	43.8	1	95
GS3CAK3072-AAWW	315	50.4	1	95
GS3CAK3072L-ALL	368	60.1	1	95
GS3CAK3072L-AWW	261	50.4	1	95
GS3CAK3072-LL	308	57.8	-	93
GS3CAK3072R-ALL	368	60.1	1	95
GS3CAK3072R-AWW	261	50.4	1	95
GS3CAK3072-WW	196	50.4	-	93
GS3DFAK3066-LL	339	30.9	-	86
GS3DFAK3066-WW	308	46.5	-	86
GS3DFAK3072-LL	354	32.7	-	86
GS3DFAK3072-WW	318	50.4	-	86
GS3DFAK3672-WW	328	60.2	-	86
GS3DFAK3678-LL	385	35.7	-	86
GS3DFAK3678-WW	338	65.0	-	86
GS3DHAK3066-LL	296	25.4	-	90
GS3DHAK3066-WW	266	46.5	-	90
GS3DHAK3072-LL	307	26.7	-	90
GS3DHAK3072-WW	276	50.4	-	90
GS3DHAK3672-LL	325	28.3	-	90
GS3DHAK3672-WW	286	60.2	-	90
GS3DHAK3678-LL	334	29.5	-	90
GS3DHAK3678-WW	296	65.0	-	90
GS3HASHRD2442-L	124	13.3	-	119
GS3HASHRD2442-W	76	9.4	-	119
GS3HASHRD2448-L	128	14.4	-	119
GS3HASHRD2448-W	80	9.4	-	119
GS3HASHRD2454-L	132	14.9	-	119
GS3HASHRD2454-W	84	9.4	-	119
GS3HASHRD2460-L	136	15.6	-	119
GS3HASHRD2460-W	86	9.4	-	119
GS3HASHRD2466-L	140	16.4	-	119
GS3HASHRD2466-W	90	9.4	-	119
GS3HASHRD2472-L	144	17.2	-	119
GS3HASHRD2472-W	94	10.8	-	119
GS3HASHRD3042-L	138	15.3	-	119
GS3HASHRD3042-W	84	11.6	-	119
GS3HASHRD3048-L	142	16.3	-	119
GS3HASHRD3048-W	88	11.6	-	119
GS3HASHRD3054-L	146	16.9	-	119
GS3HASHRD3054-W	92	11.6	-	119
GS3HASHRD3060-L	150	17.6	-	119
GS3HASHRD3060-W	96	11.6	-	119
GS3HASHRD3066-L	154	18.4	-	119

model number	weight	cubes	#locks	page
GS3HASHRD3066-W	100	11.6	-	119
GS3HASHRD3072-L	158	19.1	-	119
GS3HASHRD3072-W	104	11.6	-	119
GS3HASHRD3642-L	150	17.3	-	119
GS3HASHRD3642-W	98	14.1	-	119
GS3HASHRD3648-L	154	18.3	-	119
GS3HASHRD3648-W	102	14.1	-	119
GS3HASHRD3654-L	158	18.8	-	119
GS3HASHRD3654-W	106	14.1	-	119
GS3HASHRD3660-L	162	19.6	-	119
GS3HASHRD3660-W	110	14.1	-	119
GS3HASHRD3666-L	166	20.4	-	119
GS3HASHRD3666-W	114	14.1	-	119
GS3HASHRD3672-L	170	21.1	-	119
GS3HASHRD3672-W	118	14.1	-	119
GS3RAK2442L-ALL	283	25.5	1	100
GS3RAK2442L-AWW	228	30.5	1	100
GS3RAK2442L-LL	221	33.3	-	98
GS3RAK2442L-WW	160	30.5	-	98
GS3RAK2442R-ALL	153	18.0	1	100
GS3RAK2442R-AWW	228	30.5	1	100
GS3RAK2442R-LL	221	33.3	-	98
GS3RAK2442R-WW	160	30.5	-	98
GS3RAK2448L-ALL	294	27.2	1	100
GS3RAK2448L-AWW	233	34.5	1	100
GS3RAK2448L-LL	232	36.8	-	98
GS3RAK2448L-WW	168	34.5	-	98
GS3RAK2448R-ALL	162	19.6	1	100
GS3RAK2448R-AWW	170	25.9	1	100
GS3RAK2448R-LL	232	36.8	-	98
GS3RAK2448R-WW	168	34.5	-	98
GS3RAK2454L-ALL	304	28.8	1	100
GS3RAK2454L-AWW	237	38.5	1	100
GS3RAK2454L-LL	242	40.2	-	98
GS3RAK2454L-WW	176	38.5	-	98
GS3RAK2454R-ALL	170	21.2	1	100
GS3RAK2454R-AWW	180	28.9	1	100
GS3RAK2454R-LL	242	40.2	-	98
GS3RAK2454R-WW	176	38.5	-	98
GS3RAK2460L-ALL	319	30.4	1	100
GS3RAK2460L-AWW	242	42.5	1	100
GS3RAK2460L-LL	257	43.6	-	98
GS3RAK2460L-WW	183	42.5	-	98
GS3RAK2460R-ALL	178	22.9	1	100
GS3RAK2460R-AWW	190	32.0	1	100

model number	weight	cubes	#locks	page
GS3RAK2460R-LL	257	43.6	-	98
GS3RAK2460R-WW	183	42.5	-	98
GS3RAK2466L-ALL	337	32.0	1	100
GS3RAK2466L-AWW	248	46.5	1	100
GS3RAK2466L-LL	275	47.0	-	98
GS3RAK2466L-WW	190	46.5	-	98
GS3RAK2466R-ALL	187	24.5	1	100
GS3RAK2466R-AWW	200	35.0	1	100
GS3RAK2466R-LL	275	47.0	-	98
GS3RAK2466R-WW	190	46.5	-	98
GS3RAK2472L-ALL	347	33.6	1	100
GS3RAK2472L-AWW	258	50.4	-	100
GS3RAK2472L-LL	285	50.4	-	98
GS3RAK2472L-WW	200	50.4	-	98
GS3RAK2472R-ALL	195	26.2	1	100
GS3RAK2472R-AWW	210	38.1	1	100
GS3RAK2472R-LL	285	50.4	-	98
GS3RAK2472R-WW	200	50.4	-	98
GS3RAK3042L-ALL	301	28.1	1	101
GS3RAK3042L-AWW	215	30.5	1	101
GS3RAK3042L-LL	227	37.8	-	99
GS3RAK3042L-WW	141	30.5	-	99
GS3RAK3042R-ALL	301	28.1	1	101
GS3RAK3042R-AWW	215	30.5	1	101
GS3RAK3042R-LL	227	37.8	-	99
GS3RAK3042R-WW	141	30.5	-	99
GS3RAK3048L-ALL	312	29.8	1	101
GS3RAK3048L-AWW	221	34.5	1	101
GS3RAK3048L-LL	238	41.8	-	99
GS3RAK3048L-WW	150	34.5	-	99
GS3RAK3048R-ALL	312	29.8	1	101
GS3RAK3048R-AWW	221	34.5	1	101
GS3RAK3048R-LL	238	41.8	-	99
GS3RAK3048R-WW	150	34.5	-	99
GS3RAK3054L-ALL	324	31.5	1	101
GS3RAK3054L-AWW	226	38.5	1	101
GS3RAK3054L-LL	250	45.8	-	99
GS3RAK3054L-WW	159	38.5	-	99
GS3RAK3054R-ALL	324	31.5	1	101
GS3RAK3054R-AWW	226	38.5	1	101
GS3RAK3054R-LL	250	45.8	-	99
GS3RAK3054R-WW	159	38.5	-	99
GS3RAK3060L-ALL	341	33.1	1	101
GS3RAK3060L-AWW	232	42.5	1	101
GS3RAK3060L-LL	267	49.8	-	99

model number	weight	cubes	#locks	page
GS3RAK3060L-WW	167	42.5	-	99
GS3RAK3060R-ALL	341	33.1	1	101
GS3RAK3060R-AWW	232	42.5	1	101
GS3RAK3060R-LL	267	49.8	-	99
GS3RAK3060R-WW	167	42.5	-	99
GS3RAK3066L-ALL	359	34.8	1	101
GS3RAK3066L-AWW	239	46.5	1	101
GS3RAK3066L-LL	285	53.8	-	99
GS3RAK3066L-WW	175	46.5	-	99
GS3RAK3066R-ALL	359	34.8	1	101
GS3RAK3066R-AWW	239	46.5	1	101
GS3RAK3066R-LL	285	53.8	-	99
GS3RAK3066R-WW	175	46.5	-	99
GS3RAK3072L-ALL	371	36.5	1	101
GS3RAK3072L-AWW	250	50.4	1	101
GS3RAK3072L-LL	297	57.8	-	99
GS3RAK3072L-WW	186	50.4	-	99
GS3RAK3072R-ALL	371	36.5	1	101
GS3RAK3072R-AWW	250	50.4	1	101
GS3RAK3072R-LL	297	57.8	-	99
GS3RAK3072R-WW	186	50.4	-	99
GS3STAT7278L-ALL	505	68.1	1	84
GS3STAT7278L-AWW	505	68.1	1	84
GS3STAT7278L-LL	450	62.0	-	82
GS3STAT7278L-WW	450	62.0	-	82
GS3STAT7278R-ALL	505	68.1	1	85
GS3STAT7278R-AWW	505	68.1	1	85
GS3STAT7278R-LL	450	62.0	-	83
GS3STAT7278R-WW	450	62.0	-	83
GS3STAT7284L-ALL	519	69.3	1	84
GS3STAT7284L-AWW	519	69.3	1	84
GS3STAT7284L-LL	464	63.2	-	82
GS3STAT7284L-WW	464	63.2	-	82
GS3STAT7284R-ALL	519	69.3	1	85
GS3STAT7284R-AWW	519	69.3	1	85
GS3STAT7284R-LL	464	63.2	-	83
GS3STAT7284R-WW	464	63.2	-	83
GS3STAT7890L-ALL	547	71.9	1	84
GS3STAT7890L-AWW	547	71.9	1	84
GS3STAT7890L-LL	492	65.7	-	82
GS3STAT7890L-WW	492	65.7	-	82
GS3STAT7890R-ALL	547	71.9	1	85
GS3STAT7890R-AWW	547	71.9	1	85
GS3STAT7890R-LL	492	65.7	-	83
GS3STAT7890R-WW	492	65.7	-	83

# WEIGHTS + CUBES

Silea  
05/22

model number	weight	cubes	#locks	page
GS3STAT7896L-ALL	560	73.1	1	84
GS3STAT7896L-AWW	560	73.1	1	84
GS3STAT7896L-LL	451	60.6	-	82
GS3STAT7896L-WW	451	60.6	-	82
GS3STAT7896R-ALL	560	73.1	1	85
GS3STAT7896R-AWW	560	73.1	1	85
GS3STAT7896R-LL	505	66.9	-	83
GS3STAT7896R-WW	505	66.9	-	83
GS3XFAK3066L-ALL	370	34.4	1	88
GS3XFAK3066L-AWW	340	56.2	1	88
GS3XFAK3066L-LL	322	31.7	-	87
GS3XFAK3066L-WW	323	56.2	-	87
GS3XFAK3066R-ALL	370	36.3	1	88
GS3XFAK3066R-AWW	340	56.2	1	88
GS3XFAK3066R-LL	322	31.7	-	87
GS3XFAK3066R-WW	323	56.2	-	87
GS3XFAK3072L-ALL	384	35.9	1	88
GS3XFAK3072L-AWW	360	61.0	1	88
GS3XFAK3072L-LL	336	33.3	-	87
GS3XFAK3072L-WW	333	61.0	-	87
GS3XFAK3072R-ALL	384	37.8	1	88
GS3XFAK3072R-AWW	360	61.0	1	88
GS3XFAK3072R-LL	336	33.3	-	87
GS3XFAK3072R-WW	333	61.0	-	87
GS3XFAK3672L-ALL	412	38.2	1	88
GS3XFAK3672L-AWW	380	80.8	1	88
GS3XFAK3672L-LL	359	36.4	-	87
GS3XFAK3672L-WW	343	80.8	-	87
GS3XFAK3672R-ALL	412	40.1	1	88
GS3XFAK3672R-AWW	380	80.8	1	88
GS3XFAK3672R-LL	359	36.4	-	87
GS3XFAK3672R-WW	343	80.8	-	87
GS3XFAK3678L-ALL	427	38.5	1	88
GS3XFAK3678L-AWW	400	87.1	1	88
GS3XFAK3678L-LL	374	37.0	-	87
GS3XFAK3678L-WW	353	87.1	-	87
GS3XFAK3678R-ALL	427	40.4	1	88
GS3XFAK3678R-AWW	400	87.1	1	88
GS3XFAK3678R-LL	374	37.0	-	87
GS3XFAK3678R-WW	353	87.1	-	87
GS3XHAK3066L-LL	279	29.4	-	91
GS3XHAK3066L-WW	281	56.2	-	91
GS3XHAK3066R-LL	279	29.4	-	91
GS3XHAK3066R-WW	281	56.2	-	91
GS3XHAK3072L-LL	289	30.6	-	91

model number	weight	cubes	#locks	page
GS3XHAK3072L-WW	291	61.0	-	91
GS3XHAK3072R-LL	289	30.6	-	91
GS3XHAK3072R-WW	291	61.0	-	91
GS3XHAK3672L-LL	312	33.7	-	91
GS3XHAK3672L-WW	301	61.0	-	91
GS3XHAK3672R-LL	312	33.7	-	91
GS3XHAK3672R-WW	301	61.0	-	91
GS3XHAK3678L-LL	323	33.9	-	91
GS3XHAK3678L-WW	311	65.8	-	91
GS3XHAK3678R-LL	323	33.9	-	91
GS3XHAK3678R-WW	311	65.8	-	91
GS3XMAK3066L-LL	288	35.1	-	89
GS3XMAK3066L-WW	301	55.5	-	89
GS3XMAK3066R-LL	288	35.1	-	89
GS3XMAK3066R-WW	301	55.5	-	89
GS3XMAK3072L-LL	297	36.4	-	89
GS3XMAK3072L-WW	310	60.2	-	89
GS3XMAK3072R-LL	297	36.4	-	89
GS3XMAK3072R-WW	310	60.2	-	89
GS3XMAK3672L-LL	325	40.5	-	89
GS3XMAK3672L-WW	319	60.2	-	89
GS3XMAK3672R-LL	325	40.5	-	89
GS3XMAK3672R-WW	319	79.7	-	89
GS3XMAK3678L-LL	335	41.8	-	89
GS3XMAK3678L-WW	328	65.0	-	89
GS3XMAK3678R-LL	335	41.8	-	89
GS3XMAK3678R-WW	328	86.0	-	89
GS4LACWR2442-L	36	2.8	-	115
GS4LACWR2442-W	36	2.8	-	115
GS4LACWR2448-L	41	3.2	-	115
GS4LACWR2448-W	41	3.2	-	115
GS4LACWR2454-L	45	3.6	-	115
GS4LACWR2454-W	45	3.6	-	115
GS4LACWR2460-L	49	4.0	-	115
GS4LACWR2460-W	49	4.0	-	115
GS4LACWR2466-L	54	4.4	-	115
GS4LACWR2466-W	54	4.4	-	115
GS4LACWR2472-L	58	4.7	-	115
GS4LACWR2472-W	58	4.7	-	115
GS4LACWR3042-L	41	3.6	-	115
GS4LACWR3042-W	41	3.6	-	115
GS4LACWR3048-L	47	4.1	-	115
GS4LACWR3048-W	47	4.1	-	115
GS4LACWR3054-L	52	4.6	-	115
GS4LACWR3054-W	52	4.6	-	115



model number	weight	cubes	#locks	page
GS4LACWR3060-L	56	7.2	-	115
GS4LACWR3060-W	56	5.1	-	115
GS4LACWR3066-L	62	7.9	-	115
GS4LACWR3066-W	62	5.5	-	115
GS4LACWR3072-L	66	8.6	-	115
GS4LACWR3072-W	66	8.6	-	115
GS4LADWR3066-L	61	5.2	-	114
GS4LADWR3066-W	61	5.5	-	114
GS4LADWR3072-L	67	5.7	-	114
GS4LADWR3072-W	67	6.0	-	114
GS4LADWR3078-L	72	6.1	-	114
GS4LADWR3078-W	72	6.5	-	114
GS4LADWR3084-L	78	6.6	-	114
GS4LADWR3084-W	78	7.0	-	114
GS4LADWR3090-L	84	7.1	-	114
GS4LADWR3090-W	84	7.5	-	114
GS4LADWR3096-L	90	7.5	-	114
GS4LADWR3096-W	90	7.9	-	114
GS4LADWR3666-L	70	6.2	-	114
GS4LADWR3666-W	70	6.5	-	114
GS4LADWR3672-L	75	6.7	-	114
GS4LADWR3672-W	75	7.1	-	114
GS4LADWR3678-L	81	7.3	-	114
GS4LADWR3678-W	81	7.7	-	114
GS4LADWR3684-L	88	7.8	-	114
GS4LADWR3684-W	88	8.2	-	114
GS4LADWR3690-L	94	8.4	-	114
GS4LADWR3690-W	94	8.8	-	114
GS4LADWR3696-L	101	8.9	-	114
GS4LADWR3696-W	101	9.4	-	114
GS4LALNKDPD-3	85	9.5	-	118
GS4LALNKDPD-4	105	9.5	-	118
GS4LATOP30722442L-L	102	11.7	-	116
GS4LATOP30722442L-W	102	11.7	-	116
GS4LATOP30722442R-L	102	11.7	-	117
GS4LATOP30722442R-W	102	11.7	-	117
GS4LATOP30722448L-L	106	11.7	-	116
GS4LATOP30722448L-W	106	11.7	-	116
GS4LATOP30722448R-L	106	11.7	-	117
GS4LATOP30722448R-W	106	11.7	-	117
GS4LATOP30722454L-L	110	11.7	-	116
GS4LATOP30722454L-W	110	11.7	-	116
GS4LATOP30722454R-L	110	11.7	-	117
GS4LATOP30722454R-W	110	11.7	-	117
GS4LATOP30722460L-L	114	11.7	-	116

model number	weight	cubes	#locks	page
GS4LATOP30722460L-W	114	11.7	-	116
GS4LATOP30722460R-L	114	11.7	-	117
GS4LATOP30722460R-W	114	11.7	-	117
GS4LATOP30722466L-L	118	11.7	-	116
GS4LATOP30722466L-W	118	11.7	-	116
GS4LATOP30722466R-L	118	11.7	-	117
GS4LATOP30722466R-W	118	11.7	-	117
GS4LATOP30722472L-W	122	11.7	-	116
GS4LATOP30722472R-W	122	11.7	-	117
GS4LATOP30842442L-L	110	13.6	-	116
GS4LATOP30842442L-W	110	13.6	-	116
GS4LATOP30842442R-L	110	13.6	-	117
GS4LATOP30842442R-W	110	13.6	-	117
GS4LATOP30842448L-L	114	13.6	-	116
GS4LATOP30842448L-W	114	13.6	-	116
GS4LATOP30842448R-L	114	13.6	-	117
GS4LATOP30842448R-W	114	13.6	-	117
GS4LATOP30842454L-L	118	13.6	-	116
GS4LATOP30842454L-W	118	13.6	-	116
GS4LATOP30842454R-L	118	13.6	-	117
GS4LATOP30842454R-W	118	13.6	-	117
GS4LATOP30842460L-L	122	13.6	-	116
GS4LATOP30842460L-W	122	13.6	-	116
GS4LATOP30842460R-L	122	13.6	-	117
GS4LATOP30842460R-W	122	13.6	-	117
GS4LATOP30842466L-L	126	13.6	-	116
GS4LATOP30842466L-W	126	13.6	-	116
GS4LATOP30842466R-L	126	13.6	-	117
GS4LATOP30842466R-W	126	13.6	-	117
GS4LATOP30842472L-W	130	13.6	-	116
GS4LATOP30842472R-W	130	13.6	-	117
GS4LATOP36722442L-L	118	13.3	-	116
GS4LATOP36722442L-W	118	13.3	-	116
GS4LATOP36722442R-L	118	13.3	-	117
GS4LATOP36722442R-W	118	13.3	-	117
GS4LATOP36722448L-L	122	13.3	-	116
GS4LATOP36722448L-W	122	13.3	-	116
GS4LATOP36722448R-L	122	13.3	-	117
GS4LATOP36722448R-W	122	13.3	-	117
GS4LATOP36722454L-L	126	13.3	-	116
GS4LATOP36722454L-W	126	13.3	-	116
GS4LATOP36722454R-L	126	13.3	-	117
GS4LATOP36722454R-W	126	13.3	-	117
GS4LATOP36722460L-L	130	13.3	-	116
GS4LATOP36722460L-W	130	13.3	-	116

# WEIGHTS + CUBES

Silea  
05/22

model number	weight	cubes	#locks	page
GS4LATOP36722460R-L	130	13.3	-	117
GS4LATOP36722460R-W	130	13.3	-	117
GS4LATOP36722466L-W	134	13.3	-	116
GS4LATOP36722466R-W	134	13.3	-	117
GS4LATOP36722472L-W	138	13.3	-	116
GS4LATOP36722472R-W	138	13.3	-	117
GS4LATOP36842442L-L	121	15.4	-	116
GS4LATOP36842442L-W	121	15.4	-	116
GS4LATOP36842442R-L	121	15.4	-	117
GS4LATOP36842442R-W	121	15.4	-	117
GS4LATOP36842448L-L	125	15.4	-	116
GS4LATOP36842448L-W	125	15.4	-	116
GS4LATOP36842448R-L	125	15.4	-	117
GS4LATOP36842448R-W	125	15.4	-	117
GS4LATOP36842454L-L	129	15.4	-	116
GS4LATOP36842454L-W	129	15.4	-	116
GS4LATOP36842454R-L	129	15.4	-	117
GS4LATOP36842454R-W	129	15.4	-	117
GS4LATOP36842460L-L	133	15.4	-	116
GS4LATOP36842460L-W	133	15.4	-	116
GS4LATOP36842460R-L	133	15.4	-	117
GS4LATOP36842460R-W	133	15.4	-	117
GS4LATOP36842466L-W	137	15.4	-	116
GS4LATOP36842466R-W	137	15.4	-	117
GS4LATOP36842472L-W	141	15.4	-	116
GS4LATOP36842472R-W	141	15.4	-	117
GS4PLDMF3066L-AL	161	13.3	1	108
GS4PLDMF3066L-AW	161	15.1	1	108
GS4PLDMF3066L-L	135	9.5	-	106
GS4PLDMF3066L-W	135	9.7	-	106
GS4PLDMF3066R-AL	161	13.5	1	109
GS4PLDMF3066R-AW	161	15.1	1	109
GS4PLDMF3066R-L	135	9.8	-	107
GS4PLDMF3066R-W	135	9.7	-	107
GS4PLDMF3072L-AL	164	13.9	1	108
GS4PLDMF3072L-AW	164	15.5	1	108
GS4PLDMF3072L-L	138	10.1	-	106
GS4PLDMF3072L-W	138	10.1	-	106
GS4PLDMF3072R-AL	164	13.9	1	109
GS4PLDMF3072R-AW	164	15.5	1	109
GS4PLDMF3072R-L	138	10.1	-	107
GS4PLDMF3072R-W	138	10.1	-	107
GS4PLDMF3078L-AL	166	14.3	1	108
GS4PLDMF3078L-AW	166	15.9	1	108
GS4PLDMF3078L-L	140	10.5	-	106

model number	weight	cubes	#locks	page
GS4PLDMF3078L-W	140	10.5	-	106
GS4PLDMF3078R-AL	166	14.3	1	109
GS4PLDMF3078R-AW	166	15.9	1	109
GS4PLDMF3078R-L	140	10.5	-	107
GS4PLDMF3078R-W	140	10.5	-	107
GS4PLDMF3084L-AL	176	15.3	1	108
GS4PLDMF3084L-AW	176	16.9	1	108
GS4PLDMF3084L-L	150	11.6	-	106
GS4PLDMF3084L-W	150	11.5	-	106
GS4PLDMF3084R-AL	176	15.3	1	109
GS4PLDMF3084R-AW	176	16.9	1	109
GS4PLDMF3084R-L	150	11.6	-	107
GS4PLDMF3084R-W	150	11.5	-	107
GS4PLDMF3090L-AL	179	15.8	1	108
GS4PLDMF3090L-AW	179	17.4	1	108
GS4PLDMF3090L-L	153	12.0	-	106
GS4PLDMF3090L-W	153	12.0	-	106
GS4PLDMF3090R-AL	179	15.8	1	109
GS4PLDMF3090R-AW	179	17.4	1	109
GS4PLDMF3090R-L	153	12.0	-	107
GS4PLDMF3090R-W	153	12.0	-	107
GS4PLDMF3096L-AL	183	16.3	1	108
GS4PLDMF3096L-AW	183	17.9	1	108
GS4PLDMF3096L-L	157	12.5	-	106
GS4PLDMF3096L-W	157	12.5	-	106
GS4PLDMF3096R-AL	183	16.3	1	109
GS4PLDMF3096R-AW	183	17.9	1	109
GS4PLDMF3096R-L	157	12.5	-	107
GS4PLDMF3096R-W	157	12.5	-	107
GS4PLDMF3666L-AL	173	14.5	1	108
GS4PLDMF3666L-AW	173	15.1	1	108
GS4PLDMF3666L-L	140	10.2	-	106
GS4PLDMF3666L-W	140	10.2	-	106
GS4PLDMF3666R-AL	173	14.8	1	109
GS4PLDMF3666R-AW	173	15.1	1	109
GS4PLDMF3666R-L	140	10.5	-	107
GS4PLDMF3666R-W	140	10.2	-	107
GS4PLDMF3672L-AL	176	15.2	1	108
GS4PLDMF3672L-AW	176	15.5	1	108
GS4PLDMF3672L-L	143	10.9	-	106
GS4PLDMF3672L-W	143	10.6	-	106
GS4PLDMF3672R-AL	176	15.2	1	109
GS4PLDMF3672R-AW	176	15.5	1	109
GS4PLDMF3672R-L	143	10.9	-	107
GS4PLDMF3672R-W	143	10.6	-	107

model number	weight	cubes	#locks	page
GS4PLDMF3678L-AL	178	15.6	1	108
GS4PLDMF3678L-AW	178	15.9	1	108
GS4PLDMF3678L-L	145	11.3	-	106
GS4PLDMF3678L-W	145	11.0	-	106
GS4PLDMF3678R-AL	178	15.6	1	109
GS4PLDMF3678R-AW	178	15.9	1	109
GS4PLDMF3678R-L	145	11.3	-	107
GS4PLDMF3678R-W	145	11.0	-	107
GS4PLDMF3684L-AL	188	16.6	1	108
GS4PLDMF3684L-AW	188	16.9	1	108
GS4PLDMF3684L-L	155	12.3	-	106
GS4PLDMF3684L-W	155	12.1	-	106
GS4PLDMF3684R-AL	188	16.6	1	109
GS4PLDMF3684R-AW	188	16.9	1	109
GS4PLDMF3684R-L	155	12.3	-	107
GS4PLDMF3684R-W	155	12.1	-	107
GS4PLDMF3690L-AL	191	17.1	1	108
GS4PLDMF3690L-AW	191	17.4	1	108
GS4PLDMF3690L-L	158	12.8	-	106
GS4PLDMF3690L-W	158	12.6	-	106
GS4PLDMF3690R-AL	191	17.1	1	109
GS4PLDMF3690R-AW	191	17.4	1	109
GS4PLDMF3690R-L	158	12.8	-	107
GS4PLDMF3690R-W	158	12.6	-	107
GS4PLDMF3696L-AL	195	17.5	1	108
GS4PLDMF3696L-AW	195	17.9	1	108
GS4PLDMF3696L-L	162	13.2	-	106
GS4PLDMF3696L-W	162	13.0	-	106
GS4PLDMF3696R-AL	195	17.5	1	109
GS4PLDMF3696R-AW	195	17.9	1	109
GS4PLDMF3696R-L	162	13.2	-	107
GS4PLDMF3696R-W	162	13.0	-	107
GS4PLDMH3066L-AL	120	12.5	1	112
GS4PLDMH3066L-AW	120	14.1	1	112
GS4PLDMH3066L-L	90	8.2	-	110
GS4PLDMH3066L-W	90	8.2	-	110
GS4PLDMH3066R-AL	120	12.5	1	113
GS4PLDMH3066R-AW	120	14.1	1	113
GS4PLDMH3066R-L	90	8.2	-	111
GS4PLDMH3066R-W	90	8.2	-	111
GS4PLDMH3072L-AL	121	13.0	1	112
GS4PLDMH3072L-AW	121	14.3	1	112
GS4PLDMH3072L-L	91	8.7	-	110
GS4PLDMH3072L-W	91	8.4	-	110
GS4PLDMH3072R-AL	121	13.0	1	113

model number	weight	cubes	#locks	page
GS4PLDMH3072R-AW	121	14.3	1	113
GS4PLDMH3072R-L	91	8.7	-	111
GS4PLDMH3072R-W	91	8.4	-	111
GS4PLDMH3078L-AL	122	12.9	1	112
GS4PLDMH3078L-AW	122	14.5	1	112
GS4PLDMH3078L-L	92	8.6	-	110
GS4PLDMH3078L-W	92	8.6	-	110
GS4PLDMH3078R-AL	122	12.9	1	113
GS4PLDMH3078R-AW	122	14.5	1	113
GS4PLDMH3078R-L	92	8.6	-	111
GS4PLDMH3078R-W	92	8.6	-	111
GS4PLDMH3084L-AL	128	13.7	1	112
GS4PLDMH3084L-AW	128	15.4	1	112
GS4PLDMH3084L-L	98	9.4	-	110
GS4PLDMH3084L-W	98	9.4	-	110
GS4PLDMH3084R-AL	128	13.7	1	113
GS4PLDMH3084R-AW	128	15.4	1	113
GS4PLDMH3084R-L	98	9.4	-	111
GS4PLDMH3084R-W	98	9.4	-	111
GS4PLDMH3090L-AL	130	14.0	1	112
GS4PLDMH3090L-AW	130	15.6	1	112
GS4PLDMH3090L-L	100	9.7	-	110
GS4PLDMH3090L-W	100	9.7	-	110
GS4PLDMH3090R-AL	130	14.0	1	113
GS4PLDMH3090R-AW	130	15.6	1	113
GS4PLDMH3090R-L	100	9.7	-	111
GS4PLDMH3090R-W	100	9.7	-	111
GS4PLDMH3096L-AL	132	14.3	1	112
GS4PLDMH3096L-AW	132	15.9	1	112
GS4PLDMH3096L-L	102	10.0	-	110
GS4PLDMH3096L-W	102	10.0	-	110
GS4PLDMH3096R-AL	132	14.3	1	113
GS4PLDMH3096R-AW	132	15.9	1	113
GS4PLDMH3096R-L	102	10.0	-	111
GS4PLDMH3096R-W	102	10.0	-	111
GS4PLDMH3666L-AL	132	13.8	1	112
GS4PLDMH3666L-AW	132	14.1	1	112
GS4PLDMH3666L-L	95	9.0	-	110
GS4PLDMH3666L-W	95	8.8	-	110
GS4PLDMH3666R-AL	132	13.8	1	113
GS4PLDMH3666R-AW	132	14.1	1	113
GS4PLDMH3666R-L	95	9.0	-	111
GS4PLDMH3666R-W	95	8.8	-	111
GS4PLDMH3672L-AL	133	14.3	1	112
GS4PLDMH3672L-AW	133	14.3	1	112

# WEIGHTS + CUBES

Silea  
05/22

model number	weight	cubes	#locks	page
GS4PLDMH3672L-L	96	9.5	-	110
GS4PLDMH3672L-W	96	9.0	-	110
GS4PLDMH3672R-AL	133	14.3	1	113
GS4PLDMH3672R-AW	133	14.3	1	113
GS4PLDMH3672R-L	96	9.5	-	111
GS4PLDMH3672R-W	96	9.0	-	111
GS4PLDMH3678L-AL	134	14.2	1	112
GS4PLDMH3678L-AW	134	14.5	1	112
GS4PLDMH3678L-L	97	9.3	-	110
GS4PLDMH3678L-W	97	9.2	-	110
GS4PLDMH3678R-AL	134	14.2	1	113
GS4PLDMH3678R-AW	134	14.5	1	113
GS4PLDMH3678R-L	97	9.3	-	111
GS4PLDMH3678R-W	97	9.2	-	111
GS4PLDMH3684L-AL	140	15.0	1	112
GS4PLDMH3684L-AW	140	15.4	1	112
GS4PLDMH3684L-L	103	10.2	-	110
GS4PLDMH3684L-W	103	10.0	-	110
GS4PLDMH3684R-AL	140	15.0	1	113
GS4PLDMH3684R-AW	140	15.4	1	113
GS4PLDMH3684R-L	103	10.2	-	111
GS4PLDMH3684R-W	103	10.0	-	111
GS4PLDMH3690L-AL	142	15.3	1	112
GS4PLDMH3690L-AW	142	15.6	1	112
GS4PLDMH3690L-L	105	10.5	-	110
GS4PLDMH3690L-W	105	10.3	-	110
GS4PLDMH3690R-AL	142	15.3	1	113
GS4PLDMH3690R-AW	142	15.6	1	113
GS4PLDMH3690R-L	105	10.5	-	111
GS4PLDMH3690R-W	105	10.3	-	111
GS4PLDMH3696L-AL	144	15.5	1	112
GS4PLDMH3696L-AW	144	15.9	1	112
GS4PLDMH3696L-L	107	10.7	-	110
GS4PLDMH3696L-W	107	10.5	-	110
GS4PLDMH3696R-AL	144	15.5	1	113
GS4PLDMH3696R-AW	144	15.9	1	113
GS4PLDMH3696R-L	107	10.7	-	111
GS4PLDMH3696R-W	107	10.5	-	111
GS4PLWFP72-L	127	15.4	-	103
GS4PLWFP72-W	127	15.4	-	103
GS4PLWFP78-L	135	16.7	-	103
GS4PLWFP78-W	135	16.7	-	103
GS4PLWFP84-L	142	17.9	-	103
GS4PLWFP84-W	142	17.9	-	103
GS4PLWFP90-L	149	19.1	-	103

model number	weight	cubes	#locks	page
GS4PLWFP90-W	149	19.1	-	103
GS4PLWFP96-L	156	20.3	-	103
GS4PLWFP96-W	156	20.3	-	103
GS4PLWFP102-W	164	21.5	-	103
GS4PLWFP108-W	170	22.8	-	103
GS4PLWFP2472L-AL	166	21.6	1	104
GS4PLWFP2472L-AW	166	21.6	1	104
GS4PLWFP2472R-AL	166	21.6	1	105
GS4PLWFP2472R-AW	166	21.6	1	105
GS4PLWFP2478L-AL	174	22.8	1	104
GS4PLWFP2478L-AW	174	22.8	1	104
GS4PLWFP2478R-AL	174	22.8	1	105
GS4PLWFP2478R-AW	174	22.8	1	105
GS4PLWFP2484L-AL	181	24.0	1	104
GS4PLWFP2484L-AW	181	24.0	1	104
GS4PLWFP2484R-AL	181	24.0	1	105
GS4PLWFP2484R-AW	181	24.0	1	105
GS4PLWFP2490L-AL	189	25.3	1	104
GS4PLWFP2490L-AW	189	25.3	1	104
GS4PLWFP2490R-AL	189	25.3	1	105
GS4PLWFP2490R-AW	189	25.3	1	105
GS4PLWFP2496L-AL	196	26.5	1	104
GS4PLWFP2496L-AW	196	26.5	1	104
GS4PLWFP2496R-AL	196	26.5	1	105
GS4PLWFP2496R-AW	196	26.5	1	105
GS4PLWFP3072L-AL	174	23.5	1	104
GS4PLWFP3072L-AW	174	23.5	1	104
GS4PLWFP3072R-AL	174	23.5	1	105
GS4PLWFP3072R-AW	174	23.5	1	105
GS4PLWFP3078L-AL	182	24.7	1	104
GS4PLWFP3078L-AW	182	24.7	1	104
GS4PLWFP3078R-AL	182	24.7	1	105
GS4PLWFP3078R-AW	182	24.7	1	105
GS4PLWFP3084L-AL	189	25.9	1	104
GS4PLWFP3084L-AW	189	25.9	1	104
GS4PLWFP3084R-AL	189	25.9	1	105
GS4PLWFP3084R-AW	189	25.9	1	105
GS4PLWFP3090L-AL	197	27.2	1	104
GS4PLWFP3090L-AW	197	27.2	1	104
GS4PLWFP3090R-AL	197	27.2	1	105
GS4PLWFP3090R-AW	197	27.2	1	105
GS4PLWFP3096L-AL	204	28.4	1	104
GS4PLWFP3096L-AW	204	28.4	1	104
GS4PLWFP3096R-AL	204	28.4	1	105
GS4PLWFP3096R-AW	204	28.4	1	105

model number	weight	cubes	#locks	page
GS4PLWFP24102L-AW	204	27.7	1	104
GS4PLWFP24102R-AW	204	27.7	1	105
GS4PLWFP24108L-AW	210	28.9	1	104
GS4PLWFP24108R-AW	210	28.9	1	105
GS4PLWFP30102L-AW	212	29.6	1	104
GS4PLWFP30102R-AW	212	29.6	1	105
GS4PLWFP30108L-AW	218	30.8	1	104
GS4PLWFP30108R-AW	218	30.8	1	105
GS5BIN-LG	1	0.5	-	210
GS5BIN-SM	1	0.2	-	210
GS5CLS5H718L-LL	105	9.1	1	212
GS5CLS5H718L-WG	105	9.1	-	213
GS5CLS5H718L-WW	105	9.1	1	212
GS5CLS5H718R-LL	105	9.1	1	212
GS5CLS5H718R-WG	105	9.1	-	213
GS5CLS5H718R-WW	105	9.1	1	212
GS5CLS5H730L-LL	180	9.1	1	212
GS5CLS5H730L-WG	180	14.3	-	213
GS5CLS5H730L-WW	180	14.3	1	212
GS5CLS5H730R-LL	180	9.1	1	212
GS5CLS5H730R-WG	180	14.3	-	213
GS5CLS5H730R-WW	180	14.3	1	212
GS5CPD724-XL	48	4.9	-	211
GS5CPD724-XW	48	4.9	-	211
GS5CPD730-SL	60	6.0	2	208
GS5CPD730-SW	60	6.0	2	208
GS5CPD730-XL	55	6.0	-	211
GS5CPD730-XW	55	6.0	-	211
GS5CPD736-SL	72	7.1	2	208
GS5CPD736-SW	72	7.1	2	208
GS5CPD736-XL	62	7.1	-	211
GS5CPD736-XW	62	7.1	-	211
GS5CPD742-SL	84	8.2	2	208
GS5CPD742-SW	84	8.2	2	208
GS5CPD742-XL	69	8.2	-	211
GS5CPD742-XW	69	8.2	-	211
GS5CPD748-SL	96	9.3	2	208
GS5CPD748-SW	96	9.3	2	208
GS5CPD754-SL	108	10.4	2	208
GS5CPD754-SW	108	10.4	2	208
GS5CPD760-SL	120	11.5	4	209
GS5CPD760-SW	120	11.5	4	209
GS5CPD766-SL	132	12.6	4	209
GS5CPD766-SW	132	12.6	4	209
GS5CPD772-SL	144	13.7	4	209

model number	weight	cubes	#locks	page
GS5CPD772-SW	144	13.7	4	209
GS5CVATR3666L-LL	382	40.6	-	204
GS5CVATR3666L-WW	382	40.6	-	204
GS5CVATR3666R-LL	382	40.6	-	205
GS5CVATR3666R-WW	382	40.6	-	205
GS5CVATR3672L-LL	389	41.1	-	204
GS5CVATR3672L-WW	389	41.1	-	204
GS5CVATR3672R-LL	389	41.1	-	205
GS5CVATR3672R-WW	389	41.1	-	205
GS5CVATR3678L-LL	406	42.2	-	204
GS5CVATR3678L-WW	406	42.2	-	204
GS5CVATR3678R-LL	396	42.2	-	205
GS5CVATR3678R-WW	396	42.2	-	205
GS5CVATR3684L-LL	412	42.8	-	204
GS5CVATR3684L-WW	412	42.8	-	204
GS5CVATR3684R-LL	402	42.8	-	205
GS5CVATR3684R-WW	402	42.8	-	205
GS5CVATR4266L-LL	411	46.0	-	204
GS5CVATR4266L-WW	411	46.0	-	204
GS5CVATR4266R-LL	411	46.0	-	205
GS5CVATR4266R-WW	411	46.0	-	205
GS5CVATR4272L-LL	418	46.7	-	204
GS5CVATR4272L-WW	418	46.7	-	204
GS5CVATR4272R-LL	418	46.7	-	205
GS5CVATR4272R-WW	418	46.7	-	205
GS5CVATR4278L-LL	436	47.8	-	204
GS5CVATR4278L-WW	436	47.8	-	204
GS5CVATR4278R-LL	426	47.8	-	205
GS5CVATR4278R-WW	426	47.8	-	205
GS5CVATR4284L-LL	444	48.5	-	204
GS5CVATR4284L-WW	444	48.5	-	204
GS5CVATR4284R-LL	434	48.5	-	205
GS5CVATR4284R-WW	434	48.5	-	205
GS5CVATS304266L-LL	411	46.0	-	206
GS5CVATS304266L-WW	411	46.0	-	206
GS5CVATS304266R-LL	411	46.0	-	207
GS5CVATS304266R-WW	411	46.0	-	207
GS5CVATS304272L-LL	418	46.7	-	206
GS5CVATS304272L-WW	418	46.7	-	206
GS5CVATS304272R-LL	418	46.7	-	207
GS5CVATS304272R-WW	418	46.7	-	207
GS5CVATS304278L-LL	436	47.8	-	206
GS5CVATS304278L-WW	436	47.8	-	206
GS5CVATS304278R-LL	426	47.8	-	207
GS5CVATS304278R-WW	426	47.8	-	207

# WEIGHTS + CUBES

Silea  
05/22

model number	weight	cubes	#locks	page
GS5CVATS304284L-LL	444	48.5	-	206
GS5CVATS304284L-WW	444	48.5	-	206
GS5CVATS304284R-LL	434	48.5	-	207
GS5CVATS304284R-WW	434	48.5	-	207
GS5LKR5H724L-LG	155	21.2	-	215
GS5LKR5H724L-LL	155	21.2	-	214
GS5LKR5H724L-WG	155	11.7	-	215
GS5LKR5H724L-WW	155	11.7	-	214
GS5LKR5H724R-LG	155	21.2	-	215
GS5LKR5H724R-LL	155	21.2	-	214
GS5LKR5H724R-WG	155	11.7	-	215
GS5LKR5H724R-WW	155	11.7	-	214
GS5LKR5H736L-LG	195	21.2	-	215
GS5LKR5H736L-LL	195	21.2	-	214
GS5LKR5H736L-WG	195	16.9	-	215
GS5LKR5H736L-WW	195	16.9	-	214
GS5LKR5H736R-LG	195	21.2	-	215
GS5LKR5H736R-LL	195	21.2	-	214
GS5LKR5H736R-WG	195	16.9	-	215
GS5LKR5H736R-WW	195	16.9	-	214
GS5PNCLCUP-MPLE	1	0.2	-	217
GS5PNCLCUP-WLNT	1	0.2	-	217
GS5PNCLTRAY-MPLE	2	0.2	-	217
GS5PNCLTRAY-WLNT	2	0.2	-	217
GS5TRAY-LG	1	0.2	-	210
GS5TRAY-SM	1	0.1	-	210
GS6GBG2448-LL	111	28.9	-	126.12
GS6GBG2448-WW	111	28.9	-	126.12
GS6GBG2454-LL	123	32.5	-	126.12
GS6GBG2454-WW	123	32.5	-	126.12
GS6GBG2460-LL	36.1	135	-	126.12
GS6GBG2460-WW	36.1	135	-	126.12
GS6GCR2472L-LL	236	45	-	126.14
GS6GCR2472L-WW	236	45	-	126.14
GS6GCR2472R-LL	236	45	-	126.14
GS6GCR2472R-WW	236	45	-	126.14
GS6GCR2478L-LL	249	48.6	-	126.14
GS6GCR2478L-WW	249	48.6	-	126.14
GS6GCR2478R-LL	249	48.6	-	126.14
GS6GCR2478R-WW	249	48.6	-	126.14
GS6GCR2484L-LL	261	52.3	-	126.14
GS6GCR2484L-WW	261	52.3	-	126.14
GS6GCR2484R-LL	261	52.3	-	126.14
GS6GCR2484R-WW	261	52.3	-	126.14
GS6GDF4284L-LL	491	83.7	-	126.4

model number	weight	cubes	#locks	page
GS6GDF4284L-WW	491	83.7	-	126.4
GS6GDF4284R-LL	491	83.7	-	126.4
GS6GDF4284R-WW	491	83.7	-	126.4
GS6GDF42102L-ALL	599	101.4	1	126.5
GS6GDF42102L-AWW	599	101.3	1	126.5
GS6GDF42102R-ALL	599	101.4	1	126.5
GS6GDF42102R-AWW	599	101.3	1	126.5
GS6GDF4284L-LL	316	85.7	-	126.8
GS6GDF4284L-WW	316	85.7	-	126.8
GS6GDF4284R-LL	316	85.7	-	126.8
GS6GDF4284R-WW	316	85.7	-	126.8
GS6GDF42102L-ALL	424	103.8	1	126.9
GS6GDF42102L-AWW	424	103.8	1	126.9
GS6GDF42102R-ALL	424	103.8	1	126.9
GS6GDF42102R-AWW	424	103.8	1	126.9
GS6GDR3072-LL	269	55.7	-	126.10
GS6GDR3072L-LL	269	55.7	-	126.11
GS6GDR3072L-WW	269	55.7	-	126.11
GS6GDR3072R-LL	269	55.7	-	126.11
GS6GDR3072R-WW	269	55.7	-	126.11
GS6GDR3072-WW	269	55.7	-	126.10
GS6GDR3672-LL	299	66.4	-	126.10
GS6GDR3672L-LL	299	66.4	-	126.11
GS6GDR3672L-WW	299	66.4	-	126.11
GS6GDR3672R-LL	299	66.4	-	126.11
GS6GDR3672R-WW	299	66.4	-	126.11
GS6GDR3672-WW	299	66.4	-	126.10
GS6GDR3684-LL	327	77.1	-	126.10
GS6GDR3684L-LL	327	77.1	-	126.11
GS6GDR3684L-WW	327	77.1	-	126.11
GS6GDR3684R-LL	327	77.1	-	126.11
GS6GDR3684R-WW	327	77.1	-	126.11
GS6GDR3684-WW	327	77.1	-	126.10
GS6GDR30144-LL	458	109.5	-	126.10
GS6GDR30144LR-LL	458	109.5	-	126.11
GS6GDR30144LR-WW	458	109.5	-	126.11
GS6GDR30144-WW	458	109.5	-	126.10
GS6GDR36144-LL	503	130.5	-	126.10
GS6GDR36144LR-LL	503	130.5	-	126.11
GS6GDR36144LR-WW	503	130.5	-	126.11
GS6GDR36144-WW	503	130.5	-	126.10
GS6GDR36168-LL	559	151.9	-	126.10
GS6GDR36168LR-LL	559	151.9	-	126.11
GS6GDR36168LR-WW	559	151.9	-	126.11
GS6GDR36168-WW	559	151.9	-	126.10

model number	weight	cubes	#locks	page
GS6GDTR3072-LL	269	55.7	-	126.10
GS6GDTR3072-WW	269	55.7	-	126.10
GS6GDTR3072L-LL	269	55.7	-	126.11
GS6GDTR3072L-WW	269	55.7	-	126.11
GS6GDTR3072R-LL	269	55.7	-	126.11
GS6GDTR3072R-WW	269	55.7	-	126.11
GS6GDTR3672-LL	299	66.4	-	126.10
GS6GDTR3672-WW	299	66.4	-	126.10
GS6GDTR3672L-LL	299	66.4	-	126.11
GS6GDTR3672L-WW	299	66.4	-	126.11
GS6GDTR3672R-LL	299	66.4	-	126.11
GS6GDTR3672R-WW	299	66.4	-	126.11
GS6GDTT72-L	36	4.3	-	126.16
GS6GDTT72-S	39	5.2	-	126.16
GS6GDTT72-W	36	4.3	-	126.16
GS6GDTT84-L	42	5	-	126.16
GS6GDTT84-S	46	6	-	126.16
GS6GDTT84-W	42	5	-	126.16
GS6GDTT144-L	72	6	-	126.16
GS6GDTT144-S	78	6.9	-	126.16
GS6GDTT144-W	72	6	-	126.16
GS6GDTT168-L	84	6.9	-	126.16
GS6GDTT168-S	92	7.9	-	126.16
GS6GDTT168-W	84	6.9	-	126.16
GS6GDXA4284L-LL	494	91.7	-	126.2
GS6GDXA4284L-WW	494	91.7	-	126.2
GS6GDXA4284R-LL	494	91.7	-	126.2
GS6GDXA4284R-WW	494	91.7	-	126.2
GS6GDXA42102L-ALL	602	111	1	126.3
GS6GDXA42102L-AWW	602	111	1	126.3
GS6GDXA42102R-ALL	602	111	1	126.3
GS6GDXA42102R-AWW	602	111	1	126.3
GS6GDXF4284L-LL	316	85.6	-	126.6
GS6GDXF4284L-WW	316	85.6	-	126.6
GS6GDXF4284R-LL	316	85.6	-	126.6
GS6GDXF4284R-WW	316	85.6	-	126.6
GS6GDXF42102L-ALL	424	103.6	1	126.7
GS6GDXF42102L-AWW	424	103.6	1	126.7
GS6GDXF42102R-ALL	424	103.6	1	126.7
GS6GDXF42102R-AWW	424	103.6	1	126.7
GS6GDXMT72-L	174	14.5	-	126.15
GS6GDXMT72-S	240	54.3	-	126.15
GS6GDXMT72-W	174	14.5	-	126.15
GS6GRT2448L-LL	151	29.8	-	126.13
GS6GRT2448L-WW	151	29.8	-	126.13

model number	weight	cubes	#locks	page
GS6GRT2448R-LL	151	29.8	-	126.13
GS6GRT2448R-WW	151	29.8	-	126.13
GS6GRT2454L-LL	163	33.4	-	126.13
GS6GRT2454L-WW	163	33.4	-	126.13
GS6GRT2454R-LL	163	33.4	-	126.13
GS6GRT2454R-WW	163	33.4	-	126.13
GS6GRT2460L-LL	175	37	-	126.13
GS6GRT2460L-WW	175	37	-	126.13
GS6GRT2460R-LL	175	37	-	126.13
GS6GRT2460R-WW	175	37	-	126.13
GS6GTK71R	14	3.6	-	126.17
GS6GTK72	14	3.6	-	126.17
GS6GTK77R	15	3.8	-	126.17
GS6GTK78	15	3.8	-	126.17
GS6GTK83R	16	4.1	-	126.17
GS6GTK84	16	4.1	-	126.17
GS6GTK89R	17	4.4	-	126.17
GS6GTK94R	19	3.6	-	126.17
GS6GTK95R	18	4.6	-	126.17
GS6GTK100R	22	3.1	-	126.17
GS6GTK106R	24	3.2	-	126.17
GS6GTK112R	26	3.4	-	126.17
GS6GTK118R	28	3.6	-	126.17
GS6GTK124R	30	3.4	-	126.17
GS6GTK130R	32	3.6	-	126.17
GS6GTK144	30	4.3	-	126.17
GS6GTK168	32	4.9	-	126.17
GS6GXTK72	13	3.5	-	126.17
GS6MB24SS-L	30	5.3	-	126.18
GS6MB24SS-W	30	5.2	-	126.18
GS6MB24SS-WS	50	5.2	-	126.18
MDWBRK	1	0.4	-	201
MDWLBK24	2	0.3	-	201
MDWLBK30	2	0.4	-	201
SACORNER	8	1.7	-	347
SADSKPAD	10	2.3	-	347
SAMAGNET	1	0.1	-	349







---

---

# Gunlocke®

One Gunlocke Drive  
Wayland, NY 14572  
800 828 6300