

Sustaining Environments

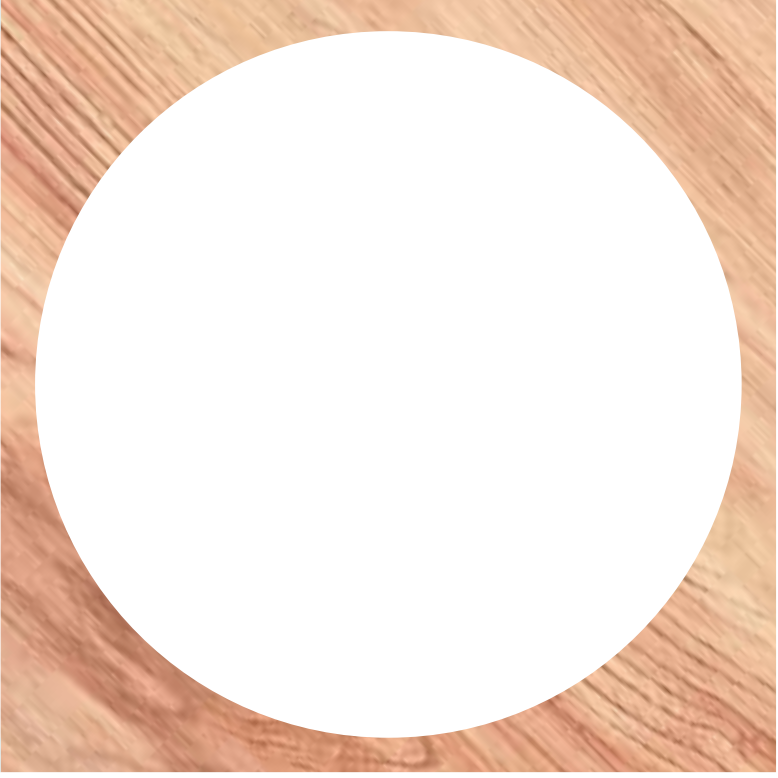
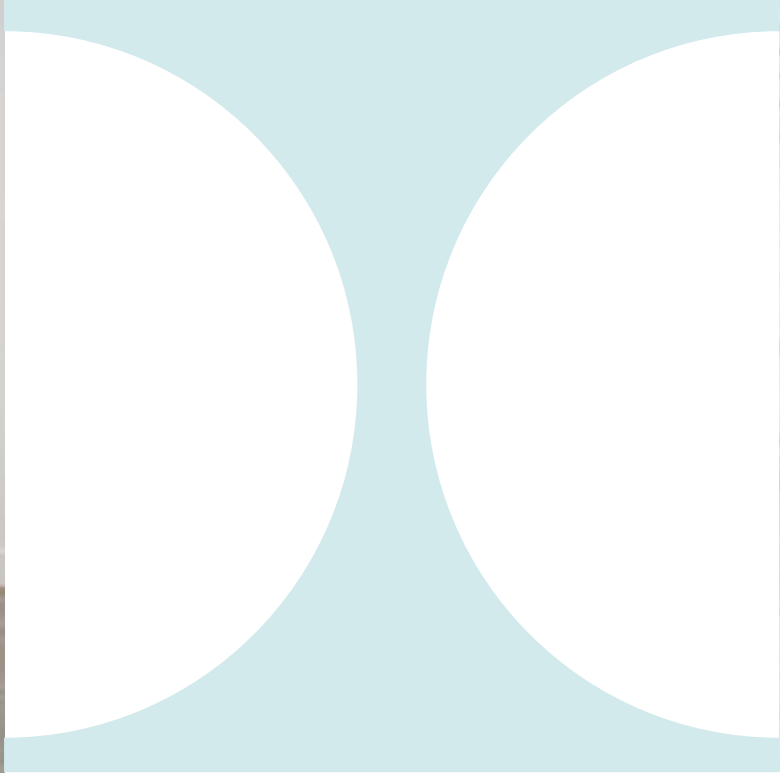
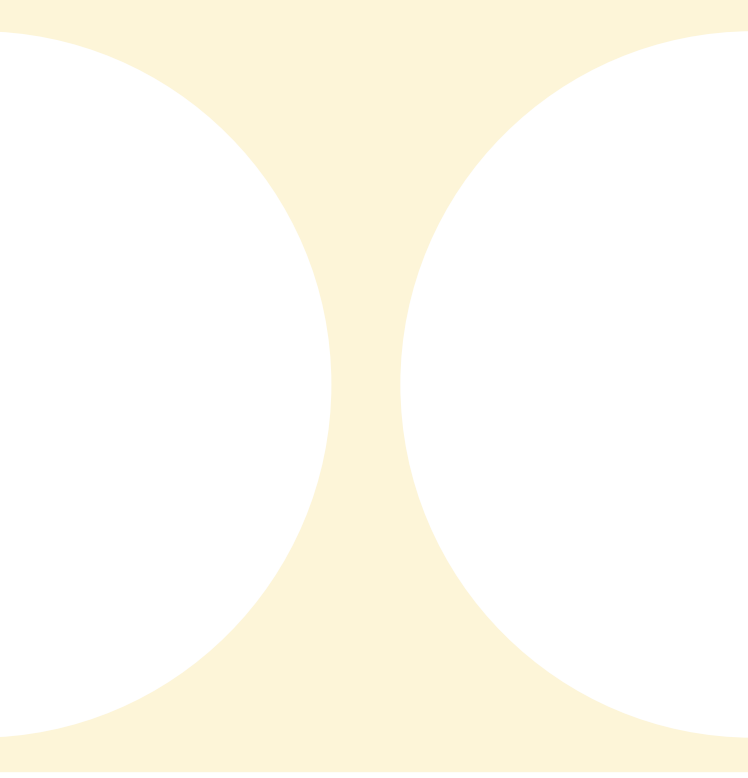
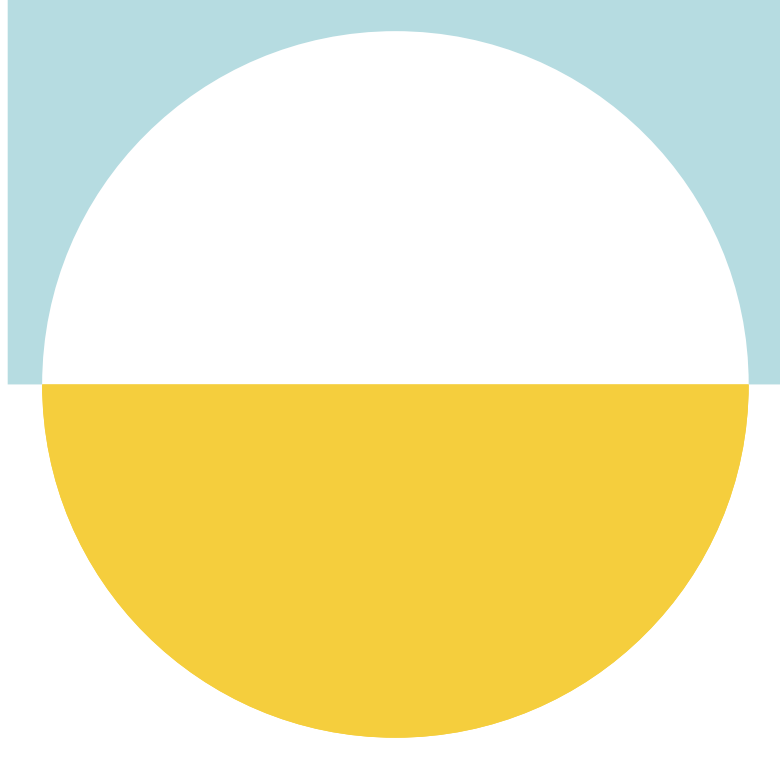
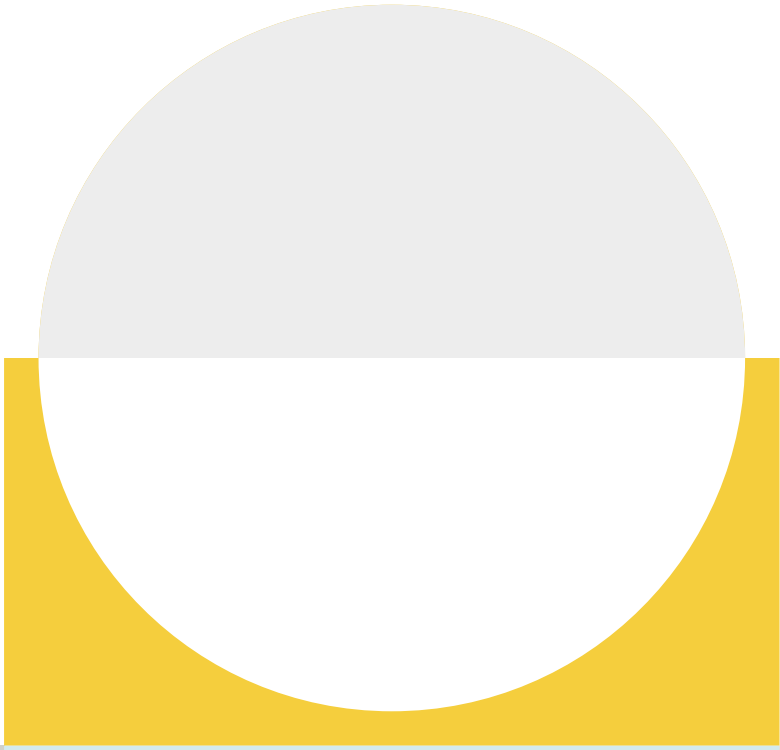

2022
Corporate
Social
Responsibility
Report

Table of Contents

3	A Message from Our CEO	11	Respecting People
4	Awards and Achievements	21	Reducing Impacts
5	Continued Engagements and Commitments	28	Redefining Tomorrow
6	About HNI/Governance	Appendix	
8	About This Report	39	GRI Content Index
9	Goals and Progress	64	TCFD Disclosure
		66	SASB Disclosure



C. Maxwell Stanley, Clement Hanson, and H. Wood Miller start a new company called Home-O-Nize.



Leadership

**Message from Jeffrey Lorenger,
Chairman, President and CEO**

In 2022, HNI celebrated 75 years of creating products that encourage collaboration and productivity in the workplace and warm memories at home. Since our founding, we are proud to have continually built a great place to work for our members.

Looking forward to our next 75 years, and beyond, we continue to build on our strong foundation and launch new initiatives to lead HNI into the future.

These initiatives are based on our belief that tomorrow must be more inclusive, safer, and more sustainable than yesterday to meet the pressing challenges ahead. We anchor this work in our corporate social responsibility (CSR) strategy called CORE: Conscious Operations and Responsible Environments. CORE is HNI's blueprint for the future to promote respect and a place for all members, reduction of our environmental and climate impacts, and creation of more sustainable products.

CORE integrates our belief in respecting people and supporting our communities, and it promotes HNI Belong. HNI Belong focuses on increasing diversity throughout the company, including growing the number of women and ethnically diverse members serving at manager level and above.

To demonstrate our commitment to CORE, in 2021, we began aligning executive compensation with our diversity goals, and in 2022, we began

aligning executive compensation with our sustainability goals. In this way, we are strengthening and motivating our entire organization toward achieving the CSR goals outlined in this report.

We understand the call to innovate and think about our resources in new ways. This year, across all HNI brands and departments, we found ways to further reduce energy consumption, emissions, and waste. We are embracing sustainability as part of our company culture and as an important consideration in all of our decisions.

As part of this work, we have aligned our emissions targets to the Science Based Targets initiative (SBTi) in an effort to reduce global warming and limit the impact of climate change.

As we build the elements of CORE into our culture, we are providing an opportunity for all of our members to get even more involved and empowered to help create positive change—being more inclusive; becoming better stewards of our resources; and building stronger, healthier communities.

As you will learn in the following pages, HNI is gaining momentum and making important strides toward our corporate CSR goals. As we continue to grow our family of brands with the addition of Kimball International, we collectively are committed to the long-term success of HNI, which includes our commitment to the objectives outlined in this report. Please join us on our journey.



Jeffrey D. Lorenger
Chairman, President, and
Chief Executive Officer
HNI Corporation



Company holds first annual recognition dinner to honor members with 5+ years of service.

Awards and Achievements

HNI named #6 of 500 of America's Most Responsible Companies



HNI Charitable Foundation Committed \$1 million to the Community Foundation of Greater Muscatine's Mulberry Health Clinic Project



HNI named to 2021 CDP Supplier Engagement Leaderboard in recognition of efforts to measure and reduce climate risk within supply chain

(Top 8% of companies that disclosed full climate questionnaire)



HNI awarded 2022 Best Place to Work in Southeast Minnesota for Hearth & Home Technologies by Workforce Development Incorporated

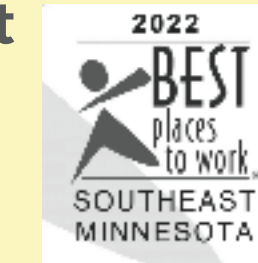

HNI named Green Power Partnership National Top 100 for several quarters



HNI recognized every year since 2018 by the Women's Forum of New York for our Board of Directors diversity

(Top F1000 and S&P 500 companies with diverse Board representation over 50%)

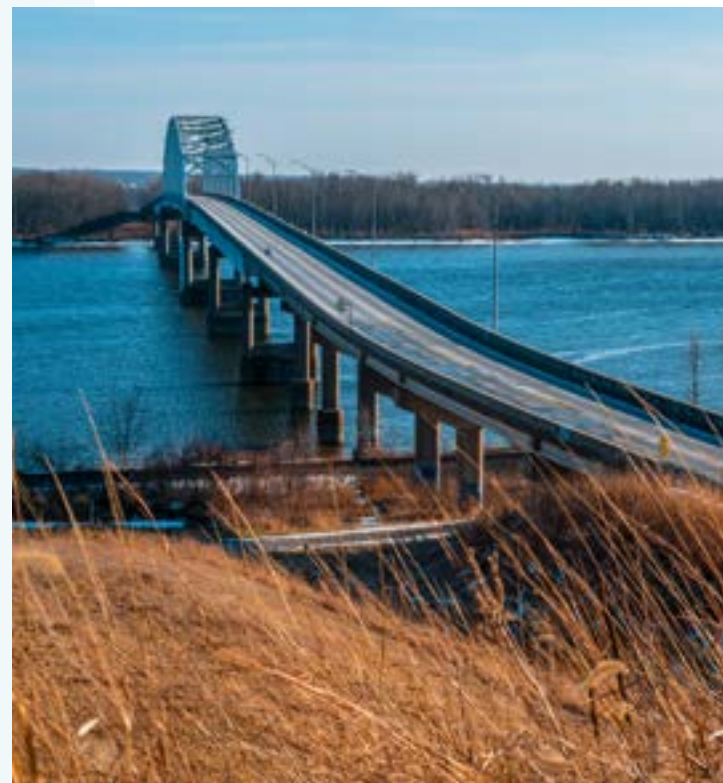

HNI recognized as Outstanding Local Partner by Iowa Urban Tree Council for our volunteerism for the City of Muscatine

HNI awarded Van Meter Education Excellence Award 2021 for Muscatine Apprentice Program



HNI recognized Best of Sustainability at NeoCon for Allsteel O6 Chair



Continued Engagements and Commitments

Signatory of United Nations Global Compact



WE SUPPORT
UN GLOBAL COMPACT

SmartWay® Transport Partner with U.S. Environmental Protection Agency (EPA)



SmartWay®
Transport Partner
Getting There With Cleaner Air

Inaugural Partner in the Better Climate™ Challenge with U.S. Department of Energy



Better Climate™
CHALLENGE
U.S. DEPARTMENT OF ENERGY

U.S. Department of Energy Better Plants® Partner



Better
Plants®
U.S. DEPARTMENT OF ENERGY

RE100 CLIMATE GROUP | CDP



Aligned emissions targets to the Science Based Targets initiative (SBTi)



SCIENCE
BASED
TARGETS
DRIVING AMBITIOUS CORPORATE CLIMATE ACTION

Partnered with Muscatine Power and Water (MPW) to build local renewable energy infrastructure for our community in Muscatine, Iowa



CHOOSE
Green
MUSCATINE

ABLE Project Participant



ABLE
Active Bystandership
for Law Enforcement

CEO Action for Diversity & Inclusion™ Signatory



CEO ACTION FOR
DIVERSITY & INCLUSION™

EPIC Corporate Challenge Participant



EPIC
ADVANCING WOMEN LEADERS



About HNI

HNI is a global family of industry-leading brands for the workplace and home. Founded in 1947 in Muscatine, Iowa, by visionaries C. Maxwell Stanley, Clement Hanson, and H. Wood Miller, HNI opened its doors under a new premise where all employees would be treated equally and respectfully as members and owners of a productive industrial enterprise.

HNI's Workplace Furnishings brands and residential building products are among the strongest, most widely known and respected in the industry. We offer a broad collection of workplace furnishing solutions from seven distinct brands that support work environments from the home office to the large commercial campus and everything in between.

Our residential building products include a full array of gas, electric, wood, and pellet fireplaces, inserts, stoves, facings, and accessories. HNI's Hearth & Home Technologies (HHT) segment is North America's largest manufacturer of hearth products and services sold through 12 unique brands.



HON

Allsteel

Gunlocke



HBF
TEXTILES

DESIGN
PUBLIC
GROUP



HEAT & GLO

heatilator

FIRESIDE
HEARTH & HOME

MAJESTIC

QUADRA-FIRE

VERMONT CASTINGS

HARMAN

STELLAR
by Heat & Glo

MONESSEN

SimpliFire

pelpro
PELLET APPLIANCES

the outdoor
greatroom
company



Company introduces profit sharing, retirement, and stock purchase benefit programs for members.

Governance

Board of Directors at a Glance

HNI's Board of Directors oversees the business affairs of the Corporation. In addition, the Board selects and provides advice and counsel to the CEO and senior executives. By carrying out its responsibilities with honesty and integrity, the Board has established a corporate culture of accountability, responsibility, and ethical behavior through the careful selection and

evaluation of senior management and directors.

There are currently 10 directors on the Board. Our directors are 50% women and 20% ethnically diverse.

The Board has determined all directors, except for the Corporation's CEO, are independent as defined under NYSE rules and applicable law.

The Board conducts a significant portion of its business through three standing committees: the Audit Committee, the Human Resources and Compensation Committee, and the Public Policy and Corporate Governance Committee.

Our CSR strategy and program, which encompass HNI's publicly announced environmental, social, and governance

(ESG) goals; climate change goals; diversity, equity, and inclusion (DEI) goals; and risk evaluation, are overseen by the Board, and responsibilities are delegated to each committee. Additional information on HNI's Board and details on committee responsibilities can be found in the [HNI 2023 Proxy Statement](#).

HNI Board Diversity 10 Board Members

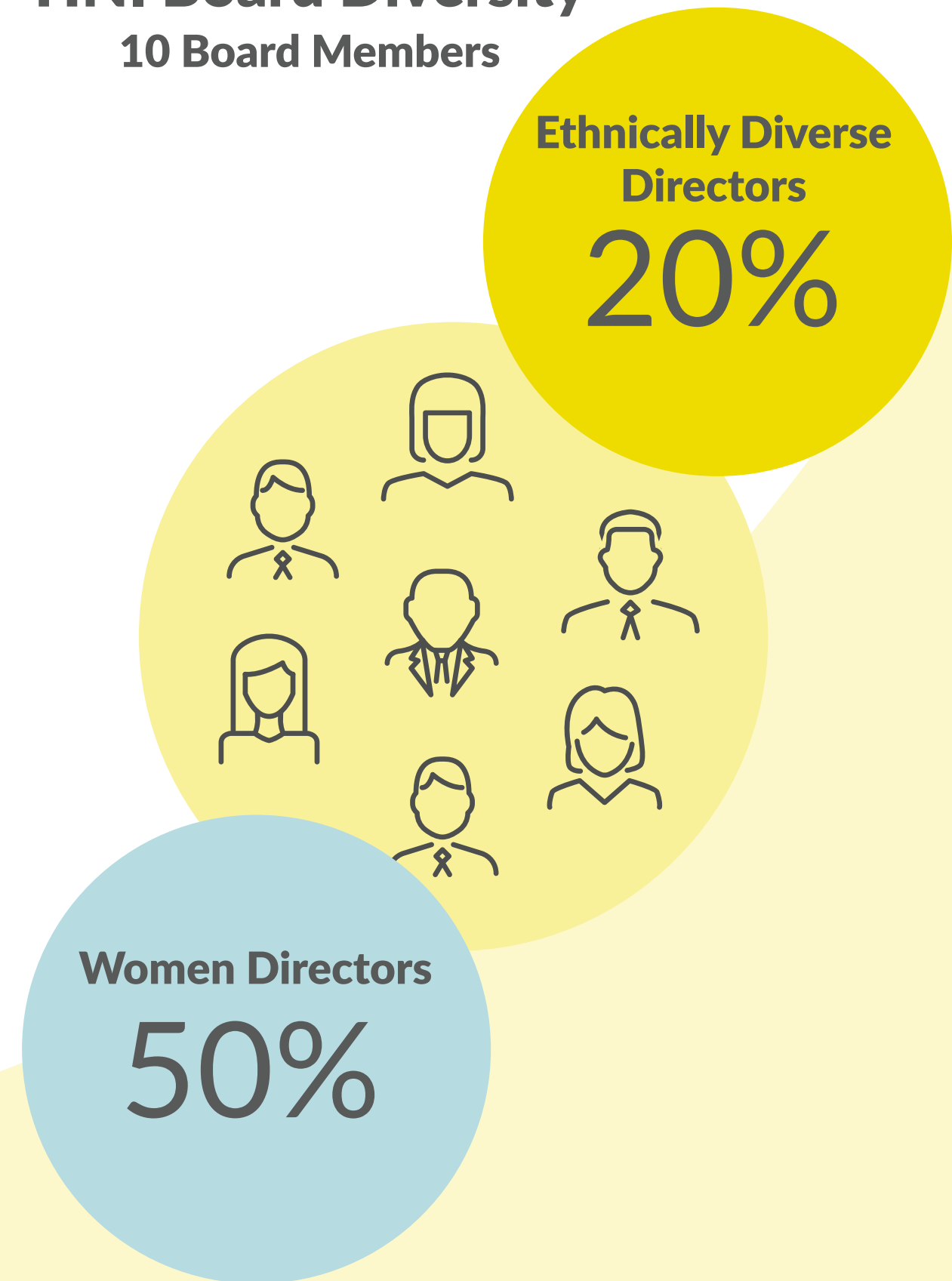

HON Industries (HON) enacts first formal environmental policy.

About This Report

HNI reports biennially on the environmental and social performance of our operations. This report focuses on our progress and performance for the full years of 2021 and 2022. The quantitative data used herein covers fiscal years 2021 and 2022, unless otherwise noted.

This report was prepared with reference to the Global Reporting Initiative (GRI) Standards and is informed by the Sustainability Accounting Standards Board (SASB) Standards, the Task Force on Climate-Related Financial Disclosures (TCFD), the United Nations (UN) Global Compact, and the UN Sustainable Development Goals (SDGs).

2022 MATERIALITY ASSESSMENT

We conducted a full materiality assessment in 2022 to identify our company's strongest environmental and social priorities across all stakeholder groups.

In working with a third-party, HNI sought to understand our greatest ESG impacts, opportunities, and risks and the influence of these on our stakeholders' decision-making. Perspectives of several key stakeholder groups, including management, members, suppliers, and customers, were included through a combination of direct

engagement, analysis, public data, and other research to determine the significance. Items of highest priority to stakeholders included but were not limited to Diversity & Inclusion, Climate Change & Strategy, and Training & Education.

HNI confirmed the results of the assessment align well with our current programs. The assessment helps to inform our approach to reporting, serves as a framework for planning our future sustainability goals and objectives, and continues to inform opportunities to improve our ESG strategy.

Sustainability Priority Matrix

Topics are listed in alphabetical order within each priority category and do not represent specific ranking within the category.

Highest Priority

-  Climate Change & Strategy
-  Diversity & Inclusion
-  Energy Efficiency & Renewables
-  Ethical Business Practices
-  Health & Safety
-  Privacy and Network & Data Security
-  Product Life Cycle Impacts
-  Regulatory Compliance
-  Training & Education
-  Waste Management
-  Work-Life Balance & Employee Wellness
-  Workplace Practices

High Priority

-  Board & Executive Oversight of ESG
-  Human Rights
-  Product Design & Safety
-  Sourcing & Supplier Management
-  Supplier Standards for Labor & Human Rights
-  Sustainable Packaging

Priority

-  Biodiversity Management
-  Business Continuity & Planning
-  Political Contributions
-  Reputational Risks
-  Stakeholder Engagement
-  Supplier Diversity
-  Sustainable Chemistry & Innovation
-  Water Management

Key:

-  Environmental
-  Social
-  Governance

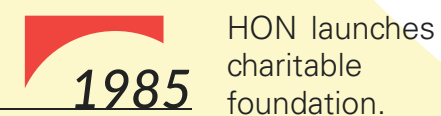

Goals and Progress

Progress key: Goal achieved Goal in progress

Respecting People

Goal Achieved:
100% Tier 1 supplier compliance with HNI Code of Conduct by 2022

Goal Achieved:
Invest 1% of pre-tax profits, on average, every year in communities where HNI operates through the HNI Charitable Foundation



In Progress:
Achieve 40% representation of women in leadership roles by 2026

In Progress:
Achieve 15% representation of ethnically diverse members in leadership by 2026



Reducing Impacts

Goal Achieved:
Source 100% renewable electricity annually for global operations*



Goal Achieved:
Reduce absolute combined Scope 1 and 2 greenhouse gas (GHG) emissions 35% by 2025 from 2018 baseline*

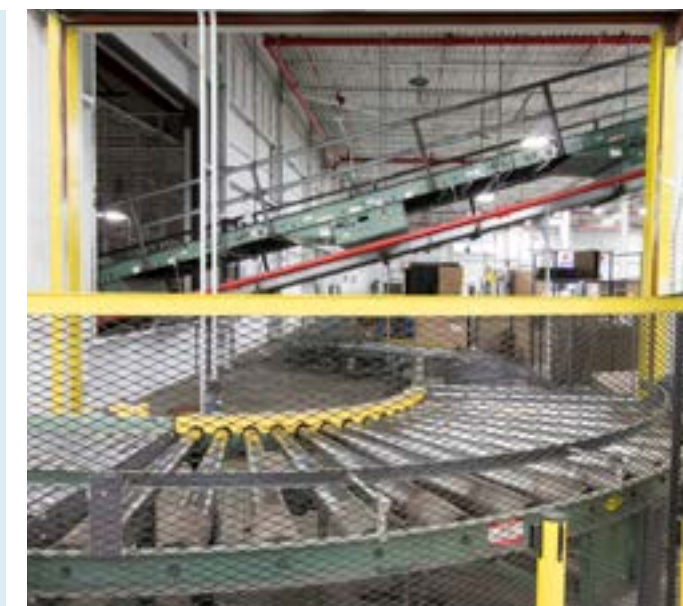

In Progress:
Reduce energy intensity 50% by 2035 from 2018 baseline

Goals and Progress

Progress key: Goal achieved Goal in progress

Reducing Impacts (Continued)



In Progress:
Achieve zero waste to landfill for all facilities by 2030



In Progress:
Reduce Scope 3 GHG emissions 40% per ton of goods sold by 2035



Redefining Tomorrow



In Progress:
Eliminate non-recyclable foam in HNI product packaging and move toward 100% recyclable packaging



In Progress:
Evaluate 100% of materials and chemical substances in products for human and ecosystem impacts and attempt to minimize those impacts through Design for the Environment (DfE)



RESPECTING PEOPLE HIGHLIGHTS

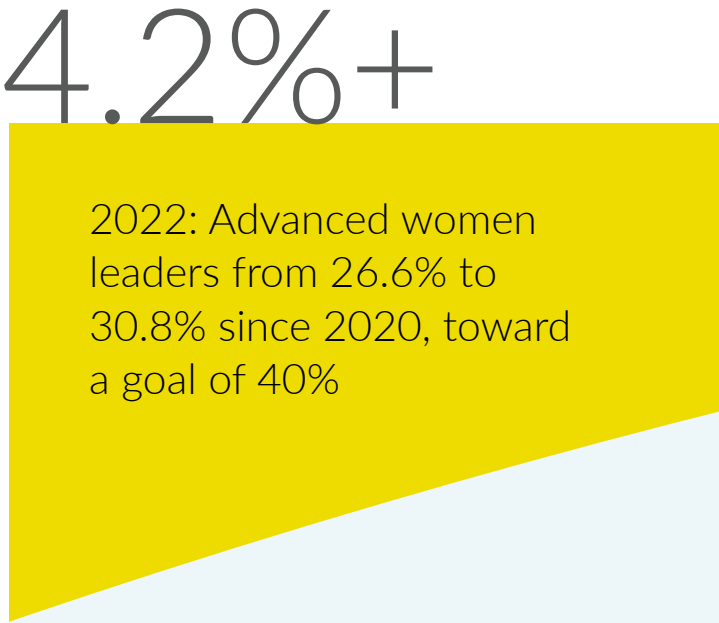
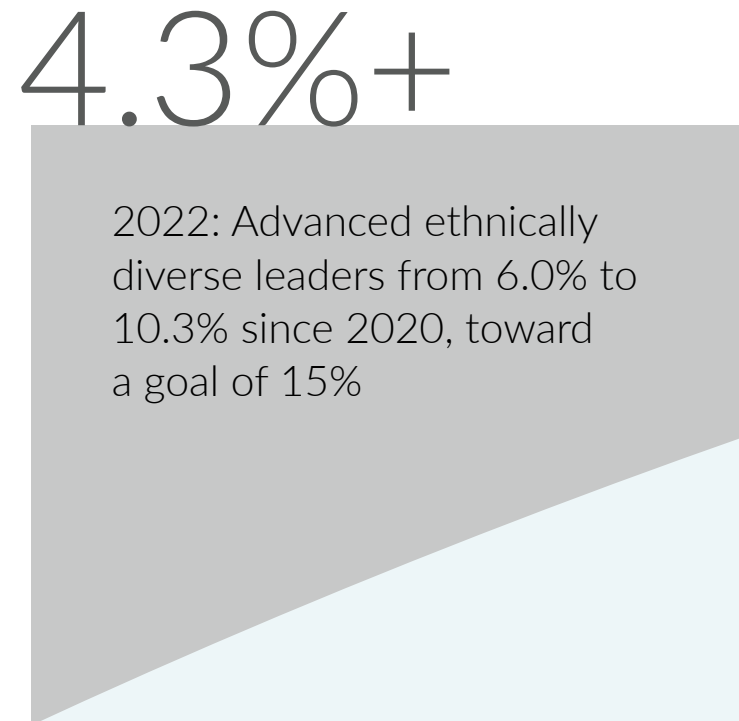

HNI's success is enabled by the hard work and dedication of our employees, whom we refer to as members or member owners. We strive to be a great employer and are committed to HNI being a safe, inclusive, and

supportive environment. We extend this commitment to partners in our supply chain and the communities where we live and work. Through this, we create a culture of inclusion and respect that values safety, sustainability, and human rights.



Respecting People

Safety on the Manufacturing Floor



The safety of our members is a core value at HNI, and we aim to have a zero harm workplace by focusing on proactive safety improvements. We have a long-standing history of using ergonomic principles in design, so our customers have a comfortable, supportive, and safe experience with our products. In 2022, guided by our Senior Ergonomics and Wellness Strategist and our Ergonomics Program Manager, we further applied our ergonomic expertise to every step of the manufacturing process. The ergonomics team consulted with safety experts to assess HNI operations and determine how to

avoid repetitive motion injuries and further integrate proactive safety into HNI manufacturing.

To advance our safety program, we implemented innovative artificial intelligence software to review each step of the manufacturing process and identify situations with a high potential for ergonomic injury, such as awkward postures, repetition, duration, and excessive force. Now managers review the findings for warning flags and use this information to modify any high-risk movements—before someone is hurt.

We estimate this work reduced the risk of injury by an average of 23.5% across 15 different HNI manufacturing facilities.

In 2022, HNI set ergonomic goals for manufacturing for the first time in company history. Members are empowered to recognize ergonomic hazards, identify early warning signs of work stress, and apply principles of prevention from product development through product manufacturing and product delivery.

“Our members are our priority and being proactive about safety is of utmost importance. I am proud of the work we are doing to support continuous improvement of safety, to understand our ergonomic risks, and to foster a culture where all members are empowered to have a positive impact on safety.”

—Tom Eberhard, VP Customer Quality and Safety



Respecting People

Diversity, Equity, and Inclusion (DEI)

Goal:

Increase diversity in leadership positions (manager level and above) to 40% women leaders and 15% ethnically diverse leaders by 2026.

Progress:

By the end of 2022, HNI has reached 30.8% women leaders and 10.3% ethnically diverse leaders.

2026 Goal Progression

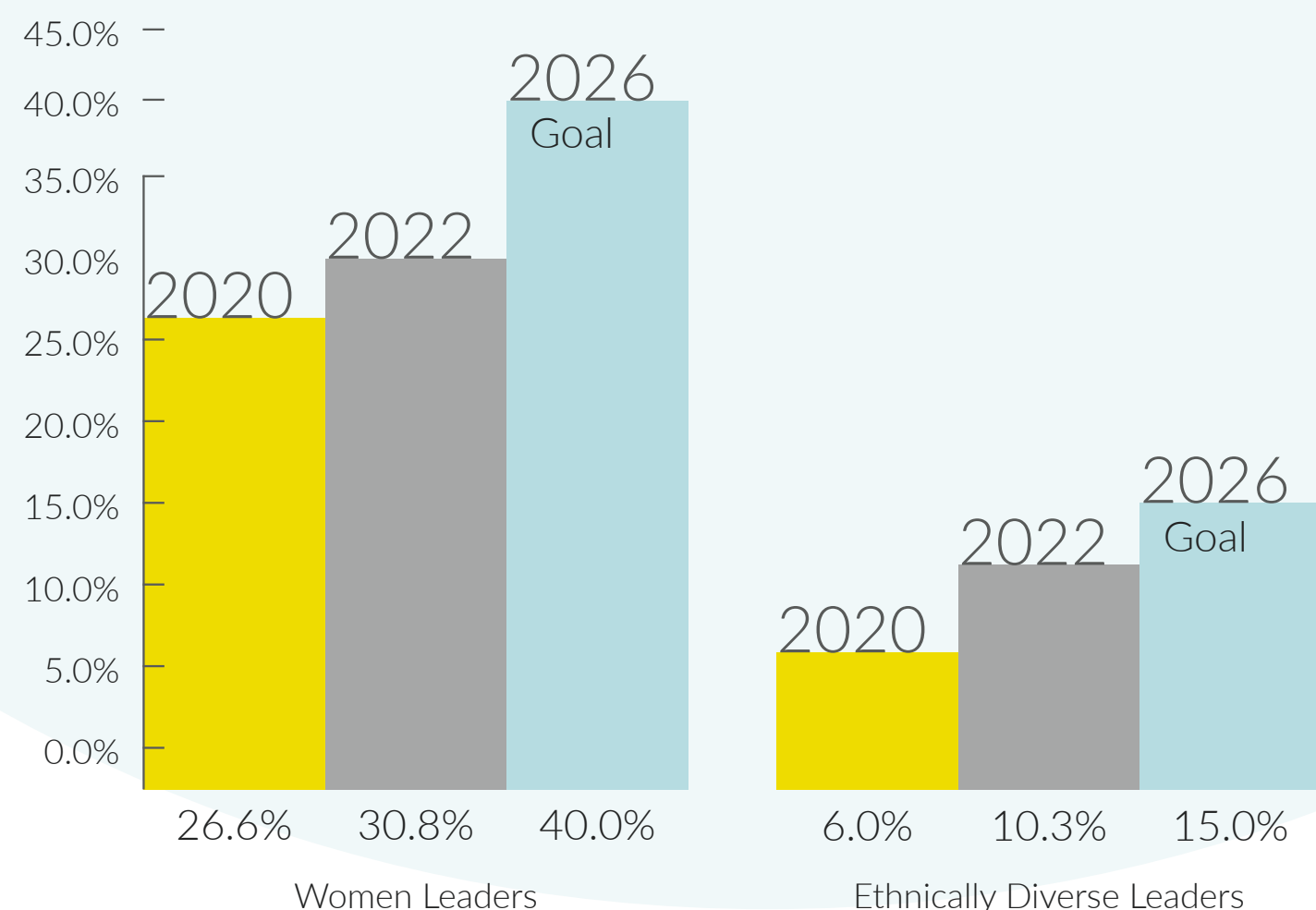

HNI is dedicated to fostering an inclusive workplace through HNI Belong, a broad-ranging strategy deeply rooted in our culture of fairness, respect, integrity, trust, transparency, and

collaboration. Our commitment to HNI Belong and DEI reflects HNI's core belief in creating a community for everyone where we value using each other's differences in experiences and ideas to solve problems and better serve our customers.

To advance our organization toward a more diverse and inclusive workplace, we set ambitious goals three years ago to increase representation in leadership across the corporation. Specifically, we are striving to increase diversity in leadership positions

to 40% women leaders and 15% ethnically diverse leaders by 2026. We understand the importance of leaders reflecting the diverse groups they are guiding and inspiring. We are dedicated to building on the progress we have made.

“Our approach to diversity is simple: It’s about embracing everyone. From cultivating a culture where all members can bring their best selves to work to deploying initiatives that support all, we’re doing what it takes to build a more inclusive workplace.”

—Jeana Gingery, Director of Diversity, Equity, and Inclusion



Heat & Glo® launches direct vent fireplace, increasing efficiency in home heating.

Respecting People

Diversity, Equity, and Inclusion

The HNI Belong Executive Council, led by our CEO and composed of senior leaders, is dedicated to championing DEI throughout our organization. The Council is responsible for establishing and advancing the DEI framework as well as working to actively promote and sustain a culture of inclusion throughout HNI. The Council provides guidance and

oversight, conducts regular reviews of our progress, and supports DEI initiatives. They recognize that diversity and inclusion are essential to our success as an organization and are fully committed to leading the way in creating a workplace that welcomes and values the unique contributions of all members.

HNI Belong focuses on three key areas:

1. LEADERSHIP COMMITMENT AND ALIGNMENT

At HNI, every member deserves to be respected and heard. We embrace that leveraging differences in backgrounds and experiences leads to better outcomes in our work. Our leaders are expected to foster an inclusive workplace culture and create an environment where all members feel comfortable sharing their ideas and perspectives. Our CEO and executive team have a portion of their compensation tied to progressing DEI within the organization.

In 2021, we provided inclusive leader training to all managers to ensure understanding of inclusive behaviors and encourage respect and openness in the workplace. Leadership development is crucial in supporting diversity and inclusion, and we continue to expand our program offerings specific to women and underrepresented members.

Through partnerships with organizations such as Women Lead Change and McKinsey & Company Connected Leaders Academy, we support our women and underrepresented members with the skills, networks, and sponsorships to help achieve their career goals.

To further drive our initiatives forward and ensure we remain focused, we hired a Director of Diversity, Equity, and Inclusion in January 2022.

2. DIVERSE TALENT

Diverse perspectives bring immense value to our culture and are crucial for solving business problems through creativity, collaboration, and innovation. At HNI, we are expanding our reach for talent by recruiting and developing a diverse talent pool both within and outside our organization.

We have engaged and expanded our relationships with universities to support a more diverse entry-level professional pipeline, and we have updated our hiring process to remove bias and promote equity. We welcomed greater numbers of women and ethnically diverse participants to our internship and early career development programs and noticeably increased diversity in job applicants for most positions in 2022.

Talent development processes are driven deep into our organization, establishing a cadence to build next generation leaders. We foster an environment that encourages our members to express and act on their career interests and supports promotions and lateral moves within and between HNI operating companies and across the business functions. In 2022, all production group leaders and factory managers attended talent scout training to learn to coach and identify internal talent. Production members were encouraged to attend information sessions focused on growing a career with HNI through front-line production supervision career tracks.



HHT develops pelletized fuel for Heatilator stoves, saving 6,000 tons of wood waste from landfill.

Respecting People

Diversity, Equity, and Inclusion

3. INCLUSIVE WORKPLACE AND MEMBER ENGAGEMENT

At HNI, we know diverse representation alone is not enough. Inclusion and belonging are crucial in creating a workplace where all members feel valued and empowered to contribute to their fullest potential. When our members bring their best authentic selves to work, it leads to better business outcomes.

To promote conversations and understanding about inclusion and diversity, we have provided member training and education on unconscious bias, inclusive leadership, and allyship.

In 2021, a baseline of awareness was established by training all managers on inclusive leadership and all members on unconscious bias. In 2022, we continued to advance

member knowledge and understanding through allyship training, providing the skills necessary to be allies to colleagues and further fostering an inclusive work environment.

We value the importance of listening to our members and gathering feedback to inform our DEI strategy. In addition to conducting an inclusion survey, all members were asked to

participate in DEI-focused listening sessions. Across the organization, over a third of our members engaged in 230 sessions. From these sessions, key themes and actions were identified, shared with members, and ultimately integrated into our DEI strategic road map.



HON implements Lean manufacturing and Rapid Continuous Improvement (RCI) practices that become the basis for future company sustainability.



Respecting People

Supporting Members at HNI

We know our differences make us stronger, and we are committed to celebrating and embracing our Member Resource Groups (MRGs). MRGs are an essential part of creating a more inclusive workplace where all members can thrive. These groups provide opportunities for professional development, community engagement, and connection among members who share common identities or experiences. MRGs are open to all, and many HNI members show support by being allies of their group of interest.

As we continue to grow and evolve as an organization, so do our MRGs. Since launching our first group in 2019, the organization has enthusiastically embraced MRGs with over 450 members actively participating. These groups provide opportunities for members to connect, support, and learn from each other, further strengthening our community at HNI.



WOMEN IN STEM



WOMEN'S NETWORKING COMMUNITY



SOMOS HNI



PRIDE WITHIN HNI



HUE COLLECTIVE

“Somos HNI is a group of talented leaders and members sharing ideas and having the opportunity to positively impact HNI members and the greater community. Being part of this MRG, I bring my life experiences as an immigrant to enrich those around me and get to learn from other members’ cultures and experiences.”

—Marco Prada, HNI member and Somos HNI group participant



HON joins U.S. EPA Green Lights Program to boost efficient lighting initiatives in manufacturing.

Respecting People

Engaging and Rewarding Members

MI IDEAS SUSTAINABILITY

COMPETITION

Every HNI product, whether it's collaborative seating for the office or a glowing hearth for the home, is made using the principles of Lean manufacturing. In tandem with Lean manufacturing, HNI's CORE strategy provides a framework to engage members and embed social responsibility deeper into our company culture.

At the center of these principles is the idea that we continually improve the manufacturing process to use all resources as efficiently as possible. Members are crucial in capturing these opportunities to improve our overall success.

Mi Ideas is an internal program to collect and implement ideas for improvement in areas such as safety, quality, efficiency, and operations. In

2022, Mi Ideas was expanded to include sustainability and launched the Mi Ideas Sustainability Competition.

The competition generated over 1,500 ideas—40% of which have already been implemented or are in the works for 2023. The member ideas included ways to minimize paper usage, conserve energy, and reduce waste.

BENEFITS FOR MEMBER OWNERS

We believe in supporting and rewarding our members through our comprehensive total rewards package, which includes programs focused on physical, emotional, and financial well-being.

Our broad offerings support members at all life stages and provide the flexibility to choose benefits that meet members' unique needs and preferences. We provide robust healthcare coverage, wellness programs, generous paid time off and leave programs, financial benefits, and more.

We continue to look for ways to modernize and personalize our programs to respond to the varying and changing needs of our members and their families. Recent enhancements support our continued commitment to creating a more inclusive workplace with programs including:

- Adoption and surrogacy financial assistance
- 80 hours of paid parental leave in addition to other forms of paid leave
- Digital well-being coaching with 24/7 access to a live nurse.

While some benefits are new, others have been integral to life at HNI for

decades and support our member owner culture. For example, after one year of service, most members are eligible to participate in our profit sharing program. Over the last 10 years, HNI has shared over \$245 million in profits with members. Members are also eligible to purchase HNI stock at a discounted rate through our Member Stock Purchase Program. Additionally, HNI contributes company stock each year to eligible members' 401(k) accounts regardless of whether they make their own retirement contributions.

For a more detailed list of HNI member benefits, please visit:

[Benefits-HNI Benefits.](#)



HNI begins offering product-specific Environmental Data Sheets with sustainability information.

Respecting People

Beyond Our Doors: Our Communities

HNI CHARITABLE FOUNDATION

The HNI Charitable Foundation began in 1985 with the mission to support the communities where members live and work and to address issues that are important to our members, their families, and the future of our company. Over the last two decades, the foundation has given over \$7.2 million in scholarships to HNI members and their families. Since 2019, the HNI Charitable Foundation has donated over \$3.6 million to nearly 150 community organizations. The HNI Foundation is fully funded by the HNI Corporation with no outside contributions.

The foundation focuses on education and health, with a priority on projects with significant community impact. In the fall of 2022, the HNI Charitable Foundation pledged \$1 million to the Community Foundation of Greater

Invest 1% of pre-tax profits, on average, every year in communities where HNI operates through the HNI Charitable Foundation

Muscatine's Mulberry Health Clinic Project. This new facility will provide primary healthcare services to people in the Muscatine, Iowa, area.

EDUCATION AND TRAINING FOR THE BROADER COMMUNITY

The educational component of HNI giving remains as strong as ever. In addition to providing financial

resources for scholarships and other forms of academic support, HNI members give their time and expertise to their communities.

HEARTH & HOME TECHNOLOGIES COLLABORATES WITH STUDENTS THROUGH LAKEVILLE WORKS

Lakeville Works, a partnership between the Lakeville Chamber, Lakeville Area Schools, and the City of Lakeville, Minnesota, began in 2018. The initiative was founded by 12 donors, including HNI's HHT, to create awareness among young people in the community of in-demand but often overlooked careers. Today HHT members collaborate with Lakeville Works to help expand learning and exploration beyond the classroom by showing students alternatives to the traditional four-year college degree.



MEMBERS GUIDE MUSCATINE HIGH SCHOOL PROJECT

In the spring of 2022, HNI members received a unique opportunity to not only donate our furniture to Muscatine High School but also collaborate with students on a design proposal for the student center. HNI members

worked with the students to assess project needs, develop the budget, and present their proposal to the school administration. By the fall, the student center opened with new furniture for open collaboration, tutoring, and private conversations. The students involved gained experience in project development, design, budgeting, and planning.



HON donates \$182,000 and three truckloads of furniture to help equip Federal Emergency Management Agency offices in New York City after 9/11.

Respecting People

Beyond Our Doors: Our Communities

STEM TEACHER EXTERNSHIPS AT HNI

Every summer, HNI hosts STEM Teacher Externships. Through this program, Iowa teachers in the fields of science, technology, engineering, and mathematics have the opportunity to work side by side with an HNI member. As a result, the teachers stay up to date on the latest developments in STEM and are able to share these experiences with their students.

HNI APPRENTICESHIP PROGRAM

HNI offers a Maintenance Apprenticeship Program registered with the U.S. Department of Labor and the State of Iowa. Currently, 21 active apprentices are learning the technical skills needed for facilities management, ranging from mechanical and electrical expertise to fabrication and automation. Because of the success of this program, HNI was awarded the 2021 Van Meter Education Excellence Award for Automation Training.

VOLUNTEERISM AT HNI

In addition to these programs, individual HNI members give their time and energy to serve local community needs. A few examples include:

Reviving Muscatine's Trees

To help revive Muscatine's trees, in 2021, over 100 HNI volunteers worked with the City of Muscatine to plant 500 trees throughout numerous city parks. In 2022, a similar number of members volunteered again, supporting the planting of \$10,000 worth of mature trees for our community. HNI matched an Iowa Department of Natural Resources grant to help fund this effort.

Freezing for Food Drive

In 2022, members participated in Freezing for Food with the Salvation Army of Muscatine County. They helped load and distribute a semi-truck filled with food for families in need.

Habitat for Humanity

Approximately 30 HNI members worked to build a home with Habitat for Humanity in Muscatine, Iowa. The home was gifted to its new owners in the fall of 2022.

Just Give Committee

In Mount Pleasant, Iowa, a member-led group called the Just Give Committee raised money for Breast Cancer Awareness month by hosting events to sell baked goods and apparel. The group

donated the proceeds to the Wig Room at Southeast Iowa Regional Medical Center.

City of Hope

Each year, HNI hosts fundraisers to support City of Hope's mission to transform the future of health through exquisite care, innovative research, and vital education focused on eliminating cancer

and diabetes. Thanks to generous donations from our members, suppliers, dealers, and channel partners, we were able to present City of Hope with a check for \$500,000 in 2021 and \$590,000 in 2022. This brings our total to over \$7.9 million raised in 21 years of supporting City of Hope.



Allsteel earns Murray J. Fox Recycling Innovation Award for circular wood waste project.

Respecting People

Beyond Our Doors: Supplier Code of Conduct



The goals of inclusion, community, and sustainability extend beyond HNI's doors. From material sourcing to product delivery, HNI depends on a vast network of suppliers to bring our products to life for our customers. HNI strives to be a global leader up and down our supply chain, helping to improve our world.

In 2022, HNI reached 100% Tier 1 supplier compliance in signing the HNI Code of Conduct. We aim to work only with suppliers who align to the highest ethical and social standards. To ensure this, HNI obtained agreement from all our material suppliers to uphold these

high standards. The HNI Code of Conduct incorporates several guiding principles. Chief among them are valuing human rights; treating

In 2022, HNI reached 100% supplier compliance in signing the HNI Code of Conduct.

others with dignity and respect; and governing all relationships with trust, openness, and honesty. In signing this document, suppliers agree to follow all laws and regulations and optimize facilities and material sourcing to make these processes as ethical and sustainable as possible. We

believe that this code of conduct is the first step in our strategy to connect, assess, and collaborate with suppliers on CSR issues.

The sustainability mindset is integrated into all HNI practices that govern vendor relationships from the code of conduct to supplier audits. We have a targeted and robust CSR auditing process in Asia to ensure suppliers follow appropriate labor, safety, environmental, and other

requirements. The program is based on SA8000, the international standard for social accountability, with additional environmental, health, and safety (EHS) related regulations. Our third-party auditor is continually engaged to monitor, provide suggestions, evolve our standards, and certify our program, with audits conducted on an annual basis.



REDUCING IMPACTS HIGHLIGHTS

6 Facilities

2022: Six facilities achieved a diversion rate above 84%, including two that achieved zero waste to landfill

8%

2022: Reduced absolute energy consumption 8% compared to 2018

64%

2022: Reduced Scope 1 & 2 combined GHG emissions by 64% since 2018

100%

2022: Sourced 100% renewable electricity for global operations

2006

Allsteel boosts shipping efficiency, creating a 1 million-pound reduction in CO₂ output.

Through HNI's environmental sustainability strategy, we work toward a tomorrow that is cleaner, safer, and more responsible than yesterday. We also understand that sustainability does not have an endpoint, and we

continually work to lessen our environmental footprint across all systems and processes.

HNI owns most of the manufacturing facilities where we fabricate our products, therefore, we are responsible for the production process. We are committed to using our resources as responsibly as possible with care for people and the environment.



Reducing Impacts

Greenhouse Gas Emissions

Goal:

Reduce absolute combined Scope 1 and 2 GHG emissions 35% by 2025 from 2018 baseline.

Progress:

As of 2022, HNI has reduced our Scope 1 and 2 emissions 64% from the 2018 baseline. This exceeds our original goal of 35% reduction.

In July 2020, HNI's GHG emission targets were approved by the SBTi. HNI's Scope 1 and 2 target is aligned with the goal of limiting global warming to 1.5°C, thus curbing the most disastrous effects of climate change.

Since 2018, we have reduced combined Scope 1 and 2 GHG emissions by 64%, primarily through the purchase of renewable electricity. Our emissions increased slightly from 2021 to 2022 due to the addition of new equipment, but we are committed to our goal and further reducing our GHG emissions. We

plan to accomplish our goal through a variety of energy initiatives, including:

- Implementing energy efficiency opportunities discovered through our energy audits
- Continuing our commitment to RE100 and the EPA Green Power Partnership
- Meeting electricity needs through renewable energy purchase agreements, renewable energy certificates, and onsite projects
- Identifying and implementing innovative technologies and solutions.

Combined Scope 1 and 2 Emissions
(MTCO₂e)

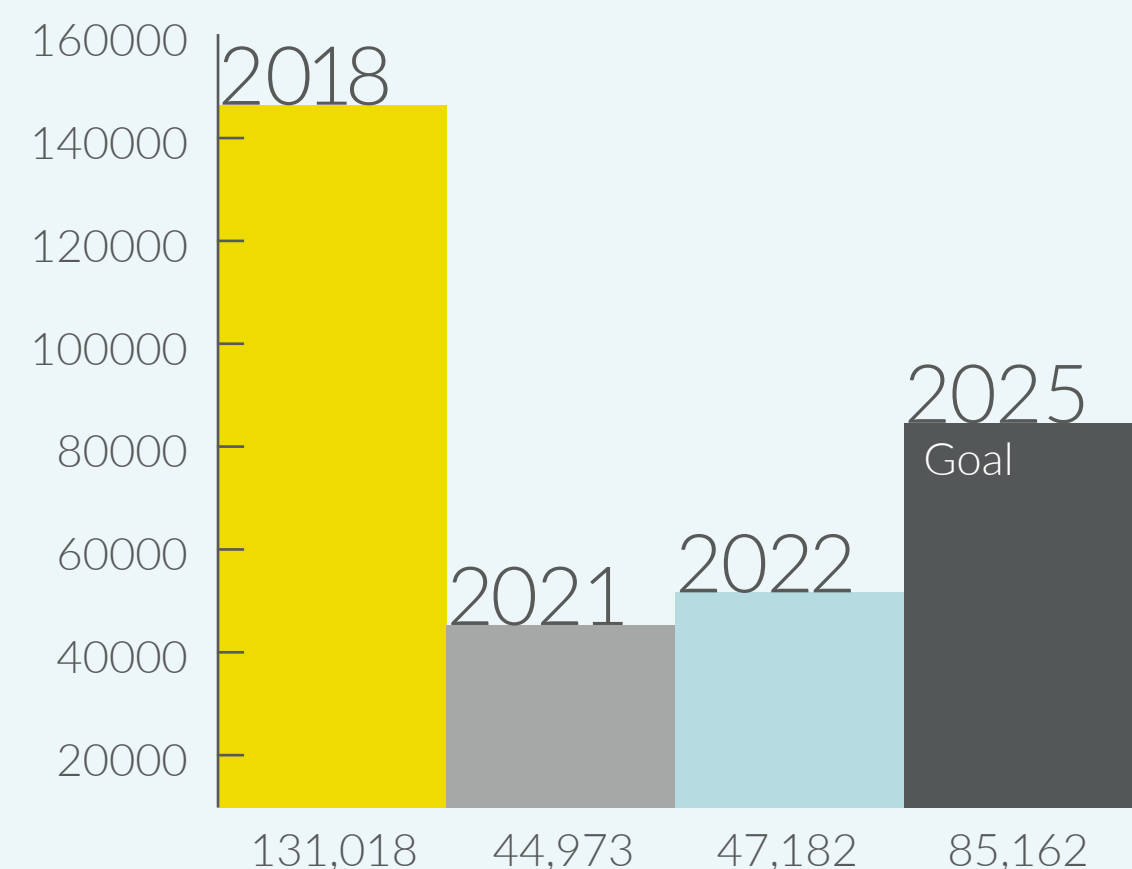

Allsteel, Gunlocke, and HON among first to achieve SCS Sustainable Choice™ certification (now LEVEL®).

HNI JOINS CHOOSE GREEN MUSCATINE

In 2022, HNI committed to a partnership with Muscatine Power and Water (MPW) to join the Choose Green Business Program. The program will bring renewable energy options to Muscatine and help HNI and other local businesses meet our sustainability goals by

participating in long-term, high-volume renewable energy projects.

We expect this project will supply renewable electricity to approximately 10% of HNI's operations in Muscatine. We believe strongly in this private and public partnership to support our community and help HNI meet our climate change goals.



Reducing Impacts

Greenhouse Gas Emissions

Goal:

Reduce Scope 3 GHG emissions 40% per ton of goods sold by 2035.

Progress:

Since 2018, Scope 3 emissions per ton of product sold have increased due to an increase in sales of HHT products and related product use emissions.

Scope 3 Emissions*
MTCO₂e per Ton of Products Sold

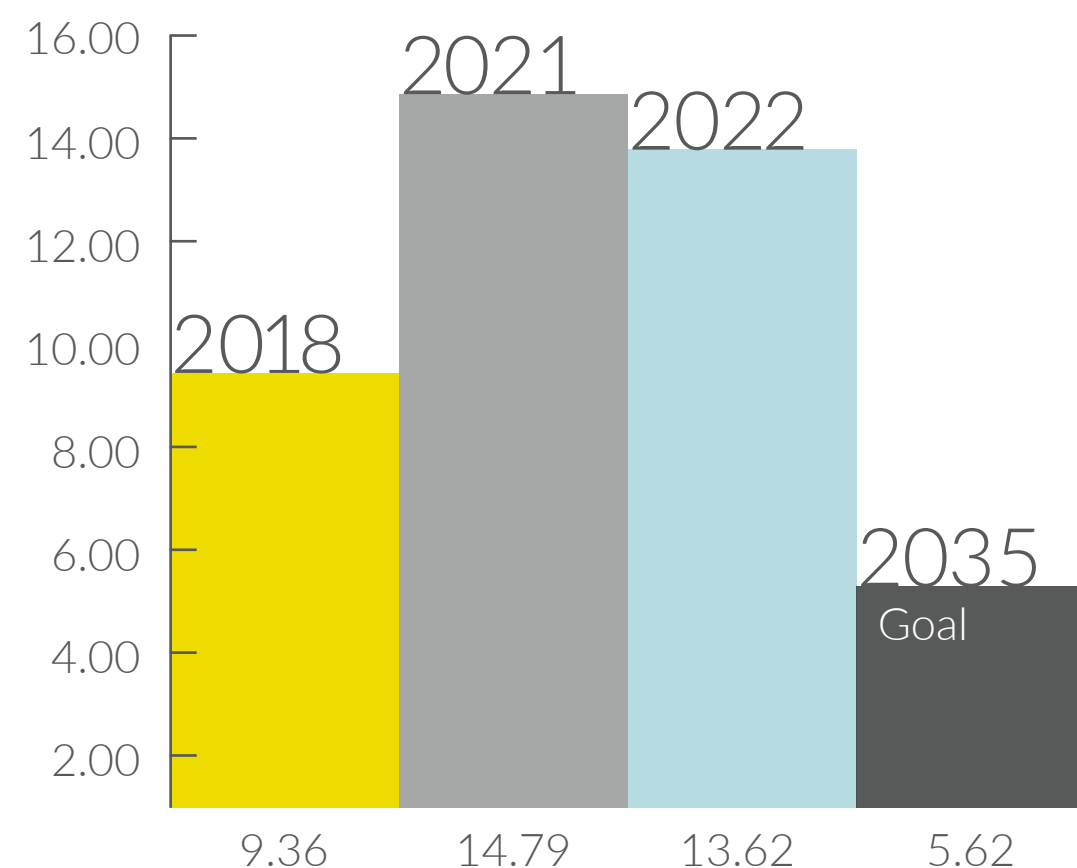

REDUCING SCOPE 3 EMISSIONS

HNI is working to reduce Scope 3 GHG emissions 40% per ton of products sold by 2035. Our three main categories of Scope 3 emissions are: 1. use of sold products 2. purchased goods and services and 3. upstream transportation and distribution.

Since 2018, Scope 3 emissions per ton of product sold have increased due to an increase in sales of HHT products and related product use emissions.

Although we are not able to show improvement currently, we are confident in our ability to make progress on this goal. We'll do so through leading in innovative electric fireplace development, conducting life cycle assessments of our products, and looking beyond our operations to our suppliers and partners' emissions practices.

TRANSPORTATION PARTNERS

Over 93% of our third-party carrier miles are completed with partners that participate in the U.S. EPA SmartWay® program to advance sustainable transportation. HNI continues to work with our carriers to encourage efficient transportation, and we have set internal goals to increase use of SmartWay® partners.

SUPPLY CHAIN SUSTAINABILITY ROAD MAP

Looking ahead, further engagement with the supply chain will be essential to HNI's sustainability success. We are sharpening our focus to include transportation efficiency, understanding supplier sustainability efforts, and gathering primary data from suppliers. We have begun to score and assess suppliers on ESG topics. This will allow HNI to establish an ESG supplier scorecard and baseline for our suppliers.

“By better understanding our sustainability metrics, our strategies can keep improving. People used to think of sustainability as solely doing better for the environment, but now we know it’s better for business, too.”

—Ramiro Artigas, HNI Sustainability Engineer



2009 Ethisphere Institute awards Ethics Inside® 2009 certification to HNI for commitment to business ethics.

Reducing Impacts

Energy Efficiency



In 2022, we conducted baseline energy audits at all HNI manufacturing facilities. The audits uncovered areas where HNI was meeting our goals, along with areas where we had opportunity to improve. Through this process, we developed a more robust understanding of energy drivers and were able to identify and prioritize projects. Although we are making progress on projects, our energy intensity per ton has increased. Since the start of the COVID-19 pandemic, we have seen continued disruption in economic

conditions and decreases in units sold. We have used this time to evaluate baseline data and invest in new equipment and are working toward optimizing efficiency and flow.

At the same time, we have decreased absolute energy usage by 8% between 2018 and 2022. We attribute this to operational and efficiency improvements, such as switching

from a wet to a powder paint system, energy audits, LED lighting projects, the conversion to electric lift trucks, and changes to production.

Goal: Reduce energy intensity 50% by 2035 from 2018 baseline.

Progress: Energy intensity per ton of goods sold has increased due to a decrease in volume of goods sold. Absolute energy has decreased almost 8% from 2018.

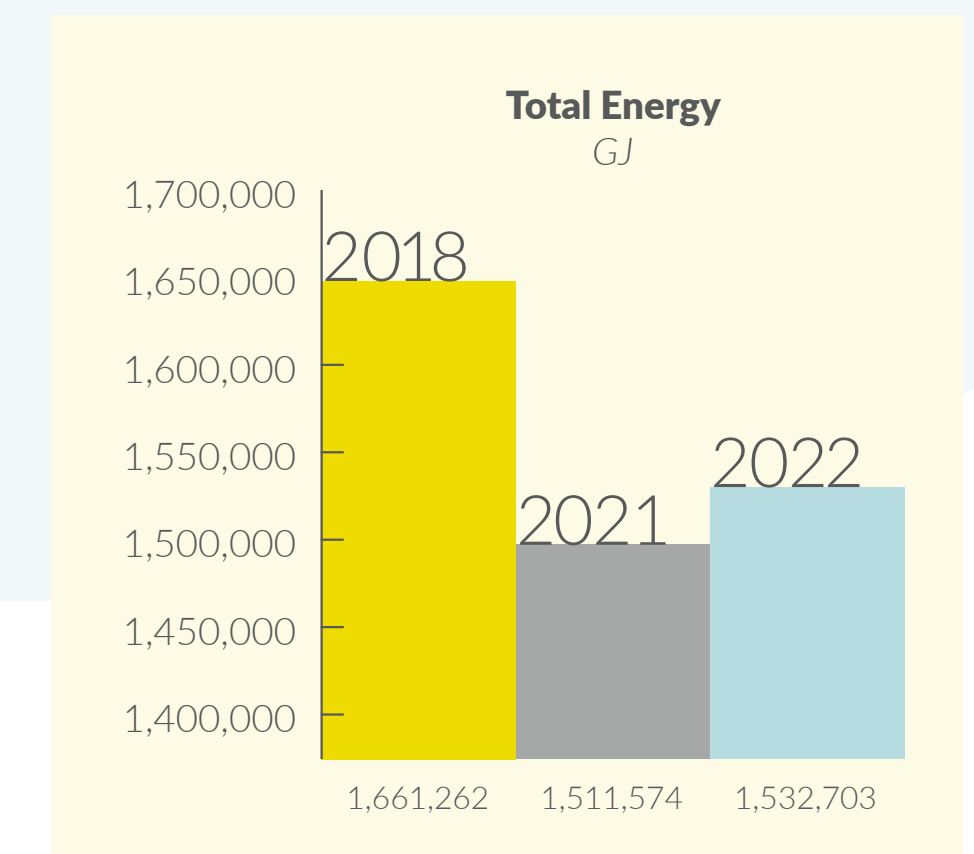
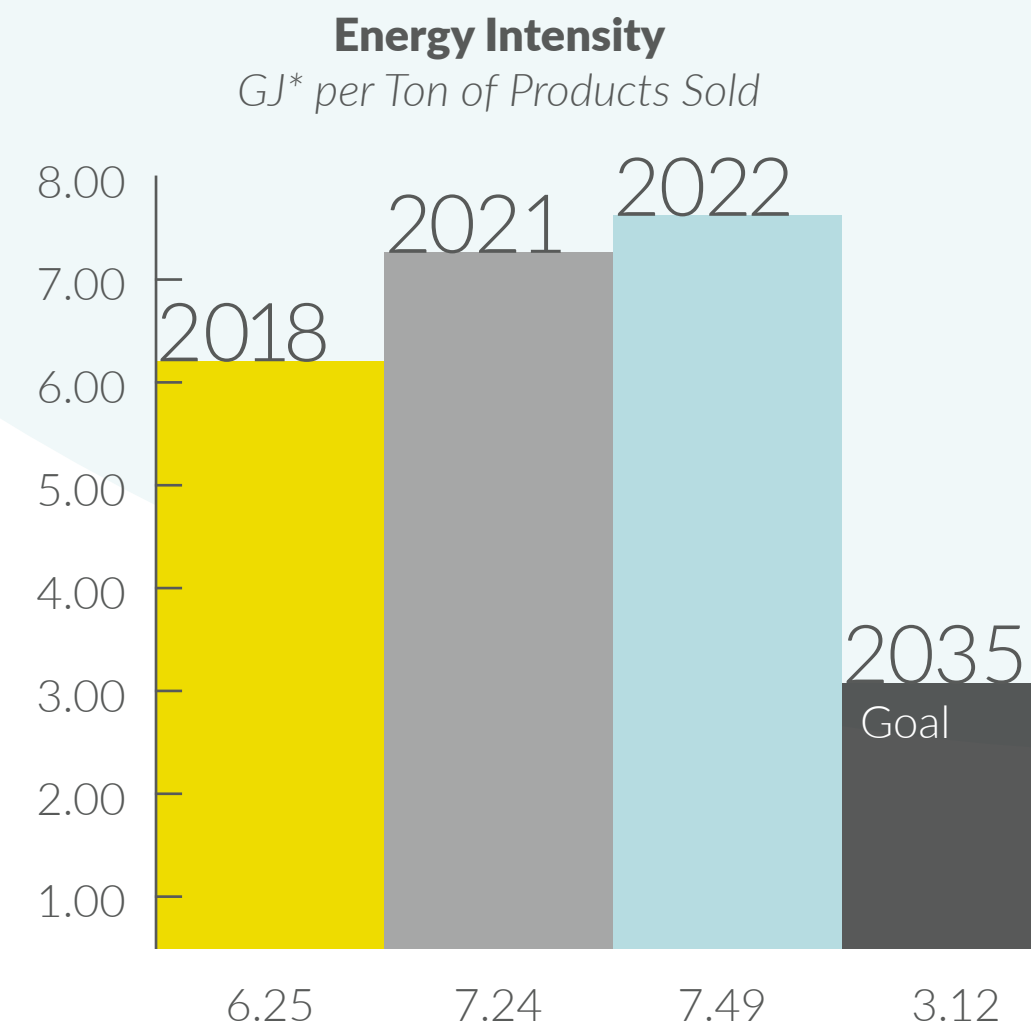

*gigajoules

Reducing Impacts

Energy Audits Uncover Opportunities

Through energy audits, we learned that compressed air accounts for between 5% and 20%, depending on the facility, of HNI's total electricity usage and produces excess heat. To correct this, we sealed air leaks, lowered air pressure requirements, and set up a plan to redirect excess heat back into the factory during winter months.

We also identified inefficient equipment use, and our members were able to design and implement a shutdown timing module that automatically turns off machines when not in use. Members also found other areas for optimization and equipment shutoff. These improvements included updating HVAC systems to ensure they operate only when needed and at the highest levels of efficiency, prioritizing lighting upgrades, converting manufacturing facilities to LED lighting, and installing motion sensors.

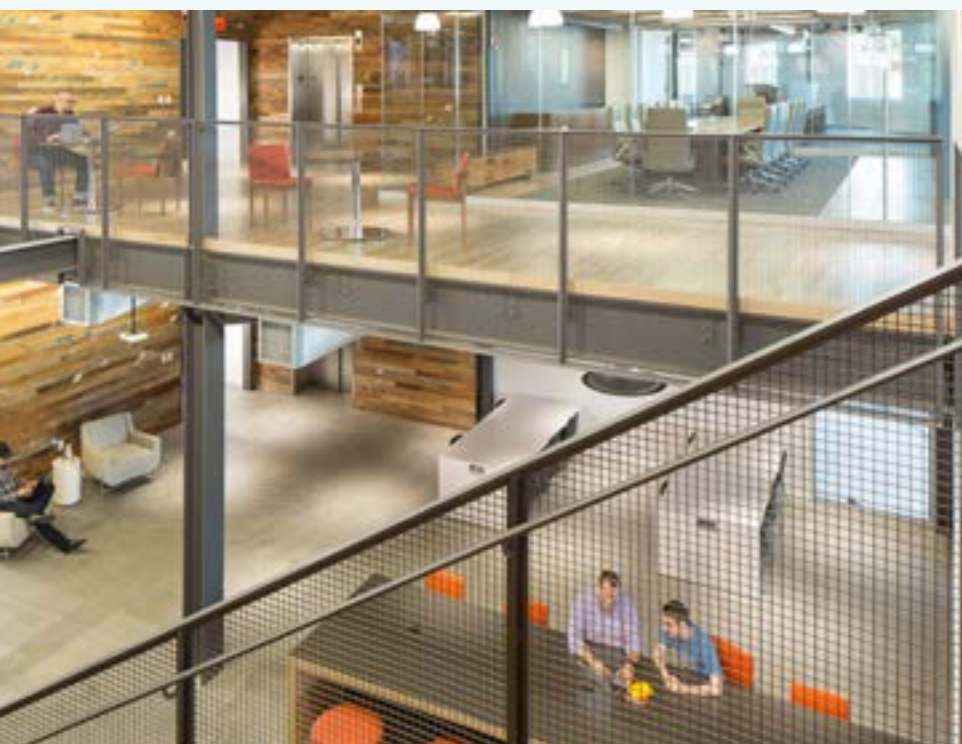

2010 Allsteel installs solar panels at company's first manufacturing site.

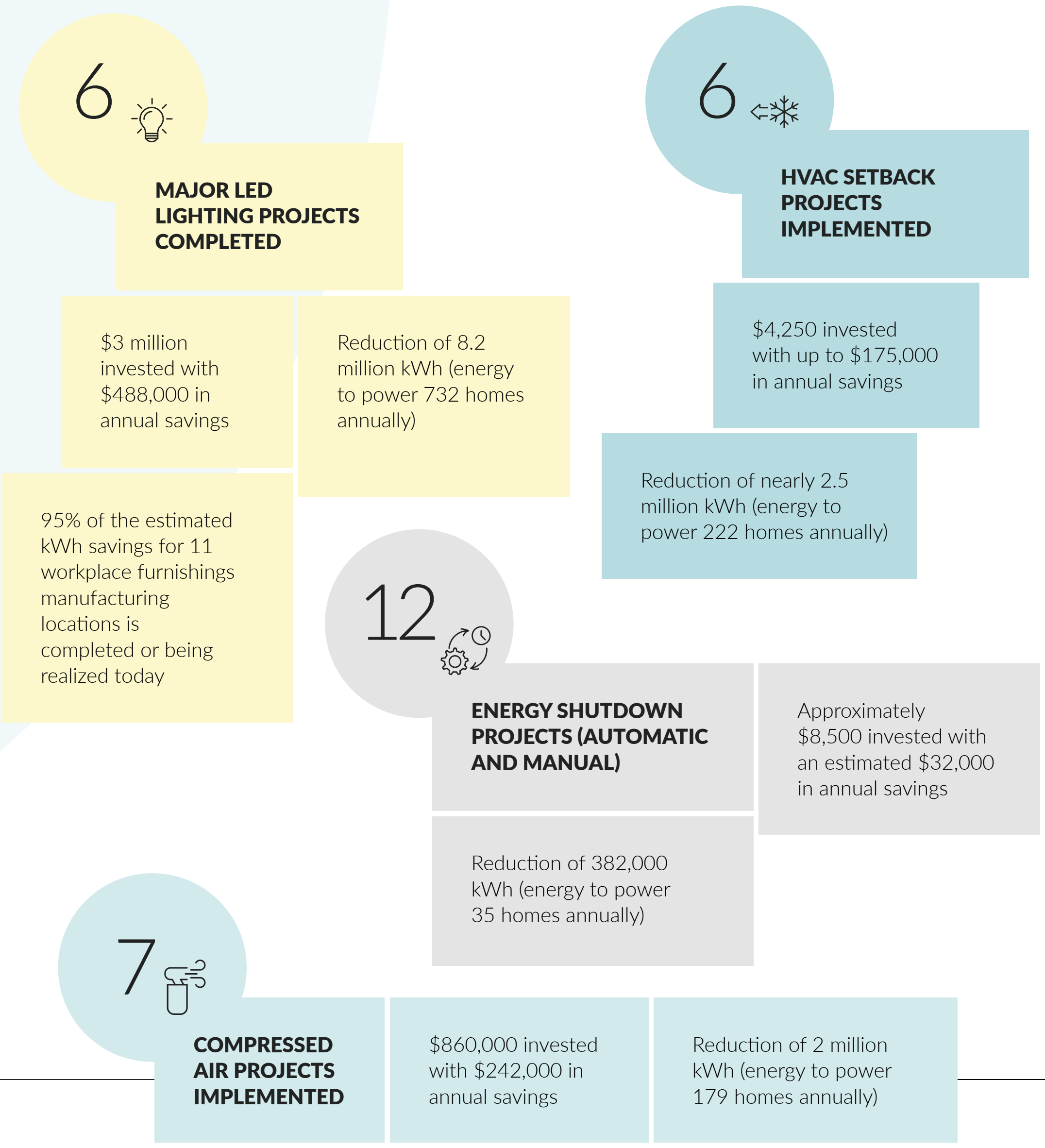

Reducing Impacts

Waste Audits Uncover Opportunities

Goal:

All facilities to reach zero waste to landfill by 2030.

Progress:

Two facilities have achieved zero waste to landfill. In 2021, we diverted over 32,000 tons and in 2022 over 36,000 for nearly 70,000 tons in total.

Waste Diversion

Tons

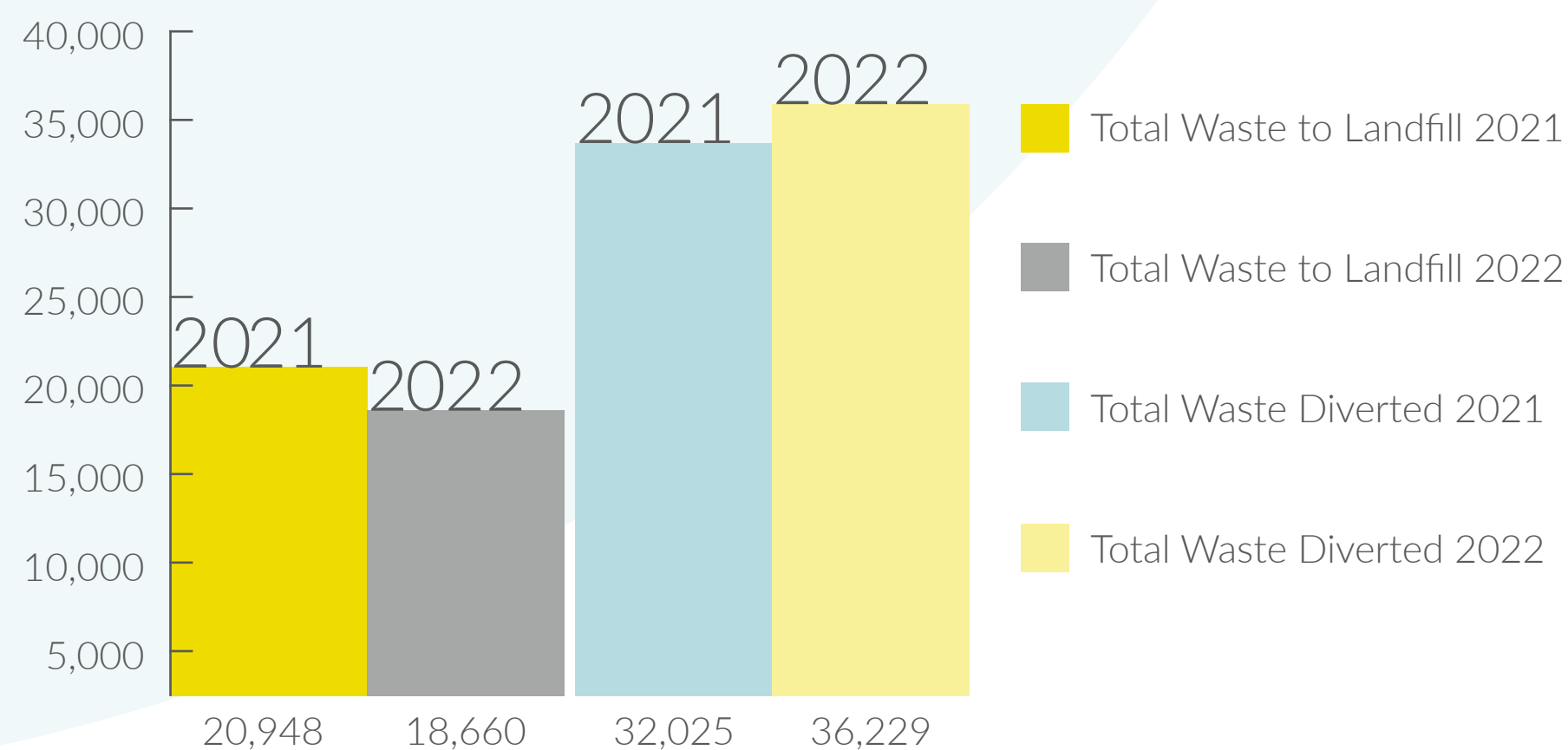

We are reducing our total waste while diverting more waste from the landfill.

HNI continues to work toward the goal of zero waste to landfill by 2030. We have two facilities at zero waste to landfill achieving 95% diversion. Since our last report, two additional facilities have achieved above 90% waste

diversion and two more facilities are now above 84% diversion. We diverted a total of almost 70,000 tons of waste in 2021 and 2022, showing increases in wood diverted and a decrease in overall solid waste.

Through waste audits, we identified opportunities to reduce waste and divert materials from the landfill. In one example, at the HHT Mount Pleasant facility, we were able to implement pallet reuse and recycling, reducing the cost of new pallets and decreasing waste to landfill.

Waste and Recycling by Type

The majority of HNI waste (63%) is now recycled or diverted from the landfill. The solid waste produced in our facilities (37%) goes to the landfill.

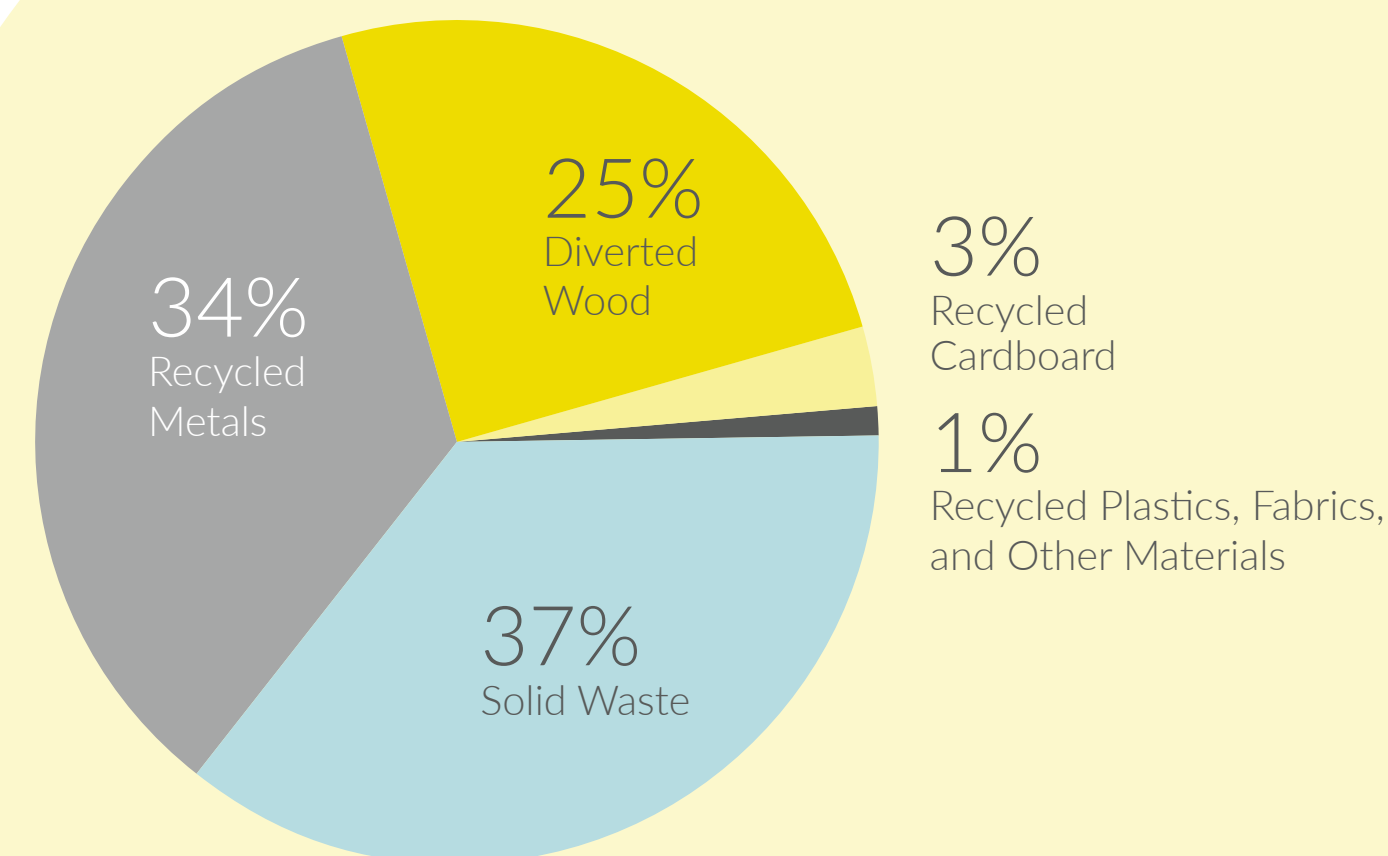

Reducing Impacts

Waste Audits Uncover Opportunities



NEW USES FOR SCRAP WOOD

Scrap wood is a significant waste stream at HNI, and in 2022, we generated approximately 9,000 tons of wood dust.

As of October 2022, HNI started working with a local partner to combine scrap wood waste with similar waste streams from other companies in manufacturing and food production from the Muscatine region. This combined waste will be utilized for steam production in the biofuel industry, offsetting additional natural gas usage. Over the years,

we have identified and tested many options for reusing and recycling waste, and we continue our effort to identify circular options for this scrap material.

CONCRETE

HNI uses concrete in making fireplaces. As a result of process sensitivity, concrete is one of HNI's largest sources of landfill waste. Historically, we have discarded approximately 730 tons of concrete per year.



To find solutions for this waste problem, we reviewed our concrete refractory system. We implemented process improvements and equipment upgrades to boost our diversion rate significantly, creating

a savings of over \$100,000 per year. Today approximately 275 tons of concrete are being diverted from the landfill, and we continue to work toward eliminating waste and finding opportunities to recycle or reuse it.

2011 Allsteel receives Best Industry Recycling Program Award from Iowa Recycling Association.

REDEFINING TOMORROW HIGHLIGHTS

By integrating sustainability, diversity, and respect into every aspect of HNI, we are creating a new tomorrow for our member owners, partners, customers, and communities. We understand that by working with intention every day, we can embrace

creative change. As a result, a better future is not a distant vision at HNI. We are taking actions today to create a safer, more sustainable, and socially responsible future with the products we design, manufacture, and sell to our customers.

47%+

2022: Eliminated over 47% of expanded polystyrene (EPS) in our packaging

40%

2022: Our workplace furnishings division team analyzed 40% of materials by spend to better understand chemical ingredients



2012

HNI achieves Forest Stewardship Council® (FSC®) Chain Certification for responsibly sourced wood under multi-site certificate.

Redefining Tomorrow

Working Toward 100% Recyclable Packaging

HNI is working to eliminate EPS (or non-recyclable foam) in packaging and move toward 100% recyclable packaging by 2025. As of the end of 2022, our HHT division had eliminated over 70,000 foam parts, putting them at over 91% progress toward the goal. HNI Workplace Furnishings omitted nearly 3.2 million parts of EPS from product packaging and achieved over 46% reduction.

Overall, we have made substantial progress and removed over 47% of EPS in our packaging—this equals over 7 million additional pounds eliminated since our 2020 CSR report.

Our product development teams continue to identify packaging solutions, and in the process, have found several types of non-recyclable foam beyond EPS that are used in our product packaging.

In several cases, we have been able to replace the non-recyclable foam with recycled corrugated cardboard, and we are continuing to research alternative materials. This requires engineering design and testing to ensure uncompromised product delivery and quality.

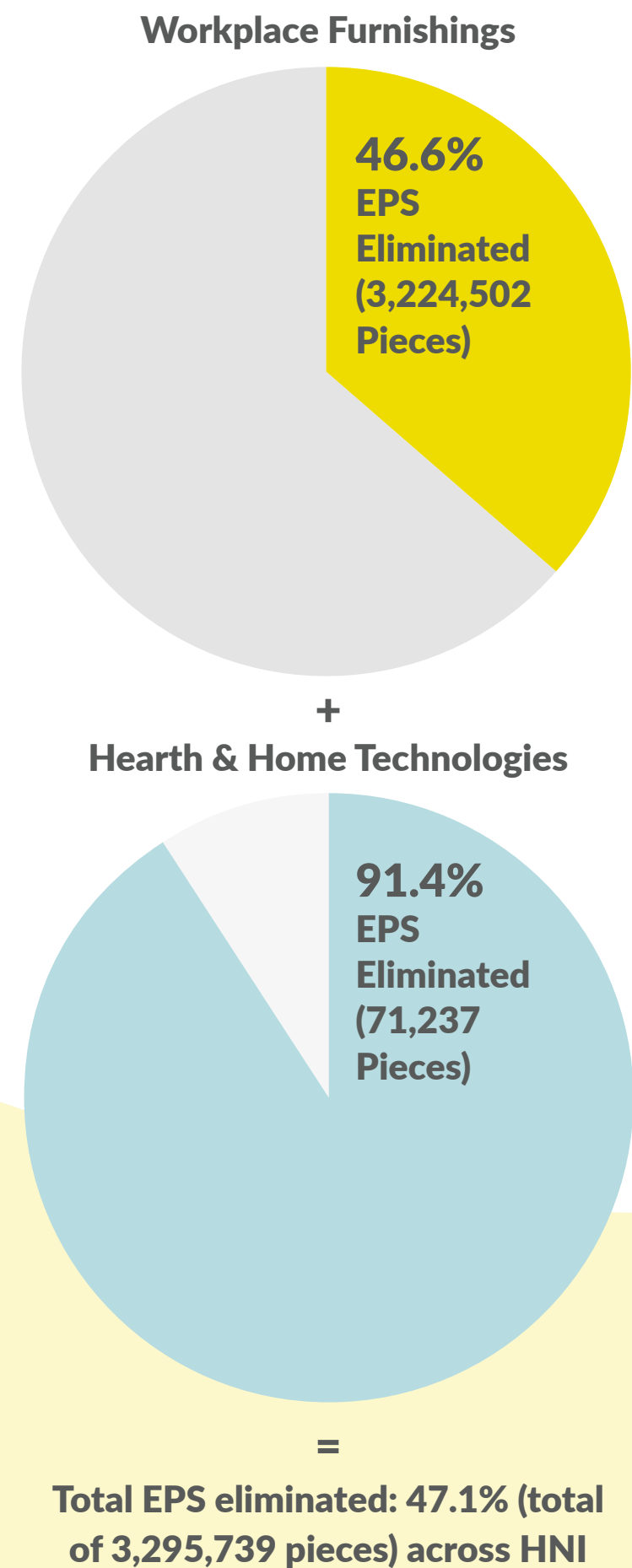

Goal:
Eliminate EPS and move toward 100% recyclable packaging.

Progress:
Removed 47.1% of EPS across HNI with an achievement of 46.6% for Workplace Furnishings and 91.4% for HHT.

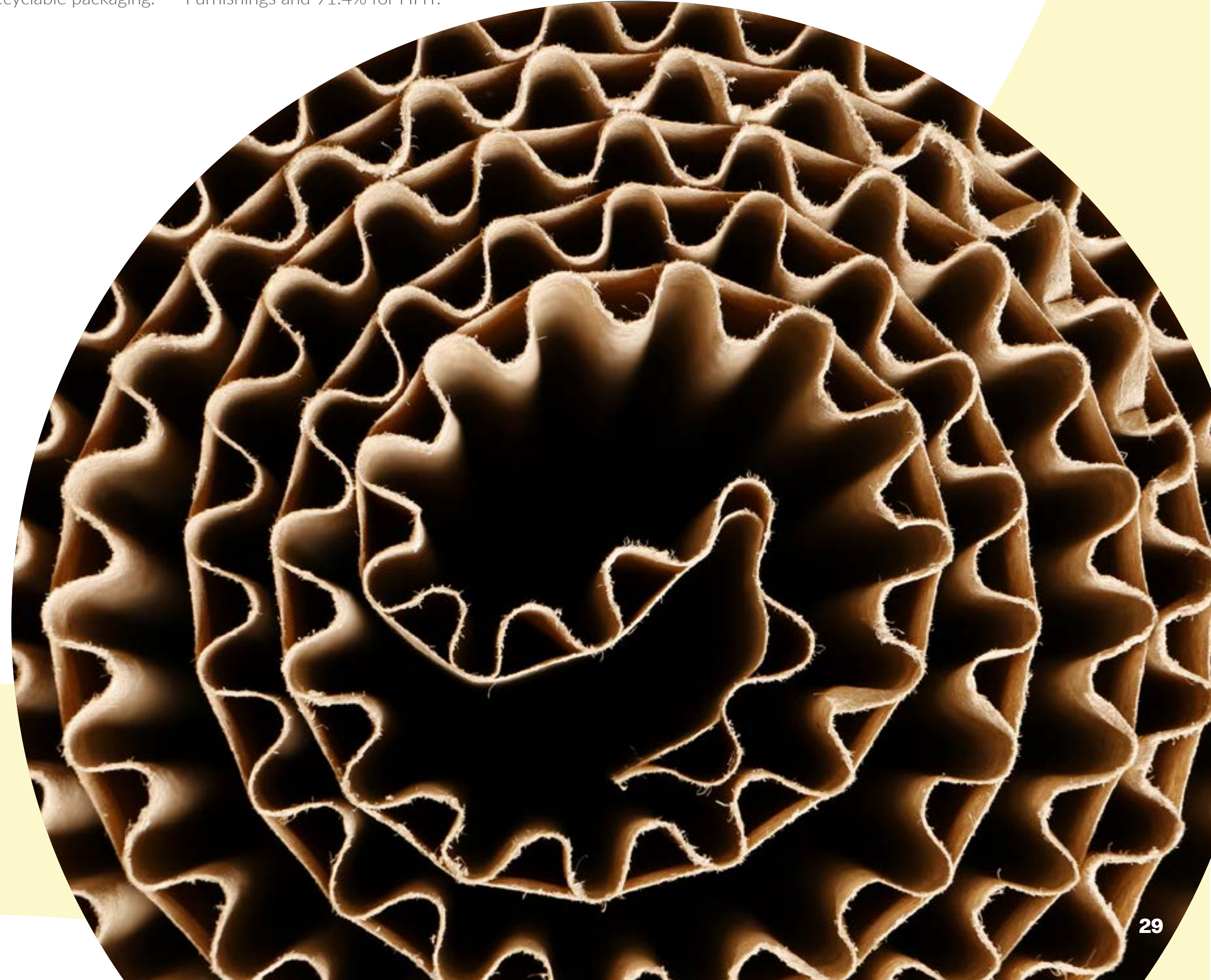

Redefining Tomorrow

Designing for Environmental (DfE) and Human Health

To meet the goal of analyzing 100% of our materials for human health and ecosystem impacts and minimizing these impacts through our DfE practices by the end of 2025, HNI members collaborate early and often with key internal and external stakeholders. Increasing access to material, product, and supply chain data is helping members understand the composition and chemical ingredients of our products. By

building this into design solutions early in the process, we can ultimately make better product development decisions.

As of 2022, we have analyzed 40% of our materials in HNI Workplace Furnishings by spend. By 2025, we are aiming to understand the chemical constituents down to 100 parts per million (ppm) for 100% of our materials by spend across the portfolio.

This effort requires internal systems to support the data, tools for HNI engineers to make informed choices, and collaboration with our supply chain partners. Ultimately, this work will enable HNI to make more sustainable and circular products, eliminate chemicals of concern, and support our ability to comply with the ever-changing landscape of chemical regulations.

DESIGNING FOR THE ENVIRONMENT

We begin the new product development process with material evaluation and sustainability analysis. Our goal is to develop products that stand the test of time, meet

rigorous third-party environmental standards, and integrate circular materials thoughtfully.

To reduce the life cycle and environmental impacts of our products, we focus on the following areas:

- 1 Responsible Materials
- 2 Reusing Waste
- 3 End of Life
- 4 Transparency Through Certification

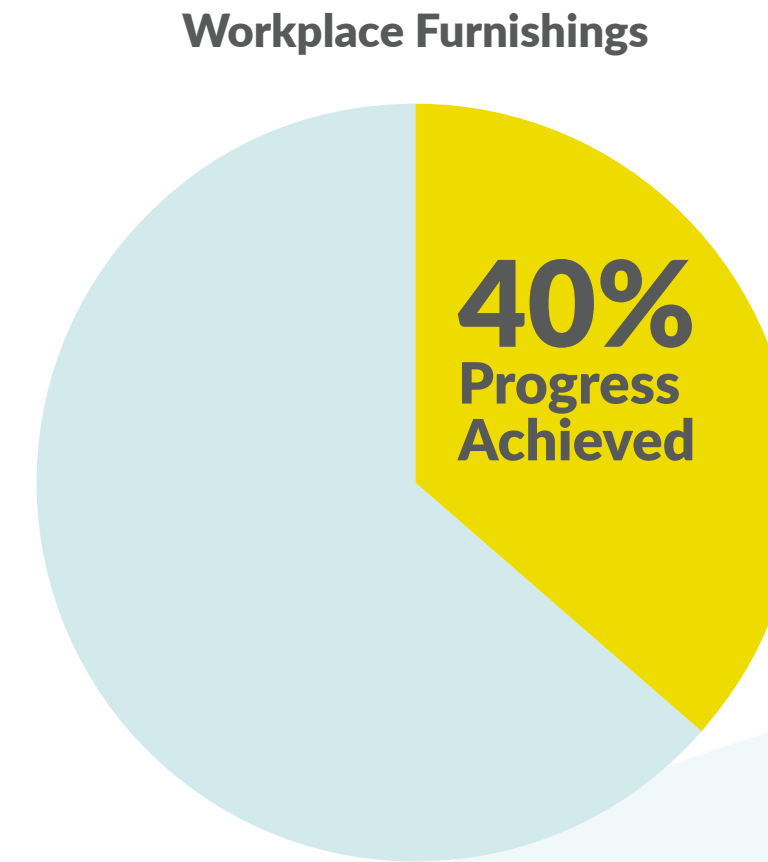

Goal:
100% material transparency (down to 100 ppm).
Progress:
40% of materials by spend achieved.



Gunlocke introduces low-VOC water-based wood finish.

Redefining Tomorrow

Designing for Environmental and Human Health

1 Responsible Materials



Approximately 95% of all task chairs

The chairs are manufactured without adhesives as part of the back construction. This allows for ease of disassembly and increased potential for the materials to be recycled at the end of life.



Forest Stewardship Council® (FSC®) Wood

In 2021, HNI purchased 50,300 tons of FSC® wood to use in our products. In 2022, we bought 58,796 tons.

Steel

The steel we purchase has 83%-90% recycled material.

Tyler Chair by HBF

The chair back is made of 100% post-consumer plastic recycled from five-gallon plastic buckets.



Particle Board

The particle board we use contains 100% recycled/recovered wood content.



Aluminum

The aluminum we source is 75%-98% recycled content.



Crumpled Paper by HBF Textiles

The fabric is made from 100% biodegradable post-consumer recycled polyester.



Allsteel and Gunlocke partner with non-profit company ANEW® to keep used furniture out of landfills.

Redefining Tomorrow

Designing for Environmental and Human Health

2 Reusing Waste

Pellet Stoves

Pellet stoves are designed to efficiently burn industrial wood waste.



Scrap Fabric

Fabric waste is converted into “shoddy,” which is used as an acoustical material for automotive interiors, such as trunk liners.

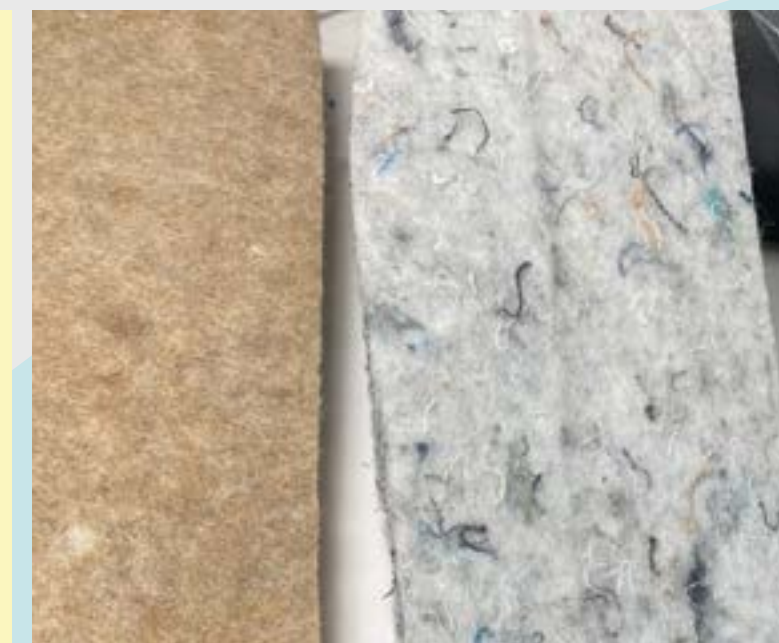

Stoves

Cast iron stoves use 100% recycled brake drums and rotors as raw material.



Comold

Wood scrap (local post-industrial waste) is used as the structural support beneath the foam in our chairs.



Counterweights

Composite counterweights are made up of 87% mill scale and 13% reground polypropylene plastic. Annually we use approximately 920,000 pounds of recycled material in our composite counterweights.



Allsteel's Further Adaptive and Mimeo seating win GREEN GOOD DESIGN Awards for use of sustainable materials and human-centric design.

Redefining Tomorrow

Designing for Environmental and Human Health

3 End of Life

END OF LIFE FOR HNI WORKPLACE PRODUCTS

In the effort to keep HNI products out of the landfill, even after years of regular use, our company is actively researching ways to give our products a second life. To this end, we have partnered with Asset Network for Education Worldwide® (ANEW®), a non-profit founded in 2004 to repurpose used office furnishings.

On average, ANEW® sends more than 3 million pounds of used furniture to schools and other organizations

every year instead of discarding these items in a landfill. They have supplied used, but still useful, furniture to over 2,000 recipient organizations in 20 countries. Through HNI's partnership with ANEW®, customers can repurpose their products, support local and national organizations, and reduce waste.

Additionally, we provide disassembly diagrams and environmental data sheets for our products. These documents detail information on product materials and recyclability. They are intended to inform and support our customers on how to effectively recycle our products at the end of their useful life.

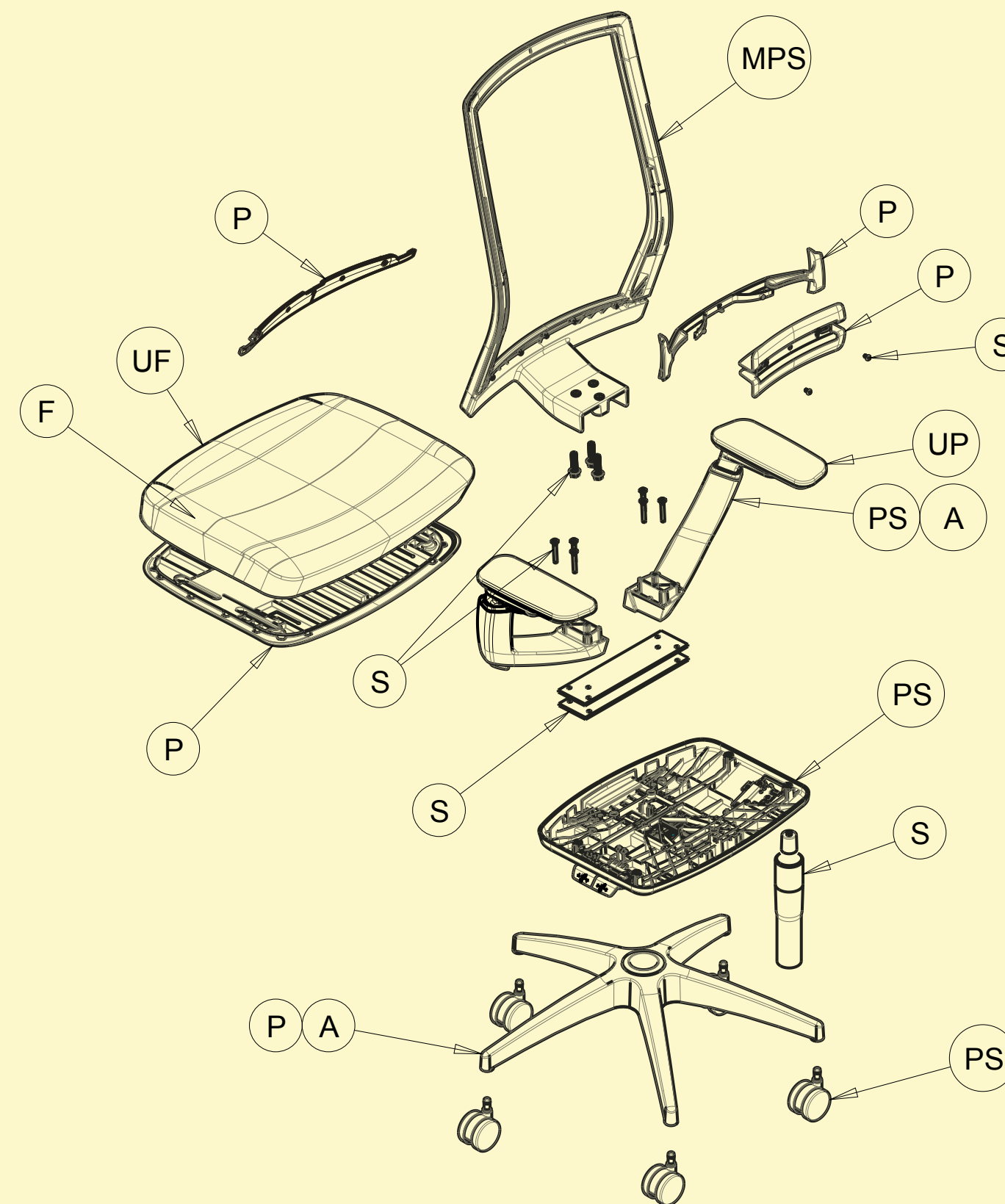

Key

- A-Aluminum
- F-Fabric
- P-Plastic
- MPS-Mesh, Plastic & Steel
- S-Steel
- PS-Plastic & Steel
- UP-Unsaturated Polyester
- UF-Urethane Foam



HNI members and partners raise a record \$650,000 for the City of Hope.

Redefining Tomorrow

Designing for Environmental and Human Health

4 Transparency Through Certification

Product Series Counts

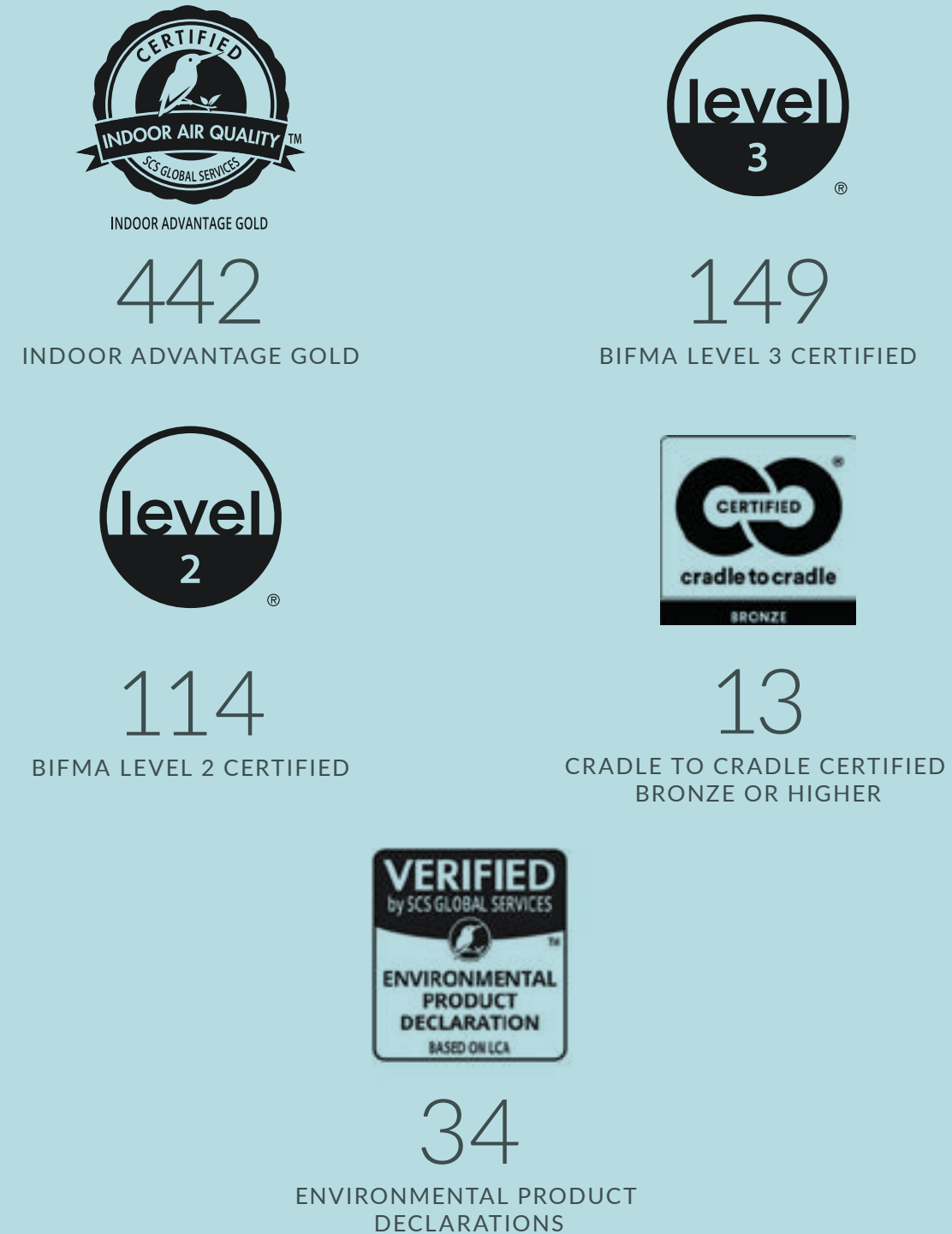

PRODUCT CERTIFICATIONS

HNI has long been committed to third-party certifications of our products. We believe they provide credibility to our claims and enable our customers to meet their own sustainable design goals. HNI continues to work on developing sustainability guidelines for our industries and the built environment. Over 90% of our furniture and textile products are certified to exceed the stringent air quality requirements of third-party certifications. Within our portfolio,

we have products that have achieved Cradle to Cradle, Bronze, and Business and Institutional Furniture Manufacturer's Association (BIFMA) LEVEL® 2 and 3. As a result of our increased material transparency work, we have advanced certification of our task seating for HON and Allsteel from LEVEL® 2 to LEVEL® 3. We are also incorporating life cycle analysis into our DfE process to generate more Environmental Product Declarations and understand the embedded carbon of our products and materials.

 HNI releases first Corporate Social Responsibility report.

Redefining Tomorrow

Designing for Environmental and Human Health



FIREPLACE AND STOVE PRODUCTS

When it comes to creating warm, glowing products for the home, HNI offers a range of fireplaces, inserts, and stoves powered by a variety of fuel sources, such as efficient natural gas, recycled wood pellets, electricity, and traditional wood. Further, HNI continuously works to improve products to meet the highest industry standards.

We promote ways to make every stove and hearth product more sustainable. Nearly all (98%) of our gas fireplaces are manufactured with intermittent pilot ignition (IPI). Unlike

traditional standing (always on) pilot lights, the IPI feature means it's only on when the fireplace is on, saving money and fuel and reducing GHGs. HHT engineers are also working on a heat management system to divert heat from a stove to a

different part of the home using a ventilation system. With every new solution, we are building upon a heritage of 36 years—and counting—of innovation from this division.

The majority of the products in Hearth & Home's stove portfolio qualifies for federal tax credits by meeting or exceeding high efficiency values.



HNI sets company science-based targets to help limit global warming to 1.5°C.

Redefining Tomorrow

A Pioneering Environmental Impact

HHT partnered with ICONIC LIFE Magazine in the Net Zero ICONIC Home, the nation’s first-ever sustainable showhouse, built in Cave Creek, Arizona. The elegant, custom home featured HHT’s

Heat & Glo® fireplaces along with a variety of sustainable and innovative products all working together to create a high-efficiency, forward-thinking residential space that will stand the test of time.

The home, which is so airtight and efficient that it produces as much energy as it consumes, includes gas, electric, and outdoor Heat & Glo® fireplaces.

“At its core, HHT is innovation. Partnering with the Net Zero ICONIC Home project was an ideal way for us to support a cause we believe in, while showing the world how we have evolved hearth products with progressive engineering. They absolutely can, and should, be part of a sustainable, environmentally responsible home.”

—V. P. Berger, President, Hearth and Home Technologies

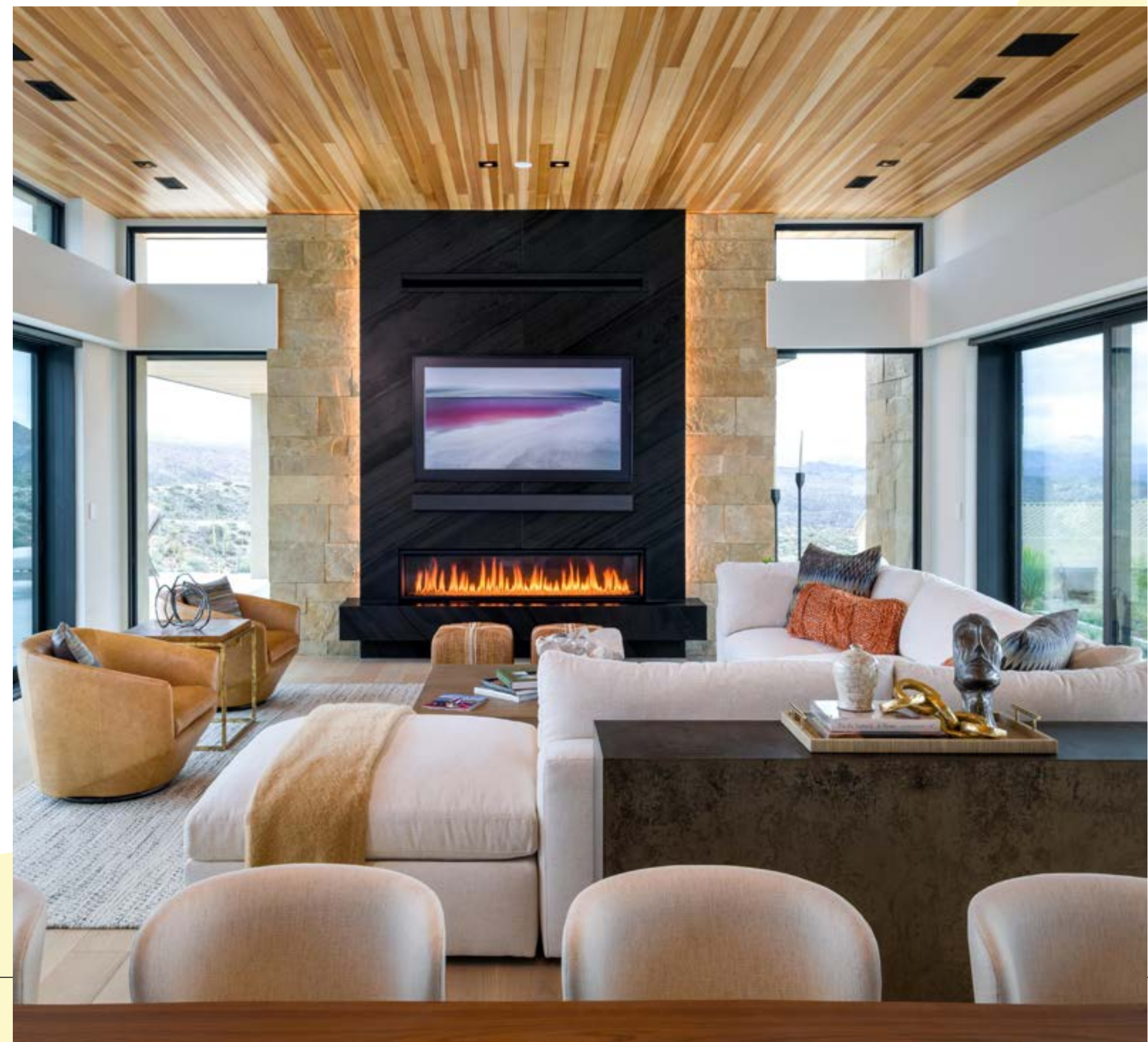

HNI donates funds to restore tree canopy in Muscatine after 2020 Midwest derecho.

Redefining Tomorrow

A Pioneering Environmental Impact

THE STANLEY CENTER LIVING BUILDING CHALLENGE

HNI has continuously supported our customers in meeting their green building goals, and our products have helped them achieve LEED® Certification and WELL Building Standard™ for decades. We are now proud to engage in the Living

Building Challenge as a pioneering effort in regenerative design.

Recently, we worked with our neighbor, the renowned Stanley Center for Peace and Security, to develop the first full Living Building certification in the state of Iowa—and one of less than 35 such buildings in the world.

HNI’s products specifically supported the Materials Petal of the Living Building Challenge. The intent of the Materials Petal is to help create a materials economy that is non-toxic, ecologically restorative, transparent, and socially equitable. Two HNI products, the Beyond architectural wall system from Allsteel and Silea caseloads from Gunlocke, earned DeclareSM labels from the International

Living Future Institute. Through this process, our members vetted all materials and provided documentation to show our products are free of Red List materials or chemicals. This collaboration demonstrates our dedication to our community, our commitment to market leadership in the healthy materials movement, and our support of evolving sustainable building standards.



“Through HNI’s collaboration with The Stanley Center in the Living Building Challenge, our organizations walk a shared path of innovation.”

—Shelby Kresel, Corporate Sustainability Manager



Declare.

Architectural Products for Stanley Center Peace & Security Allsteel Inc.

Final Assembly: Muscatine, IA
Life Expectancy: 30 Year(s)
End of Life Options: Salvageable/Reusable in its Entirety, Take Back Program (Anew), Recyclable (22-100%)

Ingredients:

Fumed Silica; Aluminum; Cellulose; Wood Fibers; Glass, oxide, chemicals; Urea, polymer with formaldehyde and 1,3,5-triazine-2,4,6-triamine¹; Polymethylene polyphenyl isocyanate; Unnamed Substance; Hydrocarbon waxes (petroleum), hydrotreated microcryst.; Phenol, polymer with formaldehyde¹; Iron; Quercus; Oak; Slack wax (petroleum); Urea; Ammonium Sulfate; Magnesium; Titanium; Zinc; Water; Copper; Undisclosed (0.029-0.033%)²; Polypropylene; Monoprene; Silicon; Manganese

¹LBC Temp Exception RL-009 - Formaldehyde
²LBC Temp Exception RL-004b - Proprietary Ingredients in Declare

Living Building Challenge Criteria: Compliant

I-13 Red List:

<input type="checkbox"/> LBC Red List Free	% Disclosed: 99.97% at 100ppm
<input checked="" type="checkbox"/> LBC Red List Approved	VOC Content: Not Applicable
<input type="checkbox"/> Declared	

I-10 Interior Performance: CDPH Standard Method v1.2-2017
I-14 Responsible Sourcing: Product Available with FSC Chain of Custody

HNI-0001
 EXP. 01 JUN 2023
 Original Issue Date: 2022

Third Party Verified

MANUFACTURER CLAIMS VERIFIED BY WAP SUSTAINABILITY INTERNATIONAL LIVING FUTURE INSTITUTE™ living-future.org/declare

APPENDIX



GRI Content Index HNI has reported the information cited in this GRI content index for the period spanning January 3, 2021 to December 31, 2022, with reference to the GRI Standards and using GRI 1: Foundation 2021.

GRI Standard	Disclosure Title	HNI 2022 Reference/Response	Related SDGs
<i>GRI 2: General Disclosures 2021</i>			
2-1	Organizational details	HNI Corporation (HNI) is a publicly traded company listed on the New York Stock Exchange (NYSE: HNI). HNI Corporation's world headquarters is located in Muscatine, Iowa. Office furniture products are manufactured in Georgia, Iowa, New York, North Carolina, Mexico, and India. Hearth products are manufactured in Iowa, Minnesota, Pennsylvania, and Vermont.	
2-2	Entities included in the organization's sustainability reporting	2022 Form 10-K ↗	
2-3	Reporting period, frequency, and contact point	This report covers fiscal years 2021 and 2022, spanning January 3, 2021 to December 31, 2022, and was published in July 2023. Sustainability data is reported biennially. Please direct questions to CSR@HNICorp.com	
2-4	Restatements of information	There are no restatements of information at this time.	
2-5	External assurance	At this time, HNI has not had this report externally assured.	
2-6	Activities, value chain, and other business relationships	<p>2022 Form 10-K ↗</p> <p>HNI partners with suppliers who are experts in their industries and who share our values and culture of integrity. In both our office furniture and hearth segments, international and domestic, we require our suppliers to comply with our Code of Conduct. Our Code of Conduct contains criteria addressing treating others with fairness and respect; being open, honest, and trustworthy; operating facilities and sourcing materials in an environmentally sustainable and socially responsible manner; prohibiting involuntary, forced, or child labor; and following all laws and regulations. We prioritize working with suppliers who share our focus on creating high-quality products and materials, delivered on time, that are cost-effective and safely manufactured.</p> <p>We source raw materials domestically that we transform in our manufacturing facilities, including steel, aluminum, zinc, wood materials, and surface finishes, among other materials. We partner with knowledgeable suppliers around the globe to source technically complex components and subassemblies.</p> <p>For suppliers located in Asia, we have a targeted and robust corporate social responsibility auditing process run by a third party to ensure suppliers follow appropriate labor, safety, environmental, and other CSR requirements. The program is based on SA8000 standards, with additional EHS-related regulations. Our third-party auditor is engaged on a continuous basis to monitor, provide suggestions, evolve our standards, and certify our program, with audits conducted on an annual basis.</p>	SDGs 8, 9, 10, 12 ↗

2-7	Employees		Men	Women	Total	% Men	% Women	Total	SDGs 8, 10 ↗	
		U.S. Members (Hourly)	2959	1454	4413	67.1%	32.9%	100.0%		
		U.S. Members (Salaried)	1296	791	2087	62.1%	37.9%	100.0%		
		Total Domestic Members	4255	2245	6500	65.5%	34.5%	100.0%		
		<i>Data presented is from 2022.</i>								
		Asia Pacific Members (Hourly)	161	1	162	99.4%	0.6%	100.0%		
		Asia Pacific Members (Salaried)	347	76	423	82.0%	18.0%	100.0%		
		Total Asia Pacific Members	508	77	585	86.8%	13.2%	100.0%		
		<i>Data presented is from 2022.</i>								
2-8	Workers who are not employees	<p>As of 2022 year end, HNI had approximately 480 workers who are not employees, based on the actual number of temporary workers and an estimate of contract workers.</p> <p>The most common types of non-employee workers are:</p> <ul style="list-style-type: none"> • Temporary workers, who augment HNI's employee workforce as needed through periods of peak or seasonal demand, particularly when availability of talent in the local labor market is insufficient to meet the business' current needs. HNI typically partners with staffing agencies to place these temporary workers as needed within our operations. Most commonly, they are used in production, distribution, and office administrative functions. • Contract workers, who are typically self-employed or employed through a contracting agency, and who provide consultation or professional support for focused projects and/or functions for specified period of time. 							SDG 8 ↗	
2-9	Governance structure and composition	<p>2022 CSR Report, Governance, page 7</p> <p>2023 Proxy Statement ↗</p>							SDGs 5, 16 ↗	
2-10	Nomination and selection of the highest governance body	HNI Corporate Governance Guidelines ↗							SDGs 5, 16 ↗	
2-11	Chair of the highest governance body	2023 Proxy Statement ↗							SDG 16 ↗	

2-12	Role of the highest governance body in overseeing the management of impacts	2023 Proxy Statement ↗ Our Board of Directors oversees economic, environmental, social, and governance impacts.	SDG 16 ↗
2-13	Delegation of responsibility for managing impacts	2023 Proxy Statement ↗	
2-14	Role of the highest governance body in sustainability reporting	2023 Proxy Statement ↗	
2-15	Conflicts of interest	Non-employee directors receive and respond to HNI’s Conflict of Interest Questionnaire annually. The questionnaire outlines HNI’s policy and allows directors to make any necessary disclosures. HNI Corporate Governance Guidelines ↗ HNI Member Code of Integrity ↗	SDG 16 ↗
2-16	Communication of critical concerns	HNI’s Executive Management team engages with the Board of Directors regarding any critical concerns. There were no reports of critical concerns to the Board of Directors in 2021 or 2022.	
2-17	Collective knowledge of the highest governance body	HNI Corporate Governance Guidelines ↗	
2-18	Evaluation of the performance of the highest governance body	HNI Corporate Governance Guidelines ↗	SDG 16 ↗
2-19	Remuneration policies	HNI Human Resources and Compensation Committee Charter ↗ 2023 Proxy Statement ↗	SDG 16 ↗
2-20	Process to determine remuneration	2023 Proxy Statement ↗	SDG 16 ↗
2-21	Annual total compensation ratio	2022 Proxy Statement ↗ 2023 Proxy Statement ↗	

2-22	Statement on sustainable development strategy	2022 CSR Report, Leadership, pages 3, 5	
2-23	Policy commitments	HNI Member Code of Integrity ↗ HNI Supplier Code of Conduct ↗	SDGs 5, 8, 10, 12, 16 ↗
2-24	Embedding Policy Commitments	2023 Proxy Statement ↗	
2-25	Processes to remediate negative impacts	HNI Member Code of Integrity ↗ HNI Supplier Code of Conduct ↗	
2-26	Mechanisms for seeking advice and raising concerns	<p>HNI’s values are outlined for our members in our Member Code of Integrity. It is HNI’s expectation that any suspected violations of our Code, company policy, and the law are reported immediately through the appropriate channels so that HNI may investigate.</p> <p>We encourage members to discuss any concerns with their manager or with their Member and Community Relations (MCR) manager. If a resolution cannot be achieved, concerns are escalated to additional levels of management, including the CEO or Vice President of MCR.</p> <p>For members, partners, or suppliers who would like to report concerns anonymously and confidentially, our web- and phone-based Speak Up system is available. Concerns reported through Speak Up are routed through the appropriate channels until a resolution can be achieved.</p> <p>HNI Member Code of Integrity ↗ HNI Supplier Code of Conduct ↗</p>	SDG 16 ↗
2-27	Compliance with laws and regulations	2022 Form 10-K ↗	

<p>2-28</p>	<p>Membership associations</p>	<p>HNI and its brands are members of the following organizations:</p> <ul style="list-style-type: none"> • American Society of Heating, Refrigerating and Air-Conditioning Engineers (ASHRAE) • American Society of Interior Designers (ASID) • ASTM International • Better Plants Partner with the U.S. Department of Energy • Business and Institutional Furniture Manufacturers Association (BIFMA) • Business Climate Leaders • Coalition for Government Procurement • Greater Muscatine Chamber of Commerce and Industry • Green Chemistry and Commerce Council • Health Product Declaration Collaborative (HPDC) • Hearth, Patio, and Barbecue Association (HPBA) • Interior Design Continuing Education Council (IDCEC) • International Interior Design Association (IIDA) • International WELL Building Institute (IWBI) • Iowa Association of Business and Industry (ABI) • Iowa Business Council • Iowa Lean Consortium • Iowa Sustainable Business Forum (ISBF) • MAPI Ethics and Compliance Council • Pellet Fuels Institute • Renewable Energy Buyers Alliance (REBA) • SmartWay® Transport Partner • TRACE International • U.N. Global Compact (UNGC) • U.S. Green Building Council (USGBC) • United Way • We Mean Business Coalition • Women Lead Change 	
<p>2-29</p>	<p>Approach to stakeholder engagement</p>	<p>HNI's stakeholders were identified as the groups that our business and actions can potentially impact in a significant way. HNI's stakeholder groups include our members (employees), customers, dealer partners, our suppliers and logistics partners, investors, peers, local organizations in our communities, the architectural and design community, general contractors, builders, policy makers, and trade associations.</p> <p>2022 CSR Report, 2022 Materiality Assessment, page 8</p>	
<p>2-30</p>	<p>Collective bargaining agreements</p>	<p>Per government regulations, a union agreement covers factory members at our Nagpur facility in India, representing 49% of HNI India members.</p> <p>Per government regulations, a collective bargaining agreement covers 51% of workers in Mexico.</p>	

<i>GRI 3: Material Topics 2021</i>			
3-1	Process to determine material topics	2022 CSR Report, 2022 Materiality Assessment, page 8 <p>HNI updated our materiality assessment utilizing a third party to outreach to stakeholders, including customers, suppliers, members, industry groups, and leaders in the organization. The assessment included direct engagement with key senior leaders to better understand management’s perspective on the risks and opportunities that are most relevant and impactful to HNI’s business success. In this second phase, the perspectives of several key stakeholder groups through a combination of direct engagement, analysis of external reported data, and other research to determine the significance of specific environmental and social topics was analyzed. Using findings from these phases, a thorough quantitative scoring system analysis was conducted to prioritize the topic areas that are most important to HNI’s management, internal and external stakeholder perspectives, and ongoing business success. From here, HNI developed a series of actions and recommendations and continues to integrate this analysis into reporting and overall ESG strategy.</p>	
3-2	List of material topics	2022 CSR Report, 2022 Materiality Assessment, page 8	
3-3	Management of material topics	2022 CSR Report	
<i>GRI 201: Economic Performance 2016</i>			
3-3	Management of material topics	2022 Form 10-K ↗	
201-1	Direct economic value generated and distributed	2022 Form 10-K ↗	SDGs 8, 9 ↗
201-2	Financial implications and other risks and opportunities due to climate change	CDP Climate Change disclosure, Sections C2 and C3 ↗	SDG 13 ↗
201-3	Defined benefit plan obligations and other retirement plans	2022 Form 10-K ↗	

201-4	Financial assistance received from government	HNI receives assistance in the form of tax credits. The tax credits received are primarily for research and development (R&D). In 2021, HNI received \$4.2 million in U.S. federal and state tax credits related to 2020 tax returns. In 2022, HNI received \$3.8 million in U.S. federal and state tax credits related to 2021 tax returns.	
<i>GRI 202: Market Presence 2016</i>			
3-3	Management of material topics	2022 Form 10-K ↗	
202-1	Ratios of standard entry-level wage by gender compared to local minimum wage	2022 Form 10-K ↗	SDG 8 ↗
202-2	Proportion of senior management hired from the local community	In 2022, 76% of senior management hired at signification locations of operation were from the local community. HNI uses the following definitions: <ul style="list-style-type: none"> • Senior management: positions of director level or higher (including Directors, Vice Presidents, Presidents, and C-level executives) who work on site at a significant location of operation • Local: within a 100-mile radius from the significant location of operation • Significant location of operation: any location on the Muscatine, Iowa, campus and any locations outside Muscatine that employ at least 100 members 	SDG 8 ↗
<i>GRI 203: Indirect Economic Impacts 2016</i>			
3-3	Management of material topics	2022 Form 10-K ↗	
203-1	Infrastructure investments and services supported	2022 CSR Report, Choose Green Muscatine, page 22	SDGs 5, 9, 11 ↗
203-2	Significant indirect economic impacts	2022 Form 10-K ↗	SDGs 1, 3, 8 ↗

GRI 204: Procurement Practices 2016			
3-3	Management of material topics	2022 CSR Report, Supplier Code of Conduct, page 20 HNI Supplier Code of Conduct ↗	
204-1	Proportion of spending on local suppliers	We follow lean management principles in our operations and, therefore, prioritize local sourcing. HNI spends about 80% of our purchasing power with suppliers local (in-country) to our operations.	SDGs 8, 9, 12 ↗
GRI 205: Anti-corruption 2016			
3-3	Management of material topics	2022 Form 10-K ↗ HNI Member Code of Integrity ↗	
205-1	Operations assessed for risks related to corruption	<p>It is the policy of HNI Corporation that our members and suppliers adhere to standards of ethical conduct. We are committed to conducting business with honesty, respect, and integrity—with every member, every customer, every supplier, every shareholder, every time.</p> <p>HNI Member Code of Integrity ↗</p> <p>HNI Supplier Code of Conduct ↗</p>	SDG 16 ↗
205-2	Communication and training about anti-corruption policies and procedures	<p>HNI trains new members on anti-corruption, and existing salaried members, including management, receive training every two years. Additional anti-corruption training is provided to members in sales, marketing, and procurement every two years.</p> <p>In 2022, 100% of salaried members received anti-corruption communication and training.</p> <p>100% of Tier 1 suppliers have acknowledged compliance to HNI’s Code of Conduct, covering anti-corruption policies and procedures.</p>	SDG 16 ↗
205-3	Confirmed incidents of corruption and actions taken	HNI strictly prohibits all forms of corruption. Related to bribery and corruption, there are no known incidents or legal cases that would have an impact on our organization or stakeholders. HNI investigates all reported incidents of questionable or unethical behavior, and we do not allow retaliation against members who make good faith reports of possible ethics violations. We provide our members and partners with the ability to report anonymously through our Speak Up system.	SDG 16 ↗

GRI 206: Anti-competitive Behavior 2016			
3-3	Management of material topics	HNI Member Code of Integrity ↗ HNI Supplier Code of Conduct ↗	
206-1	Legal actions for anti-competitive behavior, antitrust, and monopoly practices	HNI did not have any legal actions pending or completed during the reporting period regarding anti-competitive behavior or violations of antitrust and monopoly legislation.	SDG 16 ↗
GRI 301: Materials 2016			
3-3	Management of material topics	2022 CSR Report, Designing for Environmental and Human Health, pages 30-35	
301-1	Materials used by weight or volume	Our furniture products feature steel, aluminum, wood, structural plastics, foam, glass, paint, and fabrics. Our hearth products feature steel, cement, refractory, glass, paint, and complex electrical components. Product material weight and volume can vary significantly based on product type.	SDGs 8, 12 ↗
301-2	Recycled input materials used	<p>For a majority of our U.S.-based furniture products, we provide material breakdown information, including recycled contents of our materials, on our Environmental Data Sheets, available on brand websites.</p> <p>Our Hearth products feature steel with high recycled content and cast iron hearth products, made at our facility in Vermont, feature 100% post-consumer recycled material.</p> <p>2022 CSR Report, Designing for Environmental and Human Health, pages 30-35</p>	SDGs 8, 12 ↗
301-3	Reclaimed products and their packaging materials	2022 CSR Report, Designing for Environmental and Human Health, pages 30-35	SDGs 8, 12 ↗

GRI 302: Energy 2016			
3-3	Management of material topics	2022 CSR Report, GHG Emissions and Energy, pages 22-25	
302-1	Energy consumption within the organization	<p>Energy consumed across HNI's global facilities was calculated at:</p> <p>2021: 1,511,574 GJ 2022: 1,532,703 GJ</p> <p>Total fuel consumption from non-renewable sources by business segment:</p> <p>2021 Workplace Furnishings: 569,359 GJ 2021 HHT: 320,164 GJ 2021 Corporate: 5,122 GJ</p> <p>2022 Workplace Furnishings: 606,415 GJ 2022 HHT: 323,869 GJ 2022 Corporate: 4,317 GJ</p> <p>Total electricity consumption by business segment:</p> <p>2021 Workplace Furnishings: 426,732 GJ 2021 HHT: 181,986 GJ 2021 Corporate: 8,211 GJ</p> <p>2022 Workplace Furnishings: 419,317 GJ 2022 HHT: 173,529 GJ 2022 Corporate: 5,256 GJ</p> <p>HNI is committed to reducing consumption of energy from non-renewable sources. Please reference our 2022 CSR Report (pages 24-25) and HNI's annual CDP Climate Change disclosure for additional information.</p>	SDGs 7, 8, 12, 13
302-2	Energy consumption outside of the organization	<p>CDP Climate Change disclosure</p> <p>For updated data, see 2022 CSR Report, Energy, page 23</p>	SDGs 7, 8, 12, 13
302-3	Energy intensity	<p>HNI calculates energy intensity as total energy consumption within the organization per metric ton of goods sold.</p> <p>2021: 7.24 GJ per metric ton of goods sold 2022: 7.49 GJ per metric ton of goods sold</p>	SDGs 7, 8, 12, 13

302-4	Reduction of energy consumption	2022 CSR Report, Energy, pages 24-25	SDGs 7, 8, 12, 13 ↗
302-5	Reductions in energy requirements of products and services	2022 CSR Report, Energy, page 23	SDGs 7, 8, 12, 13 ↗
<i>GRI 303: Water and Effluents 2018</i>			
3-3	Management of material topics	2022 CSR Report, 2022 Materiality Assessment, page 8	
303-1	Interactions with water as a shared resource	HNI recognizes that water is a scarce natural resource in many parts of the world, and we are working to become more efficient with our water use at all facilities. Within our facilities, we use water for cutting, painting, finishing, molding, and cleaning processes, as well as for the needs of our members. We monitor our consumption on an ongoing basis and identify opportunities to reduce our water use. We also work with local municipalities on permitting, where needed. At facilities with finishing systems, we test our water regularly to ensure we are within permit limits, and we ensure our facilities and maintenance teams act in accordance with regulations. We are in compliance with water discharge regulations.	SDGs 6, 12 ↗
303-2	Management of water discharge-related impacts	HNI operates in compliance with all discharge limits and regularly tests and monitors discharged water. Our HNI India facility is ISO 14001 certified. This system helps drive and ensure compliance with all water-related activities.	SDGs 6, 12 ↗
303-3	Water withdrawal	2021 Water Withdrawal: 258 megaliters 2022 Water Withdrawal: 267 megaliters	SDG 6 ↗
303-4	Water discharge	Water discharges are not tracked, so water discharges are assumed to equal withdrawals. Most water use is for sanitary purposes. 2021 Water Discharge: 258 megaliters 2022 Water Discharge: 267 megaliters	SDGs 6, 12 ↗
303-5	Water consumption	Water discharges are not tracked, so water discharges are assumed to be equal to intake. Most water use is for sanitary purposes.	SDG 6 ↗
<i>GRI 304: Biodiversity 2016</i>			
3-3	Management of material topics	HNI Supplier Code of Conduct ↗	

304-1	Operational sites owned, leased, managed in, or adjacent to protected areas and areas of high biodiversity value outside protected areas	HNI does not own, lease, or manage any sites in or adjacent to protected areas or areas of high biodiversity value outside protected areas as defined by the International Union for Conservation of Nature (IUCN) Protected Area Management Categories, Ramsar Convention, or national legislation.	SDGs 6, 14, 15 ↗
304-2	Significant impacts of activities, products, and services on biodiversity	<p>HNI is committed to sourcing wood from legal and sustainable sources that support biodiversity.</p> <p>In 2009, we began offering FSC® Certified U.S.-based furniture products to customers. FSC® uses the High Conservation Value (HCV) approach—identifying, managing, and monitoring—in their certification standards and more generally as a resource for conservation planning. FSC® seeks to maintain, enhance, and promote the importance of these values. A key part of HCV is ensuring activity in forests does not have a negative impact on biodiversity—that is, the diversity within and between species, and the ecosystem as a whole, including forests. For FSC®, maintaining and implementing management of biodiversity and HCV go hand in hand. HNI purchased over 43,000 metric tons of FSC® controlled wood in 2021 and over 51,000 metric tons in 2022.</p>	SDGs 6, 12, 14, 15 ↗
304-3	Habitats protected or restored	<p>2022 CSR Report, Reviving Muscatine's Trees, page 19</p> <p>In 2009, we began offering FSC® Certified U.S.-based furniture products to customers. FSC® uses the High Conservation Value (HCV) approach—identifying, managing, and monitoring—in their certification standards and more generally as a resource for conservation planning. FSC® seeks to maintain, enhance, and promote the importance of these values. A key part of HCV is ensuring activity in forests does not have a negative impact on biodiversity—that is, the diversity within and between species, and the ecosystem as a whole, including forests. For FSC®, maintaining and implementing management of biodiversity and HCV go hand in hand. HNI purchased over 43,000 metric tons of FSC® controlled wood in 2021 and over 51,000 metric tons in 2022.</p>	SDGs 6, 12, 14, 15 ↗
304-4	IUCN Red List species and national conservation list species with habitats in areas affected by operations	<p>It is HNI's policy to avoid sourcing species of wood materials that are Convention on International Trade in Endangered Species of Wild Fauna and Flora (CITES) listed or identified on the IUCN's Red List of Threatened Species as endangered, critically endangered or extinct in the wild.</p> <p>It is also HNI's policy to avoid using wood from forest areas where traditional or civil rights are violated, forest areas where HCVs are threatened by management activities, wood from forests in which genetically modified trees are planted, wood that has been harvested illegally, or wood harvested from areas that have been converted from natural forest to plantations or non-forest uses.</p>	SDGs 6, 12, 14, 15 ↗
GRI 305: Emissions 2016			
3-3	Management of material topics	CDP Climate Change disclosure ↗	

305-1	Direct (Scope 1) GHG emissions	<p>2021 Scope 1 GHG emissions: 44,973 MTCO₂e 2022 Scope 1 GHG emissions: 47,182 MTCO₂e Please reference HNI's annual CDP Climate Change disclosure for additional information.</p>	SDGs 3, 7, 12, 13, 14, 15
305-2	Energy indirect (Scope 2) GHG emissions	<p>2021 Location-based Scope 2 GHG emissions: 47,469 MTCO₂e 2021 Market-based Scope 2 GHG emissions: zero MTCO₂e due to the purchase of 184,500 MWh of renewable energy certificates (RECs) 2022 Location-based Scope 2 GHG emissions: 53,578 MTCO₂e 2022 Market-based Scope 2 GHG emissions: zero MTCO₂e due to the purchase of 167,000 MWh of RECs Please reference HNI's annual CDP Climate Change disclosure for additional information.</p>	SDGs 3, 7, 12, 13, 14, 15
305-3	Other indirect (Scope 3) GHG emissions	<p>Scope 3 GHG emissions were calculated at 2,787,763 MTCO₂e in 2022 and 3,086,250 MTCO₂e in 2021. Scope 3 emissions decreased in 2022 due to a decrease in sales of HHT products and related product use emissions. The following categories are included in Scope 3 emissions calculations:</p> <ul style="list-style-type: none"> • Purchased goods and services • Fuel and energy-related activities • Upstream transportation and distribution • Waste generated in operations • Business travel • Employee commuting • Use of sold products • End-of-life treatment of sold products <p>Please reference HNI's annual CDP Climate Change disclosure for additional information.</p>	SDGs 3, 7, 12, 13, 14, 15
305-4	GHG emissions intensity	<p>HNI's GHG emissions intensities were calculated as follows:</p> <ul style="list-style-type: none"> • 2022 Combined Scope 1 and 2: 0.22 MTCO₂e per metric ton of goods sold* • 2021 Combined Scope 1 and 2: 0.23 MYCO₂e per metric ton of goods sold* • 2022 Scope 3: 13.62 MTCO₂e per metric ton of goods sold • 2021 Scope 3: 14.79 MTCO₂e per metric ton of goods sold <p>*Intensity calculated using market-based Scope 2 emissions</p>	SDGs 3, 7, 12, 13, 14, 15
305-5	Reduction of GHG emissions	2022 CSR Report, GHG Emissions, pages 22-23	SDGs 3, 7, 12, 13, 14, 15

<i>GRI 306: Effluents and Waste 2016</i>			
3-3	Management of material topics	2022 CSR Report, Waste, pages 26-27	
306-1	Waste generation and significant waste-related impacts	HNI Corporation is pursuing zero waste to landfill for all facilities by 2030. 2022 CSR Report, Waste, pages 26-27	SDGs 3, 6, 11, 12, 13 ↗
306-2	Management of significant waste-related impacts	To support HNI's goal of zero waste to landfill at all facilities by 2030, our internal teams have been leading waste audits and waste mapping efforts to understand how much waste is currently recycled or landfilled at each facility. We work with our supplier and waste hauling partners to track monthly totals and review those numbers on a regular basis. Some of our facilities produce hazardous waste. The hauling and disposal of all hazardous waste is managed by a third-party that follows all applicable regulatory requirements. To reduce the amount of waste produced in the manufacture of our products, our internal teams work to identify opportunities to remove waste from processes internally as well as upstream at our suppliers' facilities and downstream for our customers through our Design for the Environment process. We also continue to identify opportunities for reuse as well as identify partners to assist us with recycling any waste materials. To manage business waste in our corporate offices, we implemented single-stream recycling. 2022 CSR Report, Waste, pages 26-27	SDGs 3, 6, 11, 12, 13 ↗
306-3	Waste generated	2022 CSR Report, Waste, pages 26-27	SDGs 3, 6, 11, 12, 13 ↗
306-4	Waste diverted from disposal	2022 CSR Report, Waste, pages 26-27	SDGs 3, 6, 11, 12, 13 ↗
306-5	Waste directed to disposal	2022 CSR Report, Waste, pages 26-27	SDGs 3, 6, 11, 12, 13 ↗
<i>GRI 308: Supplier Environmental Assessment 2016</i>			
3-3	Management of material topics	HNI Supplier Code of Conduct ↗ 2022 CSR Report, Supplier Code of Conduct, page 20	

<p>308-1</p>	<p>New suppliers that were screened using environmental criteria</p>	<p>HNI partners with suppliers that are experts in their industries and share our values and culture of integrity. In both our office furniture and hearth segments, international and domestic, we require our suppliers to comply with our Code of Conduct. Our Code of Conduct contains criteria addressing treating others with fairness and respect; being open, honest, and trustworthy; operating facilities and sourcing materials in an environmentally sustainable and socially responsible manner; and following all laws and regulations. We prioritize working with suppliers that share our focus on creating high-quality products and materials, delivered on-time, that are cost-effective, and safely manufactured.</p> <p>For suppliers located in Asia, we have a targeted and robust corporate social responsibility auditing process run by a third party to ensure suppliers follow appropriate labor, safety, environmental, and other CSR requirements. The program is based on SA8000 standards, with additional EHS-related regulations. Our third-party auditor is engaged on a continuous basis to monitor, provide suggestions, evolve our standards, and certify our program, with audits conducted on an annual basis.</p> <p>HNI did not any have additional new suppliers during the reporting period. A total of 36 existing suppliers were screened during this period.</p> <p>2022 CSR Report, Supplier Code of Conduct, page 20 HNI Supplier Code of Conduct ↗</p>	<p>SDGs 8, 9, 12 ↗</p>
<p>308-2</p>	<p>Negative environmental impacts in the supply chain and actions taken</p>	<p>A total of 36 suppliers were assessed for their environmental impact. Based on the assessments:</p> <ul style="list-style-type: none"> • No suppliers were identified as having a significant actual negative environmental impact, and no significant actual negative environmental impacts were identified in the supply chain. • About 10 suppliers were identified as having potential negative environmental impacts, and of these suppliers 100% agreed to take corrective actions to mitigate the negative environmental impact. “Three wastes” (waste water, waste gas, industrial residue) discharged by supplier during the production process were the potential negative environmental impacts identified that required corrective action. • None of the suppliers were terminated as a result of the assessment, as the suppliers implemented corrective action plans (CAPs) for all non-compliance identified in the audit and took measures to improve their environmental performance. 	<p>SDGs 8, 9, 12 ↗</p>

GRI 401: Employment 2016									
3-3	Management of material topics	HNI Member Code of Integrity ↗							
401-1	New employee hires and employee turnover		Men	Women	Total	Total Turnover %	SDGs 5, 8, 10 ↗		
		U.S. Number of New Hires (Hourly)	1152	608	1760				
		U.S. Number of New Hires (Salary)	193	124	317				
		U.S. Turnover (Hourly)	1022	579	1601	34.7%			
		U.S. Turnover (Salary)	213	113	326	15.3%			
		Total U.S. Turnover				28.6%			
		Asia Pacific Turnover				23.3%			
Data presented is from 2022.									
401-2	Benefits provided to full-time employees that are not provided to temporary or part-time employees	<p>All members of the HNI family have access to a comprehensive benefits package to help them live happy, healthy, fulfilled lives while at work and at home. Our benefits package includes life insurance, healthcare benefits, disability insurance, parental leave, retirement plans, a member stock purchase plan, as well as other financial benefits and programs that address overall wellness.</p> <p>Benefits - HNI Benefits ↗</p> <p>Prospective Employees HNICorp ↗</p>					SDGs 3, 5, 8 ↗		
401-3	Parental Leave	Paid Parental Leave and Adoption & Surrogacy Assistance - HNI Benefits ↗					SDGs 5, 8 ↗		

GRI 403: Occupational Health and Safety 2018			
3-3	Management of material topics	2022 CSR Report, Safety, page 12	
403-1	Occupational health and safety management system	<p>HNI operates occupational health and safety programs that comply with applicable workplace safety standards. We train all members on safe practices and applicable regulatory requirements, and empower all members to report incidents and operate safely, as we focus on continuous improvement.</p> <p>2022 CSR Report, Safety, page 12</p>	SDG 8 ↗
403-2	Hazard identification, risk assessment, and incident investigation	<p>HNI Corporation is committed to zero harm. We believe we have this responsibility to our members, the environment, and the communities we serve. We assess our processes for safety hazards and work to mitigate risk through layered controls. We take proactive steps to protect our members' safety and physical well-being by promoting stretching to help members prepare for their day of work and by designing products that consider ergonomics for manufacturability, conducting ergonomic assessments, and implementing ergonomic controls. Periodic audits of processes and facilities take place to ensure safe, ergonomic working conditions.</p> <p>We believe safety is priority for all HNI members and all activities. We encourage all members to report conditions they feel are unsafe, either to their site Safety Manager, group lead, or other leader at their site. All reports are investigated thoroughly. When an incident or near miss does happen, we investigate immediately to identify the cause and assign responsibility for corrective action. We also seek regular feedback from members on proactive opportunities to improve through programs like Mi Ideas and tiered meeting boards.</p> <p>2022 CSR Report, Safety, page 12</p>	SDG 8 ↗
403-3	Occupational health services	<p>At HNI, the safety of our members is our top priority. When an incident occurs that requires treatment or care outside of our facilities, our leadership team is informed, and every step is taken to ensure our members receive the best care possible.</p> <p>We contract with a third-party claims administrator that arranges transport to health clinics and expedites service when incidents occur to ensure members receive quality care. This third party stores and maintains the confidentiality of workers' personal health-related information.</p> <p>We have a third-party early intervention specialist that works with members on a daily basis to provide job-specific coaching, health and wellness coaching, first aid treatments, and a mobility program.</p>	SDG 8 ↗

<p>403-4</p>	<p>Worker participation, consultation, and communication on occupational health and safety</p>	<p>All members are responsible for safety. Upon hiring, each new member must complete safety training and commit to working safely as well as abide by our Safe Member philosophy and CORE policy. Most sites have member-led Safety Committees, which include volunteers from each functional area, the site Safety Manager, and a leadership champion. The Safety Committees help raise awareness of health and safety issues, recognize and identify workplace risks, develop recommendations, and address and reduce risks, in addition to supporting the culture of safety throughout the facility.</p> <p>We encourage members to report any perceived unsafe work conditions. Members are instructed to cease their operation and immediately report concerns to their group leader, who will investigate with the Safety Manager. Once the concern has been addressed and corrected and the member feels safe, operation resumes.</p> <p>Our corporate Safety and Sustainability organization is composed of leaders from across HNI and helps promote a healthy and safe work environment. This focused organization is responsible for driving our safety and sustainability efforts to even better performance with updated strategies, metrics, and programs.</p> <p>2022 CSR Report, Safety, page 12</p>	<p>SDG 8, 16 ↗</p>
<p>403-5</p>	<p>Worker training on occupational health and safety</p>	<p>Upon hiring, each new HNI member must complete safety training and commit to abiding by our safe member philosophy. Throughout the year, and depending on job tasks and responsibilities, additional trainings are held. Examples of topics include lockout tagout, machine guarding, electrical safety, and confined space. Most members go through annual training on safe work practices. For non-production members, our furniture brands offer ergonomic education and video trainings so that members can work safely and comfortably.</p>	<p>SDG 8 ↗</p>
<p>403-6</p>	<p>Promotion of worker health</p>	<p>HNI wants its members to live happy, healthy, fulfilled lives while at work and at home. We offer health, dental, and vision insurance to our members, along with a member assistance program (MAP), to provide support for members' mental, emotional, and financial well-being. As part of our health coverage, members also have access to virtual care through our Doctor on Demand program and through our wellness programs, including health coaching, tobacco cessation, and educational services to reduce metabolic syndrome health risks.</p>	<p>SDGs 3, 8 ↗</p>
<p>403-7</p>	<p>Prevention and mitigation of occupational health and safety impacts directly linked by business relationships</p>	<p>Our teams work diligently to protect member and visitor safety. To that end, we have many processes and controls in place to assist us with this effort. Within our facilities, we utilize a hierarchy of controls to ensure our processes and people are safe. We implement equipment safeguards and controls and require PPE appropriate for the production process. To protect members who may be working with or around chemicals, we developed a chemical approval process that evaluates all chemicals coming into our workplace. Our management teams periodically review our practices and progress and take action to ensure any new risks have been considered.</p>	<p>SDG 8 ↗</p>
<p>403-8</p>	<p>Workers covered by an occupational health and safety management system</p>	<p>All HNI sites operate with a safety program in place. Our HNI India facility has achieved ISO 45001 certification. HNI is working to develop more robust EHS systems that align with both ISO 14001 and ISO 45001.</p>	<p>SDG 8 ↗</p>

403-9	Work-related injuries	<p>Safety continues to be a priority at HNI. We are focused on continuously improving our safety performance and driving proactive, preventative measures, including early intervention and reporting, member engagement throughout the entire organization, hazard identification and risk reduction, and ergonomic improvements to prevent injuries before they happen.</p> <p>HNI members continued to work safely in 2021 and 2022, with incident rates below the industry average.</p> <table border="1" data-bbox="1179 459 2698 769"> <thead> <tr> <th></th> <th>HNI TRIR</th> <th>BLS TRIR</th> <th></th> <th>HNI LTCR</th> <th>BLS LTCR</th> </tr> </thead> <tbody> <tr> <td>2021</td> <td>2.40</td> <td>3.90</td> <td>2021</td> <td>0.50</td> <td>1.10</td> </tr> <tr> <td>2022</td> <td>2.60</td> <td>3.49</td> <td>2022</td> <td>0.51</td> <td>1.01</td> </tr> </tbody> </table> <p>U.S. Bureau of Labor Statistics (BLS) data is based on the previous year's reported data due to reporting lags. The BLS data has been weighted by the average number of hours worked for each of our industry segments. This data represents HNI's U.S.-based operations.</p>		HNI TRIR	BLS TRIR		HNI LTCR	BLS LTCR	2021	2.40	3.90	2021	0.50	1.10	2022	2.60	3.49	2022	0.51	1.01	SDGs 3, 8 ↗
	HNI TRIR	BLS TRIR		HNI LTCR	BLS LTCR																
2021	2.40	3.90	2021	0.50	1.10																
2022	2.60	3.49	2022	0.51	1.01																
403-10	Work-related ill health	<p>HNI facilities have several controls and systems in place to reduce work-related ill health. Related to chemicals used in our facilities, we conduct chemical inventories each year to address any chemical hazards and work with process engineers to analyze changes for employee exposure and safety risks. We use OSHA and NIOSH mitigation practices and provide information to regulatory bodies when applicable.</p>	SDGs 3, 8 ↗																		
<i>GRI 404: Training and Education 2016</i>																					
3-3	Management of material topics	2022 Form 10-K ↗																			
404-1	Average hours of training per year per employee	Salaried members receive an average of 2.5 hours of compliance training per year. Non-compliance training is not currently tracked.	SDGs 4, 8, 10 ↗																		

404-2	Programs for upgrading employee skills and transition assistance programs	<p>All members have the opportunity to achieve and succeed in their careers. HNI invests in apprenticeships, on-the-job training, robust performance and talent-management processes, and leadership development programs.</p> <p>Members are trained on our Code of Integrity, business communications, workplace substance abuse prevention, and more. Additionally, members have access to a wide range of job-specific trainings.</p> <p>Through our Early Career Development and Rotation Program, we offer new college graduates and other young professionals access to senior leaders so they can learn from the best, and we provide a wide variety of opportunities for flexible career experiences across our organization.</p> <p>On the manufacturing side, we actively work with local high schools and apprenticeship programs to communicate the value of manufacturing careers with students in our region.</p>	SDG 8 ↗			
404-3	Percentage of employees receiving regular performance and career development reviews	<p>HNI's strong culture of ownership, and a sense of shared responsibility for the success of the company, is a key element to our success. In our unique and powerful member-owned environment, each member has the opportunity to participate in making our business better. We trust them to make key decisions, expect them to grow professionally and empower them to move our business forward.</p> <p>Each HNI member has an annual performance review and is provided access to internal job postings, opportunities for career development, and trainings that help them build their knowledge and skills. All U.S. members are also invited to participate in engagement surveys at least once per year.</p>	SDGs 5, 8, 10 ↗			
<i>GRI 405: Diversity and Equal Opportunity 2016</i>						
3-3	Management of material topics	<p>HNI Member Code of Integrity ↗</p> <p>2022 CSR Report, DEI, pages 13-16</p> <p>2022 Form 10-K ↗</p>				
405-1	Diversity of governance bodies and employees	Our Board of Directors	2022	Our Members (U.S.)	2022	SDGs 5, 8 ↗
		Board Members	10	Women Members	34.9%	
		Women	5	Ethnically Diverse Members	23.0%	
		Ethnically Diverse Members	2	Women Leaders	30.5%	
		Independent Members	9	Ethnically Diverse Leaders	10.2%	

405-2	Ratio of basic salary and remuneration of women to men	HNI routinely evaluates our members' job functions and responsibilities and conducts compensation analysis.	SDGs 5, 8, 10 ↗
<i>GRI 406: Non-discrimination 2016</i>			
3-3	Management of material topics	HNI Member Code of Integrity ↗ 2022 CSR Report, DEI, pages 13-16	
406-1	Incidents of discrimination and corrective actions taken	<p>HNI strives to be a great place to work. We operate in a spirit of cooperation and value treating each other honestly and with fairness and respect. At HNI, everyone is welcome. We value using each other's differences in experiences and ideas to solve problems and better serve our customers. We take seriously our commitment to acting with integrity and maintaining an inclusive work environment. We do not tolerate discrimination, and all HNI members are expected to follow our HNI Member Code of Integrity, which includes treating fellow members with honesty, dignity, fairness, and respect.</p> <p>HNI Member Code of Integrity ↗</p>	SDGs 5, 8 ↗
<i>GRI 407: Freedom of Association and Collective Bargaining 2016</i>			
3-3	Management of material topics	HNI Supplier Code of Conduct ↗	
407-1	Operations and suppliers in which the right to freedom of association and collective bargaining may be at risk	<p>HNI expects our suppliers to treat their employees with fairness and respect while also providing a safe and healthy work environment. We strictly prohibit child labor, involuntary or forced labor, abuse, and discrimination. Our suppliers must respect the rights of employees to associate, organize, and bargain collectively in a lawful and peaceful manner, without penalty.</p> <p>For suppliers located in Asia, we have a targeted and robust corporate social responsibility auditing process run by a third party to ensure suppliers follow appropriate labor, safety, environmental, and other CSR requirements. The program is based on SA8000 standards, with additional EHS-related regulations. Our third-party auditor is engaged on a continuous basis to monitor, provide suggestions, evolve our standards, and certify our program, with audits conducted on an annual basis.</p> <p>HNI Supplier Code of Conduct ↗</p>	SDG 8 ↗

GRI 408: Child Labor 2016			
3-3	Management of material topics	HNI Supplier Code of Conduct ↗	
408-1	Operations and suppliers at significant risk for incidents of child labor	<p>HNI expects our suppliers to treat their employees with fairness and respect while also providing a safe and healthy work environment. We strictly prohibit child labor, involuntary or forced labor, abuse, and discrimination. All new and existing suppliers must comply with our Code of Conduct, which outlines HNI's human rights policy. In addition to our Code of Conduct, HNI's standard MSA terms include ESG requirements.</p> <p>For suppliers located in Asia, we have a targeted and robust corporate social responsibility auditing process run by a third party to ensure suppliers follow appropriate labor, safety, environmental, and other CSR requirements. The program is based on SA8000 standards, with additional EHS-related regulations. Our third-party auditor is engaged on a continuous basis to monitor, provide suggestions, evolve our standards, and certify our program, with audits conducted on an annual basis.</p> <p>HNI Supplier Code of Conduct ↗</p>	SDGs 8, 16 ↗
GRI 409: Forced or Compulsory Labor 2016			
3-3	Management of material topics	HNI Supplier Code of Conduct ↗	
409-1	Operations and suppliers at significant risk for incidents of forced or compulsory labor	<p>HNI expects our suppliers to treat their employees with fairness and respect while also providing a safe and healthy work environment. We strictly prohibit child labor, involuntary or forced labor, abuse, and discrimination. All new and existing suppliers must comply with our Code of Conduct, which outlines HNI's human rights policy. In addition to our Code of Conduct, HNI's standard MSA terms include ESG requirements.</p> <p>For suppliers located in Asia, we have a targeted and robust corporate social responsibility auditing process run by a third party to ensure suppliers follow appropriate labor, safety, environmental, and other CSR requirements. The program is based on SA8000 standards, with additional EHS-related regulations. Our third-party auditor is engaged on a continuous basis to monitor, provide suggestions, evolve our standards, and certify our program, with audits conducted on an annual basis.</p> <p>HNI Supplier Code of Conduct ↗</p>	SDGs 5, 8, 16 ↗
GRI 413: Local Communities 2016			
3-3	Management of material topics	2022 CSR Report, Our Communities, pages 18-19	

413-1	Operations with local community engagement, impact assessments, and development programs	2022 CSR Report, Our Communities, pages 18-19	SDGs 2, 5, 8 ↗
413-2	Operations with significant actual and potential negative impacts on local communities	We have not identified any consequential negative impacts on our local communities.	
<i>GRI 414: Supplier Social Assessment 2016</i>			
3-3	Management of material topics	2022 CSR Report, Supplier Code of Conduct, page 20 HNI Supplier Code of Conduct ↗	
414-1	New suppliers that were screened using social criteria	<p>All new and existing suppliers must comply with our Code of Conduct. For suppliers located in Asia, we have a targeted and robust corporate social responsibility auditing process run by a third party to ensure suppliers follow appropriate labor, safety, environmental, and other CSR requirements. The program is based on SA8000 standards, with additional EHS-related regulations. Our third-party auditor is engaged on a continuous basis to monitor, provide suggestions, evolve our standards, and certify our program, with audits conducted on an annual basis.</p> <p>In 2022, we implemented a third-party assessment tool to rank our supplier’s ESG performance in alignment with leading sustainability frameworks. We will continue to utilize this tool to benchmark and engage with our suppliers.</p> <p>HNI did not any have additional new suppliers during the reporting period. A total of 36 existing suppliers were screened during this period.</p> <p>2022 CSR Report, Supplier Code of Conduct, page 20</p>	SDGs 8, 9, 10, 12 ↗

<p>414-2</p>	<p>Negative social impacts in the supply chain and actions taken</p>	<p>HNI has identified potential risks that our supply chain business relationships could pose on human rights. These risks are addressed within the HNI Supplier Code of Conduct, page 3.</p> <p>To mitigate these risks, HNI has taken the following actions:</p> <p>We aim to work only with suppliers who align to the highest ethical and social standards. In 2022, HNI reached 100% Tier 1 supplier compliance in signing the HNI Supplier Code of Conduct.</p> <p>For suppliers located in Asia, we have a targeted and robust corporate social responsibility auditing process run by a third party to ensure suppliers follow appropriate labor, safety, environmental, and other CSR requirements. The program is based on SA8000 standards, with additional EHS-related regulations. Our third-party auditor is engaged on a continuous basis to monitor, provide suggestions, evolve our standards, and certify our program, with audits conducted on an annual basis.</p> <p>A total of 36 suppliers were assessed for their environmental impact. Based on the assessments:</p> <ul style="list-style-type: none"> • No suppliers were identified as having a significant actual negative environmental impact, and no significant actual negative environmental impacts were identified in the supply chain. • About 10 suppliers were identified as having potential negative environmental impacts, and of these suppliers 100% agreed to take corrective actions to mitigate the negative environmental impact. “Three wastes” (waste water, waste gas, industrial residue) discharged by supplier during the production process were the potential negative environmental impacts identified that required corrective action. • None of the suppliers were terminated as a result of the assessment, as the suppliers implemented CAPs for all non-compliance identified in the audit and took measures to improve their environmental performance. <p>In 2022, we implemented a third-party assessment tool to rank our supplier’s ESG performance.</p>	<p>SDGs 8, 9, 10, 12</p>
--------------	--	--	--

GRI 416: Customer Health and Safety 2016			
3-3	Management of material topics	2022 CSR Report, Designing for Environmental and Human Health, pages 30-35	
416-1	Assessment of the health and safety impacts of product and service categories	<p>HNI's brands address customer health, safety, and well-being throughout our product development processes for our office furniture and hearth products. We strive to develop furniture products that meet industry safety standards and ergonomic guidelines, use low-emitting materials, and are third party verified to meet industry sustainability and wellness standards.</p> <p>Our hearth products are also designed to meet industry safety standards. We were the first in our industry to require a safety barrier screen on all our gas fireplaces or inserts and continue to offer free or reduced-cost safety screens to customers and fireplace owners.</p> <p>In addition to producing safe products and providing safety barrier screens for our fireplaces, we also invest in education about fireplace safety. In partnership with Safe Kids Worldwide, a nonprofit organization working to keep kids safe from injuries, HNI continues to communicate the importance of fireplace safety to parents, caregivers, and children through Safe Kids members in the U.S. and community educators. Community educators include fire departments, health departments, health professionals, and hearth retailers, among others. In addition, Safe Kids conducted a national awareness campaign on social media to promote fireplace safety.</p>	SDG 12 ↗
416-2	Incidents of non-compliance concerning the health and safety impacts of products and services	HNI has not suffered or received any material administrative or judicial sanctions for failing to comply.	
GRI 418: Customer Privacy 2016			
3-3	Management of material topics	2023 Proxy Statement ↗	
418-1	Substantiated complaints concerning breaches of customer privacy and losses of customer data	2023 Proxy Statement ↗	SDG 16 ↗

TCFD Disclosure

TCFD Disclosure Recommendation		Disclosure	Reference
<i>Governance</i>			
a)	Describe the board's oversight of climate-related risks and opportunities.	Our Board of Directors oversees economic, environmental, social, and governance impacts.	CDP, Section C1 ↗
b)	Describe management's role in assessing and managing climate-related risks and opportunities.	HNI's Executive Management team engages with the Board of Directors regarding sustainability reporting.	CDP, Section C1 ↗
<i>Strategy</i>			
a)	Describe the climate-related risks and opportunities the organization has identified over the short, medium, and long term.	Climate-related risks are integrated into the HNI Enterprise Risk Management (ERM) system. The details on the potential short-, medium-, and long-term risks and opportunities can be found in the annual CDP climate disclosure.	CDP, Section C2 ↗
b)	Describe the impact of climate-related risks and opportunities on the organization's businesses, strategy, and financial planning.	The potential impact of climate-related risks and opportunities on our business strategy and financial planning are identified in our annual CDP climate disclosure.	CDP, Sections C2 and C3 ↗
c)	Describe the resilience of the organization's strategy, taking into consideration different climate-related scenarios, including a 2°C or lower scenario.	HNI has set science-based carbon emission reduction targets that are aligned with the most ambitious goals of the 2015 Paris Climate Agreement (1.5°C scenario). HNI's strategy is aligned to achieving these goals.	CDP, Section C3 ↗

<i>Risk Management</i>			
a)	Describe the organization's processes for identifying and assessing climate-related risks.	Climate-related risks are integrated into the HNI Enterprise Risk Management (ERM) system. The details on identifying and assessing risks can be found in the annual CDP climate disclosure.	CDP, Section C2 ↗
b)	Describe the organization's processes for managing climate-related risks.	HNI process for managing climate-related risks is provided in our annual CDP climate disclosure.	2022 CSR Report, Reducing Impacts, pages 21-27 CDP, Sections C2 and C3 ↗
c)	Describe how processes for identifying, assessing, and managing climate-related risks are integrated into the organization's overall risk management.	Climate-related risks are integrated into the HNI Enterprise Risk Management (ERM) system and are detailed in our annual CDP climate disclosure.	CDP, Section C2 ↗
<i>Metrics and Targets</i>			
a)	Disclose the metrics used by the organization to assess climate-related risks and opportunities in line with its strategy and risk management process.	Metrics used by the organization to assess climate-related risks and opportunities are provided in our CSR Report and annual CDP climate disclosure.	2022 CSR Report, Reducing Impacts, pages 21-27 CDP, Sections C1 and C4 ↗
b)	Disclose Scope 1, Scope 2, and, if appropriate, Scope 3 greenhouse gas (GHG) emissions, and the related risks.	Scope 1, 2, and 3 GHG emissions are provided in our annual CDP climate disclosure.	2022 CSR Report, GHG Emissions, pages 22-23 CDP, Section C6 ↗
c)	Describe the targets used by the organization to manage climate-related risks and opportunities and performance against targets.	Targets used by the organization to assess climate-related risks and opportunities are provided in our annual CDP climate disclosure.	2022 CSR Report, Reducing Impacts, pages 21-27 CDP, Sections C1 and C4 ↗

SASB Disclosure

Topic	Accounting Metric	Category	Unit of Measure	Code	HNI Disclosure
Energy Management in Manufacturing	Total Energy Consumed	Quantitative	Gigajoules (GJ)	CG-BF-130a.1	2022: 1,532,704 GJ 2021: 1,511,573 GJ
	Percentage Grid Electricity	Quantitative	Percentage (%)	CG-BF-130a.1	2022: 40% of HNI's total energy consumption 2021: 42% of HNI's total energy consumption Electric Power per unit produced: 2022: 0.06 GJ/unit produced 2021: 0.06 GJ/unit produced
	Percentage Renewable Energy	Quantitative	Percentage (%)	CG-BF-130a.1	2022: HNI purchased 166,000 MWh of unbundled RECs, of which 161,500 MWh were Green-e Certified RECs. 2021: HNI purchased 183,300 MWh of unbundled RECs, of which 60,000 MWh were Green-e Certified RECs.
Management of Chemicals in Products	Discussion of processes to assess and manage risks and/or hazards associated with chemicals in products	Discussion and analysis	Not applicable	CG-BF-250a.1	2022 CSR Report, GRI Appendix (403-7), page 56 2022 CSR Report, Designing for Environmental and Human Health, pages 30-35
	Percentage of eligible products meeting volatile organic compound (VOC) emissions and content standards	Quantitative	Percentage (%) by revenue	CG-BF-250a.2	98% of HNI's domestically manufactured office furniture and textile products are certified for indoor air quality through the SCS Indoor Advantage Gold program.

Product Life Cycle Environmental Impacts	Description of efforts to manage product life cycle impacts and meet demand for sustainable products	Discussion and analysis	Not applicable	CG-BF-410a.1	2022 CSR Report, Designing for Environmental and Human Health, pages 30-35
	(1) Weight of end-of-life material recovered, (2) percentage of recovered materials recycled				2022 CSR Report, GRI Appendix (306), page 52 2022 CSR Report, Designing for Environmental and Human Health, pages 30-35
Wood Supply Chain Management	(1) Total weight of wood fiber materials purchased, (2) percentage from third-party certified forestlands, (3) percentage by standard, (4) percentage certified to other wood fiber standards, (5) percentage by standard	Quantitative	Metric tons (t), Percentage (%) by weight	CG-BF-430a.1	Purchases of FSC® Certified Wood inputs to support our domestically produced FSC® Certified office furniture product offering: 1,900 metric tons in 2022 and 1,870 metric tons in 2021. Purchases of FSC® Controlled Wood inputs to support our domestically produced FSC® Certified office furniture product offering: 51,439 metric tons in 2022 and 43,762 metric tons in 2021.

Activity Metric	Category	Unit of Measure	Code	HNI Disclosure
Annual Production	Quantitative	Multiple allowed	CG-BF-000.A	2021: 10,657,301 units produced 2022: 10,569,635 units produced
Area of Manufacturing Facilities	Quantitative	Square meters (m ²)	CG-BF-000.B	2022 Form 10-K