Make your space work.

HON®

2023 List Pricer

SHARED SPACES

Tables | Education | Seating



Effective Date

March 2023

Updated December 2023

LIST PRICER

Effective Date: March 2023

- All illustrations and specifications in this publication are based on the latest product information available at the time of print. For the most recent version, please go to www.hon.com.
- Software support packages furnished to the customer, either by The HON Company or by another source, which support the sale of HON products are superseded by printed price lists.
- All dimensions shown in this publication are nominal.
- Pricing is subject to change without notice.
- All orders are subject to prices in effect at the time of order.
- Ordering information appears at the beginning of a section complete with examples on how to specify. These specifying information pages are referenced at the bottom center of product pages.
- HON Full Lifetime Warranty applies unless otherwise noted.
- HON nationwide customer service:
Phone: (800) 833-3964

HON LIST PRICER

Table of Contents

INTRODUCTION			
Table of Contents.....	1-3		
Additions.....	4-4.1		
Discontinuations.....	5		
HON Full Lifetime Warranty Information.....	7		
HON Limited 5-Year Warranty Information.....	8		
Ordering Information.....	9		
HON Design Services.....	10		
Tailored Solutions Ordering Information.....	11		
Customer's Own Material Ordering Information.....	12-13		
Partnership Textile Information.....	14		
Paint Program.....	15		
HON Open Line Laminate Program.....	16		
Environmental Statement.....	17		
Important Information.....	18		
Legend.....	19		
Fabric Patterns & Codes.....	20		
Lead Times.....	21		
Seating Fabric Patterns & Codes.....	22-24.1		
Panel Fabric Patterns & Codes.....	25-26		
TABLES			
Arrange®	27		
Arrange® Café Tables Ordering Information	28		
Arrange® Café Table Tops.....	29		
Arrange® Café Table Bases.....	30		
Arrange® Café Accessories.....	31		
Between™ Tables	32		
Between™ Ordering Information	33		
Between™ Table Tops.....	34		
Between™ Table Bases.....	35		
Between™ Rectangular Table Tops.....	36		
Between™ Table Bases for Rectangular Tops.....	36		
Between™ Nesting Tables.....	37		
Between™ Shared Components.....	37		
Birk™ Tables	38		
Birk™ Ordering Information	39		
Birk™ Table Tops.....	40		
Birk™ Bases.....	41		
Birk™ Personal Table.....	42		
Cantilever Table	43		
Flock®	44		
Flock® Collaborative Tables Ordering Information	45		
Flock® Collaborative Solutions Table Specifying Information	46		
Flock® Collaborative Laminate Table Tops.....	47		
Flock® Collaborative Table Bases.....	48		
Flock® Collaborative Tables.....	49-50		
Huddle	51		
Huddle Ordering Information	52		
Huddle Multi-Purpose Tables	53		
Interlink IQ Electrical.....	54		
4-Trac Hardwire Electrical System.....	55		
Huddle Typical.....	56-57		
Huddle Multi-Purpose Table Tops.....	58		
Huddle Multi-Purpose Table Bases.....	59		
Huddle Mobile Laptop Table.....	60		
Huddle Table Accessories.....	61		
Occasional Tables	62		
Laminate Occasional Tables Options	63		
Laminate Occasional Tables.....	64		
Motivate®	65		
Motivate® Tables Specifying Information	66		
4-Trac Hardwire Electrical System.....	67		
Motivate® Fixed Height Tables.....	68		
Motivate® Nesting Tables.....	69		
Motivate® Adjustable Height Tables.....	70		
Motivate® Shared Components.....	71-72		
Preside®	73		
Preside® Ordering Information	74		
Preside® Specifying Information	75-84		
Preside® Grommet Cutout Placement.....	85		
Preside® Laminate Table Tops.....	86-87		
Preside® Laminate Bases.....	88-89		
Preside® Metal Bases.....	90-92		
Preside® Laminate Bases.....	93		
Preside® Metal Bases.....	94		
Preside® Collaborative Tables.....	95		
Preside® Ganging Tables.....	96		
Preside® Collaborative Tables.....	97		
Preside® Ganging Tables.....	98		
Preside® Mobile Collaborative Tables.....	99		
Preside® Team Touchdown Tables.....	100		
Preside® Ancillary.....	101		
Preside® Laminate Storage.....	102-103		
Modular Components.....	104		
Modular Components Back Panels.....	104		
Wall Mount Storage.....	105-106		
Preside® Laminate Shared Components.....	107		
Preside® Laminate Tables.....	108		
Preside® Laminate Tables — Pre-defined Typical.....	109		
Scramble™ Occasional Tables	110		
Scramble™ Options	111		
Scramble™ Coffee Tables.....	112		
Scramble™ End Tables.....	113		
Sculpt™	114		
Sculpt™ Ordering Information	115		
Sculpt™ Statement of Line	116		
Sculpt™ Laminate Top Tables.....	117-118		
Sculpt™ Wood Top Tables.....	119-120		
Sculpt™ Tray Top Tables.....	121-122		
Sculpt™ Personal & Console Tables.....	123		
Sculpt™ Planters.....	124		
Sculpt™ Accessories.....	125		
EDUCATION			
Cross Reference by Application	126-127		
Build™	128		
Build™ Ordering Information	129		
Build™ Shape Matrix.....	130		
Build™ Table Configurations.....	131-133		
Build™ Table Tops.....	134-136		
Build™ Tables.....	137		
Build™ Nesting Tables.....	138		
Build™ Accessories.....	139		
Build™ Student Desk Surface Dimensions.....	140		
Build™ Student Desk Configurations.....	141-142		
Build™ Student Desks.....	143-144		
Build™ Student Desk Accessories.....	145		
Build™ Makerspace Table.....	146-148		
Build™ Makerspace Table Accessories.....	149		
Build™ Makerspace Stools.....	150		
Class-ifi™	151		
Class-ifi™ Ordering Information	152		
Class-ifi™ Statement of Line	153-154		
Class-ifi™ Specifying Information	155-156		
Class-ifi™ Lockers.....	157		
Class-ifi™ Cubbies.....	158		
Class-ifi™ Combos.....	159		
Class-ifi™ Bookcases.....	160		
Class-ifi™ Tote Storage.....	161		
Class-ifi™ Command Station.....	162		
Class-ifi™ Accessories.....	163		
Confetti™	164		
Confetti™ Ordering Information	165		
Confetti™ Statement of Line	166		
Confetti™ Floor Seating.....	167		
Confetti™ Accessories.....	168		
Revel™	169		
Revel™ Stool.....	170		
Roll Call™	171		
Roll Call™ Ordering Information	172		
Roll Call™.....	173		
SmartLink®	174		
SmartLink® Ordering Information	175		
SmartLink® Specifying Information	176-181		
SmartLink® Student Desks.....	182		
SmartLink® Value Series Student Desks.....	183		
SmartLink® Student Accessories.....	184		
SmartLink® Chairs.....	185-188		
SmartLink® Value Teacher Stations.....	189-190		
SmartLink® Teacher Stations.....	191		
SmartLink® Modular Storage.....	192-193		
SmartLink® Modular Storage and Accessories.....	194		
SmartLink® Wall Rail System.....	195		
SmartLink® Wall Rail System Accessories.....	196		
SmartLink® Value Mobile Storage.....	197-199		
Storyline™	199.1		
Storyline™ Ordering Information	199.2		
Storyline™ Specifying Information	199.3-199.5		
Storyline™ Linear Bookcases.....	199.6		
Storyline™ Curved Bookcases.....	199.7		
Storyline™ Bistro Tables.....	199.8		
Storyline™ Accessories.....	199.9		
Tangram™	200		
Tangram™ Ordering Information	201-202		
Tangram™ Statement of Line	203-204		
Tangram™ Typical.....	205-206		
Tangram™ Story Steps.....	207		
Tangram™ Multi-Fabric Story Steps.....	208		
Tangram™ In-Line Tables.....	209		
Tangram™ Modular Seating.....	210		
Tangram™ Modular Seating — Multi-Fabric.....	211-212		
Tangram™ Modular Seating.....	213		

For information regarding HON registered and unregistered trademarks, please go to hon.com/protected-marks. Haworth®, Herman Miller®, Knoll®, and Steelcase® are registered trademarks of their respective owners and use of the marks do not imply affiliation or endorsement of The HON Company or its products.

LIST PRICER

Effective Date: March 2023

- All illustrations and specifications in this publication are based on the latest product information available at the time of print. For the most recent version, please go to www.hon.com.
- Software support packages furnished to the customer, either by The HON Company or by another source, which support the sale of HON products are superseded by printed price lists.
- All dimensions shown in this publication are nominal.
- Pricing is subject to change without notice.

- All orders are subject to prices in effect at the time of order.
- Ordering information appears at the beginning of a section complete with examples on how to specify. These specifying information pages are referenced at the bottom center of product pages.
- HON Full Lifetime Warranty applies unless otherwise noted.
- HON nationwide customer service:
Phone: (800) 833-3964

HON LIST PRICER

Table of Contents

Tangram™ Modular Seating — Multi-Fabric.....	214-215	Cofi™ Dimensions	303	Matter™	403
Tangram™ Modular Seating — Bistro-Back.....	216	Cofi™.....	304-305	Matter™ Multi-Purpose Chairs.....	404
Tangram™ Modular Seating — Bistro-Back, Multi-Fabric.....	217-218	Convergence®	306	Mav™	405
Tangram™ Ottomans.....	219-220	Convergence® Options	307	Mav™ Finish Options	406
Tangram™ Poufs.....	221	Convergence® Fabric Options	308	Mav™.....	407-411
Tangram™ Accessories.....	222	Convergence® Standard Task Chairs.....	309	Motivate® Chairs	412
		Convergence® Value Task Chairs.....	310	Motivate® Task Chair Options	413
WORKPLACE TOOLS		Crio™ Mesh Chairs	311	Motivate® Task Chair Fabric Options	414
Workplace Tools	223	Define™ Executive Chairs	312	Motivate® Task Chairs.....	415
Workplace Tools Ordering Information	224	Endorse® Collection	313	Motivate® High-Density Sled Base Chair Options	416
Monitor Arms.....	225-226	Endorse® Options	314	Motivate® High-Density Sled Base Chairs.....	417-418
CPU Holders.....	227	Endorse® Dimensions	315	Motivate® 4-Leg Chair Options	419
Keyboard Trays.....	228-229	Endorse® Fabric Options	316	Motivate® 4-Leg Chairs.....	420-421
Corner Sleeves.....	230	Endorse®.....	317-320	Motivate® Nesting/Stacking Flex-Back Chair Options	422
Center Drawers.....	231-232	Endorse® Accessories.....	321	Motivate® Nesting/Stacking Flex-Back Chairs.....	423
Desktop Riser.....	233	Flexion™	322	Motivate® Chair with Tablet Arm Options	424
Chair Mats.....	234	Flexion™ Options	323-324	Motivate® Chair with Tablet Arm.....	425
Task Lights.....	235-236	Flexion™.....	325	Motivate® Flex-Back Chair with Tablet Arm Options	426
Paper Management & Organizational Tools.....	237-240	Flock®	326	Motivate® Flex-Back Chair with Tablet Arm.....	427
Interlink IQ Electrical.....	241-242	Flock® Options	327-328	Nucleus®	431
4-Trac Hardwire Electrical System.....	243-244	Flock® Fabric Options	329	Nucleus® Task Chair Options	432-433
Power & Cable Management.....	245	Flock® Collaborative.....	330-333	Nucleus® Guest and Multi-Purpose Options	434
Power.....	246-248	Flock® Multi-Fabric Collaborative.....	334-337	Nucleus® Fabric Options	435
Power & Cable Management.....	249	Flock® Base Frames and Legs.....	338	Nucleus® Dimensions	436-437
		Flock® Options	339	Nucleus®.....	438-441
		Flock® Collaborative.....	340-344	High-Density Olson Stacker® 4040 Series	443
		Flock® Multi-Fabric Collaborative.....	345	High-Density Olson Stacker® 4040 Series.....	444
		Flock® Options	346	Parkwyn™	445
		Flock® Mini Cube and Cylinders.....	347	Parkwyn™ Options	446
		Flock® Multi-Fabric Mini Cube and Cylinder.....	348	Parkwyn™ Club/Lounge.....	447
SEATING		Gateway™	349	Perpetual® Nesting Chairs	448
Seating Functions	250-251	Gateway™ Fabric Options	350	Perpetual® Nesting Chairs Options	449
Seating Controls	252	Gateway™ Standard Task Chair.....	351	Perpetual® Nesting Chairs.....	450
Performance Seating Arm Matrix	253	Gateway™ Value Task Chair.....	352	Pillow-Soft® 2090 Series	451
Ordering Information	254-255	Grove®	353	Pillow-Soft® 2090 Series Options	452
Fire Code/Compliant Seating	256	Grove® Options	354-355	Pillow-Soft® 2090 Series.....	453
Accommodate®	257	Grove® Fabric Options	356	Prominent™ Mesh Chairs	454
Accommodate® Options	258	Grove®.....	357-359	Ruck™	455
Accommodate® Fabric Options	259	Grove® Multi-Fabric.....	360-363	Ruck™ Options	456
Accommodate®.....	260-263	Grove® Accessories.....	364	Ruck™ Laminate Seating.....	457
Adjustable Task/Lab Stools	264	Ignition®	367	Ruck™ Wood Seating.....	458
Astir™ Collaborative Work Seating	265	Ignition® Options	368-369	Scatter™ Guest Chairs	459
Astir™ Options	266	Ignition® 2.0 Options	370-371	Skip	460
Astir™ Finish Options	267	Ignition® 2.0 Dimensions	372-373	Skip Collaborative Chair.....	461
Astir™ Collaborative Work Seating.....	268-279	Ignition® 2.0.....	374-378	SoCo™	461.1
Astir™ Power.....	280	Ignition® 2.0 ReActiv®.....	379-380	SoCo™ Statement of Line	461.2
Cambia™ 2160 Series	281	Ignition® 2.0 Upholstered.....	381-382	SoCo™ Fabric Options	461.3
Cambia™ 2160 Series Options	282	Ignition® 2.0 Accessories.....	383-384	SoCo™ Typicals	461.4
Cambia™ 2160 Series.....	283	Ignition® Multi-Purpose Chair Options	385	SoCo™.....	461.5-461.9
Ceres®	284	Ignition® Multi-Purpose.....	386	SoCo™ Power	461.10
Ceres® Multi-Purpose Chair Options	285	Ignition® Multi-Fabric Multi-Purpose.....	387	Solutions Seating® 4000 Series	462
Ceres® Fabric Options	286	Ignition® Multi-Fabric Stools.....	388	Solutions Seating® 4000 Series Options	463
Ceres®.....	287	Ignition® Guest.....	389	Solutions Seating® 4000 Series.....	464
Cipher™	288	Ignition® Task Chair Options	390	Solve®	465
Cipher™ Options	289	Ignition® Fabric Options	391	Solve® Options	466-468
Cipher™ Task Options	290	Ignition®.....	392-395	Solve®.....	469-475
Cipher™ Guest Options	291	Ignition® Accessories.....	396	Solve® Accessories.....	476
Cipher™ Task Dimensions	292	Lota®	400		
Cipher™.....	293-294	Lota® Options	401		
Cliq™	296	Lota®.....	402		
Cliq™ Fabric Options	297				
Cliq™.....	298-299				
Cofi™	300				
Cofi™ Options	301-302				

For information regarding HON registered and unregistered trademarks, please go to hon.com/protected-marks. Haworth®, Herman Miller®, Knoll®, and Steelcase® are registered trademarks of their respective owners and use of the marks do not imply affiliation or endorsement of The HON Company or its products.

LIST PRICER

Effective Date: March 2023

- All illustrations and specifications in this publication are based on the latest product information available at the time of print. For the most recent version, please go to www.hon.com.
- Software support packages furnished to the customer, either by The HON Company or by another source, which support the sale of HON products are superseded by printed price lists.
- All dimensions shown in this publication are nominal.
- Pricing is subject to change without notice.
- All orders are subject to prices in effect at the time of order.
- Ordering information appears at the beginning of a section complete with examples on how to specify. These specifying information pages are referenced at the bottom center of product pages.
- HON Full Lifetime Warranty applies unless otherwise noted.
- HON nationwide customer service:
Phone: (800) 833-3964

HON LIST PRICER

Table of Contents

Soothe®	477	Volt®	494	West Hill™ Ottomans.....	512
Soothe® Options	478-479	Volt® 5700/5710 Series Options	495	West Hill™ Casual Lounge Seating.....	513-514
Soothe® Table Finish Options	480	Volt® 5700 Series.....	496	Throw Pillows.....	515
Soothe®.....	481	Volt® 5710 Series.....	497	West Hill™ Accessories.....	516
Soothe® Multi-Fabric.....	482-483	Volt® 5720/5730 Series Options	498	Executive Chairs	517-518
Soothe® Benches.....	484	Volt® 5720/5730 Series Fabric Options	499	Guest Chairs	519
Soothe® Tables.....	485	Volt® 5720 Series.....	500	Workplace Tools Ergonomic Solutions.....	520
Soothe® Brackets.....	486	Volt® 5730 Series.....	501	Workplace Tools Chair Mats.....	521
Torch™ Mesh Chairs.....	487	Wave™ Mesh Chairs.....	502	INDEX	
Validate™	488	West Hill™ Casual Lounge Seating	503	Cross Reference Index.....	522-527
Versant®	490	West Hill™ Options	504	Information on Ordering Parts.....	528
Versant® Options	491	West Hill™ Finish Options	505		
Versant®.....	492-493	West Hill™ Casual Lounge Seating.....	506-511		

ADDITIONS

NEW ADDITIONS: PRODUCTS

Tables	Effective Date
Scramble™ Models: HSCCSR2448LMK, HSCCSR2448BPG, HSCCSS36LMK, HSCCSS48LMK, HSCCSS36BPG, HSCCSS48BPG, HSCCR36LMK, HSCCR48LMK, HSCCR36BPG, HSCCR48BPG, HSCCSS24LMK, HSCCSS24BPG, HSCER24LMK, HSCER24BPG	January 5, 2022
Sculpt™ Models: HTGPWRKIA, HTLSULPIL1630LML, HTLSULPIL1630LWL, HTLSULPIL1630MML, HTLSULPIL1630MWL, HTLSULPIL1660LML, HTLSULPIL1660LWL, HTLSULREC1630LML, HTLSULREC1630LWL, HTLSULREC1630MML, HTLSULREC1630MWL, HTLSULREC1660LML, HTLSULREC1660LWL, HTLSULRND16HML, HTLSULRND16HWL, HTLSULRND16LML, HTLSULRND16LWL, HTLSULRND16MML, HTLSULRND16MWL, HTLSULRND30LML, HTLSULRND30LWL, HTLSULSQR13LML, HTLSULSQR13LWL, HTLSULSQR16MML, HTLSULSQR16MWL, HTLSULSQR20HML, HTLSULSQR20HWL, HTLSULSQR30LML, HTLSULSQR30LWL, HTLSUCUPERTBL, HTLSUCUPIL1830LWL, HTLSUCUPIL1830MWL, HTLSUCUPIL1860LWL, HTLSUCUPILCNSL1253, HTLSUCUPIL1830LML, HTLSUCUPIL1830MML, HTLSUCUPIL1860LML, HTLSUCUREC1830LWL, HTLSUCUREC1830MWL, HTLSUCUREC1860LWL, HTLSUCURECCNSL1253, HTLSUCURECT1830LML, HTLSUCURECT1830MML, HTLSUCURECT1860LML, HTLSUCURND18HWL, HTLSUCURND18LWL, HTLSUCURND18MWL, HTLSUCURND30LWL, HTLSUCURND18HML, HTLSUCURND18LML, HTLSUCURND18MML, HTLSUCURND1830LML, HTLSUCUSQR15PLNTH, HTLSUCUSQR15PLNTH, HTLSUCUSQR16LWL, HTLSUCUSQR18MWL, HTLSUCUSQR20HWL, HTLSUCUSQR30LWL, HTLSUCUSQR30PLNTH, HTLSUCUSQR16LML, HTLSUCUSQR18MML, HTLSUCUSQR20HML, HTLSUCUSQR30LML, HTLSUCUWPIL1630LML, HTLSUCUWPIL1630LWL, HTLSUCUWPIL1630MML, HTLSUCUWPIL1630MWL, HTLSUCUWPIL1660LML, HTLSUCUWPIL1660LWL, HTLSUCUWREC1630LML, HTLSUCUWREC1630LWL, HTLSUCUWREC1630MML, HTLSUCUWREC1630MWL, HTLSUCUWREC1660LML, HTLSUCUWREC1660LWL, HTLSUCUWRND16HML, HTLSUCUWRND16HWL, HTLSUCUWRND16LML, HTLSUCUWRND16LWL, HTLSUCUWRND16MML, HTLSUCUWRND16MWL, HTLSUCUWRND30LML, HTLSUCUWRND30LWL, HTLSUCUWSQR13LML, HTLSUCUWSQR13LWL, HTLSUCUWSQR16MML, HTLSUCUWSQR16MWL, HTLSUCUWSQR20HML, HTLSUCUWSQR20HWL, HTLSUCUWSQR30LML, HTLSUCUWSQR30LWL	April 1, 2023
Education	Effective Date
Roll Call™ Model: HETLEC-REC2430	April 1, 2023
Tangram™ Models: HECSRSP, HECSRST, HECSRB, HECSRSP, HECSRSPMF, HECSITS, HECSITD, HECSITT, HECSMSLB, HECSMTLB, HECSMAILB, HECSMAOLB, HECSMSLBMF, HECSMTLBMF, HECSMAILBMF, HECSMAOLBMF, HECSMSHB, HECSMTHB, HECSMAIHB, HECSMAOHB, HECSMSHBMF, HECSMTHBMF, HECSMAIHBMF, HECSMAOHBMF, HECSOSQ, HECSOD, HECSOTR, HECSOTP, HECSOSE, HECSOAE, HECSOAE, HECSOAE, HECSOC, HECSVAP, HECSVHP, HECSJVAP, HECSJVHP, HECSG, HECSBG	January 5, 2022
Seating	Effective Date
Flexion™ Model: HFXT1	April 1, 2023
Flock® Models: HFCS64L, HFCS64WD, HFCS64LWD, HFSS74LWD, HFCS64LDF, HFCS64WDDF, HFCS64LWDDF, HFSS74LWDDF	April 1, 2022
Parkwyn™ Models: HVLVL1, HVLVL2, HVLVL3, HVLVL0T	April 1, 2023

Fabrics and Finishes	Effective Date
Edge Beigewood (DE) Fawn Cypress (FC) Field Elm (FE)	October 1, 2022 October 1, 2022 October 1, 2022
Fabrics Davenport Leather Atlantis (DAV02) Bittersweet (DAV03) Black (DAV01) Brown (DAV14) Camel (DAV13) Cream (DAV11) Fog (DAV05) Olive (DAV09) Porcellana (DAV12) Rosewood (DAV10) Saddle (DAV07) Smoke (DAV06) Storm (DAV08) Wet Sand (DAV15)	January 5, 2022
Getaway Brig (GTWY15) Canoe (GTWY03) Catamaran (GTWY08) Cruise Ship (GTWY10) Cuddy (GTWY01) Ferry (GTWY11) Gondola (GTWY02) Jet Ski (GTWY09) Kayak (GTWY05) Pontoon (GTWY13) Runabout (GTWY14) Sailboat (GTWY07) Speedboat (GTWY12) Wakeboard (GTWY06) Yacht (GTWY04)	January 1, 2023
Kai Algae (KAI07) Barnacle (KAI19) Clownfish (KAI04) Coastal (KAI13) Conch (KAI02) Coral Reef (KAI16) Crab (KAI01) Ebb (KAI12) Flow (KAI11) Inlet (KAI03) Jellyfish (KAI18) Kelp (KAI08) Orca (KAI26) Otter (KAI22) Puffer (KAI06) Salty (KAI23) Seahorse (KAI05) Seashell (KAI20) Seaweed (KAI09) Shark (KAI24) Shoreline (KAI21) Stingray (KAI25) Tide (KAI14) Turtle (KAI10) Urchin (KAI17) Wave (KAI15)	January 1, 2023

ADDITIONS

NEW ADDITIONS: PRODUCTS

Fabrics and Finishes	Effective Date	Fabrics and Finishes	Effective Date
<i>Fabrics continued</i>		<i>Fabrics continued</i>	
Livi with Supreen™	January 1, 2023	Oxford with Supreen™	January 1, 2023
Asphalt (LIVI01)		Armor (OXFD01)	
Atlantis (LIVI02)		Azurite (OXFD02)	
Bouquet (LIVI03)		Cadet (OXFD03)	
Branch (LIVI04)		Cider (OXFD04)	
Coastal (LIVI05)		Clover (OXFD05)	
Cowboy (LIVI06)		Coal (OXFD16)	
Dawn (LIVI07)		Coin (OXFD06)	
Earth (LIVI09)		Crema (OXFD07)	
Evergreen (LIVI10)		Currant (OXFD08)	
Fennel (LIVI11)		Deluge (OXFD09)	
Fog (LIVI12)		Dewberry (OXFD10)	
Honeycomb (LIVI13)		Falcon (OXFD11)	
Jade (LIVI14)		Gingerbread (OXFD12)	
Limestone (LIVI15)		Laurel (OXFD13)	
Monochrome (LIVI16)		Odyssey (OXFD14)	
Night (LIVI17)		Pavement (OXFD15)	
Overcast (LIVI18)		Redvine (OXFD17)	
Pebble (LIVI19)		Seadrift (OXFD18)	
Pillow (LIVI08)		Shoji (OXFD19)	
Plum (LIVI20)		Tourmaline (OXFD20)	
Pumpkin (LIVI21)		Vignette (OXFD21)	
Rhubarb (LIVI22)		Vast	January 1, 2023
Saxon (LIVI23)		Atmosphere (VST06)	
Seaside (LIVI24)		Bay (VST04)	
Twine (LIVI25)		Beach (VST11)	
Noble	January 1, 2023	Country Side (VST13)	
Aegean (NBLE18)		Desert (VST12)	
Amethyst (NBLE19)		Garden (VST02)	
Aspen (NBLE14)		Grasslands (VST03)	
Aster (NBLE20)		Highway (VST09)	
Blossom (NBLE21)		Mountain Range (VST08)	
Bluebell (NBLE22)		Ocean (VST07)	
Bordeaux (NBLE01)		Open Air (VST05)	
Brick (NBLE02)		Tundra (VST10)	
Chambray (NBLE10)		Vineyard (VST01)	
Chamomile (NBLE23)		Wavelength	January 1, 2023
Clementine (NBLE04)		Base (WVL21)	
Conifer (NBLE24)		Crest (WVL14)	
Cottage (NBLE25)		Cycle (WVL20)	
Darkness (NBLE26)		Energy (WVL03)	
Dawn (NBLE13)		Frequency (WVL04)	
Denim (NBLE09)		Infrared (WVL01)	
Desert Sand (NBLE27)		Motion (WVL13)	
Dewfall (NBLE28)		Movement (WVL05)	
Dusted Sage (NBLE29)		Peak (WVL11)	
Flax (NBLE30)		Pressure (WVL06)	
Grass (NBLE07)		Shallow (WVL02)	
Gunmetal (NBLE15)		Still (WVL07)	
Harmony (NBLE31)		Surface (WVL18)	
Harvest (NBLE12)		Surge (WVL10)	
Ice Caves (NBLE32)		Swell (WVL08)	
Icicle (NBLE33)		Tide (WVL16)	
Inky (NBLE34)		Transition (WVL15)	
Iris (NBLE35)		Trough (WVL19)	
Jade (NBLE06)		Tsunami (WVL09)	
Knight (NBLE17)		Ultraviolet (WVL12)	
Mesa (NBLE03)		White Caps (WVL17)	
Monarch (NBLE36)		Laminates	
Pacific (NBLE08)		Beigewood (LWBE)	October 1, 2022
Pitch (NBLE37)		Fawn Cypress (LFC1)	October 1, 2022
Queen Bee (NBLE38)		Field Elm (LWFE)	October 1, 2022
Rainforest (NBLE05)			
Regal (NBLE11)			
Sandcastle (NBLE39)			
Sedona (NBLE40)			
Stormy (NBLE16)			
Sunbeam (NBLE41)			
Voyager (NBLE42)			
Windy Day (NBLE43)			

NOTES

HON FULL LIFETIME WARRANTY INFORMATION



FULL LIFETIME WARRANTY

YOUR HON FULL LIFETIME WARRANTY

Every time you purchase a HON product, you're making an investment in your future. We're proud to play a part in that future, and you can trust us to do our best for as long as you need us.

The HON Full Lifetime Warranty is our assurance to you that the HON desks, workstations, seating, tables, or storage you purchase will be free from defective material or workmanship for the life of the product.

In the unlikely event that any HON product or component covered by the HON Full Lifetime Warranty should fail under normal workplace use as a result of defective material or workmanship, HON shall repair or replace with comparable product (at HON's discretion), free of charge.

WHAT'S COVERED BY THE HON FULL LIFETIME WARRANTY?

Your HON Full Lifetime Warranty applies to product manufactured after January 1, 2011. All HON product lines, materials, and components are covered by the HON Full Lifetime Warranty except for the items described below.

The specific product lines, materials, and components listed below are covered under HON's Full 12-Year, Full 10-Year, and Full 5-Year Warranties (from date of purchase).

HON'S FULL 12-YEAR WARRANTY

- Electrical components (lamps and ballasts are not covered)
- 4-Way Stretch Mesh
- Seating controls
- Pneumatic Cylinders
- Wood Seating
- Accessories
- Laminate Surfaces

HON'S FULL 10-YEAR WARRANTY

- Coordinate™ Height Adjustable Bases (HHATB)

HON'S FULL 7-YEAR WARRANTY

- Coordinate™ Legacy Bases (HHAB and HREC)
- Workwall Markerboard Glass Tiles

HON'S FULL 5-YEAR WARRANTY

- All LED task lights
- Panel and seating textiles
- Coze™
- Between™ Multi-Purpose Table
- Acoustic Solutions by Unika Vaev
- Mod

HON'S FULL 1-YEAR WARRANTY

- Acrylic Screens

These warranties apply to HON products sold within the United States of America, U.S. Territories, and Canada, as well as U.S. Military and Federal Agency purchases (regardless of location).

IS ANYTHING NOT COVERED?

There are a few exclusions to the HON Full Lifetime Warranty and to the 12-, 10-, and 5-year warranties. These exclusions are:

- All HON products that are covered under a separate 5-year warranty.
- Color-fastness or matching of colors, woodgrains, or textures occurring in wood, leather, or other materials that naturally exhibit inherent color variations.
- Customer's own materials (COM) selected by and used at the request of the user.
- Modifications or attachments to the product that are not approved by The HON Company and product failures resulting from such modifications or attachments.
- Product normal wear and tear, which are to be expected over the course of ownership.
- Products that were not installed, used, or maintained in accordance with product instructions and warnings.
- Products used for rental purposes.
- Damage caused by cleaning chemicals.
- Dye transfer caused by external contaminants (including clothing and accessory dyes such as those used on denim jeans) may migrate to lighter colors. This phenomenon is increased by humidity and temperature and is irreversible.
- Fabric pattern match seat to back or chair to chair. If pattern match is needed, please submit a Tailored Solutions request or contact HON Customer Support/Tailored Solutions with questions.
- Storage Digilocks come with a 2-year warranty.

WARRANTY REQUESTS OR QUESTIONS?

Your HON Dealer is our mutual partner in supporting your warranty requests. To obtain service under this warranty, please contact your HON dealer. If you are not sure who your dealer is, please call HON Customer Support at 800.833.3964.

THAT'S YOUR HON FULL LIFETIME WARRANTY AS AN OWNER OF HON PRODUCT, THE WARRANTY EXPLAINED HERE IS YOUR SOLE AND EXCLUSIVE REMEDY. THERE ARE SOME EXCEPTIONS IF YOU PURCHASED THE PRODUCT FOR HOME OR PERSONAL USE WHICH ARE EXPLAINED BELOW. TO THE EXTENT ALLOWED BY LAW, THE HON COMPANY MAKES NO OTHER WARRANTY, EITHER EXPRESS OR IMPLIED, INCLUDING ANY WARRANTY OF MERCHANTABILITY OR FITNESS FOR A PARTICULAR PURPOSE. THE HON COMPANY WILL NOT BE LIABLE FOR ANY CONSEQUENTIAL OR INCIDENTAL DAMAGES.

A WORD ABOUT PURCHASES FOR HOME OR PERSONAL USE

Please note, this section only applies if you purchased your HON product for your home or for your own personal or family use. HON's warranties give you specific legal rights and you may have other rights, which vary from state to state. As a consumer purchaser, the complete exclusion of implied warranties noted in the above paragraph does not apply to you, however, to the extent allowed by applicable state law, the implied warranties are limited to the applicable term of the warranty. Some states do not allow the exclusion or limitation of incidental or consequential damages, so the above exclusion or limitation may not apply to you.

HON LIMITED 5-YEAR WARRANTY INFORMATION



LIMITED 5-YEAR WARRANTY

The HON Company promises to repair or replace HON products or components covered under this warranty that are found to be defective in material or workmanship within five (5) years from the date of original purchase so long as you, the original purchaser, still owns it. This is your sole and exclusive remedy. This warranty is subject to the provisions below. It applies to the products listed here manufactured after January 1, 2018.

LIMITATIONS:

- Upholstery on chairs is warranted for two years from date of purchase.
- Damage caused by the carrier in-transit is handled under separate terms.

EXCLUSIONS:

This warranty does not apply and no other warranty applies to:

- Normal wear and tear, which are to be expected over the course of ownership.
- Modifications or attachments to the product that are not approved by The HON Company.
- Products that were not installed, used or maintained in accordance with product instructions and warnings.
- Products used for rental purposes.

SEATING USAGE

Normal commercial use for seating is identified as the equivalent of a single shift, forty-(40) hour workweek. To the extent that a seating product is used in a manner exceeding this, the applicable warranty period will be reduced in a pro-rata manner.

A WORD ABOUT COLOR VARIATIONS, FABRICS AND FINISHES:

The HON Company does not warrant the color-fastness or matching of colors, grains or textures of covering materials.

CUSTOMER'S OWN MATERIAL (COM)

Not available on HON products covered under the HON 5-year warranty.

TO THE EXTENT ALLOWED BY LAW, THE HON COMPANY MAKES NO OTHER WARRANTY, EITHER EXPRESS OR IMPLIED, INCLUDING ANY WARRANTY OF MERCHANTABILITY OR FITNESS FOR A PARTICULAR PURPOSE. THE HON COMPANY WILL NOT BE LIABLE FOR ANY CONSEQUENTIAL OR INCIDENTAL DAMAGES.

NOTICE TO PURCHASERS FOR HOME OR PERSONAL USE:

Federal law does not permit the exclusion of certain implied warranties for consumer products. Therefore, if you are purchasing this product for home or personal use, the exclusion of implied warranties noted in the above paragraph does not apply to you. Some states do not allow the exclusion or limitation of incidental or consequential damages, so the above limitation or exclusion may not apply to you. This warranty gives you specific legal rights, and you may also have other rights which vary from state to state.

This warranty applies only to products sold within the United States of America and the Commonwealth of Canada.

TO OBTAIN SERVICE UNDER THIS WARRANTY:

Your HON® Dealer is our mutual partner in supporting your warranty requests. By following the procedures outlined below, you can be assured of the best level of service. Please note: Consent of The HON Company must be obtained before any warranty work is performed. To obtain consent, please take the following steps:

1. Contact the Dealer from whom the product was purchased within 30 days of discovery of the defect. Be prepared to affirm that you are the original purchaser of the product and to provide the serial number(s) from the product in question.
2. Your Dealer will gather all pertinent information regarding the claim, inspect the product and contact a HON Company customer service representative. (Please allow a reasonable amount of time for inspection and review.)
3. If The HON Company affirms that the product in question is eligible under the conditions of the warranty as stated above, the customer service representative or another representative of the Company will determine whether to provide replacement parts, authorize repairs or replace the product.

ORDERING

Electronic ordering is the standard order process for HON. HON supports the following primary methods for the electronic transmission of orders and order related documents:

Electronic Ordering

Available in the HONReady portal at honready.hon.com. There are multiple options available for processing orders electronically.

Integration with the standard Office Furniture business systems or other pre-approved proprietary software packages.

SIF file upload using fully optioned SIF files into the electronic ordering applications.

Manual entry of line items into the electronic ordering application.

EDI-System to System Integration

With standard Office Product systems or other pre-approved proprietary software systems.

Training, technical set-up and support is available through our Dealer Operations Team at honready@honcompany.com.

ORDER REQUIREMENTS

- Customer must provide complete and correct information, including complete model number, finishes, colors, options, and quantity.
- If a bid quotation or other special pricing applies, such information must be clearly stated on the order with applicable bid number or contract number.
- Order Management contact name and phone number.
- Delivery Appointment contact name and phone number at the dealership or installation company. HON does not accept orders with end user appointment contacts.
- Dealer Sales Representative, primary or multiple DSRs.
- “Best Date Available” for the entire order is standard service for HON. If eligible, other Date Requests may be requested and must be submitted with the order. Other Date Requests are subject to review by HON prior to acceptance:
 - “Ship After” requests are eligible on all order sizes
 - “Deliver On” requests are eligible for full truckload orders
- Additional services outside of HON’s standard services may be available through HON’s ‘Enhanced Services’ for a corresponding fee. Requested services from ‘Enhanced Services’ must be provided at time of order placement.
- Failure to provide complete and accurate information results in delayed order entry and acknowledgment. Incomplete orders will not be produced and will be returned to Dealer for correction.

ACKNOWLEDGMENT SERVICE

- E-mailed acknowledgments are available by customer request.
- An acknowledgment will be emailed the morning of the next business day, unless order is placed on credit or other order hold.
- The order will not receive an acknowledged shipment date until all order holds are released.

ORDER CHANGES OR CANCELLATIONS

For Order Changes or Cancellations, please contact Customer Support at 800-833-3964.

TERMS AND CONDITIONS

See **HON NOW** on honready.hon.com for more information about HON NOW delivery, services and ordering information.

HON DESIGN SERVICES

HON INTEGRATED DESIGN SOLUTIONS

Need design assistance? We can help! Our expert design staff will create a professional design package that is sure to put you one step ahead of the competition. And the best part is – it's free!

AUDIT

We will check your drawing and parts list for accuracy. We verify quantity, specification accuracy, product compatibility and structural support.

DESIGN

We will provide a professional design package including a 2D furniture plan, renderings, and complete parts list based on the rough sketch and project information you supply.

CONSULTATION

A 1:1 meeting will be scheduled where we will provide guidance on product positioning, answer specification questions, and recommend value engineering opportunities.

CONTACT HON DESIGN SERVICES

Questions? Please reach out to your region's dedicated designer. Not sure how to reach your designer? Send us a note at the email below.

E-Mail: integrateddesign@honcompany.com



Solve® Chair shown with Coordinate™ Height Adjustable Table.

Project Space

A place for all HON Project Services

Project Space provides one platform to access the full portfolio of HON services including:

- Design
- Audit
- Product Modification
- Special Laminates
- Consultation
- Customer's Own Material
- Dual Fabric Applications
- Special Paints
- Project Bid Pricing

Submit your request on the Community powered by HNI, Projects.

Project Space Lead Time: Within 3 business days depending on complexity and size of your project.

TAILORED SOLUTIONS ORDERING INFORMATION

PRODUCT MODIFICATIONS

Modifications include structural and dimensional modifications to existing product and Dual Fabric Applications, when standard model is not available.

The HON Company, at its own discretion, may modify standard products to meet specific needs. Product specials can be requested on HON brand product only.

List prices contained in published list pricers are for standard catalog items only. Changes or alterations to catalog items other than those listed as catalog options are subject to additional charges. Pricing will only be furnished upon approval of the special request.

Requests to have the product produced in more than one fabric (e.g., fabric on the seat is different than the fabric on the back), are considered a Dual Fabric Applications request and follow the Product Modification request process within the Community.

SPECIAL LAMINATES

Special laminates include requests for laminates not available as part of The HON Company's standard offering. Requests for special laminates are subject to manufacturing approval and minimum order quantities. The HON Company approved special laminates will be subject to a designated upcharge per unit.

Requests for special laminates should be submitted through the Community. Pricing will only be furnished upon approval of the special request.

SPECIAL PAINTS

- The HON Company's paint matching equipment can match almost any color, excluding some metallic and whites.
- Special paint requests must be submitted on the Community.
- In order to request a paint sample, the customer must have a minimum order of 10 like product units. Any requests with less than that amount will not be processed.
 - For each new paint request, there will be a \$250 net charge. A sample of the exact color desired is required for matching and approval. The HON Company will match the color and provide a production sample for the customer to review and approve.

- Once written approval is received by The HON Company, the request will be approved.
- Each unique color or finish combination incurs a designated upcharge per color per order (all standard discounts/competitive project pricing applies).

Special note: Some special colors could fall outside of this program due to production costs or not meeting The HON Company's quality standards. The HON Company may apply additional charges to some colors which are costly to apply, and refuse some orders on colors that cannot meet The HON Company's high-quality standards. The HON Company will notify the customer upon completion of The HON Company's evaluation if a change in price is required or rejection of the order.

DISCONTINUED PRODUCT

Requests for discontinued product require engineering evaluation, safety review, and testing to current standards prior to approval. Many discontinued products are not available for order. Requests for discontinued products should be submitted through the Community.

LEAD TIMES FOR SPECIALS PRODUCT

Lead times on orders containing specials are subject to production capacity and material availability. When possible, the customer should order special products separately to avoid extended lead times for standard products. Extended lead times will be noted on Compass.

CHANGES TO SPECIALS PRODUCT

A special model will be provided for each approved special item to process orders. Once an order is placed, no changes or cancellations can be made to the order without approval from Tailored Solutions.

CONTACT TAILORED SOLUTIONS

Phone: 800.833.3964 and listen for Tailored Solutions offering on the menu.

Email: HONSpecials@honcompany.com

CUSTOMER'S OWN MATERIAL ORDERING INFORMATION

CUSTOMER'S OWN MATERIAL (COM) PROGRAM

Customer's Own Material (COM) is a request to use fabrics not available as part of HON's standard fabric offering. Manufacture to Supply (MTS) and Dealer to Supply (DTS) are the two ordering methods. The HON Company has partnered with fabric manufacturers to provide competitive pricing and selection through the MTS program. MTS will be the standard offering unless The HON Company is unable to procure the fabric. If there is a DTS request submitted, The HON Company will advise at the time of the request if DTS is available.

CUSTOMER WARRANTY EXCLUSION

The HON Company shall have no responsibility for the condition, quality, value, performance, physical properties, or any other aspects of the COM.

The HON Company shall have no liability for any damages, injuries, or losses to the customer or to any third party that shall be caused by any COM or product modification, and the customer shall hold The HON Company harmless for all liability.

The HON Company assumes no responsibility for the overall appearance, flammability, normal durability, colorfastness, or any other quality of the COM or product modification after its application on a HON product beyond normal quality standards. The HON Company reserves the right to reject a COM fabric if the quality of the COM is not satisfactory for the product. Should this occur, the customer will be notified with an explanation of the issue.

The HON Company is not responsible for fabric that has become obsolete at the COM supplier, that is of poor quality, or that is delivered late to The HON Company from the COM supplier. The HON Company is not responsible for excess yardage created by DTS orders or yardage not attached to an order and reserves the right to dispose of the excess fabric.

As a standard HON does not pattern match any standard, partnership or COM fabric, therefore pattern match is not applicable under warranty. If pattern match is needed please submit a Tailored Solutions request or contact HON Customer Support/Tailored Solutions once your COM has been approved.

COM TESTING

As a result of recent legal requirements, The HON Company will need to obtain specific information from the fabric supplier about treatments and chemicals used in the fabric. To the extent the supplier is unwilling or unable to provide the necessary information, which could extend the testing lead time of the request.

To check if a COM has been tested previously, utilize the COM Search Tool on the HON Ready Portal > Design Resources > Textiles & Finishes section using the following information:

- COM Supplier's Name
- Fabric Pattern Name
- Color Name
- If the COM fabric has been tested and previously approved, the COM will not need to be re-tested unless testing standards have changed, fabric is to be used on a different series, or direction of the fabric has changed from what was previously approved. Please note that Panel product must be approved for each model and color.
- If the pattern has previously been tested and approved, but not in the specific requested color, the customer will need to request an order code for that color only. No further testing will be necessary since the pattern has already been approved.

If the fabric has not previously been tested, the customer must enter the COM request on the HON Ready Portal > Textiles & Finishes > COM Search Tool.

Complete the Supplier Name, Pattern, and Color drop-down fields. For quicker results in these fields, type the first letter of the (supplier, pattern, color) name and, when done, click Add and then Submit. (Multiple series can be added to the same request if they are the same supplier, pattern, and color.)

An email will be sent to the requestor stating the COM Request was successfully submitted. Up to four emails could be received: submitted, in testing, testing materials requested, and final approval/denial with price grade and fabric code. The testing process takes approximately 48 hours.

COM yardage in the pricer is shown as pattern cut only.

COM TESTING — FLAMMABILITY TESTING INFORMATION

The customer is responsible for ensuring that the COM fabric is certified to meet all flame-retardant requirements. All COM seating fabric must, at minimum, meet CAL 117 requirements. If the customer requires the chair be tested to meet the fire safety standards of CAL 133, additional testing and information is required.

MTS COM

As previously mentioned, MTS is the primary COM method.

If the COM fabric has not been tested, a COM request must be submitted on the HON Ready Portal.

For MTS orders, The HON Company will procure fabric needed for production. Should The HON Company not be able to obtain fabric yardage, the customer will be contacted.

CUSTOMER'S OWN MATERIAL ORDERING INFORMATION

When testing has been completed, the customer will be notified by the COM team of the test results. If the COM is approved, The HON Company will provide a COM tracking order code for MTS. That tracking code is required on the order in place of the standard fabric code.

If approved, MTS product will be assigned an appropriate fabric grade for pricing. The pricing can be found on the HON Ready Portal > Design Resources > Textiles & Finishes. (All standard discounts/competitive project pricing applies).

Written COM price quotes are valid for 90 days after the issue date.

DTS COM

DTS COM is only available if the COM fabric cannot be procured by The HON Company. If the fabric can be procured by The HON Company, the customer will be contacted to switch to MTS or cancel the request.

If your fabric is not listed as approved, and it is not a Partnership fabric you may request a "Dealer to Supply" code. Select the "Request COM Test" link on the COM Search website. Complete the Supplier Name, Pattern, and Color drop-down fields. For quicker results in these fields, type the first letter of the (supplier, pattern, color) name and, when done, click Add and then Submit. (Multiple series can be added to the same request if they are the same supplier, pattern, and color.)

An email will be sent to the requestor stating the COM Request was successfully submitted. Up to four emails could be received: submitted, in testing, testing materials requested, and final approval/denial with price grade and fabric code. It's rare actual test yardage is required. Testing is mainly done by reviewing the attributes of the fabric. The testing process takes approximately 48 hours.

If the COM has not been tested, a COM request must be submitted on the HON Ready Portal > Design Resources > Textiles & Finishes.

When testing has been completed, the customer will be notified by the COM team of the test results. If the COM is approved, The HON Company will provide a COM tracking order code. That tracking code is required on the order in the place of the standard fabric code.

DTS product is priced at the following grades (all standard discounts/competitive project pricing applies):

- Chairs are a Grade 4
- Panel product is a Grade D

Written COM price quotes are valid for 90 days after the issue date.

COM LEAD TIME

Ship dates will be based on fabric receipt and The HON Company's standard lead time. All fabric must be properly tagged and shipped to the appropriate producing location (provided in the approval email).

- Specific to DTS orders, COM orders will not receive a ship (acknowledged) date until The HON Company has the fabric in its possession for production.
- Specific to DTS orders, the customer may send the required yardage for the order to the address listed on the approval email to arrive no sooner than 4 weeks in advance of the acknowledgment date.

HON will make every effort to locate mis-directed COM shipments on behalf of the customer. However, The HON Company will not be responsible for any COM received without a tracking number or incorrectly shipped by the fabric vendor to an incorrect producing facility.

COM ORDERING INFORMATION

The following information must appear on or accompany the product purchase order:

- Approval tracking number and the customer's purchase order number
- COM supplier, pattern, and color name/number

The packing list for the COM must include the following information when The HON Company receives the shipment for production:

- Dealer or Wholesaler Name
- Purchase order number submitted to The HON Company
- Fabric name
- Yardage shipped
- Approval ordering code

Specific to DTS orders; the customer should send only the amount needed for the order. Excess yardage or yardage not tied to an order will be disposed of at The HON Company.

CHANGES TO COM PRODUCT

Once a COM product is ordered, no changes or cancellations can be made to the COM product without approval from the HON COM team.

CONTACT COM TEAM

Phone: 800.833.3964 and listen for COM TEAM offering on the menu.

COM Email: HONCOMTeam@honcompany.com

PARTNERSHIP TEXTILE INFORMATION

Partnership Textiles is the result of The HON Company's partnership with textile industry leaders Camira, HBF Textiles, Maharam, Momentum, Stinson, and Ultrafabrics, LLC. The extensive collection of design-driven textiles create a superior offering at a great value. Partnership Textiles significantly updates HON's offering, expanding it with fresh and exciting options.

- Fabric Warranty: Partnership Textiles are covered by HON's Full Lifetime Warranty.
- Lead Times: Orders specified with Partnership Textiles will be acknowledged based on the supplier's availability and delivery schedule.
- Availability: The HON Company will regularly introduce new Partnership Textiles and reserves the right to change the offering at any time.
- Fabric Cards: A curated set of Partnership Textiles are carded jointly by HON and the supplier.

Camira

- Blazer

HBF Textiles*

- Cloverleaf
- Denim Wash
- Everyday Textiles II
- Everyday Textures

*HBF Textiles patterns are graded in to HON's offering.

Maharam

- Apt
- Bluff
- Collection 1
- Lariat
- Meld
- 6M

Momentum

- Nexus
- Chroma
- Smart Fusion

Stinson

- Elevate II

Ultrafabrics, LLC

- Brisa
- Ultraleather Pro

Fabric Memo Samples: Please contact the supplier directly:

Camira: memos@camirafabrics.com

HBF Textiles: Phone: +1 (877) 494-5727, orders@hbftextiles.com

Maharam: (800) 645-3943

Momentum: customerservice@momtex.com (800) 366-6839

Stinson: (800) 841-6279

Ultrafabrics: (877) 309-6648

HON BRANDED, PARTNERSHIP AND COM PATTERN MATCH

- Pattern matching provides alignment of patterns or stripes across individual chair surfaces. Additional yardage may be required depending on pattern repeat. If Pattern Match is needed, please contact HON Customer Support/Tailored Solutions.
- Chair to Chair Pattern Match provides identical pattern alignment from unit to unit and is available with an upcharge. Chair to Chair Pattern Match is reviewed on a case by case basis as several factors are reviewed to determine additional yardage required, including repeat and pattern direction. If Chair to Chair Pattern Match is needed, please contact HON Customer Support/Tailored Solutions.



The HON Company has established paint grades to allow customers flexibility and ease in doing business with HON. HON has three paint grades P1, P2, and P3.

P1 PAINT COLORS

HON has established P1 paints which are available on a majority of core products.

P2 PAINT COLORS

Please see individual pricer pages for eligible series and upcharges for P2 paints. P2 paints are listed in the pricer pages under the column P2. Upcharges vary by product (all standard discounts/competitive project pricing applies). No minimum quantity required.

P3 PAINT COLORS

Please see individual pricer pages for eligible series and upcharges for P3 paints. P3 paints are listed in the pricer pages under the column P3. Upcharges vary by product (all standard discounts/competitive project pricing applies). No minimum quantity required.

SPECIAL PAINT COLORS (P4-P6)

With The HON Company's state of the art color matching equipment just about any color can be matched, excluding some metallic and whites. A sample of the exact color desired is required for matching and approval.

- For each newly requested paint, a net fee of \$250 will be charged to cover costs associated with the matching process.
- For existing, previously matched paints, there is no matching fee, however there is a \$100 net fee for sample panels required for the approval process. Refer to MyProjects on the HON Portal for a list of approved special paints.

For all special paint requests, HON will send a production sample for the customer to review and approve. Once the signed paint sample is received at HON the order can be entered. Upcharges vary by product (all standard discounts/competitive project pricing applies). A quantity of 10 like-model minimum order is required for special paints. For complete program details, access Tailored Solutions on the HON Ready Portal at honready.hon.com.

Some special colors could fall outside of this program due to production costs or not meeting HON quality standards. The HON Company may apply additional charges to some colors which are costly to apply, and deny some orders on colors that cannot meet our high-quality standards. We will notify the customer upon completion of our evaluation if a change in price is required or if the request is denied.

HON OPEN LINE LAMINATE PROGRAM

The Open Line Laminate (OLL) program makes it even easier for a customer to tailor their HON product for a custom look. Select HON furniture products accommodate hundreds of graded-in high-pressure laminates (HPL) from the leading laminate manufacturers' open lines.

Laminates that are currently available in the program can be viewed in specification tools.

Requests to add laminates to the standard specials program can be submitted through the CET Specials Integration tool as well as Community.

Matching edge options are not available offered for laminates in the OLL program. When selecting a laminate please select an edge option from the HON standard offering. If a matching edge is required a modification request can be submitted through the CET Specials Integration tool as well as Community.

The OLL program is available with the following HON products and series:

- Abound® Hard-Surface Tiles
- Birk™ Tables
- Build™ Tables
- Coordinate™ Worksurfaces
- Gallery Panels
- Huddle Tables
- Preside® Tops
- Sculpt™/Occasional Tables
- SmartLink® Value Teacher Desk
- Systems Worksurfaces
- Tangram™
- Universal Screens

Due to manufacturing techniques, materials, quality issues of varying laminates, and minimum order quantities, some product exclusions will apply and some requests may be declined.

Extended lead times may apply on orders containing special laminates.

Contact the Tailored Products Group for questions or additional information regarding pre-approved laminates and pricing.

HON

Phone: 888-255-7833, Option 4.5

Email: HONSpecials@honcompany.com

For edgeband recommendations from the HON standard offering, please email the HNI Workplace Colors, Materials, and Finishes team at honfinishes@honcompany.com.

For laminate samples, please contact the manufacturer directly:

Wilsonart

<https://www.wilsonart.com/>
1-800-433-3222

Formica

<https://www.formica.com/en-us/>
1-800-FORMICA (367-6422)

Nevamar and Pionite

<https://www.panolam.com>
877-726-6526

ENVIRONMENTAL STATEMENT

We continually reevaluate our purpose and processes, from fostering transparency and circularity in our supply chain to empowering our members to do and be better. We do it so the environments you create will be safer, more socially responsible, and more sustainable.

We've pursued product certifications to help communicate our commitment to developing sustainable products.

Clearing the air.

In 2006, The HON Company became one of the first office furniture manufacturer to have products certified under the Indoor Advantage™ program. Virtually all manufactured products emit chemical compounds into the air. Indoor Advantage™ certification helps assure customers that certified products will help improve the air quality within their offices and workspaces.

Developed by SCS Global Services, Indoor Advantage™ evaluates products against indoor air quality standards, like ANSI/BIFMA Furniture Emissions Standard, M7.1/X7.1 and CDPH Standard Method v1.1. The ANSI/BIFMA X7.1 standard allows manufacturers to test individual components, as well as complete products for emissions from volatile organic compounds (VOCs). This allows us to identify problematic materials and phase them out of our products.

Indoor Advantage™ certified products meet the LEED and WELL criteria for low-emitting materials.

Indoor Advantage™ offers two levels of certification, including Indoor Advantage™ and Indoor Advantage™ Gold.



On the LEVEL®.

LEVEL®, the certification program for the BIFMA e3 Sustainability Standard, was developed in response to increasing demand for proof that manufacturers were living up to their environmental claims. LEVEL® is a multi-attribute sustainability certification label for products that have met criteria in four categories of impact: Materials, Energy and Atmosphere, Human and Ecosystem Health, and Social Responsibility.

HON's products are certified to LEVEL 2 and LEVEL 3, the highest achievement. BIFMA LEVEL 2 and LEVEL 3 certified products can contribute to LEED and WELL projects.



Evaluating Our Impacts.

HON has begun studying the impacts our products have on the environment through lifecycle assessments and creating Environmental Product Declarations (EPDs). EPDs provide an understandable report of a product's environmental impact throughout its life cycle; including raw material extraction and processing, product assembly, distribution and use, and end-of-life.

Products that meet these specifications are identified throughout this publication with the following icons:

Certified SCS Indoor Advantage™

LEVEL® certified to the BIFMA e3 Sustainability Standard

Environmental Product Declarations

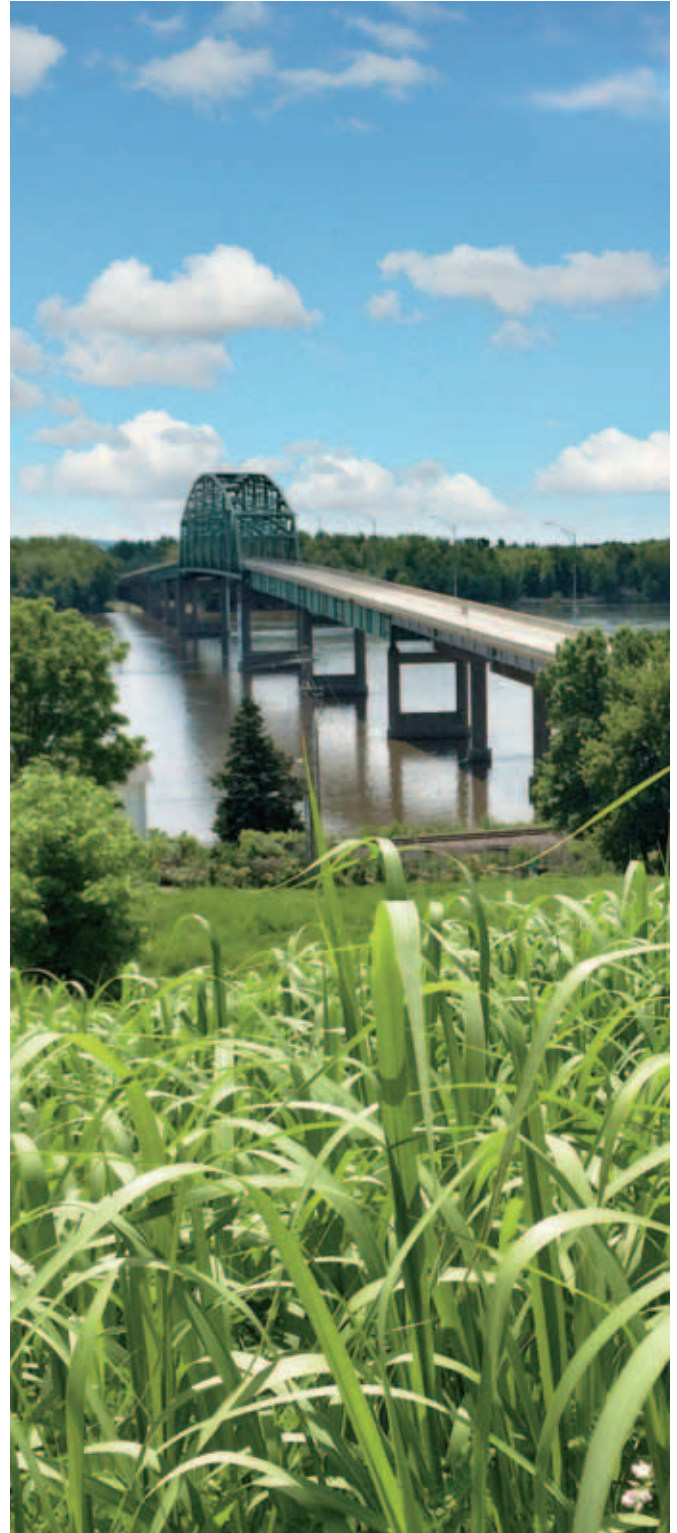

IMPORTANT INFORMATION

HON NOW™

SUPERIOR OFFICE SOLUTIONS AT THE SPEED YOU NEED

To keep your business at peak productivity, waiting is not always an option. The HON NOW™ Quickship program was designed for movers and shakers like you who want exceptional quality, durability, and versatility without compromising valuable time. Whether you're outfitting a brand new workspace or simply expanding the one you already have, we've got a variety of dependable and supportive office furniture solutions designed to fit your needs and your schedule — in a hurry, without the hassle.

To learn more, visit hon.com/hon-now.

GSA CONTRACT INFORMATION

Model numbers identified with the verbiage “**Open Market**” are not offered on HON's GSA contract GS-27F-0015S. Model numbers identified with the following verbiage “Must be purchased with a configurable end product. If ordered separately, not on GSA contract” is to mean that these configurable components or options:

- Have no functionality or capability without being integrated into an end product, and
- Are not separately orderable; an eligible Schedule ordering activity may only purchase them with a configured system that is on contract.

HON CUSTOMER SUPPORT CONTACT INFORMATION

Nationwide CS Phone – (800) 833-3964

Nationwide Order Entry – HONOE@honcompany.com

GSA Order Entry: HONGSAOE@honcompany.com

Integrated Design Solutions – integrateddesign@honcompany.com

Online Order and Tool Support – HONReady@honcompany.com

DASH (transportation and delivery assistance) – (800) 334-8057

HON Literature Fulfillment Phone – (800) 466-4808

Government Support:

GovernmentSupport@hniworkplacefurnishings.com

Product, Parts, Non-Warranty Parts Orders:

ProductSupport@hniworkplacefurnishings.com

Quick Ship Orders: QuickShip@hniworkplacefurnishings.com

Order Status: OrderStatus@hniworkplacefurnishings.com

General Inquiries: GeneralSupport@hniworkplacefurnishings.com



Nationwide CS Phone

800-833-3964

THE FOLLOWING ICONS MAY BE USED THROUGHOUT THIS PUBLICATION

	Meets or exceeds ANSI/BIFMA and ISTA performance standards		Readily Available. For additional lead time information see page 21.
	Certified SCS Indoor Advantage™ See page 17 for more details.		Available within a “standard” or “extended” lead time. For additional lead time information see page 21.
	Complies to the BIFMA e3 Sustainability Standard. See page 17 for more details.		May have extended lead times. For additional lead time information see page 21.
	Caution		Product shipped two to a carton
	Easy to assemble		Product shipped four to a carton
	Shippable by small-package carrier		Fire Code
	Wheel-chair compatible		Core Product Line
	Soft-tread caster option available		ColorCorrect® Eligible Product
	HON “One Key” Interchangeable core removable locks (see the Accessories section in the 2023 Workspaces Pricer).		Product scheduled for discontinuation. See page 5 for details.
	Omit core removable lock option available. Allows keyed alike workstations (see the Accessories section in the 2023 Workspaces Pricer).		DE-EMPHASIZED: Product or fabric/surface material is de-emphasized. Not carded.
	Base models available on the HON NOW Quickship Program with select options and finishes. View the entire NOW collection at honready.hon.com .		Warranted for multiple shift use, 24 hours a day 7 days a week

FABRIC PATTERNS & CODES



FABRIC PATTERNS & CODES

- For additional HON to Supply COM fabric grade pricing, go to honready.hon.com and search on the HON to Supply COM link.
 - All specifications in this publication are based on the latest product information available at the time of print.
 - Certain dyes (including clothing and accessory dyes such as those used on denim jeans) may migrate to lighter colors. This phenomenon is increased by humidity and temperature and is irreversible. The HON Company LLC does not assume responsibility for dye transfer caused by external contaminants.
 - COM Ordering Information and pricing on page 13.
 - See page 14 for Partnership Textile program information.
 - All standard fabrics are carded. Cards are available through HON Literature Fulfillment.
 - Fabrics and foam meet requirements for CAL-TB 117-2013.
- ⓘ Different fabrics and finishes have different recommended cleaning and maintenance methods. For the correct product care for all finishes view the HON Product Care guide at hon.com/customer-support/product-care.

LEAD TIMES

THE FOLLOWING ICONS ARE USED TO DENOTE FABRIC OPTION LEAD TIMES

FABRIC/FINISH LEAD TIME INDICATOR



Fabric is readily available. Products using these fabrics will receive the best available product lead time and are a good option for standards programs as they will be in the HON portfolio for several years. Go to honready.hon.com and use **Compass** for product lead times by series.



Fabric is available within standard lead times. Products using these fabrics will receive a “standard” or “extended” lead time. The lead time will be determined by the combination of product and fabric. Go to honready.hon.com and use **Compass** for product lead times by series.



Fabric may have extended lead times. Products using these fabrics will typically have a 4+ week lead time. Go to honready.hon.com and use the **Compass** tool for product lead times by series.

HON EXPRESS QUICK SHIP PROGRAM

For the full list of products delivered in 5 business days or less, visit honready.hon.com.

PRODUCT LEAD TIMES

Standard lead times for products are between 2-4 weeks. For current exceptions to our standard lead time, go to honready.hon.com and use the **Compass** tool.

In order to establish accurate expectations for your project, please review this listing prior to submitting your purchase order.

Lead time calculation begins when order is free from any holds (i.e., bad lines, material, credit, etc.).

Please note, these production lead time estimates do NOT include delivery time. All published lead times are estimates, not guarantees of delivery.

For further information concerning lead times, please contact HON Customer Support via email HONTeamBox@honcompany or by phone at **800-833-3964**.

SEATING FABRIC PATTERNS & CODES

Scan here to check out our full Chair Fabrics solutions



GRADE 1

APEX	APX
◆ Basalt	APX25
◆ Beet	APX12
◆ Blackberry	APX20
◆ Chive	APX05
◆ Iris	APX03
◆ Kiwi	APX06
◆ Lemonade	APX08
◆ Navy	APX13
◆ Papaya	APX09
◆ Pumice	APX23
◆ Rain	APX19
◆ Resort	APX15
◆ Royal	APX14
◆ Tiki	APX29
◆ Tomato	APX11

BLACK FABRIC	ACCF
◆ Black	ACCF10

BLACK MESH	ACCM
◆ Black	ACCM10

CENTURION	CU
◆ Apricot	CU47
◆ Bark	CU25
◆ Black	CU10
◆ Espresso	CU49
◆ Fog	CU03
◆ Frost	CU22
◆ Goldenrod	CU27
◆ Indigo	CU06
◆ Iris	CU50
◆ Iron Ore	CU19
◆ Jade	CU83
◆ Marsala	CU63
◆ Morel	CU24
◆ Navy	CU98
◆ Peacock	CU97
◆ Pear	CU84
◆ Ruby	CU67
◆ Sapphire	CU09

COMPASS	COMP
◆ Beach	COMP16
◆ Bittersweet	COMP46
◆ Chocolate	COMP49
◆ Ink	COMP10
◆ Meadow	COMP82
◆ Midnight	COMP90
◆ Putty	COMP22
◆ Ruby	COMP62
◆ Sterling	COMP19
◆ Taupe	COMP26
◆ Tide	COMP96

GRADE 1 *continued*

COMPASS FOAM*	COMF
◆ Bittersweet	COMF46
◆ Ink	COMF10
◆ Meadow	COMF82
◆ Midnight	COMF90
◆ Putty	COMF22
◆ Sterling	COMF19

**This fabric available for Solve* Upholstered Back models only.*

CONTOURETT	UR
◆ Baltic	UR94
◆ Beach	UR23
◆ Black	UR10
◆ Bordeaux	UR63
◆ Buff	UR22
◆ Cloud	UR18
◆ Coffee Bean	UR49
◆ Crater	UR51
◆ Flame	UR62
◆ Graphite	UR19
◆ Iron	UR20
◆ Luggage	UR26
◆ Marine	UR92
◆ Navy	UR95
◆ Nimbus	UR93
◆ Ocean	UR96
◆ Pumpkin	UR42
◆ Quarry	UR24
◆ Red	UR64
◆ Safari	UR27
◆ Sage	UR82
◆ Steel	UR21
◆ Storm	UR17
◆ Taupe	UR28
◆ Trunk	UR50

DAPPER	DAPR
◆ Ash	DAPR20
◆ Breeze	DAPR06
◆ Canvas	DAPR25
◆ Charcoal	DAPR01
◆ Clover	DAPR22
◆ Currant	DAPR00
◆ Fawn	DAPR35
◆ Fern	DAPR85
◆ Gerbera	DAPR16
◆ Grape	DAPR33
◆ Jewel	DAPR08
◆ Marigold	DAPR65
◆ Onyx	DAPR10
◆ Orchid	DAPR90
◆ Parrot	DAPR59
◆ Poppy	DAPR19
◆ Sapphire	DAPR07
◆ Scarlet	DAPR45

GRADE 1 *continued*

DAPPER <i>continued</i>	DAPR
◆ Sepia	DAPR30
◆ Sky	DAPR44
◆ Slate	DAPR15
◆ Sorbet	DAPR55
◆ Spring	DAPR80
◆ Terracotta	DAPR13
◆ Titanium	DAPR17
◆ Varsity	DAPR09
◆ Zest	DAPR70

ENSEMBLE	ENSB
◆ Aquamarine	ENSB30
◆ Ash	ENSB39
◆ Greige	ENSB36
◆ Harbor	ENSB34
◆ Navy	ENSB35
◆ Oat	ENSB37
◆ Pear	ENSB33
◆ Sand	ENSB38
◆ Scarlet	ENSB32
◆ Slate	ENSB31
◆ Stone	ENSB40

HAMILTON	HAML
◆ Agave	HAML28
◆ Azure	HAML10
◆ Biscotti	HAML11
◆ Cabernet	HAML08
◆ Caribbean	HAML29
◆ Carolina	HAML21
◆ Charcoal	HAML17
◆ Chocolate	HAML13
◆ Cloud	HAML18
◆ Dane	HAML16
◆ Deep	HAML27
◆ Dove Grey	HAML33
◆ Dusty Rose	HAML07
◆ Esmeralda	HAML06
◆ Fern	HAML04
◆ Fresh	HAML03
◆ Garnet	HAML22
◆ Granola	HAML19
◆ Hearth	HAML34
◆ Lilac	HAML14
◆ Lime	HAML05
◆ Lipstick	HAML09
◆ Mellow	HAML25
◆ Mossy Green	HAML26
◆ Oxford	HAML20
◆ Passion Fruit	HAML02
◆ Pepper	HAML15
◆ Powder	HAML12
◆ Royalty	HAML31
◆ Serene	HAML30
◆ Sunny Day	HAML24
◆ Sunrise	HAML01
◆ Terracotta	HAML23
◆ Winter Sky	HAML32

GRADE 1 *continued*

INERTIA	NR
◆ Amethyst	NR61
◆ Calypso	NR98
◆ Cherry	NR66
◆ Cobalt	NR91
◆ Coffee	NR49
◆ Fog	NR19
◆ Fuchsia	NR63
◆ Gecko	NR76
◆ Glow	NR27
◆ Leaf	NR75
◆ Lime	NR82
◆ Loft	NR22
◆ Mandarin	NR47
◆ Meteor	NR30
◆ Mustard	NR26
◆ Nickel	NR23
◆ Onyx	NR10
◆ Regatta	NR90
◆ Shadow	NR20
◆ Surf	NR96
◆ Tangelo	NR46

NOBLE SEATING	SNBLE
◆ Aegean	SNBLE18
◆ Amethyst	SNBLE19
◆ Aspen	SNBLE14
◆ Aster	SNBLE20
◆ Blossom	SNBLE21
◆ Bluebell	SNBLE22
◆ Bordeaux	SNBLE01
◆ Brick	SNBLE02
◆ Chambray	SNBLE10
◆ Chamomile	SNBLE23
◆ Clementine	SNBLE04
◆ Conifer	SNBLE24
◆ Cottage	SNBLE25
◆ Darkness	SNBLE26
◆ Dawn	SNBLE13
◆ Denim	SNBLE09
◆ Desert Sand	SNBLE27
◆ Dewfall	SNBLE28
◆ Dusted Sage	SNBLE29
◆ Flax	SNBLE30
◆ Grass	SNBLE07
◆ Gunmetal	SNBLE15
◆ Harmony	SNBLE31
◆ Harvest	SNBLE12
◆ Ice Caves	SNBLE32
◆ Icicle	SNBLE33
◆ Inky	SNBLE34
◆ Iris	SNBLE35
◆ Jade	SNBLE06
◆ Knight	SNBLE17
◆ Mesa	SNBLE03
◆ Monarch	SNBLE36
◆ Pacific	SNBLE08
◆ Pitch	SNBLE37
◆ Queen Bee	SNBLE38



Scan here to check out
our full Chair Fabrics
solutions

SEATING FABRIC PATTERNS & CODES

GRADE 1 *continued*

NOBLE SEATING <i>continued</i>	SNBLE
◆ Rainforest	SNBLE05
◆ Regal	SNBLE11
◆ Sandcastle	SNBLE39
◆ Sedona	SNBLE40
◆ Stormy	SNBLE16
◆ Sunbeam	SNBLE41
◆ Voyager	SNBLE42
◆ Windy Day	SNBLE43

OPTIC	OP
◆ Aurora	OP72
◆ Bark	OP24
◆ Canopy	OP84
◆ Char	OP49
◆ Ruby	OP42
◆ Sand	OP17
◆ Sky	OP83
◆ Slate	OP19
◆ Sprout	OP74
◆ Starry Night	OP11
◆ Storm	OP56
◆ Wildfire	OP66

PEBBLE	PBLE
◆ Amber	PBLE01
◆ Chalk	PBLE02
◆ Coal	PBLE03
◆ Gravel	PBLE04
◆ Magma	PBLE06
◆ Moss	PBLE05
◆ Sandstone	PBLE07
◆ Talc	PBLE08
◆ Topaz	PBLE09
◆ Zircon	PBLE10

VIBE	VIBE
◆ Bliss	VIBE03
◆ Calm	VIBE06
◆ Carefree	VIBE08
◆ Cheerful	VIBE17
◆ Compassion	VIBE01
◆ Connected	VIBE13
◆ Content	VIBE19
◆ Courage	VIBE12
◆ Dazed	VIBE21
◆ Delight	VIBE18
◆ Euphoria	VIBE15
◆ Gleeful	VIBE04
◆ Gloomy	VIBE22
◆ Hope	VIBE07
◆ Moody	VIBE05
◆ Nostalgia	VIBE09
◆ Perplexed	VIBE10
◆ Pride	VIBE02
◆ Relaxed	VIBE20
◆ Secure	VIBE16
◆ Serenity	VIBE11
◆ Trust	VIBE14

GRADE 2

APPOINT SEATING	PNS
◆ Artichoke	PNS014
◆ Blackberry	PNS012
◆ Bronze	PNS002
◆ Carbon	PNS008
◆ Chai	PNS013
◆ Cherry	PNS010
◆ Dark Pewter	PNS017
◆ Dune	PNS015
◆ Espresso	PNS003
◆ Framboise	PNS011
◆ Frost	PNS034
◆ Jet	PNS007
◆ Lawn	PNS005
◆ Mandarin	PNS009
◆ Morel	PNS001
◆ Nimbus	PNS016
◆ Platinum	PNS004
◆ Turquoise	PNS006

BLUME	BLME
◆ Chalk	BLME03
◆ Char	BLME00
◆ Coin	BLME02
◆ Driftwood	BLME05
◆ Emerald City	BLME07
◆ Fir	BLME09
◆ Harvest	BLME04
◆ Haze	BLME08
◆ Hyacinth	BLME14
◆ Jasper	BLME13
◆ Merlot	BLME10
◆ Moonstone	BLME01
◆ Opal	BLME06
◆ Scarlet	BLME11
◆ Slate	BLME12

CLYDE	CLYD
◆ Antique	CLYD04
◆ Artifact	CLYD01
◆ Blacksmith	CLYD10
◆ Claret	CLYD13
◆ Craftsman	CLYD08
◆ Crate	CLYD12
◆ Fossil	CLYD02
◆ Heirloom	CLYD05
◆ Iron	CLYD11
◆ Keepsake	CLYD15
◆ Linen	CLYD14
◆ Relic	CLYD06
◆ Seasoned	CLYD03
◆ Trestle	CLYD07

GRADE 2 *continued*

DOTTY	DOT
◆ Candy	DOT63
◆ Gelato	DOT34
◆ Indigo	DOT31
◆ Onyx	DOT35
◆ Park	DOT83
◆ Peat	DOT24
◆ Peony	DOT32
◆ Suit	DOT20
◆ Sunflower	DOT33
◆ Tailor	DOT21
◆ Tide	DOT90
◆ Velum	DOT29
◆ Violet	DOT30

KAI	KAI
◆ Algae	KAI07
◆ Barnacle	KAI19
◆ Clownfish	KAI04
◆ Coastal	KAI13
◆ Conch	KAI02
◆ Coral Reef	KAI16
◆ Crab	KAI01
◆ Ebb	KAI12
◆ Flow	KAI11
◆ Inlet	KAI03
◆ Jellyfish	KAI18
◆ Kelp	KAI08
◆ Orca	KAI26
◆ Otter	KAI22
◆ Puffer	KAI06
◆ Salty	KAI23
◆ Seahorse	KAI05
◆ Seashell	KAI20
◆ Seaweed	KAI09
◆ Shark	KAI24
◆ Shoreline	KAI21
◆ Stingray	KAI25
◆ Tide	KAI14
◆ Turtle	KAI10
◆ Urchin	KAI17
◆ Wave	KAI15

GRADE 2 *continued*

RUSH	RUSH
◆ Anchor	RUSH07
◆ Basil	RUSH16
◆ Blueberry	RUSH10
◆ Blue Sky	RUSH57
◆ Browned Butter	RUSH25
◆ Cherry Pie	RUSH40
◆ Cinnamon Sugar	RUSH35
◆ Dried Herb	RUSH62
◆ Flamingo	RUSH21
◆ Forest Green	RUSH67
◆ Greenery	RUSH15
◆ Greyhound	RUSH06
◆ Marina	RUSH13
◆ Merlot	RUSH19
◆ Midnight	RUSH11
◆ Mint	RUSH09
◆ Mulberry	RUSH18
◆ Obsidian	RUSH90
◆ Petals	RUSH77
◆ Pumice	RUSH01
◆ Punch	RUSH20
◆ Rain Drop	RUSH54
◆ Rush Smoke	RUSH84
◆ Sage	RUSH14
◆ Salsa	RUSH24
◆ Sand	RUSH05
◆ Seal	RUSH08
◆ Slate	RUSH89
◆ Soot	RUSH02
◆ Stout	RUSH03
◆ Sunshine	RUSH23
◆ Tapestry	RUSH04
◆ Tiger	RUSH22
◆ Vintage	RUSH17
◆ Wave	RUSH12

SPIN SEATING	SPNN
◆ Alabaster	SPNN02
◆ Cavern	SPNN03
◆ Cobblestone	SPNN04
◆ Ember	SPNN06
◆ Flame	SPNN07
◆ Heron	SPNN13
◆ Oat	SPNN01
◆ Ocean	SPNN12
◆ Plum	SPNN15
◆ Pool	SPNN11
◆ Raven	SPNN10
◆ Rhubarb	SPNN14
◆ Tropic	SPNN08
◆ Willow	SPNN05

SEATING FABRIC PATTERNS & CODES

Scan here to check out our full Chair Fabrics solutions



GRADE 2 *continued*

WAVELENGTH	WVL
◆ Base	WVL21
◆ Crest	WVL14
◆ Cycle	WVL20
◆ Energy	WVL03
◆ Frequency	WVL04
◆ Infrared	WVL01
◆ Motion	WVL13
◆ Movement	WVL05
◆ Peak	WVL11
◆ Pressure	WVL06
◆ Shallow	WVL02
◆ Still	WVL07
◆ Surface	WVL18
◆ Surge	WVL10
◆ Swell	WVL08
◆ Tide	WVL16
◆ Transition	WVL15
◆ Trough	WVL19
◆ Tsunami	WVL09
◆ Ultraviolet	WVL12
◆ White Caps	WVL17

WHISPER VINYL	WP
◆ Antelope	WP20
◆ Auburn	WP02
◆ Black	WP40
◆ Bone	WP17
◆ Bordeaux	WP26
◆ Breeze	WP76
◆ Brick Red *	WP99
◆ Camel	WP18
◆ Cappuccino	WP21
◆ Carotene *	WP97
◆ Cashew	WP29
◆ Cerulean	WP36
◆ Charcoal	WP39
◆ Cinnamon	WP25
◆ Coastal	WP81
◆ Cognac	WP62
◆ Cucumber *	WP88
◆ Elephant	WP38
◆ Emerald	WP80
◆ Espresso	WP49
◆ Farro	WP73
◆ Fawn	WP91
◆ Fog	WP100
◆ Forest *	WP82
◆ Fossil	WP01

GRADE 2 *continued*

WHISPER VINYL <i>continued</i>	WP
◆ Gravel *	WP19
◆ Herbal	WP79
◆ Indigo	WP86
◆ Islet	WP77
◆ Luggage	WP23
◆ Mahogany	WP93
◆ Mallard	WP90
◆ Merlot *	WP27
◆ Molten	WP98
◆ Navy	WP37
◆ Ochre *	WP96
◆ Paradise	WP85
◆ Patina	WP34
◆ Pavestone	WP74
◆ Pearl	WP71
◆ Pewter	WP83
◆ Powder	WP70
◆ Putty *	WP84
◆ Saddle	WP03
◆ Salsa	WP42
◆ Sand	WP72
◆ Sangre *	WP28
◆ Sassafras	WP89
◆ Silver Leaf	WP78
◆ Slate	WP04
◆ Storm	WP92
◆ Terracotta	WP75
◆ Truffle	WP95
◆ Wolf Grey	WP55
◆ Zest *	WP87

GRADE 3

BRADBURY	BDY
◆ Acorn	BDY01
◆ Alabaster	BDY02
◆ Aspire	BDY03
◆ Blueberry	BDY04
◆ Carbon	BDY05
◆ Concord	BDY06
◆ Cozumel	BDY07
◆ Dolphin	BDY08
◆ Gala	BDY09
◆ Honey	BDY10
◆ Mushroom	BDY11
◆ Mystic	BDY12
◆ Oat	BDY13
◆ Rhino	BDY14
◆ Scallion	BDY15
◆ Sidewalk	BDY16
◆ Terrazzo	BDY17
◆ Vellum	BDY18
◆ Walnut	BDY19

GRADE 3 *continued*

GETAWAY	GTWY
◆ Brig	GTWY15
◆ Canoe	GTWY03
◆ Catamaran	GTWY08
◆ Cruise Ship	GTWY10
◆ Cuddy	GTWY01
◆ Ferry	GTWY11
◆ Gondola	GTWY02
◆ Jet Ski	GTWY09
◆ Kayak	GTWY05
◆ Pontoon	GTWY13
◆ Runabout	GTWY14
◆ Sailboat	GTW07
◆ Speedboat	GTWY12
◆ Wakeboard	GTWY06
◆ Yacht	GTWY04

MOXIE	SX
◆ Barnwood	SX09
◆ Basalt	SX23
◆ Bayou	SX02
◆ Bermuda	SX52
◆ Biscotti	SX08
◆ Blackberry	SX48
◆ Blarney	SX49
◆ Blueberry	SX05
◆ Bonsai	SX20
◆ Brigade	SX53
◆ Butterscotch	SX54
◆ Carob	SX24
◆ Chalk	SX50
◆ Chartreuse	SX34
◆ Cherry	SX38
◆ Cinnamon	SX13
◆ Cobalt	SX01
◆ Coconut	SX06
◆ Concrete	SX43
◆ Cozumel	SX55
◆ Cumin	SX32
◆ Dover	SX56
◆ Dragonfly	SX44
◆ Earl Grey	SX40
◆ Elysian	SX04
◆ Evergreen	SX21
◆ Fatigue	SX18
◆ Fawn	SX30
◆ Flint	SX39
◆ Forsythia	SX57
◆ Grenache	SX58
◆ Hazel	SX31
◆ Hemp	SX45
◆ Hickory	SX25
◆ Holly	SX51
◆ Jam	SX16
◆ Kelly	SX33
◆ Lemongrass	SX19

GRADE 3 *continued*

MOXIE <i>continued</i>	SX
◆ Lime	SX41
◆ Macintosh	SX12
◆ Midnight	SX59
◆ Mulberry	SX15
◆ Muslin	SX60
◆ Pacifica	SX61
◆ Parchment	SX07
◆ Peacock	SX03
◆ Phantom	SX62
◆ Pineapple	SX42
◆ Plum	SX17
◆ Punch	SX46
◆ Riverstone	SX47
◆ Russet	SX14
◆ Smokestack	SX22
◆ Tangerine	SX37
◆ Terracotta	SX11
◆ Thicket	SX35
◆ Walnut	SX10
◆ Whirlwind	SX63

NOTION	NTN
◆ Agave	NTN01
◆ Bark	NTN02
◆ Beeswax	NTN03
◆ Carbon	NTN04
◆ Cassia	NTN05
◆ Cement	NTN06
◆ Char	NTN07
◆ Chroma	NTN08
◆ Dockside	NTN09
◆ Drifter	NTN10
◆ Fog	NTN11
◆ Fountain	NTN12
◆ Fox	NTN13
◆ Grassland	NTN14
◆ Henna	NTN15
◆ Horizon	NTN16
◆ Ivy	NTN17
◆ Linen	NTN18
◆ Mykonos	NTN19
◆ Peat	NTN20
◆ Poppy	NTN21
◆ Rockfall	NTN22
◆ Sandwash	NTN23
◆ Stoneware	NTN24
◆ Sumac	NTN25
◆ Twilight	NTN26

For a complete list of fabrics, including partnership fabrics, go to hon.com/fabricsandfinishes.

* Fabric is de-emphasized.



Scan here to check out
our full Chair Fabrics
solutions

SEATING FABRIC PATTERNS & CODES

GRADE 3 *continued*

PARKER	PRKR
◆ Aloe	PRKR01
◆ Cumulus	PRKR05
◆ Cyan	PRKR06
◆ Domino	PRKR07
◆ Fossil	PRKR10
◆ Graphite	PRKR11
◆ Grass	PRKR12
◆ Grenadine	PRKR13
◆ Griffin	PRKR14
◆ Kiln	PRKR16
◆ Magnesium	PRKR18
◆ Magnet	PRKR19
◆ Mica	PRKR20
◆ Mink	PRKR21
◆ Nightfall	PRKR22
◆ Paprika	PRKR24
◆ Pine	PRKR25
◆ Rapids	PRKR28
◆ Rioja	PRKR30

PURL	PURL
◆ Alpaca	PURL08
◆ Braid	PURL10
◆ Deep	PURL12
◆ Graze	PURL05
◆ Loom	PURL06
◆ Needle	PURL07
◆ Pasture	PURL02
◆ Ranch	PURL04
◆ Shuttle	PURL09
◆ Skein	PURL01
◆ Thistle	PURL11
◆ Yearling	PURL03

QUILL	QUL
◆ Aviary	QUL03
◆ Feather	QUL02
◆ Fountain	QUL06
◆ Ink	QUL05
◆ Metal	QUL04
◆ Reed	QUL08
◆ Scroll	QUL01
◆ Well	QUL07

GRADE 3 *continued*

SAXONY	SXNY
◆ Arctic	SXNY14
◆ Azure	SXNY11
◆ Black	SXNY21
◆ Clover	SXNY06
◆ Cobalt	SXNY12
◆ Emerald	SXNY08
◆ Flare	SXNY02
◆ Fog	SXNY18
◆ Grass	SXNY05
◆ Iron	SXNY20
◆ Lagoon	SXNY07
◆ Lipstick	SXNY01
◆ Mandarin	SXNY03
◆ Navy	SXNY13
◆ Sand	SXNY16
◆ Sea	SXNY10
◆ Shell	SXNY15
◆ Sky	SXNY09
◆ Storm Cloud	SXNY19
◆ Taupe	SXNY17
◆ Zest	SXNY04

GRADE 4

CONSTANCE WITH SUPREEN™	CNST
◆ Airy	CNST01
◆ Aztec	CNST02
◆ Cassis	CNST03
◆ Copperplate	CNST04
◆ Cornerstone	CNST05
◆ Envy	CNST06
◆ Flagstone	CNST07
◆ Flax	CNST08
◆ Frost	CNST09
◆ Gateway	CNST10
◆ Grounds	CNST11
◆ Hayfield	CNST12
◆ Inkpad	CNST13
◆ Pewter	CNST14
◆ Pistachio	CNST15
◆ Pompeii	CNST16
◆ Poseidon	CNST17
◆ Reflection	CNST18
◆ Scuba	CNST19
◆ Stoic	CNST20
◆ Stonnington	CNST21
◆ Thunder	CNST22
◆ Waterfall	CNST23

GRADE 4 *continued*

LIVI WITH SUPREEN™	LIVI
◆ Asphalt	LIVI01
◆ Atlantis	LIVI02
◆ Bouquet	LIVI03
◆ Branch	LIVI04
◆ Coastal	LIVI05
◆ Cowboy	LIVI06
◆ Dawn	LIVI07
◆ Earth	LIVI09
◆ Evergreen	LIVI10
◆ Fennel	LIVI11
◆ Fog	LIVI12
◆ Honeycomb	LIVI13
◆ Jade	LIVI14
◆ Limestone	LIVI15
◆ Monochrome	LIVI16
◆ Night	LIVI17
◆ Overcast	LIVI18
◆ Pebble	LIVI19
◆ Pillow	LIVI08
◆ Plum	LIVI20
◆ Pumpkin	LIVI21
◆ Rhubarb	LIVI22
◆ Saxon	LIVI23
◆ Seaside	LIVI24
◆ Twine	LIVI25

LUGANO WITH SUPREEN™	LUG
◆ Andromeda	LUG01
◆ Aquarelle	LUG02
◆ Bayou	LUG03
◆ Caviar	LUG04
◆ Cloud	LUG05
◆ Cobblestone	LUG06
◆ Dutch	LUG07
◆ Flirt	LUG08
◆ Florence	LUG09
◆ Frost	LUG10
◆ Ganache	LUG11
◆ Gravel	LUG12
◆ Juniper	LUG13
◆ Lapis	LUG14
◆ Moonstone	LUG15
◆ Mustard Seed	LUG16
◆ Sandstone	LUG17
◆ Sconce	LUG18
◆ Semolina	LUG19
◆ Spice Market	LUG20
◆ Sterling	LUG21

GRADE 4 *continued*

OXFORD WITH SUPREEN™	OXFD
◆ Armor	OXFD01
◆ Azurite	OXFD02
◆ Cadet	OXFD03
◆ Cider	OXFD04
◆ Clover	OXFD05
◆ Coal	OXFD16
◆ Coin	OXFD06
◆ Crema	OXFD07
◆ Currant	OXFD08
◆ Deluge	OXFD09
◆ Dewberry	OXFD10
◆ Falcon	OXFD11
◆ Gingerbread	OXFD12
◆ Laurel	OXFD13
◆ Odyssey	OXFD14
◆ Pavement	OXFD15
◆ Redvine	OXFD17
◆ Seadrift	OXFD18
◆ Shoji	OXFD19
◆ Tourmaline	OXFD20
◆ Vignette	OXFD21

GRADE L1

DENVER LEATHER	SS
◆ Black	SS11



Scan here to check out our full Panel Fabrics solutions

PANEL FABRIC PATTERNS & CODES

PRICE CODE AA

FACTOR	FACT
◇ Bark *	FACT20
◇ Barley *	FACT15
◇ Cascade *	FACT25
◇ Feather *	FACT30

PRICE CODE A

APPOINT	APN
◇ Artichoke	APN11
◇ Blackberry	APN32
◇ Bronze	APN22
◇ Carbon	APN28
◇ Chai	APN12
◇ Cherry	APN30
◇ Dark Pewter	APN17
◇ Dune	APN15
◇ Espresso	APN23
◇ Framboise	APN31
◇ Frost	APN34
◇ Jet	APN27
◇ Lawn	APN25
◇ Mandarin	APN29
◇ Morel	APN09
◇ Nimbus	APN16
◇ Platinum	APN24
◇ Turquoise	APN26

CENTURION	CU
◇ Apricot	CU47
◇ Bark	CU25
◇ Black	CU10
◇ Espresso	CU49
◇ Fog	CU03
◇ Frost	CU22
◇ Goldenrod	CU27
◇ Indigo	CU06
◇ Iris	CU50
◇ Iron Ore	CU19
◇ Jade	CU83
◇ Marsala	CU63
◇ Morel	CU24
◇ Navy	CU98
◇ Peacock	CU97
◇ Pear	CU84
◇ Ruby	CU67
◇ Sapphire	CU09

PRICE CODE A *continued*

ETCH*	ECH
◇ Axis	ECH13
◇ Blend	ECH14
◇ Cast	ECH12
◇ Highlight	ECH10
◇ Midtone	ECH11
◇ Outline	ECH08
◇ Shade	ECH09
◇ Tonal	ECH16
◇ Vanish	ECH15

LANDSCAPE*	LN
◇ Azure	LN55
◇ Cornsilk	LN15
◇ Drift	LN05
◇ Khaki	LN20
◇ Sheen	LN10
◇ Slate	LN35
◇ Umber	LN25
◇ Urban	LN30

LUCY*	LC
◇ Aspen	LC32
◇ Cornsilk	LC30
◇ Dusk	LC22
◇ Fawn	LC33
◇ Graphite	LC34
◇ Mist	LC20
◇ Neutra	LC24
◇ Pewter	LC35
◇ Snowdrop	LC28

PRICE CODE A *continued*

NOBLE	NBLE
◇ Aegean	NBLE18
◇ Amethyst	NBLE19
◇ Aspen	NBLE14
◇ Aster	NBLE20
◇ Blossom	NBLE21
◇ Bluebell	NBLE22
◇ Bordeaux	NBLE01
◇ Brick	NBLE02
◇ Chambray	NBLE10
◇ Chamomile	NBLE23
◇ Clementine	NBLE04
◇ Conifer	NBLE24
◇ Cottage	NBLE25
◇ Darkness	NBLE26
◇ Dawn	NBLE13
◇ Denim	NBLE09
◇ Desert Sand	NBLE27
◇ Dewfall	NBLE28
◇ Dusted Sage	NBLE29
◇ Flax	NBLE30
◇ Grass	NBLE07
◇ Gunmetal	NBLE15
◇ Harmony	NBLE31
◇ Harvest	NBLE12
◇ Ice Caves	NBLE32
◇ Icicle	NBLE33
◇ Inky	NBLE34
◇ Iris	NBLE35
◇ Jade	NBLE06
◇ Knight	NBLE17
◇ Mesa	NBLE03
◇ Monarch	NBLE36
◇ Pacific	NBLE08
◇ Pitch	NBLE37
◇ Queen Bee	NBLE38
◇ Rainforest	NBLE05
◇ Regal	NBLE11
◇ Sandcastle	NBLE39
◇ Sedona	NBLE40
◇ Stormy	NBLE16
◇ Sunbeam	NBLE41
◇ Voyager	NBLE42
◇ Windy Day	NBLE43

NOTES: Centurion fabrics not available on panels that exceed a width and height of 54"H.

Disperse is applied pattern cut and is not available on 72"W Accelerate® panels and not available on 66"W tackboards, Voi® screens, and Empower®.

◇◇◇ For lead time information see page 21.

* Directional fabrics

* Fabric is de-emphasized.

PANEL FABRIC PATTERNS & CODES

Scan here to check out our full Panel Fabrics solutions



PRICE CODE A *continued*

REFLECTIONS*	REF
◆ Galvanized	REF29
◆ Ice	REF20
◆ Loggia	REF21
◆ Mistral	REF28
◆ Moonstone	REF23
◆ Pewter	REF22
◆ Stainless	REF24
◆ Vanilla	REF25
◆ Winter	REF27

REFUGE*	RFG
◆ Artesian	RFG96
◆ Dune	RFG92
◆ Eclipse	RFG90
◆ Frost	RFG93
◆ Glacier	RFG91
◆ Mineral	RFG98
◆ Tidal	RFG94

TEMPEST*	TP
◆ Dragonfly	TP30
◆ Frost	TP15
◆ Full Stream	TP80
◆ Gold Rush	TP10
◆ Slate	TP45
◆ Tumbleweed	TP70
◆ Wind Chill	TP40
◆ Zebra	TP35

VAST	VST
◆ Atmosphere	VST06
◆ Bay	VST04
◆ Beach	VST11
◆ Country Side	VST13
◆ Desert	VST12
◆ Garden	VST02
◆ Grasslands	VST03
◆ Highway	VST09
◆ Mountain Range	VST08
◆ Ocean	VST07
◆ Open Air	VST05
◆ Tundra	VST10
◆ Vineyard	VST01

PRICE CODE B

ANALOG	ANLG
<i>Not available on Accelerate*</i>	
◆ Album*	ANLG06
◆ Cartridge*	ANLG04
◆ Cassette*	ANLG09
◆ Dial*	ANLG02
◆ Media*	ANLG08
◆ Reel*	ANLG07
◆ Signal*	ANLG03
◆ Stereo*	ANLG01
◆ Track*	ANLG05

COAST*	COA
<i>Not available on Accelerate*</i>	
◆ Channel	COA14
◆ Dune	COA03
◆ Headlands	COA10
◆ Marsh	COA02
◆ Pebble	COA12
◆ Pier	COA13
◆ Shoal	COA01
◆ Silt	COA06
◆ Tide	COA08

PRICE CODE B *continued*

DISPERSE*	DISP
◆ Autumn	DISP03
◆ Branch	DISP10
◆ Coffee Bean	DISP13
◆ Dusk	DISP09
◆ Emerald City	DISP08
◆ Gold Rush	DISP02
◆ Igloo	DISP11
◆ Ink	DISP06
◆ Mist	DISP12
◆ Oatmeal	DISP15
◆ Prince	DISP07
◆ Reservoir	DISP01
◆ Rose	DISP04
◆ Spring	DISP05
◆ Steel	DISP16
◆ Taupe	DISP14

MICA*	MCA
◆ Anthracite	MCA11
◆ Breeze	MCA18
◆ Bronze	MCA13
◆ Buff	MCA14
◆ Cremini	MCA17
◆ Crystal	MCAWIT
◆ Dew	MCA20
◆ Dove	MCA12
◆ Fresh	MCA16
◆ Mineral	MCA15
◆ Nectar	MCA19
◆ Shale	MCA10

PRICE CODE B *continued*

SPIN*	SPIN
◆ Alabaster	SPIN02
◆ Cavern	SPIN03
◆ Cobblestone	SPIN04
◆ Ember	SPIN06
◆ Flame	SPIN07
◆ Heron	SPIN13
◆ Oat	SPIN01
◆ Ocean	SPIN12
◆ Plum	SPIN15
◆ Pool	SPIN11
◆ Raven	SPIN10
◆ Rhubarb	SPIN14
◆ Tropic	SPIN08
◆ Willow	SPIN05

TERRAIN*	TRRN
◆ Bay	TRRN05
◆ Bayou	TRRN35
◆ Canyon	TRRN30
◆ Cliff	TRRN45
◆ Crest	TRRN25
◆ Delta	TRRN10
◆ Plateau	TRRN15
◆ Ridge	TRRN20
◆ Valley	TRRN40

NOTES: Disperse is applied pattern cut and is not available on 72"W Accelerate® panels and not available on 66"W tackboards, Voi® screens, and Empower®.

◆◆◆ For lead time information see page 21.

* Directional fabrics

* Fabric is de-emphasized.

ARRANGE®

Want to see more? Scan here
to check out hon.com.



ARRANGE®

Non-traditional workspace? Transform it with Arrange tables. Ideal for cafés and other collaborative spaces, Arrange tables are available in seated, counter and standing-heights, and can accommodate anywhere from two to eight people. With four tabletop shapes and more than 40 different finish options, you can create a unique and usable space that brings people together.



FEATURES

- Simple, clean design coordinates nicely with other HON furniture.
- The traditional x-base can be updated with a disc shroud.
- Tables come with optional cord grommets and outlets to accommodate a wide range of technical needs — or none at all.
- Aluminum bases are durable, long-lasting and lightweight, making it easy to move and rearrange floor plans.
- Laminate surfaces are durable and resist scratches, spills and stains.

ARRANGE® CAFÉ TABLES ORDERING INFORMATION

LAMINATE

TOPS/L1 LAMINATES CODES

Woodgrain

- ◆ Bourbon Cherry **H**
- ◆ Cognac **COGN**
- ◆ Field Elm **LWFE**
- ◆ Florence Walnut **LFW1**
- ◆ Harvest **C**
- ◆ Kingswood Walnut **LKI1**
- ◆ Mahogany **N**
- ◆ Mocha **MOCH**
- ◆ Natural Maple **D**
- ◆ Pinnacle **PINC**
- ◆ Shaker Cherry **F**
- ◆ Sterling Ash **LSA1**

Solid

- ◆ Black **P**
- ◆ Charcoal **S**
- ◆ Designer White **LDW1**
- ◆ Loft **LOFT**

Patterned

- ◆ Handspun Chestnut **LAHC**
- ◆ Handspun Dove **LAHD**
- ◆ Handspun Pearl **LAHP**
- ◆ Handspun Slate **LAHS**
- ◆ Silver Mesh **B9**
- ◆ Gray **G2**
- ◆ White **G1**

TOPS/L2 LAMINATES CODES

Woodgrain

- ◆ Beigewood **LWBE**
- ◆ Fawn Cypress **LFC1**
- ◆ Lowell Ash **LLA1**
- ◆ Natural Recon **LNRI**
- ◆ Phantom Ecru **LPE1**
- ◆ Portico Teak **LPT1**
- ◆ Skyline Walnut **LSW1**

PAINT

PAINT CODES

P1

- ◆ Charblack **CBK**
- ◆ Textured Brownstone **P7J**
- ◆ Textured Charcoal **P7A**
- ◆ Textured Designer White ... **PK7**
- ◆ Textured Loft **P7L**
- ◆ Textured Muslin **P7M**
- ◆ Textured Platinum
Metallic **PLAT**
- ◆ Textured Titanium **P8V**

P2

- ◆ Solar Black **P8X**
- ◆ Textured Silver **PR8**

EDGE BAND

EDGE BAND CODES

- ◆ Beigewood **DE**
- ◆ Black **P**
- ◆ Bourbon Cherry **H**
- ◆ Brownstone **EY**
- ◆ Charcoal **S**
- ◆ Cognac **COGN**
- ◆ Designer White **DW**
- ◆ Fawn Cypress **FC**
- ◆ Field Elm **FE**
- ◆ Florence Walnut **FW**
- ◆ Fossil **EH**
- ◆ Greige **R**
- ◆ Harvest **C**
- ◆ Kingswood Walnut **KI**
- ◆ Loft **LOFT**
- ◆ Lowell Ash **DL**
- ◆ Mahogany **N**
- ◆ Mocha **MOCH**
- ◆ Muslin **T**
- ◆ Natural Maple **D**
- ◆ Natural Recon **NR**
- ◆ Phantom Ecru **PE**
- ◆ Pinnacle **PINC**
- ◆ Platinum **K**
- ◆ Portico Teak **DP**
- ◆ Shaker Cherry **F**
- ◆ Skyline Walnut **SW**
- ◆ Sterling Ash **SA**

Recommended Edgeband Color Selection:

Laminate		Edgeband	
Bourbon Cherry	H	Bourbon Cherry	H
Cognac	COGN	Cognac	COGN
Florence Walnut	LFW1	Florence Walnut	FW
Harvest	C	Harvest	C
Kingswood Walnut	LKI1	Kingswood Walnut	KI
Mahogany	N	Mahogany	N
Mocha	MOCH	Mocha	MOCH
Natural Maple	D	Natural Maple	D
Pinnacle	PINC	Pinnacle	PINC
Shaker Cherry	F	Shaker Cherry	F
Sterling Ash	LSA1	Sterling Ash	SA
Black	P	Black	P
Charcoal	S	Charcoal	S
Designer White	LDW1	Designer White	DW
Handspun Chestnut	LAHC	Brownstone	EY
Handspun Dove	LAHD	Fossil	EH
Handspun Pearl	LAHP	Fossil	EH
Handspun Slate	LAHS	Charcoal	S
Silver Mesh	B9	Loft	LOFT
Steel Mesh	A9	Charcoal	S
Lowell Ash	LLA1	Lowell Ash	DL
Natural Recon	LNRI	Natural Recon	NR
Phantom Ecru	LPE1	Phantom Ecru	PE
Portico Teak	LPT1	Portico Teak	DP
Skyline Walnut	LSW1	Skyline Walnut	SW
Loft	LOFT	Loft	LOFT

◆◆◆ For lead time information see page 21.



Icon Legend on page 19

ARRANGE® Café Table Tops

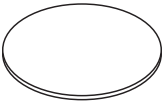
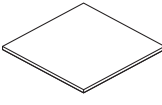
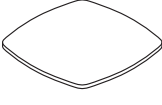
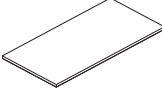
	DESCRIPTION	MODEL	SHIP WEIGHT	CUBE	LIST PRICE BY LAMINATE GRADE	
					L1	L2
	Café Round Table Tops					
	24"W Round Top	HCTRND24	19	1.9	\$426	\$442
	30"W Round Top	HCTRND30	31	2.9	\$458	\$474
	36"W Round Top	HCTRND36	44	4.0	\$499	\$515
	42"W Round Top	HCTRND42	57	5.4	\$591	\$612
	Square Table Tops					
	24"W Square Top	HCTSQR24	19	2.2	\$404	\$420
	30"W Square Top	HCTSQR30	31	2.9	\$435	\$451
	36"W Square Top	HCTSQR36	44	4.1	\$475	\$491
	42"W Square Top	HCTSQR42	57	5.6	\$566	\$587
	Soft Square Table Tops					
	24"W Soft Square Top	HCTSFT24	19	1.9	\$426	\$442
	30"W Soft Square Top	HCTSFT30	31	2.9	\$458	\$474
	36"W Soft Square Top	HCTSFT36	44	4.0	\$499	\$515
	42"W Soft Square Top	HCTSFT42	57	5.4	\$591	\$612
	Rectangle Table Tops					
	48"W x 24"D Rectangle Top	HCTRECT2448	36	3.6	\$480	\$496
	60"W x 24"D Rectangle Top	HCTRECT2460	44	4.4	\$526	\$542
	72"W x 24"D Rectangle Top	HCTRECT2472	56	4.9	\$557	\$578
	48"W x 30"D Rectangle Top	HCTRECT3048	51	4.4	\$499	\$515
	60"W x 30"D Rectangle Top	HCTRECT3060	63	5.4	\$557	\$573
	72"W x 30"D Rectangle Top	HCTRECT3072	75	6.0	\$618	\$639

NOTES:

- 2 grommet cutouts on Rectangles which will be positioned over the installed bases.
- For compatible round grommet options, see page 245.

❗ HGRMTUSB2 is not compatible with Arrange® bases.

HOW TO SPECIFY

<p>Select Model Number</p> <p>H C T R N D 2 4 .</p>	<p>Select Grommet Option</p> <p>G Round Grommet (\$16 upcharge) N No Grommet Upcharge doubles for HCTRECT models</p> <p>G .</p>	<p>Select Laminate</p> <p>See page 28</p> <p>C .</p>	<p>Select Edge Color</p> <p>See page 28</p> <p>C</p>
--	--	---	---

ARRANGE[®]

Café Table Bases

GSA SIN 33721

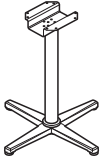

Icon Legend on page 19

**DESCRIPTION****MODEL****SHIP WEIGHT****CUBE****LIST PRICE****P2
UPCHARGE****Café Table Bases — X-Base**

Seated-Height X-base for 24"-30"D Surfaces

HCT29SX

22

3.3

\$643**\$21**

Seated-Height X-base for 36"D Surfaces

HCT29MX

23

3.3

\$715**\$21**

Seated-Height X-base for 42"D Surfaces

HCT29LX

25

3.3

\$785**\$21**

Counter-Height X-base for 24"-30"D Surfaces

HCT36SX

24

4.6

\$715**\$21**

Counter-Height X-base for 36"D Surfaces

HCT36MX

25

4.6

\$785**\$21**

Counter-Height X-base for 42"D Surfaces

HCT36LX

27

4.6

\$857**\$21**

Bar-Height X-base for 24"-30"D Surfaces

HCT42SX

25

4.6

\$785**\$21**

Bar-Height X-base for 36"D Surfaces

HCT42MX

26

4.6

\$857**\$21**

Bar-Height X-base for 42"D Surfaces

HCT42LX

27

4.6

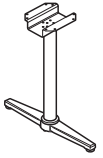
\$927**\$21****Café Table Bases — T-Leg Base**

Seated-Height T-legs for 24"D Surfaces (2 bases incl.)

HCT29ST

33

3.3

\$870**\$21**

Seated-Height T-legs for 30"D Surfaces (2 bases incl.)

HCT29MT

34

3.3

\$968**\$21**

Counter-Height T-legs for 24"D Surfaces (2 bases incl.)

HCT36ST

36

4.6

\$936**\$21**

Counter-Height T-legs for 30"D Surfaces (2 bases incl.)

HCT36MT

37

4.6

\$1009**\$21**

Bar-Height T-legs for 24"D Surfaces (2 bases incl.)

HCT42ST

37

4.6

\$1004**\$21**

Bar-Height T-legs for 30"D Surfaces (2 bases incl.)

HCT42MT

38

4.6

\$1077**\$21****NOTES:**

- Wire management is standard through table column.
- Adjustable glides available on all feet.

HOW TO SPECIFYSelect
Model NumberSelect
Paint Color

See page 28



HCT29SX

BLCK

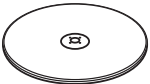

Icon Legend on page 19

ARRANGE[®] Café Accessories

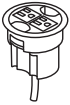
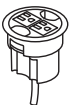
	DESCRIPTION	MODEL	SHIP WEIGHT	CUBE	LIST PRICE
 SIN 33721 	Café Table Bases — Disc Shroud Small Disc Shroud for bases that support 24"-30" Surfaces Medium Disc Shroud for bases that support 36" Surfaces Large Disc Shroud for bases that support 42" Surfaces	HCTSDS HCTMDS HCTLDS	9.0 12.0 17.0	2.0 2.4 3.4	\$130 \$151 \$174
	NOTES: Shroud is used as an optional accessory to provide the aesthetic of a disc base. Shroud can be added to existing X-base configurations to provide a new and updated aesthetic. Shroud is made of 18 gauge steel.				
	! Shroud to be used in conjunction with X-bases only and cannot be used with a T-leg configuration.				
	! Shroud cannot be used as a support piece by itself.				
	Power Hub, 3" Grommet Mount, 6' Cord	HGRMTAC	1.3	0.2	\$167
	NOTES: For additional information see page 245. ! Available in black only (no color designation so use .X - Specify: HGRMTAC.X).				
	Power Hub, 3" Grommet Mount, 10' Cord	HGRMTAC2	1.5	0.2	\$196
	NOTES: For additional information see page 245. ! Available in black finish only, no specification needed.				

NOTES:

! HGRMTUSB2 is not compatible with Arrange[®] bases.

HOW TO SPECIFY

<p>Select Model Number</p>	<p>Select Paint Color</p> <p><i>For HCTSDS, HCTMDS and HCTLDS models only</i></p> <p>See page 28</p>
<div style="display: flex; gap: 5px;"> <div style="border: 1px solid black; padding: 2px;">H</div> <div style="border: 1px solid black; padding: 2px;">C</div> <div style="border: 1px solid black; padding: 2px;">T</div> <div style="border: 1px solid black; padding: 2px;">S</div> <div style="border: 1px solid black; padding: 2px;">D</div> <div style="border: 1px solid black; padding: 2px;">S</div> </div>	<div style="display: flex; gap: 5px;"> <div style="border: 1px solid black; padding: 2px;">B</div> <div style="border: 1px solid black; padding: 2px;">L</div> <div style="border: 1px solid black; padding: 2px;">C</div> <div style="border: 1px solid black; padding: 2px;">K</div> </div>

BETWEEN™ TABLES

Want to see more? Scan here
to check out hon.com.



Between™ Tables shown
with Ruck™ Seating.

BETWEEN™ TABLES

That moment when everything you want meets everything you need. Choose Between table options that offer up a variety of sizes and top shapes, seated or café heights, training tables with fixed or nesting bases, and a wide range of laminates to fit in with any environment. With so many different uses, it will be easy to pick Between. Whether you're working here, there, or anywhere Between, this table collection's got you covered.



FEATURES

- Allows you to get the most out of every inch of space by creating hubs for people to engage, socialize, and be productive.
- This versatile, lightweight table line is simple to specify and easy to reconfigure, all at a competitive price point.
- Round, square, soft square, or rectangle tops and fixed, nesting, disc, or X-bases, allow versatility in design and function.
- With both standing- and seated-height options, Between tables can be used in multiple areas throughout your office, such as breakrooms, cafés, or breakaway spaces that support today's agile workforce.
- Choose from multiple, durable, high-quality laminate, edge, and finish options.

BETWEEN™ ORDERING INFORMATION

LAMINATE

TOPS/L1 LAMINATES CODES

Woodgrain

- ◆ Bourbon Cherry H
- ◆ Cognac COGN
- ◆ Field Elm LWFE
- ◆ Florence Walnut LFW1
- ◆ Harvest C
- ◆ Kingswood Walnut LK11
- ◆ Mahogany N
- ◆ Mocha MOCH
- ◆ Natural Maple D
- ◆ Pinnacle PINC
- ◆ Shaker Cherry F
- ◆ Sterling Ash LSA1

Solid

- ◆ Black P
- ◆ Charcoal S
- ◆ Designer White LDW1
- ◆ Loft LOFT

Patterned

- ◆ Handspun Chestnut LAHC
- ◆ Handspun Dove LAHD
- ◆ Handspun Pearl LAHP
- ◆ Handspun Slate LAHS
- ◆ Silver Mesh B9
- ◆ Steel Mesh A9

TOPS/L2 LAMINATES CODES

Woodgrain

- ◆ Beigewood LWBE
- ◆ Fawn Cypress LFC1
- ◆ Lowell Ash LLA1
- ◆ Natural Recon LNRI
- ◆ Phantom Ecru LPE1
- ◆ Portico Teak LPT1
- ◆ Skyline Walnut LSW1

SEATED-, STANDING-, AND X-BASES

PAINT CODES

P1

- ◆ Charblack CBK
- ◆ Textured Brownstone P7J
- ◆ Textured Charcoal P7A
- ◆ Textured Designer White ... PK7
- ◆ Textured Loft P7L
- ◆ Textured Muslin P7M
- ◆ Textured Titanium P8V

P2

- ◆ Textured Silver PR8

FIXED AND NESTING BASES

PAINT CODES

P1

- ◆ Black P71
- ◆ Brownstone P7D
- ◆ Charcoal P02
- ◆ Designer White PJW
- ◆ Fossil P28
- ◆ Greige T5
- ◆ Loft LOFT
- ◆ Muslin T3
- ◆ Titanium P8T

P2

- ◆ Silver PR6

EDGEBAND

EDGEBAND CODES

- ◆ Beigewood DE
- ◆ Black P
- ◆ Bourbon Cherry H
- ◆ Brownstone EY
- ◆ Charcoal S
- ◆ Cognac COGN
- ◆ Designer White DW
- ◆ Fawn Cypress FC
- ◆ Field Elm FE
- ◆ Florence Walnut FW
- ◆ Fossil EH
- ◆ Greige R
- ◆ Harvest C
- ◆ Kingswood Walnut KI
- ◆ Loft LOFT
- ◆ Lowell Ash DL
- ◆ Mahogany N
- ◆ Mocha MOCH
- ◆ Muslin T
- ◆ Natural Maple D
- ◆ Natural Recon NR
- ◆ Phantom Ecru PE
- ◆ Pinnacle PINC
- ◆ Platinum K
- ◆ Portico Teak DP
- ◆ Shaker Cherry F
- ◆ Skyline Walnut SW
- ◆ Sterling Ash SA

Recommended Edgeband Color Selection:

Laminate		Edgeband	
Bourbon Cherry	H	Bourbon Cherry	H
Cognac	COGN	Cognac	COGN
Florence Walnut	LFW1	Florence Walnut	FW
Harvest	C	Harvest	C
Kingswood Walnut	LK11	Kingswood Walnut	KI
Mahogany	N	Mahogany	N
Mocha	MOCH	Mocha	MOCH
Natural Maple	D	Natural Maple	D
Pinnacle	PINC	Pinnacle	PINC
Shaker Cherry	F	Shaker Cherry	F
Sterling Ash	LSA1	Sterling Ash	SA
Black	P	Black	P
Charcoal	S	Charcoal	S
Designer White	LDW1	Designer White	DW
Handspun Chestnut	LAHC	Brownstone	EY
Handspun Dove	LAHD	Fossil	EH
Handspun Pearl	LAHP	Fossil	EH
Handspun Slate	LAHS	Charcoal	S
Silver Mesh	B9	Loft	LOFT
Steel Mesh	A9	Charcoal	S
Lowell Ash	LLA1	Lowell Ash	DL
Natural Recon	LNRI	Natural Recon	NR
Phantom Ecru	LPE1	Phantom Ecru	PE
Portico Teak	LPT1	Portico Teak	DP
Skyline Walnut	LSW1	Skyline Walnut	SW
Loft	LOFT	Loft	LOFT

◆◆◆ For lead time information see page 21.

BETWEEN™ Table Tops

GSA SIN 33721



Icon Legend on page 19

	DESCRIPTION	MODEL	SHIP WEIGHT	CUBE	LIST PRICE BY LAMINATE GRADE	
					L1	L2
	Round Table Tops					
	30"W Round Top	HBTRND30	31	2.9	\$402	\$418
	36"W Round Top	HBTRND36	44	4.0	\$440	\$457
	42"W Round Top	HBTRND42	57	5.4	\$519	\$540
	Square Table Tops					
	30"W Square Top	HBTSQR30	31	2.9	\$383	\$398
	36"W Square Top	HBTSQR36	44	4.1	\$418	\$435
	42"W Square Top	HBTSQR42	57	5.6	\$498	\$518
	Soft Square Table Tops					
	30"W Soft Square Top	HBTSFT30	31	2.9	\$402	\$418
	36"W Soft Square Top	HBTSFT36	44	4.0	\$440	\$457
	42"W Soft Square Top	HBTSFT42	57	5.4	\$519	\$540

HOW TO SPECIFY

Select Model Number HBTRND30	Select Grommet Option N No Grommet	Select Laminate See page 33 C	Select Edge Color See page 33 C
--	--	--	--

OPEN MARKET EXCEPT AS NOTED



Icon Legend on page 19







BETWEEN™ Table Bases

TABLES

	DESCRIPTION	MODEL	SHIP WEIGHT	CUBE	LIST PRICE
 <p>SIN 33721</p>	X-Base				
	Seated-Height X-base for Support of 30", 36" Tops	HBTTX30S	27	5.2	\$387
	Seated-Height X-base for Support of 42" Tops	HBTTX30L	29	5.2	\$565
	Bar-Height X-base for Support of 30", 36" Tops	HBTTX42S 	30	5.2	\$465
	Bar-Height X-base for 42" Tops	HBTTX42L 	34	5.2	\$649

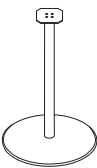
NOTES:

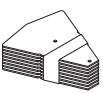
- Seated-Height (30¾" to top of surface).
- Bar-Height (42¼" to top of surface).
- Adjustable glides with ¼" adjustment available on all feet.

	Seated-Height Disc Base  Disc Base not for use with 42" square top.	HBTTD30	24	3.3	\$466
	Standing-Height Disc Base  Disc Base not for use with 42" square top.	HBTTD42	27	3.3	\$551
	Counterweight Kit for Disc Base  Required when using disc base with 42" round and soft square tops. Optional for smaller top sizes.	HBTTCW	16	0.2	\$187

NOTES:

- Seated-Height (29" to top of surface).
- Bar-Height (42" to top of surface).
- Counterweight Kit required when using disc base with 42" round or soft square tops. Kit can be used for added stability on 30" or 36" round, square, and soft square tops if desired.

HOW TO SPECIFY

Select Model Number HBTTX30S	Select Paint Color See page 33 PR8
--	---

BETWEEN™ Rectangular Table Tops

OPEN MARKET

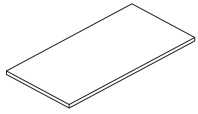

Icon Legend on page 19

**DESCRIPTION****Rectangular Table Tops**

48"W x 24"D
60"W x 24"D
72"W x 24"D

MODEL

HMPTT2448
HMPTT2460
HMPTT2472

SHIP WEIGHT

45
57
68

CUBE

3.7
4.5
5.0

LIST PRICE BY LAMINATE GRADE**L1**

\$450
\$498
\$551

L2

\$468
\$518
\$573

48"W x 30"D
60"W x 30"D
72"W x 30"D

HMPTT3048
HMPTT3060
HMPTT3072

57
71
85

4.4
5.4
6.0

\$468
\$513
\$584

\$487
\$534
\$607

NOTES:

- HON 5-Year Limited Warranty.

HOW TO SPECIFY

Select Model Number <input type="text" value="H"/> <input type="text" value="M"/> <input type="text" value="P"/> <input type="text" value="T"/> <input type="text" value="T"/> <input type="text" value="2"/> <input type="text" value="4"/> <input type="text" value="4"/> <input type="text" value="8"/>	Select Grommet Option <input type="text" value="N"/>	Select Laminate <input type="text" value="C"/>	Select Edge Color <input type="text" value="C"/>
--	--	--	--

BETWEEN™ Table Bases for Rectangular Tops

OPEN MARKET

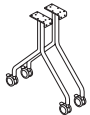

Icon Legend on page 19

**DESCRIPTION****Fixed Leg****MODEL****HMPTBFX****SHIP WEIGHT**

27

CUBE

6.3

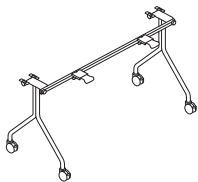
LIST PRICE**\$341****Nesting Base**

For use with 48"W Rectangular Tops
For use with 60"W and 72"W Rectangular Tops

HMPTBNSS
HMPTBNSL

18
19

6.3
6.3

\$393
\$419

NOTES:

- Tops and bases ship in separate cartons.
- Recommend ordering HMAGANG when intending to gang multiple tables together. See page 61.
- HON 5-Year Limited Warranty.

HOW TO SPECIFY

Select Model Number <input type="text" value="H"/> <input type="text" value="M"/> <input type="text" value="P"/> <input type="text" value="T"/> <input type="text" value="B"/> <input type="text" value="F"/> <input type="text" value="X"/>	Select Paint Color <input type="text" value="P"/> <input type="text" value="7"/> <input type="text" value="1"/>
--	---



BETWEEN™ Nesting Tables

	DESCRIPTION	MODEL	SHIP WEIGHT	CUBE	LIST PRICE
	Nesting Table				
	48"W x 24"D	HMPT2448NS	69	8.9	\$758
	60"W x 24"D	HMPT2460NS Ⓢ	81	10.7	\$824
	72"W x 24"D	HMPT2472NS Ⓢ	92	12.4	\$871
	48"W x 30"D	HMPT3048NS	81	10.9	\$774
	60"W x 30"D	HMPT3060NS	95	13.1	\$837
	72"W x 30"D	HMPT3072NS	109	15.0	\$901

NOTES:

- Top and base ship in one carton.
- Limited finishes available on single-carton tables.
- Recommend ordering HMAGANG when intending to gang multiple tables together. See page 61.
- **HON 5-Year Limited Warranty.**

HOW TO SPECIFY

<p>Select Model Number</p> <p>HMPT2448NS</p>	<p>Select Grommet Option</p> <p>N No Grommet</p> <p>N</p>	<p>Select Laminate/Edge</p> <p>B9LOFT Silver Mesh/Loft Edge FF Shaker Cherry/Shaker Cherry Edge PINCPINC Pinnacle/Pinnacle Edge</p> <p>B9LOFT</p>	<p>Select Base Paint</p> <p>P71 Black</p> <p>P71</p>
---	--	---	---



BETWEEN™ Shared Components

	DESCRIPTION	MODEL	SHIP WEIGHT	CUBE	LIST PRICE BY PAINT GRADE	
					P1	P2
	Universal Modesty Panel					
	For 48"W Between™ Tables	HMTUMOD38	11	2.2	\$282	\$303
	For 60"/72"W Between™ Tables	HMTUMOD50	14	3.1	\$308	\$329

NOTES:

- Table Modesty Panels are hinged for use with Nesting Table models.

HOW TO SPECIFY

<p>Select Model Number</p> <p>HMTUMOD38</p>	<p>Select Paint Color</p> <p>See page 33</p> <p>T1</p>
--	---

BIRK™ TABLES

Want to see more? Scan here
to check out hon.com.



Birk™ Tables shown with Flock® Seating.

BIRK™ TABLES

Why complicate matters when you can keep it simple? Offering a modern, minimalist design, Birk tables have a look that's as streamlined as its specification process. Whether you're looking for something well-rounded or think it's hip to be square, Birk is there for you with a variety of top shapes, sizes, and table heights. It's the support system you need to help people come together, collaborate, and socialize — anywhere.



FEATURES

- Ideal for informal meeting spaces and hospitality areas.
- Modern, minimalist design makes it easy to match a variety of styles.
- Designed for use with HON chairs, stools, and soft seating.
- Five different base heights outfit a variety of spaces.
- Five unique top shapes and sizes coordinate seamlessly with any surrounding aesthetic.
- The personal table is light in scale and gives people the ability to take notes and work in a lounge setting.

BIRK™ ORDERING INFORMATION

LAMINATE

L1 LAMINATES CODES

Woodgrain

- ◆ Bourbon Cherry H
- ◆ Cognac COGN
- ◆ Field Elm LWFE
- ◆ Florence Walnut LFW1
- ◆ Harvest C
- ◆ Kingswood Walnut LKI1
- ◆ Mahogany N
- ◆ Mocha MOCH
- ◆ Natural Maple D
- ◆ Pinnacle PINC
- ◆ Shaker Cherry F
- ◆ Sterling Ash LSA1

Solid

- ◆ Black P
- ◆ Charcoal S
- ◆ Designer White LDW1
- ◆ Loft LOFT

Patterned

- ◆ Handspun Chestnut LAHC
- ◆ Handspun Dove LAHD
- ◆ Handspun Pearl LAHP
- ◆ Handspun Slate LAHS
- ◆ Silver Mesh B9
- ◆ Steel Mesh A9

L2 LAMINATES CODES

Woodgrain

- ◆ Beigewood LWBE
- ◆ Fawn Cypress LFC1
- ◆ Lowell Ash LLA1
- ◆ Natural Recon LNR1
- ◆ Phantom Ecru LPE1
- ◆ Portico Teak LPT1
- ◆ Skyline Walnut LSW1

EDGE BAND

EDGE BAND CODES

- ◆ Beigewood DE
- ◆ Black P
- ◆ Bourbon Cherry H
- ◆ Brownstone EY
- ◆ Charcoal S
- ◆ Cognac COGN
- ◆ Designer White DW
- ◆ Fawn Cypress FC
- ◆ Field Elm FE
- ◆ Florence Walnut FW
- ◆ Fossil EH
- ◆ Greige R
- ◆ Harvest C
- ◆ Kingswood Walnut KI
- ◆ Loft LOFT
- ◆ Lowell Ash DL
- ◆ Mahogany N
- ◆ Mocha MOCH
- ◆ Muslin T
- ◆ Natural Maple D
- ◆ Natural Recon NR
- ◆ Phantom Ecru PE
- ◆ Pinnacle PINC
- ◆ Platinum K
- ◆ Portico Teak DP
- ◆ Shaker Cherry F
- ◆ Skyline Walnut SW
- ◆ Sterling Ash SA

PAINT

PAINT CODES

P1

- ◆ Charblack CBK
- ◆ Textured Brownstone P7J
- ◆ Textured Charcoal P7A
- ◆ Textured Designer White PK7
- ◆ Textured Loft P7L
- ◆ Textured Muslin P7M
- ◆ Textured Titanium P8V

P2

- ◆ Solar Black P8X
- ◆ Textured Silver PR8

Recommended Edgeband Color Selection:

Laminate		Edgeband	
Beigewood	LWBE	Beigewood	DE
Bourbon Cherry	H	Bourbon Cherry	H
Cognac	COGN	Cognac	COGN
Fawn Cypress	LFC1	Fawn Cypress	FC
Field Elm	LWFE	Field Elm	FE
Florence Walnut	LFW1	Florence Walnut	FW
Harvest	C	Harvest	C
Kingswood Walnut	LKI1	Kingswood Walnut	KI
Mahogany	N	Mahogany	N
Mocha	MOCH	Mocha	MOCH
Natural Maple	D	Natural Maple	D
Pinnacle	PINC	Pinnacle	PINC
Shaker Cherry	F	Shaker Cherry	F
Sterling Ash	LSA1	Sterling Ash	SA
Black	P	Black	P
Charcoal	S	Charcoal	S
Designer White	LDW1	Designer White	DW
Handspun Chestnut	LAHC	Brownstone	EY
Handspun Dove	LAHD	Fossil	EH
Handspun Pearl	LAHP	Fossil	EH
Handspun Slate	LAHS	Charcoal	S
Silver Mesh	B9	Loft	LOFT
Steel Mesh	A9	Charcoal	S
Lowell Ash	LLA1	Lowell Ash	DL
Natural Recon	LNR1	Natural Recon	NR
Phantom Ecru	LPE1	Phantom Ecru	PE
Portico Teak	LPT1	Portico Teak	DP
Skyline Walnut	LSW1	Skyline Walnut	SW
Loft	LOFT	Loft	LOFT

BIRK™ Table Tops

GSA SIN 33721



Icon Legend on page 19

	DESCRIPTION	MODEL	SHIP WEIGHT	CUBE	LIST PRICE BY LAMINATE GRADE	
					L1	L2
	Round Tops with Knife Edge					
	30"W Round Top	HCWTRND30J	28	2.8	\$602	\$627
	36"W Round Top	HCWTRND36J	38	3.8	\$658	\$685
	42"W Round Top	HCWTRND42J	50	5.1	\$775	\$806
	Round Tops with Flat Edge					
	30"W Round Top	HCWTRND30G	28	2.8	\$467	\$485
	36"W Round Top	HCWTRND36G	38	3.8	\$505	\$525
	42"W Round Top	HCWTRND42G	50	5.1	\$598	\$621
	Square Tops with Knife Edge					
	30"W Square Top	HCWTSQR30J	34	2.6	\$533	\$554
	36"W Square Top	HCWTSQR36J	47	3.8	\$625	\$650
	42"W Square Top	HCWTSQR42J	62	5.0	\$740	\$770
	Square Tops with Flat Edge					
	30"W Square Top	HCWTSQR30G	34	2.6	\$412	\$429
	36"W Square Top	HCWTSQR36G	47	3.8	\$482	\$501
	42"W Square Top	HCWTSQR42G	62	5.0	\$572	\$594
	Soft Square Tops with Knife Edge					
	30"W Soft Square Top	HCWTSFTS30J	34	2.6	\$602	\$627
	36"W Soft Square Top	HCWTSFTS36J	47	3.8	\$658	\$685
	42"W Soft Square Top	HCWTSFTS42J	62	5.0	\$775	\$806
	Soft Square Tops with Flat Edge					
	30"W Soft Square Top	HCWTSFTS30G	34	2.6	\$467	\$485
	36"W Soft Square Top	HCWTSFTS36G	47	3.8	\$505	\$525
	42"W Soft Square Top	HCWTSFTS42G	62	5.0	\$598	\$621
	Booth Tops with Knife Edge					
	56"W x 36"D Booth Top	HCWTB3656J	90	5.6	\$835	\$868
	84"W x 36"D Booth Top	HCWTB3684J	150	8.2	\$1259	\$1309
	Booth Tops with Flat Edge					
	56"W x 36"D Booth Top	HCWTB3656G	90	5.6	\$642	\$668
	84"W x 36"D Booth Top	HCWTB3684G	150	8.2	\$968	\$1006
	Soft Rectangle Tops with Knife Edge					
	56"W x 36"D Soft Rectangle Top	HCWTSR3656J	90	5.6	\$869	\$903
	84"W x 36"D Soft Rectangle Top	HCWTSR3684J	150	8.2	\$1294	\$1345
	Soft Rectangle Tops with Flat Edge					
	56"W x 36"D Soft Rectangle Top	HCWTSR3656G	90	5.6	\$668	\$695
	84"W x 36"D Soft Rectangle Top	HCWTSR3684G	150	8.2	\$997	\$1036

NOTES:

- Tops configured with pilot holes for easy installation of base.

HOW TO SPECIFY

<p>Select Model Number</p> <p>HCWTSQR36J</p>	<p>Select Grommet Option</p> <p>N No Grommet</p> <p>N</p>	<p>Select Laminate</p> <p>See page 39</p> <p>LSA1</p>	<p>Select Edge Color</p> <p>See page 39</p> <p>SA</p>
--	---	---	---

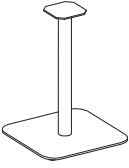
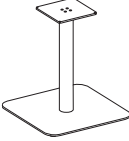
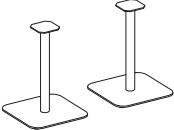

Icon Legend on page 19

	DESCRIPTION	MODEL	SHIP WEIGHT	CUBE	LIST PRICE BY PAINT GRADE	
					P1	P2
	Single Pedestal, Medium					
	Occasional-Height Single Pedestal Base	HCWTSBM18	60	3.3	\$750	\$808
	Working Lounge-Height Single Pedestal Base	HCWTSBM27	60	3.3	\$754	\$813
	Seated-Height Single Pedestal Base	HCWTSBM29	60	3.3	\$761	\$820
	Counter-Height Single Pedestal Base	HCWTSBM36	62	3.3	\$769	\$829
	Bar-Height Single Pedestal Base	HCWTSBM42	66	3.6	\$778	\$839
	Single Pedestal, Large					
	Occasional-Height Single Pedestal Base	HCWTSBL18	95	3.8	\$980	\$1056
	Working Lounge-Height Single Pedestal Base	HCWTSBL27	95	3.8	\$1015	\$1094
	Seated-Height Single Pedestal Base	HCWTSBL29	95	3.8	\$1061	\$1143
	Counter-Height Single Pedestal Base	HCWTSBL36	98	3.8	\$1075	\$1158
	Bar-Height Single Pedestal Base	HCWTSBL42	101	4.2	\$1096	\$1181
	Double Pedestal, Medium					
	Working Lounge-Height Double Pedestal Base	HCWTDSBM27	120	6.5	\$1508	\$1626
	Seated-Height Double Pedestal Base	HCWTDSBM29	120	6.5	\$1522	\$1640
	Counter-Height Double Pedestal Base	HCWTDSBM36	124	6.5	\$1538	\$1658
	Bar-Height Double Pedestal Base	HCWTDSBM42	132	7.2	\$1556	\$1678

NOTES:

- See application matrix for top and base compatibility.
- Bases feature 1/4" H non-leveling slide glides.
- Some assembly required.

Top & Base Compatibility Matrix		Top				
		Round, Square, Soft Square			Booth, Soft Rectangle	
		30"W	36"W	42"W	56"W	84"W
Base	Single Pedestal, Medium	•	•			
	Single Pedestal, Large			•		
	Double Pedestal, Medium				•	•

HOW TO SPECIFY

Select Model Number HCWTSBL36	Select Paint Color See page 39 PR8
---	---

BIRK™ Personal Table

GSA SIN 33721



Icon Legend on page 19



DESCRIPTION

Personal Table
17"W x 15"D x 28"H

MODEL	SHIP WEIGHT	CUBE	LIST PRICE BY LAMINATE GRADE	
			L1	L2
HCWPT	18	2.7	\$433	\$444

NOTES:

- Top features flat edge on all sides.
- Top configured with pilot holes for easy installation of base.
- Some assembly required.

HOW TO SPECIFY

<p>Select Model Number</p> <p>See page 39</p> <p>HCWPT</p>	<p>Select Laminate</p> <p>See page 39</p> <p>LSA1</p>	<p>Select Edge Color</p> <p>See page 39</p> <p>SA</p>	<p>Select Paint Color</p> <p>See page 39</p> <p>P2 upcharge + \$13</p> <p>PR8</p>
---	--	--	--

OPEN MARKET



Icon Legend on page 19

CANTILEVER TABLE

TABLES

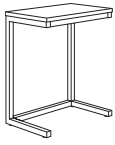

DESCRIPTION

Cantilever Table
17½"W x 9¾"D x 20¾"H

MODEL SHIP WEIGHT CUBE LIST PRICE

HML8858 12.8 1.1 \$258

NOTES:

- HON 5-Year Limited Warranty.

HOW TO SPECIFY

Select Model Number

H M L 8 8 5 8 .

Select Finish

P Black

P

FLOCK®

Want to see more? Scan here
to check out hon.com.



Flock® Tables and Seating.

FLOCK®

Great things happen when people come together, and Flock Collaborative Tables create the places that help make that possible. Quiet corners. Vibrant communal areas. Beautiful, comfortable spaces where clean lines and distinctive geometric design improve productivity and inspire big ideas. Choose from a variety of mix-and-match shapes and sizes to design spaces where your Flock will flourish.



FEATURES

- Flock Tables coordinate seamlessly with Flock Seating to support collaborative areas in any workplace.
- Choose from Square, Round, Rectangle, or Racetrack shaped table tops.
- Table bases available in multiple heights and styles.
- Add convenient options like integrated power, cord grommets, and tablet pedestals, and Flock is ready to work.
- Configurable and scalable, Flock Tables offer smaller footprints to better fit compact spaces.

COLLABORATIVE TABLES ORDERING INFORMATION

LAMINATE

TOPS/L1 LAMINATES CODES

Woodgrain

- ◆ Bourbon Cherry **H**
- ◆ Cognac **COGN**
- ◆ Field Elm **LWFE**
- ◆ Florence Walnut **LFW1**
- ◆ Harvest **C**
- ◆ Kingswood Walnut **LKI1**
- ◆ Mahogany **N**
- ◆ Mocha **MOCH**
- ◆ Natural Maple **D**
- ◆ Pinnacle **PINC**
- ◆ Shaker Cherry **F**
- ◆ Sterling Ash **LSA1**

Solid

- ◆ Black **P**
- ◆ Charcoal **S**
- ◆ Designer White **LDW1**
- ◆ Loft **LOFT**

Patterned

- ◆ Handspun Chestnut **LAHC**
- ◆ Handspun Dove **LAHD**
- ◆ Handspun Pearl **LAHP**
- ◆ Handspun Slate **LAHS**
- ◆ Silver Mesh **B9**
- ◆ Steel Mesh **A9**

TOPS/L2 LAMINATES CODES

Woodgrain

- ◆ Beigewood **LWBE**
- ◆ Fawn Cypress **LFC1**
- ◆ Lowell Ash **LLA1**
- ◆ Natural Recon **LNRI**
- ◆ Phantom Ecru **LPE1**
- ◆ Portico Teak **LPT1**
- ◆ Skyline Walnut **LSW1**

PAINT

PAINT CODES

- P1**
- ◆ Textured Charcoal **P7A**
- P2**
- ◆ Textured Silver **PR8**

EDGE BAND

EDGE BAND CODES

- ◆ Beigewood **DE**
- ◆ Black **P**
- ◆ Bourbon Cherry **H**
- ◆ Brownstone **EY**
- ◆ Charcoal **S**
- ◆ Cognac **COGN**
- ◆ Designer White **DW**
- ◆ Fawn Cypress **FC**
- ◆ Field Elm **FE**
- ◆ Florence Walnut **FW**
- ◆ Fossil **EH**
- ◆ Greige **R**
- ◆ Harvest **C**
- ◆ Kingswood Walnut **KI**
- ◆ Loft **LOFT**
- ◆ Lowell Ash **DL**
- ◆ Mahogany **N**
- ◆ Mocha **MOCH**
- ◆ Muslin **T**
- ◆ Natural Maple **D**
- ◆ Natural Recon **NR**
- ◆ Phantom Ecru **PE**
- ◆ Pinnacle **PINC**
- ◆ Platinum **K**
- ◆ Portico Teak **DP**
- ◆ Shaker Cherry **F**
- ◆ Skyline Walnut **SW**
- ◆ Sterling Ash **SA**

Recommended Edgeband Color Selection:

Laminate		Edgeband	
Bourbon Cherry	H	Bourbon Cherry	H
Cognac	COGN	Cognac	COGN
Florence Walnut	LFW1	Florence Walnut	FW
Harvest	C	Harvest	C
Kingswood Walnut	LKI1	Kingswood Walnut	KI
Mahogany	N	Mahogany	N
Mocha	MOCH	Mocha	MOCH
Natural Maple	D	Natural Maple	D
Pinnacle	PINC	Pinnacle	PINC
Shaker Cherry	F	Shaker Cherry	F
Sterling Ash	LSA1	Sterling Ash	SA
Black	P	Black	P
Charcoal	S	Charcoal	S
Designer White	LDW1	Designer White	DW
Handspun Chestnut	LAHC	Brownstone	EY
Handspun Dove	LAHD	Fossil	EH
Handspun Pearl	LAHP	Fossil	EH
Handspun Slate	LAHS	Charcoal	S
Silver Mesh	B9	Loft	LOFT
Steel Mesh	A9	Charcoal	S
Lowell Ash	LLA1	Lowell Ash	DL
Natural Recon	LNRI	Natural Recon	NR
Phantom Ecru	LPE1	Phantom Ecru	PE
Portico Teak	LPT1	Portico Teak	DP
Skyline Walnut	LSW1	Skyline Walnut	SW
Loft	LOFT	Loft	LOFT

◆◆◆ For lead time information see page 21.

FLOCK®

COLLABORATIVE SOLUTIONS TABLE SPECIFYING INFORMATION

TOP SHAPES

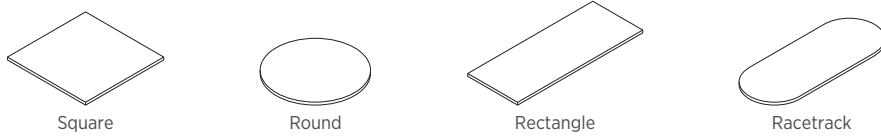
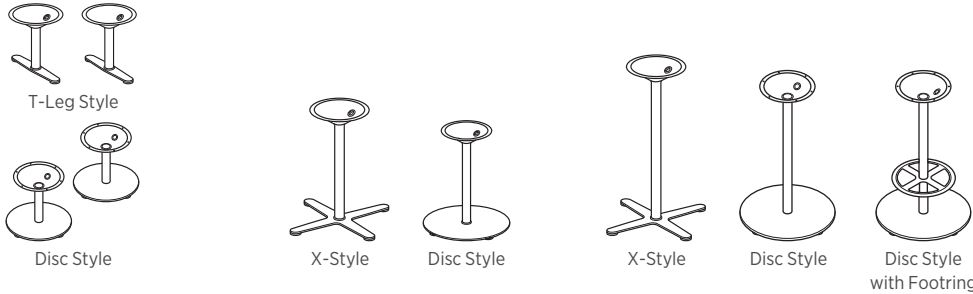

TABLE BASES

For Occasional-Height Tables

For Seated-Height Tables

For 41" H Bar-Height Tables



OCCASIONAL TABLES

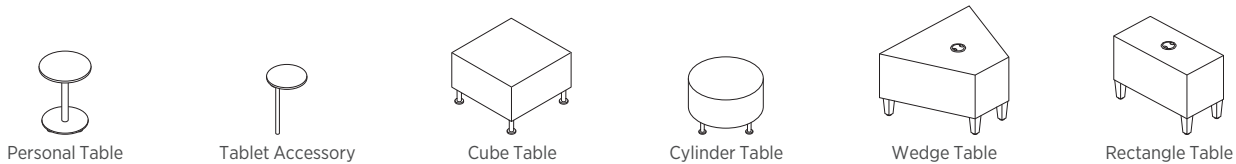

GROMMET MATRIX — ALL TABLES/TOPS

TOP WIDTH	NO GROMMET	1-3" ROUND GROMMET CENTERED	2-3" ROUND GROMMET LEFT & RIGHT
SIF OPTION CODE	N	G	G
24" Cube	YES	YES	N/A
26" Cylinder	YES	YES	N/A
18" Personal	N/A	N/A	N/A
30" Square/Round	YES	YES	N/A
36" Square/Round	YES	YES	N/A
60" Rectangle/Racetrack	YES	N/A	YES
72" Rectangle/Racetrack	YES	N/A	YES
84" Rectangle/Racetrack	YES	N/A	YES
96" Rectangle/Racetrack	YES	N/A	YES

NOTES: 3" round grommet color will need to be specified for tops. Grommet will coordinate with paint color specified for cube/cylinder tables. Charcoal grommets will be used with Textured Charcoal paint and Platinum Metallic grommets will be used with Textured Silver paint.

Grommet options can be used in conjunction with accessory ports on cube/cylinder tables. Grommet models HGRMTAC and HGRMTDATA on page 245 can also be used with Flock® tables.

3" ROUND GROMMET LOCATIONS

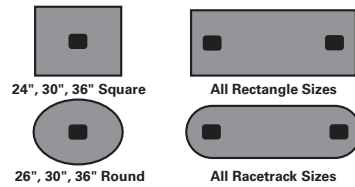

ACCESSORY PORT LOCATIONS

Only applies to models HFTLS24 and HFTLD26.

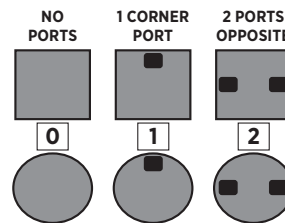

NOTES:
 Port location 1 allows for one tablet accessory — see model on pages 49-50.
 Port location 2 allows for two tablet accessories — see model on pages 49-50.



Icon Legend on page 19

Collaborative Laminate Table Tops

	DESCRIPTION	MODEL	SHIP WEIGHT	CUBE	LIST PRICE BY LAMINATE GRADE	
					L1	L2
	Laminate Table Tops					
	36" Square Top	HFTLS36	45	1.2	\$603	\$624
	30" Square Top	HFTLS30	32	1.0	\$535	\$556
	36" Round Top	HFTLD36	35	1.2	\$603	\$624
	30" Round Top	HFTLD30	25	1.0	\$535	\$556
	96"W x 33"D Rectangle Top	HFTLC3396	105	2.9	\$1063	\$1100
	84"W x 33"D Rectangle Top	HFTLC3384	90	2.5	\$909	\$941
	72"W x 33"D Rectangle Top	HFTLC3372	78	2.2	\$761	\$788
	60"W x 24"D Rectangle Top	HFTLC2460	47	1.3	\$556	\$572
	96"W x 33"D Racetrack Top	HFTLA3396	101	2.9	\$1063	\$1100
	84"W x 33"D Racetrack Top	HFTLA3384	83	2.5	\$909	\$941
	72"W x 33"D Racetrack Top	HFTLA3372	70	2.2	\$761	\$788
	60"W x 24"D Racetrack Top	HFTLA2460	43	1.3	\$556	\$572

NOTES:

- Grommet models HGRMTAC and HGRMTDATA on page 245 can also be used with Flock® tables.
- Rectangle and Racetrack tops come with 2 grommet cutouts if specified with Round grommet.
- For a complete line of compatible Flock® collaborative seating solutions, please see pages 326-348.
- For compatible round grommet options, see page 245.

HOW TO SPECIFY





<p>Select Model Number</p> <p>HFTLS36</p>	<p>Select Edge Detail</p> <p>G 2mm Edge</p> <p>Select Edge Color</p> <p>See page 45</p> <p>GK</p>	<p>Select Grommet Option</p> <p>N No Grommet G Round Grommet (\$16 upcharge per grommet cutout) See page 46 for Grommet placement</p> <p>Select Grommet Color</p> <p>S Charcoal T1 Platinum Metallic</p> <p>GT1</p>	<p>Select Laminate Color</p> <p>See page 45</p> <p>K7</p>
--	---	--	--

FLOCK® Collaborative Table Bases

GSA SIN 33721

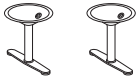
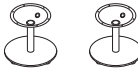
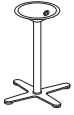

Icon Legend on page 19

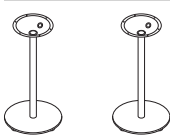
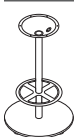
	DESCRIPTION	MODEL	SHIP WEIGHT	CUBE	LIST PRICE BY PAINT GRADE	
					P1	P2
	Base T-Leg Style — For 17”H Tables For 60”W x 24”D Rectangle or Racetrack Table Tops • Two bases shipped in separate cartons.	HFTB17N	40	6.0	\$1342	\$1363
	Base Disc Style — For 17”H Tables • Use with 60”W x 24”D Racetrack or Rectangle table tops only. • Two bases shipped in separate cartons.	HFDB17N	74	6.0	\$1470	\$1491
	Base Disc Style — For 17”H Tables For 30” and 36” Round or Square Table Tops	HFDB17B	37	3.0	\$722	\$743
	Base X-Style — For 29½”H Tables For 30” Round or Square Table Tops For 36” Round or Square Table Tops Use with 33”D x 72”W x 84”W and 96”W Rectangle or Racetrack Table Tops • Two bases shipped in separate cartons	HFXB29A HFXB29B HFXB29AN	40 53 80	16.1 16.1 32.2	\$837 \$884 \$1674	\$858 \$905 \$1716
	Base X-Style — For 18”H Tables For 30” and 36” Round or Square Table Tops	HFXB17B	37	3.0	\$722	\$743
	Base Disc Style — For 29½”H Tables For 30” Round or Square Table Tops For 36” Round or Square Table Tops Use with 33”D x 72”W x 84”W and 96”W Rectangle or Racetrack Table Tops • Two bases shipped in separate cartons	HFDB29A HFDB29B HFDB29AN	40 56 80	16.1 16.1 32.2	\$837 \$884 \$1674	\$848 \$905 \$1695
	Base X-Style — For 41”H Standing-Height Tables • Use with 33”D x 72”W, 84”W and 96”W Rectangle or Racetrack Table Tops • Two bases shipped in separate cartons	HFXB42AN	84	36.4	\$1756	\$1798
	Base X-Style — For 41”H Standing-Height Tables For 30” Round or Square Table Tops For 36” Round or Square Table Tops	HFXB42A HFXB42B	42 55	18.2 16.1	\$878 \$927	\$899 \$948
	Base Disc Style — For 41”H Standing-Height Tables • Use with 33”D x 72”W, 84”W and 96”W Rectangle or Racetrack table tops, when a Footring is not desired • Two bases shipped in separate cartons	HFDB42AN	92	19.0	\$1702	\$1744
	Base Disc Style — For 41”H Standing-Height Tables For 30” Round or Square Table Tops For 36” Round or Square Table Tops	HFDB42A HFDB42B	46 62	9.5 13.5	\$851 \$904	\$872 \$925
	Base Disc Style with Footring — For 41”H Standing-Height Tables For 30” Round or Square Table Tops For 36” Round or Square Table Tops Use with 33”D x 72”W x 84”W and 96”W Rectangle or Racetrack Table Tops • Two bases shipped in separate cartons	HFDB42AF HFDB42BF HFDB42AFN	56 68 112	9.5 13.5 32.2	\$1103 \$1156 \$2206	\$1124 \$1177 \$2248

NOTES:
 • Each base includes adjustable leveling glides.

HOW TO SPECIFY

Select Model Number	Select Paint Color
	PR8 Textured Silver P7A Textured Charcoal
HFTB17N.	PR8



FLOCK® Collaborative Tables

	DESCRIPTION	MODEL	SHIP WEIGHT	CUBE	L1 LIST PRICE	L2 UPCHARGE
	Laminated Personal Table 18" Dia. x 25"H	HFTPTL18	36	4.5	\$870	\$13

HOW TO SPECIFY

Select Model Number HFTPTL18	Select Edge Detail G 2mm Edge Select Edge Color See page 45 GK	Select Laminate Top Color See page 45 H	Select Base Paint Color PR8 Textured Silver P7A Textured Charcoal See page 45 \$21 upcharge per model, for P2 paint PR8
--	--	--	---

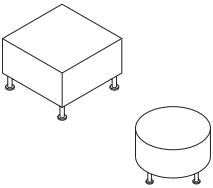
	DESCRIPTION	MODEL	SHIP WEIGHT	CUBE	L1 LIST PRICE	L2 UPCHARGE
	Laminated Collaborative Cube and Cylinder Tables 24" Laminated Cube Table — 24"W x 24"D x 17½"H 26" Laminated Cylinder Table — 26" Dia. x 17½"H	HFTLS24 HFTLD26	44 39	5.0 5.0	\$1044 \$958	\$32 \$32
	NOTES: Accessory port quantity and configuration on tables should correspond to the accessories planned for the table. For grommet and port information, see page 46.					

NOTES:

- Accessory port options on the collaborative cube and cylinder tables allow for tablet accessory to be added.
- For grommet and port information, see page 46.
- HGRMTAC and HGRMTDATA on page 245 can also be used with Flock® tables.
- Standard Leg (L) can be adjusted for leveling.
- For a complete line of compatible Flock® collaborative seating solutions, please see pages 326-348.
- For compatible round grommet options, see page 245.

HOW TO SPECIFY

Select Model Number HFTLS24	Select Grommet Option See page 46 for Grommet placement N No Grommet G Round Grommet — centered (\$16 upcharge)	Select Accessory Port Option See page 46 for Port placement 0 No Port 1 One Corner Port 2 Two Ports — Opposite (\$11 for one corner port, \$21 for two ports, \$32 for three ports)	Select Laminate See page 45 H	Select Leg Option L Standard Leg Leg Options TR Tapered Round Leg TS Tapered Square Leg	Select Paint Color PR8 Textured Silver P7A Textured Charcoal
---	---	---	--	---	---

FLOCK® Collaborative Tables

GSA SIN AS NOTED



Icon Legend on page 19

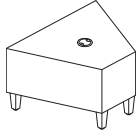

Shown with Round Grommet

OPEN MARKET

DESCRIPTION

Laminate Wedge Table
22.17"W x 29.43"D x 17"H

MODEL

HFTLW45

SHIP WEIGHT

34

CUBE

7.7

L1 LIST PRICE

\$996

L2 UPCHARGE

\$32

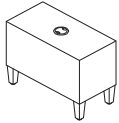

Shown with Round Grommet

OPEN MARKET

Laminate Rectangle Table
24"W x 12"D x 17"H

HFTLR12

29

3.9

\$696

\$21



SIN 33721

Laminate Tablet Accessory
14" Dia. x 10"H from table top

HFTTAL14

6

2.5

\$518

\$16

NOTES: Use with Collaborative Cube and Cylinder tables for additional workspace. Attaches to tables through ports. Multiple port location options are available. Tablet pivots/swivels toward the user.

NOTES:

- Accessory Port options on the Collaborative Cube and Cylinder Tables allow for Tablet Accessory to be added.
- For grommet and port information, see page 46.
- HGRMTAC and HGRMTDATA on page 245 can also be used with Flock® tables.
- Standard Leg (L) can be adjusted for leveling.
- For a complete line of compatible Flock® collaborative seating solutions, please see pages 326-348.
- For compatible round grommet options, see page 245.

HOW TO SPECIFY

<p>Select Model Number</p> <p>HFTLW45</p>	<p>Select Grommet Option</p> <p>See page 46 for Grommet placement</p> <p>N No Grommet G Round Grommet — centered (\$16 upcharge)</p> <p>N</p>	<p>Select Accessory Port Option</p> <p>See page 46 for Port placement</p> <p>O No Port</p> <p>O</p>	<p>Select Laminate Top Color</p> <p>See page 45</p> <p>N</p>	<p>Select Leg Option</p> <p>L Standard Leg Leg Options TR Tapered Round Leg TS Tapered Square Leg</p> <p>TS</p>	<p>Select Paint Color</p> <p>PR8 Textured Silver P7A Textured Charcoal</p> <p>P7A</p>
--	--	---	---	--	--

<p>Select Model Number</p> <p>HFTTAL14</p>	<p>Select Edge Detail</p> <p>G 2mm Edge</p> <p>Select Edge Color</p> <p>See page 45</p> <p>GK</p>	<p>Select Laminate Top Color</p> <p>See page 45</p> <p>H</p>	<p>Select Paint Color</p> <p>PR8 Textured Silver P7A Textured Charcoal</p> <p>PR8</p>
---	--	---	--

HUDDLE

Want to see more? Scan here
to check out hon.com.



Huddle Tables shown with Motivate® Seating.

HUDDLE

These sturdy, versatile tables link and unlink to quickly transform a space. Temporary workstation? Done. Impromptu conference table? Easy! Training session? No problem. Huddle helps you maximize time and square footage — not costs. And for today's businesses, that's a nice change of pace.



FEATURES

- 1½" thick solid core top is made from durable high-performance particleboard.
- Heavy-grade, warp-resistant particleboard tops and bases withstand heavy activity.
- Mobile nesting base option lets tables fold up and roll away until you need them.
- Choose wiring and power options so Huddle tables are ready to work when you are.
- Modesty panels offer the added level of privacy your employees want.
- Two edge profiles in over 20 colors and patterns to accommodate differing tastes.
- Height adjustable laptop table offers a mobile, personal table for working anywhere.

HUDDLE ORDERING INFORMATION

LAMINATE

TOPS/L1 LAMINATES CODES

- Woodgrain**
- ◆ Bourbon Cherry **H**
 - ◆ Cognac **COGN**
 - ◆ Field Elm **LWFE**
 - ◆ Florence Walnut **LFW1**
 - ◆ Harvest **C**
 - ◆ Kingswood Walnut **LKI1**
 - ◆ Mahogany **N**
 - ◆ Mocha **MOCH**
 - ◆ Natural Maple **D**
 - ◆ Pinnacle **PINC**
 - ◆ Shaker Cherry **F**
 - ◆ Sterling Ash **LSA1**
- Solid**
- ◆ Black **P**
 - ◆ Charcoal **S**
 - ◆ Designer White **LDW1**
 - ◆ Loft **LOFT**
- Patterned**
- ◆ Handspun Chestnut **LAHC**
 - ◆ Handspun Dove **LAHD**
 - ◆ Handspun Pearl **LAHP**
 - ◆ Handspun Slate **LAHS**
 - ◆ Silver Mesh **B9**
 - ◆ Steel Mesh **A9**
 - ◆ Battleship **LBT1***
 - ◆ Gray **G2**
 - ◆ Moroccan **LMN1***
 - ◆ Mushroom **LMH1***
 - ◆ Neon Carrot **LN1***
 - ◆ Tennis Ball **LTB1***
 - ◆ White **G1**

TOPS/L2 LAMINATES CODES

- Woodgrain**
- ◆ Beigewood **LWBE**
 - ◆ Fawn Cypress **LFC1**
 - ◆ Lowell Ash **LLA1**
 - ◆ Natural Recon **LN1***
 - ◆ Phantom Ecreu **LPE1**
 - ◆ Portico Teak **LPT1**
 - ◆ Skyline Walnut **LSW1**

EDGE BAND

EDGES/ EDGE BAND (2MM) CODES

- ◆ Beigewood **DE**
- ◆ Black **P**
- ◆ Bourbon Cherry **H**
- ◆ Brownstone **EY**
- ◆ Charcoal **S**
- ◆ Cognac **COGN**
- ◆ Designer White **DW**
- ◆ Fawn Cypress **FC**
- ◆ Field Elm **FE**
- ◆ Florence Walnut **FW**
- ◆ Fossil **EH**
- ◆ Greige **R**
- ◆ Harvest **C**
- ◆ Kingswood Walnut **KI**
- ◆ Loft **LOFT**
- ◆ Lowell Ash **DL**
- ◆ Mahogany **N**
- ◆ Mocha **MOCH**
- ◆ Muslin **T**
- ◆ Natural Maple **D**
- ◆ Natural Recon **NR**
- ◆ Phantom Ecreu **PE**
- ◆ Pinnacle **PINC**
- ◆ Platinum **K**
- ◆ Portico Teak **DP**
- ◆ Shaker Cherry **F**
- ◆ Skyline Walnut **SW**
- ◆ Sterling Ash **SA**

T-MOLD

T-MOLD CODES

- ◆ Atom **AT***
- ◆ Beigewood **DE**
- ◆ Black **P**
- ◆ Brownstone **EY**
- ◆ Bullseye **BY***
- ◆ Charcoal **S***
- ◆ Designer White **DW**
- ◆ Ember **MR***
- ◆ Fawn Cypress **FC**
- ◆ Field Elm **FE**
- ◆ Fossil **EH**
- ◆ Greige **R**
- ◆ Ion **IO***
- ◆ Iris **IR***
- ◆ Krypton **KT***
- ◆ Loft **LOFT**
- ◆ Lowell Ash **DL**
- ◆ Muslin **T**
- ◆ Natural Recon **NR**
- ◆ Phantom Ecreu **PE**
- ◆ Platinum **K**
- ◆ Portico Teak **DP**
- ◆ Regatta **RE***
- ◆ Skyline Walnut **SW**

PAINT

BASE PAINT CODES

- P1**
- ◆ Black **P**
 - ◆ Brownstone **P7D**
 - ◆ Charcoal **S**
 - ◆ Designer White **PJW**
 - ◆ Fossil **P28**
 - ◆ Greige **T5**
 - ◆ Light Gray **Q**
 - ◆ Loft **LOFT**
 - ◆ Muslin **T3**
 - ◆ Putty **L**
 - ◆ Titanium **P8T**
- P2**
- ◆ Champagne Metallic **T4**
 - ◆ Platinum Metallic **T1**
 - ◆ Silver **PR6**
- P3**
- ◆ Atom **P8S**
 - ◆ Bullseye **PJF**
 - ◆ Ember **P8P**
 - ◆ Ion **P8N**
 - ◆ Iris **P8J**
 - ◆ Krypton **P8F**
 - ◆ Regatta **P8M**

Recommended Edgeband Color Selection:

Laminate		Edge	
Bourbon Cherry	H	Bourbon Cherry	H
Cognac	COGN	Cognac	COGN
Florence Walnut	LFW1	Florence Walnut	FW
Harvest	C	Harvest	C
Kingswood Walnut	LKI1	Kingswood Walnut	KI
Mahogany	N	Mahogany	N
Mocha	MOCH	Mocha	MOCH
Natural Maple	D	Natural Maple	D
Pinnacle	PINC	Pinnacle	PINC
Shaker Cherry	F	Shaker Cherry	F
Sterling Ash	LSA1	Sterling Ash	SA
Black	P	Black	P
Charcoal	S	Charcoal	S
Designer White	LDW1	Designer White	DW
Handspun Chestnut	LAHC	Brownstone	EY
Handspun Dove	LAHD	Fossil	EH
Handspun Pearl	LAHP	Fossil	EH
Handspun Slate	LAHS	Charcoal	S
Loft	LOFT	Loft	LOFT
Silver Mesh	B9	Loft	LOFT
Steel Mesh	A9	Charcoal	S
Gray	G2	Charcoal	S
White	G1	Charcoal	S
Lowell Ash	LLA1	Lowell Ash	DL
Natural Recon	LN1*	Natural Recon	NR
Phantom Ecreu	LPE1	Phantom Ecreu	PE
Portico Teak	LPT1	Portico Teak	DP
Skyline Walnut	LSW1	Skyline Walnut	SW

* Available on Laptop Table only.

◆◆◆ For lead time information see page 21.

HUDDLE Multi-Purpose Tables

Huddle Multi-Purpose Tables are ready to jump into action for training, meetings, collaboration and more. Thoughtful design, flexibility and plenty of base, edge and finish options, make Huddle tables capable of meeting the needs of smart, agile businesses.

Tops - Rectangle

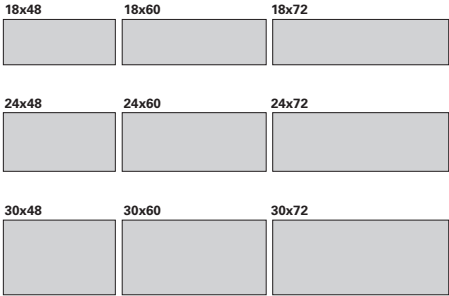

Edge Options

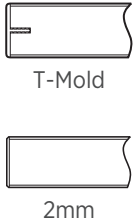

Bases

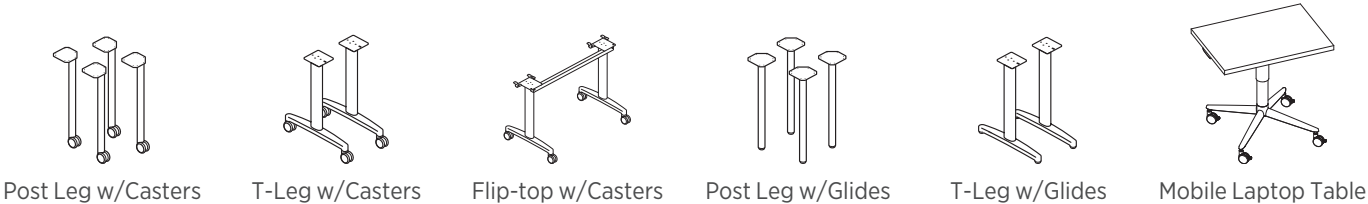

Accessories

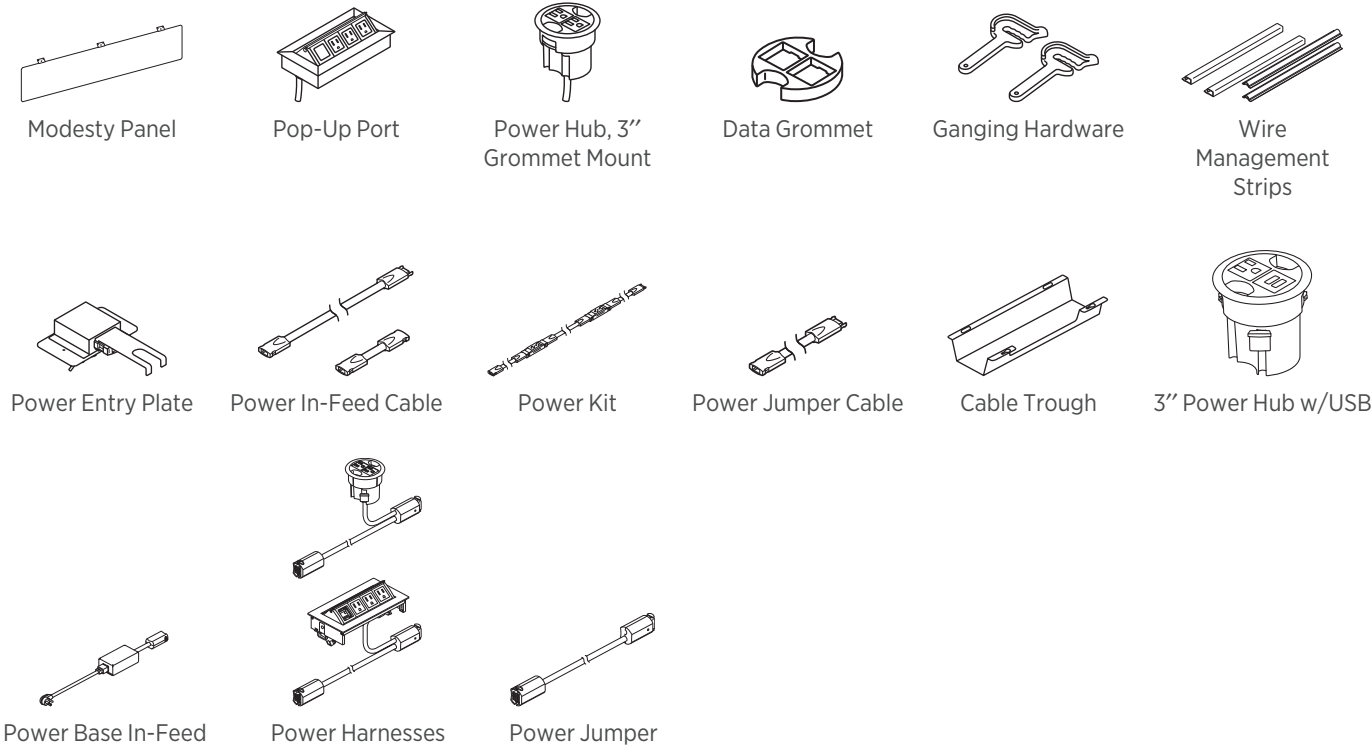

INTERLINK IQ ELECTRICAL

Specification guide for IQ Electrical on Huddle tables

Determine table width, the type of power access being used (3" grommet or 4x8 pop-up) and the desired number per table (Columns 1, 2 or 3). The table will then identify the type and quantity of components needed per table along with the maximum table run. Note that this is in addition to the Power base in-feed which is needed for each run. For example, a 48"W table with two 3" power grommets per table will require (1) HQH5-3 harness and (1) HQH1-3 harness per table with a maximum run of four tables.

Top Width	POWER ONE (1) PER TABLE 3" ROUND POWER GROMMET		POWER TWO (2) PER TABLE 3" ROUND POWER GROMMETS		POWER ONE (1) PER TABLE 4x8 POP-UP PORT	
	Component	Quantity	Component	Quantity	Component	Quantity
36"	(1) HQH5-3	8 Table Run Maximum	N/A	N/A	(1) HQH5-P	8 Max Table Run
42"	(1) HQH5-3	8 Table Run Maximum	N/A	N/A	(1) HQH5-P	8 Max Table Run
48"	(1) HQH5-3	8 Table Run Maximum	(1) HQH5-3 (1) HQH1-3	4 Max Table Run	(1) HQH5-P	8 Max Table Run
54"	(1) HQH5-3	8 Table Run Maximum	(1) HQH5-3 (1) HQH1-3	4 Max Table Run	(1) HQH5-P	8 Max Table Run
60"	(1) HQH5-3	8 Table Run Maximum	(1) HQH5-3 (1) HQH1-3	4 Max Table Run	(1) HQH5-P	8 Max Table Run
66"	(1) HQH5-3 (1) HQJ3	4 Table Run Maximum	(1) HQH5-3 (1) HQH1-3	4 Max Table Run	(1) HQH5-P (1) HQJ3	4 Max Table Run
72"	(1) HQH5-3 (1) HQJ3	4 Table Run Maximum	(1) HQH5-3 (1) HQH1-3	4 Max Table Run	(1) HQH5-P (1) HQJ3	4 Max Table Run
84"	(1) HQH5-3 (1) HQJ3	4 Table Run Maximum	(2) HQH5-3	4 Max Table Run	(1) HQH5-P (1) HQJ3	4 Max Table Run
96"	(1) HQH5-3 (1) HQJ3	4 Table Run Maximum	(2) HQH5-3	4 Max Table Run	(1) HQH5-P (1) HQJ3	4 Max Table Run
Half-Round (all sizes)	(1) HQH1-3	2 Tables Maximum	N/A	N/A	(1) HQH5-P	2 Max Table Run
Trapezoid (all sizes)	(1) HQH5-3	8 Table Run Maximum	N/A	N/A	(1) HQH5-P	8 Max Table Run

NOTES:

- Interlink IQ Electrical is a pluggable, single circuit electrical system.
 - All electrical models include wire management clips and hardware.
 - Interlink IQ Electrical is non-sequential/non-directional. It can be installed in any direction.
 - Interlink IQ Electrical is UL Recognized as a Powered Table System and meets the requirements of UL 962.
 - For compatible Interlink IQ Electrical solutions, see page 242.
- ⚠ 40' maximum run, or no more than 8 units, whichever comes first. Interlink IQ system will automatically shut off if maximum requirements are exceeded. Maximum run is based upon electrical harness width, not table width.

4-TRAC HARDWIRE ELECTRICAL SYSTEM

4-Trac Electrical System

The 4-Trac Electrical System is a UL-recognized Manufactured Wiring System that seamlessly passes power from one worksurface to another. This low-profile non-sequential electrical system allows tables to be “daisy-chained” together in any desired order and allows users to reconfigure quickly due to simple connectable/disconnectable links.

- Meets requirements of UL 183 and National Electric Code Article 604
- 4-Wires, 2-circuits, 20 Amps each (Circuit 1 and Circuit 2 only)
- 13 Duplex Receptacles per circuit, 26, 15 Amp Duplex receptacle per power in-feed
- Electrical system attaches directly to underside of worksurface with included brackets
- Up to twelve tables can be linked together
- For compatible 4-Trac Electrical solutions, see page 244.

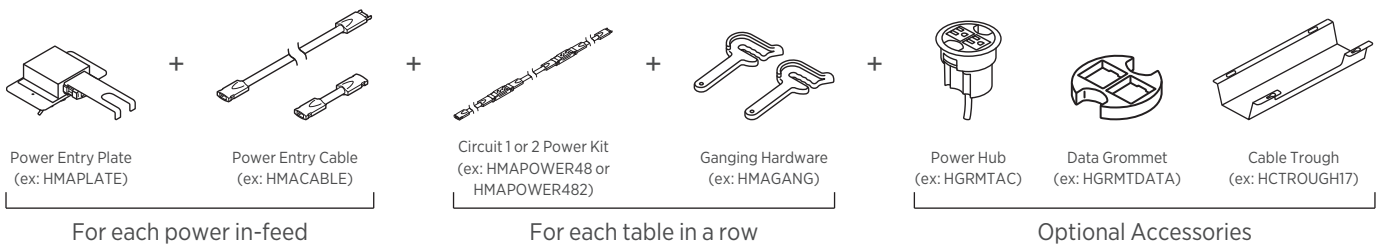

Steps for Electrical Specifications:

- Determine how many rows of tables are needed and order the following:
 - One HMAPLATE per row (or power in-feed)
 - One HMACABLE per row (or power in-feed)
- Order one power harness per table in each row
 - For 1-6 tables in a row (see illustration 1)
 - Order Circuit 1 Power Harnesses (ex. If powering six 24x60 tables order six sets of HMAPOWER60)
 - For 7-12 tables in a row (see illustration 1)
 - Order Circuit 1 Power Harness for first six tables and Circuit 2 Power Harness for remaining tables (ex. If powering eight 24x60 tables, order six sets of HMAPOWER60 and two sets of HMAPOWER602)
- Order one set of ganging hardware per table (ex. HMAGANG)
- Determine which accessories are needed:
 - Power Hub model HGRMTAC — to access power at worksurface.
 - Data Grommet model HGRMTDATA — to access data at worksurface.
 - Wire Management strips model HBTMS — for vertical and horizontal wire management.

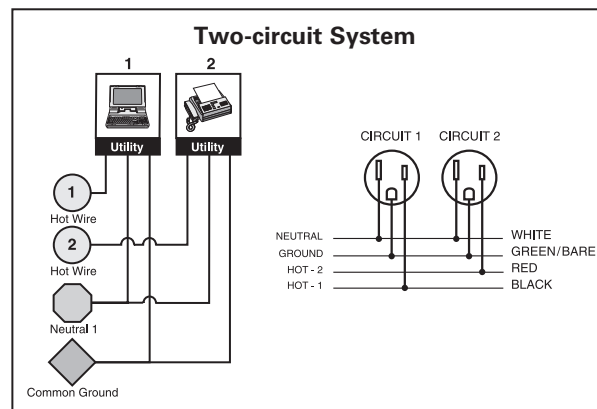
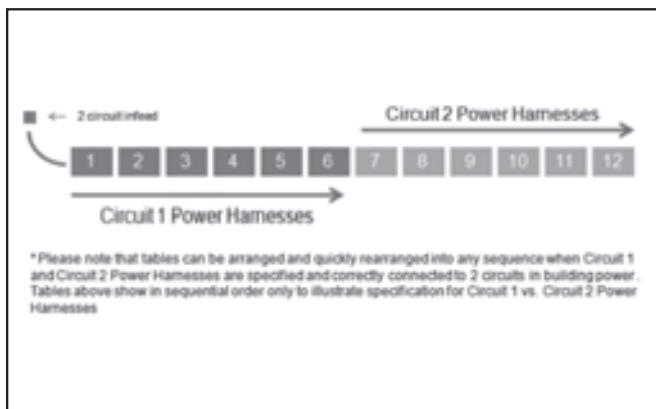

HUDDLE Typicals



Icon Legend on page 19

QTY	DESCRIPTION	MODEL	LIST PRICE	PRICE EXTENSION
12	Rectangular Table Top 60"W x 24"D	HMT2460G	\$549	\$6,588
12	Flip-top Base	HMBFLIP24L.C	\$883	\$10,596
21	Perpetual® Nesting Chair	HPN1	\$992	\$20,832
TOTAL:				\$38,016

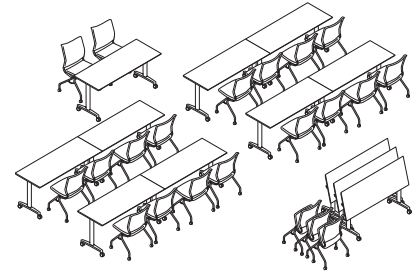

TRAINING

QTY	DESCRIPTION	MODEL	LIST PRICE	PRICE EXTENSION
4	Rectangular Table Top 72"W x 30"D	HMT3072G	\$647	\$2,588
4	Post Leg Base	HMBPOST	\$510	\$2,040
8	Perpetual® Nesting Chair	HPN1	\$992	\$7,936
TOTAL:				\$12,564

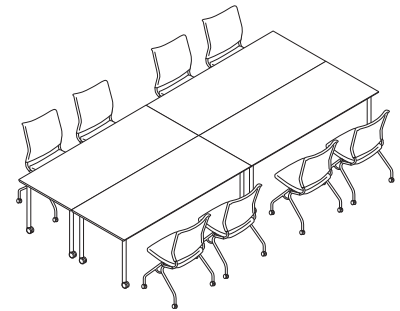

MEETING/CONFERENCE



Icon Legend on page 19

HUDDLE Typicals

QTY	DESCRIPTION	MODEL	LIST PRICE	PRICE EXTENSION
8	Rectangular Table Top 60"W x 30"D	HMT3060G	\$568	\$4,544
8	Fixed Height T-Leg Base with Casters	HMBTLEG24.C	\$602	\$4,816
8	Perpetual® Nesting Chair	HPN1	\$992	\$7,936
TOTAL:				\$17,296

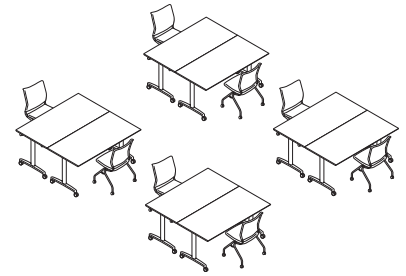

GROUP BREAKOUT

QTY	DESCRIPTION	MODEL	LIST PRICE	PRICE EXTENSION
6	Rectangular Table Top 72"W x 24"D	HMT2472G	\$608	\$3,648
6	Fixed Height T-Leg Base with Casters	HMBTLEG24.C	\$602	\$3,612
12	Perpetual® Nesting Chair	HPN1	\$992	\$11,904
TOTAL:				\$19,164

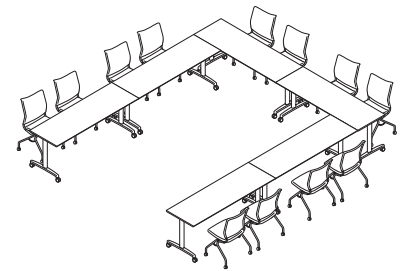

PRESENTATION

HUDDLE

Multi-Purpose Table Tops

GSA SIN 33721



Icon Legend on page 19

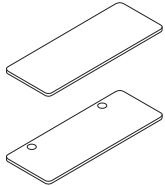

HMT1848E

DESCRIPTION

Rectangular T-Mold Table Tops

48"W x 18"D
60"W x 18"D
72"W x 18"D

48"W x 24"D
60"W x 24"D
72"W x 24"D

48"W x 30"D
60"W x 30"D
72"W x 30"D

MODEL

HMT1848E
HMT1860E
HMT1872E

HMT2448E
HMT2460E
HMT2472E

HMT3048E
HMT3060E
HMT3072E

SHIP WEIGHT CUBE

34 2.9
42 3.5
51 3.9

45 3.7
57 4.5
68 5.0

57 4.4
71 5.4
85 6.0

LIST PRICE BY LAMINATE GRADE

L1 L2

\$442 \$453
\$469 \$485
\$577 \$593

\$497 \$513
\$549 \$570
\$608 \$629

\$518 \$534
\$568 \$589
\$647 \$668

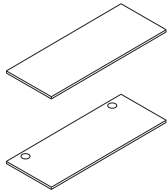

HMT1848G

Rectangular Edgeband Table Tops

48"W x 18"D
60"W x 18"D
72"W x 18"D

48"W x 24"D
60"W x 24"D
72"W x 24"D

48"W x 30"D
60"W x 30"D
72"W x 30"D

HMT1848G
HMT1860G
HMT1872G

HMT2448G
HMT2460G ⓘ
HMT2472G

HMT3048G
HMT3060G
HMT3072G

34 2.9
42 3.5
51 3.9

45 3.7
57 4.5
68 5.0

57 4.4
71 5.4
85 6.0

\$442 \$453
\$469 \$485
\$577 \$593

\$497 \$513
\$549 \$570
\$608 \$629

\$518 \$534
\$568 \$589
\$647 \$668

NOTES:

- Table tops are 1/8" thick.
- When post legs are used with 18"D tops, post leg to be specified with glides only.
- For compatible 4-Trac Electrical solutions, see page 244.
- For compatible Interlink IQ Electrical solutions, see page 242.
- 60"W and 72"W rectangular tops ship with external stiffener for stability.

- ⓘ Round grommets available in Black only.
- ⓘ Pop-up Port option (G1) is unfinished. Insert accessory must be ordered separately.

HOW TO SPECIFY

<p>Select Model Number</p> <p>HMT1848G</p>	<p>Select Grommet Option</p> <p>N No Grommet G 2 Grommets (Black only) (\$32 upcharge) G1 Cutout for Pop-up Port (\$42 upcharge). Order port separately.</p> <p>N</p>	<p>Select Laminate</p> <p>See page 52</p> <p>D</p>	<p>Select Edge Color</p> <p>See page 52</p> <p>D</p>
---	---	---	---



HUDDLE Multi-Purpose Table Bases



	DESCRIPTION	MODEL	SHIP WEIGHT	CUBE	LIST PRICE BY PAINT GRADE		
					P1	P2	P3
	Fixed Height T-Leg Base (Includes 2 T-legs)						
	For 18"D Table Tops For 24"D and 30"D Table Tops	HMBTLEG18 HMBTLEG24 ☉	12 14	3.6 3.6	\$602 \$602	\$623 \$623	\$634 \$634
	Flip-top Base (Includes 1 Complete Base)						
	For 18"D x 48"W Rectangular Table Tops	HMBFLIP18S	23	4.1	\$883	\$904	\$915
	For 18"D x 60"W, 72"W Rectangular Table Tops	HMBFLIP18L	26	4.1	\$883	\$904	\$915
	For 24"D x 48"W and 32"D x 48"W Rectangular Table Tops and 30"D x 60"W Half-Round Table Tops	HMBFLIP24S	24	4.1	\$883	\$904	\$915
	For 24"D x 60"W, 72"W Rectangular Table Tops	HMBFLIP24L ☉	27	4.1	\$883	\$904	\$915
	For 30"D x 48"W Rectangular Table Tops For 30"D x 60"W, 72"W Rectangular Table Tops	HMBFLIP30S HMBFLIP30L	24 27	4.1 4.1	\$883 \$883	\$904 \$904	\$915 \$915
	Post Leg Base (Includes 4 Post Legs)						
For all Tops	HMBPOST	18	2.3	\$510	\$531	\$542	

Table Top to Base Compatibility Chart:

	Flip-Top	T-Leg	Post Leg
18"D x 48"W	HMBFLIP18S	HMBTLEG18	HMBPOST*
18"D x 60"W	HMBFLIP18L	HMBTLEG18	HMBPOST*
18"D x 72"W	HMBFLIP18L	HMBTLEG18	HMBPOST*
24"D x 48"W	HMBFLIP24S	HMBTLEG24	HMBPOST
32"D x 48"W HR	HMBFLIP24S	HMBTLEG24	N/A
30"D x 60"W HR	HMBFLIP24S	HMBTLEG24	HMBPOST
24"D x 60"W	HMBFLIP24L	HMBTLEG24	HMBPOST
24"D x 72"W	HMBFLIP24L	HMBTLEG24	HMBPOST
30"D x 48"W	HMBFLIP30S	HMBTLEG24	HMBPOST
30"D x 60"W	HMBFLIP30L	HMBTLEG24	HMBPOST
30"D x 72"W	HMBFLIP30L	HMBTLEG24	HMBPOST

*Post legs should be specified with glides for use on 18"D worksurfaces.
NOTE: Glides/casters are NOT interchangeable on Post Leg and T-base.

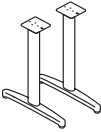
NOTES:

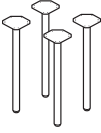
- When glides are specified, adjustable range is 1".
- Flip-top base is standard with casters.
- When post legs are used with 18"D tops, post leg to be specified with glides only.

HOW TO SPECIFY

<p>Select Model Number</p> <p>H M B T L E G 1 8</p>	<p>Select Glide/Caster Option</p> <p>G Glide C Caster</p> <p>Flip-top base is available with casters only</p> <p>When post legs are used with 18"D tops, specify with glides only</p> <p>G</p>	<p>Select Paint Color</p> <p>See page 52</p> <p>\$21 upcharge per model, for P2 paint</p> <p>\$32 upcharge per model, for P3 paint</p> <p>T 1</p>
--	---	--

HUDDLE

Mobile Laptop Table

GSA SIN 33721



Icon Legend on page 19



DESCRIPTION	MODEL	SHIP WEIGHT	CUBE	LIST PRICE	UPCHARGE BY LAMINATE/PAINT GRADE			
					L2	L5	P2	P3
T-Mold 28"W x 20"D	HPHAP2028E	59	8.7	\$1145	\$21	\$84	\$21	\$32



Edgeband 28"W x 20"D	HPHAP2028G	59	8.7	\$1145	\$21	\$84	\$21	\$32
--------------------------------	-------------------	----	-----	--------	------	------	------	------

NOTES:



- Tables adjust from 26"-33"H.
- Pneumatic height adjustment so no electricity is required to adjust height of table.

HOW TO SPECIFY

<p>Select Model Number</p> <p>HPHAP2028E</p>	<p>Select Laminate</p> <p>See page 52</p> <p>LFW1</p>	<p>Select Edge Color</p> <p>See page 52</p> <p>FW</p>	<p>Select Paint Color</p> <p>See page 52</p> <p>P8T</p>
---	--	--	--

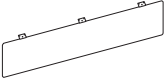

HUDDLE Table Accessories

	DESCRIPTION	MODEL	SHIP WEIGHT	CUBE	LIST PRICE BY PAINT GRADE		
					P1	P2	P3
	Universal Modesty Panel						
	For 48"W Huddle Tables	HMTUMOD32	9	1.9	\$272	\$293	\$304
	For 60"W & 72"W Huddle Tables	HMTUMOD44	12	2.5	\$296	\$317	\$328
	NOTES: Universal Modesty Panels nest between the table legs.						
	Ganging Hardware	HMAGANG	1 	0.1	\$135		
	<ul style="list-style-type: none"> Includes two ganging links and two screws No color designator when specifying. <i>Example: HMAGANG.</i> 						

NOTES:

- Ganging Hardware must be ordered and installed on tables when using 4-trac electrical systems.
- Ganging hardware attaches to underside of table in pre-drilled pilot holes.
- Vertical Wire Management Strips must be trimmed when applied to legs of T-Leg and Flip-Top Bases with casters.

HOW TO SPECIFY

<p>Select Model Number</p> <p>H M T U M O D 3 2</p>	<p>Select Paint Color</p> <p>See page 52</p> <p>S</p>
--	--

OCCASIONAL TABLES

Want to see more? Scan here
to check out hon.com.



Occasional Tables shown with Ceres® Seating.

OCCASIONAL TABLES

Durable materials and construction make HON Occasional Tables ideal for high-traffic areas such as lobbies, reception areas and lounges. The versatile design also dresses up any corner of the executive office where casual, but important, conversations are held. Use them to hold lamps, magazines and more. They're available in 14 woodgrain, patterned or solid color laminates to coordinate with any decor.



FEATURES

- A high-quality solution for any organization wanting to make a great impression on clients and visitors.
- Scratch-, spill- and stain-resistant laminate stands up to heavy use.
- Heavy-grade, warp-resistant particleboard features high recycled content.
- Complement many interiors and furniture designs.
- Brings people together comfortably in reception areas, lounges and offices.

LAMINATE OCCASIONAL TABLES OPTIONS

H80191, H80192, H80193

L1 LAMINATES CODES

Woodgrain

- ◆ Bourbon Cherry H
- ◆ Cognac COGN
- ◆ Field Elm LWFE
- ◆ Florence Walnut LFW1
- ◆ Harvest C
- ◆ Kingswood Walnut LK11
- ◆ Mahogany N
- ◆ Mocha MOCH
- ◆ Natural Maple D
- ◆ Pinnacle PINC
- ◆ Shaker Cherry F
- ◆ Sterling Ash LSA1

Solid

- ◆ Black P
- ◆ Charcoal S
- ◆ Designer White LDW1
- ◆ Loft LOFT

Patterned Top*

- ◆ Handspun Chestnut LAHC
- ◆ Handspun Dove LAHD
- ◆ Handspun Pearl LAHP
- ◆ Handspun Slate LAHS
- ◆ Silver Mesh A9

H80170, H80180

L1 LAMINATES CODES

Woodgrain

- ◆ Bourbon Cherry H
- ◆ Cognac COGN
- ◆ Florence Walnut LFW1
- ◆ Harvest C
- ◆ Kingswood Walnut LK11
- ◆ Mahogany N
- ◆ Mocha MOCH
- ◆ Natural Maple D
- ◆ Pinnacle PINC
- ◆ Shaker Cherry F
- ◆ Sterling Ash LSA1

Solid

- ◆ Black P
- ◆ Charcoal S
- ◆ Designer White LDW1
- ◆ Loft LOFT

Two-Tone Recommended Options for Laminate Occasional Tables (H80191, H80192 and H80193)

Beigewood/Black (LWBEP)	Handspun Dove/Designer White (LAHDLDW1)
Beigewood/Charcoal (LWBES)	Handspun Pearl/Black (LAHPP)
Beigewood/Designer White (LWBELDW1)	Handspun Pearl/Charcoal (LAHPS)
Black/Charcoal (PS)	Handspun Pearl/Designer White (LAHPLDW1)
Black/Designer White (PLDW1)	Handspun Slate/Black (LAHSP)
Bourbon Cherry/Black (HP)	Handspun Slate/Charcoal (LAHSS)
Bourbon Cherry/Charcoal (HS)	Handspun Slate/Designer White (LAHSLDW1)
Bourbon Cherry/Designer White (HLDW1)	Harvest/Black (CP)
Charcoal/Black (SP)	Harvest/Charcoal (CS)
Charcoal/Designer White (SLDW1)	Harvest/Designer White (CLDW1)
Cognac/Black (COGNP)	Kingswood Walnut/Black (LK11P)
Cognac/Charcoal (COGN)	Kingswood Walnut/Charcoal (LK11S)
Cognac/Designer White (COGNLDW1)	Kingswood Walnut/Designer White (LK11LDW1)
Designer White/Black (LDW1P)	Loft/Black (LOFTP)
Designer White/Bourbon Cherry (LDW1H)	Loft/Charcoal (LOFTS)
Designer White/Charcoal (LDW1S)	Loft/Designer White (LOFTLDW1)
Designer White/Cognac (LDW1COGN)	Mahogany/Black (NP)
Designer White/Harvest (LDW1C)	Mahogany/Charcoal (NS)
Designer White/Mahogany (LDW1N)	Mahogany/Designer White (NLDW1)
Designer White/Mocha (LDW1MOCH)	Mocha/Black (MOCHP)
Designer White/Natural Maple (LDW1D)	Mocha/Charcoal (MOCHS)
Designer White/Pinnacle (LDW1PINC)	Mocha/Designer White (MOCHLDW1)
Designer White/Shaker Cherry (LDW1F)	Natural Maple/Black (DP)
Fawn Cypress/Black (LFC1P)	Natural Maple/Charcoal (DS)
Fawn Cypress/Charcoal (LFC1S)	Natural Maple/Designer White (DLDW1)
Fawn Cypress/Designer White (LFC1LDW1)	Pinnacle/Black (PINCP)
Field Elm/Black (LWFEP)	Pinnacle/Charcoal (PINCS)
Field Elm/Charcoal (LWFES)	Pinnacle/Designer White (PINCLDW1)
Field Elm/Designer White (LWFELDW1)	Shaker Cherry/Black (FP)
Florence Walnut/Black (LFW1P)	Shaker Cherry/Charcoal (FS)
Florence Walnut/Charcoal (LFW1S)	Shaker Cherry/Designer White (FLDW1)
Florence Walnut/Designer White (LFW1LDW1)	Silver Mesh/Black (B9P)
Handspun Chestnut/Black (LAHCP)	Silver Mesh/Charcoal (B9S)
Handspun Chestnut/Charcoal (LAHCS)	Silver Mesh/Designer White (B9LDW1)
Handspun Chestnut/Designer White (LAHCLDW1)	Sterling Ash/Black (LSA1P)
Handspun Dove/Black (LAHDP)	Sterling Ash/Charcoal (LSA1S)
Handspun Dove/Charcoal (LAHDS)	Sterling Ash/Designer White (LSA1LDW1)

* NOTE: For patterned top laminates, select one of the following for the edgeband around the top, apron, and legs — Black (P), Bourbon Cherry (H), Charcoal (S), Cognac (COGN), Designer White (LDW1), Florence Walnut (LFW1), Harvest (C), Kingswood Walnut (LK11), Mahogany (N), Mocha (MOCH), Natural Maple (D), Pinnacle (PINC), Shaker Cherry (F), Sterling Ash (LSA1).







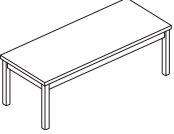

◆◆◆ For lead time information see page 21.

LAMINATE Occasional Tables

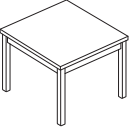
GSA SIN 33721

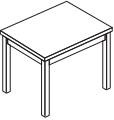

Icon Legend on page 19

	DESCRIPTION	MODEL	SHIP WEIGHT	CUBE	LIST PRICE
 	Coffee Table 48"W x 20"D x 16"H	H80191	48 	3.4	\$684
 	Corner Table 24"W x 24"D x 20"H	H80192	35 	2.1	\$590
 	End Table 24"W x 20"D x 20"H	H80193	29 	1.8	\$563
	Cylinder Table 20" Diameter x 20"H	H80170	40	6.2	\$919
	Cube Table 24"W x 24"D x 20"H	H80180	55	8.6	\$995

NOTES:

- Durable material and construction make laminate occasional tables ideal for high traffic areas such as lobbies, reception rooms and lounges. Versatile design is also well suited to private offices.
- Coffee, Corner and End Tables feature top-over-apron styling with square corner detail, which complements many interiors and furniture designs, including the 10500 Series.
- Tables accommodate lamps, magazines, plants, laptops and more.
- Tops are abrasion- and stain-resistant laminate over 1/8" thick solid core high-performance particleboard.
- Cylinder and cube tables have recessed black plinth base with tack glides. Tops and sides are covered with high-pressure laminate.



H80191, H80192, H80193
Edge Detail

HOW TO SPECIFY

<p>Select Model Number</p> <p>H 8 0 1 9 1 .</p>	<p>Select Laminate</p> <p>See page 63 for Select Laminate noted with each model</p> <p>N N</p>
--	---

MOTIVATE®

Want to see more? Scan here
to check out hon.com.



Motivate® Tables, Chairs, and Markerboard.

MOTIVATE®

Motivate tables were designed with flexible spaces in mind. Work patterns can change throughout the day. Task areas become collaborative areas. Learning areas become conference areas. Created for HON by designer Wolfgang Deisig, Motivate tables are mobile, lightweight and ready to support the many ways you work — adapting and reacting to your needs with ease. Because flexible spaces make for dynamic workplaces.



FEATURES

- 1½” thick solid core top is made from durable high-performance particleboard.
- Motivate Tables are available in three base options — fixed, nesting and height adjustable.
- Optional modular power can be ganged together without any tools.
- Motivate Tables coordinate perfectly with Motivate chairs — an ideal fit for flexible spaces.
- Add a mobile presentation cart or markerboard for increased function and productivity in your workspace.
- Available in multiple top shapes, edge types, and bases with a variety of laminate and paint finish options.

MOTIVATE® TABLES SPECIFYING INFORMATION

LAMINATE

L1 LAMINATES CODES

- Woodgrain**
- ◆ Bourbon Cherry **H**
 - ◆ Cognac **COGN**
 - ◆ Field Elm **LWFE**
 - ◆ Florence Walnut **LFW1**
 - ◆ Harvest **C**
 - ◆ Kingswood Walnut **LKI1**
 - ◆ Mahogany **N**
 - ◆ Mocha **MOCH**
 - ◆ Natural Maple **D**
 - ◆ Pinnacle **PINC**
 - ◆ Shaker Cherry **F**
 - ◆ Sterling Ash **LSA1**

- Solid**
- ◆ Black **P**
 - ◆ Charcoal **S**
 - ◆ Designer White **LDW1**
 - ◆ Loft **LOFT**

- Patterned**
- ◆ Handspun Chestnut **LAHC**
 - ◆ Handspun Dove **LAHD**
 - ◆ Handspun Pearl **LAHP**
 - ◆ Handspun Slate **LAHS**
 - ◆ Silver Mesh **B9**
 - ◆ Steel Mesh **A9**
 - ◆ Gray **G2**
 - ◆ White **G1**

L2 LAMINATES CODES

- Woodgrain**
- ◆ Beigewood **LWBE**
 - ◆ Fawn Cypress **LFC1**
 - ◆ Lowell Ash **LLA1**
 - ◆ Natural Recon **LNRI**
 - ◆ Phantom Ecrú **LPE1**
 - ◆ Portico Teak **LPT1**
 - ◆ Skyline Walnut **LSW1**

EDGE BAND

EDGE BAND 2mm CODES

- ◆ Beigewood **DE**
- ◆ Black **P**
- ◆ Bourbon Cherry **H**
- ◆ Brownstone **EY**
- ◆ Charcoal **S**
- ◆ Cognac **COGN**
- ◆ Designer White **DW**
- ◆ Fawn Cypress **FC**
- ◆ Field Elm **FE**
- ◆ Florence Walnut **FW**
- ◆ Fossil **EH**
- ◆ Greige **R**
- ◆ Harvest **C**
- ◆ Kingswood Walnut **KI**
- ◆ Loft **LOFT**
- ◆ Lowell Ash **DL**
- ◆ Mahogany **N**
- ◆ Mocha **MOCH**
- ◆ Muslin **T**
- ◆ Natural Maple **D**
- ◆ Natural Recon **NR**
- ◆ Phantom Ecrú **PE**
- ◆ Pinnacle **PINC**
- ◆ Platinum **K**
- ◆ Portico Teak **DP**
- ◆ Shaker Cherry **F**
- ◆ Skyline Walnut **SW**
- ◆ Sterling Ash **SA**

ERGO

ERGO-EDGE CODES

- ◆ Black **P**
- ◆ Platinum **K**

PAINT

PAINT CODES

- P1**
- ◆ Black **P**
 - ◆ Brownstone **P7D**
 - ◆ Charcoal **S**
 - ◆ Charblack **CBK**
 - ◆ Designer White **PJW**
 - ◆ Fossil **P28**
 - ◆ Greige **T5**
 - ◆ Loft **LOFT**
 - ◆ Muslin **T3**
 - ◆ Putty **L**
 - ◆ Textured Platinum Metallic **PLAT**
 - ◆ Titanium **P8T**
- P2**
- ◆ Champagne Metallic **T4**
 - ◆ Platinum Metallic **T1**
 - ◆ Silver **PR6**
 - ◆ Solar Black **P8X**
 - ◆ Textured Silver **PR8**
- P3**
- ◆ Atom **P8S**
 - ◆ Bullseye **PJF**
 - ◆ Ember **P8P**
 - ◆ Ion **P8N**
 - ◆ Iris **P8J**
 - ◆ Krypton **P8F**
 - ◆ Regatta **P8M**

Recommended Edgeband Color Selection:

Laminate		Edgeband	
Bourbon Cherry	H	Bourbon Cherry	H
Cognac	COGN	Cognac	COGN
Florence Walnut	LFW1	Florence Walnut	FW
Harvest	C	Harvest	C
Kingswood Walnut	LKI1	Kingswood Walnut	KI
Mahogany	N	Mahogany	N
Mocha	MOCH	Mocha	MOCH
Natural Maple	D	Natural Maple	D
Pinnacle	PINC	Pinnacle	PINC
Shaker Cherry	F	Shaker Cherry	F
Sterling Ash	LSA1	Sterling Ash	SA
Black	P	Black	P
Charcoal	S	Charcoal	S
Designer White	LDW1	Designer White	DW
Handspun Chestnut	LAHC	Brownstone	EY
Handspun Dove	LAHD	Fossil	EH
Handspun Pearl	LAHP	Fossil	EH
Handspun Slate	LAHS	Charcoal	S
Silver Mesh	B9	Loft	LOFT
Steel Mesh	A9	Charcoal	S
Gray	G2	Charcoal	S
White	G1	Charcoal	S
Lowell Ash	LLA1	Lowell Ash	DL
Natural Recon	LNRI	Natural Recon	NR
Phantom Ecrú	LPE1	Phantom Ecrú	PE
Portico Teak	LPT1	Portico Teak	DP
Skyline Walnut	LSW1	Skyline Walnut	SW
Loft	LOFT	Loft	LOFT

- Edge Treatments** • HOW TO ORDER
- 1) Select desired model numbers.
 - 2) Select desired top edge treatment.
 - 3) Replace the (?) after each model number with the suffix representing the chosen top edge treatment.



"G" 2mm Edge



"R" Ergo Edge

◆◆◆ For lead time information see page 21.

4-TRAC HARDWIRE ELECTRICAL SYSTEM

4-Trac Electrical System

The 4-Trac Electrical System is a UL-recognized Manufactured Wiring System that seamlessly passes power from one worksurface to another. This low-profile non-sequential electrical system allows tables to be “daisy-chained” together in any desired order and allows users to reconfigure quickly due to simple connectable/disconnectable links.

- Meets requirements of UL 183 and National Electric Code Article 604
- 4-Wires, 2-circuits, 20 Amps each (Circuit 1 and Circuit 2 only)
- 13 Duplex Receptacles per circuit, 26, 15 Amp Duplex receptacle per power in-feed
- Electrical system attaches directly to underside of worksurface with included brackets
- Up to twelve tables can be linked together
- For compatible 4-Trac Electrical solutions, see page 244.

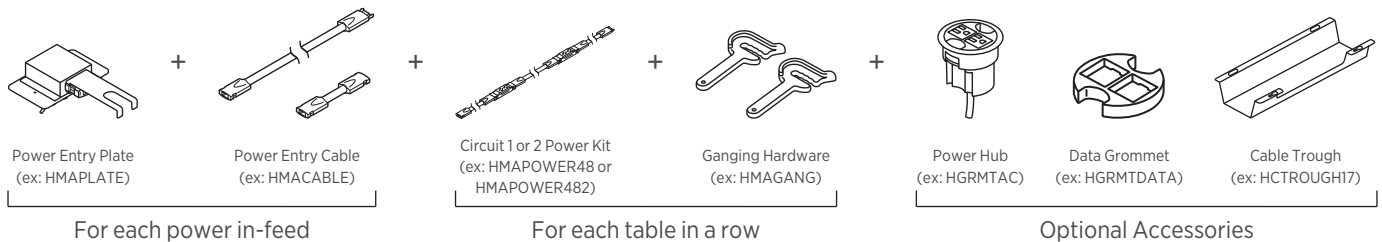

Steps for Electrical Specifications:

- Determine how many rows of tables are needed and order the following:
 - One HMAPLATE per row (or power in-feed)
 - One HMAPOWER482 per row (or power in-feed)
- Order one power harness per table in each row
 - For 1-6 tables in a row (see illustration 1)
 - Order Circuit 1 Power Harnesses (ex. If powering six 24x60 tables order six sets of HMAPOWER60)
 - For 7-12 tables in a row (see illustration 1)
 - Order Circuit 1 Power Harness for first six tables and Circuit 2 Power Harness for remaining tables (ex. If powering eight 24x60 tables, order six sets of HMAPOWER60 and two sets of HMAPOWER602)
- Order one set of ganging hardware per table (ex. HMAGANG)
- Determine which accessories are needed:
 - Power Hub model HGRMTAC — to access power at worksurface.
 - Data Grommet model HGRMTDATA — to access data at worksurface.
 - Wire Management strips model HBTMS — for vertical and horizontal wire management.

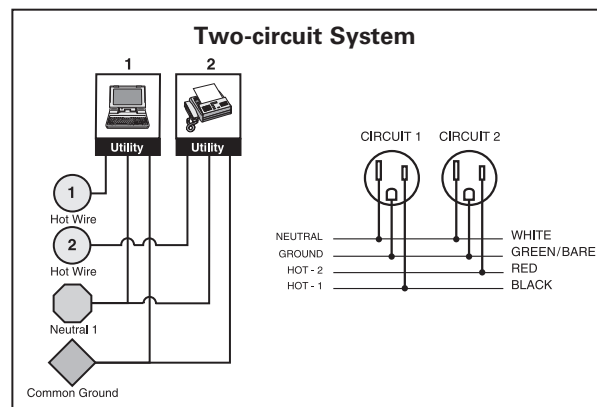
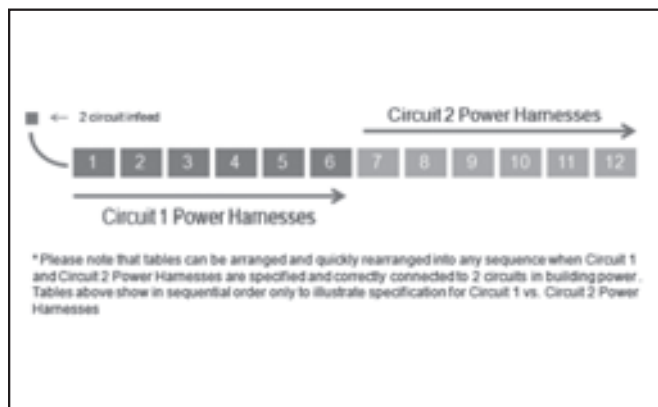

MOTIVATE® Fixed Height Tables

GSA SIN 33721



Icon Legend on page 19



DESCRIPTION	MODEL	SHIP WEIGHT	CUBE	LIST PRICE BY LAMINATE GRADE				
				"G" 2MM EDGE		"R" ERGO EDGE		
				L1	L2	L1	L2	
Rectangular Tables, Fixed Base								
72"W x 18"D	HMVR-1872(?) -FX	80	6.6	\$1201	\$1217	\$1589	\$1605	
60"W x 18"D	HMVR-1860(?) -FX	70	6.0	\$1105	\$1121	\$1442	\$1458	
48"W x 18"D	HMVR-1848(?) -FX	54	5.3	\$1096	\$1107	\$1398	\$1409	
96"W x 24"D	HMVR-2496(?) -FX	118	8.8	\$1537	\$1564	N/A	N/A	
84"W x 24"D	HMVR-2484(?) -FX	109	8.1	\$1475	\$1502	N/A	N/A	
72"W x 24"D	HMVR-2472(?) -FX	96	7.3	\$1226	\$1247	\$1634	\$1655	
66"W x 24"D	HMVR-2466(?) -FX	90	7.3	\$1202	\$1223	N/A	N/A	
60"W x 24"D	HMVR-2460(?) -FX	83	6.6	\$1175	\$1196	\$1544	\$1565	
54"W x 24"D	HMVR-2454(?) -FX	71	6.6	\$1153	\$1174	N/A	N/A	
48"W x 24"D	HMVR-2448(?) -FX	65	5.8	\$1128	\$1144	\$1459	\$1475	
42"W x 24"D	HMVR-2442(?) -FX	60	5.4	\$1103	\$1119	N/A	N/A	
36"W x 24"D	HMVR-2436(?) -FX	54	5.1	\$1084	\$1100	N/A	N/A	
96"W x 30"D	HMVR-3096(?) -FX	145	10.7	\$1664	\$1691	N/A	N/A	
84"W x 30"D	HMVR-3084(?) -FX	131	10.7	\$1649	\$1676	N/A	N/A	
72"W x 30"D	HMVR-3072(?) -FX	115	9.8	\$1337	\$1358	\$1770	\$1791	
66"W x 30"D	HMVR-3066(?) -FX	108	9.8	\$1300	\$1321	N/A	N/A	
60"W x 30"D	HMVR-3060(?) -FX	100	8.9	\$1268	\$1289	\$1665	\$1686	
54"W x 30"D	HMVR-3054(?) -FX	87	8.9	\$1244	\$1265	N/A	N/A	
48"W x 30"D	HMVR-3048(?) -FX	80	7.9	\$1227	\$1243	\$1575	\$1591	
42"W x 30"D	HMVR-3042(?) -FX	73	7.4	\$1197	\$1213	N/A	N/A	
36"W x 30"D	HMVR-3036(?) -FX	65	6.9	\$1173	\$1189	N/A	N/A	
72"W x 36"D	HMVR-3672(?) -FX	131	10.8	\$1530	\$1557	N/A	N/A	
60"W x 36"D	HMVR-3660(?) -FX	114	9.7	\$1419	\$1446	N/A	N/A	
48"W x 36"D	HMVR-3648(?) -FX	91	9.7	\$1325	\$1346	N/A	N/A	
Half-Round Tables, Fixed Base								
72"W x 36"D	HMVH-3672(?) -FX	103	10.8	\$1593	\$1620	N/A	N/A	
60"W x 30"D	HMVH-3060(?) -FX	75	7.6	\$1242	\$1269	\$1665	\$1692	
48"W x 24"D	HMVH-2448(?) -FX	56	5.8	\$1160	\$1181	\$1517	\$1538	

NOTES:

- Specification includes top and base, however, top and base are boxed separately.
- Ergo edge is a bullnose on user side and 3mm on all other sides.
- Tops are 1 1/8" thick.
- Fixed Height base is standard 29 1/2" seated-height.
- See grommet matrix on page 241 for grommet location/placement.
- 36"-42" tops and all half-round and trapezoid tops standard with one 3" round grommet, 48"-96" tops standard with two 3" round grommets. When G1 grommet is selected, all tops standard with one cutout.
- For compatible 4-Trac Electrical solutions, see page 244.
- For compatible Interlink IQ Electrical solutions, see page 242.



HOW TO SPECIFY

<p>Select Model Number</p> <p>HMVR-1872G-FX</p>	<p>Select Grommet Option</p> <p>N No Grommet G Grommet (\$16 upcharge PER grommet) G1 Electrical Port (\$42 upcharge)</p> <p>N</p>	<p>Select Laminate</p> <p>See page 66</p> <p>C</p>	<p>Select Edge Color</p> <p>See page 66</p> <p>C</p>	<p>Select Caster/Glide Option</p> <p>C Multi-Surface Caster G Glide</p> <p>T</p>	<p>Select Base Paint Color</p> <p>See page 66 \$21 upcharge per model, for P2 paint</p> <p>C</p>
--	---	---	---	---	---

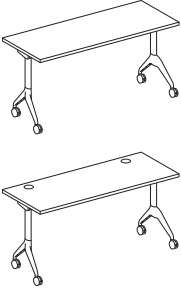

Icon Legend on page 19

MOTIVATE® Nesting Tables

	DESCRIPTION	MODEL	SHIP WEIGHT	CUBE	LIST PRICE BY LAMINATE GRADE				
					"G" 2MM EDGE		"R" ERGO EDGE		
					L1	L2	L1	L2	
	Rectangular Nesting Tables								
	72"W x 18"D	HMVR-1872(?) -NS	90	8.5	\$1581	\$1597	\$1969	\$1985	
	60"W x 18"D	HMVR-1860(?) -NS	79	7.6	\$1480	\$1496	\$1798	\$1814	
	48"W x 18"D	HMVR-1848(?) -NS	60	6.5	\$1474	\$1485	\$1770	\$1781	
	96"W x 24"D	HMVR-2496(?) -NS	134	11.4	\$1892	\$1919	N/A	N/A	
	84"W x 24"D	HMVR-2484(?) -NS	122	10.4	\$1855	\$1882	N/A	N/A	
	72"W x 24"D	HMVR-2472(?) -NS	106	9.2	\$1606	\$1627	\$2014	\$2035	
	66"W x 24"D	HMVR-2466(?) -NS	100	9.1	\$1577	\$1598	N/A	N/A	
	60"W x 24"D	HMVR-2460(?) -NS	92	8.2	\$1550	\$1571	\$1919	\$1940	
	54"W x 24"D	HMVR-2454(?) -NS	80	8.2	\$1533	\$1554	N/A	N/A	
	48"W x 24"D	HMVR-2448(?) -NS	73	7.2	\$1500	\$1516	\$1831	\$1847	
	42"W x 24"D	HMVR-2442(?) -NS	67	6.6	\$1478	\$1494	N/A	N/A	
	36"W x 24"D	HMVR-2436(?) -NS	60	6.3	\$1456	\$1472	N/A	N/A	
	96"W x 30"D	HMVR-3096(?) -NS	161	13.3	\$2069	\$2096	N/A	N/A	
	84"W x 30"D	HMVR-3084(?) -NS	144	13.0	\$2054	\$2081	N/A	N/A	
	72"W x 30"D	HMVR-3072(?) -NS	125	11.7	\$1742	\$1763	\$2175	\$2196	
	66"W x 30"D	HMVR-3066(?) -NS	118	11.6	\$1700	\$1721	N/A	N/A	
	60"W x 30"D	HMVR-3060(?) -NS	109	10.5	\$1668	\$1689	\$2048	\$2069	
54"W x 30"D	HMVR-3054(?) -NS	96	10.5	\$1649	\$1670	N/A	N/A		
48"W x 30"D	HMVR-3048(?) -NS	88	9.3	\$1624	\$1640	\$1972	\$1988		
42"W x 30"D	HMVR-3042(?) -NS	80	8.1	\$1597	\$1613	N/A	N/A		
36"W x 30"D	HMVR-3036(?) -NS	71	8.1	\$1570	\$1586	N/A	N/A		
72"W x 36"D	HMVR-3672(?) -NS	141	12.7	\$1935	\$1962	N/A	N/A		
60"W x 36"D	HMVR-3660(?) -NS	123	11.3	\$1819	\$1846	N/A	N/A		
48"W x 36"D	HMVR-3648(?) -NS	99	11.1	\$1722	\$1743	N/A	N/A		
	Half-Round Nesting Tables								
	72"W x 36"D	HMVH-3672(?) -NS	111	12.2	\$1990	\$2017	N/A	N/A	
	60"W x 30"D	HMVH-3060(?) -NS	82	8.8	\$1718	\$1745	\$2141	\$2168	
	48"W x 24"D	HMVH-2448(?) -NS	62	7.0	\$1532	\$1553	\$1889	\$1910	

NOTES:

- Ergo edge is a bullnose on user side and 3mm on all other sides.
- Tops are 1 1/8" thick.
- Specification includes top and base, however, top and base are boxed separately.
- See grommet matrix on page 241 for grommet location/placement.
- 36"-42" tops and all half-round and trapezoid tops standard with one 3" round grommet, 48"-96" tops standard with two 3" round grommets. When G1 grommet is selected, all tops standard with one cutout.
- For compatible 4-Trac Electrical solutions, see page 244.
- For compatible Interlink IQ Electrical solutions, see page 242.

HOW TO SPECIFY

<p>Select Model Number</p> <p>HMVR-1872G-NS</p>	<p>Select Grommet Option</p> <p>N No Grommet G Grommet (\$16 upcharge PER grommet) G1 Electrical Port (\$42 upcharge)</p> <p>N</p>	<p>Select Laminate</p> <p>See page 66</p> <p>C</p>	<p>Select Edge Color</p> <p>See page 66</p> <p>C</p>	<p>Select Caster/Glide Option</p> <p>C Multi-Surface Caster G Glide</p> <p>C</p>	<p>Select Base Paint Color</p> <p>See page 66 \$21 upcharge per model, for P2 paint</p> <p>T1</p>
--	---	---	---	---	--

MOTIVATE® Adjustable Height Tables

GSA SIN 33721



Icon Legend on page 19

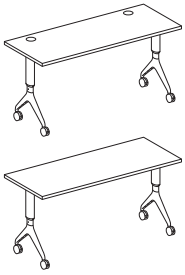

DESCRIPTION	MODEL	SHIP WEIGHT	CUBE	LIST PRICE BY LAMINATE GRADE			
				"G" 2MM EDGE		"R" ERGO EDGE	
				L1	L2	L1	L2
Rectangular Tables, Adjustable Height Base							
72"W x 18"D	HMVR-1872(?) -AH	83	6.6	\$1563	\$1579	\$1951	\$1967
60"W x 18"D	HMVR-1860(?) -AH	73	6.0	\$1467	\$1483	\$1804	\$1820
48"W x 18"D	HMVR-1848(?) -AH	57	5.3	\$1458	\$1469	\$1760	\$1771
72"W x 24"D	HMVR-2472(?) -AH	99	7.3	\$1588	\$1609	\$1996	\$2017
66"W x 24"D	HMVR-2466(?) -AH	93	7.3	\$1564	\$1585	N/A	N/A
60"W x 24"D	HMVR-2460(?) -AH	86	6.6	\$1537	\$1558	\$1906	\$1927
54"W x 24"D	HMVR-2454(?) -AH	74	6.6	\$1515	\$1536	N/A	N/A
48"W x 24"D	HMVR-2448(?) -AH	68	5.8	\$1490	\$1506	\$1821	\$1837
42"W x 24"D	HMVR-2442(?) -AH	63	5.4	\$1465	\$1481	N/A	N/A
36"W x 24"D	HMVR-2436(?) -AH	57	5.1	\$1446	\$1462	N/A	N/A
72"W x 30"D	HMVR-3072(?) -AH	118	9.8	\$1723	\$1744	\$2156	\$2177
66"W x 30"D	HMVR-3066(?) -AH	111	9.8	\$1686	\$1707	N/A	N/A
60"W x 30"D	HMVR-3060(?) -AH	103	8.9	\$1654	\$1675	\$2051	\$2072
54"W x 30"D	HMVR-3054(?) -AH	90	8.9	\$1630	\$1651	N/A	N/A
48"W x 30"D	HMVR-3048(?) -AH	83	7.9	\$1613	\$1629	\$1961	\$1977
42"W x 30"D	HMVR-3042(?) -AH	76	7.4	\$1583	\$1599	N/A	N/A
36"W x 30"D	HMVR-3036(?) -AH	68	6.9	\$1559	\$1575	N/A	N/A
72"W x 36"D	HMVR-3672(?) -AH	134	10.8	\$1916	\$1943	N/A	N/A
60"W x 36"D	HMVR-3660(?) -AH	117	9.7	\$1805	\$1832	N/A	N/A
48"W x 36"D	HMVR-3648(?) -AH	94	9.7	\$1711	\$1732	N/A	N/A

NOTES:

- Ergo edge is a bullnose on user side and 3mm on all other sides.
 - Tops are 1/8" thick.
 - Specification includes top and base, however, top and base are boxed separately.
 - Seated height adjustment from 27 1/2" - 32 1/2" in 1" increments.
 - See grommet matrix on page 241 for grommet location/placement.
 - 36"-42" tops and all half-round and trapezoid tops standard with one 3" round grommet, 48"-96" tops standard with two 3" round grommets. When G1 grommet is selected, all tops standard with one cutout.
 - For compatible 4-Trac Electrical solutions, see page 244.
 - For compatible Interlink IQ Electrical solutions, see page 242.
- ! No tool required, adjustable bases have ratchet style adjustment mechanism.

HOW TO SPECIFY

<p>Select Model Number</p> <p>HMVR-1872G-AH</p>	<p>Select Grommet Option</p> <p>N No Grommet G Grommet (\$16 upcharge PER grommet) G1 Electrical Port (\$42 upcharge)</p> <p>N</p>	<p>Select Laminate</p> <p>See page 66</p> <p>C</p>	<p>Select Edge Color</p> <p>See page 66</p> <p>C</p>	<p>Select Caster/Glide Option</p> <p>C Multi-Surface Caster G Glide</p> <p>C</p>	<p>Select Base Paint Color</p> <p>See page 66 \$21 upcharge per model, for P2 paint</p> <p>P</p>
--	---	---	---	---	---

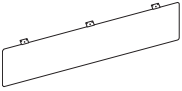

MOTIVATE® Shared Components

DESCRIPTION	MODEL	SHIP WEIGHT	CUBE	LIST PRICE BY PAINT GRADE	
				P1	P2
 <p>Universal Modesty Panel For 96"W Motivate® Tables For 84"W Motivate® Tables For 72"W Motivate® Tables For 66"W Motivate® Tables For 60"W Motivate® Tables For 54"W Motivate® Tables For 48"W Motivate® Tables For 42"W Motivate® Tables For 36"W Motivate® Tables</p>	HMTUMOD86	21	4.8	\$356	\$377
	HMTUMOD74	20	4.4	\$345	\$366
	HMTUMOD62	17	3.6	\$332	\$353
	HMTUMOD56	16	3.4	\$320	\$341
	HMTUMOD50	14	3.1	\$308	\$329
	HMTUMOD44	12	2.5	\$296	\$317
	HMTUMOD38	11	2.2	\$282	\$303
	HMTUMOD32	9	1.9	\$272	\$293
	HMTUMOD26	8	1.7	\$259	\$280

NOTES:

- Modesty Panels are hinged to nest along with Nesting Tables. Modesty Panels can be used with all base types.
- ! Use field installed Table Modesty Panels with all table widths 36"-96". Cannot be used with Half-Round or Trapezoid tables.

HOW TO SPECIFY

<p>Select Model Number</p> <p>HMTUMOD86</p>	<p>Select Paint Color</p> <p>See page 66 \$21 upcharge per model, for P2 paint</p> <p>T1</p>
--	--

MOTIVATE® Shared Components

GSA SIN 33721 EXCEPT AS NOTED



Icon Legend on page 19

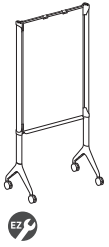

DESCRIPTION

Mobile Markerboard

36"W x 72"H
30"W x 72"H

Actual Markerboard size:
HMVMB-3672WW – 36¼"W x 42"H
HMVMB-3072WW – 30¼"W x 42"H

NOTES: 2-Sided Mobile Markerboard is porcelain over steel with four locking casters. Mobile Markerboard includes marker tray and flip-chart paper clips.

Porcelain Markerboard cleaning instructions: For everyday cleaning, use Clorox wipes. Use a citrus cleaner if a permanent marker is used by accident.

! A citrus cleaner is not recommended for everyday use as it leaves residue.

! \$21 list upcharge for P2 paint.

Specify Model.Base.Casters.Paint SPECIFYING EXAMPLE: HMVMB-3072WW.C.P

MODEL

SHIP WEIGHT

CUBE

LIST PRICE

HMVMB-3672WW	59	7.9	\$1863
HMVMB-3072WW	53	7.1	\$1828

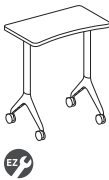

Presentation Cart, Concave Front, Fixed Leg

18"D x 30"W x 35"H, 2mm Edge
18"D x 30"W x 35"H, Ergo Edge

NOTES: Presentation Cart tops are 1⅝" thick with a concave user side. Choose from a 2mm or Ergo edge.

! \$11 list upcharge for L2 laminates.

! \$21 list upcharge for P2 paint.

Specify Model.Caster.TopLaminate.EdgeColor.Paint SPECIFYING EXAMPLE: HMVPCF-1830G.C.D.D.T1

HMVPCF-1830G	38	3.9	\$1143
HMVPCF-1830R	38	3.9	\$1546



Presentation Cart, Concave Front, Seated Height Adjustable-Leg

18"D x 30"W x 27½"-34½"H, 2mm Edge
18"D x 30"W x 27½"-34½"H, Ergo Edge

HMVPCA1-1830G	40	3.9	\$1507
HMVPCA1-1830R	40	3.9	\$1927

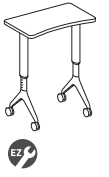

Presentation Cart, Concave Front, Standing-Height Adjustable-Leg

18"D x 30"W x 31½"-38½"H, 2mm Edge
18"D x 30"W x 31½"-38½"H, Ergo Edge

NOTES: Presentation Cart tops are 1⅝" thick with a concave user side. Choose from a 2mm or Ergo edge.

! \$11 list upcharge for L2 laminates.

! \$21 list upcharge for P2 paint.

Specify Model.Caster.TopLaminate.EdgeColor.Paint SPECIFYING EXAMPLE: HMVPCA1-1830G.C.D.D.T1

HMVPCA2-1830G	42	3.9	\$1507
HMVPCA2-1830R	42	3.9	\$1927



Presentation Cart, Modesty Panel

Specify Model.Paint SPECIFYING EXAMPLE: HMVPC-MP.P

HMVPC-MP	6	1.4	\$234
-----------------	---	-----	--------------



Presentation Cart, Storage Shelves

Single, 4" Open Back
Double, 4" Open Back / 4" Closed Back
Double, 4" Open Back / 9" Closed Back
Single, 4" Closed Back
Double, 4" Closed Back / 4" Closed Back
Double, 4" Closed Back / 9" Closed Back

HMVPCSS-40	8	1.4	\$120
HMVPCSS-404C	17	2.6	\$243
HMVPCSS-409C	20	3.6	\$380
HMVPCSS-4C	9	1.4	\$131
HMVPCSS-4C4C	18	2.6	\$255
HMVPCSS-4C9C	21	3.6	\$391

NOTES: Storage Shelves for Presentation Carts are available in three preconfigured sizes and may be used on fixed or adjustable height models.

Specify Model.Paint SPECIFYING EXAMPLE: HMVPCSS-40.T1



Presentation Cart Desk Top Lectern, 2mm Edge

NOTES: Desk Top Lectern may be used on the Presentation Cart or is removable for use on table tops.

! \$16 list upcharge for L2 laminates.

! Desktop Lectern only available with 2mm edge.

Specify Model.LaminateTop.EdgeColor.Paint SPECIFYING EXAMPLE: HMVPC-DTLG.D.D.T1

HMVPC-DTLG	16	2.4	\$436
-------------------	----	-----	--------------

OPEN MARKET

HOW TO SPECIFY

Select Model Number

H M V M B - 3 6 7 2 W W



Preside® tables and bench shown
with Flock® guest seating.

PRESIDE®

Whether you're craving social interaction or breaking away for some "me time", Preside tables support the work activities you need to get it done. Versatile enough for touchdown spaces, meeting rooms, and even cafés, Preside offers everything from a contemporary light-scale vibe to a more classic aesthetic. Add in optional power for a dynamic table collection that lets you work your way.



FEATURES

- Preside offers a complete line of conference accessories, including presentation cabinets, hospitality and more.
- Optional flip-top and pop-up ports provide options today and for future data and power needs.
- Scratch-, spill- and stain-resistant laminate will look great for years to come.
- Add a splash of color to Preside using Colorwav™ paints to brighten any space.
- Enhanced aesthetics with power management options to keep the workspace tidy and looking its best.

PRESIDE® ORDERING INFORMATION

LAMINATE GROUP A

L1 LAMINATES CODES

Woodgrain

- ◆ Bourbon Cherry H
- ◆ Cognac COGN
- ◆ Field Elm LWFE
- ◆ Florence Walnut LFW1
- ◆ Harvest C
- ◆ Kingswood Walnut LK11
- ◆ Mahogany N
- ◆ Mocha MOCH
- ◆ Natural Maple D
- ◆ Pinnacle PINC
- ◆ Shaker Cherry F
- ◆ Sterling Ash LSA1

Solid

- ◆ Black P
- ◆ Charcoal S
- ◆ Designer White LDW1
- ◆ Loft LOFT

Patterned

- ◆ Handspun Chestnut LAHC
- ◆ Handspun Dove LAHD
- ◆ Handspun Pearl LAHP
- ◆ Handspun Slate LAHS
- ◆ Silver Mesh B9
- ◆ Steel Mesh A9
- ◆ Gray G2
- ◆ White G1

L2 LAMINATES CODES

Woodgrain

- ◆ Beigewood LWBE
- ◆ Fawn Cypress LFC1
- ◆ Lowell Ash LLA1
- ◆ Natural Recon LNRI
- ◆ Phantom Ecu LPE1
- ◆ Portico Teak LPT1
- ◆ Skyline Walnut LSW1

LAMINATE GROUP B

L1 LAMINATES CODES

Woodgrain

- ◆ Bourbon Cherry H
- ◆ Cognac COGN
- ◆ Field Elm LWFE
- ◆ Florence Walnut LFW1
- ◆ Harvest C
- ◆ Kingswood Walnut LK11
- ◆ Mahogany N
- ◆ Mocha MOCH
- ◆ Natural Maple D
- ◆ Pinnacle PINC
- ◆ Shaker Cherry F
- ◆ Sterling Ash LSA1

Solid

- ◆ Black P
- ◆ Charcoal S
- ◆ Designer White LDW1
- ◆ Loft LOFT

L2 LAMINATES CODES

Woodgrain

- ◆ Beigewood LWBE
- ◆ Fawn Cypress LFC1
- ◆ Lowell Ash LLA1
- ◆ Natural Recon LNRI
- ◆ Phantom Ecu LPE1
- ◆ Portico Teak LPT1
- ◆ Skyline Walnut LSW1

LAMINATE GROUP C

L1 LAMINATES CODES

Woodgrain

- ◆ Bourbon Cherry H
- ◆ Cognac COGN
- ◆ Field Elm LWFE
- ◆ Florence Walnut LFW1
- ◆ Harvest C
- ◆ Kingswood Walnut LK11
- ◆ Mahogany N
- ◆ Mocha MOCH
- ◆ Natural Maple D
- ◆ Pinnacle PINC
- ◆ Shaker Cherry F
- ◆ Sterling Ash LSA1

Solid

- ◆ Black P
- ◆ Charcoal S
- ◆ Designer White LDW1
- ◆ Loft LOFT

L2 LAMINATES CODES

Woodgrain

- ◆ Beigewood LWBE
- ◆ Fawn Cypress LFC1
- ◆ Lowell Ash LLA1
- ◆ Natural Recon LNRI
- ◆ Phantom Ecu LPE1
- ◆ Portico Teak LPT1
- ◆ Skyline Walnut LSW1

LAMINATE GROUP D

L1 LAMINATES CODES

Woodgrain

- ◆ Mahogany N

PAINT GROUP A

P1 CODES

- ◆ Black P
- ◆ Brownstone P7D
- ◆ Charcoal S
- ◆ Designer White PJW
- ◆ Fossil P28
- ◆ Greige T5
- ◆ Loft LOFT
- ◆ Muslin T3
- ◆ Titanium P8T

P2 CODES

- ◆ Champagne Metallic T4
- ◆ Platinum Metallic T1
- ◆ Silver PR6
- ◆ Solar Black P8X

P3 CODES

- ◆ Atom P8S
- ◆ Bullseye PJF
- ◆ Ember P8P
- ◆ Ion P8N
- ◆ Iris P8J
- ◆ Krypton P8F
- ◆ Regatta P8M

HON BRANDED FABRICS

GRADE 1

- Apex
- Centurion
- Compass
- Contourett
- Dapper
- Ensemble
- Hamilton
- Inertia
- Noble Seating
- Optic
- Pebble
- Vibe

GRADE 2

- Appoint Seating
- Blume
- Clyde
- Dotty
- Kai
- Rush
- Spin
- Wavelength
- Whisper Vinyl

GRADE 3

- Bradbury
- Getaway
- Moxie
- Notion
- Parker
- Saxony

GRADE 4

- Constance with Supreen™
- Livi with Supreen™
- Lugano with Supreen™
- Oxford with Supreen™

NOTES: Fabrics on Preside® bench cushion are upholstered in the railroad direction.

◆◆◆ For lead time information see page 21.

PRESIDE® SPECIFYING INFORMATION

EDGE BAND OPTIONS	CODES	2mm (G)	Knife (J)	T-Mold (E)
Beigewood	DE	•	•	•
Bourbon Cherry	H	•	•	
Cognac	COGN	•	•	•
Fawn Cypress	FC	•	•	•
Field Elm	FE	•	•	•
Florence Walnut	FW	•	•	•
Harvest	C	•	•	
Kingswood Walnut	KI	•	•	•
Light Gray	Q	•	•	•
Mahogany	N	•	•	•
Mocha	MOCH	•	•	•
Natural Maple	D	•	•	
Shaker Cherry	F	•	•	
Sterling Ash	SA	•	•	•
Black	P	•	•	•
Brownstone	EY	•	•	•
Charcoal	S	•	•	•
Designer White	DW	•	•	•
Fossil	EH	•	•	•
Greige	R	•	•	•
Loft	LOFT	•	•	•
Muslin	T	•	•	•
Pinnacle	PINC	•	•	•
Platinum	K	•	•	•
Lowell Ash	DL	•	•	
Natural Recon	NR	•	•	
Phantom Ecu	PE	•	•	
Portico Teak	DP	•	•	•
Skyline Walnut	SW	•	•	•

Recommended Edgeband Color Selection:

Laminate		Edge	
Beigewood	LWBE	Beigewood	DE
Bourbon Cherry	H	Bourbon Cherry	H
Cognac	COGN	Cognac	COGN
Fawn Cypress	LFC1	Fawn Cypress	FC
Field Elm	LWFE	Field Elm	FE
Florence Walnut	LFW1	Florence Walnut	FW
Harvest	C	Harvest	C
Kingswood Walnut	LKI1	Kingswood Walnut	KI
Mahogany	N	Mahogany	N
Mocha	MOCH	Mocha	MOCH
Natural Maple	D	Natural Maple	D
Pinnacle	PINC	Pinnacle	PINC
Shaker Cherry	F	Shaker Cherry	F
Sterling Ash	LSA1	Sterling Ash	SA
Black	P	Black	P
Charcoal	S	Charcoal	S
Designer White	LDW1	Designer White	DW
Handspun Chestnut	LAHC	Brownstone	EY
Handspun Dove	LAHD	Fossil	EH
Handspun Pearl	LAHP	Fossil	EH
Handspun Slate	LAHS	Charcoal	S
Loft	LOFT	Loft	LOFT
Silver Mesh	B9	Loft	LOFT
Steel Mesh	A9	Charcoal	S
Gray	G2	Charcoal	S
White	G1	Charcoal	S
Lowell Ash	LLA1	Lowell Ash	DL
Natural Recon	LNRI	Natural Recon	NR
Phantom Ecu	LPE1	Phantom Ecu	PE
Portico Teak	LPTI	Portico Teak	DP
Skyline Walnut	LSW1	Skyline Walnut	SW

PRESIDE[®] SPECIFYING INFORMATION

Statement of Line

TOP SHAPES



Square



Round



Soft Square



Rectangle

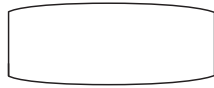

Boat



Racetrack



Arc End

TOP EDGE PROFILES

For Laminate Tops

Square/2mm Edgeband (1/8")



Knife Edge (1/8")



T-Mold Edge (1/8")



BASES

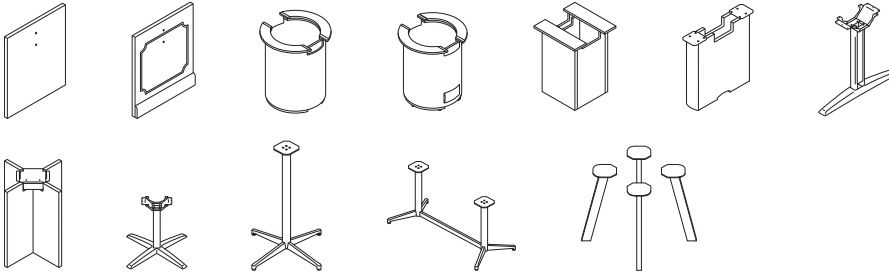

ANCILLARY COMPONENTS

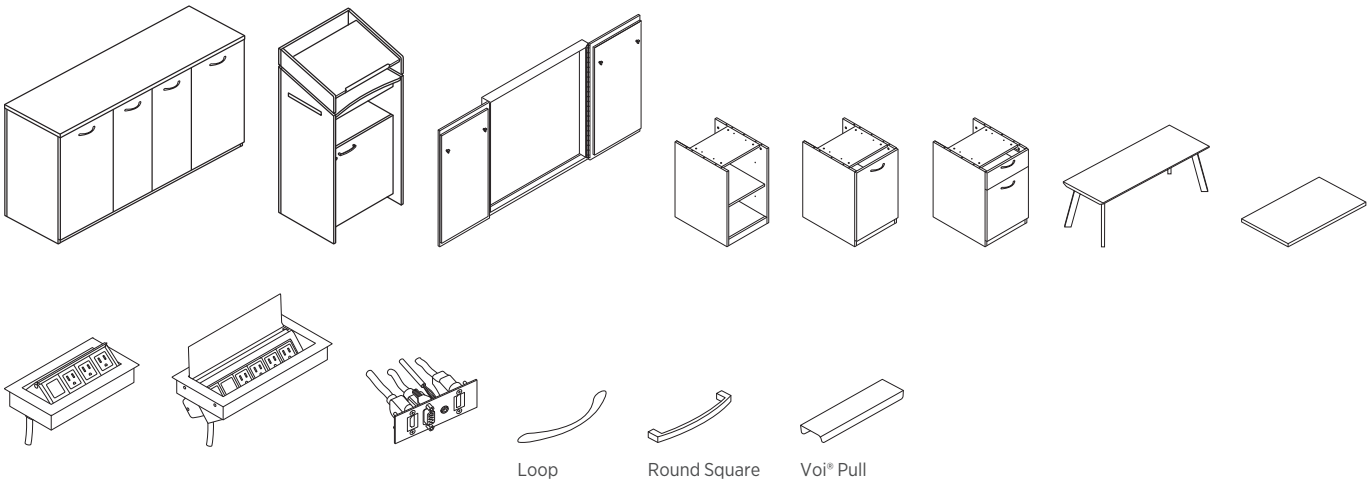

Loop

Round Square

Voi[®] Pull







PRESIDE® SPECIFYING INFORMATION

Preside conference tops come in single piece or multi-piece sections depending on specified size. See below for top sizes, sections, and suggested seating capacity.





Product Reference: Sizes, Sections, Seating Capacity

Multi-piece tops: Rectangle, Racetrack, Boat, and Arc End Tops.



Notes: Single- and two-piece tops ship in one carton, three-piece tops ship in two cartons.
Three-piece tops and larger will not contain grain match for all pieces.

	Feet	Inches	42"D	48"D	54"D	Suggested Capacity
	30	360"	6 6 6 6 6	6 6 6 6 6	6 6 6 6 6	28-30
	28	336"	5 6 6 6 5	5 6 6 6 5	5 6 6 6 5	26-28
	26	312"	7 6 6 7	7 6 6 7	7 6 6 7	24-26
	24	288"	6 6 6 6	6 6 6 6	6 6 6 6	22-24
	22	264"	5 6 6 5	5 6 6 5	5 6 6 5	20-22
	20	240"	7 6 7	7 6 7	7 6 7	18-20
	18	216"	6 6 6	6 6 6	6 6 6	16-18
	16	192"	5 6 5	5 6 5	5 6 5	14-16
	15	180"	4½ 6 4½	4½ 6 4½	4½ 6 4½	14-16
	14	168"	7 7	7 7	7 7	12-14
	12	144"	6 6	6 6	6 6	10-12
	10	120"	5 5	5 5	5 5	8-10
	9	108"	4½ 4½	4½ 4½	4½ 4½	8-10

Single-piece tops: Rectangle, Racetrack, Boat, and Arc End Tops

	Feet	Inches	30"D	36"D	42"D	48"D	Suggested Capacity
	8	96"			8	8	6-8
	7	84"			7		4-6
	6	72"		6			4-6
	5	60"	5				4-6

Single-piece tops: Round, Square, and Soft Square

		24"	30"	36"	42"	48"	60"*	Suggested Capacity
	Round	○	○	○	○	○	○	2-4 (*2-5)
	Square	□	□	□	□	□		2-4
	Soft Square	○	○	○	○	○		2-4

PRESIDE® SPECIFYING INFORMATION

Material	Type	Shape	Size					
			24"	30"	36"	42"	48"	60"
Laminate	Cylinder	Round	N/A	N/A	● ○ ○ ○ ○ ● ○ ○ ○ ○	○ ○ ○ ○ ○ ● ○ ○ ○ ○	○ ○ ○ ○ ○ ● ○ ○ ○ ○	N/A
		Square	N/A	N/A	○ ○ ○ ○ ○ ● ○ ○ ○ ○	○ ○ ○ ○ ○ ● ○ ○ ○ ○	○ ○ ○ ○ ○ ● ○ ○ ○ ○	
		Soft Square	N/A	N/A	○ ○ ○ ○ ○ ● ○ ○ ○ ○	○ ○ ○ ○ ○ ● ○ ○ ○ ○	○ ○ ○ ○ ○ ● ○ ○ ○ ○	
	Cube	Round	N/A	N/A	N/A	N/A	○ ○ ○ ○ ○ ● ○ ○ ○ ○	○ ○ ○ ○ ○ ● ○ ○ ○ ○
		Square	N/A	N/A	N/A	N/A	○ ○ ○ ○ ○ ● ○ ○ ○ ○	
		Soft Square	N/A	N/A	N/A	N/A	○ ○ ○ ○ ○ ● ○ ○ ○ ○	
	X-Base	Round	N/A	N/A	○ ○ ○ ○ ○ ● ○ ○ ○ ○	○ ○ ○ ○ ○ ● ○ ○ ○ ○	○ ○ ○ ○ ○ ● ○ ○ ○ ○	N/A
		Square	N/A	N/A	○ ○ ○ ○ ○ ● ○ ○ ○ ○	○ ○ ○ ○ ○ ● ○ ○ ○ ○	○ ○ ○ ○ ○ ● ○ ○ ○ ○	
		Soft Square	N/A	N/A	○ ○ ○ ○ ○ ● ○ ○ ○ ○	○ ○ ○ ○ ○ ● ○ ○ ○ ○	○ ○ ○ ○ ○ ● ○ ○ ○ ○	
	Traditional X-Base	Round	N/A	N/A	○ ○ ○ ○ ○ ● ○ ○ ○ ○	○ ○ ○ ○ ○ ● ○ ○ ○ ○	○ ○ ○ ○ ○ ● ○ ○ ○ ○	N/A
		Square	N/A	N/A	○ ○ ○ ○ ○ ● ○ ○ ○ ○	○ ○ ○ ○ ○ ● ○ ○ ○ ○	N/A	
		Soft Square	N/A	N/A	○ ○ ○ ○ ○ ● ○ ○ ○ ○	○ ○ ○ ○ ○ ● ○ ○ ○ ○	N/A	

●	●	●	●
○	○	○	○
Working Lounge	Seated	Counter	Standing
27H	29H	36H	42H
● Available			
○ Unavailable or Not Compatible			

PRESIDE[®] SPECIFYING INFORMATION

		Rectangle - Boat - Racetrack - Arc End														
Material	Type	Width	60"	72"	84"	96"	108"	120"	144"	168"	180"	192"	216"	240"	72" Adder	
		Depth														
Painted	Footed Y-Base	30"	●●●●●													
		36"		●●●●●												
		42"			●●●●●	●●●●●	●●●●●	●●●●●	●●●●●	●●●●●	●●●●●	●●●●●	●●●●●	●●●●●	●●●●●	●●●●●
		48"				●●●●●	●●●●●	●●●●●	●●●●●	●●●●●	●●●●●	●●●●●	●●●●●	●●●●●	●●●●●	●●●●●
		54"					N/A	N/A	N/A	N/A	N/A	N/A	N/A	N/A	N/A	N/A
	Angled Leg	30"	○●●●●													
		36"		○●●●●												
		42"			○●●●●	○●●●●	○●●●●	○●●●●	○●●●●	○●●●●	○●●●●	○●●●●	○●●●●	○●●●●	○●●●●	○●●●●
		48"				○●●●●	○●●●●	○●●●●	○●●●●	○●●●●	○●●●●	○●●●●	○●●●●	○●●●●	○●●●●	○●●●●
		54"					○●●●●	○●●●●	○●●●●	○●●●●	○●●●●	○●●●●	○●●●●	○●●●●	○●●●●	○●●●●
	T-Leg	30"	○●●●●													
		36"		○●●●●												
		42"			○●●●●	○●●●●	○●●●●	○●●●●	○●●●●	○●●●●	○●●●●	○●●●●	○●●●●	○●●●●	○●●●●	○●●●●
		48"				○●●●●	○●●●●	○●●●●	○●●●●	○●●●●	○●●●●	○●●●●	○●●●●	○●●●●	○●●●●	○●●●●
		54"					○●●●●	○●●●●	○●●●●	○●●●●	○●●●●	○●●●●	○●●●●	○●●●●	○●●●●	○●●●●

	<ul style="list-style-type: none"> ● Available ○ Unavailable or Not Compatible
--	--

PRESIDE® SPECIFYING INFORMATION

Material	Type	Rectangle - Boat - Racetrack - Arc End														
		Width Depth	60"	72"	84"	96"	108"	120"	144"	168"	180"	192"	216"	240"	72" Adder	
Laminate	Panel	30"	○ ○ ● ○ ○ ○													
		36"		○ ○ ● ○ ○ ○												
		42"			○ ○ ○ ○ ○ ○	○ ○ ○ ○ ○ ○	○ ○ ○ ○ ○ ○	○ ○ ○ ○ ○ ○	○ ○ ○ ○ ○ ○	○ ○ ○ ○ ○ ○	○ ○ ○ ○ ○ ○	○ ○ ○ ○ ○ ○	○ ○ ○ ○ ○ ○	○ ○ ○ ○ ○ ○		
		48"				○ ○ ○ ○ ○ ○	○ ○ ○ ○ ○ ○	○ ○ ○ ○ ○ ○	○ ○ ○ ○ ○ ○	○ ○ ○ ○ ○ ○	○ ○ ○ ○ ○ ○	○ ○ ○ ○ ○ ○	○ ○ ○ ○ ○ ○	○ ○ ○ ○ ○ ○		
		54"					○ ○ ○ ○ ○ ○	○ ○ ○ ○ ○ ○	○ ○ ○ ○ ○ ○	○ ○ ○ ○ ○ ○	○ ○ ○ ○ ○ ○	○ ○ ○ ○ ○ ○	○ ○ ○ ○ ○ ○	○ ○ ○ ○ ○ ○		
	Traditional Panel	30"	N/A													
		36"		○ ○ ○ ○ ○ ○												
		42"			○ ○ ○ ○ ○ ○	○ ○ ○ ○ ○ ○	○ ○ ○ ○ ○ ○	○ ○ ○ ○ ○ ○	○ ○ ○ ○ ○ ○	○ ○ ○ ○ ○ ○	N/A	N/A	N/A	N/A	N/A	
		48"				○ ○ ○ ○ ○ ○	○ ○ ○ ○ ○ ○	○ ○ ○ ○ ○ ○	○ ○ ○ ○ ○ ○	○ ○ ○ ○ ○ ○	N/A	N/A	N/A	N/A	N/A	
		54"					○ ○ ○ ○ ○ ○	○ ○ ○ ○ ○ ○	○ ○ ○ ○ ○ ○	○ ○ ○ ○ ○ ○	○ ○ ○ ○ ○ ○	N/A	N/A	N/A	N/A	
	Hollow Panel	30"	N/A													
		36"		N/A												
		42"*			○ ○ ○ ○ ○ ○	○ ○ ○ ○ ○ ○	○ ○ ○ ○ ○ ○	○ ○ ○ ○ ○ ○	○ ○ ○ ○ ○ ○	○ ○ ○ ○ ○ ○	○ ○ ○ ○ ○ ○	○ ○ ○ ○ ○ ○	○ ○ ○ ○ ○ ○	○ ○ ○ ○ ○ ○		
		48"				○ ○ ○ ○ ○ ○	○ ○ ○ ○ ○ ○	○ ○ ○ ○ ○ ○	○ ○ ○ ○ ○ ○	○ ○ ○ ○ ○ ○	○ ○ ○ ○ ○ ○	○ ○ ○ ○ ○ ○	○ ○ ○ ○ ○ ○	○ ○ ○ ○ ○ ○		
		54"					○ ○ ○ ○ ○ ○	○ ○ ○ ○ ○ ○	○ ○ ○ ○ ○ ○	○ ○ ○ ○ ○ ○	○ ○ ○ ○ ○ ○	○ ○ ○ ○ ○ ○	○ ○ ○ ○ ○ ○	○ ○ ○ ○ ○ ○		

*NOTE: With 42" deep Hollow Base will result in decreased leg room at base location.

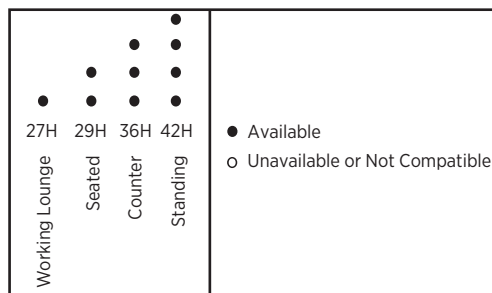

PRESIDE® SPECIFYING INFORMATION

		Rectangle - Boat - Racetrack - Arc End													
Material	Type	Width	60"	72"	84"	96"	108"	120"	144"	168"	180"	192"	216"	240"	72" Adder
		Depth													
Laminate	Cube	30"	N/A												
		36"		N/A											
		42"			○ ○ ○ ○ ● ○ ○ ○	○ ○ ○ ○ ● ○ ○ ○	○ ○ ○ ○ ● ○ ○ ○	○ ○ ○ ○ ● ○ ○ ○	○ ○ ○ ○ ● ○ ○ ○	○ ○ ○ ○ ● ○ ○ ○	○ ○ ○ ○ ● ○ ○ ○	○ ○ ○ ○ ● ○ ○ ○	○ ○ ○ ○ ● ○ ○ ○	○ ○ ○ ○ ● ○ ○ ○	○ ○ ○ ○ ● ○ ○ ○
		48"			○ ○ ○ ○ ● ○ ○ ○	○ ○ ○ ○ ● ○ ○ ○	○ ○ ○ ○ ● ○ ○ ○	○ ○ ○ ○ ● ○ ○ ○	○ ○ ○ ○ ● ○ ○ ○	○ ○ ○ ○ ● ○ ○ ○	○ ○ ○ ○ ● ○ ○ ○	○ ○ ○ ○ ● ○ ○ ○	○ ○ ○ ○ ● ○ ○ ○	○ ○ ○ ○ ● ○ ○ ○	○ ○ ○ ○ ● ○ ○ ○
		54"			○ ○ ○ ○ ● ○ ○ ○	○ ○ ○ ○ ● ○ ○ ○	○ ○ ○ ○ ● ○ ○ ○	○ ○ ○ ○ ● ○ ○ ○	○ ○ ○ ○ ● ○ ○ ○	○ ○ ○ ○ ● ○ ○ ○	○ ○ ○ ○ ● ○ ○ ○	○ ○ ○ ○ ● ○ ○ ○	○ ○ ○ ○ ● ○ ○ ○	○ ○ ○ ○ ● ○ ○ ○	○ ○ ○ ○ ● ○ ○ ○
	Cylinder	30"	N/A												
		36"		N/A											
		42"			○ ○ ○ ○ ● ○ ○ ○	○ ○ ○ ○ ● ○ ○ ○	○ ○ ○ ○ ● ○ ○ ○	○ ○ ○ ○ ● ○ ○ ○	○ ○ ○ ○ ● ○ ○ ○	○ ○ ○ ○ ● ○ ○ ○	○ ○ ○ ○ ● ○ ○ ○	○ ○ ○ ○ ● ○ ○ ○	○ ○ ○ ○ ● ○ ○ ○	○ ○ ○ ○ ● ○ ○ ○	○ ○ ○ ○ ● ○ ○ ○
		48"			○ ○ ○ ○ ● ○ ○ ○	○ ○ ○ ○ ● ○ ○ ○	○ ○ ○ ○ ● ○ ○ ○	○ ○ ○ ○ ● ○ ○ ○	○ ○ ○ ○ ● ○ ○ ○	○ ○ ○ ○ ● ○ ○ ○	○ ○ ○ ○ ● ○ ○ ○	○ ○ ○ ○ ● ○ ○ ○	○ ○ ○ ○ ● ○ ○ ○	○ ○ ○ ○ ● ○ ○ ○	○ ○ ○ ○ ● ○ ○ ○
		54"			○ ○ ○ ○ ● ○ ○ ○	○ ○ ○ ○ ● ○ ○ ○	○ ○ ○ ○ ● ○ ○ ○	○ ○ ○ ○ ● ○ ○ ○	○ ○ ○ ○ ● ○ ○ ○	○ ○ ○ ○ ● ○ ○ ○	○ ○ ○ ○ ● ○ ○ ○	○ ○ ○ ○ ● ○ ○ ○	○ ○ ○ ○ ● ○ ○ ○	○ ○ ○ ○ ● ○ ○ ○	○ ○ ○ ○ ● ○ ○ ○
	Cylinder w/ Wire Management	30"	N/A												
		36"		N/A											
		42"			○ ○ ○ ○ ● ○ ○ ○	○ ○ ○ ○ ● ○ ○ ○	○ ○ ○ ○ ● ○ ○ ○	○ ○ ○ ○ ● ○ ○ ○	○ ○ ○ ○ ● ○ ○ ○	○ ○ ○ ○ ● ○ ○ ○	○ ○ ○ ○ ● ○ ○ ○	○ ○ ○ ○ ● ○ ○ ○	○ ○ ○ ○ ● ○ ○ ○	○ ○ ○ ○ ● ○ ○ ○	○ ○ ○ ○ ● ○ ○ ○
		48"			○ ○ ○ ○ ● ○ ○ ○	○ ○ ○ ○ ● ○ ○ ○	○ ○ ○ ○ ● ○ ○ ○	○ ○ ○ ○ ● ○ ○ ○	○ ○ ○ ○ ● ○ ○ ○	○ ○ ○ ○ ● ○ ○ ○	○ ○ ○ ○ ● ○ ○ ○	○ ○ ○ ○ ● ○ ○ ○	○ ○ ○ ○ ● ○ ○ ○	○ ○ ○ ○ ● ○ ○ ○	○ ○ ○ ○ ● ○ ○ ○
		54"			○ ○ ○ ○ ● ○ ○ ○	○ ○ ○ ○ ● ○ ○ ○	○ ○ ○ ○ ● ○ ○ ○	○ ○ ○ ○ ● ○ ○ ○	○ ○ ○ ○ ● ○ ○ ○	○ ○ ○ ○ ● ○ ○ ○	○ ○ ○ ○ ● ○ ○ ○	○ ○ ○ ○ ● ○ ○ ○	○ ○ ○ ○ ● ○ ○ ○	○ ○ ○ ○ ● ○ ○ ○	○ ○ ○ ○ ● ○ ○ ○

	<ul style="list-style-type: none"> ● Available ○ Unavailable or Not Compatible
--	--

PRESIDE® SPECIFYING INFORMATION

Specify Preside tables with two steps—select a top and select a base.

1. Select desired top size, shape, and edge profile.

Multi-piece Tops:

Multi-piece tops are made of 108", 120", 144" and 168" two-piece "starter-sections" in rectangle, boat, arc end, or racetrack shapes in 42", 48", or 54" depths. For tables up to 20', models are preconfigured for you. If you need a table top longer than 20', add as many 72" adder sections as you need. The examples below illustrate preconfigured sizes as well as how starter section and adder section tops can be used to create tables in virtually any length. **Please note that 2-piece tops, in woodgrain colors, will not have exact grain alignment in the center where the two halves meet, a reasonable match can be expected. For tops utilizing an adder section, there will not be a grain match for those pieces.**

Preconfigured and Modular Size Examples

	Feet	Inches	Ex. Top Starter Section	Quantity	Adder Section	Quantity	Total Number of Top Sections
Preconfigured Sizes	9'	108"	HTLC48108	1	n/a	n/a	2
	10'	120"	HTLC48120	1	n/a	n/a	2
	12'	144"	HTLC48144	1	n/a	n/a	2
	14'	168"	HTLC48168	1	n/a	n/a	2
	15'	180"	HTLC48180	1	n/a	n/a	3
	16'	192"	HTLC48192	1	n/a	n/a	3
	18'	216"	HTLC48216	1	n/a	n/a	3
	20'	240"	HTLC48240	1	n/a	n/a	3
Modular Sizes	22'	264"	HTLC48120	1	HTLM4872	2	4
	24'	288"	HTLC48144	1	HTLM4872	2	4
	26'	312"	HTLC48168	1	HTLM4872	2	4
	28'	336"	HTLC48120	1	HTLM4872	3	5
	30'	360"	HTLC48144	1	HTLM4872	3	5

Note: Beyond 30', tables can be configured in 6' increments to any length.

Illustrations of Preconfigured Tops

48" x 108" Table Top (9')

54"	54"
-----	-----

Ex: HTLC48108

48" x 120" Table Top (10')

60"	60"
-----	-----

Ex: HTLC48120

48" x 144" Table Top (12')

72"	72"
-----	-----

Ex: HTLC48144

48" x 168" Table Top (14')

84"	84"
-----	-----

Ex: HTLC48168

48" x 180" Table Top (15')

54"	72"	54"
-----	-----	-----

Ex: HTLC48180

48" x 192" Table Top (16')

60"	72"	60"
-----	-----	-----

Ex: HTLC48192

48" x 216" Table Top (18')

72"	72"	72"
-----	-----	-----

Ex: HTLC48216

48" x 240" Table Top (20')

84"	72"	84"
-----	-----	-----

Ex: HTLC48240

Illustrations of User Configured Modular Tops

48" x 72" Adder Section

72"

Ex: HTLM4872

48"D x 360"W Table Top (30')

72"	72"	72"	72"	72"
-----	-----	-----	-----	-----

Ex: HTLC48144 + HTLM4872 + HTLM4872 + HTLM4872

PRESIDE® SPECIFYING INFORMATION

2. Select desired base style and identify model that coincides with top length.

Bases for Tops in Preconfigured Sizes

Bases include the appropriate number of supports for tables up to 20'. Simply identify the length of the table top in inches and specify the base with the same length in the model number. The example below illustrates how to select a base for a preconfigured size top.

Examples of Base for Preconfigured Top Size

Example top: HTLC48240 Top Description: 240" Rectangle Top
 Example base: HTLHP240 Base Description: Hollow Panel Base for 240" Top

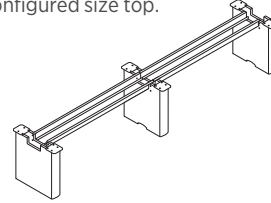

Example: HTLHP240

Bases for Tops in User Configured Modular Sizes

If you need a table top longer than 20', add as many 72" adder section bases as needed. The examples below illustrate preconfigured sizes as well as how starter section and adder section bases can be used to create tables in any desired length.

Examples of Tops and Bases for User Configured Modular Top

	Feet	Inches	Ex. Top Starter Section		Ex. Top Adder Section		Ex. Base Starter Section		Ex. Base Adder Section		Total # of Top Sections
			Quantity	Quantity	Quantity	Quantity	Quantity	Quantity			
Preconfigured Sizes	9'	108"	HTLC48108	1	n/a	n/a	HTLHP108	1	n/a	n/a	2
	10'	120"	HTLC48120	1	n/a	n/a	HTLHP120	1	n/a	n/a	2
	12'	144"	HTLC48144	1	n/a	n/a	HTLHP144	1	n/a	n/a	2
	14'	168"	HTLC48168	1	n/a	n/a	HTLHP168	1	n/a	n/a	2
	15'	180"	HTLC48180	1	n/a	n/a	HTLHP180	1	n/a	n/a	3
	16'	192"	HTLC48192	1	n/a	n/a	HTLHP192	1	n/a	n/a	3
	18'	216"	HTLC48216	1	n/a	n/a	HTLHP216	1	n/a	n/a	3
	20'	240"	HTLC48240	1	n/a	n/a	HTLHP240	1	n/a	n/a	3
Modular Sizes	22'	264"	HTLC48120	1	HTLM4872	2	HTLHP120	1	HTLHPM	2	4
	24'	288"	HTLC48144	1	HTLM4872	2	HTLHP144	1	HTLHPM	2	4
	26'	312"	HTLC48168	1	HTLM4872	2	HTLHP168	1	HTLHPM	2	4
	28'	336"	HTLC48120	1	HTLM4872	3	HTLHP120	1	HTLHPM	3	5
	30'	360"	HTLC48144	1	HTLM4872	3	HTLHP144	1	HTLHPM	3	5

Note: Tables can be configured to any desired length beyond 30' in 6' increments.

Note: Preconfigured bases include the appropriate number of supports for tables up to 20'. Depending on base type, number of required supports varies. For information regarding total number of supports please refer to chart below.

Feet	Inches	HTLP	HTTLEG	HTLHP	HTLCUBE/S	HTLR/C	HTYLEG	HTALEG
9'	108"	2	2	2	2	2	3	6
10'	120"	2	2	2	2	2	3	6
12'	144"	2	2	2	2	2	3	6
14'	168"	3	3	3	2	2	3	6
15'	180"	3	3	3	3	3	4	8
16'	192"	3	3	3	3	3	4	8
18'	216"	3	3	3	3	3	4	8
20'	240"	4	4	3	3	3	4	8

Base Model Descriptions

HTLP = Panel Base
 HTLT = Traditional Panel Base
 HTTLEG = Aluminum T-Leg
 HTLHP = Hollow Panel Base
 HTLCUBE = Cube Base
 HTLCUBES = Standing-Height Cube Base

HTLR = Cylinder Base
 HTLRC = Wire Management Cylinder Base
 HTYLEG = Footed Y-Leg Base
 HTALEG = Angled Leg

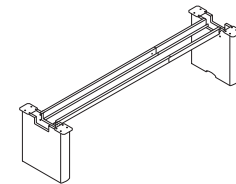

Example: HTHLP168

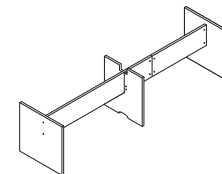

Example: HTLP168

PRESIDE® Grommet Cutout Placement

Tops specified with a grommet cutout get one cutout per section of top, centered in both directions. Cutouts do not include blank or powered inserts. Inserts must be specified separately.

- For compatible 4-Trac Electrical solutions, see page 244.
- For compatible grommet solutions, see page 247.

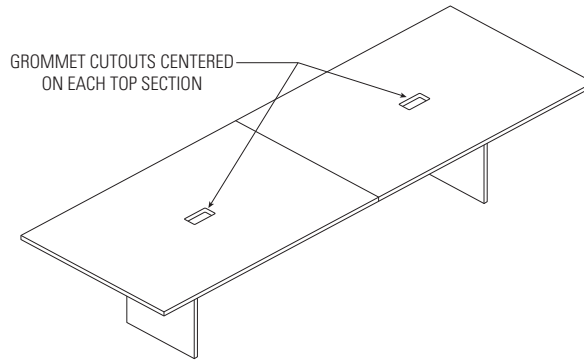

Upcharges for grommet cutouts (\$16 per G cutout, \$42 per G1 cutout, \$53 per G2 cutout)

Top Width	# Cutouts	G	G1	G2
24"	1	\$16	N/A	N/A
30"	1	\$16	N/A	N/A
36"	1	N/A	\$42	\$53
42"	1	N/A	\$42	\$53
48"	1	N/A	\$42	\$53
60"	1	N/A	\$42	\$53
72"	1	N/A	\$42	\$53
84"	1	N/A	\$42	\$53
96"	1	N/A	\$42	\$53
108"	2	N/A	\$84	\$106
120"	2	N/A	\$84	\$106
144"	2	N/A	\$84	\$106
168"	2	N/A	\$84	\$106
180"	3	N/A	\$126	\$159
192"	3	N/A	\$126	\$159
216"	3	N/A	\$126	\$159
240"	3	N/A	\$126	\$159

PRESIDE® Laminate Table Tops

GSA SIN 33721



Icon Legend on page 19

	DESCRIPTION	MODEL	SHIP WEIGHT	CUBE	LIST PRICE BY EDGE TREATMENT			L2 UPCHARGE	
					"E"	"G"	"J"		
Laminate Boat, Racetrack, Rectangle and Arc End Shaped Tops									
 A = Racetrack	240"W x 54"D	HTL(?)54240	425	25.1	N/A	\$3445	\$5331	\$131	
	216"W x 54"D	HTL(?)54216	384	23.3	N/A	\$3014	\$4554	\$110	
	192"W x 54"D	HTL(?)54192	345	21.4	N/A	\$2809	\$4315	\$105	
	180"W x 54"D	HTL(?)54180	442	21.4	N/A	\$2809	\$4315	\$105	
	168"W x 54"D	HTL(?)54168	300	13.5	\$2157	\$2312	\$3482	\$89	
	144"W x 54"D	HTL(?)54144	259	11.6	\$1762	\$1881	\$2704	\$68	
	120"W x 54"D	HTL(?)54120	220	9.8	\$1566	\$1676	\$2465	\$63	
	108"W x 54"D	HTL(?)54108	324	9.8	\$1566	\$1676	\$2465	\$63	
	 B = Boat	240"W x 48"D	HTL(?)48240	392	21.9	N/A	\$2800	\$4332	\$110
		216"W x 48"D	HTL(?)48216	351	19.7	N/A	\$2454	\$3714	\$95
192"W x 48"D		HTL(?)48192	312	18.1	N/A	\$2291	\$3521	\$89	
180"W x 48"D		HTL(?)48180	300	18.6	N/A	\$2291	\$3521	\$89	
168"W x 48"D		HTL(?)48168	281	12.1	\$1726	\$1852	\$2785	\$74	
144"W x 48"D		HTL(?)48144	240	9.8	\$1411	\$1506	\$2167	\$58	
120"W x 48"D		HTL(?)48120	201	8.2	\$1254	\$1343	\$1975	\$53	
108"W x 48"D		HTL(?)48108	203	9.8	\$1254	\$1343	\$1975	\$53	
96"W x 48"D		HTL(?)4896	153	13.2	\$1064	\$1097	\$1587	\$53	
 C = Rectangle		240"W x 42"D	HTL(?)42240	382	27.1	\$2463	\$2573	\$3877	\$104
	216"W x 42"D	HTL(?)42216	350	25.8	\$2200	\$2292	\$3463	\$92	
	192"W x 42"D	HTL(?)42192	317	22.2	\$2068	\$2152	\$3256	\$87	
	180"W x 42"D	HTL(?)42180	302	22.2	\$2068	\$2152	\$3256	\$87	
	168"W x 42"D	HTL(?)42168	255	18.7	\$1645	\$1755	\$2590	\$69	
	144"W x 42"D	HTL(?)42144	223	17.4	\$1382	\$1474	\$2176	\$58	
	120"W x 42"D	HTL(?)42120	190	13.8	\$1250	\$1334	\$1968	\$53	
	108"W x 42"D	HTL(?)42108	175	13.8	\$1250	\$1334	\$1968	\$53	
	96"W x 42"D	HTL(?)4296	159	22.8	N/A	\$1108	\$1598	\$42	
	84"W x 42"D	HTL(?)4284	157	12.1	\$1064	\$1097	\$1587	\$42	
 E = Arc End	72"W x 36"D	HTL(?)3672	90	7.9	\$710	\$767	\$1192	\$32	
	60"W x 30"D	HTL(?)3060	63	5.6	\$563	\$608	\$960	\$21	
	Laminate Adder Section for Boat, Racetrack, Rectangle and Arc Shaped Tops								
 M = Mid-section Adder	72"W x 54"D	HTLM5472	125	11.6	N/A	\$1133	\$1850	\$42	
	72"W x 48"D	HTLM4872	111	9.8	N/A	\$948	\$1547	\$37	
	72"W x 42"D	HTLM4272	127	8.4	N/A	\$873	\$1288	\$35	

! Adder section cannot be used as stand-alone table. Only long edges are finished.

NOTES:

- Tops with E and G edge details feature durable laminate tops over solid core high-performance particleboard. Tops with J edge feature an MDF core.
- Tops with E edge detail have 3" radius corners. All other edge details have 90 degree corners.
- See page 85 for number of cutouts for each table top size.
- See page 244 for compatible 4-Trac Electrical solutions and 247 for compatible grommet solutions.

! See pages 77-82 for top and base compatibility.

HOW TO SPECIFY

<p>Select Model Number</p> <p>HTLC4296</p>	<p>Select Edge Detail and Edge Color</p> <p>See page 75</p> <p>JC</p>	<p>Select Cutout Option</p> <p>N No Cutout G1 Cutout for Pop-up Port (\$42 upcharge per cutout) G2 Cutout for Flip-top Port (\$53 upcharge per cutout) Flip-top Port cannot be specified for Round or Square tops</p> <p>G2</p>	<p>Select Laminate</p> <p>See page 74, Laminate Group A</p> <p>D</p>
---	--	---	---



PRESIDE® Laminate Table Tops

DESCRIPTION	MODEL	SHIP WEIGHT				LIST PRICE BY EDGE TREATMENT			L2 UPCHARGE
		ROUND	SQUARE	SOFT SQUARE	CUBE	"E"	"G"	"J"	
Laminate Round, Square, and Soft Square Tops									
60" Round Top	HTLD60	95	N/A	N/A	10.1	\$763	\$815	\$1200	\$33
48" Top	HTL(?)48	66	76	80	6.3	\$610	\$652	\$1013	\$27
42" Top	HTL(?)42	51	61	61	4.9	\$544	\$589	\$941	\$21
36" Top	HTL(?)36	36	46	46	3.7	\$476	\$538	\$806	\$21
30" Top	HTL(?)30	28	33	33	3.0	\$430	\$460	\$676	\$18
24" Top	HTL(?)24	19	23	23	2.1	\$399	\$427	\$627	\$17

NOTES: Tops are available in three shapes: Round (D), Square (S), and Soft Square (SFT). Replace the (?) shown in each model with D, S, or SFT to specify shape.

! 60" top only available in Round (D) shape.



D = Round

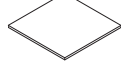

S = Square



SFT = Soft Square

NOTES:

- Tops with E and G edge details feature durable laminate tops over solid core high-performance particleboard. Tops with J edge feature an MDF core.
 - Tops with E edge detail have 3" radius corners. All other edge details have 90 degree corners.
 - See page 85 for number of cutouts for each table top size.
 - For compatible grommet solutions, see pages 245 and 247.
- !** See pages 77-82 for top and base compatibility.

HOW TO SPECIFY

<p>Select Model Number</p> <p>H T L D 4 8 .</p>	<p>Select Edge Detail and Edge Color</p> <p>See page 75</p> <p>J C .</p>	<p>Select Cutout Option</p> <p>N No Cutout G Cutout for 24" and 30" tops (+ \$16 upcharge) G1 Cutout for Pop-up Port (+ \$42 upcharge per cutout) G2 Cutout for Flip-top Port (+ \$53 upcharge per cutout)</p> <p>G 1 .</p>	<p>Select Laminate</p> <p>See page 74, Laminate Group A</p> <p>D</p>
--	---	---	---

PRESIDE® Laminate Bases

GSA SIN 33721



Icon Legend on page 19

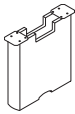
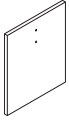

DESCRIPTION	PANELS INCLUDED PER KIT	MODEL	SHIP WEIGHT	CUBE	LIST PRICE BY LAMINATE GRADE	
					L1	L2
Laminate Seated-Height Panel Base for Tops 60" or Wider						
For 240"W Table Tops	4	HTLP240	197	16.4	\$1749	\$1833
For 216"W Table Tops	3	HTLP216	158	12.4	\$1337	\$1397
For 192"W Table Tops	3	HTLP192	147	11.6	\$1337	\$1397
For 180"W Table Tops	3	HTLP180	147	11.6	\$1337	\$1397
For 168"W Table Tops	3	HTLP168	136	10.6	\$1167	\$1225
For 144"W Table Tops	2	HTLP144	97	6.6	\$755	\$789
For 120"W Table Tops	2	HTLP120	86	5.8	\$755	\$789
For 108"W Table Tops	2	HTLP108	86	5.8	\$755	\$789
For 96"W Table Tops	2	HTLP96	75	4.9	\$755	\$789
For 84"W Table Tops	2	HTLP84	75	5.0	\$755	\$789
For 72"W Table Tops	2	HTLP72	25	2.9	\$709	\$743
For 60"W Table Tops	2	HTLP60	25	2.9	\$709	\$743
For 72" Adder Section	1	HTLPM	61	5.8	\$582	\$609
Laminate Seated-Height Hollow Panel Base for Tops 84" or Wider						
For 240"W Table Tops	3	HTLHP240	206	17.5	\$3796	\$3922
For 216"W Table Tops	3	HTLHP216	204	17.3	\$3697	\$3823
For 192"W Table Tops	3	HTLHP192	202	17.1	\$3613	\$3739
For 180"W Table Tops	3	HTLHP180	202	17.1	\$3613	\$3739
For 168"W Table Tops	3	HTLHP168	193	16.9	\$3495	\$3621
For 144"W Table Tops	2	HTLHP144	133	11.4	\$2399	\$2483
For 120"W Table Tops	2	HTLHP120	131	11.2	\$2315	\$2399
For 108"W Table Tops	2	HTLHP108	131	11.2	\$2315	\$2399
For 96"W Table Tops	2	HTLHP96	125	11.0	\$2232	\$2316
For 84"W Table Tops	2	HTLHP84	125	11.0	\$2232	\$2316
For 72" Adder Section	1	HTLHPM	71	5.9	\$1298	\$1340

NOTES:

- Tops and bases are sold and shipped separately.
- End caps for Hollow Panel bases can be matched to woodgrain finishes or specified in select solid colors.
- Bases ship with appropriate number of supports for table width. See page 84 for details.
- Laminate panel bases feature sturdy 1½" thick x 12"H particleboard support beam in matching finish.
- ! For Base and Top compatibility, see base information on pages 77-84.
- ! Laminate hollow panel bases feature dual aluminum support beams with integrated wire management.

HOW TO SPECIFY

<p>Select Model Number</p> <p>HTLHP240</p>	<p>Select Laminate</p> <p>See page 74, Laminate Group B</p> <p>D</p>	<p>Select Endcap/Inlay Option</p> <p>See page 74, Laminate Group C (Specify for Hollow Panel Bases only)</p> <p>LFW1</p>
---	---	---



PRESIDE® Laminate Bases

DESCRIPTION	PANELS INCLUDED		SHIP WEIGHT	CUBE	LIST PRICE BY LAMINATE GRADE	
	PER KIT	MODEL			L1	L2
Laminate Seated-Height Cube Base for Tops 84" or Wider						
For 240"W Table Tops	3	HTLCUBE240	278	29.2	\$4543	\$4685
For 216"W Table Tops	3	HTLCUBE216	276	29.0	\$4444	\$4586
For 192"W Table Tops	3	HTLCUBE192	274	28.8	\$4360	\$4502
For 180"W Table Tops	3	HTLCUBE180	274	28.8	\$4360	\$4502
For 168"W Table Tops	2	HTLCUBE168	183	19.4	\$2996	\$3091
For 144"W Table Tops	2	HTLCUBE144	181	19.2	\$2897	\$2992
For 120"W Table Tops	2	HTLCUBE120	179	19.0	\$2813	\$2908
For 108"W Table Tops	2	HTLCUBE108	179	19.0	\$2813	\$2908
For 96"W Table Tops	2	HTLCUBE96	164	18.2	\$2492	\$2587
For 84"W Table Tops	2	HTLCUBE84	164	18.2	\$2492	\$2587
For 72" Adder Section	1	HTLCUBEM	95	9.8	\$1547	\$1595
Laminate Standing-Height Cube Base for Tops 48" or Wider						
For 240"W Table Tops	3	HTLCUBES240	302	45.7	\$5494	\$5667
For 216"W Table Tops	3	HTLCUBES216	300	45.5	\$5395	\$5568
For 192"W Table Tops	3	HTLCUBES192	298	45.3	\$5311	\$5484
For 180"W Table Tops	3	HTLCUBES180	298	45.3	\$5311	\$5484
For 168"W Table Tops	2	HTLCUBES168	199	30.4	\$3630	\$3745
For 144"W Table Tops	2	HTLCUBES144	197	30.2	\$3531	\$3646
For 120"W Table Tops	2	HTLCUBES120	195	30.0	\$3447	\$3562
For 108"W Table Tops	2	HTLCUBES108	195	30.0	\$3447	\$3562
For 96"W Table Tops	2	HTLCUBES96	180	29.2	\$3126	\$3241
For 72" Adder	1	HTLCUBESM	103	15.3	\$1864	\$1922
Laminate Seated-Height Cylinder Base for Tops 84" or Wider						
For 240"W Table Tops	3	HTLR240	191	51.9	\$3682	\$3792
For 216"W Table Tops	3	HTLR216	189	51.7	\$3583	\$3693
For 192"W Table Tops	3	HTLR192	187	51.5	\$3499	\$3609
For 180"W Table Tops	3	HTLR180	187	51.5	\$3499	\$3609
For 168"W Table Tops	2	HTLR168	125	34.5	\$2422	\$2496
For 144"W Table Tops	2	HTLR144	123	34.3	\$2323	\$2397
For 120"W Table Tops	2	HTLR120	121	34.1	\$2239	\$2313
For 108"W Table Tops	2	HTLR108	121	34.1	\$2239	\$2313
For 96"W Table Tops	2	HTLR96	106	33.3	\$1918	\$1992
For 84"W Table Tops	2	HTLR84	106	33.3	\$1918	\$1992
For 72" Adder Section	1	HTLRM	66	17.4	\$1260	\$1297
Laminate Seated-Height Cylinder Base with Wire Management for Tops 84" or Wider						
For 240"W Table Tops	3	HTLRC240	191	51.9	\$4786	\$4928
For 216"W Table Tops	3	HTLRC216	189	51.7	\$4687	\$4829
For 192"W Table Tops	3	HTLRC192	187	51.4	\$4603	\$4745
For 180"W Table Tops	3	HTLRC180	187	51.4	\$4603	\$4745
For 168"W Table Tops	2	HTLRC168	125	34.5	\$3158	\$3253
For 144"W Table Tops	2	HTLRC144	123	34.3	\$3059	\$3154
For 120"W Table Tops	2	HTLRC120	121	34.1	\$2975	\$3070
For 108"W Table Tops	2	HTLRC108	121	34.1	\$2975	\$3070
For 96"W Table Tops	2	HTLRC96	106	33.3	\$2654	\$2749
For 84"W Table Tops	2	HTLRC84	106	33.3	\$2654	\$2749
For 72" Adder	1	HTLRM	66	17.4	\$1628	\$1676

NOTES:

- Tops and bases are sold and shipped separately.
- Bases ship with appropriate number of supports for table width. See page 84 for details.
- Standing-Height Cube Bases are 39"H.
- Laminate cube and cylinder bases for tops 108"W and greater feature dual aluminum support beams with integrated wire management.
- Cube bases feature removable door to allow access to cables and enable wire routing.
- Standing-Height Bases feature a hinged door for easy access and for cable routing through the base.

ⓘ Seated Cube Base and Cylinder Base require 150 lbs. of sand or other ballast in each base for stability (not supplied). Standing-Height Cube Base does not require additional ballast.

ⓘ For Base and Top compatibility, see base information on pages 77-84.

HOW TO SPECIFY

Select Model Number	Select Laminate	See page 74, Laminate Group B
HTLCUBE180.	LFW1	

PRESIDE® Metal Bases

GSA SIN 33721



Icon Legend on page 19

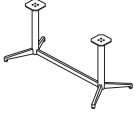

DESCRIPTION	MODEL	SHIP WEIGHT	CUBE	LIST PRICE BY PAINT GRADE		
				P1	P2	P3
Footed Y-Base for Tops 60" or Wider						
42½"H Standing Height Base for 42" and 48" x 240" Tops	HT42FB48240	88	10.8	\$3147	\$3409	\$3540
42½"H Standing Height Base for 42" and 48" x 216" Tops	HT42FB48216	85	10.4	\$3008	\$3259	\$3385
42½"H Standing Height Base for 42" and 48" x 192" Tops	HT42FB48192	82	10.1	\$2900	\$3142	\$3262
42½"H Standing Height Base for 42" and 48" x 180" Tops	HT42FB48180	82	10.1	\$2900	\$3142	\$3262
42½"H Standing Height Base for 42" and 48" x 168" Tops	HT42FB48168	67	9.3	\$2225	\$2410	\$2503
36½"H Counter Height Base for 42" and 48" x 240" Tops						
36½"H Counter Height Base for 42" and 48" x 216" Tops	HT36FB48240	86	10.8	\$3071	\$3329	\$3456
36½"H Counter Height Base for 42" and 48" x 192" Tops	HT36FB48192	80	10.1	\$2824	\$3062	\$3178
36½"H Counter Height Base for 42" and 48" x 180" Tops	HT36FB48180	80	10.1	\$2824	\$3062	\$3178
36½"H Counter Height Base for 42" and 48" x 168" Tops	HT36FB48168	65	9.3	\$2168	\$2350	\$2440
29½"H Seated Height Base for 42" and 48" x 240" Tops						
29½"H Seated Height Base for 42" and 48" x 216" Tops	HT29FB48216	81	10.4	\$2864	\$3103	\$3224
29½"H Seated Height Base for 42" and 48" x 192" Tops	HT29FB48192	78	10.1	\$2756	\$2985	\$3101
29½"H Seated Height Base for 42" and 48" x 180" Tops	HT29FB48180	78	10.1	\$2756	\$2985	\$3101
29½"H Seated Height Base for 42" and 48" x 168" Tops	HT29FB48168	63	9.3	\$2117	\$2293	\$2383
27¼"H Working Lounge Base for 42" and 48" x 240" Tops						
27¼"H Working Lounge Base for 42" and 48" x 216" Tops	HT27FB48216	79	10.4	\$2812	\$3047	\$3164
27¼"H Working Lounge Base for 42" and 48" x 192" Tops	HT27FB48192	76	10.1	\$2704	\$2929	\$3041
27¼"H Working Lounge Base for 42" and 48" x 180" Tops	HT27FB48180	76	10.1	\$2704	\$2929	\$3041
27¼"H Working Lounge Base for 42" and 48" x 168" Tops	HT27FB48168	61	9.3	\$2078	\$2251	\$2338

NOTES:

- Tops and bases are sold and shipped separately.
- Bases ship with appropriate number of supports for table width.
- ! Footed base not to be used on 54"D conference tables.
- ! See pages 77-82 for top and base compatibility.
- ! Footed Y-base for tops 84"W or greater feature dual aluminum support beams with integrated wire management. Footed Y-base for 60"W and 72"W tops do not include aluminum beams.

HOW TO SPECIFY

<p>Select Model Number</p> <p>HT27FB48168</p>	<p>Select Paint Color</p> <p>See page 74, Paint Group A</p> <p>T1</p>
--	--



Icon Legend on page 19

PRESIDE® Metal Bases

DESCRIPTION	MODEL	SHIP WEIGHT	CUBE	LIST PRICE BY PAINT GRADE		
				P1	P2	P3
Footed Y-Base for Tops 60" or Wider						
42½"H Standing Height Base for 42" and 48" x 144" Tops	HT42FB48144	64	8.9	\$2086	\$2261	\$2348
42½"H Standing Height Base for 42" and 48" x 120" Tops	HT42FB48120	61	8.7	\$1978	\$2144	\$2225
42½"H Standing Height Base for 42" and 48" x 108" Tops	HT42FB48108	61	8.7	\$1978	\$2144	\$2225
42½"H Standing Height Base for 42" and 48" x 96" Tops	HT42FB4896	37	4.9	\$1338	\$1449	\$1506
42½"H Standing Height Base for 42" x 84" Tops	HT42FB4284	36	4.8	\$1318	\$1428	\$1484
42½"H Standing Height Base for 36" x 72" Tops	HT42FB3672	27	4.2	\$1190	\$1280	\$1325
42½"H Standing Height Base for 30" x 60" Tops	HT42FB3060	25	4.2	\$1044	\$1131	\$1175
36½"H Counter Height Base for 42" and 48" x 144" Tops						
36½"H Counter Height Base for 42" and 48" x 120" Tops	HT36FB48120	59	8.7	\$1921	\$2083	\$2162
36½"H Counter Height Base for 42" and 48" x 108" Tops	HT36FB48108	59	8.7	\$1921	\$2083	\$2162
36½"H Counter Height Base for 42" and 48" x 96" Tops	HT36FB4896	36	4.9	\$1300	\$1409	\$1464
36½"H Counter Height Base for 42" x 84" Tops	HT36FB4284	35	4.8	\$1280	\$1388	\$1441
36½"H Counter Height Base for 36" x 72" Tops	HT36FB3672	26	4.2	\$1152	\$1240	\$1283
36½"H Counter Height Base for 30" x 60" Tops	HT36FB3060	24	4.2	\$1010	\$1095	\$1137
29½"H Seated Height Base for 42" and 48" x 144" Tops						
29½"H Seated Height Base for 42" and 48" x 120" Tops	HT29FB48120	57	8.7	\$1870	\$2026	\$2105
29½"H Seated Height Base for 42" and 48" x 108" Tops	HT29FB48108	57	8.7	\$1870	\$2026	\$2105
29½"H Seated Height Base for 42" and 48" x 96" Tops	HT29FB4896	35	4.9	\$1266	\$1371	\$1425
29½"H Seated Height Base for 42" x 84" Tops	HT29FB4284	34	4.8	\$1246	\$1350	\$1403
29½"H Seated Height Base for 36" x 72" Tops	HT29FB3672	25	4.2	\$1118	\$1202	\$1245
29½"H Seated Height Base for 30" x 60" Tops	HT29FB3060	23	4.2	\$970	\$1051	\$1091
27¼"H Working Lounge Base for 42" and 48" x 144" Tops						
27¼"H Working Lounge Base for 42" and 48" x 120" Tops	HT27FB48120	55	8.7	\$1831	\$1984	\$2059
27¼"H Working Lounge Base for 42" and 48" x 108" Tops	HT27FB48108	55	8.7	\$1831	\$1984	\$2059
27¼"H Working Lounge Base for 42" and 48" x 96" Tops	HT27FB4896	34	4.9	\$1240	\$1343	\$1395
27¼"H Working Lounge Base for 42" x 84" Tops	HT27FB4284	33	4.8	\$1220	\$1322	\$1373
27¼"H Working Lounge Base for 36" x 72" Tops	HT27FB3672	24	4.2	\$1092	\$1174	\$1215
27¼"H Working Lounge Base for 30" x 60" Tops	HT27FB3060	22	4.2	\$946	\$1025	\$1065
Footed Base Adder for 72"W or Wider Tops						
42"H	HT42FBM	40	4.9	\$2124	\$2250	\$2313
36"H	HT36FBM	39	4.9	\$2067	\$2191	\$2251
29"H	HT29FBM	38	4.9	\$2016	\$2136	\$2196
27"H	HT27FBM	37	4.9	\$1977	\$2095	\$2153
Wire Manager						
Manager for 42"H Footed Base — 1-Pack	HTFWMGR42	2	0.3	\$184	\$200	\$207
Manager for 36"H Footed Base — 1-Pack	HTFWMGR36	1	0.3	\$174	\$189	\$196
Manager for 29"H Footed Base — 1-Pack	HTFWMGR29	1	0.4	\$165	\$179	\$186
Manager for 27"H Footed Base — 1-Pack	HTFWMGR27	1	0.4	\$154	\$167	\$173

NOTES:

- Tops and bases are sold and shipped separately.
- Bases ship with appropriate number of supports for table width.
- To conceal any power cords from table top to floor, specify wire manager based on table height. Wire manager adheres to the vertical column of the base.

ⓘ Footed base not to be used on 54"D conference tables.

ⓘ See pages 77-82 for top and base compatibility.

ⓘ Footed Y-base for tops 84"W or greater feature dual aluminum support beams with integrated wire management. Footed Y-base for 60"W and 72"W tops do not include aluminum beams.

HOW TO SPECIFY

Select Model Number	Select Paint Color
HT29FB48144	T1
See page 74, Paint Group A	

PRESIDE® Metal Bases

GSA SIN 33721



Icon Legend on page 19

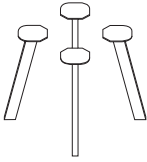

DESCRIPTION	MODEL	SHIP		LIST PRICE BY PAINT GRADE		
		WEIGHT	CUBE	P1	P2	P3
Angled Leg						
42½" H Standing Height Base for Round, Square, and Soft Square Tops	HT42ALEG	32	2.6	\$2012	\$2180	\$2263
29½" H Seated Height Base for Round, Square, and Soft Square Tops	HT29ALEG	25	2.6	\$1636	\$1772	\$1841
42½" H Standing Height Base for 96" W Tops	HT42AL96	32	2.6	\$3018	\$3269	\$3395
42½" H Standing Height Base for 84" W Tops	HT42AL84	41	3.1	\$2250	\$2438	\$2532
42½" H Standing Height Base for 72" W Tops	HT42AL72	32	2.6	\$2012	\$2180	\$2263
42½" H Standing Height Base for 60" W Tops	HT42AL60	32	2.6	\$2012	\$2180	\$2263
29½" H Seated Height Base for 240" W Tops	HT29AL240	57	4.5	\$4077	\$4417	\$4589
29½" H Seated Height Base for 216" W Tops	HT29AL216	55	4.2	\$3978	\$4310	\$4477
29½" H Seated Height Base for 192" W Tops	HT29AL192	53	4.0	\$3894	\$4218	\$4383
29½" H Seated Height Base for 180" W Tops	HT29AL180	53	4.0	\$3894	\$4218	\$4383
29½" H Seated Height Base for 168" W Tops	HT29AL168	44	3.8	\$2958	\$3205	\$3329
29½" H Seated Height Base for 144" W Tops	HT29AL144	42	3.5	\$2859	\$3098	\$3218
29½" H Seated Height Base for 120" W Tops	HT29AL120	40	3.3	\$2775	\$3006	\$3123
29½" H Seated Height Base for 108" W Tops	HT29AL108	40	3.3	\$2775	\$3006	\$3123
29½" H Seated Height Base for 96" W Tops	HT29AL96	37	3.3	\$1876	\$2030	\$2108
29½" H Seated Height Base for 84" W Tops	HT29AL84	34	3.1	\$1874	\$2030	\$2110
29½" H Seated Height Base for 72" W Tops	HT29AL72	25	2.6	\$1636	\$1772	\$1841
29½" H Seated Height Base for 60" W Tops	HT29AL60	25	2.6	\$1636	\$1772	\$1841
29½" H Seated Height Base for 72" W Adder	HT29ALM	38	3.3	\$1119	\$1213	\$1260



DESCRIPTION	MODEL	SHIP WEIGHT	SHIP CUBE	P1	P2	P3
Wire Manager						
Angled Leg Wire Manager for 42½" H Leg	HTALWMGR42	3	4.0	\$122	\$133	\$138
Angled Leg Wire Manager for 29½" H Leg	HTALWMGR29	2	4.0	\$97	\$106	\$110

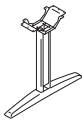

DESCRIPTION	LEGS INCLUDED PER KIT	MODEL	SHIP		LIST PRICE BY PAINT GRADE		
			WEIGHT	CUBE	P1	P2	P3
Aluminum T-Leg for Tops 60" or Wider							
For 240" W Table Tops	4	HTTLEG240	76	8.9	\$2379	\$2421	\$2442
For 216" W Table Tops	3	HTTLEG216	65	8.6	\$1902	\$1944	\$1965
For 192" W Table Tops	3	HTTLEG192	63	8.4	\$1818	\$1860	\$1881
For 180" W Table Tops	3	HTTLEG180	63	8.4	\$1818	\$1860	\$1881
For 168" W Table Tops	3	HTTLEG168	54	8.2	\$1700	\$1742	\$1763
For 144" W Table Tops	2	HTTLEG144	39	4.5	\$1192	\$1213	\$1224
For 120" W Table Tops	2	HTTLEG120	37	4.3	\$1108	\$1129	\$1140
For 108" W Table Tops	2	HTTLEG108	37	4.2	\$1108	\$1129	\$1140
For 96" W Table Tops	2	HTTLEG96	31	4.0	\$1025	\$1046	\$1057
For 84" W Table Tops	2	HTTLEG84	31	4.0	\$1025	\$1046	\$1057
For 72" W Table Tops	2	HTTLEG72	26	3.5	\$787	\$808	\$819
For 60" W Table Tops	2	HTTLEG60	22	3.5	\$787	\$808	\$819
For 72" Adder Section	1	HTTLEGM	26	4.2	\$710	N/A	N/A



NOTES:

- Tops and bases are sold and shipped separately.
- Bases ship with appropriate number of supports for table width.
- To conceal any power cords from table top to floor, specify wire manager based on table height. Angled leg wire manager is friction fit with magnets to hold in place.
- ⓘ Aluminum T-legs for tops 84" and greater feature dual aluminum support beams with integrated wire management. Aluminum T-legs for 60" and 72" tops do not include aluminum beams.
- ⓘ Footed base not to be used on 54"D conference tables.
- ⓘ See pages 77-82 for top and base compatibility.

HOW TO SPECIFY

<p>Select Model Number</p>	<p>Select Paint Color</p> <p>See page 74, Paint Group A</p>
HT42ALEG	PR6

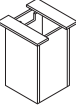
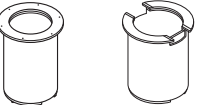

	DESCRIPTION	BASES INCLUDED PER KIT	MODEL	SHIP WEIGHT	CUBE	LIST PRICE BY LAMINATE GRADE	
						L1	L2
	Laminate Cube Base for Round, Square, and Soft Square Tops						
	For 60" Round and all 48" Tops, Seated-Height	1	HTLCUBE48	82	9.1	\$1246	\$1294
	For 60" Round and all 48" Tops, Standing-Height	1	HTLCUBES48	90	14.6	\$1563	\$1621
	Laminate Cylinder Base for Round, Square, and Soft Square Tops						
	For 48" Tops	1	HTLR48	53	16.7	\$959	\$996
	For 42" Tops	1	HTLR42	42	11.6	\$866	\$903
	For 36" Tops	1	HTLR36	42	11.6	\$866	\$903
<i>Used with 36" and 42" table tops</i>	For 48" Tops, with Wire Management	1	HTLRC48	53	16.7	\$1327	\$1375
	Laminate Panel X-Base	1	HTLXP48	54	5.2	\$557	\$578
		1	HTLXP42	54	5.2	\$557	\$578
		1	HTLXP36	47	4.7	\$519	\$540

NOTES: Can be used with 36", 42" and 48" Round and Soft Square Tops, and 36" and 42" Square Tops.

⚠ Not compatible with cutouts or power ports.

NOTES:

- Tops and bases are sold and shipped separately.
- Cube Base features removable door for wire management.
- ⚠ Cube Base requires 150 lbs. of sand or other ballast in each base for stability (not supplied).
- ⚠ See pages 77-82 for top and base compatibility.

HOW TO SPECIFY

Select Model Number HTLCUBE48	Select Laminate See page 74, Laminate Group B D
---	--

PRESIDE® Metal Bases

GSA SIN 33721



Icon Legend on page 19



DESCRIPTION	MODEL	SHIP WEIGHT	CUBE	LIST PRICE	P2 LIST PRICE
Aluminum X-Leg Base for 36", 42", and 48" Round, Square, and Soft Square Tops	HTXLEG	16	3.5	\$624	\$645

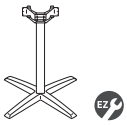

Standing-Height Aluminum X-Leg Base for 36" and 42" Round, Square, and Soft Square Tops	HTXLEGSH	17	3.5	\$780	\$801
---	----------	----	-----	-------	-------



DESCRIPTION	MODEL	SHIP WEIGHT	CUBE	LIST PRICE BY PAINT GRADE		
				P1	P2	P3
Footed Café X-Base						
42½"H Standing Height X-Base for 48" Tops	HTFXL42	32	3.7	\$863	\$936	\$971
42½"H Standing Height X-Base for 36" and 42" Tops	HTFXM42	31	3.7	\$787	\$853	\$886
42½"H Standing Height X-Base for 30" Tops	HTFXS42	30	3.7	\$675	\$732	\$760
36½"H Counter Height X-Base for 48" Tops	HTFXL36	31	3.7	\$806	\$873	\$907
36½"H Counter Height X-Base for 36" and 42" Tops	HTFXM36	30	3.7	\$728	\$789	\$819
36½"H Counter Height X-Base for 30" Tops	HTFXS36	29	3.7	\$631	\$684	\$710
29½"H Seated Height X-Base for 48" and 60" Tops	HTFXL29	30	3.7	\$718	\$778	\$808
29½"H Seated Height X-Base for 36" and 42" Tops	HTFXM29	29	3.7	\$662	\$718	\$745
29½"H Seated Height X-Base for 30" Tops	HTFXS29	28	3.7	\$587	\$637	\$661
29½"H Seated Height X-Base for 24" Tops	HTFXT29	27	3.7	\$537	\$582	\$604
27¼"H Working Lounge X-Base for 48" and 60" Tops	HTFXL27	29	3.7	\$656	\$711	\$738
27¼"H Working Lounge X-Base for 36" and 42" Tops	HTFXM27	28	3.7	\$598	\$649	\$674
27¼"H Working Lounge X-Base for 30" Tops	HTFXS27	27	3.7	\$530	\$574	\$596
27¼"H Working Lounge X-Base for 24" Tops	HTFXT27	26	3.7	\$504	\$546	\$567



Footed Café X-Base w/Power						
42½"H Standing Height X-Base for 48" Tops	HTFXL42P	32	3.7	\$863	\$936	\$971
42½"H Standing Height X-Base for 36" and 42" Tops	HTFXM42P	31	3.7	\$787	\$853	\$886
42½"H Standing Height X-Base for 30" Tops	HTFXS42P	30	3.7	\$675	\$732	\$760
36½"H Counter Height X-Base for 48" Tops	HTFXL36P	31	3.7	\$806	\$873	\$907
36½"H Counter Height X-Base for 36" and 42" Tops	HTFXM36P	31	3.7	\$728	\$789	\$819
36½"H Counter Height X-Base for 30" Tops	HTFXS36P	29	3.7	\$631	\$684	\$710
29½"H Seated Height X-Base for 48" and 60" Tops	HTFXL29P	30	3.7	\$718	\$778	\$808
29½"H Seated Height X-Base for 36" and 42" Tops	HTFXM29P	29	3.7	\$662	\$718	\$745
29½"H Seated Height X-Base for 30" Tops	HTFXS29P	28	3.7	\$587	\$637	\$661
29½"H Seated Height X-Base for 24" Tops	HTFXT29P	27	3.7	\$537	\$582	\$604
27¼"H Working Lounge X-Base for 48" and 60" Tops	HTFXL27P	29	3.7	\$656	\$711	\$738
27¼"H Working Lounge X-Base for 36" and 42" Tops	HTFXM27P	28	3.7	\$598	\$649	\$674
27¼"H Working Lounge X-Base for 30" Tops	HTFXS27P	27	3.7	\$530	\$574	\$596
27¼"H Working Lounge X-Base for 24" Tops	HTFXT27P	26	3.7	\$504	\$546	\$567

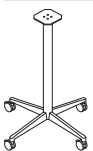

Footed Café X-Base w/Casters						
42½"H Standing Height X-Base for 48" Tops	HTFXL42C	32	3.7	\$893	\$968	\$1005
42½"H Standing Height X-Base for 36" and 42" Tops	HTFXM42C	31	3.7	\$818	\$886	\$921
36½"H Counter Height X-Base for 48" Tops	HTFXL36C	31	3.7	\$838	\$909	\$943
36½"H Counter Height X-Base for 36" and 42" Tops	HTFXM36C	30	3.7	\$760	\$824	\$856
29½"H Seated Height X-Base for 48" Tops	HTFXL29C	30	3.7	\$749	\$812	\$844
29½"H Seated Height X-Base for 36" and 42" Tops	HTFXM29C	29	3.7	\$692	\$750	\$779
27¼"H Working Lounge X-Base for 48" Tops	HTFXL27C	29	3.7	\$687	\$745	\$773
27¼"H Working Lounge X-Base for 36" and 42" Tops	HTFXM27C	28	3.7	\$631	\$684	\$710

NOTES:

- Tops and bases are sold and shipped separately.
- HTXLEG and HTXLEGSH allow wires to pass through the center of the leg.
- Grommet cutouts not compatible with Footed Café X-Base and Footed Café X-Base with Casters.
- ! Footed Café X-Base with Power allows wires to pass through the center of the leg except when using HTPWRGROM2.
- ! Cannot specify grommet cutouts in top when using footed X-base and footed X-base with casters. Utilize footed X-base with power for situations where power/grommet cutouts are needed.
- ! See pages 77-82 for top and base compatibility.

HOW TO SPECIFY

<p>Select Model Number</p> <p>HTFXL42</p>	<p>Select Paint Color</p> <p>See page 74, Paint Group A</p> <p>PJW</p>
---	--



Icon Legend on page 19

PRESIDE® Collaborative Tables

	DESCRIPTION	MODEL	SHIP WEIGHT	CUBE	LIST PRICE BY LAMINATE GRADE	
					L1	L2
	Seated-Height, Collaborative Table with Partial Modesty Panel					
	60"W x 42"D	HTLC4260LCTP	152	2.8	\$1454	\$1477
	72"W x 42"D	HTLC4272LCTP	167	14.5	\$1729	\$1761
	96"W x 42"D	HTLC4296LCTP	122	18.3	\$2130	\$2162
	Standing-Height, Collaborative Table with Partial Modesty Panel					
	60"W x 42"D	HTLC4260HCTP	187	3.7	\$1660	\$1683
	72"W x 42"D	HTLC4272HCTP	187	15.7	\$1935	\$1967
	96"W x 42"D	HTLC4296HCTP	242	19.4	\$2336	\$2368
	Seated-Height, Collaborative Table with Full Modesty Panel					
	60"W x 42"D	HTLC4260LCTFP	167	13.4	\$1454	\$1477
	72"W x 42"D	HTLC4272LCTFP	175	14.9	\$1729	\$1761
	96"W x 42"D	HTLC4296LCTFP	233	18.8	\$2130	\$2162
	Standing-Height, Collaborative Table with Full Modesty Panel					
	60"W x 42"D	HTLC4260HCTFP	202	17.0	\$1660	\$1683
	72"W x 42"D	HTLC4272HCTFP	211	17.9	\$1935	\$1967
	96"W x 42"D	HTLC4296HCTFP	275	22.4	\$2336	\$2368
	Seated-Height, Collaborative Table with Power Management, No Modesty Panel					
	60"W x 42"D	HTLC4260LCTHP	153	10.8	\$1802	\$1825
	72"W x 42"D	HTLC4272LCTHP	196	13.6	\$2075	\$2107
	96"W x 42"D	HTLC4296LCTHP	244	16.0	\$2475	\$2507
	NOTES: Wire management available underneath top and through the base. Bases include a removable door to access cords at any time.					
	Standing-Height, Collaborative Table with Power Management, No Modesty Panel					
	60"W x 42"D	HTLC4260HCTHP	173	12.0	\$2214	\$2237
	72"W x 42"D	HTLC4272HCTHP	236	15.8	\$2487	\$2519
	96"W x 42"D	HTLC4296HCTHP	284	18.3	\$2887	\$2919
	NOTES: Wire management available underneath top and through the base. Bases include a removable door to access cords at any time.					

NOTES:

- Tops feature 2mm flat edge.
- Partial modesty models will feature different modesty heights than units produced on or before March 16, 2020.
- ! Tables with partial and full modesty panels always feature cutout in modesty panel to accommodate grommet inserts in the top. However, top cutout is optional. Wire management is not included in legs.
- ! Collaborative Tables with power management will not have modesty panels.

HOW TO SPECIFY

<p>Select Model Number</p> <p>HTLC4272LCTP</p>	<p>Select Cutout Option</p> <p>N No Cutout G1 Cutout for Pop-up Port (\$42 upcharge) G2 Cutout for Flip-top Port (\$53 upcharge)</p> <p>N</p>	<p>Select Top Laminate Color</p> <p>See page 74, Laminate Group A</p> <p>H</p>	<p>Select Base Laminate Color</p> <p>See page 74, Laminate Group B</p> <p>H</p>	<p>Select Modesty Laminate Color</p> <p>See page 74, Laminate Group B</p> <p><i>Do not specify for Power Management models</i></p> <p>LDW1</p>	<p>Select 2mm Edge Color</p> <p>See page 75</p> <p>H</p>
---	---	---	--	---	---

PRESIDE® Ganging Tables

GSA SIN 33721



Icon Legend on page 19

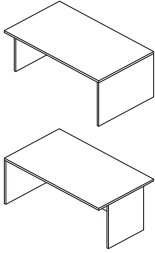

DESCRIPTION	MODEL	SHIP WEIGHT	CUBE	LIST PRICE BY LAMINATE GRADE	
				L1	L2
Seated-Height, Partial Modesty — Full Right Leg					
60"W x 42"D	HTLC4260LCTPR	165	13.8	\$1462	\$1485
72"W x 42"D	HTLC4272LCTPR	170	14.2	\$1737	\$1769
96"W x 42"D	HTLC4296LCTPR	223	38.9	\$2138	\$2183
Seated-Height, Partial Modesty — Full Left Leg					
60"W x 42"D	HTLC4260LCTPL	165	13.8	\$1462	\$1485
72"W x 42"D	HTLC4272LCTPL	170	14.2	\$1737	\$1769
96"W x 42"D	HTLC4296LCTPL	223	38.9	\$2138	\$2183
Standing-Height, Partial Modesty — Full Right Leg					
60"W x 42"D	HTLC4260HCTPR	207	16.2	\$1670	\$1693
72"W x 42"D	HTLC4272HCTPR	216	16.9	\$1945	\$1977
96"W x 42"D	HTLC4296HCTPR	274	41.6	\$2346	\$2391
Standing-Height, Partial Modesty — Full Left Leg					
60"W x 42"D	HTLC4260HCTPL	207	16.2	\$1670	\$1693
72"W x 42"D	HTLC4272HCTPL	216	16.9	\$1945	\$1977
96"W x 42"D	HTLC4296HCTPL	274	41.6	\$2346	\$2391

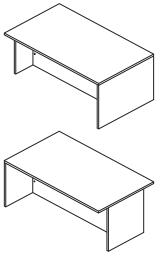

Seated-Height, Full Modesty — Full Right Leg					
60"W x 42"D	HTLC4260LCTFPR	180	14.2	\$1462	\$1485
72"W x 42"D	HTLC4272LCTFPR	188	14.2	\$1737	\$1769
96"W x 42"D	HTLC4296LCTFPR	247	39.3	\$2138	\$2183
Seated-Height, Full Modesty — Full Left Leg					
60"W x 42"D	HTLC4260LCTFPL	180	14.2	\$1462	\$1485
72"W x 42"D	HTLC4272LCTFPL	188	14.2	\$1737	\$1769
96"W x 42"D	HTLC4296LCTFPL	247	39.3	\$2138	\$2183
Standing-Height, Full Modesty — Full Right Leg					
60"W x 42"D	HTLC4260HCTFPR	223	18.0	\$1670	\$1693
72"W x 42"D	HTLC4272HCTFPR	234	18.9	\$1945	\$1977
96"W x 42"D	HTLC4296HCTFPR	299	44.7	\$2346	\$2391
Standing-Height, Full Modesty — Full Left Leg					
60"W x 42"D	HTLC4260HCTFPL	223	18.0	\$1670	\$1693
72"W x 42"D	HTLC4272HCTFPL	234	18.9	\$1945	\$1977
96"W x 42"D	HTLC4296HCTFPL	299	44.7	\$2346	\$2391

NOTES:

- Maximum of 2 ganging tables can be used together. However, different widths may be combined to optimize your space (i.e., 60"W left-hand and 96"W right-hand can be combined).
- Ganging tables ship with all required hardware and light gap filler strip for use between the two partial legs.
- Tops feature 2mm flat edge.

! Tables with partial and full modesty panels always feature cutout in modesty panel to accommodate grommet inserts in the top. However, top cutout is optional. Wire management is not included in legs.

HOW TO SPECIFY

<p>Select Model Number</p> <p>HTLC4260LCTPR</p>	<p>Select Grommet Cutout</p> <p>N No Grommet G1 G1 Grommet (centered, + \$42 upcharge) G2 G2 Grommet (centered, + \$53 upcharge)</p> <p>G1</p>	<p>Select Top Laminate Color</p> <p>See page 74, Laminate Group A</p> <p>LSA1</p>	<p>Select Base Laminate Color</p> <p>See page 74, Laminate Group B</p> <p>H</p>	<p>Select Modesty Laminate Color</p> <p>See page 74, Laminate Group B</p> <p><i>Do not specify for Power Management models</i></p> <p>LSA1</p>	<p>Select 2mm Edge Color</p> <p>See page 75</p> <p>H</p>
--	--	--	--	---	---



Icon Legend on page 19

PRESIDE® Collaborative Tables

	DESCRIPTION	MODEL	SHIP WEIGHT	CUBE	LIST PRICE BY LAMINATE GRADE	
					L1	L2
	Seated-Height, Collaborative Table with Partial Modesty Panel					
	60"W x 30"D	HTLC3060LCTP	136	11.1	\$1231	\$1251
	72"W x 30"D	HTLC3072LCTP	150	12.6	\$1485	\$1513
	96"W x 30"D	HTLC3096LCTP	184	15.7	\$1845	\$1884
	Standing-Height, Collaborative Table with Partial Modesty Panel					
	60"W x 30"D	HTLC3060HCTP	174	13.1	\$1408	\$1428
	72"W x 30"D	HTLC3072HCTP	192	14.8	\$1662	\$1690
	96"W x 30"D	HTLC3096HCTP	232	18.0	\$2022	\$2061
	Seated-Height, Collaborative Table with Full Modesty Panel					
	60"W x 30"D	HTLC3060LCTFP	151	11.5	\$1231	\$1251
	72"W x 30"D	HTLC3072LCTFP	168	13.1	\$1485	\$1513
	96"W x 30"D	HTLC3096LCTFP	208	16.1	\$1845	\$1884
	Standing-Height, Collaborative Table with Full Modesty Panel					
	60"W x 30"D	HTLC3060HCTFP	190	14.8	\$1408	\$1428
	72"W x 30"D	HTLC3072HCTFP	210	16.9	\$1662	\$1690
	96"W x 30"D	HTLC3096HCTFP	256	21.1	\$2022	\$2061
	Seated-Height, Collaborative Table with Power Management, No Modesty Panel					
	60"W x 30"D	HTLC3060LCTHP	133	8.3	\$1532	\$1552
	72"W x 30"D	HTLC3072LCTHP	135	9.1	\$1784	\$1812
	96"W x 30"D	HTLC3096LCTHP	164	11.3	\$2143	\$2182
	NOTES: Wire management available underneath top and through the base. Bases include a removable door to access cords at any time.					
	Standing-Height, Collaborative Table with Power Management, No Modesty Panel					
	60"W x 30"D	HTLC3060HCTHP	156	9.8	\$1886	\$1925
	72"W x 30"D	HTLC3072HCTHP	158	10.5	\$2138	\$2166
	96"W x 30"D	HTLC3096HCTHP	187	12.8	\$2497	\$2536
	NOTES: Wire management available underneath top and through the base. Bases include a removable door to access cords at any time.					

NOTES:

- Tops feature 2mm flat edge.
- ! Tables with partial and full modesty panels always feature cutout in modesty panel to accommodate grommet inserts in the top. However, top cutout is optional. Wire management is not included in legs.
- ! Collaborative Tables with power management will not have modesty panels.

HOW TO SPECIFY

<p>Select Model Number</p> <p>HTLC3060LCTP .</p>	<p>Select Cutout Option</p> <p>N No Cutout G1 Cutout for Pop-up Port (\$42 upcharge) G2 Cutout for Flip-top Port (\$53 upcharge)</p> <p>N .</p>	<p>Select Top Laminate Color</p> <p>See page 74, Laminate Group A</p> <p>H .</p>	<p>Select Base Laminate Color</p> <p>See page 74, Laminate Group B</p> <p>H .</p>	<p>Select Modesty Laminate Color</p> <p>See page 74, Laminate Group B</p> <p><i>Do not specify for Power Management models</i></p> <p>LDW1 .</p>	<p>Select 2mm Edge Color</p> <p>See page 75</p> <p>H</p>
---	---	---	--	---	---

PRESIDE® Ganging Tables

GSA SIN 33721



Icon Legend on page 19

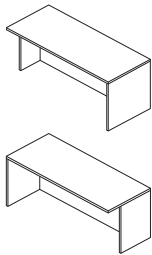
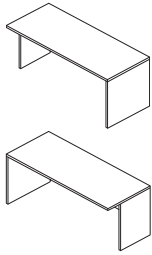

DESCRIPTION	MODEL	SHIP WEIGHT	CUBE	LIST PRICE BY LAMINATE GRADE	
				L1	L2
Seated-Height, Partial Modesty — Full Right Leg					
60"W x 30"D	HTLC3060LCTPR	128	11.1	\$1231	\$1251
72"W x 30"D	HTLC3072LCTPR	175	12.6	\$1485	\$1513
96"W x 30"D	HTLC3096LCTPR	286	15.7	\$1845	\$1884
Seated-Height, Partial Modesty — Full Left Leg					
60"W x 30"D	HTLC3060LCTPL	128	11.1	\$1231	\$1251
72"W x 30"D	HTLC3072LCTPL	175	12.6	\$1485	\$1513
96"W x 30"D	HTLC3096LCTPL	286	15.7	\$1845	\$1884
Standing-Height, Partial Modesty — Full Right Leg					
60"W x 30"D	HTLC3060HCTPR	163	13.1	\$1408	\$1428
72"W x 30"D	HTLC3072HCTPR	180	14.8	\$1662	\$1690
96"W x 30"D	HTLC3096HCTPR	220	18.0	\$2022	\$2061
Standing-Height, Partial Modesty — Full Left Leg					
60"W x 30"D	HTLC3060HCTPL	163	13.1	\$1408	\$1428
72"W x 30"D	HTLC3072HCTPL	180	14.8	\$1662	\$1690
96"W x 30"D	HTLC3096HCTPL	220	18.0	\$2022	\$2061
Seated-Height, Full Modesty — Full Right Leg					
60"W x 30"D	HTLC3060LCTFPR	143	11.5	\$1231	\$1251
72"W x 30"D	HTLC3072LCTFPR	160	13.1	\$1485	\$1513
96"W x 30"D	HTLC3096LCTFPR	200	16.1	\$1845	\$1884
Seated-Height, Full Modesty — Full Left Leg					
60"W x 30"D	HTLC3060LCTFPL	143	11.5	\$1231	\$1251
72"W x 30"D	HTLC3072LCTFPL	160	13.1	\$1485	\$1513
96"W x 30"D	HTLC3096LCTFPL	200	16.1	\$1845	\$1884
Standing-Height, Full Modesty — Full Right Leg					
60"W x 30"D	HTLC3060HCTFPR	178	14.8	\$1408	\$1428
72"W x 30"D	HTLC3072HCTFPR	199	16.9	\$1662	\$1690
96"W x 30"D	HTLC3096HCTFPR	245	21.1	\$2022	\$2061
Standing-Height, Full Modesty — Full Left Leg					
60"W x 30"D	HTLC3060HCTFPL	178	14.8	\$1408	\$1428
72"W x 30"D	HTLC3072HCTFPL	199	16.9	\$1662	\$1690
96"W x 30"D	HTLC3096HCTFPL	245	21.1	\$2022	\$2061

NOTES:

- Maximum of 2 ganging tables can be used together. However, different widths may be combined to optimize your space (i.e., 60"W left-hand and 96"W right-hand can be combined).
- Ganging tables ship with all required hardware and light gap filler strip for use between the two partial legs.
- Tops feature 2mm flat edge.
- ! Tables with partial and full modesty panels always feature cutout in modesty panel to accommodate grommet inserts in the top. However, top cutout is optional. Wire management is not included in legs.
- ! Collaborative Tables with power management will not have modesty panels.
- ! 30"D Collaborative Table Modesty Panel will be offset to allow more leg room on one side of the table.

HOW TO SPECIFY

<p>Select Model Number</p> <p>HTLC3060LCTPR</p>	<p>Select Grommet Cutout</p> <p>N No Grommet G1 G1 Grommet (centered, + \$42 upcharge) G2 G2 Grommet (centered, + \$53 upcharge)</p> <p>G1</p>	<p>Select Top Laminate Color</p> <p>See page 74, Laminate Group A</p> <p>LSA1</p>	<p>Select Base Laminate Color</p> <p>See page 74, Laminate Group B</p> <p>H</p>	<p>Select Modesty Laminate Color</p> <p>See page 74, Laminate Group B</p> <p>LSA1</p>	<p>Select 2mm Edge Color</p> <p>See page 75</p> <p>H</p>
--	---	--	--	--	---

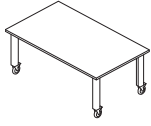

DESCRIPTION	MODEL	SHIP WEIGHT	CUBE	LIST PRICE BY LAMINATE GRADE	
				L1	L2
Mobile Collaborative Tables					
42" x 96" Seated	HTMC304296	205	16.5	\$2725	\$2770
42" x 72" Seated	HTMC304272	167	13.4	\$2390	\$2429
42" x 60" Seated	HTMC304260	147	12.1	\$2078	\$2108
Mobile Collaborative Tables with Butcher Block Top					
42" x 96" Standing	HTMC424296	219	17.8	\$2816	\$2861
42" x 72" Standing	HTMC424272	181	14.6	\$2481	\$2520
42" x 60" Standing	HTMC424260	161	13.3	\$2169	\$2199

DESCRIPTION	MODEL	SHIP WEIGHT	CUBE	BUTCHER BLOCK
42" x 96" Seated	HTMC304296BB	206	9.6	\$4068
42" x 72" Seated	HTMC304272BB	191	7.6	\$3489
42" x 60" Seated	HTMC304260BB	167	7.1	\$3061
42" x 96" Standing	HTMC424296BB	220	10.9	\$4159
42" x 72" Standing	HTMC424272BB	205	8.9	\$3580
42" x 60" Standing	HTMC424260BB	181	8.5	\$3152

NOTES:

- Mobile collaborative tables standard with 4 locking 5" casters.
- Laminate tops feature 2mm flat edge.
- Butcher block top is 1½" thick and features 1½" radius corners.
- Butcher block tops will naturally feature variation between tops due to the nature of the real wood finish. Constructed of natural Birch wood, no two tops are exactly alike. Top is coated in a clear polyurethane finish for maximum durability.

HOW TO SPECIFY

Select Model Number	Select Grommet Cutout N No Grommet	Select Top Laminate Color See page 74, Laminate Group A	Select Edge Color See page 75	Select Caster C With Caster	Select Paint Color See page 74
HTMC304296	N	LSA1	LSA1	C	T1

Select Model Number	Select Grommet Cutout N No Grommet	Select Wood LH903 Butcher Block	Select Caster C With Caster	Select Paint Color See page 74
HTMC304296BB	N	LH903	C	T1

PRESIDE® Team Touchdown Tables

GSA SIN 33721



Icon Legend on page 19

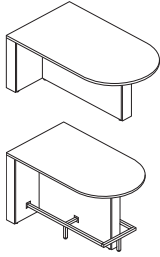

DESCRIPTION	MODEL	SHIP WEIGHT	CUBE	LIST PRICE BY LAMINATE GRADE	
				L1	L2
Team Touchdown Tables					
42" x 72" Seated Table	HTLMT4272L	202	12.5	\$1650	\$1687
42" x 60" Seated Table	HTLMT4260L	170	10.0	\$1361	\$1391
42" x 72" Standing Table	HTLMT4272H	246	14.2	\$2027	\$2064
42" x 60" Standing Table	HTLMT4260H	208	11.4	\$1680	\$1710
42" x 72" Standing Table w/ Footring	HTLMT4272HFR	272	24.5	\$3320	\$3357
42" x 60" Standing Table w/ Footring	HTLMT4260HFR	231	19.6	\$2762	\$2792

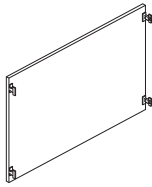

Back Panel for Seated Team Touchdown Table	HTLMTLBACK	23	3.2	\$375	\$391
Back Panel for Standing Team Touchdown Table	HTLMTLHBACK	33	4.5	\$424	\$442

NOTES: Specify Laminate, see page 74, Laminate Group B.
SPECIFYING EXAMPLE: HTLMTLBACK.LSA1

NOTES:

- Team Touchdown Tables feature open back standard. If closed back is desired, back panels must be specified separately.
- Back panel provides clearance for TV mount.
- Tops feature 2mm flat edge.

HOW TO SPECIFY

<p>Select Model Number</p> <p>HTLMT4272L</p>	<p>Select Grommet Cutout</p> <p>N No Grommet G1 G1 Grommet (centered, + \$42 upcharge) G2 G2 Grommet (centered, + \$53 upcharge)</p> <p>G1</p>	<p>Select Top Laminate Color</p> <p>See page 74, Laminate Group A</p> <p>LSA1</p>	<p>Select Edge Color</p> <p>See page 75</p> <p>LSA1</p>	<p>Select Chassis Laminate</p> <p>See page 74, Laminate Group B</p> <p>LSA1</p>	<p>Select Paint Color</p> <p><i>Footring only available on FR models in CBK only</i></p> <p>CBK</p>
---	--	--	--	--	--

DESCRIPTION	MODEL	SHIP WEIGHT	CUBE	LIST PRICE BY PAINT GRADE	
				P1	P2
TV Mount	HTLMTTV	4	1.0	\$379	\$411

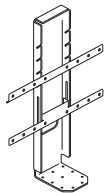

NOTES:

- TV mount is used to mount a television to the flat end of a Team Touchdown Table.
- Mounting hardware provided for television sizes 32" to 50" with VESA mounts of 100x100 to 200x200; for some televisions, additional hardware will be required (not provided).

HOW TO SPECIFY

<p>Select Model Number</p> <p>HTLMTTV</p>	<p>Select Paint Color</p> <p>P Black</p> <p>P</p>
--	---



DESCRIPTION	MODEL	SHIP WEIGHT	CUBE	LIST PRICE BY PAINT GRADE		L2 UPCHARGE
				P1	P2	
Benches						
18"D x 60"W	HTLBENCH60	23	2.3	\$1856	\$1961	\$26
18"D x 48"W	HTLBENCH48	21	1.8	\$1510	\$1594	\$21
18"D x 30"W	HTLBENCH30	18	1.8	\$1103	\$1164	\$16

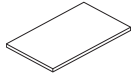

DESCRIPTION	MODEL	SHIP WEIGHT	CUBE	LIST PRICE BY FABRIC GRADE					
				1	2	3	4	5	6
Bench Cushion									
18"D x 60"W	HTLBENCHCUSH60	16	3.6	\$423	\$469	\$546	\$567	\$626	\$689
18"D x 48"W	HTLBENCHCUSH48	12	2.9	\$376	\$417	\$486	\$505	\$557	\$614
18"D x 30"W	HTLBENCHCUSH30	8	1.9	\$320	\$355	\$414	\$429	\$474	\$521

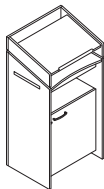

DESCRIPTION	MODEL	SHIP WEIGHT	CUBE	LIST PRICE BY LAMINATE GRADE	
				L1	L2
Laminate Lectern	HTLLECTA	132	15.6	\$1889	\$1957
<ul style="list-style-type: none"> • Overall cabinet dimensions 24"W x 18"D x 50"H. • Adjustable top worksurface features 3 tilt positions. • Top of lectern can be removed and used on table top. • Laptop shelf slides left or right. • Includes 2 locking and 2 non-locking casters. • Includes adjustable shelf in storage compartment. • Features scallops in rear of lectern to route and conceal cables and wires. • Metal components standard in black finish. 					

NOTES:

- Bench features knife edge along two long sides of seat; depth edges of top features flat edge allowing benches to be placed side by side without gaps.
- Bench cushions attach to bench seat with hook and loop.
- Fabric for bench cushions is upholstered in the railroad direction.

HOW TO SPECIFY

<p>Select Model Number</p> <p>HTLBENCH48</p>	<p>Select Top Laminate Color</p> <p>See page 74, Laminate Group A</p> <p>LSA1</p>	<p>Select Edge Color</p> <p>See page 75</p> <p>SA</p>	<p>Select Paint Color</p> <p>See page 74, Paint Group A</p> <p>T1</p>
<p>Select Model Number</p> <p>HTLBENCHCUSH48</p>	<p>Select Fabric</p> <p>See page 74</p> <p>PBLE09</p>		
<p>Select Model Number</p> <p>HTLLECTA</p>	<p>Select Laminate</p> <p>See page 74, Laminate Group B</p> <p>H</p>	<p>Select Pull</p> <p>J Loop Satin Nickel G Loop Black</p> <p>G</p>	

PRESIDE® Laminate Storage

GSA SIN AS NOTED



Icon Legend on page 19

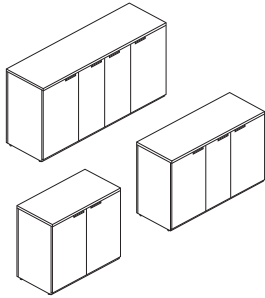

DESCRIPTION

Hospitality Credenza
21¹/₁₆"D x 72"W x 36"H
21¹/₁₆"D x 57"W x 36"H
21¹/₁₆"D x 42"W x 36"H

MODEL	SHIP WEIGHT	CUBE	L1 LIST PRICE
HTLCRED72	301	40.0	\$3517
HTLCRED57	250	31.8	\$3051
HTLCRED42	200	23.7	\$2429

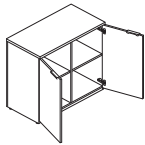

Hospitality Credenza with Shelves

21¹/₁₆"D x 72"W x 36"H
21¹/₁₆"D x 57"W x 36"H
21¹/₁₆"D x 42"W x 36"H

HTLCRED72S	311	41.5	\$3695
HTLCRED57S	260	33.3	\$3229
HTLCRED42S	210	25.2	\$2607

NOTES: Hospitality credenzas with shelves ship with 2 shelves in separate cartons. Additional shelves can be ordered separately if desired.

HOW TO SPECIFY

Select Model Number	Select Top Laminate Color	Select 2mm Edge Color	Select Chassis Laminate	Select Pull	Select Back Cutout	Select Shelf Laminate
See page 74, Laminate Group A L2 (+ \$42)	See page 74, Laminate Group B L2 (+ \$63)	See page 75	See page 74, Laminate Group B L2 (+ \$63)	See page 76 for line art visual J Loop Satin Nickel G Loop Black 3 Rounded Square Matte Chrome 4 Rounded Square Black VP HLSL Voi® Pull Black VPJW HLSL Voi® Pull Designer White VT4 HLSL Voi® Pull Champagne Metallic VT1 HLSL Voi® Pull Platinum Metallic VPR6 HLSL Voi® Pull Silver VP8X HLSL Voi® Pull Solar Black	C Vent Cutout (+ \$53) N No Cutout	See page 74, Laminate Group B L2 (+ \$21) <i>Specify for shelf models only</i>
H T L C R E D 5 7 S .	L S A 1 .	S A .	L S A 1 .	J .	C .	T 1

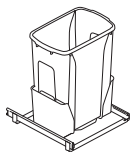

DESCRIPTION

Trash Bin Slide

- Holds a 35 quart bin.
- Trash bin is included with model.
- Can be used in outer compartments of credenza models above.

MODEL	SHIP WEIGHT	CUBE	L1 LIST PRICE	L2 UPCHARGE
HTBINSLIDE	15	3.5	\$264	N/A

OPEN MARKET

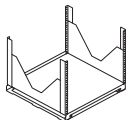

Mounted AV Rack

• Can be used in outer compartments of credenza models above.

HTRACK	15	4.8	\$2385	N/A
---------------	----	-----	---------------	------------

SIN 33721



Laminate Credenza Shelf

• Shelf can be utilized in the outer compartments of the credenza.
• 3 mounting locations within outer compartment on the credenza.
• Mounting locations are 6" apart.

HTLSHELF	10	1.5	\$89	\$11
-----------------	----	-----	-------------	-------------

SIN 33721

HOW TO SPECIFY

Select Model Number	Select Laminate
See page 74, Laminate Group B	See page 74, Laminate Group B
H T L S H E L F .	H



Icon Legend on page 19

PRESIDE® Laminate Storage

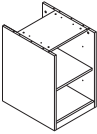
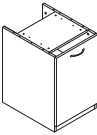
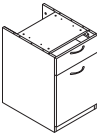
	DESCRIPTION	MODEL	SHIP WEIGHT	CUBE	LIST PRICE BY LAMINATE GRADE	
					L1	L2
	Modular Pedestal, Bookshelf, No Door	HTLMC1828O	70	9.8	\$690	\$717
<i>Model HTLMC1828O shown</i>						
	Modular Pedestal, Bookshelf, with Door (left)	HTLMC1828L	70	9.8	\$842	\$874
	Modular Pedestal, Bookshelf, with Door (right)	HTLMC1828R	70	9.8	\$842	\$874
<i>Model HTLMC1828L shown</i>						
	Modular Pedestal, Box Drawer, Cabinet Door (left)	HTLMC1828DL	70	9.8	\$895	\$927
	Modular Pedestal, Box Drawer, Cabinet Door (right)	HTLMC1828DR	70	9.8	\$895	\$927
<i>Model HTLMC1828DR shown</i>						

NOTES:

- Use Concinnity™ laminate tops and backs with Preside® modular storage for a finished look. See page 104.

HOW TO SPECIFY

<p>Select Model Number</p> <p>HTLMC1828L</p>	<p>Select Pull Option</p> <p>J Loop Satin Handle G Loop Black 3 Rounded Square Matte Chrome 4 Rounded Square Black X No Pull (for model HTLMC1828O only)</p> <p>J</p>	<p>Select Laminate</p> <p>See page 74, Laminate Group B</p> <p>N</p>
---	--	---

MODULAR COMPONENTS

GSA SIN 33721



Icon Legend on page 19

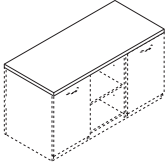

DESCRIPTION	MODEL	SHIP WEIGHT	CUBE	LIST PRICE BY LAMINATE GRADE	
				L1	L2
Concinnity™ Rectangle Worksurface with Horizontal Grain					
90"W x 24"D	HNLRC2490	75	5.5	\$686	\$718
72"W x 24"D	HNLRC2472	60	4.6	\$482	\$503
54"W x 24"D	HNLRC2454	45	3.5	\$394	\$415
36"W x 24"D Rectangle Worksurface/Pedestal Top	HNLRC2436	30	2.4	\$305	\$321

NOTES: Use Concinnity™ laminate tops and backs with Preside® modular storage for a finished look.

- ! Grain direction on all rectangle worksurfaces runs horizontal (side-to-side) except as follows: 30"W - 36"W - 42"W - 48"W - 54"W - 60"W x 24"D tops can be specified with horizontal (side-to-side) or vertical (front-to-back) grain.
- ! 42"W and 48"W x 20"D tops are available with vertical (front-to-back) grain only.

HOW TO SPECIFY

Select Model Number

H N L R C 2 4 9 0 .

Select Edge Profile and Edge Color

See page 29 in the 2023 Workspaces Pricer

B H .

Select Worksurface Grommet Finish

P Black
T1 Platinum
X No Grommet

P .

Select Worksurface Color

See page 29 in the 2023 Workspaces Pricer

H

MODULAR COMPONENTS

Back Panels

GSA SIN 33721



Icon Legend on page 19

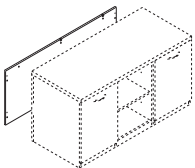

DESCRIPTION	MODEL	SHIP WEIGHT	CUBE	LIST PRICE BY LAMINATE GRADE	
				L1	L2
Concinnity™ Modesty/Back Panels — Full-Length					
90"W x 27 ⁷ / ₈ "H	HNLMP9028	58	6.7	\$550	\$577
72"W x 27 ⁷ / ₈ "H	HNLMP7228	46	5.3	\$377	\$398
54"W x 27 ⁷ / ₈ "H	HNLMP5428	34	4.0	\$310	\$331
36"W x 27 ⁷ / ₈ "H Modesty/Pedestal Back Panel	HNLMP3628	22	2.8	\$250	\$263

NOTES: Component is 3/4" thick. Provide approach-side kneespace privacy for user seated at desks, credenzas, returns, and bridges.

HOW TO SPECIFY

Select Model Number

H N L M P 7 2 2 8 .

Select Grommet

P Black
X No Grommet

X .

Select Laminate Color

See page 29 in the 2023 Workspaces Pricer

H



WALL MOUNT STORAGE

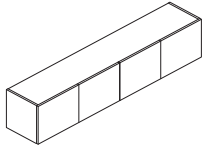

DESCRIPTION

Concinnity™ Wall Mount Storage, Laminate Doors

- 78"W x 15"D x 15"H — 4 doors, 2 compartments
- 72"W x 15"D x 15"H — 4 doors, 2 compartments
- 66"W x 15"D x 15"H — 4 doors, 2 compartments
- 60"W x 15"D x 15"H — 4 doors, 2 compartments
- 48"W x 15"D x 15"H — 3 doors, 2 compartments
- 42"W x 15"D x 15"H — 2 doors, 1 compartment
- 36"W x 15"D x 15"H — 2 doors, 1 compartment
- 30"W x 15"D x 15"H — 2 doors, 1 compartment

MODEL	SHIP WEIGHT	CUBE	L1 LIST	L2 UPCHARGES	
				CHASSIS	FRONTS
HNL1578LD	126	17.1	\$1631	\$37	\$21
HNL1572LD	118	15.9	\$1515	\$27	\$21
HNL1566LD	109	14.6	\$1444	\$27	\$21
HNL1560LD	100	13.3	\$1296	\$27	\$21
HNL1548LD	83	10.9	\$1170	\$21	\$21
HNL1542LD	68	9.7	\$1105	\$21	\$11
HNL1536LD	60	8.4	\$1008	\$21	\$11
HNL1530LD	51	7.2	\$931	\$21	\$11

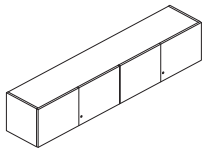

Concinnity™ Wall Mount Storage, Laminate Locking Doors

- 78"W x 15"D x 15"H — 4 doors, 2 compartments
- 72"W x 15"D x 15"H — 4 doors, 2 compartments
- 66"W x 15"D x 15"H — 4 doors, 2 compartments
- 60"W x 15"D x 15"H — 4 doors, 2 compartments
- 48"W x 15"D x 15"H — 3 doors, 2 compartments
- 42"W x 15"D x 15"H — 2 doors, 1 compartment
- 36"W x 15"D x 15"H — 2 doors, 1 compartment
- 30"W x 15"D x 15"H — 2 doors, 1 compartment

HNL1578LL	126	17.1	\$1736	\$37	\$21
HNL1572LL	118	15.9	\$1620	\$27	\$21
HNL1566LL	109	14.6	\$1550	\$27	\$21
HNL1560LL	100	13.3	\$1403	\$27	\$21
HNL1548LL	83	10.9	\$1250	\$21	\$21
HNL1542LL	68	9.7	\$1157	\$21	\$11
HNL1536LL	60	8.4	\$1062	\$21	\$11
HNL1530LL	51	7.2	\$985	\$21	\$11

! Lock available in Black (P) or Satin (SA) finish. Lock is core removable. Keyed alike cores must be ordered separately. For stack-on and wall mount storage with locking hinged doors, specify model HF27B (Black) or HF27S (Satin) and the key number, see the Desks section in the 2023 Workspaces Pricer. Model HNL1548LL has one lock, which secures two of the three doors.

NOTES:

- Preside® tables pair well with Concinnity™ Wall Mounted Storage to create a complete conference or collaborative layout.
- Convenient off-the-worksurface storage requires no additional floor space.
- Available with laminate doors, frosted/silver doors, or sliding door.
- Doors are sized to overlap the top, end panels and light valance, to provide a clean design.
- Laminate and frosted/silver door units are equipped with self-closing, adjustable hinges.
- Laminate hinged door units are available with or without a lock.
- For tackboards, see the Desks section in the 2023 Workspaces Pricer.
- For task lights, see the Desks section in the 2023 Workspaces Pricer.
- For paper organizers, see the Desks section in the 2023 Workspaces Pricer.
- **IMPORTANT: See installation guidelines in the Desks section in the 2023 Workspaces Pricer.**

HOW TO SPECIFY

<p>Select Model Number</p> <p>H N L 1 5 7 8 L D</p>	<p>Select Chassis Color</p> <p>See page 29 in the 2023 Workspaces Pricer</p> <p>H</p>	<p>Select Door Front Color</p> <p>See page 29 in the 2023 Workspaces Pricer</p> <p>H</p>
<p>Select Model Number</p> <p>H N L 1 5 7 8 L L</p>	<p>Select Lock Finish</p> <p>See page 29 in the 2023 Workspaces Pricer</p> <p>P</p>	<p>Select Chassis Color</p> <p>See page 29 in the 2023 Workspaces Pricer</p> <p>H</p>
		<p>Select Door Front Color</p> <p>See page 29 in the 2023 Workspaces Pricer</p> <p>H</p>

WALL MOUNT STORAGE

GSA SIN 33721



Icon Legend on page 19

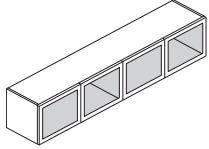

DESCRIPTION

Concinnity™ Wall Mount Storage, Frosted Doors with Silver Frame

- 78"W x 15"D x 15"H — 4 doors, 2 compartments
- 72"W x 15"D x 15"H — 4 doors, 2 compartments
- 66"W x 15"D x 15"H — 4 doors, 2 compartments
- 60"W x 15"D x 15"H — 4 doors, 2 compartments
- 48"W x 15"D x 15"H — 3 doors, 2 compartments
- 42"W x 15"D x 15"H — 2 doors, 1 compartment
- 36"W x 15"D x 15"H — 2 doors, 1 compartment
- 30"W x 15"D x 15"H — 2 doors, 1 compartment

MODEL	SHIP WEIGHT	CUBE	L1 LIST	L2 UPCHARGES	
				CHASSIS	FRONTS
HNL1578FD	106	17.1	\$2465	\$37	N/A
HNL1572FD	99	15.9	\$2347	\$27	N/A
HNL1566FD	92	14.6	\$2274	\$27	N/A
HNL1560FD	85	13.3	\$2126	\$27	N/A
HNL1548FD	71	10.9	\$1793	\$21	N/A
HNL1542FD	57	9.7	\$1525	\$21	N/A
HNL1536FD	50	8.4	\$1428	\$21	N/A
HNL1530FD	43	7.2	\$1350	\$21	N/A

❗ Frosted door models do not have a lock option.

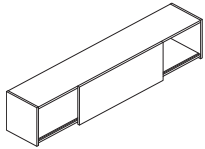

Concinnity™ Wall Mount Storage, Sliding Door

- 78"W x 15"D x 15"H
- 72"W x 15"D x 15"H
- 66"W x 15"D x 15"H
- 60"W x 15"D x 15"H
- 48"W x 15"D x 15"H

HNL1578SD	114	17.1	\$1586	\$37	\$21
HNL1572SD	107	15.9	\$1456	\$27	\$21
HNL1566SD	99	14.6	\$1358	\$27	\$21
HNL1560SD	91	13.3	\$1234	\$27	\$21
HNL1548SD	76	10.9	\$1155	\$21	\$21

NOTES: One door per unit. Standard with black lock, which is located on the inside vertical support panel.

NOTES:

- Preside® tables pair well with Concinnity™ Wall Mounted Storage to create a complete conference or collaborative layout.
- Convenient off-the-worksurface storage requires no additional floor space.
- Available with laminate doors, frosted/silver doors, or sliding door.
- Doors are sized to overlap the top, end panels and light valance, to provide a clean design.
- Laminate and frosted/silver door units are equipped with self-closing, adjustable hinges.
- Laminate hinged door units are available with or without a lock.
- For tackboards, see the Desks section in the 2023 Workspaces Pricer.
- For task lights, see the Desks section in the 2023 Workspaces Pricer.
- For paper organizers, see the Desks section in the 2023 Workspaces Pricer.
- **IMPORTANT: See installation guidelines in the Desks section in the 2023 Workspaces Pricer.**

HOW TO SPECIFY

<p>Select Model Number</p> <div style="border: 1px solid black; display: flex; justify-content: space-between; padding: 2px;"> HNL1578FD </div>	<p>Select Chassis Color</p> <p>See page 29 in the 2023 Workspaces Pricer</p> <div style="border: 1px solid black; display: flex; justify-content: space-between; padding: 2px;"> H </div>	
<p>Select Model Number</p> <div style="border: 1px solid black; display: flex; justify-content: space-between; padding: 2px;"> HNL1578SD </div>	<p>Select Chassis Color</p> <p>See page 29 in the 2023 Workspaces Pricer</p> <div style="border: 1px solid black; display: flex; justify-content: space-between; padding: 2px;"> H </div>	<p>Select Door Front Color</p> <p>See page 29 in the 2023 Workspaces Pricer</p> <div style="border: 1px solid black; display: flex; justify-content: space-between; padding: 2px;"> H </div>



Icon Legend on page 19

PRESIDE® Laminate Shared Components

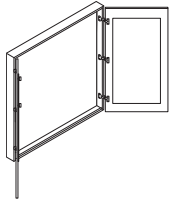
**DESCRIPTION****Laminate Presentation Cabinet**

- Overall cabinet dimensions 48⁷/₈"W x 5"D x 49¹/₂"H.
- Mounts to wall.
- Presentation cabinet features one magnetic white board, one tackboard and one paper pad.
- Self-adjusting hinges ensure doors are in alignment.

MODEL	SHIP WEIGHT	CUBE	LIST PRICE BY LAMINATE GRADE	
			L1	L2
HTLPRES	169	10.9	\$2069	\$2153

HOW TO SPECIFYSelect
Model Number

H T L P R E S .

Select
Laminate

See page 74, Laminate Group B

D

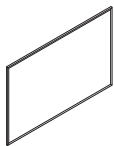

OPEN MARKET

DESCRIPTION**Markerboard**

- Overall markerboard dimensions 48"W x 31"H.
- Mounts on wall. Can be mounted horizontally or vertically.
- Markerboard is magnetic.
- No specification required.

MODEL	SHIP WEIGHT	CUBE	LIST PRICE
HLSL4831MB	44.0	3.4	\$901

HOW TO SPECIFYSelect
Model Number

H L S L 4 8 3 1 M B

PRESIDE® Laminate Tables

GSA SIN 33721



Icon Legend on page 19

	DESCRIPTION	MODEL	SHIP WEIGHT	CUBE	LIST PRICE
	Laminate Boat Shaped Table Tops with Stretcher				
	168"W x 48"D	HTLB16848P	319	11.9	\$1820
	144"W x 48"D	HTLB14448P	266	9.8	\$1446
	120"W x 48"D	HTLB12048P	217	8.2	\$1311
	Laminate Adder Section with Stretcher 72"W x 48"D	HTLM7248P	144	9.8	\$962
	Laminate Bases				
	Laminate Panel Bases, Double Pack Laminate Panel Bases, Single Pack	HTLPB HTLPBS	53 28	3.1 3.1	\$523 \$317

	With Panel Base
HTLB12048P HTLB14448P	1 x HTLPB (Laminate Panel Base)
HTLB16848P	1 x HTLPB (Laminate Panel Base) 1 x HTLPBS (Laminate Panel Mid-Base)
HTLM7248P	1 x HTLPBS (Laminate Panel Mid-Base)

NOTES:

- Tops and Modesty Panels are 1 1/8" Melamine.
 - 168"W Boat-Shaped Top needs 3 bases; 72"W Middle Adder needs 1 base. All other tops need 2 bases.
 - 120", 144", and 168"W Tops ship in 2 pieces to facilitate handling and installation; these top sizes will not have an exact grain alignment where the two halves meet, a reasonable match can be expected.
- ! Tops with Stretcher and Adder Section with Stretcher available in Harvest (C) and Mahogany (N) finishes only.
 - ! Tops available in Boat Shape with G edge (2mm self edge) only; Middle Adder is rectangular with G edge.
 - ! Edge finish always matches top finish.

HOW TO SPECIFY

<p>Select Model Number</p> <p>HTLB16848P</p>	<p>Select Grommet Option</p> <p>N No grommet (only option)</p> <p>N</p>	<p>Select Laminate</p> <p>C Harvest N Mahogany</p> <p>C</p>
---	--	--



Laminate Tables — Pre-defined Typicals

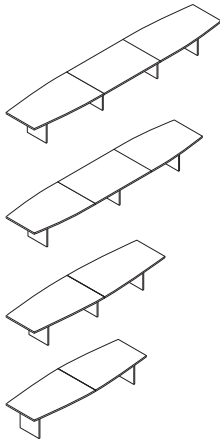

DESCRIPTION

Boat Shape Laminate Tables with Panel Base

- 240"W x 48"D
- 216"W x 48"D
- 192"W x 48"D
- 168"W x 48"D
- 144"W x 48"D
- 120"W x 48"D

MODEL

- HTLB2048LP**
- HTLB1848LP**
- HTLB1648LP**
- HTLB1448LP**
- HTLB1248LP**
- HTLB1048LP**

SHIP WEIGHT

- 572
- 491
- 442
- 400
- 319
- 270

CUBE

- 31.0
- 25.9
- 24.3
- 18.1
- 12.9
- 11.3

LIST PRICE

- \$3939**
- \$3248**
- \$3113**
- \$2660**
- \$1969**
- \$1834**

NOTES: Order entire typical with one model number to get desired table size. Table top and bases are included.

NOTES:

- Tops and Modesty Panels are 1/4" Melamine.
- 168"W Boat-Shaped Top needs 3 bases; 72"W Middle Adder needs 1 base. All other tops need 2 bases.
- 120", 144", and 168"W Tops ship in 2 pieces to facilitate handling and installation; these top sizes will not have an exact grain alignment where the two halves meet, a reasonable match can be expected.
- ! Available in Harvest (C) and Mahogany (N) finishes only.
- ! Tops available in Boat Shape with G edge (2mm self edge) only; Middle Adder is rectangular with G edge.
- ! Edge finish always matches top finish.

HOW TO SPECIFY

<p>Select Model Number</p> <p style="font-family: monospace; font-size: 1.2em; text-align: center;">H T L B 2 0 4 8 L P .</p>	<p>Select Grommet Option</p> <p>N No grommet (only option)</p> <p style="font-family: monospace; font-size: 1.2em; text-align: center;">N .</p>	<p>Select Laminate</p> <p>C Harvest N Mahogany</p> <p style="font-family: monospace; font-size: 1.2em; text-align: center;">C .</p>	<p>Select Edge Color</p> <p>C Harvest N Mahogany</p> <p style="font-family: monospace; font-size: 1.2em; text-align: center;">C</p>
--	--	--	--

SCRAMBLE™ OCCASIONAL TABLES

Want to see more? Scan here
to check out hon.com.



Scramble™ Coffee Table shown with
West Hill™ Casual Lounge Seating.

SCRAMBLE™

For every tablet, coffee mug, or notepad there's a need for an occasional table. Don't scramble to find an open meeting room when you can move to where relaxed productivity happens whether it's a lounge, commons, or nook area. Designed to coordinate with any of HON's soft seating lines, Scramble occasional tables fit in any space you need to work comfortably.



FEATURES

- Select from Soft Rectangle, Soft Square, and Round top shapes.
- Multiple size ranges available from side to large coffee tables.
- Coordinate with any of HON's soft seating series to create a space that works.
- Angled hardwood legs with metal stretcher bars provide a mid-century feel.
- Assorted leg and stretcher bar finishes available to match any aesthetic.
- Match the style of any space, with laminate tops including both flat and knife edges, as well as premium back-painted glass tops.

SCRAMBLE™ Options

MODEL OPTIONS

HSCCSR2448LM
HSCCSR2448LMK
HSCCSR2448BPG

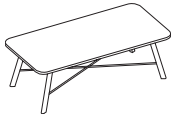

Coffee Table
Soft Rectangle

HSCCSS36LM, HSCCSS36LMK, HSCCSS36BPG
HSCCSS48LM, HSCCSS48LMK, HSCCSS48BPG



Coffee Table
Soft Square

HSCCR36LM, HSCCR36LMK, HSCCR36BPG
HSCCR48LM, HSCCSS48LMK, HSCCR48BPG



Coffee Table
Round

HSCCESS24LM
HSCCESS24LMK
HSCCESS24BPG



End Table
Soft Square

HSCER24LM
HSCER24LMK
HSCER24BPG



End Table
Round

Available Laminates and Corresponding Edge:

Laminate		Edgeband	
Beigewood	LWBE	Beigewood	DE
Charcoal	S	Charcoal	S
Designer White	LDW1	Designer White	DW
Fawn Cypress	LFC1	Fawn Cypress	FC
Field Elm	LWFE	Field Elm	FE
Florence Walnut	LFW1	Florence Walnut	FW
Handspun Chestnut	LAHC	Loft	LOFT
Handspun Dove	LAHD	Fossil	EH
Handspun Pearl	LAHP	Fossil	EH
Handspun Slate	LAHS	Charcoal	S
Kingswood Walnut	LK1I	Kingswood Walnut	KI
Lowell Ash	LLA1	Lowell Ash	DL
Natural Maple	D	Natural Maple	D
Natural Recon	LNRI	Natural Recon	NR
Phantom Ecru	LPE1	Phantom Ecru	PE
Pinnacle	PINC	Pinnacle	PINC
Portico Teak	LPT1	Portico Teak	PT
Skyline Walnut	LSW1	Skyline Walnut	SW
Sterling Ash	LSA1	Sterling Ash	SA

WOOD LEG OPTIONS

CODE	DESCRIPTION	PRICE
LFW1	Florence Walnut	+\$0
LK1I	Kingswood Walnut	+\$0
LLA1	Lowell Ash	+\$0
D	Natural Maple	+\$0
LNRI	Natural Recon	+\$0
LPE1	Phantom Ecru	+\$0
PINC	Pinnacle	+\$0
LPT1	Portico Teak	+\$0
LSW1	Skyline Walnut	+\$0
LSA1	Sterling Ash	+\$0
LE404	Warm White	+\$0
LE405	Mist	+\$0
LE408	Peppercorn	+\$0

NOTES: Wood Legs are stained solid maple. Stain finishes will be tonal matches to the respective laminate finishes. Some natural woodgrain may show through the stain; therefore, stained wood legs may have slight variation in appearance.

EDGE & MATERIAL OPTIONS

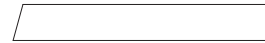

Laminate
2mm Edge, 3/4" thick



Laminate
Knife Edge, 1/8" thick

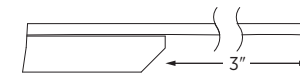

- Back-Painted Glass**
- 1/4" thick glass, painted on the bottom surface with frosted/etched top and sides.
 - 3/4" MDF sub-top inset 3" from all sides, for attachment to base.

STRETCHER BAR PAINT OPTIONS

CODE	DESCRIPTION	PRICE
Grade P1		
P7A	Textured Charcoal	+\$0
P8V	Textured Titanium	+\$0
Grade P2		
PR5	Champagne Metallic	+\$21
P8X	Solar Black	+\$21

BACK-PAINTED GLASS OPTION



CODE	DESCRIPTION	PRICE
GWH1	Ice White, Etched	+\$0

SCRAMBLE™ Coffee Tables

OPEN MARKET EXCEPT AS NOTED



Icon Legend on page 19

	DESCRIPTION	MODEL	SHIP WEIGHT	CUBE	LIST PRICE BY LAMINATE GRADE		GLASS LIST PRICE
					L1	L2	
	Coffee Table, Soft Rectangle 24"D x 48"W x 16"H, Laminate Top, 2mm Edge	HSCCSR2448LM*	46.5	9.7	\$1598	\$1619	
	24"D x 48"W x 16"H, Laminate Top, Knife Edge	HSCCSR2448LMK	94.0	6.4	\$1812	\$1833	
	24"D x 48"W x 16"H, Back-Painted Glass Top	HSCCSR2448BPG	61.5	5.9			\$3341
	Coffee Table, Soft Square 36"D x 36"W x 16"H, Laminate Top, 2mm Edge	HSCCSS36LM*	48.5	9.0	\$1535	\$1556	
	48"D x 48"W x 16"H, Laminate Top, 2mm Edge	HSCCSS48LM*	80.5	12.8	\$1660	\$1681	
	36"D x 36"W x 16"H, Laminate Top, Knife Edge	HSCCSS36LMK	63.0	6.7	\$1697	\$1718	
	48"D x 48"W x 16"H, Laminate Top, Knife Edge	HSCCSS48LMK	96.5	9.9	\$1926	\$1947	
	36"D x 36"W x 16"H, Back-Painted Glass Top	HSCCSS36BPG	66.0	6.2			\$3609
	48"D x 48"W x 16"H, Back-Painted Glass Top	HSCCSS48BPG	110.5	9.1			\$4164
	Coffee Table, Round 36"D x 16"H, Laminate Top, 2mm Edge	HSCCR36LM*	41.0	8.8	\$1535	\$1556	
	48"D x 16"H, Laminate Top, 2mm Edge	HSCCR48LM*	70.0	12.6	\$1660	\$1681	
	36"D x 16"H, Laminate Top, Knife Edge	HSCCR36LMK	49.0	6.7	\$1697	\$1718	
	48"D x 16"H, Laminate Top, Knife Edge	HSCCR48LMK	82.0	9.0	\$1926	\$1947	
	36"D x 16"H, Back-Painted Glass Top	HSCCR36BPG	49.0	6.2			\$3609
	48"D x 16"H, Back-Painted Glass Top	HSCCR48BPG	90.0	8.2			\$4164

* GSA SIN 33721

HOW TO SPECIFY

<p>Select Model Number</p>	<p>Select Laminate and Edge or Glass</p> <p>See page 111</p>	<p>Select Leg Finish</p> <p>See page 111</p>	<p>Select Stretcher Bar Paint Color</p> <p>See page 111</p>
H S C C S R 2 4 4 8 L M .	L S A 1 S A .	L S A 1 .	P 8 V



OPEN MARKET EXCEPT AS NOTED



Icon Legend on page 19

SCRAMBLE™ End Tables

TABLES

	DESCRIPTION	MODEL	SHIP WEIGHT	CUBE	LIST PRICE BY LAMINATE GRADE		GLASS LIST PRICE
					L1	L2	
	End Table, Soft Square						
	24"W x 24"D x 22"H, Laminate Top, 2mm Edge	HSCCESS24LM*	34.5	19.0	\$1470	\$1491	
	24"W x 24"D x 22"H, Laminate Top, Knife Edge	HSCCESS24LMK	42.0	3.9	\$1589	\$1610	
	24"W x 24"D x 22"H, Back-Painted Glass Top	HSCCESS24BPG	38.0	3.7			\$2845
	End Table, Round						
	24"D x 22"H, Laminate Top, 2mm Edge	HSCER24LM*	32.0	19.0	\$1470	\$1491	
	24"D x 22"H, Laminate Top, Knife Edge	HSCER24LMK	33.0	3.9	\$1589	\$1610	
	24"D x 22"H, Back-Painted Glass Top	HSCER24BPG	33.0	3.7			\$2845

* GSA SIN 33721

HOW TO SPECIFY

<p>Select Model Number</p> <p>H S C E S S 2 4 L M .</p>	<p>Select Laminate and Edge or Glass</p> <p>See page 111</p> <p>L S A 1 S A .</p>	<p>Select Leg Finish</p> <p>See page 111</p> <p>L S A 1 .</p>	<p>Select Stretcher Bar Paint Color</p> <p>See page 111</p> <p>P 8 V</p>
--	--	--	---

SCULPT™

Want to see more? Scan here
to check out hon.com.



Sculpt™ Tables shown with Mav™ Chairs.

SCULPT™ TABLES

Sophisticated and subtle, HON's Sculpt™ collection is a breath of fresh air in any busy office space. Designed to be adaptable and customizable, these occasional and personal tables enhance the productivity of shared spaces while providing a multifunctional hub for a variety of needs, both individual and collaborative. And with a variety of elegant finishes, tops, and heights — plus layering and power capabilities — Sculpt™ is the ideal surface solution for lounges, touchdown spaces, private offices, and more. Make your space work with Sculpt™.



FEATURES

- Customize your office aesthetic with a variety of top shapes, heights, and elegant finishes.
- Find flexibility with both collaborative and single-use capabilities.
- Stay powered up with an integrated personal device holder.
- Enhance the beauty of your environment and offer a fresh perspective with Sculpt™ planters, designed to bring soothing nature into the workplace.

SCULPT™ ORDERING INFORMATION

LAMINATE

L1 LAMINATES CODES

Woodgrain

◆ Bourbon Cherry	H
◆ Cognac	COGN
◆ Field Elm	LWFE
◆ Florence Walnut	LFW1
◆ Harvest	C
◆ Kingswood Walnut	LK11
◆ Mahogany	N
◆ Mocha	MOCH
◆ Natural Maple	D
◆ Pinnacle	PINC
◆ Shaker Cherry	F
◆ Sterling Ash	LSA1

Solid

◆ Black	P
◆ Charcoal	S
◆ Designer White	LDW1
◆ Loft	LOFT

Patterned

◆ Handspun Chestnut	LAHC
◆ Handspun Dove	LAHD
◆ Handspun Pearl	LAHP
◆ Handspun Slate	LAHS

L2 LAMINATES CODES

Woodgrain

◆ Beigewood	LWBE
◆ Fawn Cypress	LFC1
◆ Lowell Ash	LLA1
◆ Natural Recon	LNR1
◆ Phantom Ecru	LPE1
◆ Portico Teak	LPT1
◆ Skyline Walnut	LSW1

WOOD

WOOD CODES

Beigewood	LE878
Bourbon Cherry	LE773
Cognac	LE702
Field Elm	LE599
Florence Walnut	LE579
Harvest	LE856
Kingswood Walnut	LE518
Lowell Ash	LE394
Mahogany	LE740
Mocha	LE121
Natural Maple	LE800
Natural Recon	LE896
Phantom Ecru	LE912
Pinnacle	LE679
Portico Teak	LE150
Shaker Cherry	LE774
Skyline Walnut	LE625
Sterling Ash	LE495

NOTES: Wood legs are stained solid maples. Stain finishes will be tonal matches to the respective laminate finishes. Some natural woodgrain may show through the stain; therefore, stained wood legs may have slight variation in appearance.

PAINT

PAINT CODES

P1

◆ Black	P71
◆ Brownstone	P7D
◆ Charcoal	P02
◆ Designer White	PJW
◆ Fossil	P28
◆ Greige	T5
◆ Light Grey	Q
◆ Loft	LOFT
◆ Muslin	T3
◆ Putty	L
◆ Textured Brownstone	P7J
◆ Textured Charcoal	P7A
◆ Textured Designer White	PK7
◆ Textured Loft	P7L
◆ Textured Muslin	P7M
◆ Textured Titanium	P8T
◆ Titanium	P8T

P2

◆ Champagne Metallic	T4
◆ Gunmetal Metallic	PR3
◆ Platinum Metallic	T1
◆ Pyrite	PJE
◆ Silver	PR6
◆ Solar Black	P8X
◆ Textured Silver	PR8

P3

◆ Amethyst *	P091
◆ Atom	P8S
◆ Blossom	P8K
◆ Bullseye	PJF
◆ Cobalt Mica *	P090
◆ Ember	P8P
◆ Ion	P8N
◆ Iris	P8J
◆ Krypton	P8F
◆ Ochre	P093
◆ Regatta	P8M
◆ Sienna	P092
◆ Succulent	P8A

* De-emphasized

SCULPT™ STATEMENT OF LINE

LAMINATE/WOOD TOP TABLES

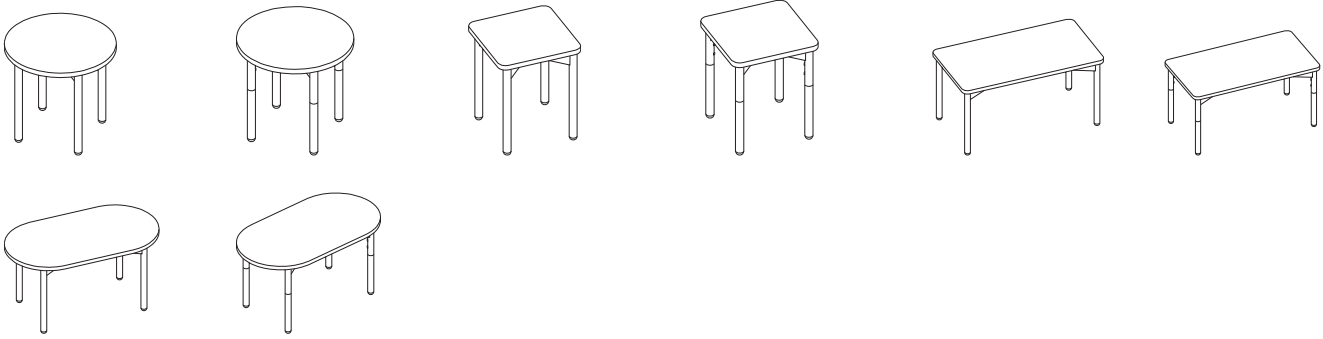

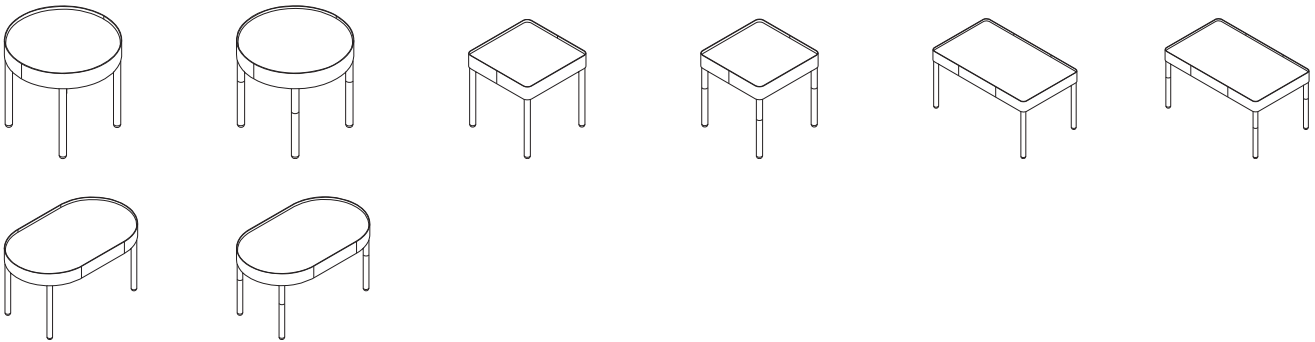

TRAY TOP TABLES

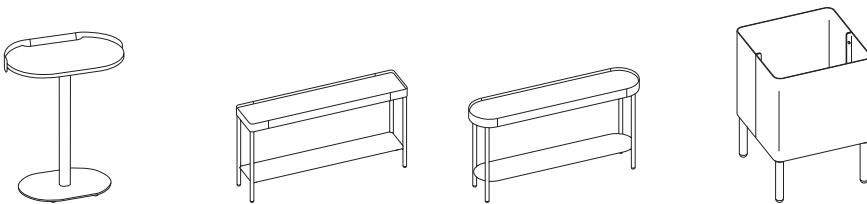

PERSONAL/CONSOLE TABLES

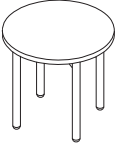
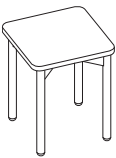

SCULPT™ Laminate Top Tables

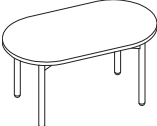
	DESCRIPTION	MODEL	SHIP WEIGHT	CUBE	LIST PRICE	UPCHARGE BY		
						LAMINATE/PAINT GRADE L2	P2	P3
	Round Laminate Top with Metal Legs							
	16½"W x 15¾"H, Low Metal Legs	HTLSCULRND16LML	19	3.0	\$739	\$10	\$55	\$82
	16½"W x 18½"H, Medium Metal Legs	HTLSCULRND16MML	20	3.0	\$752	\$10	\$56	\$84
	16½"W x 21½"H, High Metal Legs	HTLSCULRND16HML	20	3.0	\$758	\$10	\$57	\$85
	30"W x 15¾"H, Low Metal Legs	HTLSCULRND30LML	35	4.4	\$801	\$13	\$54	\$80
	Square Laminate Top with Metal Legs							
	12¾"W x 12¾"D x 15¾"H, Low Metal Legs	HTLSCULSQR13LML	10	2.7	\$688	\$9	\$50	\$75
	16½"W x 16½"D x 18½"H, Medium Metal Legs	HTLSCULSQR16MML	20	2.3	\$690	\$10	\$49	\$73
	20¼"W x 20¼"D x 21½"H, High Metal Legs	HTLSCULSQR20HML	24	3.3	\$721	\$11	\$50	\$75
	30"W x 30"D x 15¾"H, Low Metal Legs	HTLSCULSQR30LML	35	2.5	\$788	\$14	\$51	\$76
	! Cutout not available on 12¾" top.							
	Rectangle Laminate Top with Metal Legs							
	60"W x 16½"D x 15¾"H, Low Metal Legs	HTLSCULREC1660LML	42	4.1	\$927	\$14	\$64	\$96
	30"W x 16½"D x 15¾"H, Low Metal Legs	HTLSCULREC1630LML	24	5.7	\$792	\$12	\$55	\$82
	30"W x 16½"D x 18½"H, Medium Metal Legs	HTLSCULREC1630MML	25	5.7	\$806	\$12	\$56	\$84
	Pill Laminate Top with Metal Legs							
	60"W x 16½"D x 15¾"H, Low Metal Legs	HTLSCULPIL1660LML	41	6.7	\$927	\$15	\$64	\$95
	30"W x 16½"D x 15¾"H, Low Metal Legs	HTLSCULPIL1630LML	23	5.7	\$782	\$12	\$54	\$80
	30"W x 16½"D x 18½"H, Medium Metal Legs	HTLSCULPIL1630MML	24	5.7	\$786	\$12	\$54	\$81

HOW TO SPECIFY

Select Model Number HTLSCULRND16LML	Select Cutout Option N No Cutout G Grommet Cutout (+ \$40) G	Select Laminate See page 115 H	Select Leg Paint Color See page 115 P71	Select Glide Option G Glide G
---	--	---	--	--

SCULPT™ Laminate Top Tables

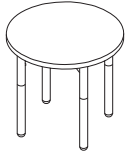

DESCRIPTION

Round Laminate Top with Wood Legs
 16½"W x 15⅜"H, Low Wood Legs
 16½"W x 18½"H, Medium Wood Legs
 16½"W x 21⅝"H, High Wood Legs
 30"W x 15⅜"H, Low Wood Legs

MODEL

HTLSCULRND16LWL
HTLSCULRND16MWL
HTLSCULRND16HWL
HTLSCULRND30LWL

SHIP WEIGHT CUBE

19 3.0
 20 3.0
 20 3.0
 35 4.4

LIST PRICE

\$1007
\$1033
\$1067
\$1217

UPCHARGE BY LAMINATE/PAINT GRADE

L2	P2	P3
\$10	\$53	\$80
\$10	\$53	\$80
\$10	\$54	\$80
\$13	\$67	\$100



Square Laminate Top with Wood Legs

12¾"W x 12¾"D x 15⅜"H, Low Wood Legs
 16½"W x 16½"D x 18½"H, Medium Wood Legs
 20¼"W x 20¼"D x 21⅝"H, High Wood Legs
 30"W x 30"D x 15⅜"H, Low Wood Legs

HTLSCULSQR13LWL
HTLSCULSQR16MWL
HTLSCULSQR20HWL
HTLSCULSQR30LWL

15 2.7
 20 2.3
 24 3.3
 35 4.4

\$1043
\$1071
\$1131
\$1157

L2	P2	P3
\$9	\$57	\$86
\$10	\$56	\$84
\$11	\$57	\$86
\$14	\$60	\$89

ⓘ Cutout not available on 12¾" top.

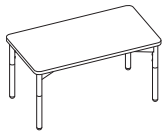

Rectangle Laminate Top with Wood Legs

60"W x 16½"D x 15⅜"H, Low Wood Legs
 30"W x 16½"D x 15⅜"H, Low Wood Legs
 30"W x 16½"D x 18½"H, Medium Wood Legs

HTLSCULREC1660LWL
HTLSCULREC1630LWL
HTLSCULREC1630MWL

42 4.1
 24 5.7
 25 5.7

\$1174
\$1055
\$1083

L2	P2	P3
\$14	\$60	\$91
\$12	\$53	\$79
\$12	\$53	\$79



Pill Laminate Top with Wood Legs

60"W x 16½"D x 15⅜"H, Low Wood Legs
 30"W x 16½"D x 15⅜"H, Low Wood Legs
 30"W x 16½"D x 18½"H, Medium Wood Legs

HTLSCULPIL1660LWL
HTLSCULPIL1630LWL
HTLSCULPIL1630MWL

41 6.7
 23 5.7
 24 5.7





\$1186
\$1040
\$1061

L2	P2	P3
\$15	\$61	\$92
\$12	\$51	\$77
\$12	\$51	\$76

HOW TO SPECIFY

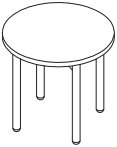
<p>Select Model Number</p> <p>HTLSCULRND16LWL .</p>	<p>Select Cutout Option</p> <p>N No Cutout G Grommet Cutout (+ \$40)</p> <p>G .</p>	<p>Select Laminate</p> <p>See page 115</p> <p>H .</p>	<p>Select Wood Leg Finish</p> <p>See page 115</p> <p>LE856 .</p>	<p>Select Leg Paint Color</p> <p>See page 115</p> <p>P71</p>
--	---	--	---	---

SCULPT™ Wood Top Tables

	DESCRIPTION	MODEL	SHIP WEIGHT	CUBE	LIST PRICE BY PAINT GRADE		
					P1	P2	P3
	Round Wood Top with Metal Legs 16½"W x 15¾"H, Low Metal Legs	HTLSCUWRND16LML	19	3.0	\$1693	\$1748	\$1775
	16½"W x 18½"H, Medium Metal Legs	HTLSCUWRND16MML	20	3.0	\$1706	\$1762	\$1790
	16½"W x 21½"H, High Metal Legs	HTLSCUWRND16HML	20	3.0	\$1712	\$1769	\$1797
	30"W x 15¾"H, Low Metal Legs	HTLSCUWRND30LML	35	6.7	\$1968	\$2022	\$2048
	Square Wood Top with Metal Legs 12¾"W x 12¾"D x 15¾"H, Low Metal Legs	HTLSCUWSQR13LML	15	2.7	\$1604	\$1654	\$1679
	16½"W x 16½"D x 18½"H, Medium Metal Legs	HTLSCUWSQR16MML	20	3.0	\$1604	\$1653	\$1677
	20¼"W x 20¼"D x 21½"H, High Metal Legs	HTLSCUWSQR20HML	24	3.3	\$1690	\$1740	\$1765
	30"W x 30"D x 15¾"H, Low Metal Legs	HTLSCUWSQR30LML	35	6.7	\$1940	\$1991	\$2016
	! Cutout not available on 12¾" top.						
	Rectangle Wood Top with Metal Legs 60"W x 16½"D x 15¾"H, Low Metal Legs	HTLSCUWREC1660LML	42	6.6	\$2250	\$2314	\$2346
	30"W x 16½"D x 15¾"H, Low Metal Legs	HTLSCUWREC1630LML	24	5.7	\$1805	\$1860	\$1887
	30"W x 16½"D x 18½"H, Medium Metal Legs	HTLSCUWREC1630MML	25	5.7	\$1819	\$1845	\$1903
	Pill Wood Top with Metal Legs 60"W x 16½"D x 15¾"H, Low Metal Legs	HTLSCUWPIL1660LML	41	6.6	\$2277	\$2341	\$2372
	30"W x 16½"D x 15¾"H, Low Metal Legs	HTLSCUWPIL1630LML	23	5.7	\$1789	\$1843	\$1869
	30"W x 16½"D x 18½"H, Medium Metal Legs	HTLSCUWPIL1630MML	24	5.7	\$1793	\$1847	\$1874

HOW TO SPECIFY

Select Model Number HTLSCUWRND16LML	Select Cutout Option N No Cutout G Grommet Cutout (+ \$40) G	Select Wood Finish See page 115 LE856	Select Leg Paint Color See page 115 P71	Select Glide Option G Glide G
---	--	--	--	--

SCULPT™

Wood Top Tables

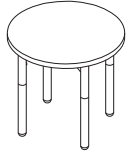

DESCRIPTION

Round Wood Top with Wood Legs
 16½"W x 15⅝"H, Low Wood Legs
 16½"W x 18½"H, Medium Wood Legs
 16½"W x 21⅝"H, High Wood Legs
 30"W x 15⅝"H, Low Wood Legs

MODEL

HTLSCUWRND16LWL
HTLSCUWRND16MWL
HTLSCUWRND16HWL
HTLSCUWRND30LWL

SHIP WEIGHT

CUBE

LIST PRICE BY PAINT GRADE

P1 P2 P3

19 3.0 \$1961 \$2014 \$2041
 20 3.0 \$1987 \$2040 \$2067
 20 3.0 \$2021 \$2075 \$2101
 35 6.7 \$2384 \$2451 \$2484



Square Wood Top with Wood Legs

12¾"W x 12¾"D x 15⅝"H, Low Wood Legs
 16½"W x 16½"D x 18½"H, Medium Wood Legs
 20¼"W x 20¼"D x 21⅝"H, High Wood Legs
 30"W x 30"D x 15⅝"H, Low Wood Legs

HTLSCUWSQR13LWL
HTLSCUWSQR16MWL
HTLSCUWSQR20HWL
HTLSCUWSQR30LWL

15 2.7 \$1959 \$2016 \$2045
 20 3.0 \$1985 \$2041 \$2069
 24 3.3 \$2100 \$2157 \$2186
 35 6.7 \$2309 \$2369 \$2398

❗ Cutout not available on 12¾" top.

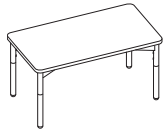

Rectangle Wood Top with Wood Legs

60"W x 16½"D x 15⅝"H, Low Wood Legs
 30"W x 16½"D x 15⅝"H, Low Wood Legs
 30"W x 16½"D x 18½"H, Medium Wood Legs

HTLSCUWREC1660LWL
HTLSCUWREC1630LWL
HTLSCUWREC1630MWL

42 6.6 \$2497 \$2557 \$2588
 24 5.7 \$2068 \$2121 \$2147
 25 5.7 \$2096 \$2149 \$2175



Pill Wood Top with Wood Legs

60"W x 16½"D x 15⅝"H, Low Wood Legs
 30"W x 16½"D x 15⅝"H, Low Wood Legs
 30"W x 16½"D x 18½"H, Medium Wood Legs

HTLSCUWPIL1660LWL
HTLSCUWPIL1630LWL
HTLSCUWPIL1630MWL

41 6.6 \$2536 \$2597 \$2628
 23 5.7 \$2047 \$2098 \$2124
 24 5.7 \$2068 \$2119 \$2144

HOW TO SPECIFY

Select Model Number

H T L S C U W R N D 1 6 L W L .

Select Cutout Option

N No Cutout
G Grommet Cutout (+ \$40)

G .

Select Wood Finish

See page 115



L E 8 5 6 .

Select Paint Color

See page 115

P 7 1

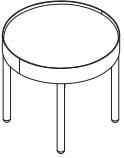
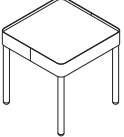
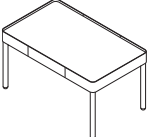

SCULPT™ Tray Top Tables

	DESCRIPTION	MODEL	SHIP WEIGHT	CUBE	LIST PRICE	UPCHARGE BY		
						LAMINATE/P2	PAINT/P2	GRADE/P3
	Round Tray Table Top with Metal Legs							
	18"W x 16 ³ / ₁₆ "H, Low Metal Legs	HTLSCURNDT18LML	37	3.1	\$1223	\$11	\$100	\$150
	18"W x 19 ³ / ₁₆ "H, Medium Metal Legs	HTLSCURNDT18MML	38	3.1	\$1400	\$11	\$118	\$177
	18"W x 22 ³ / ₁₆ "H, High Metal Legs	HTLSCURNDT18HML	39	3.1	\$1421	\$11	\$120	\$180
	30"W x 16 ³ / ₁₆ "H, Low Metal Legs	HTLSCURNDT30LML	53	6.7	\$1575	\$12	\$133	\$199
	Square Tray Table Top with Metal Legs							
	15 ³ / ₄ "W x 15 ³ / ₄ "D x 16 ³ / ₁₆ "H, Low Metal Legs	HTLSCUSQRT16LML	32	3.0	\$1129	\$10	\$93	\$140
	18"W x 18"D x 19 ³ / ₁₆ "H, Medium Metal Legs	HTLSCUSQRT18MML	42	3.1	\$1103	\$10	\$90	\$135
	20 ¹ / ₄ "W x 20 ¹ / ₄ "D x 22 ³ / ₁₆ "H, High Metal Legs	HTLSCUSQRT20HML	41	3.3	\$1367	\$11	\$116	\$173
	30"W x 30"D x 16 ³ / ₁₆ "H, Low Metal Legs	HTLSCUSQRT30LML	55	4.9	\$1455	\$13	\$120	\$181
	Rectangle Tray Table Top with Metal Legs							
	60"W x 18"D x 16 ³ / ₁₆ "H, Low Metal Legs	HTLSCURECT1860LML	64	6.9	\$1461	\$15	\$116	\$175
	30"W x 18"D x 16 ³ / ₁₆ "H, Low Metal Legs	HTLSCURECT1830LML	41	5.8	\$1663	\$18	\$130	\$195
	30"W x 18"D x 19 ³ / ₁₆ "H, Medium Metal Legs	HTLSCURECT1830MML	42	5.8	\$1672	\$18	\$131	\$196
	Pill Tray Table Top with Metal Legs							
	60"W x 18"D x 16 ³ / ₁₆ "H, Low Metal Legs	HTLSCUPILT1860LML	63	7.0	\$1720	\$15	\$143	\$214
	30"W x 18"D x 16 ³ / ₁₆ "H, Low Metal Legs	HTLSCUPILT1830LML	37	5.9	\$1352	\$12	\$110	\$166
	30"W x 18"D x 19 ³ / ₁₆ "H, Medium Metal Legs	HTLSCUPILT1830MML	38	5.9	\$1349	\$12	\$110	\$165

HOW TO SPECIFY

Select Model Number HTLSCURNDT18LML	Select Cutout Option N No Cutout G Grommet Cutout (+ \$40) G	Select Laminate See page 115 H	Select Paint Color See page 115 P71	Select Glide Option G Glide G
---	--	---	--	--

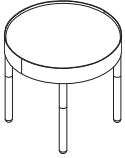
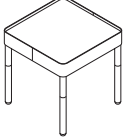
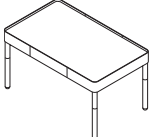
SCULPT™ Tray Top Tables

	DESCRIPTION	MODEL	SHIP WEIGHT	CUBE	LIST PRICE	UPCHARGE BY LAMINATE/PAINT GRADE		
						L2	P2	P3
	Round Tray Table Top with Wood Legs							
	18"W x 16 ³ / ₁₆ "H, Low Wood Legs	HTLSCURNDT18LWL	37	3.1	\$1589	\$11	\$109	\$163
	18"W x 19 ³ / ₁₆ "H, Medium Wood Legs	HTLSCURNDT18MWL	38	3.1	\$1589	\$11	\$106	\$159
	18"W x 22 ³ / ₁₆ "H, High Wood Legs	HTLSCURNDT18HWL	39	3.1	\$1617	\$11	\$106	\$159
	30"W x 16 ³ / ₁₆ "H, Low Wood Legs	HTLSCURNDT30LWL	53	6.7	\$1933	\$12	\$140	\$210
	Square Tray Table Top with Wood Legs							
	15 ³ / ₄ "W x 15 ³ / ₄ "D x 16 ³ / ₁₆ "H, Low Wood Legs	HTLSCUSQRT16LWL	32	3.0	\$1286	\$10	\$81	\$121
	18"W x 18"D x 19 ³ / ₁₆ "H, Medium Wood Legs	HTLSCUSQRT18MWL	42	3.1	\$1277	\$10	\$77	\$115
	20 ¹ / ₄ "W x 20 ¹ / ₄ "D x 22 ³ / ₁₆ "H, High Wood Legs	HTLSCUSQRT20HWL	41	3.3	\$1569	\$11	\$102	\$153
	30"W x 30"D x 16 ³ / ₁₆ "H, Low Wood Legs	HTLSCUSQRT30LWL	55	6.7	\$1843	\$13	\$131	\$197
	Rectangle Tray Table Top with Wood Legs							
	60"W x 18"D x 16 ³ / ₁₆ "H, Low Wood Legs	HTLSCURECT1860LWL	64	6.9	\$1624	\$15	\$105	\$157
	30"W x 18"D x 16 ³ / ₁₆ "H, Low Wood Legs	HTLSCURECT1830LWL	41	5.8	\$1819	\$18	\$117	\$176
	30"W x 18"D x 19 ³ / ₁₆ "H, Medium Wood Legs	HTLSCURECT1830MWL	42	5.8	\$1840	\$18	\$117	\$175
	Pill Tray Table Top with Wood Legs							
	60"W x 18"D x 16 ³ / ₁₆ "H, Low Wood Legs	HTLSCUPILT1860LWL	63	7.0	\$1879	\$15	\$131	\$196
	30"W x 18"D x 16 ³ / ₁₆ "H, Low Wood Legs	HTLSCUPILT1830LWL	37	5.9	\$1503	\$12	\$97	\$146
	30"W x 18"D x 19 ³ / ₁₆ "H, Medium Wood Legs	HTLSCUPILT1830MWL	38	5.9	\$1522	\$12	\$97	\$145

HOW TO SPECIFY

Select Model Number HTLSCURNDT18LWL	Select Cutout Option N No Cutout G Grommet Cutout (+ \$40)	Select Laminate See page 115	Select Wood Leg Finish See page 115	Select Paint Color See page 115
HTLSCURNDT18LWL	G	H	P856	P71

SCULPT™ Personal & Console Tables

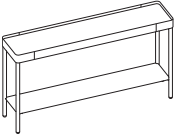
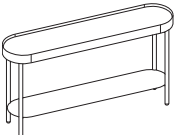
	DESCRIPTION	MODEL	SHIP WEIGHT	CUBE	LIST PRICE	UPCHARGE BY LAMINATE/PAINT GRADE		
						L2	P2	P3
	Personal Table with Metal Base 22"W x 13 ⁷ / ₈ "D x 29 ¹ / ₄ "H	HTLSCUPERTBL	39	8.0	\$890	\$8	\$73	\$109
	Rectangle Console Table with Metal Legs 53"W x 12"D x 28 ¹³ / ₁₆ "H	HTLSCURECCNSL1253	74	6.9	\$2177	\$14	\$190	\$286
	Pill Console Table with Metal Legs 53"W x 12"D x 28 ¹³ / ₁₆ "H	HTLSCUPILCNSL1253	81	6.9	\$2256	\$14	\$198	\$297

HOW TO SPECIFY

Select Model Number HTLSCUPERTBL	Select Laminate See page 115 H	Select Paint Color See page 115 P71
--	---	--

SCULPT™ Planters

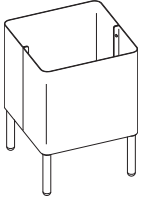

DESCRIPTION	MODEL	SHIP WEIGHT	CUBE	LIST PRICE BY PAINT GRADE		
				P1	P2	P3
Square Planters						
15"W x 15"D x 21 ⁵ / ₁₆ "H, Square Low Planter	HTLSCUSQRPLNT15L	40	4.5	\$1433	\$1576	\$1648
15"W x 15"D x 30 ⁵ / ₁₆ "H, Square High Planter	HTLSCUSQRPLNT15H	50	4.9	\$1779	\$1957	\$2046
30"W x 30"D x 15 ⁵ / ₁₆ "H, Square Low Planter	HTLSCUSQRPLNT30L	60	7.1	\$1704	\$1874	\$1960

NOTES:

- All planters come with a plastic tray insert.
- It is recommended to have all plants in pots for planters to avoid water damage to the product.
- For planning purposes, please see approximate internal dimensions for planters:
 - 15" Square = 11⁵/₁₆"W x 11⁵/₁₆"D x 13¹/₄"H
 - 30" Square = 26⁵/₁₆"W x 26⁵/₁₆"D x 7¹/₄"H

HOW TO SPECIFY

<p>Select Model Number</p> <p>HTLSCUSQRPLNT15L .</p>	<p>Select Paint Color</p> <p>See page 115</p> <p>P71 .</p>	<p>Select Glide Option</p> <p>G Glide</p> <p>G</p>
--	--	--

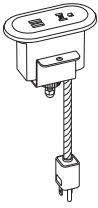

DESCRIPTION

Power Grommet

MODEL

HTGPWRKIA

SHIP WEIGHT

3

CUBE

0.2

LIST PRICE

\$255

HOW TO SPECIFY

Select
Model Number

HTGPWRKIA

Select
Grommet Color

- P Black
- STRM Storm
- SNW Snow

STRM

Select
Cord Color

- STRM Storm

STRM

CROSS REFERENCE BY APPLICATION

	Page
CLASSROOM	
Student Desks	
SmartLink® Student Desks	183-184
Teacher/Administration Desks	
SmartLink® Teacher Stations	189-190
Voi®	<i>See the Desks section in the 2023 Workspaces Pricer.</i>
10700 Series™ ...	<i>See the Desks section in the 2023 Workspaces Pricer.</i>
10500 Series™ ...	<i>See the Desks section in the 2023 Workspaces Pricer.</i>
38000 Series™ ..	<i>See the Desks section in the 2023 Workspaces Pricer.</i>
Seating	
SmartLink® Seating	185-188
Perpetual® Nesting	448-450
Olson Stacker® - 4040 Series	
High-Density	443-444
Motivate® Seating	412-427
Volt® - 5700/5710/5720/5730 Series	494-501
Ignition®/Ignition® 2.0	367-396
Solve®	465-476
Convergence®	306-310
Storage & Files	
Brigade® 800 Series Lateral Files	<i>See the Storage section in the 2023 Workspaces Pricer.</i>
Brigade® 700 Series Lateral Files	<i>See the Storage section in the 2023 Workspaces Pricer.</i>
Brigade® 600 Series Lateral Files	<i>See the Storage section in the 2023 Workspaces Pricer.</i>
Lateral File Accessories	<i>See the Storage section in the 2023 Workspaces Pricer.</i>
310 Series Vertical Files - 26½"D	<i>See the Storage section in the 2023 Workspaces Pricer.</i>
510 Series Vertical Files - 25"D	<i>See the Storage section in the 2023 Workspaces Pricer.</i>
Flagship® Bookcases and Storage Cabinets	<i>See the Storage section in the 2023 Workspaces Pricer.</i>
Brigade® Storage Cabinets	<i>See the Storage section in the 2023 Workspaces Pricer.</i>
Brigade® Steel Bookcases	<i>See the Storage section in the 2023 Workspaces Pricer.</i>
1870 Series Bookcases	<i>See the Storage section in the 2023 Workspaces Pricer.</i>
Tables	
Huddle Multi-Purpose Tables	53-61
Motivate® Tables	68-72
Learning Applications	
SmartLink® Wall Rail System	195-196
Motivate® Mobile Markerboards	72

COMPUTER LAB

Tables	
Huddle Multi-Purpose Tables	53-61
Motivate® Tables	68-72
Between™ Tables	34-37
Seating	
Motivate® Seating	412-427
Perpetual® Nesting	448-450

	Page
CAFETERIA	
Seating	
SmartLink® Seating	185-188
Motivate® Seating	412-427
Olson Stacker® - 4040 Series	
High-Density	443-444
Tables	
Huddle Multi-Purpose Tables	53-61
Motivate® Tables	68-72
Between™ Tables	34-37
COMMON AREAS	
Reception Seating	
Flock® Lounge	326-348
Grove®	353-364
Accommodate®	257-263
Cambia™ - 2160 Series	281-283
Tables	
Huddle Multi-Purpose Tables	53-61
Motivate® Tables	68-72
Laminate Occasional Tables	64
Flock®	46-50
Between™ Tables	34-37
LIBRARY / MEDIA CENTER	
Storage	
Flagship® Bookcases	<i>See the Storage section in the 2023 Workspaces Pricer.</i>
Brigade® Steel Bookcases	<i>See the Storage section in the 2023 Workspaces Pricer.</i>
Reception Seating	
Flock® Lounge	326-348
Grove®	353-364
Accommodate®	257-263
Cambia™ - 2160 Series	281-283
Student Seating	
SmartLink® Seating	185-188
Motivate® Seating	412-427
Accommodate®	257-263
Tables	
Huddle Multi-Purpose Tables	53-61
Motivate® Tables	68-72
Laminate Occasional Tables	64
Flock®	46-50
Between™ Tables	34-37

CROSS REFERENCE BY APPLICATION

	Page
ART ROOM	
Seating	
Motivate® Seating	412-427
Storage	
Flagship® Storage Cabinets	<i>See the Storage section in the 2023 Workspaces Pricer.</i>
Brigade® Storage Cabinets	<i>See the Storage section in the 2023 Workspaces Pricer.</i>
Flagship® Bookcases	<i>See the Storage section in the 2023 Workspaces Pricer.</i>
Brigade® Steel Bookcases	<i>See the Storage section in the 2023 Workspaces Pricer.</i>
1870 Series Bookcases	<i>See the Storage section in the 2023 Workspaces Pricer.</i>
Tables	
Huddle Multi-Purpose Tables	53-61
Motivate® Tables	68-72
TEACHER PLANNING	
Desks	
SmartLink® Teacher Stations	189
Voi®	<i>See the Desks section in the 2023 Workspaces Pricer.</i>
10700 Series™ ...	<i>See the Desks section in the 2023 Workspaces Pricer.</i>
10500 Series™ ...	<i>See the Desks section in the 2023 Workspaces Pricer.</i>
38000 Series™ ..	<i>See the Desks section in the 2023 Workspaces Pricer.</i>
Seating	
Volt® - 5700/5710/5720/5730 Series	494-501
Ignition®/Ignition® 2.0	367-396
Solve®	465-476
Convergence®	306-310
Storage	
Brigade® 800 Series Lateral Files	<i>See the Storage section in the 2023 Workspaces Pricer.</i>
Brigade® 700 Series Lateral Files	<i>See the Storage section in the 2023 Workspaces Pricer.</i>
Brigade® 600 Series Lateral Files	<i>See the Storage section in the 2023 Workspaces Pricer.</i>
Flagship® Lateral Files	<i>See the Storage section in the 2023 Workspaces Pricer.</i>
400 Series Lateral Files	<i>See the Storage section in the 2023 Workspaces Pricer.</i>
Lateral File Accessories	<i>See the Storage section in the 2023 Workspaces Pricer.</i>
210 Series Vertical Files - 28½"D	<i>See the Storage section in the 2023 Workspaces Pricer.</i>
310 Series Vertical Files - 26½"D	<i>See the Storage section in the 2023 Workspaces Pricer.</i>
510 Series Vertical Files - 25"D	<i>See the Storage section in the 2023 Workspaces Pricer.</i>
Vertical File Accessories	<i>See the Storage section in the 2023 Workspaces Pricer.</i>
Flagship® Storage Cabinets	<i>See the Storage section in the 2023 Workspaces Pricer.</i>
Brigade® Storage Cabinets	<i>See the Storage section in the 2023 Workspaces Pricer.</i>
Flagship® Bookcases	<i>See the Storage section in the 2023 Workspaces Pricer.</i>
Brigade® Steel Bookcases	<i>See the Storage section in the 2023 Workspaces Pricer.</i>
1870 Series Bookcases	<i>See the Storage section in the 2023 Workspaces Pricer.</i>

	Page
TEACHER PLANNING (continued)	
Tables	
Huddle Multi-Purpose Tables	53-61
Motivate® Tables	68-72
Flock®	46-50
Between™ Tables	34-37
ADMINISTRATION	
Desks	
10700 Series™ ...	<i>See the Desks section in the 2023 Workspaces Pricer.</i>
10500 Series™ ...	<i>See the Desks section in the 2023 Workspaces Pricer.</i>
38000 Series™ ..	<i>See the Desks section in the 2023 Workspaces Pricer.</i>
Reception Seating	
Cambia™ - 2160 Series	281-283
Task / Administrative Seating	
Ignition®/Ignition® 2.0	367-396
Motivate® Seating	412-427
Volt® - 5700/5710/5720/5730 Series	494-501
Solve®	465-476
Convergence®	306-310
Storage & Files	
Brigade® 800 Series Lateral Files	<i>See the Storage section in the 2023 Workspaces Pricer.</i>
Brigade® 700 Series Lateral Files	<i>See the Storage section in the 2023 Workspaces Pricer.</i>
Brigade® 600 Series Lateral Files	<i>See the Storage section in the 2023 Workspaces Pricer.</i>
Lateral File Accessories	<i>See the Storage section in the 2023 Workspaces Pricer.</i>
310 Series Vertical Files - 26½"D	<i>See the Storage section in the 2023 Workspaces Pricer.</i>
510 Series Vertical Files - 25"D	<i>See the Storage section in the 2023 Workspaces Pricer.</i>
Flagship® Bookcases and Storage Cabinets	<i>See the Storage section in the 2023 Workspaces Pricer.</i>
Brigade® Storage Cabinets	<i>See the Storage section in the 2023 Workspaces Pricer.</i>
Brigade® Steel Bookcases	<i>See the Storage section in the 2023 Workspaces Pricer.</i>
1870 Series Bookcases	<i>See the Storage section in the 2023 Workspaces Pricer.</i>
Tables	
Huddle Multi-Purpose Tables	53-61
Motivate® Tables	68-72
Flock®	46-50
Between™ Tables	34-37
Occasional Tables	
Laminate Occasional Tables	64
Flock®	46-50



Build™ Student Desks and Tables shown
with SmartLink® Seating and Storage.

BUILD™

Inspiring the next generation takes a higher degree of mobility and hands-on learning. The Build™ series, an educational product collection of tables, student desks, and seating, is lightweight, durable, reconfigurable, and customizable. Build encourages creativity and adaptability so students can support collaboration and social interaction or create personal space for focused study time. Build supports the movers and shakers, the hands-on doers, and the leaders who crave creativity. The future of education takes shape with Build.



FEATURES

- 15 table shapes and 6 student desk shapes make reconfiguration fun and easy.
- In addition to all standard HON laminates, Build tops are available in bright, bold laminates and a dry-erase markerboard finish to enhance any learning environment. Or try Butcher Block tops on Makerspace tables.
- Table legs are available in multiple height adjustable ranges and nesting bases to accommodate different user applications.
- Adjustable height student desk legs accommodate any students in K-12 grades and beyond.
- The durable Makerspace table features à la carte storage accessories and allows you to keep a creative space clean, organized, and customizable.

BUILD™ ORDERING INFORMATION

LAMINATE GROUP A (TOP LAMINATES)

L1 LAMINATES CODES

Woodgrain

- ◆ Bourbon Cherry H
- ◆ Cognac COGN
- ◆ Field Elm LWFE
- ◆ Florence Walnut LFW1
- ◆ Harvest C
- ◆ Kingswood Walnut LK11
- ◆ Loft LOFT
- ◆ Mahogany N
- ◆ Mocha MOCH
- ◆ Natural Maple D
- ◆ Pinnacle PINC
- ◆ Shaker Cherry F
- ◆ Sterling Ash LSA1

Solid

- ◆ Black P
- ◆ Charcoal S
- ◆ Designer White LDW1
- ◆ Loft LOFT

Patterned

- ◆ Handspun Chestnut LAHC
- ◆ Handspun Dove LAHD
- ◆ Handspun Pearl LAHP
- ◆ Handspun Slate LAHS
- ◆ Silver Mesh B9
- ◆ Steel Mesh A9
- ◆ Battleship LBT1
- ◆ Gray G2
- ◆ Moroccan LMN1
- ◆ Mushroom LMH1
- ◆ Neon Carrot LNC1
- ◆ Tennis Ball LTB1
- ◆ White G1

L2 LAMINATES CODES

Woodgrain

- ◆ Beigewood LWBE
- ◆ Fawn Cypress LFC1
- ◆ Lowell Ash LLA1
- ◆ Natural Recon LNR1
- ◆ Phantom Ecru LPE1
- ◆ Portico Teak LPT1
- ◆ Skyline Walnut LSW1

L4 LAMINATES CODES

- ◆ White Markerboard FMQ1

LAMINATE GROUP B (SHELF LAMINATES)

L1 LAMINATES CODES

Woodgrain

- ◆ Bourbon Cherry H
- ◆ Cognac COGN
- ◆ Field Elm LWFE
- ◆ Florence Walnut LFW1
- ◆ Harvest C
- ◆ Kingswood Walnut LK11
- ◆ Mahogany N
- ◆ Natural Maple D
- ◆ Pinnacle PINC
- ◆ Shaker Cherry F
- ◆ Sterling Ash LSA1

Solid

- ◆ Black P
- ◆ Charcoal S
- ◆ Designer White LDW1
- ◆ Loft LOFT

L2 LAMINATES CODES

Woodgrain

- ◆ Beigewood LWBE
- ◆ Fawn Cypress LFC1
- ◆ Lowell Ash LLA1
- ◆ Natural Recon LNR1
- ◆ Phantom Ecru LPE1
- ◆ Portico Teak LPT1
- ◆ Skyline Walnut LSW1

PAINT GROUP A (TABLE AND STUDENT DESK LEG PAINT)

PAINT CODES

- P1**
- ◆ Black P
- P2**
- ◆ Platinum Metallic T1

PAINT GROUP B (MAKERSPACE TABLE BASE AND STOOL)

PAINT CODES

P1

- ◆ Black P
- ◆ Brownstone P7D
- ◆ Charcoal S
- ◆ Designer White PJW
- ◆ Fossil P28
- ◆ Greige T5
- ◆ Loft LOFT
- ◆ Muslin T3
- ◆ Titanium P8T

P2

- ◆ Champagne Metallic T4
- ◆ Platinum Metallic T1
- ◆ Silver PR6

P3

- ◆ Atom P8S
- ◆ Bullseye PJF
- ◆ Ember P8P
- ◆ Ion P8N
- ◆ Iris P8J
- ◆ Krypton P8F
- ◆ Regatta P8M

PAINT GROUP C (MAKERSPACE TABLE END PANEL)

PAINT CODES

P1

- ◆ Black P
- ◆ Brownstone P7D
- ◆ Charcoal S
- ◆ Designer White PJW
- ◆ Fossil P28
- ◆ Greige T5
- ◆ Loft LOFT
- ◆ Muslin T3
- ◆ Titanium P8T

P2

- ◆ Champagne Metallic T4
- ◆ Platinum Metallic T1
- ◆ Silver PR6

P3

- ◆ Atom P8S
- ◆ Bullseye PJF
- ◆ Ember P8P
- ◆ Ion P8N
- ◆ Iris P8J
- ◆ Krypton P8F
- ◆ Regatta P8M

P6

- ◆ Markerboard MKB

MAKERSPACE BUTCHER BLOCK

- ◆ Butcher Block LH903

EDGE

EDGE CODES

Woodgrain

- ◆ Beigewood DE
- ◆ Cognac COGN
- ◆ Fawn Cypress FC
- ◆ Field Elm FE
- ◆ Florence Walnut FW
- ◆ Kingswood Walnut KI
- ◆ Lowell Ash DL
- ◆ Mahogany N
- ◆ Mocha MOCH
- ◆ Natural Maple D
- ◆ Natural Recon NR
- ◆ Phantom Ecru PE
- ◆ Pinnacle PINC
- ◆ Portico Teak DP
- ◆ Shaker Cherry F
- ◆ Skyline Walnut SW
- ◆ Sterling Ash SA















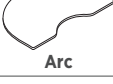

Solid

- ◆ Atom AT
- ◆ Black P
- ◆ Brownstone EY
- ◆ Bullseye BY
- ◆ Charcoal S
- ◆ Designer White DW
- ◆ Ember MR
- ◆ Fossil EH
- ◆ Greige R
- ◆ Ion IO
- ◆ Iris IR
- ◆ Krypton KT
- ◆ Loft LOFT
- ◆ Muslin T
- ◆ Platinum K
- ◆ Regatta RE

◆◆◆ For lead time information see page 21.

BUILD™ Shape Matrix

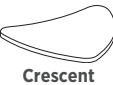
EDUCATION

Top Shape/Model	Tables				Student Desks
	Youth Height Leg Adjusts 13"-18"	Standard Height Leg Adjusts 22"-34"	Standing Height Leg Adjusts 30"-42"	Nesting Base	Seated Height Leg Adjusts 22"-34"
 Kite	X	X	X		
 Ribbon	X	X	X	X	X
 Wisp	X	X	X		
 Snap	X	X	X		
 Rectangle	X	X	X		X
 Half-Round	X	X	X		
 Arc	X	X	X		
 Round	X	X	X		
 Square	X	X	X		
 Trapezoid	X	X	X		X
 Horseshoe	X	X	X		
 Home Plate	X	X	X		
 Spooky	X	X	X	X	X
 Tide	X	X	X		
 Dart	X	X	X	X	
 Crescent					X
 Fin					X

Snap



3 PEOPLE/1 TABLE

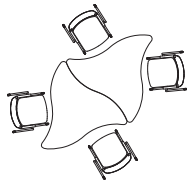

4 PEOPLE/2 TABLES

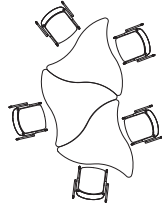

5 PEOPLE/3 TABLES

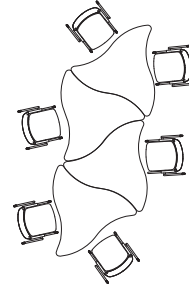

6 PEOPLE/4 TABLES

Tide

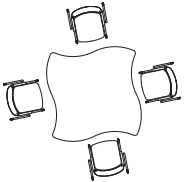

4 PEOPLE/1 TABLE

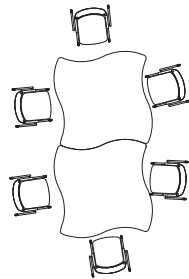

6 PEOPLE/2 TABLES

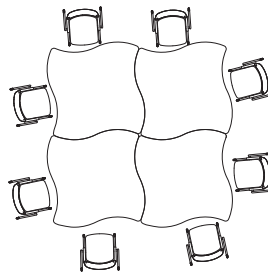

8 PEOPLE/4 TABLES

Kite



2 PEOPLE/1 TABLE

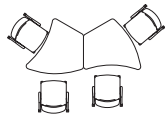

4 PEOPLE/2 TABLES

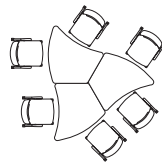

6 PEOPLE/3 TABLES

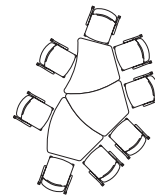

8 PEOPLE/3 TABLES

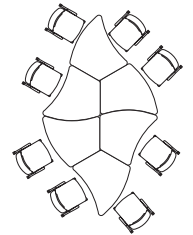

8 PEOPLE/6 TABLES

Dart

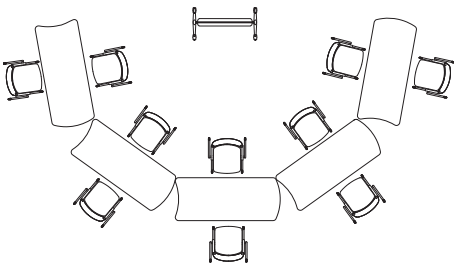

10 PEOPLE/5 TABLES

BUILD™ Table Configurations

EDUCATION

Wisp



Ribbon

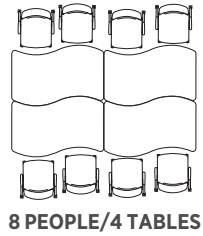
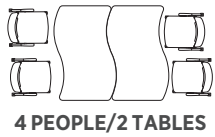
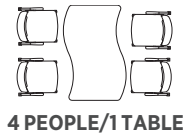

Home Plate

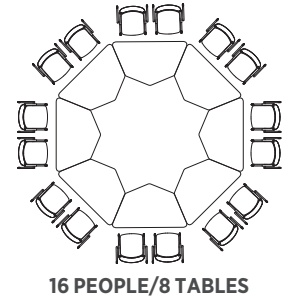
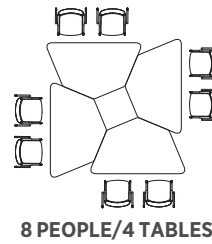
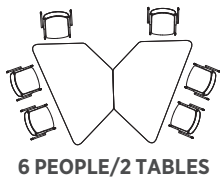

Horseshoe



Spooky



2 PEOPLE/1 TABLE

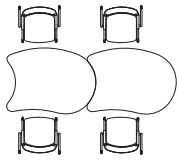

4 PEOPLE/2 TABLES

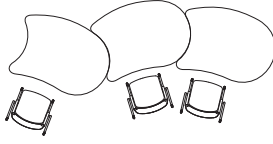

3 PEOPLE/3 TABLES

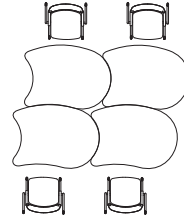

4 PEOPLE/4 TABLES

Combinations

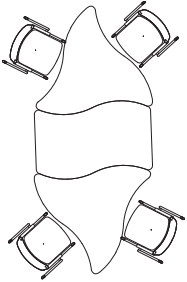

4 PEOPLE/3 TABLES
Ribbon and Snap

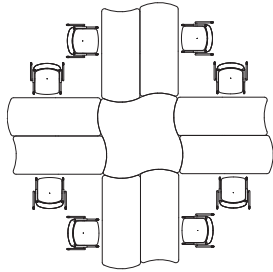

8 PEOPLE/9 TABLES
Tide and Dart

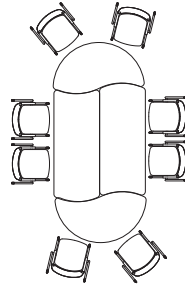

8 PEOPLE/4 TABLES
Dart and Wisp





BUILD™ Table Tops

GSA SIN 33721 EXCEPT AS NOTED

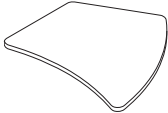

Icon Legend on page 19

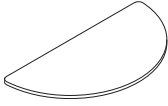
EDUCATION

	DESCRIPTION	MODEL	LEGS REQUIRED	SHIP WEIGHT	CUBE	LIST PRICE BY LAMINATE GRADE		
						L1	L2	L4
	Snap Table Top 54"W x 34"D	HESNP54E	3	46	2.8	\$588	\$613	\$659
OPEN MARKET								
	Kite Table Top 40"W x 24"D	HESA2440E*	4	30	3.9	\$564	\$580	\$612
	50"W x 30"D	HESA3050E	4	50	5.8	\$588	\$609	\$651
	Wisp Table Top 54"W x 30"D	HESN3054E	4	63	4.6	\$569	\$590	\$632
	Half-Round Table Top 60"W x 30"D	HESH3060E	4	69	6.0	\$543	\$564	\$606
	Spooky Table Top 36"W x 54"D	HESY3654E	4	61	14.4	\$509	\$530	\$571
OPEN MARKET								
	Ribbon Table Top 54"W x 30"D	HESW3054E	4	65	5.4	\$507	\$528	\$570

NOTES:





- Quick set bracket factory installed for easy leg location and installation.
- ⓘ Top and legs specified separately. Table tops compatible only with leg models on page 137.

* OPEN MARKET

HOW TO SPECIFY

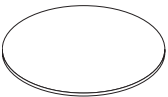
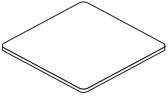
Select Model Number H E S H 3 0 6 0 E .	Select Grommet N No Grommet	Select Top Laminate See page 129, Group A L D W 1 .	Select Edge Color See page 129 D W
---	---------------------------------------	--	---

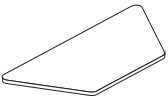
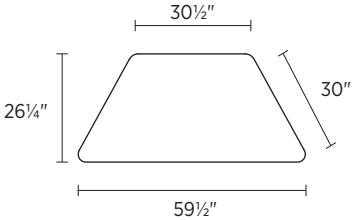

	DESCRIPTION	MODEL	LEGS REQUIRED	SHIP WEIGHT	CUBE	LIST PRICE BY LAMINATE GRADE		
						L1	L2	L4
	Rectangle Table Top							
	48"W x 24"D	HETR2448E	4	71.0	3.6	\$431	\$447	\$479
	60"W x 24"D	HETR2460E	4	57.0	4.4	\$478	\$499	\$541
	72"W x 24"D	HETR2472E	4	68.0	4.9	\$528	\$549	\$591
	48"W x 30"D	HETR3048E	4	62.0	4.4	\$450	\$466	\$498
	60"W x 30"D	HETR3060E	4	71.0	5.4	\$492	\$513	\$555
	72"W x 30"D	HETR3072E	4	85.0	4.9	\$563	\$584	\$626
	Round Table Top							
	42" Diameter	HERD42E	4	51.0	4.7	\$385	\$401	\$431
	48" Diameter	HERD48E	4	66.0	6.1	\$434	\$452	\$487
	Square Table Top							
	36"W x 36"D	HESQ36E	4	46.0	3.7	\$328	\$342	\$368
	42"W x 42"D	HESQ42E	4	61.0	4.9	\$420	\$437	\$471
	48"W x 48"D	HESQ48E	4	76.0	6.2	\$459	\$478	\$515
	Tide Table Top	HETD54E	4	106.0	9.2	\$721	\$751	\$807
	54"W x 54"D							
	Trapezoid Table Top	HETZ3060E	4	58.1	4.8	\$407	\$424	\$457
								
	Home Plate Table Top	HEHP3660E	4	64.0	15.9	\$492	\$513	\$555
	36"W x 60"D							

NOTES:

- Quick set bracket factory installed for easy leg location and installation.

! Top and legs specified separately. Table tops compatible only with leg models on page 137.

HOW TO SPECIFY

Select Model Number H E T R 2 4 4 8 E	Select Grommet N No Grommet N	Select Top Laminate See page 129, Group A L D W 1	Select Edge Color See page 129 D W
---	--	--	---



BUILD™ Table Tops

OPEN MARKET

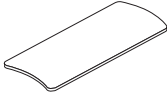

Icon Legend on page 19

EDUCATION

	DESCRIPTION	MODEL	LEGS REQUIRED	SHIP WEIGHT	CUBE	LIST PRICE BY LAMINATE GRADE		
						L1	L2	L4
	Dart Table Top 66"W x 27"D	HEDRT2766E	4	86	4.3	\$515	\$536	\$577
	Arc Table Top 72"W x 48"D	HESKD4872E	4	112	8.2	\$823	\$844	\$886
	Horseshoe Table Top 60"W x 66"D	HESH6066E	4	103	21.7	\$977	\$1019	\$1103



NOTES:

- Quick set bracket factory installed for easy leg location and installation.
- ! Top and legs specified separately. Table tops compatible only with leg models on page 137.

HOW TO SPECIFY

<p>Select Model Number</p> <p>H E S H 6 0 6 6 E .</p>	<p>Select Grommet</p> <p>N No Grommet</p> <p>N .</p>	<p>Select Top Laminate</p> <p>See page 129, Group A</p> <p>L D W 1 .</p>	<p>Select Edge Color</p> <p>See page 129</p> <p>D W</p>
--	---	---	--

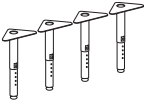
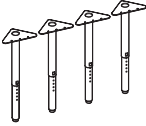

	DESCRIPTION	MODEL	HEIGHT RANGE	SHIP WEIGHT	CUBE	LIST PRICE P1/P2
	Build™ Table Adjustable Height Leg Pack Youth Height Legs, Pack of 4	HEBY4LEG	13"-18"	19	0.9	\$185
	Build™ Table Adjustable Height Leg Pack Standard Table Height Legs, Pack of 4	HEB4LEG	22"-34"	19	1.2	\$244
	Build™ Table Adjustable Height Leg Pack Standing Height Legs, Pack of 4	HEBS4LEG	30"-42"	25	2.2	\$300

NOTES:

- Specify paint for upper portion of leg. Bottom is chrome.

❗ Compatible only with top models on pages 134-136.

CASTER COMPATIBILITY CHART		
	Yes	No
Standing		X
Youth	X	
Table	X	

❗ See pages 134-136 for number of legs required per top. Legs always ship 4 per carton. Use chart below for quantity of 4-leg packs required for shapes that utilize three legs.

DESKS	LEGS NEEDED	ADJUSTABLE POST LEGS 4-PACKS
1	3	1
2	6	2
3	9	3
4	12	3
5	15	4
6	18	5
7	21	6
8	24	6
9	27	7
10	30	8

HOW TO SPECIFY

<p>Select Model Number</p> <p>HEBS4LEG.</p>	<p>Select Paint Color</p> <p>See page 129, Paint Group A</p> <p>T1</p>
--	---

BUILD™ Nesting Tables

GSA SIN 33721 EXCEPT AS NOTED



Icon Legend on page 19

EDUCATION



DESCRIPTION

Dart Table with Nesting Base
66"W x 27"D

MODEL

HEDRT-2766E-NS

SHIP WEIGHT

113

CUBE

8.7

LIST PRICE BY LAMINATE GRADE

L1

\$1382

L2

\$1403

L4

\$1444

NOTES: Ribbon, Wisp, Snap, Tide and Dart can all be used together.

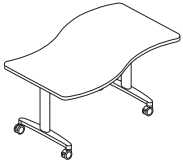

Ribbon Nesting Table
54"W x 30"D

HESW-3054E-NS

89

8.1

\$1386

\$1407

\$1449



Spooky Nesting Table
54"W x 36"D

HESY-3654E-NS

85

17.1

\$1392

\$1413

\$1454

DESCRIPTION

Nesting Spacer Kit

MODEL

HESPCR

SHIP WEIGHT

2 Ⓞ

CUBE

0.1

LIST PRICE

\$65

NOTES: Use with Build™ standard height post legs and nesting bases to create even table heights. Specify 1 kit per nesting table.

ⓘ Available in P Black only. Specify: HESPCR.P.

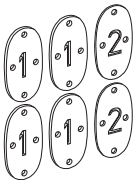

OPEN MARKET





NOTES:

ⓘ Nesting bases are not intended to be used in combination with youth, standing, or desk post-legs.

ⓘ Nesting bases have a height difference of 1/2" when used with Build™ Standard Table Height Post Leg models. Use Nesting Spacer Kit HESPCR to create even table heights.

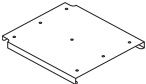
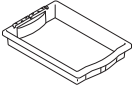
<p>Select Model Number</p> <p>H E D R T - 2 7 6 6 E - N S .</p>	<p>Select Grommet</p> <p>N No Grommet</p> <p>N .</p>	<p>Select Laminate Color</p> <p>See page 129, Group A</p> <p>L B A 1 .</p>	<p>Select Edge Color</p> <p>See page 129</p> <p>K .</p>	<p>Select Caster</p> <p>C Caster ONLY</p> <p>C .</p>	<p>Select Paint Color</p> <p>See page 129, Paint Group A</p> <p>T 1</p>
--	---	---	--	---	--



	DESCRIPTION	MODEL	SHIP WEIGHT	CUBE	LIST PRICE
 OPEN MARKET	Book Box Bracket NOTES: Use with HFMBIN3 trays. Specify 1 bracket per tray. For full book box solution specify both HEBBXRL and HFMBIN3. ⓘ Available in P Black only. No specification needed. ⓘ Minimum mounting clearance required: 13½"W x 15"D. ⓘ Book Box Bracket rated up to 25 lbs.	HEBBXRL	2.1	0.6	\$53
 SIN 33721	Accessories — Tray Kit 3"H, 2 bins and 4 rails NOTES: For full book box solution specify both HEBBXRL and HFMBIN3. (1) HFMBIN3 needed for every (2) HEBBXRL as bins are ordered in a set of 2. ⓘ Semi-translucent white. No specification needed. ⓘ Bins ship with rails intended for use in storage. When bins are used with Book Box Bracket, rails will not be used.	HFMBIN3	7.0 ⓘ	4.0	\$77
 SIN 33721 	Locking Casters, 4-Pack <ul style="list-style-type: none"> • Black only • 4 casters per pack • Caster pack adds 1⅞" to the overall height. • All casters lockable • Threaded attachment bolts • Can retrofit on Build™ units with glides. ⓘ For use on youth and standard table post legs only. * On 4-leg Build™ tables, can utilize 2 casters and 2 glides for easy repositioning of tables.	HHABCASTER*	1.0	0.1	\$90
 SIN 33721	Ganging Hardware <ul style="list-style-type: none"> • Includes two ganging links and two screws • No color designator when specifying. <i>Example: HMAGANG.</i> 	HMAGANG	1.0 ⓘ	0.1	\$135
 OPEN MARKET    	Back Pack Hook (10 per carton) 12"W x 14½"D x 1½"H NOTES: Attaches to bottom of surface with 2 screws, included. ⓘ Available in Platinum Metallic finish only, no specification needed. ⓘ Back Pack Hook rated up to 25 lbs.	HCLA65	10.0 ⓘ	0.1	\$119

HOW TO SPECIFY

Select Model Number

H H A B C A S T E R

BUILD™ Student Desk Surface Dimensions

EDUCATION

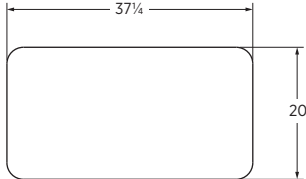
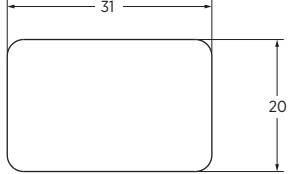
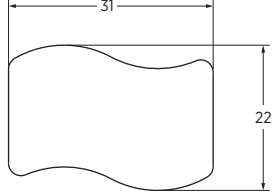
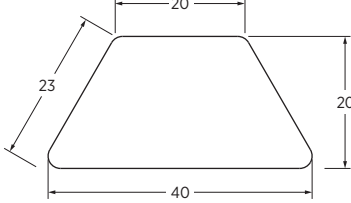
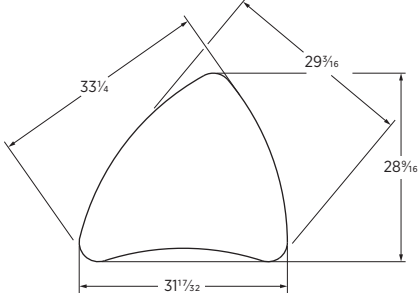
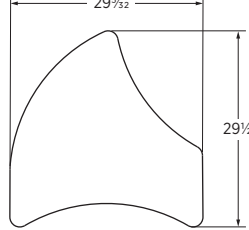
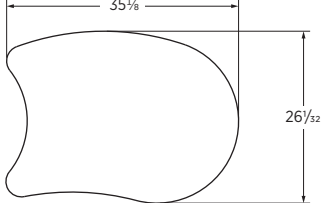
Name	Model	Dimensions
Rectangle	HBSDRECT2038	
Rectangle	HBSDRECT2031	
Ribbon	HBSDRBN2231	
Trapezoid	HBSDTRP2040	
Crescent	HBSDCSNT2832	
Fin	HBSDFN3030	
Spooky	HBSDSPY2636	

BUILD™ Student Desk Configurations

EDUCATION

Fin

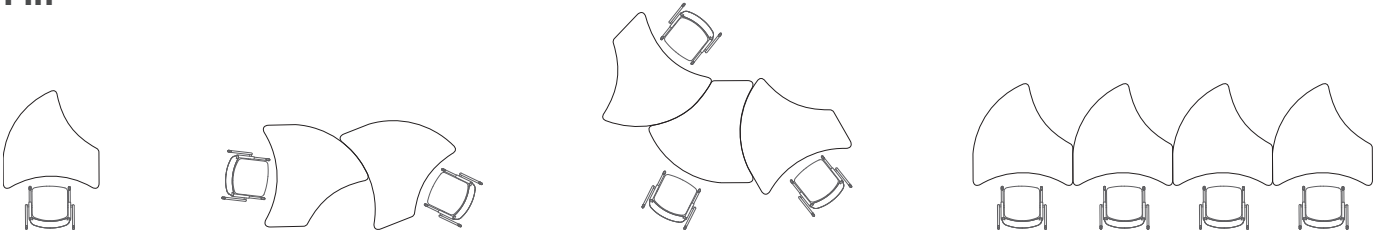

Crescent

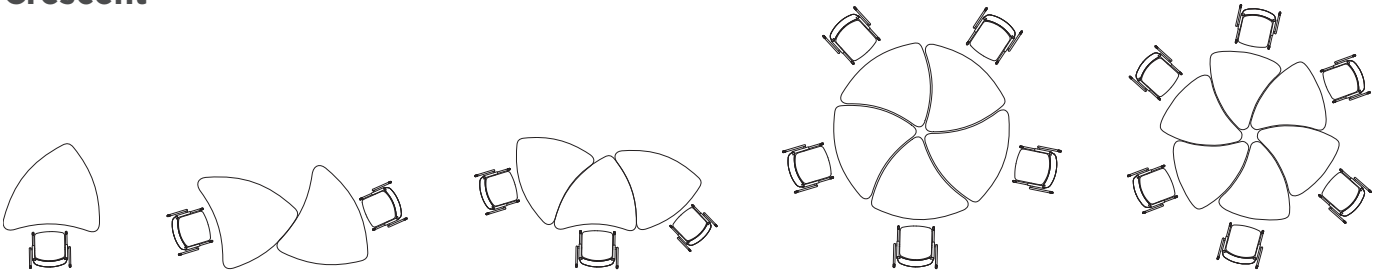

Trapezoid

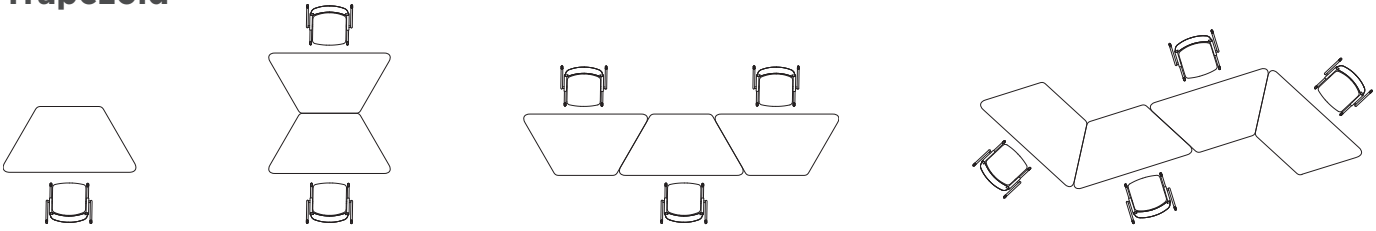

Spooky

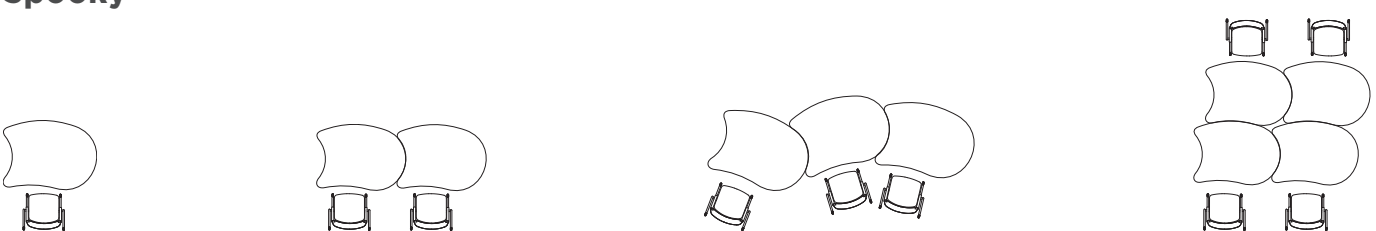

BUILD™ Student Desk Configurations

Rectangle

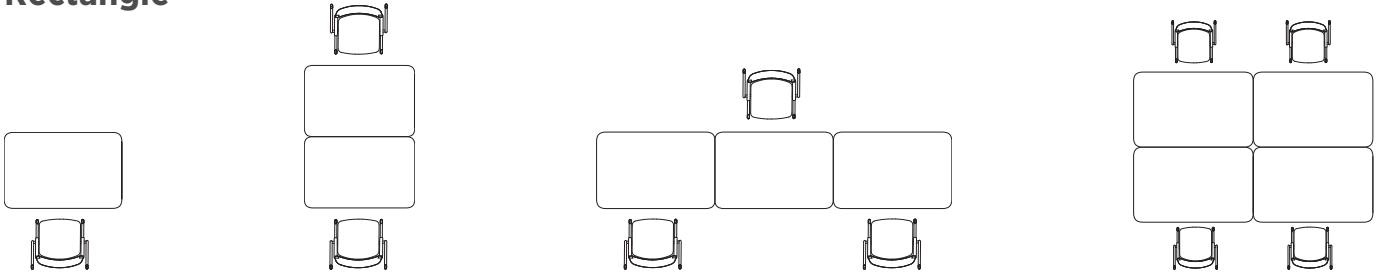



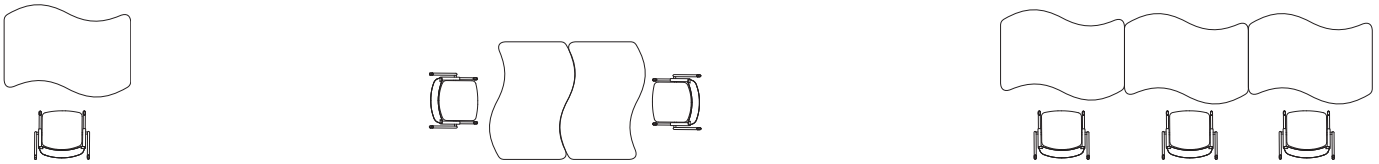



Ribbon

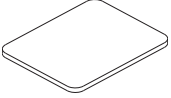



BUILD™ Student Desks

	DESCRIPTION	MODEL	LEGS REQUIRED	SHIP WEIGHT	CUBE	LIST PRICE BY LAMINATE GRADE		
						L1	L2	L4
 HBSDRECT2038	Rectangle Student Desk Top 31"W x 20"D	HBSDRECT2031	4	29	2.4	\$218	\$228	\$246
	38"W x 20"D	HBSDRECT2038*	4	33	2.0	\$222	\$232	\$251
	30"W x 24"D	HBSDRECT2430	4	27	2.2	\$220	\$230	\$249
 HBSDRECT2430	* HBSDRECT2038 desk is wheelchair friendly. ! HBSDRECT2430 can be used with casters to create a mobile student desk. Order student desk leg model number HEBSD4LEG and HHABCASTER. Casters are field installable. HBSDRECT2031 and HBSDRECT2038 are not compatible with casters as they do not pass BIFMA when used with casters.							
	Trapezoid Student Desk Top 40"W x 20"D	HBSDTRP2040	4	29	5.8	\$250	\$261	\$282
	Ribbon Student Desk Top 31"W x 22"D	HBSDRBN2231	4	27	2.2	\$222	\$232	\$251
	Spooky Student Desk Top 36"W x 26"D	HBSDSPY2636	4	32	6.5	\$250	\$261	\$282
	Fin Student Desk Top 30"W x 30"D	HBSDFN3030	3	26	5.7	\$246	\$257	\$278
	Crescent Student Desk Top 32"W x 28"D	HBSDCSNT2832	3	28	5.7	\$246	\$257	\$278

NOTES:

- Top and legs specified separately.
- ! Desk tops compatible only with legs shown on page 144.

HOW TO SPECIFY

<p>Select Model Number</p> <p>H B S D R B N 2 2 3 1 .</p>	<p>Select Grommet</p> <p>N No Grommet</p> <p>N .</p>	<p>Select Top Laminate</p> <p>See page 129, Group A</p> <p>L D W 1 .</p>	<p>Select Edge Color</p> <p>See page 129</p> <p>D W</p>
---	--	--	---

BUILD™ Student Desks

OPEN MARKET



Icon Legend on page 19

DESCRIPTION

Student Desk Leg, 4-Pack

MODEL

HEBSD4LEG

HEIGHT RANGE

22"-34"

SHIP WEIGHT

15

CUBE

1.1

LIST PRICE P1/P2

\$222



NOTES:

• Specify paint for upper portion of leg. Bottom is chrome.

❗ Casters can only be used when specifying student desk worksurface model HBSDRECT2430. Specify HHABCASTER for caster pack. Casters are field installable. Other Build™ student desk sizes and shapes do not pass BIFMA when used with casters.

❗ See page 143 for number of legs required per top. Legs always ship 4 per carton. Use chart below for quantity of 4-leg packs required for shapes that utilize three legs.

❗ Student Desk Legs compatible only with Student Desk Tops shown on page 143.

DESKS	LEGS NEEDED	ADJUSTABLE POST LEGS 4-PACKS
1	3	1
2	6	2
3	9	3
4	12	3
5	15	4
6	18	5
7	21	6
8	24	6
9	27	7
10	30	8

HOW TO SPECIFY

Select
Model Number

Select
Paint Color

See page 129, Paint Group A

H E B S D 4 L E G . T 1

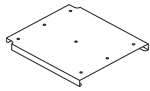

OPEN MARKET

DESCRIPTION

Book Box Bracket

NOTES: Use with HFMBIN3 trays. Specify 1 bracket per tray. For full book box solution specify both HEBBXRL and HFMBIN3.

- ⚠ Available in P Black paint only.
- ⚠ Minimum mounting clearance required: 13½"W x 15"D.
- ⚠ Book Box Bracket rated up to 25 lbs.

MODEL

HEBBXRL

SHIP WEIGHT

2.1

CUBE

0.6

LIST PRICE

\$53

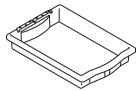

SIN 33721

Accessories — Tray Kit

3"H, 2 bins and 4 rails

NOTES: For full book box solution specify both HEBBXRL and HFMBIN3. (1) HFMBIN3 needed for every (2) HEBBXRL as bins are ordered in a set of 2.

- ⚠ Semi-translucent white. No specification needed.
- ⚠ Bins ship with rails intended for use in storage. When bins are used with Book Box Bracket, rails will not be used.

HFMBIN3

7.0 **Ⓢ**

4.0

\$77

NOTES:

- Front and rear handles are integrated for easy handling/transport.

DESCRIPTION

Back Pack Hook (10 per carton)

12"W x 14½"D x 1½"H

NOTES: Attaches to bottom of surface with 2 screws, included.

- ⚠ Available in Platinum Metallic finish only, no specification needed.
- ⚠ Back Pack Hook rated up to 25 lbs.

MODEL

HCLA65

SHIP WEIGHT

10 **Ⓢ**

CUBE

0.1

LIST PRICE

\$119

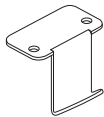

OPEN MARKET



HOW TO SPECIFY

Select Model Number	Select Paint Color
H E B B X R L .	P

BUILD™ Makerspace Table

GSA SIN 33721



Icon Legend on page 19

EDUCATION



DESCRIPTION	MODEL	SHIP WEIGHT	CUBE	LIST PRICE	UPCHARGE BY LAMINATE/PAINT GRADE				
					L2	L4	P2	P3	
Seated-Height Table with Laminate Top									
60"W x 42"D x 29"H	HEMKR426029L	153	9.4	\$2087	\$36	\$105	\$34	\$55	
72"W x 42"D x 29"H	HEMKR427229L	169	9.7	\$2275	\$43	\$129	\$34	\$55	
Seated-Height Table with Butcher Block Top									
60"W x 42"D x 29"H	HEMKR426029BB	179	9.9	\$2955	N/A	N/A	\$34	\$55	
72"W x 42"D x 29"H	HEMKR427229BB	201	10.4	\$3288	N/A	N/A	\$34	\$55	



Counter-Height Table with Laminate Top									
60"W x 42"D x 36"H	HEMKR426036L	158	10.4	\$2120	\$36	\$105	\$34	\$56	
72"W x 42"D x 36"H	HEMKR427236L	174	10.8	\$2308	\$43	\$129	\$34	\$56	
Counter-Height Table with Butcher Block Top									
60"W x 42"D x 36"H	HEMKR426036BB	184	11.0	\$2988	N/A	N/A	\$34	\$56	
72"W x 42"D x 36"H	HEMKR427236BB	213	12.9	\$3321	N/A	N/A	\$34	\$56	



Standing-Height Table with Laminate Top									
60"W x 42"D x 42"H	HEMKR426042L	173	11.4	\$2156	\$36	\$105	\$35	\$58	
72"W x 42"D x 42"H	HEMKR427242L	189	11.7	\$2344	\$43	\$129	\$35	\$58	
Standing-Height Table with Butcher Block Top									
60"W x 42"D x 42"H	HEMKR426042BB	199	11.9	\$3024	N/A	N/A	\$35	\$58	
72"W x 42"D x 42"H	HEMKR427242BB	221	12.4	\$3357	N/A	N/A	\$35	\$58	

NOTES:

- Laminate top is 1/8" thick and features 3" radius corners.
- Butcher Block top is 1 1/2" thick and features 1/2" radius corners with 1/8" radius around entire perimeter of top.
- Butcher Block tops will naturally feature variation between tops due to the nature of the real wood finish. Constructed of natural Birch wood, no two tops are exactly alike. Top is coated in a clear polyurethane finish for maximum durability.
- Both laminate and Butcher Block tops include threaded metal inserts for easy base connection. This also allows for easy base removal and reconnection if table needs to be moved through standard doorways.
- Up to 4 SmartLink® bins will fit between lower foot rails on standing-height table if desired. Applicable on counter height and standing height tables.
- HEBBXRL is not compatible with Makerspace tables.

HOW TO SPECIFY

Select Model Number H E M K R 4 2 7 2 2 9 L	Select Grommet N No Grommet	Select Laminate Color See page 129, Group A L S A 1	Select Edge Color See page 129 S A	Select Caster C Casters	Select Paint Color See page 129, Paint Group B P
---	---------------------------------------	--	---	-----------------------------------	---

Select Model Number H E M K R 4 2 7 2 2 9 B B	Select Grommet N No Grommet	Select Wood LH903 Butcher Block L H 9 0 3	Select Caster C Casters	Select Paint Color See page 129, Paint Group B P
---	---------------------------------------	--	-----------------------------------	---

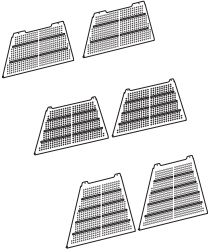
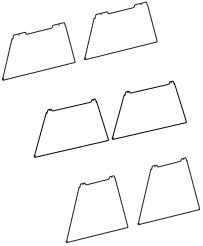

BUILD™ Makerspace Table

	DESCRIPTION	MODEL	SHIP WEIGHT	CUBE	LIST PRICE BY PAINT GRADE			
					P1	P2	P3	P6
	Slotted/Pegboard End Panels For Seated-Height (2/pack)	HEMKREND29-SP	29	2.6	\$539	\$554	\$562	\$631
	For Counter-Height (2/pack)	HEMKREND36-SP	29	2.7	\$602	\$618	\$629	\$705
	For Standing-Height (2/pack)	HEMKREND42-SP	33	3.3	\$671	\$689	\$701	\$785
	Solid Full End Panels For Seated-Height (2/pack)	HEMKREND29-F	29	2.6	\$539	\$554	\$562	\$631
	For Counter-Height (2/pack)	HEMKREND36-F	29	2.7	\$602	\$618	\$629	\$705
	For Standing-Height (2/pack)	HEMKREND42-F	33	3.3	\$671	\$689	\$701	\$785

NOTES:

- Panels ship 2 per carton.
- Slotted/pegboard end panels accept Fuse™ hanging accessories or any standard ¼" pegboard accessory.
- End panels are magnetic.
- End panels feature welded vertical stiffener on inside of panel for maximum rigidity.
- End panels are installed after table is fully built allowing you to add on to table base at a later date if desired.
- End panels are non-handed.

STANDING-HEIGHT TABLES

Top Slot	8¾"W
2nd Slot	10¼"W
3rd Slot	11¾"W
4th Slot	13¼"W

SEATED HEIGHT TABLES

Top Slot	12¼"W
Bottom Slot	13¾"W

HOW TO SPECIFY

Select Model Number	Select Paint Color See page 129, Paint Group C
H E M K R E N D 2 9 - S P .	P

BUILD™ Makerspace Table

GSA SIN 33721



Icon Legend on page 19

EDUCATION

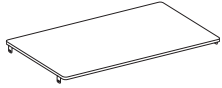

DESCRIPTION	MODEL	SHIP WEIGHT	CUBE	LIST PRICE	UPCHARGE BY LAMINATE/PAIN T GRADE		
					L2	P2	P3
Makerspace Table Shelf 50½"W x 31"D	HEMKRSHELF	39	1.1	\$779	\$22	\$8	\$12

! For use with standing-height tables only.

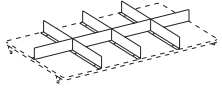

DESCRIPTION	MODEL	SHIP WEIGHT	CUBE	LIST PRICE BY PAINT GRADE		
				P1	P2	P3
Shelf Divider	HEMKRDIVIDER	10	0.6	\$195	\$201	\$204

! Shelf Divider (HEMKRDIVIDER) is only to be used when HEMKRSHELF is specified. HEMKRDIVIDER cannot be used as a stand-alone item. For use on standing-height tables only.

NOTES:

- Shelves are ¾" thick thermal-fused laminate with 1mm edgeband. Edge color is predetermined by and matches laminate selection.
- Shelf can be used with or without divider (specified separately).
- Shelf always contains small pilot through-holes for shelf divider installation.

HOW TO SPECIFY

<p>Select Model Number</p> <p>HEMKRSHELF</p>	<p>Select Laminate Color</p> <p>See page 129, Laminate Group B</p> <p>LDW1</p>	<p>Select Paint Color</p> <p>See page 129, Paint Group B</p> <p>P</p>
--	--	---

<p>Select Model Number</p> <p>HEMKRDIVIDER</p>	<p>Select Paint Color</p> <p>See page 129, Paint Group B</p> <p>P</p>
--	---



Icon Legend on page 19

Makerspace Table Accessories

	DESCRIPTION	MODEL	SHIP WEIGHT	CUBE	LIST PRICE
	Side Saddle 12¼"W x 2½"D x 4"H	HAESS	0.6	0.1	\$52
	Hook 1⅝"W x 2¼"D x 3¼"H	HAECBH	0.1	0.1	\$35
	Hot File 12¼"W x 3⅞"D x 9½"H	HAEHF	0.7	1.5	\$76

NOTES:

- Hook weight limit 20 lbs.

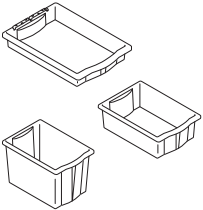
	DESCRIPTION	MODEL	SHIP WEIGHT	CUBE	LIST PRICE
	Accessories — Tray Kit				
	3"H, 2 bins and 4 rails	HFMBIN3	7 Ⓞ	4.0	\$77
	6"H, 2 bins and 4 rails	HFMBIN6	10 Ⓞ	4.5	\$92
	12"H, 2 bins and 4 rails	HFMBIN12	12 Ⓞ	5.0	\$108

SIN 33721

NOTES:

- ! Semi-translucent white. No specification needed.
- ! Bins ship with metal rails intended for use in SmartLink® Value Mobile Storage. When bins are used with shelf or foot rails on Makerspace table, rails will not be used.

HOW TO SPECIFY

Select Model Number	Select Color
HAESS	DW Designer White

BUILD™ Makerspace Stools

OPEN MARKET



Icon Legend on page 19

EDUCATION



MODEL/DESCRIPTION	DEPTH	WIDTH	HEIGHT	SHIP		LIST PRICE BY PAINT GRADE		
				WEIGHT	CUBE	P1	P2	P3
HE4LSTL18 Seated-Height Stool				12	3.3	\$179	\$185	\$188
Maximum:	15½	15½	18					
Seat:	12	12	18					
Seat to Floor:			18					
Usable Seat Depth:	12							



HE4LSTL30 Café-Height Stool				17	7.6	\$242	\$249	\$253
Maximum:	16⅞	16⅞	30					
Seat:	12	12	30					
Seat to Floor:			30					
Usable Seat Depth:	12							

NOTES:

- Weight Rating: 300 lbs.
- Features non-leveling nylon glides.
- Stackable up to 4-high.

HOW TO SPECIFY

Select Model Number

Select Paint Color

See page 129, Paint Group B

HE4LSTL18

T1

CLASS-IFI™

Want to see more? Scan here
to check out hon.com.



Class-ifi™ shown with Build™
Makerspace Tables and Stools.

EDUCATION

CLASS-IFI™

Every student and teacher deserves multifunctional, durable, and efficient organizational solutions that go the distance no matter what the subject. Class-ifi™ — a dynamic, effortlessly mobile education storage collection — is designed to maximize space, promote flexibility, and inspire creativity at any age or learning level. Today's education environments have discovered a more holistic approach to organization and kinesthetic learning, and that means more choices and smarter logistics. With its dynamic, multifunctional design, straightforward mobility, and exceptional organization capabilities, Class-ifi™ encourages healthy movement throughout the day and defines a variety of organizational and learning hubs for every student at every level. Make your space work with Class-ifi™.



FEATURES

- Choose from two panel options (Accessory End or Solid End), depending on your needs.
- Maximize your mobility with casters.
- Organize any size learning space with single- and double-sided bookcases and cubbies.
- Color your world with a variety of metal and laminate finish options.
- Reach for the stars or keep things at ground level with multiple height options.
- Open up your world with easy-access doors (also available without doors).
- Stash your stuff safely by adding a handy tote to any locker, tote storage, or Teacher Command Station (optional).
- Amp up your accessibility with Fuse™ accessories for all storage units, including hot file, side saddle, and bag hooks. (All work with slotted end planes.)
- Get a lift with a handy locker hook.
- Offer more options with a 1H bookcase or cubby that can be utilized as a seat.

CLASS-IFI™ ORDERING INFORMATION

LAMINATES

L1 LAMINATES	CODES
◆ Black	P
◆ Bourbon Cherry	H
◆ Charcoal	S
◆ Cognac	COGN
◆ Designer White	LDW1
◆ Field Elm	LWFE
◆ Florence Walnut	LFW1
◆ Harvest	C
◆ Kingswood Walnut	LK11
◆ Loft	LOFT
◆ Mahogany	N
◆ Mocha	MOCH
◆ Natural Maple	D
◆ Pinnacle	PINC
◆ Shaker Cherry	F
◆ Sterling Ash	LSA1
L2 LAMINATES	CODES
◆ Beigewood	LWBE
◆ Fawn Cypress	LFC1
◆ Lowell Ash	LLA1
◆ Natural Recon	LNR1
◆ Phantom Ecru	LPE1
◆ Portico Teak	LPT1
◆ Skyline Walnut	LSW1

CASE AND FRAME PAINT

PAINT	CODES
P1	
◆ Black	P71
◆ Brownstone	P7D
◆ Charcoal	S
◆ Designer White	PJW
◆ Fossil	P28
◆ Greige	T5
◆ Loft	LOFT
◆ Muslin	T3
◆ Putty	L
◆ Titanium	P8T
P2	
◆ Champagne Metallic	PR5
◆ Gunmetal Metallic	PR3
◆ Platinum Metallic	T1

END PANEL PAINT

PAINT	CODES
P1	
◆ Black	P71
◆ Brownstone	P7D
◆ Charcoal	S
◆ Designer White	PJW
◆ Fossil	P28
◆ Greige	T5
◆ Light Grey	Q
◆ Loft	LOFT
◆ Muslin	T3
◆ Putty	L
◆ Titanium	P8T
P2	
◆ Champagne Metallic	PR5
◆ Gunmetal Metallic	PR3
◆ Platinum Metallic	T1
◆ Silver	PR6
◆ Solar Black	P8X
P3	
◆ Amethyst*	P091
◆ Atom	P8S
◆ Blossom	P8K
◆ Bullseye	PJF
◆ Cobalt Mica*	P090
◆ Ember	P8P
◆ Ion	P8N
◆ Iris	P8J
◆ Krypton	P8F
◆ Ochre	P093
◆ Regatta	P8M
◆ Sienna	P092
◆ Succulent	P8A
P6	
◆ Markerboard	MKB

◆◆◆ For lead time information see page 21.

* De-emphasized

CLASS-IFI™ STATEMENT OF LINE

CUBBIES



18 1/2" H, 3-Wide,
Single-Sided



18 1/2" H, 3-Wide,
Double-Sided



31 1/2" H, 3-Wide,
Single-Sided



31 1/2" H, 3-Wide,
Double-Sided



44 1/2" H, 3-Wide,
Single-Sided

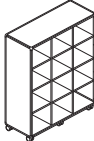

57 1/2" H, 3-Wide,
Single-Sided

LOCKERS



31 1/2" H, 2-Wide



31 1/2" H, 3-Wide



44 1/2" H, 2-Wide

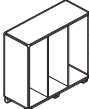

44 1/2" H, 3-Wide



57 1/2" H, 2-Wide

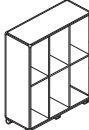

57 1/2" H, 3-Wide

COMBOS



44 1/2" H, 2-Wide

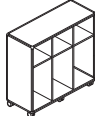

44 1/2" H, 3-Wide



57 1/2" H, 2-Wide

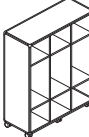

57 1/2" H, 3-Wide

BOOKCASES



1-High, 3-Wide,
Single-Sided



1-High, 3-Wide,
Double-Sided



2-High, 3-Wide,
Single-Sided



2-High, 3-Wide,
Double-Sided



3-High, 3-Wide,
Single-Sided

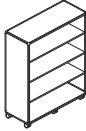

4-High, 3-Wide,
Single-Sided

CLASS-IFI™ STATEMENT OF LINE

TOTE STORAGE



31 1/4"H, 2-Wide



31 1/4"H, 3-Wide

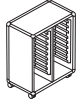

44 1/4"H, 2-Wide

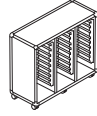

44 1/4"H, 3-Wide

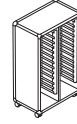

57 1/4"H, 2-Wide

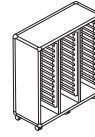

57 1/4"H, 3-Wide

COMMAND STATION

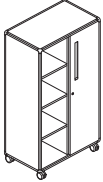

Right-Hand
Wardrobe

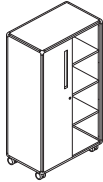

Left-Hand
Wardrobe

CLASS-IFI™ SPECIFYING INFORMATION

TOTE STORAGE CAPACITY PLANNING

Tote storage cases do not include bins; bins must be specified separately depending on available capacity and customer need. Utilize the diagram below to help in planning the number of bin kits needed based on cabinet size.

Hanging Slots	12" H Bin	6" H Bin	3" H Bin
1			
2			
3			
4			



HFMBIN12

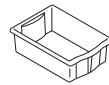

HFMBIN6

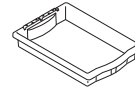

HFMBIN3

1	6
2	7
3	8
4	9
5	10
HEST2H2WS	

1	6	11
2	7	12
3	8	13
4	9	14
5	10	15
HEST2H3WS		

1	10
2	11
3	12
4	13
5	14
6	15
7	16
8	17
9	18
HEST3H2WS	

1	10	19
2	11	20
3	12	21
4	13	22
5	14	23
6	15	24
7	16	25
8	17	26
9	18	27
HEST3H3WS		

1	14
2	15
3	16
4	17
5	18
6	19
7	20
8	21
9	22
10	23
11	24
12	25
13	26
HEST4H2WS	

1	14	27
2	15	28
3	16	29
4	17	30
5	18	31
6	19	32
7	20	33
8	21	34
9	22	35
10	23	36
11	24	37
12	25	38
13	26	39
HEST4H3WS		

ACCESSORY END PANELS

Every cabinet type is available with either solid or accessory-compatible end panels. 1H cabinets feature two horizontal slots per side, while 2H, 3H, and 4H cabinets feature four.

Compatible accessories for these slots are specified separately, see page 163.

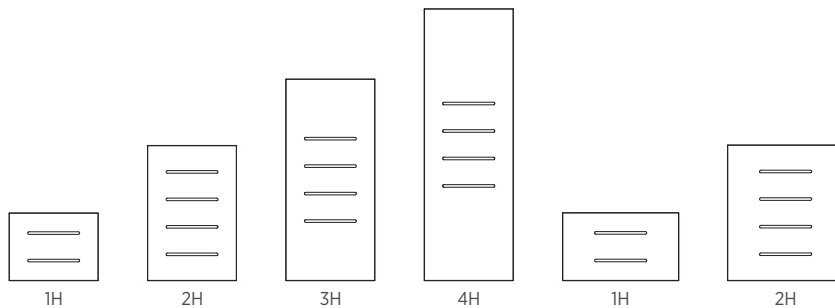

CLASS-IFI™ SPECIFYING INFORMATION

DOORS

Lockers, Combos, and Tote Storage available with or without doors. See below for door configuration based on storage type and size.

EDUCATION



2-High, 2-Wide

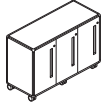

2-High, 3-Wide



3-High, 2-Wide

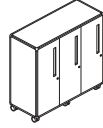

3-High, 3-Wide

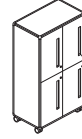

4-High, 2-Wide

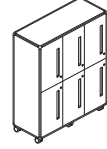

4-High, 3-Wide



3-High, 2-Wide

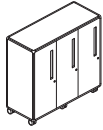

3-High, 3-Wide

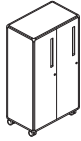

4-High, 2-Wide

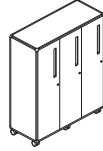

4-High, 3-Wide



2-High, 2-Wide

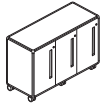

2-High, 3-Wide

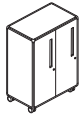

3-High, 2-Wide

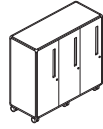

3-High, 3-Wide



4-High, 2-Wide

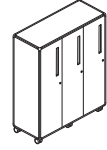

4-High, 3-Wide

FINISH SELECTION

Class-ifi™ allows for the specification of different finish options on a single model. Locations which allow for unique specification include:

- Laminate Interior
- Frame and Top/Back/Doors (if applicable)
- End Panels



	DESCRIPTION	MODEL	SHIP WEIGHT	CUBE	LIST PRICE BY CASE PAINT GRADE			END PANEL UPCHARGE			L2 UPCHARGE
					P1	P2	P3	P2	P3	P6	
	31 3/8"H, 2-Wide 31 5/8"W x 18 3/4"D	HESL2H2WS	192	14.8	\$1986	\$2185	\$2483	\$16	\$21	\$53	\$199
	NOTES: Upcharge with Door option (+ \$418). Select either Standard Lock, L , or Omit Lock, X (- \$40).										
	31 3/8"H, 3-Wide 46 5/8"W x 18 3/4"D	HESL2H3WS	181	21.1	\$2195	\$2415	\$2744	\$16	\$21	\$53	\$220
	NOTES: Upcharge with Door option (+ \$471). Select either Standard Lock, L , or Omit Lock, X (- \$60).										
	44 1/8"H, 2-Wide 31 5/8"W x 18 3/4"D	HESL3H2WS	212	21.0	\$2404	\$2645	\$3005	\$21	\$27	\$58	\$241
	NOTES: Upcharge with Door option (+ \$471). Select either Standard Lock, L , or Omit Lock, X (- \$20).										
	44 1/8"H, 3-Wide 46 5/8"W x 18 3/4"D	HESL3H3WS	232	29.9	\$2613	\$2875	\$3267	\$21	\$27	\$58	\$262
	NOTES: Upcharge with Door option (+ \$497). Select either Standard Lock, L , or Omit Lock, X (- \$60).										
	57 3/8"H, 2-Wide 31 5/8"W x 18 3/4"D	HESL4H2WS	274	27.0	\$2508	\$2759	\$3135	\$27	\$32	\$63	\$251
	NOTES: Upcharge with Door option (+ \$732). Select either Standard Lock, L , or Omit Lock, X (- \$80).										
	57 3/8"H, 3-Wide 46 5/8"W x 18 3/4"D	HESL4H3WS	334	38.4	\$2717	\$2989	\$3397	\$27	\$32	\$63	\$272
	NOTES: Upcharge with Door option (+ \$1150). Select either Standard Lock, L , or Omit Lock, X (- \$120).										

NOTES:

- End panel specification selection applies to both end panels (either 2 solid end panels or 2 accessory end panels).
- Each locker compartment includes one double coat hook.
- When selected with doors, omit lock option is available. See page 155 for ordering instructions.
- Units ship assembled; casters are field installed.
- Casters are swivel, locking casters.

HOW TO SPECIFY

Select Model Number	Select Caster	Select Door and Pull	Select End Panel	Select Case Paint	Select Frame Paint	Select Panel Paint	Select Laminate
	C Caster	See product listing for upcharge D With Door N Without Door N Integral Pull L Standard Lock X Omit Lock - \$40 (2 Doors) - \$60 (3 Doors) - \$80 (4 Doors) - \$120 (6 Doors)	S Solid AB Accessory (+ \$157)	See page 152	NA Matches Case	See page 152	See page 152
HESL2H2WS	C	DNL	S	PR6	NA	PR6	LSA1

CLASS-IFI™ Cubbies

GSA SIN 33721T



Icon Legend on page 19

EDUCATION

	DESCRIPTION	MODEL	SHIP WEIGHT	CUBE	LIST PRICE BY CASE PAINT GRADE			END PANEL UPCHARGE			L2 UPCHARGE
					P1	P2	P3	P2	P3	P6	
	18³/₈"H, 3-Wide Single-Sided	HESC1H3WS	124	12.4	\$2090	\$2299	\$2613	\$11	\$16	\$48	\$209
	Double-Sided	HESC1H3WD	181	15.3	\$2404	\$2645	\$3005	\$16	\$21	\$53	\$241
	31³/₈"H, 3-Wide Single-Sided	HESC2H3WS	192	25.9	\$2299	\$2529	\$2874	\$16	\$21	\$53	\$230
	Double-Sided	HESC2H3WD	212	36.7	\$2508	\$2759	\$3135	\$21	\$27	\$58	\$251
	44¹/₈"H, 3-Wide Single-Sided	HESC3H3WS	232	29.9	\$2613	\$2875	\$3267	\$21	\$27	\$58	\$262
	57³/₈"H, 3-Wide Single-Sided	HESC4H3WS	334	38.4	\$2717	\$2989	\$3397	\$27	\$32	\$63	\$272

NOTES:

- End panel specification selection applies to both end panels (either 2 solid end panels or 2 accessory end panels).
- Units ship assembled; casters are field installed.
- Casters are swivel, locking casters.

HOW TO SPECIFY

Select Model Number	Select Caster	Select Door and Pull	Select End Panel	Select Case Paint	Select Frame Paint	Select Panel Paint	Select Laminate
	C Caster	N Without Door	S Solid AB Accessory (+ \$157)	See page 152	NA Matches Case	See page 152	See page 152
H E S C 1 H 3 W S .	C .	N .	S .	P R 6 .	N A .	P R 6 .	L S A 1

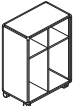
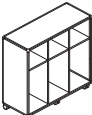
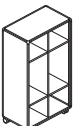
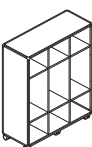

DESCRIPTION	MODEL	SHIP WEIGHT	CUBE	LIST PRICE BY CASE PAINT GRADE			END PANEL UPCHARGE			L2 UPCHARGE
				P1	P2	P3	P2	P3	P6	
 <p>44¹/₈"H, 2-Wide 31⁵/₈"W x 18³/₄"D x 44¹/₈"H</p> <p>NOTES: Upcharge with Door option (+ \$471). Upcharge is applied per model. Select either Standard Lock, L, or Omit Lock, X (- \$20). Model comes with one (1) 12"H shelf.</p>	HESCO3H2WS	212	21.0	\$2404	\$2645	\$3005	\$21	\$27	\$58	\$241
 <p>44¹/₈"H, 3-Wide 46⁵/₈"W x 18³/₄"D x 44¹/₈"H</p> <p>NOTES: Upcharge with Door option (+ \$497). Upcharge is applied per model. Select either Standard Lock, L, or Omit Lock, X (- \$60). Model comes with one (1) 12"H shelf.</p>	HESCO3H3WS	232	29.9	\$2613	\$2875	\$3267	\$21	\$27	\$58	\$262
 <p>57³/₈"H, 2-Wide 31⁵/₈"W x 18³/₄"D x 57³/₈"H</p> <p>NOTES: Upcharge with Door option (+ \$497). Upcharge is applied per model. Select either Standard Lock, L, or Omit Lock, X (- \$40). Model comes with two (2) 12"H shelves.</p>	HESCO4H2WS	274	27.0	\$2508	\$2759	\$3135	\$27	\$32	\$63	\$251
 <p>57³/₈"H, 3-Wide 46⁵/₈"W x 18³/₄"D x 57³/₈"H</p> <p>NOTES: Upcharge with Door option (+ \$523). Upcharge is applied per model. Select either Standard Lock, L, or Omit Lock, X (- \$60). Model comes with two (2) 12"H shelves.</p>	HESCO4H3WS	334	38.4	\$2717	\$2989	\$3397	\$27	\$32	\$63	\$272

EDUCATION

NOTES:

- End panel specification selection applies to both end panels (either 2 solid end panels or 2 accessory end panels).
- Each locker compartment includes one double coat hook.
- When selected with doors, omit lock option is available. See page 155 for ordering instructions.
- Units ship assembled; casters are field installed.
- Casters are swivel, locking casters.

HOW TO SPECIFY

Select Model Number	Select Caster	Select Door and Pull	Select End Panel	Select Case Paint	Select Frame Paint	Select Panel Paint	Select Laminate
	C Caster	See product listing for upcharge D With Door N Integral Pull L Standard Lock X Omit Lock - \$20 (3H2W) - \$60 (3H3W) - \$40 (4H2W) - \$60 (4H3W) N Without Door	S Solid AB Accessory (+ \$157)	See page 152	NA Matches Case	See page 152	See page 152
H E S C O 3 H 2 W S .	C .	D N L .	S .	P R 6 .	N A .	P R 6 .	L S A 1

CLASS-IFI™ Bookcases

GSA SIN 33721T



Icon Legend on page 19

EDUCATION



DESCRIPTION	MODEL	SHIP WEIGHT	CUBE	LIST PRICE BY CASE PAINT GRADE			END PANEL UPCHARGE			L2 UPCHARGE
				P1	P2	P3	P2	P3	P6	
1-High Single-Sided 46 ⁵ / ₈ "W x 18 ³ / ₄ "D x 18 ³ / ₈ "H	HESB1H3WS	124	12.4	\$1777	\$1955	\$2222	\$11	\$16	\$48	\$178



Double-Sided 46 ⁵ / ₈ "W x 23 ⁷ / ₈ "D x 18 ³ / ₈ "H	HESB1H3WD	181	15.3	\$2195	\$2415	\$2744	\$16	\$21	\$53	\$220
---	------------------	-----	------	--------	--------	--------	------	------	------	-------



2-High Single-Sided 46 ⁵ / ₈ "W x 18 ³ / ₄ "D x 31 ³ / ₈ "H	HESB2H3WS	192	21.1	\$1986	\$2185	\$2483	\$16	\$21	\$53	\$199
--	------------------	-----	------	--------	--------	--------	------	------	------	-------



Double-Sided 46 ⁵ / ₈ "W x 23 ⁷ / ₈ "D x 31 ³ / ₈ "H	HESB2H3WD	212	25.9	\$2299	\$2529	\$2874	\$21	\$27	\$58	\$230
---	------------------	-----	------	--------	--------	--------	------	------	------	-------



3-High Single-Sided 46 ⁵ / ₈ "W x 18 ³ / ₄ "D x 44 ¹ / ₈ "H	HESB3H3WS	232	29.9	\$2404	\$2645	\$3005	\$21	\$27	\$58	\$241
--	------------------	-----	------	--------	--------	--------	------	------	------	-------

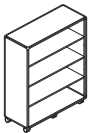

4-High Single-Sided 46 ⁵ / ₈ "W x 18 ³ / ₄ "D x 57 ³ / ₈ "H	HESB4H3WS	334	38.4	\$2508	\$2759	\$3135	\$27	\$32	\$63	\$251
--	------------------	-----	------	--------	--------	--------	------	------	------	-------

NOTES:

- End panel specification selection applies to both end panels (either 2 solid end panels or 2 accessory end panels).
- Units ship assembled; casters are field installed.
- Casters are swivel, locking casters.

HOW TO SPECIFY

Select Model Number	Select Caster	Select Door and Pull	Select End Panel	Select Case Paint	Select Frame Paint	Select Panel Paint	Select Laminate
	C Caster	N Without Door	S Solid AB Accessory (+ \$157)	See page 152	NA Matches Case	See page 152	See page 152
HESB1H3WS	C	N	S	PR6	NA	PR6	LSA1



CLASS-IFI™ Tote Storage

	DESCRIPTION	MODEL	SHIP WEIGHT	CUBE	LIST PRICE BY CASE PAINT GRADE			END PANEL UPCHARGE			L2 UPCHARGE
					P1	P2	P3	P2	P3	P6	
	31 3/8" H, 2-Wide 31 5/8" W x 18 3/4" D x 31 3/8" H	HEST2H2WS	181	14.8	\$1568	\$1725	\$1960	\$16	\$21	\$53	\$157
NOTES: Upcharge with Door option (+ \$418). Upcharge is applied per model. Select either Standard Lock, L , or Omit Lock, X (- \$40).											
	31 3/8" H, 3-Wide 46 5/8" W x 18 3/4" D x 31 3/8" H	HEST2H3WS	192	21.1	\$1881	\$2070	\$2352	\$16	\$21	\$53	\$189
NOTES: Upcharge with Door option (+ \$471). Upcharge is applied per model. Select either Standard Lock, L , or Omit Lock, X (- \$60).											
	44 1/8" H, 2-Wide 31 5/8" W x 18 3/4" D x 44 1/8" H	HEST3H2WS	212	21.0	\$1986	\$2185	\$2483	\$21	\$27	\$58	\$199
NOTES: Upcharge with Door option (+ \$471). Upcharge is applied per model. Select either Standard Lock, L , or Omit Lock, X (- \$20).											
	44 1/8" H, 3-Wide 46 5/8" W x 18 3/4" D x 44 1/8" H	HEST3H3WS	232	29.9	\$2299	\$2529	\$2874	\$21	\$27	\$58	\$230
NOTES: Upcharge with Door option (+ \$497). Upcharge is applied per model. Select either Standard Lock, L , or Omit Lock, X (- \$60).											
	57 3/8" H, 2-Wide 31 5/8" W x 18 3/4" D x 57 3/8" H	HEST4H2WS	274	27.0	\$2508	\$2759	\$3135	\$27	\$32	\$63	\$251
NOTES: Upcharge with Door option (+ \$497). Upcharge is applied per model. Select either Standard Lock, L , or Omit Lock, X (- \$40).											
	57 3/8" H, 3-Wide 46 5/8" W x 18 3/4" D x 57 3/8" H	HEST4H3WS	334	38.4	\$2822	\$3105	\$3528	\$27	\$32	\$63	\$283
NOTES: Upcharge with Door option (+ \$523). Upcharge is applied per model. Select either Standard Lock, L , or Omit Lock, X (- \$60).											

NOTES:

- End panel specification selection applies to both end panels (either 2 solid end panels or 2 accessory end panels).
- When selected with doors, omit lock option is available. See page 155 for ordering instructions.
- Cases will accept a variety of tote configurations. Refer to page 155 for capacity planning guidelines.
- Units ship assembled; casters are field installed.
- Casters are swivel, locking casters.

Specify totes separately, see page 155.

Door upcharge is applied per model, not per door.

HOW TO SPECIFY

Select Model Number	Select Caster	Select Door and Pull	Select End Panel	Select Case Paint	Select Frame Paint	Select Panel Paint	Select Laminate
	C Caster	See product listing for upcharge D With Door N Integral Pull L Standard Lock X Omit Lock - \$40 (2 Doors) - \$60 (3 Doors) N Without Door	S Solid AB Accessory (+ \$157)	See page 152	NA Matches Case	See page 152	See page 152
H E S T 2 H 2 W S .	C .	D N L .	S .	P R 6 .	N A .	P R 6 .	L S A 1

CLASS-IFI™ Command Station

GSA SIN 33721T



Icon Legend on page 19

EDUCATION

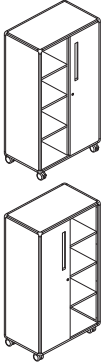

DESCRIPTION	MODEL	SHIP WEIGHT	CUBE	LIST PRICE BY CASE PAINT GRADE			END PANEL UPCHARGE			L2 UPCHARGE
				P1	P2	P3	P2	P3	P6	
Command Station										
RH Wardrobe 31 ⁵ / ₈ "W x 18 ³ / ₄ "D x 57 ³ / ₈ "H	HESCS4H2WSR	274	27.0	\$2717	\$2989	\$3397	\$27	\$32	\$63	\$272
LH Wardrobe 31 ⁵ / ₈ "W x 18 ³ / ₄ "D x 57 ³ / ₈ "H	HESCS4H2WSL	274	27.0	\$2717	\$2989	\$3397	\$27	\$32	\$63	\$272





NOTES:

- End panel specification selection applies to both end panels (either 2 solid end panels or 2 accessory end panels).
- Wardrobe compartment includes one double coat hook.
- Omit lock option is available. See page 155 for ordering instructions.
- Units ship assembled; casters are field installed.
- Casters are swivel, locking casters.

HOW TO SPECIFY

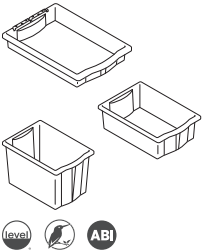
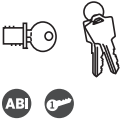
Select Model Number	Select Caster	Select Door, Pull, & Lock	Select End Panel	Select Case Paint	Select Frame Paint	Select Panel Paint	Select Laminate
	C Caster	D With Door N Integral Pull L Standard Lock X Omit Lock (-\$40)	S Solid AB Accessory (+\$157)	See page 152	NA Matches Case	See page 152	See page 152
H E S C S 4 H 2 W S R .	C .	D N L .	S .	P R 6 .	N A .	P R 6 .	L S A 1

Icon Legend on page 19

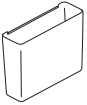
	DESCRIPTION	MODEL	SHIP WEIGHT	CUBE	LIST PRICE	
	Accessories — Tote Tray Kits 3"H, 2 bins and 4 rails 6"H, 2 bins and 4 rails 12"H, 2 bins and 4 rails ⓘ Semi-translucent white.	HFMBIN3 HFMBIN6 HFMBIN12	7.0 ⓘ 10.0 ⓘ 12.0 ⓘ	4.0 4.5 5.0	\$77 \$92 \$108	
		Removable Lock Core Kit Satin Nickel • For stack-on and wall mounted storage laminate models (with locks) in 10500, 10700, Valido, Voi, Concinnity, and 94000 Series. • Specify quantity of each key number from 101E to 225E. • Includes: 1-core, 2-keys, 1-core removal tool, and instructions. NOTES: If key number isn't specified, number will be at random.	HF23S	0.2	0.02	\$45
		Master Key (one key) Will open all HON product with HON "One Key" interchangeable core removable locks. Available to authorized dealers only. Will open HF23B, HF23C, HF23S, HF24, HF27B, and HF27S locks numbered 101E-225E. Will open old HON style MB series locks.	HF22	0.1 ⓘ	0.1	\$39
	OPEN MARKET 	Side Saddle 12¼"W x 2½"D x 4"H	HAESS	0.6 ⓘ	0.1	\$52
	Hook 1⅝"W x 2¼"D x 3¼"H	HAECBH	0.1 ⓘ	0.1	\$35	
	Hot File 12¼"W x 3⅞"D x 9½"H	HAEHF	0.7 ⓘ	1.5	\$76	

HOW TO SPECIFY

Select Model Number H A E H F .	Select Paint Color DW Designer White
---	--



Confetti™ Floor Lounge.

CONFETTI™

Every educator wants their classroom to celebrate individuality, energize ideas, and inspire imaginations. Organic, fluid environments are essential to the physical and emotional comfort of every young learner — and Confetti™ Floor Cushions and Lounges pass every test with flying colors! These comfortable, portable seating solutions encourage young learners to sit where they please, gather with ease, and stay connected and creative in their own way — from the first day of school to the last. With soft foam support and integrated handles for easy portability, Confetti™ allows students to navigate the classroom in their own way to create a safe, stress-free learning environment. Make your space work with Confetti™.



FEATURES

- Maximize student mobility with integrated handles for easy portability.
- Create comfortable support with soft foam seating.
- Get a lot (or just one) — floor cushions are sold separately or in packs of 8.
- Keep things tidy with a floor cushion cart, designed to organize and store seating when not in use — plus, this handy solution fits under tables, so you'll save valuable floor space.
- Choose from an array of colorful fabric options.

CONFETTI™ ORDERING INFORMATION

HON BRANDED FABRICS

GRADE 1

Apex
Centurion
Compass
Contourett
Dapper
Ensemble
Hamilton
Inertia
Noble Seating
Optic
Pebble
Vibe

GRADE 2

Appoint Seating
Blume
Clyde
Dotty
Kai
Rush
Spin
Wavelength
Whisper Vinyl

GRADE 3

Bradbury
Getaway
Moxie
Notion
Parker
Purl
Quill
Saxony

GRADE 4

Constance with Supreen™
Livi with Supreen™
Lugano with Supreen™
Oxford with Supreen™

CONFETTI™

Statement of Line

FLOOR SEATING

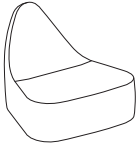

Floor Lounge



Floor Cushion

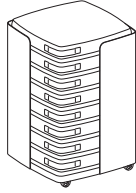

Eight Cushions
and Cart

ACCESSORIES

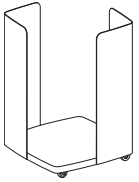

Floor Cushion Cart



CONFETTI™ Floor Seating

HEFL1

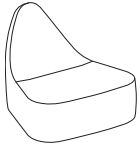

FLOOR LOUNGE

DIMENSIONS

Depth:	32½	Ship Weight:	20
Width:	30	Cube:	14.8
Seat Height:	12	Weight Rating:	300 lbs.
Seat Depth:	17¼		

FABRIC PRICE CODES

1	\$1150	8	\$1465
2	\$1203	9	\$1506
3	\$1257	10	\$1551
4	\$1298	11	\$1599
5	\$1339	12	\$1647
6	\$1380	L	—
7	\$1421		

ⓘ Due to the natural properties and shape of the Floor Lounge, material gathers and visual variation can be expected from unit to unit as well as fabric to fabric.

HELP1



FLOOR CUSHION

DIMENSIONS

Depth:	16½	Ship Weight:	5
Width:	16½	Cube:	0.7
Seat Height:	3	Weight Rating:	300 lbs.

FABRIC PRICE CODES

1	\$314	8	\$440
2	\$335	9	\$457
3	\$357	10	\$474
4	\$373	11	\$494
5	\$390	12	\$513
6	\$406	L	—
7	\$423		

HECLP8

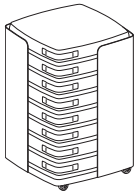

EIGHT CUSHIONS WITH CART

DIMENSIONS

Ship Weight:	70
Cube:	5.1
Weight Rating:	300 lbs.

FABRIC PRICE CODES

1	\$3553	8	\$4557
2	\$3721	9	\$4690
3	\$3896	10	\$4833
4	\$4022	11	\$4991
5	\$4155	12	\$5142
6	\$4289	L	—
7	\$4423		

NOTES:

- Only one fabric can be specified on model HECLP8. If multiple fabrics are requested on the floor cushion, order the cushion and cart separately.

HOW TO SPECIFY

<p>Select Model Number</p> <p>HECLP8</p>	<p>Select Fabric</p> <p>See page 165</p> <p>CU10</p>	<p>Select Paint Color</p> <p>See page 165</p> <p><i>Specify for HECLP8 only</i></p> <p>P71</p>
---	---	---



DESCRIPTION

Floor Cushion Cart

MODEL

HECART

SHIP WEIGHT

30

CUBE

5.1

LIST PRICE BY PAINT GRADE

P1

\$1045

P2

\$1150

P3

\$1307

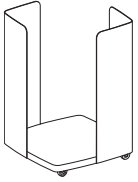

NOTES

- Cart holds quantity 8 of model HELP1.

EDUCATION

HOW TO SPECIFY

Select Model Number

Select Paint Color

See page 165

HECART.

P71

REVEL™

Want to see more? Scan here to check out hon.com.



Revel™ Fidget Stools shown with Build™ Student Desks and SmartLink® Seating.

EDUCATION

REVEL™

Revel in the movement and give classroom fidgeting a new meaning. Move side to side, back and forth, or spin in a full circle. Revel brings movement and mobility to active learners.



FEATURES

- Seat available in 3 colors, base available in 1.
- Adjust stool height with the push of a button. Stool ranges in height from 13¾”H-18½”H.
- With a slip resistant base and plastic body, you can feel comfortable using the stool in your most creative space with easy cleanup afterwards.
- Tested to hold up to 250 lbs.
- Backed by the HON Full Lifetime Warranty.

REVEL™ Stool

OPEN MARKET



Icon Legend on page 19

HEFS01

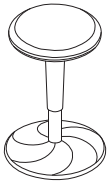

ADJUSTABLE HEIGHT FIDGET STOOL

DIMENSIONS

Depth:	15 ³ / ₈	Seat Height:	13 ³ / ₄ -18 ¹ / ₂
Width:	15 ³ / ₈	Ship Weight:	20.1
Height:	13 ³ / ₄ -18 ¹ / ₂	Cube:	1.4
Seat Depth:	15 ³ / ₈	Weight Rating:	250 lbs.
Seat Width:	15 ³ / ₈		

LIST PRICE

\$325

NOTES: Two buttons integrated in underside of seat for height adjustment control while maintaining a clean aesthetic. Stool seat and base are all plastic for easy cleanability. Anti-slip rubber attached to underside of base allows for comfortable movement of user while maintaining contact with floor. Base color is similar to HON Loft.

EDUCATION

HOW TO SPECIFY

Select Model Number	Select Seat Color
	BZ Breeze S Charcoal BL Black
<input type="text" value="HEFS01"/>	<input type="text" value="BL"/>

ROLL CALL™

Want to see more? Scan here
to check out hon.com.



Roll Call™ shown with SmartLink® Student Seating and Desks, and Class-ifi™ Storage.

EDUCATION

ROLL CALL™

Healthy, connected classrooms are never at a stand-still. To stay flexible and functional, today's learning spaces need solutions that can move anywhere, anytime. Roll Call™ — HON's light scale, easy-to-use lectern — allows students and teachers alike to adjust, administer, and engage with ease. With ample height adjustability and smooth caster mobility, Roll Call™ encourages young minds and educators to create an imaginative environment that's all their own. Make your space work with Roll Call™.



FEATURES

- Open up your options with a pneumatic cylinder and hand lever that allows for easy height adjustment (between 28½"-43½").
- Maximize your mobility (or stay put!) with 4 casters that move with you or lock in place, depending on your needs.
- Spread out with a 24"D x 30"W worksurface, designed to hold everything from lesson books to laptops.
- Rely on the exceptional durability of an easy-to-clean laminate surface.
- Backed by The HON Company's Full Lifetime Warranty.

ROLL CALL™ ORDERING INFORMATION

WOODSURFACES

L1 LAMINATES CODES

Woodgrain

- ◆ Bourbon Cherry H
- ◆ Cognac COGN
- ◆ Field Elm LWFE
- ◆ Florence Walnut LFW1
- ◆ Harvest C
- ◆ Kingswood Walnut LK11
- ◆ Loft LOFT
- ◆ Mahogany N
- ◆ Mocha MOCH
- ◆ Natural Maple D
- ◆ Pinnacle PINC
- ◆ Shaker Cherry F
- ◆ Sterling Ash LSA1

Solid

- ◆ Black P
- ◆ Charcoal S
- ◆ Designer White LDW1
- ◆ Loft LOFT

Patterned

- ◆ Handspun Chestnut LAHC
- ◆ Handspun Dove LAHD
- ◆ Handspun Pearl LAHP
- ◆ Handspun Slate LAHS
- ◆ Silver Mesh B9
- ◆ Steel Mesh A9
- ◆ Battleship LBT1
- ◆ Gray G2
- ◆ Moroccan LMN1
- ◆ Mushroom LMH1
- ◆ Neon Carrot LNC1
- ◆ Tennis Ball LTB1
- ◆ White G1

L2 LAMINATES CODES

Woodgrain

- ◆ Beigewood LWBE
- ◆ Fawn Cypress LFC1
- ◆ Lowell Ash LLA1
- ◆ Natural Recon LNR1
- ◆ Phantom Ecru LPE1
- ◆ Portico Teak LPT1
- ◆ Skyline Walnut LSW1

L4 LAMINATES CODES

- ◆ White Markerboard FMQ1

EDGE

EDGE CODES

Woodgrain

- ◆ Beigewood DE
- ◆ Cognac COGN
- ◆ Fawn Cypress FC
- ◆ Field Elm FE
- ◆ Florence Walnut FW
- ◆ Kingswood Walnut KI
- ◆ Lowell Ash DL
- ◆ Mahogany N
- ◆ Mocha MOCH
- ◆ Natural Maple D
- ◆ Natural Recon NR
- ◆ Phantom Ecru PE
- ◆ Pinnacle PINC
- ◆ Portico Teak DP
- ◆ Shaker Cherry F
- ◆ Skyline Walnut SW
- ◆ Sterling Ash SA

Solid

- ◆ Atom AT
- ◆ Black P
- ◆ Brownstone EY
- ◆ Bullseye BY
- ◆ Charcoal S
- ◆ Designer White DW
- ◆ Ember MR
- ◆ Fossil EH
- ◆ Greige R
- ◆ Ion IO
- ◆ Iris IR
- ◆ Krypton KT
- ◆ Loft LOFT
- ◆ Muslin T
- ◆ Platinum K
- ◆ Regatta RE

CYLINDER PAINT

PAINT CODES

P1

- ◆ Black P71

P2

- ◆ Silver SVR

(No upcharge will be applied to cylinder color selection.)

BASE PAINT

PAINT CODES

P1

- ◆ Black P71
- ◆ Charblack CBK

P2

- ◆ Silver PR6
- ◆ Textured Silver PR8

◆◆◆ For lead time information see page 21.

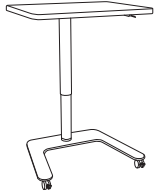

DESCRIPTION	MODEL	SHIP WEIGHT	CUBE	LIST PRICE BY LAMINATE GRADE		
				L1	L2	L4
Pneumatic Lectern 30"W x 24"D, Rectangle Top	HETLEC-REC2430	74.1	5.7	\$1380	\$1390	\$1409

NOTES:

- Lectern adjusts from 28½"-43½".
 - Pneumatic height adjustment. No electricity required.
 - Ships knocked down and assembled on site.
 - Features 4 locking casters.
- ! SmartLink® Book Box, HLDA-15, is compatible with Roll Call™. Book box hardware pack does not include wood screws which are needed to install book box to a laminate work surface. Installer to provide wood screws. Each book box requires 6, #12 phillips panhead, ¾" long screws for installation.

HOW TO SPECIFY

<p>Select Model Number</p> <p>HETLEC-REC2430</p>	<p>Select Grommet Option</p> <p>N No Grommet</p> <p>N</p>	<p>Select Laminate</p> <p>See page 172</p> <p>LDW1</p>	<p>Select Edge Color</p> <p>See page 172</p> <p>DW</p>	<p>Select Cylinder Color</p> <p>See page 172</p> <p>P2 Upcharge \$0</p> <p>P71</p>	<p>Select Base Color</p> <p>See page 172</p> <p>P2 Upcharge \$70</p> <p>P71</p>
---	--	---	---	---	--



SmartLink® Student Seating and Desks, Teacher Desk, and Storage.

SMARTLINK®

Show of hands — who loves long lectures? Today's classroom is more hands-on and collaborative, involving group interactions that better stimulate learning. That's why we've done our homework in the design of SmartLink. This collection of lightweight and mobile desks, chairs, storage, and presentation tools earns high marks by being easy to arrange and rearrange, keeping active minds and bodies fully engaged.



FEATURES

- Put teachers in control of their storage, technology and environment.
- Worksurface shape supports creative configurations.
- Designed to the unique ways students sit and move throughout the day.
- Organize lesson plans and make the most of unused wall space.
- Move educational tools wherever the activities demand.
- SmartLink chairs warranted for users up to 300 lbs.

SMARTLINK® ORDERING INFORMATION

TEACHER DESK & MODULAR STORAGE

LAMINATES CODES

- L1**
 ◆ Harvest CC
 ◆ Natural Maple DD
 ◆ Silver Mesh B9

PAINTS CODES

- P1**
 ◆ Charcoal S

P2

- ◆ Platinum Metallic T1

EDGE CODES

- ◆ Charcoal S
 ◆ Platinum K

STUDENT DESK

PLASTIC CODES

- ◆ Breeze G9
 ◆ Harvest CC
 ◆ Natural Maple DD
 ◆ Sand G8
 ◆ White G1

PAINTS CODES

- P1**
 ◆ Charcoal S

P2

- ◆ Platinum Metallic T1

VALUE MOBILE STORAGE

PAINTS CODES

- P1**
 ◆ Black P
 ◆ Brownstone P7D
 ◆ Charcoal S
 ◆ Designer White PJW
 ◆ Fossil P28
 ◆ Greige T5
 ◆ Loft LOFT
 ◆ Muslin T3
 ◆ Titanium P8T

P2

- ◆ Champagne Metallic T4
 ◆ Platinum Metallic T1
 ◆ Silver PR6

P3

- ◆ Atom P8S
 ◆ Bullseye PJF
 ◆ Ember P8P
 ◆ Ion P8N
 ◆ Iris P8J
 ◆ Krypton P8F
 ◆ Regatta P8M

VALUE TEACHER DESK

LAMINATES CODES

L1

- ◆ Black P
 ◆ Bourbon Cherry H
 ◆ Charcoal S
 ◆ Cognac COGN
 ◆ Designer White LDW1
 ◆ Florence Walnut LFW1
 ◆ Handspun Chestnut LAHC
 ◆ Handspun Dove LAHD
 ◆ Handspun Pearl LAHP
 ◆ Handspun Slate LAHS
 ◆ Harvest C
 ◆ Kingswood Walnut LK11
 ◆ Loft LOFT
 ◆ Mahogany N
 ◆ Mocha MOCH
 ◆ Natural Maple D
 ◆ Pinnacle PINC
 ◆ Shaker Cherry F
 ◆ Silver Mesh B9
 ◆ Steel Mesh A9
 ◆ Sterling Ash LSA1

L2

- ◆ Lowell Ash LLA1
 ◆ Natural Recon LNR1
 ◆ Phantom Ecru LPE1
 ◆ Portico Teak LPT1
 ◆ Skyline Walnut LSW1

PAINTS CODES

- P1**
 ◆ Charcoal S
 ◆ Designer White PJW
 ◆ Titanium P8T

P2

- ◆ Platinum Metallic T1
 ◆ Silver PR6

P3

- ◆ Atom P8S
 ◆ Bullseye PJF
 ◆ Ember P8P
 ◆ Ion P8N
 ◆ Iris P8J
 ◆ Krypton P8F
 ◆ Regatta P8M

EDGE CODES

- ◆ Atom AT
 ◆ Bullseye BY
 ◆ Charcoal S
 ◆ Ember MR
 ◆ Ion IO
 ◆ Iris IR
 ◆ Krypton KT
 ◆ Platinum K
 ◆ Regatta RE

VALUE STUDENT DESK

PLASTIC CODES

- ◆ Breeze G9
 ◆ Harvest CC
 ◆ Natural Maple DD
 ◆ Sand G8
 ◆ White G1

PAINTS CODES

P1

- ◆ Charcoal S
 ◆ Designer White PJW
 ◆ Titanium P8T

P2

- ◆ Platinum Metallic T1
 ◆ Silver PR6

P3

- ◆ Atom P8S
 ◆ Bullseye PJF
 ◆ Ember P8P
 ◆ Ion P8N
 ◆ Iris P8J
 ◆ Krypton P8F
 ◆ Regatta P8M

UNIVERSAL MODESTY PANEL

PAINTS CODES

- P1**
 ◆ Black P
 ◆ Brownstone P7D
 ◆ Charblack CBK
 ◆ Charcoal S
 ◆ Designer White PJW
 ◆ Fossil P28
 ◆ Greige T5
 ◆ Light Gray Q
 ◆ Loft LOFT
 ◆ Muslin T3
 ◆ Putty L
 ◆ Textured Platinum
 Metallic PLAT
 ◆ Titanium P8T

P2

- ◆ Champagne Metallic T4
 ◆ Platinum Metallic T1
 ◆ Silver PR6
 ◆ Solar Black P8X
 ◆ Textured Silver PR8

P3

- ◆ Atom P8S
 ◆ Bullseye PJF
 ◆ Ember P8P
 ◆ Ion P8N
 ◆ Iris P8J
 ◆ Krypton P8F
 ◆ Regatta P8M

4-LEG, CANTILEVER CHAIR, TASK CHAIR, STOOL SHELLS

SHELL CODES

- ◆ Calypso CP
 ◆ Cherry CR
 ◆ Lava LA
 ◆ Lime LM
 ◆ Mulberry MB
 ◆ Onyx ON
 ◆ Platinum PT
 ◆ Regatta RE
 ◆ Shadow SE
 ◆ Surf BU
 ◆ Tangelo RG

4-LEG AND CANTILEVER CHAIR AND STOOL FRAME

PAINTS CODES

P1

- ◆ Designer White Texture PK7
 ◆ Textured Charcoal P7A
 ◆ Textured Platinum
 Metallic PLAT
 ◆ Textured Titanium P8V

P2

- ◆ Silver Texture PR8

P3

- ◆ Atom P8S
 ◆ Bullseye PJF
 ◆ Ember P8P
 ◆ Ion P8N
 ◆ Iris P8J
 ◆ Krypton P8F
 ◆ Regatta P8M

P4

- ◆ Polished Chrome* Y

* \$55 upcharge. Polished Chrome not available on models HSS4L-06A, HSS4L-24B, and HSS4L-30B.

◆◆◆ For lead time information see page 21.

SMARTLINK® SPECIFYING INFORMATION

EDUCATION

STEP 1

Choose a grade range to find the recommended SmartLink® desk and table height.

Recommended space from chair seat to underside of table is 8"-11"							
Seat Height	6"	12"	14"	16"	18"	24"	30"
Table Height	14"	22"	24"	27"	29"	36"	42"
Pre-K							
Kindergarten - Grade 1							
Grade 2 - 4							
Grade 5 - 12							

STEP 2

Pick the SmartLink® model that meets the student height needs.



Model: HLDV-M3A
Adjustable Height
23"-33" Height Range

Use the color-coated circles in the chart on the right to find a compatible chair.



Model: HLDV-M3F
Fixed Height
30" Fixed Height



Model: HLDV-M3T
Sit-to-Stand
30"-43" Height Range

STEP 3

Determine the suggested chair height within your desk size range.

Desk Height		Chair Seat Height	Type of Chair
22"	●	12"	4-Leg, Cantilever or Task
23-24"	●		
25-27"	●		
28-29"	●	16-18"	
30"	●○●	18"	
31-33"	●○	22-24"	
34-41"	○	24-31"	
42-43"	○	30-32"	

SMARTLINK® SPECIFYING INFORMATION

Individual Layouts

- The non-handed top allows the desk to be positioned to better support right-handed or left-handed individuals or be used in a forward position.



LH Position



Forward Position



RH Position

Group/Collaborative Layouts

Below are examples of how the student desks can be configured to support multiple students or group activities.

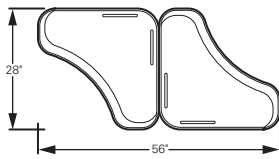

Student Desk
2-Desk Configuration

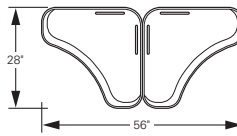

Opposing Student Desk
2-Desk Configuration

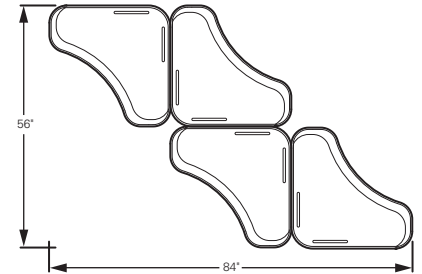

Student Desk
4-Desk Configuration

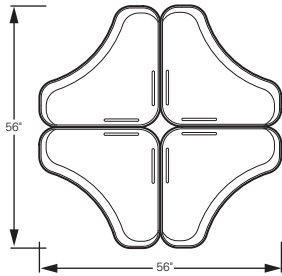

Student Desk
4-Desk Cluster Configuration

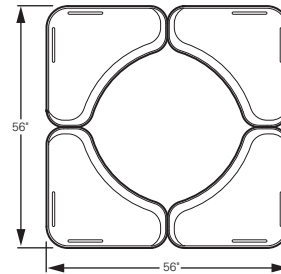

Student Desk
4-Desk Work Group Configuration
Can accommodate up to 8 students

Teacher Centered Layouts

- Reverse the layout and use the student desks to create layouts for teacher centers that can accommodate up to 6 students.
- 23 $\frac{5}{8}$ " distance between legs when used from either side.

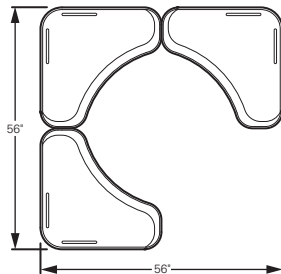

Teacher Centered Layout

Standard Row Layout

While a variety of classroom configurations are possible, a standard row layout shown below with 25 student desks utilizes a footprint of 199" deep by 284" wide. A 30 student desk row layout (5 rows deep by 6 rows wide) will require a footprint of 199" deep by 348" wide.

These dimensions are based upon 36"W aisles. Actual dimensions should be based upon local building codes.

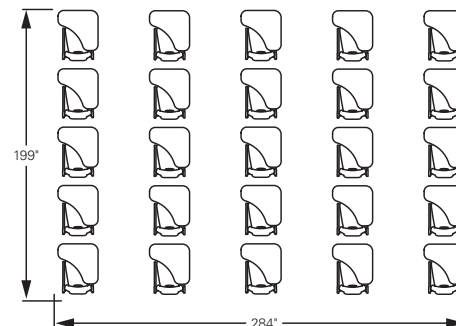

SMARTLINK® SPECIFYING INFORMATION

TEACHER STATION

SmartLink®

The following planning and specifying information is intended to help you imagine and create stimulating SmartLink classrooms that can integrate technology while helping rooms stay adaptable, organized and attractive. SmartLink offers you everything you need to create flexible, clutter-free learning environments for students of all ages.

Teacher Station – Value Double Pedestal with Modesty Panel

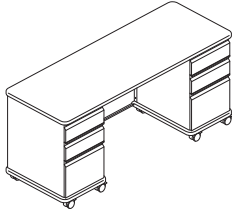

HLTV2466TMOD-33

Storage

- Box/box/file pedestal is always **standard for both the left and right handed side of the desk. Pedestals are locking.**
- Available kneespace is 33¼"W x 20"D for all models.
- Non-locking Center Drawer (HD8X) may be field installed in the kneespace. Tops are pre-drilled to accept the drawer.
- Center drawers and CPU holders cannot be installed together.

Teacher Station – Value Double Pedestal

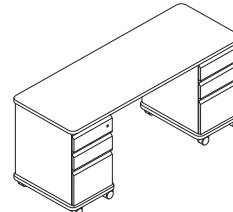

HLTV2466T-33

- Larger top size provides ample work/conference area or space for equipment.
- Standard with Heavy-duty 3", 360-degree **swivel + locking casters.**
- Storage options include: Locking box/box/file.
- Modesty specified separately.
- Power modules can be ordered separately and mounted to the desk. See Power & Cable Management page 245.

Teacher Station – Value Single Pedestal with Modesty Panel



HLTV2466TMOD-3

Storage

- Single pedestal desk available in Left-hand or Right-hand. **Right or left handedness determined when installing in the field.**
- Pedestal options include Box/Box/File locking.

Teacher Station – Value Single Pedestal

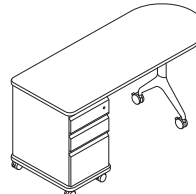

HLTV2460T-3

- Standard with Heavy-duty 3", 360-degree **swivel + locking casters.**
- Storage options include: Locking box/box/file.
- Right or left assembled in the field.
- D-shape top encourages conferencing and provides ample work and conference area.
- Modesty specified separately.
- Power modules can be ordered separately and mounted to the desk. See Power & Cable Management page 245.

SMARTLINK® SPECIFYING INFORMATION

MODULAR STORAGE

SmartLink® Modular Storage is comprised of cases, accessories and support rails. However, only the cases and accessories need to be specified. The following guidelines should help you plan and specify SmartLink Storage.

Planning Notes

Cases

- A laminate top with a soft feel vinyl edge provides a classic look with exceptional durability.
- **Storage cases do NOT include accessories. Accessories are specified and sold separately.**
- Case configurations are based off of 12"W or 30"W columns.
- Internal case configurations cannot be changed (i.e., cannot change an HLSF52-3 to a HLSF52-21).
- Cases are designed to allow the users to create a variety of accessory configurations using different tray heights and shelves.
- Cases can be specified with or without locking doors.
- Door models may be converted to non-door models in the field.

Accessories

- Accessories include trays in 3", 6" and 12" heights, shelves in 12" and 30" widths and a 12"W coat rod.
- **All accessories are sold and specified separately as kits and include 1 pair of storage rails per tray or shelf.**
- The support rails simple "no tool" attachment method allows users to easily install and change rail (tray or shelf) positions as needed.
- Kits include:

Accessory	Quantity Per Kit	Where Used
3"H trays	7 trays / 14 support rails	12"W columns only
6"H trays	4 trays / 8 support rails	12"W columns only
12"H trays	2 trays / 4 support rails	12"W columns only
12"W shelf	2 shelves / 4 support rails	12"W columns only
30"W shelf	2 shelves / 4 support rails	30"W columns only
Coat Rod	1 coat rod	12"W columns — Full Height case only

- Cabinet Whiteboard Bracket kit is available which allows whiteboards to be mounted to the back of the full height cabinets. Kit includes upper and lower rails with integrated marker tray and attachment hardware. Use wall rail sliding whiteboards. Rails will accept one (1) 48" x 48" board or two (2) 24" x 48" boards.

Specification Notes

- Number of accessory openings
SmartLink storage cases are available in six (6) standard case types that feature combinations of 12" or 30" internal column widths. The following illustration shows the number of openings by column width for each case configuration.

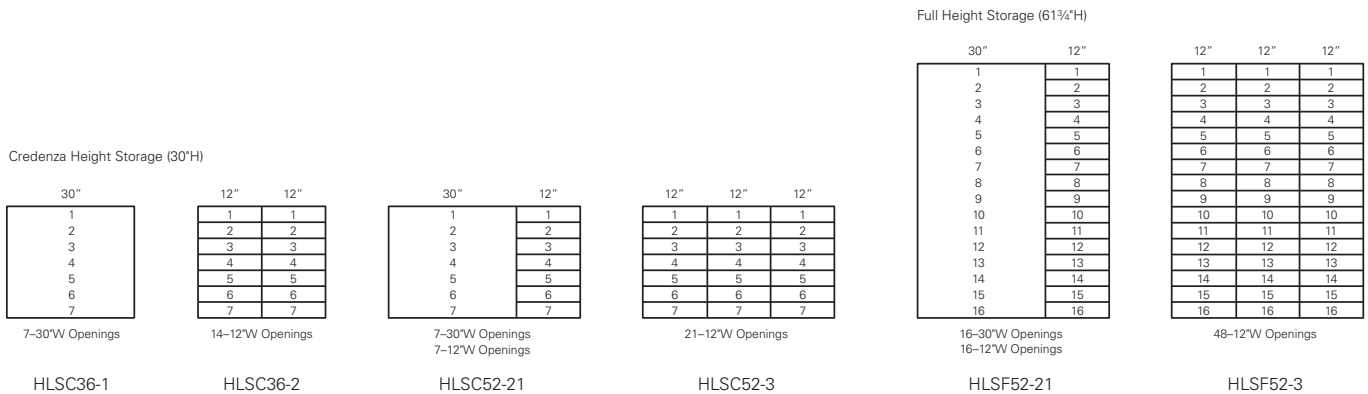

SMARTLINK® SPECIFYING INFORMATION

- Openings used by Accessory type:

Accessory	Openings used per Accessory
3”H tray	1
6”H tray	2
12”H tray	4
12”W shelf	1
30”W shelf	1

- Any combination of trays or shelves (of common width) can be used as long as the openings used equal the total number of openings available per column. The following illustrations show a variety of tray configuration options. Numbers shown in the opening refers to the tray size.

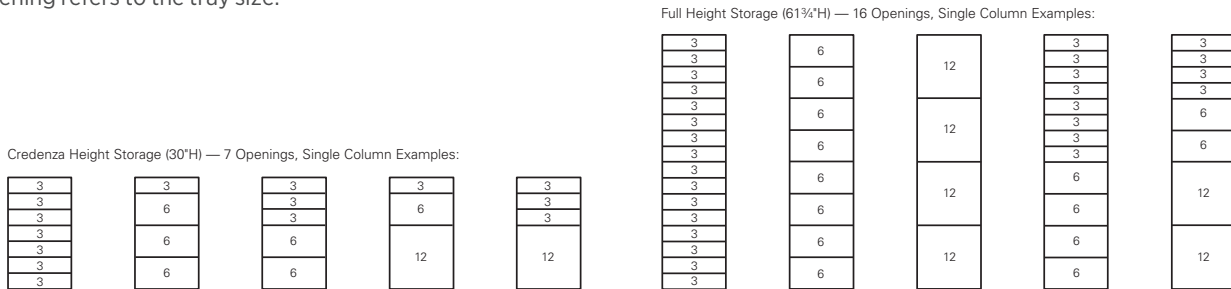

Using the information above, follow these guidelines to help determine accessory quantities.

- Determine the total number of available “openings” by width (12”, 30”) for each case type.
Example: HLSF52T-3F has 3 columns of 16 openings, total 48 openings
- On a PER COLUMN basis, determine the desired tray/shelf configurations total number of openings used so they equal the total openings available per column. Total accessory quantities per case then multiply by the total number of like cases.
Example: If each column will have 2-12” trays, 2-6” trays and 4-3” trays. The number of openings used for this column combination is 16. Assuming all three columns are the same total tray quantities for this case will be 12-3”, 6-6” and 6-12”.
- Once total tray and shelf quantities are determined, simply divide by the kit quantity to determine the number of kits required.
Example: 3” trays = $12 \div 7 = 2$ kits, 6” trays = $6 \div 4 = 2$ kits, 12” trays = $6 \div 2 = 3$ kits

Shelf Spacing

The clearance between shelves is approximately 3 3/8” for every support rail that is not used between shelves. The following illustration shows the clearance between shelves when 0-4 support rail positions are not utilized.

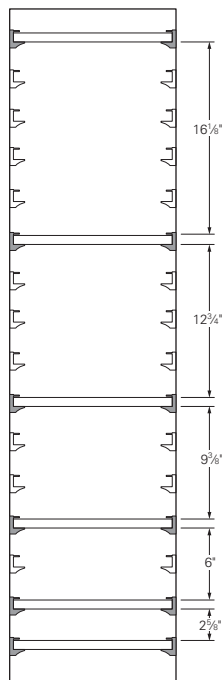

SMARTLINK® SPECIFYING INFORMATION

WALL RAIL SYSTEM

The SmartLink® wall rail is a multi-layered, multi-functional system that can accommodate a variety of presentation boards and accessories. The multiple tracks allow boards to be easily positioned and changed to support today's interactive learning environments.

Planning Notes

- Installation of the wall rail system over existing white or chalkboards is not recommended.
- The rail and wall bracket provide three separate tracks for the Learning boards. The REAR or wall/bracket track is occupied by the fixed wall board. The MIDDLE and FRONT tracks are for sliding boards.
- To allow for greater utilization of the rear fixed board a maximum width of 96" of sliding boards on the middle or front track is recommended.

The illustration below shows the overall wall space requirements for the rail system and recommended mounting height for use in K-12 classroom applications.

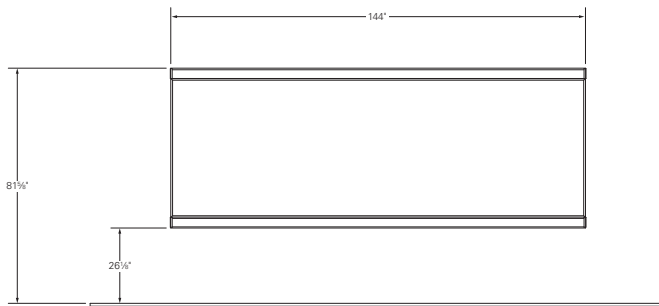

Sliding boards are removable and reversible so a wide variety of layouts are possible. The following illustrations highlight a couple of the more common applications. Layouts 2A and 2B provide the greatest amount of board space and overall flexibility. When used with rail mounted worksurfaces, use 24"W boards on the front rail as shown in 2C in front of each worksurface to provide information specific to that work area. Boards could then be added to the middle rail for information/work to be shared between the stations.

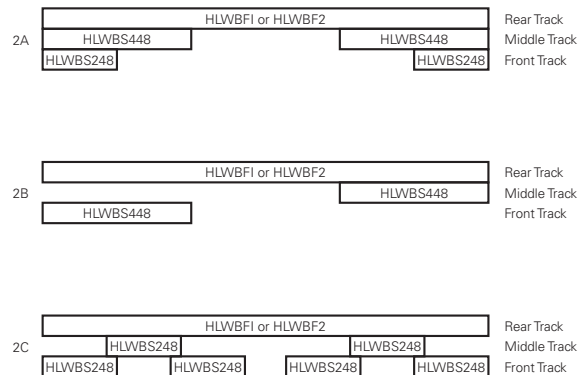

Specification Notes

- Boards are specified individually.
- Hardware to mount to the wall brackets is not provided by HON and MUST BE SOURCED LOCALLY.
- Learning board only applications require two (2) HLWR-12 rails to be specified.
- REFER TO PRODUCT INSTALLATION INSTRUCTIONS FOR DETAILED INSTALLATION INFORMATION.

NOTES



EDUCATION



Icon Legend on page 19

SMARTLINK® Value Series Student Desks

EDUCATION

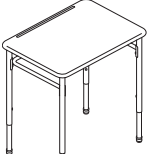
	DESCRIPTION	MODEL	SHIP WEIGHT	CUBE	LIST PRICE BY PAINT GRADE		
					P1	P2	P3
	Student Desk, Fixed Height 28"W x 28"W, User side 36¼"W 30" Fixed Height Hard Plastic Top	HLDV-M3F	63	18.0	\$746	\$746	\$778
	NOTES: The cross-brace is installed to maximize kneespace but will not allow for book box (HLDA-15) installation. The cross-brace orientation can be switched in the field to allow for book basket install. ⓘ Student Desks are ordered and shipped two (2) desks per carton. Legs and cross-brace ship attached. Lower adjustable legs ship unattached for field installation. Pricing shown is <u>per carton</u> . Ordering two of model HLDV-M3F will result in 2 cartons being shipped, giving you 4 desks.						
	Student Desk, Adjustable Height 28"W x 28"W, User side 36¼"W Adjustable: 23"-33" height adjustment range. Hard Plastic Top	HLDV-M3A	59	12.5	\$746	\$746	\$778
	NOTES: Accepts book box (HLDA-15) installation without repositioning crossbar. ⓘ Student Desks are ordered and shipped two (2) desks per carton. Upper leg and cross-brace ship attached. Lower adjustable legs ship unattached for field installation. Pricing shown is <u>per carton</u> . Ordering two of model HLDV-M3A will result in 2 cartons being shipped, giving you 4 desks.						
	Student Desk, Sit-to-Stand 28"W x 28"W, User side 36¼"W Adjustable: 30"-43" height adjustment range. Leg height is set during field installation. Hard Plastic Top	HLDV-M3T	61	15.3	\$1062	\$1062	\$1083
	NOTES: Accepts book box (HLDA-15). ⓘ Student Desks are ordered and shipped two (2) desks per carton. Legs and cross-brace ship attached. Pricing shown is <u>per carton</u> . Ordering two of model HLDV-M3T will result in 2 cartons being shipped, giving you 4 desks.						
	Rectangle Student Desk, Adjustable Height 20"W x 26"D Adjustable: 23"-33" height adjustment range.	HLDV-MRECT2026A	57	9.19	\$746	\$746	\$778
	NOTES: Accepts book box (HLDA-15) installation without repositioning crossbar. Lower adjustable legs ship unattached for field installation. ⓘ Student Desks are ordered and shipped two (2) desks per carton. Legs and cross-brace ship attached. Pricing shown is <u>per carton</u> . Ordering two of model HLDV-MRECT2026A will result in 2 cartons being shipped, giving you 4 desks.						

NOTES:

- Upper leg is painted, lower leg standard chrome finish on Adjustable Height models.
- Non-handed desk top constructed of 3/4" hard plastic.
- Hard plastic tops include pencil grooves.
- Nylon swivel glides are standard on adjustable and fixed leg models.
- Fixed Height models ship fully assembled. Adjustable models have the upper leg and cross-brace installed. The lower leg ships unattached for field installation.
- 29.60" distance between legs on user side. Outside distance between legs is 23 3/8".
- Accepts optional backpack hooks (HCLA65).
- Book boxes are only available as an accessory for field installation on Value Series desks.

SPECIFICATION TIP: Consider available kneespace when specifying under desk storage Metal Book Box. Available kneespace will vary significantly given set desk height. Use the following example to calculate the available and usable kneespace.

EXAMPLE: HLDV-M3A Student Desk, HLDA-15 Metal Book Box
 (user set desk height – top thickness – seat height = available kneespace)
 (29"H – 1" thickness – 18" seat height = 10" available kneespace)
 (available kneespace – book basket/box height = usable kneespace)
 (10" available kneespace – 5" basket height = 5" usable kneespace)

- ⓘ Field installed felt glide caps (HGDK3-F) are recommended for use on VCT flooring.
- ⓘ All Student Desks are ordered and shipped two (2) desks per carton. Ordering two of any model will result in 2 cartons being shipped, giving you 4 desks.

HOW TO SPECIFY

Select Model Number H L D V - M 3 F .	Select Glide Option E Hard-Surface (no upcharge)	Select Top Color See page 175 G 9 .	Select Upper Leg Color See page 175 S
---	--	--	--

SMARTLINK® Student Accessories

GSA SIN AS NOTED



Icon Legend on page 19

EDUCATION

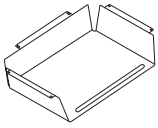

SIN 33721T



DESCRIPTION

Metal Book Box (4 per Carton)
19½"W x 13"D x 5"H

NOTES: Attaches to bottom of desk with 6 screws, included. Screws included are for SmartLink® plastic tops only. Field installed. Features integrated, full-width pencil holder.

- ! Platinum finish only.
- ! Book Box rated up to 25 lbs.
- ! SmartLink® Book Box, HLDA-15, is compatible with Roll Call™. Book box hardware pack does not include wood screws which are needed to install book box to a laminate worksurface. Installer to provide wood screws. Each book box requires 6, #12 phillips panhead, ¾" long screws for installation.

MODEL SHIP WEIGHT CUBE LIST PRICE

HLDA-15 15 2.0 \$322

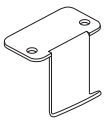

OPEN MARKET



Back Pack Hook (10 per carton)

NOTES: Assembly: attaches to bottom of desk with (2) screws, included.

- ! Available in Platinum Metallic finish only, no specification needed.
- ! Back Pack Hook rated up to 25 lbs.

HCLA65 10 0.1 \$119



OPEN MARKET

Glide Kit — Felt Glide Caps

- Recommended for use on VCT flooring.
- Caps easily and securely snap over existing nylon swivel glide.
- Kit includes 100 caps.
- Field installed.

! Not designed to be used with Sit-to-Stand Bell Glides (model HLDV-M3T).
Must be ordered with a configurable end product. If ordered separately, not on GSA Contract.





HGDK3-F 2 0.2 \$155

HOW TO SPECIFY

Select
Model Number

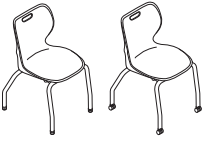
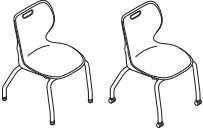
HLDA-15



	MODEL/DESCRIPTION	DEPTH	WIDTH	HEIGHT	SHIP WEIGHT	CUBE	PER CARTON LIST
	HSS4L-18B 18"H 4-Leg Chair, Armless Maximum: Seat: Back: Seat to Floor: Usable Seat Depth:	19 ⁵ / ₈ 16 ¹ / ₄ 15 ³ / ₈ 18 16 ¹ / ₈	19 ¹ / ₂ 16 ¹ / ₂ 15 ³ / ₈ 18	31 18 13 ³ / ₈ 18	58	15.6	P1 \$715
	HSS4L-16B 16"H 4-Leg Chair, Armless Maximum: Seat: Back: Seat to Floor: Usable Seat Depth:	19 ⁵ / ₈ 16 ¹ / ₄ 15 ³ / ₈ 16 16 ¹ / ₈	19 ¹ / ₄ 16 ¹ / ₂ 15 ³ / ₈ 16	29 16 13 ³ / ₈ 16	54	15.6	P1 \$715
	HSS4L-14A 14"H 4-Leg Chair, Armless Maximum: Seat: Back: Seat to Floor: Usable Seat Depth:	17 14 ¹ / ₄ 13 ³ / ₈ 14 14	17 14 ³ / ₈ 13 ³ / ₈ 14	25 ¹ / ₂ 14 11 ⁵ / ₈ 14	49	11.9	P1 \$682
	HSS4L-12A 12"H 4-Leg Chair, Armless Maximum: Seat: Back: Seat to Floor: Usable Seat Depth:	17 14 ¹ / ₄ 13 ³ / ₈ 12 14	17 14 ³ / ₈ 13 ³ / ₈ 12	23 ¹ / ₂ 12 11 ⁵ / ₈ 12	45	11.9	P1 \$682
	HSS4L-06A 6"H 4-Leg Chair, Armless Maximum: Seat: Back: Seat to Floor: Usable Seat Depth:	17 14 ¹ / ₄ 13 ³ / ₈ 6 14	17 14 ⁵ / ₈ 13 ³ / ₈ 6	17 ¹ / ₂ 6 11 ⁵ / ₈ 6	37	8.6	P1 \$665

NOTES:

- High strength tubular steel frame.
 - Seat Shell is one-piece injection molded.
 - 16"H and 18"H models accept Wire Storage Basket model HSSA-WB1618.
 - Casters are available on 16"H and 18"H chairs only.
 - 4-Leg models stack 5-high on floor.
 - Nylon or steel glides accept felt glide caps (HGDK3-F) which are recommended for use on VCT flooring.
 - Durable textured powder coated paint finish or chrome option finish.
- ⊕ SmartLink® 4-Leg Chairs are ordered and shipped four (4) chairs per carton. Pricing shown is per carton. Each set of four chairs (one carton) must have the same shell/frame color combination. Ordering 2 of Model HSS4L-06A, HSS4L-12A, HSS4L-14A, HSS4L-16B or HSS4L-18B will result in 2 cartons being shipped, giving you 8 chairs.

HOW TO SPECIFY

<p>Select Model Number</p> <p>H S S 4 L - 1 2 A</p>	<p>Select Glide Option</p> <p>E Nylon Glide N Nickel Steel Glide C Caster (\$205 upcharge) Caster option not available for models HSS4L-06A, HSS4L-12A or HSS4L-14A</p> <p>E</p>	<p>Select Shell Color</p> <p>See page 175</p> <p>R G</p>	<p>Select Frame Color</p> <p>See page 175 P4 option Polished Chrome (Y) \$55 upcharge</p> <p>P L A T</p>
--	---	---	---



MODEL/DESCRIPTION	DEPTH	WIDTH	HEIGHT	SHIP		LIST PRICE BY PAINT GRADE		
				WEIGHT	CUBE	P1	P2	P3
HSS4L-24B 24" H 4-Leg Stool, Armless				30	16.8	\$348		
Maximum:	21½	22	38¾					
Seat:	16¼	16½	24					
Back:		15¾	13¾					
Seat to Floor:			24					
Usable Seat Depth:	30							



HSS4L-30B 30" H 4-Leg Stool, Armless				31	19.1	\$367		
Maximum:	23½	22½	43¾					
Seat:	16¼	16½	30					
Back:		15¾	13¾					
Seat to Floor:			30					
Usable Seat Depth:	30							

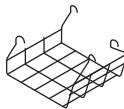

DESCRIPTION	MODEL	SHIP WEIGHT	CUBE	LIST PRICE
Wire Storage Basket (4 per carton) 15¾"W x 12¼"D x 9¾"H	HSSA-WB1618	14	1.6	\$174
<ul style="list-style-type: none"> ⓘ For 16" and 18" 4-Leg Chairs only. Chrome finish only, no specification needed. ⓘ Chairs cannot be stacked when utilizing Wire Storage Basket. ⓘ Not compatible with 4-Leg Stools or Cantilever Chairs. ⓘ Storage Basket rated up to 25 lbs. 				



Felt Cap Glide Kit for 4-Leg SmartLink®	HGDK3-F	2 ⓘ	0.2	\$155
<ul style="list-style-type: none"> • Recommended for use on VCT flooring. • Caps easily and securely snap over the existing nylon swivel glide. • Kit includes 100 caps for 25 chairs or desks. • Field installed. 				
ⓘ Must be ordered with a configurable end product. If ordered separately, not on GSA Contract.				



NOTES:

- 4-Leg Stools may stack up to 5-high on floor.
- Lead times may vary by shell color.
- ⓘ Polished Chrome (Y) not available on models HSS4L-24B and HSS4L-30B.

HOW TO SPECIFY

<p>Select Model Number</p> <p>H S S 4 L - 2 4 B .</p>	<p>Select Glide Option</p> <p>E Nylon Glide N Nickel Steel Glide</p> <p>E .</p>	<p>Select Shell Color</p> <p>See page 175</p> <p>R G .</p>	<p>Select Frame Color</p> <p>See page 175</p> <p>P L A T</p>
--	--	---	---



	MODEL/DESCRIPTION	DEPTH	WIDTH	HEIGHT	SHIP WEIGHT	CUBE	PER CARTON LIST
	HSSCL-18B 18"H Cantilever Base Chair, Armless Maximum: Seat: Back: Seat to Floor: Usable Seat Depth:	21¾ 16⅞ 16⅞ 16⅞	22¾ 16½ 15⅜	31¼ 18 13⅜ 18¼	80	23.7	P1 \$1053
	HSSCL-16B 16"H Cantilever Base Chair, Armless Maximum: Seat: Back: Seat to Floor: Usable Seat Depth:	21¾ 16⅞ 16⅞ 16⅞	22¾ 16½ 15⅜	29¼ 16 13⅜ 16¼	55	16.8	P1 \$1002
	HSSCL-14A 14"H Cantilever Base Chair, Armless Maximum: Seat: Back: Seat to Floor: Usable Seat Depth:	21¾ 16⅞ 16⅞ 16⅞	22¾ 16½ 15⅜	27¼ 14 13⅜ 14¼	52	16.8	P1 \$983



NOTES:

- High strength tubular steel frame.
 - Glides available with nylon or felt inserts. See ordering information below.
 - Seat shell is one-piece injection molded.
 - Cantilever models stack 5-high on floor.
 - Durable textured powder coated paint or chrome option finish.
- SmartLink®** Cantilever Chairs are ordered and shipped four (4) chairs per carton. Pricing shown is per carton. Each set of four chairs (one carton) must have the same shell/frame color combination. Ordering 2 of Model HSSCL-18B will result in 2 cartons being shipped, giving you 8 chairs.

HOW TO SPECIFY

<p>Select Model Number</p>	<p>Select Glide Option</p> <p>E All-purpose Glide Insert (no upcharge) F Felt Glide Insert (\$38 list upcharge; \$9.50 per single unit see page 184)</p>	<p>Select Shell Color</p> <p>See page 175</p>	<p>Select Frame Color</p> <p>See page 175 <i>P4 option Polished Chrome (Y) \$55 upcharge</i></p>
<p>H S S C L - 1 8 B .</p>	<p>E .</p>	<p>R G .</p>	<p>P L A T</p>



	MODEL/DESCRIPTION	DEPTH	WIDTH	HEIGHT	SHIP WEIGHT	CUBE	PER CARTON LIST
	HSSTK-18B 18"H Task Swivel Chair, Pneumatic Seat Height Adjustment ! Black frame only.	Maximum: 22 ⁵ / ₈ Seat: 16 ¹ / ₄ Back: 15 ³ / ₈ Seat to Floor: 16-21 Usable Seat Depth: 16 ¹ / ₈	22 ¹ / ₂	34 ³ / ₄	23	5.2	\$391
	HSSST-18B 18"H Task Swivel Stool, Pneumatic Seat Height Adjustment, Footring Adjustment ! Black frame only.	Maximum: 24 ¹ / ₄ Seat: 16 ¹ / ₄ Back: 15 ³ / ₈ Seat to Floor: 22-32 Usable Seat Depth: 16 ³ / ₈	25 ³ / ₄	45 ¹ / ₂	28	12.8	\$480

NOTES:

- Seat Shell is one-piece injection molded.
 - Task Swivel Chair has a pneumatic seat height adjustment.
 - Choose between hard and soft casters (no upcharge) or bell glide (\$27 upcharge) options.
 - Stool has an adjustable footring.
 - Swivel Task Chair and Stool ship one per carton.
- ! Swivel Task Chair and Stool are available with a black frame only.



HOW TO SPECIFY

<p>Select Model Number</p> <p>HSSTK-18B</p>	<p>Select Glide Option</p> <p>S Soft Caster (no upcharge) H Hard Caster (no upcharge) G Bell Glide (\$27 upcharge)</p> <p>S</p>	<p>Select Shell Color</p> <p>See page 175</p> <p>RG</p>
--	--	--

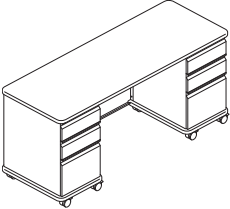

SMARTLINK® Value Teacher Stations

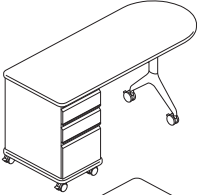
DESCRIPTION	MODEL	SHIP WEIGHT	CUBE	LIST PRICE BY PAINT GRADE			L2 UPCHARGE
				P1	P2	P3	
 <p>Value Teacher Station with Modesty Panel 66"W x 24"D x 30"H, Rectangle Box/Box/File Pedestal, Left Box/Box/File Pedestal, Right</p> <p>NOTES: Ships standard with full height modesty panel for field installation.</p>	HLTV2466TMOD-33	254	37.2	\$2496	\$2561	\$2616	\$63

 <p>Value Teacher Station with Modesty Panel 60"W x 24"D x 30"H, Peninsula Box/Box/File Storage</p> <p>NOTES: Ships standard with half height modesty panel for field installation.</p>	HLTV2460TMOD-3	136	29.3	\$1919	\$1968	\$2006	\$42
							

NOTES

- Tops/Bases are Laminate with T-mold edge.
- Standard with Heavy-duty 3", 360-degree swivel casters.
- Storage options include: Locking box/box/file.
- Kneewell space accommodates separately specified and field installed non-locking center drawer and CPU holders (see page 227).
- Peninsula top encourages conferencing and provides ample work and conference area.
- Right or left assembled in the field.
- Modesty panel included in model.
- Power modules can be ordered separately and mounted to the desk.

HOW TO SPECIFY

<p>Select Model Number</p> <p>HLTV2466TMOD-33</p>	<p>Select Top and Base Color</p> <p>Laminate</p> <p>See page 175</p> <p>B9</p>	<p>Select T-Mold Color</p> <p>See page 175</p> <p>K</p>	<p>Select Paint Color</p> <p>See page 175</p> <p>T1</p>
---	--	---	---

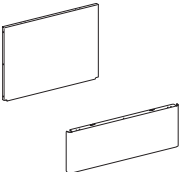
DESCRIPTION	MODEL	SHIP WEIGHT	CUBE	LIST PRICE BY PAINT GRADE		
				P1	P2	P3
 <p>Modesty Panel 34"W x 24½"H, for Rectangle Teacher Desk 35"W x 12"H, for Peninsula Teacher Desk</p> <p>NOTES: Modesty panels can be retrofitted to existing SmartLink® Value Teacher Stations.</p>	HLTVMODFULL	17	2.3	\$262	\$294	\$325
	HLTVMODPART	10	1.3	\$220	\$241	\$262

HOW TO SPECIFY

<p>Select Model Number</p> <p>HLTVMODFULL</p>	<p>Select Paint Color</p> <p>See page 175</p> <p>S</p>
---	--

SMARTLINK® Value Teacher Stations

GSA SIN 3372IT EXCEPT AS NOTED



Icon Legend on page 19

EDUCATION

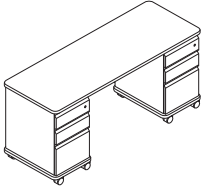

DESCRIPTION

Value Teacher Station
66"W x 24"D x 30"H
Box/Box/File Pedestal, Left
Box/Box/File Pedestal, Right

NOTES: Accepts universal modesty panel (HMTUMOD32).

MODEL

HLTV2466T-33

SHIP WEIGHT

240

CUBE

21.1

LIST PRICE BY PAINT GRADE

P1

\$2234

P2

\$2268

P3

\$2291



Value Teacher Station

60"W x 24"D x 30"H
Box/Box/File Storage

NOTES: Accepts universal modesty panel (HMTUMOD32).

HLTV2460T-3

158

14.18

\$1699

\$1727

\$1744



NOTES:

- Tops/Bases are Laminate with T-mold edge.
- Standard with Heavy-duty 3", 360-degree swivel casters.
- Storage options include: Locking box/box/file.
- Kneewell space accommodates separately specified and field installed non-locking center drawer and CPU holders (see page 227).
- D-shape top encourages conferencing and provides ample work and conference area.
- Right or left assembled in the field.
- Modesty specified separately.
- Power modules can be ordered separately and mounted to the desk.

HOW TO SPECIFY

Select Model Number

HLTV2466T-33

Select Top and Base Color

Laminate
See page 175

B9

Select T-Mold Color

See page 175

K

Select Paint Color

See page 175

T1

NOTES

EDUCATION

NOTES

EDUCATION

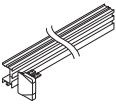
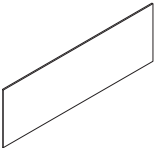
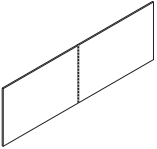
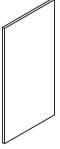
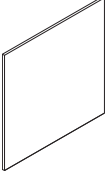

SMARTLINK® Wall Rail System

	DESCRIPTION	MODEL	SHIP WEIGHT	CUBE	LIST PRICE
	Wall Rail 144" NOTES: Rail model includes: 1 – 144" rail, 9 – wall mounting brackets and 2 – rail end caps. ⓘ Must be mounted in accordance with published installation instructions. Wall mounting hardware NOT INCLUDED. Must be sourced locally. ⓘ Must order Quantity 2 rails when using with Whiteboards and Whiteboards/Tackboards. ⓘ Platinum finish only.	HLWR-12	22	1.4	\$1054
	Learning Board, Fixed Whiteboard, 1-sided 144"W x 48"H, Quantity 1 SPECIFYING EXAMPLE: HLWBF1-1248W.X	HLWBF1-1248W	124	13.0	\$2517
	Learning Board, Fixed Whiteboards, 1-sided 72"W x 48"H, Quantity 2 with spacer (included) NOTES: Includes center cover/spacer. SPECIFYING EXAMPLE: HLWBF2-1248W.X	HLWBF2-1248W	125	6.7	\$2517
	Learning Board, Sliding Whiteboard/Whiteboard 48"W x 48"H 24"W x 48"H SPECIFYING EXAMPLE: HLWBS-448WW.X	HLWBS-448WW HLWBS-248WW	47 26	4.6 2.5	\$1215 \$777
<i>Model HLWBS-248WW shown</i>					
	Learning Board, Sliding Whiteboard/Tackboard 48"W x 48"H 24"W x 48"H NOTES: Tackboard Side available in the following fabric: Lucy Neutra (LC24). SPECIFYING EXAMPLE: HLWBS-448WT.X.LC24	HLWBS-448WT HLWBS-248WT	64 34	4.6 2.5	\$1264 \$810
<i>Model HLWBS-448WT shown</i>					

NOTES:

- Multi-functional wall rails can accommodate whiteboards and organizational accessories. See above and page 196.
- Multi-track rail allows for up to three layers of whiteboards. Rear track supports a fixed board, middle and front tracks support sliding boards. Outer rail channel is for attachment of organizational accessories.
- Sliding learning boards are removable and reversible.
- All fixed and sliding boards:
 - Require two (upper and lower) rails for installation.
 - Feature a full aluminum frame.
 - Are high-quality porcelain over steel and non-shadowing.
 - Are low gloss for projection use and allows for use of magnets.

HOW TO SPECIFY

<p>Select Model Number</p> <p>HLWBS - 448WT</p>	<p>Select Side A Color</p> <p>X Whiteboard</p>	<p>Select Tackboard Fabric</p> <p>LC24 Lucy Neutra Specify for models HLWBS-448WT and HLWBS-248WT only</p>
--	---	---

SMARTLINK® Wall Rail System Accessories

GSA SIN 33721T EXCEPT AS NOTED



Icon Legend on page 19



DESCRIPTION

Marker Tray (Single Pack)
7"W x 3½"D x 2"H

NOTES: Holds dry-erase markers, push pins and other small objects.

MODEL	SHIP WEIGHT	CUBE	LIST PRICE BY PAINT GRADE		
			P1	P2	P3
HPPMMT	1	0.2	\$124	\$137	\$149

NOTES:

- Use on the Wall Rail System — see page 195.
- Marker Tray mounts on the rail's outer channel and may be used with sliding boards.
- May be mounted and moved to any position along the width of the rail.
- May be easily removed from the rail.

EDUCATION

HOW TO SPECIFY

Select Model Number

Select Paint Color

See page 175

H P P M M T .

T 1



Icon Legend on page 19

SMARTLINK® Value Mobile Storage

EDUCATION

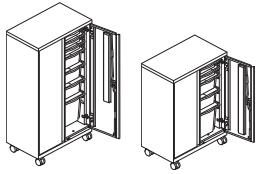

HLVMSC5630R HLVMS4330R

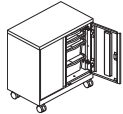

HLVMSC3330R

SIN 33721T

DESCRIPTION

Mobile Storage Cabinet with Bins

18"D x 30"W x 32¼"H
18"D x 30"W x 42¼"H
18"D x 30"W x 56"H

MODEL

HLVMSC3330R
HLVMSC4330R
HLVMSC5630R

SHIP WEIGHT CUBE

152.6 13.4
171.6 18.0
209.6 23.5

LIST PRICE BY PAINT GRADE

P1	P2	P3
\$1781	\$1827	\$1858
\$1958	\$2009	\$2042
\$2254	\$2312	\$2351

NOTES:

- Full radius "R" handle on doors.
- Units include 2 locking and 2 non-locking casters.
- Equipped with HON "One Key" interchangeable core removable locks.

1 Pre-configured trays and rails included in mobile storage cabinets with bins. See chart below for configurations and capacity. Additional bin and rail kits may be purchased separately.

DESCRIPTION

Accessories — Tray Kit

3"H, 2 bins and 4 rails
6"H, 2 bins and 4 rails
12"H, 2 bins and 4 rails

MODEL SHIP WEIGHT CUBE LIST PRICE

HFMBIN3	7	4.0	\$77
HFMBIN6	10	4.5	\$92
HFMBIN12	12	5.0	\$108

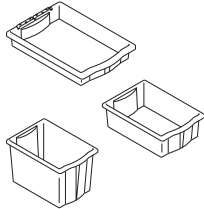

NOTES: Value mobile storage cabinets ship with pre-determined rails and bins. Additional bins and rails may be ordered in sets of two utilizing the models shown. Availability and usage are outlined below. HFMBIN3/6/12 are compatible with SmartLink® Value and Class-ifi™ Storage.

1 Semi-translucent white.

SIN 33721

Pre-Configured Cabinets/Tray Kits

56"H Cabinet		42¼"H Cabinet		32¼"H Cabinet	
1	2	1	2	1	2
3	4	3	4	3	4
5	6	1	2	1	2
1	2	3	4	3	4
3	4	1	2	1	2
5	6	3	4	3	4
1	2	1	2	1	2

56"H Cabinet		42¼"H Cabinet		32¼"H Cabinet	
1	14	1	11	1	7
2	15	2	12	2	8
3	16	3	13	3	9
4	17	4	14	4	10
5	18	5	15	5	11
6	19	6	16	6	12
7	20	7	17		
8	21	8	18		
9	22	9	19		
10	23	10	20		
11	24				
12	25				
13	26				

26 - 12"W Openings 20 - 12"W Openings 12 - 12"W Openings

HOW TO SPECIFY

<p>Select Model Number</p> <p>HLVMSC3330R</p>	<p>Select Lock Option</p> <p>L Lock (no upcharge) X Omit Lock (deduct \$20)</p> <p>L</p>	<p>Select Paint Color</p> <p>See page 175</p> <p>PJW</p>
--	---	---

SMARTLINK® Value Mobile Storage

GSA SIN AS NOTED



Icon Legend on page 19

EDUCATION

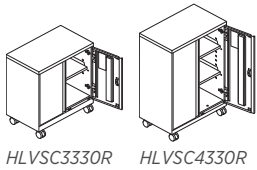

HLVSC3330R HLVSC4330R

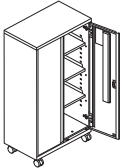

HLVSC5630R

SIN 33721T

DESCRIPTION

Mobile Storage Cabinet without Bins

- 18"D x 30"W x 32¼"H
- 18"D x 30"W x 42¼"H
- 18"D x 30"W x 56"H

MODEL

SHIP WEIGHT

CUBE

LIST PRICE BY PAINT GRADE

P1

P2

P3

HLVSC3330R	152.6	13.4	\$1621	\$1663	\$1690
HLVSC4330R	171.6	18.0	\$1781	\$1827	\$1858
HLVSC5630R	209.6	23.5	\$2136	\$2191	\$2227

NOTES:

- Full radius "R" handle on doors.
- Units include 2 locking and 2 non-locking casters.
- Includes shelves which are adjustable in 2" increments.
- Equipped with HON "One Key" interchangeable core removable locks.
- Wire management grommet in back of unit.

DESCRIPTION

Chrome Removable Lock Core Kit (for metal casegoods)

• Use when specifying omit lock application.

- Specify quantity of each key number from 101E-225E.
- Includes: 1-core, 2-keys, 1-core removal tool and instructions.
- Removable lock core kits with specific key number must be ordered to facilitate keying alike in the field.
- For specific models, look for the Omit Lock Core icon throughout this publication.

NOTES: If key number isn't specified, number will be at random. Core matches manufactured lock on metal casegoods product but can be used with Contain® and laminate product.

MODEL

SHIP WEIGHT

CUBE

LIST PRICE

HF23C

0.1

0.1

\$63

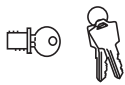

SIN 33721

HOW TO SPECIFY

Select Model Number

HLVSC3330R

Select Lock Option

- L Lock (no upcharge)
- X Omit Lock (deduct \$20)

L

Select Paint Color

See page 175

PJW



Icon Legend on page 19

SMARTLINK® Value Mobile Storage

EDUCATION

DESCRIPTION

Mobile Bookcases
 18"D x 30"W x 31¼"H
 18"D x 30"W x 42¼"H
 18"D x 30"W x 56"H

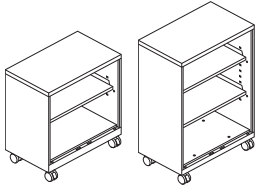

HLVBC3330

HLVBC4330

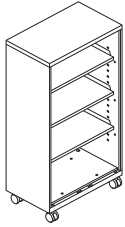

HLVBC5630

MODEL	SHIP WEIGHT	CUBE	LIST PRICE BY PAINT GRADE		
			P1	P2	P3
HLVBC3330	118.6	13.4	\$1471	\$1509	\$1534
HLVBC4330	134.6	18.0	\$1621	\$1663	\$1690
HLVBC5630	157.6	23.5	\$1943	\$1994	\$2026

NOTES:

- Units include 2 locking and 2 non-locking casters.
- Shelves adjust in 2" increments.
- Wire management grommet in back of unit.

HOW TO SPECIFY

Select Model Number

HLVBC3330

Select Paint Color

See page 175

PJW

STORYLINE™

Want to see more? Scan here
to check out hon.com.



EDUCATION



Storyline™ shown with SmartLink® Seating, Build™ Tables, & Confetti™.

STORYLINE™

Libraries and media centers aren't just for study halls and research anymore — they're the heartbeat of the school. These once basic spaces have shifted to thoughtful, holistic community hubs designed to inspire not just students, but anyone who wants to connect and create. Storyline — a versatile bookcase collection that offers organic movement and customized learning zone options — is an open book when it comes to inspired synergy in shared spaces. Whether it's an early morning reading circle, a mid-afternoon small group project, or an evening town hall meeting, Storyline bridges the gap between people and places.

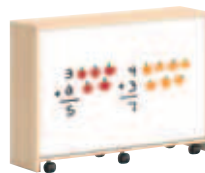
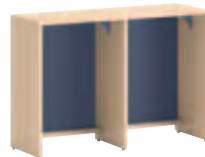

FEATURES

- Utilize 18"H bookcases as both storage and a seat.
- Single-sided bookcases and bistro tables utilize steel back to accept magnets.
- Case and shelf constructed using 1 1/8" laminate for durability and longevity.
- Cases ship fully assembled. Casters and shelves installed on site.

STORYLINE™ ORDERING INFORMATION

LAMINATE

L1 LAMINATES CODES

Woodgrain

- ◆ Bourbon Cherry H
- ◆ Cognac COGN
- ◆ Field Elm LWFE
- ◆ Florence Walnut LFW1
- ◆ Harvest C
- ◆ Kingswood Walnut LK11
- ◆ Mahogany N
- ◆ Mocha MOCH
- ◆ Natural Maple D
- ◆ Pinnacle PINC
- ◆ Shaker Cherry F
- ◆ Sterling Ash LSA1

Solid

- ◆ Black P
- ◆ Charcoal S
- ◆ Designer White LDW1
- ◆ Loft LOFT

L2 LAMINATES CODES

Woodgrain

- ◆ Beigewood LWBE
- ◆ Fawn Cypress LFC1
- ◆ Lowell Ash LLA1
- ◆ Natural Recon LNR1
- ◆ Phantom Ecru LPE1
- ◆ Portico Teak LPT1
- ◆ Skyline Walnut LSW1

PAINT

P1 CODES

- ◆ Black P71
- ◆ Brownstone P7D
- ◆ Charcoal S
- Cove P096
- ◆ Designer White PJW
- Dune P094
- Fog FOG
- ◆ Fossil P28
- ◆ Greige T5
- Harbor P097
- ◆ Light Grey Q
- ◆ Loft LOFT
- ◆ Muslin T3
- ◆ Putty L
- Sage P095
- ◆ Titanium P8T

P2 CODES

- ◆ Champagne Metallic PR5
- ◆ Gunmetal Metallic PR3
- ◆ Platinum Metallic T1
- ◆ Silver PR6
- ◆ Solar Black P8X

P3 CODES

- ◆ Atom P8S
- ◆ Blossom P8K
- ◆ Bullseye PJF
- ◆ Ember P8P
- ◆ Ion P8N
- ◆ Iris P8J
- ◆ Krypton P8F
- ◆ Ochre P093
- ◆ Regatta P8M
- ◆ Sienna P092
- ◆ Succulent P8A

P6 CODES

- ◆ Markerboard MKB

◆◆ For lead time information see page 21.

STORYLINE™ SPECIFYING INFORMATION

EDUCATION

Statement of Line

SINGLE-SIDED BOOKCASES

Linear

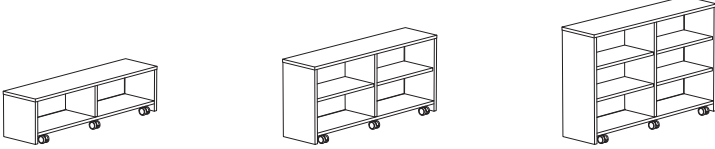

Curved In

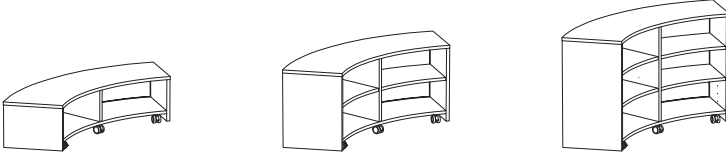

Curved Out

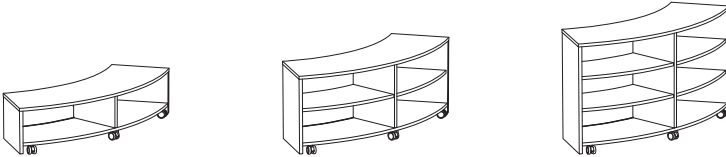

DOUBLE-SIDED BOOKCASES

Linear

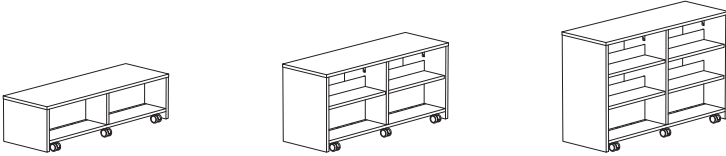

Curved

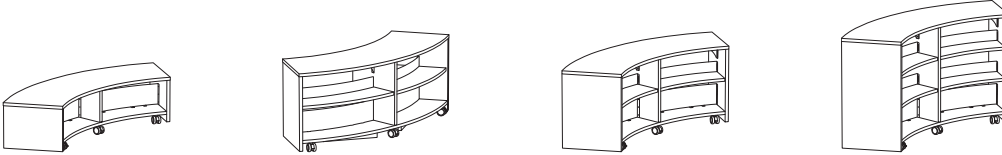

STORYLINE™ SPECIFYING INFORMATION

Statement of Line

BISTRO TABLES

Linear

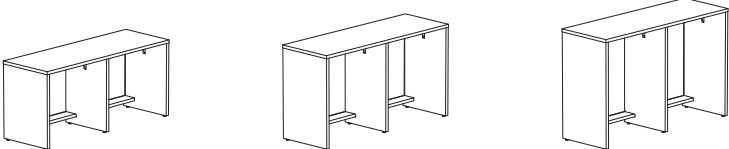

Curved

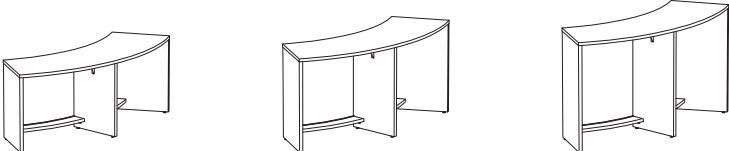

ACCESSORIES



STORYLINE™ SPECIFYING INFORMATION

EDUCATION

Dimensions

Linear Bookcases

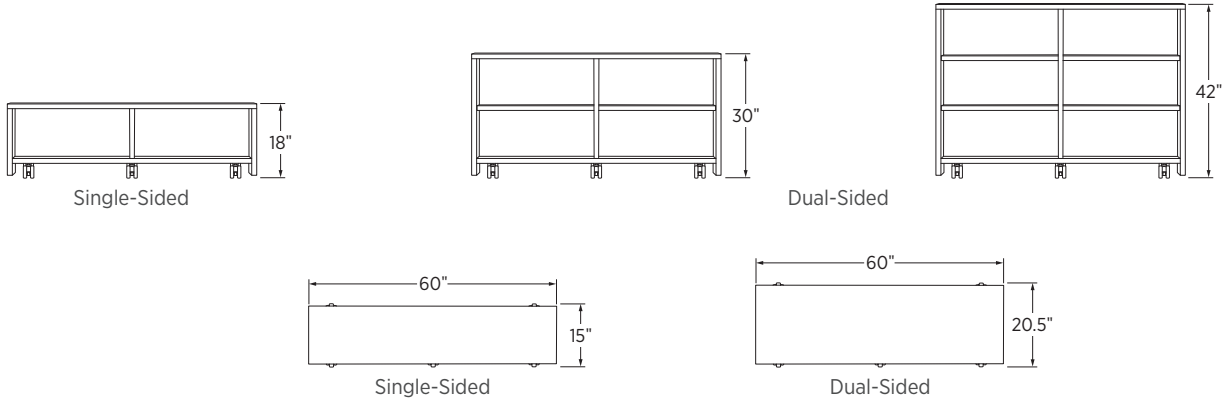

Curved Bookcases

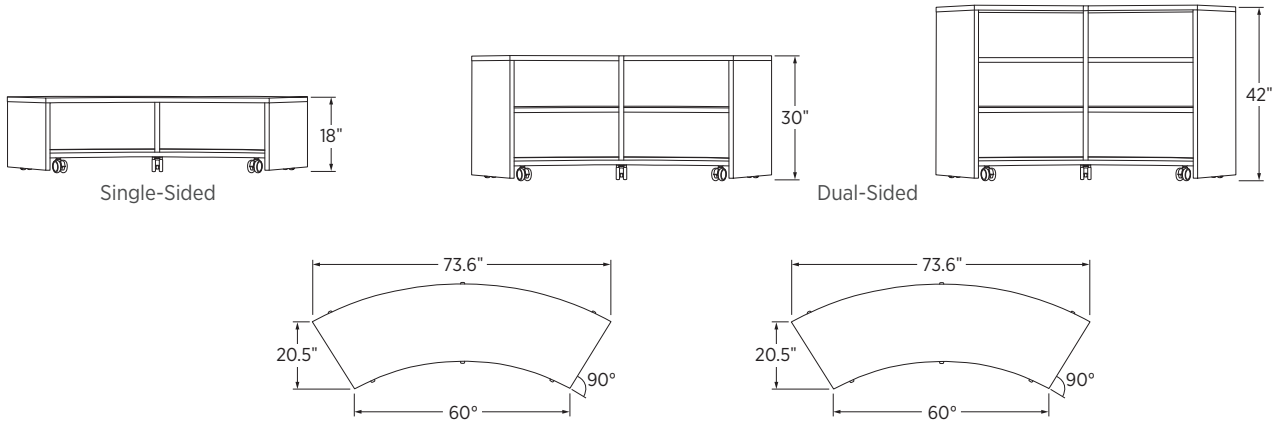

Space Planning

- The chart below provides the amount of linear feet of storage per bookcase. The calculation does not include the top of the bookcases.

	Linear		Curved	
	Single	Dual	Single	Dual
18"H	4.7	9.4	4.4	9.6
30"H	9.4	18.7	8.7	19.2
42"H	14.1	28.1	13.1	28.8

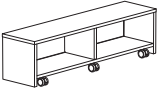
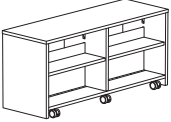

STORYLINE™ Linear Bookcases

	DESCRIPTION	MODEL	SHIP WEIGHT	CUBE	LIST PRICE	UPCHARGE BY LAMINATE/PAINT GRADE			
						L2	P2	P3	P6
	Single-Sided								
	18”H	HESWLS18	91	20.8	\$2080	\$104	\$104	\$208	\$416
	30”H	HESWLS30	139	31.1	\$2340	\$117	\$117	\$234	\$468
	42”H	HESWLS42	187	41.5	\$2600	\$130	\$130	\$260	\$520
	Dual-Sided								
	18”H	HESWLD18	125	28.0	\$2480	\$124	\$124	\$248	\$496
	30”H	HESWLD30	190	42.0	\$2640	\$132	\$132	\$264	\$528
	42”H	HESWLD42	251	56.0	\$2900	\$145	\$145	\$290	\$580

NOTES:

- 18”H units can be used as seat.
- Bookcases available in both glides or casters.
- Casters are locking casters that are recessed under the bookcase.
- Shelves ship disassembled and will be installed on site.
- Shelves are adjustable. Screwdriver required for adjustment.
- Shelves are adjustable in 1/4” increments.
- Double-sided units come with gussets for added rigidity. Gussets color will match paint selection.
- Double-sided units come with metal dividers.
- See page 199.5 for for overall dimensions of bookcases.
- Units specified with glides will match height of units specified with casters.

HOW TO SPECIFY

<p>Select Model Number</p> <p>H E S W L S 1 8 .</p>	<p>Select Glide/Caster Option</p> <p>G Glide C Caster (+ \$50)</p> <p>G .</p>	<p>Select Laminate</p> <p>See page 199.2</p> <p>L S A 1 .</p>	<p>Select Paint Color</p> <p>See page 199.2</p> <p>T 1</p>
--	--	--	---

STORYLINE™ Curved Bookcases

GSA SIN 33721



Icon Legend on page 19

EDUCATION

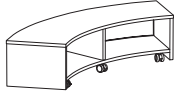
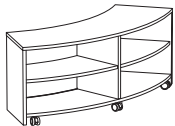
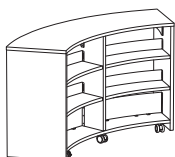
	DESCRIPTION	MODEL	SHIP WEIGHT	CUBE	LIST PRICE	UPCHARGE BY LAMINATE/PAINT GRADE			
						L2	P2	P3	P6
	Single-Sided Curved In								
	18"H	HESWCI18	131	39.6	\$2480	\$124	\$124	\$248	\$496
	30"H	HESWCI30	201	59.4	\$2790	\$140	\$140	\$279	\$558
	42"H	HESWCI42	271	79.1	\$3100	\$155	\$155	\$310	\$620
	Single-Sided Curved Out								
	18"H	HESWCO18	128	39.6	\$2480	\$124	\$124	\$248	\$496
	30"H	HESWCO30	197	59.4	\$2790	\$140	\$140	\$279	\$558
	42"H	HESWCO42	265	79.1	\$3100	\$155	\$155	\$310	\$620
	Dual-Sided								
	18"H	HESWCD18	134	39.6	\$2880	\$144	\$144	\$288	\$576
	30"H	HESWCD30	203	59.4	\$3090	\$155	\$155	\$309	\$618
	42"H	HESWCD42	268	79.1	\$3400	\$170	\$170	\$340	\$680

NOTES:



- 18"H units can be used as seat.
- Bookcases available in both glides or casters.
- Casters are locking casters that are recessed under the bookcase.
- Shelves ship disassembled and will be installed on site.
- Shelves are adjustable. Screwdriver required for adjustment.
- Shelves are adjustable in 1/4" increments.
- Double-sided units come with gussets for added rigidity. Gussets color will match paint selection.
- Double-sided units come with metal septums.
- See page 199.5 for overall dimensions of bookcases.
- Units specified with glides will match height of units specified with casters.

HOW TO SPECIFY

<p>Select Model Number</p> <p>H E S W C I 1 8 .</p>	<p>Select Glide/Caster Option</p> <p>G Glide C Caster (+ \$50)</p> <p>G .</p>	<p>Select Laminate</p> <p>See page 199.2</p> <p>L S A 1 .</p>	<p>Select Paint Color</p> <p>See page 199.2</p> <p>T 1</p>
--	--	--	---

STORYLINE™

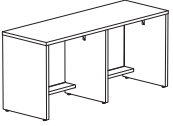
Bistro Tables

	DESCRIPTION	MODEL	SHIP WEIGHT	CUBE	LIST PRICE	UPCHARGE BY LAMINATE/PAINT GRADE			
						L2	P2	P3	P6
	Linear Bistro Tables								
	30"H	HESWLB30	127	33.9	\$1872	\$94	\$94	\$187	\$374
	36"H	HESWLB36	141	45.1	\$1984	\$99	\$99	\$198	\$397
	42"H	HESWLB42	156	45.1	\$2080	\$104	\$104	\$208	\$416
	Curved Bistro Tables								
	30"H	HESWCB30	130	59.4	\$2232	\$112	\$112	\$223	\$446
	36"H	HESWCB36	145	69.2	\$2366	\$118	\$118	\$237	\$473
	42"H	HESWCB42	159	79.1	\$2480	\$124	\$124	\$248	\$496

NOTES:

- Bistro tables are only available with glides.
- Bistro tables include gussets for added rigidity.
- Paint color selection will determine back and gusset color.
- Linear bistro table worksurface dimensions are 60"W x 20½"D.
- Bistro tables specified with glides will match height of bookcases specified with glides or casters.
- Bistro tables have integrated footrest.
- See page 199.5 for overall dimensions of bookcases.

HOW TO SPECIFY

Select Model Number H E S W C B 3 0 .	Select Glide G Glide	Select Laminate See page 199.2 L S A 1 .	Select Paint Color See page 199.2 P R 8
---	--------------------------------	---	--

STORYLINE™ Accessories

OPEN MARKET



Icon Legend on page 19

EDUCATION

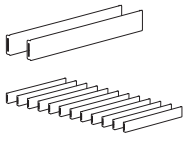
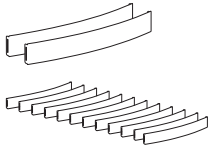
	DESCRIPTION	MODEL	SHIP WEIGHT	CUBE	LIST PRICE
	Linear Dividers				
	2-pack	HESWLD2	7.0	0.9	\$100
	12-pack	HESWLD12	17.0	5.9	\$600
	Curved Dividers				
	2-pack	HESWCD2	7.5	1.0	\$100
	12-pack	HESWCD12	19.0	6.7	\$600

NOTES:

- Shelf dividers are optional on single-sided units. Used to prevent books from being pushed back on shelves.
- Dividers attach with hardware that is included when ordering.
- All dual-sided units come standard with dividers.

HOW TO SPECIFY

Select Model Number	Select Paint Color See page 199.2
H E S W L D 2 .	T 1



Tangram™ Seating.

TANGRAM™

Tangram™ soft seating is the shape of things to come in education spaces. With 27 easily configurable shape and size options, high- and low-back models, and tiered seating, it offers the ability to create custom layouts that breathe new life into unconventional learning environments distinctive to each student. And with its single or multi-fabric options, rainbow of color choices, and playful aesthetic, this solution puts the “fun” in functional.

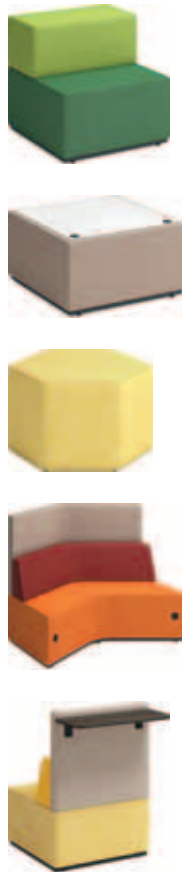

FEATURES

- Ottomans, In-Line Tables, Story Steps, and Modular units can be used together.
- Story Steps can be combined to create multiple-level learning layouts.
- Available in high- or low-back models.
- High-back models create a quiet space without losing sight lines for educators.
- In-Line Tables provide durable, easy to clean worksurfaces with optional integrated power.
- Flexible brackets allow units to be ganged together.
- Metal bases keep upholstered parts off the ground for easy cleaning.
- Stay connected with optional built-in power.
- Adjustable glides.
- Proportionately designed to fit K-12 students.
- Poufs and Ottomans offer additional seating.
- All models ship fully assembled in one carton.
- Available in a wide range of cleanable fabrics.
- Multi-fabric option — seat, back, and screen can be specified in different fabrics.
- Bistro-back models encourage additional ways to sit comfortably and offer an easily cleanable laminate surface for high-traffic daily use.

TANGRAM™ ORDERING INFORMATION

LAMINATE

L1 LAMINATES CODES

Woodgrain

◆ Bourbon Cherry	H
◆ Cognac	COGN
◆ Field Elm	LWFE
◆ Florence Walnut	LFW1
◆ Harvest	C
◆ Kingswood Walnut	LKI1
◆ Mahogany	N
◆ Mocha	MOCH
◆ Natural Maple	D
◆ Pinnacle	PINC
◆ Shaker Cherry	F
◆ Sterling Ash	LSA1

Solid

◆ Black	P
◆ Charcoal	S
◆ Designer White	LDW1
◆ Loft	LOFT

Patterned

◆ Battleship	LBT1
◆ Gray	G2
◆ Handspun Chestnut	LAHC
◆ Handspun Dove	LAHD
◆ Handspun Pearl	LAHP
◆ Handspun Slate	LAHS
◆ Moroccan	LMN1
◆ Mushroom	LMH1
◆ Neon Carrot	LNC1
◆ Silver Mesh	B9
◆ Steel Mesh	A9
◆ Tennis Ball	LTB1
◆ White	G1

L2 LAMINATES CODES

Woodgrain

◆ Beigewood	LWBE
◆ Fawn Cypress	LFC1
◆ Lowell Ash	LLA1
◆ Natural Recon	LNR1
◆ Phantom Ecu	LPE1
◆ Portico Teak	LPT1
◆ Skyline Walnut	LSW1

L4 LAMINATES CODES

◆ White Markerboard	FMQ1
---------------------------	------

IN-LINE TABLE EDGE

EDGE CODES

Solid

◆ Black	P
---------------	---

BISTRO EDGE

EDGE CODES

◆ Beigewood	DE
◆ Black	P
◆ Bourbon Cherry	H
◆ Brownstone	EY
◆ Charcoal	S
◆ Cognac	COGN
◆ Designer White	DW
◆ Fawn Cypress	FC
◆ Field Elm	FE
◆ Florence Walnut	FW
◆ Fossil	EH
◆ Greige	R
◆ Harvest	C
◆ Kingswood Walnut	KI
◆ Light Gray	Q
◆ Loft	LOFT
◆ Lowell Ash	DL
◆ Mahogany	N
◆ Mocha	MOCH
◆ Muslin	T
◆ Natural Maple	D
◆ Natural Recon	NR
◆ Phantom Ecu	PE
◆ Pinnacle	PINC
◆ Platinum	K
◆ Portico Teak	DP
◆ Shaker Cherry	F
◆ Skyline Walnut	SW
◆ Sterling Ash	SA

◆◆◆ For lead time information see page 21.

TANGRAM™ ORDERING INFORMATION

HON BRANDED FABRICS

Seat, Ottoman, Pouf

GRADE 1	GRADE 2	GRADE 3	GRADE 4
Centurion	Appoint Seating	Bradbury	Constance with Supreen™
Compass	Blume	Getaway	Livi with Supreen™
Contourett	Clyde	Moxie	Lugano with Supreen™
Dapper	Dotty	Notion	Oxford with Supreen™
Ensemble	Kai	Parker	
Hamilton	Rush	Purl	
Inertia	Spin	Quill	
Noble Seating	Wavelength	Saxony	
Optic	Whisper Vinyl		
Pebble			
Vibe			

Single Fabric Upholstery, Back, Screen

GRADE 1	GRADE 2	GRADE 3	GRADE 4
Centurion	Appoint Seating	Bradbury	Constance with Supreen™
Compass	Blume	Getaway	Livi with Supreen™
Contourett	Clyde	Moxie	Lugano with Supreen™
Dapper	Dotty	Notion	Oxford with Supreen™
Ensemble	Kai	Parker	
Hamilton	Rush	Purl	
Noble Seating	Wavelength	Quill	
Optic	Whisper Vinyl	Saxony	
Pebble			
Vibe			

EDUCATION

For a complete list of fabrics, including partnership fabrics, go to hon.com/fabricsandfinishes.

Reference Fabric Color Combinations on pages 20-24 for color codes and legend on page 21 for lead times.

COM YARDAGE

MODEL	COM		
	Seat	Back	Screen
HECSRSP	4.5	—	—
HECSRST	1.5	—	—
HECSRP	2.5		—
HECSRB	2	—	—
HECSRSPMF	3	2	—
HECSITT	2	—	—
HECSITD	2.5	—	—
HECSITS	2.5	—	—
HECSMSLB	4.5		—
HECSMAILB	6.5		—
HECSMAOLB	6.5		—
HECSMTLB	5.5		—
HECSMSHB	6		
HECSMAIHB	8.5		
HECSMAOHB	8.5		
HECSMTHB	8		

MODEL	COM		
	Seat	Back	Screen
HECSMSLBMF	3.5	2	—
HECSMAILBMF	4	2.5	—
HECSMAOLBMF	4.5	2.5	—
HECSMTLBMF	4	2.5	—
HECSMSHBMF	3	1.5	2.5
HECSMAIHBMF	4	2	3.5
HECSMAOHBMF	4.5	2	3.5
HECSMTHBMF	4	1.5	3
HECSOSQ	3	—	—
HECSOD	3	—	—
HECSOTR	2.5	—	—
HECSOTP	4	—	—
HECSOSE	2.5	—	—
HECSOAEL	2.5	—	—
HECSOAER	2.5	—	—
HECSOC	4	—	—
HECSVAP	2.5	—	—
HECSVHP	2	—	—
HECSJVAP	2	—	—
HECSJVHP	2	—	—

NOTES: Due to fabric pattern nesting and potential reduction of fabric yield, some multi-fabric models may require more total yardage than standard single fabric models.

TANGRAM™

Statement of Line

STORY STEPS

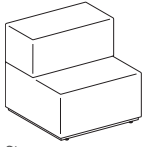

Stoop

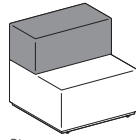

Stoop
Multi-Fabric

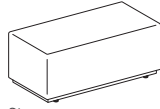

Step

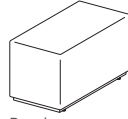

Bench

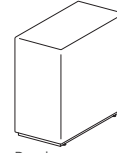

Perch

LOW-BACK SEATING

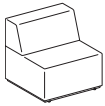

Low-Back Square

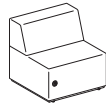

Low-Back Square
with Power

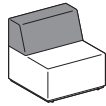

Low-Back Square
Multi-Fabric

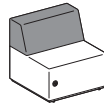

Low-Back Square
Multi-Fabric with Power



Low-Back Arrow Out

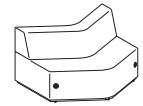

Low-Back Arrow Out
with Power

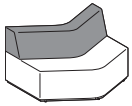

Low-Back Arrow Out
Multi-Fabric

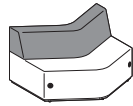

Low-Back Arrow Out
Multi-Fabric with Power



Low-Back Arrow In

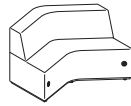

Low-Back Arrow In
with Power

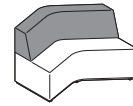

Low-Back Arrow In
Multi-Fabric

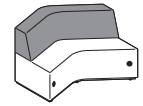

Low-Back Arrow In
Multi-Fabric with Power



Low-Back Trapezoid



Low-Back Trapezoid
with Power

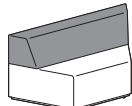

Low-Back Trapezoid
Multi-Fabric

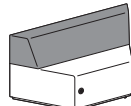

Low-Back Trapezoid
Multi-Fabric with Power

HIGH-BACK SEATING

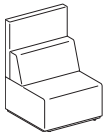

High-Back Square

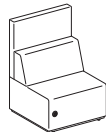

High-Back Square
with Power

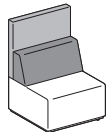

High-Back Square
Multi-Fabric

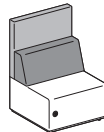

High-Back Square
Multi-Fabric with Power

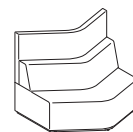

High-Back Arrow Out

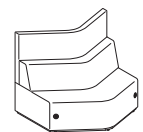

High-Back Arrow Out
with Power

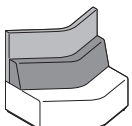

High-Back Arrow Out
Multi-Fabric

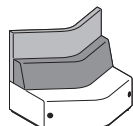

High-Back Arrow Out
Multi-Fabric with Power



High-Back Arrow In

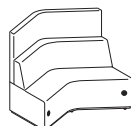

High-Back Arrow In
with Power

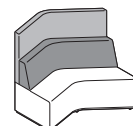

High-Back Arrow In
Multi-Fabric

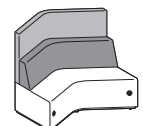

High-Back Arrow In
Multi-Fabric with Power

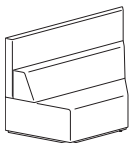

High-Back Trapezoid

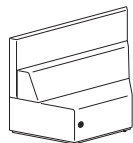

High-Back Trapezoid
with Power

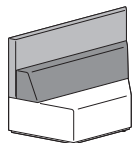

High-Back Trapezoid
Multi-Fabric

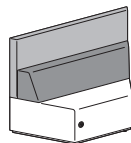

High-Back Trapezoid
Multi-Fabric with Power

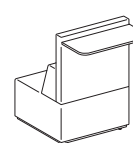

Bistro-Back Square

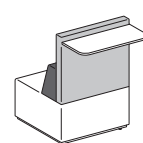

Bistro-Back Square
Multi-Fabric

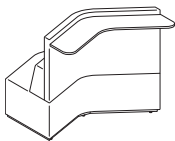

Bistro-Back Arrow Out

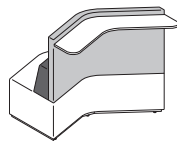

Bistro-Back Arrow Out
Multi-Fabric

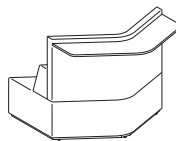

Bistro-Back Arrow In

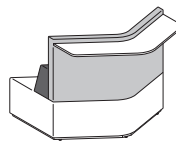

Bistro-Back Arrow In
Multi-Fabric



Bistro-Back Trapezoid

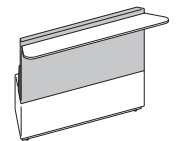

Bistro-Back Trapezoid
Multi-Fabric

TANGRAM™

Statement of Line

OTTOMANS

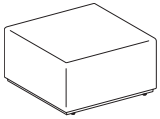

Square Ottoman

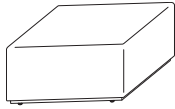

Diamond Ottoman

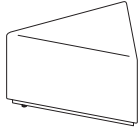

Triangle Ottoman

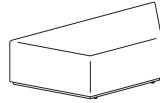

Trapezoid Ottoman



Left End Ottoman

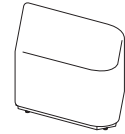

Right End Ottoman

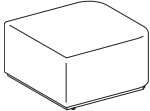

Straight End Ottoman



120° Ottoman

POUFS

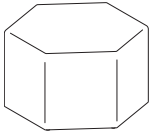

Varsity Hexagon Pouf

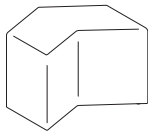

Varsity Arrow Pouf

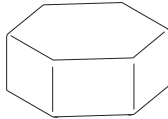

Junior Varsity Hexagon Pouf

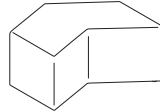

Junior Varsity Arrow Pouf

TABLES

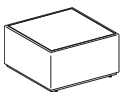

Square Table

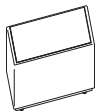

Diamond Table

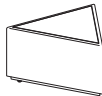

Triangle Table

TANGRAM™ Typicals

QTY	DESCRIPTION	MODEL	LIST PRICE	PRICE EXTENSION
2	High-Back Modular Seating Arrow In	HECSMAIHB	\$4,625	\$9,250
2	High-Back Modular Seating Arrow Out	HECSMAOHB	\$4,533	\$9,066
2	Ottoman Straight End	HECSESE	\$1,521	\$3,042
TOTAL:			\$21,358	

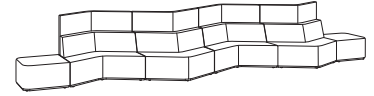

COMMONS

QTY	DESCRIPTION	MODEL	LIST PRICE	PRICE EXTENSION
2	Stoop 30"H x 30½"W	HECSRSP	\$2,134	\$4,268
4	Step 13"H x 30½"W	HECSRST	\$1,174	\$4,696
7	Perch 30"H x 30½"W	HECSRSP	\$1,600	\$11,200
1	In-Line Table 16¾"H x 30½"W	HECSITS	\$2,013	\$2,013
4	Bench 17"H x 30½"W	HECSRB	\$1,387	\$5,548
TOTAL:			\$27,725	

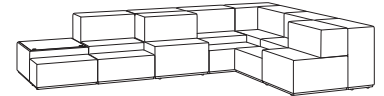

LIBRARY

QTY	DESCRIPTION	MODEL	LIST PRICE	PRICE EXTENSION
4	Low-Back Modular Seating Square	HECSMSLB	\$2,295	\$9,180
4	Perch 30"H x 30½"W	HECSRSP	\$1,600	\$6,400
TOTAL:			\$15,580	

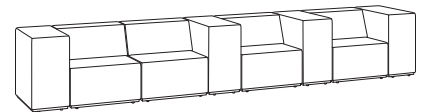

**NON-TRADITIONAL
LEARNING**

QTY	DESCRIPTION	MODEL	LIST PRICE	PRICE EXTENSION
3	Low-Back Modular Seating Arrow In	HECSMAILB	\$3,426	\$10,278
2	Low-Back Modular Seating Trapezoid	HECSMTLB	\$2,912	\$5,824
1	Ottoman Angled End, Left	HECSOAL	\$1,521	\$1,521
1	Ottoman Angled End, Right	HECSOAR	\$1,521	\$1,521
3	Ottoman Diamond	HECSOD	\$1,648	\$4,944
1	In-Line Table Diamond	HECSITD	\$2,143	\$2,143
1	Junior Varsity Pouf Hexagon	HECSJVHP	\$958	\$958
TOTAL:			\$27,189	

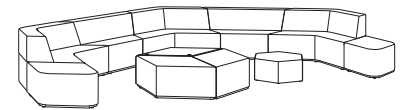

**NON-TRADITIONAL
LEARNING**

TANGRAM™ Typicals

QTY	DESCRIPTION	MODEL	LIST PRICE	PRICE EXTENSION
2	High-Back Modular Seating Arrow In	HECSMAIHB	\$4,625	\$9,250
2	Ottoman Diamond	HECSOD	\$1,648	\$3,296
2	Junior Varsity Pouf Arrow	HECSJVAP	\$876	\$1,752
TOTAL:			\$14,298	

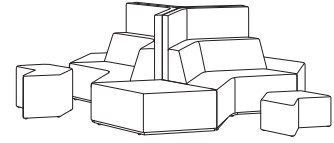

SCHOOL LOBBY

QTY	DESCRIPTION	MODEL	LIST PRICE	PRICE EXTENSION
2	High-Back Modular Seating Arrow In	HECSMAIHB	\$4,625	\$9,250
2	Ottoman Triangle	HECSOTR	\$1,361	\$2,722
2	Single Pedestal Base Lounge-Height	HCWTSBL27	\$1,015	\$2,030
2	Table Top with Flat Edge 42"W	HCWTRND42G	\$598	\$1,196
TOTAL:			\$15,198	

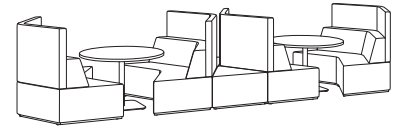

BREAKOUT SPACE

QTY	DESCRIPTION	MODEL	LIST PRICE	PRICE EXTENSION
2	Low-Back Modular Seating Arrow In	HECSMAILB	\$3,426	\$6,852
1	Ottoman Diamond	HECSOD	\$1,648	\$1,648
TOTAL:			\$8,500	

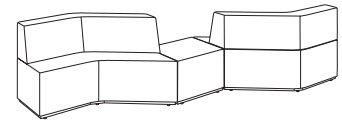

CAFETERIA



HECSRSP

STOOP

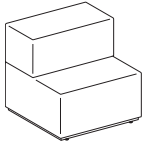

DIMENSIONS

Depth:	30½	Ship Weight:	79
Width:	30½	Cube:	17.5
Seat Height:	17	COM:	See page 202
Back Height:	30	Weight Rating:	300 lbs.

FABRIC PRICE CODES

1	\$2134	8	\$2857
2	\$2260	9	\$2951
3	\$2387	10	\$3052
4	\$2481	11	\$3162
5	\$2573	12	\$3273
6	\$2668	L	\$4045
7	\$2760		

HECSRST

STEP

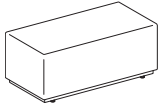

DIMENSIONS

Depth:	15¼	Ship Weight:	42
Height:	13	Cube:	4.4
Width:	30½	COM:	See page 202
		Weight Rating:	300 lbs.

FABRIC PRICE CODES

1	\$1174	8	\$1464
2	\$1225	9	\$1501
3	\$1276	10	\$1541
4	\$1313	11	\$1585
5	\$1350	12	\$1630
6	\$1388	L	\$1938
7	\$1424		

HECSRB

BENCH

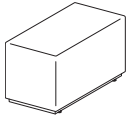

DIMENSIONS

Depth:	15¼	Ship Weight:	47
Height:	17	Cube:	5.3
Width:	30½	COM:	See page 202
		Weight Rating:	300 lbs.

FABRIC PRICE CODES

1	\$1387	8	\$1677
2	\$1438	9	\$1714
3	\$1489	10	\$1754
4	\$1526	11	\$1798
5	\$1563	12	\$1843
6	\$1601	L	\$2151
7	\$1637		

HECSRP

PERCH

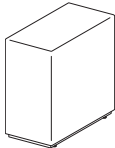

DIMENSIONS

Depth:	15¼	Ship Weight:	55
Height:	30	Cube:	9.2
Width:	30½	COM:	See page 202
		Weight Rating:	300 lbs.

FABRIC PRICE CODES

1	\$1600	8	\$2034
2	\$1676	9	\$2090
3	\$1752	10	\$2151
4	\$1808	11	\$2217
5	\$1864	12	\$2283
6	\$1921	L	\$2747
7	\$1976		

HOW TO SPECIFY

<p>Select Model Number</p> <p>HECSRSP</p>	<p>Select Power</p> <p>N None</p> <p>N</p>	<p>Select Fabric</p> <p>See page 202</p> <p>H A M L 1 6</p>	<p>Select Base and Color</p> <p>P Plinth P71 Black</p> <p>P P 7 1</p>
--	---	--	--

TANGRAM™

Multi-Fabric Story Steps

GSA SIN 33721T



Icon Legend on page 19

HECSRSPMF

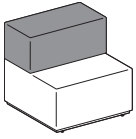

STOOP

Multi-Fabric

DIMENSIONS

Depth:	30½	Ship Weight:	79
Width:	30½	Cube:	17.5
Seat Height:	17	COM:	See page 202
Back Height:	30	Weight Rating:	300 lbs.

FABRIC PRICE CODES

1	\$2198	
<i>Add to Base Price Above</i>		
	Seat	Back
2	\$76	\$51
3	\$152	\$102
4	\$208	\$139
5	\$264	\$176
6	\$321	\$214
7	\$376	\$250
8	\$434	\$290
9	\$490	\$327
10	\$551	\$367
11	\$617	\$411
12	\$683	\$456
L	\$1147	\$764

EDUCATION

HOW TO SPECIFY

<p>Select Model Number</p>	<p>Select Power</p> <p>N None</p>	<p>Select Seat Fabric</p> <p>See page 202</p>	<p>Select Back Fabric</p> <p>See page 202</p>	<p>Select Base and Color</p> <p>P Plinth P71 Black</p>
<p>HECSRSPMF .</p>	<p>N .</p>	<p>HAML16 .</p>	<p>HAML20 .</p>	<p>PP71</p>



TANGRAM™ In-Line Tables

HECSITS

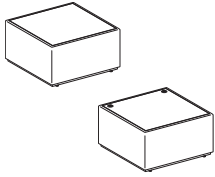

SQUARE

In-Line Table

DIMENSIONS

Depth:	30½	Ship Weight:	76
Height:	16¾	Cube:	9.3
Width:	30½	COM:	See page 202

FABRIC PRICE CODES

1	\$2013	8	\$2447
2	\$2089	9	\$2503
3	\$2165	10	\$2564
4	\$2221	11	\$2630
5	\$2277	12	\$2696
6	\$2334	L	\$3160
7	\$2389		

UPCHARGE BY LAMINATE GRADE

L1	L2	L5
\$0	\$53	\$131

HECSITD

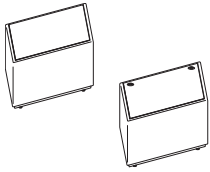

DIAMOND

In-Line Table

DIMENSIONS

Depth:	26½	Ship Weight:	70
Height:	16¾	Cube:	13.7
Width:	46	COM:	See page 202

FABRIC PRICE CODES

1	\$2143	8	\$2577
2	\$2219	9	\$2633
3	\$2295	10	\$2694
4	\$2351	11	\$2760
5	\$2407	12	\$2826
6	\$2464	L	\$3290
7	\$2519		

UPCHARGE BY LAMINATE GRADE

L1	L2	L5
\$0	\$63	\$157

HECSITT

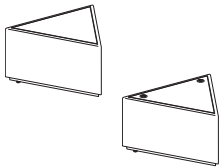

TRIANGLE

In-Line Table

DIMENSIONS

Depth:	27	Ship Weight:	48
Height:	16¾	Cube:	9.3
Width:	31	COM:	See page 202

FABRIC PRICE CODES

1	\$1908	8	\$2198
2	\$1959	9	\$2235
3	\$2010	10	\$2275
4	\$2047	11	\$2319
5	\$2084	12	\$2364
6	\$2122	L	\$2672
7	\$2158		

UPCHARGE BY LAMINATE GRADE

L1	L2	L5
\$0	\$53	\$131

HOW TO SPECIFY

Select Model Number HECSITS	Select Power N None 2 Two Power (+ \$105)	Select Fabric See page 202 HAML16	Select Base and Color P Plinth P71 Black	Select Laminate See page 201 H	Select Edge Color P Black
---	--	--	---	---	-------------------------------------

TANGRAM™ Modular Seating

GSA SIN 33721T



Icon Legend on page 19

EDUCATION

HECSMSLB

LOW-BACK

Square

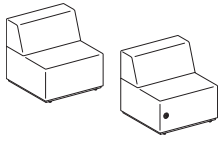

DIMENSIONS

Depth:	30½	Ship Weight:	70
Width:	30½	Cube:	18.1
Seat Height:	17	COM:	See page 202
Back Height:	30	Weight Rating:	300 lbs.

FABRIC PRICE CODES

1	\$2295	8	\$3018
2	\$2421	9	\$3112
3	\$2548	10	\$3213
4	\$2642	11	\$3323
5	\$2734	12	\$3434
6	\$2829	L	\$4206
7	\$2921		

HECSMTLB

LOW-BACK

Trapezoid

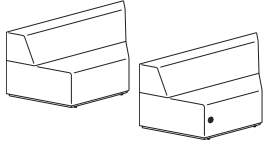

DIMENSIONS

Depth:	30½	Ship Weight:	107
Width:	60	Cube:	29.9
Seat Height:	17	COM:	See page 202
Back Height:	30	Weight Rating:	300 lbs.

FABRIC PRICE CODES

1	\$2912	8	\$3780
2	\$3063	9	\$3892
3	\$3217	10	\$4013
4	\$3329	11	\$4146
5	\$3439	12	\$4278
6	\$3553	L	\$5204
7	\$3663		

HECSMAILB

LOW-BACK

Arrow In

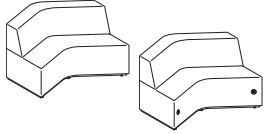

DIMENSIONS

Depth:	43½	Ship Weight:	130
Width:	52½	Cube:	43.4
Seat Height:	17	COM:	See page 202
Back Height:	30	Weight Rating:	300 lbs.

FABRIC PRICE CODES

1	\$3426	8	\$4438
2	\$3602	9	\$4569
3	\$3781	10	\$4711
4	\$3912	11	\$4865
5	\$4041	12	\$5020
6	\$4175	L	\$6101
7	\$4302		

NOTES: Due to the inherent design of the Arrow In, material gathers will be present in the back.

HECSMAOLB

LOW-BACK

Arrow Out

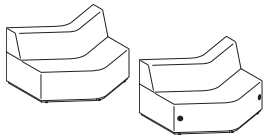

DIMENSIONS

Depth:	43½	Ship Weight:	130
Width:	52½	Cube:	43.4
Seat Height:	17	COM:	See page 202
Back Height:	30	Weight Rating:	300 lbs.

FABRIC PRICE CODES

1	\$3357	8	\$4369
2	\$3533	9	\$4500
3	\$3712	10	\$4642
4	\$3843	11	\$4796
5	\$3972	12	\$4951
6	\$4106	L	\$6032
7	\$4233		

HOW TO SPECIFY

<p>Select Model Number</p> <p>HECSMSLB</p>	<p>Select Power</p> <p>N None 1R One Power, Right-Hand User Side (+ \$53) <i>Specify for Square and Trapezoid only</i> 2B Two Power, Both Sides (+ \$105) <i>Specify for Arrow In and Arrow Out only</i></p> <p>1R</p>	<p>Select Fabric</p> <p>See page 202</p> <p>HAML16</p>	<p>Select Base and Color</p> <p>P Plinth P71 Black</p> <p>PP71</p>
---	---	---	---



TANGRAM™ Modular Seating — Multi-Fabric

HECSMSLBMF

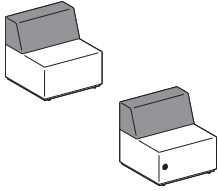

LOW-BACK

Square, Multi-Fabric

DIMENSIONS

Depth:	30½	Ship Weight:	70
Width:	30½	Cube:	18.1
Seat Height:	17	COM:	See page 202
Back Height:	30	Weight Rating:	300 lbs.

FABRIC PRICE CODES

1	\$2364	
<i>Add to Base Price Above</i>		
	Seat	Back
2	\$88	\$38
3	\$178	\$77
4	\$244	\$105
5	\$308	\$132
6	\$375	\$160
7	\$438	\$189
8	\$506	\$217
9	\$572	\$245
10	\$643	\$275
11	\$719	\$309
12	\$797	\$342
L	\$1338	\$573

HECSMTLBMF

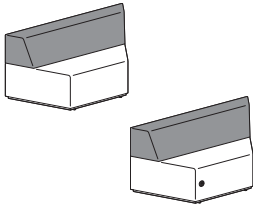

LOW-BACK

Trapezoid, Multi-Fabric

DIMENSIONS

Depth:	30½	Ship Weight:	107
Width:	60	Cube:	29.9
Seat Height:	17	COM:	See page 202
Back Height:	30	Weight Rating:	300 lbs.

FABRIC PRICE CODES

1	\$3000	
<i>Add to Base Price Above</i>		
	Seat	Back
2	\$101	\$63
3	\$203	\$127
4	\$278	\$174
5	\$352	\$220
6	\$428	\$268
7	\$501	\$313
8	\$578	\$362
9	\$654	\$408
10	\$734	\$459
11	\$823	\$515
12	\$911	\$569
L	\$1528	\$956

HOW TO SPECIFY

<p>Select Model Number</p> <p>HECSMSLBMF</p>	<p>Select Power</p> <p>N None 1R One Power, Right-Hand User Side (+ \$53) <i>Specify for Square and Trapezoid only</i> 2B Two Power, Both Sides (+ \$105) <i>Specify for Arrow In and Arrow Out only</i></p> <p>1R</p>	<p>Select Seat Fabric</p> <p>See page 202</p> <p>HAML16</p>	<p>Select Back Fabric</p> <p>See page 202</p> <p>HAML20</p>	<p>Select Base and Color</p> <p>P Plinth P71 Black</p> <p>PP71</p>
---	--	--	--	--

TANGRAM™ Modular Seating — Multi-Fabric

GSA SIN 33721T



Icon Legend on page 19

EDUCATION

HECSMAILBMF

LOW-BACK

Arrow In, Multi-Fabric

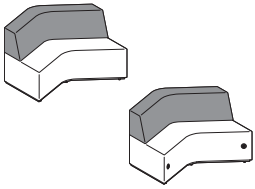

DIMENSIONS

Depth:	43½	Ship Weight:	130
Width:	52½	Cube:	43.4
Seat Height:	17	COM:	See page 202
Back Height:	30	Weight Rating:	300 lbs.

FABRIC PRICE CODES

1	\$3528	
<i>Add to Base Price Above</i>		
	Seat	Back
2	\$113	\$63
3	\$228	\$127
4	\$313	\$174
5	\$396	\$220
6	\$481	\$268
7	\$564	\$313
8	\$650	\$362
9	\$735	\$408
10	\$826	\$459
11	\$925	\$515
12	\$1025	\$569
L	\$1720	\$956

NOTES: Due to the inherent design of the Arrow In, material gathers will be present in the back.

HECSMAOLBMF

LOW-BACK

Arrow Out, Multi-Fabric

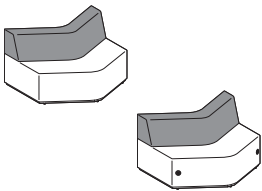

DIMENSIONS

Depth:	43½	Ship Weight:	130
Width:	52½	Cube:	43.4
Seat Height:	17	COM:	See page 202
Back Height:	30	Weight Rating:	300 lbs.

FABRIC PRICE CODES

1	\$3458	
<i>Add to Base Price Above</i>		
	Seat	Back
2	\$113	\$63
3	\$228	\$127
4	\$313	\$174
5	\$396	\$220
6	\$481	\$268
7	\$564	\$313
8	\$650	\$362
9	\$735	\$408
10	\$826	\$459
11	\$925	\$515
12	\$1025	\$569
L	\$1720	\$956

HOW TO SPECIFY

<p>Select Model Number</p> <p>HECSMAILBMF</p>	<p>Select Power</p> <p>N None 1R One Power, Right-Hand User Side (+ \$53) <i>Specify for Square and Trapezoid only</i> 2B Two Power, Both Sides (+ \$105) <i>Specify for Arrow In and Arrow Out only</i></p> <p>2B</p>	<p>Select Seat Fabric</p> <p>See page 202</p> <p>HAML16</p>	<p>Select Back Fabric</p> <p>See page 202</p> <p>HAML20</p>	<p>Select Base and Color</p> <p>P Plinth P71 Black</p> <p>PP71</p>
--	--	--	--	--



TANGRAM™ Modular Seating

EDUCATION

HECSMSHB

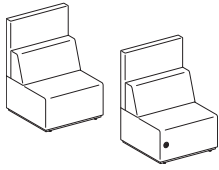

HIGH-BACK

Square

DIMENSIONS

Depth:	30½	Ship Weight:	82
Width:	30½	Cube:	29.7
Seat Height:	17	COM:	See page 202
Back Height:	30	Weight Rating:	300 lbs.
Screen Height:	44		

FABRIC PRICE CODES

1	\$2984	8	\$3852
2	\$3135	9	\$3964
3	\$3289	10	\$4085
4	\$3401	11	\$4218
5	\$3511	12	\$4350
6	\$3625	L	\$5276
7	\$3735		

HECSMTHB

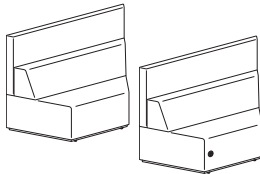

HIGH-BACK

Trapezoid

DIMENSIONS

Depth:	30½	Ship Weight:	121
Width:	60	Cube:	50.7
Seat Height:	17	COM:	See page 202
Back Height:	30	Weight Rating:	300 lbs.
Screen Height:	44		

FABRIC PRICE CODES

1	\$3931	8	\$5087
2	\$4132	9	\$5237
3	\$4337	10	\$5400
4	\$4487	11	\$5575
5	\$4634	12	\$5752
6	\$4786	L	\$6988
7	\$4933		

HECSMAIHB

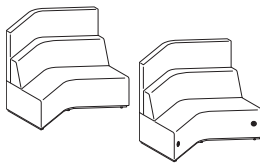

HIGH-BACK

Arrow In

DIMENSIONS

Depth:	43½	Ship Weight:	154
Width:	52½	Cube:	68.8
Seat Height:	17	COM:	See page 202
Back Height:	30	Weight Rating:	300 lbs.
Screen Height:	44		

FABRIC PRICE CODES

1	\$4625	8	\$5927
2	\$4850	9	\$6094
3	\$5081	10	\$6277
4	\$5250	11	\$6475
5	\$5416	12	\$6674
6	\$5587	L	\$8064
7	\$5751		

NOTES: Due to the inherent design of the Arrow In, material gathers will be present in the back.

HECSMAOHB

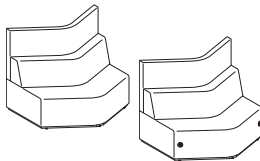

HIGH-BACK

Arrow Out

DIMENSIONS

Depth:	43½	Ship Weight:	154
Width:	52½	Cube:	68.8
Seat Height:	17	COM:	See page 202
Back Height:	30	Weight Rating:	300 lbs.
Screen Height:	44		

FABRIC PRICE CODES

1	\$4533	8	\$5835
2	\$4758	9	\$6002
3	\$4989	10	\$6185
4	\$5158	11	\$6383
5	\$5324	12	\$6582
6	\$5495	L	\$7972
7	\$5659		

HOW TO SPECIFY

<p>Select Model Number</p> <p>HECSMSHB</p>	<p>Select Power</p> <p>N None 1R One Power, Right-Hand User Side (+ \$53) <i>Specify for Square and Trapezoid only</i> 2B Two Power, Both Sides (+ \$105) <i>Specify for Arrow In and Arrow Out only</i></p> <p>1R</p>	<p>Select Fabric</p> <p>See page 202</p> <p>HAML16</p>	<p>Select Base and Color</p> <p>P Plinth P71 Black</p> <p>PP71</p>
---	---	---	---

TANGRAM™

Modular Seating — Multi-Fabric

GSA SIN 33721T



Icon Legend on page 19

EDUCATION

HECSMSHBMF

HIGH-BACK

Square, Multi-Fabric

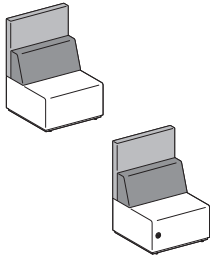

DIMENSIONS

Depth: 30½
Width: 30½
Seat Height: 17
Back Height: 30
Screen Height: 44

Ship Weight:
Cube:
COM:
Weight Rating:

82
29.7
See page 202
300 lbs.

FABRIC PRICE CODES

1 \$3074

Add to Base Price Above

	Seat	Back	Screen
2	\$76	\$38	\$51
3	\$152	\$77	\$102
4	\$208	\$105	\$139
5	\$264	\$132	\$176
6	\$321	\$160	\$214
7	\$376	\$189	\$250
8	\$434	\$217	\$290
9	\$490	\$245	\$327
10	\$551	\$275	\$367
11	\$617	\$309	\$411
12	\$683	\$342	\$456
L	\$1147	\$573	\$764

HECSMTHBMF

HIGH-BACK

Trapezoid, Multi-Fabric

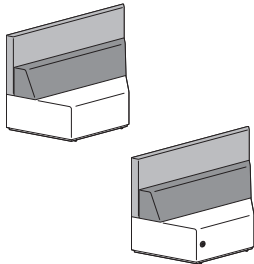

DIMENSIONS

Depth: 30½
Width: 60
Seat Height: 17
Back Height: 30
Screen Height: 44

Ship Weight:
Cube:
COM:
Weight Rating:

121
50.7
See page 202
300 lbs.

FABRIC PRICE CODES

1 \$4049

Add to Base Price Above

	Seat	Back	Screen
2	\$101	\$38	\$88
3	\$203	\$77	\$178
4	\$278	\$105	\$244
5	\$352	\$132	\$308
6	\$428	\$160	\$375
7	\$501	\$189	\$438
8	\$578	\$217	\$506
9	\$654	\$245	\$572
10	\$734	\$275	\$643
11	\$823	\$309	\$719
12	\$911	\$342	\$797
L	\$1528	\$573	\$1338

HOW TO SPECIFY

Select Model Number	Select Power	Select Seat Fabric	Select Back Fabric	Select Screen Fabric	Select Base and Color
HECSMSHBMF	<p>N None</p> <p>1R One Power, Right-Hand User Side (+ \$53) <i>Specify for Square and Trapezoid only</i></p> <p>2B Two Power, Both Sides (+ \$105) <i>Specify for Arrow In and Arrow Out only</i></p>	See page 202	See page 202	See page 202	<p>P Plinth</p> <p>P71 Black</p>
HECSMSHBMF	1R	HAML16	HAML20	HAML16	PP71



TANGRAM™ Modular Seating — Multi-Fabric

HECSMAIHBMF

HIGH-BACK

Arrow In, Multi-Fabric

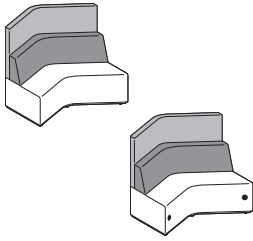

DIMENSIONS

Depth:	43½	Ship Weight:	154
Width:	52½	Cube:	68.8
Seat Height:	17	COM:	See page 202
Back Height:	30	Weight Rating:	300 lbs.
Screen Height:	44		

FABRIC PRICE CODES

1	\$4764		
	<i>Add to Base Price Above</i>		
	Seat	Back	Screen
2	\$113	\$51	\$88
3	\$228	\$102	\$178
4	\$313	\$139	\$244
5	\$396	\$176	\$308
6	\$481	\$214	\$375
7	\$564	\$250	\$438
8	\$650	\$290	\$506
9	\$735	\$327	\$572
10	\$826	\$367	\$643
11	\$925	\$411	\$719
12	\$1025	\$456	\$797
L	\$1720	\$764	\$1338

NOTES: Due to the inherent design of the Arrow In, material gathers will be present in the back.

HECSMAOHBMF

HIGH-BACK

Arrow Out, Multi-Fabric

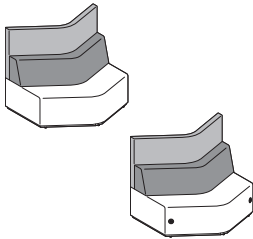

DIMENSIONS

Depth:	43½	Ship Weight:	154
Width:	52½	Cube:	68.8
Seat Height:	17	COM:	See page 202
Back Height:	30	Weight Rating:	300 lbs.
Screen Height:	44		

FABRIC PRICE CODES

1	\$4669		
	<i>Add to Base Price Above</i>		
	Seat	Back	Screen
2	\$113	\$51	\$63
3	\$228	\$102	\$127
4	\$313	\$139	\$174
5	\$396	\$176	\$220
6	\$481	\$214	\$268
7	\$564	\$250	\$313
8	\$650	\$290	\$362
9	\$735	\$327	\$408
10	\$826	\$367	\$459
11	\$925	\$411	\$515
12	\$1025	\$456	\$569
L	\$1720	\$764	\$956

HOW TO SPECIFY

Select Model Number	Select Power	Select Seat Fabric	Select Back Fabric	Select Screen Fabric	Select Base and Color
	N None 1R One Power, Right-Hand User Side (+ \$53) <i>Specify for Square and Trapezoid only</i> 2B Two Power, Both Sides (+ \$105) <i>Specify for Arrow In and Arrow Out only</i>	See page 202	See page 202	See page 202	P Plinth P71 Black
HECSMAIHBMF	2B	HAML16	HAML20	HAML16	PP71

TANGRAM™

Modular Seating — Bistro-Back

GSA SIN 33721T



Icon Legend on page 19

EDUCATION

HECSMSBB

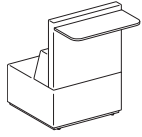

BISTRO-BACK

Square

DIMENSIONS

Depth:	30½	Ship Weight:	70
Width:	30½	Cube:	18.1
Seat Height:	17	COM:	See page 202
Back Height:	30	Seat Weight Rating:	300 lbs.
Width of Worksurface:	30½		
Depth of Worksurface:	12		
Worksurface Height:	42		

FABRIC PRICE CODES

1	\$3611	8	\$4479
2	\$3762	9	\$4591
3	\$3916	10	\$4712
4	\$4028	11	\$4845
5	\$4138	12	\$4977
6	\$4252	L	\$5903
7	\$4362		

HECSMTBB

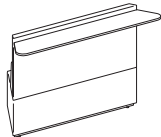

BISTRO-BACK

Trapezoid

DIMENSIONS

Depth:	30½	Ship Weight:	107
Width:	60	Cube:	29.9
Seat Height:	17	COM:	See page 202
Back Height:	30	Seat Weight Rating:	300 lbs.
Width of Worksurface:	69		
Depth of Worksurface:	12		
Worksurface Height:	42		

FABRIC PRICE CODES

1	\$4767	8	\$5923
2	\$4968	9	\$6073
3	\$5173	10	\$6236
4	\$5323	11	\$6411
5	\$5470	12	\$6588
6	\$5622	L	\$7824
7	\$5769		

HECSMAIBB

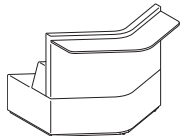

BISTRO-BACK

Arrow In

DIMENSIONS

Depth:	43½	Ship Weight:	130
Width:	52½	Cube:	43.4
Seat Height:	17	COM:	See page 202
Back Height:	30	Seat Weight Rating:	300 lbs.
Width of Worksurface:	52½		
Depth of Worksurface:	12		
Worksurface Height:	42		
Depth of Arrow:	25½		

FABRIC PRICE CODES

1	\$5461	8	\$6763
2	\$5686	9	\$6930
3	\$5917	10	\$7113
4	\$6086	11	\$7311
5	\$6252	12	\$7510
6	\$6423	L	\$8900
7	\$6587		

NOTES: Due to the inherent design of the Arrow In, material gathers will be present in the back.

HECSMAOBB

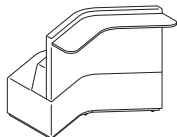

BISTRO-BACK

Arrow Out

DIMENSIONS

Depth:	43½	Ship Weight:	130
Width:	52½	Cube:	43.4
Seat Height:	17	COM:	See page 202
Back Height:	30	Seat Weight Rating:	300 lbs.
Width of Worksurface:	52½		
Depth of Worksurface:	12		
Worksurface Height:	42		
Depth of Arrow:	27½		

FABRIC PRICE CODES

1	\$5369	8	\$6671
2	\$5594	9	\$6838
3	\$5825	10	\$7021
4	\$5994	11	\$7219
5	\$6160	12	\$7418
6	\$6331	L	\$8808
7	\$6495		

HOW TO SPECIFY

Select Model Number H E C S M S B B .	Select Power N None 1R One Power, Right-Hand User Side (+ \$53) <i>Specify for Square and Trapezoid only</i> 2B Two Power, Both Sides (+ \$105) <i>Specify for Arrow In and Arrow Out only</i>	Select Fabric See page 202 H A M L 1 6 .	Select Base P Plinth P71 Black	Select Laminate See page 201 L F W 1 .	Select Edge See page 201 F W
---	--	---	---	---	---



Modular Seating — Bistro-Back, Multi-Fabric

HECSMSBBMF

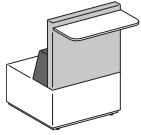

BISTRO-BACK

Square, Multi-Fabric

DIMENSIONS

Depth:	30½	Ship Weight:	70
Width:	30½	Cube:	18.1
Seat Height:	17	COM:	See page 202
Back Height:	30	Seat Weight Rating:	300 lbs.
Width of Worksurface:	30½		
Depth of Worksurface:	12		
Worksurface Height:	42		

FABRIC PRICE CODES

1	\$3701		
	<i>Add to Base Price Above</i>		
	Seat	Back	Screen
2	\$76	\$38	\$51
3	\$152	\$77	\$102
4	\$208	\$105	\$139
5	\$264	\$132	\$176
6	\$321	\$160	\$214
7	\$376	\$189	\$250
8	\$434	\$217	\$290
9	\$490	\$245	\$327
10	\$551	\$275	\$367
11	\$617	\$309	\$411
12	\$683	\$342	\$456
L	\$1147	\$573	\$764

EDUCATION

HECSMTBBMF

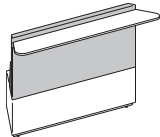

BISTRO-BACK

Trapezoid, Multi-Fabric

DIMENSIONS

Depth:	30½	Ship Weight:	107
Width:	60	Cube:	29.9
Seat Height:	17	COM:	See page 202
Back Height:	30	Seat Weight Rating:	300 lbs.
Width of Worksurface:	69		
Depth of Worksurface:	12		
Worksurface Height:	42		

FABRIC PRICE CODES

1	\$4885		
	<i>Add to Base Price Above</i>		
	Seat	Back	Screen
2	\$101	\$38	\$88
3	\$203	\$77	\$178
4	\$278	\$105	\$244
5	\$352	\$132	\$308
6	\$428	\$160	\$375
7	\$501	\$189	\$438
8	\$578	\$217	\$506
9	\$654	\$245	\$572
10	\$734	\$275	\$643
11	\$823	\$309	\$719
12	\$911	\$342	\$797
L	\$1528	\$573	\$1338

HOW TO SPECIFY

Select Model Number	Select Power	Select Seat Fabric	Select Back Fabric	Select Screen Fabric	Select Base	Select Laminate	Select Edge
	N None 1R One Power, Right-Hand User Side (+ \$53) <i>Specify for Square and Trapezoid only</i> 2B Two Power, Both Sides (+ \$105) <i>Specify for Arrow In and Arrow Out only</i>	See page 202	See page 202	See page 202	P Plinth P71 Black	See page 201	See page 201
HECSMSBBMF	1R	HAML16	HAML20	HAML16	PP71	LFW1	FW

TANGRAM™

Modular Seating — Bistro-Back, Multi-Fabric

GSA SIN 33721T



Icon Legend on page 19

EDUCATION

HECSMAIBBMF

BISTRO-BACK

Arrow In, Multi-Fabric

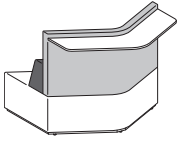

DIMENSIONS

Depth:	43½	Ship Weight:	130
Width:	52½	Cube:	43.4
Seat Height:	17	COM:	See page 202
Back Height:	30	Seat Weight Rating:	300 lbs.
Width of Worksurface:	52½		
Depth of Worksurface:	12		
Worksurface Height:	42		
Depth of Arrow:	25½		

FABRIC PRICE CODES

1	\$5600		
	<i>Add to Base Price Above</i>		
	Seat	Back	Screen
2	\$113	\$51	\$88
3	\$228	\$102	\$178
4	\$313	\$139	\$244
5	\$396	\$176	\$308
6	\$481	\$214	\$375
7	\$564	\$250	\$438
8	\$650	\$290	\$506
9	\$735	\$327	\$572
10	\$826	\$367	\$643
11	\$925	\$411	\$719
12	\$1025	\$456	\$797
L	\$1720	\$764	\$1338

NOTES: Due to the inherent design of the Arrow In, material gathers will be present in the back.

HECSMAOBBMF

BISTRO-BACK

Arrow Out, Multi-Fabric

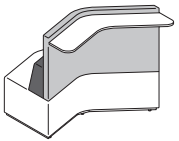

DIMENSIONS

Depth:	43½	Ship Weight:	130
Width:	52½	Cube:	43.4
Seat Height:	17	COM:	See page 202
Back Height:	30	Seat Weight Rating:	300 lbs.
Width of Worksurface:	52½		
Depth of Worksurface:	12		
Worksurface Height:	42		
Depth of Arrow:	27½		

FABRIC PRICE CODES

1	\$5505		
	<i>Add to Base Price Above</i>		
	Seat	Back	Screen
2	\$113	\$51	\$63
3	\$228	\$102	\$127
4	\$313	\$139	\$174
5	\$396	\$176	\$220
6	\$481	\$214	\$268
7	\$564	\$250	\$313
8	\$650	\$290	\$362
9	\$735	\$327	\$408
10	\$826	\$367	\$459
11	\$925	\$411	\$515
12	\$1025	\$456	\$569
L	\$1720	\$764	\$956

HOW TO SPECIFY

Select Model Number	Select Power	Select Seat Fabric	Select Back Fabric	Select Screen Fabric	Select Base	Select Laminate	Select Edge
	N None 1R One Power, Right-Hand User Side (+ \$53) <i>Specify for Square and Trapezoid only</i> 2B Two Power, Both Sides (+ \$105) <i>Specify for Arrow In and Arrow Out only</i>	See page 202	See page 202	See page 202	P Plinth P71 Black	See page 201	See page 201
HECSMAIBBMF	1R	HAML16	HAML20	HAML16	PP71	LFW1	FW



TANGRAM™ Ottomans

EDUCATION

HECSOSQ

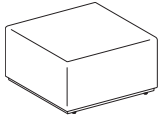

OTTOMAN

Square

DIMENSIONS

Depth:	30½	Ship Weight:	56
Height:	17	Cube:	10.4
Width:	30½	COM:	See page 202
		Weight Rating:	300 lbs.

FABRIC PRICE CODES

1	\$1600	8	\$2034
2	\$1676	9	\$2090
3	\$1752	10	\$2151
4	\$1808	11	\$2217
5	\$1864	12	\$2283
6	\$1921	L	\$2747
7	\$1976		

HECSOD

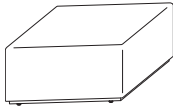

OTTOMAN

Diamond

DIMENSIONS

Depth:	26½	Ship Weight:	52
Height:	17	Cube:	12.8
Width:	46	COM:	See page 202
		Weight Rating:	300 lbs.

FABRIC PRICE CODES

1	\$1648	8	\$2226
2	\$1749	9	\$2302
3	\$1851	10	\$2382
4	\$1926	11	\$2471
5	\$2000	12	\$2559
6	\$2076	L	\$3176
7	\$2149		

HECSOTR

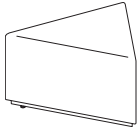

OTTOMAN

Triangle

DIMENSIONS

Depth:	27	Ship Weight:	36
Height:	17	Cube:	8.5
Width:	31	COM:	See page 202
		Weight Rating:	300 lbs.

FABRIC PRICE CODES

1	\$1361	8	\$1795
2	\$1437	9	\$1851
3	\$1513	10	\$1912
4	\$1569	11	\$1978
5	\$1625	12	\$2044
6	\$1682	L	\$2508
7	\$1737		

HECSOTP

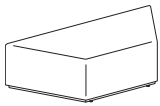

OTTOMAN

Trapezoid

DIMENSIONS

Depth:	26½	Ship Weight:	92
Height:	17	Cube:	17.0
Width:	60	COM:	See page 202
		Weight Rating:	300 lbs.

FABRIC PRICE CODES

1	\$1761	8	\$2339
2	\$1862	9	\$2415
3	\$1964	10	\$2495
4	\$2039	11	\$2584
5	\$2113	12	\$2672
6	\$2189	L	\$3289
7	\$2262		

HOW TO SPECIFY

<p>Select Model Number</p> <p>HECSOSQ</p>	<p>Select Power</p> <p>N None</p> <p>N</p>	<p>Select Fabric</p> <p>See page 202</p> <p>HAML16</p>	<p>Select Base and Color</p> <p>P Plinth P71 Black</p> <p>PP71</p>
--	---	---	---

TANGRAM™ Ottomans

GSA SIN 33721T



Icon Legend on page 19

EDUCATION

HECSEOSE

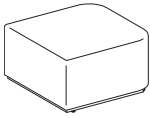

OTTOMAN

Straight End

DIMENSIONS

Depth: 30½ Ship Weight: 57
 Height: 17 Cube: 10.0
 Width: 30½ COM: See page 202
 Weight Rating: 300 lbs.

FABRIC PRICE CODES

1	\$1521	8	\$1955
2	\$1597	9	\$2011
3	\$1673	10	\$2072
4	\$1729	11	\$2138
5	\$1785	12	\$2204
6	\$1842	L	\$2668
7	\$1897		

HECSOAEEL

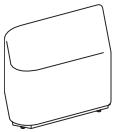

OTTOMAN

Angled End, Left

DIMENSIONS

Depth: 26½ Ship Weight: 52
 Height: 17 Cube: 12.0
 Width: 42 COM: See page 202
 Weight Rating: 300 lbs.

FABRIC PRICE CODES

1	\$1521	8	\$1955
2	\$1597	9	\$2011
3	\$1673	10	\$2072
4	\$1729	11	\$2138
5	\$1785	12	\$2204
6	\$1842	L	\$2668
7	\$1897		

HECSOAER



OTTOMAN

Angled End, Right

DIMENSIONS

Depth: 26½ Ship Weight: 52
 Height: 17 Cube: 12.0
 Width: 42 COM: See page 202
 Weight Rating: 300 lbs.

FABRIC PRICE CODES

1	\$1521	8	\$1955
2	\$1597	9	\$2011
3	\$1673	10	\$2072
4	\$1729	11	\$2138
5	\$1785	12	\$2204
6	\$1842	L	\$2668
7	\$1897		

HECSOC

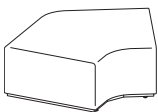

OTTOMAN

120 Degree

DIMENSIONS

Depth: 41 Ship Weight: 110
 Height: 17 Cube: 20.0
 Width: 53 COM: See page 202
 Weight Rating: 300 lbs.

FABRIC PRICE CODES

1	\$1521	8	\$2099
2	\$1622	9	\$2175
3	\$1724	10	\$2255
4	\$1799	11	\$2344
5	\$1873	12	\$2432
6	\$1949	L	\$3049
7	\$2022		

HOW TO SPECIFY

<p>Select Model Number</p> <p>HECSEOSE</p>	<p>Select Power</p> <p>N None</p> <p>N</p>	<p>Select Fabric</p> <p>See page 202</p> <p>HAML16</p>	<p>Select Base and Color</p> <p>P Plinth P71 Black</p> <p>PP71</p>
--	--	--	--



HECSVAP

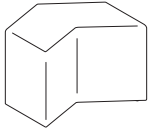

POUF

Varsity Arrow

DIMENSIONS

Depth: 23¼ Ship Weight: 37
 Height: 18¼ Cube: 7.3
 Width: 26½ COM: See page 202
 Weight Rating: 300 lbs.

FABRIC PRICE CODES

1	\$974	8	\$1408
2	\$1050	9	\$1464
3	\$1126	10	\$1525
4	\$1182	11	\$1591
5	\$1238	12	\$1657
6	\$1295	L	\$2121
7	\$1350		

HECSVHP

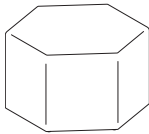

POUF

Varsity Hexagon

DIMENSIONS

Depth: 31 Ship Weight: 55
 Height: 18¼ Cube: 10.1
 Width: 26½ COM: See page 202
 Weight Rating: 300 lbs.

FABRIC PRICE CODES

1	\$1064	8	\$1498
2	\$1140	9	\$1554
3	\$1216	10	\$1615
4	\$1272	11	\$1681
5	\$1328	12	\$1747
6	\$1385	L	\$2211
7	\$1440		

HECSJVAP

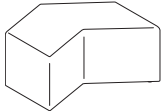

POUF

Junior Varsity Arrow

DIMENSIONS

Depth: 23¼ Ship Weight: 30
 Height: 12¼ Cube: 6.0
 Width: 26½ COM: See page 202
 Weight Rating: 300 lbs.

FABRIC PRICE CODES

1	\$876	8	\$1166
2	\$927	9	\$1203
3	\$978	10	\$1243
4	\$1015	11	\$1287
5	\$1052	12	\$1332
6	\$1090	L	\$1640
7	\$1126		

HECSJVHP

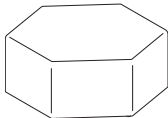

POUF

Junior Varsity Hexagon

DIMENSIONS

Depth: 31 Ship Weight: 44
 Height: 12¼ Cube: 8.3
 Width: 26½ COM: See page 202
 Weight Rating: 300 lbs.

FABRIC PRICE CODES

1	\$958	8	\$1248
2	\$1009	9	\$1285
3	\$1060	10	\$1325
4	\$1097	11	\$1369
5	\$1134	12	\$1414
6	\$1172	L	\$1722
7	\$1208		

HOW TO SPECIFY

<p>Select Model Number</p> <p>HECSVAP</p>	<p>Select Fabric</p> <p>See page 202</p> <p>HAML16</p>	<p>Select Base</p> <p>G Glide</p> <p>G</p>
---	--	--



DESCRIPTION	MODEL	SHIP WEIGHT	CUBE	LIST PRICE
Ganging Bracket, 2/Pack	HECSG	5	0.5	\$105
Ganging Bracket Bulk Pack, 12/Pack	HECSBG	10	0.6	\$523

NOTES:

- Ganging brackets used to provide alignment between adjacent pieces but can be easily removed and repositioned for reconfiguration.
- Two ganging brackets used per side; for example, if ganging a Stoop + Perch, specify one HECSG.
- Ganging brackets are unpainted anodized aluminum.
- ! Perch units automatically ship with ganging brackets and L-brackets required for proper stability.

EDUCATION

HOW TO SPECIFY

Select
Model Number

HECSG

WORKPLACE TOOLS



Flock® Modular Seating with Dean Power Module Under-Surface Mount.

WORKPLACE TOOLS

Workplace tools provide the finishing touch on any high-performance workspace. From storage options to technological tools and lighting solutions, HON's Workplace Tools deliver organization and efficiency to the office. Workplace Tools put everything you need to be productive within arm's reach, provide easy access to the connectivity you need to be successful and help you keep your workspace neat.



PRODUCT CATEGORIES

- Monitor Arms
- Keyboard Trays and Center Drawers
- Paper Management and Organizational Tools
- Task Lights
- Electrical and Power Management Accessories
- Ergonomic and Healthy Workplace Solutions

WORKPLACE TOOLS ORDERING INFORMATION

LAMINATE CENTER DRAWERS, LAMINATE PAPER MANAGEMENT MODELS HLVP1/HLDST1/ HLSL1472LS/HLSL1460LS

L1 LAMINATES CODES

Woodgrain

- ◆ Bourbon Cherry H
- ◆ Cognac COGN
- ◆ Florence Walnut LFW1
- ◆ Harvest C
- ◆ Kingswood Walnut LK11
- ◆ Mahogany N
- ◆ Mocha MOCH
- ◆ Natural Maple D
- ◆ Pinnacle PINC
- ◆ Shaker Cherry F
- ◆ Sterling Ash LSA1

Solid

- ◆ Black P
- ◆ Charcoal S
- ◆ Designer White LDW1
- ◆ Loft LOFT

L2 LAMINATES CODES

Woodgrain

- ◆ Lowell Ash LLA1
- ◆ Natural Recon LNR1
- ◆ Phantom Ecru LPE1
- ◆ Portico Teak LPT1
- ◆ Skyline Walnut LSW1

LAMINATE KEYBOARD PLATFORM MODELS H4022/HE4022

L1 LAMINATES CODES

Woodgrain

- ◆ Bourbon Cherry H
- ◆ Cognac COGN
- ◆ Field Elm LWEF
- ◆ Florence Walnut LFW1
- ◆ Harvest C
- ◆ Kingswood Walnut LK11
- ◆ Mahogany N
- ◆ Mocha MOCH
- ◆ Natural Maple D
- ◆ Pinnacle PINC
- ◆ Shaker Cherry F
- ◆ Sterling Ash LSA1

Solid

- ◆ Black P
- ◆ Charcoal S
- ◆ Designer White LDW1

Patterned

- ◆ Handspun Chestnut LAHC
- ◆ Handspun Dove LAHD
- ◆ Handspun Pearl LAHP
- ◆ Handspun Slate LAHS
- ◆ Silver Mesh B9
- ◆ Steel Mesh A9
- ◆ Gray G2
- ◆ White G1

L2 LAMINATES CODES

Woodgrain

- ◆ Beigewood LWBE
- ◆ Fawn Cypress LFC1
- ◆ Lowell Ash LLA1
- ◆ Natural Recon LNR1
- ◆ Phantom Ecru LPE1
- ◆ Portico Teak LPT1
- ◆ Skyline Walnut LSW1

METAL PAPER MANAGEMENT MODELS HHPS1 AND HDPS1

PAINT CODES

P1

- ◆ Black P
- ◆ Brownstone P7D
- ◆ Charcoal S
- ◆ Designer White PJW
- ◆ Fossil P28
- ◆ Greige T5
- ◆ Light Gray Q
- ◆ Loft LOFT
- ◆ Muslin T3
- ◆ Putty L
- ◆ Titanium P8T

P2

- ◆ Champagne Metallic T4
- ◆ Gunmetal Metallic PR3
- ◆ Platinum Metallic T1
- ◆ Silver PR6

P3

- ◆ Amethyst* P091
- ◆ Atom P8S
- ◆ Blossom P8K
- ◆ Bullseye PJF
- ◆ Cobalt Mica* P090
- ◆ Ember P8P
- ◆ Ion P8N
- ◆ Iris P8J
- ◆ Krypton P8F
- ◆ Ochre P093
- ◆ Regatta P8M
- ◆ Sienna P092
- ◆ Succulent P8A

METAL CENTER DRAWERS*, CORNER SLEEVES, METAL KEYBOARD PLATFORM, STORAGE CUBES, DRAWER ORGANIZER, HAND SANITIZER STATION

PAINT CODES

P1

- ◆ Black P
- ◆ Brownstone P7D
- ◆ Charcoal S
- ◆ Designer White PJW
- ◆ Fossil P28
- ◆ Greige T5
- ◆ Light Gray Q
- ◆ Loft LOFT
- ◆ Muslin T3
- ◆ Putty L
- ◆ Titanium P8T

P2

- ◆ Champagne Metallic T4
- ◆ Gunmetal Metallic PR3
- ◆ Platinum Metallic T1
- ◆ Silver PR6
- ◆ Solar Black P8X

P3

- ◆ Amethyst* P091
- ◆ Atom P8S
- ◆ Blossom P8K
- ◆ Bullseye PJF
- ◆ Cobalt Mica* P090
- ◆ Ember P8P
- ◆ Ion P8N
- ◆ Iris P8J
- ◆ Krypton P8F
- ◆ Ochre P093
- ◆ Regatta P8M
- ◆ Sienna P092
- ◆ Succulent P8A

* Metal center drawer models HD2 and HD8 limited to P1 Paints, Champagne Metallic, and Platinum Metallic.







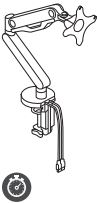
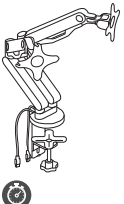
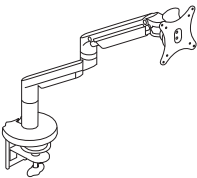

◆◆◆ For lead time information see page 21.

* De-emphasized

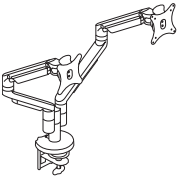

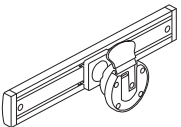
Icon Legend on page 19

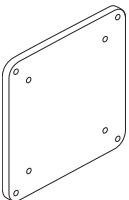
MONITOR ARMS

	DESCRIPTION	MODEL	SHIP WEIGHT	CUBE	LIST PRICE
	<p>Single Monitor Arm with 2 USB Ports</p> <p>NOTES: Easy adjustment. Height adjusts to 17" tall. Monitor tilt and swivel capability. Enclosed cable management. Grommet or desktop mounting. Clean appearance. HON 5-Year Limited Warranty.</p> <ul style="list-style-type: none"> Available in Silver only, no specification needed. Cannot be used in Empower® height adjustable applications. Arm holds monitors up to 19 lbs. 	HBSMAUSB	38.6	2.4	\$330
	<p>Dual Monitor Arm with 2 USB Ports</p> <p>NOTES: Easy adjustment. Height adjusts to 17" tall. Monitor tilt and swivel capability. Enclosed cable management. Grommet or desktop mounting. Clean appearance. In some applications the Monitor Arms may extend 12 or more inches into the worksurface. HON 5-Year Limited Warranty.</p> <ul style="list-style-type: none"> Available in Silver only, no specification needed. Cannot be used in Empower® height adjustable applications. Each arm holds monitors up to 19 lbs. 	HBDMAUSB	41.9	2.6	\$492
	<p>Single Dynamic Monitor Arm</p> <ul style="list-style-type: none"> 180° of rotation at base with optional 360° rotation. Arms extend 22" and retract up to 3". Monitor mount rotates 180° and tilts +/-30°. Monitor can be rotated from landscape to portrait position. <ul style="list-style-type: none"> Arms hold monitors from 6.2-18 lbs. Optional counterweight HPACW available to support monitors as low as 5 lbs. Back side of monitor arm base features opening for wire management through grommet when utilizing clamp mount. 	HMASTS	11.5 	0.8	\$600
	<p>Dual Dynamic Monitor Arm</p> <ul style="list-style-type: none"> Arms have 65° rotation at base with optional 130° and 360° rotations. Arms extend 22" and retract up to 3". Monitor mount rotates 180° and tilts +/-30°. Monitor can be rotated from landscape to portrait position. <ul style="list-style-type: none"> Arms hold monitors from 6.2-18 lbs. Optional counterweight HPACW available to support monitors as low as 5 lbs. Back side of monitor arm base features opening for wire management through grommet when utilizing clamp mount. 	HMASD	17.0 	1.1	\$1152
	<p>Sliding Mount for Monitor Arm</p> <ul style="list-style-type: none"> Supports monitors up to 18 lbs. Compatible with VESA 75mm and 100mm mounts. Compatible with models HMASTS, HMASD, HPASD, HPADD, and HPATF. Available in two paint finishes, Silver (SVR) and Black (BLK). Plastic components ship in like color with specified paint finish. 	HPACSM	3.0 	0.3	\$248
	<p>Monitor Arm Counterweight</p> <ul style="list-style-type: none"> Optional counterweight for monitors as low as 5 lbs. Minimum weight for monitors without counterweight is 6.2 lbs. <ul style="list-style-type: none"> Available in Black only, no specification needed. Compatible with models HMASTS, HPASD, HMASD, HPADD, and HPATF. 	HPACW	3.0 	0.1	\$37

SIN 33721

WORKPLACE TOOLS

HOW TO SPECIFY

<p>Select Model Number</p> <p>H M A S T S .</p>	<p>Select Finish</p> <p>SVR Silver BLK Black</p> <p>S V R</p>
--	--



MONITOR ARMS

DESCRIPTION

MODEL SHIP WEIGHT CUBE LIST PRICE

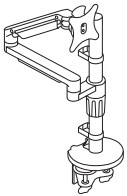

Post Mount with Single Dynamic Arm

- Arm has 360° rotation at base.
- Monitor mount rotates 180° and tilts +/-30°.
- Monitor can be rotated from landscape to portrait position.
- Arm extends up to 20".
- Arm has 17¾" of vertical adjustment.

⚠ Available in Silver (SVR) finish only.

⚠ Arms hold monitors from 6.2-18 lbs. Optional counterweight HPACW available to support monitors as low as 5 lbs. (see page 225).

HPASD 15.5 1.3 \$839

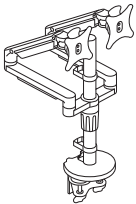

Post Mount with Dual Dynamic Arms

- Arms have 360° rotation at base.
- Monitor mount rotates 180° and tilts +/-30°.
- Monitor can be rotated from landscape to portrait position.
- Arms extend up to 20".
- Arms have 17¾" of vertical adjustment.

⚠ Available in Silver (SVR) finish only.

⚠ Arms hold monitors from 6.2-18 lbs. Optional counterweight HPACW available to support monitors as low as 5 lbs. (see page 225).

HPADD 19.5 1.3 \$1219

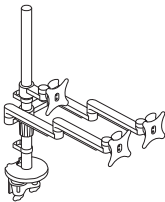

Post Mount with Triple Fixed Arms

- Features two fixed extended arms and one fixed center mount.
- Arms have 360° rotation at base.
- Monitor mount rotates 180° and tilts +/-30°.
- Monitor can be rotated from landscape to portrait position.
- Arms extend up to 20".
- Arms have 27½" of vertical adjustment.

⚠ Available in Silver (SVR) finish only.

⚠ Arms hold monitors from 6.2-18 lbs. Optional counterweight HPACW available to support monitors as low as 5 lbs. (see page 225).

HPATF 22.0 1.9 \$1395

WORKPLACE TOOLS

HOW TO SPECIFY

Select Model Number	Select Finish
HPASD.	SVR Silver
<input type="checkbox"/> H <input type="checkbox"/> P <input type="checkbox"/> A <input type="checkbox"/> S <input type="checkbox"/> D .	<input type="checkbox"/> S <input type="checkbox"/> V <input type="checkbox"/> R



CPU HOLDERS

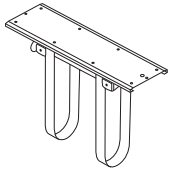

DESCRIPTION

360° Swivel CPU Holder with Adjustable Straps

- Supports CPUs 3¼" wide up to 64" perimeter and holds up to 75 lbs.
- 360° rotation.
- Ships complete and includes necessary mounting hardware and instruction sheet.

ⓘ Available in Black only, no specification needed.

MODEL	SHIP WEIGHT	CUBE	LIST PRICE
HCPU1	7	0.2	\$312

HOW TO SPECIFY



Select Model Number

H C P U 1

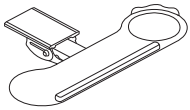

Icon Legend on page 19

KEYBOARD TRAYS

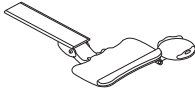
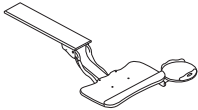
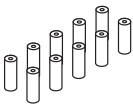
	DESCRIPTION	MODEL	SHIP WEIGHT	CUBE	LIST PRICE
	Short Track and Keyboard Platform <ul style="list-style-type: none"> Height adjustable total of 5 3/4" (1 3/4" above and 4" below). +10°, -20° of tilt adjustment. 360° rotation. 	HKTSHORT	10 	0.8	\$722
	Mid Track with Keyboard and Mouse Platform <ul style="list-style-type: none"> Height adjustable total of 8" (3" above and 5" below). +10°, -20° of tilt adjustment. 360° rotation. 	HKT MID	17	1.2	\$664
	Sit to Stand Long Track with Keyboard and Mouse <ul style="list-style-type: none"> Height adjustable total of 12 1/2" (7 1/2" above and 5" below). +10°, -20° of tilt adjustment. 360° rotation. 	HKTLONG	17	0.8	\$775
	Keyboard Spacer <ul style="list-style-type: none"> Used when attaching HKT MID or HKTLONG to Coordinate™ and Voi® or Systems Worksurface with an external channel. The kit includes ten cylinder spacers and ten screws. Spacers are 3/4"W x 2 1/8"H. Specify one kit per keyboard tray. 	HKBS	1	0.8	\$128

SIN 33721

NOTES:

-  Available in Black only, no specification needed.

WORKPLACE TOOLS

HOW TO SPECIFY

Select Model Number

H K T M I D

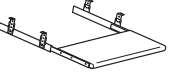
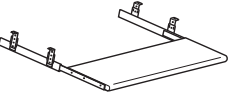

KEYBOARD TRAYS

	DESCRIPTION	MODEL	SHIP WEIGHT	CUBE	LIST PRICE BY LAMINATE GRADE	
					L1	L2
	Laminate Keyboard Platform <ul style="list-style-type: none"> Laminate Tray dimensions: 21½"W x 10"D x 1⅛" Thick. Minimum clearance for mounting: 22⅞"W x 17"D. Surface can be positioned 2", 2½", 3" or 3½" below bottom of worksurface. Will not fit on a 37" x 24" Corner worksurface. 	H4022	10	0.6	\$274	\$290
	Laminate Keyboard Platform with Extended Tray <ul style="list-style-type: none"> Laminate Tray dimensions: 30"W x 10"D x 1⅛" Thick. Minimum clearance for mounting: 32½"W x 17"D. Surface can be positioned 2", 2½", 3" or 3½" below bottom of worksurface. Will not fit on a 37" x 24" Corner worksurface. Ball-bearing slide; slide and brackets are Black. 	HE4022	12	0.7	\$387	\$403

HOW TO SPECIFY

Select Model Number <input type="text" value="H4022"/>	Select Laminate See page 224 <input type="text" value="H"/>
--	--

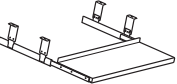
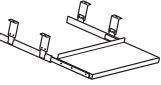
	DESCRIPTION	MODEL	SHIP WEIGHT	CUBE	LIST PRICE BY PAINT GRADE		
					P1	P2	P3
	Metal Keyboard Platforms 30"W Metal Keyboard and Mouse Tray <ul style="list-style-type: none"> Designed to hold keyboards and allow room for mouse pads. Tray dimensions: 30"W x 10"D. Minimum clearance for mounting: 32½"W x 15"D. 	H4028	11	1.5	\$198	\$209	\$217
OPEN MARKET							
	24"W Metal Keyboard Tray <ul style="list-style-type: none"> Designed to hold ONLY keyboards. Tray dimensions: 24"W x 10"D. Minimum clearance for mounting: 26½"W x 15"D. 	H4029	11	1.5	\$179	\$190	\$198
OPEN MARKET							

NOTES:

- Surface is positioned 3" below bottom of worksurface.
- Non-articulating, only movement is front-to-back. Does not tilt or swivel.

HOW TO SPECIFY

Select Model Number <input type="text" value="H4028"/>	Select Paint Color See page 224 <input type="text" value="P"/>
--	---



CORNER SLEEVES

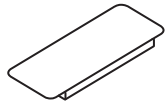

DESCRIPTION

Metal Corner Sleeves

22½"W Leading Edge x 9"D

- Fits 1/8" thick square edge detail.

MODEL	SHIP WEIGHT	CUBE	LIST PRICE BY PAINT GRADE		
			P1	P2	P3
H51204	10	1.5	\$217	\$225	\$232
H51206	10	1.5	\$217	\$228	\$235

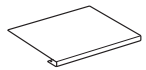

22½"W Leading Edge x 18"D

- Fits 1/8" thick square edge detail.

NOTES:

- Corner sleeve connects intersecting worksurfaces to create "corner desk" work areas.

Edge Detail



HOW TO SPECIFY

Select
Model Number

H 5 1 2 0 4 .

Select
Paint Color

See page 224

P



CENTER DRAWERS



Angled front

DESCRIPTION

Laminate Center Drawer

22"W x 15⁵/₈"D x 2¹/₂"H

- Ball-bearing slide suspension.
- 12" drawer extension (3/4).
- Inside drawer dimension for H1522: 18⁷/₈"W x 15¹/₂"D x 1¹/₂"H.
- Minimum clearance for mounting H1522: 22³/₄"W x 18¹/₂"D compatible with 72"W x 36"D, 66"W x 30"D, 60"W x 30"D Double Pedestal Desks, 72"W x 36"D, 66"W x 30"D Single Pedestal Desks, Bullet and P-Shaped Peninsulas, 72"W x 24"D, 66"W x 24"D, 60"W x 24"D Credenza w/Kneespace, 72"W x 24"D, 66"W x 24"D Single Pedestal Credenzas, 48"W x 24"D, 42"W x 24"D Returns
- Designed for use with Concinnity™, Voi®, Valido® and 10500 Series™.
- Includes pencil tray.

NOTES: For 60"W x 30"D Modular Desk Shells with two 15⁵/₈"W Storage Pedestals or 60"W x 24"D Modular Credenza Shells with two 15⁵/₈"W Storage Pedestals, use center drawer H1522.

MODEL	SHIP WEIGHT	CUBE	L1 LIST PRICE	L2 LIST PRICE
H1522	11	1.1	\$252	\$268

HOW TO SPECIFY

<p>Select Model Number</p> <p>H 1 5 2 2 .</p>	<p>Select Laminate</p> <p>See page 224</p> <p>H</p>
--	--



Icon Legend on page 19

CENTER DRAWERS

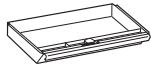

Angled front

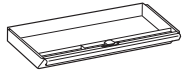

Angled front



DESCRIPTION

Metal Center Drawer w/Lock

- 19"W x 14³/₄"D x 3"H
- Ball-bearing slide suspension.
- 12" drawer extension (3/4).
- Inside drawer dimension: 19"W x 13"D x 2³/₈"H.
- Minimum clearance for mounting: 21³/₄"W x 19¹/₄"D.
- Core removable lock.

24³/₄"W x 14³/₄"D x 3"H

- Ball-bearing slide suspension.
- 12" drawer extension (3/4).
- Inside drawer dimension: 24¹/₂"W x 13"D x 2³/₈"H.
- Minimum clearance for mounting: 27³/₈"W x 19¹/₄"D.
- Core removable lock.

MODEL	SHIP WEIGHT	CUBE	LIST PRICE BY PAINT GRADE	
			P1	P2

HD2	9	1.0	\$377	\$388
------------	---	-----	--------------	--------------

HD8	12	1.2	\$377	\$388
------------	----	-----	--------------	--------------

DESCRIPTION

Polymer Center Drawer

- Material: ABS.
- Minimum clearance for mounting: 23"W x 16¹/₄"D x 2"H.
- Retracts on 16" ball-bearing slides.
- Can be used on worksurfaces with Coordinate™ Height Adjustable Bases as long as it is attached with spacer model HKBS.
- Can store up to 25 lbs.

Black finish only, no specification needed.

MODEL	SHIP WEIGHT	CUBE	LIST PRICE
-------	-------------	------	------------

HCD1	7	0.5	\$160
-------------	---	-----	--------------

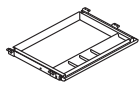

OPEN MARKET

NOTES:

- All metal center drawers feature pencil trays with three compartments for storage.
- All metal center drawers feature core removable locks for greater personal and departmental security.

WORKPLACE TOOLS

HOW TO SPECIFY

<p>Select Model Number</p> <p>HD2 .</p>	<p>Select Paint Color</p> <p>See page 224</p> <p>P</p>
--	---



Icon Legend on page 19

DESKTOP RISER



DESCRIPTION

Portable Desktop Riser
31"D x 5"-16½"H x 35"W

NOTES: Available in White (WHT) finish. Desktop riser dimensions (without keyboard tray): 22"D x 5"-16½"H x 35"W. Keyboard tray dimensions: 9"D x 30"W. Max loading capacity is 33 lbs for the desktop riser surface and 4 lbs for the keyboard tray. Easily transition from seated to standing positions throughout the workday. Sits atop an existing desk to create sit-to-stand functionality by raising the computer. Includes keyboard tray and surface for computer monitors. **HON 5-Year Limited Warranty.**

! Not intended for use on mobile workstations.

MODEL SHIP WEIGHT CUBE LIST PRICE

HBXRISER 54 4.1 \$830

HOW TO SPECIFY

Select Model Number

HBXRISER.

Select Finish

WHT White

WHT

CHAIR MATS

	DESCRIPTION	MODEL	SHIP WEIGHT	CUBE	LIST PRICE
	Lipped Chair Mat with Studs 48"W x 36"D	HCM3648LS ⓘ	8.8	0.6	\$123
	Lipped Chair Mat without Studs 60"W x 46"D 48"W x 36"D	HCM4660LN HCM3648LN ⓘ	13.2 8.3	0.5 0.3	\$205 \$123

NOTES:

- Available with studs for carpet and without studs for hard-surface floors.
- Ships rolled.
- **HON 5-Year Limited Warranty.**

ⓘ Available in Clear finish only, no specification needed.



HOW TO SPECIFY

Select
Model Number

H C M 3 6 4 8 L S



TASK LIGHTS

	DESCRIPTION	MODEL	SHIP WEIGHT	CUBE	LIST PRICE
	Articulating Desk Lamp Articulating Desk Lamp w/ Occupancy Sensor <ul style="list-style-type: none"> • Full-range dimming from 10% to 100%. • Designed for 50,000 hours of life. • Occupancy sensor is built into the head of the lamp and will automatically shut the lamp off after 6 minutes of undetected movement. • Base swivel is 180 degrees. • Uses only 5 watts of energy. • Light comes with a silver 9' 4" power cord. • Base diameter is 7.5". • 3500K Color Temperature. • 80 Color Rendering Index. • TAA Compliant. 	HLED1 HLED10C	 1.2 1.2	 6.5 6.5	 \$516 \$627
	<p>! Available in Matte Silver finish only, no specification needed.</p>				
	Task Desk Lamp <ul style="list-style-type: none"> • Full-range dimming from 10% to 100%. • Designed for 50,000 hours of life. • Lamp is 15.83" tall. • Desk lamp does not articulate at base. The pivoting head provides custom positioning, as it can be twisted 360 degrees. • Uses only 5 watts of energy. • Light comes with a silver 9' 4" power cord. • Base diameter is 6.7". • 3500K Color Temperature. • 80 Color Rendering Index. • TAA Compliant. 	HLED2	0.7	3.0	\$448
	<p>! Available in Brushed Nickel finish only, no specification needed.</p>				

WORKPLACE TOOLS

HOW TO SPECIFY

Select Model Number

H L E D 1



TASK LIGHTS

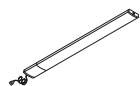

DESCRIPTION	MODEL	SHIP WEIGHT	CUBE	LIST PRICE
LED Task Lights				
17" LED Light with Power Supply (Single)	HLED17AS	1.2	0.05	\$540
31" LED Light with Power Supply (Single)	HLED31AS	1.5	0.09	\$723
17" LED Light with Power Supply for Daisy-chain (Starter)	HLED17A	1.0	0.05	\$591
31" LED Light with Power Supply for Daisy-chain (Starter)	HLED31A	1.4	0.09	\$793
17" LED Light with 8" Jumper Cord for Daisy-chain (Follower)	HLED17AUO	1.0	0.03	\$484
31" LED Light with 8" Jumper Cord for Daisy-chain (Follower)	HLED31AUO	1.0	0.05	\$646
Undercabinet Occupancy Sensor with 1" End to End Connector	HLEDOSA	0.2	0.01	\$118

NOTES: To use the daisy chain application, must start with model HLED17A or HLED31A. No finish specification required. Attaches magnetically to underside of overhead storage, or attaches with provided screws or double-sided tape. Occupancy sensor attaches to a single or starter LED light and will automatically turn the light off after no motion is detected for 30 minutes. Just like all the LED light models, the occupancy sensor features a soft-touch on/off switch. LED task lights have a lifetime of 50,000 hours and have a dimmer feature that allows the user to adjust the amount of light output.



DESCRIPTION	MODEL	SHIP WEIGHT	CUBE	LIST PRICE
Recessed Task Lights				
<ul style="list-style-type: none"> • Color: Black. • Slim profile design. • Mount to stack-on storage and wall mounted storage cabinets. • 9-foot black cord and switch off right rear corner. • Features LED strip. • Lights ordered after October 4, 2021 will feature new LED light strip. 				
18 ³ / ₈ "W x 3 ¹ / ₁₆ "D x 1 ¹ / ₈ "H	HH870924	5.0	0.40	\$293
Chicago code version (with fused plug)	HH870924CH	5.0	0.40	\$370
22 ⁷ / ₈ "W x 3 ¹ / ₁₆ "D x 1 ¹ / ₈ "H	HH870930	7.0	0.60	\$297
Chicago code version (with fused plug)	HH870930CH	7.0	0.60	\$386
34 ⁵ / ₈ "W x 3 ¹ / ₁₆ "D x 1 ¹ / ₈ "H	HH870942	10.0	0.90	\$321
Chicago code version (with fused plug)	HH870942CH	10.0	0.90	\$407
46 ¹ / ₂ "W x 3 ¹ / ₁₆ "D x 1 ¹ / ₈ "H	HH870960	12.0	1.10	\$348
Chicago code version (with fused plug)	HH870960CH	12.0	1.10	\$433

HOW TO SPECIFY

Select
Model Number

HH870924



Icon Legend on page 19

PAPER MANAGEMENT & ORGANIZATIONAL TOOLS

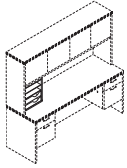

Not available in two-tone laminate

DESCRIPTION	MODEL	SHIP WEIGHT	CUBE	LIST PRICE BY LAMINATE GRADE	
				L1	L2

Vertical Paper Manager
 14⁷/₈"W x 10⁷/₈"D x 19³/₁₆"H
HLVPM1 27 2.8 **\$445** **\$456**

NOTES: Keeps papers, files, and books neatly organized and within easy reach from a seated position. Designed for desk, credenza, and return tops. Fits under stack-on storage models. Two pullout drawers and three fixed shelves. Not available in pattern laminate colors. Ships fully assembled.

⚠ Requires 19³/₄"H minimum of clear space between underside of overhead storage unit and worksurface.
SPECIFYING EXAMPLE: HLVPM1.N

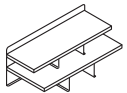

Not available in two-tone laminate



Desktop Storage Terrace
 26¹/₂"W x 12¹/₂"D x 10¹/₂"H
HLDST1 24 1.1 **\$416** **\$427**

NOTES: For use on the tops of 29¹/₂"H desks, credenzas, and returns. Features six storage sections plus top display shelf. Keeps work-in-process, priority files, loose pages, and mail neatly organized and in view. Mixed material design comprised of sturdy laminate shelves with metal back and support panels. Not available in two-tone laminate combination or pattern laminate colors. Choose from Platinum Metallic (T1), Black (P), and Charcoal (S) for the metal components. Sized to fit in stack-on and wall mount storage cabinets in 10500, Valido, Concinnity, 94000, and 38000 Series. Fits in Concinnity and Voi sliding door models, except for 48"W or smaller models. Specify: Model.Laminate.Paint

SPECIFYING EXAMPLE: HLDST1.N.T1

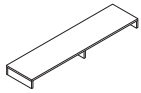

Layering Shelf
 72"W x 14¹/₂"D x 5¹/₂"H **HLSL1472LS** 50 4.6 **\$586** **\$597**
 60"W x 14¹/₂"D x 5¹/₂"H **HLSL1460LS** 39 1.3 **\$492** **\$503**

NOTES: Layering shelf works with lower credenzas to provide additional storage areas.

⚠ Layering Shelves cannot be stacked.
 ⚠ Cannot add a hutch on top of a layering shelf.

HOW TO SPECIFY

Select Model Number	Select Laminate
	See page 224
H L V P M 1 . N	

PAPER MANAGEMENT & ORGANIZATIONAL TOOLS

GSA SIN 33721



Icon Legend on page 19

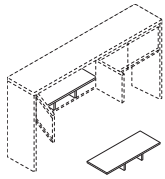

DESCRIPTION

Stacked Paper Management
32½"W x 12½"D x 4¼"H

MODEL SHIP WEIGHT CUBE LIST PRICE

HLVPM2 22 1.25 \$223

NOTES: Segments and organizes stack-on and wall mount storage compartments, as well as bookcase shelves. Unit can be used in Models H105327, H10534, H105322, H105321, H105382 and H105381.

- Available in Black finish only, no specification needed.
- In some cases, installation of Stacked Paper Management may require removing the stack-on or wall mount storage doors.

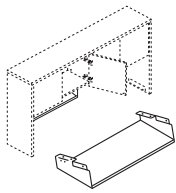

DESCRIPTION

Hanging Paper Shelf
28½"W x 11¼"D x 4¾"H

MODEL SHIP WEIGHT CUBE LIST PRICE BY PAINT GRADE

HHPS1 7 2.9 \$272 \$281 \$293

NOTES: Attaches quickly and easily (screws included). Maximizes worksurface space; de-clutters desktop while placing priority communications and active project folders within easy reach. Angled design allows contents to be distinguished at a glance. Mixed material styling features strong painted metal frame with a frosted shelf.

Attaches quickly and easily to laminate stack-on and wall mount storage models (except the 36"W Voi® overhead hutch with O-legs or panel mount brackets). Not for use with 38000 Series™ and Systems.

Specify: Model.Paint

SPECIFYING EXAMPLE: HHPS1.T1

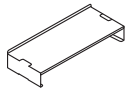

DESCRIPTION

Desktop Paper Shelf
28½"W x 11½"D x 5"H

HDPS1 7 2.9 \$272 \$281 \$293

NOTES: Desktop Paper Shelf and Storage Terrace include protective, non-slip pads on the base. Paper Shelf can stack two-high. Organizer shelf provides a place and space for work-in-process and piling to keep worksurfaces neat and tidy. Convenient, scalable design with interlocking side supports allow two units to be stacked and integrated. Durable painted metal frame with a frosted shelf; mixed material styling matches hanging paper shelf.

Can also be used inside select overhead storage, including the following stack-on with clearance and hinged door models: 10500 and Valido 36", 42", 66", 72", 78"W.

Specify: Model.Paint

SPECIFYING EXAMPLE: HDPS1.T1

WORKPLACE TOOLS





HOW TO SPECIFY

Select Model Number HHPS1.	Select Paint Color See page 224 P
--------------------------------------	--

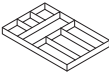
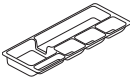
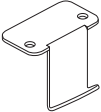

Icon Legend on page 19

PAPER MANAGEMENT & ORGANIZATIONAL TOOLS

	DESCRIPTION	MODEL	SHIP WEIGHT	CUBE	LIST PRICE BY PAINT GRADE		
					P1	P2	P3
	Storage Cube 12"W x 12"D SPECIFYING EXAMPLE: HLSL1212.P8S	HLSL1212	1	0.3	\$400	\$400	\$400
							
	Drawer Organizer 12"W x 14½"D x 1½"H SPECIFYING EXAMPLE: HSLDRWORG.P8F	HSLDRWORG	1	0.5	\$218	\$218	\$218
	DESCRIPTION	MODEL	SHIP WEIGHT	CUBE	LIST PRICE		
	Optional Pencil Tray ⚠ For use with mobile and freestanding pedestal models. ⚠ No specification required.	HV-UT1	0.5	0.1	\$94		
	Back Pack Hook (10 per carton) 12"W x 14½"D x 1½"H NOTES: Assembly: attaches to bottom of desk with (2) screws, included. ⚠ Available in Platinum Metallic finish only, no specification needed.	HCLA65	10.0	0.1	\$119		
OPEN MARKET							
							

WORKPLACE TOOLS

HOW TO SPECIFY

<p>Select Model Number</p> <p>H L S L 1 2 1 2 .</p>	<p>Select Paint Color</p> <p>See page 224 Only specify for models HLSL1212 and HSLDRWORG</p> <p>P 8 S</p>
---	--

PAPER MANAGEMENT & ORGANIZATIONAL TOOLS

GSA SIN 33721 EXCEPT AS NOTED



Icon Legend on page 19

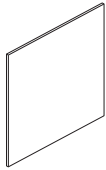

DESCRIPTION

Wall Mount Tackboard

36"W x 35¼"H
30"W x 35¼"H

36"W x 48⅝"H
30"W x 48⅝"H

MODEL

HNL3636TB
HNL3630TB

HNL4936TB
HNL4930TB

SHIP WEIGHT

20
16

27
22

CUBE

2.9
2.9

5.5
3.7

LIST PRICE

\$409
\$348

\$454
\$396

NOTES: When positioned above 29½"H floor-standing storage, the sizes align with overhead storage height options. Can be positioned side-by-side with corresponding wall mount markerboard sizes. Easy to install; includes mounting hardware. Attaches to wall with horizontally mounted, interlocking Z-clip brackets. For the space directly below stack-on and wall mount storage cabinets, use the 18"H tackboard models listed in the Desks section in the 2023 Workspaces Pricer.

SPECIFYING EXAMPLE: HNL3636TB.APN15

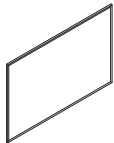

Markerboard

48"W x 31"H

NOTES: Wall mounted.

ⓘ No specification required.

HL4831MB

44

3.4

\$901

OPEN MARKET



WORKPLACE TOOLS

HOW TO SPECIFY

Select
Model Number

Select
Fabric Color

See pages 25-26

H N L 3 6 3 6 T B .

A P N 1 1

INTERLINK IQ ELECTRICAL

Specification guide for IQ Electrical on Training tables

Determine table width, the type of power access being used (3" grommet or 4x8 pop-up) and the desired number per table (Columns 1, 2 or 3). The table will then identify the type and quantity of components needed per table along with the maximum table run. Note that this is in addition to the Power base in-feed which is needed for each run. For example, a 48"W table with two 3" power grommets per table will require (1) HQH5-3 harness and (1) HQH1-3 harness per table with a maximum run of four tables.



Top Width	POWER ONE (1) PER TABLE 3" ROUND POWER GROMMET		POWER TWO (2) PER TABLE 3" ROUND POWER GROMMETS		POWER ONE (1) PER TABLE 4x8 POP-UP PORT	
	Component	Quantity	Component	Quantity	Component	Quantity
36"	(1) HQH5-3	8 Table Run Maximum	N/A	N/A	(1) HQH5-P	8 Max Table Run
42"	(1) HQH5-3	8 Table Run Maximum	N/A	N/A	(1) HQH5-P	8 Max Table Run
48"	(1) HQH5-3	8 Table Run Maximum	(1) HQH5-3 (1) HQH1-3	4 Max Table Run	(1) HQH5-P	8 Max Table Run
54"	(1) HQH5-3	8 Table Run Maximum	(1) HQH5-3 (1) HQH1-3	4 Max Table Run	(1) HQH5-P	8 Max Table Run
60"	(1) HQH5-3	8 Table Run Maximum	(1) HQH5-3 (1) HQH1-3	4 Max Table Run	(1) HQH5-P	8 Max Table Run
66"	(1) HQH5-3 (1) HQTJ3	4 Table Run Maximum	(1) HQH5-3 (1) HQH1-3	4 Max Table Run	(1) HQH5-P (1) HQTJ3	4 Max Table Run
72"	(1) HQH5-3 (1) HQTJ3	4 Table Run Maximum	(1) HQH5-3 (1) HQH1-3	4 Max Table Run	(1) HQH5-P (1) HQTJ3	4 Max Table Run
84"	(1) HQH5-3 (1) HQTJ3	4 Table Run Maximum	(2) HQH5-3	4 Max Table Run	(1) HQH5-P (1) HQTJ3	4 Max Table Run
96"	(1) HQH5-3 (1) HQTJ3	4 Table Run Maximum	(2) HQH5-3	4 Max Table Run	(1) HQH5-P (1) HQTJ3	4 Max Table Run
Half-Round (all sizes)	(1) HQTJ3	2 Tables Maximum	N/A	N/A	(1) HQH5-P	2 Max Table Run
Trapezoid (all sizes)	(1) HQH5-3	8 Table Run Maximum	N/A	N/A	(1) HQH5-P	8 Max Table Run

NOTES:

- Interlink IQ Electrical is a pluggable, single circuit electrical system.
 - All electrical models include wire management clips and hardware.
 - Interlink IQ Electrical is non-sequential/non-directional.
 - Interlink IQ Electrical is UL Recognized as a Powered Table System and meets the requirements of UL 962 when paired with Motivate® or Huddle tables.
- ⓘ 40' maximum run, or no more than 8 units, whichever comes first. Interlink IQ system will automatically shut off if maximum requirements are exceeded. Maximum run is based upon electrical harness width, not table width.

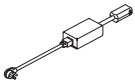
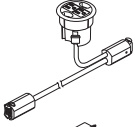
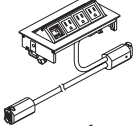
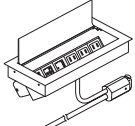
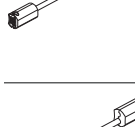
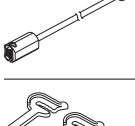
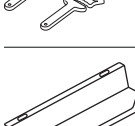
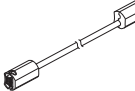

INTERLINK IQ ELECTRICAL

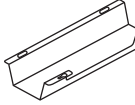
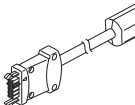
	DESCRIPTION	MODEL	SHIP WEIGHT	CUBE	LIST PRICE
	Power Base In-Feed <ul style="list-style-type: none"> 12 amp circuit breaker is built in to the Power Base In-Feed. Available in Black finish, no specification needed. 	HQB	2.0	0.2	\$676
	Power Harness – 1' Power Hub, 3" Round Grommet Mount <ul style="list-style-type: none"> Available in Black finish, no specification needed. 	HQH1-3	2.0	0.2	\$223
	Power Harness – 5' Power Hub, 3" Round Grommet Mount <ul style="list-style-type: none"> Available in Black finish, no specification needed. 	HQH5-3	2.0	0.2	\$249
	Power Harness – 5' with 4" x 8" Pop-Up Port (3 Power, 1 Blank) <ul style="list-style-type: none"> For use with tables G1 grommet. Specify paint. 	HQH5-P-3P1B	3.0	0.3	\$487
	Power Harness – 5' with 5" x 11" Flip-Top Port (3 Power, 3 Blank) <ul style="list-style-type: none"> For use with Preside® G2 grommet. Specify paint. 	HQH5-E-3P3B	5.0	0.2	\$512
	Power Harness – 5' with 5" x 11" Flip-Top Port (3 Power, 1 Extron Double Space) <ul style="list-style-type: none"> For use with Preside® G2 grommet. Specify paint. 	HQH5-E-3P1E	5.0	0.2	\$540
	Power Harness – 5' with 5" x 11" Flip-Top Port (3 Power, 2 USB A+C, 2 Blank) <ul style="list-style-type: none"> For use with Preside® G2 grommet. Specify paint. 	HQH5-E-3P1U2B	5.0	0.2	\$564
	Power Jumper – 3' <ul style="list-style-type: none"> Available in Black finish, no specification needed. 	HQJ3	2.0	0.2	\$141
	Ganging Hardware <ul style="list-style-type: none"> Includes two ganging links and two screws. No color designator when specifying. <i>Example: HMAGANG.</i> 	HMAGANG	1.0	0.1	\$135
	Cable Management Troughs 17"W – Single 17"W – 10-Pack <ul style="list-style-type: none"> Available in Graphite finish, no specification needed. NOTES: For additional information see page 249.	HCTROUGH17 HCTROUGH1710	2.7 14.0	0.5 0.5	\$94 \$841
	IQ 1.0 Backward Compatible Jumper 36" <ul style="list-style-type: none"> Available in Black finish, no specification needed. Use when connecting Interlink IQ 1.0 power harness (rectangle end) to Interlink IQ 2.0 (oval end) power harness. ! If using Interlink IQ 2.0 in-feed with Interlink IQ 1.0 power harness please contact Customer Support.	HQBCJ36	2.0	0.2	\$107

NOTES:

- Use HQH5-P models with G1 table top cutouts and HQH5-E models with G2 table top cutouts.
- Interlink IQ Electrical is a pluggable, single circuit electrical system.
- All electrical models include wire management clips and hardware.
- Interlink IQ Electrical is non-sequential/non-directional.
- Interlink IQ Electrical is UL Recognized as a Powered Table System and meets the requirements of UL 962 when paired with Motivate® or Huddle tables.
- !** 40' maximum run, or no more than 8 units, whichever comes first. Interlink IQ system will automatically shut off if maximum requirements are exceeded. Maximum run is based upon electrical harness width, not table width.

HOW TO SPECIFY

Select Model Number HQH5-E-3P3B	Select Paint Color FOG Fog SVR Silver BLK Black SVR
---	--

4-TRAC HARDWIRE ELECTRICAL SYSTEM

4-Trac Electrical System

The 4-Trac Electrical System is a UL-recognized Manufactured Wiring System that seamlessly passes power from one worksurface to another. This low-profile non-sequential electrical system allows tables to be “daisy-chained” together in any desired order and allows users to reconfigure quickly due to simple connectable/disconnectable links.

- Meets requirements of UL 183 and National Electric Code Article 604
- 4-Wires, 2-circuits, 20 Amps each (Circuit 1 and Circuit 2 only)
- 13 Duplex Receptacles per circuit, 26, 15 Amp Duplex receptacle per power in-feed
- Electrical system attaches directly to underside of worksurface with included brackets
- Up to twelve tables can be linked together

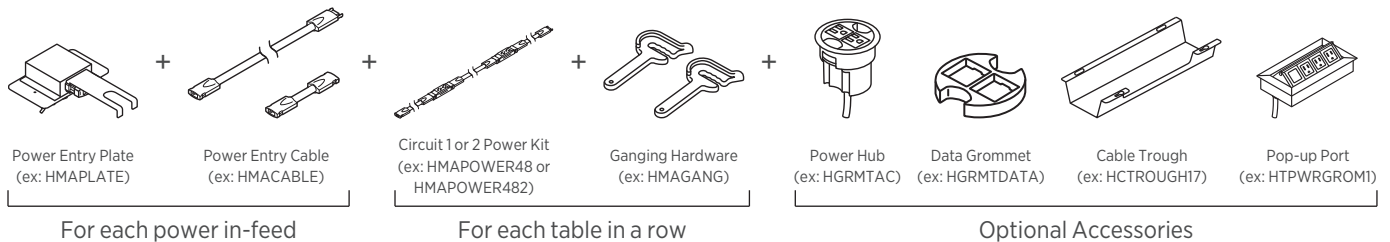



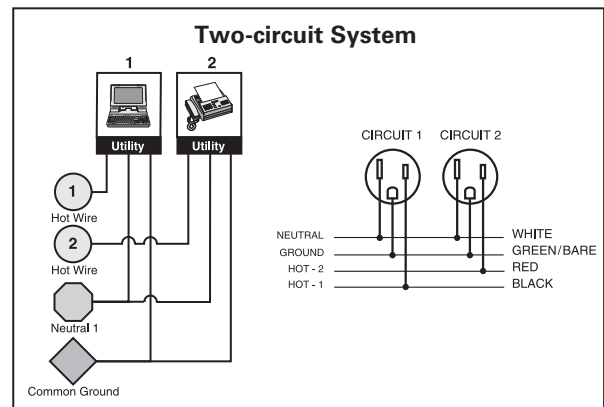
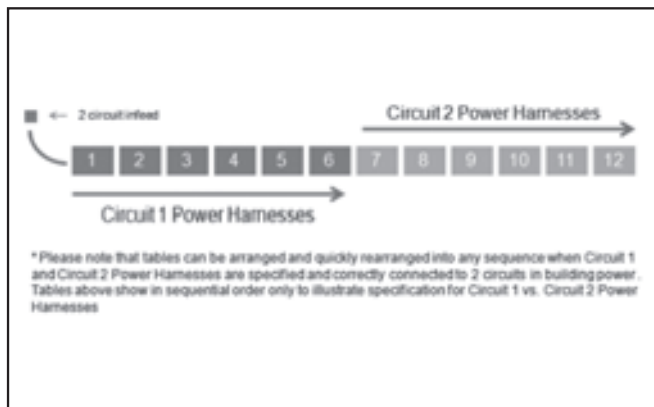

Steps for Electrical Specifications:

- Determine how many rows of tables are needed and order the following:
 - One HMAPLATE per row (or power in-feed)
 - One HMAPOWER48 per row (or power in-feed)
- Order one power harness per table in each row
 - For 1-6 tables in a row (see illustration 1)
 - Order Circuit 1 Power Harnesses (ex. If powering six 24x60 tables order six sets of HMAPOWER60)
 - For 7-12 tables in a row (see illustration 1)
 - Order Circuit 1 Power Harness for first six tables and Circuit 2 Power Harness for remaining tables (ex. If powering eight 24x60 tables, order six sets of HMAPOWER60 and two sets of HMAPOWER602)
- Order one set of ganging hardware per table (ex. HMAGANG)
- Determine which accessories are needed:
 - Power Hub model HGRMTAC — to access power at worksurface.
 - Data Grommet model HGRMTDATA — to access data at worksurface.
 - Wire Management strips model HBTMS — for vertical and horizontal wire management.

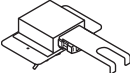
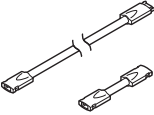

4-TRAC HARDWIRE ELECTRICAL SYSTEM

Icon Legend on page 19

	DESCRIPTION	MODEL	SHIP WEIGHT	CUBE	LIST PRICE
	Power Entry Plate	HMAPLATE	1.0	0.2	\$135
	Power Entry Cable • 6' power entry cable with male/female adapter. • Connects table to power entry plate.	HMACABLE	1.8	0.2	\$210
	Power Jumper Cable To connect tables front to front	HMAJUMP	0.5	0.3	\$72
	Circuit 1 Power Kit for 36" W Table	HMAPOWER36	1.5	0.3	\$380
	Circuit 1 Power Kit for 42" W Table	HMAPOWER42	1.8	0.3	\$386
	Circuit 1 Power Kit for 48" W Table	HMAPOWER48	1.8	0.3	\$388
	Circuit 1 Power Kit for 54" W Table	HMAPOWER54	2.0	0.3	\$394
	Circuit 1 Power Kit for 60" W Table	HMAPOWER60	2.0	0.3	\$397
	Circuit 1 Power Kit for 66" W Table	HMAPOWER66	2.2	0.3	\$404
	Circuit 1 Power Kit for 72" W Table	HMAPOWER72	2.2	0.3	\$407
	Circuit 1 Power Kit for 84" W Table	HMAPOWER84	2.4	0.3	\$422
	Circuit 1 Power Kit for 96" W Table	HMAPOWER96	2.6	0.3	\$436
	Circuit 2 Power Kit for 36" W Table	HMAPOWER362	1.5	0.3	\$380
	Circuit 2 Power Kit for 42" W Table	HMAPOWER422	1.8	0.3	\$386
	Circuit 2 Power Kit for 48" W Table	HMAPOWER482	1.8	0.3	\$388
	Circuit 2 Power Kit for 54" W Table	HMAPOWER542	2.0	0.3	\$394
	Circuit 2 Power Kit for 60" W Table	HMAPOWER602	2.0	0.3	\$397
Circuit 2 Power Kit for 66" W Table	HMAPOWER662	2.2	0.3	\$404	
Circuit 2 Power Kit for 72" W Table	HMAPOWER722	2.2	0.3	\$407	
Circuit 2 Power Kit for 84" W Table	HMAPOWER842	2.4	0.3	\$422	
Circuit 2 Power Kit for 96" W Table	HMAPOWER962	2.6	0.3	\$436	
	Electrical Connectors 4-Way Splitter  Available in Black (P) only. SPECIFYING EXAMPLE: HMASPLIT.P	HMASPLIT	0.9	0.1	\$67

NOTES:







- Each power kit includes two duplex receptacles and attaches to the underside of the worksurface with included brackets.
- Power Kits are compatible with various base types including nesting bases.
- Available in Black finish, no specification needed.

HOW TO SPECIFY

Select
Model Number

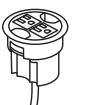
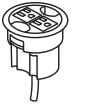
HMAPLATE

POWER & CABLE MANAGEMENT

	DESCRIPTION	MODEL	SHIP WEIGHT	CUBE	LIST PRICE
 <p>Black only SIN 33721</p>	<p>Black Field Installable Grommet with One Access Hole</p> <ul style="list-style-type: none"> Intended for use in tops and end panels to route/hide cords and facilitate reaching wall electrical outlets. Requires a 2½" diameter hole saw and drill for installation (not included). Grommet cap measures 3" diameter and includes a ¾" diameter cord access hole. Grommet sleeve measures 2½" O.D. x ¾" thick. Includes instructions to locate grommet position for desks, credenzas, returns and bridges. <p>! The grommet is not designed to be used with the following HON Series: 94000, 38000, Metro Classic or 34000.</p>	HFLDGRMT	0.1 Ⓢ	0.01	\$45
 <p>SIN 33721</p>	<p>Black Field Installable Grommet with Two Access Holes</p> <ul style="list-style-type: none"> Requires a 3" diameter hole saw and drill for installation (not included). Grommet outside dimensions measures 3½" diameter. Grommet sleeve measures 3" O.D. x 1" thick. Includes instructions to locate grommet position for desks, credenzas, returns and bridges. 	HFLDGRMT3	0.1 Ⓢ	0.3	\$45
 <p>OPEN MARKET</p>	<p>Platinum Field Installable Grommet with Two Access Holes</p> <ul style="list-style-type: none"> Requires a 3" diameter hole saw and drill for installation (not included). Outside dimension measures 3½" diameter. Sleeve hole in worksurface measures 3" O.D. x 1" thick. Includes instructions to locate grommet position for desks, credenzas, returns, and bridges. 	HFLDGRMT4	0.1	0.01	\$45
 <p>SIN 33721T</p>	<p>Power Hub, 3" Grommet Mount, 6' Cord</p> <ul style="list-style-type: none"> Fits in 3" round grommet holes. Two grounded AC power outlets. Includes 6' cord with three-prong plug. Field installed with Plug-and-play ease. <p>! Available in black only (no color designation so use .X - Specify: HGRMTAC.X).</p>	HGRMTAC	1.3	0.2	\$167
 <p>SIN 33721T</p> <p></p>	<p>3" Round Power Grommet - 2 Outlets, 10' Cord</p> <ul style="list-style-type: none"> Includes 10' cord with three-prong plug. Fits in 3" round grommet holes. Two grounded AC power outlets. Field installed with Plug-and-play ease. <p>NOTES: Power Modules will also work with standing-height applications for 10500 Series™ and Voi® desks. Optional Memory Control allows preset worksurface heights for consistency. Ships separately. Dynamic load capacity when worksurface is moving is 300 lbs.</p> <p>! Available in black finish only, no specification needed.</p>	HGRMTAC2	1.5	0.2	\$196
 <p>SIN 33721T</p>	<p>Power/USB Hub, 3" Grommet Mount</p> <ul style="list-style-type: none"> One grounded AC power outlet with 2 USB ports. UL Listed. <p>! Available in black only (no color designation so use .X - Specify: HGRMTUSB2.X).</p> <p>! Not compatible with Arrange® tables.</p>	HGRMTUSB2	1.3 Ⓢ	0.2	\$300
 <p>SIN 33721</p>	<p>Data Grommet</p> <p>Blank grommet kit that includes adapters for a variety of manufacturers jacks and couplers.</p> <ul style="list-style-type: none"> Fits in existing 3" round grommet housing. <p>! Available in black only. Specify P when ordering. Example: HGRMTDATA.P.</p>	HGRMTDATA	0.2	0.2	\$32

HOW TO SPECIFY

Select Model Number

H F L D G R M T



Icon Legend on page 19

POWER

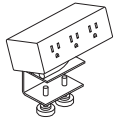

Model HPWRMOD3WC shown

DESCRIPTION

Dean Power Modules with Worksurface Clamp

- 3 Receptacles
- 2 Receptacles, 2 USB
- 2 Receptacles, 1 USB with Qi Wireless Charging Top
- 6' power cord with standard three-prong plug.
- Worksurface clamp models work on any top with a 4" overhang.
- UL Listed.

MODEL

- HPWRMOD3WC
- HPWRMOD2WC
- HPWRMOD4WC

SHIP WEIGHT

- 2.3
- 2.3
- 2.3

CUBE

- 0.2
- 0.2
- 0.2

LIST PRICE

- \$409
- \$652
- \$885

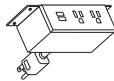

Model HPWRMOD2UWM shown

Dean Power Modules with Under-Worksurface Mounting Bracket

- 3 Receptacles
- 2 Receptacles, 2 USB
- 6' power cord with standard three-prong plug.
- Under-worksurface mounting bracket models work with any top that has a 5" x 5" square clearance.
- UL Listed.

- HPWRMOD3UWM
- HPWRMOD2UWM

- 2.3
- 2.3

- 0.2
- 0.2

- \$409
- \$652

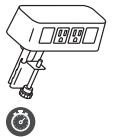

Power & Data Center

- 2 Receptacles 2 Data Accessory
- Standard with two receptacles and openings for two data ports.
- 6' power cord with standard three-prong plug.
- Fits on any worksurface with a 4" overhang.
- UL Listed.

HCOMDOME2

2.5

0.2

\$391

Color finish coordinates with HON's Loft. Specify LOFT when ordering. Example: HCOMDOME2.LOFT.

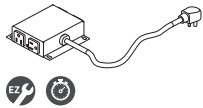

Under Worksurface Power Module -- 4 Outlets, 10' Cord

- Includes 10' cord with three-prong plug.
- Fits in cable management troughs. See page 249.
- 4 outlets on side create easy access.

HPWRMOD2

1.5

0.2

\$528

NOTES: Power Modules will also work with standing-height applications for 10500 Series™ and Voi® desks.

Available in black finish only, no specification needed.

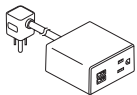

OPEN MARKET

Miki Surface Sit Power Module

- Includes 6' cord with three-prong plug.
- 1 Receptacle, 2 USB
- Unit features non-slip grip on underside.

HSMPWR-1P-2U

2.0

0.6

\$200

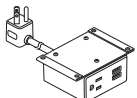

OPEN MARKET

Miki Under-Worksurface Power Module

- Includes 6' cord with three-prong plug.
- 1 Receptacle, 2 USB

HUMPWR-1P-2U

2.0

0.6

\$230



OPEN MARKET

Vesta Mobile Power Station

- Includes 10' retractable cord with three-prong plug.
- 3 AC, 1 Dual USB-A, 1 USB-C at top
- 2 AC at base
- Specify Paint and Plastic.

HPWRMOB1

14.0

3.3

\$1317

SPECIFYING EXAMPLE: HPWRMOB1.BLK.STRM

HOW TO SPECIFY

Select Model Number

Select Plastic

Specify for Dean and Miki models

- STRM Storm
- SNW Snow

HSMPWR-1P-2U

SNW

Select Model Number

Select Exterior Paint Color

Specify for model HPWRMOB1 only

- FOG Fog
- STRM Storm
- BLK Black
- SNW Snow

HPWRMOB1

BLK

Select Paint Color

Specify for model HPWRMOB1 only

- FOG Fog
- STRM Storm
- BLK Black
- SNW Snow

STRM

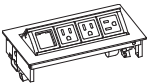
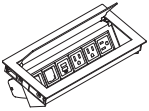
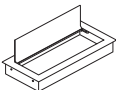

	DESCRIPTION	MODEL	SHIP WEIGHT	CUBE	LIST PRICE
	<p>MhoB 4' x 8' Pop-up Port</p> <ul style="list-style-type: none"> Specify G1 cutout in table top. Pop-up Port provides three power ports and one blank data receptacle. Sits flush with worksurface when closed. Includes 6' cord with three-prong plug. 	HTG1PWR-3P-1B	5	0.3	\$507
	<p>ElloaB 5' x 11' Flip-top Port</p> <ul style="list-style-type: none"> Specify G2 cutout in table top. Flip-top Port provides four power ports and two blank data receptacles. Conceals wires and allows power cords to be plugged in while in use. Includes 10' cord with three-prong circuit breaker plug. <p>NOTES: Two circuit breaker plugs do not fit into one duplex.</p>	HTG2PWR-4P-2B	5	0.3	\$747
	<p>ElloaB 5' x 11' Flip-top Port</p> <ul style="list-style-type: none"> Specify G2 cutout in table top. Flip-top Port provides one blank for Extron plate (HTPLATEVHAU) and three power ports. Extron AAP plates can be integrated into grommet to support changing technology. Conceals wires and allows power cords to be plugged in while in use. Includes 10' cord with three-prong plug. 	HTG2PWR-3P-1E	5	0.3	\$914
	<p>ElloaB 5' x 11' Flip-top Port</p> <ul style="list-style-type: none"> Specify G2 cutout in table top. Flip-top Port provides 3 Power, 1 USB A+C, and 2 Blank Data Ports. Conceals wires and allows power cords to be plugged in while in use. Includes 10' cord with three-prong plug. 	HTG2PWR-3P-2B-2U	5	0.3	\$1084
	<p>ElloaB 5' x 11' Flip-top Port</p> <ul style="list-style-type: none"> Specify G2 cutout in table top. Flip-top Port provides 3 Power, 1 USB A+C, and Qi wireless charging lid. Conceals wires and allows power cords to be plugged in while in use. Includes 10' cord with three-prong plug. 	HTG2PWR-3P-1U-W	5	0.3	\$1109
	Blank G1 Cutout Insert	HGROM1BLANK	2	0.2	\$195
	Blank G2 Cutout Insert	HGROM2BLANK	2	0.2	\$298
	! Grommets available in BLK, FOG, and SVR only.				

HOW TO SPECIFY

<p>Select Model Number</p> <p>HTG2PWR-4P-2B.</p>	<p>Select Paint Color</p> <p>SVR Silver BLK Black FOG Fog</p> <p>BLK</p>
--	--

POWER

OPEN MARKET



Icon Legend on page 19

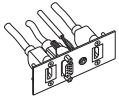

DESCRIPTION

Extron Plate (Double Space) — VGA, HDMI, HDMI, Audio

MODEL

HTPLATEVHAU

SHIP WEIGHT

1

CUBE

0.1

LIST PRICE

\$511

NOTES:

• 1 Double Space Plate can be used with HTG2PWR-3P-1E or HTPWRGROM4 Flip-top Port.

! Available in Black finish only, no specification needed.

WORKPLACE TOOLS

HOW TO SPECIFY



Select
Model Number

HTPLATEVHAU

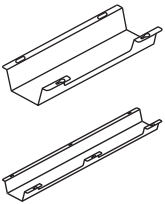

Icon Legend on page 19

POWER & CABLE MANAGEMENT

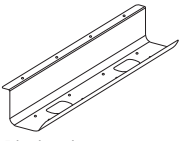
	DESCRIPTION	MODEL	SHIP WEIGHT	CUBE	LIST PRICE
	Cable Management Troughs				
	17"W — Single	HCTROUGH17	2.7 Ⓔ	0.5	\$94
	17"W — 10-Pack	HCTROUGH1710	14.0 Ⓔ	0.5	\$841
	36"W — Single	HCTROUGH36	4.9 Ⓔ	0.9	\$155
	36"W — 10-Pack	HCTROUGH3610	30.0 Ⓔ	0.9	\$1415
	<ul style="list-style-type: none"> • Cable management troughs ship flat packed. • The troughs attach to underneath the worksurface with screws. • Cutouts in trough allow access to power without the need to detach from surface. 17"W = 1 cutout; 36"W = 2 cutouts. • Color: Graphite. • Material: Metal. • TAA Compliant. 				
 <p>OPEN MARKET</p>	O-Leg Cord Clips				
	Clips for 28½" Worksurface O-Legs — 8-Pack	HWMCLIPLG	0.8 Ⓔ	0.1	\$133
	Clips for Stack-on Storage, Hutch and Layering O-Legs — 4-Pack	HWMCLIPSM	0.5 Ⓔ	0.1	\$88
	<p>NOTES: Wire clips work with 7" Low Credenza O-leg and 29"H Support O-leg. Wire clips also work with the 50" and 65" Overhead O-leg supports.</p> <p>! Available in frosted plastic material only.</p>				
 <p><i>Black only</i></p>	Cable Management Tray				
	24"	HJTRGH24	2.0 Ⓔ	0.3	\$74
	36"	HJTRGH36	3.0 Ⓔ	0.4	\$88
	! Available in Black only.				
	Vertical Wire Management Vertebrae	HMPVWM28	3.0	0.3	\$294
	<p>NOTES: 30"H x 3¼"W x 1½"D. Ships unassembled.</p> <p>! Clear finish. Specify "X" for finish option.</p> <p>SPECIFYING EXAMPLE: HMPVWM28.X</p>				

WORKPLACE TOOLS

HOW TO SPECIFY

<p>Select Model Number</p> <p>H J T R G H 2 4</p>	<p>Select Paint Color</p> <p>P Black</p> <p>P</p>
--	--

SEATING FUNCTIONS

Work/task chairs need to be adjusted to deliver optimum support. Cross-reference the letter key below to identify the chairs in this section that best meet your needs.

PROPORTIONAL ADJUSTMENTS

These controls adapt the dimensions of the chair to fit the user.



A. Pneumatic seat height adjustment — Regulates height of chair relative to floor.

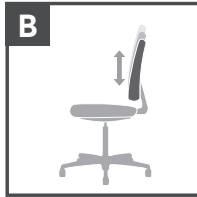

B. Back height adjustment — Positions lumbar support within a fixed range.



C. Seat depth adjustment — Positions chair back relative to seat.

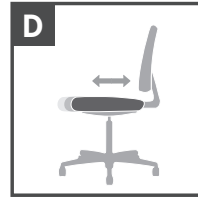

D. Seat slide mechanism — Seat cushion travels forward and back, then locks into position.

ARM OPTIONS

These adjustments accommodate different sized users and support keyboarding.



Q. Adjustable height arms — Provide improved upper-torso support. Can be adjusted periodically to relieve strain and provide variety.

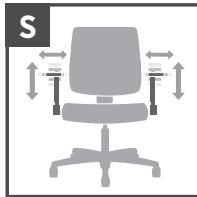

S. Height and width adjustable arms — Controls both height and width of arms for optimum comfort.



T. Loop arms — Largely specified for aesthetics. Frequently used in management settings.

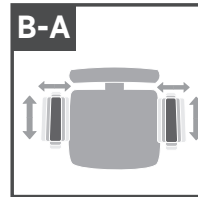

B-A. All-adjustable arms — Arms adjust in height, width, and depth.

POSTURE CONTROLS

The controls modify the position and angle of the seat and back to respond to changing tasks.



E. 360° Swivel

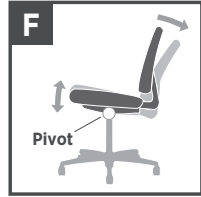

F. Tilt — Pivot point located directly above center of chair base.

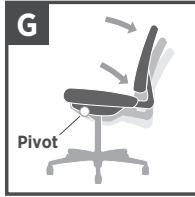

G. Mid-range knee tilt — Pivot point located slightly ahead of center of chair base. Allows user to recline at a slightly more relaxed angle than conventional tilt.

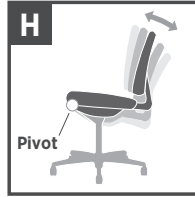

H. Knee tilt — Pivot point located near front edge of chair. Allows user to keep feet flat on floor while chair reclines.

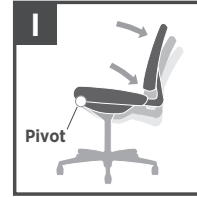

I. Synchronized knee tilt — Back reclines at a 2-to-1 ratio to seat angle. Pivot point located near front edge of chair.

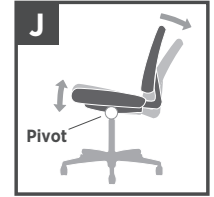

J. Synchro-tilt — Back reclines at a 2-to-1 ratio to seat angle. Allows user to recline while keeping seat cushion relatively level to floor.



K. Tilt tension — Controls rate and ease of recline.



L. Tilt lock — Locks out tilt function.



M. Posture mechanism/lock — Back angle adjusts independently of seat, and can be locked in an infinite number of positions within a fixed range.



N. Multi-task control — Adjusts seat and back angles independently with a single lever (infinite locking within a fixed range).



O. Asynchronous control — High performance system with three levers to modify: angle of back relative to seat, tilt (free float or infinite locking) and forward tilt.

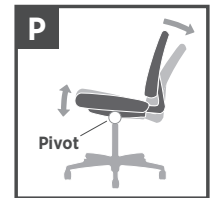

P. Weight-activated synchro-tilt — Back reclines at a 2 to 1 ratio to seat angle. Tilt tension automatically adjusts to user's body weight as user reclines.



W. Integral lumbar support — Easily adjusts to enhance comfort.



X. Dual-clutch posture control — Adjusts seat and back angles independently with two levers (infinite locking within a fixed range).

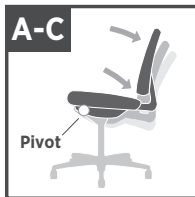

A-C. Synchronized tilt — Back reclines at a 2.5 to 1 ratio to seat angle. Variable lock.

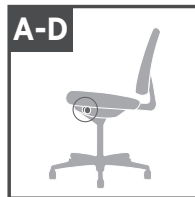

A-D. Side tilt tension — Controls rate and ease of recline. Conveniently located on the right side.



A-E. Back reclines at a 2 to 1 ratio to seat angle. Back angle adjusts independently of seat and can be locked in infinite number of positions within a fixed range.

SEATING CONTROLS

	Gateway™	Convergence®	Endorse®	Ignition®	Solve®	Current Nucleus®	Nucleus® Recharged	Cofi™	Cipher™	Flexion™	Cliq™
F											
F0										X	
S											
S0			X	X			X				
S1			X	X			X				
S2				X							
W											
W0								X			X
W2				X			X				
W5											
W6									X		
Y											
Y0				X	X			X			
Y1		X		X	X		X				
Y2			X	X	X	X	X	X			
Y3			X	X							
Y4			X	X							
Z											
Z1	X	X									

- F**
 0 Flex Mechanism One lever controls seat height and tilt lock. Bumpers integrated into seat/control to enable flexing seat.
- S**
 S0 Limited recline synchro-tilt Same as Y controls except do not recline as far. Used on stools.
 S1 Limited recline synchro-tilt w/seat slider
 S2 Limited recline advanced synchro-tilt S2 used on Ignition® Mesh Seat.
- W**
 W0 Weight activated No tension knob — recline adjusts to user.
 W2 Weight activated synchro-tilt w/seat slider
 W6 Integrated weight activated synchro-tilt w/seat slider *Cipher™ only.
- Y**
 Y0 Synchro-tilt Simple synchro-tilt (no seat slide).
 Y1 Synchro-tilt w/seat slider Same as Y0 + seat slider.
 Y2 Advanced synchro-tilt Synchro-tilt control with tilt tension (incl. seat slide).
 Y3 Synchro-tilt w/independent back angle Same as Y2 and back also moves separate from seat.
 Y4 Synchro-tilt B&T Same as Y2 for B&T — reduced recline than Y2.
- Z**
 Z1 Swivel-tilt Simple swivel-tilt (no seat slide) — back attached to seat.

PERFORMANCE SEATING ARM MATRIX

	ARM & PAD MOVEMENT			FIXED ARMS		
	2-D or A		4-D or V	Armless	Fixed Polymer	Fixed Polished Aluminum
	Width Adjustment Bracket 1) Entire arm moves wider and narrower 2) Arm moves up and down	Pad Width Adjustment 1) Pad slides side-to-side 2) Arm moves up and down	1) Pad slides side-to-side 2) Pad slides front-to-back 3) Pad pivots wider and narrower 4) Arm moves up and down			
Gateway™				X	X	
Convergence*	X			X		
Cliq™				X	X	
Solve*		X	X	X	X	
Endorse* Standard	X	X	X	X	X	X
Endorse* B&T		X	X	X		
Ignition* Standard	X	X	X	X	X	X
Ignition* B&T		X	X	X		
Flexion™				X	X	
Nucleus*		X	X	X	X	X
Cipher™			X	X		
Cofi™				X	X	X

ORDERING INFORMATION

Seating	Standard Fabric Selections by Series with Price Code and Fabric Material																													
	1	1	1	1	1	1	1	1	1	1	1	1	1	1	1	1	1	2	2	2	2	2	2	2	2	3	3	3	3	L
Model/Series	APX	EB	VA	GA	MM	EA	CU	COMP	COMF	UR	DAPR	ENSB	HAML	NR	OP	PBLE	PNS	BLME	CLYD	DOT	RUSH	SPNN	WP	SX	PRKR	PURL	GUL	DAV	SS	
	Apex	Black & Burgundy Vinyl	Black, Charcoal, & Navy Fabric	Black & Navy Fabric	Black Sandwich Mesh Fabric	Black Vinyl	Centurion	Compass	Compass Foam	Contourett	Dapper	Ensemble	Hamilton	Inertia	Optic	Pebble	Appoint Seating	Blume	Clyde	Doty	Rush	Spin Seating	Whisper Vinyl	Moxie	Parker	Purl	Guill	Davenport Leather	Denver Leather**	
Accommodate®	•						•	•		•	•	•	•	•	•	•	•	•	•	•	•	•	•	•	•	•	•		•	
Adjustable Task/Lab Stool						•																								
Astir™	•						•	•		•	•	•	•	•	•	•	•	•	•	•	•	•	•	•	•	•	•	•		
Ceres® Series *	•						•	•		•	•	•	•	•	•	•	•	•	•	•	•	•	•	•	•	•	•	•		•
Cliq™	•						•	•		•	•	•	•	•	•	•	•	•	•	•	•	•	•	•	•	•	•	•		
Cofi™	•						•	•		•	•	•	•	•	•	•	•	•	•	•	•	•	•	•	•	•	•	•	•	
ComforTask® 5900 Series *	•						•	•		•	•	•	•	•	•	•	•	•	•	•	•	•	•	•	•	•	•	•		
Convergence®	•						•	•		•	•	•	•	•	•	•	•	•	•	•	•	•	•	•	•	•	•	•		
Endorse® Task***	•						•	•		•	•	•	•	•	•	•	•	•	•	•	•	•	•	•	•	•	•	•		
Flock®	•						•	•		•	•	•	•	•	•	•	•	•	•	•	•	•	•	•	•	•	•	•		•
Flock® Round Lounge HFLRC1/DF	•						•	•		•	•	•	•	•	•	•	•	•	•	•	•	•	•	•	•	•	•	•		•
Grove®	•						•	•		•	•	•	•	•	•	•	•	•	•	•	•	•	•	•	•	•	•	•		•
Ignition® Series	•						•	•		•	•	•	•	•	•	•	•	•	•	•	•	•	•	•	•	•	•	•		•
Lota® H2285			•																											
Mav™	•						•	•		•	•	•	•	•	•	•	•	•	•	•	•	•	•	•	•	•	•	•		
Motivate®	•						•	•		•	•	•	•	•	•	•	•	•	•	•	•	•	•	•	•	•	•	•		
Nucleus® Series	•						•	•		•	•	•	•	•	•	•	•	•	•	•	•	•	•	•	•	•	•	•		•
Perpetual® Nesting	•						•	•		•	•	•	•	•	•	•	•	•	•	•	•	•	•	•	•	•	•	•		
Pillow-Soft® 2090 Series	•	•					•	•		•	•	•	•	•	•	•	•	•	•	•	•	•	•	•	•	•	•	•		
Solutions Seating® 4000 Series *	•						•	•		•	•	•	•	•	•	•	•	•	•	•	•	•	•	•	•	•	•	•		
Solve®	•						•	•		•	•	•	•	•	•	•	•	•	•	•	•	•	•	•	•	•	•	•		• (Seat Only)
Soothe®	•						•	•		•	•	•	•	•	•	•	•	•	•	•	•	•	•	•	•	•	•	•		
Soothe® High-Back																										•				
Volt® 5700/5710 Series				•																										
Volt® 5720/5730 Series	•						•	•		•	•	•	•	•	•	•	•	•	•	•	•	•	•	•	•	•	•	•		
West Hill™	•						•	•		•	•	•	•	•	•	•	•	•	•	•	•	•	•	•	•	•	•	•		
Credenza/Pedestal Cushions	•						•	•		•	•	•	•	•	•	•	•	•	•	•	•	•	•	•	•	•	•	•		

*Flock® chair model HFLRC1 has fabric limitations, please see the Flock® seating pages 330-337 for details.

**Denver Leather (SS) may not be available on every model within a specific series, please refer to the model's page for details.

***Pebble available on Endorse® Task as seat option only.

* De-emphasized

ORDERING INFORMATION

- Seating pages are now arranged in alpha, then numeric, order.
- **All specifications in this publication are based on the latest product information available at the time of print.**
- COM Ordering Information and pricing on page 13.
- Remember to add an FC to the base model number when fire code fabric is selected. See page 256 for available models/fabrics.
- Wood components are well-seasoned select hardwoods, chosen for their strength, their ability to machine well and their superior uniformity of stain and finish.
- Chairs with leather feature matching vinyl backs and vinyl seat bottom when applicable (Non-contact areas are vinyl).

Wood Seating	Finish Codes								Standard Fabric Selections by Series with Price Code and Fabric Material														
									1	1	1	1	1	1	1	2	2	2	2	2	2	3	L
Model/Series	Bourbon Cherry	Cognac	Harvest	Mahogany	Mocha	Natural Maple	Pinnacle	Shaker Cherry	EB	CU	COMP	DAPR	HAML	NR	OP	PNS	CLYD	DOT	RUSH	SPNN	WP	PURL	SS
Cambia™ 2160 Series	H	COGN	C	N	MOCH	D	PINC	F		•	•	•	•	•	•	•	•	•	•	•	•	•	•
Park Avenue Collection® 5000 Series	H	COGN	C	N	MOCH	D	PINC	F		•	•	•	•	•	•	•	•	•	•	•	•	•	•
Pillow-Soft® 2190 Series	H	COGN	C	N	MOCH	D	PINC	F	•	•	•	•	•	•	•	•	•	•	•	•	•	•	•
Versant® Wood	H	COGN	C	N	MOCH	D	PINC	F		•	•	•	•	•	•	•	•	•	•	•	•	•	•

Note: Gathers and creases may be more visible with AI and OP fabrics due to the inherent design and construction of these fabrics. Harvest, Cognac, Natural Maple, and Pinnacle de-emphasized for Park Avenue® and Pillow-Soft® Seating.

FIRE CODE/COMPLIANT SEATING

FIRE SAFETY

Definitive Protection — CAL TB 117-2013

- TB 117-2013 — The State of California, Department of Consumer Affairs, Bureau of Electronic and Home Appliance Repair, Home Furnishings and Thermal Insulation (BEARHFTI) Technical Bulletin (TB) 117-2013 is the industry flammability standard for upholstered furniture, and provides methods for smolder resistance of cover fabrics, barrier materials, resilient filling materials, and decking materials for use in upholstered furniture.
- The fabrics and resilient filling materials used in upholstered seating manufactured by The HON Company meet or exceed the flame retardant requirements of State of California TB 117-2013. The label attached to the seat bottom indicates compliance with these requirements.

Elevate Fire Safety to a Higher Standard — CAL TB 133

- The State of California announced in January 2019 that Technical Bulletin (TB) 113, The Flammability Test Procedure for Seating Furniture for Use in Public Occupancies has been repealed effective January 22, 2019.
- While the CAL 133 standard has been repealed, a select subset of The HON Company's most popular chair models are still available in an array of fabrics that include an advanced barrier of fire protection to help comply with CAL 133 requirements.
- To ensure that the chairs you order comply with CAL 133, specify one of the fabrics listed below. Then simply add "FC" to the model number when ordering one of the select available models. A standard upcharge of \$95 will be applied per seat model for all single seat chairs.
- **SPECIFYING EXAMPLE: HIWMMFC.Y2.A.H.IM.CU10.NL.SB.T**

CAL 133 COMPLIANT MODELS

IGNITION® SEATING

HIEH1FC, HIEH2FC, HIEH3FC, HIWM1FC, HIWM2FC, HIWM3FC, HITL1FC, HITL2FC, HITL3FC, HITS5FC, HIGCLFC, HIGS6FC, HISB6FC, HICS7FC, HIB50FC, HITLMFC, HIWMMFC, HITSMFC

MOTIVATE® SEATING

HMN2FC — Available in Onyx (ON) shell only.

NOTES:

- Creases and gathers may be visible with CAL 133 Fire Code seating due to the construction of the fire barrier material used.
- Please refer to each model's page for specific fabric availability.
- Contact HON Tailored Solutions Team for all other requests.

CAL 133 COMPLIANT FABRIC

GRADE 1

APX	Apex
COMP	Compass
CU	Centurion
DAPR	Dapper
ENSB	Ensemble
HAML	Hamilton
NR	Inertia
OP	Optic

GRADE 2

BLME	Blume
CLYD	Clyde
DOT	Dotty
KAI	Kai
PNS	Appoint Seating
RUSH	Rush
SPNN	Spin
WP	Whisper Vinyl
WVL	Wavelength

GRADE 3

GTWY	Getaway
PURL	Purl
QUL	Quill

GRADE 4

LIVI	Livi with Supreen™
OXFD	Oxford with Supreen™

GRADE L

SS	Leather
-----------	---------

MOISTURE BARRIER

- This extra layer of protection prevents moisture from penetrating the foam to improve cleanability and extend product longevity. Moisture barrier is available as an option for the seat only. The recliner gets moisture barrier on seat and footrest.
- **Moisture barrier is not available for the fire code models.**

How to Order

- When specifying Moisture Barrier simply add "MB" to the model number when ordering.
SPECIFYING EXAMPLE: HHCG11MB.S.AI90.P6N.PR8.

Upcharges for Moisture Barrier on Soothe® models

Model	Moisture Barrier
HHCG11*	\$80
HHCG50*	\$120
HHCG21*	\$160
HHCGB21*	\$160
HHCGB31*	\$240
HHCP1	\$80

* De-emphasized

ACCOMMODATE®

Want to see more? Scan here
to check out hon.com.



Accommodate® Café-Height Stools shown in Centurion Black.

ACCOMMODATE®

The key to designing a collaborative environment is to support productivity throughout the space. From waiting areas and cafés to meeting spaces and offices, Accommodate creates opportunities for people to get work done in a comfortable, casual setting. Cluster together. Form neat rows. Stack four high. With guest and bariatric chairs, as well as café and counter-height stools, Accommodate brings greater comfort, versatility and continuity throughout your space with a seating collection that adapts to your environment, people and budget.



FEATURES

- Thin profile seat cushion conforms to your body.
- Contoured back ergonomically supports the spine.
- Chairs can stack up to four high.
- Chairs can gang together to form neat rows.
- Waterfall seat edge enhances leg circulation.
- Lightweight frame is easy to move.
- Nylon glides slide effortlessly on hard surfaces.
- Tube rolled steel frame adds durability.
- Wall-saver design protects walls and cabinets.
- Warranted for users up to 300 lbs. (Models HSB50 and HSB50DF are warranted for users up to 500 lbs.)
- Available in Seated-, Counter-, and Café-heights.

ACCOMMODATE® Options

MODEL OPTIONS

HSGS6
HSGS6DF - Multi-Fabric



Guest Chair

HSCS1
HSCS1DF - Multi-Fabric



Counter-Height Stool

HSCS2
HSCS2DF - Multi-Fabric



Café-Height Stool

HSB50
HSB50DF - Multi-Fabric

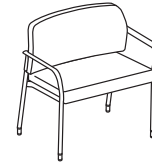

Bariatric Chair





ARM STYLE

	CODE	DESCRIPTION	PRICE
	N	Armless	+\$0
	F	Fixed Arms	+\$32

FRAME

	CODE	DESCRIPTION	PRICE
	CBK	Charblack	+\$0
	PK7	Textured Designer White	+\$0
	P7J	Textured Brownstone	+\$0
	P7A	Textured Charcoal	+\$0
	P7L	Textured Loft	+\$0
	P7M	Textured Muslin	+\$0
	PR8	Textured Silver	+\$0
	P8V	Textured Titanium	+\$0

CASTERS/ GLIDES

	CODE	DESCRIPTION	PRICE
	E	Standard Nylon Glide	+\$21
	H	Black Hard Caster	+\$0
	S	Black Soft Caster	+\$32
	B	Both Hard Casters and Standard Nylon Glides	+\$21

*Options H, S & B available for HSGS6 and HSGS6DF models only

ACCOMMODATE® Fabric Options

HON BRANDED FABRICS

GRADE 1

Apex*
Centurion
Compass
Contourett*
Dapper
Ensemble
Hamilton
Inertia
Noble Seating
Optic
Pebble
Vibe

GRADE 2

Appoint Seating
Blume
Clyde
Dotty
Kai
Rush
Spin
Wavelength
Whisper Vinyl

GRADE 3

Bradbury
Getaway
Moxie
Notion
Parker*
Purl
Quill
Saxony

GRADE 4

Constance with Supreen™
Livi with Supreen™
Lugano with Supreen™
Oxford with Supreen™

For a complete list of fabrics, including partnership fabrics, go to hon.com/fabricsandfinishes.

Reference Fabric Color Combinations on pages 20-24 for color codes and legend on page 21 for lead times.

*Only available as a seat fabric on Multi-Fabric models. Cannot be used with any Single-Fabric models.

ACCOMMODATE®

GSA SIN 33721



Icon Legend on page 19

HSGS6

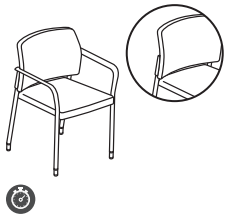

GUEST CHAIR

Set of Two Guest Chairs

DIMENSIONS

Depth:	22¼	Seat to Floor Height:	18¼
Height:	31½	Usable Seat Depth:	17
Seat Depth:	20¾	Ship Weight (with arms):	50
Seat Width:	17½	Ship Weight (armless):	48
Back Width:	19¾	Cube (with arms):	15.8
Back Height:	16¼	Cube (armless):	15.8
Width (with arms):	23½	COM (per 2 pack):	3.0
Width (armless):	19¾	Weight Rating:	300 lbs.
Arm Width:	20¼		

FABRIC PRICE CODES

1	\$1015	8	\$1448
2	\$1091	9	\$1505
3	\$1166	10	\$1561
4	\$1222	11	\$1617
5	\$1279	12	\$1674
6	\$1335	L	—
7	\$1392		

NOTES: For Ganging Brackets see page 263. Accommodate® Guest Chairs stack 4-high.

HSCS1

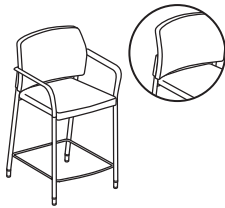

COUNTER-HEIGHT STOOL

DIMENSIONS

Depth:	23½	Seat to Floor Height:	25½
Height:	38¾	Usable Seat Depth:	17
Seat Depth:	20¾	Ship Weight (with arms):	36
Seat Width:	17½	Ship Weight (armless):	35
Back Width:	19¾	Cube (with arms):	15.8
Back Height:	16¼	Cube (armless):	15.8
Width (with arms):	23½	COM:	2.0
Width (armless):	19¾	Weight Rating:	300 lbs.
Arm Width:	20¼		

FABRIC PRICE CODES

1	\$615	8	\$832
2	\$653	9	\$860
3	\$691	10	\$888
4	\$719	11	\$916
5	\$747	12	\$945
6	\$775	L	—
7	\$804		

HSGANG

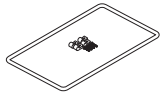

GANGING BRACKET

(hardware included)

DIMENSIONS

Ship Weight: **5** Ⓢ

LIST PRICE

\$49

NOTES: For use on models HSGS6 and HSGS6DF.

! No specification required for bracket. The ganging bracket is only available in black. The ganging bracket does not work on the bariatric unit.

HON Recommendation: HSGS6.N.E.CU__PR8 - List Price \$1015

SEATING

HOW TO SPECIFY

<p>Select Model Number</p> <p>H S G S 6 .</p>	<p>Select Arm Type</p> <p>N Armless F Fixed Arms (+ \$32 per chair)</p> <p>N .</p>	<p>Select Caster/Glide</p> <p>E Standard Nylon Glide H Hard Caster S Soft Caster (+ \$32 per chair) B Both Hard Casters and Standard Nylon Glides (+ \$21 per chair)</p> <p><i>Options H, S & B available for HSGS6 model only</i></p> <p>E .</p>	<p>Select Fabric</p> <p>See page 259</p> <p>C U 1 0 .</p>	<p>Select Frame</p> <p>See page 258</p> <p>P R 8</p>
--	---	--	--	---



ACCOMMODATE®

HSCS2

CAFÉ-HEIGHT STOOL

DIMENSIONS

FABRIC PRICE CODES



Depth:	24½	Seat to Floor Height:	31½
Height:	44¾	Usable Seat Depth:	17
Seat Depth:	20¾	Ship Weight (with arms):	38
Seat Width:	17½	Ship Weight (armless):	37
Back Width:	19¾	Cube (with arms):	19.1
Back Height:	16¼	Cube (armless):	19.1
Width (with arms):	23½	COM:	2.0
Width (armless):	19¾	Weight Rating:	300 lbs.
Arm Width:	20¼		

1	\$675	8	\$892
2	\$713	9	\$920
3	\$751	10	\$948
4	\$779	11	\$976
5	\$807	12	\$1005
6	\$835	L	—
7	\$864		

HSB50

BARIATRIC CHAIR

DIMENSIONS

FABRIC PRICE CODES

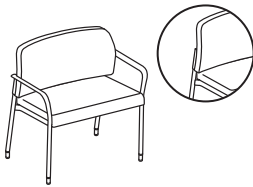

Depth:	21½	Seat to Floor Height:	19
Height:	32½	Usable Seat Depth:	16¾
Seat Depth:	20¼	Ship Weight (with arms):	50
Seat Width:	28	Ship Weight (armless):	49
Back Width:	29	Cube (with arms):	27.2
Back Height:	16½	Cube (armless):	27.2
Width (with arms):	33½	COM:	2.0
Width (armless):	30	Weight Rating:	500 lbs.
Arm Width:	30		

1	\$1088	8	\$1377
2	\$1139	9	\$1415
3	\$1189	10	\$1452
4	\$1226	11	\$1490
5	\$1264	12	\$1527
6	\$1302	L	—
7	\$1339		

HON Recommendation: HSCS2.N.E.CU__PR8 - List Price \$675

HOW TO SPECIFY

<p>Select Model Number</p> <p>H S C S 2 .</p>	<p>Select Arm Type</p> <p>N Armless F Fixed Arms (+ \$32 per chair)</p> <p>N .</p>	<p>Select Caster/Glide</p> <p>E Standard Nylon Glide</p> <p>E .</p>	<p>Select Fabric</p> <p>See page 259</p> <p>C U 1 0 .</p>	<p>Select Frame</p> <p>See page 258</p> <p>P R 8</p>
--	---	--	--	---

ACCOMMODATE®



Icon Legend on page 19

HSGS6DF

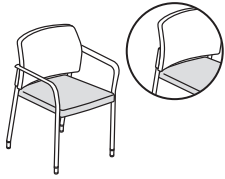

GUEST CHAIR

Multi-Fabric
Set of Two Guest Chairs

DIMENSIONS

Depth:	22¼	Seat to Floor Height:	18¼
Height:	31½	Usable Seat Depth:	17
Seat Depth:	20¾	Ship Weight (with arms):	50
Seat Width:	17½	Ship Weight (armless):	48
Back Width:	19¾	Cube (with arms):	15.8
Back Height:	16¼	Cube (armless):	15.8
Width (with arms):	23½	COM (Seat, per 2 pack):	1.5
Width (armless):	19¾	COM (Back, per 2 pack):	1.5
Arm Width:	20¼	Weight Rating:	300 lbs.

FABRIC PRICE CODES

1	\$1195	
<i>Add to Base Price Above</i>		
	Back	Seat
2	\$38	\$38
3	\$76	\$76
4	\$104	\$104
5	\$132	\$132
6	\$160	\$160
7	\$189	\$189
8	\$217	\$217
9	\$245	\$245
10	\$273	\$273
11	\$301	\$301
12	\$330	\$330

NOTES: For Ganging Brackets see page 263. Accommodate® Guest Chairs stack 4-high.

HSCS1DF

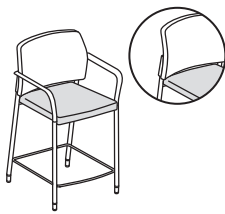

COUNTER-HEIGHT STOOL

Multi-Fabric

DIMENSIONS

Depth:	23½	Seat to Floor Height:	25½
Height:	38¾	Usable Seat Depth:	17
Seat Depth:	20¾	Ship Weight (with arms):	36
Seat Width:	17½	Ship Weight (armless):	35
Back Width:	19¾	Cube (with arms):	15.8
Back Height:	16¼	Cube (armless):	15.8
Width (with arms):	23½	COM (Seat):	1.0
Width (armless):	19¾	COM (Back):	1.0
Arm Width:	20¼	Weight Rating:	300 lbs.

FABRIC PRICE CODES

1	\$705	
<i>Add to Base Price Above</i>		
	Back	Seat
2	\$19	\$19
3	\$38	\$38
4	\$53	\$53
5	\$66	\$66
6	\$81	\$81
7	\$95	\$95
8	\$109	\$109
9	\$123	\$123
10	\$137	\$137
11	\$151	\$151
12	\$166	\$166

HON Recommendation: HSGS6DF.N.E.CU__CU__PR8 - List Price \$1195

HOW TO SPECIFY

<p>Select Model Number</p> <p>H S G S 6 D F .</p>	<p>Select Arm Type</p> <p>N Armless F Fixed Arms (+ \$32 per chair)</p> <p>N .</p>	<p>Select Caster/Glide</p> <p>E Standard Nylon Glide H Hard Caster S Soft Caster (+ \$32 per chair) B Both Hard Casters and Standard Nylon Glides (+ \$21 per chair)</p> <p><i>Options H, S & B available for HSGS6DF model only</i></p> <p>E .</p>	<p>Select Back Fabric</p> <p>See page 259</p> <p>C U 2 2 .</p>	<p>Select Seat Fabric</p> <p>See page 259</p> <p>C U 1 0 .</p>	<p>Select Frame</p> <p>See page 258</p> <p>P R 8</p>
--	---	--	---	---	---



HSCS2DF



CAFÉ-HEIGHT STOOL

Multi-Fabric

DIMENSIONS

Depth:	24½	Seat to Floor Height:	31½
Height:	44¾	Usable Seat Depth:	17
Seat Depth:	20¾	Ship Weight (with arms):	38
Seat Width:	17½	Ship Weight (armless):	37
Back Width:	19¾	Cube (with arms):	19.1
Back Height:	16¼	Cube (armless):	19.1
Width (with arms):	23½	COM (Seat):	1.0
Width (armless):	19¾	COM (Back):	1.0
Arm Width:	20¼	Weight Rating:	300 lbs.

FABRIC PRICE CODES

1	\$765	
<i>Add to Base Price Above</i>		
	Back	Seat
2	\$19	\$19
3	\$38	\$38
4	\$53	\$53
5	\$66	\$66
6	\$81	\$81
7	\$95	\$95
8	\$109	\$109
9	\$123	\$123
10	\$137	\$137
11	\$151	\$151
12	\$166	\$166

HSB50DF

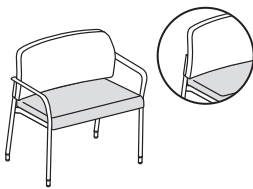

BARIATRIC CHAIR

Multi-Fabric

DIMENSIONS

Depth:	21½	Seat to Floor Height:	19
Height:	32½	Usable Seat Depth:	16¾
Seat Depth:	20¼	Ship Weight (with arms):	50
Seat Width:	28	Ship Weight (armless):	49
Back Width:	29	Cube (with arms):	27.2
Back Height:	16½	Cube (armless):	27.2
Width (with arms):	33½	COM (Seat):	1.0
Width (armless):	30	COM (Back):	1.0
Arm Width:	30	Weight Rating:	500 lbs.

FABRIC PRICE CODES

1	\$1178	
<i>Add to Base Price Above</i>		
	Back	Seat
2	\$26	\$26
3	\$51	\$51
4	\$69	\$69
5	\$88	\$88
6	\$107	\$107
7	\$126	\$126
8	\$145	\$145
9	\$164	\$164
10	\$182	\$182
11	\$201	\$201
12	\$220	\$220

HSGANG

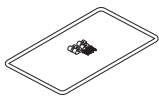

GANGING BRACKET

(hardware included)

DIMENSIONS

Ship Weight: 5 Ⓞ

LIST PRICE

\$49

NOTES: For use on models HSGS6 and HSGS6DF.

ⓘ No specification required for bracket. The ganging bracket is only available in black. The ganging bracket does not work on the bariatric unit.

HON Recommendation: HSCS2DF.N.E.CU__CU__PR8 - List Price \$765

HOW TO SPECIFY

<p>Select Model Number</p> <p>H S C S 2 D F .</p>	<p>Select Arm Type</p> <p>N Armless F Fixed Arms (+ \$32)</p> <p>N .</p>	<p>Select Caster/Glide</p> <p>E Standard Nylon Glide</p> <p>E .</p>	<p>Select Back Fabric</p> <p>See page 259</p> <p>C U 2 2 .</p>	<p>Select Seat Fabric</p> <p>See page 259</p> <p>C U 1 0 .</p>	<p>Select Frame</p> <p>See page 258</p> <p>P R 8</p>
--	---	--	---	---	---

ADJUSTABLE TASK/LAB Stools

OPEN MARKET



Icon Legend on page 19

HMTS01

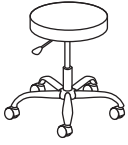

TASK/LAB STOOL

without Back

Pneumatic
Swivel

Functions: **A, E**
(Function Key on pages 250-251)

DIMENSIONS

Depth:	27¼	Seat to Floor Height:	17¾-22
Width:	24⅝	Usable Seat Depth:	16
Height:	17¾-22	Ship Weight:	22
Seat:	16" Dia.	Cube:	2.5
		Weight Rating:	250 lbs.

FABRIC PRICE CODE

1 \$509

NOTES: EA vinyl is a healthcare covering that meets AATCC Test Method 147-2004.

ⓘ Available in polished base ONLY. Available in Grade 1, Black, EA11 fabric ONLY.

HMTS11

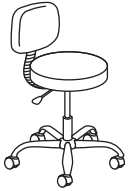

TASK/LAB STOOL

with Back

Pneumatic
Back Height
Seat Depth
Swivel

Functions: **A, B, C, E**
(Function Key on pages 250-251)

DIMENSIONS

Depth:	27¼	Seat to Floor Height:	17¾-22
Width:	24⅝	Usable Seat Depth:	14¾-16
Height:	31½-38	Ship Weight:	29
Seat:	16" Dia.	Cube:	2.7
Back Width:	15½	Weight Rating:	250 lbs.
Back Height:	8¾-16		

FABRIC PRICE CODE

1 \$682

NOTES: EA vinyl is a healthcare covering that meets AATCC Test Method 147-2004.

ⓘ Available in polished base ONLY. Available in Grade 1, Black, EA11 fabric ONLY.

HOW TO SPECIFY

Select
Model Number

H M T S 0 1 .

Select
Vinyl

EA11 Black, Grade 1 (only)

E A 1 1

ASTIR™ COLLABORATIVE WORK SEATING

Want to see more?
Scan here to check
out hon.com.



Astir™ Collaborative Work Seating shown with Birk™ Tables and Acoustic Solutions by Unika Vaev.

ASTIR™

Astir™ Collaborative Work answers the call for soft seating solutions while providing separate work spaces and sturdy posture support for those looking to step away from their desks. The line provides a soft yet upright sit to keep employees engaged and working comfortably at a table setting. High-back and side options help keep private conversations private — so teams don't have to be confined in close quarters, such as a conference room. And a unique, single-seat style with high screens on three sides creates a quiet, secure, and comfortable space for individual focus.



FEATURES

- Seat height and back angle are scaled for more of an upright working posture.
- Choose from One+, Two-, or Three-Seat Lounges in low- or high-back options.
- High-back screens available in knit mesh or fabric options provide visual privacy on back and sides.
- Fabric high-back screen option available in cleanable fabrics (see HON's cleaning guide for instructions).
- Choose from three different leg styles to customize your look.
- Two- or Three-Seat Benches add extra seating for commons or reception areas.
- Pouf model functions as both impromptu seating and a place to kick up your feet.
- Replaceable seat cushion enhances comfort and cleanability, and allows for easy changing.
- With the multi-fabric options, seat cushion and frame can be specified in different fabrics for a modern aesthetic.
- Add an optional power module to route power directly underneath the seat.

ASTIR™ Options

MODEL OPTIONS

**HASLB1, HASLB1MF -
Multi-Fabric**



Lounge
One+ Seat, Low-Back

**HASLB2, HASLB2MF -
Multi-Fabric**

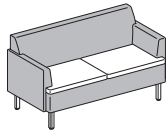

Lounge
Two-Seat, Low-Back

**HASLB3, HASLB3MF -
Multi-Fabric**

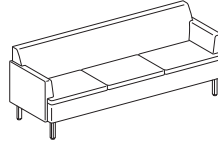

Lounge
Three-Seat, Low-Back

**HASLBTC, HASLBTCMF -
Multi-Fabric**

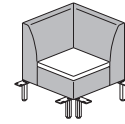

Lounge
True Corner, Low-Back

**HASHB1, HASHB1MF -
Multi-Fabric**

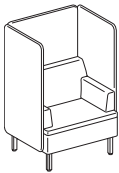

Lounge
One+ Seat, High-Back Screen

**HASHB2, HASHB2MF -
Multi-Fabric**

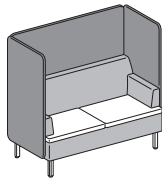

Lounge
Two-Seat, High-Back Screen

**HASHB3, HASHB3MF -
Multi-Fabric**

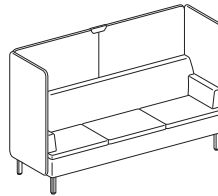

Lounge
Three-Seat, High-Back Screen

**HASHBTC, HASHBTCMF -
Multi-Fabric**

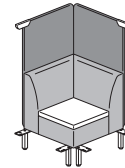

Lounge
True Corner, High-Back Screen

**HASB2, HASB2MF -
Multi-Fabric**

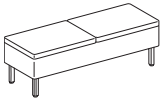

Bench
Two-Seat Bench

**HASB3, HASB3MF -
Multi-Fabric**

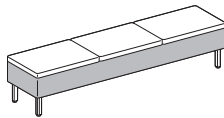

Bench
Three-Seat Bench

**HASPSS, HASPSSMF -
Multi-Fabric**



Pouf

Low-Back, Multi-Fabric



High-Back, Multi-Fabric



SCREEN FABRIC OPTIONS

HON BRANDED FABRICS

GRADE 1	GRADE 2	GRADE 3	GRADE 4	KNIT
Apex	Apport Seating	Bradbury	Constance with Supreen™	Light
Centurion	Blume	Getaway	Livi with Supreen™	Medium
Contourett	Clyde	Moxie	Lugano with Supreen™	Dark
Dapper	Kai	Notion	Oxford with Supreen™	
Ensemble	Rush	Purl		FABRICS
Hamilton	Wavelength	Quill		Apex
Inertia	Whisper Vinyl	Saxony		Blume
Noble Seating				Contourett
Pebble				Moxie
Vibe				Pebble
				Whisper Vinyl

LEG STYLE

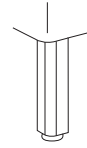

CODE	DESCRIPTION	PRICE
PM	Post Metal	+ \$53
<i>Available in the following finishes:</i>		
P8V	Textured Titanium	
P7A	Textured Charcoal	
P8X	Solar Black	+ \$21
PR5	Champagne Metallic	+ \$21

For a complete list of fabrics, including partnership fabrics, go to hon.com/fabricsandfinishes.

Reference Fabric Color Combinations on pages 20-24 for color codes and legend on page 21 for lead times.

For more details on Upholstery Pattern Match for this series, please see page 14.

LEG STYLE

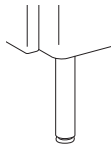

CODE	DESCRIPTION	PRICE
DW	Dowel Wood	+ \$0
<i>Available in the following finishes:</i>		
LFW1	Florence Walnut	
LKI1	Kingswood Walnut	
LLA1	Lowell Ash	
D	Natural Maple	
LNRI	Natural Recon	
LPE1	Phantom Ecru	
PINC	Pinnacle	
LPT1	Portico Teak	
LSW1	Skyline Walnut	
LSA1	Sterling Ash	

LEG STYLE

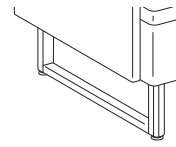

CODE	DESCRIPTION	PRICE
SW	Sled Wood	+ \$105
<i>Available in the following finishes:</i>		
LFW1	Florence Walnut	
LKI1	Kingswood Walnut	
LLA1	Lowell Ash	
D	Natural Maple	
LNRI	Natural Recon	
LPE1	Phantom Ecru	
PINC	Pinnacle	
LPT1	Portico Teak	
LSW1	Skyline Walnut	
LSA1	Sterling Ash	

MULTI-FABRIC COM YARDAGE

Due to fabric pattern nesting and potential reduction of fabric yield, some multi-fabric models may require more total yardage than standard models.

MODEL	COM (ARMLESS)			COM (ONE ARM/SIDE)			COM (BOTH ARMS/SIDES)		
	Seat	Back/Frame	Screen	Seat	Back/Frame	Screen	Seat	Back/Frame	Screen
HASLB1	—	—	—	—	—	—	6.5		
HASLB1MF	—	—	—	—	—	—	1.5	5.0	—
HASLBTC	—	5.0	—	—	—	—	—	—	—
HASLBTCMF	1.5	4.0	—	—	—	—	—	—	—
HASLB2	—	7.0	—	—	8.0	—	9.0		
HASLB2MF	3.0	4.5	—	3.0	5.5	—	3.0	6.5	—
HASLB3	—	10.0	—	—	11.0	—	12.0		
HASLB3MF	4.0	6.0	—	4.0	7.5	—	4.0	8.5	—
HASHB1	—	—	—	—	—	—	4.5		8.0
HASHB1MF	—	—	—	—	—	—	1.5	3.5	8.0
HASHBTC	—	5.0	—	—	—	—	—	—	—
HASHBTCMF	1.5	4.0	5.5	—	—	—	—	—	—
HASHB2	—	7.0	5.5	—	7.0	8.0	7.0		
HASHB2MF	3.0	4.5	5.5	3.0	4.5	8.0	3.0	4.5	11.0
HASHB3	—	10.5	5.5	—	10.5	8.0	10.5		
HASHB3MF	4.0	7.0	5.5	4.0	7.0	8.0	4.0	7.0	11.0
HASPS5	—	2.0	—	—	—	—	—	—	—
HASPS5MF	1.0	1.5	—	—	—	—	—	—	—
HASB2	—	4.5	—	—	—	—	—	—	—
HASB2MF	3.0	2.0	—	—	—	—	—	—	—
HASB3	—	6.5	—	—	—	—	—	—	—
HASB3MF	4.0	2.5	—	—	—	—	—	—	—

ASTIR™ Collaborative Work Seating

GSA SIN 33721



Icon Legend on page 19

HASLB1

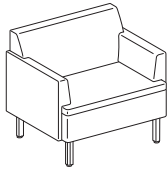

ONE+ SEAT — LOW-BACK DIMENSIONS

Depth:	29	Back Height:	16
Height:	32	Back Width:	33½
Width:	36½	Arm Height:	7½
Usable Seat Depth:	19¾	Ship Weight:	95
Seat to Floor Height:	18¾	Cube:	21.2
Seat Width:	27	COM:	See page 267
		Weight Rating:	300 lbs.

FABRIC PRICE CODES

1	\$2489	8	\$3721
2	\$2653	9	\$3751
3	\$2819	10	\$3917
4	\$2957	11	\$4083
5	\$3142	12	\$4250
6	\$3330	L	—
7	\$3523		

HASLB1MF

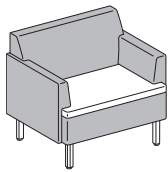

ONE+ SEAT — LOW-BACK, MULTI-FABRIC DIMENSIONS

Depth:	29	Back Height:	16
Height:	32	Back Width:	33½
Width:	36½	Arm Height:	7½
Usable Seat Depth:	19¾	Ship Weight:	95
Seat to Floor Height:	18¾	Cube:	21.2
Seat Width:	27	COM:	See page 267
		Weight Rating:	300 lbs.

FABRIC PRICE CODES

1	\$2678	
<i>Add to Base Price Above</i>		
	Seat	Frame/Back
2	\$38	\$126
3	\$77	\$253
4	\$108	\$360
5	\$151	\$502
6	\$195	\$647
7	\$239	\$796
8	\$285	\$947
9	\$292	\$971
10	\$330	\$1099
11	\$368	\$1226
12	\$407	\$1355

HON Recommendation: HASLB1.B.PURL__DW__ - List Price \$2819

SEATING

HOW TO SPECIFY

Select Model Number HASLB1MF	Select Arm Type B Both Arms	Select Fabric See page 267 Specify for Single Fabric model only	Select Seat Cushion Fabric See page 267 Specify for MF model only	Select Back and Frame Fabric See page 267 Specify for MF model only	Select Leg and Color DW Dowel Wood PM Post Metal (+ \$53) SW Sled Wood (+ \$105) See page 267 for colors
P B L E O 7	P B L E O 9	P B L E O 6	P M P 8 V		



ASTIR™ Collaborative Work Seating

HASHB1

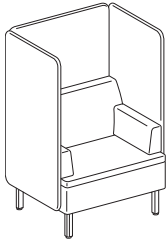

ONE+ SEAT — HIGH-BACK SCREEN

DIMENSIONS

Depth:	29¾	Back Height:	16
Height:	54	Back Width:	33½
Width:	35	Arm Height:	7½
Usable Seat Depth:	19¾	Ship Weight*:	124
Seat to Floor Height:	18¾	Cube:	24.1
Seat Width:	25½	COM:	See page 267
		Weight Rating:	300 lbs.

FABRIC PRICE CODES

1 \$3396

Add to Base Price Above

	Unit	Knit	Screen
1	—	1	\$157
2	\$126	2	\$358
3	\$253	3	\$563
4	\$360	4	\$732
5	\$502	5	\$960
6	\$647	6	\$1192
7	\$796	7	\$1429
8	\$947	8	\$1672
9	\$971	9	\$1710
10	\$1099	10	\$1915
11	\$1226	11	\$2120
12	\$1355	12	\$2324

*Ships in two cartons.

HASHB1MF

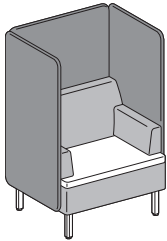

ONE+ SEAT — HIGH-BACK SCREEN, MULTI-FABRIC

DIMENSIONS

Depth:	29¾	Back Height:	16
Height:	54	Back Width:	33½
Width:	35	Arm Height:	7½
Usable Seat Depth:	19¾	Ship Weight*:	124
Seat to Floor Height:	18¾	Cube:	24.1
Seat Width:	25½	COM:	See page 267
		Weight Rating:	300 lbs.

FABRIC PRICE CODES

1 \$3583

Add to Base Price Above

	Seat	Back/ Frame	Knit	Screen
1	—	—	1	\$157
2	\$38	\$101	2	\$358
3	\$77	\$203	3	\$563
4	\$108	\$288	4	\$732
5	\$151	\$402	5	\$960
6	\$195	\$518	6	\$1192
7	\$239	\$637	7	\$1429
8	\$285	\$758	8	\$1672
9	\$292	\$777	9	\$1710
10	\$330	\$879	10	\$1915
11	\$368	\$982	11	\$2120
12	\$407	\$1084	12	\$2324

*Ships in two cartons.

HON Recommendation: HASHB1.B.PURL__KMD.DW__ - List Price \$3649

HOW TO SPECIFY

Select Model Number	Select Arm Type	Select Fabric	Select Seat Cushion Fabric	Select Back and Frame Fabric	Select Screen Knit or Fabric	Select Leg and Color
	B Both Side Screens	See page 267 Specify for Single Fabric model only	See page 267 Specify for MF model only	See page 267 Specify for MF model only	Knit Options: KLT Light KMD Medium KDK Dark See page 267 for all options	DW Dowel Wood PM Post Metal (+ \$53) SW Sled Wood (+ \$105) See page 267 for colors
H A S H B 1 M F .	B .	P B L E 0 7 .	P B L E 0 9 .	P B L E 0 6 .	K M D .	P M P 8 V

ASTIR™ Collaborative Work Seating

GSA SIN 33721



Icon Legend on page 19

HASLB2

TWO-SEAT LOUNGE — LOW-BACK

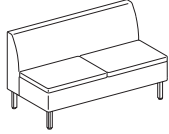

Armless

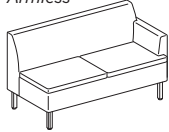

Left

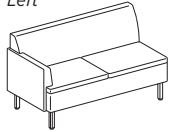

Right

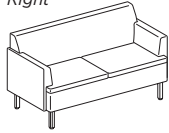

Both Arms

DIMENSIONS

Depth:	29	Back Height:	16
Height:	32	Back Width:	56½
Width (armless):	56½	Arm Height:	7½
Width (one arm):	58	Ship Weight (armless):	113
Width (both arms):	59½	Ship Weight (one arm):	122
Usable Seat Depth:	19¾	Ship Weight (both arms):	131
Seat to Floor Height:	18¾	Cube:	35.1
Seat Width (armless):	56½	COM:	See page 267
Seat Width (one arm):	53¼	Weight Rating:	300 lbs. (per seat)
Seat Width (both arms):	50		

FABRIC PRICE CODES

1	\$2779	8	\$4484
2	\$3004	9	\$4526
3	\$3235	10	\$4757
4	\$3426	11	\$4987
5	\$3682	12	\$5217
6	\$3944	L	—
7	\$4211		

HASLB2MF

TWO-SEAT LOUNGE — LOW-BACK, MULTI-FABRIC

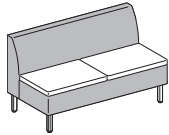

Armless

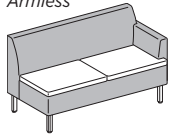

Left

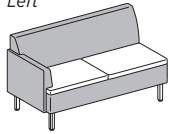

Right

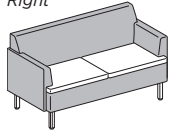

Both Arms

DIMENSIONS

Depth:	29	Back Height:	16
Height:	32	Back Width:	56½
Width (armless):	56½	Arm Height:	7½
Width (one arm):	58	Ship Weight (armless):	113
Width (both arms):	59½	Ship Weight (one arm):	122
Usable Seat Depth:	19¾	Ship Weight (both arms):	131
Seat to Floor Height:	18¾	Cube:	35.1
Seat Width (armless):	56½	COM:	See page 267
Seat Width (one arm):	53¼	Weight Rating:	300 lbs. (per seat)
Seat Width (both arms):	50		

FABRIC PRICE CODES

1	\$2967		
<i>Add to Base Price Above</i>			
		Seat	Frame/Back
2	\$76	\$164	\$164
3	\$152	\$330	\$330
4	\$216	\$468	\$468
5	\$301	\$653	\$653
6	\$388	\$841	\$841
7	\$478	\$1034	\$1034
8	\$569	\$1232	\$1232
9	\$583	\$1262	\$1262
10	\$660	\$1428	\$1428
11	\$736	\$1594	\$1594
12	\$814	\$1761	\$1761

HON Recommendation: HASLB2.B.PURL__DW__ - List Price \$3706

HOW TO SPECIFY

Select Model Number HASLB2MF	Select Arm Type N Armless L Left Side (+ \$236) R Right Side (+ \$236) B Both Arms (+ \$471)	Select Fabric See page 267 Specify for Single Fabric model only	Select Seat Cushion Fabric See page 267 Specify for MF model only	Select Back and Frame Fabric See page 267 Specify for MF model only	Select Leg and Color DW Dowel Wood PM Post Metal (+ \$53) SW Sled Wood (+ \$105) See page 267 for colors
HASLB2MF	B	PBLE07	PBLE09	PBLE06	PMP8V



ASTIR™ Collaborative Work Seating

HASHB2

TWO-SEAT LOUNGE — HIGH-BACK SCREEN

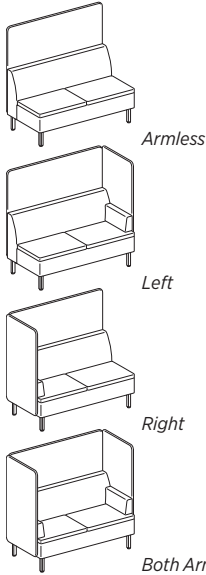

DIMENSIONS

Depth:	29¾	Back Height:	16
Height:	54	Back Width:	56½
Width (armless):	56½	Arm Height:	7½
Width (one arm):	57¼	Ship Weight* (armless):	136
Width (both arms):	58	Ship Weight* (one arm):	156
Usable Seat Depth:	19¾	Ship Weight* (both arms):	176
Seat to Floor Height:	18¾	Cube:	29.4
Seat Width (armless):	56½	COM:	See page 267
Seat Width (one arm):	52¼	Weight Rating:	300 lbs. (per seat)
Seat Width (both arms):	48¼		

FABRIC PRICE CODES

1	\$3911		
<i>Add to Base Price Above</i>			
	Unit	Knit	Screen
1	—	1	—
2	\$201	2	\$157
3	\$406	3	\$432
4	\$575	4	\$714
5	\$803	5	\$947
6	\$1035	6	\$1261
7	\$1272	7	\$1579
8	\$1516	8	\$1907
9	\$1553	9	\$2240
10	\$1758	10	\$2292
11	\$1963	11	\$2573
12	\$2167	12	\$2855

*Ships in two cartons.

HASHB2MF

TWO-SEAT LOUNGE — HIGH-BACK SCREEN, MULTI-FABRIC

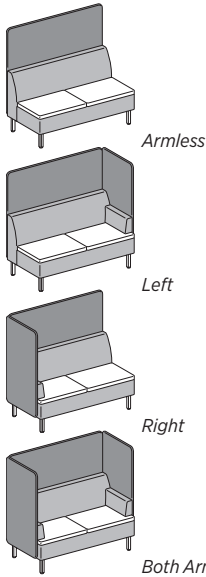

DIMENSIONS

Depth:	29¾	Back Height:	16
Height:	54	Back Width:	56½
Width (armless):	56½	Arm Height:	7½
Width (one arm):	57¼	Ship Weight* (armless):	136
Width (both arms):	58	Ship Weight* (one arm):	156
Usable Seat Depth:	19¾	Ship Weight* (both arms):	176
Seat to Floor Height:	18¾	Cube:	29.4
Seat Width (armless):	56½	COM:	See page 267
Seat Width (one arm):	52¼	Weight Rating:	300 lbs. (per seat)
Seat Width (both arms):	48¼		

FABRIC PRICE CODES

1	\$4100		
<i>Add to Base Price Above</i>			
	Seat	Back/Frame	Knit Screen
1	—	—	1 —
2	\$76	\$126	2 \$432
3	\$152	\$253	3 \$714
4	\$216	\$360	4 \$947
5	\$301	\$502	5 \$1261
6	\$388	\$647	6 \$1579
7	\$478	\$796	7 \$1907
8	\$569	\$947	8 \$2240
9	\$583	\$971	9 \$2292
10	\$660	\$1099	10 \$2573
11	\$736	\$1226	11 \$2855
12	\$814	\$1355	12 \$3137

*Ships in two cartons.

HON Recommendation: HASHB2.B.PURL__KMD.DW__ - List Price \$5258

HOW TO SPECIFY

Select Model Number	Select Arm Type	Select Fabric	Select Seat Cushion Fabric	Select Back and Frame Fabric	Select Screen Knit or Fabric	Select Leg and Color
	N Armless L Left Side (+ \$471) R Right Side (+ \$471) B Both Side Screens (+ \$941)	See page 267 <i>Specify for Single Fabric model only</i>	See page 267 <i>Specify for MF model only</i>	See page 267 <i>Specify for MF model only</i>	Knit Options: KLT Light KMD Medium KDK Dark See page 267 for all options	DW Dowel Wood PM Post Metal (+ \$53) SW Sled Wood (+ \$105) See page 267 for colors
H A S H B 2 M F .	B .	P B L E 0 7 .	P B L E 0 9 .	P B L E 0 6 .	K M D .	P M P 8 V

ASTIR™ Collaborative Work Seating

GSA SIN 33721



Icon Legend on page 19

HASLB3

THREE-SEAT LOUNGE — LOW-BACK

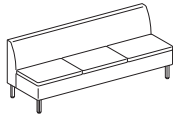

Armless

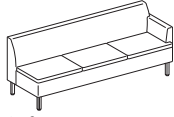

Left

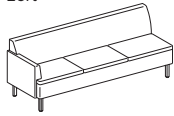

Right

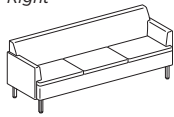

Both Arms

DIMENSIONS

Depth:	29	Back Height:	16
Height:	32	Back Width:	84½
Width (armless):	84½	Arm Height:	7½
Width (one arm):	86	Ship Weight (armless):	152
Width (both arms):	87½	Ship Weight (one arm):	161
Usable Seat Depth:	19¾	Ship Weight (both arms):	170
Seat to Floor Height:	18¾	Cube:	47.9
Seat Width (armless):	84½	COM:	See page 267
Seat Width (one arm):	81¼	Weight Rating:	300 lbs. (per seat)
Seat Width (both arms):	78		

FABRIC PRICE CODES

1	\$3672	8	\$5944
2	\$3972	9	\$6002
3	\$4281	10	\$6308
4	\$4535	11	\$6615
5	\$4876	12	\$6922
6	\$5224	L	—
7	\$5581		

HASLB3MF

THREE-SEAT LOUNGE — LOW-BACK, MULTI-FABRIC

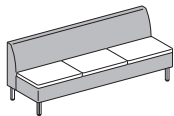

Armless

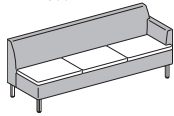

Left

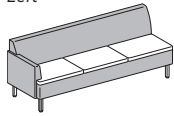

Right

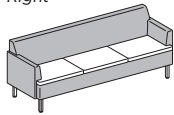

Both Arms

DIMENSIONS

Depth:	29	Back Height:	16
Height:	32	Back Width:	84½
Width (armless):	84½	Arm Height:	7½
Width (one arm):	86	Ship Weight (armless):	152
Width (both arms):	87½	Ship Weight (one arm):	161
Usable Seat Depth:	19¾	Ship Weight (both arms):	170
Seat to Floor Height:	18¾	Cube:	47.9
Seat Width (armless):	84½	COM:	See page 267
Seat Width (one arm):	81¼	Weight Rating:	300 lbs. (per seat)
Seat Width (both arms):	78		

FABRIC PRICE CODES

1	\$3860	
<i>Add to Base Price Above</i>		
	Seat	Frame/Back
2	\$101	\$213
3	\$203	\$431
4	\$288	\$611
5	\$402	\$853
6	\$518	\$1100
7	\$637	\$1352
8	\$758	\$1610
9	\$777	\$1651
10	\$879	\$1868
11	\$982	\$2085
12	\$1084	\$2303

HON Recommendation: HASLB3.B.PURL__DW__ - List Price \$4752

HOW TO SPECIFY

Select Model Number HASLB3MF	Select Arm Type N Armless L Left Side (+ \$236) R Right Side (+ \$236) B Both Arms (+ \$471)	Select Fabric See page 267 Specify for Single Fabric model only	Select Seat Cushion Fabric See page 267 Specify for MF model only	Select Back and Frame Fabric See page 267 Specify for MF model only	Select Leg and Color DW Dowel Wood PM Post Metal (+ \$53) SW Sled Wood (+ \$105) See page 267 for colors
HASLB3MF	B	PBLE07	PBLE09	PBLE06	PMP8V



ASTIR™ Collaborative Work Seating

HASHB3

THREE-SEAT LOUNGE — HIGH-BACK SCREEN

DIMENSIONS

Depth:	29¾	Back Height:	16
Height:	54	Back Width:	84½
Width (armless):	84½	Arm Height:	7½
Width (one arm):	85¼	Ship Weight* (armless):	185
Width (both arms):	86	Ship Weight* (one arm):	205
Usable Seat Depth:	19¾	Ship Weight* (both arms):	225
Seat to Floor Height:	18¾	Cube:	39
Seat Width (armless):	84½	COM:	See page 267
Seat Width (one arm):	80½	Weight Rating:	300 lbs. (per seat)
Seat Width (both arms):	76½		

FABRIC PRICE CODES

1 **\$5343**

Add to Base Price Above

	Unit	Knit	Screen
1	—	1	\$157
2	\$263	2	\$432
3	\$532	3	\$714
4	\$755	4	\$947
5	\$1054	5	\$1261
6	\$1359	6	\$1579
7	\$1670	7	\$1907
8	\$1989	8	\$2240
9	\$2038	9	\$2292
10	\$2307	10	\$2573
11	\$2575	11	\$2855
12	\$2844	12	\$3137

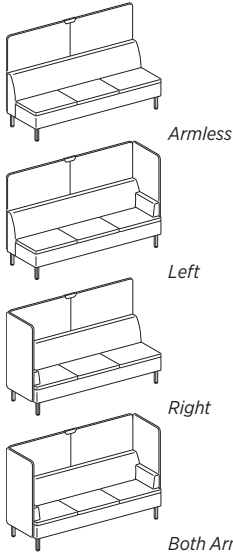

Both Arms *Ships in two cartons.

HASHB3MF

THREE-SEAT LOUNGE — HIGH-BACK SCREEN, MULTI-FABRIC

DIMENSIONS

Depth:	29¾	Back Height:	16
Height:	54	Back Width:	84½
Width (armless):	84½	Arm Height:	7½
Width (one arm):	85¼	Ship Weight* (armless):	185
Width (both arms):	86	Ship Weight* (one arm):	205
Usable Seat Depth:	19¾	Ship Weight* (both arms):	225
Seat to Floor Height:	18¾	Cube:	39
Seat Width (armless):	84½	COM:	See page 267
Seat Width (one arm):	80½	Weight Rating:	300 lbs. (per seat)
Seat Width (both arms):	76½		

FABRIC PRICE CODES

1 **\$5531**

Add to Base Price Above

	Seat	Back/Frame	Knit	Screen
1	—	—	1	\$157
2	\$101	\$176	2	\$432
3	\$203	\$355	3	\$714
4	\$288	\$503	4	\$947
5	\$402	\$703	5	\$1261
6	\$518	\$905	6	\$1579
7	\$637	\$1113	7	\$1907
8	\$758	\$1326	8	\$2240
9	\$777	\$1359	9	\$2292
10	\$879	\$1538	10	\$2573
11	\$982	\$1717	11	\$2855
12	\$1084	\$1896	12	\$3137

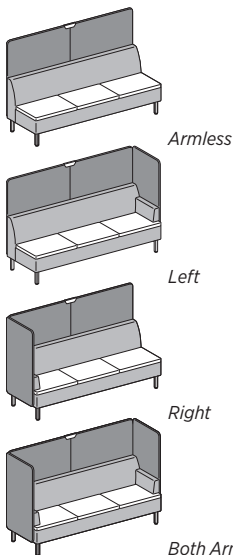

Both Arms *Ships in two cartons.

HON Recommendation: HASHB3.B.PURL__KMD.DW__ - List Price \$6816

HOW TO SPECIFY

Select Model Number	Select Arm Type	Select Fabric	Select Seat Cushion Fabric	Select Back and Frame Fabric	Select Screen Knit or Fabric	Select Leg and Color
	N Armless L Left Side (+ \$471) R Right Side (+ \$471) B Both Side Screens (+ \$941)	See page 267 <i>Specify for Single Fabric model only</i>	See page 267 <i>Specify for MF model only</i>	See page 267 <i>Specify for MF model only</i>	Knit Options: KLT Light (+ \$53) KMD Medium KDK Dark See page 267 for all options	DW Dowel Wood PM Post Metal (+ \$53) SW Sled Wood (+ \$105) See page 267 for colors
H A S H B 3 M F .	B .	P B L E 0 7 .	P B L E 0 9 .	P B L E 0 6 .	K M D .	P M P 8 V

ASTIR™ Collaborative Work Seating

GSA SIN 33721



Icon Legend on page 19

HASLBTC

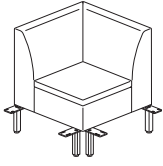

TRUE CORNER LOUNGE — LOW-BACK

DIMENSIONS

Depth:	29	Back Height:	16
Height:	32	Back Width:	29
Width:	29	Ship Weight:	90
Usable Seat Depth:	19¾	Cube:	21.2
Seat to Floor Height:	18¾	COM:	See page 267
Seat Width:	20¼	Weight Rating:	300 lbs.

FABRIC PRICE CODES

1	\$2603	8	\$3550
2	\$2729	9	\$3574
3	\$2856	10	\$3702
4	\$2963	11	\$3829
5	\$3105	12	\$3958
6	\$3250	L	—
7	\$3399		

NOTES: True Corner uses legs from adjacent units, and can work with all leg styles. For adjacent units with sled legs, pick a single leg option for the True Corner rear leg.

- ⚠ True Corner designed to act as a corner between two adjacent units, not as a stand-alone unit.
- ⚠ True Corner leg selection refers to back corner leg only, and ships with only that leg.

HASLBTCMF

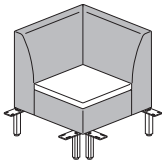

TRUE CORNER LOUNGE — LOW-BACK, MULTI-FABRIC

DIMENSIONS

Depth:	29	Back Height:	16
Height:	32	Back Width:	29
Width:	29	Ship Weight:	90
Usable Seat Depth:	19¾	Cube:	21.2
Seat to Floor Height:	18¾	COM:	See page 267
Seat Width:	20¼	Weight Rating:	300 lbs.

FABRIC PRICE CODES

1	\$2792	
<i>Add to Base Price Above</i>		
	Seat	Frame/Back
2	\$38	\$101
3	\$77	\$203
4	\$108	\$288
5	\$151	\$402
6	\$195	\$518
7	\$239	\$637
8	\$285	\$758
9	\$292	\$777
10	\$330	\$879
11	\$368	\$982
12	\$407	\$1084

NOTES: True Corner uses legs from adjacent units, and can work with all leg styles. For adjacent units with sled legs, pick a single leg option for the True Corner rear leg.

- ⚠ True Corner designed to act as a corner between two adjacent units, not as a stand-alone unit.
- ⚠ True Corner leg selection refers to back corner leg only, and ships with only that leg.

HON Recommendation: HASLBTC.PURL__DW__ - List Price \$2856

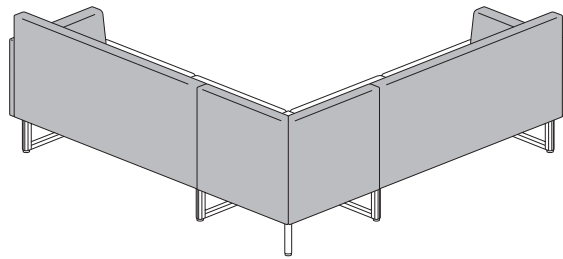
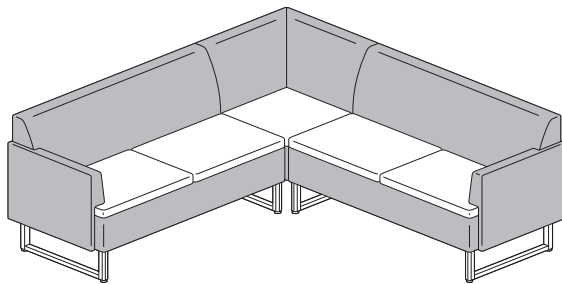

SEATING

HOW TO SPECIFY

Select Model Number

HASLBTCMF .

Select Fabric

See page 267
Specify for Single Fabric model only

PBLE07 .

Select Seat Cushion Fabric

See page 267
Specify for MF model only

PBLE09 .

Select Back and Frame Fabric

See page 267
Specify for MF model only

PBLE06 .

Select Leg and Color

DW Dowel Wood
PM Post Metal (+ \$53)
See page 267 for colors

PMP8V



ASTIR™ Collaborative Work Seating

HASHBTC

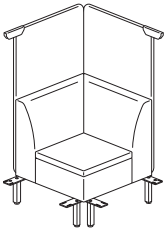

TRUE CORNER LOUNGE — HIGH-BACK SCREEN

DIMENSIONS

Depth:	29¾	Back Height:	16
Height:	54	Back Width:	29
Width:	29¾	Ship Weight:	119
Usable Seat Depth:	19¾	Cube:	28.1
Seat to Floor Height:	18¾	COM:	See page 267
Seat Width:	20¼	Weight Rating:	300 lbs.

FABRIC PRICE CODES

1 \$3582			
<i>Add to Base Price Above</i>			
	Unit	Knit	Screen
1	—	1	\$157
2	\$126	2	\$295
3	\$253	3	\$436
4	\$360	4	\$552
5	\$502	5	\$709
6	\$647	6	\$869
7	\$796	7	\$1032
8	\$947	8	\$1199
9	\$971	9	\$1224
10	\$1099	10	\$1365
11	\$1226	11	\$1506
12	\$1355	12	\$1646

NOTES: True Corner uses legs from adjacent units, and can work with all leg styles. For adjacent units with sled legs, pick a single leg option for the True Corner rear leg.

- ❗ True Corner designed to act as a corner between two adjacent units, not as a stand-alone unit.
- ❗ True Corner leg selection refers to back corner leg only, and ships with only that leg.

HASHBTCMF

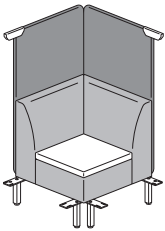

TRUE CORNER LOUNGE — HIGH-BACK SCREEN, MULTI-FABRIC

DIMENSIONS

Depth:	29¾	Back Height:	16
Height:	54	Back Width:	29
Width:	29¾	Ship Weight:	119
Usable Seat Depth:	19¾	Cube:	28.1
Seat to Floor Height:	18¾	COM:	See page 267
Seat Width:	20¼	Weight Rating:	300 lbs.

FABRIC PRICE CODES

1 \$3771			
<i>Add to Base Price Above</i>			
	Seat	Back/Frame	Knit Screen
1	—	—	1 \$157
2	\$38	\$101	2 \$295
3	\$77	\$203	3 \$436
4	\$108	\$288	4 \$552
5	\$151	\$402	5 \$709
6	\$195	\$518	6 \$869
7	\$239	\$637	7 \$1032
8	\$285	\$758	8 \$1199
9	\$292	\$777	9 \$1224
10	\$330	\$879	10 \$1365
11	\$368	\$982	11 \$1506
12	\$407	\$1084	12 \$1646

NOTES: True Corner uses legs from adjacent units, and can work with all leg styles. For adjacent units with sled legs, pick a single leg option for the True Corner rear leg.

- ❗ True Corner designed to act as a corner between two adjacent units, not as a stand-alone unit.
- ❗ True Corner leg selection refers to back corner leg only, and ships with only that leg.

HON Recommendation: HASHBTC.PURL__KMD.DW__ - List Price \$3835

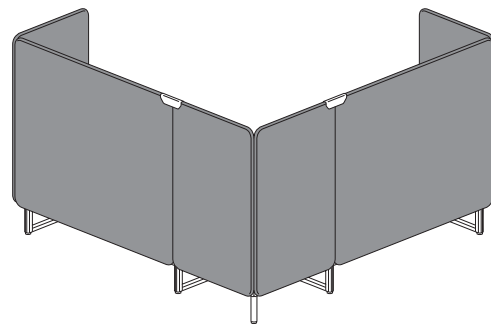
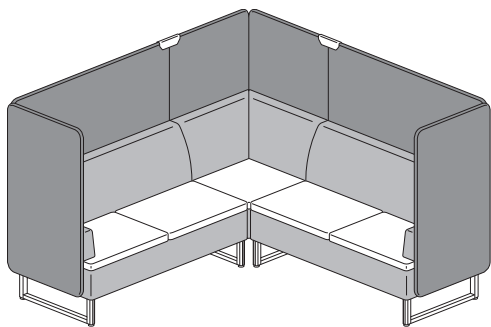

HOW TO SPECIFY

<p>Select Model Number</p> <p>H A S H B T C M F .</p>	<p>Select Fabric</p> <p>See page 267 <i>Specify for Single Fabric model only</i></p> <p>P B L E 0 7 .</p>	<p>Select Seat Cushion Fabric</p> <p>See page 267 <i>Specify for MF model only</i></p> <p>P B L E 0 9 .</p>	<p>Select Back and Frame Fabric</p> <p>See page 267 <i>Specify for MF model only</i></p> <p>P B L E 0 6 .</p>	<p>Select Screen Knit or Fabric</p> <p>Knit Options: KLT Light KMD Medium KDK Dark See page 267 for all options</p> <p>K M D .</p>	<p>Select Leg and Color</p> <p>DW Dowel Wood PM Post Metal (+ \$53) See page 267 for colors</p> <p>P M P 8 V</p>
--	--	--	--	--	---

SEATING

ASTIR™ Collaborative Work Seating

GSA SIN 33721



Icon Legend on page 19

HASB2

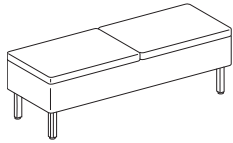

TWO-SEAT BENCH

DIMENSIONS

Depth:	20¼	Seat Width:	56¼
Height:	19	Ship Weight:	46
Width:	56½	Cube:	8.7
Usable Seat Depth:	20¼	COM:	See page 267
Seat to Floor Height:	18¾	Weight Rating:	300 lbs. (per seat)

FABRIC PRICE CODES

1	\$2514	8	\$3366
2	\$2627	9	\$3388
3	\$2742	10	\$3503
4	\$2837	11	\$3618
5	\$2966	12	\$3733
6	\$3097	L	—
7	\$3230		

HASB2MF

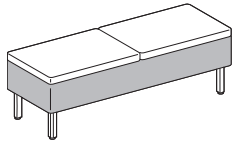

TWO-SEAT BENCH, MULTI-FABRIC

DIMENSIONS

Depth:	20¼	Seat Width:	56¼
Height:	19	Ship Weight:	46
Width:	56½	Cube:	8.7
Usable Seat Depth:	20¼	COM:	See page 267
Seat to Floor Height:	18¾	Weight Rating:	300 lbs. (per seat)

FABRIC PRICE CODES

1	\$2703
<i>Add to Base Price Above</i>	
	Seat Frame
2	\$76 \$51
3	\$152 \$102
4	\$216 \$144
5	\$301 \$201
6	\$388 \$260
7	\$478 \$318
8	\$569 \$379
9	\$583 \$388
10	\$660 \$439
11	\$736 \$491
12	\$814 \$542

HON Recommendation: HASB2.PURL__DW__ - List Price \$2742

HOW TO SPECIFY

<p>Select Model Number</p> <p>HASB2MF .</p>	<p>Select Fabric</p> <p>See page 267 Specify for Single Fabric model only</p> <p>PBLE07 .</p>	<p>Select Seat Cushion Fabric</p> <p>See page 267 Specify for MF model only</p> <p>PBLE09 .</p>	<p>Select Frame Fabric</p> <p>See page 267 Specify for MF model only</p> <p>PBLE06 .</p>	<p>Select Leg and Color</p> <p>DW Dowel Wood PM Post Metal (+ \$53) SW Sled Wood (+ \$105) See page 267 for colors</p> <p>PMP8V</p>
--	--	--	---	--



HASB3

THREE-SEAT BENCH

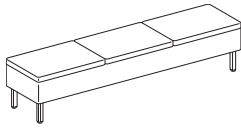

DIMENSIONS

Depth:	20¼	Seat Width:	84½
Height:	19	Ship Weight:	61
Width:	84½	Cube:	12.2
Usable Seat Depth:	20¼	COM:	See page 267
Seat to Floor Height:	18¾	Weight Rating:	300 lbs. (per seat)

FABRIC PRICE CODES

1	\$3143	8	\$4375
2	\$3307	9	\$4405
3	\$3473	10	\$4571
4	\$3611	11	\$4737
5	\$3796	12	\$4904
6	\$3984	L	—
7	\$4177		

HASB3MF

THREE-SEAT BENCH, MULTI-FABRIC

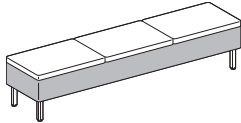

DIMENSIONS

Depth:	20¼	Seat Width:	84½
Height:	19	Ship Weight:	61
Width:	84½	Cube:	12.2
Usable Seat Depth:	20¼	COM:	See page 267
Seat to Floor Height:	18¾	Weight Rating:	300 lbs. (per seat)

FABRIC PRICE CODES

1	\$3331		
<i>Add to Base Price Above</i>			
	Seat	Frame	
2	\$101	\$63	
3	\$203	\$127	
4	\$288	\$180	
5	\$402	\$251	
6	\$518	\$323	
7	\$637	\$398	
8	\$758	\$474	
9	\$777	\$485	
10	\$879	\$549	
11	\$982	\$614	
12	\$1084	\$678	

HON Recommendation: HASB3.PURL__DW__ - List Price \$3473

HOW TO SPECIFY

<p>Select Model Number</p> <p>See page 267</p> <p><i>Specify for Single Fabric model only</i></p>	<p>Select Fabric</p> <p>See page 267</p> <p><i>Specify for Single Fabric model only</i></p>	<p>Select Seat Cushion Fabric</p> <p>See page 267</p> <p><i>Specify for MF model only</i></p>	<p>Select Frame Fabric</p> <p>See page 267</p> <p><i>Specify for MF model only</i></p>	<p>Select Leg and Color</p> <p>DW Dowel Wood PM Post Metal (+ \$53) SW Sled Wood (+ \$105) See page 267 for colors</p>
H A S B 3 M F .	P B L E 0 7 .	P B L E 0 9 .	P B L E 0 6 .	P M P 8 V

ASTIR™ Collaborative Work Seating

GSA SIN 33721



Icon Legend on page 19

HASPSS

POUF

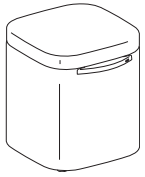

DIMENSIONS

Depth:	17¼	Seat Width:	16½
Height:	18¾	Ship Weight:	25
Width:	16½	Cube:	3.5
Usable Seat Depth:	16½	COM:	See page 267
Seat to Floor Height:	17½	Weight Rating:	300 lbs. (per seat)

FABRIC PRICE CODES

1	\$750	8	\$1129
2	\$801	9	\$1138
3	\$852	10	\$1189
4	\$894	11	\$1241
5	\$951	12	\$1292
6	\$1010	L	—
7	\$1068		

HASPSSMF

POUF, MULTI-FABRIC

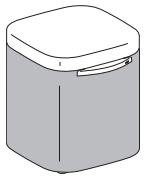

DIMENSIONS

Depth:	17¼	Seat Width:	16½
Height:	18¾	Ship Weight:	25
Width:	16½	Cube:	3.5
Usable Seat Depth:	16½	COM:	See page 267
Seat to Floor Height:	17½	Weight Rating:	300 lbs. (per seat)

FABRIC PRICE CODES

1	\$938	
<i>Add to Base Price Above</i>		
	Seat	Frame
2	\$26	\$38
3	\$51	\$77
4	\$73	\$108
5	\$101	\$151
6	\$130	\$195
7	\$159	\$239
8	\$190	\$285
9	\$195	\$292
10	\$220	\$330
11	\$246	\$368
12	\$271	\$407

HON Recommendation: HASPSS.PURL__H.BL - List Price \$852

SEATING

HOW TO SPECIFY

<p>Select Model Number</p> <p>H A S P S S .</p>	<p>Select Fabric</p> <p>See page 267</p> <p>P B L E 0 7 .</p>	<p>Select Leg and Color</p> <p>HG Hidden Glide H Caster</p> <p>H G .</p>	<p>Select Handle Color</p> <p>BL Black Handle</p> <p>B L</p>
---	---	--	--

HOW TO SPECIFY

<p>Select Model Number</p> <p>H A S P S S M F .</p>	<p>Select Seat Cushion Fabric</p> <p>See page 267</p> <p>P B L E 0 7 .</p>	<p>Select Frame Fabric</p> <p>See page 267</p> <p>P B L E 0 6 .</p>	<p>Select Leg and Color</p> <p>HG Hidden Glide H Caster</p> <p>H G .</p>	<p>Select Handle Color</p> <p>BL Black Handle</p> <p>B L</p>
---	--	---	--	--



ASTIR™ Collaborative Work Seating

HASSP

HIGH-BACK SCREEN — SIDE PRIVACY

DIMENSIONS

Ship Weight: 3.2
 Cube: 3.2
 COM: 3.0

LIST PRICE

Knit \$1887

1	\$1940	7	\$2417
2	\$2015	8	\$2508
3	\$2091	9	\$2522
4	\$2155	10	\$2599
5	\$2241	11	\$2675
6	\$2327	12	\$2753

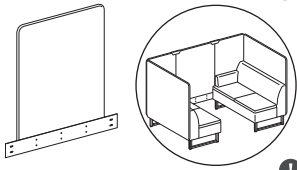

ⓘ Requires High-Back Screen units with arms on each unit.

HASGBSL

SHARED LEG GANGING BRACKET

DIMENSIONS

Ship Weight: 4
 Cube: 0.1

LIST PRICE

\$253

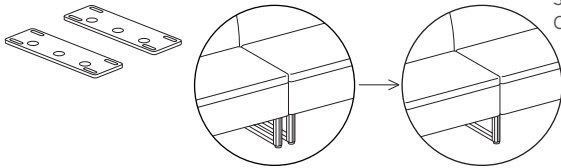

NOTES: Uses existing legs on units being ganged. No specification needed.

SPECIFYING EXAMPLE: HASGBSL

HASSGC

SCREEN GANGING CLIP

DIMENSIONS

Ship Weight: 1
 Cube: 0.1

LIST PRICE

\$127

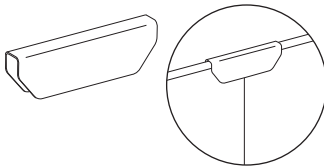

ⓘ Required when ganging multiple high-back units together.
 ⓘ Already included on individual units where applicable.

HOW TO SPECIFY

<p>Select Model Number</p> <p>HASSP.</p>	<p>Select Screen Knit or Fabric</p> <p>Knit Options: KLT Light KMD Medium KDK Dark See page 267 for all options</p> <p>KMD</p>
--	---

HOW TO SPECIFY

<p>Select Model Number</p> <p>HASSGC.</p>	<p>Select Paint Color</p> <p>P7A Textured Charcoal</p> <p>P7A</p>
---	---

SEATING

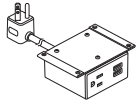

SIN 33721

DESCRIPTION

Miki Under-Mount Power Module
 • Includes 6' cord with three-prong plug.
 • 1 Receptacle, 2 USB
 • Available in **STRM** Storm and **SNW** Snow.
SPECIFYING EXAMPLE: HUMPWR-1P-2U.STRM

MODEL	SHIP WEIGHT	CUBE	LIST PRICE
HUMPWR-1P-2U	2	0.6	\$230



SIN 33721

Vesta Mobile Power Station
 • Includes 10' retractable cord with three-prong plug.
 • 3 AC, 1 Dual USB-A, 1 USB-C at top
 • Specify Paint and Plastic.
SPECIFYING EXAMPLE: HPWRMOB1.BLK.STRM

HPWRMOB1	14	3.3	\$1317
-----------------	----	-----	---------------

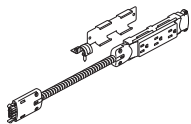

Triplex Electrical Harness
 48"W, Circuit 1
 60"W, Circuit 1
 72"W, Circuit 1

HTPKIT48	5	0.3	\$259
HTPKIT60	5	0.3	\$264
HTPKIT72	5	0.3	\$271

48"W, Circuit 2
 60"W, Circuit 2
 72"W, Circuit 2

HTPKIT482	5	0.3	\$259
HTPKIT602	5	0.3	\$264
HTPKIT722	5	0.3	\$271

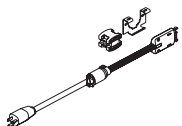

Triplex Corded In-Feed
 48"W Corded In-feed
 72"W Corded In-feed

HTPCIF48	5	0.3	\$335
HTPCIF72	5	0.3	\$355

NOTES: Corded in-feed ships with (1) 4-way splitter, (1) 4-way splitter mounting bracket, (1) conduit clip, and (1) in-feed. Utilizes standard 3-prong plug for easy setup and installation. Use with circuit 1 harnesses only. Corded in-feed not UL listed.

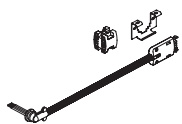

Triplex Hardwire In-Feed
 48"W Hardwire In-feed

HTPHWIF72	5	0.3	\$289
------------------	---	-----	--------------

NOTES: Hardwire in-feed ships with (1) 4-way splitter, (1) 4-way splitter mounting bracket, (1) conduit clip, and (1) in-feed. Hardwire in-feed must be installed by a licensed electrician.

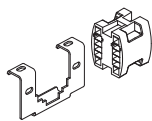

Triplex 4-Way Splitter
 4-Way Splitter

HTPSPLIT	5	0.3	\$88
-----------------	---	-----	-------------

NOTES: 4-way splitter utilized in instances where one power harness feeds into 2-3 power harnesses.

NOTES:

- Triplex is a 4-trac system with 3 connected simplexes per harness.
- Choose either a corded or hardwire in-feed.
- UL listed as a manufactured wiring system (UL 183) when hardwire in-feed is used.
- cUL Certified for Canada with hardwire in-feed.
- Hardwire in-feed complies with municipal standards such as in New York, Los Angeles, and San Francisco. However, it is customer's responsibility to verify local code compliance.
- Plug in any standard 2- or 3-prong plug accessory to triplex simplexes to get power to where you need it most.

HOW TO SPECIFY

<p>Select Model Number</p> <p>HPWRMOB1</p>	<p>Select Exterior Paint Color</p> <p><i>Specify for model HPWRMOB1 only</i></p> <p>FOG Fog STRM Storm BLK Black SNW Snow</p> <p>BLK</p>	<p>Select Paint Color</p> <p><i>Specify for model HPWRMOB1 only</i></p> <p>FOG Fog STRM Storm BLK Black SNW Snow</p> <p>STRM</p>
---	--	--

CAMBIA™ 2160 SERIES

Want to see more? Scan here
to check out hon.com.



Cambia Upholstered Back Guest
Chairs shown with Preside® table.

CAMBIA™ 2160 SERIES

Cambia's comfort and style is a warm invitation for any guest or coworker. With two back variations and arm options, this is a guest chair collection designed to adapt. Each back option offers a choice of a wood slat design or upholstered panel to suit any space or personal taste. Choose from eight rich hardwood finishes and hundreds of quality HON fabrics to express your style and reflect your brand.



FEATURES

- Wood slat back panel complements a variety of surroundings.
- Upholstered seat and back features cushioning for additional comfort and support.
- Personalize your space with a choice of back styles.
- Fixed arms provide support and take pressure off the upper body and shoulders.
- Solid hardwood in one of eight attractive finishes.
- Available in hundreds of quality HON fabrics.
- Warranted for users up to 250 lbs.

CAMBIA™ 2160 Series Options

MODEL OPTIONS

H2164



Guest Chair

Upholstered Back, Leg Base,
Arch Arms

H2165



Guest Chair

Wood Slat Back, Leg Base,
Arch Arms

AVAILABLE FINISHES

Cambia™ 2160 Series Seating is available in 8 wood finishes.

WOOD FINISHES

Bourbon Cherry (H)

Cognac (COGN)

Harvest (C)

Mahogany (N)

Mocha (MOCH)

Natural Maple (D)

Pinnacle (PINC)

Shaker Cherry (F)

HON BRANDED FABRICS

GRADE 1

Apex
Centurion
Compass
Contourett
Dapper
Ensemble
Hamilton
Inertia
Noble Seating
Optic
Pebble
Vibe

GRADE 2

Appoint Seating
Blume
Clyde
Dotty
Kai
Rush
Spin
Wavelength
Whisper Vinyl

GRADE 3

Bradbury
Getaway
Moxie
Notion
Parker
Purl
Quill
Saxony

GRADE 4

Constance with Supreen™
Livi with Supreen™
Lugano with Supreen™
Oxford with Supreen™

GRADE L

Denver Leather

For a complete list of fabrics, including partnership fabrics, go to hon.com/fabricsandfinishes.

Reference Fabric Color Combinations on pages 20-24 for color codes and legend on page 21 for lead times. For additional HON to Supply COM fabric grade pricing, go to honready.hon.com and click on the HON to Supply COM link.



CAMBIA™ 2160 Series

H2164



GUEST CHAIR

Upholstered Back
Leg Base
Arch Arms

DIMENSIONS

Depth:	24¼	Arm Width:	19
Width:	21¾	Seat to Floor Height:	19
Height:	31¾	Usable Seat Depth:	21
Seat Depth:	21	Ship Weight:	30
Seat Width:	21¾	Cube:	22.6
Back Width:	21¾	COM:	1.5
Back Height:	13¾	Weight Rating:	250 lbs.

FABRIC PRICE CODES

1	\$918	8	\$1279
2	\$981	9	\$1326
3	\$1044	10	\$1373
4	\$1091	11	\$1420
5	\$1138	12	\$1467
6	\$1185	L	\$1441
7	\$1232		

H2165



GUEST CHAIR

Wood Slat Back
Leg Base
Arch Arms

DIMENSIONS

Depth:	24¼	Arm Width:	19
Width:	21¾	Seat to Floor Height:	19
Height:	31¾	Usable Seat Depth:	21
Seat Depth:	21	Ship Weight:	30
Seat Width:	21¾	Cube:	22.6
Back Width:	21¾	COM:	1.3
Back Height:	13¾	Weight Rating:	250 lbs.

FABRIC PRICE CODES

1	\$966	8	\$1183
2	\$1004	9	\$1211
3	\$1042	10	\$1239
4	\$1070	11	\$1267
5	\$1098	12	\$1296
6	\$1126	L	\$1280
7	\$1155		

HON Recommendation: H2164.MOCH.CU__ - List Price \$918

HOW TO SPECIFY

<p>Select Model Number</p> <p>H 2 1 6 4 .</p>	<p>Select Finish</p> <p>See page 282</p> <p>M O C H .</p>	<p>Select Fabric</p> <p>See page 282</p> <p>C U 1 0 .</p>
--	--	--



Ceres® Seating shown
with Motivate® Tables.

CERES®

Seating is personal. At the same time, it's also universal. As the result of exhaustive ergonomic research, the stunning Ceres guest chairs feature total support for anyone and any space. The comfort contours cradle you throughout the workday, while projecting the right personality for your brand.



GUEST/MULTI-PURPOSE FEATURES

- 4-Way Stretch mesh back is available in seven colors.
- Model HCG6 is a four-leg multi-purpose chair with a pivoting back for added comfort.
- Model HCG6 stacks up to four high on the floor.
- Guest chairs are available with or without arms.
- Available in a multi-fabric option.
- Warranted for users up to 300 lbs.

CERES® Multi-Purpose Chair Options

MODEL OPTIONS

HCG6 *



Multi-Purpose

Four-leg stacking frame with pivoting back

HCG6DF - Multi-Fabric *



Multi-Purpose

Four-leg stacking frame with pivoting back

ARM STYLE



CODE	DESCRIPTION	PRICE
N	Armless	+\$0



F	Fixed Arms	+\$58
----------	------------	--------------

CASTERS/ GLIDE



CODE	DESCRIPTION	PRICE
H	Black Hard Caster	+\$0



S	Black All-Surface Caster	+\$32
----------	--------------------------	--------------



E	Glide	+\$0
----------	-------	-------------

BACK STYLE



CODE	DESCRIPTION	PRICE
PB	Upholstered in-back	+\$0



4-Way Stretch options:

IM	Black	+\$0
IB	Breeze	+\$0
IK	Brownstone	+\$0
IC	Charcoal	+\$0
IF	Fog	+\$0
IR	Regatta	+\$0
IT	Titanium	+\$0

FRAME

CODE	DESCRIPTION	PRICE
CBK	Charblack	+\$0
PLAT	Textured Platinum Metallic	+\$0

* De-emphasized

SEATING

CERES® Fabric Options

HON BRANDED FABRICS

GRADE 1

Apex
Centurion
Compass
Contourett
Dapper
Ensemble
Hamilton
Inertia
Noble Seating
Optic
Pebble
Vibe

GRADE 2

Appoint Seating
Blume
Clyde
Dotty
Kai
Rush
Spin
Wavelength
Whisper Vinyl

GRADE 3

Bradbury
Getaway
Moxie
Notion
Parker
Purl
Quill
Saxony

GRADE 4

Constance with Supreen™
Livi with Supreen™
Lugano with Supreen™
Oxford with Supreen™

GRADE L

Denver Leather*

For a complete list of fabrics, including partnership fabrics, go to hon.com/fabricsandfinishes.

Reference Fabric Color Combinations on pages 20-24 for color codes and legend on page 21 for lead times. For additional HON to Supply COM fabric grade pricing, go to honready.hon.com and click on the HON to Supply COM link.

*Denver Leather (SS) may not be available on every model within a specific series, please refer to the model's page for details.



HCG6 *

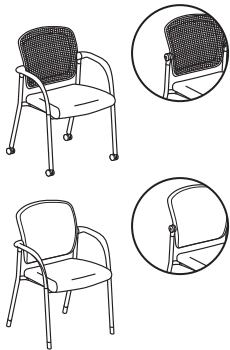

MULTI-PURPOSE

Four-leg stacking frame with pivoting back

DIMENSIONS

Depth:	25	Seat to Floor Height:	18¾
Width:	24½	Usable Seat Depth:	17¼
Height:	35	Ship Weight (upholstered back):	22
Seat Depth:	19½	Ship Weight (mesh back):	22
Seat Width:	20	Cube (upholstered back):	15.2
Back Width:	17½	Cube (mesh back):	15.2
Back Height:	17	COM (upholstered back):	1.0
Arm Width:	20¼	COM (mesh back):	1.0
		Weight Rating:	300 lbs.

FABRIC PRICE CODES

1	\$970	8	\$1115
2	\$996	9	\$1134
3	\$1021	10	\$1152
4	\$1039	11	\$1171
5	\$1058	12	\$1190
6	\$1077	L	\$1179
7	\$1096		

NOTES: Multi-purpose model HCG6, with or without arms, stacks up to 4-high.

HON Recommendation: HCG6.F.H.IM.CU__CBK - List Price \$1028

* De-emphasized

HOW TO SPECIFY

Select Model Number	Select Arm Option	Select Caster/Glide	Select Back Option	Select Fabric	Select Frame
	F Fixed Arms (+ \$58) N Armless	E Glide H Black Hard Caster S Black All-Surface Caster (+ \$32)	PB Upholstered in-back Mesh Back Options IM Black IB Breeze IK Brownstone IC Charcoal IF Fog IR Regatta IT Titanium	See page 286	CBK Charblack PLAT Textured Platinum Metallic
HCG6	F	H	IM	CU10	CBK

HCG6DF *

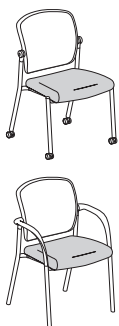

MULTI-PURPOSE

Multi-Fabric
Four-leg stacking frame with pivoting back

DIMENSIONS

Depth:	25	Arm Width:	20¼
Width:	24½	Seat to Floor Height:	18¾
Height:	35	Usable Seat Depth:	17¼
Seat Depth:	19½	Ship Weight (upholstered back):	22
Seat Width:	20	Cube (upholstered back):	15.2
Back Width:	17½	COM (back):	0.8
Back Height:	17	COM (seat):	1.0
		Weight Rating:	300 lbs.

FABRIC PRICE CODES

1	\$1045		
Add to Base Price Above			
		Back	Seat
2	\$19	\$26	
3	\$38	\$51	
4	\$53	\$69	
5	\$66	\$88	
6	\$81	\$107	
7	\$95	\$126	
8	\$109	\$145	
9	\$123	\$164	
10	\$137	\$182	
11	\$151	\$201	
12	\$166	\$220	
L	\$157	\$209	

NOTES: Multi-purpose model HCG6DF, with or without arms, stacks up to 4-high.

HON Recommendation: HCG6DF.F.H.PB.CU__CU__CBK - List Price \$1103

* De-emphasized

HOW TO SPECIFY

Select Model Number	Select Arm Option	Select Caster/Glide	Select Back Option	Select Back Fabric	Select Seat Fabric	Select Frame
	F Fixed Arms (+ \$58) N Armless	E Glide H Black Hard Caster S Black All-Surface Caster (+ \$32)	PB Upholstered in-back	See page 286	See page 286	CBK Charblack PLAT Textured Platinum Metallic
HCG6DF	F	H	PB	CU22	CU10	CBK



Cipher™ Seating.

CIPHER™

From important client consultations to project planning to impending deadlines, busy professionals are required to meet more than a few expectations throughout the day. That's why easy support and intuitive performance should be status quo when it comes to your office chair — and Cipher™ seating goes above and beyond. With intuitive functionality and customizable controls, this smart, streamlined seating solution lets you focus on the task at hand instead of distracted by clumsy mechanisms and constant adjustments. A thoughtful natural leader, Cipher™ moves with you to meet the demands of the day so you can concentrate on what lies ahead.



FEATURES

- Crack the code to productivity with intuitive functionality and thoughtful design.
- Keep things simple with an integrated weight-activated control that automatically adjusts to you as you move.
- Personalize your sit with independently adjustable lumbar support, customizable for user height and pressure preferences.
- Add a pop of color with nine Colorway™ accent options.
- Get the look you want with nine contrast stitching color choices or a fabric-matched stitch.
- Elevate your aesthetic with a thin, modern profile and open back design.
- Find the right fit for your space with three different cylinder height options.
- Stay cool with 4-Way Stretch Mesh flexes in every direction to dynamically move with you — available in 7 colors.
- Choose from 3 frame options: Salt, Charcoal, and Black.

MODEL OPTIONS

HCFRT



Task Chair

HCFRG

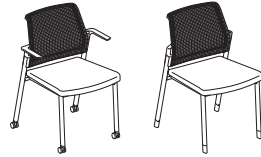

Guest Chair

HON BRANDED FABRICS

GRADE 1

Apex
Centurion
Compass
Contourett
Dapper
Ensemble
Hamilton
Inertia
Noble Seating
Optic
Pebble
Vibe

GRADE 2

Appoint Seating
Blume
Clyde
Dotty
Kai
Rush
Spin Seating
Wavelength
Whisper Vinyl

GRADE 3

Bradbury
Getaway
Moxie
Notion
Parker
Purl
Quill
Saxony

GRADE 4

Constance with Supreen™
Livi with Supreen™
Lugano with Supreen™
Oxford with Supreen™

GRADE L1

Davenport Leather

For a complete list of fabrics, including partnership fabrics, go to hon.com/fabricsandfinishes.

Reference Fabric Color Combinations on pages 20-24 for color codes and legend on page 21 for lead times.

CIPHER™ Task Options

ARM STYLE



CODE	DESCRIPTION	PRICE
N	Armless	+\$0
H	Height-Adjustable	+\$89
V	All-Adjustable (Includes Pivot)	+\$136

ACCENT COLOR



CODE	DESCRIPTION	PRICE
BL	Black	+\$0
S	Charcoal	+\$0
ST	Salt	+\$0
BY	Bullseye	+\$0
KT	Krypton	+\$0
MR	Ember	+\$0
RE	Regatta	+\$0
IR	Iris	+\$0
AT	Atom	+\$0

CASTERS/ GLIDES



CODE	DESCRIPTION	PRICE
H	Black Hard Caster	+\$0
S	Black All-Surface Caster	+\$42
E9	Charcoal All-Surface Caster	+\$42
ST	Salt All-Surface Caster	+\$42
TS	Titanium All-Surface Caster	+\$42
R	Black Roll Control Caster	+\$53
G	Black Bell Glide	+\$27

MESH COLOR

CODE	DESCRIPTION	PRICE
IM	Black	+\$0
IB	Breeze	+\$0
IK	Brownstone	+\$0
IC	Charcoal	+\$0
IF	Fog	+\$0
IR	Regatta	+\$0
IT	Titanium	+\$0

STITCH COLOR

CODE	DESCRIPTION	PRICE
TC00	Fabric-Matched	+\$0
TC01	Yellow	+\$16
TC02	Tan	+\$16
TC03	Natural	+\$16
TC04	Black	+\$16
TC05	Light Red	+\$16
TC06	Orange	+\$16
TC07	Medium Green	+\$16
TC08	Blue	+\$16
TC09	Light Gray	+\$16

BASE

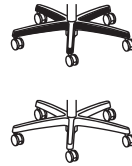

CODE	DESCRIPTION	PRICE
SB	Standard Base	+\$0
PA	Polished Aluminum	+\$115

CYLINDER

CODE	DESCRIPTION	PRICE
STC	Standard Cylinder	+\$0
SHC	Short Cylinder	+\$0
TLC	Tall Cylinder	+\$0

LUMBAR



CODE	DESCRIPTION	PRICE
NL	No Lumbar	+\$0
AL	Adjustable Lumbar	+\$53

FRAME COLOR

CODE	DESCRIPTION	PRICE
T	Black	+\$0
S	Charcoal	+\$37
STX	Salt	+\$37

CIPHER™

Guest Options

ARM STYLE

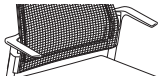

CODE	DESCRIPTION	PRICE
N	Armless	+\$0
F	Fixed Arms*	+\$32

CASTERS/ GLIDE



CODE	DESCRIPTION	PRICE
H	Black Hard Caster	+\$0
S	Black All-Surface Caster	+\$32
E	Glide	+\$0

FRAME PAINT

CODE	DESCRIPTION	PRICE
P71	Black	+\$0
CBK	Charblack	+\$0
P7A	Textured Charcoal	+\$37
P8Z	Textured Salt	+\$37

MESH COLOR

CODE	DESCRIPTION	PRICE
IM	Black	+\$0
IB	Breeze	+\$0
IK	Brownstone	+\$0
IC	Charcoal	+\$0
IF	Fog	+\$0
IR	Regatta	+\$0
IT	Titanium	+\$0

FRAME COLOR

CODE	DESCRIPTION	PRICE
T	Black	+\$0
S	Charcoal	+\$37
STX	Salt	+\$37

*Coming Soon

CIPHER™ Task Dimensions

	Model	Task								
	Arms	Armless			1D			4D		
	Cylinder	Standard	Short	Tall	Standard	Short	Tall	Standard	Short	Tall
Max Width		27.5	27.5	27.5	27.5	27.5	27.5	29.5	29.5	29.5
Max Depth		26.75	26.75	26.75	26.75	26.75	26.75	26.75	26.75	26.75
Max Height		43.125	40.625	45.125	43.125	40.625	45.125	45.125	40.625	45.125
Chair Weight		30	30	30	35	35	35	35	35	35
Shipping Weight		38	38	38	43	43	43	43	43	43
Shipping Weight (KD)		NA	NA	NA	NA	NA	NA	NA	NA	NA
Cubes		10.73	10.73	10.73	10.73	10.73	10.73	10.73	10.73	10.73
Cubes (KD)		NA	NA	NA	NA	NA	NA	NA	NA	NA
Seat										
Width		19.5	19.5	19.5	19.5	19.5	19.5	19.5	19.5	19.5
Usable Depth		18.62 - 16.58	18.62 - 16.58	18.62 - 16.58	18.62 - 16.58	18.62 - 16.58	18.62 - 16.58	18.62 - 16.58	18.62 - 16.58	18.62 - 16.58
Height from Floor		15.00 - 19.625	14.335 - 16.875	17.00 - 21.625	15.00 - 19.625	14.335 - 16.875	17.00 - 21.625	15.00 - 19.625	14.335 - 16.875	17.00 - 21.625
Seat Depth		18	18	18	18	18	18	18	18	18
Back										
Back Lumbar Height		5.9 - 11.0	5.9 - 11.0	5.9 - 11.0	5.9 - 11.0	5.9 - 11.0	5.9 - 11.0	5.9 - 11.0	5.9 - 11.0	5.9 - 11.0
Lumbar Protrusion		.512 - .787	.512 - .787	.512 - .787	.512 - .787	.512 - .787	.512 - .787	.512 - .787	.512 - .787	.512 - .787
Width		18.75	18.75	18.75	18.75	18.75	18.75	18.75	18.75	18.75
Height		24.016	24.016	24.016	24.016	24.016	24.016	24.016	24.016	24.016
Angles										
Seat Angle from Floor		-1.4	-1.4	-1.4	-1.4	-1.4	-1.4	-1.4	-1.4	-1.4
Seat Angle Reclined		-6	-6	-6	-6	-6	-6	-6	-6	-6
Back Angle from Seat		97	97	97	97	97	97	97	97	97
Back Angle from Seat Reclined		117	117	117	117	117	117	117	117	117
Arms										
Distance Between Arms		NA	NA	NA	18.813	18.813	18.813	12.625 - 19.750	12.625 - 19.750	12.625 - 19.750
Height from Floor		NA	NA	NA	22.50 - 31.625	21.375 - 28.125	24.50 - 33.625	23.0 - 32.125	21.875 - 28.625	25.0 - 34.125
Height from Seat		NA	NA	NA	4.938 - 8.625	4.938 - 8.625	4.938 - 8.625	4.938 - 8.625	5.438 - 9.125	5.438 - 9.125
Width		NA	NA	NA	3.875	3.875	3.875	3.875	3.875	3.875
Length		NA	NA	NA	9.3125	9.3125	9.3125	9.3125	9.3125	9.3125
Arm Set-Back		NA	NA	NA	4.212 - 6.259	4.212 - 6.259	4.212 - 6.259	4.212 - 6.259	4.212 - 6.259	4.212 - 6.259



HCFRT



TASK CHAIR

Mesh Back
 Pneumatic
 Swivel
 Weight-activated
 Synchro-tilt
 Tilt Lock
 Functions: **A, E, J, L, P**
 (Function Key on pages 250-251)

DIMENSIONS

Depth:	26¾	Seat to Floor Height:	15-19¼
Width:	27½	Usable Seat Depth:	16½-18½
Height:	43⅞	Ship Weight:	43
Seat Depth:	18	Cube:	10.7
Seat Width:	19½	COM:	1.0
Back Width:	18¾	Weight Rating:	300 lbs.
Back Height:	24		

FABRIC PRICE CODES

1	\$838	8	\$983
2	\$864	9	\$1002
3	\$889	10	\$1020
4	\$907	11	\$1039
5	\$926	12	\$1058
6	\$945	L	\$1236
7	\$964		

NOTES: If armless and no lumbar are selected, choose the frame color in the Accent Color field and the Frame Color field. Features weight-activated control with easy access at seat height.

HON Recommendation: HCFRT.STC.H.H.IC.CU__TC09.AL.AT.SB.S - List Price \$1033

HOW TO SPECIFY

Select Model Number	Select Cylinder	Select Arm	Select Caster	Select Mesh Color	Select Fabric	Select Seat Stitch Color	Select Lumbar	Select Accent Color	Select Base	Select Frame
STC Standard SHC Short Cylinder TLC Tall Cylinder	N Armless H Height Adjustable (+ \$89) V All-Adjustable (+ \$136)	H Black Hard Caster S Black All-Surface Caster (+ \$42) E9 Charcoal All-Surface Caster (+ \$42) ST Salt All-Surface Caster (+ \$42) TS Titanium All-Surface Caster (+ \$42) R Black Roll Control Caster (+ \$53) G Black Bell Glide (+ \$27)	IM Black IF Fog IC Charcoal IT Titanium IK Brownstone IR Regatta IB Breeze	See page 289	See page 290 (+ \$17 for non-fabric matched options)	NL No Lumbar AL Adjustable Lumbar (+ \$53)	BL Black S Charcoal ST Salt BY Bullseye KT Krypton MR Ember RE Regatta IR Iris AT Atom	SB Standard PA Polished Aluminum (+ \$115)	T Black S Charcoal (+ \$37) STX Salt (+ \$37)	
HCFRT	STC	H	H	IM	APX13	TC00	AL	BL	SB	T



Icon Legend on page 19

HCFRG



GUEST CHAIR

Mesh Back

DIMENSIONS

Depth:	24 ¹ / ₈	Seat to Floor Height:	19 ³ / ₄
Width:	24 ¹ / ₄	Usable Seat Depth:	17 ¹ / ₄
Height:	33 ¹ / ₂	Ship Weight:	30
Seat Depth:	17 ³ / ₈	Cube:	15.8
Seat Width:	19	COM:	1.0
Back Width:	19	Weight Rating:	300 lbs.
Back Height:	18		

FABRIC PRICE CODES

1	\$610	8	\$755
2	\$636	9	\$774
3	\$661	10	\$792
4	\$679	11	\$811
5	\$698	12	\$830
6	\$717	L	\$1008
7	\$736		

HON Recommendation: HCFRG.F.S.APX__APX__.TC09.S.P7A - List Price \$765

HOW TO SPECIFY

Select Model Number	Select Arms	Select Caster	Select Back Material	Select Fabric	Select Seat Stitch Color	Select Frame	Select Paint Color
N F	H S E	See page 289	See page 289	See page 290 (+ \$17 for non-fabric matched options)	T S STX	P71 CBK P7A P8Z	
HCFRG	F	S	APX13	APX13	TC00	T	P71



Cliq™ Seating shown with
Preside® Table and Credenza.

CLIQ™

Some of the best work results from a collaborative effort. That's why Cliq brings people together. Designed with a weight-activated control that responds to your body and its movements, Cliq just gets you — providing instant comfort without a lot of adjustments. It's light-scaled for a modern look that's also easy to maneuver around wherever the group discussion takes you. Available as a task chair or stool, Cliq features a wide selection of fabric choices and frame and mesh colors. Intuitive, stylish, and supportive — it just clicks with any collaborative environment.



FEATURES

- Intuitive functionality and design provides comfort and support without the need for multiple adjustments.
- Weight-activated control automatically adjusts to you as you sit.
- Thin profile offers a modern aesthetic, while a wide range of fabric choices ensures the perfect look within any space.
- 4-Way Stretch Mesh flexes in every direction to dynamically move with you — available in 7 colors.
- Choose between fixed arms or armless to get exactly the look you want.
- Task Chairs are available with a conference cylinder or task cylinder so you can choose the chair that best fits your space.
- Task Stools feature an adjustable footring for additional lower body support.
- One-touch seat height adjustment easily moves the seat up and down.
- Choose from 3 frame options: Black, Titanium, and Designer White.

HON BRANDED FABRICS

GRADE 1	GRADE 2	GRADE 3	GRADE 4
Apex	Appoint Seating	Bradbury	Constance with Supreen™
Centurion	Blume	Getaway	Livi with Supreen™
Compass	Clyde	Moxie	Lugano with Supreen™
Contourett	Dotty	Notion	Oxford with Supreen™
Dapper	Kai	Parker	
Ensemble	Rush	Purl	
Hamilton	Spin Seating	Quill	
Inertia	Wavelength	Saxony	
Noble Seating	Whisper Vinyl		
Optic			
Pebble			
Vibe			

For a complete list of fabrics, including partnership fabrics, go to hon.com/fabricsandfinishes.

Reference Fabric Color Combinations on pages 20-24 for color codes and legend on page 21 for lead times.



HCLQT



LIGHT TASK CHAIR

Mesh Back
 Pneumatic
 Swivel
 Weight-activated
 Synchro-tilt
 Tilt Lock
 Functions: **A, E, J, L, P**
 (Function Key on pages 250-251)

DIMENSIONS

Depth: 27
 Width: 27
 Height: 41
 Seat Depth: 17
 Seat Width: 19¼
 Back Width: 19¼
 Back Height: 21
 Seat to Floor Height (Task Cylinder): 17-22
 Seat to Floor Height (Conference Cylinder): 15⅝-19⅜
 Usable Seat Depth: 17
 Ship Weight: 45
 Cube: 10.7
 COM: 1.0
 Weight Rating: 300 lbs.

FABRIC PRICE CODES

1	\$748	8	\$893
2	\$774	9	\$912
3	\$799	10	\$930
4	\$817	11	\$949
5	\$836	12	\$968
6	\$855	L	—
7	\$874		

NOTES: When selecting the Conference Cylinder, the maximum arm height from floor is 28⅞”.

HON Recommendation: HCLQT.WO.TC.F.S.IT.CU__NL.SB.TI - List Price \$817

HOW TO SPECIFY

Select Model Number	Select Control Type	Select Cylinder	Select Arm Type	Select Caster	Select Back Option	Select Fabric	Select Lumbar	Select Base	Select Frame
WO Weight-Activated	TC Task Cylinder (standard height) CCI Conference Cylinder (low height)	N Armless F Fixed (+\$32)	S Black All-Surface Caster	IM Black IB Breeze IK Brownstone IC Charcoal IF Fog IR Regatta IT Titanium	See page 297	NL No Lumbar	SB Standard Base PA Polished Aluminum (+\$115)	T Black TI Titanium (+\$37) DW Designer White (+\$37)	
HCLQT	WO	TC	F	S	IT	CU19	NL	SB	TI



HCLQS



TASK STOOL

Mesh Back

- Pneumatic
- Swivel
- Weight-activated
- Synchro-tilt
- Tilt Lock

Functions: **A, E, J, L, P**
 (Function Key on pages 250-251)

DIMENSIONS

Depth:	28¾	Seat to Floor Height:	23-33
Width:	28¾	Usable Seat Depth:	17
Height:	52	Ship Weight:	50
Seat Depth:	17	Cube:	10.7
Seat Width:	19¼	Weight Rating:	300 lbs.
Back Width:	19¼		
Back Height:	21		

FABRIC PRICE CODES

1	\$830	8	\$975
2	\$856	9	\$994
3	\$881	10	\$1012
4	\$899	11	\$1031
5	\$918	12	\$1050
6	\$937	L	—
7	\$956		

HON Recommendation: HCLQS.W0.SC2.F.S.IT.CU__NL.SB.TI - List Price \$920

HOW TO SPECIFY

Select Model Number	Select Control Type	Select Cylinder	Select Arm Type	Select Caster	Select Back Option	Select Fabric	Select Lumbar	Select Base	Select Frame
W0 Weight-Activated	SC2 Stool Cylinder	N Armless F Fixed (+\$32)	S Black All-Surface Caster	IM Black IB Breeze IK Brownstone IC Charcoal IF Fog IR Regatta IT Titanium	See page 297	NL No Lumbar	SB Standard Base PA Polished Aluminum (+\$115)	T Black TI Titanium (+\$58) DW Designer White (+\$58)	
HCLQS	W0	SC2	F	S	IT	CU19	NL	SB	TI

COFI™

Want to see more? Scan here
to check out hon.com.



Best of
NeoCon
2022

Gold



Cofi™ Seating shown with Preside® and Acoustic Solutions by Unika Vaev.

COFI™

You never get a second chance to make a first impression — so why not make a memorable one with Cofi™? This eye-catching seating solution supports individual needs throughout the day with its upscale design and easy control mechanisms. Fine stitching, premium materials, and endless customization options make it easy to celebrate your unique style — and with its thoughtful detailing, and contemporary back, finish, and fabric choices, closing the deal has never been more stylish or sophisticated.



FEATURES

- Get your choice of an Executive or Managerial back.
- Amp up your aesthetic with three different back stitch details — Channel, Quilt, or Solid.
- Color your world with nine contrast stitching color choices.
- Elevate the look with polished aluminum arm and base options.
- Make the most of your conference room meetings with simple functionality and comfort.
- Go contemporary with a thin, tapered profile.
- Achieve a signature look with premium detailing and elevated design.
- Find your ideal sit and fit with three handy control mechanisms.
- Clean things up with a fabric-matched thread option.
- Add a little luxury with multi-fabric and contrast stitching choices.

SEATING

MODEL OPTIONS

HCFEU



Executive Chair

HCFEUMF



Executive Chair
Multi-Fabric

HCFMU



Managerial Chair

HCFMUMF



Managerial Chair
Multi-Fabric

HON BRANDED FABRICS

GRADE 1

Apex
Centurion
Compass
Contourett
Dapper
Ensemble
Hamilton
Inertia
Noble Seating
Optic
Pebble
Vibe

GRADE 2

Appoint Seating
Blume
Clyde
Dotty
Kai
Rush
Spin Seating
Wavelength
Whisper Vinyl

GRADE 3

Bradbury
Getaway
Moxie
Notion
Parker*
Purl
Quill
Saxony

GRADE 4

Constance with Supreen™
Livi with Supreen™
Lugano with Supreen™
Oxford with Supreen™

GRADE L1

Davenport Leather

For a complete list of fabrics, including partnership fabrics, go to hon.com/fabricsandfinishes.

Reference Fabric Color Combinations on pages 20-24 for color codes and legend on page 21 for lead times. For additional HON to Supply COM fabric grade pricing, go to honready.hon.com and click on the HON to Supply COM link.

*Only available as a seat fabric on Multi-Fabric models. Cannot be used with any Single-Fabric models.

Dotty, Parker, and Quill are not approved on the Cofi™ back.

COFI™ Options

ARM STYLE

CODE	DESCRIPTION	PRICE
N	Armless	+\$0
F	Fixed Arms	+\$89
P	Fixed Polished Aluminum Arms	+\$183

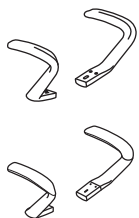

MECHANISM

CODE	DESCRIPTION	PRICE
YO	Synchro-Tilt A, E, J, K, L	+\$0
WO	Weight-Activated A, E	+\$27
Y2	Advanced Synchro-Tilt w/ Seat Slider A, D, E, J, L, A-D	+\$68

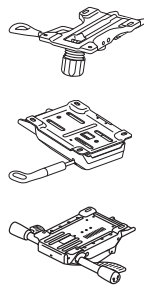

CASTERS/ GLIDE

CODE	DESCRIPTION	PRICE
H	Black Hard Caster	+\$0
S	Black All-Surface Caster	+\$42
R	Black Roll Control Caster	+\$53
G	Black Bell Glide	+\$27



BASE

CODE	DESCRIPTION	PRICE
SB	Standard Base	+\$0
PA	Polished Aluminum	+\$115

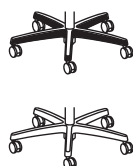

CYLINDER

CODE	DESCRIPTION	PRICE
STC	Standard Cylinder	+\$0
SHC	Short Cylinder	+\$0
TLC	Tall Cylinder	+\$0



STITCH COLOR

CODE	DESCRIPTION	PRICE
TC00	Fabric-Matched	+\$0
TC01	Yellow	+\$53
TC02	Tan	+\$53
TC03	Natural	+\$53
TC04	Black	+\$53
TC05	Light Red	+\$53
TC06	Orange	+\$53
TC07	Medium Green	+\$53
TC08	Blue	+\$53
TC09	Light Gray	+\$53

STITCH DETAIL

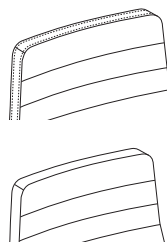

Contrast Stitch (TC01-09)

When chosen, the perimeter of the back, back panels, and seat will include a top stitch in contrasting color.

Fabric-Matched Stitch (TC00)

When chosen, top stitches listed above will not be added in those locations.

BACK STITCH

CODE	DESCRIPTION	PRICE
SLB	Solid Stitch	+\$0
CHS	Channel Stitch	+\$0
QLT	Quilt Stitch	+\$0



MODEL		HCFEU	HCFMU
Overall Width	Armless	25¼	25¼
	Fixed Arms	26	26
Overall Depth	Y0	27½	26⅝
	Y2	26⅝	26
	W0	26⅝	26
Overall Height*	Y0	43¼ - 48¼	35½ - 40½
	Y2	44 - 49	36¼ - 41¼
	W0	43½ - 48½	35¾ - 40¾
Seat Width		20½	20½
Seat Depth		17¾	17¾
Usable Seat Depth	Y0	17¼	17¼
	Y2	16¾ - 19¾	16¾ - 19¾
	W0	16¾	16¾
Seat Height*	Y0	15¾ - 20¾	15¾ - 20¾
	Y2	16¾ - 21¾	16¾ - 21¾
	W0	15½ - 20½	15½ - 20½
Back Width		20	20
Back Height	Y0	27½	20
	Y2	27	19½
	W0	28	20½
Ship Weight Armless	Y0	40	39⅝
	Y2	45¼	45
	W0	41¼	41
Ship Weight F Arms	Y0	47¼	47
	Y2	52⅝	52¼
	W0	48⅝	48¼
Ship Weight P Arms	Y0	49⅝	49
	Y2	54¾	54⅝
	W0	50¾	50⅝
Width Between Arms	Fixed Arms	21	21
Cube		16½	10¾
COM		3	3
Weight Capacity		300 lbs	300 lbs

*Dimensions are based on Standard Cylinder.

Short Cylinder: Reduce lowered seat height by 2" and raised seat height by 4¼".

Tall Cylinder: Increase seat height by 1" for lowered and raised positions.

COFI™

Icon Legend on page 19

HCFEU**EXECUTIVE HIGH-BACK**

Pneumatic
Swivel
Synchro-tilt
Tilt Tension
Tilt Lock

DIMENSIONS

Depth: 26-27½ Width (with arms): 26
Height: 43¼-49 Width (armless): 25¼
Seat Depth: 17¾ Ship Weight: 63
Seat Width: 20½ Cube: 16.5
Back Width: 20 COM: 3.0
Back Height: 27½-28 Weight Rating: 300 lbs.

FABRIC PRICE CODES

1	\$1014	8	\$1375
2	\$1077	9	\$1422
3	\$1140	10	\$1469
4	\$1187	11	\$1516
5	\$1234	12	\$1563
6	\$1281	L	\$1593
7	\$1328		

HCFMU**MANAGERIAL BACK**

Pneumatic
Swivel
Synchro-tilt
Tilt Tension
Tilt Lock

DIMENSIONS

Depth: 26 Width (with arms): 26
Height: 35¼-41¼ Width (armless): 25¼
Seat Depth: 17¾ Ship Weight: 55
Seat Width: 20½ Cube: 10.7
Back Width: 20 COM: 3.0
Back Height: 19½-20½ Weight Rating: 300 lbs.

FABRIC PRICE CODES

1	\$930	8	\$1219
2	\$981	9	\$1257
3	\$1031	10	\$1294
4	\$1068	11	\$1332
5	\$1106	12	\$1369
6	\$1144	L	\$1277
7	\$1181		

HON Recommendation: HCFEU.Y2.STC.P.H.DAV__CHSTC00.PA - List Price \$1959**HOW TO SPECIFY**

Select Model Number	Select Control Type	Select Cylinder	Select Arm Type	Select Caster	Select Fabric	Select Back Detail and Stitch Color	Select Base
Y0 Synchro-Tilt W0 Weight-Activated (+ \$27) Y2 Advanced Synchro-Tilt w/ Seat Slider (+ \$68)	STC Standard Cylinder SHC Short Cylinder TLC Tall Cylinder	N Armless F Fixed (+ \$89) P Fixed Polished Aluminum (+ \$183)	H Black Hard Caster S Black All-Surface Caster (+ \$42) R Black Roll Control Caster (+ \$53) G Black Bell Glide (+ \$27)	See page 301	SLB Solid Stitch CHS Channel Stitch QLT Quilt Stitch See page 302 for Stitch Colors and Pricing	SB Standard Base PA Polished Aluminum (+ \$115)	
H C F E U .	Y 2 .	S T C .	F .	H .	A P X 1 3 .	S L B T C 0 0 .	S B

HCFEUMF



EXECUTIVE HIGH-BACK, MULTI-FABRIC

Pneumatic
Swivel
Synchro-tilt
Tilt Tension
Tilt Lock

DIMENSIONS

Depth: 26-27½ Width (with arms): 26
 Height: 43¼-49 Width (armless): 25¼
 Seat Depth: 17¾ Ship Weight: 63
 Seat Width: 20½ Cube: 16.5
 Back Width: 20 Back COM: 2.5
 Back Height: 27½-28 Seat COM: 1.0
 Weight Rating: 300 lbs.

FABRIC PRICE CODES

1 \$1054

Add to Base Price Above

	Back	Seat
2	\$38	\$26
3	\$76	\$51
4	\$104	\$69
5	\$132	\$88
6	\$160	\$107
7	\$189	\$126
8	\$217	\$145
9	\$245	\$164
10	\$273	\$182
11	\$301	\$201
12	\$330	\$220

HCFMUMF



MANAGERIAL BACK, MULTI-FABRIC

Pneumatic
Swivel
Synchro-tilt
Tilt Tension
Tilt Lock

DIMENSIONS

Depth: 26 Width (with arms): 26
 Height: 35¼-41¼ Width (armless): 25¼
 Seat Depth: 17¾ Ship Weight: 55
 Seat Width: 20½ Cube: 10.7
 Back Width: 20 Back COM: 2.5
 Back Height: 19½-20½ Seat COM: 1.0
 Weight Rating: 300 lbs.

FABRIC PRICE CODES

1 \$969

Add to Base Price Above

	Back	Seat
2	\$26	\$26
3	\$51	\$51
4	\$69	\$69
5	\$88	\$88
6	\$107	\$107
7	\$126	\$126
8	\$145	\$145
9	\$164	\$164
10	\$182	\$182
11	\$201	\$201
12	\$220	\$220

HON Recommendation: HCFEUMF.Y2.STC.P.H.WP__CHSTC04.WP__TC04.PA - List Price \$1537

HOW TO SPECIFY

Select Model Number	Select Control Type	Select Cylinder	Select Arm Type	Select Caster	Select Back Fabric	Select Back Detail and Stitch Color	Select Seat Fabric	Select Seat Stitch Color	Select Base
YO Synchro-Tilt WO Weight-Activated (+ \$27) Y2 Advanced Synchro-Tilt w/ Seat Slider (+ \$68)	STC Standard Cylinder SHC Short Cylinder TLC Tall Cylinder	N Armless F Fixed (+ \$89) P Fixed Polished Aluminum (+ \$183)	H Black Hard Caster S Black All-Surface Caster (+ \$42) R Black Roll Control Caster (+ \$53) G Black Bell Glide (+ \$27)	See page 301	SLB Solid Stitch CHS Channel Stitch QLT Quilt Stitch See page 302 for Stitch Colors and Pricing	See page 301	See page 302 for Stitch Colors and Pricing	SB Standard Base PA Polished Aluminum (+ \$115)	
HCFEUMF	Y2	STC	F	H	APX25	SLBTC00	APX13	TC00	SB

CONVERGENCE®

Want to see more? Scan here
to check out hon.com.



Convergence® Task Chairs shown with
Empower® Height-Adjustable Workstations.

CONVERGENCE®

What happens when support and affordability come together? Convergence. This is the task chair that is as attainable as it is comfortable with customizable features. Lumbar support that adds a little extra lower back comfort. Thick seat cushions to take the stress off the lower body throughout the day. Arm choices that let you decide how much upper body support you want. A breathable mesh back that flexes and responds to your movements. Convergence puts all the features you're looking for into one low-priced task chair.



FEATURES

- Choice of swivel tilt or synchro-tilt control with seat slide.
- Black mesh back is breathable for all-day comfort and support.
- Comfort options include adjustable lumbar support, adjustable arms, seat glide and synchro-tilt.
- Three arm options.
- Two control options.
- Integrated handle on the back makes it easy to move and reposition the chair.
- Hard casters move effortlessly on any surface.
- Black frame sits atop a durable five-star base.
- Warranted for users up to 275 lbs.
- 3" thick seat cushion.







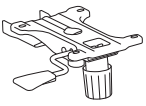

BACK OPTIONS

HCT1MM

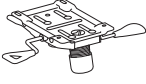

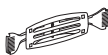
Mid-back

Mesh Task Chair
with Adjustable
Lumbar Support

MECHANISM				BACK STYLE			
	CODE	FUNCTIONS	PRICE		CODE	DESCRIPTION	PRICE
	Z1	Swivel-Tilt Control A, E, F, K, L, W	+\$0		M	Mesh	+\$0
	Y1	Limited Synchro-Tilt A, D, E, J, K, L, W	+\$37				
(See pages 250-251 for Seating Functions.)				BASE			
	CODE	DESCRIPTION	PRICE		CODE	DESCRIPTION	PRICE
					SB	Standard Base	+\$0
ARM STYLE				LUMBAR			
	CODE	DESCRIPTION	PRICE		CODE	DESCRIPTION	PRICE
	N	Armless	+\$0		AL	Adjustable Lumbar	+\$0
	H	Height-Adjustable Arms	+\$58				
	A	Height and Width Adjustable Arms	+\$89	FRAME			
	CODE	DESCRIPTION	PRICE		CODE	DESCRIPTION	PRICE
	H	Black Hard Caster	+\$0		T	Black	+\$0

CONVERGENCE®

Fabric Options

HON BRANDED FABRICS

GRADE 1

Apex
Centurion
Compass
Contourett
Dapper
Ensemble
Hamilton
Inertia
Noble Seating
Optic
Pebble
Vibe

GRADE 2

Appoint Seating
Blume
Clyde
Dotty
Kai
Rush
Spin
Wavelength
Whisper Vinyl

GRADE 3

Bradbury
Getaway
Moxie
Notion
Parker
Purl
Quill
Saxony

GRADE 4

Constance with Supreen™
Livi with Supreen™
Lugano with Supreen™
Oxford with Supreen™

For a complete list of fabrics, including partnership fabrics, go to hon.com/fabricsandfinishes.

Reference Fabric Color Combinations on pages 20-24 for color codes and legend on page 21 for lead times. For additional HON to Supply COM fabric grade pricing, go to honready.hon.com and click on the HON to Supply COM link.



Icon Legend on page 19

CONVERGENCE® Standard Task Chairs

HCT1MM



MID-BACK TASK

Mesh Back

- Pneumatic
- Swivel
- Tilt Tension
- Tilt Lock
- Adjustable Lumbar Support

Functions: **A, E, K, L, W**
(Function Key on pages 250-251)

NOTES: Arm width adjustment range is 3" (from 17"-20"). Lumbar adjustment is 3". Seat depth range is only for Y1 control. Seat depth on Z1 control is 19".

DIMENSIONS

Depth:	27½	Adjustable Arms Width:	20
Width:	27¾	Seat to Floor Height:	15¾-20
Height:	42	Usable Seat Depth:	17-19
Seat Depth:	19	Ship Weight:	44
Seat Width:	20	Cube:	5.8
Back Width:	18	COM:	1.0
Back Height:	22	Weight Rating:	275 lbs.

FABRIC PRICE CODES

1	\$434	7	\$497
2	\$447	8	\$507
3	\$460	9	\$516
4	\$469	10	\$525
5	\$478	11	\$535
6	\$488	12	\$544

HSCASTER

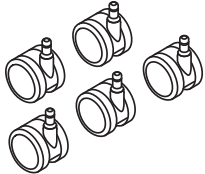

OPEN MARKET

SET OF 5 ALL-SURFACE CASTERS

DIMENSIONS

Size:	60mm
Ship Weight:	2
Cube:	0.1

LIST PRICE

\$72

! Available in Black finish only, no specification needed.

HON Recommendation: HCT1MM.Y1.A.H.M.CU10.AL.SB.T - List Price \$560

HOW TO SPECIFY

Select Model Number	Select Control Type	Select Arm Type	Select Caster	Select Back Type	Select Upholstery	Select Lumbar	Select Base	Select Frame
Z1 Swivel-Tilt Control Y1 Simple Synchro-Tilt w/ Seat Slide Control (+ \$37)	N Armless H Height-Adjustable Arms (+ \$58) A Height & Width Adjustable Arms (+ \$89)	H Black Hard Casters	M Mesh	See page 308	AL Adjustable Lumbar	SB Standard Base	T Black	
HCT1MM	Y1	A	H	M	CU10	AL	SB	T

CONVERGENCE® Value Task Chairs

OPEN MARKET



Icon Legend on page 19

HCAT1MM



MID-BACK TASK VALUE MODEL

Mesh Back
Pneumatic
Swivel
Tilt Tension
Tilt Lock
Adjustable Lumbar Support

Functions: **A, E, K, L, W**
(Function Key on pages 250-251)

NOTES: Lumbar adjustment is 3". Seat depth range is only for Y1 control. Seat depth on Z1 control is 19".

DIMENSIONS

Depth:	27½	Adjustable Arms Width:	17-20
Width:	27¾	Seat to Floor Height:	15¾-20
Height:	42	Usable Seat Depth:	17-19
Seat Depth:	19	Ship Weight:	44
Seat Width:	20	Cube:	5.8
Back Width:	18	Weight Rating:	275 lbs.
Back Height:	22		

LIST PRICE

\$501

HSCASTER

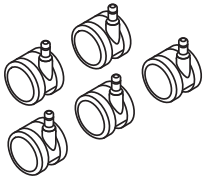

SET OF 5 ALL-SURFACE CASTERS

DIMENSIONS

Size:	60mm
Ship Weight:	2
Cube:	0.1

LIST PRICE

\$72

Available in Black finish only, no specification needed.

HON Recommendation: HCAT1MM.Z1.A.H.M.ACCF10.AL.SB.T - List Price \$501

SEATING

HOW TO SPECIFY

Select Model Number	Select Control Type	Select Arm Type	Select Caster	Select Back Type	Select Upholstery	Select Lumbar	Select Base	Select Frame
Z1 Swivel-Tilt Control Y1 Simple Synchro-Tilt w/ Seat Slide Control (+ \$37)	A Height & Width Adjustable Arms	H Black Hard Casters	M Mesh	ACCF10 Black	AL Adjustable Lumbar	SB Standard Base	T Black	
HCAT1MM	Y1	A	H	M	ACCF10	AL	SB	T



HVL581



HIGH-BACK

Pneumatic
Swivel
Tilt
Tilt Tension
Tilt Lock
Height and Width Adjustable
Arms
Adjustable Lumbar

Functions: **A, E, F, K, L, S, W**
(Function Key on pages 250-251)

NOTES: Comfortable and breathable mesh back. Black fabric or Black Bonded Leather. Black frame. Height and width adjustable arms. Adjustable lumbar. **HON 5-Year Limited Warranty.**

HON Recommendation: HVL581.ES10.T - List Price \$528

DIMENSIONS

Depth:	25½	Arm Width:	19⅞
Width:	28¾	Seat to Floor Height:	16½-20¼
Height:	42⅞	Usable Seat Depth:	17¼
Seat Depth:	17¼	Ship Weight:	39.8
Seat Width:	20¼	Cube:	4.8
Back Width:	18½	Weight Rating:	250 lbs.

PRICE CODE

Fabric	\$528
Leather	\$555

HVL582



HIGH-BACK

Pneumatic
Swivel
Tilt
Tilt Tension
Tilt Lock
Asynchronous Control
Seat Glide Mechanism
Adjustable Lumbar
Height and Width Adjustable
Arms

Functions: **A, E, F, L, O, S, W**
(Function Key on pages 250-251)

NOTES: Comfortable and breathable mesh back. Black fabric or Black Bonded Leather. Black frame. Height and width adjustable arms. Seat glide mechanism. Asynchronous control with independent seat and back angle adjustment. Adjustable lumbar. **HON 5-Year Limited Warranty.**

HON Recommendation: HVL582.ES10.T - List Price \$651

DIMENSIONS

Depth:	27½	Arm Width:	19⅞
Width:	28¾	Seat to Floor Height:	20½-22¾
Height:	43¾	Usable Seat Depth:	17¼
Seat Depth:	17¼	Ship Weight:	50.4
Seat Width:	19⅞	Cube:	6.8
Back Width:	18½	Weight Rating:	250 lbs.

PRICE CODE

Fabric	\$651
Leather	\$678

HVL585



EXECUTIVE BIG AND TALL

Pneumatic
Swivel
Tilt
Tilt Tension
Tilt Lock
Height and Width Adjustable
Arms
Adjustable Lumbar

Functions: **A, E, F, K, L, S, W**
(Function Key on pages 250-251)

NOTES: Large scale model HVL585 will support 450 lbs with normal use. Black fabric. Black frame. Height and width adjustable arms. Adjustable lumbar. **HON 5-Year Limited Warranty.**

ⓘ Available in Black fabric only.

HON Recommendation: HVL585.ES10.T - List Price \$914

DIMENSIONS

Depth:	29⅞	Arm Width:	20½
Width:	28⅞	Seat to Floor Height:	17⅞-21¾
Height:	45⅞	Usable Seat Depth:	19⅞
Seat Depth:	19⅞	Ship Weight:	55.4
Seat Width:	22	Cube:	7.2
Back Width:	20⅞	Weight Rating:	450 lbs.

PRICE CODE

Fabric	\$914
---------------	--------------

HOW TO SPECIFY

Select Model Number

H V L 5 8 1

Select Fabric

ES10 Black
SB11 Black Bonded Leather
Available on HVL581 and HVL582 only

E S 1 0

Select Frame

T Black

T

DEFINE™ Executive Chairs

OPEN MARKET



Icon Legend on page 19

HVL108



HIGH-BACK

Pneumatic
Swivel
Synchro-tilt
Height-adjustable Arms
Functions: **A, E, J, K, Q**
(Function Key on pages 250-251)

DIMENSIONS

Depth:	29 ³ / ₄	Arm Width:	19 ¹ / ₂
Width:	29 ³ / ₄	Seat to Floor Height:	17 ¹ / ₈ -21 ³ / ₈
Height:	46 ⁷ / ₈	Usable Seat Depth:	17 ¹ / ₂
Seat Depth:	17 ¹ / ₂	Ship Weight:	47.3
Seat Width:	21	Cube:	7.2
Back Width:	20	Weight Rating:	250 lbs.
Back Height:	26 ¹ / ₂		

PRICE CODE

Leather **\$847**

NOTES: Available in Black Bonded Leather. Polished base. Polished arm accents. Height-adjustable arms. **HON 5-Year Limited Warranty.**

HON Recommendation: HVL108.SB11 - List Price \$847

SEATING

HOW TO SPECIFY

Select
Model Number

H V L 1 0 8 .

Select
Fabric

SB11 Black Bonded Leather

S B 1 1

ENDORSE® COLLECTION

Want to see more? Scan here
to check out hon.com.



Endorse® Seating shown with Huddle Tables.

ENDORSE® COLLECTION

You need inviting, comfy seats up front, and task chairs that support productivity in workstations. Achieve harmony throughout your space with a multi-functional collection of Endorse task seating. Endorse supports the diversity of applications throughout your workplace with sophisticated design. Varied options. Diverse materials. Simply pick the model that suits your space and people. Add the options that fit your needs. Then get ready to Endorse a higher level of productivity.



TASK CHAIR FEATURES

- Available in high-, mid- and low-back options.
- Available in three different back materials — upholstered, mesh and plastic outer back.
- Comfort options include adjustable lumbar support, adjustable arms, seat glide, multi-position tilt and synchro-tilt.
- Optional seat slide adjustment adapts to users of various heights.
- Control options include limited synchro-tilt, advanced synchro-tilt, advanced synchro-tilt with independent back angle and weight-activated control.
- Arm options include fixed, armless, height- and width-adjustable and all-adjustable.
- Caster options include hard, All-Surface and roll control.
- Available in hundreds of quality HON fabrics.
- Warranted for users up to 300 lbs.
(450 lbs. for Big and Tall chairs)

ENDORSE® Options

BACK OPTIONS

HLWM
HLWMBT - Big & Tall



Mid-back

Mesh with Adjustable
Lumbar Support

HLTM
HLTSM - Stool

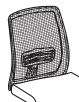

Low-back

Mesh with Adjustable
Lumbar Support

MESH BACK COLOR CODES (no upcharge): Black - **IM** Breeze - **IB** Brownstone - **IK** Charcoal - **IC** Fog - **IF** Regatta - **IR**
Titanium - **IT**

MECHANISM	CODE	FUNCTIONS	PRICE
	S0	Limited Recline Synchro-Tilt A, E, J, K, L	+\$0
	S1	Limited Recline Synchro-Tilt w/ Seat Slider (available on Stools only) A, D, E, J, K, L	+\$21
	Y2	Advanced Synchro-Tilt A, D, E, J, L, W, A-D	+\$68
	Y3	Advanced Synchro-Tilt with Independent Back Angle A, D, E, J, L, W, A-E	+\$110
	Y4	Synchro-Tilt A, D, E, J, L, W, A-D (Big and Tall models only)	+\$0

(See pages 250-251 for Seating Functions.)

BASE	CODE	DESCRIPTION	PRICE
	SB	Standard Base	+\$0
	PA	Polished Aluminum	+\$115

ARM STYLE	CODE	DESCRIPTION	PRICE
	N	Armless	+\$0
	F	Fixed - Black	+\$68
	A	Height and Width Adjustable Arms	+\$89
	V	All-Adjustable Arms - includes pivot	+\$136
	P	Fixed - Polished Alum.	+\$183

CASTERS	CODE	DESCRIPTION	PRICE
	A	Black All-Surface Caster (High-back and Big and Tall models only)	+\$0
	H	Black Hard Caster	+\$0
	S	Black All-Surface Caster	+\$42
	R	Black Roll Control Caster	+\$53

TASK DIMENSIONS

MODEL		HLWM	HLTM
Overall Width Armless		28½	28½
Overall Width with Arms	A/V	28½	28½
	F/P	28½	28½
Overall Depth		28½	28½
Overall Height	S0	45½	42
	Y2	46¼	42¾
	Y3	46	42½
	W5	48¾	43
Seat Width		20	19
Seat Depth		18½	18¾
Usable Seat Depth	S0	17¾	17⅝
	Y2	15½-18	15½-18
	Y3	15¼-18¼	15¼-18¼
	W5	15½-17¾	15½-17¾
Seat Height (mechanism)	S0	17-21½	17-21½
	Y2	17¾-22¼	17¾-22¼
	Y3	17½-22	17½-22
	W5	17¼-21¾	17¼-21¾
Back Width		19¼	18
Back Height		25	21¾
Ship Weight Armless	S0	40	41
	Y2	45 Ⓢ	46 Ⓢ
	Y3	48 Ⓢ	50 Ⓢ
	W5	44 Ⓢ	45 Ⓢ
Weight with Arms	S0	48	49
	Y2	53 Ⓢ	54 Ⓢ
	Y3	56 Ⓢ	58 Ⓢ
	W5	52 Ⓢ	53 Ⓢ
Between Arms	A/V	17½-20	16¾-19¼
	F/P	20½	20½
COM		1.0	1.0
Weight Capacity		300 lbs	300 lbs

BIG & TALL & STOOL DIMENSIONS

MODEL		HLWMBT	HLTSM
Overall Width Armless		28½	28½
Overall Width with Arms	A/V	28½	28½
	F/P	28½	28½
Overall Depth		28½	28½
Overall Height	S0/S1	-	53
	Y4	49	-
Seat Width		23	19
Seat Depth	S0/S1	-	18¾
	Y4	20¼	-
Usable Seat Depth	S0	-	17⅝
	S1	-	15¼-18¼
	Y4	17¼-18¾	-
Seat Height (mechanism)	S0/S1	-	22¾-32¾
	Y4	17½-22	-
Back Width		22½	19¾
Back Height		25¾	22¾
Ship Weight Armless	S0	-	42
	S1	-	44
	Y4	57	-
Weight with Arms	S0	-	50
	S1	-	52
	Y4	65	-
Between Arms	A/V	20½-23	16¾-19¼
	F/P	23½	20½
COM		1.5	2.0
Weight Capacity		450 lbs	300 lbs

ENDORSE® Fabric Options

HON BRANDED FABRICS *(For Seating)*

GRADE 1

Apex
Centurion
Compass
Contourett
Dapper
Ensemble
Hamilton
Inertia
Noble Seating
Optic
Pebble
Vibe

GRADE 2

Appoint Seating
Blume
Clyde
Dotty
Kai
Rush
Spin Seating
Wavelength
Whisper Vinyl

GRADE 3

Bradbury
Getaway
Moxie
Notion
Parker
Purl
Quill
Saxony

GRADE 4

Constance with Supreen™
Livi with Supreen™
Lugano with Supreen™
Oxford with Supreen™

For a complete list of fabrics, including partnership fabrics, go to hon.com/fabricsandfinishes.

Reference Fabric Color Combinations on pages 20-24 for color codes and legend on page 21 for lead times. For additional HON to Supply COM fabric grade pricing, go to honready.hon.com and click on the HON to Supply COM link.



Icon Legend on page 19

HLWM



TASK MID-BACK

4-Way Stretch Back

- Pneumatic
- Swivel
- Synchro-tilt
- Tilt Tension
- Tilt Lock
- Integral Lumbar Support
- Optional Seat Glide

Functions: **A, E, J, K, L, W**
 (Function Key on pages 250-251)

NOTES: For Mesh Back models, specify the 4-Way Stretch back option below. Headrest available on Mid-back 4-Way Stretch models only - Black only.

! See page 315 for additional specifications and dimensions.

DIMENSIONS

Depth:	28½	Back Width:	19
Width:	28½	Back Height:	25
Height:	44½	Cube:	10.8
Seat Depth:	15¾	COM:	1.0
Seat Width:	19¾	Weight Rating:	300 lbs.

FABRIC PRICE CODES

1	\$1098	8	\$1243
2	\$1124	9	\$1262
3	\$1149	10	\$1280
4	\$1167	11	\$1299
5	\$1186	12	\$1318
6	\$1205	L	—
7	\$1224		

HON Recommendation: HLWM.Y2.A.H.IM.CU__SB.N - List Price \$1255

HOW TO SPECIFY

Select Model Number	Select Control Type	Select Arm Type	Select Caster/Glide	Select Mesh Back	Select Fabric	Select Base	Select Headrest
	S0 Limited Recline Synchro-Tilt Y2 Advanced Synchro-Tilt (+ \$68) Y3 Synchro-Tilt with Independent Back Angle (+ \$110) W5 Weight-Activated (+ \$157) *	N Armless F Fixed Arms - Black (+ \$68) A Height and Width Adjustable Arms (+ \$89) V All-Adjustable Arms (includes pivot) (+ \$136) P Fixed Arms - Polished (+ \$183)	H Black Hard Caster S Black All-Surface Caster (+ \$42) R Black Roll Control Caster (+ \$53)	4-Way Stretch options IM Black IB Breeze IK Brownstone IC Charcoal IF Fog IR Regatta IT Titanium Specify the back for Mesh Back models only	See page 316	SB Standard Base PA Polished Aluminum (+ \$115)	N No Headrest HR Headrest (+ \$84) Black only. Specify for model HLWM only
HLWM	Y2	A	H	IM	CU10	SB	N

* De-emphasized



HLTM



TASK LOW-BACK

4-Way Stretch Back

- Pneumatic
- Swivel
- Synchro-tilt
- Tilt Tension
- Tilt Lock
- Integral Lumbar Support
- Optional Seat Glide

Functions: **A, E, J, K, L, W**

(Function Key on pages 250-251)

NOTES: For Mesh Back models, specify the 4-Way Stretch back option below.

! See page 315 for additional specifications and dimensions.

DIMENSIONS

Depth:	28½	Back Width:	17¾
Width:	28½	Back Height:	21¾
Height:	40¼	Cube:	10.8
Seat Depth:	15⅝	COM:	1.0
Seat Width:	18⅞	Weight Rating:	300 lbs.

FABRIC PRICE CODES

1	\$1021	8	\$1166
2	\$1047	9	\$1185
3	\$1072	10	\$1203
4	\$1090	11	\$1222
5	\$1109	12	\$1241
6	\$1128	L	—
7	\$1147		

HON Recommendation: HLTM.Y2.A.H.IM.CU__SB - List Price \$1178

HOW TO SPECIFY

Select Model Number	Select Control Type	Select Arm Type	Select Caster/Glide	Select Mesh Back	Select Fabric	Select Base
S0 Limited Recline Synchro-Tilt	Y2 Advanced Synchro-Tilt (+ \$68)	N Armless	H Black Hard Caster	4-Way Stretch options	See page 316	SB Standard Base
Y2 Advanced Synchro-Tilt (+ \$68)	Y3 Synchro-Tilt with Independent Back Angle (+ \$110)	F Fixed Arms - Black (+ \$68)	S Black All-Surface Caster (+ \$42)	IM Black		PA Polished Aluminum (+ \$115)
Y3 Synchro-Tilt with Independent Back Angle (+ \$110)	W5 Weight-Activated (+ \$157) *	A Height and Width Adjustable Arms (+ \$89)	R Black Roll Control Caster (+ \$53)	IB Breeze		
		V All-Adjustable Arms (includes pivot) (+ \$136)		IK Brownstone		
		P Fixed Arms - Polished (+ \$183)		IC Charcoal		
				IF Fog		
				IR Regatta		
				IT Titanium		
				<i>Specify the back for Mesh Back models only</i>		
HLTM	Y2	A	H	IM	CU10	SB

* De-emphasized



Icon Legend on page 19

HLWMBT



TASK MID-BACK

Big and Tall 4-Way Stretch Back

- Pneumatic
- Seat-glide
- Swivel
- Synchro-tilt
- Tilt Lock
- Side Tilt Tension
- Integral Lumbar Support

Functions: **A, D, E, A-D, J, L, W**
(Function Key on pages 250-251)

NOTES: For Mesh Back models, specify the 4-Way Stretch back option below. Headrest available on Mid-back 4-Way Stretch models only - Black only.

DIMENSIONS

Depth:	31½	Adjustable Arms Width:	21½-23¾
Width:	31½	Fixed Arms Width:	24
Height:	44½	Seat to Floor Height:	18-22
Seat Depth:	21	Usable Seat Depth:	17¼-18¾
Seat Width:	23	Ship Weight:	75
Back Width:	22½	Cube:	15.3
Back Height:	25¾	COM:	1.5
		Weight Rating:	450 lbs.

FABRIC PRICE CODES

1	\$1822	8	\$2039
2	\$1860	9	\$2067
3	\$1898	10	\$2095
4	\$1926	11	\$2123
5	\$1954	12	\$2152
6	\$1982	L	—
7	\$2011		

HON Recommendation: HLWMBT.Y4.A.A.IM.CU__SB.N - List Price \$1911

HOW TO SPECIFY

Select Model Number	Select Control Type	Select Arm Type	Select Caster/Glide	Select Mesh Back	Select Fabric	Select Base	Select Headrest
HLWMBT	Y4 Synchro-Tilt <i>Y4 is the only control option for the Big and Tall models</i>	N Armless F Fixed Arms - Black (+ \$68) * A Height and Width Adjustable Arms (+ \$89) V All-Adjustable Arms (includes pivot) (+ \$136) P Fixed Arms - Polished (+ \$183) *	A Black All-Surface Caster	4-Way Stretch option <i>Black only</i> IM Black <i>Specify the back for Mesh Back models only</i>	See page 316	SB Standard Base	N No Headrest HR Headrest (+ \$84) <i>Black only. Specify for model HLWMBT only</i>
HLWMBT	Y4	A	A	IM	CU10	SB	N

* De-emphasized



HLTSM

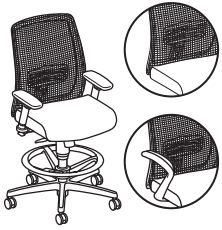

STOOL

4-Way Stretch Back

- Pneumatic
- Swivel
- Synchro-tilt
- Tilt Tension
- Tilt Lock
- Integral Lumbar Support

Functions: **A, E, J, K, L, W**
 (Function Key on pages 250-251)

DIMENSIONS

Depth:	28½	Back Width:	17¾
Width:	28½	Back Height:	21¾
Height:	52½	Cube:	10.8
Seat Depth:	15½	COM:	1.0
Seat Width:	18¾	Weight Rating:	300 lbs.

FABRIC PRICE CODES

1	\$1218	8	\$1363
2	\$1244	9	\$1382
3	\$1269	10	\$1400
4	\$1287	11	\$1419
5	\$1306	12	\$1438
6	\$1325	L	—
7	\$1344		

NOTES: For Mesh Back models, specify the 4-Way Stretch back option below. See page 315 for additional specifications and dimensions.

HON Recommendation: HLTSM.S1.A.H.IM.CU__SB - List Price \$1328

HOW TO SPECIFY

Select Model Number	Select Control Type	Select Arm Type	Select Caster/Glide	Select Mesh Back	Select Fabric	Select Base
<p>S0 Limited Recline Synchro-Tilt</p> <p>S1 Limited Recline Synchro-Tilt w/ Seat Slider (+ \$21)</p>	<p>N Armless</p> <p>F Fixed Arms - Black (+ \$68)</p> <p>A Height and Width Adjustable Arms (+ \$89)</p> <p>V All-Adjustable Arms (includes pivot) (+ \$136)</p> <p>P Fixed Arms - Polished (+ \$183)</p>	<p>H Black Hard Caster</p> <p>S Black All-Surface Caster (+ \$42)</p> <p>R Black Roll Control Caster (+ \$53)</p>	<p>4-Way Stretch options</p> <p>IM Black</p> <p>IB Breeze</p> <p>IK Brownstone</p> <p>IC Charcoal</p> <p>IF Fog</p> <p>IR Regatta</p> <p>IT Titanium</p> <p><i>Specify the back for Mesh Back models only</i></p>	See page 316	<p>SB Standard Base</p> <p>PA Polished Aluminum (+ \$115)</p>	
HLTSM	S1	A	H	IM	CU10	SB



Icon Legend on page 19

HL2DARM



ADJUSTABLE T-ARMS

Height and Width
Functions: **S**
(Function Key on pages 250-251)

DIMENSIONS

Adjustable Arms Width: 16¾-19¼
Height from Seat: 7¼-11
Ship Weight: 8
Cube: 1.0

LIST PRICE

\$165

- ⓘ Available in Black only. No need to specify.
- ⓘ Can only be used with standard models. Contact Customer Support for Big & Tall arm packs.

HL4DARM



ALL-ADJUSTABLE ARMS

Height, Width, Depth and Pivot

DIMENSIONS

Adjustable Arms Width: 16¾-19¼
Height from Seat: 7¼-11
Ship Weight: 8
Cube: 1.0

LIST PRICE

\$222

- ⓘ Available in Black only. No need to specify.
- ⓘ Can only be used with standard models. Contact Customer Support for Big & Tall arm packs.

HI2FHA



FIXED HEIGHT ARMS

DIMENSIONS

Arm Width: 20
Height from Seat: 9½
Ship Weight: 7
Cube: 1.0

LIST PRICE

\$146

- ⓘ Can only be used with standard models. Contact Customer Support for Big & Tall arm packs.

HIPAA

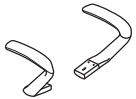

POLISHED ALUMINUM ARMS

Fixed Height

DIMENSIONS

Arm Width: 20
Height from Seat: 9½
Ship Weight: 10
Cube: 1.0

LIST PRICE

\$241

- ⓘ Can only be used with standard models. Contact Customer Support for Big & Tall arm packs.

HLMSHHR



MESH HEADREST

DIMENSIONS

Mesh Width: 12
Mesh Height: 6
Ship Weight: 3
Cube: 1.0

QA DIMENSIONS (Attachment Mechanism)

Width: 12
Depth: 6
Height: 12

LIST PRICE

\$183

- ⓘ Available in Black Mesh (IM) only. For use with Mesh Mid-back models only.

HSCASTER

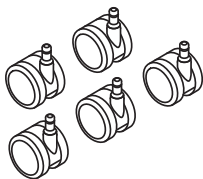

SET OF 5 ALL-SURFACE CASTERS

DIMENSIONS

Size: 60mm
Ship Weight: 2
Cube: 0.1

LIST PRICE

\$72

- ⓘ Available in Black finish only, no specification needed.

OPEN MARKET

FLEXION™

Want to see more? Scan here
to check out hon.com.



Flexion™ Seating shown with Empower® Workstation and Contain® Mobile Pedestal.

FLEXION™

Multiple meetings and hands-on project planning requires hassle free seating — you need a chair that moves and adapts to your body and your day. Flexion™ features a versatile seat for versatile work. With a clean, nimble aesthetic and straightforward mechanisms, this flexible seating solution supports an on-the-go workstyle, with minimum adjustments and ample comfort.



FEATURES

- Get comfortable with weight-activated flex functionality that responds and adapts to you as you sit.
- Move around freely with 4-point seat suspension that allows for dynamic postures.
- Maximize your back and shoulder support with a back frame designed with torsion in mind to move and flex with you.
- Find the right fit with one-touch seat height adjustment.
- Take your pick of adjustable arms, fixed arms, or an armless aesthetic.
- Meet the needs of your space with 3 different cylinder height options.
- Stay cool with 4-Way Stretch Mesh — available in 7 colors.
- Choose from 3 frame options: Salt, Titanium, and Black.

MODEL OPTIONS

HFXT1



Task Chair

HON BRANDED FABRICS

GRADE 1

Apex
Centurion
Compass
Contourett
Dapper
Ensemble
Hamilton
Inertia
Noble Seating
Optic
Pebble
Vibe

GRADE 2

Appoint Seating
Blume
Clyde
Dotty
Kai
Rush
Spin Seating
Wavelength
Whisper Vinyl

GRADE 3

Bradbury
Getaway
Moxie
Notion
Parker
Purl
Quill
Saxony

GRADE 4

Constance with Supreen™
Livi with Supreen™
Lugano with Supreen™
Oxford with Supreen™

GRADE L

Davenport Leather

For a complete list of fabrics, including partnership fabrics, go to hon.com/fabricsandfinishes.

Reference Fabric Color Combinations on pages 20-24 for color codes and legend on page 21 for lead times.

FLEXION™

Options

ARM STYLE



CODE	DESCRIPTION	PRICE
N	Armless	+\$0
A	Height-Adjustable	+\$79
F	Fixed Arms	+\$68

CASTERS/ GLIDES



CODE	DESCRIPTION	PRICE
H	Hard Caster	+\$0
S	Black All-Surface Caster	+\$32
TS	Titanium All-Surface Caster	+\$32
SS	Salt All-Surface Caster	+\$32
R	Roll Control Caster	+\$53

CYLINDER

CODE	DESCRIPTION	PRICE
STC	Standard Cylinder	+\$0
SHC	Short Cylinder	+\$0
TLC	Tall Cylinder	+\$0

BASE

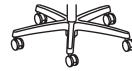

CODE	DESCRIPTION	PRICE
SB	Standard Base	+\$0
PA	Polished Aluminum	+\$115

FRAME COLOR

CODE	DESCRIPTION	PRICE
T	Black	+\$0
TI	Titanium	+\$37
ST	Salt	+\$37

HFXT1



TASK CHAIR

Mesh Back

DIMENSIONS

Depth:	25	Seat to Floor Height:	15-19 $\frac{3}{8}$
Width:	27 $\frac{1}{8}$	Usable Seat Depth:	16 $\frac{1}{2}$ -18 $\frac{5}{8}$
Height:	42 $\frac{1}{2}$	Ship Weight:	35
Seat Depth:	17 $\frac{3}{8}$	Cube:	10.7
Seat Width:	19 $\frac{1}{8}$	COM:	1.0
Back Width:	18 $\frac{3}{4}$	Weight Rating:	300 lbs.
Back Height:	24		

FABRIC PRICE CODES

1	\$780	8	\$925
2	\$806	9	\$944
3	\$831	10	\$962
4	\$849	11	\$981
5	\$868	12	\$1000
6	\$887	L	\$1060
7	\$906		

HON Recommendation: HFXT1.F0.STC.A.H.IT.CU__.NL.SB.TI - List Price \$896

HOW TO SPECIFY

Select Model Number	Select Control Type	Select Cylinder	Select Arm Type	Select Caster	Select Mesh Color	Select Fabric	Select Lumbar	Select Base	Select Frame
FO Weight-Activated Flex	STC Standard SHC Short TLC Tall	N Armless A Height Adjustable Arms (+ \$79) F Fixed \$68	H Hard Caster S Black All-Surface Caster (+ \$32) TS Titanium All-Surface Caster (+ \$32) SS Salt All-Surface Caster (+ \$32) R Roll Control Caster (+ \$53)	IM Black IF Fog IC Charcoal IT Titanium IK Brownstone IR Regatta IB Breeze	See page 323	NL No Lumbar	SB Standard PA Polished Aluminum (+ \$115)	T Black (+ \$0) TI Titanium (+ \$37) ST Salt (+ \$37)	
H F X T 1	F 0	S T C	A	H	I M	A P X 2 5	N L	S B	T



Flock® Seating and Tables.

FLOCK®

Break away. Come together. Wherever people migrate within a space, Flock is designed to support their needs. With a full collection of modular and comfortable seating elements and coordinating collaborative tables that work seamlessly together, you can make the most of every square inch of your space. Modular lounge chairs and ottomans stand alone or combine to create large arrangements. Multi-purpose stools and chairs add comfort to open spaces. Collaborative tables bring the whole group together. Flock helps people interact with each other, challenge one another, and receive the support they need.

SEATING



CHAIR FEATURES

- Round and square lounge chairs are fully upholstered.
- The contemporary aesthetic easily matches a variety of surroundings.
- Support everything from one-on-one conversations to large meetings.
- Choose from four leg options — standard, tapered round, tapered square, hard casters, or a 4-star base.
- Swivel, X-, or 4-star base options include return-to-center feature.
- 4-Leg guest chairs and counter- and bar-height stools available with both metal and wood legs.
- Available in hundreds of quality HON fabrics.
- Warranted for users up to 300 lbs.

COLLABORATIVE TABLES

- Choose from round, square, rectangle, or racetrack shaped table tops.
- Optional grommets neatly route cords.
- Bases available in disc, T-leg, and X-leg styles.
- Choose bases with or without footings.

MODEL OPTIONS

HFLSC1
HFLSC1DF - Multi-Fabric

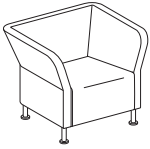

Lounge Chair
Square

HFLRC1
HFLRC1DF - Multi-Fabric



Lounge Chair
Round

HFLMC1
HFLMC1DF - Multi-Fabric



Modular Chair

HFLML1
HFLML1DF - Multi-Fabric

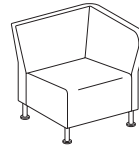

Modular
Left End

HFLMR1
HFLMR1DF - Multi-Fabric

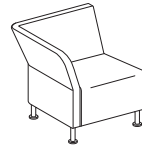

Modular
Right End

HFLCC1
HFLCC1DF - Multi-Fabric

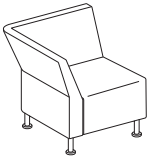

True Chair
Corner

HFLW145
HFLW145DF - Multi-Fabric

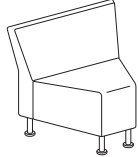

Wedge
Inside

HFLW045
HFLW045DF - Multi-Fabric

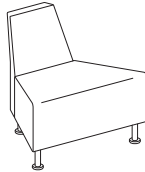

Wedge
Outside

HFL450

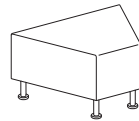

Wedge Ottoman

LEG STYLE



L Standard Leg **+\$0**



TS Tapered Square **+\$0**



TR Tapered Round **+\$0**



H Hard Casters **+\$0**

LEG COLOR

CODE DESCRIPTION PRICE

PR8 Textured Silver **+\$0**
P7A Textured Charcoal **+\$0**

**Specify PR8 & P7A for Standard Legs and Tapered Round & Tapered Square Legs only*

T Black Hard Caster **+\$0**

**Specify for Hard Caster option only*

FLOCK® Options

MODEL OPTIONS

HFLB2

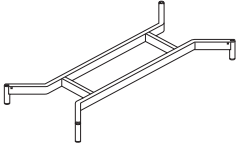

Two-Seat Base Frame

HFLB3

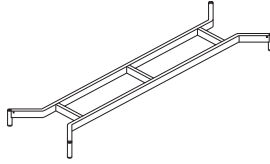

Three-Seat Base Frame

HTSSRD



Tapered Square
Leg - Shroud Pack

COMPATIBLE MODELS

HFLMC1
HFLMC1DF - Multi-Fabric



Modular Chair

HFLML1
HFLML1DF - Multi-Fabric

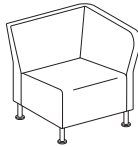

Modular
Left End

HFLMR1
HFLMR1DF - Multi-Fabric

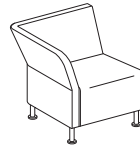

Modular
Right End

HFLCC1
HFLCC1DF - Multi-Fabric

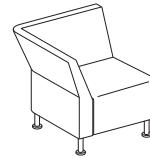

True Chair
Corner

HFLSO1

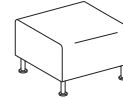

Square Ottoman

LEG STYLE



CODE	DESCRIPTION	PRICE
RS	Round Straight Leg	+\$0

Available in the following finishes:

PR8	Textured Silver
P7A	Textured Charcoal



TS	Tapered Square	+\$79
-----------	----------------	--------------

Available in the following finishes:

PR8	Textured Silver
P7A	Textured Charcoal

HON BRANDED FABRICS

GRADE 1	GRADE 2	GRADE 3	GRADE 4	GRADE L
Apex	Appoint Seating	Bradbury	Constance with Supreen™	Denver Leather*
Centurion	Blume	Getaway	Livi with Supreen™	
Compass	Clyde	Moxie	Lugano with Supreen™	
Contourett	Dotty	Notion	Oxford with Supreen™	
Dapper	Kai	Parker		
Ensemble	Rush	Purl		
Hamilton	Spin Seating	Quill		
Inertia	Wavelength	Saxony		
Noble Seating	Whisper Vinyl			
Optic				
Pebble				
Vibe				

For a complete list of fabrics, including partnership fabrics, go to hon.com/fabricsandfinishes.

Flock® chair model HFLRC1 has fabric limitations, please see the Flock® seating pages 330-337 for details.

Reference Fabric Color Combinations on pages 20-24 for color codes and legend on page 21 for lead times.

*Denver Leather (SS) may not be available on every model within a specific series, please refer to the model's page for details.

For more details on Upholstery Pattern Match for this series, please see page 14.

⚠ Due to the inherent characteristics of upholstery materials, the seat of Flock® may become more relaxed to show wrinkles over time.

FLOCK® ROUND LOUNGE HFLRC1/DF HON BRANDED FABRICS

GRADE 1	GRADE 2	GRADE 3	GRADE 4	GRADE L
Apex	Appoint Seating	Bradbury	Constance with Supreen™	Denver Leather**
Centurion	Blume	Getaway	Livi with Supreen™**	
Compass	Clyde	Moxie	Lugano with Supreen™	
Contourett	Dotty*	Notion	Oxford with Supreen™**	
Dapper	Kai	Parker		
Ensemble	Rush	Purl		
Hamilton	Spin Seating*	Quill		
Inertia	Wavelength	Saxony		
Noble Seating	Whisper Vinyl			
Optic				
Pebble				
Vibe				

For a complete list of fabrics, including partnership fabrics, go to hon.com/fabricsandfinishes.

Reference Fabric Color Combinations on pages 20-24 for color codes and legend on page 21 for lead times.

*Available on seat only.

**Denver Leather (SS) may not be available on every model within a specific series, please refer to the model's page for details.

For more details on Upholstery Pattern Match for this series, please see page 14.

⚠ Due to the inherent characteristics of upholstery materials, the seat of Flock® may become more relaxed to show wrinkles over time.



HFLSC1

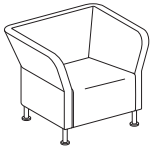

LOUNGE CHAIR

Square

DIMENSIONS

Depth:	28½	Arm Width:	27½
Width:	34¼	Seat to Floor Height:	17
Height:	28	Usable Seat Depth:	20½
Seat Depth:	20½	Ship Weight:	79
Seat Width:	21½	Cube:	21.9
Back Width:	21½	COM:	5.0
Back Height:	18½	Weight Rating:	300 lbs.

FABRIC PRICE CODES

1	\$2340	8	\$2989
2	\$2453	9	\$3074
3	\$2566	10	\$3159
4	\$2651	11	\$3243
5	\$2736	12	\$3328
6	\$2820	L	\$3281
7	\$2905		

! Leg options – Standard Leg (L), Tapered Square (TS) and Tapered Round (TR) are available in Textured Silver (PR8) and Textured Charcoal (P7A) only. Hard Casters (H) are available on Black (T) only.

HFLRC1

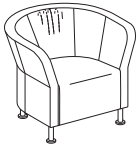

Due to the inherent design of the Round Lounge chair, material gathers will be present in the back.

LOUNGE CHAIR

Round

DIMENSIONS

Depth:	29	Arm Width:	27½
Width:	33½	Seat to Floor Height:	17
Height:	28	Usable Seat Depth:	20½
Seat Depth:	20½	Ship Weight:	57
Seat Width:	20½	Cube:	21.9
Back Width:	20½	Weight Rating:	300 lbs.
Back Height:	18½		

FABRIC PRICE CODES

1	\$2444	8	\$3021
2	\$2545	9	\$3097
3	\$2645	10	\$3172
4	\$2720	11	\$3247
5	\$2796	12	\$3322
6	\$2871	L	\$3280
7	\$2946		

! Round Lounge models HFLRC1 / HFLRC1DF are offered in select fabrics; for availability, please see the Fabric Matrix on page 329. Also approved in limited Partnership Fabrics. Leg options – Standard Leg (L), Tapered Square (TS) and Tapered Round (TR) are available in Textured Silver (PR8) and Textured Charcoal (P7A) only. Hard Casters (H) are available on Black (T) only.
! Customer's Own Material (COM) is not available on Flock® model HFLRC1.

HON Recommendation: HFLSC1.TS.PNS__PR8 - List Price \$2532

HOW TO SPECIFY

<p>Select Model Number</p> <p>HFLSC1</p>	<p>Select Leg Option</p> <p>L Standard Leg TS Tapered Square TR Tapered Round H Hard Casters</p> <p>TS</p>	<p>Select Fabric</p> <p>See page 329</p> <p>PNS007</p>	<p>Select Leg Color</p> <p>PR8 Textured Silver P7A Textured Charcoal</p> <p><i>Specify for Standard, Tapered Round and Tapered Square legs only</i></p> <p>T Black Hard Caster <i>Specify for Hard Caster option only</i></p> <p>PR8</p>
---	---	---	---



HFLMC1



MODULAR CHAIR

DIMENSIONS

Depth:	28½	Seat to Floor Height:	17
Width:	25	Usable Seat Depth:	20½
Height:	28	Ship Weight:	54
Seat Depth:	20½	Cube:	21.9
Seat Width:	25	COM:	3.0
Back Width:	25	Weight Rating:	300 lbs.
Back Height:	18½		

FABRIC PRICE CODES

1	\$1715	8	\$2148
2	\$1791	9	\$2205
3	\$1866	10	\$2261
4	\$1922	11	\$2317
5	\$1979	12	\$2374
6	\$2035	L	\$2342
7	\$2092		

! Leg options – Standard Leg (L), Tapered Square (TS) and Tapered Round (TR) are available in Textured Silver (PR8) and Textured Charcoal (P7A) only. Hard Casters (H) are available on Black (T) only.

HFLML1

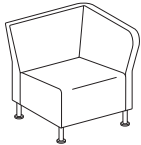

MODULAR

Left End

DIMENSIONS

Depth:	28½	Seat to Floor Height:	17
Width:	28½	Usable Seat Depth:	20½
Height:	28	Ship Weight:	72
Seat Depth:	20½	Cube:	21.9
Seat Width:	22¼	COM:	4.0
Back Width:	22¼	Weight Rating:	300 lbs.
Back Height:	18½		

FABRIC PRICE CODES

1	\$2023	8	\$2600
2	\$2124	9	\$2676
3	\$2224	10	\$2751
4	\$2299	11	\$2826
5	\$2375	12	\$2901
6	\$2450	L	\$2859
7	\$2525		

! Leg options – Standard Leg (L), Tapered Square (TS) and Tapered Round (TR) are available in Textured Silver (PR8) and Textured Charcoal (P7A) only. Hard Casters (H) are available on Black (T) only.

HFLMR1



MODULAR

Right End

DIMENSIONS

Depth:	28½	Seat to Floor Height:	17
Width:	28½	Usable Seat Depth:	20½
Height:	28	Ship Weight:	72
Seat Depth:	20½	Cube:	21.9
Seat Width:	22¼	COM:	4.0
Back Width:	22¼	Weight Rating:	300 lbs.
Back Height:	18½		

FABRIC PRICE CODES

1	\$2023	8	\$2600
2	\$2124	9	\$2676
3	\$2224	10	\$2751
4	\$2299	11	\$2826
5	\$2375	12	\$2901
6	\$2450	L	\$2859
7	\$2525		

! Leg options – Standard Leg (L), Tapered Square (TS) and Tapered Round (TR) are available in Textured Silver (PR8) and Textured Charcoal (P7A) only. Hard Casters (H) are available on Black (T) only.

HON Recommendation: HFLMC1.TS.PNS___.PR8 - List Price \$1870

HOW TO SPECIFY

<p>Select Model Number</p> <p>H F L M C 1 .</p>	<p>Select Leg Option</p> <p>L Standard Leg TS Tapered Square TR Tapered Round H Hard Casters</p> <p>T S .</p>	<p>Select Fabric</p> <p>See page 329</p> <p>P N S 0 0 7 .</p>	<p>Select Leg Color</p> <p>PR8 Textured Silver P7A Textured Charcoal</p> <p><i>Specify for Standard, Tapered Round and Tapered Square legs only</i></p> <p>T Black Hard Caster <i>Specify for Hard Caster option only</i></p> <p>P R 8</p>
--	---	--	---



HFLCC1

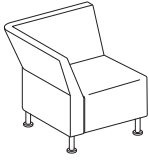

TRUE CORNER CHAIR

DIMENSIONS

Depth:	28½	Seat to Floor Height:	17
Width:	28½	Usable Seat Depth:	20½
Height:	28	Ship Weight:	60
Seat Depth:	20½	Cube:	21.9
Seat Width:	20½	COM:	4.0
Back Width:	22¼	Weight Rating:	300 lbs.
Back Height:	18½		

FABRIC PRICE CODES

1	\$2014	8	\$2834
2	\$2115	9	\$2963
3	\$2215	10	\$3093
4	\$2315	11	\$3223
5	\$2445	12	\$3352
6	\$2575	L	\$2850
7	\$2704		

! Leg options – Standard Leg (L), Tapered Square (TS) and Tapered Round (TR) are available in Textured Silver (PR8) and Textured Charcoal (P7A) only.

HFLWI45

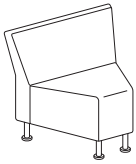

INSIDE WEDGE

DIMENSIONS

Depth:	26¼	Seat to Floor Height:	17
Width:	31½	Usable Seat Depth:	19
Height:	28	Ship Weight:	45
Seat Depth:	19½	Cube:	21.9
Seat Width:	25¾	COM:	3.0
Back Width:	31½	Weight Rating:	300 lbs.
Back Height:	18½		

FABRIC PRICE CODES

1	\$2012	8	\$2832
2	\$2113	9	\$2961
3	\$2213	10	\$3091
4	\$2313	11	\$3221
5	\$2443	12	\$3350
6	\$2573	L	\$2848
7	\$2702		

! Leg options – Standard Leg (L), Tapered Square (TS) and Tapered Round (TR) are available in Textured Silver (PR8) and Textured Charcoal (P7A) only.

HFLWO45



OUTSIDE WEDGE

DIMENSIONS

Depth:	26¼	Seat to Floor Height:	17
Width:	32	Usable Seat Depth:	19
Height:	28	Ship Weight:	35
Seat Depth:	19½	Cube:	21.9
Seat Width:	32	COM:	3.0
Back Width:	16¼	Weight Rating:	300 lbs.
Back Height:	18½		

FABRIC PRICE CODES

1	\$2012	8	\$2832
2	\$2113	9	\$2961
3	\$2213	10	\$3091
4	\$2313	11	\$3221
5	\$2443	12	\$3350
6	\$2573	L	\$2848
7	\$2702		

! Leg options – Standard Leg (L), Tapered Square (TS) and Tapered Round (TR) are available in Textured Silver (PR8) and Textured Charcoal (P7A) only.

HON Recommendation: HFLCC1.TS.PNS__PR8 - List Price \$2194

HOW TO SPECIFY

<p>Select Model Number</p> <p>HFLCC1</p>	<p>Select Leg Option</p> <p>L Standard Leg TS Tapered Square TR Tapered Round</p> <p>TS</p>	<p>Select Fabric</p> <p>See page 329</p> <p>PNS007</p>	<p>Select Leg Color</p> <p>PR8 Textured Silver P7A Textured Charcoal</p> <p><i>Specify for Standard, Tapered Round and Tapered Square legs only</i></p> <p>PR8</p>
---	--	---	---



HFL450

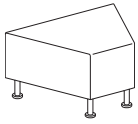

WEDGE OTTOMAN

DIMENSIONS

Depth:	23½	Usable Seat Depth:	23½
Width:	32	Ship Weight:	33
Height:	17	Cube:	12.6
Seat Depth:	23½	COM:	2.0
Seat Width:	32	Weight Rating:	300 lbs.
Seat to Floor Height:	17		

FABRIC PRICE CODES

1	\$989	8	\$1399
2	\$1040	9	\$1464
3	\$1090	10	\$1529
4	\$1140	11	\$1594
5	\$1205	12	\$1658
6	\$1270	L	\$1407
7	\$1334		

ⓘ Leg options – Standard Leg (L), Tapered Square (TS) and Tapered Round (TR) are available in Textured Silver (PR8) and Textured Charcoal (P7A) only.

HFLS01

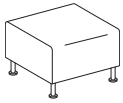

OTTOMAN

Square

DIMENSIONS

Depth:	25	Ship Weight:	30.0
Width:	25	Cube:	7.5
Height:	17	COM:	2.0
Seat Depth:	25	Weight Rating:	300 lbs.
Seat Width:	25		

FABRIC PRICE CODES

1	\$1003	8	\$1292
2	\$1054	9	\$1330
3	\$1104	10	\$1367
4	\$1141	11	\$1405
5	\$1179	12	\$1442
6	\$1217	L	\$1421
7	\$1254		

ⓘ Leg options – Standard Leg (L), Tapered Square (TS) and Tapered Round (TR) are available in Textured Silver (PR8) and Textured Charcoal (P7A) only. Hard Casters (H) are available on Black (T) only.

ⓘ While the top surface of the ottoman is flat, modular models (pages 331-332 and 335-337) have a slight angle to their seats. Therefore, there will not be alignment between these units when placed side-by-side.

HFLGANG



GANGING BRACKET

For Flock® Modular Seating Models

- Can be used for in-line ganging ONLY
- Use bracket set to connect two models. Do not connect more than four models.
- No specification required for bracket

DIMENSIONS

Ship Weight:	0.5
Cube:	0.1

LIST PRICE

\$49

HON Recommendation: HFLS01.TS.PNS__PR8 - List Price \$1133

HOW TO SPECIFY

<p>Select Model Number</p> <p>H F L S 0 1</p>	<p>Select Leg Option</p> <p>L Standard Leg TS Tapered Square TR Tapered Round H Hard Casters</p> <p>T S</p>	<p>Select Fabric</p> <p>See page 329</p> <p>P N S 0 0 7</p>	<p>Select Leg Color</p> <p>PR8 Textured Silver P7A Textured Charcoal</p> <p><i>Specify for Standard, Tapered Round and Tapered Square legs only</i></p> <p>T Black Hard Caster <i>Specify for Hard Caster option only</i></p> <p>P R 8</p>
--	---	--	---

FLOCK® Multi-Fabric Collaborative

GSA SIN 33721



Icon Legend on page 19

HFLSC1DF

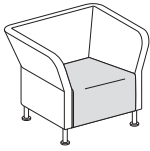

LOUNGE CHAIR

Multi-Fabric
Square

DIMENSIONS

Depth:	28½	Arm Width:	27½
Width:	34¼	Seat to Floor Height:	17
Height:	28	Usable Seat Depth:	20½
Seat Depth:	20½	Ship Weight:	48
Seat Width:	21½	Cube:	27.0
Back Width:	21½	COM:	See page 346
Back Height:	18½	Weight Rating:	300 lbs.

FABRIC PRICE CODES

1	\$2436	
<i>Add to Base Price Above</i>		
	Back	Seat
2	\$84	\$30
3	\$168	\$59
4	\$230	\$81
5	\$293	\$103
6	\$356	\$125
7	\$418	\$147
8	\$481	\$169
9	\$543	\$192
10	\$606	\$214
11	\$668	\$236
12	\$731	\$258
L	\$696	\$245

For multi-fabric models, start with the base price, then add the additional amount for the back and seat from the corresponding matrix to determine the final list price. Choose any combination of fabric grades for the back and seat.

Example: HFLSC1DF base price (\$2436) + Grade 2 back fabric (add \$84) + Grade 4 seat fabric (add \$81) = Total \$2601 List
 HFLSC1DF base price (\$2436) + Grade 5 back fabric (add \$293) + Grade 3 seat fabric (add \$59) = Total \$2788 List

HFLRC1DF

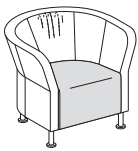

LOUNGE CHAIR

Multi-Fabric
Round

DIMENSIONS

Depth:	29	Arm Width:	27½
Width:	33½	Seat to Floor Height:	17
Height:	28	Usable Seat Depth:	20½
Seat Depth:	20½	Ship Weight:	39
Seat Width:	20½	Cube:	27.0
Back Width:	20½	Weight Rating:	300 lbs.
Back Height:	18½		

FABRIC PRICE CODES

1	\$2539	
<i>Add to Base Price Above</i>		
	Back	Seat
2	\$75	\$27
3	\$149	\$53
4	\$204	\$73
5	\$261	\$91
6	\$316	\$111
7	\$371	\$131
8	\$427	\$151
9	\$483	\$170
10	\$539	\$190
11	\$594	\$209
12	\$650	\$228
L	\$619	\$218

NOTES: Due to the inherent design of the Round Lounge chair, material gathers will be present in the back.
 ⓘ Round Lounge models HFLRC1 / HFLRC1DF are offered in select fabrics; for availability, please see the Fabric Matrix on page 329. Also approved in limited Partnership Fabrics.

For multi-fabric models, start with the base price, then add the additional amount for the back and seat from the corresponding matrix to determine the final list price. Choose any combination of fabric grades for the back and seat.

Example: HFLRC1DF base price (\$2539) + Grade 2 back fabric (add \$75) + Grade 4 seat fabric (add \$73) = Total \$2687 List
 HFLRC1DF base price (\$2539) + Grade 5 back fabric (add \$261) + Grade 3 seat fabric (add \$53) = Total \$2853 List

HON Recommendation: HFLSC1DF.TS.PNS__PNS__PR8 - List Price \$2629

SEATING

HOW TO SPECIFY

<p>Select Model Number</p> <p>HFLSC1DF</p>	<p>Select Leg Option</p> <p>L Standard Leg TS Tapered Square TR Tapered Round H Hard Casters</p> <p>TS</p>	<p>Select Back Fabric</p> <p>See page 329</p> <p>PNS004</p>	<p>Select Seat Fabric</p> <p>See page 329</p> <p>PNS007</p>	<p>Select Leg Color</p> <p>PR8 Textured Silver P7A Textured Charcoal</p> <p><i>Specify for Standard, Tapered Round and Tapered Square legs only</i></p> <p>T Black Hard Caster <i>Specify for Hard Caster option only</i></p> <p>PR8</p>
---	--	--	--	---



FLOCK® Multi-Fabric Collaborative

HFLMC1DF

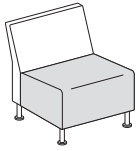

MODULAR CHAIR

Multi-Fabric

DIMENSIONS

Depth:	28½	Seat to Floor Height:	17
Width:	25	Usable Seat Depth:	20½
Height:	28	Ship Weight:	52
Seat Depth:	20½	Cube:	24.0
Seat Width:	25	COM:	See page 346
Back Width:	25	Weight Rating:	300 lbs.
Back Height:	18½		

FABRIC PRICE CODES

1	\$1811	
<i>Add to Base Price Above</i>		
	Back	Seat
2	\$38	\$38
3	\$76	\$76
4	\$104	\$104
5	\$132	\$132
6	\$160	\$160
7	\$189	\$189
8	\$217	\$217
9	\$245	\$245
10	\$273	\$273
11	\$301	\$301
12	\$330	\$330
L	\$314	\$314

HFLML1DF

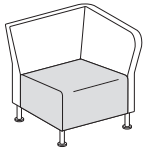

MODULAR LEFT END

Multi-Fabric

DIMENSIONS

Depth:	28½	Seat to Floor Height:	17
Width:	28½	Usable Seat Depth:	20½
Height:	28	Ship Weight:	72
Seat Depth:	20½	Cube:	24.0
Seat Width:	22¼	COM:	See page 346
Back Width:	22¼	Weight Rating:	300 lbs.
Back Height:	18½		

FABRIC PRICE CODES

1	\$2119	
<i>Add to Base Price Above</i>		
	Back	Seat
2	\$75	\$27
3	\$149	\$53
4	\$204	\$73
5	\$261	\$91
6	\$316	\$111
7	\$371	\$131
8	\$427	\$151
9	\$483	\$170
10	\$539	\$190
11	\$594	\$209
12	\$650	\$228
L	\$619	\$218

HON Recommendation: HFLMC1DF.TS.PNS__PNS__PR8 - List Price \$1966

HOW TO SPECIFY

<p>Select Model Number</p> <p>HFLMC1DF</p>	<p>Select Leg Option</p> <p>L Standard Leg TS Tapered Square TR Tapered Round H Hard Casters</p> <p>TS</p>	<p>Select Back Fabric</p> <p>See page 329</p> <p>PNS004</p>	<p>Select Seat Fabric</p> <p>See page 329</p> <p>PNS007</p>	<p>Select Leg Color</p> <p>PR8 Textured Silver P7A Textured Charcoal</p> <p><i>Specify for Standard, Tapered Round and Tapered Square legs only</i></p> <p>T Black Hard Caster</p> <p><i>Specify for Hard Caster option only</i></p> <p>PR8</p>
---	--	--	--	---

FLOCK® Multi-Fabric Collaborative

GSA SIN 33721



Icon Legend on page 19

HFLMR1DF

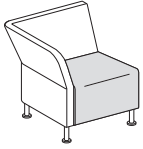

MODULAR RIGHT END

Multi-Fabric

DIMENSIONS

Depth:	28½	Seat to Floor Height:	17
Width:	28½	Usable Seat Depth:	20½
Height:	28	Ship Weight:	72.0
Seat Depth:	20½	Cube:	24.0
Seat Width:	22¼	COM:	See page 346
Back Width:	22¼	Weight Rating:	300 lbs.
Back Height:	18½		

FABRIC PRICE CODES

1	\$2119	
<i>Add to Base Price Above</i>		
	Back	Seat
2	\$75	\$27
3	\$149	\$53
4	\$204	\$73
5	\$261	\$91
6	\$316	\$111
7	\$371	\$131
8	\$427	\$151
9	\$483	\$170
10	\$539	\$190
11	\$594	\$209
12	\$650	\$228
L	\$619	\$218

HON Recommendation: HFLMR1DF.TS.PNS___.PNS___.PR8 - List Price \$2300

SEATING

HOW TO SPECIFY

Select Model Number

Select Leg Option

Select Back Fabric

Select Seat Fabric

Select Leg Color

- L Standard Leg
- TS Tapered Square
- TR Tapered Round
- H Hard Casters

See page 329

See page 329

- PR8 Textured Silver
 - P7A Textured Charcoal
- Specify for Standard, Tapered Round and Tapered Square legs only*

- T Black Hard Caster
- Specify for Hard Caster option only*

HFLMR1DF .

TS .

PNS004 .

PNS007 .

PR8



HFLCC1DF

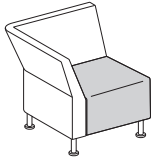

TRUE CORNER CHAIR

Multi-Fabric

DIMENSIONS

Depth:	28½	Seat to Floor Height:	17
Width:	28½	Usable Seat Depth:	21
Height:	28	Ship Weight:	60
Seat Depth:	20½	Cube:	21.9
Seat Width:	20½	COM:	See page 346
Back Width:	22¼	Weight Rating:	300 lbs.
Back Height:	18½		

FABRIC PRICE CODES

1	\$2110	
	<i>Add to Base Price Above</i>	
	Back	Seat
2	\$51	\$51
3	\$101	\$101
4	\$151	\$151
5	\$216	\$216
6	\$281	\$281
7	\$345	\$345
8	\$410	\$410
9	\$475	\$475
10	\$540	\$540
11	\$605	\$605
12	\$669	\$669
L	\$418	\$418

! Leg options – Standard Leg (L), Tapered Square (TS) and Tapered Round (TR) are available in Textured Silver (PR8) and Textured Charcoal (P7A) only. Hard Casters (H) are available on Black (T) only.

HFLWI45DF

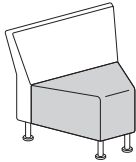

INSIDE WEDGE

Multi-Fabric

DIMENSIONS

Depth:	26¼	Seat to Floor Height:	17
Width:	31½	Usable Seat Depth:	19
Height:	28	Ship Weight:	45
Seat Depth:	19½	Cube:	21.9
Seat Width:	25¾	COM:	See page 346
Back Width:	31½	Weight Rating:	300 lbs.
Back Height:	18½		

FABRIC PRICE CODES

1	\$2108	
	<i>Add to Base Price Above</i>	
	Back	Seat
2	\$51	\$51
3	\$101	\$101
4	\$151	\$151
5	\$216	\$216
6	\$281	\$281
7	\$345	\$345
8	\$410	\$410
9	\$475	\$475
10	\$540	\$540
11	\$605	\$605
12	\$669	\$669
L	\$418	\$418

! Leg options – Standard Leg (L), Tapered Square (TS) and Tapered Round (TR) are available in Textured Silver (PR8) and Textured Charcoal (P7A) only. Hard Casters (H) are available on Black (T) only.

HFLWO45DF

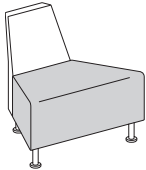

OUTSIDE WEDGE

Multi-Fabric

DIMENSIONS

Depth:	26¼	Seat to Floor Height:	17
Width:	32	Usable Seat Depth:	19
Height:	28	Ship Weight:	35
Seat Depth:	19½	Cube:	21.9
Seat Width:	32	COM:	See page 346
Back Width:	16¼	Weight Rating:	300 lbs.
Back Height:	18½		

FABRIC PRICE CODES

1	\$2108	
	<i>Add to Base Price Above</i>	
	Back	Seat
2	\$51	\$51
3	\$101	\$101
4	\$151	\$151
5	\$216	\$216
6	\$281	\$281
7	\$345	\$345
8	\$410	\$410
9	\$475	\$475
10	\$540	\$540
11	\$605	\$605
12	\$669	\$669
L	\$418	\$418

! Leg options – Standard Leg (L), Tapered Square (TS) and Tapered Round (TR) are available in Textured Silver (PR8) and Textured Charcoal (P7A) only. Hard Casters (H) are available on Black (T) only.

HOW TO SPECIFY

HON Recommendation: HFLCC1DF.TS.PNS___.PNS___.PR8 - List Price \$2291

<p>Select Model Number</p> <p>HFLCC1DF.</p>	<p>Select Leg Option</p> <p>L Standard Leg TS Tapered Square TR Tapered Round H Hard Casters</p> <p>TS.</p>	<p>Select Back Fabric</p> <p>See page 329</p> <p>PNS004.</p>	<p>Select Seat Fabric</p> <p>See page 329</p> <p>PNS007.</p>	<p>Select Leg Color</p> <p>PR8 Textured Silver P7A Textured Charcoal</p> <p><i>Specify for Standard, Tapered Round and Tapered Square legs only</i></p> <p>T Black Hard Caster <i>Specify for Hard Caster option only</i></p> <p>PR8</p>
--	---	---	---	---

FLOCK® Base Frames and Legs

OPEN MARKET



Icon Legend on page 19

	DESCRIPTION	MODEL	SHIP WEIGHT	CUBE	LIST PRICE
	Two-Seat Base Frame	HFLB2	25	5.9	\$532
	Three-Seat Base Frame	HFLB3	33	7.8	\$663

HOW TO SPECIFY

<p>Select Model Number</p> <p>H F L B 2 .</p>	<p>Select Leg Option</p> <p>RS Round Straight Leg TS Tapered Square Leg (+ \$79)</p> <p>Select Leg Color</p> <p>PR8 Textured Silver P7A Textured Charcoal</p> <p>R S P R 8</p>
--	--

	DESCRIPTION	MODEL	SHIP WEIGHT	CUBE	LIST PRICE
	Tapered Square Leg — Shroud Pack	HTSSRD	2	1.0	\$103

HOW TO SPECIFY

<p>Select Model Number</p> <p>H T S S R D .</p>	<p>Select Leg Color</p> <p>PR8 Textured Silver P7A Textured Charcoal</p> <p>P R 8</p>
--	--

SEATING

MODEL OPTIONS

SHELL COLOR

CODE	DESCRIPTION	PRICE
LA	Lava	+\$0
ON	Onyx	+\$0
PT	Platinum	+\$0
SD	Shadow	+\$0

HFCG6
HFCG6DF -
Multi-Fabric



Guest Chair
4-Leg

HFCS64L
HFCS64LDF -
Multi-Fabric



Counter-Height Stool
4-Leg

HFSS74L
HFSS74LDF -
Multi-Fabric



Bar/Café-Height Stool
4-Leg

4-LEG STOOL, METAL LEG COLOR

CODE	DESCRIPTION	PRICE
PR8	Textured Silver	+\$0

HFCG6WD
HFCGWDDF -
Multi-Fabric



Guest Chair
Wood Leg

HFCS64LWD
HFCS64LWDDF -
Multi-Fabric



Counter-Height Stool
Wood Leg

HFSS74LWD
HFSS74LWDDF -
Multi-Fabric



Bar/Café-Height Stool
Wood Leg

WOOD LEG COLOR

CODE	DESCRIPTION	PRICE
LE579	Florence Walnut	+\$0
LE518	Kingswood Walnut	+\$0
LE800	Natural Maple	+\$0
LE679	Pinnacle	+\$0
LE495	Sterling Ash	+\$0
LE394	Lowell Ash	+\$0
LE896	Natural Recon	+\$0
LE912	Phantom Ecru	+\$0
LE150	Portico Teak	+\$0
LE625	Skyline Walnut	+\$0

4-LEG STOOL, FOOTRING COLOR

CODE	DESCRIPTION	PRICE
P8X	Solar Black	+\$0
P7A	Textured Charcoal	+\$0
PR8	Textured Silver	+\$0

HFCL2
HFCL2DF - Multi-Fabric



Wide Lounge Chair
With 4-Star Return-to-Center

HFLSC2
HFLSC2DF - Multi-Fabric



Square Chair
With 4-Star Return-to-Center

BASE COLOR

CODE	DESCRIPTION	PRICE
4S	4-Star Return-to-Center	+\$0

Available in the following finishes:

PR8	Textured Silver
P7A	Textured Charcoal



HFSG6



GUEST CHAIR

4-Leg

DIMENSIONS

Depth:	23 ⁵ / ₁₆	Seat to Floor Height:	18 ¹ / ₄
Width:	19	Usable Seat Depth:	16 ⁷ / ₈
Height:	32 ¹ / ₂	Ship Weight:	27
Seat Depth:	16 ⁷ / ₈	Cube:	12.5
Seat Width:	19	COM:	2.0
Back Width:	19	Weight Rating:	300 lbs.
Back Height:	14 ¹ / ₄		

FABRIC PRICE CODES

1	\$794	8	\$1083
2	\$845	9	\$1121
3	\$895	10	\$1158
4	\$932	11	\$1196
5	\$970	12	\$1233
6	\$1008	L	\$1212
7	\$1045		

HFCS64L



COUNTER-HEIGHT STOOL

4-Leg

DIMENSIONS

Depth:	20 ⁵ / ₈	Seat to Floor Height:	23 ⁷ / ₈
Width:	17 ¹ / ₂	Usable Seat Depth:	15 ⁷ / ₈
Height:	34 ¹ / ₄	Ship Weight:	35
Seat Depth:	15 ⁵ / ₈	Cube:	12.6
Seat Width:	18	COM:	1.5
Back Width:	18	Weight Rating:	300 lbs.
Back Height:	10 ⁷ / ₈		

FABRIC PRICE CODES

1	\$959	8	\$1249
2	\$1010	9	\$1286
3	\$1061	10	\$1326
4	\$1098	11	\$1370
5	\$1135	12	\$1415
6	\$1173	L	\$1530
7	\$1209		

HFSS74L



BAR/CAFÉ-HEIGHT STOOL

4-Leg

DIMENSIONS

Depth:	21 ¹ / ₈	Seat to Floor Height:	30
Width:	18	Usable Seat Depth:	15 ⁷ / ₈
Height:	40 ⁷ / ₈	Ship Weight:	37
Seat Depth:	15 ⁷ / ₈	Cube:	12.6
Seat Width:	18	COM:	1.5
Back Width:	18	Weight Rating:	300 lbs.
Back Height:	10 ⁷ / ₈		

FABRIC PRICE CODES

1	\$998	8	\$1287
2	\$1049	9	\$1325
3	\$1099	10	\$1362
4	\$1136	11	\$1400
5	\$1174	12	\$1437
6	\$1212	L	\$1416
7	\$1249		

HON Recommendation: HFSG6.PURL__PR8 - List Price \$895

HOW TO SPECIFY

<p>Select Model Number</p> <p>HFSS74L</p>	<p>Select Fabric</p> <p>See page 329</p> <p>PURL12</p>	<p>Select Leg Color</p> <p>See page 339</p> <p>PR8</p>
--	---	---



HF CG6WD



GUEST CHAIR

Wood Leg

DIMENSIONS

Depth:	23 ³ / ₄	Seat to Floor Height:	18
Width:	22 ² / ₈	Usable Seat Depth:	16 ⁷ / ₈
Height:	32	Ship Weight:	27
Seat Depth:	16 ¹ / ₈	Cube:	12.5
Seat Width:	19	COM:	2.0
Back Width:	19	Weight Rating:	300 lbs.
Back Height:	14 ¹ / ₄		

FABRIC PRICE CODES

1	\$1127	8	\$1417
2	\$1178	9	\$1454
3	\$1229	10	\$1494
4	\$1266	11	\$1538
5	\$1303	12	\$1583
6	\$1341	L	\$1698
7	\$1377		

HF CS64LWD



COUNTER-HEIGHT STOOL

Wood Leg

DIMENSIONS

Depth:	19 ¹ / ₂	Seat to Floor Height:	23 ⁵ / ₈
Width:	19 ³ / ₈	Usable Seat Depth:	15 ¹ / ₈
Height:	34 ¹ / ₂	Ship Weight:	30
Seat Depth:	15 ⁵ / ₈	Cube:	12.6
Seat Width:	18	COM:	1.5
Back Width:	18	Weight Rating:	300 lbs.
Back Height:	10 ⁷ / ₈		

FABRIC PRICE CODES

1	\$1293	8	\$1583
2	\$1344	9	\$1620
3	\$1395	10	\$1660
4	\$1432	11	\$1704
5	\$1469	12	\$1749
6	\$1507	L	\$1864
7	\$1543		

HF SS74LWD



BAR/CAFÉ-HEIGHT STOOL

Wood Leg

DIMENSIONS

Depth:	20 ¹ / ₂	Seat to Floor Height:	29 ¹ / ₂
Width:	20 ³ / ₄	Usable Seat Depth:	15 ⁷ / ₈
Height:	40 ¹ / ₂	Ship Weight:	31
Seat Depth:	15 ⁷ / ₈	Cube:	12.6
Seat Width:	18	COM:	1.5
Back Width:	18	Weight Rating:	300 lbs.
Back Height:	10 ⁷ / ₈		

FABRIC PRICE CODES

1	\$1332	8	\$1622
2	\$1383	9	\$1659
3	\$1434	10	\$1699
4	\$1471	11	\$1743
5	\$1508	12	\$1788
6	\$1546	L	\$1903
7	\$1582		

HON Recommendation: HF CG6WD.PURL__D - List Price \$1229

HOW TO SPECIFY

<p>Select Model Number</p> <p>HF CG6WD .</p>	<p>Select Fabric</p> <p>See page 329</p> <p>PURL12 .</p>	<p>Select Wood Leg Color</p> <p>See page 339</p> <p>D .</p>	<p>Select Footring Color</p> <p><i>Specify for Stools only</i></p> <p>See page 339</p> <p>P7A</p>
---	---	--	--



HFCL2



WIDE LOUNGE CHAIR

with 4-Star Return-to-Center

DIMENSIONS

Depth:	27½	Seat to Floor Height:	17
Width:	26¾	Usable Seat Depth:	19
Height:	32¼	Ship Weight:	53
Seat Width:	26	Cube:	25.1
Back Width:	25½	COM:	2.5
Back Height:	19½	Weight Rating:	300 lbs.

FABRIC PRICE CODES

1	\$1350	8	\$1783
2	\$1426	9	\$1840
3	\$1501	10	\$1896
4	\$1557	11	\$1952
5	\$1614	12	\$2009
6	\$1670	L	\$1977
7	\$1727		

HFLSC2



SQUARE CHAIR

with 4-Star Return-to-Center

DIMENSIONS

Depth:	26½	Seat to Floor Height:	18
Width:	27½	Usable Seat Depth:	18¾
Height:	32¼	Ship Weight:	46
Seat Width:	17½	Cube:	25.1
Back Width:	16	COM:	See note
Back Height:	17¾	Weight Rating:	300 lbs.

FABRIC PRICE CODES

1	\$1945	8	\$2378
2	\$2021	9	\$2435
3	\$2096	10	\$2491
4	\$2152	11	\$2547
5	\$2209	12	\$2604
6	\$2265	L	\$2572
7	\$2322		

NOTES: Due to fabric limitations, COM is unavailable for back upholstery. See HFLSC2DF for COM available on the seat only.

HON Recommendation: HFLSC2.PURL__4SPR8 - List Price \$2096

HOW TO SPECIFY

<p>Select Model Number</p> <p>H F L S C 2</p>	<p>Select Fabric</p> <p>See page 329</p> <p>P U R L 1 2</p>	<p>Select Base Option</p> <p>See page 339</p> <p>4 S P R 8</p>
--	--	---



HFCG6DF



GUEST CHAIR

4-Leg, Multi-Fabric

DIMENSIONS

Depth:	23 ⁵ / ₁₆	Seat to Floor Height:	18 ¹ / ₄
Width:	19	Usable Seat Depth:	16 ⁷ / ₈
Height:	32 ¹ / ₂	Ship Weight:	27
Seat Depth:	16 ⁷ / ₈	Cube:	12.5
Seat Width:	19	COM:	See page 346
Back Width:	19	Weight Rating:	300 lbs.
Back Height:	14 ¹ / ₄		

FABRIC PRICE CODES

1	\$890	
<i>Add to Base Price Above</i>		
	Back	Seat
2	\$26	\$26
3	\$51	\$51
4	\$69	\$69
5	\$88	\$88
6	\$107	\$107
7	\$126	\$126
8	\$145	\$145
9	\$164	\$164
10	\$182	\$182
11	\$201	\$201
12	\$220	\$220
L	\$209	\$209

HFCS64LDF



COUNTER-HEIGHT STOOL

4-Leg, Multi-Fabric

DIMENSIONS

Depth:	20 ³ / ₈	Seat to Floor Height:	23 ⁷ / ₈
Width:	17 ¹ / ₂	Usable Seat Depth:	15 ⁷ / ₈
Height:	34 ¹ / ₄	Ship Weight:	35
Seat Depth:	15 ⁵ / ₈	Cube:	12.6
Seat Width:	18	COM:	See page 346
Back Width:	18	Weight Rating:	300 lbs.
Back Height:	10 ⁷ / ₈		

FABRIC PRICE CODES

1	\$1055	
<i>Add to Base Price Above</i>		
	Back	Seat
2	\$26	\$26
3	\$51	\$51
4	\$69	\$69
5	\$88	\$88
6	\$107	\$107
7	\$126	\$126
8	\$145	\$145
9	\$164	\$164
10	\$184	\$184
11	\$206	\$206
12	\$228	\$228
L	\$286	\$286

HFSS74LDF



BAR/CAFÉ-HEIGHT STOOL

4-Leg, Multi-Fabric

DIMENSIONS

Depth:	21 ⁷ / ₈	Seat to Floor Height:	30
Width:	18	Usable Seat Depth:	15 ⁷ / ₈
Height:	40 ⁷ / ₈	Ship Weight:	37
Seat Depth:	15 ⁵ / ₈	Cube:	12.6
Seat Width:	18	COM:	See page 346
Back Width:	18	Weight Rating:	300 lbs.
Back Height:	10 ⁷ / ₈		

FABRIC PRICE CODES

1	\$1094	
<i>Add to Base Price Above</i>		
	Back	Seat
2	\$26	\$26
3	\$51	\$51
4	\$69	\$69
5	\$88	\$88
6	\$107	\$107
7	\$126	\$126
8	\$145	\$145
9	\$164	\$164
10	\$182	\$182
11	\$201	\$201
12	\$220	\$220
L	\$209	\$209

HON Recommendation: HFCG6DF.PURL__PURL__.PR8 - List Price \$992

HOW TO SPECIFY

Select Model Number HFSS74LDF	Select Back Fabric See page 329 PURL12	Select Seat Fabric See page 329 PURL12	Select Leg Color See page 339 PR8
---	---	---	--



HF CG6WDDF

GUEST CHAIR

Wood Leg, Multi-Fabric



DIMENSIONS

Depth:	23 ³ / ₄	Seat to Floor Height:	18
Width:	22 ³ / ₈	Usable Seat Depth:	16 ⁷ / ₈
Height:	32	Ship Weight:	27
Seat Depth:	16 ⁷ / ₈	Cube:	12.5
Seat Width:	19	COM:	See page 346
Back Width:	19	Weight Rating:	300 lbs.
Back Height:	14 ¹ / ₄		

FABRIC PRICE CODES

1	\$1223	
	<i>Add to Base Price Above</i>	
	Back	Seat
2	\$26	\$26
3	\$51	\$51
4	\$69	\$69
5	\$88	\$88
6	\$107	\$107
7	\$126	\$126
8	\$145	\$145
9	\$164	\$164
10	\$184	\$184
11	\$206	\$206
12	\$228	\$228
L	\$286	\$286

HF CS64LWDDF COUNTER-HEIGHT STOOL

Wood Leg, Multi-Fabric



DIMENSIONS

Depth:	19 ¹ / ₂	Seat to Floor Height:	23 ⁵ / ₈
Width:	19 ³ / ₈	Usable Seat Depth:	15 ⁷ / ₈
Height:	34 ¹ / ₂	Ship Weight:	30
Seat Depth:	15 ⁷ / ₈	Cube:	12.6
Seat Width:	18	COM:	See page 346
Back Width:	18	Weight Rating:	300 lbs.
Back Height:	10 ⁷ / ₈		

FABRIC PRICE CODES

1	\$1389	
	<i>Add to Base Price Above</i>	
	Back	Seat
2	\$26	\$26
3	\$51	\$51
4	\$69	\$69
5	\$88	\$88
6	\$107	\$107
7	\$126	\$126
8	\$145	\$145
9	\$164	\$164
10	\$184	\$184
11	\$206	\$206
12	\$228	\$228
L	\$286	\$286

HF SS74LWDDF BAR/CAFÉ-HEIGHT STOOL

Wood Leg, Multi-Fabric



DIMENSIONS

Depth:	20 ¹ / ₂	Seat to Floor Height:	29 ¹ / ₂
Width:	20 ³ / ₄	Usable Seat Depth:	15 ⁷ / ₈
Height:	40 ¹ / ₂	Ship Weight:	31
Seat Depth:	15 ⁷ / ₈	Cube:	12.6
Seat Width:	18	COM:	See page 346
Back Width:	18	Weight Rating:	300 lbs.
Back Height:	10 ⁷ / ₈		

FABRIC PRICE CODES

1	\$1428	
	<i>Add to Base Price Above</i>	
	Back	Seat
2	\$26	\$26
3	\$51	\$51
4	\$69	\$69
5	\$88	\$88
6	\$107	\$107
7	\$126	\$126
8	\$145	\$145
9	\$164	\$164
10	\$184	\$184
11	\$206	\$206
12	\$228	\$228
L	\$286	\$286

HON Recommendation: HF CG6WDDF.PURL___.PURL___.D - List Price \$1325

HOW TO SPECIFY

Select Model Number HFSS74LWDDF	Select Back Fabric See page 329 PURL12	Select Seat Fabric See page 329 PURL12	Select Wood Leg Color See page 339 D	Select Footring Color Specify for Stools only See page 339 P7A
---	---	---	---	--



FLOCK® Multi-Fabric Collaborative

HFCL2DF



WIDE LOUNGE CHAIR

with 4-Star Return-to-Center

DIMENSIONS

Depth:	27½	Seat to Floor Height:	17
Width:	26¾	Usable Seat Depth:	19
Height:	32¼	Ship Weight:	53
Seat Width:	26	Cube:	25.1
Back Width:	25½	COM:	See page 346
Back Height:	19½	Weight Rating:	300 lbs.

FABRIC PRICE CODES

1	\$1446	
<i>Add to Base Price Above</i>		
	Back	Seat
2	\$38	\$38
3	\$113	\$113
4	\$170	\$170
5	\$226	\$226
6	\$283	\$283
7	\$339	\$339
8	\$396	\$396
9	\$452	\$452
10	\$508	\$508
11	\$565	\$565
12	\$621	\$621
L	\$314	\$314

HFLSC2DF



SQUARE CHAIR

with 4-Star Return-to-Center

DIMENSIONS

Depth:	26½	Seat to Floor Height:	18
Width:	27½	Usable Seat Depth:	18¾
Height:	32¼	Ship Weight:	46
Seat Width:	17½	Cube:	25.1
Back Width:	16	COM:	See note
Back Height:	17¾	Weight Rating:	300 lbs.

FABRIC PRICE CODES

1	\$2041	
<i>Add to Base Price Above</i>		
	Back	Seat
2	\$51	\$26
3	\$126	\$101
4	\$182	\$157
5	\$239	\$214
6	\$295	\$270
7	\$352	\$327
8	\$408	\$383
9	\$464	\$439
10	\$521	\$496
11	\$577	\$552
12	\$634	\$609
L	\$418	\$209

NOTES: Due to fabric limitations, COM is unavailable for back upholstery. See HFLSC2DF for COM available on the seat only.

HON Recommendation: HFLSC2DF.PURL___.PURL___.4SPR8 - List Price \$2268

HOW TO SPECIFY

<p>Select Model Number</p> <p>H F L S C 2 D F .</p>	<p>Select Back Fabric</p> <p>See page 329</p> <p>P U R L 1 2 .</p>	<p>Select Seat Fabric</p> <p>See page 329</p> <p>P U R L 1 2 .</p>	<p>Select Base Option</p> <p>See page 339</p> <p>4 S P R 8</p>
--	---	---	---

FLOCK® Options

MODEL OPTIONS

HFLC01
HFLC01DF - Multi-Fabric

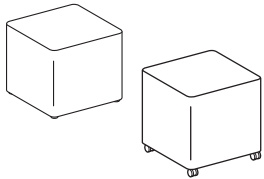

Mini Cube

HFLY01
HFLY01DF - Multi-Fabric

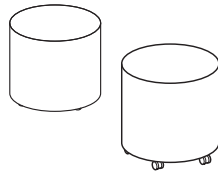

Mini Cylinder

CASTER/ GLIDES

CODE	DESCRIPTION	PRICE
A	Active Base*	+\$79
<i>*Available on models HFLY01 and HFLY01DF only</i>		
H	Hard Caster	+\$0
HG	Hidden Glide	+\$0
LPR8	Textured Silver Disc Glide	+\$48
LP7A	Textured Charcoal Disc Glide	+\$48

MULTI-FABRIC COM YARDAGE

Due to fabric pattern nesting and potential reduction of fabric yield, some multi-fabric models may require more total yardage than standard models.

MODEL	BACK COM	SEAT COM
HFLMC1DF	1.6	1.5
HFLML1DF	2.9	1.4
HFLMR1DF	2.9	1.4
HFCS64DF/HFCGCWDDF	1.0	1.5
HFCS64LDF/HFCS64LWDDF	1.0	1.0
HFSS74LDF/HFSS74LDF	1.0	1.0
HFLW145DF	2.3	1.4
HFLW045DF	1.0	1.4
HFLCC1DF	3.6	1.4
HFCL2DF	N/A	2.0
HFLSC2DF	N/A	3.0
	TOP	SIDE
HFLC01DF	0.7	1.2
HFLY01DF	0.7	1.2

HON BRANDED FABRICS

GRADE 1

Apex
Centurion
Compass
Contourett
Dapper
Ensemble
Hamilton
Inertia
Noble Seating
Optic
Pebble
Vibe

GRADE 2

Appoint Seating
Blume
Clyde
Doty
Kai
Rush
Spin Seating
Wavelength
Whisper Vinyl

GRADE 3

Bradbury
Getaway
Moxie
Notion
Parker
Purl
Quill
Saxony

GRADE 4

Constance with Supreen™
Livi with Supreen™
Lugano with Supreen™
Oxford with Supreen™

GRADE L

Denver Leather

For a complete list of fabrics, including partnership fabrics, go to hon.com/fabricsandfinishes.

Reference Fabric Color Combinations on pages 20-24 for color codes and legend on page 21 for lead times.



Mini Cube and Cylinders

HFLCO1

MINI CUBE

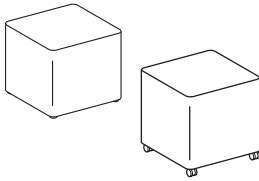

DIMENSIONS

Depth:	18½	Seat to Floor Height:	17
Width:	18½	Usable Seat Depth:	18½
Height:	17	Ship Weight:	15
Seat Depth:	18½	Cube:	5.0
Seat Width:	18½	COM:	2.0
		Weight Rating:	300 lbs.

FABRIC PRICE CODES

1	\$601	8	\$818
2	\$639	9	\$846
3	\$677	10	\$874
4	\$705	11	\$902
5	\$733	12	\$931
6	\$761	L	\$915
7	\$790		

HFLYO1

MINI CYLINDER

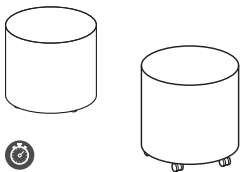

DIMENSIONS

Depth:	18½	Seat to Floor Height:	17
Width:	18½	Usable Seat Depth:	18½
Height:	17	Ship Weight:	13
Seat Depth:	18½	Cube:	5.0
Seat Width:	18½	COM:	2.0
		Weight Rating:	300 lbs.

FABRIC PRICE CODES

1	\$600	8	\$817
2	\$638	9	\$845
3	\$676	10	\$873
4	\$704	11	\$901
5	\$732	12	\$930
6	\$760	L	\$914
7	\$789		

HON Recommendation: HFLYO1.LPR8.PNS__ - List Price \$686

HOW TO SPECIFY

<p>Select Model Number</p> <p>H F L Y O 1 .</p>	<p>Select Base</p> <p>A Active Base* (+ \$79) *Available on model HFLYO1 only</p> <p>H Caster</p> <p>HG Hidden Glide</p> <p>LPR8 Textured Silver Disc Glide (+ \$48)</p> <p>LP7A Textured Charcoal Disc Glide (+ \$48)</p> <p>L P R 8 .</p>	<p>Select Fabric</p> <p>See page 346</p> <p>P N S 0 0 7 .</p>
---	--	---

FLOCK® Multi-Fabric Mini Cube and Cylinder

GSA SIN 33721



Icon Legend on page 19

HFLCO1DF

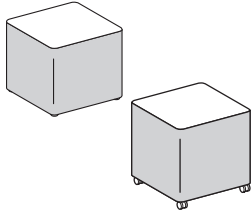

MINI CUBE

Multi-Fabric

DIMENSIONS

Depth:	18½	Seat to Floor Height:	17
Width:	18½	Usable Seat Depth:	18½
Height:	17	Ship Weight:	15
Seat Depth:	18½	Cube:	5.0
Seat Width:	18½	COM:	See page 346
		Weight Rating:	300 lbs.

FABRIC PRICE CODES

1	\$697	
<i>Add to Base Price Above</i>		
	Top	Sides
2	\$12	\$27
3	\$23	\$53
4	\$32	\$73
5	\$40	\$92
6	\$49	\$112
7	\$57	\$132
8	\$65	\$152
9	\$74	\$172
10	\$82	\$192
11	\$90	\$212
12	\$100	\$231
L	\$95	\$220

HFLYO1DF

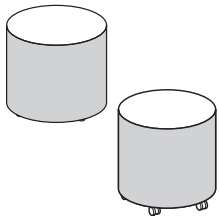

MINI CYLINDER

Multi-Fabric

DIMENSIONS

Depth:	18½	Seat to Floor Height:	17
Width:	18½	Usable Seat Depth:	18½
Height:	17	Ship Weight:	13
Seat Depth:	18½	Cube:	5.0
Seat Width:	18½	COM:	See page 346
		Weight Rating:	300 lbs.

FABRIC PRICE CODES

1	\$696	
<i>Add to Base Price Above</i>		
	Top	Sides
2	\$12	\$27
3	\$23	\$53
4	\$32	\$73
5	\$40	\$92
6	\$49	\$112
7	\$57	\$132
8	\$65	\$152
9	\$74	\$172
10	\$82	\$192
11	\$90	\$212
12	\$100	\$231
L	\$95	\$220

HON Recommendation: HFLCO1DF.HG.PNS___.PNS__ - List Price \$736

SEATING

HOW TO SPECIFY

Select Model Number HFLCO1DF	Select Base A Active Base* (+ \$79) <i>*Available on model HFLYO1DF only</i> H Caster HG Hidden Glide LPR8 Textured Silver Disc Glide (+ \$48) LP7A Textured Charcoal Disc Glide (+ \$48)	Select Top Fabric See page 346 PNS007	Select Side Fabric See page 346 PNS004
--	--	--	---



Gateway™ Chairs shown
with Huddle Tables.

GATEWAY™

So you need a new chair, but it has to look as cool as it is comfortable. We've got you covered. Gateway takes the complexity out of finding the perfect chair by focusing on exactly what you're looking for. Cool, breathable mesh. Personalized seat fabrics. Targeted back support. Just what you need. Nothing you don't. All at a price you'll have to look at twice to make sure it's not a typo.



FEATURES

- Seat has comfortable, waterfall edge.
- Mesh back material flexes for a relaxed fit.
- Adjustable lumbar.
- Adjustable tilt to recline based on body type.
- Three arm options.
- Carton is 2 cubic feet smaller than the industry average.

GATEWAY™ Fabric Options

HON BRANDED FABRICS

GRADE 1

Centurion
Contourett

GRADE 2

Dotty

For a complete list of fabrics, including partnership fabrics, go to hon.com/fabricsandfinishes.

Reference Fabric Color Combinations on pages 20-24 for color codes and legend on page 21 for lead times.



GATEWAY™ Standard Task Chair

HGTMM



TASK CHAIR

Mesh Back

- Pneumatic
- Swivel
- Tilt Tension
- Tilt Lock
- Adjustable Lumbar Support

Functions: **A, E, F, K, L, W**
(Function Key on pages 250-251)

NOTES: **HON 5-Year Limited Warranty.**

DIMENSIONS

Depth:	25¼	Seat to Floor Height:	17-22
Width:	27	Usable Seat Depth:	19
Height:	38	Ship Weight:	35
Seat Depth:	19	Cube:	3.4
Seat Width:	18½	Weight Rating:	250 lbs.
Back Width:	18		
Back Height:	18½		

FABRIC PRICE CODES

1	\$374
2	\$387

HON Recommendation: HGTMM.Z1.H.H.M.CU__AL.SB.T - List Price \$432

HOW TO SPECIFY

Select Model Number	Select Control Type	Select Arm Type	Select Caster	Select Back Type	Select Fabric	Select Lumbar	Select Base	Select Frame
Z1	Swivel-Tilt Control	N Armless F Fixed Arms (+ \$37) H Height-Adjustable Arms (+ \$58)	H Black Hard Caster	M Mesh	See page 350	AL Adjustable Lumbar	SB Standard Base	T Black
HGTMM	Z1	H	H	M	CU10	AL	SB	T

GATEWAY™ Value Task Chair

OPEN MARKET



Icon Legend on page 19

HGV1MM



TASK CHAIR VALUE MODEL

- Mesh Back**
- Pneumatic
- Swivel
- Tilt Tension
- Tilt Lock
- Adjustable Lumbar Support

Functions: **A, E, F, K, L, W**
(Function Key on pages 250-251)

NOTES: **HON 5-Year Limited Warranty.**

DIMENSIONS

Depth:	25¼	Seat to Floor Height:	17-22
Width:	27	Usable Seat Depth:	19
Height:	38	Ship Weight:	35
Seat Depth:	19	Cube:	3.4
Seat Width:	18½	Weight Rating:	250 lbs.
Back Width:	18		
Back Height:	18½		

LIST PRICE

\$333

HON Recommendation: HGV1MM.Z1.H.H.M.ACCF10.AL.SB.T - List Price \$391

SEATING

HOW TO SPECIFY

Select Model Number	Select Control Type	Select Arm Type	Select Caster	Select Back Type	Select Fabric	Select Lumbar	Select Base	Select Frame
Z1	Z1 Swivel-Tilt Control	N Armless F Fixed Arms (+ \$37) H Height-Adjustable Arms (+ \$58)	H Black Hard Caster	M Mesh	ACCF10 Black	AL Adjustable Lumbar	SB Standard Base	T Black
HGV1MM	Z1	H	H	M	ACCF10	AL	SB	T



Grove® Lounge shown with Flock® Table.

GROVE®

Find a comfy place to put your feet up, huddle up, and power up. Grove is versatile lounge seating designed to help you greet, meet, focus, relax, and accomplish more. This change-of-pace collection delivers the comfort people crave, while encouraging focus and interaction throughout the workplace. Grove's attractive design is rivaled only by its flexibility. Models include a single seat, two-seat, three-seat, and two-seat with table — all with three arm style and two leg style options, as well as accessories that support connectivity and collaboration. Grove has the look you're going for, and the comfort and versatility people have been waiting for.



FEATURES

- Each model can be combined to create arrangements suitable for any space.
- Optional integrated worksurfaces create more personal space and provide a convenient worksurface.
- Design complements Flock ottomans and tables.
- Integrated power grommets keep laptops and phones powered up anywhere.
- The multi-fabric option coordinates two high-quality HON fabrics for a contemporary look.
- Choose from Single Seat, Two-Seat, Three-Seat Lounge, or Two-Seat with Table options.
- Choose from 3 arm options — Armless (N), Straight Arms (A), or Tapered Arms (B).
- Table available with two grommets and an accessory port option.
- Offers a table between the seats that provides separation and a usable worksurface.
- Warranted for users up to 300 lbs.

MODEL OPTIONS

HML1S
HML1SDF - Multi-Fabric

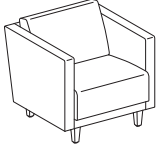

Lounge
Single Seat

HML2S
HML2SDF - Multi-Fabric

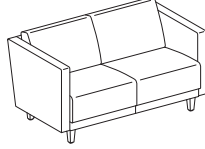

Lounge
Two-Seat

HML3S
HML3SDF - Multi-Fabric

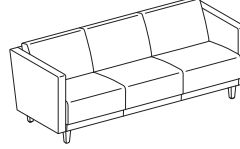

Lounge
Three-Seat

HML2ST
HML2STDF - Multi-Fabric

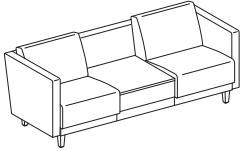

Lounge
Two-Seat with Table

ARM STYLE

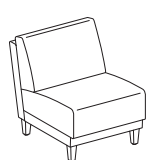

CODE	DESCRIPTION	PRICE
N	Armless	+\$0

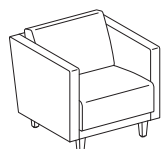

A	Straight Arms	+\$314
----------	---------------	---------------

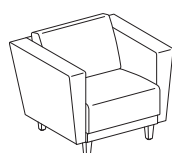

B	Tapered Arms	+\$366
----------	--------------	---------------

L1 LAMINATE	COLOR CODE
Black	P
Bourbon Cherry	H
Designer White	LDW1
Charcoal	S
Cognac	COGN
Field Elm	LWFE
Florence Walnut	LFW1
Harvest	C
Kingswood Walnut	LKI1
Loft	LOFT
Mahogany	N
Mocha	MOCH
Natural Maple	D
Pinnacle	PINC
Shaker Cherry	F
Sterling Ash	LSA1

L2 LAMINATE	COLOR CODE
Beigewood	LWBE
Fawn Cypress	LFC1
Lowell Ash	LLA1
Natural Recon	LNRI
Phantom Ecu	LPE1
Portico Teak	LPT1
Skyline Walnut	LSW1

*Specify for models HML2ST and HML2STDF only

LEG STYLE



CODE	DESCRIPTION	PRICE
TS	Tapered Square	+\$0



TR	Tapered Round	+\$0
-----------	---------------	-------------

LEG COLOR

CODE	DESCRIPTION	PRICE
PR8	Textured Silver	+\$0
P7A	Textured Charcoal	+\$0
H	Bourbon Cherry	+\$105
F	Shaker Cherry	+\$105
N	Mahogany	+\$105
C	Harvest	+\$105
D	Natural Maple	+\$105
LKI1	Kingswood Walnut	+\$105
LSW1	Skyline Walnut	+\$105
LLA1	Lowell Ash	+\$105
LSA1	Sterling Ash	+\$105
COGN	Cognac	+\$105
MOCH	Mocha	+\$105
PINC	Pinnacle	+\$105
LNRI	Natural Recon	+\$105
LPE1	Phantom Ecu	+\$105
LPT1	Portico Teak	+\$105

CUT OUT

CODE	DESCRIPTION	PRICE
N	No Cutout	+\$0
G	Round Grommet Cutout	+\$32
G1	Pop-Up Port Cutout	+\$42

*Specify for models HML2ST and HML2STDF only

ACCESSORY PORT LOCATION

CODE	DESCRIPTION	PRICE
0	No Port	+\$0
2	Two Tablet Ports Opposite	+\$21

*Specify for models HML2ST and HML2STDF only

GROVE® Fabric Options

HON BRANDED FABRICS

GRADE 1	GRADE 2	GRADE 3	GRADE 4	GRADE L
Apex	Appoint Seating	Bradbury	Constance with Supreen™	Denver Leather
Centurion	Blume	Getaway	Livi with Supreen™	
Compass	Clyde	Moxie	Lugano with Supreen™	
Contourett	Dotty	Notion	Oxford with Supreen™	
Dapper	Kai	Parker		
Ensemble	Rush	Purl		
Hamilton	Spin Seating	Quill		
Inertia	Wavelength	Saxony		
Noble Seating	Whisper Vinyl			
Optic				
Pebble				
Vibe				

For a complete list of fabrics, including partnership fabrics, go to hon.com/fabricsandfinishes.

Reference Fabric Color Combinations on pages 20-24 for color codes and legend on page 21 for lead times. For additional HON to Supply COM fabric grade pricing, go to honready.hon.com and click on the HON to Supply COM link.

For more details on Upholstery Pattern Match for this series, please see page 14.

ⓘ Due to the inherent characteristics of upholstery materials, the seat of Grove® may become more relaxed to show wrinkles over time.

MULTI-FABRIC COM YARDAGE

Due to fabric pattern nesting and potential reduction of fabric yield, some multi-fabric models may require more total yardage than standard models.

MODEL	COM (ARMLESS)		COM (w/ STRAIGHT ARMS)		COM (w/ TAPERED ARMS)	
	Back	Seat	Back	Seat	Back	Seat
HML1S	3		5		5	
HML1SDF	1.5	2	4	2	4	2
HML2S	5		7.5		7.5	
HML2SDF	2	3.5	4	3.5	4	3.5
HML2ST	6		8		8	
HML2STDF	3	3.5	5.5	3.5	5.5	3.5
HML3	7.5		9		9.5	
HML3DF	3	5	5.5	5	5.5	5



HML1S

LOUNGE
Single Seat

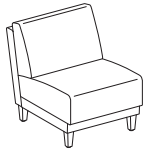

Armless

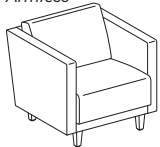

Straight Arms

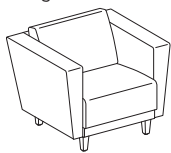

Tapered Arms

DIMENSIONS

Depth:	31½	Ship Weight (armless):	61
Height:	29¾	Ship Weight (with straight arms):	77
Seat Width:	23½	Ship Weight (with tapered arms):	85
Back Width:	23½	Cube (armless):	19.8
Back Height:	19	Cube (with straight arms):	19.8
Width (armless):	23½	Cube (with tapered arms):	19.8
Width (with straight arms):	29¾	COM:	See
Width (with tapered arms):	35		page
Arm Width:	23½		356
Seat to Floor Height:	16	Weight Rating:	300 lbs.
Usable Seat Depth:	18¾		(per seat)

FABRIC PRICE CODES

1	\$1798	8	\$2231
2	\$1874	9	\$2288
3	\$1949	10	\$2344
4	\$2005	11	\$2400
5	\$2062	12	\$2457
6	\$2118	L	\$2425
7	\$2175		

HML2S

LOUNGE
Two-Seat

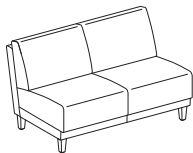

Armless

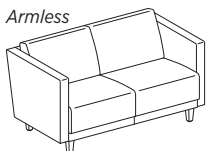

Straight Arms

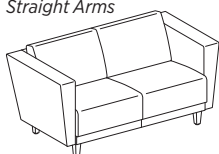

Tapered Arms

DIMENSIONS

Depth:	31½	Ship Weight (armless):	100
Height:	29¾	Ship Weight (with straight arms):	116
Seat Width:	48	Ship Weight (with tapered arms):	124
Back Width:	48	Cube (armless):	35.6
Back Height:	19	Cube (with straight arms):	35.6
Width (armless):	48	Cube (with tapered arms):	35.6
Width (with straight arms):	54¼	COM:	See
Width (with tapered arms):	59½		page
Arm Width:	48		356
Seat to Floor Height:	16	Weight Rating:	300 lbs.
Usable Seat Depth:	18¾		(per seat)

FABRIC PRICE CODES

1	\$2840	8	\$3562
2	\$2966	9	\$3656
3	\$3091	10	\$3750
4	\$3185	11	\$3844
5	\$3279	12	\$3938
6	\$3373	L	\$3885
7	\$3467		

HON Recommendation: HML1S.A.PNS__TS.P7A - List Price \$2188

HOW TO SPECIFY

Select Model Number	Select Arm Type	Select Fabric	Select Leg Type	Select Leg Color
	<p>N Armless</p> <p>A Straight Arms (+ \$314)</p> <p>B Tapered Arms (+ \$366)</p>	See page 356	<p>TS Tapered Square</p> <p>TR Tapered Round</p>	<p>PR8 Textured Silver</p> <p>P7A Textured Charcoal</p> <p>H Bourbon Cherry (+ \$105)</p> <p>F Shaker Cherry (+ \$105)</p> <p>N Mahogany (+ \$105)</p> <p>C Harvest (+ \$105)</p> <p>D Natural Maple (+ \$105)</p> <p>LK11 Kingswood Walnut (+ \$105)</p> <p>LSW1 Skyline Walnut (+ \$105)</p>
HML1S	A	PNS007	TS	P7A
				<p>LLA1 Lowell Ash (+ \$105)</p> <p>LSA1 Sterling Ash (+ \$105)</p> <p>COGN Cognac (+ \$105)</p> <p>MOCH Mocha (+ \$105)</p> <p>PINC Pinnacle (+ \$105)</p> <p>LNRI Natural Recon (+ \$105)</p> <p>LPE1 Phantom Ecru (+ \$105)</p> <p>LPT1 Portico Teak (+ \$105)</p>

! Leg options - Tapered Square (TS) and Tapered Round (TR) are available in 2 poly and 13 woodgrain options.

HML3S

LOUNGE

Three-Seat

DIMENSIONS

Depth:	31½	Ship Weight (armless):	141
Height:	29¼	Ship Weight (with straight arms):	157
Seat Width:	71½	Ship Weight (with tapered arms):	165
Back Width:	71½	Cube (armless):	48.9
Back Height:	19	Cube (with straight arms):	48.9
Width (armless):	71½	Cube (with tapered arms):	48.9
Width (with straight arms):	77½	COM:	See
Width (with tapered arms):	82½		page
Arm Width:	71½		356
Seat to Floor Height:	16	Weight Rating:	300 lbs.
Usable Seat Depth:	18¾		(per seat)

FABRIC PRICE CODES

1	\$3808	8	\$4890
2	\$3997	9	\$5031
3	\$4185	10	\$5172
4	\$4326	11	\$5313
5	\$4467	12	\$5454
6	\$4608	L	\$5376
7	\$4749		

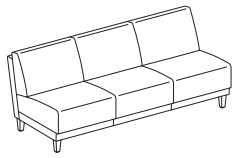

Armless

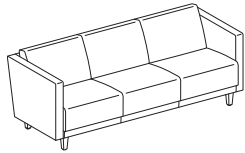

Straight Arms

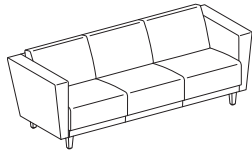

Tapered Arms

HON Recommendation: HML3S.A.PNS__TS.P7A - List Price \$4311

HOW TO SPECIFY

SEATING

Select Model Number

Select Arm Type

- N Armless
- A Straight Arms (+ \$314)
- B Tapered Arms (+ \$366)

Select Fabric

See page 356

Select Leg Type

- TS Tapered Square
- TR Tapered Round

Select Leg Color

- PR8 Textured Silver
- P7A Textured Charcoal
- H Bourbon Cherry (+ \$105)
- F Shaker Cherry (+ \$105)
- N Mahogany (+ \$105)
- C Harvest (+ \$105)
- D Natural Maple (+ \$105)
- LK11 Kingswood Walnut (+ \$105)
- LSW1 Skyline Walnut (+ \$105)
- LLA1 Lowell Ash (+ \$105)
- LSA1 Sterling Ash (+ \$105)
- COGN Cognac (+ \$105)
- MOCH Mocha (+ \$105)
- PINC Pinnacle (+ \$105)
- LNRI Natural Recon (+ \$105)
- LPE1 Phantom Ecru (+ \$105)
- LPT1 Portico Teak (+ \$105)

H M L 3 S .

A .

P N S 0 0 7 .

T S .

P 7 A

ⓘ Leg options – Tapered Square (TS) and Tapered Round (TR) are available in 2 poly and 13 woodgrain options.



HML2ST

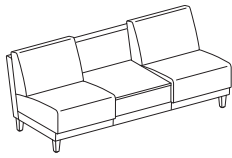

Armless

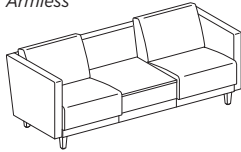

Straight Arms

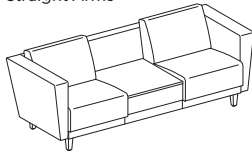

Tapered Arms

LOUNGE

Two-Seat with Table

DIMENSIONS

Depth:	31½	Ship Weight (armless):	146
Height:	29¼	Ship Weight (with straight arms):	162
Seat Width:	71½	Ship Weight (with tapered arms):	170
Back Width:	71½	Cube (armless):	48.9
Back Height:	19	Cube (with straight arms):	48.9
Width (armless):	71½	Cube (with tapered arms):	48.9
Width (with straight arms):	77½	COM:	See
Width (with tapered arms):	82½		page
Arm Width:	71½		356
Seat to Floor Height:	16	Weight Rating:	300 lbs.
Usable Seat Depth:	18¾		(per seat)

FABRIC PRICE CODES

1	\$4103	8	\$4969
2	\$4254	9	\$5082
3	\$4404	10	\$5194
4	\$4517	11	\$5307
5	\$4630	12	\$5420
6	\$4743	L	\$5357
7	\$4856		

NOTES: Offers a table between the seats that provides separation and a usable workspace. Table available with two grommet and an accessory port option.

HON Recommendation: HML2ST.A.PNS__TS.P7A.N.G1.0 - List Price \$4568

HOW TO SPECIFY

Select Model Number	Select Arm Type	Select Fabric	Select Leg Type	Select Leg Color	Select Laminate	Select Cut Out	Accessory Port Location
	N Armless A Straight Arms (+ \$314) B Tapered Arms (+ \$366)	See page 356	TS Tapered Square TR Tapered Round	PR8 Textured Silver P7A Textured Charcoal H Bourbon Cherry (+ \$105) F Shaker Cherry (+ \$105) N Mahogany (+ \$105) C Harvest (+ \$105) D Natural Maple (+ \$105) LK11 Kingswood Walnut (+ \$105) LSW1 Skyline Walnut (+ \$105) LLA1 Lowell Ash (+ \$105) LSA1 Sterling Ash (+ \$105) COGN Cognac (+ \$105) MOCH Mocha (+ \$105) PINC Pinnacle (+ \$105) LLA1 Lowell Ash (+ \$105) LNR1 Natural Recon (+ \$105) LPE1 Phantom Ecru (+ \$105) LPT1 Portico Teak (+ \$105)	<i>See Chart on page 355</i> L2 (+ \$131)	N No Cutout G Round Grommet Cutout (+ \$32) G1 Pop-Up Port Cutout (+ \$42)	0 No Port 2 Two Tablet Ports Opposite (+ \$21)
HML2ST	A	PNS007	TS	P7A	N	G1	0

! Leg options - Tapered Square (TS) and Tapered Round (TR) are available in 2 poly and 8 woodgrain options.



GROVE® Multi-Fabric

GSA SIN 33721



Icon Legend on page 19

HML1SDF

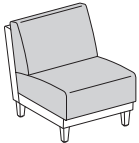

Armless

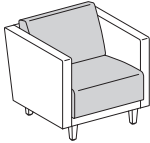

Straight Arms

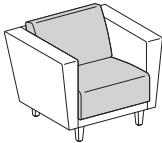

Tapered Arms

SINGLE SEAT LOUNGE

Multi-Fabric

DIMENSIONS

Depth:	31½	Ship Weight (armless):	61
Height:	29¾	Ship Weight (with straight arms):	77
Seat Width:	23½	Ship Weight (with tapered arms):	85
Back Width:	23½	Cube (armless):	19.8
Back Height:	19	Cube (with straight arms):	19.8
Width (armless):	23½	Cube (with tapered arms):	19.8
Width (with straight arms):	29¾	COM:	See
Width (with tapered arms):	35		page
Arm Width:	23½		356
Seat to Floor Height:	16	Weight Rating:	300 lbs.
Usable Seat Depth:	18¾		(per seat)

FABRIC PRICE CODES

1	\$1894		
<i>Add to Base Price Above</i>			
		Frame/ Arms	Back/Seat Cushions
2	\$38		\$51
3	\$76		\$101
4	\$104		\$138
5	\$132		\$176
6	\$160		\$214
7	\$189		\$251
8	\$217		\$289
9	\$245		\$327
10	\$273		\$364
11	\$301		\$402
12	\$330		\$439
L	\$314		\$418

For multi-fabric models, start with the base price, then add the additional amount for the back and seat from the corresponding matrix to determine the final list price. Choose any combination of fabric grades for the back and seat.

Example: HML1SDF base price (\$1894) + Grade 2 frame/arms fabric (add \$38) + Grade 4 back/seat fabric (add \$138) = Total \$2070 List
 HML1SDF base price (\$1894) + Grade 5 frame/arms fabric (add \$132) + Grade 3 back/seat fabric (add \$101) = Total \$2127 List

HON Recommendation: HML1SDF.A.PNS___.PNS___.TS.P7A - List Price \$2297

HOW TO SPECIFY

Select Model Number	Select Arm Type	Select Frame/Arms Fabric	Select Back/Seat Cushions Fabric	Select Leg Type	Select Leg Color
	N Armless A Straight Arms (+ \$314) B Tapered Arms (+ \$366)	See page 356	See page 356	TS Tapered Square TR Tapered Round	PR8 Textured Silver P7A Textured Charcoal H Bourbon Cherry (+ \$105) F Shaker Cherry (+ \$105) N Mahogany (+ \$105) C Harvest (+ \$105) D Natural Maple (+ \$105) LK11 Kingswood Walnut (+ \$105) LSW1 Skyline Walnut (+ \$105) LLA1 Lowell Ash (+ \$105) LSA1 Sterling Ash (+ \$105) COGN Cognac (+ \$105) MOCH Mocha (+ \$105) PINC Pinnacle (+ \$105) LNRI Natural Recon (+ \$105) LPE1 Phantom Ecru (+ \$105) LPT1 Portico Teak (+ \$105)
HML1SDF	A	PNS004	PNS007	TS	P7A

! Leg options - Tapered Square (TS) and Tapered Round (TR) are available in 2 poly and 8 woodgrain options.



HML2SDF

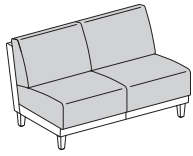

Armless

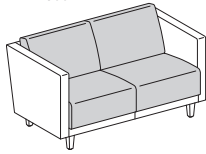

Straight Arms

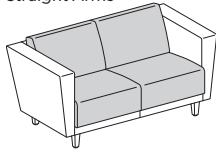

Tapered Arms

TWO-SEAT LOUNGE

Multi-Fabric

DIMENSIONS

Depth:	31½	Ship Weight (armless):	100
Height:	29¼	Ship Weight (with straight arms):	116
Seat Width:	48	Ship Weight (with tapered arms):	124
Back Width:	48	Cube (armless):	35.6
Back Height:	19	Cube (with straight arms):	35.6
Width (armless):	48	Cube (with tapered arms):	35.6
Width (with straight arms):	54¼	COM:	See
Width (with tapered arms):	59½		page
Arm Width:	48		356
Seat to Floor Height:	16	Weight Rating:	300 lbs.
Usable Seat Depth:	18¾		(per seat)

FABRIC PRICE CODES

1	\$2936		
<i>Add to Base Price Above</i>			
		Frame/ Arms	Back/Seat Cushions
2	\$63		\$88
3	\$126		\$176
4	\$173		\$242
5	\$220		\$308
6	\$267		\$374
7	\$314		\$439
8	\$361		\$505
9	\$408		\$571
10	\$455		\$637
11	\$502		\$703
12	\$549		\$769
L	\$523		\$732

For multi-fabric models, start with the base price, then add the additional amount for the back and seat from the corresponding matrix to determine the final list price. Choose any combination of fabric grades for the back and seat.

Example: HML2SDF base price (\$2936) + Grade 2 frame/arms fabric (add \$63) + Grade 4 back/seat fabric (add \$242) = Total \$3241 List
 HML2SDF base price (\$2936) + Grade 5 frame/arms fabric (add \$220) + Grade 3 back/seat fabric (add \$176) = Total \$3332 List

HON Recommendation: HML2SDF.A.PNS__PNS__TS.P7A - List Price \$3401

HOW TO SPECIFY

Select Model Number	Select Arm Type	Select Frame/Arms Fabric	Select Back/Seat Cushions Fabric	Select Leg Type	Select Leg Color
	N Armless A Straight Arms (+ \$314) B Tapered Arms (+ \$366)	See page 356	See page 356	TS Tapered Square TR Tapered Round	PR8 Textured Silver P7A Textured Charcoal H Bourbon Cherry (+ \$105) F Shaker Cherry (+ \$105) N Mahogany (+ \$105) C Harvest (+ \$105) D Natural Maple (+ \$105) LK11 Kingswood Walnut (+ \$105) LSW1 Skyline Walnut (+ \$105) LLA1 Lowell Ash (+ \$105) LSA1 Sterling Ash (+ \$105) COGN Cognac (+ \$105) MOCH Mocha (+ \$105) PINC Pinnacle (+ \$105) LNR1 Natural Recon (+ \$105) LPE1 Phantom Ecru (+ \$105) LPT1 Portico Teak (+ \$105)
HML2SDF	A	PNS004	PNS007	TS	P7A

! Leg options - Tapered Square (TS) and Tapered Round (TR) are available in 2 poly and 8 woodgrain options.

GROVE® Multi-Fabric

GSA SIN 33721



Icon Legend on page 19

HML3SDF

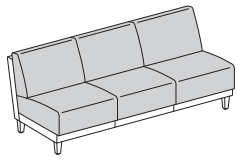

Armless

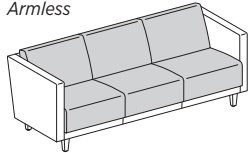

Straight Arms

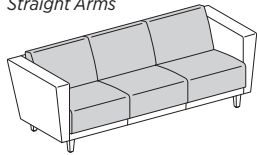

Tapered Arms

THREE-SEAT LOUNGE

Multi-Fabric

DIMENSIONS

Depth:	31½	Ship Weight (armless):	141
Height:	29¼	Ship Weight (with straight arms):	157
Seat Width:	71½	Ship Weight (with tapered arms):	165
Back Width:	71½	Cube (armless):	48.9
Back Height:	19	Cube (with straight arms):	48.9
Width (armless):	71½	Cube (with tapered arms):	48.9
Width (with straight arms):	77½	COM:	See page 356
Width (with tapered arms):	82½	Weight Rating:	300 lbs. (per seat)
Arm Width:	71½		
Seat to Floor Height:	16		
Usable Seat Depth:	18¾		

FABRIC PRICE CODES

1	\$3904	
<i>Add to Base Price Above</i>		
	Frame/ Arms	Back/Seat Cushions
2	\$76	\$138
3	\$151	\$276
4	\$207	\$380
5	\$264	\$483
6	\$320	\$587
7	\$377	\$690
8	\$433	\$794
9	\$490	\$897
10	\$546	\$1001
11	\$602	\$1104
12	\$659	\$1207
L	\$627	\$1150

For multi-fabric models, start with the base price, then add the additional amount for the back and seat from the corresponding matrix to determine the final list price. Choose any combination of fabric grades for the back and seat.

Example: HML3SDF base price (\$3904) + Grade 2 frame/arms fabric (add \$76) + Grade 4 back/seat fabric (add \$380) = Total \$4360 List
 HML3SDF base price (\$3904) + Grade 5 frame/arms fabric (add \$264) + Grade 3 back/seat fabric (add \$276) = Total \$4444 List

HON Recommendation: HML3SDF.A.PNS__.PNS__.TS.P7A - List Price \$4432

HOW TO SPECIFY

Select Model Number	Select Arm Type	Select Frame/Arms Fabric	Select Back/Seat Cushions Fabric	Select Leg Type	Select Leg Color
	N Armless A Straight Arms (+ \$314) B Tapered Arms (+ \$366)	See page 356	See page 356	TS Tapered Square TR Tapered Round	PR8 Textured Silver P7A Textured Charcoal H Bourbon Cherry (+ \$105) F Shaker Cherry (+ \$105) N Mahogany (+ \$105) C Harvest (+ \$105) D Natural Maple (+ \$105) LK11 Kingswood Walnut (+ \$105) LSW1 Skyline Walnut (+ \$105) LLA1 Lowell Ash (+ \$105) LSA1 Sterling Ash (+ \$105) COGN Cognac (+ \$105) MOCH Mocha (+ \$105) PINC Pinnacle (+ \$105) LNRI Natural Recon (+ \$105) LPE1 Phantom Ecru (+ \$105) LPT1 Portico Teak (+ \$105)
HML3SDF.	A.	PNS004.	PNS007.	TS.	P7A

! Leg options - Tapered Square (TS) and Tapered Round (TR) are available in 2 poly and 8 woodgrain options.



HML2STDF

TWO-SEAT WITH TABLE

Multi-Fabric

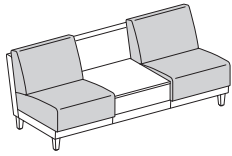

Armless

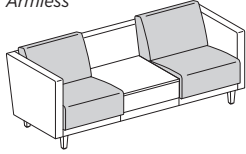

Straight Arms

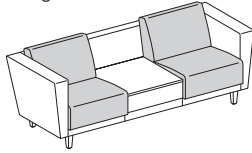

Tapered Arms

DIMENSIONS

Depth:	31½	Ship Weight (armless):	146
Height:	29¼	Ship Weight (with straight arms):	162
Seat Width:	71½	Ship Weight (with tapered arms):	170
Back Width:	71½	Cube (armless):	48.9
Back Height:	19	Cube (with straight arms):	48.9
Width (armless):	71½	Cube (with tapered arms):	48.9
Width (with straight arms):	77½	COM:	See
Width (with tapered arms):	82½		page
Arm Width:	71½		356
Seat to Floor Height:	16	Weight Rating:	300 lbs.
Usable Seat Depth:	18¾		(per seat)

FABRIC PRICE CODES

1	\$4199		
<i>Add to Base Price Above</i>			
	Frame/	Back/Seat	
	Arms	Cushions	
2	\$76	\$88	
3	\$151	\$176	
4	\$207	\$242	
5	\$264	\$308	
6	\$320	\$374	
7	\$377	\$439	
8	\$433	\$505	
9	\$490	\$571	
10	\$546	\$637	
11	\$602	\$703	
12	\$659	\$769	
L	\$627	\$732	

NOTES: Offers a table between the seats that provides separation and a usable worksurface. Table available with two grommet and an accessory port option.

HON Recommendation: HML2STDF.A.PNS__PNS__TS.P7A.N.G1.0 - List Price \$4677

HOW TO SPECIFY

Select Model Number	Select Arm Type	Select Frame/Arms Fabric	Select Back/Seat Cushions Fabric	Select Leg Type	Select Leg Color	Select Laminate	Select Cut Out	Accessory Port Location
	N Armless A Straight Arms (+ \$314) B Tapered Arms (+ \$366)	See page 356	See page 356	TS Tapered Square TR Tapered Round	PR8 Textured Silver P7A Textured Charcoal H Bourbon Cherry (+ \$105) F Shaker Cherry (+ \$105) N Mahogany (+ \$105) C Harvest (+ \$105) D Natural Maple (+ \$105) LK11 Kingswood Walnut (+ \$105) LSW1 Skyline Walnut (+ \$105) LLA1 Lowell Ash (+ \$105) LSA1 Sterling Ash (+ \$105) COGN Cognac (+ \$105) MOCH Mocha (+ \$105) PINC Pinnacle (+ \$105) LNRI Natural Recon (+ \$105) LPE1 Phantom Ecru (+ \$105) LPT1 Portico Teak (+ \$105)	See Chart on page 355 L2 (+ \$131)	N No Cutout G Round Grommet Cutout (+ \$32) G1 Pop-Up Port Cutout (+ \$42)	0 No Port 2 Two Tablet Ports Opposite (+ \$21)
HML2STDF	A	PNS004	PNS007	TS	P7A	N	G1	0

! Leg options - Tapered Square (TS) and Tapered Round (TR) are available in 2 poly and 8 woodgrain options.

HGRMTAC

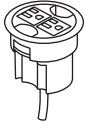

SIN 33721T

POWER HUB

3" Grommet Mount, 6' Cord

DIMENSIONS

Ship Weight: 1.3
Cube: 0.2

LIST PRICE

\$167

NOTES: Fits in 3" round grommet holes. Field installed with Plug-and-play ease. Two grounded AC power outlets. Includes 6' cord with three-prong plug.

ⓘ Available in black only (no color designation so use .X)

HGRMTAC2

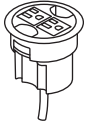

SIN 33721T

3" ROUND POWER GROMMET

2 Outlets, 10' Cord

DIMENSIONS

Ship Weight: 1.5
Cube: 0.2

LIST PRICE

\$196

NOTES: Power Modules will also work with standing-height applications for 10500 Series™ and Voi® desks. Optional Memory Control allows preset worksurface heights for consistency. Ships separately. Dynamic load capacity when worksurface is moving is 300 lbs. Includes 10' cord with three-prong plug. Fits in 3" round grommet holes on the following product lines: Coordinate™, Huddle, Motivate®, all laminate and veneer casegoods series, and Systems Worksurfaces. Two grounded AC power outlets. Field installed with Plug-and-play ease.

ⓘ Available in black finish only, no specification needed.

HGRMTUSB2



SIN 33721T

POWER/USB HUB

3" Grommet Mount

DIMENSIONS

Ship Weight: 1.3 ⓘ
Cube: 0.2

LIST PRICE

\$300

NOTES: One grounded AC power outlet with 2 USB ports. UL Listed.

ⓘ Available in black only (no color designation so use .X)

HFTTAL14



SIN 33721

TABLET ACCESSORY

Laminate

DIMENSIONS

Diameter: 14 Ship Weight: 6.0
Height from Table Top: 10 Cube: 2.5

LIST PRICE

\$518

NOTES: Use with Collaborative Cube and Cylinder tables for additional workspace. Attaches to tables through ports. Multiple port location options are available. Tablet pivots/swivels toward the user.

HTG1PWR-3P-1B

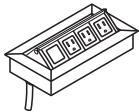

SIN 33721

POP-UP PORT

DIMENSIONS

Ship Weight: 5.0
Cube: 0.3

LIST PRICE

\$507

NOTES: Fits into 4" x 8" cutout. Specify G1 cutout in table top. Pop-up Port provides three power ports and one blank data receptacle. Sits flush with worksurface when closed. Finish is anodized aluminum. Includes 6' cord with three-prong plug.

HOW TO SPECIFY

Select
Model Number

H G R M T A C

NOTES



Ignition® Seating.

IGNITION®

People come in all shapes and sizes, which is why Ignition does as well. From guest and lounge chairs to executive seating, Ignition allows you to mix and match adjustment features, back height, lumbar, and other options to fit your chair to your needs. It's the easy, affordable way to furnish an entire workplace in style and comfort. Ignition fits who you are, where you work and how you work.



FEATURES

IGNITION® 2.0

- Choice of upholstered, 4-Way Stretch mesh or ReActiv® back options.
- ReActiv® back features zonal comfort that delivers optimal support and flexibility.
- The unique hammock-like inner support allows the upholstered back version to feature a slim profile and provide built-in comfort.
- Optional adjustable lumbar allows users to tailor their support.
- 8 different adjustable lumbar colors available on 4-Way Stretch mesh and ReActiv® task chair models.
- Passive movement back adjusts with you.
- Multiple arm options to accommodate user requirements.
- Available in 7 colors of 4-Way Stretch mesh and 3 ReActiv® colors.
- Molded foam seat for better support and added comfort.
- Black, Titanium, and Designer White frame.
- Mesh seat option with waterfall seat available to reduce pressure points and provide breathability.
- Warranted for users up to 300 lbs., 450 lbs. for Big & Tall.











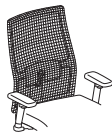

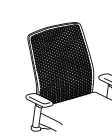
IGNITION®

- Ignition Series seating addresses the needs of the total office with Executive, Task, Stool, Guest and Lounge Seating Solutions.
- Three different back sizes, three different controls and multiple arm options to fit you and how you work.
- Back height adjustment moves the back up or down to fit various body sizes.
- Contoured back on multi-purpose seating offers greater comfort than typical stack chairs or stools.
- Warranted for users up to 300 lbs., 450 lbs. for Big & Tall.
- Multi-purpose chair stacks four high.

IGNITION® Options

MODEL OPTIONS

<p>HITLM</p>  <p>Task Low-Back 4-Way Stretch Mesh Back, Pneumatic, Swivel, Synchro-tilt, Tilt Tension, Tilt Lock, Optional Lumbar Support</p>	<p>HITSM</p>  <p>Task Low-Back Stool 4-Way Stretch Mesh Back, Pneumatic, Swivel, Synchro-tilt, Tilt Tension, Tilt Lock, Optional Lumbar Support</p>	<p>HITLRA</p>  <p>Task Low-Back ReActiv® ReActiv® Back, Pneumatic, Swivel, Synchro-tilt, Tilt Tension, Tilt Lock, Optional Lumbar Support</p>	<p>HITSRA</p>  <p>Task Low-Back Stool ReActiv® ReActiv® Back, Pneumatic, Swivel, Synchro-tilt, Tilt Tension, Tilt Lock, Optional Lumbar Support</p>
<p>HIWMM</p>  <p>Task Mid-Back 4-Way Stretch Mesh Back, Pneumatic, Swivel, Synchro-tilt, Tilt Tension, Tilt Lock, Optional Lumbar Support</p>	<p>HIWMMHR</p>  <p>Task Mid-Back w/Headrest 4-Way Stretch Mesh Back, Pneumatic, Swivel, Synchro-tilt, Tilt Tension, Tilt Lock, Optional Lumbar Support, Headrest</p>	<p>HIWMS</p>  <p>Task Mid-Back w/Mesh Seat 4-Way Stretch Mesh Back, Pneumatic, Swivel, Synchro-tilt, Tilt Tension, Tilt Lock, Optional Lumbar Support, Mesh Seat</p>	<p>HIWMBT</p>  <p>Task Mid-Back Big & Tall 4-Way Stretch Mesh Back, Pneumatic, Swivel, Synchro-tilt, Tilt Tension, Tilt Lock, Optional Lumbar Support</p>
<p>HIWMRA</p>  <p>Task Mid-Back ReActiv® ReActiv® Back, Pneumatic, Swivel, Synchro-tilt, Tilt Tension, Tilt Lock, Optional Lumbar Support</p>	<p>HIWMMU</p>  <p>Upholstered Mid-Back Upholstered Back, Pneumatic, Swivel, Synchro-tilt, Tilt Tension, Tilt Lock</p>	<p>HIWMUL</p>  <p>Upholstered Mid-Back with Lumbar Support Upholstered Back, Pneumatic, Swivel, Synchro-tilt, Tilt Tension, Tilt Lock, Adjustable Lumbar</p>	

SEATING

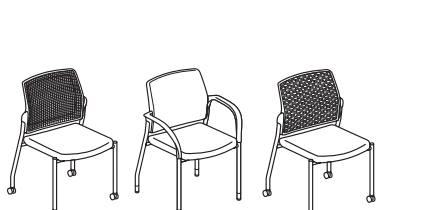
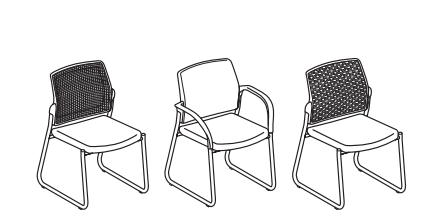
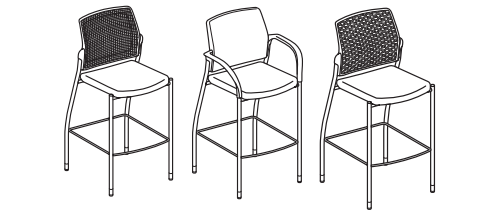
<p>HIGS6</p>  <p>Multi-Purpose Four Legs</p>	<p>HISB6</p>  <p>Multi-Purpose Sled Base</p>	<p>HICS7</p>  <p>Café-Height Stool Four Legs</p>
--	---	--

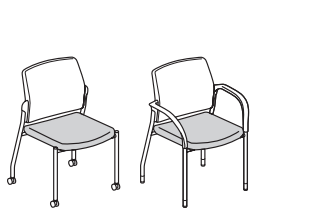
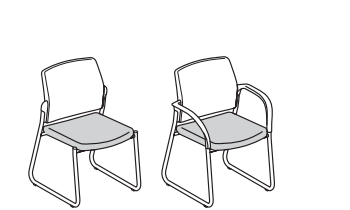
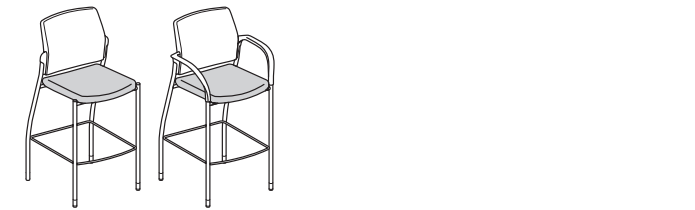
<p>HIGS6DF - Multi-Fabric</p>  <p>Multi-Purpose Four Legs</p>	<p>HISB6DF - Multi-Fabric</p>  <p>Multi-Purpose Sled Base</p>	<p>HICS7DF - Multi-Fabric</p>  <p>Café-Height Stool Four Legs</p>
---	--	---

MODEL OPTIONS

HIGCL



Guest Chair

Fixed Arms, Glides

HIB50

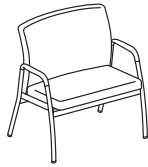

Bariatric Lounge

Fixed Arms, Glides

HITL1



Task Low-Back

Pneumatic, Back Height Adjustment, Swivel, Tilt, Tilt Tension, Tilt Lock

HITL2



Task Low-Back

Pneumatic, Back Height Adjustment, Synchro-tilt, Tilt Tension, Tilt Lock, Seat Glide

HITL3



Task Low-Back

Pneumatic, Back Height Adjustment, Synchro-tilt, Back Angle Adjustment, Tilt Tension, Tilt Lock, Seat Glide

HITS5 ⁺



Task Stool

Pneumatic, Swivel Back Height Adjustment, Adjustable Footrest

HIWM1



Mid-Back

Pneumatic, Back Height Adjustment, Swivel, Tilt, Tilt Tension, Tilt Lock

HIWM2



Mid-Back

Pneumatic, Back Height Adjustment, Synchro-tilt, Tilt Tension, Tilt Lock, Seat Glide

HIWM3



Mid-Back

Pneumatic, Back Height Adjustment, Synchro-tilt, Back Angle Adjustment, Tilt Tension, Tilt Lock, Seat Glide

HIEH1



Executive High-Back

Pneumatic, Back Height Adjustment, Swivel, Tilt, Tilt Tension, Tilt Lock

HIEH2



Executive High-Back

Pneumatic, Back Height Adjustment, Synchro-tilt, Tilt Tension, Seat Glide

HIEH3





Executive High-Back





Pneumatic, Back Height Adjustment, Synchro-tilt, Back Angle Adjustment, Tilt Tension, Seat Glide







* De-emphasized

IGNITION® 2.0

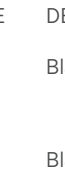
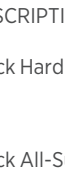
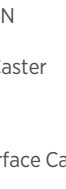
Options

ARM STYLE	CODE	DESCRIPTION	PRICE
	N	Armless	+\$0
	F	Fixed Arms	+\$68
	A	Height and Width Adjustable Arms	+\$89
	V	All-Adjustable Arms (includes Pivot)	+\$136
	P	Fixed Polished Aluminum Arms	+\$183

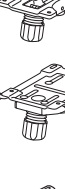
CASTERS	CODE	DESCRIPTION	PRICE
	H	Black Hard Caster	+\$0
	S	Black All-Surface Caster	+\$42
	R	Black Roll Control Caster	+\$53
	TS	Titanium All-Surface Caster	+\$42
	A	Black All-Surface Caster (Big & Tall models only)	+\$0

MECHANISM	CODE	DESCRIPTION	PRICE
	Y0	Synchro-Tilt A, E, J, K, L	+\$0
	Y1	Synchro-Tilt w/ Seat Slider A, D, E, J, K, L	+\$21
	Y2	Advanced Synchro-Tilt A, D, E, J, L, A-D	+\$68
	Y3	Synchro-Tilt with Independent Back Angle A, D, E, J, L, A-E	+\$110
	Y4	Synchro-Tilt (Big & Tall models only) A, D, E, J, L, A-D	+\$0
	W2	Weight-Activated Synchro-Tilt w/ Seat Slider A, D, E, L, P	+\$68
	S0	Limited Recline Synchro-Tilt A, E, J, K, L	+\$0
	S1	Limited Recline Synchro-Tilt w/ Seat Slider A, D, E, J, K, L	+\$21
		<i>*Only available on HITSM</i>	
	S2	Limited Recline Advanced Synchro-Tilt A, D, E, J, L, A-D	+\$68
		<i>*Only available on HIWMMS, HIWMMSKD</i>	

LUMBAR	CODE	DESCRIPTION	PRICE
	NL	No Lumbar	+\$0
	BL	Black Adjustable Lumbar	+\$32
	BY	Bullseye Adjustable Lumbar	+\$32
	DW	Designer White Adjustable Lumbar	+\$32
	MR	Ember Adjustable Lumbar	+\$32
	IR	Iris Adjustable Lumbar	+\$32
	KT	Krypton Adjustable Lumbar	+\$32
	RE	Regatta Adjustable Lumbar	+\$32
	TL	Titanium Adjustable Lumbar	+\$32
		<i>*Adjustable Lumbar not available on CAL 133 (FC) models</i>	

IGNITION® 2.0 Options

BASE



CODE	DESCRIPTION	PRICE
SB	Standard Base	+\$0

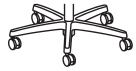

PA	Polished Aluminum	+\$115
-----------	-------------------	---------------

FRAME

CODE	DESCRIPTION	PRICE
T	Black Frame	+\$0
DWX	Designer White	+\$37
TI	Titanium Frame	+\$37

BACK STYLE

CODE	DESCRIPTION	PRICE
------	-------------	-------

4-Way Stretch mesh back options:

IM	Black	+\$0
IB	Breeze	+\$0
IK	Brownstone	+\$0
IC	Charcoal	+\$0
IF	Fog	+\$0
IR	Regatta	+\$0
IT	Titanium	+\$0

ReActiv® back options:

OS	Charcoal	+\$0
DWR	Designer White	+\$0
TI	Titanium	+\$0

IGNITION® 2.0

Dimensions

TASK DIMENSIONS

MODEL		HIWMM, HIWMRA, HIWMU, & HIWMUL	HIWMMHR	HIWMS	HITLM & HITLRA	HITSM & HITSRA
Overall Width Armless		21	21	21	20	20
Overall Width with Arms	A	27	27	27	26	26
Overall Depth		24	24	24	22	22
Overall Height	S0/S1	-	-	-	-	52½
	Y0/Y1	43¾	54	43¾	40½	-
	S2	-	-	44½	-	-
	Y2	44½	55	-	41¼	-
	Y3	44½	55	-	41¼	-
	Y4	-	-	-	-	-
	W2	44½	55	44½	41¼	-
Seat Width		20	20	20	18½	18½
Seat Depth		18⅝	18⅝	18⅝	17⅝	17⅝
Usable Seat Depth	S0	-	-	-	-	16¾
	S1	-	-	-	-	15½ - 16⅝
	S2	-	-	16½ - 18¼	-	-
	Y0	17¾	17¾	17½	16¾	-
	Y1	17½ - 19½	17½ - 19½	16¾ - 18¼	15½ - 17½	-
	Y2	16¼ - 19¼	16¼ - 19¼	-	15¾ - 18½	-
	Y3	16½ - 19½	16½ - 19½	-	16¼ - 18¾	-
	Y4	-	-	-	-	-
	W2	16¼ - 18½	16¼ - 18½	16¾ - 18¼	15¾ - 17¾	-
Seat Height	S0/S1	-	-	-	-	22⅞ - 31¾
	S2	-	-	17½ - 22¼	-	-
	Y0/Y1	16⅝ - 21¼	16⅝ - 21¼	16¾ - 21½	16¾ - 21¼	-
	Y2	17⅞ - 21½	17⅞ - 21½	-	17⅞ - 21½	-
	Y3	17½ - 21½	17½ - 21½	-	17¾ - 21¾	-
	Y4	-	-	-	-	-
	W2	17⅞ - 21½	17⅞ - 21½	17 - 21½	17⅞ - 21½	-
Back Width		19	19	19	19	17½
Back Height		23	23	23	19	19
Ship Weight Armless	S0	-	-	-	-	44 Ⓢ
	S1	-	-	-	-	46 Ⓢ
	S2	-	-	42 Ⓢ	-	-
	Y0	38 Ⓢ	38 Ⓢ	38 Ⓢ	38 Ⓢ	-
	Y1	38 Ⓢ	38 Ⓢ	38 Ⓢ	38 Ⓢ	-
	Y2	42 Ⓢ	42 Ⓢ	-	42 Ⓢ	-
	Y3	46 Ⓢ	46 Ⓢ	-	45 Ⓢ	-
	Y4	-	-	-	-	-
	W2	42 Ⓢ	42 Ⓢ	42 Ⓢ	42 Ⓢ	-
Ship Weight with Arms	S0	-	-	-	-	51 Ⓢ
	S1	-	-	-	-	53 Ⓢ
	S2	-	-	49 Ⓢ	-	-
	Y0	45 Ⓢ	45 Ⓢ	45 Ⓢ	45 Ⓢ	-
	Y1	45 Ⓢ	45 Ⓢ	45 Ⓢ	45 Ⓢ	-
	Y2	49 Ⓢ	49 Ⓢ	-	49 Ⓢ	-
	Y3	53 Ⓢ	53 Ⓢ	-	52 Ⓢ	-
	Y4	-	-	-	-	-
	W2	49 Ⓢ	49 Ⓢ	49 Ⓢ	49 Ⓢ	-
Width Between Arms	F	20¼	20¼	20¾	19	19
	P	20¼	20¼	20¾	19	19
	A	18 - 20½	18 - 20½	17½ - 21	17 - 19½	17 - 19½
	V	12½ - 27½	12½ - 27½	12 - 27	11½ - 26½	11½ - 26⅝
Cube		10.8	10.8	10.8	10.8	10.8
Cube with Y3 Control		12	12	-	12	-
COM		1.0	1.0	-	1.0	1.0
Weight Capacity		300 lbs	300 lbs	300 lbs	300 lbs	300 lbs

IGNITION® 2.0

Dimensions

TASK DIMENSIONS

MODEL	HITLMKD & HITLRAKD	HIWMMKD, HIWMRAKD, HIWUMKD, & HIWMULKD	HIWMMSKD	HIWMBT
Overall Width Armless	20	21	21	30
Overall Width with Arms	A 26	27	27	30
Overall Depth	22	24	24	30
Overall Height	S0/S1 -	-	-	-
	Y0/Y1 40½	43¾	43¾	-
	S2 -	-	44½	-
	Y2 -	-	-	-
	Y3 -	-	-	-
	Y4 -	-	-	46 (+10½ for HR)
	W2 41¼	44½	44½	-
Seat Width	18½	20	20	23½
Seat Depth	17⅝	18⅝	18⅝	20¼
Usable Seat Depth	S0 -	-	-	-
	S1 -	-	-	-
	S2 -	-	16½ - 18¼	-
	Y0 16¾	17¾	-	-
	Y1 15½ - 17½	17½ - 19½	16¾ - 18¼	-
	Y2 -	-	-	-
	Y3 -	-	-	-
	Y4 -	-	-	17¾ - 19½
	W2 15¾ - 17¾	16¼ - 18½	16¾ - 18¼	-
Seat Height	S0/S1 -	-	-	-
	S2 -	-	17½ - 22¼	-
	Y0/Y1 16¾ - 21¼	16⅝ - 21¼	16¾ - 21½	-
	Y2 -	-	-	-
	Y3 -	-	-	-
	Y4 -	-	-	18 - 22¼
	W2 17⅞ - 21½	17⅞ - 21½	17 - 21½	-
Back Width	17½	19	19	22¾
Back Height	19	23	23	24¾
Ship Weight Armless	S0 -	-	-	-
	S1 -	-	-	-
	S2 -	-	42 Ⓢ	-
	Y0 38 Ⓢ	38 Ⓢ	-	-
	Y1 38 Ⓢ	38 Ⓢ	38 Ⓢ	-
	Y2 -	-	-	-
	Y3 -	-	-	-
	Y4 -	-	-	68
	W2 42 Ⓢ	42 Ⓢ	42 Ⓢ	-
Ship Weight with Arms	S0 -	-	-	-
	S1 -	-	-	-
	S2 -	-	49 Ⓢ	-
	Y0 45 Ⓢ	45 Ⓢ	-	-
	Y1 45 Ⓢ	45 Ⓢ	45 Ⓢ	-
	Y2 -	-	-	-
	Y3 -	-	-	-
	Y4 -	-	-	75
	W2 49 Ⓢ	49 Ⓢ	49 Ⓢ	-
Width Between Arms	F 19	20¼	20¼	-
	P 19	20¼	20¼	-
	A 17 - 19½	18 - 20½	18 - 20½	-
	V 11½ - 26½	12½ - 27½	12½ - 27½	14 - 29
Cube	5.6	6.3	10.8	15.3
Cube with Y3 Control	-	-	-	-
COM	-	-	-	1.5
Weight Capacity	300 lbs	300 lbs	300 lbs	450 lbs

IGNITION® 2.0



Icon Legend on page 19

HITLM

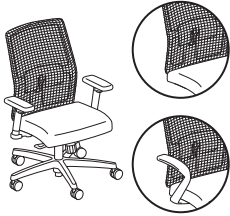

TASK LOW-BACK

- 4-Way Stretch Mesh Back**
- Pneumatic
- Swivel
- Synchro-tilt
- Tilt Tension
- Tilt Lock
- Optional Lumbar Support

DIMENSIONS

Depth:	22	Width (with arms):	26
Height:	40½	Width (armless):	20
Seat Depth:	16	Cube:	10.8
Seat Width:	18½	COM:	1.0
Back Width:	17½	Weight Rating:	300 lbs.
Back Height:	19		

FABRIC PRICE CODES

1	\$641	8	\$786
2	\$667	9	\$805
3	\$692	10	\$823
4	\$710	11	\$842
5	\$729	12	\$861
6	\$748	L	\$850
7	\$767		

! See page 372 for additional specifications and dimensions.

HIWMM

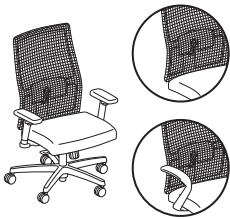

TASK MID-BACK

- 4-Way Stretch Mesh Back**
- Pneumatic
- Swivel
- Synchro-tilt
- Tilt Tension
- Tilt Lock
- Optional Lumbar Support

DIMENSIONS

Depth:	24	Width (with arms):	27
Height:	43¾	Width (armless):	21
Seat Depth:	17¾	Cube:	10.8
Seat Width:	20	COM:	1.0
Back Width:	19	Weight Rating:	300 lbs.
Back Height:	23		

FABRIC PRICE CODES

1	\$702	8	\$847
2	\$728	9	\$866
3	\$753	10	\$884
4	\$771	11	\$903
5	\$790	12	\$922
6	\$809	L	\$911
7	\$828		

! See page 372 for additional specifications and dimensions.

HITSM



TASK LOW-BACK STOOL

- 4-Way Stretch Mesh Back**
- Pneumatic
- Swivel
- Synchro-tilt
- Tilt Tension
- Tilt Lock
- Optional Lumbar Support

DIMENSIONS

Depth:	22	Width (with arms):	26
Height:	52½	Width (armless):	20
Seat Depth:	16	Cube:	10.8
Seat Width:	18½	COM:	1.0
Back Width:	17½	Weight Rating:	300 lbs.
Back Height:	19		

FABRIC PRICE CODES

1	\$768	8	\$913
2	\$794	9	\$932
3	\$819	10	\$950
4	\$837	11	\$969
5	\$856	12	\$988
6	\$875	L	\$977
7	\$894		

! See page 372 for additional specifications and dimensions.

! Not available in Polished Aluminum Base.

HON Recommendation: HIWMM.Y2.A.H.IM.CU__BL.SB.T - List Price \$891

HOW TO SPECIFY

Select Model Number	Select Control Type	Select Arm Type	Select Caster	Select Mesh	Select Fabric	Select Lumbar	Select Base	Select Frame
Y0 Synchro-Tilt	N Armless	H Black Hard Caster	IM Black	See page 391	NL No Lumbar	SB Standard Base	T Black	
Y1 Synchro-Tilt w/ Seat Slider (+ \$21)	A Height and Width Adjustable Arms (+ \$89)	S Black All-Surface Caster (+ \$42)	IB Breeze		BL Black Adjustable Lumbar (+ \$32)	PA Polished Aluminum (+ \$115)	DWX Designer White (+ \$37 for HITLM and HIWMM; + \$58 for HITSM)	
Y2 Advanced Synchro-Tilt (+ \$68)	V All-Adjustable Arms (includes pivot) (+ \$136)	TS Titanium All-Surface Caster (+ \$42)	IK Brownstone		BY Bullseye Adjustable Lumbar (+ \$32)		TI Titanium (+ \$37 for HITLM and HIWMM; + \$58 for HITSM)	
Y3 Synchro-Tilt with Independent Back Angle (+ \$110)	F Fixed Arms (+ \$68)	R Black Roll Control Caster (+ \$53)	IC Charcoal		DW Designer White Adjustable Lumbar (+ \$32)			
S0 Limited Recline Synchro-Tilt (for HITSM only)	P Fixed Arms - Polished (+ \$183)		IF Fog		MR Ember Adjustable Lumbar (+ \$32)			
S1 Limited Recline Synchro-Tilt w/ Seat Slider (+ \$21 for HITSM only)			IR Regatta		IR Iris Adjustable Lumbar (+ \$32)			
W2 Weight-Activated Synchro-Tilt w/ Seat Slider (+ \$68)			IT Titanium		KT Krypton Adjustable Lumbar (+ \$32)			
					RE Regatta Adjustable Lumbar (+ \$32)			
					TL Titanium Adjustable Lumbar (+ \$32)			

HITLM . Y2 . A . H . IM . CU10 . BL . SB . T



Icon Legend on page 19

IGNITION® 2.0

HIWMMHR



TASK MID-BACK

- 4-Way Stretch Mesh Back w/ Headrest**
- Pneumatic
- Swivel
- Synchro-tilt
- Tilt Tension
- Tilt Lock
- Optional Lumbar Support
- Headrest

DIMENSIONS

Depth:	24	Width (with arms):	27
Height:	54	Width (armless):	21
Seat Depth:	17¾	Cube:	10.8
Seat Width:	20	COM:	1.0
Back Width:	19	Weight Rating:	300 lbs.
Back Height:	23		

FABRIC PRICE CODES

1	\$702	8	\$847
2	\$728	9	\$866
3	\$753	10	\$884
4	\$771	11	\$903
5	\$790	12	\$922
6	\$809	L	\$911
7	\$828		

❗ See page 372 for additional specifications and dimensions.

HON Recommendation: HIWMMHR.Y2.A.TS.IF.CU__DW.SB.DWX.HR - List Price \$1054

HOW TO SPECIFY

Select Model Number	Select Control Type	Select Arm Type	Select Caster	Select Mesh	Select Fabric	Select Lumbar	Select Base	Select Frame	Select Headrest
YO Synchro-Tilt	N Armless	H Black Hard Caster	IM Black	See page 391	NL No Lumbar	SB Standard Base	T Black	HR Headrest (+ \$84)	
Y1 Synchro-Tilt w/ Seat Slider (+ \$21)	A Height and Width Adjustable Arms (+ \$89)	S Black All-Surface Caster (+ \$42)	IB Breeze		BL Black Adjustable Lumbar (+ \$32)	PA Polished Aluminum (+ \$115)	DWX Designer White (+ \$37)	<i>Headrest color will match chair frame selection. Headrest mesh color will match mesh back color selection.</i>	
Y2 Advanced Synchro-Tilt (+ \$68)	V All-Adjustable Arms (includes pivot) (+ \$136)	TS Titanium All-Surface Caster (+ \$42)	IK Brownstone		BY Bullseye Adjustable Lumbar (+ \$32)		TI Titanium (+ \$37)		
Y3 Synchro-Tilt with Independent Back Angle (+ \$110)	F Fixed Arms (+ \$68)	R Black Roll Control Caster (+ \$53)	IC Charcoal		DW Designer White Adjustable Lumbar (+ \$32)				
W2 Weight-Activated Synchro-Tilt w/ Seat Slider (+ \$68)	P Fixed Arms - Polished (+ \$183)		IF Fog		MR Ember Adjustable Lumbar (+ \$32)				
			IR Regatta		IR Iris Adjustable Lumbar (+ \$32)				
			IT Titanium		KT Krypton Adjustable Lumbar (+ \$32)				
					RE Regatta Adjustable Lumbar (+ \$32)				
					TL Titanium Adjustable Lumbar (+ \$32)				

SEATING

IGNITION® 2.0



Icon Legend on page 19

HITLMKD



TASK LOW-BACK

- 4-Way Stretch Mesh Back**
- Pneumatic
- Swivel
- Synchro-tilt
- Tilt Tension
- Tilt Lock
- Optional Lumbar Support

DIMENSIONS

Depth:	22	Back Height:	19
Height:	40½	Width (with arms):	26
Seat Depth:	16	Width (armless):	20
Seat Width:	18½	Cube:	5.6
Back Width:	17½	Weight Rating:	300 lbs.

FABRIC PRICE CODES

1	\$601
2	\$627
3	\$652

! See page 373 for additional specifications and dimensions.

HIWMMKD



TASK MID-BACK

- 4-Way Stretch Mesh Back**
- Pneumatic
- Swivel
- Synchro-tilt
- Tilt Tension
- Tilt Lock
- Optional Lumbar Support

DIMENSIONS

Depth:	24	Back Height:	23
Height:	43¾	Width (with arms):	27
Seat Depth:	17¾	Width (armless):	21
Seat Width:	20	Cube:	6.3
Back Width:	19	Weight Rating:	300 lbs.

FABRIC PRICE CODES

1	\$662
2	\$688
3	\$713

! See page 373 for additional specifications and dimensions.

HON Recommendation: HIWMMKD.Y2.A.H.IM.CU__BL.SB.T - List Price \$851

HOW TO SPECIFY

Select Model Number	Select Control Type	Select Arm Type	Select Caster	Select Mesh	Select Fabric	Select Lumbar	Select Base	Select Frame
Y1 Synchro-Tilt w/ Seat Slider (+ \$21) Y2 Advanced Synchro-Tilt (+ \$68) W2 Weight-Activated Synchro-Tilt w/ Seat Slider (+ \$68)	A Height and Width Adjustable Arms (+ \$89)	H Black Hard Caster	IM Black IF Fog IC Charcoal	See page 391	NL No Lumbar BL Black Adjustable Lumbar (+ \$32) BY Bullseye Adjustable Lumbar (+ \$32) DW Designer White Adjustable Lumbar (+ \$32) MR Ember Adjustable Lumbar (+ \$32) IR Iris Adjustable Lumbar (+ \$32) KT Krypton Adjustable Lumbar (+ \$32) RE Regatta Adjustable Lumbar (+ \$32) TL Titanium Adjustable Lumbar (+ \$32)	SB Standard Base	T Black DWX Designer White (+ \$37) TI Titanium (+ \$37)	
H I W M M K D .	Y 2 .	A .	H .	I M .	C U 1 0 .	B L .	S B .	T



Icon Legend on page 19

IGNITION® 2.0

HIWMBT



TASK MID-BACK BIG & TALL

4-Way Stretch Mesh Back

- Pneumatic
- Swivel
- Synchro-tilt
- Tilt Tension
- Tilt Lock
- Optional Lumbar Support

DIMENSIONS

Depth:	30	Width (with arms):	30
Height:	47	Width (armless):	30
Seat Depth:	20¼	Cube:	15.3
Seat Width:	23½	COM:	1.5
Seat Height:	18"-22¼"	Weight Rating:	450 lbs.
Back Width:	22¾		
Back Height:	24¾		

FABRIC PRICE CODES

1	\$1181	8	\$1326
2	\$1207	9	\$1345
3	\$1232	10	\$1363
4	\$1250	11	\$1382
5	\$1269	12	\$1401
6	\$1288	L	\$1390
7	\$1307		

❗ See page 373 for additional specifications and dimensions.

HON Recommendation: HIWMBT.Y4.V.A.IC.CU__TL.SB.TI.N - List Price \$1386

HOW TO SPECIFY

Select Model Number	Select Control Type	Select Arm Type	Select Caster	Select Mesh	Select Fabric	Select Lumbar	Select Base	Select Frame	Select Headrest
	Y4 Synchro-Tilt	V All-Adjustable Arms (includes pivot) (+ \$136) N Armless	A All-Surface Caster	IM Black IF Fog IC Charcoal	See page 391	NL No Lumbar BL Black Adjustable Lumbar (+ \$32) BY Bullseye Adjustable Lumbar (+ \$32) DW Designer White Adjustable Lumbar (+ \$32) MR Ember Adjustable Lumbar (+ \$32) IR Iris Adjustable Lumbar (+ \$32) KT Krypton Adjustable Lumbar (+ \$32) RE Regatta Adjustable Lumbar (+ \$32) TL Titanium Adjustable Lumbar (+ \$32)	SB Standard Base	T Black DWX Designer White (+ \$37) TI Titanium (+ \$37)	N No Headrest HR Headrest (+ \$84) <i>Big & Tall headrest frame is black. Mesh color matches mesh back selection.</i>
HIWMBT	Y4	V	A	IM	CU10	BL	SB	T	HR

SEATING

IGNITION® 2.0



Icon Legend on page 19

HIWMMS



TASK MID-BACK

- 4-Way Stretch Mesh Back and Seat**
- Pneumatic
- Swivel
- Synchro-tilt
- Tilt Tension
- Tilt Lock
- Optional Lumbar Support
- Optional Headrest

DIMENSIONS

Depth:	24	Width (with arms):	27
Height:	43¾	Width (armless):	21
Seat Depth:	17¾	Cube:	10.8
Seat Width:	20	Weight Rating:	300 lbs.
Back Width:	19		
Back Height:	23		

LIST PRICE

\$821

! See page 372 for additional specifications and dimensions.

HIWMMSKD



TASK MID-BACK

- 4-Way Stretch Mesh Back and Seat**
- Pneumatic
- Swivel
- Synchro-tilt
- Tilt Tension
- Tilt Lock
- Optional Lumbar Support
- Optional Headrest

DIMENSIONS

Depth:	24	Width (with arms):	27
Height:	43¾	Width (armless):	21
Seat Depth:	17¾	Cube:	7.9
Seat Width:	20	Weight Rating:	300 lbs.
Back Width:	19		
Back Height:	23		

LIST PRICE

\$781

! See page 373 for all other control specifications.

HON Recommendation: HIWMMS.S2.A.H.IM.IMS.BL.SB.T.N - List Price \$1010

HOW TO SPECIFY

Select Model Number	Select Control Type	Select Arm Type	Select Caster	Select Back Mesh	Select Seat Mesh	Select Lumbar	Select Base	Select Frame	Select Headrest
HIWMMS	Y0 Synchro-Tilt <i>Available on model HIWMMS only</i> Y1 Synchro-Tilt w/ Seat Slider (+ \$21) S2 Limited Recline Advanced Synchro-Tilt (+ \$68) W2 Weight-Activated Synchro-Tilt w/ Seat Slider (+ \$68)	N Armless A Height and Width Adjustable Arms (+ \$89) F Fixed Arms (+ \$68) V All-Adjustable Arms (+ \$136) P Fixed Polished Arms (+ \$183) <i>F, V, and P available on model HIWMMS only</i>	H Black Hard Caster S Black All-Surface Caster (+ \$42) <i>Available on model HIWMMS only</i>	IM Black	IMS Black Mesh	NL No Lumbar BL Black Adjustable Lumbar (+ \$32) BY Bullseye Adjustable Lumbar (+ \$32) DW Designer White Adjustable Lumbar (+ \$32) MR Ember Adjustable Lumbar (+ \$32) IR Iris Adjustable Lumbar (+ \$32) KT Krypton Adjustable Lumbar (+ \$32) RE Regatta Adjustable Lumbar (+ \$32) TL Titanium Adjustable Lumbar (+ \$32)	SB Standard Base PA Polished Aluminum (+ \$115) <i>Available on model HIWMMS only</i>	T Black	N No Headrest HR Headrest (+ \$84) <i>Headrest frame color will match chair frame selection. Headrest mesh color will match mesh back selection.</i>
Y1	A	H	IM	IMS	BL	SB	T	N	

SEATING



Icon Legend on page 19

IGNITION® 2.0 ReActiv®

HITLRA

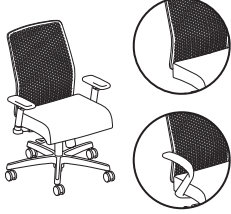

TASK LOW-BACK

- ReActiv® Back**
- Pneumatic
- Swivel
- Synchro-tilt
- Tilt Tension
- Tilt Lock
- Optional Lumbar Support

DIMENSIONS

Depth:	22	Width (with arms):	26
Height:	40½	Width (armless):	20
Seat Depth:	16	Cube:	10.8
Seat Width:	18½	COM:	1.0
Back Width:	17½	Weight Rating:	300 lbs.
Back Height:	19		

FABRIC PRICE CODES

1	\$676	8	\$821
2	\$702	9	\$840
3	\$727	10	\$858
4	\$745	11	\$877
5	\$764	12	\$896
6	\$783	L	\$885
7	\$802		

❗ See page 372 for all other control specifications.

HIWMRA

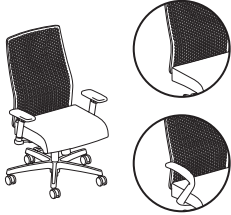

TASK MID-BACK

- ReActiv® Back**
- Pneumatic
- Swivel
- Synchro-tilt
- Tilt Tension
- Tilt Lock
- Optional Lumbar Support

DIMENSIONS

Depth:	24	Width (with arms):	27
Height:	43¾	Width (armless):	21
Seat Depth:	17¾	Cube:	10.8
Seat Width:	20	COM:	1.0
Back Width:	19	Weight Rating:	300 lbs.
Back Height:	23		

FABRIC PRICE CODES

1	\$737	8	\$882
2	\$763	9	\$901
3	\$788	10	\$919
4	\$806	11	\$938
5	\$825	12	\$957
6	\$844	L	\$946
7	\$863		

❗ See page 372 for all other control specifications.

HITSRA

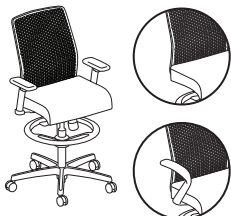

TASK LOW-BACK STOOL

- ReActiv® Back**
- Pneumatic
- Swivel
- Synchro-tilt
- Tilt Tension
- Tilt Lock
- Optional Lumbar Support

DIMENSIONS

Depth:	22	Width (with arms):	26
Height:	52½	Width (armless):	20
Seat Depth:	16	Cube:	10.8
Seat Width:	18½	COM:	1.0
Back Width:	17½	Weight Rating:	300 lbs.
Back Height:	19		

FABRIC PRICE CODES

1	\$803	8	\$948
2	\$829	9	\$967
3	\$854	10	\$985
4	\$872	11	\$1004
5	\$891	12	\$1023
6	\$910	L	\$1012
7	\$929		

❗ See page 372 for all other control specifications.

❗ Not available in Polished Aluminum Base.

HON Recommendation: HIWMRA.Y2.A.H.___CU__BL.SB.T - List Price \$926

HOW TO SPECIFY

Select Model Number	Select Control Type	Select Arm Type	Select Caster	Select Back Color	Select Fabric	Select Lumbar	Select Base	Select Frame
Y0 Synchro-Tilt	N Armless	H Black Hard Caster	OS Charcoal ReActiv®	See page 391	NL No Lumbar	SB Standard Base	T Black	
Y1 Synchro-Tilt w/ Seat Slider (+ \$21)	A Height and Width Adjustable Arms (+ \$89)	S Black All-Surface Caster (+ \$42)	DWR Designer White ReActiv®		BL Black Adjustable Lumbar (+ \$32)	PA Polished Aluminum (+ \$115)	DWX Designer White (+ \$37 for HITLRA and HIWMRA; + \$58 for HITSRA)	
Y2 Advanced Synchro-Tilt (+ \$68)	V All-Adjustable Arms (includes pivot) (+ \$136)	TS Titanium All-Surface Caster (+ \$42)	TI Titanium ReActiv®		BY Bullseye Adjustable Lumbar (+ \$32)		TI Titanium (+ \$37 for HITLRA and HIWMRA; + \$58 for HITSRA)	
Y3 Synchro-Tilt with Independent Back Angle (+ \$110)	F Fixed Arms (+ \$68)	R Black Roll Control Caster (+ \$53)			DW Designer White Adjustable Lumbar (+ \$32)			
S0 Limited Synchro-Tilt (for HITSRA only)	P Fixed Arms - Polished (+ \$183)				MR Ember Adjustable Lumbar (+ \$32)			
S1 Limited Synchro-Tilt w/ Seat Slider (+ \$21 for HITSRA only)					IR Iris Adjustable Lumbar (+ \$32)			
W2 Weight-Activated Synchro-Tilt w/ Seat Slider (+ \$68)					KT Krypton Adjustable Lumbar (+ \$32)			
					RE Regatta Adjustable Lumbar (+ \$32)			
					TL Titanium Adjustable Lumbar (+ \$32)			

Specify S0 or S1 for HITSRA model ONLY

HITLRA . Y2 . A . H . OS . CU10 . BL . SB . T

IGNITION® 2.0 ReActiv®

GSA SIN 33721



Icon Legend on page 19

HITLRAKD



TASK LOW-BACK

ReActiv® Back
Pneumatic
Swivel
Synchro-tilt
Tilt Tension
Tilt Lock
Optional Lumbar Support

DIMENSIONS

Depth:	22	Width (with arms):	26
Height:	40½	Width (armless):	20
Seat Depth:	16	Cube:	5.6
Seat Width:	18½	Weight Rating:	300 lbs.
Back Width:	17½		
Back Height:	25½		

FABRIC PRICE CODES

1 \$636
2 \$662
3 \$687

! See page 373 for all other control specifications.

HIWMRAKD

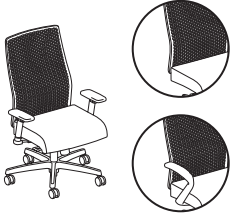

TASK MID-BACK

ReActiv® Back
Pneumatic
Swivel
Synchro-tilt
Tilt Tension
Tilt Lock
Optional Lumbar Support

DIMENSIONS

Depth:	24	Width (with arms):	27
Height:	43¾	Width (armless):	21
Seat Depth:	17¾	Cube:	6.3
Seat Width:	20	Weight Rating:	300 lbs.
Back Width:	19		
Back Height:	29		

FABRIC PRICE CODES

1 \$697
2 \$723
3 \$748

! See page 373 for all other control specifications.

HON Recommendation: HIWMRAKD.Y2.A.H.__CU__BL.SB.T - List Price \$886

SEATING

HOW TO SPECIFY

Select Model Number	Select Control Type	Select Arm Type	Select Caster	Select Back Color	Select Fabric	Select Lumbar	Select Base	Select Frame
	Y1 Synchro-Tilt w/ Seat Slider (+ \$21) Y2 Advanced Synchro-Tilt (+ \$68) W2 Weight-Activated Synchro-Tilt w/ Seat Slider (+ \$68)	N Armless A Height and Width Adjustable Arms (+ \$88)	H Black Hard Caster	OS Charcoal ReActiv® DWR Designer White ReActiv® TI Titanium ReActiv®	See page 391	NL No Lumbar BL Black Adjustable Lumbar (+ \$32) BY Bullseye Adjustable Lumbar (+ \$32) DW Designer White Adjustable Lumbar (+ \$32) MR Ember Adjustable Lumbar (+ \$32) IR Iris Adjustable Lumbar (+ \$32) KT Krypton Adjustable Lumbar (+ \$32) RE Regatta Adjustable Lumbar (+ \$32) TL Titanium Adjustable Lumbar (+ \$32)	SB Standard Base	T Black DWX Designer White (+ \$37) TI Titanium (+ \$37)
H I W M R A K D .	Y 2 .	A .	H .	O S .	C U 1 0 .	B L .	S B .	T



Icon Legend on page 19

IGNITION® 2.0 Upholstered

HIWMU



TASK MID-BACK

Upholstered Back

- Pneumatic
- Swivel
- Synchro-tilt
- Tilt Tension
- Tilt Lock

DIMENSIONS

Depth:	24	Width (with arms):	27
Height:	43¾	Width (armless):	21
Seat Depth:	17¾	Cube:	10.8
Seat Width:	20	COM:	3.0
Back Width:	19	Weight Rating:	300 lbs.
Back Height:	23		

FABRIC PRICE CODES

1	\$702	7	\$1016
2	\$765	8	\$1063
3	\$828	9	\$1110
4	\$875	10	\$1157
5	\$922	11	\$1204
6	\$969	12	\$1251

! See page 372 for additional specifications and dimensions.

HIWMUL

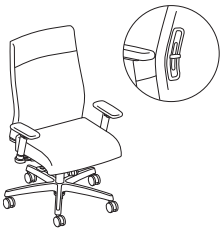

TASK MID-BACK WITH ADJUSTABLE LUMBAR

Upholstered Back

- Pneumatic
- Swivel
- Synchro-tilt
- Tilt Tension
- Tilt Lock
- Adjustable Lumbar

DIMENSIONS

Depth:	24½	Width (with arms):	27
Height:	43¾	Width (armless):	21
Seat Depth:	17¾	Cube:	10.8
Seat Width:	20	COM:	3.0
Back Width:	19	Weight Rating:	300 lbs.
Back Height:	23		

FABRIC PRICE CODES

1	\$742	7	\$1056
2	\$805	8	\$1103
3	\$868	9	\$1150
4	\$915	10	\$1197
5	\$962	11	\$1244
6	\$1009	12	\$1291

! See page 372 for additional specifications and dimensions.

HON Recommendation: HIWMU.Y2.A.H.CU__NL.SB.T - List Price \$859

HOW TO SPECIFY

Select Model Number	Select Control Type	Select Arm Type	Select Caster	Select Fabric	Select Lumbar	Select Base	Select Frame
<p>Y0 Synchro-Tilt</p> <p>Y1 Synchro-Tilt w/ Seat Slider (+ \$21)</p> <p>Y2 Advanced Synchro-Tilt (+ \$68)</p> <p>Y3 Synchro-Tilt with Independent Back Angle (+ \$110)</p> <p>W2 Weight-Activated Synchro-Tilt w/ Seat Slider (+ \$68)</p>	<p>N Armless</p> <p>A Height and Width Adjustable Arms (+ \$89)</p> <p>V All-Adjustable Arms (+ \$136)</p> <p>F Fixed Arms (+ \$68)</p> <p>P Fixed Arms - Polished (+ \$183)</p>	<p>H Black Hard Caster</p> <p>S Black All-Surface Caster (+ \$42)</p> <p>TS Titanium All-Surface Caster (+ \$42)</p> <p>R Black Roll Control Caster (+ \$53)</p>	<p>See page 391</p>	<p>NL No Lumbar</p> <p><i>Specify for model HIWMU only</i></p> <p>AL Adjustable Lumbar</p> <p><i>Specify for model HIWMUL only</i></p>	<p>SB Standard Base</p> <p>PA Polished Aluminum (+ \$115)</p>	<p>T Black</p> <p>DWX Designer White (+ \$37)</p> <p>TI Titanium (+ \$37)</p>	
HIWMU	Y2	A	H	CU10	NL	SB	T

IGNITION® 2.0 Upholstered

GSA SIN 33721



Icon Legend on page 19

HIWMUKD



TASK MID-BACK

Upholstered Back
Pneumatic
Swivel
Synchro-tilt
Tilt Tension
Tilt Lock

DIMENSIONS

Depth:	24	Back Height:	23
Height:	43¾	Width (with arms):	27
Seat Depth:	17¾	Width (armless):	21
Seat Width:	20	Cube:	6.3
Back Width:	19	Weight Rating:	300 lbs.

FABRIC PRICE CODES

1	\$662
2	\$725
3	\$788

! See page 373 for additional specifications and dimensions.

HIWMULKD



TASK MID-BACK WITH ADJUSTABLE LUMBAR

Upholstered Back
Pneumatic
Swivel
Synchro-tilt
Tilt Tension
Tilt Lock
Adjustable Lumbar

DIMENSIONS

Depth:	24½	Back Height:	23
Height:	43¾	Width (with arms):	27
Seat Depth:	17¾	Width (armless):	21
Seat Width:	20	Cube:	6.3
Back Width:	19	Weight Rating:	300 lbs.

FABRIC PRICE CODES

1	\$702
2	\$765
3	\$828

! See page 373 for additional specifications and dimensions.

HON Recommendation: HIWMUKD.Y2.A.H.CU__NL.SB.T - List Price \$819

SEATING

HOW TO SPECIFY

Select Model Number	Select Control Type	Select Arm Type	Select Caster	Select Fabric	Select Lumbar	Select Base	Select Frame
Y1 Synchro-Tilt w/ Seat Slider (+ \$21) Y2 Advanced Synchro-Tilt (+ \$68) W2 Weight-Activated Synchro-Tilt w/ Seat Slider (+ \$68)	N Armless A Height and Width Adjustable Arms (+ \$89)	H Black Hard Caster	See page 391	NL No Lumbar <i>Specify for model HIWMUKD only</i> AL Adjustable Lumbar <i>Specify for model HIWMULKD only</i>	SB Standard Base	T Black DWX Designer White (+ \$37) TI Titanium (+ \$37)	
HIWMUKD	Y2	A	H	CU10	NL	SB	T



Icon Legend on page 19

IGNITION® 2.0 Accessories

HI2ATA

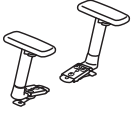

ADJUSTABLE ARMS

Height and Width
Functions: **S**
(Function Key on pages 250-251)

DIMENSIONS

Adjustable Arms Width: 17-19½
Height from Seat: 8-11
Ship Weight: 8
Cube: 1.0

LIST PRICE

\$158

! Can only be used with standard models. Contact Customer Support for Big & Tall arm packs.

HI2AAA

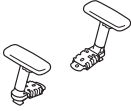

ALL-ADJUSTABLE ARMS

Height, Width, Depth and Pivot

DIMENSIONS

Adjustable Arms Width: 17-20
Height from Seat: 7-11
Ship Weight: 8
Cube: 1.0

LIST PRICE

\$212

! Can only be used with standard models. Contact Customer Support for Big & Tall arm packs.

HI2FHA



FIXED HEIGHT ARMS

DIMENSIONS

Arm Width: 20
Height from Seat: 9½
Ship Weight: 7
Cube: 1.0

LIST PRICE

\$146

! Can only be used with standard models. Contact Customer Support for Big & Tall arm packs.

HIPAA

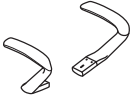

POLISHED ALUMINUM ARMS

Fixed Height

DIMENSIONS

Arm Width: 20
Height from Seat: 9½
Ship Weight: 10
Cube: 1.0

LIST PRICE

\$241

! Can only be used with standard models. Contact Customer Support for Big & Tall arm packs.

HILMBR

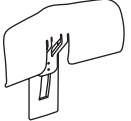

LUMBAR SUPPORT

DIMENSIONS

Ship Weight: 8
Cube: 1.0

LIST PRICE

\$43

HSCASTER

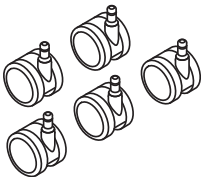

SET OF 5 ALL-SURFACE CASTERS

DIMENSIONS

Size: 60mm
Ship Weight: 2
Cube: 0.1

LIST PRICE

\$72

! Available in Black finish only, no specification needed.

OPEN MARKET

HOW TO SPECIFY

Select Model Number	Select Frame
	T Black DWX Designer White TI Titanium <i>Not specified for model HIPAA</i>
HI2ATA.	T

HOW TO SPECIFY

Select Model Number	Select Lumbar Color
	BL Black MR Ember RE Regatta BY Bullseye IR Iris TL Titanium DW Designer White KT Krypton
HILMBR.	BL

SEATING

IGNITION® 2.0 Accessories

GSA SIN 33721



Icon Legend on page 19

HI2HR

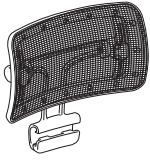

MESH HEADREST

DIMENSIONS

Mesh Width:	12
Mesh Height:	6
Ship Weight:	3
Cube:	1.0

LIST PRICE

\$174

NOTES: Headrest is compatible with Ignition® mid-back mesh back models HIWMM, HIWMMKD, HIWMMMS, and HIWMMSKD purchased after July 2021.

HI2BTHR

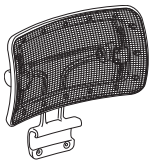

BIG & TALL MESH HEADREST

DIMENSIONS

Mesh Width:	12
Mesh Height:	6
Ship Weight:	3
Cube:	1.0

LIST PRICE

\$183

NOTES: Headrest is compatible with Ignition® mid-back mesh back Big & Tall model HIWMBT.

HOW TO SPECIFY

Select Model Number

Select Mesh

Select Frame

- IM Black
- IB Breeze
- IK Brownstone
- IC Charcoal
- IF Fog
- IR Regatta
- IT Titanium

- T Black
- DWX Designer White (+ \$37)
- TI Titanium (+ \$37)

HI2HR.

IM.

T

HOW TO SPECIFY

Select Model Number

Select Mesh

Select Frame

- IM Black
- IC Charcoal
- IF Fog

- T Black

HI2BTHR.

IM.

T

IGNITION® Multi-Purpose Chair Options

ARM STYLE

CODE	DESCRIPTION	PRICE
N	Armless	+\$0
F	Fixed Arms	+\$32



CASTERS/ GLIDE

CODE	DESCRIPTION	PRICE
H	Black Hard Caster	+\$0
S	Black All-Surface Caster	+\$32
E	Glide	+\$0



Casters only available on HIGS6

MESH STYLE

CODE	DESCRIPTION	PRICE
IM	Black	+\$0
IB	Breeze	+\$0
IK	Brownstone	+\$0
IC	Charcoal	+\$0
IF	Fog	+\$0
IR	Regatta	+\$0
IT	Titanium	+\$0
U	Upholstered	+\$0

FRAME

CODE	DESCRIPTION	PRICE
T	Black	+\$0
CBK	Charblack	+\$0
PK7	Textured Designer White	+\$37
PLAT	Textured Platinum Metallic	+\$0
PR8T	Textured Silver	+\$37

By selecting PR8T, unit will be produced with titanium colored arm caps, back frame, & glides

By selecting PK7, unit will be produced with Designer White colored arm caps, back frame, & glides

By selecting PLAT, unit will be produced with black arm caps, black back frame, black glides, and platinum colored legs

Refer to Configurator on HON.com for visualization

IGNITION® Multi-Purpose

GSA SIN 33721



Icon Legend on page 19

HIGS6

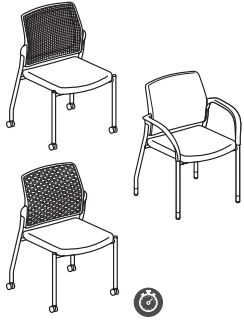

MULTI-PURPOSE

Four Legs

DIMENSIONS

Depth:	21 ³ / ₄	Seat to Floor Height:	18 ³ / ₈
Width:	25	Usable Seat Depth:	17 ³ / ₈
Height:	33 ¹ / ₂	Ship Weight:	28
Seat Depth:	17 ³ / ₈	Cube:	15.1
Seat Width:	18 ³ / ₄	COM (upholstered back):	1.5
Back Width:	18 ¹ / ₄	COM (mesh/ReActiv® back):	1.0
Back Height:	18 ¹ / ₈	Weight Rating:	300 lbs.
Arm Width:	21 ¹ / ₂		

FABRIC PRICE CODES

1	\$559	8	\$776
2	\$597	9	\$804
3	\$635	10	\$832
4	\$663	11	\$860
5	\$691	12	\$889
6	\$719	L	\$873
7	\$748		

NOTES: Stacks 4-high.

! ReActiv® back option not available on FC models.

HISB6

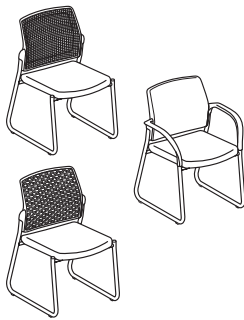

MULTI-PURPOSE

Sled Base

DIMENSIONS

Depth:	23 ³ / ₄	Seat to Floor Height:	18 ³ / ₈
Width:	25	Usable Seat Depth:	17 ³ / ₈
Height:	33 ¹ / ₂	Ship Weight:	30
Seat Depth:	17 ³ / ₈	Cube:	15.1
Seat Width:	18 ³ / ₄	COM (upholstered back):	1.5
Back Width:	18 ¹ / ₄	COM (mesh/ReActiv® back):	1.0
Back Height:	18 ¹ / ₈	Weight Rating:	300 lbs.
Arm Width:	21 ¹ / ₂		

FABRIC PRICE CODES

1	\$559	8	\$776
2	\$597	9	\$804
3	\$635	10	\$832
4	\$663	11	\$860
5	\$691	12	\$889
6	\$719	L	\$873
7	\$748		

! ReActiv® back option not available on FC models.

HICS7



CAFÉ-HEIGHT STOOL

Four Legs

DIMENSIONS

Depth:	23	Seat to Floor Height:	31
Width:	25	Usable Seat Depth:	17 ³ / ₈
Height:	46 ¹ / ₂	Ship Weight:	37
Seat Depth:	17 ³ / ₈	Cube:	21.8
Seat Width:	18 ³ / ₄	COM (upholstered back):	1.5
Back Width:	18 ¹ / ₄	COM (mesh/ReActiv® back):	1.0
Back Height:	18 ¹ / ₈	Weight Rating:	300 lbs.
Arm Width:	21 ¹ / ₂		

FABRIC PRICE CODES

1	\$705	8	\$922
2	\$743	9	\$950
3	\$781	10	\$978
4	\$809	11	\$1006
5	\$837	12	\$1035
6	\$865	L	\$1019
7	\$894		

! ReActiv® back option not available on FC models.

HON Recommendation: HIGS6.F.H.IM.CU__T - List Price \$591

HOW TO SPECIFY

Select Model Number	Select Arm Type	Select Glide	Select Back Type	Select Fabric	Select Frame
F Fixed Arms (+ \$32) N Armless	E Glide H Black Hard Caster S Black All-Surface Caster (+ \$32) <i>Casters available on HIGS6 only</i>	IM Black IB Breeze IK Brownstone IC Charcoal OS Charcoal ReActiv® (+ \$32) DWR Designer White ReActiv® (+ \$32)	IF Fog IR Regatta IT Titanium TI Titanium ReActiv® (+ \$32) U Upholstered	See page 391	T Black CBK Charblack PK7 Textured Designer White (+ \$37) PLAT Textured Platinum Metallic PR8T Textured Silver (+ \$37)
HIGS6	F	H	IM	CU10	T



Icon Legend on page 19

Multi-Fabric Multi-Purpose

HIGS6DF

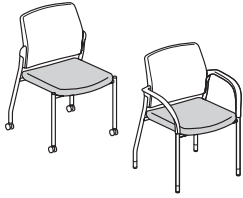

MULTI-PURPOSE

Multi-Fabric
Four Legs

DIMENSIONS

Depth:	21 ³ / ₄	Arm Width:	21 ¹ / ₂
Width:	25	Seat to Floor Height:	18 ³ / ₈
Height:	33 ¹ / ₂	Usable Seat Depth:	17 ³ / ₈
Seat Depth:	17 ³ / ₈	Ship Weight (upholstered back):	28
Seat Width:	18 ³ / ₄	Cube (upholstered back):	15.1
Back Width:	18 ¹ / ₄	COM (back):	0.75
Back Height:	18 ¹ / ₈	COM (seat):	0.75
		Weight Rating:	300 lbs.

FABRIC PRICE CODES

1	\$634	
<i>Add to Base Price Above</i>		
	Back	Seat
2	\$19	\$19
3	\$38	\$38
4	\$53	\$53
5	\$66	\$66
6	\$81	\$81
7	\$95	\$95
8	\$109	\$109
9	\$123	\$123
10	\$137	\$137
11	\$151	\$151
12	\$166	\$166
L	\$157	\$157

NOTES: Stacks 4-high.

HISB6DF

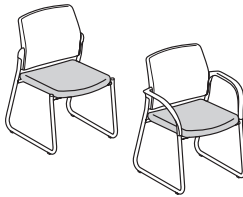

MULTI-PURPOSE

Multi-Fabric
Sled Base

DIMENSIONS

Depth:	23 ³ / ₄	Arm Width:	21 ¹ / ₂
Width:	25	Seat to Floor Height:	18 ³ / ₈
Height:	33 ¹ / ₂	Usable Seat Depth:	17 ³ / ₈
Seat Depth:	17 ³ / ₈	Ship Weight (upholstered back):	30
Seat Width:	18 ³ / ₄	Cube (upholstered back):	15.1
Back Width:	18 ¹ / ₄	COM (back):	0.75
Back Height:	18 ¹ / ₈	COM (seat):	0.75
		Weight Rating:	300 lbs.

FABRIC PRICE CODES

1	\$634	
<i>Add to Base Price Above</i>		
	Back	Seat
2	\$19	\$19
3	\$38	\$38
4	\$53	\$53
5	\$66	\$66
6	\$81	\$81
7	\$95	\$95
8	\$109	\$109
9	\$123	\$123
10	\$137	\$137
11	\$151	\$151
12	\$166	\$166
L	\$157	\$157

HON Recommendation: HIGS6DF.F.S.U.CU__UR__T - List Price \$698

HOW TO SPECIFY

Select Model Number	Select Arm Type	Select Glide	Select Back Type	Select Back Fabric	Select Seat Fabric	Select Frame
	F Fixed Arms (+ \$32) N Armless	E Glide H Black Hard Caster S Black All-Surface Caster (+ \$32) <i>Casters available on HIGS6DF only</i>	U Upholstered	See page 391	See page 391	T Black CBK Charblack PK7 Textured Designer White (+ \$37) PLAT Textured Platinum Metallic PR8T Textured Silver (+ \$37)
HIGS6DF	F	H	U	CU10	UR10	T

IGNITION® Multi-Fabric Stools

GSA SIN 33721



Icon Legend on page 19

HICS7DF



CAFÉ-HEIGHT STOOL

Multi-Fabric
Four Legs

DIMENSIONS

Depth:	23	Arm Width:	21½
Width:	25	Seat to Floor Height:	31
Height:	46½	Usable Seat Depth:	17¾
Seat Depth:	17¾	Ship Weight (upholstered back):	37
Seat Width:	18¾	Cube (upholstered back):	21.8
Back Width:	18¼	COM (back):	0.75
Back Height:	18½	COM (seat):	0.75
		Weight Rating:	300 lbs.

FABRIC PRICE CODES

1 \$780

Add to Base Price Above

	Back	Seat
2	\$19	\$19
3	\$38	\$38
4	\$53	\$53
5	\$66	\$66
6	\$81	\$81
7	\$95	\$95
8	\$109	\$109
9	\$123	\$123
10	\$137	\$137
11	\$151	\$151
12	\$166	\$166
L	\$157	\$157

HON Recommendation: HICS7DF.F.E.U.CU__UR__T - List Price \$850

SEATING

HOW TO SPECIFY

Select Model Number	Select Arm Type	Select Glide	Select Back Type	Select Back Fabric	Select Seat Fabric	Select Frame
F	F Fixed Arms (+ \$32) N Armless	E Glide	U Upholstered	See page 391	See page 391	T Black CBK Charblack PK7 Textured Designer White (+ \$37) PLAT Textured Platinum Metallic PR8T Textured Silver (+ \$37)
HICS7DF	F	E	U	CU10	UR10	T



HIGCL



GUEST CHAIR

Fixed Arms
Glides

DIMENSIONS

Depth:	24	Arm Width:	19¼
Width:	23	Seat to Floor Height:	18½
Height:	35½	Usable Seat Depth:	16¾
Seat Depth:	18	Ship Weight:	42
Seat Width:	19½	Cube:	15.2
Back Width:	19½	COM:	2.0
Back Height:	20	Weight Rating:	300 lbs.

FABRIC PRICE CODES

1	\$614	8	\$903
2	\$665	9	\$941
3	\$715	10	\$978
4	\$752	11	\$1016
5	\$790	12	\$1053
6	\$828	L	—
7	\$865		

HON Recommendation: HIGCL.E.U.CU__T - List Price \$614

HOW TO SPECIFY

Select Model Number HIGCL	Select Glide E Glide E	Select Back Type U Upholstered U	Select Fabric See page 391 CU10	Select Frame T Black CBK Charblack PLAT Textured Platinum Metallic T
---	---	---	--	--

HIB50

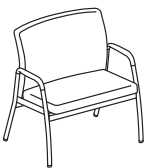

BARIATRIC LOUNGE

Fixed Arms
Glides

DIMENSIONS

Depth:	25½	Arm Width:	30
Width:	33¾	Seat to Floor Height:	20
Height:	35¾	Usable Seat Depth:	18¾
Seat Depth:	18¾	Ship Weight:	70
Seat Width:	29¾	Cube:	27.5
Back Width:	29	COM:	2.5
Back Height:	19¼	Weight Rating:	500 lbs.

FABRIC PRICE CODES



1	\$1783	8	\$2144
2	\$1846	9	\$2191
3	\$1909	10	\$2238
4	\$1956	11	\$2285
5	\$2003	12	\$2332
6	\$2050	L	—
7	\$2097		



HOW TO SPECIFY

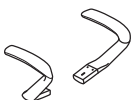

Select Model Number HIB50	Select Arm Type F Fixed Arms F	Select Glide E Glide E	Select Back Type U Upholstered U	Select Fabric See page 391 CU10	Select Frame T Black CBK Charblack PLAT Textured Platinum Metallic T
---	---	---	---	--	--

IGNITION® Task Chair Options

ARM STYLE	CODE	DESCRIPTION	PRICE
	N	Armless	+\$0
	F	Fixed Arms	+\$68
	A	Height and Width Adjustable Arms	+\$89
	V	All-Adjustable Arms (includes Pivot)	+\$136
	P	Fixed Polished Aluminum Arms	+\$183

CASTERS	CODE	DESCRIPTION	PRICE
	H	Black Hard Caster	+\$0
	S	Black All-Surface Caster	+\$32

BACK STYLE	CODE	DESCRIPTION	PRICE
	U	Upholstered	+\$0
	M	Mesh	+\$0

BASE	CODE	DESCRIPTION	PRICE
	SB	Standard Base	+\$0
	PA	Polished Aluminum	+\$115

HON BRANDED FABRICS

GRADE 1	GRADE 2	GRADE 3	GRADE 4	GRADE L
Apex	Appoint Seating	Bradbury	Constance with Supreen™	Denver Leather*
Centurion	Blume	Getaway	Livi with Supreen™	
Compass**	Clyde	Moxie	Lugano with Supreen™	
Contourett	Dotty	Notion	Oxford with Supreen™	
Dapper	Kai	Parker**		
Ensemble	Rush	Purl		
Hamilton	Spin Seating	Quill		
Inertia	Wavelength	Saxony		
Noble Seating	Whisper Vinyl			
Optic**				
Pebble				
Vibe				

For a complete list of fabrics, including partnership fabrics, go to hon.com/fabricsandfinishes.

Reference Fabric Color Combinations on pages 20-24 for color codes and legend on page 21 for lead times. For additional HON to Supply COM fabric grade pricing, go to honready.hon.com and click on the HON to Supply COM link.

*Denver Leather (SS) may not be available on every model within a specific series, please refer to the model's page for details.

**Not available as a back upholstery on Ignition[®] 2.0.

 For Fire Code model, availability, and ordering method, refer to page 256. Available on select models, contact HON Customer Support for availability.

IGNITION®



Icon Legend on page 19

HITL1



TASK LOW-BACK

Pneumatic
Back Height Adjustment
Swivel
Tilt
Tilt Tension
Tilt Lock
Functions: **A, B, E, J, K, L**
(Function Key on pages 250-251)

DIMENSIONS

Upholstered Back
Width: 17½
Upholstered Back
Height: 18¾-21¾
Mesh Back Width: 17½
Mesh Back Height: 20¾-23¼
Depth: 36
Width: 27½
Height: 41
Seat Depth: 17
Seat Width: 19

Adjustable Arms Width: 17-19½
Fixed Arms Width: 20
Seat to Floor Height: 17-21½
Usable Seat Depth: 15¾
Ship Weight (upholstered back): 50
Ship Weight (mesh back): 45
Cube (upholstered back): 10.8
Cube (mesh back): 10.8
COM (upholstered back): 2.0
COM (mesh back): 1.0
Weight Rating: 300 lbs.

FABRIC PRICE CODES

1	\$808	8	\$1097
2	\$859	9	\$1135
3	\$909	10	\$1172
4	\$946	11	\$1210
5	\$984	12	\$1247
6	\$1022	L	—
7	\$1059		

NOTES: See page 396 for arm packs.

HITL2



TASK LOW-BACK

Pneumatic
Back Height Adjustment
Synchro-tilt
Tilt Tension
Tilt Lock
Seat Glide
Functions: **A, B, D, E, J, A-D, L**
(Function Key on pages 250-251)

DIMENSIONS

Upholstered Back
Width: 17½
Upholstered Back
Height: 19½-22½
Mesh Back Width: 17½
Mesh Back Height: 20¾-23¼
Depth: 38½
Width: 27½
Height: 43
Seat Depth: 16-18
Seat Width: 19

Adjustable Arms Width: 17-19½
Fixed Arms Width: 20
Seat to Floor Height: 17-21½
Usable Seat Depth: 15½-17½
Ship Weight (upholstered back): 54
Ship Weight (mesh back): 49
Cube (upholstered back): 10.8
Cube (mesh back): 10.8
COM (upholstered back): 2.0
COM (mesh back): 1.0
Weight Rating: 300 lbs.

FABRIC PRICE CODES

1	\$911	8	\$1200
2	\$962	9	\$1238
3	\$1012	10	\$1275
4	\$1049	11	\$1313
5	\$1087	12	\$1350
6	\$1125	L	—
7	\$1162		

NOTES: See page 396 for arm packs.

HITL3



TASK LOW-BACK

Pneumatic
Back Height Adjustment
Synchro-tilt
Back Angle Adjustment
Tilt Tension
Tilt Lock
Seat Glide
Functions: **A, B, D, E, A-D, A-E, L**
(Function Key on pages 250-251)

DIMENSIONS

Upholstered Back
Width: 17½
Upholstered Back
Height: 20¾-23¾
Mesh Back Width: 17½
Mesh Back Height: 20¾-23¼
Depth: 39
Width: 27
Height: 44
Seat Depth: 16-18
Seat Width: 19

Adjustable Arms Width: 17-19½
Fixed Arms Width: 20
Seat to Floor Height: 17-21½
Usable Seat Depth: 14½-16½
Ship Weight (upholstered back): 58
Ship Weight (mesh back): 53
Cube (upholstered back): 10.8
Cube (mesh back): 10.8
COM (upholstered back): 2.0
COM (mesh back): 1.0
Weight Rating: 300 lbs.

FABRIC PRICE CODES

1	\$971	8	\$1260
2	\$1022	9	\$1298
3	\$1072	10	\$1335
4	\$1109	11	\$1373
5	\$1147	12	\$1410
6	\$1185	L	—
7	\$1222		

NOTES: See page 396 for arm packs.

HON Recommendation: HITL1.A.H.M.CU__T.SB - List Price \$897

SEATING

HOW TO SPECIFY

Select Model Number HITL1	Select Arm Type N Armless F Fixed Arms - Black (+ \$68) A Height and Width Adjustable Arms (+ \$89) V All-Adjustable Arms (includes Pivot) (+ \$136) P Fixed Arms - Polished (+ \$183)	Select Caster/Glide H Black Hard Caster S Black All-Surface Caster (+ \$42)	Select Back Type U Upholstered * M Mesh	Select Fabric See page 391	Select Frame T Black	Select Base SB Standard Base PA Polished Aluminum (+ \$115)
HITL1	A	H	M	CU10	T	SB

* De-emphasized



Icon Legend on page 19

HIWM1



MID-BACK

Pneumatic
Back Height Adjustment
Swivel
Tilt
Tilt Tension
Tilt Lock
Functions: **A, B, E, J, K, L**
(Function Key on pages 250-251)

DIMENSIONS

Upholstered Back Width:	18½	Seat to Floor Height:	17-21½
Upholstered Back Height:	21-24	Usable Seat Depth:	17½
Mesh Back Width:	19	Ship Weight (upholstered back):	54
Mesh Back Height:	21½-24	Ship Weight (mesh back):	48
Depth:	35½	Cube (upholstered back):	10.8
Width:	27	Cube (mesh back):	10.8
Height:	44	COM (upholstered back):	2.0
Seat Depth:	18	COM (mesh back):	1.0
Seat Width:	20	Weight Rating:	300 lbs.
Adjustable Arms Width:	18-20½		
Fixed Arms Width:	20		

FABRIC PRICE CODES

1	\$887	8	\$1176
2	\$938	9	\$1214
3	\$988	10	\$1251
4	\$1025	11	\$1289
5	\$1063	12	\$1326
6	\$1101	L	\$1201
7	\$1138		

NOTES: See page 396 for arm packs.

HIWM2



MID-BACK

Pneumatic
Back Height Adjustment
Synchro-tilt
Tilt Tension
Tilt Lock
Seat Glide
Functions:
A, B, D, E, J, A-D, L
(Function Key on pages 250-251)

DIMENSIONS

Upholstered Back Width:	18½	Seat to Floor Height:	17¼-21¾
Upholstered Back Height:	21-24	Usable Seat Depth:	16¼-18¼
Mesh Back Width:	19	Ship Weight (upholstered back):	58
Mesh Back Height:	21½-24	Ship Weight (mesh back):	52
Depth:	38	Cube (upholstered back):	10.8
Width:	27	Cube (mesh back):	10.8
Height:	46½	COM (upholstered back):	2.0
Seat Depth:	17-19	COM (mesh back):	1.0
Seat Width:	20	Weight Rating:	300 lbs.
Adjustable Arms Width:	18-20½		
Fixed Arms Width:	20		

FABRIC PRICE CODES

1	\$982	8	\$1271
2	\$1033	9	\$1309
3	\$1083	10	\$1346
4	\$1120	11	\$1384
5	\$1158	12	\$1421
6	\$1196	L	\$1296
7	\$1233		

NOTES: See page 396 for arm packs.

HIWM3



MID-BACK

Pneumatic
Back Height Adjustment
Synchro-tilt
Back Angle Adjustment
Tilt Tension
Tilt Lock
Seat Glide
Functions:
A, B, D, E, A-D, A-E, L
(Function Key on pages 250-251)

DIMENSIONS

Upholstered Back Width:	18½	Seat to Floor Height:	17¼-21¾
Upholstered Back Height:	21-24	Usable Seat Depth:	15¼-17¼
Mesh Back Width:	19	Ship Weight (upholstered back):	63
Mesh Back Height:	21½-24	Ship Weight (mesh back):	58
Depth:	39	Cube (upholstered back):	10.8
Width:	27	Cube (mesh back):	10.8
Height:	44	COM (upholstered back):	2.0
Seat Depth:	17-19	COM (mesh back):	1.0
Seat Width:	20	Weight Rating:	300 lbs.
Adjustable Arms Width:	18-20½		
Fixed Arms Width:	20		

FABRIC PRICE CODES

1	\$1047	8	\$1336
2	\$1098	9	\$1374
3	\$1148	10	\$1411
4	\$1185	11	\$1449
5	\$1223	12	\$1486
6	\$1261	L	\$1361
7	\$1298		

NOTES: See page 396 for arm packs.

HON Recommendation: HIWM2.A.H.M.CU__T.SB - List Price \$1071

HOW TO SPECIFY

<p>Select Model Number</p> <p>HIWM1</p>	<p>Select Arm Type</p> <p>N Armless F Fixed Arms - Black (+ \$68) A Height and Width Adjustable Arms (+ \$89) V All-Adjustable Arms (includes Pivot) (+ \$136) P Fixed Arms - Polished (+ \$183)</p> <p>A</p>	<p>Select Caster/Glide</p> <p>H Black Hard Caster S Black All-Surface Caster (+ \$42)</p> <p>H</p>	<p>Select Back Type</p> <p>U Upholstered M Mesh</p> <p>M</p>	<p>Select Fabric</p> <p>See page 391</p> <p>CU10</p>	<p>Select Frame</p> <p>T Black</p> <p>T</p>	<p>Select Base</p> <p>SB Standard Base PA Polished Aluminum (+ \$115)</p> <p>SB</p>
--	---	---	---	---	---	--

* De-emphasized

IGNITION®



Icon Legend on page 19

HIEH1



EXECUTIVE HIGH-BACK

Pneumatic
Back Height Adjustment
Swivel
Tilt
Tilt Tension
Tilt Lock
Functions: **A, B, E, F, K, L**
(Function Key on pages 250-251)

DIMENSIONS

Depth: 38½
Width: 27
Height: 47½
Seat Depth: 18
Seat Width: 20
Back Width: 20
Back Height: 24¾-27¾
Arm Width: 20
Seat to Floor Height: 16¾-21¼
Usable Seat Depth: 17⅞
Ship Weight: 56
Cube: 16.0
COM: 2.5
Weight Rating: 300 lbs.

FABRIC PRICE CODES

1	\$918	8	\$1207
2	\$969	9	\$1245
3	\$1019	10	\$1282
4	\$1056	11	\$1320
5	\$1094	12	\$1357
6	\$1132	L	\$1232
7	\$1169		

NOTES: See page 396 for arm packs.

HIEH2



EXECUTIVE HIGH-BACK

Pneumatic
Back Height Adjustment
Synchro-tilt
Tilt Tension
Seat Glide
Functions: **A, B, D, E, J, A-D, L**
(Function Key on pages 250-251)

DIMENSIONS

Depth: 41
Width: 27
Height: 49
Seat Depth: 17-19
Seat Width: 20
Back Width: 19½
Back Height: 24¾-27¾
Arm Width: 20
Seat to Floor Height: 17-21½
Usable Seat Depth: 16½-18
Ship Weight: 61
Cube: 16.0
COM: 2.5
Weight Rating: 300 lbs.

FABRIC PRICE CODES

1	\$1021	8	\$1310
2	\$1072	9	\$1348
3	\$1122	10	\$1385
4	\$1159	11	\$1423
5	\$1197	12	\$1460
6	\$1235	L	\$1335
7	\$1272		

NOTES: See page 396 for arm packs.

HIEH3



EXECUTIVE HIGH-BACK

Pneumatic
Back Height Adjustment
Synchro-tilt
Back Angle Adjustment
Tilt Tension
Seat Glide
Functions: **A, B, D, E, A-D, A-E, L**
(Function Key on pages 250-251)

DIMENSIONS

Depth: 45½
Width: 27
Height: 49
Seat Depth: 17-19
Seat Width: 20
Back Width: 19½
Back Height: 24¾-27¾
Arm Width: 20
Seat to Floor Height: 17-21½
Usable Seat Depth: 15¼-17¼
Ship Weight: 65
Cube: 16.0
COM: 2.5
Weight Rating: 300 lbs.

FABRIC PRICE CODES

1	\$1080	8	\$1369
2	\$1131	9	\$1407
3	\$1181	10	\$1444
4	\$1218	11	\$1482
5	\$1256	12	\$1519
6	\$1294	L	\$1394
7	\$1331		

NOTES: See page 396 for arm packs.

HON Recommendation: HIEH1.A.H.U.CU__T.SB - List Price \$1007

HOW TO SPECIFY

Select Model Number	Select Arm Type	Select Caster/Glide	Select Back Type	Select Fabric	Select Frame	Select Base
N Armless F Fixed Arms - Black (+ \$68) A Height and Width Adjustable Arms (+ \$89) V All-Adjustable Arms (includes Pivot) (+ \$136) P Fixed Arms - Polished (+ \$183)	H Black Hard Caster S Black All-Surface Caster (+ \$42)	U Upholstered	See page 391	T Black	SB Standard Base PA Polished Aluminum (+ \$115)	
H I E H 1 .	F .	H .	U .	C U 1 0 .	T .	S B



Icon Legend on page 19

HITS5*



TASK STOOL

Pneumatic Swivel Back Height Adjustment Adjustable Footrest
 Functions: **A, B, E**
 (Function Key on pages 250-251)

DIMENSIONS

Upholstered Back Width:	17½	Adjustable Arms Width:	17-19½
Upholstered Back Height:	18¾-21¾	Fixed Arms Width:	20
Mesh Back Width:	17½	Seat to Floor Height:	23⅝-33⅝
Mesh Back Height:	20¾-23¾	Usable Seat Depth:	15¾
Depth:	27½	Ship Weight (upholstered back):	56 Ⓢ
Width:	27	Ship Weight (mesh back):	51 Ⓢ
Height:	44	Cube (upholstered back):	10.8
Seat Depth:	17	Cube (mesh back):	10.8
Seat Width:	19	COM (upholstered back):	2.0
		COM (mesh back):	1.0
		Weight Rating:	300 lbs.

FABRIC PRICE CODES

1	\$954	8	\$1243
2	\$1005	9	\$1281
3	\$1055	10	\$1318
4	\$1092	11	\$1356
5	\$1130	12	\$1393
6	\$1168	L	—
7	\$1205		

NOTES: See page 396 for arm packs.

HON Recommendation: HITS5.A.H.M.CU__T.SB - List Price \$1043

HOW TO SPECIFY

Select Model Number HITS5	Select Arm Type N Armless F Fixed Arms - Black (+ \$68) A Height and Width Adjustable Arms (+ \$89) V All-Adjustable Arms (includes Pivot) (+ \$136) P Fixed Arms - Polished (+ \$183)	Select Caster/Glide H Black Hard Caster S Black All-Surface Caster (+ \$42)	Select Back Type U Upholstered* M Mesh	Select Fabric See page 391	Select Frame T Black	Select Base SB Standard Base
HITS5	A	H	M	CU10	T	SB

* De-emphasized

HI2ATA

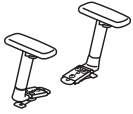

ADJUSTABLE ARMS

Height and Width
Functions: **S**
(Function Key on pages 250-251)

DIMENSIONS

Adjustable Arms Width: 17-19½
Height from Seat: 8-11
Ship Weight: 8
Cube: 1.0

LIST PRICE

\$158

HI2AAA

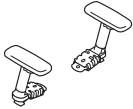

ALL-ADJUSTABLE ARMS

Height, Width, Depth and Pivot

DIMENSIONS

Adjustable Arms Width: 17-20
Height from Seat: 7-11
Ship Weight: 8
Cube: 1.0

LIST PRICE

\$212

HI2FHA

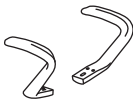

FIXED HEIGHT ARMS

DIMENSIONS

Arm Width: 20
Height from Seat: 9½
Ship Weight: 7
Cube: 1.0

LIST PRICE

\$146

HIPAA

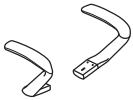

POLISHED ALUMINUM ARMS

Fixed Height

DIMENSIONS

Arm Width: 20
Height from Seat: 9½
Ship Weight: 10
Cube: 1.0

LIST PRICE

\$241

HSCASTER

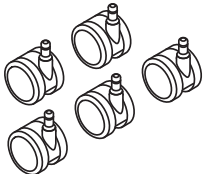

SET OF 5 ALL-SURFACE CASTERS

DIMENSIONS

Size: 60mm
Ship Weight: 2
Cube: 0.1

LIST PRICE

\$72

ⓘ Available in Black finish only, no specification needed.

OPEN MARKET

HOW TO SPECIFY

Select Model Number

Select Frame

Specify for models HI2ATA, HI2AAA, and HI2FHA

- T** Black
- DWX** Designer White
- TI** Titanium

HI2ATA.

T

NOTES



Lota® Multi-Purpose Seating
shown with HON Utility Tables.

LOTA®

If you're looking for all-day comfort without breaking the bank, look no further than Lota. This mesh back guest chair offers advanced features for customizable comfort that make it an upscale choice at an affordable price. If you sit for hours on end, put yourself in more control over your comfort.



FEATURES

- Multi-purpose chairs feature black arms and base.
- H2285 available in black fabric only.
- Multi-purpose chairs stack four high on the floor.
- Warranted for users up to 275 lbs.

MODEL OPTION

H2285



Multi-Purpose (Mesh Back)

4-Leg Stacking Frame, Fixed Arms

FRAME	CODE	DESCRIPTION	PRICE
	T	Black	+\$0

H2285



MULTI-PURPOSE CHAIR

Mesh Back
4-Leg Stacking Frame
Fixed Arms

DIMENSIONS

Depth:	24 ³ / ₄	Arm Width:	19 ¹ / ₈
Width:	23	Seat to Floor Height:	19 ¹ / ₈
Height:	34 ¹ / ₂	Usable Seat Depth:	17 ³ / ₄
Seat Depth:	17 ³ / ₄	Ship Weight:	20
Seat Width:	18 ⁷ / ₈	Cube:	2.8
Back Width:	17 ¹ / ₈	Weight Rating:	250 lbs.
Back Height:	17 ³ / ₄		

LIST PRICE

\$539

NOTES: Casters and glides ship packaged together for customer's assembly choice. Stacks 4-high on floor.

ⓘ Available in VA10 Black fabric seat and Black frame only. Black Mesh back only.

HOW TO SPECIFY

<p>Select Model Number</p> <p>H 2 2 8 5 .</p>	<p>Select Fabric</p> <p>VA10 Black Fabric</p> <p>V A 1 0 .</p>	<p>Select Frame</p> <p>T Black</p> <p>T</p>
--	---	--



Matter™ Upholstered Chair with
5-Star Base with Preside® Table.

MATTER™

This modern take on the traditional task chair combines the comfort of a lounge chair and posture of a task chair. The swivel-tilt control allows you to find that reclining position that's just right for you, and the five-star base lets you move around effortlessly. This cool twist on the traditional guest chair puts the comfort of a lounge chair right on top of a traditional four-leg base.



FEATURES

- Brings a modern design aesthetic into any reception or guest area.
- Available in a 5-star base and 4-leg natural wood base. Hardwood legs in Harvest.
- Swivel-tilt mechanism offers a full range of reclining positions.
- Chrome base provides a contemporary accent.
- 360-degree swivel.
- Easily assembled in minutes.
- Backed by **HON 5-Year Limited Warranty.**

MATTER™ Multi-Purpose Chairs

OPEN MARKET



Icon Legend on page 19

HVL232



GRAY UPHOLSTERED CHAIR

with 5-Star Base
Swivel
Tilt

DIMENSIONS

Depth:	24 ⁴ / ₅	Arm Width:	3
Width:	23	Seat to Floor Height:	19-22 ¹ / ₂
Height:	31-34 ¹ / ₂	Usable Seat Depth:	18
Seat Depth:	18 ³ / ₁₀	Ship Weight:	21
Seat Width:	16 ¹ / ₂	Cube:	5.6
Back Width:	23	Weight Rating:	250 lbs.
Back Height:	12 ² / ₅		

LIST PRICE

\$650

NOTES: HON 5-Year Limited Warranty.

HVL238



GRAY UPHOLSTERED CHAIR

Wood Leg Base
Harvest Wood Legs
4-Leg Wood Base

DIMENSIONS

Depth:	24 ⁴ / ₅	Arm Width:	3
Width:	23	Seat to Floor Height:	19 ¹ / ₄
Height:	31 ¹ / ₂	Usable Seat Depth:	18
Seat Depth:	18 ³ / ₁₀	Ship Weight:	21
Seat Width:	16 ¹ / ₂	Cube:	5.6
Back Width:	23	Weight Rating:	250 lbs.
Back Height:	12 ² / ₅		

LIST PRICE

\$600

NOTES: HON 5-Year Limited Warranty.

HOW TO SPECIFY

Select Model Number

Select Fabric

GRY01 Light Gray

H V L 2 3 8 .

G R Y 0 1



Mav™ Single Lounge shown with West Hill™ Seating and Scramble™ Coffee Table.

MAV™

With plenty of base, back, and seat options offset with mid-century flair and richly colored fabrics, the Mav Single Lounge Series is designed to function well in virtually any space. Whether it's configured for a multi-use zone, in a private office, or to stand alone as a statement piece, Mav is an ideal place for impromptu or collaborative gatherings, a quick break, or focused, heads-down work.



FEATURES

- Subtle seat and back contours and refined details create an inviting, contemporary aesthetic.
- Choose from a mid-back or high-back option.
- Contoured arms provide support and create a striking look.
- Armless models offer a range of seated postures.
- High-back models available with a 4-star metal base with return-to-center, 4-leg wood base, or 5-star base with swivel knee tilt.
- Mid-back models offered in 4-star metal base with return-to-center, 4-leg wood base, wire sled base, or 5-star base with swivel knee tilt.
- Multi-Fabric option — seat cushion and frame can be specified in different fabrics for a modern aesthetic.
- Ottoman lets you kick up your feet or use as impromptu seating.
- Seat cushion attaches with Velcro for easy cleaning or replacement.
- Available in a wide range of cleanable fabrics to achieve the perfect look (see HON's Cleaning Guide).
- Choose from 10 wood base or 4 metal base finish options.

MAV™ Finish Options

HON BRANDED FABRICS

GRADE 1	GRADE 2	GRADE 3	GRADE 4
Apex	Appoint Seating	Bradbury	Constance with Supreen™
Centurion	Blume	Getaway	Livi with Supreen™
Compass	Clyde	Moxie**	Lugano with Supreen™
Contourett**	Dotty	Notion	Oxford with Supreen™
Dapper	Kai	Parker**	
Ensemble	Rush	Purl	
Hamilton	Spin Seating	Quill	
Inertia	Wavelength	Saxony	
Noble Seating	Whisper Vinyl**		
Optic*			
Pebble			
Vibe			

For a complete list of fabrics, including partnership fabrics, go to hon.com/fabricsandfinishes.

Reference Fabric Color Combinations on pages 20-24 for color codes and legend on page 21 for lead times.

*Not available on Single Fabric models or as multi-fabric frame option.

**Due to the inherent design of Mav™ high-back chairs, coated fabrics may show material gathers, particularly around the headrest.

For more details on Upholstery Pattern Match for this series, please see page 14.

LEG STYLE

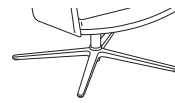

CODE	DESCRIPTION	PRICE
4S	4-Star Return-to-Center	+\$0
<i>Available in the following finishes:</i>		
P8V	Textured Titanium	
P7A	Textured Charcoal	
P8X	Solar Black	+\$21
Y	Polished	+\$53

LEG STYLE

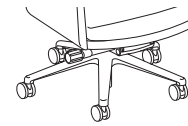

CODE	DESCRIPTION	PRICE
5S	5-Star w/Swivel Knee Tilt, Hard Caster	+\$27
5SS	5-Star w/Swivel Knee Tilt, All-Surface Caster	+\$58
<i>Available in the following finishes:</i>		
P8V	Textured Titanium	
P7A	Textured Charcoal	
P8X	Solar Black	+\$21
Y	Polished	+\$53

LEG STYLE



CODE	DESCRIPTION	PRICE
WD	Wood	+\$262
<i>Available in the following finishes:</i>		
LFW1	Florence Walnut	
LKI1	Kingswood Walnut	
LLA1	Lowell Ash	
D	Natural Maple	
LNRI	Natural Recon	
LPE1	Phantom Ecru	
PINC	Pinnacle	
LPT1	Portico Teak	
LSW1	Skyline Walnut	
LSA1	Sterling Ash	

LEG STYLE



CODE	DESCRIPTION	PRICE
SD	Sled*	+\$0
<i>Available in the following finishes:</i>		
P8V	Textured Titanium	
P7A	Textured Charcoal	
P8X	Solar Black	+\$21
Y	Polished	+\$53

*Available on Mid-Back models only

Low-Back, Multi-Fabric



High-Back, Multi-Fabric





HMAVMN



MID-BACK SINGLE LOUNGE, ARMLESS

DIMENSIONS

Depth (4-Star, 5-Star, & Wood):	28¾	Back Height:	18¾
Depth (Sled):	27½	Back Width:	20
Height (4-Star):	29½	Ship Weight:	45
Height (5-Star):	33½-37¼	Ship Weight (5-Star):	55
Height (Wood):	30	Cube:	20.1
Height (Sled):	30¾	COM:	3.5
Width:	24	Weight Rating:	300 lbs.
Usable Seat Depth:	19		
Seat to Floor Height:	17		
Seat to Floor Height (5-Star):	17¼-21		
Seat Width:	21		

FABRIC PRICE CODES

1	\$1669	8	\$2332
2	\$1757	9	\$2349
3	\$1847	10	\$2439
4	\$1921	11	\$2527
5	\$2021	12	\$2617
6	\$2122	L	\$3244
7	\$2226		

HMAVMNMF



MID-BACK SINGLE LOUNGE, ARMLESS, MULTI-FABRIC

DIMENSIONS

Depth (4-Star, 5-Star, & Wood):	28¾	Back Height:	18¾
Depth (Sled):	27½	Back Width:	20
Height (4-Star):	29½	Ship Weight:	45
Height (5-Star):	33½-37¼	Ship Weight (5-Star):	55
Height (Wood):	30	Cube:	20.1
Height (Sled):	30¾	COM (Seat Cushion):	1.5
Width:	24	COM (Back/Frame):	2.5
Usable Seat Depth:	19	Weight Rating:	300 lbs.
Seat to Floor Height:	17		
Seat to Floor Height (5-Star):	17¼-21		
Seat Width:	21		

FABRIC PRICE CODES

1	\$1851	
	<i>Add to Base Price Above</i>	
	Seat	Frame
2	\$26	\$63
3	\$51	\$127
4	\$73	\$180
5	\$101	\$251
6	\$130	\$323
7	\$159	\$398
8	\$190	\$474
9	\$195	\$485
10	\$220	\$549
11	\$246	\$614
12	\$271	\$678

HON Recommendation: HMAVMNMF.PURL__PURL__4S__ - List Price \$2029

HOW TO SPECIFY

<p>Select Model Number</p>	<p>Select Fabric</p> <p>See page 406 Specify for single fabric model only</p>	<p>Select Seat Fabric</p> <p>See page 406 Specify for multi-fabric model only</p>	<p>Select Frame Fabric</p> <p>See page 406 Specify for multi-fabric model only</p>	<p>Select Base and Base Color</p> <p>See page 406</p> <p>4S 4-Star Return-to-Center 5S 5-Star, Hard Caster (+ \$27) 5SS 5-Star, All-Surface Caster (+ \$58) WD Wood (+ \$262) SD Sled</p>
HMAVMNMF	PURL05	PURL05	PURL03	4SP7A

HMAVMA



MID-BACK SINGLE LOUNGE, ARMS

DIMENSIONS

Depth (4-Star, 5-Star, & Wood):	28¾	Back Height:	18¾
Depth (Sled):	27½	Back Width:	20
Height (4-Star):	29½	Arm Height:	8½
Height (5-Star):	33½-37¼	Ship Weight:	53
Height (Wood):	30	Ship Weight (5-Star):	63
Height (Sled):	30¾	Cube:	20.1
Width:	25	COM:	4.0
Usable Seat Depth:	19	Weight Rating:	300 lbs.
Seat to Floor Height:	17		
Seat to Floor Height (5-Star):	17¼-21		
Seat Width:	21		

FABRIC PRICE CODES

1	\$2094	8	\$2852
2	\$2195	9	\$2871
3	\$2297	10	\$2973
4	\$2382	11	\$3076
5	\$2496	12	\$3178
6	\$2612	L	\$3894
7	\$2731		

HMAVMAMF



MID-BACK SINGLE LOUNGE, ARMS, MULTI-FABRIC

DIMENSIONS

Depth (4-Star, 5-Star, & Wood):	28¾	Back Height:	18¾
Depth (Sled):	27½	Back Width:	20
Height (4-Star):	29½	Arm Height:	8½
Height (5-Star):	33½-37¼	Ship Weight:	53
Height (Wood):	30	Ship Weight (5-Star):	63
Height (Sled):	30¾	Cube:	20.1
Width:	25	COM (Seat Cushion):	1.5
Usable Seat Depth:	19	COM (Back/Frame):	4.0
Seat to Floor Height:	17	Weight Rating:	300 lbs.
Seat to Floor Height (5-Star):	17¼-21		
Seat Width:	21		

FABRIC PRICE CODES

1	\$2275	
	<i>Add to Base Price Above</i>	
	Seat	Back
2	\$26	\$76
3	\$51	\$152
4	\$73	\$216
5	\$101	\$301
6	\$130	\$388
7	\$159	\$478
8	\$190	\$569
9	\$195	\$583
10	\$220	\$660
11	\$246	\$736
12	\$271	\$814

HON Recommendation: HMAVMAMF.PURL__PURL__4S__ - List Price \$2478

HOW TO SPECIFY

<p>Select Model Number</p>	<p>Select Fabric</p> <p>See page 406</p> <p><i>Specify for single fabric model only</i></p>	<p>Select Seat Fabric</p> <p>See page 406</p> <p><i>Specify for multi-fabric model only</i></p>	<p>Select Frame Fabric</p> <p>See page 406</p> <p><i>Specify for multi-fabric model only</i></p>	<p>Select Base and Base Color</p> <p>See page 406</p> <p>4S 4-Star Return-to-Center</p> <p>5S 5-Star w/Swivel Knee Tilt, Hard Caster (+ \$27)</p> <p>5SS 5-Star w/Swivel Knee Tilt, All-Surface Caster (+ \$58)</p> <p>WD Wood (+ \$262)</p> <p>SD Sled</p>
HMAVMAMF	PURL05	PURL05	PURL03	4SP7A



HMAVHN



HIGH-BACK SINGLE LOUNGE, ARMLESS

DIMENSIONS

Depth:	30¼	Back Height:	32½
Height (4-Star):	43½	Back Width:	20
Height (5-Star):	47-50¾	Ship Weight:	50
Height (Wood):	44	Ship Weight (5-Star):	59
Width:	24	Cube:	29
Usable Seat Depth:	19	COM:	4.0
Seat to Floor Height:	17	Weight Rating:	300 lbs.
Seat to Floor Height (5-Star):	17¼-21		
Seat Width:	21		

FABRIC PRICE CODES

1	\$1881	8	\$2544
2	\$1969	9	\$2561
3	\$2059	10	\$2651
4	\$2133	11	\$2739
5	\$2233	12	\$2829
6	\$2334	L	\$3456
7	\$2438		

HMAVHNMF

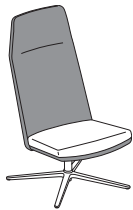

HIGH-BACK SINGLE LOUNGE, ARMLESS, MULTI-FABRIC

DIMENSIONS

Depth:	30¼	Back Height:	32½
Height (4-Star):	43½	Back Width:	20
Height (5-Star):	47-50¾	Ship Weight:	50
Height (Wood):	44	Ship Weight (5-Star):	59
Width:	24	Cube:	29
Usable Seat Depth:	19	COM (Seat Cushion):	1.5
Seat to Floor Height:	17	COM (Back/Frame):	3.5
Seat to Floor Height (5-Star):	17¼-21	Weight Rating:	300 lbs.
Seat Width:	21		

FABRIC PRICE CODES

1	\$2063	
	<i>Add to Base Price Above</i>	
	Seat	Frame
2	\$26	\$63
3	\$51	\$127
4	\$73	\$180
5	\$101	\$251
6	\$130	\$323
7	\$159	\$398
8	\$190	\$474
9	\$195	\$485
10	\$220	\$549
11	\$246	\$614
12	\$271	\$678

HON Recommendation: HMAVHNMF.PURL__PURL__4S__ - List Price \$2241

HOW TO SPECIFY

<p>Select Model Number</p> <p>See page 406</p>	<p>Select Fabric</p> <p>See page 406</p> <p><i>Specify for single fabric model only</i></p>	<p>Select Seat Fabric</p> <p>See page 406</p> <p><i>Specify for multi-fabric model only</i></p>	<p>Select Frame Fabric</p> <p>See page 406</p> <p><i>Specify for multi-fabric model only</i></p>	<p>Select Base and Base Color</p> <p>See page 406</p> <p>4S 4-Star Return-to-Center 5S 5-Star w/Swivel Knee Tilt, Hard Caster (+ \$27) 5SS 5-Star w/Swivel Knee Tilt, All-Surface Caster (+ \$58) WD Wood (+ \$262)</p>
HMAVHNMF	PURL05	PURL05	PURL03	4SP7A

HMAVHA



HIGH-BACK SINGLE LOUNGE, ARMS

DIMENSIONS

Depth:	30¼	Back Height:	32½
Height (4-Star):	43½	Back Width:	20
Height (5-Star):	47-50¾	Arm Height:	8½
Height (Wood):	44	Ship Weight:	59
Width:	25	Ship Weight (5-Star):	67
Usable Seat Depth:	19	Cube:	29
Seat to Floor Height:	17	COM:	5.0
Seat to Floor Height (5-Star):	17¼-21	Weight Rating:	300 lbs.
Seat Width:	21		

FABRIC PRICE CODES

1	\$2306	8	\$3064
2	\$2407	9	\$3083
3	\$2509	10	\$3185
4	\$2594	11	\$3288
5	\$2708	12	\$3390
6	\$2824	L	\$4106
7	\$2943		

HMAVHAMF



HIGH-BACK SINGLE LOUNGE, ARMS, MULTI-FABRIC

DIMENSIONS

Depth:	30¼	Back Height:	32½
Height (4-Star):	43½	Back Width:	20
Height (5-Star):	47-50¾	Arm Height:	8½
Height (Wood):	44	Ship Weight:	59
Width:	25	Ship Weight (5-Star):	67
Usable Seat Depth:	19	Cube:	29
Seat to Floor Height:	17	COM (Seat Cushion):	1.5
Seat to Floor Height (5-Star):	17¼-21	COM (Back/Frame):	4.0
Seat Width:	21	Weight Rating:	300 lbs.

FABRIC PRICE CODES

1	\$2488	
	<i>Add to Base Price Above</i>	
	Seat	Frame
2	\$26	\$76
3	\$51	\$152
4	\$73	\$216
5	\$101	\$301
6	\$130	\$388
7	\$159	\$478
8	\$190	\$569
9	\$195	\$583
10	\$220	\$660
11	\$246	\$736
12	\$271	\$814

HON Recommendation: HMAVHAMF.PURL__PURL__4S__ - List Price \$2691

HOW TO SPECIFY

<p>Select Model Number</p> <p>See page 406</p> <p><i>Specify for single fabric model only</i></p>	<p>Select Fabric</p> <p>See page 406</p> <p><i>Specify for single fabric model only</i></p>	<p>Select Seat Fabric</p> <p>See page 406</p> <p><i>Specify for multi-fabric model only</i></p>	<p>Select Frame Fabric</p> <p>See page 406</p> <p><i>Specify for multi-fabric model only</i></p>	<p>Select Base and Base Color</p> <p>See page 406</p> <p>4S 4-Star Return-to-Center 5S 5-Star w/Swivel Knee Tilt, Hard Caster (+ \$27) 5SS 5-Star w/Swivel Knee Tilt, All-Surface Caster (+ \$58) WD Wood (+ \$262)</p>
<p>HMAVHAMF .</p>	<p>PURL05 .</p>	<p>PURL05 .</p>	<p>PURL03 .</p>	<p>4SP7A</p>



HMAVO



SINGLE LOUNGE OTTOMAN

DIMENSIONS

Depth:	22	Ship Weight:	33
Height:	15	Cube:	9.5
Width:	24	COM:	3.5
Usable Seat Depth:	24	Weight Rating:	300 lbs.
Seat to Floor Height:	15		
Seat Width:	22		

FABRIC PRICE CODES

1	\$1032	8	\$1790
2	\$1133	9	\$1809
3	\$1235	10	\$1911
4	\$1320	11	\$2014
5	\$1434	12	\$2116
6	\$1550	L	\$2832
7	\$1669		

HMAVOMF



SINGLE LOUNGE OTTOMAN, MULTI-FABRIC

DIMENSIONS

Depth:	22	Ship Weight:	33
Height:	15	Cube:	9.5
Width:	24	COM (Seat Cushion):	1.5
Usable Seat Depth:	24	COM (Frame):	2.5
Seat to Floor Height:	15	Weight Rating:	300 lbs.
Seat Width:	22		

FABRIC PRICE CODES

1	\$1124		
<i>Add to Base Price Above</i>			
	Seat	Frame	
2	\$26	\$76	
3	\$51	\$152	
4	\$73	\$216	
5	\$101	\$301	
6	\$130	\$388	
7	\$159	\$478	
8	\$190	\$569	
9	\$195	\$583	
10	\$220	\$660	
11	\$246	\$736	
12	\$271	\$814	

HON Recommendation: HMAVOMF.PURL___.PURL___.4S__ - List Price \$1327

HOW TO SPECIFY

<p>Select Model Number</p> <p>HMAVOMF</p>	<p>Select Fabric</p> <p>See page 406 Specify for single fabric model only</p> <p>PURL05</p>	<p>Select Seat Fabric</p> <p>See page 406 Specify for multi-fabric model only</p> <p>PURL05</p>	<p>Select Frame Fabric</p> <p>See page 406 Specify for multi-fabric model only</p> <p>PURL03</p>	<p>Select Base and Base Color</p> <p>See page 406 4S 4-Star</p> <p>4SP7A</p>
--	--	--	---	---

MOTIVATE® CHAIRS

Want to see more? Scan here
to check out hon.com.



Motivate® 4-Leg Stacking Chairs and Between™ Table.

MOTIVATE® CHAIRS

A presentation in the morning. A training session in the afternoon. Today's multi-purpose spaces are in constant flux, and need an adaptable seating solution that delivers instant comfort for all, while easily moving around to support various activities. Motivate task chairs, stacking/nesting chairs and guest chairs create a streamlined collection of seating that intuitively responds to your body's natural movements and curves. Whether sitting for five minutes or five hours, when you Motivate your team you put everyone at ease.



FEATURES

- Choose plastic, upholstered or 4-Way Stretch mesh back.
- Easily move chairs around the space for quick rearrangement.
- HMN1 nesting/stacking chairs stack four high on the floor.
- HMS1 sled base chairs stack 12 high on the floor or 40 high on a cart.
- HMS2 sled base chairs stack six high on the floor.
- Dynamic flex-zone motion in seat and back provides balance and lumbar support.
- Model HMT5 task stool features an adjustable footring.
- Plastic shell is available in 13 colors.
- Available in hundreds of quality HON fabrics.
- Warranted for users up to 300 lbs.

TASK CHAIR FEATURES

- One-touch seat height adjustment easily moves the seat up and down.
- 360-degree swivel provides freedom of movement in any direction.
- Warranted for users up to 300 lbs.

MOTIVATE® Task Chair Options

MODEL OPTIONS

HMT1



Flex-back

Upholstered Seat,
Pneumatic, Swivel

HMT5



Flex-back

Upholstered Seat,
Pneumatic, Swivel
Adjustable Footring

ARM STYLE

CODE	DESCRIPTION	PRICE
N	Armless	+\$0
A	Adjustable Arms	+\$74



CASTERS

CODE	DESCRIPTION	PRICE
H	Hard Caster	+\$0
S	All-Surface Caster	+\$42



BACK STYLE

CODE	DESCRIPTION	PRICE
------	-------------	-------

Plastic/Upholstered Options:

PS	Plastic Shell	+\$0
-----------	---------------	-------------



PB	Upholstered	+\$74
-----------	-------------	--------------



4-Way Stretch Options:

IM	Black	+\$84
IB	Breeze	+\$84
IK	Brownstone	+\$84
IC	Charcoal	+\$84
IF	Fog	+\$84
IR	Regatta	+\$84
IT	Titanium	+\$84



PLASTIC SHELL COLOR CODES (no upcharge):

Tangelo - **RG**
Regatta - **RE**
Lava - **LA**

Cherry - **CR**
Mulberry - **MB**
Onyx - **ON**

Lime - **LM**
Loft - **LO**
White - **WT**

Calypso - **CP**
Platinum - **PT**

Surf - **BU**
Shadow - **SD**

BASE

CODE	DESCRIPTION	PRICE
SB	Standard Base	+\$0



FRAME COLOR

CODE	DESCRIPTION	PRICE
T	Black	+\$0

SEATING

MOTIVATE[®]

Task Chair Fabric Options

HON BRANDED FABRICS

GRADE 1

Apex
Centurion
Compass
Contourett
Dapper
Ensemble
Hamilton
Inertia
Noble Seating
Optic
Pebble
Vibe

GRADE 2

Appoint Seating
Blume
Clyde
Dotty
Kai
Rush
Spin Seating
Wavelength
Whisper Vinyl

GRADE 3

Bradbury
Getaway
Moxie
Notion
Parker
Purl
Quill
Saxony

GRADE 4

Constance with Supreen™
Livi with Supreen™
Lugano with Supreen™
Oxford with Supreen™

GRADE L

Denver Leather

For a complete list of fabrics, including partnership fabrics, go to hon.com/fabricsandfinishes.

Reference Fabric Color Combinations on pages 20-24 for color codes and legend on page 21 for lead times.



Icon Legend on page 19

MOTIVATE® Task Chairs

HMT1

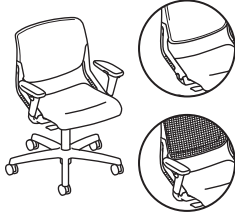

TASK CHAIR

Flex-back
Upholstered Seat
Pneumatic
Swivel

DIMENSIONS

Depth:	27½	Seat to Floor Height:	17-22½
Width:	27½	Usable Seat Depth:	18
Height:	37½	Ship Weight (upholstered back):	39
Seat Depth:	18	Ship Weight (plastic/mesh back):	38
Seat Width:	17½	Cube (upholstered back):	10.0
Back Width:	19½	Cube (plastic/mesh back):	10.0
Back Height:	17¾	COM (upholstered back):	1.5
Arm Width:	18½-20	COM (plastic/mesh back):	1.0
		Weight Rating:	300 lbs.

FABRIC PRICE CODES

1	\$583	8	\$800
2	\$621	9	\$828
3	\$659	10	\$856
4	\$687	11	\$884
5	\$715	12	\$913
6	\$743	L	—
7	\$772		

❗ When a Plastic Shell (PS) or Upholstered Back (PB) option is chosen, you must select a shell color. If the mesh back option is chosen, the shell color is not specified.

HMT5

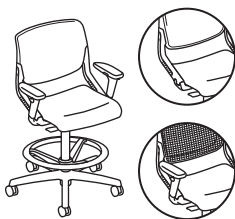

TASK STOOL

Flex-back
Upholstered Seat
Pneumatic
Swivel Adjustable Footring

DIMENSIONS

Depth:	28¼	Seat to Floor Height:	22½-32½
Width:	28¼	Usable Seat Depth:	18
Height:	50½	Ship Weight (upholstered back):	44
Seat Depth:	18	Ship Weight (plastic/mesh back):	43
Seat Width:	17½	Cube (upholstered back):	10.0
Back Width:	19½	Cube (plastic/mesh back):	10.0
Back Height:	17¾	COM (upholstered back):	1.5
Arm Width:	18½-20	COM (plastic/mesh back):	1.0
		Weight Rating:	300 lbs.

FABRIC PRICE CODES

1	\$662	8	\$879
2	\$700	9	\$907
3	\$738	10	\$935
4	\$766	11	\$963
5	\$794	12	\$992
6	\$822	L	—
7	\$851		

NOTES: Stool model has adjustable footring.

❗ When a Plastic Shell (PS) or Upholstered Back (PB) option is chosen, you must select a shell color. If the mesh back option is chosen, the shell color is not specified.

HON Recommendation: HMT1.A.H.IM.CU__SB.T - List Price \$741

HOW TO SPECIFY

Select Model Number	Select Arm Type	Select Caster	Select Back Type/Color	Select Fabric	Select Base	Select Frame
	A Adjustable Arms (+ \$74) N Armless	H Hard Caster S All-Surface Caster (+ \$42)	PS Plastic Shell PB Upholstered (+ \$74) If PS or PB options are chosen, select shell color. Plastic Shell Colors RG Tangelo LO Loft CR Cherry PT Platinum LM Lime SD Shadow CP Calypso LA Lava BU Surf ON Onyx RE Regatta WT White MB Mulberry 4-Way Stretch options (+ \$84) IM Black IF Fog IB Breeze IR Regatta IK Brownstone IT Titanium IC Charcoal	See page 414	SB Standard Base	T Black
HMT1	A	H	IM	CU10	SB	T
HMT1	A	H	PSLA	CU10	SB	T

SEATING

MOTIVATE® High-Density Sled Base Chair Options

MODEL OPTIONS

HMS1



High-Density Stacker

Sled Leg Base, Set of 4

HMS2



High-Density Stacker

Upholstered Seat, Sled Leg Base, Set of 4

ARM STYLE

CODE	DESCRIPTION	PRICE
F	Fixed Arms	+\$32



N	Armless	+\$0
----------	---------	-------------



FRAME

CODE	DESCRIPTION	PRICE
Y	Chrome	+\$0

P1 PAINT: +\$0

CBK	Charblack
P7J	Textured Brownstone
P7A	Textured Charcoal
PK7	Textured Designer White
P7L	Textured Loft
P7M	Textured Muslin
PLAT	Textured Platinum Metallic
P8V	Textured Titanium

P2 PAINT: +\$0
PR8 Textured Silver

P3 PAINT: +\$32

P8S	Atom
PJF	Bullseye
P8P	Ember
P8N	Ion
P8J	Iris
P8F	Krypton
P8M	Regatta

PLASTIC SHELL COLOR CODES (no upcharge):

Tangelo - **RG**
Regatta - **RE**
Lava - **LA**

Cherry - **CR**
Mulberry - **MB**
Onyx - **ON**

Lime - **LM**
Loft - **LO**
White - **WT**

Calypso - **CP**
Platinum - **PT**

Surf - **BU**
Shadow - **SD**

HON BRANDED FABRICS

GRADE 1

Apex
Centurion
Compass
Contourett
Dapper
Ensemble
Hamilton
Inertia
Noble Seating
Optic
Pebble
Vibe

GRADE 2

Apport Seating
Blume
Clyde
Dotty
Kai
Rush
Spin Seating
Wavelength
Whisper Vinyl

GRADE 3

Bradbury
Getaway
Moxie
Notion
Parker
Purl
Quill
Saxony

GRADE 4

Constance with Supreen™
Livi with Supreen™
Lugano with Supreen™
Oxford with Supreen™

For a complete list of fabrics, including partnership fabrics, go to hon.com/fabricsandfinishes.

Reference Fabric Color Combinations on pages 20-24 for color codes and legend on page 21 for lead times.

NOTES: Upcharges shown on this page are per chair.



MOTIVATE® High-Density Sled Base Chairs

HMS1

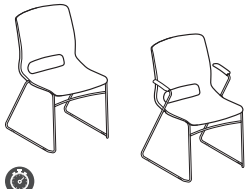

HIGH-DENSITY STACKER

Sled Leg Base
Set of 4

DIMENSIONS

Depth:	23	Arm Width:	18 $\frac{1}{8}$
Width:	21	Seat to Floor Height:	17 $\frac{3}{4}$
Height:	32 $\frac{1}{4}$	Usable Seat Depth:	18 $\frac{1}{4}$
Seat Depth:	18 $\frac{1}{4}$	Ship Weight:	72
Seat Width:	17 $\frac{3}{4}$	Cube:	15.2
Back Width:	17 $\frac{1}{4}$	Weight Rating:	300 lbs.
Back Height:	18		

LIST PRICE PER CARTON

\$1112
(reference single unit @ \$278.00)

NOTES: HMS1 Sled Base chairs stack 12-high on the floor, or 40-high on the chair cart model HMSCART. Field installed glides must be ordered separately and snap-on using existing locations on the sled base frames.

! Ganging Chair Glides must be ordered separately and are designed for use on armless models of the Motivate® High-Density Sled Base Chairs only.

HMS2

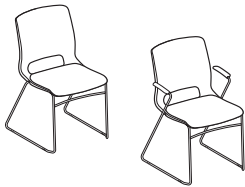

HIGH-DENSITY STACKER

Upholstered Seat
Sled Leg Base
Set of 4

DIMENSIONS

Depth:	23	Arm Width:	18 $\frac{1}{8}$
Width:	21	Seat to Floor Height:	18 $\frac{1}{4}$
Height:	32 $\frac{1}{4}$	Usable Seat Depth:	18 $\frac{1}{4}$
Seat Depth:	18 $\frac{1}{4}$	Ship Weight:	80
Seat Width:	17 $\frac{3}{4}$	Cube:	15.2
Back Width:	17 $\frac{1}{4}$	COM (per 4 pack):	1.6
Back Height:	17 $\frac{1}{2}$	Weight Rating:	300 lbs.

FABRIC PRICE CODES

1	\$1424	8	\$1569
2	\$1450	9	\$1588
3	\$1475	10	\$1606
4	\$1493	11	\$1625
5	\$1512	12	\$1644
6	\$1531	L	—
7	\$1550		

NOTES: HMS2 Sled Base chairs stack 6-high on the floor. Field installed glides must be ordered separately and snap-on using existing locations on the sled base frames.

! Ganging Chair Glides must be ordered separately and are designed for use on armless models of the Motivate® High-Density Sled Base Chairs only.

HMSCART

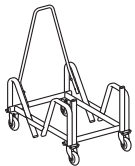

CART FOR HMS1 STACKING CHAIRS

DIMENSIONS

Depth:	34 $\frac{1}{4}$	Ship Weight:	40
Width:	21 $\frac{1}{8}$	Cube:	7.8
Height:	36 $\frac{1}{8}$		

LIST PRICE

\$639

Holds up to 40 Stacking Chairs.

! Motivate® Sled Base Chairs are ordered and shipped four (4) chairs per carton. Pricing shown is per carton. Each set of four chairs (one carton), must have the same shell/frame color combination. Ordering 2 of Model HMS1, HMS2 will result in 2 cartons being shipped, giving you 8 chairs.

HON Recommendation: HMS1.N.ON.Y - List Price \$1112

HOW TO SPECIFY

<p>Select Model Number</p> <p>HMS1 .</p> <p>HMS2 .</p>	<p>Select Arm Type</p> <p>F Fixed Arms (+ \$32 per chair)</p> <p>N Armless</p> <p>N .</p> <p>N .</p>	<p>Select Shell Color</p> <p>RG Tangelo</p> <p>CR Cherry</p> <p>LM Lime</p> <p>CP Calypso</p> <p>BU Surf</p> <p>RE Regatta</p> <p>MB Mulberry</p> <p>LO Loft</p> <p>PT Platinum</p> <p>SD Shadow</p> <p>LA Lava</p> <p>ON Onyx</p> <p>WT White</p> <p>ON .</p> <p>ON .</p>	<p>Select Fabric</p> <p>See page 416</p> <p><i>Not specified for HMS1 models</i></p> <p>CU10 .</p>	<p>Select Frame</p> <p>See page 416</p> <p>BLCK</p> <p>BLCK</p>
---	---	---	---	--

MOTIVATE® High-Density Sled Base Chairs

OPEN MARKET



Icon Legend on page 19

HMSGLD

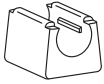

GLIDES FOR MOTIVATE® HIGH-DENSITY STACKER

- Kit includes 48 glides for 12 chairs
- Field installed
- Snap-on using existing locations on frames

DIMENSIONS

Ship Weight: 1
Cube: 0.2

LIST PRICE

\$87

HMSFLTGLD



FELT GLIDES FOR MOTIVATE® HIGH-DENSITY STACKER

- Kit includes 48 glides for 12 chairs
- Field installed
- Snap-on using existing locations on frames

DIMENSIONS

Ship Weight: 1
Cube: 0.2

LIST PRICE

\$219

HMSSTLGLD



STEEL GLIDES FOR MOTIVATE® HIGH-DENSITY STACKER

- Kit includes 48 glides for 12 chairs
- Field installed
- Snap-on using existing locations on frames

DIMENSIONS

Ship Weight: 1
Cube: 0.2

LIST PRICE

\$219

HMSGANG

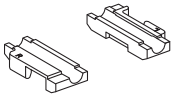

GANGING CONNECTORS FOR MOTIVATE® HIGH- DENSITY STACKER

- 48 ganging connectors
- Requires 4 connectors per ganging connection
- For use on HMS1.N and HMS2.N only (armless models)
- Field installed
- Snap-on using existing locations on frames

DIMENSIONS

Ship Weight: 1
Cube: 0.2

LIST PRICE

\$159

Floor Covering	TYPE OF GLIDE		
	Polycarbonate/Nylon	Felt	Steel
Carpet	Best	Not Recommended	Good
Polished concrete	Best	Good	Not Recommended
Hard wood	Not Recommended	Best	Not Recommended
Vinyl (includes LVT)	Best	Better	Good
VCT	Best	Good	Not Recommended
Tile (Porcelain/Ceramic)	Best	Good	Not Recommended

HOW TO SPECIFY

Select
Model Number

H M S G L D

MOTIVATE® 4-Leg Chair Options

MODEL OPTIONS

HMG1



Stack Chair

Four Legs, Set of 2

HMG2



Stack Chair

Four Legs, Upholstered Seat, Set of 2

HMG3

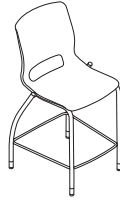

Counter-Height Stool

Four Legs

HMG4

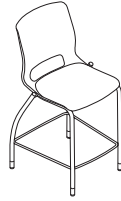

Counter-Height Stool

Four Legs, Upholstered Seat

HMG5



Café-Height Stool

Four Legs

HMG7



Café-Height Stool

Four Legs, Upholstered Seat

ARM STYLE



CODE	DESCRIPTION	PRICE
F	Fixed Arms	+\$32



N	Armless	+\$0
----------	---------	-------------

CASTERS/ GLIDES



CODE	DESCRIPTION	PRICE
H	Hard Caster	+\$0



S	All-Surface Caster	+\$32
----------	--------------------	--------------

**Casters only available on HMG1 and HMG2*



E	Standard Nylon Glide	+\$0
----------	----------------------	-------------

F	Felt Glide	+\$32
----------	------------	--------------

R	Rubber Glide	+\$32
----------	--------------	--------------

T	Steel Glide	+\$32
----------	-------------	--------------

FRAME

CODE	DESCRIPTION	PRICE
P1 PAINT:		+\$0
CBK	Charblack	
P7J	Textured Brownstone	
P7A	Textured Charcoal	
PK7	Textured Designer White	
P7L	Textured Loft	
P7M	Textured Muslin	
PLAT	Textured Platinum Metallic	
P8V	Textured Titanium	
P2 PAINT:		+\$0
PR8	Textured Silver	
P3 PAINT:		+\$32
P8S	Atom	
PJF	Bullseye	
P8P	Ember	
P8N	Ion	
P8J	Iris	
P8F	Krypton	
P8M	Regatta	

PLASTIC SHELL COLOR CODES (no upcharge):					
Tangelo - RG	Cherry - CR	Lime - LM	Calypso - CP	Surf - BU	
Regatta - RE	Mulberry - MB	Loft - LO	Platinum - PT	Shadow - SD	
Lava - LA	Onyx - ON	White - WT			

NOTES: Upcharges shown on this page are per chair.

SEATING

MOTIVATE® 4-Leg Chairs

GSA SIN 33721



Icon Legend on page 19

HMG1

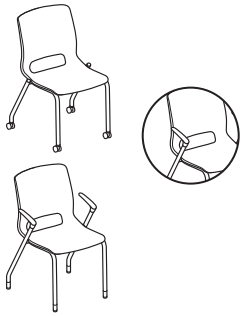

STACK CHAIR

Four Legs
Set of 2

DIMENSIONS

Depth:	23	Arm Width:	18
Width:	21	Seat to Floor Height:	17¾
Height:	32¼	Usable Seat Depth:	18¼
Seat Depth:	18¼	Ship Weight:	38
Seat Width:	17¾	Cube:	13.0
Back Width:	17¼	Weight Rating:	300 lbs.
Back Height:	18		

LIST PRICE PER CARTON

\$723

(reference single unit @ \$361.50)

NOTES: 4-Leg chairs stack 6-high on the floor.

Ships two (2) chairs per carton.

HMG2

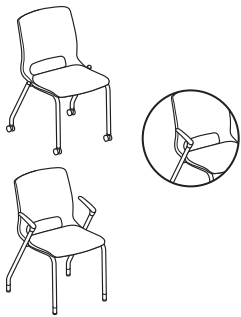

STACK CHAIR

Four Legs
Upholstered Seat
Set of 2

DIMENSIONS

Depth:	23	Arm Width:	18
Width:	21	Seat to Floor Height:	18¼
Height:	32¼	Usable Seat Depth:	18¼
Seat Depth:	18¼	Ship Weight:	44
Seat Width:	17¾	Cube:	13.0
Back Width:	17¼	COM (per 2 pack):	1.0
Back Height:	17½	Weight Rating:	300 lbs.

FABRIC PRICE CODES

1	\$890	8	\$1035
2	\$916	9	\$1054
3	\$941	10	\$1072
4	\$959	11	\$1091
5	\$978	12	\$1110
6	\$997	L	—
7	\$1016		

NOTES: 4-Leg chairs stack 6-high on the floor.

Motivate® 4-leg Chairs are ordered and shipped two (2) chairs per carton. Pricing shown is per carton. Each set of two chairs (one carton), must have the same shell/frame color combination. Ordering 2 of Model HMG1, HMG2 will result in 2 cartons being shipped, giving you 4 chairs. 4-Leg chairs stack 6-high on the floor.

HON Recommendation: HMG1.N.H.ON.PLAT - List Price \$723

HOW TO SPECIFY

Select Model Number	Select Arm Type	Select Caster/Glide	Select Shell Color	Select Fabric	Select Frame
F (+ \$32 per chair) N Armless	H Hard Caster S All-Surface Caster (+ \$32 per chair) <i>Casters only available on HMG1 and HMG2</i> E Standard Nylon Glide F Felt Glide (+ \$32 per chair) R Rubber Glide (+ \$32 per chair) T Steel Glide (+ \$32 per chair)	RG Tangelo CR Cherry LM Lime CP Calypso BU Surf RE Regatta MB Mulberry LO Loft PT Platinum SD Shadow LA Lava ON Onyx WT White	See page 416 <i>Not specified for models HMG1 and HMG5</i>	See page 419	
HMG1	N	H	ON		PLAT
HMG2	N	H	ON	CU10	PLAT



MOTIVATE® 4-Leg Chairs

HMG3

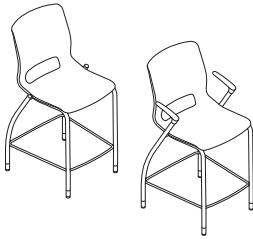

COUNTER-HEIGHT STOOL

Four Legs

DIMENSIONS

Depth:	23	Arm Width:	18
Width:	21	Seat to Floor Height:	24½
Height:	40½	Usable Seat Depth:	18½
Seat Depth:	18½	Ship Weight:	26
Seat Width:	17¾	Cube:	13.8
Back Width:	17¼	Weight Rating:	300 lbs.
Back Height:	18		

LIST PRICE

\$508

HMG4

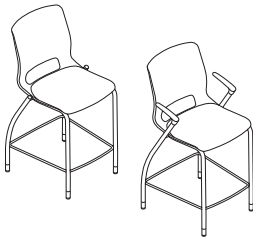

COUNTER-HEIGHT STOOL

Four Legs
Upholstered Seat

DIMENSIONS

Depth:	23	Arm Width:	18
Width:	21	Seat to Floor Height:	25
Height:	40½	Usable Seat Depth:	18¼
Seat Depth:	18½	Ship Weight:	26
Seat Width:	17¾	Cube:	13.8
Back Width:	17¼	COM:	1.0
Back Height:	17½	Weight Rating:	300 lbs.

FABRIC PRICE CODES

1	\$603	8	\$748
2	\$629	9	\$767
3	\$654	10	\$785
4	\$672	11	\$804
5	\$691	12	\$823
6	\$710	L	—
7	\$729		

HMG5

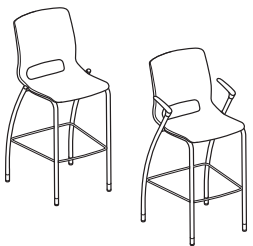

CAFÉ-HEIGHT STOOL

Four Legs

DIMENSIONS

Depth:	23	Arm Width:	18
Width:	21	Seat to Floor Height:	30
Height:	44½	Usable Seat Depth:	18½
Seat Depth:	18½	Ship Weight:	30
Seat Width:	17¾	Cube:	19.3
Back Width:	17¼	Weight Rating:	300 lbs.
Back Height:	18		

LIST PRICE

\$534

HMG7

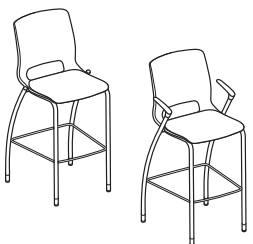

CAFÉ-HEIGHT STOOL

Four Legs
Upholstered Seat

DIMENSIONS

Depth:	23	Arm Width:	18
Width:	21	Seat to Floor Height:	30½
Height:	44½	Usable Seat Depth:	18¼
Seat Depth:	18½	Ship Weight:	34
Seat Width:	17¾	Cube:	19.3
Back Width:	17¼	COM:	1.0
Back Height:	17½	Weight Rating:	300 lbs.

FABRIC PRICE CODES

1	\$632	8	\$777
2	\$658	9	\$796
3	\$683	10	\$814
4	\$701	11	\$833
5	\$720	12	\$852
6	\$739	L	—
7	\$758		

HON Recommendation: HMG5.N.E.ON.PLAT - List Price \$534

HOW TO SPECIFY

Select Model Number	Select Arm Type	Select Glide	Select Shell Color	Select Fabric	Select Frame
F CR LM CP BU RE MB	F Fixed Arms (+ \$32 per chair) N Armless	E Standard Nylon Glide F Felt Glide (+ \$32 per chair) R Rubber Glide (+ \$32 per chair) T Steel Glide (+ \$32 per chair)	RG Tangelo CR Cherry LM Lime CP Calypso BU Surf RE Regatta MB Mulberry	LO Loft PT Platinum SD Shadow LA Lava ON Onyx WT White	See page 416 <i>Not specified for models HMG1 and HMG5</i>
HMG5	N	E	ON		PLAT
HMG7	N	E	ON	CUT0	PLAT

MOTIVATE[®]

Nesting/Stacking Flex-Back Chair Options

MODEL OPTIONS

HMN1



Flex-back

Nesting/Stacking,
Four Legs

HMN2



Flex-back

Nesting/Stacking, Four
Legs, Upholstered Seat

ARM STYLE

CODE DESCRIPTION PRICE



F Fixed Arms **+\$53**



N Armless **+\$0**

CASTERS/ GLIDE

CODE DESCRIPTION PRICE



H Hard Caster **+\$0**



S All-Surface Caster **+\$32**



E Standard Nylon Glide **+\$0**

BACK STYLE

CODE DESCRIPTION PRICE

Plastic/Upholstered Options:



PS Plastic Shell **+\$0**



PB Upholstered **+\$74**

**PB only available on HMN2*

4-Way Stretch Options:



IM Black **+\$84**

IF Fog **+\$84**

IC Charcoal **+\$84**

FRAME

CODE DESCRIPTION PRICE

P1 PAINT: **+\$0**

CBK Charblack

P7J Textured Brownstone

P7A Textured Charcoal

PK7 Textured Designer White

P7L Textured Loft

P7M Textured Muslin

PLAT Textured Platinum
Metallic

P8V Textured Titanium

P2 PAINT: **+\$0**

PR8 Textured Silver

P3 PAINT: **+\$32**

P8S Atom

PJF Bullseye

P8P Ember

P8N Ion

P8J Iris

P8F Krypton

P8M Regatta

PLASTIC SHELL COLOR CODES (no upcharge):

Tangelo - **RG**

Regatta - **RE**

Lava - **LA**

Cherry - **CR**

Mulberry - **MB**

Onyx - **ON**

Lime - **LM**

Loft - **LO**

White - **WT**

Calypso - **CP**

Platinum - **PT**

Surf - **BU**

Shadow - **SD**



Icon Legend on page 19

MOTIVATE® Nesting/Stacking Flex-Back Chairs

HMN1

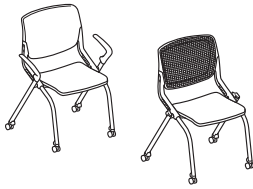

CHAIR

Flex-back
Nesting/Stacking
Four Legs

DIMENSIONS

Depth:	23 ³ / ₈	Arm Width:	24
Width:	26 ³ / ₄	Seat to Floor Height:	18 ¹ / ₄
Height:	34	Usable Seat Depth:	16 ³ / ₄
Seat Depth:	16 ³ / ₄	Ship Weight:	27
Seat Width:	17	Cube:	15.1
Back Width:	19 ¹ / ₂	Weight Rating:	300 lbs.
Back Height:	19		

LIST PRICE

\$606

NOTES: Stack 4-high on floor.

! When selecting the mesh back option, seat shell will be in the specified shell color chosen but the frame around the mesh will always be black.

HMN2



CHAIR

Flex-back
Nesting/Stacking
Four Legs
Upholstered Seat

DIMENSIONS

Depth:	23 ³ / ₈	Seat to Floor Height:	19 ¹ / ₄
Width:	26 ³ / ₄	Usable Seat Depth:	17
Height:	34	Ship Weight (upholstered back):	29
Seat Depth:	17	Ship Weight (plastic/mesh back):	28
Seat Width:	17 ³ / ₈	Cube (upholstered back):	15.1
Back Width:	19 ¹ / ₂	Cube (plastic/mesh back):	15.1
Back Height:	18 ³ / ₈	COM (upholstered back):	1.0
Arm Width:	24	COM (plastic/mesh back):	1.0
		Weight Rating:	300 lbs.

FABRIC PRICE CODES

1	\$688	8	\$833
2	\$714	9	\$852
3	\$739	10	\$870
4	\$757	11	\$889
5	\$776	12	\$908
6	\$795	L	—
7	\$814		

NOTES: Stack 4-high on floor.

! When selecting the mesh back option, seat shell will be in the specified shell color chosen but the frame around the mesh will always be black.

HON Recommendation: HMN2.F.H.IM.ON.CU__PLAT - List Price \$825

HOW TO SPECIFY

Select Model Number	Select Arm Type	Select Caster/Glide	Select Back Type	Select Shell Color	Select Fabric	Select Frame
<p>F Fixed Arms (+ \$53)</p> <p>N Armless</p>	<p>E Standard Nylon Glide</p> <p>H Hard Caster</p> <p>S All-Surface Caster (+ \$32)</p>	<p>PS Plastic Shell</p> <p>PB Upholstered (+ \$74)</p> <p><i>PB option available on HMN2 only</i></p> <p>4-Way Stretch options (+ \$84)</p> <p>IM Black</p> <p>IF Fog</p> <p>IC Charcoal</p>	<p>RG Tangelo</p> <p>CR Cherry</p> <p>LM Lime</p> <p>CP Calypso</p> <p>BU Surf</p> <p>RE Regatta</p> <p>MB Mulberry</p> <p>LO Loft</p> <p>PT Platinum</p> <p>SD Shadow</p> <p>LA Lava</p> <p>ON Onyx</p> <p>WT White</p>	<p>See page 416</p> <p><i>Specify for model HMN2 only</i></p>	<p>See page 422</p>	
<p>HMN1</p> <p>HMN2</p>	<p>N</p> <p>N</p>	<p>H</p> <p>H</p>	<p>IM</p> <p>PB</p>	<p>ON</p> <p>ON</p>	<p>CU10</p>	<p>PLAT</p> <p>PLAT</p>

MOTIVATE® Chair with Tablet Arm Options

MODEL OPTIONS

HMGT1



with Tablet Arm

Four Legs

HMGT2



with Tablet Arm

Four Legs, Upholstered Seat

CASTERS/ GLIDES



CODE	DESCRIPTION	PRICE
H	Hard Caster	+\$0



S	All-Surface Caster	+\$32
----------	--------------------	--------------



E	Standard Nylon Glide	+\$0
F	Felt Glide	+\$32
R	Rubber Glide	+\$32
T	Steel Glide	+\$32

TABLET SIDE



CODE	DESCRIPTION	PRICE
RT	Right Side	+\$0
LT	Left Side	+\$0



TABLET COLOR

CODE	DESCRIPTION	PRICE
T	Black	+\$0
D	Natural Maple	+\$0

FRAME

CODE	DESCRIPTION	PRICE
P1 PAINT:		+\$0
CBK	Charblack	
P7J	Textured Brownstone	
P7A	Textured Charcoal	
PK7	Textured Designer White	
P7L	Textured Loft	
P7M	Textured Muslin	
PLAT	Textured Platinum Metallic	
P8V	Textured Titanium	
P2 PAINT:		+\$0
PR8	Textured Silver	
P3 PAINT:		+\$32
P8S	Atom	
PJF	Bullseye	
P8P	Ember	
P8N	Ion	
P8J	Iris	
P8F	Krypton	
P8M	Regatta	

PLASTIC SHELL COLOR CODES (no upcharge):

Tangelo - **RG**
Regatta - **RE**
Lava - **LA**

Cherry - **CR**
Mulberry - **MB**
Onyx - **ON**

Lime - **LM**
Loft - **LO**
White - **WT**

Calypso - **CP**
Platinum - **PT**

Surf - **BU**
Shadow - **SD**



MOTIVATE® Chair with Tablet Arm

HMGT1

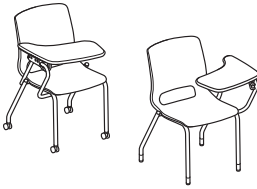

CHAIR

with Tablet Arm
Four Legs

DIMENSIONS

Depth:	30	Back Width:	17¼
Width:	21	Back Height:	18
Height:	32¼	Seat to Floor Height:	17¾
Seat Depth:	18¼	Tablet Height from Floor:	28¾
Seat Width:	17¾	Ship Weight:	41
		Cube:	18.4
		Weight Rating:	300 lbs.

LIST PRICE

\$758

NOTES: Tablet can be specified on right or left side.

❗ Cannot be stacked.

HMGT2

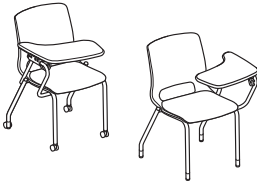

CHAIR

with Tablet Arm
Four Legs
Upholstered Seat

DIMENSIONS

Depth:	30	Back Width:	17¼
Width:	21	Back Height:	17½
Height:	32¼	Seat to Floor Height:	18¼
Seat Depth:	18¼	Tablet Height from Floor:	28¾
Seat Width:	17¾	Ship Weight:	43
		Cube:	18.4
		Weight Rating:	300 lbs.

FABRIC PRICE CODES

1	\$864	8	\$1009
2	\$890	9	\$1028
3	\$915	10	\$1046
4	\$933	11	\$1065
5	\$952	12	\$1084
6	\$971	L	—
7	\$990		

NOTES: Tablet can be specified on right or left side.

❗ Cannot be stacked.

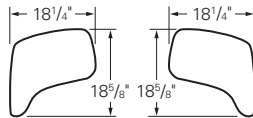

HON Recommendation: HMGT1.E.ON.RT.D.PLAT - List Price \$758

HOW TO SPECIFY

Select Model Number	Select Caster/Glide	Select Shell Color	Select Fabric	Select Tablet Side	Select Tablet Color	Select Frame
H S E F R T	H Hard Caster S All-Surface Caster (+ \$32 per chair) E Standard Nylon Glide F Felt Glide (+ \$32 per chair) R Rubber Glide (+ \$32 per chair) T Steel Glide (+ \$32 per chair)	RG Tangelo CR Cherry LM Lime CP Calypso BU Surf RE Regatta MB Mulberry LO Loft PT Platinum SD Shadow LA Lava ON Onyx WT White	See page 416 <i>Not specified for HMGT1 models</i>	RT Right Side LT Left Side	T Black D Natural Maple	See page 424
HMGT1	E	ON		RT	D	PLAT
HMGT2	E	ON	CU10	RT	D	PLAT

MOTIVATE® Flex-Back Chair with Tablet Arm Options

MODEL OPTIONS

HMNT1



Flex-back with Tablet Arm

HMNT2



Flex-back with Tablet Arm
Upholstered Seat

CASTERS/ GLIDE



CODE	DESCRIPTION	PRICE
H	Hard Caster	+\$0



S	All-Surface Caster	+\$32
----------	--------------------	--------------



E	Standard Nylon Glide	+\$0
----------	----------------------	-------------

TABLET SIDE



CODE	DESCRIPTION	PRICE
RT	Right Side	+\$0
LT	Left Side	+\$0



BACK STYLE



CODE	DESCRIPTION	PRICE
<i>Plastic/Upholstered Options:</i>		
PS	Plastic Shell	+\$0



PB	Upholstered	+\$74
-----------	-------------	--------------

TABLET COLOR

CODE	DESCRIPTION	PRICE
T	Black	+\$0
D	Natural Maple	+\$0

FRAME

CODE	DESCRIPTION	PRICE
P1 PAINT:		+\$0
CBK	Charblack	
P7J	Textured Brownstone	
P7A	Textured Charcoal	
PK7	Textured Designer White	
P7L	Textured Loft	
P7M	Textured Muslin	
PLAT	Textured Platinum Metallic	
P8V	Textured Titanium	
P2 PAINT:		+\$0
PR8	Textured Silver	
P3 PAINT:		+\$32
P8S	Atom	
PJF	Bullseye	
P8P	Ember	
P8N	Ion	
P8J	Iris	
P8F	Krypton	
P8M	Regatta	

4-Way Stretch Options:

IM	Black	+\$84
IF	Fog	+\$84
IC	Charcoal	+\$84



SEATING

PLASTIC SHELL COLOR CODES (no upcharge):

Tangelo - **RG**
Regatta - **RE**
Lava - **LA**

Cherry - **CR**
Mulberry - **MB**
Onyx - **ON**

Lime - **LM**
Loft - **LO**
White - **WT**

Calypso - **CP**
Platinum - **PT**

Surf - **BU**
Shadow - **SD**



MOTIVATE® Flex-Back Chair with Tablet Arm

HMNT1

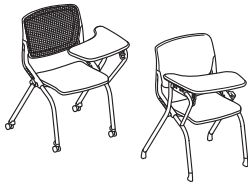

CHAIR

Flex-back with Tablet Arm

DIMENSIONS

Depth:	30 ³ / ₈	Seat to Floor Height:	18 ¹ / ₄
Width:	23 ¹ / ₂	Tablet Height from Floor:	29 ¹ / ₂
Height:	34	Ship Weight:	41
Seat Depth:	17 ¹ / ₄	Cube:	18.4
Seat Width:	17	Weight Rating:	300 lbs.
Back Width:	19 ¹ / ₂		
Back Height:	19		

LIST PRICE

\$1039

NOTES: Tablet can be specified on right or left side.

❗ Model HMNT1 is not available with an upholstered back.

❗ When selecting the mesh back option, seat shell will be in the specified shell color chosen but the frame around the mesh will always be black.

❗ Cannot be nested or stacked.

HMNT2

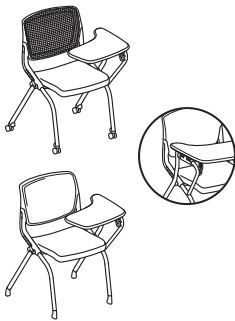

CHAIR

Flex-back with Tablet Arm
Upholstered Seat

DIMENSIONS

Depth:	30 ³ / ₈	Seat to Floor Height:	19 ¹ / ₄
Width:	23 ¹ / ₂	Tablet Height from Floor:	29 ¹ / ₂
Height:	34	Ship Weight:	42
Seat Depth:	17 ⁵ / ₈	Cube:	18.4
Seat Width:	17 ⁵ / ₈	Weight Rating:	300 lbs.
Back Width:	19 ¹ / ₂		
Back Height:	18 ³ / ₈		

FABRIC PRICE CODES

1	\$1145	8	\$1290
2	\$1171	9	\$1309
3	\$1196	10	\$1327
4	\$1214	11	\$1346
5	\$1233	12	\$1365
6	\$1252	L	—
7	\$1271		

NOTES: Tablet can be specified on right or left side.

❗ When selecting the mesh back option, seat shell will be in the specified shell color chosen but the frame around the mesh will always be black.

❗ Cannot be nested or stacked.

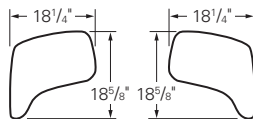

HON Recommendation: HMNT1.E.IM.ON.RT.D.PLAT - List Price \$1123

HOW TO SPECIFY

Select Model Number	Select Caster/Glide	Select Back Type	Select Shell Color	Select Fabric	Select Tablet Side	Select Tablet Color	Select Frame
E Standard Nylon Guide H Hard Caster S All-Surface Caster (+ \$32)	PS Plastic Shell PB Upholstered (+ \$74) <i>PB option not available on HMNT1</i> 4-Way Stretch options (+ \$84) IM Black IF Fog IC Charcoal	RG Tangelo CR Cherry LM Lime CP Calypso BU Surf RE Regatta MB Mulberry	LO Loft PT Platinum SD Shadow LA Lava ON Onyx WT White	See page 416 <i>Specify for model HMNT2 only</i>	RT Right Side LT Left Side	T Black D Natural Maple	See page 426
HMNT1	E	IM	ON		RT	D	PLAT
HMNT2	E	PB	ON	CU10	RT	D	PLAT

NOTES

NOTES

SEATING



Nucleus® Task Seating shown
with Voi® Desk and Storage.

NUCLEUS®

Experience comfort from the inside out. Nucleus® puts the science into seating, combining a sophisticated, high-tech aesthetic with meticulously researched ergonomic support. The 4-Way Stretch Mesh back flexes with the spine while the seat cradles you like a hammock, creating your very own custom fit with targeted support. The modern style features an organic, rounded look, making Nucleus® the family of seating that brings cool and comfortable together.



FEATURES

- Advanced suspension material in the seat combines with molded foam to create unparalleled support.
- 4-Way Stretch Mesh flexes in every direction to dynamically move with you — available in 7 colors.
- Choose between armless, fixed arms, height and width adjustable, or all-adjustable arms.
- Task chairs are available in three different cylinder height options so you can find your perfect fit.
- Optional adjustable lumbar allows users to tailor their support — available in 8 colors.
- Choose from 3 frame options: Black, Titanium, and Designer White.
- Available with Black or Polished Aluminum base.
- Task Stools feature an adjustable footring for additional lower body support.
- Stacking chairs stack up to four high on the floor.
- Guest chairs are available with glides, hard, or all-surface casters.
- Warranted for users up to 300 lbs.
- Guest back pivots for added comfort.

NUCLEUS[®] Task Chair Options

MODEL OPTIONS

HNRI,
HNRIKD





Task Chair

HNRS



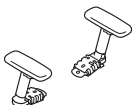
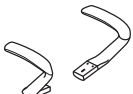

Task Stool

ARM STYLE	CODE	DESCRIPTION	PRICE
	N	Armless	+\$0
	F	Fixed Arms	+\$68
	A	Height and Width Adjustable Arms	+\$89
	V	All-Adjustable Arms (includes Pivot)	+\$136
	P	Fixed Polished Aluminum Arms	+\$183

CYLINDER	CODE	DESCRIPTION	PRICE
	STC	Standard Cylinder	+\$0
	SHC	Short Cylinder	+\$0
	TLC	Tall Cylinder	+\$0
	SC2	Stool Cylinder	+\$0

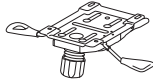
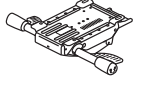
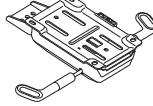
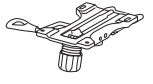
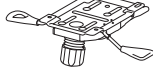
*SC2 only available on model HNRS

MECHANISM	CODE	DESCRIPTION	PRICE
	Y1	Synchro-Tilt w/ Seat Slider A, D, E, J, K, L	+\$21
	Y2	Advanced Synchro-Tilt A, D, E, J, L, A-D	+\$68
	W2	Weight-Activated with Seat Slider A, D, E, L, P	+\$68
	S0	Limited Recline Synchro-Tilt A, E, J, K, L	+\$0
	S1	Limited Recline Synchro-Tilt w/ Seat Slider A, D, E, J, K, L	+\$21

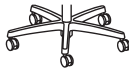
BASE	CODE	DESCRIPTION	PRICE
	SB	Standard Base	+\$0
	PA	Polished Aluminum	+\$115

NOTES: Limited finish, control, and arm options depending on base model. See product pages for details.

NUCLEUS® Task Chair Options

CASTERS



CODE	DESCRIPTION	PRICE
H	Black Hard Caster	+\$0



S	Black All-Surface Caster	+\$42
----------	--------------------------	--------------



TS	Titanium All-Surface Caster	+\$42
-----------	-----------------------------	--------------



R	Roll Control Caster	+\$53
----------	---------------------	--------------



G	Bell Glide	+\$27
----------	------------	--------------

BACK STYLE

CODE	DESCRIPTION	PRICE
------	-------------	-------

4-Way Stretch mesh back options:

IM	Black	+\$0
IB	Breeze	+\$0
IK	Brownstone	+\$0
IC	Charcoal	+\$0
IF	Fog	+\$0
IR	Regatta	+\$0
IT	Titanium	+\$0

FRAME

CODE	DESCRIPTION	PRICE
T	Black	+\$0

Model HNR1 and HNRS available with above Frame option along with those below:

		<u>Task</u>	<u>Stool</u>
TI	Titanium	+\$37	+\$58
DW	Designer White	+\$37	+\$58

LUMBAR

CODE	DESCRIPTION	PRICE
NL	No Lumbar	+\$0
BL	Black	+\$32
TL	Titanium	+\$32
DW	Designer White	+\$32
BY	Bullseye	+\$32
KT	Krypton	+\$32
MR	Ember	+\$32
RE	Regatta	+\$32
IR	Iris	+\$32

NUCLEUS® Guest and Multi-Purpose Options

MODEL OPTION

HNR6



Guest Chair

Four Legs

ARM STYLE

CODE	DESCRIPTION	PRICE
N	Armless	+\$0
F	Fixed Arms	+\$32



HNR6 Fixed Arms



HNR6 Fixed Arms

CASTERS/ GLIDE

CODE	DESCRIPTION	PRICE
H	Black Hard Caster	+\$0
S	Black All-Surface Caster	+\$32
E	Glide	+\$0



BACK STYLE

CODE	DESCRIPTION	PRICE
<i>4-Way Stretch mesh back options:</i>		
IM	Black	+\$0
IB	Breeze	+\$0
IK	Brownstone	+\$0
IC	Charcoal	+\$0
IF	Fog	+\$0
IR	Regatta	+\$0
IT	Titanium	+\$0

*HNR6 back pivots to flex to the desired position.
Available on HNR6 only.*

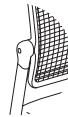

FRAME

CODE	DESCRIPTION	PRICE
T	Black	+\$0
T1	Platinum Metallic	+\$0
<i>Model HNR6 available in the following Frame options:</i>		
P71	Black	+\$0
CBK	Charblack	+\$0
P8V	Textured Titanium	+\$37
PK7	Textured Designer White	+\$37

HON BRANDED FABRICS

GRADE 1

Apex
Centurion
Compass
Contourett
Dapper
Ensemble
Hamilton
Inertia
Noble Seating
Optic
Pebble
Vibe

GRADE 2

Appoint Seating
Blume
Clyde
Dotty
Kai
Rush
Spin Seating
Wavelength
Whisper Vinyl

GRADE 3

Bradbury
Getaway
Moxie
Notion
Parker
Purl
Quill
Saxony

GRADE 4

Constance with Supreen™
Livi with Supreen™
Lugano with Supreen™
Oxford with Supreen™

GRADE L

Davenport Leather*

For a complete list of fabrics, including partnership fabrics, go to hon.com/fabricsandfinishes.

Reference Fabric Color Combinations on pages 20-24 for color codes and legend on page 21 for lead times. For additional HON to Supply COM fabric grade pricing, go to honready.hon.com and click on the HON to Supply COM link.

*Davenport Leather available on Nucleus® Recharged models only. Leather not available on Nucleus® Guest.

NUCLEUS® RECHARGED TASK

Control	W2											
	Armless			Fixed*			2D			4D		
Arms												
Cylinder	Standard	Short	Tall	Standard	Short	Tall	Standard	Short	Tall	Standard	Short	Tall
Max Width	29.00	29.00	29.00	29.00	29.00	29.00	29.00	29.00	29.00	29.00	29.00	29.00
Max Depth	29.00	29.00	29.00	29.00	29.00	29.00	29.00	29.00	29.00	29.00	29.00	29.00
Max Height	43.00	41.07	46.50	42.75	43.00	41.07	46.50	42.75	43.00	41.07	46.50	42.75
Chair Weight**	29.20	28.80	29.60	35.50	35.10	35.90	32.90	32.50	33.30	33.10	32.70	33.50
Shipping Weight**	38.10	37.70	38.50	44.40	44.00	44.80	41.80	41.40	42.20	44.00	41.60	42.40
Shipping Weight (KD)**	NA	NA	NA	NA	NA	NA	40.80	NA	NA	NA	NA	NA
Cubes	10.73	10.73	10.73	10.73	10.73	10.73	10.73	10.73	10.73	10.73	10.73	10.73
Cubes (KD)	NA	NA	NA	NA	NA	NA	7.92	NA	NA	NA	NA	NA
Seat Width	18.70	18.70	18.70	18.70	18.70	18.70	18.70	18.70	18.70	18.70	18.70	18.70
Seat Usable Depth	17.88 - 19.80	17.88 - 19.80	17.88 - 19.80	17.88 - 19.80	17.88 - 19.80	17.88 - 19.80	17.88 - 19.80	17.88 - 19.80	17.88 - 19.80	17.88 - 19.80	17.88 - 19.80	17.88 - 19.80
Seat Height from Floor	15.88 - 20	15.30 - 18.07	18.09 - 23.5	15.88 - 20	15.30 - 18.07	18.09 - 23.5	15.88 - 20	15.30 - 18.07	18.09 - 23.5	15.88 - 20	15.30 - 18.07	18.09 - 23.5
Seat Depth	18	18	18	18	18	18	18	18	18	18	18	18
Back Lumbar Height	5.9 - 9.4	5.9 - 9.4	5.9 - 9.4	5.9 - 9.4	5.9 - 9.4	5.9 - 9.4	5.9 - 9.4	5.9 - 9.4	5.9 - 9.4	5.9 - 9.4	5.9 - 9.4	5.9 - 9.4
Back Width	18.63	18.63	18.63	18.63	18.63	18.63	18.63	18.63	18.63	18.63	18.63	18.63
Back Height	23.68	23.68	23.68	23.68	23.68	23.68	23.68	23.68	23.68	23.68	23.68	23.68
Seat Angle from Floor	-0.40	-0.40	-0.40	-0.40	-0.40	-0.40	-0.40	-0.40	-0.40	-0.40	-0.40	-0.40
Seat Angle Reclined	-5.10	-5.10	-5.10	-5.10	-5.10	-5.10	-5.10	-5.10	-5.10	-5.10	-5.10	-5.10
Back Angle from Seat	96.00	96.00	96.00	96.00	96.00	96.00	96.00	96.00	96.00	96.00	96.00	96.00
Back Angle Reclined	115.00	115.00	115.00	115.00	115.00	115.00	115.00	115.00	115.00	115.00	115.00	115.00
Distance Between Arms	NA	NA	NA	30.38	30.38	30.38	16.50 - 19.63	16.50 - 19.63	16.50 - 19.63	16.50 - 19.63	16.50 - 19.63	16.50 - 19.63
Arm Height from Floor	NA	NA	NA	25 - 28.88	24.43 - 26.95	27.21 - 32.38	24.06 - 31.88	23.5 - 29.95	26.27 - 35.38	24.06 - 31.88	23.5 - 29.95	26.27 - 35.38
Arm Height from Seat	NA	NA	NA	6.63	6.63	6.63	5.69 - 9.38	5.69 - 9.38	5.69 - 9.38	5.69 - 9.38	5.69 - 9.38	5.69 - 9.38
Arm Width	NA	NA	NA	2.25	2.25	2.25	3.19	3.19	3.19	3.19	3.19	3.19
Arm Length	NA	NA	NA	9.84	9.84	9.84	10.16	10.16	10.16	10.16	10.16	10.16
Arm Set-Back	NA	NA	NA	2.83 - 4.75	2.83 - 4.75	2.83 - 4.75	3.95 - 5.88	3.95 - 5.88	3.95 - 5.88	3.95 - 5.88	3.95 - 5.88	3.95 - 5.88

Control	S0				S1			
	Armless	Fixed*	2D	4D	Armless	Fixed*	2D	4D
Arms	Stool	Stool	Stool	Stool	Stool	Stool	Stool	Stool
Cylinder	Standard	Short	Tall	Standard	Short	Tall	Standard	Short
Max Width	29.00	29.00	29.00	29.00	29.00	29.00	29.00	29.00
Max Depth	29.00	29.00	29.00	29.00	29.00	29.00	29.00	29.00
Max Height	56.50	56.50	56.50	56.50	56.50	56.50	56.50	56.50
Chair Weight**	34.35	40.65	38.05	36.75	35.20	41.50	38.90	37.60
Shipping Weight**	45.35	51.65	49.05	47.75	46.20	52.50	49.90	48.60
Cubes	12.11	12.11	12.11	12.11	12.11	12.11	12.11	12.11
Seat Width	18.70	18.70	18.70	18.70	18.70	18.70	18.70	18.70
Seat Usable Depth	18.50	18.50	18.50	18.50	17.83 - 19.33	17.83 - 19.33	17.83 - 19.33	17.83 - 19.33
Seat Height from Floor	23.44 - 33	23.44 - 33	23.44 - 33	23.44 - 33	23.44 - 33	23.44 - 33	23.44 - 33	23.44 - 33
Seat Depth	18	18	18	18	18	18	18	18
Back Lumbar Height	5.9 - 9.4	5.9 - 9.4	5.9 - 9.4	5.9 - 9.4	5.9 - 9.4	5.9 - 9.4	5.9 - 9.4	5.9 - 9.4
Back Width	18.63	18.63	18.63	18.63	18.63	18.63	18.63	18.63
Back Height	23.94	23.94	23.94	23.94	23.94	23.94	23.94	23.94
Seat Angle from Floor	-1.50	-1.50	-1.50	-1.50	-1.50	-1.50	-1.50	-1.50
Seat Angle Reclined	-7.00	-7.00	-7.00	-7.00	-7.00	-7.00	-7.00	-7.00
Back Angle from Seat	96.00	96.00	96.00	96.00	96.00	96.00	96.00	96.00
Back Angle Reclined*	105.00	105.00	105.00	105.00	105.00	105.00	105.00	105.00
Distance Between Arms	NA	30.38	16.5 - 19.63	16.5 - 19.63	NA	30.38	16.5 - 19.63	16.5 - 19.63
Arm Height from Floor	NA	32.25 - 42.5	31.25 - 45.38	31.25 - 45.38	NA	32.25 - 42.5	31.25 - 45.38	31.25 - 45.38
Arm Height from Seat	NA	6.63	5.63 - 9.5	5.63 - 9.5	NA	6.63	5.63 - 9.5	5.63 - 9.5
Arm Width	NA	2.25	3.19	3.19	NA	2.25	3.19	3.19
Arm Length	NA	9.84	10.16	10.16	NA	9.84	10.16	10.16
Arm Set-Back	NA	2.66 - 4.16	3.66 - 5.16	3.66 - 5.16	NA	2.66 - 4.16	3.66 - 5.16	3.66 - 5.16

Weight
Adders

**Base Polished Aluminum = 1.40 lbs.
*Fixed Arm Polished Aluminum = 1.50 lbs.



HNRI



TASK CHAIR

- 4-Way Stretch Back**
- Pneumatic
- Swivel
- Seat Glide
- Synchro-tilt
- Tilt Tension
- Tilt Lock

DIMENSIONS

Depth:	29	Arm Width:	16½-19¾
Width:	29	Seat to Floor Height:	16¼-20⅞
Height:	42¾	Usable Seat Depth:	18-19¾
Seat Depth:	18	Ship Weight:	41.8
Seat Width:	18¾	Cube:	10.7
Back Width:	18⅞	COM:	1.0
Back Height:	24	Weight Rating:	300 lbs.

FABRIC PRICE CODES

1	\$818	8	\$963
2	\$844	9	\$982
3	\$869	10	\$1000
4	\$887	11	\$1019
5	\$906	12	\$1038
6	\$925	L	\$1108
7	\$944		

HON Recommendation: HNRI.Y2.STC.A.H.IM.CU__BL.SB.T - List Price \$1007

HOW TO SPECIFY

Select Model Number	Select Control Type	Select Cylinder	Select Arm Type	Select Caster	Select Back Type	Select Fabric	Select Lumbar	Select Base	Select Frame
<p>Y1 Synchro-Tilt w/ Seat Slider (+ \$21)</p> <p>Y2 Advanced Synchro-Tilt (+ \$68)</p> <p>W2 Weight-Activated w/ Seat Slider (+ \$68)</p>	<p>STC Standard</p> <p>SHC Short Cylinder</p> <p>TLC Tall Cylinder</p>	<p>N Armless</p> <p>A Height and Width Adjustable Arms (+ \$89)</p> <p>V All-Adjustable Arms (+ \$136)</p> <p>F Fixed Arms (+ \$68)</p> <p>P Fixed Polished (+ \$183)</p>	<p>H Hard Caster</p> <p>S Black All-Surface Caster (+ \$42)</p> <p>TS Titanium All-Surface Caster (+ \$42)</p> <p>R Roll Control Caster (+ \$53)</p> <p>G Bell Glide (+ \$27)</p>	<p>See page 433</p>	<p>See page 435</p>	<p>See page 433</p> <p><i>Adding lumbar adds + \$32 upcharge</i></p>	<p>SB Standard Base</p> <p>PA Polished Aluminum (+ \$115)</p>	<p>T Black</p> <p>TI Titanium (+ \$37)</p> <p>DWX Designer White (+ \$37)</p>	
HNRI	Y1	STC	A	S	IM	CU10	DW	SB	DWX



Icon Legend on page 19

HNR1KD



TASK CHAIR KD

4-Way Stretch Back

- Pneumatic
- Swivel
- Seat Glide
- Synchro-tilt
- Tilt Tension
- Tilt Lock

DIMENSIONS

Depth:	29	Arm Width:	16½-19¾
Width:	29	Seat to Floor Height:	16¼-20⅝
Height:	42¾	Usable Seat Depth:	18-19¾
Seat Depth:	18	Ship Weight:	40.8
Seat Width:	18¾	Cube:	10.7
Back Width:	18⅝	COM:	1.0
Back Height:	24	Weight Rating:	300 lbs.

FABRIC PRICE CODES

1	\$778	8	\$923
2	\$804	9	\$942
3	\$829	10	\$960
4	\$847	11	\$979
5	\$866	12	\$998
6	\$885	L	\$1068
7	\$904		

ⓘ KD (Knock Down) requires arm, back, and cylinder assembly on site.

HON Recommendation: HNR1KD.Y2.STC.A.H.IM.CU__BL.SB.T - List Price \$967

HOW TO SPECIFY

Select Model Number	Select Control Type	Select Cylinder	Select Arm Type	Select Caster	Select Back Type	Select Fabric	Select Lumbar	Select Base	Select Frame
Y1 Synchro-Tilt w/ Seat Slider (+ \$21)	STC Standard	N Armless	H Hard Caster	See page 433	See page 435	See page 433	SB Standard Base	T Black	
Y2 Advanced Synchro-Tilt (+ \$68)		A Height and Width Adjustable Arms (+ \$89)				<i>Adding lumbar adds + \$32 upcharge</i>	PA Polished Aluminum (+ \$115)	TI Titanium (+ \$37)	
W2 Weight-Activated w/ Seat Slider (+ \$68)								DWX Designer White (+ \$37)	

HNR1KD . Y1 . STC . A . H . IM . CU10 . DW . SB . DWX



HNRS



TASK STOOL

- 4-Way Stretch Back**
- Pneumatic
- Swivel
- Seat Glide
- Synchro-tilt
- Tilt Tension
- Tilt Lock

DIMENSIONS

Depth:	29	Arm Width:	16½-19¾
Width:	29	Seat to Floor Height:	23¾-33
Height:	56½	Usable Seat Depth:	17⅞-19¾
Seat Depth:	18	Ship Weight:	49.9
Seat Width:	18¾	Cube:	12.11
Back Width:	18⅞	COM:	1.0
Back Height:	24	Weight Rating:	300 lbs.

FABRIC PRICE CODES

1	\$941	8	\$1086
2	\$967	9	\$1105
3	\$992	10	\$1123
4	\$1010	11	\$1142
5	\$1029	12	\$1161
6	\$1048	L	\$1231
7	\$1067		

HON Recommendation: HNRS.S1.SC2.A.H.IM.CU__BL.SB.T - List Price \$1051

HOW TO SPECIFY

Select Model Number	Select Control Type	Select Cylinder	Select Arm Type	Select Caster	Select Back Type	Select Fabric	Select Lumbar	Select Base	Select Frame
HNRS	<ul style="list-style-type: none"> SO Limited Recline Synchro-Tilt S1 Limited Recline Synchro-Tilt w/ Seat Slider (+ \$21) 	<ul style="list-style-type: none"> SC2 Stool Cylinder 	<ul style="list-style-type: none"> N Armless A Height and Width Adjustable Arms (+ \$89) V All-Adjustable Arms (+ \$136) F Fixed Arms (+ \$68) P Fixed Polished (+ \$183) 	<ul style="list-style-type: none"> H Black Hard Caster S Black All-Surface Caster (+ \$42) TS Titanium All-Surface Caster (+ \$42) R Roll Control Caster (+ \$53) G Bell Glide (+ \$27) 	See page 433	See page 435	See page 433	<ul style="list-style-type: none"> SB Standard Base PA Polished Aluminum (+ \$115) 	<ul style="list-style-type: none"> T Black TI Titanium (+ \$58) DWX Designer White (+ \$58)
HNRS	S1	SC2	A	S	IM	CU10	DW	SB	DWX



HNR6

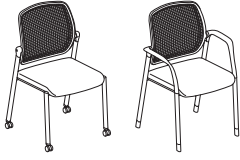

GUEST CHAIR

4-Way Stretch Back
Four Legs

DIMENSIONS

Depth:	23½	Arm Width:	21-24 ¹⁵ / ₁₆
Width:	20 ⁵ / ₁₆	Seat to Floor Height:	17 ⁵ / ₈
Height:	36 ³ / ₈	Usable Seat Depth:	17 ¹¹ / ₁₆
Seat Depth:	19½	Ship Weight:	20
Seat Width:	19	Cube:	15.8
Back Width:	17	COM:	1.0
Back Height:	19 ⁹ / ₁₆	Weight Rating:	300 lbs.

FABRIC PRICE CODES

1	\$604	8	\$749
2	\$630	9	\$768
3	\$655	10	\$786
4	\$673	11	\$805
5	\$692	12	\$824
6	\$711	L	\$894
7	\$730		

NOTES: Back includes pivot for added comfort.

HON Recommendation: HNR6.F.E.IM.CU__P71.T - List Price \$636

HOW TO SPECIFY

Select Model Number	Select Arm Type	Select Caster/Glide	Select Back Type	Select Fabric	Select Frame	Select Base Paint Color
	F Fixed Arms (+ \$32) N Armless	E Glide H Black Hard Caster S Black All-Surface Caster (+ \$32)	See page 434	See page 435	T Black TI Titanium (+ \$37) DWX Designer White (+ \$37)	P71 Black CBK Charblack P8V Textured Titanium (+ \$37) PK7 Textured Designer White (+ \$37)
HNR6	F	H	IM	CU10	T	P71

NOTES

HIGH-DENSITY OLSON STACKER® 4040 SERIES

Want to see more?
Scan here to check
out hon.com.



Olson Stacker.

HIGH-DENSITY OLSON STACKER® 4040 SERIES

Adaptable spaces such as multi-purpose and training areas demand a chair equally flexible. Olson stacking chairs fit that bill with a lightweight frame that is easy to move throughout a space. Chairs stack up to 12 high on the floor or up to 40 high on their specially designed cart to maximize floor space when not in use. A convenient cutout in the back makes it easy to pick up and move, while the molded seat shells deliver surprising comfort. Olson stacking chairs ship in sets of four to accommodate large groups. With Olson, the benefits really stack up.



FEATURES

- Chairs ship four per carton.
- Contoured seat and back shell provide targeted support.
- Integrated lumbar support delivers long-lasting comfort.
- Integrated handle makes chair easy to carry.
- Optional ganging brackets connect chairs to form neat rows.
- Stacks up to 12 high on floor.
- Stacks up to 40 high on cart.
- Shell colors are CA Technical Bulletin 133 compliant.
- Warranted for users up to 300 lbs.

HIGH-DENSITY OLSON STACKER® 4040 Series

GSA SIN 33721



Icon Legend on page 19

H4041



POLYMER SEAT AND BACK DIMENSIONS

7/16" Steel Rod Frame
Chrome Legs

Depth:	21 ⁵ / ₈	Seat to Floor Height:	17 ³ / ₄
Width:	19 ¹ / ₈	Usable Seat Depth:	17
Height:	30 ⁵ / ₈	Ship Weight:	57
Seat Depth:	18 ¹ / ₄	Cube:	10.6
Seat Width:	17 ³ / ₄	Weight Rating:	300 lbs.
Back Width:	17 ¹ / ₂		
Back Height:	16 ¹ / ₄		

LIST PRICE PER CARTON

\$987
(reference single unit @ \$246.75)

⊕ 4040 Series is ordered and shipped four (4) chairs per carton. Pricing shown is per carton. Each set of four (one carton), must have the same shell color. Ordering 2 of Model H4041 will result in 2 cartons being shipped, giving you 8 chairs.

⚠ Shipped fully assembled — 4 chairs per carton. All High-Density Olson Stacker® shell colors are CA Technical Bulletin 133 compliant (no upcharge).

H4043

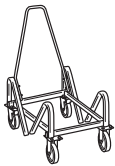

CART FOR STACKING CHAIRS

DIMENSIONS

Depth:	35 ¹ / ₂	Ship Weight:	34
Width:	21 ⁵ / ₈	Cube:	7.8
Height:	37		

LIST PRICE

\$688

NOTES: Holds 40 stack chairs (6'-8"), some assembly required. (Chairs stack 12 high without cart.)

⚠ Specify Black paint (T) ONLY.

H4048

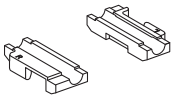

GANGING CHAIR GLIDES

Box of 48
For use on models H4041, HG51
and HG52

DIMENSIONS

Ship Weight:	1
Cube:	0.04

LIST PRICE

\$155

H4049

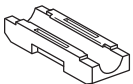

NON-GANGING CHAIR GLIDES

Box of 48
For use on models H4041,
HFLEX01, HG51 and HG52

DIMENSIONS

Ship Weight:	1
Cube:	0.04

LIST PRICE

\$122

SEATING

HOW TO SPECIFY

<p>Select Model Number</p> <p>H 4 0 4 1 .</p>	<p>Select Shell Color</p> <table border="0"> <tr> <td>RG Tangelo</td> <td>LO Loft</td> </tr> <tr> <td>CR Cherry</td> <td>PT Platinum</td> </tr> <tr> <td>LM Lime</td> <td>SD Shadow</td> </tr> <tr> <td>CP Calypso</td> <td>LA Lava</td> </tr> <tr> <td>BU Surf</td> <td>ON Onyx</td> </tr> <tr> <td>RE Regatta</td> <td>WT White</td> </tr> <tr> <td>MB Mulberry</td> <td></td> </tr> </table> <p>ON .</p>	RG Tangelo	LO Loft	CR Cherry	PT Platinum	LM Lime	SD Shadow	CP Calypso	LA Lava	BU Surf	ON Onyx	RE Regatta	WT White	MB Mulberry		<p>Select Frame</p> <p>Y Chrome</p> <p>Y</p>
RG Tangelo	LO Loft															
CR Cherry	PT Platinum															
LM Lime	SD Shadow															
CP Calypso	LA Lava															
BU Surf	ON Onyx															
RE Regatta	WT White															
MB Mulberry																



Parkwyn™ Lounge Seating
shown with Occasional Tables.

PARKWYN™

The Parkwyn™ series offers soft, comfort, ample support, and clean lines in a cozy reception area to welcome guests or in a shared space for collaboration. With a choice of a club chair, loveseat, sofa, and coordinating ottoman, this soft seating collection provides smart sophistication with a budget-friendly bottom line.



FEATURES

- Parkwyn's soft, contoured profile allows it to work in many settings including reception lobbies, collaboration areas, and private offices.
- Models include single-seat club chair, two-seat loveseat, three-seat sofa, and coordinating ottoman.
- Choice of black polyurethane with black metal legs or gray fabric with medium oak wood legs.
- Back cushions attach with integrated Velcro to maintain user support and comfort and retain long-term structure.
- Back cushions are removable for easy cleaning.
- Tall legs offer a contemporary look while making it easy to clean underneath.
- Simple, toolless assembly with the legs screwed in by hand, and easy movement with lightweight construction.
- Club chair and ottoman are small-package shippable.

PARKWYN™ Options

MODEL OPTIONS

HVLVL1

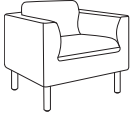

Lounge

Single-Seat Club Chair

HVLVL2



Lounge

Loveseat

HVLVL3

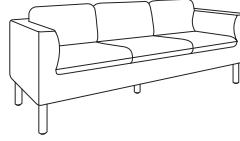

Lounge

Sofa

HVLVLOT



Lounge

Ottoman

NOTES: Black polyurethane models are available with black metal legs and gray fabric models are available with medium oak wood legs.

HVLVL1

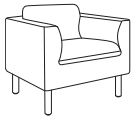

CLUB CHAIR

DIMENSIONS

Depth:	26¾	Arm Width:	5½
Width:	33	Seat to Floor Height:	18¾
Height:	30	Usable Seat Depth:	18
Seat Depth:	18	Ship Weight:	45
Seat Width:	21½	Cube:	10.2
Back Width:	21½	Weight Rating:	300 lbs.
Back Height:	25¾		

LIST PRICE

\$1303

NOTES: HON 5-Year Limited Warranty.

HVLVL2

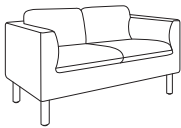

LOVESEAT

DIMENSIONS

Depth:	26¾	Arm Width:	5½
Width:	53½	Seat to Floor Height:	18¾
Height:	30	Usable Seat Depth:	18
Seat Depth:	18	Ship Weight:	65
Seat Width:	42½	Cube:	17.2
Back Width:	42½	Weight Rating:	300 lbs.
Back Height:	25¾		

LIST PRICE

\$1779

NOTES: HON 5-Year Limited Warranty.

HVLVL3

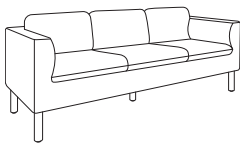

SOFA

DIMENSIONS

Depth:	26¾	Arm Width:	5½
Width:	77	Seat to Floor Height:	18¾
Height:	30	Usable Seat Depth:	19¾
Seat Depth:	19¾	Ship Weight:	85
Seat Width:	65¾	Cube:	24.7
Back Width:	65¾	Weight Rating:	300 lbs.
Back Height:	25¾		

LIST PRICE

\$2229

NOTES: HON 5-Year Limited Warranty.

HVLVLOT



OTTOMAN

DIMENSIONS

Depth:	23¼
Width:	23¼
Height:	18¼
Ship Weight:	22
Cube:	3.6
Weight Rating:	300 lbs.

LIST PRICE

\$906

NOTES: HON 5-Year Limited Warranty.

HOW TO SPECIFY

Select Model Number

Select Fabric

- BLK01** Black Polyurethane
- GRY02** Gray Fabric

H V L V L 1 .

B L K 0 1

PERPETUAL[®] NESTING CHAIRS

Want to see more? Scan here
to check out hon.com.



Perpetual Nesting Chairs and Huddle[®] Tables.

PERPETUAL[®] NESTING CHAIRS

Provide full-time comfort to even part-time workers with the Perpetual line of multi-purpose seating. The flip-up seat design maximizes space by allowing Perpetual to be easily nested. The passive back design moves with the user to deliver added comfort for all day meetings. Save space without sacrificing comfort with Perpetual.



FEATURES

- Flip-up seat allows chairs to nest and save floor space.
- Backrest reclines for added comfort.
- Tube rolled steel frame adds durability.
- Underside of seat is fully-upholstered for a clean appearance when nested.
- All-surface casters roll effortlessly and silently.
- Available in hundreds of quality HON fabrics.
- Warranted for users up to 300 lbs.

PERPETUAL[®] Nesting Chairs Options

MODEL OPTIONS

HPN1



Nesting Chair (Flex-back)

Armless, Four Legs

HPN2



Nesting Chair (Flex-back)

Fixed Arms, Four Legs

CASTER/ GLIDE



CODE	DESCRIPTION	PRICE
A	All-Surface	+\$0
G	Bell Glide	+\$27

FRAME

CODE	DESCRIPTION	PRICE
T	Black	+\$0
T1	Platinum Metallic	+\$0

BACK STYLE



CODE	DESCRIPTION	PRICE
UU	Upholstered Back	+\$0

HON BRANDED FABRICS

GRADE 1

Apex
Centurion
Compass
Contourett
Dapper
Ensemble
Hamilton
Inertia
Noble Seating
Optic
Pebble
Vibe

GRADE 2

Appoint Seating
Blume
Clyde
Dotty
Kai
Rush
Spin Seating
Wavelength
Whisper Vinyl

GRADE 3

Bradbury
Getaway
Moxie
Notion
Parker
Purl
Quill
Saxony

GRADE 4

Constance with Supreen™
Livi with Supreen™
Lugano with Supreen™
Oxford with Supreen™

For a complete list of fabrics, including partnership fabrics, go to hcn.com/fabricsandfinishes.

Reference Fabric Color Combinations on pages 20-24 for color codes and legend on page 21 for lead times. For additional HON to Supply COM fabric grade pricing, go to honready.hcn.com and click on the HON to Supply COM link.

PERPETUAL[®] Nesting Chairs

GSA SIN 33721



Icon Legend on page 19

HPN1



Model HPN1A UU shown

NESTING CHAIR

Flex-back
Armless
Four Legs

DIMENSIONS

Depth:	26	Seat to Floor Height:	19 $\frac{1}{8}$
Width:	26	Usable Seat Depth:	16 $\frac{1}{2}$
Height:	36	Ship Weight:	38
Seat Depth:	17 $\frac{3}{4}$	Cube:	15.2
Seat Width:	17	COM:	1.5
Back Width:	17 $\frac{1}{2}$	Weight Rating:	300 lbs.
Back Height:	15 $\frac{3}{4}$		

FABRIC PRICE CODES

1	\$992	8	\$1209
2	\$1030	9	\$1237
3	\$1068	10	\$1265
4	\$1096	11	\$1293
5	\$1124	12	\$1322
6	\$1152	L	—
7	\$1181		

HPN2



Model HPN2A UU shown

NESTING CHAIR

Flex-back
Fixed Arms
Four Legs

DIMENSIONS

Depth:	26	Arm Width:	20 $\frac{3}{4}$
Width:	26	Seat to Floor Height:	19 $\frac{1}{8}$
Height:	36	Usable Seat Depth:	16 $\frac{1}{2}$
Seat Depth:	17 $\frac{3}{4}$	Ship Weight:	41
Seat Width:	17	Cube:	15.2
Back Width:	17 $\frac{1}{2}$	COM:	1.5
Back Height:	15 $\frac{3}{4}$	Weight Rating:	300 lbs.

FABRIC PRICE CODES

1	\$1097	8	\$1314
2	\$1135	9	\$1342
3	\$1173	10	\$1370
4	\$1201	11	\$1398
5	\$1229	12	\$1427
6	\$1257	L	—
7	\$1286		

HOW TO SPECIFY

Select
Model Number

HPN1

Select
Caster/Glide

A All-Surface
G Glide (+ \$27)

A

Select
Back Type

UU Upholstered Back

UU

Select
Fabric

Note: For models with upholstered back, seat and back are always matching fabric
See page 449

CU10

Select
Frame

T Black
T1 Platinum Metallic

T

PILLOW-SOFT® 2090 SERIES

Want to see more? Scan here
to check out hon.com.



Pillow-Soft High-Back Executive and Sled Base Guest Chairs shown with 10700 Series™ desks.

PILLOW-SOFT® 2090 SERIES

Pillow-Soft chairs combine comfort, style and selection to deliver the ultimate seating experience. Each executive chair in the collection combines thick memory foam cushioning with built-in lumbar support to reduce fatigue and increase comfort. Besides the full body support, it adds an authoritative presence to the office. The plush tufted leather or fabric will add a touch of sophistication to your office.



FEATURES

- Responsive memory foam eliminates pressure points and provides lasting comfort.
- Loop arms relieve stress on the shoulder and neck.
- Fully-upholstered outer back.
- Memory foam seat cushion reduces pressure points and responds to contours of the body for lasting comfort.
- Task chairs come standard with pneumatic seat height adjustment, tilt, tilt tension and tilt lock.
- Dual-wheel casters roll effortlessly and silently.
- Warranted for users up to 300 lbs.
- H2095 model warranted for users up to 275 lbs.

PILLOW-SOFT® 2090 Series Options

MODEL OPTIONS

H2091



Executive High-Back

Pneumatic, Swivel, Tilt, Tilt Tension, Tilt Lock, Arms

H2095



Executive High-Back

Pneumatic, Swivel, Tilt, Tilt Tension, Tilt Lock, Arms

H2092



Managerial Mid-Back

Pneumatic, Swivel, Tilt, Tilt Tension, Tilt Lock, Arms

H2093



Guest Chair

Sled Base, Arms

CASTERS



CODE	DESCRIPTION	PRICE
H	Black Hard Caster	+ \$0



S	Black All-Surface Caster	+ \$42
----------	--------------------------	---------------

HON BRANDED FABRICS

GRADE 1

Apex
Black Vinyl
Burgundy Vinyl
Centurion
Compass
Contourett
Dapper
Ensemble
Hamilton
Inertia
Noble Seating
Optic
Pebble
Vibe

GRADE 2

Appoint Seating
Blume
Clyde
Dotty
Kai
Rush
Spin Seating
Wavelength
Whisper Vinyl

GRADE 3

Bradbury
Getaway
Moxie
Notion
Parker
Purl
Quill
Saxony

GRADE 4

Constance with Supreen™
Livi with Supreen™
Lugano with Supreen™
Oxford with Supreen™

For a complete list of fabrics, including partnership fabrics, go to hon.com/fabricsandfinishes.

Reference Fabric Color Combinations on pages 20-24 for color codes and legend on page 21 for lead times. For additional HON to Supply COM fabric grade pricing, go to honready.hon.com and click on the HON to Supply COM link.



Icon Legend on page 19

PILLOW-SOFT® 2090 Series

H2091



EXECUTIVE HIGH-BACK

Pneumatic
Swivel
Tilt
Tilt Tension
Tilt Lock
Arms

Functions: **A, E, F, K, L**
(Function Key on pages 250-251)

DIMENSIONS

Depth:	29¾	Arm Width:	20¼
Width:	26¼	Seat to Floor Height:	16¾-21¼
Height:	46½	Usable Seat Depth:	18½
Seat Depth:	21	Ship Weight:	57
Seat Width:	22	Cube:	16.0
Back Width:	22	COM:	3.0
Back Height:	25	Weight Rating:	300 lbs.

FABRIC PRICE CODES

1	\$962	8	\$1395
2	\$1038	9	\$1452
3	\$1113	10	\$1508
4	\$1169	11	\$1564
5	\$1226	12	\$1621
6	\$1282	L	\$1119
7	\$1339		

NOTES: When selecting leather, the 2090 Series uses SR Leather only. All models are also available in Grade 1 EB vinyl (which matches SR Leather).

H2095



OPEN MARKET

EXECUTIVE HIGH-BACK

Pneumatic
Swivel
Tilt
Tilt Tension
Tilt Lock
Padded Loop Arms

Functions: **A, E, F, K, L**
(Function Key on pages 250-251)

DIMENSIONS

Depth:	29½	Arm Width:	21
Width:	26¾	Seat to Floor Height:	16-21
Height:	47½	Usable Seat Depth:	17½
Seat Depth:	17½	Ship Weight:	57
Seat Width:	21	Cube:	7.1
Back Width:	21	COM:	N/A
Back Height:	29½	Weight Rating:	275 lbs.

FABRIC PRICE CODES

Fabric		
PWST10	\$762	(Black)
Black Bonded Leather		
PWST11	\$783	(Black)

NOTES: When selecting upholstery, the H2095 is only available in PWST10 (Black fabric) and PWST11 (Black Bonded Leather).

H2092



MANAGERIAL MID-BACK

Pneumatic
Swivel
Tilt
Tilt Tension
Tilt Lock
Arms

Functions: **A, E, F, K, L**
(Function Key on pages 250-251)

DIMENSIONS

Depth:	28¾	Arm Width:	20¼
Width:	26¼	Seat to Floor Height:	16¾-21¼
Height:	41¾	Usable Seat Depth:	18½
Seat Depth:	21	Ship Weight:	54
Seat Width:	22	Cube:	16.0
Back Width:	22	COM:	3.0
Back Height:	19¾	Weight Rating:	300 lbs.

FABRIC PRICE CODES

1	\$919	8	\$1352
2	\$995	9	\$1409
3	\$1070	10	\$1465
4	\$1126	11	\$1521
5	\$1183	12	\$1578
6	\$1239	L	\$1076
7	\$1296		

NOTES: When selecting leather, the 2090 Series uses SR Leather only. All models are also available in Grade 1 EB vinyl (which matches SR Leather).

H2093



GUEST CHAIR

Sled Base
Arms

DIMENSIONS

Depth:	27¾	Arm Width:	19¾
Width:	23¼	Seat to Floor Height:	19½
Height:	36	Usable Seat Depth:	19
Seat Depth:	21½	Ship Weight:	38
Seat Width:	20¾	Cube:	16.1
Back Width:	21½	COM:	2.5
Back Height:	19¼	Weight Rating:	300 lbs.

FABRIC PRICE CODES

1	\$734	8	\$1095
2	\$797	9	\$1142
3	\$860	10	\$1189
4	\$907	11	\$1236
5	\$954	12	\$1283
6	\$1001	L	\$891
7	\$1048		

NOTES: When selecting leather, the 2090 Series uses SR Leather only. All models are also available in Grade 1 EB vinyl (which matches SR Leather).

HOW TO SPECIFY

HON Recommendation: H2091.H.SR11.T - List Price \$1119

<p>Select Model Number</p> <p>H 2 0 9 1 .</p>	<p>Select Caster</p> <p>H Black Hard Caster S Black All-Surface Caster (+ \$42) <i>Does not apply to models H2093 or H2095</i></p> <p>H .</p>	<p>Select Fabric</p> <p>See page 452 <i>H2095 only available in 2 fabric options. See above for pricing and selection.</i></p> <p>S R 1 1 .</p>	<p>Select Frame</p> <p>T Black</p> <p>T</p>
--	--	--	---

PROMINENT™ Mesh Chairs

OPEN MARKET



Icon Legend on page 19

HVL531



HIGH-BACK

Pneumatic
Swivel
Tilt
Tilt Tension
Tilt Lock
Height-adjustable Arms

Functions: **A, E, F, K, L, Q**
(Function Key on pages 250-251)

DIMENSIONS

Depth:	27	Arm Width:	20¼
Width:	27	Seat to Floor Height:	18-22
Height:	42½	Usable Seat Depth:	18
Seat Depth:	18	Ship Weight:	36
Seat Width:	21½	Cube:	5.1
Back Width:	18¾	Weight Rating:	250 lbs.
Back Height:	23		

PRICE CODE

Sandwich Mesh \$582
Leather \$609

NOTES: Comfortable and breathable mesh back. Black Sandwich Mesh or Black Bonded Leather seat. Black frame. Height-adjustable arms. **HON 5-Year Limited Warranty.**

HON Recommendation: HVL531.MM10 - List Price \$582

HVL532



HIGH-BACK

Mesh Back
Pneumatic
Swivel
Asynchronous Control
Tilt
Tilt Tension
Tilt Lock
Seat Glide Mechanism
Back Height Adjustment
Height and Width Adjustable Arms

Functions: **A, B, D, E, F, L, O, S**
(Function Key on pages 250-251)

DIMENSIONS

Depth:	26	Back Height:	23¼-24½
Width:	30¾	Arm Width:	18-22½
Height:	44½	Seat to Floor Height:	17-20½
Seat Depth:	17⅝-20⅝	Ship Weight:	50
Seat Width:	20½	Cube:	6.5
Back Width:	19⅝	Weight Rating:	250 lbs.

PRICE CODE

Sandwich Mesh \$693
Leather \$720

NOTES: Comfortable and breathable mesh back. Black Sandwich Mesh or Black Bonded Leather seat. Black frame. Height and width adjustable arms. Seat glide mechanism. Asynchronous control with independent seat and back angle adjustment. **HON 5-Year Limited Warranty.**

HON Recommendation: HVL532.MM10 - List Price \$693

HVL539



TASK STOOL

Mesh Back
Pneumatic
Swivel
Height and Width Adjustable Arms
Adjustable Footring

Functions: **A, E, S**
(Function Key on pages 250-251)

DIMENSIONS

Depth:	27⅞	Arm Width:	18⅞
Width:	28⅞	Seat to Floor Height:	21⅞-28⅞
Height:	50	Usable Seat Depth:	17⅞
Seat Depth:	17⅞	Ship Weight:	44.0
Seat Width:	20⅞	Cube:	5.7
Back Width:	17⅞	Weight Rating:	250 lbs.
Back Height:	22⅞		

PRICE CODE

Sandwich Mesh \$636

NOTES: Prominent™ HVL539. Black upholstered seat. Height and width adjustable arms. **HON 5-Year Limited Warranty.**

HON Recommendation: HVL539.MM10 - List Price \$636

SEATING

HOW TO SPECIFY

Select
Model Number

Select
Fabric

MM10 Black Sandwich Mesh Fabric

H V L 5 3 9 .

M M 1 0



Ruck™ Seating shown with West Hill™ Casual Lounge, Scramble™ Occasional Tables, and Unika Vaev Screens.

RUCK™

Easy on the eyes and even easier to move and stack, Ruck™ seating brings effortless style to working alone or together. Available in a variety of finishes in both seated and stool heights, Ruck clicks with its surroundings — whether that's in a collaborative area, café setting, or as a side chair in a private office. Crafted with gentle, molded contours, Ruck makes being on the edge of your seat a more comfortable place to be.



FEATURES

- Available in both a seated and stool-height option.
- Lightweight frame can be easily moved to rearrange seating configurations.
- Waterfall seat edge promotes better leg circulation.
- Glides move effortlessly on hard surfaces.
- Both the chair and stool stack six high on the floor to maximize space.
- Single-piece shell can be quickly wiped down for easy maintenance.
- Choose from 6 laminate and 4 veneer shell colors.
- Legs are available in a variety of finish options to match or complement other HON product lines.
- Backed by HON's industry-leading Lifetime Warranty.

RUCK™ Options

MODEL OPTIONS

HRUCK1L



Chair

Laminate Shell

HRUCK5L



Stool

Laminate Shell

HRUCK1W



Chair

Wood Shell

HRUCK5W



Stool

Wood Shell

AVAILABLE FINISHES

Ruck Seating is available in 7 laminate finishes and 4 wood finishes.

LAMINATE FINISHES

Charcoal (S)

Designer White (LDW1)

Field Elm (LWFE)

Florence Walnut (LFW1)

Kingswood Walnut (LK11)

Natural Maple (D)

Pinnacle (PINC)

WOOD FINISHES

Black Wash (QA997)

Natural (QA447)

Pinnacle Walnut (QA679)

White Wash (QA921)

FRAME

CODE	DESCRIPTION	PRICE
CBK	Charblack	+\$0
P7J	Textured Brownstone	+\$0
P7A	Textured Charcoal	+\$0
PK7	Textured Designer White	+\$0
P7L	Textured Loft	+\$0
P7M	Textured Muslin	+\$0
PR8	Textured Silver	+\$0
P8V	Textured Titanium	+\$0



HRUCK1L



CHAIR, LAMINATE SHELL

DIMENSIONS

Depth:	22 ⁵ / ₈	Seat to Floor Height:	17 ³ / ₄
Width:	21 ⁵ / ₈	Usable Seat Depth:	18 ¹ / ₄
Height:	32 ⁵ / ₁₆	Ship Weight:	24
Seat Depth:	18 ¹ / ₄	Cube:	15.8
Seat Width:	17 ¹ / ₂	Weight Rating:	300 lbs.
Back Width:	17		
Back Height:	15 ⁵ / ₈		

LIST PRICE

\$627

HRUCK5L



STOOL, LAMINATE SHELL

DIMENSIONS

Depth:	22 ⁵ / ₈	Seat to Floor Height:	30
Width:	21 ⁵ / ₈	Usable Seat Depth:	18 ¹ / ₄
Height:	44 ¹ / ₂	Ship Weight:	32
Seat Depth:	18 ¹ / ₄	Cube:	22.2
Seat Width:	17 ¹ / ₂	Weight Rating:	300 lbs.
Back Width:	17		
Back Height:	15 ⁵ / ₈		

LIST PRICE

\$752

HON Recommendation: HRUCK1L.PINC.P8V - List Price \$627

HOW TO SPECIFY

<p>Select Model Number</p> <p>HRUCK1L</p>	<p>Select Laminate</p> <p>See page 456</p> <p>PINC</p>	<p>Select Frame</p> <p>See page 456</p> <p>P8V</p>
--	---	---

RUCK™ Wood Seating

GSA SIN 33721



Icon Legend on page 19

HRUCK1W

CHAIR, WOOD SHELL

DIMENSIONS

LIST PRICE



Depth:	22 ⁵ / ₈	Seat to Floor Height:	17 ³ / ₄
Width:	21 ⁵ / ₈	Usable Seat Depth:	18 ¹ / ₄
Height:	32 ⁵ / ₁₆	Ship Weight:	24
Seat Depth:	18 ¹ / ₄	Cube:	15.8
Seat Width:	17 ¹ / ₂	Weight Rating:	300 lbs.
Back Width:	17		
Back Height:	15 ⁵ / ₈		

\$659

HRUCK5W

STOOL, WOOD SHELL

DIMENSIONS

LIST PRICE



Depth:	22 ⁵ / ₈	Seat to Floor Height:	30
Width:	21 ⁵ / ₈	Usable Seat Depth:	18 ¹ / ₄
Height:	44 ¹ / ₂	Ship Weight:	32
Seat Depth:	18 ¹ / ₄	Cube:	22.2
Seat Width:	17 ¹ / ₂	Weight Rating:	300 lbs.
Back Width:	17		
Back Height:	15 ⁵ / ₈		

\$784

HON Recommendation: HRUCK1W.QA997.P8V - List Price \$659

SEATING

HOW TO SPECIFY

Select
Model Number

HRUCK1W

Select
Finish

See page 456

QA997

Select
Frame

See page 456

P8V



HVL606



GUEST CHAIR

Leg Base
Armless
Stacks up to Four High

DIMENSIONS

Depth:	21	Seat to Floor Height:	19
Width:	21¼	Usable Seat Depth:	17½
Height:	32¾	Ship Weight:	16
Seat Depth:	17½	Cube:	1.7
Seat Width:	19	Weight Rating:	250 lbs.
Back Width:	18½		
Back Height:	16		

PRICE CODE

Fabric	\$220
Leather	\$252

NOTES: Fabric or Black Bonded Leather. Stackable up to four high. Round tube construction. Frame available in Black. Casters and glides ship packaged together for customer's assembly choice. **HON 5-Year Limited Warranty.**

HON Recommendation: HVL606.VA10 - List Price \$220

HVL616



GUEST CHAIR

Leg Base
Arms
Stacks up to Four High

DIMENSIONS

Depth:	21	Arm Width:	20⅞
Width:	23¾	Seat to Floor Height:	19
Height:	32¾	Usable Seat Depth:	17½
Seat Depth:	17½	Ship Weight:	18
Seat Width:	19	Cube:	2.1
Back Width:	18½	Weight Rating:	250 lbs.
Back Height:	16		

PRICE CODE

Fabric	\$249
Leather	\$281

NOTES: Fabric or Black Bonded Leather. Stackable up to four high. Round tube construction. Frame available in Black. Casters and glides ship packaged together for customer's assembly choice. **HON 5-Year Limited Warranty.**

HON Recommendation: HVL616.VA10 - List Price \$249

HOW TO SPECIFY

Select
Model Number

Select
Fabric

- SB11** Black Bonded Leather
- VA10** Black Fabric
- VA19** Charcoal Fabric
- VA90** Navy Fabric

H V L 6 0 6 .

V A 1 0

SKIP

Want to see more? Scan here
to check out hon.com.



Skip shown with Flock® Cylinder Table.

SKIP

It's hard to get creative when you're feeling all buttoned up. That's why workplaces are adding less formal, more dynamic spaces to foster greater creativity and connection between workers. Designed to put the fun back in functional, Skip seating offers an engaging, active sit that lets you rock a meeting — literally. When it comes to casual and collaborative seating that's as lively as it is practical, this chair doesn't Skip a beat.



FEATURES

- Built-in handle makes it easy to move around.
- Textured finish is durable, easy to clean, UV resistant, and suitable for outdoor sitting.
- Optional cushion stays in place but is not permanently affixed.
- Cushion fabric is easy to wipe clean.
- Hard plastic frame is multicolored.



SKIP Collaborative Chair

HQQ1



COLLABORATIVE CHAIR

DIMENSIONS

Depth:	35½	Seat to Floor Height:	17
Width:	28	Usable Seat Depth:	17
Height:	31	Ship Weight:	35
Seat Depth:	18	Cube:	20.0
Seat Width:	28	Weight Rating:	275 lbs.
Back Width:	28		
Back Height:	21		

LIST PRICE

\$1106

NOTES: Hard plastic frame is multicolored. **HON 5-Year Limited Warranty.**

HQQ1CUSH



CUSHION

DIMENSIONS

Depth:	17½	Ship Weight:	5 Ⓞ
Width:	25¾	Cube:	2.0
Height:	1½		

LIST PRICE

\$215

NOTES: **HON 5-Year Limited Warranty.**

HOW TO SPECIFY

Select Model Number

HQQ1

HOW TO SPECIFY

Select Model Number

HQQ1CUSH.

Select Fabric

SLT Slate
NVY Navy

SLT



SoCo™ shown with Scramble™ Occasional Tables.

SoCo™

Today's busy professionals are taking meetings and project planning in a variety of different ways and places. SoCo™ is an intuitive modular lounge series designed to encourage the ease of both collaborative and individual work while supporting how people like to sit and get comfortable. Multiple shapes come together to create a wide range of configuration possibilities, from understated and sophisticated to more fun and cozy. Power is cleanly integrated within the design and is located where multiple users can access and utilize its functionality to stay connected. SoCo™ offers soft, comfortable support and a tailored aesthetic in spaces that allow you to get away from the workstation throughout the day.

FEATURES

- SoCo™ supports dynamic collaboration and casual focus work with a soft, organic, tailored aesthetic that delivers comfort for a variety of sitting postures.
- Seven modular shapes work together to create unlimited linear and curvilinear configurations.
- A fully upholstered design with a multi-fabric seat/back option softens the corporate aesthetic.
- Optional plug-in or hardwired electrical is available on select shapes and supports both USB-A and USB-C compatibility.
- Dual-purpose glides allow two functions: without glide caps furniture stays in place; with glide caps furniture easily moves for reconfiguration.

SINGLE SEATING



Single Seat



Single Seat w/ Back



Single Seat w/ Back
w/ Power



Single Seat w/ Back
Multi-Fabric

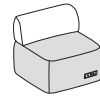

Single Seat w/ Back
Multi-Fabric w/ Power

CURVE SEATING

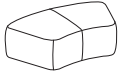

Curve Seat

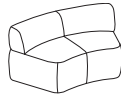

Inside Curve Seat
w/ Back



Inside Curve Seat
w/ Back w/ Power

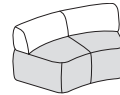

Inside Curve Seat
w/ Back Multi-Fabric

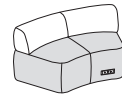

Inside Curve Seat w/ Back
Multi-Fabric w/ Power



Outside Curve Seat
w/ Back



Outside Curve Seat
w/ Back w/ Power



Outside Curve Seat
w/ Back Multi-Fabric



Outside Curve Seat
w/ Back Multi-Fabric w/ Power

SQUARE SEATING



Square Corner Seat
w/ Back



Square Corner Seat
w/ Back Multi-Fabric

QUARTER CIRCLE SEATING



Quarter Circle Seat

SoCo™ Fabric Options

HON BRANDED FABRICS

GRADE 1	GRADE 2	GRADE 3	GRADE 4
Apex	Apport Seating	Bradbury	Constance with Supreen™
Centurion	Blume	Moxie*	Livi with Supreen™**
Compass	Clyde	Notion	Lugano with Supreen™
Contourett*	Kai	Parker*	Oxford with Supreen™**
Dapper	Rush	Purl	
Ensemble	Spin Seating	Saxony	
Hamilton	Taylor		
Inertia	Whisper Vinyl*		
Noble Seating			
Optic			
Vibe			

For a complete list of fabrics, including partnership fabrics, go to hon.com/fabricsandfinishes.

Reference Fabric Color Combinations on pages 20-24 for color codes and legend on page 21 for lead times.

❗ Solid, non-patterned fabrics are recommended due to SoCo's curvilinear profile. HON does not pattern match fabrics that have a distinct linear or repeating pattern. It is recommended to choose from one of HON's many standard non-patterned fabrics. For more details on Upholstery Pattern Match for this series, please see page 14.

*Due to the inherent characteristics of upholstery materials, such as coated textiles and stiffer fabrics, and the curved nature of SoCo™, fabric may show some wrinkles along seams and may become more relaxed to show additional wrinkles over time.

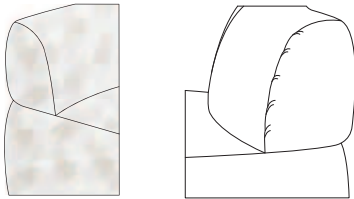

COM YARDAGE

MODEL	COM											
	Fabric (P)	Vinyl (P)	Fabric Seat (P)	Vinyl Seat (P)	Fabric Back (P)	Vinyl Back (P)	Fabric (R)	Vinyl (R)	Fabric Seat (R)	Vinyl Seat (R)	Fabric Back (R)	Vinyl Back (R)
EXISTING SINGLE FAB UNITS												
HSLMSS	3	3	—	—	—	—	2.75	2.75	—	—	—	—
HSLMSB1	4	4	—	—	—	—	3.5	3.5	—	—	—	—
HSLMSB2	—	—	3	3	1.5	1.5	—	—	2.75	2.75	1.5	1.5
HSLMTCB1	5	5	—	—	—	—	3.75	3.75	—	—	—	—
HSLMTCB2	—	—	3	3	2	2	—	—	2.75	2.75	1.75	1.75
HSLMCS	3.75	3.75	—	—	—	—	3.5	3.5	—	—	—	—
HSLMICB1	5.5	5.5	—	—	—	—	5.25	5.25	—	—	—	—
HSLMICB2	—	—	3.75	3.75	2	2	—	—	3.5	3.5	1.75	1.75
HSLMOCB1	5	5	—	—	—	—	5	5	—	—	—	—
HSLMOCB2	—	—	3.75	3.75	1.5	1.5	—	—	3.5	3.5	1.5	1.5
HSLMQCS	2.5	2.5	—	—	—	—	2.5	2.5	—	—	—	—

SEATING

QTY	DESCRIPTION	MODEL	LIST PRICE	PRICE EXTENSION
2	Curve Seat	HSLMCS	\$2,070	\$4,140
2	Inside Curve Seat w/ Back	HSLMICB1	\$3,470	\$6,940
2	Outside Curve Seat w/ Back	HSLMOCB1	\$3,470	\$6,940
TOTAL:				\$18,020

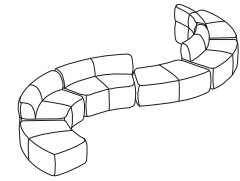

SERPENTINE

QTY	DESCRIPTION	MODEL	LIST PRICE	PRICE EXTENSION
2	Single Seat	HSLMSS	\$1,440	\$2,880
2	Single Seat w/ Back	HSLMSB1	\$2,340	\$4,680
2	Square Corner Seat w/ Back	HSLMTCB1	\$2,440	\$4,880
2	Quarter Circle Seat	HSLMQCS	\$1,240	\$2,480
TOTAL:				\$14,920

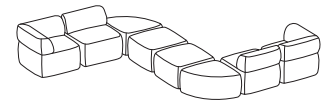

ZIGZAG

QTY	DESCRIPTION	MODEL	LIST PRICE	PRICE EXTENSION
2	Curve Seat	HSLMCS	\$2,070	\$4,140
2	Inside Curve Seat w/ Back	HSLMICB1	\$3,470	\$6,940
TOTAL:				\$11,080

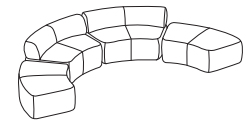

HALF-CIRCLE

QTY	DESCRIPTION	MODEL	LIST PRICE	PRICE EXTENSION
2	Single Seat w/ Back	HSLMSB1	\$2,340	\$4,680
4	Quarter Circle Seat	HSLMQCS	\$1,240	\$4,960
TOTAL:				\$9,640

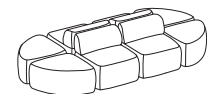

ISLAND

HSLMSS

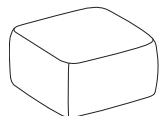

LOUNGE

Single Seat

DIMENSIONS

Depth: 30 Ship Weight: 44.0
 Width: 30 Cube: 11.3
 Height: 18½ COM: See page 461.3
 Weight Rating: 300 lbs.

FABRIC PRICE CODES

1	\$1440	8	\$1870
2	\$1513	9	\$1927
3	\$1587	10	\$1988
4	\$1643	11	\$2054
5	\$1699	12	\$2120
6	\$1756	L	—
7	\$1812		

❗ No Power Cutout Option

HSLMSB1

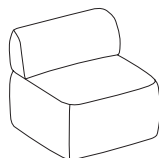

LOUNGE

Single Seat w/ Back

DIMENSIONS

Depth: 30 Ship Weight: 57.4
 Width: 30 Cube: 18.3
 Height: 30 COM: See page 461.3
 Usable Seat Depth 20½ Weight Rating: 300 lbs.
 Seat to Floor Height 18½

FABRIC PRICE CODES

1	\$2340	8	\$2893
2	\$2434	9	\$2966
3	\$2529	10	\$3044
4	\$2601	11	\$3129
5	\$2672	12	\$3214
6	\$2747	L	—
7	\$2818		

NOTES: Power models specified separately. Power models found on page 461.10.

❗ Optional Power Cutout

HSLMSB2

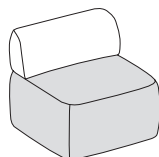

LOUNGE

Single Seat w/ Back —
 Multi-Fabric

DIMENSIONS

Depth: 30 Ship Weight: 57.4
 Width: 30 Cube: 18.3
 Height: 30 COM: See page 461.3
 Usable Seat Depth 20½ Weight Rating: 300 lbs.
 Seat to Floor Height 18½

FABRIC PRICE CODES

1 **\$2440**
 Add to Base Price Above

	Seat	Back
2	\$73	\$31
3	\$147	\$63
4	\$203	\$87
5	\$259	\$111
6	\$316	\$136
7	\$372	\$159
8	\$430	\$184
9	\$487	\$209
10	\$548	\$235
11	\$614	\$263
12	\$680	\$291
L	—	—

NOTES: Power models specified separately. Power models found on page 461.10.

❗ Optional Power Cutout

HOW TO SPECIFY

<p>Select Model Number</p> <p>H S L M S S .</p>	<p>Select FSC Wood</p> <p>F S C FSC Wood</p> <p>F S C .</p>	<p>Select Power</p> <p>Y Power Cutout (+ \$40) N No Power Cutout</p>	<p>Select Seat Fabric</p> <p>See page 461.3</p>	<p>Select Back Fabric (if applicable)</p> <p>See page 461.3</p>
--	--	--	--	--

HSLMCS

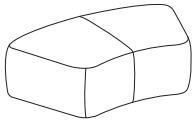

LOUNGE

Curve Seat

DIMENSIONS

Depth: 30 Ship Weight: 54.9
 Width: 55 Cube: 20.7
 Height: 18½ COM: See page 461.3
 Weight Rating: 300 lbs.

FABRIC PRICE CODES

1	\$2070	8	\$2562
2	\$2153	9	\$2626
3	\$2238	10	\$2696
4	\$2302	11	\$2771
5	\$2365	12	\$2847
6	\$2431	L	—
7	\$2495		

❗ No Power Cutout Option

HSLMICB1

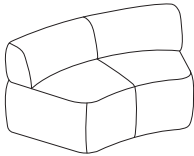

LOUNGE

Inside Curve Seat w/ Back

DIMENSIONS

Depth: 30 Ship Weight: 72.9
 Width: 55 Cube: 33.9
 Height: 30 COM: See page 461.3
 Usable Seat Depth 20½ Weight Rating: 300 lbs.
 Seat to Floor Height 18½

FABRIC PRICE CODES

1	\$3470	8	\$4208
2	\$3595	9	\$4304
3	\$3722	10	\$4409
4	\$3818	11	\$4522
5	\$3913	12	\$4635
6	\$4012	L	—
7	\$4107		

NOTES: Power models specified separately. Power models found on page 461.10.
 ❗ Optional Power Cutout

HSLMICB2

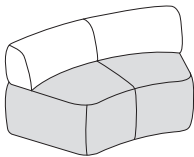

LOUNGE

Inside Curve Seat w/ Back —
 Multi-Fabric

DIMENSIONS

Depth: 30 Ship Weight: 72.9
 Width: 55 Cube: 33.9
 Height: 30 COM: See page 461.3
 Usable Seat Depth 20½ Weight Rating: 300 lbs.
 Seat to Floor Height 18½

FABRIC PRICE CODES

1	\$3570		
<i>Add to Base Price Above</i>			
	Seat	Back	
2	\$83	\$52	
3	\$168	\$105	
4	\$232	\$145	
5	\$295	\$185	
6	\$361	\$226	
7	\$425	\$265	
8	\$492	\$307	
9	\$556	\$348	
10	\$626	\$391	
11	\$701	\$438	
12	\$777	\$485	
L	—	—	

NOTES: Power models specified separately. Power models found on page 461.10.
 ❗ Optional Power Cutout

HOW TO SPECIFY

<p>Select Model Number</p> <p>H S L M C S .</p>	<p>Select FSC Wood</p> <p>F S C .</p>	<p>Select Power</p> <p>Y Power Cutout (+ \$40) N No Power Cutout</p>	<p>Select Seat Fabric</p> <p>See page 461</p>	<p>Select Back Fabric (if applicable)</p> <p>See page 461</p>
--	--	--	--	--



HSLMOCB1

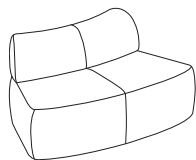

LOUNGE

Outside Curve Seat w/ Back

DIMENSIONS

Depth:	30	Ship Weight:	67.2
Width:	55	Cube:	33.9
Height:	30	COM:	See page 461.3
Usable Seat Depth	20½	Weight Rating:	300 lbs.
Seat to Floor Height	18½		

FABRIC PRICE CODES

1	\$3470	8	\$4208
2	\$3595	9	\$4304
3	\$3722	10	\$4409
4	\$3818	11	\$4522
5	\$3913	12	\$4635
6	\$4012	L	—
7	\$4107		

NOTES: Power models specified separately. Power models found on page 461.10.

! Optional Power Cutout

HSLMOCB2

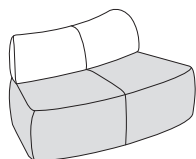

LOUNGE

Outside Curve Seat w/ Back — Multi-Fabric

DIMENSIONS

Depth:	30	Ship Weight:	67.2
Width:	55	Cube:	33.9
Height:	30	COM:	See page 461.3
Usable Seat Depth	20½	Weight Rating:	300 lbs.
Seat to Floor Height	18½		

FABRIC PRICE CODES

1 \$3570

Add to Base Price Above

	Seat	Back
2	\$83	\$52
3	\$168	\$105
4	\$232	\$145
5	\$295	\$185
6	\$361	\$226
7	\$425	\$265
8	\$492	\$307
9	\$556	\$348
10	\$626	\$391
11	\$701	\$438
12	\$777	\$485
L	—	—

NOTES: Power models specified separately. Power models found on page 461.10.

! Optional Power Cutout

HOW TO SPECIFY

<p>Select Model Number</p> <p>H S L M O C B 1 .</p>	<p>Select FSC Wood</p> <p>F S C FSC Wood</p> <p>F S C .</p>	<p>Select Power</p> <p>Y Power Cutout (+ \$40) N No Power Cutout</p>	<p>Select Seat Fabric</p> <p>See page 461.3</p>	<p>Select Back Fabric (if applicable)</p> <p>See page 461.3</p>
--	--	---	--	--

HSLMTCB1

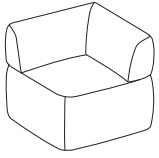

LOUNGE

Square Corner Seat w/ Back

DIMENSIONS

Depth:	30	Ship Weight:	67.8
Width:	30	Cube:	18.5
Height:	30	COM:	See page 461.3
Usable Seat Depth	20½	Weight Rating:	300 lbs.
Seat to Floor Height	18½		

FABRIC PRICE CODES

1	\$2440	8	\$3116
2	\$2554	9	\$3205
3	\$2671	10	\$3301
4	\$2759	11	\$3404
5	\$2846	12	\$3508
6	\$2937	L	—
7	\$3024		

ⓘ No Power Cutout Option

HSLMTCB2

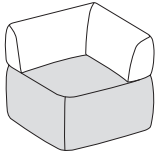

LOUNGE

Square Corner Seat w/ Back — Multi-Fabric

DIMENSIONS

Depth:	30	Ship Weight:	67.8
Width:	30	Cube:	18.5
Height:	30	COM:	See page 461.3
Usable Seat Depth	20½	Weight Rating:	300 lbs.
Seat to Floor Height	18½		

FABRIC PRICE CODES

1	\$2540	
	<i>Add to Base Price Above</i>	
	Seat	Back
2	\$73	\$52
3	\$147	\$105
4	\$203	\$145
5	\$259	\$185
6	\$316	\$226
7	\$372	\$265
8	\$430	\$307
9	\$487	\$348
10	\$548	\$391
11	\$614	\$438
12	\$680	\$485
L	—	—

ⓘ No Power Cutout Option

HOW TO SPECIFY

Select Model Number

H S L M T C B 1 .

Select FSC Wood

FSC FSC Wood

F S C .

Select Seat Fabric

See page 461.3

Select Back Fabric (if applicable)

See page 461.3

HSLMQCS

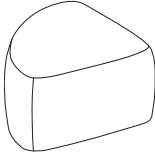

LOUNGE

Quarter Circle Seat

DIMENSIONS

Depth: 30
Width: 30
Height: 18½

Ship Weight: 32.4
Cube: 11.3
COM: See page 461.3
Weight Rating: 300 lbs.

FABRIC PRICE CODES

1	\$1240	8	\$1609
2	\$1302	9	\$1657
3	\$1366	10	\$1709
4	\$1414	11	\$1766
5	\$1462	12	\$1822
6	\$1511	L	—
7	\$1559		

ⓘ No Power Cutout Option.

HSLMGK

LOUNGE

Ganging Kit (2-Pack)

DIMENSIONS

Ship Weight: 6.3
Cube: 0.1

LIST PRICE

\$65

NOTES: Ganging brackets used to provide alignment between adjacent pieces but can be easily disengaged and repositioned for reconfiguration.

HOW TO SPECIFY

Select Model Number

H S L M Q C S .

Select FSC Wood

FSC FSC Wood

F S C .

Select Seat Fabric

See page 461.3

SoCo™ Power

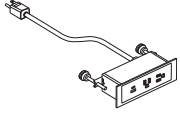

DESCRIPTION

Dean Power Module
 In-Surface Bezel Mount
 2 Receptacles
 1 USB-A
 1 USB-C

- Straight (10'), braided (10'), hardwire (10'), and cord options available.
- In-Surface Bezel Mount model applicable in SoCo power module cut-out.
- UL Listed.

MODEL	SHIP WEIGHT	CUBE	LIST PRICE
HBPWRMOD	4.5 Ⓞ	0.2	\$475

HOW TO SPECIFY

Select Model Number

H B P W R M O D .

Select Last Port Option

AC USB-A/C

A C .

Select Cord Type

- S Straight
- B Braided (+ \$50)
- H Hardwire (+ \$70)

S .

Select Color/Finish

- SNW Snow
- STRM Storm
- BLK Black

S N W

SOLUTIONS SEATING® 4000 SERIES

Want to see more? Scan here
to check out hon.com.



Solutions Managerial Mid-Back Chair shown with
34000 Series Desk and Brigade® 700 Series Lateral Files.

SOLUTIONS SEATING® 4000 SERIES

Looking for the perfect answer for your task and guest chair needs? HON has four Solutions for everything from workstations to open areas. The Solutions series includes a high-back and mid-back task chair, as well as matching four-leg and sled base guest chairs. The floating backrest provides ergonomic support for your spine. The tilt mechanism delivers a natural recline. Solutions are the chairs that really live up to their name.



GUEST CHAIR FEATURES

- Guest chairs feature molded polymer outer back shell for added durability.
- Back cushion enhances lumbar support and minimizes fatigue.
- Available in hundreds of quality HON fabrics.
- Warranted for users up to 300 lbs.

TASK CHAIR FEATURES

- One-touch seat height adjustment easily moves the seat up and down.
- Tilt tension controls the rate and ease of recline.
- Tilt lock allows the user to lock out the tilt function.
- 360-degree swivel provides freedom of movement in any direction.
- Back cushion enhances lumbar support and minimizes fatigue.
- Dual-wheeled casters roll effortlessly and quietly.
- Available in hundreds of quality HON fabrics.
- Warranted for users up to 300 lbs.

SOLUTIONS SEATING®

4000 Series Options

MODEL OPTIONS

H4003 *



Guest Chair

Leg Base, Arms

H4008 *



Guest Chair

Sled Base, Arms

FRAME

CODE	DESCRIPTION	PRICE
T	Black	+\$0

HON BRANDED FABRICS

GRADE 1

Apex
Centurion
Compass
Contourett
Dapper
Ensemble
Hamilton
Inertia
Noble Seating
Optic
Pebble
Vibe

GRADE 2

Appoint Seating
Blume
Clyde
Dotty
Kai
Rush
Spin Seating
Wavelength
Whisper Vinyl

GRADE 3

Bradbury
Getaway
Moxie
Notion
Parker
Purl
Quill
Saxony

GRADE 4

Constance with Supreen™
Livi with Supreen™
Lugano with Supreen™
Oxford with Supreen™

For a complete list of fabrics, including partnership fabrics, go to hon.com/fabricsandfinishes.

Reference Fabric Color Combinations on pages 20-24 for color codes and legend on page 21 for lead times. COM yardage shown is for Pattern Cut only. Contact Customer Service for Railroaded yardage requirements. For additional HON to Supply COM fabric grade pricing, go to honready.hon.com and click on the HON to Supply COM link.

* De-emphasized

SOLUTIONS SEATING®

4000 Series

GSA SIN 33721



Icon Legend on page 19

H4003 *



GUEST CHAIR

Leg Base
Arms

DIMENSIONS

Depth:	24½	Arm Width:	18¾
Width:	23½	Seat to Floor Height:	19¼
Height:	32	Usable Seat Depth:	18¼
Seat Depth:	18	Ship Weight:	29
Seat Width:	20	Cube:	12.6
Back Width:	21	COM:	1.0
Back Height:	15	Weight Rating:	250 lbs.

FABRIC PRICE CODES

1	\$555	8	\$700
2	\$581	9	\$719
3	\$606	10	\$737
4	\$624	11	\$756
5	\$643	12	\$775
6	\$662	L	—
7	\$681		

H4008 *



GUEST CHAIR

Sled Base
Arms

DIMENSIONS

Depth:	25½	Arm Width:	19
Width:	23½	Seat to Floor Height:	19¼
Height:	32½	Usable Seat Depth:	18¼
Seat Depth:	18	Ship Weight:	33
Seat Width:	20	Cube:	12.6
Back Width:	21	COM:	1.0
Back Height:	15	Weight Rating:	250 lbs.

FABRIC PRICE CODES

1	\$620	8	\$765
2	\$646	9	\$784
3	\$671	10	\$802
4	\$689	11	\$821
5	\$708	12	\$840
6	\$727	L	—
7	\$746		

HON Recommendation: H4008.CU__T - List Price \$620

* De-emphasized

HOW TO SPECIFY

<p>Select Model Number</p> <p>H 4 0 0 8 .</p>	<p>Select Fabric</p> <p>See page 463</p> <p>C U 1 0 .</p>	<p>Select Frame</p> <p>T Black</p> <p>T</p>
---	---	---



Solve Task Chairs and Stools.

SOLVE®

If you want to make a powerful statement, simply have a seat. With three back materials and an optional adjustable lumbar support, Solve answers the need for a higher level of personalization. Solve task chairs feature a geometric ReActiv® back to create a contemporary look, while the 4-Way Stretch mesh back offers a softer, more relaxed feel. The synchronized seat and back move in harmony with the user to provide continuous comfort that can be customized. Helping anyone achieve optimal balance, proper alignment and lumbar support, Solve is an ideal solution for everywhere and everybody.



FEATURES

- Synchronized seat and back create continuous comfort.
- Waterfall seat edge encourages leg circulation.
- Optional seat depth adjustment adapts to users of various heights.
- ReActiv® back design moves with your body to provide continuous support and airflow for lasting comfort.
- Available with three control types — synchro-tilt, synchro-tilt with seat slider and advanced synchro-tilt.
- Choose from four different arm options — armless, fixed, height- and width-adjustable or all-adjustable arms.
- Optional lumbar support delivers long-lasting comfort.
- Available with bell glides, hard casters or all-surface casters.
- Upholstered ReActiv® back offers all the benefits of the ReActiv® back with a fabric cover for additional comfort.
- Back upholstery available in one of six attractive fabrics.
- Choose from 3 frame options: Black, Titanium and White.
- Available in seven mesh back and seven lumbar colors and thousands of fabrics.
- Warranted for users up to 300 lbs.

SOLVE[®] Options

MODEL OPTIONS

HSLVTMM



Mid-Back Task (4-Way Stretch Back)

Pneumatic, Swivel, Synchro-tilt, Tilt Tension, Tilt Lock

HSLVSMM



Stool (4-Way Stretch Back)

Pneumatic, Swivel, Synchro-tilt, Tilt Tension, Tilt Lock

HSLVTMMS



Mid-Back Task (4-Way Stretch Back) with Designer White frame

Pneumatic, Swivel, Synchro-tilt, Tilt Tension, Tilt Lock

HSLVSMMS



Stool (4-Way Stretch Back) with Designer White frame

Pneumatic, Swivel, Synchro-tilt, Tilt Tension, Tilt Lock

HSLVTMR



Mid-Back Task (ReActiv[®] Back)

Pneumatic, Swivel, Synchro-tilt, Tilt Tension, Tilt Lock

HSLVSMR



Stool (ReActiv[®] Back)

Pneumatic, Swivel, Synchro-tilt, Tilt Tension, Tilt Lock

HSLVTMRS



Mid-Back Task (ReActiv[®] Back) with Designer White frame

Pneumatic, Swivel, Synchro-tilt, Tilt Tension, Tilt Lock

HSLVSMRS



Stool (ReActiv[®] Back) with Designer White frame

Pneumatic, Swivel, Synchro-tilt, Tilt Tension, Tilt Lock

HSLVTMU



Mid-Back Task (Upholstered Back)

Pneumatic, Swivel, Synchro-tilt, Tilt Tension, Tilt Lock

HSLVSMU



Stool (Upholstered Back)

Pneumatic, Swivel, Synchro-tilt, Tilt Tension, Tilt Lock

HSLVTMUS



Mid-Back Task (Upholstered Back) with Designer White frame

Pneumatic, Swivel, Synchro-tilt, Tilt Tension, Tilt Lock

HSLVSMUS







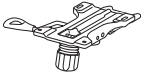
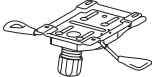
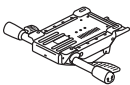

Stool (Upholstered Back) with Designer White frame

Pneumatic, Swivel, Synchro-tilt, Tilt Tension, Tilt Lock

MECHANISM	CODE	DESCRIPTION	PRICE
	Y0	Synchro-Tilt A, E, J, K, L	+\$0
	Y1	Synchro-Tilt w/Seat Slider A, D, E, J, K, L	+\$21
	Y2	Advanced Synchro-Tilt A, D, E, J, L, A-D	+\$68

**Y2 control not available on stool models*

ARM STYLE	CODE	DESCRIPTION	PRICE
	N	Armless	+\$0
	F	Fixed Arms	+\$68
		<i>*Not available on Designer White models</i>	
	A	Height and Width Adjustable Arms	+\$89
	V	All-Adjustable Arms (includes Pivot)	+\$136
		<i>*Not available on Designer White models</i>	
	ADW	Height and Width Adjustable Arms	+\$89

CASTERS/ GLIDE	CODE	DESCRIPTION	PRICE
	H	Black Hard Caster	+\$0
	S	Black All-Surface Caster	+\$42
	R	Roll Control Caster	+\$53
	G	Bell Glide	+\$27

BACK STYLE	CODE	DESCRIPTION	PRICE
		<i>4-Way Stretch mesh back options:</i>	
	IM	Black	+\$0
	IB	Breeze	+\$0
	IK	Brownstone	+\$0
	IC	Charcoal	+\$0
	IF	Fog	+\$0
	IR	Regatta	+\$0
	IT	Titanium	+\$0
		<i>ReActiv® back options:</i>	
	OS	Charcoal	+\$0
	DW	Designer White	+\$0
	TI	Titanium	+\$0
		<i>Fabric options:</i>	
	COMF46	Bittersweet	+\$0
	COMF10	Ink	+\$0
	COMF82	Meadow	+\$0
	COMF90	Midnight	+\$0
	COMF22	Putty	+\$0
	COMF19	Sterling	+\$0

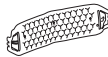
LUMBAR	CODE	DESCRIPTION	PRICE
	NL	No Lumbar	+\$0
	BL	Black Adjustable Lumbar	+\$32
	BY	Bullseye Adjustable Lumbar	+\$32
	DW	Designer White Adjustable Lumbar	+\$32
	KT	Krypton Adjustable Lumbar	+\$32
	MR	Ember Adjustable Lumbar	+\$32
	RE	Regatta Adjustable Lumbar	+\$32
	TL	Titanium Adjustable Lumbar	+\$32

BASE	CODE	DESCRIPTION	PRICE
	SB	Standard Base	+\$0

FRAME	CODE	DESCRIPTION	PRICE
	T	Black	+\$0
	TI	Titanium	+\$37
	DW	Designer White	+\$37

SOLVE[®] Options

HON BRANDED FABRICS

GRADE 1	GRADE 2	GRADE 3	GRADE 4	GRADE L
Apex	ApPOINT Seating	Bradbury	Constance with Supreen™	Denver Leather (Seat Only)
Centurion	Blume	Getaway	Livi with Supreen™	
Compass	Clyde	Moxie	Lugano with Supreen™	
Compass Foam	Dotty	Notion	Oxford with Supreen™	
Contourett	Kai	Parker		
Dapper	Rush	Purl		
Ensemble	Spin Seating	Quill*		
Hamilton	Wavelength	Saxony		
Inertia	Whisper Vinyl			
Noble Seating				
Optic				
Pebble				
Vibe				

For a complete list of fabrics, including partnership fabrics, go to hon.com/fabricsandfinishes.

Reference Fabric Color Combinations on pages 20-24 for color codes and legend on page 21 for lead times.

*Quill available on Seat only.

DIMENSIONS

NOTE: When selecting the .TI Titanium or .DW Designer White frame option, the chair's back frame, arms, and base will match. 4-Way Stretch, ReActiv®, and/or lumbar color must be selected separately.

MODEL		HSLVTMM /HSLVTMMS	HSLVSMM /HSLVSMS	HSLVTMR /HSLVTMRS	HSLVSMR /HSLVSMRS	HSLVTMU /HSLVTMUS	HSLVSMU /HSLVSMUS
Overall Width Armless		29½"	29½"	29½"	29½"	29½"	29½"
Overall Width with Arms	(A)	29½"	29½"	29½"	29½"	29½"	29½"
Overall Depth		29½"	29½"	29½"	29½"	29½"	29½"
Overall Height – Max	(Y0/Y1)	41¾"	52¾"	41¾"	52¾"	41¾"	52¾"
	(Y2)	42½"	—	42½"	—	42½"	—
Seat Width		19"	19"	19"	19"	19"	19"
Seat Depth (Cushion)		19¼"	19¼"	19¼"	19¼"	19¼"	19¼"
Usable Seat Depth	(Y0)	17⅝"	17⅝"	17⅝"	17⅝"	17⅝"	17⅝"
	(Y1)	16¼"-18½"	16¼"-18½"	16¼"-18½"	16¼"-18½"	16¼"-18½"	16¼"-18½"
	(Y2)	16¼"-19¼"	—	16¼"-19¼"	—	16¼"-19¼"	—
Seat Height	(Y0/Y1)	16¾"-21¾"	22¾"-32¾"	16¾"-21¾"	22¾"-32¾"	16¾"-21¾"	22¾"-32¾"
	(Y2)	17½"-22½"	—	17½"-22½"	—	17½"-22½"	—
Back Width		18¼"	18¼"	18¼"	18¼"	18¼"	18¼"
Back Height		21½"	21½"	21½"	21½"	21½"	21½"
Ship Weight Armless	(Y0)	40 Ⓢ	45 Ⓢ	41 Ⓢ	46 Ⓢ	41 Ⓢ	46 Ⓢ
	(Y1)	42 Ⓢ	47 Ⓢ	43 Ⓢ	48 Ⓢ	43 Ⓢ	48 Ⓢ
	(Y2)	45 Ⓢ	—	46 Ⓢ	—	46 Ⓢ	—
Ship Weight with Arms	(Y0)	44 Ⓢ	49 Ⓢ	45 Ⓢ	50 Ⓢ	45 Ⓢ	50 Ⓢ
	(Y1)	46 Ⓢ	51 Ⓢ	47 Ⓢ	52 Ⓢ	47 Ⓢ	52 Ⓢ
	(Y2)	49 Ⓢ	—	50 Ⓢ	—	50 Ⓢ	—
Width Between Arms		17½"-20"	17½"-20"	17½"-20"	17½"-20"	17½"-20"	17½"-20"
COM		1.0	1.0	1.0	1.0	1.0	1.0
Weight Capacity		300 lbs	300 lbs	300 lbs	300 lbs	300 lbs	300 lbs



Icon Legend on page 19

HSLVTMM

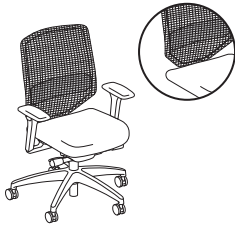

MID-BACK TASK

- 4-Way Stretch Back**
- Pneumatic
- Swivel
- Synchro-tilt
- Tilt Tension
- Tilt Lock

DIMENSIONS

- Seat Depth: 19¼
- Seat Width: 19
- Back Width: 18¼
- Back Height: 21½
- Arm Width: 17½-20
- Cube: 10.8
- Weight Rating: 300 lbs.

FABRIC PRICE CODES

1	\$616	8	\$689
2	\$629	9	\$698
3	\$642	10	\$707
4	\$651	11	\$717
5	\$660	12	\$726
6	\$670	L	\$721
7	\$679		

NOTES: Please reference pages 467-468 for additional specifications and mechanism information.

HSLVTMMS

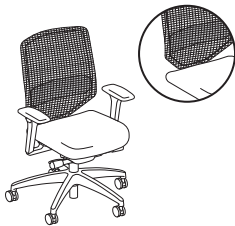

MID-BACK TASK IN DESIGNER WHITE

- 4-Way Stretch Back**
- Pneumatic
- Swivel
- Synchro-tilt
- Tilt Tension
- Tilt Lock

DIMENSIONS

- Seat Depth: 19¼
- Seat Width: 19
- Back Width: 18¼
- Back Height: 21½
- Arm Width: 17½-20
- Cube: 10.8
- Weight Rating: 300 lbs.

FABRIC PRICE CODES

1	\$616	8	\$689
2	\$629	9	\$698
3	\$642	10	\$707
4	\$651	11	\$717
5	\$660	12	\$726
6	\$670	L	\$721
7	\$679		

OPEN MARKET

NOTES: Please reference pages 467-468 for additional specifications and mechanism information.

HON Recommendation: HSLVTMM.Y1.A.H.IM.CU__BL.SB.T - List Price \$758

HOW TO SPECIFY

Select Model Number	Select Control Type	Select Arm Type	Select Caster/Glide	Select Mesh Back	Select Fabric	Select Lumbar	Select Base	Select Frame
Y0 Synchro-Tilt Y1 Synchro-Tilt w/ Seat Slider (+ \$21) Y2 Advanced Synchro-Tilt (+ \$68)	HSLVTMM Options N Armless F Fixed Arms (+ \$68) A Height and Width Adjustable Arms (+ \$89) V All-Adjustable Arms (includes pivot) (+ \$136) HSLVTMMS Options ADW Height and Width Adjustable Arms (+ \$89) Available for model HSLVTMMS only	H Black Hard Caster S Black All-Surface Caster (+ \$42) G Bell Glide (+ \$27) R Black Roll Control Caster (+ \$53)	4-Way Stretch options IM Black IB Breeze IK Brownstone IC Charcoal IF Fog IR Regatta IT Titanium	See page 468	NL No Lumbar BL Black Adjustable Lumbar (+ \$32) BY Bullseye Adjustable Lumbar (+ \$32) DW Designer White Adjustable Lumbar (+ \$32) KT Krypton Adjustable Lumbar (+ \$32) MR Ember Adjustable Lumbar (+ \$32) RE Regatta Adjustable Lumbar (+ \$32) TL Titanium Adjustable Lumbar (+ \$32)	SB Standard Base	HSLVTMM Options T Black TI Titanium (+ \$37) HSLVTMMS Options DW Designer White (+ \$37) Available for model HSLVTMMS only	
H S L V T M M	Y 1	A	S	I M	C U 1 0	B L	S B	T

SEATING



HSLVSMM

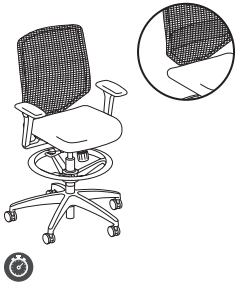

STOOL

- 4-Way Stretch Back
- Pneumatic
- Swivel
- Synchro-tilt
- Tilt Tension
- Tilt Lock

DIMENSIONS

Seat Depth:	19¼	Arm Width:	17½-20
Seat Width:	19	Cube:	10.8
Back Width:	18¼	Weight Rating:	300 lbs.
Back Height:	21½		

FABRIC PRICE CODES

1	\$691	8	\$764
2	\$704	9	\$773
3	\$717	10	\$782
4	\$726	11	\$792
5	\$735	12	\$801
6	\$745	L	\$796
7	\$754		

NOTES: Please reference pages 467-468 for additional specifications and mechanism information.

HSLVSMMS



STOOL IN DESIGNER WHITE

- 4-Way Stretch Back
- Pneumatic
- Swivel
- Synchro-tilt
- Tilt Tension
- Tilt Lock

DIMENSIONS

Seat Depth:	19¼	Arm Width:	17½-20
Seat Width:	19	Cube:	10.8
Back Width:	18¼	Weight Rating:	300 lbs.
Back Height:	21½		

FABRIC PRICE CODES

1	\$691	8	\$764
2	\$704	9	\$773
3	\$717	10	\$782
4	\$726	11	\$792
5	\$735	12	\$801
6	\$745	L	\$796
7	\$754		

NOTES: Please reference pages 467-468 for additional specifications and mechanism information.

OPEN MARKET

HON Recommendation: HSLVSMM.Y1.A.H.IM.CU__BL.SB.T - List Price \$833

HOW TO SPECIFY

Select Model Number	Select Control Type	Select Arm Type	Select Caster/Glide	Select Mesh Back	Select Fabric	Select Lumbar	Select Base	Select Frame
Y1	YO Synchro-Tilt Y1 Synchro-Tilt w/ Seat Slider (+ \$21)	HSLVSMM Options N Armless F Fixed Arms (+ \$68) A Height and Width Adjustable Arms (+ \$89) V All-Adjustable Arms (includes pivot) (+ \$136) HSLVSMMS Options ADW Height and Width Adjustable Arms (+ \$89) <i>Available for model HSLVSMMS only</i>	H Black Hard Caster S Black All-Surface Caster (+ \$42) G Bell Glide (+ \$27) R Black Roll Control Caster (+ \$53)	4-Way Stretch options IM Black IB Breeze IK Brownstone IC Charcoal IF Fog IR Regatta IT Titanium	See page 468	NL No Lumbar BL Black Adjustable Lumbar (+ \$32) BY Bullseye Adjustable Lumbar (+ \$32) DW Designer White Adjustable Lumbar (+ \$32) KT Krypton Adjustable Lumbar (+ \$32) MR Ember Adjustable Lumbar (+ \$32) RE Regatta Adjustable Lumbar (+ \$32) TL Titanium Adjustable Lumbar (+ \$32)	SB Standard Base	T Black TI Titanium (+ \$37 for HSLVSMM; + \$58 for HSLVSMMS) DWX Designer White (+ \$58; available on HSLVSMMS only)
H S L V S M M .	Y 1 .	A .	S .	I M .	C U I O .	B L .	S B .	T

SEATING



Icon Legend on page 19

HSLVTMR

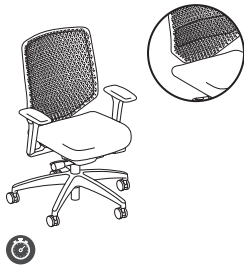

MID-BACK TASK

- ReActiv[®] Back**
- Pneumatic
- Swivel
- Synchro-tilt
- Tilt Tension
- Tilt Lock

DIMENSIONS

- Seat Depth: 19¼
- Seat Width: 19
- Back Width: 18¼
- Back Height: 21½
- Arm Width: 17½-20
- Cube: 10.8
- Weight Rating: 300 lbs.

FABRIC PRICE CODES

1	\$651	8	\$724
2	\$664	9	\$733
3	\$677	10	\$742
4	\$686	11	\$752
5	\$695	12	\$761
6	\$705	L	\$756
7	\$714		

NOTES: Please reference pages 467-468 for additional specifications and mechanism information.

HSLVTMRS

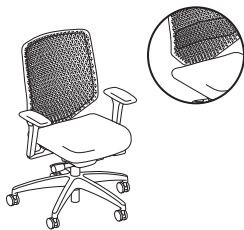

MID-BACK TASK IN DESIGNER WHITE

- ReActiv[®] Back**
- Pneumatic
- Swivel
- Synchro-tilt
- Tilt Tension
- Tilt Lock

DIMENSIONS

- Seat Depth: 19¼
- Seat Width: 19
- Back Width: 18¼
- Back Height: 21½
- Arm Width: 17½-20
- Cube: 10.8
- Weight Rating: 300 lbs.

FABRIC PRICE CODES

1	\$651	8	\$724
2	\$664	9	\$733
3	\$677	10	\$742
4	\$686	11	\$752
5	\$695	12	\$761
6	\$705	L	\$756
7	\$714		

OPEN MARKET

NOTES: Please reference pages 467-468 for additional specifications and mechanism information.

HON Recommendation: HSLVTMR.Y1.A.H.OS.CU__NL.SB.T - List Price \$761

HOW TO SPECIFY

Select Model Number	Select Control Type	Select Arm Type	Select Caster/Glide	Select Back Color	Select Fabric	Select Lumbar	Select Base	Select Frame
<p>Y0 Synchro-Tilt</p> <p>Y1 Synchro-Tilt w/ Seat Slider (+ \$21)</p> <p>Y2 Advanced Synchro-Tilt (+ \$68)</p>	<p>HSLVTMR Options</p> <p>N Armless</p> <p>F Fixed Arms (+ \$68)</p> <p>A Height and Width Adjustable Arms (+ \$89)</p> <p>V All-Adjustable Arms (includes pivot) (+ \$136)</p> <p>HSLVTMRS Options</p> <p>ADW Height and Width Adjustable Arms (+ \$89) <i>Available for model HSLVTMRS only</i></p>	<p>H Black Hard Caster</p> <p>S Black All-Surface Caster (+ \$42)</p> <p>G Bell Glide (+ \$27)</p> <p>R Black Roll Control Caster (+ \$53)</p>	<p>OS Charcoal</p> <p>TI Titanium</p> <p>DW Designer White</p>	See page 468	<p>NL No Lumbar</p> <p>BL Black Adjustable Lumbar (+ \$32)</p> <p>BY Bullseye Adjustable Lumbar (+ \$32)</p> <p>DW Designer White Adjustable Lumbar (+ \$32)</p> <p>KT Krypton Adjustable Lumbar (+ \$32)</p> <p>MR Ember Adjustable Lumbar (+ \$32)</p> <p>RE Regatta Adjustable Lumbar (+ \$32)</p> <p>TL Titanium Adjustable Lumbar (+ \$32)</p>	<p>SB Standard Base</p>	<p>HSLVTMR Options</p> <p>T Black</p> <p>TI Titanium (+ \$37)</p> <p>HSLVTMRS Options</p> <p>DW Designer White (+ \$37) <i>Available for model HSLVTMRS only</i></p>	
H S L V T M R .	Y 1 .	A .	H .	O S .	C U 1 0 .	N L .	S B .	T

SEATING



HSLVSMR



STOOL

ReActiv® Back
Pneumatic
Swivel
Synchro-tilt
Tilt Tension
Tilt Lock

DIMENSIONS

Seat Depth: 19¼ Arm Width: 17½-20
Seat Width: 19 Cube: 10.8
Back Width: 18¼ Weight Rating: 300 lbs.
Back Height: 21½

FABRIC PRICE CODES

1	\$726	8	\$799
2	\$739	9	\$808
3	\$752	10	\$817
4	\$761	11	\$827
5	\$770	12	\$836
6	\$780	L	\$831
7	\$789		

NOTES: Please reference pages 467-468 for additional specifications and mechanism information.

HSLVSMRS

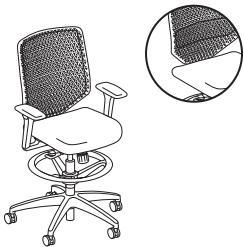

STOOL IN DESIGNER WHITE

ReActiv® Back
Pneumatic
Swivel
Synchro-tilt
Tilt Tension
Tilt Lock

DIMENSIONS

Seat Depth: 19¼ Arm Width: 17½-20
Seat Width: 19 Cube: 10.8
Back Width: 18¼ Weight Rating: 300 lbs.
Back Height: 21½

FABRIC PRICE CODES

1	\$726	8	\$799
2	\$739	9	\$808
3	\$752	10	\$817
4	\$761	11	\$827
5	\$770	12	\$836
6	\$780	L	\$831
7	\$789		

OPEN MARKET

NOTES: Please reference pages 467-468 for additional specifications and mechanism information.

HON Recommendation: HSLVSMR.Y1.A.H.OS.CU__NL.SB.T - List Price \$836

HOW TO SPECIFY

Select Model Number	Select Control Type	Select Arm Type	Select Caster/Glide	Select Back Color	Select Fabric	Select Lumbar	Select Base	Select Frame
YO Synchro-Tilt Y1 Synchro-Tilt w/ Seat Slider (+ \$21)	N Armless F Fixed Arms (+ \$68) A Height and Width Adjustable Arms (+ \$89) V All-Adjustable Arms (includes pivot) (+ \$136)	H Black Hard Caster S Black All-Surface Caster (+ \$42) G Bell Glide (+ \$27) R Black Roll Control Caster (+ \$53)	OS Charcoal TI Titanium DW Designer White	See page 468	NL No Lumbar BL Black Adjustable Lumbar (+ \$32) BY Bullseye Adjustable Lumbar (+ \$32) DW Designer White Adjustable Lumbar (+ \$32) KT Krypton Adjustable Lumbar (+ \$32) MR Ember Adjustable Lumbar (+ \$32) RE Regatta Adjustable Lumbar (+ \$32) TL Titanium Adjustable Lumbar (+ \$32)	SB Standard Base	T Black TI Titanium (+ \$37 for HSLVSMR; + \$58 for HSLVSMRS) DWX Designer White (+ \$58; available on HSLVSMRS only)	
H S L V S M R	Y 1	A	H	O S	C U I O	N L	S B	T

SEATING



Icon Legend on page 19

HSLVTMU

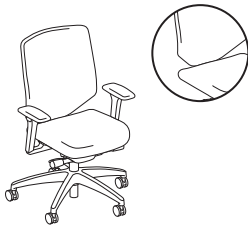

MID-BACK TASK

- Upholstered Back**
- Pneumatic
- Swivel
- Synchro-tilt
- Tilt Tension
- Tilt Lock

DIMENSIONS

- Seat Depth: 19¼
- Seat Width: 19
- Back Width: 18¼
- Back Height: 21½
- Arm Width: 17½-20
- Cube: 10.8
- Weight Rating: 300 lbs.

FABRIC PRICE CODES

- | | | | |
|---|-------|----|-------|
| 1 | \$678 | 8 | \$751 |
| 2 | \$691 | 9 | \$760 |
| 3 | \$704 | 10 | \$769 |
| 4 | \$713 | 11 | \$779 |
| 5 | \$722 | 12 | \$788 |
| 6 | \$732 | L | \$783 |
| 7 | \$741 | | |

NOTES: Please reference pages 467-468 for additional specifications and mechanism information.

HSLVTMUS

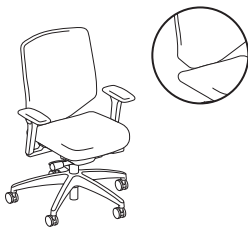

MID-BACK TASK IN DESIGNER WHITE

- Upholstered Back**
- Pneumatic
- Swivel
- Synchro-tilt
- Tilt Tension
- Tilt Lock

DIMENSIONS

- Seat Depth: 19¼
- Seat Width: 19
- Back Width: 18¼
- Back Height: 21½
- Arm Width: 17½-20
- Cube: 10.8
- Weight Rating: 300 lbs.

FABRIC PRICE CODES

- | | | | |
|---|-------|----|-------|
| 1 | \$678 | 8 | \$751 |
| 2 | \$691 | 9 | \$760 |
| 3 | \$704 | 10 | \$769 |
| 4 | \$713 | 11 | \$779 |
| 5 | \$722 | 12 | \$788 |
| 6 | \$732 | L | \$783 |
| 7 | \$741 | | |

OPEN MARKET

NOTES: Please reference pages 467-468 for additional specifications and mechanism information.

HON Recommendation: HSLVTMU.Y1.A.H.OS.COMF10.COMP10.NL.SB.T - List Price \$788

HOW TO SPECIFY

Select Model Number	Select Control Type	Select Arm Type	Select Caster/Glide	Select Back Color	Select Back Fabric	Select Seat Fabric	Select Lumbar	Select Base	Select Frame
	Y0 Synchro-Tilt Y1 Synchro-Tilt w/ Seat Slider (+ \$21) Y2 Advanced Synchro-Tilt (+ \$68)	HSLVTMU Options N Armless F Fixed Arms (+ \$68) A Height and Width Adjustable Arms (+ \$89) V All-Adjustable Arms (includes pivot) (+ \$136)	H Black Hard Caster S Black All-Surface Caster (+ \$42) G Bell Glide (+ \$27) R Black Roll Control Caster (+ \$53)	OS Charcoal TI Titanium DW Designer White	COMF46 Bittersweet COMF10 Ink COMF82 Meadow COMF90 Midnight COMF22 Putty COMF19 Sterling	See page 468	NL No Lumbar BL Black Adjustable Lumbar (+ \$32) BY Bullseye Adjustable Lumbar (+ \$32) DW Designer White Adjustable Lumbar (+ \$32) KT Krypton Adjustable Lumbar (+ \$32) MR Ember Adjustable Lumbar (+ \$32) RE Regatta Adjustable Lumbar (+ \$32) TL Titanium Adjustable Lumbar (+ \$32)	SB Standard Base	HSLVTMU Options T Black TI Titanium (+ \$37)
		HSLVTMUS Options ADW Height and Width Adjustable Arms (+ \$89) <i>Available for model HSLVTMUS only</i>							HSLVTMUS Options DW Designer White (+ \$37) <i>Available for model HSLVTMUS only</i>
H S L V T M U	Y 1	A	H	O S	C O M F 1 0	C O M P 1 0	N L	S B	T

SEATING



HSLVSMU

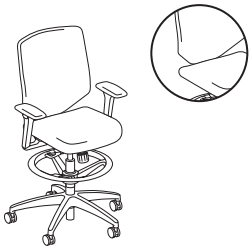

STOOL

Upholstered Back
Pneumatic
Swivel
Synchro-tilt
Tilt Tension
Tilt Lock

DIMENSIONS

Seat Depth: 19¼ Arm Width: 17½-20
Seat Width: 19 Cube: 10.8
Back Width: 18¼ Weight Rating: 300 lbs.
Back Height: 21½

FABRIC PRICE CODES

1	\$753	8	\$826
2	\$766	9	\$835
3	\$779	10	\$844
4	\$788	11	\$854
5	\$797	12	\$863
6	\$807	L	\$858
7	\$816		

NOTES: Please reference pages 467-468 for additional specifications and mechanism information.

HSLVSMUS



STOOL IN DESIGNER WHITE

Upholstered Back
Pneumatic
Swivel
Synchro-tilt
Tilt Tension
Tilt Lock

DIMENSIONS

Seat Depth: 19¼ Arm Width: 17½-20
Seat Width: 19 Cube: 10.8
Back Width: 18¼ Weight Rating: 300 lbs.
Back Height: 21½

FABRIC PRICE CODES

1	\$753	8	\$826
2	\$766	9	\$835
3	\$779	10	\$844
4	\$788	11	\$854
5	\$797	12	\$863
6	\$807	L	\$858
7	\$816		

OPEN MARKET

NOTES: Please reference pages 467-468 for additional specifications and mechanism information.

HON Recommendation: HSLVSMU.Y1.A.H.OS.COMF10.COMP10.NL.SB.T - List Price \$863

HOW TO SPECIFY

Select Model Number	Select Control Type	Select Arm Type	Select Caster/Glide	Select Back Color	Select Back Fabric	Select Seat Fabric	Select Lumbar	Select Base	Select Frame
	Y0 Synchro-Tilt Y1 Synchro-Tilt w/ Seat Slider (+ \$21)	HSLVSMU Options N Armless F Fixed Arms (+ \$68) A Height and Width Adjustable Arms (+ \$89) V All-Adjustable Arms (includes pivot) (+ \$136) HSLVSMUS Options ADW Height and Width Adjustable Arms (+ \$89) <i>Available for model HSLVSMUS only</i>	H Black Hard Caster S Black All-Surface Caster (+ \$42) G Bell Glide (+ \$27) R Black Roll Control Caster (+ \$53)	OS Charcoal TI Titanium DW Designer White	COMF46 Bittersweet COMF10 Ink COMF82 Meadow COMF90 Midnight COMF22 Putty COMF19 Sterling	See page 468	NL No Lumbar BL Black Adjustable Lumbar (+ \$32) BY Bullseye Adjustable Lumbar (+ \$32) DW Designer White Adjustable Lumbar (+ \$32) KT Krypton Adjustable Lumbar (+ \$32) MR Ember Adjustable Lumbar (+ \$32) RE Regatta Adjustable Lumbar (+ \$32) TL Titanium Adjustable Lumbar (+ \$32)	SB Standard Base	T Black TI Titanium (+ \$37 for HSLVSMU; + \$58 for HSLVSMUS) DWX Designer White (+ \$58; available on HSLVSMUS only)
H S L V S M U	. Y 1 .	. A .	. H .	. O S .	. C O M F 1 0 .	. C O M P 1 0 .	. N L .	. S B .	. T



HSLVTMMKD

MID-BACK TASK

DIMENSIONS

FABRIC PRICE CODES



- 4-Way Stretch Back**
- Pneumatic
- Swivel
- Synchro-tilt
- Tilt Tension
- Tilt Lock

Seat Depth:	19¼	Arm Width:	17½-20
Seat Width:	19	Cube:	5.6
Back Width:	18¼	Weight Rating:	300 lbs.
Back Height:	21½		

1	\$576
2	\$589
3	\$602

NOTES: Please reference pages 467-468 for additional specifications and mechanism information.

HSLVTMRKD

MID-BACK TASK

DIMENSIONS

FABRIC PRICE CODES

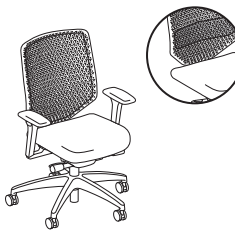

- ReActiv[®] Back**
- Pneumatic
- Swivel
- Synchro-tilt
- Tilt Tension
- Tilt Lock

Seat Depth:	19¼	Arm Width:	17½-20
Seat Width:	19	Cube:	5.6
Back Width:	18¼	Weight Rating:	300 lbs.
Back Height:	21½		

1	\$611
2	\$624
3	\$637

NOTES: Please reference pages 467-468 for additional specifications and mechanism information.

HSLVTMUKD

MID-BACK TASK

DIMENSIONS

FABRIC PRICE CODES

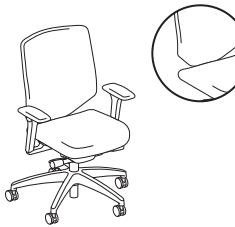

- Upholstered Back**
- Pneumatic
- Swivel
- Synchro-tilt
- Tilt Tension
- Tilt Lock

Seat Depth:	19¼	Arm Width:	17½-20
Seat Width:	19	Cube:	5.6
Back Width:	18¼	Weight Rating:	300 lbs.
Back Height:	21½		

1	\$638
2	\$651
3	\$664

NOTES: Please reference pages 467-468 for additional specifications and mechanism information.

HON Recommendation: HSLVTMMKD.Y1.A.H.IM.CU__BL.SB.T - List Price \$718

HOW TO SPECIFY

Select Model Number	Select Control Type	Select Arm Type	Select Caster	Select Mesh Back	Select Back Color	Select Back Fabric	Select Seat Fabric	Select Lumbar	Select Base	Select Frame
	Y1 Synchro-Tilt w/ Seat Slider (+ \$21)	A Height and Width Adjustable Arms (+ \$89)	H Black Hard Caster	4-Way Stretch options IM Black <i>Specify for model HSLVTMMKD only</i>	OS Charcoal TI Titanium <i>Specify for models HSLVTMRKD and HSLVTMUKD only</i>	COMF46 Bittersweet COMF10 Ink COMF82 Meadow COMF90 Midnight COMF22 Putty COMF19 Sterling <i>Specify for model HSLVTMUKD only</i>	See page 468	NL No Lumbar BL Black Adjustable Lumbar (+ \$32)	SB Standard Base	T Black
HSLVTMMKD	Y1	A	H	IM			CU10	BL	SB	T
HSLVTMRKD	Y1	A	H		OS		CU10	BL	SB	T
HSLVTMUKD	Y1	A	H		OS	COMF46	CU10	BL	SB	T



HSLVLMBR

LUMBAR PACK

DIMENSIONS

LIST PRICE

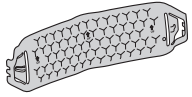

Ship Weight: 1
Cube: 0.2

\$46

HOW TO SPECIFY

Select Model Number

Select Color

- BY** Bullseye Adjustable Lumbar
- DW** Designer White Adjustable Lumbar
- KT** Krypton Adjustable Lumbar
- MR** Ember Adjustable Lumbar
- RE** Regatta Adjustable Lumbar
- T** Black
- TI** Titanium

H S L V L M B R . T

HSLVFAP

FIXED ARM PACK

DIMENSIONS

LIST PRICE



Ship Weight: 6
Cube: 1.0

\$148

HSLV2DAP

ADJUSTABLE ARM PACK

DIMENSIONS

LIST PRICE



Height and Width

Adjustable Arms Width: 17½-20
Height from Seat: 7¼-11¼
Ship Weight: 6
Cube: 1.0

\$161

HSLV4DAP

ALL-ADJUSTABLE ARM PACK

DIMENSIONS

LIST PRICE



Including Pivot

Ship Weight: 6
Cube: 1.0

\$217

HSCASTER

SET OF 5 ALL-SURFACE CASTERS

DIMENSIONS

LIST PRICE

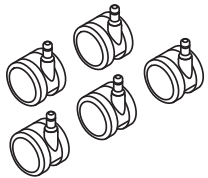

Size: 60mm
Ship Weight: 2
Cube: 0.1

\$72

ⓘ Available in Black finish only, no specification needed.

HOW TO SPECIFY

Select Model Number

Select Color

- T** Black
- TI** Titanium
- DW** Designer White (available on HSLV2DAP only)

H S L V 2 D A P . T



Soothe Guest
Chairs and Tables.

SOOTHE®

Soothe offers the comfort and versatility to support a variety of healthcare and waiting environments. This family of patient and guest seats is constructed from durable materials and thoughtfully designed to be easily cleaned. The entire collection maximizes comfort along the patient's journey to recovery, enhances functionality for the caregiver, and creates the versatility required to deliver a higher level of care.



FEATURES

- Select Charcoal Urethane or solid hardwood arms in one of eight finishes.
- Wipeout space at the back of the seat allows for easy maintenance.
- Model HHCP1 has a responsive design back that moves with the patient for added comfort.
- Bench seating is available in two-seat or three-seat options.
- Choose Textured Charcoal or Textured Satin Chrome frame.
- Multi-fabric option offers endless color combinations.
- Chairs can be ganged together to create straight rows.
- Warranted for users up to 350 lbs. (Model HHCG50 bariatric chair warranted for 750 lbs.)
- Wall-saver design protects walls and cabinets.

SOOTHE[®] Options

MODEL OPTIONS

HHCG11
HHCG11DF - Multi-Fabric



Guest Chair

HHCG21
HHCG21DF - Multi-Fabric

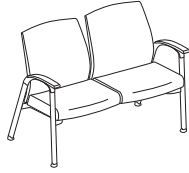

Two-Seat Chair

HHCG50
HHCG50DF - Multi-Fabric

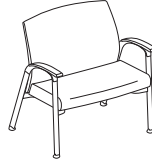

Bariatric Chair

HHCP1
HHCP1DF - Multi-Fabric

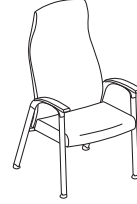

High-Back Patient Chair

HHCGB21

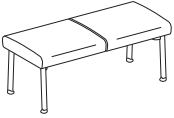

Two-Seat Bench

HHCGB31

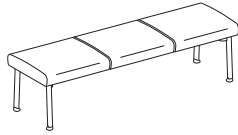

Three-Seat Bench

ARM CAP FINISH

CODE	DESCRIPTION	PRICE
S	Charcoal Urethane	+\$0
F*	Shaker Cherry	+\$105
C*	Harvest	+\$105
D*	Natural Maple	+\$105
N*	Mahogany	+\$105
MOCH*	Mocha	+\$105
PINC*	Pinnacle	+\$105
LKI1*	Kingswood Walnut	+\$105

FRAME

CODE	DESCRIPTION	PRICE
GRADE P1		
CBK	Charblack	+\$0
PK7	Textured Designer White	+\$0
P7A	Textured Charcoal	+\$0
P7J	Textured Brownstone	+\$0
P7L	Textured Loft	+\$0
P7M	Textured Muslin	+\$0
P8V	Textured Titanium	+\$0
GRADE P2		
PR8	Textured Silver	+\$0

HON BRANDED FABRICS

GRADE 1

Apex
Centurion
Compass
Contourett
Dapper
Ensemble
Hamilton
Inertia
Noble Seating
Pebble
Vibe

GRADE 2

Appoint Seating
Blume
Clyde
Dotty
Kai
Rush
Spin Seating
Wavelength
Whisper Vinyl

GRADE 3

Bradbury
Getaway
Moxie*
Notion
Parker
Purl
Quill
Saxony

GRADE 4

Constance with Supreen™
Livi with Supreen™
Lugano with Supreen™
Oxford with Supreen™

For a complete list of fabrics, including partnership fabrics, go to hon.com/fabricsandfinishes.

Reference Fabric Color Combinations on pages 20-24 for color codes and legend on page 21 for lead times. For Fire Code and Moisture Barrier model availability and ordering method, refer to pages 256. For additional HON to Supply COM fabric grade pricing, go to honready.hon.com and click on the HON to Supply COM link.

*High Back models approved in Moxie only.

MULTI-FABRIC COM YARDAGE

Due to fabric pattern nesting and potential reduction of fabric yield, some multi-fabric models may require more total yardage than standard models.

	SEAT	BACK
HHCG11DF	1.4 yd	1.5 yd
HHCG21DF	1.7 yd	2.3 yd
HHCG50DF	1.4 yd	2.3 yd
HHCP1DF*	1.4 yd	1.9 yd

* De-emphasized

SOOTHE® Table Finish Options

AVAILABLE FINISHES

Soothe® Tables are available in 20 laminate colors. Each laminate has a specific selection of edges available.

LAMINATE TOP COLORS	EDGE BAND COLORS
Beigewood (LWBE)	Beigewood (DE)
Designer White (LDWI)	Designer White (DW)
Charcoal (S)	Charcoal (S)
Field Elm (LWFE)	Field Elm (FE)
Handspun Chestnut (LAHC)	Fossil (EH), Brownstone (EY), Black (P), Charcoal (S), Designer White (DW), Loft (LOFT), Platinum (K), Greige (R), Light Gray (Q), Muslin (T)
Handspun Dove (LAHD)	Fossil (EH), Brownstone (EY), Black (P), Charcoal (S), Designer White (DW), Loft (LOFT), Platinum (K), Greige (R), Light Gray (Q), Muslin (T)
Handspun Pearl (LAHP)	Fossil (EH), Brownstone (EY), Black (P), Charcoal (S), Designer White (DW), Loft (LOFT), Platinum (K), Greige (R), Light Gray (Q), Muslin (T)
Handspun Slate (LAHS)	Fossil (EH), Brownstone (EY), Black (P), Charcoal (S), Designer White (DW), Loft (LOFT), Platinum (K), Greige (R), Light Gray (Q), Muslin (T)
Silver Mesh (B9)	Loft (LOFT)
Mahogany (N)	Mahogany (N), Loft (LOFT)
Natural Maple (D)	Natural Maple (D), Muslin (T), White (DW), Loft (LOFT)
Shaker Cherry (F)	Shaker Cherry (F), Muslin (T), White (DW), Loft (LOFT)
Harvest (C)	Harvest (C), Muslin (T), White (DW), Loft (LOFT)
Mocha (MOCH)	Mocha (MOCH), Muslin (T), White (DW), Loft (LOFT)
Pinnacle (PINC)	Pinnacle (PINC), Muslin (T), White (DW), Loft (LOFT)
Kingswood Walnut (LK11)	Kingswood Walnut (KI)



Icon Legend on page 19

HHCG11

GUEST CHAIR



DIMENSIONS

Depth:	27	Arm Width:	20½
Width:	25½	Seat to Floor Height:	18⅝
Height:	35	Usable Seat Depth:	18
Seat Depth:	18	Ship Weight:	55
Seat Width:	21½	Cube:	14.9
Back Width:	21	COM:	2.0
Back Height:	20½	Weight Rating:	350 lbs.

FABRIC PRICE CODES

1	\$1459	8	\$1748
2	\$1510	9	\$1786
3	\$1560	10	\$1823
4	\$1597	11	\$1861
5	\$1635	12	\$1898
6	\$1673	L	—
7	\$1710		

HHCG21

TWO-SEAT CHAIR

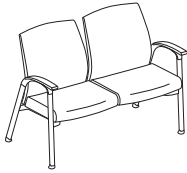

Outside Arms

DIMENSIONS

Depth:	27	Arm Width:	42¾
Width:	48	Seat to Floor Height:	18⅝
Height:	35	Usable Seat Depth:	18
Each Seat Depth:	18	Ship Weight:	109
Each Seat Width:	21½	Cube:	33.8
Each Back Width:	21	COM:	3.4
Each Back Height:	20¼	Weight Rating:	350 lbs.

FABRIC PRICE CODES

1	\$2409	8	\$2914
2	\$2497	9	\$2980
3	\$2585	10	\$3046
4	\$2651	11	\$3112
5	\$2717	12	\$3178
6	\$2783	L	—
7	\$2848		

HHCG50

BARIATRIC CHAIR



DIMENSIONS

Depth:	26	Arm Width:	29½
Width:	34½	Seat to Floor Height:	18⅝
Height:	35	Usable Seat Depth:	18
Seat Depth:	18	Ship Weight:	80
Seat Width:	30½	Cube:	25.1
Back Width:	30	COM:	3.0
Back Height:	20½	Weight Rating:	750 lbs.

FABRIC PRICE CODES

1	\$1830	8	\$2335
2	\$1918	9	\$2401
3	\$2006	10	\$2467
4	\$2072	11	\$2533
5	\$2138	12	\$2599
6	\$2204	L	—
7	\$2269		

! HHCG50 is a Single Seat Bariatric chair warranted to 750 lbs.

HHCP1*

HIGH-BACK PATIENT CHAIR

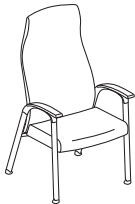

DIMENSIONS

Depth:	27	Arm Width:	20½
Width:	25½	Seat to Floor Height:	18⅝
Height:	46½	Usable Seat Depth:	18
Seat Depth:	18	Ship Weight:	61
Seat Width:	21½	Cube:	19.1
Back Width:	21	COM:	2.4
Back Height:	32	Weight Rating:	350 lbs.

FABRIC PRICE CODES

1	\$1624	8	\$2129
2	\$1712	9	\$2195
3	\$1800	10	\$2261
4	\$1866	11	\$2327
5	\$1932	12	\$2393
6	\$1998	L	—
7	\$2063		

! Only available in Moxie under HON's Standard Fabric. Healthcare Grade Partnership Fabrics are available. For a complete list, please visit the Fabrics and Finishes page at HON.com.

OPEN MARKET

HOW TO SPECIFY

<p>Select Model Number</p> <p>HHCG11</p>	<p>Select Arm Cap Finish</p> <p>S Charcoal Urethane F Shaker Cherry (+ \$105) * C Harvest (+ \$105) * D Natural Maple (+ \$105) * N Mahogany (+ \$105) * MOCH Mocha (+ \$105) * PINC Pinnacle (+ \$105) * LK11 Kingswood Walnut (+ \$105) *</p>	<p>Select Fabric</p> <p>See page 479</p>	<p>Select Frame</p> <p>See page 479</p>
<p>HHCG11</p>	<p>S</p>	<p>A190</p>	<p>PR8</p>

* De-emphasized

SOOTHE® Multi-Fabric

GSA SIN 33721



Icon Legend on page 19

HHCG11DF



GUEST CHAIR

Multi-Fabric

DIMENSIONS

Depth:	27	Arm Width:	20½
Width:	25½	Seat to Floor Height:	18⅞
Height:	35	Usable Seat Depth:	18
Seat Depth:	18	Ship Weight:	55
Seat Width:	21½	Cube:	14.9
Back Width:	21	COM:	See page 479
Back Height:	20½	Weight Rating:	350 lbs.

FABRIC PRICE CODES

1	\$1549	
<i>Add to Base Price Above</i>		
	Back	Seat
2	\$26	\$26
3	\$51	\$51
4	\$69	\$69
5	\$88	\$88
6	\$107	\$107
7	\$126	\$126
8	\$145	\$145
9	\$164	\$164
10	\$182	\$182
11	\$201	\$201
12	\$220	\$220

NOTES: For multi-fabric models, start with the base price, then add the additional amount for the back and seat from the corresponding matrix to determine final price. Choose any combination of fabric grades for back and seat. See examples below:
HHCG11DF base price (\$1549) + Grade 2 back fabric (add \$26) + Grade 4 seat fabric (add \$69) = Total \$1644 List

HHCG21DF

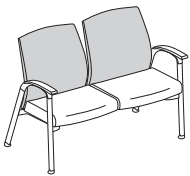

TWO-SEAT CHAIR

Multi-Fabric
Outside Arms

DIMENSIONS

Depth:	27	Arm Width:	42¾
Width:	48	Seat to Floor Height:	18⅞
Height:	35	Usable Seat Depth:	18
Each Seat Depth:	18	Ship Weight:	109
Each Seat Width:	21½	Cube:	33.8
Each Back Width:	21	COM:	See page 479
Each Back Height:	20¼	Weight Rating:	350 lbs.

FABRIC PRICE CODES

1	\$2499	
<i>Add to Base Price Above</i>		
	Back	Seat
2	\$51	\$38
3	\$101	\$76
4	\$138	\$104
5	\$176	\$132
6	\$213	\$161
7	\$250	\$190
8	\$288	\$218
9	\$325	\$246
10	\$363	\$274
11	\$401	\$303
12	\$438	\$331

NOTES: For multi-fabric models, start with the base price, then add the additional amount for the back and seat from the corresponding matrix to determine final price. Choose any combination of fabric grades for back and seat. See examples below:
HHCG21DF base price (\$2499) + Grade 2 back fabric (add \$51) + Grade 4 seat fabric (add \$104) = Total \$2654 List

HOW TO SPECIFY

Select Model Number H H C G 1 1 D F	Select Arm Cap Finish S Charcoal Urethane F Shaker Cherry (+ \$105) * C Harvest (+ \$105) * D Natural Maple (+ \$105) * N Mahogany (+ \$105) * MOCH Mocha (+ \$105) * PINC Pinnacle (+ \$105) * LK11 Kingswood Walnut (+ \$105) *	Select Back Fabric See page 479 A I 9 0	Select Seat Fabric See page 479 R S 1 4	Select Frame See page 479 P R 8
---	--	--	--	--

* De-emphasized



SOOTHE® Multi-Fabric

HHCG50DF

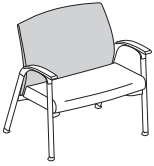

SIN 33721

BARIATRIC CHAIR

Multi-Fabric

DIMENSIONS

Depth:	26	Arm Width:	29½
Width:	34½	Seat to Floor Height:	18⅝
Height:	35	Usable Seat Depth:	18
Seat Depth:	18	Ship Weight:	80
Seat Width:	30½	Cube:	25.1
Back Width:	30	COM:	See page 479
Back Height:	20½	Weight Rating:	750 lbs.

FABRIC PRICE CODES

1	\$1920	
<i>Add to Base Price Above</i>		
	Back	Seat
2	\$51	\$38
3	\$101	\$76
4	\$138	\$104
5	\$176	\$132
6	\$213	\$161
7	\$250	\$190
8	\$288	\$218
9	\$325	\$246
10	\$363	\$274
11	\$401	\$303
12	\$438	\$331

NOTES: For multi-fabric models, start with the base price, then add the additional amount for the back and seat from the corresponding matrix to determine final price. Choose any combination of fabric grades for back and seat. See examples below:

HHCG50DF base price (\$1920) + Grade 2 back fabric (add \$51) + Grade 4 seat fabric (add \$104) = Total \$2075 List

! HHCG50DF is a Single Seat Bariatric chair warranted to 750 lbs.

HHCP1DF *

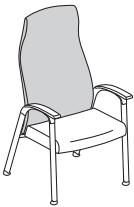

OPEN MARKET

HIGH-BACK PATIENT CHAIR

Multi-Fabric

DIMENSIONS

Depth:	27	Arm Width:	20½
Width:	25½	Seat to Floor Height:	18⅝
Height:	46½	Usable Seat Depth:	18
Seat Depth:	18	Ship Weight:	61
Seat Width:	21½	Cube:	19.1
Back Width:	21	COM:	See page 479
Back Height:	32	Weight Rating:	350 lbs.

FABRIC PRICE CODES

1	\$1714	
<i>Add to Base Price Above</i>		
	Back	Seat
2	\$63	\$26
3	\$125	\$52
4	\$172	\$71
5	\$219	\$89
6	\$265	\$109
7	\$312	\$128
8	\$359	\$147
9	\$406	\$166
10	\$452	\$185
11	\$499	\$204
12	\$546	\$223

NOTES: For multi-fabric models, start with the base price, then add the additional amount for the back and seat from the corresponding matrix to determine final price. Choose any combination of fabric grades for back and seat. See examples below:

HHCP1DF base price (\$1714) + Grade 2 back fabric (add \$63) + Grade 4 seat fabric (add \$71) = Total \$1848 List

! Only available in Moxie under HON's Standard Fabric. Healthcare Grade Partnership Fabrics are available. For a complete list, please visit the Fabrics and Finishes page at HON.com.

HOW TO SPECIFY

Select Model Number HHCG50DF	Select Arm Cap Finish S Charcoal Urethane F Shaker Cherry (+ \$105) * C Harvest (+ \$105) * D Natural Maple (+ \$105) * N Mahogany (+ \$105) * MOCH Mocha (+ \$105) * PINC Pinnacle (+ \$105) * LKI1 Kingswood Walnut (+ \$105) *	Select Back Fabric See page 479	Select Seat Fabric See page 479	Select Frame See page 479
HHCG50DF	S	A190	RS14	PR8

* De-emphasized



HHCGB21

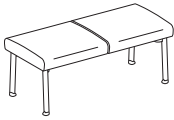

TWO-SEAT BENCH

DIMENSIONS

Depth:	20½	Seat to Floor Height:	17¾
Width:	44	Usable Seat Depth:	17¼
Height:	18¾	Ship Weight:	55
Seat Width:	22	Cube:	18.4
		COM:	1.9
		Weight Rating:	350 lbs.

FABRIC PRICE CODES

1	\$1747	8	\$1964
2	\$1785	9	\$1992
3	\$1823	10	\$2020
4	\$1851	11	\$2048
5	\$1879	12	\$2077
6	\$1907	L	—
7	\$1936		

ⓘ Benches cannot be ganged.

HHCGB31

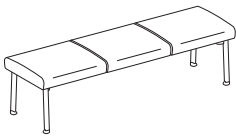

THREE-SEAT BENCH

DIMENSIONS

Depth:	20½	Seat to Floor Height:	17¾
Width:	66	Usable Seat Depth:	17¼
Height:	18¾	Ship Weight:	69
Seat Width:	22	Cube:	25.7
		COM:	2.6
		Weight Rating:	350 lbs.

FABRIC PRICE CODES

1	\$2249	8	\$2466
2	\$2287	9	\$2494
3	\$2325	10	\$2522
4	\$2353	11	\$2550
5	\$2381	12	\$2579
6	\$2409	L	—
7	\$2438		

ⓘ Benches cannot be ganged.

HOW TO SPECIFY

Select Model Number

HH C GB 2 1 .

Select Fabric

See page 479

RS 1 4 .

Select Frame

See page 479

PR 8



HHCTS*



IN-LINE TABLE TOP

DIMENSIONS

Depth:	22	Ship Weight:	8
Width:	16	Cube:	1.7
Height:	1½		

LIST PRICE

\$494

NOTES: Can be ganged between two chairs or freestanding.

HHCTC*



90-DEGREE RADIUS CORNER TABLE TOP

DIMENSIONS

Depth:	29	Ship Weight:	15
Width:	29	Cube:	2.4
Height:	1½		

LIST PRICE

\$620

! Freestanding only.

HHCTRT*



RECTANGLE TABLE TOP

DIMENSIONS

Depth:	22	Ship Weight:	20
Width:	40	Cube:	2.7
Height:	1½		

LIST PRICE

\$823

! Freestanding only.

HHCTL4*

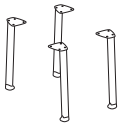

TABLE LEGS

Set of 4

DIMENSIONS

Ship Weight:	8
Cube:	0.4

LIST PRICE

\$334

NOTES: Can be attached to any of the table tops above to create a freestanding table.

* De-emphasized

HOW TO SPECIFY

Select Model Number	Select Laminate and Edge See page 480
HHCTS.	DWHIT

HOW TO SPECIFY

Select Model Number	Select Frame Color See page 479
HHCTL4.	PR8



HHCGBRCH

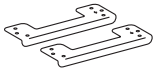

GANGING BRACKET

DIMENSIONS

Ship Weight: 2
Cube: 0.2

LIST PRICE

\$113

NOTES: For chair to chair connection. Does not connect a bench to other type of seating. Ganging brackets can be used with the seating models on pages 481-483. Bench models do not gang. Brackets are Charcoal only.

HHCGBR*

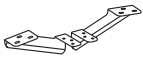

GANGING BRACKET

DIMENSIONS

Ship Weight: 5
Cube: 0.2

LIST PRICE

\$166

NOTES: For chair to table connection. Ganging brackets can be used with the seating models on pages 481-483. Bench models do not gang. Brackets are Charcoal only.

* De-emphasized

HOW TO SPECIFY

Select
Model Number

H H C G B R C H



TORCH™ Mesh Chairs

HVL511



MID-BACK

Pneumatic
Swivel
Tilt
Tilt Tension
Tilt Lock
Fixed Arms

Functions: **A, E, F, K, L**
(Function Key on pages 250-251)

DIMENSIONS

Depth:	26	Arm Width:	18¾
Width:	26	Seat to Floor Height:	16⅝-20⅝
Height:	40½	Usable Seat Depth:	18¾
Seat Depth:	18¾	Ship Weight:	30
Seat Width:	19½	Cube:	3.8
Back Width:	17¾	Weight Rating:	250 lbs.
Back Height:	21¾		

PRICE CODE

Fabric **\$412**

NOTES: Mid-back Mesh chair. Comfortable and breathable mesh back. Black fabric seat. Black frame. Fixed arms. **HON 5-Year Limited Warranty.**

HON Recommendation: HVL511.LH10 - List Price \$412

HVL515

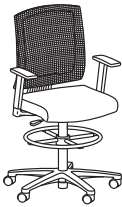

TASK STOOL

Pneumatic
Swivel
Fixed Arms

Functions: **A, E**
(Function Key on pages 250-251)

DIMENSIONS

Depth:	26	Arm Width:	18¾
Width:	26	Seat to Floor Height:	23⅝-33
Height:	52	Usable Seat Depth:	18¾
Seat Depth:	18¾	Ship Weight:	38
Seat Width:	19½	Cube:	4.6
Back Width:	17¾	Weight Rating:	250 lbs.
Back Height:	21¾		

PRICE CODE

Fabric **\$574**

NOTES: Comfortable and breathable mesh back. Black fabric seat. Fixed arms. **HON 5-Year Limited Warranty.**

HON Recommendation: HVL515.LH10 - List Price \$574

HOW TO SPECIFY

Select Model Number	Select Fabric
	LH10 Black Fabric
H V L 5 1 1 .	L H 1 0



HVL685 *



HIGH-BACK

- Pneumatic Swivel
- Tilt Tension
- Tilt Lock
- Fixed Padded Arms

Functions: **A, E, K, L**
 (Function Key on pages 250-251)

DIMENSIONS

Depth:	32	Back Height:	28½
Width:	27½	Seat to Floor Height:	18¾-21¾
Height:	45	Usable Seat Depth:	20
Seat Depth:	20	Ship Weight:	67
Seat Width:	22¼	Cube:	9.5
Back Width:	21	Weight Rating:	450 lbs.

PRICE CODE

Leather **\$1309**

NOTES: Large scale model HVL685 will support up to 450 lbs with normal use. Available in Black Bonded Leather SB11. **HON 5-Year Limited Warranty.**

HON Recommendation: HVL685.SB11 - List Price \$1309

* De-emphasized

HOW TO SPECIFY

<p>Select Model Number</p>	<p>Select Fabric</p> <p>SB11 Black Bonded Leather</p>
<p>H V L 6 8 5 .</p>	<p>S B 1 1</p>



Versant® Seating and Laminate Occasional Tables.

VERSANT®

Everyone deserves a break from time to time, and a comfy seat in which to enjoy one. Bring stylish support to your welcome areas, public spaces, and breakrooms with Versant. With a combination of chairs and benches, it's ideal for both healthcare environments and offices. Arched arms support the upper body and padded seats put people at ease for longer periods of time. Versant brings versatility to every corner of your space.



FEATURES

- Stylish arched arm offers greater upper body support.
- Seats are removable for easy cleaning and replacement.
- Contrasting covers are available as special order (please contact customer service).
- Solid hardwood in one of eight attractive finishes.
- Available in hundreds of quality HON fabrics.
- Warranted for users up to 350 lbs. (Model HHCB50 is warranted for users up to 500 lbs.)

MODEL OPTIONS

HHB02



Two-Seat Bench

HHB03

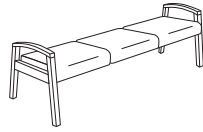

Three-Seat Bench

HHCT01



Single Seat

Leg Base, Arms

HHCB50

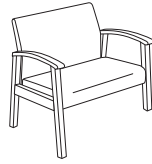

Bariatric Chair

Leg Base, Arms

AVAILABLE FINISHES

Versant® Seating is available in 8 wood finishes.

WOOD FINISHES

- Bourbon Cherry (H)
- Cognac (COGN)
- Harvest (C)
- Mahogany (N)
- Mocha (MOCH)
- Natural Maple (D)
- Pinnacle (PINC)
- Shaker Cherry (F)

AVAILABLE LAMINATES

Versant® Laminate Occasional Tables are available in 8 laminates.

LAMINATES

- Bourbon Cherry (H)
- Cognac (COGN)
- Harvest (C)
- Mahogany (N)
- Mocha (MOCH)
- Natural Maple (D)
- Pinnacle (PINC)
- Shaker Cherry (F)

HON BRANDED FABRICS

GRADE 1

- Apex
- Centurion
- Contourett
- Dapper
- Ensemble
- Hamilton
- Inertia
- Noble Seating
- Optic
- Pebble
- Vibe

GRADE 2

- Appoint Seating
- Blume
- Clyde
- Dotty
- Kai
- Rush
- Spin Seating
- Wavelength
- Whisper Vinyl

GRADE 3

- Bradbury
- Getaway
- Moxie
- Notion
- Parker
- Purl
- Quill
- Saxony

GRADE 4

- Constance with Supreen™
- Livi with Supreen™
- Lugano with Supreen™
- Oxford with Supreen™

For a complete list of fabrics, including partnership fabrics, go to hon.com/fabricsandfinishes.

Reference Fabric Color Combinations on pages 20-24 for color codes and legend on page 21 for lead times. Contrasting covers on seat and back are available as special order. Please contact Customer Service. For additional HON to Supply COM fabric grade pricing, go to honready.hon.com and click on the HON to Supply COM link.



HHB02

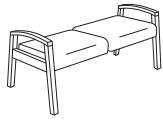

TWO-SEAT BENCH

DIMENSIONS

Depth:	20 ³ / ₈	Seat to Floor Height:	19 ¹ / ₂
Width:	45 ¹ / ₂	Usable Seat Depth:	19 ³ / ₄
Height:	23	Ship Weight:	62
Each Seat Depth:	20 ³ / ₈	Cube:	16.2
Each Seat Width:	21 ¹ / ₂	COM:	2.0
Arm Width:	42 ¹ / ₂	Weight Rating:	350 lbs. (per seat)

FABRIC PRICE CODES

1	\$2328	8	\$2617
2	\$2379	9	\$2655
3	\$2429	10	\$2692
4	\$2466	11	\$2730
5	\$2504	12	\$2767
6	\$2542	L	\$2746
7	\$2579		

HHB03

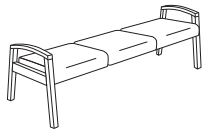

THREE-SEAT BENCH

DIMENSIONS

Depth:	20 ³ / ₈	Seat to Floor Height:	19 ¹ / ₂
Width:	66 ¹ / ₂	Usable Seat Depth:	19 ³ / ₄
Height:	23	Ship Weight:	80
Each Seat Depth:	20 ³ / ₈	Cube:	24.5
Each Seat Width:	21 ¹ / ₂	COM:	2.5
Arm Width:	63 ¹ / ₂	Weight Rating:	350 lbs. (per seat)

FABRIC PRICE CODES

1	\$2992	8	\$3353
2	\$3055	9	\$3400
3	\$3118	10	\$3447
4	\$3165	11	\$3494
5	\$3212	12	\$3541
6	\$3259	L	\$3515
7	\$3306		

HON Recommendation: HHB02.MOCH.SX__ - List Price \$2429

HOW TO SPECIFY

Select Model Number

HHB02

Select Finish

See page 491

MOCH

Select Seat Fabric

See page 491

SX05



HHCT01



SINGLE SEAT

Leg Base
Arms

DIMENSIONS

Depth:	27	Arm Width:	20½
Width:	25	Seat to Floor Height:	18
Height:	34	Usable Seat Depth:	19¼
Seat Depth:	20¼	Ship Weight:	57
Seat Width:	21	Cube:	20.1
Back Width:	21	COM:	2.0
Back Height:	17	Weight Rating:	350 lbs.

FABRIC PRICE CODES

1	\$1777	8	\$2066
2	\$1828	9	\$2104
3	\$1878	10	\$2141
4	\$1915	11	\$2179
5	\$1953	12	\$2216
6	\$1991	L	\$2195
7	\$2028		

HHCB50

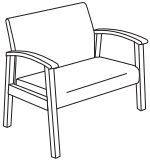

BARIATRIC SINGLE SEAT

Leg Base
Arms

DIMENSIONS

Depth:	27	Arm Width:	29
Width:	33½	Seat to Floor Height:	18
Height:	34	Usable Seat Depth:	19¼
Each Seat Depth:	20¼	Ship Weight:	80
Each Seat Width:	30	Cube:	29.0
Each Back Width:	30	COM:	3.0
Each Back Height:	17	Weight Rating:	500 lbs.

FABRIC PRICE CODES

1	\$2657	8	\$3090
2	\$2733	9	\$3147
3	\$2808	10	\$3203
4	\$2864	11	\$3259
5	\$2921	12	\$3316
6	\$2977	L	\$3284
7	\$3034		

HON Recommendation: HHCT01.MOCH.SX__ - List Price \$1878

HOW TO SPECIFY

<p>Select Model Number</p> <p>HHCT01</p>	<p>Select Finish</p> <p>See page 491</p> <p>MOCH</p>	<p>Select Seat Fabric</p> <p>See page 491</p> <p>SX05</p>
--	--	---



Volt® Task Chairs and Stools
shown with Voi® Desks.

VOLT®

Customizable comfort, distinctive styling and an affordable price point make Volt the family of task seating that supports your body and your budget. The stylish V-shaped back design can be specified in fabric, leather or breathable mesh, giving you more control over your look and feel. The personalized controls and generously proportioned seat and back deliver greater comfort, and are designed support to a wider variety of users. Volt delivers the look you desire, the comfort you demand, and the quality you expect. That's the power of practicality.

SEATING



FEATURES

- Optional synchro-tilt control provides a smooth, natural recline.
- Optional height-adjustable arms provide a custom fit.
- Optional mesh back offers breathable support.
- Task stools feature an adjustable footring for additional lower body support.
- One-touch seat height adjustment easily moves the seat up and down.
- Tilt tension controls the rate and ease of recline.
- Tilt lock allows the user to lock out the tilt function.
- 360-degree swivel provides freedom of movement in any direction.
- Select models available in hundreds of quality HON fabrics.
- Warranted for users up to 275 lbs.

VOLT® 5700/5710 Series Options

MODEL OPTIONS

H5701



Task Chair

Pneumatic, Swivel, Tilt, Tilt Tension, Tilt Lock

H5703



Task Chair

Pneumatic, Swivel, Synchro-tilt, Tilt Tension, Tilt Lock

H5705



Task Stool

Pneumatic, Swivel, Adjustable Footring

H5711



Task Chair (Mesh Back)

Pneumatic, Swivel, Tilt, Tilt Tension, Tilt Lock

H5713



Task Chair (Mesh Back)

Pneumatic, Swivel, Synchro-tilt, Tilt Tension, Tilt Lock

H5715



Task Stool (Mesh Back)

Pneumatic, Swivel, Adjustable Footring

HON BRANDED FABRICS

GRADE 1

Black Fabric
Navy Fabric

GRADE 2

GRADE 3

For a complete list of fabrics, including partnership fabrics, go to hon.com/fabricsandfinishes.

Navy only available on select models.

Reference Fabric Color Combinations on pages 20-24 for color codes and legend on page 21 for lead times.

VOLT® 5700 Series

OPEN MARKET



Icon Legend on page 19

H5701



TASK CHAIR

Pneumatic
Swivel
Tilt
Tilt Tension
Tilt Lock
Functions: **A, E, F, K, L**
(Function Key on pages 250-251)

DIMENSIONS

Depth: 25³/₄
Width: 26
Height: 40
Seat Depth: 18³/₄
Seat Width: 18¹/₂
Back Width: 17¹/₄
Back Height: 18³/₄
Seat to Floor Height: 18-22¹/₄
Usable Seat Depth: 18³/₄
Ship Weight: 29
Cube: 5.1
Weight Rating: 275 lbs.

FABRIC PRICE CODES

1 \$373 L \$405

H5703



TASK CHAIR

Pneumatic
Swivel
Synchro-tilt
Tilt Tension
Tilt Lock
Functions: **A, E, J, K, L**
(Function Key on pages 250-251)

DIMENSIONS

Depth: 25³/₄
Width: 26
Height: 40
Seat Depth: 18³/₄
Seat Width: 18¹/₂
Back Width: 17¹/₄
Back Height: 18³/₄
Seat to Floor Height: 18-22¹/₄
Usable Seat Depth: 18³/₄
Ship Weight: 29
Cube: 5.1
Weight Rating: 275 lbs.

FABRIC PRICE CODES

1 \$432 L \$464

H5705



TASK STOOL

Pneumatic
Swivel
Adjustable Footring
Functions: **A, E**
(Function Key on pages 250-251)

DIMENSIONS

Depth: 29¹/₂
Width: 27
Height: 49⁷/₈
Seat Depth: 20
Seat Width: 19
Back Width: 16¹/₂
Back Height: 20
Seat to Floor Height: 22⁷/₈-32³/₈
Usable Seat Depth: 18
Ship Weight: 36
Cube: 6.0
Weight Rating: 275 lbs.

FABRIC PRICE CODES

1 \$609 L \$641

H5795

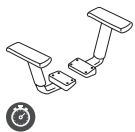

HEIGHT-ADJUSTABLE ARMS

Non-upholstered
Functions: **Q**
(Function Key on pages 250-251)

DIMENSIONS

Adjustable Arms Width: 17³/₈
Height from Seat: 7⁵/₈-10⁵/₈
Ship Weight: 5
Cube: 0.6

LIST PRICE

\$118

HON Recommendation: H5703.GA10.T with H5795 Arm Pack - List Price \$550

HOW TO SPECIFY

Select
Model Number

H 5 7 0 3 .

Select
Fabric

SB11 Black Bonded Leather
GA10 Black
GA90 Navy (only available on H5701)

G A 1 0 .

Select
Frame

T Black

T



VOLT® 5710 Series

H5711



TASK CHAIR

Mesh Back
Pneumatic
Swivel
Tilt
Tilt Tension
Tilt Lock
Functions: **A, E, F, K, L**
(Function Key on pages 250-251)

DIMENSIONS

Depth: 25³/₄ Seat to Floor Height: 18³/₄-22³/₈
Width: 26 Usable Seat Depth: 18
Height: 38³/₄ Ship Weight: 29
Seat Depth: 18³/₄ Cube: 5.1
Seat Width: 19¹/₄ Weight Rating: 275 lbs.
Back Width: 18
Back Height: 18³/₄

FABRIC PRICE CODES

1 \$515 L \$547

H5713



TASK CHAIR

Mesh Back
Pneumatic
Swivel
Synchro-tilt
Tilt Tension
Tilt Lock
Functions: **A, E, J, K, L**
(Function Key on pages 250-251)

DIMENSIONS

Depth: 25³/₄ Seat to Floor Height: 17⁷/₈-21¹/₈
Width: 26 Usable Seat Depth: 17⁷/₈
Height: 38¹/₂ Ship Weight: 32
Seat Depth: 18³/₄ Cube: 5.1
Seat Width: 19¹/₄ Weight Rating: 275 lbs.
Back Width: 18
Back Height: 18³/₄

FABRIC PRICE CODES

1 \$578 L \$610

H5715



TASK STOOL

Mesh Back
Pneumatic
Swivel
Adjustable Footring
Functions: **A, E**
(Function Key on pages 250-251)

DIMENSIONS

Depth: 28 Seat to Floor Height: 22⁷/₈-32³/₈
Width: 26 Usable Seat Depth: 18
Height: 49⁷/₈ Ship Weight: 36
Seat Depth: 20 Cube: 6.0
Seat Width: 19 Weight Rating: 275 lbs.
Back Width: 18
Back Height: 18¹/₂

FABRIC PRICE CODES

1 \$758 L \$790

H5795

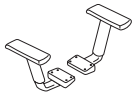

HEIGHT-ADJUSTABLE ARMS

Non-upholstered
Functions: **Q**
(Function Key on pages 250-251)

DIMENSIONS

Adjustable Arms Width: 17³/₈
Height from Seat: 7³/₈-10⁵/₈
Ship Weight: 5
Cube: 0.6

LIST PRICE

\$118

HON Recommendation: H5713.GA10.T with H5795 Arm Pack - List Price \$696

HOW TO SPECIFY

<p>Select Model Number</p> <p>H 5 7 1 3 .</p>	<p>Select Fabric</p> <p>SB11 Black Bonded Leather GA10 Black</p> <p>G A 1 0 .</p>	<p>Select Frame</p> <p>T Black</p> <p>T</p>
--	--	---

VOLT® 5720/5730 Series Options

MODEL OPTIONS

H5721



Task Chair

Pneumatic, Swivel, Tilt, Tilt Tension, Tilt Lock

H5723



Task Chair

Pneumatic, Swivel, Synchro-tilt, Tilt Tension, Tilt Lock

H5725



Task Stool

Pneumatic, Swivel, Adjustable Footring

H5731



Task Chair (Mesh Back)

Pneumatic, Swivel, Tilt, Tilt Tension, Tilt Lock

H5733



Task Chair (Mesh Back)

Pneumatic, Swivel, Synchro-tilt, Tilt Tension, Tilt Lock

H5735



Task Stool (Mesh Back)

Pneumatic, Swivel, Adjustable Footring

CASTERS



CODE	DESCRIPTION	PRICE
H	Black Hard Caster	+\$0



S	Black All-Surface Caster	+\$42
----------	--------------------------	--------------

FRAME

CODE	DESCRIPTION	PRICE
T	Black	+\$0

5720/5730 Series Fabric Options

HON BRANDED FABRICS

GRADE 1	GRADE 2	GRADE 3	GRADE 4
Apex	Appoint Seating	Getaway	Livi with Supreen™
Centurion	Blume	Moxie	Oxford with Supreen™
Contourett	Clyde	Parker	
Dapper	Dotty	Purl	
Ensemble	Kai	Quill	
Hamilton	Rush		
Inertia	Spin Seating		
Optic	Wavelength		
Pebble	Whisper Vinyl		

For a complete list of fabrics, including partnership fabrics, go to hon.com/fabricsandfinishes.

Reference Fabric Color Combinations on pages 20-24 for color codes and legend on page 21 for lead times. For additional HON to Supply COM fabric grade pricing, go to honready.hon.com and click on the HON to Supply COM link.

VOLT® 5720 Series

GSA SIN 33721 EXCEPT AS NOTED



Icon Legend on page 19

H5721



TASK CHAIR

Pneumatic
Swivel
Tilt
Tilt Tension
Tilt Lock
Functions: **A, E, F, K, L**
(Function Key on pages 250-251)

DIMENSIONS

Depth: 25³/₄ Seat to Floor Height: 17¹/₄-22¹/₄
Width: 25³/₄ Usable Seat Depth: 18³/₄
Height: 40 Ship Weight: 36
Seat Depth: 18³/₄ Cube: 5.1
Seat Width: 18¹/₂ COM: 1.5
Back Width: 17¹/₄ Weight Rating: 275 lbs.
Back Height: 18³/₄

FABRIC PRICE CODES

1	\$488	8	\$633
2	\$514	9	\$652
3	\$539	10	\$670
4	\$557	11	\$689
5	\$576	12	\$708
6	\$595	L	—
7	\$614		

H5723



TASK CHAIR

Pneumatic
Swivel
Synchro-tilt
Tilt Tension
Tilt Lock
Functions: **A, E, J, K, L**
(Function Key on pages 250-251)

DIMENSIONS

Depth: 25³/₄ Seat to Floor Height: 17¹/₄-22¹/₄
Width: 25³/₄ Usable Seat Depth: 18³/₄
Height: 40 Ship Weight: 38
Seat Depth: 18³/₄ Cube: 5.1
Seat Width: 18¹/₂ COM: 1.5
Back Width: 17¹/₄ Weight Rating: 275 lbs.
Back Height: 18³/₄

FABRIC PRICE CODES

1	\$543	8	\$688
2	\$569	9	\$707
3	\$594	10	\$725
4	\$612	11	\$744
5	\$631	12	\$763
6	\$650	L	—
7	\$669		

H5725

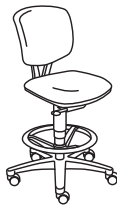

TASK STOOL

Pneumatic
Swivel
Adjustable Footring
Functions: **A, E**
(Function Key on pages 250-251)

DIMENSIONS

Depth: 29¹/₂ Seat to Floor Height: 22⁷/₈-32³/₈
Width: 27 Usable Seat Depth: 18³/₄
Height: 49⁷/₈ Ship Weight: 39
Seat Depth: 20 Cube: 6.0
Seat Width: 19 COM: 1.5
Back Width: 17¹/₄ Weight Rating: 275 lbs.
Back Height: 18³/₄

FABRIC PRICE CODES

1	\$708	8	\$853
2	\$734	9	\$872
3	\$759	10	\$890
4	\$777	11	\$909
5	\$796	12	\$928
6	\$815	L	—
7	\$834		

H5795

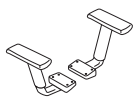

OPEN MARKET

HEIGHT-ADJUSTABLE ARMS

Non-upholstered
Functions: **Q**
(Function Key on pages 250-251)

DIMENSIONS

Adjustable Arms Width: 17³/₈
Height from Seat: 7⁷/₈-10⁵/₈
Ship Weight: 5
Cube: 0.6

LIST PRICE

\$118

HSCASTER

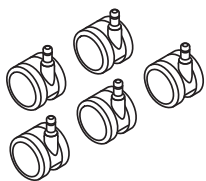

OPEN MARKET

SET OF 5 ALL-SURFACE CASTERS

Available in Black finish only, no specification needed.

DIMENSIONS

Size: 60mm
Ship Weight: 2
Cube: 0.1

LIST PRICE

\$72

HON Recommendation: H5723.H.CU__T with H5795 Arm Pack - List Price \$661

HOW TO SPECIFY

Select Model Number H 5 7 2 3 .	Select Caster H Black Hard Caster S Black All-Surface Caster (+ \$42)	Select Fabric See page 499 CU 1 0 .	Select Frame T Black
---	--	--	--------------------------------



H5731



TASK CHAIR

Mesh Back
Pneumatic
Swivel
Tilt
Tilt Tension
Tilt Lock
Functions: **A, E, F, K, L**
(Function Key on pages 250-251)

DIMENSIONS

Depth: 25³/₄ Seat to Floor Height: 18³/₄-22³/₈
Width: 26 Usable Seat Depth: 18
Height: 38³/₄ Ship Weight: 29
Seat Depth: 18³/₄ Cube: 5.1
Seat Width: 19¹/₄ COM: 1.5
Back Width: 18 Weight Rating: 275 lbs.
Back Height: 18³/₄

FABRIC PRICE CODES

1	\$633	8	\$706
2	\$646	9	\$715
3	\$659	10	\$724
4	\$668	11	\$734
5	\$677	12	\$743
6	\$687	L	—
7	\$696		

H5733



TASK CHAIR

Mesh Back
Pneumatic
Swivel
Synchro-tilt
Tilt Tension
Tilt Lock
Functions: **A, E, J, K, L**
(Function Key on pages 250-251)

DIMENSIONS

Depth: 25³/₄ Seat to Floor Height: 17³/₈-21¹/₈
Width: 26 Usable Seat Depth: 17⁷/₈
Height: 38¹/₂ Ship Weight: 32
Seat Depth: 18³/₄ Cube: 5.1
Seat Width: 19¹/₄ COM: 1.5
Back Width: 18 Weight Rating: 275 lbs.
Back Height: 18³/₄

FABRIC PRICE CODES

1	\$693	8	\$766
2	\$706	9	\$775
3	\$719	10	\$784
4	\$728	11	\$794
5	\$737	12	\$803
6	\$747	L	—
7	\$756		

H5735



TASK STOOL

Mesh Back
Pneumatic
Swivel
Adjustable Footring
Functions: **A, E**
(Function Key on pages 250-251)

DIMENSIONS

Depth: 28 Seat to Floor Height: 22⁷/₈-32³/₈
Width: 26 Usable Seat Depth: 18
Height: 49⁷/₈ Ship Weight: 36
Seat Depth: 20 Cube: 6.0
Seat Width: 19 COM: 1.5
Back Width: 18 Weight Rating: 275 lbs.
Back Height: 18¹/₂

FABRIC PRICE CODES

1	\$860	8	\$933
2	\$873	9	\$942
3	\$886	10	\$951
4	\$895	11	\$961
5	\$904	12	\$970
6	\$914	L	—
7	\$923		

H5795

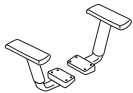

HEIGHT-ADJUSTABLE ARMS

Non-upholstered
Functions: **Q**
(Function Key on pages 250-251)

DIMENSIONS

Adjustable Arms Width: 17³/₈
Height from Seat: 7³/₈-10³/₈
Ship Weight: 5
Cube: 0.6

LIST PRICE

\$118

HSCASTER

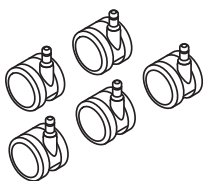

SET OF 5 ALL-SURFACE CASTERS

i Available in Black finish only, no specification needed.

DIMENSIONS

Size: 60mm
Ship Weight: 2
Cube: 0.1

LIST PRICE

\$72

HON Recommendation: H5733.H.CU__T with H5795 Arm Pack - List Price \$811

HOW TO SPECIFY

Select Model Number H 5 7 3 3	Select Caster H Black Hard Caster S Black All-Surface Caster (+ \$42) H	Select Fabric See page 499 CU10	Select Frame T Black T
---	---	--	---

WAVE™ Mesh Chairs

GSA SIN AS NOTED



Icon Legend on page 19

HVL701



SIN 33721

HIGH-BACK

Pneumatic
Swivel
Knee Tilt
Tilt Tension
Infinite Tilt Lock
Adjustable Lumbar
Height-adjustable Arms

Functions: **A, E, H, K, L, Q, W**
(Function Key on pages 250-251)

DIMENSIONS

Depth:	28	Arm Width:	19½
Width:	27½	Seat to Floor Height:	18½-21¼
Height:	44⅝	Usable Seat Depth:	19¼
Seat Depth:	20¾	Ship Weight:	53
Seat Width:	22	Cube:	5.8
Back Width:	23	Weight Rating:	250 lbs.
Back Height:	23¾		

PRICE CODE

Leather **\$976**

NOTES: Comfortable and breathable mesh back. Sturdy textured black frame. HVL701 has a Black Bonded Leather upholstered seat with side mesh panels. Adjustable lumbar support. **HON 5-Year Limited Warranty.**

HON Recommendation: HVL701.SB11 - List Price \$976

HVL702



OPEN MARKET

HIGH-BACK

Pneumatic
Swivel
Synchro-tilt
Tilt Tension
Tilt Lock
Height-adjustable Arms

Functions: **A, E, J, K, L, Q**
(Function Key on pages 250-251)

DIMENSIONS

Depth:	26½	Arm Width:	19½
Width:	26½	Seat to Floor Height:	18½-23½
Height:	40½	Usable Seat Depth:	19¾
Seat Depth:	19¾	Ship Weight:	40
Seat Width:	21	Cube:	5.0
Back Width:	19½	Weight Rating:	250 lbs.
Back Height:	24		

PRICE CODE

Sandwich Mesh **\$792**

NOTES: Black Sandwich Mesh seat and mesh back. **HON 5-Year Limited Warranty.**

HON Recommendation: HVL702.MM10 - List Price \$792

HVL705



OPEN MARKET

EXECUTIVE BIG AND TALL

Pneumatic
Knee Tilt
Tilt Tension
Tilt Lock
Height and Width Adjustable Arms
Integrated Lumbar Support

Functions: **A, E, H, K, L, S**
(Function Key on pages 250-251)

DIMENSIONS

Depth:	25⅝	Back Height:	28
Width:	30¼	Seat to Floor Height:	18¾-23¾
Height:	43⅝	Usable Seat Depth:	18¾
Seat Depth:	18¾	Ship Weight:	59
Seat Width:	21⅝	Cube:	6.1
Back Width:	22¾	Weight Rating:	450 lbs.

PRICE CODE

Mesh **\$1162**

NOTES: Large scale model HVL705 will support up to 450 lbs with normal use. Available in Black Mesh fabric VM10. **HON 5-Year Limited Warranty.**

HON Recommendation: HVL705.VM10 - List Price \$1162

HVL712



SIN 33721

MID-BACK

Pneumatic
Swivel
Synchro-tilt
Tilt Tension
Tilt Lock
Height-adjustable Arms

Functions: **A, E, J, K, L, Q**
(Function Key on pages 250-251)

DIMENSIONS

Depth:	28½	Arm Width:	18⅝
Width:	29½	Seat to Floor Height:	18-22¼
Height:	41¾	Usable Seat Depth:	18
Seat Depth:	18½	Ship Weight:	39
Seat Width:	19¾	Cube:	5.4
Back Width:	20½	Weight Rating:	250 lbs.
Back Height:	20¾		

PRICE CODE

Sandwich Mesh **\$668**

NOTES: Black Sandwich Mesh seat and mesh back. **HON 5-Year Limited Warranty.**

HON Recommendation: HVL712.MM10 - List Price \$668

HOW TO SPECIFY

Select
Model Number

Select
Fabric

- SB11** Black Bonded Leather
Specify for model HVL701 only
- MM10** Black Sandwich Mesh Fabric
Specify for models HVL702 and HVL712 only
- VM10** Black Mesh Fabric
Specify for model HVL705 only

HVL701.

SB11

WEST HILL™ CASUAL LOUNGE SEATING

Want to see more? Scan here
to check out hon.com.



West Hill™ Casual Lounge Seating
shown with Scramble™ Coffee Table.

WEST HILL™

Whether you're a thought leader, innovator, or highly motivated team player, West Hill casual lounge creates an inviting space that inspires relaxed productivity, sustains concentration, and sparks creativity.

With solid construction, a multitude of back cushion styling, seating options from a single seat to three or more, and choices in leg styles, fabrics, and configurations, West Hill makes it easier to make your space exceptional.



FEATURES

- Contoured seat cushion design brings living room comfort to the work space.
- Choose between a Square Back or sink into a comfy Pillow Back cushion.
- Semi-attached back and seat cushions make replacement easy.
- Square, welted back cushion creates a modern look while providing casual comfort.
- The multi-fabric option allows you to specify up to three fabrics on one model.
- Select one of two square metal leg options or hardwood cone feet in one of 10 finishes.
- Order an optional Throw Pillow to add a little extra comfort or a splash of color.
- Cushion packs available in both Standard and Pillow Back, apply to both side and back applications.
- Each seat is warranted for users up to 300 pounds.
- Pair with Scramble™ Occasional Tables to complete the modern aesthetic.

WEST HILL™ Options

MODEL OPTIONS

HWH1SS, HWH1SP
HWH1SSCF, HWH1SPCF -
Multi-Fabric



Lounge
Single Seat

HWH2SS, HWH2SP
HWH2SSCF, HWH2SPCF -
Multi-Fabric

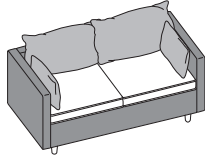

Lounge
Two-Seat

HWH3SS, HWH3SP
HWH3SSCF, HWH3SPCF -
Multi-Fabric

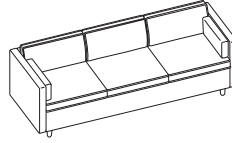

Lounge
Three-Seat

HWHITCS, HWHITCP
HWHITCSCF, HWHITPCF -
Multi-Fabric

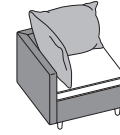

Lounge
True Corner

HWH1C
HWH1CCF - Multi-Fabric



Ottoman

HWHACPS, HWHACPP

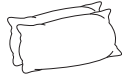

Arm Cushion Pack

HWHBCPS, HWHBCPP

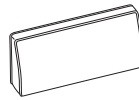

Back Cushion Pack

HWHLP, HWHSP18



**Lumbar and 18" Square
Throw Pillow**

Pillow Back Option, Multi-Fabric



Standard Back Option, Multi-Fabric

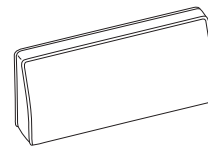
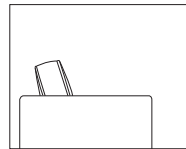
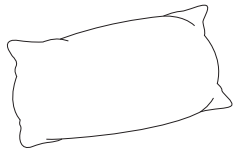
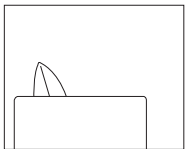

Choose from standard Single Fabric or Multi-Fabric options.
Specify up to three fabrics with the Multi-Fabric option.

HON BRANDED FABRICS

GRADE 1	GRADE 2	GRADE 3	GRADE 4
Apex	Appoint Seating	Bradbury	Constance with Supreen™
Centurion	Blume	Getaway	Livi with Supreen™
Contourett	Clyde	Moxie*	Lugano with Supreen™
Dapper	Dotty	Notion	Oxford with Supreen™
Ensemble	Kai	Parker	
Hamilton	Rush	Purl	
Inertia*	Spin Seating	Quill	
Noble Seating	Wavelength	Saxony	
Pebble	Whisper Vinyl*		
Vibe			

For a complete list of fabrics, including partnership fabrics, go to hon.com/fabricsandfinishes.

Reference Fabric Color Combinations on pages 20-24 for color codes and legend on page 21 for lead times.

*Because of the differing upholstery process for the standard back and pillow back options, these fabrics are not available as an option for the pillow back. Contact your HON representative for questions.

For more details on Upholstery Pattern Match for this series, please see page 14.

ⓘ Due to the inherent characteristics of upholstery materials and the casual nature of West Hill™, fabric may relax to show wrinkles over time especially on the pillow back options.

LEG STYLE

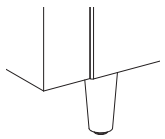

CODE	DESCRIPTION	PRICE
CW	Cone Wood	+ \$0
<i>Available in the following finishes:</i>		
LFW1	Florence Walnut	
LK11	Kingswood Walnut	
LLA1	Lowell Ash	
D	Natural Maple	
LN1	Natural Recon	
LPE1	Phantom Ecru	
PINC	Pinnacle	
LPT1	Portico Teak	
LSW1	Skyline Walnut	
LSA1	Sterling Ash	

LEG STYLE

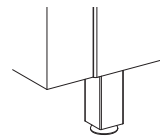

CODE	DESCRIPTION	PRICE
SM	Square Metal	+ \$53
<i>Available in the following finishes:</i>		
P7A	Textured Charcoal	
P8V	Textured Titanium	

MULTI-FABRIC COM YARDAGE

Due to fabric pattern nesting and potential reduction of fabric yield, some multi-fabric models may require more total yardage than standard models.

MODEL	COM (ARMLESS)			COM (ONE ARM)			COM (BOTH ARMS)		
	Seat	Frame	Back	Seat	Frame	Back	Seat	Frame	Back
HWHISS		—			—			7.0	
HWHISSCF	—	—	—	—	—	—	1.5	5.0	2.5
HWHISP		—			—			7.0	
HWH1SPCF	—	—	—	—	—	—	1.5	5.0	1.5
HWH2SS		8.5			9.5			10.5	
HWH2SSCF	3.0	4.0	2.5	3.0	5.0	3.0	3.0	6.0	3.0
HWH2SP		8.5			9.5			11.0	
HWH2SPCF	3.0	4.0	2.0	3.0	5.0	2.5	3.0	6.0	3.0
HWH3SS		12.0			13.0			14.0	
HWH3SSCF	4.0	5.5	3.0	4.0	6.5	3.5	4.0	7.5	3.5
HWH3SP		12.5			13.5			14.5	
HWH3SPCF	4.0	5.5	3.0	4.0	6.5	3.5	4.0	7.5	4.0
HWHIC		3.0			—			—	
HWH1CCF	1.5	2.0	—	—	—	—	—	—	—
HWHITCS		6.0			—			—	
HWHITCSCF	1.5	3.5	2.5	—	—	—	—	—	—
HWHITCP		7.0			—			—	
HWHITPCF	1.5	3.5	2.0	—	—	—	—	—	—

WEST HILL™ Casual Lounge Seating

GSA SIN 33721



Icon Legend on page 19

HWH1SS

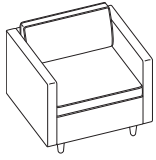

SINGLE SEAT LOUNGE — STANDARD CUSHION

DIMENSIONS

Depth:	30½	Back Height:	12
Height:	29¾	Back Width:	26¾
Width:	33¼	Arm Height:	8
Usable Seat Depth:	19	Ship Weight:	81
Seat to Floor Height:	17¾	Cube:	18.4
Seat Width:	26¾	COM:	See page 505
		Weight Rating:	300 lbs.

FABRIC PRICE CODES

1	\$2550	8	\$3876
2	\$2726	9	\$3909
3	\$2905	10	\$4088
4	\$3053	11	\$4267
5	\$3253	12	\$4446
6	\$3455	L	—
7	\$3663		

HWH1SP

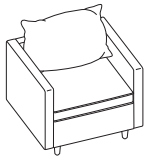

SINGLE SEAT LOUNGE — PILLOW CUSHION

DIMENSIONS

Depth:	30½	Back Height:	13¾
Height:	31½	Back Width:	26¾
Width:	33¼	Arm Height:	8
Usable Seat Depth:	16½	Ship Weight:	81
Seat to Floor Height:	17¾	Cube:	18.4
Seat Width:	26¾	COM:	See page 505
		Weight Rating:	300 lbs.

FABRIC PRICE CODES

1	\$2550	8	\$3876
2	\$2726	9	\$3909
3	\$2905	10	\$4088
4	\$3053	11	\$4267
5	\$3253	12	\$4446
6	\$3455	L	—
7	\$3663		

HON Recommendation: HWH1SP.B.PURL__CW__ - List Price \$2905

SEATING

HOW TO SPECIFY

Select
Model Number

HWH1SP

Select
Arm Type

B Both Arms

B

Select
Fabric

See page 505

PBLE03

Select
Foot and Foot Color

SM Square Metal (+ \$53)

CW Cone Wood

See page 505 for colors

SMP8V



WEST HILL™ Casual Lounge Seating

HWH1SSCF

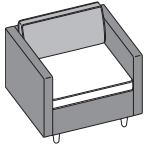

**SINGLE SEAT LOUNGE —
STANDARD CUSHION,
MULTI-FABRIC**

DIMENSIONS

Depth:	30½	Back Height:	12
Height:	29¾	Back Width:	26¾
Width:	33¼	Arm Height:	8
Usable Seat Depth:	19	Ship Weight:	81
Seat to Floor Height:	17¾	Cube:	18.4
Seat Width:	26¾	COM:	See page 505
		Weight Rating:	300 lbs.

FABRIC PRICE CODES

1	\$2747		
<i>Add to Base Price Above</i>			
	Seat	Frame	Back
2	\$38	\$126	\$38
3	\$77	\$253	\$77
4	\$108	\$360	\$108
5	\$151	\$502	\$151
6	\$195	\$647	\$195
7	\$239	\$796	\$239
8	\$285	\$947	\$285
9	\$292	\$971	\$292
10	\$330	\$1099	\$330
11	\$368	\$1226	\$368
12	\$407	\$1355	\$407

HWH1SPCF

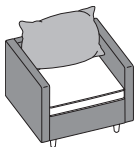

**SINGLE SEAT LOUNGE —
PILLOW CUSHION,
MULTI-FABRIC**

DIMENSIONS

Depth:	30½	Back Height:	13¾
Height:	31½	Back Width:	26¾
Width:	33¼	Arm Height:	8
Usable Seat Depth:	16½	Ship Weight:	81
Seat to Floor Height:	17¾	Cube:	18.4
Seat Width:	26¾	COM:	See page 505
		Weight Rating:	300 lbs.

FABRIC PRICE CODES

1	\$2747		
<i>Add to Base Price Above</i>			
	Seat	Frame	Back
2	\$38	\$126	\$38
3	\$77	\$253	\$77
4	\$108	\$360	\$108
5	\$151	\$502	\$151
6	\$195	\$647	\$195
7	\$239	\$796	\$239
8	\$285	\$947	\$285
9	\$292	\$971	\$292
10	\$330	\$1099	\$330
11	\$368	\$1226	\$368
12	\$407	\$1355	\$407

HON Recommendation: HWH1SPCF.B.PURL__PURL__PURL__CW__ - List Price \$3154

HOW TO SPECIFY

<p>Select Model Number</p> <p>HWH1SPCF</p>	<p>Select Arm Type</p> <p>B Both Arms</p> <p>B</p>	<p>Select Seat Fabric</p> <p>See page 505</p> <p>PBLE07</p>	<p>Select Frame Fabric</p> <p>See page 505</p> <p>PBLE03</p>	<p>Select Back Fabric</p> <p>See page 505</p> <p>PBLE01</p>	<p>Select Foot and Foot Color</p> <p>SM Square Metal (+ \$53) CW Cone Wood See page 505 for colors</p> <p>SMP8V</p>
---	---	--	---	--	--

WEST HILL™ Casual Lounge Seating

GSA SIN 33721



Icon Legend on page 19

HWH2SS

TWO SEAT LOUNGE — STANDARD CUSHION

DIMENSIONS

FABRIC PRICE CODES



Armless

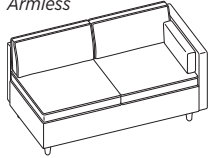

Left

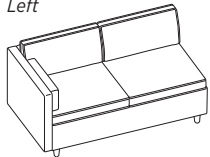

Right

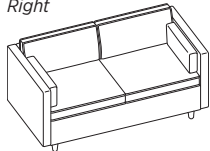

Both Arms

Depth:	30½	Back Height:	12
Height:	29¾	Back Width:	53¾
Width (armless):	53¾	Arm Height:	8
Width (one arm):	57	Ship Weight (armless):	107
Width (both arms):	60¼	Ship Weight (one arm):	121
Usable Seat Depth:	19	Ship Weight (both arms):	135
Seat to Floor Height:	17¾	Cube:	34.0
Seat Width (armless):	53¾	COM:	See page 505
Seat Width (one arm):	49½	Weight Rating:	300 lbs. (per seat)
Seat Width (both arms):	45¼		

1	\$3467	8	\$5456
2	\$3730	9	\$5505
3	\$3999	10	\$5774
4	\$4222	11	\$6042
5	\$4521	12	\$6311
6	\$4826	L	—
7	\$5137		

NOTES: Includes semi-attached arm cushions as shown.

HWH2SP

TWO SEAT LOUNGE — PILLOW CUSHION

DIMENSIONS

FABRIC PRICE CODES



Armless



Left

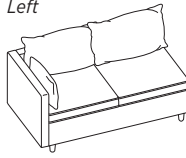

Right

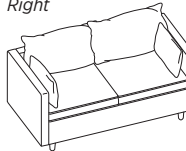

Both Arms

Depth:	30½	Back Height:	13¾
Height:	29¾	Back Width:	53¾
Width (armless):	53¾	Arm Height:	8
Width (one arm):	57	Ship Weight (armless):	107
Width (both arms):	60¼	Ship Weight (one arm):	121
Usable Seat Depth:	16½	Ship Weight (both arms):	135
Seat to Floor Height:	17¾	Cube:	34.0
Seat Width (armless):	53¾	COM:	See page 505
Seat Width (one arm):	48½	Weight Rating:	300 lbs. (per seat)
Seat Width (both arms):	43¼		

1	\$3467	8	\$5550
2	\$3742	9	\$5602
3	\$4024	10	\$5884
4	\$4258	11	\$6166
5	\$4571	12	\$6447
6	\$4890	L	—
7	\$5217		

NOTES: Includes semi-attached arm cushions as shown.

SEATING

HOW TO SPECIFY

HON Recommendation: HWH2SP.B.PURL__CW__ - List Price \$4390

Select Model Number HWH2SP	Select Arm Type N No Arms L Left Arm Only (+ \$183) R Right Arm Only (+ \$183) B Both Arms (+ \$366)	Select Fabric See page 505 PBLE03	Select Foot and Foot Color SM Square Metal (+ \$53) CW Cone Wood See page 505 for colors SMP8V
--------------------------------------	---	--	---



WEST HILL™ Casual Lounge Seating

HWH2SSCF

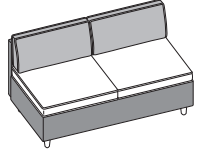

Armless

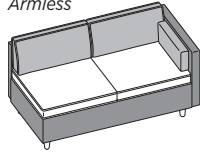

Left

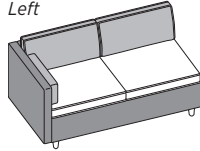

Right

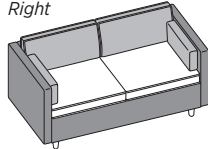

Both Arms

TWO SEAT LOUNGE — STANDARD CUSHION, MULTI-FABRIC

DIMENSIONS

Depth:	30½	Back Height:	12
Height:	29¾	Back Width:	53¾
Width (armless):	53¾	Arm Height:	8
Width (one arm):	57	Ship Weight (armless):	107
Width (both arms):	60¼	Ship Weight (one arm):	121
Usable Seat Depth:	19	Ship Weight (both arms):	135
Seat to Floor Height:	17¾	Cube:	34.0
Seat Width (armless):	53¾	COM:	See page 505
Seat Width (one arm):	49½	Weight Rating:	300 lbs. (per seat)
Seat Width (both arms):	45¼		

FABRIC PRICE CODES

1	\$3662		
<i>Add to Base Price Above</i>			
	Seat	Frame	Back
2	\$76	\$151	\$76
3	\$152	\$305	\$152
4	\$216	\$431	\$216
5	\$301	\$602	\$301
6	\$388	\$777	\$388
7	\$478	\$955	\$478
8	\$569	\$1136	\$569
9	\$583	\$1165	\$583
10	\$660	\$1318	\$660
11	\$736	\$1472	\$736
12	\$814	\$1625	\$814

NOTES: Includes semi-attached arm cushions as shown.

HWH2SPCF

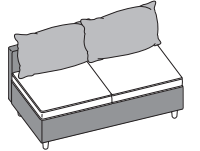

Armless

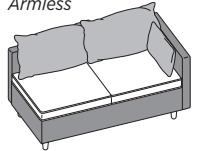

Left

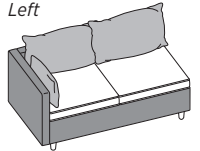

Right

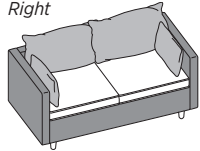

Both Arms

TWO SEAT LOUNGE — PILLOW CUSHION, MULTI-FABRIC

DIMENSIONS

Depth:	30½	Back Height:	13¾
Height:	29¾	Back Width:	53¾
Width (armless):	53¾	Arm Height:	8
Width (one arm):	57	Ship Weight (armless):	107
Width (both arms):	60¼	Ship Weight (one arm):	121
Usable Seat Depth:	16½	Ship Weight (both arms):	135
Seat to Floor Height:	17¾	Cube:	34.0
Seat Width (armless):	53¾	COM:	See page 505
Seat Width (one arm):	48½	Weight Rating:	300 lbs. (per seat)
Seat Width (both arms):	43¼		

FABRIC PRICE CODES

1	\$3662		
<i>Add to Base Price Above</i>			
	Seat	Frame	Back
2	\$76	\$151	\$76
3	\$152	\$305	\$152
4	\$216	\$431	\$216
5	\$301	\$602	\$301
6	\$388	\$777	\$388
7	\$478	\$955	\$478
8	\$569	\$1136	\$569
9	\$583	\$1165	\$583
10	\$660	\$1318	\$660
11	\$736	\$1472	\$736
12	\$814	\$1625	\$814

NOTES: Includes semi-attached arm cushions as shown.

HON Recommendation: HWH2SPCF.B.PURL__PURL__PURL__CW__ - List Price \$4637

HOW TO SPECIFY

Select Model Number HWH2SPCF	Select Arm Type N No Arms L Left Arm Only (+ \$183) R Right Arm Only (+ \$183) B Both Arms (+ \$366) B	Select Seat Fabric See page 505 PBLE07	Select Frame Fabric See page 505 PBLE03	Select Back Fabric See page 505 PBLE01	Select Foot and Foot Color SM Square Metal (+ \$53) CW Cone Wood See page 505 for colors SMP8V
--	--	---	--	---	---

SEATING

WEST HILL™ Casual Lounge Seating

GSA SIN 33721



Icon Legend on page 19

HWH3SS

THREE SEAT LOUNGE — STANDARD CUSHION

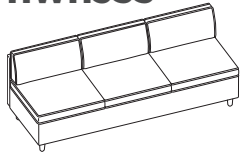

Armless

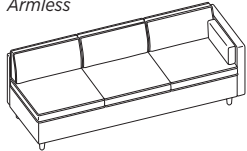

Left

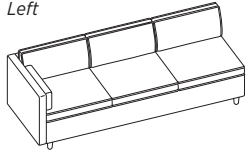

Right

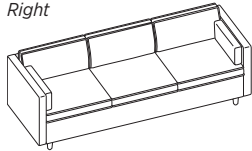

Both Arms

DIMENSIONS

Depth:	30½	Back Height:	12
Height:	29¾	Back Width:	80¾
Width (armless):	80¾	Arm Height:	8
Width (one arm):	84	Ship Weight (armless):	146
Width (both arms):	87¼	Ship Weight (one arm):	160
Usable Seat Depth:	19	Ship Weight (both arms):	174
Seat to Floor Height:	17¾	Cube:	46.5
Seat Width (armless):	80¾	COM:	See page 505
Seat Width (one arm):	76½	Weight Rating:	300 lbs. (per seat)
Seat Width (both arms):	72¼		

FABRIC PRICE CODES

1	\$4708	8	\$7360
2	\$5059	9	\$7425
3	\$5418	10	\$7784
4	\$5714	11	\$8142
5	\$6112	12	\$8500
6	\$6519	L	—
7	\$6934		

NOTES: Includes semi-attached arm cushions as shown.

HWH3SP

THREE SEAT LOUNGE — PILLOW CUSHION

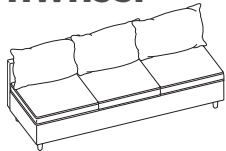

Armless

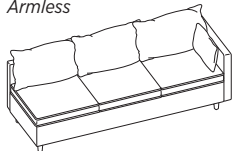

Left

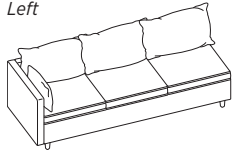

Right

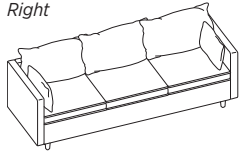

Both Arms

DIMENSIONS

Depth:	30½	Back Height:	13¾
Height:	31½	Back Width:	80¾
Width (armless):	80¾	Arm Height:	8
Width (one arm):	84	Ship Weight (armless):	146
Width (both arms):	87¼	Ship Weight (one arm):	160
Usable Seat Depth:	16½	Ship Weight (both arms):	174
Seat to Floor Height:	17¾	Cube:	46.5
Seat Width (armless):	80¾	COM:	See page 505
Seat Width (one arm):	75½	Weight Rating:	300 lbs. (per seat)
Seat Width (both arms):	70¼		

FABRIC PRICE CODES

1	\$4708	8	\$7454
2	\$5071	9	\$7523
3	\$5443	10	\$7894
4	\$5750	11	\$8265
5	\$6162	12	\$8636
6	\$6584	L	—
7	\$7014		

NOTES: Includes semi-attached arm cushions as shown.

HON Recommendation: HWH3SP.B.PURL__CW__ - List Price \$5809

HOW TO SPECIFY

Select Model Number HWH3SP	Select Arm Type N No Arms L Left Arm Only (+ \$183) R Right Arm Only (+ \$183) B Both Arms (+ \$366)	Select Fabric See page 505 PBLE03	Select Foot and Foot Color SM Square Metal (+ \$53) CW Cone Wood See page 505 for colors SMP8V
--------------------------------------	---	--	---



WEST HILL™ Casual Lounge Seating

HWH3SSCF

THREE SEAT LOUNGE — STANDARD CUSHION, MULTI-FABRIC

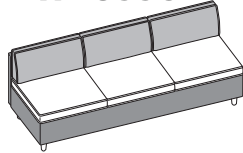

Armless

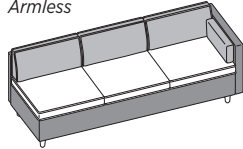

Left

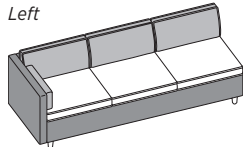

Right

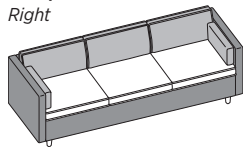

Both Arms

DIMENSIONS

Depth:	30½	Back Height:	12
Height:	29¾	Back Width:	80¾
Width (armless):	80¾	Arm Height:	8
Width (one arm):	84	Ship Weight (armless):	146
Width (both arms):	87¼	Ship Weight (one arm):	160
Usable Seat Depth:	19	Ship Weight (both arms):	174
Seat to Floor Height:	17¾	Cube:	46.5
Seat Width (armless):	80¾	COM:	See page 505
Seat Width (one arm):	76½	Weight Rating:	300 lbs. (per seat)
Seat Width (both arms):	72¼		

FABRIC PRICE CODES

1	\$4905		
<i>Add to Base Price Above</i>			
	Seat	Frame	Back
2	\$101	\$189	\$88
3	\$203	\$381	\$178
4	\$288	\$540	\$252
5	\$402	\$753	\$352
6	\$518	\$970	\$453
7	\$637	\$1193	\$557
8	\$758	\$1421	\$663
9	\$777	\$1456	\$680
10	\$879	\$1647	\$770
11	\$982	\$1840	\$858
12	\$1084	\$2032	\$948

NOTES: Includes semi-attached arm cushions as shown.

HWH3SPCF

THREE SEAT LOUNGE — PILLOW CUSHION, MULTI-FABRIC

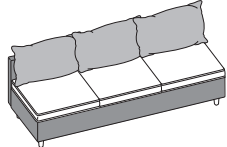

Armless

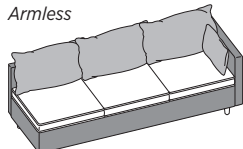

Left

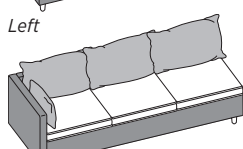

Right

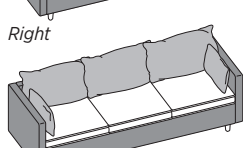

Both Arms

DIMENSIONS

Depth:	30½	Back Height:	13¾
Height:	31½	Back Width:	80¾
Width (armless):	80¾	Arm Height:	8
Width (one arm):	84	Ship Weight (armless):	146
Width (both arms):	87¼	Ship Weight (one arm):	160
Usable Seat Depth:	16½	Ship Weight (both arms):	174
Seat to Floor Height:	17¾	Cube:	46.5
Seat Width (armless):	80¾	COM:	See page 505
Seat Width (one arm):	75½	Weight Rating:	300 lbs. (per seat)
Seat Width (both arms):	70¼		

FABRIC PRICE CODES

1	\$4905		
<i>Add to Base Price Above</i>			
	Seat	Frame	Back
2	\$101	\$189	\$101
3	\$203	\$381	\$203
4	\$288	\$540	\$288
5	\$402	\$753	\$402
6	\$518	\$970	\$518
7	\$637	\$1193	\$637
8	\$758	\$1421	\$758
9	\$777	\$1456	\$777
10	\$879	\$1647	\$879
11	\$982	\$1840	\$982
12	\$1084	\$2032	\$1084

NOTES: Includes semi-attached arm cushions as shown.

HON Recommendation: HWH3SPCF.B.PURL__PURL__PURL__CW__ - List Price \$6058

HOW TO SPECIFY

<p>Select Model Number</p> <p>HWH3SPCF</p>	<p>Select Arm Type</p> <p>N No Arms L Left Arm Only (+ \$183) R Right Arm Only (+ \$183) B Both Arms (+ \$366)</p> <p>B</p>	<p>Select Seat Fabric</p> <p>See page 505</p> <p>PBLE07</p>	<p>Select Frame Fabric</p> <p>See page 505</p> <p>PBLE03</p>	<p>Select Back Fabric</p> <p>See page 505</p> <p>PBLE01</p>	<p>Select Foot and Foot Color</p> <p>SM Square Metal (+ \$53) CW Cone Wood See page 505 for colors</p> <p>SMP8V</p>
---	--	--	---	--	--

WEST HILL™ Ottomans

GSA SIN 33721



Icon Legend on page 19

HWH1C

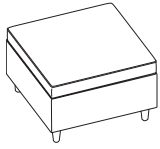

OTTOMAN

DIMENSIONS

Depth:	27¼	Ship Weight:	47
Height:	17¾	Cube:	18.4
Width:	27¼	COM:	See page 505
Usable Seat Depth:	27¼	Weight Rating:	300 lbs.
Seat to Floor Height:	17¾		
Seat Width:	27¼		

FABRIC PRICE CODES

1	\$1505	8	\$2074
2	\$1581	9	\$2088
3	\$1657	10	\$2165
4	\$1721	11	\$2241
5	\$1806	12	\$2319
6	\$1893	L	—
7	\$1983		

HWH1CCF

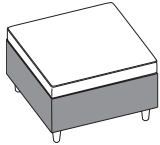

OTTOMAN, MULTI-FABRIC

DIMENSIONS

Depth:	27¼	Ship Weight:	47
Height:	17¾	Cube:	18.4
Width:	27¼	COM:	See page 505
Usable Seat Depth:	27¼	Weight Rating:	300 lbs.
Seat to Floor Height:	17¾		
Seat Width:	27¼		

FABRIC PRICE CODES

1	\$1702	
<i>Add to Base Price Above</i>		
	Seat	Frame
2	\$38	\$38
3	\$77	\$77
4	\$108	\$108
5	\$151	\$151
6	\$195	\$195
7	\$239	\$239
8	\$285	\$285
9	\$292	\$292
10	\$330	\$330
11	\$368	\$368
12	\$407	\$407

HON Recommendation: HWH1C.PURL___.CW__ - List Price \$1657

SEATING

HOW TO SPECIFY

Select
Model Number

HWH1CCF .

Select
Fabric

See page 505

PBLE03 .

Select
Seat Fabric

*Specify for model HWH1CCF
only*

PBLE03 .

Select
Frame Fabric

*Specify for model HWH1CCF
only*

PBLE07 .

Select
Foot and Foot Color

SM Square Metal (+ \$53)
CW Cone Wood
See page 505 for colors

SMP8V



WEST HILL™ Casual Lounge Seating

HWH1TCS

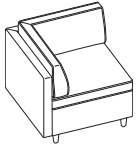

TRUE CORNER — STANDARD CUSHION

DIMENSIONS

Depth:	30½	Ship Weight:	73
Height:	29¾	Cube:	18.4
Width:	30½	COM:	See page 505
Usable Seat Depth:	19	Weight Rating:	300 lbs.
Seat to Floor Height:	17¾		
Back Height:	12		

FABRIC PRICE CODES

1	\$2550	8	\$3686
2	\$2701	9	\$3715
3	\$2855	10	\$3868
4	\$2981	11	\$4022
5	\$3152	12	\$4175
6	\$3327	L	—
7	\$3505		

HWH1TCP

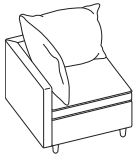

TRUE CORNER — PILLOW CUSHION

DIMENSIONS

Depth:	30½	Ship Weight:	73
Height:	31½	Cube:	18.4
Width:	30½	COM:	See page 505
Usable Seat Depth:	16½	Weight Rating:	300 lbs.
Seat to Floor Height:	17¾		
Back Height:	13¾		

FABRIC PRICE CODES

1	\$2550	8	\$3876
2	\$2726	9	\$3909
3	\$2905	10	\$4088
4	\$3053	11	\$4267
5	\$3253	12	\$4446
6	\$3455	L	—
7	\$3663		

HON Recommendation: HWH1TCP.PURL__CW__ - List Price \$2905

HOW TO SPECIFY

<p>Select Model Number</p> <p>HWH1TCP</p>	<p>Select Fabric</p> <p>See page 505</p> <p>PBLE03</p>	<p>Select Foot and Foot Color</p> <p>SM Square Metal (+ \$53) CW Cone Wood</p> <p>See page 505 for colors</p> <p>SMP8V</p>
--	---	---

WEST HILL™ Casual Lounge Seating

GSA SIN 33721



Icon Legend on page 19

HWH1TCSCF

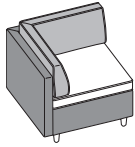

**TRUE CORNER —
STANDARD CUSHION,
MULTI-FABRIC**

DIMENSIONS

Depth:	30½	Ship Weight:	73
Height:	29¾	Cube:	18.4
Width:	30½	COM:	See page 505
Usable Seat Depth:	19	Weight Rating:	300 lbs.
Seat to Floor Height:	17¾		
Back Height:	12		

FABRIC PRICE CODES

1 \$2747

Add to Base Price Above

	Seat	Frame	Back
2	\$38	\$88	\$63
3	\$77	\$178	\$127
4	\$108	\$252	\$180
5	\$151	\$352	\$251
6	\$195	\$453	\$323
7	\$239	\$557	\$398
8	\$285	\$663	\$474
9	\$292	\$680	\$485
10	\$330	\$770	\$549
11	\$368	\$858	\$614
12	\$407	\$948	\$678

HWH1TCPF



**TRUE CORNER —
PILLOW CUSHION,
MULTI-FABRIC**

DIMENSIONS

Depth:	30½	Ship Weight:	73
Height:	31½	Cube:	18.4
Width:	30½	COM:	See page 505
Usable Seat Depth:	16½	Weight Rating:	300 lbs.
Seat to Floor Height:	17¾		
Back Height:	13¾		

FABRIC PRICE CODES

1 \$2747

Add to Base Price Above

	Seat	Frame	Back
2	\$38	\$88	\$51
3	\$77	\$178	\$102
4	\$108	\$252	\$144
5	\$151	\$352	\$201
6	\$195	\$453	\$260
7	\$239	\$557	\$318
8	\$285	\$663	\$379
9	\$292	\$680	\$388
10	\$330	\$770	\$439
11	\$368	\$858	\$491
12	\$407	\$948	\$542

HON Recommendation: HWH1TCPF.PURL__PURL__PURL__CW__ - List Price \$3104

HOW TO SPECIFY

<p>Select Model Number</p> <p>HWH1TCPCF</p>	<p>Select Seat Fabric</p> <p>See page 505</p> <p>PBLE07</p>	<p>Select Frame Fabric</p> <p>See page 505</p> <p>PBLE03</p>	<p>Select Back Fabric</p> <p>See page 505</p> <p>PBLE01</p>	<p>Select Foot and Foot Color</p> <p>SM Square Metal (+ \$53) CW Cone Wood</p> <p>See page 505 for colors</p> <p>SMP8V</p>
--	--	---	--	---



THROW PILLOWS

HWHLP

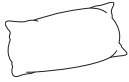

LUMBAR THROW PILLOW

DIMENSIONS

Height:	10
Width:	18
COM:	1.0
Ship Weight:	2.5
Cube:	2.3

FABRIC PRICE CODES

1	\$178	8	\$368
2	\$204	9	\$373
3	\$229	10	\$398
4	\$251	11	\$424
5	\$279	12	\$449
6	\$308	L	—
7	\$337		

HWHSP18



18" SQUARE THROW PILLOW

DIMENSIONS

Height:	18
Width:	18
COM:	1.0
Ship Weight:	3.0
Cube:	2.3

FABRIC PRICE CODES

1	\$219	8	\$409
2	\$245	9	\$414
3	\$270	10	\$439
4	\$292	11	\$465
5	\$320	12	\$490
6	\$349	L	—
7	\$378		

HOW TO SPECIFY

<p>Select Model Number</p> <p>HWHSP18</p>	<p>Select Fabric</p> <p>See page 505</p> <p>PBLE03</p>
--	---



HWHACPS



ARM CUSHION PACK — STANDARD

DIMENSIONS

COM: 1.0
Ship Weight: 4.1
Cube: 3.9

FABRIC PRICE CODES

1	\$264	8	\$454
2	\$290	9	\$459
3	\$315	10	\$484
4	\$337	11	\$510
5	\$365	12	\$535
6	\$394	L	—
7	\$423		

NOTES: Includes both L and R Arm Cushions.

ⓘ Cushion arm cushions can be replaced or switched out with these cushion packs.

HWHACPP



ARM CUSHION PACK — PILLOW

DIMENSIONS

COM: 1.0
Ship Weight: 5.7
Cube: 3.9

FABRIC PRICE CODES

1	\$264	8	\$454
2	\$290	9	\$459
3	\$315	10	\$484
4	\$337	11	\$510
5	\$365	12	\$535
6	\$394	L	—
7	\$423		

NOTES: Includes both L and R Arm Cushions.

ⓘ Cushion arm cushions can be replaced or switched out with these cushion packs.

HWHBCPS



BACK CUSHION PACK — STANDARD

DIMENSIONS

COM: 2.5
Ship Weight: 8.1
Cube: 3.9

FABRIC PRICE CODES

1	\$264	8	\$738
2	\$327	9	\$749
3	\$391	10	\$813
4	\$444	11	\$878
5	\$515	12	\$942
6	\$587	L	—
7	\$662		

NOTES: Includes a single Standard Back Cushion.

ⓘ Cushion backs can be replaced or switched out with these cushion packs.

HWHBCPP



BACK CUSHION PACK — PILLOW

DIMENSIONS

COM: 1.5
Ship Weight: 8.1
Cube: 3.9

FABRIC PRICE CODES

1	\$264	8	\$549
2	\$302	9	\$556
3	\$341	10	\$594
4	\$372	11	\$632
5	\$415	12	\$671
6	\$459	L	—
7	\$503		

NOTES: Includes a single Pillow Back Cushion.

ⓘ Cushion backs can be replaced or switched out with these cushion packs.

HWHGB

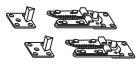

GANGING BRACKET

DIMENSIONS

Ship Weight: 1.0
Cube: 0.1

LIST PRICE

\$67

OPEN MARKET

SPECIFYING EXAMPLE: HWHGB

HOW TO SPECIFY

<p>Select Model Number</p> <p>HWHBCPP</p>	<p>Select Fabric</p> <p>See page 505</p> <p>PBLE03</p>
---	--



EXECUTIVE CHAIRS

HVL151



HIGH-BACK

- Pneumatic
- Swivel
- Tilt
- Tilt Tension
- Tilt Lock
- Fixed Padded Loop Arms

Functions: **A, E, F, K, L, T**
 (Function Key on pages 250-251)

NOTES: Black Bonded Leather. Black frame. Padded loop arms. **HON 5-Year Limited Warranty.**

DIMENSIONS

Depth:	37½	Arm Width:	20½
Width:	27	Seat to Floor Height:	17¾-21½
Height:	45½	Usable Seat Depth:	18⅝
Seat Depth:	18⅝	Ship Weight:	38
Seat Width:	20½	Cube:	5.1
Back Width:	20½	Weight Rating:	250 lbs.
Back Height:	27¼		

PRICE CODE

Leather **\$557**

HON Recommendation: HVL151.SB11 - List Price \$557

HOW TO SPECIFY

<p>Select Model Number</p>	<p>Select Fabric</p> <p>SB11 Black Bonded Leather</p>
<div style="display: flex; gap: 5px;"> <div style="border: 1px solid black; padding: 2px 5px;">H</div> <div style="border: 1px solid black; padding: 2px 5px;">V</div> <div style="border: 1px solid black; padding: 2px 5px;">L</div> <div style="border: 1px solid black; padding: 2px 5px;">1</div> <div style="border: 1px solid black; padding: 2px 5px;">5</div> <div style="border: 1px solid black; padding: 2px 5px;">1</div> </div>	<div style="display: flex; gap: 5px;"> <div style="border: 1px solid black; padding: 2px 5px;">S</div> <div style="border: 1px solid black; padding: 2px 5px;">B</div> <div style="border: 1px solid black; padding: 2px 5px;">1</div> <div style="border: 1px solid black; padding: 2px 5px;">1</div> </div>



EXECUTIVE CHAIRS

HVL402



HIGH-BACK

Pneumatic
Swivel
Tilt
Tilt Tension
Tilt Lock
Fixed Padded Loop Arms

Functions: **A, E, F, K, L, T**
(Function Key on pages 250-251)

DIMENSIONS

Depth:	28	Arm Width:	19½
Width:	26	Seat to Floor Height:	16½-20½
Height:	45½	Usable Seat Depth:	17½
Seat Depth:	17½	Ship Weight:	44
Seat Width:	19½	Cube:	6.1
Back Width:	19	Weight Rating:	250 lbs.
Back Height:	24½		

PRICE CODE

Vinyl **\$620**

NOTES: Available in Black and Brown vinyl with contrasting top stitch. EN11 features silver frame. EN45 features black frame. Padded loop arms. **HON 5-Year Limited Warranty.**

HON Recommendation: HVL402.EN11 - List Price \$620

HVL601



HIGH-BACK

Pneumatic
Swivel
Tilt
Tilt Tension
Tilt Lock
Loop Arms

Functions: **A, E, F, K, L, T**
(Function Key on pages 250-251)

DIMENSIONS

Depth:	27	Arm Width:	20½
Width:	26½	Seat to Floor Height:	16¾-20½
Height:	44	Usable Seat Depth:	17
Seat Depth:	17	Ship Weight:	38
Seat Width:	20½	Cube:	4.1
Back Width:	20½	Weight Rating:	250 lbs.
Back Height:	26½		

PRICE CODE

Fabric **\$411**
Leather **\$443**

NOTES: Tailored stitching detail in Black Bonded Leather or Black fabric. Fixed loop arms. Black frame. **HON 5-Year Limited Warranty.**

HON Recommendation: HVL601.SB11 - List Price \$443

* De-emphasized

HOW TO SPECIFY

Select Model Number	Select Fabric
	SB11 Black Bonded Leather <i>Specify for model HVL601 only</i>
	EN11 Black Vinyl <i>Specify for model HVL402 only</i>
	EN45 Brown Vinyl <i>Specify for model HVL402 only</i>
	VA10 Black Fabric <i>Specify for model HVL601 only</i>

H	V	L	6	0	1	S	B	1	1
---	---	---	---	---	---	---	---	---	---



GUEST CHAIRS

HVL653 *



GUEST CHAIR

Sled Base
Padded Arms

DIMENSIONS

Depth:	23	Arm Width:	17 ³ / ₄
Width:	22 ¹ / ₄	Seat to Floor Height:	17 ⁵ / ₈
Height:	32	Usable Seat Depth:	16 ³ / ₄
Seat Depth:	17	Ship Weight:	28
Seat Width:	20 ¹ / ₄	Cube:	3.1
Back Width:	18 ¹ / ₂	Weight Rating:	250 lbs.
Back Height:	12		

PRICE CODE

Leather **\$361**

NOTES: Black Bonded Leather with tailored stitching detail. Frame features steel tubular construction. Black frame. **HON 5-Year Limited Warranty.**

HON Recommendation: HVL653.SB11 - List Price \$361

* De-emphasized

HOW TO SPECIFY

Select Model Number	Select Fabric
	SB11 Black Bonded Leather
H V L 6 5 3 .	S B 1 1

WORKPLACE TOOLS

Ergonomic Solutions

OPEN MARKET



Icon Legend on page 19

HSCASTER

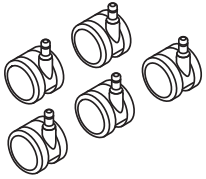

SET OF 5 SOFT CASTERS

DIMENSIONS

Size: 60mm
Ship Weight: 2 **5**
Cube: 0.1

LIST PRICE

\$72

i Available in Black finish only, no specification needed.

SEATING





HOW TO SPECIFY

Select
Model Number

H S C A S T E R

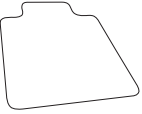
WORKPLACE TOOLS

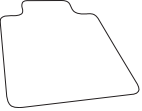
Chair Mats

	DESCRIPTION	MODEL	SHIP WEIGHT	CUBE	LIST PRICE
	Lipped Chair Mat with Studs 48"W x 36"D	HCM3648LS 	8.8	0.6	\$123
	Lipped Chair Mat without Studs 60"W x 46"D 48"W x 36"D	HCM4660LN HCM3648LN 	13.2 8.3	0.5 0.3	\$205 \$123

NOTES:

- Available with studs for carpet and without studs for hard-surface floors.
- Ships rolled.
- **HON 5-Year Limited Warranty.**

 Available in Clear finish only, no specification needed.

HOW TO SPECIFY

Select Model Number

H C M 3 6 4 8 L S

CROSS REFERENCE INDEX

MODEL	PAGE	MODEL	PAGE	MODEL	PAGE	MODEL	PAGE
HEMKR426036BB	146	HESWCB42	199.8	HFLDGRMT	245	HGVIMM	352
HEMKR426036L	146	HESWCD12	199.9	HFLDGRMT3	245	HH870924	236
HEMKR426042BB	146	HESWCD18	199.7	HFLDGRMT4	245	HH870924CH	236
HEMKR426042L	146	HESWCD2	199.9	HFLGANG	333	HH870930	236
HEMKR427229BB	146	HESWCD30	199.7	HFLMCI	331	HH870930CH	236
HEMKR427229L	146	HESWCD42	199.7	HFLMCIDF	335	HH870942	236
HEMKR427236BB	146	HESWCII8	199.7	HFLML1	331	HH870942CH	236
HEMKR427236L	146	HESWCI30	199.7	HFLMLIDF	335	HH870960	236
HEMKR427242BB	146	HESWCI42	199.7	HFLMR1	331	HH870960CH	236
HEMKR427242L	146	HESWCO18	199.7	HFLMRIDF	336	HHABCASTER	139
HEMKRDIVIDER	148	HESWCO30	199.7	HFLRC1	330	HHB02	492
HEMKREND29-F	147	HESWCO42	199.7	HFLRCIDF	334	HHB03	492
HEMKREND29-SP	147	HESWLB30	199.8	HFLSC1	330	HHCB50	493
HEMKREND36-F	147	HESWLB36	199.8	HFLSCIDF	334	HHCG11	481
HEMKREND36-SP	147	HESWLB42	199.8	HFLSC2	342	HHCG1IDF	482
HEMKREND42-F	147	HESWLD12	199.9	HFLSC2DF	345	HHCG21	481
HEMKREND42-SP	147	HESWLD18	199.6	HFLSO1	333	HHCG2IDF	482
HEMKRSHELF	148	HESWLD2	199.9	HFLWI45	332	HHCG50	481
HERD42E	135	HESWLD30	199.6	HFLWI45DF	337	HHCG50DF	483
HERD48E	135	HESWLD42	199.6	HFLWO45	332	HHCGB21	484
HESA2440E	134	HESWLS18	199.6	HFLWO45DF	337	HHCGB31	484
HESA3050E	134	HESWLS30	199.6	HFLYO1	347	HHCGBR	486
HESBIH3WD	160	HESWLS42	199.6	HFLYO1DF	348	HHCGBRCH	486
HESBIH3WS	160	HESY-3654E-NS	138	HFMBIN12	149, 163, 197	HHCP1	481
HESB2H3WD	160	HESY3654E	134	HFMBIN3	139, 145, 149, 163, 197	HHCPIDF	483
HESB2H3WS	160	HETD54E	135	HFMBIN6	149, 163, 197	HHCTO1	493
HESB3H3WS	160	HETLEC-REC2430	173	HFSS74L	340	HHCTC	485
HESB4H3WS	160	HETR2448E	135	HFSS74LDF	343	HHCTL4	485
HESCIH3WD	158	HETR2460E	135	HFSS74LWD	341	HHCTRT	485
HESCIH3WS	158	HETR2472E	135	HFSS74LWDDF	344	HHCTS	485
HESC2H3WD	158	HETR3048E	135	HFTB17N	48	HHPS1	238
HESC2H3WS	158	HETR3060E	135	HFTLA2460	47	HI2AAA	383, 396
HESC3H3WS	158	HETR3072E	135	HFTLA3372	47	HI2ATA	383, 396
HESC4H3WS	158	HETZ3060E	135	HFTLA3384	47	HI2BTHR	384
HESCO3H2WS	159	HF22	163	HFTLA3396	47	HI2FHA	321, 383, 396
HESCO3H3WS	159	HF23C	198	HFTLC2460	47	HI2HR	384
HESCO4H2WS	159	HF23S	163	HFTLC3372	47	HIB50	389
HESCO4H3WS	159	HFCG6	340	HFTLC3384	47	HICS7	386
HESCS4H2WSL	162	HFCG6DF	343	HFTLC3396	47	HICS7DF	388
HESCS4H2WSR	162	HFCG6WD	341	HFTLD26	49	HIEH1	394
HESH3060E	134	HFCG6WDDF	344	HFTLD30	47	HIEH2	394
HESH6066E	136	HFCL2	342	HFTLD36	47	HIEH3	394
HESKD4872E	136	HFCL2DF	345	HFTLR12	50	HIGCL	389
HESL2H2WS	157	HFCS64L	340	HFTLS24	49	HIGS6	386
HESL2H3WS	157	HFCS64LDF	343	HFTLS30	47	HIGS6DF	387
HESL3H2WS	157	HFCS64LWD	341	HFTLS36	47	HILMBR	383
HESL3H3WS	157	HFCS64LWDDF	344	HFTLW45	50	HIPAA	321, 383, 396
HESL4H2WS	157	HFDB17B	48	HFTPTL18	49	HISB6	386
HESL4H3WS	157	HFDB17N	48	HFTTAL14	50, 364	HISB6DF	387
HESN3054E	134	HFDB29A	48	HFXB17B	48	HITL1	392
HESNP54E	134	HFDB29AN	48	HFXB29A	48	HITL2	392
HESPCR	138	HFDB29B	48	HFXB29AN	48	HITL3	392
HESQ36E	135	HFDB42A	48	HFXB29B	48	HITLM	374
HESQ42E	135	HFDB42AF	48	HFXB42A	48	HITLMKD	376
HESQ48E	135	HFDB42AFN	48	HFXB42AN	48	HITLRA	379
HEST2H2WS	161	HFDB42AN	48	HFXB42B	48	HITLRAKD	380
HEST2H3WS	161	HFDB42B	48	HFXT1	325	HITS5	395
HEST3H2WS	161	HFDB42BF	48	HGDK3-F	184, 186	HITSM	374
HEST3H3WS	161	HFL450	333	HGRMTAC	31, 245, 364	HITSRA	379
HEST4H2WS	161	HFLB2	338	HGRMTAC2	31, 245, 364	HIWM1	393
HEST4H3WS	161	HFLB3	338	HGRMTDATA	245	HIWM2	393
HESW-3054E-NS	138	HFLCC1	332	HGRMTUSB2	245, 364	HIWM3	393
HESW3054E	134	HFLCCIDF	337	HGROM1BLANK	247	HIWMBT	377
HESWCB30	199.8	HFLCO1	347	HGROM2BLANK	247	HIWMM	374
HESWCB36	199.8	HFLCO1DF	348	HGTMM	351	HIWMMHR	375

CROSS REFERENCE INDEX

MODEL	PAGE	MODEL	PAGE	MODEL	PAGE	MODEL	PAGE
HIWMMKD	376	HLWMBT	319	HMNT1	427	HMVPC-MP	72
HIWMMMS	378	HLWR-12	195	HMNT2	427	HMVPCA1-1830G	72
HIWMMSKD	378	HMACABLE	244	HMPT2448NS	37	HMVPCA1-1830R	72
HIWMRA	379	HMAGANG	61, 139, 242	HMPT2460NS	37	HMVPCA2-1830G	72
HIWMRAKD	380	HMAJUMP	244	HMPT2472NS	37	HMVPCA2-1830R	72
HIWMU	381	HMAPLATE	244	HMPT3048NS	37	HMVPCF-1830G	72
HIWMUKD	382	HMAPOWER36	244	HMPT3060NS	37	HMVPCF-1830R	72
HIWMUL	381	HMAPOWER362	244	HMPT3072NS	37	HMVPCSS-4C	72
HIWMULKD	382	HMAPOWER42	244	HMPTBFX	36	HMVPCSS-4C4C	72
HJTRGH24	249	HMAPOWER422	244	HMPTBNSL	36	HMVPCSS-4C9C	72
HJTRGH36	249	HMAPOWER48	244	HMPTBNSS	36	HMVPCSS-4O	72
HKBS	228	HMAPOWER482	244	HMPTT2448	36	HMVPCSS-4O4C	72
HKTLONG	228	HMAPOWER54	244	HMPTT2460	36	HMVPCSS-4O9C	72
HKT MID	228	HMAPOWER542	244	HMPTT2472	36	HMVR-1848(?)-AH	70
HKTSHORT	228	HMAPOWER60	244	HMPTT3048	36	HMVR-1848(?)-FX	68
HL2DARM	321	HMAPOWER602	244	HMPTT3060	36	HMVR-1848(?)-NS	69
HL4DARM	321	HMAPOWER66	244	HMPPT3072	36	HMVR-1860(?)-AH	70
HLDA-15	184	HMAPOWER662	244	HMPVWM28	249	HMVR-1860(?)-FX	68
HL DST1	237	HMAPOWER72	244	HMS1	417	HMVR-1860(?)-NS	69
HL DV-M3A	183	HMAPOWER722	244	HMS2	417	HMVR-1872(?)-AH	70
HL DV-M3F	183	HMAPOWER84	244	HMSCART	417	HMVR-1872(?)-FX	68
HL DV-M3T	183	HMAPOWER842	244	HMSFLTGLD	418	HMVR-1872(?)-NS	69
HL DV-MRECT2026A	183	HMAPOWER96	244	HMSGANG	418	HMVR-2436(?)-AH	70
HLED1	235	HMAPOWER962	244	HMSGLD	418	HMVR-2436(?)-FX	68
HLED17A	236	HMASD	225	HMSSTLGLD	418	HMVR-2436(?)-NS	69
HLED17AS	236	HMASPLIT	244	HMT1	415	HMVR-2442(?)-AH	70
HLED17AUO	236	HMASTS	225	HMT1848E	58	HMVR-2442(?)-FX	68
HLED10C	235	HMAVHA	410	HMT1848G	58	HMVR-2442(?)-NS	69
HLED2	235	HMAVHAMF	410	HMT1860E	58	HMVR-2448(?)-AH	70
HLED31A	236	HMAVHN	409	HMT1860G	58	HMVR-2448(?)-FX	68
HLED31AS	236	HMAVHNMF	409	HMT1872E	58	HMVR-2448(?)-NS	69
HLED31AUO	236	HMAVMA	408	HMT1872G	58	HMVR-2454(?)-AH	70
HLEDOSA	236	HMAVMAMF	408	HMT2448E	58	HMVR-2454(?)-FX	68
HLSMHR	321	HMAVMN	407	HMT2448G	58	HMVR-2454(?)-NS	69
HLSL1212	239	HMAVMNMF	407	HMT2460E	58	HMVR-2460(?)-AH	70
HLSL1460LS	237	HMAVO	411	HMT2460G	58	HMVR-2460(?)-FX	68
HLSL1472LS	237	HMAVOMF	411	HMT2472E	58	HMVR-2460(?)-NS	69
HLSL4831MB	107, 240	HMBFLIP18L	59	HMT2472G	58	HMVR-2466(?)-AH	70
HLSLDRWORG	239	HMBFLIP18S	59	HMT3048E	58	HMVR-2466(?)-FX	68
HLTM	318	HMBFLIP24L	59	HMT3048G	58	HMVR-2466(?)-NS	69
HLTSM	320	HMBFLIP24S	59	HMT3060E	58	HMVR-2472(?)-AH	70
HLTV2460T-3	190	HMBFLIP30L	59	HMT3060G	58	HMVR-2472(?)-FX	68
HLTV2460TMOD-3	189	HMBFLIP30S	59	HMT3072E	58	HMVR-2472(?)-NS	69
HLTV2466T-33	190	HMBPOST	59	HMT3072G	58	HMVR-2484(?)-FX	68
HLTV2466TMOD-33	189	HMBTLEG18	59	HMT5	415	HMVR-2484(?)-NS	69
HLTVMODFULL	189	HMBTLEG24	59	HMTS01	264	HMVR-2496(?)-FX	68
HLTVMODPART	189	HMG1	420	HMTS11	264	HMVR-2496(?)-NS	69
HLVBC3330	199	HMG2	420	HMTUMOD26	71	HMVR-3036(?)-AH	70
HLVBC4330	199	HMG3	421	HMTUMOD32	61, 71	HMVR-3036(?)-FX	68
HLVBC5630	199	HMG4	421	HMTUMOD38	37, 71	HMVR-3036(?)-NS	69
HLVMSC3330R	197	HMG5	421	HMTUMOD44	61, 71	HMVR-3042(?)-AH	70
HLVMSC4330R	197	HMG7	421	HMTUMOD50	37, 71	HMVR-3042(?)-FX	68
HLVMSC5630R	197	HMG1	425	HMTUMOD56	71	HMVR-3042(?)-NS	69
HLVPM1	237	HMG2	425	HMTUMOD62	71	HMVR-3048(?)-AH	70
HLVPM2	238	HML1S	357	HMTUMOD74	71	HMVR-3048(?)-FX	68
HLVSC3330R	198	HML1SDF	360	HMTUMOD86	71	HMVR-3048(?)-NS	69
HLVSC4330R	198	HML2S	357	HMVH-2448(?)-FX	68	HMVR-3054(?)-AH	70
HLVSC5630R	198	HML2SDF	361	HMVH-2448(?)-NS	69	HMVR-3054(?)-FX	68
HLWBF1-1248W	195	HML2ST	359	HMVH-3060(?)-FX	68	HMVR-3054(?)-NS	69
HLWBF2-1248W	195	HML2STDF	363	HMVH-3060(?)-NS	69	HMVR-3060(?)-AH	70
HLWBS-248WT	195	HML3S	358	HMVH-3672(?)-FX	68	HMVR-3060(?)-FX	68
HLWBS-248WW	195	HML3SDF	362	HMVH-3672(?)-NS	69	HMVR-3060(?)-NS	69
HLWBS-448WT	195	HML8858	43	HMVMB-3072WWW	72	HMVR-3066(?)-AH	70
HLWBS-448WW	195	HMN1	423	HMVMB-3672WWW	72	HMVR-3066(?)-FX	68
HLWM	317	HMN2	423	HMVPC-DTLG	72	HMVR-3066(?)-NS	69

CROSS REFERENCE INDEX

MODEL	PAGE	MODEL	PAGE	MODEL	PAGE	MODEL	PAGE
HMVR-3072(?)-AH	70	HPATF	226	HSLMOCB2	461.7	HT29ALEG	92
HMVR-3072(?)-FX	68	HPHAP2028E	60	HSLMQCS	461.9	HT29ALM	92
HMVR-3072(?)-NS	69	HPHAP2028G	60	HSLMSB1	461.5	HT29FB3060	91
HMVR-3084(?)-FX	68	HPN1	450	HSLMSB2	461.5	HT29FB3672	91
HMVR-3084(?)-NS	69	HPN2	450	HSLMSS	461.5	HT29FB4284	91
HMVR-3096(?)-FX	68	HPPMMT	196	HSLMTCB1	461.8	HT29FB48108	91
HMVR-3096(?)-NS	69	HPWRMOB1	246, 280	HSLMTCB2	461.8	HT29FB48120	91
HMVR-3648(?)-AH	70	HPWRMOD2	246	HSLV2DAP	476	HT29FB48144	91
HMVR-3648(?)-FX	68	HPWRMOD2UWM	246	HSLV4DAP	476	HT29FB48168	90
HMVR-3648(?)-NS	69	HPWRMOD2WC	246	HSLVFAP	476	HT29FB48180	90
HMVR-3660(?)-AH	70	HPWRMOD3UWM	246	HSLVLMBR	476	HT29FB48192	90
HMVR-3660(?)-FX	68	HPWRMOD3WC	246	HSLVSMM	470	HT29FB48216	90
HMVR-3660(?)-NS	69	HPWRMOD4WC	246	HSLVSMMS	470	HT29FB48240	90
HMVR-3672(?)-AH	70	HQB	242	HSLVSMR	472	HT29FB4896	91
HMVR-3672(?)-FX	68	HQBCJ36	242	HSLVSMRS	472	HT29FBM	91
HMVR-3672(?)-NS	69	HQHI-3	242	HSLVSMU	474	HT36FB3060	91
HNL1530FD	106	HQH5-3	242	HSLVSMUS	474	HT36FB3672	91
HNL1530LD	105	HQH5-E-3PIE	242	HSLVTMM	469	HT36FB4284	91
HNL1530LL	105	HQH5-E-3PIU2B	242	HSLVTMMKD	475	HT36FB48108	91
HNL1536FD	106	HQH5-E-3P3B	242	HSLVTMMS	469	HT36FB48120	91
HNL1536LD	105	HQH5-P-3PIB	242	HSLVTMR	471	HT36FB48144	91
HNL1536LL	105	HQJ3	242	HSLVTMRKD	475	HT36FB48168	90
HNL1542FD	106	HQQ1	461	HSLVTMRS	471	HT36FB48180	90
HNL1542LD	105	HQQICUSH	461	HSLVTMU	473	HT36FB48192	90
HNL1542LL	105	HRUCKIL	457	HSLVTMUKD	475	HT36FB48216	90
HNL1548FD	106	HRUCKIW	458	HSLVTMUS	473	HT36FB48240	90
HNL1548LD	105	HRUCK5L	457	HSPMPWR-1P-2U	246	HT36FB4896	91
HNL1548LL	105	HRUCK5W	458	HSS4L-06A	185	HT36FBM	91
HNL1548SD	106	HSB50	261	HSS4L-12A	185	HT42AL60	92
HNL1560FD	106	HSB50DF	263	HSS4L-14A	185	HT42AL72	92
HNL1560LD	105	HSCASTER	309, 310, 321, 383, 396,	HSS4L-16B	185	HT42AL84	92
HNL1560LL	105		476, 500, 501, 520	HSS4L-18B	185	HT42AL96	92
HNL1560SD	106	HSCCR36BPG	112	HSS4L-24B	186	HT42ALEG	92
HNL1566FD	106	HSCCR36LM	112	HSS4L-30B	186	HT42FB3060	91
HNL1566LD	105	HSCCR36LMK	112	HSSA-WB1618	186	HT42FB3672	91
HNL1566LL	105	HSCCR48BPG	112	HSSCL-14A	187	HT42FB4284	91
HNL1566SD	106	HSCCR48LM	112	HSSCL-16B	187	HT42FB48108	91
HNL1572FD	106	HSCCR48LMK	112	HSSCL-18B	187	HT42FB48120	91
HNL1572LD	105	HSCCSR2448BPG	112	HSSST-18B	188	HT42FB48144	91
HNL1572LL	105	HSCCSR2448LM	112	HSSTK-18B	188	HT42FB48168	90
HNL1572SD	106	HSCCSR2448LMK	112	HT27FB3060	91	HT42FB48180	90
HNL1578FD	106	HSCCSS36BPG	112	HT27FB3672	91	HT42FB48192	90
HNL1578LD	105	HSCCSS36LM	112	HT27FB4284	91	HT42FB48216	90
HNL1578LL	105	HSCCSS36LMK	112	HT27FB48108	91	HT42FB48240	90
HNL1578SD	106	HSCCSS48BPG	112	HT27FB48120	91	HT42FB4896	91
HNL3630TB	240	HSCCSS48LM	112	HT27FB48144	91	HT42FBM	91
HNL3636TB	240	HSCCSS48LMK	112	HT27FB48168	90	HTALWMGR29	92
HNL4930TB	240	HSCER24BPG	113	HT27FB48180	90	HTALWMGR42	92
HNL4936TB	240	HSCER24LM	113	HT27FB48192	90	HTBINSLIDE	102
HNLMP3628	104	HSCER24LMK	113	HT27FB48216	90	HTFWMGR27	91
HNLMP5428	104	HSCCESS24BPG	113	HT27FB48240	90	HTFWMGR29	91
HNLMP7228	104	HSCCESS24LM	113	HT27FB4896	91	HTFWMGR36	91
HNLMP9028	104	HSCCESS24LMK	113	HT27FBM	91	HTFWMGR42	91
HNLRC2436	104	HSCS1	260	HT29AL108	92	HTFXL27	94
HNLRC2454	104	HSCSIDF	262	HT29AL120	92	HTFXL27C	94
HNLRC2472	104	HSCS2	261	HT29AL144	92	HTFXL27P	94
HNLRC2490	104	HSCS2DF	263	HT29AL168	92	HTFXL29	94
HNR1	438	HSGANG	260, 263	HT29AL180	92	HTFXL29C	94
HNR1KD	439	HSGS6	260	HT29AL192	92	HTFXL29P	94
HNR6	441	HSGS6DF	262	HT29AL216	92	HTFXL36	94
HNRS	440	HSLMCS	461.6	HT29AL240	92	HTFXL36C	94
HPACSM	225	HSLMGK	461.9	HT29AL60	92	HTFXL36P	94
HPACW	225	HSLMICB1	461.6	HT29AL72	92	HTFXL42	94
HPADD	226	HSLMICB2	461.6	HT29AL84	92	HTFXL42C	94
HPASD	226	HSLMOCB1	461.7	HT29AL96	92	HTFXL42P	94

CROSS REFERENCE INDEX

MODEL	PAGE	MODEL	PAGE	MODEL	PAGE	MODEL	PAGE
HTFXM27	94	HTLB12048P	108	HTLC4260LCTFPR	96	HTLHP144	88
HTFXM27C	94	HTLB1248LP	109	HTLC4260LCTHP	95	HTLHP168	88
HTFXM27P	94	HTLB14448P	108	HTLC4260LCTP	95	HTLHP180	88
HTFXM29	94	HTLB1448LP	109	HTLC4260LCTPL	96	HTLHP192	88
HTFXM29C	94	HTLB1648LP	109	HTLC4260LCTPR	96	HTLHP216	88
HTFXM29P	94	HTLB16848P	108	HTLC4272HCTFP	95	HTLHP240	88
HTFXM36	94	HTLB1848LP	109	HTLC4272HCTFPL	96	HTLHP84	88
HTFXM36C	94	HTLB2048LP	109	HTLC4272HCTFPR	96	HTLHP96	88
HTFXM36P	94	HTLBENCH30	101	HTLC4272HCTHP	95	HTLHPM	88
HTFXM42	94	HTLBENCH48	101	HTLC4272HCTP	95	HTLLECTA	101
HTFXM42C	94	HTLBENCH60	101	HTLC4272HCTPL	96	HTLM4272	86
HTFXM42P	94	HTLBENCHCUSH30	101	HTLC4272HCTPR	96	HTLM4872	86
HTFXS27	94	HTLBENCHCUSH48	101	HTLC4272LCTFP	95	HTLM5472	86
HTFXS27P	94	HTLBENCHCUSH60	101	HTLC4272LCTFPL	96	HTLM7248P	108
HTFXS29	94	HTLC3060HCTFP	97	HTLC4272LCTFPR	96	HTLMC1828DL	103
HTFXS29P	94	HTLC3060HCTFPL	98	HTLC4272LCTHP	95	HTLMC1828DR	103
HTFXS36	94	HTLC3060HCTFPR	98	HTLC4272LCTP	95	HTLMC1828L	103
HTFXS36P	94	HTLC3060HCTHP	97	HTLC4272LCTPL	96	HTLMC1828O	103
HTFXS42	94	HTLC3060HCTP	97	HTLC4272LCTPR	96	HTLMC1828R	103
HTFXS42P	94	HTLC3060HCTPL	98	HTLC4296HCTFP	95	HTLMT4260H	100
HTFXT27	94	HTLC3060HCTPR	98	HTLC4296HCTFPL	96	HTLMT4260HFR	100
HTFXT27P	94	HTLC3060LCTFP	97	HTLC4296HCTFPR	96	HTLMT4260L	100
HTFXT29	94	HTLC3060LCTFPL	98	HTLC4296HCTHP	95	HTLMT4272H	100
HTFXT29P	94	HTLC3060LCTFPR	98	HTLC4296HCTP	95	HTLMT4272HFR	100
HTG1PWR-3P-1B	247, 364	HTLC3060LCTHP	97	HTLC4296HCTPL	96	HTLMT4272L	100
HTG2PWR-3P-1E	247	HTLC3060LCTP	97	HTLC4296HCTPR	96	HTLMT4272L	100
HTG2PWR-3P-1U-W	247	HTLC3060LCTPL	98	HTLC4296LCTFP	95	HTLMT4272L	100
HTG2PWR-3P-2B-2U	247	HTLC3060LCTPR	98	HTLC4296LCTFPL	96	HTLMT4272L	100
HTG2PWR-4P-2B	247	HTLC3072HCTFP	97	HTLC4296LCTFPR	96	HTLMT4272L	100
HTGPWRKIA	125	HTLC3072HCTFPL	98	HTLC4296LCTHP	95	HTLMT4272L	100
HTL(?)24	87	HTLC3072HCTFPR	98	HTLC4296LCTP	95	HTLMT4272L	100
HTL(?)30	87	HTLC3072HCTHP	97	HTLC4296LCTPL	96	HTLMT4272L	100
HTL(?)3060	86	HTLC3072HCTP	97	HTLC4296LCTPR	96	HTLMT4272L	100
HTL(?)36	87	HTLC3072HCTPL	98	HTLCRED42	102	HTLMT4272L	100
HTL(?)3672	86	HTLC3072HCTPR	98	HTLCRED42S	102	HTLMT4272L	100
HTL(?)42	87	HTLC3072LCTFP	97	HTLCRED57	102	HTLMT4272L	100
HTL(?)42108	86	HTLC3072LCTFPL	98	HTLCRED57S	102	HTLMT4272L	100
HTL(?)42120	86	HTLC3072LCTFPR	98	HTLCRED72	102	HTLMT4272L	100
HTL(?)42144	86	HTLC3072LCTHP	97	HTLCRED72S	102	HTLMT4272L	100
HTL(?)42168	86	HTLC3072LCTP	97	HTLCUBE108	89	HTLMT4272L	100
HTL(?)42180	86	HTLC3072LCTPL	98	HTLCUBE120	89	HTLMT4272L	100
HTL(?)42192	86	HTLC3072LCTPR	98	HTLCUBE144	89	HTLMT4272L	100
HTL(?)42216	86	HTLC3096HCTFP	97	HTLCUBE168	89	HTLMT4272L	100
HTL(?)42240	86	HTLC3096HCTFPL	98	HTLCUBE180	89	HTLMT4272L	100
HTL(?)4284	86	HTLC3096HCTFPR	98	HTLCUBE192	89	HTLMT4272L	100
HTL(?)4296	86	HTLC3096HCTHP	97	HTLCUBE216	89	HTLMT4272L	100
HTL(?)48	87	HTLC3096HCTP	97	HTLCUBE240	89	HTLMT4272L	100
HTL(?)48108	86	HTLC3096HCTPL	98	HTLCUBE48	93	HTLMT4272L	100
HTL(?)48120	86	HTLC3096HCTPR	98	HTLCUBE84	89	HTLMT4272L	100
HTL(?)48144	86	HTLC3096LCTFP	97	HTLCUBE96	89	HTLMT4272L	100
HTL(?)48168	86	HTLC3096LCTFPL	98	HTLCUBEM	89	HTLMT4272L	100
HTL(?)48180	86	HTLC3096LCTFPR	98	HTLCUBES108	89	HTLMT4272L	100
HTL(?)48192	86	HTLC3096LCTHP	97	HTLCUBES120	89	HTLMT4272L	100
HTL(?)48216	86	HTLC3096LCTP	97	HTLCUBES144	89	HTLMT4272L	100
HTL(?)48240	86	HTLC3096LCTPL	98	HTLCUBES168	89	HTLMT4272L	100
HTL(?)4896	86	HTLC3096LCTPR	98	HTLCUBES180	89	HTLMT4272L	100
HTL(?)54108	86	HTLC4260HCTFP	95	HTLCUBES192	89	HTLMT4272L	100
HTL(?)54120	86	HTLC4260HCTFPL	96	HTLCUBES216	89	HTLMT4272L	100
HTL(?)54144	86	HTLC4260HCTFPR	96	HTLCUBES240	89	HTLMT4272L	100
HTL(?)54168	86	HTLC4260HCTHP	95	HTLCUBES48	93	HTLMT4272L	100
HTL(?)54180	86	HTLC4260HCTP	95	HTLCUBES96	89	HTLMT4272L	100
HTL(?)54192	86	HTLC4260HCTPL	96	HTLCUBESM	89	HTLMT4272L	100
HTL(?)54216	86	HTLC4260HCTPR	96	HTLD60	87	HTLMT4272L	100
HTL(?)54240	86	HTLC4260LCTFP	95	HTLHP108	88	HTLMT4272L	100
HTLB1048LP	109	HTLC4260LCTFPL	96	HTLHP120	88	HTLMT4272L	100

CROSS REFERENCE INDEX

MODEL	PAGE	MODEL	PAGE	MODEL	PAGE	MODEL	PAGE
HTLRC48	93	HTLSCURNDT18HWL	122	HTLXP48	93	HVL511	487
HTLRC84	89	HTLSCURNDT18LML	121	HTMC304260	99	HVL515	487
HTLRC96	89	HTLSCURNDT18LWL	122	HTMC304260BB	99	HVL531	454
HTLRCM	89	HTLSCURNDT18MML	121	HTMC304272	99	HVL532	454
HTLRM	89	HTLSCURNDT18MWL	122	HTMC304272BB	99	HVL539	454
HTLSCULPIL1630LML	117	HTLSCURNDT30LML	121	HTMC304296	99	HVL581	311
HTLSCULPIL1630LWL	118	HTLSCURNDT30LWL	122	HTMC304296BB	99	HVL582	311
HTLSCULPIL1630MML	117	HTLSCUSQRPLNT15H	124	HTMC424260	99	HVL585	311
HTLSCULPIL1630MWL	118	HTLSCUSQRPLNT15L	124	HTMC424260BB	99	HVL601	518
HTLSCULPIL1660LML	117	HTLSCUSQRPLNT30L	124	HTMC424272	99	HVL606	459
HTLSCULPIL1660LWL	118	HTLSCUSQRT16LML	121	HTMC424272BB	99	HVL616	459
HTLSCULREC1630LML	117	HTLSCUSQRT16LWL	122	HTMC424296	99	HVL653	519
HTLSCULREC1630LWL	118	HTLSCUSQRT18MML	121	HTMC424296BB	99	HVL685	488
HTLSCULREC1630MML	117	HTLSCUSQRT18MWL	122	HTPCIF48	280	HVL701	502
HTLSCULREC1630MWL	118	HTLSCUSQRT20HML	121	HTPCIF72	280	HVL702	502
HTLSCULREC1660LML	117	HTLSCUSQRT20HWL	122	HTPHWIF72	280	HVL705	502
HTLSCULREC1660LWL	118	HTLSCUSQRT30LML	121	HTPKIT48	280	HVL712	502
HTLSCULRND16HML	117	HTLSCUSQRT30LWL	122	HTPKIT482	280	HVLVL1	447
HTLSCULRND16HWL	118	HTLSCUWPIL1630LML	119	HTPKIT60	280	HVLVL2	447
HTLSCULRND16LML	117	HTLSCUWPIL1630LWL	120	HTPKIT602	280	HVLVL3	447
HTLSCULRND16LWL	118	HTLSCUWPIL1630MML	119	HTPKIT72	280	HVLVLOT	447
HTLSCULRND16MML	117	HTLSCUWPIL1630MWL	120	HTPKIT722	280	HWHIC	512
HTLSCULRND16MWL	118	HTLSCUWPIL1660LML	119	HTPLATEVHAU	248	HWHICCF	512
HTLSCULRND30LML	117	HTLSCUWPIL1660LWL	120	HTPSPLIT	280	HWHISP	506
HTLSCULRND30LWL	118	HTLSCUWREC1630LML	119	HTRACK	102	HWHISPCF	507
HTLSCULSQR13LML	117	HTLSCUWREC1630LWL	120	HTSSRD	338	HWHISS	506
HTLSCULSQR13LWL	118	HTLSCUWREC1630MML	119	HTTLEG108	92	HWHISSCF	507
HTLSCULSQR16MML	117	HTLSCUWREC1630MWL	120	HTTLEG120	92	HWHITCP	513
HTLSCULSQR16MWL	118	HTLSCUWREC1660LML	119	HTTLEG144	92	HWHITCPCF	514
HTLSCULSQR20HML	117	HTLSCUWREC1660LWL	120	HTTLEG168	92	HWHITCS	513
HTLSCULSQR20HWL	118	HTLSCUWRND16HML	119	HTTLEG180	92	HWHITCSCF	514
HTLSCULSQR30LML	117	HTLSCUWRND16HWL	120	HTTLEG192	92	HWH2SP	508
HTLSCULSQR30LWL	118	HTLSCUWRND16LML	119	HTTLEG216	92	HWH2SPCF	509
HTLSCUPERTBL	123	HTLSCUWRND16LWL	120	HTTLEG240	92	HWH2SS	508
HTLSCUPILCNLS1253	123	HTLSCUWRND16MML	119	HTTLEG60	92	HWH2SSCF	509
HTLSCUPILT1830LML	121	HTLSCUWRND16MWL	120	HTTLEG72	92	HWH3SP	510
HTLSCUPILT1830LWL	122	HTLSCUWRND30LML	119	HTTLEG84	92	HWH3SPCF	511
HTLSCUPILT1830MML	121	HTLSCUWRND30LWL	120	HTTLEG96	92	HWH3SS	510
HTLSCUPILT1830MWL	122	HTLSCUWSQR13LML	119	HTTLEGM	92	HWH3SSCF	511
HTLSCUPILT1860LML	121	HTLSCUWSQR13LWL	120	HTXLEG	94	HWHACPP	516
HTLSCUPILT1860LWL	122	HTLSCUWSQR16MML	119	HTXLEGSH	94	HWHACPS	516
HTLSCURECCNSL1253	123	HTLSCUWSQR16MWL	120	HUMPWR-1P-2U	246, 280	HWHBCPP	516
HTLSCURECT1830LML	121	HTLSCUWSQR20HML	119	HV-UT1	239	HWHBCPS	516
HTLSCURECT1830LWL	122	HTLSCUWSQR20HWL	120	HVL108	312	HWHGB	516
HTLSCURECT1830MML	121	HTLSCUWSQR30LML	119	HVL151	517	HWHLP	515
HTLSCURECT1830MWL	122	HTLSCUWSQR30LWL	120	HVL232	404	HWHSP18	515
HTLSCURECT1860LML	121	HTLSHELF	102	HVL238	404	HWMCLIPLG	249
HTLSCURECT1860LWL	122	HTLXP36	93	HVL402	518	HWMCLIPSM	249
HTLSCURNDT18HML	121	HTLXP42	93				

INFORMATION ON ORDERING PARTS

When parts are needed to repair HON products, the following guidelines should be followed to expedite the process.

1. Warranty orders are submitted on HON Ready via the Quick Claim tool.
2. There are no discounts applied to parts. Pricing quoted is the net value. Parts pricing is subject to change without notice.
3. For a part not covered by warranty applicable shipping charges will apply.
4. All keys are \$6.00 each plus a shipping and handling fee of \$3.00 per shipping location.
5. Parts may be paid for with an approved credit card. Approved Cards: MasterCard, VISA and American Express.
6. Payment terms for invoiced parts are Net 30 days.
7. Due to short leadtimes on parts, no changes will be accepted after the order has been placed.
8. When placing a **warranty** parts order:

If the product is under warranty, the product serial number must be provided. Most finished goods products have a serial number placed on them at the factory. The label containing the serial number is located:

Vertical Files — right side of the uppermost drawer

Lateral Files — left side of the uppermost drawer or shelf

Desk Towers — outside of top drawer

Desks, Credenzas, & Returns — on the outside, kneespace side of the top drawer. Fully extend the drawer to find it.

Desks, Credenzas, Corner Units, Bridges, Peninsulas & Returns without drawers — underside of top

Tables and Stands — underside of the top

Table Trucks — underside of side rail

Cabinets & Bookcases — left inner side of the case

Modular Component Top and Backs — underside of top

Modular End Panels — top inside surface

Reception Stations — top inside surface of back panel

Organizers — top inside surface of left end panel near back panel

Vertical Paper Manager — back panel inside surface near top

Pedestals — bottom drawer right side exterior

Seating — underside of the seat

Panels — underside of the top cap

Hutches, Storage Units, Overhead Storage — underside of the shelf

Hanging Bookshelves — underside of shelf

NOTE: Removal of the serial number tag from the product voids the warranty.

An important note regarding Product Serial Numbers:

HON desks, tables, chairs, files and systems components are tagged with a serial number. This number helps us identify *when and where your product was made*, and to identify and correct the root causes for the problem. NEITHER THE DEALER NOR THE CONSUMER SHOULD REMOVE THIS TAG UNDER ANY CIRCUMSTANCES. To do so immediately voids your Warranty coverage for that particular item *and prevents us from further identifying it*. Instead, please transcribe the number and call your Dealer.