

Make your space work.

HON®



2021 List Pricer

WORKSPACES

Desks | Workstations | Storage | Universal Screens

Effective Date
October 2021

LIST PRICER

Effective Date: October 2021

- All illustrations and specifications in this publication are based on the latest product information available at the time of print. For the most recent version, please go to www.hon.com.
- Software support packages furnished to the customer, either by The HON Company or by another source, which support the sale of HON products are superseded by printed price lists.
- All dimensions shown in this publication are nominal.
- Pricing is subject to change without notice.
- All orders are subject to prices in effect at the time of order.
- Ordering information appears at the beginning of a section complete with examples on how to specify. These specifying information pages are referenced at the bottom center of product pages.
- HON Full Lifetime Warranty applies unless otherwise noted.
- HON nationwide customer service:
Phone: (800) 833-3964

HON LIST PRICER

Table of Contents

INTRODUCTION

Table of Contents.....	1-4
Additions.....	5-6
Discontinuations.....	7
HON Full Lifetime Warranty Information.....	8
HON Limited 5-Year Warranty Information.....	9
Ordering Information.....	10
Integrated Design Solutions.....	11
Tailored Solutions Ordering Information.....	12
Customer's Own Material Ordering Information.....	13-14
Partnership Textile Information.....	15
Paint Program.....	16
Environmental Statement.....	17
Important Information.....	18
Legend.....	19
Fabric Patterns & Codes.....	20
Lead Times.....	21
Fabric Patterns & Codes.....	22-24
Panel Fabric Patterns & Codes.....	25-26

DESKS

Features Offered on HON Laminate Caseloads.....	27
Concinnity™	28
Concinnity™ Ordering Information	29
Concinnity™ Laminate Design/Materials Information	30-31
Concinnity™ Laminate Ordering/Specification Information	32-33
Concinnity™ Cord Management.....	34-35
Concinnity™ Typicals.....	36-40
Concinnity™ Desks.....	41-43
Concinnity™ Peninsulas.....	44-45
Concinnity™ Corner Unit.....	46
Concinnity™ Credenzas.....	47
Concinnity™ Low Credenzas.....	48
Concinnity™ Returns.....	49
Concinnity™ Bridges.....	50
Concinnity™ Stack-on Storage Applications	51-52
Concinnity™ Stack-on Storage.....	53-57
Concinnity™ Wall Mount Storage Applications	58-59
Concinnity™ Wall Mount Storage.....	60-63
Concinnity™ Bookcase Hutches.....	64-65
Concinnity™ Reception Stations.....	66-68
Concinnity™ Mobile Pedestals.....	69
Concinnity™ Lateral Files.....	70
Concinnity™ Storage Cabinets.....	71-72
Concinnity™ Wardrobes.....	73
Concinnity™ Storage Towers.....	74
Concinnity™ Bookcases.....	75
Concinnity™ Components	76-77
Concinnity™ Components — Worksurfaces.....	78-81
Concinnity™ Components — Supports.....	82
Concinnity™ Components — Modesty/Back Panels.....	83
Concinnity™ Modesty/Back Panels.....	84-86
Concinnity™ Components — Supports.....	87
Concinnity™ Kneespace Clearance End Panels.....	88
Concinnity™ Components — Supports.....	89-94
Concinnity™ Height Adjustable Bases.....	95

Concinnity™ Components — Privacy Screens.....	96
Concinnity™ Privacy Screens.....	97
Concinnity™ Components — Supports.....	98-101
Concinnity™ Components — Pedestal Tops.....	102
Concinnity™ Components — Pedestal Back Panels.....	103
Concinnity™ Accessories.....	104-105
Concinnity™ Accessories — Cable Management & Electrical.....	106-107
Concinnity™ Accessories — Paper Organizers.....	108
Concinnity™ Paper Organizer Compatibility.....	109
Concinnity™ Accessories — Lock Kits.....	110
Concinnity™ Accessories — Task Lights.....	111
Concinnity™ Accessories.....	112-114
Coordinate™	115
Coordinate™ Ordering Information	116
Coordinate™ Height Adjustable Bases.....	117
Coordinate™ Worksurfaces.....	118-120
Coordinate™ Screens.....	121
Coordinate™ Accessories.....	122
Coordinate™ Worksurfaces.....	123
Systems Worksurfaces — 120 Degree Corner.....	124
Coordinate™ Shared Components.....	125
Coordinate™ Accessories.....	126-127
Coze™	128
Coze™ Table Desks.....	129-130
Mod	131
Mod Ordering Information	132
Mod Laminate Grain Direction	133
Mod Typicals.....	134-136
Mod Bundles Typicals.....	137-139
Mod Laminate Modular Components.....	140-141
Mod Laminate Modular Storage Components.....	142-144
Mod Laminate and Metal Desk Modular Components.....	145
Mod Laminate Modular Storage Components.....	146
Mod Conference Table Modular Components.....	147
Mod Reception Modular Components.....	148
Valido™	149
Valido™ Ordering Information	150
Valido™ Typicals.....	151-153
Valido™ Laminate Modular Desks.....	154
Valido™ Modular Credenzas.....	155
Valido™ Modular Returns.....	156
Valido™ Laminate Modular Components.....	157-158
Valido™ Laminate Wood Desks — Full Pedestals.....	159-160
Valido™ Laminate Wood Desks — 3/4 Pedestals.....	161-162
Valido™ Shared Components & Accessories.....	163-179
Valido™ Accessories.....	180-181
Voi™	182
Voi™ Ordering Information	183
Voi™ Laminate Typicals.....	184-189
Voi™ Bundles Typicals.....	190-192
Voi™ Specifying/Design Guide	193-197
Voi™ Laminate Worksurfaces — Rectangle.....	198-200
Voi™ Worksurface Supports.....	201-203
Voi™ Standing-Height Worksurface Supports.....	204
Voi™ Standing-Height Laminate Support.....	205

Voi™ — Coordinate™ Sit-to-Stand Worksurfaces.....	206
Voi™ Height Adjustable Bases.....	207
Voi™ Laminate Support/Support Pedestals.....	208
Voi™ Laminate Support/Support Storage.....	209
Voi™ Modesty Panels.....	210-211
Voi™ Privacy Screens.....	212-214
Voi™ Laminate Overhead Storage.....	215
Voi™ Laminate Overhead and Stack-on Storage.....	216
Voi™ Laminate Shared Overhead Storage Components.....	217
Voi™ Overhead Storage Supports/Accessories.....	218
Voi™ Laminate Stack-on Storage — Built-up.....	219
Voi™ Laminate Low Credenzas.....	220-221
Voi™ Laminate Low Footed Credenzas.....	222-223
Voi™ Laminate Credenzas.....	224
Voi™ Laminate Mobile Storage.....	225
Voi™ Laminate Storage.....	226
Voi™ Laminate Storage Cubes.....	227
Voi™ Laminate Storage Cube Bundles.....	228
Voi™ Laminate Storage Towers.....	229-231
Voi™ Laminate Storage.....	232
Voi™ Laminate Bookcases.....	233
Voi™ Accessories.....	234-240
Voi™ Softwire Electrical Components.....	241
Voi™ Electrical Components.....	242-243
Workwall™	245
Workwall Ordering Information	246
Workwall Statement of Line	247
Workwall Specifying/Design Guide	248-252
Workwall Typicals.....	253-255
Workwall Fabric Tiles.....	256-257
Workwall Glass Markerboard Tiles.....	258
Workwall Laminate Tiles.....	259
Workwall Laminate Media Tiles.....	260
Workwall Painted Metal Tiles.....	261
Workwall Slotted Tool Tiles.....	262
Workwall Accessories.....	263-264
10500 Series™	265
10500 Series™ Ordering Information	266-267
10500 Series™ Typicals.....	268-270
10500 Series™ Bundles Typicals.....	271-273
10500 Series™ Laminate Modular Components.....	274-278
10500 Series™ Worksurfaces.....	279
10500 Series™ Worksurface Supports.....	280-284
10500 Series™ Components — Supports.....	285
10500 Series™ Height Adjustable Bases.....	286
10500 Series™ Shared Components.....	287-288
10500 Series™ Laminate Modular Components.....	289-291
10500 Series™ Laminate Wood Desks — Full Pedestals.....	292-295
10500 Series™ Laminate Wood Desks — 3/4 Pedestals.....	296-297
10500 Series™ Shared Components & Accessories.....	298-308
10500 Series™ Storage.....	309
10500 Series™ Shared Components & Accessories.....	310-320
10500 Series™ Laminate Occasional Tables.....	321

For information regarding HON registered and unregistered trademarks, please go to hon.com/protected-marks. Haworth®, Herman Miller®, Knoll®, and Steelcase® are registered trademarks of their respective owners and use of the marks do not imply affiliation or endorsement of The HON Company or its products.

LIST PRICER

Effective Date: October 2021

- All illustrations and specifications in this publication are based on the latest product information available at the time of print. For the most recent version, please go to www.hon.com.
- Software support packages furnished to the customer, either by The HON Company or by another source, which support the sale of HON products are superseded by printed price lists.
- All dimensions shown in this publication are nominal.
- Pricing is subject to change without notice.

- All orders are subject to prices in effect at the time of order.
- Ordering information appears at the beginning of a section complete with examples on how to specify. These specifying information pages are referenced at the bottom center of product pages.
- HON Full Lifetime Warranty applies unless otherwise noted.
- HON nationwide customer service:
Phone: (800) 833-3964

HON LIST PRICER

Table of Contents

10500 Series™ Shared Components & Accessories.....	322-325	Abound® Working with Tiles	437	Empower® 60"W Typical with 24"D Worksurfaces.....	509-510
10500 Series™ Accessories.....	326-327	Abound® Gallery Panels Overview.....	438-443	Empower® 72"W Typical with 30"D Worksurfaces.....	511-512
10700 Series™	328	Abound® Systems Electrical and Data.....	444	Empower® 60"W Typical with 30"D Worksurfaces.....	513-514
10700 Series™ Ordering Information	329	Abound® Panel Frames.....	445-446	Empower® 120° Workstation Typical.....	515-516
10700 Series™ Typical.....	330-332	Abound® Open Base Panel Frames.....	447	Empower® 72"W Height Adjustable Typical with 24"D Worksurfaces.....	517-518
10700 Series™ Bundles Typical.....	333-335	Abound® Stacking Panel Frames.....	448	Empower® 60"W Height Adjustable Typical with 24"D Worksurfaces.....	519-520
10700 Series™ Laminate Modular Components.....	336-341	Abound® Stiffener Supports.....	449	Empower® 72"W Height Adjustable Typical with 30"D Worksurfaces.....	521-522
10700 Series™ Laminate Wood Desks — Full Pedestals.....	342-343	Abound® Panel Door.....	450	Empower® Legs for Linear Applications.....	525
10700 Series™ Laminate Wood Desks — 3/4 Pedestals.....	344-345	Abound® Sliding Door.....	451	Empower® Legs for 120° Applications.....	526
10700 Series™ Shared Components and Accessories.....	346-358	Abound® Connectors.....	452-453	Empower® Support Beams.....	527
10700 Series™ Accessories.....	359-360	Abound® Variable Height Finished End and Wall Starter Kits.....	454	Empower® Wire Troughs.....	528
94000 Series™	361	Wall Hanger Bars and Off-Module Bracket.....	455	Empower® Return Components.....	529
94000 Series™ Typical.....	362-363	Abound® Tackable Acoustical Tiles.....	456-457	Empower® Systems Worksurfaces.....	530
94000 Series™ Laminate Wood Desks.....	364-369	Abound® Power/Data Fabric Tiles.....	458-459	Systems Worksurfaces — 120 Degree Corner.....	531
94000 Series™ Accessories.....	370-372	Abound® Hard-surface Tiles.....	460	Empower® Height Adjustable Bases.....	532
Mentor®	373	Abound® Clear Glass Tiles.....	461	Empower® Height Adjustable Worksurfaces.....	533
Mentor® Ordering Information	374	Abound® Frosted Glass Tiles.....	462	Empower® Side Screens.....	534
Mentor® Steel Desks.....	375-376	Abound® Frameless Glass.....	463	Empower® Center Screens Fabric.....	535
Mentor® Accessories.....	377-379	Abound® Pass-thru Tiles.....	464	Empower® Center Screens Frosted Glass.....	536
Metro Classic	380	Abound® Slotted Tool Tiles.....	465	Empower® Modesty Panels/End of Run Screens.....	537
Metro Classic Ordering Information	381	Systems Paper Management Support Bar.....	465	Empower® Typical.....	538
Metro Classic Steel Desks.....	382-383	Systems Paper Management Accessories.....	466	Empower® Height Adjustable Typical.....	539
Metro Classic Accessories.....	384-386	Abound® Markerboard Tiles.....	467	Empower® Electrical Specifying Information	540-543
34000 Series	387	Abound® Painted Metal Tiles.....	468	Empower® Electrical and Data.....	544-545
34000 Series Ordering Information	388	Abound® Custom Material Bracket Kit.....	469	Empower® Electrical Accessories.....	546
34000 Series Steel Desks.....	389	Abound® Gallery Panels — Wing.....	470	Empower® — Voi® Laminate Low Credenzas.....	547-548
34000 Series Accessories.....	390-392	Abound® Gallery Panels — Wing, Accepts Glass.....	471	Empower® — Voi® Laminate Mobile Storage.....	549
38000 Series™	393	Abound® Gallery Glass.....	472	Empower® — Voi® Laminate Storage Towers.....	550-551
38000 Series™ Ordering Information	394	Abound® Gallery Connector Kits.....	473	Empower® — Contain® Metal Credenzas.....	552
38000 Series™ Typical — 3/4 Height Pedestals.....	395	Abound® Gallery Panel Tackboards.....	474	Empower® — Contain® Footed Metal Credenzas.....	553
38000 Series™ Typical — Modular.....	396	Abound® Gallery-to-Gallery Connections.....	475-478	Empower® — Contain® Metal Credenzas with Laminate Fronts.....	554
38000 Series™ Bundles Typical.....	397-398	Abound® Height Adjustable Tie-In Brackets.....	479	Empower® — Contain® Footed Metal Credenzas with Laminate Fronts.....	555
38000 Series™ Steel Desks — 3/4 Pedestals.....	399	Accelerate®	480	Empower® — Contain® Metal Credenzas Accessories.....	556
38000 Series™ Modular Desks.....	400	Accelerate® Ordering Information	481	Empower® — Contain® Metal Personal Towers.....	557
38000 Series™ Shared Components and Accessories.....	401	Accelerate® Fabric Patterns & Codes	482-483	Empower® — Contain® Metal Personal Towers with Laminate Fronts.....	559
38000 Series™ Accessories.....	402-404	Accelerate® Typical.....	484-485	Empower® — Contain® Metal Side Access Towers.....	560
38000 Series™ Steel Stack-on Units.....	405-406	Accelerate® Panels Overview.....	486-487	Empower® — Contain® Footed Metal Personal Towers.....	561
38000 Series™ Accessories.....	407	Accelerate® Working with Panels.....	488	Empower® — Contain® Footed Metal Side Access Towers.....	562
WORKSTATIONS		Accelerate® Connector Overview.....	489	Empower® — Contain® Footed Metal Personal Towers with Laminate Fronts.....	563
Abode™	409	Accelerate® Tackable Raceway Panels.....	490	Empower® — Contain® Footed Metal Side Access Towers.....	564
Abode™ Ordering Information	410	Accelerate® Top-Tier Glass Panels.....	491	Empower® — Contain® Metal Pedestals.....	565
Abode™.....	411-412	Accelerate® Panel Door.....	492		
Abode™ Typical.....	413-417	Accelerate® Top Caps.....	493		
Abode™ Components.....	418-421	Accelerate® Stacking Panels.....	494-495		
Abound®	422	Accelerate® Frameless Glass.....	496		
Abound® Ordering Information	423	Accelerate® Strengthened Connection Posts.....	497		
Abound® Fabric Patterns & Codes	424-425	Accelerate® Strengthened Connections — Connector Straps.....	498		
Abound® Typical.....	426-427	Accelerate® Variable Height Finished End and Wall Starter Kits.....	499		
Abound® Open Base Typical.....	428	Accelerate® Bracket Kits and Stability Feet.....	500		
Abound® Frames Overview.....	429-432	Empower®	501		
Abound® Connector Overview.....	433	Empower® Fabric Screens — All Panel Models	502-503		
Abound® Tile Overview.....	434	Empower® Finish Options	504		
Abound® Specifying/Design Guide	435-436	Empower® Step-by-Step Guide	505		
		Empower® 72"W Typical with 24"D Worksurfaces.....	506-508		

For information regarding HON registered and unregistered trademarks, please go to hon.com/protected-marks. Haworth®, Herman Miller®, Knoll®, and Steelcase® are registered trademarks of their respective owners and use of the marks do not imply affiliation or endorsement of The HON Company or its products.

LIST PRICER

Effective Date: October 2021

- All illustrations and specifications in this publication are based on the latest product information available at the time of print. For the most recent version, please go to www.hon.com.
- Software support packages furnished to the customer, either by The HON Company or by another source, which support the sale of HON products are superseded by printed price lists.
- All dimensions shown in this publication are nominal.
- Pricing is subject to change without notice.
- All orders are subject to prices in effect at the time of order.
- Ordering information appears at the beginning of a section complete with examples on how to specify. These specifying information pages are referenced at the bottom center of product pages.
- HON Full Lifetime Warranty applies unless otherwise noted.
- HON nationwide customer service:
Phone: (800) 833-3964

HON LIST PRICER

Table of Contents

Empower® — Contain® Footed Metal Pedestals.....	566	Versé®	645	Contain® Footed Metal Pedestals with	
Empower® — Contain® Metal Pedestals		Versé® Panel System.....	646-649	Laminate Fronts.....	703-704
with Laminate Fronts.....	567			Flagship®	705
Empower® — Contain® Footed Metal Pedestals		STORAGE		Flagship® Ordering Information	706
with Laminate Fronts.....	568	Overview of Personal Storage and Pedestals	650	Flagship® Hanging and Standard Height	
Empower® — Flagship® Mobile Pedestals.....	569	HON Lateral Files at a Glance.....	651	Pedestals.....	707
Empower® Workplace Tools.....	570	HON Vertical Files at a Glance.....	652	Flagship® Mobile Pedestals.....	708
Empower® Accessories.....	571	Storage and Files Ordering Information	653	Flagship® 18" Deep Lateral Files with Drawers.....	709
Gravitation™ Power Beam	572	Brigade®	654	Flagship® Lateral File with Storage.....	710
Gravitation™ Power Beam Ordering		Brigade® Ordering Information	655	Flagship® Modular Storage.....	711
Information	573-574	Brigade® Standard Height Pedestals.....	656	Flagship® Bookcases.....	712
Gravitation™ 48"W Bundles.....	575	Brigade® 800 Series Lateral Files w/Drawers.....	657	Flagship® Storage Cabinets.....	713
Gravitation™ 60"W Bundles.....	576	Brigade® 800 Series Lateral Files w/Storage.....	658	Flamesafe™ Ordering Information	714
Gravitation™ 72"W Bundles.....	577	Brigade® 700 Series Lateral Files w/Drawers.....	659	FlameSafe™ Fire-Resistant Files.....	715
Gravitation™ Power Beam.....	578-580	Brigade® 700 Series Lateral Files w/Storage.....	660	Fuse™	716
Gravitation™ Power Beam Electrical.....	581	Brigade® 600 Series Lateral Files w/Drawers.....	661	Fuse™ Ordering Information	717
Gravitation™ Power Beam Screens.....	582	Brigade® Metal Dividers.....	662	Fuse™ Pedestals.....	718
Systems Shared Components	583	Brigade® Steel Bookcases.....	663	Fuse™ Digital Lock Specifications.....	719
Systems Overhead and Shelves Specifying	584-585	Brigade® Storage Cabinets.....	664	Fuse™ Mobile Pedestals.....	720
Systems Overhead and Shelves.....	586	Contain®	665	Fuse™ Mobile Pedestals with eLock.....	721
Systems ETA Overheads and Shelves.....	587	Contain® Ordering Information	666	Fuse™ Freestanding Pedestals.....	722
Systems Overhead Storage.....	588	Contain® Metal Storage	667	Fuse™ Freestanding Pedestals with eLock.....	723
Systems Laminate Front Overhead Storage.....	589	Contain® Metal Credenzas.....	668	Fuse™ Pedestal Cushion.....	724
Voi® Overhead Storage.....	590-591	Contain® Footed Metal Credenzas.....	669	Fuse™ Undermount Storage.....	725
Voi® Overhead and Stack-on Storage.....	592	Contain® Metal Credenzas with Laminate		Fuse™ Workplace Tools.....	726
Voi® Shared Overhead Storage Components.....	593	Fronts.....	670	Storage Islands	727
Systems Overhead and Shelves.....	594	Contain® Footed Metal Credenzas with		Storage Islands Ordering Information	728
Systems Accessories.....	595-596	Laminate Fronts.....	671	Storage Islands Specifying Guide.....	729-730
Abound® Electrical and Data.....	597-599	Contain® Personal Files.....	672	Storage Islands Planning Typical.....	731-732
Accelerate® Electrical and Data.....	600-601	Contain® Lateral Files.....	673	Storage Islands Specifying Guide.....	733
Systems Electrical and Data.....	602	Contain® Lateral File Accessories.....	674	Storage Islands Top Only Applications.....	734
Systems Electrical Specifying Information	603-605	Contain® Metal Credenzas Accessories.....	675-676	Storage Islands Tops for Use with 2 End Panels.....	735
Working with Cable Management.....	606	Contain® Towers.....	677	Storage Islands Tops for Use with 2 End Panels	
Systems Electrical Components.....	607-612	Contain® Lockers & Wardrobes.....	678	and Back/Septum.....	736
Systems Electrical and Data.....	613	Contain® Digital Lock Specifications.....	679	Storage Islands — Islands Tops for Use with 1 End	
Systems Working with Worksurfaces		Contain® Metal Personal Towers.....	680	Panel and Septum.....	737
and Supports.....	614-616	Contain® Metal Side Access Towers.....	681	Storage Islands — Islands Septum/Back and End	
Systems Worksurfaces — Primary.....	617-618	Contain® Metal Personal Towers with		Panels.....	738
Systems Worksurfaces — Wedge.....	619	Laminate Fronts.....	682	Storage Islands Peninsula Supports.....	739
Systems Worksurfaces — Corner.....	620-621	Contain® Metal Side Access Towers with		400 Series	740
Systems Worksurfaces — 120 Degree Corner.....	622	Laminate Fronts.....	683	400 Series Lateral Files.....	741
Systems Worksurfaces — Corner Cove.....	623-624	Contain® Footed Metal Personal Towers.....	684	Vertical Files	742
Systems Worksurfaces — Jetty / Peninsula.....	625	Contain® Footed Metal Side Access Towers.....	685	Vertical Files Ordering Information	743
Systems Worksurfaces — Half-Round /		Contain® Footed Metal Personal Towers with		210 Series Vertical Files — 28½"D.....	744
Quarter Round / 60° Wedge.....	626	Laminate Fronts.....	686	310 Series Vertical Files — 26½"D.....	745
Systems Countertops — Straight and Corner.....	627-628	Contain® Footed Metal Side Access Towers with		510 Series Vertical Files — 25"D.....	746
Systems Shelves — Corner Shelves.....	629	Laminate Fronts.....	687	Lateral File Accessories.....	747
Systems Worksurface Supports.....	630-632	Contain® 18"W Slim Metal Personal Towers.....	688-689	Vertical File Accessories.....	748
Worksurface Brackets.....	633	Contain® 18"W Slim Personal Towers with		Mobile Pedestals.....	749
Systems Worksurface Supports.....	634	Laminate Fronts.....	690-691	Pedestal Accessories.....	750-751
Standing-Height Worksurface Supports.....	635	Contain® Wardrobes.....	692-693	Laminate Bookcases	752
Systems Standard Height Support Pedestals.....	636	Contain® Metal Lockers.....	694	Bookcases Ordering Information	753
Voi® Laminate Support Pedestals.....	637	Contain® Metal Lockers with Laminate Fronts.....	695	10500 Series™ Laminate Bookcases.....	754
Voi® Laminate Support Storage.....	638	Contain® Metal Lockers with eLock.....	696	1870 Series Laminate Bookcases.....	755
Systems Accessories — Paper Management /		Contain® Metal Lockers with Laminate Fronts		UNIVERSAL SCREENS	
Markerboards.....	639	and eLock.....	697	Acoustic Solutions by unika vaev	757
Systems Accessories — Task Lights.....	640	Contain® eLock Accessories.....	698	Acoustic Solutions Ordering Information	758-759
Systems Accessories — Electrical.....	641	Contain® Metal Pedestals.....	699	Acoustic Solutions Wall.....	760
Systems Accessories — Monitor Arms.....	642	Contain® Footed Metal Pedestals.....	700-701	Acoustic Solutions Ceiling Tiles and Screens.....	761
Systems Accessories.....	643-644	Contain® Metal Pedestals with Laminate Fronts.....	702		

For information regarding HON registered and unregistered trademarks, please go to hon.com/protected-marks. Haworth®, Herman Miller®, Knoll®, and Steelcase® are registered trademarks of their respective owners and use of the marks do not imply affiliation or endorsement of The HON Company or its products.

LIST PRICER

Effective Date: October 2021

- All illustrations and specifications in this publication are based on the latest product information available at the time of print. For the most recent version, please go to www.hon.com.
- Software support packages furnished to the customer, either by The HON Company or by another source, which support the sale of HON products are superseded by printed price lists.
- All dimensions shown in this publication are nominal.
- Pricing is subject to change without notice.
- All orders are subject to prices in effect at the time of order.
- Ordering information appears at the beginning of a section complete with examples on how to specify. These specifying information pages are referenced at the bottom center of product pages.
- HON Full Lifetime Warranty applies unless otherwise noted.
- HON nationwide customer service:
Phone: (800) 833-3964

HON LIST PRICER

Table of Contents

Acoustic Solutions Floor Screens.....	762-763
Desktop Screens Ordering Information	764
Desktop Screens.....	765-766
Universal Screens Ordering Information	767
Universal Screens Table Screens.....	768-769
Universal Screens Plexi-Glass Screens.....	770
Universal Screens Floor Screens.....	771
Universal Screens Panel Stackers.....	772

ACCESSORIES

Core Removable Lock Kits.....	773
Touch-up Paint.....	774

INDEX

Cross Reference Index.....	775-792
Information on Ordering Parts.....	800

ADDITIONS

NEW ADDITIONS: PRODUCTS

Desks	Effective Date	Desks	Effective Date
Coordinate™ Models: HHATB2S2LT, HHATB2S2LC, HHATB3S2LT, HHATB2S2LC, HHATM3S2LT, HHATB3S3LT, HHATB3S3LC, HHATW224OCT, HHATW2246CT, HHATW2252CT, HHATW2258CT, HHATW2264CT, HHATW227OCT, HHATW2276CT, HHATW2282CT, HHATW2288CT, HHATW2294CT, HHATW284OCT, HHATW2846CT, HHATW2852CT, HHATW2858CT, HHATW2864CT, HHATW287OCT, HHATW2876CT, HHATW2882CT, HHATW2888CT, HHATW2894CT, HHATW2442CT, HHATW2448CT, HHATW2454CT, HHATW246OCT, HHATW2466CT, HHATW2472CT, HHATW2478CT, HHATW2484CT, HHATW249OCT, HHATW2496CT, HHATW3042CT, HHATW3048CT, HHATW3054CT, HHATW306OCT, HHATW3066CT, HHATW3072CT, HHATW3078CT, HHATW3084CT, HHATW309OCT, HHATW3096CT, HHATCC583422L, HHATCC584622L, HHATCC584628L, HHATCC703422L, HHATCC704622L, HHATCC704628L, HHATCC583422R, HHATCC584622R, HHATCC584628R, HHATCC703422R, HHATCC704622R, HHATCC704628R, HHATCC603624L, HHATCC604824L, HHATCC604830L, HHATCC722624L, HHATCC724824L, HHATCC724830L, HHATCC603624R, HHATCC604824R, HHATCC604830R, HHATCC722624R, HHATCC724824R, HHATCC724830R, HHATW2246EA, HHATW2252EA, HHATW2258EA, HHATW2846EA, HHATW2852EA, HHATW2858EA, HHATW2448EA, HHATW2454EA, HHATW2460EA, HHATW3048EA, HHATW3054EA, HHATW3060EA, HHABBT	July 1, 2021	Workwall Models: HWWT718F, HWWT724F, HWWT730F, HWWT736F, HWWT742F, HWWT748F, HWWT754F, HWWT760F, HWWT1518F, HWWT1524F, HWWT1530F, HWWT1536F, HWWT1542F, HWWT1548F, HWWT1554F, HWWT1560F, HWWT2218F, HWWT2224F, HWWT2230F, HWWT2236F, HWWT2242F, HWWT2248F, HWWT2254F, HWWT2260F, HWWT3018F, HWWT3024F, HWWT3036F, HWWT3042F, HWWT3048F, HWWT3054F, HWWT3060F, HWWT3718F, HWWT3724F, HWWT3730F, HWWT3736F, HWWT3742F, HWWT3748F, HWWT3754F, HWWT3760F, HWWT4518F, HWWT4524F, HWWT4530F, HWWT4536F, HWWT4542F, HWWT4548F, HWWT4554F, HWWT4560F, HWWT1530M, HWWT1536M, HWWT2230M, HWWT2236M, HWWT3030M, HWWT3036M, HWWT3730M, HWWT3736M, HWWT3742M, HWWT3748M, HWWT3754M, HWWT3760M, HWWT4530M, HWWT4536M, HWWT4542M, HWWT4548M, HWWT4554M, HWWT4560M, HWWT718L, HWWT724L, HWWT730L, HWWT736L, HWWT1518L, HWWT1524L, HWWT1530L, HWWT1536L, HWWT2218L, HWWT2224L, HWWT2236L, HWWT3018L, HWWT3024L, HWWT3030L, HWWT3036L, HWWT3718L, HWWT3724L, HWWT3730L, HWWT3736L, HWWT4518L, HWWT4524L, HWWT4530L, HWWT4536L, HWWT3036V, HWWT3042V, HWWT3048V, HWWT3736V, HWWT3742V, HWWT3748V, HWWT3754V, HWWT4536V, HWWT4542V, HWWT4548V, HWWT4554V, HWWT718P, HWWT724P, HWWT730P, HWWT736P, HWWT1518P, HWWT1524P, HWWT1530P, HWWT1536P, HWWT2218P, HWWT2224P, HWWT2230P, HWWT2236P, HWWT3018P, HWWT3024P, HWWT3030P, HWWT3036P, HWWT724T, HWW730T, HWWT736T, HWWT742T, HWWT748T, HWWT754T, HWWT760T, HWWT1524T, HWWT1530T, HWWT1536T, HWWT1542T, HWWT1548T, HWWT1554T, HWWT1560T, HWWASHELF18, HWWASHELF24, HWWASHELF30, HWWASHELF36, HWWARAIL18, HWWARAIL24, HWWARAIL30, HWWARAIL36, HWWARAIL42, HWWARAIL48, HWWARAIL54, HWWARAIL60, HWWATS, HWWASB, HWWAST, HWWAP, HWWAPH, HWWAC, HWWAH	July 1, 2021
Mod Models: HLPLPEN7236E, HLPLPEN6630E	June 1, 2021	10500 Series™ Models: H10521E, H105209E, H10522E, H10523E, H10525RE, H10526LE, H105201RE, H105202LE, H105203RE, H105204LE, H105205RE, H105206LE	July 1, 2021
Valido® Models: H11521E, H11522E, H11523E, H11525RE, H11526LE, H115201RE, H115202LE, H115203RE, H115204LE	June 1, 2021	10700 Series™ Models: H10721E, H10722E	July 1, 2021
		38000 Series™ Models: H38941E, H38942E, H38966E	July 1, 2021

ADDITIONS

Workstations	Effective Date
Abound®	July 1, 2021
Models: HRVF5724P, HRVF5730P, HRVF5736P, HRVF5742P, HRVF5748P, HRVF5760P, HRVTC24F, HRVTC30F, HRVTC36F, HRVTC42F, HRVTC48F, HRVTC54F, HRVTC60F, HRVTC66F, HRVTC72F, HRVTC78F, HRVTC84F, HRVTC90F, HRVTC96F, HRFF5724P, HRFF5730P, HRFF5736P, HRFF5742P, HRFF5748P, HRFF5760P, HRVC7PLF, HRVC15PLF, HRVC22PLF, HRVC30PLF, HRVC35PLF, HRVC42PLF, HRVC50PLF, HRVC57PL, HRVC57PLF, HRVC65PLF, HRVC80PLF, HRVC7PTF, HRVC15PTF, HRVC22PTF, HRVC30PTF, HRVC35PTF, HRVC42PTF, HRVC50PTF, HRVC57PT, HRVC57PTF, HRVC65PTF, HRVC80PTF, HRVC7PXF, HRVC15PXF, HRVC22PXF, HRVC30PXF, HRVC35PXF, HRVC42PXF, HRVC50PXF, HRVC57PX, HRVC57PXF, HRVC65PXF, HRVC80PXF, HRVC7PSF, HRVC15PSF, HRVC22PSF, HRVC30PSF, HRVC35PSF, HRVC42PSF, HRVC50PSF, HRVC57PS, HRVC57PSF, HRVC65PSF, HRVC80PSF, HRVC35PY2F, HRVC42PY2F, HRVC50PY2F, HRVC57PY2, HRVC57PY2F, HRVC65PY2F, HRVC35PY3F, HRVC42PY3F, HRVC50PY3F, HRVC57PY3, HRVCPY3F, HRVC65PY3F, HRVC15PFF, HRVC30PFF, HRVC35PFF, HRVC42PFF, HRVC50PFF, HRVC57PF, HRVC57PFF, HRVC65PFF, HRVC80PFF, HRVC7PFV, HRVC15PFV, HRVC22PFV, HRVC30PFV, HRVC7FFV, HRVC15FFV, HRVC65PWF, HRVT5224T, HRVT5230T, HRVT5236T, HRVT5242T, HRVT5248T, HRVT5260T, HRVT5224E, HRVT5230E, HRVT5236E, HRVT5242E, HRVT5248E, HRVT5260E, HRVT0724FF, HRVT0730FF, HRVT0736FF, HRVT0742FF, HRVT0748FF, HRVT0754FF, HRVT0760FF, HRVT0766FF, HRVT0772FF, HRVT0778FF, HRVT0784FF, HRVT0790FF, HRVT0796FF, HRVT1524FF, HRVT1530FF, HRVT1536FF, HRVT1542FF, HRVT1548FF, HRVT1554FF, HRVT1560FF, HRVT1566FF, HRVT1572FF, HRVT1578FF, HRVT1584, HRVT1590FF, HRVT1596FF, HRVBR1524F, HRVBR1530F, HRVBR1536F, HRVBR1542F, HRVBR1548F, HRVBR1560F, HRVBR1566F, HRVBR1572F, HRVBR1524PF, HRVBR1530PF, HRVBR1536PF, HBCKIT24F, HBCKIT30F, HBCKIT36, HBCKIT42F, HBCKIT48F, HBCKIT60F, HBCKIT66F, HBCKIT72F, HBCKIT24F, HBCKIT30F, HBCKIT36F	
Accelerate®	July 1, 2021
Models: HEFGS0720, HEFGS0724, HEFGS0730, HEFGS0736, HEFGS0742, HEFGS0748, HEFGS0754, HEFGS0760, HEFGS0766, HEFGS0772, HEFGS1520, HEFGS1524, HEFGS1530, HEFGS1536, HEFGS1542, HEFGS1548, HEFGS1554, HEFGS1560, HEFGS1566, HEFGS1572, HEVHG07P, HEVHG15P	
Shared Components	July 1, 2021
Model: HOLEG18	

Fabrics and Finishes	Effective Date
Laminates	July 1, 2021
Handspun Chestnut (LAHC), Handspun Dove (LAHD), Handspun Pearl (LAHP), Handspun Slate (LAHS)	

DISCONTINUATIONS

Desks	Effective Date	Workstations	Effective Date
Coordinate™ Models: HS1100, HS1101, HHAW2448P, HHAW2448PN, HHAW2454P, HHAW2460P, HHAW2460PN, HHAW2466P, HHAW2472P, HHAW2472PN, HHAW2484P, HHAW2484PN, HHAW2484PNS, HHAW2484PS, HHAW2496P, HHAW2496PN, HHAW2496PNS, HHAW2496PS, HHAW3048P, HHAW3048PN, HHAW3054P, HHAW3060P, HHAW3060PN, HHAW3066P, HHAW3072PN, HHAW3084P, HHAW3084PN, HHAW3084PNS, HHAW3084PS, HHAW3096P, HHAW3096PN, HHAW3096PNS, HHAW3096PS, HHAWD2450PN, HHAWD3062PN, HHAWV603624LP, HHAWV603624RP, HHAWV604824LP, HHAWV604824RP, HHAWV604830LP, HHAWV604830RP, HHAWV723624LP, HHAWV723624RP, HHAWV724824LP, HHAWV724824RP, HHAWV724830LP, HREC3S3LTF, HREC3S3LCF, HREC2S2LTF, HREC2S2LCF, HMREC3S2LTF, HREC3S2LTF, HREC3S2LCF	December 31, 2021	Accelerate® Models: HEFG0720, HEFG0724, HEFG0730, HEFG0736, HEFG0742, HEFG0748, HEFG0754, HEFG0760, HEFG0766, HEFG0772, HEFG1520, HEFG1524, HEFG1530, HEFG1554, HEFG1536, HEFG1542, HEFG1548, HEFG1560, HEFG1566, HEFG1572	December 31, 2021
Coordinate™ Models: HHAB2S2L, HHAB3S2L, HHAB3S3L Model: HS1102	July 1, 2021 June 30, 2021	Fabrics and Finishes Fabrics Clyde Weathered (CLYD09) Laminates Sheer Mesh (A5) Canyon Zephyr (K9) Desert Zephyr (K8) Shadow Zephyr (K1) Grey Tigris (L6) Whitestone (K4)	December 31, 2020 June 30, 2022 June 30, 2022 June 30, 2022 June 30, 2022 June 30, 2022
Mod Models: HLPLPEN7236, HLPLPEN6630	December 31, 2021		
Valido® Models: H115201R, H115202L, H115203R, H115204L, H11521, H11522, H11523, H11525R, H11526L	December 31, 2021		
10500 Series™ Models: H105201R, H105202L, H105203R, H105204L, H105205R, H105206L, H105209, H10521, H10522, H10523, H10525R, H10526L, H105T2430C, H105T3036C	December 31, 2021		
10700 Series™ Models: H10721, H10722	December 31, 2021		
38000 Series™ Models: H38941, H38942, H38966	December 31, 2021		

HON FULL LIFETIME WARRANTY INFORMATION



FULL LIFETIME WARRANTY

YOUR HON FULL LIFETIME WARRANTY

Every time you purchase a HON product, you're making an investment in your future. We're proud to play a part in that future, and you can trust us to do our best for as long as you need us.

The HON Full Lifetime Warranty is our assurance to you that the HON desks, workstations, seating, tables, or storage you purchase will be free from defective material or workmanship for the life of the product.

In the unlikely event that any HON product or component covered by the HON Full Lifetime Warranty should fail under normal workplace use as a result of defective material or workmanship, HON shall repair or replace with comparable product (at HON's discretion), free of charge.

WHAT'S COVERED BY THE HON FULL LIFETIME WARRANTY?

Your HON Full Lifetime Warranty applies to product manufactured after January 1, 2011. All HON product lines, materials, and components are covered by the HON Full Lifetime Warranty except for the items described below.

The specific product lines, materials, and components listed below are covered under HON's Full 12-Year, Full 10-Year, and Full 5-Year Warranties (from date of purchase).

HON'S FULL 12-YEAR WARRANTY

- Electrical components (lamps and ballasts are not covered)
- 4-Way Stretch Mesh
- Seating controls
- Pneumatic Cylinders
- Wood Seating
- Accessories
- Laminate Surfaces

HON'S FULL 10-YEAR WARRANTY

- Coordinate™ Height Adjustable Bases (HHATB)

HON'S FULL 7-YEAR WARRANTY

- Coordinate™ Legacy Bases (HHAB and HREC)
- Workwall Markerboard Glass Tiles

HON'S FULL 5-YEAR WARRANTY

- All LED task lights
- Panel and seating textiles
- Coordinate™ ETA Height Adjustable Base (HHABETA2S2L)
- Coze™
- Between™ Multi-Purpose Table
- Acoustic Solutions by Unika Vaev
- Mod

HON'S FULL 1-YEAR WARRANTY

- Healthy Workplace Tools & Acrylic Screens

These warranties apply to HON products sold within the United States of America, U.S. Territories, and Canada, as well as U.S. Military and Federal Agency purchases (regardless of location).

IS ANYTHING NOT COVERED?

There are a few exclusions to the HON Full Lifetime Warranty and to the 12-, 10-, and 5-year warranties. These exclusions are:

- All HON products that are covered under a separate 5-year warranty.
- Color-fastness or matching of colors, woodgrains, or textures occurring in wood, leather, or other materials that naturally exhibit inherent color variations.
- Customer's own materials (COM) selected by and used at the request of the user.
- Modifications or attachments to the product that are not approved by The HON Company and product failures resulting from such modifications or attachments.
- Product normal wear and tear, which are to be expected over the course of ownership.
- Products that were not installed, used, or maintained in accordance with product instructions and warnings.
- Products used for rental purposes.
- Damage caused by cleaning chemicals.
- Dye transfer caused by external contaminants (including clothing and accessory dyes such as those used on denim jeans) may migrate to lighter colors. This phenomenon is increased by humidity and temperature and is irreversible.
- Fabric pattern match seat to back or chair to chair. If pattern match is needed, please submit a Tailored Solutions request or contact HON Customer Support/Tailored Solutions with questions.

WARRANTY REQUESTS OR QUESTIONS?

Your HON Dealer is our mutual partner in supporting your warranty requests. To obtain service under this warranty, please contact your HON dealer. If you are not sure who your dealer is, please call HON Customer Support at 800.833.3964.

THAT'S YOUR HON FULL LIFETIME WARRANTY AS AN OWNER OF HON PRODUCT, THE WARRANTY EXPLAINED HERE IS YOUR SOLE AND EXCLUSIVE REMEDY. THERE ARE SOME EXCEPTIONS IF YOU PURCHASED THE PRODUCT FOR HOME OR PERSONAL USE WHICH ARE EXPLAINED BELOW. TO THE EXTENT ALLOWED BY LAW, THE HON COMPANY MAKES NO OTHER WARRANTY, EITHER EXPRESS OR IMPLIED, INCLUDING ANY WARRANTY OF MERCHANTABILITY OR FITNESS FOR A PARTICULAR PURPOSE. THE HON COMPANY WILL NOT BE LIABLE FOR ANY CONSEQUENTIAL OR INCIDENTAL DAMAGES.

A WORD ABOUT PURCHASES FOR HOME OR PERSONAL USE

Please note, this section only applies if you purchased your HON product for your home or for your own personal or family use. HON's warranties give you specific legal rights and you may have other rights, which vary from state to state. As a consumer purchaser, the complete exclusion of implied warranties noted in the above paragraph does not apply to you, however, to the extent allowed by applicable state law, the implied warranties are limited to the applicable term of the warranty. Some states do not allow the exclusion or limitation of incidental or consequential damages, so the above exclusion or limitation may not apply to you.

HON LIMITED 5-YEAR WARRANTY INFORMATION



LIMITED 5-YEAR WARRANTY

The HON Company promises to repair or replace HON products or components covered under this warranty that are found to be defective in material or workmanship within five (5) years from the date of original purchase so long as you, the original purchaser, still owns it. This is your sole and exclusive remedy. This warranty is subject to the provisions below. It applies to the products listed here manufactured after January 1, 2018.

LIMITATIONS:

- Upholstery on chairs is warranted for two years from date of purchase.
- Damage caused by the carrier in-transit is handled under separate terms.

EXCLUSIONS:

This warranty does not apply and no other warranty applies to:

- Normal wear and tear, which are to be expected over the course of ownership.
- Modifications or attachments to the product that are not approved by The HON Company.
- Products that were not installed, used or maintained in accordance with product instructions and warnings.
- Products used for rental purposes.

SEATING USAGE

Normal commercial use for seating is identified as the equivalent of a single shift, forty-(40) hour workweek. To the extent that a seating product is used in a manner exceeding this, the applicable warranty period will be reduced in a pro-rata manner.

A WORD ABOUT COLOR VARIATIONS, FABRICS AND FINISHES:

The HON Company does not warrant the color-fastness or matching of colors, grains or textures of covering materials.

CUSTOMER'S OWN MATERIAL (COM)

Not available on HON products covered under the HON 5-year warranty.

TO THE EXTENT ALLOWED BY LAW, THE HON COMPANY MAKES NO OTHER WARRANTY, EITHER EXPRESS OR IMPLIED, INCLUDING ANY WARRANTY OF MERCHANTABILITY OR FITNESS FOR A PARTICULAR PURPOSE. THE HON COMPANY WILL NOT BE LIABLE FOR ANY CONSEQUENTIAL OR INCIDENTAL DAMAGES.

NOTICE TO PURCHASERS FOR HOME OR PERSONAL USE:

Federal law does not permit the exclusion of certain implied warranties for consumer products. Therefore, if you are purchasing this product for home or personal use, the exclusion of implied warranties noted in the above paragraph does not apply to you. Some states do not allow the exclusion or limitation of incidental or consequential damages, so the above limitation or exclusion may not apply to you. This warranty gives you specific legal rights, and you may also have other rights which vary from state to state.

This warranty applies only to products sold within the United States of America and the Commonwealth of Canada.

TO OBTAIN SERVICE UNDER THIS WARRANTY:

Your HON® Dealer is our mutual partner in supporting your warranty requests. By following the procedures outlined below, you can be assured of the best level of service. Please note: Consent of The HON Company must be obtained before any warranty work is performed. To obtain consent, please take the following steps:

1. Contact the Dealer from whom the product was purchased within 30 days of discovery of the defect. Be prepared to affirm that you are the original purchaser of the product and to provide the serial number(s) from the product in question.
2. Your Dealer will gather all pertinent information regarding the claim, inspect the product and contact a HON Company customer service representative. (Please allow a reasonable amount of time for inspection and review.)
3. If The HON Company affirms that the product in question is eligible under the conditions of the warranty as stated above, the customer service representative or another representative of the Company will determine whether to provide replacement parts, authorize repairs or replace the product.

ORDERING INFORMATION

ORDERING

Electronic ordering is the standard order process for HON. HON supports the following primary methods for the electronic transmission of orders and order related documents:

Electronic Ordering

Available in the HONReady portal at honready.hon.com. There are multiple options available for processing orders electronically.

Integration with the standard Office Furniture business systems or other pre-approved proprietary software packages.

SIF file upload using fully optioned SIF files into the electronic ordering applications.

Manual entry of line items into the electronic ordering application.

EDI-System to System Integration

With standard Office Product systems or other pre-approved proprietary software systems.

Training, technical set-up and support is available through our Dealer Operations Team at honready@honcompany.com.

ORDER REQUIREMENTS

- Customer must provide complete and correct information, including complete model number, finishes, colors, options, and quantity.
- If a bid quotation or other special pricing applies, such information must be clearly stated on the order with applicable bid number or contract number.
- Order Management contact name and phone number.
- Delivery Appointment contact name and phone number at the dealership or installation company. HON does not accept orders with end user appointment contacts.
- Dealer Sales Representative, primary or multiple DSRs.
- “Best Date Available” for the entire order is standard service for HON. If eligible, other Date Requests may be requested and must be submitted with the order. Other Date Requests are subject to review by HON prior to acceptance:
 - “Ship After” requests are eligible on all order sizes
 - “Deliver On” requests are eligible for full truckload orders
- Additional services outside of HON’s standard services may be available through HON’s ‘Enhanced Services’ for a corresponding fee. Requested services from ‘Enhanced Services’ must be provided at time of order placement.
- The Company reserves the right to require electronic orders or charge \$50 fee per Purchase Order (PO) for manual order processing.
- Failure to provide complete and accurate information results in delayed order entry and acknowledgment. Incomplete orders will not be produced and will be returned to Dealer for correction.

ACKNOWLEDGMENT SERVICE

- E-mailed acknowledgments are available by customer request.
- An acknowledgment will be emailed the morning of the next business day, unless order is placed on credit or other order hold.
- The order will not receive an acknowledged shipment date until all order holds are released.

ORDER CHANGES OR CANCELLATIONS

For Order Changes or Cancellations, please contact Customer Support at 800-833-3964.

TERMS AND CONDITIONS

See **HON NOW** on honready.hon.com for more information about HON NOW delivery, services and ordering information.

INTEGRATED DESIGN SOLUTIONS

HON INTEGRATED DESIGN SOLUTIONS

Need design assistance? We can help! Our expert design staff will create a professional design package that is sure to put you one step ahead of the competition. And the best part is – it's free!

AUDIT

We will check your drawing and parts list for accuracy. We verify quantity, specification accuracy, product compatibility and structural support.

PLAN & SPECIFY

We will provide a professional design package including a CAD furniture plan, 3-D line drawing and complete parts list based on the rough sketch and work order forms you supply.

VALUE ENGINEERING

We will optimize workstation layouts and propose potential cost saving measures to help your customer save money and make you more competitive and profitable.

RENDERING

We will create a photo realistic rendering of your furniture plan to help your customer visualize what their desired office space will look like.

*SPACE PLANNING (BILLABLE SERVICE)

Let our team do the creative work for you. Our low rates and expert staff will create a furniture layout and design that best suits your customer.

PLANNING TYPICALS

Quick planning ideas to share with your clients. Various settings showcasing desks, tables and workstations available in multiple formats. View them today under Design Resources on the HON Ready Portal.

CONTACT INTEGRATED DESIGN SOLUTIONS

Questions? Please reach out to your region's dedicated designer. Not sure how to reach your designer? Send us a note at the email below.

E-Mail: integrateddesign@honcompany.com



Solve® Chair shown with Coordinate™ Height Adjustable Table.

Project Space

A place for all HON Project Services

Project Space provides one platform to access the full portfolio of HON services including:

- Plan & Specify
- Audit
- Product Modification
- Special Laminates
- Value Engineering
- Rendering
- Customer's Own Material
- Dual Fabric Applications
- Space Planning
- Special Paints
- Project Bid Pricing

Submit your request on the Community powered by HNI, Projects.

Project Space Lead Time: 1-3 business days depending on complexity and size of your project.

TAILORED SOLUTIONS ORDERING INFORMATION

PRODUCT MODIFICATIONS

Modifications include structural and dimensional modifications to existing product and Dual Fabric Applications, when standard model is not available.

The HON Company, at its own discretion, may modify standard products to meet specific needs. Product specials can be requested on HON brand product only.

List prices contained in published list pricers are for standard catalog items only. Changes or alterations to catalog items other than those listed as catalog options are subject to additional charges. Pricing will only be furnished upon approval of the special request.

Requests to have the product produced in more than one fabric (e.g., fabric on the seat is different than the fabric on the back), are considered a Dual Fabric Applications request and follow the Product Modification request process within MyProjects.

SPECIAL LAMINATES

Special laminates include requests for laminates not available as part of The HON Company's standard offering. Requests for special laminates are subject to manufacturing approval and minimum order quantities. The HON Company approved special laminates will be subject to a designated upcharge per unit.

Requests for special laminates should be submitted through the MyProjects Application on the HON Ready portal. Pricing will only be furnished upon approval of the special request.

SPECIAL PAINTS

- The HON Company's paint matching equipment can match almost any color, excluding some metallic and whites.
- Special paint requests must be submitted on the HON Ready Portal MyProjects application.
- In order to request a paint sample, the customer must have a minimum order of 10 like product units. Any requests with less than that amount will not be processed.
 - For each new paint request, there will be a \$500 net charge. A sample of the exact color desired is required for matching and approval. The HON Company will match the color and provide a production sample for the customer to review and approve.

- Once the signed paint sample is received at The HON Company, the request will be approved.
- Each unique color or finish combination incurs a designated upcharge per color per order (all standard discounts/competitive project pricing applies).

Special note: Some special colors could fall outside of this program due to production costs or not meeting The HON Company's quality standards. The HON Company may apply additional charges to some colors which are costly to apply, and refuse some orders on colors that cannot meet The HON Company's high-quality standards. The HON Company will notify the customer upon completion of The HON Company's evaluation if a change in price is required or rejection of the order.

DISCONTINUED PRODUCT

Requests for discontinued product require engineering evaluation, safety review, and testing to current standards prior to approval. Many discontinued products are not available for order. Requests for discontinued products should be submitted through the MyProjects Application on the HON Ready portal.

LEAD TIMES FOR SPECIALS PRODUCT

Lead times on orders containing specials are subject to production capacity and material availability. When possible, the customer should order special products separately to avoid extended lead times for standard products. Extended lead times will be noted on the specials request.

CHANGES TO SPECIALS PRODUCT

A special model will be provided for each approved special item to process orders. Once an order is placed, no changes or cancellations can be made to the order without approval from Tailored Solutions.

CONTACT TAILORED SOLUTIONS

Phone: 800.833.3964 and listen for Tailored Solutions offering on the menu.

Email: HONSpecials@honcompany.com

CUSTOMER'S OWN MATERIAL ORDERING INFORMATION

CUSTOMER'S OWN MATERIAL (COM) PROGRAM

Customer's Own Material (COM) is a request to use fabrics not available as part of HON's standard fabric offering. Manufacture to Supply (MTS) and Dealer to Supply (DTS) are the two ordering methods. The HON Company has partnered with fabric manufacturers to provide competitive pricing and selection through the MTS program. MTS will be the standard offering unless The HON Company is unable to procure the fabric. If there is a DTS request submitted, The HON Company will advise at the time of the request if DTS is available.

CUSTOMER WARRANTY EXCLUSION

The HON Company shall have no responsibility for the condition, quality, value, performance, physical properties, or any other aspects of the COM.

The HON Company shall have no liability for any damages, injuries, or losses to the customer or to any third party that shall be caused by any COM or product modification, and the customer shall hold The HON Company harmless for all liability.

The HON Company assumes no responsibility for the overall appearance, flammability, normal durability, colorfastness, or any other quality of the COM or product modification after its application on a HON product beyond normal quality standards. The HON Company reserves the right to reject a COM fabric if the quality of the COM is not satisfactory for the product. Should this occur, the customer will be notified with an explanation of the issue.

The HON Company is not responsible for fabric that has become obsolete at the COM supplier, that is of poor quality, or that is delivered late to The HON Company from the COM supplier. The HON Company is not responsible for excess yardage created by DTS orders and reserves the right to dispose of the excess fabric.

As a standard HON does not pattern match any standard, partnership or COM fabric, therefore pattern match is not applicable under warranty. If pattern match is needed please submit a Tailored Solutions request or contact HON Customer Support/Tailored Solutions once your COM has been approved.

COM TESTING

As a result of recent legal requirements, The HON Company will need to obtain specific information from the fabric supplier about treatments and chemicals used in the fabric. To the extent the supplier is unwilling or unable to provide the necessary information, which could extend the testing lead time of the request.

To check if a COM has been tested previously, utilize the COM Search Tool on the HON Ready Portal > Design Resources > Textiles & Finishes section using the following information:

- COM Supplier's Name
- Fabric Pattern Name
- Color Name
- If the COM fabric has been tested and previously approved, the COM will not need to be re-tested unless testing standards have changed, fabric is to be used on a different series, or direction of the fabric has changed from what was previously approved. Please note that Panel product must be approved for each model and color.
- If the pattern has previously been tested and approved, but not in the specific requested color, the customer will need to request an order code for that color only. No further testing will be necessary since the pattern has already been approved.

If the fabric has not previously been tested, the customer must enter the COM request on the HON Ready Portal > Textiles & Finishes > COM Search Tool.

Complete the Supplier Name, Pattern, and Color drop-down fields. For quicker results in these fields, type the first letter of the (supplier, pattern, color) name and, when done, click Add and then Submit. (Multiple series can be added to the same request if they are the same supplier, pattern, and color.)

An email will be sent to the requestor stating the COM Request was successfully submitted. Up to four emails could be received: submitted, in testing, testing materials requested, and final approval/denial with price grade and fabric code. The testing process takes approximately 48 hours.

COM yardage in the pricer is shown as pattern cut only.

COM TESTING — FLAMMABILITY TESTING INFORMATION

The customer is responsible for ensuring that the COM fabric is certified to meet all flame-retardant requirements. All COM seating fabric must, at minimum, meet CAL 117 requirements. If the customer requires the chair be tested to meet the fire safety standards of CAL 133, additional testing and information is required.

MTS COM

As previously mentioned, MTS is the primary COM method.

If the COM fabric has not been tested, a COM request must be submitted on the HON Ready Portal.

For MTS orders, The HON Company will procure fabric needed for production. Should The HON Company not be able to obtain fabric yardage, the customer will be contacted.

CUSTOMER'S OWN MATERIAL ORDERING INFORMATION

When testing has been completed, the customer will be notified by the COM team of the test results. If the COM is approved, The HON Company will provide a COM tracking order code for MTS. That tracking code is required on the order in place of the standard fabric code.

If approved, MTS product will be assigned an appropriate fabric grade for pricing. The pricing can be found on the HON Ready Portal > Design Resources > Textiles & Finishes. (All standard discounts/competitive project pricing applies).

Written COM price quotes are valid for 90 days after the issue date.

DTS COM

DTS COM is only available if the COM fabric cannot be procured by The HON Company. If the fabric can be procured by The HON Company, the customer will be contacted to switch to MTS or cancel the request.

If your fabric is not listed as approved, and it is not a Partnership fabric you may request a "Dealer to Supply" code. Select the "Request COM Test" link on the COM Search website. Complete the Supplier Name, Pattern, and Color drop-down fields. For quicker results in these fields, type the first letter of the (supplier, pattern, color) name and, when done, click Add and then Submit. (Multiple series can be added to the same request if they are the same supplier, pattern, and color.)

An email will be sent to the requestor stating the COM Request was successfully submitted. Up to four emails could be received: submitted, in testing, testing materials requested, and final approval/denial with price grade and fabric code. It's rare actual test yardage is required. Testing is mainly done by reviewing the attributes of the fabric. The testing process takes approximately 48 hours.

If the COM has not been tested, a COM request must be submitted on the HON Ready Portal > Design Resources > Textiles & Finishes.

When testing has been completed, the customer will be notified by the COM team of the test results. If the COM is approved, The HON Company will provide a COM tracking order code. That tracking code is required on the order in the place of the standard fabric code.

DTS product is priced at the following grades (all standard discounts/competitive project pricing applies):

- Chairs are a Grade 4
- Panel product is a Grade D

Written COM price quotes are valid for 90 days after the issue date.

COM LEAD TIME

Ship dates will be based on fabric receipt and The HON Company's standard lead time. All fabric must be properly tagged and shipped to the appropriate producing location (provided in the approval email).

- Specific to DTS orders, COM orders will not receive a ship (acknowledged) date until The HON Company has the fabric in its possession for production.
- Specific to DTS orders, the customer may send the required yardage for the order to the address listed on the approval email to arrive no sooner than 4 weeks in advance of the acknowledgment date.

HON will make every effort to locate mis-directed COM shipments on behalf of the customer. However, The HON Company will not be responsible for any COM received without a tracking number or incorrectly shipped by the fabric vendor to an incorrect producing facility.

COM ORDERING INFORMATION

The following information must appear on or accompany the product purchase order:

- Approval tracking number and the customer's purchase order number
- COM supplier, pattern, and color name/number

The packing list for the COM must include the following information when The HON Company receives the shipment for production:

- Dealer or Wholesaler Name
- Purchase order number submitted to The HON Company
- Fabric name
- Yardage shipped
- Approval ordering code

If The HON Company receives fabric with incorrect labeling that cannot be linked to an order, The HON Company will hold the fabric for up to 7 days while the COM team attempts to identify the order. After 7 days, The HON Company will return the fabric to the sender.

Specific to DTS orders; the customer should send only the amount needed for the order. Excess yardage will be disposed of at The HON Company's discretion.

CHANGES TO COM PRODUCT

Once a COM product is ordered, no changes or cancellations can be made to the COM product without approval from the HON COM team.

CONTACT COM TEAM

Phone: 800.833.3964 and listen for COM TEAM offering on the menu.

COM Email: HONCOMTeam@honcompany.com

PARTNERSHIP TEXTILE INFORMATION

Partnership Textiles is the result of The HON Company's partnership with textile industry leaders Camira, HBF Textiles, Maharam, Stinson, and Ultrafabrics, LLC. The extensive collection of design-driven textiles create a superior offering at a great value. Partnership Textiles significantly updates HON's offering, expanding it with fresh and exciting options.

- **Fabric Warranty:** Partnership Textiles are covered by HON's Full Lifetime Warranty.
- **Lead Times:** Orders specified with Partnership Textiles will be acknowledged based on the supplier's availability and delivery schedule.
- **Availability:** The HON Company will regularly introduce new Partnership Textiles and reserves the right to change the offering at any time.
- **Fabric Cards:** A curated set of Partnership Textiles are carded jointly by HON and the supplier.

Camira

- Blazer

HBF Textiles*

- Everyday Textures

*HBF Textiles patterns are graded in to HON's offering.

Maharam

- Apt
- Bluff
- Collection 1
- Lariat
- Meld
- 6M

Stinson

- Edge
- Elevate
- Flow II
- Reliance IV

Ultrafabrics, LLC

- Brisa
- Ultraleather Pro

Fabric Memo Samples: Please contact the supplier directly:

Camira: memos@camirafabrics.com

HBF Textiles: Phone: +1 (877) 494-5727, orders@hbftextiles.com

Maharam: (800) 645-3943

Stinson: (800) 841-6279

Ultrafabrics: (877) 309-6648

HON BRANDED, PARTNERSHIP AND COM PATTERN MATCH

- Pattern matching provides alignment of patterns or stripes across individual chair surfaces. Additional yardage may be required depending on pattern repeat. If Pattern Match is needed, please contact HON Customer Support/Tailored Solutions.
- Chair to Chair Pattern Match provides identical pattern alignment from unit to unit and is available with an upcharge. Chair to Chair Pattern Match is reviewed on a case by case basis as several factors are reviewed to determine additional yardage required, including repeat and pattern direction. If Chair to Chair Pattern Match is needed, please contact HON Customer Support/Tailored Solutions.



PAINT PROGRAM

The HON Company has established paint grades to allow customers flexibility and ease in doing business with HON. HON has three paint grades P1, P2, and P3.

P1 PAINT COLORS

HON has established P1 paints which are available on a majority of core products.

P2 PAINT COLORS

Please see individual pricer pages for eligible series and upcharges for P2 paints. P2 paints are listed in the pricer pages under the column P2. Upcharges vary by product (all standard discounts/competitive project pricing applies). No minimum quantity required.

P3 PAINT COLORS

Please see individual pricer pages for eligible series and upcharges for P3 paints. P3 paints are listed in the pricer pages under the column P3. Upcharges vary by product (all standard discounts/competitive project pricing applies). No minimum quantity required.

SPECIAL PAINT COLORS (P4-P6)

With The HON Company's state of the art color matching equipment just about any color can be matched, excluding some metallic and whites. A sample of the exact color desired is required for matching and approval.

- For each newly requested paint, a net fee of \$500 will be charged to cover costs associated with the matching process.
- For existing, previously matched paints, there is no matching fee, however there is a \$100 net fee for sample panels required for the approval process. Refer to MyProjects on the HON Portal for a list of approved special paints.

For all special paint requests, HON will send a production sample for the customer to review and approve. Once the signed paint sample is received at HON the order can be entered. Upcharges vary by product (all standard discounts/competitive project pricing applies). A quantity of 10 like-model minimum order is required for special paints. For complete program details, access Tailored Solutions on the HON Ready Portal at honready.hon.com.

Some special colors could fall outside of this program due to production costs or not meeting HON quality standards. The HON Company may apply additional charges to some colors which are costly to apply, and deny some orders on colors that cannot meet our high-quality standards. We will notify the customer upon completion of our evaluation if a change in price is required or if the request is denied.

ENVIRONMENTAL STATEMENT

We continually reevaluate our purpose and processes, from fostering transparency and circularity in our supply chain to empowering our members to do and be better. We do it so the environments you create will be safer, more socially responsible, and more sustainable.

We've pursued product certifications to help communicate our commitment to developing sustainable products.

Clearing the air.

In 2006, The HON Company became one of the first office furniture manufacturer to have products certified under the Indoor Advantage™ program. Virtually all manufactured products emit chemical compounds into the air. Indoor Advantage™ certification helps assure customers that certified products will help improve the air quality within their offices and workspaces.

Developed by SCS Global Services, Indoor Advantage™ evaluates products against indoor air quality standards, like ANSI/BIFMA Furniture Emissions Standard, X7.1 and CDPH. The ANSI/BIFMA X7.1 standard allows manufacturers to test individual components, as well as complete products for emissions from volatile organic compounds (VOCs). This allows us to identify problematic materials and phase them out of our products.

Indoor Advantage™ certified products meet the LEED and WELL criteria for low-emitting materials.

Indoor Advantage™ offers two levels of certification, including Indoor Advantage™ and Indoor Advantage™ Gold.



On the LEVEL®.

LEVEL®, the certification program for the BIFMA e3 Sustainability Standard, was developed in response to increasing demand for proof that manufacturers were living up to their environmental claims. LEVEL® is a multi-attribute sustainability certification label for products that have met criteria in four categories of impact: Materials, Energy and Atmosphere, Human and Ecosystem Health, and Social Responsibility.

HON's products are certified to LEVEL 2 and LEVEL 3, the highest achievement.



Evaluating Our Impacts.

HON has begun studying the impacts our products have on the environment through lifecycle assessments and creating Environmental Product Declarations (EPDs). EPDs provide an understandable report of how a product impacts natural resources, the environment, and the atmosphere throughout its lifecycle.

Products that meet these specifications are identified throughout this publication with the following icons:

Certified SCS Indoor Advantage™

LEVEL® certified to the BIFMA e3 Sustainability Standard

Environmental Product Declarations

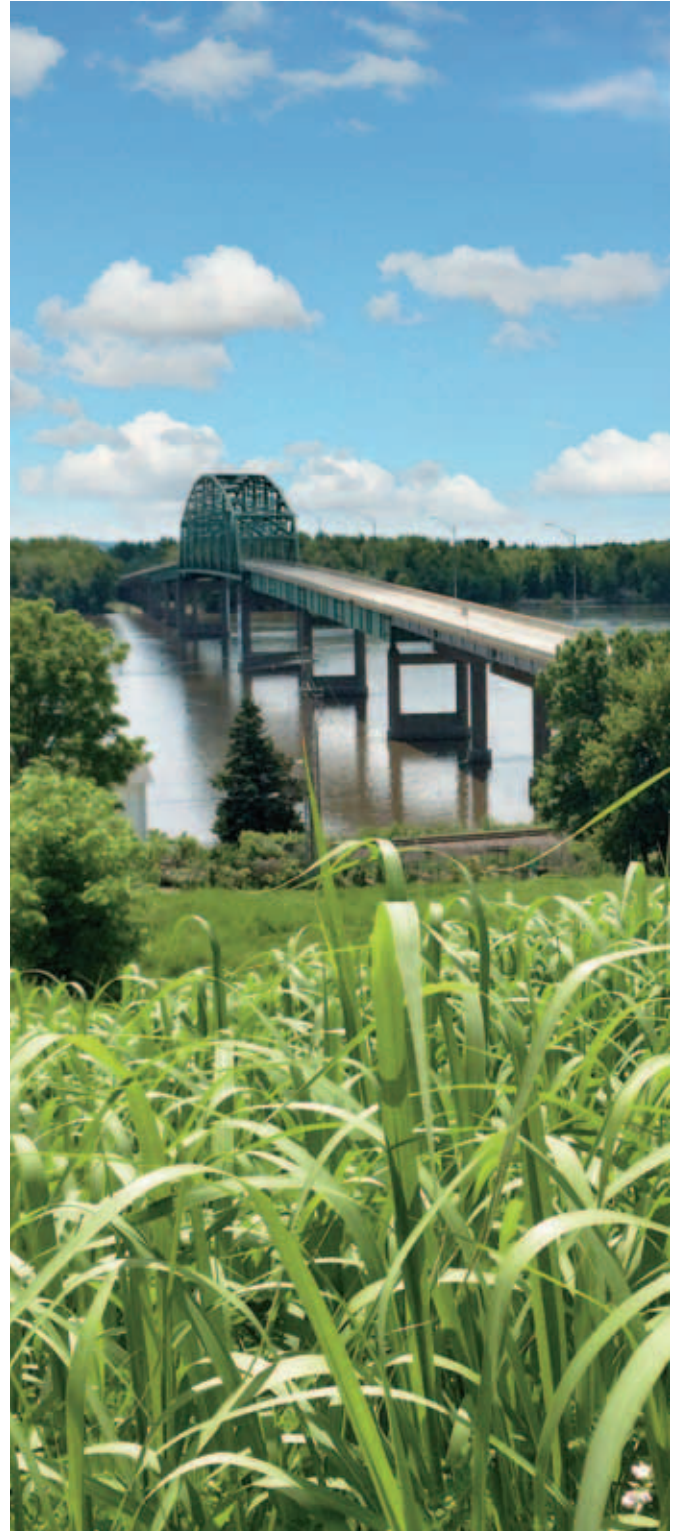

IMPORTANT INFORMATION

HON NOW™

SUPERIOR OFFICE SOLUTIONS AT THE SPEED YOU NEED

To keep your business at peak productivity, waiting is not always an option. The HON NOW™ Quickship program was designed for movers and shakers like you who want exceptional quality, durability, and versatility without compromising valuable time. Whether you're outfitting a brand new workspace or simply expanding the one you already have, we've got a variety of dependable and supportive office furniture solutions designed to fit your needs and your schedule — in a hurry, without the hassle.

To learn more, visit hon.to/now.

GSA CONTRACT INFORMATION

Model numbers identified with the verbiage “**Open Market**” are not offered on HON's GSA contract GS-27F-0015S. Model numbers identified with the following verbiage “Must be purchased with a configurable end product. If ordered separately, not on GSA contract” is to mean that these configurable components or options:

- Have no functionality or capability without being integrated into an end product, and
- Are not separately orderable; an eligible Schedule ordering activity may only purchase them with a configured system that is on contract.

HON CUSTOMER SUPPORT CONTACT INFORMATION

Nationwide CS Phone – (800) 833-3964

Nationwide CS Email – HONTeamBox@honcompany.com

Nationwide Order Entry – email: HONOE@honcompany.com

Government CS Phone – (800) 466-8694

GSA Team: HONGSATEAM@honcompany.com

GSA Order Entry: HONGSAOE@honcompany.com

Integrated Design Solutions – integrateddesign@honcompany.com

Online Order and Tool Support – HONReady@honcompany.com

DASH (transportation and delivery assistance) – (800) 334-8057

HON Literature Fulfillment Phone – (800) 466-4808



Nationwide CS Phone

800-833-3964

THE FOLLOWING ICONS MAY BE USED THROUGHOUT THIS PUBLICATION

	Meets or exceeds ANSI/BIFMA and ISTA performance standards		Readily Available. For additional lead time information see page 21.
	Certified SCS Indoor Advantage™ See page 17 for more details.		Available within a “standard” or “extended” lead time. For additional lead time information see page 21.
	Complies to the BIFMA e3 Sustainability Standard. See page 17 for more details.		May have extended lead times. For additional lead time information see page 21.
	Caution		Product shipped two to a carton
	Easy to assemble		Product shipped four to a carton
	Shippable by small-package carrier		Fire Code
	Wheel-chair compatible		Core Product Line
	Soft-tread caster option available		ColorCorrect® Eligible Product
	HON “One Key” Interchangeable core removable locks (see page 773)		Product scheduled for discontinuation
	Omit core removable lock option available. Allows keyed alike workstations (see page 773).		DE-EMPHASIZED: Product or fabric/surface material is de-emphasized, effective date as noted. Not carded. View online at honready.hon.com
	Base models available on the HON NOW Quickship Program with select options and finishes. View the entire NOW collection at honready.hon.com .		Warranted for multiple shift use, 24 hours a day 7 days a week

FABRIC PATTERNS & CODES



FABRIC PATTERNS & CODES

- For additional HON to Supply COM fabric grade pricing, go to honready.hon.com and search on the HON to Supply COM link.
 - All specifications in this publication are based on the latest product information available at the time of print.
 - Certain dyes (including clothing and accessory dyes such as those used on denim jeans) may migrate to lighter colors. This phenomenon is increased by humidity and temperature and is irreversible. The HON Company LLC does not assume responsibility for dye transfer caused by external contaminants.
 - COM Ordering Information and pricing on page 14.
 - See page 15 for Partnership Textile program information.
 - All standard fabrics are carded. Cards are available through HON Literature Fulfillment.
 - Fabrics and foam meet requirements for CAL-TB 117-2013.
- ! Different fabrics and finishes have different recommended cleaning and maintenance methods. For the correct product care for all finishes view the HON Product Care guide at hon.com/customer-support/product-care.

LEAD TIMES

THE FOLLOWING ICONS ARE USED TO DENOTE FABRIC OPTION LEAD TIMES

FABRIC/FINISH LEAD TIME INDICATOR



Fabric is readily available. Products using these fabrics will receive the best available product lead time and are a good option for standards programs as they will be in the HON portfolio for several years. Go to honready.hon.com and use **Compass** for product lead times by series.



Fabric is available within standard lead times. Products using these fabrics will receive a “standard” or “extended” lead time. The lead time will be determined by the combination of product and fabric. Go to honready.hon.com and use **Compass** for product lead times by series.



Fabric may have extended lead times. Products using these fabrics will typically have a 4+ week lead time. Go to honready.hon.com and use the **Compass** tool for product lead times by series.

HON EXPRESS QUICK SHIP PROGRAM

For the full list of products delivered in 5 business days or less, visit honready.hon.com.

PRODUCT LEAD TIMES

Standard lead times for products are between 2-4 weeks. For current exceptions to our standard lead time, go to honready.hon.com and use the **Compass** tool.

In order to establish accurate expectations for your project, please review this listing prior to submitting your purchase order.

Lead time calculation begins when order is free from any holds (i.e., bad lines, material, credit, etc.).

Please note, these production lead time estimates do NOT include delivery time. All published lead times are estimates, not guarantees of delivery.

For further information concerning lead times, please contact HON Customer Support via email HONTeamBox@honcompany or by phone at **800-833-3964**.

FABRIC PATTERNS & CODES

GRADE 1

APEX	APX
◆ Basalt	APX25
◆ Beet	APX12
◆ Blackberry	APX20
◆ Chive	APX05
◆ Iris	APX03
◆ Kiwi	APX06
◆ Lemonade	APX08
◆ Navy	APX13
◆ Papaya	APX09
◆ Pumice	APX23
◆ Rain	APX19
◆ Resort	APX15
◆ Royal	APX14
◆ Tiki	APX29
◆ Tomato	APX11

ATTIRE AI

◆ Blaze *	AI42
◆ Blue Lagoon *	AI90
◆ Crimson *	AI62
◆ Fatigue *	AI76
◆ Ivy *	AI82
◆ Lithium *	AI19
◆ Onyx *	AI10
◆ Sable *	AI49
◆ Taupe *	AI26
◆ Turquoise *	AI96

BLACK FABRIC ACCF

◆ Black	ACCF10
---------	--------

BLACK MESH ACCM

◆ Black	ACCM10
---------	--------

CENTURION CU

◆ Apricot	CU47
◆ Bark	CU25
◆ Black	CU10
◆ Espresso	CU49
◆ Fog	CU03
◆ Frost	CU22
◆ Goldenrod	CU27
◆ Indigo	CU06
◆ Iris	CU50
◆ Iron Ore	CU19
◆ Jade	CU83
◆ Marsala	CU63
◆ Morel	CU24
◆ Navy	CU98
◆ Peacock	CU97
◆ Pear	CU84
◆ Ruby	CU67
◆ Sapphire	CU09

GRADE 1 *continued*

COMPASS	COMP
◆ Beach	COMP16
◆ Bittersweet	COMP46
◆ Chocolate	COMP49
◆ Ink	COMP10
◆ Meadow	COMP82
◆ Midnight	COMP90
◆ Putty	COMP22
◆ Ruby	COMP62
◆ Sterling	COMP19
◆ Taupe	COMP26
◆ Tide	COMP96

COMPASS FOAM* COMF

◆ Bittersweet	COMF46
◆ Ink	COMF10
◆ Meadow	COMF82
◆ Midnight	COMF90
◆ Putty	COMF22
◆ Sterling	COMF19

**This fabric available for Solve* Upholstered Back models only.*

CONTOURETT UR

◆ Baltic	UR94
◆ Beach	UR23
◆ Black	UR10
◆ Bordeaux	UR63
◆ Buff	UR22
◆ Cloud	UR18
◆ Coffee Bean	UR49
◆ Crater	UR51
◆ Flame	UR62
◆ Graphite	UR19
◆ Iron	UR20
◆ Luggage	UR26
◆ Marine	UR92
◆ Navy	UR95
◆ Nimbus	UR93
◆ Ocean	UR96
◆ Pumpkin	UR42
◆ Quarry	UR24
◆ Red	UR64
◆ Safari	UR27
◆ Sage	UR82
◆ Steel	UR21
◆ Storm	UR17
◆ Taupe	UR28
◆ Trunk	UR50

GRADE 1 *continued*

DAPPER	DAPR
◆ Ash	DAPR20
◆ Azalea *	DAPR95
◆ Breeze	DAPR06
◆ Canvas	DAPR25
◆ Charcoal	DAPR01
◆ Clover	DAPR22
◆ Currant	DAPR00
◆ Emerald *	DAPR75
◆ Fawn	DAPR35
◆ Fern	DAPR85
◆ Gerbera	DAPR16
◆ Grape	DAPR33
◆ Jewel	DAPR08
◆ Marigold	DAPR65
◆ Onyx	DAPR10
◆ Orchid	DAPR90
◆ Parrot	DAPR59
◆ Peony *	DAPR50
◆ Pool *	DAPR05
◆ Poppy	DAPR19
◆ Rose *	DAPR40
◆ Sapphire	DAPR07
◆ Scarlet	DAPR45
◆ Sepia	DAPR30
◆ Sky	DAPR44
◆ Slate	DAPR15
◆ Sorbet	DAPR55
◆ Spice *	DAPR60
◆ Spring	DAPR80
◆ Terracotta	DAPR13
◆ Titanium	DAPR17
◆ Varsity	DAPR09
◆ Zest	DAPR70

ENSEMBLE ENSB

◆ Aquamarine	ENSB30
◆ Ash	ENSB39
◆ Greige	ENSB36
◆ Harbor	ENSB34
◆ Navy	ENSB35
◆ Oat	ENSB37
◆ Pear	ENSB33
◆ Sand	ENSB38
◆ Scarlet	ENSB32
◆ Slate	ENSB31
◆ Stone	ENSB40

GRADE 1 *continued*

HAMILTON	HAML
◆ Azure	HAML10
◆ Biscotti	HAML11
◆ Cabernet	HAML08
◆ Carolina	HAML21
◆ Charcoal	HAML17
◆ Chocolate	HAML13
◆ Cloud	HAML18
◆ Dane	HAML16
◆ Dusty Rose	HAML07
◆ Esmeralda	HAML06
◆ Fern	HAML04
◆ Fresh	HAML03
◆ Granola	HAML19
◆ Lilac	HAML14
◆ Lime	HAML05
◆ Lipstick	HAML09
◆ Oxford	HAML20
◆ Passion Fruit	HAML02
◆ Pepper	HAML15
◆ Powder	HAML12
◆ Sunrise	HAML01

INERTIA NR

◆ Amethyst	NR61
◆ Calypso	NR98
◆ Cherry	NR66
◆ Cobalt	NR91
◆ Coffee	NR49
◆ Fog	NR19
◆ Fuchsia	NR63
◆ Gecko	NR76
◆ Glow	NR27
◆ Leaf	NR75
◆ Lime	NR82
◆ Loft	NR22
◆ Mandarin	NR47
◆ Meteor	NR30
◆ Mustard	NR26
◆ Nickel	NR23
◆ Onyx	NR10
◆ Regatta	NR90
◆ Shadow	NR20
◆ Surf	NR96
◆ Tangelo	NR46

OPTIC OP

◆ Aurora	OP72
◆ Bark	OP24
◆ Canopy	OP84
◆ Char	OP49
◆ Ruby	OP42
◆ Sand	OP17
◆ Sky	OP83
◆ Slate	OP19
◆ Sprout	OP74
◆ Starry Night	OP11
◆ Storm	OP56
◆ Wildfire	OP66

* Fabric is de-emphasized.

FABRIC PATTERNS & CODES

GRADE 1 *continued*

PEBBLE	PBLE
◆ Amber	PBLE01
◆ Chalk	PBLE02
◆ Coal	PBLE03
◆ Gravel	PBLE04
◆ Magma	PBLE06
◆ Moss	PBLE05
◆ Sandstone	PBLE07
◆ Talc	PBLE08
◆ Topaz	PBLE09
◆ Zircon	PBLE10

GRADE 2

APPOINT SEATING	PNS
◆ Artichoke	PNS014
◆ Blackberry	PNS012
◆ Bronze	PNS002
◆ Carbon	PNS008
◆ Chai	PNS013
◆ Cherry	PNS010
◆ Dark Pewter	PNS017
◆ Dune	PNS015
◆ Espresso	PNS003
◆ Framboise	PNS011
◆ Frost	PNS034
◆ Jet	PNS007
◆ Lawn	PNS005
◆ Mandarin	PNS009
◆ Morel	PNS001
◆ Nimbus	PNS016
◆ Platinum	PNS004
◆ Turquoise	PNS006

BLUME	BLME
◆ Chalk	BLME03
◆ Char	BLME00
◆ Coin	BLME02
◆ Driftwood	BLME05
◆ Emerald City	BLME07
◆ Fir	BLME09
◆ Harvest	BLME04
◆ Haze	BLME08
◆ Hyacinth	BLME14
◆ Jasper	BLME13
◆ Merlot	BLME10
◆ Moonstone	BLME01
◆ Opal	BLME06
◆ Scarlet	BLME11
◆ Slate	BLME12

CLYDE	CLYD
◆ Antique	CLYD04
◆ Artifact	CLYD01
◆ Blacksmith	CLYD10
◆ Claret	CLYD13
◆ Craftsman	CLYD08
◆ Crate	CLYD12
◆ Fossil	CLYD02
◆ Heirloom	CLYD05
◆ Iron	CLYD11
◆ Keepsake	CLYD15
◆ Linen	CLYD14
◆ Relic	CLYD06
◆ Seasoned	CLYD03
◆ Trestle	CLYD07

GRADE 2 *continued*

DOTTY	DOT
◆ Candy	DOT63
◆ Gelato	DOT34
◆ Indigo	DOT31
◆ Onyx	DOT35
◆ Park	DOT83
◆ Peat	DOT24
◆ Peony	DOT32
◆ Suit	DOT20
◆ Sunflower	DOT33
◆ Tailor	DOT21
◆ Tide	DOT90
◆ Velum	DOT29
◆ Violet	DOT30

RUSH	RUSH
◆ Anchor	RUSH07
◆ Basil	RUSH16
◆ Blueberry	RUSH10
◆ Flamingo	RUSH21
◆ Greenery	RUSH15
◆ Greyhound	RUSH06
◆ Marina	RUSH13
◆ Merlot	RUSH19
◆ Midnight	RUSH11
◆ Mint	RUSH09
◆ Mulberry	RUSH18
◆ Pumice	RUSH01
◆ Punch	RUSH20
◆ Sage	RUSH14
◆ Salsa	RUSH24
◆ Sand	RUSH05
◆ Seal	RUSH08
◆ Soot	RUSH02
◆ Stout	RUSH03
◆ Sunshine	RUSH23
◆ Tapestry	RUSH04
◆ Tiger	RUSH22
◆ Vintage	RUSH17
◆ Wave	RUSH12

SEED	SED
◆ Apple	SED11
◆ Ash	SED15
◆ Cardinal	SED09
◆ Cinder	SED17
◆ Cream	SED12
◆ Driftwood	SED13
◆ Harbor	SED10
◆ Onyx	SED18
◆ Smoke	SED16
◆ Truffle	SED14

GRADE 2 *continued*

SPIN SEATING	SPNN
◆ Alabaster	SPNN02
◆ Cavern	SPNN03
◆ Cobblestone	SPNN04
◆ Ember	SPNN06
◆ Flame	SPNN07
◆ Heron	SPNN13
◆ Oat	SPNN01
◆ Ocean	SPNN12
◆ Plum	SPNN15
◆ Pool	SPNN11
◆ Raven	SPNN10
◆ Rhubarb	SPNN14
◆ Tropic	SPNN08
◆ Willow	SPNN05

WHISPER VINYL	WP
◆ Antelope	WP20
◆ Black	WP40
◆ Bone	WP17
◆ Bordeaux	WP26
◆ Brick Red	WP99
◆ Camel	WP18
◆ Cappuccino	WP21
◆ Carotene	WP97
◆ Cashew	WP29
◆ Cerulean	WP36
◆ Charcoal	WP39
◆ Cinnamon	WP25
◆ Cognac	WP62
◆ Cucumber	WP88
◆ Elephant	WP38
◆ Espresso	WP49
◆ Fawn	WP91
◆ Fog	WP100
◆ Forest	WP82
◆ Gravel	WP19
◆ Indigo	WP86
◆ Luggage	WP23
◆ Mahogany	WP93
◆ Mallard	WP90
◆ Merlot	WP27
◆ Molten	WP98
◆ Navy	WP37
◆ Ochre	WP96
◆ Paradise	WP85
◆ Patina	WP34
◆ Pewter	WP83
◆ Putty	WP84
◆ Salsa	WP42
◆ Sangre	WP28
◆ Sassafras	WP89
◆ Storm	WP92
◆ Truffle	WP95
◆ Zest	WP87

FABRIC PATTERNS & CODES

GRADE 3

IN SEASON	ISN
◇ Black	ISN001
◇ Blue Jay	ISN007
◇ Fire	ISN004
◇ Jungle	ISN008
◇ Lake	ISN006
◇ Lead	ISN002
◇ Limestone	ISN041
◇ Ocean	ISN005
◇ Silver	ISN003
◇ Smoke	ISN020
◇ Tundra	ISN011

MOXIE

SX

◆ Barnwood	SX09
◆ Basalt	SX23
◆ Bayou	SX02
◆ Biscotti	SX08
◆ Blackberry	SX48
◆ Blarney	SX49
◆ Blueberry	SX05
◆ Bonsai	SX20
◆ Carob	SX24
◆ Chalk	SX50
◆ Chartreuse	SX34
◆ Cherry	SX38
◆ Cinnamon	SX13
◆ Cobalt	SX01
◆ Coconut	SX06
◆ Concrete	SX43
◆ Cumin	SX32
◆ Dragonfly	SX44
◆ Earl Grey	SX40
◆ Elysian	SX04
◆ Evergreen	SX21
◆ Fatigue	SX18
◆ Fawn	SX30
◆ Flint	SX39
◆ Hazel	SX31
◆ Hemp	SX45
◆ Hickory	SX25
◆ Holly	SX51
◆ Jam	SX16
◆ Kelly	SX33
◆ Lemongrass	SX19
◆ Lime	SX41
◆ Macintosh	SX12
◆ Mulberry	SX15
◆ Parchment	SX07
◆ Peacock	SX03
◆ Pineapple	SX42
◆ Plum	SX17
◆ Punch	SX46
◆ Riverstone	SX47
◆ Russet	SX14
◆ Smokestack	SX22
◆ Tangerine	SX37
◆ Terracotta	SX11
◆ Thicket	SX35
◆ Walnut	SX10

GRADE 3

continued

PARKER	PRKR
◇ Aloe	PRKR01
◆ Cumulus	PRKR05
◆ Cyan	PRKR06
◆ Domino	PRKR07
◆ Fossil	PRKR10
◆ Graphite	PRKR11
◇ Grass	PRKR12
◆ Grenadine	PRKR13
◆ Griffin	PRKR14
◆ Kiln	PRKR16
◆ Magnesium	PRKR18
◆ Magnet	PRKR19
◆ Mica	PRKR20
◆ Mink	PRKR21
◆ Nightfall	PRKR22
◆ Paprika	PRKR24
◆ Pine	PRKR25
◆ Rapids	PRKR28
◆ Rioja	PRKR30

PURL

PURL

◇ Alpaca	PURL08
◇ Braid	PURL10
◇ Deep	PURL12
◆ Graze	PURL05
◆ Loom	PURL06
◆ Needle	PURL07
◆ Pasture	PURL02
◆ Ranch	PURL04
◆ Shuttle	PURL09
◆ Skein	PURL01
◆ Thistle	PURL11
◆ Yearling	PURL03

QUILL

QUL

◇ Aviary	QUL03
◇ Feather	QUL02
◇ Fountain	QUL06
◇ Ink	QUL05
◆ Metal	QUL04
◆ Reed	QUL08
◆ Scroll	QUL01
◆ Well	QUL07

GRADE L1

DENVER LEATHER	SS
◆ Black	SS11

For a complete list of fabrics, including partnership fabrics, go to hon.com/fabricsandfinishes.

PANEL FABRIC PATTERNS & CODES

PRICE CODE AA		PRICE CODE A		PRICE CODE A <i>continued</i>		PRICE CODE A <i>continued</i>	
FACTOR	FACT	APPOINT	APN	ETCH*	ECH	REFLECTIONS*	REF
◇ Bark	FACT20	◇ Artichoke	APN11	◇ Axis	ECH13	◇ Galvanized	REF29
◇ Barley	FACT15	◇ Blackberry	APN32	◇ Blend	ECH14	◇ Ice	REF20
◇ Cascade	FACT25	◇ Bronze	APN22	◇ Cast	ECH12	◇ Loggia	REF21
◇ Feather	FACT30	◇ Carbon	APN28	◇ Highlight	ECH10	◇ Mistral	REF28
		◇ Chai	APN12	◇ Midtone	ECH11	◇ Moonstone	REF23
		◇ Cherry	APN30	◇ Outline	ECH08	◇ Pewter	REF22
		◇ Dark Pewter	APN17	◇ Shade	ECH09	◇ Stainless	REF24
		◇ Dune	APN15	◇ Tonal	ECH16	◇ Vanilla	REF25
		◇ Espresso	APN23	◇ Vanish	ECH15	◇ Winter	REF27
		◇ Framboise	APN31				
		◇ Frost	APN34	EXCHANGE*		REFUGE*	
		◇ Jet	APN27	IRON	EXG	ARTESIAN	RFG
		◇ Lawn	APN25	◇ Iron	EXG916	◇ Artesian	RFG96
		◇ Mandarin	APN29	◇ Nickel	EXG914	◇ Dune	RFG92
		◇ Morel	APN09	◇ Pistachio	EXG910	◇ Eclipse	RFG90
		◇ Nimbus	APN16	◇ Root	EXG913	◇ Frost	RFG93
		◇ Platinum	APN24	◇ Rupee	EXG903	◇ Glacier	RFG91
		◇ Turquoise	APN26	◇ Shadow	EXG911	◇ Mineral	RFG98
				◇ Silver	EXG915	◇ Tidal	RFG94
				◇ Sisal	EXG917		
				◇ Stone	EXG912		
		CENTURION CU		LANDSCAPE* LN			
		◇ Apricot	CU47	◇ Azure	LN55	◇ Ash	SRT88
		◇ Bark	CU25	◇ Cornsilk	LN15	◇ Fog	SRT14
		◇ Black	CU10	◇ Drift	LN05	◇ Lemongrass	SRT49
		◇ Espresso	CU49	◇ Khaki	LN20	◇ Mist	SRT45
		◇ Fog	CU03	◇ Sheen	LN10	◇ Mushroom	SRT76
		◇ Frost	CU22	◇ Slate	LN35	◇ Oyster	SRT18
		◇ Goldenrod	CU27	◇ Umber	LN25	◇ Reef	SRT64
		◇ Indigo	CU06	◇ Urban	LN30	◇ Sesame	SRT93
		◇ Iris	CU50			◇ Shale	SRT52
		◇ Iron Ore	CU19	LUCY* LC			
		◇ Jade	CU83	◇ Aspen	LC32	TEMPEST* TP	
		◇ Marsala	CU63	◇ Cornsilk	LC30	◇ Dragonfly	TP30
		◇ Morel	CU24	◇ Dusk	LC22	◇ Frost	TP15
		◇ Navy	CU98	◇ Fawn	LC33	◇ Full Stream	TP80
		◇ Peacock	CU97	◇ Graphite	LC34	◇ Gold Rush	TP10
		◇ Pear	CU84	◇ Mist	LC20	◇ Slate	TP45
		◇ Ruby	CU67	◇ Neutra	LC24	◇ Tumbleweed	TP70
		◇ Sapphire	CU09	◇ Pewter	LC35	◇ Wind Chill	TP40
				◇ Snowdrop	LC28	◇ Zebra	TP35

NOTES: Centurion fabrics not available on panels that exceed a width and height of 54"H.

Exchange is applied pattern cut and is not available on 78"W tackboards, Voi® screens, and Empower®.

Disperse is applied pattern cut and is not available on 72"W Accelerate® panels and not available on 66"W tackboards, Voi® screens, and Empower®.

◇◇◇ For lead time information see page 19.

* Directional fabrics

PANEL FABRIC PATTERNS & CODES

PRICE CODE B

ANALOG	ANLG
<i>Not available on Accelerate®</i>	
◆ Album	ANLG06
◆ Cartridge	ANLG04
◆ Cassette	ANLG09
◆ Dial	ANLG02
◆ Media	ANLG08
◆ Reel	ANLG07
◆ Signal	ANLG03
◆ Stereo	ANLG01
◆ Track	ANLG05

COAST*	COA
<i>Not available on Accelerate®</i>	
◆ Channel	COA14
◆ Dune	COA03
◆ Headlands	COA10
◆ Marsh	COA02
◆ Pebble	COA12
◆ Pier	COA13
◆ Shoal	COA01
◆ Silt	COA06
◆ Tide	COA08

PRICE CODE B *continued*

DISPERSE*	DISP
◆ Autumn	DISP03
◆ Branch	DISP10
◆ Coffee Bean	DISP13
◆ Dusk	DISP09
◆ Emerald City	DISP08
◆ Gold Rush	DISP02
◆ Igloo	DISP11
◆ Ink	DISP06
◆ Mist	DISP12
◆ Oatmeal	DISP15
◆ Prince	DISP07
◆ Reservoir	DISP01
◆ Rose	DISP04
◆ Spring	DISP05
◆ Steel	DISP16
◆ Taupe	DISP14

MICA*	MCA
◆ Anthracite	MCA11
◆ Breeze	MCA18
◆ Bronze	MCA13
◆ Buff	MCA14
◆ Cremini	MCA17
◆ Crystal	MCAWIT
◆ Dew	MCA20
◆ Dove	MCA12
◆ Fresh	MCA16
◆ Mineral	MCA15
◆ Nectar	MCA19
◆ Shale	MCA10

PRICE CODE B *continued*

SPIN*	SPIN
◆ Alabaster	SPIN02
◆ Cavern	SPIN03
◆ Cobblestone	SPIN04
◆ Ember	SPIN06
◆ Flame	SPIN07
◆ Heron	SPIN13
◆ Oat	SPIN01
◆ Ocean	SPIN12
◆ Plum	SPIN15
◆ Pool	SPIN11
◆ Raven	SPIN10
◆ Rhubarb	SPIN14
◆ Tropic	SPIN08
◆ Willow	SPIN05

TERRAIN*	TRRN
◆ Bay	TRRN05
◆ Bayou	TRRN35
◆ Canyon	TRRN30
◆ Cliff	TRRN45
◆ Crest	TRRN25
◆ Delta	TRRN10
◆ Plateau	TRRN15
◆ Ridge	TRRN20
◆ Valley	TRRN40

NOTES: Exchange is applied pattern cut and is not available on 78"W tackboards, Voi® screens, and Empower®.

Disperse is applied pattern cut and is not available on 72"W Accelerate® panels and not available on 66"W tackboards, Voi® screens, and Empower®.

◆◆◆ For lead time information see page 19.

* Directional fabrics

FEATURES OFFERED ON HON LAMINATE CASEGOODS

	10500	10700	Valido	Concinnity	94000	Voi
Worksurfaces						
• Scratch, stain and spill-resistant surface over durable 1/4" solid core high performance particleboard	•	•		•		•
• Scratch, stain and spill-resistant surface over extra-thick 1/2" solid core high performance particleboard			•			
• Scratch, stain and spill-resistant high gloss surface over durable 1/4" solid core high performance particleboard					•	
• Contoured hardwood accent trim		•			•	
• User-friendly waterfall-shaped edges and rounded corners improves worker comfort		•				
• Edge profile options				•		
Chassis Construction						
• European-designed fastening system – Precision, metal-to-metal, fasteners eliminate need for external cleats or exposed screws; enables tops or end panels to be interchanged or replaced	•	•	•	•	•	•
• Inner frame constructed using mortise and tenon joinery for superior structural strength and precisely positioning/securing the pedestal to the modesty panel; endures frequent moving/handling; ensures a longer product life cycle	•	•	•		•	
• All fasteners and dowels are positioned by computer to maintain rigorous dimensional standards	•	•	•	•	•	•
• End panels on base units and stack-ons feature PVC bottom edgebanding for added strength and to seal out moisture	•	•	•	•	•	•
Drawer Construction						
• Steel ball-bearing drawer suspensions for smooth, quiet, long-lasting operation	•	•	•	•	•	•
• 5-sided drawer construction for added strength and easy alignment or replacement of drawer fronts	•	•	•	•	•	•
• Full extension box and file drawers	•	•	•	•	•	•
• Hangrails provided in all file drawers for side-to-side letter, legal, A4 or EDP filing; and front-to-back for letter filing	•	•	•	•	•	•
Amenities						
• Conference overhang (select models) provides visitor's kneespace on approach side of desk for meetings	•	•	•	•	•	•
• Formal, full height modesty panels	•	•	•	•	•	•
• Short modesty panel option for easy access to wall electrical outlets	•	•	•	•		•
• Patented, side-mounted drawer handles provide good ergonomics and clean appearance	•	•				
• Antique brass drawer handles					•	
• Decorative drawer/door handle design and finish options			•	•		•
• Vertical grain direction on drawer fronts and modesty panels				•	•	•
• Upscale mixed material door options (select models) on overhead storage	•	•	•	•	•	•
• Adjustable hex leveling glides to level furniture without lifting	•	•	•	•	•	•
• Pullout reference/writing shelf provides additional worksurface space					•	
• Interchangeable lock cores (allow multiple units to be keyed alike)	•	•	•	•	•	•
• Central locking on desks (one lock secures all drawers)					•	
• Cord management (standard) to route and hide wires and cables	•	•	•	•	•	
• Cord management options on modular components (worksurfaces, end and modesty panels, pedestals)				•		•
Configuration Options						
• Components for efficient "U" and "L" shaped workstation layouts	•	•	•	•	•	•
• Peninsulas and corner units	•	•	•	•		
• Worksurfaces or shells up to 96"W	•			•		
• Standing, 42"H desking solutions	•			•		•
• Overheads sized to span multiple base units	•	•	•	•	•	•
• Reception station/transaction counter	•	•	•	•	•	
• Light scale styling, including worksurface components with O-leg supports	•			•		•
• Two-tone color options	•		•	•		•
Storage Options						
• 3/4 pedestals provide increased budget flexibility	•	•	•			
• Full desktop-to-floor pedestals maximize storage space	•	•	•	•	•	•
• Modular components/storage with precise, custom cabinet-like fits				•		•
• Modular shells w/ a variety of storage-pedestal solutions	•	•	•			
• Back wall storage in conventional (65") and executive (78") heights				•		
• Overheads, storage cabinets, wardrobes, lateral files, and bookcases	•	•	•	•	•	•
Companion Products						
• Matching conference tables	•			•	•	•
• Coordinating conference tables		•	•			
Endorsements						
• Meets or exceeds current ANSI/BIFMA and ISTA standards	•	•	•	•	•	•
• Meets SCS Indoor Advantage Certification (see page 17)	•	•	•	•	•	•
• level® certified in conformance with the BIFMA e3 furniture sustainability standard	•	•	•	•	•	•

CONCINNITY™

Want to see more? Scan here
to check out hon.com.



Concinnity™ Executive Workstation shown with Ignition® and Grove® Seating and Flock® Tables.

CONCINNITY™

Clean styling. Rich woodgrains. Mixed materials. A coordinated suite of components. With Concinnity, you can create an upscale look for all types of office spaces — from open to collaborative to private. Choose from a variety of desk configurations and an extensive selection of storage options to create the ideal solution to fit your footprint and your needs.



FEATURES

- Cohesive visual signature highlighted by clean lines, vertical grain, and components that fit together like custom cabinetry.
- Modular design delivers an unbeatable combination of versatility, style, and personalization to any workspace.
- Wide array of aesthetic options, including edge profiles, handles, mixed materials, and laminate finish combinations.
- Extensive assortment of storage solutions allow users to increase functionality, maximize space and keep everything conveniently within reach.
- Products to create flat, continuous horizontal planes or multi-level, overlapping, layered surfaces.
- Standing-height workstations to support today's healthy work styles; available with adjustable or fixed height bases.

CONCINNITY™ ORDERING INFORMATION

WORKSURFACES

L1 LAMINATES CODES

Woodgrain

- ◆ Bourbon Cherry H
- ◆ Cognac COGN
- ◆ Florence Walnut LFW1
- ◆ Harvest C
- ◆ Kingswood Walnut LK11
- ◆ Mahogany N
- ◆ Mocha MOCH
- ◆ Natural Maple D
- ◆ Pinnacle PINC
- ◆ Shaker Cherry F
- ◆ Sterling Ash LSA1

Solid

- ◆ Black P
- ◆ Charcoal S
- ◆ Designer White LDW1
- ◆ Loft LOFT

Patterned

- ◆ Sheer Mesh * A5
- ◆ Silver Mesh B9

L2 LAMINATES CODES

Woodgrain

- ◆ Lowell Ash LLA1
- ◆ Natural Recon LNRI
- ◆ Phantom Ecru LPE1
- ◆ Portico Teak LPT1
- ◆ Skyline Walnut LSW1

DRAWER AND DOOR FRONTS

L1 LAMINATES CODES

Woodgrain

- ◆ Bourbon Cherry H
- ◆ Cognac COGN
- ◆ Florence Walnut LFW1
- ◆ Harvest C
- ◆ Kingswood Walnut LK11
- ◆ Mahogany N
- ◆ Mocha MOCH
- ◆ Natural Maple D
- ◆ Pinnacle PINC
- ◆ Shaker Cherry F
- ◆ Sterling Ash LSA1

Solid

- ◆ Black P
- ◆ Charcoal S
- ◆ Designer White LDW1
- ◆ Loft LOFT

L2 LAMINATES CODES

Woodgrain

- ◆ Lowell Ash LLA1
- ◆ Natural Recon LNRI
- ◆ Phantom Ecru LPE1
- ◆ Portico Teak LPT1
- ◆ Skyline Walnut LSW1

HANDLE/LOCK

FINISHES CODES

P1

- ◆ Black P
- ◆ Satin SA

CHASSIS, END, MODESTY, AND BACK PANELS

L1 LAMINATES CODES

Woodgrain

- ◆ Bourbon Cherry H
- ◆ Cognac COGN
- ◆ Florence Walnut LFW1
- ◆ Harvest C
- ◆ Kingswood Walnut LK11
- ◆ Mahogany N
- ◆ Mocha MOCH
- ◆ Natural Maple D
- ◆ Pinnacle PINC
- ◆ Shaker Cherry F
- ◆ Sterling Ash LSA1

Solid

- ◆ Black P
- ◆ Charcoal S
- ◆ Designer White LDW1
- ◆ Loft LOFT

L2 LAMINATES CODES

Woodgrain

- ◆ Lowell Ash LLA1
- ◆ Natural Recon LNRI
- ◆ Phantom Ecru LPE1
- ◆ Portico Teak LPT1
- ◆ Skyline Walnut LSW1

HMBPOST AND HMBTLEG24

PAINTS CODES

P1

- ◆ Black P

P2

- ◆ Platinum Metallic T1

SILVER COLORWAY: The following finish options are coordinating silver colorways — Satin, Satin Nickel, Matte Chrome, Platinum, and Platinum Metallic.

EDGE PROFILES “B” AND “V”

EDGEBAND COLORS CODES

Woodgrain

- ◆ Bourbon Cherry H
- ◆ Cognac COGN
- ◆ Florence Walnut FW
- ◆ Harvest C
- ◆ Kingswood Walnut KI
- ◆ Mahogany N
- ◆ Mocha MOCH
- ◆ Natural Maple D
- ◆ Pinnacle PINC
- ◆ Shaker Cherry F
- ◆ Sterling Ash SA

EDGE PROFILE “G”

EDGEBAND COLORS CODES

Woodgrain

- ◆ Bourbon Cherry H
- ◆ Cognac COGN
- ◆ Florence Walnut FW
- ◆ Harvest C
- ◆ Kingswood Walnut KI
- ◆ Lowell Ash DL
- ◆ Mahogany N
- ◆ Mocha MOCH
- ◆ Natural Maple D
- ◆ Natural Recon NR
- ◆ Phantom Ecru PE
- ◆ Pinnacle PINC
- ◆ Portico Teak DP
- ◆ Shaker Cherry F
- ◆ Skyline Walnut SW
- ◆ Sterling Ash SA

Solid

- ◆ Black P
- ◆ Brownstone EY
- ◆ Charcoal S
- ◆ Designer White DW
- ◆ Fossil EH
- ◆ Loft LOFT

Pattern laminates do not have a matching edgiband color; they are available with a woodgrain or solid color edge.

◆◆◆ For lead time information see page 19.

* De-emphasized

CONCINNITY™ LAMINATE DESIGN/MATERIALS INFORMATION

STYLING AND CONSTRUCTION

- Conventional desking or light scale components.
- Clean, uninterrupted lines and precise fits; no gaps.
- All end, modesty, and back panels, as well as drawer and door fronts, that are specified in a woodgrain color, feature vertical grain; drawer fronts are vertically-aligned, continuous grain and are matched sets.
 - Modesty panels wider than 60" have horizontal grain on L2 and non-standard finishes.
- All desk, credenza, and return models feature full-to-the-floor pedestals to maximize storage space.
- Factory-configured (i.e., built-up; assembled) 72"W desks can be specified with breakfront or recessed modesty panels.
- Formal, full height modesty panels on factory-configured (i.e., built-up; assembled) desks, credenzas, and returns; modular components available with full or 10" modesty panels.
- Drawer and door fronts over end panels.
- Back panel-over-end panel on desks, credenzas, returns, mobile pedestals, 29½"H lateral files and storage cabinets, and full-length modesty panels for modular pedestals.
- Top-between-end panels on stack-on and wall mount storage, 66⅝"H & 79½"H storage and combination storage cabinets, wardrobes and towers.
- Option choices include:
 - Edge profile and edge color
 - Handle design
 - Handle/worksurface grommet/lock face finish
 - Worksurface color
 - Chassis color
 - Drawer front/door color
- **IMPORTANT NOTE:** Designed and sized to coordinate with 65"H Accelerate® Panels.
 - Desks, credenzas, returns, 2-drawer lateral files, and 29½"H storage cabinets, plus 35¼"H stack-on storage or bookcase hutch, are 64¾"H.
 - Additional solutions ≤65"H include the following: storage cabinet, storage/file cabinet, storage cabinet/lateral file, 18" and 36"W wardrobe/storage cabinets, wardrobe/bookcase, storage tower, and 5-shelf bookcase.

MATERIALS

- Easy-care, scratch-, spill- and stain-resistant thermal-fused laminate (TFL) over solid core, high performance particleboard;
 - Component model thickness: 1⅛" worksurfaces and end panels; ¾" modesty panel and drawer/door fronts.

- Durable, impact-resistant banding protects edges.
- Bottom of end panels on base units and stack-ons feature edgebanding for added strength and to seal out moisture.
- HPL worksurfaces are available via special request.

DRAWER SPECIFICATIONS

- Operate on steel ball-bearing slides to ensure smooth, quiet, long-lasting operation.
- Full extension drawers allow complete access to contents.
- Drawers feature 5-sided construction for added strength and easy alignment or replacement of drawer fronts.
- File drawers include integrated hangrails for side-to-side letter or legal filing; and front-to-back for letter filing.
- One molded black pencil tray is included in each box/box/file pedestal.
- Drawer fronts are edgebanded on all four sides.

CORE REMOVABLE LOCKS

- All drawers/doors lock on the following products:
 - All desk, credenza, and return pedestals (NOTE: The lock is on the face of the pedestal)
 - Stack-on and wall mount storage with laminate locking doors ("LL" models)
 - Wall mount storage with sliding door
 - Mobile pedestals
 - Lateral files
 - Storage cabinets
 - Storage/file cabinet
 - Storage cabinet/lateral file
 - Wardrobe/storage cabinets
 - Storage towers
 - Modular pedestals
- On products that are equipped with two locks, the locks are keyed alike:
 - Double pedestal desks
 - Credenza with storage
 - Credenzas with kneespace
 - Low credenzas with four drawers
 - Storage and combination storage/file cabinets
 - Storage towers
 - Stack-on and wall mount storage 60" - 78"W
- Lock faces are available in black or satin.

CONCINNITY™ LAMINATE DESIGN/MATERIALS INFORMATION

- Locks feature a removable cylinder (core) that can be interchanged as needed; allows all furniture pieces within an individual workstation to be accessed with one key for convenience, and allows locks to be differentiated between workstations and offices for security. Makes re-keying quick and easy.
 - Keyed alike cores must be ordered separately by specification of the key number. For all products, except stack-on and wall mounted storage, the removable lock core kits are HF23B for Black and HF23S for Satin (Silver).
 - EXCEPTION - IMPORTANT - NOTE: The removable lock core kit for stack-on and wall mounted storage is model HF27B (Black) or HF27S (Satin).

CORD MANAGEMENT

- Cord management grommets and pass-through cutouts, for routing and hiding wires and cables, are standard in a pre-determined location on a number of factory-configured (i.e., built-up; assembled) products:
 - Two grommets are located in the tops of desks and credenzas; one grommet is located in the top of returns, bridges, jetty peninsulas, and corner units.
 - All desk, credenza, and return pedestals are designed with two cord pass-through grommets, one per side; end panels of single pedestal desks and single pedestal credenzas feature one cord pass-through grommet.
 - Pass-through in the sides of pedestals and end panels enable the routing of cords below the worksurface and connections between workstations.
 - A pass-through grommet, to facilitate reaching wall electrical outlets, is located in the back panels of credenza with storage, credenza with kneespace, single pedestal credenzas, credenzas with 36" lateral file, returns and bridges.
- See chart on page 34 for cord management options. Worksurfaces/tops, end and modesty panels, and pedestals can be specified with or without grommets.
- Grommets on worksurfaces are sized to accept optional grommet mount power hub (HGRMTAC) and USB (HGRMTUSB2) models.

- Grommet color/shape/size:
 - Worksurfaces, Black or Platinum, Round, 3" diameter hole with a 3½" plastic cap.
 - Back/modesty panels, Black, Round, 2½" diameter hole with a 3" plastic cap.
 - End panels and pedestal sides, Black, Half-round, 1¾" diameter hole with a 2" x 2½" plastic cap.

LEVELING GLIDES

- Adjustable hex glides to compensate for uneven floors; allow furniture to be easily leveled without lifting the unit.
 - Glides have a 1¼" adjustable range.
 - The hex adjustment is on the foot of the glide for all products except for the 9½", 15¾", and 18"W modular pedestals, in which case it is on the top of the glide stem.







IMPORTANT — OTHER

- Products ship fully assembled, unless otherwise noted (NOTE:  — easy-to-assemble — items are designated in the "DESCRIPTIONS").
- All models must meet or exceed ANSI/BIFMA & ISTA performance standards.
- Products covered by HON Limited Lifetime Warranty.
- Indoor Advantage™ Gold. Indoor Air Quality Certified to SCS-EC10.3-2014 v3.0.
- BIFMA level® 2 certified. Conforms to ANSI/BIFMA e32014e Furniture Sustainability Standard.

CONCINNITY™ LAMINATE ORDERING/SPECIFICATION INFORMATION

WORKSURFACE/TOP EDGE DETAILS

- Three options; two contoured profiles and one smooth, flat edge.
- For beaded (B) and tri-oval (V) edge shapes, tops are profiled on the user and approach sides, and flat on the ends; the flat edges allow side-by-side placement of worksurfaces without gaps. The only exceptions are return, bridge, corner unit, extended corner worksurface, and rectangle worksurface with vertical grain models, tops on these items are profiled on the user's side and flat banded on the approach side and ends.
 - Bookcases have profiled edge on the front, user side only.
 - The reception station transaction counter and the L-reception station with transaction counter (for the desk) models, have profiled edgeband on the approach and user sides.
 - The L-reception station with the transaction counter models, on which the counter runs around the entire perimeter of the L-configuration, have a profiled edge on the front of the transaction counter on the desk approach side only.

Edge Options:	Profiles	Designator
Beaded		 B
Smooth, Flat		 G
Tri-Oval		 V

WORKSURFACE EDGE COLORS

- Woodgrain and solid color laminates can be specified with a matching, complementary, or contrasting edgeband color; options include:
 - Matching the worksurface edge to a common worksurface, chassis, and drawer front color.
 - Matching the worksurface edge to the worksurface laminate and selecting a different laminate color for the chassis.
 - Matching the worksurface edge to the chassis laminate and selecting a different laminate color for the worksurface.

- Beaded (B) and tri-oval (V) edges are available in L1 woodgrain colors only.
- The smooth, flat (G) edge is available in woodgrain and solid colors.
- Pattern laminates do not have a matching edgeband color; the patterns are available with a woodgrain or solid color edge.

DRAWER/DOOR DECORATIVE HANDLES

- Three handle style options, each available in Satin or Black finish.
- Distinct, easy to grasp designs.
- Handles are metal.
- The hole spacing is 128mm.
- The handle style/finish has to be specified on drawer fronts (desk/credenza/return, mobile and modular pedestals), lateral file drawer fronts, the doors of the storage cabinet, storage/file cabinet, storage cabinet/lateral file, wardrobe/storage cabinet, wardrobe/bookcase, and storage tower.
 - NOTE: Decorative handles are not used on the doors of stack-on storage units or wall mounted storage cabinets.
 - Bookcase hutches with frosted doors are equipped with a push latch release.

Handle Options	Finish	Designator
Cylinder	Satin	A
Cylinder	Black	B
Canopy	Satin	C
Canopy	Black	D
Loop	Satin	E
Loop	Black	F

- NOTE: The Linear and Arch field installable drawer/door handle kit models can be attached using 128mm hole spacing.

CONCINNITY™

LAMINATE ORDERING/SPECIFICATION INFORMATION

CORD MANAGEMENT GROMMETS

- Grommets are standard on desk, credenza, return, bridge, jetty peninsula, and corner unit models. Specification logic includes the grommet finish for tops; choose from Black (P) or Platinum (T1). Grommets in modesty and end panels are Black only.
- Grommets are optional on modular component worksurfaces, full-length (27⁷/₈"H) modesty panels, end panels (1¹/₈", L-shaped) and the sides of support storage pedestals. On worksurfaces, choose from Black (P), Platinum (T1), or no grommet(s) (X). On modesty, end, and side panels the options are grommet Black (P) or no grommet (X).
- See cord management chart on page 34 for details.

LOCK FINISH

- Finish is determined by, and automatically aligned with, the handle finish specified. If there is no decorative handle on the product, such as on locking stack-on or wall mount storage models, the lock finish is specified separately in the option string.
 - When specification is required, the lock finish options are Black (P) or Satin (SA).
- Removable, interchangeable lock core kits must be ordered separately:
 - For all models, except stack-on and wall mount storage, specify model HF23B (Black) or HF23S (Satin), and the specific key number required.
 - For stack-on and wall mount storage, specify model HF27B (Black) or HF27S (Satin), and the specific key number required.

SILVER COLORWAY

- The following finish options are coordinating Silver colorways: Satin, Satin Nickel, Matte Chrome, Platinum, and Platinum Metallic.

LAMINATE COLORS

- Palette choices include sixteen (16) woodgrain, four (4) solid, and two (2) pattern colors.

Woodgrain		Solid Color		Pattern	
Bourbon Cherry	H	Black	P	Sheer Mesh	A5
Cognac	COGN	Charcoal	S	Silver Mesh	B9
Florence Walnut	LFW1	Designer White	LDW1		
Harvest	C	Loft	LOFT		
Kingswood Walnut	LKI1				
Lowell Ash	LLA1				
Mahogany	N				
Mocha	MOCH				
Natural Maple	D				
Natural Recon	LNR1				
Phantom Ecru	LPE1				
Pinnacle	PINC				
Portico Teak	LPT1				
Shaker Cherry	F				
Skyline Walnut	LSW1				
Sterling Ash	LSA1				

- Worksurface, chassis and drawer/door fronts are specified separately to enable a single, color-matched visual, or a complementary or contrasting, multi-tone aesthetic.
- Worksurfaces/tops are available in woodgrain, solid, or pattern laminate colors.
- Chassis and drawer fronts are available in woodgrain or solid laminate colors.
- Pattern colors are available on worksurface tops only.

Worksurface		Chassis		Drawer/Door	
Bourbon Cherry	H	Bourbon Cherry	H	Bourbon Cherry	H
Cognac	COGN	Cognac	COGN	Cognac	COGN
Florence Walnut	LFW1	Florence Walnut	LFW1	Florence Walnut	LFW1
Harvest	C	Harvest	C	Harvest	C
Kingswood Walnut	LKI1	Kingswood Walnut	LKI1	Kingswood Walnut	LKI1
Lowell Ash	LLA1	Lowell Ash	LLA1	Lowell Ash	LLA1
Mahogany	N	Mahogany	N	Mahogany	N
Mocha	MOCH	Mocha	MOCH	Mocha	MOCH
Natural Maple	D	Natural Maple	D	Natural Maple	D
Natural Recon	LNR1	Natural Recon	LNR1	Natural Recon	LNR1
Phantom Ecru	LPE1	Phantom Ecru	LPE1	Phantom Ecru	LPE1
Pinnacle	PINC	Pinnacle	PINC	Pinnacle	PINC
Portico Teak	LPT1	Portico Teak	LPT1	Portico Teak	LPT1
Shaker Cherry	F	Shaker Cherry	F	Shaker Cherry	F
Skyline Walnut	LSW1	Skyline Walnut	LSW1	Skyline Walnut	LSW1
Sterling Ash	LSA1	Sterling Ash	LSA1	Sterling Ash	LSA1
Black	P	Black	P	Black	P
Charcoal	S	Charcoal	S	Charcoal	S
Designer White	LDW1	Designer White	LDW1	Designer White	LDW1
Loft	LOFT	Loft	LOFT	Loft	LOFT
Sheer Mesh	A5				
Silver Mesh	B9				

- Two-tone color options allow specification of different, complementary laminate combinations:

Color #1	Color #2
Top	Chassis and Drawer Fronts
Top and Drawer Fronts	Chassis
Top and Chassis	Drawer Fronts

- Modesty panels and the backs of storage chassis that are specified in L2 laminates and wider than 60"W will ship as horizontal grain.

CONCINNITY™ CORD MANAGEMENT

	GROMMET	# OF GROMMETS	LOCATION	CUTOUT SHAPE	MATERIAL	COLOR/FINISH
BUILT-UP/FACTORY-CONFIGURED						
DESK						
Top	Standard/Fixed Location	2	Back Left & Right	3" Round	Plastic	Black or Platinum
End Panel	Standard/Fixed Location	2 (1 per EP)	Top Back Corner	1¼" Round	Plastic	Black
Modesty/Back	Not Available	0	N/A	N/A	N/A	N/A
CREDENZA						
Top	Standard/Fixed Location	2	Back Left & Right	3" Round	Plastic	Black or Platinum
End Panel	Standard/Fixed Location	2 (1 per EP)	Top Back Corner	1¼" Round	Plastic	Black
Modesty/Back	Standard/Fixed Location	1	Top Center	2½" Round	Plastic	Black
RETURN						
Top	Standard/Fixed Location	1	Top Center	3" Round	Plastic	Black or Platinum
End Panel	Standard/Fixed Location	1	Top Back Corner	1¼" Round	Plastic	Black
Modesty/Back	Standard/Fixed Location	1	Top Center	2½" Round	Plastic	Black
BRIDGE						
Top	Standard/Fixed Location	1	Back Center	3" Round	Plastic	Black or Platinum
Modesty/Back	Standard/Fixed Location	1	Top Center	2½" Round	Plastic	Black
BULLET PENINSULA						
Top	Not Available	0				
End Panel	Not Available; Pass-Thru in Brace Panel	0				
JETTY PENINSULA						
Top	Standard/Fixed Location	1	Back, Approach-Side Corner	3" Round	Plastic	Black or Platinum
End Panel	Not Available; Pass-Thru Standard in Brace Panel	0				
CORNER UNIT						
Top	Standard/Fixed Location	1	Back Corner	3" Round	Plastic	Black or Platinum
Modesty/Back	Not Available; Pass-Thru Standard in Brace Panels	0				
Stack-on	Standard/Fixed Location	1	1¼" Side-to-Side Gap at Top or Bottom of Back Panel, Below Cabinet			
MODULAR COMPONENTS – WORKSURFACES						
Rectangle – 60" to 96"W	Optional – Specify: Black (P) or Platinum (T1) or None (X)	2	Back Left & Right	3" Round	Plastic	Black or Platinum
Rectangle – 30" to 54"W	Optional – Specify: Black (P) or Platinum (T1) or None (X)	1	Back Center	3" Round	Plastic	Black or Platinum
Bullet Shape	Optional – Specify: Black (P) or Platinum (T1) or None (X)	1	Centered Along EP; Over Brace Leg Cutout	3" Round	Plastic	Black or Platinum
Ext. Corner	Optional – Specify: Black (P) or Platinum (T1) or None (X)	1	Back Corner of Top and Long End Panel	3" Round	Plastic	Black or Platinum
MODULAR COMPONENTS – MODESTY PANELS						
Full-Length – ≥30"W	Optional – Specify: Black (P) or None (X)	1	Top Center	2½" Round	Plastic	Black
10"	No	0				
MODULAR COMPONENTS – END PANELS						
1½" Thick	Optional – Specify: Black (P) or None (X)	1	Top Back Corner	1¼" Round	Plastic	Black
T-Shaped	No	0				
L-Shaped	Optional – Specify: Black (P) or None (X)	1	Top or Bottom Centered	1¼" Round	Plastic	Black
MODULAR COMPONENTS – STORAGE PEDESTALS						
Pedestal	Optional – Specify: Black (P) or None (X)	2 (1 per EP)	Top Back Corner	1¼" Round	Plastic	Black

NOTE: If customer wants a desk, credenza, return, or bridge without grommets, they can specify modular components.

Grommet Locations in Tops

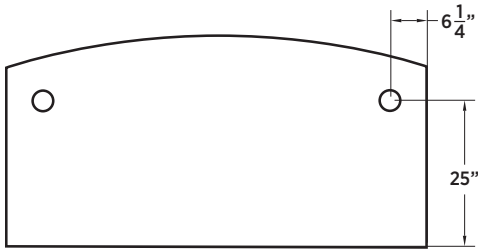

Bow Top Desks and Worksurfaces

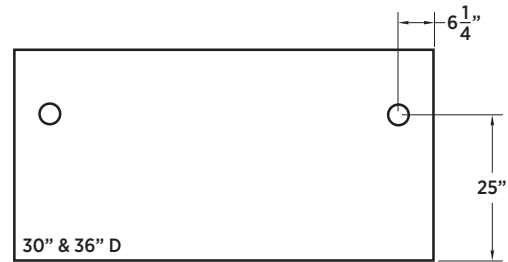

Desks and Rectangle Worksurfaces

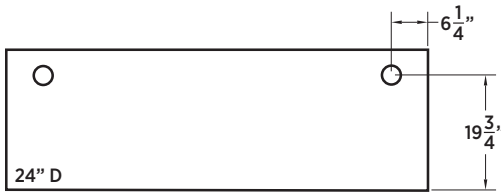

Credenzas and Rectangle Worksurfaces

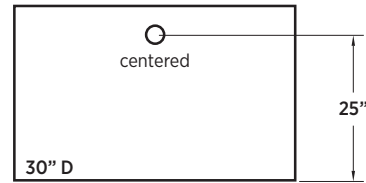

Rectangle Worksurfaces

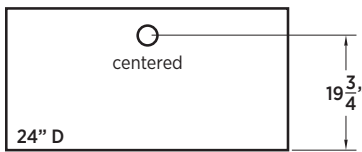

Returns, Bridges, and Rectangle Worksurfaces

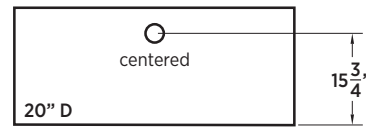

Rectangle Worksurfaces



Bullet Worksurfaces

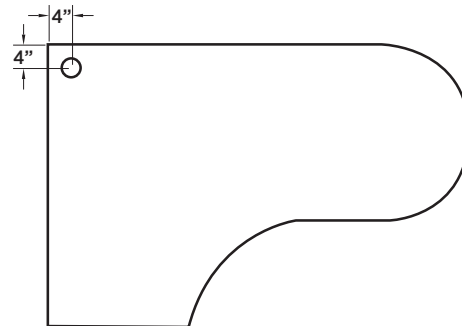

Jetty Peninsula

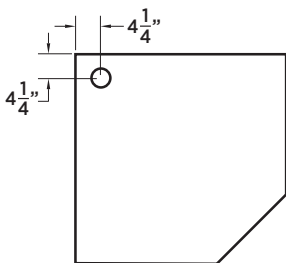

Corner Unit

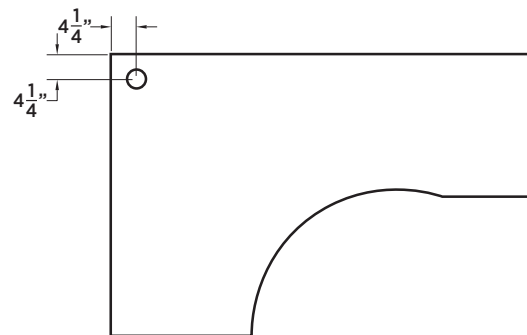

Extended Corner Worksurfaces

CONCINNITY™

Typicals



Icon Legend on page 19

QTY	DESCRIPTION	MODEL	LIST PRICE	PRICE EXTENSION
1	Double Pedestal Desk, Bow Top, Breakfront Frosted Modesty Panel 72"W x 36"D x 29½"H	HNL3672DPBBF	\$3,153	\$3,153
1	Credenza with Kneespace 72"W x 24"D x 29½"H	HNL2472DPK	\$1,989	\$1,989
1	Wall Mount Storage, Frosted Doors with Silver Frame 72"W x 15"D x 28½"H	HNL2972FD	\$2,607	\$2,607
1	Storage/File Cabinet, Hinged Right 18"W x 24"D x 64¾"H	HNL241865SFLR	\$1,903	\$1,903
1	Storage/File Cabinet, Hinged Left 18"W x 24"D x 64¾"H	HNL241865SFL	\$1,903	\$1,903
TOTAL:			\$11,555	

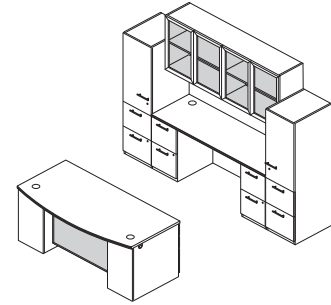
**DESK — CREDENZA — STORAGE**

QTY	DESCRIPTION	MODEL	LIST PRICE	PRICE EXTENSION
1	Left Pedestal Desk, Rectangle Top, Breakfront Modesty Panel 72"W x 36"D x 29½"H	HNL3672LPRB	\$2,090	\$2,090
1	Rectangle Worksurface with Vertical Grain 42"W x 24"D	HNLRC2442V	\$281	\$281
1	Narrow File/File Pedestal 9½"W x 23⅞"D x 28½"H	HNL231028PFF	\$756	\$756
1	Modesty/Back Panel — Full-Length 42"W x 27⅞"H	HNLMP4228	\$224	\$224
1	Stack-on Storage, Sliding Door 78"W x 15"D x 35¼"H	HNL3678SD	\$1,387	\$1,387
1	Storage/File Cabinet, Open Shelves 18"W x 24"D x 64¾"H	HNL241865SFX	\$1,807	\$1,807
TOTAL:			\$6,545	

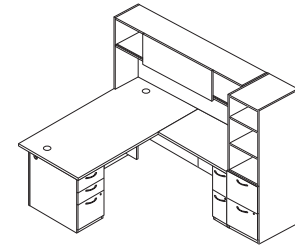
**L-WORKSTATION**

QTY	DESCRIPTION	MODEL	LIST PRICE	PRICE EXTENSION
1	Rectangle Worksurface 72"W x 30"D	HNLRC3072	\$470	\$470
1	Narrow Box/Box/File Pedestal 9½"W x 29⅞"D x 28½"H	HNL291028PBBF	\$844	\$844
1	Full Back Panel — For 9½"W Pedestal 9½"W x 27⅞"H	HNLPB1028	\$139	\$139
1	Laminate Floating Modesty Panel 36"W x 14"H	HLSL3614L	\$202	\$202
1	Bookcase End Support 12"W x 30"D x 28½"H	HNL123028BKE	\$556	\$556
1	Rectangle Worksurface 72"W x 24"D	HNLRC2472	\$402	\$402
1	Shelf/Box/Box/Lateral File Pedestal 36"W x 23⅞"D x 28½"H	HNL233628PSL	\$1,362	\$1,362
1	Storage Cabinet Pedestal 36"W x 23⅞"D x 28½"H	HNL233628PSC	\$887	\$887
1	Modesty/Back Panel — Full-Length 72"W x 27⅞"H	HNLMP7228	\$314	\$314
1	Stack-on Storage, Sliding Door 72"W x 15"D x 35¼"H	HNL3672SD	\$1,345	\$1,345
1	Bookcase with Coat Hooks, 5-Shelf, Left 24"W x 24"D x 64¾"H	HNL2424BK5CL	\$1,048	\$1,048
TOTAL:			\$7,569	

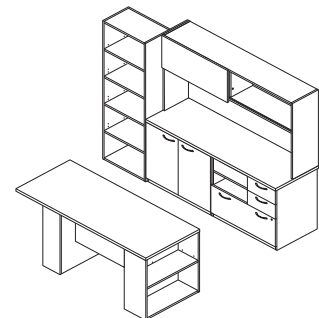
**DESK — CREDENZA — STORAGE**



Icon Legend on page 19

CONCINNITY™ Typicals

QTY	DESCRIPTION	MODEL	LIST PRICE	PRICE EXTENSION
1	Rectangle Worksurface 60"W x 24"D	HNLRC2460	\$358	\$358
1	Height Adjustable Base	HHATB3S2LT	\$1,047	\$1,047
1	External Stiffener 48"W for 54" Worksurface	HLSLZ5SC60	\$106	\$106
1	Rectangle Worksurface 84"W x 24"D	HNLRC2484	\$540	\$540
1	End Panel, Left 1½"W x 23⅝"D x 28½"H	HNLEP2428L	\$224	\$224
1	Shelf/Box/Box/Lateral File Pedestal 36"W x 23⅝"D x 28½"H	HNL233628PSL	\$1,362	\$1,362
1	Modesty/Back Panel — Short 84"W x 10"H	HNLMP8410	\$381	\$381
1	Low Back Panel — For 28½"H Pedestal 36"W x 18"H	HNLB3618	\$164	\$164
2	Stack-on Storage, Frosted Doors with Silver Frame 42"W x 15"D x 35¼"H	HNL3642FD	\$1,451	\$2,902
1	Space Saver End Panels for Stack-on Storage ¾"W x 14¼"D x 35¼"H	HNL3605SSEP	\$417	\$417
1	Wardrobe/Storage Cabinet, Hinged Right 18"W x 24"D x 64¾"H	HNL241865WLR	\$1,739	\$1,739

TOTAL: \$9,240

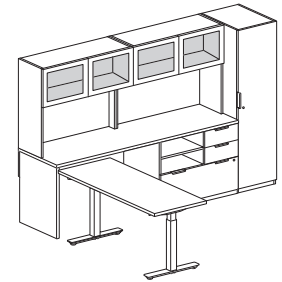

L-WORKSTATION WITH HEIGHT-ADJUSTABLE DESK — OPEN PLAN

QTY	DESCRIPTION	MODEL	LIST PRICE	PRICE EXTENSION
1	Bullet Worksurface 84"W x 30"D	HNLBU3084	\$660	\$660
1	T-Shaped End Panel — For Bullet Worksurface 11⅝"W x 29⅞"D x 28½"H	HNLTEP3028	\$386	\$386
1	Support Column — For Bullet Worksurface 3" Diameter	HPC190X	\$173	\$173
1	Bridge 48"W x 24"D x 29½"H	HNL2448BF	\$491	\$491
1	Rectangle Worksurface 84"W x 24"D	HNLRC2484	\$540	\$540
1	End Panel, Left 1½"W x 23⅝"D x 28½"H	HNLEP2428L	\$224	\$224
1	Shelf/Box/Box/Lateral File Pedestal 36"W x 23⅝"D x 28½"H	HNL233628PSL	\$1,362	\$1,362
1	Modesty/Back Panel — Full-Length 84"W x 27⅞"H	HNLMP8428	\$381	\$381
2	Stack-on Storage, Laminate Doors 42"W x 15"D x 48⅝"H	HNL4942LD	\$1,320	\$2,640
1	Space Saver End Panels for Stack-on Storage ¾"W x 14¼"D x 48⅝"H	HNL4905SSEP	\$561	\$561

TOTAL: \$7,418

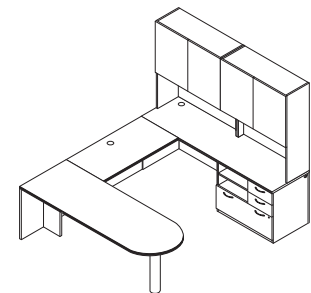

U-WORKSTATION WITH 84" W WORKSURFACE

QTY	DESCRIPTION	MODEL	LIST PRICE	PRICE EXTENSION
1	Left Pedestal Desk, Rectangle Top, Breakfront Frosted Modesty Panel 72"W x 36"D x 29½"H	HNL3672LPRBF	\$2,608	\$2,608
1	Rectangle Worksurface with Vertical Grain 48"W x 24"D	HNLRC2448V	\$302	\$302
1	Modesty/Back Panel — Short 48"W x 10"H	HNLMP4810	\$244	\$244
1	Right Credenza with Lateral File 72"W x 24"D x 29½"H	HNL2472RLC	\$1,733	\$1,733
1	Stack-on Storage, Frosted Doors with Silver Frame 72"W x 15"D x 48⅝"H	HNL4972FD	\$2,839	\$2,839
1	Vertical Paper Manager	HLVPM1	\$351	\$351
1	Wardrobe Left, Bookcase Right 36"W x 24"D x 78⅞"H	HNL243679WLBR	\$2,771	\$2,771

TOTAL: \$10,848

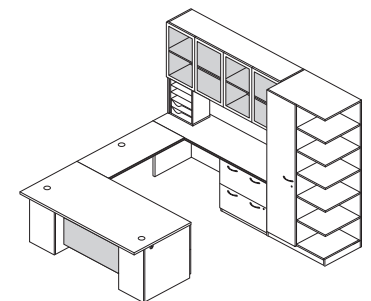

U-WORKSTATION

CONCINNITY™

Typicals



Icon Legend on page 19

QTY	DESCRIPTION	MODEL	LIST PRICE	PRICE EXTENSION
1	Rectangle Worksurface 72"W x 30"D	HNLRC3072	\$470	\$470
1	Rectangle Worksurface with Vertical Grain 42"W x 24"D	HNLRC2442V	\$281	\$281
1	Height Adjustable Base, 3-Leg	HHATB3S3LT	\$1,729	\$1,729
1	External Stiffener 60"W for 66" Worksurface	HLSLZ5SC72	\$119	\$119
1	Mixed Material Floating Modesty Panel 60"W x 14"H	HLSL6014MM	\$1,243	\$1,243
1	Rectangle Worksurface 72"W x 24"D	HNLRC2472	\$402	\$402
1	End Panel, Right 1½"W x 23½"D x 28½"H	HNLEP2428R	\$224	\$224
1	Box/Box/File Pedestal 15¾"W x 23½"D x 28½"H	HNL231628PBBF	\$782	\$782
1	Low Back Panel — For 15¾"W Pedestal 15¾"W x 18"H	HNLLB1618	\$141	\$141
1	Modesty/Back Panel — Short 72"W x 10"H	HNLMP7210	\$314	\$314
1	Wall Mount Storage, Frosted Doors with Silver Frame 72"W x 15"D x 15"H	HNL1572FD	\$1,961	\$1,961
1	Storage/File Cabinet, Hinged Left 18"W x 24"D x 64¾"H	HNL241865SFL	\$1,903	\$1,903
			TOTAL:	\$9,569

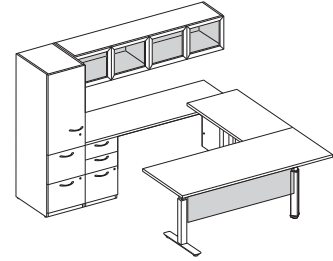

U-WORKSTATION WITH HEIGHT-ADJUSTABLE L-WORKSURFACE

QTY	DESCRIPTION	MODEL	LIST PRICE	PRICE EXTENSION
1	Rectangle Worksurface 72"W x 24"D	HNLRC2472	\$402	\$402
2	O-Leg Support for 24"D Worksurface 24"D x 28½"H	HLSL2428O	\$357	\$714
1	External Support Channel for 72"W Worksurface	HLSLZ5SC78	\$119	\$119
1	Low Credenza, Drawers Left, Bookcase Right 60"W x 20"D x 21½"H	HNL206021LD2	\$1,384	\$1,384
1	Rectangle Worksurface 54"W x 24"D	HNLRC2454	\$328	\$328
1	Standing-Height O-Leg Support for 24"D Worksurface 24"D x 41"H	HLSL2441O	\$476	\$476
1	Narrow Box/Box/File/File Pedestal 9½"W x 23½"D x 41"H	HNL231041PBBFF	\$1,446	\$1,446
1	Full Back Panel — For 41"H Pedestal 9½"W x 40¾"H	HNLPB1041	\$153	\$153
1	Storage Tower, Hinged Left 18"W x 24"D x 50"H	HNL241850TLL	\$1,362	\$1,362
			TOTAL:	\$6,384

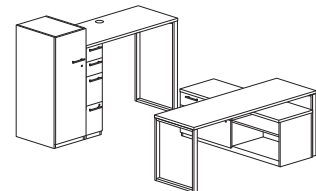

U-WORKSTATION WITH SITTING AND STANDING-HEIGHT WORKSURFACES — OPEN PLAN



Icon Legend on page 19

CONCINNITY™ Typicals

QTY	DESCRIPTION	MODEL	LIST PRICE	PRICE EXTENSION
1	Rectangle Worksurface 72"W x 30"D	HNLRC3072	\$470	\$470
1	O-Leg Support for 30"D Worksurface 30"D x 28½"H	HLSL30280	\$395	\$395
1	O-Leg Support over Low Credenza 30"D x 7"H	HLSL3070	\$305	\$305
1	External Support Channel for 72"W Worksurface	HLSLZ5SC78	\$119	\$119
1	Low Credenza, Drawers Right, Bookcase Left 60"W x 20"D x 21½"H	HNL206021RD2	\$1,384	\$1,384
1	Low Credenza, Drawers Left, Bookcase Right 60"W x 20"D x 21½"H	HNL206021LD2	\$1,384	\$1,384
2	Wall Mount Storage, Laminate Doors 30"W x 15"D x 28½"H	HNL2930LD	\$897	\$1,794
1	Wall Mount Storage, Frosted Doors with Silver Frame 30"W x 15"D x 28½"H	HNL2930FD	\$1,418	\$1,418
1	Wall Mount Markerboard 30"W x 48⅝"H	HNL4930WB	\$249	\$249
TOTAL:			\$7,518	

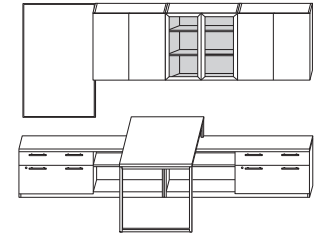

**WORKSTATION WITH
WORKWALL – OPEN PLAN**

QTY	DESCRIPTION	MODEL	LIST PRICE	PRICE EXTENSION
3	Rectangle Worksurface with Vertical Grain 48"W x 24"D	HNLRC2448V	\$302	\$906
3	O-Leg Support for 48"W x 24"D Worksurface 24"D x 28½"H	HLSL24280	\$357	\$1,071
3	Mixed Material Floating Modesty Panel 42"W x 14"H	HLSL4214MM	\$906	\$2,718
3	Rectangle Worksurface 72"W x 24"D	HNLRC2472	\$402	\$1,206
3	L-Shaped End Panel, Left 15¾"W x 24"D x 28½"H	HNLLEP2428L	\$364	\$1,092
3	Shelf/Box/Box/Lateral File Pedestal 30"W x 23⅜"D x 28½"H	HNL233028PSL	\$1,336	\$4,008
3	Modesty/Pedestal Back Panel 30"W x 27⅞"H	HNLMP3028	\$192	\$576
3	Wall Mount Storage, Frosted Doors with Silver Frame 72"W x 15"D x 15"H	HNL1572FD	\$1,961	\$5,883
TOTAL:			\$17,460	

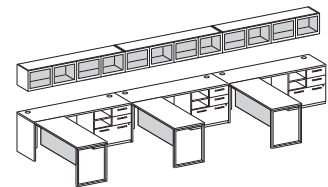

L-WORKSTATIONS – OPEN PLAN

CONCINNITY™

Typicals



Icon Legend on page 19

QTY	DESCRIPTION	MODEL	LIST PRICE	PRICE EXTENSION
1	Rectangle Worksurface with Vertical Grain 48"W x 24"D	HNLRC2448V	\$302	\$302
1	O-Leg Support for 48"W x 24"D Worksurface 24"D x 28½"H	HLSL2428O	\$357	\$357
1	Rectangle Worksurface 96"W x 24"D	HNLRC2496	\$583	\$583
1	Storage Cabinet Pedestal 36"W x 23⅞"D x 28½"H	HNL233628PSC	\$887	\$887
1	End Panel, Left 1⅞"W x 23⅞"D x 28½"H	HNLEP2428L	\$224	\$224
1	Modesty/Back Panel — Full-Length 96"W x 27⅞"H	HNLMP9628	\$471	\$471
1	Bookcase Hutch, Frosted Doors with Silver Frame 36"W x 15"D x 48⅝"H	HNL4936BHFD	\$1,854	\$1,854
1	Wall Mount Storage, Frosted Doors with Silver Frame 60"W x 15"D x 28½"H	HNL2960FD	\$2,449	\$2,449
1	Vertical Paper Manager	HLVPM1	\$351	\$351
1	Storage Tower, Wardrobe Right, Cabinet Left 24"W x 24"D x 78⅞"H	HNL242465TLR	\$2,445	\$2,445
TOTAL:			\$9,923	

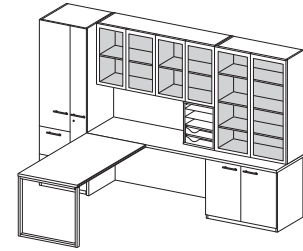

WORKSTATION WITH WORKWALL — OPEN PLAN

QTY	DESCRIPTION	MODEL	LIST PRICE	PRICE EXTENSION
4	Rectangle Worksurface 60"W x 24"D	HNLRC2460	\$358	\$1,432
4	Shelf/Box/Box/File Pedestal 15¾"W x 23⅞"D x 41"H	HNL231641PSBBF	\$1,645	\$6,580
4	Full Back Panel — For 15¾"W Pedestal 15¾"W x 40⅝"H	HNLPB1641	\$168	\$672
4	Narrow Box/Box/File/File Pedestal 9½"W x 23⅞"D x 41"H	HNL231041PBFF	\$1,446	\$5,784
4	Full Back Panel — For 9½"W Pedestal 9½"W x 40⅝"H	HNLPB1041	\$153	\$612
2	Above/Below Privacy Screen, Frosted 30"W x 28"H	HLSL2830	\$896	\$1,792
2	5-Shelf Bookcase with Coat Hooks, Right 24"W x 24"D x 64¾"H	HNL2424BK5CR	\$1,048	\$2,096
2	5-Shelf Bookcase with Coat Hooks, Left 24"W x 24"D x 64¾"H	HNL2424BK5CL	\$1,048	\$2,096
TOTAL:			\$21,064	

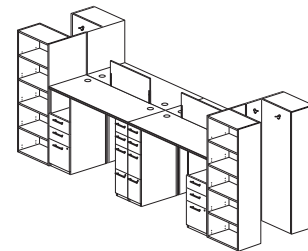

STANDING-HEIGHT — TEAMING WORKSTATION — OPEN PLAN

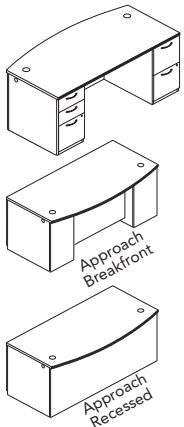

DESCRIPTION	APPROACH SIDE OVERHANG	MODEL	SHIP WEIGHT	CUBE	L1 LIST	L2 UPCHARGES		
						WORKSURFACES	CHASSIS	FRONTS
Double Pedestal Desk — Bow Top								
72"W x 36"D x 29½"H, Recessed Modesty Panel	6"	HNL3672DPBR	298	51.8	\$2525	\$25	\$40	\$10
72"W x 36"D x 29½"H, Breakfront Modesty Panel	6-12"	HNL3672DPBB	282	51.8	\$2625	\$25	\$40	\$10
72"W x 36"D x 29½"H, Breakfront Frosted Modesty Panel	6-12"	HNL3672DPBBF	266	51.8	\$3153	\$25	\$40	\$10

NOTES: For laminate center drawer, see page 104. For pull-out collaborative shelf, for desks with breakfront modesty panel, see page 104.

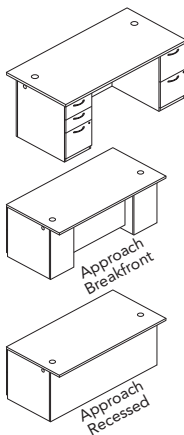

Double Pedestal Desk — Rectangle Top								
72"W x 36"D x 29½"H, Rectangle Top, Recessed Modesty Panel	6"	HNL3672DPRR	292	51.8	\$2137	\$25	\$40	\$10
66"W x 30"D x 29½"H, Rectangle Top, Flush Modesty Panel		HNL3066DPRF	267	40.2	\$2011	\$20	\$35	\$10
60"W x 30"D x 29½"H, Rectangle Top, Flush Modesty Panel		HNL3060DPRF	257	40.2	\$1880	\$20	\$45	\$20
72"W x 36"D x 29½"H, Rectangle Top, Breakfront Modesty Panel	6-12"	HNL3672DPRB	287	51.8	\$2379	\$25	\$40	\$10
72"W x 36"D x 29½"H, Rectangle Top, Breakfront Frosted Modesty Panel	6-12"	HNL3672DPRBF	270	51.8	\$2907	\$25	\$40	\$10

NOTES: For laminate center drawer, see page 104. For pull-out collaborative shelf, for desks with breakfront modesty panel, see page 104.

NOTES:

- Feature full-to-the-floor pedestals to maximize storage space.
- Double pedestal desks have 3/2 drawer configuration (box/box/file on left pedestal, file/file on right pedestal).
- Single pedestal desks have a box/box/file pedestal.
- One molded black pencil tray is included in each box/box/file pedestal.
- 72"W models are available with Rectangle- or bow-shaped tops.
- Bow top desk models measure 36"D at the crest and 30"D along the end panels.
- Formal breakfront or recessed modesty panel.
- Breakfront desk features a floating modesty panel which can be specified in laminate or frosted material. Floating design provides space for optional pull-out collaborative shelf for visitors. See page 104.
- Recessed modesty panel design has a full-width conference overhang, providing worksurface and kneespace for guests.
- 66"W and 60"W desks have a flush modesty panel (i.e., no conference overhang).
- Two cord management grommets, for routing and hiding wires and cables, are located in desktops.
- Grommets can be replaced with optional Power (model HGRMTAC) or USB Hub (HGRMTUSB2).
- Pedestal sides and end panels are standard with pass-through grommets to enable the routing of cords below the worksurface, and connections between workstations.
- Specification logic includes the grommet finish for tops; choose from Black (P) or Platinum (T1). Side grommets on pedestal are black only.
- See "Modular Components" for cord management options. Worksurfaces/tops, end and modesty panels, and pedestals can be specified with or without grommets.
- Finish of pedestal lock(s) is determined by, and aligned with, the handle finish specified.
- Adjustable hex leveling glides.
- Ship fully assembled.

HOW TO SPECIFY

Select Model Number	Select Edge Profile and Edge Color	Select Handle	Select Worksurface Grommet Finish	Select Worksurface Color	Select Chassis Color	Select Drawer Front Color
See page 29	See page 29	<p>A Cylinder – Satin B Cylinder – Black C Canopy – Satin D Canopy – Black E Loop – Satin F Loop – Black</p>	<p>P Black T1 Platinum</p>	See page 29	See page 29	See page 29
HNL3672DPBR	BH	E	T1	H	H	H

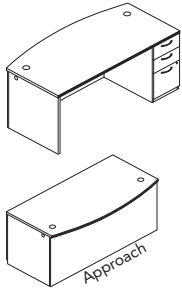

DESCRIPTION	APPROACH SIDE OVERHANG	MODEL	SHIP WEIGHT	CUBE	L1 LIST	L2 UPCHARGES		
						WORKSURFACES	CHASSIS	FRONTS
Single Pedestal Desk — Bow Top 72"W x 36"D x 29½"H, Right, Recessed Modesty Panel (shown)	6"	HNL3672RPBR	238	51.8	\$2029	\$25	\$40	\$10
72"W x 36"D x 29½"H, Left, Recessed Modesty Panel	6"	HNL3672LPBR	238	51.8	\$2029	\$25	\$40	\$10
72"W x 36"D x 29½"H, Right, Breakfront Modesty Panel	6-12"	HNL3672RPBB	237	51.8	\$2288	\$25	\$40	\$10
72"W x 36"D x 29½"H, Left, Breakfront Modesty Panel	6-12"	HNL3672LPBB	237	51.8	\$2288	\$25	\$40	\$10
72"W x 36"D x 29½"H, Right, Breakfront Frosted Modesty Panel	6-12"	HNL3672RPBBF	221	51.8	\$2805	\$25	\$40	\$10
72"W x 36"D x 29½"H, Left, Breakfront Frosted Modesty Panel	6-12"	HNL3672LPBBF	221	51.8	\$2805	\$25	\$40	\$10

NOTES: For laminate center drawer, see page 104. For pull-out collaborative shelf, for desks with breakfront modesty panel, see page 104.

NOTES:

- Feature full-to-the-floor pedestals to maximize storage space.
- Double pedestal desks have 3/2 drawer configuration (box/box/file on left pedestal, file/file on right pedestal).
- Single pedestal desks have a box/box/file pedestal.
- One molded black pencil tray is included in each box/box/file pedestal.
- 72"W models are available with Rectangle- or bow-shaped tops.
- Bow top desk models measure 36"D at the crest and 30"D along the end panels.
- Formal breakfront or recessed modesty panel.
- Breakfront desk features a floating modesty panel which can be specified in laminate or frosted material. Floating design provides space for optional pull-out collaborative shelf for visitors. See page 104.
- Recessed modesty panel design has a full-width conference overhang, providing workspace and kneespace for guests.
- 66"W and 60"W desks have a flush modesty panel (i.e., no conference overhang).
- Two cord management grommets, for routing and hiding wires and cables, are located in desktops.
- Grommets can be replaced with optional Power (model HGRMTAC) or USB Hub (HGRMTUSB2).
- Pedestal sides and end panels are standard with pass-through grommets to enable the routing of cords below the workspace, and connections between workstations.
- Specification logic includes the grommet finish for tops; choose from Black (P) or Platinum (TI). Side grommets on pedestal are black only.
- See "Modular Components" for cord management options. Worksurfaces/tops, end and modesty panels, and pedestals can be specified with or without grommets.
- Finish of pedestal lock(s) is determined by, and aligned with, the handle finish specified.
- Adjustable hex leveling glides.
- Ship fully assembled.

HOW TO SPECIFY

Select Model Number	Select Edge Profile and Edge Color	Select Handle	Select Worksurface Grommet Finish	Select Worksurface Color	Select Chassis Color	Select Drawer Front Color
See page 29	See page 29	See page 29	See page 29	See page 29	See page 29	See page 29
H N L 3 6 7 2 R P B R	B H	E	T I	H	H	H



DESCRIPTION	APPROACH SIDE OVERHANG	MODEL	SHIP WEIGHT	CUBE	L1 LIST	L2 UPCHARGES			
						WORKSURFACES	CHASSIS	FRONTS	
Single Pedestal Desk — Rectangle Top									
72"W x 36"D x 29½"H, Right, Recessed Modesty Panel (shown)	6"	HNL3672RPRR	242	51.8	\$1753	\$25	\$40	\$10	
72"W x 36"D x 29½"H, Left, Recessed Modesty Panel	6"	HNL3672LPRR	242	51.8	\$1753	\$25	\$40	\$10	
66"W x 30"D x 29½"H, Right, Flush Modesty Panel		HNL3066RPRF	217	40.2	\$1711	\$20	\$35	\$10	
66"W x 30"D x 29½"H, Left, Flush Modesty Panel		HNL3066LPRF	217	40.2	\$1711	\$20	\$35	\$10	
72"W x 36"D x 29½"H, Right, Breakfront Modesty Panel	6-12"	HNL3672RPRB	242	51.8	\$2090	\$25	\$40	\$10	
72"W x 36"D x 29½"H, Left, Breakfront Modesty Panel	6-12"	HNL3672LPRB	242	51.8	\$2090	\$25	\$40	\$10	
72"W x 36"D x 29½"H, Right, Breakfront Frosted Modesty Panel	6-12"	HNL3672RPRBF	225	51.8	\$2608	\$25	\$40	\$10	
72"W x 36"D x 29½"H, Left, Breakfront Frosted Modesty Panel	6-12"	HNL3672LPRBF	225	51.8	\$2608	\$25	\$40	\$10	

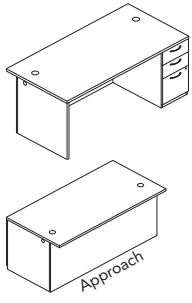

NOTES: For laminate center drawer, see page 104. For pull-out collaborative shelf, for desks with breakfront modesty panel, see page 104.

NOTES:

- Feature full-to-the-floor pedestals to maximize storage space.
- Double pedestal desks have 3/2 drawer configuration (box/box/file on left pedestal, file/file on right pedestal).
- Single pedestal desks have a box/box/file pedestal.
- One molded black pencil tray is included in each box/box/file pedestal.
- 72"W models are available with Rectangle- or bow-shaped tops.
- Bow top desk models measure 36"D at the crest and 30"D along the end panels.
- Formal breakfront or recessed modesty panel.
- Breakfront desk features a floating modesty panel which can be specified in laminate or frosted material. Floating design provides space for optional pull-out collaborative shelf for visitors. See page 104.
- Recessed modesty panel design has a full-width conference overhang, providing workspace and kneespace for guests.
- 66"W and 60"W desks have a flush modesty panel (i.e., no conference overhang).
- Two cord management grommets, for routing and hiding wires and cables, are located in desktops.
- Grommets can be replaced with optional Power (model HGRMTAC) or USB Hub (HGRMTUSB2).
- Pedestal sides and end panels are standard with pass-through grommets to enable the routing of cords below the worksurface, and connections between workstations.
- Specification logic includes the grommet finish for tops; choose from Black (P) or Platinum (T1). Side grommets on pedestal are black only.
- See "Modular Components" for cord management options. Worksurfaces/tops, end and modesty panels, and pedestals can be specified with or without grommets.
- Finish of pedestal lock(s) is determined by, and aligned with, the handle finish specified.
- Adjustable hex leveling glides.
- Ship fully assembled.

HOW TO SPECIFY

Select Model Number	Select Edge Profile and Edge Color	Select Handle	Select Worksurface Grommet Finish	Select Worksurface Color	Select Chassis Color	Select Drawer Front Color
See page 29	See page 29	A Cylinder – Satin B Cylinder – Black C Canopy – Satin D Canopy – Black E Loop – Satin F Loop – Black	P Black T1 Platinum	See page 29	See page 29	See page 29
H N L 3 6 7 2 R P R R	B H	E	T 1	H	H	H

CONCINNITY™

Peninsulas

GSA SIN 33721



Icon Legend on page 19

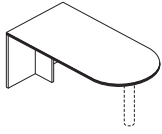

Support column sold separately



DESCRIPTION	MODEL	SHIP WEIGHT	CUBE	L1 LIST	L2 UPCHARGES	
					WORKSURFACE	CHASSIS
Bullet Peninsula with End Panel						
72"W x 36"D x 29½"H	HNL3672BUEP	131	6.6	\$983	\$25	\$40
72"W x 30"D x 29½"H	HNL3072BUEP	112	5.6	\$857	\$20	\$25
66"W x 30"D x 29½"H	HNL3066BUEP	105	5.1	\$768	\$20	\$35

NOTES: For use in "U" or "L" shaped furniture layouts; not to be used freestanding. Comprised of top and end/brace panels (Note: Must specify support column; sold separately). Cord routing notch in the brace panel. Adjustable hex leveling glides. For cord grommet options, see "Modular Components". Options include center drawers and modesty panels. Modesty panel is available in laminate or frosted material. Ships

Not designed to be used freestanding.

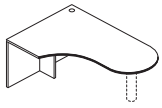
Right-hand model
HNL4872JREP shown

Support column sold separately



Jetty Peninsula with End Panel						
72"W x 30/48"D x 29½"H, Right	HNL4872JREP	147	8.9	\$1181	\$30	\$25
72"W x 30/48"D x 29½"H, Left	HNL4872JLEP	147	8.9	\$1181	\$30	\$25
72"W x 30/42"D x 29½"H, Right	HNL4272JREP	134	17.0	\$1099	\$30	\$25
72"W x 30/42"D x 29½"H, Left	HNL4272JLEP	134	17.0	\$1099	\$30	\$25

NOTES: Worksurface designed and sized to efficiently serve as both a computing and conferencing space. Two sizes, 42"D and 48"D. The 48"D unit is specifically intended to be used with the 48"D extended corner modular top/back components to form a two-piece U-shaped workstation with a 42" cockpit area. For use in "U" or "L" shaped furniture layouts; not to be used freestanding. Comprised of top and end/brace panels (Note: Must specify support column; sold separately). One cord management grommet in the top; cord routing notch in the brace panel. Adjustable hex leveling glides. Field installable modesty panel is optional. Ships

Not designed to be used freestanding.

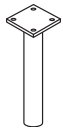

DESCRIPTION	MODEL	SHIP WEIGHT	CUBE	LIST PRICE
Support Column for Bullet and Jetty Peninsulas 3" Diameter. Specify: HPC190X.P. Black only.	HPC190X	12	1.0	\$173
Support Column for Bullet and Jetty Peninsulas 3" Diameter. Specify: HPC191X.X. Available in Silver only.	HPC191X	12	1.0	\$173

Support Column must be specified/ordered with Bullet and Jetty peninsulas.



NOTES:

- See pages 90-94 for shared components.

HOW TO SPECIFY

Select Model Number H N L 3 6 7 2 B U E P	Select Edge Profile and Edge Color See page 29 B H	Select Worksurface Color See page 29 H	Select Chassis Color See page 29 H	
Select Model Number H N L 4 8 7 2 J R E P	Select Edge Profile and Edge Color See page 29 B H	Select Worksurface Grommet Finish P Black T1 Platinum	Select Worksurface Color See page 29 H	Select Chassis Color See page 29 H



	DESCRIPTION	MODEL	SHIP WEIGHT	CUBE	LIST PRICE BY PAINT GRADE		
					P1	P2	P3
	Post Leg Base 28½" H x 2" square NOTES: Can only be used as the outbound support in a peninsula or island extension worksurface application. Glides have 2" of adjustability. Ship 1/pack. SPECIFYING EXAMPLE: HLSL28P.T1	HLSL28P	15	1.0	\$321	\$325	\$341
	Field Installable Modesty Panel for Bullet and Jetty Peninsulas, Laminate (Vertical Grain) 50¼"W x ¾" Thick x 18"H NOTES: Center drawer model H1522 can be used in conjunction with laminate modesty panel model HPC180W. Cord pass-through notch in top corner. SPECIFYING EXAMPLE: HPC180W.H	HPC180W	28	3.6	\$232		
	Field Installable Modesty Panel for Bullet and Jetty Peninsulas, Frosted with Silver Frame 50¼"W x ¾" Thick x 18"H ⚠ Cord pass-through notch is not available on the Frosted/Silver model HPC180G. Notch is on laminate model HPC180W only. ⚠ Center drawers not designed to be used with the frosted/silver modesty panel model HPC180G.	HPC180G	33	1.5	\$745		

NOTES:

- See pages 90-94 for shared components.

HOW TO SPECIFY

Select Model Number

H	L	S	L	2	8	P
---	---	---	---	---	---	---

CONCINNITY™

Corner Unit

GSA SIN 33721



Icon Legend on page 19

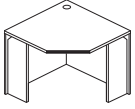

DESCRIPTION	MODEL	SHIP WEIGHT	CUBE	L1 LIST	L2 UPCHARGES	
					WORKSURFACE	CHASSIS
Corner Unit 24"W x 36"D x 24" x 29½"H	HNL3636CU	109	26.4	\$1034	\$15	\$20

NOTES: Designed for use with 24"D returns or bridges. Can be used freestanding. Can be used with two 36"W modular returns to achieve an efficient 6' x 6' layout. One cord management grommet in the top; cord routing notches in the leg panels. The worksurface grommet can be replaced with optional power (model HGRMTAC) or USB (model HGRMTUSB2) hub. Adjustable hex leveling glides. When connected to a 42"W return or modular return, the 78"W stack-on storage unit spans the total depth dimension (78"D). When connected to a 36"W modular return, the 72"W stack-on storage unit spans the total depth dimension (72"D). Edgebanding on the corner unit is profiled on the user's side and flat on the back (approach side) and ends. Ships fully assembled.

NOTES:

- For Extended Corner Worksurface sizes, see "Modular Components" on page 76.

HOW TO SPECIFY

Select
Model Number

H N L 3 6 3 6 C U .

Select
Edge Profile and Edge
Color

See page 29

B H .

Select
Worksurface Grommet
Finish

P Black
T1 Platinum

P .

Select
Worksurface Color

See page 29

H .

Select
Chassis Color

See page 29

H

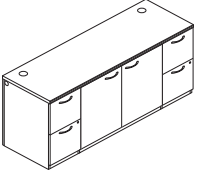
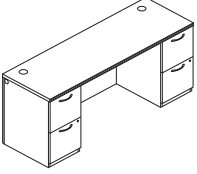
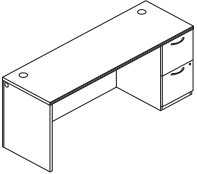
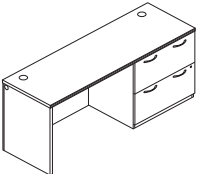

DESCRIPTION	MODEL	SHIP WEIGHT	CUBE	L1 LIST	L2 UPCHARGES		
					WORKSURFACES	CHASSIS	FRONTS
 <p>Credenza with Storage 72"W x 24"D x 29½"H</p> <p>NOTES: For use behind a desk or as a stand-alone storage piece. Four file drawers, 2-left, 2-right and one storage cabinet with hinged doors. One adjustable shelf, which adjusts in 2½" increments, behind doors. Drawers lock. Finish of locks is determined by, and aligned with, the handle finish specified. Storage cabinet doors are non-locking.</p>	HNL2472DPS	323	35.6	\$2628	\$20	\$45	\$40
 <p>Credenza with Kneespace 72"W x 24"D x 29½"H 66"W x 24"D x 29½"H 60"W x 24"D x 29½"H</p> <p>NOTES: For use behind a desk or as a stand-alone storage piece. Four locking file drawers, 2-left, 2-right. Finish of locks determined by, and aligned with, the handle finish specified.</p>	HNL2472DPK	247	35.6	\$1989	\$20	\$40	\$20
	HNL2466DPK	239	32.7	\$1898	\$20	\$40	\$20
	HNL2460DPK	230	29.9	\$1867	\$20	\$35	\$20
 <p>Credenza, Single Pedestal 72"W x 24"D x 29½"H, Right 72"W x 24"D x 29½"H, Left</p> <p>NOTES: Primary use is as part of a connected U-shaped workstation with a bridge and single pedestal desk. Two locking file drawers. Finish of lock determined by, and aligned with, the handle finish specified. Can be used with modular or mobile pedestals.</p>	HNL2472RP	199	35.6	\$1586	\$20	\$35	\$10
	HNL2472LP	199	35.6	\$1586	\$20	\$35	\$10
 <p>Credenza with Lateral File 72"W x 24"D x 29½"H, Right 72"W x 24"D x 29½"H, Left</p> <p>NOTES: Storage file measures 30"W (36"W can be specified using modular components). Mechanical interlock inhibits the extension of more than one drawer at a time. Finish of lock is determined by, and aligned with, the handle finish specified. Can be used with modular or mobile pedestals.</p>	HNL2472RLC	245	35.6	\$1733	\$20	\$35	\$20
	HNL2472LLC	245	35.6	\$1733	\$20	\$35	\$20

NOTES:

- Optional 72"W, 66"W and 60"W stack-on sizes maximize storage space.
- Two cord management grommets, for routing and hiding wires and cables, are located in top.
- Modesty panel and pedestal grommets are black only.
- A cord pass-through grommet is located in the sides of the pedestal and top center of the back (modesty panel) to facilitate reaching wall electrical outlets.
- Specification logic includes the grommet finish for tops; choose from Black (P) or Platinum (T1).
- Worksurfaces/tops, end and modesty panels, and pedestals can be specified with or without grommets. See "Modular Components" on page 34 for cord management options.
- For paper organizers, see page 108.

HOW TO SPECIFY

Select Model Number	Select Edge Profile and Edge Color	Select Handle	Select Worksurface Grommet Finish	Select Worksurface Color	Select Chassis Color	Select Drawer Front Color
	See page 29	A Cylinder – Satin B Cylinder – Black C Canopy – Satin D Canopy – Black E Loop – Satin F Loop – Black	P Black T1 Platinum	See page 29	See page 29	See page 29
H N L 2 4 7 2 D P S	B H	E	T 1	H	H	H

CONCINNITY™ Low Credenzas

GSA SIN 33721



Icon Legend on page 19

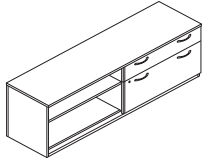

DESCRIPTION	MODEL	SHIP WEIGHT	CUBE	L1 LIST	L2 UPCHARGES		
					WORKSURFACES	CHASSIS	FRONTS
Low Credenza (Bench-Height) 72"W x 20"D x 21½"H, Drawers Right, Bookcase Left (shown)	HNL207221RD2	219	21.6	\$1541	\$15	\$25	\$20
72"W x 20"D x 21½"H, Drawers Left, Bookcase Right	HNL207221LD2	219	21.6	\$1541	\$15	\$25	\$20
60"W x 20"D x 21½"H, Drawers Right, Bookcase Left	HNL206021RD2	187	18.1	\$1384	\$20	\$15	\$20
60"W x 20"D x 21½"H, Drawers Left, Bookcase Right	HNL206021LD2	187	18.1	\$1384	\$20	\$15	\$20

NOTES: Combination storage design comprised of two locking drawers (1-box/supply and 1-file) plus a bookcase. File drawers include integrated hangrails for letter- or legal-sized folders. Bookcase has one adjustable shelf; adjusts in 2½" increments.

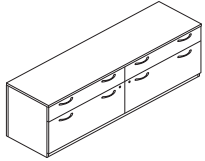

Low Credenza, 2 Box/2 File 72"W x 20"D x 21½"H	HNL207221D4	308	21.6	\$1874	\$15	\$25	\$40
60"W x 20"D x 21½"H	HNL206021D4	260	18.1	\$1660	\$15	\$20	\$40

NOTES: Four locking drawers (2-box/supply and 2-file). File drawers include integrated hangrails for letter- or legal-sized folders.

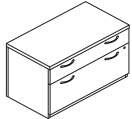

Low Credenza, Box/File 36"W x 20"D x 21½"H	HNL203621D2	143	11.8	\$1086	\$10	\$15	\$20
30"W x 20"D x 21½"H	HNL203021D2	121	10.0	\$1020	\$10	\$15	\$20

NOTES: Unit contains two drawers, one box and one lateral file.

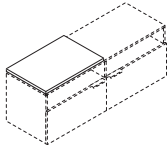

DESCRIPTION	MODEL	SHIP WEIGHT	CUBE	LIST PRICE BY FABRIC GRADE					
				1	2	3	4	5	6
Credenza Cushion 36"W x 20"D x 1"H for 72" and 36"W Low Credenzas	HLSL2036CH2	11	2.2	\$451	\$489	\$527	\$566	\$615	\$665
30"W x 20"D x 1"H for 60" and 30"W Low Credenzas	HLSL2030CH2	9	1.9	\$418	\$454	\$490	\$526	\$572	\$619

NOTES: See pages 22-24 for available fabrics.

Seat cushions are optional; HLSL2036CH2 for 72" and 36"W, HLSL2030CH2 for 60" and 30"W.

! For model HLSL2030CH2 must order two cushions to cover entire 60" Credenza surface.

SPECIFYING EXAMPLE: HLSL2036CH2.APN23

NOTES:

- Versatile, space-saving solutions double as a compact storage unit and convenient bench seat.
- When combined with 29½"H worksurfaces, the 21½"H credenzas can be positioned to create multi-level, overlapping surfaces that optimize floor space, organization and display needs.
- The distinct, clean horizontal planes provide a light scale, layered look.
- Low-heights help facilitate team collaboration.
- Finish of lock(s) is determined by, and aligned with, the handle finish specified.
- Overlapping surfaces can be supported by a 28½"H or 7"H O-leg or 7"H laminate end panel.

HOW TO SPECIFY

<p>Select Model Number</p> <p>See page 29</p> <p>H N L 2 0 7 2 2 1 R D 2</p>	<p>Select Edge Profile and Edge Color</p> <p>See page 29</p> <p>B H</p>	<p>Select Handle</p> <p>A Cylinder - Satin B Cylinder - Black C Canopy - Satin D Canopy - Black E Loop - Satin F Loop - Black</p> <p>E</p>	<p>Select Top Color</p> <p>See page 29</p> <p>H</p>	<p>Select Chassis Color</p> <p>See page 29</p> <p>H</p>	<p>Select Drawer Front Color</p> <p>See page 29</p> <p>H</p>
--	---	--	---	---	--

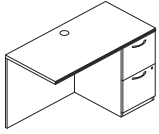

DESCRIPTION	MODEL	SHIP		L1 LIST	L2 UPCHARGES		
		WEIGHT	CUBE		WORKSURFACES	CHASSIS	FRONTS
Return							
48"W x 24"D x 29½"H, Right (shown)	HNL2448RP	141	24.8	\$1138	\$15	\$15	\$10
48"W x 24"D x 29½"H, Left	HNL2448LP	141	24.8	\$1138	\$15	\$15	\$10
42"W x 24"D x 29½"H, Right	HNL2442RP	132	22.0	\$1090	\$15	\$15	\$10
42"W x 24"D x 29½"H, Left	HNL2442LP	132	22.0	\$1090	\$15	\$15	\$10

NOTES: For L-shaped workstations. Connects to single pedestal desk, peninsula (bullet or jetty), or component worksurface with end panel. Drawers lock. Finish of lock is determined by, and aligned with, the handle finish specified. Formal, full-height modesty panel. One cord grommet in top for routing and hiding wires and cables. One cord pass-through grommet is located in the sides of the pedestal and top center of the back (modesty panel) to facilitate reaching wall electrical outlets. Specification logic includes the grommet finish for tops; choose from Black (P) or Platinum (TI). Modesty panel and pedestal grommets are black only. Edgebanding on 42"W and 48"W returns is profiled on the user's side and flat on the back (approach side) and ends. Woodgrain direction on worksurface runs vertical (i.e., front-to-back). Smaller and larger return sizes can be specified using modular worksurface and modesty panel components. Optional stack-on solutions maximize storage space. Ship fully assembled.

See chart on page 34 for cord management options. Worksurfaces/tops, end and modesty panels, and pedestals can be specified with or without grommets. For easy access to wall electrical outlets, options include a short (10") modesty panel or no back panel.

For paper organizers, see page 108.

HOW TO SPECIFY

<p>Select Model Number</p>	<p>Select Edge Profile and Edge Color</p> <p>See page 29</p>	<p>Select Handle</p> <p>A Cylinder – Satin B Cylinder – Black C Canopy – Satin D Canopy – Black E Loop – Satin F Loop – Black</p>	<p>Select Worksurface Grommet Finish</p> <p>P Black TI Platinum</p>	<p>Select Worksurface Color</p> <p>See page 29</p>	<p>Select Chassis Color</p> <p>See page 29</p>	<p>Select Drawer Front Color</p> <p>See page 29</p>
<p>H N L 2 4 4 8 R P .</p>	<p>B H .</p>	<p>E .</p>	<p>T I .</p>	<p>H .</p>	<p>H .</p>	<p>H .</p>

CONCINNITY™ Bridges

GSA SIN 33721



Icon Legend on page 19

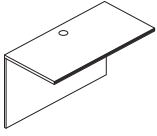

DESCRIPTION	MODEL	SHIP WEIGHT	CUBE	L1 LIST	L2 UPCHARGES		
					WORKSURFACES	CHASSIS	FRONTS
Bridge 48"W x 24"D x 29½"H	HNL2448BF	71	3.0	\$491	\$15	\$15	N/A
42"W x 24"D x 29½"H	HNL2442BF	62	2.5	\$469	\$15	\$15	N/A

NOTES: For U-shaped workstation layouts. Connects single pedestal desk, peninsula (bullet or jetty), or component worksurface to corner unit or to single pedestal credenza, credenza with lateral file, or rectangle worksurface. Formal, full-height modesty panel. One cord grommet in top for routing and hiding wires and cables. One cord pass-through grommet in top center of back (modesty panel). Specification logic includes the grommet finish for tops; choose from Black (P) or Platinum (T1). Clear inside depth 22⁷/₈"D. Edgebanding on 42"W and 48"W bridges is profiled on the user's side and flat on the back (approach side) and ends. Woodgrain direction on worksurface runs vertical (i.e., front-to-back). Additional sizes, including 30"W and 36"W for use with corner or extended corner units, as well as jetty peninsulas, can be specified using modular worksurface and modesty panel components. Ship — quick, simple assembly. See chart on page 34 for cord management options. Worksurfaces/tops and modesty panels can be specified with or without grommets. For easy access to wall electrical outlets, options include a short (10") modesty panel or no back panel.

HOW TO SPECIFY

Select
Model Number

H N L 2 4 4 8 B F .

Select
Edge Profile and Edge
Color

See page 29

B H .

Select
Worksurface Grommet
Finish

P Black
T1 Platinum

P .

Select
Worksurface Color

See page 29

H .

Select
Chassis Color

See page 29

H .

CONCINNITY™ STACK-ON STORAGE APPLICATIONS

STACK-ON STORAGE APPLICATIONS

78"W

- Spans full-width of 78"W modular credenza or return.
- Spans total depth dimension of "L" workstation configurations comprised of:
 - 48"W return or modular return attached to a 36"D single pedestal desk with a bow front (78"D).
 - NOTE: The 36"D single pedestal desk with bow front is 30"D along end panel.
 - 48"W return or modular return attached to a 30"D single pedestal desk, modular desk, or bullet peninsula (78"D).
 - 42"W return or modular return attached to a 36"D single pedestal desk with rectangle top, modular desk, or bullet peninsula (78"D).
 - 42"W return or modular return attached to a 36" corner unit or 36"D extended corner unit (78"D).
 - 36"W modular return attached to a 42"D jetty peninsula (78"D).
 - 30"W modular return attached to a 48"D jetty peninsula (78"D).
 - 30"W modular return attached to a 48"D extended corner unit (78"D).

72"W

- Spans full-width of 72"W desks with rectangle top, credenzas, extended corner units, or modular desk, credenza, or return.
- Spans total depth dimension of "L" workstation configurations comprised of:
 - 48"W return or modular return attached to a 24"D single pedestal credenza or modular credenza (72"D).
 - 42"W return or modular return attached to a 36"D single pedestal desk with a bow front (72"D).
 - NOTE: The 36"D single pedestal desk with bow front is 30"D along end panel.
 - 42"W return or modular return attached to a 30"D single pedestal desk, modular desk, or bullet peninsula (72"D).
 - 36"W modular return attached to a 36"D single pedestal desk with rectangle top, modular desk, or bullet peninsula (72"D).
 - 36"W modular return attached to a 36" corner unit or 36"D extended corner unit (72"D).
 - 30"W modular return attached to a 42"D jetty peninsula (72"D).

66"W

- Spans full-width of 66"W desk, credenza, or modular desk, credenza, or return.
- Spans total depth dimension of "L" workstation configurations comprised of:
 - 42"W return or modular return attached to a 24"D single pedestal credenza or modular credenza (66"D).

- 36"W modular return attached to a 30"D single pedestal desk, bullet peninsula, or modular desk (66"D).
- 36"W modular return attached to a 36"D single pedestal desk with a bow front (66"D).
 - NOTE: The 36"D single pedestal desk with bow front is 30"D along end panel.
- 30"W modular return attached to a 36"D single pedestal desk with rectangle top or modular desk (66"D).
- 30"W modular return attached to a 36" corner unit (66"D).

60"W

- Spans full-width of 60"W desk, credenza, or modular desk, credenza, or return.
- Spans total depth dimension of "L" workstation configurations comprised of:
 - 36"W modular return attached to a 24"D single pedestal credenza or modular credenza (60"D).
 - 30"W modular return attached to a 30"D single pedestal desk or modular desk (60"D).

48"W

- Spans full-width of 48"W return, modular return, or modular desk or credenza.
- Spans full-depth of the 48"D jetty peninsula or extended corner unit.

42"W

- Spans full-width of 42"W return, modular return, or modular desk or credenza.
- Spans full-depth of 42"D jetty peninsula.

36"W

- Spans full-width of 36"W modular return, modular desk or credenza, two drawer lateral file, or 29½"H storage cabinet with doors.
- Spans full-depth of 36"D desks with rectangle top, bullet peninsula, extended corner unit, or 36" corner unit.

OPTIONS INCLUDE:

- Door/Storage Options:

Door(s)	Standard-Height	Executive-Height
Laminate	•	•
Laminate Locking	•	•
Frosted/Silver	•	•
Sliding	•	•

- Available in 35¼" or 78⅞"H; when positioned on 29½"H base unit, heights respectively align with 64¾" and 78⅞"H storage- and wardrobe-type cabinets.
- Paper organizers for stack-on and wall mounted storage cabinets (see application and compatibility information on page 109).

CONCINNITY™ STACK-ON STORAGE APPLICATIONS

- Fabric-Covered Tackboards:
 - Sized $\frac{3}{4}$ " narrower than the stack-on storage back enclosure, allowing $\frac{3}{8}$ " on each side to route task light cords.
 - Includes adhesive latch & hook tape for attachment to stack-on storage back panel and fasteners for wall mount applications.
 - For a list of standard fabrics, see pages 25-26. For a complete list of fabrics, please go to hon.com/fabricsandfinishes.
- Markerboards:
 - HLSL1530SOMB: 29½"W x 12½"H panel attaches to 60" and 66"W stack-on and wall mounted storage with sliding door models with double-sided tape.
 - HLSL1536SOMB: 35½"W x 12½"H panel attaches to 72" and 78"W stack-on and wall mounted storage with sliding door models with double-sided tape.
- Markerboards will not fit on stack-on storage laminate or laminate locking door models.
- Task Lights:
 - Attach to underside of stack-on and wall mount storage cabinets.
 - Fluorescent or LED options.
 - Tackboard and fluorescent and LED task light solutions, by model, for each stack-on storage size:

Stack-on Storage	Tackboard	Fluorescent Task Light	LED Task Light
78"W	H90057	HH870960, HH870960CH	HLED31A, HLED31AUO
72"W	H90056	HH870960, HH870960CH	HLED31A, HLED31AUO
66"W	H90055	HH870960, HH870960CH	HLED31A, HLED17AUO
60"W	H90054	HH870960, HH870960CH	HLED31A, HLED17AUO
48"W	H90053	HH870942, HH870942CH	HLED31AS
42"W	H90052	HH870942, HH870942CH	HLED31AS
36"W	H90051	HH870930, HH870930CH	HLED17AS



CONCINNITY™ Stack-on Storage

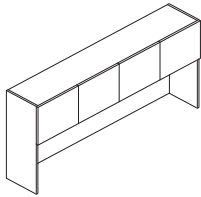

DESCRIPTION

Stack-on Storage, Laminate Doors

- 78"W x 15"D x 35¼"H — 4 doors, 2 compartments
- 72"W x 15"D x 35¼"H — 4 doors, 2 compartments
- 66"W x 15"D x 35¼"H — 4 doors, 2 compartments
- 60"W x 15"D x 35¼"H — 4 doors, 2 compartments
- 48"W x 15"D x 35¼"H — 3 doors, 2 compartments
- 42"W x 15"D x 35¼"H — 2 doors, 1 compartment
- 36"W x 15"D x 35¼"H — 2 doors, 1 compartment

MODEL	SHIP WEIGHT	CUBE	L1 LIST	L2 UPCHARGES	
				CHASSIS	FRONTS
HNL3678LD	173	31.8	\$1446	\$45	\$20
HNL3672LD	162	29.0	\$1387	\$35	\$20
HNL3666LD	151	26.7	\$1369	\$35	\$20
HNL3660LD	139	24.3	\$1248	\$35	\$20
HNL3648LD	117	19.6	\$1126	\$30	\$20
HNL3642LD	100	18.1	\$1099	\$30	\$10
HNL3636LD	88	15.3	\$929	\$30	\$10

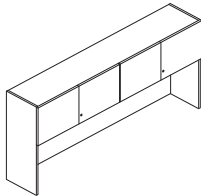

Stack-on Storage, Laminate Locking Doors

- 78"W x 15"D x 35¼"H — 4 doors, 2 compartments
- 72"W x 15"D x 35¼"H — 4 doors, 2 compartments
- 66"W x 15"D x 35¼"H — 4 doors, 2 compartments
- 60"W x 15"D x 35¼"H — 4 doors, 2 compartments
- 48"W x 15"D x 35¼"H — 3 doors, 2 compartments
- 42"W x 15"D x 35¼"H — 2 doors, 1 compartment
- 36"W x 15"D x 35¼"H — 2 doors, 1 compartment

HNL3678LL	173	31.8	\$1541	\$45	\$20
HNL3672LL	162	29.0	\$1476	\$35	\$20
HNL3666LL	151	26.7	\$1458	\$35	\$20
HNL3660LL	139	24.3	\$1337	\$35	\$20
HNL3648LL	117	19.6	\$1193	\$30	\$20
HNL3642LL	100	18.1	\$1143	\$30	\$10
HNL3636LL	88	15.3	\$974	\$30	\$10

! Lock available in Black (P) or Satin (SA) finish. Lock is core removable. Keyed alike cores must be ordered separately. For stack-on and wall mount storage with locking hinged doors, specify model HF27B (Black) or HF27S (Satin) and the key number, see page 110. Model HNL3648LL has one lock, which secures two of the three doors.

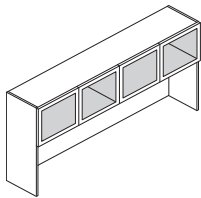

Stack-on Storage, Frosted Doors with Silver Frame

- 78"W x 15"D x 35¼"H — 4 doors, 2 compartments
- 72"W x 15"D x 35¼"H — 4 doors, 2 compartments
- 66"W x 15"D x 35¼"H — 4 doors, 2 compartments
- 60"W x 15"D x 35¼"H — 4 doors, 2 compartments
- 48"W x 15"D x 35¼"H — 3 doors, 2 compartments
- 42"W x 15"D x 35¼"H — 2 doors, 1 compartment
- 36"W x 15"D x 35¼"H — 2 doors, 1 compartment

HNL3678FD	153	31.8	\$2144	\$45	N/A
HNL3672FD	143	29.0	\$2084	\$35	N/A
HNL3666FD	134	26.7	\$2065	\$35	N/A
HNL3660FD	124	24.3	\$1943	\$35	N/A
HNL3648FD	104	19.6	\$1649	\$30	N/A
HNL3642FD	89	18.1	\$1451	\$30	N/A
HNL3636FD	79	15.3	\$1280	\$30	N/A

! Frosted/silver door units do not have a lock option.

NOTES:

- Convenient off-the-worksurface storage requires no additional floor space.
- 35¼"H stack-on storage models ship fully assembled.
- Fully enclosed back provides privacy; includes a 1¼", full-width pass-through for 3-prong electrical plugs; facilitates routing cords and reaching wall electrical outlets.
- Lower back panel can be attached with cord pass-through at bottom next to the worksurface or at top for close proximity to task light cord.
- Lower back panel can be removed to facilitate collaboration in teaming configurations.
- Valance hides task light.
- Vertical clearance for computer monitor is 20".
- Laminate vertical paper organizer (HLVPMI) sized to fit below storage compartments.
- Can be specified in seven widths (36", 42", 48", 60", 66", 72", and 78"W) and two heights, standard (35¼"H) or executive (48⅝"H).
- Available with laminate doors, frosted/silver doors, or sliding door.
- Doors are sized to overlap the top, end panels and light valance, to provide a clean design.
- Laminate and frosted/silver door units are equipped with self-closing, adjustable hinges.
- Laminate hinged door units are available with or without a lock.
- For tackboards, see page 57.
- For task lights, see page 111.
- For paper organizers, see page 108.

HOW TO SPECIFY

<p>Select Model Number</p> <p>H N L 3 6 7 2 L D</p>	<p>Select Chassis Color</p> <p>See page 29</p> <p>H</p>	<p>Select Door Front Color</p> <p>See page 29</p> <p>H</p>	
<p>Select Model Number</p> <p>H N L 3 6 7 2 L L</p>	<p>Select Lock Finish</p> <p>See page 29</p> <p>P</p>	<p>Select Chassis Color</p> <p>See page 29</p> <p>H</p>	<p>Select Door Front Color</p> <p>See page 29</p> <p>H</p>
<p>Select Model Number</p> <p>H N L 3 6 7 2 F D</p>	<p>Select Chassis Color</p> <p>See page 29</p> <p>H</p>		

CONCINNITY™

Stack-on Storage

GSA SIN 33721

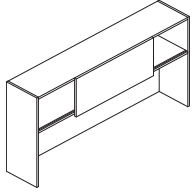

Icon Legend on page 19

**DESCRIPTION****Stack-on Storage, Sliding Door**

78"W x 15"D x 35¼"H
 72"W x 15"D x 35¼"H
 66"W x 15"D x 35¼"H
 60"W x 15"D x 35¼"H
 48"W x 15"D x 35¼"H

MODEL

HNL3678SD
HNL3672SD
HNL3666SD
HNL3660SD
HNL3648SD

SHIP WEIGHT

161
 151
 141
 131
 110

CUBE

31.8
 29.0
 26.7
 24.3
 19.6

L1 LIST

\$1387
\$1345
\$1240
\$1206
\$1140

L2 UPCHARGES

CHASSIS	FRONTS
\$45	\$20
\$35	\$20
\$35	\$20
\$35	\$20
\$30	\$20

NOTES: Sliding door units have one door per cabinet; standard with black lock, which is located on inside vertical support panel. Lock is core removable. Keyed alike cores must be ordered separately. For stack-on and wall mount storage with sliding door, specify model HF23B (Black) and the key number, see page 110. Sliding door availability limited to select sizes.

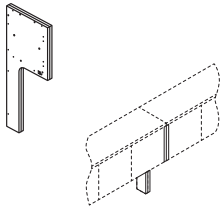
**Stack-on Space Saver End Panels**

¾"W x 14¼"D x 35¼"H

HNL3605SSEP

14

1.7

\$417**\$15****N/A**

NOTES: Two field installable end panels (1-right; 1-left) for use in ganging two stack-on storage units. Combining stack-on allows users to span longer worksurfaces, including 84" (2 - 42"W), 96" (2 - 48"W), 120" (2 - 60"W), and 144" (2 - 72"W). Narrow, space-saving panel size replaces the full 15"D end panels to expand worksurface space. The 4¼" right end panel is to replace the standard 15"D right end panel on one stack-on storage unit, the 4¼" left end panel is to replace the standard 15"D left end panel on a separate, adjacent stack-on storage unit that is in linear alignment with the first unit. Kit includes: (2) narrow end panel supports; European-style fasteners; dowels; joint connector bolts with sleeve nuts (for ganging stack-on storage units). Can be used to connect up to two stack-on storage units in a line (requires 1 kit). Can be specified in a woodgrain or solid laminate color only.

SPECIFYING EXAMPLE: HNL3605SSEP.H

NOTES:

- Convenient off-the-worksurface storage requires no additional floor space.
- 35¼"H stack-on storage models ship fully assembled.
- Fully enclosed back provides privacy; includes a 1¼", full-width pass-through for 3-prong electrical plugs; facilitates routing cords and reaching wall electrical outlets.
- Lower back panel can be attached with cord pass-through at bottom next to the worksurface or at top for close proximity to task light cord.
- Lower back panel can be removed to facilitate collaboration in teaming configurations.
- Valance hides task light.
- Vertical clearance for computer monitor is 20".
- Laminate vertical paper organizer (HLVPM1) sized to fit below storage compartments.
- Can be specified in seven widths (36", 42", 48", 60", 66", 72", and 78"W) and two heights, standard (35¼"H) or executive (48⅝"H).
- Available with laminate doors, frosted/silver doors, or sliding door.
- Doors are sized to overlap the top, end panels and light valance, to provide a clean design.
- Laminate and frosted/silver door units are equipped with self-closing, adjustable hinges.
- Laminate hinged door units are available with or without a lock.
- For tackboards, see page 57.
- For task lights, see page 111.
- For paper organizers, see page 108.

HOW TO SPECIFY**Select Model Number**

H N L 3 6 7 2 S D

Select Chassis Color

See page 29

H

Select Door Front Color

See page 29

H



CONCINNITY™ Stack-on Storage

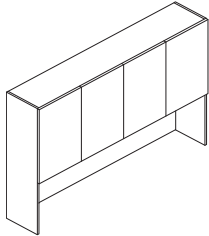

DESCRIPTION

Stack-on Storage, Laminate Doors
 78"W x 15"D x 48 5/8"H — 4 doors, 2 compartments
 72"W x 15"D x 48 5/8"H — 4 doors, 2 compartments
 66"W x 15"D x 48 5/8"H — 4 doors, 2 compartments
 60"W x 15"D x 48 5/8"H — 4 doors, 2 compartments
 48"W x 15"D x 48 5/8"H — 3 doors, 2 compartments
 42"W x 15"D x 48 5/8"H — 2 doors, 1 compartment
 36"W x 15"D x 48 5/8"H — 2 doors, 1 compartment

MODEL	SHIP WEIGHT	CUBE	L1 LIST	L2 UPCHARGES	
				CHASSIS	FRONTS
HNL4978LD	264	31.3	\$1952	\$60	\$20
HNL4972LD	243	29.1	\$1796	\$50	\$20
HNL4966LD	229	26.8	\$1698	\$50	\$20
HNL4960LD	212	24.5	\$1579	\$50	\$20
HNL4948LD	175	26.4	\$1506	\$45	\$20
HNL4942LD	149	23.2	\$1320	\$45	\$20
HNL4936LD	145	20.3	\$1278	\$45	\$20

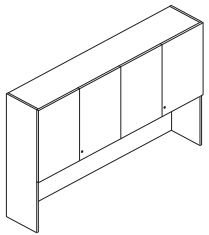

Stack-on Storage, Laminate Locking Doors
 78"W x 15"D x 48 5/8"H — 4 doors, 2 compartments
 72"W x 15"D x 48 5/8"H — 4 doors, 2 compartments
 66"W x 15"D x 48 5/8"H — 4 doors, 2 compartments
 60"W x 15"D x 48 5/8"H — 4 doors, 2 compartments
 48"W x 15"D x 48 5/8"H — 3 doors, 2 compartments
 42"W x 15"D x 48 5/8"H — 2 doors, 1 compartment
 36"W x 15"D x 48 5/8"H — 2 doors, 1 compartment

HNL4978LL	264	31.3	\$2041	\$60	\$20
HNL4972LL	243	29.1	\$1885	\$50	\$20
HNL4966LL	229	26.8	\$1787	\$50	\$20
HNL4960LL	212	24.5	\$1668	\$50	\$20
HNL4948LL	175	26.4	\$1572	\$45	\$20
HNL4942LL	149	23.2	\$1365	\$45	\$20
HNL4936LL	145	20.3	\$1322	\$45	\$20

! Lock available in Black (P) or Satin (SA) finish. Lock is core removable. Keyed alike cores must be ordered separately. For stack-on and wall mount storage with locking hinged doors, specify model HF27B (Black) or HF27S (Satin) and the key number, see page 110. Model HNL4948LL has one lock, which secures two of the three doors.

NOTES:

- Convenient off-the-worksurface storage requires no additional floor space.
- 48 5/8"H units have a fixed, intermittent shelf; storage space above and below the shelf is 12 5/8".
- Product applications are detailed on pages 51-52.
- Fully enclosed back provides privacy; includes a 1 1/4", full-width pass-through for 3-prong electrical plugs; facilitates routing cords and reaching wall electrical outlets.
- Lower back panel can be attached with cord pass-through at bottom next to the worksurface or at top for close proximity to task light cord.
- Lower back panel can be removed to facilitate collaboration in teaming configurations.
- Valance hides task light.
- Vertical clearance for computer monitor is 20".
- Laminate vertical paper organizer (HLVPMI) sized to fit below storage compartments.
- Can be specified in seven widths (36", 42", 48", 60", 66", 72", and 78"W) and two heights, standard (35 1/4"H) or executive (48 5/8"H).
- Available with laminate doors, frosted/silver doors, or sliding door.
- Doors are sized to overlap the top, end panels and light valance, to provide a clean design.
- Laminate and frosted/silver door units are equipped with self-closing, adjustable hinges.
- Laminate hinged door units are available with or without a lock.
- For tackboards, see page 57.
- For task lights, see page 111.
- For paper organizers, see page 108.

HOW TO SPECIFY

<p>Select Model Number</p> <p>H N L 4 9 7 8 L D</p>	<p>Select Chassis Color</p> <p>See page 29</p> <p>H</p>	<p>Select Door Front Color</p> <p>See page 29</p> <p>H</p>	
<p>Select Model Number</p> <p>H N L 4 9 7 8 L L</p>	<p>Select Lock Finish</p> <p>See page 29</p> <p>P</p>	<p>Select Chassis Color</p> <p>See page 29</p> <p>H</p>	<p>Select Door Front Color</p> <p>See page 29</p> <p>H</p>

CONCINNITY™

Stack-on Storage

GSA SIN 33721



Icon Legend on page 19

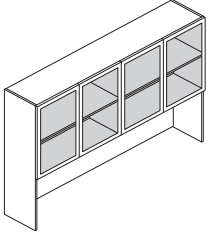

DESCRIPTION	MODEL	SHIP WEIGHT	CUBE	L1 LIST	L2 UPCHARGES	
					CHASSIS	FRONTS
Stack-on Storage, Frosted Doors with Silver Frame						
78"W x 15"D x 48 ⁵ / ₈ "H — 4 doors, 2 compartments	HNL4978FD	225	31.3	\$2995	\$60	N/A
72"W x 15"D x 48 ⁵ / ₈ "H — 4 doors, 2 compartments	HNL4972FD	207	29.1	\$2839	\$50	N/A
66"W x 15"D x 48 ⁵ / ₈ "H — 4 doors, 2 compartments	HNL4966FD	196	26.8	\$2741	\$50	N/A
60"W x 15"D x 48 ⁵ / ₈ "H — 4 doors, 2 compartments	HNL4960FD	182	24.5	\$2619	\$50	N/A
48"W x 15"D x 48 ⁵ / ₈ "H — 3 doors, 2 compartments	HNL4948FD	152	26.4	\$2290	\$45	N/A
42"W x 15"D x 48 ⁵ / ₈ "H — 2 doors, 1 compartment	HNL4942FD	128	23.2	\$1846	\$45	N/A
36"W x 15"D x 48 ⁵ / ₈ "H — 2 doors, 1 compartment	HNL4936FD	114	20.3	\$1802	\$45	N/A

Frosted/silver door units do not have a lock option.

NOTES:

- Convenient off-the-worksurface storage requires no additional floor space.
- 48⁵/₈"H units have a fixed, intermittent shelf; storage space above and below the shelf is 12⁵/₈".
- Product applications are detailed on pages 51-52.
- Fully enclosed back provides privacy; includes a 1/4", full-width pass-through for 3-prong electrical plugs; facilitates routing cords and reaching wall electrical outlets.
- Lower back panel can be attached with cord pass-through at bottom next to the worksurface or at top for close proximity to task light cord.
- Lower back panel can be removed to facilitate collaboration in teaming configurations.
- Valance hides task light.
- Vertical clearance for computer monitor is 20".
- Laminate vertical paper organizer (HLVPM1) sized to fit below storage compartments.
- Can be specified in seven widths (36", 42", 48", 60", 66", 72", and 78"W) and two heights, standard (35¹/₄"H) or executive (48⁵/₈"H).
- Available with laminate doors, frosted/silver doors, or sliding door.
- Doors are sized to overlap the top, end panels and light valance, to provide a clean design.
- Laminate and frosted/silver door units are equipped with self-closing, adjustable hinges.
- Laminate hinged door units are available with or without a lock.
- For tackboards, see page 57.
- For task lights, see page 111.
- For paper organizers, see page 108.

HOW TO SPECIFY

Select
Model Number

Select
Chassis Color

See page 29

H N L 4 9 7 8 F D . H



CONCINNITY™ Stack-on Storage

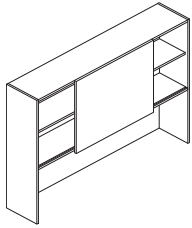

DESCRIPTION	MODEL	COM	SHIP WEIGHT	CUBE	L1 LIST	L2 UPCHARGES	
						CHASSIS	FRONTS
Stack-on Storage, Sliding Door							
78"W x 15"D x 48 ⁵ / ₈ "H	HNL4978SD		236	31.3	\$1981	\$60	\$20
72"W x 15"D x 48 ⁵ / ₈ "H	HNL4972SD		221	29.1	\$1874	\$50	\$20
66"W x 15"D x 48 ⁵ / ₈ "H	HNL4966SD		207	26.8	\$1831	\$50	\$20
60"W x 15"D x 48 ⁵ / ₈ "H	HNL4960SD		192	24.5	\$1614	\$50	\$20
48"W x 15"D x 48 ⁵ / ₈ "H	HNL4948SD		162	26.4	\$1537	\$45	\$20

NOTES: Sliding door units have one door per cabinet; standard with black lock, which is located on inside vertical support panel. Lock is core removable. Keyed alike cores must be ordered separately. For stack-on and wall mount storage with sliding door, specify model HF23B (Black) and the key number, see page 110. Sliding door availability limited to select sizes.

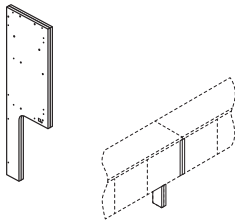

DESCRIPTION	MODEL	COM	SHIP WEIGHT	CUBE	L1 LIST	L2 UPCHARGES
Stack-on Space Saver End Panels 3/4"W x 14 1/4"D x 48 5/8"H	HNL4905SSEP		23	2.2	\$561	\$15 N/A

NOTES: Two field installable end panels (1-right; 1-left) for use in ganging two stack-on storage units. Combining stack-on allows users to span longer worksurfaces, including 84" (2 - 42"W), 96" (2 - 48"W), 120" (2 - 60"W), and 144" (2 - 72"W). Narrow, space-saving panel size replaces the full 15"D end panels to expand worksurface space. The 4 1/4" right end panel is to replace the standard 15"D right end panel on one stack-on storage unit, the 4 1/4" left end panel is to replace the standard 15"D left end panel on a separate, adjacent stack-on storage unit that is in linear alignment with the first unit. Kit includes: (2) narrow end panel supports; European-style fasteners; dowels; joint connector bolts with sleeve nuts (for ganging stack-on storage units). Can be used to connect up to two stack-on storage units in a line (requires 1 kit). Can be specified in a woodgrain or solid laminate color only.

SPECIFYING EXAMPLE: HNL4905SSEP.H

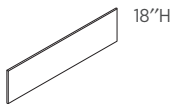

DESCRIPTION	MODEL	COM	SHIP WEIGHT	CUBE	L1 LIST	L2 UPCHARGES
Tackboards for use with Stack-on Storage						
75"W - for 78"W	H90057	3.0	13	3.2	\$337	N/A N/A
68 3/4"W - for 72"W	H90056	2.0	12	2.7	\$320	N/A N/A
62 3/4"W - for 66"W	H90055	2.0	11	2.5	\$304	N/A N/A
56 3/4"W - for 60"W	H90054	2.0	10	2.2	\$268	N/A N/A
44 3/4"W - for 48"W	H90053	2.0	8	1.8	\$257	N/A N/A
39"W - for 42"W	H90052	2.0	7	1.6	\$237	N/A N/A
33"W - for 36"W	H90051	1.0	6	1.4	\$208	N/A N/A
26 3/4"W	H90050	1.0	5	1.2	\$208	N/A N/A

NOTES: Specify fabric, see pages 25-26. Upcharges may apply to premium fabric grades.

Disperse (DISP) fabric not available on sizes wider than 60". Analog (ANLG) and Exchange (EXG) not available on sizes wider than 72".

SPECIFYING EXAMPLE: H90057.APN15

NOTES:

- Convenient off-the-worksurface storage requires no additional floor space.
- 48⁵/₈"H units have a fixed, intermittent shelf; storage space above and below the shelf is 12⁵/₈".
- Fully enclosed back provides privacy; includes a 1/4", full-width pass-through for 3-prong electrical plugs; facilitates routing cords and reaching wall electrical outlets.
- Lower back panel can be attached with cord pass-through at bottom next to the worksurface or at top for close proximity to task light cord.
- Lower back panel can be removed to facilitate collaboration in teaming configurations.
- Valance hides task light.
- Vertical clearance for computer monitor is 20".
- Laminate vertical paper organizer (HLVPM1) sized to fit below storage compartments.
- Can be specified in seven widths (36", 42", 48", 60", 66", 72", and 78"W) and two heights, standard (35 1/4"H) or executive (48 5/8"H).
- Available with laminate doors, frosted/silver doors, or sliding door.
- Doors are sized to overlap the top, end panels and light valance, to provide a clean design.
- Laminate and frosted/silver door units are equipped with self-closing, adjustable hinges.
- Laminate hinged door units are available with or without a lock.
- For tackboards, see above.
- For task lights, see page 111.
- For paper organizers, see page 108.

HOW TO SPECIFY

Select Model Number H N L 4 9 7 8 S D	Select Chassis Color See page 29 H	Select Door Front Color See page 29 H
---	---	--

CONCINNITY™ WALL MOUNT STORAGE APPLICATIONS

- Installation (review carefully):
 - **Attachment requires individual cabinets be secured by a minimum of two (2) wall mounting locations/studs.**
 - **Designed for interior and perimeter walls that are constructed with wood or metal studs.**
 - **Attaches to wall with horizontally mounted, interlocking brackets.**
 - **The HON Company is not responsible for any liabilities resulting from wall mounted storage cabinets that are not properly installed.**
- Laminate, laminate locking, and frosted/silver door units can be specified in eight widths (30", 36", 42", 48", 60", 66", 72", and 78"W) and two heights, standard (15"H) or executive (29½"H).
- Sliding door units can be specified in five widths (48", 60", 66", 72", and 78"W) and two heights, standard (15"H) or executive (29½"H).
- Product placement can be aligned to match the height of 64¾"H or 78⅛"H storage- and wardrobe-type cabinets.
- Available with laminate doors, frosted/silver doors, or sliding door.
 - Door design overlaps end panels so that when multiple units are placed side-by-side they appear as one continuous unit.
 - Laminate and frosted/silver door units are equipped with self-closing, adjustable hinges.
 - Laminate hinged door units are available with or without a lock.
 - Lock available in Black (P) or Satin (SA).
 - Lock is core removable; keyed alike cores must be ordered separately — for overhead storage with hinged doors specify model HF27B or HF27S and the key number.
 - Frosted/silver hinged door units do not have a lock option.
 - Sliding door units have one door per cabinet; standard with black lock, which is located on inside vertical support panel. Lock is core removable; keyed alike cores must be ordered separately — for overhead storage with a sliding door specify model HF23B (Black) and the key number.
 - Laminate and frosted/silver door cabinets in 30", 36", and 42"W have two doors; 48"W has three doors; 60", 66", 72", and 78"W have four doors.
- Inside storage dimensions of 15"H cabinets:
 - 30"W = one compartment, sized 28⅜"W x 13⅜"D x 12¾"H
 - 36"W = one compartment, sized 34⅜"W x 13⅜"D x 12¾"H
 - 42"W = one compartment, sized 40⅜"W x 13⅜"D x 12¾"H
 - 48"W = two compartments, one sized 30⅝"W x 13⅜"D x 12¾"H; one sized 14⅝"W x 13⅜"D x 12¾"H
 - 60"W = two compartments, each 28⅝"W x 13⅜"D x 12¾"H
 - 66"W = two compartments, each 31⅝"W x 13⅜"D x 12¾"H
 - 72"W = two compartments, each 34⅝"W x 13⅜"D x 12¾"H
 - 78"W = two compartments, each 37⅝"W x 13⅜"D x 12¾"H
- 28½"H units have a fixed, intermittent shelf; storage space above and below the shelf is 12⅝".
- Wall mounted storage cabinets are not designed for attachment to O-leg models HLSL65OS or HLSL50OS.
- Horizontal interlocking rails are included; due to varying types of walls, installers are responsible for selecting and supplying the appropriate fasteners.
- Ship fully assembled.

CONCINNITY™ WALL MOUNT STORAGE APPLICATIONS

OPTIONS INCLUDE:

- Door/Storage Options:

Door(s)	Standard-Height	Executive-Height
Laminate	•	•
Laminate Locking	•	•
Frosted/Silver	•	•
Sliding	48"-78"W only	48"-78"W only

- Paper organizers for stack-on and wall mounted storage cabinets (see compatibility information on page 109).
- Fabric-Covered Tackboards:
 - Tackboards mount directly to wall using the fasteners or hook-and-loop tape provided.
 - For a list of standard fabrics, see pages 25-26. For a complete list of fabrics, please go to hon.com/fabricsandfinishes.
 - See compatibility cross reference below.
 - NOTE: Tackboard widths differ slightly from the wall mounted storage cabinet widths. For applications where multiple wall mounted storage units are placed side-by-side, the preferred tackboard solution may be to utilize a larger tackboard size.
For example, H90057 = 75"W; H90056 = 68³/₄"W; H90055 = 62³/₄"W; H90054 = 56³/₄"W.
- Markerboards:
 - HL1530SOMB: 29¹/₂"W x 12¹/₂"H panel attaches to 60" and 66"W stack-on and wall mounted storage with sliding door models with double-sided tape.
 - HL1536SOMB: 35¹/₂"W x 12¹/₂"H panel attaches to 72" and 78"W stack-on and wall mounted storage with sliding door models with double-sided tape.
- Task Lights:
 - Attach to underside of stack-on and wall mount storage cabinets.
 - Fluorescent or LED options.
 - Compatibility: Tackboard and task light solutions, by model, for each wall mounted storage cabinet size:

Wall Mounted Storage	Tackboard	Fluorescent Task Light	LED Task Light
78"W	H90057 (75"W) or qty 2 of H90052 (39"W ea.)	HH870960, HH870960CH	HLED31A, HLED31AUO
72"W	H90056 (71 ¹ / ₂ "W)	HH870960, HH870960CH	HLED31A, HLED31AUO
66"W	H90055 (65 ¹⁵ / ₁₆ "W)	HH870960, HH870960CH	HLED31A, HLED17AUO
60"W	H90054 (59 ¹⁵ / ₁₆ "W)	HH870960, HH870960CH	HLED31A, HLED17AUO
48"W	H90053 (44 ³ / ₄ "W)	HH870942, HH870942CH	HLED31AS
42"W	H90052 (39"W)	HH870942, HH870942CH	HLED31AS
36"W	H90051 (33"W)	HH870930, HH870930CH	HLED17AS
30"W	H90050 (26 ³ / ₄ "W)	HH870930, HH870930CH	HLED17AS

CONCINNITY™

Wall Mount Storage

GSA SIN 33721

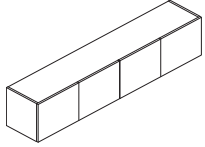

Icon Legend on page 19

**DESCRIPTION****Wall Mount Storage, Laminate Doors**

78"W x 15"D x 15"H — 4 doors, 2 compartments
 72"W x 15"D x 15"H — 4 doors, 2 compartments
 66"W x 15"D x 15"H — 4 doors, 2 compartments
 60"W x 15"D x 15"H — 4 doors, 2 compartments
 48"W x 15"D x 15"H — 3 doors, 2 compartments
 42"W x 15"D x 15"H — 2 doors, 1 compartment
 36"W x 15"D x 15"H — 2 doors, 1 compartment
 30"W x 15"D x 15"H — 2 doors, 1 compartment

MODEL**SHIP WEIGHT****CUBE****L1 LIST****L2 UPCHARGES**
CHASSIS FRONTS

HNL1578LD	126	17.1	\$1362	\$35	\$20
HNL1572LD	118	15.9	\$1265	\$25	\$20
HNL1566LD	109	14.6	\$1206	\$25	\$20
HNL1560LD	100	13.3	\$1083	\$25	\$20
HNL1548LD	83	10.9	\$977	\$20	\$20
HNL1542LD	68	9.7	\$923	\$20	\$10
HNL1536LD	60	8.4	\$842	\$20	\$10
HNL1530LD	51	7.2	\$777	\$20	\$10

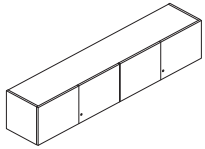
**Wall Mount Storage, Laminate Locking Doors**

78"W x 15"D x 15"H — 4 doors, 2 compartments
 72"W x 15"D x 15"H — 4 doors, 2 compartments
 66"W x 15"D x 15"H — 4 doors, 2 compartments
 60"W x 15"D x 15"H — 4 doors, 2 compartments
 48"W x 15"D x 15"H — 3 doors, 2 compartments
 42"W x 15"D x 15"H — 2 doors, 1 compartment
 36"W x 15"D x 15"H — 2 doors, 1 compartment
 30"W x 15"D x 15"H — 2 doors, 1 compartment

HNL1578LL	126	17.1	\$1451	\$35	\$20
HNL1572LL	118	15.9	\$1354	\$25	\$20
HNL1566LL	109	14.6	\$1295	\$25	\$20
HNL1560LL	100	13.3	\$1172	\$25	\$20
HNL1548LL	83	10.9	\$1044	\$20	\$20
HNL1542LL	68	9.7	\$967	\$20	\$10
HNL1536LL	60	8.4	\$887	\$20	\$10
HNL1530LL	51	7.2	\$822	\$20	\$10

! Lock available in Black (P) or Satin (SA) finish. Lock is core removable. Keyed alike cores must be ordered separately. For stack-on and wall mount storage with locking hinged doors, specify model HF27B (Black) or HF27S (Satin) and the key number, see page 110. Model HNL1548LL has one lock, which secures two of the three doors.

NOTES:

- Convenient off-the-worksurface storage requires no additional floor space.
- Available with laminate doors, frosted/silver doors, or sliding door.
- Doors are sized to overlap the top, end panels and light valance, to provide a clean design.
- Laminate and frosted/silver door units are equipped with self-closing, adjustable hinges.
- Laminate hinged door units are available with or without a lock.
- For tackboards, see page 63.
- For task lights, see page 111.
- For paper organizers, see page 108.
- **IMPORTANT: See installation guidelines at top of page 58.**

HOW TO SPECIFY**Select Model Number**

H N L 1 5 7 8 L D

Select Chassis Color

See page 29

H

Select Door Front Color

See page 29

H

Select Model Number

H N L 1 5 7 8 L L

Select Lock Finish

See page 29

P

Select Chassis Color

See page 29

H

Select Door Front Color

See page 29

H



CONCINNITY™ Wall Mount Storage

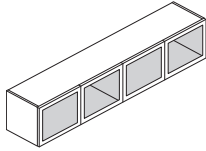

DESCRIPTION

Wall Mount Storage, Frosted Doors with Silver Frame

- 78"W x 15"D x 15"H — 4 doors, 2 compartments
- 72"W x 15"D x 15"H — 4 doors, 2 compartments
- 66"W x 15"D x 15"H — 4 doors, 2 compartments
- 60"W x 15"D x 15"H — 4 doors, 2 compartments
- 48"W x 15"D x 15"H — 3 doors, 2 compartments
- 42"W x 15"D x 15"H — 2 doors, 1 compartment
- 36"W x 15"D x 15"H — 2 doors, 1 compartment
- 30"W x 15"D x 15"H — 2 doors, 1 compartment

MODEL

SHIP WEIGHT

CUBE

L1 LIST

L2 UPCHARGES
CHASSIS FRONTS

HNL1578FD	106	17.1	\$2060	\$35	N/A
HNL1572FD	99	15.9	\$1961	\$25	N/A
HNL1566FD	92	14.6	\$1901	\$25	N/A
HNL1560FD	85	13.3	\$1777	\$25	N/A
HNL1548FD	71	10.9	\$1498	\$20	N/A
HNL1542FD	57	9.7	\$1274	\$20	N/A
HNL1536FD	50	8.4	\$1193	\$20	N/A
HNL1530FD	43	7.2	\$1127	\$20	N/A

! Frosted door models do not have a lock option.

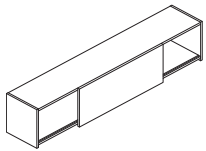

Wall Mount Storage, Sliding Door

- 78"W x 15"D x 15"H
- 72"W x 15"D x 15"H
- 66"W x 15"D x 15"H
- 60"W x 15"D x 15"H
- 48"W x 15"D x 15"H

HNL1578SD	114	17.1	\$1325	\$35	\$20
HNL1572SD	107	15.9	\$1217	\$25	\$20
HNL1566SD	99	14.6	\$1135	\$25	\$20
HNL1560SD	91	13.3	\$1031	\$25	\$20
HNL1548SD	76	10.9	\$965	\$20	\$20

NOTES: One door per unit. Standard with black lock, which is located on the inside vertical support panel. Lock is core removable. Keyed alike cores must be ordered separately. For stack-on and wall mount storage with sliding door, specify model HF23B (Black) and the key number, see page 110.

NOTES:

- Convenient off-the-worksurface storage requires no additional floor space.
- Available with laminate doors, frosted/silver doors, or sliding door.
- Doors are sized to overlap the top, end panels and light valance, to provide a clean design.
- Laminate and frosted/silver door units are equipped with self-closing, adjustable hinges.
- Laminate hinged door units are available with or without a lock.
- For tackboards, see page 63.
- For task lights, see page 111.
- For paper organizers, see page 108.
- **IMPORTANT: See installation guidelines at top of page 58.**

HOW TO SPECIFY

<p>Select Model Number</p> <div style="border: 1px solid black; display: flex; justify-content: space-between; align-items: center; padding: 2px;"> HNL1578FD </div>	<p>Select Chassis Color</p> <p>See page 29</p> <div style="border: 1px solid black; display: flex; justify-content: space-between; align-items: center; padding: 2px;"> H </div>	
<p>Select Model Number</p> <div style="border: 1px solid black; display: flex; justify-content: space-between; align-items: center; padding: 2px;"> HNL1578SD </div>	<p>Select Chassis Color</p> <p>See page 29</p> <div style="border: 1px solid black; display: flex; justify-content: space-between; align-items: center; padding: 2px;"> H </div>	<p>Select Door Front Color</p> <p>See page 29</p> <div style="border: 1px solid black; display: flex; justify-content: space-between; align-items: center; padding: 2px;"> H </div>

CONCINNITY™

Wall Mount Storage

GSA SIN 33721

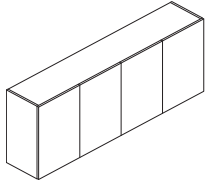

Icon Legend on page 19

**DESCRIPTION****Wall Mount Storage, Laminate Doors**

78"W x 15"D x 28½"H — 4 doors, 2 compartments
 72"W x 15"D x 28½"H — 4 doors, 2 compartments
 66"W x 15"D x 28½"H — 4 doors, 2 compartments
 60"W x 15"D x 28½"H — 4 doors, 2 compartments
 48"W x 15"D x 28½"H — 3 doors, 2 compartments
 42"W x 15"D x 28½"H — 2 doors, 1 compartment
 36"W x 15"D x 28½"H — 2 doors, 1 compartment
 30"W x 15"D x 28½"H — 2 doors, 1 compartment

MODEL**SHIP WEIGHT****CUBE****L1 LIST****L2 UPCHARGES**
CHASSIS FRONTS

HNL2978LD	213	30.8	\$1651	\$50	\$40
HNL2972LD	199	28.6	\$1566	\$40	\$40
HNL2966LD	185	26.4	\$1517	\$40	\$40
HNL2960LD	170	24.1	\$1409	\$40	\$40
HNL2948LD	142	19.7	\$1284	\$35	\$30
HNL2942LD	116	17.4	\$1054	\$35	\$20
HNL2936LD	101	15.2	\$1005	\$35	\$20
HNL2930LD	87	12.9	\$897	\$35	\$20

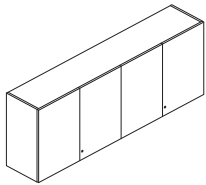
**Wall Mount Storage, Laminate Locking Doors**

78"W x 15"D x 28½"H — 4 doors, 2 compartments
 72"W x 15"D x 28½"H — 4 doors, 2 compartments
 66"W x 15"D x 28½"H — 4 doors, 2 compartments
 60"W x 15"D x 28½"H — 4 doors, 2 compartments
 48"W x 15"D x 28½"H — 3 doors, 2 compartments
 42"W x 15"D x 28½"H — 2 doors, 1 compartment
 36"W x 15"D x 28½"H — 2 doors, 1 compartment
 30"W x 15"D x 28½"H — 2 doors, 1 compartment

HNL2978LL	213	30.8	\$1740	\$50	\$40
HNL2972LL	199	28.6	\$1655	\$40	\$40
HNL2966LL	185	26.4	\$1606	\$40	\$40
HNL2960LL	170	24.1	\$1498	\$40	\$40
HNL2948LL	142	19.7	\$1351	\$35	\$30
HNL2942LL	116	17.4	\$1099	\$35	\$20
HNL2936LL	101	15.2	\$1050	\$35	\$20
HNL2930LL	87	12.9	\$942	\$35	\$20

! Lock available in Black (P) or Satin (SA) finish. Lock is core removable. Keyed alike cores must be ordered separately. For stack-on and wall mount storage with locking hinged doors, specify model HF27B (Black) or HF27S (Satin) and the key number, see page 110. Model HNL2948LL has one lock, which secures two of the three doors.

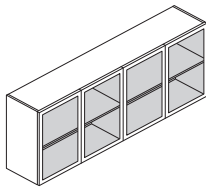
**Wall Mount Storage, Frosted Doors with Silver Frame**

78"W x 15"D x 28½"H — 4 doors, 2 compartments
 72"W x 15"D x 28½"H — 4 doors, 2 compartments
 66"W x 15"D x 28½"H — 4 doors, 2 compartments
 60"W x 15"D x 28½"H — 4 doors, 2 compartments
 48"W x 15"D x 28½"H — 3 doors, 2 compartments
 42"W x 15"D x 28½"H — 2 doors, 1 compartment
 36"W x 15"D x 28½"H — 2 doors, 1 compartment
 30"W x 15"D x 28½"H — 2 doors, 1 compartment

HNL2978FD	174	30.8	\$2693	\$50	N/A
HNL2972FD	163	28.6	\$2607	\$40	N/A
HNL2966FD	152	26.4	\$2558	\$40	N/A
HNL2960FD	140	24.1	\$2449	\$40	N/A
HNL2948FD	118	19.7	\$2066	\$35	N/A
HNL2942FD	94	17.4	\$1578	\$35	N/A
HNL2936FD	83	15.2	\$1528	\$35	N/A
HNL2930FD	72	12.9	\$1418	\$35	N/A

! Frosted door models do not have a lock option.

NOTES:

- Convenient off-the-worksurface storage requires no additional floor space.
- Available with laminate doors, frosted/silver doors, or sliding door.
- Doors are sized to overlap the top, end panels and light valance, to provide a clean design.
- Laminate and frosted/silver door units are equipped with self-closing, adjustable hinges.
- Laminate hinged door units are available with or without a lock.
- 28½"H units have a fixed, intermittent shelf; storage space above and below the shelf is 12½".
- For tackboards, see page 63.
- For task lights, see page 111.
- For paper organizers, see page 108.
- **IMPORTANT: See installation guidelines at top of page 58.**

HOW TO SPECIFY**Select Model Number**

H N L 2 9 7 8 L D

Select Chassis Color

See page 29

H

Select Door Front Color

See page 29

H

Select Model Number

H N L 2 9 7 8 L L

Select Lock Finish

See page 29

P

Select Chassis Color

See page 29

H

Select Door Front Color

See page 29

H

Select Model Number

H N L 2 9 7 8 F D

Select Chassis Color

See page 29

H



CONCINNITY™

Wall Mount Storage

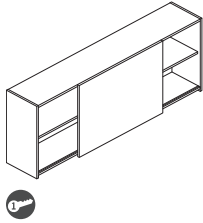

DESCRIPTION	MODEL	COM	SHIP WEIGHT	CUBE	L1 LIST	L2 UPCHARGES	
						CHASSIS	FRONTS
Wall Mount Storage, Sliding Door							
78"W x 15"D x 28½"H	HNL2978SD		189	30.8	\$1717	\$50	\$40
72"W x 15"D x 28½"H	HNL2972SD		177	28.6	\$1638	\$40	\$40
66"W x 15"D x 28½"H	HNL2966SD		165	26.4	\$1600	\$40	\$40
60"W x 15"D x 28½"H	HNL2960SD		153	24.1	\$1497	\$40	\$40
48"W x 15"D x 28½"H	HNL2948SD		129	19.7	\$1314	\$35	\$30

NOTES: One door per unit. Standard with black lock, which is located on the inside vertical support panel. Lock is core removable. Keyed alike cores must be ordered separately. For stack-on and wall mount storage with sliding door, specify model HF23B (Black) and the key number, see page 110.

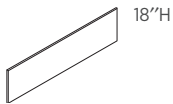

18"H

Tackboards for use with Wall Mount Storage

75"W - for 78"W	H90057	3.0	13	3.2	\$337	N/A	N/A
68¾"W - for 72"W	H90056	2.0	12	2.7	\$320	N/A	N/A
62¾"W - for 66"W	H90055	2.0	11	2.5	\$304	N/A	N/A
56¾"W - for 60"W	H90054	2.0	10	2.2	\$268	N/A	N/A
44¾"W - for 48"W	H90053	2.0	8	1.8	\$257	N/A	N/A
39"W - for 42"W	H90052	2.0	7	1.6	\$237	N/A	N/A
33"W - for 36"W	H90051	1.0	6	1.4	\$208	N/A	N/A
26¾"W	H90050	1.0	5	1.2	\$208	N/A	N/A

NOTES: Specify fabric, see pages 25-26. Upcharges may apply to premium fabric grades.

Tackboard widths differ slightly from the wall mounted storage cabinet widths. For applications where multiple wall mounted storage units are placed side-by-side, the preferred tackboard solution may be to utilize a larger tackboard size. For example, H90057 = 75"W; H90056 = 68¾"W; H90055 = 62¾"W; H90054 = 56¾"W.

ⓘ Disperse (DISP) fabric not available on sizes wider than 60". Analog (ANLG) and Exchange (EXG) not available on sizes wider than 72".

SPECIFYING EXAMPLE: H90057.APN15

NOTES:

- Convenient off-the-worksurface storage requires no additional floor space.
- Valance hides task light.
- Available with laminate doors, frosted/silver doors, or sliding door.
- Doors are sized to overlap the top, end panels and light valance, to provide a clean design.
- Laminate and frosted/silver door units are equipped with self-closing, adjustable hinges.
- Laminate hinged door units are available with or without a lock.
- 28½"H units have a fixed, intermittent shelf; storage space above and below the shelf is 12⅝".
- For tackboards, see above.
- For task lights, see page 111.
- For paper organizers, see page 108.
- **IMPORTANT: See installation guidelines at top of page 58.**

HOW TO SPECIFY

Select
Model Number

H N L 2 9 7 8 S D

Select
Chassis Color

See page 29

H

Select
Door Front Color

See page 29

H

CONCINNITY™ Bookcase Hutches

GSA SIN 33721

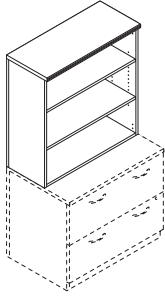

Icon Legend on page 19

**DESCRIPTION****Bookcase Hutch, No Doors/Open**

36"W x 14 1/4"D x 35 1/4"H (shown)
30"W x 14 1/4"D x 35 1/4"H

36"W x 14 1/4"D x 48 5/8"H
30"W x 14 1/4"D x 48 5/8"H

MODEL**SHIP WEIGHT****CUBE****L1 LIST****L2 UPCHARGES**
CHASSIS FRONTS

HNL3636BHxD
HNL3630BHxD

213
199

15.3
12.5

\$640
\$626

\$15
\$15

N/A
N/A

HNL4936BHxD
HNL4930BHxD

213
199

125.0
109.0

\$808
\$755

\$25
\$25

N/A
N/A

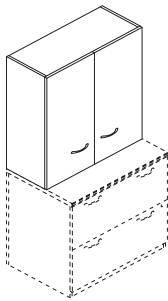
**Bookcase Hutch, Laminate Doors**

36"W x 15"D x 35 1/4"H (shown)
30"W x 15"D x 35 1/4"H

36"W x 15"D x 48 5/8"H
30"W x 15"D x 48 5/8"H

HNL3636BHLD
HNL3630BHLD

213
199

15.3
12.5

\$827
\$775

\$15
\$15

\$20
\$20

HNL4936BHLD
HNL4930BHLD

213
199

165.0
142.0

\$991
\$929

\$25
\$25

\$30
\$30

NOTES:

- Designed for use on worksurfaces, or on 30" or 36" W x 29 1/2" H lateral file or storage cabinet with doors.
- Two widths, 30" and 36"; two heights, 35 1/4" and 48 5/8".
- The 35 1/4" H unit has three shelves, two are adjustable in 1/4" increments with a total range of 17 1/2"; bottom shelf is fixed.
- The 48 5/8" H unit has four shelves, three are adjustable in 1/4" increments with a total range of 25"; bottom shelf is fixed.
- Available with laminate doors or frosted/silver doors or no doors (open).
- Door units equipped with self-closing, adjustable hinges.
- Laminate doors have decorative handles.
- Frosted door units have push/touch latch release.
- Doors are non-locking.
- To align with the top of the 35 1/4" bookcase hutch, use 64 3/4" H floor-standing storage models; to align with the top of the 48 5/8" H bookcase hutch, use 78 3/8" H models.
- Ship fully assembled.

HOW TO SPECIFY**Select Model Number**

H N L 3 6 3 6 B H X D .

Select Laminate Color

See page 29

H

Select Model Number

H N L 3 6 3 6 B H L D .

Select Handle

- A Cylinder - Satin
- B Cylinder - Black
- C Canopy - Satin
- D Canopy - Black
- E Loop - Satin
- F Loop - Black

E .

Select Chassis Color

See page 29

H .

Select Door Front Color

See page 29

H



CONCINNITY™

Bookcase Hutches

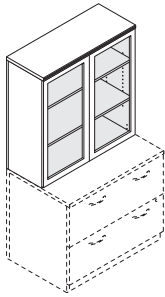

DESCRIPTION	MODEL	SHIP WEIGHT	CUBE	L1 LIST	L2 UPCHARGES	
					CHASSIS	FRONTS
Bookcase Hutch, Frosted Doors with Silver Frame 36"W x 15"D x 35¼"H (shown)	HNL3636BHFD	199	15.3	\$1518	\$15	N/A
36"W x 15"D x 48⅝"H	HNL4936BHFD	213	134.0	\$1854	\$25	N/A

NOTES:

- Designed for use on worksurfaces, or on 30" or 36"W x 29½"H lateral file or storage cabinet with doors.
- Two widths, 30" and 36"; two heights, 35¼" and 48⅝".
- The 35¼"H unit has three shelves, two are adjustable in 1¼" increments with a total range of 17½"; bottom shelf is fixed.
- The 48⅝"H unit has four shelves, three are adjustable in 1¼" increments with a total range of 25"; bottom shelf is fixed.
- Available with laminate doors or frosted/silver doors or no doors (open).
- Door units equipped with self-closing, adjustable hinges.
- Laminate doors have decorative handles.
- Frosted door units have push/touch latch release.
- Doors are non-locking.
- To align with the top of the 35¼"H bookcase hutch, use 64¾"H floor-standing storage models; to align with the top of the 48⅝"H bookcase hutch, use 78⅝"H models.
- Ship fully assembled.

HOW TO SPECIFY

Select
Model Number

H N L 3 6 3 6 B H F D .

Select
Chassis Color

See page 29

H

CONCINNITY™ Reception Stations

GSA SIN 33721



Icon Legend on page 19

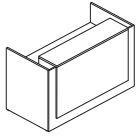

DESCRIPTION	MODEL	SHIP WEIGHT	CUBE	L1 LIST	L2 UPCHARGES		ACCENT PANEL
					WORKSURFACE	CHASSIS	

Reception Desk with Transaction Counter 72"W x 36 3/4"D x 44"H	HLAM3772RD	324	13.5	\$1563	\$35	\$70	\$25
--	-------------------	-----	------	---------------	-------------	-------------	-------------

NOTES: Non-handed. Counter measures 60"W x 15 1/4"D. Flat edge (G) matches 10500 Series™. For beaded (B) and tri-oval (V) edge shapes, the transaction counter is profiled on the approach and user sides, and the desk worksurface is profiled on the user's side. Beaded (B) and tri-oval (V) edges are available in L1 woodgrains colors only. Smooth and flat (G) edge available in all woodgrains and solid colors. Vertical grain on approach side and front accent panel for L1 laminates except Kingswood Walnut and Florence Walnut. Horizontal grain on L2 laminates and Kingswood and Florence Walnut. Vertical grain on end panels and horizontal grain on worksurface and transaction counter. Two worksurface cord management grommets for routing and hiding wires and cables; can be specified in Black (P) or Platinum (TI) finish.

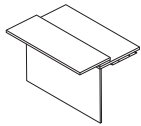

Reception Return with 32'H Transaction Counter 48 1/4"W x 32 7/8"D x 32"H	HLAM3348RR	145	3.7	\$879	\$35	\$35	N/A
---	-------------------	-----	-----	--------------	-------------	-------------	------------

NOTES: Non-handed. For use with HLAM3772RD and Reception Desk Shell (H105724). Counter facilitates accessibility; measures 48"W x 12"D x 32"H. Flat edge (G) matches 10500 Series™. For beaded (B) and tri-oval (V) edge shapes, the transaction counter is profiled on the approach side, and the return worksurface is profiled on the user's side. All other edges are flat banded. Beaded (B) and tri-oval (V) available in L1 woodgrain colors only. Flat edge (G) available in all woodgrains and solid colors. Pattern laminates do not have matching edge color; patterns can be specified with woodgrain or solid edge. Vertical grain on approach side, end panel, worksurface, and transaction counter. Assembly required. Cam covers used to allow for non-handed design.

Specify: Model.Edge Profile & EdgeColor.Worksurface & Counter Color.Chassis Color

SPECIFYING EXAMPLE: HLAM3348RR.GN.N.N

HOW TO SPECIFY

<p>Select Model Number</p> <p>HLAM3772RD</p>	<p>Select Edge Profile and Edge Color</p> <p>See page 29</p> <p>GN</p>	<p>Select Grommet Color</p> <p>P Black TI Platinum Not specified for model HLAM3348RR</p> <p>P</p>	<p>Select Worksurface Laminate</p> <p>See page 29</p> <p>N</p>	<p>Select Chassis Laminate</p> <p>See page 29</p> <p>N</p>	<p>Select Accent Panel Laminate</p> <p>See page 29 Not specified for model HLAM3348RR</p> <p>LDW1</p>
---	---	---	---	---	--



CONCINNITY™ Reception Stations

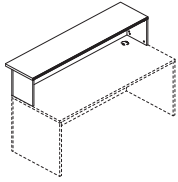

DESCRIPTION

Reception Station Counter for Desk
72"W x 17"D x 14 5/8"H

MODEL	SHIP WEIGHT	CUBE	L1 LIST	L2 UPCHARGES	
				COUNTER	CHASSIS
HNL1772RT	74	4.3	\$605	\$10	\$15

Compatible for use on 72"W x 30" or 36"D desktops and worksurfaces. For cleanest approach-side aesthetic, use on desk built with modular components; desk comprised of either 72"W x 30"D rectangle worksurface and 72"W x 27 7/8"H modesty/back panel, supported by 29 1/8"D pedestal(s) and/or end panel(s), or 72"W x 36"D worksurface and 72"W x 27 7/8"H modesty/back panel, supported by 35"D left and right end panels. The counter is 17"D with a 4" approach-side overhang; end panels are 12 3/8"D. Ships with Transaction counter organizer (model HTCOL52) is available as an option; fits under transaction counter; organizer is available in black only.

SPECIFYING EXAMPLE: HNL1772RT.BH.H.H

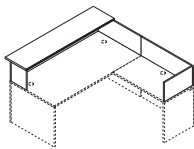

For Station with Right Return

L-Reception Station with Transaction Counter for Desk

72"W x 88"D x 14 5/8"H
72"W x 82"D x 14 5/8"H

HNL8472RT	103	4.5	\$965	\$10	\$25
HNL7872RT	101	4.5	\$941	\$10	\$25

NOTES: Intended for use on desk built with modular components, for clean approach-side aesthetic, connected to a return or modular return. Layout for 78" and 84"D footprints:

- 72"W x 78"D:
 - Desk = 72"W x 30"D worksurface, 72"W x 27 7/8"H modesty/back panel, supported by 29 1/8"D pedestal(s) and/or end panel(s).
 - Return = 48"W x 24"D return; or 48"W x 24"D worksurface with vertical grain, 48"W x 27 7/8"H modesty/back panel, supported by a 23 1/8"D pedestal and/or end panel.
- 72"W x 84"D:
 - Desk = 72"W x 36"D worksurface, 72"W x 27 7/8"H modesty/back panel, supported by 1-left and 1-right 35"D panel.
 - Return = 42"W x 24"D return; or 42"W x 24"D worksurface with vertical grain, 42"W x 27 7/8"H modesty/back panel, supported by a 23 1/8"D pedestal and/or end panel.
- 72"W x 88"D:
 - Desk = 72"W x 36"D worksurface, 72"W x 27 7/8"H modesty/back panel, supported by 1-left and 1-right 35"D end panel.
 - Return = 48"W x 24"D return; or 48"W x 24"D worksurface with vertical grain, 48"W x 27 7/8"H modesty/back panel, supported by a 23 1/8"D pedestal and/or end panel.

Comprised of 17"D transaction counter, with 4" approach-side overhang, for the desk and a vertical privacy panel extending the depth of the desk and width of the return. Ships with Transaction counter organizer (model HTCOL52) is available as an option; fits under transaction counter; organizer is available in black only.

SPECIFYING EXAMPLE: HNL8472RT.BH.H.H

NOTES:

- Reception Station Counter for Desk, and L-Reception Station with Transaction Counter for Desk, have profiled edgeband on the approach and user sides.
- L-Reception Station with Transaction Counter for Desk and Return has profiled edgeband on front side of transaction counter on desk approach-side only.
- For L-reception station layouts where the return is not against a wall, specify return using modular components, as the modesty/back panel can be specified without a grommet. Assembled returns come standard with cord grommet in modesty/back panel.

HOW TO SPECIFY

<p>Select Model Number</p> <p>H N L 1 7 7 2 R T</p>	<p>Select Edge Profile and Edge Color</p> <p>See page 29</p> <p>B H</p>	<p>Select Counter Color</p> <p>See page 29</p> <p>H</p>	<p>Select Chassis Color</p> <p>See page 29</p> <p>H</p>
--	--	--	--

CONCINNITY™

Reception Stations

GSA SIN 33721



Icon Legend on page 19

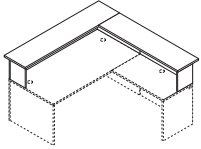

For Station with Right Return

DESCRIPTION	MODEL	SHIP WEIGHT	CUBE	L1 LIST	L2 UPCHARGES	
					COUNTER	CHASSIS
L- Reception Station with Transaction Counter for Desk and Return 76"W x 88"D x 14 $\frac{5}{8}$ "H	HNL8472RLT	145	5.6	\$1155	\$10	\$25
76"W x 82"D x 14 $\frac{5}{8}$ "H	HNL7872RLT	139	5.6	\$1115	\$10	\$25

NOTES: Intended for use on desk built with modular components, for clean approach-side aesthetic, connected to a return or modular return. Layout for 78" and 84"D footprints:

- 72"W x 78"D:
 - Desk = 72"W x 30"D worksurface, 72"W x 27 $\frac{7}{8}$ "H modesty/back panel, supported by 29 $\frac{1}{8}$ "D pedestal(s) and/or end panel(s).
 - Return = 48"W x 24"D worksurface with vertical grain, 48"W x 27 $\frac{7}{8}$ "H modesty/back panel, supported by a 23 $\frac{1}{8}$ "D pedestal and/or end panel.
- 72"W x 78"D:
 - Desk = 72"W x 36"D worksurface, 72"W x 27 $\frac{7}{8}$ "H modesty/back panel, supported by 1-left and 1-right 35"D panel.
 - Return = 42"W x 24"D worksurface with vertical grain, 42"W x 27 $\frac{7}{8}$ "H modesty/back panel, supported by a 23 $\frac{1}{8}$ "D pedestal and/or end panel.
- 72"W x 84"D:
 - Desk = 72"W x 36"D worksurface, 72"W x 27 $\frac{7}{8}$ "H modesty/back panel, supported by 1-left and 1-right 35"D end panel.
 - Return = 48"W x 24"D worksurface with vertical grain, 48"W x 27 $\frac{7}{8}$ "H modesty/back panel, supported by a 23 $\frac{1}{8}$ "D pedestal and/or end panel.

! The 17"D transaction counter, with 4" overhang, extends around the perimeter of the station, across the width of the desk, as well as along the depth of the desk and width of the return. Ships with Transaction counter organizer (model HTCOL52) is available as an option; fits under transaction counter; organizer is available in black only.

SPECIFYING EXAMPLE: HNL8472RLT.BH.H.H

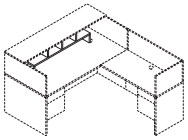

Transaction Counter Organizer

48 $\frac{3}{4}$ "W x 11 $\frac{1}{8}$ "D x 13"H

HTCOL52

24

1.1

\$300

N/A

N/A

NOTES: Fits under reception station counters.

! Black only.

SPECIFYING EXAMPLE: HTCOL52.P

NOTES:

- Reception Station Counter for Desk, and L-Reception Station with Transaction Counter for Desk, have profiled edgeband on the approach and user sides.
- ! L-Reception Station with Transaction Counter for Desk and Return has profiled edgeband on front side of transaction counter on desk approach-side only.
- ! For L-reception station layouts where the return is not against a wall, specify return using modular components, as the modesty/back panel can be specified without a grommet. Assembled returns come standard with cord grommet in modesty/back panel.

HOW TO SPECIFY

Select Model Number H N L 8 4 7 2 R L T .	Select Edge Profile and Edge Color See page 29 B H .	Select Counter Color See page 29 H .	Select Chassis Color See page 29 H
---	---	---	---



CONCINNITY™ Mobile Pedestals



DESCRIPTION	MODEL	SHIP WEIGHT	CUBE	L1 LIST	L2 UPCHARGES			
					TOP	CHASSIS	FRONTS	
Mobile Pedestal — 15¾" W								
15¾"W x 20⅞"D x 28⅜"H, Box/Box/File	HNL2116MBBF	69	7.4	\$983	N/A	\$20	\$10	
15¾"W x 20⅞"D x 28⅜"H, File/File	HNL2116MFF	70	7.4	\$983	N/A	\$20	\$10	
15¾"W x 20⅞"D x 21½"H, Box/File	HNL2116MBF	55	5.8	\$833	N/A	\$20	\$10	

NOTES: Well suited to a variety of office layouts, including private, open floor plan, and cubicle workspaces. Design positions the center of gravity towards the back of the cabinet to inhibit tipping. All drawers lock; interchangeable core removable lock makes re-keying quick and easy. Finish of lock is determined by, and aligned with, the handle finish specified. Keyed alike cores must be ordered separately; specify model HF23B (Black) or HF23S (Satin) and specific key number required. Pedestals, excluding cushion option, are sized to be positioned under 29½"H worksurfaces. Seat cushion model HLSL2016PH2 is optional. Cushion adds 1" to the height of the pedestal. Box/File unit with cushion will fit below 29½"H worksurface. ¾" thick top with flat edgeband; back inside end panel construction. Ships fully assembled.

SPECIFYING EXAMPLE: HNL2116MBBF.E.H.H

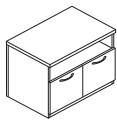

Mobile Pedestal — 30" W								
30"W x 20"D x 21½"H, Shelf/File/Cabinet	HNL2030MSFC	105	10.7	\$1235	\$10	\$25	\$15	

NOTES: Sized to align with 20"D x 20½"H low credenzas. Open shelf over file drawer left and cabinet with door right. Design positions the center of gravity towards the back of the cabinet to inhibit tipping. Seat cushion model HNL2030CH2 is optional. Cushion adds 1" to the height of the pedestal. 1⅞" thick top matches low credenza design. Ships fully assembled.

SPECIFYING EXAMPLE: HNL2030MSFC.BH.E.H.H.H

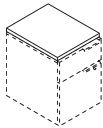

DESCRIPTION	MODEL	SHIP WEIGHT	CUBE	LIST PRICE BY FABRIC GRADE						
				1	2	3	4	5	6	
Mobile Pedestal Cushion										
30"W x 20"D x 1"H	HLSL2030CH2	9	1.9	\$418	\$454	\$490	\$526	\$572	\$619	
15¾"W x 20"D x 1"H	HLSL2016PH2	6	1.1	\$347	\$371	\$395	\$419	\$450	\$481	

NOTES: See pages 22-24 for available fabrics.

SPECIFYING EXAMPLE: HLSL2016PH2.APN23

NOTES:

- Mobile pedestals roll easily on four casters to provide convenient, flexible placement of personal storage needs.
- Drawers operate on steel ball-bearing suspension with full extension.
- File drawers include hangrails for side-to-side letter and legal filing; and front-to-back for letter filing.
- ! 28⅜"H mobile pedestals are not designed for use with the 28½"H metal O-leg due to interference caused by (1) the O-leg worksurface attachment bracket, and (2) the external support channel on the underside of a 72", 66", and 60"W rectangle worksurface supported by O-leg(s).

HOW TO SPECIFY

<p>Select Model Number</p> <p>H N L 2 1 1 6 M B B F .</p>	<p>Select Handle</p> <p>A Cylinder – Satin B Cylinder – Black C Canopy – Satin D Canopy – Black E Loop – Satin F Loop – Black</p> <p>E .</p>	<p>Select Chassis Color</p> <p>See page 29</p> <p>H .</p>	<p>Select Drawer Front Color</p> <p>See page 29</p> <p>H</p>
--	---	--	---

<p>Select Model Number</p> <p>H N L 2 0 3 0 M S F C .</p>	<p>Select Edge Profile and Edge Color</p> <p>See page 29</p> <p>B H .</p>	<p>Select Handle</p> <p>A Cylinder – Satin B Cylinder – Black C Canopy – Satin D Canopy – Black E Loop – Satin F Loop – Black</p> <p>E .</p>	<p>Select Top Color</p> <p>See page 29</p> <p>H .</p>	<p>Select Chassis Color</p> <p>See page 29</p> <p>H .</p>	<p>Select Drawer/Door Front Color</p> <p>See page 29</p> <p>H</p>
--	--	---	--	--	--

CONCINNITY™ Lateral Files

GSA SIN 33721



Icon Legend on page 19

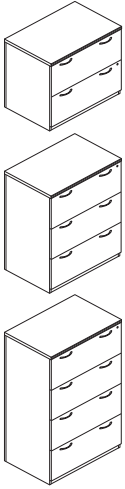

DESCRIPTION	MODEL	SHIP WEIGHT	CUBE	L1 LIST	L2 UPCHARGES		
					TOP	CHASSIS	FRONTS
Lateral File 36"W x 24"D x 59½"H, 4-Drawer	HNL2436LD4	276	34.3	\$2325	\$15	\$30	\$30
36"W x 24"D x 45½"H, 3-Drawer	HNL2436LD3	222	26.0	\$1928	\$15	\$25	\$25
36"W x 24"D x 29½"H, 2-Drawer	HNL2436LD2	178	18.4	\$1278	\$15	\$20	\$20

NOTES: Equipped with safety restraints; mechanical interlock inhibits the extension of more than one drawer at a time; counterweight positions the center of gravity towards the back of the cabinet to inhibit tipping. 24" depth aligns evenly with credenzas, returns, storage cabinet, storage/file cabinet, storage cabinet/lateral file, wardrobe/storage cabinet, wardrobe/bookcase, storage towers, and 24"D modular components. 29½"H unit is sized to accommodate 36"W stack-on storage or bookcase hutch options. Drawers lock; interchangeable core removable lock makes re-keying quick and easy. Finish of lock is determined by, and aligned with, the handle finish specified. Keyed alike cores must be ordered separately; specify model HF23B (Black) or HF23S (Satin) and specific key number required. Ship fully assembled. 30"W two-drawer size can be specified and assembled using modular components. Drawers include hangrails to accept folders in letter or legal size.

SPECIFYING EXAMPLE: HNL2436LD2.BH.E.H.H.H

HOW TO SPECIFY

<p>Select Model Number</p> <p>H N L 2 4 3 6 L D 4 .</p>	<p>Select Edge Profile and Edge Color</p> <p>See page 29</p> <p>B H .</p>	<p>Select Handle</p> <p>A Cylinder – Satin B Cylinder – Black C Canopy – Satin D Canopy – Black E Loop – Satin F Loop – Black</p> <p>E .</p>	<p>Select Top Color</p> <p>See page 29</p> <p>H .</p>	<p>Select Chassis Color</p> <p>See page 29</p> <p>H .</p>	<p>Select Drawer Front Color</p> <p>See page 29</p> <p>H .</p>
--	--	--	--	--	---



CONCINNITY™ Storage Cabinets

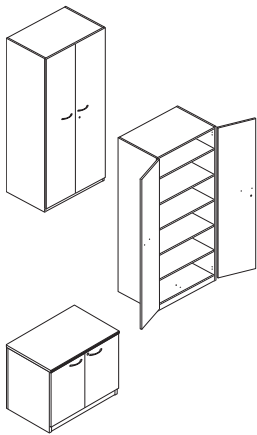

DESCRIPTION

Storage Cabinet with Laminate Doors

36"W x 24"D x 78 1/8"H (shown)
36"W x 24"D x 64 3/4"H
36"W x 24"D x 29 1/2"H

MODEL

HNL243679SC
HNL243665SC
HNL243629SC

SHIP WEIGHT

CUBE

L1 LIST

L2 UPCHARGES
TOP CHASSIS FRONTS

317	47.4	\$2516	N/A	\$60	\$25
252	40.8	\$2367	N/A	\$55	\$20
158	18.4	\$1138	\$15	\$20	\$20

NOTES: 29 1/2"H size has one adjustable interior shelf. Shelf adjusts in 2 1/2" increments over a total range of 10"H, 64 3/4"H and 78 1/8" have five shelves (four adjustable) and six shelves (five adjustable), respectively; shelves adjust in 2 1/2" increments. Locking doors. 24" depth aligns evenly with credenzas, returns, lateral files, storage/file cabinet, storage cabinet/lateral file, wardrobe/storage cabinet, wardrobe/bookcase, storage tower, bookcase with coat hook, and 24"D modular components. 29 1/2"H unit is sized to accommodate 36"W stack-on storage or bookcase hutch options. Ships fully assembled. 30"W x 24"D x 29 1/2"H freestanding unit can be built using modular components.

SPECIFYING EXAMPLE (29 1/2"H): HNL243629SC.BH.E.H.H.H
SPECIFYING EXAMPLE (64 3/4-78 1/8"H): HNL243665SC.E.H.H

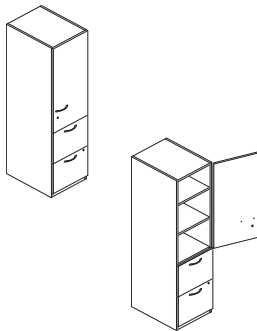

Storage/File Cabinet

18"W x 24"D x 64 3/4"H, File/File, Laminate
Door Hinged Right (shown)
18"W x 24"D x 64 3/4"H, File/File, Laminate
Door Hinged Left
18"W x 24"D x 64 3/4"H, File/File, Open
Shelves

HNL241865SFLR
HNL241865SFLL
HNL241865SFX

184	21.6	\$1903	N/A	\$25	\$15
184	21.6	\$1903	N/A	\$25	\$15
169	21.6	\$1807	N/A	\$25	\$15

NOTES: Versatile unit features a storage cabinet plus two file drawers. Storage cabinet includes three shelves, two are adjustable; shelves adjust in 2 1/2" increments. Can be specified with door hinged left, door hinged right, or no door/open shelves. File drawers operate on steel ball-bearing suspensions with full extension. File drawers include hangrails to accept folders in letter or legal size. Storage cabinet door and file drawers lock separately; the two locks are keyed alike. Unit height is designed to match desk, credenza, or return plus 35 1/4"H stack-on storage (= 64 3/4"). Ships fully assembled.

SPECIFYING EXAMPLE (WITH DOOR): HNL241865SFLR.E.H.H
SPECIFYING EXAMPLE (WITHOUT DOOR): HNL241865SFX.E.H.H

NOTES:

- Interchangeable core removable lock makes re-keying quick and easy.
- Finish of lock is determined by, and aligned with, the handle finish specified.
- Keyed alike cores must be ordered separately; specify model HF23B (Black) or HF23S (Satin) and specific key number required.

HOW TO SPECIFY

<p>Select Model Number</p> <p>H N L 2 4 3 6 2 9 S C .</p>	<p>Select Edge Profile and Edge Color</p> <p>See page 29</p> <p>B H .</p>	<p>Select Handle</p> <p>A Cylinder - Satin B Cylinder - Black C Canopy - Satin D Canopy - Black E Loop - Satin F Loop - Black</p> <p>E .</p>	<p>Select Top Color</p> <p>See page 29</p> <p>H .</p>	<p>Select Chassis Color</p> <p>See page 29</p> <p>H .</p>	<p>Select Drawer Front Color</p> <p>See page 29</p> <p>H .</p>
--	--	---	--	--	---

<p>Select Model Number</p> <p>H N L 2 4 3 6 6 5 S C .</p> <p>H N L 2 4 1 8 6 5 S F X .</p>	<p>Select Handle</p> <p>A Cylinder - Satin B Cylinder - Black C Canopy - Satin D Canopy - Black E Loop - Satin F Loop - Black</p> <p>E .</p> <p>E .</p>	<p>Select Chassis Color</p> <p>See page 29</p> <p>H .</p> <p>H .</p>	<p>Select Drawer Front Color</p> <p>See page 29</p> <p>H .</p> <p>H .</p>
---	--	---	--

CONCINNITY™

Storage Cabinets

GSA SIN 33721



Icon Legend on page 19

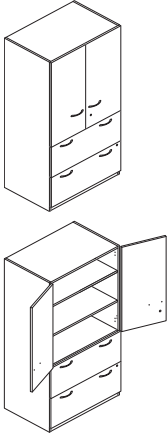

DESCRIPTION	MODEL	SHIP WEIGHT	CUBE	L1 LIST	L2 UPCHARGES		
					TOP	CHASSIS	FRONTS
Storage Cabinet/Lateral File, Laminate Doors 36"W x 24"D x 64¾"H	HNL243665SLL	328	40.8	\$2553	N/A	\$55	\$20

NOTES: Cabinet includes one fixed and two full-width adjustable shelves; adjustable shelves can be removed. Overall storage compartment measures 34"W x 22"D x 34½"H and will accommodate supplies, books and binders. Lateral file equipped with mechanical interlock to inhibit the extension of more than one drawer at a time. Lateral file drawers include hangrails to accept folders in letter or legal size. Storage cabinet and lateral file lock independently; upper lock secures cabinet; lower locks secure file drawers. Locks are keyed alike. Door hinges rotate to 94 degrees. Unit height is designed to match desk, credenza, or return plus 35¼"H stack-on storage (= 64¾"). Ships fully assembled.

SPECIFYING EXAMPLE: HNL243665SLL.E.H.H

NOTES:

- Interchangeable core removable lock makes re-keying quick and easy.
- Finish of lock is determined by, and aligned with, the handle finish specified.
- Keyed alike cores must be ordered separately; specify model HF23B (Black) or HF23S (Satin) and specific key number required.

HOW TO SPECIFY

Select Model Number H N L 2 4 3 6 6 5 S L L .	Select Handle A Cylinder – Satin B Cylinder – Black C Canopy – Satin D Canopy – Black E Loop – Satin F Loop – Black E .	Select Chassis Color See page 29 H .	Select Door/Drawer Front Color See page 29 H
---	---	---	---

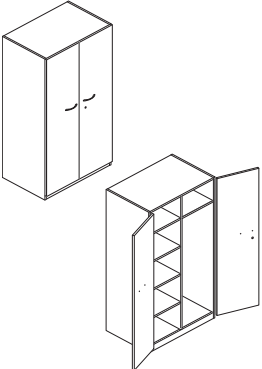
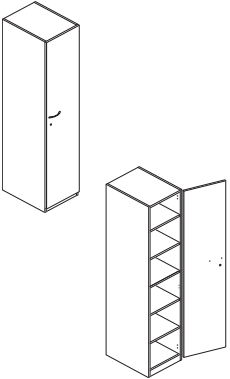
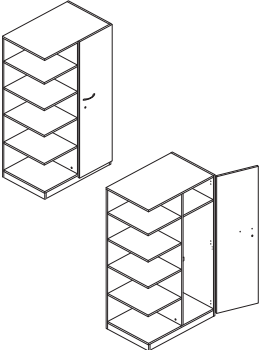

DESCRIPTION	MODEL	SHIP WEIGHT	CUBE	L1 LIST	L2 UPCHARGES	
					CHASSIS	FRONTS
Wardrobe/Storage Cabinet, Laminate Doors — 36"W 36"W x 24"D x 78 ¹ / ₈ "H 36"W x 24"D x 64 ³ / ₄ "H	HNL243679WL	303	40.8	\$2890	\$60	\$25
	HNL243665WL	284	40.8	\$2771	\$55	\$20
NOTES: Spacious design combines a cabinet with adjustable shelves and a generous personal wardrobe compartment with a coat rod and upper shelf. 64 ³ / ₄ "H and 78 ¹ / ₈ "H have five shelves (four adjustable) and six shelves (five adjustable), respectively; shelves adjust in 2 ¹ / ₂ " increments. One lock secures both doors. Ships fully assembled. SPECIFYING EXAMPLE: HNL243665WL.E.H.H						
						
Wardrobe/Storage Cabinet, Laminate Door — 18"W 18"W x 24"D x 78 ¹ / ₈ "H, Hinged Right (shown) 18"W x 24"D x 78 ¹ / ₈ "H, Hinged Left 18"W x 24"D x 64 ³ / ₄ "H, Hinged Right 18"W x 24"D x 64 ³ / ₄ "H, Hinged Left	HNL241879WLR	205	24.8	\$1897	\$30	\$20
	HNL241879WLL	205	24.8	\$1897	\$30	\$20
	HNL241865WLR	157	21.6	\$1739	\$25	\$15
	HNL241865WLL	157	21.6	\$1739	\$25	\$15
	NOTES: Design includes coat rod and shelves. 64 ³ / ₄ "H and 78 ¹ / ₈ "H have five shelves (four adjustable) and six shelves (five adjustable), respectively; shelves adjust in 2 ¹ / ₂ " increments. Middle shelves can be removed to provide space for garments; coat rod can be removed for storage only applications. Lock to secure contents. Ships fully assembled. SPECIFYING EXAMPLE: HNL241865WLR.E.H.H					
						
Wardrobe/Bookcase, Laminate Door 36"W x 24"D x 78 ¹ / ₈ "H, Wardrobe Left, Bookcase Right 36"W x 24"D x 78 ¹ / ₈ "H, Wardrobe Right, Bookcase Left 36"W x 24"D x 64 ³ / ₄ "H, Wardrobe Left, Bookcase Right 36"W x 24"D x 64 ³ / ₄ "H, Wardrobe Right, Bookcase Left (shown)	HNL243679WLBR	302	47.4	\$2771	\$60	\$25
	HNL243679WRBL	302	47.4	\$2771	\$60	\$25
	HNL243665WLBR	230	40.8	\$2619	\$55	\$20
	HNL243665WRBL	230	40.8	\$2619	\$55	\$20
	NOTES: Combination closed-door wardrobe closet and open shelf bookcase. 64 ³ / ₄ "H and 78 ¹ / ₈ "H bookcases have five and six fixed shelves, respectively. Locking wardrobe compartment includes a coat rod and one shelf; shelf is positioned above the coat rod. Bookcase can be accessed from front or side. Left (L) model is wardrobe on left, bookcase on right; Right (R) model is wardrobe on right, bookcase on left. Ships fully assembled. SPECIFYING EXAMPLE: HNL243665WRBL.E.H.H					
						

NOTES:

- Heights designed to match desk, credenza, or return plus 35¹/₄"H stack-on storage (= 64³/₄"") or 48⁵/₈"H stack-on storage (= 78¹/₈"H).
- Finish of locks is determined by, and aligned with, the handle finish specified.
- Keyed alike cores must be ordered separately; specify model HF23B (Black) or HF23S (Satin) and specific key number required.

HOW TO SPECIFY

<p>Select Model Number</p> <p>H N L 2 4 3 6 5 W L .</p>	<p>Select Handle</p> <p>A Cylinder – Satin B Cylinder – Black C Canopy – Satin D Canopy – Black E Loop – Satin F Loop – Black</p> <p>E .</p>	<p>Select Chassis Color</p> <p>See page 29</p> <p>H .</p>	<p>Select Door Front Color</p> <p>See page 29</p> <p>H</p>
--	--	--	---

CONCINNITY™

Storage Towers

GSA SIN 33721

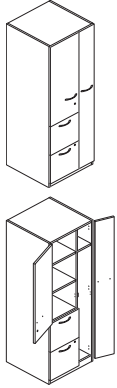

Icon Legend on page 19

**DESCRIPTION****Storage Towers, Laminate Doors — 24"W**24"W x 24"D x 78⁵/₈"H, Wardrobe Hinged Left, Cabinet Hinged Right**MODEL****HNL242479TLL****SHIP WEIGHT**

284

CUBE

32.4

L1 LIST**\$2684****L2 UPCHARGES****\$70****\$45**24"W x 24"D x 78⁵/₈"H, Wardrobe Hinged Right, Cabinet Hinged Left**HNL242479TLR**

284

32.4

\$2684**\$70****\$45**24"W x 24"D x 64³/₄"H, Wardrobe Hinged Left, Cabinet Hinged Right**HNL242465TLL**

241

27.6

\$2445**\$60****\$35**24"W x 24"D x 64³/₄"H, Wardrobe Hinged Right, Cabinet Hinged Left (shown)**HNL242465TLR**

241

27.6

\$2445**\$60****\$35**

NOTES: Versatile design includes a wardrobe closet, storage cabinet, and two file drawers, in one compact unit. Wardrobe contains a coat rod and upper shelf. 64³/₄"H and 78⁵/₈"H cabinets have three shelves (two adjustable) and four shelves (three adjustable), respectively; shelves adjust in 2¹/₂" increments. File drawers operate on ball-bearing suspensions with full extension. File drawer design includes integrated hangrails for side-to-side letter or legal filing; and front-to-back for letter filing. Upper lock secures wardrobe closet and storage cabinet; lower lock secures file drawers; the two locks are keyed alike. Left (L) model is wardrobe hinged left, cabinet hinged right; Right (R) model is wardrobe hinged right, cabinet hinged left. Ships fully assembled.

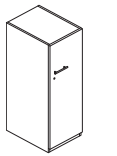
SPECIFYING EXAMPLE: HNL242465TLR.E.H.HHinged Right
HNL241850TLR shown**Storage Towers, Laminate Door — 50"H**

18"W x 30"D x 50"H, Hinged Right

HNL301850TLR

135

19.8

\$1515**\$50****\$35**

18"W x 30"D x 50"H, Hinged Left

HNL301850TLL

135

19.8

\$1515**\$50****\$35**

18"W x 24"D x 50"H, Hinged Right

HNL241850TLR

121

15.9

\$1362**\$50****\$35**

18"W x 24"D x 50"H, Hinged Left

HNL241850TLL

121

15.9

\$1362**\$50****\$35**

NOTES: Low profile design is well-suited for open plan layouts. Can be used next to 29¹/₂"H to standing, 42"H worksurfaces. Cabinet includes coat hook on back of door, perfect for jackets, sweaters, and purses. Two adjustable interior shelves, plus bottom of unit; shelves adjust in 2¹/₂" increments. 30"D size has a slim side access storage space at rear of unit with two fixed interior shelves; the lower shelf is positioned to align with a 29¹/₂"H worksurface, the upper shelf with a 42"H worksurface. Hardware bag includes an extra coat hook which can be positioned on the side of the unit, below the worksurface; ideal for back packs. Left (L) model is door hinged left; Right (R) model is door hinged right. Worksurface tower bracket kit (model HSTB2W1) can be used to attach a worksurface directly to the tower. Bracket (1) eliminates the need for one end panel or O-leg support; (2) is not designed to be used as a support when a stack-on storage unit is placed over bracket. Ships fully assembled.

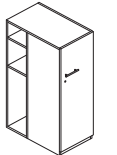
SPECIFYING EXAMPLE: HNL182450TLR.E.H.HHinged Right
HNL301850TLR shown**NOTES:**

- Equipped with interchangeable core removable locks.
- Finish of locks is determined by, and aligned with, the handle finish specified.
- Keyed alike cores must be ordered separately; specify model HF23B (Black) or HF23S (Satin) and specific key number required.

CABINET/WARDROBE/TOWER SOLUTIONS BY SIZE

	Low/50"H	Standard/64 ³ / ₄ "H	Executive/78 ⁵ / ₈ "H
Storage Cabinet with Doors		•	•
Storage/File Cabinet		•	
Storage Cabinet/Lateral File		•	
Wardrobe/Storage Cabinet		•	•
Wardrobe/Bookcase		•	•
Storage Tower		•	•
Storage Tower with Side Access on 30"D	•		
Bookcase with Coat Hook		•	

HOW TO SPECIFYSelect
Model Number

H N L 2 4 2 4 6 5 T L R .

Select
Handle

- A Cylinder – Satin
- B Cylinder – Black
- C Canopy – Satin
- D Canopy – Black
- E Loop – Satin
- F Loop – Black

E .

Select
Chassis Color

See page 29

H .

Select
Door Front Color

See page 29

E

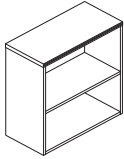

DESCRIPTION

Bookcase with Adjustable Shelves

- 30"W x 14 1/4"D x 78 1/8"H, 6-Shelf
- 30"W x 14 1/4"D x 65"H, 5-Shelf
- 30"W x 14 1/4"D x 52 3/4"H, 4-Shelf
- 30"W x 14 1/4"D x 42"H, 3-Shelf
- 30"W x 14 1/4"D x 29 1/2"H, 2-Shelf

MODEL	SHIP WEIGHT	CUBE	L1 LIST	L2 UPCHARGES TOP	CHASSIS
HNL1530BK6	170	25.7	\$1037	\$30	\$35
HNL1530BK5	143	21.1	\$920	\$25	\$30
HNL1530BK4	118	17.4	\$798	\$20	\$25
HNL1530BK3	95	14.1	\$701	\$15	\$20
HNL1530BK2	69	10.2	\$616	\$15	\$15

NOTES: Profiled top edge; choose from edge detail options. Number of total and adjustable shelves:

Height	Shelves	Adjustable Shelves
29 1/2"	2	1
42"	3	2
52 3/4"	4	3
65"	5	4
78 1/8"	6	5

3/4" thick shelves adjust in 1/4" increments. Inside shelf dimensions on all units are 28 1/2"W x 13 1/4"D. Ships fully assembled.

SPECIFYING EXAMPLE: HNL1530BK2.BH.H.H

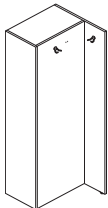
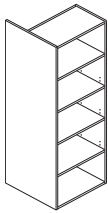

Back View

DESCRIPTION

Bookcase with Coat Hooks

- 24"W x 24"D x 64 3/4"H, 5-Shelf, with Coat Hooks, Right (shown)
- 24"W x 24"D x 64 3/4"H, 5-Shelf, with Coat Hooks, Left

MODEL	SHIP WEIGHT	CUBE	L1 LIST PRICE	L2 UPCHARGE
HNL2424BK5CR	133	27.6	\$1048	\$30
HNL2424BK5CL	133	27.6	\$1048	\$30

NOTES: Inside shelf dimensions are 28 1/2"W x 13 1/4"D. Two out of sight coat hooks for garments are secluded behind bookcase. One end panel measures 14 1/4"D, the other 24"D. "R" indicates coat hook access is on the right and the full 24"D end panel is on the left; for use next to credenza or return with pedestal on right. "L" indicates coat hook access is on the left and the full 24"D end panel is on the right; for use next to credenza or return with pedestal on left. Unit height is designed to match desk, credenza, or return plus 35 1/4"H stack-on storage (= 64 3/4"). 3/4" thick, non-profiled top edge. Not available in two-tone laminate color combinations. Ships fully assembled.

SPECIFYING EXAMPLE: HNL2424BK5CR.H

HOW TO SPECIFY

Select Model Number

H N L 1 5 3 0 B K 2 .

Select Edge Profile and Edge Color

See page 29

B H .

Select Top Color

See page 29

H .

Select Chassis Color

See page 29

H

Select Model Number

H N L 2 4 2 4 B K 5 C R .

Select Laminate

See page 29

H

CONCINNITY™ COMPONENTS

MODULAR COMPONENTS

- Smart, adaptable, reconfigurable assortment to maximize office layout flexibility and optimize floor space.
- Components for all popular office layouts.
- Selection allows user to choose their own workstation shape, size, and storage.
- Sizes for large and small spaces:
 - 36"D x 72"W or 84"W
 - 30"D — six sizes up to 84"W
 - 24"D — in 6" increments, from 30"W to 96"W
- Worksurfaces supported by post legs with casters provide added layout flexibility.
- Mobile desks quickly convert an office into a small conference space; desks roll easily and can be repositioned in seconds.
- Grommet options provide cord management from the top, side, and back in appropriate models.
- Broad menu of under-surface storage to enable user to specify the solution that best meets their individual needs.
 - Non-handed units can be configured to meet individual tastes and reconfigured when preferences or floor space requirements change.
 - Applications include:
 - The ability to “build” contiguous customized/personalized storage behind the desk that looks like custom architectural millwork, but at a fraction of the price. Allows for multiple storage pedestals to be configured under a single top with clean lines and no gaps.
 - Choosing the storage solution to go under desks, credenzas, and returns.

WORKSURFACES

- Available in a variety of shapes and sizes.
- Scratch-, stain-, and spill-resistant laminate over durable 1½" solid core high performance particleboard; resists warping.
- An external support channel, for attachment under worksurfaces, is required for all unsupported spans — a distance in which there is not a vertical support (point of contact) between the underside of the worksurface and the floor — greater than 54"W.
- For tri-oval and beaded edge options on tops with horizontal grain, there is a shaped profile on the user and approach sides, and a flat edge on the ends.
- For tri-oval and beaded edge options on tops with vertical grain, there is a shaped profile on the user side and a flat edge on the approach side and the ends.
- Grommets are an option and require specification. If grommets are selected, grommets come in a pre-determined location.

- Must be specified with support components; for pedestal, end panel, column, and leg options, see “Components — Supports” listings.

SUPPORTS

- For use with rectangle, bow, bullet, and extended corner worksurfaces.
- Available in 28½" and 41"H.
- Adjustable hex glides allow floor-standing units to be easily leveled, without lifting, to compensate for uneven floors; glides have 1¼" adjustable range on most components; 2" on O-legs.
- Bottom of laminate end panels are edgebanded for added strength and to seal out moisture.

FOR 29½"H WORKSURFACES

- Specify from a broad assortment of solutions, including —
 - Modular Pedestals
 - Laminate end panels (must be used in conjunction with a laminate modesty panel)
 - Laminate L-shaped end panels
 - Laminate T-shaped end panels
 - Metal O-legs — for use with worksurfaces up to 78"W (when using an 84" or wider worksurface, cannot use two O-legs; must use at least one 15¾" or wider pedestal for the other support).
 - 4½" diameter metal column
 - 2" square metal post leg

FOR 42"H WORKSURFACES

- 42", fixed standing-height workstations give users the option of changing postures from sitting to standing throughout the day to help achieve their wellness goals.
- Specify supports from —
 - Modular Pedestals
 - Laminate end panels (must be used in conjunction with a laminate modesty panel)
 - Laminate L-shaped end panels
 - Metal O-legs
- When combined with a stool-height task chair, provides users the benefit of alternating their work between a seated or standing position.
- An external support channel, for attachment under worksurfaces, is required for all unsupported spans greater than 54"W.

- Worksurface End Support (panel, leg, column, base, pedestal) requirements by product type are as follows —
 - Desk, peninsula, or credenza — qty. 2
 - Return — qty. 1
 - Island extension — qty. 1

COORDINATE™ HEIGHT ADJUSTABLE BASE

- Multiple base options available.
- Height adjustable bases deliver a healthier style of working by allowing a seamless transition between sitting and standing throughout the day. For open, private, or training spaces.
- Frame rises from 21⁵/₈" to 47³/₄".
- Telescoping base design.
- Accommodates rectangle worksurface sizes 24" to 30"D and 42" to 72"W.
- Standard-height adjustable control included with base. Memory control allows preset worksurface heights for consistency.
- Shipped complete with a pre-assembled electric motor.

CONCINNITY™

Components — Worksurfaces

GSA SIN 33721



Icon Legend on page 19

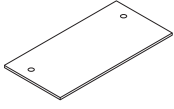

DESCRIPTION	MODEL	SHIP WEIGHT	CUBE	L1 LIST PRICE	L2 UPCHARGE
Rectangle Worksurface with Horizontal Grain					
84"W x 36"D	HNLRC3684	105	7.7	\$701	\$30
72"W x 36"D (shown)	HNLRC3672	90	6.7	\$587	\$30
84"W x 30"D	HNLRC3084	88	6.5	\$567	\$25
78"W x 30"D	HNLRC3078	81	6.1	\$514	\$25
72"W x 30"D	HNLRC3072	75	5.6	\$470	\$20
66"W x 30"D	HNLRC3066	69	5.2	\$433	\$20
60"W x 30"D	HNLRC3060	62	4.7	\$404	\$20
48"W x 30"D	HNLRC3048	50	3.9	\$330	\$15
96"W x 24"D	HNLRC2496	80	5.8	\$583	\$30
90"W x 24"D	HNLRC2490	75	5.5	\$572	\$30
84"W x 24"D	HNLRC2484	70	5.3	\$540	\$25
78"W x 24"D	HNLRC2478	65	4.9	\$483	\$20
72"W x 24"D	HNLRC2472	60	4.6	\$402	\$20
66"W x 24"D	HNLRC2466	55	4.2	\$387	\$20
60"W x 24"D	HNLRC2460	50	3.9	\$358	\$20
54"W x 24"D	HNLRC2454	45	3.5	\$328	\$20
48"W x 24"D	HNLRC2448	40	3.1	\$302	\$15
42"W x 24"D	HNLRC2442	35	2.8	\$281	\$15
36"W x 24"D Rectangle Worksurface/Pedestal Top	HNLRC2436	30	2.4	\$253	\$15
30"W x 24"D Rectangle Worksurface/Pedestal Top	HNLRC2430	25	2.1	\$253	\$15

NOTES: See chart on page 34 for cord management options.

- When grommets are specified for 30"D and 36"D rectangle worksurfaces, pre-drilled holes will not be included for a 4½" diameter support column.

NOTES:

- Grain direction on all rectangle worksurfaces runs horizontal (side-to-side) except as follows: 30"W - 36"W - 42"W - 48"W - 54"W - 60"W x 24"D tops can be specified with horizontal (side-to-side) or vertical (front-to-back) grain.
- 42"W and 48"W x 20"D tops are available with vertical (front-to-back) grain only.
- For standing-height requirements, use worksurface with 41"H O-leg, end panel, L-shaped end panel, or pedestal supports.
- For mobile desks and tables, use post leg with casters.
- For paper organizers, see page 108.
- If using worksurfaces with Coordinate™ Height Adjustable Bases, an External Stiffener must be used.
- Attachment of above privacy screen models requires a minimum 1" clear space/overhang on the underside of worksurface.
- Worksurfaces used with Coordinate™ Height Adjustable Bases should have 1" perimeter gap on each side to provide clearance between other furniture. Failure to do so risks injury or product damage (not covered by warranty).
- When using end panels or O-legs with 84", 90", or 96"W worksurfaces, interior weight-bearing support components are required to minimize worksurface deflection.
- Attachment of above/below privacy screen models requires a minimum 2" clear space/overhang on the underside of the worksurface.
- Steel external support channel can be attached to the underside of worksurfaces that are subjected to heavier loads. Channel is recommended to provide extra support on unsupported spans of 54"W or greater or per user preference. Ordered separately from worksurface.
- If using a 54"W or 60"W floating modesty panel, it is not necessary to specify an external support channel.
- When using an external support channel under the worksurface, the depth clearance for center drawers and keyboard platforms decreases by 8".
- See "External Channel (Recommended Use)" chart on page 83.

HOW TO SPECIFY

Select Model Number

H N L R C 3 6 8 4 .

Select Edge Profile and Edge Color

See page 29

B H .

Select Worksurface Grommet Finish

P Black
T1 Platinum
X No Grommet

P .

Select Worksurface Color

See page 29

H



CONCINNITY™

Components — Worksurfaces

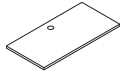

DESCRIPTION	MODEL	SHIP WEIGHT	CUBE	L1 LIST PRICE	L2 UPCHARGE
Rectangle Worksurface with Vertical Grain					
60"W x 24"D	HNLRC2460V	50	3.9	\$358	\$20
54"W x 24"D	HNLRC2454V	45	3.5	\$328	\$20
48"W x 24"D (shown)	HNLRC2448V	40	3.1	\$302	\$15
42"W x 24"D	HNLRC2442V	35	2.8	\$281	\$15
36"W x 24"D Rectangle Worksurface/Pedestal Top	HNLRC2436V	30	2.4	\$253	\$15
30"W x 24"D Rectangle Worksurface/Pedestal Top	HNLRC2430V	25	2.1	\$253	\$15
48"W x 20"D	HNLRC2048V	33	2.7	\$282	\$10
42"W x 20"D	HNLRC2042V	29	2.3	\$260	\$10

NOTES: Can be used in a host of applications, including as a desk, credenza, return, bridge, stationary or mobile table surface, in U- or L-shaped configurations, as part of a work wall layout with an island extension, or with the height adjustable electric base. The conference overhang dimension on the approach side of worksurfaces varies depending on the supports and modesty panels specified. Top can be positioned with a cantilevered conference overhang on one end when used with select worksurface supports, including an O-leg or 9½"W modular pedestal. For return applications in which there is an unsupported span wider than 54", such as a 72"W x 24"D worksurface supported by a 15¾"W modular pedestal (= 56¼") or a 60"W x 24"D worksurface supported by a 1½" thick end panel (= 58¾"), use internal support panel model HNL11SUPP. For bridges wider than 54", use internal support panel HNL11SUPP. When using a 30"W, 36"W, 42"W, or 48"W rectangle worksurface as a bridge, no support legs are needed. When specifying a 84"W, 90"W, or 96"W worksurface, cannot use two O-legs for the supports. In these applications, the maximum number of supports that can be an O-leg is one; must choose from a 15¾" or wider modular pedestal for use as the additional support component. For applications requiring connection to an adjoining worksurface, two flat brackets are included with 24"D and 20"D worksurfaces that are ≤48"W; one flat bracket is included with 24"D worksurfaces that are ≥54"W. Underside of worksurface includes pilot mounting holes for O-leg, 1½" thick laminate end panel, pedestals, and flat brackets. See chart on page 34 for cord management options.

ⓘ When grommets are specified for 30"D and 36"D rectangle worksurfaces, pre-drilled holes will not be included for attachment of a 4½" diameter support column.

NOTES:

- Grain direction on all rectangle worksurfaces runs horizontal (side-to-side) except as follows: 30"W - 36"W - 42"W - 48"W - 54"W - 60"W x 24"D tops can be specified with horizontal (side-to-side) or vertical (front-to-back) grain.
- 42"W and 48"W x 20"D tops are available with vertical (front-to-back) grain only.
- For standing-height requirements, use worksurface with 41"H O-leg, end panel, L-shaped end panel, or pedestal supports.
- For mobile desks and tables, use post leg with casters.
- For paper organizers, see page 108.
- ⓘ If using worksurfaces with Coordinate™ Height Adjustable Bases, an External Stiffener must be used.
- ⓘ Attachment of above privacy screen models requires a minimum 1" clear space/overhang on the underside of worksurface.
- ⓘ Worksurfaces used with Coordinate™ Height Adjustable Bases should have 1" perimeter gap on each side to provide clearance between other furniture. Failure to do so risks injury or product damage (not covered by warranty).
- ⓘ Attachment of above/below privacy screen models requires a minimum 2" clear space/overhang on the underside of the worksurface.
- ⓘ Steel external support channel can be attached to the underside of worksurfaces that are subjected to heavier loads. Channel is recommended to provide extra support on unsupported spans of 54"W or greater or per user preference. Ordered separately from worksurface.
- ⓘ If using a 54"W or 60"W floating modesty panel, it is not necessary to specify an external support channel.
- ⓘ When using an external support channel under the worksurface, the depth clearance for center drawers and keyboard platforms decreases by 8".
- ⓘ See "External Channel (Recommended Use)" chart on page 83.

HOW TO SPECIFY

Select Model Number See page 29 H N L R C 2 4 6 0 V	Select Edge Profile and Edge Color See page 29 B H	Select Worksurface Grommet Finish P Black T1 Platinum X No Grommet P	Select Worksurface Color See page 29 H
---	--	---	--

CONCINNITY™

Components — Worksurfaces

GSA SIN 33721

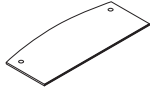

Icon Legend on page 19

**DESCRIPTION****Bow Worksurface**

84"W x 36"D

72"W x 36"D

MODEL**HNLBW3684****HNLBW3672****SHIP WEIGHT**

94

80

CUBE

7.7

6.7

L1 LIST PRICE**\$748****\$675****L2 UPCHARGE****\$30****\$30**

NOTES: 84"W size is ideal for executive layouts or for user's who require additional worksurface space. 72"W top can be combined with different pedestal support options to allow users to personalize their storage needs. Underside of worksurface includes pilot mounting holes for 1½" and L-shaped laminate end panels, and 29½"D pedestals. Grain direction runs horizontal (side-to-side). See chart on page 34 for cord management options.

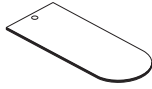
**Bullet Worksurface**

84"W x 30"D

78"W x 30"D

72"W x 30"D

66"W x 30"D

60"W x 30"D

48"W x 30"D

HNLBU3084**HNLBU3078****HNLBU3072****HNLBU3066****HNLBU3060****HNLBU3048**

84

78

72

66

60

54

6.3

6.3

5.5

5.5

4.7

3.7

\$660**\$628****\$545****\$521****\$484****\$424****\$25****\$20****\$20****\$20****\$20****\$15**

NOTES: Applications include U- or L-shaped peninsula configurations and island extensions. Underside of worksurface includes pilot mounting holes for O-leg, T-shaped end panel, 29½"D pedestals, 4½" diameter support column, and 2" square post leg. One flat bracket is packaged with each worksurface for applications requiring connection to an adjoining worksurface. Grain direction runs horizontal (side-to-side). Can be used in combination with a 15¾"W or 9½"W x 29½"D x 28¼"H modular pedestal to create a freestanding desk. See chart on page 34 for cord management options.

NOTES:

- ❗ When specifying an 84"W size, cannot use two O-legs; must use another type of support component such as a pedestal.
- ❗ Steel external support channel can be attached to the underside of worksurfaces that are subjected to heavier loads. Channel is recommended to provide extra support on unsupported spans of 54"W or greater or per user preference. Ordered separately from worksurface.
- ❗ If using a 54"W or 60"W floating modesty panel, it is not necessary to specify an external support channel.
- ❗ When using an external support channel under the worksurface, the depth clearance for center drawers and keyboard platforms decreases by 8".
- ❗ See "External Channel (Recommended Use)" chart on page 83.

HOW TO SPECIFY**Select Model Number**

H N L B W 3 6 8 4 .

Select Edge Profile and Edge Color

See page 29

B H .

Select Worksurface Grommet Finish

P Black
 T1 Platinum
 X No Grommet

P .

Select Worksurface Color

See page 29

H



CONCINNITY™

Components — Worksurfaces

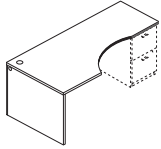

Right-hand model
HNLEC367224R shown

DESCRIPTION	MODEL	SHIP WEIGHT	CUBE	L1 LIST	L2 UPCHARGES	
					WORKSURFACE	END PANEL
Extended Corner Worksurface						
72"W x 48"D, Right	HNLEC487224R	130	8.9	\$1138	\$50	\$50
72"W x 48"D, Left	HNLEC487224L	130	8.9	\$1138	\$50	\$50
72"W x 36"D, Right	HNLEC367224R	106	6.6	\$941	\$45	\$45
72"W x 36"D, Left	HNLEC367224L	106	6.6	\$941	\$45	\$45

NOTES: For use in U- or L-shaped layouts. Includes top and long (47"D or 35"D) end panel components. Installation also requires modesty panel and either a 1½" thick end panel or 15¾" x 23⅜"D pedestal support for opposite end; both ordered separately. 72"W x 24/48"D or 48/24"D top is intended for use with 30/48"D or 48/30"D jetty peninsula to create a 2-piece "U" station with a curved cockpit on user's side. 72"W x 24/36"D or 36/24"D size is intended for use with 24"D returns or bridges. Underside of worksurface has pilot mounting holes for 1½" thick end panel and 15¾" x 23⅜"D modular pedestal. Edgebanding on the extended corner worksurface is profiled on the user's side and flat on the back (approach side) and ends. Grain direction runs horizontal (side-to-side).

❗ One flat bracket is packaged with each 48"D worksurface for applications requiring connection to a 48"D jetty peninsula. For 36"D extended corner worksurface, the flat bracket is shipped with the adjoining return or bridge. See chart on page 34 for cord management options. If grommet option is chosen, the worksurface component will match the color specified; the long end panel grommet color will be black.

NOTES:

- ❗ When specifying an 84"W size, cannot use two O-legs; must use another type of support component such as a pedestal.
- ❗ Steel external support channel can be attached to the underside of worksurfaces that are subjected to heavier loads. Channel is recommended to provide extra support on unsupported spans of 54"W or greater or per user preference. Ordered separately from worksurface.
- ❗ If using a 54"W or 60"W floating modesty panel, it is not necessary to specify an external support channel.
- ❗ When using an external support channel under the worksurface, the depth clearance for center drawers and keyboard platforms decreases by 8".
- ❗ See "External Channel (Recommended Use)" chart on page 83.

HOW TO SPECIFY

Select Model Number HNLEC487224R	Select Edge Profile and Edge Color See page 29 BH	Select Worksurface Grommet Finish P Black T1 Platinum X No Grommet X	Select Worksurface Color See page 29 H	Select End Panel Color See page 29 H
--	--	---	---	---

CONCINNITY™ Components — Supports

GSA SIN 33721 EXCEPT AS NOTED



Icon Legend on page 19

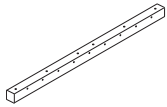

DESCRIPTION

External Support Channel
72"W for a 78" Worksurface
66"W for a 72" Worksurface
60"W for a 66" Worksurface
54"W for a 60" Worksurface
48"W for a 54" Worksurface

MODEL

HLSLZ5SC84
HLSLZ5SC78
HLSLZ5SC72
HLSLZ5SC66
HLSLZ5SC60

SHIP WEIGHT

12
7
7
7
6

CUBE

0.7
0.5
0.5
0.5
0.5

LIST PRICE

\$119
\$119
\$119
\$110
\$106

- ⓘ Available in Graphite paint only.
- ⓘ Attaches to underside of worksurface; required for unsupported spans greater than 54"W.
- ⓘ When specifying a 54"W or 60"W Floating Modesty Panel, it is not necessary to specify an external channel.

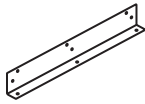

HVPWLBK24 shown

OPEN MARKET

Worksurface Wall Mount Bracket

For 30"
For 24"

HVPWLBK30
HVPWLBK24

2
2

0.3
0.3

\$99
\$90

NOTES: Can be used in place of an end panel to support a worksurface. Cannot be used as a support when placing a stack-on storage unit on worksurface over bracket; must have two full-sized floor supports when using stack-on storage. Finish option not required.

SPECIFYING EXAMPLE: HVPWLBK30



DESCRIPTION

Worksurface to Tower Bracket Kit
18½" long bracket for attaching 24"D worksurface directly to storage tower, wardrobe/bookcase, wardrobe/storage cabinet, storage cabinet/lateral file, storage cabinet, or lateral file.

MODEL

HSTB2W1

SHIP WEIGHT

4

CUBE

0.6

LIST PRICE BY PAINT GRADE

P1

\$88

P2

\$101

P3

\$103

NOTES: Can be used in place of end panel or O-leg to support worksurfaces.

- ⓘ Bracket not designed for use as a support if placing Stack-on Storage on worksurface over/above bracket. Two full-sized supports required when using Stack-on Storage.

NOTES:

- Use the worksurface to tower bracket kit to attach worksurfaces to Storage Tower models.
- ⓘ Depending on your support combination, an external channel may be required for extra support on unsupported spans greater than 54"W.

HOW TO SPECIFY

Select Model Number

H L S L Z 5 S C 8 4

HNL Support Options — External Channel (model HLSLZ5SCxx) - Recommended Use

	Support Combination		Worksurface Width											
	Support 1	Support 2	30"	36"	42"	48"	54"	60"	66"	72"	78"	84"	90"	96"
O-LEG ON ONE END	O-Leg	O-Leg	NR	NR	NR	NR	60	66	72	78	84	NA	NA	NA
	O-Leg	9½"W Ped	NR	NR	NR	NR	NR	60	66	72	78	84	NA	NA
	O-Leg	End Bookcase	NA	NR	NR	NR	NR	NR	60	66	72	78	84	NA
	O-Leg	L End Panel	NR	NR	NR	NR	NR	60	66	72	78	84	NA	NA
	O-Leg	15¾"W Ped	NA	NR	NR	NR	NR	NR	NR	60	66	72	78	NA
	O-Leg	18"W Ped	NA	NA	NR	NR	NR	NR	NR	60	66	72	78	84
	O-Leg	30"W Ped	NA	NA	NA	NA	NR	NR	NR	NR	NR	60	66	72
	O-Leg	36"W Ped	NA	NA	NA	NA	NA	NR	NR	NR	NR	NR	60	66
	NARROW PED	9½"W Ped	9½"W Ped	NA	NA	NR	NR	NR	NR	NR	60	66	72	78
9½"W Ped		End Bookcase	NA	NA	NR	NR	NR	NR	NR	60	66	72	78	84
9½"W Ped		L End Panel	NA	NR	NR	NR	NR	NR	60	66	72	78	84	NA
9½"W Ped		15¾"W Ped	NA	NA	NA	NR	NR	NR	NR	NR	60	66	72	78
9½"W Ped		18"W Ped	NA	NA	NA	NR	NR	NR	NR	NR	60	66	72	78
9½"W Ped		30"W Ped	NA	NA	NA	NA	NA	NR	NR	NR	NR	NR	60	66
9½"W Ped		36"W Ped	NA	NA	NA	NA	NA	NA	NR	NR	NR	NR	NR	60
END BOOKCASE PED	End Bookcase	End Bookcase	NA	NA	NR	NR	NR	NR	NR	NR	60	66	72	78
	End Bookcase	L End Panel	NA	NA	NR	NR	NR	NR	NR	60	66	72	78	84
	End Bookcase	15¾"W Ped	NA	NA	NA	NR	NR	NR	NR	NR	60	66	72	78
	End Bookcase	18"W Ped	NA	NA	NA	NR	NR	NR	NR	NR	60	66	72	78
	End Bookcase	30"W Ped	NA	NA	NA	NA	NA	NR	NR	NR	NR	NR	60	66
	End Bookcase	36"W Ped	NA	NA	NA	NA	NA	NA	NR	NR	NR	NR	NR	60
L END PANEL	L End Panel	L End Panel	NA	NR	NR	NR	NR	NR	60	66	72	78	84	NA
	L End Panel	15¾"W Ped	NA	NA	NR	NR	NR	NR	NR	NR	60	66	72	78
	L End Panel	18"W Ped	NA	NA	NA	NR	NR	NR	NR	NR	60	66	72	78
	L End Panel	30"W Ped	NA	NA	NA	NA	NA	NR	NR	NR	NR	NR	60	66
	L End Panel	36"W Ped	NA	NA	NA	NA	NA	NA	NR	NR	NR	NR	NR	60
TWO PEDS	15¾"W Ped	15¾"W Ped	NA	NA	NA	NA	NR	NR	NR	NR	NR	60	66	72
	15¾"W Ped	18"W Ped	NA	NA	NA	NA	NR	NR	NR	NR	NR	60	66	72
	15¾"W Ped	30"W Ped	NA	NA	NA	NA	NA	NR	NR	NR	NR	NR	NR	60
	15¾"W Ped	36"W Ped	NA	NA	NA	NA	NA	NA	NR	NR	NR	NR	NR	60
	18"W Ped	18"W Ped	NA	NR	NA	NA	NR	NR	NR	NR	NR	NR	60	66
	18"W Ped	30"W Ped	NA	NA	NA	NR	NA	NA	NR	NR	NR	NR	NR	60
	18"W Ped	36"W Ped	NA	NA	NA	NA	NA	NA	NR	NR	NR	NR	NR	60
	30"W Ped	30"W Ped	NA	NA	NA	NA	NA	NR	NR	NR	NR	NR	NR	60
	30"W Ped	36"W Ped	NA	NA	NA	NA	NA	NR	NR	NR	NR	NR	NR	60
	36"W Ped	36"W Ped	NA	NA	NA	NA	NA	NR	NR	NR	NR	NR	NR	60
RETURN CONFIGURATION	None	O-Leg	NR	NR	NR	NR	60	66	72	78	84	NA	NA	NA
	None	9½"W Ped	NR	NR	NR	NR	NR	60	66	72	78	84	NA	NA
	None	End Bookcase	NA	NR	NR	NR	NR	NR	60	66	72	78	84	NA
	None	L End Panel	NR	NR	NR	NR	NR	60	66	72	78	84	NA	NA
	None	15¾"W Ped	NA	NR	NR	NR	NR	NR	NR	60	66	72	78	NA
	None	18"W Ped	NA	NA	NR	NR	NR	NR	NR	60	66	72	78	84
	None	30"W Ped	NA	NA	NA	NA	NR	NR	NR	NR	NR	60	66	72
	None	36"W Ped	NA	NA	NA	NA	NA	NR	NR	NR	NR	NR	60	66

NA = Stiffener not applicable due to invalid worksurface width and support combination

NR = Applicable worksurface width and support combination, but stiffener not required

! The chart reference is to be used to complete the model number. It is not the actual length dimension of the external support channel.

CONCINNITY™

Components — Modesty/Back Panels

GSA SIN 33721

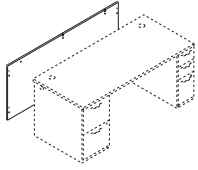

Icon Legend on page 19

**DESCRIPTION****Modesty/Back Panels — Full-Length**

96"W x 27¹/₈"H
 90"W x 27¹/₈"H
 84"W x 27¹/₈"H
 78"W x 27¹/₈"H
 72"W x 27¹/₈"H
 66"W x 27¹/₈"H
 60"W x 27¹/₈"H
 54"W x 27¹/₈"H
 48"W x 27¹/₈"H
 42"W x 27¹/₈"H

MODEL

HNLMP9628
HNLMP9028
HNLMP8428
HNLMP7828
HNLMP7228
HNLMP6628
HNLMP6028
HNLMP5428
HNLMP4828
HNLMP4228

SHIP WEIGHT

62
58
54
50
46
42
38
34
30
26

CUBE

7.2
6.7
6.1
5.5
5.3
4.8
4.4
4.0
3.6
3.2

L1 LIST PRICE

\$471
\$459
\$381
\$338
\$314
\$295
\$267
\$258
\$244
\$224

L2 UPCHARGE

\$25
\$25
\$25
\$20
\$20
\$20
\$20
\$20
\$15
\$15

36"W x 27¹/₈"H Modesty/Pedestal Back Panel
 30"W x 27¹/₈"H Modesty/Pedestal Back Panel

HNLMP3628
HNLMP3028

22
18

2.8
2.4

\$208
\$192

\$12
\$12

Modesty/Back Panels — Short

96"W x 10"H
 90"W x 10"H
 84"W x 10"H
 78"W x 10"H
 72"W x 10"H
 66"W x 10"H
 60"W x 10"H
 54"W x 10"H
 48"W x 10"H
 42"W x 10"H
 36"W x 10"H
 30"W x 10"H

HNLMP9610
HNLMP9010
HNLMP8410
HNLMP7810
HNLMP7210
HNLMP6610
HNLMP6010
HNLMP5410
HNLMP4810
HNLMP4210
HNLMP3610
HNLMP3010

22
21
20
19
18
17
16
15
14
13
12
11

3.0
2.8
2.8
2.3
2.1
1.9
1.8
1.6
1.4
1.3
1.1
0.9

\$471
\$459
\$381
\$338
\$314
\$295
\$267
\$258
\$244
\$224
\$208
\$192

\$15
\$15
\$15
\$12
\$12
\$12
\$12
\$12
\$10
\$10
\$10
\$10

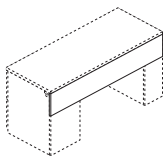

Back View

NOTES: For use with modular worksurface and support components. Component is 3/4" thick. Full-to-floor sizes can be specified with or without grommet; see chart on page 34 for cord management options. For standing-height applications, a worksurface supported by 1 1/8" thick x 41"H laminate end panel(s) and/or 41"H support pedestal(s), the recommended modesty panel length extends 27 1/8" below the underside of the top, leaving 13" of wall access; 9 1/2" and 15 3/4" W x 13"H backs are available to enclose the balance of the pedestal back. Worksurfaces supported by a 1 1/8" thick x 41"H laminate end panel and 41"H support pedestal, or by two 41"H support pedestals, can be used with a 10" modesty panel to increase the amount of wall access, however in this application the pedestal(s) should be positioned against a wall, as there is not a 30 7/8"H panel to cover the back of the pedestal that is exposed below the modesty panel. The 10"H modesty panel is not recommended for use in a standing-height shell, where both supports are 41"H laminate end panels; for this solution use the 27 1/8"H modesty panel. For standing-height applications with the worksurface supported by 41"H O-legs or L-shaped end panels, use the appropriate floating modesty panel size.

NOTES:

- Provide approach-side kneespace privacy for user seated at desks, credenzas, returns, and bridges.
- Full-width laminate panel can be specified in 6" increments from 30"-96"W, and in full-length (27 1/8"H) or short (10"H).
- Formal, full-length, 27 1/8"H models extend from the underside of the worksurface to the floor.
- 10"H sizes allow quick and easy access to wall power outlets.
- 30"W and 36"W x 27 1/8"H are sized to serve as a modesty panel, or pedestal back for respective 30"W and 36"W support storage pedestal models.

! The full-width panel designs are specifically for use when the worksurface supports are two 1 1/8" thick end panels, two support storage pedestals, or one 1 1/8" thick end panel and one support storage pedestal; not for use with O-legs or L-shaped end panels.

HOW TO SPECIFY

Select Model Number H N L M P 7 2 2 8	Select Grommet P Black X No Grommet	Select Laminate Color See page 29 H
---	--	--

Select Model Number H N L M P 7 2 1 0	Select Laminate Color See page 29 H
---	--



CONCINNITY™

Components — Modesty/Back Panels

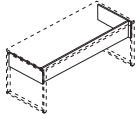

Not available in two-tone laminate

DESCRIPTION	MODEL	SHIP WEIGHT	CUBE	L1 LIST PRICE	L2 UPCHARGE
Modesty Panels for Desks with O-Legs					
68 $\frac{3}{8}$ "W x $\frac{3}{4}$ "D x 10"H — For 72" x 30" Desks	HLAMMP7230	26	2.1	\$307	\$15
56 $\frac{3}{8}$ "W x $\frac{3}{4}$ "D x 10"H — For 60" x 30" Desks	HLAMMP6030	23	1.8	\$280	\$15

NOTES: For use with 60"W or 72"W worksurfaces supported by O-legs. Comprised of three panels: one approach side and one for each end. Length below bottom of worksurface is 10". Steel external support channel (ordered separately) is recommended for unsupported spans greater than 54"W (i.e.: a distance in which there is not a vertical support between the underside of the worksurface and floor). Grain direction is vertical on approach and side panels for 56 $\frac{3}{8}$ "W (all laminate colors) and 68 $\frac{3}{8}$ "W (L1 laminate except Florence Walnut and Kingswood Walnut). Vertical on 27 $\frac{5}{8}$ " end panels (all laminate colors). Horizontal on all panels for L2 laminates as well as Florence Walnut and Kingswood Walnut.

Specify: Model.Laminate

SPECIFYING EXAMPLE: HLAMMP7230.N

! \$15 upcharge for L2 laminates. See pages 266-267 for laminate options.

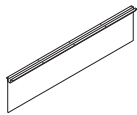

Laminate Floating Modesty Panel	MODEL	SHIP WEIGHT	CUBE	L1 LIST PRICE	L2 UPCHARGE
60"W x 14"H	HLSL6014L	20	1.1	\$277	\$12
54"W x 14"H	HLSL5414L	18	1.1	\$258	\$12
48"W x 14"H	HLSL4814L	16	1.1	\$236	\$12
42"W x 14"H	HLSL4214L	14	0.8	\$214	\$10
36"W x 14"H	HLSL3614L	12	0.8	\$202	\$10
30"W x 14"H	HLSL3014L	10	0.8	\$191	\$10

NOTES: The attachment bracket and modesty panel are packaged separately.

Specify: Model.Laminate.Paint

SPECIFYING EXAMPLE: HLSL3014L.N.P (Black is the only paint option for this model)

! When specifying the 54"W or 60"W Laminate Floating Modesty Panel, it is not necessary to specify an external support channel.

! 30"W and 36"W screens attach with L-brackets, not the external channel.

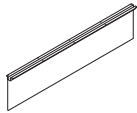

Mixed Material Floating Modesty Panel	MODEL	SHIP WEIGHT	CUBE	L1 LIST PRICE	L2 UPCHARGE
60"W x 14"H	HLSL6014MM ☺	13	3.3	\$1243	N/A
54"W x 14"H	HLSL5414MM ☺	13	3.3	\$1089	N/A
48"W x 14"H	HLSL4814MM ☺	11	2.6	\$1002	N/A
42"W x 14"H	HLSL4214MM ☺	9	2.3	\$906	N/A
36"W x 14"H	HLSL3614MM	8	2.0	\$810	N/A
30"W x 14"H	HLSL3014MM	8	2.0	\$755	N/A

NOTES: The attachment bracket and modesty panel are packaged separately.

Specify: Model.Mixed Material.Paint

SPECIFYING EXAMPLE: HLSL3014MM.FT01.P (Frosted Translucent mixed material and Black paint are the only options for this model)

! When specifying the 54"W or 60"W Mixed Material Floating Modesty Panel, it is not necessary to specify an external support channel.

NOTES:

- Floating panel options attach under worksurfaces and are available in laminate or mixed (frosted translucent) material. The modesty panel and attachment bracket are packaged separately.
- If using a 54"W or 60"W floating modesty panel, it is not necessary to specify an external support channel.
- When using a floating modesty panel under the worksurface, the depth clearance for center drawers and keyboard platforms decreases by 8".
- The full width/half-height and full-to-floor/full-height panels are filler options designed only for use on 60", 66", and 72"W x 29 $\frac{1}{2}$ "H, double, 15 $\frac{3}{4}$ "W, pedestal desks and credenzas that are specified/built with modular components.

HOW TO SPECIFY

Select Model Number HLSL3014MM	Select Mixed Material FT01 Frosted Translucent
--	--

CONCINNITY™

Components — Modesty/Back Panels

GSA SIN 33721

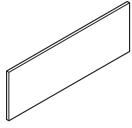

Icon Legend on page 19

**DESCRIPTION****MODEL****SHIP WEIGHT****CUBE****L1 LIST PRICE****L2 UPCHARGE****Full Width/Half-Height Laminate Modesty Panel**

40"W x 14"H, for use with 72" desks

HLSL4014LM

29

2.4

\$224**\$10**

34"W x 14"H, for use with 66" desks

HLSL3414LM

23

1.9

\$215**\$10**

28"W x 14"H, for use with 60" desks

HLSL2814LM

19

1.6

\$208**\$10**

NOTES: Filler piece that can only be used between the following supports: two 15¾"W modular pedestals, two 15¾"W L-shaped end panels, or one 15¾"W modular pedestal and one 15¾"W L-shaped end panel. Attachment brackets included.

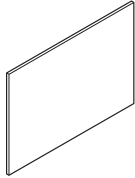
**Full-to-Floor/Full-Length Laminate Modesty Panel**

40"W x 28½"H, for use with 72" desks

HLSL4028LM

44

3.6

\$343**\$12**

34"W x 28½"H, for use with 66" desks

HLSL3428LM

38

3.2

\$326**\$12**

28"W x 28½"H, for use with 60" desks

HLSL2828LM

33

2.7

\$277**\$12**

NOTES: Filler piece that can only be used between the following supports: two 15¾"W modular pedestals, two 15¾"W L-shaped end panels, or one 15¾"W modular pedestal and one 15¾"W L-shaped end panel. Attachment brackets included.

NOTES:

- Floating panel options attach under worksurfaces and are available in laminate or mixed (frosted translucent) material. The modesty panel and attachment bracket are packaged separately.
- If using a 54"W or 60"W floating modesty panel, it is not necessary to specify an external support channel.
- When using a floating modesty panel under the worksurface, the depth clearance for center drawers and keyboard platforms decreases by 8".
- The full width/half-height and full-to-floor/full-height panels are filler options designed only for use on 60", 66", and 72"W x 29½"H, double, 15¾"W, pedestal desks and credenzas that are specified/built with modular components.

HOW TO SPECIFY
**Select
Model Number**
**Select
Laminate Color**

See page 29

HLSL2814LM.

N

CONCINNITY™ MODESTY/BACK PANELS

HNL Floating Modesty Panel — HSLx14L/MM — Selection Guide														
	Support Combination		Worksurface Width											
	Support 1	Support 2	30"	36"	42"	48"	54"	60"	66"	72"	78"	84"	90"	96"
O-LEG ON ONE END	O-Leg	O-Leg	NA	NA	36	42	48	54	60	60	60	NA	NA	NA
	O-Leg	9½"W Ped	NA	NA	NA	30	36	42	48	54	60	60	NA	NA
	O-Leg	End Bookcase	NA	NA	NA	30	36	42	48	54	60	60	60	NA
	O-Leg	L End Panel	NA	NA	NA	36	42	48	54	60	60	60	NA	NA
	O-Leg	15¾"W Ped	NA	NA	NA	NA	30	36	42	48	54	60	60	NA
	O-Leg	18"W Ped	NA	NA	NA	NA	30	36	42	48	54	60	60	60
	O-Leg	30"W Ped	NA	NA	NA	NA	NA	NA	30	36	42	48	54	60
	O-Leg	36"W Ped	NA	NA	NA	NA	NA	NA	NA	30	36	42	48	54
NARROW PED	9½"W Ped	9½"W Ped	NA	NA	NA	NA	30	36	42	48	54	60	60	60
	9½"W Ped	End Bookcase	NA	NA	NA	NA	30	36	42	48	54	60	60	60
	9½"W Ped	L End Panel	NA	NA	NA	NA	30	36	42	48	54	60	60	NA
	9½"W Ped	15¾"W Ped	NA	NA	NA	NA	NA	30	36	42	48	54	60	60
	9½"W Ped	18"W Ped	NA	NA	NA	NA	NA	30	36	42	48	54	60	60
	9½"W Ped	30"W Ped	NA	NA	NA	NA	NA	NA	NA	NA	30	36	48	48
	9½"W Ped	36"W Ped	NA	NA	NA	NA	NA	NA	NA	NA	30	36	42	48
END BOOKCASE PED	End Bookcase	End Bookcase	NA	NA	NA	NA	NA	30	36	42	48	54	60	60
	End Bookcase	L End Panel	NA	NA	NA	NA	30	36	36	48	54	60	60	60
	End Bookcase	15¾"W Ped	NA	NA	NA	NA	NA	30	36	42	48	54	60	60
	End Bookcase	18"W Ped	NA	NA	NA	NA	NA	NA	30	36	42	48	54	60
	End Bookcase	30"W Ped	NA	NA	NA	NA	NA	NA	NA	NA	30	36	42	48
	End Bookcase	36"W Ped	NA	NA	NA	NA	NA	NA	NA	NA	NA	30	36	42
L END PANEL	L End Panel	L End Panel	NA	NA	NA	NA	36	36	48	54	60	60	60	NA
	L End Panel	15¾"W Ped	NA	NA	NA	NA	NA	30	36	42	48	54	60	60
	L End Panel	18"W Ped	NA	NA	NA	NA	NA	30	36	42	48	54	60	60
	L End Panel	30"W Ped	NA	NA	NA	NA	NA	NA	NA	30	36	42	48	54
	L End Panel	36"W Ped	NA	NA	NA	NA	NA	NA	NA	NA	30	36	42	48
TWO PEDS	15¾"W Ped	15¾"W Ped	NA	NA	NA	NA	NA	NA	30	36	42	48	54	60
	15¾"W Ped	18"W Ped	NA	NA	NA	NA	NA	NA	30	36	36	48	54	60
	15¾"W Ped	30"W Ped	NA	NA	NA	NA	NA	NA	NA	NA	30	36	42	48
	15¾"W Ped	36"W Ped	NA	NA	NA	NA	NA	NA	NA	NA	30	36	42	48
	18"W Ped	18"W Ped	NA	NA	NA	NA	NA	NA	NA	30	36	42	48	54
	18"W Ped	30"W Ped	NA	NA	NA	NA	NA	NA	NA	NA	NA	30	36	42
	18"W Ped	36"W Ped	NA	NA	NA	NA	NA	NA	NA	NA	NA	NA	30	36
	30"W Ped	30"W Ped	NA	NA	NA	NA	NA	NA	NA	NA	NA	NA	NA	30
	30"W Ped	36"W Ped	NA	NA	NA	NA	NA	NA	NA	NA	NA	NA	NA	NA
	36"W Ped	36"W Ped	NA	NA	NA	NA	NA	NA	NA	NA	NA	NA	NA	NA
HT ADJ BASE	Height Adjustable Electric Base (models HHATB3S2LT/C)		NA	NA	NA	42	48	54	60	60	NA	NA	NA	NA
PENINSULA	Support Column	T End Panel	NA	NA	NA	30	30	36	42	48	54	60	60	60
	Support Column	9½"W Ped	NA	NA	NA	NA	NA	30	36	42	48	54	60	60
	Support Column	15¾"W Ped	NA	NA	NA	NA	NA	NA	30	36	42	48	54	60
	Support Column	18"W Ped	NA	NA	NA	NA	NA	NA	30	36	42	48	54	60
	Support Column	30"W Ped	NA	NA	NA	NA	NA	NA	NA	NA	30	36	42	48
	Support Column	36"W Ped	NA	NA	NA	NA	NA	NA	NA	NA	NA	30	36	42
RETURN CONFIGURATION	None	O-Leg	NA	NA	36	42	48	54	60	60	60	NA	NA	NA
	None	9½"W Ped	NA	NA	NA	30	36	42	48	54	60	60	NA	NA
	None	End Bookcase	NA	NA	NA	30	36	42	48	54	60	60	60	NA
	None	L End Panel	NA	NA	36	36	42	48	54	60	60	60	NA	NA
	None	15¾"W Ped	NA	NA	NA	NA	30	36	42	48	54	60	60	NA
	None	18"W Ped	NA	NA	NA	NA	30	36	42	48	54	60	60	60
	None	30"W Ped	NA	NA	NA	NA	NA	NA	30	36	42	48	54	60
	None	36"W Ped	NA	NA	NA	NA	NA	NA	NA	30	36	42	48	60

NA = Floating Modesty Panel not applicable for use with worksurface width and support combination

CONCINNITY™ Components — Supports

GSA SIN 33721



Icon Legend on page 19

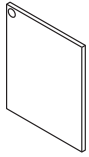

HNLEP2428R shown

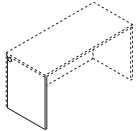

HNLEP2428L shown

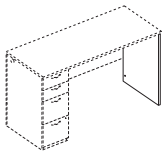
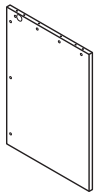

HNLEP2441R shown

DESCRIPTION

1 1/8" Laminate End Panels — For 29 1/2"H
1 1/8"W x 35"D x 28 1/2"H for 36"D, Right
1 1/8"W x 35"D x 28 1/2"H for 36"D, Left

1 1/8"W x 29 1/8"D x 28 1/2"H for 30"D, Right
1 1/8"W x 29 1/8"D x 28 1/2"H for 30"D, Left

1 1/8"W x 23 1/8"D x 28 1/2"H for 24"D, Right
1 1/8"W x 23 1/8"D x 28 1/2"H for 24"D, Left

MODEL

HNLEP3628R
HNLEP3628L

HNLEP3028R
HNLEP3028L

HNLEP2428R
HNLEP2428L

SHIP WEIGHT

CUBE

L1 LIST PRICE

L2 UPCHARGE

39
39

2.8
2.8

\$286
\$286

\$20
\$20

32
32

2.3
2.3

\$252
\$252

\$15
\$15

22
22

1.9
1.9

\$224
\$224

\$10
\$10

1 1/8" Laminate End Panels — For 42"H

1 1/8"W x 29 1/8"D x 41"H for 30"D, Right
1 1/8"W x 29 1/8"D x 41"H for 30"D, Left

1 1/8"W x 23 1/8"D x 41"H for 24"D, Right
1 1/8"W x 23 1/8"D x 41"H for 24"D, Left

HNLEP3041R
HNLEP3041L

HNLEP2441R
HNLEP2441L

47
47

3.2
3.2

\$284
\$284

\$20
\$20

37
37

2.6
2.6

\$267
\$267

\$15
\$15

NOTES: Supports the end of a component worksurface where there is no modular pedestal. 1 1/8" Laminate End Panels must be used with a full-length (27 7/8"H) or short (10"H) modesty/back panel; ordered separately, see page 84. The depth of an end panel is 3/4" less than the depth of the worksurface, to accommodate the modesty/back panel. Handed design (left and right models). Bottom of end panel is edgebanded for added strength and to seal out moisture. Applications include — For the non-pedestal end of single pedestal desks or credenzas utilizing modular storage components. For returns that do not have a modular storage pedestal to support the worksurface. For extended corner units that do not utilize a 15 3/4"W x 23 1/8"D modular storage pedestal to support the 24"D worksurface dimension. For building desk or credenza shells comprised of a worksurface top and modesty/back panel components, and left and right end panel. Available in a woodgrain or solid laminate color only. Can be specified with or without grommet; see chart on page 34 for cord management options. If grommet option is chosen, the color is black only.

NOTES:

1 1/8" Laminate End Panels must be used with a full-length (27 7/8"H) or short (10"H) modesty/back panel; ordered separately, see page 84.

HOW TO SPECIFY

Select Model Number

H N L E P 2 4 2 8 R .

Select Grommet

P Black
X No Grommet

X .

Select Laminate Color

See page 29

H

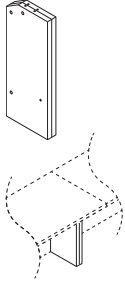

DESCRIPTION	MODEL	SHIP WEIGHT	CUBE	L1	L2
				LIST PRICE	UPCHARGE
Kneespace Clearance End Panels 1 1/8"W x 11 1/4"D x 41"H for 24"D, 2 pk	HNLEP1141	25	2.8	\$314	\$10
1 1/8"W x 11 1/4"D x 28 1/2"H for 24"D, 2 pk	HNLEP1128	25	2.0	\$256	\$10

NOTES: Creates additional kneespace for the user. Two 1 1/8"W x 11 1/4"D laminate end panels, one left, one right; sized to support two adjoining, contiguous 24"D worksurfaces. Can be specified with worksurfaces at time of installation or ordered as replacement for two side-by-side 1 1/8"W x 23"D end panels. Available in 28 1/2" and 41"H. Can be used to connect up to three credenzas in line (2 kits). Not designed for use with returns. Allows conversion of units currently in the field; European fasteners make installation quick and easy. Cord routing notch in top back of each panel. Includes two 1 1/8" thick panels; European fastening hardware; flat connector bracket; self-tapping wood screws for ganging credenza to adjacent worksurface; and adjustable leveling glides. Can be specified in a woodgrain or solid laminate color only; not in a two-tone combination.

SPECIFYING EXAMPLE: HNLEP1128.H

HOW TO SPECIFY

<p>Select Model Number</p> <p>HNLEP1128</p>	<p>Select Grommet</p> <p>P Black X No Grommet</p> <p>X</p>
--	---

CONCINNITY™

Components — Supports

GSA SIN 33721



Icon Legend on page 19

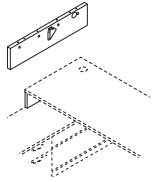

HNLEP307L shown

DESCRIPTION	MODEL	SHIP WEIGHT	CUBE	L1 LIST PRICE	L2 UPCHARGE
Laminate End Panel — 7”H Support for Worksurfaces					
1½”W x 30”D x 7”H, Right	HNLEP307R	7	0.7	\$147	\$10
1½”W x 30”D x 7”H, Left	HNLEP307L	7	0.7	\$147	\$10
1½”W x 24”D x 7”H, Right	HNLEP247R	6	0.7	\$147	\$10
1½”W x 24”D x 7”H, Left	HNLEP247L	6	0.7	\$147	\$10

NOTES: Specifically for layered surface applications; used to support a 29½”H component worksurface over a 21½”H low credenza unit. 1½” thick. Handed design (left and right models). Includes cord routing notch. Bottom of end panel is edgebanded for added strength and to seal out moisture. Attaches to underside of worksurface via cam fasteners and L-bracket; attaches to top of low credenza with double-sided tape. Can be specified in a woodgrain or solid laminate color only. For 7”H metal O-leg support see page 92.

SPECIFYING EXAMPLE: HNLEP307R.H

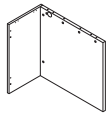

HNLLEP3028R shown

Laminate L-Shaped End Panels — For 29½”H					
15¾”W x 30”D x 28½”H, Right	HNLLEP3028R	38	4.3	\$404	\$15
15¾”W x 30”D x 28½”H, Left	HNLLEP3028L	38	4.3	\$404	\$15
15¾”W x 24”D x 28½”H, Right	HNLLEP2428R	32	2.8	\$364	\$15
15¾”W x 24”D x 28½”H, Left	HNLLEP2428L	32	2.8	\$364	\$15

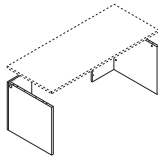

HNLLEP3028R and HNLLEP3028L shown

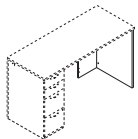
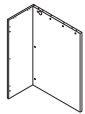

HNLLEP3041R shown



Laminate L-Shaped End Panels — For 42”H					
15¾”W x 30”D x 41”H, Right	HNLLEP3041R	55	4.3	\$447	\$20
15¾”W x 30”D x 41”H, Left	HNLLEP3041L	55	4.3	\$447	\$20
15¾”W x 24”D x 41”H, Right	HNLLEP2441R	47	2.8	\$400	\$20
15¾”W x 24”D x 41”H, Left	HNLLEP2441L	47	2.8	\$400	\$20

NOTES: Supports the end of a component worksurface where there is no modular pedestal. Provides easy, open access to wall electrical outlets. For configurations requiring a modesty panel, options include a laminate floating modesty panel or a mixed material floating modesty panel — see page 85. Tops and bottoms of panels are edgebanded. Two pieces; 1½” end panel and ¾” back panel. Ships simple assembly. Can be specified in a woodgrain or solid laminate color only; not available in a two-tone combination. See chart on page 34 for cord management options. If grommet option is chosen for the end panel, the color is black only.

SPECIFYING EXAMPLE: HNLLEP2428R.X.H

HOW TO SPECIFY

Select Model Number HNLEP307R	Select Laminate Color See page 29 H
---	--

Select Model Number HNLLEP3028R	Select Grommet P Black X No Grommet X	Select Laminate Color See page 29 H
---	---	--



CONCINNITY™ Components — Supports

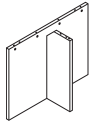

DESCRIPTION

MODEL

SHIP WEIGHT

CUBE

L1 LIST PRICE

L2 UPCHARGE

Laminate T-Shaped End Panels — For 29½”H

11⅝”W x 35⅞”D x 28½”H

HNLTEP3628

45

3.7

\$413

\$20

11⅝”W x 29⅞”D x 28½”H

HNLTEP3028

39

3.3

\$386

\$20

11⅝”W x 23⅞”D x 28½”H

HNLTEP2428

33

2.9

\$364

\$20

NOTES: Supports the end of a component worksurface where there is no modular pedestal. Available in 24”, 30”, and 36”D x 28½”H. Two 1⅝” thick pieces; one end and one brace panel. Cord routing notch in brace panel. Non-handed. Ships ; simple assembly. Can be specified in a woodgrain or solid laminate color only; not available in a two-tone combination.

SPECIFYING EXAMPLE: HNLTEP3628.H

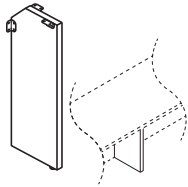

Support Brace — For 29½”H

1⅝”W x 10½”D x 28½”H

HNL11SUPP

11

0.9

\$164

\$10

NOTES: Minimizes worksurface deflection by providing added internal support under 24”D tops with an unsupported span of 54” or wider (distance for which there is no panel, leg, or pedestal support component). Not for use as an end panel. 11”D size provides kneespace clearance. Attaches with brackets to both the underside of the worksurface top and either a conventional full-length or 10” laminate modesty panel; not for use with O-leg or L-shaped end panel supports. 1⅝” thick. Cord routing notch in brace panel. Can be specified in a woodgrain or solid laminate color only.

SPECIFYING EXAMPLE: HNL11SUPP.H

HOW TO SPECIFY

<p>Select Model Number</p> <p>H N L 1 1 S U P P . H</p>	<p>Select Laminate Color</p> <p>See page 29</p> <p>H</p>
--	---

CONCINNITY™

Components — Supports

GSA SIN 33721

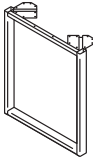
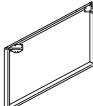
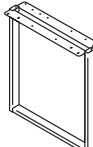
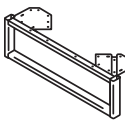
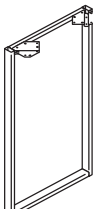
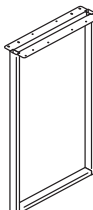

Icon Legend on page 19

	DESCRIPTION	MODEL	SHIP WEIGHT	CUBE	LIST PRICE BY PAINT GRADE		
					P1	P2	P3
	O-Leg 30"D x 28½"H 24"D x 28½"H	HLSL30280 ⓘ HLSL24280	19 17	5.4 3.7	\$395 \$357	\$399 \$361	\$415 \$377
	NOTES: Ship fully assembled, 1/pack. Non-handed. IMPORTANT: The O-leg attachment bracket interferes with placement of 28¾"H mobile pedestals, preventing them from being positioned directly next to (flush with) the O-leg. Box/file mobile pedestal (model HNL2116MBF) can be positioned along side the O-leg. SPECIFYING EXAMPLE: HLSL24280.T1						
	Double-Depth O-Leg Support for Worksurfaces 60"D x 28½"H 48"D x 28½"H	HLSL60280 HLSL48280	19 18	8.7 7.0	\$746 \$670	\$754 \$678	\$766 \$690
	NOTES: Ship fully assembled, 1/pack. Non-handed. 48"D and 60"D sizes span back-to-back 24"D and 30"D worksurfaces, respectively.						
	O-Leg Shared Support for Worksurfaces 30"D x 28½"H 24"D x 28½"H	HLSL3028SL ⓘ HLSL2428SL	19 17	5.4 3.7	\$491 \$443	\$495 \$447	\$511 \$463
	NOTES: Ship fully assembled, 1/pack. Non-handed. ⓘ Specify paint only. SPECIFYING EXAMPLE: HLSL2028SL.T1						
	O-Leg Support for Low Credenzas 30"D x 7"H 24"D x 7"H	HLSL3070 ⓘ HLSL2470	7 6	1.0 1.0	\$305 \$240	\$309 \$244	\$325 \$260
	NOTES: Ship fully assembled, 1/pack. Non-handed. For 7"H laminate support see page 90. ⓘ Specify paint only. SPECIFYING EXAMPLE: HLSL2070.T1						
	Standing-Height O-Leg Support for Worksurfaces 30"D x 41"H 24"D x 41"H	HLSL30410 HLSL24410	17 16	6.5 5.3	\$533 \$476	\$539 \$482	\$553 \$496
	NOTES: Ship fully assembled, 1/pack. Non-handed.						
	Standing-Height O-Leg Shared Support for Worksurfaces 30"D x 41"H 24"D x 41"H	HLSL3041SL HLSL2441SL	17 16	6.5 5.3	\$593 \$537	\$599 \$543	\$613 \$557
	NOTES: Ship fully assembled, 1/pack. Non-handed. For use with two 24"D or 30"D worksurfaces positioned side-by-side along the depth dimension.						

NOTES:

- Open frame, metal design.
- O-leg ships fully assembled with mounting hardware.
- O-leg glides have 2" adjustability.
- Will have 6" overhang when using 30"D O-legs with a 36"D worksurface.
- Shared O-legs create a cleaner aesthetic in all applications where two legs are used side-by-side.

ⓘ O-legs may only be attached to worksurfaces, not storage units.

ⓘ O-leg installation requires 6" of clearance from the worksurface end.



ⓘ For use with worksurfaces up to 78"W. When using an 84"W or wider worksurface, cannot use two O-legs; must use one 15¾" or wider pedestal for the other support.

HOW TO SPECIFY

Select Model Number	Select Paint Color
HLSL30280	See page 183
T1	



CONCINNITY™ Components — Supports

	DESCRIPTION	MODEL	SHIP WEIGHT	CUBE	LIST PRICE
	Support Column 3" Diameter. Specify: HPC190X.P. Black only.	HPC190X	12 	1.0	\$173
	Support Column 3" Diameter. Specify: HPC191X.X. Available in Silver only.	HPC191X	12 	1.0	\$173
	NOTES: For peninsula or island extension worksurface application.				

	DESCRIPTION	MODEL	SHIP WEIGHT	CUBE	LIST PRICE BY PAINT GRADE	
					P1	P2
	Post Leg Base 28½"H x 2" square	HLSL28P	15	1.0	\$321	\$325
	NOTES: Can only be used as the outbound support in a peninsula or island extension worksurface application. Glides have 2" of adjustability. Ship 1/pack. SPECIFYING EXAMPLE: HLSL28P.T1					

NOTES:



- All bases allow tops to sit at 29½" from the floor with glides half-way seated.

Height Adjustable Base

- 3-Stage column design.
- Frame rises from 23¾" to 49¼" for a sit-to-stand desk option.
- Ships complete with a pre-assembled motor.
- Base telescopes to accommodate any worksurface between 48"W and 72"W.
- Accommodates rectangular worksurfaces between 24"D x 48"W and 30"D x 72"W.
- Standard height adjustable control ships with base.
- Dynamic load capacity when worksurface is moving is 300 lbs.
- Optional Memory Control allows preset worksurface heights for consistency. Ships separately.
- Silver finish matches any neutral HON paint or finish color.
- Tops and bases are ordered and sold separately.

Post and T-Leg Bases

- Both glides and casters attach to the foot easily without tools for assembly.
- Bases specified with casters include two locking and two non-locking casters.
- Bases specified with glides have four adjustable glides, which adjust 1".
- When post legs are used with 18"W tops, post leg to be specified with glides only.

-  Support column must be specified for worksurfaces used as peninsulas or as an island extension.
-  Post leg can only be used to support peninsula, not as primary supports for a top.

HOW TO SPECIFY

<p>Select Model Number</p> <p>H P C 1 9 0 X .</p>	<p>Select Paint Color</p> <p>See page 183</p> <p>T 1</p>
--	---

CONCINNITY™

Components — Supports

GSA SIN 33721

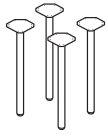

Icon Legend on page 19

**DESCRIPTION****Post Leg Base (Includes 4 Post Legs)**

24"D and 30"D Worksurfaces up to 72"W

MODEL**HMBPOST****SHIP WEIGHT**

18

CUBE

2.3

LIST PRICE**\$388**

NOTES: For 54" and 60" worksurfaces, use one external channel, centered between user and approach sides. For 66" and 72"W worksurfaces, use two external channels; if no grommets, locate the channels 3" from user and approach sides; if grommets are in the worksurface, locate channels 3" from user and 6" from approach sides.

1¾" diameter Post Leg Base with glide (HMBPOST.G); qty. 4; for 30" to 72"W x 24"D and 48" to 72"W x 30"D tops

1¾" diameter Post Leg Base with casters (HMBPOST.C); qty. 4; for 30" to 72"W x 24"D and 48" to 72"W x 30"D tops

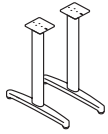
**Fixed Height T-Leg Base (Includes 2 T-legs)**

For 24"D and 30"D Worksurfaces up to 72"W

HMBTLEG24

14

3.6

\$459

NOTES: Use external channel when space between the two legs is 54"W or greater. Center the channel between approach and user sides. See model listing on page 82.

Fixed Height T-Leg Base with glide (HMBTLEG24.G); qty. 2; for 24" and 30"D tops up to 72"W; adjustable glides have 1" range

Fixed Height T-Leg Base with casters (HMBTLEG24.C); qty. 2; for 24" and 30"D tops up to 72"W; two locking and two non-locking casters

NOTES:

- All bases allow tops to sit at 29½" from the floor with glides half-way seated.

Post and T-Leg Bases

- Both glides and casters attach to the foot easily without tools for assembly.
- Bases specified with glides have four adjustable glides, which adjust 1".
- When post legs are used with 18"W tops, post leg to be specified with glides only.

⚠ Support column must be specified for worksurfaces used as peninsulas or as an island extension.

⚠ Post leg can only be used to support peninsula, not as primary supports for a top.

HOW TO SPECIFY**Select Model Number**

H M B T L E G 2 4

Select Glide/Caster Option**G** Glide**C** Caster

18"D tops are not available in Concinnity™

G

Select Paint Color

See page 29

\$20 upcharge per model, for Metallic paint

T 1



CONCINNITY™ Height Adjustable Bases

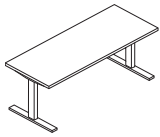

Base shown with worksurface attached.

DESCRIPTION

Coordinate™ Height Adjustable Base – 2 Stage
2-Leg Rectangle T Foot

MODEL

HHATB2S2LT

SHIP WEIGHT

66

CUBE

2.4

LIST PRICE

\$950

NOTES:

- Dual motor two-leg design. Legs raise from 25½" to 45¼".
- Base accommodates any rectangular worksurface between 23"D x 40"W and 30"D x 72"W.
- Weight capacity of 250 lbs. (excluding the weight of the worksurface) distributed evenly.

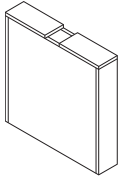

Not available in two-tone laminate.

SIN 33721

Shroud for Height Adjustable Base

5½"W x 26"D x 2¼"H for Base with 30"D Top

HLAMSHB30

39

3.7

\$899

NOTES: Decorative laminate enclosure covers the Coordinate™ metal leg and foot. For use with standard 10500 Series™, Concinnity™, and Voi® rectangle worksurfaces, 42-72"W x 30"D, supported by Height Adjustable Base model HHATB2S2LT. For height adjustable desks requiring a modesty panel, options include: 14"H laminate (HLSLXX14L) or mixed material (HLSLXX14MM) floating modesty panels, laminate full length (HNLMPXX28) or short (HNLMPXX10) modesty/back panel plus external support channel (HLSLZ5SCXX). External support channel attachment screws and modesty/back panel cover caps are included in the shroud hardware pack. External support channel size recommendation, specific to worksurface attached to Height Adjustable Base with optional laminate full-length or short modesty back/panel (HNLMPXX28/10) see below. Ships one per carton. To conceal both metal legs on the Height Adjustable Base order two. When using a modesty panel set height adjustable table at 29"H to ensure table stops before hitting shroud.

Specify: Model.Laminate; see pages 266-267.

SPECIFYING EXAMPLE: HLAMSHB30.N

- ! Lowest base adjustment position when the shroud is installed is 29½"H; memory controller must be set at that height to avoid interference.
- ! The Height Adjustable Base must be reset at the time of installation, after every loss of power, if the unit is not functioning properly, or if the legs are uneven. To reset the base requires removing the laminate shroud(s), as well as the full-length modesty panel if one is being used, then adjusting the base to its lowest position. Disassembly of the shroud is quick and easy.
- ! \$25 upcharge for L2 laminates.

Worksurface Width	Modesty/Back Panel Width	External Support Channel
72"W	72"W	HLSLZ5SC78
66"W	66"W	HLSLZ5SC72
60"W	60"W	HLSLZ5SC66
54"W	54"W	HLSLZ5SC60
48"W	48"W	HLSLZ5SC54

NOTES:

Height Adjustable Base

- Control Box: 120V, 4A, 60Hz, 400W.
- 9' grounded power cord.
- 1½"/second travel speed.
- <50 dB noise rating.
- **HON 10-Year Warranty.**

! Requires the use of an external stiffener (purchased separately) for worksurfaces over 60"W when not used with a Coordinate™ worksurface.

HOW TO SPECIFY

<p>Select Model Number</p> <p>HHATB2S2LT</p>	<p>Select Paint Color</p> <p>See page 116</p> <p>P71</p>	<p>Select Foot</p> <p>X Standard Foot S Slide Glide</p> <p>X</p>	<p>Select Keypad</p> <p>UD Basic Up/Down MEM Memory Preset PDL Paddle FPD Foot Pedal (+ \$175)</p> <p>MEM</p>
---	---	---	--

CONCINNITY™

Components — Privacy Screens

GSA SIN 33721

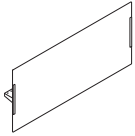

Icon Legend on page 19

**DESCRIPTION****Above/Below Privacy Screen**

60"W x 28"H
54"W x 28"H
48"W x 28"H
42"W x 28"H
36"W x 28"H
30"W x 28"H

MODEL

HLSL2860
HLSL2854
HLSL2848
HLSL2842
HLSL2836
HLSL2830

SHIP WEIGHT

9
9
8
6
6
6

CUBE

8.6
8.6
8.2
6.3
6.4
6.4

LIST PRICE

\$1565
\$1556
\$1336
\$1253
\$1240
\$896

NOTES: Attachment bracket extends 2" into top and underside of worksurface. Screen is frosted translucent acrylic. All brackets are platinum (no need to specify). Extends 13" above and 13" below worksurface.

❗ See page 97 for the "Above-Below Privacy Screen — HLSL28xx — Selection Guide".

❗ Available in Frosted Translucent Acrylic ONLY HLSL2830.FT01.

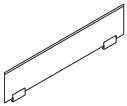
**Above Privacy Screen**

60"W x 13"H
54"W x 13"H
48"W x 13"H
42"W x 13"H
36"W x 13"H
30"W x 13"H

HLSL1260
HLSL1254
HLSL1248
HLSL1242
HLSL1236
HLSL1230

24
22
20
18
15
13

2.9
2.9
2.3
2.3
1.8
1.5

\$508
\$473
\$443
\$387
\$345
\$313

NOTES: Attachment requires 1" clear space/overhang on the underside of the worksurface. Screen is frosted glass. All brackets are platinum (no need to specify).

❗ Available in Frosted Glass ONLY HLSL1230.G.

❗ Above only privacy screen clamps onto worksurface and cannot be installed where support storage will be attached.

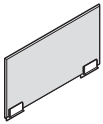
**Above Frosted Polymer (Side) Privacy Screen**

36"W x 13"H
30"W x 13"H
24"W x 13"H

HLSL1236FS
HLSL1230FS
HLSL1224FS

19 Ⓢ
16 Ⓢ
14 Ⓢ

1.9
1.6
1.4

\$447
\$399
\$369

NOTES: Attach to top and side of worksurface with adhesive banding. Platinum color brackets are intended to be attached between users sitting side-by-side. Brackets create a 1/8" separation between adjacent worksurfaces.

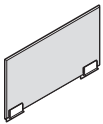
**Above Frosted Glass (Side) Privacy Screen**

36"W x 13"H
30"W x 13"H
24"W x 13"H

HLSL1236GS
HLSL1230GS
HLSL1224GS

20 Ⓢ
18 Ⓢ
16 Ⓢ

1.9
1.6
1.4

\$371
\$333
\$308

NOTES: Attach to top and side of worksurface with adhesive banding. Platinum color brackets are intended to be attached between users sitting side-by-side. Brackets create a 1/8" separation between adjacent worksurfaces.

NOTES:

- Ships complete with attachment brackets.
- All brackets are Platinum.
- Above Privacy Screen attaches to top of worksurface.
- Above and below privacy screen extends 13" above and 13" below the worksurface.
- ❗ Above screens must attach to edgeband and top of surface.
- ❗ Screens cannot be used with T-mold on series such as tables. Screens can only attach to edgeband. Surfaces must be cleaned prior to adhering the screen and must be left to cure for 24 hours without touching for best adhesion.

HOW TO SPECIFY**Select Model Number**

HLSL2830 .

HLSL1230 .

Select Mixed Material**FT01** Frosted Translucent Acrylic

Specified for Above/Below Privacy Screens only

G Frosted Glass

Specified for Above Privacy Screens only

FT01

G

Select Model Number

HLSL1224FS .

HLSL1224GS .

Select Mixed Material**FT01** Frosted Translucent Acrylic

Specified for Above Screen models HLSL1224FS-HLSL1236FS only

G Frosted Glass

Specified for Above Screen models HLSL1224GS-HLSL1236GS only

FT01

G

CONCINNITY™ PRIVACY SCREENS

HNL Above-Below Privacy Screen — HLSL28xx — Selection Guide

	Support Combination		Worksurface Width											
	Support 1	Support 2	30"	36"	42"	48"	54"	60"	66"	72"	78"	84"	90"	96"
O-LEG ON ONE END	O-Leg	O-Leg	NA	30	36	42	48	54	60	60	60	NA	NA	NA
	O-Leg	9½"W Ped	NA	NA	30	36	42	48	54	60	60	60	NA	NA
	O-Leg	End Bookcase	NA	NA	NA	30	36	42	48	54	60	60	60	NA
	O-Leg	L End Panel	NA	NA	NA	36	42	48	54	60	60	60	NA	NA
	O-Leg	15¾"W Ped	NA	NA	NA	30	36	42	48	54	60	60	60	NA
	O-Leg	18"W Ped	NA	NA	NA	NA	30	36	42	48	54	60	60	60
	O-Leg	30"W Ped	NA	NA	NA	NA	NA	NA	30	36	42	48	54	60
	O-Leg	36"W Ped	NA	NA	NA	NA	NA	NA	NA	30	36	42	48	54
NARROW PED	9½"W Ped	9½"W Ped	NA	NA	NA	NA	30	36	42	48	54	60	60	60
	9½"W Ped	End Bookcase	NA	NA	NA	NA	30	36	42	48	54	60	60	60
	9½"W Ped	L End Panel	NA	NA	NA	30	36	42	48	48	60	60	60	NA
	9½"W Ped	15¾"W Ped	NA	NA	NA	NA	NA	30	36	42	48	54	60	60
	9½"W Ped	18"W Ped	NA	NA	NA	NA	NA	30	36	42	48	54	60	60
	9½"W Ped	30"W Ped	NA	NA	NA	NA	NA	NA	NA	30	36	42	48	54
	9½"W Ped	36"W Ped	NA	NA	NA	NA	NA	NA	NA	NA	30	36	42	48
END BOOKCASE PED	End Bookcase	End Bookcase	NA	NA	NA	NA	30	36	42	48	54	60	60	60
	End Bookcase	L End Panel	NA	NA	NA	NA	30	36	42	48	54	60	60	60
	End Bookcase	15¾"W Ped	NA	NA	NA	NA	NA	30	36	42	48	54	60	60
	End Bookcase	18"W Ped	NA	NA	NA	NA	NA	30	36	42	48	54	60	60
	End Bookcase	30"W Ped	NA	NA	NA	NA	NA	NA	NA	30	36	42	48	54
	End Bookcase	36"W Ped	NA	NA	NA	NA	NA	NA	NA	NA	30	36	42	48
L END PANEL	L End Panel	L End Panel	NA	NA	NA	30	36	42	48	54	60	60	60	NA
	L End Panel	15¾"W Ped	NA	NA	NA	NA	30	36	42	48	54	60	60	60
	L End Panel	18"W Ped	NA	NA	NA	NA	NA	30	36	42	48	54	60	60
	L End Panel	30"W Ped	NA	NA	NA	NA	NA	NA	NA	30	36	42	48	54
	L End Panel	36"W Ped	NA	NA	NA	NA	NA	NA	NA	NA	30	36	42	48
TWO PEDS	15¾"W Ped	15¾"W Ped	NA	NA	NA	NA	NA	NA	30	36	42	48	54	60
	15¾"W Ped	18"W Ped	NA	NA	NA	NA	NA	NA	30	36	42	48	54	60
	15¾"W Ped	30"W Ped	NA	NA	NA	NA	NA	NA	NA	NA	30	36	42	48
	15¾"W Ped	36"W Ped	NA	NA	NA	NA	NA	NA	NA	NA	NA	30	36	42
	18"W Ped	18"W Ped	NA	NA	NA	NA	NA	NA	30	36	42	48	48	60
	18"W Ped	30"W Ped	NA	NA	NA	NA	NA	NA	NA	NA	30	36	42	48
	18"W Ped	36"W Ped	NA	NA	NA	NA	NA	NA	NA	NA	NA	30	36	42
	30"W Ped	30"W Ped	NA	NA	NA	NA	NA	NA	NA	NA	NA	NA	30	36
	30"W Ped	36"W Ped	NA	NA	NA	NA	NA	NA	NA	NA	NA	NA	NA	30
	36"W Ped	36"W Ped	NA	NA	NA	NA	NA	NA	NA	NA	NA	NA	NA	NA
HT ADJ BASE	Height Adjustable Base (models HHATB3S2LT/C)		NA	NA	NA	42	48	54	60	60	NA	NA	NA	NA
RETURN CONFIGURATION	None	O-Leg	NA	30	36	42	48	54	60	60	60	NA	NA	NA
	None	9½"W Ped	NA	NA	30	36	42	48	54	60	60	60	NA	NA
	None	End Bookcase	NA	NA	NA	30	36	42	48	54	60	60	60	NA
	None	L End Panel	NA	NA	30	36	42	48	54	60	60	60	NA	NA
	None	15¾"W Ped	NA	NA	NA	30	36	36	48	54	60	60	60	NA
	None	18"W Ped	NA	NA	NA	NA	30	36	42	48	54	60	60	60
	None	30"W Ped	NA	NA	NA	NA	NA	NA	30	36	42	48	54	60
	None	36"W Ped	NA	NA	NA	NA	NA	NA	NA	30	36	42	48	54

NA = Above-Below Screen not applicable for use with worksurface width and support combination

CONCINNITY™ COMPONENTS — SUPPORTS

SUPPORT STORAGE PEDESTALS — 28½”H

- Non-handed, interchangeable design reconfigures easily.
- For use with component top and modesty/back panels or pedestal top and back panels.
 - Pedestals are not fully enclosed and require a component top/worksurface and modesty/back panel or a pedestal back, both of which must be ordered separately.
 - Pedestal’s front and side panels are finished.
- The pedestal depth dimension is less than the like-size depth of the component top, to accommodate addition of a modesty/back panel.
 - 29½”D pedestals can be used under 30” or 36”D worksurfaces; 23½”D pedestals can be used under 24” or 30”D worksurfaces.
 - When specifying a 29½”D pedestal with ¾” modesty panel under a 36”D worksurface, or a 23½”D pedestal with a ¾” modesty panel under a 30”D worksurface, there will be a 6” approach side overhang.
- Bottom of side panels are edgebanded for added strength and to seal out moisture.
- Drawers:
 - Operate on steel ball-bearing suspensions to ensure smooth, quiet, long-lasting operation; full extension allows easy access to contents.
 - Fronts are edgebanded on all four sides.
 - Feature 5-sided construction for added strength and easy alignment or replacement of drawer fronts.



- Interchangeable core removable locks are located on front of all modular storage products, except the storage cabinet.
- Finish of lock is determined by, and aligned with, the handle finish specified.
- Locks feature a removable cylinder that can be interchanged as needed; allows users to access all furniture pieces in an office with a single key for convenience and security. Makes re-keying quick and easy. Keyed alike cores must be ordered separately by specification of the key number (removable lock core kit models available in Black [model HF23B] or Satin [model HF23S]).
- Ship fully assembled.
- Chassis and drawer front colors are specified separately; can be selected with common woodgrain or solid laminate color, or with different, complementary chassis and drawer/door colors.
- See chart on page 34 for cord management options. If the pedestal grommet option is chosen, two cutouts, one per end/side panel, each with a black plastic cap, are included.

SUPPORT STORAGE PEDESTALS — 41”H STANDING-HEIGHT

- Same as above except — not to be used freestanding; top and back are not enclosed.
 - Rear of pedestal can be enclosed with a full, 40¾”H back panel or with a 27⅞”H modesty panel combined with a lower, 13”H pedestal back component. Pedestal back and modesty panel must be ordered separately.

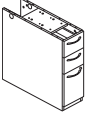
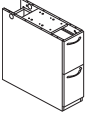

CONCINNITY™ Components — Supports

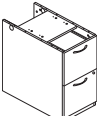
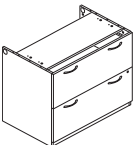
	DESCRIPTION	MODEL	SHIP WEIGHT	CUBE	L1 LIST	L2 UPCHARGES	
						CHASSIS	FRONTS
	Narrow Box/Box/File Pedestal 9½"W x 29⅞"D x 28½"H	HNL291028PBBF	64	10.6	\$844	\$25	\$10
	9½"W x 23⅞"D x 28½"H	HNL231028PBBF	53	8.6	\$756	\$20	\$10
NOTES: Efficient, space saving design for smaller footprints. Three locking drawers; two box (supply) drawers, one for files. File drawer has high sides to accept hanging folders; hangrails are included for side-to-side letter or legal filing. Pedestal's top and back are open and require top and back panel components — ordered separately. See chart on page 34 for cord management options. Ships fully assembled. SPECIFYING EXAMPLE: HNL291028PBBF.E.X.H.H							
	Narrow File/File Pedestal 9½"W x 29⅞"D x 28½"H	HNL291028PFF	69	10.6	\$844	\$25	\$10
	9½"W x 23⅞"D x 28½"H	HNL231028PFF	54	10.6	\$756	\$20	\$10
NOTES: Efficient, space saving design for smaller footprints. Two locking file drawers. Drawers have high sides to accept hanging folders; hangrails are included for side-to-side letter or legal filing. Pedestal's top and back are open and require top and back panel components — ordered separately. See chart on page 34 for cord management options. Ships fully assembled. SPECIFYING EXAMPLE: HNL291028PFF.E.X.H.H							
	Box/Box/File Pedestal 15¾"W x 29⅞"D x 28½"H	HNL291628PBBF	76	10.6	\$857	\$25	\$10
	18"W x 23⅞"D x 28½"H	HNL231828PBBF	72	9.8	\$860	\$20	\$10
	15¾"W x 23⅞"D x 28½"H	HNL231628PBBF	69	8.6	\$782	\$20	\$10
NOTES: Three locking drawers; two box (supply) drawers, one for files. File drawer has high sides to accept hanging folders; hangrails are included for side-to-side letter or legal filing; and front-to-back for letter filing. Pedestal's top and back are open and require top and back panel components — ordered separately. See chart on page 34 for cord management options. Ships fully assembled. SPECIFYING EXAMPLE: HNL291628PBBF.E.X.H.H							
	File/File Pedestal 15¾"W x 29⅞"D x 28½"H	HNL291628PFF	78	10.6	\$857	\$25	\$10
	18"W x 23⅞"D x 28½"H	HNL231828PFF	72	9.8	\$860	\$20	\$10
	15¾"W x 23⅞"D x 28½"H	HNL231628PFF	70	8.6	\$782	\$20	\$10
NOTES: Two locking file drawers. Drawers have high sides to accept hanging folders; hangrails are included for side-to-side letter or legal filing; and front-to-back for letter filing. Pedestal's top and back are open and require top and back panel components — ordered separately. See chart on page 34 for cord management options. Ships fully assembled. SPECIFYING EXAMPLE: HNL291628PFF.E.X.H.H							
	Lateral File Pedestal 36"W x 23⅞"D x 28½"H	HNL233628PLF	134	18.4	\$1155	\$40	\$20
	30"W x 23⅞"D x 28½"H	HNL233028PLF	115	15.0	\$1054	\$35	\$20
NOTES: Two locking file drawers; drawers include hangrails to accept folders in letter or legal size. For use under 24"D rectangle worksurface. Widths can also span depth dimension of respective 30" or 36"D rectangle worksurface. Anti-tip design includes mechanical interlock to inhibit the extension of more than one drawer at a time. Pedestal's top and back are open and require top and back panel components — ordered separately. See chart on page 34 for cord management options. Ships fully assembled. SPECIFYING EXAMPLE: HNL233628PLF.E.X.H.H							

NOTES:

- 29⅞"D pedestals can be used under 30" or 36"D worksurfaces; 23⅞"D pedestals can be used under 24" or 30"D worksurfaces.
- Drawers operate on steel ball-bearing suspensions to ensure smooth, quiet, long-lasting operation; full extension allows easy access to contents.
- Interchangeable core removable locks allow users to access all furniture pieces in an office with a single key for convenience and security. Makes re-keying quick and easy.
- See chart on page 34 for cord management options. If the pedestal grommet option is chosen, two cutouts, one per end/side panel, each with a black plastic cap, are included.

ⓘ Pedestal tops and backs are open and require top and back panel components — ordered separately.

ⓘ 9½"W pedestals are not designed to be used independently in a stand-alone application.

HOW TO SPECIFY

<p>Select Model Number</p> <p>H N L 2 9 1 0 2 8 P B B F . E . X . H . H</p>	<p>Select Handle</p> <p>A Cylinder – Satin B Cylinder – Black C Canopy – Satin D Canopy – Black E Loop – Satin F Loop – Black</p> <p>E .</p>	<p>Select Grommet</p> <p>P Black X No Grommet</p> <p>X .</p>	<p>Select Chassis Color</p> <p>See page 29</p> <p>H .</p>	<p>Select Drawer Front Color</p> <p>See page 29</p> <p>H</p>
--	---	---	--	---

CONCINNITY™

Components — Supports

GSA SIN 33721

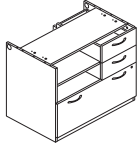

Icon Legend on page 19

**DESCRIPTION****Shelf/Box/Box/Lateral File Pedestal**

36"W x 23½"D x 28½"H

30"W x 23½"D x 28½"H

MODEL**HNL233628PSL****HNL233028PSL****SHIP WEIGHT**

145

126

CUBE

18.4

15.0

L1 LIST**\$1362****\$1336****L2 UPCHARGES****CHASSIS****\$40****\$35****FRONTS****\$20****\$20**

NOTES: Versatile unit features an open shelf and three drawers; two for supplies and one for files. For use under 24"D rectangle worksurface. Widths can also span depth dimension of respective 30" or 36"D rectangle worksurface. Box (supply) drawers are located on the right and open shelves on the left. All drawers lock. Pedestal's top and back are open and require top and back panel components — ordered separately. See chart on page 34 for cord management options. Ships fully assembled.

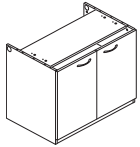
SPECIFYING EXAMPLE: HNL233628PSL.E.X.H.H**Storage Cabinet Pedestal**

36"W x 23½"D x 28½"H

30"W x 23½"D x 28½"H

HNL233628PSC**HNL233028PSC**

104

91

18.4

15.0

\$887**\$857****\$40****\$35****\$20****\$20**

NOTES: One adjustable shelf, which adjusts in 2½" increments. For use under 24"D rectangle worksurface. Widths can also span depth dimension of respective 30" or 36"D rectangle worksurface. Doors are non-locking. Pedestal's top and back are open and require top and back panel components — ordered separately. See chart on page 34 for cord management options. Ships fully assembled.

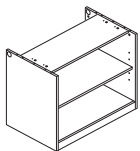
SPECIFYING EXAMPLE: HNL233628PSC.E.X.H.H**Bookcase Pedestal**

36"W x 23½"D x 28½"H

30"W x 23½"D x 28½"H

HNL233628PBK**HNL233028PBK**

82

73

18.4

15.0

\$779**\$762****\$40****\$35****N/A****N/A**

NOTES: Two shelves; bottom of unit plus one adjustable shelf, which adjusts in 2½" increments. For use under 24"D rectangle worksurface. Widths can also span depth dimension of respective 30" or 36"D rectangle worksurface. Pedestal's top and back are open and require top and back panel components — ordered separately. See chart on page 34 for cord management options. Ships fully assembled.

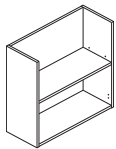
SPECIFYING EXAMPLE: HNL233628PBK.X.H**Bookcase End Support**

12"W x 36"D x 28½"H

12"W x 30"D x 28½"H

12"W x 24"D x 28½"H

HNL123628BKE**HNL123028BKE****HNL122428BKE**

48

48

41

11.0

10.2

7.4

\$587**\$556****\$527****\$25****\$20****\$20****N/A****N/A****N/A**

NOTES: Two shelves; bottom of unit plus one adjustable shelf, which adjusts in 1¼" increments. Designed to span the depth dimension of 24", 30", or 36"D rectangle worksurface; shelves can be oriented facing outwards, or inwards towards the user's kneespace. Includes fully finished back. Ships with two (2) extra L-brackets for applications requiring attachment of a laminate modesty panel; the panel brackets to the back of the bookcase end support. Modesty panel specified should be 12" less than the worksurface width. Open top; for use under worksurface only — ordered separately. Ships fully assembled.

SPECIFYING EXAMPLE: HNL123628BKE.H**NOTES:**

- 23½"D pedestals can be used under 24" or 30"D worksurfaces.
- Drawers operate on steel ball-bearing suspensions to ensure smooth, quiet, long-lasting operation; full extension allows easy access to contents.
- Interchangeable core removable locks allow users to access all furniture pieces in an office with a single key for convenience and security. Makes re-keying quick and easy.
- See chart on page 34 for cord management options. If the pedestal grommet option is chosen, two cutouts, one per end/side panel, each with a black plastic cap, are included.

! Pedestal tops and backs are open and require top and back panel components — ordered separately.

HOW TO SPECIFY

Select Model Number	Select Handle	Select Grommet	Select Chassis Color	Select Drawer Front Color
A Cylinder – Satin B Cylinder – Black C Canopy – Satin D Canopy – Black E Loop – Satin F Loop – Black	P Black X No Grommet	See page 29	See page 29	
H N L 2 3 3 6 2 8 P S L .	E .	X .	H .	H



CONCINNITY™

Components — Supports

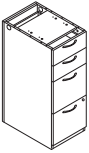
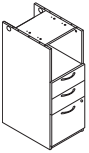
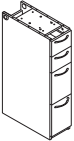
	DESCRIPTION	MODEL	SHIP WEIGHT	CUBE	L1 LIST	L2 UPCHARGES	
						CHASSIS	FRONTS
	Box/Box/File/File Pedestal 15¾"W x 29⅞"D x 41"H	HNL291641PBBFF	114	14.7	\$1753	\$45	\$10
	15¾"W x 23⅞"D x 41"H	HNL231641PBBFF	102	11.9	\$1645	\$40	\$10
	NOTES: Four drawers: two box (supply) and two file. File drawer has high sides to accept hanging folders; hangrails are included for side-to-side letter or legal filing; and front-to-back for letter filing. The two box drawers do not lock. Pedestal's top and back are open and require top and back panel components — ordered separately. See chart on page 34 for cord management options. Ships fully assembled. SPECIFYING EXAMPLE: HNL291641PBBFF.E.X.H.H						
	Shelf/Box/Box/File Pedestal 15¾"W x 29⅞"D x 41"H	HNL291641PSBBF	99	14.7	\$1753	\$45	\$10
	15¾"W x 23⅞"D x 41"H	HNL231641PSBBF	89	11.9	\$1645	\$40	\$10
	NOTES: Open shelf over three drawers: two box (supply) and one file. Interior dimensions of the open storage area are: 14⅞"W x 28¼"D x 12¼"H for the 29⅞"D pedestal. 14⅞"W x 22¼"D x 12¼"H for the 23⅞"D pedestal. File drawer has high sides to accept hanging folders; hangrails are included for side-to-side letter or legal filing; and front-to-back for letter filing. All drawers lock. Pedestal's top and back are open and require top and back panel components — ordered separately. See chart on page 34 for cord management options. Ships fully assembled. SPECIFYING EXAMPLE: HNL291641PSBBF.E.X.H.H						
	Narrow Box/Box/File/File Pedestal 9½"W x 29⅞"D x 41"H	HNL291041PBBFF	88	14.7	\$1543	\$45	\$20
	9½"W x 23⅞"D x 41"H	HNL231041PBBFF	79	11.9	\$1446	\$40	\$20
	NOTES: Efficient, space saving design for smaller footprints. Four drawers: two box (supply) and two file. File drawers have high sides to accept hanging folders; hangrails are included for side-to-side letter or legal filing. When used in a double pedestal configuration under a 60" and 48"W worksurface, provides 41" and 29" of kneespace width, respectively. The two box drawers do not lock. Pedestal's top and back are open and require top and back panel components — ordered separately. See chart on page 34 for cord management options. Ships fully assembled. SPECIFYING EXAMPLE: HNL291041PBBFF.E.X.H.H						

NOTES:

- Pedestals for standing-height workstations.
- 29⅞"D pedestals can be used under 30" or 36"D worksurfaces; 23⅞"D pedestals can be used under 24" or 30"D worksurfaces.
- Drawers operate on steel ball-bearing suspensions to ensure smooth, quiet, long-lasting operation; full extension allows easy access to contents.
- See chart on page 34 for cord management options. If the pedestal grommet option is chosen, two cutouts, one per end/side panel, each with a black plastic cap, are included.

- ! Pedestal tops and backs are open and require top and back panel components — ordered separately.
- ! 9½"W pedestals are not designed to be used independently in a stand-alone application.

HOW TO SPECIFY

Select Model Number	Select Handle	Select Grommet	Select Chassis Color	Select Drawer Front Color
	A Cylinder – Satin B Cylinder – Black C Canopy – Satin D Canopy – Black E Loop – Satin F Loop – Black	P Black X No Grommet	See page 29	See page 29
H N L 2 9 1 6 4 1 P B B F F .	E .	X .	H .	H .

CONCINNITY™

Components — Pedestal Tops

GSA SIN 33721



Icon Legend on page 19

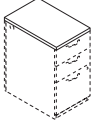

DESCRIPTION	MODEL	SHIP WEIGHT	CUBE	L1	L2
				LIST PRICE	UPCHARGE
Pedestal Tops					
15¾"W x 30"D	HNLPT3016	16	1.4	\$254	\$10
18"W x 24"D	HNLPT2418	15	1.3	\$238	\$10
15¾"W x 24"D	HNLPT2416	13	1.2	\$238	\$10

NOTES: Component is 1½" thick. Underside of top includes pilot mounting holes for pedestals. Grain direction on 15¾" and 18"W pedestal tops runs horizontal (side-to-side). Component tops for 30" and 36"W pedestals are listed with rectangle worksurface sizes. Grain direction on 30" and 36"W pedestal tops can be specified horizontal (side-to-side) or vertical (front-to-back). For tri-oval and beaded edge options, there is a shaped profile on the user and approach sides, and a flat edge on the ends.

ⓘ For modular pedestals used in freestanding applications; not compatible when pedestal is positioned under a worksurface.

ⓘ 9½"W pedestals are not designed to be used independently in a freestanding application, so 9½"W tops are not available to order.

HOW TO SPECIFY

Select
Model Number

H N L P T 3 0 1 6 .

Select
Edge Profile and Edge Color

See page 29

B H .

Select
Top Color

See page 29

H



CONCINNITY™

Components — Pedestal Back Panels

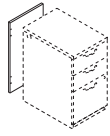
**DESCRIPTION****MODEL****SHIP WEIGHT****CUBE****L1 LIST PRICE****L2 UPCHARGE****Full Back Panels — For 28½”H Pedestals**

18”W x 27⅞”H

HNLBP1828

11

1.5

\$164**\$10**

15¾”W x 27⅞”H

HNLBP1628

10

1.3

\$147**\$10**

9½”W x 27⅞”H

HNLBP1028

6

0.9

\$139**\$10**

NOTES: Encloses the rear of 28½”H modular support pedestals, which come standard with an open, unfinished back. For use when a support storage pedestal is positioned under a 29½”H worksurface and a conventional worksurface width x 27⅞”H modesty/back panel is not specified to cover the back of the pedestal. Examples of when to use a 27⅞” pedestal back include: A worksurface supported by an O-leg on one end and support pedestal on the other, with open wall access; or a worksurface with an O-leg and pedestal support flanking a floating modesty panel. Can be specified in a woodgrain or solid laminate color only. For 30” and 36”W pedestals, use the respective modesty/pedestal back panel size, see page 84.

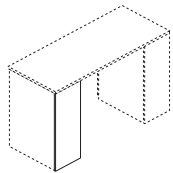
SPECIFYING EXAMPLE (9½”, 15¾”, 18”W): HNLBP1028.H

Back View

Full Back Panels — For 41”H Pedestals

15¾”W x 40⅜”H

HNLBP1641

15

1.8

\$168**\$15**

9½”W x 40⅜”H

HNLBP1041

9

1.2

\$153**\$15**

NOTES: Encloses the rear of 41”H modular support pedestals, which come standard with an open, unfinished back. For use when a support storage pedestal is positioned under a 42”H worksurface and no full-width, 27⅞”H laminate modesty and low, 13”H pedestal back panel are specified. Examples of when to use a 40⅜” pedestal back include: A worksurface supported by an O-leg on one end and support pedestal on the other, with open wall access; or a worksurface with an O-leg and pedestal support flanking a floating modesty panel. Can be specified in a woodgrain or solid laminate color only.

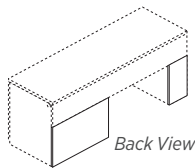
SPECIFYING EXAMPLE: HNLBP1641.H

Back View

Shown with HNLB3018 and HNLB1018

Low Back Panels — For 28½”H Pedestals

36”W x 18”H

HNLB3618

15

1.9

\$164**\$15**

30”W x 18”H

HNLB3018

12

1.6

\$164**\$15**

18”W x 18”H

HNLB1818

7

1.0

\$147**\$15**

15¾”W x 18”H

HNLB1618

6

0.9

\$141**\$10**

9½”W x 18”H

HNLB1018

4

0.6

\$132**\$10**

NOTES: Encloses the rear of 28½”H modular support pedestals when positioned under a 29½”H worksurface with a full-width, 10” laminate modesty panel. The modesty panel extends down from the underside of the worksurface to cover the upper back portion of the pedestal, the lower panel component encloses the remainder of the pedestal back. When used in combination, the 10” modesty and pedestal low back panels fully conceal the rear of the pedestal. The pedestal low back panel is only for use when a modular pedestal is used in conjunction with a worksurface with a 10” laminate modesty panel and the customer wants/needs to fully enclose the back section of the pedestal. Can be specified in a woodgrain or solid laminate color only.

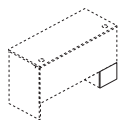

Back View

Low Back Panels — For 41”H Pedestals

15¾”W x 13”H

HNLB1613

4

0.7

\$141**\$10**

9½”W x 13”H

HNLB1013

3

0.5

\$132**\$10**

NOTES: Encloses the rear of 41”H modular support pedestals when positioned under a 42”H worksurface with a full-width, 27⅞” laminate modesty panel. The modesty panel extends down from the underside of the worksurface to cover the upper back portion of the pedestal, the lower panel component encloses the remainder of the pedestal back. When used in combination, the 27⅞” modesty and pedestal low back panels fully conceal the rear of the pedestal. The pedestal low back panel is only for use when a modular pedestal is used in conjunction with a worksurface with a 27⅞” laminate modesty panel and the customer wants/needs to fully enclose the back section of the pedestal. Can be specified in a woodgrain or solid laminate color only.

HOW TO SPECIFY**Select Model Number**

H N L P B 1 8 2 8

Select Laminate Color

See page 29

H

Select Model Number

H N L L B 3 6 1 8

Select Laminate Color

See page 29

H



Refer to page 104 for Center Drawer compatibility information

DESCRIPTION	MODEL	SHIP WEIGHT	CUBE	L1 LIST PRICE	L2 UPCHARGE
Laminate Center Drawer 26" x 15 ³ / ₈ "	H1526	12 Ⓔ	1.2	\$214	\$15
22" x 15 ³ / ₈ " • 12" drawer extension (3/4). • Inside drawer dimension for H1526: 22 ¹ / ₈ "W x 15 ¹ / ₂ "D x 1 ¹ / ₂ "H. • Inside drawer dimension for H1522: 18 ⁷ / ₈ "W x 15 ¹ / ₂ "D x 1 ¹ / ₂ "H. • Minimum clearance for mounting H1526: 27 ¹ / ₄ "W x 18 ¹ / ₂ "D compatible with 72"W x 36"D, 66"W x 30"D, 60"W x 30"D Double Pedestal Desks, 72"W x 24"D, 66"W x 24"D, 60"W x 24"D Credenza w/Kneespace, 48"W x 24"D Return • Minimum clearance for mounting H1522: 22 ³ / ₄ "W x 18 ¹ / ₂ "D compatible with 72"W x 36"D, 66"W x 30"D, 60"W x 30"D Double Pedestal Desks, 72"W x 36"D, 66"W x 30"D Single Pedestal Desks, Bullet and P-shaped Peninsulas, 72"W x 24"D, 66"W x 24"D, 60"W x 24"D Credenza w/Kneespace, 72"W x 24"D, 66"W x 24"D Single Pedestal Credenzas, 48"W x 24"D, 42"W x 24"D Returns	H1522	11 Ⓔ	1.1	\$199	\$15

NOTES: Specify laminate for drawer. Model H1522 or H1022 can be used on peninsulas with modesty panel, model HPC180W. Laminate center drawers include pencil tray. For center drawer laminate colors, see page 29.

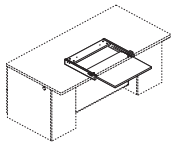

Collaborative Desk Shelf 25"W x 23"D x 2 ¹ / ₂ "H	HNLCDSEHF	18	1.5	\$370	\$20
---	------------------	----	-----	--------------	-------------

NOTES: Convenient slide-out shelf on approach-side of desk provides workspace for guests. For use with 72"W x 36"D breakfront desk designs — see listings on page 41 — or with 60" or wider worksurface, supported by pedestals, and no modesty panel. Minimum clearance for mounting: 28"W x 19³/₄"D. Fully extended shelf dimensions: 24"W x 19"D. Shelf extends 12³/₈", ³/₄" thick. Not compatible on desks with under-surface center drawer or keyboard platform attached. Can be specified in a woodgrain or solid laminate color only.

! Collaborative desk shelf for use with 72"W x 36"D breakfront, floating modesty panel desk designs or with 60" or wider worksurface, supported by pedestals, and no modesty panel.

SPECIFYING EXAMPLE: HNLCDSEHF.H

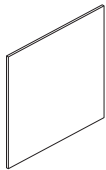

DESCRIPTION	MODEL	SHIP WEIGHT	CUBE	LIST PRICE
Wall Mount Tackboard 36"W x 35 ¹ / ₄ "H	HNL3636TB	20	2.9	\$323
30"W x 35 ¹ / ₄ "H	HNL3630TB	16	2.9	\$275
36"W x 48 ⁵ / ₈ "H	HNL4936TB	27	5.5	\$359
30"W x 48 ⁵ / ₈ "H	HNL4930TB	22	3.7	\$312

NOTES: For a list of standard fabrics, see pages 25-26. For a complete list of fabrics, please go to hon.com/fabricsandfinishes. When positioned above 29¹/₂"H floor-standing storage, the sizes align with overhead storage height options. Can be positioned side-by-side with corresponding wall mount markerboard sizes. Easy to install; includes mounting hardware. Attaches to wall with horizontally mounted, interlocking Z-clip brackets. For the space directly below stack-on and wall mount storage cabinets, use the 18"H tackboard models listed on Pricer pages 57 and 63.

SPECIFYING EXAMPLE: HNL3636TB.APN15

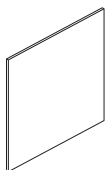

Wall Mount Markerboard 36"W x 35 ¹ / ₄ "H	HNL3636WB	16	2.9	\$221
30"W x 35 ¹ / ₄ "H	HNL3630WB	14	2.9	\$206
36"W x 48 ⁵ / ₈ "H	HNL4936WB	22	5.5	\$270
30"W x 48 ⁵ / ₈ "H	HNL4930WB	20	3.7	\$249

NOTES: Smooth, white, magnetic surface. Metal material produces clear graphics and cleans easily. Compatible for use with dry- or wet-erase markers. When positioned above 29¹/₂"H floor-standing storage, the sizes align with overhead storage height options. Can be positioned side-by-side with corresponding wall mount tackboard sizes. Easy to install; includes mounting hardware. Attaches to wall with horizontally mounted, interlocking Z-clip brackets.

SPECIFYING EXAMPLE: HNL3636WB

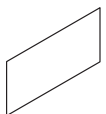

Markerboard 36"W x 15"D	HLSL1536SOMB	8	1.0	\$192
30"W x 15"D	HLSL1530SOMB	6	1.0	\$143

NOTES: Markerboard laminate material with black edges, no frame. Adheres to laminate doors. Includes double-sided tape. No specification necessary.

HOW TO SPECIFY

Select Model Number	Select Laminate Color
	See page 29
H N L C D S H E L F .	H

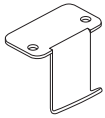

DESCRIPTION

Back Pack Hook (10 per carton)

12"W x 14½"D x 1½"H

NOTES: Assembly: attaches to bottom of desk with (2) screws, included.

ⓘ Available in Platinum Metallic finish only, no specification needed.

MODEL

SHIP WEIGHT

CUBE

LIST PRICE

HCLA65

10

0.1

\$101

HOW TO SPECIFY

Select
Model Number

H C L A 6 5



Black only

SIN 33721

DESCRIPTION**MODEL****SHIP WEIGHT****CUBE****LIST PRICE****Field Installable Grommet — For 2½" Diameter Hole****HFLDGRMT**

0.1 Ⓢ

0.01

\$35

- Intended for use in tops and end panels to route/hide cords and in modesty panels to facilitate reaching wall electrical outlets.
- Grommet is field installable.
- Requires a 2½" diameter hole saw and drill for installation (not included).
- Grommet shape is round.
- Includes grommet cap and sleeve.
- Grommet cap measures 3" diameter and includes a ¾" diameter cord access hole.
- Grommet sleeve measures 2½" O.D. x ¾" thick.
- Includes instructions to locate grommet position for desks, credenzas, returns, and bridges.

! Black Finish

SPECIFYING EXAMPLE: HFLDGRMT

SIN 33721

Field Installable Grommet — For 3" Diameter Hole**HFLDGRMT3**

0.1 Ⓢ

0.3

\$35

- Intended for use in tops and end panels to route/hide cords and in modesty panels to facilitate reaching wall electrical outlets.
- Grommet is field installable.
- Requires a 3" diameter hole saw and drill for installation (not included).
- Grommet shape is round.
- Includes grommet cap and sleeve.
- Grommet outside dimensions measures 3½" diameter and includes two cord access holes.
- Grommet sleeve measures 3" O.D. x 1" thick.
- Includes instructions to locate grommet position for desks, credenzas, returns, and bridges.

! Black Finish

SPECIFYING EXAMPLE: HFLDGRMT3

OPEN MARKET

Field Installable Grommet — For 3" Diameter Hole**HFLDGRMT4**

0.1

0.01

\$35

- Intended for use in tops to route/hide cords.
- Requires a 3" diameter hole saw and drill for installation (not included).
- Includes grommet cap, with two access holes, and sleeve components.
- Outside dimension measures 3½" diameter.
- Sleeve hole in worksurface measures 3" O.D. x 1" thick.
- Includes instructions to locate grommet position for desks, credenzas, returns, and bridges.

! Platinum Finish

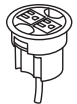
SPECIFYING EXAMPLE: HFLDGRMT4

SIN 33721T

Power Hub, 3" Grommet Mount, 6' Cord**HGRMTAC**

1.3

0.2

\$126

- Fits in 3" round grommet holes on the following product lines: 10500, 10700, Concinnity, Coordinate, and Voi desks; Abound Worksurfaces; Huddle and Motivate tables and SmartLink.
- Two grounded AC power outlets.
- Two cord pass-through holes in cap.
- Includes 6' cord with three-prong plug.
- Field installed; easy plug-and-play.
- UL Listed.

! Available in black only (no color designation so use .X - Specify: HGRMTAC.X).

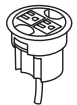

SIN 33721T

3" Round Power Grommet – 2 Outlets, 10' Cord**HGRMTAC2**

1.5

0.2

\$159

- Includes 10' cord with three-prong plug.
- Fits in 3" round grommet holes on the following product lines: Coordinate, Huddle, Motivate, all laminate casegoods series, and Systems Worksurfaces.
- Two grounded AC power outlets.
- Field installed with Plug-and-play ease.

NOTES: Power Modules will also work with standing-height applications for 10500 Series™ and Voi® desks. Optional Memory Control allows preset worksurface heights for consistency. Ships separately. Dynamic load capacity when worksurface is moving is 300 lbs.

! Available in black finish only, no specification needed.



SIN 33721T

Power/USB Hub, 3" Grommet Mount**HGRMTUSB2**

1.3 Ⓢ

0.2

\$250

- One grounded AC power outlet with 2 USB ports.
- Two cord pass-through holes in cap.
- Includes 6' cord with three-prong plug.
- Field installed; easy plug-and-play.
- UL Listed.





! Available in black only (no color designation so use .X - Specify: HGRMTUSB2.X).

HOW TO SPECIFYSelect
Model Number

HGRMTAC

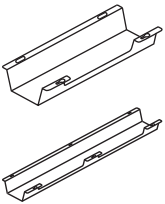

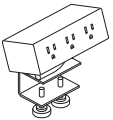
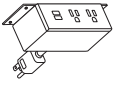
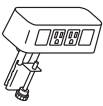
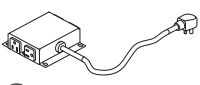
Icon Legend on page 19

	DESCRIPTION	MODEL	SHIP WEIGHT	CUBE	LIST PRICE
	Cable Management Troughs				
	17"W — Single	HCTROUGH17	2.7 Ⓢ	0.5	\$73
	17"W — 10-Pack	HCTROUGH1710	14.0 Ⓢ	0.5	\$665
	36"W — Single	HCTROUGH36	4.9 Ⓢ	0.9	\$122
	36"W — 10-Pack	HCTROUGH3610	30.0 Ⓢ	0.9	\$1121
	<ul style="list-style-type: none"> Cable management troughs ship flat packed. The troughs attach to underneath the worksurface with screws. The 17"W has one wire access cut out on the user side. The 36" has two wire access cut outs. These cut outs give users access to inside the trough without having to detach it from the worksurface. Color: Graphite. Material: Metal. TAA Compliant. 				
 <p>OPEN MARKET</p>	O-Leg Cord Clips				
	Clips for 28½" Worksurface O-Legs — 8-Pack	HWMCLIPLG	0.8 Ⓢ	0.1	\$110
	Clips for Layering O-Legs — 4-Pack	HWMCLIPSM	0.5 Ⓢ	0.1	\$73
	<p>NOTES: Wire clips work with 7" Low Credenza O-leg and 29"H Support O-leg.</p> <p>ⓘ Available in frosted plastic material only.</p>				
 <p>Model HPWRMOD3WC shown</p>  <p>Model HPWRMOD2UWM shown</p>	Power Modules				
	3 Receptacles with Worksurface Clamp	HPWRMOD3WC	2.3 Ⓢ	0.2	\$342
	3 Receptacles with Under-Worksurface Mounting Bracket	HPWRMOD3UWM	2.3 Ⓢ	0.2	\$342
	2 Receptacles 2 USB with Worksurface Clamp	HPWRMOD2WC	2.3 Ⓢ	0.2	\$546
	2 Receptacles 2 USB with Under-Worksurface Mounting Bracket	HPWRMOD2UWM	2.3 Ⓢ	0.2	\$546
	<ul style="list-style-type: none"> 6' power cord with standard three-prong plug. Under-worksurface mounting bracket models work with any top that has a 5" x 5" square clearance. Worksurface clamp models work on any top with a 4" overhang. UL Listed. <p>ⓘ Color finish coordinates with HON's Charcoal or White. Specify <i>STRM</i> for Storm or <i>SNW</i> for Snow when ordering. Example: <i>HPWRMOD3WC.STRM</i>.</p>				
	Power & Data Center				
	2 Receptacles 2 Data Accessory	HCOMDOME2	2.5 Ⓢ	0.2	\$327
	<ul style="list-style-type: none"> Standard with two receptacles and openings for two data ports. 6' power cord with standard three-prong plug. Fits on any worksurface with a 4" overhang. UL Listed. <p>ⓘ Color finish coordinates with HON's Loft. Specify <i>LOFT</i> when ordering. Example: <i>HCOMDOME2.LOFT</i>.</p>				
 <p>EZ</p>	Under Worksurface Power Module — 4 Outlets, 10' Cord	HPWRMOD2	1.5	0.2	\$441
	<ul style="list-style-type: none"> Includes 10' cord with three-prong plug. Fits in cable management troughs. 4 outlets on side create easy access. <p>NOTES: Power Modules will also work with standing-height applications for 10500 Series™ and Voi® desks.</p> <p>ⓘ Available in black finish only, no specification needed.</p>				
	Vertebrae	HMPVWM28	3.0	0.3	\$246
	<p>NOTES: 30"H x 3¼"W x 1½"D. Ships unassembled.</p> <p>ⓘ Clear finish. Specify "X" for finish option.</p> <p>SPECIFYING EXAMPLE: HMPVWM28.X</p>				

HOW TO SPECIFY

Select Model Number

H P W R M O D 3 W C

CONCINNITY™

Accessories — Paper Organizers

GSA SIN 33721



Icon Legend on page 19

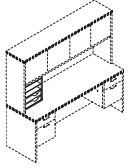

Not available in two-tone laminates

DESCRIPTION

Vertical Paper Manager
14⁷/₈"W x 10⁷/₈"D x 19¹/₈"H

MODEL**HLVPM1****SHIP WEIGHT**

27

CUBE

2.8

L1 LIST PRICE**\$351****L2 UPCHARGE****\$10**

NOTES: Keeps papers, files, and books neatly organized and within easy reach from a seated position. Designed for desk, credenza, and return tops. Fits under stack-on storage models. Two pullout drawers and three fixed shelves. Not available in pattern laminate colors. Ships fully assembled.

ⓘ When used in conjunction with wall mounted storage cabinets, allow 19³/₄" minimum clearance above the worksurface.

SPECIFYING EXAMPLE: HLVPM1.N

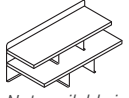

Not available in two-tone laminate

DESCRIPTION

Desktop Storage Terrace
26¹/₂"W x 12¹/₂"D x 10¹/₂"H

MODEL**HLDSTI**

24

1.1

\$329**\$10**

NOTES: Keeps work-in-process, priority files, loose pages, and mail neatly organized and in view. Mixed material design comprised of sturdy laminate shelves with metal back and support panels. Not available in two-tone laminate combination or pattern laminate colors. Choose from Platinum Metallic (T1), Black (P), and Charcoal (S) for the metal components. Designed to be used on worksurfaces. Also sized to fit in stack-on and wall mounted storage cabinets, see compatibility chart on page 109.

Specify: Model.Laminate.Paint

SPECIFYING EXAMPLE: HLDSTI.N.T1

**DESCRIPTION**

Stacked Paper Management
32¹/₂"W x 12⁵/₈"D x 4¹/₄"H

MODEL**HLVPM2****SHIP WEIGHT**

22

CUBE

1.25

LIST PRICE**\$175**

NOTES: Segments and organizes stack-on and wall mount storage compartments (see compatibility chart on page 109), as well as bookcase shelves. In some cases, installation may require removing the stack-on or wall mount storage doors.

ⓘ Black only.

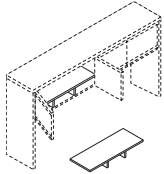
**DESCRIPTION**

Hanging Paper Shelf
28¹/₈"W x 11⁷/₈"D x 4⁵/₈"H

MODEL**HHPS1**

7

2.9

\$214

NOTES: Attaches quickly and easily (screws included). Maximizes worksurface space; de-clutters desktop while placing priority communications and active project folders within easy reach. Angled design allows contents to be distinguished at a glance. Mixed material styling features strong painted metal frame with a frosted shelf.

Attaches quickly and easily to laminate stack-on and wall mount storage models (except the 36"W Voi® overhead hutch with O-legs or panel mount brackets). Not for use with 38000 Series™ and Systems.

Specify: Model.Paint

SPECIFYING EXAMPLE: HHPS1.T1

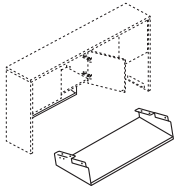
**DESCRIPTION**

Desktop Paper Shelf
28¹/₈"W x 11⁵/₈"D x 5"H

MODEL**HDPS1**

7

2.9

\$214

NOTES: Desktop Paper Shelf and Storage Terrace include protective, non-slip pads on the base. Paper Shelf can stack two-high. Organizer shelf provides a place and space for work-in-process and piling to keep worksurfaces neat and tidy. Convenient, scalable design with interlocking side supports allow two units to be stacked and integrated. Durable painted metal frame with a frosted shelf; mixed material styling matches hanging paper shelf.

Can also be used inside select overhead storage, including the following stack-on with clearance and hinged door models: 10500 and Valido 36", 42", 66", 72", 78"W and 10700 68⁵/₈"W.

Specify: Model.Paint

SPECIFYING EXAMPLE: HDPS1.T1

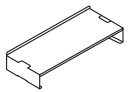
**DESCRIPTION**

Storage Cube
12"W x 12"D

MODEL**HLSL1212**

1

0.3

\$316

SPECIFYING EXAMPLE: HLSL1212.P8S

**HOW TO SPECIFY**

Select
Model Number

H L V P M 1 .

Select
Laminate Color

See page 29

N

CONCINNITY™ PAPER ORGANIZER COMPATIBILITY

PAPER ORGANIZERS FOR STACK-ON AND WALL MOUNTED STORAGE CABINETS

- Laminate vertical paper manager (HLVPM1) is designed for desk, credenza, and return tops; fits under stack-on and wall mount storage units.
- Laminate desktop storage terrace (HLDST1) for use on worksurfaces, or inside overhead storage compartments >26½"W.
- Metal desktop paper shelf (HDPS1) for use on worksurfaces, can be stacked two high, or inside overhead storage compartments >28¾"W.
- Stacked paper management (HLVPM2) can be positioned inside overhead storage cabinets >32½"W.
- Metal hanging paper shelf (HHPS1) attaches quickly and easily to the underside of stack-on and wall mounted storage models.
- For applications using the organizers inside stack-on and wall mounted storage compartments, the fit compatibility is as follows:

OUTSIDE WIDTH	INSIDE WIDTH	Stacked Paper Mgt. — 32½"W HLVPM2	Desktop Paper Shelf — 28¾"W HDPS1	Desktop Storage Terrace — 26½"W HLDST1	Hanging Paper Shelf — 28¾"W HHPS1
		Yes or No	Yes or No	Yes or No	*Qty — see NOTE
STACK-ON STORAGE W/ LAM DOORS, LAM LOCKING DOORS, FROSTED DOORS					
36"W	34.34	Y	Y	Y	1
42"W	40.34	Y	Y	Y	1
48"W (large compartment)	30.60	N	Y	Y	1
60"W	28.60	N	N	Y	2
66"W	31.60	N	Y	Y	2
72"W	34.60	Y	Y	Y	2
78"W	37.60	Y	Y	Y	2
STACK-ON STORAGE W/ SLIDING DOOR					
48"W	22.60	N	N	N	1
60"W	28.60	N	N	Y	2
66"W	31.60	N	Y	Y	2
72"W	34.60	Y	Y	Y	2
78"W	37.60	Y	Y	Y	2
WALL MOUNT STORAGE W/ LAM DOORS, LAM LOCKING DOORS, FROSTED DOORS					
30"W	28.35	N	N	Y	N
36"W	33.67	Y	Y	Y	1
42"W	39.67	Y	Y	Y	1
48"W (large compartment)	30.22	N	Y	Y	1
60"W	28.22	N	N	Y	2
66"W	31.22	N	Y	Y	2
72"W	34.22	Y	Y	Y	2
78"W	37.22	Y	Y	Y	2
WALL MOUNT STORAGE W/ SLIDING DOOR					
48"W	22.46	N	N	N	1
60"W	28.46	N	N	Y	2
66"W	31.46	N	Y	Y	2
72"W	34.46	Y	Y	Y	2
78"W	37.46	Y	Y	Y	2

*NOTE: For model HHPS1, quantity represents the number that can be mounted side-by-side under the cabinet.



CONCINNITY™

Accessories — Lock Kits

GSA SIN 33721 EXCEPT AS NOTED

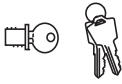
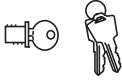

Icon Legend on page 19

	DESCRIPTION	MODEL	SHIP WEIGHT	CUBE	LIST PRICE
	Black Removable Lock Core Kit <ul style="list-style-type: none"> Specify quantity of each key number from 101E-225E. Includes: 1-core, 2-keys, 1-core removal tool, and instructions. NOTES: If key number isn't specified, number will be at random.	HF23B	0.1 Ⓞ	0.1	\$35
	Satin Removable Lock Core Kit <ul style="list-style-type: none"> Specify quantity of each key number from 101E-225E. Includes: 1-core, 2-keys, 1-core removal tool, and instructions. NOTES: If key number isn't specified, number will be at random.	HF23S	0.1 Ⓞ	0.1	\$47
	Removable Lock Core Kit Black Satin	HF27B HF27S	0.2 0.2	0.02 0.02	\$35 \$35
OPEN MARKET	<ul style="list-style-type: none"> For stack-on and wall mounted storage laminate models (with locks) in 10500, 10700, Valido, Voi, Concinnity, and 94000 Series. Specify quantity of each key number from 101E to 225E. Includes: 1-core, 2-keys, 1-core removal tool, and instructions. NOTES: If key number isn't specified, number will be at random.				

NOTES:

- Interchangeable core removable locks are standard on most HON products.
- Removable lock core kits with specific key number must be ordered to facilitate keying alike in the field.
- For keyed alike locks:
 - Order standard product which will be shipped with factory installed locks and random numbered cores.
 - Order the appropriate quantity of like numbered cores required for each workstation or keyed area.
 - Simply replace the factory installed cores with the replacement cores after product has been installed.
- To install new core:
 - Lock must be in the unlocked position.
 - Insert core removal key and pull core straight out.
 - Insert new core with core removable key, hold core into lock and withdraw core removal key.
 - Retain original core for future use.
- For master key, see model HF22 on page 773.
- To provide normal lead times, key numbers cannot be specified on HON products at time of order. This also eliminates need for tagging and tracking each product's lock number during installation.

HOW TO ORDER CORE REMOVABLE LOCK KITS:

Specify: Model Number.X
Key Number

Examples: HF23S.X121E
HF23S.X (Key number not specified)

NOTES: Key orders without numbers specified will be keyed at random.
Numbers 101E-225E are available.

SAMPLE ORDER:

Quantity	Model	Key Code
4	HF23B.	X121E

HOW TO SPECIFY

Select
Model Number

H F 2 3 B



CONCINNITY™

Accessories — Task Lights

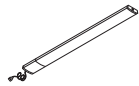

OPEN MARKET

DESCRIPTION**LED Task Lights — For Stack-on and Wall Mounted Storage Cabinets**

17" LED Light with Power Supply (Single)

31" LED Light with Power Supply (Single)

17" LED Light with Power Supply for Daisy-chain (Starter)

31" LED Light with Power Supply for Daisy-chain (Starter)

17" LED Light with 8" Jumper Cord for Daisy-chain (Follower)

31" LED Light with 8" Jumper Cord for Daisy-chain (Follower)

Undercabinet Occupancy Sensor with 1" End to End Connector**MODEL****SHIP WEIGHT****CUBE****LIST PRICE****HLED17AS** ☉

1.2

0.05

\$450**HLED31AS** ☉

1.5

0.09

\$603**HLED17A**

1.0

0.05

\$493**HLED31A**

1.4

0.09

\$662**HLED17AUO** ☉

1.0

0.03

\$404**HLED31AUO** ☉

1.0

0.05

\$539**HLEDOSA** ☉

0.2

0.01

\$97

NOTES: To use the daisy chain application, must start with model HLED17A or HLED31A. No finish specification required. Attaches magnetically to underside of overhead storage, or attaches with provided screws or double-sided tape. Occupancy sensor attaches to a single or starter LED light and will automatically turn the light off after no motion is detected for 30 minutes. Just like all the LED light models, the occupancy sensor features a soft-touch on/off switch. LED task lights have a lifetime of 50,000 hours and have a dimmer feature that allows the user to adjust the amount of light output.



OPEN MARKET

Recessed Task Lights — For Stack-on and Wall Mounted Storage Cabinets

- Color: Black.
- Slim profile design.
- Mount to stack-on storage and wall mounted storage cabinets (see pages 53-57 and 60-63).
- Electronic ballast for increased energy efficiency.
- T5 bulb, included, which contains less mercury.
- 9-foot black cord and switch off right rear corner.

22⁷/₈"W x 3¹/₁₆"D x 1¹/₈"H

Chicago code version (with fused plug)

34⁵/₈"W x 3¹/₁₆"D x 1¹/₈"H

Chicago code version (with fused plug)

46¹/₂"W x 3¹/₁₆"D x 1¹/₈"H

Chicago code version (with fused plug)

HH870930

7.0

0.60

\$247**HH870930CH**

7.0

0.60

\$322**HH870942**

10.0

0.90

\$267**HH870942CH**

10.0

0.90

\$339**HH870960**

12.0

1.10

\$290**HH870960CH**

12.0

1.10

\$361

SIN 33721

Articulating Desk Lamp**Articulating Desk Lamp w/ Occupancy Sensor****HLED1**

1.2

6.5

\$430**HLED1OC**

1.2

6.5

\$524

SIN 33721

Task Desk Lamp**HLED2**

0.7

3.0

\$373**HOW TO SPECIFY**Select
Model Number

H H 8 7 0 9 3 0

CONCINNITY™

Accessories

OPEN MARKET EXCEPT AS NOTED



Icon Legend on page 19



Refer to the Workplace Tools section in the 2021 Shared Spaces Pricer for additional product information

SIN 33721



DESCRIPTION	MODEL	SHIP WEIGHT	CUBE	LIST PRICE BY PAINT GRADE	
				P1	P2
Slide-Away Keyboard Platform (Specify: Laminate)	H4022	10	0.6	\$228	
Extended Tray Slide-Away Keyboard Platform (Specify: Laminate)	HE4022	12	0.7	\$323	
Metal Keyboard and Mouse Tray (Specify paint)	H4028 OPEN MARKET	11	1.5	\$164	\$174
Metal Keyboard Tray (Specify paint)	H4029 OPEN MARKET	11	1.5	\$148	\$158

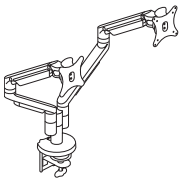

DESCRIPTION	MODEL	SHIP WEIGHT	CUBE	LIST PRICE
Dual Dynamic Monitor Arm <ul style="list-style-type: none"> Arms have 65° rotation at base with optional 130° and 360° rotations. Arms extend 22" and retract up to 3". Monitor mount rotates 180° and tilts +/-30°. Monitor can be rotated from landscape to portrait position. <p>! Arms hold monitors from 6.2-18 lbs. Optional counterweight HPACW available to support monitors as low as 5 lbs. (see the Workplace Tools section in the 2021 Shared Spaces Pricer).</p>	HMASD	17.0	1.1	\$962

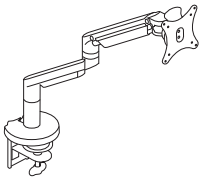

Single Dynamic Monitor Arm <ul style="list-style-type: none"> 180° of rotation at base with optional 360° rotation. Arms extend 22" and retract up to 3". Monitor mount rotates 180° and tilts +/-30°. Monitor can be rotated from landscape to portrait position. <p>! Arms hold monitors from 6.2-18 lbs. Optional counterweight HPACW available to support monitors as low as 5 lbs. (see the Workplace Tools section in the 2021 Shared Spaces Pricer).</p>	HMASTS	11.5	0.8	\$501
--	---------------	------	-----	--------------

NOTES:**Monitor Arms Only**

- Arms fold back to post to allow more desktop room.
- Arms feature double extension, allowing 20"+ of back and forth movement.
- Cable management on both pole and arm assemblies.
- Counterbalance adjustment provides stability for monitors up to 17 lbs per arm.
- Made of high-quality aluminum alloy material.
- See the Workplace Tools section in the 2021 Shared Spaces Pricer for additional monitor arm models.

HOW TO SPECIFY**Select Model Number****Select Finish**

Specify for models HMASD and HMASTS only

SVR Silver
BLK Black

HMASD.

SVR

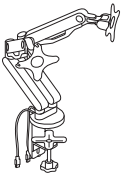

	DESCRIPTION	MODEL	SHIP WEIGHT	CUBE	LIST PRICE
	<p>Coordinate™ Portable Desktop Riser 31"D x 5"-16½"H x 35"W</p> <p>NOTES: Available in Black (BLK) or White (WHT) finish. Desktop riser dimensions (without keyboard tray): 22"D x 5"-16½"H x 35"W. Keyboard tray dimensions: 9"D x 30"W. Max loading capacity is 33 lbs for the desktop riser surface and 4 lbs for the keyboard tray. Easily transition from seated to standing positions throughout the workday. Sits atop an existing desk to create sit-to-stand functionality by raising the computer. Includes keyboard tray and surface for computer monitors. HON 5-Year Limited Warranty.</p> <p>⚠ Not intended for use on mobile workstations.</p>	HBXRISER	54.0	4.1	\$657
	<p>Dual Monitor Arm with 2 USB Ports</p> <p>NOTES: Easy adjustment. Height adjusts to 17" tall. Monitor tilt and swivel capability. Enclosed cable management. Grommet or desktop mounting. Clean appearance. In some applications the Monitor Arms may extend 12 or more inches into the worksurface. For additional information see the Workplace Tools section in the 2021 Shared Spaces Pricer. HON 5-Year Limited Warranty.</p> <p>⚠ No specification needed.</p>	HBDMAUSB	41.9	2.6	\$410

HOW TO SPECIFY

<p>Select Model Number</p> <p>H B X R I S E R .</p>	<p>Select Finish</p> <p>BLK Black WHT White</p> <p>B L K</p>
--	---

CONCINNITY™ Accessories

OPEN MARKET



Icon Legend on page 19

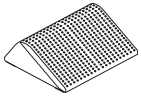

DESCRIPTION

Footrest — Anti-Slip Cover
13¾"D x 5½"H x 16"W

ⓘ Available in Black (T) finish ONLY. Recommended weight capacity not to exceed 250 pounds. **HON 5-Year Limited Warranty.**
SPECIFYING EXAMPLE: HVL991.T

MODEL

HVL991

SHIP WEIGHT

7 Ⓞ

CUBE

0.9

LIST PRICE

\$89

HOW TO SPECIFY

Select Model Number

H V L 9 9 1 .

Select Finish

T Black

T

COORDINATE™

Want to see more? Scan here
to check out hon.com.



Coordinate™ Height Adjustable Base shown with Ignition® 2.0 Seating and 10500 Series™ Desking.

COORDINATE™

The power to choose is now at your fingertips — sit tight or stretch out with a Coordinate height adjustable base! It doesn't matter if you're perfecting that project in a private office or collaborating with the crew from your cubicle, Coordinate easily adapts to your body and your day with streamlined style and effortless versatility.



FEATURES

- Make quick and easy adjustments all day long with standard memory preset and hands-free foot pedal, Wireless, or paddle control options.
- Bases available in 2- or 3-leg rectangle C- and T-shaped foot options to accommodate your layout preferences.
- Newly designed base is lighter scale with a clean aesthetic and easy assembly.
- All bases are compatible with electrical accessories and select worksurfaces.

COORDINATE™ ORDERING INFORMATION

BASE PAINT

PAINT	CODES
◆ Black	P71
◆ Charcoal	S
◆ Designer White	PJW
◆ Loft	LOFT
◆ Silver	PR6

GROMMET

GROMMET	CODES
◆ Black	P
◆ Charcoal	S
◆ Designer White	DW
◆ Greige	T5
◆ Light Gray	Q
◆ Loft	LOFT
◆ Muslin	T3
◆ Platinum	T1
◆ Shadow *	SHDW

LAMINATE

L1 LAMINATES

Woodgrain	
◆ Bourbon Cherry	H
◆ Cognac	COGN
◆ Florence Walnut	LFW1
◆ Harvest	C
◆ Kingswood Walnut	LK11
◆ Mahogany	N
◆ Mocha	MOCH
◆ Natural Maple	D
◆ Pinnacle	PINC
◆ Shaker Cherry	F
◆ Sterling Ash	LSA1

Solid

◆ Black	P
◆ Charcoal	S
◆ Designer White	LDW1
◆ Loft	LOFT

Patterned

◆ Handspun Chestnut	LAHC
◆ Handspun Dove	LAHD
◆ Handspun Pearl	LAHP
◆ Handspun Slate	LAHS
◆ Sheer Mesh *	A5
◆ Silver Mesh	B9
◆ Steel Mesh *	A9
◆ Canyon Zephyr *	K9
◆ Desert Zephyr *	K8
◆ Shadow Zephyr *	K1
◆ Gray	G2
◆ Grey Tigris *	L6
◆ White	G1
◆ Whitestone *	K4

L2 LAMINATES

Woodgrain	
◆ Lowell Ash	LLA1
◆ Natural Recon	LNRI
◆ Phantom Ecrú	LPE1
◆ Portico Teak	LPT1
◆ Skyline Walnut	LSW1

EDGE

EDGE

Woodgrain	
◆ Bourbon Cherry	H
◆ Cognac	COGN
◆ Florence Walnut	FW
◆ Harvest	C
◆ Kingswood Walnut	KI
◆ Light Gray	Q
◆ Lowell Ash	DL
◆ Mahogany	N
◆ Mocha	MOCH
◆ Natural Maple	D
◆ Natural Recon	NR
◆ Phantom Ecrú	PE
◆ Pinnacle	PINC
◆ Portico Teak	DP
◆ Shaker Cherry	F
◆ Skyline Walnut	SW
◆ Sterling Ash	SA

Solid

◆ Black	P
◆ Brownstone	EY
◆ Charcoal	S
◆ Designer White	DW
◆ Fossil	EH
◆ Greige	R
◆ Loft	LOFT
◆ Muslin	T
◆ Platinum	K

SCREEN PAINT

PAINT

P1	
◆ Black	P
◆ Brownstone	P7D
◆ Charcoal	S
◆ Designer White	PJW
◆ Fossil	P28
◆ Greige	T5
◆ Light Gray	Q
◆ Loft	LOFT
◆ Muslin	T3
◆ Putty	L
◆ Shadow *	SHDW
◆ Titanium	P8T

P2

◆ Champagne Metallic	T4
◆ Platinum Metallic	T1
◆ Silver	PR6
◆ Solar Black	P8X

P3

◆ Amethyst	P091
◆ Atom	P8S
◆ Blossom	P8K
◆ Bullseye	PJF
◆ Cabernet *	P7T
◆ Cobalt Mica	P090
◆ Conifer *	P8H
◆ Ember	P8P
◆ Ion	P8N
◆ Iris	P8J
◆ Krypton	P8F
◆ Ochre	P093
◆ Regatta	P8M
◆ Sienna	P092
◆ Succulent	P8A

LEG OPTIONS



Rectangle Leg, T Foot



Rectangle Leg, C Foot

CONTROL OPTIONS



Basic Up/Down



Memory Control



Paddle

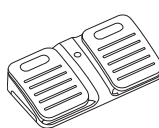

Foot Control



Wireless Dongle*







* Wireless dongle can be used with the AiDesk App.

◆◆◆ For lead time information see page 19.

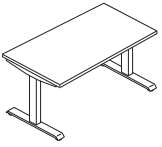
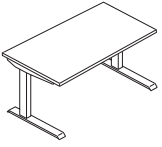
* De-emphasized

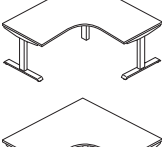

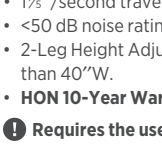
COORDINATE™ Height Adjustable Bases

	DESCRIPTION	MODEL	SHIP WEIGHT	CUBE	LIST PRICE
	Coordinate™ Height Adjustable Base – 2 Stage				
	2-Leg Rectangle T Foot	HHATB2S2LT	66	2.4	\$950
	2-Leg Rectangle C Foot	HHATB2S2LC	66	2.4	\$950
	NOTES: <ul style="list-style-type: none"> • Dual motor two-leg design. Legs raise from 25⁵/₈" to 45³/₄". • Base accommodates any rectangular worksurface between 23"D x 40"W and 30"D x 72"W. • Weight capacity of 250 lbs. (including the weight of the worksurface) distributed evenly. 				
	Coordinate™ Height Adjustable Base – 3 Stage				
	2-Leg Rectangle T Foot	HHATB3S2LT	66	2.4	\$1047
	2-Leg Rectangle C Foot	HHATB3S2LC	66	2.4	\$1047
	NOTES: <ul style="list-style-type: none"> • Dual motor two-leg design. Legs raise from 21⁵/₈" to 47³/₄". • Base accommodates any rectangular worksurface between 23"D x 40"W and 30"D x 72"W. • Weight capacity of 250 lbs. (including the weight of the worksurface) distributed evenly. 				
	Coordinate™ Height Adjustable Base – Max 3 Stage				
	2-Leg Rectangle T Foot	HHATM3S2LT	66	2.4	\$1173
	Coordinate™ Height Adjustable Base – 3 Stage				
	3-Leg Rectangle T Foot	HHATB3S3LT	91	3.6	\$1729
	3-Leg Rectangle C Foot	HHATB3S3LC	91	3.6	\$1729
	NOTES: <ul style="list-style-type: none"> • Tri-motor three-leg design. Legs raise from 21⁵/₈" to 47³/₄". • Base accommodates worksurfaces between 23"D x 40"W x 40"W and 30"D x 72"W x 72"W. Can be used with 48" 120° worksurface models. • Weight capacity of 375 lbs. (including the weight of the worksurface) distributed evenly. ⚠ When using two worksurfaces, a flat bracket is required. Bracket purchased separately — HHN831124, HHN831130 — see page 632. ⚠ Each worksurface 58"W or wider requires the use of an external stiffener; including secondary return worksurface in an "L" 3-leg base application if wider than 58"W. External stiffener purchased separately when not used with a Coordinate™ worksurface. 				

NOTES:

- Control Box: 120V, 4A, 60Hz, 400W.
- 9' grounded power cord.
- 1¹/₂" / second travel speed.
- <50 dB noise rating.
- 2-Leg Height Adjustable Bases can accommodate rectangular worksurfaces down to 24"W. 10500 Series™, Concinnity™, and Voi® all have rectangular worksurfaces shorter than 40"W.
- **HON 10-Year Warranty.**

⚠ Requires the use of an external stiffener (purchased separately) for worksurfaces over 58"W or wider when not used with a Coordinate™ worksurface.

HOW TO SPECIFY

<p>Select Model Number</p> <p>HHATB3S2LT</p>	<p>Select Paint Color</p> <p>See page 116</p> <p>P71</p>	<p>Select Foot</p> <p>X Standard Foot S Slide Glide</p> <p>X</p>	<p>Select Keypad</p> <p>UD Basic Up/Down MEM Memory Preset PDL Paddle FPD Foot Pedal (+ \$175)</p> <p>MEM</p>
---	---	---	--

COORDINATE™

Worksurfaces

OPEN MARKET



Icon Legend on page 19

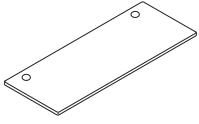

DESCRIPTION	MODEL	SHIP WEIGHT	CUBE	LIST PRICE BY LAMINATE GRADE	
				L1	L2
Rectangle Worksurfaces for Standard C/T Bases, Flat Edge					
40"W x 22"D	HHATW2240CT	40	2.8	\$419	\$434
46"W x 22"D	HHATW2246CT	58	3.1	\$446	\$461
52"W x 22"D	HHATW2252CT	64	3.9	\$473	\$493
58"W x 22"D	HHATW2258CT	70	3.9	\$527	\$547
64"W x 22"D	HHATW2264CT	86	4.3	\$566	\$586
70"W x 22"D	HHATW2270CT	89	4.6	\$583	\$603
76"W x 22"D	HHATW2276CT	91	5.0	\$628	\$653
82"W x 22"D	HHATW2282CT	92	5.4	\$702	\$727
88"W x 22"D	HHATW2288CT	94	5.7	\$744	\$774
94"W x 22"D	HHATW2294CT	95	6.1	\$759	\$789
40"W x 28"D	HHATW2840CT	55	3.4	\$456	\$471
46"W x 28"D	HHATW2846CT	68	3.9	\$481	\$496
52"W x 28"D	HHATW2852CT	80	4.8	\$517	\$537
58"W x 28"D	HHATW2858CT	101	4.8	\$574	\$594
64"W x 28"D	HHATW2864CT	105	5.3	\$612	\$632
70"W x 28"D	HHATW2870CT	105	5.7	\$653	\$673
76"W x 28"D	HHATW2876CT	107	6.1	\$668	\$693
82"W x 28"D	HHATW2882CT	108	6.6	\$736	\$761
88"W x 28"D	HHATW2888CT	110	7.0	\$781	\$811
94"W x 28"D	HHATW2894CT	111	7.5	\$797	\$827
! Must be used as worksurfaces on Coordinate™ Height Adjustable Bases within Panel Systems. These are shorter in width and depth on each side to provide clearance between panels and other worksurfaces.					
42"W x 24"D	HHATW2442CT	52	2.8	\$419	\$434
48"W x 24"D	HHATW2448CT	58	3.1	\$446	\$461
54"W x 24"D	HHATW2454CT	64	3.9	\$473	\$493
60"W x 24"D	HHATW2460CT	70	3.9	\$512	\$532
66"W x 24"D	HHATW2466CT	86	4.3	\$557	\$577
72"W x 24"D	HHATW2472CT	89	4.6	\$571	\$591
78"W x 24"D	HHATW2478CT	96	5.0	\$618	\$643
84"W x 24"D	HHATW2484CT	103	5.4	\$702	\$727
90"W x 24"D	HHATW2490CT	113	5.7	\$744	\$774
96"W x 24"D	HHATW2496CT	121	6.1	\$759	\$789
42"W x 30"D	HHATW3042CT	48	3.4	\$456	\$471
48"W x 30"D	HHATW3048CT	68	3.9	\$481	\$496
54"W x 30"D	HHATW3054CT	80	4.8	\$517	\$537
60"W x 30"D	HHATW3060CT	101	4.8	\$559	\$579
66"W x 30"D	HHATW3066CT	105	5.3	\$604	\$624
72"W x 30"D	HHATW3072CT	105	5.7	\$641	\$661
78"W x 30"D	HHATW3078CT	123	6.1	\$659	\$684
84"W x 30"D	HHATW3084CT	127	6.6	\$736	\$761
90"W x 30"D	HHATW3090CT	145	7.0	\$781	\$811
96"W x 30"D	HHATW3096CT	155	7.5	\$797	\$827

! For use with Coordinate™ Height Adjustable Bases only in Freestanding Applications where the tables/desks are not attached or adjacent to another work surface or systems panel. If used in other than Freestanding Applications, worksurfaces will not provide proper clearance and may cause injury or work surface damage (not covered by warranty).

HOW TO SPECIFY

Select Model Number

Select Laminate

See page 116

Select Edge Color

See page 116

Select Grommet and Color

See page 116

X No Grommet
G1 1 Grommet, Centered
G2 2 Grommets, Offset
(not available on C-leg base)

Select Stiffener Paint

Specify for worksurfaces 58"W or greater

P Black

HHATW2448CT

LSA1

SA

G2P

P

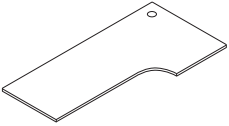

Icon Legend on page 19

DESCRIPTION	MODEL	SHIP WEIGHT	CUBE	L1 LIST PRICE	L2 LIST PRICE	
 <p>Corner Cove Worksurfaces, Left Hand 58" A x 34" B x 22" C x 22" D 58" A x 46" B x 22" C x 22" D 58" A x 46" B x 28" C x 28" D</p> <p>70" A x 34" B x 22" C x 22" D 70" A x 46" B x 22" C x 22" D 70" A x 46" B x 28" C x 28" D</p>	HHATCC583422L	67	6.1	\$673	\$698	
	HHATCC584622L	85	7.4	\$737	\$767	
	HHATCC584628L	99	7.4	\$791	\$821	
	HHATCC703422L	75	6.8	\$736	\$766	
	HHATCC704622L	105	8.8	\$918	\$953	
	HHATCC704628L	112	8.8	\$974	\$1009	
	<p>Corner Cove Worksurfaces, Right Hand 58" A x 34" B x 22" C x 22" D 58" A x 46" B x 22" C x 22" D 58" A x 46" B x 28" C x 28" D</p> <p>70" A x 34" B x 22" C x 22" D 70" A x 46" B x 22" C x 22" D 70" A x 46" B x 28" C x 28" D</p>	HHATCC583422R	67	6.1	\$673	\$698
		HHATCC584622R	85	7.4	\$737	\$767
		HHATCC584628R	99	7.4	\$791	\$821
HHATCC703422R		75	6.8	\$736	\$766	
HHATCC704622R		105	8.8	\$918	\$953	
HHATCC704628R		112	8.8	\$974	\$1009	

NOTES: Use the 3-Leg Coordinate™ Base when specifying Coordinate™ Corner Cove Worksurfaces.

! Must be used as worksurfaces on Coordinate™ Height Adjustable Bases within Panel Systems. These are shorter in width and depth on each side to provide clearance between panels and other worksurfaces.

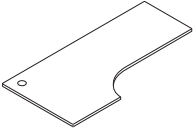
 <p>Corner Cove Worksurfaces, Left Hand 60" A x 36" B x 24" C x 24" D 60" A x 48" B x 24" C x 24" D 60" A x 48" B x 30" C x 30" D</p> <p>72" A x 36" B x 24" C x 24" D 72" A x 48" B x 24" C x 24" D 72" A x 48" B x 30" C x 30" D</p>	HHATCC603624L	67	6.1	\$673	\$698	
	HHATCC604824L	85	7.4	\$737	\$767	
	HHATCC604830L	99	7.4	\$791	\$821	
	HHATCC723624L	75	6.8	\$736	\$766	
	HHATCC724824L	105	8.8	\$918	\$953	
	HHATCC724830L	115	8.8	\$974	\$1009	
	<p>Corner Cove Worksurfaces, Right Hand 60" A x 36" B x 24" C x 24" D 60" A x 48" B x 24" C x 24" D 60" A x 48" B x 30" C x 30" D</p> <p>72" A x 36" B x 24" C x 24" D 72" A x 48" B x 24" C x 24" D 72" A x 48" B x 30" C x 30" D</p>	HHATCC603624R	67	6.1	\$673	\$698
		HHATCC604824R	85	7.4	\$737	\$767
		HHATCC604830R	99	7.4	\$791	\$821
HHATCC723624R		75	6.8	\$736	\$766	
HHATCC724824R		96	8.8	\$918	\$953	
HHATCC724830R		112	8.8	\$974	\$1009	

NOTES: Use the 3-leg Coordinate™ Base when specifying Coordinate™ Corner Cove Worksurfaces.

! For use with Coordinate™ Height Adjustable Bases only in Freestanding Applications where the tables/desks are not attached or adjacent to another worksurface or systems panel. If used in other than Freestanding Applications, worksurfaces will not provide proper clearance and may cause injury or worksurface damage (not covered by warranty).

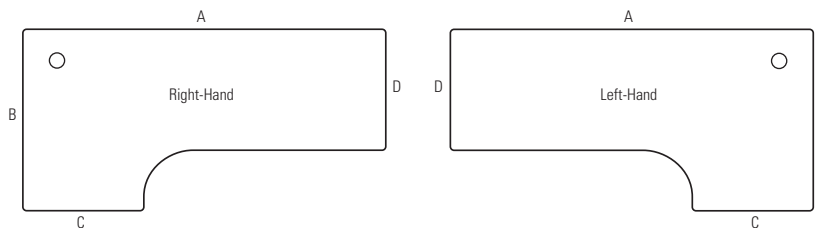

HOW TO SPECIFY

<p>Select Model Number</p> <p>HHATCC584622L</p>	<p>Select Laminate</p> <p>See page 116</p> <p>LSA1</p>	<p>Select Edge Color</p> <p>See page 116</p> <p>SA</p>	<p>Select Grommet and Color</p> <p>See page 116</p> <p>X No Grommet G1 1 Grommet, Corner G2 2 Grommets, Offset (not available on C-leg base)</p> <p>G2P</p>	<p>Select Stiffener Paint</p> <p>P Black</p> <p>P</p>
--	---	---	--	--

COORDINATE™ Worksurfaces

OPEN MARKET

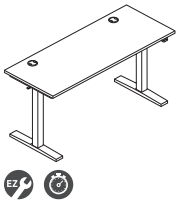

Icon Legend on page 19

**DESCRIPTION****MODEL****SHIP WEIGHT****CUBE****LIST PRICE**

Coordinate™ Easy to Assemble 2-Leg Height Adjustable Base – 2 Stage
24”D Feet

HHABETA2S2L

77

4.0

\$728**NOTES:**

- Legs raise from 26¼” to 43½”, excluding worksurface.
- Base telescopes to accommodate rectangular worksurfaces between 24”D x 48”W and 30”D x 60”W.
- Supports weight capacity of 180 lbs.
- Control Box: 100-240V, 3.6A, 50/60Hz, 400W.
- 9’ grounded power cord.
- 1½”/second travel speed.
- **HON 5-Year Limited Warranty.**

! Available in SVR Silver finish with Basic Up/Down control only.

SPECIFYING EXAMPLE: HHABETA2S2L.SVR.X.UD

DESCRIPTION**MODEL****SHIP WEIGHT****CUBE****L1
LIST PRICE****L2
LIST PRICE**

Rectangle Worksurfaces for Easy to Assemble Bases, Flat Edge

46”W x 22”D

HHATW2246EA

58

3.1

\$446**\$461**

52”W x 22”D

HHATW2252EA

64

3.9

\$473**\$493**

58”W x 22”D

HHATW2258EA

70

3.9

\$526**\$546**

46”W x 28”D

HHATW2846EA

68

3.9

\$481**\$496**

52”W x 28”D

HHATW2852EA

80

4.8

\$517**\$537**

58”W x 28”D

HHATW2858EA

101

4.8

\$573**\$593**

! Must be used as worksurfaces on Easy to Assemble Coordinate™ Height Adjustable Bases within Panel Systems. These are shorter in width and depth on each side to provide clearance between panels and other worksurfaces.

! For use with Coordinate™ Easy to Assemble Height Adjustable Bases only. Not compatible with standard Coordinate™ 2-leg or 3-leg Height Adjustable Bases.

48”W x 24”D

HHATW2448EA

58

3.1

\$446**\$461**

54”W x 24”D

HHATW2454EA

64

3.9

\$473**\$493**

60”W x 24”D

HHATW2460EA

70

3.9

\$526**\$546**

48”W x 30”D

HHATW3048EA

68

3.9

\$481**\$496**

54”W x 30”D

HHATW3054EA

80

4.8

\$517**\$537**

60”W x 30”D

HHATW3060EA

101

4.8

\$573**\$593**

! For use with Easy to Assemble Coordinate™ Height Adjustable Bases only in Freestanding Applications where the tables/desks are not attached or adjacent to another worksurface or systems panel. If used in other than Freestanding Applications, worksurfaces will not provide proper clearance and may cause injury or worksurface damage (not covered by warranty).

! For use with Coordinate™ Easy to Assemble Height Adjustable Bases only. Not compatible with standard Coordinate™ 2-leg or 3-leg Height Adjustable Bases.

HOW TO SPECIFY

Select
Model Number

HHATW2448EA

Select
Laminate

See page 116

LSA1

Select
Edge Color

See page 116

SA

Select
Grommet and Color

See page 116

- X** No Grommet
- G1** 1 Grommet, Corner
- G2** 2 Grommets, Offset

G2P

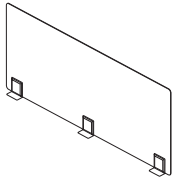

DESCRIPTION	MODEL	SHIP WEIGHT	CUBE	LIST PRICE BY PAINT GRADE		
				P1	P2	P3
Above Screens						
20"H x 45½"W, for 48"W Surfaces	HMTLSCRN2048	36.4	5.5	\$684	\$704	\$724
20"H x 51½"W, for 54"W Surfaces	HMTLSCRN2054	39.7	6.1	\$718	\$738	\$758
20"H x 57½"W, for 60"W Surfaces	HMTLSCRN2060	43.1	6.7	\$755	\$775	\$795
20"H x 63½"W, for 66"W Surfaces	HMTLSCRN2066	46.4	7.3	\$792	\$812	\$832
25"H x 45½"W, for 48"W Surfaces	HMTLSCRN2548	42.8	6.7	\$752	\$772	\$792
25"H x 51½"W, for 54"W Surfaces	HMTLSCRN2554	46.9	7.4	\$790	\$810	\$830
25"H x 57½"W, for 60"W Surfaces	HMTLSCRN2560	51.1	8.2	\$829	\$849	\$869
25"H x 63½"W, for 66"W Surfaces	HMTLSCRN2566	55.3	9.0	\$871	\$891	\$911

NOTES:

- Above screens are single-piece steel construction.
- Screens mount by using double stick tape, which provides the ability to mount to any surface.

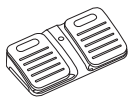

DESCRIPTION	MODEL	SHIP WEIGHT	CUBE	LIST PRICE
Foot Control Pedal	HFTPDL	5	0.1	\$188
NOTES: Provides hands-free method for height adjustment. No specification needed. Pedal can be ordered with table or to retrofit on a current table.				
Height Adjustable Base Wireless Module	HHABBT	1 Ⓞ	0.1	\$133
NOTES: Allows users to control their base by pairing via the AiDesk App (compatible with both iOS and Android phones).				

NOTES:

- Provides hands-free method for height adjustment.
- No specification needed.
- Pedal can be ordered with table or to retrofit on a current table.

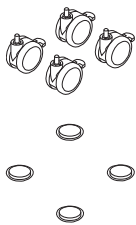

DESCRIPTION	MODEL	SHIP WEIGHT	CUBE	LIST PRICE
Caster 4-Pack	HHABCSTRPK	1 Ⓞ	0.1	\$80
ⓘ Field installable. Not available on model HHABETA2S2L. No specification needed.				
Slide Glide 4-Pack	HHABGLIDE	1 Ⓞ	0.1	\$64
ⓘ Field installable. When placed under base, allows table to be pushed/pulled to move. No specification needed.				

HOW TO SPECIFY

<p>Select Model Number</p> <p>H M T L S C R N 2 0 5 4 .</p>	<p>Select Frame Paint</p> <p>See page 116</p> <p>P 8 T .</p>	<p>Select Bracket Paint</p> <p>See page 116</p> <p>P 8 T</p>
--	---	---

COORDINATE™ Accessories

GSA SIN AS NOTED

ABI

Icon Legend on page 19

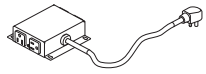

SIN 33721

**DESCRIPTION****Under Worksurface Power Module – 4 Outlets, 10' Cord**

- Includes 10' cord with three-prong plug.
- Fits in cable management troughs. See page 613.
- 4 outlets on side create easy access.

NOTES: Power Modules will also work with standing-height applications for 10500 Series™ and Voi® desks. For additional information see the Workplace Tools section in the 2021 Shared Spaces Pricer.

- ! Available in black finish only, no specification needed.

MODEL**HPWRMOD2****SHIP WEIGHT**

1.5

CUBE

0.2

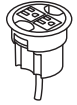
LIST PRICE**\$441**

SIN 33721T

**3" Round Power Grommet – 2 Outlets, 10' Cord**

- Includes 10' cord with three-prong plug.
- Fits in 3" round grommet holes.
- Two grounded AC power outlets.
- Field installed with Plug-and-play ease.

- ! Available in black finish only, no specification needed.

HGRMTAC2

1.5

0.2

\$159

SIN 33721T

**Power/USB Hub, 3" Grommet Mount**

- One grounded AC power outlet with 2 USB ports.
- UL Listed.

NOTES: For additional information see the Workplace Tools section in the 2021 Shared Spaces Pricer.

- ! Available in black only (no color designation so use .X – Specify: HGRMTUSB2.X).

HGRMTUSB2

1.3 Ⓢ

0.2

\$250**Wire Managers for Height Adjustable
Trough to Floor****HMPHATFWML**

2.0

0.3

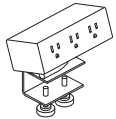
\$269**OPEN MARKET**

Model HPWRMOD3WC shown

SIN 33721

Dean Power Modules with Worksurface Clamp

- 3 Receptacles
- 2 Receptacles, 2 USB
- 2 Receptacles, 2 USB with Qi Wireless Charging Top
- 6' power cord with standard three-prong plug.
- Worksurface clamp models work on any top with a 4" overhang.
- UL Listed.

HPWRMOD3WC Ⓢ

2.3 Ⓢ

0.2

\$342**HPWRMOD2WC** Ⓢ

2.3 Ⓢ

0.2

\$546**HPWRMOD4WC**

2.3 Ⓢ

0.2

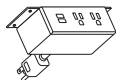
\$738

Model HPWRMOD2UWM shown

SIN 33721

Dean Power Modules with Under-Worksurface Mounting Bracket

- 3 Receptacles
- 2 Receptacles, 2 USB
- 6' power cord with standard three-prong plug.
- Under-worksurface mounting bracket models work with any top that has a 5" x 5" square clearance.
- UL Listed.

HPWRMOD3UWM

2.3 Ⓢ

0.2

\$342**HPWRMOD2UWM**

2.3 Ⓢ

0.2

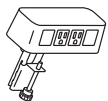
\$546

SIN 33721

**Power & Data Center**

- 2 Receptacles 2 Data Accessory
- Standard with two receptacles and openings for two data ports.
- 6' power cord with standard three-prong plug.
- Fits on any worksurface with a 4" overhang.
- UL Listed.

NOTES: For additional information see the Workplace Tools section in the 2021 Shared Spaces Pricer.

- ! Color finish coordinates with HON's Loft. Specify LOFT when ordering. Example: HCOMDOME2.LOFT.

HCOMDOME2

2.5 Ⓢ

0.2

\$327**HOW TO SPECIFY**

Select
Model Number

H P W R M O D 2



	DESCRIPTION	MODEL	SHIP WEIGHT	CUBE	L1 LIST PRICE	L2 LIST PRICE
	Concinnity™ Rectangle Worksurfaces					
	48"W x 24"D	HNLRC2448	40	3.1	\$302	\$317
	60"W x 24"D	HNLRC2460	50	3.9	\$358	\$378
	66"W x 24"D	HNLRC2466	55	4.2	\$387	\$407
	72"W x 24"D	HNLRC2472	60	4.6	\$402	\$422
	48"W x 30"D	HNLRC3048	50	3.9	\$330	\$345
	60"W x 30"D	HNLRC3060	62	4.7	\$404	\$424
	66"W x 30"D	HNLRC3066	69	5.2	\$433	\$453
	72"W x 30"D	HNLRC3072	75	5.6	\$470	\$490
		10500 Series™ Rectangle Worksurfaces				
48"W x 24"D		H105R2448	44	3.4	\$280	\$295
60"W x 24"D		H105R2460	55	4.2	\$330	\$350
66"W x 24"D		H105R2466	61	4.9	\$351	\$371
72"W x 24"D		H105R2472	66	4.9	\$363	\$383
48"W x 30"D		H105R3048	55	4.1	\$304	\$319
60"W x 30"D		H105R3060	69	5.2	\$370	\$390
66"W x 30"D		H105R3066	76	6.1	\$397	\$417
72"W x 30"D		H105R3072	83	6.1	\$427	\$447

NOTES:

- ❗ For use with Coordinate™ Height Adjustable Bases only in freestanding applications, which are applications where the tables/desks are not attached or adjacent to another unit, table/desk, or systems panel. The widths are true to stated dimensions. If used with Panel Systems or other than in freestanding applications, worksurfaces will not provide proper clearance between panels or other worksurfaces, and may cause injury or worksurface damage (not covered by warranty).
- ❗ Coordinate™ Height Adjustable Bases are not compatible with 36"D rectangular worksurfaces.
- ❗ Coordinate™ Height Adjustable Bases requires the use of an external stiffener (purchased separately) for worksurfaces over 58"W or wider when not used with a Coordinate™ worksurface.

HOW TO SPECIFY

<p>Select Model Number</p>	<p>Select Worksurface Laminate and Edge Color</p> <p><i>For Concinnity™ Worksurfaces, see page 29</i> <i>For 10500 Series™ Worksurfaces, see page 266</i></p>	<p>Select Worksurface Grommet Finish</p> <p><i>Specify for Concinnity™ Worksurfaces only</i></p> <p>P Black TI Platinum X No Grommet</p>	<p>Select Worksurface Color</p> <p><i>For Concinnity™ Worksurfaces, see page 29</i></p>
<p>H N L R C 2 4 4 8</p> <p>H 1 0 5 R 2 4 4 8</p>	<p>B H</p> <p>N N</p>	<p>P</p>	<p>H</p>

SYSTEMS WORKSURFACES

120 Degree Corner

GSA SIN 33721



Icon Legend on page 19

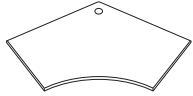

W=panel width
D=worksurface depth

DESCRIPTION	MODEL	SHIP WEIGHT	CUBE	L1 LIST PRICE	L2 LIST PRICE
Around® and Accelerate® 120 Degree Corner Worksurfaces with Curved User Edge					
42"W x 24"D	HBWCT4224P	96	9.2	\$917	\$932
48"W x 24"D	HBWCT4824P	107	9.2	\$1063	\$1078
42"W x 30"D	HBWCT4230P	102	11.4	\$1205	\$1220
48"W x 30"D	HBWCT4830P	112	11.4	\$1282	\$1297

• One small work surface bracket standard with each work surface.

❗ Corner work surfaces must match exactly the panel behind them, i.e.: a 42" panel must be used on the back two sides of model HBWCT4224P.

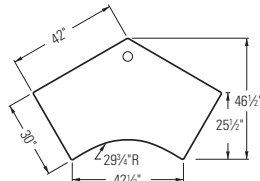

HBWCT4230P

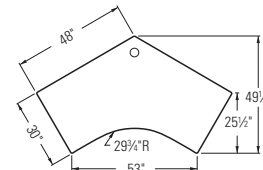

HBWCT4830P

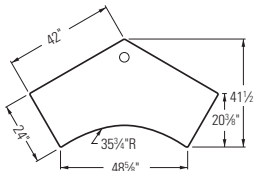

HBWCT4224P

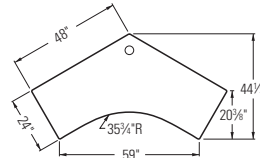

HBWCT4824P

NOTES:

- Worksurfaces are constructed of laminate on 1/8" solid core high-performance particleboard.
- Add suffix **"N"** to Model Number for worksurfaces with no grommets. No upcharge.
- Cannot use keyboard tray or pedestal under 120 degree corner work surface.
- Refer to Worksurface Supports, pages 630-634.
- If used at an end of run, full end panel needs to be ordered — see page 630.

❗ Coordinate™ Height Adjustable Bases requires the use of an external stiffener (purchased separately) for worksurfaces over 58"W or wider when not used with a Coordinate™ work surface.

HOW TO SPECIFY**Select Model Number**

No Grommet option: Add **"N"** suffix (no upcharge)

HBWCT4224P .

HBWCT4224PN .

Select Laminate

See page 481

A5 .

A5 .

Select Edge Color

See page 481

K .

K .

Select Grommet Color

See page 481

T1



COORDINATE™ Shared Components

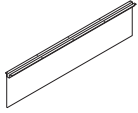

DESCRIPTION	MODEL	SHIP WEIGHT	CUBE	L1	L2
				LIST PRICE	UPCHARGE
Laminate Floating Modesty Panel					
30"W x 14"H	HLSL3014L	10	0.8	\$191	\$10
36"W x 14"H	HLSL3614L	12	0.8	\$202	\$10
42"W x 14"H	HLSL4214L	14	0.8	\$214	\$10
48"W x 14"H	HLSL4814L	16	1.1	\$236	\$12
54"W x 14"H	HLSL5414L	18	1.1	\$258	\$12
60"W x 14"H	HLSL6014L	20	1.1	\$277	\$12

NOTES: The attachment bracket and modesty panel are packaged separately.
Specify: Model.Laminate.Paint

SPECIFYING EXAMPLE: HLSL3014L.N.P (Black is the only paint option for this model)

- ! When specifying the 54"W or 60"W Laminate Floating Modesty Panel, it is not necessary to specify an external channel.
- ! 30"W and 36"W screens attach with L-brackets, not the external channel.

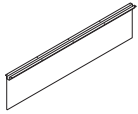

DESCRIPTION	MODEL	SHIP WEIGHT	CUBE	LIST PRICE
Mixed Material Floating Modesty Panel				
30"W x 14"H	HLSL3014MM	8	2.0	\$755
36"W x 14"H	HLSL3614MM	8	2.0	\$810
42"W x 14"H	HLSL4214MM	9	2.3	\$906
48"W x 14"H	HLSL4814MM	11	2.6	\$1002
54"W x 14"H	HLSL5414MM	13	3.3	\$1089
60"W x 14"H	HLSL6014MM	13	3.3	\$1243

NOTES: The attachment bracket and modesty panel are packaged separately.
Specify: Model.Mixed Material.Paint

SPECIFYING EXAMPLE: HLSL3014MM.FT01.P (Frosted Translucent mixed material and Black paint are the only options for this model)

- ! When specifying the 54"W or 60"W Mixed Material Floating Modesty Panel, it is not necessary to specify an external channel.

FLOATING MODESTY PANELS – MODEL SELECTION GUIDE				
Rectangle Worksurface Width				
72 in	66 in	60 in	48 in	42 in
HLSL6014	HLSL5414	HLSL4814	HLSL3614	HLSL3014

NOTES:

- When using a floating modesty panel under the worksurface, the depth clearance for center drawers and keyboard platforms decreases by 8".

HOW TO SPECIFY

<p>Select Model Number</p> <p>HLSL3014MM</p>	<p>Select Mixed Material</p> <p>FT01 Frosted Translucent</p> <p>FT01</p>
---	--

COORDINATE™ Accessories

OPEN MARKET



Icon Legend on page 19

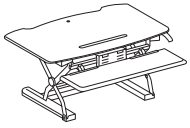

DESCRIPTION

MODEL

SHIP WEIGHT

CUBE

LIST PRICE

Portable Desktop Riser
31"D x 5"-16½"H x 35"W

HBXRISER

54.0

4.1

\$657

NOTES: Available in Black (BLK) or White (WHT) finish. Desktop riser dimensions (without keyboard tray): 22"D x 5"-16½"H x 35"W. Keyboard tray dimensions: 9"D x 30"W. Max loading capacity is 33 lbs for the desktop riser surface and 4 lbs for the keyboard tray. Easily transition from seated to standing positions throughout the workday. Sits atop an existing desk to create sit-to-stand functionality by raising the computer. Includes keyboard tray and surface for computer monitors. **HON 5-Year Limited Warranty.**

⚠ Not intended for use on mobile workstations.

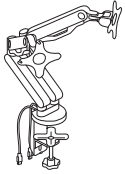

Dual Monitor Arm with 2 USB Ports

HBDMAUSB

41.9

2.6

\$410

NOTES: Easy adjustment. Height adjusts to 17" tall. Monitor tilt and swivel capability. Enclosed cable management. Grommet or desktop mounting. Clean appearance. In some applications the Monitor Arms may extend 12 or more inches into the worksurface. For additional information see the Workplace Tools section in the 2021 Shared Spaces Pricer. **HON 5-Year Limited Warranty.**

⚠ No specification needed.

HOW TO SPECIFY

Select Model Number

Select Finish

BLK Black
WHT White

HBXRISER.

BLK

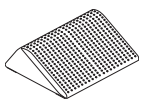

Icon Legend on page 19

	DESCRIPTION	MODEL	SHIP WEIGHT	CUBE	LIST PRICE
	<p>Footrest — Anti-Slip Cover 13 3/4" D x 5 1/2" H x 16" W</p> <p>ⓘ Available in Black (T) finish ONLY. Recommended weight capacity not to exceed 250 pounds. HON 5-Year Limited Warranty. SPECIFYING EXAMPLE: HVL991.T</p>	<p>HVL991</p>	<p>7 ⓘ</p>	<p>0.9</p>	<p>\$89</p>

HOW TO SPECIFY

<p>Select Model Number</p> <p>H V L 9 9 1 .</p>	<p>Select Finish</p> <p>T Black</p> <p>T</p>
---	--

COZE™

Want to see more? Scan here
to check out hon.com.



Coze™ Table Desk shown with
Cliq™ Seating and Fuse™ Storage.

COZE™



There's no place like home, especially when you're working. Stay as productive in your own digs as you are in the office with Coze table desks. Designed to keep things nice and easy, Coze features simple and quick assembly and optional fast shipping so you can get down to business in no time. Not too big and not too small, Coze comes in three sizes, so it's just right for whatever space you're working in. With optional built-in storage to help you stay organized and a clean, light-scale look in a variety of laminate and finish colors, Coze feels right at home no matter your personal style.



FEATURES

- Enjoy a higher quality desk at a lower price.
- Simple one-tool installation with video takes only minutes.
- Light scale design and small footprint fit any room in the house.
- Optional integrated storage lets you decide how to best stay organized.
- Available in a variety of laminate and paint colors so you can get exactly what you need in the look you want.
- Leveling glides adjust for uneven floors.
- Durable laminate surfaces resist scratches, spills, and stains.

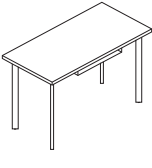

	DESCRIPTION	MODEL	SHIP WEIGHT	CUBE	LIST PRICE
	Table Desk with Post Legs				
	54"W x 24"D	HLCRPL5424WFH	71	5.7	\$570
	48"W x 24"D	HLCRPL4824WFH	66	5.4	\$543
	42"W x 24"D	HLCRPL4224WFH	61	5.2	\$516
	54"W x 30"D	HLCRPL5430WFH	81	6.3	\$650
	48"W x 30"D	HLCRPL4830WFH	76	5.9	\$628
	NOTES: Product ships with desk top and 4 legs in 2 cartons.				
	Table Desk with Post Legs and U-Storage				
	54"W x 24"D	HLCRPL5424WFH-US	78	5.7	\$630
	48"W x 24"D	HLCRPL4824WFH-US	73	5.4	\$603
	42"W x 24"D	HLCRPL4224WFH-US	68	5.2	\$576
	54"W x 30"D	HLCRPL5430WFH-US	88	6.3	\$710
	48"W x 30"D	HLCRPL4830WFH-US	83	5.9	\$688
	NOTES: Product ships with desk top, 4 legs, and U-storage in 2 cartons.				
	Table Desk with Post Legs and Pencil Storage				
	54"W x 24"D	HLCRPL5424WFH-PS	77	5.7	\$630
	48"W x 24"D	HLCRPL4824WFH-PS	72	5.4	\$603
	42"W x 24"D	HLCRPL4224WFH-PS	67	5.2	\$576
	54"W x 30"D	HLCRPL5430WFH-PS	87	6.3	\$710
	48"W x 30"D	HLCRPL4830WFH-PS	82	5.9	\$688
	NOTES: Product ships with desk top, 4 legs, and pencil storage in 2 cartons.				

NOTES:

- **HON 5-Year Limited Warranty.**

HOW TO SPECIFY

<p>Select Model Number</p>	<p>Select Laminate and Edge</p> <p>PP Black LDW1DW Designer White LFW1FW Florence Walnut LNR1NR Natural Recon</p>	<p>Select Paint Color</p> <p>P71 Black PJW Designer White PR6 Silver</p>
<p>H L C R P L 4 8 2 4 W F H - U S .</p>	<p>L F W 1 F W .</p>	<p>P R 6</p>

COZE™ Table Desks

OPEN MARKET



Icon Legend on page 19

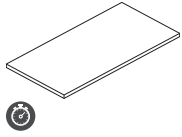

DESCRIPTION

Coze™ Rectangle Worksurface

42"W x 24"D
48"W x 24"D
54"W x 24"D

48"W x 30"D
54"W x 30"D

NOTES: Compatible with Coordinate™ Height Adjustable Base model HHABETA2S2L. Base telescopes to accommodate worksurfaces between 24"D x 48"W and 30"D x 60"W. Worksurfaces include pre-drilled pilot holes. Worksurfaces come with threaded inserts for ease of installation with Post Legs models HLCPL29WFH, HLCPL29WFH-US, and HLCPL29WFH-PS.

MODEL

SHIP WEIGHT

CUBE

LIST PRICE

HLCR2442WFH	35	2.1	\$269
HLCR2448WFH	40	2.4	\$296
HLCR2454WFH	45	2.7	\$323
HLCR3048WFH	50	2.9	\$381
HLCR3054WFH	55	3.3	\$403

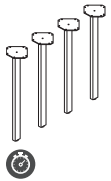

Post Legs, Pack of 4

HLCPL29WFH

26

3.0

\$247

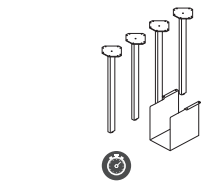

Post Legs, Pack of 4 with U-Storage

HLCPL29WFH-US

33

3.0

\$307

NOTES: Metal storage ships same color as legs.

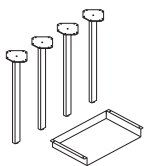

Post Legs, Pack of 4 with Pencil Storage

HLCPL29WFH-PS

32

3.0

\$307

NOTES: Metal storage ships same color as legs.

! Hardware included is specific to the attachment of the following models: HLCR2442WFH, HLCR2448WFH, HLCR2454WFH.

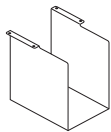

U-Storage

HLCWFH-US

9

1.2

\$151

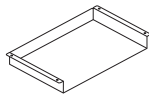

Pencil Storage

HLCWFH-PS

8

1.2

\$151

! Hardware included is specific to the attachment of the following models: HLCR2442WFH, HLCR2448WFH, HLCR2454WFH.

NOTES:

- HON 5-Year Limited Warranty.

HOW TO SPECIFY

Select Model Number

H L C R 2 4 4 8 W F H .

Select Laminate and Edge

- PP** Black
- LDW1DW** Designer White
- LFW1FW** Florence Walnut
- LNR1NR** Natural Recon

L F W 1 F W

Select Model Number

H L C P L 2 9 W F H - P S .

Select Paint Color

- P71** Black
- PJW** Designer White
- PR6** Silver

P R 6

MOD

Want to see more? Scan here
to check out hon.com.



Mod Desks shown with Coordinate™ Height Adjustable Tables and Solve® Seating.

MOD

There is always beauty in simplicity, but with the Mod desk collection you'll also find variety and value. The contemporary design feels perfectly at home in either a private office or an open floor plan, giving it the versatility that allows you to unify your space. Choose from a selection of finishes that express your modern sense of style, or dress it up with a classic look. Whether setting up a single desk, shared workstations, or full private office suite with storage, this collection is totally adaptable. Totally productive. Totally Mod.



FEATURES

- The Mod collection allows you to create a premium workspace at an affordable price.
- Straightforward styling blends with any office design with the option for metal A- and U-legs.
- Available in 6 laminate finishes.
- Storage options that let you create spaces that work the way you do.
- All components feature a scratch- and stain-resistant laminate for unbeatable beauty and durability.

MOD ORDERING INFORMATION

LAMINATES

L1 LAMINATES CODES

Woodgrain

- ◆ Java Oak LJA1
- ◆ Russet Cherry LRC1
- ◆ Sepia Walnut LSE1
- ◆ Slate Teak LSL1
- ◆ Traditional Mahogany LTM1

Solid

- ◆ Simply White* LPW1

METAL A-LEGS, U-LEGS, AND SUPPORT LEGS

PAINTS CODES

- ◆ Black BLKP
- ◆ Silver SLVR

FABRIC CUSHIONS & TACKBOARDS

FABRIC CODES

- ◆ Cool Neutral CN02
- ◆ Warm Neutral WM01

◆◆◆ For lead time information see page 19.

MOD LAMINATE GRAIN DIRECTION

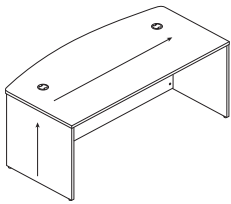

Bow Top Desk Shell

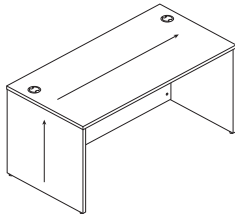

Rectangle Desk Shell

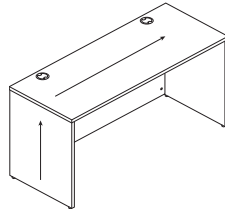

Rectangle Credenza Shell

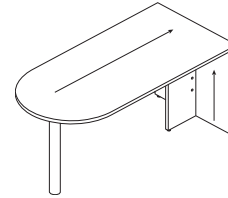

Peninsula

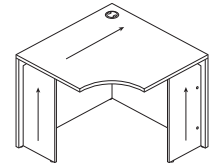

Corner Shell

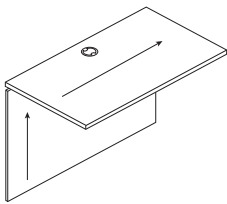

Bridge

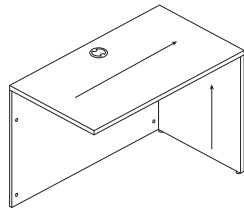

Return

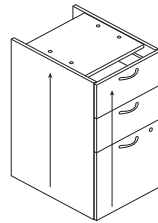

Pedestals

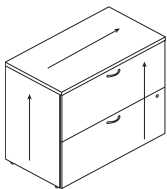
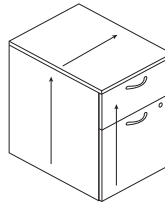

Laterals

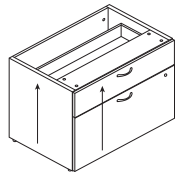

Low Credenzas

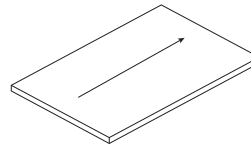
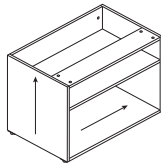

Low Credenza Top



Wardrobe

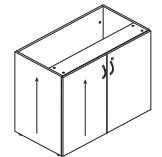

Storage Cabinet

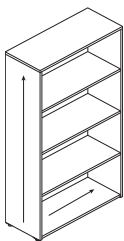

Bookcase

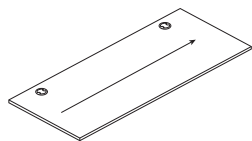

Rectangle Worksurface

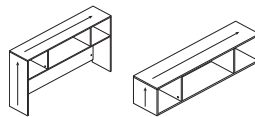

Overhead Hutch, Storage, and Laminate Doors

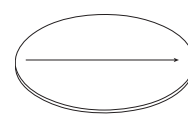

Conference Table Tops and Bases

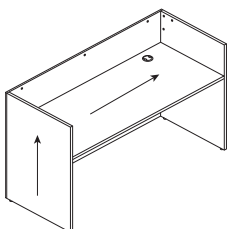
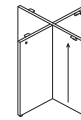

Reception Desk and Transaction Top

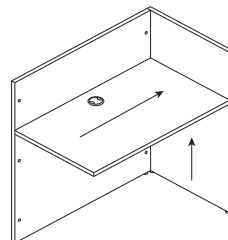
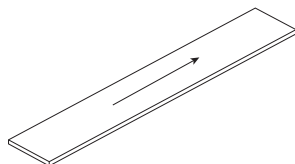

Reception Return Shell

MOD Typicals

Components used are listed on pages 140-148. Order components individually. Other configurations are possible, including various sizes of some components.

QTY	DESCRIPTION	MODEL	LIST PRICE	PRICE EXTENSION
1	Desk Shell 66"W x 30"D	HLPLDS6630	\$300	\$300
1	Credenza Shell 66"W x 24"D	HLPLCS6624	\$279	\$279
1	Bridge 42"W x 24"D	HLPLB4224	\$171	\$171
1	Pedestal - B/B/F 15"W x 20"D x 28"H	HLPLPSBBF	\$334	\$334
1	Pedestal - F/F 15"W x 20"D x 28"H	HLPLPSFF	\$334	\$334
1	Hutch without Doors 66"W x 14"D x 39 3/4"H	HLPLDH66	\$324	\$324
2	Laminate Hutch Doors Pack of 2 Doors	HLPLDR66LM	\$40	\$80
TOTAL:				\$1,822

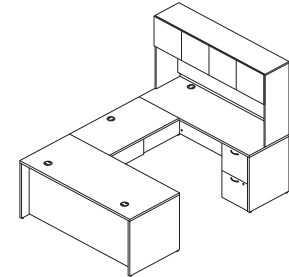

U-STATION (NON-HANDED)

66"W x 96"D

QTY	DESCRIPTION	MODEL	LIST PRICE	PRICE EXTENSION
1	Peninsula 66"W x 30"D	HLPLPEN6630E	\$310	\$310
1	Credenza Shell 66"W x 24"D	HLPLCS6624	\$279	\$279
1	Bridge 42"W x 24"D	HLPLB4224	\$171	\$171
1	Pedestal - B/B/F 15"W x 20"D x 28"H	HLPLPSBBF	\$334	\$334
1	Hutch without Doors 66"W x 14"D x 39 3/4"H	HLPLDH66	\$324	\$324
1	Laminate Hutch Doors Pack of 2 Doors	HLPLDR66LM	\$40	\$40
TOTAL:				\$1,458

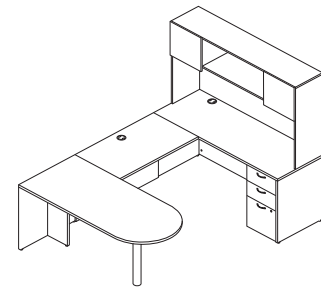

U-STATION WITH PENINSULA (NON-HANDED)

66"W x 96"D

QTY	DESCRIPTION	MODEL	LIST PRICE	PRICE EXTENSION
1	Desk Shell 66"W x 30"D	HLPLDS6630	\$300	\$300
1	Return Shell 42"W x 24"D	HLPLRS4224	\$204	\$204
1	Pedestal - B/B/F 15"W x 20"D x 28"H	HLPLPSBBF	\$334	\$334
1	Pedestal - F/F 15"W x 20"D x 28"H	HLPLPSFF	\$334	\$334
1	Hutch without Doors 66"W x 14"D x 39 3/4"H	HLPLDH66	\$324	\$324
2	Glass Hutch Doors Pack of 2 Doors	HLPLDR66GS	\$141	\$282
TOTAL:				\$1,778

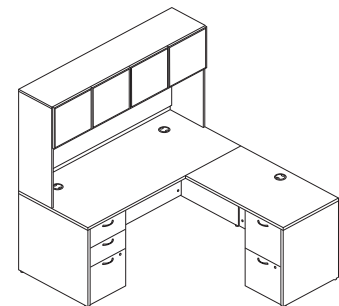

L-STATION (NON-HANDED)

66"W x 72"D

Components used are listed on pages 140-148. Order components individually. Other configurations are possible, including various sizes of some components.

QTY	DESCRIPTION	MODEL	LIST PRICE	PRICE EXTENSION
1	Bow Front Desk Shell 72"W x 36"D	HLPLDS7236B	\$379	\$379
1	Credenza Shell 72"W x 24"D	HLPLCS7224	\$290	\$290
1	Pedestal - B/B/F 15"W x 20"D x 28"H	HLPLPSBBF	\$334	\$334
1	Pedestal - F/F 15"W x 20"D x 28"H	HLPLPSFF	\$334	\$334
1	Hutch without Doors 66"W x 14"D x 39 ³ / ₄ "H	HLPLDH66	\$324	\$324
2	Laminate Hutch Doors Pack of 2 Doors	HLPLDR66LM	\$40	\$80
TOTAL:			\$1,741	

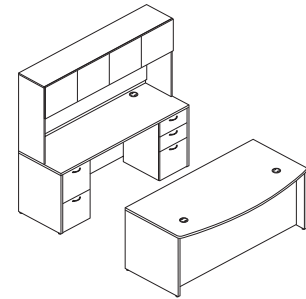

OFFICE SUITE
72"W x 96"D

QTY	DESCRIPTION	MODEL	LIST PRICE	PRICE EXTENSION
1	Reception Desk Shell 72"W x 30"D	HLPLRCPNDS7230	\$436	\$436
1	Reception Return Shell 42"W x 25"D	HLPLRCPNRS4225	\$263	\$263
1	Reception Laminate Transaction Top 72"W x 12"D	HLPLRCPNTPLM	\$93	\$93
1	Pedestal - B/B/F 15"W x 20"D x 28"H	HLPLPSBBF	\$334	\$334
TOTAL:			\$1,126	

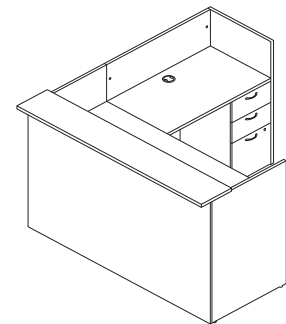

**RECEPTION STATION
(NON-HANDED)**
72"W x 72"D

QTY	DESCRIPTION	MODEL	LIST PRICE	PRICE EXTENSION
1	Rectangle Conference Table Top 48"W x 120"L, 2-Piece	HLPLTBL4812ORCT	\$706	\$706
1	Conference Table Base For 120" Table Tops	HLPLTBL120BASE	\$114	\$114
2	Wardrobe 24"W x 24"D x 65"H	HLPLW2424	\$854	\$1,708
2	Low Open Storage Credenza 36"W x 20"D x 21"H	HLPLCL3620S	\$261	\$522
1	Low Credenza Top 72"W x 20"D	HLPLCL7220TOP	\$137	\$137
TOTAL:			\$3,187	

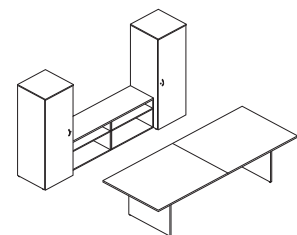

CONFERENCE ROOM
144"W x 180"D

MOD Typicals

Components used are listed on pages 140-148. Order components individually. Other configurations are possible, including various sizes of some components.

QTY	DESCRIPTION	MODEL	LIST PRICE	PRICE EXTENSION
1	Rectangle Worksurface 66"W x 30"D	HLPLRW6630	\$192	\$192
1	Rectangle Worksurface 48"W x 24"D	HLPLRW4824	\$146	\$146
1	Flat Bracket 24"D	HLPLFB24	\$49	\$49
2	U-Leg Support 30"W	HLPLLEG30U	\$155	\$310
1	U-Leg Support 24"W	HLPLLEG24U	\$146	\$146
1	External Stiffener For 66"W Worksurfaces	HLPLXS66	\$76	\$76
1	Mobile Pedestal - B/F 15"W x 20"D x 20"H	HLPLPMBF	\$292	\$292
1	Pedestal Cushion 15"W x 20"D	HLPLPSEAT1520	\$93	\$93

TOTAL: \$1,304

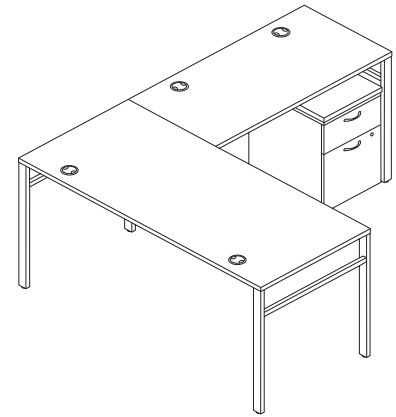

**L-STATION (NON-HANDED)
66"W x 78"D**

QTY	DESCRIPTION	MODEL	LIST PRICE	PRICE EXTENSION
1	Rectangle Worksurface 66"W x 30"D	HLPLRW6630	\$192	\$192
1	U-Leg Support 30"W	HLPLLEG30U	\$155	\$155
1	External Stiffener For 66"W Worksurfaces	HLPLXS66	\$76	\$76
1	Credenza Leg Support 7"H x 30"D	HLPLSL30	\$102	\$102
1	Low 2-Drawer Credenza 30"W x 20"D x 21"H	HLPLCL3020BF	\$542	\$542
1	Low Open Storage Credenza 30"W x 20"D x 21"H	HLPLCL3020S	\$250	\$250
1	Low Credenza Top 60"W x 20"D	HLPLCL6020TOP	\$126	\$126

TOTAL: \$1,443

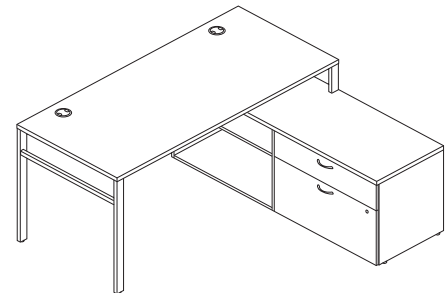

**L-STATION WITH CREDEZZA
(NON-HANDED)
66"W x 60"D**

MOD Bundles Typicals

Traditional Mahogany
HLPLDS72PSTM1

Sepia Walnut
HLPLDS72PSSE1

Java Oak
HLPLDS72PSJA1

Russet Cherry
HLPLDS72PSRC1

Slate Teak
HLPLDS72PSSL1

QTY	DESCRIPTION	MODEL	LIST PRICE	PRICE EXTENSION
1	Rectangular Desk Shell	HLPLDS7230	\$317	\$317
1	B/B/F Support Pedestal	HLPLPSBBF	\$334	\$334
1	F/F Support Pedestal	HLPLPSFF	\$334	\$334
TOTAL:			\$985	

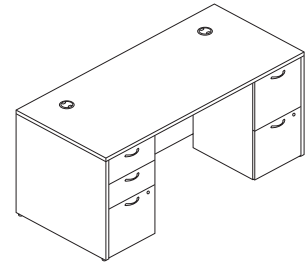

LAMINATE DESK WITH 2 PEDESTALS
72"W

Traditional Mahogany
HLPLDS66PSTM1

Sepia Walnut
HLPLDS66PSSE1

Java Oak
HLPLDS66PSJA1

Russet Cherry
HLPLDS66PSRC1

Slate Teak
HLPLDS66PSSL1

QTY	DESCRIPTION	MODEL	LIST PRICE	PRICE EXTENSION
1	Rectangular Desk Shell	HLPLDS6630	\$300	\$300
1	B/B/F Support Pedestal	HLPLPSBBF	\$334	\$334
1	F/F Support Pedestal	HLPLPSFF	\$334	\$334
TOTAL:			\$968	

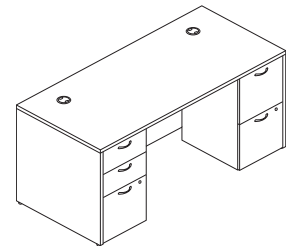

LAMINATE DESK WITH 2 PEDESTALS
66"W

Traditional Mahogany
HLPLDS60PSTM1

Sepia Walnut
HLPLDS60PSSE1

Java Oak
HLPLDS60PSJA1

Russet Cherry
HLPLDS60PSRC1

Slate Teak
HLPLDS60PSSL1

QTY	DESCRIPTION	MODEL	LIST PRICE	PRICE EXTENSION
1	Rectangular Desk Shell	HLPLDS6030	\$274	\$274
1	B/B/F Support Pedestal	HLPLPSBBF	\$334	\$334
TOTAL:			\$608	

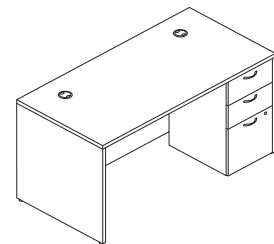

LAMINATE DESK WITH 1 PEDESTAL
60"W

Traditional Mahogany
HLPLDS48HBFM1

Sepia Walnut
HLPLDS48HBFSE1

Java Oak
HLPLDS48HBFJA1

Russet Cherry
HLPLDS48HBFRC1

Slate Teak
HLPLDS48HBFSL1

QTY	DESCRIPTION	MODEL	LIST PRICE	PRICE EXTENSION
1	Rectangular Desk Shell	HLPLDS4830	\$263	\$263
1	B/F Hanging Pedestal	HLPLPHBF	\$245	\$245
TOTAL:			\$508	

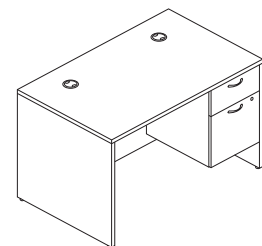

SMALL OFFICE DESK WITH 3/4 PEDESTAL
48"W

MOD Bundles Typicals

Black/Traditional Mahogany
HLPLW60LEG30UBLKPTM1

Black/Russet Cherry
HLPLW60LEG30UBLKPRC1

Black/Java Oak
HLPLW60LEG30UBLKPJA1

Black/Sepia Walnut
HLPLW60LEG30UBLKPSE1

Black/Slate Teak
HLPLW60LEG30UBLKPSL1

Black/Simply White
HLPLW60LEG30UBLKPPW1

Silver/Traditional Mahogany
HLPLW60LEG30USLVRTM1

Silver/Russet Cherry
HLPLW60LEG30USLVRR1

Silver/Java Oak
HLPLW60LEG30USLVRJA1

Silver/Sepia Walnut
HLPLW60LEG30USLVRSE1

Silver/Slate Teak
HLPLW60LEG30USLVRSL1

Silver/Simply White
HLPLW60LEG30USLVRPW1

QTY	DESCRIPTION	MODEL	LIST PRICE	PRICE EXTENSION
1	Rectangular Worksurface	HLPLRW6030	\$182	\$182
1	External Stiffener	HLPLXS60	\$70	\$70
2	U-Leg Support 30"W	HLPLLEG30U	\$155	\$310
TOTAL:			\$562	

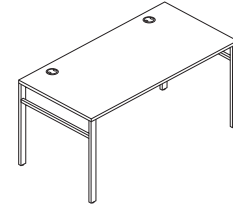

TABLE DESK WITH U-LEG
60"W x 30"D

Black/Traditional Mahogany
HLPLW66LEG30UBLKPTM1

Black/Russet Cherry
HLPLW66LEG30UBLKPRC1

Black/Java Oak
HLPLW66LEG30UBLKPJA1

Black/Sepia Walnut
HLPLW66LEG30UBLKPSE1

Black/Slate Teak
HLPLW66LEG30UBLKPSL1

Black/Simply White
HLPLW66LEG30UBLKPPW1

Silver/Traditional Mahogany
HLPLW66LEG30USLVRTM1

Silver/Russet Cherry
HLPLW66LEG30USLVRR1

Silver/Java Oak
HLPLW66LEG30USLVRJA1

Silver/Sepia Walnut
HLPLW66LEG30USLVRSE1

Silver/Slate Teak
HLPLW66LEG30USLVRSL1

Silver/Simply White
HLPLW66LEG30USLVRPW1

QTY	DESCRIPTION	MODEL	LIST PRICE	PRICE EXTENSION
1	Rectangular Worksurface	HLPLRW6630	\$192	\$192
1	External Stiffener	HLPLXS66	\$76	\$76
2	U-Leg Support 30"W	HLPLLEG30U	\$155	\$310
TOTAL:			\$578	

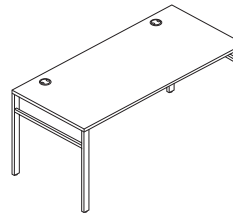

TABLE DESK WITH U-LEG
66"W x 30"D

MOD Bundles Typicals

Nickel/Traditional Mahogany
HLPLRW6024CONHATTM1

Nickel/Sepia Walnut
HLPLRW6024CONHATSE1

Nickel/Russet Cherry
HLPLRW6024CONHATRC1

Nickel/Slate Teak
HLPLRW6024CONHATSL1

Nickel/Java Oak
HLPLRW6024CONHATJA1

Nickel/Simply White
HLPLRW6024CONHATPW1

QTY	DESCRIPTION	MODEL	LIST PRICE	PRICE EXTENSION
1	Height Adjustable Base, 2-Stage	HHABETA2S2L	\$728	\$728
1	Rectangular Worksurface	HLPLRW6024	\$150	\$150
TOTAL:				\$878

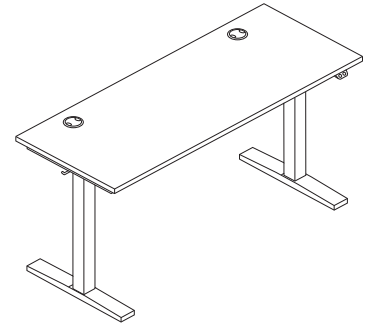

HEIGHT ADJUSTABLE TABLE
60"W x 24"D

Nickel/Traditional Mahogany
HLPLRW6030CONHATTM1

Nickel/Sepia Walnut
HLPLRW6030CONHATSE1

Nickel/Russet Cherry
HLPLRW6030CONHATRC1

Nickel/Slate Teak
HLPLRW6030CONHATSL1

Nickel/Java Oak
HLPLRW6030CONHATJA1

Nickel/Simply White
HLPLRW6030CONHATPW1

QTY	DESCRIPTION	MODEL	LIST PRICE	PRICE EXTENSION
1	Height Adjustable Base, 2-Stage	HHABETA2S2L	\$728	\$728
1	Rectangular Worksurface	HLPLRW6030	\$182	\$182
TOTAL:				\$910

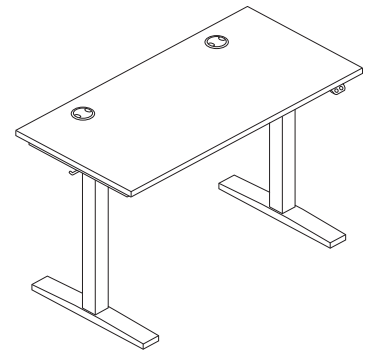

HEIGHT ADJUSTABLE TABLE
60"W x 30"D

Nickel/Traditional Mahogany
HLPLRW4824CONHATTM1

Nickel/Sepia Walnut
HLPLRW4824CONHATSE1

Nickel/Russet Cherry
HLPLRW4824CONHATRC1

Nickel/Slate Teak
HLPLRW4824CONHATSL1

Nickel/Java Oak
HLPLRW4824CONHATJA1

Nickel/Simply White
HLPLRW4824CONHATPW1

QTY	DESCRIPTION	MODEL	LIST PRICE	PRICE EXTENSION
1	Height Adjustable Base, 2-Stage	HHABETA2S2L	\$728	\$728
1	Rectangular Worksurface	HLPLRW4824	\$146	\$146
TOTAL:				\$874

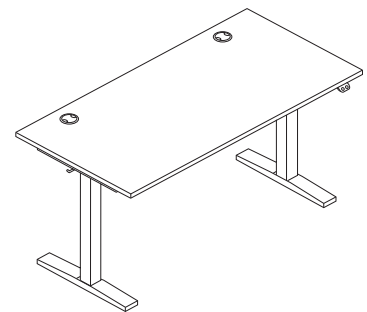

HEIGHT ADJUSTABLE TABLE
48"W x 24"D

MOD

Laminate Modular Components

OPEN MARKET



Icon Legend on page 19

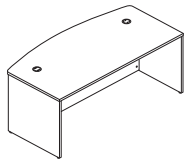

HLPLDS7236B shown

DESCRIPTION**Desk Shell**

72"W x 36"/30"D x 29"H, Bow Top
 72"W x 36"D x 29"H, Rectangle Top
 72"W x 30"D x 29"H, Rectangle Top
 66"W x 30"D x 29"H, Rectangle Top
 60"W x 30"D x 29"H, Rectangle Top
 48"W x 30"D x 29"H, Rectangle Top

MODEL**SHIP WEIGHT****CUBE****LIST PRICE**

HLPLDS7236B	149	6.6	\$379
HLPLDS7236	149	6.6	\$323
HLPLDS7230	149	5.6	\$317
HLPLDS6630	116	5.1	\$300
HLPLDS6030	111	4.7	\$274
HLPLDS4830	75	4.7	\$263

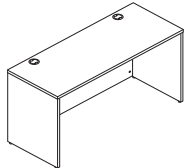
**Credenza Shell**

72"W x 24"D x 29"H
 66"W x 24"D x 29"H
 60"W x 24"D x 29"H
 48"W x 24"D x 29"H

HLPLCS7224	108	5.3	\$290
HLPLCS6624	96	4.8	\$279
HLPLCS6024	96	4.4	\$258
HLPLCS4824	75	3.7	\$253

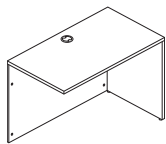
**Return Shell**

48"W x 24"D x 29"H
 42"W x 24"D x 29"H
 36"W x 24"D x 29"H

HLPLRS4824	66	4.2	\$214
HLPLRS4224	60	4.2	\$204
HLPLRS3624	54	2.8	\$169

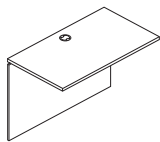
**Bridge**

48"W x 24"D x 29"H
 42"W x 24"D x 29"H
 36"W x 24"D x 29"H

HLPLB4824	53	4.2	\$173
HLPLB4224	46	4.2	\$171
HLPLB3624	40	3.7	\$144

NOTES:

- Scratch- and stain-resistant thermal-fused laminate surfaces.
- Durable 1" thick tops and end panels.
- Full height modesty panels.
- Desk, Credenza, Return Shells, and Bridge assemble quickly and easily.
- Desks, Credenzas, Return Shells, and Bridges come standard with 3" round Black grommets.
- Adjustable floor leveling glides provide 3/4" of adjustment.
- **HON 5-Year Limited Warranty.**

HOW TO SPECIFY

Select
Model Number

HLPLDS6030

Select
Woodgrain Laminate

See page 132

LSL1

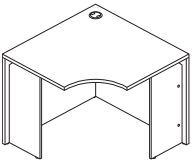
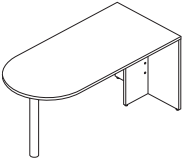

MOD Laminate Modular Components

	DESCRIPTION	MODEL	SHIP WEIGHT	CUBE	LIST PRICE
	Corner Shell 36"W x 36"D x 29"H 30"W x 30"D x 29"H	HLPLCS36	114	5.3	\$273
		HLPLCS30	93	3.2	\$246
	Peninsula w/End Panel 72"W x 36"D x 29½"H 66"W x 30"D x 29½"H ⓘ Peninsula must be ganged to another unit, return, or bridge. ⓘ Support column available in Black only. Specify: Model.Woodgrain Laminate.Paint SPECIFYING EXAMPLE: HLPLPEN6630E.LSL1.BLKP	HLPLPEN7236E	124	7.1	\$349
		HLPLPEN6630E	117	6.6	\$310

NOTES:

- Scratch- and stain-resistant thermal-fused laminate surfaces.
- Durable 1" thick tops and end panels.
- Full height modesty panels.
- Corner Shells and Peninsula assemble quickly and easily.
- Corner Shells come standard with 3" round Black grommets.
- Adjustable floor leveling glides provide ¾" of adjustment.
- **HON 5-Year Limited Warranty.**

HOW TO SPECIFY

<p>Select Model Number</p> <p>HLPLPEN7236E .</p>	<p>Select Woodgrain Laminate</p> <p>See page 132</p> <p>LSL1 .</p>	<p>Select Paint Color</p> <p><i>Specify for new peninsula models only</i></p> <p>P Black</p> <p>P</p>
---	---	--

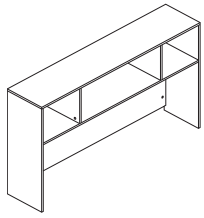
**DESCRIPTION****Hutch without Doors**

72"W x 14"D x 39³/₄"H
66"W x 14"D x 39³/₄"H
60"W x 14"D x 39³/₄"H

NOTES: Full back with gap at bottom for wire management.
Specify: Model.Woodgrain Laminate

! Hutch and Wall Mounted Storage units are sold without doors. 2 Doors or 4 Doors can be added to 72"W, 66"W, and 60"W units. 48"W Wall Mounted Storage Doors are sold in packages of 3 only.

SPECIFYING EXAMPLE: HLPLDH66.LSL1

MODEL**SHIP WEIGHT****CUBE****LIST PRICE****HLPLDH72**

106

7.1

\$340**HLPLDH66**

99

7.2

\$324**HLPLDH60**

92

5.3

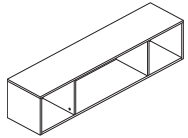
\$315**Wall Mounted Storage without Doors**

72"W x 14"D x 13¹/₂"H
66"W x 14"D x 13¹/₂"H
60"W x 14"D x 13¹/₂"H
48"W x 14"D x 13¹/₂"H

! Hutch and Wall Mounted Storage units are sold without doors. 2 Doors or 4 Doors can be added to 72"W, 66"W, and 60"W units. 48"W Wall Mounted Storage Doors are sold in packages of 3 only.

HLPLWMH72

66

3.1

\$404**HLPLWMH66**

62

3.6

\$387**HLPLWMH60**

57

3.0

\$379**HLPLWMH48**

48

2.5

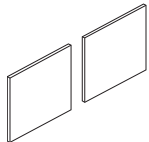
\$363**Laminate Doors for Hutch and Wall Mounted Storage**

2 Pack, for HLPLDH72 and HLPLWMH72
2 Pack, for HLPLDH66 and HLPLWMH66
2 Pack, for HLPLDH60 and HLPLWMH60
3 Pack, for HLPLWMH48

HLPLDR72LM

12

0.8

\$40**HLPLDR66LM**

12

0.8

\$40**HLPLDR60LM**

12

0.8

\$40**HLPLDR48LM**

17

0.8

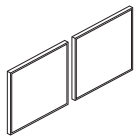
\$59**Glass Doors for Hutch and Wall Mounted Storage**

2 Pack, for HLPLDH72 and HLPLWMH72
2 Pack, for HLPLDH66 and HLPLWMH66
2 Pack, for HLPLDH60 and HLPLWMH60
3 Pack, for HLPLWMH48

HLPLDR72GS

9

0.8

\$141**HLPLDR66GS**

9

0.8

\$141**HLPLDR60GS**

9

0.8

\$141**HLPLDR48GS**

13

0.8

\$214

NOTES: No specification needed.

SPECIFYING EXAMPLE: HLPLDR66GS

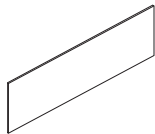
**Tackboards**

72"W x 18"H
66"W x 18"H
60"W x 18"H
48"W x 18"H

Specify: Model.Fabric

SPECIFYING EXAMPLE: HLPLTACK66.CN02

HLPLTACK72

12

2.4

\$125**HLPLTACK66**

12

2.2

\$119**HLPLTACK60**

10

2.1

\$114**HLPLTACK48**

8

1.7

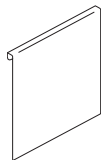
\$103**Markerboard**

12"W x 12"H

NOTES: No specification needed. Markerboard is designed to fit over the top of the laminate doors for hutches to create a writable/movable surface.

SPECIFYING EXAMPLE: HLPLDR12MB

HLPLDR12MB

3

0.6

\$70**NOTES:**

- Scratch- and stain-resistant thermal-fused laminate surfaces.
- Durable ⁵/₈" thick tops and end panels.
- 72"W, 66"W, and 60"W hutches include fully enclosed back.
- Hutches and Wall Mounted Storage assemble quickly and easily.
- **HON 5-Year Limited Warranty.**

HOW TO SPECIFY

Select
Model Number

HLPLWMH66

Select
Laminate

See page 132

LSL1

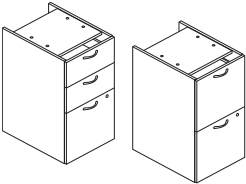
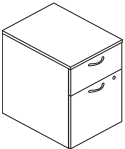

	DESCRIPTION	MODEL	SHIP WEIGHT	CUBE	LIST PRICE
	Support Pedestal 15"W x 20"D x 28"H, Box/Box/File 15"W x 20"D x 28"H, File/File NOTES: Optional Pulls available, see below. ⓘ Top is unfinished. Not to be used freestanding.	HLPLPSBBF HLPLPSFF	81.0 79.0	7.4 7.4	\$334 \$334
	Hanging Pedestal 15"W x 20"D x 20"H, Box/File NOTES: Optional Pulls available, see below. ⓘ Top is unfinished. Not to be used freestanding. ⓘ Hanging Pedestal is designed to attach to the underside of the worksurface and is non-handed (can be assembled on left or right side).	HLPLPHBF	63.0	5.8	\$245
 HLPLPMBF shown	Mobile Pedestal 15"W x 20"D x 28"H, Box/Box/File 15"W x 20"D x 28"H, File/File 15"W x 20"D x 20"H, Box/File NOTES: Optional Pulls available, see below.	HLPLPMBBF HLPLPMFF HLPLPMBF	81.0 79.0 63.0	7.4 7.4 5.8	\$412 \$412 \$292
	Pedestal Cushion 15"W x 20"D Specify: Model.Fabric SPECIFYING EXAMPLE: HLPLPSEAT1520.CN02	HLPLPSEAT1520	6.0	1.1	\$93
	Field Installed Contemporary Pull — 2-pack Silver NOTES: For use on Lateral Files, Pedestals, Wardrobe, and 2-Drawer Low Credenza. ⓘ Silver finish only, no specification needed.	HBLPCONTEMP	0.4 ⓘ	0.1	\$13
Field Installed Bridge Pull — 2-pack Silver NOTES: For use on Lateral Files, Pedestals, Wardrobe, and 2-Drawer Low Credenza. ⓘ Polished finish only, no specification needed.	HBLPBRIDGE	0.4 ⓘ	0.1	\$13	
Field Installed Classic Pull — 2-pack Black NOTES: For use on Lateral Files, Pedestals, Wardrobe, and 2-Drawer Low Credenza. ⓘ Black finish only, no specification needed.	HBLPCLASSIC	0.4 ⓘ	0.1	\$13	

NOTES:

- Pedestals ship assembled.
- Support Pedestals are designed to be used under a desk, credenza, or return shell and installed by leveling up the glides to a tight fit under tops (hardware not included).
- Drawers operate on full extension, ball-bearing suspensions to ensure smooth, quiet, and long-lasting operation.
- Pedestals come standard with Arch pull in Silver finish.
- **HON 5-Year Limited Warranty.**

HOW TO SPECIFY

Select Model Number H L P L P S B B F	Select Laminate See page 132 L S L 1
--	--

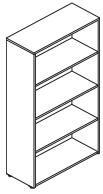

HLPLBC3013B5 shown

DESCRIPTION**Bookcase**

30"W x 13"D x 65"H, 5-Shelf, 3 Adjustable Shelves, 1 Fixed Shelf
 30"W x 13"D x 53"H, 4-Shelf, 2 Adjustable Shelves, 1 Fixed Shelf
 30"W x 13"D x 29"H, 2-Shelf, 1 Fixed Shelf

MODEL

HLPLBC3013B5
HLPLBC3013B4
HLPLBC3013B2

SHIP WEIGHT

137
 112
 63

CUBE

6.1
 5.2
 3.2

LIST PRICE

\$329
\$236
\$162

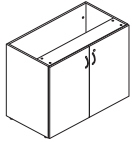
**Storage Cabinet**

36"W x 20"D x 29"H

HLPLSC3620

76

15.7

\$382

NOTES: Optional Pulls available, see page 143.

! Top is unfinished, not to be used freestanding. To convert to a freestanding cabinet, order model HLPLCL3620TOP, see page 146.

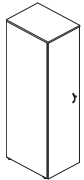
**Wardrobe**

24"W x 24"D x 65"H
 18"W x 24"D x 65"H

HLPLW2424
HLPLW1824

99
 84

4.2
 4.2

\$854
\$559

NOTES: Optional Pulls available, see page 143. Non-handed door which can be installed in left- or right-hand configuration. Coat rod, fixed shelf, and lock included.

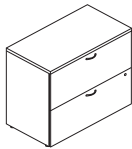

HLPLLF3620L2 shown

Lateral

36"W x 20"D x 53"H, 4-Drawer
 36"W x 20"D x 40"H, 3-Drawer
 36"W x 20"D x 29"H, 2-Drawer w/Removable Top

HLPLLF3620L4
HLPLLF3620L3
HLPLLF3620L2

193
 166
 145

27.4
 21.1
 15.7

\$951
\$841
\$541

NOTES: Optional Pulls available, see page 143.

! 2-Drawer Lateral, HLPLLF3620L2, available in all Laminate finishes including Simply White.

! To change the top of model HLPLLF3620L2 in order to make a two-tone unit, use model HLPLCL3620TOP, see page 146.

NOTES:

- Lateral files ship assembled.
- Drawers operate on full extension, ball-bearing suspensions to ensure smooth, quiet, and long-lasting operation.
- Hangrails are included in each file drawer for side-to-side legal filing, and for front-to-back letter and legal filing.
- Storage Cabinet, Wardrobe, and Lateral Files come standard with Arch pull in Silver finish.
- **HON 5-Year Limited Warranty.**

HOW TO SPECIFY

Select
Model Number

HLPLBC3013B5.

Select
Woodgrain Laminate

See page 132

LSL1



	DESCRIPTION	MODEL	SHIP WEIGHT	CUBE	LIST PRICE		
	Rectangular Worksurface 72"W x 30"D 72"W x 24"D	HLPLRW7230 HLPLRW7224	110 89	6.0 4.9	\$206 \$169		
	66"W x 30"D 66"W x 24"D	HLPLRW6630 HLPLRW6624	101 82	5.5 4.5	\$192 \$158		
	60"W x 30"D 60"W x 24"D	HLPLRW6030 HLPLRW6024	92 75	5.0 4.1	\$182 \$150		
	48"W x 30"D 48"W x 24"D	HLPLRW4830 HLPLRW4824	75 61	4.1 3.4	\$173 \$146		
	Specify: Model.Laminate SPECIFYING EXAMPLE: HLPLRW6630.LSL1						
		External Stiffener For 72"W Worksurfaces For 66"W Worksurfaces For 60"W Worksurfaces	HLPLXS72 HLPLXS66 HLPLXS60	7 7 6	0.7 0.6 0.6	\$81 \$70 \$70	
		ⓘ Available in Graphite paint only. SPECIFYING EXAMPLE: HLPLXS66.BLKP					
			A-Leg Support 30"W Angled Leg 24"W Angled Leg	HLPLLEG30A HLPLLEG24A	16 14	5.1 3.7	\$155 \$146
			NOTES: A-Leg will have adjustable floor leveling glides which provide 2" of adjustment.				
		U-Leg Support 30"W U-Leg 24"W U-Leg	HLPLLEG30U HLPLLEG24U	17 15	5.1 3.7	\$155 \$146	
NOTES: U-Leg will have adjustable floor leveling glides which provide 3" of adjustment.							
	Credenza Leg Support 7"H x 30"D Support Leg 7"H x 24"D Support Leg	HLPLSL30 HLPLSL24	6 5	1.0 1.0	\$102 \$93		
	Overhead Support Leg 23"H, Pack of 2 10½"H, Pack of 2	HLPLOS23 HLPLOS10	13 9	1.1 0.8	\$146 \$114		
	Flat Bracket 24"D Bracket	HLPLFB24	3	0.6	\$49		
	ⓘ Available in Graphite paint only, no paint selection. SPECIFYING EXAMPLE: HLPLFB24						

NOTES:

- Scratch- and stain-resistant thermal-fused laminate surfaces.
- Durable 1" thick tops.
- Worksurfaces come standard with 3" round Black grommets.
- **HON 5-Year Limited Warranty.**

HOW TO SPECIFY

<p>Select Model Number</p>	<p>Select Paint Color</p> <p>See page 132</p>
<p>HLPLLEG30A.</p>	<p>BLKP</p>

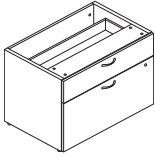
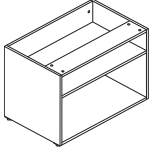
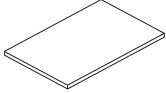
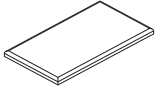

	DESCRIPTION	MODEL	SHIP WEIGHT	CUBE	LIST PRICE
	Low Credenza, 2 Drawers, Personal Cabinet, No Top 36"W x 20"D x 21"H 30"W x 20"D x 21"H	HLPLCL3620BF	113	11.8	\$554
		HLPLCL3020BF	80	10.1	\$542
NOTES: Optional Pulls available, see page 143. Unit ships fully assembled. Two low credenza units (2 drawer or Open Storage) can be combined using 1 top to create 60", 66", or 72" low credenzas. ! Top is unfinished, not to be used freestanding. Use with low credenza tops below to create a finished credenza.					
	Low Credenza, 2 Open Shelves, Open Storage Cabinet, No Top 36"W x 20"D x 21"H 30"W x 20"D x 21"H	HLPLCL3620S	63	3.0	\$261
		HLPLCL3020S	48	2.5	\$250
NOTES: Unit ships flat packed; assembly required. Two low credenza units (2 drawer or Open Storage) can be combined using 1 top to create 60", 66", or 72" low credenzas. ! Top is unfinished, cannot be used without a top. Use with low credenza tops below to create a finished credenza.					
	Low Credenza Cabinet Top 72"W x 20"D 66"W x 20"D 60"W x 20"D 36"W x 20"D 30"W x 20"D	HLPLCL7220TOP	74	4.2	\$137
		HLPLCL6620TOP	68	3.9	\$135
		HLPLCL6020TOP	63	3.5	\$126
		HLPLCL3620TOP	37	2.2	\$88
		HLPLCL3020TOP	30	1.9	\$81
	Low Credenza Cushion 36"W x 20"D 30"W x 20"D Specify: Model.Fabric SPECIFYING EXAMPLE: HLPLCSEAT3620.CN02	HLPLCSEAT3620	11	2.2	\$188
		HLPLCSEAT3020	9	1.9	\$193

NOTES:

- Scratch- and stain-resistant thermal-fused laminate surfaces.
- Durable 1" thick tops.
- Low credenzas ship assembled.
- Drawers operate on full extension, ball-bearing suspensions to ensure smooth, quiet, and long-lasting operation.
- Hangrails are included in each file drawer for side-to-side legal filing, and for front-to-back letter and legal filing.
- Low Credenza, 2 Drawer comes standard with Arch pull in Silver finish.
- **HON 5-Year Limited Warranty.**

! Top must be specified with low credenza when using a cushion.

HOW TO SPECIFY

Select Model Number HLPLCL3620BF	Select Laminate See page 132 LSL1
--	--

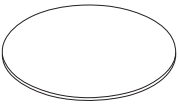
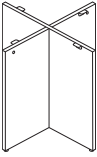
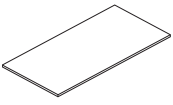
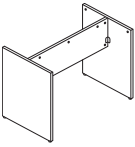

Conference Table Modular Components

	DESCRIPTION	MODEL	SHIP WEIGHT	CUBE	LIST PRICE
	Round Conference Table Tops				
	48" Round Top	HLPLTBL48RND	63	6.5	\$217
	42" Round Top	HLPLTBL42RND	50	5.1	\$211
	36" Round Top	HLPLTBL36RND	39	3.8	\$173
	Round Conference Table Bases				
	X-Base for 48" Table Tops	HLPLTBL48BASE	45	3.2	\$91
	X-Base for 42" Table Tops	HLPLTBL42BASE	42	3.2	\$87
	X-Base for 36" Table Tops	HLPLTBL36BASE	36	2.5	\$84
	Rectangle Conference Table Tops				
	48"W x 120"L Rectangular Top, 2-Piece	HLPLTBL48120RCT	293	7.8	\$706
	42"W x 96"L Rectangular Top	HLPLTBL4296RCT	205	10.7	\$486
	36"W x 72"L Rectangular Top	HLPLTBL3672RCT	132	7.1	\$287
	Rectangle Conference Table Bases				
	Slab Base for 120" Table Tops	HLPLTBL120BASE	86	4.2	\$114
	Slab Base for 96" Table Tops	HLPLTBL96BASE	64	5.1	\$109
	Slab Base for 72" Table Tops	HLPLTBL72BASE	48	3.0	\$103

NOTES:

- Scratch- and stain-resistant thermal-fused laminate surfaces.
- Durable 1" thick tops and support legs.
- **HON 5-Year Limited Warranty.**

HOW TO SPECIFY

<p>Select Model Number</p> <p>HLPLTBL42RND</p>	<p>Select Laminate</p> <p>See page 132</p> <p>LSL1</p>
---	---



MOD

Reception Modular Components

OPEN MARKET

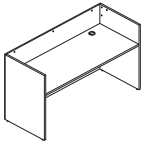
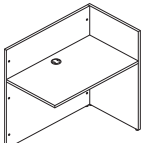
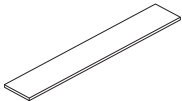

Icon Legend on page 19

	DESCRIPTION	MODEL	SHIP WEIGHT	CUBE	LIST PRICE
	Reception Desk Shell 72"W x 30"D x 41"H	HLPLRCPNDS7230	182	8.3	\$436
	Reception Return Shell 42"W x 25"D x 41"H	HLPLRCPNRS4225	110	5.1	\$263
	Transaction Tops 72"W x 12"D Laminate 72"W x 12"D Frosted Glass	HLPLRCPNTPLM HLPLRCPNTPGS	45 35	3.5 3.2	\$93 \$327
	 No selection for Glass Transaction Top, only one finish option.				

NOTES:

- Scratch- and stain-resistant thermal-fused laminate surfaces.
- Durable 1" thick tops and end panels.
- Adjustable floor leveling glides provide $\frac{3}{4}$ " of adjustment.
- Reception stations assemble quickly and easily.
- 3" round Black grommet(s) in tops of desks to route cords.
- **HON 5-Year Limited Warranty.**

HOW TO SPECIFY

Select Model Number HLPLRCPNDS7230	Select Woodgrain Laminate See page 132 LSL1
--	--



Valido® shown with Preside® Conference Table, HON® Occasional Tables, Flock® and Ignition® seating.

VALIDO®

Valido knows how to make them. Impeccable design. Quality craftsmanship. A tailored, signature style that lasts. With precision-machined edges and more than 100 different surface combinations, Valido lets you create a custom-built look with an executive edge. And thanks to a variety of flexible component options — plus high-quality laminate that resists scratches, stains, spills and wear — Valido is the very definition of form meeting function.



FEATURES

- Formal 1½-thick worksurfaces are finished with an elegant, ribbon-edge detail.
- Multiple storage options let you create spaces that work the way you do.
- Valido components are designed to fit, form and grow into every area and any space.
- Metal-to-metal fastening system for precise fit and unsurpassed durability.
- Available in durable mix-and-match laminates, including woodgrain, solid, and pattern colors.
- Four decorative handle options to choose from.

VALIDO® ORDERING INFORMATION

LAMINATE FINISHES AVAILABILITY

L1 LAMINATES CODES

Woodgrain

- ◆ Bourbon Cherry **HH**
- ◆ Cognac **COGNCOGN**
- ◆ Florence Walnut **LFWILFW1**
- ◆ Harvest **CC**
- ◆ Kingswood Walnut **LK1LK1I**
- ◆ Mahogany **NN**
- ◆ Mocha **MOCHMOCH**
- ◆ Natural Maple **DD**
- ◆ Pinnacle **PINCPINC**
- ◆ Shaker Cherry **FF**
- ◆ Sterling Ash **LSA1LSA1**

Solid

- ◆ Black **PP**
- ◆ Charcoal **SS**
- ◆ Designer White **LDWILDW1**

Patterned Top

- ◆ Grey Tigris * **L6(*)**
- ◆ Handspun Chestnut **LAHC**
- ◆ Handspun Dove **LAHD**
- ◆ Handspun Pearl **LAHP**
- ◆ Handspun Slate **LAHS**
- ◆ Sheer Mesh * **A5(*)**
- ◆ Silver Mesh **B9(*)**
- ◆ Canyon Zephyr * **K9(*)**
- ◆ Desert Zephyr * **K8(*)**

(* Patterned top laminates are available with the following base/edgebanding laminate selection: C, COGN, D, F, H, MOCH, N, P, PINC, S, DW, FW, KI, or SA. Edgebanding will match base laminate selected.

SPECIFYING EXAMPLE: H11592.L6N

The following Valido products are not available as two-tone and require only one color code:

- Modular pedestals — box/file, box/box/file, file/file, lateral file, multi file, and cabinet.

- ◆◆◆ For lead time information see page 19.
- * De-emphasized

Patterned Top

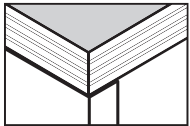

Edgeband Around Top / Laminate Base

- Edgebanding on patterned laminates matches the laminate base selected.
- LAMINATE DESKS
SPECIFY: Model Number.
Laminate
- EXAMPLE: H11596.NN
- WORKSURFACES
SPECIFY: Model Number.
Top Laminate
Edgeband
- All specifications in this publication are based on the latest product information available at the time of print.
- ! Tops with a patterned color are not available with a matching edgeband.

Edge Option:



Ribbon Edge "A"

Handle Options:



Sweep Designator
Black A
Satin Nickel C
4 7/8" W



Crescent Designator
Black D
Satin Nickel F
5" W

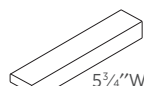

Linear
Black G
Matte Chrome J
5 3/4" W

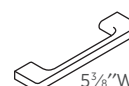

Arch
Black K
Matte Chrome M
5 3/8" W

TWO-TONE LAMINATE TOP / BASE

L1 LAMINATES CODES

Two-Tone Top/Base

- ◆ Black/Charcoal **PS**
- ◆ Black/Designer White ... **PLDW1**
- ◆ Bourbon Cherry/Black **HP**
- ◆ Bourbon Cherry/Charcoal ... **HS**
- ◆ Bourbon Cherry/Designer
White **HLDW1**
- ◆ Charcoal/Black **SP**
- ◆ Charcoal/Designer
White **SLDW1**
- ◆ Cognac/Black **COGNP**
- ◆ Cognac/Charcoal **COGNS**
- ◆ Cognac/Designer
White **COGNLDW1**
- ◆ Designer White/Black ... **LDW1P**
- ◆ Designer White/Bourbon
Cherry **LDW1H**
- ◆ Designer
White/Charcoal **LDW1S**
- ◆ Designer
White/Cognac **LDW1COGN**
- ◆ Designer
White/Harvest **LDW1C**
- ◆ Designer
White/Mahogany **LDW1N**
- ◆ Designer
White/Mocha **LDW1MOCH**
- ◆ Designer White/Natural
Maple **LDW1D**
- ◆ Designer
White/Pinnacle **LDW1PINC**
- ◆ Designer White/Shaker
Cherry **LDW1F**
- ◆ Florence Walnut/Black . **LFW1P**
- ◆ Florence
Walnut/Charcoal **LFW1S**

- ◆◆◆ For lead time information see page 19.

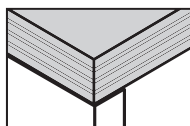

Laminate Base

- Two-tone laminates: Top and edgebanding are the same, base is different laminate color.
- Edgebanding on two-tone laminates matches top, base is a different laminate color.
 - A complete selection of Conference Room and Occasional Tables is shown in the Tables section in the 2021 Shared Spaces Pricer.
 - LAMINATE DESKS
SPECIFY: Model Number.
Laminate
 - EXAMPLE: H11596.HP
 - All specifications in this publication are based on the latest product information available at the time of print.

TWO-TONE LAMINATE TOP / BASE

continued

L1 LAMINATES CODES

Two-Tone Top/Base

- ◆ Florence Walnut/Designer
White **LFWILDW1**
- ◆ Harvest/Black **CP**
- ◆ Harvest/Charcoal **CS**
- ◆ Harvest/Designer
White **CLDW1**
- ◆ Kingswood
Walnut/Black **LK11P**
- ◆ Kingswood
Walnut/Charcoal **LK11S**
- ◆ Kingswood Walnut/Designer
White **LK11LDW1**
- ◆ Mahogany/Black **NP**
- ◆ Mahogany/Charcoal **NS**
- ◆ Mahogany/Designer
White **NLDW1**
- ◆ Mocha/Black **MOCHP**
- ◆ Mocha/Charcoal **MOCHS**
- ◆ Mocha/Designer
White **MOCHLDW1**
- ◆ Natural Maple/Black **DP**
- ◆ Natural Maple/Charcoal **DS**
- ◆ Natural Maple/Designer
White **DLDW1**
- ◆ Pinnacle/Black **PINCP**
- ◆ Pinnacle/Charcoal **PINCS**
- ◆ Pinnacle/Designer
White **PINCLDW1**
- ◆ Shaker Cherry/Black **FP**
- ◆ Shaker Cherry/Charcoal **FS**
- ◆ Shaker Cherry/Designer
White **FLDW1**
- ◆ Sterling Ash/Black **LSA1P**
- ◆ Sterling Ash/Charcoal **LSA1S**
- ◆ Sterling Ash/Designer
White **LSA1LDW1**



Icon Legend on page 19

Components used are listed on pages 154-176. Order components individually. Other configurations are possible, including various sizes of some components.

QTY	DESCRIPTION	MODEL	LIST PRICE	PRICE EXTENSION
1	Double Pedestal Desk - 2/2 72"W x 36"D x 29½"H	H11593	\$1,989	\$1,989
1	Credenza with Kneespace - 2/2 72"W x 24"D x 29½"H	H11543	\$1,843	\$1,843
1	Stack-on Storage 72"W x 14⅝"D x 37½"H	H11534	\$1,432	\$1,432
2	Vertical Paper Manager	HLVPM1	\$351	\$702
TOTAL:			\$5,966	

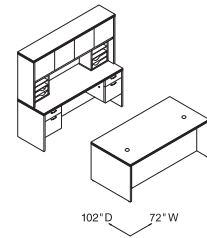

DESK/CREDENZA
72"W x 102"D

QTY	DESCRIPTION	MODEL	LIST PRICE	PRICE EXTENSION
1	Double Pedestal Bow Top Desk - 2/2 72"W x 36"D x 29½"H	H11595	\$2,172	\$2,172
1	Credenza with Kneespace - 2/2 72"W x 24"D x 29½"H	H115900	\$2,291	\$2,291
1	Stack-on Storage 72"W x 14⅝"D x 37½"H	H11534	\$1,432	\$1,432
1	Personal Wardrobe/Storage Cabinet, Left 18"W x 24"D x 67"H	H115296L	\$1,970	\$1,970
1	Storage/File Cabinet, Right 18"W x 24"D x 67"H	H115297R	\$2,278	\$2,278
TOTAL:			\$10,143	

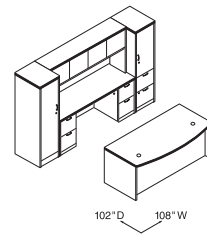

DESK/CREDENZA
108"W x 102"D

QTY	DESCRIPTION	MODEL	LIST PRICE	PRICE EXTENSION
1	Single Pedestal Desk, Left - B/F 72"W x 36"D x 29½"H	H11586L	\$1,691	\$1,691
1	Return, Right - B/F 48"W x 24"D x 29½"H	H11515R	\$1,231	\$1,231
1	Stack-on Storage 48"W x 14⅝"D x 37½"H	H115323	\$1,164	\$1,164
1	Square End Cap Bookshelf 24"W x 24"D x 29½"H	H115525R	\$834	\$834
TOTAL:			\$4,920	

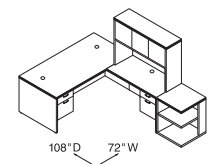

"L" WORKSTATION
72"W x 108"D

QTY	DESCRIPTION	MODEL	LIST PRICE	PRICE EXTENSION
1	Single Pedestal Desk, Left - B/F 66"W x 30"D x 29½"H	H11584L	\$1,580	\$1,580
1	Return, Right - B/F 48"W x 24"D x 29½"H	H11515R	\$1,231	\$1,231
1	Stack-on Storage 78"W x 14⅝"D x 37½"H	H115327	\$1,593	\$1,593
1	Vertical Paper Manager	HLVPM1	\$351	\$351
1	End Cap Bookshelf 24"W x 24"D x 29½"H	H115520	\$847	\$847
1	End Cap Bookshelf 15"W x 15"D x 37½"H	H115523	\$749	\$749
TOTAL:			\$6,351	

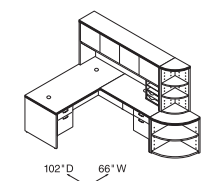

"L" WORKSTATION
66"W x 102"D



Components used are listed on pages 154-176. Order components individually. Other configurations are possible, including various sizes of some components.

QTY	DESCRIPTION	MODEL	LIST PRICE	PRICE EXTENSION
1	Single Pedestal Desk, Right - B/F 72"W x 36"D x 29½"H	H11585R	\$1,691	\$1,691
1	Bridge 47"W x 24"D x 29½"H	H11570	\$560	\$560
1	Credenza with 36" Lateral, Left 72"W x 24"D x 29½"H	H11548L	\$1,977	\$1,977
1	Stack-on Storage 72"W x 14⅝"D x 37½"H	H11534	\$1,432	\$1,432
1	Storage Cabinet/Lateral File 36"W x 24"D x 67"H	H115293	\$2,953	\$2,953
TOTAL:			\$8,613	

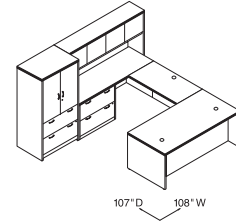

"U" WORKSTATION
108"W x 107"D

QTY	DESCRIPTION	MODEL	LIST PRICE	PRICE EXTENSION
1	Single Full Pedestal Bow Front Desk 72"W x 36"D x 29½"H	H115893R	\$2,370	\$2,370
1	Bridge 42"W x 24"D x 29½"H	H11560	\$536	\$536
1	Left Single Full Pedestal Credenza 72"W x 24"D x 29½"H	H115904L	\$1,885	\$1,885
1	Stack-on Storage 72"W x 14⅝"D x 37½"H	H11534	\$1,432	\$1,432
1	Vertical Paper Manager	HLVPM1	\$351	\$351
1	Personal Wardrobe/Storage Cabinet 36"W x 24"D x 67"H	H11530	\$2,884	\$2,884
TOTAL:			\$9,458	

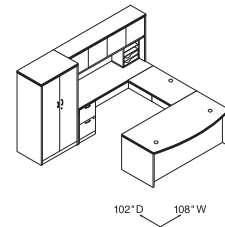

"U" WORKSTATION
108"W x 102"D

QTY	DESCRIPTION	MODEL	LIST PRICE	PRICE EXTENSION
1	Single Pedestal Bow Front Desk, Right - B/F 72"W x 36"D x 29½"H	H11587R	\$1,914	\$1,914
1	Bridge 36"W x 24"D x 29½"H	H115599	\$536	\$536
1	36" Corner Unit	H115811	\$1,000	\$1,000
1	Return, Left 42"W x 24"D x 29½"H	H11512L	\$1,217	\$1,217
1	Stack-on Storage 78"W x 14⅝"D x 37½"H	H115327	\$1,593	\$1,593
1	Vertical Paper Manager	HLVPM1	\$351	\$351
1	Personal Storage Tower 24"W x 24"D x 67"H	H115301R	\$2,884	\$2,884
TOTAL:			\$9,495	

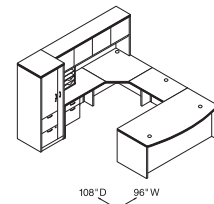

"U" WORKSTATION
102"W x 108"D

QTY	DESCRIPTION	MODEL	LIST PRICE	PRICE EXTENSION
1	Extended Corner Unit, Left 24"D x 72"W x 36"D x 24"W x 29½"H	H115816L	\$1,450	\$1,450
1	Box/Box/File Mobile Pedestal 15⅝"W x 22¾"D x 28"H	H115102	\$1,041	\$1,041
1	Stack-on Storage 72"W x 14⅝"D x 37½"H	H11534	\$1,432	\$1,432
1	Vertical Paper Manager	HLVPM1	\$351	\$351
1	Return Shell (with Full Modesty Panel) 48"W x 24"D x 29½"H	H11561	\$764	\$764
1	File/File Mobile Pedestal 15⅝"W x 22¾"D x 28"H	H115104	\$1,041	\$1,041
TOTAL:			\$6,079	

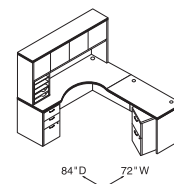

MODULAR "L" WORKSTATION
72"W x 84"D



Icon Legend on page 19

Components used are listed on pages 154-176. Order components individually. Other configurations are possible, including various sizes of some components.

QTY	DESCRIPTION	MODEL	LIST PRICE	PRICE EXTENSION
1	Jetty Peninsula, Left 72"W x 42"/30"D x 29½"H	H115202L	\$1,546	\$1,546
1	File/File Mobile Pedestal 15⅝"W x 22¾"D x 28"H	H115104	\$1,041	\$1,041
1	Return Shell 72"W x 24"D x 29½"H	H115686	\$998	\$998
1	Multi File Pedestal 36"W x 20"D x 28"H	H11505	\$1,559	\$1,559
2	Wall Mounted Storage Cabinet 42"W x 14⅝"D x 18⅞"H	H115382	\$1,095	\$2,190
1	Wall Mounted Storage Cabinet 30"W x 14⅝"D x 18⅞"H	H115380	\$967	\$967
1	End Cap Bookshelf 24"W x 24"D x 29½"H	H115520	\$847	\$847
TOTAL:			\$9,148	

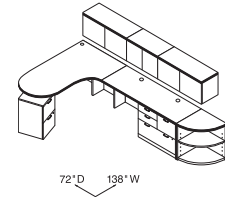

MODULAR "L" WORKSTATION
138"W x 72"D

QTY	DESCRIPTION	MODEL	LIST PRICE	PRICE EXTENSION
1	Storage/File Cabinet, Left 18"W x 24"D x 67"H	H115298L	\$2,278	\$2,278
1	Return Shell 72"W x 24"D x 29½"H	H115686	\$998	\$998
1	File/File Modular Pedestal 15⅝"W x 22¾"D x 28"H	H11504	\$851	\$851
1	Mobile Printer/Fax Cart 20"W x 19⅞"D x 14⅞"H	H105679	\$451	\$451
1	Stack-on Storage 72"W x 14⅝"D x 37½"H	H11534	\$1,432	\$1,432
1	Vertical Paper Manager	HLVPM1	\$351	\$351
1	36" Corner Unit	H115811	\$1,000	\$1,000
1	Stack-on Storage 36"W x 14⅝"D x 37½"H	H115321	\$960	\$960
1	Return Shell 60"W x 24"D x 29½"H	H115684	\$933	\$933
1	Multi File Pedestal 36"W x 20"D x 28"H	H11505	\$1,559	\$1,559
TOTAL:			\$10,813	

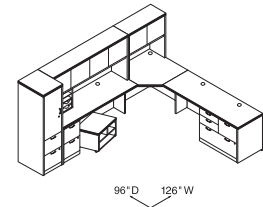

MODULAR "L" CORNER WORKSTATION
126"W x 96"D

QTY	DESCRIPTION	MODEL	LIST PRICE	PRICE EXTENSION
1	Boomerang Peninsula, Left 72"W x 42"/30"D x 29½"H	H115204L	\$1,546	\$1,546
1	Box/Box/File Mobile Pedestal 15⅝"W x 22¾"D x 28"H	H115102	\$1,041	\$1,041
1	Bridge 30"W x 24"D x 29½"H	H115598	\$536	\$536
1	Extended Corner Unit, Right 24"W x 36"D x 72"W x 24"D x 29½"H	H115815R	\$1,450	\$1,450
1	File/File Modular Pedestal 15⅝"W x 22¾"D x 28"H	H11504	\$851	\$851
1	Stack-on Storage 72"W x 14⅝"D x 37½"H	H11534	\$1,432	\$1,432
1	Storage/File Cabinet, Right 18"W x 24"D x 67"H	H115297R	\$2,278	\$2,278
1	End Cap Bookshelf 24"W x 24"D x 67"H	H115524	\$1,345	\$1,345
TOTAL:			\$10,479	

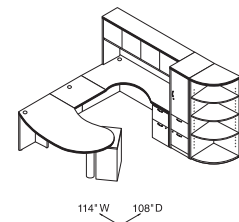

MODULAR "U" WORKSTATION
114"W x 108"D

VALIDO® Laminate Modular Desks

GSA SIN 33721



Icon Legend on page 19

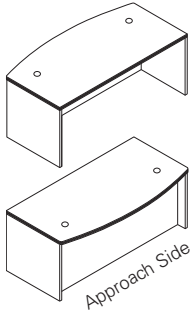

Model H11596 shown

DESCRIPTION

Desk Shell (with Full Modesty Panel)

- 72"W x 36"D x 29½"H, Bow Top (end panels 30"D)
- 72"W x 36"D x 29½"H, Rectangle Top
- 72"W x 30"D x 29½"H, Rectangle Top
- 66"W x 30"D x 29½"H, Rectangle Top
- 60"W x 30"D x 29½"H, Rectangle Top
- 48"W x 30"D x 29½"H, Rectangle Top (1 grommet)

NOTES: See page 174 for optional center drawers.

INSIDE DIMENSIONS

FULL WIDTH OVERHANG

MODEL

SHIP WEIGHT

CUBE

LIST PRICE

69½"W x 24⅝"D	10½"	H11596	218	5.8	\$1184
69½"W x 24⅝"D	10½"	H11594	239	5.8	\$1134
69½"W x 24⅝"D	4½"	H11592	206	6.6	\$1058
63½"W x 24⅝"D	4½"	H11579	194	4.5	\$998
57½"W x 24⅝"D	4½"	H11578	182	4.1	\$956
45½"W x 24⅝"D	4½"	H11598	154	4.0	\$903

NOTES:

- Non-handed desk, credenza, and return shells, combined with a variety of under-the-worksurface storage solutions, maximize office layout flexibility. Shells and pedestals can be reconfigured quickly and easily when user preferences or space needs change.
- Tops are abrasion- and stain-resistant laminate over extra-thick 1½" solid core high-performance particleboard; resists warping.
- "Ribbon" edge profile; shape is on all four sides.
- Full height modesty panels.
- Cord management grommets, for routing and hiding wires and cables, are located in the tops of desk and return shells.
- 3" round worksurface grommet can be replaced with optional Power Hub (model HGRMTAC) or Power/USB Hub (model HGRMTUSB2) to bring the ease of plug-and-play to the desktop. See page 178.
- Credenza shells have a cord pass-through grommet in the top center of the modesty panel.
- The narrow design of the kneespace clearance end panel kits replace full end panels to provide added kneespace.
- Adjustable hex leveling glides allow floor-standing furniture to be easily leveled; glides have ¾" adjustable range.
- For conference table options, see the Preside® table tops and bases in the Tables section in the 2021 Shared Spaces Pricer. Order edge option "K".
- See pages 157-158 for modular storage components.

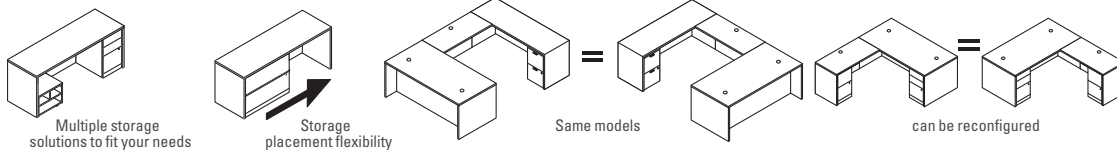

HOW TO SPECIFY

<p>Select Model Number</p> <p>H 1 1 5 9 6 .</p>	<p>Select Edge Profile</p> <p>See page 150</p> <p>A .</p>	<p>Select Laminate</p> <p>See page 150</p> <p>N N</p>
--	--	--



Icon Legend on page 19

VALIDO® Modular Credenzas

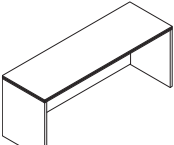
	DESCRIPTION	INSIDE DIMENSIONS	MODEL	SHIP WEIGHT	CUBE	LIST PRICE
	24"D Credenza Shell (with Full Modesty Panel)					
	72"W x 24"D x 29½"H	69½"W x 22¾"D	H11541	169	4.5	\$998
	66"W x 24"D x 29½"H	63½"W x 22¾"D	H11542	159	4.2	\$970
	60"W x 24"D x 29½"H	57½"W x 22¾"D	H11564	148	3.8	\$933
	48"W x 24"D x 29½"H	45½"W x 22¾"D	H115692	135	2.8	\$877
	42¼"W x 24"D x 29½"H	39¾"W x 22¾"D	H115691	118	3.4	\$834

Model H11541 shown

NOTES: Cord pass-through grommet in top center of modesty panel. See pages 166-167 for optional stack-on storage.

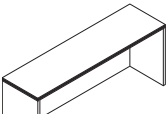
	20"D Credenza Shell (with Full Modesty Panel)					
	72"W x 20"D x 29½"H	69½"W x 18¾"D	H115581	154	5.3	\$944
	66"W x 20"D x 29½"H	63½"W x 18¾"D	H115582	145	4.8	\$916
	60"W x 20"D x 29½"H	57½"W x 18¾"D	H115583	135	4.4	\$883

NOTES: Cord pass-through grommet in top center of modesty panel. See pages 166-167 for optional stack-on storage.

	24"D Credenza Shell (with 10" Modesty Panel)					
	72"W x 24"D x 29½"H	69½"W x 22¾"D	H11541X	162	5.0	\$998
	66"W x 24"D x 29½"H	63½"W x 22¾"D	H11542X	124	4.0	\$970
	60"W x 24"D x 29½"H	57½"W x 22¾"D	H11564X	120	4.0	\$933
	48"W x 24"D x 29½"H	45½"W x 22¾"D	H115692X	107	4.0	\$877
	42¼"W x 24"D x 29½"H	39¾"W x 22¾"D	H115691X	98	4.0	\$834

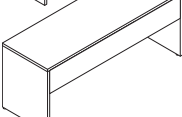
	20"D Credenza Shell (with 10" Modesty Panel)					
	72"W x 20"D x 29½"H	69½"W x 18¾"D	H115581X	124	4.6	\$944
	66"W x 20"D x 29½"H	63½"W x 18¾"D	H115582X	117	4.2	\$916
	60"W x 20"D x 29½"H	57½"W x 18¾"D	H115583X	110	3.8	\$883

NOTES: Makes reaching wall electrical outlets quick and easy. Provides more than 18" of clearance. See pages 166-167 for optional stack-on storage.

	Kneespace Clearance End Panel Kits (field installable)					
	1½"W x 11¼"D x 28⅞"H		H105098	13	0.9	\$223
Not available in two-tone laminate	1½"W x 17¼"D x 28⅞"H		H105099	11	0.8	\$234

For use at either end of Valido, 10500 or 10700 Series™ 24"D Credenza Shells (with full or 10" modesty panel) or non-pedestal end of single pedestal credenzas or credenzas with lateral files.

For use at either end of Valido, 10500 or 10700 Series™ 30"D Desk Shells or non-pedestal end of 30"D single pedestal desks.

Kits include: (1) support panel; European fastening hardware; flat connector bracket; joint connector bolts with sleeve nuts (for ganging credenza to adjacent worksurface); and adjustable leveling glides. Allows conversion of units currently in the field.

NOTES: Can be used to connect up to three 24"D credenzas or 30"D desks in line (requires 4 kits).

⚠ Not designed to be used freestanding. Not designed to be used with returns, 36"D desks or desk shells.

SPECIFYING EXAMPLE: H105098.N

NOTES:

- Non-handed desk, credenza, and return shells, combined with a variety of under-the-worksurface storage solutions, maximize office layout flexibility. Shells and pedestals can be reconfigured quickly and easily when user preferences or space needs change.
- Tops are abrasion- and stain-resistant laminate over extra-thick 1½" solid core high-performance particleboard; resists warping.
- "Ribbon" edge profile; shape is on all four sides.
- Cord management grommets, for routing and hiding wires and cables, are located in the tops of desk and return shells.
- Credenza shells have a cord pass-through grommet in the top center of the modesty panel.
- The narrow design of the kneespace clearance end panel kits replace full end panels to provide added kneespace.
- Adjustable hex leveling glides allow floor-standing furniture to be easily leveled; glides have ¾" adjustable range.
- Credenza Shells available with Full or 10" Modesty Panel options.
- For conference table options, see the Preside® table tops and bases in the Tables section in the 2021 Shared Spaces Pricer. Order edge option "K".
- See pages 157-158 for modular storage components.

HOW TO SPECIFY

<p>Select Model Number</p> <p>H 1 1 5 4 1 .</p>	<p>Select Edge Profile</p> <p>See page 150</p> <p>A .</p>	<p>Select Laminate</p> <p>See page 150</p> <p>N N</p>
---	---	---

VALIDO® Modular Returns

GSA SIN 33721



Icon Legend on page 19

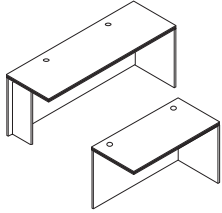

Model H115686 shown

DESCRIPTION

24" D Return Shell (with Full Modesty Panel)
 72"W x 24"D x 29½"H, (w/support; 2 grommets)
 60"W x 24"D x 29½"H, (w/support; 2 grommets)
 48"W x 24"D x 29½"H, (1 grommet)
 42"W x 24"D x 29½"H, (1 grommet)
 36"W x 24"D x 29½"H, (1 grommet)
 30"W x 24"D x 29½"H, (1 grommet)

INSIDE DIMENSIONS**MODEL****SHIP WEIGHT****CUBE****LIST PRICE**

67"W x 22¾"D	H115686	161	5.4	\$998
55"W x 22¾"D	H115684	142	4.9	\$933
47"W x 22¾"D	H11561	97	3.2	\$764
41"W x 22¾"D	H115681	97	2.5	\$748
34⅞"W x 22¾"D	H115680	91	3.2	\$748
28⅞"W x 22¾"D	H11568	78	2.8	\$694

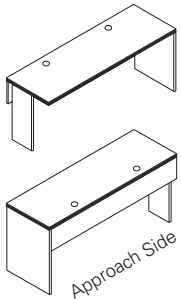
**24" D Return Shell (with 10" Modesty Panel)**

72"W x 24"D x 29½"H
 60"W x 24"D x 29½"H
 48"W x 24"D x 29½"H
 42"W x 24"D x 29½"H
 36"W x 24"D x 29½"H
 30"W x 24"D x 29½"H

67"W x 22¾"D	H115686X	124	5.0	\$998
55"W x 22¾"D	H115684X	108	4.0	\$933
47"W x 22¾"D	H11561X	90	3.0	\$764
41"W x 22¾"D	H115681X	80	3.0	\$748
34⅞"W x 22¾"D	H115680X	76	3.0	\$748
28⅞"W x 22¾"D	H11568X	65	2.8	\$694

NOTES: Shells are non-handed. No pre-drilled grommet in modesty panel (field installable grommet included). Woodgrain direction on modesty/back panel runs vertical on 30"W-60"W sizes and horizontal on 72"W unit. 36"W return shell can be used to achieve an efficient 6' x 6' footprint when connected to either a 72"W x 36"D single pedestal desk, desk shell, or peninsula, or when two are connected to a 36"W corner unit model H115811. 30"W return shell can be used to accomplish a 5' x 5' footprint when connected to a 60"W x 30"D desk shell or peninsula. See pages 166-167 for optional stack-on storage.

NOTES:

- Non-handed desk, credenza, and return shells, combined with a variety of under-the-worksurface storage solutions, maximize office layout flexibility. Shells and pedestals can be reconfigured quickly and easily when user preferences or space needs change.
- Tops are abrasion- and stain-resistant laminate over extra-thick 1½" solid core high-performance particleboard; resists warping.
- "Ribbon" edge profile; shape is on all four sides.
- Cord management grommets, for routing and hiding wires and cables, are located in the tops of desk and return shells.
- Credenza shells have a cord pass-through grommet in the top center of the modesty panel.
- The narrow design of the kneespace clearance end panel kits replace full end panels to provide added kneespace.
- Adjustable hex leveling glides allow floor-standing furniture to be easily leveled; glides have ¾" adjustable range.
- Credenza Shells available with Full or 10" Modesty Panel options.
- For conference table options, see the Preside® table tops and bases in the Tables section in the 2021 Shared Spaces Pricer. Order edge option "K".
- For work-in-process paper management tools, see page 175.
- See pages 157-158 for modular storage components.

HOW TO SPECIFY**Select Model Number**

H 1 1 5 6 8 6

Select Edge Profile

See page 150

A

Select Laminate

See page 150

N N

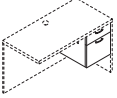
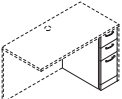
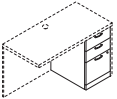
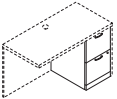

VALIDO® Laminate Modular Components

	DESCRIPTION	MODEL	SHIP WEIGHT	CUBE	LIST PRICE
 Not available in two-tone laminate	Box/File Pedestal (with core removable lock) 15 $\frac{5}{8}$ "W x 22 $\frac{3}{4}$ "D x 17 $\frac{3}{4}$ "H NOTES: For use under 24"D, 30"D and 36"D desk, credenza and return shells. Hangrails included. Lock can be positioned on either the right or left side. Attaches to underside of worksurface top. Unfinished top and back. ! Not designed to be used freestanding.	H11501	57	5.5	\$658
 Not available in two-tone laminate	Narrow Box/Box/File Pedestal — floor-standing 9 $\frac{1}{2}$ "W x 22 $\frac{3}{4}$ "D x 28"H NOTES: For use under 24"D, 30"D and 36"D modular desk, credenza and return shells. Unfinished top and back. ! Handle choices for this model are the Sweep, Crescent and Arch designs only. The linear handle (options "G" and "J") is not available on this product as the width of the component interferes with lock on the drawer face. ! Not designed to be used freestanding.	H115093	61	5.6	\$838
 Not available in two-tone laminate	Box/Box/File Pedestal (with core removable lock) — floor-standing 15 $\frac{5}{8}$ "W x 22 $\frac{3}{4}$ "D x 28"H — for use under 24"D, 30"D and 36"D desk, credenza and return shells 15 $\frac{5}{8}$ "W x 18 $\frac{3}{4}$ "D x 28"H — for use under 20"D, 24"D, 30"D and 36"D desk, credenza and return shells NOTES: Top box drawer does not lock. Hangrails included. Unfinished top and back. ! Not designed to be used freestanding.	H11502	90	8.4	\$851
 Not available in two-tone laminate	File/File Pedestal (with core removable lock) — floor-standing 15 $\frac{5}{8}$ "W x 22 $\frac{3}{4}$ "D x 28"H — for use under 24"D, 30"D and 36"D desk, credenza and return shells 15 $\frac{5}{8}$ "W x 18 $\frac{3}{4}$ "D x 28"H — for use under 20"D, 24"D, 30"D and 36"D desk, credenza and return shells NOTES: Hangrails included. Unfinished top and back. ! Not designed to be used freestanding.	H11504	85	8.4	\$851
		H115014	72	7.0	\$802

NOTES:

- Pedestals can be reconfigured quickly and easily when user preferences or space needs change.
- File drawers accept hanging folders in letter or legal size.
- Narrow pedestal features a compact design that is ideal for use in U- and L-shaped layouts for smaller spaces, such as a 5' x 8' U-shaped workstation or a 5' x 5' L-shaped workstation.
- Pedestal drawers operate on full extension, ball-bearing suspensions to ensure smooth, quiet, long-lasting operation.
- Handle options shown on page 150.
- Pedestal sides are notched to enable the routing of cords and cables.
- Mobile pedestals shown on page 170, work well in a variety of configurations.
- Pedestal models ship assembled unless designated .
- Modular pedestals to be used with 24"D, 30"D and 36"D Modular Shells.
- Pedestal models not designed to be used freestanding.
- See pages 154-156 for desk, credenza and return shells.

HOW TO SPECIFY

Select Model Number H 1 1 5 0 1	Select Handle Option Linear handles "G" and "J" not available on model H115093 See page 150 C	Select Laminate See page 150 N
---	---	---

VALIDO® Laminate Modular Components

GSA SIN 33721



Icon Legend on page 19

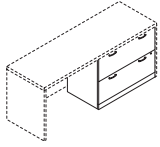

Not available in two-tone laminate

DESCRIPTION

Lateral File Pedestal (with core removable lock) — floor-standing

36"W x 20"D x 28"H — for use under 24"D, 30"D and 36"D desk, credenza and return shells

MODEL

H11503

SHIP WEIGHT

127

CUBE

15.6

LIST PRICE

\$1307

NOTES: Hangrails included. **Unfinished top and back.** Mechanical interlock inhibits extension of more than one drawer at a time.

⚠ Not designed to be used freestanding.

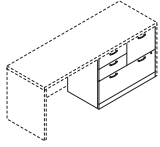

Not available in two-tone laminate

Multi File Pedestal (with core removable lock) — floor-standing

36"W x 20 1/4"D x 28"H — for use under 24"D, 30"D and 36"D desk, credenza and return shells

H11505

155

15.6

\$1559

NOTES: Versatile four drawer unit features one lateral file drawer, one vertical file drawer, and two box drawers. Box drawers do not lock. Hangrails included. **Unfinished top and back.** Mechanical interlock in lateral drawer inhibits extension of more than one drawer at a time.

⚠ Not designed to be used freestanding.

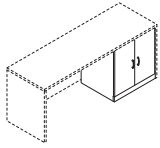

Not available in two-tone laminate

Cabinet Pedestal — floor-standing

26"W x 21 1/4"D x 28"H — for use under 24"D, 30"D and 36"D desk, credenza and return shells

H11508

78

12.2

\$948

NOTES: One adjustable shelf at 2 1/2" increments. Doors are non-locking. **Unfinished top and back.**

⚠ Not designed to be used freestanding.

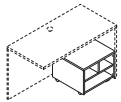

Mobile Printer/Fax Cart

20"W x 19 7/8"D x 14 1/8"H

H105679

52

2.9

\$451

NOTES: Holds laser printers, inkjet printers or fax machines. Ideal for limited space. Low profile cart stores conveniently and easily under desks and workstations. Interior compartment shelving is Black. Four casters. **1 1/8" thick top with flat, non-profiled edge.**

SPECIFYING EXAMPLE: H105679.NN

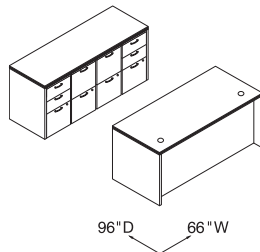

- 1 - H11579
- 1 - H11542
- 2 - H115102
- 2 - H115104

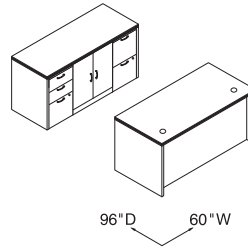

- 1 - H11578
- 1 - H11564
- 1 - H11502
- 1 - H11504
- 1 - H11508

NOTES:

- Pedestals can be reconfigured quickly and easily when user preferences or space needs change.
- See page 150 for handle design/finish options.
- File drawers accept hanging folders in letter or legal size.
- Pedestal drawers operate on full extension, ball-bearing suspensions to ensure smooth, quiet, long-lasting operation.
- Pedestal sides are notched to enable the routing of cords and cables.
- Mobile pedestals shown on page 170, work well in a variety of configurations.
- Pedestal models ship assembled unless designated ⚠.
- See pages 154-156 for desk, credenza and return shells.

HOW TO SPECIFY

<p>Select Model Number</p> <p>H 1 1 5 0 3</p>	<p>Select Handle Option</p> <p>See page 150 Not specified for model H105679</p> <p>C</p>	<p>Select Laminate</p> <p>See page 150</p> <p>N</p>
--	---	--

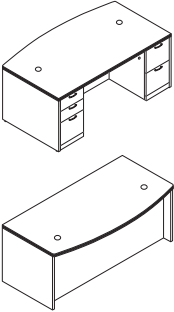
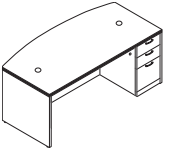
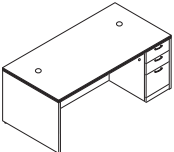

	DESCRIPTION	FULL WIDTH OVERHANG	MODEL	SHIP WEIGHT	CUBE	LIST PRICE
	Double Pedestal Desk, 3/2					
	72"W x 36"D x 29½"H, Bow Top	10½"	H115899	362	52.2	\$2702
	72"W x 36"D x 29½"H, Rectangle Top	10½"	H115890	370	52.2	\$2570
	66"W x 30"D x 29½"H, Rectangle Top	4½"	H115891	312	40.9	\$2472
	60"W x 30"D x 29½"H, Rectangle Top	4½"	H115892	303	37.3	\$2348
	NOTES: All drawers lock. Two worksurface grommets to route/hide cords. See page 174 for optional center drawers. Bow top model measures 36"D at the crest and 30" along the end panels.					
	Single Pedestal Desk, Bow Top					
	72"W x 36"D x 29½"H, Right	10½"	H115893R	308	52.2	\$2370
	72"W x 36"D x 29½"H, Left	10½"	H115894L	308	52.2	\$2370
	NOTES: Box/box/file drawer configuration. Drawers lock. Two worksurface grommets to route/hide cords. See page 174 for optional center drawers. Bow top model measures 36"D at the crest and 30" along the end panels.					
	Single Pedestal Desk, Rectangle Top					
	72"W x 36"D x 29½"H, Right	10½"	H115895R	316	52.2	\$2218
	66"W x 30"D x 29½"H, Right	4½"	H115897R	269	40.9	\$2015
	72"W x 36"D x 29½"H, Left	10½"	H115896L	316	52.2	\$2218
	66"W x 30"D x 29½"H, Left	4½"	H115898L	269	40.9	\$2015
	NOTES: Box/box/file drawer configuration. Drawers lock. Two worksurface grommets to route/hide cords. See page 174 for optional center drawers.					

NOTES:

- Full pedestal design provides a more formal styling aesthetic and maximizes storage space.
- Drawers in pedestal extend from underside of worksurface to the floor.
- Tops are abrasion- and stain-resistant laminate over extra-thick 1½" solid core high-performance particleboard; resists warping.
- 3" round worksurface grommet can be replaced with optional Power Hub (model HGRMTAC) or Power/USB Hub (model HGRMTUSB2) to bring the ease of plug-and-play to the desktop. See page 178.
- Recessed modesty panel design facilitates conferencing. See approach side illustration at left.
- Full height modesty panels.
- Drawers operate on full extension, ball-bearing suspensions to ensure smooth, quiet, long-lasting operation.
- See page 150 for handle design/finish options.
- File drawer design includes integrated hangrails for side-to-side letter or legal filing; and front-to-back for letter filing.
- All drawers are 5-sided construction, which allows easy drawer alignment or replacement of drawer fronts.
- Desk, credenza and return models ship assembled.
- For conference table options, see the Preside® table tops and bases in the Tables section in the 2021 Shared Spaces Pricer. Order edge option "K".
- See pages 163-179 for shared components.

HOW TO SPECIFY

Select Model Number See page 150 H 1 1 5 8 9 9	Select Edge Profile See page 150 A	Select Handle Option See page 150 C	Select Laminate See page 150 N N
--	--	---	--

VALIDO®

Laminate Wood Desks — Full Pedestals

GSA SIN 33721

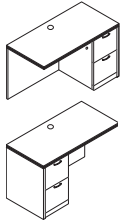

Icon Legend on page 19

**DESCRIPTION****Return, File/File**

48"W x 24"D x 29½"H, Right
 42"W x 24"D x 29½"H, Right
 48"W x 24"D x 29½"H, Left
 42"W x 24"D x 29½"H, Left

NOTES: Return is for use with single pedestal desks, desk shells, peninsulas or corner units. Drawers lock. One worksurface grommet and one cord pass-through grommet in top center of modesty panel to reach wall electrical outlets. See pages 166-167 for optional stack-on storage.

FULL WIDTH OVERHANG**MODEL****SHIP WEIGHT****CUBE****LIST PRICE**

	H115905R	168	24.9	\$1472
	H115907R	159	20.5	\$1457
	H115906L	168	24.9	\$1472
	H115908L	159	20.5	\$1457

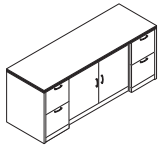
**Credenza with Doors**

72"W x 24"D x 29½"H

3½"

H115909

340

36.0

\$2690

NOTES: All drawers lock. Doors are non-locking. One cord pass-through grommet in top center of modesty panel. Includes a fixed shelf located at the bottom of the center storage area. No intermittent shelf. See pages 166-167 for optional stack-on storage.

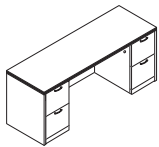
**Credenza with Kneespace — 2/0/2**

72"W x 24"D x 29½"H

3½"

H115900

296

36.0

\$2291

66"W x 24"D x 29½"H

3½"

H115901

286

31.6

\$2180

60"W x 24"D x 29½"H

3½"

H115902

257

28.8

\$2110

NOTES: All drawers lock. One cord pass-through grommet in top center of modesty panel. See pages 166-167 for optional stack-on storage.

ⓘ Not designed to be used with Valido/11500 Series 22¾"D modular or mobile pedestals. Modesty/back panel is inset 3½".

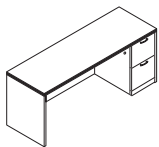
**Single Pedestal Credenza, File/File**

72"W x 24"D x 29½"H, Right (shown)

3½"

H115903R

251

36.0

\$1885

72"W x 24"D x 29½"H, Left

3½"

H115904L

251

36.0

\$1885

NOTES: Drawers lock. One cord pass-through grommet in top center of modesty panel. See pages 166-167 for optional stack-on storage.

ⓘ Not designed to be used with Valido/11500 Series 22¾"D modular or mobile pedestals. Modesty/back panel is inset 3½".

NOTES:

- Full pedestal design provides a more formal styling aesthetic and maximizes storage space.
- Drawers in pedestal extend from underside of worksurface to the floor.
- Tops are abrasion- and stain-resistant laminate over extra-thick 1½" solid core high-performance particleboard; resists warping.
- Recessed modesty panel design facilitates conferencing. See approach side illustration at left.
- Full height modesty panels.
- Drawers operate on full extension, ball-bearing suspensions to ensure smooth, quiet, long-lasting operation.
- See page 150 for handle design/finish options.
- File drawer design includes integrated hangrails for side-to-side letter or legal filing; and front-to-back for letter filing.
- All drawers are 5-sided construction, which allows easy drawer alignment or replacement of drawer fronts.
- Valido® 18¾"D modular and mobile pedestals can be positioned under credenza with kneespace and single pedestal credenza models.
- Desk, credenza and return models ship assembled.
- For conference table options, see the Preside® table tops and bases in the Tables section in the 2021 Shared Spaces Pricer. Order edge option "K".
- See pages 163-179 for shared components.

HOW TO SPECIFY**Select Model Number**

H 1 1 5 9 0 5 R .

Select Edge Profile

See page 150

A .

Select Handle Option

See page 150

C .

Select Laminate

See page 150

N N

	DESCRIPTION	FULL WIDTH OVERHANG	MODEL	SHIP WEIGHT	CUBE	LIST PRICE
	Double Pedestal Desk, 2-2					
	72"W x 36"D x 29½"H, Bow Top	10½"	H11595	356	52.2	\$2172
	72"W x 36"D x 29½"H, Rectangle Top	10½"	H11593	364	52.2	\$1989
	66"W x 30"D x 29½"H, Rectangle Top	4½"	H11571	304	40.9	\$1897
	60"W x 30"D x 29½"H, Rectangle Top	4½"	H11573	288	37.3	\$1790
	NOTES: All drawers lock. Two worksurface grommets to route/hide cords. See page 174 for optional center drawers.					
	Single Pedestal Desk, Bow Top					
	72"W x 36"D x 29½"H, Right	10½"	H11587R	264	52.9	\$1914
	72"W x 36"D x 29½"H, Left	10½"	H11588L	264	52.9	\$1914
	NOTES: Drawers lock. Two worksurface grommets to route/hide cords. See page 174 for optional center drawers. Bow top models measure 36"D at the crest and 30"D along the end panels.					
	Single Pedestal Desk, Rectangle Top					
	72"W x 36"D x 29½"H, Right	10½"	H11585R	303	52.2	\$1691
	66"W x 30"D x 29½"H, Right	4½"	H11583R	247	40.9	\$1580
	72"W x 36"D x 29½"H, Left	10½"	H11586L	303	52.2	\$1691
	66"W x 30"D x 29½"H, Left	4½"	H11584L	247	40.9	\$1580
	NOTES: Drawers lock. Two worksurface grommets to route/hide cords. See page 174 for optional center drawers.					
	Small Office Desk					
	48"W x 30"D x 29½"H	4½"	H115885R	183	30.0	\$1275
	NOTES: Small footprint makes this desk ideal for limited space. Drawers lock. One cord grommet in top for routing and hiding wires and cables. 3/4 length modesty panel facilitates reaching wall electrical outlets. Optional stack-on storage model H115323 maximizes storage space; see pages 166-167 for additional stack-on storage models.					
	Return, Box/File					
	48"W x 24"D x 29½"H, Right		H11515R	158	24.9	\$1231
	42"W x 24"D x 29½"H, Right		H11511R	146	20.5	\$1217
	48"W x 24"D x 29½"H, Left		H11516L	158	24.9	\$1231
	42"W x 24"D x 29½"H, Left		H11512L	146	20.5	\$1217
	NOTES: Return is for use with single pedestal desks, desk shells, peninsulas or corner units. Drawers lock. One worksurface grommet and one cord pass-through grommet in top center of modesty panel to reach wall electrical outlets. See pages 166-167 for optional stack-on storage.					
	ⓘ Not designed to be used freestanding.					
			H11584L H11515R H115327 H115520 H115523 HLVPM1			
				H11587R H115598 H115811 H11516L H115301	H115524 H115327 HLVPM1	

NOTES:

- For components that can be shared with Valido/11500 Series, see pages 163-179.
- Tops are abrasion- and stain-resistant laminate over extra-thick 1½" solid core high-performance particleboard; resists warping.
- 3/4 pedestal design increases budget flexibility.
- Formal, full height modesty panels.
- 3" round worksurface grommet can be replaced with optional Power Hub (model HGRMTAC) or Power/USB Hub (model HGRMTUSB2) to bring the ease of plug-and-play to the desktop. See page 178.
- All drawers are 5-sided construction, which allows easy drawer alignment or replacement of drawer fronts.
- The small footprint of the Small Office Desk is ideal for limited space.
- Drawers operate on full extension, ball-bearing suspensions to ensure smooth, quiet, long-lasting operation.
- See page 150 for handle design/finish options.
- Center drawers conveniently store writing instruments, paper and other miscellaneous items. Includes pencil tray. See page 174.
- File drawer design includes integrated hangrails for side-to-side letter or legal filing; and front-to-back for letter filing.
- Desk, credenza and return models ship assembled.
- See pages 166-167 for optional stack-on storage.
- For conference table options, see the Preside® table tops and bases in the Tables section in the 2021 Shared Spaces Pricer. Order edge option "K".

HOW TO SPECIFY

Select Model Number	Select Edge Profile	Select Handle Option	Select Laminate
See page 150	See page 150	See page 150	See page 150
H 1 1 5 9 5 .	A .	C .	N N

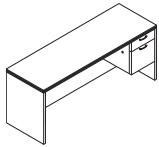
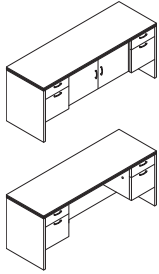

DESCRIPTION	FULL WIDTH OVERHANG	MODEL	SHIP WEIGHT	CUBE	LIST PRICE
Credenza with Doors 72"W x 24"D x 29½"H	3½"	H11544	294	36.0	\$2189
NOTES: Includes one fixed shelf at the bottom of the center storage area. All drawers lock. Doors are non-locking.					
Credenza with Kneespace 72"W x 24"D x 29½"H	3½"	H11543	259	36.0	\$1843
66"W x 24"D x 29½"H	3½"	H11566	249	31.6	\$1790
60"W x 24"D x 29½"H	3½"	H11565	239	28.8	\$1725
NOTES: One cord pass-through grommet in top center of modesty panel to reach wall electrical outlets. All drawers lock. See pages 166-167 for optional stack-on storage.					
! Not designed to be used with Valido/11500 Series 22¾"D modular or mobile pedestals. Modesty/back panel is inset 3½".					
Credenza, Single Pedestal, Box/File 72"W x 24"D x 29½"H, Right (shown)	3½"	H11545R	228	36.0	\$1546
72"W x 24"D x 29½"H, Left	3½"	H11546L	228	36.0	\$1546
NOTES: One cord pass-through grommet in top center of modesty panel to reach wall electrical outlets. Drawers lock. See pages 166-167 for optional stack-on storage.					
! Not designed to be used with Valido/11500 Series 22¾"D modular or mobile pedestals. Modesty/back panel is inset 3½".					

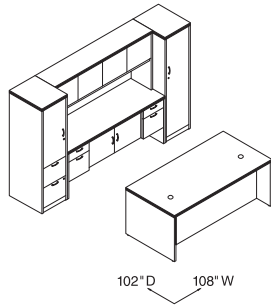

H11593
H11544
H115295R
H115298L
H11534

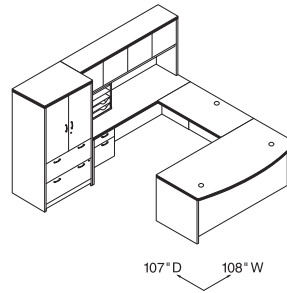

H11587R
H11570
H11546L
H11534
H115293
HLVPM1

NOTES:

- For components that can be shared with Valido/11500 Series, see pages 163-179.
- Tops are abrasion- and stain-resistant laminate over extra-thick 1½" solid core high-performance particleboard; resists warping.
- Formal, full height modesty panels.
- Cord management grommets, for routing and hiding wires and cables, are located in the tops of desks, returns, bridges and corner units.
- All drawers are 5-sided construction, which allows easy drawer alignment or replacement of drawer fronts.
- Drawers operate on full extension, ball-bearing suspensions to ensure smooth, quiet, long-lasting operation.
- See page 150 for handle design/finish options.
- File drawer design includes integrated hangrails for side-to-side letter or legal filing; and front-to-back for letter filing.
- For conference table options, see the Preside® table tops and bases in the Tables section in the 2021 Shared Spaces Pricer. Order edge option "K".

HOW TO SPECIFY

<p>Select Model Number</p> <p>H 1 1 5 4 4 .</p>	<p>Select Edge Profile</p> <p>See page 150</p> <p>A .</p>	<p>Select Handle Option</p> <p>See page 150</p> <p>C .</p>	<p>Select Laminate</p> <p>See page 150</p> <p>N N</p>
---	---	--	---

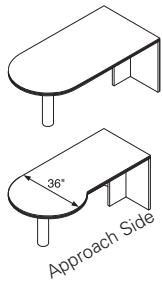
**DESCRIPTION****Peninsula w/End Panel**

72"W x 36"D x 29½"H
66"W x 30"D x 29½"H
60"W x 30"D x 29½"H

MODEL

H11521E
H11522E
H11523E

SHIP WEIGHT

167
138
115

CUBE

8.1
6.6
6.6

LIST PRICE

\$1196
\$1091
\$1014

P-shaped Peninsula w/End Panel

72"W x 30/36"D x 29½"H, Right
72"W x 36/30"D x 29½"H, Left

H11525RE
H11526LE

159
159

8.1
8.1

\$1330
\$1330

NOTES: Use for "U" or "L" configuration. 60"W ideal for smaller spaces. Cord routing notch in brace panel. Accept field installable modesty panel model H10528 (see page 164). See page 174 for optional center drawers. Peninsulas ship complete with end panel and support column. Support column is black.

❗ Not designed to be used freestanding.

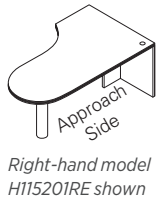
**Jetty Peninsula w/End Panel**

72"W x 30/42"D x 29½"H, Right
72"W x 42/30"D x 29½"H, Left

H115201RE
H115202LE

175
175

9.4
9.4

\$1542
\$1542

NOTES: For use in "U" or "L" configuration. Designed and sized to efficiently serve as both a computing and conferencing space. One cord management grommet in the top; cord routing notch in brace panel. Jetty units manufactured on or after 10/24/2005 accept field installable modesty panel H10528 (see page 164). Peninsulas ship complete with end panel and support column. Support column is black.

❗ Not designed to be used freestanding.

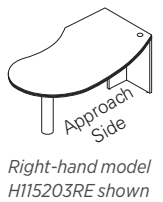
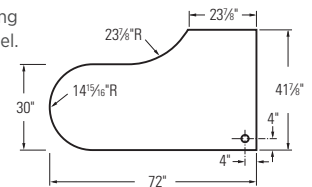
**Boomerang Peninsula w/End Panel**

72"W x 30/42"D x 29½"H, Right
72"W x 42/30"D x 29½"H, Left

H115203RE
H115204LE

175
175

9.4
9.4

\$1542
\$1542

NOTES: For use in "U" or "L" configuration. Designed and sized to efficiently serve as both a computing and conferencing space. One cord management grommet in the top; cord routing notch in brace panel. Accepts field installable modesty panel H10528 (see page 164). Peninsulas ship complete with end panel and support column. Support column is black.

❗ Not designed to be used freestanding.

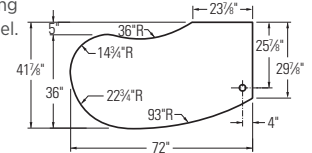
**NOTES:**

- Shared components shown on this page can be used with modular components shown on pages 154-158, full pedestal models shown on pages 159-160, and 3/4 pedestal models shown on pages 161-162.
- Mobile pedestals shown on page 170 work well in a variety of configurations.
- Peninsulas ship complete with end panel and black 3" diameter support column. For a silver support column option, please see model HPC191X on page 281 (ordered separately).
- Jetty, Boomerang, and Rudder peninsulas are designed and sized to efficiently serve as both a computing and conferencing space.
- Adjustable hex leveling glides allow floor-standing furniture to be easily leveled; glides have 3/4" adjustable range.
- For conference table options, see the Preside® table tops and bases in the Tables section in the 2021 Shared Spaces Pricer. Order edge option "K".
- See pages 163-179 for shared components.

HOW TO SPECIFY

Select Model Number	Select Edge Profile	Select Laminate	Select Paint Color
See page 150	See page 150	See page 150	Specify for new peninsula models only
P	A	NN	P Black

VALIDO® Shared Components & Accessories

GSA SIN 33721



Icon Legend on page 19

**DESCRIPTION****MODEL****SHIP WEIGHT****CUBE****LIST PRICE****Field Installable Modesty Panel for Peninsulas**

50¼"W x ¾"Thick x 18"H

H10528

25

1.3

\$203

NOTES: Center drawer model H1522 can be used in conjunction with modesty panel. Laminate Modesty Panel has a cord pass-through notch in top corner.

⚠ Not designed to be used on jetty peninsulas manufactured prior to 10/24/2005.

SPECIFYING EXAMPLE: H10528.N

**Field Installable Modesty Panel for Bullet, Jetty and Boomerang Peninsulas, Frosted with Silver Frame**

50¼"W x ¾"Thick x 18"H

HPC180G

33 Ⓢ

1.5

\$745

NOTES: For use on 72"W peninsulas. Frosted/silver modesty panel HPC180G can be used with Valido, 10700, 10600 and 10500 Series™ peninsula models. Cord pass-through notch is not available on the Frosted/Silver model HPC180G. Notch is on laminate model H10528 only.

⚠ Center drawers not designed to be used with the frosted/silver modesty panel model HPC180G.

NOTES:

- Shared components shown on this page can be used with modular components shown on pages 154-158, full pedestal models shown on pages 159-160, and 3/4 pedestal models shown on pages 161-162.
- Mobile pedestals shown on page 170 work well in a variety of configurations.
- Peninsulas ship complete with end panel and black 3" diameter support column. For a silver support column option, please see model HPC191X on page 281 (ordered separately).
- Jetty, Boomerang and Rudder peninsulas are designed and sized to efficiently serve as both a computing and conferencing space.
- Adjustable hex leveling glides allow floor-standing furniture to be easily leveled; glides have ¾" adjustable range.
- For conference table options, see the Preside® table tops and bases in the Tables section in the 2021 Shared Spaces Pricer. Order edge option "K".
- See pages 163-179 for shared components.

HOW TO SPECIFY**Select Model Number**

H 1 0 5 2 8 .

Select Laminate

See page 150

N N

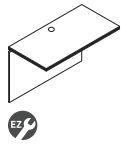
**DESCRIPTION****MODEL****SHIP WEIGHT****CUBE****LIST PRICE****Bridge (Single Ped. Desk, Desk Shell or Peninsula, to Corner Unit, Single Ped. Credenza or Credenza Shell)**

47"W x 24"D x 29½"H, (Clear inside depth = 21⅞"D)	H11570	86	3.2	\$560
42"W x 24"D x 29½"H, (Clear inside depth = 21⅞"D)	H11560	81	2.9	\$536
36"W x 24"D x 29½"H, (Clear inside depth = 21⅞"D) (see notes below)	H115599	69	2.9	\$536
30"W x 24"D x 29½"H, (Clear inside depth = 21⅞"D) (see notes below)	H115598	57	2.2	\$536
47"W x 20"D x 29½"H, (Clear inside depth = 17⅞"D) (see notes below)	H115699	70	3.2	\$536
42"W x 20"D x 29½"H, (Clear inside depth = 17⅞"D) (see notes below)	H115698	62	2.9	\$513

NOTES: One worksurface grommet and one grommet in top and in top center of modesty panel. Grommet can be replaced with optional Power Hub or Power/USB Hub for easy plug-and-play (see page 178). Kneespace of desk limited to 24¾"W if bridge is used with 66"W single pedestal desk. H115599 is for use with corner or extended corner units or jetty or boomerang peninsulas. H115598 is for use with corner or extended corner units. H115699 and H115698 are for use with single pedestal desks, desk shells or peninsulas (excluding jetty and boomerang).

Specify: Model.Edge.Laminate

SPECIFYING EXAMPLE: H11570.A.NN

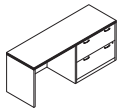
**Credenza with 36" Lateral (with core removable locks)**

72"W x 24"D x 29½"H, Right (shown)	H11547R	264	36.0	\$1977
72"W x 24"D x 29½"H, Left	H11548L	264	36.0	\$1977

NOTES: Includes hangrails. Mechanical interlock inhibits the extension of more than one drawer at a time. See pages 166-167 for optional stack-on storage.

⚠ Not designed to be used with Valido/11500 Series 22¾"D modular or mobile pedestals. Modesty/back panel is inset 3½".

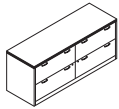
**Credenza with two Lateral Files (with core removable locks)**

72"W x 24"D x 29½"H	H115491	330	36.0	\$2771
---------------------	----------------	-----	------	---------------

NOTES: 4 locking drawers. Each lock secures 2 drawers. Includes hangrails; mechanical interlock inhibits the extension of more than one drawer at a time. If side-by-side drawers are opened or closed simultaneously, one drawer may interfere with the other. See pages 166-167 for optional stack-on storage.

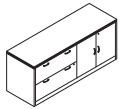
**Credenza with Lateral File, left and Storage Cabinet, right (with core removable locks)**

72"W x 24"D x 29½"H	H115492	323	36.0	\$2513
---------------------	----------------	-----	------	---------------

NOTES: Includes hangrails; mechanical interlock inhibits the extension of more than one drawer at a time. Storage cabinet locks and includes one adjustable interior shelf. Shelf adjusts in 1¼" increments with a total range of 5"H. See pages 166-167 for optional stack-on storage.

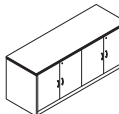
**Credenza w/Two Storage Cabinets**

72"W x 24"D x 29½"H	H115493	320	35.6	\$2231
---------------------	----------------	-----	------	---------------

NOTES: Each storage cabinet has one interior shelf which adjusts in 1¼" increments over a total range of 5". Each cabinet locks independently. Locks are keyed alike. For optional stack-on storage, see pages 166-167 for additional stack-on storage models.

NOTES:

- Shared components shown on this page can be used with modular components shown on pages 154-158, full pedestal models shown on pages 159-160, and 3/4 pedestal models shown on pages 161-162.
- Mobile pedestals shown on page 170 work well in a variety of configurations.
- Locking units equipped with interchangeable core removable locks.
- File drawers accept hanging folders in letter or legal size.
- See page 150 for handle design/finish options.
- Adjustable hex leveling glides allow floor-standing furniture to be easily leveled; glides have ¾" adjustable range.
- See pages 163-179 for shared components.

⚠ Keyed alike cores must be ordered separately — see page 773.

HOW TO SPECIFY

Select Model Number	Select Edge Profile	Select Handle Option	Select Laminate
See page 150	See page 150	See page 150 Not specified on Bridge models	See page 150
H 1 1 5 4 7 R .	A .	C .	N N

VALIDO® Shared Components & Accessories

GSA SIN 33721

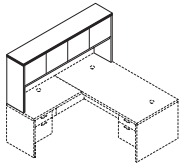

Icon Legend on page 19

**DESCRIPTION**

Stack-on Storage for an "L" Workstation
78"W x 14⁵/₈"D x 37¹/₂"H

MODEL SHIP WEIGHT CUBE LIST PRICE**H115327 209 17.6 \$1593**

Stack-on Storage for an "L" Workstation, Locking
78"W x 14⁵/₈"D x 37¹/₂"H

H115327K 209 17.6 \$1682

NOTES: Spans the total depth dimension of configurations comprised of: 48"W return or return shell attached to a 30"D single pedestal desk, desk shell or peninsula (78"D); 42"W return or return shell attached to a 36"D single pedestal desk, desk shell or peninsula (78"D). 42"W return or return shell attached to a 36" corner unit (78"D); or 42"W curved return attached to 36" curved corner unit (78"D). Use back enclosure model H105857 and tackboard model H90057 (see page 168). Use task light models HH870960, or HH870960CH (see page 595). For vertical paper manager model HLVPM1, see page 175.

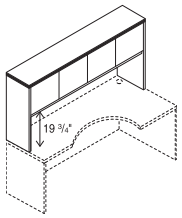
**Stack-on Storage (See page 168 for Back Enclosures and Fabric Tackboards)**72"W x 14⁵/₈"D x 37¹/₂"H, 4 doors (Use Task Light model HH870960, see page 177)**H11534 195 16.9 \$1432**66"W x 14⁵/₈"D x 37¹/₂"H, 4 doors (Use Task Light model HH870960, see page 177)**H11533 184 15.3 \$1398**60"W x 14⁵/₈"D x 37¹/₂"H, 4 doors (Use Task Light model HH870960, see page 177)**H115324 172 14.0 \$1338**48"W x 14⁵/₈"D x 37¹/₂"H, 3 doors (Use Task Light model HH870942, see page 177)**H115323 148 11.3 \$1164**42"W x 14⁵/₈"D x 37¹/₂"H, 2 doors (Use Task Light model HH870942, see page 177)**H115322 141 4.0 \$1001**36"W x 14⁵/₈"D x 37¹/₂"H, 2 doors (Use Task Light model HH870930, see page 177)**H115321 107 3.5 \$960****Stack-on Storage, Locking (See page 168 for Back Enclosures and Fabric Tackboards)**72"W x 14⁵/₈"D x 37¹/₂"H, 4 doors (Use Task Light model HH870960, see page 177)**H11534K 195 16.9 \$1523**66"W x 14⁵/₈"D x 37¹/₂"H, 4 doors (Use Task Light model HH870960, see page 177)**H11533K 184 15.3 \$1489**60"W x 14⁵/₈"D x 37¹/₂"H, 4 doors (Use Task Light model HH870960, see page 177)**H115324K 172 14.0 \$1429**48"W x 14⁵/₈"D x 37¹/₂"H, 3 doors (Use Task Light model HH870942, see page 177)**H115323K 148 11.3 \$1232**42"W x 14⁵/₈"D x 37¹/₂"H, 2 doors (Use Task Light model HH870942, see page 177)**H115322K 141 4.0 \$1046**36"W x 14⁵/₈"D x 37¹/₂"H, 2 doors (Use Task Light model HH870930, see page 177)**H115321K 107 3.5 \$1005**

NOTES: Models H11534 and H11534K can be used for "L" configuration comprised of 30"D desk, desk shell or peninsula and 42"W return or return shell. Model H115323K has one lock which secures two of the three doors. For vertical paper manager, see page 175.

NOTES:

- Shared components shown on this page can be used with modular components shown on pages 154-158, full pedestal models shown on pages 159-160, and 3/4 pedestal models shown on pages 161-162.
- Stack-on storage models are equipped with self-closing, adjustable hinged doors and valance to hide task light.
- For work-in-process paper management tools, see page 175.
- See pages 163-179 for shared components.

❗ Removable lock core kit for stack-on and wall mount storage is model HF27B, see page 773.

❗ The HON Company is not responsible for any liabilities resulting from wall mounted storage cabinets that are not properly installed.

HOW TO SPECIFY

Select
Model Number

H 1 1 5 3 4

Select
Edge Profile

See page 150

A

Select
Laminate

See page 150

N N

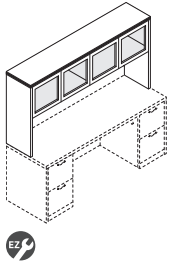

DESCRIPTION

MODEL SHIP WEIGHT CUBE LIST PRICE

Stack-on Storage for an "L" Workstation, Frosted Doors with Silver Frame

78"W x 14 5/8"D x 37 1/2"H, 4 doors (Use Task Light model HH870960, see page 177)

H115327G 210 18.4 **\$2355**

NOTES: Spans the total depth dimension of configurations comprised of: 48"W return or return shell attached to a 30"D single pedestal desk, desk shell or peninsula (78"D); 42"W return or return shell attached to a 36"D single pedestal desk or desk shell with a rectangle top, or to a peninsula (78"D). 42"W return or return shell attached to a 36" corner unit (78"D); 42"W curved return attached to 36" curved corner unit (78"D); or 36"W return shell attached to a jetty peninsula (78"D). Use back enclosure model H105857 and tackboard model H90057. Use task light models HH870960 or HH870960CH. For vertical paper manager model HLVPM1, see page 175.

Stack-on Storage, w/Frosted Doors with Silver Frame

72"W x 14 5/8"D x 37 1/2"H, 4 doors (Use Task Light model HH870960, see page 177)

H11534G 196 17.0 **\$2189**

66"W x 14 5/8"D x 37 1/2"H, 4 doors (Use Task Light model HH870960, see page 177)

H11533G 185 15.6 **\$2154**

60"W x 14 5/8"D x 37 1/2"H, 4 doors (Use Task Light model HH870960, see page 177)

H115324G 173 14.2 **\$2091**

48"W x 14 5/8"D x 37 1/2"H, 3 doors (Use Task Light model HH870942, see page 177)

H115323G 148 11.5 **\$1733**

42"W x 14 5/8"D x 37 1/2"H, 2 doors (Use Task Light model HH870942, see page 177)

H115322G 141 4.1 **\$1389**

36"W x 14 5/8"D x 37 1/2"H, 2 doors (Use Task Light model HH870930, see page 177)

H115321G 107 4.1 **\$1345**

NOTES: For respective desk, credenza or return widths. Model 11534 can be used for "L" configuration comprised of a 42"W return or return shell attached to a 30"D single pedestal desk, desk shell or peninsula (72"); 36"W return shell attached to a 36"D single pedestal desk, desk shell or peninsula (72"); or 30"W return shell attached to a jetty peninsula (72"). Back enclosures, tackboards for use with back enclosures and task lights are available as options. See vertical paper manager model HLVPM1 on page 175.

Stack-on Storage models H115327G, H11534G, H11533G and H115324G use task light model HH870960. Models H115323G and H115322G use task light model HH870942 and model H115321G uses task light model HH870930. All task lights can be found on page 177.

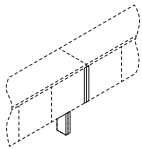

Stack-on Storage Clearance End Panel Kit

1 1/8"W x 4 5/8"-14 5/8"D x 36"H

H105349 29 3.4 **\$382**

Two field installable end panels (1-right; 1-left) for use in ganging two 10500 or Valido® Series stack-on storage units. See page 302.

NOTES: Can be used to connect up to two stack-on storage units in a line (requires 1 kit). Not available in two-tone laminate.

SPECIFYING EXAMPLE: H105349.N

NOTES:

- Shared components shown on this page can be used with modular components shown on pages 154-158, full pedestal models shown on pages 159-160, and 3/4 pedestal models shown on pages 161-162.
- Stack-on storage models are equipped with self-closing, adjustable hinged doors and valance to hide task light.
- For work-in-process paper management tools, see page 175.
- See pages 163-179 for shared components.

! Removable lock core kit for stack-on and wall mount storage is model HF27B, see page 773.

! The HON Company is not responsible for any liabilities resulting from wall mounted storage cabinets that are not properly installed.

HOW TO SPECIFY

<p>Select Model Number</p> <p>H 1 1 5 3 2 7 G .</p>	<p>Select Edge Profile</p> <p>See page 150</p> <p>A .</p>	<p>Select Laminate</p> <p>See page 150</p> <p>NN</p>
---	---	--

VALIDO® Shared Components & Accessories

GSA SIN 33721

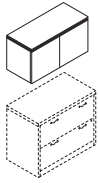

Icon Legend on page 19

**DESCRIPTION****Wall Mounted Storage Cabinet**

30"W x 14⁵/₈"D x 17⁷/₈"H, 2 doors
(Use Task Light model HH870930, see page 177)
36"W x 14⁵/₈"D x 17⁷/₈"H, 2 doors
(Use Task Light model HH870930, see page 177)
42"W x 14⁵/₈"D x 17⁷/₈"H, 2 doors
(Use Task Light model HH870942, see page 177)
48"W x 14⁵/₈"D x 17⁷/₈"H, 3 doors
(Use Task Light model HH870942, see page 177)

MODEL**COM****SHIP WEIGHT****CUBE****LIST PRICE**

H115380		77	8.7	\$967
H115381		92	10.2	\$1018
H115382		103	11.7	\$1095
H115383		121	14.0	\$1183

Wall Mounted Storage Cabinet, Locking

30"W x 14⁵/₈"D x 17⁷/₈"H, 2 doors
(Use Task Light model HH870930, see page 177)
36"W x 14⁵/₈"D x 17⁷/₈"H, 2 doors
(Use Task Light Model HH870930, see page 177)
42"W x 14⁵/₈"D x 17⁷/₈"H, 2 doors
(Use Task Light Model HH870942, see page 177)
48"W x 14⁵/₈"D x 17⁷/₈"H, 3 doors
(Use Task Light Model HH870942, see page 177)

H115380K		77	8.7	\$1013
H115381K		92	10.2	\$1064
H115382K		103	11.7	\$1141
H115383K		121	14.0	\$1252

NOTES: Horizontal interlocking rails are included; due to varying types of walls, installers are responsible for selecting and supplying the appropriate fasteners. Tackboard widths differ slightly from wall mounted storage cabinet widths. For applications where multiple wall mounted storage cabinets are placed side-by-side, the preferred tackboard solution may be to utilize a larger tackboard size. For example, H90057 = 75"W; H90056 = 68³/₄"W; H90055 = 62³/₄"W; H90054 = 56³/₄"W. For paper organizer tools, see page 175.

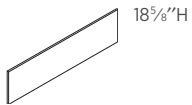
18⁵/₈"H

Not available in two-tone laminate

Back Enclosure for Stack-on Storage

75³/₄"W - for 78"W model #H115327
69³/₄"W - for 72"W model #H11534
63³/₄"W - for 66"W model #H11533
57³/₄"W - for 60"W model #H115324
45³/₄"W - for 48"W model #H115323
39³/₄"W - for 42"W model #H115322
33³/₄"W - for 36"W model #H115321

H105857		39	1.4	\$275
H105856		33	1.3	\$252
H105855		31	1.3	\$235
H105854		29	1.3	\$224
H105853		23	0.9	\$224
H105852		21	0.9	\$214
H105851		18	0.9	\$202

NOTES: Non-tackable. Specify laminate.

SPECIFYING EXAMPLE: H105857.N

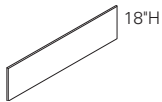

18"H

Tackboards for use with Stack-on Back Enclosures

75"W - for 78"W model #H115327 Hutch with #H105857 Enclosure
68³/₄"W - for 72"W model #H11534 Hutch with #H105856 Enclosure
62³/₄"W - for 66"W model #H11533 Hutch with #H105855 Enclosure
56³/₄"W - for 60"W model #H115324 Hutch with #H105854 Enclosure
44³/₄"W - for 48"W model #H115323 Hutch with #H105853 Enclosure
39"W - for 42"W model #H115322 Hutch with #H105852 Enclosure
33"W - for 36"W model #H115321 Hutch with #H105851 Enclosure

H90057	3.0	13	3.2	\$337
H90056	2.0	12	2.7	\$320
H90055	2.0	11	2.5	\$304
H90054	2.0	10	2.2	\$268
H90053	2.0	8	1.8	\$257
H90052	2.0	7	1.6	\$237
H90051	1.0	6	1.4	\$208

NOTES: Specify fabric, see pages 25-26. Upcharges may apply to premium fabric grades.

❗ Disperse (DISP) fabric not available on sizes wider than 60". Analog (ANLG) and Exchange (EXG) not available on sizes wider than 72".

❗ Back Enclosures must be ordered separately.

SPECIFYING EXAMPLE: H90057.APN15

NOTES:

- Shared components shown on this page can be used with modular components shown on pages 154-158, full pedestal models shown on pages 159-160, and 3/4 pedestal models shown on pages 161-162.
- Back enclosure features full-width 1¹/₈" slot at the bottom to facilitate routing cords and reaching wall electrical outlets.
- Tackboard is sized ³/₄" narrower than stack-on storage back enclosure, allowing ³/₈" on each side to route task light cord.
- Wall mounted storage cabinet attachment requires individual cabinets be secured by a minimum of two wall mounting locations/studs.
- Wall mounted storage cabinets are designed for interior and perimeter walls that are constructed with wood or metal studs.
- Wall attachment methodology: horizontally mounted, interlocking brackets.
- Wall mounted storage cabinet door design overlaps end panels so that when multiple units are placed side-by-side they appear as one continuous unit.
- See pages 163-179 for shared components.

❗ Removable lock core kit for stack-on and wall mount storage is model HF27B, see page 773.

❗ The HON Company is not responsible for any liabilities resulting from wall mounted storage cabinets that are not properly installed.

HOW TO SPECIFY

Select
Model Number

H 1 1 5 3 8 0 .

Select
Edge Profile

See page 150

A .

Select
Laminate

See page 150

N N

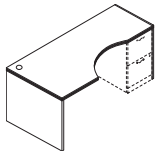

Right-hand model
H115815R shown

DESCRIPTION

Extended Corner Unit

24"W x 36"D x 72"W x 24"D x 29½"H, Right (shown)
24"D x 72"W x 36"D x 24"W x 29½"H, Left

MODEL SHIP WEIGHT CUBE LIST PRICE

H115815R	203	7.0	\$1450
H115816L	203	7.0	\$1450

NOTES: Can be used freestanding. One grommet in top and in modesty panel. Accept Valido/11500 Series modular or mobile pedestals. See pages 166-167 for optional stack-on storage.

ⓘ Designed to be used with returns or bridges.

SPECIFYING EXAMPLE: H115815R.A.NN

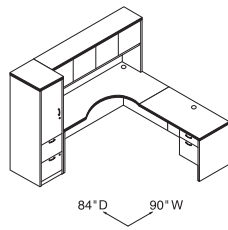
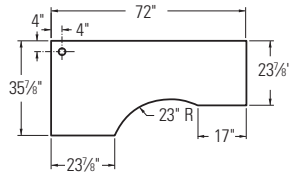

H115298L
H115816L
H11534
H11515R

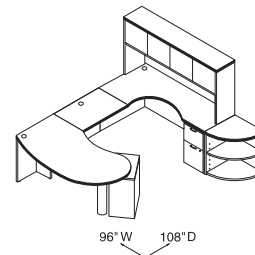

H115103
H115204L
H115598
H115815R
H115104
H11534
H115520

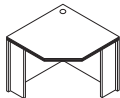

Corner Unit

24" x 36" x 36" x 24" x 29½"H

H115811	141	3.1	\$1000
----------------	-----	-----	---------------

NOTES: Can be used freestanding.

ⓘ Designed to be used with 24"D x 29½"H returns or bridges.

SPECIFYING EXAMPLE: H115811.A.NN

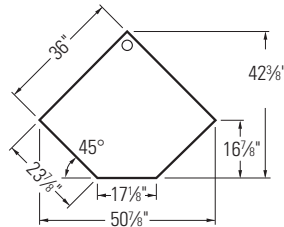

NOTES:

- Shared components shown on this page can be used with modular components shown on pages 154-158, full pedestal models shown on pages 159-160, and 3/4 pedestal models shown on pages 161-162.
- Mobile pedestals, shown on page 170, work well in a variety of configurations.
- Extended corner units (H115815R and H115816L) can be used with 36"W return shell (H115680) to achieve a 6' x 6' layout.
- 36" corner unit (H115811) can be used with two 36"W return shells (H115680) to achieve a 6' x 6' layout.
- For conference table options, see the Preside® table tops and bases in the Tables section in the 2021 Shared Spaces Pricer. Order edge option "K".
- For work-in-process paper management tools, see page 175.
- See pages 163-179 for shared components.

HOW TO SPECIFY

<p>Select Model Number</p> <p>H 1 1 5 8 1 7 R .</p>	<p>Select Edge Profile</p> <p>See page 150</p> <p>A .</p>	<p>Select Laminate</p> <p>See page 150</p> <p>NN</p>
--	--	---











VALIDO®

Shared Components & Accessories

GSA SIN 33721

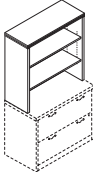

Icon Legend on page 19

	DESCRIPTION	MODEL	SHIP WEIGHT	CUBE	LIST PRICE
	Mobile Pedestal (with core removable lock) — Box/Box/File 15 ³ / ₄ "W x 22 ³ / ₄ "D x 28 ³ / ₈ "H — use freestanding or under 24"D, 30"D and 36"D modular shells NOTES: Top box drawer does not lock.	H115102	121	8.4	\$1041
	Mobile Pedestal (with core removable lock) — File/File 15 ³ / ₄ "W x 22 ³ / ₄ "D x 28 ³ / ₈ "H — use freestanding or under 24"D, 30"D and 36"D modular shells	H115104	121	8.4	\$1041
	Mobile Pedestal (with core removable lock) — Box/File 15 ³ / ₄ "W x 18 ³ / ₄ "D x 21 ¹ / ₈ "H — use freestanding or under 20"D, 24"D, 30"D and 36"D modular shells	H115106	68	5.8	\$872
	Mobile Pedestal — Shelf/Box/File 15 ³ / ₄ "W x 18 ³ / ₄ "D x 28 ³ / ₈ "H — use freestanding or under 20"D, 24"D, 30"D and 36"D modular shells NOTES: All mobile pedestals have a 1 ¹ / ₈ " thick top with flat, non-profiled edge. SPECIFYING EXAMPLE: H115102.C.NN	H115109	76	7.3	\$957
	Lateral File (with core removable lock) 36"W x 24"D x 29 ¹ / ₂ "H — two drawer	H115690	199	18.4	\$1459
	36"W x 20"D x 29 ¹ / ₂ "H — two drawer	H11563	177	15.6	\$1389
	36"W x 20"D x 45 ¹ / ₂ "H — three drawer	H11517	247	23.2	\$2110
	36"W x 20"D x 59 ¹ / ₈ "H — four drawer NOTES: Includes hangrails, mechanical interlock, and in H11563 and H115690, a counterweight. Stack-on storage (H115321) and bookcase hutch (H115292) can be used with H11563 and H115690. Interlock inhibits the extension of more than one drawer from opening at a time. 24"D two-drawer model aligns with the depth of 24"D credenzas and returns. SPECIFYING EXAMPLE: H11563.A.C.NN	H11516	312	31.0	\$2941
	Storage Cabinet with Doors (with core removable lock) 36"W x 24"D x 29 ¹ / ₂ "H	H115290	176	18.4	\$1255
	36"W x 20"D x 29 ¹ / ₂ "H NOTES: Includes one adjustable shelf. Shelf adjusts in 1 ¹ / ₄ " increments with a total range of 5"H. Stack-on storage (H115321) and bookcase hutch (H115292) can be used with H115290 or H115291. 24"D model aligns with the depth of 24"D credenzas and returns. SPECIFYING EXAMPLE: H115291.A.C.NN	H115291	154	15.0	\$1078
	Bookcase Hutch (for use with lateral file models H11563 or H115690 or storage cabinet with door models H115291 or H115290) 36"W x 14 ³ / ₈ "D x 37 ¹ / ₂ "H NOTES: Cord pass-through gap behind shelves and a 1 ¹ / ₈ "H full-width cord management slot at the bottom of the back panel to facilitate routing cords and reaching wall electrical outlets. When placed on top of 29 ¹ / ₂ "H base unit the total height (67"H) matches the height of credenzas with stack-on storage and the height of the wardrobe/storage cabinets and storage cabinet/lateral file. Two shelves are adjustable in 1 ¹ / ₄ " increments with a total range of 17 ¹ / ₂ "H. SPECIFYING EXAMPLE: H115292.A.NN	H115292	108	3.8	\$840

NOTES:

- For additional components that can be shared with Valido/11500 Series, see pages 163-179.
- Drawers operate on full extension, ball-bearing suspensions to ensure smooth, quiet, long-lasting operation.
- Versatile mobile pedestals work well in a variety of configurations. Can be used freestanding or under modular shells. 1¹/₈" thick top with a square, non-profiled edge.
- 24"D two drawer lateral file and 24"D storage cabinet with door models align with 24"D credenzas and returns, credenza and return shells as well as wardrobe/storage cabinets to provide linear layout continuity.
- Mobile printer/fax cart shown on page 158 is ideal for limited space.
- File drawer design includes integrated hangrails for side-to-side letter or legal filing; and front-to-back for letter filing.
- Adjustable hex leveling glides allow floor-standing furniture to be easily leveled; glides have 3/4" adjustable range.
- For conference table options, see the Preside® table tops and bases in the Tables section in the 2021 Shared Spaces Pricer. Order edge option "K".

HOW TO SPECIFY

Select Model Number See page 150	Select Edge Profile See page 150 Not specified for models H115102, H115103 and H115104	Select Handle Option See page 150 Not specified for models H115292, H115520, H115523 and H115524	Select Laminate See page 150
H 1 1 5 6 3 .	A .	C .	NN

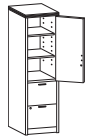

Right-hand model
H115297R shown

DESCRIPTION**Storage/File Cabinet (with core removable locks)**

18"W x 24"D x 67"H, Hinged Right (shown)
18"W x 24"D x 67"H, Hinged Left

MODEL**H115297R****H115298L****SHIP WEIGHT**

262

262

CUBE

22.7

22.7

LIST PRICE**\$2278****\$2278**

NOTES: Versatile unit features a storage cabinet and two file drawers. Storage cabinet includes three shelves, two are adjustable in 2½" increments. Door hinged left or right models available. File drawers operate on ball-bearing suspensions with full extension. File drawers have high sides to accept hanging folders in letter or legal size. Drawers standard with hangrails. Both the storage cabinet and the file drawers are equipped with an interchangeable core removable lock. Unit height is designed to match credenza or return plus stack-on storage height.



Doors open 110 degrees from
closed position.

Storage Cabinet/Lateral File (with core removable lock)

36"W x 24"D x 67"H

H115293

373

41.0

\$2953

NOTES: Storage cabinet is standard with one fixed and two full-width adjustable shelves in top compartment; adjustable shelves can be removed. Overall storage compartment measures 31¼"W x 22"D x 36¼"H and will accommodate supplies, books and binders, as well as business machines and electronic equipment. Cord pass-through gap behind shelves and grommet in back of cabinet to facilitate routing cords and reaching wall electrical outlets. Two drawer lateral file on bottom. Lateral file comes with mechanical interlock and hangrails. Cabinet and lateral file lock independently. Unit height is designed to match credenza or return plus stack-on storage height.

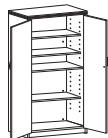

Doors open 110 degrees from
closed position.

Storage Cabinet w/Doors (with core removable lock)

36"W x 24"D x 67"H

H115299

349

41.0

\$2639

NOTES: Large capacity storage area includes five, full-width (side-to-side) shelves; three are adjustable in 2½" increments. Unit height matches credenza or return plus stack-on storage height.

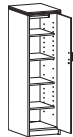

Right-hand model
H115295R shown

Personal Wardrobe/Storage Cabinet (with core removable lock)

18"W x 24"D x 67"H, Hinged Right (shown)
18"W x 24"D x 67"H, Hinged Left

H115295R**H115296L**

227

227

22.9

22.9

\$1970**\$1970**

NOTES: Unit is standard with four adjustable shelves, coat rod, and core removable lock. Shelves adjust in 2½" increments. Unit height is designed to match credenza or return plus stack-on storage height. Cabinet can be used as a wardrobe by removing four adjustable shelves. Coat rod can be removed from cabinet for storage only applications.

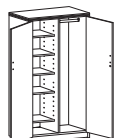

Doors open 110 degrees from
closed position.

Personal Wardrobe/Storage Cabinet (with core removable lock)

36"W x 24"D x 67"H

H11530

349

41.0

\$2884

NOTES: Spacious design is standard with four adjustable shelves (one shelf is fixed), coat rod and core removable lock which locks both doors. Shelves adjust in 2½" increments. Unit height is designed to match credenza or return plus stack-on storage height.

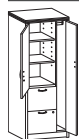

Right-hand model
H115301R shown

Personal Storage Tower (with core removable locks)

24"W x 24"D x 67"H, Wardrobe Hinged Right, Storage Cabinet Hinged
Left (shown)
24"W x 24"D x 67"H, Wardrobe Hinged Left, Storage Cabinet Hinged
Right

H115301R**H115302L**

304

304

27.9

27.9

\$2884**\$2884**

NOTES: Spacious design includes a wardrobe closet, storage cabinet, and two file drawers in one compact unit. Wardrobe closet contains a coat rod. Storage cabinet includes three shelves, two are adjustable in 2½" increments. Door hinged left or right models available. File drawers operate on ball-bearing suspensions with full extension. File drawers have high sides to accept hanging folders in letter or legal size. Drawers standard with hangrails. Equipped with interchangeable core removable locks. Upper lock secures storage cabinet and wardrobe closet doors; lower lock secures file drawers. Unit height is designed to match credenza or return plus stack-on storage height.

NOTES:

- Adjustable hex leveling glides allow floor-standing furniture to be easily leveled; glides have ¾" adjustable range.
- Locking units equipped with interchangeable core removable locks.
- For conference table options, see the Preside® table tops and bases in the Tables section in the 2021 Shared Spaces Pricer. Order edge option "K".
- See pages 163-179 for shared components.

ⓘ Keyed alike cores must be ordered separately — see model HF23B on page 773.

HOW TO SPECIFY

Select Model Number	Select Edge Profile	Select Handle Option	Select Laminate
See page 150	See page 150	See page 150	See page 150
H 1 1 5 2 9 7 R .	A .	C .	N N

VALIDO® Shared Components & Accessories

GSA SIN 33721



Icon Legend on page 19



H11552 shown

DESCRIPTION**Bookcase**

36"W x 13 7/8"D x 29 5/8"H, 2-Shelf

36"W x 13 7/8"D x 43 3/8"H, 3-Shelf

36"W x 13 7/8"D x 57 7/8"H, 4-Shelf

36"W x 13 7/8"D x 71"H, 5-Shelf

MODEL**SHIP WEIGHT****CUBE****LIST PRICE****H11552**

94

10.2

\$722**H11553**

126

15.6

\$846**H11554**

160

20.3

\$1006**H11555**

191

25.3

\$1134

NOTES: Fixed shelves. Inside shelf dimensions on all units is 33 3/4"W x 12"D x 13"H. No assembly required.

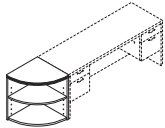
SPECIFYING EXAMPLE: H11552.A.NN**End Cap Bookshelf**

24"W x 24"D x 29 1/2"H

H115520

87

2.6

\$847

(2 shelves, 1 fixed, 1 adjustable. Adjusts in 2 1/2" increments with a total range of 10"H)

NOTES: Unit is freestanding. Designed to be positioned at the end of 24"D credenzas and returns. Holds books and personal items.

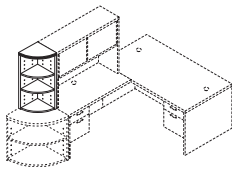
SPECIFYING EXAMPLE: H115520.A.NN**End Cap Bookshelf**

15"W x 15"D x 37 1/2"H

H115523

54

2.2

\$749

(3 shelves, 1 fixed, 2 adjustable. Adjusts in 2 1/2" increments with a total range of 25"H)

NOTES: Unit is designed to be positioned at the end of stack-on storage and on top of model H115520. Combined height of models H115520 and H115523 matches credenza plus stack-on storage height. Can be used freestanding.

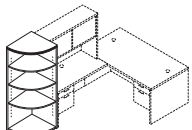
SPECIFYING EXAMPLE: H115523.A.NN**End Cap Bookshelf**

24"W x 24"D x 67"H

H115524

167

4.8

\$1345

NOTES: Designed to be positioned at the end of 24"D credenzas with stack-on storage, 24"D returns with stack-on storage, 24"D storage/file cabinet, 24"D storage cabinet/lateral file, 24"D wardrobe/storage cabinets, or the 24"D personal storage tower. Unit has four shelves, three are adjustable in 2 1/2" increments, with a total range of 45"H; bottom shelf is fixed.

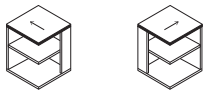
SPECIFYING EXAMPLE: H115524.A.NN

Model H115525R Model H115526L

**Square End Cap Bookshelf — 2-Fixed Shelves**

24"W x 24"D x 29 1/2"H, Right

H115525R

98

3.7

\$834

24"W x 24"D x 29 1/2"H, Left

H115526L

98

3.7

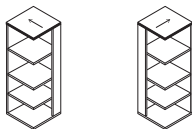
\$834**SPECIFYING EXAMPLE: H115525R.A.NN**

Model H115527R Model H115528L

**Square End Cap Bookshelf — 4-Fixed Shelves**

24"W x 24"D x 67"H, Right

H115527R

178

11.4

\$1287

24"W x 24"D x 67"H, Left

H115528L

178

11.4

\$1287**SPECIFYING EXAMPLE: H115527R.A.NN**

NOTES: Units are freestanding. Designed to be positioned next to 24"D models or as a corner bookcase.

End cap, left: grain direction on top aligns with grain direction on tops of left pedestal returns and left credenza models or when positioned to the left side of credenzas with doors or kneespace models.

End cap, right: grain direction on top aligns with grain direction on tops of right pedestal returns and right credenza models or when positioned to the right side of credenzas with doors or kneespace models.

NOTES:

- Choose from square or rounded versions of the end cap bookshelves.
- End cap bookshelf units are ideal for books, photos and mementos.
- End Cap Bookcases are designed to be positioned at the end of 24"D credenzas and returns.
- Adjustable hex leveling glides allow floor-standing furniture to be easily leveled; glides have 3/4" adjustable range.
- End cap bookshelf units are ideal for books, photos and mementos.
- For conference table options, see the Preside® table tops and bases in the Tables section in the 2021 Shared Spaces Pricer. Order edge option "K".
- See pages 163-179 for shared components.

HOW TO SPECIFY**Select Model Number**

H 1 1 5 5 2 7 R .

Select Edge Profile

See page 150

A .

Select Laminate

See page 150

N N

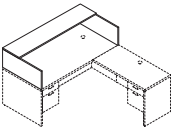
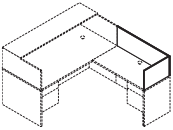
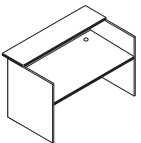
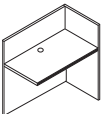
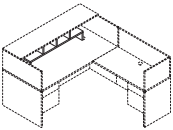
	DESCRIPTION	MODEL	SHIP WEIGHT	CUBE	LIST PRICE
	Reception Station with Transaction Counter for 72"W x 36"D Desk, or Desk Shell, with rectangle top 72"W x 36"D x 14 ⁵ / ₈ "H	H115720	100	3.0	\$804
	NOTES: For desk tops without grommets, see field installable grommet kit, model HFLDGRMT or HFLDGRMT3 on page 177. Transaction counter organizer (HTCOL52) fits under/inside of transaction counter (see below).				
	Reception Station for 42"W x 24"D Return or Return Shell 42"W x 24"D x 13"H	H105722	21	1.0	\$269
	Reception Station for 48"W x 24"D Return or Return Shell 48"W x 24"D x 13"H	H105721	25	3.6	\$306
	NOTES: For return tops without grommets, see field installable grommet kit, model HFLDGRMT or HFLDGRMT3 on page 177. ⚠ Not available in two tone laminate.				
	Reception Desk Shell 72"W x 39 ⁷ / ₈ "D x 44 ¹ / ₈ "H	H115724	328	16.8	\$1610
	NOTES: Non-handed design. Integrated 18 ⁵ / ₈ "D transaction counter with a 4" full-width overhang. Two cord management grommets in top for routing and hiding wires and cables. Transaction counter organizer (HTCOL52) fits under/inside of transaction counter.				
	Reception Return Shell 42"W x 24"D x 43 ⁵ / ₈ "H	H115726	140	16.8	\$1045
	NOTES: Non-handed design. Attaches to reception desk shell to form an L-shaped workstation. One cord management grommet in top for routing and hiding wires and cables. Woodgrain on approach side is vertical to match grain direction on end panels of reception desk.				
	Transaction Counter Organizer 48 ³ / ₄ "W x 11 ¹ / ₈ "D x 13"H	HTCOL52	24	1.1	\$300
	NOTES: Fits under reception station with transaction counter model H115720 or reception desk shell H115724. ⚠ Black only.				

NOTES:

- Two welcoming reception station designs to choose from — stack-on enclosure or full-to-floor shell.
- See pages 163-179 for shared components.

HOW TO SPECIFY













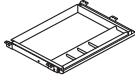

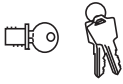

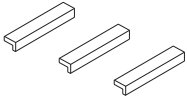



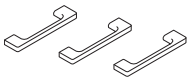

Select Model Number <div style="border: 1px solid black; padding: 2px; display: flex; gap: 5px;"> H115724 </div>	Select Edge Profile See page 150 <div style="border: 1px solid black; padding: 2px; display: flex; gap: 5px;"> A </div>	Select Laminate See page 150 <div style="border: 1px solid black; padding: 2px; display: flex; gap: 5px;"> NN </div>
---	---	---

VALIDO® Shared Components & Accessories

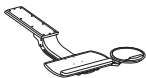
GSA SIN 33721 EXCEPT AS NOTED

ABI

Icon Legend on page 19

	DESCRIPTION	MODEL	SHIP WEIGHT	CUBE	LIST PRICE	
	Angled Wood Center Drawer					
	26" x 15 ³ / ₈ " 22" x 15 ³ / ₈ "	H1526 H1522	12.0  11.0 	1.2 1.1	\$214 \$199	
	NOTES: Specify laminate for drawer. For additional information see the Workplace Tools section in the 2021 Shared Spaces Pricer.					
	Polymer Center Drawer	HCD1	7.0	0.5	\$126	
	<ul style="list-style-type: none"> • Color: Black. • Material: ABS. • Minimum clearance for mounting: 23"W x 16¹/₄"D x 2"H. • Retracts on 16" ball-bearing slides. • Can be used on worksurfaces with Coordinate™ Height Adjustable Bases as long as it is attached with spacer model HKBS. • Can store up to 25 lbs. 					
OPEN MARKET	 Black finish only, no specification needed.					
	Black Removable Lock Core Kit — see page 773.	HF23B	0.1 	0.1	\$35	
	NOTES: Lock with a removable cylinder that can be interchanged as needed; allows users to access all furniture pieces in an office with a single key for convenience and security. Makes re-keying quick and easy. For use in all Valido® Series product lock cores, except the stack-on and wall mounted storage "K" models. For the latter, use lock core kit model HF27B.					
	Field Installable Drawer/Door Handle Kits (fit Valido® 96mm hole spacing)					
	Linear, Black, 2-pack	HLINEARA2	0.4 	0.3	\$61	
	Linear, Matte Chrome, 2-pack	HLINEARC2	0.4 	0.3	\$61	
	Linear, Black, 3-pack	HLINEARA3	0.5 	0.3	\$69	
	Linear, Matte Chrome, 3-pack	HLINEARC3	0.5 	0.3	\$69	
	NOTES: The Linear and Arch handles attach using the same 96mm hole spacing as the Valido® Sweep and Crescent handles. The Linear handle is not recommended for use on the Valido® Narrow/Box/Box/File Modular Pedestal — model H115093.					
	Arch, Black, 2-pack	HARCHA2	0.4 	0.3	\$61	
	Arch, Matte Chrome, 2-pack	HARCHC2	0.4 	0.3	\$61	
	Arch, Black, 3-pack	HARCHA3	0.5 	0.3	\$69	
	Arch, Matte Chrome, 3-pack	HARCHC3	0.5 	0.3	\$69	
	 Must be ordered with a configurable end product. If ordered separately, not on GSA contract.					
	DESCRIPTION	MODEL	SHIP WEIGHT	CUBE	LIST PRICE BY PAINT GRADE	
	Slide-Away Keyboard Platform (Specify: Laminate)	H4022	10 	0.6	\$228	
	Extended Tray Slide-Away Keyboard Platform (Specify: Laminate)	HE4022	12 	0.7	\$323	
	Metal Keyboard and Mouse Tray (Specify paint)	H4028 OPEN MARKET	11 	1.5	\$164	\$174
	Metal Keyboard Tray (Specify paint)	H4029 OPEN MARKET	11 	1.5	\$148	\$158
Refer to the Workplace Tools section in the 2021 Shared Spaces Pricer for additional product information	NOTES: For additional information see the Workplace Tools section in the 2021 Shared Spaces Pricer.					
						

NOTES:

- Linear and Arch field installable handles attach using Valido® 96mm (approx. 3³/₄") hole spacing. No drilling required.
- Center drawers ideal for pens, pencils and other miscellaneous storage. Feature ball-bearing slide suspension.
- For conference table options, see the Preside® table tops and bases in the Tables section in the 2021 Shared Spaces Pricer. Order edge option "K".



VALIDO® Shared Components & Accessories

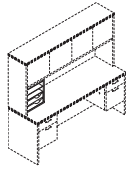

Not available in two-tone laminates

DESCRIPTION**Vertical Paper Manager**14⁷/₈"W x 10⁷/₈"D x 19¹/₁₆"H**MODEL****HLVPM1****SHIP WEIGHT**

27

CUBE

2.8

LIST PRICE**\$351**

NOTES: Keeps papers, files, and books neatly organized and within easy reach from a seated position. Designed for desk, credenza, and return tops. Fits under stack-on storage models. Two pullout drawers and three fixed shelves. Not available in pattern laminate colors. Ships fully assembled. For additional information see the Workplace Tools section in the 2021 Shared Spaces Pricer.

! When used in conjunction with wall mounted storage cabinets, the top of the wall mounted storage cabinets must be positioned a minimum of 68³/₈" above the floor.

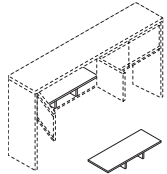
SPECIFYING EXAMPLE: HLVPM1.N**Stacked Paper Management**32¹/₂"W x 12⁵/₈"D x 4¹/₄"H**HLVPM2**

22

1.25

\$175

NOTES: Segments and organizes stack-on and wall mount storage compartments, as well as bookcase shelves. Unit can be used in Models H115327, H11534, H115322, H115321, H115382 and H115381. In some cases, installation may require removing the stack-on or wall mount storage doors. For additional information see the Workplace Tools section in the 2021 Shared Spaces Pricer.

! Black (P) only.

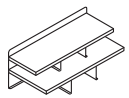

Not available in two-tone laminate

**Desktop Storage Terrace**26¹/₂"W x 12¹/₂"D x 10¹/₂"H**HLDST1**

24

1.1

\$329

NOTES: Keeps work-in-process, priority files, loose pages, and mail neatly organized and in view. Mixed material design comprised of sturdy laminate shelves with metal back and support panels. Not available in two-tone laminate combination or pattern laminate colors. Choose from Platinum Metallic (TI), Black (P), and Charcoal (S) for the metal components.

Sized to fit in stack-on and wall mounted storage cabinets in 10500, 10700, Valido, 94000, and 38000 Series. Fits in Voi stack-on and overhead cabinets except for 48"W or smaller sliding door models. For additional information see the Workplace Tools section in the 2021 Shared Spaces Pricer.

Specify: Model.Laminate.Paint

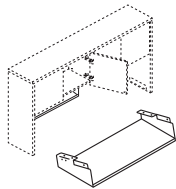
SPECIFYING EXAMPLE: HLDST1.N.TI**Hanging Paper Shelf**28¹/₁₆"W x 11⁷/₁₆"D x 4⁵/₁₆"H**HHPS1**

7

2.9

\$214

NOTES: Maximizes worksurface space; de-clutters desktop while placing priority communications and active project folders within easy reach. Angled design allows contents to be distinguished at a glance. Mixed material styling features strong painted metal frame with a frosted shelf.

Attaches quickly and easily to stack-on and wall mount storage models in the following series: 10500, 10700, Valido, 94000, and Voi (except the 36"W overhead hutch with O-legs or panel mount brackets). Not for use with 38000 Series.

For additional information see the Workplace Tools section in the 2021 Shared Spaces Pricer.

Specify: Model.Paint

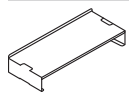
SPECIFYING EXAMPLE: HHPS1.TI**Desktop Paper Shelf**28¹/₁₆"W x 11⁵/₁₆"D x 5"H**HDPS1**

7

2.9

\$214

NOTES: Organizer shelf provides a place and space for work-in-process and piling to keep worksurfaces neat and tidy. Convenient, scalable design with interlocking side supports allow two units to be stacked and integrated. Durable painted metal frame with a frosted shelf; mixed material styling matches hanging paper shelf.

Can also be used inside select overhead storage, including the following stack-on with hinged door models: 10500 and Valido 36", 42", 66", 72", 78"W and 10700 68⁵/₈"W.

For additional information see the Workplace Tools section in the 2021 Shared Spaces Pricer.

Specify: Model.Paint

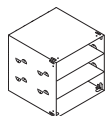
SPECIFYING EXAMPLE: HDPS1.TI**Storage Cube**

12"W x 12"D

HLSL1212

1

0.3

\$316**SPECIFYING EXAMPLE: HLSL1212.P8S****HOW TO SPECIFY****Select Model Number**

H L V P M 1 .

Select Laminate

See page 150

N

VALIDO® Shared Components & Accessories

OPEN MARKET EXCEPT AS NOTED

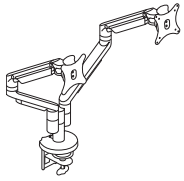

Icon Legend on page 19

**DESCRIPTION****Dual Dynamic Monitor Arm**

- 150° of rotation at base with optional 360° rotation.
- Arms extend 22" and retract up to 3".
- Monitor mount rotates 180° and tilts +/-30°.
- Monitor can be rotated from landscape to portrait position.

! Arms hold monitors from 6.2-18 lbs. Optional counterweight HPACW available to support monitors as low as 5 lbs. (see the Workplace Tools section in the 2021 Shared Spaces Pricer).

MODEL**HMASD****SHIP WEIGHT**

17.0

CUBE

1.1

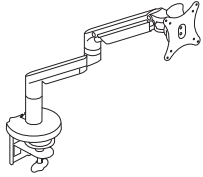
LIST PRICE**\$962****Single Dynamic Monitor Arm**

- 180° of rotation at base with optional 360° rotation.
- Arms extend 22" and retract up to 3".
- Monitor mount rotates 180° and tilts +/-30°.
- Monitor can be rotated from landscape to portrait position.

! Arms hold monitors from 6.2-18 lbs. Optional counterweight HPACW available to support monitors as low as 5 lbs. (see the Workplace Tools section in the 2021 Shared Spaces Pricer).

HMASTS

11.5

0.8

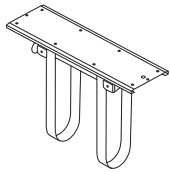
\$501**360° Swivel CPU Holder with Adjustable Straps**

- Supports CPUs 3¾" wide up to 64" perimeter and holds up to 75 lbs.
- 360° rotation.
- Ships complete and includes necessary mounting hardware and instruction sheet.

! Available in Black only, no specification needed.

HCPUI

7.0

0.2

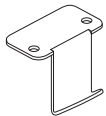
\$260**SIN 33721****Back Pack Hook (10 per carton)**

12"W x 14½"D x 1½"H

HCLA65

10.0

0.1

\$101

NOTES: Assembly: attaches to bottom of desk with (2) screws, included.

! Available in Platinum Metallic finish only, no specification needed.

**NOTES:**

- See the Workplace Tools section in the 2021 Shared Spaces Pricer for additional monitor arm models.

HOW TO SPECIFY**Select Model Number****Select Finish**

Specify for models HMASD and HMASTS only

SVR Silver
BLK Black

HMASD.

SVR



Icon Legend on page 19

Shared Components & Accessories

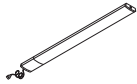

OPEN MARKET

DESCRIPTION

LED Task Lights

- 17" LED Light with Power Supply (Single)
- 31" LED Light with Power Supply (Single)
- 17" LED Light with Power Supply for Daisy-chain (Starter)
- 31" LED Light with Power Supply for Daisy-chain (Starter)
- 17" LED Light with 8" Jumper Cord for Daisy-chain (Follower)
- 31" LED Light with 8" Jumper Cord for Daisy-chain (Follower)

MODEL

- HLED17AS** ⓘ
- HLED31AS** ⓘ
- HLED17A**
- HLED31A**
- HLED17AUO** ⓘ
- HLED31AUO** ⓘ

SHIP WEIGHT

- 1.2
- 1.5
- 1.0
- 1.4
- 1.0
- 1.0

CUBE

- 0.05
- 0.09
- 0.05
- 0.09
- 0.03
- 0.05

LIST PRICE

- \$450**
- \$603**
- \$493**
- \$662**
- \$404**
- \$539**

Undercabinet Occupancy Sensor with 1" End to End Connector

HLEDOSA ⓘ

0.2

0.01

\$97

NOTES: To use the daisy chain application, must start with model HLED17A or HLED31A. No finish specification required. Attaches magnetically to underside of overhead storage, or attaches with provided screws or double-sided tape. Occupancy sensor attaches to a single or starter LED light and will automatically turn the light off after no motion is detected for 30 minutes. Just like all the LED light models, the occupancy sensor features a soft-touch on/off switch. LED task lights have a lifetime of 50,000 hours and have a dimmer feature that allows the user to adjust the amount of light output.



Refer to page 111

OPEN MARKET

Recessed Task Light

- 46½"W x 3⅞"D x 1⅞"H for Models H115327, H11534, H11533 and H115324
- 34⅞"W x 3⅞"D x 1⅞"H for Models H115323, H115322, H115382 and H115383
- 22⅞"W x 3⅞"D x 1⅞"H for Models H115321, H115380 and H115381

- HH870960**
- HH870942**
- HH870930**

- 12.0
- 10.0
- 7.0

- 1.1
- 0.9
- 0.6

- \$290**
- \$267**
- \$247**

NOTES: For additional information see the Workplace Tools section in the 2021 Shared Spaces Pricer.



LED Task Lights

- Articulating Desk Lamp**
- Articulating Desk Lamp w/ Occupancy Sensor**

- HLED1**
- HLED1OC**

- 1.2
- 1.2

- 6.5
- 6.5

- \$430**
- \$524**

NOTES: For additional information see the Workplace Tools section in the 2021 Shared Spaces Pricer.

Task Desk Lamp

HLED2

0.7

3.0

\$373

NOTES: For additional information see the Workplace Tools section in the 2021 Shared Spaces Pricer.



Black only

Field Installable Grommet

- Grommet is field installable.
- Grommet shape is round.
- Includes grommet cap and sleeve.

- Grommet cap measures 3" diameter and includes a ¾" diameter cord access hole.
- Grommet sleeve measures 2½" O.D. x ¾" thick.
- Includes instructions to locate grommet position for desks, credenzas, returns and bridges.

HFLDGRMT

0.1

0.01

\$35

NOTES: For additional information see the Workplace Tools section in the 2021 Shared Spaces Pricer.

- ⓘ Designed to be used in top and end panels to route/hide cords, and in modesty panels to facilitate reaching wall electrical outlets.
- ⓘ Black Finish
- ⓘ Requires a 2½" diameter hole saw and drill for installation (not included).



Field Installable Grommet

- Grommet is field installable.
- Grommet shape is round.
- Includes grommet cap and sleeve.

- Grommet outside dimensions measure 3½" diameter and includes two cord access holes.
- Grommet sleeve measures 3" O.D. x 1" thick.
- Includes instructions to locate grommet position for desks, credenzas, returns and bridges.

HFLDGRMT3

0.1

0.3

\$35

NOTES: For additional information see the Workplace Tools section in the 2021 Shared Spaces Pricer.

- ⓘ Designed to be used in top and end panels to route/hide cords, and in modesty panels to facilitate reaching wall electrical outlets.
- ⓘ Black Finish
- ⓘ Requires a 3" diameter hole saw and drill for installation (not included).

NOTES:

- See pages 163-179 for shared components.

HOW TO SPECIFY

Select Model Number

H	H	8	7	0	9	6	0	.
---	---	---	---	---	---	---	---	---

Select Color

Available in Black (P) only

P

VALIDO® Shared Components & Accessories

GSA SIN 33721T EXCEPT AS NOTED

ABI

Icon Legend on page 19

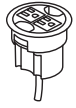
**DESCRIPTION****MODEL****SHIP WEIGHT****CUBE****LIST PRICE****Power Hub, 3" Grommet Mount, 6' Cord****HGRMTAC**

1.3

0.2

\$126

- Fits in 3" round grommet holes on the following product lines: 10500, 10700, Concinnity, Coordinate, and Voi desks; Abound Worksurfaces; Huddle and Motivate tables and SmartLink.
- Two grounded AC power outlets.
- Includes 6' cord with three-prong plug.
- Two cord pass-through holes in cap.
- Field installed; easy plug-and-play.
- UL Listed.

NOTES: For additional information see the Workplace Tools section in the 2021 Shared Spaces Pricer.

! Available in black only (no color designation so use .X - Specify: HGRMTAC.X).

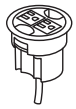
**3" Round Power Grommet - 2 Outlets, 10' Cord****HGRMTAC2**

1.5

0.2

\$159

- Includes 10' cord with three-prong plug.
- Fits in 3" round grommet holes on the following product lines: Coordinate, Huddle, Motivate, all laminate casegoods series, and Systems Worksurfaces.
- Two grounded AC power outlets.
- Field installed with Plug-and-play ease.

NOTES: Power Modules will also work with standing-height applications for 10500 Series™ and Voi® desks. Optional Memory Control allows preset worksurface heights for consistency. Ships separately. Dynamic load capacity when worksurface is moving is 300 lbs.

! Available in black finish only, no specification needed.

**Power/USB Hub, 3" Grommet Mount****HGRMTUSB2**

1.3 Ⓢ

0.02

\$250

- One grounded AC power outlet with 2 USB ports.
- Two cord pass-through holes in cap.
- Includes 6' cord with three-prong plug.
- Field installed; easy plug-and-play.
- UL Listed.

NOTES: For additional information see the Workplace Tools section in the 2021 Shared Spaces Pricer.

! Available in black only (no color designation so use .X - Specify: HGRMTUSB2.X).

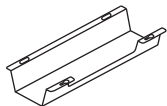
**Cable Management Troughs**

17"W - Single

HCTROUGH17

2.7 Ⓢ

0.5

\$73

17"W - 10-Pack

HCTROUGH1710

14.0 Ⓢ

0.5

\$665

36"W - Single

HCTROUGH36

4.9 Ⓢ

0.9

\$122

36"W - 10-Pack

HCTROUGH3610

30.0 Ⓢ

0.9

\$1121

- Cable management troughs ship flat packed.
- The troughs attach to underneath the worksurface with screws.
- The 17"W has one wire access cut out on the user side. The 36" has two wire access cut outs. These cut outs give users access to inside the trough without having to detach it from the worksurface.
- Color: Graphite.
- Material: Metal.
- TAA Compliant.

NOTES: For additional information see the Workplace Tools section in the 2021 Shared Spaces Pricer.

SIN 33721

HOW TO SPECIFYSelect
Model Number

H G R M T A C

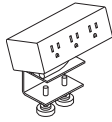

Model HPWRMOD3WC shown

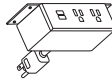

Model HPWRMOD2UWM shown

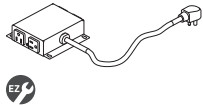
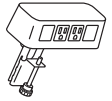

DESCRIPTION	MODEL	SHIP WEIGHT	CUBE	LIST PRICE
Power Modules				
3 Receptacles with Worksurface Clamp	HPWRMOD3WC	2.3 Ⓢ	0.2	\$342
3 Receptacles with Under-Worksurface Mounting Bracket	HPWRMOD3UWM	2.3 Ⓢ	0.2	\$342
2 Receptacles 2 USB with Worksurface Clamp	HPWRMOD2WC	2.3 Ⓢ	0.2	\$546
2 Receptacles 2 USB with Under-Worksurface Mounting Bracket	HPWRMOD2UWM	2.3 Ⓢ	0.2	\$546
<ul style="list-style-type: none"> • 6' power cord with standard three-prong plug. • Under-worksurface mounting bracket models work with any top that has a 5" x 5" square clearance. • Worksurface clamp models work on any top with a 4" overhang. • UL Listed. 				
<p>! Color finish coordinates with HON's Charcoal or White. Specify <i>STRM</i> for Storm or <i>SNW</i> for Snow when ordering. Example: <i>HPWRMOD3WC.STRM</i>.</p>				
Power & Data Center				
2 Receptacles 2 Data Accessory	HCOMDOME2	2.5 Ⓢ	0.2	\$327
<ul style="list-style-type: none"> • Standard with two receptacles and openings for two data ports. • 6' power cord with standard three-prong plug. • Fits on any worksurface with a 4" overhang. • UL Listed. 				
<p>! Color finish coordinates with HON's Loft. Specify <i>LOFT</i> when ordering. Example: <i>HCOMDOME2.LOFT</i>.</p>				
Under Worksurface Power Module — 4 Outlets, 10' Cord				
	HPWRMOD2	1.5	0.2	\$441
<ul style="list-style-type: none"> • Includes 10' cord with three-prong plug. • Fits in cable management troughs. See page 178. • 4 outlets on side create easy access. 				
<p>NOTES: Power Modules will also work with standing-height applications for 10500 Series™ and Voi® desks.</p>				
<p>! Available in black finish only, no specification needed.</p>				
Vertebrae				
	HMPVWM28	3.0	0.3	\$246
<p>NOTES: 30"H x 3½"W x 1½"D. Ships unassembled.</p>				
<p>! Clear finish. Specify "X" for finish option. SPECIFYING EXAMPLE: HMPVWM28.X</p>				

NOTES:

- For additional information see the Workplace Tools section in the 2021 Shared Spaces Pricer.

HOW TO SPECIFY

Select Model Number

H P W R M O D 3 W C



DESCRIPTION

MODEL

SHIP WEIGHT

CUBE

LIST PRICE

Coordinate™ Portable Desktop Riser
31"D x 5"-16½"H x 35"W

HBXRISER

54.0

4.1

\$657

NOTES: Available in Black (BLK) or White (WHT) finish. Desktop riser dimensions (without keyboard tray): 22"D x 5"-16½"H x 35"W. Keyboard tray dimensions: 9"D x 30"W. Max loading capacity is 33 lbs for the desktop riser surface and 4 lbs for the keyboard tray. Easily transition from seated to standing positions throughout the workday. Sits atop an existing desk to create sit-to-stand functionality by raising the computer. Includes keyboard tray and surface for computer monitors. **HON 5-Year Limited Warranty.**

⚠ Not intended for use on mobile workstations.

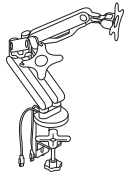

Dual Monitor Arm with 2 USB Ports

HBDMAUSB

41.9

2.6

\$410

NOTES: Easy adjustment. Height adjusts to 17" tall. Monitor tilt and swivel capability. Enclosed cable management. Grommet or desktop mounting. Clean appearance. In some applications the Monitor Arms may extend 12 or more inches into the worksurface. For additional information see the Workplace Tools section in the 2021 Shared Spaces Pricer. **HON 5-Year Limited Warranty.**

⚠ No specification needed.

HOW TO SPECIFY

Select Model Number

Select Finish

BLK Black
WHT White

HBXRISER.

BLK

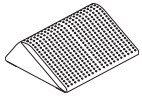

	DESCRIPTION	MODEL	SHIP WEIGHT	CUBE	LIST PRICE
	Footrest — Anti-Slip Cover 13¾"D x 5½"H x 16"W ⓘ Available in Black (T) finish ONLY. Recommended weight capacity not to exceed 250 pounds. HON 5-Year Limited Warranty. SPECIFYING EXAMPLE: HVL991.T	HVL991	7 ⓘ	0.9	\$89

HOW TO SPECIFY

<p>Select Model Number</p> <p>H V L 9 9 1 .</p>	<p>Select Finish</p> <p>T Black</p> <p>T</p>
---	--

VOI®

Want to see more? Scan here
to check out hon.com.



Voi® shown with Ignition® Seating.

VOI®

Voi gets you. Your needs. Your style. Your environment. Voi packs a lot of functionality into a little space, so you can maximize yours. Plus, versatile Voi integrates easily with a variety of spaces, systems — even open plans. Solidly built and strikingly designed, Voi combines classic warmth and contemporary cool with an extensive variety of laminates, colors, components and configurations. So you can create a sophisticated, professional look that is uniquely yours.



FEATURES

- Big. Small. Functional. Adaptable. Voi has multiple options to meet your storage needs and available space.
- To create an office look that's uniquely yours, mix things up — with tasteful modesty panels, stylish storage cubes and mixed surface materials.
- Refined scale. Layered workspaces. Together they help streamline your office to create small-footprint spaces that work BIG.
- With so many configurations and combinations, Voi® makes it easy to create a stylish, unified look across your entire office.

VOI® ORDERING INFORMATION

WORKSURFACES

L1 LAMINATES CODES

Woodgrain

- ◆ Bourbon Cherry H
- ◆ Cognac COGN
- ◆ Florence Walnut LFW1
- ◆ Harvest C
- ◆ Kingswood Walnut LK1I
- ◆ Mahogany N
- ◆ Mocha MOCH
- ◆ Natural Maple D
- ◆ Pinnacle PINC
- ◆ Shaker Cherry F
- ◆ Sterling Ash LSA1

Solid

- ◆ Black P
- ◆ Charcoal S
- ◆ Designer White LDW1
- ◆ Loft LOFT

Patterned

- ◆ Handspun Chestnut LAHC
- ◆ Handspun Dove LAHD
- ◆ Handspun Pearl LAHP
- ◆ Handspun Slate LAHS
- ◆ Sheer Mesh* A5
- ◆ Silver Mesh** B9

L2 LAMINATES*** CODES

Woodgrain

- ◆ Lowell Ash LLA1
- ◆ Natural Recon LNR1
- ◆ Phantom Ecu LPE1
- ◆ Portico Teak LPT1
- ◆ Skyline Walnut LSW1

WORKSURFACE EDGE BAND

Woodgrain

- ◆ Bourbon Cherry H
- ◆ Cognac COGN
- ◆ Florence Walnut FW
- ◆ Harvest C
- ◆ Kingswood Walnut KI
- ◆ Lowell Ash DL
- ◆ Mahogany N
- ◆ Mocha MOCH
- ◆ Natural Maple D
- ◆ Natural Recon NR
- ◆ Phantom Ecu PE
- ◆ Pinnacle PINC
- ◆ Portico Teak DP
- ◆ Shaker Cherry F
- ◆ Skyline Walnut SW
- ◆ Sterling Ash SA

Solid

- ◆ Black P
- ◆ Brownstone EY
- ◆ Charcoal S
- ◆ Designer White DW
- ◆ Fossil EH
- ◆ Greige R
- ◆ Light Gray Q
- ◆ Loft LOFT
- ◆ Muslin T
- ◆ Platinum K
- ◆ Shadow* SHDW

CHASSIS/CABINET DRAWER/DOOR FRONTS, LAMINATE END PANELS, LAYERING SHELVES AND MODESTY PANELS

L1 LAMINATES CODES

Woodgrain

- ◆ Bourbon Cherry H
- ◆ Cognac COGN
- ◆ Florence Walnut LFW1
- ◆ Harvest C
- ◆ Kingswood Walnut LK1I
- ◆ Mahogany N
- ◆ Mocha MOCH
- ◆ Natural Maple D
- ◆ Pinnacle PINC
- ◆ Shaker Cherry F
- ◆ Sterling Ash LSA1

Solid

- ◆ Black P
- ◆ Charcoal S
- ◆ Designer White LDW1
- ◆ Loft LOFT

L2 LAMINATES*** CODES

Woodgrain

- ◆ Lowell Ash LLA1
- ◆ Natural Recon LNR1
- ◆ Phantom Ecu LPE1
- ◆ Portico Teak LPT1
- ◆ Skyline Walnut LSW1

WORKSURFACE GROMMETS

PLASTIC CODES

- ◆ Black P
- ◆ Brownstone EY
- ◆ Charcoal S
- ◆ Designer White DW
- ◆ Fossil EH
- ◆ Greige R
- ◆ Loft LOFT
- ◆ Muslin T3
- ◆ Platinum T1
- ◆ Shadow* SD
- ◆ Titanium T1

PULLS & FEET

PAINT CODES

- P1**
- ◆ Black P
- ◆ Designer White PJW
- P2**
- ◆ Champagne Metallic T4
- ◆ Platinum Metallic T1
- ◆ Silver PR6
- ◆ Solar Black P8X

O-LEGS, STEEL LEGS, POST LEGS, SHELF BRACKETS, SHARED LEGS, STORAGE CUBES

PAINTS CODES

- P1**
- ◆ Black P
- ◆ Brownstone P7D
- ◆ Charcoal S
- ◆ Designer White PJW
- ◆ Fossil P28
- ◆ Greige T5
- ◆ Loft LOFT
- ◆ Muslin T3
- ◆ Shadow* SHDW
- ◆ Titanium P8T
- P2**
- ◆ Champagne Metallic T4
- ◆ Platinum Metallic T1
- ◆ Silver PR6
- ◆ Solar Black P8X

O-LEGS, STEEL LEGS, POST LEGS, SHELF BRACKETS, SHARED LEGS, STORAGE CUBES *continued*

PAINTS CODES

- P3**
- ◆ Amethyst P091
- ◆ Atom P8S
- ◆ Blossom**** P8K
- ◆ Bullseye PJF
- ◆ Cabernet***** P7T
- ◆ Cobalt Mica P090
- ◆ Conifer***** P8H
- ◆ Ember P8P
- ◆ Ion P8N
- ◆ Iris P8J
- ◆ Krypton P8F
- ◆ Ochre P093
- ◆ Regatta P8M
- ◆ Sienna P092
- ◆ Succulent**** P8A

ANGLED WOOD LEGS

- ◆ Clear Ash LA400
- ◆ Medium Ash LA484

WORKSURFACE LAMINATES	CODES	EDGE BAND OPTIONS				
		Matching Edge	Designer White (DW)	Loft (LOFT)	Muslin (T)	Black (P)
Black	P					*
Bourbon Cherry	H	*	*		*	
Charcoal	S	*				
Cognac	COGN	*	*		*	
Designer White	LDW1		*			
Harvest	C	*	*		*	
Loft	LOFT			*		
Lowell Ash	LLA1	*	*	*	*	
Mahogany	N	*		*		
Mocha	MOCH	*	*		*	
Natural Maple	D	*	*	*	*	
Natural Recon	LNR1	*	*	*	*	
Phantom Ecu	LPE1	*	*	*	*	
Pinnacle	PINC	*	*		*	
Portico Teak	LPT1	*	*	*	*	
Shaker Cherry	F	*	*	*	*	
Sheer Mesh	A5				*	
Silver Mesh	B9			*		
Skyline Walnut	LSW1	*	*	*	*	
Sterling Ash	LSA1	*	*	*	*	*
Kingswood Walnut	LK1I	*	*	*	*	*
Florence Walnut	LFW1	*	*	*	*	*

* Sheer Mesh laminate will have Muslin Edgeband. Sheer Mesh NOT available on Chassis/Cabinet, Drawer/Door Fronts, Laminate End Panels, Layering Shelves and Modesty Panels.

** Silver Mesh laminate will have Loft Edgeband. Silver Mesh NOT available on Chassis/Cabinet, Drawer/Door Fronts, Laminate End Panels, Layering Shelves and Modesty Panels.

*** Storage chassis that are specified in L2 laminates and are longer than 60" W will ship with back panels that are horizontal grain.

**** TREND COLORS: These colors are intended to be an inspirational option for the trending market. Product application is limited and color availability is approximately two years to coincide with evolving workplace trends.

◆◆◆ For lead time information see page 19.

* De-emphasized

VOI® Laminate Typicals



Icon Legend on page 19

QTY	DESCRIPTION	MODEL	LIST PRICE	PRICE EXTENSION
1	External Channel 54"W	HLSLZ5SC66	\$110	\$110
1	Rectangle Worksurface 24"D x 66"W	HLSLR2466	\$428	\$428
1	Low Credenza (Right hand drawers) 60"W x 20"D x 21½"H	HLSL2060LR2	\$1,412	\$1,412
1	Layering Shelf 60"W x 14½"D x 5½"H	HLSL1460LS	\$410	\$410
2	O-Leg Support for Worksurface (1 pack) 24"D x 28½"H	HLSL24280	\$357	\$714
1	Overhead Cabinet with Wall Bracket with One Sliding Door 60"W x 14¼"D x 14"H	HLSL1460S	\$1,451	\$1,451
TOTAL:			\$4,525	

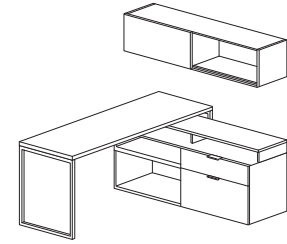
**SMALL FOOTPRINT****66" x 60"**

QTY	DESCRIPTION	MODEL	LIST PRICE	PRICE EXTENSION
1	External Channel 54"W	HLSLZ5SC66	\$110	\$110
1	Rectangle Worksurface 24"D x 66"W	HLSLR2466	\$428	\$428
1	Low Credenza (2 file/2 box) 60"W x 20"D x 21½"H	HLSL2060LD4	\$1,647	\$1,647
2	O-Leg Support for Worksurface (1 pack) 24"D x 28½"H	HLSL24280	\$357	\$714
1	Overhead Cabinet with 4 Doors 60"W x 14¼"D x 14"H	HLSL1460D	\$1,301	\$1,301
1	O-Leg Support for Overhead Cabinet 14½"D x 20½"H for 65"H Overhead Cabinet	HLSL650S	\$526	\$526
TOTAL:			\$4,726	

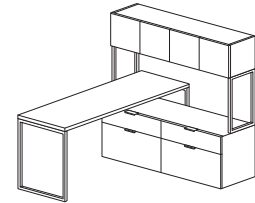
**SMALL FOOTPRINT****66" x 60"**

QTY	DESCRIPTION	MODEL	LIST PRICE	PRICE EXTENSION
1	Low Credenza, Right Hand Drawers, Footed 60"W x 20"D x 24½"H	HLSL2060LR2F	\$1,487	\$1,487
1	Cube Bundle A	HLSL15-SOO	\$326	\$326
2	Drawer Cube 15"W x 13"D x 4"H	HLSL154LSD	\$243	\$486
1	Voi® Shelf 30"W x 13"D	HLSLR1330	\$210	\$210
1	Angled Steel Leg 29"H	HLSL28AM2	\$356	\$356
1	4"H Steel Stanchion	HLSL4AM2	\$167	\$167
1	Rectangle Worksurface 72"W x 30"D	HLSLR3072	\$527	\$527
1	Mixed Material Floating Modesty Panel 42"W x 14"H	HLSL4214MM	\$906	\$906
TOTAL:			\$4,465	

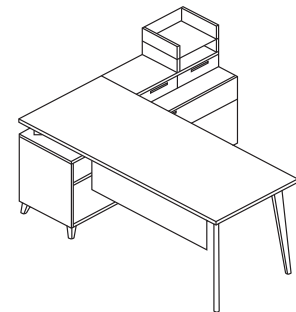
**SMALL FOOTPRINT****60" W x 72" D**



Icon Legend on page 19

VOI®

Laminate Typical

DESKS

QTY	DESCRIPTION	MODEL	LIST PRICE	PRICE EXTENSION
1	Mixed Material Floating Modesty Panel 42"W x 14"H	HLSL4214MM	\$906	\$906
1	Rectangular Worksurface 48"W x 24"D	HLSLR2448	\$337	\$337
2	Drawer Cube 15"W x 13"D x 4"H	HLSL154LSD	\$243	\$486
1	Cube Bundle A	HLSL15-SOO	\$326	\$326
2	Angled Steel Leg 29"H	HLSL28AM2	\$356	\$712
1	Rectangle Worksurface 60"W x 30"D	HLSLR3060	\$451	\$451
1	Voi® Shelf 30"W x 13"D	HLSLR1330	\$210	\$210
1	Support Pedestal 24"W x 28"D	HLSL2428B	\$855	\$855
TOTAL:			\$4,283	

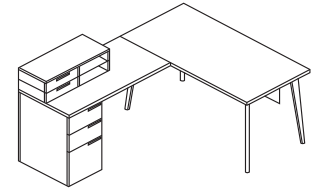

SMALL FOOTPRINT
78"W x 60"D

QTY	DESCRIPTION	MODEL	LIST PRICE	PRICE EXTENSION
1	Box/File Pedestal, Footed 16"W x 20"D x 28½"H	HLSL2016FP2	\$952	\$952
2	Drawer Cube 15"W x 13"D x 4"H	HLSL154LSD	\$243	\$486
1	Cube Bundle A	HLSL15-SOO	\$326	\$326
1	Short Open Cube 15"W x 13"D x 4"H	HLSL154LSO	\$163	\$163
1	Voi® Shelf 30"W x 13"D	HLSLR1330	\$210	\$210
2	Voi® Shelf 45"W x 13"D	HLSLR1345	\$256	\$512
1	4"H Steel Stanchion	HLSL4AM2	\$167	\$167
1	Rectangle Worksurface 72"W x 30"D	HLSLR3072	\$527	\$527
1	Rectangular Worksurface 48"W x 24"D	HLSLR2448	\$337	\$337
1	Shelf Brackets	HLSLSB	\$106	\$106
1	Mixed Material Floating Modesty Panel 54"W x 14"H	HLSL5414MM	\$1,089	\$1,089
2	Angled Wood Leg 29"H	HLSL28AW2	\$462	\$924
TOTAL:			\$5,799	

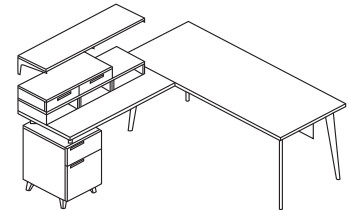

SMALL FOOTPRINT WITH SHELF
78"W x 72"D

QTY	DESCRIPTION	MODEL	LIST PRICE	PRICE EXTENSION
1	Low Credenza, 2 File/Open, Footed 60"W x 20"D x 24½"H	HLSL2060LD2F	\$1,617	\$1,617
1	Cabinet Cube, Left Handed 15"W x 13"D x 12"H	HLSL1512LSCL	\$243	\$243
1	Short Open Cube 15"W x 13"D x 4"H	HLSL154LSO	\$163	\$163
2	Drawer Cube 15"W x 13"D x 4"H	HLSL154LSD	\$243	\$486
1	Voi® Shelf 45"W x 13"D	HLSLR1345	\$256	\$256
2	Angled Steel Leg 29"H	HLSL28AM2	\$356	\$712
1	Rectangle Worksurface with Stiffener 60"W x 30"D	HLSLR3060W	\$532	\$532
1	Mixed Material Floating Modesty Panel 42"W x 14"H	HLSL4214MM	\$906	\$906
TOTAL:			\$4,915	

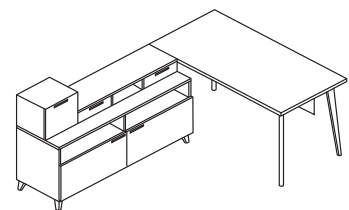

SMALL FOOTPRINT
90"W x 60"D

VOI® Laminate Typicals



Icon Legend on page 19

QTY	DESCRIPTION	MODEL	LIST PRICE	PRICE EXTENSION
1	Cube Bundle A	HLSL15-SOO	\$326	\$326
2	Angled Steel Leg 29"H	HLSL28AM2	\$356	\$712
1	Rectangle Worksurface 72"W x 30"D	HLSLR3072	\$527	\$527
1	Mixed Material Floating Modesty Panel 54"W x 14"H	HLSL5414MM	\$1,089	\$1,089
1	Low Credenza, 2 File/Open, Footed 60"W x 20"D x 24½"H	HLSL2060LD2F	\$1,617	\$1,617
4	Drawer Cube 15"W x 13"D x 4"H	HLSL154LSD	\$243	\$972
2	Voi® Shelf 30"W x 13"D	HLSLR1330	\$210	\$420
TOTAL:			\$5,663	

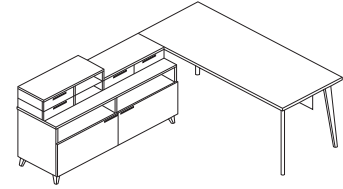

**SMALL FOOTPRINT WITH
SIX CUBES**
90" W x 72" D

QTY	DESCRIPTION	MODEL	LIST PRICE	PRICE EXTENSION
1	Low Credenza, 2 File/Open, Footed 60"W x 20"D x 24½"H	HLSL2060LD2F	\$1,617	\$1,617
1	Low Credenza, Open, Footed 30"W x 20"D x 24½"H	HLSL2030LD0F	\$1,036	\$1,036
1	Cube Bundle C	HLSL15-SODLOC	\$843	\$843
2	Voi® Shelf 45"W x 13"D	HLSLR1345	\$256	\$512
1	Angled Steel Leg 29"H	HLSL28AM2	\$356	\$356
1	4"H Steel Stanchion	HLSL4AM2	\$167	\$167
1	Rectangle Worksurface 72"W x 30"D	HLSLR3072	\$527	\$527
1	Mixed Material Floating Modesty Panel 42"W x 14"H	HLSL4214MM	\$906	\$906
TOTAL:			\$5,964	

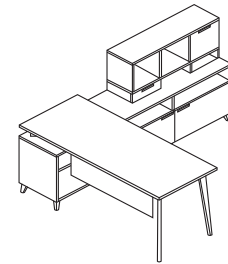

**MEDIUM FOOTPRINT WITH
CUBE BUNDLE C**
90" W x 72" D

QTY	DESCRIPTION	MODEL	LIST PRICE	PRICE EXTENSION
1	External Channel 48"W	HLSLZ5SC60	\$106	\$106
1	Rectangle Worksurface 30"D x 72"W	HLSLR3072	\$527	\$527
1	Rectangle Worksurface 20"D x 72"W	HLSLR2072	\$439	\$439
1	Low Credenza (2 file drawers) 60"W x 20"D x 21½"H	HLSL2060LD2	\$1,543	\$1,543
1	Overhead Cabinet - Metal Frame, Glass Doors 72"W x 14¼"D x 14"H	HLSL1472M	\$2,412	\$2,412
1	O-Leg Stack-on Storage Support (2 pack) 65"H	HLSL65OS	\$526	\$526
1	O-Leg Support for Worksurface (1 pack) 20"D x 28½"H	HLSL2028O	\$328	\$328
2	O-Leg Support for Worksurface (1 pack) 30"D x 28½"H	HLSL3028O	\$395	\$790
1	Box/Box/File Pedestal Support 20"D x 28½"H	HLSL2028B	\$773	\$773
1	Mixed Material Floating Modesty Panel 60"W x 14"H	HLSL6014MM	\$1,243	\$1,243
1	Storage Cube 12" x 12"	HLSL1212	\$316	\$316
TOTAL:			\$9,003	

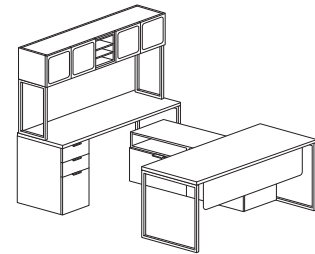

PRIVATE OFFICE
92" x 72"



Icon Legend on page 19

VOI® Laminate Typicals

DESKS

QTY	DESCRIPTION	MODEL	LIST PRICE	PRICE EXTENSION
1	Box/Box/File Pedestal Support 30"D x 28"H	HLSL3028B	\$962	\$962
1	Rectangle Worksurface 36"D x 72"W	HLSLR3672	\$684	\$684
1	End Panel Support 24"D x 28½"H	HLSL2428E	\$228	\$228
1	End Panel Support 30"D x 28½"H	HLSL3028E	\$243	\$243
1	Rectangle Worksurface 20"D x 42"W	HLSLR2042	\$295	\$295
1	Rectangle Worksurface 24"D x 72"W	HLSLR2472	\$443	\$443
1	Mixed Material Floating Modesty Panel 42"W x 14"H	HLSL4214MM	\$906	\$906
1	Lateral File 31½"W x 24"D x 28½"H	HLSL2430L	\$1,325	\$1,325
1	Overhead Cabinet - Metal Frame, Glass Doors 72"W x 14¼"D x 14"H	HLSL1472M	\$2,562	\$2,562
1	Storage Cube 12" x 12"	HLSL1212	\$316	\$316
TOTAL:			\$7,964	

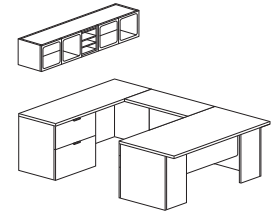

PRIVATE OFFICE
102" x 72"

QTY	DESCRIPTION	MODEL	LIST PRICE	PRICE EXTENSION
1	Low Credenza, 2 File/Open, Footed 60"W x 20"D x 24½"H	HLSL2060LD2F	\$1,617	\$1,617
1	Low Credenza, 1 File/Open, Footed 30"W x 20"D x 24½"H	HLSL2030LD1F	\$1,144	\$1,144
1	Left Hand Door, Footed 18"W x 20"D x 4"H	HLSLW084LF	\$1,434	\$1,434
2	Drawer Cube 15"W x 13"D x 4"H	HLSL154LSD	\$243	\$486
2	Cube Bundle A	HLSL15-SOO	\$326	\$652
1	Cube Bundle D	HLSL15-SDDLCC	\$972	\$972
2	Voi® Shelf 45"W x 13"D	HLSLR1345	\$256	\$512
2	Voi® Shelf 30"W x 13"D	HLSLR1330	\$210	\$420
2	Angled Wood Leg 29"H	HLSL28AW2	\$462	\$924
1	Rectangle Top, Knife Edge 72"W x 30"D	HLSLR3072J	\$720	\$720
1	Mixed Material Floating Modesty Panel 54"W x 14"H	HLSL5414MM	\$1,089	\$1,089
TOTAL:			\$9,970	

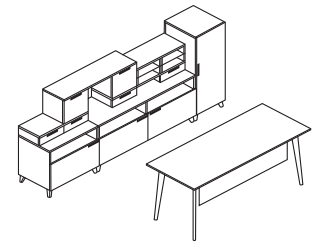

**PRIVATE OFFICE WITH
TABLE DESK**
108"W x 50"D

QTY	DESCRIPTION	MODEL	LIST PRICE	PRICE EXTENSION
1	Tower (Right hand drawers/Left hand door) 24"W x 20"D x 65"H, Left	HLSLW046L	\$2,449	\$2,449
1	Layering Shelf 60"W x 14½"D x 5½"H	HLSL1460LS	\$410	\$410
1	Rectangle Worksurface 30"D x 72"W	HLSLR3072	\$527	\$527
1	Mixed Material Floating Modesty Panel 42"W x 14"H	HLSL4214MM	\$906	\$906
2	O-Leg Support for Worksurface (1 pack) 30"D x 28½"H	HLSL3028O	\$395	\$790
1	Low Credenza (2 file/2 box) 60"W x 20"D x 21½"H	HLSL2060LD4	\$1,647	\$1,647
1	Low Credenza (Open/Right hand drawers) 60"W x 20"D x 21½"H	HLSL2060LR2	\$1,412	\$1,412
1	Credenza Cushion 20"W x 30"D x 1"H	HLSL2030CH2	\$418	\$418
TOTAL:			\$8,559	

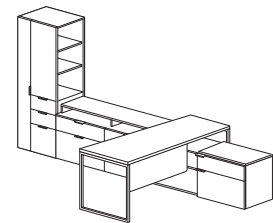

PRIVATE OFFICE
144" x 72"

VOI® Laminate Typicals



Icon Legend on page 19

QTY	DESCRIPTION	MODEL	LIST PRICE	PRICE EXTENSION
1	Personal Storage Tower (Left handed) 24"W x 24"D x 65"H	HLSLW446LP	\$2,920	\$2,920
2	Lateral File 31 ³ / ₈ "W x 24"D x 28 ¹ / ₂ "H	HLSL2430L	\$1,325	\$2,650
1	Rectangle Worksurface 24"D x 60"W	HLSLR2460	\$394	\$394
1	Rectangle Worksurface 30"D x 72"W	HLSLR3072	\$527	\$527
1	Rectangle Worksurface 24"D x 54"W	HLSLR2454	\$363	\$363
2	O-Leg Support for Worksurface (1 pack) 30"D x 28 ¹ / ₂ "H	HLSL30280	\$395	\$790
2	Overhead Cabinet with Wall Bracket with One Sliding Door 72"W x 14 ¹ / ₄ "D x 13"H	HLSL1472S	\$1,717	\$3,434
2	Storage Cube 12" x 12"	HLSL1212	\$316	\$632
1	External Channel 60"W	HLSLZ55C72	\$119	\$119
TOTAL:			\$11,829	

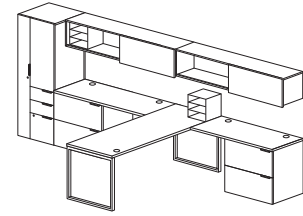

OPEN PLAN
168" x 72"

QTY	DESCRIPTION	MODEL	LIST PRICE	PRICE EXTENSION
4	External Channel 48"W	HLSLZ55C60	\$106	\$424
2	Accelerate® Raceway Panels 42 ¹ / ₂ "H x 60"W	HETP4260FP	\$476	\$952
2	Accelerate® Raceway Panels 50"H x 60"W	HETP5060FP	\$530	\$1,060
2	Electrical Power Harness, 3-1 & 2-2 60"W	HH871260	\$239	\$478
4	Duplex Receptacle Circuit 3, 3-1	HH871503	\$47	\$188
1	Power In-Feed	HH879072	\$253	\$253
2	Low Credenza (Right hand drawers) 60"W x 20"D x 21 ¹ / ₂ "H	HLSL2060LR2	\$1,412	\$2,824
2	Low Credenza (Left hand drawers) 60"W x 20"D x 21 ¹ / ₂ "H	HLSL2060LL2	\$1,412	\$2,824
4	Credenza Cushion 20"W x 30"D x 1"H	HLSL2030CH2	\$418	\$1,672
4	O-Leg Support for Worksurface (1 pack) 30"D x 28 ¹ / ₂ "H	HLSL24280	\$357	\$1,428
2	Left O-Leg to Panel Bracket	HLSLPBL	\$111	\$222
2	Right O-Leg to Panel Bracket	HLSLPBR	\$111	\$222
4	Accelerate® Top Cap 60"W	HETC60	\$94	\$376
2	Accelerate® Variable Height Finishing Kit	HECVH07P	\$60	\$120
2	Accelerate® Finished End Cover 50"H	HEFEC50P	\$65	\$130
2	Accelerate® Finished End Cover 42¹/₂"H	HEFEC42P	\$61	\$122
1	Accelerate® "X" Connector 50"H	HEC50PXN	\$133	\$133
4	O-Leg Support for Worksurface 24"D x 7"H	HLSL2470	\$240	\$960
4	Rectangle Worksurface 24"D x 60"W	HLSLR2460	\$394	\$1,576
TOTAL:			\$15,964	

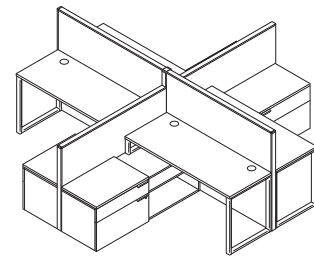

OPEN PLAN
120" x 120"



Icon Legend on page 19

VOI®

Laminate Typicals

DESKS

QTY	DESCRIPTION	MODEL	LIST PRICE	PRICE EXTENSION
4	External Channel 60"W	HLSLZ5SC72	\$119	\$476
4	Rectangle Worksurface 24"D x 72"W	HLSLR2472	\$443	\$1,772
2	O-Leg Shared Support for Low Credenzas	HLSL247SL	\$299	\$598
2	Double Depth O-Leg Support for Worksurface 48"D x 28½"H	HLSL4828O	\$670	\$1,340
2	Low Credenza (Right hand drawers) 60"W x 20"D x 21½"H	HLSL2060LR2	\$1,412	\$2,824
2	Low Credenza (Left hand drawers) 60"W x 20"D x 21½"H	HLSL2060LL2	\$1,412	\$2,824
2	Above/Below Privacy Screen 60"W x 28½"H	HLSL2860	\$1,565	\$3,130
TOTAL:				\$12,964

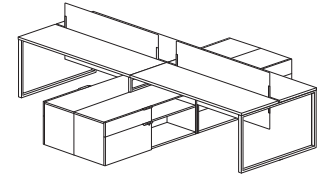

OPEN PLAN
144" x 120"

QTY	DESCRIPTION	MODEL	LIST PRICE	PRICE EXTENSION
1	Low Credenza, Right Hand Drawers, Footed 60"W x 20"D x 24½"H	HLSL2060LR2F	\$1,487	\$1,487
1	Low Credenza, Left Hand Drawers, Footed 60"W x 20"D x 24½"H	HLSL2060LL2F	\$1,487	\$1,487
1	Cube Bundle A	HLSL15-SOO	\$326	\$326
2	Drawer Cube 15"W x 13"D x 4"H	HLSL154LSD	\$243	\$486
1	Cabinet Cube, Right Handed 15"W x 13"D x 12"H	HLSL1512LSCR	\$243	\$243
1	Cabinet Cube, Left Handed 15"W x 13"D x 12"H	HLSL1512LSCL	\$243	\$243
3	Voi® Shelf 30"W x 13"D	HLSLR1330	\$210	\$630
4	Angled Steel Leg 29"H	HLSL28AM2	\$356	\$1,424
2	Rectangle Top, Knife Edge 60"W x 30"D	HLSLR3060J	\$616	\$1,232
TOTAL:				\$7,558

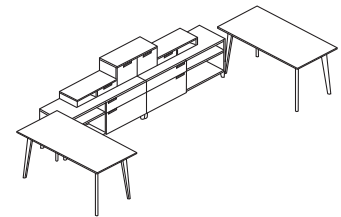

LARGE FOOTPRINT
TEAMING
180" W x 80" D

VOI® Bundles Typical



Icon Legend on page 19

VT6030MB

Worksurface is Silver Mesh, Mobile Pedestal is Harvest, O-Leg Supports and grommets are Platinum Metallic.

QTY	DESCRIPTION	MODEL	LIST PRICE	PRICE EXTENSION
1	Rectangle Worksurface with External Support Channel	HLSLR3060W*	\$532	\$532
2	O-Leg Support for Worksurface	HLSL3028O	\$399	\$798
1	Mobile Pedestal	HLSL2016MP2	\$893	\$893
TOTAL:			\$2,223	

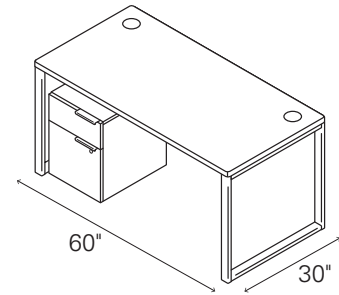
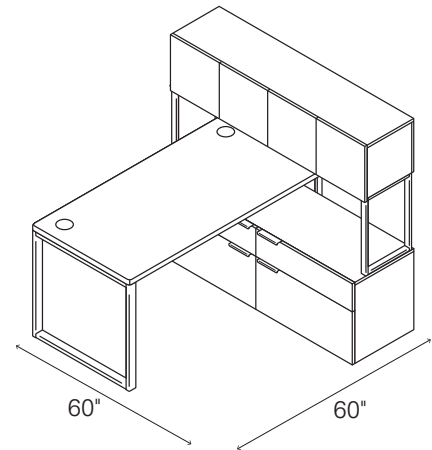

**TABLE DESK WITH MOBILE PEDESTAL
(NON-HANDED)**

VS6060L1B

Worksurface is Silver Mesh, Low Credenza and Overhead Cabinet are Harvest, O-Leg Supports and grommets are Platinum Metallic.

QTY	DESCRIPTION	MODEL	LIST PRICE	PRICE EXTENSION
1	Rectangle Worksurface with External Support Channel	HLSLR3060W*	\$532	\$532
2	O-Leg Support for Worksurface	HLSL3028O	\$399	\$798
1	Low Credenza, 2 File/2 Box	HLSL2060LD4	\$1,647	\$1,647
1	Overhead Cabinet with 4 Doors	HLSL1460D	\$1,301	\$1,301
1	O-Leg Support for Overhead Cabinet (Pair)	HLSL650S	\$530	\$530
TOTAL:			\$4,808	



**SMALL FOOTPRINT L-STATION
(NON-HANDED)**

VS6060L6B

Worksurface is Silver Mesh, Low Credenza and Layering Shelf are Harvest, O-Leg Supports and grommets are Platinum Metallic.

QTY	DESCRIPTION	MODEL	LIST PRICE	PRICE EXTENSION
1	Rectangle Worksurface with External Support Channel	HLSLR3060W*	\$532	\$532
2	O-Leg Support for Worksurface	HLSL3028O	\$399	\$798
1	Low Credenza, Right-hand Drawers	HLSL2060LR2	\$1,412	\$1,412
1	Layering Shelf	HLSL1460LS	\$410	\$410
TOTAL:			\$3,152	

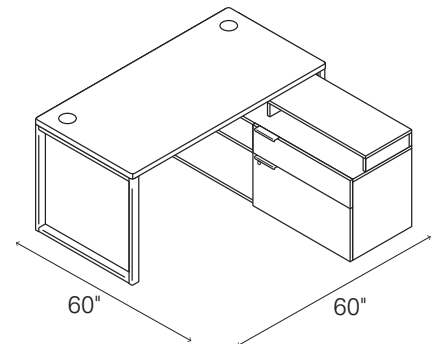

**SMALL FOOTPRINT L-STATION
(RIGHT HANDED, LOW CREDENZA)**

*Worksurface model **HLSLR3060W** can only be ordered with bundles.



Icon Legend on page 19

VOI® Bundles Typicals

DESKS

VS6060L4B

Worksurface is Silver Mesh, Low Credenza and Layering Shelf are Harvest, O-Leg Supports and grommets are Platinum Metallic.

QTY	DESCRIPTION	MODEL	LIST PRICE	PRICE EXTENSION
1	Rectangle Worksurface with External Support Channel	HLSLR3060W*	\$532	\$532
2	O-Leg Support for Worksurface	HLSL30280	\$399	\$798
1	Low Credenza, Left-hand Drawers	HLSL2060LL2	\$1,412	\$1,412
1	Layering Shelf	HLSL1460LS	\$410	\$410
TOTAL:			\$3,152	

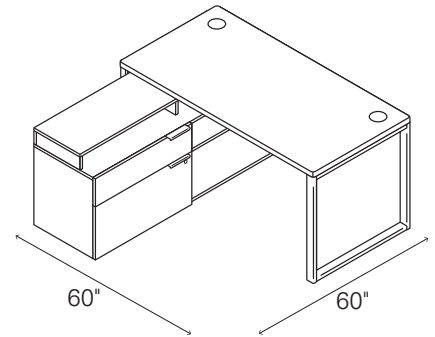

**SMALL FOOTPRINT L-STATION
(LEFT HANDED, LOW CREDENZA)**

VS6060L5B

Worksurface is Silver Mesh, Low Credenza and Overhead Cabinet are Harvest, O-Leg Supports and grommets are Platinum Metallic.

QTY	DESCRIPTION	MODEL	LIST PRICE	PRICE EXTENSION
1	Rectangle Worksurface with External Support Channel	HLSLR3060W*	\$532	\$532
2	O-Leg Support for Worksurface	HLSL30280	\$399	\$798
1	Low Credenza, Right-hand Drawers	HLSL2060LR2	\$1,412	\$1,412
1	Overhead Cabinet with 4 Doors	HLSL1460D	\$1,301	\$1,301
1	O-Leg Support for Overhead Cabinet (Pair)	HLSL650S	\$530	\$530
TOTAL:			\$4,573	

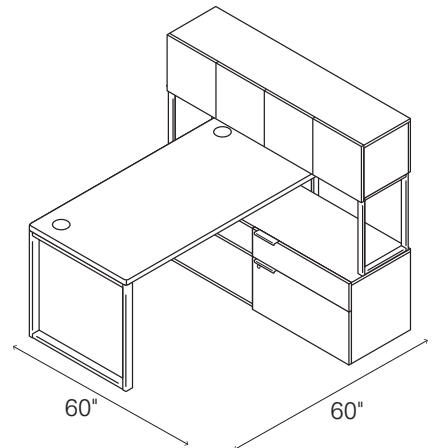

**SMALL FOOTPRINT L-STATION
(RIGHT HANDED, LOW CREDENZA)**

VS6060L3B

Worksurface is Silver Mesh, Low Credenza and Overhead Cabinet are Harvest, O-Leg Supports and grommets are Platinum Metallic.

QTY	DESCRIPTION	MODEL	LIST PRICE	PRICE EXTENSION
1	Rectangle Worksurface with External Support Channel	HLSLR3060W*	\$532	\$532
2	O-Leg Support for Worksurface	HLSL30280	\$399	\$798
1	Low Credenza, Left-hand Drawers	HLSL2060LL2	\$1,412	\$1,412
1	Overhead Cabinet with 4 Doors	HLSL1460D	\$1,301	\$1,301
1	O-Leg Support for Overhead Cabinet (Pair)	HLSL650S	\$530	\$530
TOTAL:			\$4,573	

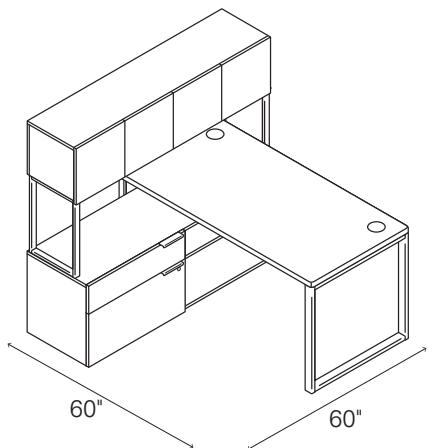

**SMALL FOOTPRINT L-STATION
(LEFT HANDED, LOW CREDENZA)**

*Worksurface model HLSLR3060W can only be ordered with bundles.

VOI® Bundles Typicals



Icon Legend on page 19

VS6060L2B

Worksurface is Silver Mesh, Low Credenza and Layering Shelf are Harvest, O-Leg Supports and grommets are Platinum Metallic.

QTY	DESCRIPTION	MODEL	LIST PRICE	PRICE EXTENSION
1	Rectangle Worksurface with External Support Channel	HLSLR3060W*	\$532	\$532
2	O-Leg Support for Worksurface	HL30280	\$399	\$798
1	Low Credenza, 2 File/2 Box	HLSL2060LD4	\$1,647	\$1,647
1	Layering Shelf	HLSL1460LS	\$410	\$410
TOTAL:			\$3,387	

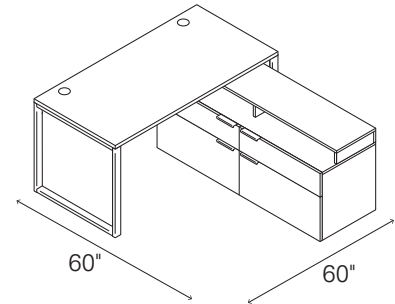

**SMALL FOOTPRINT L-STATION
(LOW CREDENZA, LAYERING SHELF)
(NON-HANDED)**

VC7260L2B

Worksurface is Silver Mesh, Low Credenza is Harvest, O-Leg Supports and grommets are Platinum Metallic.

QTY	DESCRIPTION	MODEL	LIST PRICE	PRICE EXTENSION
1	Rectangle Worksurface with External Support Channel	HLSLR3072W*	\$617	\$617
2	O-Leg Support for Worksurface	HL30280	\$399	\$798
1	Low Credenza, 2 File/2 Box	HLSL2060LD4	\$1,647	\$1,647
TOTAL:			\$3,062	

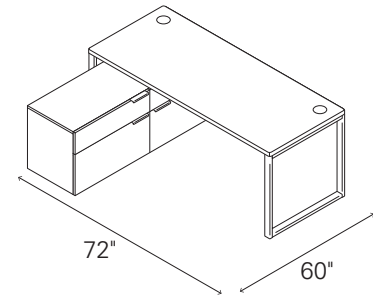

**CONTEMPORARY L-STATION
(NON-HANDED)**

*Worksurface models **HLSLR3060W** and **HLSLR3072W** can only be ordered with bundles.

This Specifying Guide is designed to walk you through the steps when choosing the Voi desks elements that will meet your particular workplace needs. From private office to open plan, there are endless combinations that will fit your style and need.

Regardless of the application, Voi presents an integrated, unified aesthetic for the entire workplace.

The step-by-step instructions make it easy to specify elements that personalize workspaces and achieve the right mix of functionality and style.

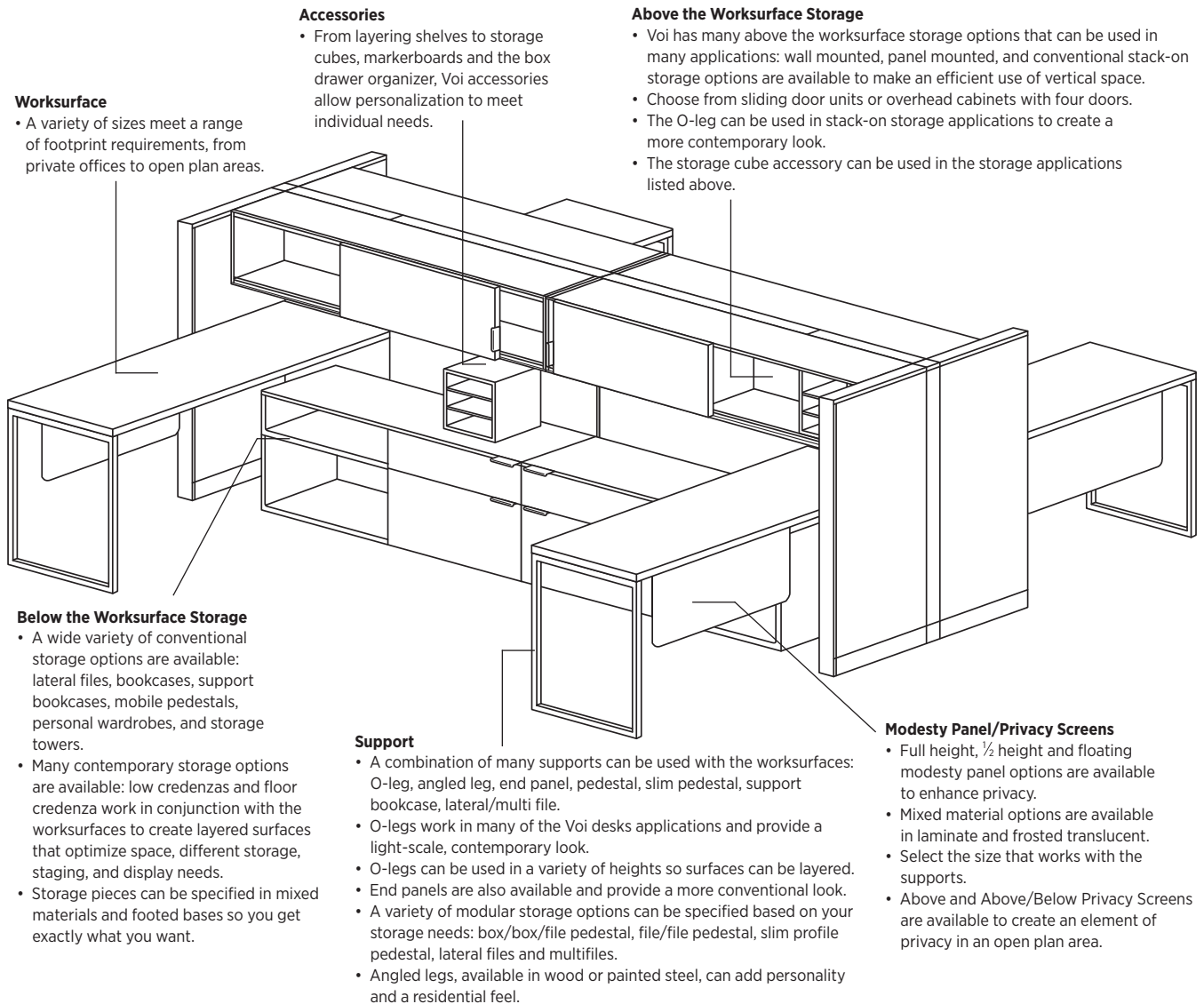

Worksurface

- A variety of sizes meet a range of footprint requirements, from private offices to open plan areas.

Accessories

- From layering shelves to storage cubes, markerboards and the box drawer organizer, Voi accessories allow personalization to meet individual needs.

Above the Worksurface Storage

- Voi has many above the worksurface storage options that can be used in many applications: wall mounted, panel mounted, and conventional stack-on storage options are available to make an efficient use of vertical space.
- Choose from sliding door units or overhead cabinets with four doors.
- The O-leg can be used in stack-on storage applications to create a more contemporary look.
- The storage cube accessory can be used in the storage applications listed above.

Below the Worksurface Storage

- A wide variety of conventional storage options are available: lateral files, bookcases, support bookcases, mobile pedestals, personal wardrobes, and storage towers.
- Many contemporary storage options are available: low credenzas and floor credenza work in conjunction with the worksurfaces to create layered surfaces that optimize space, different storage, staging, and display needs.
- Storage pieces can be specified in mixed materials and footed bases so you get exactly what you want.

Support

- A combination of many supports can be used with the worksurfaces: O-leg, angled leg, end panel, pedestal, slim pedestal, support bookcase, lateral/multi file.
- O-legs work in many of the Voi desks applications and provide a light-scale, contemporary look.
- O-legs can be used in a variety of heights so surfaces can be layered.
- End panels are also available and provide a more conventional look.
- A variety of modular storage options can be specified based on your storage needs: box/box/file pedestal, file/file pedestal, slim profile pedestal, lateral files and multifiles.
- Angled legs, available in wood or painted steel, can add personality and a residential feel.

Modesty Panel/Privacy Screens

- Full height, ½ height and floating modesty panel options are available to enhance privacy.
- Mixed material options are available in laminate and frosted translucent.
- Select the size that works with the supports.
- Above and Above/Below Privacy Screens are available to create an element of privacy in an open plan area.

VOI[®] SPECIFYING/DESIGN GUIDE

Steps for specification:

1. Select the right worksurface.

Choose the worksurface shape and size that best fits your office layout.

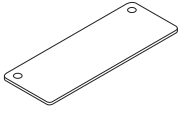

Rectangle Flat Edge Worksurface

Depths: 20", 24", 30", 36"
Widths: 36", 42", 48", 54",
60", 66", 72", 84"

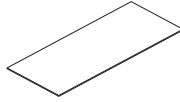

Rectangle Knife Edge Worksurface

Depths: 24", 30"
Widths: 48", 60", 72"

2. Select the supports.

Countless combinations of support options meet a variety of support and storage needs.

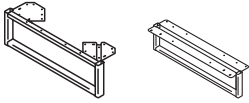

O-Leg and Shared Support for Low Credenza

20"D x 7"H, 24"D x 7"H, 30"D x 7"H
7"H only O-legs attach to worksurface and sit on top of credenzas.

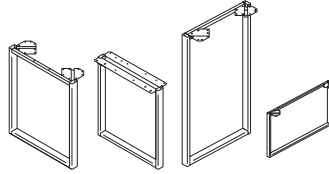

O-Leg and Shared Support for Worksurfaces

20"D x 28½"H, 24"D x 28½"H, 30"D x 28½"H
28½"H, 24"D x 41"H, 30"D x 41"H, 48"D x 28½"H,
60"D x 28½"H O-legs provide support for the worksurface.

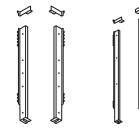

O-Leg-to-Panel Attachment Bracket

Left handed bracket (quantity 1)
Right handed bracket (quantity 1)

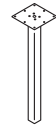

Post Leg

28½"H, 2" square

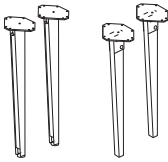

Angled Legs

12"W x 8"D x 32"H, Steel
12"W x 8"D x 32"H, Wood

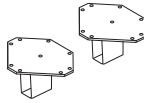

Steel Stanchions

4"H
Stanchions attach to worksurface and sit on top of credenzas.

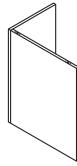

End Panel Support

16"W x 20"D x 28½"H,
16"W x 24"D x 28½"H,
16"W x 30"D x 28½"H

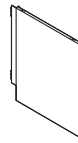

Laminate End Panel Support With Panel Attachment Bracket

24"D x 28½"H, 30"D x 28"H

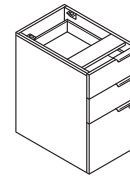

B/B/F Pedestals

16"W x 20"D x 28½"H,
16"W x 24"D x 28½"H,
16"W x 30"D x 28½"H

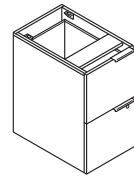

F/F Pedestals

16"W x 20"D x 28½"H,
16"W x 24"D x 28½"H,
16"W x 30"D x 28½"H

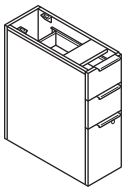

B/B/F Standard Slim Profile Pedestals

9½"W x 24"D x 28½"H,
9½"W x 30"D x 28½"H

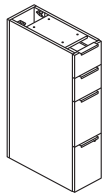

Standing-Height Pedestals

9½"W x 24"D x 41"H,
9½"W x 30"D x 41"H

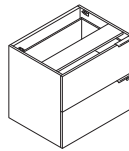

2 Drawer Lateral with Pulls

30"W x 24"D x 28½"H

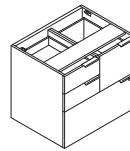

Multi-Drawer Standard File Center

30"W x 24"D x 28½"H

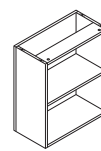

Bookcase Support

30"W x 12"D x 28½"H,
24"W x 12"D x 28½"H

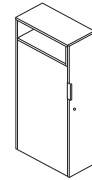

Standing-Height Towers

12"W x 30"D x 50"H,
12"W x 24"D x 50"H

Tips

- When using an O-leg in open plan, panel supported, applications, you must specify an O-leg to panel attachment bracket separately (available in 28"H and 41"H).
- Bookcase Support can only be used exterior facing.
- Telescoping ball-bearing slides used on box and file drawers. Lateral drawers use a progressive ball-bearing slide.
- When specifying a 30"D support on a 36"D worksurface, there will be a 6" overhang.
- All modular pedestals have an easy attach method to the worksurface for quick assembly.
- One double-depth O-leg can replace two regular O-legs in teaming applications.
- Shared O-legs create cleaner aesthetic where two legs are used side-by-side.
- 2" adjustable glides on O-leg supports.
- Standing-Height Support Pedestals bottom two file drawers are locking.
- Standing-Height Bookcase Support contains easy-access, fixed storage shelves.

3. Select the modesty panel/privacy screen that works in conjunction with the supports you have specified.

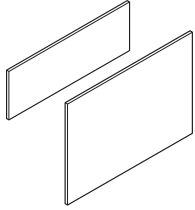

**14”H Full Width/
Half-height
Laminate Modesty
Panel**
28”, 34”, 40”W
(Modesty Size)
**28”H Full-to-Floor/
Full-Length
Laminate Modesty
Panel**
28”, 34”, 40”W
(Modesty Size)

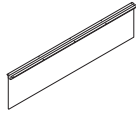

**Laminate Floating
Modesty Panel**
30”W x 14”H, 36”W x
14”H, 42”W x 14”H,
48”W x 14”H, 54”W x
14”H, 60”W x 14”H

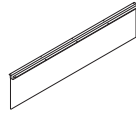

**Mixed Material
Floating Modesty
Panel**
30”W x 14”H, 36”W x
14”H, 42”W x 14”H,
48”W x 14”H, 54”W x
14”H, 60”W x 14”H
Available in Frosted
Translucent only

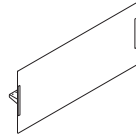

**Above/Below
Privacy Screen**
30”W x 28”H, 36”W
x 28”H, 42”W x 28”H,
48”W x 28”H, 54”W
x 28”H, 60”W x 28”H
Available in Frosted
Translucent only

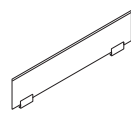

**Above Privacy
Screen**
30”W x 13”H, 36”W x
13”H, 42”W x 13”H,
48”W x 13”H, 54”W x
13”H, 60”W x 13”H
Available in Frosted
Glass only

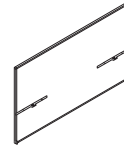

**Above/Below Fabric
Screen**
36”W x 35”H, 42”W
x 35”H, 48”W x 35”H,
54”W x 35”H, 60”W
x 35”H, 66”W x 35”H,
72”W x 35”H

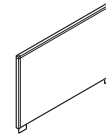

Above Fabric Screen
20”W x 20”H, 20”W
x 13”H, 24”W x 20”H,
24”W x 13”H, 30”W x
20”H, 30”W x 13”H,
36”W x 20”H, 36”W
x 13”H

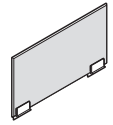

**Above Polymer or
Glass (Side) Screen**
20”W x 13”H, 24”W x
13”H, 30”W x 13”H,
36”W x 13”H

Tips

- Mixed material and laminate floating modesty panels create a lighter scale look by attaching to the top of the worksurface.
- Choose from a variety of materials to create your desired look.
- Laminate modesty panels to create a more conventional look.
- 54”W and 60”W Floating Modesty panels eliminate the need for an external channel.
- Above Privacy Screens provide a division between two worksurfaces and create a division of space in an open plan area.
- Modesty panels cannot be used as a support.
- See modesty panel chart to choose proper modesty size depending on support options.

4. Select Above the Worksurface Storage (Stack-on Storage) or Overhead Cabinets

Select the above the worksurface storage that meets your storage criteria, choose from overhead cabinets, panel mounted storage, conventional or contemporary stack-on storage.

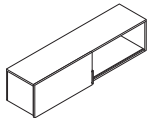

**14 1/4” D x 14” H Shared Overhead
Cabinet with One Sliding Door**
60”, 72”

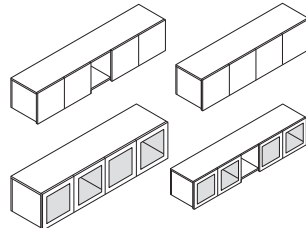

**14 1/4” Overhead Cabinet with 4 Laminate
Doors with or without Cubbie or 4 Frosted
Metal Doors with or without Cubbie**
36”, 42”, 48” and 60” with 4 Laminate or
Frosted Doors
60”, 66” and 72” with Laminate or
Frosted Doors and Cubbie

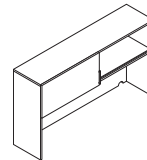

**14 1/4” D x 35” H Stack-on Storage,
Built-up, with Sliding Doors**
72”W only

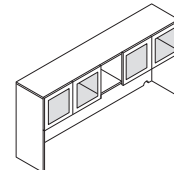

**14 1/4” D x 35” H Stack-on Storage, Built-up,
4 Frosted Metal Doors with Cubbie**
72”W only with Laminate or Frosted Doors
and Cubbie

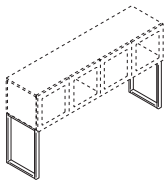

**O-Leg Support for Overhead
Cabinet**
50”-14 1/8” D x 5 1/2” H
65”-14 1/8” D x 20 1/2” H

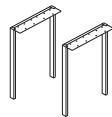

Post Legs for Shared Storage
14”H and 22”H



**Tackboard for Overhead Cabinet Applications
Tackboard for Built-up Stack-on Storage**
72”W only

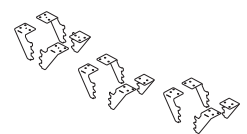

**Panel Mount Bracket for Shared
Overhead**
Abound and Accelerate

Tips

- Select sliding or hinged doors.
- Specify O-leg separately for a contemporary look.
- Optional storage shelf works in conjunction with the O-leg design to provide additional storage space. Only works with 65”H O-legs.
- O-legs come in two sizes to make a 50”H or 65”H stack-on storage unit.
- Wall mount brackets carry a \$150 upcharge and are specified the model ordering logic.
- Use shared overhead and attachments in small footprint applications.
- Shared overhead must be ordered as left or right to determine open storage location.
- Shared overhead panel mount brackets and overhead post legs allow overhead to span over all panels systems or run down the spine wall, centered on top of the panel.
- Use the 65”H for a more conventional design. 65”H and 50”H aligns with Abound and Accelerate.
- Stack-on Storage must be placed over two full-height supports. Cannot be placed over non-supported sections such as returns using a flat bracket or tower-to-worksurface bracket.
- If the end panel conventional look is preferred, order the built-up stack-on storage models.
- There are two types of tackboards for use on Overhead Cabinet and Stack-on Storage.

VOI® SPECIFYING/DESIGN GUIDE

5. Select the right storage.

Choose from a variety of below the worksurface, as well as traditional, storage options.

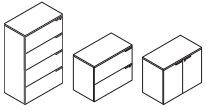

Laterals and Storage Cabinet

2-Drawer Lateral, 4-Drawer Lateral, Storage Cabinet

36"W x 24"D x 29½"H, 36"W x 20"D x 29½"H,
36"W x 24"D x 57"H, 36"W x 20"D x 57"H,
36"W x 24"D x 29½"H, 36"W x 20"D x 29½"H

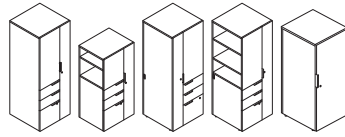

Storage Towers

18"W x 20"D, 18"W x 24"D, 24"W x 20"D, 24"W x 24"D, 50"H and 65"H

Storage Tower, One Door

18"W x 20"D x 42"H
Available in Footed Option

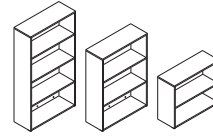

Bookshelves

36"W x 13"D x 29½"H (2 Shelf)
36"W x 13"D x 50"H (3 Shelf)
36"W x 13"D x 65"H (4 Shelf)

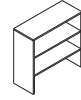

Bookcase Hutch without Doors

36"W x 14"D x 35"H

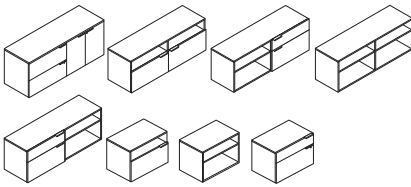

Credenzas

Credenza: 24"D x 72"W x 29½"H

Low Credenzas: 20"D x 21½"H x 30", 36", 60", 72"W

Low Credenzas with a variety of door/drawer options

Limited dimensions available in Footed Option

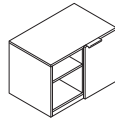

Mobile Credenza

30"W x 20"D x 21½"H

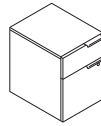

Mobile Pedestal

15¾"W x 20¼"D x 21⅞"H

Available in Footed Option

Tips

- Small credenza models can be used in small footprint applications.
- Can use pedestal or credenza seat cushions on smaller credenza models.
- Low credenzas work in conjunction with worksurface 7" O-leg designed to create a unique layering design.
- Bookcase/laterals and other conventional storage components provide additional storage space.
- Must specify chassis and drawer front color separately.
- Low Credenzas, Laterals and Mobile Pedestals have seat cushions to create additional seating in the workspace.
- Storage and Personal Tower models offer conventional storage as well as wardrobes with a coat rod.
- A worksurface-to-tower bracket kit allows the attachment of worksurfaces to Storage and Personal Tower models.
- Telescoping ball-bearing slides used on box and file drawers. Lateral drawers use a progressive ball-bearing slide.

6. Select Accessories to add color, additional storage and organization to your workspace.

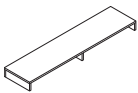

Layering Shelf

60"W x 14¼"D x 5½"H
72"W x 14¼"D x 5½"H

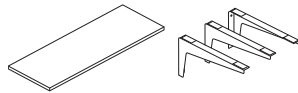

Shelves and Shelf Brackets

Shelf Depth: 13"
Shelf Widths: 30", 36", 45"
Bracket sold separately, set of three

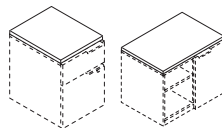

Seat Cushion for Credenzas and Mobile Credenza/Pedestal

15⅞"W x 20"D x 2"H

Credenza Cushion

20"W x 30"D x 2"H, 20"W x 36"D x 2"H

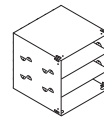

Metal Storage Cube

12" x 12"

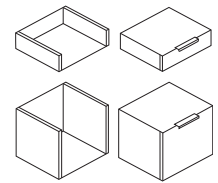

Laminate Storage Cubes

15"W x 13"D x 4"H
15"W x 13"D x 12"H

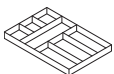

Drawer Organizer

12"W x 14½"D x 1½"H

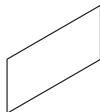

Markerboard for Shared Overhead

30"W x 15"D for use with 60"W Shared Overhead
36"W x 15"D for use with 72"W Shared Overhead

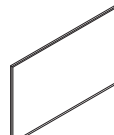

Markerboard

48"W x 31"H

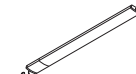

LED Task Light

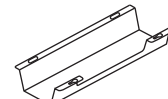

Cable Management Trough

17"W

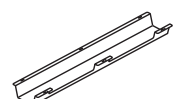

Cable Management Trough

36"W

Tips

- Choose from many bright Storage Cube colors for a colorful design element while providing additional storage.
- Use the Drawer Organizer to keep small items in order. Also offered in the same bright Storage Cube colors.
- Layering shelves are great for filing and piling or in conjunction with the lower credenza.
- Optimize shared overhead capabilities by adding the Markerboard for Shared Overhead.

VOI® AND SYSTEMS INTEGRATION

Worksurface Applications

Either Voi or Systems worksurfaces can be used with Voi in an open plan application. There are several support options:

- A. Completely panel supported.
- B. Combination of panel supported and another worksurface support such as:
 - Bookcase support
 - Pedestal (Brigade®, Flagship®, Contain®, or Voi®)
 - Systems open leg
 - Voi O-leg
 - End panel (Systems or Voi)
 - Tower to worksurface bracket
 - Support column
 - Systems round post leg
 - Voi post leg
- C. Freestanding:
 - Bookcase support
 - Two pedestals (Brigade®, Flagship®, Contain®, or Voi®)
 - Two Voi O-legs
 - One Voi O-leg and one Voi O-leg support for lower credenzas
 - Two end panels (metal or Voi)—requires metal or Voi modesty panel
 - Four (Two 2-Pack) Voi angled legs, wood or steel
 - Two Voi angled legs, steel and two Voi steel stanchion supports for low credenzas

Additional application guidelines for worksurfaces:

- Systems worksurfaces are available with grommets or no grommets.
- When Voi lower credenzas are used along the spine wall and are placed adjacent to the wing wall, one electrical/data cutout on the wing wall will be blocked.
- When Voi credenzas are used along the wing wall and are placed adjacent to the spine wall, one electrical/data cutout on the spine wall will be blocked.
- When the Voi O-leg support for credenzas is used, it is recommended to also panel attach the worksurface with the worksurface anti-dislodgement bracket kit HWSA2.
- When the Voi O-leg support is used with panels, it is recommended to also panel attach the O-leg to the panel with the O-leg to panel bracket kit HLSPPB (left) and/or HLSPPR (right). This bracket will provide additional workstation rigidity.
- When the Voi end panel support is used with panels, it is recommended to use the end panel support with panel bracket model. This model will provide additional workstation rigidity.
- The worksurface to tower bracket kit, HSTB2W1, will work with Voi towers, Voi worksurfaces, and systems worksurfaces.
- Knife Edge surfaces are recommended to only use angled post legs as supports.
- Knife Edge worksurfaces are intended to be stand-alone. Surface gaps may occur if connecting to a panel or using return worksurfaces.

Application Guidelines—Combination of Panel Supported and Another Worksurface Support

- For applications where 1) the worksurface is perpendicular to the spine wall; 2) the worksurface is panel supported off the spine wall; and 3) there are Voi credenzas placed under the worksurface along the spine: there is not enough clearance to use standard worksurface cantilevers to attach the worksurface to the spine. Use the worksurface anti-dislodgement bracket kit HWSA2 to panel attach the worksurface in lieu of cantilevers.

Panel Mounted Stack-on Storage Applications

- The Voi stack-on storage cabinets can be used on Abound and Accelerate as panel mounted overheads.
- The sliding door stack-on storage units are available in 36", 42", 48" widths in addition to 60", 66", and 72" widths.
- The 4 door stack-on storage units are only available in 36", 42", 48", 60", 66", and 72" widths.
- The storage units require a storage to panel bracket kit, model HLSPMB. This model includes one left hand, one right hand, and one center bracket. The brackets are available in all P1 and P2 paint colors.
- The storage cabinets do not have off modular capabilities.
- For proper installation and support, the storage units must follow the following specification rules:
 - There should be a storage unit of the same construction on each side of a given panel.
 - The storage units on opposite sides of a given panel should be in the same location vertically and horizontally.
 - Only one storage unit per panel, per side.
 - The wing panel adjacent to the spine wall needs to be the same height as the spine wall.

Contact HON's Integrated Design Services team with specification questions.

VOI® Laminate Worksurfaces — Rectangle

GSA SIN 33721



Icon Legend on page 19

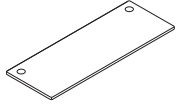

DESCRIPTION	MODEL	SHIP WEIGHT	CUBE	LIST PRICE BY LAMINATE GRADE	
				L1	L2
Rectangle Worksurfaces					
36"W x 20"D	HLSLR2036	40	2.2	\$265	\$275
42"W x 20"D	HLSLR2042	46	2.6	\$295	\$305
48"W x 20"D	HLSLR2048	52	2.9	\$318	\$328
54"W x 20"D	HLSLR2054	64	3.5	\$357	\$372
60"W x 20"D	HLSLR2060	70	3.5	\$392	\$407
66"W x 20"D	HLSLR2066	76	4.2	\$426	\$441
72"W x 20"D	HLSLR2072	82	4.2	\$439	\$454
36"W x 24"D	HLSLR2436	47	2.6	\$277	\$292
42"W x 24"D	HLSLR2442	54	3.0	\$311	\$326
48"W x 24"D	HLSLR2448	61	3.4	\$337	\$352
54"W x 24"D	HLSLR2454	68	4.2	\$363	\$383
60"W x 24"D	HLSLR2460	75	4.2	\$394	\$414
66"W x 24"D	HLSLR2466	82	5.0	\$428	\$448
72"W x 24"D	HLSLR2472	89	5.0	\$443	\$463
84"W x 24"D	HLSLR2484	103	5.7	\$650	\$675

NOTES:

- Systems worksurfaces can be used with all Voi components.
- Worksurfaces are abrasion- and stain-resistant laminate over durable 1/8" solid core high performance particleboard: resists wrapping.
- There is one 3" grommet in 36"W and 42"W worksurfaces and two in 48"W-84"W worksurfaces.
- One flat bracket ships with each worksurface.
- When attaching tops to panels, refer to Systems section of this pricer.
- Square edge detail.
- When using a floating modesty panel or an external channel under the worksurface, the depth clearance for keyboard trays and center drawers decreases by 8". See accessory matrix in accessory section of the pricer.
- 3" Power Hub model HGRMTAC can be interchanged with 3" standard grommet.
- ! Voi® worksurfaces cannot be used with Abode™ Desks components.
- ! Grommets in worksurfaces must be specified. If grommets are specified, grommets come in predetermined location.
- ! Edgeband option only on all Voi worksurfaces. For edgeband options, see matrix on page 183.
- ! When specifying an 84" Worksurface, cannot use two O-legs, must use at least one additional support such as a pedestal or lateral file.
- ! When using a worksurface as a bridge, no additional supports are needed. One support is required for returns, two supports are required for desks and credenzas.
- ! Lateral file or multi files must be used with surfaces 24"D and 60"W or greater.
- ! Depending on your support combination, an external channel may be required for extra support on unsupported spans greater than 54"W. Please see the matrix on page 201 for more details.
- ! If using a 54"W or 60"W floating modesty, it is not necessary to spec an external channel.
- ! When attaching worksurfaces to panels, one or more of the following are required: anti-dislodgement brackets, end panel, support leg and/or cantilevers. Cantilevers and anti-dislodgement brackets must be ordered separately when attaching worksurfaces to panels.
- ! A return worksurface is considered 48"W or shorter. Longer returns cannot be supported by a flat bracket only.

HOW TO SPECIFY**Select Model Number**

HLSLR2036

Select Worksurface Laminate and Edge Color

See page 183

NN

Select Grommet Option and Color

- X** No Grommet If choosing the grommet option
G Grommet Select Grommet Color
 See page 183

GT5



Laminate Worksurfaces — Rectangle

	DESCRIPTION	MODEL	SHIP WEIGHT	CUBE	LIST PRICE BY LAMINATE GRADE	
					L1	L2
	Rectangle Worksurfaces					
	36"W x 30"D	HLSLR3036	58	3.2	\$318	\$333
	42"W x 30"D	HLSLR3042	67	3.7	\$342	\$357
	48"W x 30"D	HLSLR3048	75	4.2	\$363	\$378
	54"W x 30"D	HLSLR3054	84	5.1	\$403	\$423
	60"W x 30"D	HLSLR3060	92	5.1	\$451	\$471
	66"W x 30"D	HLSLR3066	101	6.1	\$485	\$505
	72"W x 30"D	HLSLR3072	110	6.1	\$527	\$547
	84"W x 30"D	HLSLR3084	127	7.0	\$718	\$743
	60"W x 36"D	HLSLR3660	110	6.1	\$564	\$589
66"W x 36"D	HLSLR3666	120	7.2	\$610	\$635	
72"W x 36"D	HLSLR3672	130	7.2	\$684	\$709	

NOTES:

- Systems worksurfaces can be used with all Voi components.
- Worksurfaces are abrasion- and stain-resistant laminate over durable 1/8" solid core high performance particleboard: resists wrapping.
- There is one 3" grommet in 36"W and 42"W worksurfaces and two in 48"W-84"W worksurfaces.
- One flat bracket ships with each worksurface.
- When attaching tops to panels, refer to Systems section of this pricer.
- Square edge detail.
- When using a floating modesty panel or an external channel under the worksurface, the depth clearance for keyboard trays and center drawers decreases by 8". See accessory matrix in accessory section of the pricer.
- 3" Power Hub model HGRMTAC can be interchanged with 3" standard grommet.
- ! Voi® worksurfaces cannot be used with Abode™ Desks components.
- ! Grommets in worksurfaces must be specified. If grommets are specified, grommets come in predetermined location.
- ! Edgeband option only on all Voi worksurfaces.
- ! When specifying an 84" Worksurface, cannot use two O-legs, must use at least one additional support such as a pedestal or lateral file.
- ! When using a worksurface as a bridge, no additional supports are needed. One support is required for returns, two supports are required for desks and credenzas.
- ! Lateral file or multi files must be used with surfaces 24"D and 60"W or greater.
- ! Depending on your support combination, an external channel may be required for extra support on unsupported spans greater than 54"W. Please see page 201 for models and a matrix to aid in specifying.
- ! If using a 54"W or 60"W floating modesty, it is not necessary to spec an external channel.
- ! When attaching worksurfaces to panels, one or more of the following are required: anti-dislodgement brackets, end panel, support leg and/or cantilevers. Cantilevers and anti-dislodgement brackets must be ordered separately when attaching worksurfaces to panels.
- ! A return worksurface is considered 48"W or shorter. Longer returns cannot be supported by a flat bracket only.

HOW TO SPECIFY

Select Model Number <div style="border: 1px solid black; padding: 2px; display: inline-block;">H L S L R 3 0 3 6</div>	Select Worksurface Laminate and Edge Color See page 183 <div style="border: 1px solid black; padding: 2px; display: inline-block;">N N</div>	Select Grommet Option and Color X No Grommet If choosing the grommet option G Grommet Select Grommet Color See page 183 <div style="border: 1px solid black; padding: 2px; display: inline-block;">G T 5</div>
--	---	---

Laminate Worksurfaces — Rectangle

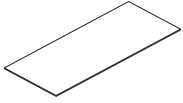

DESCRIPTION	MODEL	SHIP WEIGHT	CUBE	LIST PRICE BY LAMINATE GRADE	
				L1	L2
Rectangle Worksurfaces Top with Knife Edge 48"W x 24"D 60"W x 24"D 72"W x 24"D	HLSLR2448J	54	3.4	\$462	\$477
	HLSLR2460J	75	4.2	\$538	\$558
	HLSLR2472J	89	5.0	\$605	\$625
48"W x 30"D 60"W x 30"D 72"W x 30"D	HLSLR3048J	75	4.2	\$496	\$511
	HLSLR3060J	92	5.1	\$616	\$636
	HLSLR3072J	110	6.1	\$720	\$740

NOTES:

- Systems worksurfaces can be used with all Voi® components.
- Worksurfaces are abrasion- and stain-resistant laminate over durable 1½" solid core high performance particleboard: resists wrapping.
- There are two 3" grommets in Knife Edge worksurfaces, if specified.
- When using a floating modesty panel or an external channel under the worksurface, the depth clearance for keyboard trays and center drawers decreases by 8". See accessory matrix in accessory section of the pricer.
- 3" Power Hub model HGRMTAC can be interchanged with 3" standard grommet.
- ! Voi® worksurfaces cannot be used with Abode™ Desks components.
- ! Grommets in worksurfaces must be specified. If grommets are specified, grommets come in predetermined location.
- ! Depending on your support combination, an external channel may be required for extra support on unsupported spans greater than 54"W. Please see the matrix on page 201 for more details.
- ! If using a 54"W or 60"W floating modesty, it is not necessary to spec an external channel.
- ! Voi® Knife Edge surfaces are recommended to only use angled post legs as supports.
- ! Knife Edge worksurfaces are intended to be stand-alone. Surface gaps may occur if connecting to a panel or using return worksurfaces.

HOW TO SPECIFY

<p>Select Model Number</p> <p>HLSLR2448J .</p>	<p>Select Worksurface Laminate and Edge Color</p> <p>See page 183</p> <p>NN .</p>	<p>Select Grommet Option and Color</p> <p>X No Grommet G Grommet</p> <p>If choosing the grommet option, select Grommet Color. See page 183.</p> <p>GT1</p>
---	--	---

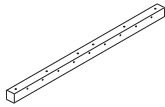

DESCRIPTION

External Support Channel
 42"W for a 54" Worksurface
 48"W for a 60" Worksurface
 54"W for a 66" Worksurface
 60"W for a 72" Worksurface
 72"W for an 84" Worksurface

MODEL

SHIP WEIGHT

CUBE

LIST PRICE

HLSLZ5SC54 ☹	5	0.5	\$101
HLSLZ5SC60 ☹	6	0.5	\$106
HLSLZ5SC66 ☹	7	0.5	\$110
HLSLZ5SC72 ☹	7	0.5	\$119
HLSLZ5SC84	12	0.7	\$119

- ⓘ Available in Graphite paint only.
- ⓘ When specifying panel-hung worksurfaces, specify external channel as if supported by two O-legs via selection chart.
- ⓘ When specifying a 54"W or 60"W Floating Modesty Panel, it is not necessary to specify an external channel.

EXTERNAL CHANNEL SELECTION GUIDE						
Support Combination		Worksurface Width for Rectangle, Wedge, and Saddle				
Support 1	Support 2	84 in	72 in	66 in	60 in	54 in
O-Leg	O-Leg	NA	HLSLZ5SC72	HLSLZ5SC66	HLSLZ5SC60	HLSLZ5SC54
O-Leg	Slim Profile Pedestal	HLSLZ5SC84	HLSLZ5SC66	HLSLZ5SC60	HLSLZ5SC54	NA
O-Leg	Bookcase	HLSLZ5SC72	HLSLZ5SC66	HLSLZ5SC60	HLSLZ5SC54	NA
O-Leg	Pedestal	HLSLZ5SC72	HLSLZ5SC60	HLSLZ5SC54	NA	NA
O-Leg	End-Panel	HLSLZ5SC84	HLSLZ5SC60	HLSLZ5SC54	NA	NA
Slim Profile Pedestal	Slim Profile Pedestal	HLSLZ5SC72	HLSLZ5SC60	HLSLZ5SC54	NA	NA
Slim Profile Pedestal	Bookcase	HLSLZ5SC72	HLSLZ5SC60	HLSLZ5SC54	NA	NA
Slim Profile Pedestal	Pedestal	HLSLZ5SC66	HLSLZ5SC54	NA	NA	NA
Slim Profile Pedestal	End-Panel	HLSLZ5SC66	HLSLZ5SC54	NA	NA	NA
Pedestal	Bookcase	HLSLZ5SC66	HLSLZ5SC54	NA	NA	NA
End-Panel	Bookcase	HLSLZ5SC66	HLSLZ5SC54	NA	NA	NA
Bookcase	Bookcase	HLSLZ5SC66	HLSLZ5SC54	NA	NA	NA
End-Panel	End-Panel	HLSLZ5SC60	NA	NA	NA	NA
Pedestal	Pedestal	HLSLZ5SC60	NA	NA	NA	NA
Pedestal	End-Panel	HLSLZ5SC60	NA	NA	NA	NA
O-Leg	Lateral/Multifile	HLSLZ5SC54	NA	NA	NA	NA
Bookcase	Lateral/Multifile	NA	NA	NA	NA	NA
Slim Profile Pedestal	Lateral/Multifile	NA	NA	NA	NA	NA
Pedestal	Lateral/Multifile	NA	NA	NA	NA	NA
End-Panel	Lateral/Multifile	NA	NA	NA	NA	NA
Height Adjustable Base	NA	HLSLZ5SC72	HLSLZ5SC60	HLSLZ5SC54	HLSLZ5SC48	NA

*All Rudder worksurfaces use external channel model HLSLZ5SC60.

HOW TO SPECIFY







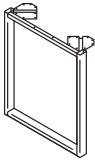

<p>Select Model Number</p> <p>H L S L Z 5 S C 8 4 .</p>	<p>Select Paint Color</p> <p>See page 183</p> <p>P</p>
--	---

VOI® Worksurface Supports

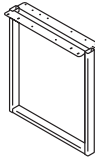
GSA SIN 33721

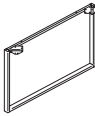
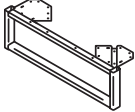

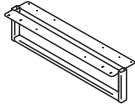
Icon Legend on page 19

	DESCRIPTION	MODEL	SHIP WEIGHT	CUBE	LIST PRICE BY PAINT GRADE		
					P1	P2	P3
	O-Leg Support for Worksurfaces						
	20"D x 28½"H	HLSL2028O	15	3.7	\$328	\$332	\$348
	24"D x 28½"H	HLSL2428O	17	3.7	\$357	\$361	\$377
	30"D x 28½"H	HLSL3028O 	19	5.4	\$395	\$399	\$415
	NOTES: Ship fully assembled, 1/pack. Non-handed.  Specify paint only. SPECIFYING EXAMPLE: HLSL2028O.T1						
	O-Leg Shared Support for Worksurfaces						
	20"D x 28½"H	HLSL2028SL	15	3.7	\$392	\$396	\$412
	24"D x 28½"H	HLSL2428SL	17	3.7	\$443	\$447	\$463
	30"D x 28½"H	HLSL3028SL 	19	5.4	\$491	\$495	\$511
	NOTES: Ship fully assembled, 1/pack. Non-handed.  Specify paint only. SPECIFYING EXAMPLE: HLSL2028SL.T1						
	Double-Depth O-Leg Support for Worksurfaces						
	48"D x 28½"H	HLSL4828O	18	7.0	\$670	\$678	\$690
	60"D x 28½"H	HLSL6028O	19	8.7	\$746	\$754	\$766
	NOTES: Ship fully assembled, 1/package. Non-handed.						
	O-Leg Support for Low Credenzas						
	20"D x 7"H	HLSL207O	5	1.0	\$222	\$226	\$242
	24"D x 7"H	HLSL247O	6	1.0	\$240	\$244	\$260
	30"D x 7"H	HLSL307O 	7	1.0	\$305	\$309	\$325
	NOTES: Ship fully assembled, 1/pack. Non-handed.  Specify paint only. SPECIFYING EXAMPLE: HLSL207O.T1						
	O-Leg Shared Support for Low Credenzas						
	20"D x 7"H	HLSL207SL	5	1.0	\$275	\$279	\$295
	24"D x 7"H	HLSL247SL	6	1.0	\$299	\$303	\$319
	30"D x 7"H	HLSL307SL	7	1.0	\$379	\$383	\$399
	NOTES: Ship fully assembled, 1/pack. Non-handed.  Specify paint only. SPECIFYING EXAMPLE: HLSL207SL.T1						









NOTES:

- A variety of pedestals, end panels, and O-legs can be combined to create a conventional or contemporary desk.
- O-leg ships fully assembled with mounting hardware.
- Shared O-Legs create a cleaner aesthetic in all applications where two legs are used side-by-side.
- Shared O-Leg bracket will span both worksurfaces to provide the same support with the look of a single O-leg.
- Will have a 6" overhang when using 30" worksurface supports with a 36"D worksurface.
- Glides on O-Leg Support for Worksurfaces and Post Leg Base have 2" of adjustability. No glides on 7"H O-leg. Glides on end panels have 1¼" adjustability.

 O-legs may only be attached to worksurfaces, not storage units.

HOW TO SPECIFY

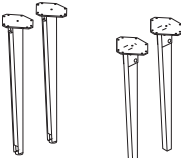
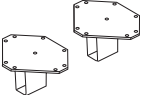
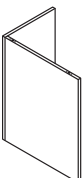
Select Model Number	Select Paint Color
HLSL2028O	See page 183
T1	

	DESCRIPTION	MODEL	SHIP WEIGHT	CUBE	LIST PRICE BY PAINT GRADE		
					P1	P2	P3
  	Post Leg Base 28½"H x 2" square ! Post leg cannot be used on primary worksurface with an O-leg as the other support. ! Post leg can only be used to support peninsula, not as primary supports for a top.	HLSL28P	15	1.0	\$321	\$325	\$341
  	28½"H O-Leg-to-Panel Attachment Bracket 28½"H Left handed bracket (quantity 1) 28½"H Right handed bracket (quantity 1) NOTES: Used to connect Voi O-Leg to a systems panel for additional workstation rigidity. Bracket designed to work with edgeband worksurfaces only. Brackets are handed, come one per package and include self-tapping screws. Specify paint.	HLSLPBL HLSLPBR	3 Ⓔ 3 Ⓔ	0.4 0.4	\$111 \$111	\$115 \$115	N/A N/A
 HLSL28AM2 HLSL28AW2	Angled Legs 12"W x 8"D x 32"H Steel — 2-Pack 12"W x 8"D x 32"H Wood — 2-Pack NOTES: Angled Steel Legs come equipped with a removable wire management channel in each leg. ! 4"H Stanchions to be used on floor storage with feet ONLY. ! O-Leg Support to be used on floor storage without feet ONLY. ! Wood legs use natural wood material. The color on each leg may contain natural variation. Ⓔ Pricing shown is <u>per carton</u> . Ordering 2 of either model will result in 2 cartons being shipped, giving you 4 legs.	HLSL28AM2 Ⓔ HLSL28AW2	15 Ⓔ 14 Ⓔ	1.3 1.5	\$356 \$462	\$364	\$376
	Steel Stanchions — 2-Pack 4"H ! 4"H Stanchions to be used on floor storage with feet ONLY. ! O-Leg Support to be used on floor storage without feet ONLY. ! Wood legs use natural wood material. The color on each leg may contain natural variation. Ⓔ Pricing shown is <u>per carton</u> . Ordering 2 of either model will result in 2 cartons being shipped, giving you 4 legs.	HLSL4AM2	5 Ⓔ	0.2	\$167	\$175	\$187
  	End Panel Support 16"W x 20"D x 28½"H 16"W x 24"D x 28½"H 16"W x 30"D x 28½"H NOTES: Ship in two pieces.	HLSL2028E HLSL2428E HLSL3028E	39 44 50	3.2 3.7 4.2	\$212 \$228 \$243	\$222 \$238 \$253	

NOTES:

- A variety of pedestals, end panels, and O-legs can be combined to create a conventional or contemporary desk.
- Voi® square support column is interchangeable with the Systems worksurface round support column: HCNLEG29.
- Glides on Post Leg Base have 2" of adjustability. Glides on end panels have 1¼" adjustability.

HOW TO SPECIFY

Select Model Number H L S L 2 0 2 8 E	Select Laminate/Paint See page 183 H
---	---

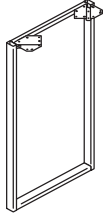
**DESCRIPTION****Standing-Height O-Leg Support for Worksurfaces**

24"D x 41"H

30"D x 41"H

MODEL**HLSL2441O****HLSL3041O****SHIP WEIGHT**

16

17

CUBE

5.3

6.5

LIST PRICE BY PAINT GRADE**P1****\$476****\$533****P2****\$482****\$539****P3****\$496****\$553**

NOTES: Ship fully assembled, 1/package. Non-handed.

Coordinate™ Power Modules will work with standing-height applications for 10500™ and Voi® desks. Please see page 122 for more information.

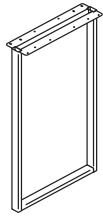
**Standing-Height O-Leg Shared Support for Worksurfaces**

24"D x 41"H

30"D x 41"H

HLSL2441SL**HLSL3041SL**

16

17

5.3

6.5

\$537**\$593****\$543****\$599****\$557****\$613**

NOTES: Ship fully assembled, 1/package. Non-handed.

Coordinate™ Power Modules will work with standing-height applications for 10500™ and Voi® desks. Please see page 122 for more information.

**Standing-Height O-Leg to Panel Attachment Bracket**

41"H Left-hand Bracket

41"H Right-hand Bracket

HLSLSPBL**HLSLSPBR**

6

6

1.0

1.0

\$140**\$140****\$144****\$144****N/A****N/A**

NOTES: 1/package. Brackets are handed as shown above. To be used with 41"H O-legs shown above (HLSL2441O and HLSL3041O).

NOTES:

- O-leg glides have 2" adjustability.
- O-Leg to Panel Attachment Brackets are used to connect Voi® O-Legs to a systems panel for additional worksurface rigidity.

! O-legs may only be attached to worksurfaces, not storage units.

HOW TO SPECIFY**Select Model Number**

HLSL2441O

Select Paint Color

See page 183

T1

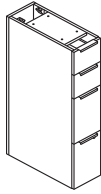

Standing-Height Laminate Support

**DESCRIPTION****MODEL****SHIP WEIGHT****CUBE****L1 LIST****L2 UPCHARGES**
CHASSIS FRONTS**Standing-Height Support Pedestals — Box/Box/File/File**

9½"W x 24"D x 41"H

HLSL2441S

94

11.9

\$1657**\$40****\$20**

9½"W x 30"D x 41"H

HLSL3041S

113

14.7

\$1722**\$45****\$20**

NOTES: Top two drawers are non-locking.

❗ Cannot use grommet worksurfaces with Standing-Height Support Storage.

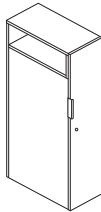
**Standing-Height Side Access Storage Tower**

12"W x 24"D x 50"H - Left

HLSLW1224L

100

11.0

\$1511**\$35****\$20**

12"W x 24"D x 50"H - Right

HLSLW1224R

100

11.0

\$1511**\$35****\$20**

12"W x 30"D x 50"H - Left

HLSLW1230L

121

13.6

\$1576**\$35****\$20**

12"W x 30"D x 50"H - Right

HLSLW1230R

121

13.6

\$1576**\$35****\$20****NOTES:**







- Tower includes coat hook on back of door.
- Chassis and drawer front panels can be specified separately.
- Tower door is locking. Ships with one handle.
- Support Pedestals bottom file drawers will lock, top box drawers will not.
- Standing-Height Pedestals will have 6" overhang when using 30"D support storage with a 36"D worksurface.
- Use the worksurface to tower bracket kit model HSTB2W1 on page 229 to attach worksurfaces to the Storage Tower models.

❗ Pedestals ship fully assembled but must attach to a worksurface with a quick release bracket, provided. Pedestals are non-handed and are interchangeable.

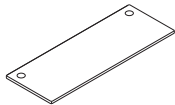
❗ Locking units equipped with HON "One Key" interchangeable core removable locks. Keyed alike core must be ordered separately.

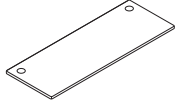
HOW TO SPECIFY

Select Model Number	Select Chassis Laminate	Select Drawer Front Laminate	Select Pull Color
See page 183	See page 183	See page 183	See page 183
HLSL2441S	N	N	T4

	DESCRIPTION	MODEL	SHIP WEIGHT	CUBE	LIST PRICE BY LAMINATE GRADE	
					L1	L2
	Rectangle Worksurfaces					
	48"W x 24"D	HLSLR2448 	61	3.4	\$337	\$352
	54"W x 24"D	HLSLR2454	68	4.2	\$363	\$383
	60"W x 24"D	HLSLR2460	75	4.2	\$394	\$414
	66"W x 24"D	HLSLR2466	82	5.0	\$428	\$448
	72"W x 24"D	HLSLR2472	89	5.0	\$443	\$463
	Rectangle Worksurfaces					
	48"W x 30"D	HLSLR3048	75	4.2	\$363	\$378
	54"W x 30"D	HLSLR3054	84	5.1	\$403	\$423
	60"W x 30"D	HLSLR3060 	92	5.1	\$451	\$471
	66"W x 30"D	HLSLR3066 	101	6.1	\$485	\$505
	72"W x 30"D	HLSLR3072 	110	6.1	\$527	\$547

HOW TO SPECIFY

<p>Select Model Number</p> <p>HLSLR2448</p>	<p>Select Worksurface Laminate and Edge Color</p> <p>See page 183</p> <p>NN</p>	<p>Select Grommet Option and Color</p> <p>X No Grommet If choosing the grommet option G Grommet Select Grommet Color See page 183</p> <p>GT5</p>
--	--	---

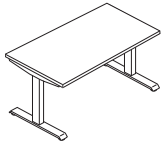

DESCRIPTION

Coordinate™ Height Adjustable Base – 2 Stage

- 2-Leg Rectangle T Foot
- 2-Leg Rectangle C Foot

MODEL

SHIP WEIGHT

CUBE

LIST PRICE

HHATB2S2LT	66	2.4	\$950
HHATB2S2LC	66	2.4	\$950

NOTES:

- Dual motor two-leg design. Legs raise from 25⁵/₈" to 45¹/₄".
- Base accommodates any rectangular worksurface between 23"D x 40"W and 30"D x 72"W.
- Weight capacity of 250 lbs. (including the weight of the worksurface) distributed evenly.

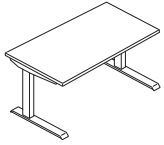

Coordinate™ Height Adjustable Base – 3 Stage

- 2-Leg Rectangle T Foot
- 2-Leg Rectangle C Foot

HHATB3S2LT	66	2.4	\$1047
HHATB3S2LC	66	2.4	\$1047

NOTES:

- Dual motor two-leg design. Legs raise from 21⁵/₈" to 47³/₄".
- Base accommodates any rectangular worksurface between 23"D x 40"W and 30"D x 72"W.
- Weight capacity of 250 lbs. (including the weight of the worksurface) distributed evenly.

Coordinate™ Height Adjustable Base – Max 3 Stage

- 2-Leg Rectangle T Foot

HHATM3S2LT	66	2.4	\$1173
-------------------	----	-----	---------------

NOTES:

- Dual motor two-leg design. Legs raise from 21⁵/₈" to 47³/₄".
- Base accommodates any rectangular worksurface between 23"D x 40"W and 30"D x 96"W.
- Weight capacity of 350 lbs. (including the weight of the worksurface) distributed evenly.

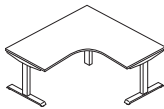

Coordinate™ Height Adjustable Base – 3 Stage

- 3-Leg Rectangle T Foot
- 3-Leg Rectangle C Foot

HHATB3S3LT	91	3.6	\$1729
HHATB3S3LC	91	3.6	\$1729

NOTES:

- Tri-motor three-leg design. Legs raise from 21⁵/₈" to 47³/₄".
- Base accommodates worksurfaces between 23"D x 40"W x 40"W and 30"D x 72"W x 72"W. Can be used with 48" 120° worksurface models.
- Weight capacity of 375 lbs. (including the weight of the worksurface) distributed evenly.

ⓘ When using two worksurfaces, a flat bracket is required. Bracket purchased separately — HHN831124, HHN831130 — see page 632.

NOTES:





- Control Box: 120V, 4A, 60Hz, 400W.
- 9' grounded power cord.
- 1¹/₈" second travel speed.
- <50 dB noise rating.
- **HON 10-Year Warranty.**

ⓘ Requires the use of an external stiffener (purchased separately) for worksurfaces over 58" W or wider when not used with a Coordinate™ worksurface.

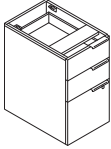

HOW TO SPECIFY

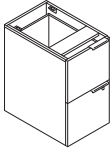
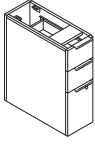
<p>Select Model Number</p> <p>HHATB3S2LT</p>	<p>Select Paint Color</p> <p>See page 116</p> <p>P71</p>	<p>Select Foot</p> <p>X Standard Foot S Slide Glide</p> <p>X</p>	<p>Select Keypad</p> <p>UD Basic Up/Down MEM Memory Preset PDL Paddle FPD Foot Pedal (+ \$175)</p> <p>MEM</p>
---	---	---	--



	DESCRIPTION	MODEL	SHIP WEIGHT	CUBE	L1 LIST	L2 UPCHARGES	
						CHASSIS	FRONTS
	Support Pedestals — Box/Box/File						
	16"W x 20"D x 28½"H	HLSL2028B	73	7.3	\$773	\$15	\$10
	16"W x 24"D x 28½"H	HLSL2428B 	85	8.5	\$855	\$20	\$10
	16"W x 30"D x 28½"H	HLSL3028B	105	10.5	\$962	\$25	\$10
	NOTES: Top box drawer does not lock.						
	Support Pedestals — File/File						
	16"W x 20"D x 28½"H	HLSL2028F	72	7.3	\$773	\$15	\$10
	16"W x 24"D x 28½"H	HLSL2428F	84	8.5	\$855	\$20	\$10
	16"W x 30"D x 28½"H	HLSL3028F	104	10.5	\$962	\$25	\$10
	NOTES: Unit is locking.						
	Slim Profile Pedestals — Box/Box/File						
	9½"W x 24"D x 28½"H	HLSL2428S	69	6.9	\$848	\$20	\$10
	9½"W x 30"D x 28½"H	HLSL3028S	56	5.6	\$931	\$25	\$10
	NOTES: Top box drawer does not lock.  Grommet will be located under Slim Pedestal when attached.						

NOTES:

- A variety of pedestals, end panels, and O-legs can be combined to create a conventional or contemporary desk.
- Chassis and drawer front woodgrain and solid laminates are specified separately (see SIF options below).
- Will have a 6" overhang when using 30" worksurface supports with a 36"D worksurface.
- File drawers accept hanging folders in letter or legal size.
- Multiple handle locations possible per customer preference.
- Ships with one handle per drawer.
- Drawer Organizer model HLSLDRWORG works with box drawers.
- Box and file drawers operate on ball-bearing suspension with full extension.
- Adjustable hex leveling glides allow floor-standing furniture to be easily leveled without lifting the unit; glides have 1¼" adjustable range.
-  Pedestals ship fully assembled but must attach to a worksurface with a quick release bracket, provided. Pedestals are non-handed and are interchangeable.
-  Locking units equipped with HON "One Key" interchangeable core removable locks. Keyed alike core must be ordered separately.



HOW TO SPECIFY

Select Model Number	Select Chassis Laminate	Select Drawer Front Laminate	Select Pull Color
See page 183	See page 183	See page 183	See page 183
HLSL2028B	N	N	T4

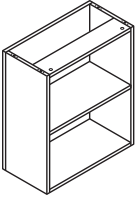

Icon Legend on page 19

Laminate Support/Support Storage

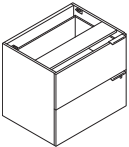
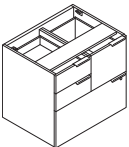
	DESCRIPTION	MODEL	SHIP WEIGHT	CUBE	L1 LIST	L2 UPCHARGES	
						CHASSIS	FRONTS
	Bookcase Support 24"W x 12"D x 28½"H 30"W x 12"D x 28½"H Specify: Model.Laminate SPECIFYING EXAMPLE: HLSL24OBC.N	HLSL24OBC HLSL30OBC	60 75	3.0 3.0	\$574 \$600	\$20 \$25	N/A N/A
							
	Lateral File — 2 Drawer 31⅜"W x 24"D x 28½"H NOTES: Unit is locking.	HLSL2430L	121	15.6	\$1325	\$35	\$20
	Multi File Lateral File 31⅜"W x 24"D x 28½"H NOTES: Box drawers do not lock.	HLSL2430MF	163	15.6	\$1574	\$35	\$20

NOTES:

- Ships with one handle per drawer on all units.
 - A variety of pedestals, end panels, and O-legs can be combined to create conventional or contemporary desk.
 - Bookcase can only mount exterior facing under a worksurface.
 - Chassis and drawer front woodgrain and solid laminates are specified separately (see SIF options below).
 - File drawers accept hanging folders in letter or legal size.
 - Multiple handle locations possible per customer preference.
 - Storage accessory model HLSLDRWORG works with box doors.
 - Standard box drawers operate on ball-bearing suspension with full extension. File, lateral, and wide box drawers operate on ball-bearing suspension with full extension.
 - Adjustable hex leveling glides allow floor-standing furniture to be easily leveled without lifting the unit; glides have 2" adjustable range.
 - When using two lateral files, a 60" worksurface cannot be used, a 66" worksurface must be specified, which will show a gap.
- ⚠ A single multi file or lateral file must be specified under a worksurface 60"W or wider.
- ⚠ Locking units equipped with HON "One Key" interchangeable core removable locks. Keyed alike core must be ordered separately.

HOW TO SPECIFY

Select Model Number HLSL2430L	Select Chassis Laminate See page 183 N	Select Laminate See page 183 N	Select Pull Color See page 183 T4
---	---	---	--

VOI® Modesty Panels

GSA SIN 33721

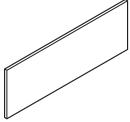
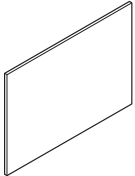
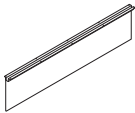

Icon Legend on page 19

	DESCRIPTION	MODEL	SHIP WEIGHT	CUBE	LIST PRICE BY LAMINATE GRADE	
					L1	L2
	Full Width/Half-height Laminate Modesty Panel					
	28"W x 14"H, for use with 60" desks	HLSL2814LM	19	1.6	\$208	\$218
	34"W x 14"H, for use with 66" desks	HLSL3414LM	23	1.9	\$215	\$225
	40"W x 14"H, for use with 72" desks	HLSL4014LM	29	2.4	\$224	\$234
	NOTES: Three sizes available for 60", 66" and 72" desks. Can only be used when using end panels and pedestals for support.					
	Full-to-Floor/Full-Length Laminate Modesty Panel					
	28"W x 28½"H, for use with 60" desks	HLSL2828LM	33	2.7	\$277	\$289
	34"W x 28½"H, for use with 66" desks	HLSL3428LM	38	3.2	\$326	\$338
	40"W x 28½"H, for use with 72" desks	HLSL4028LM	44	3.6	\$343	\$355
	NOTES: Three sizes available for 60", 66" and 72" desks. Can only be used when using end panels and pedestals for support.					
	Laminate Floating Modesty Panel					
	30"W x 14"H	HLSL3014L	10	0.8	\$191	\$201
	36"W x 14"H	HLSL3614L	12	0.8	\$202	\$212
	42"W x 14"H	HLSL4214L	14	0.8	\$214	\$224
	48"W x 14"H	HLSL4814L	16	1.1	\$236	\$248
	54"W x 14"H	HLSL5414L	18	1.1	\$258	\$270
	60"W x 14"H	HLSL6014L	20	1.1	\$277	\$289
NOTES: The attachment bracket and modesty panel are packaged separately. Specify: Model.Laminate.Paint SPECIFYING EXAMPLE: HLSL3014L.N (Black is the only paint option for this model)						
ⓘ When specifying the 54"W or 60"W Laminate Floating Modesty Panel, it is not necessary to specify an external channel.						
ⓘ 30"W and 36"W screens attach with L-brackets, not the external channel.						

NOTES:

- Full width laminate modesty panel (14"H) and full width/full-length laminate modesty panels are designed to work with 60", 66", & 72" desks.
- Laminate and frosted translucent laminate are available options on modesty panels.
- Full height and half height laminate modesty panels can only be used when specifying a pedestal and/or end panel.

HOW TO SPECIFY

Select Model Number	Select Laminate
HLSL2814LM	See page 183
N	

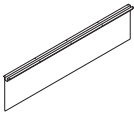

DESCRIPTION

Mixed Material Floating Modesty Panel

- 30"W x 14"H
- 36"W x 14"H
- 42"W x 14"H
- 48"W x 14"H
- 54"W x 14"H
- 60"W x 14"H

MODEL

- HLSL3014MM**
- HLSL3614MM**
- HLSL4214MM** ☉
- HLSL4814MM** ☉
- HLSL5414MM** ☉
- HLSL6014MM** ☉

SHIP WEIGHT

- 8
- 8
- 9
- 11
- 13
- 13

CUBE

- 2.0
- 2.0
- 2.3
- 2.6
- 3.3
- 3.3

LIST PRICE

- \$755**
- \$810**
- \$906**
- \$1002**
- \$1089**
- \$1243**

NOTES: The attachment bracket and modesty panel are packaged separately.

Specify: Model.Mixed Material.Paint

SPECIFYING EXAMPLE: HLSL3014MM.FT01 (Frosted Translucent mixed material and Black paint are the only options for this model)

! When specifying the 54"W or 60"W Mixed Material Floating Modesty Panel, it is not necessary to specify an external channel.

NOTES:

- Full width laminate modesty panel (14"H) and full width/full-length laminate modesty panels are designed to work with 60", 66", & 72" desks.
- Laminate and frosted translucent laminate are available options on modesty panels.
- Full height and half height laminate modesty panels can only be used when specifying a pedestal and/or end panel.

FLOATING MODESTY SELECTION GUIDE

Support Combination		Top Size								
Support 1	Support 2	84 in	72 in	66 in	60 in	54 in	48 in	42 in	36 in	30 in
O-Leg/Angled Leg	O-Leg/Angled Leg	NA	HLSL6014	HLSL5414	HLSL4814	HLSL4214	HLSL3614	HLSL3014	NA	NA
O-Leg/Angled Leg	Slim Profile Pedestal	HLSL6014	HLSL5414	HLSL4814	HLSL4214	HLSL3614	HLSL3014	NA	NA	NA
O-Leg/Angled Leg	Bookcase	HLSL6014	HLSL5414	HLSL4814	HLSL4214	HLSL3614	HLSL3014	NA	NA	NA
O-Leg/Angled Leg	Pedestal	HLSL6014	HLSL4814	HLSL4214	HLSL3614	HLSL3014	NA	NA	NA	NA
O-Leg/Angled Leg	End-Panel	HLSL6014	HLSL4814	HLSL4214	HLSL3614	HLSL3014	NA	NA	NA	NA
Slim Profile Pedestal	Slim Profile Pedestal	HLSL6014	HLSL4814	HLSL4214	HLSL3614	HLSL3014	NA	NA	NA	NA
Slim Profile Pedestal	Bookcase	HLSL6014	HLSL4814	HLSL4214	HLSL3614	HLSL3014	NA	NA	NA	NA
Slim Profile Pedestal	Pedestal	HLSL5414	HLSL4214	HLSL3614	HLSL3014	NA	NA	NA	NA	NA
Slim Profile Pedestal	End-Panel	HLSL5414	HLSL4214	HLSL3614	HLSL3014	NA	NA	NA	NA	NA
Pedestal	Bookcase	HLSL5414	HLSL4214	HLSL3614	HLSL3014	NA	NA	NA	NA	NA
End-Panel	Bookcase	HLSL5414	HLSL4214	HLSL3614	HLSL3014	NA	NA	NA	NA	NA
Bookcase	Bookcase	HLSL5414	HLSL4214	HLSL3614	HLSL3014	NA	NA	NA	NA	NA
End-Panel	End-Panel	HLSL4814	HLSL3614	HLSL3014	NA	NA	NA	NA	NA	NA
Pedestal	Pedestal	HLSL4814	HLSL3614	HLSL3014	NA	NA	NA	NA	NA	NA
Pedestal	End-Panel	HLSL4814	HLSL3614	HLSL3014	NA	NA	NA	NA	NA	NA
O-Leg/Angled Leg	Lateral/Multifile	HLSL4214	HLSL3614	HLSL3014	NA	NA	NA	NA	NA	NA
Bookcase	Lateral/Multifile	HLSL3614	NA	NA	NA	NA	NA	NA	NA	NA
Slim Profile Pedestal	Lateral/Multifile	HLSL3614	NA	NA	NA	NA	NA	NA	NA	NA
Pedestal	Lateral/Multifile	HLSL3014	NA	NA	NA	NA	NA	NA	NA	NA
End-Panel	Lateral/Multifile	HLSL3014	NA	NA	NA	NA	NA	NA	NA	NA

HOW TO SPECIFY

<p>Select Model Number</p> <p>HLSL3014MM.</p>	<p>Select Mixed Material</p> <p>FT01 Frosted Translucent</p> <p>FT01</p>
--	---

VOI® Privacy Screens

GSA SIN 33721



Icon Legend on page 19

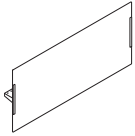

DESCRIPTION

Above/Below Privacy Screen

- 30"W x 28"H
- 36"W x 28"H
- 42"W x 28"H
- 48"W x 28"H
- 54"W x 28"H
- 60"W x 28"H

MODEL

- HLSL2830**
- HLSL2836**
- HLSL2842**
- HLSL2848**
- HLSL2854**
- HLSL2860**

SHIP WEIGHT

CUBE

LIST PRICE

- 6 6.4 **\$896**
- 6 6.4 **\$1240**
- 6 6.3 **\$1253**
- 8 8.2 **\$1336**
- 9 8.6 **\$1556**
- 9 8.6 **\$1565**

NOTES: Attachment bracket extends 2" into the worksurface. Brackets are Platinum only, no need to specify.

! Available in Frosted Translucent Acrylic ONLY HLSL2830.FT01.

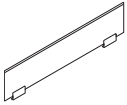

Above Privacy Screen

- 30"W x 13"H
- 36"W x 13"H
- 42"W x 13"H
- 48"W x 13"H
- 54"W x 13"H
- 60"W x 13"H

- HLSL1230**
- HLSL1236**
- HLSL1242**
- HLSL1248**
- HLSL1254**
- HLSL1260**

- 13
- 15
- 18
- 20
- 22
- 24

- 1.5
- 1.8
- 2.3
- 2.3
- 2.9
- 2.9

- \$313**
- \$345**
- \$387**
- \$443**
- \$473**
- \$508**

NOTES: Bracket is Platinum only, no need to specify.

! Available in Frosted Glass ONLY HLSL1230.G.

! Above only Privacy Screen clamps onto worksurface and cannot be installed where support storage will be attached.

NOTES:

- Ships complete with attachment brackets.
- Voi® Privacy Screens can be used on the HON Height Adjustable Base.
- All brackets are Platinum.
- Above Privacy Screen attaches to top of worksurface.
- Above and Below Privacy Screen extends 13" above and 13" below the worksurface.
- ! Above/Below Privacy Screens cannot be used with Knife Edge worksurfaces.

ABOVE-BELOW PRIVACY SCREEN SELECTION GUIDE

Support Combination		Top Size								
Support 1	Support 2	84 in	72 in	66 in	60 in	54 in	48 in	42 in	36 in	30 in
O-Leg/Angled Leg	O-Leg/Angled Leg	NA	HLSL2860	HLSL2854	HLSL2848	HLSL2842	HLSL2836	HLSL2830	NA	NA
O-Leg/Angled Leg	Slim Profile Pedestal	HLSL2860	HLSL2854	HLSL2848	HLSL2842	HLSL2836	HLSL2830	NA	NA	NA
O-Leg/Angled Leg	Bookcase	HLSL2860	HLSL2854	HLSL2848	HLSL2842	HLSL2836	HLSL2830	NA	NA	NA
O-Leg/Angled Leg	Pedestal	HLSL2860	HLSL2848	HLSL2842	HLSL2836	HLSL2830	NA	NA	NA	NA
O-Leg/Angled Leg	End-Panel	HLSL2860	HLSL2848	HLSL2842	HLSL2836	HLSL2830	NA	NA	NA	NA
Slim Profile Pedestal	Slim Profile Pedestal	HLSL2860	HLSL2848	HLSL2842	HLSL2836	HLSL2830	NA	NA	NA	NA
Slim Profile Pedestal	Bookcase	HLSL2860	HLSL2848	HLSL2842	HLSL2836	HLSL2830	NA	NA	NA	NA
Slim Profile Pedestal	Pedestal	HLSL2854	HLSL2842	HLSL2836	HLSL2830	NA	NA	NA	NA	NA
Slim Profile Pedestal	End-Panel	HLSL2854	HLSL2842	HLSL2836	HLSL2830	NA	NA	NA	NA	NA
Pedestal	Bookcase	HLSL2854	HLSL2842	HLSL2836	HLSL2830	NA	NA	NA	NA	NA
End-Panel	Bookcase	HLSL2854	HLSL2842	HLSL2836	HLSL2830	NA	NA	NA	NA	NA
Bookcase	Bookcase	HLSL2854	HLSL2842	HLSL2836	HLSL2830	NA	NA	NA	NA	NA
End-Panel	End-Panel	HLSL2848	HLSL2836	HLSL2830	NA	NA	NA	NA	NA	NA
Pedestal	Pedestal	HLSL2848	HLSL2836	HLSL2830	NA	NA	NA	NA	NA	NA
Pedestal	End-Panel	HLSL2848	HLSL2836	HLSL2830	NA	NA	NA	NA	NA	NA
O-Leg/Angled Leg	Lateral/Multifile	HLSL2842	HLSL2836	HLSL2830	NA	NA	NA	NA	NA	NA
Bookcase	Lateral/Multifile	HLSL2836	NA	NA	NA	NA	NA	NA	NA	NA
Slim Profile Pedestal	Lateral/Multifile	HLSL2836	NA	NA	NA	NA	NA	NA	NA	NA
Pedestal	Lateral/Multifile	HLSL2830	NA	NA	NA	NA	NA	NA	NA	NA
End-Panel	Lateral/Multifile	HLSL2830	NA	NA	NA	NA	NA	NA	NA	NA

HOW TO SPECIFY

Select Model Number

HLSL2830 .

HLSL1230 .

Select Mixed Material

FT01 Frosted Translucent Acrylic
Specified for Above/Below Privacy Screens only

G Frosted Glass
Specified for Above Privacy Screens only

FT01

G

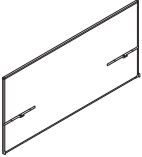
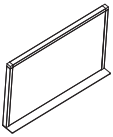

	DESCRIPTION	MODEL	SHIP WEIGHT	CUBE	CORE LIST PRICE BY CODE		
					A	B	
	Above/Below Fabric Privacy Screen						
	36"W x 35"H	HLSSL3635TS	21	3.8	\$965	\$990	
	42"W x 35"H	HLSSL4235TS	27	4.4	\$1014	\$1039	
	48"W x 35"H	HLSSL4835TS	33	6.0	\$1078	\$1113	
	54"W x 35"H	HLSSL5435TS	39	6.0	\$1126	\$1161	
	60"W x 35"H	HLSSL6035TS	45	6.0	\$1196	\$1239	
	66"W x 35"H	HLSSL6635TS	51	7.4	\$1260	\$1303	
72"W x 35"H	HLSSL7235TS	57	7.4	\$1314	\$1357		
	NOTES: Brackets are Platinum only, no need to specify. Above/Below Privacy Screens must be ordered the same width as the worksurface it is being used with to properly attach.						
	Above Fabric (Side) Privacy Screen						
	20"W x 20"H	HLSSL2020TS	13 Ⓞ	1.4	\$375	\$382	
	24"W x 20"H	HLSSL2024TS	15 Ⓞ	1.4	\$385	\$393	
	30"W x 20"H	HLSSL2030TS	17 Ⓞ	1.9	\$403	\$414	
	36"W x 20"H	HLSSL2036TS	19 Ⓞ	2.2	\$444	\$457	
	20"W x 13"H	HLSSL1220TS	11 Ⓞ	1.1	\$358	\$364	
	24"W x 13"H	HLSSL1224TS	13 Ⓞ	1.1	\$366	\$372	
	30"W x 13"H	HLSSL1230TS	15 Ⓞ	1.6	\$381	\$388	
	36"W x 13"H	HLSSL1236TS	17 Ⓞ	1.9	\$405	\$413	
		NOTES: Brackets are Platinum only, no need to specify. Brackets intended to be attached between users sitting side-by-side, and will create 1/8" separation between worksurfaces.					

NOTES:

- Ships complete with attachment brackets.
 - All brackets are Platinum.
 - Above Privacy Screen attaches to top and side of worksurface with adhesive banding.
 - Lower attachment brackets may be shifted to attach to support components.
 - Above/Below Privacy Screen extends 20" above and 13" below worksurface.
- ⓘ Screens cannot be used with T-mold on series such as tables. Screens can only attach to edgeband. Surfaces must be cleaned prior to adhering the screen and must be left to cure for 24 hours without touching for best adhesion.
- ⓘ Above/Below Fabric Privacy Screens can attach to worksurfaces that are either O-leg supported on both sides, or worksurfaces that are supported by a support pedestal on one side and an O-leg on the other. They cannot be attached to worksurfaces supported by support pedestals on both sides, unless additional hardware is specified.
- ⓘ Above Screens must attach to edgeband and top of surface.
- ⓘ Above/Below Privacy Screens must be ordered the same width as the worksurface it is being used with to properly attach.
- ⓘ Above/Below Privacy Screens cannot be used with Knife Edge worksurfaces.
- ⓘ Shared O-legs should not be used with Above/Below Fabric Privacy Screens.

HOW TO SPECIFY

Select Model Number	Select Fabric
	See pages 25-26
HLSSL3635TS	PN15

VOI® Privacy Screens

GSA SIN 33721

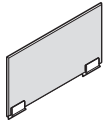

Icon Legend on page 19

**DESCRIPTION****Above Frosted Polymer (Side) Privacy Screen**

20"W x 13"H

24"W x 13"H

30"W x 13"H

36"W x 13"H

MODEL**HLSL1220FS****HLSL1224FS****HLSL1230FS****HLSL1236FS****SHIP WEIGHT**

12

14

16

19

CUBE

1.3

1.4

1.6

1.9

LIST PRICE**\$347****\$369****\$399****\$447**

NOTES: Brackets are Platinum only, no need to specify. Brackets intended to be attached between users sitting side-by-side, and will create 1/8" separation between workspaces.

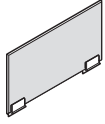
**Above Frosted Glass (Side) Privacy Screen**

20"W x 13"H

24"W x 13"H

30"W x 13"H

36"W x 13"H

HLSL1220GS**HLSL1224GS****HLSL1230GS****HLSL1236GS**

13

16

18

20

1.3

1.4

1.6

1.9

\$290**\$308****\$333****\$371**

NOTES: Brackets are Platinum only, no need to specify. Brackets intended to be attached between users sitting side-by-side, and will create 1/8" separation between workspaces.

NOTES:

- Above Privacy Screens are intended to be attached between users sitting side-by-side but will create 1/8" spacing between the workspaces. Please consider stack up if using in a panel-wrapped application.
 - Ships complete with attachment brackets.
 - All brackets are Platinum.
 - Above Privacy Screen attaches to top and side of worksurface with adhesive banding.
 - Lower attachment brackets may be shifted to attach to support components.
 - Above/Below Privacy Screen extends 20" above and 13" below worksurface.
- ⓘ Screens cannot be used with T-mold on series such as tables. Screens can only attach to edgeband. Surfaces must be cleaned prior to adhering the screen and must be left to cure for 24 hours without touching for best adhesion.

HOW TO SPECIFY**Select
Model Number**

HLSL1220FS
HLSL1220GS

**Select
Mixed Material****FT01** Frosted Translucent Acrylic

Specified for Above Screen models HLSL1220FS-HLSL1236FS only

G Frosted Glass

Specified for Above Screen models HLSL1220GS-HLSL1236GS only

FT01
G

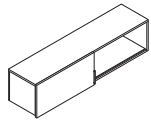
**DESCRIPTION****Overhead Cabinet with One Sliding Door**

36"W x 14¼"D x 14"H
 42"W x 14¼"D x 14"H
 48"W x 14¼"D x 14"H
 60"W x 14¼"D x 14"H
 66"W x 14¼"D x 14"H
 72"W x 14¼"D x 14"H

MODEL

HLSL1436S
HLSL1442S
HLSL1448S
HLSL1460S
HLSL1466S
HLSL1472S

SHIP WEIGHT

39
 48
 57
 69
 83
 95

CUBE

9.7
 9.7
 12.1
 13.3
 14.6
 15.9

L1 LIST

\$1120
\$1174
\$1208
\$1301
\$1436
\$1567

L2 UPCHARGES

CABINET	DOOR
\$25	\$20
\$25	\$20
\$25	\$20
\$30	\$25
\$30	\$25
\$35	\$25

NOTES:

- Sliding door overhead does not ship with a pull — door overhangs chassis to slide.
- If locking unit is selected, HF27 is used for lock core.

HOW TO SPECIFY

Select Model Number	Select Cabinet Laminate	Select Door Laminate	Select Pull Option	Specify Bracket Option
For locking overhead models, add an "L" suffix (\$40 upcharge per model)	See page 183	See page 183	X No Pull	X No Bracket W Wall Bracket (\$150 upcharge)
H L S L 1 4 7 2 S	N	N	X	W

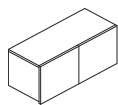
**DESCRIPTION****Overhead Cabinet with Doors**

36"W x 14¼"D x 14"H, 2 doors
 42"W x 14¼"D x 14"H, 2 doors
 48"W x 14¼"D x 14"H, 3 doors
 60"W x 14¼"D x 14"H, 4 doors

MODEL

HLSL1436D
HLSL1442D
HLSL1448D
HLSL1460D

SHIP WEIGHT

39
 48
 57
 115

CUBE

9.7
 9.7
 12.1
 13.3

L1 LIST

\$945
\$1051
\$1166
\$1301

L2 UPCHARGES

CABINET	DOOR
\$25	\$20
\$25	\$20
\$25	\$30
\$30	\$30

! 2-Door and 3-Door Overhead Cabinet with Doors models HLSL1436D–HLSL1448D available in laminate only. The 60" model HLSL1460D is available in all door finish options—see "Select Door Material for 2/3/4 Door Models" below.

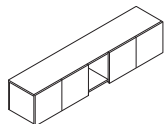
**Overhead Cabinet with 4 Doors/Cubbies**

66"W x 14¼"D x 14"H with 6" Cubbie
 72"W x 14¼"D x 14"H with 12" Cubbie

HLSL1466D
HLSL1472D

126
 139

14.6
 15.9

\$1436
\$1567

CABINET	DOOR
\$30	\$30
\$35	\$35

NOTES: Doors available in laminate or mixed materials.

NOTES:

- All Overhead Cabinets shown above can be used as a wall mount, panel mount or stack-on storage with O-leg.
- Tackboards are available for wall mount storage applications and conventional stack-on. Use wall mount tackboards when using O-leg supports.
- 5½"H and 20½"H O-legs can be purchased to create stack-on storage. Heights line up with Abound® and Accelerate® panels.
- Overhead cabinets with four doors are available in laminate or mixed materials.
- Wall mount brackets specified with unit. Brackets attach to case horizontally.
- Storage cases accept binder height items.
- The Metal Storage Cube HLSL1212 fits inside stack-on storage or overhead cabinet units to provide paper management.
- For panel mounted applications, brackets and hardware are ordered separately, see pages 592-593. Brackets attach to panel and case is screwed into brackets. Two brackets needed for 60" unit.
- If locking unit is selected, HF27 is used for lock core.

! Stack-on Storage must be placed over two full-height supports. Cannot be placed over non-supported sections such as returns using a flat bracket or tower-to-worksurface bracket.

! TIG doors not available with a locking option.

HOW TO SPECIFY

Select Model Number	Select Cabinet Laminate	Select Door Material for 2/3/4 Door Models	Select Bracket Option
For locking overhead models, add an "L" suffix (\$40 upcharge per model)	See page 183	Upcharge for door selection: TIG Platinum Polymer with Frosted glass Also available in laminate doors. See page 183. Not specified for models HLSL1436D–HLSL1448D. These models are available in laminate only.	X No Bracket W Wall Bracket (\$150 upcharge)
H L S L 1 4 6 0 D	N	T I G	X

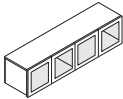
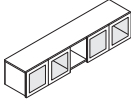
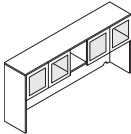
	DESCRIPTION	MODEL	SHIP WEIGHT	CUBE	LIST PRICE BY LAMINATE GRADE	
					L1	L2
	Overhead Cabinet with 4 Frosted, Metal Frame Doors 60"W x 14¼"D x 14"H ! Must specify an X or W for attachment bracket option below.	HLSL1460M	115	11.4	\$2141	\$2171
	Overhead Cabinet with 4 Frosted, Metal Frame Doors 72"W x 14¼"D x 14"H with 12" Cubbie 66"W x 14¼"D x 14"H with 6" Cubbie ! Must specify an X or W for attachment bracket option below.	HLSL1472M HLSL1466M	139 126	13.6 12.5	\$2412 \$2275	\$2447 \$2305
	Stack-on Storage, Built-up with 4 Frosted Doors with Metal Frame with Cubbies 72"W x 14¼"D x 35"H with 12" Cubbie NOTES: Ships complete with Back Enclosure and laminate End Panels. Ships factory assembled. ! Does not require bracket specification.	HLSL1472MB	165	30.4	\$2541	\$2586

	DESCRIPTION	MODEL	SHIP WEIGHT	CUBE	LIST PRICE BY FABRIC GRADE	
					A	B
 18"H	Tackboard for Wall Mount Overhead Cabinets For 78"W For 72"W For 66"W For 60"W For 48"W For 42"W For 36"W SPECIFYING EXAMPLE: HLSL48TW.DB30	HLSL78TW HLSL72TW HLSL66TW HLSL60TW HLSL48TW HLSL42TW HLSL36TW	13 12 11 10 13 12 11	1.4 1.4 1.4 1.1 1.4 1.4 1.4	\$419 \$399 \$382 \$339 \$295 \$275 \$259	\$431 \$411 \$394 \$351 \$305 \$285 \$269

NOTES:



- Use O-Leg Support models for Overhead Cabinets. See page 218.
- The Metal Storage Cube HLSL1212 fits inside stack-on storage or wall mount units to provide paper management. See page 218.
- ! Metal Frame Overhead and Stack-on Storage units are not available with a lock.
- ! Stack-on Storage must be placed over two full-height supports. Cannot be placed over non-supported sections such as returns using a flat bracket or tower-to-worksurface bracket.
- ! Specify fabric, see pages 25-26. Upcharges may apply to premium fabric grades. Analog (ANLG), Disperse (DISP), and Exchange (EXG) not available on sizes wider than 72".

HOW TO SPECIFY

Select Model Number	Select Cabinet Laminate See page 183	Select Door Material TIG Platinum Metal Doors with Frosted Glass (no upcharge)	Select Bracket Option X No Bracket W Wall Bracket (\$150 upcharge) Not specified for model HLSL1472MB
HLSL1460M	N	TIG	X

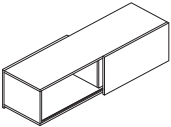
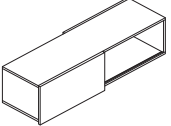

Laminate Shared Overhead Storage Components

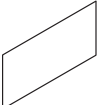
	DESCRIPTION	MODEL	SHIP WEIGHT	CUBE	L1 LIST	L2 UPCHARGES	
						CABINET	DOOR
	Shared Overhead Storage — Left						
	60"W x 17"D x 14"H 72"W x 17"D x 14"H	HLSL1760SOL HLSL1772SOL	115 139	14.8 17.0	\$1429 \$1723	\$20 \$25	\$40 \$40
	Shared Overhead Storage — Right						
	60"W x 17"D x 14"H 72"W x 17"D x 14"H	HLSL1760SOR HLSL1772SOR	115 139	14.8 17.0	\$1429 \$1723	\$20 \$25	\$40 \$40
	DESCRIPTION	MODEL	SHIP WEIGHT	CUBE	LIST PRICE BY PAINT GRADE		
	Post Legs for Shared Storage				P1	P2	P3
	14"H Post Legs 22"H Post Legs	HLSL14OSPL HLSL22OSPL	10 Ⓞ 13 Ⓞ	1.1 3.7	\$381 \$422	\$385 \$426	\$401 \$442
	NOTES: 14"H post legs on worksurfaces will span 35"H panel or shorter. 14"H post legs on low credenzas will span 30"H panel or shorter. 22"H post legs on worksurfaces will span 50"H panel or shorter. 22"H post legs on low credenzas will span 35"H panel or shorter. Specify paint. SPECIFYING EXAMPLE: HLSL14OSPL.T4						
	Panel Mount Bracket for Shared Overhead						
	Panel Mount Bracket for Overhead Storage — Accelerate®	HLSLPMBSOA	4 Ⓞ	0.1	\$150	\$154	N/A
	Panel Mount Bracket for Overhead Storage — Abound®	HLSLPMBSOB	4 Ⓞ	0.1	\$150	\$154	N/A
	Panel Mount Bracket for Overhead Storage — Accelerate®/Abound® 42½"H panels only	HLSLPMBSO42	4 Ⓞ	0.1	\$140	\$144	N/A
	NOTES: Specify paint. SPECIFYING EXAMPLE: HLSLPMBSOA.T4						
	Markerboard for Shared Storage						
	30"W x 13"H for use with 60"W Shared Overhead 36"W x 13"H for use with 72"W Shared Overhead	HLSL1530SOMB HLSL1536SOMB	6 Ⓞ 8 Ⓞ	1.0 1.0	\$143 \$192		
	NOTES: No specification necessary.						

NOTES:

- Overall case depth is 19"D including the sliding door.
 - Use Shared Overhead and attachments in small footprint applications.
 - Sliding door is 15"H, providing a 1" valance below the case which can be used as a finger pull if desired.
 - Shared Overhead panel mount brackets and overhead post legs allow overhead to span over all panels systems or run down the spine wall, centered on top of the panel.
 - Post legs can attach to all low credenza models and all worksurface models.
 - Markerboard insert is markerboard laminate with black edges, no frame.
- ⓘ Shared Overhead must be ordered as left or right to determine open storage location.
- ⓘ Shared Overhead Storage is not available with a lock.

HOW TO SPECIFY

<p>Select Model Number</p> <p>HLSL1760SOL</p>	<p>Select Chassis Laminate</p> <p>See page 183</p> <p>N</p>	<p>Select Door Front Laminate</p> <p>See page 183</p> <p>N</p>
<p>Select Model Number</p> <p>HLSL14OSPL</p>	<p>Select Paint Color</p> <p>See page 183</p> <p>T4</p>	

Overhead Storage Supports/Accessories

Icon Legend on page 19

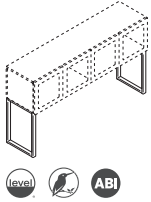

DESCRIPTION

O-Leg Support for Overhead Cabinet

Ships 2/pack
 14 7/8" D x 20 1/2" H
 14 7/8" D x 5 1/2" H

MODEL

HLSL650S
HLSL500S

SHIP WEIGHT

8
 6

CUBE

1.1
 1.0

LIST PRICE BY PAINT GRADE

P1 P2 P3

\$526 \$530 \$546
\$437 \$441 \$457

NOTES: 20 1/2" H legs used to reach 65" H when overhead storage is stacked on top of a worksurface. 5 1/2" H legs used to reach 50" H when overhead storage is stacked on top of a worksurface. O-leg ships fully assembled with mounting hardware. O-legs can be used with all overhead cabinet models. See pages 215 and 216.

- ⚠ Not for use on Shared Overhead Storage, use post leg models on page 217.
- ⚠ Stack-on Storage must be placed over two full-height supports. Cannot be placed over non-supported sections such as returns using a flat bracket or tower-to-worksurface bracket.

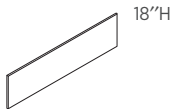

DESCRIPTION

Wall Mounted Tackboards

For 78" W
 For 72" W
 For 66" W
 For 60" W
 For 48" W
 For 42" W
 For 36" W

MODEL

HLSL78TW
HLSL72TW
HLSL66TW
HLSL60TW
HLSL48TW
HLSL42TW
HLSL36TW

SHIP WEIGHT

13
 12
 11
 10
 13
 12
 11

CUBE

1.4
 1.4
 1.4
 1.1
 1.4
 1.4
 1.4

LIST PRICE BY FABRIC GRADE

A B

\$419 \$431
\$399 \$411
\$382 \$394
\$339 \$351
\$295 \$305
\$275 \$285
\$259 \$269

NOTES: Specify fabric, see pages 25-26. Upcharges may apply to premium fabric grades. Analog (ANLG), Disperse (DISP), and Exchange (EXG) not available on sizes wider than 72".

SPECIFYING EXAMPLE: HLSL78TW.APN23



DESCRIPTION

Storage Cube

12" W x 12" D

MODEL

HLSL1212

SHIP WEIGHT

1

CUBE

0.3

LIST PRICE

\$316

SPECIFYING EXAMPLE: HLSL1212.P8S

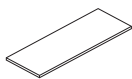

DESCRIPTION

Shelves

30" W x 13" D
 36" W x 13" D
 45" W x 13" D

MODEL

HLSLR1330
HLSLR1336
HLSLR1345

SHIP WEIGHT

10 Ⓞ
 12 Ⓞ
 15 Ⓞ

CUBE

1.3
 1.5
 1.9

L1 LIST PRICE

\$210
\$236
\$256

L2 UPCHARGE

\$10
\$10
\$10

DESCRIPTION

Shelf Bracket (set of 3)

MODEL

HLSLSB

SHIP WEIGHT

3 Ⓞ

CUBE

0.2

LIST PRICE BY PAINT GRADE

P1 P2 P3

\$106 \$114 \$126

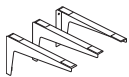

HOW TO SPECIFY

Select Model Number	Select Laminate/Paint
	See page 183
HLSL650S	T1



Laminate Stack-on Storage — Built-up

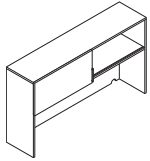

DESCRIPTION	MODEL	SHIP WEIGHT	CUBE	L1 LIST	L2 UPCHARGES	
					CABINET	DOOR
Stack-on Storage, Built-up, with Sliding Doors 72"W x 14¼"D x 35"H	HLSL1472SB	139	30.4	\$1705	\$45	\$20

NOTES: Ships complete with Back Enclosure and laminate End Panels. Ships factory assembled.

HOW TO SPECIFY

Select Model Number	Select Cabinet Laminate See page 183 L2 (\$45 upcharge)	Select Door Laminate See page 183 L2 (\$20 upcharge)	Select Pull Option X No Pull
HLSL1472SB	N	N	X

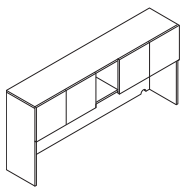

DESCRIPTION	MODEL	SHIP WEIGHT	CUBE	L1 LIST	L2 UPCHARGES	
					CABINET	DOOR
Stack-on Storage, Built-up, with 4 Doors/Cubbies 72"W x 14¼"D x 35"H with 12" Cubbie	HLSL1472DB	144	30.4	\$1705	\$45	N/A

NOTES: Ships complete with Back Enclosure and laminate End Panels. Ships factory assembled.

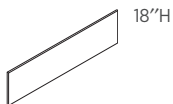

18"H

DESCRIPTION	MODEL	SHIP WEIGHT	CUBE	LIST PRICE BY FABRIC GRADE	
				A	B
Tackboard for Built-up Stack-on Storage For 72"	HLSL7265TE	12	1.4	\$399	\$411

NOTES: For a list of standard fabrics, see pages 25-26. For a complete list of fabrics, please go to hon.com/fabricsandfinishes. Analog (ANLG), Disperse (DISP), and Exchange (EXG) not available on sizes wider than 72".

SPECIFYING EXAMPLE: HLSL7265TE.APN23

NOTES:

- The Metal Storage Cube HLSL1212 fits inside stack-on storage or wall mount units to provide paper management.

❗ Stack-on Storage is not available with a lock.

❗ Tackboards are available for Built-up models only. Tackboards cannot be added to O-leg supported units.

❗ Stack-on Storage must be placed over two full-height supports. Cannot be placed over non-supported sections such as returns using a flat bracket or tower-to-worksurface bracket.

HOW TO SPECIFY

Select Model Number	Select Cabinet Chassis Laminate See page 183 L2 (\$45 upcharge)	Select Door Material for 4-Door Models Upcharge for door selection: 4-Door T1G Platinum Polymer with Frosted glass \$315 Also available in laminate doors. See page 183.
HLSL1472DB	N	T1G

VOI® Laminate Low Credenzas

GSA SIN 33721



Icon Legend on page 19

	DESCRIPTION	MODEL	SHIP WEIGHT	CUBE	L1 LIST	L2 UPCHARGES	
						CHASSIS	FRONTS
	Low Credenza, 2 File/2 Box 72"W x 20"D x 21½"H 60"W x 20"D x 21½"H	HLSL2072LD4	230	21.9	\$1806	\$40	\$40
	NOTES: Unit is locking.	HLSL2060LD4	190	18.9	\$1647	\$35	\$40
	Low Credenza, 2 File Drawers, Open Top 72"W x 20"D x 21½"H 60"W x 20"D x 21½"H	HLSL2072LD2	200	21.9	\$1688	\$40	\$30
	NOTES: Unit is non-locking.	HLSL2060LD2 	160	18.9	\$1543	\$35	\$30
	Low Credenza, Left Hand Drawers 72"W x 20"D x 21½"H 60"W x 20"D x 21½"H	HLSL2072LL2	200	21.9	\$1672	\$40	\$20
	NOTES: Unit is locking.	HLSL2060LL2	160	18.9	\$1412	\$35	\$20
	Low Credenza, Right Hand Drawers 72"W x 20"D x 21½"H 60"W x 20"D x 21½"H	HLSL2072LR2	200	21.9	\$1672	\$40	\$20
	NOTES: Unit is locking.	HLSL2060LR2	160	18.9	\$1412	\$35	\$20
	Low Credenza, Open 72"W x 20"D x 21½"H 60"W x 20"D x 21½"H	HLSL2072LDO	170	21.9	\$1421	\$40	N/A
	SPECIFYING EXAMPLE: HLSL2072LDO.Z (model.chassis only)	HLSL2060LDO	130	18.9	\$1180	\$35	N/A
	Low Credenza, 4 Storage Doors 72"W x 20"D x 21½"H 60"W x 20"D x 21½"H	HLSL2072S4	190	21.9	\$1792	\$40	\$40
	NOTES: Unit is locking.	HLSL2060S4	160	18.9	\$1540	\$35	\$40

NOTES:

- Worksurfaces with 7" O-legs, may be placed upon low credenzas to create layering.
- Chassis and drawer fronts woodgrains and solid laminates are specified separately (see SIF options below).
- File drawers accept hanging folders in letter size.
- Multiple handle locations possible per customer preference.
- Seat cushions are available for low credenzas and mobile pedestals (specify separately).
- Storage accessory model HLSLDRWORG works with box doors.
- Layering shelf works with low credenzas to provide additional storage areas.
- File, lateral, and wide box drawers operate on ball-bearing suspension with full extension.
- Adjustable hex leveling glides allow floor-standing furniture to be easily leveled without lifting the unit; glides have 1/4" adjustable range.
- Ships with one handle per drawer on all units.

 Locking units equipped with HON "One Key" interchangeable core removable locks. Keyed alike core must be ordered separately.

HOW TO SPECIFY

Select Model Number	Select Chassis Laminate See page 183	Select Drawer Front Laminate See page 183	Select Pull Color See page 183 Not specified for Open Credenza models HLSL2072LDO, HLSL2060LDO
HLSL2072LD4	N	N	T4

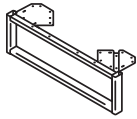

DESCRIPTION

7" O-Leg Support for Worksurfaces

30"D x 7"H

24"D x 7"H

20"D x 7"H

Specify: Model.Paint HL3070.T1.

NOTES: 7" O-Leg Support to be placed upon Low Credenza models to support worksurfaces. Ship 1/pack.

MODEL	SHIP WEIGHT	CUBE	LIST PRICE BY PAINT GRADE		
			P1	P2	P3
HL3070 ☺	7	1.0	\$305	\$309	\$325
HL2470	6	1.0	\$240	\$244	\$260
HL2070	5	1.0	\$222	\$226	\$242

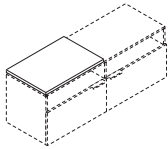

DESCRIPTION

Credenza Cushion

20"W x 36"D x 1"H for 72" Credenzas

20"W x 30"D x 1"H for 60" Credenzas

NOTES: See pages 22-24 for available fabrics.

COM: .75

SPECIFYING EXAMPLE: HL2036CH2.APN23

MODEL	SHIP WEIGHT	CUBE	LIST PRICE BY FABRIC GRADE					
			1	2	3	4	5	6
HL2036CH2	11	2.2	\$451	\$489	\$527	\$566	\$615	\$665
HL2030CH2	9	1.9	\$418	\$454	\$490	\$526	\$572	\$619

NOTES:

- Worksurfaces with 7" O-legs, may be placed upon low credenzas to create layering.
- Chassis and drawer fronts woodgrains and solid laminates are specified separately (see SIF options on preceding page).
- Seat cushions are available for low credenzas and mobile pedestals (specify separately).
- Storage accessory model HL3DRWORG works with box doors.
- Layering shelf works with low credenzas to provide additional storage areas.
- File, lateral, and wide box drawers operate on ball-bearing suspension with full extension.
- Adjustable hex leveling glides allow floor-standing furniture to be easily leveled without lifting the unit; glides have 1/4" adjustable range.
- Ships with one handle per drawer on all units.

HOW TO SPECIFY

<p>Select Model Number</p> <p>HL3070.</p>	<p>Select Paint Color</p> <p>See page 183</p> <p>T1</p>
--	--

Laminate Low Footed Credenzas

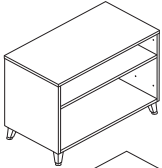
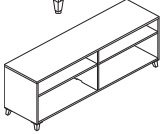
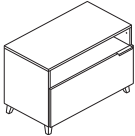
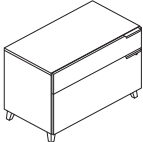
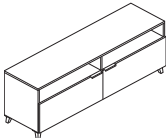
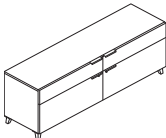
	DESCRIPTION	MODEL	SHIP WEIGHT	CUBE	L1 LIST	L2 UPCHARGES	
						CHASSIS	FRONTS
	Low Credenza, Open, Footed						
	30"W x 20"D x 24½"H	HLSL2030LD0F Ⓢ	67	9.8	\$1036	\$25	N/A
	36"W x 20"D x 24½"H	HLSL2036LD0F	87	11.9	\$1066	\$30	N/A
	60"W x 20"D x 24½"H	HLSL2060LD0F	132	19.9	\$1254	\$35	N/A
	72"W x 20"D x 24½"H	HLSL2072LD0F	172	23.7	\$1495	\$40	N/A
	Low Credenza, 1 File/Open, Footed						
	30"W x 20"D x 24½"H	HLSL2030LD1F	77	9.8	\$1144	\$25	\$15
	36"W x 20"D x 24½"H	HLSL2036LD1F	97	11.9	\$1177	\$30	\$15
	Low Credenza, 1 File/1 Box, Footed						
	30"W x 20"D x 24½"H	HLSL2030LD2F	82	9.8	\$1265	\$25	\$20
	36"W x 20"D x 24½"H	HLSL2036LD2F	102	11.9	\$1300	\$30	\$20
	Low Credenza, 2 File/Open, Footed						
	60"W x 20"D x 24½"H	HLSL2060LD2F	162	19.9	\$1617	\$35	\$30
	72"W x 20"D x 24½"H	HLSL2072LD2F	202	23.7	\$1762	\$40	\$30
	Low Credenza, 2 File/2 Box, Footed						
	60"W x 20"D x 24½"H	HLSL2060LD4F	192	19.9	\$1721	\$35	\$40
	72"W x 20"D x 24½"H	HLSL2072LD4F	232	23.7	\$1880	\$40	\$40

NOTES:

- Worksurfaces with 4" stanchions may be placed upon low credenzas to create layering.
- Chassis and drawer fronts woodgrains and solid laminates are specified separately (see SIF options below).
- File drawers accept hanging folders in letter size.
- Multiple handle locations possible per customer preference.
- Seat cushions are available for low credenzas (specify separately).
- Storage accessory model HLSLDRWORG works with box drawers.
- Layering shelf works with low credenzas to provide additional storage areas.
- File, lateral, and wide box drawers operate on ball-bearing suspension with full extension.
- Adjustable hex leveling glides allow floor-standing furniture to be easily leveled without lifting the unit; glides have 1/4" adjustable range.
- Ships with one handle per drawer on all units.

ⓘ Locking units equipped with HON "One Key" interchangeable core removable locks. Keyed alike core must be ordered separately.

ⓘ 7" O-legs cannot be used as a support on footed credenzas.

HOW TO SPECIFY

Select Model Number See page 183 HLSL2030LD0F	Select Chassis Laminate See page 183 C	Select Drawer Front Laminate See page 183 C	Select Pull Color See page 183 Not specified for Open Credenza models T1	Select Foot Color See page 183 T1
---	--	---	---	---

Laminate Low Footed Credenzas

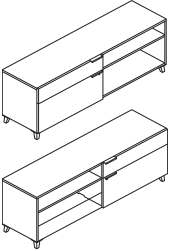
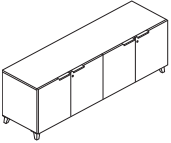
	DESCRIPTION	MODEL	SHIP WEIGHT	CUBE	L1 LIST	L2 UPCHARGES	
						CHASSIS	FRONTS
	Low Credenza, Box/File, Open, Footed						
	60"W x 20"D x 24½"H — Left Hand Drawers	HLSL2060LL2F	162	19.9	\$1487	\$35	\$20
	72"W x 20"D x 24½"H — Left Hand Drawers	HLSL2072LL2F	202	23.7	\$1746	\$40	\$20
	60"W x 20"D x 24½"H — Right Hand Drawers	HLSL2060LR2F	162	19.9	\$1487	\$40	\$20
	72"W x 20"D x 24½"H — Right Hand Drawers	HLSL2072LR2F	202	23.7	\$1746	\$40	\$20
	Low Credenza, 4 Storage Doors, Footed						
	60"W x 20"D x 24½"H	HLSL2060S4F	162	19.9	\$1614	\$35	\$40
	72"W x 20"D x 24½"H	HLSL2072S4F	192	23.7	\$1866	\$40	\$40

NOTES:

- Worksurfaces with 4" stanchions may be placed upon low credenzas to create layering.
- Chassis and drawer fronts woodgrains and solid laminates are specified separately (see SIF options below).
- File drawers accept hanging folders in letter size.
- Multiple handle locations possible per customer preference.
- Seat cushions are available for low credenzas and mobile pedestals (specify separately).
- Storage accessory model HSLDRWORG works with box doors.
- Layering shelf works with low credenzas to provide additional storage areas.
- File, lateral, and wide box drawers operate on ball-bearing suspension with full extension.
- Adjustable hex leveling glides allow floor-standing furniture to be easily leveled without lifting the unit; glides have 1/4" adjustable range.
- Ships with one handle per drawer on all units.

❗ HLSL2060S4F and HLSL2072S4F require model HF27 lock cores.

❗ Locking units equipped with HON "One Key" interchangeable core removable locks. Keyed alike core must be ordered separately.

❗ 7" O-legs cannot be used as a support on footed credenzas.

HOW TO SPECIFY

Select Model Number	Select Chassis Laminate See page 183	Select Drawer Front Laminate See page 183	Select Pull Color See page 183 Not specified for Open Credenza models	Select Foot Color See page 183
HLSL2060LL2F	C	C	T1	T1

VOI® Laminate Credenzas

GSA SIN 33721

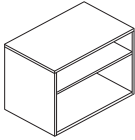
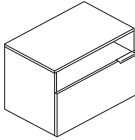
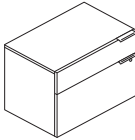

Icon Legend on page 19

	DESCRIPTION	MODEL	SHIP WEIGHT	CUBE	L1 LIST	L2 UPCHARGES	
						CHASSIS	FRONTS
	Low Credenza — Open 30"W x 20"D x 21½"H 36"W x 20"D x 21½"H	HLSL2030LDO	65	9.8	\$977	\$25	N/A
		HLSL2036LDO	85	12.0	\$1006	\$30	N/A
	Low Credenza — Open Top, File Drawer 30"W x 20"D x 21½"H 36"W x 20"D x 21½"H	HLSL2030LD1	75	9.8	\$1085	\$25	\$15
	NOTES: Unit is non-locking.	HLSL2036LD1	95	12.0	\$1118	\$30	\$15
	Low Credenza — 1 File Drawer, 1 Box Drawer 30"W x 20"D x 21½"H 36"W x 20"D x 21½"H	HLSL2030LD2	80	9.8	\$1206	\$25	\$20
	NOTES: Unit is locking.	HLSL2036LD2	100	12.0	\$1241	\$30	\$20

NOTES:

- Worksurfaces with 7" O-legs, may be placed upon low credenzas to create layering.
- File drawers accept hanging folders in letter size.
- Multiple handle locations possible per customer preference.
- Post legs on Shared Overhead are compatible to attach to low credenzas.
- Storage accessory model HLSLDRWORG works with box doors.
- File, lateral, and wide box drawers operate on ball-bearing suspension with full extension.
- Utilize in small footprint applications.
- Adjustable hex leveling glides allow floor-standing furniture to be easily leveled without lifting the unit; glides have 1/4" adjustable range.
- Ships with one handle per drawer on all units.

Locking units equipped with HON "One Key" interchangeable core removable locks. Keyed alike core must be ordered separately.

HOW TO SPECIFY

<p>Select Model Number</p> <p>See page 183</p> <p>H L S L 2 0 3 0 L D O .</p>	<p>Select Chassis Laminate</p> <p>See page 183</p> <p>N .</p>	<p>Select Drawer Front Laminate</p> <p>See page 183</p> <p>Not specified for Open Credenza models HLSL2030LDO, HLSL2036LDO</p> <p>N .</p>	<p>Select Pull Color</p> <p>See page 183</p> <p>Not specified for Open Credenza models HLSL2030LDO, HLSL2036LDO</p> <p>T 4</p>
--	--	--	---

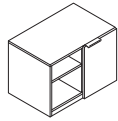

VOI® Laminate Mobile Storage

**DESCRIPTION**

Mobile Credenza
30"W x 20"D x 21½"H

NOTES: Unit is non-locking.

MODEL	SHIP WEIGHT	CUBE	L1 LIST	L2 UPCHARGES	
				CHASSIS	FRONTS
HLSL2030MCO	80	9.8	\$1566	\$25	\$10

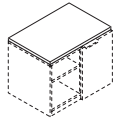
**DESCRIPTION**

Credenza Cushion
20"W x 30"D x 1"H for 60" Credenzas

NOTES: See pages 22-24 for available fabrics.

COM: .75

SPECIFYING EXAMPLE: HLSL2030CH2.APN23

MODEL	SHIP WEIGHT	CUBE	LIST PRICE BY FABRIC GRADE					
			1	2	3	4	5	6
HLSL2030CH2	9	1.9	\$418	\$454	\$490	\$526	\$572	\$619

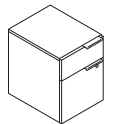
**DESCRIPTION**

Mobile Pedestal
15¾"W x 20½"D x 21¾"H

NOTES: Unit is locking.

MODEL	SHIP WEIGHT	CUBE	L1 LIST	L2 UPCHARGES	
				CHASSIS	FRONTS
HLSL2016MP2	65	5.7	\$893	\$20	\$10

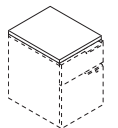
**DESCRIPTION**

Mobile Pedestal Cushion
15¾"W x 20"D x 1"H for Pedestals

NOTES: See pages 22-24 for available fabrics.

SPECIFYING EXAMPLE: HLSL2016PH2.APN23

MODEL	SHIP WEIGHT	CUBE	LIST PRICE BY FABRIC GRADE					
			1	2	3	4	5	6
HLSL2016PH2	6	1.1	\$347	\$371	\$395	\$419	\$450	\$481

**NOTES:**

- Chassis and drawer fronts woodgrains and solid laminates are specified separately (see SIF options below).
- File drawers accept hanging folders in letter or legal size.
- Multiple handle locations possible per customer preference.
- Seat cushions are available for low credenzas, floor credenzas, and mobile pedestals (specify separately).
- Storage accessory model HLSLDRWORG works with box doors.
- Standard box drawers operate on ball-bearing suspension with 70% extension. File drawers operate on ball-bearing suspension with 70% extension.
- Ships with one handle per drawer on all units.

! Locking units equipped with HON "One Key" interchangeable core removable locks. Keyed alike core must be ordered separately.

HOW TO SPECIFY

Select Model Number HLSL2030MCO	Select Chassis Laminate See page 183 N	Select Drawer Front Laminate See page 183 N	Select Pull Color See page 183 T4
---	---	--	--

VOI® Laminate Storage

GSA SIN 33721

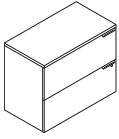
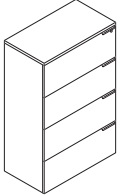
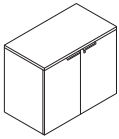
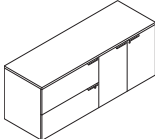
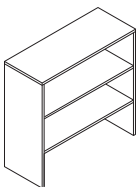

Icon Legend on page 19

	DESCRIPTION	MODEL	SHIP WEIGHT	CUBE	L1 LIST	L2 UPCHARGES	
						CHASSIS	FRONTS
	2-Drawer Lateral Files						
	36"W x 24"D x 29½"H 36"W x 20"D x 29½"H	HLSL2436L2 HLSL2036L2	305 170	29.8 15.7	\$1438 \$1291	\$35 \$30	\$20 \$20
	4-Drawer Lateral Files						
	36"W x 24"D x 57"H 36"W x 20"D x 57"H	HLSL2436L4 HLSL2036L4	366 204	35.9 18.3	\$2045 \$1921	\$45 \$40	\$30 \$30
	Storage Cabinet						
	36"W x 24"D x 29½"H 36"W x 20"D x 29½"H	HLSL2436SC HLSL2036SC	150 147	18.3 15.7	\$1089 \$1023	\$35 \$30	\$20 \$20
	Lateral/Storage Cabinet Credenza						
	72"W x 24"D x 29½"H	HLSL2472LC	300	35.6	\$2899	\$45	\$30
	Bookcase Hutch (no doors)						
	36"W x 14"D x 35"H NOTES: Bookcase Hutch model works with Storage Cabinet and Lateral File models shown above. ⚠ Specify: Chassis laminate only. ⚠ Top two shelves have 12" spacing to allow for binder storage and bottom shelf has 8¼" spacing.	HLSL1436BH	125	3.7	\$787	\$20	N/A

NOTES:

- Ships with one handle per drawer on all units.
 - All models shown below are locking.
 - Chassis and drawer fronts woodgrains and solid laminates are specified separately (see SIF options below).
 - File drawers accept hanging folders in letter or legal size.
 - Multiple handle locations possible per customer preference.
 - Adjustable hex leveling glides allow floor-standing furniture to be easily leveled without lifting the unit; glides have 1/4" adjustable range.
- ⚠ Locking units equipped with HON "One Key" interchangeable core removable locks. Keyed alike core must be ordered separately.

HOW TO SPECIFY

Select Model Number HLSL2036L2	Select Chassis Laminate See page 183 N	Select Drawer Front Laminate See page 183 Not specified for model HLSL1436BH N	Select Pull Color See page 183 Not specified for Bookcase Hutch model HLSL1436BH T4
--	---	--	---



Icon Legend on page 19

Laminate Storage Cubes

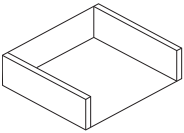
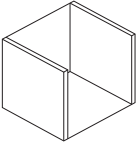
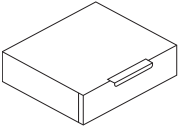
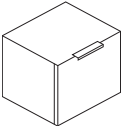
	DESCRIPTION	MODEL	SHIP WEIGHT	CUBE	L1 LIST	L2/P2 UPCHARGES		
						CHASSIS	DOOR FRONT	PAINT
	Short Open Cube 15"W x 13"D x 4"H	HLSL154LSO	9	1.4	\$163	\$10	N/A	\$8
	Tall Open Cube 15"W x 13"D x 12"H	HLSL1512LSO	16	2.9	\$194	\$10	N/A	\$8
	Drawer Cube 15"W x 13"D x 4"H	HLSL154LSD	19	1.4	\$243	\$10	\$5	\$8
	Cabinet Cube 15"W x 13"D x 12"H – Right Handed 15"W x 13"D x 12"H – Left Handed	HLSL1512LSCR	24	2.9	\$243	\$10	\$5	\$8
		HLSL1512LSCCL	24	2.9	\$243	\$10	\$5	\$8

NOTES:

- 4"H and 12"H cubes attach to credenzas, worksurfaces, or wall mounted shelves.
- Configurable components are assembled using double-sided tape.
- Three 4"H cubes can be stacked to the height of one 12"H cube.
- ⓘ Do not leave a gap wider than 15" between cubes while assembled with a shelf.
- ⓘ Do not stack cube and shelf configurations higher than 30".
- ⓘ Do not span cubes across worksurface-to-credenza applications.

HOW TO SPECIFY

<p>Select Model Number</p> <p>HLSL154LSD</p>	<p>Select Chassis Laminate</p> <p>See page 183</p> <p>C</p>	<p>Select Front Laminate</p> <p>See page 183</p> <p>Not specified on HLSL154LSO and HLSL1512LSO</p> <p>C</p>	<p>Select Paint Color</p> <p>See page 183</p> <p>P3 upcharge (+ \$20)</p> <p>T1</p>	<p>Select Pull Color</p> <p>See page 183</p> <p>Not specified on HLSL154LSO and HLSL1512LSO</p> <p>T1</p>
---	--	---	--	--

	DESCRIPTION	MODEL	SHIP WEIGHT	CUBE	L1 LIST PRICE	L2 UPCHARGE
	Shelves					
	30"W x 13"D	HLSLR1330	10	1.3	\$210	\$10
	36"W x 13"D	HLSLR1336	12	1.5	\$236	\$10
	45"W x 13"D	HLSLR1345	15	1.9	\$256	\$10

NOTES:

- Use shelves in between cubes to create another layering element, if desired.

HOW TO SPECIFY

<p>Select Model Number</p> <p>HLSLR1330</p>	<p>Select Laminate</p> <p>See page 183</p> <p>C</p>
--	--

VOI® Laminate Storage Cube Bundles

QTY	DESCRIPTION	MODEL	LIST PRICE	PRICE EXTENSION
2	Cube Bundle A Short Open Cube 15"W x 13"D x 4"H	HLSL154LSO	\$163	\$326
HLSL15-SOO			TOTAL:	\$326

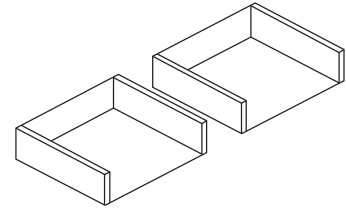

HLSL15-SOO

QTY	DESCRIPTION	MODEL	LIST PRICE	PRICE EXTENSION
3	Cube Bundle B Short Open Cube 15"W x 13"D x 4"H	HLSL154LSO	\$163	\$489
1	Tall Open Cube 15"W x 13"D x 12"H	HLSL1512LSO	\$194	\$194
HLSL15-SOOOLO			TOTAL:	\$683

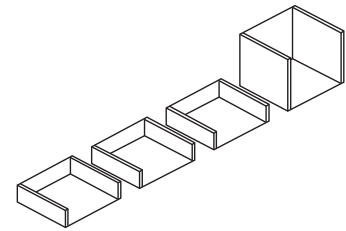

HLSL15-SOOOLO

QTY	DESCRIPTION	MODEL	LIST PRICE	PRICE EXTENSION
1	Cube Bundle C Short Open Cube 15"W x 13"D x 4"H	HLSL154LSO	\$163	\$163
1	Tall Open Cube 15"W x 13"D x 12"H	HLSL1512LSO	\$194	\$194
1	Drawer Cube 15"W x 13"D x 4"H	HLSL154LSD	\$243	\$243
1	Cabinet Cube, Right Handed 15"W x 13"D x 12"H	HLSL1512LSCR	\$243	\$243
HLSL15-SODLOC			TOTAL:	\$843

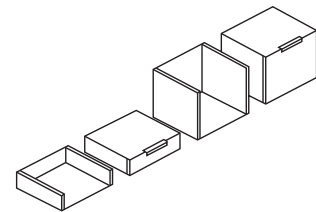

HLSL15-SODLOC

QTY	DESCRIPTION	MODEL	LIST PRICE	PRICE EXTENSION
2	Cube Bundle D Drawer Cube 15"W x 13"D x 4"H	HLSL154LSD	\$243	\$486
2	Cabinet Cube, Right Handed 15"W x 13"D x 12"H	HLSL1512LSCR	\$243	\$486
HLSL15-SDDLCC			TOTAL:	\$972

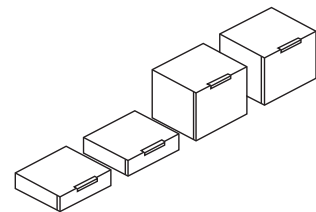

HLSL15-SDDLCC

QTY	DESCRIPTION	MODEL	LIST PRICE	PRICE EXTENSION
2	Cube Bundle E Drawer Cube 15"W x 13"D x 4"H	HLSL154LSD	\$243	\$486
2	Short Open Cube 15"W x 13"D x 4"H	HLSL154LSO	\$163	\$326
1	Tall Open Cube 15"W x 13"D x 12"H	HLSL1512LSO	\$194	\$194
1	Cabinet Cube, Right Handed 15"W x 13"D x 12"H	HLSL1512LSCR	\$243	\$243
HLSL15-SOODDLOC			TOTAL:	\$1,249

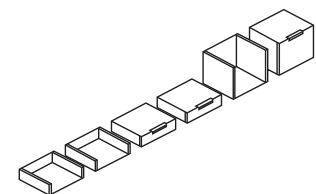

HLSL15-SOODDLOC



VOI® Laminate Storage Towers

	DESCRIPTION	MODEL	SHIP WEIGHT	CUBE	L1 LIST	L2 UPCHARGES	
						CHASSIS	FRONTS
	24\"/>						
	24\"/>	HLSLW045L	167	17.4	\$2159	\$50	\$35
	24\"/>	HLSLW046L	200	22.5	\$2449	\$55	\$35
	24\"/>						
	24\"/>	HLSLW045R	167	17.4	\$2159	\$50	\$35
	24\"/>	HLSLW046R	200	22.5	\$2449	\$55	\$35
	24\"/>						
	24\"/>	HLSLW445L	200	20.7	\$2339	\$55	\$35
	24\"/>	HLSLW446L	240	27.8	\$2578	\$60	\$35
	24\"/>						
	24\"/>	HLSLW445R	200	20.7	\$2339	\$55	\$35
	24\"/>	HLSLW446R	240	27.8	\$2578	\$60	\$35
	24\"/>						
	24\"/>	HLSLW446LP	250	27.8	\$2920	\$60	\$35
	24\"/>	HLSLW446RP	250	27.8	\$2920	\$60	\$35
	Worksurface to Tower Bracket Kit						
	Bracket to attach storage towers or pedestal to worksurfaces.	HSTB2W1	4	0.6	\$88	\$101	\$103
	NOTES: Can be used in place of end panel or O-leg to support worksurfaces.						
	! Bracket cannot be used as a support when placing Stack-on Storage on worksurface over bracket. Must use two full-sized supports when using Stack-on Storage.						

NOTES:

- Use the worksurface to tower bracket kit to attach worksurfaces to Storage Towers models shown above.
- Chassis and drawer fronts woodgrains and solid laminates are specified separately (see SIF options below).
- File drawers accept hanging folders in letter or legal size.
- Wardrobe, middle box drawer and file drawer are locking.
- Standard box drawers operate on ball-bearing suspension with full extension. File, lateral, and wide box drawers operate on ball-bearing suspension with full extension.
- Ships with one handle per drawer on all units.
- Adjustable hex leveling glides allow floor-standing furniture to be easily leveled without lifting the unit; glides have 1/4" adjustable range.
- Wardrobe/storage cabinet includes coat rod.
- Wardrobes contain easy access side storage shelves.

! Locking units equipped with HON "One Key" interchangeable core removable locks. Keyed alike core must be ordered separately.

HOW TO SPECIFY

Select Model Number	Select Chassis Laminate	Select Drawer Front Laminate	Select Pull Color
See page 183	See page 183	See page 183	See page 183
H L S L W 0 4 5 L	N	N	T 4

VOI® Laminate Storage Towers

GSA SIN 33721



Icon Legend on page 19

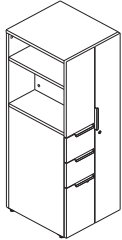

DESCRIPTION	MODEL	SHIP WEIGHT	CUBE	L1 LIST	L2 UPCHARGES	
					CHASSIS	FRONTS
18''W x 20''D Storage Towers — Right Hand Drawers, Left Hand Door						
18''W x 20''D x 50''H, Left	HLSLW085L	139	13.4	\$1943	\$45	\$35
18''W x 20''D x 65''H, Left	HLSLW086L	167	17.3	\$2208	\$50	\$35
18''W x 20''D Storage Towers — Left Hand Drawers, Right Hand Door						
18''W x 20''D x 50''H, Right	HLSLW085R	139	13.4	\$1943	\$45	\$35
18''W x 20''D x 65''H, Right	HLSLW086R	167	17.3	\$2208	\$50	\$35

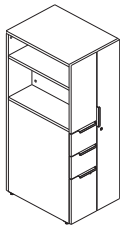

18''W x 24''D Storage Towers — Right Hand Drawers, Left Hand Door						
18''W x 24''D x 50''H, Left	HLSLW485L	167	15.8	\$2212	\$50	\$35
18''W x 24''D x 65''H, Left	HLSLW486L	200	21.5	\$2452	\$55	\$35
18''W x 24''D Storage Towers — Left Hand Drawers, Right Hand Door						
18''W x 24''D x 50''H, Right	HLSLW485R	167	15.8	\$2212	\$50	\$35
18''W x 24''D x 65''H, Right	HLSLW486R	200	21.5	\$2452	\$55	\$35

NOTES:

- Ships with one handle per drawer on all units.
 - Chassis and drawer fronts woodgrains and solid laminates are specified separately (see SIF options below).
 - File drawers accept hanging folders in letter or legal size.
 - Standard box drawers operate on ball-bearing suspension with full extension. File and box drawers operate on ball-bearing suspension with full extension.
 - Adjustable hex leveling glides allow floor-standing furniture to be easily leveled without lifting the unit; glides have 1/4" adjustable range.
 - Wardrobe/storage cabinet includes coat rod.
 - Wardrobes contain easy access side storage shelves.
 - Wardrobe, middle box drawer and file drawer are locking.
- ! Locking units equipped with HON "One Key" interchangeable core removable locks. Keyed alike core must be ordered separately.
- ! Worksurface-to-tower bracket cannot be used as a support when placing Stack-on Storage on worksurface over bracket. Must use two full-sized supports when using Stack-on Storage.

HOW TO SPECIFY

Select Model Number	Select Chassis Laminate	Select Door/Drawer Front Laminate	Select Pull Color
See page 183	See page 183	See page 183	See page 183
H L S L W 0 8 5 L	N	N	T 4

Laminate Storage Towers

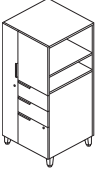
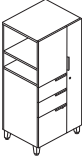
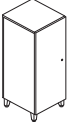
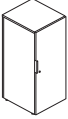
	DESCRIPTION	MODEL	SHIP WEIGHT	CUBE	L1 LIST	L2 UPCHARGES	
						CHASSIS	FRONTS
	Storage Towers, Right Hand Drawers, Left Hand Doors, Footed						
	20"W x 18"D x 54"H	HLSLW085LF	141	13.7	\$2003	\$45	\$35
	24"W x 18"D x 54"H	HLSLW485LF	169	16.2	\$2271	\$50	\$35
	20"W x 24"D x 54"H	HLSLW045LF	169	17.8	\$2218	\$50	\$35
	24"W x 24"D x 54"H	HLSLW445LF	202	21.1	\$2398	\$55	\$35
	Storage Towers, Left Hand Drawers, Right Hand Doors, Footed						
	20"W x 18"D x 54"H	HLSLW085RF	141	13.7	\$2003	\$45	\$35
	24"W x 18"D x 54"H	HLSLW485RF	169	16.2	\$2271	\$50	\$35
	20"W x 24"D x 54"H	HLSLW045RF	169	17.8	\$2218	\$50	\$35
	24"W x 24"D x 54"H	HLSLW445RF	202	21.1	\$2398	\$55	\$35
	Storage Towers, One Door, Footed						
	18"W x 20"D x 46"H — Left Hand Door	HLSLW084LF	105	11.3	\$1434	\$35	\$25
	18"W x 20"D x 46"H — Right Hand Door	HLSLW084RF	105	11.3	\$1434	\$35	\$25
	Storage Towers, One Door, Non-Footed						
	18"W x 20"D x 42"H — Left Hand Door	HLSLW084L	102	11.3	\$1374	\$35	\$25
	18"W x 20"D x 42"H — Right Hand Door	HLSLW084R	102	11.3	\$1374	\$35	\$25

NOTES:

- Use the worksurface to tower bracket kit to attach worksurfaces to Storage Towers models shown above.
- Chassis and drawer fronts woodgrains and solid laminates are specified separately (see SIF options below).
- File drawers accept hanging folders in letter or legal size.
- Wardrobe, middle box drawer and file drawer are locking.
- Standard box drawers operate on ball-bearing suspension with full extension. File, lateral, and wide box drawers operate on ball-bearing suspension with full extension.
- Ships with one handle per drawer on all units.
- Adjustable hex leveling glides allow floor-standing furniture to be easily leveled without lifting the unit; glides have 1/4" adjustable range.
- Wardrobe/storage cabinet includes coat rod.
- Wardrobes contain easy access side storage shelves.

! Locking units equipped with HON "One Key" interchangeable core removable locks. Keyed alike core must be ordered separately.

HOW TO SPECIFY

Select Model Number	Select Chassis Laminate	Select Drawer Front Laminate	Select Pull Color	Select Foot Color
See page 183	See page 183	See page 183	See page 183	See page 183
HL SLW085LF	C	C	T1	T1

VOI® Laminate Storage



DESCRIPTION	MODEL	SHIP WEIGHT	CUBE	L1 LIST	L2 UPCHARGES	
					CHASSIS	FRONTS
Box/File Pedestal, Footed 16"W x 20"D x 28½"H	HL2016FP2	65	5.8	\$952	\$20	\$10

NOTES:

- Ships with one handle per drawer on all units.
- All models shown below are locking.
- Chassis and drawer fronts woodgrains and solid laminates are specified separately (see SIF options below).
- File drawers accept hanging folders in letter or legal size.
- Multiple handle locations possible per customer preference.
- Adjustable hex leveling glides allow floor-standing furniture to be easily leveled without lifting the unit; glides have 1/4" adjustable range.

⚠ Locking units equipped with HON "One Key" interchangeable core removable locks. Keyed alike core must be ordered separately.

HOW TO SPECIFY

<p>Select Model Number</p> <p>HL2016FP2</p>	<p>Select Chassis Laminate</p> <p>See page 183</p> <p>C</p>	<p>Select Drawer Front Laminate</p> <p>See page 183</p> <p>C</p>	<p>Select Pull Color</p> <p>See page 183</p> <p>T1</p>	<p>Select Foot Color</p> <p>See page 183</p> <p>T1</p>
--	--	---	---	---

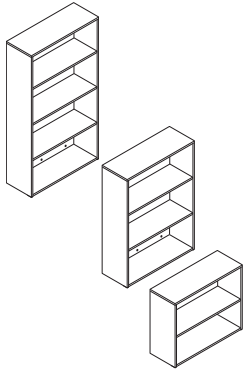

DESCRIPTION	MODEL	SHIP WEIGHT	CUBE	LIST PRICE BY LAMINATE GRADE	
				L1	L2
Bookcase 36"W x 13"D x 29½"H, 2-Shelf	HLSL1336B2	90	10.7	\$625	\$640
36"W x 13"D x 50"H, 3-Shelf	HLSL1336B3	122	17.3	\$806	\$826
36"W x 13"D x 65"H, 4-Shelf	HLSL1336B4	156	22.2	\$948	\$973

NOTES: Bookcases available in 2, 3 and 4 shelf models. Adjustable glides allow bookcases to be easily leveled. Glides have 1/4" of adjustability.

HOW TO SPECIFY

<p>Select Model Number</p> <p>H L S L 1 3 3 6 B 2 . N</p>	<p>Select Laminate</p> <p>See page 183</p>
--	---

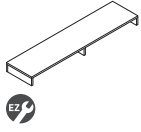
**DESCRIPTION****Layering Shelf**

72"W x 14½"D x 5½"H
60"W x 14½"D x 5½"H

MODEL

HLSL1472LS
HLSL1460LS

SHIP WEIGHT

50
39

CUBE

4.6
1.3

**L1
LIST PRICE**

\$488
\$410

**L2
UPCHARGE**

\$10
\$10

NOTES: Layering shelf works with lower credenzas to provide additional storage areas. For additional information see the Workplace Tools section in the 2021 Shared Spaces Pricer.

! Layering Shelves cannot be stacked.

! Cannot add a hutch on top of a layering shelf.

**DESCRIPTION****Storage Cube**

12"W x 12"D

MODEL

HLSL1212

SHIP WEIGHT

1.0

CUBE

0.3

LIST PRICE

\$316

SPECIFYING EXAMPLE: HLSL1212.P8S

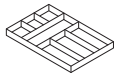
**DESCRIPTION****Drawer Organizer**

12"W x 14½"D x 1½"H

MODEL

HLSLDRWORG

SHIP WEIGHT

1.0

CUBE

0.5

LIST PRICE

\$172

NOTES: For additional information see the Workplace Tools section in the 2021 Shared Spaces Pricer.

SPECIFYING EXAMPLE: HLSLDRWORG.P8F

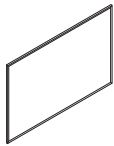
**DESCRIPTION****Markerboard**

48"W x 31"H

MODEL

HLSL4831MB

SHIP WEIGHT

44.0

CUBE

3.4

LIST PRICE

\$713

NOTES: No specification required. For additional information see the Workplace Tools section in the 2021 Shared Spaces Pricer.



OPEN MARKET

LED Task Lights

17" LED Light with Power Supply (Single)
31" LED Light with Power Supply (Single)

HLED17AS ☼
HLED31AS ☼

1.2 ☼
1.5 ☼

0.05
0.09

\$450
\$603

17" LED Light with Power Supply for Daisy-chain (Starter)
31" LED Light with Power Supply for Daisy-chain (Starter)

HLED17A
HLED31A

1.0 ☼
1.4 ☼

0.05
0.09

\$493
\$662

17" LED Light with 8" Jumper Cord for Daisy-chain (Follower)
31" LED Light with 8" Jumper Cord for Daisy-chain (Follower)

HLED17AUO ☼
HLED31AUO ☼

1.0 ☼
1.0 ☼

0.03
0.05

\$404
\$539

Undercabinet Occupancy Sensor with 1" End to End Connector

HLEDOSA ☼

0.2 ☼

0.01

\$97

NOTES: To use the daisy chain application, must start with model HLED17A or HLED31A. No finish specification required. Attaches magnetically to underside of overhead storage, or attaches with provided screws or double-sided tape. Occupancy sensor attaches to a single or starter LED light and will automatically turn the light off after no motion is detected for 30 minutes. Just like all the LED light models, the occupancy sensor features a soft-touch on/off switch. LED task lights have a lifetime of 50,000 hours and have a dimmer feature that allows the user to adjust the amount of light output.

HOW TO SPECIFY

Select
Model Number

Select
Laminate

See page 183

HLSL1472LS

N

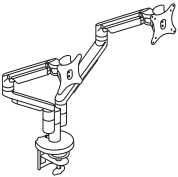
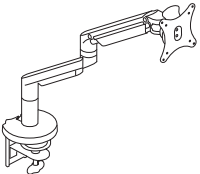
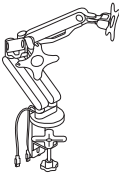
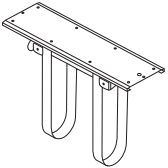

Icon Legend on page 19

	DESCRIPTION	MODEL	SHIP WEIGHT	CUBE	LIST PRICE
	<p>Dual Dynamic Monitor Arm</p> <ul style="list-style-type: none"> • 150° of rotation at base with optional 360° rotation. • Arms extend 22" and retract up to 3". • Monitor mount rotates 180° and tilts +/-30°. • Monitor can be rotated from landscape to portrait position. <p>! Arms hold monitors from 6.2-18 lbs. Optional counterweight HPACW available to support monitors as low as 5 lbs. (see the Workplace Tools section in the 2021 Shared Spaces Pricer).</p>	HMASD	17.0 Ⓢ	1.1	\$962
	<p>Single Dynamic Monitor Arm</p> <ul style="list-style-type: none"> • 180° of rotation at base with optional 360° rotation. • Arms extend 22" and retract up to 3". • Monitor mount rotates 180° and tilts +/-30°. • Monitor can be rotated from landscape to portrait position. <p>! Arms hold monitors from 6.2-18 lbs. Optional counterweight HPACW available to support monitors as low as 5 lbs. (see the Workplace Tools section in the 2021 Shared Spaces Pricer).</p>	HMASTS	11.5 Ⓢ	0.8	\$501
	<p>Dual Monitor Arm with 2 USB Ports</p> <p>NOTES: Easy adjustment. Height adjusts to 17" tall. Monitor tilt and swivel capability. Enclosed cable management. Grommet or desktop mounting. Clean appearance. In some applications the Monitor Arms may extend 12 or more inches into the worksurface. For additional information see the Workplace Tools section in the 2021 Shared Spaces Pricer. HON 5-Year Limited Warranty.</p> <p>! No specification needed.</p>	HBDMAUSB	41.9	2.6	\$410
	<p>360° Swivel CPU Holder with Adjustable Straps</p> <ul style="list-style-type: none"> • Supports CPUs 3¾" wide up to 64" perimeter and holds up to 75 lbs. • 360° rotation. • Ships complete and includes necessary mounting hardware and instruction sheet. <p>! Available in Black only, no specification needed.</p>	HCPU1	7.0 Ⓢ	0.2	\$260

SIN 33721

NOTES:

- For additional information see the Workplace Tools section in the 2021 Shared Spaces Pricer.

Monitor Arms

- Arms fold back to post to allow more desktop room.
- Arms feature double extension, allowing 20"+ of back and forth movement.
- Cable management on both pole and arm assemblies.
- Counterbalance adjustment provides stability for monitors up to 17.6 lbs per arm.
- Made of high-quality aluminum alloy material.
- See the Workplace Tools section in the 2021 Shared Spaces Pricer for additional monitor arm models.

HOW TO SPECIFY

<p>Select Model Number</p>	<p>Select Finish</p> <p><i>Specify for models HMASD and HMASTS only</i></p> <p>SVR Silver BLK Black</p>
<p>HMASD.</p>	<p>SVR</p>

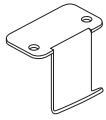

OPEN MARKET

**DESCRIPTION**

Back Pack Hook (10 per carton)
12"W x 14½"D x 1½"H

NOTES: Assembly: attaches to bottom of desk with (2) screws, included.

! Available in Platinum Metallic finish only, no specification needed.

MODEL**HCLA65****SHIP WEIGHT**

10

CUBE

0.1

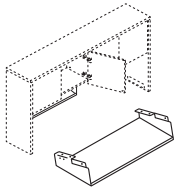
LIST PRICE**\$101****Hanging Paper Shelf**

28⅞"W x 11⅞"D x 4⅜"H

HHPS1

7

2.9

\$214

NOTES: Attaches quickly and easily (screws included). Maximizes worksurface space; de-clutters desktop while placing priority communications and active project folders within easy reach. Angled design allows contents to be distinguished at a glance. Mixed material styling features strong painted metal frame with a frosted shelf.

Attaches quickly and easily to laminate stack-on and wall mount storage models (except the 36"W Voi® overhead hutch with O-legs or panel mount brackets). Not for use with 38000 Series™ and Systems.

For additional information see the Workplace Tools section in the 2021 Shared Spaces Pricer.

Specify: Model.Paint

SPECIFYING EXAMPLE: HHPS1.T1

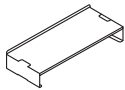
**Desktop Paper Shelf**

28⅞"W x 11⅞"D x 5"H

HDPS1

7

2.9

\$214

NOTES: Desktop Paper Shelf and Storage Terrace include protective, non-slip pads on the base. Paper Shelf can stack two-high. Organizer shelf provides a place and space for work-in-process and piling to keep work-surfaces neat and tidy. Convenient, scalable design with interlocking side supports allow two units to be stacked and integrated. Durable painted metal frame with a frosted shelf; mixed material styling matches hanging paper shelf.

Can also be used inside select overhead storage, including the following stack-on with clearance and hinged door models: 10500 and Valido 36", 42", 66", 72", 78"W and 10700 68⅝"W.

For additional information see the Workplace Tools section in the 2021 Shared Spaces Pricer.

Specify: Model.Paint

SPECIFYING EXAMPLE: HDPS1.T1

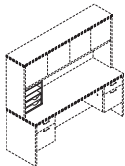

Not available in two-tone laminates

Vertical Paper Manager

14⅞"W x 10⅞"D x 19⅞"H

HLVPM1

27

2.8

\$351

NOTES: Keeps papers, files, and books neatly organized and within easy reach from a seated position. Designed for desk, credenza, and return tops. Fits under stack-on storage models. Two pullout drawers and three fixed shelves. Not available in pattern laminate colors. Ships fully assembled. For additional information see the Workplace Tools section in the 2021 Shared Spaces Pricer.

! When used in conjunction with wall mounted storage cabinets, the top of the wall mounted storage cabinets must be positioned a minimum of 68⅝" above the floor.

SPECIFYING EXAMPLE: HLVPM1.N

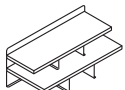

Not available in two-tone laminate

**Desktop Storage Terrace**

26½"W x 12½"D x 10½"H

HLDST1

24

1.1

\$329

NOTES: Keeps work-in-process, priority files, loose pages, and mail neatly organized and in view. Mixed material design comprised of sturdy laminate shelves with metal back and support panels. Not available in two-tone laminate combination or pattern laminate colors. Choose from Platinum Metallic (T1), Black (P), and Charcoal (S) for the metal components.

Sized to fit in stack-on and wall mounted storage cabinets in 10500, 10700, Valido, 94000, and 38000 Series. Fits in Voi stack-on and overhead cabinets except for 48"W or smaller sliding door models. For additional information see the Workplace Tools section in the 2021 Shared Spaces Pricer.









Specify: Model.Laminate.Paint

SPECIFYING EXAMPLE: HLDST1.N.T1

HOW TO SPECIFY

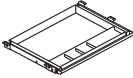
Select
Model Number

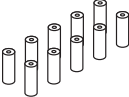
H C L A 6 5

	DESCRIPTION	MODEL	SHIP WEIGHT	CUBE	LIST PRICE
 Refer to page 104 for Center Drawer compatibility information SIN 33721 	Angled Wood Center Drawer 26" x 15 ³ / ₈ " 22" x 15 ³ / ₈ "	H1526 H1522	12  11 	1.2 1.1	\$214 \$199
	NOTES: Specify laminate for drawer. Ideal for pens, pencils and other miscellaneous storage. Feature ball-bearing slide suspension. For additional information see the Workplace Tools section in the 2021 Shared Spaces Pricer.				
 OPEN MARKET	Polymer Center Drawer <ul style="list-style-type: none"> • Color: Black. • Material: ABS. • Minimum clearance for mounting: 23"W x 16¹/₄"D x 2"H. • Retracts on 16" ball-bearing slides. • Can be used on worksurfaces with Coordinate™ Height Adjustable Bases as long as it is attached with spacer model HKBS. • Can store up to 25 lbs.  Black finish only, no specification needed.	HCD1	7	0.5	\$126
 OPEN MARKET	Keyboard Spacer <ul style="list-style-type: none"> • For use when attaching a keyboard tray to Coordinate™ and Voi® or Systems Worksurface with an external channel. • The kit includes ten cylinder spacers and ten screws. • Spacers are ³/₄"W x 2¹/₈"H. • Specify one kit per keyboard tray. NOTES: For additional information see the Workplace Tools section in the 2021 Shared Spaces Pricer.	HKBS	1 	0.8	\$100

HOW TO SPECIFY

Select
Model Number

H C D 1

**DESCRIPTION**
Articulating Desk Lamp
Articulating Desk Lamp w/ Occupancy Sensor

- Color: Matte Silver.
- Full-range dimming from 10% to 100%.
- Designed for 50,000 hours of life.
- Occupancy sensor is built into the head of the lamp and will automatically shut the lamp off after 6 minutes of undetected movement.
- Base swivel is 180 degrees.
- Uses only 5 watts of energy.
- Light comes with a silver 9' 4" power cord.
- Base diameter is 7.5".
- 3500K Color Temperature.
- 80 Color Rendering Index.
- TAA Compliant.

MODEL**SHIP WEIGHT****CUBE****LIST PRICE****HLED1**

1.2

6.5

\$430**HLED1OC**

1.2

6.5

\$524**Task Desk Lamp**

- Color: Brushed Nickel.
- Full-range dimming from 10% to 100%.
- Designed for 50,000 hours of life.
- Lamp is 15.83" tall.
- Desk lamp does not articulate at base. The pivoting head provides custom positioning, as it can be twisted 360 degrees.
- Uses only 5 watts of energy.
- Light comes with a silver 9' 4" power cord.
- Base diameter is 6.7".
- 3500K Color Temperature.
- 80 Color Rendering Index.
- TAA Compliant.

HLED2

0.7

3.0

\$373**NOTES:**

- For additional information see the Workplace Tools section in the 2021 Shared Spaces Pricer.

HOW TO SPECIFY

Select
Model Number

H L E D 1



Icon Legend on page 19

DESCRIPTION

MODEL

SHIP WEIGHT

CUBE

LIST PRICE



Coordinate™ Portable Desktop Riser

31"D x 5"-16½"H x 35"W

HBXRISER

54

4.1

\$657

NOTES: Available in Black (BLK) or White (WHT) finish. Desktop riser dimensions (without keyboard tray): 22"D x 5"-16½"H x 35"W. Keyboard tray dimensions: 9"D x 30"W. Max loading capacity is 33 lbs for the desktop riser surface and 4 lbs for the keyboard tray. Easily transition from seated to standing positions throughout the workday. Sits atop an existing desk to create sit-to-stand functionality by raising the computer. Includes keyboard tray and surface for computer monitors. **HON 5-Year Limited Warranty.**

! Not intended for use on mobile workstations.

HOW TO SPECIFY

Select Model Number

H B X R I S E R .

Select Finish

BLK Black
WHT White

B L K

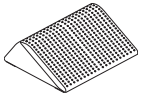

DESCRIPTION

Footrest — Anti-Slip Cover
13¾"D x 5½"H x 16"W

ⓘ Available in Black (T) finish ONLY. Recommended weight capacity not to exceed 250 pounds. **HON 5-Year Limited Warranty.**
SPECIFYING EXAMPLE: HVL991.T

MODEL

HVL991

SHIP WEIGHT

7 ⓘ

CUBE

0.9

LIST PRICE

\$89

HOW TO SPECIFY

Select Model Number

Select Finish

T Black



H V L 9 9 1 .

T

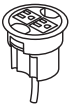
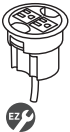

Icon Legend on page 19

Softwire Electrical Components

	DESCRIPTION	MODEL	SHIP WEIGHT	CUBE	LIST PRICE
	<p>Power Hub, 3" Grommet Mount, 6' Cord</p> <ul style="list-style-type: none"> Fits in 3" round grommet holes Field installed with Plug-and-play ease Two grounded AC power outlets Includes 6' cord with three-prong plug <p>NOTES: For additional information see the Workplace Tools section in the 2021 Shared Spaces Pricer.</p> <p>ⓘ Available in Black only. Specify X when ordering. Example: HGRMTAC.X.</p>	HGRMTAC	1.3	0.2	\$126
	<p>3" Round Power Grommet - 2 Outlets, 10' Cord</p> <ul style="list-style-type: none"> Includes 10' cord with three-prong plug. Fits in 3" round grommet holes on the following product lines: Coordinate, Huddle, Motivate, all laminate casegoods series, and Systems Worksurfaces. Two grounded AC power outlets. Field installed with Plug-and-play ease. <p>NOTES: Power Modules will also work with standing-height applications for 10500 Series™ and Voi® desks. Optional Memory Control allows preset worksurface heights for consistency. Ships separately. Dynamic load capacity when worksurface is moving is 300 lbs.</p> <p>ⓘ Available in black finish only, no specification needed.</p>	HGRMTAC2	1.5	0.2	\$159
	<p>Power/USB Hub, 3" Grommet Mount</p> <ul style="list-style-type: none"> One grounded AC power outlet with 2 USB ports. Two cord pass-through holes in cap. Includes 6' cord with three-prong plug. Field installed; easy plug-and-play. UL Listed. <p>NOTES: For additional information see the Workplace Tools section in the 2021 Shared Spaces Pricer.</p> <p>ⓘ Available in black only (no color designation so use .X - Specify: HGRMTUSB2.X).</p>	HGRMTUSB2	1.3	0.2	\$250
 SIN 33721	<p>Data Grommet</p> <p>Blank grommet kit that includes adapters for a variety of manufacturers jacks and couplers.</p> <ul style="list-style-type: none"> Fits in existing 3" round grommet housing <p>NOTES: For additional information see the Workplace Tools section in the 2021 Shared Spaces Pricer.</p> <p>ⓘ Available in Black only. Specify P when ordering. Example: HGRMTDATA.P.</p>	HGRMTDATA	0.2	0.2	\$23

HOW TO SPECIFY

Select Model Number

H G R M T A C



OPEN MARKET

DESCRIPTION**O-Leg Cord Clips**

Clips for 28½" Worksurface O-Legs — 8-Pack
Clips for Stack-on Storage, Hutch and Layering O-Legs — 4-Pack

MODEL

HWMCLIPLG
HWMCLIPSM

SHIP WEIGHT

0.8 **Ⓢ**
0.5 **Ⓢ**

CUBE

0.1
0.1

LIST PRICE

\$110
\$73

NOTES: Wire clips work with 7" Low Credenza O-leg and 29"H Support O-leg. Wire clips also work with the 50" and 65" Hutch O-legs. For additional information see the Workplace Tools section in the 2021 Shared Spaces Pricer.

⚠ Available in frosted plastic material only.

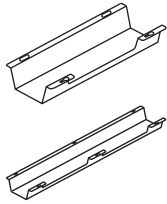
**Cable Management Troughs**

17"W — Single
17"W — 10-Pack
36"W — Single
36"W — 10-Pack

HCTROUGH17
HCTROUGH1710
HCTROUGH36
HCTROUGH3610

2.7 **Ⓢ**
14.0 **Ⓢ**
4.9 **Ⓢ**
30.0 **Ⓢ**

0.5
0.5
0.9
0.9

\$73
\$665
\$122
\$1121

- Cable management troughs ship flat packed.
- The troughs attach to underneath the worksurface with screws.
- The 17"W has one wire access cut out on the user side. The 36" has two wire access cut outs. These cut outs give users access to inside the trough without having to detach it from the worksurface.
- Color: Graphite.
- Material: Metal.
- TAA Compliant.

NOTES: For additional information see the Workplace Tools section in the 2021 Shared Spaces Pricer.

**Power Pole — w/o Receptacles**

10'5"

HH870070

14.0

0.5

\$477

⚠ Specify paint; not available in Putty (L), Platinum Metallic (T1), and Champagne Metallic (T4).

Specify paint color for
HH870070, not available in
Putty

**Field Installable Grommet****HFLDGRMT3**0.1 **Ⓢ**

0.3

\$35

- Intended for use in tops and end panels to route/hide cords and in modesty panels to facilitate reaching wall electrical outlets.
- Grommet is field installable.
- Grommet shape is round.
- Includes grommet cap and sleeve.
- Grommet outside dimensions measure 3½" diameter and includes two cord access holes.
- Grommet sleeve measures 3" O.D. x 1" thick.
- Includes instructions to locate grommet position for desks, credenzas, returns and bridges.

NOTES: For additional information see the Workplace Tools section in the 2021 Shared Spaces Pricer.

- ⚠ Black Finish
- ⚠ Requires a 3" diameter hole saw and drill for installation (not included).
- ⚠ Not for use with credenzas, pedestals, laterals or towers.

HOW TO SPECIFY

Select
Model Number

H W M C L I P L G

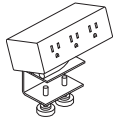

Model HPWRMOD3WC shown

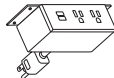

Model HPWRMOD2UWM shown

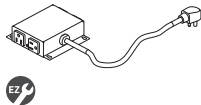
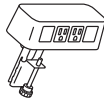

DESCRIPTION

Power Modules

- 3 Receptacles with Worksurface Clamp
- 3 Receptacles with Under-Worksurface Mounting Bracket
- 2 Receptacles 2 USB with Worksurface Clamp
- 2 Receptacles 2 USB with Under-Worksurface Mounting Bracket
- 6' power cord with standard three-prong plug.
- Under-worksurface mounting bracket models work with any top that has a 5" x 5" square clearance.
- Worksurface clamp models work on any top with a 4" overhang.
- UL Listed.

! Color finish coordinates with HON's Charcoal or White. Specify STRM for Storm or SNW for Snow when ordering. Example: HPWRMOD3WC.STRM.

Power & Data Center

- 2 Receptacles 2 Data Accessory
- Standard with two receptacles and openings for two data ports.
- 6' power cord with standard three-prong plug.
- Fits on any worksurface with a 4" overhang.
- UL Listed.

! Color finish coordinates with HON's Loft. Specify LOFT when ordering. Example: HCOMDOME2.LOFT.

Under Worksurface Power Module — 4 Outlets, 10' Cord

- Includes 10' cord with three-prong plug.
- Fits in cable management troughs. See page 242.
- 4 outlets on side create easy access.

NOTES: Power Modules will also work with standing-height applications for 10500 Series™ and Voi® desks.

! Available in black finish only, no specification needed.

Vertebrae

NOTES: 30"H x 3 3/8"W x 1 1/2"D. Ships unassembled.

! Clear finish. Specify "X" for finish option.

SPECIFYING EXAMPLE: HMPVWM28.X

MODEL

SHIP WEIGHT

CUBE

LIST PRICE

HPWRMOD3WC	2.3 Ⓢ	0.2	\$342
HPWRMOD3UWM	2.3 Ⓢ	0.2	\$342
HPWRMOD2WC	2.3 Ⓢ	0.2	\$546
HPWRMOD2UWM	2.3 Ⓢ	0.2	\$546

HCOMDOME2	2.5 Ⓢ	0.2	\$327
-----------	-------	-----	-------

HPWRMOD2	1.5	0.2	\$441
----------	-----	-----	-------

HMPVWM28	3.0	0.3	\$246
----------	-----	-----	-------

NOTES:

- For additional information see the Workplace Tools section in the 2021 Shared Spaces Pricer.

HOW TO SPECIFY

Select Model Number

H P W R M O D 3 W C

NOTES

WORKWALL

Want to see more? Scan here
to check out hon.com.



Workwall featuring Voi® Storage and Desks
and Ignition® 2.0 and Mav™ Seating.

WORKWALL

You need a solution that does it all: Encourages creative collaboration, organizes everything from photos to files, delivers exceptional functionality, and celebrates what makes your brand and the members of your team so unique. Look no further than Workwall — a brilliant tile system that mixes and matches fabric, metal, glass, and laminate materials with accessories, making it a powerhouse performer and an exemplary partner to a variety of HON products in any private office, teaming station, or meeting area. Make your space work with Workwall.



FEATURES

- High-quality materials add a remarkable aesthetic and dynamic functionality to the evolving workplace, making any private office, teaming station, or open collaboration area pop with personality and productivity.
- Tiles are offered in a variety of heights, widths, and materials, including laminate, laminate media, painted metal, slotted tool, fabric, and glass markerboard.
- Make your space an organizational oasis with Workwall's additional hanging additions — floating shelves, metal single tool rails, and a variety of painted metal accessories to keep you focused and efficient.
- Workwall can be universally paired with laminate casegoods — including HON's 10500 Series™, Concinnity™, and Voi® — or retrofitted to add on to existing workstations throughout the workspace.
- Mix-and-match tiles are designed with flexibility and adaptability in mind — create the space you want for the work environment you need.

WORKWALL ORDERING INFORMATION

LAMINATE TILES, LAMINATE MEDIA TILES, SHELVES

L1 LAMINATES/EDGE CODES

Woodgrain

- ◆ Bourbon Cherry/
Bourbon Cherry **HH**
- ◆ Cognac/Cognac ... **COGNCOGN**
- ◆ Florence Walnut/
Florence Walnut **LFW1FW**
- ◆ Harvest/Harvest **CC**
- ◆ Kingswood Walnut/
Kingswood Walnut **LK11KI**
- ◆ Mahogany/Mahogany **NN**
- ◆ Mocha/Mocha **MOCHMOCH**
- ◆ Natural Maple/
Natural Maple **DD**
- ◆ Pinnacle/Pinnacle **PINCPINC**
- ◆ Shaker Cherry/
Shaker Cherry **FF**
- ◆ Sterling Ash/
Sterling Ash **LSA1SA**

Solid

- ◆ Black/Black **PP**
- ◆ Designer White/
Designer White **LDW1DW**
- ◆ Loft/Loft **LOFTLOFT**

Patterned

- ◆ Sheer Mesh * /Muslin **A5T**
- ◆ Silver Mesh/Loft **B9LOFT**

L2 LAMINATES/EDGE CODES

Woodgrain

- ◆ Lowell Ash/Lowell Ash . **LLA1DL**
- ◆ Natural Recon/
Natural Recon **LNR1NR**
- ◆ Phantom Ecru/
Phantom Ecru **LPE1PE**
- ◆ Portico Teak/
Portico Teak **LPT1DP**
- ◆ Skyline Walnut/
Skyline Walnut **LSW1SW**

PAINTED METAL TILES, SLOTTED TOOL TILES, SINGLE TOOL RAILS, ACCESSORIES

PAINTS CODES

P1

- ◆ Black **P**
- ◆ Brownstone **P7D**
- ◆ Charcoal **S**
- ◆ Designer White **PJW**
- ◆ Fossil **P28**
- ◆ Greige **T5**
- ◆ Light Gray **Q**
- ◆ Loft **LOFT**
- ◆ Muslin **T3**
- ◆ Putty **L**
- ◆ Shadow * **SHDW**
- ◆ Titanium **P8T**

P2

- ◆ Champagne Metallic **T4**
- ◆ Platinum Metallic **T1**
- ◆ Silver **PR6**
- ◆ Solar Black **P8X**

P3

- ◆ Amethyst **P091**
- ◆ Atom **P8S**
- ◆ Blossom **P8K**
- ◆ Bullseye **PJF**
- ◆ Cabernet * **P7T**
- ◆ Cobalt Mica **P090**
- ◆ Conifer * **P8H**
- ◆ Ember **P8P**
- ◆ Ion **P8N**
- ◆ Iris **P8J**
- ◆ Krypton **P8F**
- ◆ Ochre **P093**
- ◆ Regatta **P8M**
- ◆ Sienna **P092**
- ◆ Succulent **P8A**

GLASS MARKERBOARD TILES

GLASS CODES

- ◆ Beige **GBG2**
- ◆ Charcoal **GCH2**
- ◆ Cream **GCR2**
- ◆ Ice White **GWH2**
- ◆ Pebble **GPB2**

TILE MOUNTING HARDWARE PAINT

PAINTS CODES

- ◆ Black **P**
- ◆ Charcoal **S**
- ◆ Designer White **PJW**

NOTE: For available fabrics see pages 25-26.

◆◆◆ For lead time information see page 19.

* De-emphasized

WORKWALL STATEMENT OF LINE

TILES

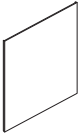

FABRIC TILE

Heights: 7½", 15", 22½", 30", 37½", 45"
Widths: 18", 24", 30", 36", 42", 48", 54", 60"

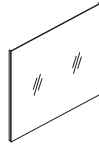

GLASS MARKERBOARD TILE

Heights: 15", 22½", 30", 37½", 45"
Widths: 30", 36", 42", 48", 54", 60"

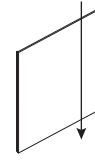

LAMINATE TILE

Grain direction shown
Heights: 7½", 15", 22½", 30", 37½", 45"
Widths: 18", 24", 30", 36"

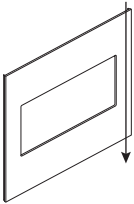

LAMINATE MEDIA TILE

Grain direction shown
Heights: 30", 37½", 45"
Widths: 36", 42", 48", 54"

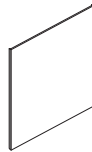

PAINTED METAL TILE

Heights: 7½", 15", 22½", 30"
Widths: 18", 24", 30", 36"

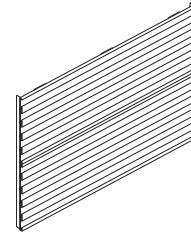

SLOTTED TOOL TILE

Heights: 7½", 15"
Widths: 24", 30", 36", 42", 48", 54", 60"

ACCESSORIES

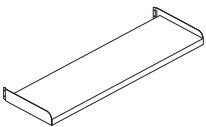

FLOATING SHELF

Widths: 18", 24", 30", 36"

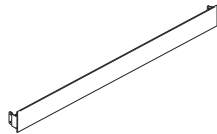

SINGLE TOOL RAIL

Widths: 18", 24", 30", 36", 42", 48", 54", 60"

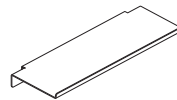

SMALL SHELF

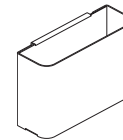

SMALL BIN

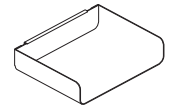

SMALL TRAY

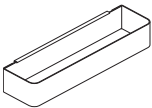

HANGING FILE FOLDER

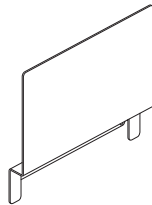

MAGNETIC PICTURE HOLDER

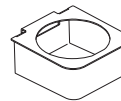

CUP

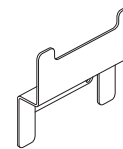

HOOK

WORKWALL SPECIFYING/DESIGN GUIDE

This Specification Guide is designed to walk you through the steps when choosing Workwall elements that will meet your particular workplace needs. The step-by-step instructions make it easy to specify elements that personalize workspaces and achieve the right mix of functionality and style.

Desking With Tower Storage (Example Shown Below)

Recommended to align Workwall tiles with tower height and work your way down the wall.

Desking Without Tower Storage

Recommended to mount Workwall tiles above worksurface and work your way up the wall.

Without Desking or Storage

Floating application can be utilized in open wall environments such as conference rooms or collaboration spaces. Any size of tiles can be used to fit your space.

STEP 1

- Specify desk.
- Please note differences in storage heights and low credenza heights.
- Standard worksurface height is 29½".
- Note the tower and overhead height differences between casegood series (see diagram on pages 249-250).

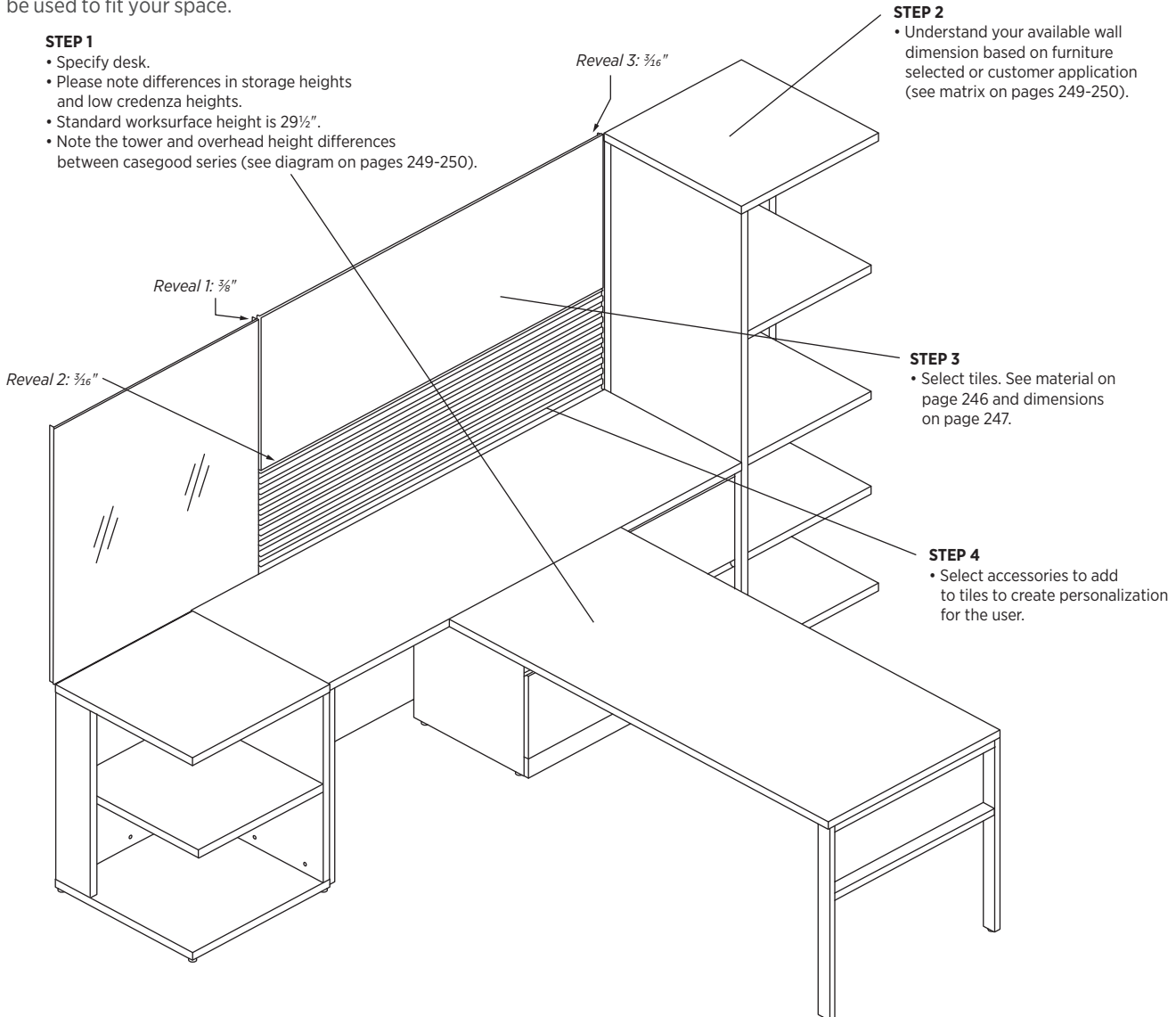

STEP 2

- Understand your available wall dimension based on furniture selected or customer application (see matrix on pages 249-250).

STEP 3

- Select tiles. See material on page 246 and dimensions on page 247.

STEP 4

- Select accessories to add to tiles to create personalization for the user.

NOTES:

- There is a 3/16" vertical reveal (Reveal 1) and a 3/16" horizontal reveal between tiles (Reveal 2). There is a 3/16" vertical reveal between towers and tiles (Reveal 3).
- Wall attachment method is Z-brackets (2 per tile).
 - i. Thickness is 7/8" from wall to front of tile (includes tile and hardware).
 - ii. Accessory Single Tool Rail + Accessories (7) + Floating Shelf add to depth dimension.
 - iii. Vertical mounting brackets come pre-installed on tile and hang on Z-brackets. Z-brackets are in two parts. The second part of the Z-bracket is attached to the wall in the field.
 - iv. Wall attachment not included due to different wall types and materials. Attachments must be provided by the installers.
- Wire management or television mounting brackets not included with tiles.

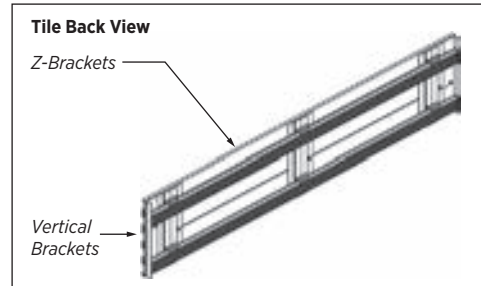

WORKWALL SPECIFYING/DESIGN GUIDE

Below are wall dimensions for Concinnity™ and 10500 Series™. These diagrams should be used to understand sizing between storage and usable wall space.

CONCINNITY™ EXAMPLE

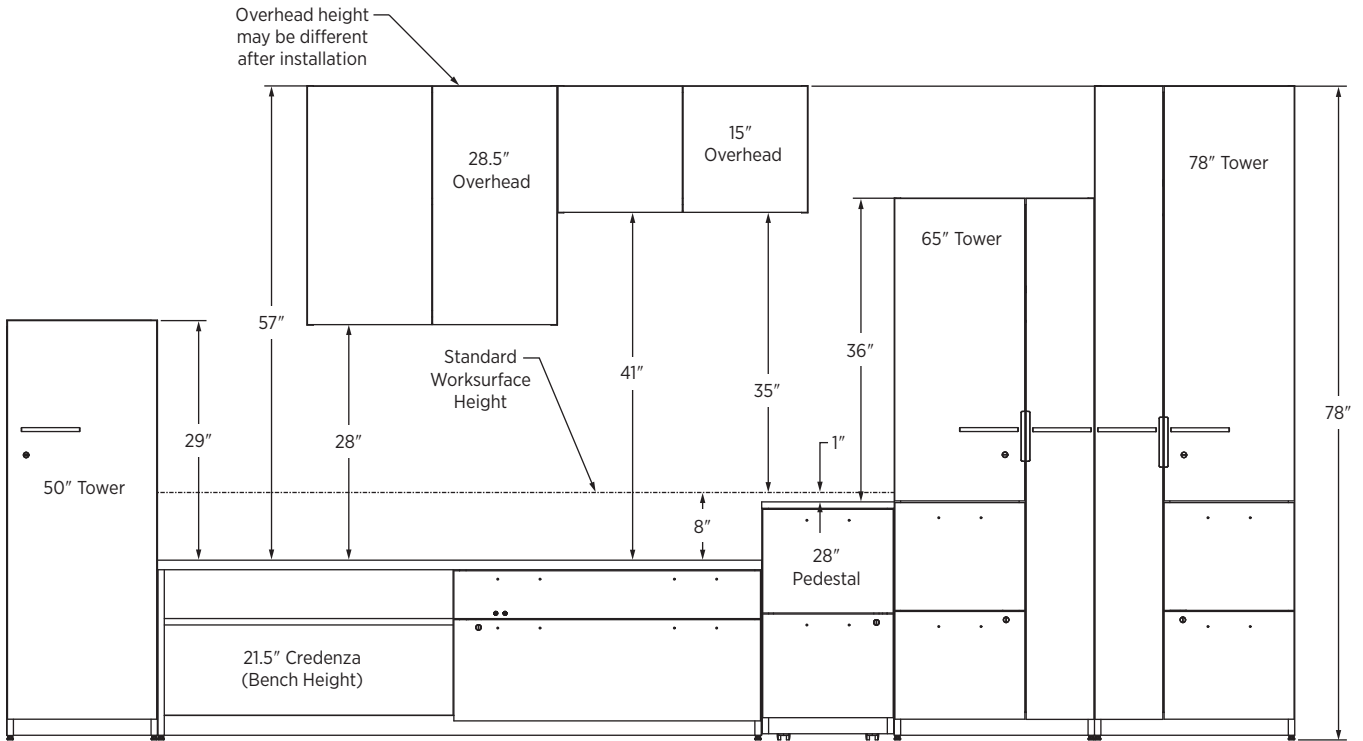

10500 SERIES™ EXAMPLE

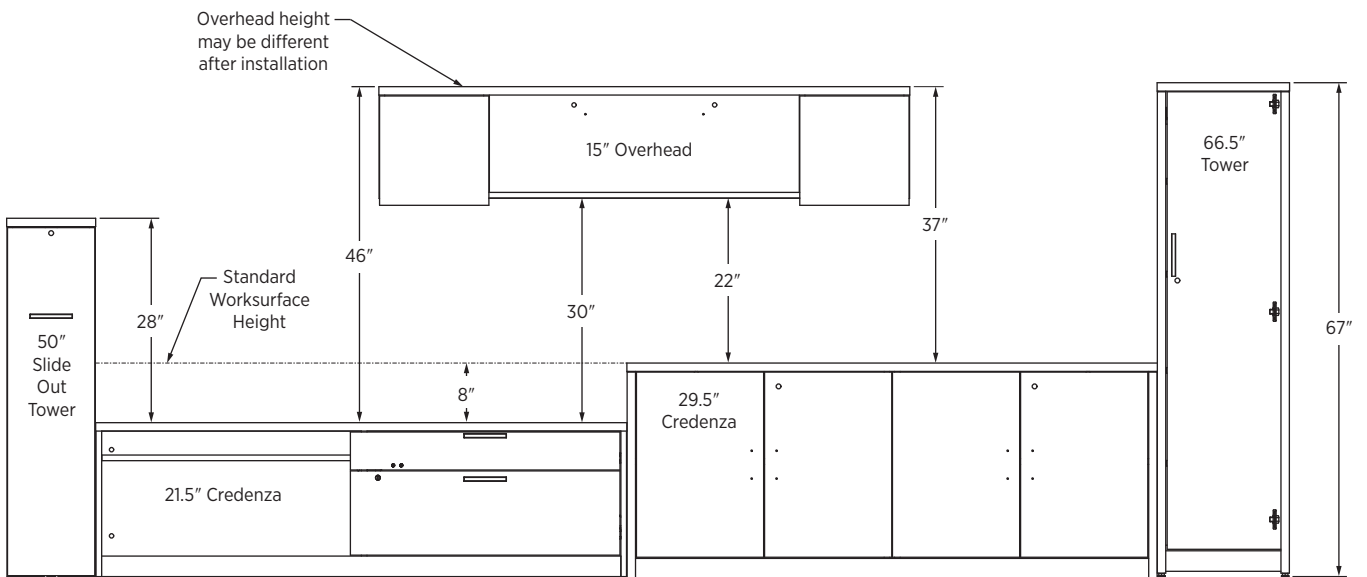

NOTES:

- Overheads can be mounted above or next to Workwall but do not mount to Workwall. Elevation shown above is typical overhead height and may vary in installation.

WORKWALL SPECIFYING/DESIGN GUIDE

Below are wall dimensions for Voi®. This diagram should be used to understand sizing between storage and usable wall space.

VOI® EXAMPLE

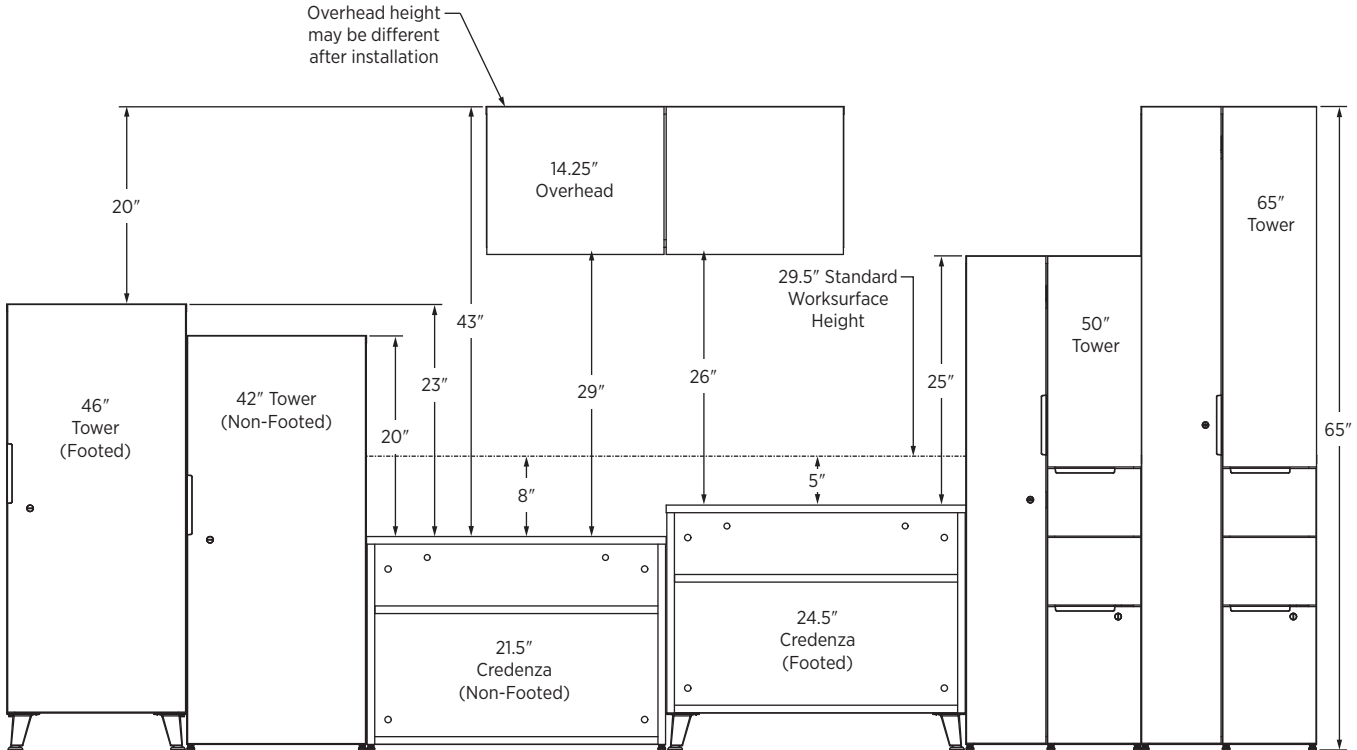

NOTES:

- ❶ Overheads can be mounted above or next to Workwall but do not mount to Workwall. Elevation shown above is typical overhead height and may vary in installation.

TILE CROSS-SECTION

Side view



Z-Bracket

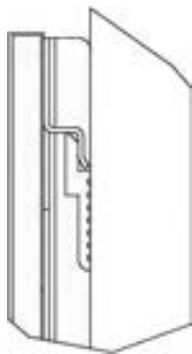

WORKWALL SPECIFYING/DESIGN GUIDE

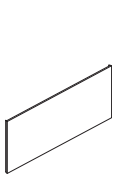

Fabric Tile

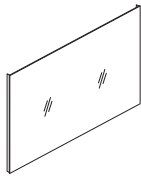

Glass Markerboard Tile

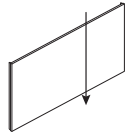

Laminate Tile

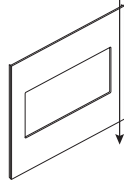

Laminate Media Tile

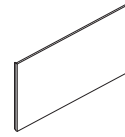

Painted Metal Tile

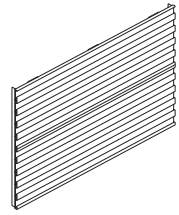

Slotted Tool Tile

Fabric Tiles

	18"W	24"W	30"W	36"W	42"W	48"W	54"W	60"W
7 1/2"H								
15"H								
22 1/2"H								
30"H								
37 1/2"H								
45"H								

Glass Markerboard Tiles

	30"W	36"W	42"W	48"W	54"W	60"W
15"H						
22 1/2"H						
30"H						
37 1/2"H						
45"H						

WORKWALL SPECIFYING/DESIGN GUIDE

Laminate Tiles

7 1/2"H	18"W	24"W	30"W	36"W
15"H				
22 1/2"H				
30"H				
37 1/2"H				
45"H				

Laminate Media Tiles

	36"W	42"W	48"W	54"W
30"H				
37 1/2"H				
45"H				

Painted Metal Tiles

7 1/2"H	18"W	24"W	30"W	36"W
15"H				
22 1/2"H				
30"H				

Slotted Tool Tiles

7 1/2"H	24"W	30"W	36"W	42"W	48"W	54"W	60"W
15"H							

WORKWALL Typicals

QTY	DESCRIPTION	MODEL	LIST PRICE	PRICE EXTENSION
1	Lateral File Pedestal 36"W x 20"D x 28"H	H10503	\$1,105	\$1,105
1	Credenza Shell 72"W x 24"D x 29½"H	H10541	\$738	\$738
1	Square End Cap Bookshelf Left 24"W x 24"D x 29"H	H105526L	\$634	\$634
1	Square End Cap Bookshelf Right 24"W x 24"D x 66"H	H105527R	\$1,017	\$1,017
1	H-Leg Support 30"W x 28¾"H	H105HLEG3028	\$374	\$374
1	Rectangular Worksurface 66"W x 30"D	H105R3066	\$397	\$397
1	External Stiffener 60"W	HLSLZ5SC72	\$119	\$119
1	Fabric Tile 22½"H x 60"W	HWWT2260F	\$534	\$534
1	Slotted Tool Tile 15"H x 60"W	HWWT1560T	\$677	\$677
1	Glass Markerboard Tile 37½"H x 36"W	HWWT3736M	\$1,166	\$1,166
TOTAL:				\$6,761

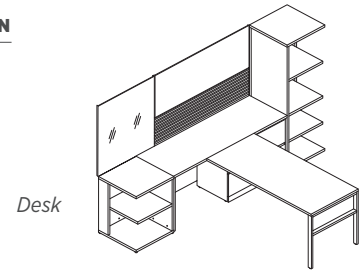

Desk

**10500 SERIES™
PRIVATE OFFICE**
118"W x 66½"H x 90"D

Workwall

QTY	DESCRIPTION	MODEL	LIST PRICE	PRICE EXTENSION
1	HAT Modular Credenza Top, Left 72"W x 24"D	H105CTHAT7224L	\$851	\$851
1	HAT Modular Credenza Top, Right 72"W x 24"D	H105CTHAT7224R	\$851	\$851
2	2-Drawer Credenza, No Top 36"W x 24"D x 21½"H	H105LC3624BF	\$557	\$1,114
2	HAT Open Storage Cabinet Back 36"W x 21½"H	H105LCHAT3620B	\$234	\$468
1	HAT Open Credenza, No Top 36"W x 24"D x 21½"H	H105LCHAT3624S	\$255	\$255
1	Open Wardrobe Tower, B/F Left 18"W x 24"D x 50"H	H105LT182450BFL	\$2,014	\$2,014
1	Open Wardrobe Tower, B/F Right 18"W x 24"D x 50"H	H105LT182450BFR	\$2,014	\$2,014
2	Rectangular Worksurface 72"W x 30"D	H105R3072	\$427	\$854
2	Shroud for Height Adjustable Base 5⅞"W x 26"D x 26¼"H	HLAMSHB30	\$899	\$1,798
2	Height Adjustable Base 3 Stage, 2-Leg, Rectangle T Foot	HREC3S2LTF	\$1,210	\$2,420
2	External Stiffener 66"W	HLSLZ5SC78	\$119	\$238
2	Fabric Tile 45"H x 36"W	HWWT4536F	\$518	\$1,036
2	Laminate Tile 37½"H x 35"W	HWWT3736L	\$459	\$918
1	Laminate Tile 15"H x 36"W	HWWT1536L	\$324	\$324
2	Slotted Tool Tile 7½"H x 36"W	HWWT736T	\$430	\$860
2	Floating Shelf 36"W	HWWASHELF36	\$273	\$546
TOTAL:				\$16,561

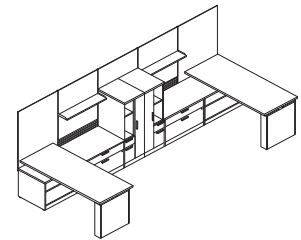

Desk

**10500 SERIES™
TEAMING STATION**
180"W x 64"H x 73"D

Workwall

NOTES: To enhance Workwall, use accessories, single tool rail, or floating shelf. See pages 263-264.

WORKWALL

Typicals

QTY	DESCRIPTION	MODEL	LIST PRICE	PRICE EXTENSION
3	Lateral File Pedestal 36"W x 20"D x 28"H	H10503	\$1,105	\$3,315
2	Storage Cabinet/Lateral File 36"W x 20"D x 66 ⁵ / ₈ "H	H105293	\$2,415	\$4,830
1	Rectangle Worksurface 36"W x 24"D	H105R2436	\$220	\$220
1	Rectangle Worksurface 72"W x 24"D	H105R2472	\$363	\$363
10	Field Installed Pull Kit Linear Matte Chrome, 2-Pack	HLINEARC2	\$61	\$610
2	Fabric Tile 7 ¹ / ₂ "H x 36"W	HWWT736F	\$333	\$666
2	Slotted Tool Tile 15"H x 36"W	HWWT1536T	\$477	\$954
2	Fabric Tile 15"H x 36"W	HWWT1536F	\$351	\$702
1	Glass Markerboard Tile 37 ¹ / ₂ "H x 36"W	HWWT3736M	\$1,166	\$1,166
TOTAL:			\$12,826	

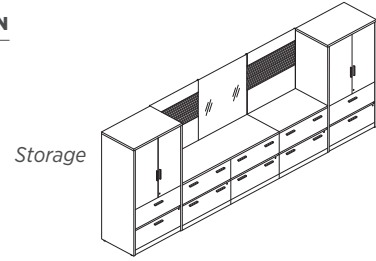

Storage

**10500 SERIES™
STORAGE WALL**
180"W x 66"H x 24"D

Workwall

QTY	DESCRIPTION	MODEL	LIST PRICE	PRICE EXTENSION
1	2-Drawer Lateral File 36"W x 24"D	HNL2436LD2	\$1,278	\$1,278
1	Pedestal Credenza, Right 72"W x 24"D	HNL2472RP	\$1,586	\$1,586
1	Bridge with Full Modesty 48"W x 24"D	HNL2448BF	\$491	\$491
1	Breakfront Rectangle Desk w/Frosted Modesty 72"W x 36"D	HNL3672LPRBF	\$2,608	\$2,608
1	Laminate Tile 45"H x 36"W	HWWT4536L	\$508	\$508
1	Glass Markerboard Tile 45"H x 48"W	HWWT4548M	\$1,474	\$1,474
1	Fabric Tile 45"H x 24"W	HWWT4524F	\$441	\$441
2	Floating Shelf 36"W	HWWASHELF36	\$273	\$546
TOTAL:			\$8,932	

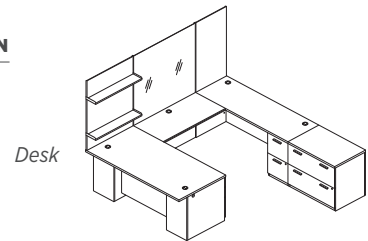

Desk

**CONCINNITY™
PRIVATE OFFICE**
108"W x 74"H x 108"D

Workwall

QTY	DESCRIPTION	MODEL	LIST PRICE	PRICE EXTENSION
1	O-Leg Support 30"D x 28"H	HLSL3028O	\$395	\$395
1	Bookcase End Support 12"W x 30"D x 28 ¹ / ₂ "H	HNL123028BKE	\$556	\$556
2	Low Credenza, 2 Box/2 File 60"W x 20"D x 21 ¹ / ₂ "H	HNL206021D4	\$1,660	\$3,320
1	Storage Cabinet/Lateral File 36"W x 24"D x 64 ³ / ₄ "H	HNL243665SLL	\$2,553	\$2,553
1	Rectangle Worksurface 72"W x 30"D	HNLRC3072	\$470	\$470
2	Fabric Tile 37 ¹ / ₂ "H x 60"W	HWWT3760F	\$662	\$1,324
1	Laminate Tile 37 ¹ / ₂ "H x 30"W	HWWT3730L	\$432	\$432
2	Floating Shelf 30"W	HWWASHELF30	\$260	\$520
TOTAL:			\$9,570	

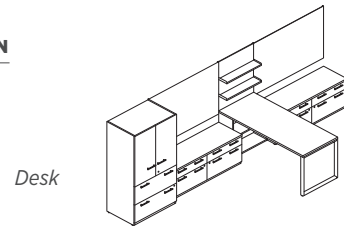

Desk

**CONCINNITY™ LARGE
PRIVATE OFFICE**
186"W x 64"H x 73"D

Workwall

NOTES: To enhance Workwall, use accessories, single tool rail, or floating shelf. See pages 263-264.

WORKWALL Typicals

QTY	DESCRIPTION	MODEL	LIST PRICE	PRICE EXTENSION
1	Low Credenza, 2 File Drawers and Open Top 72"W x 20"D x 21½"H	HLSL2072LD2	\$1,688	\$1,688
2	Support Pedestal 41"H	HLSL2441S	\$1,657	\$3,314
2	Angled Steel Leg 2-Pack	HLSL28AM2	\$356	\$712
1	Rectangle Worksurface 72"W x 24"D	HLSLR2472	\$443	\$443
1	Rectangle Worksurface 72"W x 30"D	HLSLR3072	\$527	\$527
1	External Stiffener 60"W	HLSLZ55C72	\$119	\$119
1	Low Credenza, 4 Storage Doors 72"W x 20"D x 21½"H	HLSL2072S4	\$1,792	\$1,792
2	Laminate Tile 45"H x 36"W	HWWT4536L	\$508	\$1,016
2	Painted Metal Tile 22½"H x 36"W	HWWT2236P	\$293	\$586
1	Fabric Tile 45"H x 36"W	HWWT4536F	\$518	\$518
1	Glass Markerboard Tile 45"H x 36"W	HWWT4536M	\$1,276	\$1,276
TOTAL:			\$11,991	

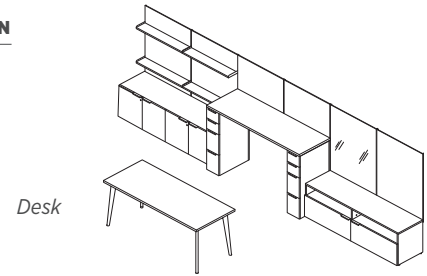

**VOI®
PRIVATE OFFICE**
216"W x 64"H x 107"D*

*Depth is dependent on how far the table desk is away from Workwall.

QTY	DESCRIPTION	MODEL	LIST PRICE	PRICE EXTENSION
1	Seated Height Mobile Collaborative Table 72"W x 42"D	HTMC304272	\$2,050	\$2,050
1	Fabric Tile 45"H x 24"W	HWWT4524F	\$441	\$441
1	Laminate Tile 45"H x 24"W	HWWT4524L	\$448	\$448
1	Glass Markerboard Tile 45"H x 60"W	HWWT4560M	\$1,826	\$1,826
1	Floating Shelf 24"W	HWWASHELF24	\$247	\$247
TOTAL:			\$5,012	

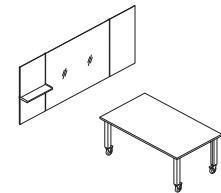

**OPEN COLLABORATIVE
WALL SPACE**
108"W x 45"H

QTY	DESCRIPTION	MODEL	LIST PRICE	PRICE EXTENSION
4	Lateral File Pedestal 30"W x 23⅞"D x 28½"H	HNL233028PLF	\$1,054	\$4,216
2	Modesty Back Panel, Full Length 60"W x 27⅞"H	HNLMP6028	\$267	\$534
2	Rectangle Worksurface 60"W x 24"D	HNLRC2460	\$358	\$716
1	Rectangle Table Top 96"W x 48"D	HTLC4896	\$914	\$914
1	Angled Metal Legs for 96"W Tops 29½"H	HT29AL96	\$1,609	\$1,609
2	Laminate Tile 37½"H x 36"W	HWWT3736L	\$459	\$918
1	Laminate Media Tile 37½"H x 48"W	HWWT3748V	\$569	\$569
1	Floating Shelf 36"W	HWWASHELF36	\$273	\$273
1	Single Tool Rail 36"W	HWWARAIL36	\$219	\$219
TOTAL:			\$9,968	

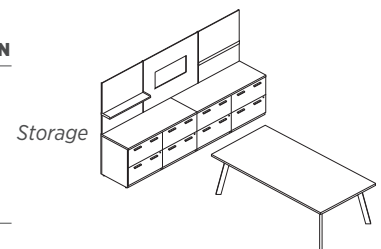

**STORAGE WALL IN
OPEN COLLABORATIVE SPACE**
120"W x 66"H x 30"D

NOTES: To enhance Workwall, use accessories, single tool rail, or floating shelf. See pages 263-264.

WORKWALL

Fabric Tiles

OPEN MARKET

Icon Legend on page 19

DESCRIPTION	MODEL	SHIP WEIGHT	CUBE	LIST PRICE BY FABRIC GRADE								
				AA	A	B	C	D	E	F	G	
7½" H Fabric Tiles												
7½" H x 18" W	HWWT718F	4	0.7	\$286	\$290	\$293	\$295	\$301	\$306	\$311	\$314	
7½" H x 24" W	HWWT724F	4	0.8	\$302	\$306	\$309	\$311	\$317	\$322	\$327	\$330	
7½" H x 30" W	HWWT730F	4	1.0	\$320	\$324	\$327	\$331	\$337	\$344	\$347	\$350	
7½" H x 36" W	HWWT736F	4	1.3	\$333	\$337	\$340	\$344	\$350	\$357	\$360	\$363	
7½" H x 42" W	HWWT742F	4	1.5	\$419	\$424	\$428	\$432	\$442	\$445	\$449	\$453	
7½" H x 48" W	HWWT748F	4	1.5	\$444	\$449	\$453	\$457	\$467	\$470	\$474	\$478	
7½" H x 54" W	HWWT754F	5	1.7	\$450	\$470	\$474	\$479	\$491	\$495	\$498	\$501	
7½" H x 60" W	HWWT760F	5	1.8	\$464	\$484	\$488	\$493	\$505	\$509	\$512	\$515	
15" H Fabric Tiles												
15" H x 18" W	HWWT1518F	4	1.0	\$300	\$309	\$317	\$325	\$341	\$359	\$375	\$383	
15" H x 24" W	HWWT1524F	4	1.0	\$319	\$328	\$336	\$344	\$360	\$378	\$394	\$402	
15" H x 30" W	HWWT1530F	4	1.2	\$336	\$347	\$357	\$367	\$389	\$410	\$421	\$431	
15" H x 36" W	HWWT1536F	4	1.4	\$351	\$362	\$372	\$382	\$404	\$425	\$436	\$446	
15" H x 42" W	HWWT1542F	4	1.6	\$441	\$454	\$466	\$481	\$514	\$525	\$535	\$546	
15" H x 48" W	HWWT1548F	4	1.7	\$463	\$476	\$488	\$503	\$536	\$547	\$557	\$568	
15" H x 54" W	HWWT1554F	5	2.1	\$477	\$490	\$502	\$517	\$550	\$561	\$571	\$582	
15" H x 60" W	HWWT1560F	5	2.1	\$490	\$503	\$515	\$530	\$563	\$574	\$584	\$595	
22½" H Fabric Tiles												
22½" H x 18" W	HWWT2218F	5	1.0	\$318	\$328	\$337	\$347	\$366	\$388	\$402	\$411	
22½" H x 24" W	HWWT2224F	5	1.3	\$337	\$347	\$356	\$366	\$385	\$407	\$421	\$430	
22½" H x 30" W	HWWT2230F	5	1.3	\$356	\$368	\$379	\$392	\$415	\$443	\$470	\$480	
22½" H x 36" W	HWWT2236F	5	1.7	\$379	\$394	\$407	\$418	\$455	\$485	\$496	\$506	
22½" H x 42" W	HWWT2242F	5	1.7	\$473	\$488	\$501	\$515	\$558	\$582	\$593	\$604	
22½" H x 48" W	HWWT2248F	5	2.1	\$494	\$509	\$522	\$536	\$579	\$603	\$614	\$625	
22½" H x 54" W	HWWT2254F	6	2.1	\$523	\$538	\$551	\$565	\$608	\$632	\$643	\$654	
22½" H x 60" W	HWWT2260F	6	2.3	\$534	\$549	\$562	\$576	\$619	\$643	\$654	\$665	



NOTES:

- Accepts single tool rail, accessories, and floating shelf on select sizes (see pages 263-264 for accessory sizes).
- Fabric tiles are tackable.

ⓘ Tiles with accessories or shelves could conflict with the movement of height adjustable table.

HOW TO SPECIFY

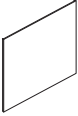
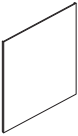
Select Model Number HWWT 2 2 3 6 F	Select Fabric Color See pages 25-26 A P N 1 5	Select Mounting Hardware Paint P Black PJW Designer White S Charcoal P
--	--	---

	DESCRIPTION	MODEL	SHIP WEIGHT	CUBE	LIST PRICE BY FABRIC GRADE							
					AA	A	B	C	D	E	F	G
	30"H Fabric Tiles											
	30"H x 18"W	HWWT3018F	5	1.2	\$334	\$345	\$355	\$366	\$388	\$415	\$426	\$436
	30"H x 24"W	HWWT3024F	5	1.7	\$358	\$369	\$379	\$390	\$412	\$439	\$450	\$460
	30"H x 30"W	HWWT3030F	5	2.1	\$386	\$399	\$411	\$426	\$451	\$485	\$529	\$539
	30"H x 36"W	HWWT3036F	5	2.5	\$410	\$428	\$444	\$456	\$509	\$547	\$558	\$568
	30"H x 42"W	HWWT3042F	6	2.9	\$516	\$532	\$547	\$559	\$613	\$650	\$662	\$672
	30"H x 48"W	HWWT3048F	6	3.3	\$535	\$551	\$566	\$578	\$632	\$669	\$681	\$691
	30"H x 54"W	HWWT3054F	7	4.1	\$559	\$575	\$590	\$602	\$656	\$693	\$705	\$715
	30"H x 60"W	HWWT3060F	7	4.1	\$581	\$597	\$612	\$624	\$678	\$715	\$727	\$737
	37 1/2"H Fabric Tiles											
	37 1/2"H x 18"W	HWWT3718F	6	1.6	\$361	\$377	\$392	\$410	\$463	\$495	\$507	\$517
	37 1/2"H x 24"W	HWWT3724F	6	2.1	\$400	\$416	\$431	\$449	\$502	\$534	\$546	\$556
	37 1/2"H x 30"W	HWWT3730F	7	2.6	\$427	\$443	\$458	\$476	\$529	\$561	\$573	\$583
	37 1/2"H x 36"W	HWWT3736F	8	2.5	\$454	\$473	\$492	\$513	\$577	\$624	\$635	\$646
	37 1/2"H x 42"W	HWWT3742F	8	3.6	\$571	\$592	\$612	\$636	\$717	\$765	\$775	\$786
	37 1/2"H x 48"W	HWWT3748F	9	4.1	\$602	\$623	\$645	\$668	\$751	\$800	\$812	\$823
	37 1/2"H x 54"W	HWWT3754F	10	3.2	\$627	\$653	\$679	\$710	\$792	\$852	\$863	\$875
	37 1/2"H x 60"W	HWWT3760F	11	5.2	\$662	\$688	\$714	\$745	\$827	\$887	\$898	\$910
	45"H Fabric Tiles											
	45"H x 18"W	HWWT4518F	6	1.8	\$401	\$420	\$440	\$461	\$527	\$575	\$586	\$598
	45"H x 24"W	HWWT4524F	6	2.5	\$441	\$460	\$480	\$501	\$567	\$615	\$626	\$638
	45"H x 30"W	HWWT4530F	7	3.1	\$482	\$503	\$523	\$548	\$631	\$679	\$691	\$703
	45"H x 36"W	HWWT4536F	8	3.7	\$518	\$539	\$561	\$584	\$667	\$716	\$728	\$739
	45"H x 42"W	HWWT4542F	8	4.3	\$644	\$665	\$685	\$710	\$792	\$841	\$853	\$865
	45"H x 48"W	HWWT4548F	9	5.0	\$685	\$706	\$734	\$751	\$834	\$883	\$895	\$906
	45"H x 54"W	HWWT4554F	10	6.2	\$725	\$751	\$778	\$809	\$890	\$950	\$962	\$974
	45"H x 60"W	HWWT4560F	11	6.2	\$775	\$801	\$828	\$859	\$940	\$1000	\$1012	\$1024

NOTES:

- Accepts single tool rail, accessories, and floating shelf on select sizes (see pages 263-264 for accessory sizes).
- Fabric tiles are tackable.

! Tiles with accessories or shelves could conflict with the movement of height adjustable table.

HOW TO SPECIFY

<p>Select Model Number</p> <p>HWWT3036F</p>	<p>Select Fabric Color</p> <p>See pages 25-26</p> <p>APN15</p>	<p>Select Mounting Hardware Paint</p> <p>P Black PJW Designer White S Charcoal</p> <p>P</p>
--	---	--

WORKWALL

Glass Markerboard Tiles

OPEN MARKET

Icon Legend on page 19

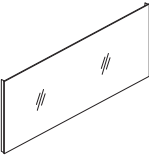
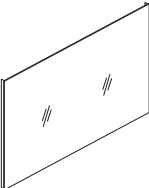
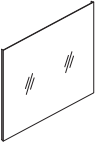
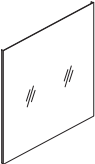
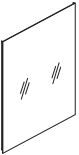
	DESCRIPTION	MODEL	SHIP WEIGHT	CUBE	LIST PRICE
	15"H Glass Markerboard Tiles				
	15"H x 30"W 15"H x 36"W	HWWT1530M HWWT1536M	16 18	2.2 2.6	\$594 \$660
	22½"H Glass Markerboard Tiles				
	22½"H x 30"W 22½"H x 36"W	HWWT2230M HWWT2236M	21 24	3.1 3.6	\$792 \$880
	30"H Glass Markerboard Tiles				
	30"H x 30"W 30"H x 36"W	HWWT3030M HWWT3036M	25 29	4.0 4.7	\$968 \$1034
	37½"H Glass Markerboard Tiles				
	37½"H x 30"W	HWWT3730M	30	4.8	\$1100
	37½"H x 36"W	HWWT3736M	35	5.7	\$1166
	37½"H x 42"W	HWWT3742M	40	6.5	\$1232
	37½"H x 48"W	HWWT3748M	44	7.4	\$1342
	37½"H x 54"W	HWWT3754M	48	8.3	\$1452
	45"H Glass Markerboard Tiles				
	45"H x 30"W	HWWT4530M	35	5.8	\$1188
	45"H x 36"W	HWWT4536M	41	6.8	\$1276
	45"H x 42"W	HWWT4542M	46	7.8	\$1364
	45"H x 48"W	HWWT4548M	52	8.8	\$1474
	45"H x 54"W	HWWT4554M	58	9.9	\$1694
	45"H x 60"W	HWWT4560M	63	10.9	\$1826

NOTES:

- Markerboard is magnetic. Recommend using rare earth magnets for best results.
- Material is back-painted glass with square edges, low iron clear (glossy) completely opaque finish and is tempered glass.

HOW TO SPECIFY

Select Model Number <div style="border: 1px solid #ccc; padding: 2px; display: flex; gap: 5px;"> HWWT3036M </div>	Select Glass GBG2 Beige GCH2 Charcoal GCR2 Cream GWH2 Ice White GPB2 Pebble	Select Mounting Hardware Paint P Black PJW Designer White S Charcoal
<div style="border: 1px solid #ccc; padding: 2px; display: flex; gap: 5px;"> HWWT3036M </div>	<div style="border: 1px solid #ccc; padding: 2px; display: flex; gap: 5px;"> GCH2 </div>	<div style="border: 1px solid #ccc; padding: 2px; display: flex; gap: 5px;"> P </div>

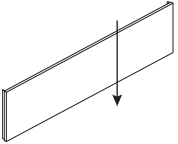
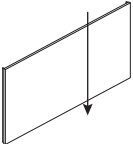
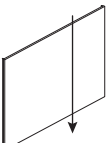
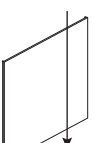
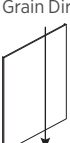
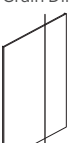
	DESCRIPTION	MODEL	SHIP WEIGHT	CUBE	LIST PRICE BY LAMINATE GRADE	
					L1	L2
Grain Direction 	7½”H Laminate Tiles					
	7½”H x 18”W	HWWT718L	5	0.7	\$279	\$284
	7½”H x 24”W	HWWT724L	5	0.8	\$285	\$295
	7½”H x 30”W	HWWT730L	6	1.0	\$291	\$301
	7½”H x 36”W	HWWT736L	6	1.2	\$296	\$306
Grain Direction 	15”H Laminate Tiles					
	15”H x 18”W	HWWT1518L	6	1.0	\$297	\$302
	15”H x 24”W	HWWT1524L	7	1.0	\$305	\$315
	15”H x 30”W	HWWT1530L	8	1.2	\$315	\$325
	15”H x 36”W	HWWT1536L	9	1.4	\$324	\$334
Grain Direction 	22½”H Laminate Tiles					
	22½”H x 18”W	HWWT2218L	10	1.0	\$319	\$329
	22½”H x 24”W	HWWT2224L	11	2.6	\$332	\$347
	22½”H x 30”W	HWWT2230L	13	2.6	\$346	\$361
	22½”H x 36”W	HWWT2236L	14	4.2	\$360	\$375
Grain Direction 	30”H Laminate Tiles					
	30”H x 18”W	HWWT3018L	11	1.2	\$338	\$348
	30”H x 24”W	HWWT3024L	13	1.5	\$358	\$373
	30”H x 30”W	HWWT3030L	15	1.8	\$376	\$391
	30”H x 36”W	HWWT3036L	17	2.1	\$392	\$407
Grain Direction 	37½”H Laminate Tiles					
	37½”H x 18”W	HWWT3718L	15	1.5	\$378	\$393
	37½”H x 24”W	HWWT3724L	17	1.8	\$405	\$425
	37½”H x 30”W	HWWT3730L	19	2.2	\$432	\$452
	37½”H x 36”W	HWWT3736L	22	2.5	\$459	\$479
Grain Direction 	45”H Laminate Tiles					
	45”H x 18”W	HWWT4518L	16	1.7	\$418	\$433
	45”H x 24”W	HWWT4524L	19	2.1	\$448	\$468
	45”H x 30”W	HWWT4530L	22	2.5	\$478	\$498
	45”H x 36”W	HWWT4536L	25	3.0	\$508	\$528

NOTES:

• Accepts single tool rail, accessories, and floating shelf on select sizes (see pages 263-264 for accessory sizes).

ⓘ Tiles with accessories or shelves could conflict with the movement of height adjustable table.

HOW TO SPECIFY

<p>Select Model Number</p> <p>HWWT3036L</p>	<p>Select Laminate and Edge</p> <p>See page 246</p> <p>LSA1SA</p>	<p>Select Mounting Hardware Paint</p> <p>P Black PJW Designer White S Charcoal</p> <p>P</p>
--	--	--

WORKWALL Laminate Media Tiles

OPEN MARKET

Icon Legend on page 19

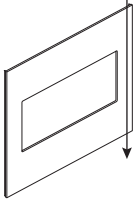
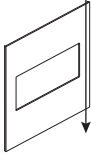
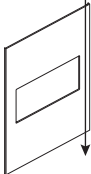
	DESCRIPTION	MODEL	SHIP WEIGHT	CUBE	LIST PRICE BY LAMINATE GRADE	
					L1	L2
Grain Direction 	30"H Laminate Media Tiles					
	30"H x 36"W	HWWT3036V	9	2.1	\$442	\$457
	30"H x 42"W	HWWT3042V	11	2.4	\$472	\$487
	30"H x 48"W	HWWT3048V	14	2.7	\$502	\$522
Grain Direction 	37½"H Laminate Media Tiles					
	37½"H x 36"W	HWWT3736V	14	2.5	\$509	\$529
	37½"H x 42"W	HWWT3742V	16	2.9	\$539	\$559
	37½"H x 48"W	HWWT3748V	19	3.2	\$569	\$594
	37½"H x 54"W	HWWT3754V	21	3.6	\$599	\$624
Grain Direction 	45"H Laminate Media Tiles					
	45"H x 36"W	HWWT4536V	17	3.0	\$558	\$578
	45"H x 42"W	HWWT4542V	20	3.4	\$588	\$613
	45"H x 48"W	HWWT4548V	23	3.8	\$618	\$643
	45"H x 54"W	HWWT4554V	26	4.2	\$648	\$678

NOTES:

- Media tile does not include wire management. Intended for power to be behind TV. Cords do not route behind tile.
- Tiles with accessories or shelves could conflict with the movement of height adjustable table.
- Wire management or television mounting brackets not included with tiles.

TV SCREEN DIMENSIONS			Workwall Tile	APPROXIMATE DIMENSIONS AROUND TV	
TV Size	Screen Height	Screen Width		Top & Bottom Border	Left & Right Border
32	15.7	27.9	HWWT3036M	7"	4"
			HWWT3736M	10.5"	
			HWWT4536M	14.5"	
40	19.6	34.9	HWWT3042M	5"	3.5"
			HWWT3742M	8.5"	
			HWWT4542V	12.5"	
43	21.1	37.5	HWWT3048V	4"	5"
			HWWT3748V	8"	
			HWWT4548V	11.5"	
50	24.5	43.6	HWWT3748V	6"	2"
			HWWT4548V	10"	
			HWWT3754V	6"	5"
			HWWT4554V	10"	

NOTES:

- TV true size height and width are for screen only, it does not take TV/monitor bevel into account. Please note chart is directional for TV sizes and actual dimensions should be confirmed with TV manufacturer.
- Borders show dimensions of visual laminate tile around the outside of the TV.
- TV Mount Opening is 12"H x 27"W and is centered on all Media Tiles.

HOW TO SPECIFY

<p>Select Model Number</p> <p>HWWT3036V</p>	<p>Select Laminate and Edge</p> <p>See page 246</p> <p>LSA1SA</p>	<p>Select Mounting Hardware Paint</p> <p>P Black PJW Designer White S Charcoal</p> <p>P</p>
--	--	--

WORKWALL Painted Metal Tiles

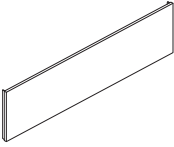
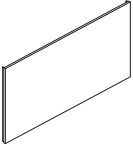
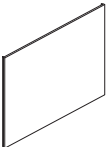
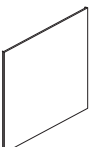
	DESCRIPTION	MODEL	SHIP WEIGHT	CUBE	LIST PRICE BY PAINT GRADE		
					P1	P2	P3
	7 1/2" H Painted Metal Tiles						
	7 1/2" H x 18" W	HWWT718P	4	0.7	\$213	\$228	\$242
	7 1/2" H x 24" W	HWWT724P	4	0.8	\$233	\$248	\$264
	7 1/2" H x 30" W	HWWT730P	6	1.0	\$253	\$268	\$286
	7 1/2" H x 36" W	HWWT736P	6	1.2	\$273	\$288	\$310
	15" H Painted Metal Tiles						
	15" H x 18" W	HWWT1518P	6	1.0	\$223	\$244	\$259
	15" H x 24" W	HWWT1524P	6	1.0	\$243	\$264	\$281
	15" H x 30" W	HWWT1530P	7	1.2	\$263	\$284	\$303
	15" H x 36" W	HWWT1536P	7	1.4	\$283	\$304	\$327
	22 1/2" H Painted Metal Tiles						
	22 1/2" H x 18" W	HWWT2218P	8	1.0	\$233	\$260	\$276
	22 1/2" H x 24" W	HWWT2224P	8	1.3	\$253	\$280	\$298
	22 1/2" H x 30" W	HWWT2230P	9	1.3	\$273	\$300	\$320
	22 1/2" H x 36" W	HWWT2236P	9	1.7	\$293	\$320	\$344
	30" H Painted Metal Tiles						
	30" H x 18" W	HWWT3018P	9	1.2	\$243	\$276	\$293
	30" H x 24" W	HWWT3024P	9	1.7	\$263	\$296	\$318
	30" H x 30" W	HWWT3030P	10	2.1	\$283	\$316	\$343
	30" H x 36" W	HWWT3036P	11	2.5	\$303	\$336	\$371

NOTES:

- Accepts single tool rail, accessories, and floating shelf on select sizes (see pages 263-264 for accessory sizes).
- Metal tiles are magnetic.

! Tiles with accessories or shelves could conflict with the movement of height adjustable table.

HOW TO SPECIFY

<p>Select Model Number</p> <p>HWWT3036P</p>	<p>Select Tile Paint Color</p> <p>See page 246</p> <p>PJW</p>	<p>Select Mounting Hardware Paint</p> <p>P Black PJW Designer White S Charcoal</p> <p>P</p>
--	--	--

WORKWALL

Slotted Tool Tiles

OPEN MARKET

Icon Legend on page 19

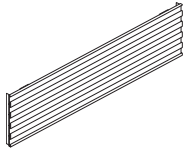
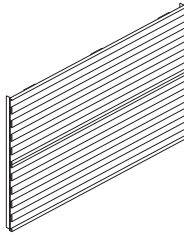
	DESCRIPTION	MODEL	SHIP WEIGHT	CUBE	LIST PRICE BY PAINT GRADE		
					P1	P2	P3
	7 1/2" H Slotted Tool Tiles						
	7 1/2" H x 24" W	HWWT724T	6	0.8	\$343	\$358	\$381
	7 1/2" H x 30" W	HWWT730T	7	1.0	\$388	\$403	\$430
	7 1/2" H x 36" W	HWWT736T	8	1.2	\$430	\$445	\$476
	7 1/2" H x 42" W	HWWT742T	9	1.3	\$475	\$490	\$525
	7 1/2" H x 48" W	HWWT748T	11	1.5	\$520	\$535	\$573
	7 1/2" H x 54" W	HWWT754T	12	1.7	\$575	\$590	\$630
	7 1/2" H x 60" W	HWWT760T	13	1.8	\$630	\$645	\$687
	15" H Slotted Tool Tiles						
	15" H x 24" W	HWWT1524T	11	1.0	\$390	\$419	\$442
	15" H x 30" W	HWWT1530T	13	1.2	\$434	\$463	\$490
	15" H x 36" W	HWWT1536T	15	1.4	\$477	\$506	\$537
	15" H x 42" W	HWWT1542T	17	1.6	\$522	\$551	\$586
	15" H x 48" W	HWWT1548T	20	1.7	\$567	\$596	\$634
	15" H x 54" W	HWWT1554T	22	2.1	\$622	\$651	\$691
	15" H x 60" W	HWWT1560T	24	2.1	\$677	\$706	\$748

NOTES:

- Abound® accessories can be used on Slotted Tool Tiles. See page 466.
- ! Slotted Tool Tile tested to 80 lbs. per tile (including accessories and what is stored in them) and must not exceed.
- ! Tiles with accessories or shelves could conflict with the movement of height adjustable table.

HOW TO SPECIFY

<p>Select Model Number</p> <p>HWWT1536T</p>	<p>Select Tile Paint Color</p> <p>See page 246</p> <p>PJW</p>	<p>Select Mounting Hardware Paint</p> <p>P Black PJW Designer White S Charcoal</p> <p>P</p>
--	--	--

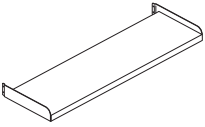
	DESCRIPTION	MODEL	SHIP WEIGHT	CUBE	LIST PRICE	UPCHARGE BY LAMINATE/PAINT GRADE		
						L2	P2	P3
	Floating Shelves							
	18"W	HWWASHELF18	9	0.4	\$234	\$5	\$6	\$11
	24"W	HWWASHELF24	10	0.5	\$247	\$10	\$6	\$11
	30"W	HWWASHELF30	11	0.6	\$260	\$10	\$6	\$11
	36"W	HWWASHELF36	12	0.7	\$273	\$10	\$6	\$11

NOTES:

- Shelves can be mounted on laminate, fabric, and metal tiles.
 - Can be mounted up to 2 on a single tile.
 - Shelves tested to 50 lbs. per floating shelf.
 - Shelves can be mounted at predetermined locations, pilot holes included.
- ⚠ Tiles with accessories or shelves could conflict with the movement of height adjustable table.

HOW TO SPECIFY

<p>Select Model Number</p> <p>HWWASHELF36</p>	<p>Select Laminate and Edge</p> <p>See page 246</p> <p>LSA1SA</p>	<p>Select Floating Shelf Bracket Paint</p> <p>See page 246</p> <p>P</p>
--	--	--

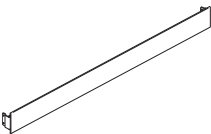
	DESCRIPTION	MODEL	SHIP WEIGHT	CUBE	LIST PRICE BY PAINT GRADE		
					P1	P2	P3
	Single Tool Rail Accessory						
	18"W	HWWARAIL18	2	0.4	\$192	\$198	\$203
	24"W	HWWARAIL24	2	0.4	\$199	\$205	\$210
	30"W	HWWARAIL30	2	0.5	\$212	\$218	\$223
	36"W	HWWARAIL36	3	0.6	\$219	\$225	\$230
	42"W	HWWARAIL42	3	0.6	\$231	\$237	\$242
	48"W	HWWARAIL48	4	0.7	\$240	\$246	\$251
	54"W	HWWARAIL54	4	0.7	\$259	\$265	\$270
	60"W	HWWARAIL60	4	0.8	\$273	\$279	\$284

NOTES:

- Accessory rails can be mounted on laminate, laminate media, fabric, and metal tiles.
 - Can be mounted up to 2 on a single tile.
 - Accessory rails can be mounted at predetermined locations, pilot holes included.
 - Brackets match paint selected for single tool rail.
- ⚠ 18-36"W Single Tool Rails are tested to a distributed 20 lbs. per single tool rail (including accessories and what is stored in them) and must not exceed.
- ⚠ 42-60"W Single Tool Rails are tested to a distributed 10 lbs. per single tool rail (including accessories and what is stored in them) and must not exceed.
- ⚠ Abound® accessories cannot be used on single rail but can be used on Slotted Tool Tiles.
- ⚠ Tiles with accessories or shelves could conflict with the movement of height adjustable table.

HOW TO SPECIFY

<p>Select Model Number</p> <p>HWWARAIL36</p>	<p>Select Single Tool Rail and Bracket Paint</p> <p>See page 246</p> <p>P</p>
---	--

WORKWALL

Accessories

OPEN MARKET

Icon Legend on page 19

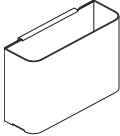
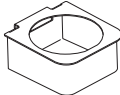
	DESCRIPTION	MODEL	SHIP WEIGHT	CUBE	LIST PRICE BY PAINT GRADE		
					P1	P2	P3
	Small Shelf 1"H x 10"W x 3/4"D	HWWATS	2	0.1	\$117	\$123	\$128
	Small Bin 4"H x 6"W x 2 1/4"D	HWWASB	3	0.1	\$117	\$123	\$128
	Small Tray 2"H x 9"W x 7/4"D	HWWAST	2	0.1	\$131	\$137	\$142
	Hanging File Folder 2"H x 12 1/4"W x 3 1/4"D	HWWAP	1	0.1	\$131	\$137	\$142
	Magnetic Picture Holder 5 1/4"H x 6"W x 3/4"D	HWWAPH	2	0.5	\$107	\$113	\$118
	Cup 2"H x 4 1/4"W x 4 1/2"D	HWWAC	1	0.1	\$107	\$113	\$118
	Hook 2 3/4"H x 3"W x 3/4"D	HWWAH	1	0.1	\$107	\$113	\$118

NOTES:

- Accessories work on single tool rail and Slotted Tool Tiles.

HOW TO SPECIFY

Select
Model Number

H W W A S T .

Select
Paint Color

See page 246

P

10500 SERIES™

Want to see more? Scan here
to check out hon.com.



10500 Series™ Workstation
shown with Ignition® Seating.

10500 SERIES™

Endlessly adaptable and unexpectedly affordable, our 10500 Series offers truly lasting value. The versatile design and options give you an even wider range of layout possibilities and the flexibility to maximize footprints — even smaller ones. And with more ways to customize your personal storage, the 10500 Series simply gives you more for less.



FEATURES

- The 10500 Series' fresh aesthetic includes airy H- or O-legs and frosted modesty panels.
- Available in 25 durable mix-and-match laminates, including new textured styles.
- With so many convenient and compact storage options, even the smallest footprints feel big.
- The versatile 10500 Series™ offers a variety of components to accommodate any size workspace.
- Support today's healthy work styles by offering the choice of sitting or standing while working, with storage options that fit your needs.

10500 SERIES™ ORDERING INFORMATION

LAMINATE TOP, CHASSIS, AND WORKSURFACES

L1 LAMINATES CODES

Woodgrain

◆ Bourbon Cherry	H
◆ Cognac	COGN
◆ Florence Walnut	LFW1
◆ Harvest	C
◆ Kingswood Walnut	LK11
◆ Mahogany	N
◆ Mocha	MOCH
◆ Natural Maple	D
◆ Pinnacle	PINC
◆ Shaker Cherry	F
◆ Sterling Ash	LSA1

Solid

◆ Black	P
◆ Charcoal	S
◆ Designer White	LDW1
◆ Loft	LOFT

Patterned Top

◆ Grey Tigris *	L6(*)
◆ Handspun Chestnut	LAHC
◆ Handspun Dove	LAHD
◆ Handspun Pearl	LAHP
◆ Handspun Slate	LAHS
◆ Sheer Mesh *	A5(*)
◆ Silver Mesh	B9(*)
◆ Canyon Zephyr *	K9(*)
◆ Desert Zephyr *	K8(*)

L2 LAMINATES CODES

Woodgrain

◆ Lowell Ash	LLA1
◆ Natural Recon	LNRI
◆ Phantom Ecrú	LPE1
◆ Portico Teak	LPT1
◆ Skyline Walnut	LSW1

EDGE BAND

EDGE BAND COLORS CODES

Woodgrain

◆ Bourbon Cherry	H
◆ Cognac	COGN
◆ Florence Walnut	FW
◆ Harvest	C
◆ Kingswood Walnut	KI
◆ Lowell Ash	DL
◆ Mahogany	N
◆ Mocha	MOCH
◆ Natural Maple	D
◆ Natural Recon	NR
◆ Phantom Ecrú	PE
◆ Pinnacle	PINC
◆ Portico Teak	DP
◆ Shaker Cherry	F
◆ Skyline Walnut	SW
◆ Sterling Ash	SA

Solid

◆ Black	P
◆ Brownstone	EY
◆ Charcoal	S
◆ Designer White	DW
◆ Fossil	EH
◆ Loft	LOFT

10500 SERIES™ MOBILE TABLES

PAINTS CODES

P1

◆ Black	P
◆ Brownstone	P7D
◆ Charcoal	S
◆ Designer White	PJW
◆ Fossil	P28
◆ Greige	T5
◆ Loft	LOFT
◆ Muslin	T3
◆ Titanium	P8T

P2

◆ Champagne Metallic	T4
◆ Platinum Metallic	T1
◆ Silver	PR6

H-LEGS, O-LEGS, POST LEGS, STORAGE CUBE

PAINTS CODES

P1

◆ Black	P
◆ Brownstone	P7D
◆ Charcoal	S
◆ Designer White	PJW
◆ Fossil	P28
◆ Greige	T5
◆ Loft	LOFT
◆ Muslin	T3
◆ Shadow *	SHDW
◆ Titanium	P8T

P2

◆ Champagne Metallic	T4
◆ Platinum Metallic	T1
◆ Silver	PR6
◆ Solar Black	P8X

P3

◆ Amethyst	P091
◆ Atom	P8S
◆ Blossom	P8K
◆ Bullseye	PJF
◆ Cabernet *	P7T
◆ Cobalt Mica	P090
◆ Conifer *	P8H
◆ Ember	P8P
◆ Ion	P8N
◆ Iris	P8J
◆ Krypton	P8F
◆ Ochre	P093
◆ Regatta	P8M
◆ Sienna	P092
◆ Succulent	P8A

◆◆◆ For lead time information see page 19.

* De-emphasized

Patterned Top

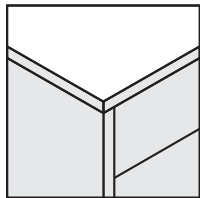

Edgeband Around Top / Laminate Chassis

- Edgebanding on patterned laminates matches the laminate chassis selected.
- Patterned top laminates are available with the following edgeband laminate selection: C, COGN, D, F, FW, H, KI, DW, MOCH, N, P, PINC, SA, and S.
- For 10500 Series™ worksurface models, the finish specification options include matching the top and edgeband colors or choosing a two-tone combination.

LAMINATE DESKS

SPECIFY: Model Number.
Laminate

EXAMPLE: H105413.NN

WORKSURFACES

SPECIFY: Model Number.
Top Laminate
Edgeband

- All specifications in this publication are based on the latest product information available at the time of print.

! Tops with a patterned color are not available with a matching edgeband.

10500 SERIES™ ORDERING INFORMATION

TWO-TONE LAMINATE TOP / CHASSIS

L1 LAMINATES	CODES
Two-Tone Top/Chassis	
◆ Black/Charcoal	PS
◆ Black/Designer White	PLDW1
◆ Black/Loft	PLOFT
◆ Bourbon Cherry/Black	HP
◆ Bourbon Cherry/Charcoal	HS
◆ Bourbon Cherry/Designer White	HLDW1
◆ Bourbon Cherry/Loft	HLOFT
◆ Charcoal/Black	SP
◆ Charcoal/Designer White	SLDW1
◆ Charcoal/Loft	SOFT
◆ Cognac/Black	COGNP
◆ Cognac/Charcoal	COGNS
◆ Cognac/Designer White	COGNLDW1
◆ Cognac/Loft	COGNLOFT
◆ Designer White/Black	LDW1P
◆ Designer White/Bourbon Cherry	LDW1H
◆ Designer White/Charcoal	LDW1S
◆ Designer White/Cognac	LDW1COGN
◆ Designer White/Florence Walnut	LDW1LFW1
◆ Designer White/Harvest	LDW1C
◆ Designer White/Kingswood Walnut	LDW1LKI1
◆ Designer White/Loft	LDW1LOFT
◆ Designer White/Mahogany	LDW1N
◆ Designer White/Mocha	LDW1MOCH
◆ Designer White/Natural Maple	LDW1D
◆ Designer White/Pinnacle	LDW1PINC

TWO-TONE LAMINATE TOP / CHASSIS *continued*

L1 LAMINATES	CODES
Two-Tone Top/Chassis	
◆ Designer White/Shaker Cherry	LDW1F
◆ Designer White/Sterling Ash	LDW1LSA1
◆ Florence Walnut/Black	LFW1P
◆ Florence Walnut/Charcoal	LFW1S
◆ Florence Walnut/Designer White	LFW1LDW1
◆ Florence Walnut/Loft	LFW1LOFT
◆ Harvest/Black	CP
◆ Harvest/Charcoal	CS
◆ Harvest/Designer White	CLDW1
◆ Harvest/Loft	CLOFT
◆ Kingswood Walnut/Black	LKI1P
◆ Kingswood Walnut/Charcoal	LKI1S
◆ Kingswood Walnut/Designer White	LKI1LDW1
◆ Kingswood Walnut/Loft	LKI1LOFT
◆ Loft/Black	LOFTP
◆ Loft/Charcoal	LOFTS
◆ Loft/Designer White	LOFTLDW1
◆ Mahogany/Black	NP
◆ Mahogany/Charcoal	NS
◆ Mahogany/Designer White	NLDW1
◆ Mahogany/Loft	NLOFT
◆ Mocha/Black	MOCHP
◆ Mocha/Charcoal	MOCHS
◆ Mocha/Designer White	MOCHLDW1
◆ Mocha/Loft	MOCHLOFT

TWO-TONE LAMINATE TOP / CHASSIS *continued*

L1 LAMINATES	CODES
Two-Tone Top/Chassis	
◆ Natural Maple/Black	DP
◆ Natural Maple/Charcoal	DS
◆ Natural Maple/Designer White	DLDW1
◆ Natural Maple/Loft	DLOFT
◆ Pinnacle/Black	PINCP
◆ Pinnacle/Charcoal	PINCS
◆ Pinnacle/Designer White	PINCLDW1
◆ Pinnacle/Loft	PINCLOFT
◆ Shaker Cherry/Black	FP
◆ Shaker Cherry/Charcoal	FS
◆ Shaker Cherry/Designer White	FLDW1
◆ Shaker Cherry/Loft	FLOFT
◆ Sterling Ash/Black	LSA1P
◆ Sterling Ash/Charcoal	LSA1S
◆ Sterling Ash/Designer White	LSA1LDW1
◆ Sterling Ash/Loft	LSA1LOFT

L2 LAMINATES	CODES
Two-Tone Top/Chassis	
◆ Designer White/Lowell Ash	LDWILLA1
◆ Designer White/Natural Recon	LDWILNR1
◆ Designer White/Phantom Ecru	LDW1PE1
◆ Designer White/Portico Teak	LDW1LPT1
◆ Designer White/Skyline Walnut	LDW1LSW1
◆ Lowell Ash/Black	LLA1P
◆ Lowell Ash/Charcoal	LLA1S
◆ Lowell Ash/Designer White	LLA1LDW1
◆ Lowell Ash/Loft	LLA1LOFT
◆ Natural Recon/Black	LNR1P
◆ Natural Recon/Charcoal	LNR1S
◆ Natural Recon/Designer White	LNR1LDW1
◆ Natural Recon/Loft	LNR1LOFT

TWO-TONE LAMINATE TOP / CHASSIS *continued*

L2 LAMINATES	CODES
Two-Tone Top/Chassis	
◆ Phantom Ecru/Black	LPE1P
◆ Phantom Ecru/Charcoal	LPE1S
◆ Phantom Ecru/Designer White	LPE1LDW1
◆ Phantom Ecru/Loft	LPE1LOFT
◆ Portico Teak/Black	LPT1P
◆ Portico Teak/Charcoal	LPT1S
◆ Portico Teak/Designer White	LPT1LDW1
◆ Portico Teak/Loft	LPT1LOFT
◆ Skyline Walnut/Black	LSW1P
◆ Skyline Walnut/Charcoal	LSW1S
◆ Skyline Walnut/Designer White	LSW1LDW1
◆ Skyline Walnut/Loft	LSW1LOFT

HLAM3772RD, HLAM3348RR

EDGEBAND COLORS CODES

EDGEBAND COLORS	CODES
Woodgrain	
◆ Bourbon Cherry	H
◆ Cognac	COGN
◆ Florence Walnut	FW
◆ Harvest	C
◆ Kingswood Walnut	KI
◆ Lowell Ash	DL
◆ Mahogany	N
◆ Mocha	MOCH
◆ Natural Maple	D
◆ Natural Recon	NR
◆ Phantom Ecru	PE
◆ Pinnacle	PINC
◆ Portico Teak	DP
◆ Shaker Cherry	F
◆ Skyline Walnut	SW
◆ Sterling Ash	SA
Solid	
◆ Black	P
◆ Charcoal	S
◆ Designer White	DW
◆ Loft	LOFT

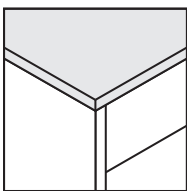

Laminate Chassis

Two-tone laminates: Top and edgebanding are the same, chassis is different laminate color.

The following 10500 Series™ products are not available as two-tone. They are one color and require only one color code:

- Modular pedestals — box/file, box/box/file, file/file, lateral file, multi file, and cabinet (also applies to Valido/11500 Series).
- Access strip and end panel kits
- Back enclosures
- Wall mounted open shelf
- Reception stations for return
- T-shaped end panels
- L-shaped end panels

Storage chassis that are specified in L2 laminates and are longer than 60" W will ship with back panels that are horizontal grain.

- Edgebanding on two-tone laminates matches top, chassis is a different laminate color.
- A complete selection of Conference Room and Occasional Tables is shown in the Tables section of the 2021 Shared Spaces Pricer.

LAMINATE DESKS

SPECIFY: Model Number.

Laminate

EXAMPLE: H10596.HP

- All specifications in this publication are based on the latest product information available at the time of print.

◆◆◆ For lead time information see page 19.

10500 SERIES™

Typicals



Icon Legend on page 19

Components used are listed on pages 274-325. Order components individually. Other configurations are possible, including various sizes of some components.

QTY	DESCRIPTION	MODEL	LIST PRICE	PRICE EXTENSION
1	Rectangle Worksurface 78"W x 30"D	H105R3078	\$455	\$455
1	O-Leg 30"D x 28½"H	HLSL30280	\$395	\$395
1	Low Credenza 72"W x 20"D x 21½"H, Drawers Right, Bookcase Left	H105975R	\$1,404	\$1,404
1	O-Leg Support over Low Credenza 30"D x 7"H	HLSL3070	\$305	\$305
1	Multi-Use Stack-On Storage 36"W x 18"D x 45⅝"H	H105310	\$1,123	\$1,123
TOTAL:			\$3,682	

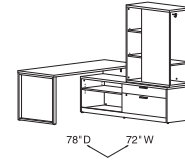

DESK L-WORKSTATION
72\"/>

QTY	DESCRIPTION	MODEL	LIST PRICE	PRICE EXTENSION
1	Rectangle Worksurface 72"W x 30"D	H105R3072	\$427	\$427
1	Modesty/Back Panels - Full Length 72"W x 27⅞"H	HNLMP7228	\$314	\$314
1	Coordinate™ Height Adjustable Base	HHATB2S2LT	\$950	\$950
2	Shroud for Height Adjustable Base	HLAMSHB30	\$899	\$1,798
1	Credenza with Doors 72"W x 24"D x 29½"H	H105909	\$1,933	\$1,933
1	Stack-On Storage 72"W x 14⅝"D x 37⅞"H, 4 Doors	H10534	\$1,072	\$1,072
1	External Stiffener 60"W for 72"W Worksurfaces	HLSLZ55C72	\$119	\$119
TOTAL:			\$6,613	

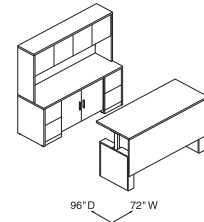

HEIGHT ADJUSTABLE TABLE
WORKSTATION WITH STACK-ON
STORAGE
72\"/>

QTY	DESCRIPTION	MODEL	LIST PRICE	PRICE EXTENSION
1	Single Pedestal Desk, Left - B/F 66"W x 30"D x 29½"H	H10584L	\$1,102	\$1,102
1	Return, Right - B/F 42"W x 24"D x 29½"H	H10511R	\$869	\$869
1	Stack-on Storage 72"W x 14⅝"D x 37⅞"H	H10534	\$1,072	\$1,072
TOTAL:			\$3,043	

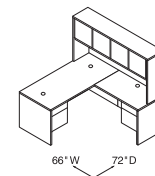

DESK "L" WORKSTATION - RIGHT
66\"/>

QTY	DESCRIPTION	MODEL	LIST PRICE	PRICE EXTENSION
1	Double Full Pedestal Desk - 3/2 72"W x 36"D x 29½"H	H105890	\$1,805	\$1,805
1	Credenza with Kneespace - 2/0/2 72"W x 24"D x 29½"H	H105900	\$1,583	\$1,583
1	Stack-on Storage, Frosted Doors with Silver Frame 72"W x 14⅝"D x 37⅞"H	H10534G	\$1,759	\$1,759
TOTAL:			\$5,147	

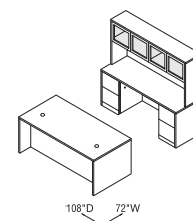

DESK/CREDENZA/STACK-ON STORAGE
WITH FROSTED DOORS
72\"/>



Icon Legend on page 19

10500 SERIES™ Typicals

DESKS

Components used are listed on pages 274-325. Order components individually. Other configurations are possible, including various sizes of some components.

QTY	DESCRIPTION	MODEL	LIST PRICE	PRICE EXTENSION
1	Storage/File Cabinet 18"W x 24"D x 66 $\frac{5}{8}$ "H, Hinged Right	H105297R	\$1,794	\$1,794
1	Open Credenza 36"W x 24"D x 21 $\frac{1}{2}$ "H	H105LCHAT3024S	\$234	\$234
1	Open/Lateral Credenza 30"W x 24"D x 21 $\frac{1}{2}$ "H	H105LC3024SF	\$520	\$520
1	Modular Credenza Top 60"W x 24"D	H105CTHAT6024L	\$724	\$724
1	Wall Mounted Open Hutch, Cubby w/Glass Doors 60"W x 14 $\frac{5}{8}$ "D x 20"H	H105WMH60PCG	\$1,761	\$1,761
1	Height Adjustable Base	HHATB2S2LT	\$950	\$950
1	External Stiffener 60"W for 72" Worksurface	HLSLZ5SC66	\$110	\$110
1	Shroud for Height Adjustable Base 5 $\frac{1}{8}$ "W x 26"D x 26 $\frac{1}{4}$ "H	HLAMSHB30	\$899	\$899
1	Rectangle Worksurface 66"W x 30"D	H105R3066	\$397	\$397
1	Mixed Material Floating Modesty Panel 36"W x 14"H	HLSL3614MM	\$810	\$810
TOTAL:			\$8,199	

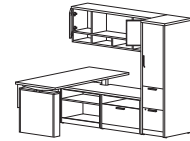

**HEIGHT ADJUSTABLE
"L" WORKSTATION**
66"W x 78"D

QTY	DESCRIPTION	MODEL	LIST PRICE	PRICE EXTENSION
1	H-Leg Support 30"W x 28 $\frac{3}{8}$ "H	H105HLEG3028	\$374	\$374
1	Rectangle Worksurface 66"W x 30"D	H105R3066	\$397	\$397
1	External Channel 54"W	HLSLZ5SC66	\$110	\$110
1	Flat Bracket 24"D	HHN831124	\$72	\$72
1	Return Shell w/Full Modesty Panel 72"W x 24"D x 29 $\frac{1}{2}$ "H	H105686	\$738	\$738
1	Multi File Pedestal, Floor-Standing 36"W x 20"D x 28"H	H10505	\$1,324	\$1,324
1	Personal Storage Tower, Hinged Right 24"W x 24"D x 66 $\frac{5}{8}$ "H	H105301R	\$2,268	\$2,268
1	Wall Mounted Open Hutch 72"W x 14 $\frac{5}{8}$ "D x 15"H	H105WMH72P	\$1,484	\$1,484
1	Laminate Floating Modesty Panel 54"W x 14"H	HLSL5414L	\$258	\$258
TOTAL:			\$7,025	

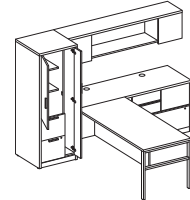

**EXTENDED STORAGE
"L" WORKSTATION**
66"W x 96"D

QTY	DESCRIPTION	MODEL	LIST PRICE	PRICE EXTENSION
1	Single Full Pedestal Desk, Right - B/B/F 72"W x 36"D x 29 $\frac{1}{2}$ "H	H105895R	\$1,443	\$1,443
1	Bridge 47"W x 24"D x 29 $\frac{1}{2}$ "H	H10570	\$386	\$386
1	Single Full Pedestal Credenza, Left - F/F 72"W x 24"D x 29 $\frac{1}{2}$ "H	H105904L	\$1,283	\$1,283
1	Stack-on Storage 72"W x 14 $\frac{5}{8}$ "D x 37 $\frac{1}{8}$ "H	H10534	\$1,072	\$1,072
TOTAL:			\$4,184	

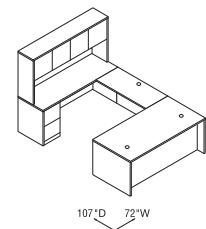

**"U" WORKSTATION
WITH FULL PEDESTALS**
72"W x 107"D

10500 SERIES™

Typicals



Icon Legend on page 19

Components used are listed on pages 274-325. Order components individually. Other configurations are possible, including various sizes of some components.

QTY	DESCRIPTION	MODEL	LIST PRICE	PRICE EXTENSION
1	Rudder Peninsula with End Panel, Right 72"W x 30/38"D x 29½"H	H105205R	\$1,180	\$1,180
1	Return, Left - F/F 42"W x 24"D x 29½"H	H105908L	\$998	\$998
1	Stack-on Storage 72"W x 14⅝"D x 37⅞"H	H10534	\$1,072	\$1,072
TOTAL:			\$3,250	

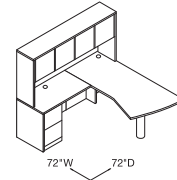

PENINSULA "L" WORKSTATION

72" W x 72" D

QTY	DESCRIPTION	MODEL	LIST PRICE	PRICE EXTENSION
1	Peninsula with End Panel 72"W x 36"D x 29½"H	H10521	\$930	\$930
1	Bridge 42"W x 24"D x 29½"H	H10560	\$371	\$371
1	Extended Corner Unit, Left 72"W x 24"-36"D x 29½"H	H105816L	\$1,139	\$1,139
1	Mobile Pedestal - B/B/F 15¾"W x 22¾"D x 28"H	H105102	\$906	\$906
1	Stack-on Storage 72"W x 14⅝"D x 37⅞"H	H10534	\$1,072	\$1,072
1	Storage Cabinet/Lateral File 36"W x 24"D x 66⅝"H	H105293	\$2,415	\$2,415
TOTAL:			\$6,833	

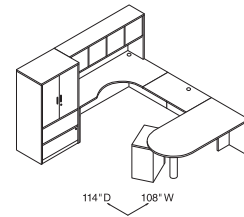

PENINSULA "U" WORKSTATION - LEFT

108" W x 114" D

QTY	DESCRIPTION	MODEL	LIST PRICE	PRICE EXTENSION
1	Slide Out Tower, Left Hinged 12"W x 24"D x 50"H	H105ST122450L	\$2,868	\$2,868
1	Open Credenza 30"W x 24"D x 21½"H	H105LCHAT3024S	\$234	\$234
1	Open/Lateral Credenza 30"W x 24"D x 21½"H	H105LC3024SF	\$520	\$520
1	Modular Credenza Top 60"W x 24"D	H105CTHAT6024R	\$724	\$724
1	Height Adjustable Base	HHATB2S2LT	\$950	\$950
1	External Stiffener 60"W for 72" Worksurface	HLSLZ5SC66	\$110	\$110
1	Shroud for Height Adjustable Base 5⅞"W x 26"D x 26¼"H	HLAMSHB30	\$899	\$899
1	Rectangle Worksurface 66"W x 30"D	H105R3066	\$397	\$397
1	Laminate Floating Modesty Panel 30"W x 14"H	HLSL3014L	\$191	\$191
1	2-Drawer Credenza 30"W x 24"D x 21½"H	H105LC3024BF	\$590	\$590
1	Modular Credenza Top 30"W x 24"D	H105CT3024	\$419	\$419
1	Fabric Credenza Top 30"W x 24"D	HLAMSEAT3024	\$430	\$430
TOTAL:			\$8,332	

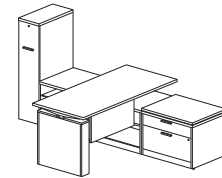

HEIGHT ADJUSTABLE "L" WORKSTATION WITH SLIDE OUT STORAGE

66" W x 102" D



Icon Legend on page 19

10500 SERIES™ Bundles Typicals

Mahogany
H105LL7284N

Harvest
H105LL7284C

QTY	DESCRIPTION	MODEL	LIST PRICE	PRICE EXTENSION
1	Left Pedestal Desk	H10586L	\$1,253	\$1,253
1	Right Return	H10515R	\$888	\$888
TOTAL:			\$2,141	

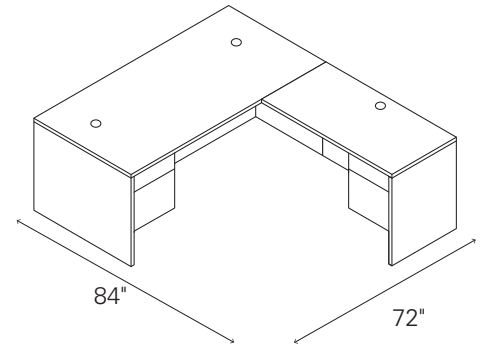

L-STATION (LEFT DESK/RIGHT RETURN)

Mahogany
H105LR7284N

Harvest
H105LR7284C

QTY	DESCRIPTION	MODEL	LIST PRICE	PRICE EXTENSION
1	Right Pedestal Desk	H10585R	\$1,253	\$1,253
1	Left Return	H10516L	\$888	\$888
TOTAL:			\$2,141	

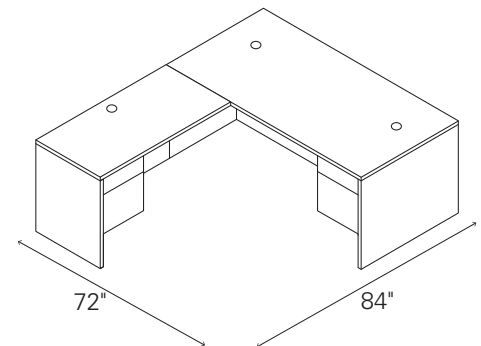

L-STATION (RIGHT DESK/LEFT RETURN)

Mahogany
H105LLH7284N

Harvest
H105LLH7284C

QTY	DESCRIPTION	MODEL	LIST PRICE	PRICE EXTENSION
1	Left Pedestal Desk	H10586L	\$1,253	\$1,253
1	Right Return	H10515R	\$888	\$888
1	Stack-on Storage	H105323	\$901	\$901
TOTAL:			\$3,042	

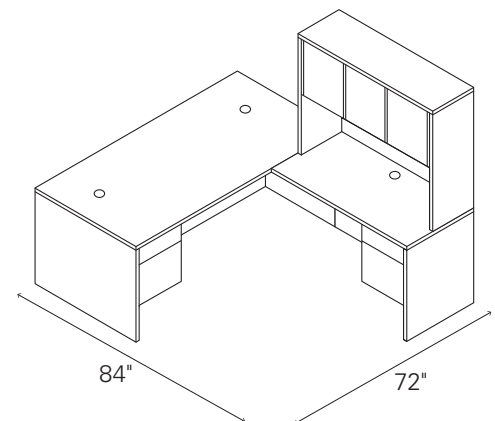

**L-STATION WITH STACK-ON STORAGE
(LEFT DESK/RIGHT RETURN)**

10500 SERIES™

Bundles Typicals



Icon Legend on page 19

Mahogany
H105LRH7284N

Harvest
H105LRH7284C

QTY	DESCRIPTION	MODEL	LIST PRICE	PRICE EXTENSION
1	Right Pedestal Desk	H10585R	\$1,253	\$1,253
1	Left Return	H10516L	\$888	\$888
1	Stack-on Storage	H105323	\$901	\$901
TOTAL:			\$3,042	

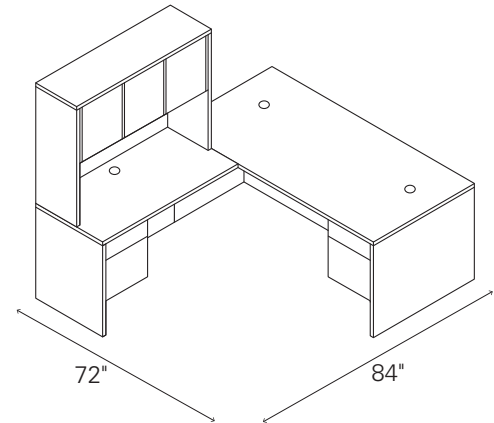

**L-STATION WITH STACK-ON STORAGE
(RIGHT DESK/LEFT RETURN)**

Mahogany
H105ULH72108N

Harvest
H105ULH72108C

QTY	DESCRIPTION	MODEL	LIST PRICE	PRICE EXTENSION
1	Left Pedestal Desk	H10586L	\$1,253	\$1,253
1	Right Pedestal Credenza	H10545R	\$1,085	\$1,085
1	Bridge	H10570	\$386	\$386
1	Stack-on Storage	H10534	\$1,072	\$1,072
TOTAL:			\$3,796	

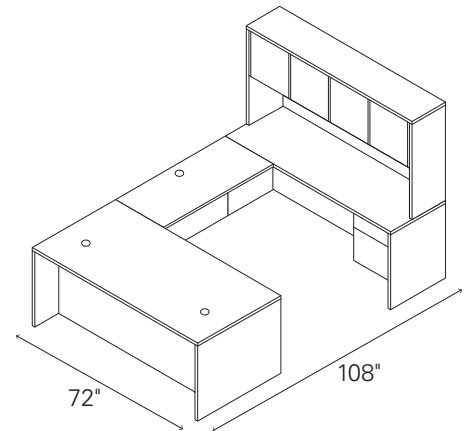

**U-STATION WITH STACK-ON STORAGE
(LEFT DESK/RIGHT CREDENZA)**

Mahogany
H105URH72108N

Harvest
H105URH72108C

QTY	DESCRIPTION	MODEL	LIST PRICE	PRICE EXTENSION
1	Right Pedestal Desk	H10585R	\$1,253	\$1,253
1	Left Pedestal Credenza	H10546L	\$1,085	\$1,085
1	Bridge	H10570	\$386	\$386
1	Stack-on Storage	H10534	\$1,072	\$1,072
TOTAL:			\$3,796	

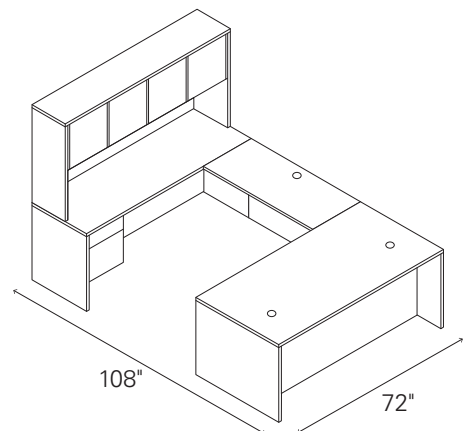

**U-STATION WITH STACK-ON STORAGE
(RIGHT DESK/LEFT CREDENZA)**



Icon Legend on page 19

10500 SERIES™ Bundles Typicals

Mahogany
H105DLH7298N

Harvest
H105DLH7298C

QTY	DESCRIPTION	MODEL	LIST PRICE	PRICE EXTENSION
1	Double Pedestal Desk	H10593	\$1,475	\$1,475
2	Bookcase Hutch	H105292	\$605	\$1,210
1	2-Drawer Lateral File	H10563	\$1,032	\$1,032
1	Storage Cabinet with Doors	H105291	\$828	\$828
TOTAL:			\$4,545	

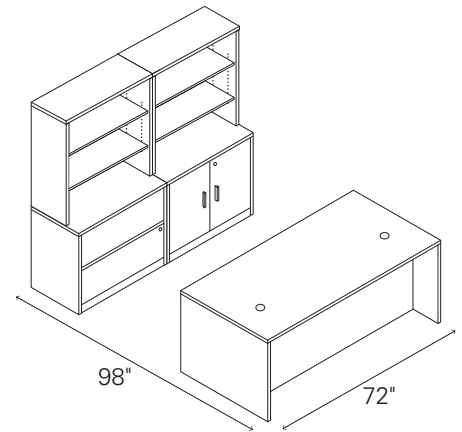

STORAGE WORKSTATION

Mahogany
H105DCH6098N

Harvest
H105DCH6098C

QTY	DESCRIPTION	MODEL	LIST PRICE	PRICE EXTENSION
1	Double Pedestal Desk	H10573	\$1,243	\$1,243
1	Double Pedestal Credenza	H10565	\$1,243	\$1,243
1	Stack-on Storage	H105324	\$1,000	\$1,000
TOTAL:			\$3,486	

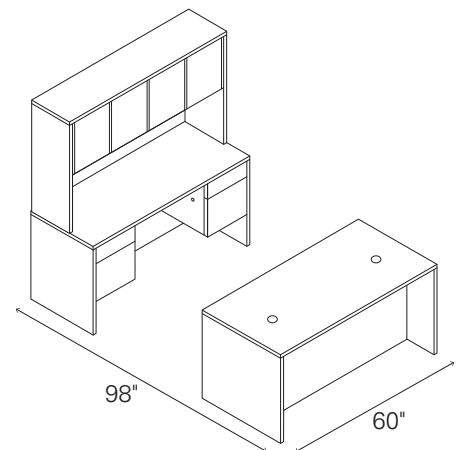

DESK CREDENZA STACK-ON #1

Mahogany
H105DCH7298N

Harvest
H105DCH7298C

QTY	DESCRIPTION	MODEL	LIST PRICE	PRICE EXTENSION
1	Double Pedestal Desk	H10593	\$1,475	\$1,475
1	Double Pedestal Credenza	H10543	\$1,315	\$1,315
1	Stack-on Storage	H10534	\$1,072	\$1,072
TOTAL:			\$3,862	

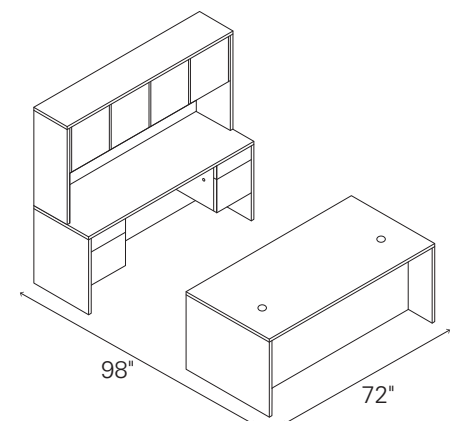

DESK CREDENZA STACK-ON #2

10500 SERIES™ Laminate Modular Components

GSA SIN 33721



Icon Legend on page 19

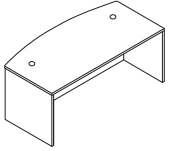

Model H10596 shown

DESCRIPTION	INSIDE DIMENSIONS	FULL WIDTH OVERHANG	MODEL	SHIP WEIGHT	CUBE	LIST PRICE BY LAMINATE GRADE	
						L1	L2
Desk Shell (with full modesty panel and 2 grommets)							
72"W x 36"D x 29½"H, Bow Top (end panels 30"D)	69½"W x 24⅝"D	10½"	H10596	192	6.9	\$948	\$998
72"W x 36"D x 29½"H, Rectangle Top	69½"W x 24⅝"D	10½"	H10594	209	6.9	\$856	\$906
72"W x 30"D x 29½"H, Rectangle Top	69½"W x 24⅝"D	4½"	H10592	182	5.8	\$811	\$851
66"W x 30"D x 29½"H, Rectangle Top	63½"W x 24⅝"D	4½"	H10579	172	5.4	\$769	\$809
60"W x 30"D x 29½"H, Rectangle Top	57½"W x 24⅝"D	4½"	H10578	161	5.0	\$715	\$755
48"W x 30"D x 29½"H, Rectangle Top (1 grommet)	45½"W x 24⅝"D	4½"	H10598	141	5.0	\$664	\$694
NOTES: See page 325 for optional center drawers.							
Desk Shell (with 10"H modesty panel and 2 grommets)							
72"W x 36"D x 29½"H, Bow Top (end panels 30"D)	69½"W x 24⅝"D	10½"	H10596X	155	6.1	\$948	\$998
72"W x 36"D x 29½"H, Rectangle Top	69½"W x 24⅝"D	10½"	H10594X	153	6.1	\$856	\$906
72"W x 30"D x 29½"H, Rectangle Top	69½"W x 24⅝"D	4½"	H10592X	143	5.1	\$811	\$851
66"W x 30"D x 29½"H, Rectangle Top	63½"W x 24⅝"D	4½"	H10579X	134	4.7	\$769	\$809
60"W x 30"D x 29½"H, Rectangle Top	57½"W x 24⅝"D	4½"	H10578X	125	4.4	\$715	\$755
48"W x 30"D x 29½"H, Rectangle Top (1 grommet)	45½"W x 24⅝"D	4½"	H10598X	115	4.4	\$664	\$694
NOTES: Makes reaching wall electrical outlets quick and easy. Provides more than 18" of clearance. See pages 302-303 for optional stack-on storage and page 325 for optional center drawers.							

NOTES:

- Non-handed desk, credenza, and return shells, combined with a variety of under-the-worksurface storage solutions, maximize office layout flexibility. Products can be reconfigured quickly and easily when user preferences or space needs change.
- For under-surface storage options, see pages 289-291.
- For additional components see pages 298-325.
- Tops and end panels are abrasion- and stain-resistant laminate over durable 1⅝" solid core high-performance particleboard; resists warping.
- Cord management grommets, for routing and hiding wires and cables, are located in the tops of desks and return shells.
- 3" round worksurface grommet can be replaced with optional Power Hub (model HGRMTAC) or Power/USB Hub (model HGRMTUSB2) to bring the ease of plug-and-play to the desktop. See page 324.
- Adjustable hex leveling glides allow floor-standing furniture to be easily leveled without lifting the unit; glides have ¾" adjustable range.
- For standing, 42"H shells, see page 277.

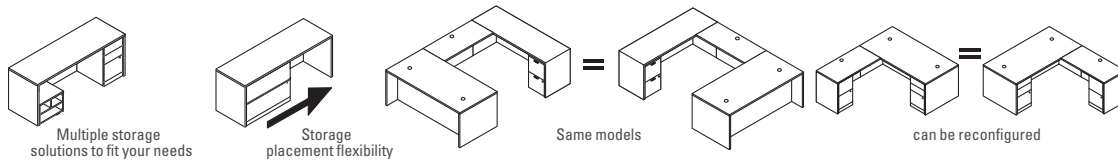

HOW TO SPECIFY

<p>Select Model Number</p> <p>H 1 0 5 9 6 .</p>	<p>Select Laminate Top and Chassis Color</p> <p>See pages 266-267</p> <p>N N</p>
--	---



Icon Legend on page 19

10500 SERIES™

Laminate Modular Components

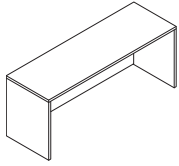

DESCRIPTION	INSIDE DIMENSIONS	MODEL	SHIP WEIGHT	CUBE	LIST PRICE BY LAMINATE GRADE	
					L1	L2
Credenza Shell (with full modesty panel)						
72"W x 24"D x 29½"H	69½"W x 22¾"D	H10541	153	5.6	\$738	\$778
66"W x 24"D x 29½"H	63½"W x 22¾"D	H10542	144	5.1	\$722	\$762
60"W x 24"D x 29½"H	57½"W x 22¾"D	H10564	135	4.7	\$676	\$711
48"W x 24"D x 29½"H	45½"W x 22¾"D	H105692	124	3.9	\$647	\$677
42¼"W x 24"D x 29½"H	39¾"W x 22¾"D	H105691	110	3.8	\$626	\$656
72"W x 20"D x 29½"H	69½"W x 18¾"D	H105581	138	5.6	\$697	\$732
66"W x 20"D x 29½"H	63½"W x 18¾"D	H105582	130	5.1	\$680	\$715
60"W x 20"D x 29½"H	57½"W x 18¾"D	H105583	122	4.7	\$645	\$675

NOTES: Cord pass-through in top center of modesty panel. See pages 302-303 for optional stack-on storage.

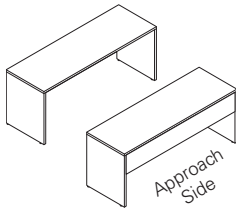

DESCRIPTION	INSIDE DIMENSIONS	MODEL	SHIP WEIGHT	CUBE	LIST PRICE BY LAMINATE GRADE	
					L1	L2
Credenza Shell (with 10" H modesty panel)						
72"W x 24"D x 29½"H	69½"W x 22¾"D	H10541X	114	4.8	\$738	\$778
66"W x 24"D x 29½"H	63½"W x 22¾"D	H10542X	107	4.4	\$722	\$762
60"W x 24"D x 29½"H	57½"W x 22¾"D	H10564X	105	4.0	\$676	\$711
48"W x 24"D x 29½"H	45½"W x 22¾"D	H105692X	95	3.8	\$647	\$677
42¼"W x 24"D x 29½"H	39¾"W x 22¾"D	H105691X	87	3.8	\$626	\$656
72"W x 20"D x 29½"H	69½"W x 18¾"D	H105581X	107	4.8	\$697	\$732
66"W x 20"D x 29½"H	63½"W x 18¾"D	H105582X	101	4.4	\$680	\$715
60"W x 20"D x 29½"H	57½"W x 18¾"D	H105583X	96	4.0	\$645	\$675

NOTES: Makes reaching wall electrical outlets quick and easy. Provides more than 18" of clearance. See pages 302-303 for optional stack-on storage.



Not available in two-tone laminate

DESCRIPTION	MODEL	SHIP WEIGHT	CUBE	L1	L2
				LIST PRICE	LIST PRICE
Kneespace Clearance End Panel Kits (field installable)					
1½"W x 11¼"D x 28½"H	H105098	13	0.9	\$223	\$233
For use at either end of 10500, 10700 or Valido Series® 24"D Credenza Shells (with full or 10" modesty panel) or non-pedestal end of single pedestal credenzas or credenzas with lateral files.					
1½"W x 17¼"D x 28½"H	H105099	11	0.8	\$234	\$244
For use at either end of 10500, 10700 or Valido Series® 30"D Desk Shells or non-pedestal end of 30"D single pedestal desks.					
Kits include: (1) support panel; European fastening hardware; flat connector bracket; joint connector bolts with sleeve nuts (for ganging credenza to adjacent worksurface); and adjustable leveling glides. Allows conversion of units currently in the field.					
NOTES: Can be used to connect up to three 24"D credenzas or 30"D desks in line (requires 4 kits).					
⚠ Not designed to be used freestanding. Not designed to be used with returns, 36"D desks or desk shells.					
SPECIFYING EXAMPLE: H105098.N					

NOTES:

- Non-handed desk, credenza, and return shells, combined with a variety of under-the-worksurface storage solutions, maximize office layout flexibility. Products can be reconfigured quickly and easily when user preferences or space needs change.
- For 78", 84", 90", and 96"W credenza shells, see page 276.
- For under-surface storage options, see pages 289-291.
- Tops and end panels are abrasion- and stain-resistant laminate over durable 1/8" solid core high-performance particleboard; resists warping.
- For additional components see pages 298-325.
- For work-in-process paper management tools, see pages 319-320.
- Cord management grommets, for routing and hiding wires and cables, are located in the tops of desks and return shells.
- Credenza shells have a cord pass-through grommet in the top center of the modesty panel.
- Kneespace Clearance End Panel Kit model H105098, can be used to create "L" configurations with leg clearance, by connecting credenzas to single pedestal desks or credenzas, desk or credenza shells, corners, extended corners or peninsulas.
- Adjustable hex leveling glides allow floor-standing furniture to be easily leveled without lifting the unit; glides have 3/4" adjustable range.

HOW TO SPECIFY

Select Model Number <input type="text" value="H10541"/>	Select Laminate Top and Chassis Color See pages 266-267 <input type="text" value="NN"/>
---	--

10500 SERIES™

Laminate Modular Components

GSA SIN 33721



Icon Legend on page 19

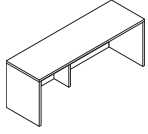

DESCRIPTION	INSIDE DIMENSIONS	MODEL	SHIP WEIGHT	CUBE	LIST PRICE BY LAMINATE GRADE	
					L1	L2
Credenza Shell (with full modesty panel)						
96"W x 24"D x 29½"H	93½"W x 22¾"D	H105413	215	7.0	\$1051	\$1106
90"W x 24"D x 29½"H	87½"W x 22¾"D	H105412	202	6.6	\$1022	\$1072
84"W x 24"D x 29½"H	81½"W x 22¾"D	H105411	189	6.2	\$907	\$957
78"W x 24"D x 29½"H	75½"W x 22¾"D	H105410	176	5.8	\$882	\$927

NOTES: Larger sizes can be used in conjunction with a 10500 Series rectangle- or bullet-shaped worksurface, supported by an end panel, column or leg, to achieve a space efficient work wall configuration. Shells wider than 72" include an internal, 10½"D vertical support leg. The internal leg can be removed if it is replaced with a 10500 Series 28"H modular pedestal that is adjusted to support the credenza shell top. Cord pass-through in top center of modesty panel. See pages 302-303 for optional stack-on storage and the stack-on storage end panel kit (model H105349).

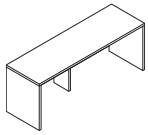

Credenza Shell (with 10"H modesty panel)						
96"W x 24"D x 29½"H	93½"W x 22¾"D	H105413X	163	6.1	\$1051	\$1106
90"W x 24"D x 29½"H	87½"W x 22¾"D	H105412X	152	5.7	\$1022	\$1072
84"W x 24"D x 29½"H	81½"W x 22¾"D	H105411X	141	5.4	\$907	\$957
78"W x 24"D x 29½"H	75½"W x 22¾"D	H105410X	130	5.0	\$882	\$927

NOTES: Makes reaching wall electrical outlets quick and easy. Provides more than 18" of clearance. Larger sizes can be used in conjunction with a 10500 Series rectangle- or bullet-shaped worksurface, supported by an end panel, column or leg, to achieve a space efficient work wall configuration. Shells wider than 72" include an internal, 10½"D vertical support leg. The internal leg can be removed if it is replaced with a 10500 Series 28"H modular pedestal that is adjusted to support the credenza shell top. See pages 302-303 for optional stack-on storage and the stack-on storage end panel kit (model H105349).

NOTES:

- Non-handed desk, credenza, and return shells, combined with a variety of under-the-worksurface storage solutions, maximize office layout flexibility. Products can be reconfigured quickly and easily when user preferences or space needs change.
- For under-surface storage options, see pages 289-291.
- For additional components see pages 298-325.
- Tops and end panels are abrasion- and stain-resistant laminate over durable 1½" solid core high-performance particleboard; resists warping.
- Credenza shells have a cord pass-through grommet in the top center of the modesty panel.
- Kneespace Clearance End Panel Kit model H105098, can be used to create "L" configurations with leg clearance, by connecting credenzas to single pedestal desks or credenzas, desk or credenza shells, corners, extended corners or peninsulas.
- Adjustable hex leveling glides allow floor-standing furniture to be easily leveled without lifting the unit; glides have ¾" adjustable range.

HOW TO SPECIFY

Select
Model Number

H 1 0 5 4 1 3 .

Select
Laminate Top and Chassis Color

See pages 266-267

N N



10500 SERIES™

Laminate Modular Components

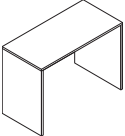
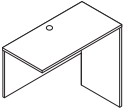
	DESCRIPTION	INSIDE DIMENSIONS	MODEL	SHIP WEIGHT	CUBE	LIST PRICE BY LAMINATE GRADE	
						L1	L2
	Standing-Height Desk Shell						
	60"W x 30"D x 42"H	57½"W x 24½"D x 41⅝"H	H105397	185	6.2	\$888	\$928
	60"W x 24"D x 42"H	57½"W x 22¾"D x 41⅝"H	H105393	154	5.1	\$819	\$859
	48"W x 24"D x 42"H	45⅞"W x 22¾"D x 41⅝"H	H105392	143	4.2	\$766	\$801
	NOTES: Fixed height surface is 42"H. When combined with a stool-height task chair, provides users the benefit of alternating their work between a seated or standing position without the additional cost of an adjustable-height mechanism. Short, 22⅝" modesty panel provides over 18" of wall access; makes reaching wall electrical outlets quick and easy. Box/File Pedestal (H10501) attaches to the underside of the worksurface top to position supplies and files within easy reach.						
	Standing-Height Return Shell						
	48"W x 24"D x 42"H	47"W x 22¾"D x 41⅝"H	H105663	96	3.1	\$643	\$678
	NOTES: Non-handed design. Attaches to sit/stand desk shells to form an L-shaped workstation. Short, 22⅝" modesty panel makes reaching wall electrical outlets quick and easy. One cord management grommet in top for routing and hiding wires and cables. Grommet can be replaced with optional Power Hub (model HGRMTAC). Box/File Pedestal (H10501) attaches to the underside of the worksurface top to position supplies and files within easy reach.						

NOTES:

- 42"H shells help support a healthy work style by allowing users to switch between sitting and standing.
- Non-handed desk and return shells maximize office layout flexibility. Products can be reconfigured quickly and easily when user preferences or space needs change.
- Tops and end panels are abrasion- and stain-resistant laminate over durable 1⅝" solid core high-performance particleboard; resists warping.
- For additional components see pages 298-325.
- Mobile pedestals, shown on page 311, work well in a variety of applications and configurations.
- Adjustable hex leveling glides allow floor-standing furniture to be easily leveled without lifting the unit; glides have ¾" adjustable range.

HOW TO SPECIFY

Select Model Number H 1 0 5 3 9 7 .	Select Laminate Top and Chassis Color See pages 266-267 N N
---	--

10500 SERIES™

Laminate Modular Components

GSA SIN 33721



Icon Legend on page 19

Model H105686
shown

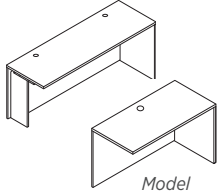

Model
H105686
shown

DESCRIPTION	INSIDE DIMENSIONS	MODEL	SHIP WEIGHT	CUBE	LIST PRICE BY LAMINATE GRADE	
					L1	L2
Return Shell (with full modesty panel)						
72"W x 24"D x 29½"H, (w/support; 2 grommets)	67"W x 22¾"D	H105686	145	5.4	\$738	\$778
60"W x 24"D x 29½"H, (w/support; 2 grommets)	55"W x 22¾"D	H105684	129	4.4	\$676	\$711
48"W x 24"D x 29½"H, (1 grommet)	47"W x 22¾"D	H10561	86	3.7	\$556	\$586
42"W x 24"D x 29½"H, (1 grommet)	41"W x 22¾"D	H105681	89	2.5	\$522	\$552
36"W x 24"D x 29½"H, (1 grommet)	34⅞"W x 22¾"D	H105680	83	3.2	\$522	\$547
30"W x 24"D x 29½"H, (1 grommet)	28⅞"W x 22¾"D	H10568	69	2.6	\$499	\$524

NOTES: Shells are non-handed. No pre-drilled grommet in modesty panel (field installable grommet included). Woodgrain direction on modesty/back panel runs vertical on 30"W-60"W sizes and horizontal on 72"W unit. 36"W return shell can be used to achieve a 6' x 6' L-shaped footprint when connected to either a 72"W x 36"D single pedestal desk, desk shell, or peninsula, or when two are connected to 36"W corner unit model H105811. 30"W return shell can be used to accomplish a 5' x 5' L-shaped footprint when connected to a 60"W x 30"D desk shell or peninsula. See pages 302-303 for optional stack-on storage.

⚠ Not designed to attach to corner units manufactured prior to 5/24/99.

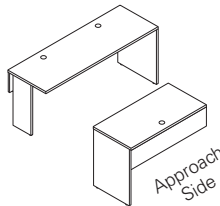

Return Shell (with 10"H modesty panel)						
72"W x 24"D x 29½"H, (w/support; 2 grommets)	67"W x 22¾"D	H105686X	106	4.6	\$738	\$778
60"W x 24"D x 29½"H, (w/support; 2 grommets)	55"W x 22¾"D	H105684X	93	3.9	\$676	\$711
48"W x 24"D x 29½"H, (1 grommet)	47"W x 22¾"D	H10561X	78	3.1	\$556	\$586
42"W x 24"D x 29½"H, (1 grommet)	41"W x 22¾"D	H105681X	69	3.8	\$522	\$552
36"W x 24"D x 29½"H, (1 grommet)	34⅞"W x 22¾"D	H105680X	67	3.8	\$522	\$547
30"W x 24"D x 29½"H, (1 grommet)	28⅞"W x 22¾"D	H10568X	56	2.6	\$499	\$524

NOTES: Makes reaching wall electrical outlets quick and easy. Provides more than 18" of clearance. See pages 302-303 for optional stack-on storage.

NOTES:

- Non-handed desk, credenza, and return shells, combined with a variety of under-the-worksurface storage solutions, maximize office layout flexibility. Products can be reconfigured quickly and easily when user preferences or space needs change.
- For additional components see pages 298-325.
- Tops and end panels are abrasion- and stain-resistant laminate over durable 1⅞" solid core high-performance particleboard; resists warping.
- Cord management grommets, for routing and hiding wires and cables, are located in the tops of desks and return shells.
- Adjustable hex leveling glides allow floor-standing furniture to be easily leveled without lifting the unit; glides have ¾" adjustable range.
- 36"W and 30"W return shells enable L-shaped layouts for smaller spaces.
- One cord management grommet in tops of Return Shell models, H10568 and H10568X, is used for routing and hiding wires and cables. The 3" round grommet can be replaced with optional Power Hub or Power/USB Hub — see page 324.

HOW TO SPECIFY

Select
Model Number

H 1 0 5 6 8 6 .

Select
Laminate Top and Chassis Color

See pages 266-267

N N



Icon Legend on page 19

10500 SERIES™ Worksurfaces

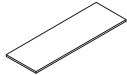
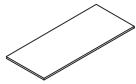

DESCRIPTION

Rectangle Worksurface

84"W x 30"D
78"W x 30"D
72"W x 30"D
66"W x 30"D
60"W x 30"D
48"W x 30"D

84"W x 24"D
78"W x 24"D
72"W x 24"D
66"W x 24"D
60"W x 24"D
48"W x 24"D
42"W x 24"D
36"W x 24"D
30"W x 24"D

MODEL	SHIP WEIGHT	CUBE	LIST PRICE BY LAMINATE GRADE	
			L1	L2
H105R3084	88	6.5	\$504	\$529
H105R3078	81	6.1	\$455	\$480
H105R3072	83	6.1	\$427	\$447
H105R3066	76	6.1	\$397	\$417
H105R3060	69	5.2	\$370	\$390
H105R3048	55	4.1	\$304	\$319
H105R2484	70	5.3	\$464	\$489
H105R2478	65	4.9	\$413	\$433
H105R2472	66	4.9	\$363	\$383
H105R2466	61	4.9	\$351	\$371
H105R2460	55	4.2	\$330	\$350
H105R2448	44	3.4	\$280	\$295
H105R2442	39	3.0	\$254	\$269
H105R2436	30	2.4	\$220	\$235
H105R2430	25	2.0	\$220	\$235

NOTES: Underside of rectangle worksurfaces includes pilot mounting holes for end panels, support columns, post legs, H-legs, and O-legs, and height adjustable base. Applications for 24"D worksurfaces include desks, credenzas, returns, and bridges. For Above Privacy Screen sizes, see page 212.



Bullet Worksurface

72"W x 30"D
66"W x 30"D
60"W x 30"D

60"W x 24"D

H105B3072	79	6.1	\$443	\$463
H105B3066	73	6.1	\$418	\$438
H105B3060	66	5.2	\$399	\$419
H105B2460	45	4.2	\$342	\$357

NOTES: Applications include use as a peninsula in a U- or L-shaped workstation or as an island extension. One flat bracket (mounting plate) ships with each worksurface for applications requiring connection to an adjoining worksurface. Underside includes pilot mounting holes for T- and L-shaped end panels, H-leg, O-leg, support column, post leg, or flat bracket. Grain direction runs horizontal.

ⓘ When specifying 60"W Floating Modesty Panel, it is not necessary to specify an external channel.

DESCRIPTION

External Support Channel

42"W for a 54" Worksurface
48"W for a 60" Worksurface
54"W for a 66" Worksurface
60"W for a 72" Worksurface
72"W for an 84" Worksurface

ⓘ Available in Graphite paint only.

ⓘ When specifying panel-hung worksurfaces, specify external channel as if supported by two H-legs or O-legs via selection chart.

ⓘ When specifying a 54"W or 60"W Floating Modesty Panel, it is not necessary to specify an external channel.

MODEL

SHIP WEIGHT

CUBE

LIST PRICE

HLSLZ5SC54 ⓘ	5	0.5	\$101
HLSLZ5SC60	6	0.5	\$106
HLSLZ5SC66	7	0.5	\$110
HLSLZ5SC72	7	0.5	\$119
HLSLZ5SC84	12	0.7	\$119

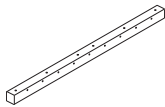

NOTES:

- Easy-care, scratch-, spill- and stain-resistant laminate over 1/8" solid core high-performance particleboard.
- Grain direction on all worksurfaces runs horizontal.
- One flat bracket (mounting plate) ships with each worksurface for applications requiring connection to an adjoining worksurface.
- For standing-height requirements, use worksurface with 41"H laminate L-shaped end panel or metal O-leg.
- For 30", 36", 42" and 48"W x 24"D mobile desks and tables, use post leg with casters model HMBPOST.C.
- For end panels, legs, columns and bases, see the Worksurface Supports listing on pages 280-281.
- When using a floating modesty panel or an external channel under the worksurface, the depth clearance for keyboard trays and center drawers decreases by 8". See accessory matrix in accessory section of the pricer.

ⓘ 84"W worksurfaces are for 29 1/2"H applications only (not 42"H) and require a T-support brace or other weight-bearing floor support to be positioned between the O-legs or L-shaped end panels.

ⓘ Worksurfaces are subject to slight bowing. The magnitude of the deflection is dependent upon the weight, placement, and duration of the load.

ⓘ When using a worksurface as a bridge, no additional supports are needed. One support is required for returns, two supports are required for desks and credenzas.

ⓘ External channel support is recommended for extended unsupported spans or heavily loaded worksurfaces. See above for details.

EXTERNAL SUPPORT CHANNEL (Model HLSLZ5SCxx) — RECOMMENDED USE							
	Support Combination		Rectangle Worksurface Width				
	Support 1	Support 2	60"	66"	72"	78"	84"
O-Leg	O-Leg	O-Leg	66	72	78	84	NA
	O-Leg	4 1/2" Dia. Support Column	NR	60	66	72	78
	O-Leg	2" Square Post Leg	NR	60	66	72	78
L-Shaped End Panel	L End Panel	L End Panel	NR	60	66	72	78
	L End Panel	O-Leg	60	66	72	78	84
	L End Panel	4 1/2" Dia. Support Column	NR	60	66	72	78
	L End Panel	2" Square Post Leg	NR	60	66	72	78
T-Shaped End Panel	T End Panel	O-Leg	60	66	72	78	84
	T End Panel	4 1/2" Dia. Support Column	NR	60	66	72	78
	T End Panel	2" Square Post Leg	NR	60	66	72	78
Return Config End Panel	None	O-Leg	66	72	78	84	NA
	None	L End Panel	60	66	72	78	84

HOW TO SPECIFY

<p>Select Model Number</p> <p>H 1 0 5 R 3 0 7 2</p>	<p>Select Worksurface Laminate and Edge Color</p> <p>See pages 266-267</p> <p>N N</p>
--	--

10500 SERIES™ Worksurface Supports

GSA SIN 33721



Icon Legend on page 19

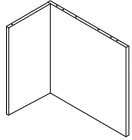

Not available in two-tone laminate

DESCRIPTION	MODEL	SHIP WEIGHT	CUBE	LIST PRICE BY LAMINATE GRADE	
				L1	L2
L-shaped End Panel					
15¾"W x 29⅞"D x 28½"H	H10530LEP	49	4.1	\$306	\$318
15¾"W x 23⅞"D x 28½"H	H10524LEP	43	3.7	\$287	\$299
15¾"W x 29⅞"D x 41"H	H1053041LEP	68	4.2	\$386	\$406
15¾"W x 23⅞"D x 41"H	H1052441LEP	60	3.4	\$349	\$369

NOTES: Non-handed. 29⅞"D for use with 48"-78"W x 30"D worksurfaces; 23⅞"D for use with 30"-78"W x 24"D worksurfaces. Not for use with 84"W unless additional floor supports are placed between the end panels. Design facilitates easy, open access to wall electrical outlets. Adjustable hex glides allow floor-standing units to be easily leveled without lifting to compensate for uneven floors. Glides have ¾" adjustable range. Two pieces; 1⅞" end panel and ¾" back panel. 10500 Series™ modular and mobile pedestals fit flush to the end panel. Simple assembly.

⚠ Not designed to be used freestanding.

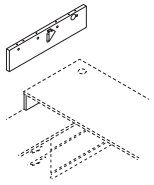

HNLEP307L shown

DESCRIPTION	MODEL	SHIP WEIGHT	CUBE	L1	L2
Laminate End Panel — 7"H Support for Worksurfaces					
1⅞"W x 30"D x 7"H, Right	HNLEP307R	7	0.7	\$147	\$10
1⅞"W x 30"D x 7"H, Left	HNLEP307L	7	0.7	\$147	\$10
1⅞"W x 24"D x 7"H, Right	HNLEP247R	6	0.7	\$147	\$10
1⅞"W x 24"D x 7"H, Left	HNLEP247L	6	0.7	\$147	\$10

NOTES: Specifically for layered surface applications; used to support a 29½"H component worksurface over a 21½"H low credenza unit. 1⅞" thick. Handed design (left and right models). Includes cord routing notch. Bottom of end panel is edgedbanded for added strength and to seal out moisture. Attaches to underside of worksurface via cam fasteners and L-bracket; attaches to top of low credenza with double-sided tape. Can be specified in a woodgrain or solid laminate color only. For 7"H metal O-leg support see page 92.

SPECIFYING EXAMPLE: HNLEP307R.H

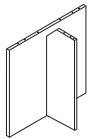

Not available in two-tone laminate

DESCRIPTION	MODEL	SHIP WEIGHT	CUBE	L1	L2
T-shaped End Panel					
11⅝"W x 29⅞"D x 28½"H	H10530TEP	45	3.7	\$281	\$293
11⅝"W x 23⅞"D x 28½"H	H10524TEP	38	3.2	\$263	\$275

NOTES: Non-handed. For use with 30"D and 24"D 10500 Series worksurfaces. Two 1⅞" thick pieces; one end and one brace panel. Cord routing notch in brace panel. Simple assembly.

⚠ Not designed to be used freestanding.

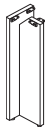

Not available in two-tone laminate

DESCRIPTION	MODEL	SHIP WEIGHT	CUBE	L1	L2
T-Support Brace					
8"W x 8"D x 28½"H	H10524TSUPP	14	0.8	\$238	\$253

NOTES: Intermediate support option for 29½"H workstations. Designed for 24"D and 30"D worksurfaces without a modesty or back panel, with an unsupported span greater than 48"W. Can be used to support the junction of two 24"D adjoining linear worksurfaces. Adjustable hex glides allow floor-standing units to be easily leveled without lifting to compensate for uneven floors; glides have ¾" adjustable range. Simple assembly.

NOTES:

- Adjustable hex leveling glides allow floor-standing furniture to be easily leveled without lifting the unit; glides have ¾" adjustable range.
- ⚠ Laminate L- and T-shaped end panels can be specified as one color only; not available in two-tone laminate combination or in a pattern laminate.

HOW TO SPECIFY

<p>Select Model Number</p> <p>H 1 0 5 3 0 T E P . N</p>	<p>Select Laminate</p> <p>See pages 266-267</p>
---	---



10500 SERIES™ Worksurface Supports

**DESCRIPTION****Support Column for 10500 Series Rectangle and Bullet Worksurfaces**

3" Diameter
For **Black**, specify HPC190X.P.
For **Silver**, specify HPC191X.X.

MODEL SHIP WEIGHT CUBE LIST PRICE

HPC190X	12 Ⓞ	1.0	\$173
HPC191X	12 Ⓞ	1.0	\$173

NOTES: Can only be used as the outbound support in a peninsula or island extension worksurface application. Glides have 3/4" adjustable range.

! Support column must be specified for worksurfaces used as peninsulas or as an island extension.

**DESCRIPTION**

Post Leg Base
28 1/2" H x 2" square

MODEL	SHIP WEIGHT	CUBE	LIST PRICE BY PAINT GRADE		
			P1	P2	P3

HLSL28P	15	1.0	\$321	\$325	\$341
----------------	----	-----	--------------	--------------	--------------

NOTES: Can only be used as the outbound support in a peninsula or island extension worksurface application. Glides have 2" of adjustability. Ship 1/pack.

! Post leg can only be used to support peninsula, not as primary supports for a top.

SPECIFYING EXAMPLE: HLSL28P.T1

24" D Rectangle Worksurface Support Options

Product Application	Support Combination		Support Model Numbers for 72" W, 66" W, or 60" W Worksurfaces	Support Model Numbers for 48" W or 42" W Worksurfaces
	Support 1	Support 2		
Desk or Credenza	O-Leg	O-Leg	HLSL24280 (2)	HLSL24280 (2)
	O-Leg	L-Shaped End Panel	HLSL24280 / H10524LEP	HLSL24280 / H10524LEP
	L-Shaped End Panel	L-Shaped End Panel	H10524LEP (2)	H10524LEP (2)
	T-Shaped End Panel	O-Leg	H10524TEP / HLSL24280	H10524TEP / HLSL24280
	T-Shaped End Panel	L-Shaped End Panel	H10524TEP / H10524LEP	H10524TEP / H10524LEP
Peninsula for U- or L-Configuration; Not Freestanding	O-Leg	3" Diameter Support Column	HLSL24280 / HPC190X-191X	NA
	O-Leg	2" Square Post Leg	HLSL24280 / HLSL28P	NA
	L-Shaped End Panel	3" Diameter Support Column	H10524LEP / HPC190X-191X	NA
	L-Shaped End Panel	2" Square Post Leg	H10524LEP / HLSL28P	NA
	T-Shaped End Panel	3" Diameter Support Column	H10524TEP / HPC190X-191X	NA
	T-Shaped End Panel	2" Square Post Leg	H10524TEP / HLSL28P	NA
Desk, Credenza, or Freestanding Return or Bridge	Adjustable Height Base - Electric		HHATB3S2LT/C	HHATB3S2LT/C (48" W min.)
Return (requires one support)	O-Leg	—	HLSL24280	HLSL24280
	L-Shaped End Panel	—	H10524LEP	H10524LEP
	T-Shaped End Panel	—	H10524TEP	H10524TEP
	3" Diameter Support Column	—	HPC190X or HPC191X	HPC190X or HPC191X
	2" Square Post Leg	—	HLSL28P	HLSL28P
Island Extension (requires one support)	O-Leg	—	HLSL24280	HLSL24280
	3" Diameter Support Column	—	HPC190X or HPC191X	HPC190X or HPC191X
	2" Square Post Leg	—	HLSL28P	HLSL28P

72" W, 66" W, or 60" W x 30" D Bullet Worksurface Support Options

Product Application	Support Combination		Support Model Numbers
	Support 1	Support 2	
Peninsula for U- or L-Configuration; Not Freestanding	O-Leg	3" Diameter Support Column	HLSL30280 / HPC190X or HPC191X
	O-Leg	2" Square Post Leg	HLSL30280 / HLSL28P
	L-Shaped End Panel	3" Diameter Support Column	H10530LEP / HPC190X or HPC191X
	L-Shaped End Panel	2" Square Post Leg	H10530LEP / HLSL28P
	T-Shaped End Panel	3" Diameter Support Column	H10530TEP / HPC190X or HPC191X
	T-Shaped End Panel	2" Square Post Leg	H10530TEP / HLSL28P
Island Extension	3" Diameter Support Column	—	HPC190X or HPC191X
	2" Square Post Leg	—	HLSL28P

HOW TO SPECIFY

Select
Model Number

H P C 1 9 0 X .

Select
Paint Color

See page 183

T 1

10500 SERIES™ Worksurface Supports

OPEN MARKET



Icon Legend on page 19

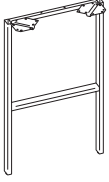

DESCRIPTION	MODEL	SHIP WEIGHT	CUBE	LIST PRICE BY PAINT GRADE		
				P1	P2	P3
H-Leg Support for Worksurfaces 30"W x 28 ³ / ₈ "H 24"W x 28 ³ / ₈ "H	H105HLEG3028	13.6	5.1	\$374	\$378	\$394
	H105HLEG2428	12.5	3.7	\$335	\$339	\$355
Standing-Height H-Leg Support for Worksurfaces 30"W x 41"H 24"W x 41"H	H105HLEG3041	16.5	6.5	\$503	\$511	\$523
	H105HLEG2441	15.4	5.3	\$450	\$458	\$470

NOTES:

- Legs ship fully assembled with mounting hardware, 1 per pack. Non-handed. H-leg glides have 2" adjustability. Will have 6" overhang when using 30"D H-legs with a 36"D worksurface.

! The H-leg attachment bracket interferes with placement of 10500 Series™ modular pedestals and 28³/₈"H mobile pedestals, preventing them from being positioned directly next to (flush with) the H-leg. Box/File mobile pedestal model H105106 and mobile printer/fax cart model H105679 can be positioned along side the H-leg.

! O- and H-legs may only be attached to worksurfaces, not storage units.

HOW TO SPECIFY

Select Model Number

H105HLEG2441.

Select Paint Color











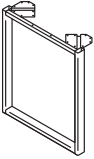



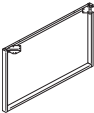

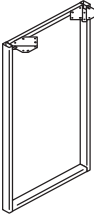

See page 183

T1

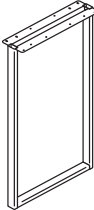

Icon Legend on page 19

10500 SERIES™ Worksurface Supports

	DESCRIPTION	MODEL	SHIP WEIGHT	CUBE	LIST PRICE BY PAINT GRADE		
					P1	P2	P3
  	O-Leg 30"D x 28½"H 24"D x 28½"H	HLSL30280  HLSL24280	19.0 17.0	5.4 3.7	\$395 \$357	\$399 \$361	\$415 \$377
	NOTES: Ship fully assembled with mounting hardware, 1/pack. Non-handed. O-leg glides have 2" adjustability. Shared O-legs create a cleaner aesthetic in all applications where two legs are used side-by-side. Will have 6" overhang when using 30"D O-legs with a 36"D worksurface. IMPORTANT: The O-leg attachment bracket interferes with placement of 10500 Series modular pedestals and 28¾"H mobile pedestals, preventing them from being positioned directly next to (flush with) the O-leg. Box/file mobile pedestal (model H105106) and mobile printer/fax cart model (H105679) can be positioned along side the O-leg.  O-legs may only be attached to worksurfaces, not storage units. SPECIFYING EXAMPLE: HLSL24280.T1						
  	Double-Depth O-Leg Support for Worksurfaces 60"D x 28½"H 48"D x 28½"H	HLSL60280 HLSL48280	19.0 18.0	8.7 7.0	\$746 \$670	\$754 \$678	\$766 \$690
	NOTES: Ship fully assembled with mounting hardware, 1/package. Non-handed. 48"D and 60"D sizes span back-to-back 24"D and 30"D worksurfaces, respectively. O-leg glides have 2" adjustability. Shared O-legs create a cleaner aesthetic in all applications where two legs are used side-by-side. Will have 6" overhang when using 30"D O-legs with a 36"D worksurface.  O-legs may only be attached to worksurfaces, not storage units.						
  	Standing-Height O-Leg Support for Worksurfaces 30"D x 41"H 24"D x 41"H	HLSL30410 HLSL24410	17.0 16.0	6.5 5.3	\$533 \$476	\$539 \$482	\$553 \$496
	NOTES: Ship fully assembled with mounting hardware, 1/package. Non-handed. O-leg glides have 2" adjustability. O-leg installation requires 6" of clearance from the worksurface end. Shared O-legs create a cleaner aesthetic in all applications where two legs are used side-by-side. Will have 6" overhang when using 30"D O-legs with a 36"D worksurface. Coordinate™ Power Modules will work with standing-height applications for 10500™ and Voi® desks.  O-legs may only be attached to worksurfaces, not storage units.						
  	Standing-Height O-Leg Shared Support for Worksurfaces 30"D x 41"H 24"D x 41"H	HLSL3041SL HLSL2441SL	17.0 16.0	6.5 5.3	\$593 \$537	\$599 \$543	\$613 \$557
	NOTES: Ship fully assembled with mounting hardware, 1/package. Non-handed. For use with two 24"D or 30"D worksurfaces positioned side-by-side along the depth dimension. O-leg glides have 2" adjustability. O-leg installation requires 6" of clearance from the worksurface end. Shared O-legs create a cleaner aesthetic in all applications where two legs are used side-by-side. Will have 6" overhang when using 30"D O-legs with a 36"D worksurface. Coordinate™ Power Modules will work with standing-height applications for 10500™ and Voi® desks. Please see Coordinate™ Accessories Stand-Alone Pricer pages for more information.  O-legs may only be attached to worksurfaces, not storage units.						
 OPEN MARKET	O-Leg Cord Clips Clips for 28½" Worksurface O-Legs — 8-Pack	HWMCLIPG	0.8 	0.1	\$110	N/A	N/A
	NOTES: Wire clips work with 7" Low Credenza O-leg and 29"H Support O-leg. Wire clips also work with the 50" and 65" Hutch O-legs. For additional information see the Workplace Tools section in the 2021 Shared Spaces Pricer.  Available in frosted plastic material only.						

NOTES:

 For shared components such as modesty panels and Privacy Screens see pages 210-212.

HOW TO SPECIFY

Select Model Number HLSL30280	Select Paint Color See page 183 T1
---	---

10500 SERIES™ Worksurface Supports

GSA SIN 33721 EXCEPT AS NOTED



Icon Legend on page 19

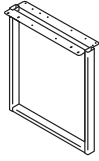

DESCRIPTION

O-Leg Shared Support for Worksurfaces

30"D x 28½"H
24"D x 28½"H

MODEL

HLSL3028SL ⓘ
HLSL2428SL

SHIP WEIGHT

19
17

CUBE

5.4
3.7

LIST PRICE BY PAINT GRADE

P1	P2	P3
\$491	\$495	\$511
\$443	\$447	\$463

NOTES: Ship fully assembled, 1/pack. Non-handed.

ⓘ Specify paint only.

SPECIFYING EXAMPLE: HLSL2028SL.T1

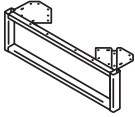

O-Leg Support for Low Credenzas

30"D x 7"H
24"D x 7"H

HLSL3070 ⓘ
HLSL2470

7
6

1.0
1.0

P1	P2	P3
\$305	\$309	\$325
\$240	\$244	\$260

NOTES: Ship fully assembled, 1/pack. Non-handed. For 7"H laminate support see page 90.

ⓘ Specify paint only.

SPECIFYING EXAMPLE: HLSL2070.T1

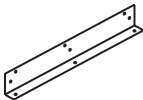

HVPWLBK24 shown

DESCRIPTION

Worksurface Wall Mount Bracket

For 30"
For 24"

MODEL

HVPWLBK30
HVPWLBK24

SHIP WEIGHT

2
2

CUBE

0.3
0.3

LIST PRICE

\$99
\$90

NOTES: Can be used in place of an end panel or O-leg to support a worksurface. Cannot be used as a support when placing a stack-on storage unit on worksurface over bracket; must have two full-sized floor supports when using stack-on storage. Finish option not required.

SPECIFYING EXAMPLE: HVPWLBK30

OPEN MARKET



DESCRIPTION

Worksurface to Tower Bracket Kit

18½" long bracket for attaching 24"D worksurface directly to storage tower, wardrobe/bookcase, wardrobe/storage cabinet, storage cabinet/lateral file, storage cabinet, or lateral file.

MODEL

HSTB2W1

SHIP WEIGHT

4

CUBE

0.6

LIST PRICE BY PAINT GRADE

P1	P2	P3
\$88	\$101	\$103

NOTES: Can be used in place of end panel or O-leg to support worksurfaces.

ⓘ Bracket not designed for use as a support if placing Stack-on Storage on worksurface over/above bracket. Two full-sized supports required when using Stack-on Storage.

NOTES:

- O-leg glides have 2" adjustability.
- For shared components such as modesty panels and Privacy Screens see pages 210-212.
- O-leg ships fully assembled with mounting hardware.
- For standing-height O-leg sizes, see page 283.
- Shared O-legs create a cleaner aesthetic in all applications where two legs are used side-by-side.
- Will have 6" overhang when using 30"D O-legs with a 36"D worksurface.

ⓘ O-legs may only be attached to worksurfaces, not storage units.

ⓘ O-leg installation requires 6" of clearance from the worksurface end.

HOW TO SPECIFY

<p>Select Model Number</p> <p>HVPWLBK30 . T1</p>	<p>Select Paint Color</p> <p>See page 183</p>
--	---

10500 SERIES™

Components — Supports

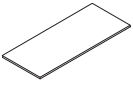
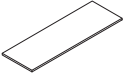
	DESCRIPTION	MODEL	SHIP WEIGHT	CUBE	LIST PRICE BY LAMINATE GRADE	
					L1	L2
	Rectangle Worksurface					
	72"W x 30"D	H105R3072	83	6.1	\$427	\$447
	66"W x 30"D	H105R3066	76	6.1	\$397	\$417
	60"W x 30"D	H105R3060	69	5.2	\$370	\$390
	48"W x 30"D	H105R3048	55	4.1	\$304	\$319
	72"W x 24"D	H105R2472	66	4.9	\$363	\$383
	66"W x 24"D	H105R2466	61	4.9	\$351	\$371
	60"W x 24"D	H105R2460	55	4.2	\$330	\$350
	48"W x 24"D	H105R2448	44	3.4	\$280	\$295
	42"W x 24"D	H105R2442	39	3.0	\$254	\$269

NOTES: Underside of rectangle worksurfaces includes pilot mounting holes for end panels, support columns, post and O-legs, and height adjustable base. Applications for 24"D worksurfaces include desks, credenzas, returns, and bridges. The 42"W x 24"D size is not compatible with Height Adjustable Base model HHATB3S2LT/C; it can however, be used in combination with the 72"W x 30"D worksurface on 3-Leg Height Adjustable Base model HHATB3S3LT. For Above Privacy Screen sizes, see page 212.

NOTES:

- Height Adjustable Base is a 3-stage column design.
- Frame rises from 21⁵/₈" to 47³/₄" for a sit-to-stand desk option.
- Height Adjustable Bases shipped complete with a pre-assembled motor.
- Base telescopes to accommodate any worksurface between 48"W and 72"W.
- Height Adjustable Base accommodates rectangular worksurfaces between 24"D x 48"W and 30"D x 72"W. Systems, Voi®, 10500, and Preside® all have worksurfaces within this range.
- Comes standard with one-touch, four memory controller with digital display; no specification needed, available in black finish only.
- Standard height adjustable control ships with base.
- Dynamic load capacity when worksurface is moving is 250 lbs.
- ! If using worksurfaces with Coordinate™ Height Adjustable Bases, an External Stiffener must be specified separately.
- ! Worksurfaces used with Coordinate™ Height Adjustable Bases should have 1" perimeter gap on each side to provide clearance between other furniture. Failure to do so risks injury or product damage (not covered by warranty).

HOW TO SPECIFY

Select Model Number	Select Laminate
	See pages 266-267
H 1 0 5 R 3 0 7 2	N N

10500 SERIES™ Height Adjustable Bases

GSA SIN AS NOTED



Icon Legend on page 19

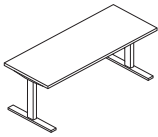

Base shown with work surface attached.

OPEN MARKET

DESCRIPTION

Coordinate™ Height Adjustable Base – 2 Stage
2-Leg Rectangle T Foot

MODEL

HHATB2S2LT

SHIP WEIGHT

66.0

CUBE

2.4

LIST PRICE

\$950

NOTES:

- Dual motor two-leg design. Legs raise from 25⁵/₈" to 45¹/₄".
- Base accommodates any rectangular work surface between 23"D x 40"W and 30"D x 72"W.
- Weight capacity of 250 lbs. (including the weight of the work surface) distributed evenly.
- Control Box: 120V, 4A, 60Hz, 400W.
- 9' grounded power cord.
- 1¹/₂" / second travel speed.
- <50 dB noise rating.
- **HON 10-Year Warranty.**

ⓘ Requires the use of an external stiffener (purchased separately) for work surfaces over 58"W or wider when not used with a Coordinate™ work surface.

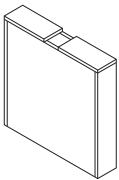

Not available in two-tone laminate.

SIN 33721

Shroud for Height Adjustable Base

5¹/₈" W x 26" D x 24¹/₄" H for Base with 30" D Top

HLAMSHB30

39.0

3.7

\$899

NOTES: Decorative laminate enclosure covers the Coordinate™ metal leg and foot. For use with standard 10500 Series™, Concinnity™, and Voi® rectangle work surfaces, 48-72"W x 30"D, supported by Height Adjustable Base model HHATB2S2LT. For height adjustable desks requiring a modesty panel, options include: 14"H laminate (HLSLXX14L) or mixed material (HLSLXX14MM) floating modesty panels, laminate full length (HNLMPXX28) or short (HNLMPXX10) modesty/back panel plus external support channel (HLSLZ5SCXX). External support channel attachment screws and modesty/back panel cover caps are included in the shroud hardware pack. External support channel size recommendation, specific to work surface attached to Height Adjustable Base with optional laminate full-length or short modesty back/panel (HNLMPXX28/10) see below. Ships one per carton. To conceal both metal legs on the Height Adjustable Base order two. When using a modesty panel set height adjustable table at 29"H to ensure table stops before hitting shroud.

Specify: Model.Laminate; see pages 266-267.

SPECIFYING EXAMPLE: HLAMSHB30.N

- ⓘ Lowest base adjustment position when the shroud is installed is 29¹/₂" H; memory controller must be set at that height to avoid interference.
- ⓘ The Height Adjustable Base must be reset at the time of installation, after every loss of power, if the unit is not functioning properly, or if the legs are uneven. To reset the base requires removing the laminate shroud(s), as well as the full-length modesty panel if one is being used, then adjusting the base to its lowest position. Disassembly of the shroud is quick and easy.
- ⓘ \$25 upcharge for L2 laminates.

Work surface Width	Modesty/Back Panel Width	External Support Channel
72"W	72"W	HLSLZ5SC78
66"W	66"W	HLSLZ5SC72
60"W	60"W	HLSLZ5SC66
54"W	54"W	HLSLZ5SC60
48"W	48"W	HLSLZ5SC54



SIN 33721

Under Work surface Power Module – 4 Outlets, 10' Cord

HPWRMOD2

1.5

0.2

\$441

- Includes 10' cord with three-prong plug.
- Fits in cable management troughs. See page 242.
- 4 outlets on side create easy access.

NOTES: Power Modules will also work with standing-height applications for 10500 Series™ and Voi® desks. For additional information see the Workplace Tools section in the 2021 Shared Spaces Pricer.

- ⓘ Available in black finish only, no specification needed.

NOTES:

- ⓘ Coordinate™ Height Adjustable Bases not compatible with 36"D rectangular work surfaces.

HOW TO SPECIFY

Select Model Number HHATB2S2LT	Select Paint Color See page 116 P71	Select Foot X Standard Foot S Slide Glide X	Select Keypad UD Basic Up/Down MEM Memory Preset PDL Paddle FPD Foot Pedal (+ \$175) MEM
--	--	---	--



10500 SERIES™ Shared Components

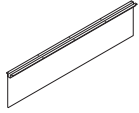

DESCRIPTION	MODEL	SHIP WEIGHT	CUBE	LIST PRICE BY LAMINATE GRADE	
				L1	L2
Laminate Floating Modesty Panel					
60"W x 14"H	HLSL6014L	20	1.1	\$277	\$289
54"W x 14"H	HLSL5414L	18	1.1	\$258	\$270
48"W x 14"H	HLSL4814L	16	1.1	\$236	\$248
42"W x 14"H	HLSL4214L	14	0.8	\$214	\$224
36"W x 14"H	HLSL3614L	12	0.8	\$202	\$212
30"W x 14"H	HLSL3014L	10	0.8	\$191	\$201

NOTES: The attachment bracket and modesty panel are packaged separately.

Specify: Model.Laminate.Paint

SPECIFYING EXAMPLE: HLSL3014L.N.P (Black is the only paint option for this model)

ⓘ When specifying the 54"W or 60"W Laminate Floating Modesty Panel, it is not necessary to specify an external channel.

ⓘ 30"W and 36"W screens attach with L-brackets, not the external channel.

NOTES:

- Laminate or mixed material floating modesty panels options are available for attachment under 10500 Series worksurfaces. The modesty panel and attachment bracket are packaged separately.
- If using a 54"W or 60"W floating modesty panel, it is not necessary to specify an external support channel under the worksurface.
- When using a floating modesty panel under the worksurface, the depth clearance for center drawers and keyboard platforms decreases by 8".

FLOATING MODESTY PANELS - MODEL SELECTION GUIDE						
Support Combination		Rectangle Worksurface Width				
Support 1	Support 2	72 in	66 in	60 in	48 in	42 in
O-Leg	O-Leg	HLSL6014	HLSL5414	HLSL4814	HLSL3614	HLSL3014
O-Leg	L-Shaped End Panel	HLSL4814	HLSL4214	HLSL3614	NA	NA
O-Leg	4½" Diameter Support Column	HLSL4814	HLSL4814	HLSL4814	HLSL3614	HLSL3014
O-Leg	2" Square Post Leg	HLSL4814	HLSL4814	HLSL4814	HLSL3614	HLSL3014
L-Shaped End Panel	L-Shaped End Panel	HLSL3614	HLSL3014	NA	NA	NA
L-Shaped End Panel	4½" Diameter Support Column	HLSL3614	HLSL3614	HLSL3614	NA	NA
L-Shaped End Panel	2" Square Post Leg	HLSL3614	HLSL3614	HLSL3614	NA	NA
T-Shaped End Panel	O-Leg	HLSL5414	HLSL4814	HLSL4214	HLSL3014	NA
T-Shaped End Panel	L-Shaped End Panel	HLSL3614	HLSL3014	NA	NA	NA
T-Shaped End Panel	4½" Diameter Support Column	HLSL3614	HLSL3014	NA	NA	NA
T-Shaped End Panel	2" Square Post Leg	HLSL3614	HLSL3014	NA	NA	NA

Support Combination		Bullet Worksurface Width		
Support 1	Support 2	72 in	66 in	60 in
O-Leg	4½" Diameter Support Column	HLSL4814	HLSL4814	HLSL4814
O-Leg	2" Square Post Leg	HLSL4814	HLSL4814	HLSL4814
L-Shaped End Panel	4½" Diameter Support Column	HLSL3614	HLSL3614	HLSL3614
L-Shaped End Panel	2" Square Post Leg	HLSL3614	HLSL3614	HLSL3614
T-Shaped End Panel	4½" Diameter Support Column	HLSL3614	HLSL3614	HLSL3614
T-Shaped End Panel	2" Square Post Leg	HLSL3614	HLSL3614	HLSL3614

HOW TO SPECIFY

Select
Model Number

H L S L 3 0 1 4 L

Select
Laminate

See pages 266-267

N

10500 SERIES™

Shared Components

GSA SIN 33721

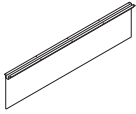

Icon Legend on page 19

**DESCRIPTION****Mixed Material Floating Modesty Panel**

60"W x 14"H
54"W x 14"H
48"W x 14"H
42"W x 14"H
36"W x 14"H
30"W x 14"H

MODEL

HLSL6014MM ☉
HLSL5414MM ☉
HLSL4814MM ☉
HLSL4214MM ☉
HLSL3614MM
HLSL3014MM

SHIP WEIGHT

13
13
11
9
8
8

CUBE

3.3
3.3
2.6
2.3
2.0
2.0

LIST PRICE

\$1243
\$1089
\$1002
\$906
\$810
\$755

NOTES: The attachment bracket and modesty panel are packaged separately. Laminate or mixed material floating modesty panels options are available for attachment under 10500 Series worksurfaces. The modesty panel and attachment bracket are packaged separately. If using a 54"W or 60"W floating modesty panel, it is not necessary to specify an external support channel under the worksurface. When using a floating modesty panel under the worksurface, the depth clearance for center drawers and keyboard platforms decreases by 8". See charts on previous page.

Specify: Model.Mixed Material.Paint

SPECIFYING EXAMPLE: HLSL3014MM.FT01.P (Frosted Translucent mixed material and Black paint are the only options for this model)

⚠ When specifying the 54"W or 60"W Mixed Material Floating Modesty Panel, it is not necessary to specify an external channel.

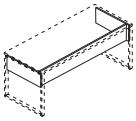

Not available in
two-tone laminate

Modesty Panels for Desks with O-Legs

68³/₈"W x 3¹/₄"D x 10"H — For 72" x 30" Desks
56³/₈"W x 3¹/₄"D x 10"H — For 60" x 30" Desks

HLAMMP7230
HLAMMP6030

26
23

2.1
1.8

\$307
\$280

NOTES: For use with 60"W or 72"W worksurfaces supported by O-legs. Comprised of three panels: one approach side and one for each end. Length below bottom of worksurface is 10". Steel external support channel (ordered separately) is recommended for unsupported spans greater than 54"W (i.e.: a distance in which there is not a vertical support between the underside of the worksurface and floor). Grain direction is vertical on approach and side panels for 56³/₈"W (all laminate colors) and 68³/₈"W (L1 laminate except Florence Walnut and Kingswood Walnut). Vertical on 27⁵/₈" end panels (all laminate colors). Horizontal on all panels for L2 laminates as well as Florence Walnut and Kingswood Walnut.

Specify: Model.Laminate

SPECIFYING EXAMPLE: HLAMMP7230.N

⚠ \$15 upcharge for L2 laminates. See pages 266-267 for laminate options.

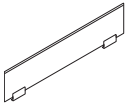
**Above Privacy Screen**

60"W x 13"H
54"W x 13"H
48"W x 13"H
42"W x 13"H
36"W x 13"H
30"W x 13"H

HLSL1260
HLSL1254
HLSL1248
HLSL1242
HLSL1236
HLSL1230

24
22
20
18
15
13

2.9
2.9
2.3
2.3
1.8
1.5

\$508
\$473
\$443
\$387
\$345
\$313

NOTES: Ships complete with attachment bracket. Bracket is Platinum only, no need to specify. Attaches to top of rectangle worksurfaces; requires a minimum overhang of 1¹/₂".

⚠ Available in Frosted Glass ONLY HLSL1230.G.

⚠ Above only Privacy Screen clamps onto worksurface and cannot be installed where support storage will be attached.

HOW TO SPECIFY

Select
Model Number

HLSL3014MM.

Select
Mixed Material

FT01 Frosted Translucent

FT01

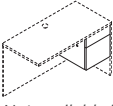
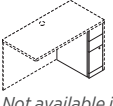
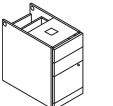
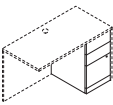
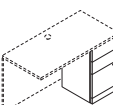

10500 SERIES™ Laminate Modular Components

	DESCRIPTION	MODEL	SHIP WEIGHT	CUBE	LIST PRICE BY LAMINATE GRADE	
					L1	L2
 Not available in two-tone laminate	Box/File Pedestal (with core removable lock) 15 $\frac{5}{8}$ "W x 22 $\frac{3}{4}$ "D x 17 $\frac{3}{4}$ "H — for use under 24"D, 30"D and 36"D desk, credenza and return shells NOTES: Attaches to underside of worksurface top. Lock can be positioned on either the right or left side. File drawer includes integrated hangrails for letter- or legal-sized folders. Not for use under 20"D shells. ⓘ Not designed to be used freestanding. Unfinished top and back.	H10501	57	5.5	\$555	\$575
 Not available in two-tone laminate	Narrow Box/Box/File Pedestal (with core removable lock) — floor-standing 9 $\frac{1}{2}$ "W x 22 $\frac{3}{4}$ "D x 28"H — for use under 24"D, 30"D and 36"D desk, credenza and return shells NOTES: Space-saving design supports smaller footprints. Middle box drawer and file drawer lock; top box drawer does not lock. File drawer includes integrated hangrails for side-to-side letter or legal filing. Not for use under 20"D shells. ⓘ Not designed to be used freestanding. Unfinished top and back.	H105093	61	5.6	\$717	\$742
 Not available in two-tone laminate	Box/Box/File Pedestal — floor-standing 15 $\frac{5}{8}$ "W x 28 $\frac{3}{4}$ "D x 28"H — for use under 10500 Series 30"D worksurfaces supported by 29 $\frac{7}{8}$ "D L-shaped end panel model H10530LEP NOTES: Top box drawer does not lock. File drawer includes integrated hangrails for letter- or legal-sized folders. Not for use under shells, per "Inside Dimensions" listings. ⓘ Not designed to be used freestanding. Unfinished top and back.	H105062	105	10.5	\$788	\$818
 Not available in two-tone laminate	Box/Box/File Pedestal (with core removable lock) — floor-standing 15 $\frac{5}{8}$ "W x 22 $\frac{3}{4}$ "D x 28"H — for use under 24"D, 30"D and 36"D desk, credenza and return shells or worksurface supported by 23 $\frac{7}{8}$ "D L-shaped end panel(s) NOTES: Top box drawer does not lock. File drawer includes integrated hangrails for letter- or legal-sized folders. Not for use under 20"D shells. ⓘ Not designed to be used freestanding. Unfinished top and back.	H10502	90	8.4	\$728	\$753
 Not available in two-tone laminate	Box/Box/File Pedestal (with core removable lock) — floor-standing 15 $\frac{5}{8}$ "W x 18 $\frac{3}{4}$ "D x 28"H — for use under 20"D, 24"D, 30"D and 36"D desk, credenza and return shells NOTES: Top box drawer does not lock. File drawer includes integrated hangrails for letter- or legal-sized hanging folders. ⓘ Not designed to be used freestanding. Unfinished top and back.	H105012	73	7.3	\$686	\$706

NOTES:

- Pedestals can be reconfigured quickly and easily when user preferences or space needs change.
- Locking units equipped with interchangeable core removable locks.
- Pedestal models ship assembled unless designated ☞.
- Mobile pedestals shown on page 311, work well in a variety of configurations.
- Narrow Pedestal features a compact design that is ideal for use in U- and L-shaped layouts for smaller spaces such as a 5' x 8' U-shaped workstation or a 5' x 5' L-shaped workstation.
- 10500 Series™ modular pedestals are for use with desk, credenza and return shells (see pages 274-278), as well as L-shaped end panels (page 280).
- ⓘ Keyed alike cores must be ordered separately — see model HF23B on page 773 — makes re-keying quick and easy.
- ⓘ Access strip (filler) required when box/box file, file/file, and or narrow box/box/file pedestals are configured side-by-side to allow access for opening the drawers.
- ⓘ Modular pedestals can be specified as one color only; not available in two-tone laminate combination or in a pattern laminate.

HOW TO SPECIFY



Select Model Number H 1 0 5 0 9 3	Select Laminate Chassis Color See pages 266-267 N
---	--

10500 SERIES™ Laminate Modular Components

GSA SIN 33721

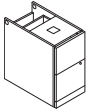
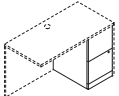
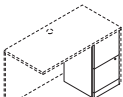

Icon Legend on page 19

	DESCRIPTION	MODEL	SHIP WEIGHT	CUBE	LIST PRICE BY LAMINATE GRADE	
					L1	L2
 Not available in two-tone laminate	File/File Pedestal — floor-standing 15 ⁵ / ₈ "W x 28 ³ / ₄ "D x 28"H — for use under 10500 Series 30"D worksurfaces supported by 29 ⁷ / ₈ "D L-shaped end panel model H10530LEP NOTES: File drawer includes integrated hangrails for letter- or legal-sized folders. Not for use under shells, per "Inside Dimensions" listings. ⓘ Not designed to be used freestanding. Unfinished top and back.	H105064	104	10.5	\$788	\$818
 Not available in two-tone laminate	File/File Pedestal (with core removable lock) — floor-standing 15 ⁵ / ₈ "W x 22 ³ / ₄ "D x 28"H — for use under 24"D, 30"D and 36"D desk, credenza and return shells or worksurface supported by 23 ⁷ / ₈ "D L-shaped end panel(s) NOTES: File drawers include integrated hangrails for letter- or legal-sized folders. Not for use under 20"D shells. ⓘ Not designed to be used freestanding. Unfinished top and back.	H10504	85	8.2	\$728	\$753
 Not available in two-tone laminate	File/File Pedestal (with core removable lock) — floor-standing 15 ⁵ / ₈ "W x 18 ³ / ₄ "D x 28"H — for use under 20"D, 24"D, 30"D and 36"D desk, credenza and return shells NOTES: File drawers include integrated hangrails for letter- or legal-sized folders. ⓘ Not designed to be used freestanding. Unfinished top and back.	H105014	72	7.3	\$686	\$706
 Not available in two-tone laminate	Access Strip (Filler) 1 ¹ / ₈ "W x 20 ¹ / ₂ "D x 28"H NOTES: For use under 24"D, 30"D and 36"D desk, credenza or return shells when B/B/F, F/F, and or narrow B/B/F pedestals are configured side-by-side. Not required when pedestals are used in conjunction with lateral file pedestals, multi file pedestals or cabinet pedestal. Not sized for use with 20"D modular shells. NOTE: See pages 274-278 for desk, credenza and return shells.	H10524	21	0.9	\$187	\$197

NOTES:

- Pedestals can be reconfigured quickly and easily when user preferences or space needs change.
- Locking units equipped with interchangeable core removable locks.
- Pedestal models ship assembled unless designated ⓘ.
- Mobile pedestals shown on page 311, work well in a variety of configurations.
- Narrow Pedestal features a compact design that is ideal for use in U- and L-shaped layouts for smaller spaces such as a 5' x 8' U-shaped workstation or a 5' x 5' L-shaped workstation.
- 10500 Series™ modular pedestals are for use with desk, credenza and return shells (see pages 274-278), as well as L-shaped end panels (page 280).
- ⓘ Keyed alike cores must be ordered separately — see model HF23B on page 773 — makes re-keying quick and easy.
- ⓘ Access strip (filler) required when box/box file, file/file, and or narrow box/box/file pedestals are configured side-by-side to allow access for opening the drawers.
- ⓘ Modular pedestals can be specified as one color only; not available in two-tone laminate combination or in a pattern laminate.

HOW TO SPECIFY

<p>Select Model Number</p> <p>H 1 0 5 0 4 . N</p>	<p>Select Laminate Chassis Color</p> <p>See pages 266-267</p> <p>N</p>
--	---

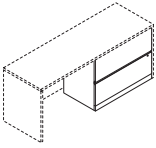
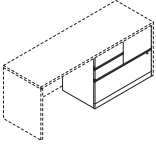
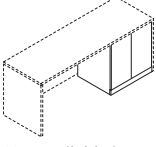
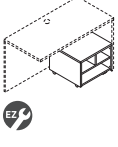
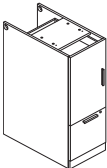

10500 SERIES™ Laminate Modular Components

	DESCRIPTION	MODEL	SHIP WEIGHT	CUBE	LIST PRICE BY LAMINATE GRADE	
					L1	L2
 Not available in two-tone laminate	Lateral File Pedestal (with core removable lock) — Floor-standing 36"W x 20"D x 28"H — For use under 24"D, 30"D and 36"D desk, credenza and return shells NOTES: Drawers include integrated hangrails for letter- or legal-sized folders. Mechanical interlock inhibits extension of more than one drawer at a time. Not for use under 20"D shells. ! Not designed to be used freestanding. Unfinished top and back.	H10503	127	15.6	\$1105	\$1145
 Not available in two-tone laminate	Multi File Pedestal (with core removable lock) — Floor-standing 36"W x 20"D x 28"H — For use under 24"D, 30"D and 36"D desk, credenza and return shells NOTES: Versatile four drawer unit features a lateral file, vertical file, and two box drawers. Box drawers do not lock. File drawers include integrated hangrails for letter- or legal-sized folders. Mechanical interlock in lateral drawer inhibits extension of more than one drawer at a time. Not for use under 20"D shells. ! Not designed to be used freestanding. Unfinished top and back.	H10505	155	15.6	\$1324	\$1364
 Not available in two-tone laminate	Cabinet Pedestal — Floor-standing 26"W x 21¼"D x 28"H — For use under 24"D, 30"D and 36"D desk, credenza and return shells NOTES: One adjustable shelf at 2½" increments. Doors are non-locking. Not for use under 20"D shells. ! Not designed to be used freestanding. Unfinished top and back.	H10508	78	12.2	\$824	\$864
 EZ	Mobile Printer/Fax Cart 20"W x 19¼"D x 14½"H — For use under 24"D, 30"D and 36"D desk, credenza and return shells NOTES: Holds laser printers, inkjet printers or fax machines. Ideal for limited space. Low profile cart stores conveniently and easily under desks and workstations. Interior compartment shelving is Black. Four casters. Specify laminate top and chassis color. Not for use under 20"D shells. SPECIFYING EXAMPLE: H105679.NN	H105679	52	2.9	\$451	\$471
 Not available in two-tone laminate	Box/Shelf/File Pedestal 15½"W x 28¾"D x 41"H — For 30"D worksurfaces 15½"W x 22¾"D x 41"H — For 24"D or 30"D worksurfaces NOTES: For 42"H standing-height desks. Designed to be used under a component worksurface supported on the pedestal end(s) by 41"H L-shaped end panel(s). For single pedestal workstations, the non-pedestal end can be supported by a 41"H L-shaped end panel, H-leg, or O-leg. Adjustable hex glides allow floor-standing units to be easily leveled without lifting to compensate for uneven floors; glides have ¾" adjustable range. Cabinet includes one box (supply) drawer and two shelves (one fixed, one adjustable); shelf adjusts in ¼" increments with a range of 5". Not to be used freestanding, top and back are not enclosed. Pedestal depth is less than the depth of the respective component top to accommodate L-shaped end panel. File drawer includes integrated hangrails. Standard with linear handles in black finish.	H105077 H105076	104 89	14.7 11.9	\$1521 \$1468	\$1576 \$1518

NOTES:

- Pedestals can be reconfigured quickly and easily when user preferences or space needs change.
- File drawers accept hanging folders in letter or legal size.
- Mobile pedestals shown on page 311, work well in a variety of configurations.
- Locking units equipped with interchangeable core removable locks.
- Pedestal models ship assembled unless designated .
- See pages 274-278 for desk, credenza and return shells.

 Keyed alike cores must be ordered separately — see model HF23B on page 773 — makes re-keying quick and easy.

 Access strip (filler) required when box/box file, file/file, and or narrow box/box/file pedestals are configured side-by-side to allow access for opening the drawers.

HOW TO SPECIFY

Select Model Number H 1 0 5 0 3 . N	Select Laminate Chassis Color See pages 266-267
---	---

10500 SERIES™

Laminate Wood Desks — Full Pedestals

GSA SIN 33721



Icon Legend on page 19

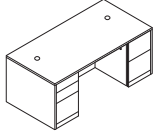

DESCRIPTION	FULL WIDTH OVERHANG	MODEL	SHIP WEIGHT	CUBE	LIST PRICE BY LAMINATE GRADE	
					L1	L2
Double Pedestal Desk						
72"W x 36"D x 29½"H, Bow Top, 3/2	10½"	H105899	315	50.9	\$1980	\$2060
72"W x 36"D x 29½"H, Rectangle Top, 3/2	10½"	H105890	340	50.9	\$1805	\$1880
66"W x 30"D x 29½"H, Rectangle Top, 3/2	4½"	H105891	290	39.4	\$1682	\$1747
60"W x 30"D x 29½"H, Rectangle Top, 3/2	4½"	H105892	278	35.9	\$1581	\$1641

NOTES: All drawers lock. Two cord grommets in top for routing and hiding wires and cables. Bow top models measure 36"D at crest and 30"D along the end panels. See page 319 for optional center drawers.

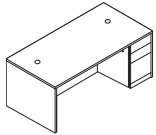

Single Pedestal Desk						
72"W x 36"D x 29½"H, Bow Top, Right	10½"	H105893R	292	50.9	\$1622	\$1692
72"W x 36"D x 29½"H, Rectangle Top, Right	10½"	H105895R Ⓞ	278	50.9	\$1443	\$1513
66"W x 30"D x 29½"H, Rectangle Top, Right	4½"	H105897R	226	39.4	\$1303	\$1358
72"W x 36"D x 29½"H, Bow Top, Left	10½"	H105894L	292	50.9	\$1622	\$1692
72"W x 36"D x 29½"H, Rectangle Top, Left	10½"	H105896L Ⓞ	278	50.9	\$1443	\$1513
66"W x 30"D x 29½"H, Rectangle Top, Left	4½"	H105898L	226	39.4	\$1303	\$1358

NOTES: Box/box/file drawers. Drawers lock. Two cord grommets in top for routing and hiding wires and cables. Bow top models measure 36"D at crest and 30"D along the end panels. See page 319 for optional center drawers.

NOTES:

- Factory-configured desks, credenzas and returns ship fully assembled for ease and speed of installation.
- Full-to-floor pedestals maximize storage space.
- Smooth, flat edges provide a clean look.
- Tops are easy-care, scratch-, spill- and stain-resistant laminate over 1⅛" solid core high-performance particleboard.
- 3" round cord management grommets, for routing and hiding wires and cables, are located in the tops of desks, returns, bridges, and corner units. Grommet cutout accepts optional Power Hub (model HGRMTAC) or Power/USB Hub (model HGRMTUSB2) — see page 324.
- For work-in-process paper management tools, see pages 319-320.
- Drawers operate on full extension, ball-bearing suspensions to ensure smooth, quiet, long-lasting operation.
- File drawer design includes integrated hangrails for side-to-side letter or legal filing; and front-to-back for letter filing.
- For field installable decorative handle options, see page 322.
- All drawers are five-sided construction for added strength and easy alignment or replacement of drawer fronts.
- Center drawers conveniently store writing instruments, paper and other miscellaneous items. Includes pencil tray. See page 325.

HOW TO SPECIFY

<p>Select Model Number</p> <p>H 1 0 5 8 9 9 .</p>	<p>Select Laminate Top and Chassis Color</p> <p>See pages 266-267</p> <p>N N</p>
---	--

10500 SERIES™

Laminate Wood Desks — Full Pedestals

	DESCRIPTION	FULL WIDTH OVERHANG	MODEL	SHIP WEIGHT	CUBE	LIST PRICE BY LAMINATE GRADE	
						L1	L2
	Return, file/file						
	48"W x 24"D x 29½"H, Right		H105905R	167	24.2	\$1020	\$1060
	42"W x 24"D x 29½"H, Right		H105907R	147	21.4	\$998	\$1038
	48"W x 24"D x 29½"H, Left		H105906L	167	24.2	\$1020	\$1060
	42"W x 24"D x 29½"H, Left		H105908L	147	21.4	\$998	\$1038
NOTES: Return is for use with single pedestal desks, desk shells, peninsulas or corner units. One worksurface grommet and one cord pass-through grommet in top center of modesty panel to reach wall electrical outlets. Drawers lock. Not to be used freestanding. Will not attach to Corner Units manufactured prior to 5/24/99. See pages 302-303 for optional Stack-on Storage.							
	Credenza with Doors						
	72"W x 24"D x 29½"H	3½"	H105909	323	34.8	\$1868	\$1933
NOTES: All drawers lock. Doors are non-locking. Includes a fixed shelf located at the bottom of the center storage area. No intermittent shelf. See pages 302-303 for optional Stack-on Storage.							
	Credenza with Kneespace, file/file						
	72"W x 24"D x 29½"H	3½"	H105900	274	34.8	\$1583	\$1643
	66"W x 24"D x 29½"H	3½"	H105901	262	32.0	\$1567	\$1627
	60"W x 24"D x 29½"H	3½"	H105902	248	29.2	\$1509	\$1564
NOTES: All drawers lock. One cord pass-through grommet in top center of modesty panel to reach wall electrical outlets. Not designed for use with 22¾"D modular or mobile pedestals. Modesty/back panel is inset 3½". See pages 302-303 for optional Stack-on Storage.							
	Single Pedestal Credenza, file/file						
	72"W x 24"D x 29½"H, Right (shown)	3½"	H105903R	226	34.8	\$1283	\$1338
	72"W x 24"D x 29½"H, Left	3½"	H105904L	226	34.8	\$1283	\$1338
NOTES: Drawers lock. One cord pass-through grommet in top center of modesty panel to reach wall electrical outlets. Not designed for use with 22¾"D modular or mobile pedestals. Modesty/back panel is inset 3½". See pages 302-303 for optional Stack-on Storage.							
	Low Credenza						
	72"W x 20"D x 21½"H, Drawers Right, Bookcase Left		H105975R	219	23.5	\$1404	\$1464
	72"W x 20"D x 21½"H, Drawers Left, Bookcase Right		H105976L	219	23.5	\$1404	\$1464
	60"W x 20"D x 21½"H, Drawers Right, Bookcase Left		H105973R	187	19.7	\$1293	\$1348
	60"W x 20"D x 21½"H, Drawers Left, Bookcase Right		H105974L	187	19.7	\$1293	\$1348
NOTES: Combines with overlapping, 29½"H worksurfaces to create a multi-level workstation for a modern aesthetic. For use in open plan spaces or private offices. Two locking drawers (1 box and 1 file) and open shelving. File drawers include integrated handrails for letter- or legal-sized folders. Bookcase has one adjustable shelf; adjusts in 1¼" increments with a range of 6". Overlapping surfaces can be supported by a 28½"H H-leg or O-leg, or 7"H O-leg, or by 7"H laminate end panel. On 60"W models, grain on back panel runs vertical for all woodgrain laminates. On 72", grain on back panel runs vertical for L1 woodgrains except for Florence and Kingswood Walnuts and horizontal on L2 laminates and Florence and Kingswood Walnuts. Optional seat cushions HLSL2036CH2 for 72"W and HLSL2030CH2 for 60"W.							

NOTES:

- Factory-configured desks, credenzas and returns ship fully assembled for ease and speed of installation.
 - Formal, full-length modesty panels.
 - Tops are easy-care, scratch-, spill- and stain-resistant laminate over 1/8" solid core high-performance particleboard.
 - 3" round cord management grommets, for routing and hiding wires and cables, are located in the tops of desks, returns, bridges, and corner units. Grommet cutout accepts optional Power Hub (model HGRMTAC) or Power/USB Hub (model HGRMTUSB2) — see page 324.
 - Drawers operate on full extension, ball-bearing suspensions to ensure smooth, quiet, long-lasting operation.
 - All drawers are five-sided construction for added strength and easy alignment or replacement of drawer fronts.
 - File drawer design includes integrated handrails for side-to-side letter or legal filing; and front-to-back for letter filing.
 - For field installable decorative handle options, see page 322.
 - 10500 Series™ 18¾"D modular and mobile pedestals can be positioned under credenza with kneespace and single pedestal credenza models.
- Keyed alike cores must be ordered separately — see model HF23B on page 773 — makes re-keying quick and easy.

HOW TO SPECIFY

Select Model Number	Select Laminate Top and Chassis Color See pages 266-267 Kickplates will match chassis color
<input type="text" value="H105905R"/>	<input type="text" value="NN"/>

10500 SERIES™

Laminate Wood Desks — Full Pedestals

OPEN MARKET

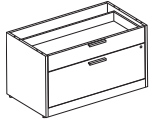

Icon Legend on page 19

**DESCRIPTION****2-Drawer Credenza, No Top**

36"W x 24"D x 19⁷/₈"H
 36"W x 20"D x 19⁷/₈"H
 30"W x 24"D x 19⁷/₈"H
 30"W x 20"D x 19⁷/₈"H

MODEL

H105LC3624BF
H105LC3620BF
H105LC3024BF
H105LC3020BF

SHIP WEIGHT

105.5
 97.9
 92.3
 85.4

CUBE

13.9
 11.7
 11.7
 9.9

L1 LIST

\$557
\$557
\$590
\$536

L2 UPCHARGES

CHASSIS	FRONTS
\$35	\$20
\$30	\$20
\$30	\$15
\$25	\$15

NOTES: Use in conjunction with Modular Credenza tops on page 295.

① Keyed alike cores must be ordered separately — see model HF23B on page 773 — makes re-keying quick and easy.

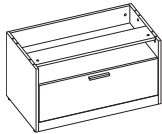
**Open/Lateral Credenza, No Top**

36"W x 24"D x 19⁷/₈"H
 36"W x 20"D x 19⁷/₈"H
 30"W x 24"D x 19⁷/₈"H
 30"W x 20"D x 19⁷/₈"H

H105LC3624SF
H105LC3620SF
H105LC3024SF
H105LC3020SF

117.2
 106.1
 101.7
 91.8

13.9
 11.7
 11.7
 9.9

\$536
\$536
\$520
\$520

CHASSIS	FRONTS
\$35	\$20
\$30	\$20
\$30	\$15
\$25	\$15

NOTES: Use in conjunction with Modular Credenza tops on page 295. Drawer is non-locking.

**DESCRIPTION****Open HAT Credenza, No Top**

36"W x 24"D x 19⁷/₈"H
 36"W x 20"D x 19⁷/₈"H
 30"W x 24"D x 19⁷/₈"H
 30"W x 20"D x 19⁷/₈"H

MODEL

H105LCHAT3624S
H105LCHAT3620S
H105LCHAT3024S
H105LCHAT3020S

SHIP WEIGHT

82.3
 71.2
 72.2
 62.3

CUBE

13.9
 11.7
 11.7
 9.9

LIST PRICE BY LAMINATE GRADE**L1**

\$255
\$255
\$234
\$234

L2

\$290
\$285
\$264
\$259

NOTES: False back allows HAT base leg to be concealed. Use in conjunction with Modular Credenza tops with HAT cutout on page 295.

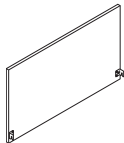
**Back for Open Storage Cabinet**

36"W x 19⁷/₈"H
 30"W x 19⁷/₈"H

H105LCHAT3620B
H105LCHAT3020B

25.0
 25.0

2.1
 1.8

\$234
\$212

\$249
\$227

NOTES: Optional model to conceal HAT base leg when used in open office settings. Use with Open HAT Credenzas, No Top when the back of the unit will be visible in an open plan office.

NOTES:

- Units can be combined to create 60"W, 66"W, and 72"W low credenzas utilizing Modular Credenzas.
- Units have unfinished tops.
- File drawers include integrated hangrails for letter- or legal-sized folders.
- Open Credenzas have one adjustable shelf; adjusts 1¹/₄" increments with a range of 6".
- Overlapping surfaces can be supported by a 28¹/₂"H or 7"H O-leg or by 7"H laminate end panel.

HOW TO SPECIFY

Select Model Number H 1 0 5 L C 3 6 2 0 B F .	Select Chassis Laminate See page 266 Kickplates will match chassis color L F W 1 .	Select Door Front Laminate See page 266 L F W 1 .	Select Pull and Color L Linear P Black L P .	Select Lock Option Only available on 2-Drawer Credenzas L Lock L
--	---	---	---	---

Select Model Number H 1 0 5 L C H A T 3 6 2 0 B .	Select Chassis Laminate See page 266 Kickplates will match chassis color L F W 1
--	---



Icon Legend on page 19

10500 SERIES™ Laminate Wood Desks — Full Pedestals

	DESCRIPTION	MODEL	SHIP WEIGHT	CUBE	LIST PRICE BY LAMINATE GRADE	
					L1	L2
	Modular Credenza Tops, Height Adjustable Base					
	30"W x 24"D, Non-handed	H105CTHAT3024	23.5	2.3	\$419	\$434
	30"W x 20"D, Non-handed	H105CTHAT3020	19.6	1.9	\$419	\$434
	72"W x 24"D, Right	H105CTHAT7224R	72.3	5.0	\$851	\$871
	72"W x 20"D, Right	H105CTHAT7220R	72.3	4.2	\$851	\$871
	66"W x 24"D, Right	H105CTHAT6624R	66.3	4.6	\$789	\$809
	66"W x 20"D, Right	H105CTHAT6620R	60.3	3.9	\$789	\$809
	60"W x 24"D, Right	H105CTHAT6024R	60.3	4.2	\$724	\$744
	60"W x 20"D, Right	H105CTHAT6020R	66.3	3.6	\$724	\$744
	36"W x 24"D, Right	H105CTHAT3624R	36.1	2.6	\$525	\$540
	36"W x 20"D, Right	H105CTHAT3620R	36.1	2.3	\$525	\$540
	72"W x 24"D, Left	H105CTHAT7224L	72.3	5.0	\$851	\$871
	72"W x 20"D, Left	H105CTHAT7220L	72.3	4.2	\$851	\$871
66"W x 24"D, Left	H105CTHAT6624L	66.3	4.6	\$789	\$809	
66"W x 20"D, Left	H105CTHAT6620L	66.3	3.9	\$789	\$809	
60"W x 24"D, Left	H105CTHAT6024L	60.3	4.2	\$724	\$744	
60"W x 20"D, Left	H105CTHAT6020L	60.3	3.6	\$724	\$744	
36"W x 24"D, Left	H105CTHAT3624L	36.1	2.6	\$525	\$540	
36"W x 20"D, Left	H105CTHAT3620L	36.1	2.3	\$525	\$540	
	Modular Credenza Tops					
	30"W x 20"D	H105CT3020	19.6	1.9	\$419	\$434
	36"W x 20"D	H105CT3620	36.1	2.3	\$525	\$540
	30"W x 24"D	H105CT3024	23.5	2.3	\$419	\$434
	36"W x 24"D	H105CT3624	36.1	2.6	\$525	\$540

NOTES:

- Easy care, scratch-, spill- and stain-resistant laminate over 1/8" solid core high-performance particleboard.
- Grain direction on all worksurfaces runs horizontal.
- Tops are intended to be used with modular low credenzas on page 294.
- Tops come with hardware to attach to low credenzas.
- Tops have a right or left notch to accommodate HON's Height Adjustable Base legs.

	DESCRIPTION	MODEL	SHIP WEIGHT	CUBE	LIST PRICE BY FABRIC GRADE					
					1	2	3	4	5	6
	Fabric Credenza Tops									
	36"W x 24"D x 1"H for 36"W Credenzas	HLAMSEAT3624	12	2.6	\$462	\$500	\$538	\$576	\$614	\$652
	30"W x 24"D x 1"H for 36"W Credenzas	HLAMSEAT3024	10	2.3	\$430	\$466	\$502	\$538	\$574	\$610
	36"W x 20"D x 1"H for 72"W Credenzas	HLSL2036CH2	11	2.2	\$451	\$489	\$527	\$566	\$615	\$665
	36"W x 20"D x 1"H for 60"W Credenzas	HLSL2030CH2	9	1.9	\$418	\$454	\$490	\$526	\$572	\$619
	NOTES: See pages 22-24 for available fabrics.									
	COM: .75									
	SPECIFYING EXAMPLE: HLAMSEAT3624.APN23									

HOW TO SPECIFY

<p>Select Model Number</p> <p>H 1 0 5 C T H A T 3 6 2 0 .</p>	<p>Select Laminate and Edge Color</p> <p>See page 266</p> <p>L F W 1 F W</p>
---	--

10500 SERIES™

Laminate Wood Desks — 3/4 Pedestals

GSA SIN 33721



Icon Legend on page 19

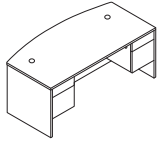

DESCRIPTION	FULL WIDTH OVERHANG	MODEL	SHIP WEIGHT	CUBE	LIST PRICE BY LAMINATE GRADE	
					L1	L2
Double Pedestal Desk						
72"W x 36"D x 29½"H, Bow Top, 2-2	10½"	H10595	300	52.9	\$1654	\$1734
72"W x 36"D x 29½"H, Rectangle Top, 2-2	10½"	H10593 Ⓞ	320	52.9	\$1475	\$1550
66"W x 30"D x 29½"H, Rectangle Top, 2-2	4½"	H10571	286	40.9	\$1350	\$1415
60"W x 30"D x 29½"H, Rectangle Top, 2-2	4½"	H10573 Ⓞ	271	37.4	\$1243	\$1303

NOTES: All drawers lock. Two cord grommets in top for routing and hiding wires and cables. Bow top models measure 36"D at crest and 30"D along the end panels. See page 325 for optional center drawers.

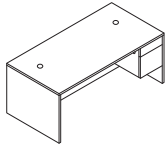

Single Pedestal Desk						
72"W x 36"D x 29½"H, Bow Top, Right	10½"	H10587R	238	52.9	\$1428	\$1498
72"W x 36"D x 29½"H, Rectangle Top, Right	10½"	H10585R	279	52.9	\$1253	\$1318
66"W x 30"D x 29½"H, Rectangle Top, Right	4½"	H10583R Ⓞ	229	41.0	\$1102	\$1157
72"W x 36"D x 29½"H, Bow Top, Left	10½"	H10588L	238	52.9	\$1428	\$1498
72"W x 36"D x 29½"H, Rectangle Top, Left	10½"	H10586L	279	52.9	\$1253	\$1318
66"W x 30"D x 29½"H, Rectangle Top, Left	4½"	H10584L Ⓞ	229	41.0	\$1102	\$1157

NOTES: Box/file drawers. Drawers lock. Two cord grommets in top for routing and hiding wires and cables. Bow top models measure 36"D at crest and 30"D along the end panels. See page 325 for optional center drawers.

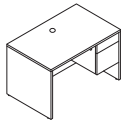

Small Office Desk						
48"W x 30"D x 29½"H, 3/4 Pedestal, Right box/file	4½"	H105885R	168	30.5	\$979	\$1019

NOTES: Small footprint makes this desk ideal for limited space. Drawers lock. One cord grommet in top for routing and hiding wires and cables. 3/4 height modesty panel facilitates reaching wall electrical outlets. Optional stack-on storage model H105323 maximizes storage space; see page 302.

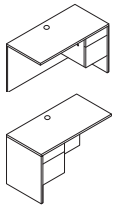

Return, box/file						
48"W x 24"D x 29½"H, Right		H10515R Ⓞ	147	25.6	\$888	\$928
42"W x 24"D x 29½"H, Right		H10511R	138	20.5	\$869	\$909
48"W x 24"D x 29½"H, Left		H10516L Ⓞ	147	25.6	\$888	\$928
42"W x 24"D x 29½"H, Left		H10512L	138	20.5	\$869	\$909

NOTES: Return is for use with single pedestal desks, desk shells, peninsulas or corner units. One worksurface grommet and one cord pass-through grommet in top center of modesty panel to reach wall electrical outlets. Drawers lock. See pages 302-303 for optional stack-on storage.

⚠ Not designed to be used freestanding. Will not attach to Corner Units manufactured prior to 5/24/99.

NOTES:

- For components that can be shared with 10500 Series™, see pages 298-325.
- Tops and end panels are abrasion- and stain-resistant laminate over durable 1½" solid core high-performance particleboard; resists warping.
- Formal, full height modesty panels.
- 3/4 pedestal design increases budget flexibility.
- 3" round cord management grommets, for routing and hiding wires and cables, are located in the tops of desks, returns, bridges, and corner units. Grommet cutout accepts optional Power Hub (model HGRMTAC) or Power/USB Hub (model HGRMTUSB2) — see page 324.
- All drawers are 5-sided construction, which allows easy drawer alignment or replacement of drawer fronts.
- Drawers operate on full extension, ball-bearing suspensions to ensure smooth, quiet, long-lasting operation.
- File drawer design includes integrated hangrails for side-to-side letter or legal filing; and front-to-back for letter filing.
- For field installable decorative handle options, see page 322.
- Desk, credenza, and return models ship assembled.
- See stack-on storage and stack-on PC organizer options on pages 301-303.
- Use with Above Worksurface Privacy Screens. See page 288.

HOW TO SPECIFY

Select Model Number

H 1 0 5 9 5 .

Select Laminate Top and Chassis Color

See pages 266-267

N N



10500 SERIES™

Laminate Wood Desks — 3/4 Pedestals

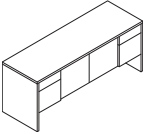
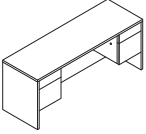
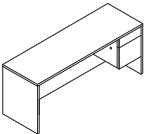
	DESCRIPTION	FULL WIDTH OVERHANG	MODEL	SHIP WEIGHT	CUBE	LIST PRICE BY LAMINATE GRADE	
						L1	L2
	Credenza with Doors 72"W x 24"D x 29½"H	3½"	H10544	278	36.0	\$1603	\$1668
NOTES: All drawers lock. Doors are non-locking. Includes a fixed shelf located at the bottom of the center storage area. No intermittent shelf. See pages 302-303 for optional stack-on storage.							
	Credenza with Kneespace — box/file 72"W x 24"D x 29½"H 66"W x 24"D x 29½"H 60"W x 24"D x 29½"H	3½" 3½" 3½"	H10543 Ⓞ H10566 H10565 Ⓞ	243 234 229	36.3 33.4 28.8	\$1315 \$1302 \$1243	\$1375 \$1362 \$1298
NOTES: All drawers lock. One cord pass-through grommet in top center of modesty panel to reach wall electrical outlets. ⓘ Not designed to be used with 22¾"D modular or mobile pedestals. Modesty/back panel is inset 3½".							
	Single Pedestal Credenza — box/file 72"W x 24"D x 29½"H, Right (shown) 72"W x 24"D x 29½"H, Left	3½" 3½"	H10545R H10546L	212 212	36.0 36.0	\$1085 \$1085	\$1140 \$1140
NOTES: Drawers lock. One cord pass-through grommet in top center of modesty panel to reach wall electrical outlets. See page 302 for optional stack-on storage. ⓘ Not designed to be used with 22¾"D modular or mobile pedestals. Modesty/back panel is inset 3½".							

NOTES:

- For components that can be shared with 10500 Series™, see pages 298-325.
- Tops and end panels are abrasion- and stain-resistant laminate over durable 1½" solid core high-performance particleboard; resists warping.
- Formal, full height modesty panels.
- 3/4 pedestal design increases budget flexibility.
- 3" round cord management grommets, for routing and hiding wires and cables, are located in the tops of desks, returns, bridges, and corner units. Accepts optional Power Hub Grommet model HGRMTAC — page 324.
- All drawers are 5-sided construction, which allows easy drawer alignment or replacement of drawer fronts.
- Drawers operate on full extension, ball-bearing suspensions to ensure smooth, quiet, long-lasting operation.
- File drawer design includes integrated hangrails for side-to-side letter or legal filing; and front-to-back for letter filing.
- For field installable decorative handle options, see page 322.
- Desk, credenza, and return models ship assembled.
- See stack-on storage and stack-on PC organizer options on pages 301-303.
- Use with Above Worksurface Privacy Screens. See page 288.

HOW TO SPECIFY

Select Model Number	Select Laminate Top and Chassis Color See pages 266-267
H 1 0 5 4 4 .	N N

10500 SERIES™

Shared Components & Accessories

GSA SIN 33721

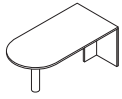

Icon Legend on page 19

**DESCRIPTION****Peninsula w/End Panel**

72"W x 36"D x 29½"H
72"W x 30"D x 29½"H
66"W x 30"D x 29½"H
60"W x 30"D x 29½"H

MODEL

H10521E
H105209E
H10522E
H10523E

SHIP WEIGHT

146
126
121
96

CUBE

8.1
7.0
6.6
6.6

LIST PRICE BY LAMINATE GRADE**L1**

\$930
\$869
\$857
\$803

L2

\$975
\$914
\$902
\$848

NOTES: Use for "U" or "L" configuration. 60"W size ideal for smaller spaces. Cord routing notch in brace panel. Accepts field installable modesty panel model H10528. Accepts center drawer model H1526 and H1522. Model H1522 can be used in conjunction with the laminate modesty panel model H10528. Round support column is black.

⚠ Not designed to be used freestanding.

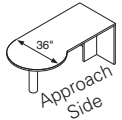

72"W x 30/36"D x 29½"H, P-shaped Right
72"W x 36/30"D x 29½"H, P-shaped Left

H10525RE
H10526LE

138
138

8.1
8.1

\$1088
\$1088

\$1133
\$1133

NOTES: Use for "U" or "L" configuration. Cord routing notch in brace panel. Accept field installable modesty panel model H10528 (see page 299). See page 325 for optional center drawers. Round support column is black.

⚠ Not designed to be used freestanding.

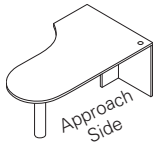

Right-hand model
H105201RE shown

Jetty Peninsula w/End Panel

72"W x 30/42"D x 29½"H, Right
72"W x 42/30"D x 29½"H, Left

H105201RE
H105202LE

152
152

9.4
9.4

\$1207
\$1207

\$1262
\$1262

NOTES: For use in "U" or "L" configuration. Designed and sized to efficiently serve as both a computing and conferencing space. One cord management grommet in the top; cord routing notch in brace panel. Round support column is black.

⚠ Not designed to be used freestanding. Jetty units manufactured on or after 10/24/2005 accept field installable modesty panel H10528 (see page 299).

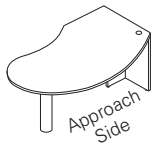
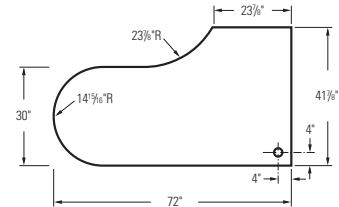

Right-hand model
H105203RE shown

Boomerang Peninsula w/End Panel

72"W x 30/42"D x 29½"H, Right
72"W x 42/30"D x 29½"H, Left

H105203RE
H105204LE

150
150

7.0
7.0

\$1207
\$1207

\$1262
\$1262

NOTES: For use in "U" or "L" configuration. Designed and sized to efficiently serve as both a computing and conferencing space. One cord management grommet in the top; cord routing notch in brace panel. Round support column is black.

⚠ Not designed to be used freestanding. Accept field installable modesty panel H10528 (see page 299).

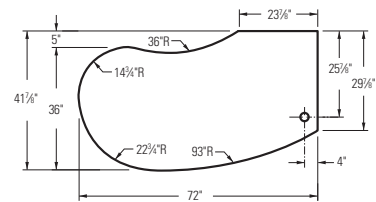
**NOTES:**

- Shared components shown on this page can be used with modular components shown on pages 274-291, full pedestal models shown on pages 292-293 and 3/4 pedestal models shown on pages 296-297.
- Jetty, boomerang, and rudder peninsulas are designed and sized to efficiently serve as both a computing and conferencing space.
- Peninsulas ship complete with end panel and black 3" diameter support column. For a silver support column option, please see model HPC191X on page 281 (ordered separately).
- Mobile pedestals shown on page 311 work well in a variety of configurations.
- Adjustable hex leveling glides allow floor-standing furniture to be easily leveled without lifting the unit; glides have 3/4" adjustable range.
- See pages 298-325 for shared components.

HOW TO SPECIFY**Select Model Number**

H 1 0 5 2 1 E .

Select Laminate Top and Chassis Color

See pages 266-267

N N .

Select Paint Color

Specify for new peninsula models only

P Black

P



10500 SERIES™

Shared Components & Accessories

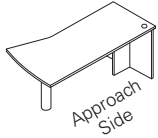

Model H105205RE shown

**DESCRIPTION****Rudder Peninsula with End Panel**

72"W x 30/38"D x 29½"H, Right
72"W x 30/38"D x 29½"H, Left

MODEL

H105205RE
H105206LE

SHIP WEIGHT

140
140

CUBE

8.1
8.1

LIST PRICE BY LAMINATE GRADE**L1**

\$1180
\$1180

L2

\$1225
\$1225

NOTES: Use for "U" or "L" configuration. One cord management grommet in top; cord routing notch in brace panel. 30"D along end panel. Round support column is black.

ⓘ Not designed to be used freestanding.

**Field Installable Laminate Modesty Panel for Peninsulas**

50¼"W x ¾"Thick x 18"H

H10528

25

1.3

\$203

\$213

NOTES: Center drawer model H1522 can be used in conjunction with the laminate modesty panel. Laminate modesty panel has a cord pass-through notch in top corner.

ⓘ Not compatible with Peninsula models H10525R, H10526L, H10621 manufactured prior to 12/1/2001 or jetty models H105201R and H105202L manufactured prior to 10/24/2005.

SPECIFYING EXAMPLE: H10528.N

DESCRIPTION**Field Installable Modesty Panel, Frosted with Silver Frame**

50¼"W x ¾"Thick x 18"H — for use on 72"W peninsulas

MODEL

HPC180G

SHIP WEIGHT

33 Ⓞ

CUBE

1.5

LIST PRICE

\$745

ⓘ Center drawers not designed to be used with the frosted/silver modesty panel. Cord pass-through notch is not available on the Frosted/Silver model HPC180G. Notch is on laminate model H10528 only.

NOTES:**Panels**

- Shared components shown on this page can be used with modular components shown on pages 274-291, full pedestal models shown on pages 292-293 and 3/4 pedestal models shown on pages 296-297.
- Jetty, boomerang and rudder peninsulas are designed and sized to efficiently serve as both a computing and conferencing space.
- Peninsulas ship complete with end panel and black 3" diameter support column. For a silver support column option, please see model HPC191X on page 281 (ordered separately).
- Mobile pedestals shown on page 311 work well in a variety of configurations.
- Adjustable hex leveling glides allow floor-standing furniture to be easily leveled without lifting the unit; glides have ¾" adjustable range.
- See pages 298-325 for shared components.

HOW TO SPECIFY**Select Model Number**

H 1 0 5 2 0 5 R E

Select Laminate Top and Chassis Color

See pages 266-267

N N

Select Paint Color

Specify for new peninsula models only

P Black

P

10500 SERIES™

Shared Components & Accessories

GSA SIN 33721



Icon Legend on page 19



DESCRIPTION	MODEL	SHIP WEIGHT	CUBE	LIST PRICE BY LAMINATE GRADE	
				L1	L2
Bridge (Single Ped. Desk, Desk Shell, or Peninsula, to Corner Unit, Single Ped. Credenza or Credenza Shell)					
47"W x 24"D x 29½"H (Clear inside depth = 21⅞"D)	H10570	76	2.8	\$386	\$416
42"W x 24"D x 29½"H (Clear inside depth = 21⅞"D)	H10560	72	2.6	\$371	\$401
Bridge (for use with Corner or Extended Corner Units or Jetty or Boomerang Peninsulas)					
36"W x 24"D x 29½"H (Clear inside depth = 21⅞"D)	H105599	61	2.6	\$371	\$401
Bridge (for use with Corner or Extended Corner Units)					
30"W x 24"D x 29½"H (Clear inside depth = 21⅞"D)	H105598	50	1.9	\$371	\$401
NOTES: One cord grommet in top; one pass-through grommet in top center of modesty panel. Grommet can be replaced with optional Power Hub or Power/USB Hub for easy plug-and-play (see page 324). Kneespace of desk limited to 24¾"W if bridge is used with 66"W single pedestal desk.					
ⓘ Not designed to attach to corner units manufactured prior to 5/24/99.					
Bridge (Single Ped. Desk, Desk Shell, or Peninsula to Single Ped. Credenza or Credenza Shell)					
47"W x 20"D x 29½"H (Clear inside depth = 17⅞"D)	H105699	61	2.8	\$371	\$401
42"W x 20"D x 29½"H (Clear inside depth = 17⅞"D)	H105698	54	2.6	\$345	\$375
NOTES: One cord grommet in top; one pass-through grommet in top center of modesty panel.					
ⓘ Models H105699 and H105698 cannot be connected to corner or extended corner units or to the jetty or boomerang peninsulas, due to the 20"D "hook-up".					

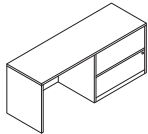

Credenza with 36" Lateral (with core removable lock)					
72"W x 24"D x 29½"H, Right (shown)	H10547R	248	35.6	\$1484	\$1544
72"W x 24"D x 29½"H, Left	H10548L	248	35.6	\$1484	\$1544
NOTES: One cord pass-through grommet in top center of modesty panel. Includes hangrails. Mechanical interlock inhibits the extension of more than one drawer at a time. Accepts optional stack-on storage model H10534 (page 302) or PC Organizer model H105388 (page 301).					
ⓘ Not designed to be used with 10500 Series™ 22¾"D modular or mobile pedestals. Modesty/back panel is inset 3½".					

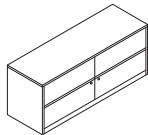

Credenza with two Lateral Files (4 locking drawers. Each core removable lock secures 2 drawers)					
72"W x 24"D x 29½"H	H105491	314	34.7	\$2143	\$2218
NOTES: Includes hangrails; mechanical interlock inhibits the extension of more than one drawer at a time. If side-by-side drawers are opened or closed simultaneously, one drawer may interfere with the other. Two locks (keyed alike). Accepts optional stack-on storage model H10534 (page 302) or PC Organizer model H105388 (page 301).					

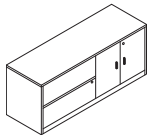

Credenza with Lateral File, left and Storage Cabinet, right (with core removable locks)					
72"W x 24"D x 29½"H	H105492	307	34.7	\$1875	\$1950
NOTES: Includes hangrails; mechanical interlock inhibits the extension of more than one drawer at a time. Storage cabinet locks and includes one adjustable interior shelf. Shelf adjusts in ¼" increments with a total range of 5"H. Two locks (keyed alike). Accepts optional stack-on storage model H10534 (page 302) or PC Organizer model H105388 (page 301).					

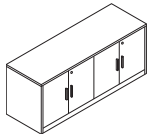

Credenza with Two Storage Cabinets (with core removable locks)					
72"W x 24"D x 29½"H	H105493	302	34.8	\$1747	\$1822
NOTES: Each storage cabinet has one interior shelf which adjusts in ¼" increments over a total range of 5". Each cabinet locks independently; locks are keyed alike. Accepts optional stack-on storage model H10534 (page 302) or PC Organizer model H105388 (page 301).					

NOTES:

- Shared components shown on this page can be used with modular components shown on pages 274-291, full pedestal models shown on pages 292-293, and ¾ pedestal models shown on pages 296-297.
- Locking units equipped with interchangeable core removable locks.
- File drawers accept hanging folders in letter or legal size.
- Mobile pedestals shown on page 311 work well in a variety of configurations.
- Work Organizer models accept 3-ring binders and organizer model HTC052. See page 317.
- See stack-on storage and organizer options for desks, credenzas and returns, pages 301-303.
- See pages 298-325 for shared components.

ⓘ Keyed alike cores must be ordered separately — see model HF23B on page 773.

HOW TO SPECIFY

Select
Model Number

H 1 0 5 7 0 .

Select
Laminate Top and Chassis Color

See pages 266-267

N N



Icon Legend on page 19

10500 SERIES™

Shared Components & Accessories

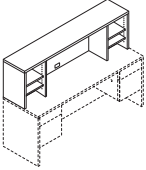
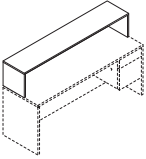
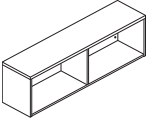
	DESCRIPTION	MODEL	SHIP WEIGHT	CUBE	LIST PRICE BY LAMINATE GRADE	
					L1	L2
	Stack-on PC Organizer					
	72"W x 14 ⁵ / ₈ "D x 22"H (for 72"W desks, credenzas and shells) 60"W x 14 ⁵ / ₈ "D x 22"H (for 60"W desks, credenzas and shells)	H105388 H105386	124 111	5.0 4.3	\$863 \$801	\$898 \$836
	NOTES: Features two adjustable paper management shelves both left and right; shelves are adjustable in 1/4" increments. Shelves keep papers, files, and books within easy reach from a seated position. One cord management grommet located in the bottom center of the back panel. Design allows 20 ³ / ₄ " of vertical clearance for computer equipment.					
	Work Organizer (shell only)					
	72"W x 14 ⁵ / ₈ "D x 14 ¹ / ₈ "H (for 72"W unit) 66"W x 14 ⁵ / ₈ "D x 14 ¹ / ₈ "H (for 66"W unit)	H10537 H10536	73 68	2.9 2.7	\$447 \$424	\$477 \$454
	NOTES: Space below counter accepts 3-ring binders and organizer model HTC0L52. See page 317.					
	Open Shared Storage					
	60"W x 14 ⁵ / ₈ "D x 16 ⁷ / ₈ "H 48"W x 14 ⁵ / ₈ "D x 16 ⁷ / ₈ "H	H105368 H105367	81 68	14.2 11.5	\$816 \$794	\$846 \$819
	NOTES: Attaches to laminate end panels with horizontally mounted interlocking brackets. Mounting applications include: 60"W — two 30"D desks/desk shells, 60"W — two 48"W (minimum) x 30"D rectangle worksurfaces supported by 28 ¹ / ₂ "H L-shaped end panels, 48"W — two 24"D credenzas/credenza shells, 48"W — two 24"D returns/return shells, 48"W — two 60"W (minimum) x 24"D rectangle worksurfaces supported by 28 ¹ / ₂ "H L-shaped end panels. Can also be positioned on the worksurface; double-sided tape included. Grain direction is vertical on top, back, end panels, and shelf. Ships fully assembled. Not designed for attachment to a worksurface supported by H-legs or O-legs. Inside dimensions for 60"W: each compartment 28 ³ / ₄ "W x 13 ¹ / ₂ "D x 15 ¹ / ₂ "H. Inside dimensions for 48"W: each compartment 22 ³ / ₄ "W x 13 ¹ / ₂ "D x 15 ¹ / ₂ "H.					

NOTES:

- Shared components shown on this page can be used with modular components shown on pages 274-291, full pedestal models shown on pages 292-293, and 3/4 pedestal models shown on pages 296-297.
 - Mobile pedestals shown on page 311 work well in a variety of configurations.
 - See stack-on storage and organizer options for desks, credenzas and returns, pages 301-303.
 - See pages 298-325 for shared components.
 - Locking units equipped with interchangeable core removable locks.
- ① Keyed alike cores must be ordered separately — see model HF23B on page 773.

HOW TO SPECIFY

Select Model Number <div style="border: 1px solid black; padding: 2px; display: flex; gap: 5px;"> H105388 </div>	Select Laminate Top and Chassis Color See pages 266-267 <div style="border: 1px solid black; padding: 2px; display: flex; gap: 5px;"> NN </div>
---	--

10500 SERIES™

Shared Components & Accessories

GSA SIN 33721



Icon Legend on page 19

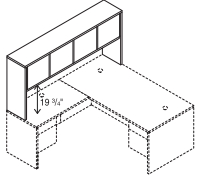

DESCRIPTION	MODEL	SHIP		LIST PRICE BY LAMINATE GRADE	
		WEIGHT	CUBE	L1	L2
Stack-on Storage for an "L" Workstation 78"W x 14 ⁵ / ₈ "D x 37 ¹ / ₈ "H	H105327	198	17.6	\$1213	\$1278
Stack-on Storage for an "L" Workstation, Locking	H105327K	198	17.6	\$1302	\$1367

NOTES: Spans the total depth dimension of configurations comprised of: 48"W return or return shell attached to a 30"D single pedestal desk, desk shell or peninsula (78"D); 42"W return or return shell attached to a 36"D single pedestal desk or desk shell with a rectangle top, or to a peninsula (78"D). 42"W return or return shell attached to a 36" corner unit (78"D); or 42"W curved return attached to 36" curved corner unit (78"D). Use back enclosure model H105857 and tackboard model H90057. Use task light models HH870960 or HH870960CH (see page 595). For vertical paper manager model HLVPM1, see page 319.

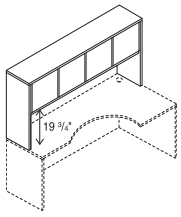

Stack-on Storage 72"W x 14 ⁵ / ₈ "D x 37 ¹ / ₈ "H, 4 doors (Use Task Light HH870960, see page 309)	H10534	185	17.1	\$1072	\$1112
66"W x 14 ⁵ / ₈ "D x 37 ¹ / ₈ "H, 4 doors (Use Task Light HH870960, see page 309)	H10533	175	15.3	\$1042	\$1097
60"W x 14 ⁵ / ₈ "D x 37 ¹ / ₈ "H, 4 doors (Use Task Light HH870960, see page 309)	H105324	164	14.0	\$1000	\$1055
48"W x 14 ⁵ / ₈ "D x 37 ¹ / ₈ "H, 3 doors (Use Task Light HH870942, see page 309)	H105323	141	11.3	\$901	\$946
42"W x 14 ⁵ / ₈ "D x 37 ¹ / ₈ "H, 2 doors (Use Task Light HH870942, see page 309)	H105322	135	4.0	\$738	\$783
36"W x 14 ⁵ / ₈ "D x 37 ¹ / ₈ "H, 2 doors (Use Task Light HH870930, see page 309)	H105321	102	3.5	\$697	\$727
Stack-on Storage, Locking					
72"W x 14 ⁵ / ₈ "D x 37 ¹ / ₈ "H, 4 doors (Use Task Light HH870960, see page 309)	H10534K	185	17.1	\$1161	\$1216
66"W x 14 ⁵ / ₈ "D x 37 ¹ / ₈ "H, 4 doors (Use Task Light HH870960, see page 309)	H10533K	175	15.3	\$1132	\$1187
60"W x 14 ⁵ / ₈ "D x 37 ¹ / ₈ "H, 4 doors (Use Task Light HH870960, see page 309)	H105324K	164	14.0	\$1089	\$1144
48"W x 14 ⁵ / ₈ "D x 37 ¹ / ₈ "H, 3 doors (Use Task Light HH870942, see page 309)	H105323K	141	11.3	\$968	\$1013
42"W x 14 ⁵ / ₈ "D x 37 ¹ / ₈ "H, 2 doors (Use Task Light HH870942, see page 309)	H105322K	135	4.0	\$783	\$828
36"W x 14 ⁵ / ₈ "D x 37 ¹ / ₈ "H, 2 doors (Use Task Light HH870930, see page 309)	H105321K	102	3.5	\$741	\$781

NOTES: For use on respective desk, credenza or return widths. Model H10534 can be used for "L" configuration comprised of 30"D desk, desk shell or peninsula and 42"W return or return shell; or a 36"D desk, desk shell, peninsula, or corner unit and 36"W return shell. Model H105323K has one lock which secures two of the three doors. See vertical paper manager model HLVPM1 on page 319.

NOTES:

- Shared components shown on this page can be used with modular components shown on pages 274-291, full pedestal models shown on pages 292-293, and 3/4 pedestal models shown on pages 296-297.
- Rich woodgrain laminate and frosted doors with silver frames adds a contemporary mixed materials option to the 10500 Series™.
- Stack-on storage models are equipped with self-closing, adjustable hinged doors and valance to hide task light.
- See page 305 for stack-on storage back enclosures and tackboards, and page 309 for task lights.
- For work-in-process paper management tools, see pages 319-320.
- See pages 298-325 for shared components.
- **Removable lock core kit for locking stack-on storage is model HF27B. See page 773.**

HOW TO SPECIFYSelect
Model Number

H 1 0 5 3 2 7 .

Select
Laminate Top and Chassis Color

See pages 266-267

N N



10500 SERIES™

Shared Components & Accessories

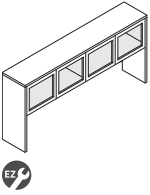
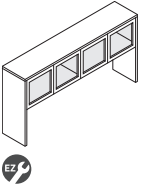
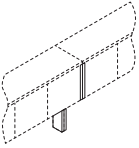
DESCRIPTION	MODEL	SHIP WEIGHT	CUBE	LIST PRICE BY LAMINATE GRADE	
				L1	L2
 <p>Stack-on Storage for an "L" Workstation, Frosted Doors with Silver Frame 78"W x 14⁵/₈"D x 37¹/₈"H</p> <p>NOTES: Spans the total depth dimension of configurations comprised of: 48"W return or return shell attached to a 30"D single pedestal desk, desk shell or peninsula (78"D); 42"W return or return shell attached to a 36"D single pedestal desk or desk shell with a rectangle top, or to a peninsula (78"D); 42"W return or return shell attached to a 36" corner unit (78"D); 42"W curved return attached to 36" curved corner unit (78"D); or 36"W return shell attached to a jetty peninsula (78"D). Use back enclosure model H105857 and tackboard model H90057. Use task light models HH870960 or HH870960CH. For vertical paper manager model HLVP M1, see page 319.</p>	H105327G	198	17.3	\$1904	\$1954
 <p>Stack-on Storage, Frosted Doors with Silver Frame 72"W x 14⁵/₈"D x 37¹/₈"H, 4 doors (Use Task Light HH870960, see page 309) 66"W x 14⁵/₈"D x 37¹/₈"H, 4 doors (Use Task Light HH870960, see page 309) 60"W x 14⁵/₈"D x 37¹/₈"H, 4 doors (Use Task Light HH870960, see page 309) 48"W x 14⁵/₈"D x 37¹/₈"H, 3 doors (Use Task Light HH870942, see page 309) 42"W x 14⁵/₈"D x 37¹/₈"H, 2 doors (Use Task Light HH870942, see page 309) 36"W x 14⁵/₈"D x 37¹/₈"H, 2 doors (Use Task Light HH870930, see page 309)</p> <p>NOTES: For respective desk, credenza or return widths. Model 10534 can be used for "L" configuration comprised of a 42"W return or return shell attached to a 30"D single pedestal desk, desk shell or peninsula (72"); 36"W return shell attached to a 36"D single pedestal desk, desk shell or peninsula (72"); or 30"W return shell attached to a jetty peninsula (72"). Back enclosures, tackboards for use with back enclosures and task lights are available as options. See vertical paper manager model HLVP M1 on page 319.</p>	H10534G	185	15.9	\$1759	\$1799
	H10533G	175	14.6	\$1728	\$1768
	H105324G	164	13.3	\$1685	\$1725
	H105323G	141	10.8	\$1419	\$1449
	H105322G	135	3.6	\$1088	\$1118
	H105321G	102	3.1	\$1045	\$1070
 <p>Stack-on Storage Clearance End Panel Kit 1¹/₈"W x 4⁵/₈-14⁵/₈"D x 36"H</p> <p>Two field installable end panels (1-right; 1-left) for use in ganging two 10500 or Valido® Series stack-on storage units. Narrow design replaces the full 14⁵/₈"D end panels to expand worksurface space. The narrow right end panel replaces the standard 14⁵/₈"D right end panel on one stack-on storage unit, the narrow left end panel replaces the standard 14⁵/₈"D left end panel on a separate, adjacent stack-on storage unit that is in linear alignment with the first unit. Kit includes: (2) narrow end panel supports; European-style fasteners; dowels; joint connector bolts with sleeve nuts (for ganging stack-on storage units).</p> <p>NOTES: Can be used to connect up to two stack-on storage units in a line (requires 1 kit). Not available in two-tone laminate.</p> <p>SPECIFYING EXAMPLE: H105349.N</p>	H105349	29	3.4	\$382	\$397

NOTES:

- Shared components shown on this page can be used with modular components shown on pages 274-291, full pedestal models shown on pages 292-293, and 3/4 pedestal models shown on pages 296-297.
- Rich woodgrain laminate and frosted doors with silver frames adds a contemporary mixed materials option to the 10500 Series™.
- Stack-on storage models are equipped with self-closing, adjustable hinged doors and valance to hide task light.
- See page 305 for stack-on storage back enclosures and tackboards, and page 309 for task lights.
- For work-in-process paper management tools, see pages 319-320.
- See pages 298-325 for shared components.
- Removable lock core kit for locking stack-on storage is model HF27B. See page 773.**

HOW TO SPECIFY

Select Model Number H 1 0 5 3 2 7 G .	Select Laminate Top and Chassis Color See pages 266-267 N N
---	--

10500 SERIES™

Shared Components & Accessories

GSA SIN 33721



Icon Legend on page 19

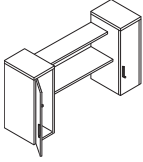

DESCRIPTION	MODEL	SHIP WEIGHT	CUBE	L1 LIST	L2 UPCHARGES	
					CHASSIS	SHELF
Stack-on Cabinets with Open Shelves, Center Overall measures: 72"W x 20"D x 37 $\frac{1}{8}$ "H Cabinet measures: 13 $\frac{1}{2}$ "W x 19 $\frac{1}{8}$ "D x 37 $\frac{1}{8}$ "H NOTES: Contemporary, light scale design blends open and closed storage. Features two locking cabinets bridged by two open shelves. The clearance between the worksurface and underside of the lower shelf is 18 $\frac{3}{8}$ ". Top shelf is 45"W x 11"D, bottom shelf is 45"W x 14"D; space between the shelves is 12 $\frac{1}{4}$ ". Some assembly required; cabinets are fully assembled; simple shelf attachment. For two-tone color combinations, the first color designator defines the top of the storage cabinet(s), the second designator defines the color of the cabinet vertical panels and the open (exterior) shelves.	H105319	218	20.3	\$1866	\$60	\$20

NOTES:

- Stack-on Cabinets with Open Shelves, Center is sized to fit on 72" desk, credenza, return, or desk with return worksurfaces.
- Easy-care, scratch-, spill- and stain-resistant laminate over 1 $\frac{1}{8}$ " solid core high-performance particleboard.
- Cabinets have three shelves, two are adjustable.
- Removable lock core kit for the cabinet models above is HF23B. See page 773.
- Back of cabinet door has a convenient double coat hook; the lower peg is for jackets and lighter items, the upper peg for heavier coats and bags.
- Open shelves display books, photos, and mementos, shelves are fixed height; top shelf is $\frac{3}{4}$ " thick, lower shelf is 1 $\frac{1}{8}$ ".
- Task light can be attached to underside of the bottom shelf.

HOW TO SPECIFY

Select
Model Number

H 1 0 5 3 1 9 .

Select
Cabinet Top and Chassis Color

See pages 266-267

H H .

Select
Open Shelf Laminate

See pages 266-267

H



10500 SERIES™

Shared Components & Accessories

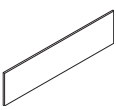
	DESCRIPTION	MODEL	SHIP WEIGHT	CUBE	LIST PRICE BY LAMINATE GRADE	
					L1	L2
 <p>18 5/8" H</p> <p>Not available in two-tone laminate</p>	Back Enclosure for Stack-on Storage					
	75 3/4" W - for 78" W model #H105327/H105327K/H105327G	H105857	39	1.4	\$275	\$285
	69 3/4" W - for 72" W model #H10534/H10534K/H10534G	H105856 ⓘ	33	1.3	\$252	\$262
	63 3/4" W - for 66" W model #H10533/H10533K/H10533G	H105855	31	1.3	\$235	\$245
	57 3/4" W - for 60" W model #H105324/H105324K/H105324G	H105854	29	1.3	\$224	\$234
	45 3/4" W - for 48" W model #H105323/H105323K/H105323G	H105853	23	0.9	\$224	\$234
	39 3/4" W - for 42" W model #H105322/H105322K/H105322G	H105852	21	0.9	\$214	\$224
33 3/4" W - for 36" W model #H105321/H105321K/H105321G	H105851	18	0.9	\$202	\$212	

NOTES: Non-tackable.

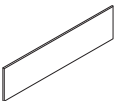
	DESCRIPTION	MODEL	COM	SHIP WEIGHT	CUBE	LIST PRICE
 <p>18" H</p>	Tackboards for use with Stack-on Back Enclosures (Back Enclosures must be ordered separately.)					
	75" W - for 78" W model #H105327 Hutch with #H105857 Enclosure	H90057	3.0	13	3.2	\$337
	68 3/4" W - for 72" W model #H10534 Hutch with #H105856 Enclosure	H90056	2.0	12	2.7	\$320
	62 3/4" W - for 66" W model #H10533 Hutch with #H105855 Enclosure	H90055	2.0	11	2.5	\$304
	56 3/4" W - for 60" W model #H105324 Hutch with #H105854 Enclosure	H90054	2.0	10	2.2	\$268
	44 3/4" W - for 48" W model #H105323 Hutch with #H105853 Enclosure	H90053	2.0	8	1.8	\$257
	39" W - for 42" W model #H105322 Hutch with #H105852 Enclosure	H90052	2.0	7	1.6	\$237
	33" W - for 36" W model #H105321 Hutch with #H105851 Enclosure	H90051	1.0	6	1.4	\$208
26 3/4" W	H90050	1.0	5	1.2	\$208	

NOTES: Specify fabric, see pages 25-26. Upcharges may apply to premium fabric grades.

ⓘ Disperse (DISP) fabric not available on sizes wider than 60". Analog (ANLG) and Exchange (EXG) not available on sizes wider than 72".

SPECIFYING EXAMPLE: H90057.APN15**NOTES:**

- When connected to the stack-on storage unit, back enclosure features full-width 1 1/8" slot at the bottom to facilitate routing cords and reaching wall electrical outlets.
- Tackboard is sized 3/4" narrower than stack-on storage back enclosure, allowing 3/8" on each side to route task light cord.
- Tackboard includes adhesive tape to secure to back enclosure and hardware for wall attachment.
- See pages 298-325 for shared components.

HOW TO SPECIFY

Select Model Number <div style="border: 1px solid black; padding: 2px; display: flex; gap: 5px;"> H105857 </div>	Select Laminate See pages 266-267 <div style="border: 1px solid black; padding: 2px; display: flex; gap: 5px;"> N </div>
---	--

10500 SERIES™

Shared Components & Accessories

GSA SIN 33721



Icon Legend on page 19

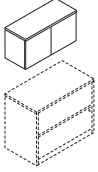

DESCRIPTION	MODEL	SHIP		LIST PRICE BY LAMINATE GRADE	
		WEIGHT	CUBE	L1	L2
Wall Mounted Storage Cabinet 48"W x 14 ⁵ / ₈ "D x 17 ¹ / ₂ "H, 3 doors (Use task light model HH870942, see page 309)	H105383	114	13.2	\$931	\$966
42"W x 14 ⁵ / ₈ "D x 17 ¹ / ₂ "H, 2 doors (Use task light model HH870942, see page 309)	H105382	97	11.7	\$871	\$906
36"W x 14 ⁵ / ₈ "D x 17 ¹ / ₂ "H, 2 doors (Use task light model HH870930, see page 309)	H105381	87	10.2	\$793	\$828
30"W x 14 ⁵ / ₈ "D x 17 ¹ / ₂ "H, 2 doors (Use task light model HH870930, see page 309)	H105380	73	8.7	\$739	\$774
Wall Mounted Storage Cabinet, Locking 48"W x 14 ⁵ / ₈ "D x 17 ¹ / ₂ "H, 3 doors (Use task light model HH870942, see page 309)	H105383K	114	13.2	\$998	\$1033
42"W x 14 ⁵ / ₈ "D x 17 ¹ / ₂ "H, 2 doors (Use task light model HH870942, see page 309)	H105382K	97	11.7	\$915	\$950
36"W x 14 ⁵ / ₈ "D x 17 ¹ / ₂ "H, 2 doors (Use task light model HH870930, see page 309)	H105381K	87	10.2	\$838	\$873
30"W x 14 ⁵ / ₈ "D x 17 ¹ / ₂ "H, 2 doors (Use task light model HH870930, see page 309)	H105380K	73	8.7	\$784	\$819

NOTES: Horizontal interlocking rails are included; due to varying types of walls, installers are responsible for selecting and supplying the appropriate fasteners. Tackboard widths differ slightly from wall mounted storage cabinet widths. For applications where multiple wall mounted storage cabinets are placed side-by-side, the preferred tackboard solution may be to utilize a larger tackboard size. For wall mounted storage cabinets with frosted doors, see page 309.

SPECIFYING EXAMPLE: H105380.NN
If Specifying with Lock Option: H105380K.NN

NOTES:

- Tackboard is sized ³/₄" narrower than stack-on storage back enclosure, allowing ³/₈" on each side to route task light cord.
- Wall attachment methodology: horizontally mounted, interlocking brackets.
- Wall mounted storage cabinet door design overlaps end panels so that when multiple units are placed side-by-side they appear as one continuous unit.
- Wall mounted storage cabinets available with laminate doors, locking laminate doors or frosted doors.
- Removable lock core kit for locking stack-on and wall mounted storage is model HF27B. See page 773.
- See pages 298-325 for shared components.

- ! Wall mounted storage cabinet attachment requires individual cabinets be secured by a minimum of two wall mounting locations/studs.
- ! Wall mounted storage cabinets are designed for interior and perimeter walls that are constructed with wood or metal studs.
- ! The HON Company is not responsible for any liabilities resulting from wall mounted storage cabinets that are not properly installed.

HOW TO SPECIFY

Select Model Number	Select Laminate Top and Chassis Color See pages 266-267
H 1 0 5 3 8 0 K .	N N



Icon Legend on page 29

10500 SERIES™ Shared Components & Accessories

	DESCRIPTION	MODEL	SHIP WEIGHT	CUBE	L1 LIST	L2 UPCHARGES	
						CHASSIS	FRONTS
	Wall Mounted Hutch						
	66"W x 14 ⁵ / ₈ "D x 15"H, 4 doors	H105WMH66	120	16.1	\$1359	\$30	\$30
	48"W x 14 ⁵ / ₈ "D x 15"H, 3 doors	H105WMH48	97	12.6	\$974	\$25	\$30
	42"W x 14 ⁵ / ₈ "D x 15"H, 2 doors	H105WMH42	77	10.7	\$913	\$25	\$20
	36"W x 14 ⁵ / ₈ "D x 15"H, 2 doors	H105WMH36	67	9.8	\$836	\$25	\$20
	30"W x 14 ⁵ / ₈ "D x 15"H, 2 doors	H105WMH30	57	8.3	\$782	\$25	\$20
	Wall Mounted Cubby Hutch						
	66"W x 14 ⁵ / ₈ "D x 20"H, 4 doors	H105WMH66C	155	19.6	\$1359	\$30	\$30
	48"W x 14 ⁵ / ₈ "D x 20"H, 3 doors	H105WMH48C	128	15.2	\$974	\$25	\$30
	42"W x 14 ⁵ / ₈ "D x 20"H, 2 doors	H105WMH42C	114	13.0	\$913	\$25	\$20
	36"W x 14 ⁵ / ₈ "D x 20"H, 2 doors	H105WMH36C	89	11.8	\$836	\$25	\$20
	30"W x 14 ⁵ / ₈ "D x 20"H, 2 doors	H105WMH30C	76	10.0	\$782	\$25	\$20
	Wall Mounted Open Hutch						
	72"W x 14 ⁵ / ₈ "D x 15"H, 2 Doors	H105WMH72P	119	17.5	\$1484	\$35	\$35
	66"W x 14 ⁵ / ₈ "D x 15"H, 2 Doors	H105WMH66P	111	16.1	\$1359	\$30	\$30
	60"W x 14 ⁵ / ₈ "D x 15"H, 2 Doors	H105WMH60P	104	14.7	\$1231	\$30	\$30
	48"W x 14 ⁵ / ₈ "D x 15"H, 2 Doors	H105WMH48P	89	12.6	\$1103	\$25	\$30
	Wall Mounted Open Hutch with Cubby						
	72"W x 14 ⁵ / ₈ "D x 20"H, 2 Doors	H105WMH72PC	162	21.3	\$1484	\$35	\$35
	66"W x 14 ⁵ / ₈ "D x 20"H, 2 Doors	H105WMH66PC	151	19.6	\$1359	\$30	\$30
	60"W x 14 ⁵ / ₈ "D x 20"H, 2 Doors	H105WMH60PC	140	14.7	\$1231	\$30	\$30
	48"W x 14 ⁵ / ₈ "D x 20"H, 2 Doors	H105WMH48PC	117	12.6	\$1103	\$25	\$30

NOTES:

- Wall attachment methodology: horizontally mounted, interlocking brackets.
- Wall mounted storage cabinet door design overlaps end panels so that when multiple units are placed side-by-side they appear as one continuous unit.
- Laminate doors are non-locking.
- Horizontal interlocking rails are included; due to varying types of walls, installers are responsible for selecting and supplying the appropriate fasteners. Tackboard widths differ slightly from wall mounted storage cabinet widths. For applications where multiple wall mounted storage cabinets are placed side-by-side, the preferred tackboard solution may be to utilize a larger tackboard size.
- ! Wall mounted storage cabinet attachment requires individual cabinets be secured by a minimum of two wall mounting locations/studs.
- ! Wall mounted storage cabinets are designed for interior and perimeter walls that are constructed with wood or metal studs.
- ! The HON Company is not responsible for any liabilities resulting from wall mounted storage cabinets that are not properly installed.

HOW TO SPECIFY

<p>Select Model Number</p> <p>H 1 0 5 W M H 4 8</p>	<p>Select Laminate Top and Chassis Color</p> <p>See page 266</p> <p>N N</p>	<p>Select Door Front Laminate</p> <p>See page 266</p> <p>N</p>
---	---	--

10500 SERIES™

Shared Components & Accessories

OPEN MARKET

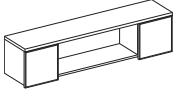
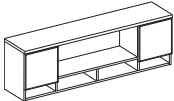

Icon Legend on page 19

	DESCRIPTION	MODEL	SHIP		LIST PRICE BY LAMINATE GRADE	
			WEIGHT	CUBE	L1	L2
	Wall Mounted Open Hutch, Glass Doors					
	72"W x 14 ⁵ / ₈ "D x 15"H, 2 Doors	H105WMH72PG	162	17.5	\$2014	\$2049
	66"W x 14 ⁵ / ₈ "D x 15"H, 2 Doors	H105WMH66PG	115	16.1	\$1889	\$1919
	60"W x 14 ⁵ / ₈ "D x 15"H, 2 Doors	H105WMH60PG	108	14.7	\$1761	\$1791
	48"W x 14 ⁵ / ₈ "D x 15"H, 2 Doors	H105WMH48PG	93	12.6	\$1633	\$1663
	Wall Mounted Open Hutch with Cubby, Glass Doors					
	72"W x 14 ⁵ / ₈ "D x 20"H, 2 Doors	H105WMH72PCG	166	21.3	\$2014	\$2049
	66"W x 14 ⁵ / ₈ "D x 20"H, 2 Doors	H105WMH66PCG	155	19.6	\$1889	\$1919
	60"W x 14 ⁵ / ₈ "D x 20"H, 2 Doors	H105WMH60PCG	144	17.9	\$1761	\$1791
	48"W x 14 ⁵ / ₈ "D x 20"H, 2 Doors	H105WMH48PCG	121	15.2	\$1633	\$1663

NOTES:

- Wall attachment methodology: horizontally mounted, interlocking brackets.
 - Wall mounted storage cabinet door design overlaps end panels so that when multiple units are placed side-by-side they appear as one continuous unit.
 - Rich woodgrain laminate and frosted doors with silver frames adds a contemporary mixed materials option to the 10500 Series™.
 - Horizontal interlocking rails are included; due to varying types of walls, installers are responsible for selecting and supplying the appropriate fasteners. Tackboard widths differ slightly from wall mounted storage cabinet widths. For applications where multiple wall mounted storage cabinets are placed side-by-side, the preferred tackboard solution may be to utilize a larger tackboard size.
- ⚠ Wall mounted storage cabinet attachment requires individual cabinets be secured by a minimum of two wall mounting locations/studs.
- ⚠ Wall mounted storage cabinets are designed for interior and perimeter walls that are constructed with wood or metal studs.
- ⚠ The HON Company is not responsible for any liabilities resulting from wall mounted storage cabinets that are not properly installed.

HOW TO SPECIFY

Select
Model Number

H 1 0 5 W M H 6 6 P G .

Select
Laminate Top and Chassis Color

See page 266

N N



Icon Legend on page 19

10500 SERIES™ Storage

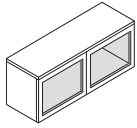

DESCRIPTION	MODEL	SHIP WEIGHT	CUBE	LIST PRICE BY LAMINATE GRADE	
				L1	L2
Wall Mounted Storage Cabinet, Frosted Doors with Silver Frame					
48"W x 14 5/8"D x 17 1/2"H	H105383G	114.0	13.9	\$1451	\$1476
42"W x 14 5/8"D x 17 1/2"H	H105382G	97.0	12.3	\$1224	\$1249
36"W x 14 5/8"D x 17 1/2"H	H105381G	87.0	10.7	\$1144	\$1169
30"W x 14 5/8"D x 17 1/2"H	H105380G	73.0	9.1	\$1089	\$1114

NOTES: Door design overlaps end panels so that when multiple units are placed side-by-side they appear as one continuous unit. Product placement can be aligned to match the height of storage cabinets, wardrobes and towers. Equipped with self-closing, adjustable side-hinged doors. The 30", 36", and 42"W units have two doors; the 48"W has three doors. Frosted door units do not have a lock option. Wall attachment methodology: horizontally mounted, interlocking brackets.

Tackboard widths differ slightly from wall mounted storage cabinet widths. For applications where multiple wall mounted storage cabinets are placed side-by-side, the preferred tackboard width may be to utilize a larger tackboard size.

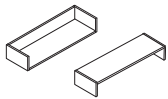

Not available in two-tone laminate



DESCRIPTION	MODEL	SHIP WEIGHT	CUBE	LIST PRICE BY LAMINATE GRADE	
				L1	L2
Wall Mounted Open Shelf					
48"W x 9 7/8"D x 4 3/4"H	H105363	18.0	1.2	\$328	\$348
42"W x 9 7/8"D x 4 3/4"H	H105362	16.0	0.8	\$297	\$317
36"W x 9 7/8"D x 4 3/4"H	H105361	14.0	0.8	\$270	\$285
30"W x 9 7/8"D x 4 3/4"H	H105360	12.0	0.8	\$256	\$271

NOTES: Ideal for books, photographs, and mementos up to 9"D. Two attachment orientation options, open ended shelf or shelf with book ends. Available in woodgrain or solid color laminates only. No patterns. No two-tone combinations. Simple assembly.

SPECIFYING EXAMPLE: H105363.N

NOTES:

- Easy-care, scratch-, spill- and stain-resistant laminate over solid core high-performance particleboard.
- Stacked paper management (model HLVPM2), which is 32 1/2"W, is compatible with the 30"W and 36"W wall mounted storage cabinets.
- ! Wall mounted storage cabinet attachment requires individual cabinets be secured by a minimum of two wall mounting locations/studs.
- ! Wall mounted storage cabinets are designed for interior and perimeter walls that are constructed with wood or metal studs.
- ! The HON Company is not responsible for any liabilities resulting from wall mounted storage cabinets that are not properly installed.



OPEN MARKET

DESCRIPTION	MODEL	SHIP WEIGHT	CUBE	LIST PRICE
LED Task Lights				
31" LED Light with Power Supply (Single)	HLED31AS ☉	1.5 ☉	0.09	\$603
17" LED Light with Power Supply (Single)	HLED17AS ☉	1.2 ☉	0.05	\$450
31" LED Light with Power Supply for Daisy-chain (Starter)	HLED31A	1.4 ☉	0.09	\$662
17" LED Light with Power Supply for Daisy-chain (Starter)	HLED17A	1.0 ☉	0.05	\$493
31" LED Light with 8" Jumper Cord for Daisy-chain (Follower)	HLED31AUO ☉	1.0 ☉	0.05	\$539
17" LED Light with 8" Jumper Cord for Daisy-chain (Follower)	HLED17AUO ☉	1.0 ☉	0.03	\$404

Undercabinet Occupancy Sensor with 1" End to End Connector **HLEDOSA** ☉ 0.2 ☉ 0.01 **\$97**

NOTES: To use the daisy chain application, must start with model HLED17A or HLED31A. No finish specification required. Attaches magnetically to underside of overhead storage, or attaches with provided screws or double-sided tape. Occupancy sensor attaches to a single or starter LED light and will automatically turn the light off after no motion is detected for 30 minutes. Just like all the LED light models, the occupancy sensor features a soft-touch on/off switch. LED task lights have a lifetime of 50,000 hours and have a dimmer feature that allows the user to adjust the amount of light output.

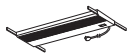

Refer to the Workplace Tools section in the 2021 Shared Spaces Pricer

OPEN MARKET

Recessed Task Light , 46 1/2"W x 3 1/16"D, for Models H105327, H10534, H10533 and H105324	HH870960	12.0 ☉	1.1	\$290
Recessed Task Light , 34 5/8"W x 3 1/16"D, for Models H105323, H105322, H105382 and H105383	HH870942	10.0 ☉	0.9	\$267
Recessed Task Light , 22 7/8"W x 3 1/16"D, for Models H105321, H105380 and H105381	HH870930	7.0 ☉	0.6	\$247

NOTES: For additional information see the Workplace Tools section in the 2021 Shared Spaces Pricer.

HOW TO SPECIFY

<p>Select Model Number</p> <p>H 1 0 5 3 8 3 G .</p>	<p>Select Laminate Top and Chassis Color</p> <p>See pages 266-267</p> <p>H H</p>
---	--

10500 SERIES™ Shared Components & Accessories

GSA SIN 33721



Icon Legend on page 19

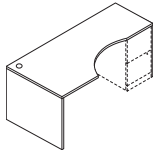

Right-hand model
H105815R shown



DESCRIPTION

Extended Corner Unit

24" W x 36" D x 72" W x 24" D x 29½" H, Right (shown)
24" D x 72" W x 36" D x 24" W x 29½" H, Left

MODEL

H105815R
H105816L

SHIP WEIGHT CUBE

184 7.0
184 7.0

LIST PRICE BY LAMINATE GRADE
L1 L2

\$1139 \$1184
\$1139 \$1184

NOTES: Intended for use with returns or bridges. Can be used freestanding. The 17" user side dimension is designed to accommodate 10500 Series™ modular or mobile pedestals up to 15¾"W. One grommet in top and one cord pass-through grommet in modesty panel. See pages 301-305 for optional stack-ons and tackboards. Extended corner units (H105815R and H105816L) can be used with 36"W return shell (H105680) to achieve a 6' x 6' layout.

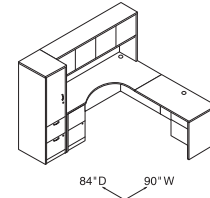
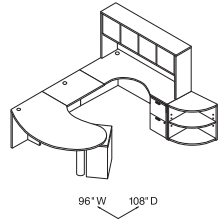
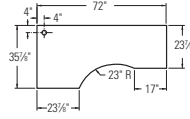

H105204L
H105102
H105598
H105815R
H105104
H10534
H105520

H105298L
H105816L
H10504
H10534
H10515R

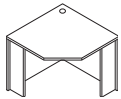

Corner Unit

24" x 36" x 36" x 24" x 29½"H

H105811

130 3.1

\$820 \$855

NOTES: Intended for use with 24"D x 29½"H returns or bridges. Can be used freestanding. 36" corner unit (H105811) can be used with two 36"W return shells (H105680) to achieve a 6' x 6' layout.

⚠ Not designed to attach to returns or bridges manufactured prior to 5/24/99.

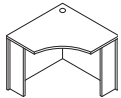
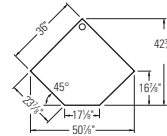

Curved Corner Unit

18" x 36" x 36" x 18" x 29½"H

H105810

128 5.4

\$820 \$855

NOTES: Can be used freestanding.

⚠ Designed to be used with curved returns only.

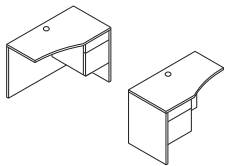

Curved Return — box/file

42" W x 18-24" D x 29½" H, Right
42" W x 24-18" D x 29½" H, Left

H105817R
H105818L

134 20.5
134 20.5

\$888 \$928
\$888 \$928

NOTES: Pedestal locks. One cord grommet in top; one pass-through grommet in top center of modesty panel. H105327 stack-on storage (78"W) can be used to span corner unit and return. H105322 stack-on storage (42"W) can be used on return. See page 302.

⚠ Designed to be used with curved corner unit only.
⚠ Not designed to be used freestanding.

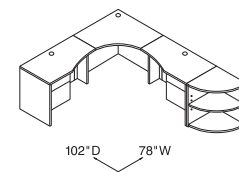
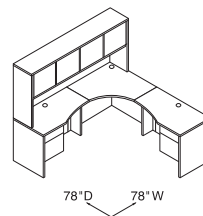

H105818L
H105810
H105327
H105817R

H105818
H105810
H105817R
H105520

NOTES:

- Shared components shown on this page can be used with modular components shown on pages 274-291, full pedestal models shown on pages 292-293, and 3/4 pedestal models shown on pages 296-297.
- Mobile pedestals, shown on page 311, work well in a variety of configurations.
- End cap bookshelf units are ideal for books and personal items — see page 316.
- For work-in-process paper management tools, see pages 319-320.
- For 10500 Series™ matching occasional tables, use the H80191, H80192, and H80193 on page 321.
- For conference table options, see the Preside® table tops and bases in the Tables section in the 2021 Shared Spaces Pricer.
- See pages 298-325 for shared components.

HOW TO SPECIFY

Select Model Number

Select Laminate Top and Chassis Color





See pages 266-267

H 1 0 5 8 1 5 R . N N



10500 SERIES™

Shared Components & Accessories

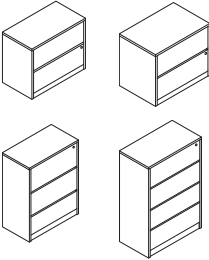
	DESCRIPTION	MODEL	SHIP WEIGHT	CUBE	LIST PRICE BY LAMINATE GRADE	
					L1	L2
	Box/Box/File Mobile Pedestal (with core removable lock) 15 ³ / ₄ "W x 22 ³ / ₄ "D x 28 ³ / ₈ "H — use freestanding or under 24"D, 30"D and 36"D modular shells NOTES: Top box drawer does not lock. File drawer includes hangrails.	H105102	121	8.5	\$906	\$946
	File/File Mobile Pedestal (with core removable lock) 15 ³ / ₄ "W x 22 ³ / ₄ "D x 28 ³ / ₈ "H — use freestanding or under 24"D, 30"D and 36"D modular shells NOTES: File drawers include hangrails.	H105104	121	8.4	\$906	\$946
	Box/File Mobile Pedestal (with core removable lock) 15 ³ / ₄ "W x 18 ⁷ / ₈ "D x 21 ⁷ / ₈ "H — use freestanding or under 20"D, 24"D, 30"D and 36"D modular shells	H105106	65	5.8	\$757	\$787
	Shelf/Box/File Mobile Pedestal (with core removable lock) 15 ³ / ₄ "W x 18 ⁷ / ₈ "D x 28 ³ / ₈ "H — use freestanding or under 20"D, 24"D, 30"D and 36"D modular shells NOTES: Interior dimensions of the open storage area of the Shelf/Box/File model are 14 ¹ / ₈ "W x 16 ³ / ₄ "D x 6 ⁵ / ₈ "H.	H105109	73	7.3	\$834	\$874
	Lateral File (with core removable lock) 36"W x 20"D x 59 ¹ / ₈ "H — four drawer 36"W x 20"D x 45 ¹ / ₂ "H — three drawer 36"W x 24"D x 29 ¹ / ₂ "H — two drawer 36"W x 20"D x 29 ¹ / ₂ "H — two drawer NOTES: Includes hangrails, mechanical interlock and in H10563 and H105690, a counterweight. Stack-on storage (H105321) and bookcase hutch (H105292) can be used with H10563 and H105690. Interlock inhibits the extension of more than one drawer from opening at a time. Model H105690 aligns with 24"D credenzas and returns.	H10516 ☉ 305 H10517 240 H105690 191 H10563 ☉ 170	31.0 23.2 17.6 15.6	\$2232 \$1694 \$1085 \$1032	\$2302 \$1759 \$1140 \$1082	

NOTES:

- For additional components that can be shared with 10500 Series™, see pages 298-325.
- Mobile pedestals feature clean styling with hidden casters. Versatile designs roll easily and work well in a variety of configurations. Can be used freestanding, under modular shells, or with 10500 Series™ component worksurfaces and supports.
- 24"D lateral file, storage cabinet, and bookcase models align evenly with credenzas and returns to provide linear layout continuity.
- At 45¹/₂"H, the three-drawer lateral file can be used as a standing-height worksurface or to support office equipment.
- Drawers operate on full extension, ball-bearing suspensions to ensure smooth, quiet, long-lasting operation.
- File drawer design includes integrated hangrails for side-to-side letter or legal filing; and front-to-back for letter filing.
- Mobile printer/fax cart shown on page 291 is ideal for limited space.

HOW TO SPECIFY

Select Model Number H 1 0 5 1 0 2	Select Laminate Top and Chassis Color See pages 266-267 N N
---	--

10500 SERIES™

Shared Components & Accessories

GSA SIN 33721 EXCEPT AS NOTED

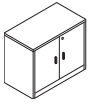
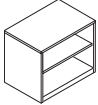
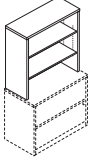
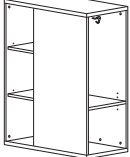
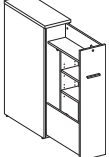

Icon Legend on page 19

	DESCRIPTION	MODEL	SHIP WEIGHT	CUBE	LIST PRICE BY LAMINATE GRADE	
					L1	L2
	Storage Cabinet with Doors (with core removable lock)					
	36"W x 24"D x 29½"H 36"W x 20"D x 29½"H	H105290 H105291	168 147	17.6 15.0	\$983 \$828	\$1038 \$878
	NOTES: Includes one adjustable shelf. Shelf adjusts in ¼" increments with a total range of 5"H. Stack-on storage (H105321), and bookcase hutch (H105292) can be used with H105291 or H105290. Model H105290 aligns with 24"D credenzas and returns.					
	Bookcase					
	36"W x 24"D x 29½"H, 2-Shelf, 1-Adjustable	H105531	102	18.4	\$803	\$818
	NOTES: Adjustable shelf is 22"D and adjusts in ¼" increments, with a total range of 5". 24" depth aligns evenly with 24"D credenzas, credenza shells, returns, return shells, and wardrobe/storage cabinets to provide linear layout continuity. Adjustable leveling glides. Accommodates the 36"W stack-on storage or bookcase hutch. Ships fully assembled.					
	Bookcase Hutch (for use with lateral file models H10563/H105690, storage cabinet models H105291/H105290, and bookcase model H105531)					
	36"W x 14⅝"D x 37⅞"H	H105292	103	3.6	\$605	\$620
	NOTES: Cord pass-through gap behind shelves and a 1⅞"H full-width cord management slot at the bottom of the back panel. Two shelves are adjustable in ¼" increments with a total range of 17½"H.					
	Multi-Use Stack-On Storage					
	36"W x 18"D x 45⅝"H	H105310	142	21.9	\$1123	\$1158
	NOTES: Non-handed. Design features user's side bookcase and end access mixed storage compartment. Three fixed bookcase compartments, each 12"W x 13¾"H. Versatile mixed storage area includes two coat hooks and two shelves; one adjustable in ¼"H increments with a total range of 5" (shelf count includes bottom of the unit). For use on worksurfaces 36" or wider and 18" or deeper. Total height, in combination with low credenza, is 66⅝". Accepts markerboard models HLSL1536SOMB or HLSL1530SOMB (sold separately). Ships fully assembled.					
	DESCRIPTION	MODEL	SHIP WEIGHT	CUBE	L1 LIST	L2 UPCHARGES CHASSIS FRONTS
	Slide Out Tower					
	12"W x 30"D x 50"H, Right	H105ST123050R	215	13.8	\$3180	\$60 \$20
	12"W x 30"D x 50"H, Left	H105ST123050L	215	13.8	\$3180	\$60 \$20
	12"W x 24"D x 50"H, Right	H105ST122450R	182	11.4	\$2868	\$50 \$20
	12"W x 24"D x 50"H, Left	H105ST122450L	182	11.4	\$2868	\$50 \$20
	NOTES: Wardrobe space contains one coat hook. Storage space includes three shelves; two are adjustable in 2½" increments. Door access left or right models available. Equipped with HON "One Key" interchangeable core removable locks. Standard with Black linear pull.					

OPEN MARKET**NOTES:**

- For additional components that can be shared with 10500 Series™, see pages 298-325.
- Versatile mobile pedestals roll easily and work well in a variety of configurations. Can be used freestanding, under modular shells, or with 10500 Series™ component worksurfaces and supports.
- 24"D lateral file, storage cabinet, and bookcase models align evenly with credenzas and returns to provide linear layout continuity.
- Mobile printer/fax cart shown on page 291 is ideal for limited space.

HOW TO SPECIFY

Select Model Number H 1 0 5 2 9 1 .	Select Laminate Top and Chassis Color See pages 266-267 N N			
Select Model Number H 1 0 5 S T 1 2 3 0 5 0 R .	Select Laminate Top and Chassis Color See page 266 N N .	Select Door Front Laminate See page 266 N .	Select Pull and Color L Linear P Black L P .	Select Lock Option Not available on Open Credenzas L Lock L



10500 SERIES™ Shared Components & Accessories

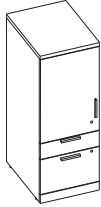

DESCRIPTION

Storage Wardrobe

- 24"W x 24"D x 50"H, Right
- 24"W x 24"D x 50"H, Left
- 24"W x 20"D x 50"H, Right
- 24"W x 20"D x 50"H, Left
- 18"W x 24"D x 50"H, Right
- 18"W x 24"D x 50"H, Left
- 18"W x 20"D x 50"H, Right
- 18"W x 20"D x 50"H, Left

MODEL

- H105LT242450CBFR**
- H105LT242450CBFL**
- H105LT242050CBFR**
- H105LT242050CBFL**
- H105LT182450CBFR**
- H105LT182450CBFL**
- H105LT182050CBFR**
- H105LT182050CBFL**

SHIP WEIGHT

- 202
- 202
- 178
- 178
- 168
- 168
- 147
- 147

CUBE

- 21.3
- 21.3
- 17.9
- 17.9
- 16.2
- 16.2
- 13.7
- 13.7

L1 LIST

- \$2173**
- \$2173**
- \$2120**
- \$2120**
- \$2067**
- \$2067**
- \$1832**
- \$1832**

L2 UPCHARGES
CHASSIS FRONTS

- \$60 \$35**
- \$60 \$35**
- \$50 \$35**
- \$50 \$35**
- \$50 \$30**
- \$50 \$30**
- \$45 \$30**
- \$45 \$30**

NOTES: Spacious design includes a wardrobe closet, storage cabinet, one box drawer, and one file drawer in one compact unit. Wardrobe closet contains a coat rod. Storage cabinet includes two shelves, one is adjustable in 2½" increments. Door hinged left or right models available. Box and file drawers operate on ball-bearing suspensions with full extension. File drawers have high sides to accept hanging folders in letter or legal size. Drawers standard with hangrails. Equipped with HON "One Key" interchangeable core removable locks. Upper lock secures storage cabinet and wardrobe closet doors; lower lock secures file drawers.

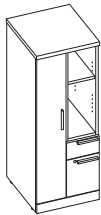

Open Wardrobe

- 24"W x 24"D x 50"H, Right
- 24"W x 24"D x 50"H, Left
- 24"W x 20"D x 50"H, Right
- 24"W x 20"D x 50"H, Left
- 18"W x 24"D x 50"H, Right
- 18"W x 24"D x 50"H, Left
- 18"W x 20"D x 50"H, Right
- 18"W x 20"D x 50"H, Left

- H105LT242450BFR**
- H105LT242450BFL**
- H105LT242050BFR**
- H105LT242050BFL**
- H105LT182450BFR**
- H105LT182450BFL**
- H105LT182050BFR**
- H105LT182050BFL**

- 190
- 190
- 167
- 167
- 161
- 161
- 141
- 141

- 21.3
- 21.3
- 17.9
- 17.9
- 16.2
- 16.2
- 13.7
- 13.7

- \$2120**
- \$2120**
- \$1908**
- \$1908**
- \$2014**
- \$2014**
- \$1779**
- \$1779**

- \$60 \$35**
- \$60 \$35**
- \$50 \$35**
- \$50 \$35**
- \$50 \$30**
- \$50 \$30**
- \$45 \$30**
- \$45 \$30**

NOTES: Spacious design includes a wardrobe closet, open storage, one box drawer, and one file drawer in one compact unit. Wardrobe closet contains a coat rod. Storage cabinet includes two shelves, one is adjustable in 2½" increments. Door hinged left or right models available. Box and file drawers operate on ball-bearing suspensions with full extension. File drawers have high sides to accept hanging folders in letter or legal size. Drawers standard with hangrails. Equipped with HON "One Key" interchangeable core removable locks. Lock secures box and file drawers; wardrobe is non-locking.



Side Access Wardrobe

- 24"W x 24"D x 50"H, Right
- 24"W x 24"D x 50"H, Left
- 24"W x 20"D x 50"H, Right
- 24"W x 20"D x 50"H, Left
- 18"W x 24"D x 50"H, Right
- 18"W x 24"D x 50"H, Left
- 18"W x 20"D x 50"H, Right
- 18"W x 20"D x 50"H, Left

- H105LT242450SBFR**
- H105LT242450SBFL**
- H105LT242050SBFR**
- H105LT242050SBFL**
- H105LT182450SBFR**
- H105LT182450SBFL**
- H105LT182050SBFR**
- H105LT182050SBFL**

- 187
- 187
- 166
- 166
- 153
- 153
- 135
- 135

- 21.3
- 21.3
- 17.9
- 17.9
- 16.2
- 16.2
- 13.7
- 13.7

- \$2203**
- \$2203**
- \$2014**
- \$2014**
- \$2084**
- \$2084**
- \$1832**
- \$1832**

- \$60 \$35**
- \$60 \$35**
- \$50 \$35**
- \$50 \$35**
- \$50 \$30**
- \$50 \$30**
- \$45 \$30**
- \$45 \$30**

NOTES: Spacious design includes a wardrobe closet, open side access storage, one box drawer, and one file drawer in one compact unit. Wardrobe closet contains a coat rod. Storage cabinet includes two shelves, one is adjustable in 2½" increments. Door hinged left or right models available. Box and file drawers operate on ball-bearing suspensions with full extension. File drawers have high sides to accept hanging folders in letter or legal size. Drawers standard with hangrails. Equipped with HON "One Key" interchangeable core removable locks. Lock secures box and file drawers; wardrobe is non-locking.

NOTES:

- Broad family of storage components beyond the confines of a desk drawer.
- Locking units equipped with interchangeable core removable locks.
- Adjustable hex leveling glides allow floor-standing furniture to be easily leveled without lifting the unit; glides have ¾" adjustable range.

HOW TO SPECIFY

<p>Select Model Number</p> <p>H 1 0 5 L T 1 8 2 4 5 0 B F R .</p>	<p>Select Laminate Top and Chassis Color</p> <p>See page 266 Kickplates will match chassis color</p> <p>N N .</p>	<p>Select Door Front Laminate</p> <p>See page 266</p> <p>N .</p>	<p>Select Pull and Color</p> <p>L Linear P Black</p> <p>L P .</p>	<p>Select Lock Option</p> <p>L Lock</p> <p>L</p>
--	--	---	--	---

10500 SERIES™

Shared Components & Accessories

OPEN MARKET



Icon Legend on page 19

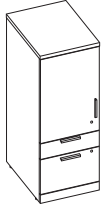

DESCRIPTION	MODEL	SHIP WEIGHT	CUBE	L1 LIST	L2 UPCHARGES	
					CHASSIS	FRONTS
Storage Cabinet 18"W x 24"D x 50"H, Right	H105LT182450SCBFR	158	16.2	\$1670	\$50	\$30
18"W x 24"D x 50"H, Left	H105LT182450SCBFL	158	16.2	\$1670	\$50	\$30

NOTES:

- Versatile unit features a storage cabinet, one box drawer, and one file drawer.
- Storage cabinet includes two shelves, one is adjustable in 2½" increments.
- Door hinged left or right models available.
- File drawers operate on ball-bearing suspensions with full extension.
- File drawers have high sides to accept hanging folders in letter or legal size.
- Drawers standard with hangrails.
- Both the storage cabinet and the file drawers are equipped with a HON "One Key" interchangeable core removable lock.
- Upper lock secures storage cabinet; lower lock secures box and file drawers.
- Broad family of storage components beyond the confines of a desk drawer.
- Locking units equipped with interchangeable core removable locks.
- Adjustable hex leveling glides allow floor-standing furniture to be easily leveled without lifting the unit; glides have ¾" adjustable range.



HOW TO SPECIFY

Select Model Number H 1 0 5 L T 1 8 2 4 5 0 S C B F R .	Select Laminate Top and Chassis Color See page 266 Kickplates will match chassis color N N .	Select Door Front Laminate See page 266 N .	Select Pull and Color L Linear P Black L P .	Select Lock Option L Lock L
--	---	---	---	--

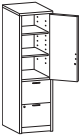

10500 SERIES™

Shared Components & Accessories

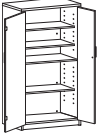
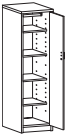
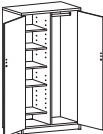
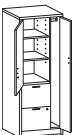
	DESCRIPTION	MODEL	SHIP WEIGHT	CUBE	LIST PRICE BY LAMINATE GRADE	
					L1	L2
 Right-hand model H105297R shown	Storage/File Cabinet (with core removable locks)					
	18"W x 24"D x 66 $\frac{5}{8}$ "H, Hinged Right (shown)	H105297R	258	22.7	\$1794	\$1869
	18"W x 24"D x 66 $\frac{5}{8}$ "H, Hinged Left	H105298L	258	22.7	\$1794	\$1869
	NOTES: Versatile unit features a storage cabinet and two file drawers. Storage cabinet includes three shelves, two are adjustable in 2 $\frac{1}{2}$ " increments. Door hinged left or right models available. File drawers operate on ball-bearing suspensions with full extension. File drawers have high sides to accept hanging folders in letter or legal size. Drawers standard with hangrails. Both the storage cabinet and the file drawers are equipped with a HON "One Key" interchangeable core removable lock. Unit height is designed to match credenza or return plus stack-on storage height.					
 Doors open 110 degrees from closed position.	Storage Cabinet/Lateral File (with core removable lock)					
	36"W x 24"D x 66 $\frac{5}{8}$ "H	H105293	365	41.0	\$2415	\$2515
	NOTES: Storage cabinet is standard with one fixed and two full-width adjustable shelves in top compartment; adjustable shelves can be removed. Overall storage compartment measures 31 $\frac{1}{4}$ "W x 22"D x 36 $\frac{1}{8}$ "H and will accommodate supplies, books and binders, as well as business machines and electronic equipment. Cord pass-through gap behind shelves and grommet in back of the cabinet to facilitate routing cords and reaching wall electrical outlets. Two drawer lateral file on bottom. Lateral file comes with mechanical interlock and hangrails. Cabinet and lateral file lock independently. Unit height is designed to match credenza or return plus stack-on storage height.					
 Doors open 110 degrees from closed position.	Storage Cabinet with Full-width Shelves (with core removable lock)					
	36"W x 24"D x 66 $\frac{5}{8}$ "H	H105299	341	39.6	\$2254	\$2354
	NOTES: Large storage area includes five, full-width (side-to-side) shelves; three are adjustable in 2 $\frac{1}{2}$ " increments. Unit height matches credenza or return plus stack-on storage height.					
 Right-hand model H105295R shown	Personal Wardrobe/Storage Cabinet (with core removable lock)					
	18"W x 24"D x 66 $\frac{5}{8}$ "H, Hinged Right (shown)	H105295R	223	22.9	\$1625	\$1700
	18"W x 24"D x 66 $\frac{5}{8}$ "H, Hinged Left	H105296L	223	22.9	\$1625	\$1700
	NOTES: Unit is standard with four adjustable shelves, coat rod, and core removable lock. Shelves adjust in 2 $\frac{1}{2}$ " increments. Cabinet can be used as a wardrobe by removing four adjustable shelves. Coat rod can be removed from cabinet for storage only applications. Unit height is designed to match credenza or return plus stack-on storage height.					
 Doors open 110 degrees from closed position.	Personal Wardrobe/Storage Cabinet (with core removable lock)					
	36"W x 24"D x 66 $\frac{5}{8}$ "H	H10530	341	41.0	\$2415	\$2427
	NOTES: Spacious design is standard with four adjustable shelves (one shelf is fixed), coat rod and core removable lock which locks both doors. Shelves adjust in 2 $\frac{1}{2}$ " increments. Unit height is designed to match credenza or return plus stack-on storage height.					
 Right-hand model H105301R shown	Personal Storage Tower (with core removable locks)					
	24"W x 24"D x 66 $\frac{5}{8}$ "H, wardrobe Hinged Right, storage cabinet Hinged Left (shown)	H105301R	299	27.9	\$2268	\$2363
	24"W x 24"D x 66 $\frac{5}{8}$ "H, wardrobe Hinged Left, storage cabinet Hinged Right	H105302L	299	27.9	\$2268	\$2363
	NOTES: Spacious design includes a wardrobe closet, storage cabinet, and two file drawers in one compact unit. Wardrobe closet contains a coat rod. Storage cabinet includes three shelves, two are adjustable in 2 $\frac{1}{2}$ " increments. Door hinged left or right models available. File drawers operate on ball-bearing suspensions with full extension. File drawers have high sides to accept hanging folders in letter or legal size. Drawers standard with hangrails. Equipped with HON "One Key" interchangeable core removable locks. Upper lock secures storage cabinet and wardrobe closet doors; lower lock secures file drawers. Unit height is designed to match credenza or return plus stack-on storage height.					

NOTES:

- Broad family of storage components takes organization way beyond the confines of a desk drawer.
- Locking units equipped with interchangeable core removable locks.
- Adjustable hex leveling glides allow floor-standing furniture to be easily leveled without lifting the unit; glides have $\frac{3}{4}$ " adjustable range.
- See pages 298-325 for shared components.

🔑 Keyed alike cores must be ordered separately — see model HF23B on page 773 — makes re-keying quick and easy.

HOW TO SPECIFY

Select Model Number	Select Laminate Top and Chassis Color
	See pages 266-267
H 1 0 5 2 9 7 R .	N N

10500 SERIES™

Shared Components & Accessories

GSA SIN 33721



Icon Legend on page 19



H105532 shown



DESCRIPTION	MODEL	SHIP WEIGHT	CUBE	LIST PRICE BY LAMINATE GRADE	
				L1	L2
Bookcase					
5 Shelf, 36"W x 13 ¹ / ₈ "D x 71"H	H105535	187	25.1	\$875	\$905
4 Shelf, 36"W x 13 ¹ / ₈ "D x 57 ¹ / ₈ "H	H105534	156	20.2	\$753	\$778
3 Shelf, 36"W x 13 ¹ / ₈ "D x 43 ³ / ₈ "H	H105533	122	15.6	\$639	\$659
2 Shelf, 36"W x 13 ¹ / ₈ "D x 29 ⁵ / ₈ "H	H105532	90	11.0	\$503	\$518

NOTES: Fixed shelves. Inside shelf dimensions on all units is 33³/₄"W x 12"D x 13"H. No assembly required.

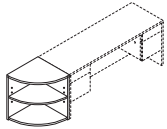

End Cap Bookshelf (2 shelves, 1 fixed, 1 adjustable. Adjusts in 2¹/₂" increments with a total range of 10"H)					
24"W x 24"D x 29 ¹ / ₂ "H	H105520	84	2.6	\$640	\$655

NOTES: Unit is freestanding. Designed to be positioned at the end of 24"D credenzas and returns. Ideal for books, photos, plants and mementos.

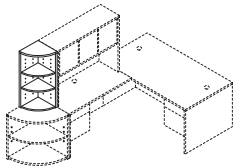

End Cap Bookshelf (3 shelves, 1 fixed, 2 adjustable. Adjusts in 2¹/₂" increments with a total range of 25"H)					
15"W x 15"D x 37 ¹ / ₈ "H	H105523	53	2.2	\$551	\$566

NOTES: Unit is designed to be positioned at the end of stack-on storage and on top of model H105520. Combined height of models H105520 and H105523 matches credenza or return plus stack-on storage height. Can be used freestanding.

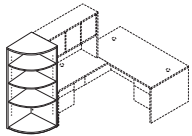

End Cap Bookshelf					
24"W x 24"D x 66 ⁵ / ₈ "H	H105524	164	4.8	\$1066	\$1091

NOTES: Designed to be positioned at the end of 24"D credenzas with stack-on storage, 24"D returns with stack-on storage, 24"D storage/file cabinet, 24"D storage cabinet/lateral file, 24"D wardrobe/storage cabinets, or the 24"D personal storage tower. Unit has four shelves, three are adjustable in 2¹/₂" increments, with a total range of 45"H; bottom shelf is fixed.



Model H105525R



Model H105526L

Square End Cap Bookshelf — 2-Fixed Shelves					
24"W x 24"D x 29 ¹ / ₂ "H, Right	H105525R	92	3.6	\$634	\$649
24"W x 24"D x 29 ¹ / ₂ "H, Left	H105526L	92	3.6	\$634	\$649

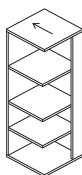

Model H105527R

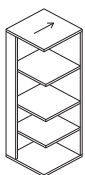

Model H105528L

Square End Cap Bookshelf — 4-Fixed Shelves					
24"W x 24"D x 66 ⁵ / ₈ "H, Right	H105527R	172	5.9	\$1017	\$1042
24"W x 24"D x 66 ⁵ / ₈ "H, Left	H105528L	172	5.9	\$1017	\$1042

NOTES: Units are freestanding. Designed to be positioned next to 24"D models or as a corner bookcase.

End cap, left: grain direction on top aligns with grain direction on tops of left pedestal returns and left credenza models or when positioned to the left side of credenzas with doors or kneespace models.

End cap, right: grain direction on top aligns with grain direction on tops of right pedestal returns and right credenza models or when positioned to the right side of credenzas with doors or kneespace models.



NOTES:

- For 36"W x 24"D x 29¹/₂"H two-shelf bookcase, to align evenly with credenzas and returns, see page 312.

HOW TO SPECIFY

Select Model Number H 1 0 5 5 3 2 .	Select Laminate Top and Chassis Color See pages 266-267 N N
---	--

10500 SERIES™

Shared Components & Accessories

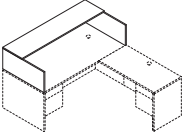
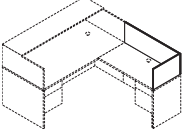
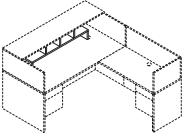
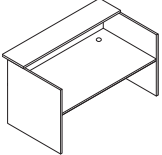
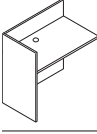
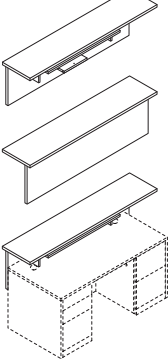
	DESCRIPTION	MODEL	SHIP WEIGHT	CUBE	LIST PRICE BY LAMINATE GRADE	
					L1	L2
	Reception Station with Transaction Counter, for 72"W x 36"D Desk, or Desk Shell, with rectangle top 72"W x 36"D x 14¼"H	H105720	92	3.0	\$535	\$570
	NOTES: For desk tops without grommets, see field installable grommet kit, model HFLDGRMT on page 324. Transaction counter organizer (HTCOL52) fits under/inside of transaction counter (see below).					
	Reception Station for 42"W x 24"D Return or Return Shell 42"W x 24"D x 13"H	H105722	2	1.0	\$269	\$289
	Reception Station for 48"W x 24"D Return or Return Shell 48"W x 24"D x 13"H	H105721	25	3.6	\$306	\$326
	NOTES: For return tops without grommets, see field installable grommet kit, model HFLDGRMT on page 324. Not available in two-tone laminate. Designed specifically for use with Reception Station with Transaction Counter, model H105720.					
	SPECIFYING EXAMPLE: H105722.N					
	DESCRIPTION	MODEL	SHIP WEIGHT	CUBE	LIST PRICE	
	Transaction Counter Organizer 48¾"W x 11⅞"D x 13"H	HTCOL52	24	1.1	\$300	
	NOTES: Fits under reception station with transaction counter model H105720 reception desk shell (H105724), and work organizer models H10537 and H10536.					
	Black only.					
	SPECIFYING EXAMPLE: HTCOL52.P					
	DESCRIPTION	MODEL	SHIP WEIGHT	CUBE	LIST PRICE BY LAMINATE GRADE	
	Reception Desk Shell, with rectangle top 72"W x 39⅞"D x 44⅞"H	H105724	294	17.0	\$1142	\$1197
	NOTES: Non-handed design. Integrated 18⅝"D transaction counter with a 4" full-width overhang. Two cord management grommets in top for routing and hiding wires and cables. Transaction counter organizer model TCOL52 fits under/inside transaction counter. When a two-tone color combination is specified, the first designator defines the transaction countertop and the desk worksurface.					
	Reception Station Return Shell 42"W x 24⅜"D x 42⅝"H	H105726	131	17.0	\$795	\$830
	NOTES: Non-handed design for use with reception desk shell. One cord management grommet in top for routing and hiding wires and cables. Woodgrain on approach side is vertical to match grain direction on end panels of reception station desk. Designed specifically for use with Reception Desk Shell, model H105724.					
	Transaction Counter for Reception Desk 66"W x 14⅝"D x 14¼"H	H105729	100	4.2	\$664	\$689
	NOTES: Off-the-worksurface solution designed for use with 72"W or 66"W desks or desk shells with a 1⅞" thick rectangle top and a full-width conference (approach-side) overhang of 4½"D minimum. Choose from two height options at time of installation; 13⅞"H (upper position) or 5½"H (lower position) above the desktop. Attaches easily and securely without any drilling or double-sided tape on the worksurface. Grain direction: side-to-side on countertop; horizontal on approach and users side vertical panel.					

NOTES:

- Three welcoming reception station designs to choose from — stack-on enclosure, full-to-floor shell, or front-suspended counter.
- For 10500 Series™ matching reception area furniture, see Occasional Tables on page 321.
- See pages 298-325 for shared components.

HOW TO SPECIFY

Select Model Number	Select Laminate Top and Chassis Color
	See pages 266-267
H 1 0 5 7 2 0 .	N N

10500 SERIES™

Shared Components & Accessories

GSA SIN 33721



Icon Legend on page 19

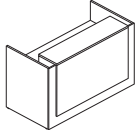

DESCRIPTION	MODEL	SHIP WEIGHT	CUBE	L1 LIST	L2 UPCHARGES		ACCENT PANEL
					WORKSURFACE	CHASSIS	

Reception Desk with Transaction Counter

72"W x 36¾"D x 44"H

HLAM3772RD

324

13.5

\$1563**\$35****\$70****\$25**

NOTES: Non-handed. Counter measures 60"W x 15¼"D. Flat edge (G) matches 10500 Series™. For beaded (B) and tri-oval (V) edge shapes, the transaction counter is profiled on the approach and user sides, and the desk worksurface is profiled on the user's side. Beaded (B) and tri-oval (V) edges are available in L1 woodgrains colors only. Smooth and flat (G) edge available in all woodgrains and solid colors. Vertical grain on approach side and front accent panel for L1 laminates except Kingswood Walnut and Florence Walnut. Horizontal grain on L2 laminates and Kingswood and Florence Walnut. Vertical grain on end panels and horizontal grain on worksurface and transaction counter. Two worksurface cord management grommets for routing and hiding wires and cables; can be specified in Black (P) or Platinum (TI) finish.

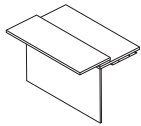
**Reception Return with 32"H Transaction Counter**

48¼"W x 32⅞"D x 32"H

HLAM3348RR

145

3.7

\$879**\$35****\$35****N/A**

NOTES: Non-handed. For use with HLAM3772RD and Reception Desk Shell (H105724). Counter facilitates accessibility; measures 48"W x 12"D x 32"H. Flat edge (G) matches 10500 Series™. For beaded (B) and tri-oval (V) edge shapes, the transaction counter is profiled on the approach side, and the return worksurface is profiled on the user's side. All other edges are flat banded. Beaded (B) and tri-oval (V) available in L1 woodgrain colors only. Flat edge (G) available in all woodgrains and solid colors. Pattern laminates do not have matching edge color; patterns can be specified with woodgrain or solid edge. Vertical grain on approach side, end panel, worksurface, and transaction counter. Assembly required. Cam covers used to allow for non-handed design.

Specify: Model.Edge Profile & EdgeColor.Worksurface & Counter Color.Chassis Color

SPECIFYING EXAMPLE: HLAM3348RR.GN.N.N**HOW TO SPECIFY**

Select Model Number HLAM3772RD	Select Edge Profile and Edge Color See page 266 GN	Select Grommet Color P Black TI Platinum Not specified for model HLAM3348RR P	Select Worksurface Laminate See page 266 N	Select Chassis Laminate See page 266 N	Select Accent Panel Laminate See page 266 Not specified for model HLAM3348RR LDW1
---	--	---	--	--	--

10500 SERIES™

Shared Components & Accessories

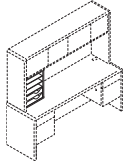

Not available in two-tone laminate



DESCRIPTION	MODEL	SHIP WEIGHT	CUBE	LIST PRICE BY LAMINATE GRADE	
				L1	L2
Vertical Paper Manager 14 ⁷ / ₈ "W x 10 ⁷ / ₈ "D x 19 ³ / ₈ "H NOTES: Keeps papers, files, and books neatly organized and within easy reach from a seated position. Designed for desk, credenza, and return tops. Fits under stack-on storage models. Two pullout drawers and three fixed shelves. Unit can also be used with 10700 Series™, Valido®, and 94000 Series™. When used in conjunction with wall mounted storage cabinets, the top of the wall mounted storage cabinets must be positioned a minimum of 68" above the floor. For additional information see the Workplace Tools section in the 2021 Shared Spaces Pricer. SPECIFYING EXAMPLE: HLVP1.N	HLVP1	27	2.8	\$351	\$361

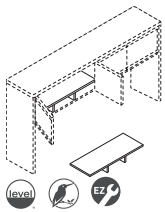

DESCRIPTION	MODEL	SHIP WEIGHT	CUBE	LIST PRICE
Stacked Paper Management 32 ¹ / ₂ "W x 12 ⁵ / ₈ "D x 4 ¹ / ₄ "H NOTES: Segments and organizes stack-on and wall mount storage compartments, as well as bookcase shelves. In some cases, installation may require removing the stack-on or wall mount storage doors. For additional information see the Workplace Tools section in the 2021 Shared Spaces Pricer. ! Black only.	HLVPM2	22	1.25	\$175



Not available in two-tone laminate



DESCRIPTION	MODEL	SHIP WEIGHT	CUBE	LIST PRICE BY LAMINATE GRADE	
				L1	L2
Desktop Storage Terrace 26 ¹ / ₂ "W x 12 ¹ / ₂ "D x 10 ¹ / ₂ "H NOTES: Keeps work-in-process, priority files, loose pages, and mail neatly organized and in view. Mixed material design comprised of sturdy laminate shelves with metal back and support panels. Not available in two-tone laminate combination or pattern laminate colors. Choose from Platinum Metallic (T1), Black (P), and Charcoal (S) for the metal components. Sized to fit in stack-on and wall mounted storage cabinets in 10500, 10700, Valido, 94000, and 38000 Series. Fits in Voi stack-on and overhead cabinets except for 48"W or smaller sliding door models. For additional information see the Workplace Tools section in the 2021 Shared Spaces Pricer. Specify: Model.Laminate.Paint SPECIFYING EXAMPLE: HLDST1.N.T1	HLDST1	24	1.1	\$329	\$339



Refer to page 104 for Center Drawer compatibility information

DESCRIPTION	MODEL	SHIP WEIGHT	CUBE	L1	L2
				LIST PRICE	LIST PRICE
Angled Wood Center Drawer 26" x 15 ³ / ₈ " 22" x 15 ³ / ₈ " NOTES: Specify laminate for drawer. Model H1522 can be used on peninsulas with modesty panel, model H10528. For additional information see the Workplace Tools section in the 2021 Shared Spaces Pricer.	H1526	12	1.2	\$214	\$229
	H1522	11	1.1	\$199	\$214

NOTES:

- For 10500 Series™ matching Occasional Tables, see page 321.
- Vertical paper manager designed for desk, credenza, and return tops. Fits under stack-on storage.
- Stacked paper management segments and organizes stack-on and wall mount storage compartments, as well as bookcase shelves. Unit can be used in models H105327, H10534, H105322, H105321, H105382 and H105381.
- Desktop Storage Terrace is for use on the tops of 29¹/₂"H desks, credenzas, and returns.
- Desktop Storage Terrace features six storage sections plus top display shelf.
- Desktop Storage Terrace includes protective, non-slip pads on the base.
- See pages 298-325 for shared components.

! In some cases, installation of Stacked Paper Management may require removing the stack-on or wall mount storage doors.

HOW TO SPECIFY

Select Model Number HLVP1.N	Select Laminate See pages 266-267 N
---------------------------------------	--

10500 SERIES™

Shared Components & Accessories

GSA SIN 33721

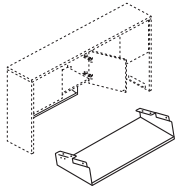

Icon Legend on page 19

**DESCRIPTION****Hanging Paper Shelf**28¹/₁₆"W x 11⁷/₁₆"D x 4³/₁₆"H**MODEL****HHPS1****SHIP WEIGHT**

7

CUBE

2.9

LIST PRICE**\$214**

NOTES: Maximizes worksurface space; de-clutters desktop while placing priority communications and active project folders within easy reach. Angled design allows contents to be distinguished at a glance. Mixed material styling features strong painted metal frame with a frosted shelf.

Attaches quickly and easily to stack-on and wall mount storage models in the following series: 10500, 10700, Valido, 94000, and Voi (except the 36"W overhead hutch with O-legs or panel mount brackets). Not for use with 38000 Series.

For additional information see the Workplace Tools section in the 2021 Shared Spaces Pricer.

Specify: Model.Paint

SPECIFYING EXAMPLE: HHPS1.T1

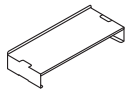
**Desktop Paper Shelf**28¹/₁₆"W x 11⁵/₁₆"D x 5"H**HDPS1**

7

2.9

\$214

NOTES: Organizer shelf provides a place and space for work-in-process and piling to keep worksurfaces neat and tidy. Convenient, scalable design with interlocking side supports allow two units to be stacked and integrated. Durable painted metal frame with a frosted shelf; mixed material styling matches hanging paper shelf.

Can also be used inside select overhead storage, including the following stack-on with hinged door models: 10500 and Valido 36", 42", 66", 72", 78"W and 10700 68⁵/₁₆"W.

For additional information see the Workplace Tools section in the 2021 Shared Spaces Pricer.

Specify: Model.Paint

SPECIFYING EXAMPLE: HDPS1.T1

**Storage Cube**

12"W x 12"D

HL1212

1

0.3

\$316

SPECIFYING EXAMPLE: HL1212.P8S

**NOTES:**

- For 10500 Series™ matching Occasional Tables, see page 321.
- Desktop Paper Shelf includes protective, non-slip pads on the base.
- Paper Shelf can stack two-high.
- Hanging Paper Shelf attaches quickly and easily (screws included).
- See pages 298-325 for shared components.
- For additional information see the Workplace Tools section in the 2021 Shared Spaces Pricer.

HOW TO SPECIFY

Select Model Number	Select Paint Color
	See page 183
HHPS1.	T1



10500 Series™ Laminate Occasional Tables

	DESCRIPTION	MODEL	SHIP WEIGHT	CUBE	LIST PRICE
	Coffee Table 48"W x 20"D x 16"H	H80191	48	3.4	\$541
	Corner Table 24"W x 24"D x 20"H	H80192	35	2.1	\$466
	End Table 24"W x 20"D x 20"H	H80193	29	1.8	\$445

Laminate Occasional Tables (H80191, H80192 and H80193)

Woodgrain	Solid	Patterned	Two-Tone	
Bourbon Cherry (HH) Cognac (COGNCOGN) Florence Walnut (LFWILFW1) Harvest (CC) Kingswood Walnut (LKIILKI1) Mahogany (NN) Mocha (MOCHMOCH) Natural Maple (DD) Pinnacle (PINCPINC) Shaker Cherry (FF) Sterling Ash (LSA1LSA1)	Black (PP) Charcoal (SS) Designer White (LDWILDW1) Loft (LOFTLOFT)	Canyon Zephyr (K9) Desert Zephyr (K8) Grey Tigris (L6*) Sheer Mesh (A5) Silver Mesh (B9) *Select edge/apron/leg color Black (P) Bourbon Cherry (H) Charcoal (S) Cognac (COGN) Designer White (LDW1) Florence Walnut (LFW1) Harvest (C) Kingswood Walnut (LK11) Mahogany (N) Mocha (MOCH) Natural Maple (D) Pinnacle (PINC) Shaker Cherry (F) Sterling Ash (LSA1)	Black/Charcoal (PS) Black/Designer White (PLDW1) Bourbon Cherry/Black (HP) Bourbon Cherry/Charcoal (HS) Bourbon Cherry/Designer White (HLDW1) Charcoal/Black (SP) Charcoal/Designer White (SLDW1) Cognac/Black (COGNP) Cognac/Charcoal (COGNS) Cognac/Designer White (COGNLDW1) Designer White/Black (LDW1P) Designer White/Bourbon Cherry (LDWIH) Designer White/Charcoal (LDW1S) Designer White/Cognac (LDWICOGN) Designer White/Florence Walnut (LDWILFW1) Designer White/Harvest (LDW1C) Designer White/Kingswood Walnut (LDWILKI1) Designer White/Mahogany (LDWIN) Designer White/Mocha (LDW1MOCH) Designer White/Natural Maple (LDW1D) Designer White/Pinnacle (LDW1PINC) Designer White/Sterling Ash (LDW1LSA1)	Designer White/Shaker Cherry (LDW1F) Florence Walnut/Black (LFW1P) Florence Walnut/Charcoal (LFW1S) Florence Walnut/Designer White (LFWILDW1) Florence Walnut/Loft (LFW1LOFT) Harvest/Black (CP) Harvest/Charcoal (CS) Harvest/Designer White (CLDW1) Kingswood Walnut/Black (LKIIP) Kingswood Walnut/Charcoal (LKIIS) Kingswood Walnut/Designer White (LKIILDW1) Kingswood Walnut/Loft (LKI1LOFT) Mahogany/Black (NP) Mahogany/Charcoal (NS) Mahogany/Designer White (NLDW1) Mocha/Black (MOCHP) Mocha/Charcoal (MOCHS) Mocha/Designer White (MOCHLDW1) Natural Maple/Black (DP) Natural Maple/Charcoal (DS) Natural Maple/Designer White (DLDW1) Pinnacle/Black (PINCP) Pinnacle/Charcoal (PINCS) Pinnacle/Designer White (PINCLDW1) Shaker Cherry/Black (FP) Shaker Cherry/Charcoal (FS) Shaker Cherry/Designer White (FLDW1) Sterling Ash/Black (LSA1P) Sterling Ash/Charcoal (LSA1S) Sterling Ash/Designer White (LSA1LDW1)

NOTES:

- Durable material and construction make laminate occasional tables ideal for high traffic areas such as lobbies, reception rooms and lounges. Versatile design is also well suited to private offices.
- Tables accommodate lamps, magazines, telephones, plants, laptops and more.
- Coffee, Corner and End Tables feature top-over-apron styling with square corner detail, which complements many interiors and furniture designs.
- Tops are abrasion- and stain-resistant laminate over 1/8" thick solid core high-performance particleboard.
- See pages 298-325 for shared components.

HOW TO SPECIFY

<p>Select Model Number</p> <p>H 8 0 1 9 1 .</p> <p>H 8 0 1 9 1 .</p>	<p>Select Laminate</p> <p>See above</p> <p>NN</p> <p>L 6 N</p>
---	---

10500 Series™ Shared Components & Accessories

GSA SIN 33721

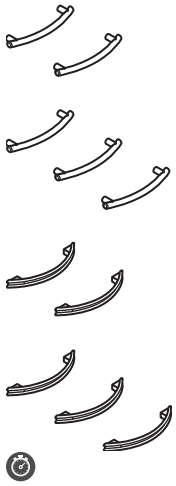

Icon Legend on page 19

**DESCRIPTION****MODEL****SHIP WEIGHT****CUBE****LIST PRICE****Field Installable Drawer/Door Handle Kits**

Sweep Black, 2-pack
Sweep Satin Nickel, 2-pack

HSWEEPA2
HSWEEPC2

0.4
0.4

0.3
0.3

\$47
\$47

Sweep Black, 3-pack
Sweep Satin Nickel, 3-pack

HSWEEPA3
HSWEEPC3

0.5
0.5

0.3
0.3

\$61
\$61

Crescent Black, 2-pack
Crescent Satin Nickel, 2-pack

HCRESCENTA2
HCRESCENTC2

0.4
0.4

0.3
0.3

\$47
\$47

Crescent Black, 3-pack
Crescent Satin Nickel, 3-pack

HCRESCENTA3
HCRESCENTC3

0.5
0.5

0.3
0.3

\$61
\$61

NOTES: Handles are for purchase and field installation on 10500 or 10700 Series™ desks, credenzas, returns, and lateral files, as well as for the modular pedestals used with 10700 and 10500.

Applications include:

- box/file and file/file pedestals = one 2-pack per pedestal
- box/box/file and pencil/media/file pedestals = one 3-pack per pedestal
- two drawer lateral file = two 2-packs per unit
- four drawer lateral file = four 2-packs per unit

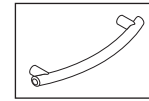
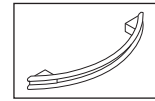
**Sweep Handle****Crescent Handle**

The hole spacing for the Sweep and Crescent handles is 96mm (approx. 3¾"). Important note: effective January 1, 2007, the holes used for the black drawer/door handle that comes standard on several HON 10500 and 10700 Series™ products, including mobile pedestals, storage cabinet with doors, storage/file cabinet, storage cabinet/lateral file, personal wardrobe/storage cabinets, and personal storage towers, will accept the Sweep and Crescent handles. Units manufactured prior to January 1, 2007, have 64mm (approx. 2½") hole spacing and will not accept the Sweep and Crescent handles. Instructions include mounting hardware and paper template.

! Must be ordered with a configurable end product. If ordered separately, not on GSA contract.

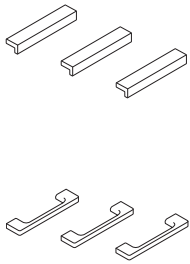
**Field Installable Drawer/Door Handle Kits**

Linear, Black, 2-pack
Linear, Matte Chrome, 2-pack

HLINEARA2
HLINEARC2

0.4
0.4

0.3
0.3

\$61
\$61

Linear, Black, 3-pack
Linear, Matte Chrome, 3-pack

HLINEARA3
HLINEARC3

0.5
0.5

0.3
0.3

\$69
\$69

Specify Linear handles in black to coordinate with 10500 Series™ models that ship standard with a decorative handle, such as mobile pedestals, storage cabinets and wardrobes.

Arch, Black, 2-pack
Arch, Matte Chrome, 2-pack

HARCHA2
HARCHC2

0.4
0.4

0.3
0.3

\$61
\$61

Arch, Black, 3-pack
Arch, Matte Chrome, 3-pack

HARCHA3
HARCHC3

0.5
0.5

0.3
0.3

\$69
\$69

NOTES: Handles are for purchase and field installation on 10500 or 10700 Series™ desks, credenzas, returns, lateral files and modular pedestals. Instructions include mounting hardware and paper template for drilling holes.

Applications include:

- box/file and file/file pedestals = one 2-pack per pedestal
- box/box/file and pencil/media/file pedestals = one 3-pack per pedestal
- two drawer lateral file = two 2-packs per unit
- four drawer lateral file = four 2-packs per unit

The Linear and Arch handles can be attached using 96mm (approx. 3¾") or 128mm (approx. 5") hole spacing. Important note: effective January 1, 2007, the holes used for the black drawer/door handle that comes standard on several HON 10500 and 10700 Series™ products, including mobile pedestals, storage cabinet with doors, storage/file cabinet, storage cabinet/lateral file, personal wardrobe/storage cabinets, and personal storage towers, will accept the Linear and Arch handles. Units manufactured prior to January 1, 2007, have 64mm (approx. 2½") hole spacing and will not accept the Linear and Arch handles.

! Must be ordered with a configurable end product. If ordered separately, not on GSA contract.

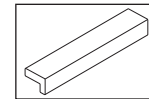
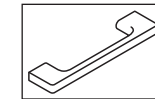
**Linear Handle****Arch Handle****NOTES:**

- Field Installable Drawer/Door Handle Kits for use on 10500 Series™ desks, credenzas, returns and lateral files.
- A metal template is available to facilitate field installation of the Linear, Arch, Sweep and Crescent decorative handles on 10500 and 10700 Series™ drawer fronts; order model SPLH-SYST-DRKNB.M263164.
- See pages 298-325 for shared components.

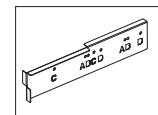
**Metal Template****HOW TO SPECIFY**







Select
Model Number

H S W E E P A 2

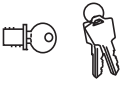

Icon Legend on page 19

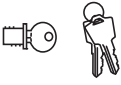
10500 SERIES™ Shared Components & Accessories

	DESCRIPTION	MODEL	SHIP WEIGHT	CUBE	LIST PRICE
 SIN 33721 	Black Removable Lock Core Kit	HF23B	0.1 	0.1	\$35
	Satin Removable Lock Core Kit	HF23S	0.1 	0.1	\$47
	<ul style="list-style-type: none"> Specify quantity of each key number from 101E-225E. Includes: 1-core, 2-keys, 1-core removal tool, and instructions. <p>NOTES: Lock with a removable cylinder that can be interchanged as needed; allows users to access all furniture pieces in an office with a single key for convenience and security. Makes re-keying quick and easy. For use in all 10500 Series™ product lock cores, except the stack-on and wall mounted storage “K” models. For the latter use model HF27B or HF27S, listed below.</p>				
 	Removable Lock Core Kit				
	Black HF27B 0.2 0.02 \$35 Satin HF27S 0.2 0.02 \$35				
	<ul style="list-style-type: none"> For stack-on and wall mounted storage laminate models (with locks) in 10500, 10700, Valido, Voi, Concinnity, and 94000 Series. Specify quantity of each key number from 101E to 225E. Includes: 1-core, 2-keys, 1-core removal tool, and instructions. <p>NOTES: If key number isn't specified, number will be at random.</p>				

NOTES:

- See pages 298-325 for shared components.
- For master key, see model HF22 on page 773.

HOW TO ORDER CORE REMOVABLE LOCK KITS:





Specify: Model Number.X
Key Number

Examples: HF23S.X121E
HF23S.X (Key number not specified)

NOTES: Key orders without numbers specified will be keyed at random.
Numbers 101E-225E are available.

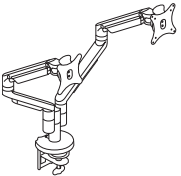
SAMPLE ORDER:

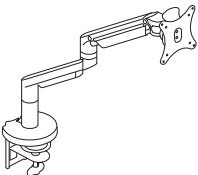
Quantity	Model	Key Code
4	HF23B.	X121E

	DESCRIPTION	MODEL	SHIP WEIGHT	CUBE	LIST PRICE
	Dual Dynamic Monitor Arm	HMASD	17.0 	1.1	\$962
	<ul style="list-style-type: none"> 150° of rotation at base with optional 360° rotation. Arms extend 22" and retract up to 3". Monitor mount rotates 180° and tilts +/-30°. Monitor can be rotated from landscape to portrait position. <p> Arms hold monitors from 6.2-18 lbs. Optional counterweight HPACW available to support monitors as low as 5 lbs. (see the Workplace Tools section in the 2021 Shared Spaces Pricer).</p>				
	Single Dynamic Monitor Arm	HMASTS	11.5 	0.8	\$501
	<ul style="list-style-type: none"> 180° of rotation at base with optional 360° rotation. Arms extend 22" and retract up to 3". Monitor mount rotates 180° and tilts +/-30°. Monitor can be rotated from landscape to portrait position. <p> Arms hold monitors from 6.2-18 lbs. Optional counterweight HPACW available to support monitors as low as 5 lbs. (see the Workplace Tools section in the 2021 Shared Spaces Pricer).</p>				

HOW TO SPECIFY

<p>Select Model Number</p>	<p>Select Finish</p> <p><i>Specify for models HMASD and HMASTS only</i></p> <p>SVR Silver BLK Black</p>
<p>HMASD.</p>	<p>SVR</p>

10500 Series™ Shared Components & Accessories

GSA SIN 33721T EXCEPT AS NOTED

ABI

Icon Legend on page 19



SIN 33721

DESCRIPTION**Field Installable Grommet**

- Intended for use in tops and end panels to route/hide cords and in modesty panels to facilitate reaching wall electrical outlets.
- Grommet is field installable.
- Grommet shape is round.
- Includes grommet cap and sleeve.
- Grommet cap measures 3" diameter and includes a 3/4" diameter cord access hole.
- Grommet sleeve measures 2 1/2" O.D. x 3/4" thick.
- Includes instructions to locate grommet position for desks, credenzas, returns and bridges.

NOTES: For additional information see the Workplace Tools section in the 2021 Shared Spaces Pricer.

! Black Finish

! Requires a 2 1/2" diameter hole saw and drill for installation (not included).

MODEL**HFLDGRMT****SHIP WEIGHT**

0.1 Ⓢ

CUBE

0.01

LIST PRICE**\$35**

SIN 33721

Field Installable Grommet

- Intended for use in tops and end panels to route/hide cords and in modesty panels to facilitate reaching wall electrical outlets.
- Grommet is field installable.
- Grommet shape is round.
- Includes grommet cap and sleeve.
- Grommet outside dimensions measure 3 1/2" diameter and includes two cord access holes.
- Grommet sleeve measures 3" O.D. x 1" thick.
- Includes instructions to locate grommet position for desks, credenzas, returns and bridges.

NOTES: For additional information see the Workplace Tools section in the 2021 Shared Spaces Pricer.

! Black Finish

! Requires a 3" diameter hole saw and drill for installation (not included).

HFLDGRMT3

0.1 Ⓢ

0.3

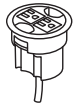
\$35**Power Hub, 3" Grommet Mount, 6' Cord**

- Brings the ease of plug-and-play to the desktop.
- Fits in 3" round grommet holes in 10500 Series™ desks, credenzas and returns; not compatible with 10500 Series™ 2 1/2" round grommets.
- Two grounded AC power outlets.
- Two cord pass-through holes in cap.
- Includes 6' cord with three-prong plug.
- For field installation.
- UL Listed.

NOTES: For additional information see the Workplace Tools section in the 2021 Shared Spaces Pricer.

! Available in Black only (no color designation - Specify: HGRMTAC.X).

HGRMTAC

1.3

0.2

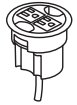
\$126**3" Round Power Grommet - 2 Outlets, 10' Cord**

- Includes 10' cord with three-prong plug.
- Fits in 3" round grommet holes on the following product lines: Coordinate, Huddle, Motivate, all laminate casegoods series, and Systems Worksurfaces.
- Two grounded AC power outlets.
- Field installed with Plug-and-play ease.

NOTES: Power Modules will also work with standing-height applications for 10500 Series™ and Voi® desks. Optional Memory Control allows preset worksurface heights for consistency. Ships separately. Dynamic load capacity when worksurface is moving is 300 lbs.

! Available in black finish only, no specification needed.

HGRMTAC2

1.5

0.2

\$159**Power/USB Hub, 3" Grommet Mount**

- Brings the ease of plug-and-play to the desktop.
- Fits in 3" round grommet holes in 10500 Series™ desks, credenzas and returns; not compatible with 10500 Series™ 2 1/2" round grommets.
- One grounded AC power outlet with 2 USB ports.
- Two cord pass-through holes in cap.
- Includes 6' cord with three-prong plug.
- For field installation.
- UL Listed.

NOTES: For additional information see the Workplace Tools section in the 2021 Shared Spaces Pricer.

! Available in black only (no color designation so use .X - Specify: HGRMTUSB2.X).

HGRMTUSB2

1.3 Ⓢ

0.02

\$250**NOTES:**

- See pages 298-325 for shared components.

HOW TO SPECIFYSelect
Model Number

H F L D G R M T

10500 SERIES™

Shared Components & Accessories



SIN 33721

DESCRIPTION

Articulating Desk Lamp
Articulating Desk Lamp w/ Occupancy Sensor

MODEL

HLED1
HLED10C

SHIP WEIGHT

1.2 Ⓢ
 1.2 Ⓢ

CUBE

6.5
 6.5

LIST PRICE

\$430
\$524

NOTES: For additional information see the Workplace Tools section in the 2021 Shared Spaces Pricer.

! Silver finish only, no specification needed.



SIN 33721

Task Desk Lamp**HLED2**

0.7 Ⓢ

3.0

\$373

NOTES: For additional information see the Workplace Tools section in the 2021 Shared Spaces Pricer.

! Brushed nickel finish only, no specification needed.

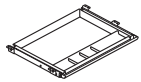

OPEN MARKET

Polymer Center Drawer**HCD1**

7.0

0.5

\$126

- Color: Black.
- Material: ABS.
- Minimum clearance for mounting: 23"W x 16¼"D x 2"H.
- Retracts on 16" ball-bearing slides.
- Can be used on worksurfaces with Coordinate™ Height Adjustable Bases as long as it is attached with spacer model HKBS.
- Can store up to 25 lbs.

! Black finish only, no specification needed.

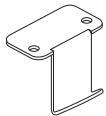

OPEN MARKET

Back Pack Hook (10 per carton)

12"W x 14½"D x 1½"H

HCLA65

10.0 Ⓢ

0.1

\$101

NOTES: Assembly: attaches to bottom of desk with (2) screws, included.

! Available in Platinum Metallic finish only, no specification needed.

**DESCRIPTION****MODEL****SHIP WEIGHT CUBE****LIST PRICE BY PAINT GRADE****P1****P2**

Slide-Away Keyboard Platform (Specify: Laminate) **H4022**

10 Ⓢ 0.6

\$228

Extended Tray Slide-Away Keyboard Platform **HE4022**

12 Ⓢ 0.7

\$323

(Specify: Laminate)

Metal Keyboard and Mouse Tray (Specify paint) **H4028 OPEN MARKET**

11 Ⓢ 1.5

\$164**\$174**

Metal Keyboard Tray (Specify paint) **H4029 OPEN MARKET**

11 Ⓢ 1.5

\$148**\$158**

Refer to the Workplace Tools section in the 2021 Shared Spaces Pricer for additional product information

SIN 33721

**NOTES:**

- See pages 298-325 for shared components.

HOW TO SPECIFY

Select
Model Number

H L E D 1

10500 SERIES™

Accessories

OPEN MARKET



Icon Legend on page 19

**DESCRIPTION**

Coordinate™ Portable Desktop Riser
31"D x 5"-16½"H x 35"W

MODEL**HBXRISER****SHIP WEIGHT**

54.0

CUBE

4.1

LIST PRICE**\$657**

NOTES: Available in Black (BLK) or White (WHT) finish. Desktop riser dimensions (without keyboard tray): 22"D x 5"-16½"H x 35"W. Keyboard tray dimensions: 9"D x 30"W. Max loading capacity is 33 lbs for the desktop riser surface and 4 lbs for the keyboard tray. Easily transition from seated to standing positions throughout the workday. Sits atop an existing desk to create sit-to-stand functionality by raising the computer. Includes keyboard tray and surface for computer monitors. **HON 5-Year Limited Warranty.**

⚠ Not intended for use on mobile workstations.

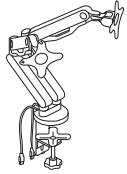
**Dual Monitor Arm with 2 USB Ports****HBDMAUSB**

41.9

2.6

\$410

NOTES: Easy adjustment. Height adjusts to 17" tall. Monitor tilt and swivel capability. Enclosed cable management. Grommet or desktop mounting. Clean appearance. In some applications the Monitor Arms may extend 12 or more inches into the worksurface. For additional information see the Workplace Tools section in the 2021 Shared Spaces Pricer. **HON 5-Year Limited Warranty.**

⚠ No specification needed.

HOW TO SPECIFY

Select
Model Number

Select
Finish

BLK Black
WHT White

HBXRISER.

BLK



Icon Legend on page 19

10500 SERIES™ Accessories

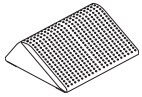
	DESCRIPTION	MODEL	SHIP WEIGHT	CUBE	LIST PRICE
	Footrest — Anti-Slip Cover 13¾"D x 5½"H x 16"W ⓘ Available in Black (T) finish ONLY. Recommended weight capacity not to exceed 250 pounds. HON 5-Year Limited Warranty. SPECIFYING EXAMPLE: HVL991.T	HVL991	7 ⓘ	0.9	\$89

HOW TO SPECIFY

<p>Select Model Number</p> <p>H V L 9 9 1 .</p>	<p>Select Finish</p> <p>T Black</p> <p>T</p>
---	--

10700 SERIES™

Want to see more? Scan here
to check out hon.com.



10700 Series™ Teaming Workstations
shown with Ignition® and Flock® Seating.

10700 SERIES™

Talk about a high achiever! The versatile 10700 Series offers a wide selection of layout configurations — making it easy to get the clean, cohesive look your office needs. Designed to withstand frequent moving and reconfiguration, the 10700 Series boasts contract grade high-pressure laminate and a durable inner-frame construction. Whatever the look you go for, this all-around performer is a smart choice.



FEATURES

- Contoured, solid wood accents and waterfall-shaped edges combine form and function for lasting comfort.
- Make the most of both large and small spaces with flexible storage options that work well together.
- With a variety of mixed materials to choose from, you can customize your look to perfectly match your aesthetic.
- Available in eight woodgrain patterns, our laminate desks are the definition of scratch-, spill- and stain-resistant durability.

10700 SERIES™ ORDERING INFORMATION

LAMINATE FINISHES AVAILABILITY

L1 LAMINATES CODES

Woodgrain

- ◆ Bourbon Cherry HH
- ◆ Cognac **COGNCOGN**
- ◆ Harvest CC
- ◆ Mahogany NN
- ◆ Mocha **MOCHMOCH**
- ◆ Natural Maple DD
- ◆ Pinnacle **PINCPINC**
- ◆ Shaker Cherry FF

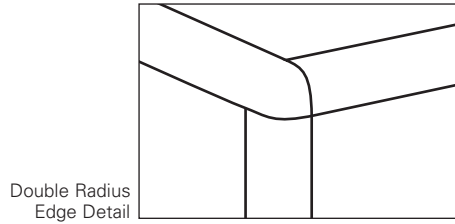

Double Radius
Edge Detail

◆◆◆ For lead time information see page 19.

10700 SERIES™

Typicals



Icon Legend on page 19

Components used are listed on pages 336-357. Order components individually. Other configurations are possible, including various sizes of some components.

QTY	DESCRIPTION	MODEL	LIST PRICE	PRICE EXTENSION
1	Double Pedestal Desk – 2/2 60"W x 30"D x 29½"H	H10771	\$1,576	\$1,576
1	Credenza with Kneespace – 2/0/2 60"W x 24"D x 29½"H	H10765	\$1,503	\$1,503
TOTAL:			\$3,079	

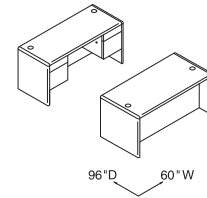

DESK WORKSTATION
60"W x 96"D

QTY	DESCRIPTION	MODEL	LIST PRICE	PRICE EXTENSION
1	Corner Unit 24" x 36" x 36" x 24" x 29½"H	H107811	\$1,381	\$1,381
1	Return, Right – B/F 48"W x 24"D x 29½"H	H10715R	\$1,044	\$1,044
1	Return, Left – B/F 48"W x 24"D x 29½"H	H10716L	\$1,044	\$1,044
1	Stack-on Storage 44½"W x 14½"D x 37½"H	H107313	\$1,231	\$1,231
TOTAL:			\$4,700	

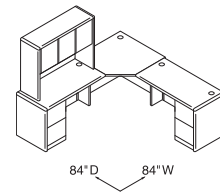

CORNER "L" WORKSTATION
84"W x 84"D

QTY	DESCRIPTION	MODEL	LIST PRICE	PRICE EXTENSION
1	Single Pedestal Desk, Left – B/F 72"W x 36"D x 29½"H	H10786L	\$1,552	\$1,552
1	Bridge 47"W x 24"D x 29½"H	H10770	\$472	\$472
1	Credenza with Lateral, Right 72"W x 24"D x 29½"H	H10747R	\$1,874	\$1,874
1	Stack-on Storage 68½"W x 14½"D x 37½"H	H10734	\$1,396	\$1,396
TOTAL:			\$5,294	

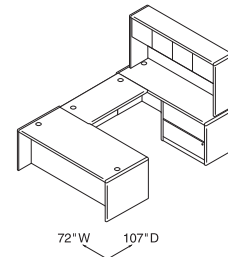

DESK "U" WORKSTATION – RIGHT
72"W x 107"D

QTY	DESCRIPTION	MODEL	LIST PRICE	PRICE EXTENSION
1	Double Pedestal Desk – 3/2 72"W x 36"D x 29½"H	H10799	\$2,398	\$2,398
1	Credenza with Storage 72"W x 24"D x 29½"H	H10742	\$2,398	\$2,398
TOTAL:			\$4,796	

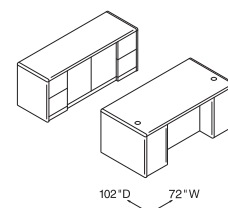

**DESK WORKSTATION WITH
STORAGE CRENZENZA**
72"W x 102"D



Icon Legend on page 19

10700 SERIES™ Typicals

Components used are listed on pages 336-357. Order components individually. Other configurations are possible, including various sizes of some components.

QTY	DESCRIPTION	MODEL	LIST PRICE	PRICE EXTENSION
1	Double Pedestal Desk – 3/2 72"W x 36"D x 29½"H	H10799	\$2,398	\$2,398
1	Credenza with Kneespace – 2/0/2 72"W x 24"D x 29½"H	H10741	\$2,071	\$2,071
1	Stack-on Storage 68⅝"W x 14⅝"D x 37⅞"H	H10734	\$1,396	\$1,396
1	Wardrobe/Storage Cabinet, Right 18"W x 24"D x 66⅝"H	H107295R	\$2,121	\$2,121
TOTAL:			\$7,986	

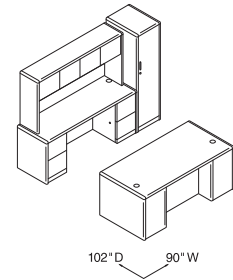

DESK WORKSTATION
90"W x 102"D

QTY	DESCRIPTION	MODEL	LIST PRICE	PRICE EXTENSION
1	Peninsula 72"W x 36"D x 29½"H	H10721E	\$1,529	\$1,529
1	Return, Left – F/F 42"W x 24"D x 29½"H	H107192L	\$1,259	\$1,259
1	Stack-on Storage 74⅝"W x 14⅝"D x 37⅞"H	H107318	\$1,533	\$1,533
TOTAL:			\$4,321	

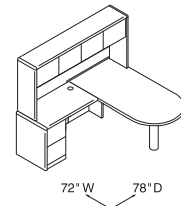

PENINSULA "L" WORKSTATION – LEFT
72"W x 78"D

QTY	DESCRIPTION	MODEL	LIST PRICE	PRICE EXTENSION
1	Single Pedestal Desk, Right – B/B/F 66"W x 30"D x 29½"H	H10701R	\$1,904	\$1,904
1	Return, Left – F/F 48"W x 24"D x 29½"H	H10712L	\$1,274	\$1,274
1	Stack-on Storage 74⅝"W x 14⅝"D x 37⅞"H	H107318	\$1,533	\$1,533
1	2-Drawer Lateral File 36"W x 24"D x 29½"H	H107690	\$1,390	\$1,390
TOTAL:			\$6,101	

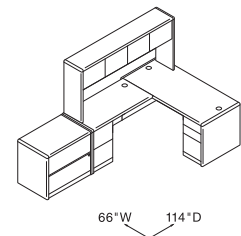

DESK "L" WORKSTATION – LEFT
66"W x 114"D

QTY	DESCRIPTION	MODEL	LIST PRICE	PRICE EXTENSION
1	Peninsula 72"W x 36"D x 29½"H	H10721E	\$1,529	\$1,529
1	Bridge 47"W x 24"D x 29½"H	H10770	\$472	\$472
1	Credenza Shell with Full Modesty Panel 72"W x 24"D x 29½"H	H107817	\$1,043	\$1,043
1	Multi File Pedestal 36"W x 20"D x 28"H	H10505	\$1,324	\$1,324
1	Stack-on Storage 68⅝"W x 14⅝"D x 37⅞"H	H10734	\$1,396	\$1,396
TOTAL:			\$5,764	

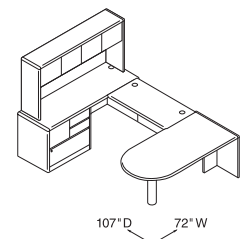

PENINSULA "U" WORKSTATION – LEFT
72"W x 107"D

10700 SERIES™

Typicals



Icon Legend on page 19

Components used are listed on pages 336-357. Order components individually. Other configurations are possible, including various sizes of some components.

QTY	DESCRIPTION	MODEL	LIST PRICE	PRICE EXTENSION
1	Single Pedestal Desk, Left - B/B/F 72"W x 36"D x 29½"H	H10788L	\$2,071	\$2,071
1	Bridge 47"W x 24"D x 29½"H	H10770	\$472	\$472
1	Single Pedestal Credenza, Right - F/F 72"W x 24"D x 29½"H	H10707R	\$1,695	\$1,695
1	Stack-on Storage 68⅝"W x 14⅝"D x 37⅞"H	H10734	\$1,396	\$1,396
1	Wardrobe/Storage Cabinet, Right 18"W x 24"D x 66⅝"H	H107295R	\$2,121	\$2,121
TOTAL:			\$7,755	

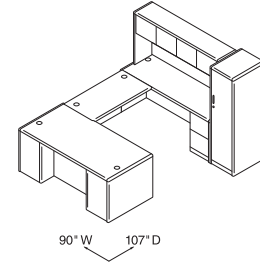

DESK "U" WORKSTATION - RIGHT

90" W x 107" D

QTY	DESCRIPTION	MODEL	LIST PRICE	PRICE EXTENSION
1	Return Shell, Left 36"W x 24"D x 29½"H	H107802L	\$702	\$702
1	Corner Unit 24" x 36" x 36" x 24" x 29½"H	H107811	\$1,381	\$1,381
1	Return Shell, Right 36"W x 24"D x 29½"H	H107801R	\$702	\$702
1	Stack-on Storage 68⅝"W x 14⅝"D x 37⅞"H	H10734	\$1,396	\$1,396
1	Mobile Pedestal - B/B/F 15¾"W x 22¾"D x 28"H	H105102	\$906	\$906
1	Mobile Pedestal - F/F 15¾"W x 22¾"D x 28"H	H105104	\$906	\$906
TOTAL:			\$5,993	

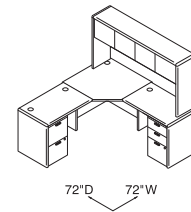

CORNER 6' X 6' WORKSTATION

72" W x 72" D

QTY	DESCRIPTION	MODEL	LIST PRICE	PRICE EXTENSION
1	Desk Shell 66"W x 30"D x 29½"H	H107826	\$1,117	\$1,117
1	Credenza Shell 66"W x 24"D x 29½"H	H107816	\$973	\$973
2	Mobile Pedestal - B/B/F 15¾"W x 22¾"D x 28"H	H105102	\$906	\$1,812
2	Mobile Pedestal - F/F 15¾"W x 22¾"D x 28"H	H105104	\$906	\$1,812
TOTAL:			\$5,714	

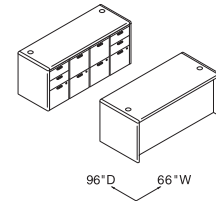

MODULAR DESK AND CREDEZA

66" W x 96" D

QTY	DESCRIPTION	MODEL	LIST PRICE	PRICE EXTENSION
1	Peninsula 66"W x 30"D x 29½"H	H10722E	\$1,336	\$1,336
1	Bridge 42"W x 24"D x 29½"H	H10760	\$455	\$455
1	Corner Unit 24" x 36" x 36" x 24" x 29½"H	H107811	\$1,381	\$1,381
1	Return Shell, Right 42"W x 24"D x 29½"H	H107803R	\$702	\$702
1	Mobile Pedestal - B/B/F 15¾"W x 22¾"D x 28"H	H105102	\$906	\$906
1	Mobile Pedestal - F/F 15¾"W x 22¾"D x 28"H	H105104	\$906	\$906
1	Stack-on Storage 74⅝"W x 14⅝"D x 37⅞"H	H107318	\$1,533	\$1,533
TOTAL:			\$7,219	

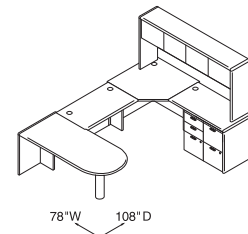

**PENINSULA "U" WITH
MODULAR COMPONENTS**

78" W x 108" D



Icon Legend on page 19

10700 SERIES™ Bundles Typicals

Mahogany H107LL7284N

QTY	DESCRIPTION	MODEL	LIST PRICE	PRICE EXTENSION
1	Left Pedestal Desk	H10786L	\$1,552	\$1,552
1	Right Return	H10715R	\$1,044	\$1,044
TOTAL:			\$2,596	

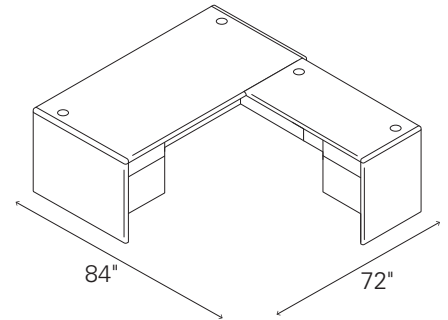

L-STATION (LEFT DESK, RIGHT RETURN)

Mahogany H107LR7284N

QTY	DESCRIPTION	MODEL	LIST PRICE	PRICE EXTENSION
1	Right Pedestal Desk	H10785R	\$1,552	\$1,552
1	Left Return	H10716L	\$1,044	\$1,044
TOTAL:			\$2,596	

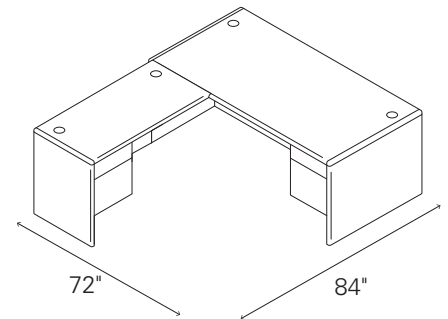

L-STATION (RIGHT DESK, LEFT RETURN)

Mahogany H107UL72108N

QTY	DESCRIPTION	MODEL	LIST PRICE	PRICE EXTENSION
1	Left Pedestal Desk	H10786L	\$1,552	\$1,552
1	Right Pedestal Credenza	H10745R	\$1,361	\$1,361
1	Bridge	H10770	\$472	\$472
TOTAL:			\$3,385	

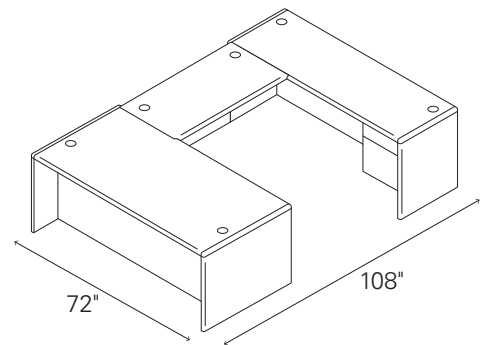

U-STATION (LEFT DESK, RIGHT CREDENZA)

10700 SERIES™

Bundles Typicals



Icon Legend on page 19

Mahogany
H107UR72108N

QTY	DESCRIPTION	MODEL	LIST PRICE	PRICE EXTENSION
1	Right Pedestal Desk	H10785R	\$1,552	\$1,552
1	Left Pedestal Credenza	H10746L	\$1,361	\$1,361
1	Bridge	H10770	\$472	\$472
TOTAL:			\$3,385	

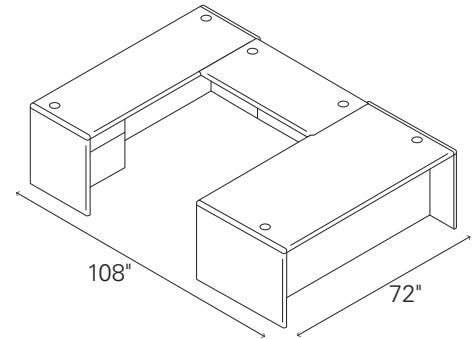

U-STATION (RIGHT DESK, LEFT CREDENZA)

Mahogany
H107LLH7284N

QTY	DESCRIPTION	MODEL	LIST PRICE	PRICE EXTENSION
1	Left Pedestal Desk	H10786L	\$1,552	\$1,552
1	Right Return	H10715R	\$1,044	\$1,044
1	Stack-on Storage	H107313	\$1,231	\$1,231
TOTAL:			\$3,827	

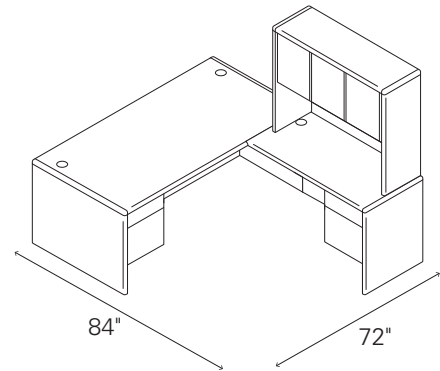

**L-STATION WITH STACK-ON STORAGE
(LEFT DESK, RIGHT RETURN)**

Mahogany
H107LRH7284N

QTY	DESCRIPTION	MODEL	LIST PRICE	PRICE EXTENSION
1	Right Pedestal Desk	H10785R	\$1,552	\$1,552
1	Left Return	H10716L	\$1,044	\$1,044
1	Stack-on Storage	H107313	\$1,231	\$1,231
TOTAL:			\$3,827	

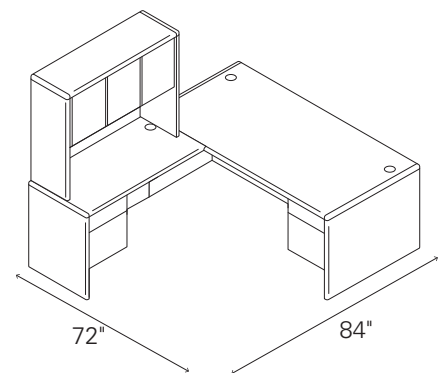

**L-STATION WITH STACK-ON STORAGE
(RIGHT DESK, LEFT RETURN)**



Icon Legend on page 19

10700 SERIES™ Bundles Typicals

Mahogany
H107ULH72108N

QTY	DESCRIPTION	MODEL	LIST PRICE	PRICE EXTENSION
1	Left Pedestal Desk	H10786L	\$1,552	\$1,552
1	Right Pedestal Credenza	H10745R	\$1,361	\$1,361
1	Bridge	H10770	\$472	\$472
1	Stack-on Storage	H10734	\$1,396	\$1,396
TOTAL:			\$4,781	

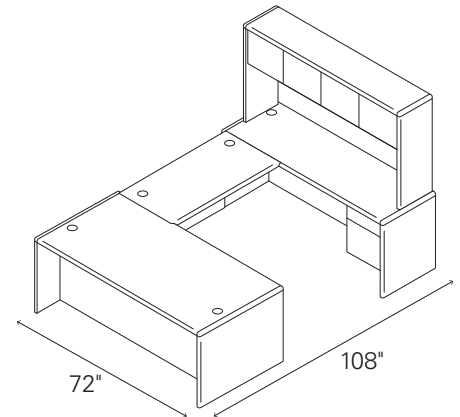

**U-STATION WITH STACK-ON STORAGE
(LEFT DESK, RIGHT CREDENZA)**

Mahogany
H107URH72108N

QTY	DESCRIPTION	MODEL	LIST PRICE	PRICE EXTENSION
1	Right Pedestal Desk	H10785R	\$1,552	\$1,552
1	Left Pedestal Credenza	H10746L	\$1,361	\$1,361
1	Bridge	H10770	\$472	\$472
1	Stack-on Storage	H10734	\$1,396	\$1,396
TOTAL:			\$4,781	

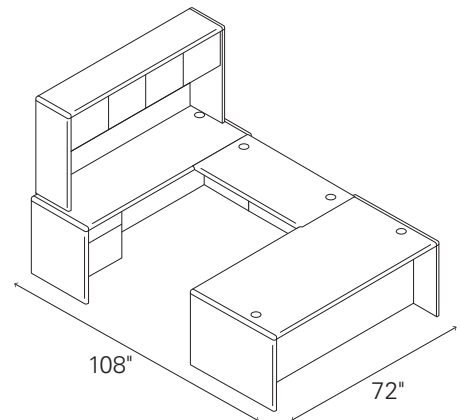

**U-STATION WITH STACK-ON STORAGE
(RIGHT DESK, LEFT CREDENZA)**

10700 SERIES™ Laminate Modular Components

GSA SIN 33721



Icon Legend on page 19

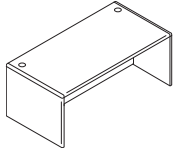

DESCRIPTION	INSIDE DIMENSIONS	FULL WIDTH OVERHANG	MODEL	SHIP WEIGHT	CUBE	LIST PRICE
Desk Shell w/Full Modesty Panel						
72"W x 36"D x 29½"H	69½"W x 24⅝"D	10½"	H107827	213	7.0	\$1261
72"W x 30"D x 29½"H	69½"W x 24⅝"D	4½"	H107829	167	4.7	\$1121
66"W x 30"D x 29½"H	63½"W x 24⅝"D	4½"	H107826	175	5.5	\$1117
60"W x 30"D x 29½"H	57½"W x 24⅝"D	4½"	H107825	164	5.0	\$967
48"W x 30"D x 29½"H	45½"W x 24⅝"D	4½"	H107824	143	5.0	\$939

NOTES: Can be used freestanding or connected to a 42"W return shell to achieve a space efficient 6' x 6' L-shaped workstation layout. Accepts stack-on storage models H10734, H10734K or H10734G. See page 356 for optional center drawers.

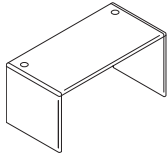

Desk Shell w/10" Modesty Panel						
60"W x 30"D x 29½"H	57½"W x 24⅝"D	4½"	H107825X	161	4.0	\$967

NOTES: Makes reaching wall electrical outlets quick and easy. Provides more than 18" of clearance. Can be used freestanding or connected to a 30"W return shell to achieve a compact 5' x 5' L-shaped workstation layout. Accepts stack-on storage models H10732, H10732K. See page 356 for optional center drawers.

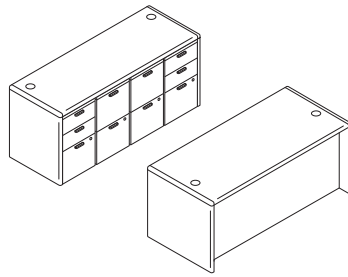

96" D 66" W

- 1 - H107826
- 1 - H107816
- 2 - H105102
- 2 - H105104

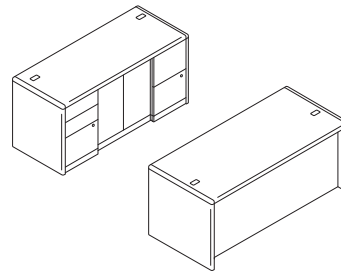

96" D 60" W

- 1 - H107825
- 1 - H107815
- 1 - H10508
- 1 - H10504
- 1 - H10502

! All 10700 Series™ grommets on desk, credenza, credenza shell, return, return shell, bridge and corner unit worksurfaces changed from rectangle-shaped to round, effective November, 2011.

NOTES:

- Desk, credenza, and return shells, combined with a variety of under-the-worksurface storage solutions, maximize office layout flexibility. Products can be reconfigured quickly and easily when user preferences or space needs change.
- Worksurfaces and end panels feature contract-grade scratch, stain and spill resistant laminate over durable 1⅛" solid core high-performance particleboard; resists warping.
- Contoured hardwood trim; stained to match laminate.
- User friendly waterfall-shaped edges and round corners.
- 3" round cord management grommets, for routing and hiding wires and cables, are located in the tops of desk, credenza, and return shells. Grommets also serve as anchor points for stack-on storage and organizers.
- Grommet can be replaced with optional Power Hub or Power/USB Hub for easy plug-and-play. See page 358.
- Shells utilize 10500 Series™ mobile pedestals or modular pedestals. See pages 289-291.
- See pages 340-341 for modular storage components.



HOW TO SPECIFY

Select Model Number	Select Laminate
	See page 329
H 1 0 7 8 2 7 .	N N

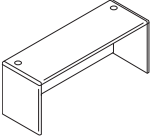
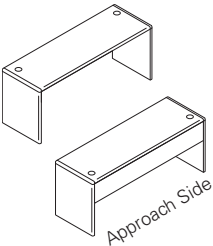

10700 SERIES™

Laminate Modular Components

	DESCRIPTION	INSIDE DIMENSIONS	MODEL	SHIP WEIGHT	CUBE	LIST PRICE
	Credenza Shell w/Full Modesty Panel					
	72"W x 24"D x 29½"H	69½"W x 22¾"D	H107817	156	6.0	\$1043
	66"W x 24"D x 29½"H	63½"W x 22¾"D	H107816	145	5.5	\$973
	60"W x 24"D x 29½"H	57½"W x 22¾"D	H107815	133	5.0	\$918
	72"W x 20"D x 29½"H	69½"W x 18¾"D	H107837	140	5.3	\$1019
	66"W x 20"D x 29½"H	63½"W x 18¾"D	H107836	132	4.8	\$949
	60"W x 20"D x 29½"H	57½"W x 18¾"D	H107835	127	3.8	\$903
	NOTES: One cord pass-through grommet in top center of modesty panel to reach wall electrical outlets. See pages 348-349 for optional stack-on storage.					
	Credenza Shell w/10"H Modesty Panel					
	72"W x 24"D x 29½"H	69½"W x 22¾"D	H107817X	127	6.0	\$1043
	66"W x 24"D x 29½"H	63½"W x 22¾"D	H107816X	121	5.5	\$973
	60"W x 24"D x 29½"H	57½"W x 22¾"D	H107815X	115	5.0	\$918
	NOTES: Makes reaching wall electrical outlets quick and easy. Provides more than 18" of clearance. See pages 348-349 for optional stack-on storage.					
 <p>Not available in two-tone laminate</p>	Kneespace Clearance End Panel Kits (field installable)					
	1½"W x 11¼"D x 28⅝"H		H105098	13	0.9	\$223
	For use at either end of 10700, 10500 or Valido Series® 24"D Credenza Shells (with full or 10" modesty panel) or non-pedestal end of single pedestal credenzas or credenzas with lateral files.					
	1⅝"W x 17¼"D x 28⅝"H		H105099	11	0.8	\$234
	For use at either end of 10700, 10500 or Valido Series® 30"D Desk Shells or non-pedestal end of 30"D single pedestal desks.					
	Kits include: (1) support panel; European fastening hardware; flat connector bracket; joint connector bolts with sleeve nuts (for ganging credenza to adjacent worksurface); and adjustable leveling glides. Allows conversion of units currently in the field.					
	NOTES: Can be used to connect up to three 24"D credenzas or 30"D desks in line (requires 4 kits).					
	⚠ Not designed to be used freestanding. Not designed to be used with returns, 36"D desks or desk shells.					
	SPECIFYING EXAMPLE: H105098.N					

NOTES:

- Desk, credenza, and return shells, combined with a variety of under-the-worksurface storage solutions, maximize office layout flexibility. Products can be reconfigured quickly and easily when user preferences or space needs change.
- Worksurfaces and end panels feature contract-grade scratch, stain and spill resistant laminate over durable 1/8" solid core high-performance particleboard; resists warping.
- Contoured hardwood trim; stained to match laminate.
- User friendly waterfall-shaped edges and rounded corners.
- Formal, full height or 10" modesty panels.
- Cord management grommets, for routing and hiding wires and cables, are located in the tops of desk, credenza, and return shells. Grommets also serve as anchor points for stack-on storage and organizers.
- Shells utilize 10500 Series™ mobile pedestals or modular pedestals. See pages 289-291.
- See pages 340-341 for modular storage components.

HOW TO SPECIFY

Select Model Number	Select Laminate
	See page 329
H 1 0 7 8 1 7 .	N N

10700 SERIES™ Laminate Modular Components

GSA SIN 33721



Icon Legend on page 19

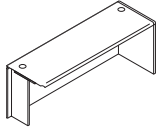

Model H107727R shown

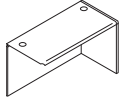

Model H107805R shown

DESCRIPTION	INSIDE DIMENSIONS	MODEL	SHIP WEIGHT	CUBE	LIST PRICE
Right Return Shell w/Full Modesty Panel					
72"W x 24"D x 29½"H, Right (w/support; 2 grommets)	67"W x 22¾"D	H107727R	145	5.6	\$1043
60"W x 24"D x 29½"H, Right (w/support; 2 grommets)	55"W x 22¾"D	H107807R	129	4.7	\$918
48"W x 24"D x 29½"H, Right (2 grommets)	47"W x 22¾"D	H107805R	100	4.0	\$736
42"W x 24"D x 29½"H, Right (2 grommets)	41"W x 22¾"D	H107803R	95	3.5	\$702
36"W x 24"D x 29½"H, Right (2 grommets)	34¾"W x 22⅝"D	H107801R	83	3.4	\$702
30"W x 24"D x 29½"H (1 grommet)	28¾"W x 22¾"D	H107725R	69	2.4	\$681
Left Return Shell w/Full Modesty Panel					
72"W x 24"D x 29½"H, Left (w/support; 2 grommets)	67"W x 22¾"D	H107728L	145	5.6	\$1043
60"W x 24"D x 29½"H, Left (w/support; 2 grommets)	55"W x 22¾"D	H107808L	129	4.7	\$918
48"W x 24"D x 29½"H, Left (2 grommets)	47"W x 22¾"D	H107806L	100	4.0	\$736
42"W x 24"D x 29½"H, Left (2 grommets)	41"W x 22¾"D	H107804L	95	3.5	\$702
36"W x 24"D x 29½"H, Left (2 grommets)	34¾"W x 22⅝"D	H107802L	83	3.4	\$702
30"W x 24"D x 29½"H (1 grommet)	28¾"W x 22¾"D	H107726L	69	2.4	\$681

NOTES: One cord pass-through grommet in top center of modesty panel to reach wall electrical outlets. Woodgrain direction on modesty/back panel runs vertical on 30"W-60"W sizes and horizontal on 72"W unit. Stack-on model H10734 is sized to be used on the 72"W return shell. Stack-on model H10732 will work on the 60"W return shell. Stack-on storage model H107313 fits on the 48"W return shell. Stack-on storage model H10734 will work on a 36"W return shell attached to the 36" corner unit; attaches to the return shell through the grommet hole and to the corner unit via double-sided tape. 36"W return shell can be used to achieve a 6' x 6' footprint when connected to either a 72"W x 36"D single pedestal desk, desk shell or peninsula, or when two are connected to a 36" corner unit model H107811.

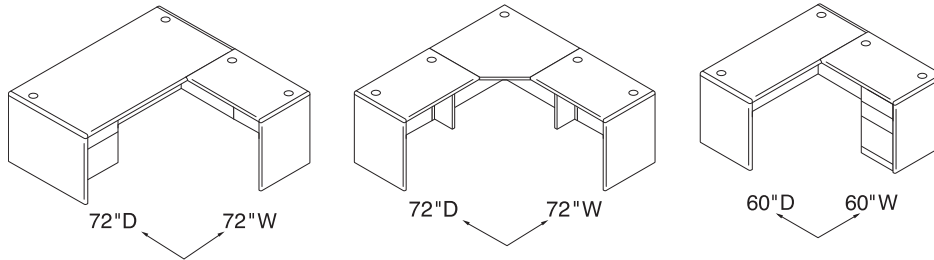

! All 10700 Series™ grommets on desk, credenza, credenza shell, return, return shell, bridge and corner unit worksurfaces changed from rectangle-shaped to round, effective November, 2011.

NOTES:

- Worksurfaces and end panels feature contract-grade scratch, stain and spill resistant laminate over durable 1½" solid core high-performance particleboard; resists warping.
- Contoured hardwood trim; stained to match laminate.
- User friendly waterfall-shaped edges and rounded corners.
- Formal, full height or 10" modesty panels.
- Cord management grommets, for routing and hiding wires and cables, are located in the tops of desk, credenza, and return shells. Grommets also serve as anchor points for stack-on storage and organizers.
- For work-in-process paper management tools, see page 355.
- For conference table options, see the Preside® table tops and bases in the Tables section in the 2021 Shared Spaces Pricer.
- Shells utilize 10500 Series™ mobile pedestals or modular pedestals. See pages 289-291.
- See pages 340-341 for modular storage components.

HOW TO SPECIFY

Select
Model Number

H 1 0 7 7 2 7 R .

Select
Laminate

See page 329

N N

10700 SERIES™ Laminate Modular Components

	DESCRIPTION	INSIDE DIMENSIONS	MODEL	SHIP WEIGHT	CUBE	LIST PRICE
	Right Return Shell w/10" H Modesty Panel					
	72"W x 24"D x 29½"H, Right (w/support; 2 grommets)	67"W x 22¾"D	H107727RX	113	5.6	\$1043
	60"W x 24"D x 29½"H, Right (w/support; 2 grommets)	55"W x 22¾"D	H107807RX	105	4.7	\$918
	48"W x 24"D x 29½"H, Right (2 grommets)	47"W x 22¾"D	H107805RX	81	4.0	\$736
	42"W x 24"D x 29½"H, Right (2 grommets)	41"W x 22¾"D	H107803RX	78	3.5	\$702
	36"W x 24"D x 29½"H, Right (2 grommets)	34¾"W x 22⅝"D	H107801RX	69	3.4	\$702
	Left Return Shell w/10" H Modesty Panel					
	72"W x 24"D x 29½"H, Left (w/support; 2 grommets)	67"W x 22¾"D	H107728LX	113	5.6	\$1043
	60"W x 24"D x 29½"H, Left (w/support; 2 grommets)	55"W x 22¾"D	H107808LX	105	4.7	\$918
	48"W x 24"D x 29½"H, Left (2 grommets)	47"W x 22¾"D	H107806LX	81	4.0	\$736
	42"W x 24"D x 29½"H, Left (2 grommets)	41"W x 22¾"D	H107804LX	78	3.5	\$702
	36"W x 24"D x 29½"H, Left (2 grommets)	34¾"W x 22⅝"D	H107802LX	69	3.4	\$702

NOTES: Makes reaching wall electrical outlets quick and easy. Provides more than 18" of clearance.

	Non-Handed Return Shell w/10" H Modesty Panel					
	30"W x 20"D x 29½"H	28¾"W x 18¾"D	H107270X	47	2.4	\$653

NOTES: Makes reaching wall electrical outlets quick and easy; provides more than 18" of clearance. Ideal for smaller spaces. Connects to single pedestal desks and credenzas, peninsulas, or desk or credenza shells. Designed to fit over 10500 Series™ mobile pedestal models H105106 (box/file) or H105109 (shelf/box/file) and modular pedestal models H105012 (box/box/file) or H105014 (file/file).

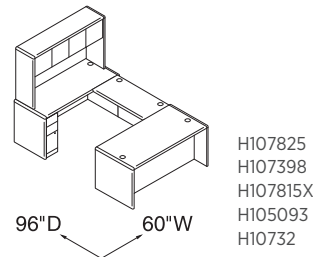
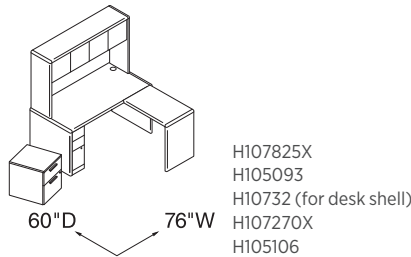

! All 10700 Series™ grommets on desk, credenza, credenza shell, return, return shell, bridge and corner unit worksurfaces changed from rectangle-shaped to round, effective November, 2011.

NOTES:

- Worksurfaces and end panels feature contract-grade scratch, stain and spill resistant laminate over durable 1½" solid core high-performance particleboard; resists warping.
- Contoured hardwood trim; stained to match laminate.
- User friendly waterfall-shaped edges and rounded corners.
- Formal, full height or 10" modesty panels.
- 3" round cord management grommets, for routing and hiding wires and cables, are located in the tops of desk, credenza, and return shells. Grommets also serve as anchor points for stack-on storage and organizers.
- Grommet can be replaced with optional Power Hub or Power/USB Hub for easy plug-and-play. See page 358.
- For conference table options, see the Preside® table tops and bases in the Tables section in the 2021 Shared Spaces Pricer.
- Shells utilize 10500 Series™ mobile pedestals or modular pedestals. See pages 289-291.
- See pages 340-341 for modular storage components.

! Disperse fabrics not available on 72"W panels.

HOW TO SPECIFY

<p>Select Model Number</p> <p>H 1 0 7 7 2 7 R X</p>	<p>Select Laminate</p> <p>See page 329</p> <p>N N</p>
---	---

10700 SERIES™

Laminate Modular Components

GSA SIN 33721

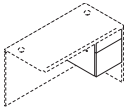
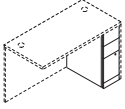
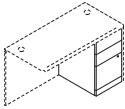
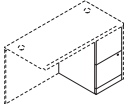
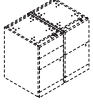

Icon Legend on page 19

	DESCRIPTION	MODEL	SHIP WEIGHT	CUBE	LIST PRICE
	<p>Box/File Pedestal (with core removable lock) 15$\frac{3}{4}$"W x 22$\frac{3}{4}$"D x 17$\frac{3}{4}$"H — for use under 24"D, 30"D and 36"D desk, credenza and return shells</p> <p>NOTES: Hangrails included. Lock can be positioned on either the right or left side. Attaches to underside of worksurface top. Not for use under 20"D shells.</p> <p>⚠ Not designed to be used freestanding. Unfinished top and back.</p>	H10501	57	5.5	\$555
	<p>Narrow Box/Box/File Pedestal (with core removable lock) — floor-standing 9$\frac{1}{2}$"W x 22$\frac{3}{4}$"D x 28"H — for use under 24"D, 30"D and 36"D desk, credenza and return shells</p> <p>NOTES: Compact design is ideal for use in U- and L-shaped layouts for smaller spaces such as 5' x 8' U-workstation or a 5' x 5' L-workstation. Middle box drawer and file drawer lock; top box drawer does not lock. File drawer includes integrated hangrails for side-to-side letter or legal filing. Field installable handle choices for this model are the Sweep, Crescent, and Arch only. Not for use with 20"D shells.</p> <p>⚠ Not designed to be used freestanding; unfinished top and back.</p>	H105093	61	5.6	\$717
	<p>Box/Box/File Pedestal (with core removable lock) — floor-standing 15$\frac{3}{4}$"W x 22$\frac{3}{4}$"D x 28"H — for use under 24"D, 30"D and 36"D desk, credenza and return shells</p> <p>NOTES: Top box drawer does not lock. Hangrails included. Not for use under 20"D shells.</p> <p>⚠ Not designed to be used freestanding. Unfinished top and back.</p>	H10502	90	8.4	\$728
	<p>File/File Pedestal (with core removable lock) — floor-standing 15$\frac{3}{4}$"W x 22$\frac{3}{4}$"D x 28"H — for use under 24"D, 30"D and 36"D desk, credenza and return shells</p> <p>NOTES: Hangrails included. Not for use under 20"D shells.</p> <p>⚠ Not designed to be used freestanding. Unfinished top and back.</p>	H10504	85	8.2	\$728
	<p>Access Strip (Filler) 1$\frac{1}{8}$"W x 20$\frac{1}{2}$"D x 28"H</p> <p>NOTES: For use with B/B/F, F/F, and or P/M/F pedestals are configured side-by-side. Not required when pedestals are used in conjunction with lateral file pedestal, multi file pedestal or cabinet pedestal. Not for use under 20"D shells.</p> <p>⚠ All 10700 Series™ grommets on desk, credenza, credenza shell, return, return shell, bridge and corner unit worksurfaces changed from rectangle-shaped to round, effective November, 2011.</p>	H10524	21	0.9	\$187

NOTES:

- Pedestals can be reconfigured quickly and easily when user preferences or space needs change.
- Pedestal models ship assembled unless designated ⚠.
- Locking units equipped with interchangeable core removable locks.
- See pages 336-339 for modular desk, credenza and return shells.
- ⚠ Keyed alike cores must be ordered separately — see page 773.
- ⚠ Pedestals are not designed to be used freestanding. Unfinished top and back.
- ⚠ Access strip (filler) required when full height pedestals are configured side-by-side to allow access for opening the drawers.

HOW TO SPECIFY

Select Model Number <input type="text" value="H10501"/>	Select Laminate <input type="text" value="N"/> See page 329
---	--

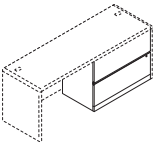
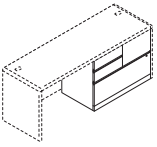
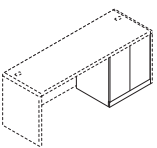
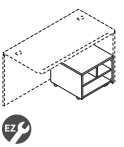

10700 SERIES™ Laminate Modular Components

	DESCRIPTION	MODEL	SHIP WEIGHT	CUBE	LIST PRICE
	<p>Lateral File Pedestal (with core removable lock) – floor-standing 36"W x 20"D x 28"H — for use under 24"D, 30"D and 36"D desk, credenza and return shells</p> <p>NOTES: Designed for use with credenza or return shells. Hangrails included. Mechanical interlock inhibits extension of more than one drawer at a time. Not for use under 20"D shells.</p> <p>⚠ Not designed to be used freestanding. Unfinished top and back.</p>	H10503	127	15.6	\$1105
	<p>Multi File Pedestal (with core removable lock) – floor-standing 36"W x 20"D x 28"H — for use under 24"D, 30"D and 36"D desk, credenza and return shells</p> <p>NOTES: Designed for use with credenza or return shells. Versatile four drawer unit features one lateral file drawer, one vertical file drawer, and two box drawers. Box drawers do not lock. Hangrails included. Mechanical interlock in lateral drawer inhibits extension of more than one drawer at a time. Not for use under 20"D shells.</p> <p>⚠ Not designed to be used freestanding. Unfinished top and back.</p>	H10505	155	15.6	\$1324
	<p>Cabinet Pedestal – floor-standing 26"W x 21¼"D x 28"H — for use under 24"D, 30"D and 36"D desk, credenza and return shells</p> <p>NOTES: One adjustable shelf at 2½" increments. For use with credenza or return shells. Doors are non-locking. Not for use under 20"D shells.</p> <p>⚠ Not designed to be used freestanding. Unfinished top and back.</p>	H10508	78	12.2	\$824
	<p>Mobile Printer/Fax Cart 20"W x 19⅞"D x 14⅞"H</p> <p>NOTES: Holds laser printers, inkjet printers or fax machines. Ideal for limited space. Low profile cart stores conveniently and easily under desks and workstations. Interior compartment shelving is Black. Four casters. Not for use under 20"D shells. Flat edge profile on top.</p> <p>SPECIFYING EXAMPLE: H105679.NN</p> <p>⚠ All 10700 Series™ grommets on desk, credenza, credenza shell, return, return shell, bridge and corner unit worksurfaces changed from rectangle-shaped to round, effective November, 2011.</p>	H105679	52	2.9	\$451

NOTES:

- Pedestals can be reconfigured quickly and easily when user preferences or space needs change.
- Locking units equipped with interchangeable core removable locks.
- See pages 336-339 for modular desk, credenza and return shells.
- ⚠ Keyed alike cores must be ordered separately — see HF23B on page 773.
- ⚠ Pedestals are not designed to be used freestanding. Unfinished top and back.
- ⚠ Access strip (filler) required when full height pedestals are configured side-by-side to allow access for opening the drawers.

HOW TO SPECIFY

Select Model Number H 1 0 5 0 3 . N	Select Laminate See page 329
---	--

10700 SERIES™

Laminate Wood Desks — Full Pedestals

GSA SIN 33721



Icon Legend on page 19

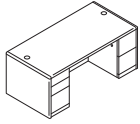

DESCRIPTION	RECESSED MODESTY PANEL	MODEL	SHIP WEIGHT	CUBE	LIST PRICE
Double Pedestal Desk w/Woodgrain Breakfront Modesty Panel — 3/2					
72"W x 36"D x 29½"H	10½"	H10799	371	52.9	\$2398
66"W x 30"D x 29½"H	4½"	H10774	313	40.9	\$2314
60"W x 30"D x 29½"H	4½"	H10773	305	37.3	\$2202
NOTES: All drawers lock. Two worksurface grommets to route/hide cords. See page 356 for optional center drawers.					

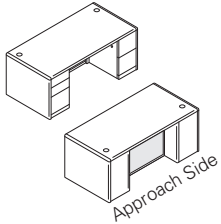

Double Pedestal Desk w/Frosted Breakfront Modesty Panel — 3/2					
72"W x 36"D x 29½"H	10½"	H10799G	366	51.8	\$2940
NOTES: All drawers lock. Two worksurface grommets to route/hide cords. See page 356 for optional center drawers.					

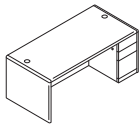

Single Pedestal Desk w/Woodgrain Breakfront Modesty Panel — Box/box/file					
72"W x 36"D x 29½"H, Right	10½"	H10787R	317	52.9	\$2071
66"W x 30"D x 29½"H, Right	4½"	H10701R	270	40.9	\$1904
72"W x 36"D x 29½"H, Left	10½"	H10788L	317	52.9	\$2071
66"W x 30"D x 29½"H, Left	4½"	H10702L	270	40.9	\$1904
NOTES: Drawers lock. Two worksurface grommets to route/hide cords. See page 356 for optional center drawers.					

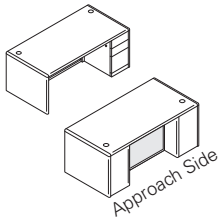

Single Pedestal Desk w/Frosted Breakfront Modesty Panel — Box/box/file					
72"W x 36"D x 29½"H, Right	10½"	H10787RG	313	51.8	\$2611
72"W x 36"D x 29½"H, Left	10½"	H10788LG	313	51.8	\$2611
NOTES: Drawers lock. Two worksurface grommets to route/hide cords. See page 356 for optional center drawers.					

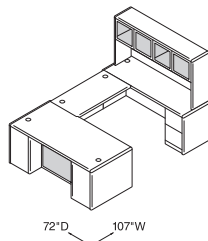

H10788L
H10770
H10707R
H10734G

! All 10700 Series™ grommets on desk, credenza, credenza shell, return, return shell, bridge and corner unit worksurfaces changed from rectangle-shaped to round, effective November, 2011.

NOTES:

- Worksurfaces and end panels feature contract-grade scratch, stain and spill resistant high-pressure laminate over durable 1/8" solid core high-performance particleboard.
- Contoured hardwood trim; stained to match laminate.
- User friendly waterfall-shaped edges.
- Full-to-floor pedestals maximize storage space.
- Breakfront modesty panel design on full height pedestal desks. See approach side illustration above.
- Grommet can be replaced with optional Power Hub or Power/USB Hub for easy plug-and-play. See page 358.
- All drawers are 5-sided construction, which allows easy drawer alignment or replacement of drawer fronts.
- File drawer design includes integrated hangrails for side-to-side letter or legal filing; and front-to-back for letter filing.
- Adjustable hex leveling glides allow floor-standing furniture to be easily leveled without lifting the unit; glides have 3/4" adjustable range.
- Desk, credenza, and return models ship assembled; ready to set in place.
- See pages 346-358 for shared components.

HOW TO SPECIFY

<p>Select Model Number</p> <p>H 1 0 7 9 9 .</p>	<p>Select Laminate</p> <p>See page 329</p> <p>N N</p>
---	---



10700 SERIES™

Laminate Wood Desks — Full Pedestals

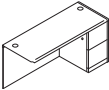
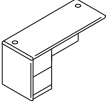
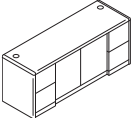
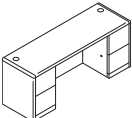
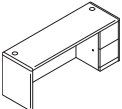
	DESCRIPTION	RECESSED MODESTY PANEL	MODEL	SHIP WEIGHT	CUBE	LIST PRICE
	Return — Right file/file (2 grommets)					
	60"W x 24"D x 29½"H		H10709R	176	29.7	\$1471
	48"W x 24"D x 29½"H		H10711R	158	24.9	\$1274
	42"W x 24"D x 29½"H		H107191R	150	22.1	\$1259
	NOTES: Drawers lock. Two worksurface grommets to route/hide cords and one cord pass-through grommet in top center of modesty panel. See pages 348-349 for optional stack-on storage.					
	⚠ Not designed to be used freestanding.					
	Return — Left file/file (2 grommets)					
	60"W x 24"D x 29½"H		H10710L	176	29.7	\$1471
	48"W x 24"D x 29½"H		H10712L	158	24.9	\$1274
	42"W x 24"D x 29½"H		H107192L	150	22.1	\$1259
	NOTES: Drawers lock. Two worksurface grommets to route/hide cords and one cord pass-through grommet in top center of modesty panel. See pages 348-349 for optional stack-on storage.					
	⚠ Not designed to be used freestanding.					
	Credenza with Doors					
	72"W x 24"D x 29½"H	3½"	H10742	314	36.0	\$2398
	NOTES: All drawers lock. Doors are non-locking. Two worksurface grommets to route/hide cords and one pass-through grommet in top center of modesty panel. Includes a fixed shelf located at the bottom of the center storage area. No intermittent shelf. See pages 348-349 for optional stack-on storage.					
	Credenza with Kneespace — 2/0/2					
	72"W x 24"D x 29½"H	3½"	H10741	280	36.0	\$2071
	66"W x 24"D x 29½"H	3½"	H10768	270	33.4	\$1947
	60"W x 24"D x 29½"H	3½"	H10767	241	28.8	\$1893
	NOTES: All drawers lock. Two worksurface grommets to route/hide cords and one pass-through grommet in top center of modesty panel. See pages 348-349 for optional stack-on storage.					
	⚠ Not designed to be used with 22¾"D modular or mobile pedestals. Modesty/back panel is inset 3½".					
	Single Pedestal Credenza, File/File					
	72"W x 24"D x 29½"H, Right	3½"	H10707R	235	36.3	\$1695
	66"W x 24"D x 29½"H, Right	3½"	H10705R	225	33.4	\$1665
	72"W x 24"D x 29½"H, Left	3½"	H10708L	235	36.3	\$1695
	66"W x 24"D x 29½"H, Left	3½"	H10706L	225	33.4	\$1665
	NOTES: Drawers lock. Two worksurface grommets to route/hide cords and one cord pass-through grommet in top center of modesty panel. See pages 348-349 for optional stack-on storage.					
	⚠ Not designed to be used with 22¾"D modular or mobile pedestals. Modesty/back panel is inset 3½".					
	⚠ All 10700 Series™ grommets on desk, credenza, credenza shell, return, return shell, bridge and corner unit worksurfaces changed from rectangle-shaped to round, effective November, 2011.					

NOTES:

- Worksurfaces and end panels feature contract-grade scratch, stain and spill resistant high-pressure laminate over durable 1/8" solid core high-performance particleboard.
- Contoured hardwood trim; stained to match laminate.
- User friendly waterfall-shaped edges.
- Full-to-floor pedestals maximize storage space.
- Breakfront modesty panel design on full height pedestal desks. See approach side illustration on page 342.
- Cord management grommets serve as anchor points for stack-on storage and organizers.
- All drawers are 5-sided construction, which allows easy drawer alignment or replacement of drawer fronts.
- File drawer design includes integrated hangrails for side-to-side letter or legal filing; and front-to-back for letter filing.
- Adjustable hex leveling glides allow floor-standing furniture to be easily leveled without lifting the unit; glides have 3/4" adjustable range.
- Desk, credenza, and return models ship assembled; ready to set in place.
- For work-in-process paper management tools, see page 355.
- See pages 346-358 for shared components.

HOW TO SPECIFY

Select Model Number	Select Laminate
H 1 0 7 0 9 R .	See page 329 N N

10700 SERIES™

Laminate Wood Desks — 3/4 Pedestals

GSA SIN 33721

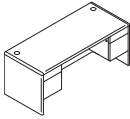
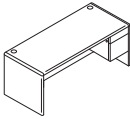
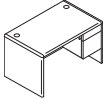
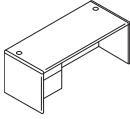
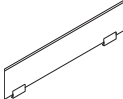

Icon Legend on page 19

	DESCRIPTION	FULL WIDTH OVERHANG	MODEL	SHIP WEIGHT	CUBE	LIST PRICE
	Double Pedestal Desk, 2-2					
	72"W x 36"D x 29½"H	10½"	H10791	340	52.9	\$1873
	66"W x 30"D x 29½"H	4½"	H10775	290	40.9	\$1789
	60"W x 30"D x 29½"H	4½"	H10771	266	37.4	\$1576
	NOTES: All drawers lock. Two worksurface grommets to route/hide cords. See page 356 for optional center drawers.					
	Single Pedestal Desk, Right box/file					
	72"W x 36"D x 29½"H	10½"	H10785R	279	52.9	\$1552
	66"W x 30"D x 29½"H	4½"	H10783R	239	41.0	\$1415
	NOTES: Drawers lock. Two worksurface grommets to route/hide cords. See page 356 for optional center drawers.					
	Small Office Desk, 3/4 Pedestal, Right box/file					
	48"W x 30"D x 29½"H		H107885R	191	30.2	\$1299
	NOTES: Footprint is ideal for limited space. Drawers lock. Two cord management grommets in the top. 3/4 height modesty panel facilitates reaching wall electrical outlets. Optional stack-on storage model H107313 maximizes storage space. See page 356 for optional center drawers.					
	Single Pedestal Desk, Left box/file					
	72"W x 36"D x 29½"H	10½"	H10786L	279	52.9	\$1552
	66"W x 30"D x 29½"H	4½"	H10784L	239	41.0	\$1415
	NOTES: Drawers lock. Two worksurface grommets to route/hide cords. See page 356 for optional center drawers.					
<p>! All 10700 Series™ grommets on desk, credenza, credenza shell, return, return shell, bridge and corner unit worksurfaces changed from rectangle-shaped to round, effective November, 2011.</p>						
	Above Privacy Screen					
	60"W x 13"H		HLSL1260	24	2.9	\$508
	54"W x 13"H		HLSL1254	22	2.9	\$473
	48"W x 13"H		HLSL1248	20	2.3	\$443
	42"W x 13"H		HLSL1242	18	2.3	\$387
	36"W x 13"H		HLSL1236	15	1.8	\$345
	30"W x 13"H		HLSL1230	13	1.5	\$313
	NOTES: Ships complete with attachment bracket. Bracket is Platinum only, no need to specify. Attaches to top of rectangle worksurfaces; requires a minimum overhang of 1½".					
	! Available in Frosted Glass ONLY HLSL1230.G.					
	! Above only Privacy Screen clamps onto worksurface and cannot be installed where support storage will be attached.					

NOTES:

- Worksurfaces and end panels feature contract-grade scratch, stain and spill resistant high-pressure laminate over durable 1½" solid core high-performance particleboard.
- Contoured hardwood trim; stained to match laminate.
- User friendly waterfall-shaped edges and rounded corners.
- 3/4 pedestal design increases budget flexibility.
- Formal, full height modesty panels.
- Drawers operate on full extension, ball-bearing suspensions to ensure smooth, quiet, long-lasting operation.
- All drawers are 5-sided construction, which allows easy drawer alignment or replacement of drawer fronts.
- File drawer design includes integrated hangrails for side-to-side letter or legal filing; and front-to-back for letter filing.
- Grommet can be replaced with optional Power Hub or Power/USB Hub for easy plug-and-play. See page 358.
- Adjustable hex leveling glides allow floor-standing furniture to be easily leveled without lifting the unit; glides have ¾" adjustable range.
- Desk, credenza, and return models ship assembled; ready to set in place.
- Center drawers conveniently store writing instruments, paper and other miscellaneous items. Includes pencil tray. See page 356.
- See pages 346-358 for shared components.

HOW TO SPECIFY

Select Model Number	Select Laminate
	See page 329
H 1 0 7 9 1 .	N N



10700 SERIES™

Laminate Wood Desks — 3/4 Pedestals

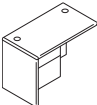
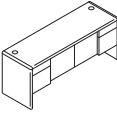
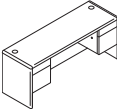
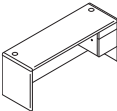
	DESCRIPTION	FULL WIDTH OVERHANG	MODEL	SHIP WEIGHT	CUBE	LIST PRICE
 <p>Model H10717R shown</p>	Return — Right box/file (2 grommets)					
	60"W x 24"D x 29½"H		H10717R	173	29.7	\$1183
	48"W x 24"D x 29½"H		H10715R	147	25.3	\$1044
	42"W x 24"D x 29½"H		H107193R	136	22.1	\$1017
	NOTES: Drawers lock. Two worksurface grommets and one cord pass-through grommet in top center of modesty panel. See pages 348-349 for optional stack-on storage.					
	⚠ Not designed to be used freestanding.					
 <p>Model H10716L shown</p>	Return — Left box/file (2 grommets)					
	60"W x 24"D x 29½"H		H10718L	173	29.7	\$1183
	48"W x 24"D x 29½"H		H10716L	147	25.3	\$1044
	42"W x 24"D x 29½"H		H107194L	136	22.1	\$1017
	NOTES: Drawers lock. Two worksurface grommets and one cord pass-through grommet in top center of modesty panel to reach wall electrical outlets. See pages 348-349 for optional stack-on storage.					
	⚠ Not designed to be used freestanding.					
	Credenza with Doors	3½"	H10744	278	36.0	\$1888
	72"W x 24"D x 29½"H					
	NOTES: All drawers lock. Hinged doors are non-locking. Two worksurface grommets and one cord pass-through grommet in top center of modesty panel to reach wall electrical outlets. Includes a fixed shelf located at the bottom of the center storage area. No intermittent shelf. See pages 348-349 for optional stack-on storage.					
	Credenza with Kneespace					
	72"W x 24"D x 29½"H	3½"	H10743	243	36.3	\$1684
	66"W x 24"D x 29½"H	3½"	H10766	234	33.4	\$1574
	60"W x 24"D x 29½"H	3½"	H10765	229	28.8	\$1503
	NOTES: Drawers lock. Two worksurface grommets and one cord pass-through grommet in top center of modesty panel to reach wall electrical outlets. See pages 348-349 for optional stack-on storage.					
	⚠ Not designed to be used with 22¾"D modular or mobile pedestals. Modesty/back panel is inset 3½".					
	Single Pedestal Credenza, Box/File					
	72"W x 24"D x 29½"H, Right	3½"	H10745R	212	36.0	\$1361
	66"W x 24"D x 29½"H, Right	3½"	H10763R	203	33.4	\$1339
	72"W x 24"D x 29½"H, Left	3½"	H10746L	212	36.0	\$1361
	66"W x 24"D x 29½"H, Left	3½"	H10764L	203	33.4	\$1339
	NOTES: Drawers lock. Two worksurface grommets and one cord pass-through grommet in top center of modesty panel to reach wall electrical outlets. See pages 348-349 for optional stack-on storage.					
	⚠ Not designed to be used with 22¾"D modular or mobile pedestals. Modesty/back panel is inset 3½".					
	⚠ All 10700 Series™ grommets on desk, credenza, credenza shell, return, return shell, bridge and corner unit worksurfaces changed from rectangle-shaped to round, effective November, 2011.					

NOTES:

- Worksurfaces and end panels feature contract-grade scratch, stain and spill resistant high-pressure laminate over durable 1½" solid core high-performance particleboard.
- Contoured hardwood trim; stained to match laminate.
- User friendly waterfall-shaped edges and rounded corners.
- 3/4 pedestal design increases budget flexibility.
- Formal, full height modesty panels.
- Cord management grommets also serve as anchor points for stack-on storage and organizers.
- All drawers are 5-sided construction, which allows easy drawer alignment or replacement of drawer fronts.
- File drawer design includes integrated hangrails for side-to-side letter or legal filing; and front-to-back for letter filing.
- Adjustable hex leveling glides allow floor-standing furniture to be easily leveled without lifting the unit; glides have ¾" adjustable range.
- Desk, credenza, and return models ship assembled; ready to set in place.
- For work-in-process paper management tools, see page 355.
- See pages 346-358 for shared components.

HOW TO SPECIFY

Select Model Number	Select Laminate
See page 329	See page 329
H 1 0 7 4 5 R .	N N

10700 SERIES™

Shared Components and Accessories

GSA SIN 33721

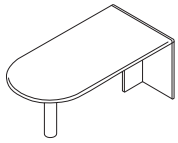

Icon Legend on page 19

**DESCRIPTION****Peninsula w/End Panel and Steel Support Column**

72"W x 36"D x 29½"H
66"W x 30"D x 29½"H

MODEL

H10721E
H10722E

SHIP WEIGHT

146
121

CUBE

8.1
8.1

LIST PRICE

\$1529
\$1336

NOTES: Use for "U" or "L" configuration. Cord routing notch in brace panel. Round support column is black. For a silver support column option, please see model HPC191X on page 281 (ordered separately).

⚠ Not designed to be used freestanding.

**Field Installable Laminate Modesty Panel**

50¼"W x ¾"Thick x 18"H

H10528

25

1.3

\$203

NOTES: Center drawer model H1522 can be used in conjunction with modesty panel. Cord pass-through notch in top corner of modesty panel. See page 356 for optional center drawers.

⚠ Not designed to attach to peninsulas manufactured prior to 12/1/2001.

SPECIFYING EXAMPLE: H10528.N

**Field Installable Modesty Panel, Frosted with Silver Frame**

50¼"W x ¾"Thick x 18"H — for use on 72"W peninsulas

HPC180G

33 Ⓢ

1.5

\$745

⚠ Center drawers not designed to be used with the frosted/silver modesty panel.

NOTES:

- Shared components on this page can be used with modular, full pedestal, and 3/4 pedestal models shown on pages 336-345.
- Multi file is a versatile four drawer unit featuring two box drawers, one file drawer, and one lateral file drawer with mechanical interlock.
- Cord management grommets, for routing and hiding wires and cables, are located in the tops of desks, credenzas, and returns. Grommets also serve as anchor points for stack-on storage and organizers.
- Cord pass-through grommet located in the back/modesty panel of returns, bridges and credenzas, facilitates reaching wall electrical outlets.
- All drawers are 5-sided construction, which allows easy drawer alignment or replacement of drawer fronts.
- Locking units equipped with interchangeable core removable locks.
- Stack-on storage attaches with two removable mounting brackets.
- Adjustable hex leveling glides allow floor-standing furniture to be easily leveled without lifting the unit; glides have ¾" adjustable range.
- See pages 346-358 for shared components.

⚠ Keyed alike cores must be ordered separately — see page 773.

HOW TO SPECIFY**Select Model Number**

H 1 0 7 2 1 E .

Select Laminate

See page 329

N N .

Select Paint Color*Specify for new peninsula models only***P** Black**P**

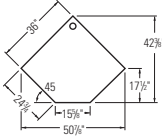

10700 SERIES™ Shared Components and Accessories

DESCRIPTION	MODEL	SHIP WEIGHT	CUBE	LIST PRICE
 <p>Corner Unit 24" x 36" x 36" x 24" x 29½"H – (1 grommet in top) Works with 24"D x 29½"H returns or bridges.</p> <p>NOTES: The corner unit has rounded, solid wood trim on the front and back. Return and bridge connections are inset inside the wood profiles, per the drawing shown. Support legs feature cutouts for routing cords. Can be used freestanding.</p> 	H107811	136	4.2	\$1381

DESCRIPTION	FULL WIDTH OVERHANG	MODEL	SHIP WEIGHT	CUBE	LIST PRICE
 <p>Bridge (Single Ped. Desk, Desk Shell or Peninsula to Corner Unit or Single Ped. Credenza or Credenza Shell) 47"W x 24"D x 29½"H, (Clear inside depth = 22¾"D) 42"W x 24"D x 29½"H, (Clear inside depth = 22¾"D) 36"W x 24"D x 29½"H, (Clear inside depth = 22¾"D) (for use with Corner Units) 47"W x 20"D x 29½"H, (Clear inside depth = 18¾"D) 42"W x 20"D x 29½"H, (Clear inside depth = 18¾"D)</p> <p>NOTES: Two cord grommets in top; one cord pass-through grommet in top center of modesty panel. Grommets can be replaced with optional Power Hub or Power/USB Hub for easy plug-and-play (see page 358). Kneespace of desk limited to 24¾"W if bridge is used with 66"W single pedestal desk.</p>		H10770 H10760 H10751 H107399 H107398	81 69 64 68 56	2.5 2.6 2.5 2.8 2.6	\$472 \$455 \$452 \$455 \$440

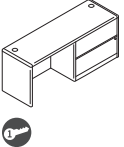
 <p>Credenza with 36" Lateral (with core removable lock) – 2 cord grommets in top 72"W x 24"D x 29½"H, Right 3½" H10747R 247 36.0 \$1874 72"W x 24"D x 29½"H, Left 3½" H10748L 247 36.0 \$1874</p> <p>NOTES: One cord pass-through grommet in top center of modesty panel. Mechanical interlock inhibits the extension of more than one drawer at a time. Optional stack-on models H10734, H10734K, and H10734G maximize storage space.</p> <p>⚠ Not designed to be used with 22¾"D modular or mobile pedestals. Modesty/back panel is inset 3½".</p>					
--	--	--	--	--	--

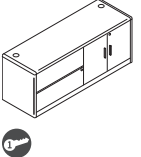
 <p>Credenza with Lateral File, Left and Storage Cabinet, Right 72"W x 24"D x 29½"H 3½" H107492 307 35.6 \$2323</p> <p>NOTES: Lateral file is equipped with mechanical interlock to inhibit the extension of more than one drawer at a time. Storage cabinet has one adjustable interior shelf which adjusts in 1¼" increments over a range of 5". Drawers and doors lock separately; the two locks are keyed alike. Can be used with optional stack-on storage. See page 348 for Stack-on Storage models H10734/H10734K/H10734G.</p>					
--	--	--	--	--	--

NOTES:

- Cord management grommets, for routing and hiding wires and cables, are located in the tops of desks, credenzas, and returns. Grommets also serve as anchor points for stack-on storage and organizers.
- Cord pass-through grommet located in the back/modesty panel of returns, bridges and credenzas, facilitates reaching wall electrical outlets.
- All drawers are 5-sided construction, which allows easy drawer alignment or replacement of drawer fronts.
- Locking units equipped with interchangeable core removable locks.
- Stack-on storage attaches with two removable mounting brackets.
- Adjustable hex leveling glides allow floor-standing furniture to be easily leveled without lifting the unit; glides have ¾" adjustable range.
- See pages 346-358 for shared components.

HOW TO SPECIFY

<p>Select Model Number</p> <p>H 1 0 7 7 0 .</p>	<p>Select Laminate</p> <p>See page 329</p> <p>N N</p>
---	---

10700 SERIES™

Shared Components and Accessories

GSA SIN 33721

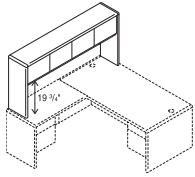

Icon Legend on page 19

**DESCRIPTION****Stack-on Storage for "L" Workstation**

74⁵/₈"W x 14⁵/₈"D x 37¹/₈"H
(Use Task Light model HH870960, see page 357)

MODEL**H107318****SHIP WEIGHT**

198

CUBE

15.8

LIST PRICE**\$1533****Stack-on Storage for "L" Workstation, Locking**

74⁵/₈"W x 14⁵/₈"D x 37¹/₈"H
(Use Task Light model HH870960, see page 357)

H107318K

198

15.8

\$1624

NOTES: Spans the total depth dimension of configurations comprised of: 48"W return or return shell attached to a 30"D single pedestal desk, desk shell or peninsula (78"D); 42"W return or return shell attached to a 36"D single pedestal desk, desk shell or peninsula (78"D) or 42"W return or return shell attached to a 36" corner unit (78"D). Attaches to desk, peninsula, or corner unit via double-sided tape, and to return through grommet hole. Inside storage consists of two compartments each 34³/₄"W x 12¹/₈"D x 12"H. Use back enclosure model H107358 and tackboard model H90035. For vertical paper manager, see page 355.

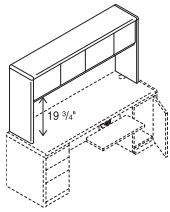
**Stack-on Storage**

68⁵/₈"W x 14⁵/₈"D x 37¹/₈"H, 4 doors (For 72"W Credenza)

H10734

175

16.0

\$1396

62⁵/₈"W x 14⁵/₈"D x 37¹/₈"H, 4 doors (For 66"W Credenza)

H10733

168

14.4

\$1380

56⁵/₈"W x 14⁵/₈"D x 37¹/₈"H, 4 doors (For 60"W Credenza or Return)

H10732

161

13.0

\$1339

44⁵/₈"W x 14⁵/₈"D x 37¹/₈"H, 3 doors (For 48"W Return or 48"W Small Office Desk)

H107313

147

10.3

\$1231**Stack-on Storage, Locking**

68⁵/₈"W x 14⁵/₈"D x 37¹/₈"H, 4 doors (For 72"W Credenza)

H10734K

175

16.0

\$1487

62⁵/₈"W x 14⁵/₈"D x 37¹/₈"H, 4 doors (For 66"W Credenza)

H10733K

168

14.4

\$1471

56⁵/₈"W x 14⁵/₈"D x 37¹/₈"H, 4 doors (For 60"W Credenza or Return)

H10732K

161

13.0

\$1431

44⁵/₈"W x 14⁵/₈"D x 37¹/₈"H, 3 doors (For 48"W Return or 48"W Small Office Desk)

H107313K

147

10.3

\$1299

NOTES: Inside storage for H10734, H10733 and H10732 contains two compartments each sized: 32¹/₂"W, 28³/₄"W, 25³/₄"W respectively x 12¹/₈"D x 12"H. H107313 has 3 doors. Inside storage for H107313 contains two compartments: right side 12¹/₈"W, left side 26³/₄"W respectively x 12¹/₈"D x 12"H. Stack-ons attach through grommet holes on the worksurfaces of desks, credenzas and returns. Model 10734 can be used for "L" configuration comprised of 30"D desk, desk shell or peninsula and 42"W return or return shell; or a 36"D desk, desk shell, peninsula or corner unit and 36"W return shell. Model H107313K has one lock which secures two of the three doors. For task light and vertical paper manager, see pages 355 and 357.

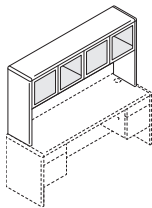
**Stack-on Storage w/ Frosted Doors w/ Silver Frame**

68⁵/₈"W x 14⁵/₈"D x 37¹/₈"H

H10734G

185

16.2

\$2097

NOTES: Rich woodgrain laminate and contemporary frosted doors with silver frames add a sleek mixed materials option to 10700 Series™. Accepts back enclosure model H10738, tackboard for use with back enclosure model H90034, task light HH870960 and vertical paper manager HVLPM1. Frosted door models are non-locking.

NOTES:

- Shared components on this page can be used with modular, full pedestal, and 3/4 pedestal models shown on pages 336-345.
- Stack-on storage models are equipped with self closing, adjustable hinged doors, and valance to hide task light.
- When spanning the total depth of an L-workstation, stack-on storage attaches to the desk, peninsula or corner unit via double-sided tape, and to the return through the grommet hole.
- Stack-on storage end panels are
- Stack-on storage and organizers attach with two removable mounting brackets, except for "L" workstation unit.
- Stacked paper management segments and organizes stack-on storage compartments and bookcase shelves. Unit can be used in stack-on storage models H107318 and H10734. See HLVPM2 on page 355.
- Vertical paper manager keeps papers, files, and books neatly organized and within easy reach from a seated position. Fits under stack-on storage models. See page 355.
- See pages 346-358 for shared components.

Upcharges may apply to premium tackboard fabric grades.

Removable lock core kit for locking stack-on storage is model HF27B. See page 773.

HOW TO SPECIFY

Select Model Number

H 1 0 7 3 4 .

Select Laminate

See page 329

N N



10700 SERIES™

Shared Components and Accessories

	DESCRIPTION	MODEL	COM	SHIP WEIGHT	CUBE	LIST PRICE		
 18 5/8" H	Back Enclosure for Stack-on Storage 72 1/4" W - for 74 5/8" W model #H107318/H107318K 66 1/4" W - for 68 5/8" W model #H10734/H10734K 60 1/4" W - for 62 5/8" W model #H10733/H10733K 54 1/4" W - for 56 5/8" W model #H10732/H10732K 42 1/4" W - for 44 5/8" W model #H107313/H107313K	H107358 H10738 H10737 H10736 H107353		34 31 29 27 22	1.3 1.3 1.3 1.3 0.9	\$303 \$279 \$259 \$248 \$248		
	NOTES: Non-tackable. Specify laminate. Features full width 1 1/8" slot at bottom to facilitate routing cords and reaching wall electrical outlets. H10738 can also be used with H10634 and H94234 stack-ons.							
	 18" H	Tackboards for use with Stack-on Back Enclosures (Back Enclosures must be ordered separately.) 71 1/2" W - for 74 5/8" W model #H107318/H107318K Hutch with #H107358 Enclosure 65 1/4" W - for 68 5/8" W model #H10734/H10734K Hutch with #H10738 Enclosure 59 1/4" W - for 62 5/8" W model #H10733/H10733K Hutch with #H10737 Enclosure 53 1/4" W - for 56 5/8" W model #H10732/H10732K Hutch with #H10736 Enclosure 41 1/2" W - for 44 5/8" W model #H107313/H107313K Hutch with #H107353 Enclosure	H90035 H90034 H90033 H90032 H90031	2.0 2.0 2.0 2.0 2.0	13 11 10 9 7	2.8 2.0 1.8 1.8 1.7	\$353 \$337 \$321 \$281 \$270	
		NOTES: Tackboards are sized 3/4" narrower than respective stack-on storage back enclosure, allowing 3/8" each side to route task light cords. Specify fabric selection from pages 25-26. Board is attached using latch & hook tape provided. H90034 can also be used with H10738 on H10634 and H94234 stack-ons.						
		ⓘ Disperse (DISP) fabric not available on sizes wider than 60".						
SPECIFYING EXAMPLE: H90035.APN15								

NOTES:

- Shared components on this page can be used with modular, full pedestal, and 3/4 pedestal models shown on pages 336-345.
- Stacked paper management segments and organizes stack-on storage compartments and bookcase shelves. Unit can be used in stack-on storage models H107318 and H10734. See HLVPM2 on page 355.
- Vertical paper manager keeps papers, files, and books neatly organized and within easy reach from a seated position. Fits under stack-on storage models. See page 355.
- See pages 346-358 for shared components.

ⓘ Upcharges may apply to premium tackboard fabric grades.

HOW TO SPECIFY

Select Model Number H 1 0 7 3 5 8	Select Laminate See page 329 N
---	---





10700 SERIES™

Shared Components and Accessories

GSA SIN 33721

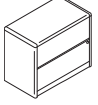
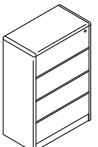
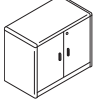
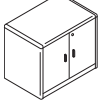
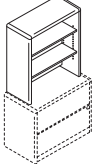

Icon Legend on page 19

	DESCRIPTION	MODEL	SHIP WEIGHT	CUBE	LIST PRICE
	Box/Box/File Mobile Pedestal (with core removable lock) 15 ³ / ₄ "W x 22 ³ / ₄ "D x 28 ⁵ / ₈ "H — use freestanding or under 24"D, 30"D and 36"D modular shells NOTES: Top box drawer does not lock. File drawer includes hangrails.	H105102	121	8.5	\$906
	File/File Mobile Pedestal (with core removable lock) 15 ³ / ₄ "W x 22 ³ / ₄ "D x 28 ⁵ / ₈ "H — use freestanding or under 24"D, 30"D and 36"D modular shells NOTES: File drawers include hangrails.	H105104	121	8.4	\$906
	Box/File Mobile Pedestal (with core removable lock) 15 ³ / ₄ "W x 18 ¹ / ₈ "D x 21 ¹ / ₈ "H — use freestanding or under 20"D, 24"D, 30"D and 36"D modular shells	H105106	65	5.8	\$757
 <i>Mobile pedestals have smooth, flat edges.</i>	Shelf/Box/File Mobile Pedestal (with core removable lock) 15 ³ / ₄ "W x 18 ¹ / ₈ "D x 28 ⁵ / ₈ "H — use freestanding or under 20"D, 24"D, 30"D and 36"D modular shells NOTES: Interior dimensions of the open storage area of the Shelf/Box/File model are 14 ¹ / ₈ "W x 16 ³ / ₄ "D x 6 ⁵ / ₈ "H.	H105109	73	7.3	\$834
	Lateral File (with core removable lock) 36"W x 24"D x 29 ¹ / ₂ "H — two drawer — matches depth of credenzas and returns 36"W x 20"D x 29 ¹ / ₂ "H — two drawer 36"W x 20"D x 45 ¹ / ₂ "H — three drawer 36"W x 20"D x 59 ¹ / ₈ "H — four drawer NOTES: Includes hangrails, mechanical interlock and, in H10762 and H107690, a counterweight. Interlock inhibits the extension of more than one drawer from opening at a time. 24"D size aligns evenly with 24"D credenzas, credenza shells, returns, return shells, and wardrobe/storage cabinets to provide linear layout continuity.	H107690	191	18.6	\$1390
	H10762 168 15.6 \$1339 H107698 240 23.2 \$2061 H107699 296 31.0 \$2841				
	Storage Cabinet with Doors (with core removable lock) 36"W x 20"D x 29 ¹ / ₂ "H NOTES: One adjustable interior shelf.	H107291	144	15.0	\$1084
	Storage Cabinet with Doors (with core removable lock) 36"W x 24"D x 29 ¹ / ₂ "H — matches depth of credenzas and returns NOTES: One adjustable interior shelf. 24"D size aligns evenly with 24"D credenzas, credenza shells, returns, return shells, and wardrobe/storage cabinets to provide linear layout continuity.	H107290	162	18.6	\$1192
	Bookcase Hutch 32 ⁵ / ₈ "W x 14 ⁵ / ₈ "D x 37 ¹ / ₈ "H NOTES: For use with Lateral Files (H10762, H107690) and Storage Cabinets (H107291, H107290). Cord pass-through gap behind shelves and a 1 ¹ / ₈ " full-width cord management slot at the bottom of the back panel to facilitate routing cords and reaching wall electrical outlets. When placed on a 29 ¹ / ₂ "H base unit, the total 66 ⁵ / ₈ "H matches the height of credenzas with stack-on storage and the height of the wardrobe/storage cabinet. Two shelves are adjustable in 1 ¹ / ₄ " increments.	H107292	93	5.1	\$806

NOTES:

- Shared components on this page can be used with modular, full pedestal, and 3/4 pedestal models shown on pages 336-345.
- Broad family of storage components takes organization way beyond the confines of a desk drawer.
- Mobile pedestal tops have smooth, flat edges. Units are standard with counterweight and four 2" diameter, non-locking casters.
- Locking units equipped with interchangeable core removable locks.
- Mobile pedestals, lateral files, storage cabinets, and bookcases ship assembled.
- See pages 346-358 for shared components.

! Keyed alike cores must be ordered separately — see model HF23B on page 773 — makes re-keying quick and easy.

HOW TO SPECIFY

Select Model Number	Select Laminate
See page 329	See page 329
H 1 0 5 1 0 2 .	N N



10700 SERIES™

Shared Components and Accessories

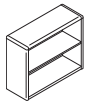
**DESCRIPTION****Bookcase w/Fixed Shelves**

36"W x 13¹/₈"D x 71"H, 5-Shelf
 36"W x 13¹/₈"D x 57¹/₈"H, 4-Shelf
 36"W x 13¹/₈"D x 43³/₈"H, 3-Shelf
 36"W x 13¹/₈"D x 29⁵/₈"H, 2-Shelf

MODEL**SHIP WEIGHT****CUBE****LIST PRICE**

H10755	187	25.3	\$1193
H10754	156	20.3	\$1011
H10753	122	15.6	\$897
H10752	90	10.9	\$744

NOTES: 36"W models with finished back. No assembly required. Ready to set in place.

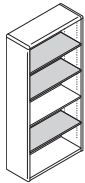
**Bookcase w/Adjustable Shelves**

32³/₈"W x 13¹/₈"D x 71"H, 5-Shelf

H107569

170

25.1

\$1180

NOTES: 32³/₈"W design with five shelves; two fixed, three adjustable. Shelves adjust in 2¹/₂" increments. Finished back.

Shaded shelves are adjustable.

NOTES:

- Shared components on this page can be used with modular, full pedestal, and 3/4 pedestal models shown on pages 336-345.
- Broad family of storage components takes organization way beyond the confines of a desk drawer.
- Conventional bookcase designs ship fully assembled to ease and speed installation.
- See pages 346-358 for shared components.

HOW TO SPECIFY

Select
Model Number

H 1 0 7 5 2 .

Select
Laminate

See page 329

N N

10700 SERIES™

Shared Components and Accessories

GSA SIN 33721



Icon Legend on page 19



Doors open 110 degrees from closed position.

DESCRIPTION	MODEL	SHIP WEIGHT	CUBE	LIST PRICE
Storage Cabinet (with core removable lock) 36"W x 24"D x 66 ⁵ / ₈ "H	H107299	341	41.0	\$2623
NOTES: Large storage area includes five, full-width (side-to-side) shelves; three are adjustable in 2 ¹ / ₂ " increments. Unit height is designed to match credenza or return plus stack-on height (66 ⁵ / ₈ ").				

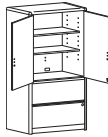

Doors open 110 degrees from closed position.

Storage Cabinet/Lateral File (with core removable lock) 36"W x 24"D x 66 ⁵ / ₈ "H	H107293	365	41.0	\$2882
NOTES: Storage cabinet is standard with one fixed and two full-width adjustable shelves in top compartment; adjustable shelves can be removed. Overall storage compartment measures 31 ¹ / ₄ "W x 22"D x 36 ¹ / ₈ "H and will accommodate supplies, books and binders, as well as business machines and electronic equipment. Cord pass-through gap behind shelves and grommet in back of the cabinet to facilitate routing cords and reaching wall electrical outlets. Two drawer lateral file on bottom. Cabinet and lateral file lock independently.				

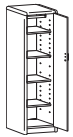

Right-hand model H107295R shown.

Wardrobe/Storage Cabinet (with core removable lock) 18"W x 24"D x 66 ⁵ / ₈ "H, with coat rod and 4 adjustable shelves, Hinged Right	H107295R	225	22.9	\$2121
18"W x 24"D x 66 ⁵ / ₈ "H, with coat rod and 4 adjustable shelves, Hinged Left	H107296L	225	22.9	\$2121
NOTES: Unit is standard with four adjustable shelves, coat rod, and core removable lock. Shelves adjust in 2 ¹ / ₂ " increments. Unit height is designed to match credenza or return plus stack-on storage height. Cabinet can be used as a wardrobe by removing four adjustable shelves. Coat rod can be removed from cabinet for storage only applications.				

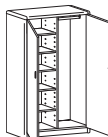

Doors open 110 degrees from closed position.

Personal Wardrobe/Storage Cabinet (with core removable lock) 36"W x 24"D x 66 ⁵ / ₈ "H	H10730	335	40.6	\$2864
NOTES: Spacious design is standard with four adjustable shelves (one shelf is fixed), coat rod and core removable lock which locks both doors. Shelves adjust in 2 ¹ / ₂ " increments. Unit height is designed to match credenza or return plus stack-on storage height.				



Right-hand model H107301R shown.

Personal Storage Towers 24"W x 24"D x 66 ⁵ / ₈ "H, Wardrobe Hinged Right, Storage Cabinet Hinged Left	H107301R	299	27.8	\$2720
24"W x 24"D x 66 ⁵ / ₈ "H, Wardrobe Hinged Left, Storage Cabinet Hinged Right	H107302L	299	27.8	\$2720
NOTES: Spacious design includes a wardrobe closet, storage cabinet, and two file drawers in one compact unit. Wardrobe closet contains a coat rod. Storage cabinet includes three shelves, two are adjustable in 2 ¹ / ₂ " increments. Door hinged left or right models available. File drawers operate on ball-bearing suspensions with full extension. File drawers have high sides to accept hanging folders in letter or legal size. Drawers standard with hangrails. Equipped with interchangeable core removable locks. Upper lock secures storage cabinet and wardrobe closet doors; lower lock secures file drawers. Unit height is designed to match credenza or return plus stack-on storage height.				

NOTES:

- Broad family of storage components takes storage way beyond the confines of a desk drawer.
- The 18"W wardrobe/storage cabinet can be used as wardrobe by removing some or all of the adjustable shelves, coat rod can be removed for storage only.
- Locking units equipped with interchangeable core removable locks.
- See pages 346-358 for shared components.

! Keyed alike cores must be ordered separately — see model HF23B on page 773 — makes re-keying quick and easy.







HOW TO SPECIFY

Select Model Number	Select Laminate
H 1 0 7 2 9 3 .	See page 329
N N	

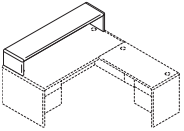

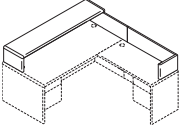
10700 SERIES™

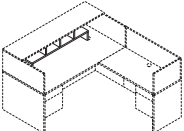
Shared Components and Accessories

	DESCRIPTION	MODEL	SHIP WEIGHT	CUBE	LIST PRICE
 	Reception Station/Transaction Counter 68 ⁵ / ₈ "W x 14 ⁵ / ₈ "D x 14 ¹ / ₄ "H Intended for use with H10700 72"W double and single pedestal desk models and 72"W desk shells. NOTES: Cord management grommets on desktops serve as anchor points. Transaction counter organizer (HTCOL52) fits under/inside of transaction counter.	H107720	76	3.2	\$782
 	Reception Station for an "L" Workstation 68 ⁵ / ₈ "W x 75 ⁵ / ₈ "D x 14 ¹ / ₄ "H Intended for use with a 72"W x 36"D left single pedestal desk or modular desk shell with a 42"W x 24"D right pedestal return or modular right return shell. Intended for use with a 72"W x 36"D right single pedestal desk or modular desk shell with a 42"W x 24"D left pedestal return or modular left return shell. NOTES: Cord management grommets on desktop and return serves as the anchor points for the reception station for return.	H107721R	108	4.3	\$1125
		H107722L	108	4.3	\$1125
 	Transaction Counter Organizer 48 ³ / ₄ "W x 11 ¹ / ₈ "D x 13"H Fits under Transaction Counter Models H107720, H107721R and H107722L. ! Black only. SPECIFYING EXAMPLE: HTCOL52.P	HTCOL52	24	1.1	\$300
 <p>Base sold separately.</p>	42" Diameter Table Top NOTES: Underside of top features a factory-installed template. The template, which is trilingual, facilitates assembly of the base to the top by designating the specific attachment location for multiple base designs. Bases attach to the top with self drilling screws, no drilling is required. All top + base models are 29 ¹ / ₂ "H. For Base Options see Preside® Table Base in the Tables section in the 2021 Shared Spaces Pricer. ! Requires specification of a support base model shown in the Tables section in the 2021 Shared Spaces Pricer. SPECIFYING EXAMPLE: H107242.N	H107242	58	4.1	\$751

NOTES:

- "L" Reception station includes components for both the reception/transaction counter for desk and the reception station for return.
- Round table design is well suited to a variety of applications, including use in private or open plan offices.
- See pages 346-358 for shared components.

HOW TO SPECIFY

Select Model Number H 1 0 7 7 2 0	Select Laminate See page 329 N N
---	---

10700 SERIES™

Shared Components and Accessories

GSA SIN 33721

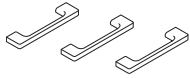
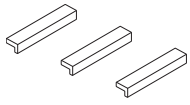

DESCRIPTION	MODEL	SHIP WEIGHT	CUBE	LIST PRICE
Field Installable Drawer/Door Handle Kits				
Linear, Black, 2-pack	HLINEARA2	0.4	0.3	\$61
Linear, Matte Chrome, 2-pack	HLINEARC2	0.4	0.3	\$61
Linear, Black, 3-pack	HLINEARA3	0.5	0.3	\$69
Linear, Matte Chrome, 3-pack	HLINEARC3	0.5	0.3	\$69
Specify Linear handles in black to coordinate with 10700 or 10500 Series™ models that ship standard with a decorative handle, such as mobile pedestals, storage cabinets and wardrobes.				
Arch, Black, 2-pack	HARCHA2	0.4	0.3	\$61
Arch, Matte Chrome, 2-pack	HARCHC2	0.4	0.3	\$61
Arch, Black, 3-pack	HARCHA3	0.5	0.3	\$69
Arch, Matte Chrome, 3-pack	HARCHC3	0.5	0.3	\$69

NOTES: Handles are for purchase and field installation on 10700 or 10500 Series™ desks, credenzas, returns, lateral files and modular pedestals. Instructions include mounting hardware and paper template for drilling holes.

Applications include:

- box/file and file/file pedestals = one 2-pack per pedestal
- box/box/file and pencil/media/file pedestals = one 3-pack per pedestal
- two drawer lateral file = two 2-packs per unit
- four drawer lateral file = four 2-packs per unit

The Linear and Arch handles can be attached using 96mm (approx. 3 $\frac{3}{4}$ "") or 128mm (approx. 5") hole spacing. Important note: effective January 1, 2007, the holes used for the black drawer/door handle that comes standard on several HON 10700 or 10500 Series™ products, including mobile pedestals, storage cabinet with doors, storage/file cabinet, storage cabinet/lateral file, personal wardrobe/storage cabinets, and personal storage towers, will accept the Linear and Arch handles. Units manufactured prior to January 1, 2007, have 64mm (approx. 2 $\frac{1}{2}$ "") hole spacing and will not accept the Linear and Arch handles.

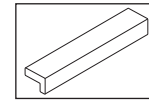

Linear Handle

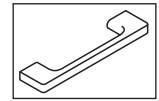

Arch Handle

! **Must be ordered with a configurable end product. If ordered separately, not on GSA contract.**



Field Installable Drawer/Door Handle Kits				
Sweep Black, 2-pack	HSWEEPA2	0.4	0.3	\$47
Sweep Satin Nickel, 2-pack	HSWEEPC2	0.4	0.3	\$47
Sweep Black, 3-pack	HSWEEPA3	0.5	0.3	\$61
Sweep Satin Nickel, 3-pack	HSWEEPC3	0.5	0.3	\$61
Crescent Black, 2-pack	HCRESCENTA2	0.4	0.3	\$47
Crescent Satin Nickel, 2-pack	HCRESCENTC2	0.4	0.3	\$47
Crescent Black, 3-pack	HCRESCENTA3	0.5	0.3	\$61
Crescent Satin Nickel, 3-pack	HCRESCENTC3	0.5	0.3	\$61

NOTES: Handles are for purchase and field installation on 10700 or 10500 Series™ desks, credenzas, returns, and lateral files, as well as for the modular pedestals used with 10700 and 10500.

Applications include:

- box/file and file/file pedestals = one 2-pack per pedestal
- box/box/file and pencil/media/file pedestals = one 3-pack per pedestal
- two drawer lateral file = two 2-packs per unit
- four drawer lateral file = four 2-packs per unit

The hole spacing for the Sweep and Crescent handles is 96mm (approx. 3 $\frac{3}{4}$ ""). Important note: effective January 1, 2007, the holes used for the black drawer/door handle that comes standard on several HON 10700 or 10500 Series™ products, including mobile pedestals, storage cabinet with doors, storage/file cabinet, storage cabinet/lateral file, personal wardrobe/storage cabinets, and personal storage towers, will accept the Sweep and Crescent handles. Units manufactured prior to January 1, 2007, have 64mm (approx. 2 $\frac{1}{2}$ "") hole spacing and will not accept the Sweep and Crescent handles. Instructions include mounting hardware and paper template.

! **Must be ordered with a configurable end product. If ordered separately, not on GSA contract.**

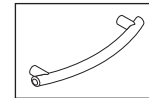

Sweep Handle

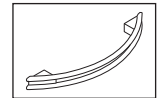

Crescent Handle

NOTES:

- Field Installable Drawer/Door Handle Kits for use on 10700 Series™ desks, credenzas, returns, lateral files and storage cabinets.
- A metal template is available to facilitate field installation of the Linear, Arch, Sweep and Crescent decorative handles on 10500 and 10700 Series™ drawer fronts; order model SPLH-SYST-DRKNB.M263164.
- See pages 346-358 for shared components.

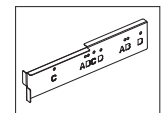

Metal Template

HOW TO SPECIFY

Select
Model Number

H L I N E A R A 2



10700 SERIES™

Shared Components and Accessories

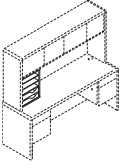
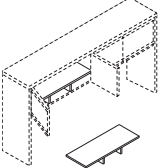
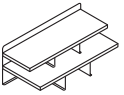
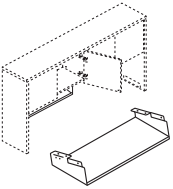
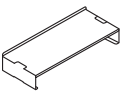
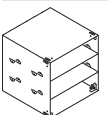
	DESCRIPTION	MODEL	SHIP WEIGHT	CUBE	LIST PRICE
	Vertical Paper Manager 14 ⁷ / ₈ "W x 10 ⁷ / ₈ "D x 19 ¹ / ₁₆ "H NOTES: Keeps papers, files, and books neatly organized and within easy reach from a seated position. Designed for desk, credenza, and return tops. Fits under stack-on storage models. Two pullout drawers and three fixed shelves. Vertical paper manager designed for desk, credenza, and return tops. Fits under stack-on storage. For additional information see the Workplace Tools section in the 2021 Shared Spaces Pricer.	HLVPM1	27	2.8	\$351
	Stacked Paper Management 32 ¹ / ₂ "W x 12 ⁵ / ₈ "D x 4 ¹ / ₄ "H NOTES: Segments and organizes stack-on and wall mount storage compartments, as well as bookcase shelves. In some cases, installation may require removing the stack-on or wall mount storage doors. For additional information see the Workplace Tools section in the 2021 Shared Spaces Pricer. ! Black only.	HLVPM2	22	1.25	\$175
 <i>Not available in two-tone laminate</i>	Desktop Storage Terrace 26 ¹ / ₂ "W x 12 ¹ / ₂ "D x 10 ¹ / ₂ "H NOTES: Keeps work-in-process, priority files, loose pages, and mail neatly organized and in view. Mixed material design comprised of sturdy laminate shelves with metal back and support panels. Not available in two-tone laminate combination or pattern laminate colors. Choose from Platinum Metallic (TI), Black (P), and Charcoal (S) for the metal components. Sized to fit in stack-on and wall mounted storage cabinets in 10500, 10700, Valido, 94000, and 38000 Series. Fits in Voi stack-on and overhead cabinets except for 48"W or smaller sliding door models. For additional information see the Workplace Tools section in the 2021 Shared Spaces Pricer. Specify: Model.Laminate.Paint SPECIFYING EXAMPLE: HLDSTI.N.TI	HLDSTI	24	1.1	\$329
	Hanging Paper Shelf 28 ¹ / ₁₆ "W x 11 ⁷ / ₁₆ "D x 4 ⁵ / ₁₆ "H NOTES: Maximizes worksurface space; de-clutters desktop while placing priority communications and active project folders within easy reach. Angled design allows contents to be distinguished at a glance. Mixed material styling features strong painted metal frame with a frosted shelf. Attaches quickly and easily to stack-on and wall mount storage models in the following series: 10500, 10700, Valido, 94000, and Voi (except the 36"W overhead hutch with O-legs or panel mount brackets). Not for use with 38000 Series. For additional information see the Workplace Tools section in the 2021 Shared Spaces Pricer. Specify: Model.Paint SPECIFYING EXAMPLE: HHPS1.TI	HHPS1	7	2.9	\$214
	Desktop Paper Shelf 28 ¹ / ₁₆ "W x 11 ⁵ / ₁₆ "D x 5"H NOTES: Organizer shelf provides a place and space for work-in-process and piling to keep worksurfaces neat and tidy. Convenient, scalable design with interlocking side supports allow two units to be stacked and integrated. Durable painted metal frame with a frosted shelf; mixed material styling matches hanging paper shelf. Can also be used inside select overhead storage, including the following stack-on with hinged door models: 10500 and Valido 36", 42", 66", 72", 78"W and 10700 68 ⁵ / ₈ "W. For additional information see the Workplace Tools section in the 2021 Shared Spaces Pricer. Specify: Model.Paint SPECIFYING EXAMPLE: HDPS1.TI	HDPS1	7	2.9	\$214
	Storage Cube 12"W x 12"D SPECIFYING EXAMPLE: HLSL1212.P8S	HLSL1212	1	0.3	\$316

NOTES:

- See pages 346-358 for shared components.

HOW TO SPECIFY

Select Model Number H L V P M 1 . N	Select Laminate See page 329
---	--









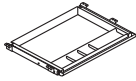

10700 SERIES™

Shared Components and Accessories

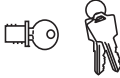
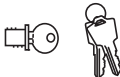
OPEN MARKET EXCEPT AS NOTED

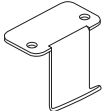

Icon Legend on page 19

	DESCRIPTION	MODEL	SHIP WEIGHT	CUBE	LIST PRICE
 Refer to page 104 for Center Drawer compatibility information SIN 33721	Angled Wood Center Drawer 26" x 15 ³ / ₈ " 22" x 15 ³ / ₈ "	H1526 H1522	12.0  11.0 	1.2 1.1	\$214 \$199
	NOTES: Center drawers ideal for pens, pencils and other miscellaneous storage. Feature ball-bearing slide suspension. Compatibility (where to use) information is detailed on page 104. Specify laminate for drawer. Model H1522 or H1022 can be used on peninsulas with modesty panel, model H10528. For additional information see the Workplace Tools section in the 2021 Shared Spaces Pricer.				
 SIN 33721	Polymer Center Drawer <ul style="list-style-type: none"> Color: Black. Material: ABS. Minimum clearance for mounting: 23"W x 16¹/₄"D x 2"H. Retracts on 16" ball-bearing slides. Can be used on worksurfaces with Coordinate™ Height Adjustable Bases as long as it is attached with spacer model HKBS. Can store up to 25 lbs.  Black finish only, no specification needed.	HCD1	7.0	0.5	\$126
 SIN 33721	Black Removable Lock Core Kit — see page 773. NOTES: Lock with a removable cylinder that can be interchanged as needed; allows users to access all furniture pieces in an office with a single key for convenience and security. Makes re-keying quick and easy.	HF23B	0.1	0.1	\$35
 	Removable Lock Core Kit Black <ul style="list-style-type: none"> For stack-on and wall mounted storage laminate models (with locks) in 10500, 10700, Valido, Voi, Concinnity, and 94000 Series. Specify quantity of each key number from 101E to 225E. Includes: 1-core, 2-keys, 1-core removal tool, and instructions. NOTES: If key number isn't specified, number will be at random.	HF27B	0.2	0.02	\$35
 	Back Pack Hook (10 per carton) 12"W x 14 ¹ / ₂ "D x 1 ¹ / ₂ "H NOTES: Assembly: attaches to bottom of desk with (2) screws, included.  Available in Platinum Metallic finish only, no specification needed.	HCLA65	10.0 	0.1	\$101

NOTES:

- For master key, see model HF22 on page 773.
- See pages 346-358 for shared components.

HOW TO SPECIFY

Select Model Number H 1 5 2 6 .	Select Laminate See page 329 N N
---	---



10700 SERIES™

Shared Components and Accessories



Refer to the Workplace Tools section in the 2021 Shared Spaces Pricer for additional product information

SIN 33721



DESCRIPTION	MODEL	SHIP		LIST PRICE BY PAINT GRADE	
		WEIGHT	CUBE	P1	P2
Slide-Away Keyboard Platform (Specify: Laminate)	H4022	10	0.6	\$228	
Extended Tray Slide-Away Keyboard Platform (Specify: Laminate)	HE4022	12	0.7	\$323	
Metal Keyboard and Mouse Tray (Specify paint)	H4028 OPEN MARKET	11	1.5	\$164	\$174
Metal Keyboard Tray (Specify paint)	H4029 OPEN MARKET	11	1.5	\$148	\$158
Corner Sleeve — Square Edge (22½" leading edge x 18"D) Specify paint color.	H51206	10	1.5	\$171	\$181

NOTES: For additional information see the Workplace Tools section in the 2021 Shared Spaces Pricer.



SIN 33721

DESCRIPTION	MODEL	SHIP WEIGHT	CUBE	LIST PRICE
LED Task Lights				
Articulating Desk Lamp	HLED1	1.2	6.5	\$430
Articulating Desk Lamp w/ Occupancy Sensor	HLED1OC	1.2	6.5	\$524

NOTES: For additional information see the Workplace Tools section in the 2021 Shared Spaces Pricer.



SIN 33721

Task Desk Lamp	HLED2	0.7	3.0	\$373
-----------------------	--------------	-----	-----	--------------

NOTES: For additional information see the Workplace Tools section in the 2021 Shared Spaces Pricer.

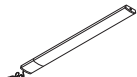

OPEN MARKET

LED Task Lights — for Stack-on Storage Models				
17" LED Light with Power Supply (Single)	HLED17AS ☉	1.2	0.05	\$450
31" LED Light with Power Supply (Single)	HLED31AS ☉	1.5	0.09	\$603
17" LED Light with Power Supply for Daisy-chain (Starter)	HLED17A	1.0	0.05	\$493
31" LED Light with Power Supply for Daisy-chain (Starter)	HLED31A	1.4	0.09	\$662
17" LED Light with 8" and 30" Jumper Cord for Daisy-chain (Follower)	HLED17AUO ☉	1.0	0.03	\$404
31" LED Light with 8" and 30" Jumper Cord for Daisy-chain (Follower)	HLED31AUO ☉	1.0	0.05	\$539

Undercabinet Occupancy Sensor with 1" End to End Connector	HLEDOSA ☉	0.2	0.01	\$97
---	------------------	-----	------	-------------

NOTES: To use the daisy chain application, must start with model HLED17A or HLED31A. No finish specification required. Attaches magnetically to underside of overhead storage, or attaches with provided screws or double-sided tape. Occupancy sensor attaches to a single or starter LED light and will automatically turn the light off after no motion is detected for 30 minutes. Just like all the LED light models, the occupancy sensor features a soft-touch on/off switch. LED task lights have a lifetime of 30,000 hours and have a dimmer feature that allows the user to adjust the amount of light output.



Refer to the Workplace Tools section in the 2021 Shared Spaces Pricer

OPEN MARKET

Task Light — for Stack-on Storage Models				
46½"W x 3½"D x 1½"H, for models H107318, H10734, H10733 or H10732	HH870960	12.0	1.1	\$290
34½"W x 3½"D x 1½"H, for model H107313	HH870942	10.0	0.9	\$267

NOTES: Task light and Chicago Code models see page 595. For additional information see the Workplace Tools section in the 2021 Shared Spaces Pricer.

NOTES:

- Task lights are designed for use with stack-on storage and wall mounted storage cabinets.
- Task lights feature a new slim profile and electronic ballast for increased energy efficiency.
- Task lights include a T5 bulb which contains less mercury.

10700 SERIES™

Shared Components and Accessories

GSA SIN 33721T EXCEPT AS NOTED

ABI

Icon Legend on page 19



SIN 33721

DESCRIPTION**MODEL****SHIP WEIGHT****CUBE****LIST PRICE****Field Installable Grommet****HFLDGRMT**

0.1 Ⓢ

0.01

\$35

- Intended for use in tops and end panels to route/hide cords and in modesty panels to facilitate reaching wall electrical outlets.
- Grommet is field installable.
- Grommet shape is round.
- Includes grommet cap and sleeve.
- Grommet cap measures 3" diameter and includes a 3/4" diameter cord access hole.
- Grommet sleeve measures 2 1/2" O.D. x 3/4" thick.
- Includes instructions to locate grommet position for desks, credenzas, returns and bridges.

! Black Finish

! Requires a 2 1/2" diameter hole saw and drill for installation (not included).



SIN 33721

Field Installable Grommet**HFLDGRMT3**

0.1 Ⓢ

0.3

\$159

- Intended for use in tops and end panels to route/hide cords and in modesty panels to facilitate reaching wall electrical outlets.
- Grommet is field installable.
- Grommet shape is round.
- Includes grommet cap and sleeve.
- Grommet outside dimensions measure 3 1/2" diameter and includes two cord access holes.
- Grommet sleeve measures 3" O.D. x 1" thick.
- Includes instructions to locate grommet position for desks, credenzas, returns and bridges.

! Black Finish

! Requires a 3" diameter hole saw and drill for installation (not included).

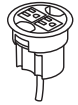
**Power Hub, 3" Grommet Mount, 6' Cord****HGRMTAC**

1.3

0.2

\$126

- Two grounded AC power outlets.
- Two cord pass-through holes in cap.
- Includes 6' cord with three-prong plug.

! Available in Black only (no color designation - Specify: HGRMTAC.X).

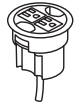
**3" Round Power Grommet - 2 Outlets, 10' Cord****HGRMTAC2**

1.5

0.2

\$159

- Includes 10' cord with three-prong plug.
- Fits in 3" round grommet holes on the following product lines: Coordinate, Huddle, Motivate, all laminate casegoods series, and Systems Worksurfaces.
- Two grounded AC power outlets.
- Field installed with Plug-and-play ease.

NOTES: Power Modules will also work with standing-height applications for 10500 Series™ and Voi® desks. Optional Memory Control allows preset worksurface heights for consistency. Ships separately. Dynamic load capacity when worksurface is moving is 300 lbs.

! Available in black finish only, no specification needed.

**Power/USB Hub, 3" Grommet Mount****HGRMTUSB2**

1.3 Ⓢ

0.02

\$250

- One grounded AC power outlet with 2 USB ports.
- Two cord pass-through holes in cap.
- Includes 6' cord with three-prong plug.

! Available in black only (no color designation so use .X - Specify: HGRMTUSB2.X).

NOTES:

- The power and power/USB hub models bring the ease of plug-and-play to the desktop.
- Models HFLDGRMT3, HGRMTAC, and HGRMTUSB2 fit in 3" round grommet holes in 10700 Series™ desks, credenzas, and returns; not compatible with 10700 products with rectangle-shaped grommets.
- For additional information see the Workplace Tools section in the 2021 Shared Spaces Pricer.

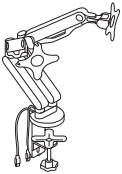

	DESCRIPTION	MODEL	SHIP WEIGHT	CUBE	LIST PRICE
	<p>Coordinate™ Portable Desktop Riser 31"D x 5"-16½"H x 35"W</p> <p>NOTES: Available in Black (BLK) or White (WHT) finish. Desktop riser dimensions (without keyboard tray): 22"D x 5"-16½"H x 35"W. Keyboard tray dimensions: 9"D x 30"W. Max loading capacity is 33 lbs for the desktop riser surface and 4 lbs for the keyboard tray. Easily transition from seated to standing positions throughout the workday. Sits atop an existing desk to create sit-to-stand functionality by raising the computer. Includes keyboard tray and surface for computer monitors. HON 5-Year Limited Warranty.</p> <p>⚠ Not intended for use on mobile workstations.</p>	HBXRISER	54.0	4.1	\$657
	<p>Dual Monitor Arm with 2 USB Ports</p> <p>NOTES: Easy adjustment. Height adjusts to 17" tall. Monitor tilt and swivel capability. Enclosed cable management. Grommet or desktop mounting. Clean appearance. In some applications the Monitor Arms may extend 12 or more inches into the worksurface. For additional information see the Workplace Tools section in the 2021 Shared Spaces Pricer. HON 5-Year Limited Warranty.</p> <p>⚠ No specification needed.</p>	HBDMAUSB	41.9	2.6	\$410

HOW TO SPECIFY

<p>Select Model Number</p> <p>HBXRISER.</p>	<p>Select Finish</p> <p>BLK Black WHT White</p> <p>BLK</p>
--	---

10700 SERIES™ Accessories

OPEN MARKET



Icon Legend on page 19

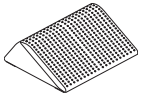

DESCRIPTION

Footrest — Anti-Slip Cover
13¾"D x 5½"H x 16"W

ⓘ Available in Black (T) finish ONLY. Recommended weight capacity not to exceed 250 pounds. **HON 5-Year Limited Warranty.**
SPECIFYING EXAMPLE: HVL991.T

MODEL

SHIP WEIGHT

CUBE

LIST PRICE

HVL991

7 ⓘ

0.9

\$89

HOW TO SPECIFY

<p>Select Model Number</p> <p>H V L 9 9 1 .</p>	<p>Select Finish</p> <p>T Black</p> <p>T</p>
--	---

94000 SERIES™

Want to see more? Scan here
to check out hon.com.



94000 Series™ shown with 6550 Series Seating.

94000 SERIES™

Confident. Accomplished. Your office speaks volumes about you, and the 94000 Series says all the right things. Exceptionally crafted and solidly engineered, it's finished with warm, durable mahogany laminate — a timeless example of classic beauty and executive elegance.



FEATURES

- Traditional furniture design features solid wood trim and plinth style bases.
- From gleaming brass fixtures to raised accent moldings, details make this desk a standout.
- Our comprehensive selection makes it easy to create a complete executive look.
- It's all about the amenities — like pull out writing surfaces for extra room when you need it and central locking center drawers on all desks.

94000 SERIES™

Typicals



Icon Legend on page 19

Components used are listed on pages 364-369. Order components individually. Other configurations are possible, including various sizes of some components.

QTY	DESCRIPTION	MODEL	LIST PRICE	PRICE EXTENSION
1	Double Pedestal Desk 72"W x 36"D x 29½"H	H94271	\$2,725	\$2,725
1	Credenza with Kneespace 72"W x 24"D x 29½"H	H94243	\$2,276	\$2,276
1	Stack-on Storage 70"W x 16⅞"D x 37"H	H94234	\$1,640	\$1,640
TOTAL:			\$6,641	

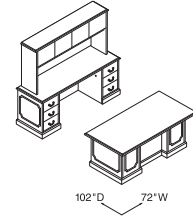

DESK WORKSTATION
72"W x 102"D

QTY	DESCRIPTION	MODEL	LIST PRICE	PRICE EXTENSION
1	Laminate Rectangle Top with Traditional Edge Detail 72"W x 36"D	HTLC3672T	\$1,167	\$1,167
1	Laminate Traditional Panel Base 29½"H with HTLC3672T Top	HTLT72	\$818	\$818
1	Credenza with Doors 72"W x 24"D x 29½"H	H94244	\$2,627	\$2,627
1	Stack-on Storage 70"W x 16⅞"D x 37"H	H94234	\$1,640	\$1,640
TOTAL:			\$6,252	

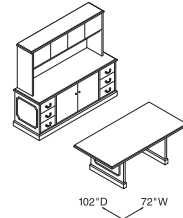
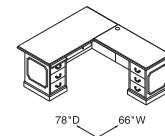

TABLE WORKSTATION
72"W x 102"D

QTY	DESCRIPTION	MODEL	LIST PRICE	PRICE EXTENSION
1	Single Pedestal Desk, Left 66"W x 30"D x 29½"H	H94284L	\$2,241	\$2,241
1	Right Return - box/file 48"W x 24"D x 29½"H	H94215R	\$1,530	\$1,530
TOTAL:			\$3,771	



DESK "L" WORKSTATION - RIGHT
66"W x 78"D



Icon Legend on page 19

94000 SERIES™ Typicals

Components used are listed on pages 364-369. Order components individually. Other configurations are possible, including various sizes of some components.

QTY	DESCRIPTION	MODEL	LIST PRICE	PRICE EXTENSION
1	Single Pedestal Desk, Right 66"W x 30"D x 29½"H	H94283R	\$2,241	\$2,241
1	Left Return - box/file 48"W x 24"D x 29½"H	H94216L	\$1,530	\$1,530
1	Stack-on-Storage 76"W x 16⅞"D x 37"H	H94237	\$1,708	\$1,708
TOTAL:			\$5,479	

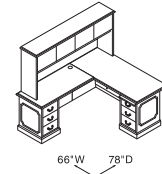

DESK "L" WORKSTATION - LEFT

66"W x 78"D

QTY	DESCRIPTION	MODEL	LIST PRICE	PRICE EXTENSION
1	Single Pedestal Desk, Left 72"W x 36"D x 29½"H	H94286L	\$2,385	\$2,385
1	Bridge 48"W x 24"D x 29½"H	H94270	\$900	\$900
1	Single Pedestal Credenza, Right 72"W x 24"D x 29½"H	H94245R	\$1,967	\$1,967
1	Stack-on Storage 70"W x 16⅞"D x 37"H	H94234	\$1,640	\$1,640
TOTAL:			\$6,892	

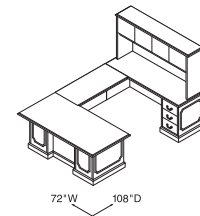

DESK "U" WORKSTATION - RIGHT

72"W x 108"D

QTY	DESCRIPTION	MODEL	LIST PRICE	PRICE EXTENSION
1	Single Pedestal Desk, Right 72"W x 36"D x 29½"H	H94285R	\$2,385	\$2,385
1	Bridge 48"W x 24"D x 29½"H	H94270	\$900	\$900
1	Credenza w/Lateral, Left 72"W x 24"D x 29½"H	H94248L	\$2,234	\$2,234
1	Stack-on Storage w/Glass Doors 70"W x 16⅞"D x 37"H	H94236	\$2,194	\$2,194
TOTAL:			\$7,713	

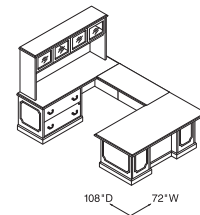

DESK "U" WORKSTATION - LEFT

72"W x 108"D

94000 SERIES™ Laminate Wood Desks

GSA SIN 33721



Icon Legend on page 19

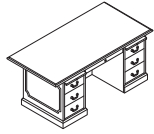

DESCRIPTION

Double Pedestal Desk 2-2 — Box/File
72"W x 36"D x 29½"H

**FULL WIDTH
OVERHANG**

7"

MODEL

H94271

**SHIP
WEIGHT**

307

CUBE

52.9

**LIST
PRICE**

\$2725

NOTES: 7" conference overhang on approach side (provides kneespace for visitors), and a 6¾" conference overhang on each end. Convenient pull out writing shelf above pedestal provides added workspace. Center drawer features central locking (locks all drawers).

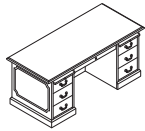

Double Pedestal Desk 2-2 — Box/File
66"W x 30"D x 29½"H
60"W x 30"D x 29½"H

1"

H94276

340

42.8

\$2656

1"

H94251

284

39.0

\$2564

NOTES: Convenient pull out writing shelf above pedestal provides added workspace. Center drawer features central locking (locks all drawers).

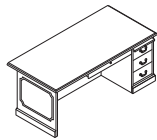

Single Pedestal Desk — Box/File
72"W x 36"D x 29½"H, Right
66"W x 30"D x 29½"H, Right
72"W x 36"D x 29½"H, Left
66"W x 30"D x 29½"H, Left

7"

H94285R

275

54.0

\$2385

1"

H94283R

233

42.8

\$2241

7"

H94286L

275

54.0

\$2385

1"

H94284L

233

42.8

\$2241

NOTES: Convenient pull out writing shelf above pedestal provides added workspace. Center drawer features central locking (locks all drawers).

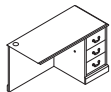

Model H94215R shown

Return — Box/File
48"W x 24"D x 29½"H, Right
42"W x 24"D x 29½"H, Right
48"W x 24"D x 29½"H, Left
42"W x 24"D x 29½"H, Left

H94215R

154

24.9

\$1530

H94211R

146

22.1

\$1418

H94216L

154

24.9

\$1530

H94212L

146

22.1

\$1418

NOTES: Drawers lock. One round cord grommet in the top. One cord pass-through grommet in the modesty panel to facilitate reaching wall electrical outlets.

⚠ Not designed to be used freestanding.

NOTES:

- 18th century elegance, 21st century engineering.
- Traditional furniture applications include state and local government, military bases, banks, and attorney offices.
- Tops are premium abrasion- and stain-resistant high pressure, high-gloss laminate over durable 1¼" solid core high-performance particleboard.
- Solid wood edge profile.
- Antique brass drawer pulls; hand-applied raised decorative molding, and plinth style base.
- Pullout reference/writing shelf is standard on all desk pedestals.
- Desk, credenza, and return drawers are 5-sided construction, which allows easy drawer alignment or replacement of drawer fronts.
- Center drawer on desks equipped with built-in pencil tray and central locking (locks all drawers).
- Drawers operate on full extension, ball-bearing suspensions to ensure smooth, quiet, long-lasting operation.
- File drawer design includes integrated hangrails for side-to-side letter or legal filing; and front-to-back for letter filing.
- Locking units equipped with interchangeable core removable locks.
- Adjustable hex leveling glides allow floor-standing furniture to be easily leveled without lifting the unit; glides have ¾" adjustable range.



⚠ Keyed alike cores must be ordered separately — see model HF23B on page 773 — makes re-keying quick and easy.

HOW TO SPECIFY

<p>Select Model Number</p> <p>H 9 4 2 7 1</p>	<p>Select Laminate</p> <p>NN Mahogany</p> <p>N N</p>
---	--

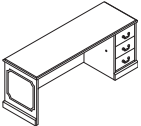
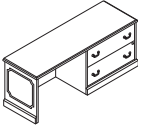
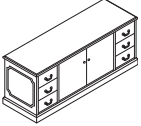
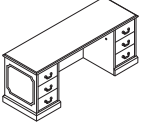

94000 SERIES™ Laminate Wood Desks

	DESCRIPTION	MODEL	SHIP WEIGHT	CUBE	LIST PRICE
 	Bridge (single ped. desk to single ped. credenza or credenza with lateral) 48"W x 24"D x 29½"H, (clear inside depth is 22½"D) 42"W x 24"D x 29½"H, (clear inside depth is 22½"D)	H94270 H94260	85 76	4.3 4.3	\$900 \$833
	NOTES: One cord pass-through grommet in top center of modesty panel to facilitate reaching wall electrical outlets. Kneespace of desk is limited to 24¾"W if bridge is used with 66"W single pedestal desk.				
 Model H94245R shown	Credenza, Single Pedestal — Box/File 72"W x 24"D x 29½"H, Right 72"W x 24"D x 29½"H, Left	H94245R H94246L	230 230	36.0 36.0	\$1967 \$1967
	NOTES: Drawers lock. One cord pass-through grommet in top center of modesty panel to facilitate reaching wall electrical outlets. See pages 366-367 for optional Overhead Hutch and Stack-on Storage.				
 Model H94247R shown	Credenza with 36" Lateral 72"W x 24"D x 29½"H, Right 72"W x 24"D x 29½"H, Left	H94247R H94248L	239 239	36.0 36.0	\$2234 \$2234
	NOTES: Lateral file drawers lock. See pages 366-367 for optional Overhead Hutch and Stack-on Storage.				
 Model H94244 shown	Credenza with Doors — Box/File 72"W x 24"D x 29½"H	H94244	313	36.0	\$2627
	NOTES: All drawers lock. Doors are non-locking. One removable shelf (38¾"W x 13¾"D). Shelf is not adjustable. See pages 366-367 for optional Overhead Hutch and Stack-on Storage.				
 Model H94243 shown	Credenza with Kneespace — Box/File 72"W x 24"D x 29½"H	H94243	253	36.0	\$2276
	NOTES: All drawers lock. One cord pass-through grommet in top center of modesty panel to facilitate reaching wall electrical outlets. See pages 366-367 for optional Overhead Hutch and Stack-on Storage.				

NOTES:

- 18th century elegance, 21st century engineering.
- Tops are premium abrasion- and stain-resistant high pressure, high-gloss laminate over durable 1½" solid core high-performance particleboard.
- Solid wood edge profile.
- Antique brass drawer pulls; hand-applied raised decorative molding, and plinth style base.
- Pullout reference/writing shelf is standard on all desk pedestals.
- Desk, credenza, and return drawers are 5-sided construction, which allows easy drawer alignment or replacement of drawer fronts.
- Center drawer on desks equipped with built-in pencil tray and central locking (locks all drawers).
- Drawers operate on full extension, ball-bearing suspensions to ensure smooth, quiet, long-lasting operation.
- File drawer design includes integrated hangrails for side-to-side letter or legal filing; and front-to-back for letter filing.
- Locking units equipped with interchangeable core removable locks.
- 94000 Series™ products produced after 10/26/98 have been improved with a thicker top. Joining with older products before that date may cause misalignment.
- Adjustable hex leveling glides allow floor-standing furniture to be easily leveled without lifting the unit; glides have ¾" adjustable range.

! Keyed alike cores must be ordered separately — see model HF23B on page 773 — makes re-keying quick and easy.

HOW TO SPECIFY

Select Model Number H 9 4 2 4 5 R .	Select Laminate NN Mahogany
---	---------------------------------------

94000 SERIES™

Laminate Wood Desks

GSA SIN 33721

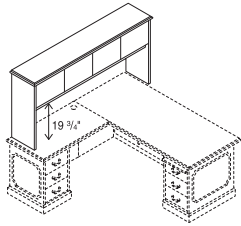

Icon Legend on page 19

**DESCRIPTION****MODEL****SHIP WEIGHT****CUBE****LIST PRICE****Stack-on Storage for 78" D "L" Shaped Workstation**

76"W x 16 $\frac{1}{8}$ "D x 37"H (Accepts Back Enclosure H107358, Fabric Tackboard H90035 and Task Light HH870960.)

H94237

198

18.4

\$1708**Stack-on Storage for 78" D "L" Shaped Workstation, Locking**

76"W x 16 $\frac{1}{8}$ "D x 37"H (Accepts Back Enclosure H107358, Fabric Tackboard H90035 and Task Light HH870960.)

H94237K

198

18.4

\$1808

NOTES: Spans the total dimension of "L" shaped layouts comprised of a 48"W return attached to a 30"D single pedestal desk (78"D); or a 42"W return attached to 36"D single pedestal desk (78"D). For vertical paper manager model HLVPM1, see page 369.

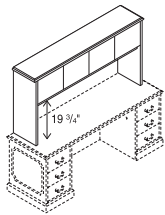
**Stack-on Storage**

70"W x 16 $\frac{1}{8}$ "D x 37"H (Accepts Back Enclosure H10738, Fabric Tackboard H90034 and Task Light HH870960.)

H94234

175

18.0

\$1640**Stack-on Storage, Locking**

70"W x 16 $\frac{1}{8}$ "D x 37"H (Accepts Back Enclosure H10738, Fabric Tackboard H90034 and Task Light HH870960.)

H94234K

175

18.0

\$1729

NOTES: For use on 72"W credenza models or on 72"D "L" shaped workstations comprised of a 30"D single pedestal desk and a 42"W return. Inside storage contains two compartments each sized: 31 $\frac{3}{4}$ "W x 12 $\frac{1}{8}$ "D x 12"H. Vertical paper manager, model HLVPM1, fits under stack-on storage. See page 369.

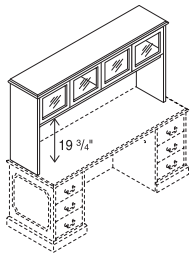
**Stack-on Storage with Glass Doors**

70"W x 16 $\frac{1}{8}$ "D x 37"H (Accepts Back Enclosure H10738 and Fabric Tackboard H90034.) (Use Task Light HH870960, see page 367)

H94236

171

18.0

\$2194

NOTES: Elegant wood-framed, clear glass door design. For use on 72"W credenza models or on 72"D "L" shaped workstations comprised of a 30"D single pedestal desk and a 42"W return. No lock option for glass doors. For vertical paper manager model HLVPM1, see page 369.

NOTES:

- Stack-on storage equipped with self-closing, adjustable hinged doors.
- Stack-on storage design includes valance to hide task light.
- Vertical paper manager keeps papers, files and books organized and within easy reach from a seated position. Fits under stack-on storage models. See page 369.
- Stacked paper management segments and organizes stack-on storage compartments and bookcase shelves. Unit can be used in models H94327, H94234 and H94236. In some cases, installation may require removing the stack-on storage doors. See page 355.
- For a variety of work-in-process paper management tools, see pages 319-320.
- Overhead Hutch features one cord pass-through grommet located in bottom center of back panel.
- Overhead Hutch is not designed to accept task light.
- Removable lock core kit for locking stack-on storage is model HF27B. See page 773.

HOW TO SPECIFY**Select Model Number**

H 9 4 2 3 7

Select Laminate



NN Mahogany

N N

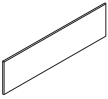

Icon Legend on page 19

94000 SERIES™ Laminate Wood Desks

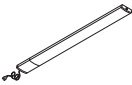
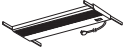
	DESCRIPTION	MODEL	COM	SHIP WEIGHT	CUBE	LIST PRICE
 <p>18⁵/₈"H</p>	Back Enclosure for Stack-on Storage 76"W model #H94237 70"W model #H94234 or H94236	H107358		34.0	1.30	\$303
		H10738		31.0	1.30	\$279
NOTES: Specify laminate with a single designator. Non-tackable surface. Feature full width 1 ¹ / ₈ " slot at bottom to facilitate routing cords and reaching wall electrical outlets. SPECIFYING EXAMPLE: H107358.N						
 <p>18"H</p>	Taskboards for use with Stack-on Storage Back Enclosures (Back Enclosures must be ordered separately.) 71 ¹ / ₂ "W for 76"W model #H94237 Stack-on with #H107358 Enclosure 65 ¹⁵ / ₁₆ "W for 70"W model #H94234 or H94236 Stack-on with #H10738 Enclosure	H90035	2.0	13.0	2.80	\$353
		H90034	2.0	11.0	2.00	\$337
NOTES: Specify fabric selection from pages 25-26. Upcharges may apply to premium fabric grades. Taskboards are sized ³ / ₄ " narrower than respective stack-on storage back enclosure, allowing ³ / ₈ " each side to route task light cords. Attached to back enclosure using latch & hook tape provided. ⓘ Disperse (DISP) fabric not available on sizes wider than 60". SPECIFYING EXAMPLE: H930035.APN15						
 <p>OPEN MARKET</p>	LED Task Lights — For Stack-on and Wall Mounted Storage Cabinets 17" LED Light with Power Supply (Single) 31" LED Light with Power Supply (Single)	HLED17AS ⓘ		1.2 ⓘ	0.05	\$450
		HLED31AS ⓘ		1.5 ⓘ	0.09	\$603
NOTES: No finish specification required. Attaches magnetically to underside of overhead storage, or attaches with provided screws or double-sided tape. Occupancy sensor attaches to a single or starter LED light and will automatically turn the light off after no motion is detected for 30 minutes. Just like all the LED light models, the occupancy sensor features a soft-touch on/off switch. LED task lights have a lifetime of 50,000 hours and have a dimmer feature that allows the user to adjust the amount of light output.						
 <p>Refer to the Workplace Tools section in the 2021 Shared Spaces Pricer</p> <p>OPEN MARKET</p>	Recessed Task Light 46 ¹ / ₂ "W x 3 ¹ / ₁₆ "D for Models H94234, H94234K, H94236, H94237 and H94237K. Chicago code version (with fused plug)	HH870960		12.0 ⓘ	1.10	\$290
		HH870960CH		12.0 ⓘ	1.10	\$361
NOTES: For additional information see the Workplace Tools section in the 2021 Shared Spaces Pricer.						

NOTES:

- Stack-on storage equipped with self-closing, adjustable hinged doors.
 - Stack-on storage design includes valance to hide task light.
 - Vertical paper manager keeps papers, files and books organized and within easy reach from a seated position. Fits under stack-on storage models. See page 369.
 - Stacked paper management segments and organizes stack-on storage compartments and bookcase shelves. Unit can be used in models H94237, H94234 and H94236. In some cases, installation may require removing the stack-on storage doors. See page 355.
 - For a variety of work-in-process paper management tools, see pages 319-320.
- ⓘ Removable lock core kit for locking stack-on storage is model HF27B. See page 773.

HOW TO SPECIFY

Select Model Number H 1 0 7 3 5 8	Select Laminate N Mahogany
---	--------------------------------------



94000 SERIES™

Laminate Wood Desks

GSA SIN 33721

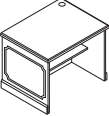
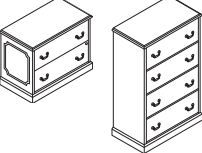
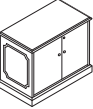
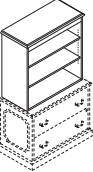
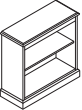

Icon Legend on page 19

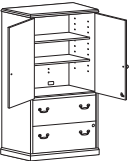
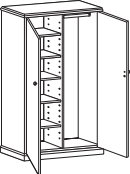
	DESCRIPTION	MODEL	SHIP WEIGHT	CUBE	LIST PRICE
	Computer Work Table with cord grommet 36"W x 30"D x 29½"H NOTES: One removable shelf (32⅜"W x 12⅝"D).	H94226	130	23.8	\$1243
	Lateral Files (with core removable lock) 37½"W x 20½"D x 29½"H — two drawer 37½"W x 20½"D x 59⅞"H — four drawer NOTES: High capacity file storage. Includes hangrails; mechanical interlock inhibits the extension of more than one drawer at a time. Two drawer design is equipped with a counterweight.	H94223 H94229	172 300	17.7 34.0	\$1570 \$2694
	Storage Cabinet (with core removable lock) 37½"W x 20½"D x 29½"H NOTES: Bookcase hutch H94210 can be used with H94291. One adjustable shelf, adjusts in 1¼" increments.	H94291	165	16.7	\$1408
	Bookcase Hutch 35¾"W x 14⅝"D x 37"H, (3 shelves; 2 adjustable, includes bottom of unit) Designed to be used on model H94223 lateral file or model H94291 storage cabinet. NOTES: One cord pass-through grommet located at bottom center of back panel. Two adjustable shelves, adjust in 1¼" increments.	H94210	95	14.0	\$1053
	Bookcase 35¾"W x 14⅝"D x 35½"H, 2-Shelf 35¾"W x 14⅝"D x 49⅝"H, 3-Shelf 35¾"W x 14⅝"D x 64"H, 4-Shelf 35¾"W x 14⅝"D x 78¼"H, 5-Shelf NOTES: Fixed shelves.	H94221 H94222 H94224 H94225	100 130 160 200	14.8 20.6 26.3 32.3	\$983 \$1101 \$1249 \$1369
	Bookcase with Glass Doors 35¾"W x 14⅝"D x 49⅝"H NOTES: Upscale design brings order, utility and a touch of elegance to the traditional office. Wood-framed, clear glass doors with hinges provide easy access to interior. Three fixed shelves provide spacious storage. Shelf measures 32¾"W x 11¾"D. Bookcase with glass doors brings order, utility and a touch of elegance to the traditional office. ! Doors are not designed to lock.	H94220	155	20.6	\$1755
	Storage Cabinet/Lateral File (with core removable lock) 37½"W x 24"D x 66½"H NOTES: Standard with one fixed and two full-width adjustable shelves in top compartment; adjustable shelves can be removed. Overall storage compartment measures 33¾"W x 22"D x 36⅞"H and will accommodate supplies, books and binders, as well as business machines and electronic equipment. Cord pass-through gap behind shelves and grommet in back of the cabinet to facilitate routing cords and reaching wall electrical outlets. Two drawer lateral file on bottom. Lateral file comes with mechanical interlock and hangrails. Cabinet and lateral file lock independently. Unit height is designed to match credenza or return plus stack-on storage height or the two drawer lateral file or storage cabinet plus the bookcase hutch height (66½"H).	H94435	355	44.4	\$2871
<i>Doors open 110 degrees from closed position.</i>					
	Personal Wardrobe/Storage Cabinet (with core removable lock) 37½"W x 24"D x 66½"H NOTES: Spacious design is standard with four adjustable shelves (one shelf is fixed) plus a generous wardrobe section with a coat rod. Shelves adjust in 2½" increments. One lock secures both doors. Unit height is designed to match credenza plus stack-on storage height or the two drawer lateral file or storage cabinet plus the bookcase hutch height (66½"H). Personal wardrobe/storage cabinet is standard with four adjustable shelves (one shelf is fixed) plus a generous wardrobe section with a coat rod.	H94430	351	44.4	\$2822

NOTES:

- File drawers accommodate letter and legal width side-to-side filing, and letter-width front-to-back filing; use hanging folders with a maximum overall height of 9⅜".
- Adjustable hex leveling glides allow floor-standing furniture to be easily leveled without lifting the unit; glides have ¼" adjustable range.
- For conference table options, see the Preside® table tops and bases in the Tables section in the 2021 Shared Spaces Pricer. Order edge option "T" for 94000 Desks edge compatibility.
- Removable lock core kit – HF23B – allows multiple units to be keyed alike. See page 773.

HOW TO SPECIFY

Select Model Number

H 9 4 2 2 6 .









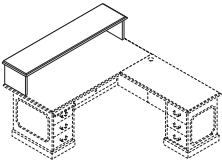

Select Laminate

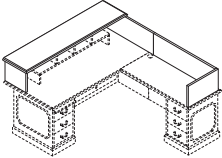
NN Mahogany

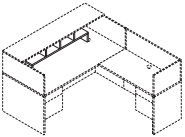
NN

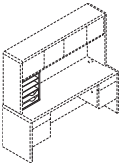

94000 SERIES™ Laminate Wood Desks

	DESCRIPTION	MODEL	SHIP WEIGHT	CUBE	LIST PRICE
 	Reception Station/Transaction Counter 71 $\frac{3}{4}$ "W x 16 $\frac{1}{8}$ "D x 14 $\frac{1}{4}$ "H Designed for use with 72"W single pedestal desk models H94285R or H94286L. NOTES: Reception station/transaction counter has traditional-styled decorative molding on the approach side.	H94720	75	2.6	\$1024
	Reception Station for an "L" Workstation 71 $\frac{3}{4}$ "W x 82 $\frac{3}{4}$ "D x 14 $\frac{1}{4}$ "H Designed for use with 72"W single pedestal desk H94286L and 48"W return H94215R (shown) Designed for use with 72"W single pedestal desk H94285R and 48"W return H94216L. NOTES: Reception station for "L" workstation includes components for both the reception/transaction counter for desk and the reception station for return.	H94721R H94722L	100	4.0	\$1242 \$1242
 Model H94721R shown 	Transaction Counter Organizer 48 $\frac{3}{4}$ "W x 11 $\frac{1}{8}$ "D x 13"H Fits under Transaction Counter on models H94720, H94721R and H94722L. NOTES: Transaction Counter Organizer model HTCOL52 fits under/inside of transaction counter.  Black only. SPECIFYING EXAMPLE: HTCOL52.P	HTCOL52	24	1.1	\$300
 	Vertical Paper Manager 14 $\frac{7}{8}$ "W x 10 $\frac{7}{8}$ "D x 19 $\frac{1}{16}$ "H NOTES: Keeps papers, files, and books neatly organized and within easy reach from a seated position. Designed for desk, credenza, and return tops. Fits under stack-on storage models. Two pullout drawers and three fixed shelves. NOTES: For additional information see the Workplace Tools section in the 2021 Shared Spaces Pricer. SPECIFYING EXAMPLE: HLVPM1.N	HLVPM1	27	2.8	\$351
 Not available in two-tone laminate	Angled Wood Center Drawer 26" x 15 $\frac{3}{8}$ " 22" x 15 $\frac{3}{8}$ " NOTES: Specify laminate. For additional information see the Workplace Tools section in the 2021 Shared Spaces Pricer. SPECIFYING EXAMPLE: H1526.N	H1526 H1522	12  11 	1.2 1.1	\$214 \$199
 Refer to page 104 for Center Drawer compatibility information					

NOTES:

- For conference table options, see the Preside® table tops and bases in the Tables section in the 2021 Shared Spaces Pricer. Order edge option "T" for 94000 Desks edge compatibility.

HOW TO SPECIFY

Select Model Number H 9 4 7 2 0 .	Select Laminate NN Mahogany N N
---	--

94000 SERIES™

Accessories

GSA SIN AS NOTED

ABI

Icon Legend on page 19

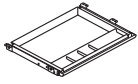

OPEN MARKET

DESCRIPTION**Polymer Center Drawer**

- Color: Black.
- Material: ABS.
- Minimum clearance for mounting: 23"W x 16¼"D x 2"H.
- Retracts on 16" ball-bearing slides.
- Can be used on worksurfaces with Coordinate™ Height Adjustable Bases as long as it is attached with spacer model HKBS.
- Can store up to 25 lbs.

! Black finish only, no specification needed.

MODEL**HCD1****SHIP WEIGHT**

7.0

CUBE

0.5

LIST PRICE**\$126**

Refer to the Workplace Tools section in the 2021 Shared Spaces Pricer for additional product information

Slide-Away Keyboard Platform (Specify: Laminate)**H4022**10.0 **Ⓢ**

0.6

\$228**Extended Tray Slide-Away Keyboard Platform** (Specify: Laminate)**HE4022**12.0 **Ⓢ**

0.7

\$323

NOTES: For additional information see the Workplace Tools section in the 2021 Shared Spaces Pricer.

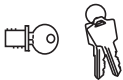
SIN 33721**SIN 33721****Black Removable Lock Core Kit (for laminate products)****HF23B**0.1 **Ⓢ**

0.1

\$35

- Specify quantity of each key number from 101E-225E.
- Includes: 1-core, 2-keys, 1-core removal tool, and instructions.

NOTES: If key number isn't specified, number will be at random. Core matches manufactured lock on laminate product but can be used with metal casegoods product.

NOTES:

- For conference table options, see the Preside® table tops and bases in the Tables section in the 2021 Shared Spaces Pricer. Order edge option "T" for 94000 Desks edge compatibility.

HOW TO SPECIFY

Select
Model Number

H	C	D	1
---	---	---	---

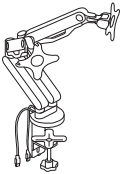

	DESCRIPTION	MODEL	SHIP WEIGHT	CUBE	LIST PRICE
	<p>Coordinate™ Portable Desktop Riser 31"D x 5"-16½"H x 35"W</p> <p>NOTES: Available in Black (BLK) or White (WHT) finish. Desktop riser dimensions (without keyboard tray): 22"D x 5"-16½"H x 35"W. Keyboard tray dimensions: 9"D x 30"W. Max loading capacity is 33 lbs for the desktop riser surface and 4 lbs for the keyboard tray. Easily transition from seated to standing positions throughout the workday. Sits atop an existing desk to create sit-to-stand functionality by raising the computer. Includes keyboard tray and surface for computer monitors. HON 5-Year Limited Warranty.</p> <p>⚠ Not intended for use on mobile workstations.</p>	HBXRISER	54.0	4.1	\$657
	<p>Dual Monitor Arm with 2 USB Ports</p> <p>NOTES: Easy adjustment. Height adjusts to 17" tall. Monitor tilt and swivel capability. Enclosed cable management. Grommet or desktop mounting. Clean appearance. In some applications the Monitor Arms may extend 12 or more inches into the worksurface. For additional information see the Workplace Tools section in the 2021 Shared Spaces Pricer. HON 5-Year Limited Warranty.</p> <p>⚠ No specification needed.</p>	HBDMAUSB	41.9	2.6	\$410

HOW TO SPECIFY

<p>Select Model Number</p> <p>HBXRISER.</p>	<p>Select Finish</p> <p>BLK Black WHT White</p> <p>BLK</p>
--	---

94000 SERIES™ Accessories

OPEN MARKET



Icon Legend on page 19

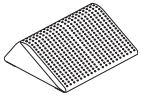

DESCRIPTION

Footrest — Anti-Slip Cover
13¾"D x 5½"H x 16"W

ⓘ Available in Black (T) finish ONLY. Recommended weight capacity not to exceed 250 pounds. **HON 5-Year Limited Warranty.**
SPECIFYING EXAMPLE: HVL991.T

MODEL

SHIP WEIGHT

CUBE

LIST PRICE

HVL991

7 ⓘ

0.9

\$89

HOW TO SPECIFY

Select Model Number

Select Finish

T Black

H V L 9 9 1 .

T



Mentor® Double Pedestal Desk with Volt® Task Chair and Brigade® Bookcases.

MENTOR®

Users appreciate the clean lines and rounded corners of the Mentor desk from HON. Stylish detailing and soft edges create an attractive, contemporary desk that's very user-friendly. Performance and durability make Mentor ideal for use in intensive environments. Featuring central locking drawers and integrated wire management, Mentor works hard for hard-working professionals.



FEATURES

- Durable baked enamel finish will hold up beautifully under years of daily use.
- Functional features like central locking center drawers and integrated wire management.
- Sturdy steel construction and heavy-duty reinforced frames.
- Mentor's performance and durability make it ideal for intensive use environments.
- Half-round legs and radius top corners are excellent for high-traffic areas.
- Arch drawer handles match Flagship® laterals, pedestals and towers.

MENTOR[®] ORDERING INFORMATION

FINISHES AVAILABILITY

L1 LAMINATES CODES

Woodgrain

◆ Bourbon Cherry	H
◆ Cognac	COGN
◆ Florence Walnut	LFW1
◆ Harvest	C
◆ Kingswood Walnut	LK11
◆ Mahogany	N
◆ Mocha	MOCH
◆ Natural Maple	D
◆ Shaker Cherry	F
◆ Sterling Ash	LSA1

Solid

◆ Black	P
◆ Charcoal	S
◆ Designer White	LDW1
◆ Loft	LOFT

Patterned

◆ Handspun Chestnut	LAHC
◆ Handspun Dove	LAHD
◆ Handspun Pearl	LAHP
◆ Handspun Slate	LAHS
◆ Sheer Mesh *	A5
◆ Silver Mesh	B9
◆ Steel Mesh *	A9
◆ Canyon Zephyr *	K9
◆ Desert Zephyr *	K8
◆ Shadow Zephyr *	K1
◆ Gray	G2
◆ Grey Tigris *	L6
◆ White	G1
◆ Whitestone *	K4

PAINTS CODES

P1

◆ Black	P
◆ Brownstone	P7D
◆ Charcoal	S
◆ Fossil	P28
◆ Greige	T5
◆ Light Gray	Q
◆ Loft	LOFT
◆ Muslin	T3
◆ Putty	L
◆ Shadow *	SHDW
◆ Titanium	P8T

NOTE: Vinyl edge and grommets match specified chassis color.

• STEEL DESKS

SPECIFY: Model Number.
Top Laminate
Paint Color

EXAMPLE: H88976.NS

◆◆◆ For lead time information see page 19.

* De-emphasized



Icon Legend on page 19

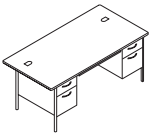
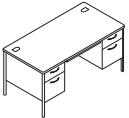
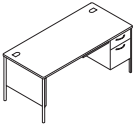
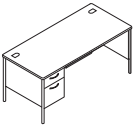
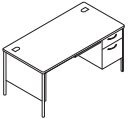
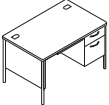

	DESCRIPTION	MODEL	SHIP WEIGHT	CUBE	LIST PRICE
	Double Pedestal Desk with Center Drawer (6" overhang on 3 sides) — 2/2 72"W x 36"D x 29½"H, Chrome Leg and Pull NOTES: Model H88976 requires Model H386560N 60"W Stack-on as top of desk extends over end panels.	H88976	203	37.7	\$1987
	Double Pedestal Desk with Center Drawer — 2/2 60"W x 30"D x 29½"H, Chrome Leg and Pull	H88962	178	26.7	\$1647
	Single Pedestal Desk with Center Drawer – Right, box/file 66"W x 30"D x 29½"H, Chrome Leg and Pull	H88265R	162	29.2	\$1495
	Single Pedestal Desk with Center Drawer – Left, box/file 66"W x 30"D x 29½"H, Chrome Leg and Pull	H88266L	162	29.2	\$1495
	Single Pedestal Desk with Center Drawer – Right, box/file 60"W x 30"D x 29½"H, Chrome Leg and Pull	H88263R	145	26.7	\$1420
	Single Pedestal Desk with Center Drawer – Right, box/file 48"W x 30"D x 29½"H, Chrome Leg and Pull	H88251R	130	21.6	\$1346

NOTES:

- Leg available in Chrome.
- Attractive radius leg design and arched drawer pulls.
- Legs ship unattached.
- 3/4 height modesty panels.
- Rounded edge desk top with soft feel-vinyl edge.
- Wire management grommets in desk tops and pedestals.
- Laminate tops are constructed of 1½" thick particleboard.
- 13½" deep, central locking center drawer equipped with HON "One Key" interchangeable lock cores.
- High-sided file drawers accept hanging files without hangrails.
- Full extension steel ball-bearing suspensions on file drawers for easy access to all contents.
- Reinforced double "O" frame inner structure keeps desk solid and sturdy for years of use.
- Box drawers equipped with 3/4 extension steel ball-bearing suspensions and one divider.
- Vinyl edge and grommets match specified chassis color.
- All interior drawer bodies are gray, pre-painted steel.

ⓘ Keyed alike cores must be ordered separately — see page 773.

HOW TO SPECIFY



Select Model Number 	Select Laminate See page 374 	Select Paint Color See page 374 
---	---	--

MENTOR® Steel Desks

GSA SIN 33721





Icon Legend on page 19

	DESCRIPTION	MODEL	SHIP WEIGHT	CUBE	LIST PRICE
	Double Pedestal Credenza with Kneespace, box/file (non-locking) 60"W x 24"D x 29½"H, Chrome Leg and Pull	H88231	149	21.8	\$1625
	Return, Right, box/file (non-locking) 42"W x 24"D x 29½"H, Chrome Leg and Pull	H88235R	92	15.5	\$1046
	Return, Left, box/file (non-locking) 42"W x 24"D x 29½"H, Chrome Leg and Pull	H88236L	92	15.5	\$1046

NOTES:

- Leg available in Chrome.
- Attractive radius leg design and arched drawer pulls.
- Legs ship unattached.
- ¾ height modesty panels.
- Rounded edge desk top with soft feel-vinyl edge.
- Wire management grommets in desk tops and pedestals.
- Laminate tops are constructed of 1/8" thick particleboard.
- High-sided file drawers accept hanging files without hangrails.
- Full extension steel ball-bearing suspensions on file drawers for easy access to all contents.
- Reinforced double "O" frame inner structure keeps desk solid and sturdy for years of use.
- Box drawers equipped with ¾ extension steel ball-bearing suspensions and one divider.
- Vinyl edge and grommets match specified chassis color.
- All interior drawer bodies are gray, pre-painted steel.

HOW TO SPECIFY

Select Model Number 	Select Laminate See page 374 	Select Paint Color See page 374 
--	---	--

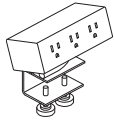

Model HPWRMOD3WC shown

DESCRIPTION**Power Modules**

3 Receptacles with Worksurface Clamp

2 Receptacles 2 USB with Worksurface Clamp

- 6' power cord with standard three-prong plug.
- Under-worksurface mounting bracket models work with any top that has a 5" x 5" square clearance.
- Worksurface clamp models work on any top with a 4" overhang.
- UL Listed.

NOTES: For additional information see the Workplace Tools section in the 2021 Shared Spaces Pricer.

! Color finish coordinates with HON's Charcoal or White. Specify *STRM* for Storm or *SNW* for Snow when ordering. Example: *HPWRMOD3WC.STRM*.

MODEL**SHIP WEIGHT****CUBE****LIST PRICE****HPWRMOD3WC**

2.3 Ⓞ

0.2

\$342**HPWRMOD2WC**

2.3 Ⓞ

0.2

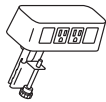
\$546**Power & Data Center**

2 Receptacles 2 Data Accessory

- Standard with two receptacles and openings for two data ports.
- 6' power cord with standard three-prong plug.
- Fits on any worksurface with a 4" overhang.
- UL Listed.

NOTES: For additional information see the Workplace Tools section in the 2021 Shared Spaces Pricer.

! Color finish coordinates with HON's Loft. Specify *LOFT* when ordering. Example: *HCOMDOME2.LOFT*.

HCOMDOME2

2.5 Ⓞ

0.2

\$327**Vertebrae**

NOTES: 30"H x 3 1/8"W x 1 1/2"D. Ships unassembled. For additional information see the Workplace Tools section in the 2021 Shared Spaces Pricer.

! Clear finish. Specify "X" for finish option.

SPECIFYING EXAMPLE: HMPVWM28.X**HMPVWM28**

3.0

0.3

\$246**Storage Cube**

12"W x 12"D

SPECIFYING EXAMPLE: HLSL1212.P8S**HLSL1212**

1.0

0.3

\$316**HOW TO SPECIFY**

Select
Model Number

H P W R M O D 3 W C

**DESCRIPTION****MODEL****SHIP WEIGHT****CUBE****LIST PRICE**

Coordinate™ Portable Desktop Riser
31"D x 5"-16½"H x 35"W

HBXRISER

54.0

4.1

\$657

NOTES: Available in Black (BLK) or White (WHT) finish. Desktop riser dimensions (without keyboard tray): 22"D x 5"-16½"H x 35"W. Keyboard tray dimensions: 9"D x 30"W. Max loading capacity is 33 lbs for the desktop riser surface and 4 lbs for the keyboard tray. Easily transition from seated to standing positions throughout the workday. Sits atop an existing desk to create sit-to-stand functionality by raising the computer. Includes keyboard tray and surface for computer monitors. **HON 5-Year Limited Warranty.**

⚠ Not intended for use on mobile workstations.

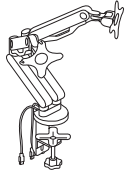

Dual Monitor Arm with 2 USB Ports

HBDMAUSB

41.9

2.6

\$410

NOTES: Easy adjustment. Height adjusts to 17" tall. Monitor tilt and swivel capability. Enclosed cable management. Grommet or desktop mounting. Clean appearance. In some applications the Monitor Arms may extend 12 or more inches into the worksurface. For additional information see the Workplace Tools section in the 2021 Shared Spaces Pricer. **HON 5-Year Limited Warranty.**

⚠ No specification needed.

HOW TO SPECIFY

Select
Model Number

Select
Finish

BLK Black
WHT White

HBXRISER.

BLK

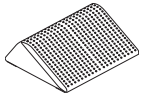

	DESCRIPTION	MODEL	SHIP WEIGHT	CUBE	LIST PRICE
	Footrest — Anti-Slip Cover 13¾"D x 5½"H x 16"W ⓘ Available in Black (T) finish ONLY. Recommended weight capacity not to exceed 250 pounds. HON 5-Year Limited Warranty. SPECIFYING EXAMPLE: HVL991.T	HVL991	7 ⓘ	0.9	\$89

HOW TO SPECIFY

<p>Select Model Number</p> <p>H V L 9 9 1 .</p>	<p>Select Finish</p> <p>T Black</p> <p>T</p>
---	--

METRO CLASSIC

Want to see more? Scan here
to check out hon.com.



Metro Classic Desk shown with Ignition® Seating.

METRO CLASSIC

The Metro Classic is a forward-thinking flashback that marries '60s styling with today's technology. This handsomely built collection offers excellent performance for the price — with best-in-class construction, easy-care laminate tops, built-in wire management and more. If you're looking for iconic style that lasts, you'll find it in Metro Classic.



FEATURES

- Retro-styled, but with up-to-date amenities, this classic reflects the enduring Modernist office designs of the 1960s.
- With tubular steel legs painted to match the desk body, Metro Classic gives you a clean look from top to bottom.
- Pedestals feature Tru-Fit mitered drawer fronts for precision alignment when closed.
- Contract-grade, multi-ply laminate stands up to scratches, spills, stains and boiling liquids.
- Recessed plastic drawer handles are color-matched to HON core paint colors.
- All drawers lock by securing the center drawer; lock core can be changed as security needs require.

METRO CLASSIC ORDERING INFORMATION

FINISHES AVAILABILITY

L1 LAMINATES/EDGE BAND

COLOR CODES

Woodgrain

- ◆ Bourbon Cherry/
Bourbon Cherry H
- ◆ Cognac/Cognac COGN
- ◆ Florence Walnut/
Florence Walnut LFW1
- ◆ Harvest/Harvest C
- ◆ Kingswood Walnut/
Kingswood Walnut LK11
- ◆ Mahogany/Mahogany N
- ◆ Mocha/Mocha MOCH
- ◆ Natural Maple/
Natural Maple D
- ◆ Pinnacle/Pinnacle PINC
- ◆ Shaker Cherry/
Shaker Cherry F
- ◆ Sterling Ash/
Sterling Ash LSA1

Solid

- ◆ Black/Black P
- ◆ Charcoal/Charcoal S
- ◆ Designer White/
Designer White LDW1
- ◆ Loft/Loft LOFT

Patterned

- ◆ Handspun Chestnut LAHC
- ◆ Handspun Dove LAHD
- ◆ Handspun Pearl LAHP
- ◆ Handspun Slate LAHS
- ◆ Sheer Mesh * /Muslin A5
- ◆ Silver Mesh/Loft B9
- ◆ Steel Mesh * /Charcoal A9
- ◇ Canyon Zephyr * /
Greige K9
- ◇ Desert Zephyr * /
Greige K8
- ◇ Shadow Zephyr * /
Loft K1
- ◆ Gray/Matches Paint Color G2
- ◆ Grey Tigris * /Greige L6
- ◇ White/Matches Paint
Color G1
- ◆ Whitestone * /Matches Paint
Color K4

PAINTS CODES

P1

- ◆ Black P
- ◆ Brownstone P7D
- ◆ Charcoal S
- ◆ Fossil P28
- ◆ Greige T5
- ◆ Light Gray Q
- ◆ Loft LOFT
- ◆ Muslin T3
- ◆ Putty L
- ◆ Shadow * SHDW
- ◆ Titanium P8T

• STEEL DESKS

SPECIFY: Model Number.
Top Laminate
Paint Color

EXAMPLE: HP3276.NS

◆◆◆ For lead time information see page 19.

* De-emphasized



METRO CLASSIC

Steel Desks

GSA SIN 33721

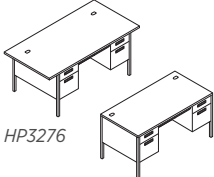

Icon Legend on page 19

	DESCRIPTION	MODEL	SHIP WEIGHT	CUBE	LIST PRICE
 HP3276	Double Pedestal — 2/2 (locking) 72"W x 36"D x 29½"H (6" overhang on 3 sides) NOTES: HP3276 requires Model H386560N 60"W Stack-on as top of desk extends over end panels.	HP3276	218	37.7	\$1907
	60"W x 30"D x 29½"H (Non-Locking, 24"D chassis) (6" overhang on approach side only)	HP3261	165	26.7	\$1337
	60"W x 30"D x 29½"H (locking)	HP3262	186	26.7	\$1559
 HP3262	Single Pedestal (locking) 66"W x 30"D x 29½"H — 2R 66"W x 30"D x 29½"H — 2L	HP3265R	167	29.2	\$1440
		HP3266L	167	29.2	\$1440
	48"W x 30"D x 29½"H — 2R	HP3251R	142	21.6	\$1283
	Return, Right — box/file (non-locking) 42"W x 24"D x 29½"H	HP3235R	95	15.5	\$1007
	Return, Left — box/file (non-locking) 42"W x 24"D x 29½"H	HP3236L	95	15.5	\$1007

NOTES:

- Two wire grommets in desk, credenza, and return tops.
- 3/4 height modesty panels.
- Legs shipped unattached.
- Color of pulls and grommets match paint selection for core colors.
- "Tru-fit" mitered drawer fronts for better visual alignment.
- Color of legs match paint selection.
- Central locking center drawer standard, with HON "One Key" interchangeable lock cores.
- High-sided file drawers accept hanging files without hangrails.
- Full extension steel ball-bearing suspensions on file drawers for easy access to all contents.
- Box drawers equipped with 3/4 extension steel ball-bearing suspensions.
- Reinforced, double "O" frame inner structure keeps desk solid and sturdy for years of use.
- All interior drawer bodies are gray pre-painted steel.
- 38000 Series™ stack-on units can be used on Metro desks and credenzas.

ⓘ Keyed alike cores ordered separately — see page 773.

HOW TO SPECIFY



Select Model Number HP3276	Select Laminate See page 381 Not specified for models H386566N, H386560N and H386548N N	Select Paint Color See page 381 S
--	---	--



Icon Legend on page 19

METRO CLASSIC

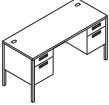
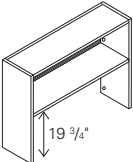
Steel Desks

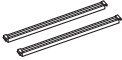
	DESCRIPTION	MODEL	SHIP WEIGHT	CUBE	LIST PRICE
	Credenza w/Kneespace — 2/2 (non-locking) 60"W x 24"D x 29½"H Accommodates optional HD2 or HD8 center drawer. NOTES: Non-locking.	HP3231	165.0	21.8	\$1559
	Stack-on Full Clearance without Doors 66"W x 13½"D x 34¾"H 60"W x 13½"D x 34¾"H 48"W x 13½"D x 34¾"H NOTES: Interior is 12¾"H. Specify: Paint color. For additional 38000 Series™ Stack-on accessory items, see pages 405-407. HP3276 requires Model H386560N 60"W Stack-on as top of desk extends over end panels.	H386566N H386560N H386548N	68.0 64.0 53.0	6.3 5.7 4.7	\$981 \$908 \$829
	Chrome Leg Packs — Field Installable 4 pk-29½"H	HC14	7.2	0.2	\$149
	Double-Rail Hanging File Racks — 2 Pack (for side-to-side) ⓘ Gray only	H519495	0.5	0.5	\$39

NOTES:

- Two wire grommets in desk, credenza, and return tops.
- ¾ height modesty panels.
- Legs shipped unattached.
- Color of pulls and grommets match paint selection for core colors.
- "Tru-fit" mitered drawer fronts for better visual alignment.
- Color of legs match paint selection.
- Central locking center drawer standard, with HON "One Key" interchangeable lock cores.
- High-sided file drawers accept hanging files without hangrails.
- Full extension steel ball-bearing suspensions on file drawers for easy access to all contents.
- Box drawers equipped with ¾ extension steel ball-bearing suspensions.
- Reinforced, double "O" frame inner structure keeps desk solid and sturdy for years of use.
- All interior drawer bodies are gray pre-painted steel.
- 38000 Series™ stack-on units can be used on Metro desks and credenzas.

ⓘ Keyed alike cores ordered separately — see page 773.

HOW TO SPECIFY

Select Model Number HP3231	Select Laminate See page 381 Not specified for models H386566N, H386560N and H386548N N	Select Paint Color See page 381 S
--	---	--

METRO CLASSIC

Accessories

GSA SIN 33721

ABI

Icon Legend on page 19

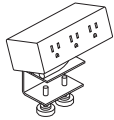

Model HPWRMOD3WC shown

DESCRIPTION

Power Modules

3 Receptacles with Worksurface Clamp

MODEL

SHIP WEIGHT

CUBE

LIST PRICE

2 Receptacles 2 USB with Worksurface Clamp

HPWRMOD3WC

2.3 Ⓢ

0.2

\$342

HPWRMOD2WC

2.3 Ⓢ

0.2

\$546

- 6' power cord with standard three-prong plug.

- Under-worksurface mounting bracket models work with any top that has a 5" x 5" square clearance.

- Worksurface clamp models work on any top with a 4" overhang.

- UL Listed.

❗ Color finish coordinates with HON's Charcoal or White. Specify *STRM* for Storm or *SNW* for Snow when ordering.

Example: *HPWRMOD3WC.STRM*.

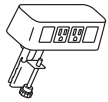

Power & Data Center

2 Receptacles 2 Data Accessory

HCOMDOME2

2.5 Ⓢ

0.2

\$327

- Standard with two receptacles and openings for two data ports.

- 6' power cord with standard three-prong plug.

- Fits on any worksurface with a 4" overhang.

- UL Listed.

❗ Color finish coordinates with HON's Loft. Specify *LOFT* when ordering. Example: *HCOMDOME2.LOFT*.



Vertebrae

HMPVWM28

3.0

0.3

\$246

NOTES: 30"H x 3 1/8"W x 1 1/2"D. Ships unassembled.

❗ Clear finish. Specify "X" for finish option.

SPECIFYING EXAMPLE: HMPVWM28.X



Storage Cube

12"W x 12"D

HLSL1212

1.0

0.3

\$316

SPECIFYING EXAMPLE: HLSL1212.P8S



HOW TO SPECIFY

Select
Model Number

H P W R M O D 3 W C

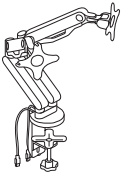

	DESCRIPTION	MODEL	SHIP WEIGHT	CUBE	LIST PRICE
	<p>Coordinate™ Portable Desktop Riser 31"D x 5"-16½"H x 35"W</p> <p>NOTES: Available in Black (BLK) or White (WHT) finish. Desktop riser dimensions (without keyboard tray): 22"D x 5"-16½"H x 35"W. Keyboard tray dimensions: 9"D x 30"W. Max loading capacity is 33 lbs for the desktop riser surface and 4 lbs for the keyboard tray. Easily transition from seated to standing positions throughout the workday. Sits atop an existing desk to create sit-to-stand functionality by raising the computer. Includes keyboard tray and surface for computer monitors. HON 5-Year Limited Warranty.</p> <p>⚠ Not intended for use on mobile workstations.</p>	HBXRISER	54.0	4.1	\$657
	<p>Dual Monitor Arm with 2 USB Ports</p> <p>NOTES: Easy adjustment. Height adjusts to 17" tall. Monitor tilt and swivel capability. Enclosed cable management. Grommet or desktop mounting. Clean appearance. In some applications the Monitor Arms may extend 12 or more inches into the worksurface. For additional information see the Workplace Tools section in the 2021 Shared Spaces Pricer. HON 5-Year Limited Warranty.</p> <p>⚠ No specification needed.</p>	HBDMAUSB	41.9	2.6	\$410

HOW TO SPECIFY

<p>Select Model Number</p> <p>H B X R I S E R .</p>	<p>Select Finish</p> <p>BLK Black WHT White</p> <p>B L K</p>
--	---

METRO CLASSIC

Accessories

OPEN MARKET



Icon Legend on page 19

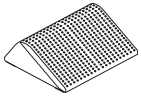

DESCRIPTION

Footrest — Anti-Slip Cover
13¾"D x 5½"H x 16"W

ⓘ Available in Black (T) finish ONLY. Recommended weight capacity not to exceed 250 pounds. **HON 5-Year Limited Warranty.**
SPECIFYING EXAMPLE: HVL991.T

MODEL

HVL991

SHIP WEIGHT

7 ⓘ

CUBE

0.9

LIST PRICE

\$89

HOW TO SPECIFY

<p>Select Model Number</p> <p>H V L 9 9 1 .</p>	<p>Select Finish</p> <p>T Black</p> <p>T</p>
--	---

34000 SERIES

Want to see more? Scan here
to check out hon.com.



**34000 Series shown with 500 Series
Lateral and Volt® Seating.**

34000 SERIES

The 34000 Series gets high marks in the classroom — or any environment requiring a heavy-duty metal desk that knows how to look good. The square Chrome legs and brushed Aluminum handles look clean and uncomplicated. The Tru-Fit mitered drawer fronts line up perfectly every time. Desk models offer central locking, so all the drawers can be secured with the turn of a single key. And with HON's best-in-class construction, 34000 Series will stand up to years of use.



FEATURES

- Legs are Chrome for a contemporary accent.
- Pedestals feature Tru-Fit mitered drawer fronts that align precisely when closed.
- All drawers lock by securing the center drawer; lock core can be changed as security needs require.
- Contract-grade, multi-ply laminate worksurface stands up to scratches, spills, stains and boiling liquids.
- Brushed Aluminum drawer handles match HON vertical file handles.

34000 SERIES ORDERING INFORMATION

FINISHES AVAILABILITY

L1 LAMINATES/EDGE BAND

COLOR CODES

Woodgrain

- ◆ Bourbon Cherry/
Bourbon Cherry **H**
- ◆ Cognac/Cognac **COGN**
- ◆ Florence Walnut/
Florence Walnut **LFW1**
- ◆ Harvest/Harvest **C**
- ◆ Kingswood Walnut/
Kingswood Walnut **LK11**
- ◆ Mahogany/Mahogany **N**
- ◆ Mocha/Mocha **MOCH**
- ◆ Natural Maple/
Natural Maple **D**
- ◆ Shaker Cherry/
Shaker Cherry **F**
- ◆ Sterling Ash/
Sterling Ash **LSA1**

Solid

- ◆ Black/Black **P**
- ◆ Charcoal/Charcoal **S**
- ◆ Designer White/
Designer White **LDW1**
- ◆ Loft/Loft **LOFT**

Patterned

- ◆ Handspun Chestnut **LAHC**
- ◆ Handspun Dove **LAHD**
- ◆ Handspun Pearl **LAHP**
- ◆ Handspun Slate **LAHS**
- ◆ Sheer Mesh * /Muslin **A5**
- ◆ Silver Mesh /Loft **B9**
- ◆ Steel Mesh * /Charcoal **A9**
- ◆ Canyon Zephyr * /Greige **K9**
- ◆ Desert Zephyr * /Greige **K8**
- ◆ Shadow Zephyr * /Loft **K1**
- ◆ Gray/Matches Paint Color **G2**
- ◆ Grey Tigris/Grey Tigris * **L6**
- ◆ White/Matches Paint
Color **G1**
- ◆ Whitestone * /Matches Paint
Color **K4**

PAINTS CODES

P1

- ◆ Black **P**
- ◆ Brownstone **P7D**
- ◆ Charcoal **S**
- ◆ Fossil **P28**
- ◆ Greige **T5**
- ◆ Light Gray **Q**
- ◆ Loft **LOFT**
- ◆ Muslin **T3**
- ◆ Putty **L**
- ◆ Shadow * **SHDW**
- ◆ Titanium **P8T**

• STEEL DESKS

*SPECIFY: Model Number.
Top Laminate
Paint Color*









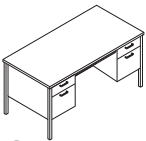

EXAMPLE: HP3276.NS

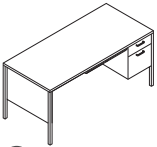
◆◆◆ For lead time information see page 19.

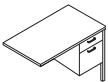
* De-emphasized

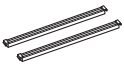

34000 SERIES Steel Desks

	DESCRIPTION	MODEL	SHIP WEIGHT	CUBE	LIST PRICE
	Double Pedestal — 2/2 (locking) 60"W x 30"D x 29½"H	H34962	162.0	26.7	\$1487
					
	Single Pedestal, box/file (locking) 66"W x 30"D x 29½"H, Right 66"W x 30"D x 29½"H, Left 48"W x 30"D x 29½"H, Right 45¼"W x 24"D x 29½"H, Right	H34973R H34974L H34251 H34002R	161.0 161.0 115.0 83.0	29.2 29.2 21.6 16.6	\$1284 \$1284 \$1134 \$969
					
	Return, Box/File (non-locking) 42"W x 24"D x 29½"H, Right 42"W x 24"D x 29½"H, Left	H34834R H34835L	89.0 89.0	15.5 15.5	\$854 \$854
	NOTES: Returns are for use with 66"W Single Pedestal Desks.				
	Credenza with Kneespace — 2/2 (non-locking) 60"W x 24"D x 29½"H	H34480	160.0	21.8	\$1494
	! Accommodates optional HD2 or HD8 center drawer.				
	Chrome Leg Packs — Field Installable 4 pk-29½"H	HC14	7.2 	0.2	\$149
	Double-Rail Hanging File Racks — 2 Pack (for side-to-side) ! Gray only	H519495	0.5	0.5	\$39

NOTES:

- "Tru-fit" mitered drawer fronts for better visual alignment.
- 3/4 height modesty panels.
- Chrome legs shipped unattached.
- Laminate tops.
- Central locking center drawer standard, with HON "One Key" interchangeable lock cores.
- Full extension steel ball-bearing suspensions on file drawers for easy access to all contents.
- High-sided file drawers accept hanging files without hangrails.
- Box drawers equipped with 3/4 extension steel ball-bearing suspensions.
- Reinforced, double "O" frame inner structure keeps desk solid and sturdy for years of use.
- All interior drawer bodies are gray, pre-painted steel.
- ! Keyed alike cores ordered separately — see page 773.

HOW TO SPECIFY

Select Model Number	Select Laminate See page 388	Select Paint Color See page 388
H 3 4 9 6 2	N	S

34000 SERIES

Accessories

GSA SIN 33721

ABI

Icon Legend on page 19

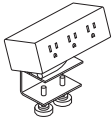

Model HPWRMOD3WC shown

DESCRIPTION

Power Modules

3 Receptacles with Worksurface Clamp

MODEL

SHIP WEIGHT

CUBE

LIST PRICE

HPWRMOD3WC

2.3 Ⓢ

0.2

\$342

2 Receptacles 2 USB with Worksurface Clamp

HPWRMOD2WC

2.3 Ⓢ

0.2

\$546

- 6' power cord with standard three-prong plug.

- Under-worksurface mounting bracket models work with any top that has a 5" x 5" square clearance.

- Worksurface clamp models work on any top with a 4" overhang.

- UL Listed.

NOTES: For additional information see the Workplace Tools section in the 2021 Shared Spaces Pricer.

! Color finish coordinates with HON's Charcoal or White. Specify *STRM* for Storm or *SNW* for Snow when ordering. Example: *HPWRMOD3WC.STRM*.

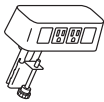

Power & Data Center

2 Receptacles 2 Data Accessory

HCOMDOME2

2.5 Ⓢ

0.2

\$327

- Standard with two receptacles and openings for two data ports.

- 6' power cord with standard three-prong plug.

- Fits on any worksurface with a 4" overhang.

- UL Listed.

NOTES: For additional information see the Workplace Tools section in the 2021 Shared Spaces Pricer.

! Color finish coordinates with HON's Loft. Specify *LOFT* when ordering. Example: *HCOMDOME2.LOFT*.



Vertebrae

HMPVWM28

3.0

0.3

\$246

NOTES: 30"H x 3 1/8"W x 1 1/2"D. Ships unassembled. For additional information see the Workplace Tools section in the 2021 Shared Spaces Pricer.

! Clear finish. Specify "X" for finish option.

SPECIFYING EXAMPLE: HMPVWM28.X



Storage Cube

12"W x 12"D

HLSL1212

1.0

0.3

\$316

SPECIFYING EXAMPLE: HLSL1212.P8S



HOW TO SPECIFY

Select
Model Number

H P W R M O D 3 W C

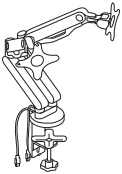

34000 SERIES Accessories

	DESCRIPTION	MODEL	SHIP WEIGHT	CUBE	LIST PRICE
	<p>Coordinate™ Portable Desktop Riser 31"D x 5"-16½"H x 35"W</p> <p>NOTES: Available in Black (BLK) or White (WHT) finish. Desktop riser dimensions (without keyboard tray): 22"D x 5"-16½"H x 35"W. Keyboard tray dimensions: 9"D x 30"W. Max loading capacity is 33 lbs for the desktop riser surface and 4 lbs for the keyboard tray. Easily transition from seated to standing positions throughout the workday. Sits atop an existing desk to create sit-to-stand functionality by raising the computer. Includes keyboard tray and surface for computer monitors. HON 5-Year Limited Warranty.</p> <p>⚠ Not intended for use on mobile workstations.</p>	HBXRISER	54.0	4.1	\$657
	<p>Dual Monitor Arm with 2 USB Ports</p> <p>NOTES: Easy adjustment. Height adjusts to 17" tall. Monitor tilt and swivel capability. Enclosed cable management. Grommet or desktop mounting. Clean appearance. In some applications the Monitor Arms may extend 12 or more inches into the worksurface. For additional information see the Workplace Tools section in the 2021 Shared Spaces Pricer. HON 5-Year Limited Warranty.</p> <p>⚠ No specification needed.</p>	HBDMAUSB	41.9	2.6	\$410

HOW TO SPECIFY

<p>Select Model Number</p> <p>H B X R I S E R .</p>	<p>Select Finish</p> <p>BLK Black WHT White</p> <p>B L K</p>
--	---

34000 SERIES Accessories

OPEN MARKET



Icon Legend on page 19

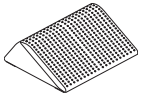

DESCRIPTION

Footrest — Anti-Slip Cover
13¾"D x 5½"H x 16"W

ⓘ Available in Black (T) finish ONLY. Recommended weight capacity not to exceed 250 pounds. **HON 5-Year Limited Warranty.**
SPECIFYING EXAMPLE: HVL991.T

MODEL

SHIP WEIGHT

CUBE

LIST PRICE

HVL991

7 ⓘ

0.9

\$89

HOW TO SPECIFY

Select Model Number

Select Finish

T Black

H V L 9 9 1 .

T

38000 SERIES™

Want to see more? Scan here
to check out hon.com.



38000 Series™ Station shown with Solve® Seating.

38000 SERIES™

The 38000 Series is America's best-selling steel desk — and with good reason. Rugged good looks. Precision engineering. Best-in-class construction. This modular collection blends designer touches like stylish, high-pressure laminate with useful details like cord-management. Which makes the 38000 Series the ideal desk solution for any organization seeking premium performance for a moderate price.



FEATURES

- Our steel construction is best in class — so it stands up to heavy use and frequent relocation.
- Integrated wire management and optional power hub accommodate today's electronic office.
- Pedestals feature Tru-Fit mitered drawer fronts for precision alignment when closed.
- Curved, waterfall-shaped edge profile provides a comfortable typing surface.
- Premium, multi-ply laminate worksurface stands up to scratches, spills and stains, and holds up under heavy use.
- Steel ball-bearing drawer suspensions operate easily and quietly.
- Cord management provides access to wall outlets, and allows cords to run through the or between components.

38000 SERIES™ ORDERING INFORMATION

FINISHES AVAILABILITY

L1 LAMINATES/EDGE BAND

COLOR CODES

Woodgrain

- ◆ Bourbon Cherry/
Bourbon Cherry **H**
- ◆ Cognac/Cognac **COGN**
- ◆ Florence Walnut/
Florence Walnut **LFW1**
- ◆ Harvest/Harvest **C**
- ◆ Kingswood Walnut/
Kingswood Walnut **LK11**
- ◆ Mahogany/Mahogany **N**
- ◆ Mocha/Mocha **MOCH**
- ◆ Natural Maple/
Natural Maple **D**
- ◆ Pinnacle/Pinnacle **PINC**
- ◆ Shaker Cherry/
Shaker Cherry **F**
- ◆ Sterling Ash/
Sterling Ash **LSA1**

Solid

- ◆ Black/Black **P**
- ◆ Charcoal/Charcoal **S**
- ◆ Designer White/
Designer White **LDW1**
- ◆ Loft/Loft **LOFT**

Patterned

- ◆ Handspun Chestnut **LAHC**
- ◆ Handspun Dove **LAHD**
- ◆ Handspun Pearl **LAHP**
- ◆ Handspun Slate **LAHS**
- ◆ Sheer Mesh * /Muslin **A5**
- ◆ Silver Mesh /Loft **B9**
- ◆ Steel Mesh * /Charcoal **A9**
- ◆ Canyon Zephyr * /
Greige **K9**
- ◆ Desert Zephyr * /
Greige **K8**
- ◆ Shadow Zephyr * /
Loft **K1**
- ◆ Gray/Matches Paint Color **G2**
- ◆ Grey Tigris * /Greige **L6**
- ◆ White/Matches Paint Color .. **G1**
- ◆ Whitestone * /Matches Paint
Color **K4**

FINISHES AVAILABILITY *continued*

PAINTS CODES

P1

- ◆ Black **P**
- ◆ Brownstone **P7D**
- ◆ Charcoal **S**
- ◆ Designer White **PJW**
- ◆ Fossil **P28**
- ◆ Greige **T5**
- ◆ Light Gray **Q**
- ◆ Loft **LOFT**
- ◆ Muslin **T3**
- ◆ Putty **L**
- ◆ Shadow * **SHDW**
- ◆ Titanium **P8T**

P2

- ◆ Champagne Metallic **T4**
- ◆ Platinum Metallic **T1**

NOTE: Where 38000 edgeband does not match laminate color, alternative color is on flat edges only (sides, sides and back edge on returns and bridges, flat sides of corner unit, and flat end of peninsulas).

• STEEL DESKS

*SPECIFY: Model Number.
Top Laminate
Paint Color*

EXAMPLE: H38934.NS

• 38000 TACKBOARDS

(Fabric listed on pages 25-26)

*SPECIFY: Model Number
Fabric Style.
Color Code
Paint Color*

EXAMPLE: HT72.CE18.P

◆◆◆ For lead time information see page 19.

* De-emphasized



Icon Legend on page 19

38000 SERIES™ Typicals — 3/4 Height Pedestals

Components used are listed on pages 399-407. Order components individually. Other configurations are possible, including various sizes of some components.

QTY	DESCRIPTION	MODEL	LIST PRICE	PRICE EXTENSION
1	Double Pedestal Desk 72"W x 36"D x 29½"H	H38180	\$2,196	\$2,196
1	Credenza with Kneespace 72"W x 24"D x 29½"H	H38854	\$1,906	\$1,906

TOTAL: \$4,102

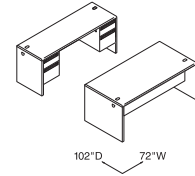

DESK WORKSTATION WITH CREDEZA
72"W x 102"D

QTY	DESCRIPTION	MODEL	LIST PRICE	PRICE EXTENSION
1	Single Pedestal Desk 72"W x 36"D x 29½"H	H38293R	\$1,958	\$1,958
1	Stack-on Storage w/o Doors 72½"W x 13½"D x 34¾"H	H386572N	\$1,034	\$1,034
1	Bridge 48"W x 24"D x 37⅞"H	H38210	\$661	\$661
1	Flipper Doors 2@36"W x 15"H	H387215	\$643	\$643
1	Single Pedestal Credenza 72"W x 24"D x 29½"H	H38855L	\$1,625	\$1,625

TOTAL: \$5,921

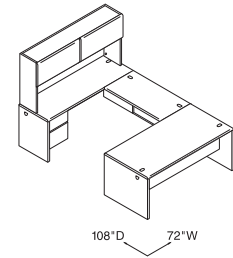

DESK "U" WORKSTATION
72"W x 108"D

QTY	DESCRIPTION	MODEL	LIST PRICE	PRICE EXTENSION
1	Single Pedestal Desk 72"W x 36"D x 29½"H	H38293R	\$1,958	\$1,958
1	Stack-on Storage w/o Doors 72½"W x 13½"D x 34¾"H	H386572N	\$1,034	\$1,034
1	Left, Return, box/file 60"W x 24"D x 29½"H	H38218L	\$1,301	\$1,301
1	Flipper Doors 2@36"W x 15"H	H387215	\$643	\$643

TOTAL: \$4,936

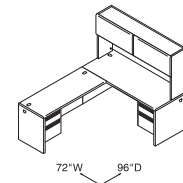

DESK "L" WORKSTATION
72"W x 96"D

QTY	DESCRIPTION	MODEL	LIST PRICE	PRICE EXTENSION
1	Peninsula with Full End Panel 70"W x 36"D x 29½"H	H38941E	\$1,530	\$1,530
1	Stack-on Storage w/o Doors 72½"W x 13½"D x 34¾"H	H386572N	\$1,034	\$1,034
1	Bridge 42"W x 24"D x 29½"H	H38220	\$628	\$628
1	Flipper Doors 2@36"W x 15"H	H387215	\$643	\$643
1	Single Pedestal Credenza, Left 72"W x 24"D x 29½"H	H38855L	\$1,625	\$1,625

TOTAL: \$5,460

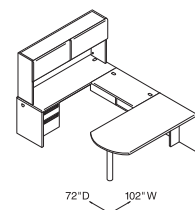

PENINSULA "U" WORKSTATION
72"W x 102"D

38000 SERIES™

Typicals — Modular



Icon Legend on page 19

Components used are listed on pages 399-407. Order components individually. Other configurations are possible, including various sizes of some components.

QTY	DESCRIPTION	MODEL	LIST PRICE	PRICE EXTENSION
1	Shell Desk 72"W x 36"D x 29½"H	H38934	\$1,332	\$1,332
1	Flagship Mobile Pedestal – file/file 15"W x 22⅞"D x 28"H	H18823R	\$851	\$851
1	Return Shell, Left 48"W x 24"D x 29½"H	H38944L	\$928	\$928
1	Standard Height Mobile Pedestal – box/box/file 15"W x 16⅞"D x 28"H	H18717R	\$790	\$790
TOTAL:			\$3,901	

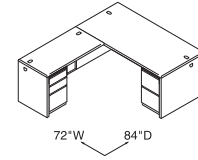

MODULAR DESK WORKSTATION
84"W x 72"D

QTY	DESCRIPTION	MODEL	LIST PRICE	PRICE EXTENSION
1	Shell Desk 72"W x 36"D x 29½"H	H38934	\$1,332	\$1,332
1	Flagship Mobile Pedestal – file/file 15"W x 22⅞"D x 28"H	H18823R	\$851	\$851
1	Bridge 48"W x 24"D x 29½"H	H38210	\$661	\$661
1	Shell Desk 72"W x 24"D x 29½"H	H38925	\$1,288	\$1,288
1	Standard Height Mobile Pedestal – box/box/file 15"W x 16⅞"D x 28"H	H18717R	\$790	\$790
1	Stack-on Storage w/o Doors 72⅝"W x 13½"D x 34¾"H	H386572N	\$1,034	\$1,034
TOTAL:			\$5,956	

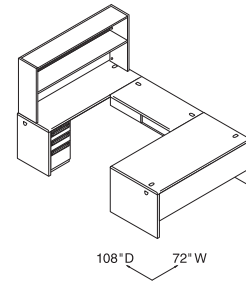

MODULAR DESK "U" WORKSTATION
72"W x 108"D

QTY	DESCRIPTION	MODEL	LIST PRICE	PRICE EXTENSION
1	Corner Unit	H38928	\$1,496	\$1,496
1	Peninsula with End Panel 70"W x 36"D x 29½"H	H38941E	\$1,530	\$1,530
1	Bridge 42"W x 24"D x 29½"H	H38220	\$628	\$628
1	Shell Return, Right 72"W x 24"D x 29½"H	H38947R	\$1,236	\$1,236
1	Flagship Lateral File 30"W x 18"D x 28"H	H9170R	\$1,116	\$1,116
1	Stack-on Storage w/o Doors 72⅝"W x 13½"D x 34¾"H	H386572N	\$1,034	\$1,034
1	Flipper Doors 2@36"W x 15"H	H387215	\$643	\$643
TOTAL:			\$7,683	

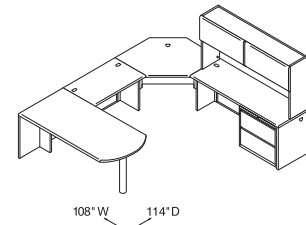

PENINSULA "U" WORKSTATION
108"W x 114"D

QTY	DESCRIPTION	MODEL	LIST PRICE	PRICE EXTENSION
1	Corner Unit	H38928	\$1,496	\$1,496
1	Shell Return, Left 72"W x 24"D x 29½"H	H38948L	\$1,236	\$1,236
1	Standard Height Mobile Pedestal – box/box/file 15"W x 16⅞"D x 28"H	H18717R	\$790	\$790
1	Stack-on Storage w/o Doors 72⅝"W x 13½"D x 34¾"H	H386572N	\$1,034	\$1,034
1	Flipper Doors 2@36"W x 15"H	H387215	\$643	\$643
1	Shell Return – Right 72"W x 24"D x 29½"H	H38947R	\$1,236	\$1,236
1	Standard Height Mobile Pedestal – file/file 15"W x 16⅞"D x 28"H	H18817R	\$790	\$790
TOTAL:			\$7,225	

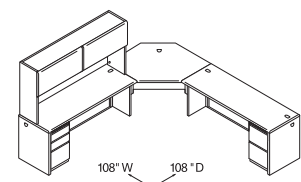

CORNER UNIT WITH RETURNS WORKSTATION
108"W x 108"D



Icon Legend on page 19

38000 SERIES™ Bundles Typicals

Mahogany/Charcoal
H38LL7284NS

Harvest/Putty
H38LL7284CL

QTY	DESCRIPTION	MODEL	LIST PRICE	PRICE EXTENSION
1	Left Pedestal Desk	H38294L	\$1,958	\$1,958
1	Right Return	H38215R	\$1,186	\$1,186
TOTAL:			\$3,144	

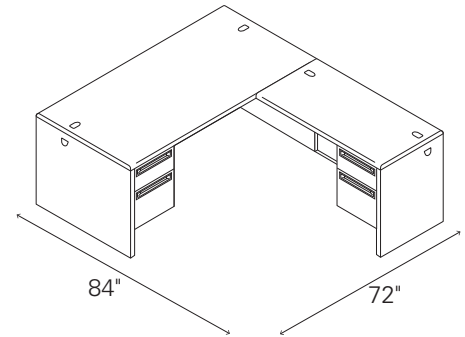

L-STATION (LEFT DESK/RIGHT RETURN)

Mahogany/Charcoal
H38LR7284NS

Harvest/Putty
H38LR7284CL

QTY	DESCRIPTION	MODEL	LIST PRICE	PRICE EXTENSION
1	Right Pedestal Desk	H38293R	\$1,958	\$1,958
1	Left Return	H38216L	\$1,186	\$1,186
TOTAL:			\$3,144	

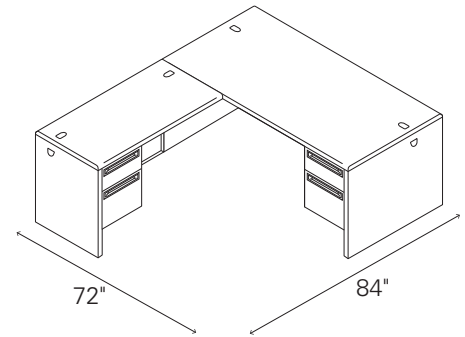

L-STATION (RIGHT DESK/LEFT RETURN)

Mahogany/Charcoal
H38URH72108NS2

Harvest/Putty
H38URH72108CL2

QTY	DESCRIPTION	MODEL	LIST PRICE	PRICE EXTENSION
1	Single Pedestal Desk, Right	H38293R	\$1,958	\$1,958
1	Single Pedestal Credenza, Left	H38855L	\$1,625	\$1,625
1	Hutch without Doors	H386572N	\$1,034	\$1,034
1	Flipper Doors, Pair	H387215	\$643	\$643
1	Bridge	H38210	\$661	\$661
TOTAL:			\$5,921	

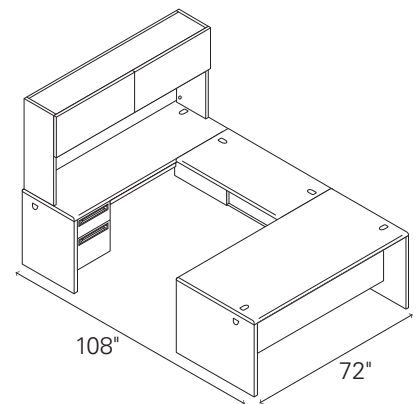

**U-STATION WITH HUTCH
(RIGHT DESK/LEFT CREDENZA)**

38000 SERIES™

Bundles Typicals



Icon Legend on page 19

Mahogany/Charcoal
H38ULH72108NS2

Harvest/Putty
H38ULH72108CL2

QTY	DESCRIPTION	MODEL	LIST PRICE	PRICE EXTENSION
1	Single Pedestal Desk, Left	H38294L	\$1,958	\$1,958
1	Single Pedestal Credenza, Right	H38856R	\$1,625	\$1,625
1	Hutch without Doors	H386572N	\$1,034	\$1,034
1	Flipper Doors, Pair	H387215	\$643	\$643
1	Bridge	H38210	\$661	\$661
TOTAL:			\$5,921	\$5,921

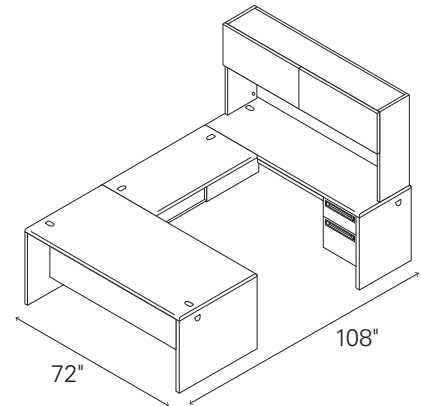

**U-STATION WITH HUTCH
(LEFT DESK/RIGHT CREDENZA)**

Mahogany/Charcoal
H38DCH6096NS2

Harvest/Putty
H38DCH6096CL2

QTY	DESCRIPTION	MODEL	LIST PRICE	PRICE EXTENSION
1	Double Pedestal Desk	H38155	\$1,878	\$1,878
1	Double Pedestal Credenza	H38852	\$1,833	\$1,833
1	Hutch without Doors	H386560N	\$908	\$908
1	Flipper Doors, Pair	H386015	\$605	\$605
TOTAL:			\$5,224	\$5,224

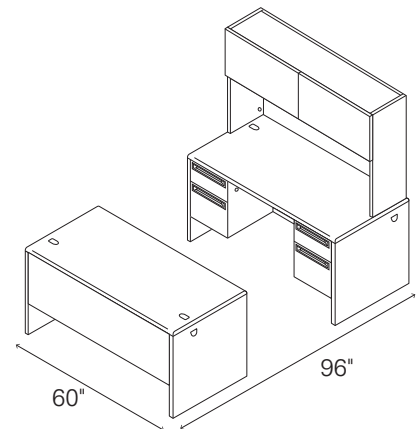

WORKSTATION



38000 SERIES™

Steel Desks — 3/4 Pedestals

	DESCRIPTION	FULL WIDTH OVERHANG	MODEL	SHIP WEIGHT	CUBE	LIST PRICE BY PAINT GRADE		
						P1	P2	P3
	Double Pedestal — 2/2 w/Locks	6"						
	72"W x 36"D x 29½"H		H38180	256	51.7	\$2196	\$2270	\$2341
	66"W x 30"D x 29½"H		H38170	224	40.1	\$2102	\$2176	\$2247
	60"W x 30"D x 29½"H		H38155	217	36.6	\$1878	\$1952	\$2023
	Single Pedestal w/Lock	6"						
	72"W x 36"D x 29½"H — 2R		H38293R	214	51.7	\$1958	\$2032	\$2103
	66"W x 30"D x 29½"H — 2R		H38291R	181	40.1	\$1804	\$1878	\$1949
	48"W x 30"D x 29½"H — 2R	H38251	155	29.6	\$1597	\$1671	\$1742	
	72"W x 36"D x 29½"H — 2L	6"	H38294L	214	51.7	\$1958	\$2032	\$2103
	66"W x 30"D x 29½"H — 2L		H38292L	181	40.1	\$1804	\$1878	\$1949
	48"W x 30"D x 29½"H — 2L		H38252L	155	29.6	\$1597	\$1671	\$1742
	Flush Return — box/file w/Lock							
	60"W x 24"D x 29½"H — 2R		H38217R	138	30.1	\$1301	\$1346	\$1390
	48"W x 24"D x 29½"H — 2R		H38215R	124	24.1	\$1186	\$1231	\$1275
	60"W x 24"D x 29½"H — 2L		H38218L	138	30.1	\$1301	\$1346	\$1390
	48"W x 24"D x 29½"H — 2L		H38216L	124	24.1	\$1186	\$1231	\$1275
	NOTES: Returns have 2 grommets each in worksurface top and full height modesty panel.							
	Credenza w/Doors w/Locks							
72"W x 24"D x 29½"H		H38853	230	35.6	\$2072	\$2146	\$2217	
NOTES: Pedestals lock.								
	Credenza w/Kneespace w/Locks							
	72"W x 24"D x 29½"H		H38854	172	35.6	\$1906	\$1980	\$2051
	Kneespace: 39¾"W							
	66"W x 24"D x 29½"H		H38851	166	32.7	\$1866	\$1940	\$2011
	Kneespace: 33¾"W							
60"W x 24"D x 29½"H		H38852	154	29.8	\$1833	\$1907	\$1978	
	Kneespace: 27¾"W							
NOTES: Pedestals lock.								
	Single Pedestal Credenza — 2R w/Lock							
	72"W x 24"D x 29½"H		H38856R	159	35.6	\$1625	\$1699	\$1770
	66"W x 24"D x 29½"H		H38858R	153	32.7	\$1507	\$1581	\$1652
NOTES: Pedestal locks.								
	Single Pedestal Credenza — 2L w/Lock							
	72"W x 24"D x 29½"H		H38855L	159	35.6	\$1625	\$1699	\$1770
	66"W x 24"D x 29½"H		H38857L	153	32.7	\$1507	\$1581	\$1652
NOTES: Pedestal locks.								

NOTES:

- 3/4 height modesty panels unless noted.
- Color of pulls and grommets match paint selection for core colors.
- One pencil tray standard per unit except returns.
- Laminate particleboard tops feature attractive, radius edges on front and rear edges of desks. Returns and bridges have radius front and flat rear edge to match the side edge it attaches to.
- Wire grommets standard in all tops.
- Wire grommets in end panels allow cable connections between desks.
- "Tru-fit" mitered drawer fronts for better visual alignment.
- Optional center drawer features steel ball-bearing suspension.
- High-sided file drawers accept hanging files without hangrails.
- Three-part full extension steel ball-bearing suspension on all file drawers for full access to interior contents.
- Box drawers feature two-part, ¾" extension steel ball-bearing suspension.
- Baked enamel finish over rust-inhibiting phosphate pre-treatment.
- See page 401 for 38000 Series™ shared components.
- Optional follower block accessory available to organize drawer storage.

HOW TO SPECIFY

Select Model Number	Select Laminate	Select Paint Color
See page 394	See page 394	See page 394
H 3 8 1 8 0	N	S

38000 SERIES™ Modular Desks

GSA SIN 33721



Icon Legend on page 19

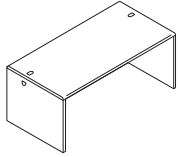

DESCRIPTION	INSIDE SHELL DIMENSIONS	FULL WIDTH OVERHANG	MODEL	SHIP WEIGHT	CUBE	LIST PRICE BY PAINT GRADE		
						P1	P2	P3
Desk Shell								
72"W x 36"D x 29½"H	69½"W x 28¾"D	6"	H38934	134	7.1	\$1332	\$1406	\$1477
72"W x 30"D x 29½"H	69½"W x 28¾"D		H38935	118	6.0	\$1297	\$1371	\$1442
66"W x 30"D x 29½"H	63½"W x 28¾"D		H38933	108	6.0	\$1278	\$1352	\$1423
60"W x 30"D x 29½"H	57½"W x 28¾"D		H38932	103	5.1	\$1215	\$1289	\$1360
48"W x 30"D x 29½"H	45½"W x 28¾"D		H38931	89	5.1	\$1123	\$1197	\$1268
72"W x 24"D x 29½"H	69½"W x 22¾"D		H38925	99	5.0	\$1288	\$1362	\$1433
66"W x 24"D x 29½"H	63½"W x 22¾"D		H38923	95	5.0	\$1234	\$1308	\$1379
60"W x 24"D x 29½"H	57½"W x 22¾"D		H38922	89	4.2	\$1174	\$1248	\$1319
48"W x 24"D x 29½"H	45½"W x 22¾"D		H38921	83	4.2	\$1099	\$1173	\$1244

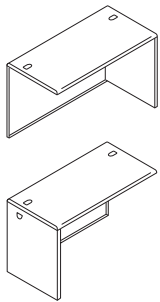

Return Shell								
72"W x 24"D x 29½"H, Right	69½"W x 22¾"D (2 grommets)		H38947R	87	6.0	\$1236	\$1281	\$1325
60"W x 24"D x 29½"H, Right	57½"W x 22¾"D (2 grommets)		H38945R	80	5.1	\$1108	\$1153	\$1197
48"W x 24"D x 29½"H, Right	45½"W x 22¾"D (2 grommets)		H38943R	71	4.2	\$928	\$973	\$1017
42"W x 24"D x 29½"H, Right	39½"W x 22¾"D (2 grommets)		H38949R	65	4.2	\$865	\$910	\$954
72"W x 24"D x 29½"H, Left	69½"W x 22¾"D (2 grommets)		H38948L	87	6.0	\$1236	\$1281	\$1325
60"W x 24"D x 29½"H, Left	57½"W x 22¾"D (2 grommets)		H38946L	80	5.1	\$1108	\$1153	\$1197
48"W x 24"D x 29½"H, Left	45½"W x 22¾"D (2 grommets)		H38944L	71	4.2	\$928	\$973	\$1017
42"W x 24"D x 29½"H, Left	39½"W x 22¾"D (2 grommets)		H38950L	65	4.2	\$865	\$910	\$954

NOTES: Modular returns feature full height modesty panels.

⚠ Not designed to be used freestanding.

NOTES:

- 38000 Series™ Modular Desks offers designer styling, configuration flexibility and storage versatility.
- Create both individual managerial stations and task-oriented work areas.
- Designed with adaptability for today's electronic office.
- Color of pulls and grommets match paint selection for core colors. If Titanium paint is selected then Loft is provided.
- Wire grommets standard in all tops, except peninsulas.
- Wire grommets in end panels allow cable connections between desks.
- Optional center drawer features steel ball-bearing suspension.
- For components that can be shared with 38000 Series™, see page 401.
- 3/4 height modesty panels unless noted.
- Ability to use all HON laterals and pedestals.

Recommended Pedestal Options:

38000 Series™	36" Deep Desk			30" Deep Desk			24" Deep Desk		
Contain®, Flagship® or Brigade® Pedestals	Ability to Attach	Ability to Use Wire Port	Ability to Attach Hutch	Ability to Attach	Ability to Use Wire Port	Ability to Attach Hutch	Ability to Attach	Ability to Use Wire Port	Ability to Attach Hutch
16¾"D Hanging Pedestal	•	•	•	•	•	•	•	•	•
22⅞"D Hanging Pedestal	•	•	•	•	•	•	•	•	•
16¾"D Freestanding or Mobile	•	•	•	•	•	•	•	•	•
22⅞"D Freestanding or Mobile	•	•	•	•	•	•	•	•	•
28⅞"D Freestanding or Mobile	•	•	•	•	•	•	•	•	•

Use of a pedestal spacer or 28"H standard height pedestals will block wire access from the grommet to the kneespace area.

NOTES: Stack-on units can be attached regardless of pedestal configuration.

Personalize Your Storage Needs**With These Possible Solutions:**

Use coordinating HON components such as Pedestals shown on page 707 and Lateral Files shown on pages 657-661 and 709-710.

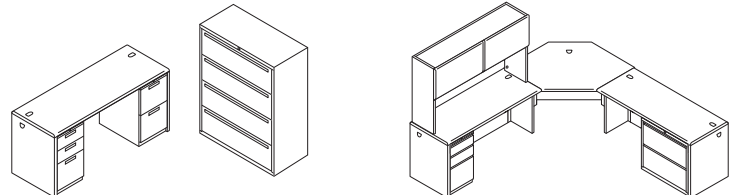





**HOW TO SPECIFY**

Select Model Number H 3 8 9 3 4 .	Select Laminate See page 394 N .	Select Paint Color See page 394 S .
---	---	--

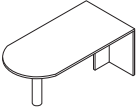

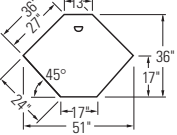
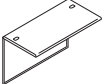
Icon Legend on page 19

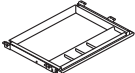
38000 SERIES™ Shared Components and Accessories

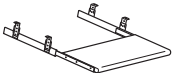
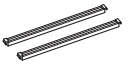
	DESCRIPTION	MODEL	SHIP WEIGHT	CUBE	LIST PRICE BY PAINT GRADE		
					P1	P2	P3
	Peninsula with Support Column and End Panel 70"W x 36"D x 29½"H 70"W x 30"D x 29½"H 66"W x 30"D x 29½"H	H38941E H38942E H38966E	132.0 126.0 113.0	8.1 7.0 8.1	\$1530 \$1453 \$1413	\$1575 \$1498 \$1458	\$1619 \$1542 \$1502
	NOTES: Use to create "L" configuration with a Return or "U" configuration with a Bridge and Credenza, Desk or Corner Unit. ⓘ Not designed to be used freestanding.						
		Corner Unit 24" x 36" x 36" x 24" x 29½"H Leading edge is 17"W; leading edge to rear edge is 36"D.	H38928	85.0	7.4	\$1496	\$1570
	ⓘ Designed to be used with Returns or Bridges.						
	Bridge 48"W x 24"D x 29½"H 42"W x 24"D x 29½"H	H38210 H38220	54.0 ⓘ 50.0 ⓘ	4.2 4.2	\$661 \$628	\$679 \$646	\$694 \$661
	NOTES: Full height modesty panel.						
	Metal Center Drawers with core removable locks 24¾"W x 14¾"D for H38180, H38170, H38155 19"W x 14¾"D for H38293R, H38294L, H38291R, H38292L	HD8 HD2	12.0 ⓘ 9.0 ⓘ	1.2 1.0	\$297 \$297	\$307 \$307	\$315 \$315
	NOTES: For additional information see the Workplace Tools section in the 2021 Shared Spaces Pricer. Specify: Paint color.						
	Polymer Center Drawer	HCD1	7.0	0.5	\$126		
	• Color: Black. • Material: ABS. • Minimum clearance for mounting: 23"W x 16¼"D x 2"H. • Retracts on 16" ball-bearing slides. • Can be used on worksurfaces with Coordinate™ Height Adjustable Bases as long as it is attached with spacer model HKBS. • Can store up to 25 lbs.						
OPEN MARKET	ⓘ Black finish only, no specification needed.						
	Corner Sleeve — Square Edge 22½" leading edge x 18"D	H51206	10.0 ⓘ	1.5	\$171	\$181	\$188
	NOTES: For additional information see the Workplace Tools section in the 2021 Shared Spaces Pricer. Specify: Paint color.						
	Slide-Away Keyboard Platform (Specify: Laminate)	H4022	10.0 ⓘ	0.6	\$228		
	Metal Keyboard and Mouse Tray (Specify paint)	H4028	11.0 ⓘ	1.5	\$164	\$174	
	Metal Keyboard Tray (Specify paint)	H4029	11.0 ⓘ	1.5	\$148	\$158	
	NOTES: For additional information see the Workplace Tools section in the 2021 Shared Spaces Pricer.	OPEN MARKET OPEN MARKET					
	Double-Rail Hanging File Racks — 2 Pack (for side-to-side)	H519495	0.5	0.5	\$39		

- NOTES:**
- Full end panel legs have neat, contemporary appearance.
 - 3/4 height modesty panels unless noted.
 - Our broadest selection of components, including components for "U" and "L" workstation arrangements.
 - All worksurfaces shown are particleboard.
 - Color of grommets match paint selection for core colors.
 - 38000 Series™ Stack-on units and accessories listed on pages 401-407.

HOW TO SPECIFY

Select Model Number H 3 8 9 4 1 E	Select Laminate See page 394 N	Select Paint Color See page 394 S	Select Support Column Paint Specify for new peninsula models only P Black P
---	---	--	---

38000 SERIES™

Accessories

GSA SIN 33721

ABI

Icon Legend on page 19

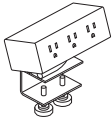

Model HPWRMOD3WC shown

DESCRIPTION**Power Modules**

3 Receptacles with Worksurface Clamp

MODEL**HPWRMOD3WC****SHIP WEIGHT**

2.3 Ⓢ

CUBE

0.2

LIST PRICE**\$342**

2 Receptacles 2 USB with Worksurface Clamp

HPWRMOD2WC

2.3 Ⓢ

0.2

\$546

- 6' power cord with standard three-prong plug.

- Under-worksurface mounting bracket models work with any top that has a 5" x 5" square clearance.

- Worksurface clamp models work on any top with a 4" overhang.

- UL Listed.

NOTES: For additional information see the Workplace Tools section in the 2021 Shared Spaces Pricer.

! Color finish coordinates with HON's Charcoal or White. Specify *STRM* for Storm or *SNW* for Snow when ordering.
Example: HPWRMOD3WC.STRM.

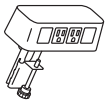
**Power & Data Center**

2 Receptacles 2 Data Accessory

HCOMDOME2

2.5 Ⓢ

0.2

\$327

- Standard with two receptacles and openings for two data ports.

- 6' power cord with standard three-prong plug.

- Fits on any worksurface with a 4" overhang.

- UL Listed.

NOTES: For additional information see the Workplace Tools section in the 2021 Shared Spaces Pricer.

! Color finish coordinates with HON's Loft. Specify *LOFT* when ordering. Example: HCOMDOME2.LOFT.

**Vertebrae****HMPVWM28**

3.0

0.3

\$246

NOTES: 30"H x 3 1/8"W x 1 1/2"D. Ships unassembled. For additional information see the Workplace Tools section in the 2021 Shared Spaces Pricer.

! Clear finish. Specify "X" for finish option.

SPECIFYING EXAMPLE: HMPVWM28.X**Storage Cube**

12"W x 12"D

HLSL1212

1.0

0.3

\$316**SPECIFYING EXAMPLE: HLSL1212.P8S****HOW TO SPECIFY**

Select
Model Number

H P W R M O D 3 W C

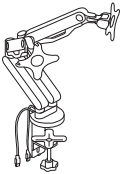

	DESCRIPTION	MODEL	SHIP WEIGHT	CUBE	LIST PRICE
	<p>Coordinate™ Portable Desktop Riser 31"D x 5"-16½"H x 35"W</p> <p>NOTES: Available in Black (BLK) or White (WHT) finish. Desktop riser dimensions (without keyboard tray): 22"D x 5"-16½"H x 35"W. Keyboard tray dimensions: 9"D x 30"W. Max loading capacity is 33 lbs for the desktop riser surface and 4 lbs for the keyboard tray. Easily transition from seated to standing positions throughout the workday. Sits atop an existing desk to create sit-to-stand functionality by raising the computer. Includes keyboard tray and surface for computer monitors. HON 5-Year Limited Warranty.</p> <p>⚠ Not intended for use on mobile workstations.</p>	HBXRISER	54.0	4.1	\$657
	<p>Dual Monitor Arm with 2 USB Ports</p> <p>NOTES: Easy adjustment. Height adjusts to 17" tall. Monitor tilt and swivel capability. Enclosed cable management. Grommet or desktop mounting. Clean appearance. In some applications the Monitor Arms may extend 12 or more inches into the worksurface. For additional information see the Workplace Tools section in the 2021 Shared Spaces Pricer. HON 5-Year Limited Warranty.</p> <p>⚠ No specification needed.</p>	HBDMAUSB	41.9	2.6	\$410

HOW TO SPECIFY

<p>Select Model Number</p> <p>HBXRISER.</p>	<p>Select Finish</p> <p>BLK Black WHT White</p> <p>BLK</p>
--	---

38000 SERIES™ Accessories

OPEN MARKET



Icon Legend on page 19

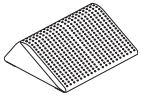

DESCRIPTION

Footrest — Anti-Slip Cover
13¾"D x 5½"H x 16"W

ⓘ Available in Black (T) finish ONLY. Recommended weight capacity not to exceed 250 pounds. **HON 5-Year Limited Warranty.**
SPECIFYING EXAMPLE: HVL991.T

MODEL

HVL991

SHIP WEIGHT

7 ⓘ

CUBE

0.9

LIST PRICE

\$89

HOW TO SPECIFY

Select Model Number

Select Finish

T Black

H V L 9 9 1 .

T



Icon Legend on page 19

38000 SERIES™

Steel Stack-on Units

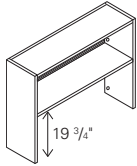
**DESCRIPTION****Stack-on Full Clearance without Doors**

72"W x 13½"D x 34¾"H

66"W x 13½"D x 34¾"H

60"W x 13½"D x 34¾"H

48"W x 13½"D x 34¾"H

NOTES: Interior is 12¾"H.

Specify: Paint color.

MODEL	SHIP WEIGHT	CUBE	LIST PRICE BY PAINT GRADE		
			P1	P2	P3
H386572N	72	6.8	\$1034	\$1085	\$1134
H386566N	68	6.3	\$981	\$1032	\$1081
H386560N	64	5.7	\$908	\$959	\$1008
H386548N	53	4.7	\$829	\$880	\$929

HOW TO SPECIFY**Select Model Number**

H 3 8 6 5 7 2 N .

Select Paint Color

See page 394

P

DESCRIPTION**Front Flipper Doors**

2 @ 36"W x 15"H, Flipper Doors for 72"W Stack-on

2 @ 33"W x 15"H, Flipper Doors for 66"W Stack-on

2 @ 30"W x 15"H, Flipper Doors for 60"W Stack-on

1 @ 48"W x 15"H, Flipper Door for 48"W Stack-on

Specify: Paint color.

MODEL	SHIP WEIGHT	CUBE	LIST PRICE BY PAINT GRADE		
			P1	P2	P3
H387215	19	0.9	\$643	\$661	\$687
H386615	17	0.9	\$629	\$647	\$673
H386015	16	0.9	\$605	\$623	\$649
H384815	12	0.5	\$368	\$386	\$412

NOTES:

- Flipper doors are standard with a core removable lock located on the underside of stack-on shelf.
- Many Stack-on sizes available, from 48" to 72" wide.
- Equipped with HON "One Key" interchangeable core removable locks.
- Stack-on units attach to worksurface with double stick tape or with screws provided.
- Stack-ons also compatible with Abode™, Mentor®, Metro Classic, and 66000 Series Computer Furniture.
- Cabinet/door combination kits available for field installation.
- Two dividers standard with every stack-on.
- Color of grommets match paint selection for core colors.

ⓘ Keyed alike cores must be ordered separately — see page 773.

ⓘ Stack-on Units not designed to be used on Corner Units.

HOW TO SPECIFY**Select Model Number**

H 3 8 7 2 1 5 .

Select Lock Option

L Lock
 X Omit Lock
 (deduct \$20)

See page 773 for omit lock ordering instructions

L .

Select Paint Color

See page 394

P

38000 SERIES™ Steel Stack-on Units

GSA SIN 33721



Icon Legend on page 19

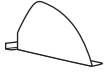

DESCRIPTION	MODEL	SHIP WEIGHT	CUBE	LIST PRICE BY PAINT GRADE		
				P1	P2	P3
Shelf Dividers — package of 6 Specify: Paint color. Shelf dividers can only be used on stack-ons manufactured after 7/3/2000.	H38SHFDV	3	0.2	\$167	\$178	\$186

HOW TO SPECIFY

<p>Select Model Number</p> <p>H 3 8 S H F D V . P</p>	<p>Select Paint Color</p> <p>See page 394</p>
---	---



Icon Legend on page 19

38000 SERIES™ Accessories

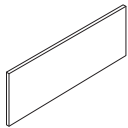

SIN 33721

DESCRIPTION

Tackboard for Stack-on — 20”H
72”W
66”W
60”W
48”W

MODEL

HT72ND
HT66ND
HT60ND
HT48ND

SHIP WEIGHT

26.0
24.0
22.0
18.0

CUBE

2.3
2.1
1.9
1.5

LIST PRICE

\$577
\$555
\$537
\$480

Specify: Model.Fabric.Paint. Upcharges may apply to premium fabric grades.

! Disperse (DISP) fabric not available on sizes wider than 60”.

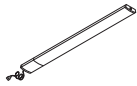

OPEN MARKET

LED Task Lights

17” LED Light with Power Supply (Single)
31” LED Light with Power Supply (Single)

17” LED Light with Power Supply for Daisy-chain (Starter)
31” LED Light with Power Supply for Daisy-chain (Starter)

17” LED Light with 8” Jumper Cord for Daisy-chain (Follower)
31” LED Light with 8” Jumper Cord for Daisy-chain (Follower)

HLED17AS ☉
HLED31AS ☉

HLED17A
HLED31A

HLED17AUO ☉
HLED31AUO ☉

1.2 \$
1.5 \$

1.0 \$
1.4 \$

1.0 \$
1.0 \$

0.05
0.09

0.05
0.09

0.03
0.05

\$450
\$603

\$493
\$662

\$404
\$539

Undercabinet Occupancy Sensor with 1” End to End Connector

HLEDOSA ☉

0.2 \$

0.01

\$97

NOTES: To use the daisy chain application, must start with model HLED17A or HLED31A. No finish specification required. Attaches magnetically to underside of overhead storage, or attaches with provided screws or double-sided tape. Occupancy sensor attaches to a single or starter LED light and will automatically turn the light off after no motion is detected for 30 minutes. Just like all the LED light models, the occupancy sensor features a soft-touch on/off switch. LED task lights have a lifetime of 50,000 hours and have a dimmer feature that allows the user to adjust the amount of light output.

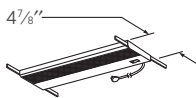

Refer to the Workplace Tools section in the 2021 Shared Spaces Pricer

OPEN MARKET

Recessed Task Light for use under 72”, 66” and 60”W Stack-on or Open Shelf
46½”W x 3¼”D x 1⅞”H

HH870960

12.0 \$

1.1

\$290

NOTES: For additional information see the Workplace Tools section in the 2021 Shared Spaces Pricer.

Recessed Task Light for use under 48”W Stack-on or Open Shelf
34⅝”W x 3¼”D x 1⅞”H

HH870942

10.0 \$

0.9

\$267

NOTES: For additional information see the Workplace Tools section in the 2021 Shared Spaces Pricer.



SIN 33721

Articulating Desk Lamp
Articulating Desk Lamp w/ Occupancy Sensor

HLED1
HLED1OC

1.2 \$
1.2 \$

6.5
6.5

\$430
\$524

NOTES: For additional information see the Workplace Tools section in the 2021 Shared Spaces Pricer.



SIN 33721

Task Desk Lamp

HLED2

0.7 \$

3.0

\$373

NOTES: For additional information see the Workplace Tools section in the 2021 Shared Spaces Pricer.

NOTES:

- See specifying information above for Choice/Metallic paint and pages 16 and 394 for Custom Paint ordering instructions.
- Tackboards feature painted steel backs and can be installed in the field.

HOW TO SPECIFY

<p>Select Model Number</p> <p>HT72ND</p>	<p>Select Fabric Color</p> <p>See pages 25-26</p> <p>APN15</p>	<p>Select Paint Color</p> <p>See page 394</p> <p>P</p>
---	---	---

NOTES



Abode™ shown with Contain®
Storage and Endorse® Seating.

ABODE™

The Abode systems desk gives you a consistent look throughout your space and can help you respond easily to future layout changes. It integrates seamlessly with Abound® and Accelerate®, and can be configured to create freestanding or height adjustable workstations. For greater flexibility and durability in the workspace, look no further than Abode.



FEATURES

- Create a freestanding metal desk that accommodates storage above and below the worksurface.
- Full compatibility with Abound and Accelerate workstations elevates the functionality of Abode.
- Incorporating Coordinate™ makes it easy for workers to adjust their desk height throughout the day, keeping them active, healthy and focused.

ABODE™ ORDERING INFORMATION

WORKSURFACES, COUNTERTOPS, CORNER SHELVES W/EDGE BAND

L1 LAMINATES CODES

Woodgrain

- ◆ Bourbon Cherry H
- ◆ Cognac COGN
- ◆ Florence Walnut LFW1
- ◆ Harvest C
- ◆ Kingswood Walnut LK11
- ◆ Mahogany N
- ◆ Mocha MOCH
- ◆ Natural Maple D
- ◆ Pinnacle PINC
- ◆ Shaker Cherry F
- ◆ Sterling Ash LSA1

Solid

- ◆ Black P
- ◆ Charcoal S
- ◆ Designer White LDW1
- ◆ Loft LOFT

Patterned

- ◆ Handspun Chestnut LAHC
- ◆ Handspun Dove LAHD
- ◆ Handspun Pearl LAHP
- ◆ Handspun Slate LAHS
- ◆ Sheer Mesh * A5
- ◆ Silver Mesh B9
- ◆ Steel Mesh * A9
- ◆ Canyon Zephyr * K9
- ◆ Desert Zephyr * K8
- ◆ Shadow Zephyr * K1
- ◆ Gray G2
- ◆ Grey Tigris * L6
- ◆ White G1
- ◆ Whitestone * K4

L2 LAMINATES CODES

Woodgrain

- ◆ Lowell Ash LLA1
- ◆ Natural Recon LNR1
- ◆ Phantom Ecru LPE1
- ◆ Portico Teak LPT1
- ◆ Skyline Walnut LSW1

(Door panels not available in L2)

WORKSURFACE EDGE BAND

- ◆ Black P
- ◆ Bourbon Cherry H
- ◆ Brownstone EY
- ◆ Charcoal S
- ◆ Cognac COGN
- ◆ Designer White DW
- ◆ Florence Walnut FW
- ◆ Fossil EH
- ◆ Greige R
- ◆ Harvest C
- ◆ Kingswood Walnut KI
- ◆ Light Gray Q
- ◆ Loft LOFT
- ◆ Lowell Ash DL
- ◆ Mahogany N
- ◆ Mocha MOCH
- ◆ Muslin T
- ◆ Natural Maple D
- ◆ Natural Recon NR
- ◆ Phantom Ecru PE
- ◆ Pinnacle PINC
- ◆ Platinum K
- ◆ Portico Teak DP
- ◆ Shadow * SHDW
- ◆ Shaker Cherry F
- ◆ Skyline Walnut SW
- ◆ Sterling Ash SA

WORKSURFACE GROMMET

- ◆ Black P
- ◆ Brownstone EY
- ◆ Charcoal S
- ◆ Fossil EH
- ◆ Greige T5
- ◆ Light Gray Q
- ◆ Loft LOFT
- ◆ Muslin T3
- ◆ Shadow * SHDW
- ◆ Titanium T1
- ◆ Designer White DW
- ◆ Champagne Metallic T4
- ◆ Platinum Metallic T1

FRAMES, TRIM, METAL TILES, CUSTOM BRACKET KIT, WORKSURFACE SUPPORTS, STEEL OVERHEAD STORAGE CHASSIS

PAINT CODES

- P1
- ◆ Black P
- ◆ Brownstone P7D
- ◆ Charcoal S
- ◆ Designer White PJW
- ◆ Fossil P28
- ◆ Greige T5
- ◆ Light Gray Q
- ◆ Loft LOFT
- ◆ Muslin T3
- ◆ Putty L
- ◆ Shadow * SHDW
- ◆ Titanium P8T

- P2
- ◆ Champagne Metallic T4
- ◆ Platinum Metallic T1
- ◆ Silver PR6

DUPLEX/PORTED TILE

PLASTIC CODES

- ◆ Black P
- ◆ Charcoal S
- ◆ Designer White DW
- ◆ Loft LOFT
- ◆ Muslin T3
- ◆ Titanium TI

Recommendations

Paint	Duplex-Data Code
Black P	Black P
Brownstone P7D	Brownstone EY
Charcoal S	Charcoal S
Designer White PJW	Designer White DW
Fossil P28	Charcoal S
Greige T5	Muslin T3
Light Gray Q	Loft LOFT
Loft LOFT	Loft LOFT
Muslin T3	Muslin T3
Putty L	Black P
Shadow SHDW	Muslin T3
Silver PR6	Titanium T1
Titanium P8T	Titanium T1
Champagne Metallic T4	Muslin T3
Platinum Metallic T1	Titanium T1

► LAMINATE TOPS

SPECIFY: Model Number,
Laminate
Edge Color
Grommet Color

EXAMPLE: HWR2424P.K&R.T5

► PAINTED PRODUCTS

SPECIFY: Model Number,
Paint Color

EXAMPLE: HRVSHV24.T1

◆◆◆ For lead time information see page 19.

* De-emphasized

Edge Treatments



"P" Edgeband

(Color must be selected.)

WORKING WITH ABODE™ COMPONENTS

Configurations

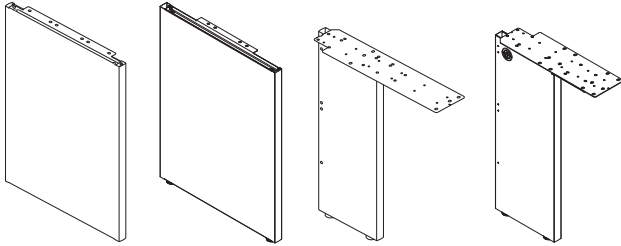

End Panels and Support Legs

Each are available in two options: freestanding or panel mount. The only difference between the two options are the panel-mount models come with a left- or right-handed bracket to attach the support to a panel in a systems application.

The 11"D end panel is used to support peninsulas.

Corner Desk Legs

Corner desk legs have a 90-degree bend and welded construction. The strong construction allows gussets or half-height modesty panels to be used with corner legs.

Bridge Kits

Bridge kits include: two flat brackets, two modesty panel-to-end panel attachment brackets, and two tie straps. This kit is used when attaching a bridge unit between two rectangular worksurfaces.

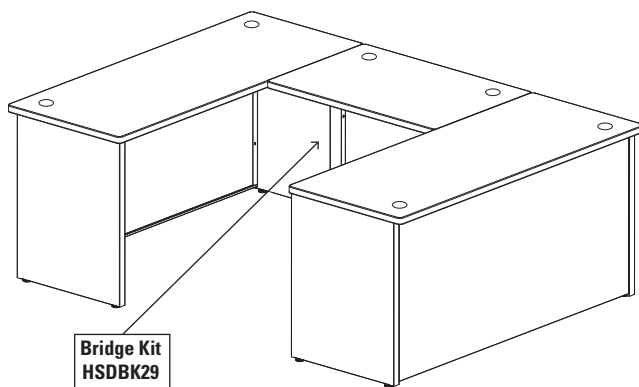

There are some bridge instances where only half of a bridge kit is needed (e.g., using a bridge between a rectangular worksurface and a corner or peninsula). A return kit may be ordered for these instances.

Support Column

Support columns are used to support one end of curvilinear worksurfaces. Includes column, worksurface bracket kit HWSA2, attaching hardware, and adjustable glides.

Return Kits

Return kits include: one flat bracket, one modesty panel-to-end panel attachment bracket, and one tie strap. These are used when attaching a return to a primary desk. Return kits can also be used in some bridge applications — one example is shown below when using a peninsula.

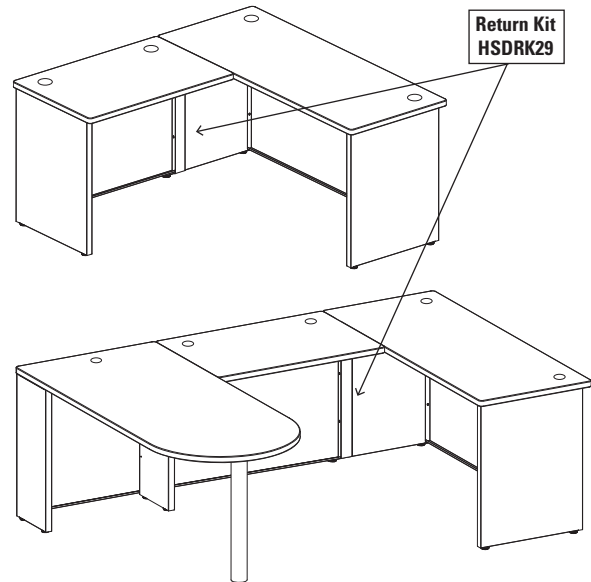

Desk-to-Panel Attachment Kits

Desk-to-panel attachment kits are used to connect a worksurface and modesty panel perpendicular to a panel of corresponding width. Opposing end of worksurface must be attached with an end panel, support leg, or corner leg mounted directly under this worksurface.

When using a corner or corner cove worksurface with the rear corner attached to a panel, and opposing end of worksurface is attached to a freestanding desk, use corner w/desk attachment kit. Hand of unit is determined from the user's side of the desk (right-hand unit attaches to right side of modesty).

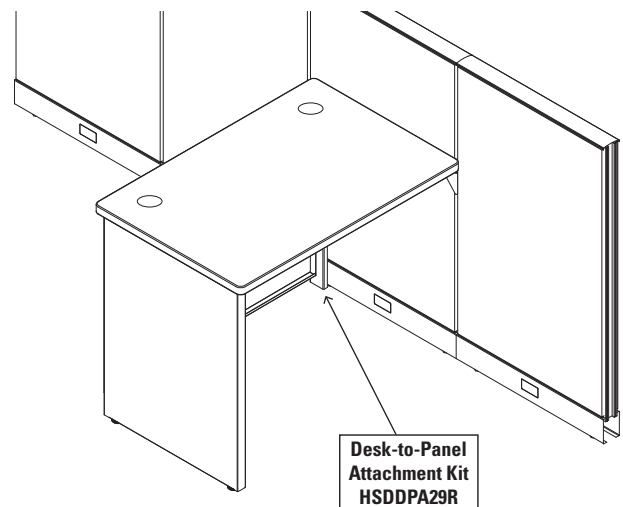

Corner w/Desk Panel Attachment Kit

Corner w/desk panel attachment kit connects the rear corner of a corner or corner cove worksurface and modesty panel to a panel when the opposing end of the worksurface shares a support leg with an adjacent freestanding desk and the support leg is mounted under the freestanding desk. Hand of unit is determined from the user's side of the desk (left-hand unit attaches to left side of modesty).

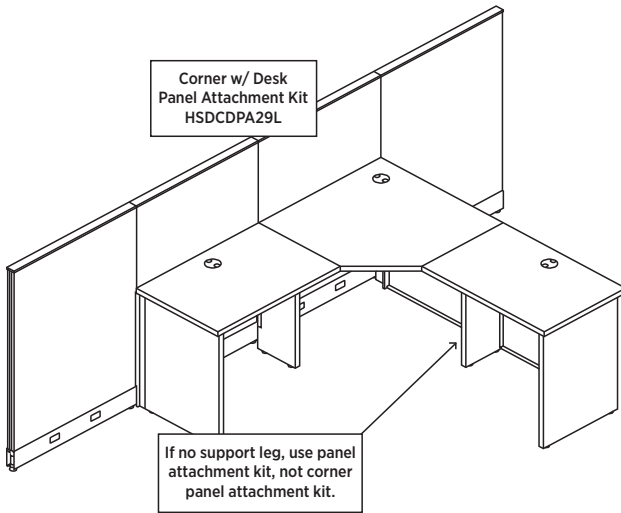

Corner Worksurfaces

Corner worksurfaces accommodate 90-degree corner desk legs.

In-Line Connections of Desks

Shared leg can be used at in-line connections to support adjacent rectangular desks.

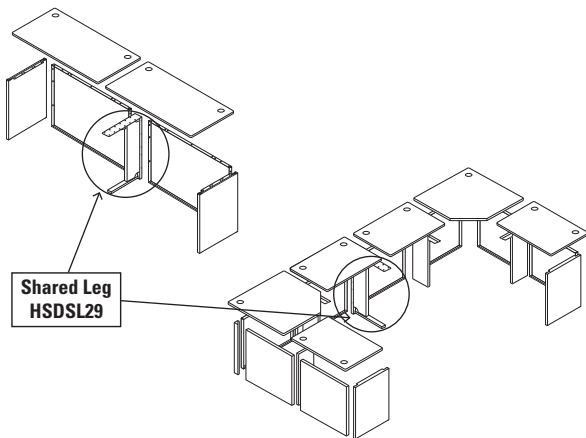

Pedestals and Storage

Pedestals must be ordered smaller than the depth of the worksurface. For example, 18"D peds should be used with 24"D worksurfaces. 18"D or 23"D pedestals can be used with 30"D worksurfaces. Using 18"D laterals or personal files provide additional storage options under 24"D worksurfaces.

Modesty Panels

The following are some general guidelines for Abode™ modesty panels:

- **Desk:** Modesty panel width is the same width as the worksurface
- **Return:** Modesty panel width is 6" greater than the width of the worksurface
- **Bridge connecting two rectangular worksurfaces:** Modesty panel width is 12" greater than the width of the bridge worksurface
- **Bridge connecting a rectangular worksurface and corner or peninsula:** Modesty panel width is 6" greater than the width of the worksurface
- **Corner connecting to an adjacent worksurface:** Modesty panel width is the same width as the worksurface.

Stand-Alone Corner Modesty Panels

Stand-alone corner modesty panels are used only when one or both sides of a corner or corner cove worksurface are freestanding and NOT attached to another worksurface. Specify the width the same as the width of the worksurface.

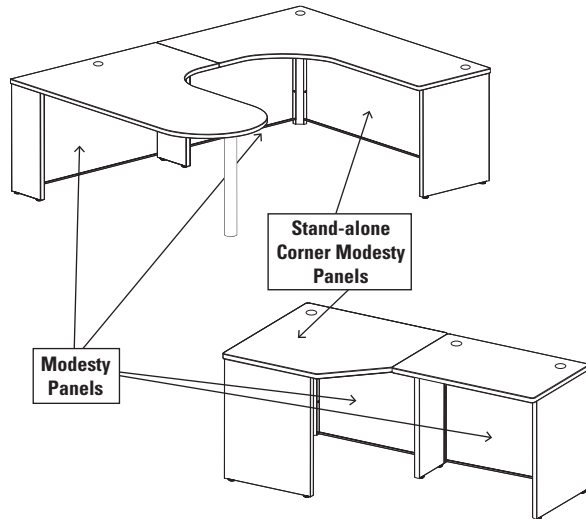

Gussets "G"

Gussets can be used in place of a modesty panel with desks 36"W to 60"W. Gussets can also be used with corner desk legs.

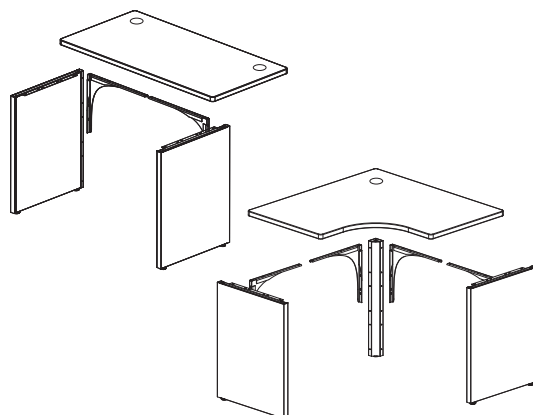



Icon Legend on page 19

The following five pages contain examples of Abode™ workstations. Each “typical” is shown in 3D hidden line perspective. Along with each typical is a complete listing of all the components. Use the information and format to better understand the layout and specifying of Abode™.

QTY	DESCRIPTION	MODEL	LIST PRICE	PRICE EXTENSION
1	Rectangle Worksurface 24”D x 36”W	HWR2436P	\$382	\$382
2	Freestanding End Panel Support 24”D x 29½”H	HSDEP2429F	\$220	\$440
1	Full-Height Modesty Panel 36”W x 29½”H	HSDMP369	\$207	\$207
TOTAL:			\$1,029	

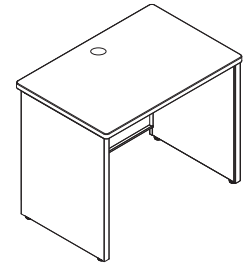

FREESTANDING DESK

QTY	DESCRIPTION	MODEL	LIST PRICE	PRICE EXTENSION
1	Rectangle Worksurface 24”D x 36”W	HWR2436P	\$382	\$382
1	Freestanding End Panel Support 24”D x 29½”H	HSDEP2429F	\$220	\$220
1	Full-Height Modesty Panel 36”W x 29½”H	HSDMP369	\$207	\$207
1	Desk-to-Panel Attachment Kit – Right-Handed 29½”H	HSDPPA29R	\$112	\$112
TOTAL:			\$921	

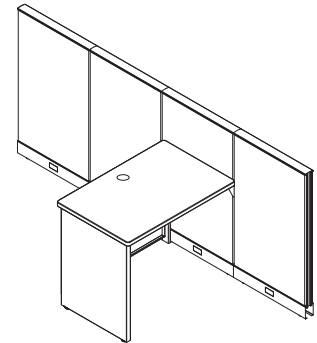

PANEL-ATTACHED DESK

QTY	DESCRIPTION	MODEL	LIST PRICE	PRICE EXTENSION
1	Rectangle Worksurface 24”D x 36”W	HWR2436P	\$382	\$382
1	Rectangle Worksurface 24”D x 60”W	HWR2460P	\$526	\$526
1	Full-Height Modesty Panel 42”W x 29½”H	HSDMP429	\$212	\$212
3	Freestanding End Panel Support 24”D x 29½”H	HSDEP2429F	\$220	\$660
1	Return Kit 29½”H	HSDRK29	\$115	\$115
1	Full-Height Modesty Panel 60”W x 29½”H	HSDMP609	\$225	\$225
TOTAL:			\$2,120	

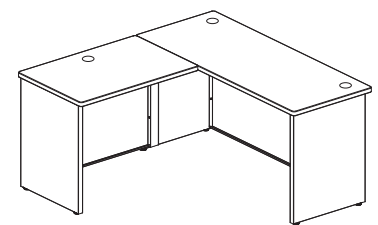

RETURN DESK

Attached to a primary or return desk

QTY	DESCRIPTION	MODEL	LIST PRICE	PRICE EXTENSION
1	Rectangle Worksurface 24”D x 48”W	HWR2448P	\$446	\$446
1	Full-Height Modesty Panel 54”W x 29½”H	HSDMP549	\$223	\$223
1	Freestanding End Panel Support 24”D x 29½”H	HSDEP2429F	\$220	\$220
1	Return Kit 29½”H	HSDRK29	\$115	\$115
1	End Panel Support – Right 24”D x 29½”H	HRVEP2429R	\$246	\$246
1	End Panel Support – Left 24”D x 29½”H	HRVEP2429L	\$246	\$246
1	Rectangle Worksurface 24”D x 60”W	HWR2460P	\$526	\$526
TOTAL:			\$2,022	

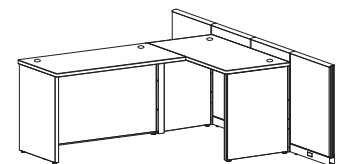

RETURN DESK

Attached to a panel-hung worksurface



QTY	DESCRIPTION	MODEL	LIST PRICE	PRICE EXTENSION
1	Rectangle Worksurface 24"D x 42"W	HWR2442P	\$419	\$419
2	Rectangle Worksurface 24"D x 72"W	HWR2472P	\$583	\$1,166
1	Full-Height Modesty Panel 54"W x 29½"H	HSDMP549	\$223	\$223
1	Bridge Kit	HSDBK29	\$219	\$219
2	Full-Height Modesty Panel 72"W x 29½"H	HSDMP729	\$234	\$468
4	Freestanding End Panel Support 24"D x 29½"H	HSDEP2429F	\$220	\$880
TOTAL:				\$3,375

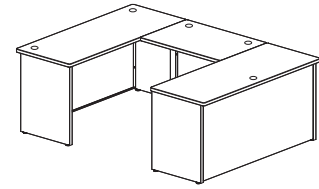

BRIDGE DESK

Attached between two primary desks

QTY	DESCRIPTION	MODEL	LIST PRICE	PRICE EXTENSION
1	Rectangle Worksurface 24"D x 36"W	HWR2436P	\$382	\$382
1	Rectangle Worksurface 24"D x 60"W	HWR2460P	\$526	\$526
1	Peninsula Worksurface 30"D x 60"W	HWP3060P	\$693	\$693
1	Full-Height Modesty Panel 42"W x 29½"H	HSDMP429	\$212	\$212
1	Full-Height Modesty Panel 30"W x 29½"H	HSDMP309	\$205	\$205
2	Freestanding End Panel Support 24"D x 29½"H	HSDEP2429F	\$220	\$440
1	Full-Height Modesty Panel 60"W x 29½"H	HSDMP609	\$225	\$225
1	Freestanding End Panel Support 11"D x 29½"H	HSDEP1129F	\$207	\$207
1	Freestanding Support Leg 24"D x 29½"H	HSDSL2429F	\$231	\$231
1	Support Column for Peninsula	HCNLEG29	\$240	\$240
1	Return Kit 29½"H	HSDRK29	\$115	\$115
TOTAL:				\$3,476

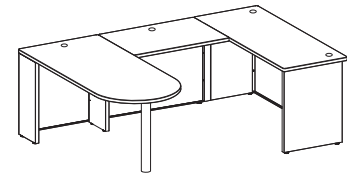

BRIDGE DESK AND PENINSULA

Attached to a primary desk

QTY	DESCRIPTION	MODEL	LIST PRICE	PRICE EXTENSION
1	Corner Worksurface 24"D x 36"W	HWCS3624P	\$575	\$575
2	Stand-Alone Corner Modesty Panel 36"W x 29½"H	HSDCMP3629	\$207	\$414
2	Freestanding End Panel Support 24"D x 29½"H	HSDEP2429F	\$220	\$440
1	Corner Desk Leg 29½"H	HSDDL29	\$187	\$187
TOTAL:				\$1,616

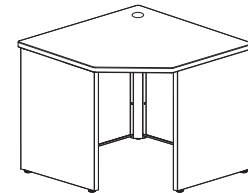

CORNER DESK

Stand-alone

QTY	DESCRIPTION	MODEL	LIST PRICE	PRICE EXTENSION
1	Corner Worksurface 24"D x 36"W	HWCS3624P	\$575	\$575
1	Rectangle Worksurface 24"D x 36"W	HWR2436P	\$382	\$382
1	Stand-Alone Corner Modesty Panel 36"W x 29½"H	HSDCMP3629	\$207	\$207
2	Full-Height Modesty Panel 36"W x 29½"H	HSDMP369	\$207	\$414
2	Freestanding End Panel Support 24"D x 29½"H	HSDEP2429F	\$220	\$440
1	Freestanding Support Leg 24"D x 29½"H	HSDSL2429F	\$231	\$231
1	Corner Desk Leg 29½"H	HSDDL29	\$187	\$187
TOTAL:				\$2,436

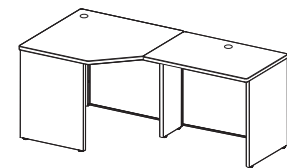

CORNER DESK

With adjacent desk attached at one side



Icon Legend on page 19

ABODE™ Typicals

WORKSTATIONS

QTY	DESCRIPTION	MODEL	LIST PRICE	PRICE EXTENSION
2	Rectangle Worksurface 24"D x 36"W	HWR2436P	\$382	\$764
1	Rectangle Worksurface 24"D x 72"W	HWR2472P	\$583	\$583
1	Corner Worksurface 24"D x 36"W	HWCS3624P	\$575	\$575
1	Full-Height Modesty Panel 42"W x 29½"H	HSDMP429	\$212	\$212
1	Return Kit 29½"H	HSDRK29	\$115	\$115
2	Freestanding Support Leg 24"D x 29½"H	HSDSL2429F	\$231	\$462
3	Freestanding End Panel Support 24"D x 29½"H	HSDEP2429F	\$220	\$660
1	Full-Height Modesty Panel 72"W x 29½"H	HSDMP729	\$234	\$234
3	Full-Height Modesty Panel 36"W x 29½"H	HSDMP369	\$207	\$621
1	Corner Desk Leg 29½"H	HSDDL29	\$187	\$187
TOTAL:			\$4,413	

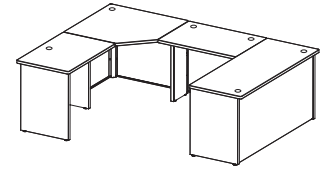

BRIDGE DESK

Attached between corner and primary desk

QTY	DESCRIPTION	MODEL	LIST PRICE	PRICE EXTENSION
1	Jetty - Right-Handed 48"D x 72"W x 24" x 30"	HWJ59ABRP	\$929	\$929
1	Corner Cove - Right-Handed 72" x 48" x 24" x 24"	HWV95AARP	\$918	\$918
2	Full-Height Modesty Panel 48"W x 29½"H	HSDMP489	\$220	\$440
1	Stand-Alone Corner Modesty Panel 72"W x 29½"H	HSDCMP7229	\$234	\$234
1	Freestanding End Panel Support 11"D x 29½"H	HSDEP1129F	\$207	\$207
1	Freestanding Support Leg 24"D x 29½"H	HSDSL2429F	\$231	\$231
1	Freestanding End Panel Support 24"D x 29½"H	HSDEP2429F	\$220	\$220
1	Corner Desk Leg 29½"H	HSDDL29	\$187	\$187
1	Support Column	HCNLEG29	\$240	\$240
TOTAL:			\$3,606	

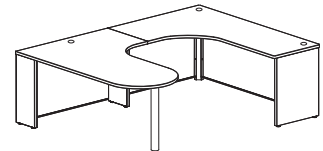

"U" WITH JETTY AND CORNER COVE

QTY	DESCRIPTION	MODEL	LIST PRICE	PRICE EXTENSION
4	Rectangular Worksurface 24"D x 72"W	HWR2472P	\$583	\$2,332
2	Abound® Panel Frame 35"H x 24"W	HRVF3524P	\$258	\$516
2	Abound® Panel Frame 35"H x 48"W	HRVF3548P	\$298	\$596
4	Abound® Fabric Tile 30"H x 24"W	HRVT3024T	\$110	\$440
4	Abound® Fabric Tile 30"H x 48"W	HRVT3048T	\$150	\$600
2	Abound® Frameless Glass 7½"H x 72"W	HRVT072F	\$929	\$1,858
2	Abound® Finished End Trim 30"H	HRVC30PF	\$86	\$172
2	Abode™ Desk-to-Panel Attachment Kits - Left 29½"H	HSDDPA29L	\$112	\$224
2	Abode™ Desk-to-Panel Attachment Kits - Right 29½"H	HSDDPA29R	\$112	\$224
4	Abode™ Full-Height Modesty Panel 72"W	HSDMP729	\$234	\$936
4	Abode™ Freestanding End Panel 24"D	HSDEP2429F	\$220	\$880
2	Contain® Low Credenza, Box/Lateral - Right 48"W	HSCP224818LBFOM	\$1,792	\$3,584
2	Contain® Low Credenza, Box/Lateral - Left 48"W	HSCP224818RBFOM	\$1,792	\$3,584
4	Flagship® Freestanding Support Ped B/B/F	H19717A	\$779	\$3,116
4	Voi® Above Privacy Screen 60"W x 13"H	HLSL1260	\$508	\$2,032
4	Credenza Storage-to-Panel Bracket	HSCAPB	\$220	\$880
TOTAL:			\$21,974	

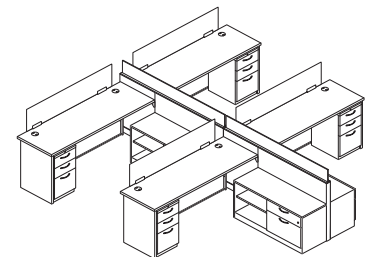

ABODE™ WITH ABOUND®

ABODE™ Typicals



Icon Legend on page 19

WORKSTATIONS

QTY	DESCRIPTION	MODEL	LIST PRICE	PRICE EXTENSION
2	Rectangular Worksurface 24"D x 36"W	HWR2436P	\$382	\$764
1	Corner Worksurface 24"D x 36"W	HWCS3624P	\$575	\$575
2	Abode™ Freestanding End Panel 24"D	HSDEP2429F	\$220	\$440
2	Abode™ Freestanding Support Leg 24"D	HSDSL2429F	\$231	\$462
1	Abode™ Corner Desk Leg 29½"H	HSDDL29	\$187	\$187
4	Abode™ Full-Height Modesty Panel 36"W	HSDMP369	\$207	\$828
2	Flagship® Freestanding Support Ped B/B/F	H19717A	\$779	\$1,558
TOTAL:				\$4,814

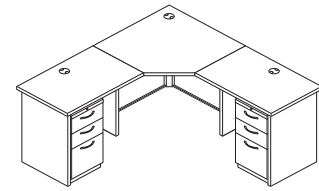

CORNER WITH RETURN

QTY	DESCRIPTION	MODEL	LIST PRICE	PRICE EXTENSION
8	Accelerate® Tackable Panel 65"H x 24"W	HETP6524FP	\$410	\$3,280
2	Accelerate® Tackable Panel 65"H x 48"W	HETP6548FP	\$526	\$1,052
6	Accelerate® Top Cap 24"W	HETC24	\$42	\$252
2	Accelerate® Top Cap 72"W	HETC72	\$114	\$228
4	Rectangular Worksurface 24"D x 72"W	HWR2472P	\$583	\$2,332
4	Rectangular Worksurface 24"D x 48"W	HWR2448P	\$446	\$1,784
2	Accelerate® "T" Connector 65"H	HEC65PTN	\$155	\$310
1	Accelerate® "X" Connector 65"H	HEC65PXN	\$149	\$149
6	Accelerate® Panel Finished End Covers 65"H	HEFEC65P	\$73	\$438
8	Accelerate® Worksurface Bracket Kit	HWSB2	\$52	\$416
4	Flat Bracket 24"D	HHN831124	\$72	\$288
4	Flagship® Freestanding Support Ped B/B/F	H19717A	\$779	\$3,116
2	Abode™ Desk-to-Panel Attachment Kits - Left 29½"H	HSDDPA29L	\$112	\$224
2	Abode™ Desk-to-Panel Attachment Kits - Right 29½"H	HSDDPA29R	\$112	\$224
4	Abode™ Freestanding End Panel 24"D	HSDEP2429F	\$220	\$880
4	Abode™ Full-Height Modesty Panel 72"W	HSDMP729	\$234	\$936
4	Systems Overhead Storage Flipper Door 48"W	HRVOH48FM	\$697	\$2,788
4	Systems Overhead Storage Shelf 24"W	HRVSH24	\$257	\$1,028
4	Vol® Above Privacy Screen 42"W x 13"H	HLSL1242	\$387	\$1,548
2	"T" Connector	HECST	\$24	\$48
1	"X" Connector	HECSX	\$29	\$29
TOTAL:				\$21,350

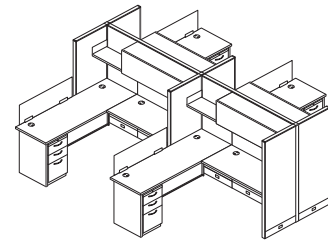

ABODE™ WITH ACCELERATE®

QTY	DESCRIPTION	MODEL	LIST PRICE	PRICE EXTENSION
1	Rectangular Worksurface 24"D x 72"W	HWR2472P	\$583	\$583
1	Rectangular Worksurface 24"D x 48"W	HWR2448P	\$446	\$446
1	Peninsula Worksurface 30"D x 72"W	HWP3072P	\$837	\$837
1	Stack-on Full Clearance w/o Doors 13"D x 72"W x 34¾"H	H386572N	\$1,034	\$1,034
1	Flipper Doors w/ Lock 36"W x 16"H	H387215	\$643	\$643
1	Tackboard for 72"W Hutch 72"	HT72ND	\$577	\$577
1	Support Column for Peninsula 29"H	HCNLEG29	\$240	\$240
2	Abode™ Freestanding End Panel 24"D	HSDEP2429F	\$220	\$440
1	Abode™ Freestanding End Panel 11"D	HSDEP1129F	\$207	\$207
1	Abode™ Freestanding Support Leg 24"D	HSDSL2429F	\$231	\$231
1	Abode™ Return Kit	HSDRK29	\$115	\$115
1	Abode™ Full-Height Modesty Panel 72"W	HSDMP729	\$234	\$234
1	Abode™ Full-Height Modesty Panel 54"W	HSDMP549	\$223	\$223
1	Abode™ Full-Height Modesty Panel 30"W	HSDMP309	\$205	\$205
1	Flagship® 2 Drawer "A" Pull Lateral 30"W	H9170A	\$1,116	\$1,116
TOTAL:				\$7,131

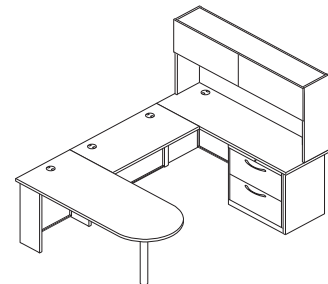

PENINSULA U



Icon Legend on page 19

ABODE™ Typicals

QTY	DESCRIPTION	MODEL	LIST PRICE	PRICE EXTENSION
2	Rectangular Worksurface 24"D x 72"W	HWR2472P	\$583	\$1,166
1	Height Adjustable Worksurface 24"D x 48"W	HHATW2448CT	\$446	\$446
1	Stack-on Full Clearance w/o Doors 13"D x 72"W x 34¾"H	H386572N	\$1,034	\$1,034
1	Flipper Doors w/ Lock 36"W x 16"H	H387215	\$643	\$643
1	Tackboard for 72"W Hutch 72"	HT72ND	\$577	\$577
2	Abode™ Full-Height Modesty Panel 72"W	HSDMP729	\$234	\$468
4	Abode™ Freestanding End Panel 24"D	HSDEP2429F	\$220	\$880
1	Coordinate™ Height Adjustable Base, Rectangle T-Foot	HHATB3S2LT	\$1,047	\$1,047
2	Flagship® 2 Drawer "A" Pull Lateral 30"W	H9170A	\$1,116	\$2,232
TOTAL:				\$8,493

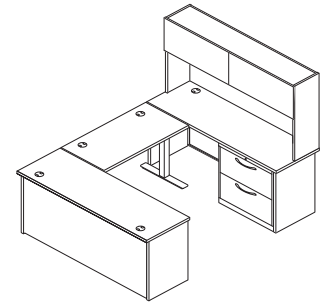

WORKSTATION U

WORKSTATIONS

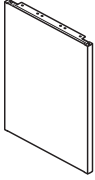

DESCRIPTION	MODEL	SHIP WEIGHT	CUBE	LIST PRICE BY PAINT GRADE	
				P1	P2
Freestanding End Panel Supports					
11"D	HSDEP1129F	15	1.1	\$207	\$234
24"D	HSDEP2429F	25	1.1	\$220	\$247
30"D	HSDEP3029F	30	1.1	\$244	\$271

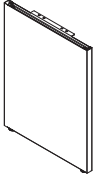

Panel Mounted Full End Panel Supports*					
29½"H x 11"D — Right — Panel Mount	HRVEP1129R	16	1.4	\$228	\$257
29½"H x 11"D — Left — Panel Mount	HRVEP1129L	16	1.4	\$228	\$257
29½"H x 24"D — Right — Panel Mount	HRVEP2429R	21	1.4	\$246	\$275
29½"H x 24"D — Left — Panel Mount	HRVEP2429L	21	1.4	\$246	\$275
29½"H x 30"D — Right — Panel Mount	HRVEP3029R	23	1.4	\$268	\$297
29½"H x 30"D — Left — Panel Mount	HRVEP3029L	23	1.4	\$268	\$297

*Must be connected into panel slots. When an installation of worksurfaces is 8 feet or greater, a full end panel or universal support leg must be used at 90 degree panel junctions or in a shared position to support adjoining worksurfaces.

Specify paint

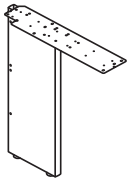

Freestanding Support Leg					
24"D	HSDSL2429F	25	1.1	\$231	\$258
30"D	HSDSL3029F	25	1.1	\$259	\$286

NOTES: To be used when connecting a non-rectangular worksurface to a rectangular worksurface.

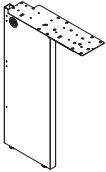

Panel Mounted Support Leg*					
29½"H to support 24"D	HRVCLG24	16	1.4	\$218	\$247
29½"H to support 30"D	HRVCLG30	17	1.4	\$238	\$267

*Must be connected into panel slots. When an installation of worksurfaces is 8 feet or greater, a full end panel or universal support leg must be used at 90 degree panel junctions or in a shared position to support adjoining worksurfaces.

Non-handed unit
Specify paint

NOTES:

All Abode™ Components are compatible with Abound® and Accelerate® panel systems and Systems Worksurfaces.





HOW TO SPECIFY

<p>Select Model Number</p> <p>HSDEP1129F . T1</p>	<p>Select Paint Color</p> <p>See page 410</p>
---	---

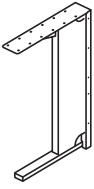

Icon Legend on page 19

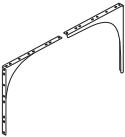
ABODE™ Components

	DESCRIPTION	MODEL	SHIP WEIGHT	CUBE	LIST PRICE BY PAINT GRADE	
					P1	P2
	Abode™ Shared Leg NOTES: To be used when joining two rectangular surfaces. Can be used as a stand-alone support in panel systems. 1/2" radius opening for cord management.	HDSL29	18	1.5	\$420	\$447
	Corner Desk Leg 29 1/2" H NOTES: Corner desk legs have 90° bend and welded construction.	HDDL29	7	0.4	\$187	\$214
	Gussets (1 pair) NOTES: Gussets may be used instead of a modesty panel to create freestanding desks 36" W to 60" W.	HSDG	7	0.5	\$129	\$146
	Flat Bracket 24" D 30" D ! Charcoal only.	HHN831124 ☺ HHN831130	3 3	0.3 0.4	\$72 \$72	N/A N/A

NOTES:

! All Abode™ Components are compatible with Abound® and Accelerate® panel systems and Systems Worksurfaces.

EXTERNAL CHANNEL SELECTION GUIDE						
Support Combination		Worksurface Width for Rectangle, Wedge, and Saddle				
Support 1	Support 2	84 in	72 in	66 in	60 in	54 in
O-Leg	O-Leg	NA	HLSLZ5SC72	HLSLZ5SC66	HLSLZ5SC60	HLSLZ5SC54
O-Leg	Slim Profile Pedestal	HLSLZ5SC84	HLSLZ5SC66	HLSLZ5SC60	HLSLZ5SC54	NA
O-Leg	Bookcase	HLSLZ5SC72	HLSLZ5SC66	HLSLZ5SC60	HLSLZ5SC54	NA
O-Leg	Pedestal	HLSLZ5SC72	HLSLZ5SC60	HLSLZ5SC54	NA	NA
O-Leg	End-Panel	HLSLZ5SC84	HLSLZ5SC60	HLSLZ5SC54	NA	NA
Slim Profile Pedestal	Slim Profile Pedestal	HLSLZ5SC72	HLSLZ5SC60	HLSLZ5SC54	NA	NA
Slim Profile Pedestal	Bookcase	HLSLZ5SC72	HLSLZ5SC60	HLSLZ5SC54	NA	NA
Slim Profile Pedestal	Pedestal	HLSLZ5SC66	HLSLZ5SC54	NA	NA	NA
Slim Profile Pedestal	End-Panel	HLSLZ5SC66	HLSLZ5SC54	NA	NA	NA
Pedestal	Bookcase	HLSLZ5SC66	HLSLZ5SC54	NA	NA	NA
End-Panel	Bookcase	HLSLZ5SC66	HLSLZ5SC54	NA	NA	NA
Bookcase	Bookcase	HLSLZ5SC66	HLSLZ5SC54	NA	NA	NA
End-Panel	End-Panel	HLSLZ5SC60	NA	NA	NA	NA
Pedestal	Pedestal	HLSLZ5SC60	NA	NA	NA	NA
Pedestal	End-Panel	HLSLZ5SC60	NA	NA	NA	NA
O-Leg	Lateral/Multifile	HLSLZ5SC54	NA	NA	NA	NA
Bookcase	Lateral/Multifile	NA	NA	NA	NA	NA
Slim Profile Pedestal	Lateral/Multifile	NA	NA	NA	NA	NA
Pedestal	Lateral/Multifile	NA	NA	NA	NA	NA
End-Panel	Lateral/Multifile	NA	NA	NA	NA	NA

*All Rudder worksurfaces use external channel model HLSLZ5SC60.

HOW TO SPECIFY

<p>Select Model Number</p> <p>H S D S L 2 9 .</p>	<p>Select Paint Color</p> <p>See page 410</p> <p>T 1</p>
--	---

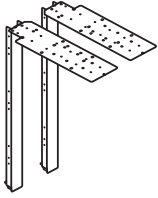

DESCRIPTION

MODEL

SHIP WEIGHT

CUBE

LIST PRICE BY PAINT GRADE

P1

P2

Bridge Kit

29½”H

HSDBK29

10

0.4

\$219

\$246

NOTES: Add 12” to your modesty width when using a Bridge Kit. Bridge Kits include two flat brackets, two modesty panel-to-end panel attachment brackets, and two tie straps.

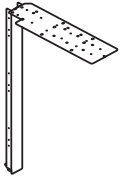

Return Kit

29½”H

HSDRK29

6

0.4

\$115

\$142

NOTES: Add 6” to your modesty width when using a Return Kit. Return Kits include one flat bracket, one modesty panel-to-end panel attachment bracket, and one tie strap.



Desk-to-Panel Attachment Kit

29½”H

HSDDPA29L

5

0.3

\$112

\$122

29½”H

HSDDPA29R

5

0.3

\$112

\$122



Corner with Desk-to-Panel Attachment Kit

29½”H

HSDCPA29L

5

0.3

\$112

\$122

29½”H

HSDCPA29R

5

0.3

\$112

\$122

NOTES: This Attachment Kit utilizes the same modesty panel specification rules as the Freestanding Corner Leg.

HOW TO SPECIFY

Select Model Number

Select Paint Color

See page 410

H S D B K 2 9 .

T 1

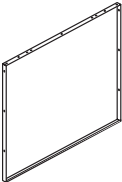
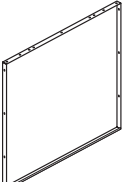
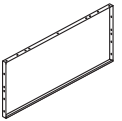
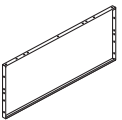

	DESCRIPTION	MODEL	SHIP WEIGHT	CUBE	LIST PRICE BY PAINT GRADE	
					P1	P2
	Full-Height Modesty Panel					
	29½" H x 24" W	HSDMP249	5.0 Ⓢ	0.6	\$199	\$216
	29½" H x 30" W	HSDMP309	7.0 Ⓢ	0.6	\$205	\$222
	29½" H x 36" W	HSDMP369	8.0	0.8	\$207	\$224
	29½" H x 42" W	HSDMP429	9.0	0.9	\$212	\$229
	29½" H x 48" W	HSDMP489	11.0	1.0	\$220	\$237
	29½" H x 54" W	HSDMP549	12.0	2.2	\$223	\$240
	29½" H x 60" W	HSDMP609	13.0	2.2	\$225	\$242
	29½" H x 66" W	HSDMP669	15.0	2.6	\$231	\$248
	29½" H x 72" W	HSDMP729	16.0	3.0	\$234	\$251
! To be used in all applications except when connecting a Corner Leg to an End Panel or a Corner Leg to a Shared Leg.						
	Full-Height Stand-Alone Corner Modesty Panel					
	29½" H x 36" W	HSDCMP3629	7.0	1.9	\$207	\$224
	29½" H x 42" W	HSDCMP4229	9.0	1.9	\$212	\$229
	29½" H x 48" W	HSDCMP4829	10.0	2.3	\$220	\$237
	29½" H x 60" W	HSDCMP6029	14.0	4.7	\$225	\$242
NOTES: To be used when connecting a Corner Leg to an End Panel or Shared Leg.						
	Half-Height Modesty Panel					
	14" H x 24" W	HSDMP244	5.1 Ⓢ	0.4	\$186	\$203
	14" H x 30" W	HSDMP304	6.6 Ⓢ	0.4	\$190	\$207
	14" H x 36" W	HSDMP364	8.1 Ⓢ	0.5	\$193	\$210
	14" H x 42" W	HSDMP424	9.6 Ⓢ	0.6	\$204	\$221
	14" H x 48" W	HSDMP484	11.0 Ⓢ	0.6	\$207	\$224
	14" H x 54" W	HSDMP544	13.0 Ⓢ	0.8	\$210	\$227
	14" H x 60" W	HSDMP604	14.0 Ⓢ	0.8	\$214	\$231
	14" H x 66" W	HSDMP664	16.0 Ⓢ	1.0	\$220	\$237
	14" H x 72" W	HSDMP724	17.0 Ⓢ	1.0	\$223	\$240
	Half-Height Stand-Alone Corner Modesty Panel					
	14" H x 36" W	HSDCMP3614	4.0 Ⓢ	0.5	\$193	\$210
	14" H x 42" W	HSDCMP4214	4.0 Ⓢ	0.6	\$204	\$221
	14" H x 48" W	HSDCMP4814	5.0 Ⓢ	0.6	\$207	\$224
	14" H x 60" W	HSDCMP6014	6.0 Ⓢ	0.8	\$214	\$231
	14" H x 72" W	HSDCMP7214	7.0 Ⓢ	1.0	\$223	\$240

NOTES:

- Desk: Modesty panel width is the same width as the worksurface.
- Return: Modesty panel width is 6" greater than the width of the return worksurface.
- Bridge connecting two rectangular worksurfaces: Modesty panel width is 12" greater than the width of the bridge worksurface.
- Bridge connecting a rectangular worksurface and corner or peninsula: Modesty panel width is 6" greater than the width of the worksurface.
- Corner connecting to an adjacent worksurface: Modesty panel width is the same width as the worksurface.

HOW TO SPECIFY

Select Model Number	Select Paint Color
HSDMP249	See page 410
T1	

ABOUND®

Want to see more? Scan here
to check out hon.com.



WORKSTATIONS



Abound® shown with Contain® Storage, Ignition® Seating, and Voi® Desking.

ABOUND®

Why settle for a one-dimensional, uninspired cubicle when you can choose a workstation with dynamic flexibility, powerful performance, and stunning architectural aesthetics? Abound raises the bar on cohesive solutions that keep us connected, engaged, and productive. With numerous tile styles to choose from — fabric, glass, gallery panels, and more. You can customize Abound to suit any space, from collaborative meeting spaces to private offices and everything in between.

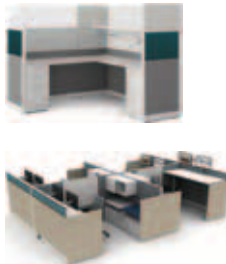

FEATURES

- With multiple tile options, materials and fabrics, Abound supports a variety of work styles and office budgets.
- Top channel lay-in or beltline capabilities expand your cabling capacity.
- Open Base frame option brings a lighter scale aesthetic and allows for easier cleaning.
- Straight lines, crisp edges and rectilinear worksurfaces fit precisely together to create a tailored, architectural presence.
- With a variety of layout options and compatibility with HON storage, height adjustable bases and freestanding desks, the options with Abound are endless.

ABOUT® ORDERING INFORMATION

GALLERY PANELS, WORKSURFACES, COUNTERTOPS, CORNER SHELVES W/EDGE BAND, HARD-SURFACE TILE OVERHEAD STORAGE DOORS*

L1 LAMINATES CODES

Woodgrain

- ◆ Bourbon Cherry H
- ◆ Cognac COGN
- ◆ Florence Walnut LFW1
- ◆ Harvest C
- ◆ Kingswood Walnut LK1I
- ◆ Mahogany N
- ◆ Mocha MOCH
- ◆ Natural Maple D
- ◆ Pinnacle PINC
- ◆ Shaker Cherry F
- ◆ Sterling Ash LSA1

Solid

- ◆ Black P
- ◆ Charcoal S
- ◆ Designer White LDW1
- ◆ Loft LOFT

Patterned

- ◆ Handspun Chestnut LAHC
- ◆ Handspun Dove LAHD
- ◆ Handspun Pearl LAHP
- ◆ Handspun Slate LAHS
- ◆ Sheer Mesh * A5
- ◆ Silver Mesh B9
- ◆ Steel Mesh * A9
- ◆ Canyon Zephyr * K9
- ◆ Desert Zephyr * K8
- ◆ Shadow Zephyr * K1
- ◆ Gray G2
- ◆ Grey Tigris * L6
- ◆ White G1
- ◆ Whitestone * K4

► **LAMINATE TOPS**
SPECIFY: Model Number.
Laminate
Edge Color
Grommet Color
EXAMPLE: HWR2424P.K8.R.T5

► **PAINTED PRODUCTS**
SPECIFY: Model Number.
Paint Color
EXAMPLE: HRVSHV24.T1

► **PANEL FRAMES**
SPECIFY: Model Number.
Paint
EXAMPLE: HRVF3524P.T3

Suffix "A"



Satin Chrome Arch Pull

* Laminate Front Overheads only available in L1 Woodgrain Laminates.

◆◆◆ For lead time information see page 19.
* De-emphasized

GALLERY PANELS, WORKSURFACES, COUNTERTOPS, CORNER SHELVES W/EDGE BAND, HARD-SURFACE TILE OVERHEAD STORAGE DOORS* *continued*

L2 LAMINATES CODES

Woodgrain

- ◆ Lowell Ash LLA1
- ◆ Natural Recon LNR1
- ◆ Phantom Ecru LPE1
- ◆ Portico Teak LPT1
- ◆ Skyline Walnut LSW1
(Door panels not available in L2)

WORKSURFACE EDGE BAND

- ◆ Black P
- ◆ Bourbon Cherry H
- ◆ Brownstone EY
- ◆ Charcoal S
- ◆ Cognac COGN
- ◆ Designer White DW
- ◆ Florence Walnut FW
- ◆ Fossil EH
- ◆ Greige R
- ◆ Harvest C
- ◆ Kingswood Walnut KI
- ◆ Light Gray Q
- ◆ Loft LOFT
- ◆ Lowell Ash DL
- ◆ Mahogany N
- ◆ Mocha MOCH
- ◆ Muslin T
- ◆ Natural Maple D
- ◆ Natural Recon NR
- ◆ Phantom Ecru PE
- ◆ Pinnacle PINC
- ◆ Platinum K
- ◆ Portico Teak DP
- ◆ Shadow * SHDW
- ◆ Shaker Cherry F
- ◆ Skyline Walnut SW
- ◆ Sterling Ash SA

Edge Treatments



"P" Edgeband

(Color must be selected.)

► **HOW TO ORDER**

- 1) Select desired model numbers.
- 2) Order worksurfaces to correspond to width of panel behind them.
- 3) Add appropriate prefix and suffix if Tee-Span worksurfaces are needed.

WORKSURFACE GROMMET

PLASTIC CODES

- ◆ Black P
- ◆ Brownstone EY
- ◆ Charcoal S
- ◆ Fossil EH
- ◆ Greige T5
- ◆ Light Gray Q
- ◆ Loft LOFT
- ◆ Muslin T3
- ◆ Titanium TI
- ◆ Shadow * SHDW
- ◆ Designer White DW
- ◆ Champagne Metallic T4
- ◆ Platinum Metallic T1

FRAMES, TRIM, METAL TILES, CUSTOM BRACKET KIT, WORKSURFACE SUPPORTS, STEEL OVERHEAD STORAGE CHASSIS

PAINT CODES

P1

- ◆ Black P
- ◆ Brownstone P7D
- ◆ Charcoal S
- ◆ Designer White PJW
- ◆ Fossil P28
- ◆ Greige T5
- ◆ Light Gray Q
- ◆ Loft LOFT
- ◆ Muslin T3
- ◆ Putty L
- ◆ Shadow * SHDW
- ◆ Titanium P8T

P2

- ◆ Champagne Metallic T4
- ◆ Platinum Metallic T1
- ◆ Silver PR6
- ◆ Solar Black P8X

DUPLEX/PORTED TILE

PLASTIC CODES

- ◆ Black P
- ◆ Charcoal S
- ◆ Designer White DW
- ◆ Loft LOFT
- ◆ Muslin T3
- ◆ Titanium TI

Recommendations

Paint	Duplex-Data Code
Black P	Black P
Brownstone P7D	Brownstone EY
Charcoal S	Charcoal S
Designer White PJW	Designer White DW
Fossil P28	Charcoal S
Greige T5	Muslin T3
Light Gray Q	Muslin T3
Loft LOFT	Loft LOFT
Muslin T3	Muslin T3
Putty L	Black P
Shadow SHDW	Muslin T3
Silver PR6	Titanium TI
Titanium P8T	Titanium TI
Champagne Metallic T4	Muslin T3
Platinum Metallic T1	Titanium TI

ABOUND[®] FABRIC PATTERNS & CODES

PRICE CODE AA

FACTOR	FACT
◆ Bark	FACT20
◆ Barley	FACT15
◆ Cascade	FACT25
◆ Feather	FACT30

PRICE CODE A

APPOINT	APN
◆ Artichoke	APN11
◆ Blackberry	APN32
◆ Bronze	APN22
◆ Carbon	APN28
◆ Chai	APN12
◆ Cherry	APN30
◆ Dark Pewter	APN17
◆ Dune	APN15
◆ Espresso	APN23
◆ Framboise	APN31
◆ Frost	APN34
◆ Jet	APN27
◆ Lawn	APN25
◆ Mandarin	APN29
◆ Morel	APN09
◆ Nimbus	APN16
◆ Platinum	APN24
◆ Turquoise	APN26

CENTURION CU

Not available on heights over 54"H

◆ Apricot	CU47
◆ Bark	CU25
◆ Black	CU10
◆ Espresso	CU49
◆ Fog	CU03
◆ Frost	CU22
◆ Goldenrod	CU27
◆ Indigo	CU06
◆ Iris	CU50
◆ Iron Ore	CU19
◆ Jade	CU83
◆ Marsala	CU63
◆ Morel	CU24
◆ Navy	CU98
◆ Peacock	CU97
◆ Pear	CU84
◆ Ruby	CU67
◆ Sapphire	CU09

PRICE CODE A *continued*

ETCH*	ECH
◆ Axis	ECH13
◆ Blend	ECH14
◆ Cast	ECH12
◆ Highlight	ECH10
◆ Midtone	ECH11
◆ Outline	ECH08
◆ Shade	ECH09
◆ Tonal	ECH16
◆ Vanish	ECH15

EXCHANGE* EXG

◆ Iron	EXG916
◆ Nickel	EXG914
◆ Pistachio	EXG910
◆ Root	EXG913
◆ Rupee	EXG903
◆ Shadow	EXG911
◆ Silver	EXG915
◆ Sisal	EXG917
◆ Stone	EXG912

LANDSCAPE* LN

◆ Azure	LN55
◆ Cornsilk	LN15
◆ Drift	LN05
◆ Khaki	LN20
◆ Sheen	LN10
◆ Slate	LN35
◆ Umber	LN25
◆ Urban	LN30

LUCY* LC

◆ Aspen	LC32
◆ Cornsilk	LC30
◆ Dusk	LC22
◆ Fawn	LC33
◆ Graphite	LC34
◆ Mist	LC20
◆ Neutra	LC24
◆ Pewter	LC35
◆ Snowdrop	LC28

PRICE CODE A *continued*

REFLECTIONS*	REF
◆ Galvanized	REF29
◆ Ice	REF20
◆ Loggia	REF21
◆ Mistral	REF28
◆ Moonstone	REF23
◆ Pewter	REF22
◆ Stainless	REF24
◆ Vanilla	REF25
◆ Winter	REF27

REFUGE* RFG

◆ Artesian	RFG96
◆ Dune	RFG92
◆ Eclipse	RFG90
◆ Frost	RFG93
◆ Glacier	RFG91
◆ Mineral	RFG98
◆ Tidal	RFG94

SARTO* SRT

◆ Ash	SRT88
◆ Fog	SRT14
◆ Lemongrass	SRT49
◆ Mist	SRT45
◆ Mushroom	SRT76
◆ Oyster	SRT18
◆ Reef	SRT64
◆ Sesame	SRT93
◆ Shale	SRT52

TEMPEST* TP

◆ Dragonfly	TP30
◆ Frost	TP15
◆ Full Stream	TP80
◆ Gold Rush	TP10
◆ Slate	TP45
◆ Tumbleweed	TP70
◆ Wind Chill	TP40
◆ Zebra	TP35

NOTES: Analog, Disperse, and Exchange panel fabrics will be applied pattern cut. Disperse will not be available on 72"W panels.

◆◆◆ For lead time information see page 19.

* Directional fabrics

ABOUND[®] FABRIC PATTERNS & CODES

PRICE CODE B

ANALOG*	ANLG
◆ Album	ANLG06
◆ Cartridge	ANLG04
◆ Cassette	ANLG09
◆ Dial	ANLG02
◆ Media	ANLG08
◆ Reel	ANLG07
◆ Signal	ANLG03
◆ Stereo	ANLG01
◆ Track	ANLG05

COAST*	COA
◆ Channel	COA14
◆ Dune	COA03
◆ Headlands	COA10
◆ Marsh	COA02
◆ Pebble	COA12
◆ Pier	COA13
◆ Shoal	COA01
◆ Silt	COA06
◆ Tide	COA08

DISPERSE*	DISP
◆ Autumn	DISP03
◆ Branch	DISP10
◆ Coffee Bean	DISP13
◆ Dusk	DISP09
◆ Emerald City	DISP08
◆ Gold Rush	DISP02
◆ Igloo	DISP11
◆ Ink	DISP06
◆ Mist	DISP12
◆ Oatmeal	DISP15
◆ Prince	DISP07
◆ Reservoir	DISP01
◆ Rose	DISP04
◆ Spring	DISP05
◆ Steel	DISP16
◆ Taupe	DISP14

PRICE CODE B *continued*

MICA*	MCA
◆ Anthracite	MCA11
◆ Breeze	MCA18
◆ Bronze	MCA13
◆ Buff	MCA14
◆ Cremini	MCA17
◆ Crystal	MCAWIT
◆ Dew	MCA20
◆ Dove	MCA12
◆ Fresh	MCA16
◆ Mineral	MCA15
◆ Nectar	MCA19
◆ Shale	MCA10

SPIN*	SPIN
◆ Alabaster	SPIN02
◆ Cavern	SPIN03
◆ Cobblestone	SPIN04
◆ Ember	SPIN06
◆ Flame	SPIN07
◆ Heron	SPIN13
◆ Oat	SPIN01
◆ Ocean	SPIN12
◆ Plum	SPIN15
◆ Pool	SPIN11
◆ Raven	SPIN10
◆ Rhubarb	SPIN14
◆ Tropic	SPIN08
◆ Willow	SPIN05

PRICE CODE B *continued*

TERRAIN*	TRRN
◆ Bay	TRRN05
◆ Bayou	TRRN35
◆ Canyon	TRRN30
◆ Cliff	TRRN45
◆ Crest	TRRN25
◆ Delta	TRRN10
◆ Plateau	TRRN15
◆ Ridge	TRRN20
◆ Valley	TRRN40

NOTES: Disperse panel fabric is applied pattern cut and is not available on 72"W Accelerate[®] panels or on 66"W tackboards, Voi[®] screens, and Empower[®].

Analog and Exchange panel fabric is applied pattern cut and is not available on 78"W tackboards, Voi[®] screens, and Empower[®].

◆◆◆ For lead time information see page 19.

* Directional fabrics

ABOUND[®] Typicals



Icon Legend on page 19

WORKSTATIONS

QTY	DESCRIPTION	MODEL	LIST PRICE	PRICE EXTENSION
1	Flagship Series Pedestal "R" Pull Freestanding B/B/F	H19723R	\$837	\$837
1	Flagship 30"W 2-Drw "R" Pull Lateral 30"W x 28"H x 18"D	H9170R	\$1,116	\$1,116
2	Electrical Power Harness 3-1 & 2-2 Systems 36"W	HH871236	\$227	\$454
1	Circuit 1	HH873501	\$47	\$47
1	Circuit 4	HH873504	\$47	\$47
1	Base In-Feed Cable Base 3-1 & 2-2 Systems	HH879072	\$253	\$253
2	Abound Finished End Painted 65"	HRVC65PF	\$110	\$220
3	Abound L Connector Painted 65"	HRVC65PL	\$180	\$540
6	Abound Panel Frame 65"H x 36"W	HRVF6536P	\$318	\$1,908
6	Abound Top Cap Trim 36"W	HRVTC36	\$65	\$390
1	Cantilever One Pair 24"D	HCTL242	\$93	\$93
24	Abound Segment Bar 36"W	HRVFSB36	\$25	\$600
1	Abound Overhead Metal Flipper Door 36"	HRVOH36FM	\$635	\$635
24	Abound Fabric Tile 15"H x 36"W	HRVT1536T	\$81	\$1,944
12	Abound Fabric Tile 30"H x 36"W	HRVT3036T	\$111	\$1,332
1	Systems Rectangular Worksurface Edgeband 24"D x 36"W	HWR2436P	\$382	\$382
1	Systems Left Corner Cove Worksurface Edgeband 72" x 36" x 24" x 24"	HWV93AALP	\$736	\$736
TOTAL:				\$11,534

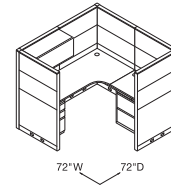

L-SHAPE WORKSTATION
72" W x 72" D

QTY	DESCRIPTION	MODEL	LIST PRICE	PRICE EXTENSION
1	Electrical Power Harness 3-1 & 2-2 Systems 48"W	HH871248	\$239	\$239
1	Circuit 1	HH873501	\$47	\$47
1	Circuit 4	HH873504	\$47	\$47
1	Base In-Feed Cable Base 3-1 & 2-2 Systems	HH879072	\$253	\$253
1	Overhead Cabinet w/Sliding Door 48"W x 14 1/4"D x 14"H	HLSL1448S	\$1,208	\$1,208
1	Mobile Ped 20" x 15 1/8" x 21 1/2"	HLSL2016MP2	\$893	\$893
1	Ped Cushion (Fabric Grade 2) 20" x 15 1/8" x 1"	HLSL2016PH2	\$371	\$371
1	Stack-on Storage Panel Mounted Bracket	HLSLPMB	\$145	\$145
2	Rectangle Worksurface 24"D x 48" W	HLSLR2448	\$337	\$674
1	Personal Storage Tower (RH) 24"D x 24"W x 65"H	HLSLW446RP	\$2,920	\$2,920
1	Abound Variable Height Finished End Painted 15"	HRVC15PFV	\$72	\$72
1	Abound Finished End Painted 50"	HRVC50PF	\$104	\$104
1	Abound L Connector Painted 50"	HRVC50PL	\$169	\$169
1	Abound Finished End Painted 65"	HRVC65PF	\$110	\$110
2	Abound L Connector Painted 65"	HRVC65PL	\$180	\$360
1	Abound Panel Frame 50"H x 24"W	HRVF5024P	\$284	\$284
1	Abound Panel Frame 50"H x 48"W	HRVF5048P	\$324	\$324
3	Abound Panel Frame 65"H x 24"W	HRVF6524P	\$307	\$921
1	Abound Panel Frame 65"H x 48"W	HRVF6548P	\$351	\$351
4	Abound Top Cap Trim 24"W	HRVTC24	\$40	\$160
2	Abound Top Cap Trim 48"W	HRVTC48	\$75	\$150
1	Flat Bracket 24"D	HHN831124	\$72	\$72
2	Abound Segment Bar 24"W	HRVFSB24	\$24	\$48
2	Abound Segment Bar 48"W	HRVFSB48	\$27	\$54
1	Abound 15" High Clear Glass Tile 15"H x 24"W	HRVT1524G	\$515	\$515
1	Abound 15" High Clear Glass Tile 15"H x 48"W	HRVT1548G	\$661	\$661
2	Abound Fabric Tile 30"H x 24"W	HRVT3024T	\$99	\$198
2	Abound Fabric Tile 30"H x 48"W	HRVT3048T	\$134	\$268
6	Abound Fabric Tile 60"H x 24"W	HRVT6024T	\$147	\$882
2	Abound Fabric Tile 60"H x 48"W	HRVT6048T	\$237	\$474
1	Bracket to Attach Towers to Worksurfaces	HSTB2W1	\$88	\$88
2	Worksurface Bracket Kit	HWSB2	\$52	\$104
TOTAL:				\$13,166

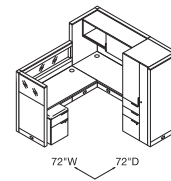

L-SHAPE WORKSTATION WITH STORAGE TOWER
72" W x 72" D



Icon Legend on page 19

ABOUND® Typicals

QTY	DESCRIPTION	MODEL	LIST PRICE	PRICE EXTENSION
2	Electrical Pass-Thru Cable 3-1 & 2-2 Systems 60"W	HH871160	\$151	\$302
1	Electrical Power Harness 3-1 & 2-2 Systems 24"W	HH871224	\$227	\$227
1	Circuit 1	HH873501	\$47	\$47
1	Circuit 2	HH873502	\$47	\$47
1	Circuit 3	HH873503	\$47	\$47
1	Circuit 4	HH873504	\$47	\$47
1	Base In-Feed Cable Base 3-1 & 2-2 Systems	HH879072	\$253	\$253
6	Abound Finished End Painted 50"	HRVC50PF	\$104	\$624
2	Abound T Connector Painted 50"	HRVC50PT	\$169	\$338
1	Abound X Connector Painted 50"	HRVC50PX	\$164	\$164
6	Abound Panel Frame 50"H x 24"W	HRVF5024P	\$284	\$1,704
2	Abound Panel Frame 50"H x 60"W	HRVF5060P	\$356	\$712
6	Abound Top Cap Trim 24"W	HRVTC24	\$40	\$240
2	Abound Top Cap Trim 60"W	HRVTC60	\$92	\$184
8	Worksurface Bracket Kit	HWSB2	\$52	\$416
12	Abound Segment Bar 24"W	HRVFSB24	\$24	\$288
4	Abound Segment Bar 60"W	HRVFSB60	\$28	\$112
4	Abound Open Shelf 60"	HRVSH60	\$394	\$1,576
12	Abound Fabric Tile 15"H x 24"W	HRVT1524T	\$73	\$876
4	Abound Fabric Tile 15"H x 60"W	HRVT1560T	\$104	\$416
12	Abound Fabric Tile 30"H x 24"W	HRVT3024T	\$99	\$1,188
4	Abound Fabric Tile 30"H x 60"W	HRVT3060T	\$151	\$604
4	Systems Rectangular Worksurface Edgeband 24"D x 60"W	HWR2460P	\$526	\$2,104
TOTAL:			\$12,516	

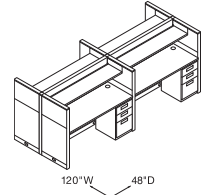

TOUCH-DOWN STATION
120"W x 48"D

QTY	DESCRIPTION	MODEL	LIST PRICE	PRICE EXTENSION
2	External Stiffener 72"W	HLSLZ5SC72	\$119	\$238
2	Abound Panel Frame 35"H x 30"W	HRFF3530P	\$265	\$530
4	Abound Fabric Tile 30"H x 30"W	HRVT3030T	\$103	\$412
4	Abound Panel Frame 35"H x 36"W	HRFF3536P	\$271	\$1,084
8	Abound Fabric Tile 30"H x 36"W	HRVT3036T	\$111	\$888
2	Abound Panel Frame 35"H x 42"W	HRFF3542P	\$281	\$562
4	Abound Fabric Tile 30"H x 42"W	HRVT3042T	\$126	\$504
2	Abound Finished End Painted 35"	HRVC35PF	\$86	\$172
2	Abound L Connector Painted 35"	HRVC35PL	\$151	\$302
4	Frameless Frosted Glass 15"H x 72"W	HRVT1572F	\$1,041	\$4,164
2	Contain® 35 LB Credenza Counterweight Kit	HSCACW35	\$221	\$442
2	Contain® Credenza Cushion (Fabric Grade 2) 36"W x 18"D	HSCAUC1836	\$351	\$702
2	Worksurface O-Leg 6½"H x 30"W	HSCAWS6530	\$254	\$508
1	Contain® Footed Metal Credenza with Laminate Front, Left 22" x 72" x 18"	HSCF227218RBFOL	\$2,564	\$2,564
1	Contain® Footed Metal Credenza with Laminate Front, Right 22" x 72" x 18"	HSCF227218LBFOL	\$2,564	\$2,564
2	Systems Rectangular Worksurface Edgeband 30"D x 72"W	HWR3072P	\$653	\$1,306
2	Worksurface Bracket Kit	HWSB2	\$52	\$104
TOTAL:			\$17,046	

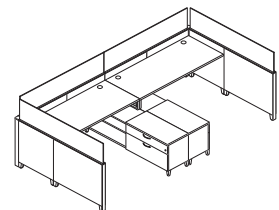

U-SHAPE TEAMING STATION
144"W x 72"D

ABOUND® Open Base Typicals



Icon Legend on page 19

WORKSTATIONS

QTY	DESCRIPTION	MODEL	LIST PRICE	PRICE EXTENSION
1	Abound Panel Frame 50"H x 24"W	HRFF5024P	\$284	\$284
2	Abound Fabric Tile 30"H x 24"W	HRVT3024T	\$99	\$198
1	Abound 15" High Clear Glass Tile 12"H x 24"W	HRVT1524G	\$515	\$515
2	Abound 24"W Segment Bar	HRVFSB24	\$24	\$48
1	Abound Panel Frame 50"H x 48"W	HRFF5048P	\$324	\$324
2	Abound Fabric Tile 30"H x 48"W	HRVT3048T	\$134	\$268
1	Abound 15" High Clear Glass Tile 15"H x 48"W	HRVT1548G	\$661	\$661
2	Abound 48"W Segment Bar	HRVFSB48	\$27	\$54
3	Abound Panel Frame 65"H x 24"W	HRFF6524P	\$307	\$921
6	Abound Fabric Tile 60"H x 24"W	HRVT6024T	\$147	\$882
1	Abound Panel Frame 65"H x 48"W	HRFF6548P	\$351	\$351
2	Abound Fabric Tile 60"H x 48"W	HRVT6048T	\$237	\$474
1	Overhead Cabinet with Sliding Door 48"W x 14¼"D x 14"H	HLSL1448S	\$1,208	\$1,208
1	Mobile Ped 20" x 15½" x 21½"	HLSL2016MP2	\$893	\$893
1	Ped Cushion 20" x 15½" x 1"	HLSL2016PH2	\$371	\$371
1	Stack-on Storage Panel Mounted Bracket	HLSLPMB	\$145	\$145
1	Personal Storage Tower (RH) 24"D x 24"W x 65"H	HLSLW446RP	\$2,920	\$2,920
1	Abound Variable Height Finished End Painted 15"	HRVC15PFV	\$72	\$72
1	Abound Finished End Painted 50"	HRVC50PF	\$104	\$104
1	Abound L Connector Painted 50"	HRVC50PL	\$169	\$169
1	Abound Finished End Painted 65"	HRVC65PF	\$110	\$110
2	Abound L Connector Painted 65"	HRVC65PL	\$180	\$360
1	Bracket to Attach Towers to Worksurfaces	HSTB2W1	\$88	\$88
2	Systems Rectangular Worksurface Edgeband 24"D x 48"W	HWR2448P	\$446	\$892
2	Worksurface Bracket Kit	HWSB2	\$52	\$104
1	Abound Top Cap Trim 24"W	HRVTC24	\$40	\$40
1	Abound Top Cap Trim 48"W	HRVTC48	\$75	\$75
1	Abound Top Cap Trim 72"W	HRVTC72	\$113	\$113
1	Flat Bracket 24"D	HHN831124	\$72	\$72
			TOTAL:	\$12,716

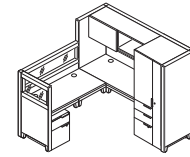

**L-SHAPE WORKSTATION
WITH STORAGE TOWER**

72"W x 72"D

ABOUT® FRAMES OVERVIEW

PANEL FRAME

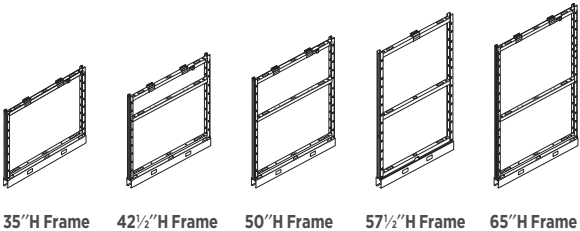

35\"/>

OPEN BASE PANEL FRAME

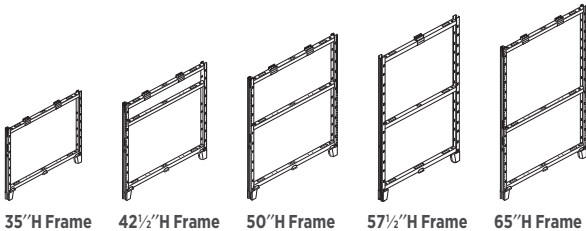

35\"/>

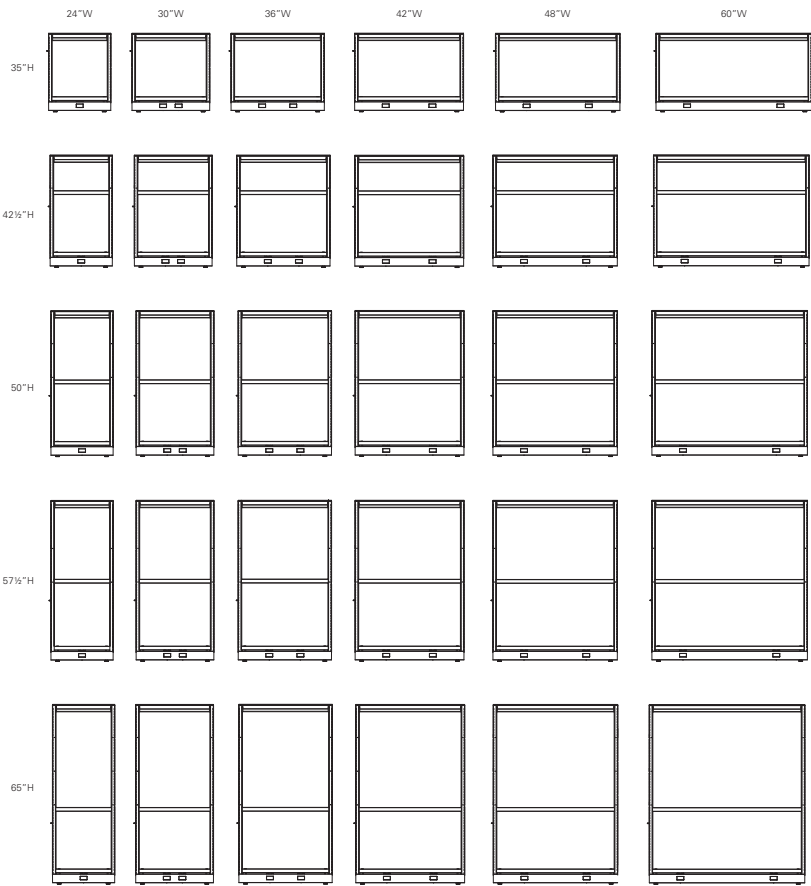

STACKING FRAMES

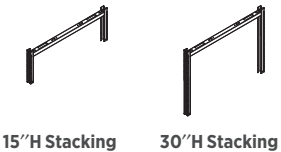

15\"/>

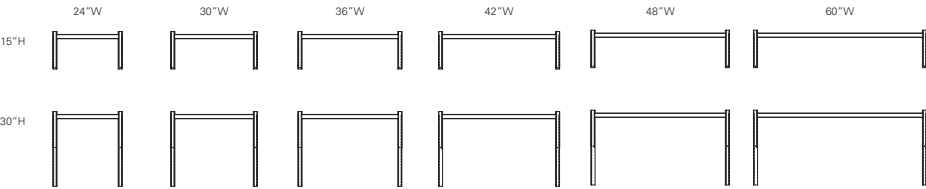

Reminder: Panel frame top caps must be ordered separately. Please refer to page 445. Do not specify top caps when putting frameless glass on top of the panel frame or when using a countertop work surface.

ABOUND[®] FRAMES OVERVIEW

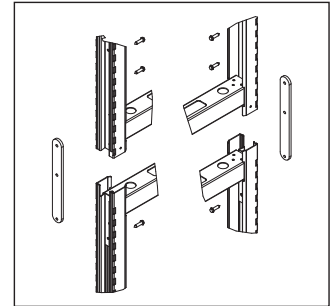
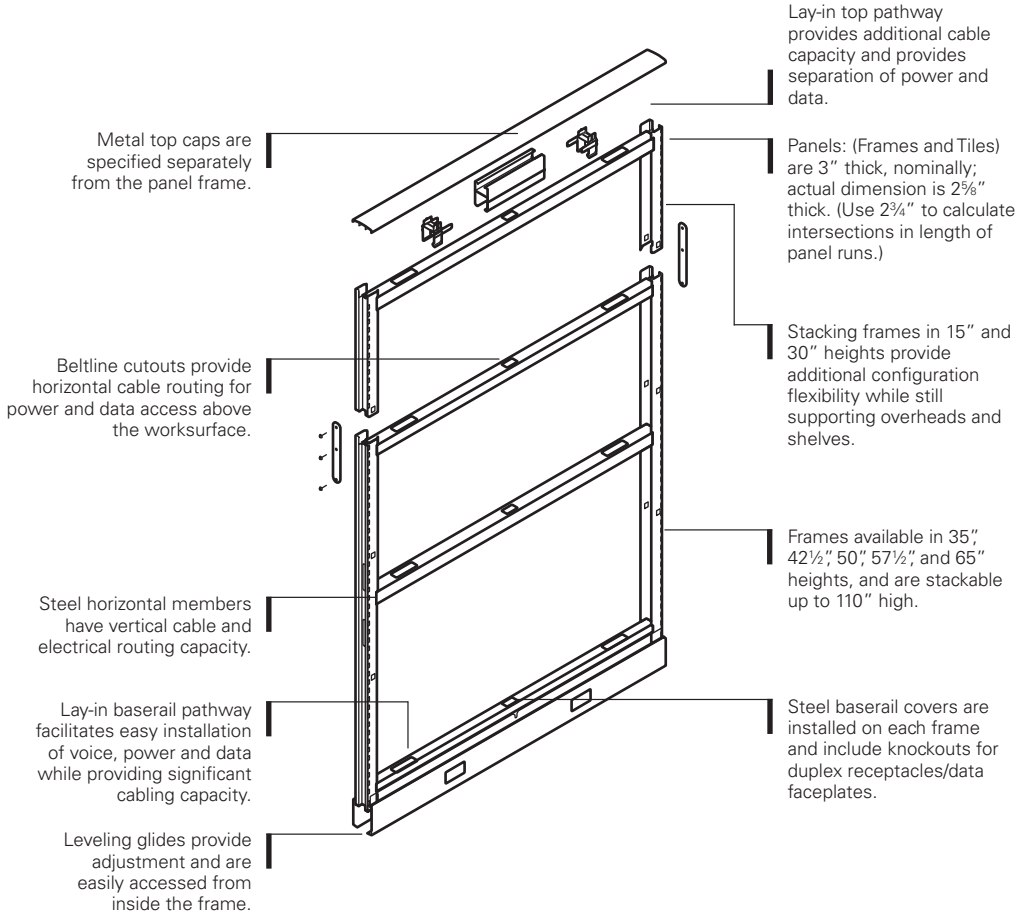

Stacking connection provides a solid metal-to-metal connection, allowing the stacking frame to accept hang-on components, per configuration guidelines.

Construction and Features

Specifications—formed, steel vertical members, with tubular steel horizontal members are welded into a sturdy, structural panel frame. Panel frames are shipped with base pathway covers installed.

Tiles, Panel Top Caps, and Segment Bars are ordered separately.

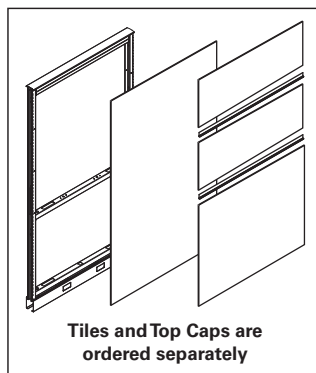

Additional design and specification information available at hon.com.

ABOUND[®] FRAMES OVERVIEW

FRAME DIMENSIONS (ACTUAL)

Depth: 2⁵/₈" (use 2³/₄" to calculate intersections in length of panel run)

Widths: 24", 30", 36", 42", 48", 60"

Heights*: Painted trim: 34¹/₂", 42", 49¹/₂", 57"H, 64¹/₂"

Stacking Frames: 15"H, 30"H

*with levelers fully retracted

Stacking frames can be added to the top of any 35"H, 50"H or 65"H frame. Adding stacking frames to 42¹/₂"H and 57¹/₂"H frames is not recommended due to inconsistencies in segmentation. 15"H and 30"H stacking frames can be used to add up to 45" of additional height to a standard frame. Do not combine differing frame widths in a single stack.

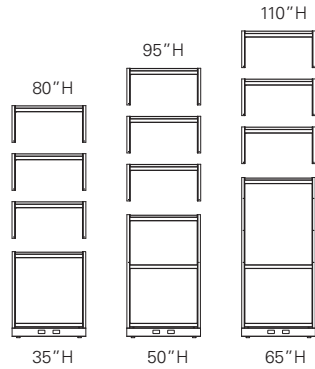

NOTE: When stacking on 42¹/₂"H or 57¹/₂"H frames, panel slots will be off by ¹/₂" compared to any other height panel. When stacking on 42¹/₂"H and 57¹/₂"H frames, hanging accessories will be ¹/₂" off in height compared to accessories hanging on panels at any height other than 42¹/₂"H and 57¹/₂"H.

BUILDING HORIZONTALLY WITH ABOUND FRAMES

Important planning guidelines: For adequate stability, one of two methods of stabilization must be adhered to:

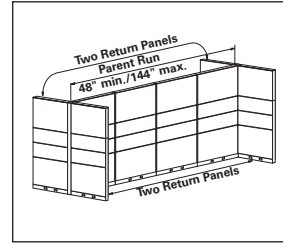

Method 1—Opposing returns:

A parent run must be a minimum of 48" and a maximum of 144" between return panels. The parent run must have a minimum of two return panels running in opposing directions on each end of run.

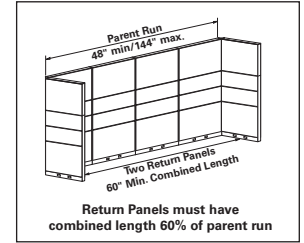

Method 2—Single-sided

Spine Length:	90 degree connector	120 degree connector
48"-108"	72" total	84" total
110"-132"	84" total	96" total
134"-144"	96" total	108" total

ABOUND[®] FRAMES OVERVIEW

INTERSECTING CONNECTIONS

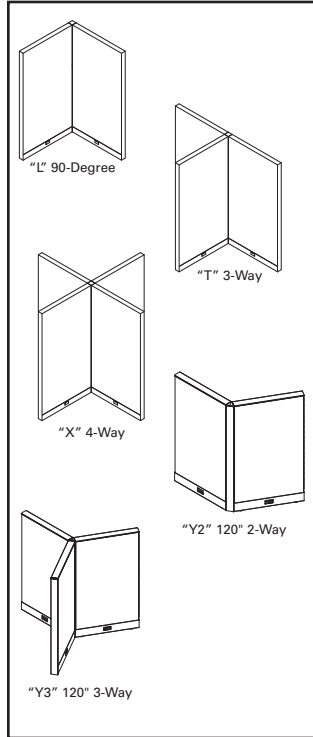

“L”, “T”, “X”, “Y2” and “Y3” connector kits are used when connecting frames at intersecting runs. For “L”, “T” and “X” connector kits, add $2\frac{3}{4}$ ” to the total length of the panel run for each intersection, whether located in the middle or at the end of the run.

Wall starter kits provide a means to affix a panel run to a permanent building wall. Kit adds $1\frac{1}{2}$ ” to length of panel run.

Segment bars — horizontal cross members required between tile segments. Must be specified on each side of frame. One Segment Bar is needed for each reveal between tiles.

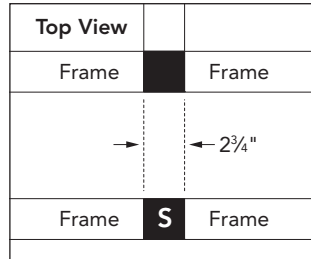
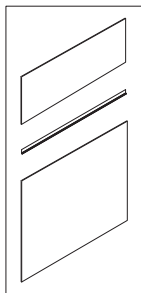

Extended straight connector kit “S” can be used to keep continuous runs dimensionally consistent with opposing panel runs which incorporate “T” or “X” intersections. (Add $2\frac{3}{4}$ ” to the length of the run for every extended straight connector used.)

IN-LINE CONNECTIONS

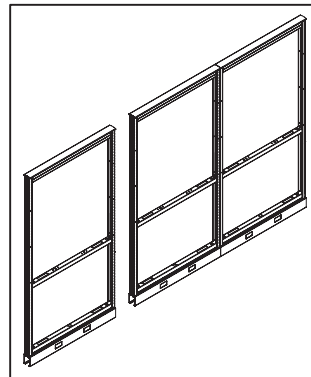

Direct connections between same height frames in a continuous run are accomplished with provided hardware. There is no incremental increase in dimension along the run.

END OF RUN

Finished end trim must be specified for the unconnected sides of panel frames. The Abound end trim adds $\frac{3}{8}$ ” to the length of the panel run. When adding a stacking frame, order finished end trim in the height that matches the stacking frame height. Move the end cap from the standard frame end trim to the stacking frame end trim.

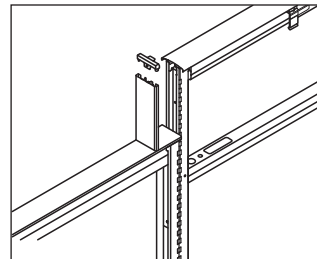

IN-LINE VARIABLE HEIGHT TRIM
In-line connections between different height panels require trim to cover the exposed frame of the taller panel. The bottom of the trim is contoured to match the profile of the frame top cap.

Multiple-height connections are accomplished by combining standard height panel connectors (35”H, 42½”H, 50”H, 57½”H, and 65”H) with shorter connectors (7”H, 15”H, 22”H, and 30”H). Start from the bottom-up — select the standard connector that corresponds to the height and connection type of the tallest panel, then use the shorter connectors for variable height and connector top cap trim. (See examples.)

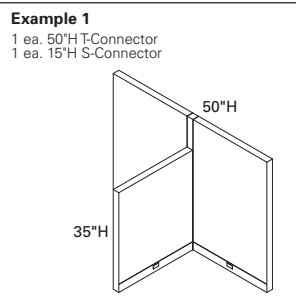

In variable height “T” connections — as shown above — you would use the connectors as indicated.

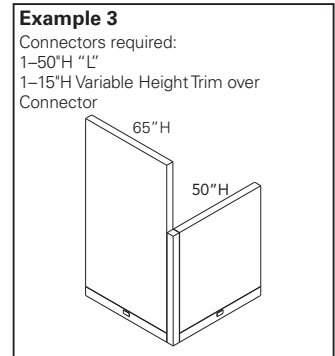
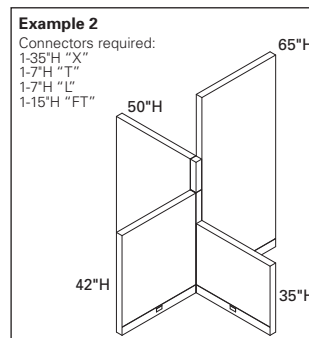

Example above represents Abound variable height “L” for 65” to 50” connection over connector.

VARIABLE HEIGHT CONNECTION TRIM

L, X and T connections between different height panels require trim to cover the exposed frame of the taller panel. The bottom of the trim is flat to match the profile of the Universal Connector top cap. Models are designated as “Variable Height Finished End over Connector Trim”. For variable height connections in a Y configuration, contact the HON Product Solutions group.

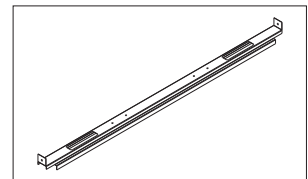

OPTIONAL STIFFENER SUPPORT

Stiffener supports can be used to provide additional rigidity to a panel when fabric tiles are on both sides of the frame. May also be used for routing power/data at non-standard heights.

ABOUT® CONNECTOR OVERVIEW

CONNECTOR KITS — ABOUT

- “L” 90° Connector Kit
- “T” 3-way Connector Kit
- “X” 4-way Connector Kit
- “S” “S” Extended Straight Connector Kit
- “Y2” 2-way 120° Connector Kit
- “Y3” 3-way 120° Connector Kit
- “W” Wall Starter Kit
- “F” End Trim Kit
- “V” Variable Height Finished End
- “FT” Variable Height Finished End over Connector

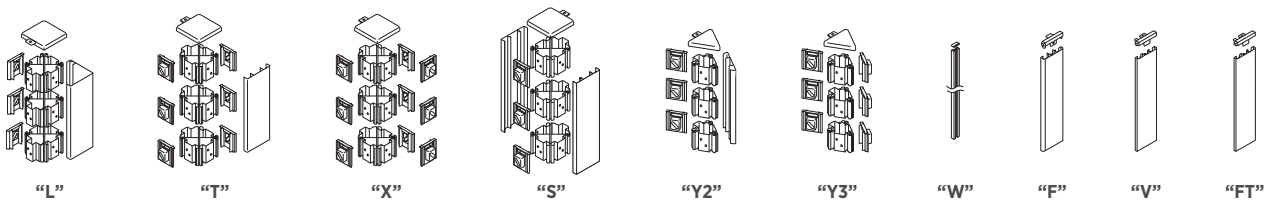

- About Connector Kits include universal connector block(s), bracket clips and painted metal trim.
- The universal connector block can be used for an L, T, X, or Extended Straight connections, simplifying staging and installation at the project site as well as future reconfigurations.
- Bracket clips are attached to the connector blocks as needed based upon connection type.
- While the connectors themselves are universal, About connector kits must be specified by connection type (X, L, T, S, 120 degree) in order to receive the correct type of trim.

CHAMFERED TRIM*

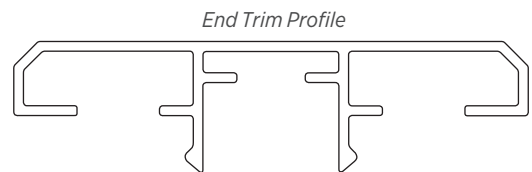
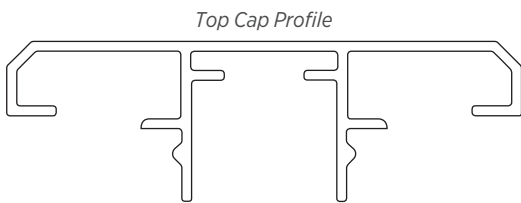

FLAT TRIM

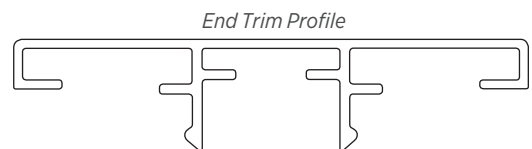
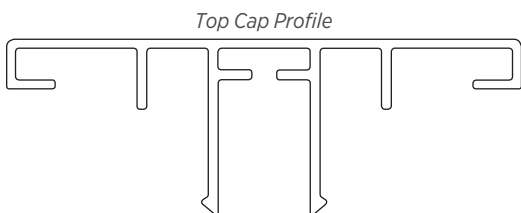

*Used on all products produced prior to July 2021.

ABOUND® TILE OVERVIEW

About tiles come in a variety of styles.

WORKSTATIONS

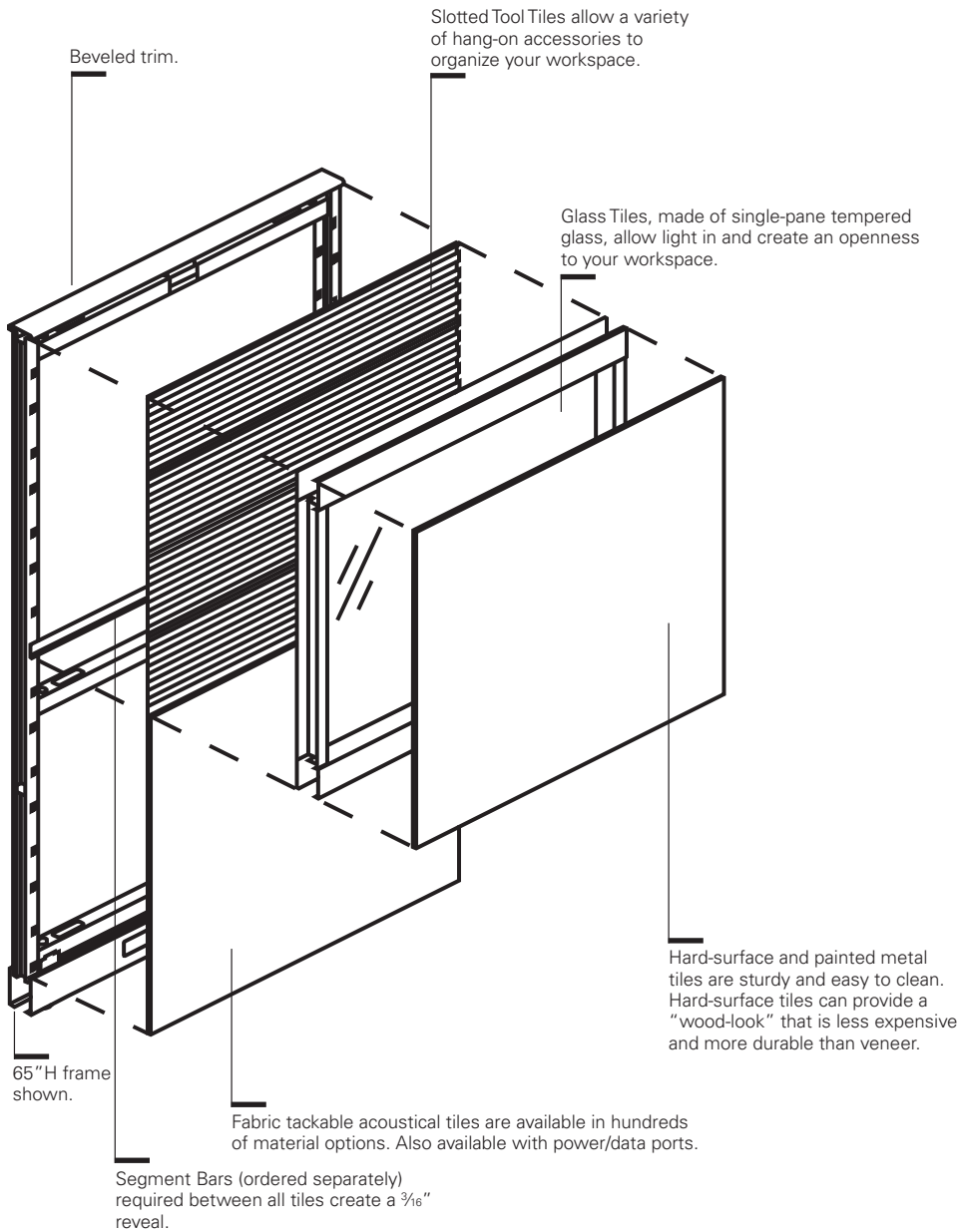

*Aesthetics of opposing tile surface and/or frame interior should be considered when selecting light-colored sheer materials.

ABOUT® SPECIFYING/DESIGN GUIDE

Tile Heights

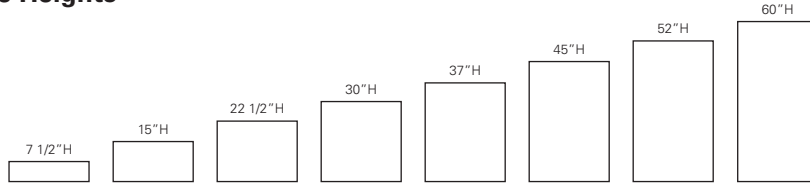

Monolithic tiles are 5" shorter than frame heights to account for top trim and base raceway.

Typical Tile Height Configurations

Segment bars are required between any two tiles — order separately based on tile configuration on each side of frame. Note: Most CAD specification programs will calculate quantity of segment bars required.

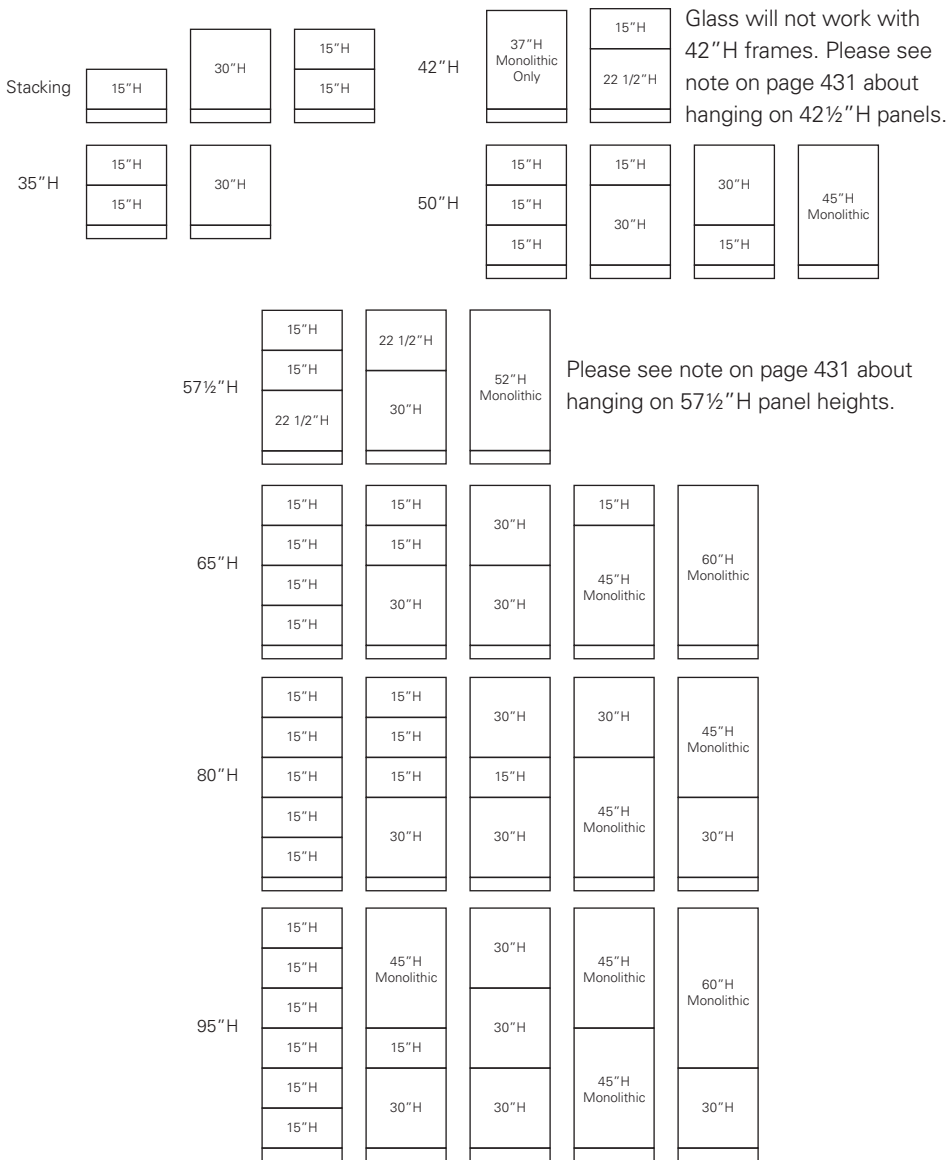

*Additional tile combinations to those shown above are possible; heights above 65" require stacking frames - maximum height is 110."

To calculate the total height of tiles(s) required, deduct 5" (height of base/top trim) from the total nominal panel height.

EXAMPLE: 65" H Frame takes 2 30" H tiles. $65 - 5 = 2 \times 30$ or $45 + 15$

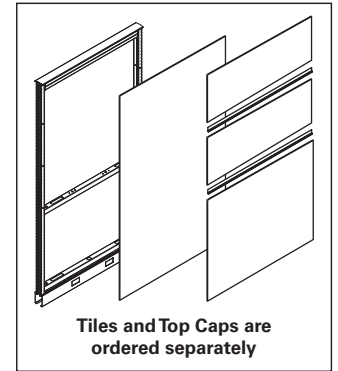

Tiles can be ordered in the size that matches the frame height plus the stacker height.

EXAMPLE: If you are using a 35" H frame plus a 30" H stacker, you can order 2 - 30" H tiles or 1 - 60" H tile.

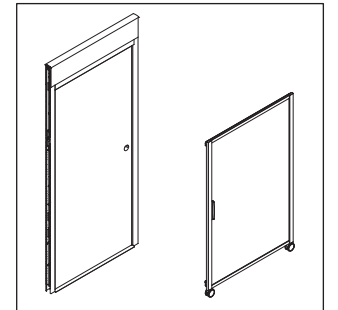

Door panels include frame, 42" W door, hinges and attaching hardware. Two 7 1/2" H fabric tiles for the top of the door frame are required and ordered separately (HRVDO742T).

Sliding doors are available in 50", 65", and 80" H models and can mount to 30", 36", 42", and 48" W panels. The doors provide a 36" W opening and are 42" W, nominally. The doors ship non-handed. A Mounting Bracket Kit must be ordered for each door corresponding to the mounting panel's width (30", 36", 42", or 48" W).

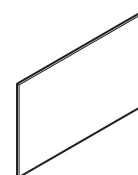

Hard-surface Tiles include tile and Custom Bracket Kit.

ABOUND[®] SPECIFYING/DESIGN GUIDE

WORKSTATIONS

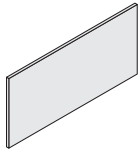

Fabric Tackable Acoustical Tile

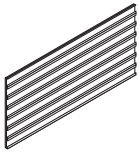

Slotted Tool Tile

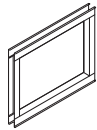

Glass Tile

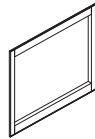

Pass-thru Tile

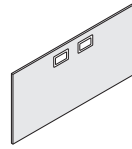

Fabric Tackable Acoustical Ported Tile

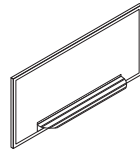

Markerboard Tile
*Markerboard tray ordered separately

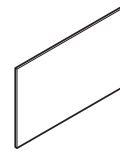

Hard-surface Tiles

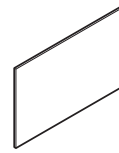

Painted Metal Tile

Tiles — Tackable Acoustical, Tackable Acoustical/Ported

	24"W	30"W	36"W	42"W	48"W	60"W
7 1/2"H						
15"H						
22 1/2"H						
30"H						
37"H						
45"H						
52"H						
60"H						

Glass Tile Kits, Markerboard, Painted Metal Tiles

	24"W	30"W	36"W	42"W	48"W	60"W
15"H						
30"H						

Pass-thru Tiles

	24"W	30"W	36"W	42"W	48"W	60"W
30"H						

Slotted Tool Tile

	24"W	30"W	36"W	42"W	48"W	60"W
15"H						

Hard-surface Tiles

	24"W	30"W	36"W	42"W	48"W	60"W
15"H						
30"H						
37"H						

TILES

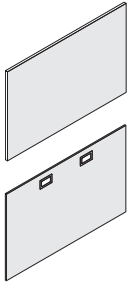

Tackable Acoustical Fabric Tiles

- Tiles do not include segment bars — order separately.

Port Tiles

- Receptacle openings with blank covers (1 in 24"W tiles; 2 in wider tiles). Located 30" above bottom of base raceway and 10½" from the edge of the frame.
- Tiles do not include segment bars — order separately.
- 30"H ported tiles on 35"H frame will need additional stiffener support.
- Ported tiles should only be used to accommodate beltline height. If a port is needed at an alternate height, please submit a special request.
- Tiles cannot be flipped to move data ports.
- Duplex brackets must be specified for ported tiles.

Painted Metal

- Tiles do not include segment bars — order separately.
- Painted steel construction.
- 15"H and 30"H tiles are non-dedicated and can be used in any tile position.
- Tiles can accept magnets.

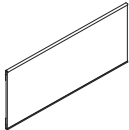

Tool Tiles

- Tiles do not include segment bars — order separately.
- Sturdy aluminum extrusion with steel support construction.
- Powder coated for durable finish.
- Work tools available.
- Use in place of standard 15"H tiles.
- Cannot be used in the bottom location of a panel frame or on wall track.
- Each tool tile has a suggested weight capacity of 80 lbs. of paper management accessories.

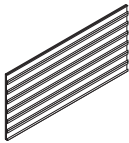

Pass-Thru Tiles

- Pass-thru opening is 22½"H.
- Used as 30"H tile.
- Must order quantity of one 7½"H tile if finishing one side and quantity of two 7½"H tiles if finishing both sides.
- No segment bar needed above tile.
- Built into trim pieces.

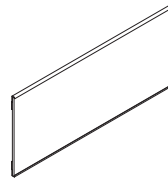
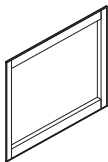

Hard Surface

- High Pressure Laminate — available in standard laminate colors.
- Tiles do not ship with segment bars — order separately.
- Tiles come completely assembled and attach with custom tile bracket kit. Specify paint color.
- 15"H, 30"H, and 37"H tiles are non-dedicated and can be used in any tile position.
- Vertical grain on all tile sizes.

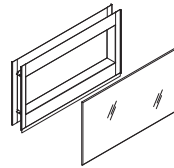

Glass Tiles

- Clear and frosted glass.
- Clear glass is writeable with dry erase marker — frosted glass is not.
- Tempered safety glass encased within a frame.
- Single-pane construction, glass is flush on one side.
- Glass opening is 4" less than nominal heights and widths.
- Cannot be used in top tile position of a 42½"H panel frame or any frame with integrated power pole.
- Cannot be used at the bottom or beltline location of panel frame.
- 30"H glass tiles can only be placed in top position of 65"H frames or only in 30"H stacking frame. Segment bar needs to be ordered.

Marker Board Tiles

- White marker board tile; painted steel surface.
- Accepts magnetic accessories.
- 15"W magnetically attachable tray is natural aluminum color — order separately.
- 15"H and 30"H tiles are non-dedicated and can be used in any tile position.

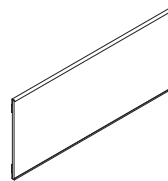

Gallery Panels

- 1½" thick laminate panels used as wing or end of run panels only.
- Available in 35"H, 42½"H, and 50"H options.
- Options available to include frameless glass.
- Gallery Panel connectors purchased separately.

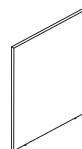

Custom Material Bracket Kit

- Do not ship with segment bars — order separately.
- Used with Customer's Own Material — thickness is ¼".
- Contact HON for insert dimensions.

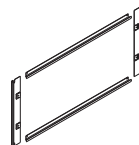

ABOUND® GALLERY PANELS OVERVIEW

GALLERY PANELS

Abound® Gallery Panels are an affordable, sleek way to incorporate laminate wing and end of run panels where power is not needed. The simplistic design provides a great new way to add woodgrains or solid laminate finishes to your workstation allowing for greater customization and value engineering.

BASIC CHARACTERISTICS

- Available in L-, T-, and Mid-configurations.
- Made of 1 1/8" board with high-pressure laminate.
- Use 1/8" thickness for space planning.
- Can be specified with matching or contrasting edge colors.
- Available in woodgrain and solid laminates.
- Woodgrain laminates can be specified with vertical grain on panels from 24" to 60"W.
- Horizontal grain available on all panel sizes.
- Gallery Panels offer 2 1/2" leveling capacity.
- Overall heights line up with adjacent panel.
- Available with and without integrated glass options (specified separately).
- Gallery Panels for use with glass have separate model numbers.
- All configurations are non-handed and secured using hidden fasteners.
- Standard Gallery Panels cannot connect to each other, you must use Gallery-to-Gallery Panels for connections.
- Additional support is required after every 60" in Gallery Panel width (i.e., storage or workstation tie-in).
- Gallery Panel widths are true to size.
- Please adhere to all standard systems specification guides.

GALLERY PANEL OFFERING

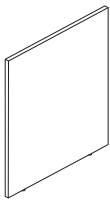

Wing End of Run
42"H, 50"H x 27", 33", 39", 45", 51", 63"W
Wing Middle of Run
42"H, 50"H x 24", 30", 36", 42", 48", 60"W
Spanning End of Run
42"H, 50"H x 51", 63", 75"W

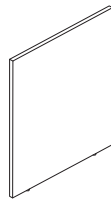

Wing End of Run, Glass
42"H, 50"H x 27", 33", 39", 45", 51", 63"W
Wing Middle, Glass
42"H, 50"H x 24", 30", 36", 42", 48", 60"W
Spanning End of Run, Glass
42"H, 50"H x 51", 63", 75"W

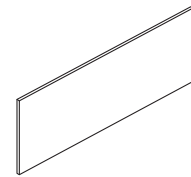

Wing End of Run, Glass
7 1/2"H x 27", 33", 39", 45", 51", 63"W
Wing Middle, Glass
7 1/2"H x 24", 30", 36", 42", 48", 60"W
Spanning End of Run, Glass
7 1/2"H x 51", 63", 75"W

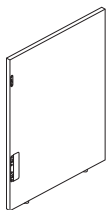

Gallery-to-Gallery, L-Connection
35"H, 42"H, 50"H x 18", 24", 30", 36", 42", 48", 60"W
Gallery-to-Gallery, L-Connection, Glass
35"H, 42"H, 50"H x 18", 24", 30", 36", 42", 48", 60"W

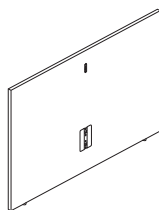

Gallery-to-Gallery, T-Connection
35"H, 42"H, 50"H x 18", 24", 30", 36", 42", 48", 60"W
Gallery-to-Gallery, T-Connection, Glass
35"H, 42"H, 50"H x 18", 24", 30", 36", 42", 48", 60"W

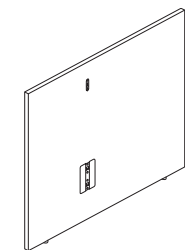

Gallery-to-Gallery, Non-Symmetrical Connection
35"H, 42"H, 50"H x 18", 24", 30"W
Gallery-to-Gallery, Non-Symmetrical, Glass
35"H, 42"H, 50"H x 18", 24", 30"W

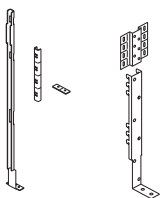

Gallery Panel Connectors
Spanning End of Run, L Connectors, and Wing Middle Brackets



Gallery Connector
("Block and Trim" Kit)
For 35"-65"H Panels

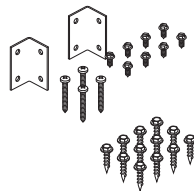

Gallery to Metal/Laminate Kits

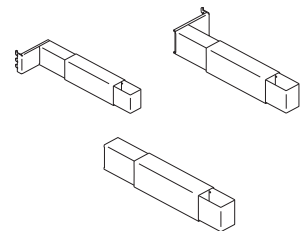

Height Adjustable Tie-In Brackets

ABOUND® GALLERY PANELS OVERVIEW

GALLERY PANELS DIMENSIONS

Gallery Panel Widths

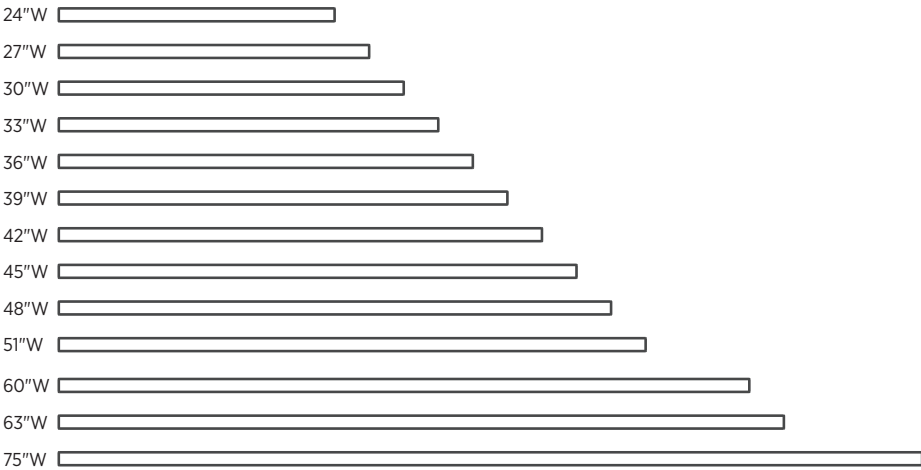

Gallery Panel Heights

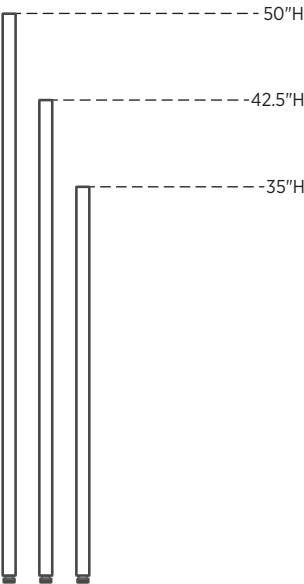

WORKING WITH INTEGRATED GLASS

- Gallery Panels for use with glass offer a routed top edge.
- Glass mounts directly into the Gallery Panel route via a gasket.
- The routing is inset 1½" from each end of the panel on standard Gallery Panels.
- Total glass width will be 3" narrower than the Gallery Panel.
- Glass height is available in 7½"H.
- Glass is available on all Gallery Panel widths.
- Specify glass models separate from Gallery Panel models.
- Routing is inset ½" on L and T Gallery Panels.

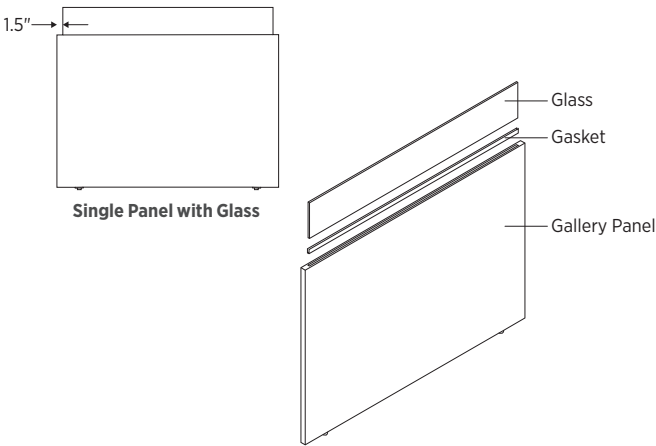

ABOUND® GALLERY PANELS OVERVIEW

T-CONFIGURATION

- Provides privacy to one or both ends of the Abound® system in a dual-sided application.
- All T-configurations connect using HRVCE connector kit.
- When the system panel is higher than the Gallery Panel, a variable height system's trim must be specified to finish off the exposed frame.
- T-configuration can be used for off-modular planning. The HRVCE connector kit location must be field measured.
- Accommodate for 2⁵/₈" frame thickness when planning with Abound® panel system.

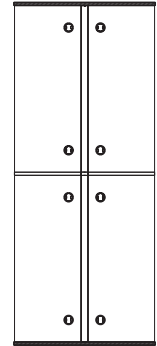
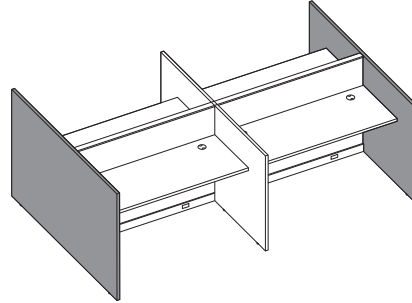

L-CONFIGURATION

- Provides privacy to one or both ends of the system in a single-sided application.
- L-configuration caps over the system panel.
- Due to the thickness of the Abound® panel L-configuration overhangs by approximately 3/16" on both sides.
- Accommodate for 2⁵/₈" frame thickness planning with Abound® panel system.
- All L-configuration Gallery Panels require the connector kit HRVCE to attach to the parent run.
- When the system panel is higher than the Gallery Panel, the variable height system's trim must be specified to finish off exposed frame.

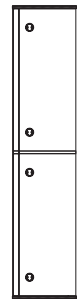
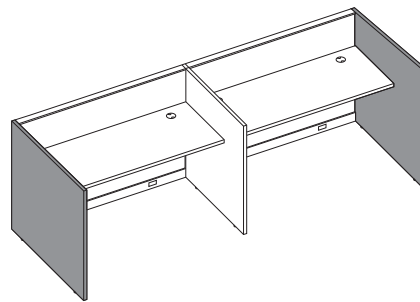

MID-CONFIGURATION (SINGLE-SIDED OR DUAL-SIDED)

- Mid-configuration panel does not overlap parent system panel.
- When specifying mid-configuration panels, one Gallery Panel "block and trim" kit (HRVCXXGP) is required to space the system panels out 1¹/₈". Kits include: Connector blocks, vertical trim, and a top cap.
- "Block and trim" models must match the height of the parent run.
- Specify one mid-connector kit (HRVCM) per Gallery Panel to attach to parent run. Gallery Panel and mid-connector kit attach over "block and trim" kit. Dual-sided application requires two connector kit models.
- When using a mid-configuration Gallery Panel, both panel frames in the spine must be of equal height.
- Mid-configuration Gallery Panel may exceed the height of the parent run by a maximum of 15".
- Trims can be painted to match the system panel trims.

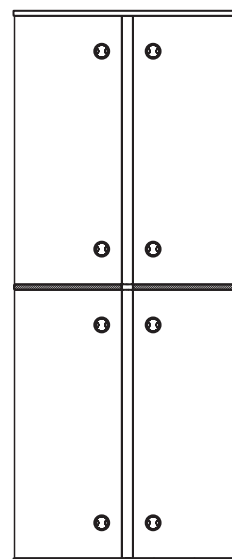

Dual-Sided Configuration

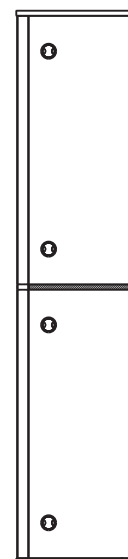

Single-Sided Configuration

ABOUT® GALLERY PANELS OVERVIEW

STORAGE AND WORKSURFACE CONNECTORS

- Use HRVGLSK to connect to laminate storage or HRVGMSK for metal storage.
- To connect to worksurfaces use HSTB2W1 bracket when used in perpendicular to parent run or use standard systems cantilever brackets when used in parallel to parent run in panel systems.

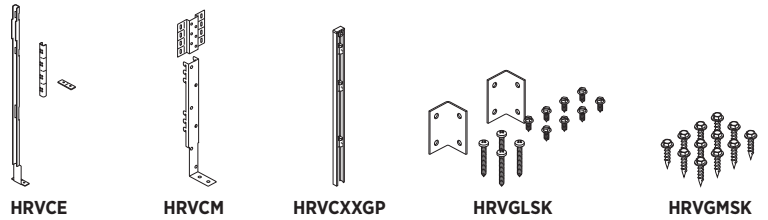

PANEL SYSTEMS

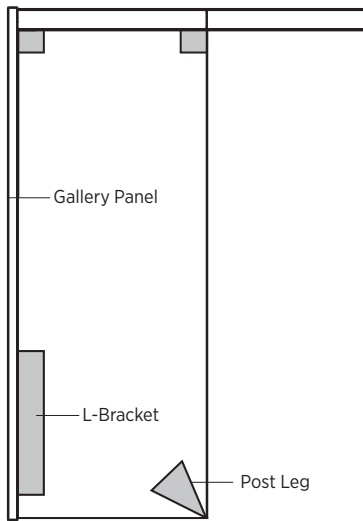

Perpendicular panel system with L-bracket (HSTB2W1) and post leg.

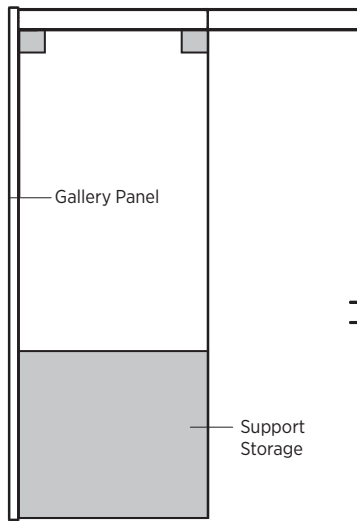

Perpendicular panel system with storage support.

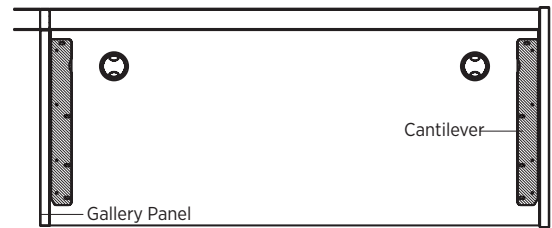

Panel system with cantilever support.

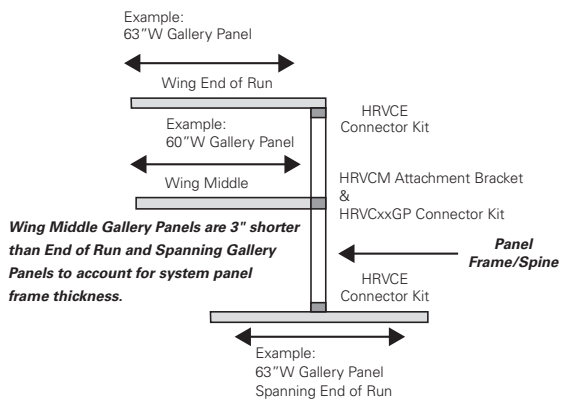

ABOUND® GALLERY PANELS OVERVIEW

GALLERY-TO-GALLERY PANELS

- Gallery-to-Gallery Panels connect to other Gallery Panels and are available in L-, T-, and Non-symmetrical T-configurations.
- When specifying Gallery-to-Gallery Panels, the installation template HRVGTGG is required. The recommendation is one template for every 30 panels.
- Gallery-to-Gallery Panels must be of equal or lower height than the Standard Gallery Panel attached. The Gallery-to-Gallery Panel cannot be taller than the adjacent panel. If this is needed, please reach out to Tailored Solutions for a custom solution.
- Made of 1½" board with HPL laminate.
- Can be specified with matching or contrasting edge.
- Edgeband is 2mm ABS.
- Available in woodgrain and solid laminates.
- Woodgrain laminates can be specified with vertical grain up to 48"W.
- Gallery-to-Gallery Panel widths are available in 18", 24", 30", 36", 42", 48", 60"W, and 72" (T).
- Gallery Panels offer 2½" leveling capability.
- Overall heights line up with adjacent panel.
- Gallery-to-Gallery Panels cap over Standard Gallery Panels and are oversized by 1½" to maintain true interior dimensions.
- Available with or without the integrated glass option.
- Glass is specified separately. Use mid-connection glass.
- Gallery Panels for use with glass have separate model numbers.
- Gallery-to-Gallery Panels are secured with an inset flat bracket under a painted metal cover. Paint color is specifiable to blend in with laminate choice.
- L-panels are handed.
- Non-symmetrical T-panels vary in size on either side of the adjacent panel.
- Please adhere to all standard systems specification guidelines.
- Additional support is required after every 60" in Gallery Panel width (i.e., a storage or worksurface tie-in).

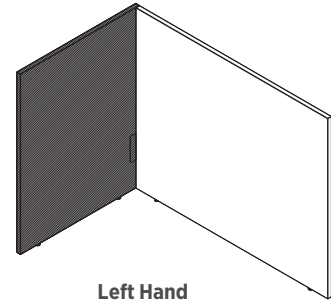

Left Hand

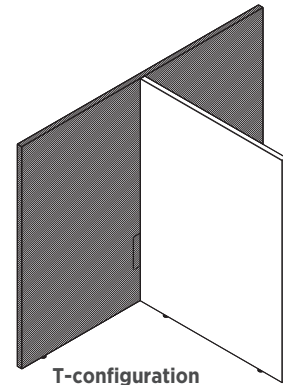

T-configuration

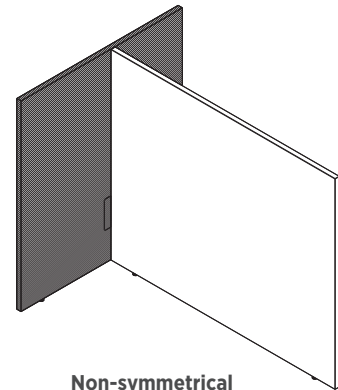

Non-symmetrical

ABOUT® GALLERY PANELS OVERVIEW

GALLERY-TO-GALLERY FREESTANDING SCREENS

Freestanding screens can be created using Standard Gallery Panels and Gallery-to-Gallery Panels. All Gallery Panel heights are allowed. Increase minimum return length by 3" (or next largest width) of panel for every 7½" variation in panel height.

Freestanding L-Screens

Parent	Minimum Return*
30"-36"	30"
>42"-60"	36"
60"-75"	42"

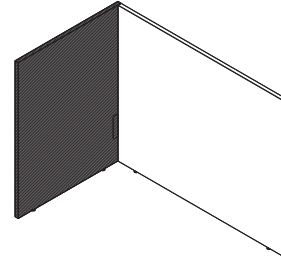
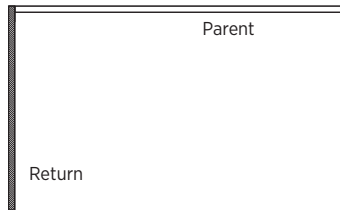

* 18"-24" not valid

Freestanding U-Screens

Parent	Minimum Return*
24"-48"	24"
60"-75"	30"

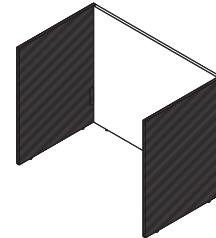
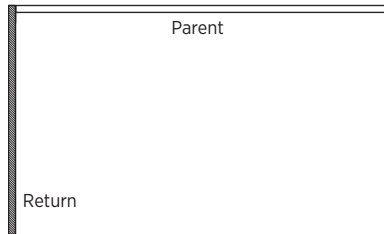

* 18"-24" not valid

Freestanding T-Screens

Parent	Minimum Return*
30"-75"	30"
36"-75"	36"
42"-72"	42"

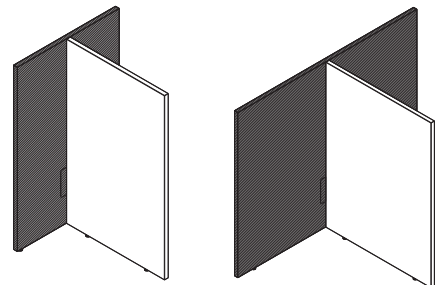
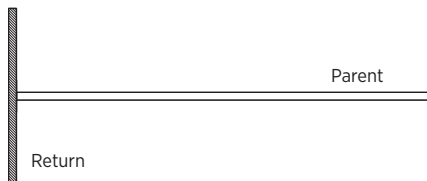

* 18"-24" not valid

Freestanding H-Screens

Freestanding T (Dual-Sided)	
Parent	Minimum Return
30"-60"	18"

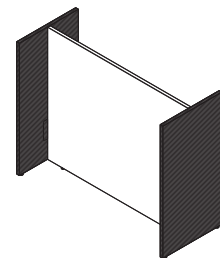
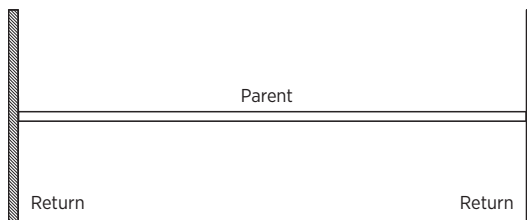

NOTES: Increase minimum return length by 3" or next largest width of panel for every 7½" variation in panel height.

ABOUND® SYSTEMS

Electrical and Data

About String-in Capacity

Openings in frame sides permit electrical data and communication cables to be run between frames in Abound. Using tackable acoustical tiles, the beltline pathway accommodates up to 62 cables (.25" dia) or 46 cables with electrical components installed.

DO NOT run electrical equipment or extension cords through cable openings in frame sides. Use beltline or base-mounted electrical system for all electrical supply.

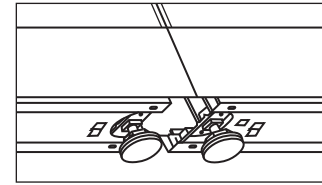
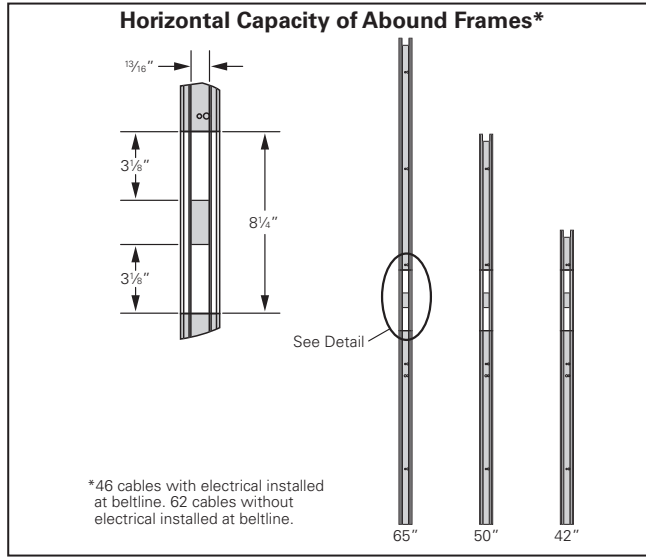

Cables can enter/exit panel through underside of base pathway at juncture between frames. Openings are sized as follows (in sq. in.):

Straight connection	6.0
"S" Extended Straight Connection	10.0
"L" 90° Connection	8.9
"T" Connection	15.9
"X" Connection	17.9
"Y" Connection	—

When leveling glides are fully retracted, panel-to-floor clearance is 7/16". This may affect the volume of cabling that can be fed into the frame from the bottom of the pathway.

Vertical Capacity

Vertical Capacity Through Panel Frames

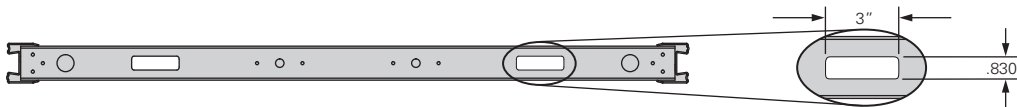

- A 60% fill ratio is achievable; however, when electrical components are installed in the beltline area, cabling capacity through the beltline area will be limited to approximately 45% fill ratio.

	Panel Width	Qty of .25" Cables at 45% Fill Ratio	Qty of .25" Cables at 60% Fill Ratio	Total Space (sq. in.)
Abound	24" - 60"W	48	64	5.26

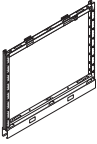
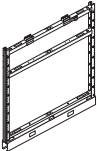
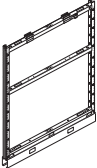
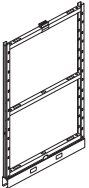
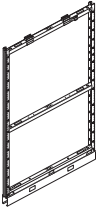

ABOUND® Panel Frames

	DESCRIPTION	MODEL	SHIP WEIGHT	CUBE	LIST PRICE BY PAINT GRADE	
					P1	P2
	35" H Panel Frame					
	35" H x 24" W	HRVF3524P	8	1.7	\$258	\$294
	35" H x 30" W	HRVF3530P	11	2.1	\$265	\$301
	35" H x 36" W	HRVF3536P	13	2.4	\$271	\$307
	35" H x 42" W	HRVF3542P	16	2.8	\$281	\$317
	35" H x 48" W	HRVF3548P	18	3.2	\$298	\$334
	35" H x 60" W	HRVF3560P	23	4.0	\$330	\$366
	42" H Panel Frame					
	42" H x 24" W	HRVF4224P	11	2.0	\$265	\$301
	42" H x 30" W	HRVF4230P	14	2.4	\$276	\$312
	42" H x 36" W	HRVF4236P	17	2.9	\$281	\$317
	42" H x 42" W	HRVF4242P	19	3.4	\$299	\$335
	42" H x 48" W	HRVF4248P	22	3.8	\$313	\$349
	42" H x 60" W	HRVF4260P	28	4.7	\$349	\$385
	<p>ⓘ When stacking on 42½" H frames, panel slots will be off by ½" compared to any other height panel.</p> <p>ⓘ When stacking on 42½" H frames, hanging accessories will be ½" off in height compared to accessories hanging on panels at any height other than 42½" H.</p>					
	50" H Panel Frame					
	50" H x 24" W	HRVF5024P	14	2.3	\$284	\$320
	50" H x 30" W	HRVF5030P	17	2.9	\$298	\$334
	50" H x 36" W	HRVF5036P	20	3.4	\$298	\$334
	50" H x 42" W	HRVF5042P	24	4.0	\$316	\$352
	50" H x 48" W	HRVF5048P	27	4.5	\$324	\$360
	50" H x 60" W	HRVF5060P	34	5.6	\$356	\$392
	57½" H Panel Frame					
	57½" H x 24" W	HRVF5724P	17	2.7	\$296	\$332
	57½" H x 30" W	HRVF5730P	22	3.3	\$306	\$342
	57½" H x 36" W	HRVF5736P	25	4.0	\$309	\$345
	57½" H x 42" W	HRVF5742P	30	4.6	\$326	\$362
	57½" H x 48" W	HRVF5748P	35	5.2	\$339	\$375
	57½" H x 60" W	HRVF5760P	43	6.5	\$368	\$404
	65" H Panel Frame					
	65" H x 24" W	HRVF6524P	17	3.0	\$307	\$343
	65" H x 30" W	HRVF6530P	22	3.7	\$313	\$349
	65" H x 36" W	HRVF6536P	25	4.4	\$318	\$354
	65" H x 42" W	HRVF6542P	30	5.1	\$331	\$367
	65" H x 48" W	HRVF6548P	35	5.8	\$351	\$387
	65" H x 60" W	HRVF6560P	43	7.2	\$382	\$418

NOTES:

- Includes frame, baserail covers, attaching hardware and bottom segment bar.
- Frames, top caps and tiles are ordered and shipped separately.
- Frames are 2½" thick with a 5" H baserail.
- Frames are standard with two adjustable leveling glides which can be adjusted from the bottom of the glide or from the interior of frame.
- Two wire and data management openings standard per raceway, 24" panel has one opening.
- Lay-in wire management available in base. Horizontal cable routing available at beltline.
- Lay-in top pathway provides additional data cabling capacity.
- For worksurfaces that can be used with both Abound® and Accelerate® systems, see pages 617-629.
- ⓘ Panels should not be used in unsupported applications or take the place of permanent walls. Panels are intended to be supported with floor supports and/or storage or tied in with worksurfaces. Refer to Specifying and Design Guide pages.

HOW TO SPECIFY

Select Model Number H R V F 3 5 2 4 P	Select Trim Color See page 423 T 4
---	---

ABOUND® Panel Frames

GSA SIN 33721



Icon Legend on page 19

WORKSTATIONS



DESCRIPTION	FLAT MODEL	CHAMFERED MODEL	SHIP WEIGHT	CUBE	LIST PRICE BY PAINT GRADE	
					P1	P2
Panel Top Cap						
24"W	HRVTC24F	HRVTC24	1.6	0.3	\$40	\$60
30"W	HRVTC30F	HRVTC30	1.8	0.3	\$50	\$70
36"W	HRVTC36F	HRVTC36	2.0	0.3	\$65	\$85
42"W	HRVTC42F	HRVTC42	2.2	0.3	\$68	\$88
48"W	HRVTC48F	HRVTC48	3.4	0.4	\$75	\$95
54"W	HRVTC54F	HRVTC54	3.7	0.5	\$92	\$112
60"W	HRVTC60F	HRVTC60	3.9	0.6	\$92	\$112
66"W	HRVTC66F	HRVTC66	4.0	0.6	\$109	\$129
72"W	HRVTC72F	HRVTC72	5.3	0.8	\$113	\$133
78"W	HRVTC78F	HRVTC78	6.5	0.8	\$118	\$138
84"W	HRVTC84F	HRVTC84	6.7	0.9	\$128	\$148
90"W	HRVTC90F	HRVTC90	7.0	0.9	\$134	\$154
96"W	HRVTC96F	HRVTC96	7.2	0.9	\$140	\$160

NOTES: Top caps can span more than one panel in an in-line connection.

! Top cap models are to be used on Abound® frames only.

NOTES:

- Includes frame, baserail covers, attaching hardware and bottom segment bar.
- Frames, top caps and tiles are ordered and shipped separately.
- Frames are 2½" thick with a 5"H baserail.
- Frames are standard with two adjustable leveling glides which can be adjusted from the bottom of the glide or from the interior of frame.
- Two wire and data management openings standard per raceway, 24" panel has one opening.
- Lay-in wire management available in base. Horizontal cable routing available at beltline.
- Lay-in top pathway provides additional data cabling capacity.
- For worksurfaces that can be used with both Abound® and Accelerate® systems, see pages 617-629.
- ! Panels should not be used in unsupported applications or take the place of permanent walls. Panels are intended to be supported with floor supports and/or storage or tied in with worksurfaces. Refer to Specifying and Design Guide pages.

HOW TO SPECIFY

Select Model Number HRVTC24	Select Trim Color See page 423 T4
---------------------------------------	--



ABOUND® Open Base Panel Frames

	DESCRIPTION	MODEL	SHIP WEIGHT	CUBE	LIST PRICE BY PAINT GRADE	
					P1	P2
	35" H Open Base Panel Frame					
	35" H x 24" W	HRFF3524P	8	1.7	\$258	\$294
	35" H x 30" W	HRFF3530P	11	2.1	\$265	\$301
	35" H x 36" W	HRFF3536P	13	2.4	\$271	\$307
	35" H x 42" W	HRFF3542P	16	2.8	\$281	\$317
	35" H x 48" W	HRFF3548P	18	3.2	\$298	\$334
	35" H x 60" W	HRFF3560P	23	4.0	\$330	\$366
	42" H Open Base Panel Frame					
	42" H x 24" W	HRFF4224P	11	2.0	\$265	\$301
	42" H x 30" W	HRFF4230P	14	2.4	\$276	\$312
	42" H x 36" W	HRFF4236P	17	2.9	\$281	\$317
	42" H x 42" W	HRFF4242P	19	3.4	\$299	\$335
	42" H x 48" W	HRFF4248P	22	3.8	\$313	\$349
	42" H x 60" W	HRFF4260P	28	4.7	\$349	\$385
<p>ⓘ When stacking on 42½" H frames, panel slots will be off by ½" compared to any other height panel.</p> <p>ⓘ When stacking on 42½" H frames, hanging accessories will be ½" off in height compared to accessories hanging on panels at any height other than 42½" H.</p>						
	50" H Open Base Panel Frame					
	50" H x 24" W	HRFF5024P	14	2.3	\$284	\$320
	50" H x 30" W	HRFF5030P	17	2.9	\$298	\$334
	50" H x 36" W	HRFF5036P	20	3.4	\$298	\$334
	50" H x 42" W	HRFF5042P	24	4.0	\$316	\$352
	50" H x 48" W	HRFF5048P	27	4.5	\$324	\$360
	50" H x 60" W	HRFF5060P	34	5.6	\$356	\$392
	57½" H Open Base Panel Frame					
	57½" H x 24" W	HRFF5724P	17	2.7	\$296	\$332
	57½" H x 30" W	HRFF5730P	22	3.3	\$306	\$342
	57½" H x 36" W	HRFF5736P	25	4.0	\$309	\$345
	57½" H x 42" W	HRFF5742P	30	4.6	\$326	\$362
	57½" H x 48" W	HRFF5748P	35	5.2	\$339	\$375
	57½" H x 60" W	HRFF5760P	43	6.5	\$368	\$404
	65" H Open Base Panel Frame					
	65" H x 24" W	HRFF6524P	17	3.0	\$307	\$343
	65" H x 30" W	HRFF6530P	22	3.7	\$313	\$349
	65" H x 36" W	HRFF6536P	25	4.4	\$318	\$354
	65" H x 42" W	HRFF6542P	30	5.1	\$331	\$367
	65" H x 48" W	HRFF6548P	35	5.8	\$351	\$387
	65" H x 60" W	HRFF6560P	43	7.2	\$382	\$418
	Raceway to Open Base Conversion Kit	HRVFFOOT	4	0.1	\$186	\$206

NOTES:

- Includes frame, attaching hardware and bottom segment bar.
- Tiles and top caps are ordered and shipped separately.
- Frames are 2½" thick with a 5" H open base.
- Frames are standard with two adjustable leveling glides which can be adjusted from the bottom of the glide.
- Horizontal cable routing available at beltline.

- Lay-in top pathway provides additional data cabling capacity.
- See page 446 for top cap options.
- For worksurfaces that can be used with Abound® and Accelerate® systems, see pages 617-629.
- ⓘ Panels should not be used in unsupported applications or take the place of permanent walls. Panels are intended to be supported with floor supports and/or storage or tied in with worksurfaces. Refer to Specifying and Design Guide pages.

HOW TO SPECIFY

<p>Select Model Number</p> <p>HRFF3524P</p>	<p>Select Trim Color</p> <p>See page 423</p> <p>T4</p>
---	--

ABOUND[®] Stacking Panel Frames

GSA SIN 33721



Icon Legend on page 19

WORKSTATIONS



DESCRIPTION

15" H Stacking Panel Frame

15" H x 24" W
15" H x 30" W
15" H x 36" W
15" H x 42" W
15" H x 48" W
15" H x 60" W

MODEL

HRVF1524
HRVF1530
HRVF1536
HRVF1542
HRVF1548
HRVF1560

SHIP WEIGHT

8
10
12
14
16
20

CUBE

0.8
0.9
1.1
1.3
1.5
1.8

LIST PRICE

\$241
\$252
\$258
\$269
\$271
\$279

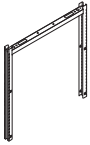

30" H Stacking Panel Frame

30" H x 24" W
30" H x 30" W
30" H x 36" W
30" H x 42" W
30" H x 48" W
30" H x 60" W

HRVF3024
HRVF3030
HRVF3036
HRVF3042
HRVF3048
HRVF3060

10
12
14
16
18
22

1.4
1.8
2.1
2.4
2.8
3.4

\$254
\$269
\$277
\$288
\$293
\$311



Full Segment Bars

24" W
30" W
36" W
42" W
48" W
60" W

HRVFSB24
HRVFSB30
HRVFSB36
HRVFSB42
HRVFSB48
HRVFSB60

2
2
3
3
3
4

0.4
0.4
0.5
0.5
0.6
0.7

\$24
\$24
\$25
\$26
\$27
\$28

! Must order one segment bar per panel reveal, per panel side.

NOTES:

- Frames, top caps and tiles are ordered and shipped separately.
- Includes attachment hardware.
- Stacking frames can be added to the top of any 35" H, 50" or 65" H frame.
- No paint selection necessary on stacking frames.
- Overhead storage units can be suspended from stacking frames. See pages 584-585.
- Segment Bars do not need to be specified for monolithic tiles, when only a single tile is attached to the frame.

- ! When stacking on 42½" H frames, panel slots will be off by ½" compared to any other height panel.
- ! When stacking on 42½" H frames, hanging accessories will be ½" off in height compared to accessories hanging on panels at any height other than 42½" H.
- ! Not designed to combine differing frame widths in a single stack.
- ! Stacking frames not designed to be used as a base frame.
- ! Segment bars available in Black only.
- ! Segment Bars are formed, steel cross members and are required between tiles and on each side of the frame.

HOW TO SPECIFY

Select
Model Number

HRVF1524



ABOUND® Stiffener Supports



DESCRIPTION

Stiffener Support

- 24"W
- 30"W
- 36"W
- 42"W
- 48"W
- 60"W

MODEL

SHIP WEIGHT

CUBE

LIST PRICE

HRVSS24	1	0.4	\$63
HRVSS30	1	0.4	\$65
HRVSS36	4	0.5	\$69
HRVSS42	4	0.5	\$85
HRVSS48	4	0.5	\$96
HRVSS60	4	0.7	\$104

! Black only. No need to specify paint.

NOTES:

- Tile stiffener supports can be used to increase the stiffness of a panel and can also be used to mount power/data anywhere vertically on an Abound frame. Can only be used when there are fabric tiles on both sides of the frame.
- Self-drilling screws included.

! Black only. No need to specify paint.

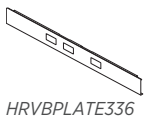

HRVBPLATE336

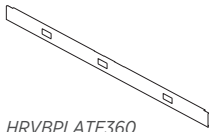

HRVBPLATE360

DESCRIPTION

Abound® Base Pathway Cover w/Additional Knockout

- 36"W
- 42"W
- 48"W
- 60"W

MODEL

SHIP WEIGHT

CUBE

LIST PRICE BY PAINT GRADE

P1

P2

HRVBPLATE336	7	0.4	\$81	\$91
HRVBPLATE342	8	0.4	\$83	\$93
HRVBPLATE348	9	0.4	\$86	\$96
HRVBPLATE360	11	0.5	\$99	\$109

NOTES: Specify paint, see page 423.

SPECIFYING EXAMPLE: HRVBPLATE336.T4

NOTES:

- ! Specify Pathways to match trim color.
- ! Standard raceways with two knockouts are standard on panels. If additional three knockout kickplate is ordered, the two port version can be saved or discarded.

HOW TO SPECIFY

<p>Select Model Number</p>	<p>Select Paint Color</p> <p>See page 423</p>
<div style="border: 1px solid black; display: flex; gap: 2px;"> H R V B P L A T E 3 3 6 </div>	<div style="border: 1px solid black; display: flex; gap: 2px;"> T 4 </div>

ABOUND® Panel Door

GSA SIN 33721



Icon Legend on page 19

WORKSTATIONS



DESCRIPTION	MODEL	SHIP WEIGHT	CUBE	L1 LIST PRICE BY PAINT GRADE	
				P1	P2

Door Panel — Laminate 42"W x 95"H	HRVD9542P	155	5.4	\$2478	\$2514
---	------------------	-----	-----	---------------	---------------

NOTES: Includes frame, 42"W door, hinges and attaching hardware. Lockset or Knob ordered separately. Best placement of a door is at an L, T, X connector or wall starter connector for rigidity. Use of spanning top caps at an in-line will also help add additional rigidity.

- ❗ Two HRVD0742T tiles for above the door must be ordered per each door ordered. See below.
- ❗ Top Cap must be ordered separately. See page 446 for top cap specification.

HOW TO SPECIFY

Select Model Number	Select Trim Color See page 423	Select Door Laminate L1 Woodgrain only See page 423
HRVD9542P	T4	K2

DESCRIPTION	MODEL	SHIP WEIGHT	CUBE	LIST PRICE BY FABRIC GRADE						
				A	B	C	D	E	F	G

Fabric Tiles for Door Panel 7½"H x 42"W	HRVD0742T	3	1.2	\$93	\$97	\$101	\$111	\$114	\$118	\$122
---	------------------	---	-----	-------------	-------------	--------------	--------------	--------------	--------------	--------------

- ❗ Must be ordered with the Door Panel model above.
- ❗ Required for door installation.
- ❗ Two tiles must be ordered for installation. Tiles ship 1/pkg.

HOW TO SPECIFY

Select Model Number	Select Fabric Color See pages 424-425
HRVD0742T	APN15

DESCRIPTION	MODEL	SHIP WEIGHT	CUBE	LIST PRICE
-------------	-------	-------------	------	------------



Lockset (Door Knob) Polished Brass, keyed on one side	HN899900	2.0	0.1	\$126
---	-----------------	-----	-----	--------------



Door Lever Brushed Aluminum, keyed on one side	HN899910	2.0	0.1	\$347
--	-----------------	-----	-----	--------------



Carpet Grippers	HICG12	0.5	0.1	\$23
------------------------	---------------	-----	-----	-------------

NOTES: Used with Glide Towers
Shipped 12 per package
No need to specify finish

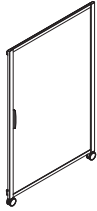

ABOUND[®] Sliding Door

**DESCRIPTION****Abound Sliding Door**

50"H x 42"W

65"H x 42"W

80"H x 42"W

! Door is only available in Frosted Translucent Acrylic. Specify paint for frame.

! Can only install Sliding Door at the end of a run, not at a corner.

MODEL**HH15042SD****HH16542SD****HH18042SD****SHIP
WEIGHT**

28

38

46

CUBE

5.5

7.1

8.6

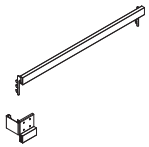
LIST PRICE BY PAINT GRADE**P1****\$2266****\$2583****\$3160****P2****\$2302****\$2619****\$3196****Mounting Kit for Abound Sliding Door**

For 30"W Panel

For 36"W Panel

For 42"W Panel

For 48"W Panel

NOTES: Specify paint.

HHKDMK30**HHKDMK36****HHKDMK42****HHKDMK48**

4

5

6

7

0.4

0.5

0.5

0.5

\$196**\$205****\$211****\$222****\$208****\$217****\$223****\$234****NOTES:**

- The Sliding Doors are available in 50", 65", and 80"H models and can mount to 30", 36", 42", and 48"W panels.
- All doors are 42" wide, provide a 36"W opening, and are non-handed.
- ! A Mounting Bracket Kit must be ordered for each door corresponding to the mounting panels width (30", 36", 42", or 48"W).

HOW TO SPECIFY**Select
Model Number**

H H 1 5 0 4 2 S D

**Select
Paint Color**

See page 423

T 1

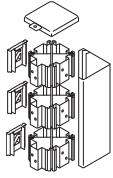

DESCRIPTION	FLAT MODEL	CHAMFERED MODEL	SHIP WEIGHT	CUBE	LIST PRICE BY PAINT GRADE	
					P1	P2
"L" 90° Painted Connector						
7"H Frame	HRVC7PLF	HRVC7PL	1	0.1	\$105	\$122
15"H Frame	HRVC15PLF	HRVC15PL	2	0.1	\$118	\$135
22"H Frame	HRVC22PLF	HRVC22PL	2	0.2	\$132	\$149
30"H Frame	HRVC30PLF	HRVC30PL	3	0.3	\$151	\$168
35"H Frame	HRVC35PLF	HRVC35PL	3	0.3	\$151	\$168
42"H Frame	HRVC42PLF	HRVC42PL	4	0.4	\$164	\$181
50"H Frame	HRVC50PLF	HRVC50PL	5	0.5	\$169	\$186
57½"H Frame	HRVC57PLF	HRVC57PL	5	0.5	\$175	\$192
65"H Frame	HRVC65PLF	HRVC65PL	6	0.6	\$180	\$197
80"H Frame	HRVC80PLF	HRVC80PL	6	0.8	\$186	\$203

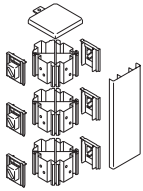

"T" 3-Way Painted Connector						
7"H Frame	HRVC7PTF	HRVC7PT	1	0.1	\$105	\$122
15"H Frame	HRVC15PTF	HRVC15PT	2	0.1	\$118	\$135
22"H Frame	HRVC22PTF	HRVC22PT	2	0.2	\$132	\$149
30"H Frame	HRVC30PTF	HRVC30PT	3	0.3	\$151	\$168
35"H Frame	HRVC35PTF	HRVC35PT	3	0.3	\$151	\$168
42"H Frame	HRVC42PTF	HRVC42PT	4	0.4	\$164	\$181
50"H Frame	HRVC50PTF	HRVC50PT	5	0.5	\$169	\$186
57½"H Frame	HRVC57PTF	HRVC57PT	5	0.5	\$175	\$192
65"H Frame	HRVC65PTF	HRVC65PT	6	0.6	\$180	\$197
80"H Frame	HRVC80PTF	HRVC80PT	6	0.8	\$186	\$203

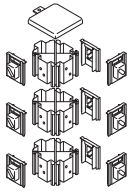

"X" 4-Way Painted Connector						
7"H Frame	HRVC7PXF	HRVC7PX	1	0.1	\$84	\$94
15"H Frame	HRVC15PXF	HRVC15PX	2	0.1	\$97	\$107
22"H Frame	HRVC22PXF	HRVC22PX	2	0.2	\$106	\$116
30"H Frame	HRVC30PXF	HRVC30PX	3	0.3	\$118	\$128
35"H Frame	HRVC35PXF	HRVC35PX	3	0.3	\$118	\$128
42"H Frame	HRVC42PXF	HRVC42PX	4	0.4	\$158	\$168
50"H Frame	HRVC50PXF	HRVC50PX	6	0.5	\$164	\$174
57½"H Frame	HRVC57PXF	HRVC57PX	5	0.5	\$166	\$176
65"H Frame	HRVC65PXF	HRVC65PX	7	0.6	\$169	\$179
80"H Frame	HRVC80PXF	HRVC80PX	6	0.8	\$180	\$190

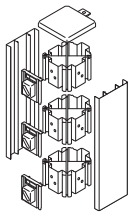

"S" Extended Straight Painted Connector						
7"H Frame	HRVC7PSF	HRVC7PS	1	0.1	\$129	\$146
15"H Frame	HRVC15PSF	HRVC15PS	2	0.1	\$140	\$157
22"H Frame	HRVC22PSF	HRVC22PS	2	0.2	\$152	\$169
30"H Frame	HRVC30PSF	HRVC30PS	3	0.3	\$164	\$181
35"H Frame	HRVC35PSF	HRVC35PS	3	0.3	\$164	\$181
42"H Frame	HRVC42PSF	HRVC42PS	4	0.4	\$188	\$205
50"H Frame	HRVC50PSF	HRVC50PS	6	0.5	\$197	\$214
57½"H Frame	HRVC57PSF	HRVC57PS	6	0.5	\$202	\$219
65"H Frame	HRVC65PSF	HRVC65PS	7	0.6	\$209	\$226
80"H Frame	HRVC80PSF	HRVC80PS	7	0.8	\$224	\$241

NOTES:

- All connectors include a light-gap strip.
- Abound connectors utilize a universal connector block designed to make one connection to the panel.
- Bracket clips come standard.
- 7"H connectors include one connector block; 15"H, 22"H, 30"H include two connector blocks; 50"H includes three connector blocks and 65"H includes four connector blocks.
- Connectors ship complete with trim.
- Outer trim snaps easily into place.
- Extended Straight Connectors are used to keep a frame run dimensionally consistent with opposing frame runs. Add 2¾" to the length of the run with each Extended Straight Connector used.

ⓘ Trim with Abound connectors can only be attached to connectors, not on panels.

HOW TO SPECIFY

<p>Select Model Number</p> <p>HRVC35PL . T4</p>	<p>Select Paint Color</p> <p>See page 423</p>
---	---

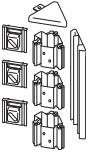
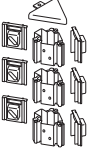

	DESCRIPTION	FLAT MODEL	CHAMFERED MODEL	SHIP WEIGHT	CUBE	LIST PRICE BY PAINT GRADE	
						P1	P2
	"Y" 120° Degree, Two-Sided, Painted Connector						
	35"H Frame	HRVC35PY2F	HRVC35PY2	3	0.3	\$151	\$168
	42"H Frame	HRVC42PY2F	HRVC42PY2	4	0.4	\$164	\$181
	50"H Frame	HRVC50PY2F	HRVC50PY2	5	0.5	\$180	\$197
	57½"H Frame	HRVC57PY2F	HRVC57PY2	5	0.5	\$189	\$206
	65"H Frame	HRVC65PY2F	HRVC65PY2	6	0.6	\$197	\$214
	"Y" 120° Degree, Three-Sided, Painted Connector						
	35"H Frame	HRVC35PY3F	HRVC35PY3	3	0.3	\$132	\$149
	42"H Frame	HRVC42PY3F	HRVC42PY3	4	0.4	\$151	\$168
	50"H Frame	HRVC50PY3F	HRVC50PY3	5	0.5	\$164	\$181
	57½"H Frame	HRVC57PY3F	HRVC57PY3	5	0.5	\$171	\$188
	65"H Frame	HRVC65PY3F	HRVC65PY3	6	0.6	\$180	\$197

NOTES:

- 35"H-42"H connectors include two universal connector blocks, 50"H includes three brackets and 65"H includes four brackets.
- Use Y Connectors for 120° applications.
- Abound connectors utilize a universal connector block designed to make one connection to the panel.
- Connectors ship complete with trim.
- Bracket clips come standard.
- Outer trim snaps easily into place.

HOW TO SPECIFY

Select Model Number HRVC35PY2	Select Paint Color See page 423 T3
---	---

Variable Height Finished End and Wall Starter Kits

WORKSTATIONS



DESCRIPTION	FLAT MODEL	CHAMFERED MODEL	SHIP WEIGHT	CUBE	LIST PRICE BY PAINT GRADE	
					P1	P2
Finished End						
15"H Finished End	HRVC15PFF	HRVC15PF	1 Ⓢ	0.1	\$72	\$89
30"H Finished End	HRVC30PFF	HRVC30PF	2 Ⓢ	0.3	\$86	\$103
35"H Finished End	HRVC35PFF	HRVC35PF	2 Ⓢ	0.3	\$86	\$103
42"H Finished End	HRVC42PFF	HRVC42PF	2 Ⓢ	0.4	\$97	\$114
50"H Finished End	HRVC50PFF	HRVC50PF	3 Ⓢ	0.5	\$104	\$121
57½"H Finished End	HRVC57PFF	HRVC57PF	3 Ⓢ	0.5	\$106	\$123
65"H Finished End	HRVC65PFF	HRVC65PF	4 Ⓢ	0.6	\$110	\$127
80"H Finished End	HRVC80PFF	HRVC80PF	4 Ⓢ	0.8	\$116	\$133



Variable Height Painted Finished End						
7" Variable Height Finished End	HRVC7PFVF	HRVC7PFV	1 Ⓢ	0.1	\$72	\$82
15" Variable Height Finished End	HRVC15PFVF	HRVC15PFV	1 Ⓢ	0.1	\$72	\$82
22" Variable Height Finished End	HRVC22PFVF	HRVC22PFV	2 Ⓢ	0.2	\$86	\$96
30" Variable Height Finished End	HRVC30PFVF	HRVC30PFV	2 Ⓢ	0.3	\$86	\$96



Variable Height Painted Finished End Over Connector						
7" Variable Height Finished End Over Connector	HRVC7PFT		1 Ⓢ	0.1	\$72	\$82
15" Variable Height Finished End Over Connector	HRVC15PFT		1 Ⓢ	0.1	\$72	\$82
22" Variable Height Finished End Over Connector	HRVC22PFT		2 Ⓢ	0.2	\$86	\$96
30" Variable Height Finished End Over Connector	HRVC30PFT		2 Ⓢ	0.3	\$86	\$96

NOTES: Flat Variable Height Finished End can be used for Variable Height Painted Finished End Over Connectors.



Frameless Glass Variable Height Trim						
7½"H	HRVC7FFVF	HRVC7FFV	1	0.1	\$65	\$74
15"H	HRVC15FFVF	HRVC15FFV	1	0.1	\$95	\$104

Specify paint only.

! Model only used with Frameless Glass on page 463.

SPECIFYING EXAMPLE: HRVC7FFV.T1



Wall Starter Kit						
65"H	HRVC65PWF	HRVC65PW	5 Ⓢ	0.6	\$197	\$214



Permanent Wall Hanger Kit						
2½"W x 7/8"D x 66"H		HRVC35PCE	6 Ⓢ	0.7	\$243	\$263
4¼"W x 7/8"D x 66"H		HRVC35PCM	3 Ⓢ	0.7	\$128	\$138

NOTES: Permanent Wall Hanger Kit can be used with both Flat and Chamfered models.

! Anchor devices are not supplied with this model. Refer to Abound® Installation instructions for appropriate hardware. Attachment to masonry walls is not recommended.

Specify paint

NOTES:

- Snaps easily onto end of frame.
- 35"H end trim includes top cap and vertical trim.
- 15"H and 30"H Finished End Trims do not include a top cap. These are only used for stacking frames which utilize the top trim and cap from the base frame to which they are attached.
- 42", 50" and 65"H finished end trim includes painted top transition piece, vertical trim and carpet grippers for extra stability.

- End trim is full-length to floor; no baserail cap is necessary.
- Finished Ends include top cap trim. Adds 1½" to panel run.
- Wall Starter Kit allows panel to start from a wall. Specify trim color.
- Wall Starter adds 1½" to length of panel run.
- Anchor devices are not supplied with the wall starter kits.

! Variable height trim and finished ends can only be attached to panels, not attached to connectors.

HOW TO SPECIFY

<p>Select Model Number</p>	<p>Select Paint Color</p> <p>See page 423</p>
<p>HRVC7PFT</p>	<p>T3</p>



WALL HANGER BARS AND OFF-MODULE BRACKET

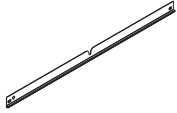

DESCRIPTION	MODEL	SHIP WEIGHT	CUBE	LIST PRICE BY PAINT GRADE	
				P1	P2
Wall Hanger Segment Bars					
24"W	HRVFSBW24	2	0.4	\$37	N/A
30"W	HRVFSBW30	2	0.4	\$37	N/A
36"W	HRVFSBW36	3	0.5	\$39	N/A
42"W	HRVFSBW42	3	0.5	\$43	N/A
48"W	HRVFSBW48	3	0.6	\$47	N/A
60"W	HRVFSBW60	4	0.7	\$51	N/A

ⓘ Includes two tile bars. Top bar may only be used in the top uppermost position on Wall Track. Bottom bar can be used in the bottom position at any point on the wall hangers. When segmenting tiles on Wall Hangers, standard Segment Bars (page 448) must be ordered for placement between each tile reveal or at the top position of a single tile that is not in the uppermost position.

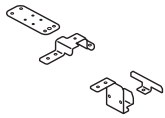

Off-Module Bracket Kit	HRVOMOD	2	0.1	\$97	\$107
-------------------------------	----------------	---	-----	-------------	--------------

- Includes top and bottom attachment brackets and top trim finished end.
- Installation requires defacing of the top tile.

ⓘ Cannot be mounted in locations where the bottom bracket covers electrical cutouts in the base pathway on parent run panels.

HOW TO SPECIFY

Select Model Number

HRVFSBW24

ABOUND[®] Tackable Acoustical Tiles

GSA SIN 33721



Icon Legend on page 19

WORKSTATIONS

DESCRIPTION	MODEL	SHIP WEIGHT	CUBE	LIST PRICE BY FABRIC GRADE							
				AA	A	B	C	D	E	F	G
7½" H Tackable Acoustical Fabric Tiles											
7½" H x 24" W	HRVT0724T	2 ②	0.4	\$70	\$74	\$77	\$79	\$85	\$90	\$95	\$98
7½" H x 30" W	HRVT0730T	2 ②	0.5	\$82	\$86	\$89	\$93	\$99	\$106	\$109	\$112
7½" H x 36" W	HRVT0736T	2 ②	0.6	\$88	\$92	\$95	\$99	\$105	\$112	\$115	\$118
7½" H x 42" W	HRVT0742T	2 ②	0.7	\$97	\$102	\$106	\$110	\$120	\$123	\$127	\$131
7½" H x 48" W	HRVT0748T	2 ②	0.8	\$103	\$108	\$112	\$116	\$126	\$129	\$133	\$137
7½" H x 60" W	HRVT0760T	3 ②	1.0	\$123	\$143	\$147	\$152	\$164	\$168	\$171	\$174
15" H Tackable Acoustical Fabric Tiles											
15" H x 24" W	HRVT1524T	2 ②	0.8	\$73	\$82	\$90	\$98	\$114	\$132	\$148	\$156
15" H x 30" W	HRVT1530T	2 ②	0.9	\$74	\$85	\$95	\$105	\$127	\$148	\$159	\$169
15" H x 36" W	HRVT1536T	2 ②	1.1	\$81	\$92	\$102	\$112	\$134	\$155	\$166	\$176
15" H x 42" W	HRVT1542T	2 ②	1.3	\$83	\$96	\$108	\$123	\$156	\$167	\$177	\$188
15" H x 48" W	HRVT1548T	2 ②	1.5	\$91	\$104	\$116	\$131	\$164	\$175	\$185	\$196
15" H x 60" W	HRVT1560T	3 ②	1.8	\$104	\$117	\$129	\$144	\$177	\$188	\$198	\$209
22½" H Tackable Acoustical Tiles											
22½" H x 24" W	HRVT2224T	2	1.1	\$83	\$93	\$102	\$112	\$131	\$153	\$167	\$176
22½" H x 30" W	HRVT2230T	2	1.4	\$86	\$98	\$109	\$122	\$145	\$173	\$200	\$210
22½" H x 36" W	HRVT2236T	2	1.6	\$95	\$110	\$123	\$134	\$171	\$201	\$212	\$222
22½" H x 42" W	HRVT2242T	2	1.9	\$102	\$117	\$130	\$144	\$187	\$211	\$222	\$233
22½" H x 48" W	HRVT2248T	2	2.2	\$109	\$124	\$137	\$151	\$194	\$218	\$229	\$240
22½" H x 60" W	HRVT2260T	3	2.6	\$126	\$141	\$154	\$168	\$211	\$235	\$246	\$257
30" H Tackable Acoustical Tiles											
30" H x 24" W	HRVT3024T	2 ②	1.4	\$99	\$110	\$120	\$131	\$153	\$180	\$191	\$201
30" H x 30" W	HRVT3030T	2 ②	1.8	\$103	\$116	\$128	\$143	\$168	\$202	\$246	\$256
30" H x 36" W	HRVT3036T	2 ②	2.1	\$111	\$129	\$145	\$157	\$210	\$248	\$259	\$269
30" H x 42" W	HRVT3042T	3 ②	2.4	\$126	\$142	\$157	\$169	\$223	\$260	\$272	\$282
30" H x 48" W	HRVT3048T	3 ②	2.8	\$134	\$150	\$165	\$177	\$231	\$268	\$280	\$290
30" H x 60" W	HRVT3060T	4 ②	3.4	\$151	\$167	\$182	\$194	\$248	\$285	\$297	\$307
37" H Tackable Acoustical Tiles											
37" H x 24" W	HRVT3724T	2 ②	2.0	\$113	\$129	\$144	\$162	\$215	\$247	\$259	\$269
37" H x 30" W	HRVT3730T	3 ②	2.4	\$129	\$145	\$160	\$178	\$231	\$263	\$275	\$285
37" H x 36" W	HRVT3736T	4 ②	2.9	\$147	\$166	\$185	\$206	\$270	\$317	\$328	\$339
37" H x 42" W	HRVT3742T	4 ②	3.4	\$164	\$185	\$205	\$229	\$310	\$358	\$368	\$379
37" H x 48" W	HRVT3748T	5 ②	3.8	\$172	\$193	\$215	\$238	\$321	\$370	\$382	\$393
37" H x 60" W	HRVT3760T	6	4.6	\$197	\$223	\$249	\$280	\$362	\$422	\$433	\$445

① Segment bars ordered separately. See page 448.

NOTES:

- Tiles attach directly onto the panels. No additional hardware is needed.
- Tiles are non-dedicated.
- For monolithic applications, subtract 5" from the frame height to determine monolithic tile height.
- ④ Fabric tiles have a Class A fire rating.
- ① Tiles do not include segment bars, must be ordered separately. See page 448. Not needed on monolithic tiles.
- ① One segment bar required per panel reveal, per panel side.

HOW TO SPECIFY

Select Model Number	Select Fabric Color
	See pages 424-425
HRVT1524T	APN11



ABOUND® Tackable Acoustical Tiles



DESCRIPTION	MODEL	SHIP WEIGHT	CUBE	LIST PRICE BY FABRIC GRADE								
				AA	A	B	C	D	E	F	G	
45°H Tackable Acoustical Tiles												
45°H x 24"W	HRVT4524T	2	2.3	\$125	\$144	\$164	\$185	\$251	\$299	\$310	\$322	
45°H x 30"W	HRVT4530T	3	2.9	\$141	\$162	\$182	\$207	\$290	\$338	\$350	\$362	
45°H x 36"W	HRVT4536T	5	3.4	\$168	\$189	\$211	\$234	\$317	\$366	\$378	\$389	
45°H x 42"W	HRVT4542T	5	4.0	\$197	\$218	\$238	\$263	\$345	\$394	\$406	\$418	
45°H x 48"W	HRVT4548T	6	4.5	\$222	\$243	\$271	\$288	\$371	\$420	\$432	\$443	
45°H x 60"W	HRVT4560T	7	5.6	\$242	\$268	\$295	\$326	\$407	\$467	\$479	\$491	



52½°H Tackable Acoustical Tiles												
52½°H x 24"W	HRVT5224T	2	2.6	\$138	\$166	\$196	\$227	\$309	\$362	\$374	\$408	
52½°H x 30"W	HRVT5230T	3	3.2	\$157	\$189	\$223	\$257	\$347	\$407	\$420	\$471	
52½°H x 36"W	HRVT5236T	4	3.8	\$185	\$217	\$251	\$283	\$374	\$435	\$448	\$499	
52½°H x 42"W	HRVT5242T	5	4.4	\$205	\$241	\$279	\$312	\$415	\$476	\$488	\$560	
52½°H x 48"W	HRVT5248T	6	4.9	\$231	\$267	\$307	\$338	\$441	\$535	\$548	\$619	
52½°H x 60"W	HRVT5260T	7	6.1	\$249	\$291	\$334	\$368	\$500	\$576	\$588	\$659	

Segment bars ordered separately. See page 448.



60°H Tackable Acoustical Tiles												
60°H x 24"W	HRVT6024T	3	3.0	\$147	\$178	\$211	\$245	\$333	\$387	\$400	\$441	
60°H x 30"W	HRVT6030T	4	3.7	\$166	\$202	\$240	\$277	\$369	\$434	\$447	\$511	
60°H x 36"W	HRVT6036T	6	4.4	\$193	\$229	\$267	\$302	\$395	\$460	\$474	\$538	
60°H x 42"W	HRVT6042T	6	5.1	\$209	\$250	\$294	\$330	\$439	\$504	\$517	\$608	
60°H x 48"W	HRVT6048T	7	5.8	\$237	\$278	\$322	\$358	\$467	\$576	\$590	\$680	
60°H x 60"W	HRVT6060T	9	7.2	\$252	\$299	\$347	\$383	\$531	\$613	\$625	\$716	

Segment bars ordered separately. See page 448.

NOTES:

- Tiles are non-dedicated.
- Tiles attach directly onto the panels. No additional hardware is needed.
- For monolithic applications, subtract 5" from the frame height to determine monolithic tile height.
- Fabric tiles have a Class A fire rating.
- Tiles do not include segment bars, must be ordered separately. See page 448. Not needed on monolithic tiles.
- One segment bar required per panel reveal, per panel side.

HOW TO SPECIFY

<p>Select Model Number</p> <p>HRVT4524T</p>	<p>Select Fabric Color</p> <p>See pages 424-425</p> <p>APN11</p>
---	--

ABOUND[®] Power/Data Fabric Tiles

GSA SIN 33721



Icon Legend on page 19

WORKSTATIONS



DESCRIPTION	MODEL	SHIP WEIGHT	CUBE	LIST PRICE BY FABRIC GRADE									
				AA	A	B	C	D	E	F	G		
15" H Power/Data Fabric Tiles													
15" H x 24" W	HRVT1524E	2	0.8	\$144	\$153	\$161	\$169	\$185	\$203	\$219	\$227		
15" H x 30" W	HRVT1530E	2	0.9	\$145	\$156	\$166	\$176	\$198	\$219	\$230	\$240		
15" H x 36" W	HRVT1536E	2	1.1	\$153	\$164	\$174	\$184	\$206	\$227	\$238	\$248		
15" H x 42" W	HRVT1542E	2	1.3	\$155	\$168	\$180	\$195	\$228	\$239	\$249	\$260		
15" H x 48" W	HRVT1548E	2	1.5	\$162	\$175	\$187	\$202	\$235	\$246	\$256	\$267		
15" H x 60" W	HRVT1560E	3	1.8	\$175	\$188	\$200	\$215	\$248	\$259	\$269	\$280		

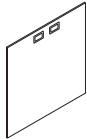

30" H Power/Data Fabric Tiles													
30" H x 24" W	HRVT3024E	2	1.4	\$168	\$179	\$189	\$200	\$222	\$249	\$260	\$270		
30" H x 30" W	HRVT3030E	2	1.8	\$173	\$186	\$198	\$213	\$238	\$272	\$316	\$326		
30" H x 36" W	HRVT3036E	2	2.1	\$184	\$202	\$218	\$230	\$283	\$321	\$332	\$342		
30" H x 42" W	HRVT3042E	3	2.4	\$201	\$217	\$232	\$244	\$298	\$335	\$347	\$357		
30" H x 48" W	HRVT3048E	3	2.8	\$207	\$223	\$238	\$250	\$304	\$341	\$353	\$363		
30" H x 60" W	HRVT3060E	4	3.4	\$222	\$238	\$253	\$265	\$319	\$356	\$368	\$378		

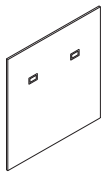

37" H Power/Data Fabric Tiles													
37" H x 24" W	HRVT3724E	2	2.0	\$186	\$202	\$217	\$235	\$288	\$320	\$332	\$342		
37" H x 30" W	HRVT3730E	3	2.4	\$203	\$219	\$234	\$252	\$305	\$337	\$349	\$359		
37" H x 36" W	HRVT3736E	4	2.9	\$215	\$234	\$253	\$274	\$338	\$385	\$396	\$407		
37" H x 42" W	HRVT3742E	4	3.4	\$229	\$250	\$270	\$294	\$375	\$423	\$433	\$444		
37" H x 48" W	HRVT3748E	5	3.8	\$246	\$267	\$289	\$312	\$395	\$444	\$456	\$467		
37" H x 60" W	HRVT3760E	6	4.7	\$271	\$297	\$323	\$354	\$436	\$496	\$507	\$519		

Segment bars ordered separately. See page 448.

NOTES:

- Power/Data tiles are tackable and acoustical.
- Tiles attach directly onto the panels. No additional hardware is needed.
- Tiles are non-dedicated.
- 24" W tiles have one port. Other widths have two.
- Power/Data grommet opening is 2 1/8" W x 1 3/8" H. With glides retracted grommets are 30" from the floor and 10 1/2" from the edge of the frame.
- Power/Data ports are factory installed.

Fabric tiles have a Class A fire rating.

Ports on all tile sizes are located above the worksurface. Tiles cannot be flipped to change port location.

Tiles do not include segment bars, must be ordered separately. See page 448. Can be used in any combination.

One segment bar required per panel reveal, per panel side.

Electrical mounting brackets must be ordered separately. See page 613.

HOW TO SPECIFY

<p>Select Model Number</p> <p>HRVT1524E</p>	<p>Select Fabric Color</p> <p>See pages 424-425</p> <p>APN11</p>	<p>Select Electrical Power/Data Grommet Color</p> <p>See page 423</p> <p>T5</p>
---	--	---



ABOUND® Power/Data Fabric Tiles

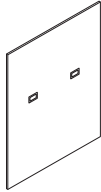

DESCRIPTION	MODEL	SHIP WEIGHT	CUBE	LIST PRICE BY FABRIC GRADE								
				AA	A	B	C	D	E	F	G	
45"H Power/Data Fabric Tiles												
45"H x 24"W	HRVT4524E	2	2.3	\$200	\$219	\$239	\$260	\$326	\$374	\$385	\$397	
45"H x 30"W	HRVT4530E	3	2.9	\$215	\$236	\$256	\$281	\$364	\$412	\$424	\$436	
45"H x 36"W	HRVT4536E	5	3.4	\$244	\$265	\$287	\$310	\$393	\$442	\$454	\$465	
45"H x 42"W	HRVT4542E	5	4.0	\$271	\$292	\$312	\$337	\$419	\$468	\$480	\$492	
45"H x 48"W	HRVT4548E	6	4.5	\$298	\$319	\$347	\$364	\$447	\$496	\$508	\$519	
45"H x 60"W	HRVT4560E	7	5.6	\$318	\$344	\$371	\$402	\$483	\$543	\$555	\$567	

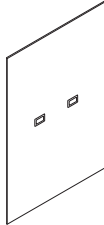

52½"H Power/Data Fabric Tiles												
52½"H x 24"W	HRVT5224E	2	2.8	\$212	\$242	\$272	\$302	\$385	\$432	\$450	\$484	
52½"H x 30"W	HRVT5230E	3	3.4	\$232	\$267	\$301	\$335	\$424	\$483	\$498	\$549	
52½"H x 36"W	HRVT5236E	4	4.0	\$259	\$293	\$327	\$359	\$450	\$511	\$524	\$575	
52½"H x 42"W	HRVT5242E	5	4.6	\$279	\$317	\$355	\$388	\$490	\$551	\$564	\$635	
52½"H x 48"W	HRVT5248E	6	5.1	\$307	\$345	\$385	\$416	\$519	\$613	\$626	\$696	
52½"H x 60"W	HRVT5260E	7	6.3	\$325	\$368	\$411	\$445	\$577	\$653	\$665	\$736	

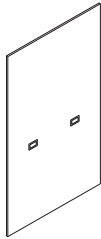

60"H Power/Data Fabric Tiles												
60"H x 24"W	HRVT6024E	3	3.0	\$219	\$250	\$283	\$317	\$405	\$459	\$472	\$513	
60"H x 30"W	HRVT6030E	4	3.7	\$242	\$278	\$316	\$353	\$445	\$510	\$523	\$587	
60"H x 36"W	HRVT6036E	6	4.4	\$268	\$304	\$342	\$377	\$470	\$535	\$549	\$613	
60"H x 42"W	HRVT6042E	6	5.1	\$285	\$326	\$370	\$406	\$515	\$580	\$593	\$684	
60"H x 48"W	HRVT6048E	7	5.8	\$312	\$353	\$397	\$433	\$542	\$651	\$665	\$755	
60"H x 60"W	HRVT6060E	9	7.2	\$328	\$375	\$423	\$459	\$607	\$689	\$701	\$792	

! Segment bars ordered separately. See page 448.

NOTES:

- Tiles are non-dedicated.
- Tiles attach directly onto the panels. No additional hardware is needed.
- 24"W tiles have one port. Other widths have two.
- Power/Data grommet opening is 2 1/16"W x 1 1/8"H. With glides retracted grommet are 30" from the floor and 10 1/2" from the edge of the frame.
- Power/Data ports are factory installed.
- ! Fabric tiles have a Class A fire rating.
- ! Ports on all tile sizes are located above the worksurface. Tiles cannot be flipped to change port location.
- ! Tiles do not include segment bars, must be ordered separately. See page 448. Can be used in any combination.
- ! One segment bar required per panel reveal, per panel side.
- ! Electrical mounting brackets must be ordered separately. See page 613.

HOW TO SPECIFY

<p>Select Model Number</p> <p>HRVT4524E</p>	<p>Select Fabric Color</p> <p>See pages 424-425</p> <p>APN11</p>	<p>Select Electrical Power/Data Grommet Color</p> <p>See page 423</p> <p>T5</p>
---	--	---

ABOUND[®] Hard-surface Tiles

GSA SIN 33721



Icon Legend on page 19

WORKSTATIONS

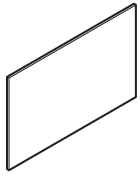

DESCRIPTION

15" Hard-surface Tile and Mounting Kit

- 15"H x 24"W
- 15"H x 30"W
- 15"H x 36"W
- 15"H x 42"W
- 15"H x 48"W
- 15"H x 60"W

MODEL

- HRVT1524HS2**
- HRVT1530HS2**
- HRVT1536HS2**
- HRVT1542HS2**
- HRVT1548HS2**
- HRVT1560HS2**

SHIP WEIGHT

- 11
- 13
- 15
- 17
- 21
- 25

CUBE

- 0.8
- 0.9
- 1.1
- 1.3
- 1.5
- 1.8

LIST PRICE BY LAMINATE GRADE

L1

- \$239**
- \$251**
- \$269**
- \$285**
- \$298**
- \$338**

L2

- \$249**
- \$261**
- \$279**
- \$295**
- \$313**
- \$353**

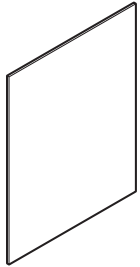

30" Hard-surface Tile and Mounting Kit

- 30"H x 24"W
- 30"H x 30"W
- 30"H x 36"W
- 30"H x 42"W
- 30"H x 48"W
- 30"H x 60"W

- HRVT3024HS2**
- HRVT3030HS2**
- HRVT3036HS2**
- HRVT3042HS2**
- HRVT3048HS2**
- HRVT3060HS2**

- 17
- 19
- 21
- 24
- 28
- 30

- 1.4
- 1.8
- 2.1
- 2.4
- 2.8
- 3.4

- \$292**
- \$314**
- \$349**
- \$381**
- \$402**
- \$441**

- \$307**
- \$329**
- \$364**
- \$396**
- \$422**
- \$461**

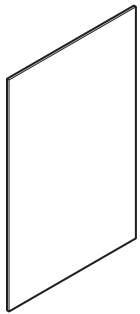

37" Hard-surface Tile and Mounting Kit

- 37"H x 24"W
- 37"H x 30"W
- 37"H x 36"W
- 37"H x 42"W
- 37"H x 48"W
- 37"H x 60"W

- HRVT3724HS2**
- HRVT3730HS2**
- HRVT3736HS2**
- HRVT3742HS2**
- HRVT3748HS2**
- HRVT3760HS2**

- 17
- 17
- 19
- 21
- 24
- 30

- 1.4
- 1.8
- 2.1
- 2.4
- 2.8
- 3.4

- \$356**
- \$392**
- \$430**
- \$473**
- \$511**
- \$578**

- \$376**
- \$412**
- \$450**
- \$493**
- \$536**
- \$603**

NOTES:

- Tiles are made from high-pressure laminate.
- Available in all standard HON laminates.
- On woodgrain laminates, grain direction is vertical.
- Specify paint color.
- 15"H and 30"H tiles are non-dedicated and can be used in any tile position (except on 42"H frames.)

- ❗ All tiles ship with Custom Bracket Kit installed on the tile.
- ❗ One segment bar is required per panel reveal, per panel side.
- ❗ Tiles do not ship with segment bars — must be ordered separately. See page 448. Segment bars are not needed for 42"H monolithic tiles.

HOW TO SPECIFY

<p>Select Model Number</p> <p>HRVT1524HS2</p>	<p>Select Laminate Color</p> <p>See page 423</p> <p>H</p>	<p>Select Paint Color</p> <p>See page 423</p> <p>T1</p>
--	--	--



Icon Legend on page 19

ABOUND® Clear Glass Tiles

WORKSTATIONS

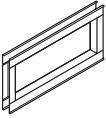
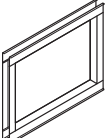
	DESCRIPTION	MODEL	SHIP WEIGHT	CUBE	LIST PRICE BY PAINT GRADE	
					P1	P2
	15”H Clear Glass Tiles					
	15”H x 24”W	HRVT1524G	12	0.8	\$515	\$534
	15”H x 30”W	HRVT1530G	15	0.9	\$545	\$564
	15”H x 36”W	HRVT1536G	17	1.1	\$576	\$595
	15”H x 42”W	HRVT1542G	19	1.3	\$615	\$635
	15”H x 48”W	HRVT1548G	20	1.5	\$661	\$681
	15”H x 60”W	HRVT1560G	26	1.8	\$790	\$810
	30”H Clear Glass Tiles					
	30”H x 24”W	HRVT3024G	15	1.4	\$684	\$704
	30”H x 30”W	HRVT3030G	21	1.8	\$730	\$750
	30”H x 36”W	HRVT3036G	22	2.1	\$777	\$797
	30”H x 42”W	HRVT3042G	25	2.4	\$840	\$860
	30”H x 48”W	HRVT3048G	28	2.9	\$904	\$924
	30”H x 60”W	HRVT3060G	33	3.4	\$1059	\$1079

! Segment bars ordered separately. See page 448.

NOTES:

- Glass is off-set and may be placed on either side of the frame.
- Tile is a single-pane, tempered glass.
- For worksurfaces that can be used with both Abound® and Accelerate® systems, see pages 617-629.
- ! Glass tiles have a Class A fire rating.
- ! Tiles do not include segment bars, must be ordered separately. See page 448. Can be used in any combination.
- ! Glass tiles cannot be placed in the second tier (20”-35” range) due to interference with the horizontal support. Glass tiles cannot be placed in the bottom tier of a frame.
- ! Glass tiles will not work with 42”H frames — use stackers with glass on 42½”H panels.
- ! When stacking on 42½”H frames, panel slots will be off by ½” compared to any other height panel.

HOW TO SPECIFY

<p>Select Model Number</p> <p>H R V T 1 5 2 4 G</p>	<p>Select Interior Shroud Paint Color</p> <p>See page 423. Available in all P1/P2 paint colors.</p> <p>T 1</p>
--	---

ABOUND® Frosted Glass Tiles

GSA SIN 33721



Icon Legend on page 19

WORKSTATIONS

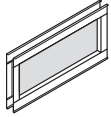

DESCRIPTION

15" H Frosted Glass Tiles

15" H x 24" W
15" H x 30" W
15" H x 36" W
15" H x 42" W
15" H x 48" W
15" H x 60" W

MODEL

SHIP WEIGHT

CUBE

LIST PRICE BY PAINT GRADE

P1

P2

HRVT1524R	12	0.8	\$633	\$652
HRVT1530R	15	0.9	\$680	\$699
HRVT1536R	17	1.1	\$726	\$745
HRVT1542R	19	1.3	\$777	\$797
HRVT1548R	20	1.5	\$838	\$858
HRVT1560R	26	1.8	\$980	\$1000

30" H Frosted Glass Tiles

30" H x 24" W
30" H x 30" W
30" H x 36" W
30" H x 42" W
30" H x 48" W
30" H x 60" W

HRVT3024R	15	1.4	\$894	\$914
HRVT3030R	21	1.8	\$954	\$974
HRVT3036R	22	2.1	\$1018	\$1038
HRVT3042R	25	2.4	\$1095	\$1115
HRVT3048R	28	2.9	\$1172	\$1192
HRVT3060R	33	3.4	\$1345	\$1365

! Segment bars ordered separately. See page 448.

NOTES:

- Glass is off-set and may be placed on either side of the frame.
- Tile is a single-pane, tempered glass.
- For worksurfaces that can be used with both Abound® and Accelerate® systems, see pages 617-629.
- ! Glass tiles have a Class A fire rating.
- ! Tiles do not include segment bars, must be ordered separately. See page 448. Can be used in any combination.
- ! Glass tiles cannot be placed in the second tier (20"-35" range) due to interference with the horizontal support. Glass tiles cannot be placed in the bottom tier of a frame.
- ! Glass tiles will not work with 42" H frames — use stackers with glass on 42½" H panels.
- ! When stacking on 42½" H frames, panel slots will be off by ½" compared to any other height panel.

HOW TO SPECIFY

Select
Model Number

Select
Interior Shroud Paint Color

See page 423. Available in all P1/P2 paint colors.

HRVT1524R . T1



Icon Legend on page 19

ABOUND® Frameless Glass

WORKSTATIONS

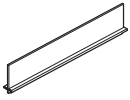

DESCRIPTION

7 1/2" H Frameless Glass

7 1/2" H x 24" W
7 1/2" H x 30" W
7 1/2" H x 36" W
7 1/2" H x 42" W
7 1/2" H x 48" W
7 1/2" H x 54" W (24" + 30")
7 1/2" H x 60" W
7 1/2" H x 66" W (30" + 36")
7 1/2" H x 72" W (36" + 36")
7 1/2" H x 78" W (48" + 30")
7 1/2" H x 84" W (36" + 48" or 42" + 42")
7 1/2" H x 90" W (42" + 48")
7 1/2" H x 96" W (48" + 48" or 36" + 60")

FLAT MODEL	CHAMFERED MODEL	SHIP WEIGHT	CUBE	CLEAR GLASS	FROSTED GLASS
HRVT0724FF	HRVT0724F	18	0.5	\$457	\$492
HRVT0730FF	HRVT0730F	18	0.5	\$489	\$526
HRVT0736FF	HRVT0736F	21	0.6	\$568	\$611
HRVT0742FF	HRVT0742F	25	0.7	\$598	\$644
HRVT0748FF	HRVT0748F	28	0.8	\$640	\$690
HRVT0754FF	HRVT0754F	28	0.8	\$711	\$765
HRVT0760FF	HRVT0760F	35	1.0	\$781	\$842
HRVT0766FF	HRVT0766F	35	1.0	\$856	\$922
HRVT0772FF	HRVT0772F	42	1.9	\$929	\$1001
HRVT0778FF	HRVT0778F	42	1.9	\$998	\$1075
HRVT0784FF	HRVT0784F	50	2.1	\$1065	\$1148
HRVT0790FF	HRVT0790F	50	2.1	\$1139	\$1226
HRVT0796FF	HRVT0796F	57	2.4	\$1205	\$1297

NOTES: For models 54" W-96" W, glass can span multiple panel widths. See examples of panel sizes by glass width above.

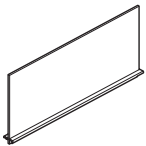

15" H Frameless Glass

15" H x 24" W
15" H x 30" W
15" H x 36" W
15" H x 42" W
15" H x 48" W
15" H x 54" W (24" + 30")
15" H x 60" W
15" H x 66" W (30" + 36")
15" H x 72" W (36" + 36")
15" H x 78" W (48" + 30")
15" H x 84" W (36" + 48" or 42" + 42")
15" H x 90" W (42" + 48")
15" H x 96" W (48" + 48" or 36" + 60")

HRVT1524FF	HRVT1524F	28	1.5	\$514	\$551
HRVT1530FF	HRVT1530F	28	1.5	\$546	\$587
HRVT1536FF	HRVT1536F	34	1.8	\$633	\$680
HRVT1542FF	HRVT1542F	39	2.0	\$674	\$724
HRVT1548FF	HRVT1548F	45	2.3	\$720	\$774
HRVT1554FF	HRVT1554F	51	2.6	\$798	\$859
HRVT1560FF	HRVT1560F	57	2.8	\$877	\$943
HRVT1566FF	HRVT1566F	62	3.2	\$960	\$1032
HRVT1572FF	HRVT1572F	67	3.5	\$1041	\$1119
HRVT1578FF	HRVT1578F	63	3.7	\$1185	\$1273
HRVT1584FF	HRVT1584F	78	3.9	\$1323	\$1422
HRVT1590FF	HRVT1590F	74	4.2	\$1363	\$1465
HRVT1596FF	HRVT1596F	89	4.4	\$1401	\$1507

NOTES: For models 54" W-96" W, glass can span multiple panel widths. See suggested panel sizes by glass width above.

NOTES:

- Tile is a single-pane, 3/8" laminated safety glass.
- Available in clear or frosted glass.
- New top cap ships with Frameless Glass which fits around the glass insert.
- Frameless Glass can span multiple panels with one piece of glass.
- Lamination is in the center of the glass, making both clear and frosted glass a writable surface with dry-erase markers.
- ⚠ Glass tiles have a Class A fire rating.
- ⚠ Frameless Glass can only be used on the top of panels. Glass integrates into top cap trim.
- ⚠ Power and data cords cannot lay in the top of panel frames when using frameless glass.
- ⚠ Variable height trim for Frameless Glass must be ordered when using panel heights one step up; see page 454.
- ⚠ Cannot hang or stack on top of Frameless Glass.
- ⚠ Abound® power pole cannot be used with Frameless Glass. Freestanding power pole HH870070 can be used at the end of run or one panel needs to be specified without Frameless Glass for ceiling in-feed to enter the panel.

HOW TO SPECIFY

<p>Select Model Number</p> <div style="border: 1px solid black; padding: 5px; display: flex; gap: 5px;"> HRVT0724F </div>	<p>Select Glass Option</p> <p>G Clear R Frosted</p> <div style="border: 1px solid black; padding: 5px; display: flex; gap: 5px;"> G </div>	<p>Select Paint Color</p> <p>See page 423 P1 Paint (no upcharge) P2 Paint (\$17 upcharge)</p> <div style="border: 1px solid black; padding: 5px; display: flex; gap: 5px;"> T1 </div>
---	--	--

ABOUND[®] Pass-thru Tiles

GSA SIN 33721



Icon Legend on page 19

WORKSTATIONS

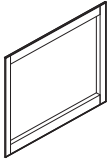

DESCRIPTION	MODEL	SHIP WEIGHT	CUBE	LIST PRICE BY PAINT GRADE	
				P1	P2
30" H Pass-Thru Tile Kit					
22½" H x 24" W	HRVT3024P	8	1.2	\$143	\$163
22½" H x 30" W	HRVT3030P	8	1.5	\$163	\$183
22½" H x 36" W	HRVT3036P	9	1.8	\$180	\$200
22½" H x 42" W	HRVT3042P	10	2.1	\$187	\$207
22½" H x 48" W	HRVT3048P	11	2.3	\$207	\$227
22½" H x 60" W	HRVT3060P	12	2.9	\$215	\$235

NOTES: Pass-thru opening is 22½" H. To be used with 30" H tiles. Order one 7½" H fabric tiles per pass-thru tile, if finishing only one side of panel.

! Must order a quantity of two (2) 7½" H fabric tiles per pass-thru tile, if finishing both sides of panel.

HOW TO SPECIFY

Select Model Number HRVT3024P	Select Paint Color T1 <small>See page 423</small>
---	--

DESCRIPTION	MODEL	SHIP WEIGHT	CUBE	LIST PRICE BY FABRIC GRADE								
				AA	A	B	C	D	E	F	G	
7½" H Fabric Tackable Tile												
7½" H x 24" W	HRVT0724T	2 ⑤	1.4	\$70	\$74	\$77	\$79	\$85	\$90	\$95	\$98	
7½" H x 30" W	HRVT0730T	2 ⑤	1.8	\$82	\$86	\$89	\$93	\$99	\$106	\$109	\$112	
7½" H x 36" W	HRVT0736T	2 ⑤	2.1	\$88	\$92	\$95	\$99	\$105	\$112	\$115	\$118	
7½" H x 42" W	HRVT0742T	2 ⑤	2.4	\$97	\$102	\$106	\$110	\$120	\$123	\$127	\$131	
7½" H x 48" W	HRVT0748T	2 ⑤	2.8	\$103	\$108	\$112	\$116	\$126	\$129	\$133	\$137	
7½" H x 60" W	HRVT0760T	3 ⑤	3.4	\$123	\$143	\$147	\$152	\$164	\$168	\$171	\$174	

NOTES:

• Order one 7½" H fabric tiles per pass-thru tile, if finishing only one side of panel.

! Must order a quantity of two (2) 7½" H fabric tiles per pass-thru tile, if finishing both sides of panel.

HOW TO SPECIFY

Select Model Number HRVT0724T	Select Fabric Color APN15 <small>See pages 424-425</small>
---	---



ABOUND[®] Slotted Tool Tiles

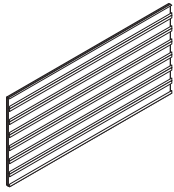

DESCRIPTION

15”H Slotted Tool Tiles

- 15”H x 24”W
- 15”H x 30”W
- 15”H x 36”W
- 15”H x 42”W
- 15”H x 48”W
- 15”H x 60”W

! Segment bars ordered separately. See page 448.

MODEL	SHIP WEIGHT	CUBE	LIST PRICE BY PAINT GRADE		
			P1	P2	P3
HRVT1524W	11	0.8	\$289	\$318	\$341
HRVT1530W	13	0.9	\$311	\$340	\$367
HRVT1536W	15	1.1	\$332	\$361	\$392
HRVT1542W	17	1.3	\$355	\$384	\$419
HRVT1548W	20	1.5	\$375	\$404	\$442
HRVT1560W	24	1.8	\$398	\$427	\$469

NOTES:

- Tiles made from sturdy aluminum extrusion and steel supports with a powder coat finish.
- Choose from hang-on accessories for a variety of organizational options. See page 466.
- ! Tiles do not include segment bars, must be ordered separately. See page 448. Can be used in any combination.
- ! Weight capacity of hang-on accessories should not exceed 80 pounds.

HOW TO SPECIFY

Select Model Number

HRVT1524W

Select Paint Color

See page 182 in the 2021 Shared Spaces Pricer
P1, P2, and P3 Paint Option

P8S



SYSTEMS PAPER MANAGEMENT SUPPORT BAR

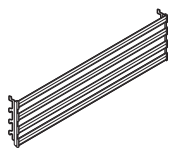

DESCRIPTION

Systems Paper Management Support Bars

- 24”W x 5”H
- 30”W x 5”H
- 36”W x 5”H
- 42”W x 5”H
- 48”W x 5”H
- 60”W x 5”H

! Recommended weight capacity not to exceed 80 pounds.

MODEL	SHIP WEIGHT	CUBE	LIST PRICE BY PAINT GRADE		
			P1	P2	P3
HNPBSW24	1.3	0.4	\$210	\$222	\$232
HNPBSW30	1.5	0.5	\$224	\$236	\$246
HNPBSW36	2.0	0.6	\$232	\$244	\$254
HNPBSW42	5.0	0.7	\$244	\$256	\$266
HNPBSW48	7.0	0.8	\$254	\$266	\$276
HNPBSW60	9.0	0.9	\$289	\$301	\$311

NOTES:

- Paper management bar attaches to Systems Panels to accommodate work flow accessories.

HOW TO SPECIFY

Select Model Number

HNPBSW24

Select Paint Color

See page 182 in the 2021 Shared Spaces Pricer
P1, P2, and P3 Paint Option

P8S

SYSTEMS PAPER MANAGEMENT ACCESSORIES

GSA SIN 33721



Icon Legend on page 19

WORKSTATIONS

	DESCRIPTION	MODEL	SHIP WEIGHT	CUBE	LIST PRICE BY PAINT GRADE		
					P1	P2	P3
	Accessories for Slotted Tool Tiles Paper Shelf 15"W x 9½"D x 2"H NOTES: Paper Shelf holds letter size paper and inter-office envelopes.	HPPMPS	2	0.3	\$110	\$122	\$133
	Accessory Shelf 21¾"W x 9"D x 2"H NOTES: Accessory Shelf holds office supplies and personal effects.	HPPMAS	2	0.3	\$114	\$126	\$137
	Tray 9"W x 10¾"D x 2"H	HPPMPT	2	0.3	\$139	\$151	\$162
	Pencil Holder 5¼"W x 1½"D x 5"H	HPPMPB	1	0.2	\$114	\$126	\$137
	Sorter Tray 6"W x 10"D x 2½"H NOTES: Sorter Tray provides 3 slots for organizing files.	HPPMST	2	0.3	\$150	\$162	\$173
	Folder Bin 12¼"W x 1¼"D x 9"H NOTES: Folder Bin accommodates manila envelopes and can be hung from other folder binds to maximize storage.	HPPMFB	2	0.3	\$114	\$126	\$137

NOTES:











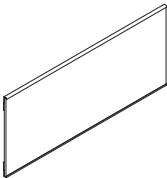

- For use with Slotted Tool Tiles and Systems Paper Management Support Bars on page 465.

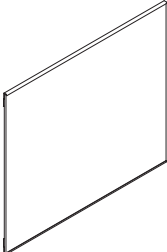
HOW TO SPECIFY



<p>Select Model Number</p> <p>H P P M P S .</p>	<p>Select Paint Color</p> <p>See page 182 in the 2021 Shared Spaces Pricer P1, P2, and P3 Paint Option</p> <p>P 8 S</p>
--	--



ABOUND[®] Markerboard Tiles

	DESCRIPTION	MODEL	SHIP WEIGHT	CUBE	LIST PRICE
	15"H Markerboard Tiles				
	15"H x 24"W	HRVT1524M	4 	1.2	\$263
	15"H x 30"W	HRVT1530M	4 	1.8	\$281
	15"H x 36"W	HRVT1536M	5 	2.5	\$295
	15"H x 42"W	HRVT1542M	5 	3.4	\$313
	15"H x 48"W	HRVT1548M	6	4.3	\$322
	15"H x 60"W	HRVT1560M	7	6.7	\$334
	30"H Markerboard Tiles				
	30"H x 24"W	HRVT3024M	6 	1.2	\$288
	30"H x 30"W	HRVT3030M	7 	1.8	\$309
	30"H x 36"W	HRVT3036M	8 	2.5	\$340
	30"H x 42"W	HRVT3042M	10 	3.4	\$362
	30"H x 48"W	HRVT3048M	11	4.3	\$398
	30"H x 60"W	HRVT3060M	13	6.7	\$440
	Magnetic Markerboard Tray 15" Natural Aluminum	HRVTRAYM	4 	0.4	\$67
	 Natural Aluminum only, no need to specify paint.				

NOTES:

- Markerboard tile has a painted, steel surface.
- Accepts magnetic accessories.
- Markerboard tray attaches to the tile magnetically. Order separately.
-  Tiles do not include segment bars, must be ordered separately. See page 448. Can be used in any combination.
-  Markerboard cleaning instructions: For everyday cleaning, use Chlorox[®] wipes. Use citrus cleaner if a permanent marker is used by accident. A citrus cleaner is not recommended for everyday use as it leaves residue.

HOW TO SPECIFY

Select Model Number <input type="text" value="HRVT1524M"/>	Select Paint Color <input checked="" type="checkbox"/> No Specification Needed
--	--

ABOUND[®] Painted Metal Tiles

GSA SIN 33721



Icon Legend on page 19

WORKSTATIONS

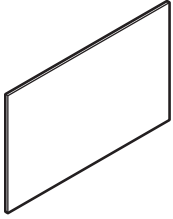

DESCRIPTION

15'H Painted Metal Tile

15"H x 24"W
15"H x 30"W
15"H x 36"W
15"H x 42"W
15"H x 48"W
15"H x 60"W

MODEL

SHIP WEIGHT

CUBE

LIST PRICE BY PAINT GRADE

P1

P2

HRVT1524PM	4	1.2	\$168	\$189
HRVT1530PM	4	1.8	\$180	\$201
HRVT1536PM	5	2.5	\$193	\$214
HRVT1542PM	5	3.4	\$209	\$230
HRVT1548PM	6	4.3	\$229	\$250
HRVT1560PM	7	6.7	\$253	\$274

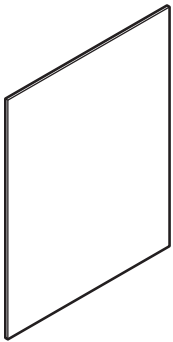

30'H Painted Metal Tile

30"H x 24"W
30"H x 30"W
30"H x 36"W
30"H x 42"W
30"H x 48"W
30"H x 60"W

HRVT3024PM	6	1.2	\$245	\$278
HRVT3030PM	7	1.8	\$267	\$300
HRVT3036PM	8	2.5	\$300	\$333
HRVT3042PM	10	3.4	\$322	\$355
HRVT3048PM	11	4.3	\$359	\$392
HRVT3060PM	13	6.7	\$402	\$435

NOTES:

- Painted steel construction.

! Tiles do not include segment bars, must be ordered separately. See page 448. Can be used in any combination.

HOW TO SPECIFY

Select
Model Number

Select
Paint Color

See page 423

HRVT1524PM.

T3



ABOUND® Custom Material Bracket Kit

	DESCRIPTION	MODEL	SHIP WEIGHT	CUBE	LIST PRICE
	Custom Material Mounting Bracket Kit				
	15"H x 24"W	HRVT1524CK	1 Ⓢ	0.8	\$75
	15"H x 30"W	HRVT1530CK	1 Ⓢ	0.9	\$78
	15"H x 36"W	HRVT1536CK	1 Ⓢ	1.1	\$84
	15"H x 42"W	HRVT1542CK	1 Ⓢ	1.3	\$86
	15"H x 48"W	HRVT1548CK	2 Ⓢ	1.5	\$92
	15"H x 60"W	HRVT1560CK	2 Ⓢ	1.8	\$101
	30"H x 24"W	HRVT3024CK	3 Ⓢ	1.4	\$75
	30"H x 30"W	HRVT3030CK	3 Ⓢ	1.8	\$78
	30"H x 36"W	HRVT3036CK	3 Ⓢ	2.1	\$84
	30"H x 42"W	HRVT3042CK	4 Ⓢ	2.4	\$86
	30"H x 48"W	HRVT3048CK	5 Ⓢ	2.8	\$92
30"H x 60"W	HRVT3060CK	5 Ⓢ	3.4	\$101	

NOTES: Custom Material Bracket Kits can be ordered to use with Customer's Own Material. Please contact HON Customer Support for exact dimensions if further information is needed.

	Coat Hooks				
	Package of six	HHPMC6	1 Ⓢ	0.2	\$94

NOTES: Compatible with Accelerate® and Abound® panels. Coat hooks hang directly into slotted Abound panel frame.
 Ⓢ Black only. Ship 6 per package.

HOW TO SPECIFY

Select Model Number

H	R	V	T	1	5	2	4	C	K
---	---	---	---	---	---	---	---	---	---

	DESCRIPTION	MODEL	SHIP WEIGHT	CUBE	LIST PRICE
	Abound® Anchor Bracket				
	Package of ten	HRABAB	5 Ⓢ	0.08	\$95

NOTES: For use when panels need to be anchored to the floor such as high traffic areas or community spaces.
 Ⓢ Only available in Black (P).
 Ⓢ Only for use at the end of a wing panel.
SPECIFYING EXAMPLE: HRABAB.P

	DESCRIPTION	MODEL	SHIP WEIGHT	CUBE	LIST PRICE BY PAINT GRADE	
					P1	P2
	Abound® Stability Foot	HRFTAB	3	0.1	\$413	\$423
	NOTES: Stabilizes bottom of panel from movement. Will not prohibit movement at top of panel. Ⓢ Only for use at the end of a wing panel.					

NOTES:

- Ⓢ The Anchor Bracket and Stability Foot are not intended to create a freestanding panel. Please follow Abound® stability standards.
- Ⓢ Attachment hardware for floor anchor not included.

HOW TO SPECIFY

Select Model Number	Select Paint Color						
<table border="1"> <tr> <td>H</td><td>R</td><td>F</td><td>T</td><td>A</td><td>B</td> </tr> </table>	H	R	F	T	A	B	See page 423
H	R	F	T	A	B		
<table border="1"> <tr> <td>T</td><td>1</td> </tr> </table>	T	1					
T	1						

ABOUND[®] Gallery Panels — Wing

OPEN MARKET



Icon Legend on page 19

WORKSTATIONS

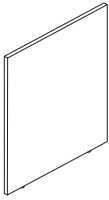

DESCRIPTION	MODEL	SHIP WEIGHT	CUBE	LIST PRICE BY LAMINATE GRADE	
				L1	L2
Wing End of Run or Spanning End of Run					
35"H x 27"W	HRVG3527L	30.1	2.5	\$388	\$405
35"H x 33"W	HRVG3533L	36.8	3.0	\$472	\$493
35"H x 39"W	HRVG3539L	43.6	3.6	\$534	\$558
35"H x 45"W	HRVG3545L	50.3	4.1	\$593	\$620
35"H x 51"W	HRVG3551L	57.0	4.6	\$639	\$668
35"H x 63"W	HRVG3563L	70.4	5.7	\$727	\$760
35"H x 75"W	HRVG3575L	83.8	6.7	\$883	\$923
42"H x 27"W	HRVG4227L	42.5	2.9	\$421	\$440
42"H x 33"W	HRVG4233L	50.0	3.6	\$511	\$534
42"H x 39"W	HRVG4239L	58.0	4.2	\$581	\$607
42"H x 45"W	HRVG4245L	65.0	4.8	\$627	\$655
42"H x 51"W	HRVG4251L	73.5	5.4	\$694	\$725
42"H x 63"W	HRVG4263L	89.0	6.7	\$780	\$815
42"H x 75"W	HRVG4275L	104.5	7.9	\$900	\$941
50"H x 27"W	HRVG5027L	49.0	3.5	\$484	\$506
50"H x 33"W	HRVG5033L	58.0	4.2	\$567	\$593
50"H x 39"W	HRVG5039L	67.5	4.9	\$632	\$661
50"H x 45"W	HRVG5045L	77.0	5.6	\$715	\$747
50"H x 51"W	HRVG5051L	86.0	6.4	\$752	\$786
50"H x 63"W	HRVG5063L	104.5	7.8	\$845	\$883
50"H x 75"W	HRVG5075L	123.0	9.3	\$979	\$1023

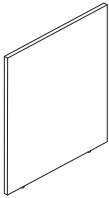

Wing Middle					
35"H x 24"W	HRVG3524L	26.8	2.4	\$368	\$384
35"H x 30"W	HRVG3530L	33.5	2.9	\$449	\$469
35"H x 36"W	HRVG3536L	40.2	3.3	\$500	\$522
35"H x 42"W	HRVG3542L	46.9	3.8	\$559	\$584
35"H x 48"W	HRVG3548L	53.6	4.4	\$617	\$645
35"H x 60"W	HRVG3560L	67.0	5.4	\$711	\$743
42"H x 24"W	HRVG4224L	38.5	2.6	\$399	\$417
42"H x 30"W	HRVG4230L	46.0	3.3	\$486	\$508
42"H x 36"W	HRVG4236L	54.0	3.9	\$542	\$567
42"H x 42"W	HRVG4242L	62.0	4.5	\$606	\$633
42"H x 48"W	HRVG4248L	69.5	5.1	\$652	\$682
42"H x 60"W	HRVG4260L	85.0	6.3	\$761	\$795
50"H x 24"W	HRVG5024L	44.5	3.1	\$459	\$480
50"H x 30"W	HRVG5030L	53.0	3.8	\$540	\$564
50"H x 36"W	HRVG5036L	63.0	4.6	\$596	\$623
50"H x 42"W	HRVG5042L	72.0	5.3	\$666	\$696
50"H x 48"W	HRVG5048L	81.5	6.0	\$734	\$767
50"H x 60"W	HRVG5060L	100.0	7.5	\$828	\$866

NOTES:

- Gallery Panels come standard with two adjustable leveling glides.
- When specifying Wing End of Run panels, the Gallery Panels are 3" wider to allow for the panel to cover the width of the spine.
- Mid-configuration creates 1½" space between the system panels. This gap matches the thickness of the Gallery Panel.
- Wing End of Run widths of 51", 63", and 75"W can be used as spanning end of run configurations.
- Gallery Panels come standard with two adjustable leveling glides.
- Gallery Panels require connectors to attach to the spine of the panel. See connectors on page 473.
- Gallery Panels up to 60"W can specify vertical or horizontal woodgrain direction. Panels larger than 60"W will have horizontal woodgrain.
- ! Minimum panel length must be 50% of the Gallery Panel for stability.
- ! When system panel is higher than the Gallery Panel, system's variable height trim kit must be specified to finish off the exposed frame.
- ! Standard Gallery Panels can only connect to standard panel frames. Use Gallery-to-Gallery Panels to connect Standard Gallery Panels to other Gallery Panels.
- ! Gallery Panels longer than 60"W require a floor or storage support.

HOW TO SPECIFY

<p>Select Model Number</p> <p>HRVG3527L</p>	<p>Select Laminate</p> <p>See page 423</p> <p>C</p>	<p>Select Edge</p> <p>See page 423</p> <p>C</p>	<p>Select Grain Direction</p> <p>VST Vertical Grain (not available on 63"W or wider) VLG Horizontal Grain and Solid Laminate only</p> <p>VST</p>	<p>Select Glide</p> <p>G Glide</p> <p>G</p>
--	--	--	---	--



Gallery Panels — Wing, Accepts Glass

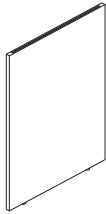

DESCRIPTION	MODEL	SHIP WEIGHT	CUBE	LIST PRICE BY LAMINATE GRADE	
				L1	L2
Wing End of Run or Spanning End of Run, Accepts Glass					
35”H x 27”W	HRVG3527LG	30.1	2.5	\$527	\$551
35”H x 33”W	HRVG3533LG	36.8	3.0	\$611	\$638
35”H x 39”W	HRVG3539LG	43.6	3.6	\$675	\$705
35”H x 45”W	HRVG3545LG	50.3	4.1	\$732	\$765
35”H x 51”W	HRVG3551LG	57.0	4.6	\$776	\$811
35”H x 63”W	HRVG3563LG	70.4	5.7	\$867	\$906
35”H x 75”W	HRVG3575LG	83.8	6.7	\$1019	\$1065
42”H x 27”W	HRVG4227LG	42.5	2.9	\$560	\$585
42”H x 33”W	HRVG4233LG	50.0	3.6	\$650	\$679
42”H x 39”W	HRVG4239LG	58.0	4.2	\$718	\$751
42”H x 45”W	HRVG4245LG	66.0	4.8	\$766	\$801
42”H x 51”W	HRVG4251LG	73.5	5.4	\$832	\$870
42”H x 63”W	HRVG4263LG	89.0	6.7	\$918	\$960
42”H x 75”W	HRVG4275LG	104.5	7.9	\$1037	\$1084
50”H x 27”W	HRVG5027LG	49.0	3.5	\$622	\$650
50”H x 33”W	HRVG5033LG	58.0	4.2	\$705	\$737
50”H x 39”W	HRVG5039LG	67.5	4.9	\$770	\$805
50”H x 45”W	HRVG5045LG	77.0	5.6	\$853	\$892
50”H x 51”W	HRVG5051LG	86.0	6.4	\$890	\$930
50”H x 63”W	HRVG5063LG	104.5	7.8	\$983	\$1028
50”H x 75”W	HRVG5075LG	123.0	9.3	\$1118	\$1169

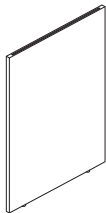

Wing Middle, Accepts Glass					
35”H x 24”W	HRVG3524LG	26.8	2.4	\$507	\$530
35”H x 30”W	HRVG3530LG	33.5	2.9	\$588	\$614
35”H x 36”W	HRVG3536LG	40.2	3.3	\$640	\$669
35”H x 42”W	HRVG3542LG	46.9	3.8	\$698	\$729
35”H x 48”W	HRVG3548LG	53.6	4.4	\$756	\$790
35”H x 60”W	HRVG3560LG	67.0	5.4	\$852	\$890
42”H x 24”W	HRVG4224LG	38.5	2.6	\$537	\$561
42”H x 30”W	HRVG4230LG	46.0	3.3	\$625	\$653
42”H x 36”W	HRVG4236LG	54.0	3.9	\$681	\$712
42”H x 42”W	HRVG4242LG	62.0	4.5	\$744	\$778
42”H x 48”W	HRVG4248LG	69.5	5.1	\$790	\$826
42”H x 60”W	HRVG4260LG	85.0	6.3	\$897	\$938
50”H x 24”W	HRVG5024LG	44.5	3.1	\$597	\$624
50”H x 30”W	HRVG5030LG	54.0	3.8	\$678	\$709
50”H x 36”W	HRVG5036LG	63.0	4.6	\$735	\$768
50”H x 42”W	HRVG5042LG	72.0	5.3	\$805	\$842
50”H x 48”W	HRVG5048LG	81.5	6.0	\$853	\$893
50”H x 60”W	HRVG5060LG	100.0	7.5	\$966	\$1010

NOTES:

- Gallery Panels come standard with two adjustable leveling glides.
- When specifying Wing End of Run panels, the Gallery Panels are 3” wider to allow for the panel to cover the width of the spine.
- Mid-configuration creates 1½” space between the system panels. This gap matches the thickness of the Gallery Panel.
- Wing End of Run widths of 51”, 63”, and 75”W can be used as spanning end of run configurations.
- Gallery Panels come standard with two adjustable leveling glides.
- Gallery Panels require connectors to attach to the spine of the panel. See connectors on page 473.
- Gallery Panels up to 60”W can specify vertical or horizontal woodgrain direction. Panels larger than 60”W will have horizontal woodgrain.
- ! Minimum panel length must be 50% of the Gallery Panel for stability.
- ! When system panel is higher than the Gallery Panel, system’s variable height trim kit must be specified to finish off the exposed frame.
- ! Standard Gallery Panels can only connect to standard panel frames. Use Gallery-to-Gallery Panels to connect STANDARD Gallery Panels to other Gallery Panels.
- ! Gallery Panels longer than 60”W require a floor or storage support.

HOW TO SPECIFY

<p>Select Model Number</p> <p>HRVG3527LG</p>	<p>Select Laminate</p> <p>See page 423</p> <p>C</p>	<p>Select Edge</p> <p>See page 423</p> <p>C</p>	<p>Select Grain Direction</p> <p>VST Vertical Grain (not available on 63”W or wider) VLG Horizontal Grain and Solid Laminate only</p> <p>VST</p>	<p>Select Glide</p> <p>G Glide</p> <p>G</p>
---	--	--	---	--

ABOUND[®] Gallery Glass

OPEN MARKET



Icon Legend on page 19

WORKSTATIONS

	DESCRIPTION	MODEL	SHIP WEIGHT	CUBE	CLEAR GLASS	FROSTED GLASS
	7½”H Gallery Glass, Wing, End of Run					
	7½”H x 24”W, For 27”D Panels	SPLH-ABND-GALGLSS.M482172	9.0	0.7	\$397	\$434
	7½”H x 30”W, For 33”D Panels	SPLH-ABND-GALGLSS.M482174	10.5	0.9	\$420	\$457
	7½”H x 36”W, For 39”D Panels	SPLH-ABND-GALGLSS.M482176	12.0	1.1	\$481	\$518
	7½”H x 42”W, For 45”D Panels	SPLH-ABND-GALGLSS.M482178	13.0	1.3	\$508	\$545
	7½”H x 48”W, For 51”D Panels	SPLH-ABND-GALGLSS.M482180	14.5	1.5	\$561	\$598
	7½”H x 60”W, For 63”D Panels	SPLH-ABND-GALGLSS.M482182	17.0	1.8	\$660	\$697
	7½”H Gallery Glass, Middle					
	7½”H x 21”W, For 24”D Panels	SPLH-ABND-GALGLSS.M482171	8.0	0.7	\$387	\$424
	7½”H x 27”W, For 30”D Panels	SPLH-ABND-GALGLSS.M482173	10.0	0.8	\$409	\$446
	7½”H x 33”W, For 36”D Panels	SPLH-ABND-GALGLSS.M482175	11.0	1.0	\$430	\$467
	7½”H x 39”W, For 42”D Panels	SPLH-ABND-GALGLSS.M482177	12.5	1.2	\$493	\$530
	7½”H x 45”W, For 48”D Panels	SPLH-ABND-GALGLSS.M482179	14.0	1.4	\$540	\$577
	7½”H x 57”W, For 60”D Panels	SPLH-ABND-GALGLSS.M482181	16.0	1.7	\$649	\$686
NOTES: Compatible with Gallery-to-Gallery connections, see page 475-478.						
	7½”H Gallery Glass, Spanning End of Run					
	7½”H x 48”W, For 51”D Panels	SPLH-ABND-GALGLSS.M482180	14.5	1.5	\$561	\$598
	7½”H x 60”W, For 63”D Panels	SPLH-ABND-GALGLSS.M482182	17.0	1.8	\$660	\$697
	7½”H x 72”W, For 75”D Panels	SPLH-ABND-GALGLSS.M482183	19.5	2.2	\$780	\$817

NOTES:

- Gallery Panels are 3” wider than corresponding glass to allow for proper fit and function.
- Glass is inset 1½” from end of Standard Gallery Panels. Gallery-to-Gallery Panels have ½” glass inset.

- ❗ Cannot hang or stack on top of Frameless Glass.
- ❗ Frameless Glass can only be used on the top of Gallery Panels. Glass integrates into notch cutout in the top of the panel.

HOW TO SPECIFY

<p>Select Model Number</p> <p>S P L H - A B N D - G A L G L S S . M 4 8 2 1 7 1 .</p>	<p>Select Glass</p> <p>Q Clear Glass R Frosted Glass</p> <p>Q</p>
---	---

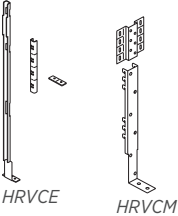

ABOUND® Gallery Connector Kits

	DESCRIPTION	MODEL	SHIP WEIGHT	CUBE	LIST PRICE BY PAINT GRADE	
					P1	P2
	Gallery Panel Connectors					
	Spanning End of Run and L Connector	HRVCE	0.83	0.1	\$83	\$90
	Wing Middle Attachment Brackets	HRVCM	0.62	0.1	\$96	\$105

	Gallery Connector Kits					
	35"	HRVC35GP	1.0	0.3	\$193	\$206
	42"	HRVC42GP	1.5	0.4	\$215	\$230
	50"	HRVC50GP	1.5	0.5	\$225	\$240
	65"	HRVC65GP	2.0	0.6	\$261	\$278

	DESCRIPTION	MODEL	SHIP WEIGHT	CUBE	LIST PRICE
	Gallery Panel-to-Storage Kits				
	Laminate Storage Ganging Kit	HRVGLSK	0.1	0.1	\$46
	Metal Storage Ganging Kit	HRVGMSK	0.1	0.1	\$10

NOTES:

- HRVCE is used in L and spanning (T) end of run applications.
- Wing Middle Connector Kits accommodate both single-sided and dual-sided applications.
- For more rigidity, the Gallery Panel can be tied to a storage or a non-adjustable surface. Use HRVGLSK for laminate or HRVGMSK for metal storage.
- HAT bases can be tied to Gallery Panels using HAT-to-Gallery brackets on page 479.
- ! Wing Middle Connector Kits must be used in any Wing Middle application in conjunction with model HRVCM.
- ! Wing Middle Connector Kits are required for Wing Middle applications and are used only with Wing Middle Gallery Panels.
- ! Gallery Panels can only connect to standard panel frames; Gallery Panels cannot connect to each other.

HOW TO SPECIFY

<p>Select Model Number</p> <p>HRVC42GP</p>	<p>Select Paint Color</p> <p>See page 423</p> <p>T1</p>
--	---

<p>Select Model Number</p> <p>HRVGMSK</p>

ABOUND[®] Gallery Panel Tackboards

OPEN MARKET



Icon Legend on page 19

WORKSTATIONS

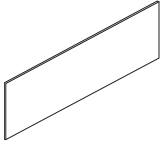

DESCRIPTION	MODEL	SHIP WEIGHT	CUBE	LIST PRICE BY FABRIC GRADE								
				AA	A	B	C	D	E	F	G	
Gallery Panel Tackboards												
36"W x 11"H	HRVTB11	7	1.1	\$280	\$285	\$288	\$291	\$294	\$299	\$304	\$309	
36"W x 18½"H	HRVTB18	10	1.8	\$329	\$334	\$337	\$340	\$343	\$348	\$353	\$358	

NOTES:

- Tackboard attaches to Gallery Panel by screwing painted metal frame onto Gallery Panel surface. Fabric insert attaches to painted metal frame with hook and loop.
- Attachment hardware for Tackboard is provided.

! No template is provided for placement and leveling of Tackboard.

HOW TO SPECIFY

Select Model Number	Select Fabric
	See pages 424-425
HRVTB11	APN11



Icon Legend on page 19

ABOUT® Gallery-to-Gallery Connections

WORKSTATIONS

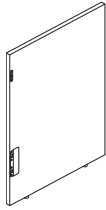

DESCRIPTION	MODEL	SHIP WEIGHT	CUBE	LIST PRICE BY LAMINATE GRADE	
				L1	L2
L-Connections, Right Hand					
35"H x 18"W	HRVG3518GGR	23.6	2.0	\$612	\$637
35"H x 24"W	HRVG3524GGR	30.5	2.6	\$660	\$687
35"H x 30"W	HRVG3530GGR	37.4	3.1	\$712	\$741
35"H x 36"W	HRVG3536GGR	44.3	3.6	\$764	\$795
35"H x 42"W	HRVG3542GGR	51.1	4.1	\$820	\$854
35"H x 48"W	HRVG3548GGR	58.0	4.7	\$881	\$918
35"H x 60"W	HRVG3560GGR	71.8	5.7	\$945	\$985
42"H x 18"W	HRVG4218GGR	28.5	2.4	\$636	\$662
42"H x 24"W	HRVG4224GGR	36.9	3.0	\$686	\$714
42"H x 30"W	HRVG4230GGR	45.3	3.7	\$740	\$770
42"H x 36"W	HRVG4236GGR	53.7	4.3	\$798	\$831
42"H x 42"W	HRVG4242GGR	62.1	4.9	\$863	\$899
42"H x 48"W	HRVG4248GGR	70.5	5.6	\$931	\$970
42"H x 60"W	HRVG4260GGR	87.3	6.8	\$1001	\$1043
50"H x 18"W	HRVG5018GGR	33.4	2.8	\$686	\$714
50"H x 24"W	HRVG5024GGR	43.3	3.5	\$740	\$770
50"H x 30"W	HRVG5030GGR	53.2	4.3	\$798	\$831
50"H x 36"W	HRVG5036GGR	63.1	5.0	\$857	\$893
50"H x 42"W	HRVG5042GGR	73.1	5.7	\$920	\$958
50"H x 48"W	HRVG5048GGR	83.0	6.5	\$988	\$1030
50"H x 60"W	HRVG5060GGR	102.8	7.9	\$1062	\$1107

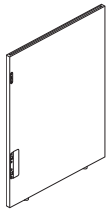

DESCRIPTION	MODEL	SHIP WEIGHT	CUBE	LIST PRICE BY LAMINATE GRADE	
				L1	L2
L-Connections, Right Hand, Accepts Glass					
35"H x 18"W	HRVG3518GGRG	23.6	2.0	\$707	\$736
35"H x 24"W	HRVG3524GGRG	30.5	2.6	\$763	\$794
35"H x 30"W	HRVG3530GGRG	37.4	3.1	\$824	\$858
35"H x 36"W	HRVG3536GGRG	44.3	3.6	\$885	\$922
35"H x 42"W	HRVG3542GGRG	51.1	4.1	\$950	\$990
35"H x 48"W	HRVG3548GGRG	58.0	4.7	\$1021	\$1064
35"H x 60"W	HRVG3560GGRG	71.8	5.7	\$1097	\$1143
42"H x 18"W	HRVG4218GGRG	28.4	2.4	\$723	\$753
42"H x 24"W	HRVG4224GGRG	36.9	3.0	\$781	\$813
42"H x 30"W	HRVG4230GGRG	45.3	3.7	\$844	\$879
42"H x 36"W	HRVG4236GGRG	53.7	4.3	\$911	\$949
42"H x 42"W	HRVG4242GGRG	62.1	4.9	\$985	\$1026
42"H x 48"W	HRVG4248GGRG	70.5	5.6	\$1064	\$1109
42"H x 60"W	HRVG4260GGRG	87.3	6.8	\$1145	\$1194
50"H x 18"W	HRVG5018GGRG	33.4	2.8	\$763	\$794
50"H x 24"W	HRVG5024GGRG	43.3	3.5	\$824	\$858
50"H x 30"W	HRVG5030GGRG	53.2	4.3	\$889	\$926
50"H x 36"W	HRVG5036GGRG	63.1	5.0	\$955	\$995
50"H x 42"W	HRVG5042GGRG	73.1	5.7	\$1026	\$1069
50"H x 48"W	HRVG5048GGRG	83.0	6.5	\$1103	\$1150
50"H x 60"W	HRVG5060GGRG	102.8	7.9	\$1186	\$1236

NOTES:

- Gallery-to-Gallery Panels connect to other Gallery Panels and are available in L-, T-, and Non-symmetrical T-configurations.
- When specifying Gallery-to-Gallery Panels, the installation template (HRVGTGG) is required. The recommendation is one template for every 30 panels. Templates are reusable.
- Gallery-to-Gallery Panels must be of equal or lower height than the Standard Gallery Panel attached. The Gallery-to-Gallery Panel cannot be taller than the adjacent panel. If this is needed, please reach out to Tailored Solutions for a custom solution.
- Made of 1/8" board with HPL laminate.
- Can be specified with matching or contrasting edge.
- Edgeband is 2mm ABS.
- Available in woodgrain and solid laminates.
- Woodgrain laminates can be specified with vertical grain up to 48"W. Horizontal grain is available on all sizes.
- Gallery-to-Gallery Panel widths are available in 18", 24", 30", 36", 42", 48", and 60"W.
- Gallery Panels offer 2 1/2" leveling capability.
- Overall heights line up with adjacent panel.
- Gallery-to-Gallery Panels cap over Standard Gallery Panels and are oversized by 1/8" to maintain true interior dimensions.
- Available with or without the integrated glass option.
- Glass specified separately, see 7 1/2"H Gallery Glass on page 472.
- Gallery Panels for use with glass have separate model numbers.
- Gallery-to-Gallery Panels are secured with an inset flat bracket under a painted metal cover.
- L-panels are handed.

HOW TO SPECIFY

Select Model Number	Select Laminate	Select Edge	Select Grain Direction	Select Paint Color	Select Glide
See page 423	See page 423	See page 423	VLG Horizontal Grain and Solid Laminate only VST Vertical Grain	See page 423	G Glide
HRVG4236GGR	H	H	VLG	P8T	G

ABOUND[®] Gallery-to-Gallery Connections

OPEN MARKET



Icon Legend on page 19

WORKSTATIONS

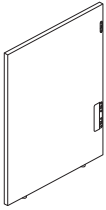

DESCRIPTION	MODEL	SHIP WEIGHT	CUBE	LIST PRICE BY LAMINATE GRADE	
				L1	L2
L-Connections, Left Hand					
35"H x 18"W	HRVG3518GGGL	23.6	2.0	\$612	\$637
35"H x 24"W	HRVG3524GGGL	30.5	2.6	\$660	\$687
35"H x 30"W	HRVG3530GGGL	37.4	3.1	\$712	\$741
35"H x 36"W	HRVG3536GGGL	44.3	3.6	\$764	\$795
35"H x 42"W	HRVG3542GGGL	51.1	4.1	\$820	\$854
35"H x 48"W	HRVG3548GGGL	58.0	4.7	\$881	\$918
35"H x 60"W	HRVG3560GGGL	71.8	5.7	\$945	\$985
42"H x 18"W	HRVG4218GGGL	28.5	2.4	\$636	\$662
42"H x 24"W	HRVG4224GGGL	36.9	3.0	\$686	\$714
42"H x 30"W	HRVG4230GGGL	45.3	3.7	\$740	\$770
42"H x 36"W	HRVG4236GGGL	53.7	4.3	\$798	\$831
42"H x 42"W	HRVG4242GGGL	62.1	4.9	\$863	\$899
42"H x 48"W	HRVG4248GGGL	70.5	5.6	\$931	\$970
42"H x 60"W	HRVG4260GGGL	87.3	6.8	\$1001	\$1043
50"H x 18"W	HRVG5018GGGL	33.4	2.8	\$686	\$714
50"H x 24"W	HRVG5024GGGL	43.3	3.5	\$740	\$770
50"H x 30"W	HRVG5030GGGL	53.2	4.3	\$798	\$831
50"H x 36"W	HRVG5036GGGL	63.1	5.0	\$857	\$893
50"H x 42"W	HRVG5042GGGL	73.1	5.7	\$920	\$958
50"H x 48"W	HRVG5048GGGL	83.0	6.5	\$988	\$1030
50"H x 60"W	HRVG5060GGGL	102.8	7.9	\$1062	\$1107
L-Connections, Left Hand, Accepts Glass					
35"H x 18"W	HRVG3518GGGLG	23.6	2.0	\$707	\$736
35"H x 24"W	HRVG3524GGGLG	30.5	2.6	\$763	\$794
35"H x 30"W	HRVG3530GGGLG	37.4	3.1	\$824	\$858
35"H x 36"W	HRVG3536GGGLG	44.3	3.6	\$885	\$922
35"H x 42"W	HRVG3542GGGLG	51.1	4.1	\$950	\$990
35"H x 48"W	HRVG3548GGGLG	58.0	4.7	\$1021	\$1064
35"H x 60"W	HRVG3560GGGLG	71.8	5.7	\$1097	\$1143
42"H x 18"W	HRVG4218GGGLG	28.4	2.4	\$723	\$753
42"H x 24"W	HRVG4224GGGLG	36.9	3.0	\$781	\$813
42"H x 30"W	HRVG4230GGGLG	45.3	3.7	\$844	\$879
42"H x 36"W	HRVG4236GGGLG	53.7	4.3	\$911	\$949
42"H x 42"W	HRVG4242GGGLG	62.1	4.9	\$985	\$1026
42"H x 48"W	HRVG4248GGGLG	70.5	5.6	\$1064	\$1109
42"H x 60"W	HRVG4260GGGLG	87.3	6.8	\$1145	\$1194
50"H x 18"W	HRVG5018GGGLG	33.4	2.8	\$763	\$794
50"H x 24"W	HRVG5024GGGLG	43.3	3.5	\$824	\$858
50"H x 30"W	HRVG5030GGGLG	53.2	4.3	\$889	\$926
50"H x 36"W	HRVG5036GGGLG	63.1	5.0	\$955	\$995
50"H x 42"W	HRVG5042GGGLG	73.1	5.7	\$1026	\$1069
50"H x 48"W	HRVG5048GGGLG	83.0	6.5	\$1103	\$1150
50"H x 60"W	HRVG5060GGGLG	102.8	7.9	\$1186	\$1236

NOTES:

- Gallery-to-Gallery Panels connect to other Gallery Panels and are available in L-, T-, and Non-symmetrical T-configurations.
- When specifying Gallery-to-Gallery Panels, the installation template (HRVGTGG) is required. The recommendation is one template for every 30 panels. Templates are reusable.
- Gallery-to-Gallery Panels must be of equal or lower height than the Standard Gallery Panel attached. The Gallery-to-Gallery Panel cannot be taller than the adjacent panel. If this is needed, please reach out to Tailored Solutions for a custom solution.
- Made of 1/8" board with HPL laminate.
- Can be specified with matching or contrasting edge.
- Edgeband is 2mm ABS.
- Available in woodgrain and solid laminates.
- Woodgrain laminates can be specified with vertical grain up to 48"W. Horizontal grain is available on all sizes.
- Gallery-to-Gallery Panel widths are available in 18", 24", 30", 36", 42", 48", and 60"W.
- Gallery Panels offer 2 1/2" leveling capability.
- Overall heights line up with adjacent panel.
- Gallery-to-Gallery Panels cap over Standard Gallery Panels and are oversized by 1/8" to maintain true interior dimensions.
- Available with or without the integrated glass option.
- Glass specified separately, see 7 1/2"H Gallery Glass on page 472.
- Gallery Panels for use with glass have separate model numbers.
- Gallery-to-Gallery Panels are secured with an inset flat bracket under a painted metal cover.
- L-panels are handed.

HOW TO SPECIFY

<p>Select Model Number</p> <p>HRVG4236GGGLG</p>	<p>Select Laminate</p> <p>See page 423</p> <p>H</p>	<p>Select Edge</p> <p>See page 423</p> <p>H</p>	<p>Select Grain Direction</p> <p>VLG Horizontal Grain and Solid Laminate only VST Vertical Grain</p> <p>VLG</p>	<p>Select Paint Color</p> <p>See page 423</p> <p>P8T</p>	<p>Select Glide</p> <p>G Glide</p> <p>G</p>
--	--	--	--	---	--



ABOUT® Gallery-to-Gallery Connections

DESCRIPTION	MODEL	SHIP WEIGHT	CUBE	LIST PRICE BY LAMINATE GRADE		
				L1	L2	
T-Connections						
	35"H x 18"W	HRVG3518GGT	23.6	2.0	\$703	\$729
	35"H x 36"W	HRVG3536GGT	44.3	3.6	\$862	\$895
	35"H x 42"W	HRVG3542GGT	51.1	4.1	\$921	\$957
	35"H x 48"W	HRVG3548GGT	58.0	4.7	\$984	\$1023
	35"H x 60"W	HRVG3560GGT	71.8	5.7	\$1052	\$1094
	35"H x 72"W	HRVG3572GGT	85.5	6.8	\$1137	\$1182
	42"H x 18"W	HRVG4218GGT	28.5	2.4	\$728	\$755
	42"H x 36"W	HRVG4236GGT	53.7	4.3	\$897	\$932
	42"H x 42"W	HRVG4242GGT	62.1	4.9	\$964	\$1002
	42"H x 48"W	HRVG4248GGT	70.5	5.6	\$1038	\$1079
42"H x 60"W	HRVG4260GGT	87.3	6.8	\$1110	\$1154	
42"H x 72"W	HRVG4272GGT	104.1	8.1	\$1214	\$1263	
50"H x 18"W	HRVG5018GGT	33.4	2.8	\$779	\$808	
50"H x 36"W	HRVG5036GGT	63.1	5.0	\$962	\$1000	
50"H x 42"W	HRVG5042GGT	73.1	5.7	\$1035	\$1076	
50"H x 48"W	HRVG5048GGT	83.0	6.5	\$1113	\$1157	
50"H x 60"W	HRVG5060GGT	102.8	7.9	\$1199	\$1247	
50"H x 72"W	HRVG5072GGT	122.7	9.4	\$1292	\$1344	
T-Connections, Accepts Glass						
	35"H x 18"W	HRVG3518GGTG	23.6	2.0	\$803	\$833
	35"H x 36"W	HRVG3536GGTG	44.3	3.6	\$988	\$1027
	35"H x 42"W	HRVG3542GGTG	51.1	4.1	\$1057	\$1099
	35"H x 48"W	HRVG3548GGTG	58.0	4.7	\$1131	\$1176
	35"H x 60"W	HRVG3560GGTG	71.8	5.7	\$1212	\$1261
	35"H x 72"W	HRVG3572GGTG	85.5	6.8	\$1299	\$1352
	42"H x 18"W	HRVG4218GGTG	28.5	2.4	\$820	\$851
	42"H x 36"W	HRVG4236GGTG	53.7	4.3	\$1016	\$1056
	42"H x 42"W	HRVG4242GGTG	62.1	4.9	\$1093	\$1136
	42"H x 48"W	HRVG4248GGTG	70.5	5.6	\$1178	\$1225
42"H x 60"W	HRVG4260GGTG	87.3	6.8	\$1263	\$1314	
42"H x 72"W	HRVG4272GGTG	104.1	8.1	\$1366	\$1422	
50"H x 18"W	HRVG5018GGTG	33.4	2.8	\$860	\$893	
50"H x 36"W	HRVG5036GGTG	63.1	5.0	\$1070	\$1112	
50"H x 42"W	HRVG5042GGTG	73.1	5.7	\$1153	\$1199	
50"H x 48"W	HRVG5048GGTG	83.0	6.5	\$1242	\$1292	
50"H x 60"W	HRVG5060GGTG	102.8	7.9	\$1337	\$1391	
50"H x 72"W	HRVG5072GGTG	122.7	9.4	\$1443	\$1502	

NOTES:

- Gallery-to-Gallery Panels connect to other Gallery Panels and are available in L-, T-, and Non-symmetrical T-configurations.
- When specifying Gallery-to-Gallery Panels, the installation template (HRVGTGG) is required. The recommendation is one template for every 30 panels. Templates are reusable.
- Gallery-to-Gallery Panels must be of equal or lower height than the Standard Gallery Panel attached. The Gallery-to-Gallery Panel cannot be taller than the adjacent panel. If this is needed, please reach out to Tailored Solutions for a custom solution.
- Made of 1 1/8" board with HPL laminate.
- Can be specified with matching or contrasting edge.
- Edgeband is 2mm ABS.
- Available in woodgrain and solid laminates.
- Non-symmetrical T-panels vary in size on either side of the adjacent panel.
- Woodgrain laminates can be specified with vertical grain up to 48"W. Horizontal grain is available on all sizes.
- Gallery-to-Gallery Panel widths are available in 18", 24", 30", 36", 42", 48", and 60"W.
- Gallery Panels offer 2 1/2" leveling capability.
- Overall heights line up with adjacent panel.
- Gallery-to-Gallery Panels cap over Standard Gallery Panels and are oversized by 1/8" to maintain true interior dimensions.
- Available with or without the integrated glass option.
- Glass specified separately, see 7 1/2"H Gallery Glass on page 472.
- Gallery Panels for use with glass have separate model numbers.
- Gallery-to-Gallery Panels are secured with an inset flat bracket under a painted metal cover.

HOW TO SPECIFY

Select Model Number	Select Laminate See page 423	Select Edge See page 423	Select Grain Direction VLG Horizontal Grain and Solid Laminate only VST Vertical Grain	Select Paint Color See page 423	Select Glide G Glide
HRVG4242GGT	H	H	VLG	P8T	G

ABOUND® Gallery-to-Gallery Connections

OPEN MARKET



Icon Legend on page 19

WORKSTATIONS

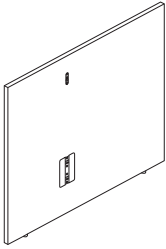

DESCRIPTION	MODEL	SHIP WEIGHT	CUBE	LIST PRICE BY LAMINATE GRADE	
				L1	L2
Non-Symmetrical Connections					
35"H x 18"W/24"W	HRVG351824GGNS	51.1	4.1	\$921	\$957
35"H x 24"W/18"W	HRVG352418GGNS	51.1	4.1	\$921	\$957
35"H x 18"W/30"W	HRVG351830GGNS	58.0	4.7	\$984	\$1023
35"H x 30"W/18"W	HRVG353018GGNS	58.0	4.7	\$984	\$1023
35"H x 24"W/30"W	HRVG352430GGNS	64.9	5.2	\$1019	\$1059
35"H x 30"W/24"W	HRVG353024GGNS	64.9	5.2	\$1019	\$1059
42"H x 18"W/24"W	HRVG421824GGNS	62.1	4.9	\$964	\$1002
42"H x 24"W/18"W	HRVG422418GGNS	62.1	4.9	\$964	\$1002
42"H x 18"W/30"W	HRVG421830GGNS	70.5	5.6	\$1038	\$1079
42"H x 30"W/18"W	HRVG423018GGNS	70.5	5.6	\$1038	\$1079
42"H x 24"W/30"W	HRVG422430GGNS	78.9	6.2	\$1074	\$1117
42"H x 30"W/24"W	HRVG423024GGNS	78.9	6.2	\$1074	\$1117
50"H x 18"W/24"W	HRVG501824GGNS	73.1	5.7	\$1035	\$1076
50"H x 24"W/18"W	HRVG502418GGNS	73.1	5.7	\$1035	\$1076
50"H x 18"W/30"W	HRVG501830GGNS	83.0	6.5	\$1113	\$1157
50"H x 30"W/18"W	HRVG503018GGNS	83.0	6.5	\$1113	\$1157
50"H x 24"W/30"W	HRVG502430GGNS	92.9	7.2	\$1157	\$1203
50"H x 30"W/24"W	HRVG503024GGNS	92.9	7.2	\$1157	\$1203

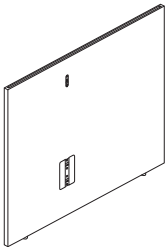

DESCRIPTION	MODEL	SHIP WEIGHT	CUBE	LIST PRICE BY LAMINATE GRADE	
				L1	L2
Non-Symmetrical Connections, Accepts Glass					
35"H x 18"W/24"W	HRVG351824GGNSG	51.1	4.1	\$1057	\$1099
35"H x 24"W/18"W	HRVG352418GGNSG	51.1	4.1	\$1057	\$1099
35"H x 18"W/30"W	HRVG351830GGNSG	58.0	4.7	\$1131	\$1176
35"H x 30"W/18"W	HRVG353018GGNSG	58.0	4.7	\$1131	\$1176
35"H x 24"W/30"W	HRVG352430GGNSG	64.9	5.2	\$1173	\$1220
35"H x 30"W/24"W	HRVG353024GGNSG	64.9	5.2	\$1173	\$1220
42"H x 18"W/24"W	HRVG421824GGNSG	62.1	4.9	\$1093	\$1136
42"H x 24"W/18"W	HRVG422418GGNSG	62.1	4.9	\$1093	\$1136
42"H x 18"W/30"W	HRVG421830GGNSG	70.5	5.6	\$1178	\$1225
42"H x 30"W/18"W	HRVG423018GGNSG	70.5	5.6	\$1178	\$1225
42"H x 24"W/30"W	HRVG422430GGNSG	78.9	6.2	\$1219	\$1268
42"H x 30"W/24"W	HRVG423024GGNSG	78.9	6.2	\$1219	\$1268
50"H x 18"W/24"W	HRVG501824GGNSG	73.1	5.7	\$1153	\$1199
50"H x 24"W/18"W	HRVG502418GGNSG	73.1	5.7	\$1153	\$1199
50"H x 18"W/30"W	HRVG501830GGNSG	83.0	6.5	\$1242	\$1292
50"H x 30"W/18"W	HRVG503018GGNSG	83.0	6.5	\$1242	\$1292
50"H x 24"W/30"W	HRVG502430GGNSG	92.9	7.2	\$1290	\$1342
50"H x 30"W/24"W	HRVG503024GGNSG	92.9	7.2	\$1290	\$1342

NOTES:

- Gallery-to-Gallery Panels connect to other Gallery Panels and are available in L-, T-, and Non-symmetrical T-configurations.
- When specifying Gallery-to-Gallery Panels, the installation template (HRVGTGG) is required. The recommendation is one template for every 30 panels. Templates are reusable.
- Gallery-to-Gallery Panels must be of equal or lower height than the Standard Gallery Panel attached. The Gallery-to-Gallery Panel cannot be taller than the adjacent panel. If this is needed, please reach out to Tailored Solutions for a custom solution.
- Made of 1½" board with HPL laminate.
- Can be specified with matching or contrasting edge.
- Edgeband is 2mm ABS.
- Available in woodgrain and solid laminates.
- Non-symmetric T-panels vary in size on either side of the adjacent panel.
- Woodgrain laminates can be specified with vertical grain up to 48"W. Horizontal grain is available on all sizes.
- Gallery-to-Gallery Panel widths are available in 18", 24", 30", 36", 50", 48", and 60"W.
- Gallery Panels offer 2½" leveling capability.
- Overall heights line up with adjacent panel.
- Gallery-to-Gallery Panels cap over Standard Gallery Panels and are oversized by 1½" to maintain true interior dimensions.
- Available with or without the integrated glass option.
- Glass specified separately, see 7½"H Gallery Glass on page 472.
- Gallery Panels for use with glass have separate model numbers.
- Gallery-to-Gallery Panels are secured with an inset flat bracket under a painted metal cover.

HOW TO SPECIFY

Select Model Number	Select Laminate See page 423	Select Edge See page 423	Select Grain Direction VLG Horizontal Grain and Solid Laminate only VST Vertical Grain	Select Paint Color See page 423	Select Glide G Glide
HRVG421830GGNS	H	H	VLG	P8T	G



Height Adjustable Tie-In Brackets

	DESCRIPTION	MODEL	SHIP WEIGHT	CUBE	LIST PRICE BY PAINT GRADE		
					P1	P2	P3
	Rectangle Leg, T-Foot Brackets HAT to Panel, Left Hand	HHALRETL	4.0	0.2	\$162	\$177	\$185
	HAT to Panel, Right Hand	HHALRETR	4.0	0.2	\$162	\$177	\$185
	HAT to Gallery Panel	HHALRETG	3.5	0.2	\$162	\$177	\$185
	Rectangle Leg, C-Foot Brackets HAT to Panel, Left Hand	HHALRECL	4.0	0.2	\$162	\$177	\$185
	HAT to Panel, Right Hand	HHALRECR	4.0	0.2	\$162	\$177	\$185
	HAT to Gallery Panel ⓘ Not compatible with Coordinate™ model HHABETA2S2L.	HHALRECG	3.5	0.2	\$162	\$177	\$185
	DESCRIPTION	MODEL	SHIP WEIGHT	CUBE	LIST PRICE		
	Gallery-to-Gallery Template	HRVGTGG	1.1	0.5	\$63		
	HAT-to-Gallery Template	HHALGPT	1.1	0.1	\$49		

NOTES:

- Tie-in brackets are used to tie a height adjustable table to either a Standard Panel or Gallery Panel for added rigidity.
- Bracket ties into the approach side of the height adjustable worksurface — this removes the need for a wing panel.
- Can be used as a value engineering option to replace wing panels.
- Available in all paint colors to match panel trim or coordinating colors to the height adjustable base.
- Brackets telescope to account for 24" and 30" deep worksurfaces and screen attachments.

ⓘ Brackets must be used on a return panel, not a spine wall, except if stations are back-to-back on a spine wall and a tie-in bracket is used at a minimum every 96".

ⓘ C-legs with a 30"D worksurface and a screen must be specified with T-leg brackets.

SINGLE BRACKET

Systems Application

- Max Height (with Glass): 65"H
- Max Width: 96"; tops greater than 72"W **will not align.**

Gallery Panel Application

- Max Height (with Glass): 65"H
- Max Width: 75"; no top size restrictions.

DUAL-SIDED PANEL BENCH

Systems Application

- Max Height (with Glass): 65"H
- Bracket needed every 96" on both sides; tops greater than 72"W **will not align.**

Gallery Panel Application

- Max Height (with Glass): 65"H
- Bracket Needed: Single Panel (75") with brackets on each leg (same height).

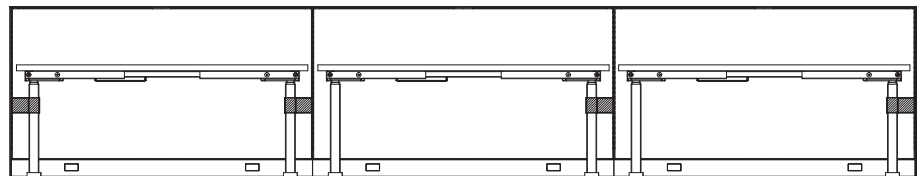
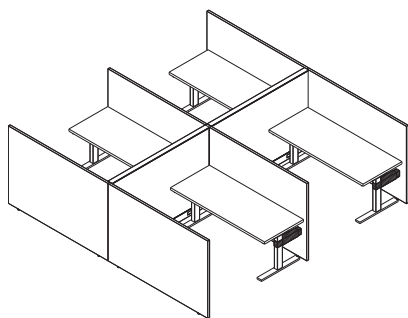

ⓘ Overhead storage cannot be used without return panels.

HOW TO SPECIFY

<p>Select Model Number</p> <p>HHALRECL .</p>	<p>Select Paint Color</p> <p>See page 423</p> <p>DW</p>
--	---

ACCELERATE®

Want to see more? Scan here
to check out hon.com.



WORKSTATIONS



Accelerate® 120° Degree Workstations
shown with Contain® and Voi®.

ACCELERATE®

Today's office moves at the speed of light. And that means you need a sensible, streamlined workflow that can adapt to any employee, project, or space. Accelerate workstations are designed with meaningful connection, peak productivity, and seamless adaptability in mind. Whether it's operating as a stand-alone or in a large, open space, Accelerate optimizes any environment with easy-to-configure layout options, exceptional storage capabilities, and stunning customization choices.



FEATURES

- Customize your spaces! Add fabric stackers for height and privacy, or glass stackers to let the light in.
- Accelerate's crisp details have been designed to meet today's contemporary aesthetic. Clean. Minimal. Beautiful.
- Accelerate panels are compatible with other HON products, like Abode™ desks, Contain® storage and more.
- The interchangeable components allow you to customize your space with a clean, contemporary look — and change your mind without changing your furniture.

ACCELERATE® ORDERING INFORMATION

WORKSURFACES, COUNTERTOPS, CORNER SHELVES W/EDGE BAND

L1 LAMINATES CODES

Woodgrain

◆ Bourbon Cherry	H
◆ Cognac	COGN
◆ Florence Walnut	LFW1
◆ Harvest	C
◆ Kingswood Walnut	LK11
◆ Mahogany	N
◆ Mocha	MOCH
◆ Natural Maple	D
◆ Pinnacle	PINC
◆ Shaker Cherry	F
◆ Sterling Ash	LSA1

Solid

◆ Black	P
◆ Charcoal	S
◆ Designer White	LDW1
◆ Loft	LOFT

Patterned

◆ Handspun Chestnut	LAHC
◆ Handspun Dove	LAHD
◆ Handspun Pearl	LAHP
◆ Handspun Slate	LAHS
◆ Sheer Mesh *	A5
◆ Silver Mesh	B9
◆ Steel Mesh *	A9
◆ Canyon Zephyr *	K9
◆ Desert Zephyr *	K8
◆ Shadow Zephyr *	K1
◆ Gray	G2
◆ Grey Tigris *	L6
◆ White	G1
◆ Whitestone *	K4

L2 LAMINATES CODES

Woodgrain

◆ Lowell Ash	LLA1
◆ Natural Recon	LNR1
◆ Phantom Ecru	LPE1
◆ Portico Teak	LPT1
◆ Skyline Walnut	LSW1

(Door panels not available in L2)

WORKSURFACE EDGE BAND

◆ Black	P
◆ Bourbon Cherry	H
◆ Brownstone	EY
◆ Charcoal	S
◆ Cognac	COGN
◆ Designer White	DW
◆ Florence Walnut	FW
◆ Fossil	EH
◆ Greige	R
◆ Harvest	C
◆ Kingswood Walnut	KI
◆ Light Gray	Q
◆ Loft	LOFT
◆ Lowell Ash	DL
◆ Mahogany	N
◆ Mocha	MOCH
◆ Muslin	T
◆ Natural Maple	D
◆ Natural Recon	NR
◆ Phantom Ecru	PE
◆ Pinnacle	PINC
◆ Platinum	K
◆ Portico Teak	DP
◆ Shadow *	SHDW
◆ Shaker Cherry	F
◆ Skyline Walnut	SW
◆ Sterling Ash	SA

WORKSURFACE GROMMET

◆ Black	P
◆ Brownstone	EY
◆ Charcoal	S
◆ Fossil	EH
◆ Greige	T5
◆ Light Gray	Q
◆ Loft	LOFT
◆ Muslin	T3
◆ Shadow *	SHDW
◆ Titanium	T1
◆ Designer White	DW
◆ Platinum Metallic	T1

FRAMES, TRIM, METAL TILES, CUSTOM BRACKET KIT, WORKSURFACE SUPPORTS, STEEL OVERHEAD STORAGE CHASSIS

PAINT CODES

P1

◆ Black	P
◆ Brownstone	P7D
◆ Charcoal	S
◆ Designer White	PJW
◆ Fossil	P28
◆ Greige	T5
◆ Light Gray	Q
◆ Loft	LOFT
◆ Muslin	T3
◆ Putty	L
◆ Shadow *	SHDW
◆ Titanium	P8T

P2

◆ Champagne Metallic	T4
◆ Platinum Metallic	T1
◆ Silver	PR6
◆ Solar Black	P8X

DUPLEX/PORTED TILE

PLASTIC CODES

◆ Black	P
◆ Brownstone	P7D
◆ Charcoal	S
◆ Designer White	DW
◆ Loft	LOFT
◆ Muslin	T3
◆ Titanium	TI

Recommendations

Paint	Duplex-Data Code
Black P	Black P
Brownstone P7D	Brownstone EY
Charcoal S	Charcoal S
Designer White PJW	Designer White DW
Fossil P28	Charcoal S
Greige T5	Muslin T3
Light Gray Q	Loft LOFT
Loft LOFT	Loft LOFT
Muslin T3	Muslin T3
Putty L	Black P
Shadow SHDW	Muslin T3
Silver PR6	Titanium T1
Titanium P8T	Titanium T1
Champagne Metallic T4	Muslin T3
Platinum Metallic T1	Titanium T1

► LAMINATE TOPS

SPECIFY: Model Number.
Laminate.
Edge Color.
Grommet Color
EXAMPLE: HWR2424P.K8.R.T5

► PANELS

SPECIFY: Model Number.
Fabric
Paint
EXAMPLE: HETP3520FP.APN11.S

► CONNECTORS

SPECIFY: Model Number.
Paint
EXAMPLE: HEC35PS.T3

◆◆◆ For lead time information see page 19.

* De-emphasized

Replacement Duplex Receptacle Covers are made from a polymer material and are available in the following colors only:

Black	P
Muslin	T3
Shadow	SHDW

ACCELERATE[®] FABRIC PATTERNS & CODES

PRICE CODE AA

FACTOR	FACT
◆ Bark	FACT20
◆ Barley	FACT15
◆ Cascade	FACT25
◆ Feather	FACT30

PRICE CODE A

APPOINT	APN
◆ Artichoke	APN11
◆ Blackberry	APN32
◆ Bronze	APN22
◆ Carbon	APN28
◆ Chai	APN12
◆ Cherry	APN30
◆ Dark Pewter	APN17
◆ Dune	APN15
◆ Espresso	APN23
◆ Framboise	APN31
◆ Frost	APN34
◆ Jet	APN27
◆ Lawn	APN25
◆ Mandarin	APN29
◆ Morel	APN09
◆ Nimbus	APN16
◆ Platinum	APN24
◆ Turquoise	APN26

CENTURION CU

◆ Apricot	CU47
◆ Bark	CU25
◆ Black	CU10
◆ Espresso	CU49
◆ Fog	CU03
◆ Frost	CU22
◆ Goldenrod	CU27
◆ Indigo	CU06
◆ Iris	CU50
◆ Iron Ore	CU19
◆ Jade	CU83
◆ Marsala	CU63
◆ Morel	CU24
◆ Navy	CU98
◆ Peacock	CU97
◆ Pear	CU84
◆ Ruby	CU67
◆ Sapphire	CU09

PRICE CODE A *continued*

ETCH*	ECH
◆ Axis	ECH13
◆ Blend	ECH14
◆ Cast	ECH12
◆ Highlight	ECH10
◆ Midtone	ECH11
◆ Outline	ECH08
◆ Shade	ECH09
◆ Tonal	ECH16
◆ Vanish	ECH15

EXCHANGE* EXG

◆ Iron	EXG916
◆ Nickel	EXG914
◆ Pistachio	EXG910
◆ Root	EXG913
◆ Rupee	EXG903
◆ Shadow	EXG911
◆ Silver	EXG915
◆ Sisal	EXG917
◆ Stone	EXG912

LANDSCAPE* LN

◆ Azure	LN55
◆ Cornsilk	LN15
◆ Drift	LN05
◆ Khaki	LN20
◆ Sheen	LN10
◆ Slate	LN35
◆ Umber	LN25
◆ Urban	LN30

LUCY* LC

◆ Aspen	LC32
◆ Cornsilk	LC30
◆ Dusk	LC22
◆ Fawn	LC33
◆ Graphite	LC34
◆ Mist	LC20
◆ Neutra	LC24
◆ Pewter	LC35
◆ Snowdrop	LC28

PRICE CODE A *continued*

REFLECTIONS*	REF
◆ Galvanized	REF29
◆ Ice	REF20
◆ Loggia	REF21
◆ Mistral	REF28
◆ Moonstone	REF23
◆ Pewter	REF22
◆ Stainless	REF24
◆ Vanilla	REF25
◆ Winter	REF27

REFUGE* RFG

◆ Artesian	RFG96
◆ Dune	RFG92
◆ Eclipse	RFG90
◆ Frost	RFG93
◆ Glacier	RFG91
◆ Mineral	RFG98
◆ Tidal	RFG94

SARTO* SRT

◆ Ash	SRT88
◆ Fog	SRT14
◆ Lemongrass	SRT49
◆ Mist	SRT45
◆ Mushroom	SRT76
◆ Oyster	SRT18
◆ Reef	SRT64
◆ Sesame	SRT93
◆ Shale	SRT52

TEMPEST* TP

◆ Dragonfly	TP30
◆ Frost	TP15
◆ Full Stream	TP80
◆ Gold Rush	TP10
◆ Slate	TP45
◆ Tumbleweed	TP70
◆ Wind Chill	TP40
◆ Zebra	TP35

NOTES: Centurion fabric not available on panels that exceed a width and height of 54".

Analog, Disperse, and Exchange panel fabrics will be applied pattern cut. Disperse will not be available on 72"W panels.

◆◆◆ For lead time information see page 19.

* Directional fabrics

ACCELERATE® FABRIC PATTERNS & CODES

PRICE CODE B		PRICE CODE B <i>continued</i>		PRICE CODE B <i>continued</i>		PRICE CODE B <i>continued</i>	
DISPERSE*	DISP	MICA*	MCA	SPIN*	SPIN	TERRAIN*	TRRN
◆ Autumn	DISP03	◆ Anthracite	MCA11	◆ Alabaster	SPIN02	◆ Bay	TRRN05
◆ Branch	DISP10	◆ Breeze	MCA18	◆ Cavern	SPIN03	◆ Bayou	TRRN35
◆ Coffee Bean	DISP13	◆ Bronze	MCA13	◆ Cobblestone	SPIN04	◆ Canyon	TRRN30
◆ Dusk	DISP09	◆ Buff	MCA14	◆ Ember	SPIN06	◆ Cliff	TRRN45
◆ Emerald City	DISP08	◆ Cremini	MCA17	◆ Flame	SPIN07	◆ Crest	TRRN25
◆ Gold Rush	DISP02	◆ Crystal	MCAWIT	◆ Heron	SPIN13	◆ Delta	TRRN10
◆ Igloo	DISP11	◆ Dew	MCA20	◆ Oat	SPIN01	◆ Plateau	TRRN15
◆ Ink	DISP06	◆ Dove	MCA12	◆ Ocean	SPIN12	◆ Ridge	TRRN20
◆ Mist	DISP12	◆ Fresh	MCA16	◆ Plum	SPIN15	◆ Valley	TRRN40
◆ Oatmeal	DISP15	◆ Mineral	MCA15	◆ Pool	SPIN11		
◆ Prince	DISP07	◆ Nectar	MCA19	◆ Raven	SPIN10		
◆ Reservoir	DISP01	◆ Shale	MCA10	◆ Rhubarb	SPIN14		
◆ Rose	DISP04			◆ Tropic	SPIN08		
◆ Spring	DISP05			◆ Willow	SPIN05		
◆ Steel	DISP16						
◆ Taupe	DISP14						

WORKSTATIONS

NOTES: Disperse and Exchange panel fabrics will be applied pattern cut. Disperse will not be available on 72"W panels.

◆◆◆ For lead time information see page 19.

* Directional fabrics

ACCELERATE® Typicals



Icon Legend on page 19

WORKSTATIONS

QTY	DESCRIPTION	MODEL	FABRIC GRADE	LIST PRICE	PRICE EXTENSION
2	Accelerate® Top Cap 72"W	HETC72		\$114	\$228
2	Tackable Panel 50"H x 72"W	HETP5072FP		\$643	\$1,286
1	"L" Connector 50"H	HEC50PLN		\$144	\$144
1	"L" Connector Strap	HECSL		\$17	\$17
2	Panel Finished End Covers 50"H	HEFEC50P		\$65	\$130
2	Electrical Power Harness Panels w/Duplex Capacity	HH871272		\$239	\$478
1	Duplex Receptacle Circuit 1 3-1 & 2-2	HH871501		\$47	\$47
1	Duplex Receptacle Circuit 4 3-1 & 2-2	HH871504		\$47	\$47
1	Base In-Feed Cable Base 3-1 & 2-2	HH879072		\$253	\$253
1	Rectangular Worksurface 24"D x 48"W	HWR2448P		\$446	\$446
1	Rectangular Worksurface 24"D x 72"W	HWR2472P		\$583	\$583
1	24"D Cantilever - One Pair	HCTL242		\$93	\$93
1	Flat Bracket 24"D	HHN831124		\$72	\$72
1	External Stiffener 48"W	HLSLZ5SC60		\$106	\$106
1	Flagship® Series Freestanding Pedestal "A" Pull B/B 15"W x 22 1/8"D x 28"H	H19723A		\$837	\$837
1	Flagship® Series Freestanding Pedestal "A" Pull F/F 15"W x 22 1/8"D x 28"H	H19823A		\$837	\$837
1	Pedestal-to-Panel Bracket, Left	HPD2PNBRK2L		\$122	\$122
1	Pedestal-to-Panel Bracket, Right	HPD2PNBRK2R		\$122	\$122
1	Lota® Mid-Back Chair	H2281	1	\$828	\$828

TOTAL: \$6,676

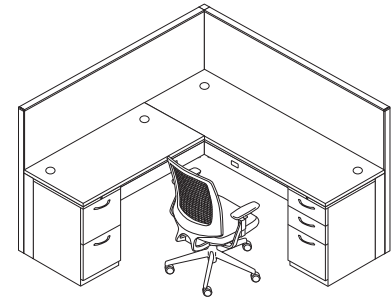

QTY	DESCRIPTION	MODEL	FABRIC GRADE	LIST PRICE	PRICE EXTENSION
2	Tackable Top-Tier Glass Panel 50"H x 20"W	HETP5020DP		\$561	\$1,122
2	Tackable Top-Tier Glass Panel 50"H x 42"W	HETP5042DP		\$665	\$1,330
5	Tackable Panel 65"H x 24"W	HETP6524FP		\$395	\$1,975
2	Tackable Panel 65"H x 48"W	HETP6548FP		\$506	\$1,012
2	Accelerate® Top Cap 72"W	HETC72		\$114	\$228
3	Accelerate® Top Cap 24"W	HETC24		\$42	\$126
2	Accelerate® Top Cap 20"W	HETC20		\$42	\$84
2	Accelerate® Top Cap 42"W	HETC42		\$68	\$136
4	Worksurface Bracket Kits	HWSB2		\$52	\$208
2	Flat Bracket 24"D	HHN831124		\$72	\$144
2	Straight Connector Kits	HSCKTPS		\$22	\$44
2	"L" Connector 50"H	HEC50PLN		\$144	\$288
2	"L" Connector 65"H	HEC65PLN		\$161	\$322
1	"T" Connector 65"H	HEC65PTN		\$155	\$155
4	"L" Connector Strap	HECSL		\$17	\$68
1	"T" Connector Strap	HECST		\$24	\$24
2	Panel Finished End Covers 50"H	HEFEC50P		\$65	\$130
1	Panel Finished End Covers 65"H	HEFEC65P		\$73	\$73
2	In-line Variable Height Finishing Kit 15"W	HEVHF15P		\$64	\$128
2	Electrical Power Harness 3-1 & 2-2 48"W	HH871248		\$239	\$478
1	Electrical Pass-Thru w/o Power Block 3-1 & 2-2 48"W	HH871048		\$137	\$137
1	Base In-Feed Cable Base 3-1 & 2-2	HH879072		\$253	\$253
1	Duplex Receptacle Circuit 1 3-1 & 2-2	HH871501		\$47	\$47
1	Duplex Receptacle Circuit 2 3-1 & 2-2	HH871502		\$47	\$47
1	Duplex Receptacle Circuit 4 3-1 & 2-2	HH871504		\$47	\$47
1	Duplex Receptacle Circuit 1 3-1 & 2-2	HH871506		\$47	\$47
2	Rectangular Worksurface 18"D x 42"W	HWR1842P		\$366	\$732
2	Rectangular Worksurface 24"D x 48"W	HWR2448P		\$446	\$892
2	Worksurface to Tower Bracket Kits	HSTB2W1		\$88	\$176
2	Stack-on Storage w/Sliding Doors 14 1/4"D x 48"W x 13"H	HLSL1448S		\$1,208	\$2,416
2	Voi® for Systems Stack-on Storage Panel Mounted Bracket	HLSLPMB		\$145	\$290
2	Voi® Mobile Pedestal 15 3/4"W x 21 1/8"D x 21 1/8"H	HLSL2016MP2	1	\$893	\$1,786
2	Voi® Pedestal Cushion	HLSL2016PH2	2	\$371	\$742
1	Voi® Personal Storage Tower (LH) 24"D x 24"W x 65"H	HLSLW446LP		\$2,920	\$2,920
1	Voi® Personal Storage Tower (RH) 24"D x 24"W x 65"H	HLSLW446RP		\$2,920	\$2,920
2	Nucleus® 4-Way Stretch Back Work Chair	HNI	1	\$932	\$1,864

TOTAL: \$23,391

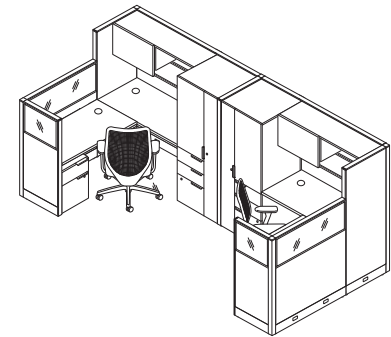



Icon Legend on page 19

ACCELERATE® Typicals

WORKSTATIONS

QTY	DESCRIPTION	MODEL	FABRIC GRADE	LIST PRICE	PRICE EXTENSION
1	In-Line Connector	HSCKTPS		\$22	\$22
2	Tackable Panel 42½"H x 24"W	HETP4224FP		\$326	\$652
2	Tackable Panel 42½"H x 60"W	HETP4260FP		\$457	\$914
2	Accelerate® Top Cap 60"W	HETC60		\$94	\$188
2	Accelerate® Top Cap 24"W	HETC24		\$42	\$84
4	Accelerate® Countertop Kit	HECB42		\$60	\$240
2	Worksurface Bracket Kit	HWSB2		\$52	\$104
1	Universal Support Leg 24"D	HRVCLG24		\$218	\$218
2	"L" Connector 42½"H	HEC42PLN		\$125	\$250
2	"L" Connector Strap	HECSL		\$17	\$34
1	"T" Connector Strap	HECST		\$24	\$24
2	Panel Finished End Covers 42½"H	HEFEC42P		\$61	\$122
1	Base In-Feed Cable Base 3-1 & 2-2	HH879072		\$253	\$253
1	Electrical Pass-Thru Cable w/Duplex For 24"W Panel	HH871124		\$143	\$143
2	Electrical Power Harness 3-1 & 2-2 60"W	HH871260		\$239	\$478
2	Duplex Receptacle Circuit 4 3-1 & 2-2	HH871504		\$47	\$94
2	Rectangular Worksurface 24"D x 60"W	HWR2460P		\$526	\$1,052
2	Straight Countertop 60"W x 15"D	HBCSR1560P		\$417	\$834
2	Flagship® Mobile Series Pedestal "A" Pull B/B/F 15"W x 22½"D x 28"H	H18723A		\$851	\$1,702
2	Ignition® Mid-Back Work Chair	HIWM3	1	\$850	\$1,700
				TOTAL:	\$9,108



QTY	DESCRIPTION	MODEL	FABRIC GRADE	LIST PRICE	PRICE EXTENSION
3	Systems Corner Worksurface w/ 120° Curve Edge 42"W x 24"D	HBWCT4224P		\$917	\$2,751
3	Systems 60° Wedge Worksurface Edgeband 24"W x 24"D	HCWQT2424P		\$433	\$1,299
3	120° 2-way Connector 35"H	HEC35P2N		\$99	\$297
3	120° 2-way Connector Strap	HECSV		\$24	\$72
2	Panel Finished End Covers 35"H	HEFEC35P		\$57	\$114
4	Frameless Glass 15"H x 42"W	HEFGS1542		\$613	\$2,452
4	Tackable Panel 35"H x 42"W	HETP3542FP		\$350	\$1,400
4	Electrical Power Harness 3-1 & 2-2 Systems 42"W	HH871242		\$239	\$956
1	Duplex Receptacle Circuit 1 3-1 & 2-2 Systems	HH871501		\$47	\$47
2	Duplex Receptacle Circuit 2 3-1 & 2-2 Systems	HH871502		\$47	\$94
2	Duplex Receptacle Circuit 3 3-1 System Only	HH871503		\$47	\$94
3	Duplex Receptacle Circuit 4 3-1 & 2-2 Systems	HH871504		\$47	\$141
1	Base In-Feed Cable Base 3-1 & 2-2 Systems	HH879072		\$253	\$253
3	Mobile Pedestal 20"W x 15¼"D x 21½"H	HLSL2016MP2		\$893	\$2,679
3	Pedestal Cushion 20"W x 15¼"D x 1"H	HLSL2016PH2	2	\$371	\$1,113
2	Abound® Left End Panel 29"H x 24"D	HRVEP2429L		\$246	\$492
2	Abound® Right End Panel 29"H x 24"D	HRVEP2429R		\$246	\$492
2	Systems Rectangular Worksurface Edgeband 24"D x 42"W	HWR2442P		\$419	\$838
6	Universal Support Leg 24"D	HRVCLG24		\$218	\$1,308
				TOTAL:	\$16,892

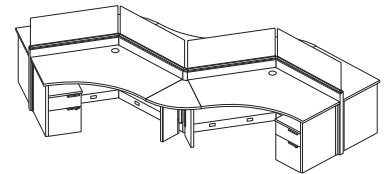

ACCELERATE® PANELS OVERVIEW

INTERSECTING CONNECTIONS

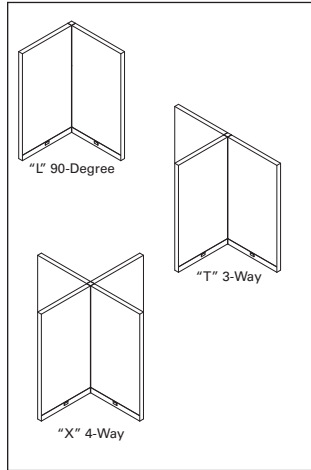

“L”, “T” and “X” connector kits are used when connecting frames at intersecting runs. For “L”, “T” and “X” connector kits, add 2¼” to the total length of the panel run for each intersection, whether located in the middle or at the end of the run.

Wall starter kits provide a means to affix a panel run to a permanent building wall. Kit adds ⅞” to length of panel run.

STACKING PANELS

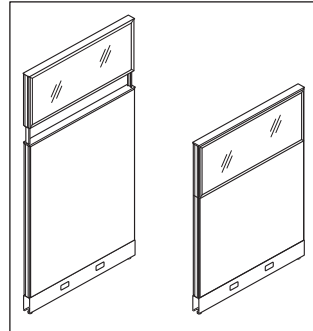

Stackers add 15” to the height of the base panel and can be ordered separately or as part of the panel model, see pages 491 and 494.

When adding stackers to an existing panel, a new connector must be ordered, to the tallest panel height.

Please note that Stacking Panels are not to be used freestanding and must match the panel width of the panel it is stacking on.

Cannot use a stacking panel on a Top Tier Glass Panel model.

Stackers ship with pins to connect stacker to post connector for added rigidity.

Stackers can be stacked up to 80”H on a base panel. Overheads can be placed on the first stacker only, up to 65”H. Voi overheads are not to be placed on stackers.

Top View			
Panel		Panel	
	→	← 2¼"	
Panel	S	Panel	

Extended straight connector kit “S” can be used to keep continuous runs dimensionally consistent with opposing panel runs which incorporate “T” or “X” intersections. (Add 2¼” to the length of the run for every extended straight connector used.)

IN-LINE CONNECTIONS

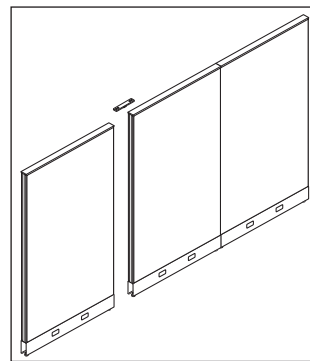

There is no incremental increase in dimension along the panel run when using an in-line connector kit.

END OF RUN

Finished end trim must be specified for the unconnected sides of panel. When adding a stacking panel, order finished end trim in the height that matches the total stacked height. Move the end cap from the standard frame end trim to the stacking frame end trim.

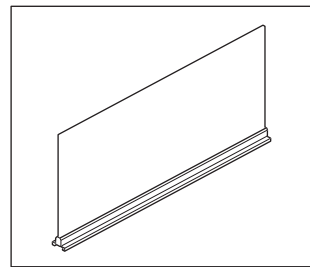

Accelerate® frameless glass is single pane, ⅜” thick laminate safety glass, available in clear or frosted glass.

Frameless glass is not allowed on top of glass stackers or glass header panels and hanging or stacking on frameless glass is not permitted.

Frameless glass can span multiple panels with one piece of glass, creating a clean, seamless look.

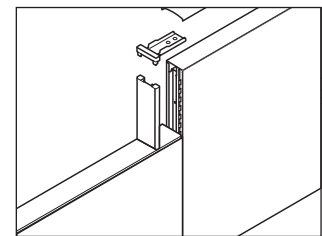

IN-LINE VARIABLE HEIGHT TRIM
In-line connections between different height panels require trim to cover the exposed frame of the taller panel.

VARIABLE HEIGHT CONNECTOR TRIM

L, X and T connections between different height panels require trim to cover the exposed connector. The bottom of the trim is flat to match the profile of the top cap. Models are designated as “Variable Height Connector Trim”. For variable height connections in a Y configuration, contact the Accelerate Specials Department.

Multiple-height connections are accomplished by combining standard height panel connectors (35”H, 42”H, 50”H and 65”H) with shorter trim kits (7”H, 15”H, 22”H and 30”H). Start from the top-down — select the standard connector that corresponds to the height and connection type of the tallest panel. (See examples.)

ACCELERATE® PANELS OVERVIEW

Example 1

Connectors required:
1-50"H "T" Connector
2-15"H Connector VH Kit
2-35"H End Trim
1-65"H End Trim

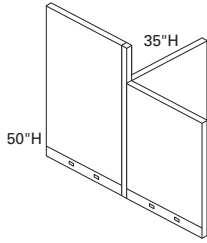

In variable height "T" connections — as shown above — you would use the connectors as indicated.

Example 2

Connectors required:
1-50"H "X" Connector
2-7½"H Connector VH Kit
2-50"H End Trim
2-42"H End Trim

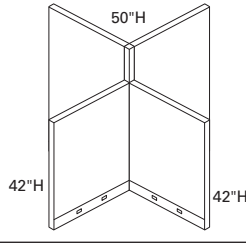

Example 3

Connectors required:
1-65"H "T" Connector
1-15"H Connector VH Kit
1-22½"H Connector VH Kit
1-65"H End Trim
1-50"H End Trim
1-42"H End Trim

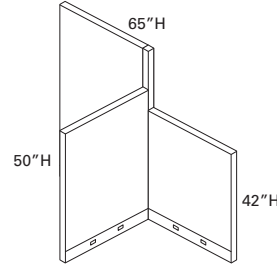

Example above represents Accelerate variable height "L" for 65" to 50".

TOP CAPS

Top caps must be specified as a separate model from the panel. Top caps can span more than one panel when panels are connected in an in-line.

ACCELERATE® WORKING WITH PANELS

PANELS

- Accelerate® Panels are 2½" thick and available in 4 heights / 8 widths.

NOTE: Actual panel height varies depending on position of levelers.

NOMINAL PANEL HEIGHT	PANEL WIDTHS							
	20"	24"	30"	36"	42"	48"	60"	72"
35"	20"	24"	30"	36"	42"	48"	60"	72"
42½"	20"	24"	30"	36"	42"	48"	60"	72"
50"	20"	24"	30"	36"	42"	48"	60"	72"
65"	20"	24"	30"	36"	42"	48"	60"	72"

Maximum Receptacle Capacity in Panel Base Pathways

Widths	20	24	30	36	42	48	60	72
Maximum of 1 duplex per panel side	N/A	X						
Maximum of 2 duplexes per panel side	N/A		X	X	X	X	X	X

The center of the duplex is always 12" from the end of the panel on all Accelerate® panels.

PANEL SPECIFICATION AND INSTALLATION NOTES

Definitions:

Parent Panel Run – Panels (or a single panel) configured in a straight line intended to divide space. It is usually longer than the panels used to stabilize it.

Return Panels – Panels attached to a parent run for the purpose of stabilizing it. Return panels may also have the effect of dividing space.

Note: Return panels must be no more than 30" lower than the maximum height of the parent panel run. When stacking, the maximum height allowed is 80". This includes frameless glass. If attaching overhead storage, return panels must be the same height as parent run.

Method 1: Opposing Returns

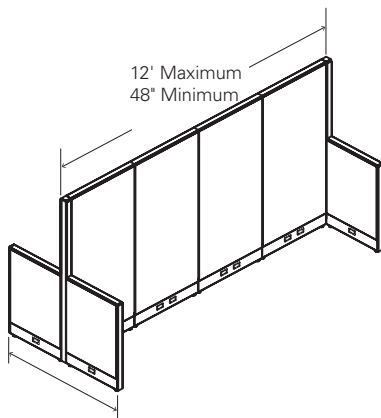

Method 2: Single-Sided

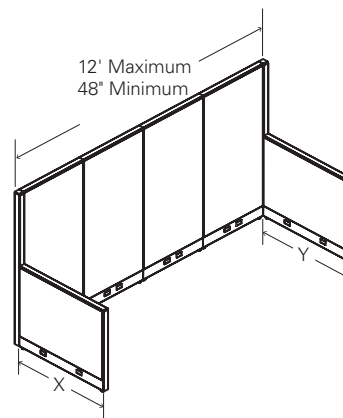

A parent panel run must be a minimum of 4 feet and a maximum of 12 feet, and must have a minimum of two return panels extended in opposing directions on each side of the parent run.

Panel Run Length	Minimum Return Panels	Minimum Return Panels with Stack-ons
48"	20"	20"
54"	20"	20"
60"	20"	20"
66"	20"	20"
72"	20"	20"
78"	20"	20"
84"	20"	20"
90"	20"	20"
96"	20"	20"
102"	20"	20"
108"	24"	24"
114"	24"	24"
120"	24"	24"
144"	24"	24"

A parent panel run must be a minimum of 4 feet and a maximum of 12 feet, and must have a minimum of two return panels (X+Y) extended in one direction (one at the beginning and at the end of the parent run) as defined below.

Panel Run Length	Minimum Return Panels Total (X+Y)	Minimum Return Panels Total (X+Y) with Stack-ons
48"	84"	84"
54"	84"	84"
60"	84"	84"
66"	84"	84"
72"	84"	84"
78"	84"	84"
84"	84"	84"
90"	84"	84"
96"	84"	84"
102"	84"	84"
108"	84"	96"
114"	84"	96"
120"	84"	96"
144"	84"	96"

Design:

- Slots allow hanging worksurfaces and hang-on units, in 1" increments.
- Panels standard with two adjustable leveling glides.
- No panel creep.
- Meets or exceeds ANSI/BIFMA Standards.

Top Tier and Stacking Panels

- Available in tackable fabric as well as clear and frosted glass.
- Select from a full height panel/top tier panels or stackers.
- Stackers can be stacked up to 80"H on a base panel.
- Overheads can be placed on the first stacker only, up to 65"H. Voi overheads are not to be placed on stackers.

ACCELERATE® CONNECTOR OVERVIEW

CONNECTOR KITS — ACCELERATE®

- TPS** In-line Connector
- PSN** Extended Straight Connector
- PLN** “L” Connector
- PTN** “T” Connector
- PXN** “X” Connector
- P2N** 120° 2-way Connector
- P3N** 120° 3-way Connector
- CV** Connector Variable Height Finishing Kit
- VH** In-line Variable Height Finishing Kit

ADDITIONAL MODELS FOR USE WITH CONNECTOR KITS

- FE** Finished End Covers
- WS** Wall Starter Kit
- WT** Wall Track

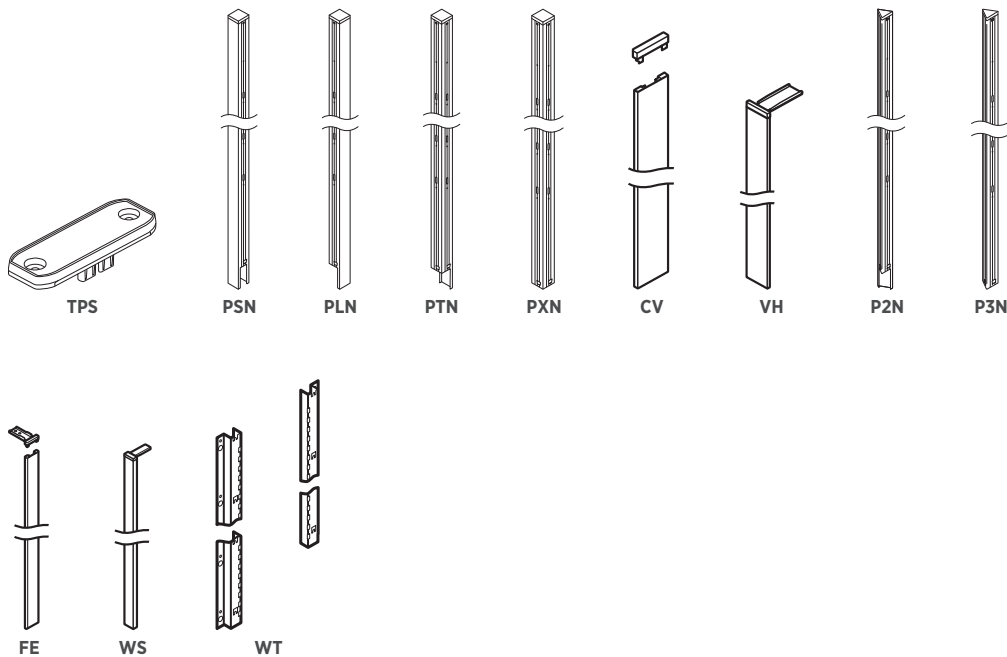

Panel-to-Panel Connector

- Attaches same height, panel-to-panel in a straight run with screws.
- Ensures alignment on panels in a straight run.

Wall Starter Kit (see page 499)

- Anchor devices are not supplied with the wall starter kit. Refer to Accelerate® Installation Instructions for appropriate hardware.
- Adds 7/8" to length of run.

ACCELERATE® Tackable Raceway Panels

GSA SIN 33721



Icon Legend on page 19

WORKSTATIONS

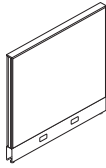

DESCRIPTION

MODEL

SHIP WEIGHT

CUBE

CORE LIST PRICE BY CODE

AA

A

B

35" H Tackable Acoustical Panels

35" H x 20" W	HETP3520FP	13	1.0	\$296	\$307	\$326
35" H x 24" W	HETP3524FP	14	1.2	\$308	\$319	\$361
35" H x 30" W	HETP3530FP	16	1.5	\$322	\$335	\$380
35" H x 36" W	HETP3536FP	18	1.8	\$345	\$359	\$406
35" H x 42" W	HETP3542FP	20	2.1	\$350	\$365	\$418
35" H x 48" W	HETP3548FP	23	2.4	\$368	\$384	\$439
35" H x 60" W	HETP3560FP	27	3.0	\$400	\$418	\$483
35" H x 72" W*	HETP3572FP	33	3.6	\$560	\$579	\$652

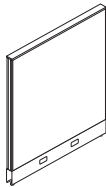

42 1/2" H Tackable Acoustical Panels

42 1/2" H x 20" W	HETP4220FP	14	1.2	\$312	\$325	\$357
42 1/2" H x 24" W	HETP4224FP	16	1.5	\$326	\$339	\$371
42 1/2" H x 30" W	HETP4230FP	18	1.8	\$345	\$357	\$396
42 1/2" H x 36" W	HETP4236FP	20	2.2	\$363	\$377	\$419
42 1/2" H x 42" W	HETP4242FP	23	2.6	\$395	\$411	\$460
42 1/2" H x 48" W	HETP4248FP	25	3.0	\$410	\$428	\$487
42 1/2" H x 60" W	HETP4260FP	30	3.7	\$457	\$476	\$545
42 1/2" H x 72" W*	HETP4272FP	36	4.4	\$589	\$611	\$690

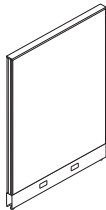

50" H Tackable Acoustical Panels

50" H x 20" W	HETP5020FP	16	1.4	\$358	\$373	\$436
50" H x 24" W	HETP5024FP	17	1.7	\$371	\$386	\$449
50" H x 30" W	HETP5030FP	20	2.2	\$382	\$398	\$442
50" H x 36" W	HETP5036FP	22	2.6	\$394	\$410	\$460
50" H x 42" W	HETP5042FP	25	3.0	\$441	\$459	\$517
50" H x 48" W	HETP5048FP	28	3.5	\$467	\$487	\$552
50" H x 60" W	HETP5060FP	32	4.3	\$509	\$530	\$604
50" H x 72" W*	HETP5072FP	38	5.2	\$643	\$666	\$752



65" H Tackable Acoustical Panels

65" H x 20" W	HETP6520FP	19	1.9	\$381	\$396	\$444
65" H x 24" W	HETP6524FP	20	2.3	\$395	\$410	\$458
65" H x 30" W	HETP6530FP	23	2.8	\$416	\$432	\$483
65" H x 36" W	HETP6536FP	26	3.4	\$446	\$464	\$522
65" H x 42" W	HETP6542FP	29	3.9	\$485	\$504	\$569
65" H x 48" W	HETP6548FP	32	4.5	\$506	\$526	\$599
65" H x 60" W	HETP6560FP	37	5.6	\$540	\$560	\$642
65" H x 72" W*	HETP6572FP	43	6.8	\$731	\$754	\$846

NOTES:

- Panels are 2 1/8" thick.
- Baserails ship standard with panels.
- Top caps ordered separately; see page 493.
- Packaging: stretch wrapped with edge protection.
- Base rail matches trim color.
- For worksurfaces that can be used with Abound® and Accelerate® systems, see pages 617-629.
- Panel end trim ordered separately; see page 499.
- Panels may be connected end to end, with wall starter kit, or with panel connectors; see pages 497-499.
- Order Accelerate® connectors separately; see page 497.
- Panels have a class A fire rating.
- Bulk packing is available in quantities of 3 or 9.
- Fabrics and finishes available on pages 481-483.

- ! Raceway panels option only.
- ! Do not remove electrical knockouts unless duplex is needed. For replacement covers, see page 610.
- ! Accepts electrical power kits, except for 20" W. See page 608 for electrical.
- ! Stack on panels add 15" of height and can be added to any monolithic panel. See stackers on pages 494-495.
- ! Disperse and Analog fabrics are not available on 72" W panels.
- ! If adding to existing panels produced prior to 04/13/16, please contact Customer Support for compatibility.
- ! If a third cutout for data is desired, order the separate kickplate model HEBPLATE.
- ! Panels should not be used in unsupported applications or take the place of permanent walls. Panels are intended to be supported with floor supports and/or storage or tied in with worksurfaces. Refer to Specifying and Design Guide pages.

HOW TO SPECIFY

Select Model Number

HETP3520FP

Select Fabric

See pages 482-483

APN15

Select Trim Color

See page 481

P1 Paint (no upcharge)
P2 Paint (\$30 upcharge)

S



ACCELERATE® Top-Tier Glass Panels

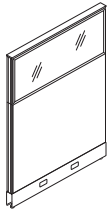

DESCRIPTION

50" H Tackable Panels — Top-Tier Glass

- 50" H x 20" W
- 50" H x 24" W
- 50" H x 30" W
- 50" H x 36" W
- 50" H x 42" W
- 50" H x 48" W
- 50" H x 60" W
- 50" H x 72" W*

MODEL	SHIP WEIGHT	CUBE	CORE LIST PRICE BY CODE		
			AA	A	B
HETP5020DP	21 Ⓢ	1.4	\$561	\$581	\$644
HETP5024DP	23 Ⓢ	1.7	\$585	\$605	\$668
HETP5030DP	27 Ⓢ	2.2	\$596	\$618	\$662
HETP5036DP	31 Ⓢ	2.6	\$608	\$630	\$680
HETP5042DP	34 Ⓢ	3.0	\$665	\$689	\$747
HETP5048DP	39 Ⓢ	3.5	\$694	\$721	\$786
HETP5060DP	46	4.3	\$748	\$778	\$853
HETP5072DP	55	5.2	\$997	\$1030	\$1115

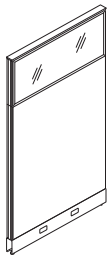

65" H Tackable Panels — Top-Tier Glass

- 65" H x 20" W
- 65" H x 24" W
- 65" H x 30" W
- 65" H x 36" W
- 65" H x 42" W
- 65" H x 48" W
- 65" H x 60" W
- 65" H x 72" W*

HETP6520DP	24 Ⓢ	1.9	\$588	\$609	\$657
HETP6524DP	27 Ⓢ	2.3	\$605	\$626	\$674
HETP6530DP	30 Ⓢ	2.8	\$626	\$648	\$699
HETP6536DP	34 Ⓢ	3.4	\$661	\$685	\$743
HETP6542DP	39 Ⓢ	3.9	\$709	\$735	\$800
HETP6548DP	43 Ⓢ	4.5	\$733	\$760	\$833
HETP6560DP	51	5.6	\$765	\$795	\$879
HETP6572DP	60	6.8	\$1088	\$1121	\$1213

NOTES:

- On top-tier panel models, the glass tier is 15" H.
- Glass is clear or frosted, tempered safety glass.
- Panels are 2 1/8" thick.
- Panels have steel baserails.
- Packaging: stretch wrapped with edge protection.
- Base rail matches trim color.
- Top caps ordered separately; see page 493.
- For worksurfaces that can be used with Abound® and Accelerate® systems, see pages 617-629.
- Panel end trim ordered separately; see page 499.
- Panels may be connected end to end, with wall starter kit, or with panel connectors; see pages 497-499.
- Order Accelerate® connectors separately; see page 497.
- Panels have a class A fire rating.
- Bulk packing is available in quantities of 3 or 9.
- Fabrics and finishes available on pages 481-483.

- ⓘ Raceway panels option only.
- ⓘ Do not remove electrical knockouts unless duplex is needed. For replacement covers, see page 610.
- ⓘ Accepts electrical power kits, except for 20" W. See page 608 for electrical.
- ⓘ Cannot stack stacker on top-tier glass panels.
- ⓘ Disperse and Analog fabrics are not available on 72" W panels.
- ⓘ If adding to existing panels produced prior to 04/13/16, please contact Customer Support for compatibility.
- ⓘ If a third cutout for data is desired, order the separate kickplate model HEBPLATE.
- ⓘ Panels should not be used in unsupported applications or take the place of permanent walls. Panels are intended to be supported with floor supports and/or storage or tied in with worksurfaces. Refer to Specifying and Design Guide pages.

HOW TO SPECIFY

<p>Select Model Number</p> <p>HETP5020DP .</p>	<p>Select Fabric</p> <p>See pages 482-483</p> <p>APN15 .</p>	<p>Select Trim Color</p> <p>See page 481</p> <p>P1 Paint (no upcharge)</p> <p>P2 Paint (\$30 upcharge)</p> <p>S .</p>	<p>Select Glass</p> <p>Q Clear Glass</p> <p>R Frosted Glass (\$30 upcharge)</p> <p>Q</p>
---	---	--	---

ACCELERATE® Panel Door

GSA SIN 33721



Icon Legend on page 19

WORKSTATIONS

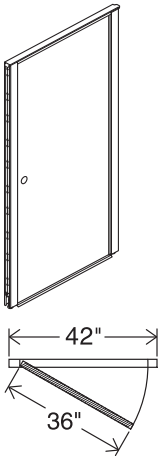

DESCRIPTION	MODEL	SHIP WEIGHT	CUBE	LIST PRICE BY PAINT GRADE	
				P1	P2

Door Panel — Laminate 42"W x 80"H	HEPDMK42P	155.0	7.3	\$2123	\$2156
---	------------------	-------	-----	---------------	---------------

NOTES: Ships with door, frame, hinges and hardware. Best placement of a door is at an L, T, X connector or wall starter connector for rigidity. Use of spanning top caps at an in-line will also help add additional rigidity.

❗ Must be used with a base panel and stacker equaling 80"H.

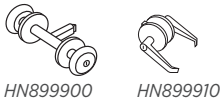

Standard Lock Set

Door knob (polished brass)
Door lever (brushed aluminum)

HN899900	2.0 ☹	0.1	\$126
HN899910	2.0 ☹	0.1	\$347

NOTES: Door knob and lever are both keyed on one side.



Abound® and Accelerate® Sliding Door

50"H x 42"W
65"H x 42"W
80"H x 42"W

HH15042SD	28.0	5.5	\$2266	\$2302
HH16542SD	38.0	7.1	\$2583	\$2619
HH18042SD	46.0	8.6	\$3160	\$3196

❗ Door is only available in Frosted Translucent Acrylic. Specify paint for frame.

❗ Can only install Sliding Door at the end of a run, not at a corner.

❗ A Mounting Bracket Kit must be ordered for each sliding door corresponding to the mounting panels width (30", 36", 42", or 48"W).

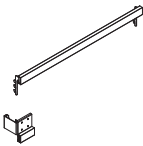

Accelerate® Mounting Kit for Sliding Door

For 30"W Panel
For 36"W Panel
For 42"W Panel
For 48"W Panel

HESDMK30	4.0	0.4	\$189	\$201
HESDMK36	5.0	0.5	\$199	\$211
HESDMK42	6.0	0.5	\$207	\$219
HESDMK48	7.0	0.5	\$217	\$229

NOTES: Specify paint.



Carpet Grippers

NOTES: Used with Glide Towers
Shipped 12 per package
No need to specify paint

HICG12	0.5 ☹	0.1	\$23
---------------	-------	-----	-------------



Coat Hooks

Package of six

HHPMC6	1.0 ☹	0.2	\$94
---------------	-------	-----	-------------

NOTES: Compatible with Accelerate® and Abound® panels.

❗ Black only.

NOTES:

- Order handle separately. See handle model options above.
- Specify top caps separately when ordering the laminate panel door; see page 493.
- Order Accelerate® connectors separately; see page 497.
- Fabrics and finishes available on pages 481-483.
- The Sliding Doors are available in 50", 65", and 80"H models and can mount to 30", 36", 42", and 48"W panels.
- All doors are 42" wide, provide a 36"W opening, and are non-handed.

HOW TO SPECIFY

Select Model Number H E P D M K 4 2 P .	Select Trim Color See page 481 T 4 .	Select Door Laminate L2 Laminate Upcharge \$60 See page 481 H
---	---	---



Icon Legend on page 19

ACCELERATE® Top Caps

WORKSTATIONS

DESCRIPTION	MODEL	SHIP WEIGHT	CUBE	LIST PRICE BY PAINT GRADE	
				P1	P2
Panel Top Cap					
20"W	HETC20	1.5	0.3	\$42	\$62
24"W	HETC24	1.6	0.3	\$42	\$62
30"W	HETC30	1.8	0.3	\$51	\$71
36"W	HETC36	2.0	0.3	\$65	\$85
42"W	HETC42	2.2	0.3	\$68	\$88
48"W	HETC48	3.4	0.4	\$76	\$96
60"W	HETC60	3.9	0.6	\$94	\$114
66"W	HETC66	4.0	0.6	\$110	\$130
72"W	HETC72	5.3	0.8	\$114	\$134
78"W	HETC78	6.5	0.8	\$119	\$139
84"W	HETC84	6.7	0.9	\$130	\$150
90"W	HETC90	7.0	0.9	\$136	\$156
96"W	HETC96	7.2	0.9	\$143	\$163

NOTES:

- Models above are specified for panel models on pages 490-491.
 - Top caps ship separately from panels.
 - Top caps are able to span multiple panels for a clean aesthetic.
 - Top caps are bulk packed for ease at installation sites.
- ! If adding to existing panels produced prior to 04/13/16, please contact Customer Support for compatibility.

HOW TO SPECIFY

Select Model Number	Select Paint Color
HETC20	T3

DESCRIPTION	MODEL	SHIP WEIGHT	CUBE	LIST PRICE BY PAINT GRADE	
				P1	P2
Accelerate® Base Pathway Cover w/Additional Knockout					
36"W	HEBPLATE336	7	0.4	\$82	\$92
42"W	HEBPLATE342	8	0.4	\$84	\$94
48"W	HEBPLATE348	9	0.4	\$88	\$98
60"W	HEBPLATE360	11	0.5	\$100	\$110
72"W	HEBPLATE372	14	0.6	\$111	\$121

NOTES: Specify paint, see page 481.
SPECIFYING EXAMPLE: HEBPLATE336.T4

NOTES:

- ! Specify Pathways to match trim color.
- ! Standard raceways with two knockouts are standard on panels. If additional three knockout kickplate is ordered, the two port version can be saved or discarded.

HOW TO SPECIFY

Select Model Number	Select Paint Color
HEBPLATE336	T4

ACCELERATE[®] Stacking Panels

GSA SIN 33721



Icon Legend on page 19

WORKSTATIONS



DESCRIPTION

15" H Stacking Panels — Fabric

15" H x 20" W
15" H x 24" W
15" H x 30" W
15" H x 36" W
15" H x 42" W
15" H x 48" W
15" H x 60" W
15" H x 72" W

MODEL	SHIP WEIGHT	CUBE	CORE LIST PRICE BY CODE		
			AA	A	B
HES1520F	6	0.5	\$203	\$224	\$272
HES1524F	7	0.6	\$224	\$245	\$293
HES1530F	8	0.8	\$242	\$264	\$315
HES1536F	9	0.9	\$259	\$283	\$341
HES1542F	11	1.1	\$280	\$306	\$371
HES1548F	12	1.2	\$298	\$325	\$398
HES1560F	14	1.5	\$337	\$367	\$451
HES1572F	17	1.8	\$639	\$672	\$764

NOTES:

- Stacking panels ship without top caps.
- Stackers add 15" or 30" to the height of the base panel.
- Stacker ships with pins to connect stacker to post connector for added rigidity.
- Select complete panels with top-tier glass, or add glass/fabric stackers separately to existing panels. See page 491 for complete panels information.

- Not to be used freestanding.
- Stackers can be stacked up to 80" H on a base panel or 30" of stacker height total, whichever comes first.
- The first stacker on a base panel is weight bearing and can accommodate overhead storage up to 65" H.
- Stacking model must match the width of the panel it is stacking on.
- Total panel height cannot exceed 80" high. Glass stacker must be the top tier. A stacking panel cannot be placed above a glass panel or glass stacker. Frameless Glass can be installed on a fabric stacker.
- Voi overheads not to be placed on stackers.
- If adding to existing panels produced prior to 04/13/16, please contact Customer Support for compatibility.

HOW TO SPECIFY

<p>Select Model Number</p> <p>H E S 1 5 2 0 F .</p>	<p>Select Fabric Color</p> <p>See pages 482-483</p> <p>A P N 1 1</p>
---	--



ACCELERATE® Stacking Panels

	DESCRIPTION	MODEL	SHIP WEIGHT	CUBE	CLEAR GLASS	FROSTED GLASS	
	30”H Stacking Panels — Glass						
	30”H x 20”W	HES3020G	14 Ⓔ	1.0	\$661	\$691	
	30”H x 24”W	HES3024G	17 Ⓔ	1.2	\$695	\$725	
	30”H x 30”W	HES3030G	20 Ⓔ	1.5	\$788	\$818	
	30”H x 36”W	HES3036G	23 Ⓔ	1.8	\$815	\$845	
	30”H x 42”W	HES3042G	26 Ⓔ	2.1	\$901	\$931	
	30”H x 48”W	HES3048G	29 Ⓔ	2.4	\$970	\$1000	
	30”H x 60”W	HES3060G	36	3.0	\$1112	\$1142	
	NOTES: 30”H stacker ships with pins to connect stacker to post connector for added rigidity.						
	15”H Stacking Panels — Glass						
	15”H x 20”W	HES1520G	8 Ⓔ	0.5	\$441	\$471	
	15”H x 24”W	HES1524G Ⓢ	9 Ⓔ	0.6	\$467	\$497	
	15”H x 30”W	HES1530G Ⓢ	11 Ⓔ	0.8	\$526	\$556	
	15”H x 36”W	HES1536G Ⓢ	12 Ⓔ	0.9	\$545	\$575	
	15”H x 42”W	HES1542G	14 Ⓔ	1.1	\$602	\$632	
	15”H x 48”W	HES1548G Ⓢ	16 Ⓔ	1.2	\$648	\$678	
	15”H x 60”W	HES1560G Ⓢ	19 Ⓔ	1.5	\$741	\$771	
		15”H x 72”W	HES1572G	22	1.8	\$903	\$933

NOTES:

- Stacking panels ship without top caps.
- Stackers add 15” or 30” to the height of the base panel.
- Stacker ships with pins to connect stacker to post connector for added rigidity.
- Select complete panels with top-tier glass, or add glass/fabric stackers separately to existing panels. See page 491 for complete panels information.
- !** Not to be used freestanding.
- !** Stackers can be stacked up to 80”H on a base panel or 30” of stacker height total, whichever comes first.
- !** The first stacker on a base panel is weight bearing and can accommodate overhead storage up to 65”H.
- !** Stacking model must match the width of the panel it is stacking on.
- !** Total panel height cannot exceed 80” high. Glass stacker must be the top tier. A stacking panel cannot be placed above a glass panel or glass stacker. Frameless Glass can be installed on a fabric stacker.
- !** If adding to existing panels produced prior to 04/13/16, please contact Customer Support for compatibility.

HOW TO SPECIFY

<p>Select Model Number</p> <p>HES3020G</p>	<p>Select Paint Color</p> <p>See page 481 P1 Paint (no upcharge) P2 Paint (\$30 upcharge)</p> <p>T1</p>	<p>Select Glass</p> <p>Q Clear Glass R Frosted Glass</p> <p>Q</p>
---	--	--

ACCELERATE® Frameless Glass

GSA SIN 33721



Icon Legend on page 19

WORKSTATIONS

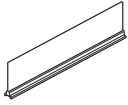

DESCRIPTION

Frameless Glass Stacker

7½"H x 20"W
7½"H x 24"W
7½"H x 30"W
7½"H x 36"W
7½"H x 42"W
7½"H x 48"W
7½"H x 54"W
7½"H x 60"W
7½"H x 66"W
7½"H x 72"W

MODEL	SHIP WEIGHT	CUBE	CLEAR GLASS	FROSTED GLASS
HEFGS0720	17	0.7	\$347	\$377
HEFGS0724	18	0.8	\$410	\$447
HEFGS0730	18	1.0	\$441	\$482
HEFGS0736	21	1.2	\$507	\$554
HEFGS0742	25	1.5	\$541	\$591
HEFGS0748	28	1.5	\$582	\$636
HEFGS0754	28	1.7	\$656	\$717
HEFGS0760	35	1.8	\$712	\$778
HEFGS0766	35	2.0	\$793	\$865
HEFGS0772	42	2.2	\$842	\$920

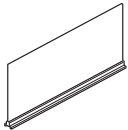

Frameless Glass Stacker

15"H x 20"W
15"H x 24"W
15"H x 30"W
15"H x 36"W
15"H x 42"W
15"H x 48"W
15"H x 54"W
15"H x 60"W
15"H x 66"W
15"H x 72"W

HEFGS1520	27	1.2	\$430	\$460
HEFGS1524	28	1.4	\$466	\$503
HEFGS1530	28	1.7	\$498	\$539
HEFGS1536	34	2.0	\$571	\$618
HEFGS1542	39	2.3	\$613	\$663
HEFGS1548	45	2.6	\$661	\$715
HEFGS1554	51	2.7	\$723	\$784
HEFGS1560	57	3.0	\$806	\$872
HEFGS1566	62	3.3	\$880	\$952
HEFGS1572	67	3.6	\$950	\$1028



DESCRIPTION

Frameless Glass Finishing Kit

7½"H
15"H
22½"H
30"H

MODEL	SHIP WEIGHT	CUBE	LIST PRICE BY PAINT GRADE	
			P1	P2
HEVHG07P	2	0.2	\$60	\$69
HEVHG15P	2	0.4	\$64	\$73
HEVHG22P	3	0.4	\$70	\$79
HEVHG30P	3	0.4	\$80	\$92

NOTES: Specify paint, see page 483.

SPECIFYING EXAMPLE: HEVHG15P.PJW

NOTES:

- Glass is a single-pane, 3/8" laminated safety glass.
- Available in clear or frosted glass.
- Frameless Glass can span multiple panels with one piece of glass.
- Lamination is in the center of the glass, making both clear and frosted glass a writable surface with dry-erase markers.

⚠ Glass tiles have a Class A fire rating.

⚠ Frameless Glass cannot be used on top of glass stackers or headers.

⚠ Frameless Glass can only be used on the top of panels. Glass integrates into top cap trim. Do not order a separate top cap model for your frame when using Frameless Glass.

⚠ Cannot hang or stack on top of Frameless Glass.

⚠ If adding to existing panels produced prior to July 2021, please contact Customer Support for compatibility.

HOW TO SPECIFY

Select Model Number <div style="border: 1px solid black; padding: 2px; display: flex; gap: 5px;"> HEFGS1520 </div>	Select Paint Color See page 481 P1 Paint (no upcharge) P2 Paint (\$17 upcharge) <div style="border: 1px solid black; padding: 2px; display: flex; gap: 5px;"> T1 </div>	Select Glass Option G Clear Glass R Frosted Glass <div style="border: 1px solid black; padding: 2px; display: flex; gap: 5px;"> G </div>
---	--	---



Icon Legend on page 19

ACCELERATE® Strengthened Connection Posts

WORKSTATIONS

DESCRIPTION	MODEL	SHIP		LIST PRICE BY PAINT GRADE		
		WEIGHT	CUBE	P1	P2	P3
120° 2-Way Connector Posts						
For 35"H Panels	HEC35P2N	6	0.5	\$99	\$108	\$125
For 42½"H Panels	HEC42P2N	6	0.5	\$119	\$128	\$145
For 50"H Panels	HEC50P2N	7	0.6	\$138	\$147	\$164
For 57½"H Panels	HEC57P2N	8	0.8	\$148	\$157	\$174
For 65"H Panels	HEC65P2N	8	0.8	\$155	\$164	\$181
For 72½"H Panels	HEC72P2N	9	0.9	\$164	\$173	\$190
For 80"H Panels	HEC80P2N	9	0.9	\$171	\$180	\$197
120° 3-Way Connector Posts						
For 35"H Panels	HEC35P3N	6	0.5	\$94	\$103	\$120
For 42½"H Panels	HEC42P3N	6	0.5	\$112	\$121	\$138
For 50"H Panels	HEC50P3N	7	0.6	\$133	\$142	\$159
For 57½"H Panels	HEC57P3N	8	0.8	\$141	\$150	\$167
For 65"H Panels	HEC65P3N	8	0.8	\$149	\$158	\$175
For 72½"H Panels	HEC72P3N	9	0.9	\$158	\$167	\$184
For 80"H Panels	HEC80P3N	9	0.9	\$166	\$175	\$192
Extended Straight Connector Posts						
For 35"H Panels	HEC35PSN	6	0.5	\$99	\$108	\$125
For 42½"H Panels	HEC42PSN	6	0.5	\$119	\$128	\$145
For 50"H Panels	HEC50PSN	7	0.6	\$138	\$147	\$164
For 57½"H Panels	HEC57PSN	8	0.8	\$148	\$157	\$174
For 65"H Panels	HEC65PSN	8	0.8	\$155	\$164	\$181
For 72½"H Panels	HEC72PSN	9	0.9	\$166	\$175	\$192
For 80"H Panels	HEC80PSN	9	0.9	\$171	\$180	\$197
"L" Connector Posts						
For 35"H Panels	HEC35PLN	6	0.5	\$104	\$113	\$130
For 42½"H Panels	HEC42PLN ☉	6	0.5	\$125	\$134	\$151
For 50"H Panels	HEC50PLN ☉	7	0.6	\$144	\$153	\$170
For 57½"H Panels	HEC57PLN ☉	8	0.8	\$154	\$163	\$180
For 65"H Panels	HEC65PLN ☉	8	0.8	\$161	\$170	\$187
For 72½"H Panels	HEC72PLN	9	0.9	\$169	\$178	\$195
For 80"H Panels	HEC80PLN	9	0.9	\$178	\$187	\$204
"T" Connector Posts						
For 35"H Panels	HEC35PTN	6	0.5	\$99	\$108	\$125
For 42½"H Panels	HEC42PTN ☉	6	0.5	\$119	\$128	\$145
For 50"H Panels	HEC50PTN ☉	7	0.6	\$138	\$147	\$164
For 57½"H Panels	HEC57PTN ☉	8	0.8	\$148	\$157	\$174
For 65"H Panels	HEC65PTN ☉	8	0.8	\$155	\$164	\$181
For 72½"H Panels	HEC72PTN	9	0.9	\$164	\$173	\$190
For 80"H Panels	HEC80PTN	9	0.9	\$171	\$180	\$197
"X" Connector Posts						
For 35"H Panels	HEC35PXN	6	0.5	\$94	\$103	\$120
For 42½"H Panels	HEC42PXN ☉	6	0.5	\$112	\$121	\$138
For 50"H Panels	HEC50PXN ☉	7	0.6	\$133	\$142	\$159
For 57½"H Panels	HEC57PXN ☉	8	0.8	\$141	\$150	\$167
For 65"H Panels	HEC65PXN ☉	8	0.8	\$149	\$158	\$175
For 72½"H Panels	HEC72PXN	9	0.9	\$158	\$167	\$184
For 80"H Panels	HEC80PXN	9	0.9	\$166	\$175	\$192

NOTES:

- Specify connectors based on number and placement of panels.
- Connector posts are specified separately from connector straps — specify post to tallest panel and straps based on connection (see variable height example on straps page).
- Specify connector to fit height of tallest panel.
- Connectors are made of extruded aluminum.
- Straight Connector model HSCKTPS ships standard in bulk pack.
- Connector posts where power pole will enter need to be specified with single connector straps, model HECS1.

☉ In-line connector must be specified for all in-line connections.

☉ If adding to existing panels produced prior to 04/13/2016, please contact Customer Support for compatibility.

HOW TO SPECIFY

<p>Select Model Number</p>	<p>Select Paint Color</p> <p>See page 481</p>
<p>H E C 3 5 P 2 N .</p>	<p>T 3</p>

	DESCRIPTION	MODEL	SHIP WEIGHT	CUBE	LIST PRICE
	120° 2-Way Connector Strap	HECSV	1.4	0.2	\$24
	120° 3-Way Connector Strap	HECSY	2.2	0.2	\$29
	Extended Straight Connector Strap	HECSS	1.6	0.2	\$24
	"L" Connector Strap	HECSL	1.5	0.2	\$17
	"T" Connector Strap	HECST	2.3	0.2	\$24
	"X" Connector Strap	HECSX	3.0	0.2	\$29
	Single Connector Strap	HECSI	1.9	0.2	\$17
	In-line Connector NOTES: No need to specify finish. SPECIFYING EXAMPLE: HSCKTPS.X	HSCKTPS	0.5	0.1	\$22

NOTES:

- Strengthened Connection Straps provide more rigidity to panel connections, especially when not tied into a station with a worksurface or storage, i.e., when Coordinate™ Height Adjustable bases are used or when using panels strictly to divide space without tying in other components.
- Connector strap type should be specified based on the tallest panel connection type. Connector straps and posts are specified separately.
- Lower height panels will connect with variable height trim.
- See examples below.
- Connector straps can be retrofitted on any existing Accelerate® stations that were produced from April 2016 to present.
- Will fit on existing connector posts — only straps would need to be specified.
- Single Straps (HECSI) are used when power poles enter at the connector post and in variable height applications where the tallest panel is a single and one or more panels is lower.

Connector Post



New Connector Straps

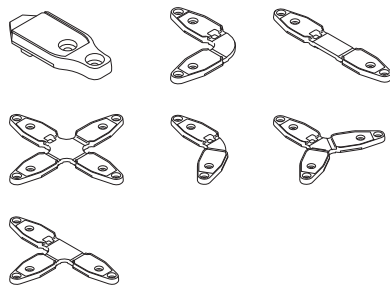

"T" 2 High, "L" 1 Low

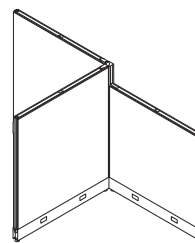

- 1 — "T" Connector Post
- 1 — VH Post Trim
- 3 — Top Caps
- 3 — End Caps
- 1 — "L" Connector Strap

"T" 1 High, "L" 2 Low

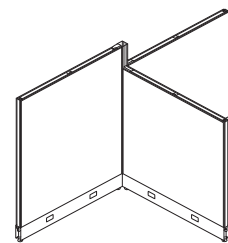

- 1 — "T" Connector Post
- 2 — VH Post Trim
- 3 — Top Caps
- 3 — End Caps
- 1 — Single Connector Strap

HOW TO SPECIFY

Select Model Number



Variable Height Finished End and Wall Starter Kits



DESCRIPTION	MODEL	SHIP WEIGHT	CUBE	LIST PRICE BY PAINT GRADE	
				P1	P2
Finished End Covers					
35"H	HEFEC35P	3	0.4	\$57	\$66
42½"H	HEFEC42P	3	0.5	\$61	\$70
50"H	HEFEC50P	4	0.6	\$65	\$74
57½"H	HEFEC57P	5	0.6	\$68	\$77
65"H	HEFEC65P	5	0.7	\$73	\$82
72½"H	HEFEC72P	6	0.8	\$78	\$87
80"H	HEFEC80P	6	0.9	\$81	\$90

NOTES: Finished End Covers include top bracket, end trim clips and end trim.



In-line Variable Height Finishing Kit					
7½"H	HEVHF07P	2	0.2	\$60	\$69
15"H	HEVHF15P	2	0.4	\$64	\$73
22½"H	HEVHF22P	3	0.4	\$75	\$84
30"H	HEVHF30P	3	0.4	\$88	\$97

NOTES: In-line Variable Height Finishing Kits include top and bottom bracket, end trim clips and end trim. In-line Variable Height Finishing Kit is used to connect a finished in-line panel connection.



Connector Variable Height Finishing Kit					
7½"H	HECVH07P	2	0.2	\$60	\$69
15"H	HECVH15P	2	0.4	\$64	\$73
22½"H	HECVH22P	3	0.4	\$75	\$84
30"H	HECVH30P	3	0.4	\$88	\$97

NOTES: Connector Variable Height Finishing Kits include top and bottom bracket, end trim and end trim connection piece.



Wall Starter Kit					
35"H	HEWS35P	4	0.4	\$96	\$105
42½"H	HEWS42P	4	0.5	\$101	\$110
50"H	HEWS50P	5	0.6	\$105	\$114
57½"H	HEWS57P	6	0.6	\$111	\$120
65"H	HEWS65P	6	0.7	\$119	\$128
72½"H	HEWS72P	7	0.8	\$127	\$136
80"H	HEWS80P	7	0.9	\$133	\$142

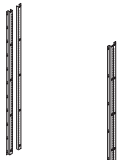

Permanent Wall Hanger Kit					
2½"W x 7/8"D x 66"H	HRVC35PCE	6	0.7	\$243	\$263
4¼"W x 7/8"D x 66"H	HRVC35PCM	3	0.7	\$128	\$138

Anchor devices are not supplied with this model. Refer to Abound® Installation instructions for appropriate hardware. Attachment to masonry walls is not recommended.

Specify paint

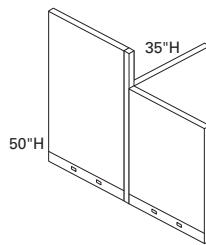

T-Connection
Connector, Variable Height Finishing Kit

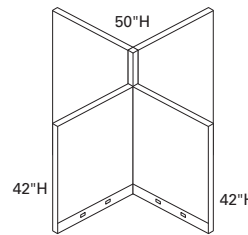

X-Connection
Connector, Variable Height Finishing Kit

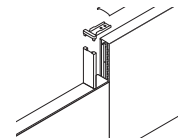

In-line Variable
Height Trim Kit

NOTES:

- In-line Variable Height Finishing Kit is used to connect a finished in-line panel connection.
- Connector variable height finishing kit is used at a drop in height at an L, T, X, or S connection.
- All kits come with all hardware needed to install the kit.
- Variable height kit needs to be specified any time a change of panel height occurs.
- Finished end covers must be specified at all end of panel runs.
- If adding to existing panels produced prior to 04/13/16, please contact Customer Support for compatibility.

HOW TO SPECIFY

<p>Select Model Number</p> <p>HEFEC35P</p>	<p>Select Paint Color</p> <p>See page 481</p> <p>T3</p>
--	---

ACCELERATE® Bracket Kits and Stability Feet

GSA SIN 33721



Icon Legend on page 19

WORKSTATIONS



DESCRIPTION

Accelerate® Anchor Bracket
Package of ten

NOTES: For use when panels need to be anchored to the floor such as high traffic areas or community spaces.

⚠ Only available in Black (P).

SPECIFYING EXAMPLE: HEABAC.P

MODEL SHIP WEIGHT CUBE LIST PRICE

HEABAC 5 0.08 \$95

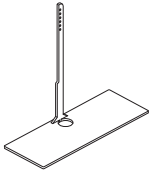

DESCRIPTION

Accelerate® Stability Foot

NOTES: Stabilizes bottom of panel from movement. Will not prohibit movement at top of panel.

MODEL SHIP WEIGHT CUBE LIST PRICE BY PAINT GRADE
P1 P2

HEFTAC 3 0.1 \$413 \$423

NOTES:

- ⚠ The Anchor Bracket and Stability Foot are not intended to create a freestanding panel. Please follow Accelerate® stability standards.
- ⚠ Attachment hardware for floor anchor not included.

HOW TO SPECIFY

<p>Select Model Number</p> <p>HEFTAC .</p>	<p>Select Paint Color</p> <p>See page 481</p> <p>T1</p>
---	--



Empower 2- and 4-Pack Benching Systems with Ignition® Seating, Voi® and Contain® Storage and Arrange® Tables.

EMPOWER®

Need a simple way to get up and running fast? No problem. Looking to expand and customize workstations for a growing business? Empower does that, too. With Empower benching, you've got the power to do more. Offer more personal space. Enjoy more adaptability. Route power more efficiently. It's simple to order, easy to install and quick to reconfigure. When you Empower your people, you keep pace with the changing demands of today's workplace.



FEATURES

- With numerous laminate selections to choose from, it's easy to get the exact look you want.
- Integrated height adjustability supports the work style of any user.
- Frosted glass. Colorful fabrics. Magnetic metal. Empower screens add style, privacy and functionality.
- Choose from multiple paint finishes to blend in or stand out.
- As the main electrical artery, power and data cables are laid into the trough.
- Plug power modules into the duplex in the trough and attach them to the worksurface for easy access to electrical and USB ports.
- Power entry can be accommodated through the ceiling, floor, or wall.
- Keep cords collected and controlled from floor to wire trough with vertebra.
- Support any work style by adding HON pedestals, credenzas and storage towers to Empower benching.

EMPOWER[®] FABRIC SCREENS — ALL PANEL MODELS

PRICE CODE AA

FACTOR	FACT
◆ Bark	FACT20
◆ Barley	FACT15
◆ Cascade	FACT25
◆ Feather	FACT30

PRICE CODE A

APPOINT	APN
◆ Artichoke	APN11
◆ Blackberry	APN32
◆ Bronze	APN22
◆ Carbon	APN28
◆ Chai	APN12
◆ Cherry	APN30
◆ Dark Pewter	APN17
◆ Dune	APN15
◆ Espresso	APN23
◆ Framboise	APN31
◆ Frost	APN34
◆ Jet	APN27
◆ Lawn	APN25
◆ Mandarin	APN29
◆ Morel	APN09
◆ Nimbus	APN16
◆ Platinum	APN24
◆ Turquoise	APN26

CENTURION CU

◆ Apricot	CU47
◆ Bark	CU25
◆ Black	CU10
◆ Espresso	CU49
◆ Fog	CU03
◆ Frost	CU22
◆ Goldenrod	CU27
◆ Indigo	CU06
◆ Iris	CU50
◆ Iron Ore	CU19
◆ Jade	CU83
◆ Marsala	CU63
◆ Morel	CU24
◆ Navy	CU98
◆ Peacock	CU97
◆ Pear	CU84
◆ Ruby	CU67
◆ Sapphire	CU09

PRICE CODE A *continued*

ETCH*	ECH
◆ Axis	ECH13
◆ Blend	ECH14
◆ Cast	ECH12
◆ Highlight	ECH10
◆ Midtone	ECH11
◆ Outline	ECH08
◆ Shade	ECH09
◆ Tonal	ECH16
◆ Vanish	ECH15

EXCHANGE* EXG

◆ Iron	EXG916
◆ Nickel	EXG914
◆ Pistachio	EXG910
◆ Root	EXG913
◆ Rupee	EXG903
◆ Shadow	EXG911
◆ Silver	EXG915
◆ Sisal	EXG917
◆ Stone	EXG912

LANDSCAPE* LN

◆ Azure	LN55
◆ Cornsilk	LN15
◆ Drift	LN05
◆ Khaki	LN20
◆ Sheen	LN10
◆ Slate	LN35
◆ Umber	LN25
◆ Urban	LN30

LUCY* LC

◆ Aspen	LC32
◆ Cornsilk	LC30
◆ Dusk	LC22
◆ Fawn	LC33
◆ Graphite	LC34
◆ Mist	LC20
◆ Neutra	LC24
◆ Pewter	LC35
◆ Snowdrop	LC28

PRICE CODE A *continued*

REFLECTIONS*	REF
◆ Galvanized	REF29
◆ Ice	REF20
◆ Loggia	REF21
◆ Mistral	REF28
◆ Moonstone	REF23
◆ Pewter	REF22
◆ Stainless	REF24
◆ Vanilla	REF25
◆ Winter	REF27

REFUGE* RFG

◆ Artesian	RFG96
◆ Dune	RFG92
◆ Eclipse	RFG90
◆ Frost	RFG93
◆ Glacier	RFG91
◆ Mineral	RFG98
◆ Tidal	RFG94

SARTO* SRT

◆ Ash	SRT88
◆ Fog	SRT14
◆ Lemongrass	SRT49
◆ Mist	SRT45
◆ Mushroom	SRT76
◆ Oyster	SRT18
◆ Reef	SRT64
◆ Sesame	SRT93
◆ Shale	SRT52

TEMPEST* TP

◆ Dragonfly	TP30
◆ Frost	TP15
◆ Full Stream	TP80
◆ Gold Rush	TP10
◆ Slate	TP45
◆ Tumbleweed	TP70
◆ Wind Chill	TP40
◆ Zebra	TP35

NOTES: Analog, Disperse, and Exchange panel fabrics will be applied pattern cut. Disperse will not be available on 72"W panels.

◆◆◆ For lead time information see page 19.

* Directional fabrics

EMPOWER® FABRIC SCREENS — ALL PANEL MODELS

PRICE CODE B

ANALOG*	ANLG
◆ Album	ANLG06
◆ Cartridge	ANLG04
◆ Cassette	ANLG09
◆ Dial	ANLG02
◆ Media	ANLG08
◆ Reel	ANLG07
◆ Signal	ANLG03
◆ Stereo	ANLG01
◆ Track	ANLG05

COAST*	COA
◆ Channel	COA14
◆ Dune	COA03
◆ Headlands	COA10
◆ Marsh	COA02
◆ Pebble	COA12
◆ Pier	COA13
◆ Shoal	COA01
◆ Silt	COA06
◆ Tide	COA08

DISPERSE*	DISP
◆ Autumn	DISP03
◆ Branch	DISP10
◆ Coffee Bean	DISP13
◆ Dusk	DISP09
◆ Emerald City	DISP08
◆ Gold Rush	DISP02
◆ Igloo	DISP11
◆ Ink	DISP06
◆ Mist	DISP12
◆ Oatmeal	DISP15
◆ Prince	DISP07
◆ Reservoir	DISP01
◆ Rose	DISP04
◆ Spring	DISP05
◆ Steel	DISP16
◆ Taupe	DISP14

PRICE CODE B *continued*

MICA*	MCA
◆ Anthracite	MCA11
◆ Breeze	MCA18
◆ Bronze	MCA13
◆ Buff	MCA14
◆ Cremini	MCA17
◆ Crystal	MCAWIT
◆ Dew	MCA20
◆ Dove	MCA12
◆ Fresh	MCA16
◆ Mineral	MCA15
◆ Nectar	MCA19
◆ Shale	MCA10

PRICE CODE B *continued*

SPIN*	SPIN
◆ Alabaster	SPIN02
◆ Cavern	SPIN03
◆ Cobblestone	SPIN04
◆ Ember	SPIN06
◆ Flame	SPIN07
◆ Heron	SPIN13
◆ Oat	SPIN01
◆ Ocean	SPIN12
◆ Plum	SPIN15
◆ Pool	SPIN11
◆ Raven	SPIN10
◆ Rhubarb	SPIN14
◆ Tropic	SPIN08
◆ Willow	SPIN05

PRICE CODE B *continued*

TERRAIN*	TRRN
◆ Bay	TRRN05
◆ Bayou	TRRN35
◆ Canyon	TRRN30
◆ Cliff	TRRN45
◆ Crest	TRRN25
◆ Delta	TRRN10
◆ Plateau	TRRN15
◆ Ridge	TRRN20
◆ Valley	TRRN40

NOTES: Analog, Disperse, and Exchange panel fabrics will be applied pattern cut. Disperse will not be available on 72"W panels.

◆◆◆ For lead time information see page 19.

* Directional fabrics

EMPOWER® FINISH OPTIONS

WORKSURFACES

L1 LAMINATES CODES

- Woodgrain**
- ◆ Bourbon Cherry H
 - ◆ Cognac COGN
 - ◆ Florence Walnut LFW1
 - ◆ Harvest C
 - ◆ Kingswood Walnut LK11
 - ◆ Mahogany N
 - ◆ Mocha MOCH
 - ◆ Natural Maple D
 - ◆ Pinnacle PINC
 - ◆ Shaker Cherry F
 - ◆ Sterling Ash LSA1

- Solid**
- ◆ Black P
 - ◆ Charcoal S
 - ◆ Designer White LDW1
 - ◆ Loft LOFT

- Patterned**
- ◆ Handspun Chestnut LAHC
 - ◆ Handspun Dove LAHD
 - ◆ Handspun Pearl LAHP
 - ◆ Handspun Slate LAHS
 - ◆ Sheer Mesh * A5
 - ◆ Silver Mesh B9
 - ◆ Steel Mesh * A9
 - ◆ Canyon Zephyr * K9
 - ◆ Desert Zephyr * K8
 - ◆ Shadow Zephyr * K1
 - ◆ Gray G2
 - ◆ Grey Tigris * L6
 - ◆ White G1
 - ◆ Whitestone * K4

L2 LAMINATES CODES

- Woodgrain**
- ◆ Lowell Ash LLA1
 - ◆ Natural Recon LNR1
 - ◆ Phantom Ecrú LPE1
 - ◆ Portico Teak LPT1
 - ◆ Skyline Walnut LSW1

WORKSURFACE EDGE BAND

- Woodgrain**
- ◆ Bourbon Cherry H
 - ◆ Cognac COGN
 - ◆ Florence Walnut FW
 - ◆ Harvest C
 - ◆ Kingswood Walnut KI
 - ◆ Lowell Ash DL
 - ◆ Mahogany N
 - ◆ Mocha MOCH
 - ◆ Natural Maple D
 - ◆ Natural Recon NR
 - ◆ Phantom Ecrú PE
 - ◆ Pinnacle PINC
 - ◆ Portico Teak DP
 - ◆ Shaker Cherry F
 - ◆ Skyline Walnut SW
 - ◆ Sterling Ash SA

WORKSURFACE EDGE BAND *continued*

- Solid**
- ◆ Black P
 - ◆ Brownstone EY
 - ◆ Charcoal S
 - ◆ Designer White LDW1
 - ◆ Fossil EH
 - ◆ Greige R
 - ◆ Loft LOFT
 - ◆ Muslin T
 - ◆ Platinum K
 - ◆ Shadow * SHDW

END OF RUN SCREENS

L1 LAMINATES CODES

- Woodgrain**
- ◆ Bourbon Cherry H
 - ◆ Cognac COGN
 - ◆ Florence Walnut LFW1
 - ◆ Harvest C
 - ◆ Kingswood Walnut LK11
 - ◆ Mahogany N
 - ◆ Mocha MOCH
 - ◆ Natural Maple D
 - ◆ Pinnacle PINC
 - ◆ Shaker Cherry F
 - ◆ Sterling Ash LSA1

- Solid**
- ◆ Black P
 - ◆ Charcoal S
 - ◆ Designer White LDW1
 - ◆ Loft LOFT

- Patterned**
- ◆ Sheer Mesh A5
 - ◆ Silver Mesh B9

L2 LAMINATES CODES

- Woodgrain**
- ◆ Lowell Ash LLA1
 - ◆ Natural Recon LNR1
 - ◆ Phantom Ecrú LPE1
 - ◆ Portico Teak LPT1
 - ◆ Skyline Walnut LSW1

STATIC LEGS AND TROUGHS

PAINTS CODES

- P1**
- ◆ Black P
 - ◆ Brownstone P7D
 - ◆ Charcoal S
 - ◆ Designer White PJW
 - ◆ Fossil P28
 - ◆ Greige T5
 - ◆ Light Gray Q
 - ◆ Loft LOFT
 - ◆ Muslin T3
 - ◆ Putty L
 - ◆ Shadow * SHDW
 - ◆ Titanium P8T

- P2**
- ◆ Champagne Metallic T4
 - ◆ Platinum Metallic T1
 - ◆ Silver PR6
 - ◆ Solar Black P8X

- P3**
- ◆ Atom P8S
 - ◆ Bullseye PJF
 - ◆ Ember P8P
 - ◆ Ion P8N
 - ◆ Iris P8J
 - ◆ Krypton P8F
 - ◆ Regatta P8M

POWER POLE

PAINTS CODES

- P1**
- ◆ Black P
 - ◆ Charcoal S
 - ◆ Designer White PJW
 - ◆ Greige T5
 - ◆ Light Gray Q
 - ◆ Loft LOFT
 - ◆ Muslin T3
 - ◆ Shadow * SHDW

PAINTED METAL SCREENS AND SCREEN BRACKETS

PAINTS CODES

- P1**
- ◆ Black P
 - ◆ Brownstone P7D
 - ◆ Charcoal S
 - ◆ Designer White PJW
 - ◆ Fossil P28
 - ◆ Greige T5
 - ◆ Light Gray Q
 - ◆ Loft LOFT
 - ◆ Muslin T3
 - ◆ Putty L
 - ◆ Shadow * SHDW
 - ◆ Titanium P8T

- P2**
- ◆ Champagne Metallic T4
 - ◆ Platinum Metallic T1
 - ◆ Silver PR6
 - ◆ Solar Black P8X
 - ◆ White Markerboard MKB

- P3**
- ◆ Atom P8S
 - ◆ Bullseye PJF
 - ◆ Ember P8P
 - ◆ Ion P8N
 - ◆ Iris P8J
 - ◆ Krypton P8F
 - ◆ Regatta P8M

Recommended Color to use with Duplex and Data Electric Kits

Paint	Duplex-Data Code
Black P	Black P
Brownstone P7D	Brownstone EY
Charcoal S	Charcoal S
Designer White PJW	Designer White DW
Fossil P28	Charcoal S
Greige T5	Muslin T3
Light Gray Q	Loft LOFT
Loft LOFT	Loft LOFT
Muslin T3	Muslin T3
Putty L	Black P
Shadow SHDW	Muslin T3
Silver PR6	Titanium T1
Titanium P8T	Titanium T1
Champagne Metallic T4	Muslin T3
Platinum Metallic T1	Titanium T1

WORKSURFACE LAMINATES	CODES	EDGE BAND OPTIONS											
		Matching Edge	Designer White (DW)	Loft (LOFT)	Muslin (T)	Shadow (SHDW)	Black (P)	Brownstone (EY)	Charcoal (S)	Fossil (EH)	Greige (R)	Light Gray (Q)	Platinum (K)
Black	P						*						
Bourbon Cherry	H	*	*		*								
Charcoal	S							*					
Cognac	COGN	*	*		*								
Designer White	LDW1		*										
Handspun Chestnut	LAHC	*	*	*	*		*	*	*	*	*	*	*
Handspun Dove	LAHD	*	*	*	*		*	*	*	*	*	*	*
Handspun Pearl	LAHP	*	*	*	*		*	*	*	*	*	*	*
Handspun Slate	LAHS	*	*	*	*		*	*	*	*	*	*	*
Harvest	C	*	*		*								
Loft	LOFT			*									
Lowell Ash	LLA1	*	*	*	*								
Mahogany	N	*	*	*	*	*							
Mocha	MOCH	*	*	*	*								
Natural Maple	D	*	*	*	*								
Natural Recon	LNR1	*	*	*	*								
Phantom Ecrú	LPE1	*	*	*	*								
Pinnacle	PINC	*	*	*	*								
Portico Teak	LPT1	*	*	*	*								
Shaker Cherry	F	*	*	*	*	*							
Sheer Mesh	A5			*									
Silver Mesh	B9			*									
Skyline Walnut	LSW1	*	*	*	*								
Sterling Ash	LSA1	*	*	*	*	*							

◆◆◆ For lead time information see page 19.
* De-emphasized

EMPOWER® Step-by-Step Guide

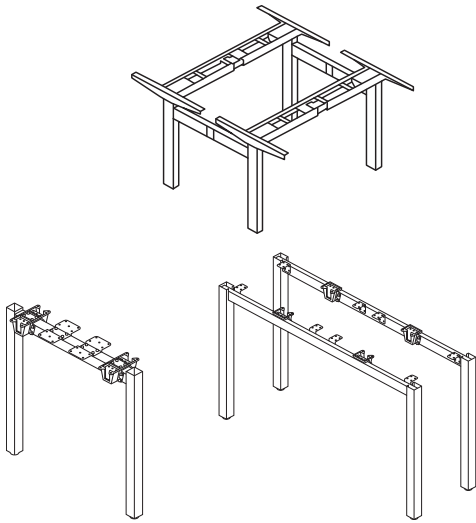

STEP 1: LEGS

All necessary brackets ship attached to the legs.

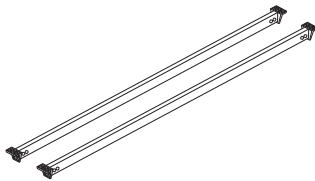

STEP 2: SUPPORT BEAMS (STATIC ONLY)

All necessary brackets ship attached to the beam. Simply fasten to the legs with the provided screws.

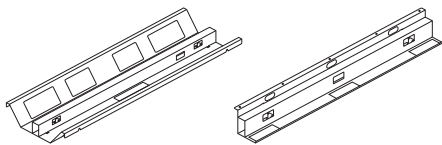

STEP 3: TROUGHS

Slide the trough over the support beams for double-sided. Screw the trough into the surface for single-sided.

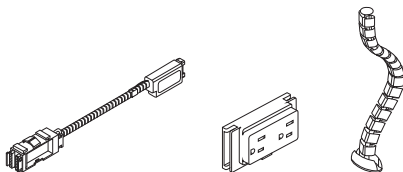

STEP 4: ELECTRICAL

Slide 8-wire harnesses/duplexes into pre-installed clips on the trough. Lay in data if necessary and cover.

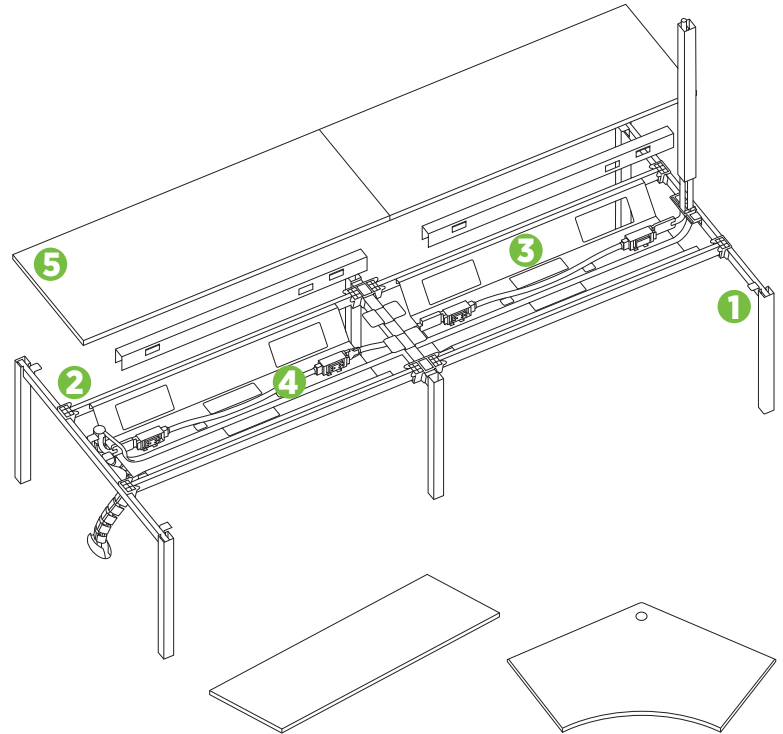

STEP 5: WORKSURFACES

All necessary brackets ship attached to the beam. Simply fasten to the legs with the provided screws.

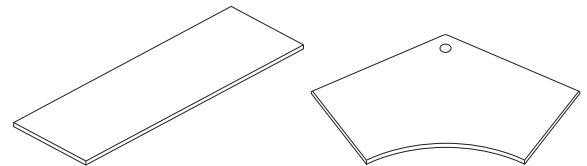

STEP 6: SCREENS

Drop shared screens into installed brackets, slide side screens into place or attach end of run screens at end of worksurfaces.

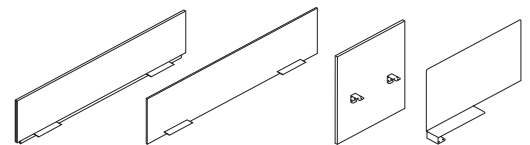

STEP 7: STORAGE

Choose your storage, from pedestals, to credenzas to towers — whatever suits your needs.

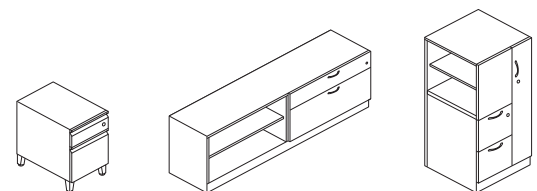

EMPOWER® 72"W Typical with 24"D Worksurfaces



Icon Legend on page 19

WORKSTATIONS

QTY	DESCRIPTION	MODEL	LIST PRICE	PRICE EXTENSION
2	Worksurface, Edgeband, No Grommets 24" x 72"	HWR2472PN	\$583	\$1,166
1	Double Depth U-Leg (Box of 2)	HMPEL4828	\$1,251	\$1,251
1	Support Beams (Box of 2) 72"W	HMPUB272	\$775	\$775
1	Shared Trough 72"W	HMP TROUGH72	\$528	\$528
1	End of Run Electrical Kit 72"W	HMPEEK72	\$249	\$249
1	Duplex 1	HH871501	\$47	\$47
1	Duplex 2	HH871502	\$47	\$47
1	Duplex 3	HH871503	\$47	\$47
1	Duplex 4	HH871504	\$47	\$47
TOTAL:			\$4,157	

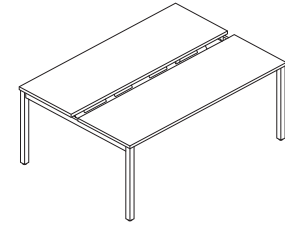

**2-PACK — 72"
72"W x 51"D**

QTY	DESCRIPTION	BUNDLE SKU	LIST PRICE
1	2-PACK BUNDLE Includes all Components Listed Above	HMP2472PK2	\$4,396

SPECIFYING EXAMPLE: Model.Laminate.Edgeband.Paint2.DuplexColor

NOTES: Typical DO NOT include power in-feeds, screens, storage, or seating.

ADD 1 FABRIC SCREEN: \$803— SEE PAGE 535

ADD 2 MOBILE PEDESTALS: \$1,326— SEE PAGE 569

SEE PAGE 538 FOR BUNDLE SKU INFORMATION

QTY	DESCRIPTION	MODEL	LIST PRICE	PRICE EXTENSION
4	Worksurface, Edgeband, No Grommets 24" x 72"	HWR2472PN	\$583	\$2,332
1	Double Depth U-Leg (Box of 2)	HMPEL4828	\$1,251	\$1,251
1	Double Depth Shared U-Leg (Singles)	HMPSL4828	\$516	\$516
2	Support Beams (Box of 2) 72"W	HMPUB272	\$775	\$1,550
2	Shared Trough 72"W	HMP TROUGH72	\$528	\$1,056
1	Power Harness 72"W	HH871272	\$239	\$239
1	End of Run Electrical Kit 72"W	HMPEEK72	\$249	\$249
2	Duplex 1	HH871501	\$47	\$94
2	Duplex 2	HH871502	\$47	\$94
2	Duplex 3	HH871503	\$47	\$94
2	Duplex 4	HH871504	\$47	\$94
TOTAL:			\$7,569	

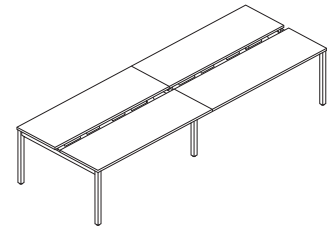

**4-PACK — 72"
144"W x 51"D**

QTY	DESCRIPTION	BUNDLE SKU	LIST PRICE
1	4-PACK BUNDLE Includes all Components Listed Above	HMP2472PK4	\$7,569

SPECIFYING EXAMPLE: Model.Laminate.Edgeband.Paint2.DuplexColor

NOTES: Typical DO NOT include power in-feeds, screens, storage, or seating.

ADD 2 FABRIC SCREENS: \$1,606— SEE PAGE 535

ADD 4 MOBILE PEDESTALS: \$2,652— SEE PAGE 569

SEE PAGE 538 FOR BUNDLE SKU INFORMATION



Icon Legend on page 19

EMPOWER[®]

72"W Typicals with 24"D Worksurfaces

QTY	DESCRIPTION	MODEL	LIST PRICE	PRICE EXTENSION
6	Worksurface, Edgeband, No Grommets 24" x 72"	HWR2472PN	\$583	\$3,498
1	Double Depth U-Leg (Box of 2)	HMPEL4828	\$1,251	\$1,251
2	Double Depth Shared U-Leg (Singles)	HMPSL4828	\$516	\$1,032
3	Support Beams (Box of 2) 72"W	HMPUB272	\$775	\$2,325
3	Shared Trough 72"W	HMPROUGH72	\$528	\$1,584
2	Power Harness 72"W	HH871272	\$239	\$478
1	End of Run Electrical Kit 72"W	HMPEEK72	\$249	\$249
3	Duplex 1	HH871501	\$47	\$141
3	Duplex 2	HH871502	\$47	\$141
3	Duplex 3	HH871503	\$47	\$141
3	Duplex 4	HH871504	\$47	\$141
TOTAL:				\$10,981

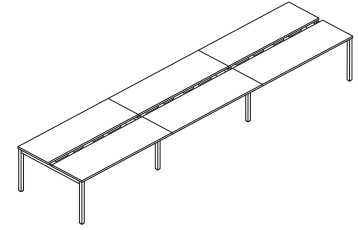

6-PACK — 72"
216"W x 51"D

QTY	DESCRIPTION	BUNDLE SKU	LIST PRICE
1	6-PACK BUNDLE Includes all Components Listed Above	HMP2472PK6	\$10,981

SPECIFYING EXAMPLE: Model.Laminate.Edgeband.Paint2.DuplexColor

NOTES: Typicals DO NOT include power in-feeds, screens, storage, or seating.

ADD 3 FABRIC SCREENS: \$2,409 — SEE PAGE 535

ADD 6 MOBILE PEDESTALS: \$3,978 — SEE PAGE 569

SEE PAGE 538 FOR BUNDLE SKU INFORMATION

QTY	DESCRIPTION	MODEL	LIST PRICE	PRICE EXTENSION
8	Worksurface, Edgeband, No Grommets 24" x 72"	HWR2472PN	\$583	\$4,664
1	Double Depth U-Leg (Box of 2)	HMPEL4828	\$1,251	\$1,251
3	Double Depth Shared U-Leg (Singles)	HMPSL4828	\$516	\$1,548
4	Support Beams (Box of 2) 72"W	HMPUB272	\$775	\$3,100
4	Shared Trough 72"W	HMPROUGH72	\$528	\$2,112
3	Power Harness 72"W	HH871272	\$239	\$717
1	End of Run Electrical Kit 72"W	HMPEEK72	\$249	\$249
4	Duplex 1	HH871501	\$47	\$188
4	Duplex 2	HH871502	\$47	\$188
4	Duplex 3	HH871503	\$47	\$188
4	Duplex 4	HH871504	\$47	\$188
TOTAL:				\$14,393

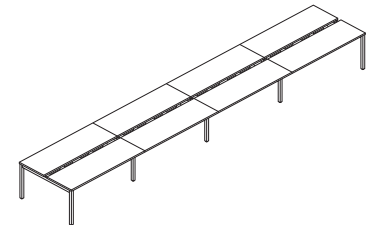

8-PACK — 72"
288"W x 51"D

QTY	DESCRIPTION	BUNDLE SKU	LIST PRICE
1	8-PACK BUNDLE Includes all Components Listed Above	HMP2472PK8	\$14,393

SPECIFYING EXAMPLE: Model.Laminate.Edgeband.Paint2.DuplexColor

NOTES: Typicals DO NOT include power in-feeds, screens, storage, or seating.

ADD 4 FABRIC SCREENS: \$3,212 — SEE PAGE 535

ADD 8 MOBILE PEDESTALS: \$5,304 — SEE PAGE 569

SEE PAGE 538 FOR BUNDLE SKU INFORMATION

EMPOWER[®] 72"W Typical with 24"D Worksurfaces



Icon Legend on page 19

WORKSTATIONS

QTY	DESCRIPTION	MODEL	LIST PRICE	PRICE EXTENSION
2	Electrical Power Harness Panels w/Duplex Capacity	HH871272	\$239	\$478
1	End of Run Electrical Kit 72"W	HMPPEEK72	\$249	\$249
1	Duplex Receptacle Circuit 1 3-1 & 2-2 Systems	HH871501	\$47	\$47
1	Duplex Receptacle Circuit 2 3-1 & 2-2 Systems	HH871502	\$47	\$47
1	Duplex Receptacle Circuit 3 3-1 System Only	HH871503	\$47	\$47
3	Duplex Receptacle Circuit 4 3-1 & 2-2 Systems	HH871504	\$47	\$141
1	Single Depth U-Leg (Box of 2)	HMPPEL2428	\$625	\$625
1	Single Depth Return Leg — Left	HMPRLEL2428	\$381	\$381
2	Single Depth Return Leg — Right	HMPRREL2428	\$381	\$762
2	Single Depth Shared U-Leg (Singles)	HMPSL2428	\$381	\$762
3	Single-Side Trough 72"W	HMPSTROUGH72	\$561	\$1,683
2	Support Beams (Box of 1) 48"W	HMPUB148	\$315	\$630
1	Support Beams (Box of 1) 60"W	HMPUB160	\$352	\$352
3	Support Beams (Box of 1) 72"W	HMPUB172	\$390	\$1,170
2	Systems Rectangular Worksurface, Edgeband, No Grommets 24"D x 36"W	HWR2436PN	\$382	\$764
1	Systems Rectangular Worksurface, Edgeband, No Grommets 24"D x 48"W	HWR2448PN	\$446	\$446
3	Systems Rectangular Worksurface, Edgeband, No Grommets 24"D x 72"W	HWR2472PN	\$583	\$1,749
TOTAL:			\$10,333	

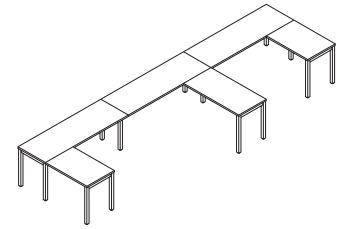

**6-PACK W/RETURNS — 72"
216"W x 72"D**

NOTES: Typical DO NOT include power in-feeds, screens, storage, or seating.

ADD 3 FABRIC SCREENS: \$2,178 — SEE PAGE 535

ADD 3 MOBILE PEDESTALS: \$1,989 — SEE PAGE 569

SEE PAGE 538 FOR BUNDLE SKU INFORMATION

QTY	DESCRIPTION	MODEL	LIST PRICE	PRICE EXTENSION
2	Electrical Power Harness Panels w/Duplex Capacity	HH871272	\$239	\$478
1	End of Run Electrical Kit 72"W	HMPPEEK72	\$249	\$249
3	Duplex Receptacle Circuit 1 3-1 & 2-2 Systems	HH871501	\$47	\$141
3	Duplex Receptacle Circuit 2 3-1 & 2-2 Systems	HH871502	\$47	\$141
3	Duplex Receptacle Circuit 3 3-1 System Only	HH871503	\$47	\$141
3	Duplex Receptacle Circuit 4 3-1 & 2-2 Systems	HH871504	\$47	\$141
1	Double Depth U-Leg (Box of 2)	HMPPEL4828	\$1,251	\$1,251
2	Single Depth Return Leg — Left	HMPRLEL2428	\$381	\$762
2	Single Depth Return Leg — Right	HMPRREL2428	\$381	\$762
2	Double Depth Shared U-Leg (Singles)	HMPSL4828	\$516	\$1,032
3	Shared Trough 72"W	HMPSTROUGH72	\$528	\$1,584
3	Support Beams (Box of 1) 48"W	HMPUB148	\$315	\$945
1	Support Beams (Box of 1) 60"W	HMPUB160	\$352	\$352
3	Support Beams (Box of 2) 72"W	HMPUB272	\$775	\$2,325
3	Systems Rectangular Worksurface, Edgeband, No Grommets 24"D x 36"W	HWR2436PN	\$382	\$1,146
1	Systems Rectangular Worksurface, Edgeband, No Grommets 24"D x 48"W	HWR2448PN	\$446	\$446
6	Systems Rectangular Worksurface, Edgeband, No Grommets 24"D x 72"W	HWR2472PN	\$583	\$3,498
TOTAL:			\$15,394	

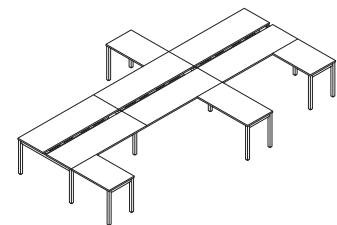

**3-PACK W/RETURNS — 72"
216"W x 132"D**

NOTES: Typical DO NOT include power in-feeds, screens, storage, or seating.

ADD 3 FABRIC SCREENS: \$2,409 — SEE PAGE 535

ADD 6 MOBILE PEDESTALS: \$3,978 — SEE PAGE 569

SEE PAGE 538 FOR BUNDLE SKU INFORMATION



Icon Legend on page 19

EMPOWER[®]

60"W Typicals with 24"D Worksurfaces

QTY	DESCRIPTION	MODEL	LIST PRICE	PRICE EXTENSION
2	Worksurface, Edgeband, No Grommets 24" x 60"	HWR2460PN	\$526	\$1,052
1	Double Depth U-Leg (Box of 2)	HMPEL4828	\$1,251	\$1,251
1	Support Beams (Box of 2) 60"W	HMPUB260	\$700	\$700
1	Shared Trough 60"W	HMPTROUGH60	\$481	\$481
1	End of Run Electrical Kit 60"W	HMPEEK60	\$249	\$249
1	Duplex 1	HH871501	\$47	\$47
1	Duplex 2	HH871502	\$47	\$47
1	Duplex 3	HH871503	\$47	\$47
1	Duplex 4	HH871504	\$47	\$47
TOTAL:			\$3,921	

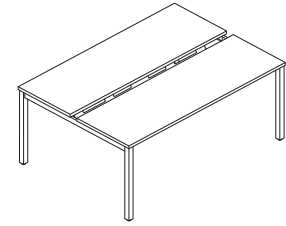

2-PACK — 60"
60"W x 51"D

QTY	DESCRIPTION	BUNDLE SKU	LIST PRICE
1	2-PACK BUNDLE Includes all Components Listed Above	HMP2460PK2	\$4,409

SPECIFYING EXAMPLE: Model.Laminate.Edgeband.Paint2.DuplexColor

NOTES: Typicals DO NOT include power in-feeds, screens, storage, or seating.

ADD 1 FABRIC SCREEN: \$724 — SEE PAGE 535

ADD 2 MOBILE PEDESTALS: \$1,326 — SEE PAGE 569

SEE PAGE 538 FOR BUNDLE SKU INFORMATION

QTY	DESCRIPTION	MODEL	LIST PRICE	PRICE EXTENSION
4	Worksurface, Edgeband, No Grommets 24" x 60"	HWR2460PN	\$526	\$2,104
1	Double Depth U-Leg (Box of 2)	HMPEL4828	\$1,251	\$1,251
1	Double Depth Shared U-Leg (Singles)	HMPSL4828	\$516	\$516
2	Support Beams (Box of 2) 60"W	HMPUB260	\$700	\$1,400
2	Shared Trough 60"W	HMPTROUGH60	\$481	\$962
1	Power Harness 60"W	HH871260	\$239	\$239
1	End of Run Electrical Kit 60"W	HMPEEK60	\$249	\$249
2	Duplex 1	HH871501	\$47	\$94
2	Duplex 2	HH871502	\$47	\$94
2	Duplex 3	HH871503	\$47	\$94
2	Duplex 4	HH871504	\$47	\$94
TOTAL:			\$7,097	

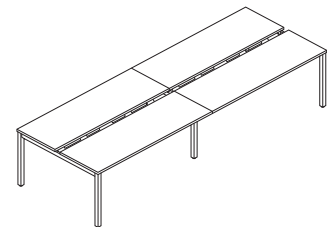

4-PACK — 60"
144"W x 51"D

QTY	DESCRIPTION	BUNDLE SKU	LIST PRICE
1	4-PACK BUNDLE Includes all Components Listed Above	HMP2460PK4	\$7,097

SPECIFYING EXAMPLE: Model.Laminate.Edgeband.Paint2.DuplexColor

NOTES: Typicals DO NOT include power in-feeds, screens, storage, or seating.

ADD 2 FABRIC SCREENS: \$1,448 — SEE PAGE 535

ADD 4 MOBILE PEDESTALS: \$2,652 — SEE PAGE 569

SEE PAGE 538 FOR BUNDLE SKU INFORMATION

EMPOWER®

60"W Typicals with 24"D Worksurfaces



Icon Legend on page 19

WORKSTATIONS

QTY	DESCRIPTION	MODEL	LIST PRICE	PRICE EXTENSION
6	Worksurface, Edgeband, No Grommets 24" x 60"	HWR2460PN	\$526	\$3,156
1	Double Depth U-Leg (Box of 2)	HMPEL4828	\$1,251	\$1,251
2	Double Depth Shared U-Leg (Singles)	HMPSL4828	\$516	\$1,032
3	Support Beams (Box of 2) 60"W	HMPUB260	\$700	\$2,100
3	Shared Trough 60"W	HMPROUGH60	\$481	\$1,443
2	Power Harness 60"W	HH871260	\$239	\$478
1	End of Run Electrical Kit 60"W	HMPEEK60	\$249	\$249
3	Duplex 1	HH871501	\$47	\$141
3	Duplex 2	HH871502	\$47	\$141
3	Duplex 3	HH871503	\$47	\$141
3	Duplex 4	HH871504	\$47	\$141
TOTAL:				\$10,273

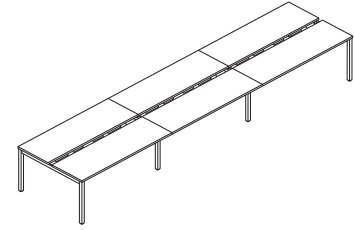

**6-PACK — 60"
180"W x 51"D**

QTY	DESCRIPTION	BUNDLE SKU	LIST PRICE
1	6-PACK BUNDLE Includes all Components Listed Above	HMP2460PK6	\$10,273

SPECIFYING EXAMPLE: Model.Laminate.Edgeband.Paint2.DuplexColor

NOTES: Typicals DO NOT include power in-feeds, screens, storage, or seating.

ADD 3 FABRIC SCREENS: \$2,172 — SEE PAGE 535

ADD 6 MOBILE PEDESTALS: \$3,978 — SEE PAGE 569

SEE PAGE 538 FOR BUNDLE SKU INFORMATION

QTY	DESCRIPTION	MODEL	LIST PRICE	PRICE EXTENSION
8	Worksurface, Edgeband, No Grommets 24" x 60"	HWR2460PN	\$526	\$4,208
1	Double Depth U-Leg (Box of 2)	HMPEL4828	\$1,251	\$1,251
3	Double Depth Shared U-Leg (Singles)	HMPSL4828	\$516	\$1,548
4	Support Beams (Box of 2) 60"W	HMPUB260	\$700	\$2,800
4	Shared Trough 60"W	HMPROUGH60	\$481	\$1,924
3	Power Harness 60"W	HH871260	\$239	\$717
1	End of Run Electrical Kit 60"W	HMPEEK60	\$249	\$249
4	Duplex 1	HH871501	\$47	\$188
4	Duplex 2	HH871502	\$47	\$188
4	Duplex 3	HH871503	\$47	\$188
4	Duplex 4	HH871504	\$47	\$188
TOTAL:				\$13,449

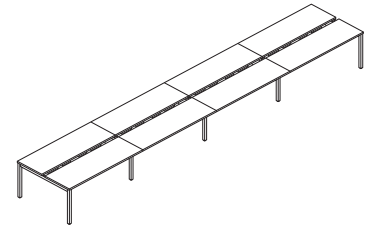

**8-PACK — 60"
240"W x 51"D**

QTY	DESCRIPTION	BUNDLE SKU	LIST PRICE
1	8-PACK BUNDLE Includes all Components Listed Above	HMP2460PK8	\$13,449

SPECIFYING EXAMPLE: Model.Laminate.Edgeband.Paint2.DuplexColor

NOTES: Typicals DO NOT include power in-feeds, screens, storage, or seating.

ADD 4 FABRIC SCREENS: \$2,896 — SEE PAGE 535

ADD 8 MOBILE PEDESTALS: \$5,304 — SEE PAGE 569

SEE PAGE 538 FOR BUNDLE SKU INFORMATION



Icon Legend on page 19

EMPOWER[®]

72"W Typical with 30"D Worksurfaces

QTY	DESCRIPTION	MODEL	LIST PRICE	PRICE EXTENSION
2	Worksurface, Edgeband, No Grommets 30" x 72"	HWR3072PN	\$653	\$1,306
1	Double Depth U-Leg (Box of 2)	HMPEL6028	\$1,375	\$1,375
1	Support Beams (Box of 2) 72"W	HMPUB272	\$775	\$775
1	Shared Trough 72"W	HMPROUGH72	\$528	\$528
1	End of Run Electrical Kit 72"W	HMPEEK72	\$249	\$249
1	Duplex 1	HH871501	\$47	\$47
1	Duplex 2	HH871502	\$47	\$47
1	Duplex 3	HH871503	\$47	\$47
1	Duplex 4	HH871504	\$47	\$47
TOTAL:			\$4,421	

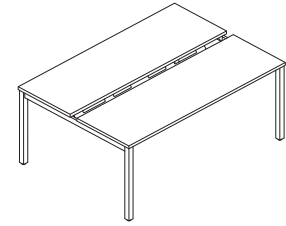

2-PACK — 72"
72"W x 63"D

QTY	DESCRIPTION	BUNDLE SKU	LIST PRICE
1	2-PACK BUNDLE Includes all Components Listed Above	HMP3072PK2	\$4,660

SPECIFYING EXAMPLE: Model.Laminate.Edgeband.Paint2.DuplexColor

NOTES: Typicals DO NOT include power in-feeds, screens, storage, or seating.

ADD 1 FABRIC SCREEN: \$803 — SEE PAGE 535

ADD 2 MOBILE PEDESTALS: \$1,326 — SEE PAGE 569

SEE PAGE 538 FOR BUNDLE SKU INFORMATION

QTY	DESCRIPTION	MODEL	LIST PRICE	PRICE EXTENSION
4	Worksurface, Edgeband, No Grommets 30" x 72"	HWR3072PN	\$653	\$2,612
1	Double Depth U-Leg (Box of 2)	HMPEL6028	\$1,375	\$1,375
1	Double Depth Shared U-Leg (Singles)	HMPSL6028	\$567	\$567
2	Support Beams (Box of 2) 72"W	HMPUB272	\$775	\$1,550
2	Shared Trough 72"W	HMPROUGH72	\$528	\$1,056
1	Power Harness 72"W	HH871272	\$239	\$239
1	End of Run Electrical Kit 72"W	HMPEEK72	\$249	\$249
2	Duplex 1	HH871501	\$47	\$94
2	Duplex 2	HH871502	\$47	\$94
2	Duplex 3	HH871503	\$47	\$94
2	Duplex 4	HH871504	\$47	\$94
TOTAL:			\$8,024	

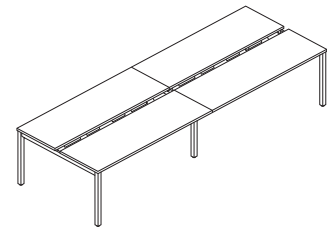

4-PACK — 72"
144"W x 63"D

QTY	DESCRIPTION	BUNDLE SKU	LIST PRICE
1	4-PACK BUNDLE Includes all Components Listed Above	HMP3072PK4	\$8,024

SPECIFYING EXAMPLE: Model.Laminate.Edgeband.Paint2.DuplexColor

NOTES: Typicals DO NOT include power in-feeds, screens, storage, or seating.

ADD 2 FABRIC SCREENS: \$1,606 — SEE PAGE 535

ADD 4 MOBILE PEDESTALS: \$2,652 — SEE PAGE 569

SEE PAGE 538 FOR BUNDLE SKU INFORMATION

EMPOWER® 72"W Typicals with 30"D Worksurfaces



Icon Legend on page 19

WORKSTATIONS

QTY	DESCRIPTION	MODEL	LIST PRICE	PRICE EXTENSION
6	Worksurface, Edgeband, No Grommets 30" x 72"	HWR3072PN	\$653	\$3,918
1	Double Depth U-Leg (Box of 2)	HMPEL6028	\$1,375	\$1,375
2	Double Depth Shared U-Leg (Singles)	HMP5L6028	\$567	\$1,134
3	Support Beams (Box of 2) 72"W	HMPUB272	\$775	\$2,325
3	Shared Trough 72"W	HMPTROUGH72	\$528	\$1,584
2	Power Harness 72"W	HH871272	\$239	\$478
1	End of Run Electrical Kit 72"W	HMPEEK72	\$249	\$249
3	Duplex 1	HH871501	\$47	\$141
3	Duplex 2	HH871502	\$47	\$141
3	Duplex 3	HH871503	\$47	\$141
3	Duplex 4	HH871504	\$47	\$141
TOTAL:				\$11,627

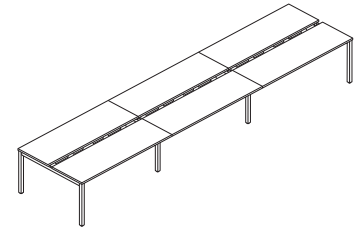

**6-PACK — 72"
216"W x 63"D**

QTY	DESCRIPTION	BUNDLE SKU	LIST PRICE
1	6-PACK BUNDLE Includes all Components Listed Above	HMP3072PK6	\$11,627

SPECIFYING EXAMPLE: Model.Laminate.Edgeband.Paint2.DuplexColor

NOTES: Typicals DO NOT include power in-feeds, screens, storage, or seating.

ADD 3 FABRIC SCREENS: \$2,409 — SEE PAGE 535

ADD 6 MOBILE PEDESTALS: \$3,978 — SEE PAGE 569

SEE PAGE 538 FOR BUNDLE SKU INFORMATION

QTY	DESCRIPTION	MODEL	LIST PRICE	PRICE EXTENSION
8	Worksurface, Edgeband, No Grommets 30" x 72"	HWR3072PN	\$653	\$5,224
1	Double Depth U-Leg (Box of 2)	HMPEL6028	\$1,375	\$1,375
3	Double Depth Shared U-Leg (Singles)	HMP5L6028	\$567	\$1,701
4	Support Beams (Box of 2) 72"W	HMPUB272	\$775	\$3,100
4	Shared Trough 72"W	HMPTROUGH72	\$528	\$2,112
3	Power Harness 72"W	HH871272	\$239	\$717
1	End of Run Electrical Kit 72"W	HMPEEK72	\$249	\$249
4	Duplex 1	HH871501	\$47	\$188
4	Duplex 2	HH871502	\$47	\$188
4	Duplex 3	HH871503	\$47	\$188
4	Duplex 4	HH871504	\$47	\$188
TOTAL:				\$15,230

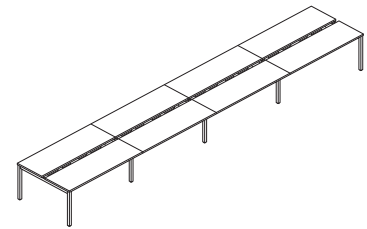

**8-PACK — 72"
288"W x 63"D**

QTY	DESCRIPTION	BUNDLE SKU	LIST PRICE
1	8-PACK BUNDLE Includes all Components Listed Above	HMP3072PK8	\$15,230

SPECIFYING EXAMPLE: Model.Laminate.Edgeband.Paint2.DuplexColor

NOTES: Typicals DO NOT include power in-feeds, screens, storage, or seating.

ADD 4 FABRIC SCREENS: \$3,212 — SEE PAGE 535

ADD 8 MOBILE PEDESTALS: \$5,304 — SEE PAGE 569

SEE PAGE 538 FOR BUNDLE SKU INFORMATION



Icon Legend on page 19

EMPOWER®

60"W Typicals with 30"D Worksurfaces

QTY	DESCRIPTION	MODEL	LIST PRICE	PRICE EXTENSION
2	Worksurface, Edgeband, No Grommets 30" x 60"	HWR3060PN	\$573	\$1,146
1	Double Depth U-Leg (Box of 2)	HMPEL6028	\$1,375	\$1,375
1	Support Beams (Box of 2) 60"W	HMPUB260	\$700	\$700
1	Shared Trough 60"W	HMPROUGH60	\$481	\$481
1	End of Run Electrical Kit 60"W	HMPEEK60	\$249	\$249
1	Duplex 1	HH871501	\$47	\$47
1	Duplex 2	HH871502	\$47	\$47
1	Duplex 3	HH871503	\$47	\$47
1	Duplex 4	HH871504	\$47	\$47
TOTAL:			\$4,139	

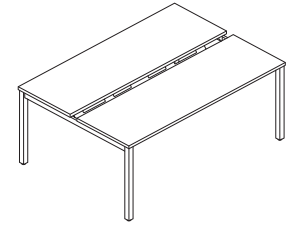

2-PACK — 60"
60"W x 63"D

QTY	DESCRIPTION	BUNDLE SKU	LIST PRICE
1	2-PACK BUNDLE Includes all Components Listed Above	HMP3060PK2	\$4,378

SPECIFYING EXAMPLE: Model.Laminate.Edgeband.Paint2.DuplexColor

NOTES: Typicals DO NOT include power in-feeds, screens, storage, or seating.

ADD 1 FABRIC SCREEN: \$724 — SEE PAGE 535

ADD 2 MOBILE PEDESTALS: \$1,326 — SEE PAGE 569

SEE PAGE 538 FOR BUNDLE SKU INFORMATION

QTY	DESCRIPTION	MODEL	LIST PRICE	PRICE EXTENSION
4	Worksurface, Edgeband, No Grommets 30" x 60"	HWR3060PN	\$573	\$2,292
1	Double Depth U-Leg (Box of 2)	HMPEL6028	\$1,375	\$1,375
1	Double Depth Shared U-Leg (Singles)	HMPSL6028	\$567	\$567
2	Support Beams (Box of 2) 60"W	HMPUB260	\$700	\$1,400
2	Shared Trough 60"W	HMPROUGH60	\$481	\$962
1	Power Harness 60"W	HH871260	\$239	\$239
1	End of Run Electrical Kit 60"W	HMPEEK60	\$249	\$249
2	Duplex 1	HH871501	\$47	\$94
2	Duplex 2	HH871502	\$47	\$94
2	Duplex 3	HH871503	\$47	\$94
2	Duplex 4	HH871504	\$47	\$94
TOTAL:			\$7,460	

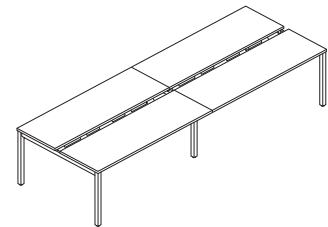

4-PACK — 60"
144"W x 63"D

QTY	DESCRIPTION	BUNDLE SKU	LIST PRICE
1	4-PACK BUNDLE Includes all Components Listed Above	HMP3060PK4	\$7,460

SPECIFYING EXAMPLE: Model.Laminate.Edgeband.Paint2.DuplexColor

NOTES: Typicals DO NOT include power in-feeds, screens, storage, or seating.

ADD 2 FABRIC SCREENS: \$1,448 — SEE PAGE 535

ADD 4 MOBILE PEDESTALS: \$2,652 — SEE PAGE 569

SEE PAGE 538 FOR BUNDLE SKU INFORMATION

EMPOWER®

60"W Typicals with 30"D Worksurfaces



Icon Legend on page 19

WORKSTATIONS

QTY	DESCRIPTION	MODEL	LIST PRICE	PRICE EXTENSION
6	Worksurface, Edgeband, No Grommets 30" x 60"	HWR3060PN	\$573	\$3,438
1	Double Depth U-Leg (Box of 2)	HMPEL6028	\$1,375	\$1,375
2	Double Depth Shared U-Leg (Singles)	HMPSL6028	\$567	\$1,134
3	Support Beams (Box of 2) 60"W	HMPUB260	\$700	\$2,100
3	Shared Trough 60"W	HMPTROUGH60	\$481	\$1,443
2	Power Harness 60"W	HH871260	\$239	\$478
1	End of Run Electrical Kit 60"W	HMPEEK60	\$249	\$249
3	Duplex 1	HH871501	\$47	\$141
3	Duplex 2	HH871502	\$47	\$141
3	Duplex 3	HH871503	\$47	\$141
3	Duplex 4	HH871504	\$47	\$141
TOTAL:				\$10,781

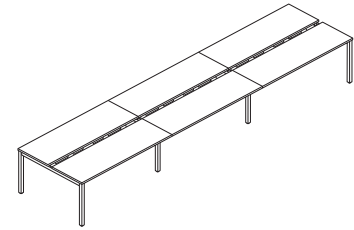

**6-PACK — 60"
180"W x 63"D**

QTY	DESCRIPTION	BUNDLE SKU	LIST PRICE
1	6-PACK BUNDLE Includes all Components Listed Above	HMP3060PK6	\$10,781

SPECIFYING EXAMPLE: Model.Laminate.Edgeband.Paint2.DuplexColor

NOTES: Typicals DO NOT include power in-feeds, screens, storage, or seating.

ADD 3 FABRIC SCREENS: \$2,172 — SEE PAGE 535

ADD 6 MOBILE PEDESTALS: \$3,978 — SEE PAGE 569

SEE PAGE 538 FOR BUNDLE SKU INFORMATION

QTY	DESCRIPTION	MODEL	LIST PRICE	PRICE EXTENSION
8	Worksurface, Edgeband, No Grommets 30" x 60"	HWR3060PN	\$573	\$4,584
1	Double Depth U-Leg (Box of 2)	HMPEL6028	\$1,375	\$1,375
3	Double Depth Shared U-Leg (Singles)	HMPSL6028	\$567	\$1,701
4	Support Beams (Box of 2) 60"W	HMPUB260	\$700	\$2,800
4	Shared Trough 60"W	HMPTROUGH60	\$481	\$1,924
3	Power Harness 60"W	HH871260	\$239	\$717
1	End of Run Electrical Kit 60"W	HMPEEK60	\$249	\$249
4	Duplex 1	HH871501	\$47	\$188
4	Duplex 2	HH871502	\$47	\$188
4	Duplex 3	HH871503	\$47	\$188
4	Duplex 4	HH871504	\$47	\$188
TOTAL:				\$14,102

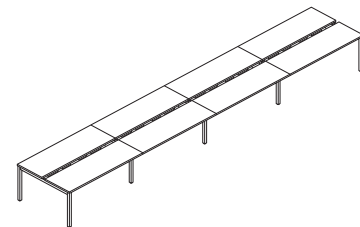

**8-PACK — 60"
240"W x 63"D**

QTY	DESCRIPTION	BUNDLE SKU	LIST PRICE
1	8-PACK BUNDLE Includes all Components Listed Above	HMP3060PK8	\$14,102

SPECIFYING EXAMPLE: Model.Laminate.Edgeband.Paint2.DuplexColor

NOTES: Typicals DO NOT include power in-feeds, screens, storage, or seating.

ADD 4 FABRIC SCREENS: \$2,896 — SEE PAGE 535

ADD 8 MOBILE PEDESTALS: \$5,304 — SEE PAGE 569

SEE PAGE 538 FOR BUNDLE SKU INFORMATION



Icon Legend on page 19

EMPOWER[®] 120° Workstation Typicals

QTY	DESCRIPTION	MODEL	LIST PRICE	PRICE EXTENSION
3	120 Degree Corner Worksurfaces with Curved User Edge, No Grommets 48"W x 30"D	HBWCT4830PN	\$1,282	\$3,846
3	Double Depth U-Leg (Single Leg)	HMP120EL4828	\$627	\$1,881
3	Single Post Leg 28½"H	HMP120POST	\$328	\$984
3	Support Beams (Box of 2) 48"W	HMP120UB248	\$629	\$1,887
3	Double-Sided Trough 48"W	HMP120TROUGH48	\$437	\$1,311
TOTAL:				\$9,909

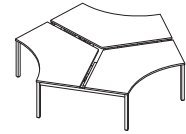

3-PACK – 120°

NOTES: Typicals DO NOT include power in-feeds, screens, storage, or seating.

ADD 3 FABRIC SCREENS: \$1,836 — SEE PAGE 535

ADD 3 MOBILE PEDESTALS: \$1,989 — SEE PAGE 569

QTY	DESCRIPTION	MODEL	LIST PRICE	PRICE EXTENSION
6	120 Degree Corner Worksurfaces with Curved User Edge, No Grommets 48"W x 30"D	HBWCT4830PN	\$1,282	\$7,692
4	Double Depth U-Leg (Single Leg)	HMP120EL6028	\$689	\$2,756
6	Single Post Leg 28½"H	HMP120POST	\$328	\$1,968
6	Support Beams (Box of 2) 48"W	HMP120UB248	\$629	\$3,774
6	Double-Sided Trough 48"W	HMP120TROUGH48	\$437	\$2,622
2	Double Depth Shared U-Leg (Singles)	HMP120SL6028	\$567	\$1,134
2	Worksurface with Edgeband 48"W x 30"D	HWR3048PN	\$481	\$962
1	Support Beams (Box of 2) 48"W	HMPUB248	\$629	\$629
1	Double-Sided Trough 48"W	HMP120TROUGH48	\$437	\$437
TOTAL:				\$21,974

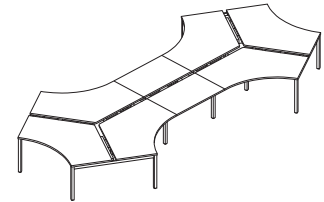

DOG BONE – 120°

NOTES: Typicals DO NOT include power in-feeds, screens, storage, or seating.

ADD 7 FABRIC SCREENS: \$4,284 — SEE PAGE 535

ADD 6 MOBILE PEDESTALS: \$3,978 — SEE PAGE 569

EMPOWER[®] 120° Workstation Typical



Icon Legend on page 19

WORKSTATIONS

QTY	DESCRIPTION	MODEL	LIST PRICE	PRICE EXTENSION
9	120 Degree Corner Worksurfaces with Curved User Edge, No Grommets 48"W x 30"D	HBWCT4830PN	\$1,282	\$11,538
5	Double Depth U-Leg (Single Leg)	HMP120EL4828	\$627	\$3,135
9	Single Post Leg 28½"H	HMP120POST	\$328	\$2,952
9	Support Beams (Box of 2) 48"W	HMP120UB248	\$629	\$5,661
9	Double-Sided Trough 48"W	HMP120TROUGH48	\$437	\$3,933
2	Double Depth Shared U-Leg (Singles)	HMPSL4828	\$516	\$1,032
TOTAL:				\$28,251

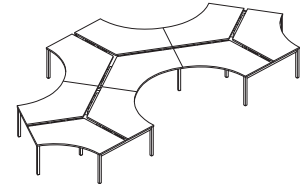

MULTIPLE PODS — 120°

NOTES: Typical DO NOT include power in-feeds, screens, storage, or seating.

ADD 9 FABRIC SCREENS: \$5,508 — SEE PAGE 535

ADD 9 MOBILE PEDESTALS: \$5,967 — SEE PAGE 569



Icon Legend on page 19

QTY	DESCRIPTION	MODEL	LIST PRICE	PRICE EXTENSION
2	Worksurface, Edgeband, No Grommets 23" x 70"	HHATW237OEM	\$583	\$1,166
1	Height Adjustable Base	HMPHA2S4C	\$2,518	\$2,518
1	Height Adjustable Shared Trough 72"W	HMPHATROUGH72	\$528	\$528
2	Single-Sided Trough Lid	HMPHASLID72	\$153	\$306
1	End of Run Electrical Kit 72"W	HMPEEK72	\$249	\$249
1	Duplex 1	HH871501	\$47	\$47
1	Duplex 2	HH871502	\$47	\$47
1	Duplex 3	HH871503	\$47	\$47
1	Duplex 4	HH871504	\$47	\$47
TOTAL:				\$4,955

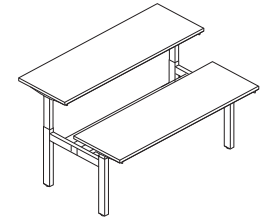
**2-PACK — 72"**
72"W x 51"D

QTY	DESCRIPTION	BUNDLE SKU	LIST PRICE
1	2-PACK BUNDLE Includes all Components Listed Above	HMPHA2472PK2	\$5,200

SPECIFYING EXAMPLE: Model.Laminate.Edgeband.BasePaint.TroughPaint.DuplexColor

NOTES: Typicals DO NOT include power in-feeds, screens, storage, or seating.

ADD 2 FABRIC SCREENS: \$1,606— SEE PAGE 535**ADD 2 MOBILE PEDESTALS: \$1,326— SEE PAGE 569****SEE PAGE 539 FOR BUNDLE SKU INFORMATION**

QTY	DESCRIPTION	MODEL	LIST PRICE	PRICE EXTENSION
4	Worksurface, Edgeband, No Grommets 23" x 70"	HHATW237OEM	\$583	\$2,332
2	Height Adjustable Base	HMPHA2S4C	\$2,518	\$5,036
2	Height Adjustable Shared Trough 72"W	HMPHATROUGH72	\$528	\$1,056
4	Single-Sided Trough Lid	HMPHASLID72	\$153	\$612
1	Power Harness 72"W	HH871272	\$239	\$239
1	End of Run Electrical Kit 72"W	HMPEEK72	\$249	\$249
2	Duplex 1	HH871501	\$47	\$94
2	Duplex 2	HH871502	\$47	\$94
2	Duplex 3	HH871503	\$47	\$94
2	Duplex 4	HH871504	\$47	\$94
TOTAL:				\$9,900

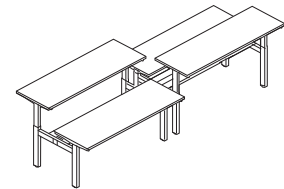
**4-PACK — 72"**
144"W x 51"D

QTY	DESCRIPTION	BUNDLE SKU	LIST PRICE
1	4-PACK BUNDLE Includes all Components Listed Above	HMPHA2472PK4	\$9,912

SPECIFYING EXAMPLE: Model.Laminate.Edgeband.BasePaint.TroughPaint.DuplexColor

NOTES: Typicals DO NOT include power in-feeds, screens, storage, or seating.

ADD 4 FABRIC SCREENS: \$3,212— SEE PAGE 535**ADD 4 MOBILE PEDESTALS: \$2,652— SEE PAGE 569****SEE PAGE 539 FOR BUNDLE SKU INFORMATION**



QTY	DESCRIPTION	MODEL	LIST PRICE	PRICE EXTENSION
6	Worksurface, Edgeband, No Grommets 23" x 70"	HHATW237OEM	\$583	\$3,498
3	Height Adjustable Base	HMPHA2S4C	\$2,518	\$7,554
3	Height Adjustable Shared Trough 72"W	HMPHATROUGH72	\$528	\$1,584
6	Single-Sided Trough Lid	HMPHASLID72	\$153	\$918
2	Power Harness 72"W	HH871272	\$239	\$478
1	End of Run Electrical Kit 72"W	HMPEEK72	\$249	\$249
3	Duplex 1	HH871501	\$47	\$141
3	Duplex 2	HH871502	\$47	\$141
3	Duplex 3	HH871503	\$47	\$141
3	Duplex 4	HH871504	\$47	\$141
TOTAL:				\$14,845

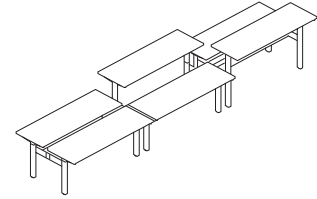

6-PACK — 72"

216"W x 51"D

QTY	DESCRIPTION	BUNDLE SKU	LIST PRICE
1	6-PACK BUNDLE Includes all Components Listed Above	HMPHA2472PK6	\$14,863

SPECIFYING EXAMPLE: Model.Laminate.Edgeband.BasePaint.TroughPaint.DuplexColor

NOTES: Typicals DO NOT include power in-feeds, screens, storage, or seating.

ADD 6 FABRIC SCREENS: \$4,818 — SEE PAGE 535

ADD 6 MOBILE PEDESTALS: \$3,978 — SEE PAGE 569

SEE PAGE 539 FOR BUNDLE SKU INFORMATION

QTY	DESCRIPTION	MODEL	LIST PRICE	PRICE EXTENSION
8	Worksurface, Edgeband, No Grommets 23" x 70"	HHATW237OEM	\$583	\$4,664
4	Height Adjustable Base	HMPHA2S4C	\$2,518	\$10,072
4	Height Adjustable Shared Trough 72"W	HMPHATROUGH72	\$528	\$2,112
8	Single-Sided Trough Lid	HMPHASLID72	\$153	\$1,224
3	Power Harness 72"W	HH871272	\$239	\$717
1	End of Run Electrical Kit 72"W	HMPEEK72	\$249	\$249
4	Duplex 1	HH871501	\$47	\$188
4	Duplex 2	HH871502	\$47	\$188
4	Duplex 3	HH871503	\$47	\$188
4	Duplex 4	HH871504	\$47	\$188
TOTAL:				\$19,790

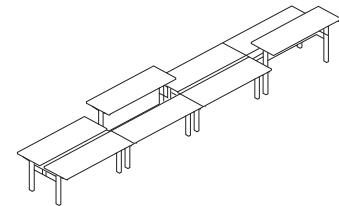

8-PACK — 72"

288"W x 51"D

QTY	DESCRIPTION	BUNDLE SKU	LIST PRICE
1	8-PACK BUNDLE Includes all Components Listed Above	HMPHA2472PK8	\$19,814

SPECIFYING EXAMPLE: Model.Laminate.Edgeband.BasePaint.TroughPaint.DuplexColor

NOTES: Typicals DO NOT include power in-feeds, screens, storage, or seating.

ADD 8 FABRIC SCREENS: \$6,424 — SEE PAGE 535

ADD 8 MOBILE PEDESTALS: \$5,304 — SEE PAGE 569

SEE PAGE 539 FOR BUNDLE SKU INFORMATION



Icon Legend on page 19

QTY	DESCRIPTION	MODEL	LIST PRICE	PRICE EXTENSION
2	Worksurface, Edgeband, No Grommets 23" x 58"	HHATW2358EM	\$526	\$1,052
1	Height Adjustable Base	HMPHA2S4C	\$2,518	\$2,518
1	Height Adjustable Shared Trough 60"W	HMPHATROUGH60	\$481	\$481
2	Single-Sided Trough Lid	HMPHASLID60	\$139	\$278
1	End of Run Electrical Kit 60"W	HMPEEK60	\$249	\$249
1	Duplex 1	HH871501	\$47	\$47
1	Duplex 2	HH871502	\$47	\$47
1	Duplex 3	HH871503	\$47	\$47
1	Duplex 4	HH871504	\$47	\$47
TOTAL:				\$4,766

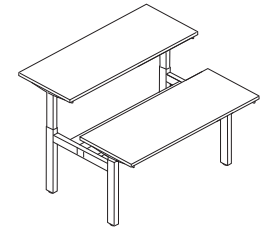
**2-PACK — 60"
60"W x 51"D**

QTY	DESCRIPTION	BUNDLE SKU	LIST PRICE
1	2-PACK BUNDLE Includes all Components Listed Above	HMPHA2460PK2	\$5,011

SPECIFYING EXAMPLE: Model.Laminate.Edgeband.BasePaint.TroughPaint.DuplexColor

NOTES: Typicals DO NOT include power in-feeds, screens, storage, or seating.

ADD 2 FABRIC SCREENS: \$1,448 — SEE PAGE 535**ADD 2 MOBILE PEDESTALS: \$1,326 — SEE PAGE 569****SEE PAGE 539 FOR BUNDLE SKU INFORMATION**

QTY	DESCRIPTION	MODEL	LIST PRICE	PRICE EXTENSION
4	Worksurface, Edgeband, No Grommets 23" x 58"	HHATW2358EM	\$526	\$2,104
2	Height Adjustable Base	HMPHA2S4C	\$2,518	\$5,036
2	Height Adjustable Shared Trough 60"W	HMPHATROUGH60	\$481	\$962
4	Single-Sided Trough Lid	HMPHASLID60	\$139	\$556
1	Power Harness 60"W	HH871260	\$239	\$239
1	End of Run Electrical Kit 60"W	HMPEEK60	\$249	\$249
2	Duplex 1	HH871501	\$47	\$94
2	Duplex 2	HH871502	\$47	\$94
2	Duplex 3	HH871503	\$47	\$94
2	Duplex 4	HH871504	\$47	\$94
TOTAL:				\$9,522

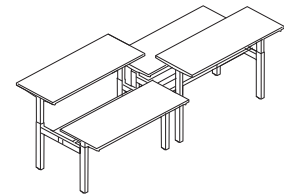
**4-PACK — 60"
120"W x 51"D**

QTY	DESCRIPTION	BUNDLE SKU	LIST PRICE
1	4-PACK BUNDLE Includes all Components Listed Above	HMPHA2460PK4	\$9,534

SPECIFYING EXAMPLE: Model.Laminate.Edgeband.BasePaint.TroughPaint.DuplexColor

NOTES: Typicals DO NOT include power in-feeds, screens, storage, or seating.

ADD 4 FABRIC SCREENS: \$2,896 — SEE PAGE 535**ADD 4 MOBILE PEDESTALS: \$2,652 — SEE PAGE 569****SEE PAGE 539 FOR BUNDLE SKU INFORMATION**



QTY	DESCRIPTION	MODEL	LIST PRICE	PRICE EXTENSION
6	Worksurface, Edgeband, No Grommets 23" x 58"	HHATW2358EM	\$526	\$3,156
3	Height Adjustable Base	HMPHA2S4C	\$2,518	\$7,554
3	Height Adjustable Shared Trough 60"W	HMPHATROUGH60	\$481	\$1,443
6	Single-Sided Trough Lid	HMPHASLID60	\$139	\$834
2	Power Harness 60"W	HH871260	\$239	\$478
1	End of Run Electrical Kit 60"W	HMPEEK60	\$249	\$249
3	Duplex 1	HH871501	\$47	\$141
3	Duplex 2	HH871502	\$47	\$141
3	Duplex 3	HH871503	\$47	\$141
3	Duplex 4	HH871504	\$47	\$141
TOTAL:				\$14,278

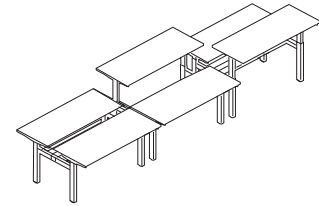

6-PACK — 60"
180"W x 51"D

QTY	DESCRIPTION	BUNDLE SKU	LIST PRICE
1	6-PACK BUNDLE Includes all Components Listed Above	HMPHA2460PK6	\$14,296

SPECIFYING EXAMPLE: Model.Laminate.Edgeband.BasePaint.TroughPaint.DuplexColor

NOTES: Typicals DO NOT include power in-feeds, screens, storage, or seating.

ADD 6 FABRIC SCREENS: \$4,344 — SEE PAGE 535

ADD 6 MOBILE PEDESTALS: \$3,978 — SEE PAGE 569

SEE PAGE 539 FOR BUNDLE SKU INFORMATION

QTY	DESCRIPTION	MODEL	LIST PRICE	PRICE EXTENSION
8	Worksurface, Edgeband, No Grommets 23" x 58"	HHATW2358EM	\$526	\$4,208
4	Height Adjustable Base	HMPHA2S4C	\$2,518	\$10,072
4	Height Adjustable Shared Trough 60"W	HMPHATROUGH60	\$481	\$1,924
8	Single-Sided Trough Lid	HMPHASLID60	\$139	\$1,112
3	Power Harness 60"W	HH871260	\$239	\$717
1	End of Run Electrical Kit 60"W	HMPEEK60	\$249	\$249
4	Duplex 1	HH871501	\$47	\$188
4	Duplex 2	HH871502	\$47	\$188
4	Duplex 3	HH871503	\$47	\$188
4	Duplex 4	HH871504	\$47	\$188
TOTAL:				\$19,034

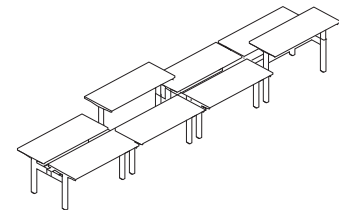

8-PACK — 60"
240"W x 51"D

QTY	DESCRIPTION	BUNDLE SKU	LIST PRICE
1	8-PACK BUNDLE Includes all Components Listed Above	HMPHA2460PK8	\$19,058

SPECIFYING EXAMPLE: Model.Laminate.Edgeband.BasePaint.TroughPaint.DuplexColor

NOTES: Typicals DO NOT include power in-feeds, screens, storage, or seating.

ADD 8 FABRIC SCREENS: \$5,792 — SEE PAGE 535

ADD 8 MOBILE PEDESTALS: \$5,304 — SEE PAGE 569

SEE PAGE 539 FOR BUNDLE SKU INFORMATION



Icon Legend on page 19

72"W Height Adjustable Typicals with 30"D Worksurfaces

QTY	DESCRIPTION	MODEL	LIST PRICE	PRICE EXTENSION
2	Worksurface, Edgeband, No Grommets 29" x 70"	HHATW2970EM	\$653	\$1,306
1	Height Adjustable Base	HMPHA2S4C	\$2,518	\$2,518
1	Height Adjustable Shared Trough 72"W	HMPHATROUGH72	\$528	\$528
2	Single-Sided Trough Lid	HMPHASLID72	\$153	\$306
1	End of Run Electrical Kit 72"W	HMPEEK72	\$249	\$249
1	Duplex 1	HH871501	\$47	\$47
1	Duplex 2	HH871502	\$47	\$47
1	Duplex 3	HH871503	\$47	\$47
1	Duplex 4	HH871504	\$47	\$47
TOTAL:				\$5,095

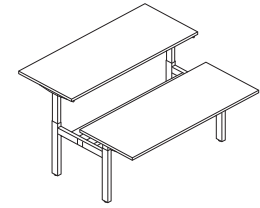

**2-PACK — 72"
72"W x 63"D**

QTY	DESCRIPTION	BUNDLE SKU	LIST PRICE
1	2-PACK BUNDLE Includes all Components Listed Above	HMPHA3072PK2	\$5,334

SPECIFYING EXAMPLE: Model.Laminate.Edgeband.BasePaint.TroughPaint.DuplexColor

NOTES: Typicals DO NOT include power in-feeds, screens, storage, or seating.

ADD 2 FABRIC SCREENS: \$1,606 — SEE PAGE 535

ADD 2 MOBILE PEDESTALS: \$1,326 — SEE PAGE 569

SEE PAGE 539 FOR BUNDLE SKU INFORMATION

QTY	DESCRIPTION	MODEL	LIST PRICE	PRICE EXTENSION
4	Worksurface, Edgeband, No Grommets 29" x 70"	HHATW2970EM	\$653	\$2,612
2	Height Adjustable Base	HMPHA2S4C	\$2,518	\$5,036
2	Height Adjustable Shared Trough 72"W	HMPHATROUGH72	\$528	\$1,056
4	Single-Sided Trough Lid	HMPHASLID72	\$153	\$612
1	Power Harness 72"W	HH871272	\$239	\$239
1	End of Run Electrical Kit 72"W	HMPEEK72	\$249	\$249
2	Duplex 1	HH871501	\$47	\$94
2	Duplex 2	HH871502	\$47	\$94
2	Duplex 3	HH871503	\$47	\$94
2	Duplex 4	HH871504	\$47	\$94
TOTAL:				\$10,180

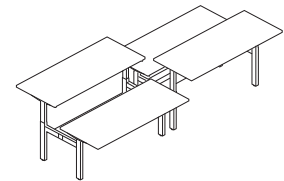

**4-PACK — 72"
144"W x 63"D**

QTY	DESCRIPTION	BUNDLE SKU	LIST PRICE
1	4-PACK BUNDLE Includes all Components Listed Above	HMPHA3072PK4	\$10,180

SPECIFYING EXAMPLE: Model.Laminate.Edgeband.BasePaint.TroughPaint.DuplexColor

NOTES: Typicals DO NOT include power in-feeds, screens, storage, or seating.

ADD 4 FABRIC SCREENS: \$3,212 — SEE PAGE 535

ADD 4 MOBILE PEDESTALS: \$2,652 — SEE PAGE 569

SEE PAGE 539 FOR BUNDLE SKU INFORMATION



QTY	DESCRIPTION	MODEL	LIST PRICE	PRICE EXTENSION
6	Worksurface, Edgeband, No Grommets 29" x 70"	HHATW297OEM	\$653	\$3,918
3	Height Adjustable Base	HMPHA2S4C	\$2,518	\$7,554
3	Height Adjustable Shared Trough 72"W	HMPHATROUGH72	\$528	\$1,584
6	Single-Sided Trough Lid	HMPHASLID72	\$153	\$918
2	Power Harness 72"W	HH871272	\$239	\$478
1	End of Run Electrical Kit 72"W	HMPEEK72	\$249	\$249
3	Duplex 1	HH871501	\$47	\$141
3	Duplex 2	HH871502	\$47	\$141
3	Duplex 3	HH871503	\$47	\$141
3	Duplex 4	HH871504	\$47	\$141
TOTAL:				\$15,265

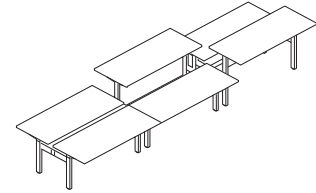

**6-PACK — 72"
216"W x 63"D**

QTY	DESCRIPTION	BUNDLE SKU	LIST PRICE
1	6-PACK BUNDLE Includes all Components Listed Above	HMPHA3072PK6	\$15,265

SPECIFYING EXAMPLE: Model.Laminate.Edgeband.BasePaint.TroughPaint.DuplexColor

NOTES: Typicals DO NOT include power in-feeds, screens, storage, or seating.

ADD 6 FABRIC SCREENS: \$4,818 — SEE PAGE 535

ADD 6 MOBILE PEDESTALS: \$3,978 — SEE PAGE 569

SEE PAGE 539 FOR BUNDLE SKU INFORMATION

QTY	DESCRIPTION	MODEL	LIST PRICE	PRICE EXTENSION
8	Worksurface, Edgeband, No Grommets 29" x 70"	HHATW297OEM	\$653	\$5,224
4	Height Adjustable Base	HMPHA2S4C	\$2,518	\$10,072
4	Height Adjustable Shared Trough 72"W	HMPHATROUGH72	\$528	\$2,112
8	Single-Sided Trough Lid	HMPHASLID72	\$153	\$1,224
3	Power Harness 72"W	HH871272	\$239	\$717
1	End of Run Electrical Kit 72"W	HMPEEK72	\$249	\$249
4	Duplex 1	HH871501	\$47	\$188
4	Duplex 2	HH871502	\$47	\$188
4	Duplex 3	HH871503	\$47	\$188
4	Duplex 4	HH871504	\$47	\$188
TOTAL:				\$20,350

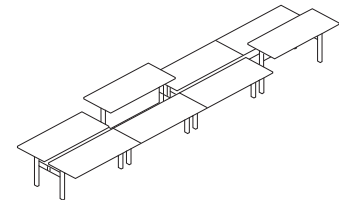

**8-PACK — 72"
288"W x 63"D**

QTY	DESCRIPTION	BUNDLE SKU	LIST PRICE
1	8-PACK BUNDLE Includes all Components Listed Above	HMPHA3072PK8	\$20,350

SPECIFYING EXAMPLE: Model.Laminate.Edgeband.BasePaint.TroughPaint.DuplexColor

NOTES: Typicals DO NOT include power in-feeds, screens, storage, or seating.

ADD 8 FABRIC SCREENS: \$6,424 — SEE PAGE 535

ADD 8 MOBILE PEDESTALS: \$5,304 — SEE PAGE 569

SEE PAGE 539 FOR BUNDLE SKU INFORMATION



Icon Legend on page 19

QTY	DESCRIPTION	MODEL	LIST PRICE	PRICE EXTENSION
2	Worksurface, Edgeband, No Grommets 29" x 58"	HHATW2958EM	\$573	\$1,146
1	Height Adjustable Base	HMPHA2S4C	\$2,518	\$2,518
1	Height Adjustable Shared Trough 60"W	HMPHATROUGH60	\$481	\$481
2	Single-Sided Trough Lid	HMPHASLID60	\$139	\$278
1	End of Run Electrical Kit 60"W	HMPEEK60	\$249	\$249
1	Duplex 1	HH871501	\$47	\$47
1	Duplex 2	HH871502	\$47	\$47
1	Duplex 3	HH871503	\$47	\$47
1	Duplex 4	HH871504	\$47	\$47
TOTAL:				\$4,860

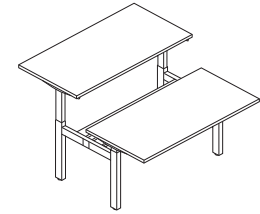
**2-PACK – 60"
60"W x 63"D**

QTY	DESCRIPTION	BUNDLE SKU	LIST PRICE
1	2-PACK BUNDLE Includes all Components Listed Above	HMPHA3060PK2	\$5,107

SPECIFYING EXAMPLE: Model.Laminate.Edgeband.BasePaint.TroughPaint.DuplexColor

NOTES: Typicals DO NOT include power in-feeds, screens, storage, or seating.

ADD 2 FABRIC SCREENS: \$1,448 — SEE PAGE 535**ADD 2 MOBILE PEDESTALS: \$1,326 — SEE PAGE 569****SEE PAGE 539 FOR BUNDLE SKU INFORMATION**

QTY	DESCRIPTION	MODEL	LIST PRICE	PRICE EXTENSION
4	Worksurface, Edgeband, No Grommets 29" x 58"	HHATW2958EM	\$573	\$2,292
2	Height Adjustable Base	HMPHA2S4C	\$2,518	\$5,036
2	Height Adjustable Shared Trough 60"W	HMPHATROUGH60	\$481	\$962
4	Single-Sided Trough Lid	HMPHASLID60	\$139	\$556
1	Power Harness 60"W	HH871260	\$239	\$239
1	End of Run Electrical Kit 60"W	HMPEEK60	\$249	\$249
2	Duplex 1	HH871501	\$47	\$94
2	Duplex 2	HH871502	\$47	\$94
2	Duplex 3	HH871503	\$47	\$94
2	Duplex 4	HH871504	\$47	\$94
TOTAL:				\$9,710

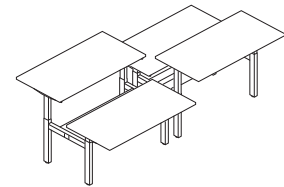
**4-PACK – 60"
120"W x 63"D**

QTY	DESCRIPTION	BUNDLE SKU	LIST PRICE
1	4-PACK BUNDLE Includes all Components Listed Above	HMPHA3060PK4	\$9,726

SPECIFYING EXAMPLE: Model.Laminate.Edgeband.BasePaint.TroughPaint.DuplexColor

NOTES: Typicals DO NOT include power in-feeds, screens, storage, or seating.

ADD 4 FABRIC SCREENS: \$2,896 — SEE PAGE 535**ADD 4 MOBILE PEDESTALS: \$2,652 — SEE PAGE 569****SEE PAGE 539 FOR BUNDLE SKU INFORMATION**



QTY	DESCRIPTION	MODEL	LIST PRICE	PRICE EXTENSION
6	Worksurface, Edgeband, No Grommets 29" x 58"	HHATW2958EM	\$573	\$3,438
3	Height Adjustable Base	HMPHA2S4C	\$2,518	\$7,554
3	Height Adjustable Shared Trough 60"W	HMPHATROUGH60	\$481	\$1,443
6	Single-Sided Trough Lid	HMPHASLID60	\$139	\$834
2	Power Harness 60"W	HH871260	\$239	\$478
1	End of Run Electrical Kit 60"W	HMPEEK60	\$249	\$249
3	Duplex 1	HH871501	\$47	\$141
3	Duplex 2	HH871502	\$47	\$141
3	Duplex 3	HH871503	\$47	\$141
3	Duplex 4	HH871504	\$47	\$141
TOTAL:				\$14,560

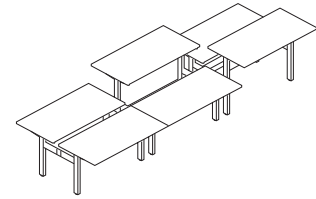

**6-PACK — 60"
180"W x 63"D**

QTY	DESCRIPTION	BUNDLE SKU	LIST PRICE
1	6-PACK BUNDLE Includes all Components Listed Above	HMPHA3060PK6	\$14,584

SPECIFYING EXAMPLE: Model.Laminate.Edgeband.BasePaint.TroughPaint.DuplexColor

NOTES: Typicals DO NOT include power in-feeds, screens, storage, or seating.

ADD 6 FABRIC SCREENS: \$4,344 — SEE PAGE 535

ADD 6 MOBILE PEDESTALS: \$3,978 — SEE PAGE 569

SEE PAGE 539 FOR BUNDLE SKU INFORMATION

QTY	DESCRIPTION	MODEL	LIST PRICE	PRICE EXTENSION
8	Worksurface, Edgeband, No Grommets 29" x 58"	HHATW2958EM	\$573	\$4,584
4	Height Adjustable Base	HMPHA2S4C	\$2,518	\$10,072
4	Height Adjustable Shared Trough 60"W	HMPHATROUGH60	\$481	\$1,924
8	Single-Sided Trough Lid	HMPHASLID60	\$139	\$1,112
3	Power Harness 60"W	HH871260	\$239	\$717
1	End of Run Electrical Kit 60"W	HMPEEK60	\$249	\$249
4	Duplex 1	HH871501	\$47	\$188
4	Duplex 2	HH871502	\$47	\$188
4	Duplex 3	HH871503	\$47	\$188
4	Duplex 4	HH871504	\$47	\$188
TOTAL:				\$19,410

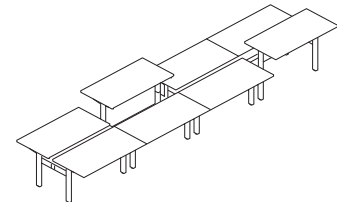

**8-PACK — 60"
240"W x 63"D**

QTY	DESCRIPTION	BUNDLE SKU	LIST PRICE
1	8-PACK BUNDLE Includes all Components Listed Above	HMPHA3060PK8	\$19,442

SPECIFYING EXAMPLE: Model.Laminate.Edgeband.BasePaint.TroughPaint.DuplexColor

NOTES: Typicals DO NOT include power in-feeds, screens, storage, or seating.

ADD 8 FABRIC SCREENS: \$5,792 — SEE PAGE 535

ADD 8 MOBILE PEDESTALS: \$5,304 — SEE PAGE 569

SEE PAGE 539 FOR BUNDLE SKU INFORMATION

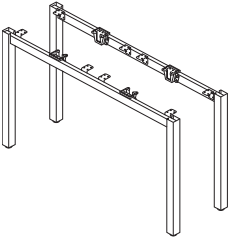
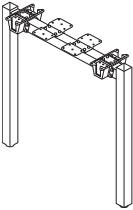
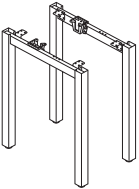
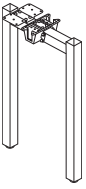
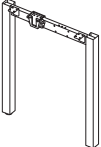

EMPOWER® Legs for Linear Applications

DESCRIPTION	MODEL	SHIP WEIGHT	CUBE	LIST PRICE BY PAINT GRADE		
				P1	P2	P3
 <p>Double Depth U-Leg (Box of 2) 50½"D for use with 24"D Worksurfaces 62½"D for use with 30"D Worksurfaces NOTES: Ships as a box of 2 legs.</p>	HMPPEL4828 ☉	32.4	14.9	\$1251	\$1255	\$1285
	HMPPEL6028	34.8	18.5	\$1375	\$1379	\$1412
 <p>Double Depth Shared U-Leg (Singles) 30"D for use with 24"D Worksurfaces 42"D for use with 30"D Worksurfaces</p>	HMPPSL4828 ☉	21.1	4.9	\$516	\$520	\$530
	HMPPSL6028	22.5	6.4	\$567	\$571	\$582
 <p>Single Depth U-Leg (Box of 2) 24"D for use with 24"D Worksurfaces 30"D for use with 30"D Worksurfaces</p>	HMPPEL2428	23.7	7.6	\$625	\$629	\$653
	HMPPEL3028	24.9	9.4	\$689	\$693	\$720
 <p>Single Depth Shared U-Leg (Singles) 18"D for use with 24"D Worksurfaces 24"D for use with 30"D Worksurfaces</p>	HMPPSL2428	14.8	3.2	\$381	\$385	\$398
	HMPPSL3028	15.6	4.0	\$419	\$423	\$438
 <p>Single Depth Return U-Leg (Singles) Left Right NOTES: Return U-Legs ship with two flat brackets.</p>	HMPPREL2428	23.7	4.0	\$381	\$385	\$398
	HMPPREL2428	23.7	4.0	\$381	\$385	\$398

HOW TO SPECIFY

<p>Select Model Number</p> <p>H M P E L 4 8 2 8</p>	<p>Select Paint Color</p> <p>See page 504</p> <p>T 1</p>
--	---

EMPOWER® Legs for 120° Applications

GSA SIN 33721



Icon Legend on page 19

WORKSTATIONS

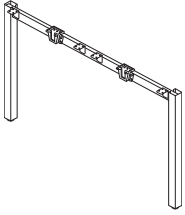

DESCRIPTION	MODEL	SHIP WEIGHT	CUBE	LIST PRICE BY PAINT GRADE		
				P1	P2	P3
Double Depth U-Leg (Single Leg for 120° Applications) 50½"D for use with 24"D Worksurfaces	HMP120EL4828	19	7.9	\$627	\$631	\$655
60½"D for use with 30"D Worksurfaces	HMP120EL6028	20	9.6	\$689	\$693	\$720

NOTES: Ships as single leg for 120 degree applications.

! 120 degree surfaces must be used in back-to-back applications — cannot be used freestanding.

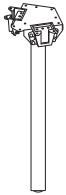

DESCRIPTION	MODEL	SHIP WEIGHT	CUBE	P1	P2	P3
Post Leg for 120° Applications (Singles) 28½"H	HMP120POST	10	1.4	\$328	\$332	\$343

NOTES: One post leg needed per 120 degree worksurface. Post leg ships with attachment brackets needed to connect support beams and worksurfaces.

! 120 degree surfaces must be used in back-to-back applications — cannot be used freestanding.

Worksurface Width	Electrical Model	Quantity
36"	HH871124	1
36"	HH871148	2
42"	HH871124	1
42"	HH871160	2
48"	HH871124	1
48"	HH871172	2

HOW TO SPECIFY

<p>Select Model Number</p> <p>HMP120EL4828</p>	<p>Select Paint Color</p> <p>See page 504</p> <p>T1</p>
---	--



EMPOWER[®] Support Beams

WORKSTATIONS

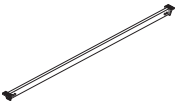
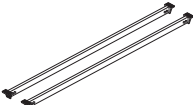
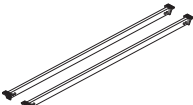
	DESCRIPTION	MODEL	SHIP WEIGHT	CUBE	LIST PRICE
	Support Beams (Box of 1)				
	48"W	HMPUB148	7.0	0.5	\$315
	60"W	HMPUB160	8.3	0.7	\$352
	72"W	HMPUB172	9.6	0.9	\$390
	NOTES: One support beam per worksurface is needed. ⓘ Available in graphite finish only. No specification needed.				
	Support Beams (Box of 2)				
	48"W	HMPUB248	13.3	0.5	\$629
	60"W	HMPUB260 ⓘ	15.8	0.7	\$700
	72"W	HMPUB272	18.2	0.9	\$775
	NOTES: For use with double-sided stations. One support beam per worksurface is needed. ⓘ Available in graphite finish only. No specification needed.				
	Support Beams for 120° Applications (Box of 2)				
	36"W	HMP120UB236	7.8	0.9	\$499
	42"W	HMP120UB242	9.5	0.9	\$561
	48"W	HMP120UB248	11.0	0.9	\$629
	NOTES: Two support beams per 120 degree worksurface are needed. ⓘ Available in graphite finish only. No specification needed.				

NOTES:

- For use with stationary, single-sided stations. 36"W returns will use the 48"W Support Beam and 48"W returns will use the 60"W Support Beam.

HOW TO SPECIFY

Select Model Number

H M P 1 2 0 U B 2 3 6

EMPOWER® Wire Troughs

GSA SIN 33721



Icon Legend on page 19

WORKSTATIONS

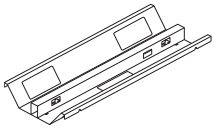

DESCRIPTION

Trough — Double-Sided

48"W
60"W
72"W

! Available in graphite finish only. No specification needed.

MODEL

HMPTROUGH48
HMPTROUGH60
HMPTROUGH72

SHIP WEIGHT

3.3
4.3
5.3

CUBE

5.3
6.8
8.3

LIST PRICE

\$437
\$481
\$528

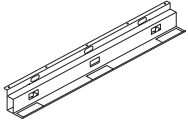

Trough — Single-Sided

48"W
60"W
72"W

! Available in graphite finish only. No specification needed.

HMPSTROUGH48
HMPSTROUGH60
HMPSTROUGH72

3.0
4.0
5.0

5.3
6.8
8.3

\$327
\$444
\$561

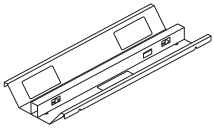

Trough — Double-Sided for 120° Applications

36"W
42"W
48"W

! Available in graphite finish only. No specification needed.

HMP120TROUGH36
HMP120TROUGH42
HMP120TROUGH48

6.9
8.4
9.9

3.8
3.8
5.3

\$356
\$394
\$437

NEW!

NOTES:

- Slots available in trough to zip tie data cables to the trough.
- Double-sided wire trough rests on top of support bars. No fasteners needed.
- Single-sided trough is used for single-sided applications only. Screws into bottom side of worksurface for attachment.

! For use with stationary Empower® only.

HOW TO SPECIFY

Select
Model Number

H M P T R O U G H 4 8



EMPOWER® Return Components

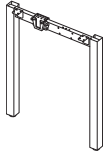

DESCRIPTION

Single Depth Return Leg (Singles)

Left
Right

NOTES: Return legs ship with two flat brackets.

MODEL	SHIP WEIGHT	CUBE	LIST PRICE BY PAINT GRADE		
			P1	P2	P3
HMPRELE2428	23.7	4.0	\$381	\$385	\$398
HMPRREL2428	23.7	4.0	\$381	\$385	\$398

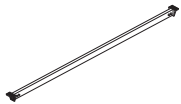

DESCRIPTION

Support Beams (Box of 1)

48"W
60"W

NOTES: For use with single-sided stations. 36"W returns will use the 48"W Support Beam and 48"W returns will use the 60"W Support Beam.

! Available in graphite finish only. No specification needed.

MODEL	SHIP WEIGHT	CUBE	LIST PRICE
HMPUB148	7.0	0.5	\$315
HMPUB160	8.3	0.7	\$352

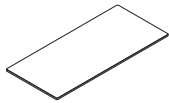

DESCRIPTION

24"D Worksurface with Edgeband

36"W x 24"D

NOTES: For use as a return surface only.

48"W x 24"D

NOTES: Can be used as a primary surface or a return surface.

MODEL	SHIP WEIGHT	CUBE	LIST PRICE BY LAMINATE GRADE	
			L1	L2
HWR2436PN	46	2.5	\$382	\$397
HWR2448PN	58	3.3	\$446	\$461

NOTES:

- Worksurfaces are constructed of laminate on 1/8" solid core high-performance particleboard.
- Return legs ship with two flat brackets. 36"W returns will use the 48"W Support Beam and 48"W returns will use the 60"W Support Beam.
- ! All worksurfaces load tested to BIFMA standards.
- ! Stack-on storage cannot be used on Empower® benching.
- ! For use with static linear applications only.

HOW TO SPECIFY

<p>Select Model Number</p> <p>H M P R L E L 2 4 2 8 .</p>	<p>Select Paint Color</p> <p>See page 504</p> <p>T 1</p>	
<p>Select Model Number</p> <p>H W R 2 4 3 6 P N .</p>	<p>Select Laminate Color</p> <p>See page 504</p> <p>L D W 1 .</p>	<p>Select Edgeband Color</p> <p>See page 504</p> <p>L D W 1</p>







EMPOWER[®] Systems Worksurfaces

GSA SIN 33721

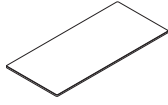

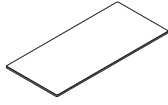

Icon Legend on page 19

WORKSTATIONS

	DESCRIPTION	MODEL	SHIP WEIGHT	CUBE	LIST PRICE BY LAMINATE GRADE	
					L1	L2
	24"D Worksurface with Edgeband					
	48"W x 24"D	HWR2448PN	58 	3.3	\$446	\$461
	NOTES: Can be used as a primary surface or a return surface.					
	60"W x 24"D	HWR2460PN 	70	4.0	\$526	\$546
	72"W x 24"D	HWR2472PN	89	4.8	\$583	\$603
	NOTES: For use as a primary surface.					
	30"D Worksurface with Edgeband					
	48"W x 30"D	HWR3048PN 	58 	3.3	\$481	\$496
	60"W x 30"D	HWR3060PN 	70	4.0	\$573	\$593
	72"W x 30"D	HWR3072PN	89	4.8	\$653	\$673

NOTES:

- Worksurfaces are constructed of laminate on 1/8" solid core high-performance particleboard.
-  All worksurfaces load tested to BIFMA standards.
-  Stack-on storage cannot be used on Empower® benching.
-  Height adjustable worksurfaces are reduced 2" in width and 0.75" in depth to prevent pinch points.

HOW TO SPECIFY

<p>Select Model Number</p> <p>HWR2448PN</p>	<p>Select Laminate Color</p> <p>See page 504</p> <p>LDW1</p>	<p>Select Edgeband Color</p> <p>See page 504</p> <p>LDW1</p>
---	--	--



SYSTEMS WORKSURFACES

120 Degree Corner

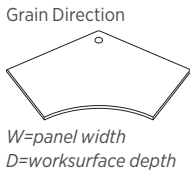

DESCRIPTION

Abound® and Accelerate® 120 Degree Corner Worksurfaces with Curved User Edge

36"W x 24"D
42"W x 24"D
48"W x 24"D

42"W x 30"D
48"W x 30"D

MODEL

HBWCT3624P
HBWCT4224P
HBWCT4824P

HBWCT4230P
HBWCT4830P

SHIP WEIGHT

75
96
107

102
112

CUBE

7.7
9.2
9.2

11.4
11.4

L1 LIST PRICE

\$856
\$917
\$1063

\$1205
\$1282

L2 LIST PRICE

\$871
\$932
\$1078

\$1220
\$1297

- HBWCT3624P will not accept the H4022, HE4022, H4028, or H4029 keyboard platforms.
- One small worksurface bracket standard with each worksurface.

❗ Corner worksurfaces must match exactly the panel behind them, i.e.: a 36" panel must be used on the back two sides of model HBWCT3624P.

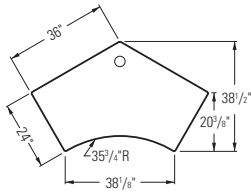

HBWCT3624P

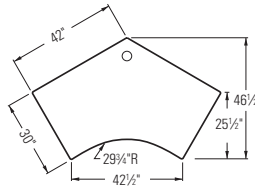

HBWCT4230P

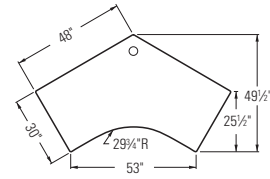

HBWCT4830P

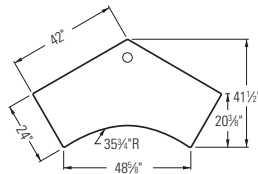

HBWCT4224P

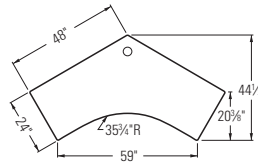

HBWCT4824P

NOTES:

- Worksurfaces are constructed of laminate on 1/8" solid core high-performance particleboard.
- Add suffix "N" to Model Number for worksurfaces with no grommets. No upcharge.
- Refer to Worksurface Supports, pages 630-634.
- If used at an end of run, full end panel needs to be ordered — see page 630.

- ❗ Cannot use keyboard tray or full height pedestal under 120 degree corner worksurface.
- ❗ For use with linear applications only.

HOW TO SPECIFY

<p>Select Model Number</p> <p>No Grommet option: Add "N" suffix (no upcharge)</p> <p>HBWCT3624P .</p> <p>HBWCT3624PN .</p>	<p>Select Laminate</p> <p>See page 481</p> <p>AS .</p> <p>AS .</p>	<p>Select Edge Color</p> <p>See page 481</p> <p>K .</p> <p>K .</p>	<p>Select Grommet Color</p> <p>See page 481</p> <p>T1</p>
---	---	---	--

EMPOWER® Height Adjustable Bases

GSA SIN 33721 EXCEPT AS NOTED

Icon Legend on page 19

WORKSTATIONS

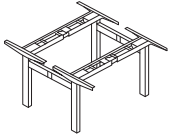

OPEN MARKET



DESCRIPTION

Height Adjustable Base
Back-to-Back Workstation

MODEL

HMPHA2S4C

SHIP WEIGHT

130

CUBE

5.3

LIST PRICE

\$2518

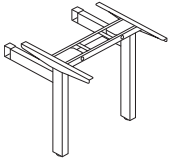

OPEN MARKET



DESCRIPTION

End of Run Kit
! End of Run Kit needs to be attached to one side of HMPHA2S4C. End of Run Kit cannot stand on its own.

MODEL

HMPHABEORKIT

SHIP WEIGHT

15

CUBE

3.1

LIST PRICE

\$194

NOTES:

• Bases are steel construction with telescoping horizontal frame that adjusts from 41"-71"W to accommodate 42"-72"W worksurfaces. Memory controller features four memory presets, programmable upper and lower limit, and keypad lock to prevent unintentional movement. Dour motor with 250 lbs. load capacity per surface. Travel range of 19⁵/₈" adjustment from 25⁵/₈" to 45¹/₄" (excluding worksurface dimension).

! Height adjustable benching cannot be single-sided; must always be used in back to back layouts.

! HBSMAUSB and HBDMAUSB cannot be used in Empower® height adjustable applications.

	DESCRIPTION	MODEL	SHIP WEIGHT	CUBE	LIST PRICE
	Trough for Height Adjustable Base — Double-Sided				
	48"W	HMPHATROUGH48	5.0	1.7	\$437
	60"W	HMPHATROUGH60 ©	6.5	2.2	\$481
	72"W	HMPHATROUGH72	7.0	2.7	\$528
	Trough for Height Adjustable End of Run				
	20"W	HMPHATROUGH20	3.0	0.4	\$353
	Single-Sided Trough Lid — Single Pack				
	For 48"W Trough	HMPHASLID48	3.0	0.4	\$128
	For 60"W Trough	HMPHASLID60 ©	4.0	0.5	\$139
	For 72"W Trough	HMPHASLID72	5.0	0.6	\$153
	For Height Adjustable Base 20"W End of Run Trough	HMPHASLID20	2.0	0.4	\$103

NOTES:

- Slots available in trough to zip tie data cables to the trough.
- Trough attaches to crossbeam connected to the height adjustable columns.
- 2 trough lids needed per double-sided trough.
- 1 trough lid needed for end of run trough.
- \$4 upcharge for P2 Paints.
- \$10 upcharge for P3 Paints on Trough Covers and End of Run Trough.
- \$20 upcharge for P3 Paints on Troughs.

HOW TO SPECIFY

<p>Select Model Number</p> <p>H M P H A 2 S 4 C .</p>	<p>Select Paint Color</p> <p>P71 Black P8L Nickel PD8 White</p> <p>P 8 L</p>
---	--

<p>Select Model Number</p> <p>H M P H A T R O U G H 4 8 .</p>	<p>Select Paint Color</p> <p>See page 504</p> <p>P 8 S</p>
---	--



EMPOWER® Height Adjustable Worksurfaces

	DESCRIPTION	MODEL	SHIP WEIGHT	CUBE	LIST PRICE BY LAMINATE GRADE	
					L1	L2
	23"D Worksurface with Edgeband					
	46"W x 23"D	HHATW2346EM	58	3.1	\$446	\$461
	58"W x 23"D	HHATW2358EM	70	3.9	\$526	\$546
	70"W x 23"D	HHATW2370EM	89	4.6	\$583	\$603
	29"D Worksurface with Edgeband					
	46"W x 29"D	HHATW2946EM	68	3.9	\$481	\$496
	58"W x 29"D	HHATW2958EM	101	4.8	\$573	\$593
	70"W x 29"D	HHATW2970EM	105	5.7	\$653	\$673

NOTES:

- Worksurfaces are constructed of laminate on 1 1/8" solid core high-performance particleboard.
- ❗ All worksurfaces load tested to BIFMA standards.
- ❗ Stack-on storage cannot be used on Empower® benching.
- ❗ Height adjustable worksurfaces are reduced 2" in width and 0.75" in depth to prevent pinch points.

HOW TO SPECIFY

<p>Select Model Number</p> <p>HHATW2346EM.</p>	<p>Select Laminate Color</p> <p>See page 504</p> <p>WHIT.</p>	<p>Select Edgeband Color</p> <p>See page 504</p> <p>WHIT</p>
---	--	---

EMPOWER[®] Side Screens

GSA SIN 33721



Icon Legend on page 19

WORKSTATIONS

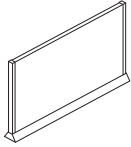

DESCRIPTION

Fabric Side Screen

24"D x 13"H
24"D x 20"H

30"D x 13"H
30"D x 20"H

MODEL

HMPDFS2413
HMPDFS2420

HMPDFS3013
HMPDFS3020

SHIP WEIGHT CUBE

4.5	2.1
4.5	1.6
5.0	1.9
5.0	2.2

LIST PRICE BY FABRIC GRADE

AA	A	B
\$439	\$459	\$479
\$485	\$505	\$525
\$484	\$504	\$524
\$534	\$554	\$574

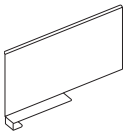

DESCRIPTION

Painted Metal Side Screen

24"D x 13"H
30"D x 13"H

MODEL

HMPDMS2413
HMPDMS3013

SHIP WEIGHT CUBE

6.3	2.0
7.7	2.8

LIST PRICE BY PAINT GRADE

P1	P2	P3
\$309	\$313	\$329
\$356	\$360	\$376

NOTES:

- Fabric screen adheres to the top of the worksurface with heavy-duty double stick tape.
- Metal screen slides over the edge of the worksurface and screws in under the worksurface.
- Metal screen is available in markerboard paint.
- For use on stationary and height adjustable setups.

HOW TO SPECIFY

Select Model Number H M P D F S 2 4 1 3 .	Select Paint Color See page 504 T 1 .	Select Fabric See pages 502-503 A P N 1 1
---	--	--

Select Model Number H M P D M S 2 4 1 3 .	Select Paint Color See page 504 P 8 S
---	--

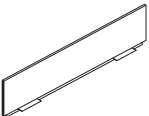
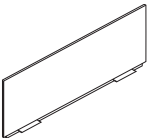
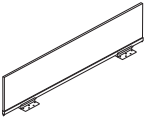
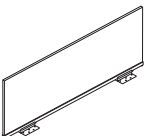

EMPOWER[®] Center Screens Fabric

DESCRIPTION	MODEL	SHIP WEIGHT	CUBE	LIST PRICE BY FABRIC GRADE			
				AA	A	B	
 Fabric Screens (Shared) — 13”H 24”W 30”W 36”W 42”W 48”W 60”W ⓘ For use on stationary stations only.	HMPCFS2413	6.3	0.9	\$332	\$352	\$372	
	HMPCFS3013	7.3	1.1	\$411	\$431	\$451	
	HMPCFS3613	8.3	1.4	\$501	\$521	\$541	
	HMPCFS4213	9.3	1.6	\$516	\$536	\$556	
	HMPCFS4813	10.3	1.8	\$636	\$656	\$676	
	HMPCFS6013	12.3	2.3	\$732	\$752	\$772	
	 Fabric Screens (Shared) — 20”H 24”W 30”W 36”W 42”W 48”W 60”W ⓘ For use on stationary stations only.	HMPCFS2420	7.3	1.6	\$422	\$442	\$462
		HMPCFS3020	8.5	1.6	\$524	\$544	\$564
		HMPCFS3620	9.8	2.1	\$637	\$657	\$677
		HMPCFS4220	11.0	2.4	\$612	\$632	\$652
HMPCFS4820		12.3	2.8	\$724	\$744	\$764	
HMPCFS6020		14.8	3.5	\$803	\$823	\$843	
 Fabric Screens (Single) — 13”H 36”W 42”W 48”W 54”W 60”W NOTES: For use on single-sided stationary stations or height adjustable stations (one per worksurface).		HMPFSS3613	9.7	2.4	\$495	\$515	\$535
		HMPFSS4213	11.0	1.7	\$510	\$530	\$550
		HMPFSS4813 ⓘ	12.3	2.9	\$630	\$650	\$670
		HMPFSS5413 ⓘ	13.6	2.4	\$662	\$682	\$702
	HMPFSS6013 ⓘ	14.8	3.6	\$726	\$746	\$766	
	NOTES: For use on single-sided stationary stations or height adjustable stations (one per worksurface).						
 Fabric Screens (Single) — 20”H 36”W 42”W 48”W 54”W 60”W NOTES: For use on single-sided stationary stations or height adjustable stations (one per worksurface).	HMPFSS3620	11.2	3.2	\$631	\$651	\$671	
	HMPFSS4220	12.8	2.7	\$606	\$626	\$646	
	HMPFSS4820	14.3	4.0	\$718	\$738	\$758	
	HMPFSS5420	15.9	3.6	\$752	\$772	\$792	
	HMPFSS6020	17.3	4.9	\$797	\$817	\$837	
	NOTES: For use on single-sided stationary stations or height adjustable stations (one per worksurface).						

NOTES:

- ⓘ Only single-sided screens can be specified with height adjustable workstations.
- ⓘ When using a power pole, the screen on the station with the pole must be 6” shorter to allow space for the pole to be mounted.

Fabric Screen Specifying Guide

Static Rectangle Worksurface Width	Inset 6” on Each Side	Full Length
48”	36”	48”
60”	48”	60”
72”	60”	N/A

120 Side Width	Inset 6” on Each Side	Full Length
36”	24”	36”
42”	30”	42”
48”	36”	48”

Height Adjustable Rectangle Worksurface Width	Inset 5” on Each Side	Inset 2” on Each Side
48” (undersized)	36”	42”
60” (undersized)	48”	54”
72” (undersized)	60”	N/A

HOW TO SPECIFY

<p>Select Model Number</p> <p>H M P C F S 3 6 2 0 .</p>	<p>Select Paint Color</p> <p>See page 504 \$4 upcharge for P2 Paints \$20 upcharge for P3 Paints</p> <p>T 1 .</p>	<p>Select Fabric</p> <p>See pages 502-503</p> <p>A P N 1 1</p>
--	--	---

EMPOWER® Center Screens Frosted Glass

GSA SIN 33721



Icon Legend on page 19

WORKSTATIONS

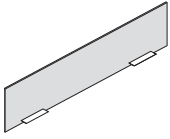

DESCRIPTION

Frosted Glass Screens (Shared) — 13”H

DESCRIPTION	MODEL	SHIP WEIGHT	CUBE	LIST PRICE BY PAINT GRADE	
				P1	P2
24”W	HMPFG2413	18.2	1.4	\$365	\$369
30”W	HMPFG3013	21.0	1.6	\$452	\$456
36”W	HMPFG3613	23.8	1.9	\$549	\$553
42”W	HMPFG4213	26.5	2.2	\$569	\$573
48”W	HMPFG4813	29.3	2.4	\$671	\$675
60”W	HMPFG6013	35.3	3.0	\$804	\$808
72”W	HMPFG7213	43.3	3.5	\$883	\$887

! For use on stationary stations only.

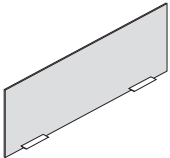

Frosted Glass Screens (Shared) — 20”H

24”W	HMPFG2420	24.8	2.0	\$463	\$467
30”W	HMPFG3020	28.8	2.4	\$576	\$580
36”W	HMPFG3620	32.8	2.8	\$671	\$675
42”W	HMPFG4220	37.3	3.1	\$672	\$676
48”W	HMPFG4820	41.3	3.5	\$794	\$798
60”W	HMPFG6020	49.3	4.3	\$882	\$886
72”W	HMPFG7220	60.3	5.1	\$969	\$973

! For use on stationary stations only.

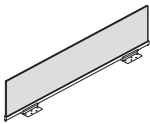

Frosted Glass Screens (Single) — 13”H

36”W	HMPFGS3613	25.2	1.9	\$543	\$547
42”W	HMPFGS4213	28.3	2.2	\$563	\$567
48”W	HMPFGS4813	31.3	2.4	\$665	\$669
54”W	HMPFGS5413	34.4	2.8	\$728	\$732
60”W	HMPFGS6013	37.8	3.0	\$798	\$802
72”W	HMPFGS7213	46.3	3.5	\$877	\$881

NOTES: For use on single-sided stationary stations or height adjustable stations (one per worksurface).

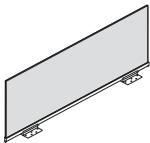

Frosted Glass Screens (Single) — 20”H

36”W	HMPFGS3620	34.2	2.8	\$665	\$669
42”W	HMPFGS4220	38.8	3.1	\$666	\$670
48”W	HMPFGS4820	43.3	3.5	\$788	\$792
54”W	HMPFGS5420	47.9	3.8	\$829	\$833
60”W	HMPFGS6020	51.8	4.3	\$876	\$880
72”W	HMPFGS7220	63.3	5.1	\$963	\$967

NOTES: For use on single-sided stationary stations or height adjustable stations (one per worksurface).

! 20”H glass cannot be used on 24”D single-sided stations.

NOTES:

- ! Only single-sided screens can be specified with height adjustable workstations.
- ! When using a power pole, the screen on the station with the pole must be 6” shorter to allow space for the pole to be mounted.

Glass Screen Specifying Guide

Rectangle Worksurface Width	Inset 6” on Each Side	Full Length
48”	36”	48”
60”	48”	60”
72”	60”	72”

120 Side Width	Inset 6” on Each Side	Full Length
36”	24”	36”
42”	30”	42”
48”	36”	48”



Height Adjustable Rectangle Worksurface Width	Inset 5” on Each Side	Inset 2” on Each Side
48” (undersized)	36”	42”
60” (undersized)	48”	54”
72” (undersized)	60”	N/A

HOW TO SPECIFY

Select Model Number H M P F G 3 6 1 3 .	Select Paint Color See page 504 T 1 .	Select Frosted Glass R Frosted Glass R
---	--	---

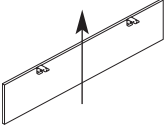

EMPOWER® Modesty Panels/End of Run Screens

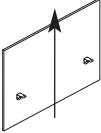
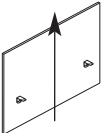
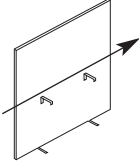
DESCRIPTION	MODEL	SHIP WEIGHT	CUBE	LIST PRICE BY LAMINATE GRADE	
				L1	L2
 <p>Laminate Modesty Panels — 13”H 36”W for use with 48”W Worksurfaces 48”W for use with 60”W Worksurfaces 60”W for use with 72”W Worksurfaces</p> <p>NOTES: Vertical grain.  For use on single-sided stationary Empower® only.</p>	HMPLM3613	12.9	1.9	\$202	\$212
	HMPLM4813	16.9	2.4	\$303	\$313
	HMPLM6013	19.9	2.9	\$344	\$354
 <p>Single-Side Laminate End of Run Screens Single — 24”W x 26”H Single — 24”W x 34”H Single — 30”W x 26”H Single — 30”W x 34”H</p> <p>NOTES: 24”W and 48”W models used on 24”D Worksurfaces and 30”W and 60”W models are used on 30”D Worksurfaces. Vertical grain.</p>	HMPLM2426	16.9	2.2	\$205	\$215
	HMPLM2434	20.9	2.8	\$225	\$235
	HMPLM3026	20.5	2.7	\$233	\$243
	HMPLM3034	25.5	3.4	\$257	\$267
 <p>Double-Side Laminate End of Run Screens Double — 48”W x 26”H Double — 48”W x 34”H Double — 60”W x 26”H Double — 60”W x 34”H</p> <p>NOTES: 24”W and 48”W models used on 24”D Worksurfaces and 30”W and 60”W models are used on 30”D Worksurfaces. Vertical grain.</p>	HMPLM4826	30.9	4.1	\$300	\$310
	HMPLM4834	38.9	5.2	\$328	\$338
	HMPLM6026	38.1	5.1	\$405	\$415
	HMPLM6034	48.3	6.4	\$439	\$449
 <p>Double-Side Laminate Gallery Panel for Height Adjustable 48”W x 50”H 60”W x 50”H</p> <p>NOTES: Horizontal grain.</p>	HMPLGP4850	82.0	6.6	\$679	\$689
	HMPLGP6050	100.0	9.2	\$752	\$762

NOTES:

- End of run screens sit -1” inset on each side of the depth of the run.
- Static end of run screens are 13” below the surface and either 13”H or 20”H above the surface.
- Height adjustable end of run screens extend to the floor and are 50”H.

HOW TO SPECIFY

Select Model Number HMPLM3613	Select Laminate Color See page 504 PINCPINC	Select Paint Color Bracket paint must be specified T1
---	--	--

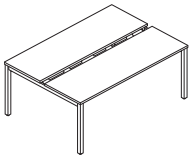
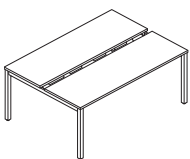
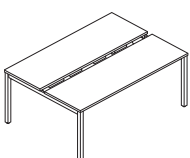
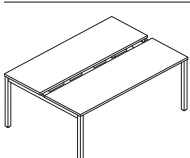
	DESCRIPTION	MODEL	SHIP WEIGHT	CUBE	LIST PRICE BY LAMINATE GRADE	
					L1	L2
	Bundles — 72" W with 24" D Worksurfaces					
	2-Pack	HMP2472PK2	238.9	35.3	\$4396	\$4436
	4-Pack	HMP2472PK4	465.8	59.4	\$7569	\$7649
	6-Pack	HMP2472PK6	692.7	83.9	\$10981	\$11101
	8-Pack	HMP2472PK8	919.6	108.5	\$14393	\$14553
	Bundles — 60" W with 24" D Worksurfaces					
	2-Pack	HMP2460PK2	198.9	35.3	\$4409	\$4449
	4-Pack	HMP2460PK4	385.8	59.4	\$7097	\$7177
	6-Pack	HMP2460PK6	572.7	83.9	\$10273	\$10393
	8-Pack	HMP2460PK8	759.6	108.5	\$13449	\$13609
	Bundles — 72" W with 30" D Worksurfaces					
	2-Pack	HMP3072PK2	238.9	35.3	\$4660	\$4700
	4-Pack	HMP3072PK4	465.8	59.4	\$8024	\$8104
	6-Pack	HMP3072PK6	692.7	83.9	\$11627	\$11747
	8-Pack	HMP3072PK8	919.6	108.5	\$15230	\$15390
	Bundles — 60" W with 30" D Worksurfaces					
	2-Pack	HMP3060PK2	198.9	35.3	\$4378	\$4418
	4-Pack	HMP3060PK4	385.8	59.4	\$7460	\$7540
	6-Pack	HMP3060PK6	572.7	83.9	\$10781	\$10901
	8-Pack	HMP3060PK8	759.6	108.5	\$14102	\$14262
SPECIFYING EXAMPLE: Model.Laminate.Edgeband.Paint2.DuplexColor (S only)						

NOTES:

- Bundles include worksurfaces, support legs, support bars, wire management troughs, harnesses, and duplexes.
- Please specify in-feed, screens, storage, and seating separately.

ⓘ Stack-on storage cannot be used on Empower benching.

HOW TO SPECIFY

<p>Select Model Number</p> <p>HMP2472PK2</p>	<p>Select Laminate Color</p> <p>See page 504</p> <p>LDW1</p>	<p>Select Edgeband Color</p> <p>See page 504</p> <p>LDW1</p>	<p>Select Paint Color</p> <p>See page 504</p> <p>\$4 upcharge for P2 Paints</p> <p>T1</p>	<p>Select Duplex Color</p> <p>See page 504</p> <p>S</p>
---	---	---	--	--



EMPOWER® Height Adjustable Typicals

	DESCRIPTION	MODEL	SHIP WEIGHT	CUBE	LIST PRICE BY LAMINATE GRADE	
					L1	L2
	Bundles — 72" W with 24" D Worksurfaces					
	2-Pack	HMPHA2472PK2	331	19.1	\$5200	\$5240
	4-Pack	HMPHA2472PK4	662	37.6	\$9912	\$9992
	6-Pack	HMPHA2472PK6	993	56.2	\$14863	\$14983
	8-Pack	HMPHA2472PK8	1324	74.7	\$19814	\$19974
	Bundles — 60" W with 24" D Worksurfaces					
	2-Pack	HMPHA2460PK2	291	16.9	\$5011	\$5051
	4-Pack	HMPHA2460PK4	581	33.1	\$9534	\$9614
	6-Pack	HMPHA2460PK6	872	49.4	\$14296	\$14416
	8-Pack	HMPHA2460PK8	1162	65.7	\$19058	\$19218
	Bundles — 72" W with 30" D Worksurfaces					
	2-Pack	HMPHA3072PK2	363	21.3	\$5334	\$5374
	4-Pack	HMPHA3072PK4	726	41.9	\$10180	\$10260
	6-Pack	HMPHA3072PK6	1089	62.6	\$15265	\$15385
	8-Pack	HMPHA3072PK8	1452	83.3	\$20350	\$20510
	Bundles — 60" W with 30" D Worksurfaces					
	2-Pack	HMPHA3060PK2	353	18.7	\$5107	\$5147
	4-Pack	HMPHA3060PK4	705	36.7	\$9726	\$9806
	6-Pack	HMPHA3060PK6	1058	54.8	\$14584	\$14704
	8-Pack	HMPHA3060PK8	1410	72.9	\$19442	\$19602

SPECIFYING EXAMPLE: Model.Laminate.Edgeband.BasePaint.TroughPaint.DuplexColor

NOTES:

- Bundles include worksurfaces, wire management troughs, trough covers, harnesses, duplexes, and bases.
- Please specify in-feed, screens, storage, and seating separately.

- ! Stack-on storage cannot be used on Empower benching.
- ! HBSMAUSB and HBDMAUSB cannot be used in Empower® height adjustable applications.

HOW TO SPECIFY

Select Model Number	Select Laminate Color	Select Edgeband Color	Select Base Paint Color	Select Trough Paint Color	Select Duplex Color
	See page 504	See page 504	See page 504 Upcharge for P2 and P3 Paints	See page 504	See page 504
H M P H A 2 4 7 2 P K 2 .	L D W 1 .	L D W 1 .	T 1 .	S .	S .

EMPOWER[®] ELECTRICAL SPECIFYING INFORMATION

To Order:

- Determine which electrical system you will use after consulting your electrician and computer support personnel:
 - The Four-circuit system (4-Hot/2-Neutral/2-Ground)**
 - 3 + 1 option
 - 2 + 2 option
 - The Three-circuit system (3-Hot/3-Neutral/2-Ground)**
 - Determine location, quantity and circuit of duplexes.
 - Determine the appropriate choice and use of Isolated, Isolated/Dedicated and Separate Neutral circuits.
 - Specify appropriate Power Harnesses* and Pass-Thru Cables.*
 - Determine the location, quantity and type of Power In-feed needed.
- * Select Power Harness models (HH8712XX) and Pass-Thru Cables (HH8711XX) with the last two digits being the same as the associated worksurface width.

Electrical System Options

The four-circuit, eight-wire electrical system is widely specified and trusted by hundreds of thousands of end-users. This proven system delivers four circuits for every power in-feed in either a 3 + 1 or 2 + 2 configuration. The isolated/dedicated circuits are ideal for sensitive computing equipment, while the common circuits are suitable for faxes, copiers, task lights and other peripherals.

Both the 3 + 1 and 2 + 2 systems use the same pre-wired components, making it easy to adjust as electrical needs change.

You can also choose a three-circuit, eight-wire system that has a dedicated neutral for every hot circuit. The three-circuit components have model numbers with an "A" suffix and appear in a gray box in this pricer.

Four-circuit, 3 + 1 Receptacle Option

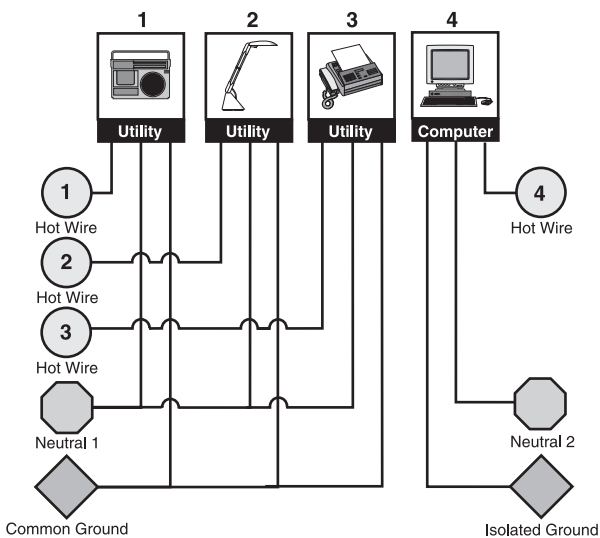

The 3 + 1 option is the electrical standard used by The HON Company for many years in most of their systems products. This wiring option provides three utility circuits plus an isolated/dedicated circuit for more sensitive equipment.

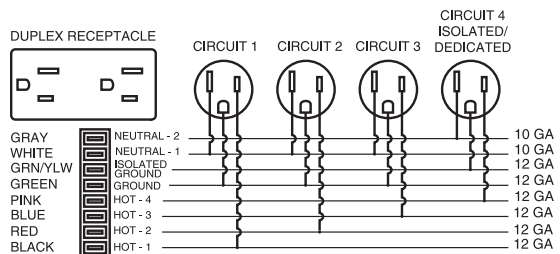

Four-circuit, 2 + 2 Receptacle Option

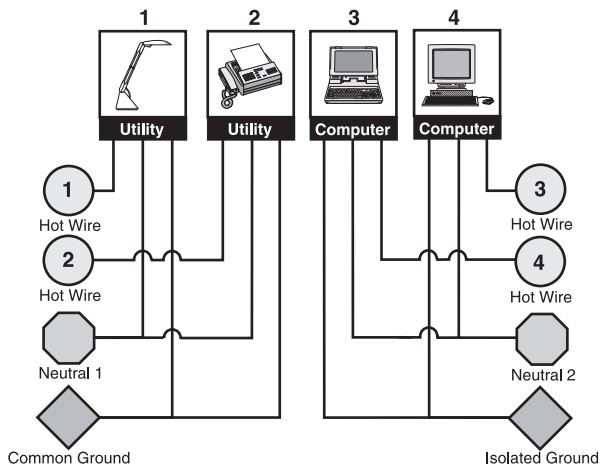

The 2 + 2 option is a wiring option that provides two utility circuits and two isolated circuits for more extensive computer usage applications.

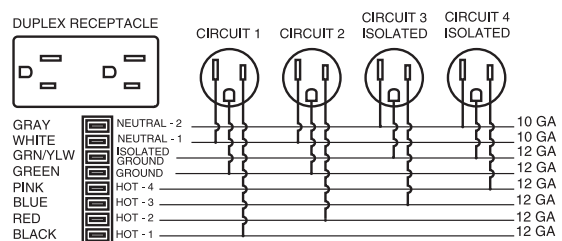

EMPOWER[®] ELECTRICAL SPECIFYING INFORMATION

Three-circuit, separate neutrals

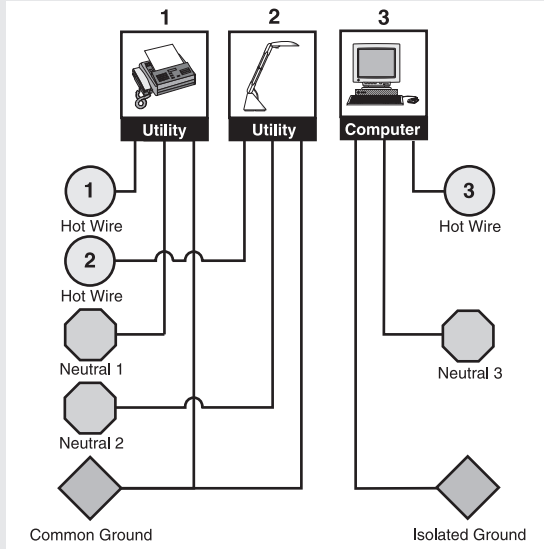

The Three-circuit, separate neutrals configuration is a wiring option that provides separate neutrals for each of the three circuits. Two circuits share a common ground, and one circuit is isolated/dedicated. The three-circuit components have model numbers with an "A" suffix and appear in a gray box in this pricer.

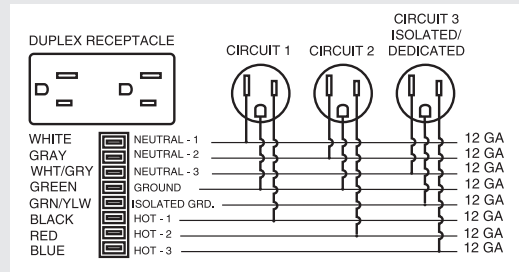

Two 8-wire, 20 AMP (15 AMP Canadian) electrical systems are offered					
Electrical System	Circuitry	Receptacle Capacity			
Four-circuit 4-Hot/2-Neutral/2-Ground (10 gauge neutral wires)	3 + 1	Common Circuit-1 HH873501	Common Circuit-2 (1) HH873502	Common Circuit-3 HH873503	Iso/Dedicated Circuit-4 HH873504
	2 + 2	Common Circuit-1 HH873501	Common Circuit-2 HH873502	Isolated Circuit-3 HH873506	Isolated Circuit-4 HH873504
Three-circuit 3-Hot/3-Neutral/2-Ground (12 gauge neutral wires)	w/separate neutrals	Common Circuit-1 HH873501A	Common Circuit-2 HH873502A	Iso/Dedicated Circuit-3 HH873503A	N/A

(1) Circuit-2 (one of the 3 common circuits sharing a neutral wire) cannot be used with a single-phase building electrical supply.

Notes:

- Four-circuit components and three-circuit components (with suffix "A") cannot be used together.
- Components of the two systems are keyed differently to prevent components of one system from being connected to components of another system.
- HON Cat. Nos. are printed on the UL labels, and components are color-coded to provide visual identification of the different components.
- Four-circuit components have black plastic parts.
- Three-circuit components have rust-colored terminal ends and receptacle backs are rust colored.

Typical power usage by the most commonly specified office equipment.

Source: Industry Analysis, Inc., Rochester, NY

EQUIPMENT	AMPS	EQUIPMENT	AMPS	EQUIPMENT	AMPS
Computers		Copiers		FAX Machines	
Personal Computer	3	Desktop Copier	15	InkJet FAX	less than 1
Notebook Computer	3	Console Copier	20	Thermal FAX	less than 1
		Copier/Duplicator	30	Plain paper FAX	8
Monitors		Printers		Task Lights	
13" Color Monitor	2	Dot Matrix	less than 1	36" T8 Fluorescent	0.2/bulb
17" Color Monitor	3	InkJet	less than 1	48" T8 Fluorescent	0.3/bulb
21" Color Monitor	4	Personal Laser or LED	8		
		Workgroup Laser or LED	15		

Duplex Receptacles



15 AMP Receptacle



20 AMP Receptacle
(Required by some large copiers.)

EMPOWER[®] ELECTRICAL SPECIFYING INFORMATION

- Electrical components are UL Listed and CSA Certified.
- It is the customer's responsibility to ensure that use of the pre-wired electrical system, the number of receptacles used on a given circuit, and connection to a building power source, be in compliance with all local and national electrical codes.
- Contact Customer Service for additional information.
- Four-circuit components and Three-circuit components (with suffix "A") cannot be used together. See pages 540-541.
- ! A licensed electrician must make connections to a building electrical supply.

Definition of components:

Electrical Power Harness



- Used to distribute power in workstations.
- Power distribution in either direction.
- Specify Power Harness to match workstation width.
- Double-sided: receptacles can be inserted into both sides of Power Blocks.

Electrical Pass-Thru Cables

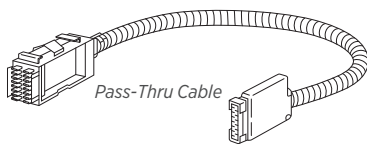

Pass-Thru Cable With Duplex Capacity:

- Use in workstations where multiple receptacles are not required.
- Added feature: has capacity for one receptacle on each side of a workstation. Feature offers future expansion and is an alternative to Power Harnesses.

Duplex Receptacles

- 15 amp outlet configuration.
- Models HH871601 and HH871601A have a 20 amp outlet configuration.
- Fit back-to-back into the Power Block(s) of Power and Pass-Thru Harnesses.
- Labeled with the provided circuit. Circuits connected to the Isolated Ground are identified with an orange triangle; circuits that do not share a neutral or ground have an orange circuit number.

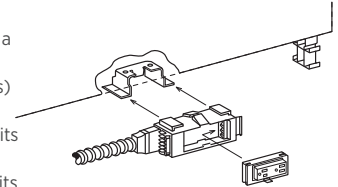

Power In-Feed Model (Floor or Ceiling) HMP144

- Used to connect the workstation electrical system to the building electrical supply.
- ! A licensed electrician must make connections to a building electrical supply.
- ! Conduit is UL listed Black Liquid-tight conduit (outside diameter is 7/8").

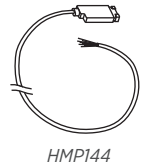

Note: In-feed cables listed above may be field-cut to desired length.

3-Pack 120 Degree Electric Specification Guide

	A	B
36" 120 surface	HH871124	HH871148
42" 120 surface	HH871124	HH871160
48" 120 surface	HH871124	HH871172

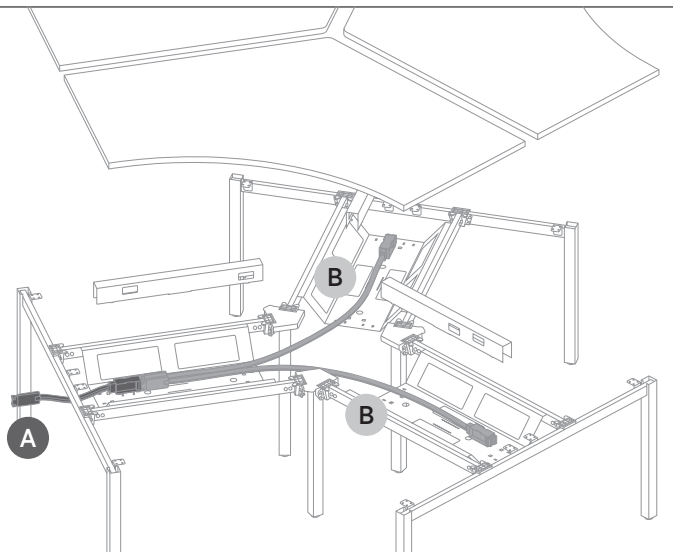

EMPOWER[®] ELECTRICAL SPECIFYING INFORMATION

- Electrical components are UL Listed and CSA Certified.
- It is the customer's responsibility to ensure that use of the pre-wired electrical system, the number of receptacles used on a given circuit, and connection to a building power source, be in compliance with all local and national electrical codes.
- ! A licensed electrician must make connections to a building electrical supply.

Vertebrae:
17 Cables, 0.250 Diameter (CAT-6)

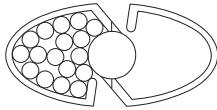

Single-Depth Cable Trough Cover Capacity:
13 Cables, 0.250 Diameter (CAT-6)

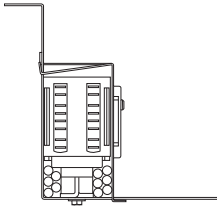

Double-Depth Cable Trough Cover Capacity:
14 Cables, 0.250 Diameter (CAT-6)

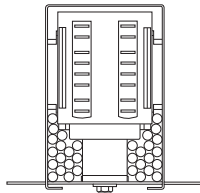

Data Cable Packing in Power Pole:
33 Cables, 0.250 Diameter (CAT-6)

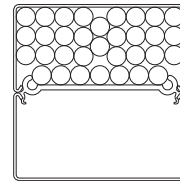

Data Cable Packing in Wire Trough Cover:
14 Cables, 0.250 Diameter (CAT-6)

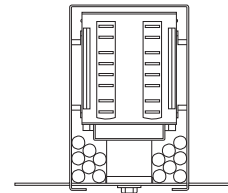











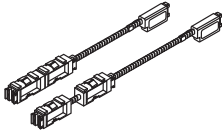





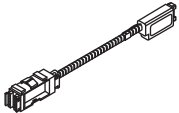

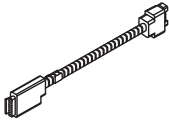

EMPOWER® Electrical and Data

GSA SIN 33721

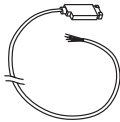
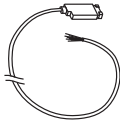

Icon Legend on page 19

WORKSTATIONS

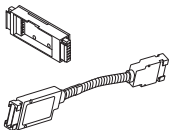
	DESCRIPTION	MAX. RECEPT. CAP. PER PANEL SIDE	MODEL		SHIP WEIGHT	CUBE	LIST PRICE
			FOUR-CIRCUIT 3+1 2+2	THREE-CIRCUIT, SEPARATE NEUTRALS			
	Electrical Power Harnesses, Frames — w/duplex capacity						
	For 48"W	2	HH871248 	HH871248A	3.0 	0.5	\$239
	For 60"W	2	HH871260 	HH871260A	3.0 	0.5	\$239
	For 72"W	2	HH871272	HH871272A	5.0 	0.5	\$239
	Electrical Pass-Thru Cables, Frames — w/duplex capacity						
	For 48"W	1	HH871148 	HH871148A	2.5 	0.5	\$151
	For 60"W	1	HH871160 	HH871160A	3.0 	0.5	\$151
	For 72"W	1	HH871172	HH871172A	5.0 	0.5	\$151
	Electrical Pass-Thru Harness without Power Block						
	For 24"W Frames	0	HH871024	HH871024A	2.0 	0.5	\$132
	For 48"W Frames	0	HH871048	HH871048A	3.0 	0.5	\$137
	For 60"W Frames	0	HH871060	HH871060A	3.0 	0.5	\$137
	For 72"W Frame Runs	0	HH871072		4.0 	0.5	\$189
 24" Pass-Thru Harness without Power Block is only used when specifying Power In-Feed with Sealtight as a floor in-feed. Harness is not needed for the standard in-feed.							
	Power In-Feed — Sealtight						
	144" long conduit, Sealtight Cable — 7/8" diameter		HMP144		7.0	1.2	\$367
NOTES: For use as ceiling, floor and wall in-feed. If three-circuit, separate neutral in-feed is required, please contact Tailored Solutions.							
	Metal Flexible Conduit						
	144" long conduit, Flex Cable — 7/8" dia.		HMP1912		4.0 	0.5	\$263
NOTES: Metal Flexible Conduit. Best option for use with power pole due to bend radius flexibility.							
	Power Jumper						
	For End of Run		HMPJUMP		2.0	0.3	\$188

HOW TO SPECIFY

Select
Model Number

HH871248

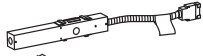

Use when local codes require



Each marked with
Circuit Number

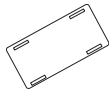

DESCRIPTION	MODEL		SHIP WEIGHT	CUBE	LIST PRICE
	FOUR-CIRCUIT 3 + 1 2 + 2	THREE-CIRCUIT, SEPARATE NEUTRALS			
Hardwire Applications Hardwire Power In-feed	HH871400	HH871400A	4.0	0.3	\$247
! Customer to furnish all cabling and wiring from power entry to power source (approved for use by city of New York).					
Hardwire Junction Box (6-pack)	HH871500		4.5	0.1	\$526
! Hardwire Junction Boxes cannot be installed back-to-back in panel applications.					
! Contact Tailored Solutions for back-to-back Junction Box standard special number.					
Duplex Receptacles					
Circuit 1	HH871501 Ⓞ	HH871501A	1.0	0.5	\$47
Circuit 2	HH871502 Ⓞ	HH871502A	1.0	0.5	\$47
Circuit 3 (except 2 + 2 — see below)	HH871503 Ⓞ	HH871503A	1.0	0.5	\$47
Circuit 4 — isolated, dedicated circuit	HH871504		1.0	0.5	\$47
Circuit 1 (20 amp outlet configuration)	HH871601		1.0	0.5	\$47
Circuit 3 (2 + 2)	HH871506		1.0	0.5	\$47
Specify Paint. Charcoal (S) matches Empower trough.					

DESCRIPTION	MODEL	SHIP WEIGHT	CUBE	LIST PRICE
Receptacle Cover Replacements				
Quantity 25	HERECPCVR	1.0	0.1	\$82
! Specify Color—Available in Black (P), Muslin (T3) and Shadow (SHDW) only.				

NOTES:

- ! Customer must furnish conduit, wiring and designer type receptacles. (Approved for use by city of Chicago.)
- ! Junction boxes cannot be used back-to-back.

Duplex Color Recommended to Coordinate with Paint Color			
Paint Color	Paint Code	Duplex Color	Duplex Code
Black	P	Black	P
Brownstone	P7D	Brownstone	EY
Charcoal	S	Charcoal	S
Designer White	PJW	Designer White	DW
Fossil	P28	Charcoal	S
Greige	T5	Muslin	T3
Light Gray	Q	Loft	LOFT
Loft	LOFT	Loft	LOFT
Muslin	T3	Muslin	T3
Putty	L	Black	P
Shadow	SHDW	Muslin	T3
Silver	PR6	Titanium	TI
Titanium	P8T	Titanium	TI
Champagne Metallic	T4	Muslin	T3
Platinum Metallic	T1	Titanium	Ti

HOW TO SPECIFY

<p>Select Model Number</p> <p>HH871400 .</p>	<p>Select Paint Color</p> <p>See page 504</p> <p>P</p>
--	--

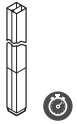

DESCRIPTION

Power Pole
10'5"

MODEL

HMPPP125

SHIP WEIGHT

14

CUBE

0.7

LIST PRICE

P1

\$512

NOTES: Power Pole ships with bracket to attach under stationary Empower® worksurfaces and feed directly into the Wire Management Trough. Power Pole will run to the floor on height adjustable Empower®.



DESCRIPTION

Vertebrae

MODEL

HMPVWM28

SHIP WEIGHT

3.0

CUBE

0.3

LIST PRICE

\$246

NOTES: 30"H x 3 1/8"W x 1 1/2"D. Ships unassembled. For additional information see the Workplace Tools section in the 2021 Shared Spaces Pricer. For use with stationary Empower®.

! Clear finish. Specify "X" for finish option.

SPECIFYING EXAMPLE: HMPVWM28.X

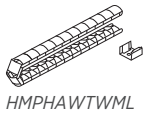

HMPHAWTWML



HMPHATFWML

Wire Managers for Height Adjustable

Workstation to Trough
Trough to Floor

HMPHAWTWML ☉

3.0

0.1

\$295

HMPHATFWML

2.0

0.3

\$269

! Wire Manager Workstation to Trough only available in black.

! HMPHATFWML Trough to Floor cable manager is 3" x 1 1/2".

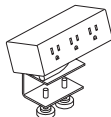

Model HPWRMOD3WC shown

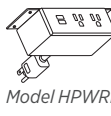

Model HPWRMOD2UWM shown

Power Modules

3 Receptacles with Worksurface Clamp
3 Receptacles with Under-Worksurface Mounting Bracket
2 Receptacles 2 USB with Worksurface Clamp
2 Receptacles 2 USB with Under-Worksurface Mounting Bracket

HPWRMOD3WC ☉

2.3 **S**

0.2

\$342

HPWRMOD3UWM

2.3

0.2

\$342

HPWRMOD2WC ☉

2.3

0.2

\$546

HPWRMOD2UWM

2.3

0.2

\$546

- 6' power cord with standard three-prong plug.
- Under-worksurface mounting bracket models work with any top that has a 5" x 5" square clearance.
- Worksurface clamp models work on any top with a 4" overhang.
- UL Listed.

NOTES: For additional information see the Workplace Tools section in the 2021 Shared Spaces Pricer.

! Color finish coordinates with HON's Charcoal or White. Specify STRM for Storm or SNW for Snow when ordering.
Example: HPWRMOD3WC.STRM.

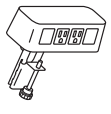

Power & Data Center

2 Receptacles 2 Data Accessory
• Standard with two receptacles and openings for two data ports.
• 6' power cord with standard three-prong plug.
• Fits on any worksurface with a 4" overhang.
• UL Listed.

HCOMDOME2

2.5 **S**

0.2

\$327

NOTES: For additional information see the Workplace Tools section in the 2021 Shared Spaces Pricer.

! Color finish coordinates with HON's Loft. Specify LOFT when ordering. Example: HCOMDOME2.LOFT

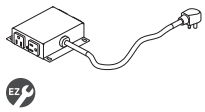

EZ

Under Worksurface Power Module — 4 Outlets, 10' Cord

• Includes 10' cord with three-prong plug.
• Fits in cable management troughs. See page 613.
• 4 outlets on side create easy access.

HPWRMOD2

1.5 **S**

0.2

\$441

NOTES: Power Modules will also work with standing-height applications for 10500 Series™ and Voi® desks. Mounting Clearance: 5.025" x 4.875" x 1.375". For additional information see the Workplace Tools section in the 2021 Shared Spaces Pricer.

! Black finish only, no specification needed.

HOW TO SPECIFY

Select Model Number

Select Finish Color

STRM Storm
SNW Snow
LOFT Loft

Specify Loft finish for HCOMDOME2 only

H M P P P 1 2 5 .

S T R M



Icon Legend on page 19

EMPOWER[®] Voi[®] Laminate Low Credenzas

WORKSTATIONS

	DESCRIPTION	MODEL	SHIP WEIGHT	CUBE	L1 LIST	L2 UPCHARGES				
						CHASSIS	FRONTS			
	Low Credenza, 2 File/2 Box 72"W x 20"D x 21½"H 60"W x 20"D x 21½"H NOTES: Unit is locking.	HLSL2072LD4	230	21.9	\$1806	\$40	\$40			
		HLSL2060LD4	190	18.9	\$1647	\$35	\$40			
	Low Credenza, 2 File Drawers, Open Top 72"W x 20"D x 21½"H 60"W x 20"D x 21½"H NOTES: Unit is non-locking.	HLSL2072LD2	200	21.9	\$1688	\$40	\$30			
		HLSL2060LD2	160	18.9	\$1543	\$35	\$30			
	Low Credenza, Left Hand Drawers 72"W x 20"D x 21½"H 60"W x 20"D x 21½"H NOTES: Unit is locking.	HLSL2072LL2	200	21.9	\$1672	\$40	\$20			
		HLSL2060LL2	160	18.9	\$1412	\$35	\$20			
	Low Credenza, Right Hand Drawers 72"W x 20"D x 21½"H 60"W x 20"D x 21½"H NOTES: Unit is locking.	HLSL2072LR2	200	21.9	\$1672	\$40	\$20			
		HLSL2060LR2	160	18.9	\$1412	\$35	\$20			
	Low Credenza, Open 72"W x 20"D x 21½"H 60"W x 20"D x 21½"H SPECIFYING EXAMPLE: HLSL2072LD0.Z (model.chassis only)	HLSL2072LD0	170	21.9	\$1421	\$40	N/A			
		HLSL2060LD0	130	18.9	\$1180	\$35	N/A			
	Low Credenza, 4 Storage Doors 72"W x 20"D x 21½"H 60"W x 20"D x 21½"H NOTES: Unit is locking.	HLSL2072S4	190	21.9	\$1792	\$40	\$40			
		HLSL2060S4	160	18.9	\$1540	\$35	\$40			
	Credenza Cushion 20"W x 36"D x 1"H for 72" Credenzas 20"W x 30"D x 1"H for 60" Credenzas NOTES: See pages 502-503 for available fabrics. SPECIFYING EXAMPLE: HLSL2036CH2.APN23	HLSL2036CH2	11	2.2	\$451	\$489	\$527	\$566	\$615	\$665
		HLSL2030CH2	9	1.9	\$418	\$454	\$490	\$526	\$572	\$619

NOTES:

- Chassis and drawer fronts woodgrains and solid laminates are specified separately (see SIF options below).
- File drawers accept hanging folders in letter size.
- Multiple handle locations possible per customer preference.
- Seat cushions are available for low credenzas and mobile pedestals (specify separately).
- Storage accessory model HLSLDRWORG works with box doors.
- Adjustable hex leveling glides allow floor-standing furniture to be easily leveled without lifting the unit; glides have 1/4" adjustable range.
- Ships with one handle per drawer on all units.
- ⓘ Locking units equipped with HON "One Key" interchangeable core removable locks. Keyed alike core must be ordered separately.

HOW TO SPECIFY

<p>Select Model Number</p> <p>HLSL2072LD4</p>	<p>Select Chassis Laminate</p> <p>See page 183</p> <p>N</p>	<p>Select Drawer Front Laminate</p> <p>See page 183</p> <p>N</p>	<p>Select Pull Color</p> <p>See page 183</p> <p>Not specified for Open Credenza models HLSL2072LD0, HLSL2060LD0</p> <p>T4</p>
--	--	---	--

EMPOWER[®] Voi[®] Laminate Low Credenzas

GSA SIN 33721



Icon Legend on page 19

WORKSTATIONS

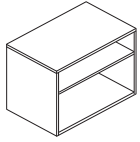

DESCRIPTION

Low Credenza — Open
30"W x 20"D x 21½"H
36"W x 20"D x 21½"H

MODEL

HLSL2030LDO
HLSL2036LDO

SHIP WEIGHT

65
85

CUBE

9.8
12.0

L1 LIST

\$977
\$1006

L2 UPCHARGES

\$25 **N/A**
\$30 **N/A**

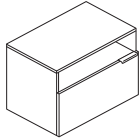

Low Credenza — Open Top, File Drawer
30"W x 20"D x 21½"H
36"W x 20"D x 21½"H

HLSL2030LD1
HLSL2036LD1

75
95

9.8
12.0

\$1085
\$1118

\$25 **\$15**
\$30 **\$15**

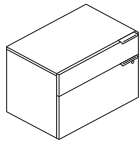

Low Credenza — 1 File Drawer, 1 Box Drawer
30"W x 20"D x 21½"H
36"W x 20"D x 21½"H

HLSL2030LD2
HLSL2036LD2

80
100

9.8
12.0

\$1206
\$1241

\$25 **\$20**
\$30 **\$20**

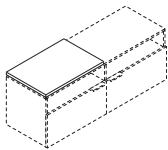

DESCRIPTION

Credenza Cushion
20"W x 36"D x 1"H for 72" Credenzas
20"W x 30"D x 1"H for 60" Credenzas

MODEL

HLSL2036CH2
HLSL2030CH2

SHIP WEIGHT

11
9

CUBE

2.2
1.9

1 2 3 4 5 6

\$451 **\$489** **\$527** **\$566** **\$615** **\$665**
\$418 **\$454** **\$490** **\$526** **\$572** **\$619**

NOTES: See pages 502-503 for available fabrics.

! For model HLSL2030CH2 must order two cushions to cover entire 60" Credenza surface.

SPECIFYING EXAMPLE: HLSL2036CH2.APN23

NOTES:

- File drawers accept hanging folders in letter size.
- Multiple handle locations possible per customer preference.
- Seat cushions are available for low credenzas and mobile pedestals (specify separately).
- Storage accessory model HLSLDRWORG works with box doors.
- Utilize in small footprint applications.
- Adjustable hex leveling glides allow floor-standing furniture to be easily leveled without lifting the unit; glides have 1/4" adjustable range.
- Ships with one handle per drawer on all units.

! Locking units equipped with HON "One Key" interchangeable core removable locks. Keyed alike core must be ordered separately.

HOW TO SPECIFY

Select Model Number

HLSL2030LDO

Select Chassis Laminate

See page 183

N

Select Drawer Front Laminate

See page 183

Not specified for Open Credenza models HLSL2030LDO, HLSL2036LDO

N

Select Pull Color

See page 183

Not specified for Open Credenza models HLSL2030LDO, HLSL2036LDO

T4



EMPOWER[®] Voi[®] Laminate Mobile Storage

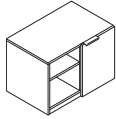

DESCRIPTION

Mobile Credenza
30"W x 20"D x 21½"H
NOTES: Unit is non-locking.

MODEL	SHIP WEIGHT	CUBE	L1 LIST	L2 UPCHARGES	
				CHASSIS	FRONTS
HLSL2030MCO	80	9.8	\$1566	\$25	\$10

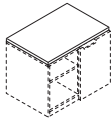

DESCRIPTION

Credenza Cushion
20"W x 30"D x 1"H for 60" Credenzas
NOTES: See pages 502-503 for available fabrics.
SPECIFYING EXAMPLE: HLSL2030CH2.APN23

MODEL	SHIP WEIGHT	CUBE	L2 UPCHARGES					
			1	2	3	4	5	6
HLSL2030CH2	9	1.9	\$418	\$454	\$490	\$526	\$572	\$619

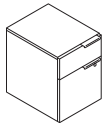

DESCRIPTION

Mobile Pedestal
15¾"W x 20⅞"D x 21⅞"H
NOTES: Unit is locking.

MODEL	SHIP WEIGHT	CUBE	L1 LIST	L2 UPCHARGES	
				CHASSIS	FRONTS
HLSL2016MP2	65	5.7	\$893	\$20	\$10

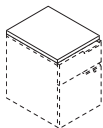

DESCRIPTION

Mobile Pedestal Cushion
15⅞"W x 20"D x 1"H for Pedestals
NOTES: See pages 502-503 for available fabrics.
SPECIFYING EXAMPLE: HLSL2016PH2.APN23

MODEL	SHIP WEIGHT	CUBE	L2 UPCHARGES					
			1	2	3	4	5	6
HLSL2016PH2	6	1.1	\$347	\$371	\$395	\$419	\$450	\$481

NOTES:

- Chassis and drawer fronts woodgrains and solid laminates are specified separately (see SIF options below).
- File drawers accept hanging folders in letter or legal size.
- Multiple handle locations possible per customer preference.
- Seat cushions are available for low credenzas, floor credenzas, and mobile pedestals (specify separately). See pages 547-549 for Pedestal and Credenza cushion models.
- Storage accessory model HSLDRWORG works with box doors.
- Standard box drawers operate on ball-bearing suspension with 70% extension. File drawers operate on ball-bearing suspension with 70% extension.
- Ships with one handle per drawer on all units.

! Locking units equipped with HON "One Key" interchangeable core removable locks. Keyed alike core must be ordered separately.

HOW TO SPECIFY

<p>Select Model Number</p> <p>HLSL2030MCO . N .</p>	<p>Select Chassis Laminate</p> <p>See page 504</p> <p>N .</p>	<p>Select Drawer Front Laminate</p> <p>See page 504</p> <p>N .</p>	<p>Select Pull Color</p> <p>P Black T4 Champagne T1 Platinum PJW Designer White PR6 Silver PBX Solar Black</p> <p>T4</p>
--	--	---	---

EMPOWER® Voi® Laminate Storage Towers

GSA SIN 33721



Icon Legend on page 19

WORKSTATIONS

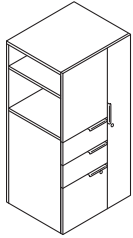

DESCRIPTION	MODEL	SHIP WEIGHT	CUBE	L1 LIST	L2 UPCHARGES	
					CHASSIS	FRONTS
24"W x 20"D Storage Tower — Right Hand Drawers, Left Hand Door						
24"W x 20"D x 50"H, Left	HLSLW045L	167	17.4	\$2159	\$50	\$35
24"W x 20"D x 65"H, Left	HLSLW046L	200	22.5	\$2449	\$55	\$35
24"W x 20"D Storage Tower — Left Hand Drawers, Right Hand Door						
24"W x 20"D x 50"H, Right	HLSLW045R	167	17.4	\$2159	\$50	\$35
24"W x 20"D x 65"H, Right	HLSLW046R	200	22.5	\$2449	\$55	\$35

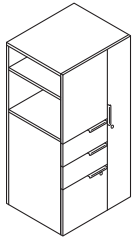

24"W x 24"D Storage Tower — Right Hand Drawers, Left Hand Door						
24"W x 24"D x 50"H, Left	HLSLW445L	200	20.7	\$2339	\$55	\$35
24"W x 24"D x 65"H, Left	HLSLW446L	240	27.8	\$2578	\$60	\$35
24"W x 24"D Storage Tower — Left Hand Drawers, Right Hand Door						
24"W x 24"D x 50"H, Right	HLSLW445R	200	20.7	\$2339	\$55	\$35
24"W x 24"D x 65"H, Right	HLSLW446R	240	27.8	\$2578	\$60	\$35

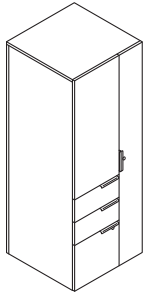

24"W x 24"D Personal Storage Tower						
24"W x 24"D x 65"H, Left	HLSLW446LP	250	27.8	\$2920	\$60	\$35
24"W x 24"D x 65"H, Right	HLSLW446RP	250	27.8	\$2920	\$60	\$35

NOTES:

- Chassis and drawer fronts woodgrains and solid laminates are specified separately (see SIF options below).
- File drawers accept hanging folders in letter or legal size.
- Wardrobe, middle box drawer and file drawer are locking.
- Standard box drawers operate on ball-bearing suspension with full extension. File, lateral, and wide box drawers operate on ball-bearing suspension with full extension.
- Ships with one handle per drawer on all units.
- Adjustable hex leveling glides allow floor-standing furniture to be easily leveled without lifting the unit; glides have 1/4" adjustable range.
- Wardrobe/storage cabinet includes coat rod.
- Wardrobes contain easy access side storage shelves.

ⓘ Locking units equipped with HON "One Key" interchangeable core removable locks. Keyed alike core must be ordered separately.

HOW TO SPECIFY

Select Model Number HLSLW045L	Select Chassis Laminate See page 183 N	Select Drawer Front Laminate See page 183 N	Select Pull Color See page 183 T4
---	---	--	--



Icon Legend on page 19

EMPOWER[®] Voi[®] Laminate Storage Towers

WORKSTATIONS

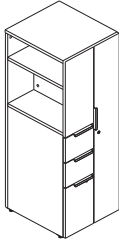

DESCRIPTION

MODEL

SHIP WEIGHT

CUBE

L1 LIST

L2 UPCHARGES
CHASSIS FRONTS

18" W x 20" D Storage Towers — Right Hand Drawers, Left Hand Door

18" W x 20" D x 50" H, Left
18" W x 20" D x 65" H, Left

HLSLW085L
HLSLW086L

139
167

13.4
17.3

\$1943
\$2208

\$45
\$50

\$35
\$35

18" W x 20" D Storage Towers — Left Hand Drawers, Right Hand Door

18" W x 20" D x 50" H, Right
18" W x 20" D x 65" H, Right

HLSLW085R
HLSLW086R

139
167

13.4
17.3

\$1943
\$2208

\$45
\$50

\$35
\$35

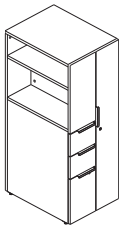

18" W x 24" D Storage Towers — Right Hand Drawers, Left Hand Door

18" W x 24" D x 50" H, Left
18" W x 24" D x 65" H, Left

HLSLW485L
HLSLW486L

167
200

15.8
21.5

\$2212
\$2452

\$50
\$55

\$35
\$35

18" W x 24" D Storage Towers — Left Hand Drawers, Right Hand Door

18" W x 24" D x 50" H, Right
18" W x 24" D x 65" H, Right

HLSLW485R
HLSLW486R

167
200

15.8
21.5

\$2212
\$2452

\$50
\$55

\$35
\$35

NOTES:

- Ships with one handle per drawer on all units.
- Chassis and drawer fronts woodgrains and solid laminates are specified separately (see SIF options below).
- File drawers accept hanging folders in letter or legal size.
- Standard box drawers operate on ball-bearing suspension with full extension. File and box drawers operate on ball-bearing suspension with full extension.
- Adjustable hex leveling glides allow floor-standing furniture to be easily leveled without lifting the unit; glides have 1/4" adjustable range.
- Wardrobe/storage cabinet includes coat rod.
- Wardrobes contain easy access side storage shelves.
- Wardrobe, middle box drawer and file drawer are locking.

! Locking units equipped with HON "One Key" interchangeable core removable locks. Keyed alike core must be ordered separately.

HOW TO SPECIFY

<p>Select Model Number</p> <p>HL SLW085L</p>	<p>Select Chassis Laminate</p> <p>See page 183</p> <p>N</p>	<p>Select Door/Drawer Front Laminate</p> <p>See page 183</p> <p>N</p>	<p>Select Pull Color</p> <p>See page 183</p> <p>T4</p>
---	--	--	---

EMPOWER[®] Contain[®] Metal Credenzas

GSA SIN 33721



Icon Legend on page 19

WORKSTATIONS

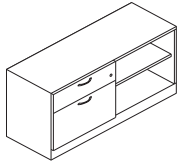

DESCRIPTION

Low Credenza, Box/Lateral Left, Open Shelf Right
72"W x 18"D x 22"H
60"W x 18"D x 22"H
48"W x 18"D x 22"H

MODEL

HSCP227218RBFOM
HSCP226018RBFOM
HSCP224818RBFOM

SHIP WEIGHT

150
130
111

CUBE

20.7
17.3
14.0

LIST PRICE BY PAINT GRADE

P1 P2 P3

\$2154 \$2221 \$2289
\$1943 \$2010 \$2078
\$1792 \$1859 \$1927

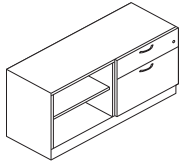

Low Credenza, Box/Lateral Right, Open Shelf Left
72"W x 18"D x 22"H
60"W x 18"D x 22"H
48"W x 18"D x 22"H

HSCP227218LBFOM
HSCP226018LBFOM
HSCP224818LBFOM

150
130
111

20.7
17.3
14.0

\$2154 \$2221 \$2289
\$1943 \$2010 \$2078
\$1792 \$1859 \$1927

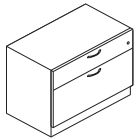

Low Credenza, Box/Lateral
36"W x 18"D x 22"H
30"W x 18"D x 22"H

HSCP223618BFM
HSCP223018BFM

87
76

10.6
9.0

\$1318 \$1351 \$1386
\$1263 \$1296 \$1331

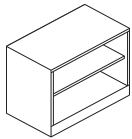

Open Shelf
36"W x 18"D x 22"H
30"W x 18"D x 22"H

HSCP223618O
HSCP223018O

66
60

10.6
9.0

\$939 \$972 \$1007
\$865 \$898 \$933

NOTES:

- Metal chassis and drawer fronts.
- Lateral and wide box drawers operate on ball-bearing suspension with full extension.
- Steel ball-bearing drawer suspensions.
- Ships complete with standard kickplate.
- Field installable counterweight sold separately.
- File drawers accept hanging folders in letter or legal size.
- Steel frame provides durability.
- Use with laminate tops and credenza seat cushions. Order separately — see pages 675-676.

⚠ Locking units equipped with HON "One Key" interchangeable core removable locks. Keyed alike core model HF23S, in Satin, must be ordered separately. See page 675.

HOW TO SPECIFY

<p>Select Model Number</p> <p>H S C P 2 2 3 6 1 8 0 .</p>	<p>Select Base</p> <p>BK Flush Plinth BX Recessed Plinth</p> <p>B K .</p>	<p>Select Case Paint</p> <p>See page 666</p> <p>P J W .</p>	<p>Select Shelf Paint</p> <p>See page 666</p> <p>P J W</p>
--	--	--	---

<p>Select Model Number</p> <p>H S C P 2 2 7 2 1 8 R B F O M .</p>	<p>Select Base</p> <p>BK Flush Plinth BX Recessed Plinth</p> <p>B K .</p>	<p>Select Pull</p> <p>A Arch PRO Silver R Radius N Integral S Square PR6 Silver</p> <p>A P R O .</p>	<p>Select Case Paint</p> <p>See page 666</p> <p>P J W .</p>	<p>Select Front Paint</p> <p>NA Matches Case</p> <p>N A .</p>	<p>Select Shelf Paint</p> <p>See page 666 Not specified for models HSCP223018BFM and HSCP223618BFM</p> <p>P J W .</p>	<p>Select Lock</p> <p>L Standard Lock X Omit Lock (- \$20) Not specified for models HSCP223618O and HSCP223018O</p> <p>L</p>
--	--	---	--	--	--	---



Icon Legend on page 19

EMPOWER® Contain® Footed Metal Credenzas

WORKSTATIONS

	DESCRIPTION	MODEL	SHIP WEIGHT	CUBE	LIST PRICE BY PAINT GRADE		
					P1	P2	P3
	Footed Low Credenza, Box/Lateral Left, Open Shelf Right						
	72"W x 18"D x 22"H	HSCF227218RBFOM	150	17.7	\$2327	\$2394	\$2462
	60"W x 18"D x 22"H	HSCF226018RBFOM	130	14.9	\$2118	\$2185	\$2253
	48"W x 18"D x 22"H	HSCF224818RBFOM	111	12.0	\$1932	\$1999	\$2067
	Footed Low Credenza, Box/Lateral Right, Open Shelf Left						
	72"W x 18"D x 22"H	HSCF227218LBFOM	150	17.7	\$2327	\$2394	\$2462
	60"W x 18"D x 22"H	HSCF226018LBFOM	130	14.9	\$2118	\$2185	\$2253
	48"W x 18"D x 22"H	HSCF224818LBFOM	111	12.0	\$1932	\$1999	\$2067
	Footed Low Credenza, Box/Lateral						
	36"W x 18"D x 22"H	HSCF223618BFM	87	9.1	\$1457	\$1490	\$1525
	30"W x 18"D x 22"H	HSCF223018BFM	76	7.7	\$1401	\$1434	\$1469
	Footed Open Shelf						
	36"W x 18"D x 22"H	HSCF223618O	66	9.1	\$1079	\$1112	\$1147
	30"W x 18"D x 22"H	HSCF223018O	60	7.7	\$1004	\$1037	\$1072

NOTES:

- Lateral and wide box drawers operate on ball-bearing suspension with full extension.
 - Steel ball-bearing drawer suspensions.
 - Ships complete with standard footed base.
 - Field installable counterweight sold separately.
 - File drawers accept hanging folders in letter or legal size.
 - Steel frame provides durability.
 - Feet are shipped with the credenza unit and are easily assembled.
 - Use with laminate tops and credenza seat cushions. Order separately — see pages 675-676.
- ⓘ Locking units equipped with HON "One Key" interchangeable core removable locks. Keyed alike core model HF23S, in Satin, must be ordered separately. See page 675.

HOW TO SPECIFY

<p>Select Model Number</p> <p>HSCF223618O</p>	<p>Select Foot</p> <p>SF Contain Foot T1 Platinum Metallic PR6 Silver</p> <p>SFT1</p>	<p>Select Case Paint</p> <p>See page 666</p> <p>PJW</p>	<p>Select Shelf Paint</p> <p>See page 666</p> <p>PJW</p>
--	--	--	---

<p>Select Model Number</p> <p>HSCF227218RBFOM</p>	<p>Select Foot</p> <p>SF Contain Foot T1 Platinum Metallic PR6 Silver</p> <p>SFT1</p>	<p>Select Pull</p> <p>A Arch PRO Silver R Radius N Integral S Square PR6 Silver</p> <p>APRO</p>	<p>Select Case Paint</p> <p>See page 666</p> <p>PJW</p>	<p>Select Front Paint</p> <p>NA Matches Case</p> <p>NA</p>	<p>Select Shelf Paint</p> <p>See page 666 Not specified for models HSCF223618BFM and HSCF223018BFM</p> <p>PJW</p>	<p>Select Lock</p> <p>L Standard Lock X Omit Lock (- \$20) Not specified for models HSCF223618O and HSCF223018O</p> <p>L</p>
--	--	--	--	---	--	---



Icon Legend on page 19

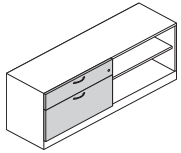

DESCRIPTION

Metal Low Credenza, Laminate Front, Box/Lateral Left, Open Shelf Right
 72"W x 18"D x 22"H
 60"W x 18"D x 22"H
 48"W x 18"D x 22"H

MODEL

HSCP227218RBFOL
HSCP226018RBFOL
HSCP224818RBFOL

SHIP WEIGHT

CUBE

LIST PRICE BY PAINT GRADE

P1 P2 P3

152	20.7	\$2389	\$2456	\$2524
132	17.3	\$2179	\$2246	\$2314
113	14.0	\$2027	\$2094	\$2162

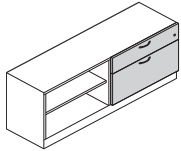

Metal Low Credenza, Laminate Front, Box/Lateral Right, Open Shelf Left
 72"W x 18"D x 22"H
 60"W x 18"D x 22"H
 48"W x 18"D x 22"H

HSCP227218LBFOL
HSCP226018LBFOL
HSCP224818LBFOL

152	20.7	\$2389	\$2456	\$2524
132	17.3	\$2179	\$2246	\$2314
113	14.0	\$2027	\$2094	\$2162

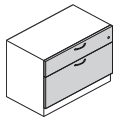

Metal Low Credenza, Laminate Front Box/Lateral
 36"W x 18"D x 22"H
 30"W x 18"D x 22"H

HSCP223618BFL
HSCP223018BFL

89	10.6	\$1553	\$1586	\$1621
76	9.0	\$1497	\$1530	\$1565

NOTES:

- Lateral and wide box drawers operate on ball-bearing suspension with full extension.
- Steel ball-bearing drawer suspensions.
- Ships complete with standard kickplate.
- Field installable counterweight sold separately.
- File drawers accept hanging folders in letter or legal size.
- Steel frame provides durability.
- Use with laminate tops and credenza seat cushions. Order separately — see pages 675-676.

ⓘ Locking units equipped with HON "One Key" interchangeable core removable locks. Keyed alike core model HF23S, in Satin, must be ordered separately. See page 675.

HOW TO SPECIFY

Select Model Number	Select Base	Select Pull	Select Case Paint	Select Laminate	Select Shelf Paint	Select Lock
	BX Recessed Plinth	A Arch PRO Silver S Square PR6 Silver	See page 666	See page 666	See page 666 Not specified for models HSCP223618BFL and HSCP223018BFL	L Standard Lock X Omit Lock (- \$20)
H S C P 2 2 7 2 1 8 R B F O L .	B X .	A P R O .	P J W .	L S A 1 .	P J W .	L



Icon Legend on page 19

Contain® Footed Metal Credenzas with Laminate Fronts

	DESCRIPTION	MODEL	SHIP WEIGHT	CUBE	LIST PRICE BY PAINT GRADE		
					P1	P2	P3
	Footed Low Credenza, Laminated Front, Box/Lateral Left, Open Shelf Right						
	72"W x 18"D x 22"H	HSCF227218RBFOL	152	17.7	\$2564	\$2631	\$2699
	60"W x 18"D x 22"H	HSCF226018RBFOL	132	14.9	\$2352	\$2419	\$2487
	48"W x 18"D x 22"H	HSCF224818RBFOL	113	12.0	\$2167	\$2234	\$2302
	Footed Low Credenza, Laminated Front, Box/Lateral Right, Open Shelf Left						
	72"W x 18"D x 22"H	HSCF227218LBFOL	152	17.7	\$2564	\$2631	\$2699
	60"W x 18"D x 22"H	HSCF226018LBFOL	132	14.9	\$2352	\$2419	\$2487
	48"W x 18"D x 22"H	HSCF224818LBFOL	113	12.0	\$2167	\$2234	\$2302
	Footed Low Credenza, Laminated Front Box/Lateral						
	36"W x 18"D x 22"H	HSCF223618BFL	89	9.1	\$1692	\$1725	\$1760
	30"W x 18"D x 22"H	HSCF223018BFL	78	7.7	\$1638	\$1671	\$1706

NOTES:

- Lateral and wide box drawers operate on ball-bearing suspension with full extension.
- Steel ball-bearing drawer suspensions.
- Ships complete with standard footed base.
- Field installable counterweight sold separately.
- File drawers accept hanging folders in letter or legal size.
- Steel frame provides durability.
- Feet are shipped with the credenza unit and are easily assembled.
- Use with laminate tops and credenza seat cushions. Order separately — see pages 675-676.

! Locking units equipped with HON "One Key" interchangeable core removable locks. Keyed alike core model HF23S, in Satin, must be ordered separately. See page 675.

HOW TO SPECIFY

Select Model Number H S C F 2 2 7 2 1 8 R B F O L	Select Foot SF Contain Foot T1 Platinum Metallic PR6 Silver	Select Pull A Arch PRO Silver S Square PR6 Silver	Select Case Paint See page 666 P J W	Select Laminate See page 666 L S A 1	Select Shelf Paint See page 666 Not specified for models HSCF223618BFL and HSCF223018BFL P J W	Select Lock L Standard Lock X Omit Lock (- \$20) L
---	--	--	---	---	--	--

EMPOWER® Contain® Metal Credenzas Accessories

GSA SIN 33721



Icon Legend on page 19

WORKSTATIONS

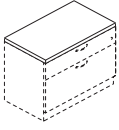

DESCRIPTION	MODEL	SHIP WEIGHT CUBE													
		1	2	3	4	5	6	7	8	9	10	11	12		
Credenza Cushion 36"W x 18"D for 36", 60", and 72" Credenzas	HSCAUC1836	16.3	1.6	\$313	\$351	\$389	\$428	\$477	\$527	\$577	\$626	\$676	\$725	\$775	\$825
30"W x 18"D for 30", 48", and 60" Credenzas	HSCAUC1830	16.3	1.6	\$292	\$330	\$368	\$407	\$456	\$506	\$556	\$605	\$655	\$704	\$754	\$804
24"W x 18"D for 48" Credenzas	HSCAUC1824	16.3	1.9	\$273	\$311	\$349	\$388	\$437	\$487	\$537	\$586	\$636	\$685	\$735	\$785

NOTES: See pages 22-24 for available fabrics.
SPECIFYING EXAMPLE: HSCAUC1836.APN23

NOTES:

- For matching Pedestal Seats, see page 701.
- Credenza Cushions are available in 24", 30" and 36" size options.
- Choose from multiple upholstery options, see pages 22-24.

HOW TO SPECIFY

Select Model Number

H S C A U C 1 8 3 6 .

Select Fabric

See pages 22-24

A B 1 0

	DESCRIPTION	MODEL	SHIP WEIGHT	CUBE	LIST PRICE
					P1
	Metal Box Divider 10 pack	HSCABD10	7	0.7	\$189
	2 pack	HSCABD02	2	0.7	\$48
! Metal dividers available in Black only. No need to specify.					
	Metal File Divider 10 pack	HSCAFD10	12	0.7	\$224
	2 pack	HSCAFD02	3	0.7	\$60
! Metal dividers available in Black only. No need to specify.					



Icon Legend on page 19

EMPOWER® Contain® Metal Personal Towers

WORKSTATIONS

	DESCRIPTION	MODEL	SHIP WEIGHT	CUBE	LIST PRICE BY PAINT GRADE		
					P1	P2	P3
	Personal Tower with Metal Fronts, Door/Box/Box/File						
	65”H x 24”W x 24”D, Wardrobe Left	HSTP652424LBBFM	178	27.2	\$2266	\$2343	\$2411
	65”H x 24”W x 24”D, Wardrobe Right	HSTP652424RBBFM	178	27.2	\$2266	\$2343	\$2411
	50”H x 24”W x 24”D, Wardrobe Left	HSTP502424LBBFM	146	21.2	\$2120	\$2197	\$2265
	50”H x 24”W x 24”D, Wardrobe Right	HSTP502424RBBFM	146	21.2	\$2120	\$2197	\$2265
	42”H x 24”W x 24”D, Wardrobe Left	HSTP422424LBBFM	132	16.8	\$1822	\$1872	\$1947
	42”H x 24”W x 24”D, Wardrobe Right	HSTP422424RBBFM	132	16.8	\$1822	\$1872	\$1947
	Personal Tower with Metal Fronts, Door/File/File						
	65”H x 24”W x 24”D, Wardrobe Left	HSTP652424LFFM	178	27.2	\$2208	\$2285	\$2353
	65”H x 24”W x 24”D, Wardrobe Right	HSTP652424RFFM	178	27.2	\$2208	\$2285	\$2353
	50”H x 24”W x 24”D, Wardrobe Left	HSTP502424LFFM	146	21.1	\$2065	\$2142	\$2210
	50”H x 24”W x 24”D, Wardrobe Right	HSTP502424RFFM	146	21.1	\$2065	\$2142	\$2210
	42”H x 24”W x 24”D, Wardrobe Left	HSTP422424LFFM	132	16.8	\$1765	\$1815	\$1890
	42”H x 24”W x 24”D, Wardrobe Right	HSTP422424RFFM	132	16.8	\$1765	\$1815	\$1890

NOTES:

- Metal chassis and drawer fronts.
- Steel frame provides durability.
- Leveling glides can be adjusted from outside or inside the case.
- Heavy-duty, telescoping ball-bearing slides.
- Baked, epoxy/polyester, powder coating finish.
- One lock secures doors and drawers.
- Pencil tray standard in top box drawer.
- One box divider standard in each box drawer.
- One crossrail standard in each file drawer.

! Locking units equipped with HON “One Key” interchangeable core removable locks. Keyed alike core model HF23S, in Satin, must be ordered separately. See page 675.

HOW TO SPECIFY

<p>Select Model Number</p> <p>H S T P 6 5 2 4 2 4 L F F M .</p>	<p>Select Base</p> <p>BK Flush Plinth BX Recessed Plinth</p> <p>B X .</p>	<p>Select Pull</p> <p>A Arch PRO Silver R Radius N Integral S Square PR6 Silver</p> <p>S P R 6 .</p>	<p>Select Case Paint</p> <p>See page 666</p> <p>P 7 T .</p>	<p>Select Front Paint</p> <p>NA Matches Case</p> <p>N A .</p>	<p>Select Lock</p> <p>L Standard Lock X Omit Lock (- \$20)</p> <p>L</p>
--	--	---	--	--	--

EMPOWER® Contain® Metal Side Access Towers

GSA SIN 33721



Icon Legend on page 19

WORKSTATIONS

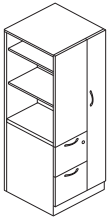
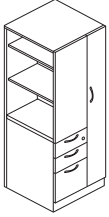

DESCRIPTION	MODEL	SHIP WEIGHT	CUBE	LIST PRICE BY PAINT GRADE		
				P1	P2	P3
Side Access Tower with Metal Fronts, Shelves/Box/Box/File						
65"H x 24"W x 24"D, Wardrobe Left	HSTSP652424LBBFM	178	27.2	\$2399	\$2476	\$2544
65"H x 24"W x 24"D, Wardrobe Right	HSTSP652424RBBFM	178	27.2	\$2399	\$2476	\$2544
50"H x 24"W x 24"D, Wardrobe Left	HSTSP502424LBBFM	146	21.2	\$2247	\$2324	\$2392
50"H x 24"W x 24"D, Wardrobe Right	HSTSP502424RBBFM	146	21.2	\$2247	\$2324	\$2392
42"H x 24"W x 24"D, Wardrobe Left	HSTSP422424LBBFM	132	16.8	\$2027	\$2077	\$2152
42"H x 24"W x 24"D, Wardrobe Right	HSTSP422424RBBFM	132	16.8	\$2027	\$2077	\$2152
Side Access Tower with Metal Fronts, Shelves/File/File						
65"H x 24"W x 24"D, Wardrobe Left	HSTSP652424LFFM	178	27.2	\$2344	\$2421	\$2489
65"H x 24"W x 24"D, Wardrobe Right	HSTSP652424RFFM	178	27.2	\$2344	\$2421	\$2489
50"H x 24"W x 24"D, Wardrobe Left	HSTSP502424LFFM	146	21.2	\$2190	\$2267	\$2335
50"H x 24"W x 24"D, Wardrobe Right	HSTSP502424RFFM	146	21.2	\$2190	\$2267	\$2335
42"H x 24"W x 24"D, Wardrobe Left	HSTSP422424LFFM	132	16.8	\$1971	\$2021	\$2096
42"H x 24"W x 24"D, Wardrobe Right	HSTSP422424RFFM	132	16.8	\$1971	\$2021	\$2096

NOTES:

- Towers can be used to support a worksurface. In order to do so, order bracket model HSTB2W1.
- Metal chassis and drawer fronts.
- Steel frame provides durability.
- Leveling glides can be adjusted from outside or inside the case.
- Heavy-duty, telescoping ball-bearing slides.
- Baked, epoxy/polyester, powder coating finish.
- One lock secures doors and drawers.
- Pencil tray standard in top box drawer.
- One box divider standard in each box drawer.
- One crossrail standard in each file drawer.

⚠ Locking units equipped with HON "One Key" interchangeable core removable locks. Keyed alike core model HF23S, in Satin, must be ordered separately. See page 675.

HOW TO SPECIFY

<p>Select Model Number</p> <p>H S T S P 6 5 2 4 2 4 L F F M .</p>	<p>Select Base</p> <p>BK Flush Plinth BX Recessed Plinth</p> <p>B X .</p>	<p>Select Pull</p> <p>A Arch PRO Silver R Radius N Integral S Square PR6 Silver</p> <p>S P R 6 .</p>	<p>Select Case Paint</p> <p>See page 666</p> <p>P 7 T .</p>	<p>Select Front Paint</p> <p>NA Matches Case</p> <p>N A .</p>	<p>Select Panel Paint</p> <p>NA Matches Case</p> <p>N A .</p>	<p>Select Lock</p> <p>L Standard Lock X Lock Omit Lock (- \$20)</p> <p>L</p>
--	--	---	--	--	--	---



Icon Legend on page 19

Contain® Metal Personal Towers with Laminate Fronts

	DESCRIPTION	MODEL	SHIP WEIGHT	CUBE	LIST PRICE BY PAINT GRADE		
					P1	P2	P3
	Personal Tower with Laminate Fronts, Door/Box/Box/File						
	65”H x 24”W x 24”D, Wardrobe Left	HSTP652424LBBFL	178	27.2	\$2595	\$2672	\$2740
	65”H x 24”W x 24”D, Wardrobe Right	HSTP652424RBBFL	178	27.2	\$2595	\$2672	\$2740
	50”H x 24”W x 24”D, Wardrobe Left	HSTP502424LBBFL	146	21.2	\$2430	\$2507	\$2575
	50”H x 24”W x 24”D, Wardrobe Right	HSTP502424RBBFL	146	21.2	\$2430	\$2507	\$2575
	42”H x 24”W x 24”D, Wardrobe Left	HSTP422424LBBFL	132	16.8	\$2086	\$2136	\$2211
	42”H x 24”W x 24”D, Wardrobe Right	HSTP422424RBBFL	132	16.8	\$2086	\$2136	\$2211
	Personal Tower with Laminate Fronts, Door/File/File						
	65”H x 24”W x 24”D, Wardrobe Left	HSTP652424LFFL	178	27.2	\$2539	\$2616	\$2684
	65”H x 24”W x 24”D, Wardrobe Right	HSTP652424RFFL	178	27.2	\$2539	\$2616	\$2684
	50”H x 24”W x 24”D, Wardrobe Left	HSTP502424LFFL	146	21.2	\$2374	\$2451	\$2519
	50”H x 24”W x 24”D, Wardrobe Right	HSTP502424RFFL	146	21.2	\$2374	\$2451	\$2519
	42”H x 24”W x 24”D, Wardrobe Left	HSTP422424LFFL	132	16.8	\$2029	\$2079	\$2154
	42”H x 24”W x 24”D, Wardrobe Right	HSTP422424RFFL	132	16.8	\$2029	\$2079	\$2154

NOTES:

- Metal chassis with laminate drawer/door fronts.
- Steel frame provides durability.
- Leveling glides can be adjusted from outside or inside the case.
- Heavy-duty, telescoping ball-bearing slides.
- Baked, epoxy/polyester, powder coating finish.
- One lock secures doors and drawers.
- Pencil tray standard in top box drawer.
- One box divider standard in each box drawer.
- One crossrail standard in each file drawer.

! Locking units equipped with HON “One Key” interchangeable core removable locks. Keyed alike core model HF23S, in Satin, must be ordered separately. See page 675.

HOW TO SPECIFY

Select Model Number	Select Base	Select Pull	Select Case Paint	Select Laminate	Select Lock
	BX Recessed Plinth	A Arch PRO Silver S Square PR6 Silver	See page 666	See page 666	L Standard Lock X Omit Lock (- \$20)
H S T P 6 5 2 4 2 4 L F F L .	B X .	S P R 6 .	P 7 T .	L S A 1 .	L

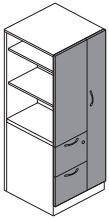
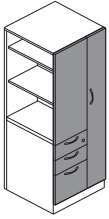

DESCRIPTION	MODEL	SHIP WEIGHT	CUBE	LIST PRICE BY PAINT GRADE		
				P1	P2	P3
Side Access Tower with Laminate Fronts, Shelves/Box/Box/File						
65"H x 24"W x 24"D, Wardrobe Left	HSTSP652424LBBFL	178	27.2	\$2750	\$2827	\$2895
65"H x 24"W x 24"D, Wardrobe Right	HSTSP652424RBBFL	178	27.2	\$2750	\$2827	\$2895
50"H x 24"W x 24"D, Wardrobe Left	HSTSP502424LBBFL	146	21.2	\$2574	\$2651	\$2719
50"H x 24"W x 24"D, Wardrobe Right	HSTSP502424RBBFL	146	21.2	\$2574	\$2651	\$2719
42"H x 24"W x 24"D, Wardrobe Left	HSTSP422424LBBFL	132	16.8	\$2322	\$2372	\$2447
42"H x 24"W x 24"D, Wardrobe Right	HSTSP422424RBBFL	132	16.8	\$2322	\$2372	\$2447
Side Access Tower with Laminate Fronts, Shelves/File/File						
65"H x 24"W x 24"D, Wardrobe Left	HSTSP652424LFFL	178	27.2	\$2695	\$2772	\$2840
65"H x 24"W x 24"D, Wardrobe Right	HSTSP652424RFFL	178	27.2	\$2695	\$2772	\$2840
50"H x 24"W x 24"D, Wardrobe Left	HSTSP502424LFFL	146	21.2	\$2519	\$2596	\$2664
50"H x 24"W x 24"D, Wardrobe Right	HSTSP502424RFFL	146	21.2	\$2519	\$2596	\$2664
42"H x 24"W x 24"D, Wardrobe Left	HSTSP422424LFFL	132	16.8	\$2267	\$2317	\$2392
42"H x 24"W x 24"D, Wardrobe Right	HSTSP422424RFFL	132	16.8	\$2267	\$2317	\$2392

NOTES:

- Towers can be used to support a worksurface. In order to do so, order bracket model HSTB2W1.
- Metal chassis with laminate drawer/door fronts.
- Steel frame provides durability.
- Leveling glides can be adjusted from outside or inside the case.
- Heavy-duty, telescoping ball-bearing slides.
- Baked, epoxy/polyester, powder coating finish.
- One lock secures doors and drawers.
- Pencil tray standard in top box drawer.
- One box divider standard in each box drawer.
- One crossrail standard in each file drawer.

⚠ Locking units equipped with HON "One Key" interchangeable core removable locks. Keyed alike core model HF23S, in Satin, must be ordered separately. See page 675.

HOW TO SPECIFY

<p>Select Model Number</p> <p>H S T S P 6 5 2 4 2 4 L F F L .</p>	<p>Select Base</p> <p>BX Recessed Plinth</p> <p>B X .</p>	<p>Select Pull</p> <p>A Arch PRO Silver S Square PR6 Silver</p> <p>S P R 6 .</p>	<p>Select Case Paint</p> <p>See page 666</p> <p>P 7 T .</p>	<p>Select Laminate</p> <p>See page 666</p> <p>L S A 1 .</p>	<p>Select Lock</p> <p>L Standard Lock X Omit Lock (- \$20)</p> <p>L</p>
--	--	---	--	--	--



Icon Legend on page 19

Contain® Footed Metal Personal Towers

	DESCRIPTION	MODEL	SHIP WEIGHT	CUBE	LIST PRICE BY PAINT GRADE		
					P1	P2	P3
	Footed Personal Tower with Metal Fronts, Door/Box/Box/File						
	65”H x 24”W x 24”D, Wardrobe Left	HSTF652424LBBFM	178	25.8	\$2399	\$2476	\$2544
	65”H x 24”W x 24”D, Wardrobe Right	HSTF652424RBBFM	178	25.8	\$2399	\$2476	\$2544
	50”H x 24”W x 24”D, Wardrobe Left	HSTF502424LBBFM	146	19.8	\$2255	\$2332	\$2400
	50”H x 24”W x 24”D, Wardrobe Right	HSTF502424RBBFM	146	19.8	\$2255	\$2332	\$2400
	42”H x 24”W x 24”D, Wardrobe Left	HSTF422424LBBFM	132	18.2	\$1955	\$2005	\$2080
	42”H x 24”W x 24”D, Wardrobe Right	HSTF422424RBBFM	132	18.2	\$1955	\$2005	\$2080
	Footed Personal Tower with Metal Fronts, Door/File/File						
	65”H x 24”W x 24”D, Wardrobe Left	HSTF652424LFFM	178	25.8	\$2344	\$2421	\$2489
	65”H x 24”W x 24”D, Wardrobe Right	HSTF652424RFFM	178	25.8	\$2344	\$2421	\$2489
	50”H x 24”W x 24”D, Wardrobe Left	HSTF502424LFFM	146	19.8	\$2199	\$2276	\$2344
	50”H x 24”W x 24”D, Wardrobe Right	HSTF502424RFFM	146	19.8	\$2199	\$2276	\$2344
	42”H x 24”W x 24”D, Wardrobe Left	HSTF422424LFFM	132	18.2	\$1900	\$1950	\$2025
	42”H x 24”W x 24”D, Wardrobe Right	HSTF422424RFFM	132	18.2	\$1900	\$1950	\$2025

NOTES:

- Metal chassis and drawer fronts.
- Steel frame provides durability.
- Leveling glides can be adjusted from outside or inside the case.
- Heavy-duty, telescoping ball-bearing slides.
- Baked, epoxy/polyester, powder coating finish.
- One lock secures doors and drawers.
- Pencil tray standard in top box drawer.
- One box divider standard in each box drawer.
- One crossrail standard in each file drawer.

! Locking units equipped with HON “One Key” interchangeable core removable locks. Keyed alike core model HF23S, in Satin, must be ordered separately. See page 675.

HOW TO SPECIFY

<p>Select Model Number</p> <p>H S T F 4 2 2 4 2 4 L B B F M .</p>	<p>Select Foot</p> <p>SF Contain Foot T1 Platinum Metallic PR6 Silver</p> <p>S F T 1 .</p>	<p>Select Pull</p> <p>A Arch PRO Silver R Radius N Integral S Square PR6 Silver</p> <p>S P R 6 .</p>	<p>Select Paint Color</p> <p>See page 666</p> <p>P 7 T .</p>	<p>Select Front Paint</p> <p>NA Matches Case</p> <p>N A .</p>	<p>Select Lock</p> <p>L Standard Lock X Omit Lock (- \$20)</p> <p>L</p>
--	---	---	---	--	--

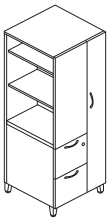
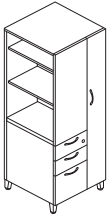

DESCRIPTION	MODEL	SHIP WEIGHT	CUBE	LIST PRICE BY PAINT GRADE		
				P1	P2	P3
Footed Side Access Tower with Metal Fronts, Shelves/Box/Box/File						
65"H x 24"W x 24"D, Wardrobe Left	HSTSF652424LBBFM	178	25.8	\$2534	\$2611	\$2679
65"H x 24"W x 24"D, Wardrobe Right	HSTSF652424RBBFM	178	25.8	\$2534	\$2611	\$2679
50"H x 24"W x 24"D, Wardrobe Left	HSTSF502424LBBFM	146	19.8	\$2380	\$2457	\$2525
50"H x 24"W x 24"D, Wardrobe Right	HSTSF502424RBBFM	146	19.8	\$2380	\$2457	\$2525
42"H x 24"W x 24"D, Wardrobe Left	HSTSF422424LBBFM	132	18.2	\$2162	\$2212	\$2287
42"H x 24"W x 24"D, Wardrobe Right	HSTSF422424RBBFM	132	18.2	\$2162	\$2212	\$2287
Footed Side Access Tower with Metal Fronts, Shelves/File/File						
65"H x 24"W x 24"D, Wardrobe Left	HSTSF652424LFFM	178	25.8	\$2478	\$2555	\$2623
65"H x 24"W x 24"D, Wardrobe Right	HSTSF652424RFFM	178	25.8	\$2478	\$2555	\$2623
50"H x 24"W x 24"D, Wardrobe Left	HSTSF502424LFFM	146	19.8	\$2324	\$2401	\$2469
50"H x 24"W x 24"D, Wardrobe Right	HSTSF502424RFFM	146	19.8	\$2324	\$2401	\$2469
42"H x 24"W x 24"D, Wardrobe Left	HSTSF422424LFFM	132	18.2	\$2106	\$2156	\$2231
42"H x 24"W x 24"D, Wardrobe Right	HSTSF422424RFFM	132	18.2	\$2106	\$2156	\$2231

NOTES:

- Towers can be used to support a worksurface. In order to do so, order bracket model HSTB2W1.
- Metal chassis and drawer fronts.
- Steel frame provides durability.
- Leveling glides can be adjusted from outside or inside the case.
- Heavy-duty, telescoping ball-bearing slides.
- Baked, epoxy/polyester, powder coating finish.
- One lock secures doors and drawers.
- Pencil tray standard in top box drawer.
- One box divider standard in each box drawer.
- One crossrail standard in each file drawer.

! Locking units equipped with HON "One Key" interchangeable core removable locks. Keyed alike core model HF23S, in Satin, must be ordered separately. See page 675.

HOW TO SPECIFY

<p>Select Model Number</p> <p>H S T S F 4 2 2 4 2 4 R B B F M</p>	<p>Select Foot</p> <p>SF Contain Foot T1 Platinum Metallic PR6 Silver</p> <p>S F T 1</p>	<p>Select Pull</p> <p>A Arch PRO Silver R Radius N Integral S Square PR6 Silver</p> <p>S P R 6</p>	<p>Select Paint Color</p> <p>See page 666</p> <p>P 7 T</p>	<p>Select Front Paint</p> <p>NA Matches Case</p> <p>N A</p>	<p>Select Panel Paint</p> <p>NA Matches Case</p> <p>N A</p>	<p>Select Lock</p> <p>L Standard X Lock Omit Lock (- \$20)</p> <p>L</p>
--	---	---	---	--	--	--



Icon Legend on page 19

Contain® Footed Metal Personal Towers with Laminate Fronts

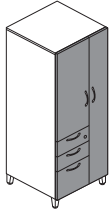

DESCRIPTION	MODEL	SHIP WEIGHT	CUBE	LIST PRICE BY PAINT GRADE		
				P1	P2	P3
Footed Personal Tower with Laminate Fronts, Door/Box/Box/File						
65"H x 24"W x 24"D, Wardrobe Left	HSTF652424LBBFL	178	25.8	\$2730	\$2807	\$2875
65"H x 24"W x 24"D, Wardrobe Right	HSTF652424RBBFL	178	25.8	\$2730	\$2807	\$2875
50"H x 24"W x 24"D, Wardrobe Left	HSTF502424LBBFL	146	19.8	\$2564	\$2641	\$2709
50"H x 24"W x 24"D, Wardrobe Right	HSTF502424RBBFL	146	19.8	\$2564	\$2641	\$2709
42"H x 24"W x 24"D, Wardrobe Left	HSTF422424LBBFL	132	18.2	\$2220	\$2270	\$2345
42"H x 24"W x 24"D, Wardrobe Right	HSTF422424RBBFL	132	18.2	\$2220	\$2270	\$2345

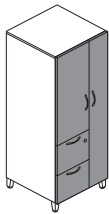

Footed Personal Tower with Laminate Fronts, Door/File/File						
65"H x 24"W x 24"D, Wardrobe Left	HSTF652424LFFL	178	25.8	\$2674	\$2751	\$2819
65"H x 24"W x 24"D, Wardrobe Right	HSTF652424RFFL	178	25.8	\$2674	\$2751	\$2819
50"H x 24"W x 24"D, Wardrobe Left	HSTF502424LFFL	146	19.8	\$2507	\$2584	\$2652
50"H x 24"W x 24"D, Wardrobe Right	HSTF502424RFFL	146	19.8	\$2507	\$2584	\$2652
42"H x 24"W x 24"D, Wardrobe Left	HSTF422424LFFL	132	18.2	\$2165	\$2215	\$2290
42"H x 24"W x 24"D, Wardrobe Right	HSTF422424RFFL	132	18.2	\$2165	\$2215	\$2290

NOTES:

- Metal chassis with laminate drawer/door fronts.
- Steel frame provides durability.
- Leveling glides can be adjusted from outside or inside the case.
- Heavy-duty, telescoping ball-bearing slides.
- Baked, epoxy/polyester, powder coating finish.
- One lock secures doors and drawers.
- Pencil tray standard in top box drawer.
- One box divider standard in each box drawer.
- One crossrail standard in each file drawer.

ⓘ Locking units equipped with HON "One Key" interchangeable core removable locks. Keyed alike core model HF23S, in Satin, must be ordered separately. See page 675.

HOW TO SPECIFY

Select Model Number H S T F 6 5 2 4 2 4 L B B F L .	Select Foot SF Contain Foot T1 Platinum Metallic PR6 Silver	Select Pull A Arch PRO Silver S Square PR6 Silver	Select Case Paint See page 666 P 7 T .	Select Laminate See page 666 L S A 1 .	Select Lock L Standard Lock X Omit Lock (- \$20) L
---	---	--	---	---	--

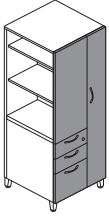

DESCRIPTION	MODEL	SHIP WEIGHT	CUBE	LIST PRICE BY PAINT GRADE		
				P1	P2	P3
Footed Side Access Tower with Laminate Fronts, Shelves/Box/Box/File						
65"H x 24"W x 24"D, Wardrobe Left	HSTSF652424LBBFL	178	25.8	\$2885	\$2962	\$3030
65"H x 24"W x 24"D, Wardrobe Right	HSTSF652424RBBFL	178	25.8	\$2885	\$2962	\$3030
50"H x 24"W x 24"D, Wardrobe Left	HSTSF502424LBBFL	146	19.8	\$2709	\$2786	\$2854
50"H x 24"W x 24"D, Wardrobe Right	HSTSF502424RBBFL	146	19.8	\$2709	\$2786	\$2854
42"H x 24"W x 24"D, Wardrobe Left	HSTSF422424LBBFL	132	18.2	\$2457	\$2507	\$2582
42"H x 24"W x 24"D, Wardrobe Right	HSTSF422424RBBFL	132	18.2	\$2457	\$2507	\$2582

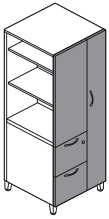

Footed Side Access Tower with Laminate Fronts, Shelves/File/File						
65"H x 24"W x 24"D, Wardrobe Left	HSTSF652424LFFFL	178	25.8	\$2829	\$2906	\$2974
65"H x 24"W x 24"D, Wardrobe Right	HSTSF652424RFFFL	178	25.8	\$2829	\$2906	\$2974
50"H x 24"W x 24"D, Wardrobe Left	HSTSF502424LFFFL	146	19.8	\$2653	\$2730	\$2798
50"H x 24"W x 24"D, Wardrobe Right	HSTSF502424RFFFL	146	19.8	\$2653	\$2730	\$2798
42"H x 24"W x 24"D, Wardrobe Left	HSTSF422424LFFFL	132	18.2	\$2400	\$2450	\$2525
42"H x 24"W x 24"D, Wardrobe Right	HSTSF422424RFFFL	132	18.2	\$2400	\$2450	\$2525



Tower Kickplates (Field Installable)						
For 24" Tower, Left	HSTAKL	2	0.3	\$179	\$187	\$192
For 24" Tower, Right	HSTAKR	2	0.3	\$179	\$187	\$192

Specify: Model.Paint
SPECIFYING EXAMPLE: HSATKL.P

NOTES:

- Towers can be used to support a worksurface. In order to do so, order bracket model HSTB2W1.
 - Metal chassis with laminate drawer/door fronts.
 - Steel frame provides durability.
 - Leveling glides can be adjusted from outside or inside the case.
 - Heavy-duty, telescoping ball-bearing slides.
 - Baked, epoxy/polyester, powder coating finish.
 - One lock secures doors and drawers.
 - Pencil tray standard in top box drawer.
 - One box divider standard in each box drawer.
 - One crossrail standard in each file drawer.
- ⚠ Locking units equipped with HON "One Key" interchangeable core removable locks. Keyed alike core model HF23S, in Satin, must be ordered separately. See page 675.

HOW TO SPECIFY

Select Model Number H S T S F 6 5 2 4 2 4 L B B F L	Select Foot SF Contain Foot T1 Platinum Metallic PR6 Silver	Select Pull A Arch PRO Silver S Square PR6 Silver	Select Case Paint See page 666	Select Laminate See page 666	Select Lock L Standard Lock X Omit Lock (- \$20)
H S T S F 6 5 2 4 2 4 L B B F L .	S F T 1 .	S P R 6 .	P 7 T .	L S A 1 .	L



Icon Legend on page 19

EMPOWER[®] Contain[®] Metal Pedestals

WORKSTATIONS

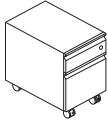

DESCRIPTION	MODEL	SHIP WEIGHT	CUBE	LIST PRICE BY PAINT GRADE		
				P1	P2	P3
Mobile Pedestal with Metal Fronts, Box/File						
21"H x 15"W x 18"D	HSPM211518BFM(?)	63.5	4.4	\$627	\$655	\$683
21"H x 15"W x 24"D	HSPM211524BFM(?)	61.9	5.7	\$673	\$701	\$729

NOTES: Ball-bearing suspension on box and file drawer. (100%) Drawers color to be interior gray steel. See page 568 for Pedestal Seat. File drawer has high sides and back for filing front-to-back and side-to-side. Counterweight standard on all mobile peds. Optional steel tops and pedestal seat cushions available. See pages 566 and 569. Pencil tray standard in top box drawer. One box divider standard in each box drawer. One crossrail standard in each file drawer.

- ! Available drawer fronts; R-Pull, A-Pull and N-Pull. A-Pull available in Satin Chrome only.
- ! Peds come with a plinth base, footed base or mobile base.

HOW TO SPECIFY

<p>Select Model Number</p> <p>Replace (?) with handle choice</p> <p>A Satin Chrome Arch N Full Face Integral R Full Radius</p> <p>H S P M 2 1 1 5 1 8 B F M A .</p>	<p>Select Paint Color</p> <p>See page 504 Contain[®] Storage finish options</p> <p>P .</p>	<p>Select Lock Option</p> <p>L Standard Lock X Omit Lock (deduct \$20)</p> <p>L</p>
--	---	---

EMPOWER® Contain® Footed Metal Pedestals

GSA SIN 33721 EXCEPT AS NOTED



Icon Legend on page 19

WORKSTATIONS

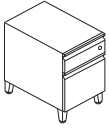

DESCRIPTION	MODEL	SHIP WEIGHT	CUBE	LIST PRICE BY PAINT GRADE		
				P1	P2	P3
Footed Freestanding Pedestal with Metal Fronts, Box/File						
22"H x 15"W x 18"D	HSPFSF221518BFM(?)	66.8	4.4	\$737	\$765	\$793
22"H x 15"W x 24"D	HSPFSF221524BFM(?)	73.1	5.7	\$779	\$807	\$835

NOTES: Ball-bearing suspension on box and file drawer. (100%) Drawers color to be interior gray steel. File drawer has high sides and back for filing front-to-back and side-to-side. Counterweight standard on all mobile peds. Optional steel tops and pedestal seat cushions available. See pages 566 and 569. Pencil tray standard in top box drawer. One box divider standard in each box drawer. One crossrail standard in each file drawer.

- Available drawer fronts; R-Pull, A-Pull and N-Pull. A-Pull available in Satin Chrome only.
- Peds come with a plinth base, footed base or mobile base.

DESCRIPTION	MODEL	SHIP WEIGHT	CUBE	LIST PRICE
Counterweight — Freestanding Support Pedestals or Systems Support and Mobile Pedestals	HPCW1	18	0.1	\$223

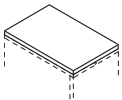

OPEN MARKET



DESCRIPTION	MODEL	SHIP WEIGHT	CUBE	FABRIC PRICE CODES			
Pedestal Seat							
15"W x 22 7/8"D x 2"H	HPSEAT24ND	10 Ⓞ	1.2	1	\$222	8	\$418
				2	\$246	9	\$449
				3	\$270	10	\$480
				4	\$294	11	\$511
				5	\$325	12	\$542
				6	\$356	L	—
				7	\$387		

NOTES: For seating fabrics, see pages 22-24.
SPECIFYING EXAMPLE: **HPSEAT24ND.APN23**

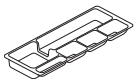

DESCRIPTION	MODEL	SHIP WEIGHT	CUBE	LIST PRICE
Optional Pencil Tray	HV-UT1	0.5	0.1	\$77

NOTES: For additional information see the Workplace Tools section in the 2021 Shared Spaces Pricer.

- For use with mobile and freestanding pedestal models.
- No specification required.

HOW TO SPECIFY

Select Model Number

Replace (?) with handle choice

- A** Satin Chrome Arch
- N** Full Face Integral
- R** Full Radius

H S P F S F 2 2 1 5 1 8 B F M A .

Select Paint Color

See page 504 Contain® Storage finish options

P .

Select Lock Option

- L** Standard Lock
- X** Omit Lock (deduct \$20)

L .

Select Foot Color

- T1** Platinum Metallic
- PR6** Silver

T 1



Icon Legend on page 19

Contain® Metal Pedestals with Laminate Fronts

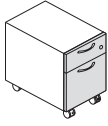

DESCRIPTION	MODEL	SHIP WEIGHT	CUBE	LIST PRICE BY PAINT GRADE		
				P1	P2	P3
Mobile Pedestal with Laminate Fronts, Box/File						
21"H x 15"W x 18"D, Arch Pull	HSPM211518BFL(?)	65.3	4.4	\$802	\$830	\$858
21"H x 15"W x 24"D, Arch Pull	HSPM211524BFL(?)	63.7	5.7	\$847	\$875	\$903

NOTES: Ball-bearing suspension on box and file drawer. (100%) Drawers color to be interior gray steel. File drawer has high sides and back for filing front-to-back and side-to-side. Counterweight standard on all mobile peds. See page 568 for Pedestal Seat. Optional pedestal seat cushions available. See page 569. Pencil tray standard in top box drawer. One box divider standard in each box drawer. One crossrail standard in each file drawer.

- ! Drawer Fronts available with Satin Chrome Arch only.
- ! Peds come with a plinth base, footed base or mobile base.

HOW TO SPECIFY

<p>Select Model Number</p> <p>Replace (?) with handle choice</p> <p>A Satin Chrome Arch</p>	<p>Select Paint Color</p> <p>See page 504 Contain® Storage finish options</p>	<p>Select Lock Option</p> <p>L Standard Lock X Omit Lock (deduct \$20)</p>	<p>Select Laminate Option</p> <p>L1 (no upcharge)</p> <p>COGN Cognac C Harvest N Mahogany MOCH Mocha D Natural Maple PINC Pinnacle F Shaker Cherry</p> <p>L2 (\$10 upcharge)</p> <p>LLA1 Lowell Ash LNRI Natural Recon LPE1 Phantom Ecru LPT1 Portico Teak LSW1 Skyline Walnut</p>
<p>H S P M 2 1 1 5 1 8 B F L A .</p>	<p>P .</p>	<p>L .</p>	<p>C</p>



Icon Legend on page 19

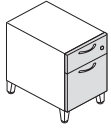

SIN 33721

DESCRIPTION	MODEL	SHIP WEIGHT	CUBE	LIST PRICE BY PAINT GRADE		
				P1	P2	P3
Footed Freestanding Pedestal with Laminate Fronts, Box/File						
22"H x 15"W x 18"D, Arch Pull	HSPFSF221518BFL(?)	69.0	4.4	\$912	\$940	\$968
22"H x 15"W x 24"D, Arch Pull	HSPFSF221524BFL(?)	75.3	5.7	\$953	\$981	\$1009

NOTES: Ball-bearing suspension on box and file drawer. (100%) Drawers color to be interior gray steel. File drawer has high sides and back for filing front-to-back and side-to-side. Counterweight standard on all mobile peds. See below for pedestal seat. Optional pedestal seat cushions available. See page 569. Pencil tray standard in top box drawer. One box divider standard in each box drawer. One crossrail standard in each file drawer. See Brigade® pedestals on page 656 for additional pedestal options. See pages 750-751 for Pedestal Accessories.

- ❗ Drawer Fronts available with Satin Chrome Arch only.
- ❗ Peds come with a plinth base, footed base or mobile base.

HOW TO SPECIFY

<p>Select Model Number</p> <p>Replace (?) with handle choice</p> <p>A Satin Chrome Arch</p>	<p>Select Paint Color</p> <p>See page 504 Contain® Storage finish options</p>	<p>Select Lock Option</p> <p>L Standard Lock X Omit Lock (deduct \$20)</p>	<p>Select Laminate Option</p> <p>L1 (no upcharge)</p> <p>COGN Cognac C Harvest N Mahogany MOCH Mocha D Natural Maple PINC Pinnacle F Shaker Cherry</p> <p>L2 (\$10 upcharge)</p> <p>LLA1 Lowell Ash LNR1 Natural Recon LPE1 Phantom Ecrú LPT1 Portico Teak LSW1 Skyline Walnut</p>	<p>Select Foot Color</p> <p>T1 Platinum Metallic PR6 Silver</p>
H S P F S F 2 2 1 5 1 8 B F L A .	P .	L .	C .	T 1

DESCRIPTION	MODEL	SHIP WEIGHT	CUBE	FABRIC PRICE CODES			
Pedestal Seat 15"W x 22 ⁷ / ₈ "D x 2"H	HPSEAT24ND	10 Ⓞ	1.2	1	\$222	8	\$418
NOTES: For seating fabrics, see pages 22-24.				2	\$246	9	\$449
				3	\$270	10	\$480
				4	\$294	11	\$511
				5	\$325	12	\$542
				6	\$356	L	—
				7	\$387		



HOW TO SPECIFY

<p>Select Model Number</p>	<p>Select Fabric</p> <p>See pages 502-503 for seating fabric options</p>
H P S E A T 2 4 .	A P N 2 3



Icon Legend on page 19

EMPOWER[®] Flagship[®] Mobile Pedestals



H15923N

SIN 33721

DESCRIPTION	MODEL	SHIP WEIGHT	CUBE	LIST PRICE BY PAINT GRADE		
				P1	P2	P3
Mobile Pedestals — Box/File 15"W x 22 ⁷ / ₈ "D x 22"H NOTES: Pencil tray standard in top box drawer. One box divider standard in each box drawer. One crossrail standard in each file drawer. File drawers have high sides for filing front-to-back. Steel ball-bearing suspension on file and box drawers. See pages 750-751 for accessories and pedestal utilization information. Arch pull available in Satin Chrome only. Choose from any of three pull options with no upcharge. Available in Arch (A), Full Face Integral (N) and Full Radius (R) Drawer Pulls. See page 653 for pull options. Equipped with HON "One Key" interchangeable core removable locks. Counterweight standard. Omit lock-option available. See page 773 for ordering instructions. See Brigade [®] pedestals on page 656 for additional pedestal options. See pages 750-751 for Pedestal Accessories.	H15923(?)	92	6.0	\$663	\$691	\$719

HOW TO SPECIFY

Select Model Number A Satin Chrome Arch N Full Face Integral R Full Radius H 1 5 9 2 3 A	Select Lock Option L Lock (no upcharge) X Omit Lock (deduct \$20) X	Select Paint Color See page 504 T 1
---	---	--

DESCRIPTION	MODEL	SHIP WEIGHT	CUBE	FABRIC PRICE CODES			
Pedestal Seat 15"W x 22 ⁷ / ₈ "D x 2"H NOTES: For seating fabrics, see pages 22-24.	HPSEAT24ND	10	1.2	1	\$222	8	\$418
				2	\$246	9	\$449
				3	\$270	10	\$480
				4	\$294	11	\$511
				5	\$325	12	\$542
				6	\$356	L	—
				7	\$387		

OPEN MARKET



HOW TO SPECIFY

Select Model Number H P S E A T 2 4	Select Fabric See pages 502-503 for seating fabric options A P N 2 3
---	---

DESCRIPTION

MODEL SHIP WEIGHT CUBE LIST PRICE

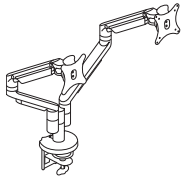

Dual Dynamic Monitor Arm

- 150° of rotation at base with optional 360° rotation.
- Arms extend 22" and retract up to 3".
- Monitor mount rotates 180° and tilts +/-30°.
- Monitor can be rotated from landscape to portrait position.

! Arms hold monitors from 6.2-18 lbs. Optional counterweight HPACW available to support monitors as low as 5 lbs. (see the Workplace Tools section in the 2021 Shared Spaces Pricer).

HMASD 17.0 1.1 \$962

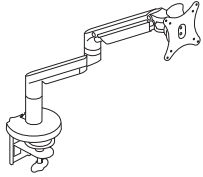

Single Dynamic Monitor Arm

- 180° of rotation at base with optional 360° rotation.
- Arms extend 22" and retract up to 3".
- Monitor mount rotates 180° and tilts +/-30°.
- Monitor can be rotated from landscape to portrait position.

! Arms hold monitors from 6.2-18 lbs. Optional counterweight HPACW available to support monitors as low as 5 lbs. (see the Workplace Tools section in the 2021 Shared Spaces Pricer).

HMASTS 11.5 0.8 \$501

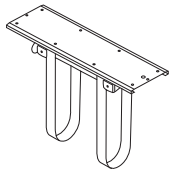

360° Swivel CPU Holder with Adjustable Straps

- Supports CPUs 3¾" wide up to 64" perimeter and holds up to 75 lbs.
- 360° rotation.
- Ships complete and includes necessary mounting hardware and instruction sheet.

! Available in Black only, no specification needed.

HCPUI 7.0 0.2 \$260

SIN 33721

NOTES:

- For additional information see the Workplace Tools section in the 2021 Shared Spaces Pricer.

Monitor Arms

- Arms fold back to post to allow more desktop room.
- Arms feature double extension, allowing 20"+ of back and forth movement.
- Cable management on both pole and arm assemblies.
- Counterbalance adjustment provides stability for monitors up to 17.6 lbs per arm.
- Made of high-quality aluminum alloy material.
- See the Workplace Tools section in the 2021 Shared Spaces Pricer for additional monitor arm models.

HOW TO SPECIFY

Select Model Number	Select Finish
	<i>Specify for models HMASD and HMASTS only</i>
	SVR Silver
	BLK Black
HMASD.	SVR

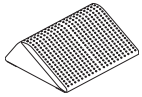

	DESCRIPTION	MODEL	SHIP WEIGHT	CUBE	LIST PRICE
	Footrest — Anti-Slip Cover 13¾"D x 5½"H x 16"W ⓘ Available in Black (T) finish ONLY. Recommended weight capacity not to exceed 250 pounds. HON 5-Year Limited Warranty. SPECIFYING EXAMPLE: HVL991.T	HVL991	7 ⓘ	0.9	\$89

HOW TO SPECIFY

<p>Select Model Number</p> <p>H V L 9 9 1 .</p>	<p>Select Finish</p> <p>T Black</p> <p>T</p>
---	--

GRAVITATION™ POWER BEAM

Want to see more? Scan here
to check out hon.com.



WORKSTATIONS



Graviton™ Power Beam shown with Coordinate™ Height Adjustable Tables, Fuse™ Storage, Astir™, Mav, and Solve® Seating.

GRAVITATION™ BEAM

Bringing power and privacy to individual workspaces and team areas, Graviton™ Beam offers a sleek look and multiple aesthetic options to complement any environment. Designed for movement and flexibility, it adapts to changing needs with ease.



FEATURES

- Pairs perfectly with height adjustable tables or alongside soft seating.
- Offered in a variety of paint options.
- Available in 3 widths: 48", 60", and 72".
- Create L, X, and T configurations using universal connectors.
- Painted metal screens available to provide privacy and space division.

GRAVITATION™ POWER BEAM ORDERING INFORMATION

PAINT

PAINT CODES

P1

- ◆ Black P71
- ◆ Brownstone P7D
- ◆ Charcoal P02
- ◆ Designer White PJW
- ◆ Fossil P28
- ◆ Greige T5
- ◆ Loft LOFT
- ◆ Muslin T3
- ◆ Shadow * SHDW
- ◆ Titanium P8T

P2

- ◆ Champagne Metallic T4
- ◆ Silver PR6
- ◆ Solar Black P8X

P3

- ◆ Atom P8S
- ◆ Bullseye PJF
- ◆ Ember P8P
- ◆ Ion P8N
- ◆ Iris P8J
- ◆ Krypton P8F
- ◆ Regatta P8M

P6

- ◆ Markerboard MKB

Duplex Color Recommended to Coordinate with Paint Color			
Paint Color	Paint Code	Duplex Color	Duplex Code
Black	P	Black	P
Brownstone	P7D	Brownstone	EY
Charcoal	S	Charcoal	S
Designer White	PJW	Designer White	DW
Fossil	P28	Charcoal	S
Greige	T5	Muslin	T3
Light Gray	Q	Loft	LOFT
Loft	LOFT	Loft	LOFT
Muslin	T3	Muslin	T3
Putty	L	Black	P
Shadow	SHDW	Muslin	T3
Silver	PR6	Titanium	TI
Titanium	P8T	Titanium	TI
Champagne Metallic	T4	Muslin	T3
Platinum Metallic	T1	Titanium	TI

◆◆◆ For lead time information see page 19.

* De-emphasized

GRAVITATION™ POWER BEAM ORDERING INFORMATION

Gravitation™ Ordering Checklist

When specifying Gravitation™ Power Beams for your workspace, follow the ordering checklist below to ensure full functionality.

- Beams (HBEAM48, 60, or 72).
- Legs to go with beams based on how the beams will be connected (HBLEG23).
- Electrical Harnesses, Receptacles, and In-feeds.
- Specify connectors, power hubs, and/or power poles (HBEORH23, HBEORT23, HBILNH23, HBCONU, etc.).
- Port Covers (for any power/data ports left unused).
- Metal Screens (if desired).

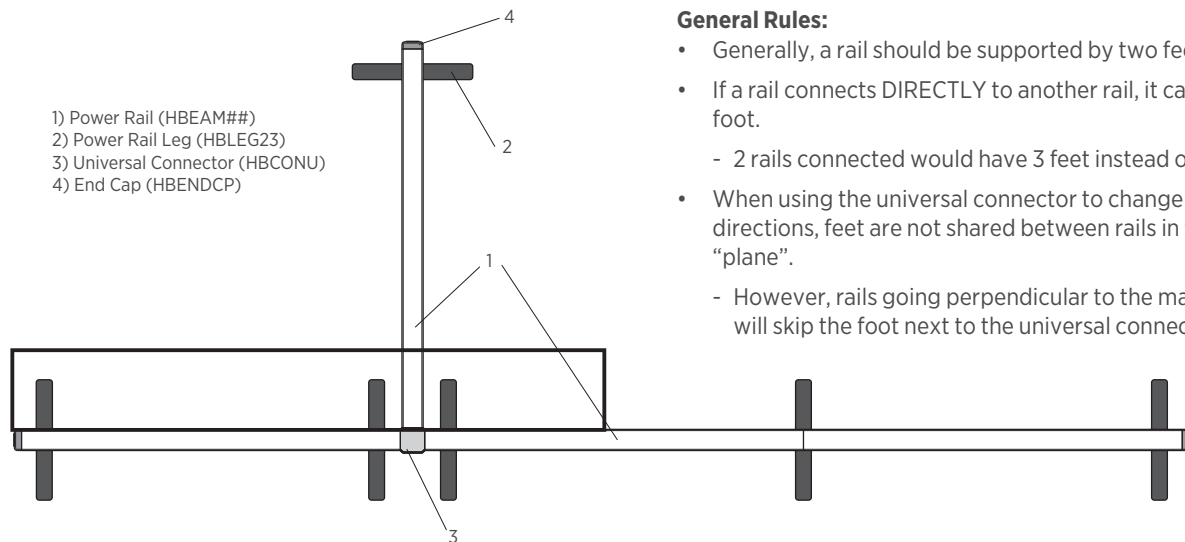

General Rules:

- Generally, a rail should be supported by two feet.
- If a rail connects DIRECTLY to another rail, it can share a foot.
 - 2 rails connected would have 3 feet instead of 4.
- When using the universal connector to change directions, feet are not shared between rails in the same “plane”.
 - However, rails going perpendicular to the main line will skip the foot next to the universal connector.

ⓘ When two rails share a leg, the leg is centered between the legs in the “outer slot”. When the leg is positioned **at the end of a run of rails** (i.e., the rail doesn’t connect to another rail), the leg will be inset 1/8” from the end of the rail, not the end cap, in the “inner slot”.

Cable Capacity

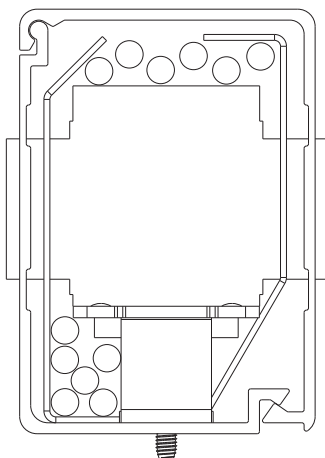

- The Power Rail housing allows continuous voice and data lines to run without interruption.
- Lay-in is provided for environments where systems furniture or cabling are subject to frequent change.
- Lower cavity allows for 6 voice/data cables (1/4” diameter).
- Upper cavity lay-in allows 6 voice/data cables (1/4” diameter).



Icon Legend on page 19

GRAVITATION™ 48"W Bundles

WORKSTATIONS

QTY	DESCRIPTION	MODEL	LIST PRICE	PRICE EXTENSION
1	Gravitation™ Power Beam 48"W	HBEAM48	\$381	\$381
2	Gravitation™ Legs 23"H	HBLEG23	\$133	\$266
1	End of Run Power Harness	HMPEEK48	\$249	\$249
4	Duplexes	HH873501	\$47	\$188
2	Gravitation™ Power Beam End Cap	HBENDCP	\$70	\$140
TOTAL:			\$1,224	\$1,224

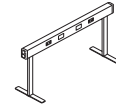

1-PACK — 48"W

QTY	DESCRIPTION	BUNDLE SKU	LIST PRICE BY PAINT GRADE		
			P1	P2	P3
1	1-PACK BUNDLE	HBDL148	\$1,224	\$1,295	\$1,330

SPECIFYING EXAMPLE: Model.Paint

QTY	DESCRIPTION	MODEL	LIST PRICE	PRICE EXTENSION
2	Gravitation™ Power Beam 48"W	HBEAM48	\$381	\$762
3	Gravitation™ Legs 23"H	HBLEG23	\$133	\$399
1	End of Run Power Harness	HMPEEK48	\$249	\$249
1	Power Harness	HH871248	\$239	\$239
4	Duplexes	HH873501	\$47	\$188
4	Duplexes	HH873502	\$47	\$188
2	Gravitation™ Power Beam End Cap	HBENDCP	\$70	\$140
TOTAL:			\$2,165	\$2,165

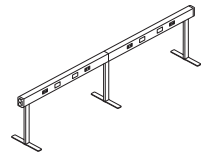

2-PACK — 48"W

QTY	DESCRIPTION	BUNDLE SKU	LIST PRICE BY PAINT GRADE		
			P1	P2	P3
1	2-PACK BUNDLE	HBDL248	\$2,165	\$2,283	\$2,341

SPECIFYING EXAMPLE: Model.Paint

QTY	DESCRIPTION	MODEL	LIST PRICE	PRICE EXTENSION
3	Gravitation™ Power Beam 48"W	HBEAM48	\$381	\$1,143
4	Gravitation™ Legs 23"H	HBLEG23	\$133	\$532
1	End of Run Power Harness	HMPEEK48	\$249	\$249
2	Power Harness	HH871248	\$239	\$478
4	Duplexes	HH873501	\$47	\$188
4	Duplexes	HH873502	\$47	\$188
4	Duplexes	HH873503	\$47	\$188
2	Gravitation™ Power Beam End Cap	HBENDCP	\$70	\$140
TOTAL:			\$3,106	\$3,106

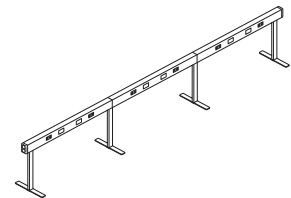

3-PACK — 48"W

QTY	DESCRIPTION	BUNDLE SKU	LIST PRICE BY PAINT GRADE		
			P1	P2	P3
1	3-PACK BUNDLE	HBDL348	\$3,106	\$3,271	\$3,352

SPECIFYING EXAMPLE: Model.Paint

QTY	DESCRIPTION	MODEL	LIST PRICE	PRICE EXTENSION
4	Gravitation™ Power Beam 48"W	HBEAM48	\$381	\$1,524
5	Gravitation™ Legs 23"H	HBLEG23	\$133	\$665
1	End of Run Power Harness	HMPEEK48	\$249	\$249
3	Power Harness	HH871248	\$239	\$717
4	Duplexes	HH873502	\$47	\$188
4	Duplexes	HH873503	\$47	\$188
4	Duplexes	HH873504	\$47	\$188
2	Gravitation™ Power Beam End Cap	HBENDCP	\$70	\$140
TOTAL:			\$3,859	\$3,859

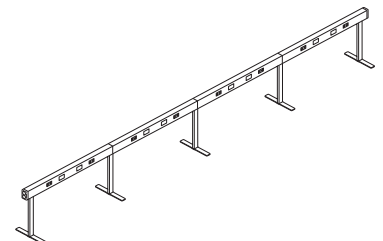

4-PACK — 48"W

QTY	DESCRIPTION	BUNDLE SKU	LIST PRICE BY PAINT GRADE		
			P1	P2	P3
1	4-PACK BUNDLE	HBDL448	\$4,047	\$4,259	\$4,363

SPECIFYING EXAMPLE: Model.Paint

! Power in-feeds and port covers are not included in Bundles and must be specified separately.

GRAVITATION™ 60"W Bundles



Icon Legend on page 19

WORKSTATIONS

QTY	DESCRIPTION	MODEL	LIST PRICE	PRICE EXTENSION
1	Gravitation™ Power Beam 60"W	HBEAM60	\$419	\$419
2	Gravitation™ Legs 23"H	HBLEG23	\$133	\$266
1	End of Run Power Harness	HMPEEK60	\$249	\$249
4	Duplexes	HH873501	\$47	\$188
2	Gravitation™ Power Beam End Cap	HBENDCP	\$70	\$140
TOTAL:			\$1,262	\$1,262

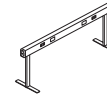

1-PACK — 60"W

QTY	DESCRIPTION	BUNDLE SKU	LIST PRICE BY PAINT GRADE		
			P1	P2	P3
1	1-PACK BUNDLE	HBDL160	\$1,262	\$1,336	\$1,373

SPECIFYING EXAMPLE: Model.Paint

QTY	DESCRIPTION	MODEL	LIST PRICE	PRICE EXTENSION
2	Gravitation™ Power Beam 60"W	HBEAM60	\$419	\$838
3	Gravitation™ Legs 23"H	HBLEG23	\$133	\$399
1	End of Run Power Harness	HMPEEK60	\$249	\$249
1	Power Harness	HH871260	\$239	\$239
4	Duplexes	HH873501	\$47	\$188
4	Duplexes	HH873502	\$47	\$188
2	Gravitation™ Power Beam End Cap	HBENDCP	\$70	\$140
TOTAL:			\$2,241	\$2,241

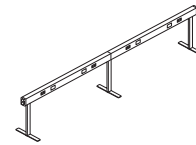

2-PACK — 60"W

QTY	DESCRIPTION	BUNDLE SKU	LIST PRICE BY PAINT GRADE		
			P1	P2	P3
1	2-PACK BUNDLE	HBDL260	\$2,241	\$2,365	\$2,427

SPECIFYING EXAMPLE: Model.Paint

QTY	DESCRIPTION	MODEL	LIST PRICE	PRICE EXTENSION
3	Gravitation™ Power Beam 60"W	HBEAM60	\$419	\$1,257
4	Gravitation™ Legs 23"H	HBLEG23	\$133	\$532
1	End of Run Power Harness	HMPEEK60	\$249	\$249
2	Power Harness	HH871260	\$239	\$478
4	Duplexes	HH873501	\$47	\$188
4	Duplexes	HH873502	\$47	\$188
4	Duplexes	HH873503	\$47	\$188
2	Gravitation™ Power Beam End Cap	HBENDCP	\$70	\$140
TOTAL:			\$3,220	\$3,220

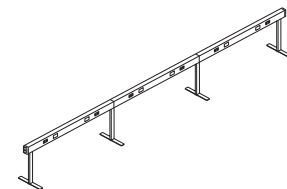

3-PACK — 60"W

QTY	DESCRIPTION	BUNDLE SKU	LIST PRICE BY PAINT GRADE		
			P1	P2	P3
1	3-PACK BUNDLE	HBDL360	\$3,220	\$3,394	\$3,481

SPECIFYING EXAMPLE: Model.Paint

QTY	DESCRIPTION	MODEL	LIST PRICE	PRICE EXTENSION
4	Gravitation™ Power Beam 60"W	HBEAM60	\$419	\$1,676
5	Gravitation™ Legs 23"H	HBLEG23	\$133	\$665
1	End of Run Power Harness	HMPEEK60	\$249	\$249
3	Power Harness	HH871260	\$239	\$717
4	Duplexes	HH873502	\$47	\$188
4	Duplexes	HH873503	\$47	\$188
4	Duplexes	HH873504	\$47	\$188
2	Gravitation™ Power Beam End Cap	HBENDCP	\$70	\$140
TOTAL:			\$4,011	\$4,011

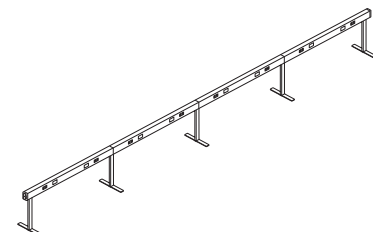

4-PACK — 60"W

QTY	DESCRIPTION	BUNDLE SKU	LIST PRICE BY PAINT GRADE		
			P1	P2	P3
1	4-PACK BUNDLE	HBDL460	\$4,199	\$4,423	\$4,535

SPECIFYING EXAMPLE: Model.Paint

! Power in-feeds and port covers are not included in Bundles and must be specified separately.



Icon Legend on page 19

GRAVITATION™ 72"W Bundles

WORKSTATIONS

QTY	DESCRIPTION	MODEL	LIST PRICE	PRICE EXTENSION
1	Gravitation™ Power Beam 72"W	HBEAM72	\$490	\$490
2	Gravitation™ Legs 23"H	HBLEG23	\$133	\$266
1	End of Run Power Harness	HMPEEK72	\$249	\$249
4	Duplexes	HH873501	\$47	\$188
2	Gravitation™ Power Beam End Cap	HBENDCP	\$70	\$140
TOTAL:			\$1,333	

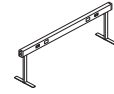

1-PACK – 72"W

QTY	DESCRIPTION	BUNDLE SKU	LIST PRICE BY PAINT GRADE		
			P1	P2	P3
1	1-PACK BUNDLE	HBDL172	\$1,333	\$1,414	\$1,454

SPECIFYING EXAMPLE: Model.Paint

QTY	DESCRIPTION	MODEL	LIST PRICE	PRICE EXTENSION
2	Gravitation™ Power Beam 72"W	HBEAM72	\$490	\$980
3	Gravitation™ Legs 23"H	HBLEG23	\$133	\$399
1	End of Run Power Harness	HMPEEK72	\$249	\$249
1	Power Harness	HH871272	\$239	\$239
4	Duplexes	HH873501	\$47	\$188
4	Duplexes	HH873502	\$47	\$188
2	Gravitation™ Power Beam End Cap	HBENDCP	\$70	\$140
TOTAL:			\$2,383	

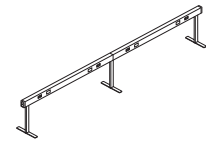

2-PACK – 72"W

QTY	DESCRIPTION	BUNDLE SKU	LIST PRICE BY PAINT GRADE		
			P1	P2	P3
1	2-PACK BUNDLE	HBDL272	\$2,383	\$2,521	\$2,589

SPECIFYING EXAMPLE: Model.Paint

QTY	DESCRIPTION	MODEL	LIST PRICE	PRICE EXTENSION
3	Gravitation™ Power Beam 72"W	HBEAM72	\$490	\$1,470
4	Gravitation™ Legs 23"H	HBLEG23	\$133	\$532
1	End of Run Power Harness	HMPEEK72	\$249	\$249
2	Power Harness	HH871272	\$239	\$478
4	Duplexes	HH873501	\$47	\$188
4	Duplexes	HH873502	\$47	\$188
4	Duplexes	HH873503	\$47	\$188
2	Gravitation™ Power Beam End Cap	HBENDCP	\$70	\$140
TOTAL:			\$3,433	

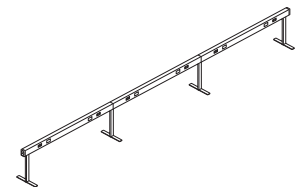

3-PACK – 72"W

QTY	DESCRIPTION	BUNDLE SKU	LIST PRICE BY PAINT GRADE		
			P1	P2	P3
1	3-PACK BUNDLE	HBDL372	\$3,433	\$3,628	\$3,724

SPECIFYING EXAMPLE: Model.Paint

QTY	DESCRIPTION	MODEL	LIST PRICE	PRICE EXTENSION
4	Gravitation™ Power Beam 72"W	HBEAM72	\$490	\$1,960
5	Gravitation™ Legs 23"H	HBLEG23	\$133	\$665
1	End of Run Power Harness	HMPEEK72	\$249	\$249
3	Power Harness	HH871272	\$239	\$717
4	Duplexes	HH873502	\$47	\$188
4	Duplexes	HH873503	\$47	\$188
4	Duplexes	HH873504	\$47	\$188
2	Gravitation™ Power Beam End Cap	HBENDCP	\$70	\$140
TOTAL:			\$4,295	

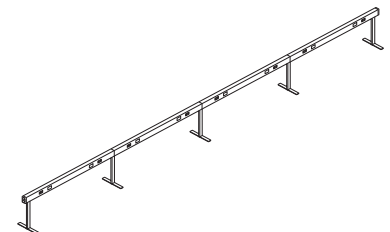

4-PACK – 72"W

QTY	DESCRIPTION	BUNDLE SKU	LIST PRICE BY PAINT GRADE		
			P1	P2	P3
1	4-PACK BUNDLE	HBDL472	\$4,483	\$4,735	\$4,859

SPECIFYING EXAMPLE: Model.Paint

! Power in-feeds and port covers are not included in Bundles and must be specified separately.



GRAVITATION™ POWER BEAM

WORKSTATIONS

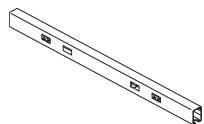

DESCRIPTION

Power Beam

48"W
60"W
72"W

MODEL	SHIP WEIGHT	CUBE	LIST PRICE BY PAINT GRADE		
			P1	P2	P3
HBEAM48	7	0.6	\$381	\$416	\$433
HBEAM60	9	0.7	\$419	\$457	\$476
HBEAM72	11	0.9	\$490	\$535	\$557

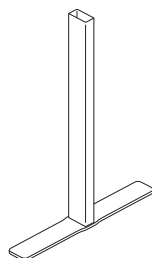

Beam Legs

23"H

HBLEG23	5	0.6	\$133	\$142	\$147
----------------	---	-----	--------------	--------------	--------------

NOTES:

- Beams and legs specified separately.
 - Order power harness separately to corresponding beam length.
 - Beams ship with mounting brackets for 8-Trac electrical to be installed in the field.
 - Beams ship with internal guides to retain power/data wires during installation (internal wire management).
 - 2 ports for electrical and 2 ports for data are provided on each side of the rail, total of 8 ports.
 - Electrical in-feed can also be accomplished through an electrical knockout (not data) in the face of the rail using a base in-feed.
 - Beam height when installed is 23"H. This height aligns with the Empower® height adjustable trough. Gravitation™ and Coordinate™ can be used as single-sided height adjustable benching.
 - 2-Pack metal port covers specified separately to cover unused power/data ports.
 - Electrical harnesses, duplexes, and power feeds ordered separately.
 - Leveling capability of 1/4" internal to rail for clean aesthetic.
- ❗ With in-line connections between beams, one leg can be shared. Requires one more leg than the number of beams.
 - ❗ Specify paint; not available in Putty (L), Platinum Metallic (T1), and Champagne Metallic (T4).
 - ❗ When two rails share a leg, the leg is centered between the legs in the "outer slot". When the leg is positioned **at the end of a run of rails** (i.e., the rail doesn't connect to another rail), the leg will be inset 1/8" from the end of the rail, not the end cap, in the "inner slot".

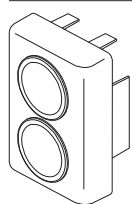

Power Beam End Cap

HBENDCP	1	0.1	\$70	\$76	\$79
----------------	---	-----	-------------	-------------	-------------

NOTES:

- Power can enter into the beam from the floor, wall, or ceiling.
- When using the power pole, please note attachment to beam is up to the installer, as well as field-cutting the power pole to access power and data wires.
- End caps have integral knockout ports with plastic grommets to allow for power/data in-feed (without sharp edges).
- End caps add 1" to the length of the run.



HOW TO SPECIFY

<p>Select Model Number</p> <p>H B E A M 6 0 .</p>	<p>Select Paint Color</p> <p>See page 573</p> <p>P R 8</p>
--	---



Icon Legend on page 19

GRAVITATION™ POWER BEAM

	DESCRIPTION	MODEL	SHIP WEIGHT	CUBE	LIST PRICE BY PAINT GRADE		
					P1	P2	P3
 HBPRTCV	Knockout Port Covers, Metal	HBPRTCV	0.5	0.1	\$26	\$28	\$29
 HBCONU	Universal Connector ! Used to change direction of beam (L, T, X). Cannot bring in-feed into Universal Connector; use Power Hubs in these instances (HBXXX23).	HBCONU	2.0	0.1	\$199	\$213	\$220

NOTES:

- Universal Connector is used to change beam direction when power is not coming in at that location. Power Hub will be used to bring in power at a change of connection.
- Port Covers used to cover open power or data ports if not in use, as desired.
- Able to connect rails in T-, X-, or L-configurations.

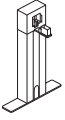
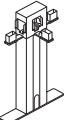
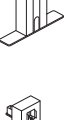
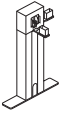
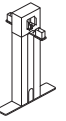
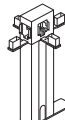
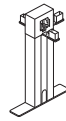
	DESCRIPTION	MODEL	SHIP WEIGHT	CUBE	LIST PRICE BY PAINT GRADE		
					P1	P2	P3
	Power Hub End of Run Power Hub	HBEORH23	10	4.0	\$260	\$284	\$295
	End of Run Power Hub, T	HBEORT23	14	4.0	\$287	\$313	\$326
	End of Run Power Hub, L	HBEORL23	13	4.0	\$254	\$277	\$289
	In-Line Power Hub	HBILNH23	13	4.0	\$274	\$299	\$311
	In-Line Power Hub, X	HBILNX23	15	4.0	\$290	\$316	\$329
	In-Line Power Hub, T	HBILNT23	14	4.0	\$277	\$302	\$315
	! Power Hub is used when electrical needs to enter at a connection. For change of direction only (not bringing in power) use Universal Connector.						

NOTES:

- Hub connectors allow power to enter the beam by bringing it through the bottom of the hub or knocking out the mouse hole in the hub.
- Specify correct hub based on desired location of power entering the beam.
- ! Power Hub is used when electrical needs to enter at a connection. For change of direction only (not bringing in power) use Universal Connector (HBCONU).
- ! Hubs are dual use — change of direction “connector” (when choosing L, T, or X hubs) and to bring power to the beam; choose Universal Connector if change of direction is needed **without** bringing power to the beam (HBCONU).
- ! Power can enter the beam in six different ways.
 1. Bring in-feed from floor or wall into end of beam with no cover (see local electrical codes to ensure the use of this solution) — metal flexible (HH871912) or Sealtight (HMP144) conduit available based on code compliance.
 2. HH870070 freestanding Power Pole at end of run.
 3. Vertebrae Wire Manager (HBVWM) from end of beam.
 4. 96” Power Pole (HB96PP) with beam Power Pole Connectors (HBPP*K).
 5. Power Hubs (HBXXX23, see above).
 6. Power Hubs (HBXXX23, see above) with 96” Power Pole (HB96PP) with Hub Connectors (HBPPCK).

HOW TO SPECIFY

<p>Select Model Number</p> <p>H B C O N U .</p>	<p>Select Paint Color</p> <p>See page 573</p> <p>P R 8</p>
--	---

GRAVITATION™ POWER BEAM

WORKSTATIONS



SIN 33721

DESCRIPTION	MODEL	SHIP WEIGHT	CUBE	LIST PRICE
Power Pole — w/o Receptacles 10'5" NOTES: For ceiling in-feed, utilize a freestanding Power Pole placed adjacent to the Power Beam. Power Pole runs to the floor. Specify paint. ⓘ Must be field cut. ⓘ Does not ship with attachment hardware, it is up to the installer to attach Power Pole to the beam.	HH870070	14	0.5	\$477



DESCRIPTION	MODEL	SHIP WEIGHT	CUBE	LIST PRICE BY PAINT GRADE		
				P1	P2	P3
Power Pole 96" NOTES: Power Pole connects to hub or with Mid or End Cap connectors. Power Pole terminates at beam or hub height (does not run to the floor).	HB96PP	5.0	0.9	\$731	\$797	\$830

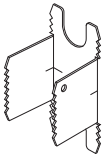

Power Pole Splice Kit NOTES: Use Splice Kit to join two Power Poles when one pole does not meet the required ceiling height.	HBPPSK	0.25 ⓘ	0.1	\$56	N/A	N/A
--	---------------	--------	-----	-------------	------------	------------

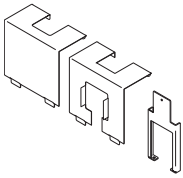

Power Pole Power Hub Connector NOTES: Specify when bringing Power Pole into Power Hub.	HBPPCK	1.0 ⓘ	0.1	\$56	\$61	\$64
--	---------------	-------	-----	-------------	-------------	-------------

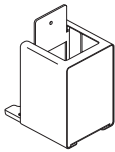

Power Pole End Cap Connector NOTES: Specify when bringing Power Pole into the end of a beam.	HBPPEK	1.5 ⓘ	0.1	\$56	\$61	\$64
--	---------------	-------	-----	-------------	-------------	-------------

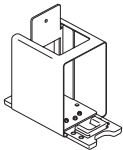

Power Pole Mid Connector NOTES: Specify when bringing Power Pole into junction of two beams.	HBPPMK	1.5 ⓘ	0.1	\$56	\$61	\$64
--	---------------	-------	-----	-------------	-------------	-------------



Vertebrae Wire Manager NOTES: Connects to end of beam — Vertebrae conceals cords entering the beam.	HBVWM	1.8 ⓘ	0.2	\$302	\$329	\$343
---	--------------	-------	-----	--------------	--------------	--------------



Floor Anchor Bracket NOTES: Used to connect beam to the floor in situations where the beam needs to be tethered to the ground so users cannot move it.	HBFAB	0.2 ⓘ	0.1	\$23	\$25	\$26
--	--------------	-------	-----	-------------	-------------	-------------

HOW TO SPECIFY

Select Model Number HB96PP	Select Paint Color See page 573 PR8
--------------------------------------	--



GRAVITATION™ POWER BEAM Electrical

DESCRIPTION	MAX. RECEPT. CAP. PER PANEL SIDE	MODEL		SHIP WEIGHT	CUBE	LIST PRICE
		FOUR-CIRCUIT 3 + 1 2 + 2	THREE-CIRCUIT, SEPARATE NEUTRALS			
Electrical Power Harnesses, Frames — w/duplex capacity						
For 48"W	2	HH871248	HH871248A	3.0 Ⓞ	0.5	\$239
For 60"W	2	HH871260	HH871260A	3.0 Ⓞ	0.5	\$239
For 72"W	2	HH871272	HH871272A	5.0 Ⓞ	0.5	\$239
Abound® Duplex Receptacles						
Circuit 1		HH873501	HH873501A	0.5 Ⓞ	0.1	\$47
Circuit 2		HH873502	HH873502A	0.5 Ⓞ	0.1	\$47
Circuit 3		HH873503	HH873503A	0.5 Ⓞ	0.1	\$47
Circuit 4		HH873504		0.5 Ⓞ	0.1	\$47
Circuit 1 — 20 amp outlet		HH871601	HH871601A	1.0 Ⓞ	0.1	\$47
Circuit 3 (2 + 2)		HH873506		0.5 Ⓞ	0.1	\$47
Specify color.						
Ceiling In-Feed						
144" long conduit, Flex Cable — 7/8" dia.		HH871912	HH871912A	4.0 Ⓞ	0.5	\$263
216" long conduit, Flex Cable — 7/8" dia.		HH871918	HH871918A	4.0 Ⓞ	0.5	\$342
ⓘ Must be used with Power Pole. Power in-feed models HH871912 and HH871918 plug into the end of any power block. No portion of the cable can be exposed after installation.						
Power In-Feed — Sealtight						
144" long conduit, Sealtight Cable — 7/8" diameter		HMP144		7	1.2	\$367
NOTES: For use as ceiling, floor and wall in-feed. If three-circuit, separate neutral in-feed is required, please contact Tailored Solutions.						
ⓘ Bend radius of Sealtight in-feed is limited — use in straight entrance applications.						
AMP Data Faceplates						
Three-port flex-mode faceplate		HHTADF3		1 Ⓞ	0.2	\$29
Four-port flex-mode faceplate		HHTADF4		1 Ⓞ	0.2	\$29
ⓘ Data faceplates available in Black (E4) only.						
AMP RJ45 CAT 5E Jack — Black (P)		HHTADJ5		1 Ⓞ	0.1	\$46
AMP RJ45 CAT 6 Jack — Black (P)		HHTADJ6		1 Ⓞ	0.1	\$62
Models HHTADJ5 and HHTADJ6 snap into faceplate.						
NOTES: AMP Data Faceplates attach to bottom of panel or at worksurface height in front of baserail covers for easy cable routing. Faceplates cannot be installed back-to-back in a panel application.						
End of Run Electrical Kit						
48"W		HMPEEK48		3	0.5	\$249
60"W		HMPEEK60		3	0.5	\$249
72"W		HMPEEK72		5	0.5	\$249

HOW TO SPECIFY

Select Model Number

HH871248

GRAVITATION™ POWER BEAM Screens

OPEN MARKET

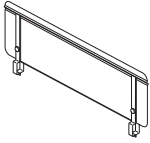

DESCRIPTION

Gravitation™ Metal Screen
 48"W x 18¾"H
 60"W x 18¾"H
 72"W x 18¾"H

MODEL

HBSCRAOMTL48
HBSCRAOMTL60
HBSCRAOMTL72

SHIP WEIGHT

10.3
 12.0
 15.7

CUBE

3.1
 3.7
 4.4

LIST PRICE BY PAINT GRADE

P1	P2	P3
\$375	\$409	\$426
\$452	\$493	\$514
\$485	\$529	\$551

NOTES:

- A screen can be mounted above the beam to add privacy.
- Screens ship with mounting hardware.
- Screens are wipeable.
- Screens are magnetic.
- Also available in Markerboard paint.

HOW TO SPECIFY

Select Model Number

H B S C R A O M T L 6 0 .

Select Paint Color

See page 573

P 7 1

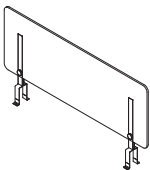

DESCRIPTION

Gravitation™ Beam PET Screen
 48"W x 20"H
 60"W x 20"H
 72"W x 20"H

MODEL

HUVDSBS2048
HUVDSBS2060
HUVDSBS2072

SHIP WEIGHT

3.5 Ⓞ
 4.4 Ⓞ
 5.3 Ⓞ

CUBE

4.1
 5.0
 5.9

LIST PRICE BY PAINT GRADE

P1	P2	P3
\$621	\$625	\$641
\$679	\$683	\$699
\$842	\$846	\$862

HOW TO SPECIFY

Select Model Number

H U V D S B 2 0 6 0 .

Select PET Color

- DDB1** Dark Blue
- DGN1** Green
- DGY4** Dark Gray
- DGY3** Medium Gray

D G N 1 .

Select Paint Color

See page 573

P R 6

SYSTEMS SHARED COMPONENTS

Want to see more?
Scan here to check
out hon.com.



WORKSTATIONS

Systems Worksurfaces, Accelerate® Panels, Systems Overhead Storage, Voi® O-Legs and Storage shown with Lota® Task Chairs.

SYSTEMS SHARED COMPONENTS

Panel-based workstations make efficient use of space, giving your people a place of their own that's still part of the action. Modular components are easy to specify and install, so you can configure them just about any which way — and reconfigure fast when your needs change. Systems models integrate seamlessly with Abode, Abound, Accelerate, Empower and Voi models and can be configured to create freestanding or height adjustable workstations.



FEATURES

- Systems worksurfaces and supports can be used with Abode, Abound, Accelerate, Coordinate, Empower and Voi products.
- Systems electrical and data components can be used with Abode, Abound, Accelerate and Empower products.
- Systems storage can be used with Abound and Accelerate products.

SYSTEMS OVERHEAD AND SHELVES SPECIFYING

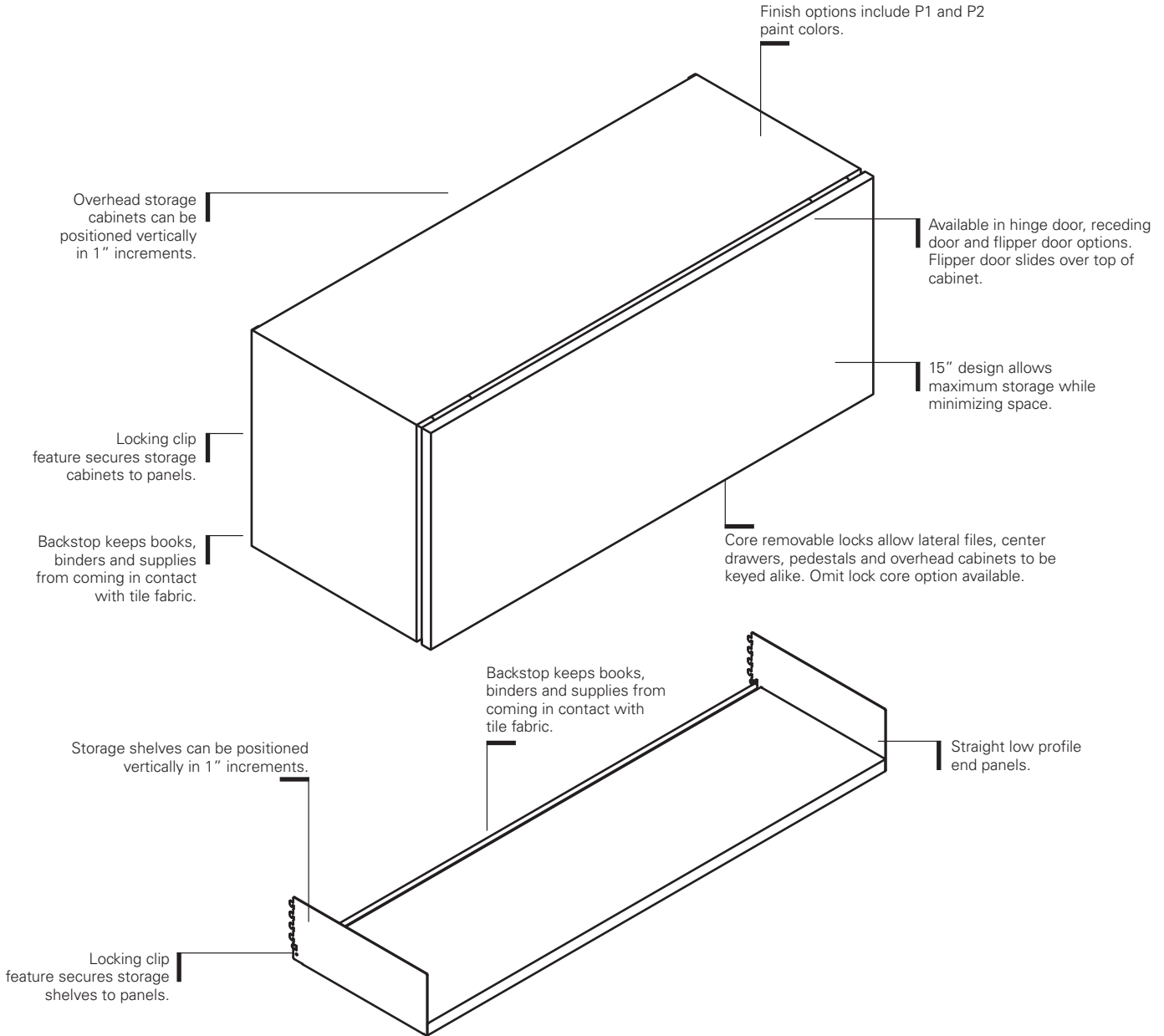

PRODUCT DIMENSIONS

Overhead Storage Cabinet

Width 24", 30", 36", 42", 48", 60"

Inside width Flipper and Receding door — $\frac{3}{8}$ " less than width
Hinged door — $1\frac{3}{4}$ " less than width

Depth $14\frac{7}{8}$ "

Inside depth $12\frac{7}{8}$ "

Height 15"

Inside height $12\frac{3}{4}$ "

Open Shelf

Width 24", 30", 36", 42", 48", 60"

Depth $14\frac{3}{8}$ "

Height $5\frac{5}{8}$ "

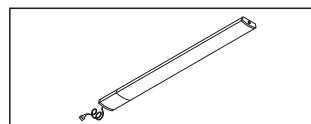

Task lights can be mounted beneath storage shelves and overhead storage cabinets.

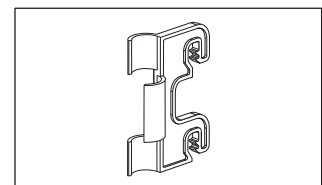

Cord retainer clips fasten into panel slots to anchor power cords. Available in black only. Clips are provided with undershelf mounted task lights.

SYSTEMS OVERHEAD AND SHELVES SPECIFYING

SPECIFICATION GUIDELINES

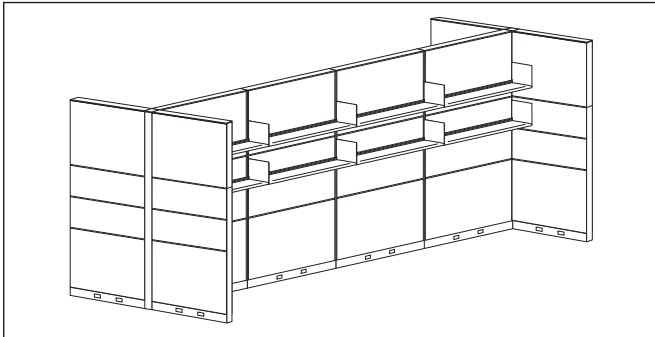

In a panel run, only two overhead storage cabinets or open storage shelves are recommended per panel side. When suspending overhead storage off-module only one storage unit per panel side is allowed.

When overhead storage units are suspended from stacking frames, the following guidelines should be adhered to:

A maximum of two overhead storage units can be suspended from each side of stacking frames on any given panel.

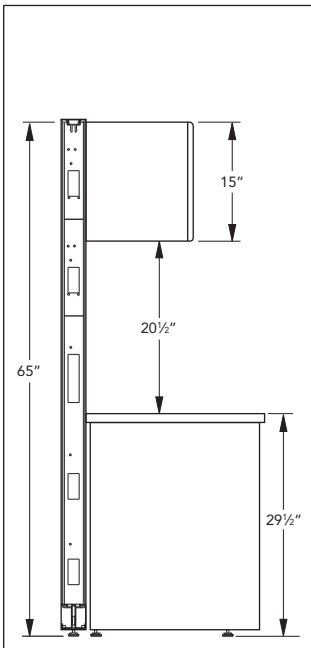

Overhead Storage cabinets and the **Open Shelf** can also be mounted to a maximum height of 65"H on all systems. Voi overheads not to be mounted on Accelerate stackers.

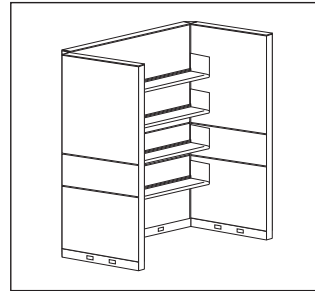

No limitation to the number of units on structural frames when units are spaced 12" apart and when the run is supported with return panels of equal height to the spine wall on each side of storage shelves or overhead storage cabinets.

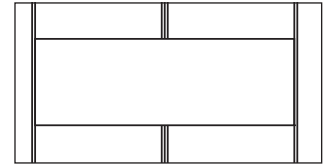

Storage shelf and overhead width must correspond with width of panel(s). It is possible to span two panels when combined panel width equals cabinet or shelf width.

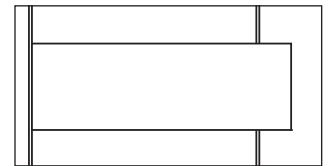

Overhead Cabinets can be mounted on a panel equal to or up to 18" narrower than cabinet.

Not applicable for ETA overheads, Voi overheads, and shelves.

SYSTEMS

Overhead and Shelves

GSA SIN 33721



Icon Legend on page 19

WORKSTATIONS

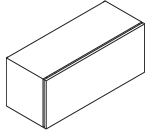

DESCRIPTION

Metal Flipper Door Overheads

24"W x 14³/₈"D x 15"H
 30"W x 14³/₈"D x 15"H
 36"W x 14³/₈"D x 15"H
 42"W x 14³/₈"D x 15"H
 48"W x 14³/₈"D x 15"H
 60"W x 14³/₈"D x 15"H
 72"W x 14³/₈"D x 15"H

MODEL

HRVOH24FM
 HRVOH30FM
 HRVOH36FM
 HRVOH42FM
 HRVOH48FM
 HRVOH60FM
 HRVOH72FM

SHIP WEIGHT

35
 38
 41
 46
 52
 62
 82

CUBE

3.6
 4.4
 5.3
 6.1
 6.9
 8.6
 10.6

LIST PRICE BY PAINT GRADE

P1 P2

\$597 \$646
 \$607 \$656
 \$635 \$684
 \$666 \$715
 \$697 \$746
 \$917 \$966
 \$1052 \$1101

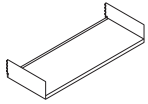

Open Shelf

24"W x 14³/₈"D x 5⁵/₈"H
 30"W x 14³/₈"D x 5⁵/₈"H
 36"W x 14³/₈"D x 5⁵/₈"H
 42"W x 14³/₈"D x 5⁵/₈"H
 48"W x 14³/₈"D x 5⁵/₈"H
 60"W x 14³/₈"D x 5⁵/₈"H
 72"W x 14³/₈"D x 5⁵/₈"H

HRVSH24
 HRVSH30
 HRVSH36
 HRVSH42
 HRVSH48
 HRVSH60
 HRVSH72

13
 15
 16
 17
 18
 20
 32

1.2
 1.5
 1.8
 1.9
 2.3
 2.9
 3.6

\$257 \$274
 \$279 \$296
 \$297 \$314
 \$308 \$325
 \$322 \$339
 \$394 \$411
 \$514 \$531

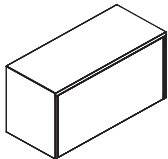

Receding Door Overhead

30"W x 13³/₈"D x 15"H
 36"W x 13³/₈"D x 15"H
 42"W x 13³/₈"D x 15"H
 48"W x 13³/₈"D x 15"H
 60"W x 13³/₈"D x 15"H

HRVOH1530RM
 HRVOH1536RM
 HRVOH1542RM
 HRVOH1548RM
 HRVOH1560RM

38
 41
 46
 52
 62

5.7
 6.8
 7.8
 8.9
 11.2

\$770 \$823
 \$812 \$865
 \$863 \$916
 \$935 \$988
 \$1417 \$1470

NOTES:

- Overhead Storage Cabinets with doors are standard with a factory installed core removable lock located on the underside of the cabinet.
- All units feature an anti-dislodgement device.
- 60" and 72"W units are one piece cabinet with two doors.
- Upmount kits can be used with all metal overheads.

Keyed alike cores must be ordered separately — see page 773.

HOW TO SPECIFY

Select Model Number

HRVOH24FM

Select Paint Color

See page 481

T4

Select Lock Option

- L Lock
 - X Omit Lock (deduct \$20) (where applicable)
- See page 773











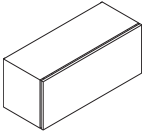





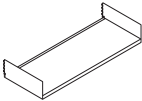

L





Icon Legend on page 19

SYSTEMS

ETA Overheads and Shelves

	DESCRIPTION	MODEL	SHIP WEIGHT	CUBE	LIST PRICE BY PAINT GRADE	
					P1	P2
	Flipper Door Overheads					
	24"W x 13"D x 15"H	HEOHRTA1524FD	21	1.6	\$479	\$528
	30"W x 13"D x 15"H	HEOHRTA1530FD 	24	1.6	\$486	\$535
	36"W x 13"D x 15"H	HEOHRTA1536FD 	27	1.6	\$510	\$559
	42"W x 13"D x 15"H	HEOHRTA1542FD	30	1.8	\$536	\$585
	48"W x 13"D x 15"H	HEOHRTA1548FD 	33	2.1	\$557	\$606
	60"W x 13"D x 15"H	HEOHRTA1560FD 	42	2.5	\$735	\$784
72"W x 13"D x 15"H	HEOHRTA1572FD 	49	3.0	\$913	\$962	
	Open Shelves					
	24"W x 13"D x 5 5/8"H	HESHRTA24	10 	1.9	\$224	\$241
	30"W x 13"D x 5 5/8"H	HESHRTA30 	11 	1.9	\$242	\$259
	36"W x 13"D x 5 5/8"H	HESHRTA36 	12 	1.9	\$257	\$274
	42"W x 13"D x 5 5/8"H	HESHRTA42	13 	2.1	\$265	\$282
	48"W x 13"D x 5 5/8"H	HESHRTA48 	14 	2.4	\$280	\$297
	60"W x 13"D x 5 5/8"H	HESHRTA60 	16 	3.0	\$341	\$358
72"W x 13"D x 5 5/8"H	HESHRTA72	18 	3.5	\$402	\$419	

NOTES:

- Storage Cabinets with doors are standard with a factory installed core removable lock located on the underside of the cabinet.
 - All units feature an anti-dislodgement device.
 - Accepts under cabinet lighting.
 - ETA overheads and shelves ship flat packed.
 - Only one installer is needed to assemble an ETA overhead on a panel (all sizes).
 - Attachment brackets are attached to the back of the unit (included).
 - ETA overheads and shelves are slightly less deep than built-up models. Please note when using next to built-up models.
 - Order overhead and shelf to match the width of panel being used.
-  Keyed alike cores must be ordered separately — see page 773.
-  Cannot be used in off-modular applications because attachment bracket is attached to the back of the case and cannot be moved.

HOW TO SPECIFY

Select Model Number H E O H R T A 1 5 2 4 F D . T 1	Select Paint Color See page 481
---	---

SYSTEMS

Overhead Storage

GSA SIN 33721



Icon Legend on page 19

WORKSTATIONS

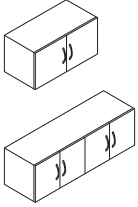

DESCRIPTION

Steel Front Hinged Door Overhead with Arch Pull

24"W x 15"D x 15"H
30"W x 15"D x 15"H
36"W x 15"D x 15"H
42"W x 15"D x 15"H
48"W x 15"D x 15"H

MODEL

HRVOHV24HMA
HRVOHV30HMA
HRVOHV36HMA
HRVOHV42HMA
HRVOHV48HMA

SHIP WEIGHT

32
36
42
52
56

CUBE

5.6
6.8
7.7
8.1
9.2

LIST PRICE BY PAINT GRADE

P1 **P2**

\$805 **\$854**
\$833 **\$882**
\$862 **\$911**
\$892 **\$941**
\$924 **\$973**

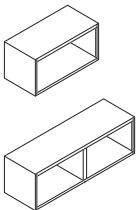

Open Storage Cabinet

24"W x 15"D x 15"H
30"W x 15"D x 15"H
36"W x 15"D x 15"H
42"W x 15"D x 15"H
48"W x 15"D x 15"H

HRVSHV24
HRVSHV30
HRVSHV36
HRVSHV42
HRVSHV48

21
26
29
32
37

5.6
6.8
7.7
8.1
9.2

\$734 **\$783**
\$758 **\$807**
\$790 **\$839**
\$819 **\$868**
\$850 **\$899**

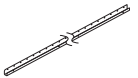

Abound®/Accelerate® Horizontal Wall Track for Overhead Storage

60"W

HTWTH

5

0.8

\$95

N/A

NOTES: Use when mounting overhead storage and when a permanent wall hanger kit is not desired. For 72"W overheads, use two wall tracks cut to 36".

⚠ Cannot be used with ETA storage or Voi®. Can only be used with systems flipper door, receding door and hinged door overheads.

NOTES:

- Overhead Storage Cabinets with doors are standard with a factory installed core removable lock located on the underside of the cabinet.
- Upmount kits can be used with all metal overheads.

⚠ Keyed alike cores must be ordered separately — see page 773.

HOW TO SPECIFY

Select Model Number

Select the Pull

A Satin Chrome Arch

H R V O H V 2 4 H M A .

Select Lock Option

L Lock
X Omit Lock (deduct \$20) (where applicable)
See page 773

L .

Select Paint Color

See page 481

T 4



Icon Legend on page 19

Laminate Front Overhead Storage

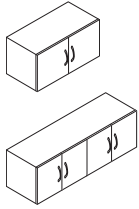

DESCRIPTION	MODEL	SHIP WEIGHT	CUBE	LIST PRICE BY PAINT GRADE	
				P1	P2
Laminate Front Hinged Door Overheads with Arch Pull					
24"W x 15"D x 15"H	HRVOHV24HLA	35	5.6	\$989	\$1038
30"W x 15"D x 15"H	HRVOHV30HLA	40	6.8	\$1020	\$1069
36"W x 15"D x 15"H	HRVOHV36HLA	48	7.7	\$1049	\$1098
42"W x 15"D x 15"H	HRVOHV42HLA	53	8.1	\$1079	\$1128
48"W x 15"D x 15"H	HRVOHV48HLA	64	9.2	\$1105	\$1154

NOTES:

- Unit features metal chassis and laminate doors.
- Laminate fronts are available in L1 woodgrain only.
- Overhead Storage Cabinets with doors are standard with a factory installed core removable lock located on the underside of the cabinet.
- Upmount kits can be used with all metal overheads.

! Keyed alike cores must be ordered separately — see page 773.

HOW TO SPECIFY

<p>Select Model Number</p> <p>Select the Pull</p> <p>A Satin Chrome Arch</p>	<p>Select Lock Option</p> <p>L Lock X Omit Lock (deduct \$20) See page 773</p>	<p>Select Front Laminate Color</p> <p>L1 Woodgrain only See page 481</p>	<p>Select Case Paint Color</p> <p>See page 481</p>
<div style="border: 1px solid black; display: inline-block; padding: 2px;">H R V O H V 2 4 H L A .</div>	<div style="border: 1px solid black; display: inline-block; padding: 2px;">L .</div>	<div style="border: 1px solid black; display: inline-block; padding: 2px;">H .</div>	<div style="border: 1px solid black; display: inline-block; padding: 2px;">T 4</div>

VOI® Overhead Storage

GSA SIN 33721



Icon Legend on page 19

WORKSTATIONS

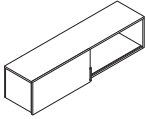

DESCRIPTION

Overhead Cabinet with One Sliding Door

36"W x 14¼"D x 14"H
42"W x 14¼"D x 14"H
48"W x 14¼"D x 14"H
60"W x 14¼"D x 14"H
66"W x 14¼"D x 14"H
72"W x 14¼"D x 14"H

MODEL	SHIP WEIGHT	CUBE	L1 LIST	L2 UPCHARGES	
				CABINET	DOOR
HLSL1436S	39	9.7	\$1120	\$25	\$20
HLSL1442S	48	9.7	\$1174	\$25	\$20
HLSL1448S	57	12.1	\$1208	\$25	\$20
HLSL1460S	69	13.3	\$1301	\$30	\$25
HLSL1466S	83	14.6	\$1436	\$30	\$25
HLSL1472S	95	15.9	\$1567	\$35	\$25

NOTES: Only available in laminate.

❗ Overhead and Stack-on storage units do not lock.

NOTES:

- Voi® Overhead Storage can be used with Accelerate® and Abound® panels.
- All Overhead Cabinets shown above and on next page can be used as a wall mount, panel mount or stack-on storage with O-leg.
- Can be mounted on O-legs, panel brackets or wall mount brackets. See page 592.
- Tackboards are available for wall mount storage applications.
- Sliding door overhead does not ship with a pull — door overhangs chassis to slide.
- Overhead cabinets with four doors are available in laminate or mixed materials.
- For all color specifying combinations, see matrix on page 183.
- Storage cases accept binder height items.
- Storage cube fits inside stack-on storage or overhead cabinet units to provide paper management.
- Wall mount brackets specified with unit. Brackets attach to case horizontally.
- For panel mounted applications, brackets and hardware are ordered separately, see page 630. Brackets attach to panel and case is screwed into brackets. Two brackets needed for 60" unit; three brackets needed for 66" and larger.
- If Wall Bracket option is selected, \$150 upcharge applies.
- For additional information see the Workplace Tools section in the 2021 Shared Spaces Pricer.

❗ Stack-on Storage must be placed over two full-height supports. Cannot be placed over non-supported sections such as returns using a flat bracket or tower-to-worksurface bracket.

HOW TO SPECIFY

<p>Select Model Number</p> <p>For locking overhead models, add an "L" suffix (\$40 upcharge per model)</p> <p>H L S L 1 4 7 2 S .</p>	<p>Select Cabinet Laminate</p> <p>See page 183</p> <p>N .</p>	<p>Select Door Laminate</p> <p>See page 183</p> <p>N .</p>	<p>Select Pull</p> <p>X No Pull</p> <p>X .</p>	<p>Specify Bracket Option</p> <p>X No Bracket W Wall Bracket (\$150 upcharge)</p> <p>W</p>
--	--	---	---	---



VOI® Overhead Storage

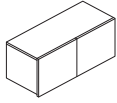

DESCRIPTION

Overhead Cabinet with Doors

- 36"W x 14¼"D x 14"H, 2 doors
- 42"W x 14¼"D x 14"H, 2 doors
- 48"W x 14¼"D x 14"H, 3 doors
- 60"W x 14¼"D x 14"H, 4 doors

MODEL	SHIP WEIGHT	CUBE	L1 LIST	L2 UPCHARGES	
				CABINET	DOOR
HLSL1436D	39	9.7	\$945	\$25	\$20
HLSL1442D	48	9.7	\$1051	\$25	\$20
HLSL1448D	57	12.1	\$1166	\$25	\$30
HLSL1460D	115	13.3	\$1301	\$30	N/A

❗ 2-Door and 3-Door Overhead Cabinet with Doors models HLSL1436D – HLSL1448D available in laminate only. The 60" model HLSL1460D is available in all door finish options.

❗ Overhead and Stack-on storage units do not lock.

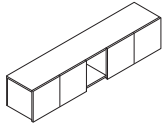

Overhead Cabinet with 4 Doors/Cubbies

- 66"W x 14¼"D x 14"H with 6" Cubbie
- 72"W x 14¼"D x 14"H with 12" Cubbie

HLSL1466D	126	14.6	\$1436	\$30	\$30
HLSL1472D	139	15.9	\$1567	\$35	\$35

NOTES: Doors available in laminate or mixed materials.

NOTES:

- Voi® Overhead Storage can be used with Accelerate® and Abound® panels.
- All Overhead Cabinets shown above and on previous page can be used as a wall mount, panel mount or stack-on storage with O-leg.
- Can be mounted on O-legs, panel brackets or wall mount brackets. See page 592.
- Tackboards are available for wall mount storage applications.
- Overhead cabinets with four doors are available in laminate or mixed materials.
- For all color specifying combinations, see matrix on page 183.
- Storage cases accept binder height items.
- Storage cube fits inside stack-on storage or overhead cabinet units to provide paper management.
- Wall mount brackets specified with unit. Brackets attach to case horizontally.
- For panel mounted applications, brackets and hardware are ordered separately, see page 630. Brackets attach to panel and case is screwed into brackets. Two brackets needed for 60" unit.
- If Wall Bracket option is selected, \$150 upcharge applies.
- ❗ Stack-on Storage must be placed over two full-height supports. Cannot be placed over non-supported sections such as returns using a flat bracket or tower-to-worksurface bracket.
- ❗ TIG doors not available with a locking option.

HOW TO SPECIFY

<p>Select Model Number</p> <p>For locking overhead models, add an "L" suffix (\$40 upcharge per model)</p>	<p>Select Cabinet Laminate</p> <p>See page 183</p>	<p>Select Door Material</p> <p>Upcharges for door selection:</p> <table style="width: 100%; border: none;"> <tr> <td style="width: 70%;">4-Door</td> <td style="text-align: right;">\$315</td> </tr> </table> <p>TIG Platinum Polymer with Frosted Glass</p> <p>Also available in laminate doors. See page 183.</p> <p>Not specified for models HLSL1436D – HLSL1448D. These models are available in laminate only.</p>	4-Door	\$315	<p>Select Bracket Option</p> <p>X No Bracket W Wall Bracket (\$150 upcharge)</p>
4-Door	\$315				
<div style="display: flex; justify-content: space-around; border: 1px solid black; width: 100%;"> HLSL1460D </div>	<div style="display: flex; justify-content: space-around; border: 1px solid black; width: 100%;"> N </div>	<div style="display: flex; justify-content: space-around; border: 1px solid black; width: 100%;"> TIG </div>	<div style="display: flex; justify-content: space-around; border: 1px solid black; width: 100%;"> X </div>		

VOI® Overhead and Stack-on Storage

GSA SIN 33721



Icon Legend on page 19

WORKSTATIONS

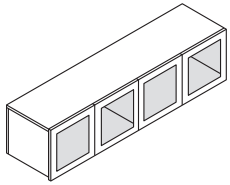

DESCRIPTION	MODEL	SHIP WEIGHT	CUBE	LIST PRICE BY LAMINATE GRADE	
				L1	L2
Overhead Cabinet with 4 Frosted, Metal Frame Doors 60"W x 14¼"D x 14"H ⓘ Must specify an X or W for attachment bracket option below.	HLSL1460M	115	11.4	\$2141	\$2171

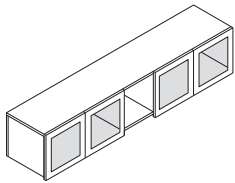

Overhead Cabinet with 4 Frosted, Metal Frame Doors 72"W x 14¼"D x 14"H with 12" Cubbie HLSL1472M	139	13.6	\$2412	\$2447
66"W x 14¼"D x 14"H with 6" Cubbie HLSL1466M	126	12.5	\$2275	\$2305

ⓘ Must specify an X or W for attachment bracket option below.



Storage Cube 12"W x 12"D HLSL1212	1	0.3	\$316	N/A
---	---	-----	-------	-----

SPECIFYING EXAMPLE: HLSL1212.P8S

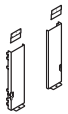

DESCRIPTION	MODEL	SHIP WEIGHT	CUBE	LIST PRICE BY PAINT GRADE	
				P1	P2
Voi® for Systems Stack-on Storage Panel Mounted Bracket Used to panel mount stack-on storage units Specify paint NOTES: Ships with one set of three brackets, which includes one right, one center and one left bracket. When using a 60"W overhead on a 60"W panel or a 72"W overhead on a 72"W panel, only two of the three brackets provided are required. SPECIFYING EXAMPLE: HLSLPMB.T1	HLSLPMB	3 ⓘ	1.0	\$145	\$155

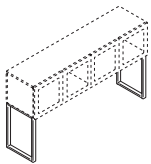

O-Leg Support for Overhead Cabinet Ships 2/pack 14⅞"D x 20½"H for 65"H Overhead Cabinet HLSL650S	8	1.1	\$526	\$530
14⅞"D x 5½"H for 50"H Overhead Cabinet HLSL500S	6	1.0	\$437	\$441

NOTES:

- Voi® Overhead Storage can be used with Accelerate® and Abound® panels.
- Overhead and Stack-on storage units do not lock.
- Use O-Leg Support models for Overhead Cabinets.
- If Wall Bracket option is selected, \$150 upcharge applies.
- Storage cube fits inside stack-on storage or wall mount units to provide paper management.
- Storage Cubes are available in the following colors: Atom (P8S), Bullseye (PJF), Ember (P8P), Ion (P8N), Iris (P8J), Krypton (P8F), and Regatta (P8M).

ⓘ Stack-on Storage must be placed over two full-height supports. Cannot be placed over non-supported sections such as returns using a flat bracket or tower-to-worksurface bracket.

HOW TO SPECIFY

Select Model Number HLSL1460M . N .	Select Cabinet Laminate See page 183 N .	Select Door Material TIG Platinum Metal Doors with Frosted Glass (no upcharge) TIG .	Select Bracket Option X No Bracket W Wall Bracket (\$150 upcharge) X
---	---	---	--



Shared Overhead Storage Components

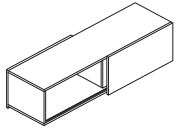

DESCRIPTION

Shared Overhead Storage — Left
 60"W x 17"D x 14"H
 72"W x 17"D x 14"H

MODEL

HLSL1760SOL
HLSL1772SOL

SHIP WEIGHT

115
 139

CUBE

14.8
 17.0

L1 LIST

\$1429
\$1723

L2 UPCHARGES
CABINET DOOR

\$20 \$40
\$25 \$40

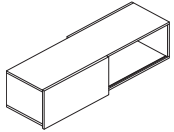

Shared Overhead Storage — Right
 60"W x 17"D x 14"H
 72"W x 17"D x 14"H

HLSL1760SOR
HLSL1772SOR

115
 139

14.8
 17.0

\$1429
\$1723

\$20 \$40
\$25 \$40



DESCRIPTION

Post Legs for Shared Storage
 14"H Post Legs
 22"H Post Legs

MODEL

HLSL140SPL
HLSL220SPL

SHIP WEIGHT

10
 13

CUBE

1.1
 3.7

LIST PRICE BY PAINT GRADE
P1 P2

\$381 \$385
\$422 \$426

NOTES: 14"H post legs on worksurfaces will span 35"H panel or shorter. 14"H post legs on low credenzas will span 30"H panel or shorter. 22"H post legs on worksurfaces will span 50"H panel or shorter. 22"H post legs on low credenzas will span 35"H panel or shorter. Specify paint.

SPECIFYING EXAMPLE: HLSL140SPL.T4



Panel Mount Bracket for Shared Overhead

Panel Mount Bracket for Overhead Storage — Accelerate®
 Panel Mount Bracket for Overhead Storage — Abound®
 Panel Mount Bracket for Overhead Storage — Accelerate®/Abound® 42½"H panels only

HLSLPMBSOA
HLSLPMBSOB
HLSLPMBSO42

4
 4
 4

0.1
 0.1
 0.1

\$150 \$154
\$150 \$154
\$140 \$144

NOTES: Specify paint.

SPECIFYING EXAMPLE: HLSLPMBSOA.T4

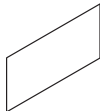

Markerboard for Shared Storage

30"W x 15"D for use with 60"W Shared Overhead
 36"W x 15"D for use with 72"W Shared Overhead

HLSL1530SOMB
HLSL1536SOMB

6
 8

1.0
 1.0

\$143
\$192

NOTES: No specification necessary.

HOW TO SPECIFY

<p>Select Model Number</p> <p>HLSL1760SOL .</p>	<p>Select Chassis Laminate</p> <p>See page 183</p> <p>N .</p>	<p>Select Door Front Laminate</p> <p>See page 183</p> <p>N .</p>	<p>Select Pull Color</p> <p>T4 Champagne Metallic T1 Platinum Metallic WHIT White</p> <p>T4</p>
--	--	---	--

<p>Select Model Number</p> <p>HLSL140SPL .</p> <p>HLSLPMBSOA .</p>	<p>Select Paint Color</p> <p>See page 183</p> <p>T4</p> <p>T4</p>
---	--

SYSTEMS

Overhead and Shelves

GSA SIN 33721



Icon Legend on page 19

WORKSTATIONS

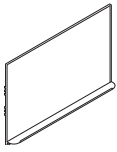

DESCRIPTION

Markerboards
 36"W x 24"H
 42"W x 24"H
 48"W x 24"H

MODEL

HHMRK36
HHMRK42
HHMRK48

SHIP WEIGHT

15 Ⓞ
 17 Ⓞ
 19 Ⓞ

CUBE

3.2
 4.0
 4.6

LIST PRICE

\$546
\$591
\$637

NOTES:

- Brushed aluminum finish around low-glare porcelain coated steel magnetic writing surface.
- Brushed aluminum marker tray attaches to frame.
- Width of markerboard must correspond to the width of the panel.
- Markerboards will attach to the Abound and Accelerate® frame with brackets provided.
- Able to use multiple markerboards next to each other and multiple boards per panel.

! No color specification required.

! Porcelain Markerboard cleaning instructions: For everyday cleaning, use Chlorox wipes. Use citrus cleaner if a permanent marker is used by accident. A citrus cleaner is not recommended for everyday use as it leaves residue.

HOW TO SPECIFY

Select Model Number

HHMRK36

DESCRIPTION

Tackboard
 20"W x 18"H
 24"W x 18"H
 30"W x 18"H
 36"W x 18"H
 42"W x 18"H
 48"W x 18"H
 60"W x 18"H
 72"W x 18"H

MODEL

HETB2018
HETB2418
HETB3018
HETB3618
HETB4218
HETB4818
HETB6018
HETB7218

SHIP WEIGHT

2
 3
 3
 8
 10
 12
 13
 15

CUBE

0.5
 0.6
 0.7
 0.9
 1.0
 1.2
 1.5
 1.8

LIST PRICE

\$118
\$144
\$168
\$191
\$214
\$235
\$259
\$285

SPECIFYING EXAMPLE: HETB2018.APN15

NOTES:

- Works with both Abound® and Accelerate® panel systems.
- Specify fabric, see pages 424-425 for fabric options.

HOW TO SPECIFY

Select Model Number

HETB2018.

Select Fabric Color

APN15



Icon Legend on page 19

SYSTEMS Accessories

WORKSTATIONS

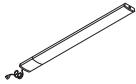

DESCRIPTION

LED Task Lights

17" LED Light with Power Supply (Single)
31" LED Light with Power Supply (Single)

17" LED Light with Power Supply for Daisy-chain (Starter)
31" LED Light with Power Supply for Daisy-chain (Starter)

17" LED Light with 8" Jumper Cord for Daisy-chain (Follower)
31" LED Light with 8" Jumper Cord for Daisy-chain (Follower)

Undercabinet Occupancy Sensor with 1" End to End Connector

MODEL

SHIP WEIGHT

CUBE

LIST PRICE

HLED17AS ⓘ	1.2 Ⓔ	0.05	\$450
HLED31AS ⓘ	1.5 Ⓔ	0.09	\$603
HLED17A	1.0 Ⓔ	0.05	\$493
HLED31A	1.4 Ⓔ	0.09	\$662
HLED17AUO ⓘ	1.0 Ⓔ	0.03	\$404
HLED31AUO ⓘ	1.0 Ⓔ	0.05	\$539
HLEDOSA ⓘ	0.2 Ⓔ	0.01	\$97

NOTES: To use the daisy chain application, must start with model HLED17A or HLED31A. No finish specification required. Attaches magnetically to underside of overhead storage, or attaches with provided screws or double-sided tape. Occupancy sensor attaches to a single or starter LED light and will automatically turn the light off after no motion is detected for 30 minutes. Just like all the LED light models, the occupancy sensor features a soft-touch on/off switch. LED task lights have a lifetime of 50,000 hours and have a dimmer feature that allows the user to adjust the amount of light output.

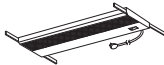

DESCRIPTION

MODEL

SHIP WEIGHT

CUBE

**BASIC
(NO SUFFIX
REQUIRED)**

**CHICAGO
CODE
"CH"**

Task Lights

- Slim profile design mounts recessed under storage unit and shelves with spring steel clips.
- T5 bulb included which contains less mercury than other types of bulbs.
- 9-foot black cord and switch off right rear corner.
- Electronic ballast for increased energy efficiency.
- 2 lights (HH870930) can be mounted under 60"W storage cabinets.

Chicago Code Version —
Specify: Model/"CH".
EXAMPLE: HH870924CH

For 24"W storage cabinets or shelves,

18³/₈"W x 3¹/₁₆"D x 1¹/₈"H

HH870924(?)	5.0	0.4	\$243	\$308
--------------------	-----	-----	--------------	--------------

For 30"W and 36"W storage cabinets or shelves,

22¹/₈"W x 3¹/₁₆"D x 1¹/₈"H

HH870930(?) ⓘ	7.0	0.6	\$247	\$322
----------------------	-----	-----	--------------	--------------

For 42"W and 48"W storage cabinets or shelves,

34⁵/₈"W x 3¹/₁₆"D x 1¹/₈"H

HH870942(?) ⓘ	10.0	0.9	\$267	\$339
----------------------	------	-----	--------------	--------------

For 60"W and 72"W storage cabinets or shelves,

46¹/₂"W x 3¹/₁₆"D x 1¹/₈"H

HH870960(?)	12.0	1.1	\$290	\$361
--------------------	------	-----	--------------	--------------

NOTES: For additional information see the Workplace Tools section in the 2021 Shared Spaces Pricer.

ⓘ Color: Black.

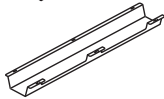
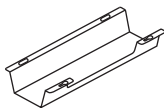

SIN 33721

DESCRIPTION

MODEL

SHIP WEIGHT

CUBE

LIST PRICE

Cable Management Troughs

17"W — Single

HCTROUGH17	2.7	0.5	\$73
-------------------	-----	-----	-------------

17"W — 10-Pack

HCTROUGH1710	14.0	0.5	\$665
---------------------	------	-----	--------------

36"W — Single

HCTROUGH36	4.9	0.9	\$122
-------------------	-----	-----	--------------

36"W — 10-Pack

HCTROUGH3610	30.0	0.9	\$1121
---------------------	------	-----	---------------

- Cable management troughs ship flat packed.
- The troughs attach to underneath the worksurface with screws.
- The 17"W has one wire access cut out on the user side. The 36" has two wire access cut outs. These cut outs give users access to inside the trough without having to detach it from the worksurface.
- Color: Graphite.
- Material: Metal.
- TAA Compliant.

NOTES: For additional information see the Workplace Tools section in the 2021 Shared Spaces Pricer.

SYSTEMS Accessories

GSA SIN 33721



Icon Legend on page 19

WORKSTATIONS

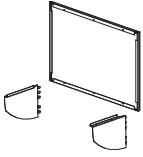

DESCRIPTION	MODEL	SHIP WEIGHT	CUBE	LIST PRICE BY PAINT GRADE	
				P1	P2
Upmount Kits for Overheads					
24"W	HRVUP24	7.0	0.3	\$171	\$189
30"W	HRVUP30	8.0	0.3	\$180	\$198
36"W	HRVUP36	10.0	0.4	\$185	\$203
42"W	HRVUP42	11.0	0.4	\$194	\$212
48"W	HRVUP48	12.0	0.5	\$202	\$220
60"W	HRVUP60	16.0	0.6	\$217	\$235
<ul style="list-style-type: none"> Includes two upmount brackets, full back panel and installation hardware. Brackets require a clearance of 6½" below bottom of overhead cabinet. Full back panel adds ½" to depth of overhead case. 					
<p>! Kit width must correspond to the width of the overhead case.</p>					



Overhead Shelf Dividers Shelf Dividers — package of 6	H38SHFDV	3.0 Ⓔ	0.2	\$167	\$178
---	-----------------	--------------	-----	--------------	--------------

Specify paint

NOTES:

- Upmount Bracket allows mounting of Overhead Cabinet up to 15" above height of panel.
- Upmount Kits for overheads can be used with flipper or receding door overheads. See page 586.

! Upmount Kits not for use on Accelerate stackers.

HOW TO SPECIFY

Select Model Number	Select Paint Color
See page 481	See page 481
H 3 8 S H F D V .	T 1



DESCRIPTION	MODEL	SHIP WEIGHT	CUBE	LIST PRICE BY PAINT GRADE	
				P1	P2
Cord Cover					
• Allows routing of task light cords.					
• Vertical height 10".	HECC10	0.7 Ⓔ	0.2	\$43	\$50
• Vertical height 15".	HECC15	1.0 Ⓔ	0.3	\$43	\$50
• Cord cover can be positioned into panel slots and used under task lights and under worksurfaces.					

Specify paint

HOW TO SPECIFY

Select Model Number	Select Paint Color
See page 481	See page 481
H E C C 1 0 .	T 1

ABOUND® Electrical and Data

Abound® features capabilities for cable management, including electrical, voice, and data. The 8-wire electrical system can be integrated at base pathway and beltline. The open structure of the frame allows voice and data cables to be routed both vertically and horizontally.

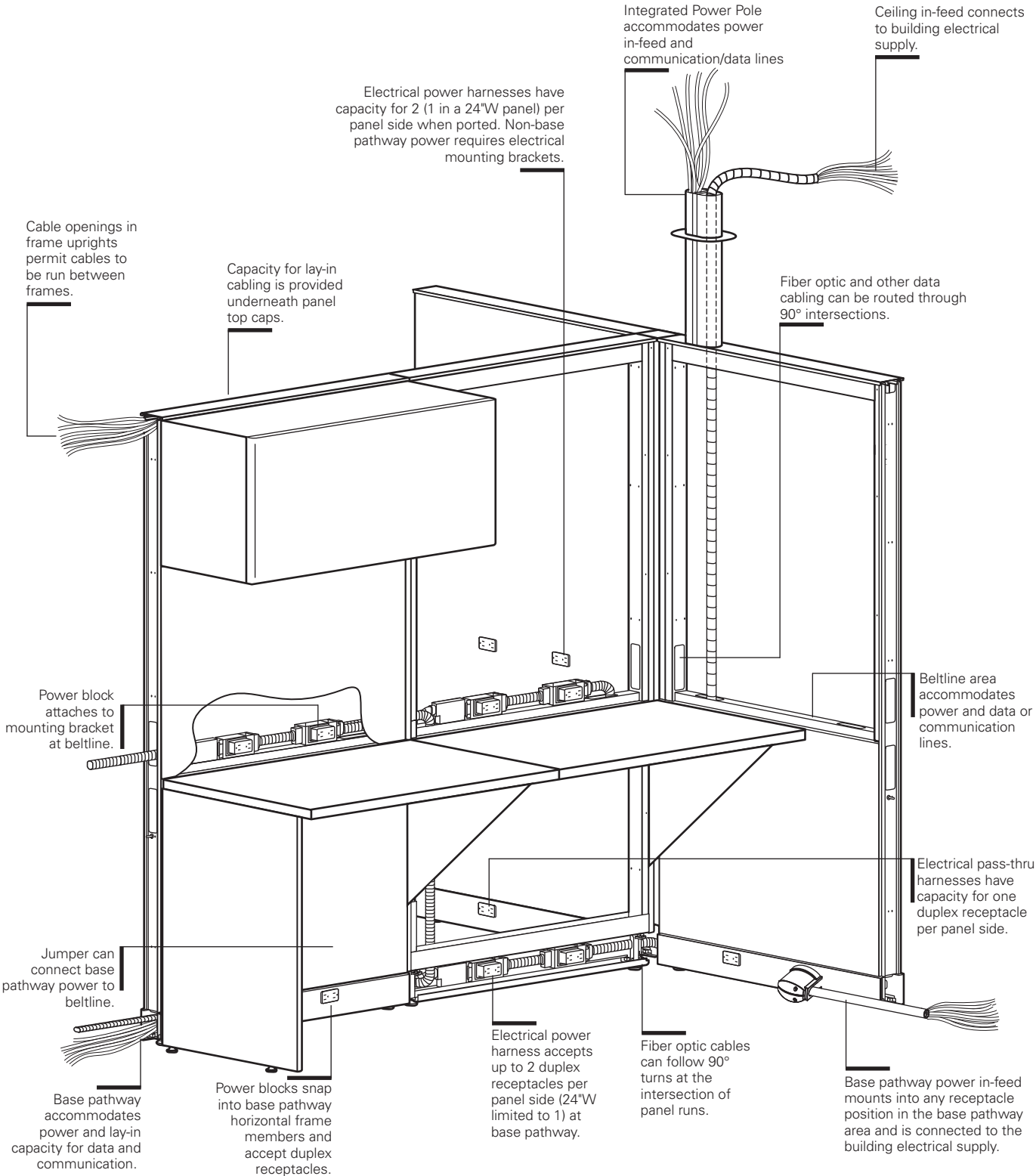

ABOUND® Electrical and Data

THE ABOUND ELECTRICAL SYSTEMS

Abound offers a choice of three electrical systems:

- Four-circuit, 3 + 1
- Four-circuit, 2 + 2
- Three-circuit, separate neutrals

All three systems utilize an 8-wire electrical system, rated at 20 amps per circuit (15 amps Canadian). See pages 603-604 for a detailed explanation of each electrical system.

Abound frames and electrical components are UL Listed. Electrical components are also CSA certified.

Installation and use of the electrical system, the number of receptacles used on a given circuit and connections to the building power supply should be in compliance with all local and national electrical codes.

Caution: Electrical equipment cords or extension cords MUST NOT BE ROUTED through cable openings in frame sides.

Abound's electrical harnesses are UL listed and are considered raceways themselves as defined by the National Electrical Code. This means there is no separation requirement between the electrical harnesses and communications cables per Sec. 800-52 of the National Electrical Code. Communication cables may be placed next to Abound's electrical components without a metal septum and will still meet the guidelines of the Telecommunications Industry Association for separation of power and data.

IN-FEEDS

Power in-feed cables deliver power from building to system. In-feed cables are housed in conduit to separate electrical system from communications and data lines.

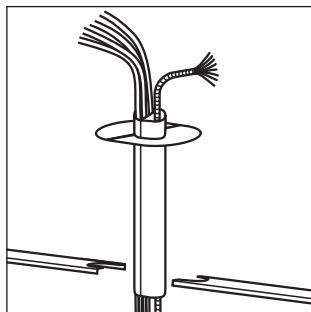

Integrated power and communications poles provide capacity for routing power supply directly through the top of any structural or stacking frame using same width trim/connector kit in place of top cap. Avoid glass or translucent tiles in upper position of frames with integrated power poles. Power pole has a cavity on each side of a center septum. When using a ceiling power in-feed, consider that the in-feed must connect into an electrical harness located in an adjacent panel. (See pages 605-606 for cable capacity.)

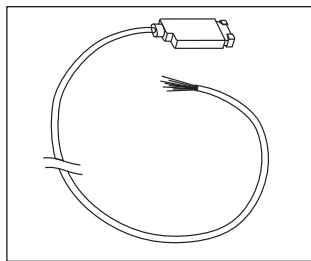

Ceiling power in-feed connects to a prewired electrical harness in the beltline or base pathway, traverses through an adjacent panel and terminates in the junction box at the top of the integrated power pole. For use with integrated power pole models HEP65 and HEP35. No portion of the flex cable can be exposed after installation.

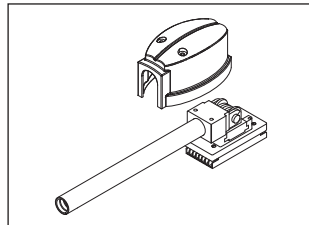

Sealtight base pathway power in-feed attaches to a receptacle opening at the base pathway. A heavy rubber sheathing shields conduit, allowing in-feed to be exposed.

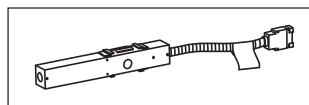

Hardwire (New York Code) power in-feed (model H871400) is used when local electrical codes require hardwire entry. When used in 24"W, 30"W and 36"W panels, power can be routed only in one direction. When used in 42", 48"W and 60"W panels, an electrical pass-thru cable or harness for that panel width can be used to route power back in the opposite direction. Unit must connect to a power or pass-thru harness positioned in the base pathway area of an adjacent panel. Customer to furnish all cabling and wiring from power entry to power source. Junction box can be positioned at any duplex receptacle location.

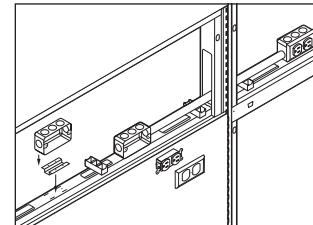

HARDWIRE (CHICAGO CODE) JUNCTION BOX

Wiring harnesses and snap connectors are not allowed in Chicago — base pathways must be comprised of all metallic components. Concealed mounting is the only option at beltline. For the base pathway, junction box (model HH873500) clips directly into receptacle locations. Customer must furnish conduit, wiring, standard duplex receptacles with metal covers for the beltline and designer-type receptacles for the base pathway. Power entry can be routed from the ceiling, via an Abound power pole, or from the floor into a junction box (model HH873500).

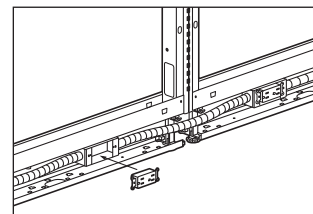

POWER

Power blocks on electrical power harness and pass-thru harness accept duplex receptacles.

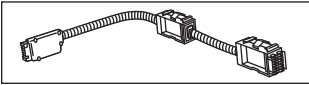

Electrical power harnesses are used to distribute power in panels. Abound electrical can be located at base pathway or beltline only. Connectors at both ends of power harnesses allow power distribution in either direction.

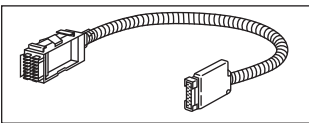

Electrical pass-thru harnesses have capacity to handle one duplex receptacle on each side of the panel when exposed.

A 60" pass-thru harness can be used to jump up to a single duplex receptacle per side at beltline and connecting to a power harness at base pathway.

Electrical power harnesses and pass-thru cables cannot be routed at 90° at beltline once frames are connected to connector blocks.

Electrical pass-thru cables distribute power through any panel where receptacles are not required. Cable length cannot be stretched.

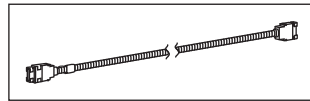

Electrical jumper cables connect power from base pathway or beltline to a harness located on any horizontal member as needed. Jumper cable plugs into power block end of electrical power harness or electrical pass-thru harness.

Model HH871366 is 66" to jump up to 30 inches vertically – base pathway to beltline or beltline to base pathway.

Jumper can also be used from beltline to adjacent beltline at 90° juncture.

POWER BLOCKS

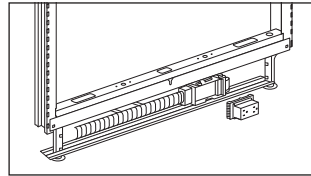

Base pathway mounting: Power blocks snap directly onto brackets in base pathway area.

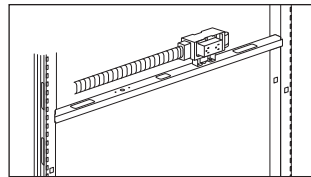

Beltline electrical mounting: For ported receptacles at beltline mount power blocks onto Electrical Mounting Brackets which screw into the panel frame. Electrical Mounting Brackets must be ordered separately. Data/Electrical Port Tiles must be used where exposed receptacles will be located.

RECEPTACLES

Duplex receptacles snap into power blocks of power harnesses or pass-through harnesses. Duplexes are available in multiple colors. Each receptacle is labeled to indicate which circuit it will be connected to.

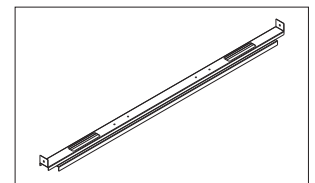
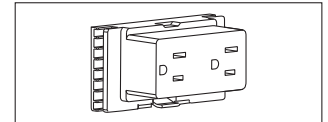

OPTIONAL STIFFENER SUPPORT Stiffener supports can be used to provide additional rigidity to a panel when fabric tiles are on both sides of the frame. May also be used for routing power/data at non-standard heights.

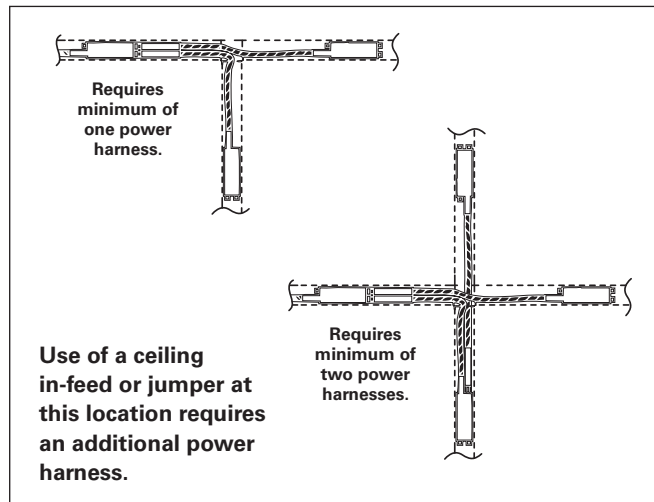

All electrical power harnesses and pass-thru harnesses will stretch 3½", allowing them to span "T" and "X" intersections and "S" extended straight connections.

ACCELERATE® Electrical and Data

WORKSTATIONS

Accelerate® features capabilities for cable management, including electrical, voice, and data. The 8-wire electrical system can be integrated at base pathway. See Systems electrical pages 608-613 for electrical models to be used with Accelerate® Systems products. See page 444 for Abound® frame horizontal and vertical wire capacity and page 606 for base pathway capacity.

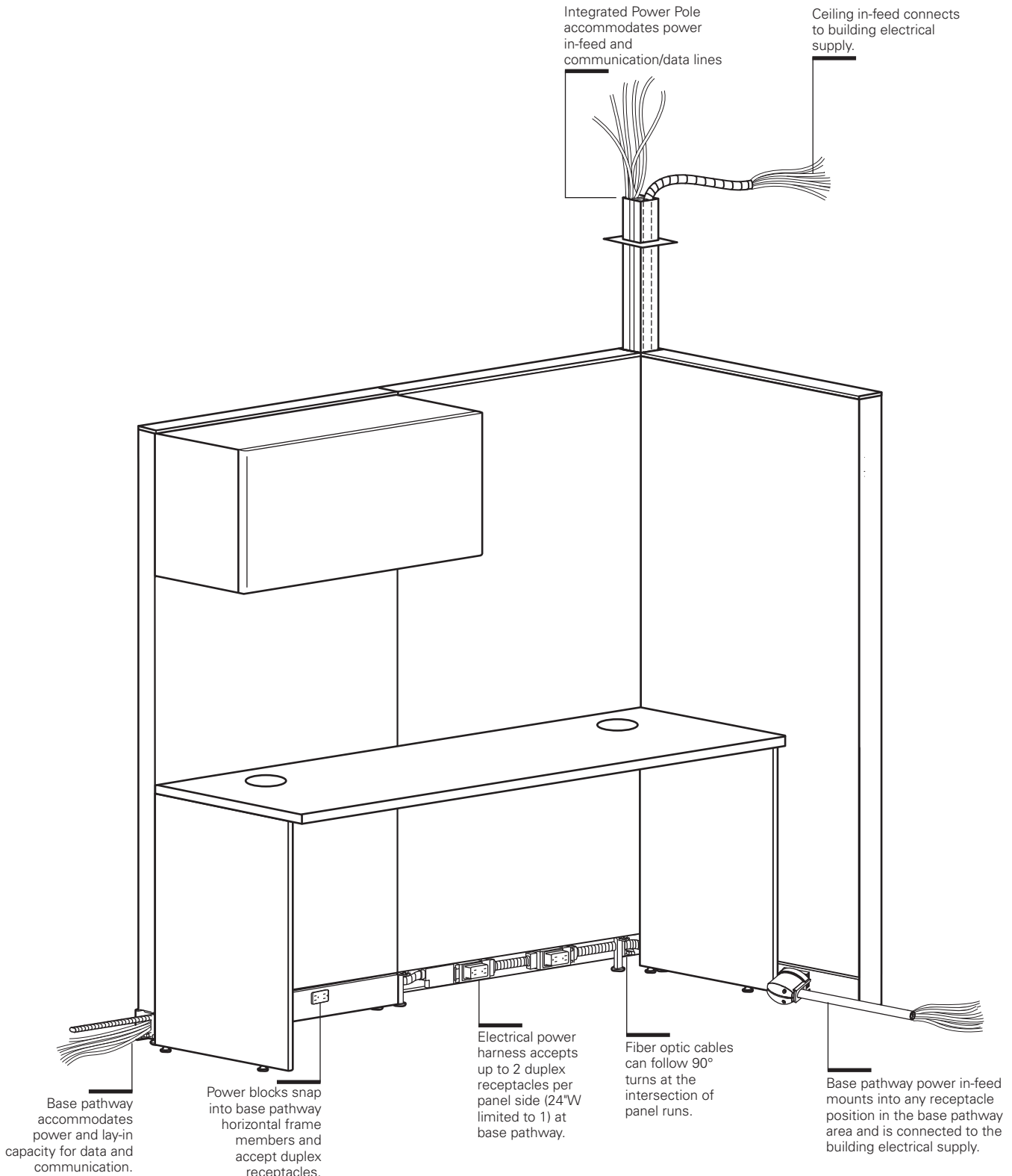

THE ACCELERATE ELECTRICAL SYSTEMS

Accelerate offers a choice of three electrical systems:

- Four-circuit, 3 + 1
- Four-circuit, 2 + 2
- Three-circuit, separate neutrals

All three systems utilize an 8-wire electrical system, rated at 20 amps per circuit (15 amps Canadian). See pages 603-604 for a detailed explanation of each electrical system.

Accelerate panels and electrical components are UL Listed. Electrical components are also CSA certified.

Installation and use of the electrical system, the number of receptacles used on a given circuit and connections to the building power supply should be in compliance with all local and national electrical codes.

Caution: Electrical equipment cords or extension cords MUST NOT BE ROUTED through cable openings in frame sides.

Accelerate's electrical harnesses are UL listed and are considered raceways themselves as defined by the National Electrical Code. This means there is no separation requirement between the electrical harnesses and communications cables per Sec. 800-52 of the National Electrical Code. Communication cables may be placed next to Accelerate's electrical components without a metal septum and will still meet the guidelines of the Telecommunications Industry Association for separation of power and data.

IN-FEEDS

Power in-feed cables deliver power from building to system. In-feed cables are housed in conduit to separate electrical system from communications and data lines.

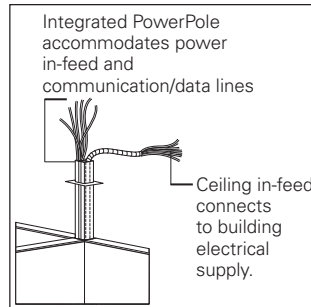

Integrated power and communications poles provide capacity for routing power supply directly through the top of any connector. When using a ceiling power in-feed, consider that the in-feed must connect into an electrical harness located in an adjacent panel. (See pages 605-606 for cable capacity.)

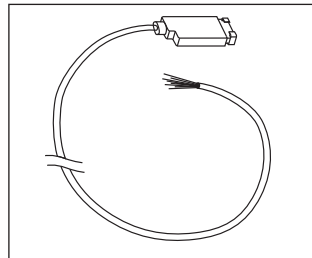

Ceiling power in-feed connects to a prewired electrical harness in the beltline or base pathway, traverses through an adjacent panel and terminates in the junction box at the top of the integrated power pole. For use with integrated power pole models HECPP. No portion of the flex cable can be exposed after installation.

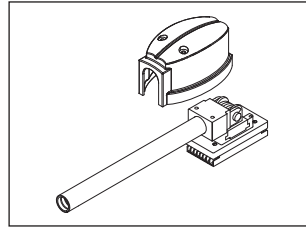

Sealtight base pathway power in-feed attaches to a receptacle opening at the base pathway. A heavy rubber sheathing shields conduit, allowing in-feed to be exposed.

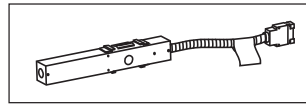

Hardwire (New York Code) power in-feed (model H871400) is used when local electrical codes require hardwire entry. When used in 24"W, 30"W and 36"W panels, power can be routed only in one direction. When used in 42", 48"W and 60"W panels, an electrical pass-thru cable or harness for that panel width can be used to route power back in the opposite direction. Unit must connect to a power or pass-thru harness positioned in the base pathway area of an adjacent panel. Customer to furnish all cabling and wiring from power entry to power source. Junction box can be positioned at any duplex receptacle location.

HARDWARE (CHICAGO CODE) JUNCTION BOX

Wiring harnesses and snap connectors are not allowed in Chicago — base pathways must be comprised of all metallic components. Concealed mounting is the only option at beltline. For the base pathway, junction box (model HH871500) clips directly into receptacle locations. Customer must furnish conduit, wiring, standard duplex receptacles with metal covers for the beltline and designer-type receptacles for the base pathway. Power entry can be routed from the ceiling, via an Accelerate power pole, or from the floor into a junction box (model HH871500). See Systems electrical pages 608-613 for electrical models to be used with Accelerate® Systems products.

DUPLEX RECEPTACLES

For Duplex Receptacle models that can be used on Accelerate® panel systems, please see page 611.

All Systems electrical components can be found on pages 608-613.

SYSTEMS

Electrical and Data

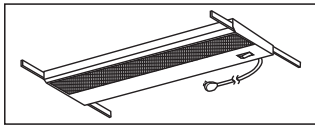

LIGHTING

Task lights can be recessed under storage cabinets or storage shelves.

Task lights in four sizes are available to correspond to cabinet or shelf width. They have 9' power cords in black, connected in the right rear corner. All models feature electronic ballast for longer bulb life and cooler operating temperature. Task lights with a fused plug to meet Chicago electrical code are also available.

Recommendation: Provide a separate circuit for task lights for proper long-term operation without RF interference to computers that may be in use.

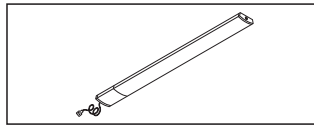

LED TASK LIGHTS

No finish specification required. Attaches magnetically to underside of overhead storage, or attaches with provided screws.

Occupancy sensor attaches to a single or starter LED light and will automatically turn the light off after no motion is detected for 30 minutes.

Just like all the LED light models, the occupancy sensor features a soft-touch on/off switch. LED task lights have a lifetime of 50,000 hours and have a dimmer feature that allows the user to adjust the amount of light output.

Daisy chain options are available. To use the daisy chain application, must start with model HLED17A or HLED31A.

VOICE/DATA RECEPTACLES

Abound not only provides space for large volumes of voice and data cables, it also offers several means of mounting commercially available voice and data components.

Commercially available modular data faceplates can be mounted in vacant base receptacle openings or can be mounted in data/electrical port tiles above or below the worksurface.

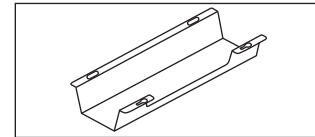

Cable management troughs attach to worksurfaces with provided screws. The graphite metal troughs are designed with cord access cut outs. These cut outs give users access to inside the trough without having to detach it from the worksurface.

SYSTEMS ELECTRICAL SPECIFYING INFORMATION

To Order:

- Determine which electrical system you will use after consulting your electrician and computer support personnel:
 - The Four-circuit system (4-Hot/2-Neutral/2-Ground)**
 - 3 + 1 option
 - 2 + 2 option
 - The Three-circuit system (3-Hot/3-Neutral/2-Ground)**
- Determine location, quantity and circuit of duplexes.
- Determine the appropriate choice and use of Isolated, Isolated/Dedicated and Separate Neutral circuits.
- Specify appropriate Power Harnesses* and Pass-Thru Cables.*
- Determine the location, quantity and type of Power In-feed needed.

* Select Power Harness models (HH8712XX) and Pass-Thru Cables (HH8711XX) with the last two digits being 1" (or 2") smaller than the associate panel width.

Electrical System Options

The four-circuit, eight-wire electrical system is widely specified and trusted by hundreds of thousands of end-users. This proven system delivers four circuits for every power in-feed in either a 3 + 1 or 2 + 2 configuration. The isolated/dedicated circuits are ideal for sensitive computing equipment, while the common circuits are suitable for faxes, copiers, task lights and other peripherals.

Both the 3 + 1 and 2 + 2 systems use the same pre-wired components, making it easy to adjust as electrical needs change.

You can also choose a three-circuit, eight-wire system that has a dedicated neutral for every hot circuit. The three-circuit components have model numbers with an "A" suffix and appear in a gray box in this pricer.

Four-circuit, 3 + 1 Receptacle Option

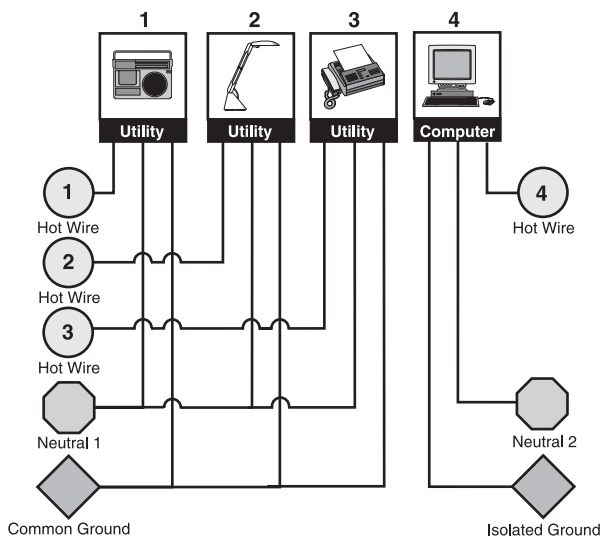

The 3 + 1 option is the electrical standard used by The HON Company for many years in most of their systems products. This wiring option provides three utility circuits plus an isolated/dedicated circuit for more sensitive equipment.

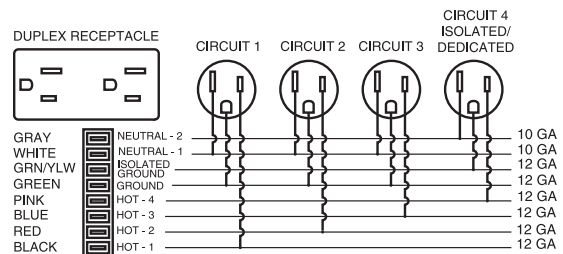

Four-circuit, 2 + 2 Receptacle Option

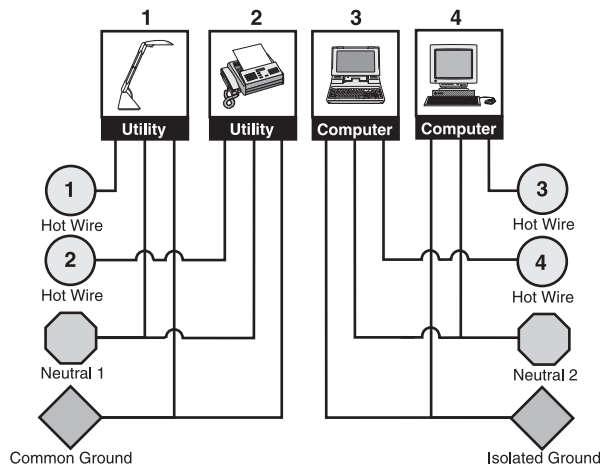

The 2 + 2 option is a wiring option that provides two utility circuits and two isolated circuits for more extensive computer usage applications.

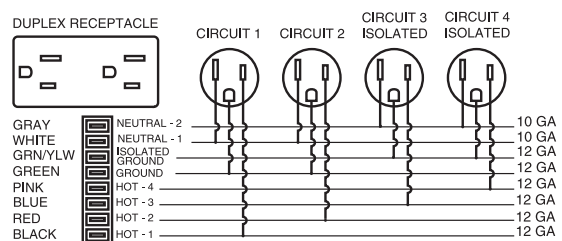

SYSTEMS ELECTRICAL SPECIFYING INFORMATION

Three-circuit, separate neutrals

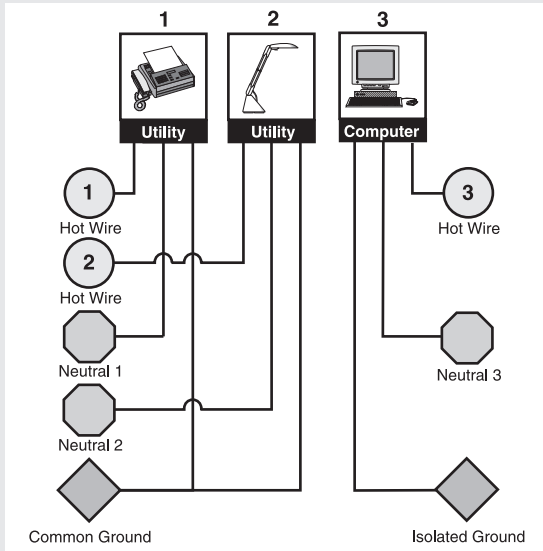

The Three-circuit, separate neutrals configuration is a wiring option that provides separate neutrals for each of the three circuits. Two circuits share a common ground, and one circuit is isolated/dedicated. The three-circuit components have model numbers with an "A" suffix and appear in a gray box in this pricer.

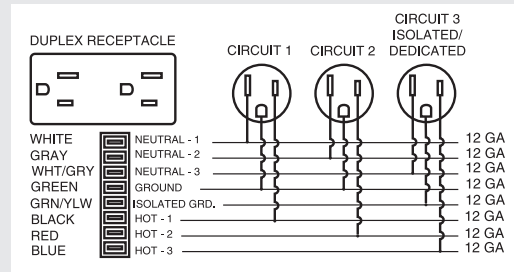

Two 8-wire, 20 AMP (15 AMP Canadian) electrical systems are offered					
Electrical System	Circuitry	Receptacle Capacity			
Four-circuit 4-Hot/2-Neutral/2-Ground (10 gauge neutral wires)	3 + 1	Common Circuit-1 HH873501	Common Circuit-2 (1) HH873502	Common Circuit-3 HH873503	Iso/Dedicated Circuit-4 HH873504
	2 + 2	Common Circuit-1 HH873501	Common Circuit-2 HH873502	Isolated Circuit-3 HH873506	Isolated Circuit-4 HH873504
Three-circuit 3-Hot/3-Neutral/2-Ground (12 gauge neutral wires)	w/separate neutrals	Common Circuit-1 HH873501A	Common Circuit-2 HH873502A	Iso/Dedicated Circuit-3 HH873503A	N/A

(1) Circuit-2 (one of the 3 common circuits sharing a neutral wire) cannot be used with a single-phase building electrical supply.

Notes:

- Four-circuit components and three-circuit components (with suffix "A") cannot be used together.
- Components of the two systems are keyed differently to prevent components of one system from being connected to components of another system.
- HON Cat. Nos. are printed on the UL labels, and components are color-coded to provide visual identification of the different components.
- Four-circuit components have black plastic parts.
- Three-circuit components have rust-colored terminal ends and receptacle backs are rust colored.

Typical power usage by the most commonly specified office equipment.

Source: Industry Analysis, Inc., Rochester, NY

EQUIPMENT	AMPS	EQUIPMENT	AMPS	EQUIPMENT	AMPS
Computers		Copiers		FAX Machines	
Personal Computer	3	Desktop Copier	15	InkJet FAX	less than 1
Notebook Computer	3	Console Copier	20	Thermal FAX	less than 1
		Copier/Duplicator	30	Plain paper FAX	8
Monitors		Printers		Task Lights	
13" Color Monitor	2	Dot Matrix	less than 1	36" T8 Fluorescent	0.2/bulb
17" Color Monitor	3	InkJet	less than 1	48" T8 Fluorescent	0.3/bulb
21" Color Monitor	4	Personal Laser or LED	8		
		Workgroup Laser or LED	15		

Duplex Receptacles



15 AMP Receptacle

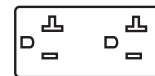

20 AMP Receptacle
(Required by some large copiers.)

SYSTEMS ELECTRICAL SPECIFYING INFORMATION

- Abound and Accelerate panels are UL listed.
- Electrical components are UL Listed and CSA Certified.
- It is the customer's responsibility to ensure that use of the pre-wired electrical system, the number of receptacles used on a given circuit, and connection to a building power source, be in compliance with all local and national electrical codes.
- Contact Customer Service for additional information.
- Pedestals and Lateral Files, positioned under worksurfaces, may render some receptacles inaccessible, and may prohibit use of grommets.
- Four-circuit components and Three-circuit components (with suffix "A") cannot be used together. See pages 603-604.
- Three-way panel connections require at least one power harness.
- Four-way panel connections require at least two power harnesses.
- ! A licensed electrician must make connections to a building electrical supply.

Definition of components:

Electrical Power Harness

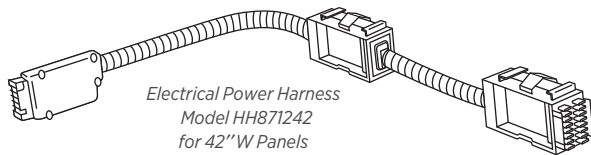

- Used to distribute power in panels.
- Power distribution in either direction.
- Specify Power Harness to match panel width.
- Double-sided: receptacles can be inserted into both sides of Power Blocks.

- ! Three-way panel connections require at least one power harness.
- ! 4-way panel connections require at least two power harnesses.

Electrical Pass-Thru Cables

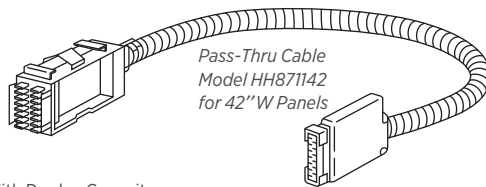

Pass-Thru Cable With Duplex Capacity:

- Use in panels where multiple receptacles are not required.
- Added feature: has capacity for one receptacle on each side of a panel. Feature offers future expansion and is an alternative to Power Harnesses.

Various Electrical Layouts



Straight Line

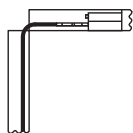

90 Degree Corner

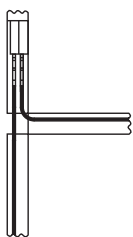

"T" Connection

When ending power in two return panels, wiring pigtails must be returned to original panel run.

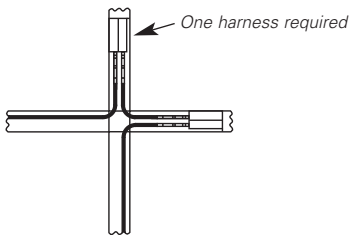

"X" or Cross Connection

To power a 4-way panel connection from one direction, specify at least two double block harnesses.

Duplex Receptacles

- 15 amp outlet configuration.
- Models HH871601 and HH871601A have a 20 amp outlet configuration.
- Fit back-to-back into the Power Block(s) of Power and Pass-Thru Harnesses.
- Labeled with the provided circuit. Circuits connected to the Isolated Ground are identified with an orange triangle; circuits that do not share a neutral or ground have an orange circuit number.

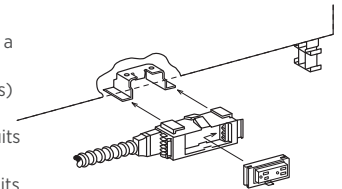

Power In-Feed (Base) Models HH879072 (72") and HH879168 (168")

- Used to connect the panel electrical system to the building electrical supply at a power block.
- Plugs into any receptacle position; can be rotated Left or Right.
- Conduit is UL listed Black Liquid-tight conduit (outside diameter is 7/8").

- ! A licensed electrician must make connections to a building electrical supply.
- ! Must be positioned through a receptacle opening in the baserail cover, prior to an electrician connecting to the power source.

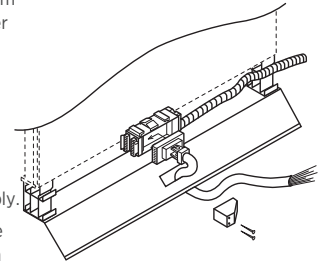

Power In-Feed Model (Ceiling) HH871912 and HH871918

- Used to connect the panel electrical system to the building electrical supply.

- ! A licensed electrician must make connections to a building electrical supply.
- ! Model uses UL recognized flex-cable conduit — no portion can be left exposed (i.e., must be in a power pole).
- ! Power Pole must be ordered separately.



HH871972

Note: In-feed cables listed above may be field-cut to desired length.

Electrical Jumper Cables

- ! When used to connect power between the base pathway and the beltline area, the jumper must be connected to a power block at one end of a run, routed into an adjacent panel that does not contain a power harness, then routed back into the panel containing a power harness or pass-thru cable and connected to a power harness in the other pathway.

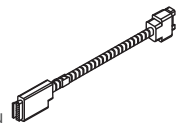

HH871366

Abound Electrical Mounting Brackets

- Use to mount ported receptacles at beltline.
- Screw into the panel frame.
- ! One mounting bracket required at beltline for each 24"W pass-thru or power harness. Two required for 30"-60"W power harness.

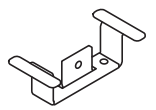

HH8988EBN

WORKING WITH CABLE MANAGEMENT

Base Pathway Receptacle Locations

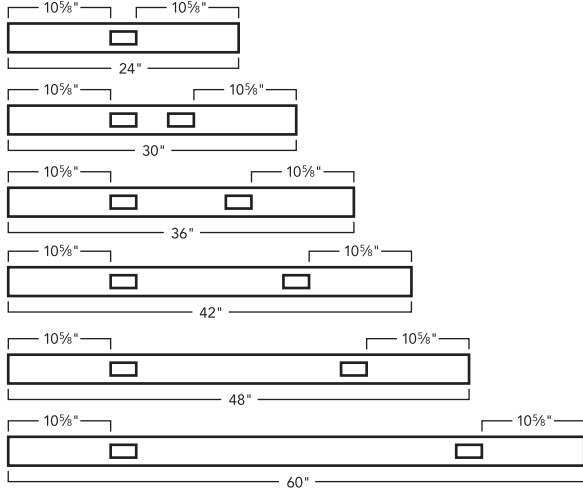

Abound® Lay-in Cable Capacity

The top and base pathway allow continuous voice and data lines to run through and between panels without interruption. Lay-in is provided for environments where systems furniture or cabling are subject to frequent change. All capacities are for Cat 6 cable with a 0.25" diameter.

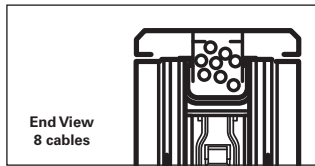

Top pathway accepts up to 8 voice/data cables (.25" dia.).

Abound® Cable Capacity

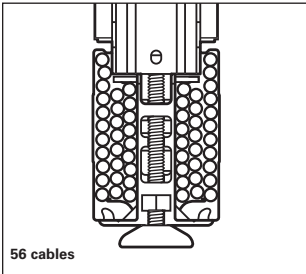

Abound® base pathway accepts up to 56 voice/data cables (.25" dia.) (6.03 sq. in.) at 60% fill.

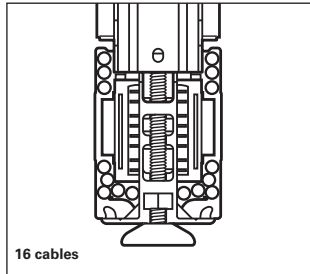

When electrical system shares base pathway, the cable capacity in Abound is reduced to 16 cables (2.25 sq. in.). Cable quantities listed are at 60% fill ratio.

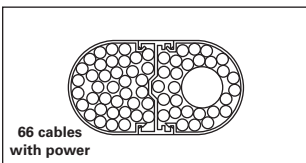

Cable capacity of the power pole, in addition to electrical in-feed is 2.79 sq. in. on one side and 2.91 sq. in. on the other for a total capacity of 66 cables with power of .25" diameter.

Circuit Usage

Strategy 1

Circuits to Equipment

Assign specific uses for each of the circuits:

- For example, in a four-circuit system:
Circuit 1 – Calculators, fans, etc.
Circuit 2 – Task lights (could be wired to wall switch)
Circuit 3 – Computer monitors
Circuit 4 – CPUs

Strategy 2

Circuits to Workstations

Assign specific workstations to each of the three available circuits. Use circuit 4 for power-sensitive electronic equipment.

Placement of pedestals and lateral files may render some duplex locations inaccessible. Pedestal placement may also affect compatibility with pull-up receptacles.

Abound® Lay-In Cable Capacity

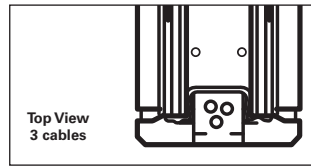

Variable height junctions accept up to 3 voice/data cables (.25" dia.).

Accelerate® Cable Capacity

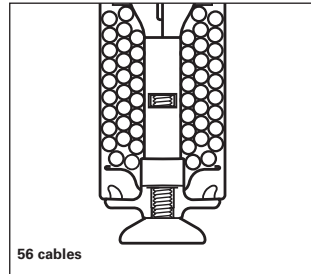

Accelerate® base pathway accepts up to 56 voice/data cables (.25" dia.) (6.27 sq. in.) at 60% fill.

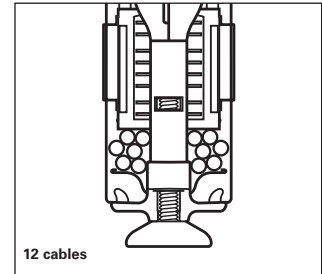

When the electrical system shares the base pathway, the cable capacity in Accelerate® is reduced to 12 cables (.25" dia.) (2.03 sq. in.) at 60% fill ratio.

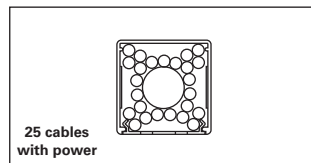

Integrated Power Pole: 2" x 2" overall, 3.3"² interior accommodates a total of 25 cables with power of .25" diameter. Available in two heights: 6'6" or 13', the power pole connects via the universal connector and the overall height is the sum of the connector and the power pole. Constructed of aluminum with a powder coat paint finish in the specified color. Power pole requires a Ceiling In-Feed.

Ceiling In-Feeds: UL

listed as raceways. This means the electrical components are completely shielded and meet any requirements for separation of electrical components and communications cables per Section 800-52 of the National Electrical Code.



SYSTEMS

Electrical Components

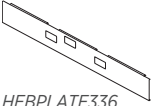
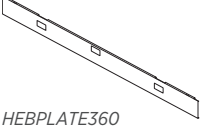
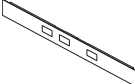
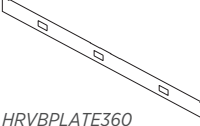
	DESCRIPTION	MODEL	SHIP WEIGHT	CUBE	LIST PRICE BY PAINT GRADE		
					P1	P2	
 HEBPLATE336	Accelerate® Base Pathway Cover w/Additional Knockout						
	36"W	HEBPLATE336	7	0.4	\$82	\$92	
	42"W	HEBPLATE342	8	0.4	\$84	\$94	
	48"W	HEBPLATE348	9	0.4	\$88	\$98	
	60"W	HEBPLATE360	11	0.5	\$100	\$110	
 HEBPLATE360	72"W	HEBPLATE372	14	0.6	\$111	\$121	
	NOTES: Specify paint, see page 481. SPECIFYING EXAMPLE: HEBPLATE336.T4						
	<hr/>						
	 HRVBPLATE336	Abound® Base Pathway Cover w/Additional Knockout					
		36"W	HRVBPLATE336	7	0.4	\$81	\$91
42"W		HRVBPLATE342	8	0.4	\$83	\$93	
48"W		HRVBPLATE348	9	0.4	\$86	\$96	
60"W		HRVBPLATE360	11	0.5	\$99	\$109	
 HRVBPLATE360	NOTES: Specify paint, see page 423. SPECIFYING EXAMPLE: HRVBPLATE336.T4						

NOTES:

- Specify Pathways to match trim color.
- Standard raceways with two knockouts are standard on panels. If additional three knockout kickplate is ordered, the two port version can be saved or discarded.

HOW TO SPECIFY

Select
Model Number

H E B P L A T E 3 3 6 .

Select
Paint Color

See page 481

T 4

SYSTEMS

Electrical Components

GSA SIN 33721



Icon Legend on page 19

WORKSTATIONS

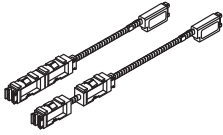

DESCRIPTION	MAX. RECEPT. CAP. PER PANEL SIDE	MODEL		SHIP WEIGHT	CUBE	LIST PRICE
		FOUR-CIRCUIT 3 + 1 2 + 2	THREE-CIRCUIT, SEPARATE NEUTRALS			
Electrical Power Harnesses, Frames — w/duplex capacity						
For 24"W	1	HH871224	HH871224A	2.0	0.5	\$227
For 30"W	2	HH871230	HH871230A	2.0	0.5	\$227
For 36"W	2	HH871236	HH871236A	2.5	0.5	\$227
For 42"W	2	HH871242	HH871242A	3.0	0.5	\$239
For 48"W	2	HH871248	HH871248A	3.0	0.5	\$239
For 60"W	2	HH871260	HH871260A	3.0	0.5	\$239
For 72"W (for use with Accelerate® 72"W panels only)	2	HH871272	HH871272A	5.0	0.5	\$239

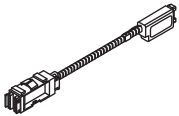

Electrical Pass-Thru Cables, Frames — w/duplex capacity						
For 24"W	1	HH871124	HH871124A	2.0	0.5	\$143
For 30"W	1	HH871130	HH871130A	2.0	0.5	\$143
For 36"W	1	HH871136	HH871136A	2.0	0.5	\$143
For 42"W	1	HH871142	HH871142A	2.5	0.5	\$151
For 48"W	1	HH871148	HH871148A	2.5	0.5	\$151
For 60"W	1	HH871160	HH871160A	3.0	0.5	\$151
For 72"W (for use with Accelerate® 72"W panels only)	1	HH871172	HH871172A	5.0	0.5	\$151

NOTES: For use when data will be terminated in one cutout in the panel.

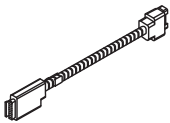

Electrical Pass-Thru Harness without Power Block						
For 24"W Frames	0	HH871024	HH871024A	2.0	0.5	\$132
For 30"W Frames	0	HH871030	HH871030A	2.0	0.5	\$132
For 36"W Frames	0	HH871036	HH871036A	2.0	0.5	\$132
For 42"W Frames	0	HH871042	HH871042A	3.0	0.5	\$137
For 48"W Frames	0	HH871048	HH871048A	3.0	0.5	\$137
For 60"W Frames	0	HH871060	HH871060A	3.0	0.5	\$137
For 72"W Frame Runs	0	HH871072		4.0	0.5	\$189

NOTES:

- Duplex receptacles on page 611.
- Electric harnesses are intended for use with HON Systems furniture and are approved under GSA SIN 33721. When purchased separately and used without HON Systems furniture, the models are considered Open Market.
- ! Four-circuit components and three-circuit components (with "A" suffix) not designed to be used together. See pages 603-604.

HOW TO SPECIFY

<p>Select Model Number</p> <p>HH871048 . P</p>	<p>Select Color</p> <p>See page 481</p>
--	---

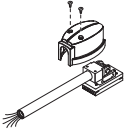
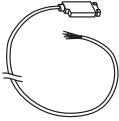
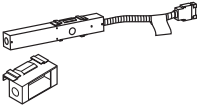

SYSTEMS Electrical Components

DESCRIPTION	MODEL		SHIP WEIGHT	CUBE	LIST PRICE
	FOUR-CIRCUIT 3 + 1 2 + 2	THREE-CIRCUIT, SEPARATE NEUTRALS			
 <p>Electrical Jumper Cables Jumper for up to 36" vertical jump, 66" long</p>	HH871366	HH871366A	3.0	0.5	\$154
 <p>Power In-Feed Cables — Base In-Feed 72" long conduit, Sealtight Cable — 7/8" diameter 168" long conduit, Sealtight Cable — 7/8" diameter</p>	HH879072 ⓘ HH879168	HH879072A HH879168A	4.5 9.0	0.3 0.4	\$253 \$589
 <p>Ceiling In-Feed 144" long conduit, Flex Cable — 7/8" dia. 216" long conduit, Flex Cable — 7/8" dia.</p> <p>ⓘ Must be used with Power Pole. Power in-feed models HH871912 and HH871918 plug into the end of any power block. No portion of the cable can be exposed after installation.</p>	HH871912 ⓘ HH871918	HH871912A HH871918A	4.0 4.0	0.5 0.5	\$263 \$342
 <p>Hardwire Applications Hardwire Power In-feed</p> <p>ⓘ Customer to furnish all cabling and wiring from power entry to power source (approved for use by city of New York).</p> <p>Hardwire Junction Box (6-pack)</p> <p>ⓘ For use with Accelerate® and Abound® Beltline only. ⓘ Hardwire Junction Boxes cannot be installed back-to-back in panel applications.</p> <p>Hardwire Junction Box (6-pack)</p> <p>ⓘ For use with Abound® Raceway panels only.</p> <p>NOTES: Junction Box can be positioned at any Duplex Receptacle location in 30"W or wider panels. ⓘ Contact Tailored Solutions for back-to-back Junction Box standard special number.</p> <p><i>Use when local codes require</i></p>	HH871400 ⓘ	HH871400A	4.0	0.3	\$247
	HH871500 ⓘ		4.5	0.1	\$526
	HH873500		4.5	0.2	\$491

NOTES:

- Duplex receptacles on page 611.
- ⓘ Four-circuit components and three-circuit components (with "A" suffix) not designed to be used together. See pages 603-604.
- ⓘ To connect power between the base pathway and the beltline area on Abound, four-circuit jumper cables (H8713xx) must be connected to a power block at one end of a run, routed into an adjacent panel that contains no power harness, then routed back into the panel that contains a power harness (or pass-thru cable), and connected to a power harness in the other pathway.

HOW TO SPECIFY

<p>Select Model Number</p> <p>HH871366 .</p>	<p>Select Color</p> <p>See page 481</p> <p>P</p>
--	--

SYSTEMS

Electrical Components

GSA SIN 33721



Icon Legend on page 19

WORKSTATIONS



DESCRIPTION

Abound® Integrated Power Pole
For 35"H-50"H Frames. Poles are 78"H.
For 65"H-95"H Frames. Poles are 52"H.

NOTES: Power Pole includes ceiling trim piece.

MODEL

SHIP WEIGHT

CUBE

LIST PRICE BY PAINT GRADE

HEP35	9 Ⓢ	0.6	\$422
HEP65	6 Ⓢ	0.4	\$298

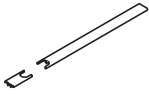

Power Pole Trim Kit (Abound® only)

24"W
30"W
36"W
42"W
48"W
60"W

HRVP24P	2 Ⓢ	0.3	\$149
HRVP30P	3 Ⓢ	0.4	\$157
HRVP36P	4 Ⓢ	0.5	\$165
HRVP42P	5 Ⓢ	0.5	\$168
HRVP48P	6 Ⓢ	0.6	\$173
HRVP60P	7 Ⓢ	0.7	\$184

DESCRIPTION

Power Pole — w/o Receptacles (Voi® only)
10'5"

MODEL

SHIP WEIGHT

CUBE

LIST PRICE

HH870070	14	0.5	\$477
-----------------	----	-----	--------------

• Used for routing In-Feed Cable from ceiling to panel baserail. Double cavity, plus conduit of In-Feed Cable serves as the division of electrical and communications cabling.



Specify paint color for HH870070, not available in Putty



DESCRIPTION

Accelerate® Integrated Power Pole
78"H x 2"W x 2"D
156"H x 2"W x 2"D

MODEL

SHIP WEIGHT

CUBE

LIST PRICE BY PAINT GRADE

HECPP Ⓢ	14 Ⓢ	0.5	\$305	\$325	\$327
HECPP156	28 Ⓢ	1.0	\$736	\$756	\$758



DESCRIPTION

Receptacle Cover Replacements
Quantity 25

MODEL

SHIP WEIGHT

CUBE

LIST PRICE

HEREPCVR	1 Ⓢ	0.1	\$82
-----------------	-----	-----	-------------

- ⚠ For use with Accelerate® panels only.
- ⚠ Specify Color — Available in Black (P), Muslin (T3) and Shadow (SHDW) only.

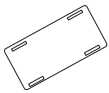

HOW TO SPECIFY

Select Model Number

Select Paint Color

See page 481

HRVP24P.

T4



SYSTEMS Electrical Components



Each marked with Circuit Number

DESCRIPTION	MODEL		SHIP WEIGHT	CUBE	LIST PRICE
	FOUR-CIRCUIT 3 + 1 2 + 2	THREE-CIRCUIT, SEPARATE NEUTRALS			
Abound® Duplex Receptacles					
Circuit 1	HH873501	HH873501A	0.5	0.1	\$47
Circuit 2	HH873502	HH873502A	0.5	0.1	\$47
Circuit 3	HH873503	HH873503A	0.5	0.1	\$47
Circuit 4 — isolated, dedicated circuit	HH873504		0.5	0.1	\$47
Circuit 1 — 20 amp outlet	HH871601	HH871601A	1.0	0.1	\$47
Circuit 3 (2 + 2)	HH873506		0.5	0.1	\$47

Specify color.

❗ Duplex receptacle models above are for use with Abound® models only.



Each marked with Circuit Number

DESCRIPTION	MODEL		SHIP WEIGHT	CUBE	CORE LIST PRICE
	FOUR-CIRCUIT 3 + 1 2 + 2	THREE-CIRCUIT, SEPARATE NEUTRALS			
Accelerate® Duplex Receptacles					
Circuit 1	HH871501 ☉	HH871501A	1.0	0.5	\$47
Circuit 2	HH871502 ☉	HH871502A	1.0	0.5	\$47
Circuit 3 (except 2 + 2 — see below)	HH871503 ☉	HH871503A	1.0	0.5	\$47
Circuit 4 — isolated, dedicated circuit	HH871504		1.0	0.5	\$47
Circuit 1 (20 amp outlet configuration)	HH871601		1.0	0.5	\$47
Circuit 3 (2 + 2)	HH871506		1.0	0.5	\$47

Specify Paint.

NOTES: Use with Accelerate® models.

SPECIFYING EXAMPLE: HH871501.S

See page 481 for color options.



DESCRIPTION	MODEL		SHIP WEIGHT	CUBE	LIST PRICE
	FOUR-CIRCUIT 3 + 1 2 + 2	THREE-CIRCUIT, SEPARATE NEUTRALS			
Data/Electrical Port Kit					
Specify color	HHT2DP		1.0	0.1	\$28

NOTES:

• Data/Electrical Port Kit used for field installations of additional data accessories.

❗ Four-circuit components and three-circuit components (with "A" suffix) not designed to be used together. See pages 603-604.

Maximum Receptacle Capacity in Abound Panel Base Raceways

Widths	24	30	36	42	48	60
Maximum of 1 duplex per panel side	X					
Maximum of 2 duplexes per panel side		X	X	X	X	X

Duplex Color Recommended to Coordinate with Paint Color			
Paint Color	Paint Code	Duplex Color	Duplex Code
Black	P	Black	P
Brownstone	P7D	Brownstone	EY
Charcoal	S	Charcoal	S
Designer White	PJW	Designer White	DW
Fossil	P28	Charcoal	S
Greige	T5	Muslin	T3
Light Gray	Q	Loft	LOFT
Loft	LOFT	Loft	LOFT
Muslin	T3	Muslin	T3
Putty	L	Black	P
Shadow	SHDW	Muslin	T3
Silver	PR6	Titanium	TI
Titanium	P8T	Titanium	TI
Champagne Metallic	T4	Muslin	T3
Platinum Metallic	T1	Titanium	TI

Data / Electrical Port Kit Color Recommended to Coordinate with Paint Color			
Paint Color	Paint Code	Data / Port Kit Color	Data / Port Kit Code
Black	P	Black	P
Brownstone	P7D	Brownstone	EY
Charcoal	S	Charcoal	S
Designer White	PJW	Designer White	DW
Fossil	P28	Charcoal	S
Greige	T5	Muslin	T3
Light Gray	Q	Loft	LOFT
Loft	LOFT	Loft	LOFT
Muslin	T3	Muslin	T3
Putty	L	Black	P
Shadow	SHDW	Muslin	T2
Silver	PR6	Titanium	TI
Titanium	P8T	Titanium	TI
Champagne Metallic	T4	Muslin	T3
Platinum Metallic	T1	Titanium	TI

HOW TO SPECIFY

<p>Select Model Number</p> <p>HH873501 .</p>	<p>Select Color</p> <p>P</p> <p>See page 481</p>
--	--

SYSTEMS

Electrical Components

GSA SIN 33721 EXCEPT AS NOTED



Icon Legend on page 19

WORKSTATIONS

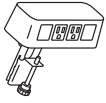

DESCRIPTION

Power & Data Center

2 Receptacles 2 Data Accessory

- Standard with two receptacles and openings for two data ports.
- 6' power cord with standard three-prong plug.
- Fits on any worksurface with a 4" overhang.
- UL Listed.

NOTES: Cable ports accommodate up to four individual voice and data outlets, and can be mounted anywhere there is an electrical receptacle opening. Data/Electrical Port Kit used for field installations of additional data accessories.

- ! Four-circuit components and three-circuit components (with "A" suffix) not designed to be used together. See pages 603-604.
- ! Duplex receptacle models shown on the previous page are for use with Abound® models only.
- ! Color finish coordinates with HON's Loft. *Specify LOFT when ordering. Example: HCOMDOME2.LOFT*

MODEL

HCOMDOME2

SHIP WEIGHT

2.5 Ⓢ

CUBE

0.2

LIST PRICE

\$327

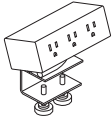

Model HPWRMOD3WC shown

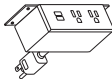

Model HPWRMOD2UWM shown

Power Modules

3 Receptacles with Worksurface Clamp

HPWRMOD3WC Ⓢ

2.3 Ⓢ

0.2

\$342

3 Receptacles with Under-Worksurface Mounting Bracket

HPWRMOD3UWM

2.3 Ⓢ

0.2

\$342

2 Receptacles 2 USB with Worksurface Clamp

HPWRMOD2WC Ⓢ

2.3 Ⓢ

0.2

\$546

2 Receptacles 2 USB with Under-Worksurface Mounting Bracket

HPWRMOD2UWM

2.3 Ⓢ

0.2

\$546

- 6' power cord with standard three-prong plug.
- Under-worksurface mounting bracket models work with any top that has a 5" x 5" square clearance.
- Worksurface clamp models work on any top with a 4" overhang.
- UL Listed.

NOTES: Cable ports accommodate up to four individual voice and data outlets, and can be mounted anywhere there is an electrical receptacle opening. Data/Electrical Port Kit used for field installations of additional data accessories.

- ! Four-circuit components and three-circuit components (with "A" suffix) not designed to be used together. See pages 603-604.
- ! Duplex receptacle models shown on the previous page are for use with Abound® models only.
- ! Color finish coordinates with HON's Charcoal or White. *Specify STRM for Storm and SNW for Snow when ordering. Example: HPWRMOD3WC.STRM*

Vertebrae

HMPVWM28

3.0

0.3

\$246

NOTES: 30"H x 3 1/8"W x 1 1/2"D. Ships unassembled.

- ! Clear finish. Specify "X" for finish option.
- SPECIFYING EXAMPLE: HMPVWM28.X**

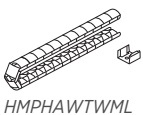

HMPHAWTWML



HMPHATFWML

Wire Managers for Height Adjustable

Workstation to Trough

HMPHAWTWML Ⓢ

3.0

0.1

\$295

Trough to Floor

HMPHATFWML

2.0

0.3

\$269

- ! Wire Manager Workstation to Trough only available in black.
- ! HMPHATFWML Trough to Floor cable manager is 3" x 1 1/2".

OPEN MARKET

NOTES:

- For additional information see the Workplace Tools section in the 2021 Shared Spaces Pricer.

HOW TO SPECIFY

Select Model Number

Select Color



See page 481

H C O M D O M E 2 .

L O F T

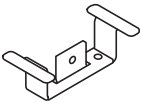
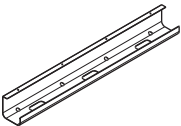
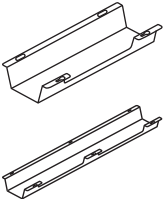
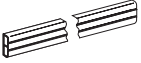
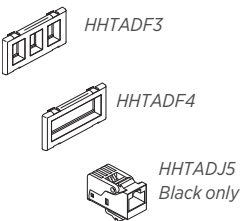
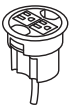

Icon Legend on page 19

	DESCRIPTION	MODEL	SHIP WEIGHT	CUBE	LIST PRICE
	Abound Electrical Mounting Brackets (pack of 12) ⚠ 1 bracket required at beltline for each pass-thru harness and 24"W power harness and 2 for 30"-60"W power harness. ⚠ Bracket for use at beltline only. Dimension of raceway mounting bracket is different and not interchangeable. Bracket height for beltline changed Q1 2019. ⚠ If adding onto product produced prior to Q1 2019, please contact HON Customer Support.	HH8988EBN	3.0 Ⓔ	0.1	\$70
	Cable Management Tray 24" 36"	HHCMT24 HHCMT36	2.0 Ⓔ 3.0 Ⓔ	0.3 0.4	\$82 \$101
<i>Black only</i>					
	Cable Management Troughs 17"W – Single 17"W – 10-Pack 36"W – Single 36"W – 10-Pack • Cable management troughs ship flat packed. • The troughs attach to underneath the worksurface with screws. • The 17"W has one wire access cut out on the user side. The 36" has two wire access cut outs. These cut outs give users access to inside the trough without having to detach it from the worksurface. • Color: Graphite. • Material: Metal. • TAA Compliant. • Slim profile design.	HCTROUGH17 HCTROUGH1710 HCTROUGH36 HCTROUGH3610	2.7 Ⓔ 14.0 Ⓔ 4.9 Ⓔ 30.0 Ⓔ	0.5 0.5 0.9 0.9	\$73 \$665 \$122 \$1121
	NOTES: For additional information see the Workplace Tools section in the 2021 Shared Spaces Pricer.				
	Wire Manager • HHEM model clips to bottom of panels. (62"W) • Slits in wire manager allows cable to be passed into unit.	HHEM620	10.0 Ⓔ	0.5	\$115
<i>Black only</i>					
	AMP Data Faceplates Three-port flex-mode faceplate Four-port flex-mode faceplate ⚠ Data faceplates available in Black (E4) only. AMP RJ45 CAT 5E Jack – Black (P) AMP RJ45 CAT 6 Jack – Black (P)	HHTADF3 Ⓢ HHTADF4 Ⓢ HHTADJ5 Ⓢ HHTADJ6 Ⓢ	1.0 Ⓔ 1.0 Ⓔ 1.0 Ⓔ 1.0 Ⓔ	0.2 0.2 0.1 0.1	\$29 \$29 \$46 \$62
	Models HHTADJ5 and HHTADJ6 snap into faceplate. NOTES: AMP Data Faceplates attach to bottom of panel or at worksurface height in front of baserail covers for easy cable routing. Faceplates cannot be installed back-to-back in a panel application.				
	Power Hub, 3" Grommet Mount, 6' Cord • Fits in 3" round grommet holes on the following product lines: Coordinate, Huddle, Motivate, all laminate and veneer casegoods series, and Systems Worksurfaces. • Two grounded AC power outlets. • Includes 6' cord with three-prong plug. • Field installed with Plug-and-play ease.	HGRMTAC	1.3	0.2	\$126
SIN 33721T	NOTES: For additional information see the Workplace Tools section in the 2021 Shared Spaces Pricer. ⚠ Available in black only (no color designation so use .X – Specify: HGRMTAC.X).				
	Power/USB Hub, 3" Grommet Mount • One grounded AC power outlet with 2 USB ports. • UL Listed.	HGRMTUSB2	1.3 Ⓔ	0.2	\$250
SIN 33721T	NOTES: For additional information see the Workplace Tools section in the 2021 Shared Spaces Pricer. ⚠ Available in black only (no color designation so use .X – Specify: HGRMTUSB2.X).				

SYSTEMS

Working with Worksurfaces and Supports

Worksurfaces are 1½" thick with particle-board core and with top surfaces finished in high-pressure laminate. Bottom surfaces are covered with a backer sheet.

Worksurface bracket kits support worksurface by attaching to an adjacent return panel the same width as the worksurface depth. Brackets allow one end of a worksurface to be supported by a panel return.



Cantilever brackets can be inserted into panel reveals in 1" vertical increments. Left or right handed. One size is used for both 24"D and 30"D worksurfaces. 18" Cantilever brackets are used for 18"D worksurfaces. DO NOT USE cantilever brackets at the end of a worksurface where no return panel is positioned or in worksurface runs longer than 72"W.

Wire management grommets are standard in most worksurfaces (unless "no grommet" worksurfaces selected).

Corner worksurfaces optimize use of space, and provide a convenient location for computer and monitor.

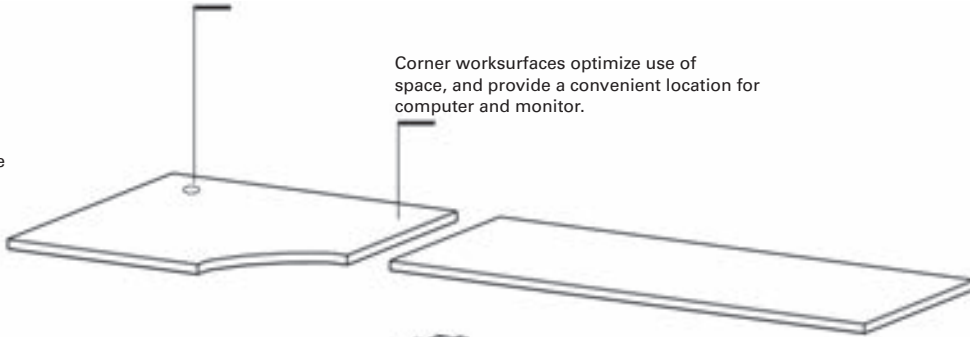

Flat brackets can be used to connect one worksurface perpendicular to another worksurface.



End-panel supports are used at the end of a run when no return panel is present. Straight worksurfaces adjacent to 120° connections must be supported by full end panels. Leveling glides provide 2¾" of adjustment.

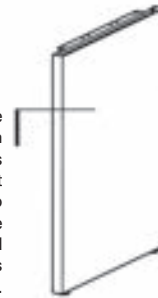

Support legs are used to support worksurfaces only in a shared position.

Primary worksurfaces are available in 18", 24" and 30" depths. Nominal worksurface width is equal to nominal panel width. Other support hardware is ordered separately.

Corner worksurfaces with woodgrain laminate have grain direction diagonal to adjacent worksurfaces. One rear center support bracket is included. All other support hardware is ordered separately.

Wire management grommets are standard in most worksurfaces. Worksurfaces less than 48"W have one grommet centered on edge of worksurface. Rectangular worksurfaces over 42"W have two grommets. Peninsulas have one grommet. Corner Worksurfaces have one grommet (one on each back edge). D-Shaped worksurfaces and countertops do not have grommets.

Edgeband is available on laminate tops in standard colors (customer specified) to match or complement solid, patterned, or woodgrain laminates.

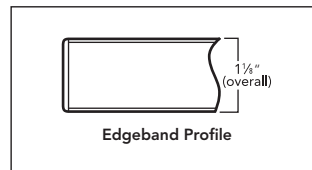

Working with Worksurfaces and Supports

Optional width worksurfaces are available for use with panel runs having a TEE or Extended Straight connection.

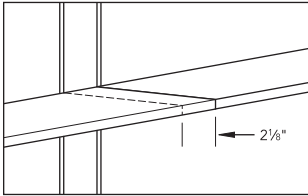

Worksurfaces can be configured at 29 1/2" with end-panel supports and support legs, or at various heights on 1" increments using specific product configurations.

Worksurface support options include:

- Open leg models
- Support column
- Flat brackets
- Worksurface bracket kit
- Cantilever bracket
- Universal support leg
- End-panel support
- Freestanding pedestal

Other worksurface supports include:

- Support columns
- External channel supports
- Support pedestals
- Pedestals with panel-to-pedestal bracket
- Desking freestanding shared leg

Support Guidelines:

- Unsupported panel runs greater than 72"W need floor support for improved stability.
- Worksurface bracket kit should be used to tie panels to worksurfaces for added stability.
- A panel run without a return needs a floor support.
- Unsupported worksurface spans of 60"W-84"W require an external worksurface support channel. It is recommended for 48"W-60"W.
- Cantilevers only to be used on worksurface runs 48"W or less.

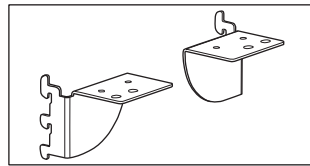

Worksurface bracket kit allows one end of a worksurface to be supported by a return panel. Return panel width must be the same as the depth of the worksurface.

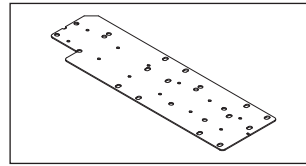

Flat brackets can be used to connect one worksurface perpendicular to another worksurface.

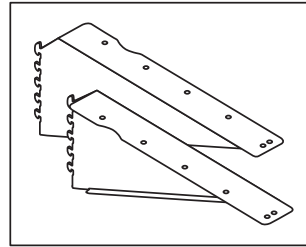

Cantilever brackets are left or right handed. They can be inserted into panel reveals in 1" vertical increments. One size is used for both 24" and 30"D worksurfaces. 18" Cantilever brackets are used for 18"D worksurfaces. Both left and right brackets are required in shared applications.

Important: Do not use cantilever brackets at the end of a worksurface where no 90° return panel is positioned.

- Do not use to support worksurfaces from which a hanging pedestal is suspended, or which a peninsula worksurface is attached.
- Do not use to support worksurfaces supported with permanent wall hanger kit.

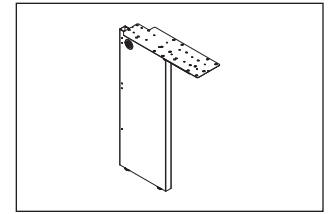

Universal support legs are used to support worksurfaces only in a shared position.

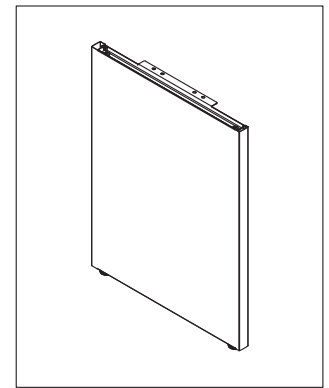

End-panel supports are used in place of return panels at the end of worksurface runs. Straight worksurfaces adjacent to 120° connections must be supported by full end panels. End-panel supports are ordered for right- or left-handed application. Leveling glides provide 1/2" of adjustment.

SYSTEMS

Working with Worksurfaces and Supports

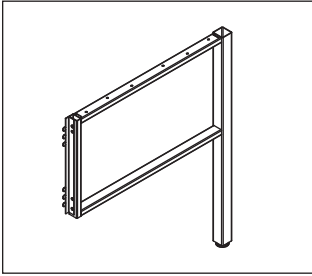

Open Leg models are used to support various worksurface configurations and include attaching hardware and leveling glides.

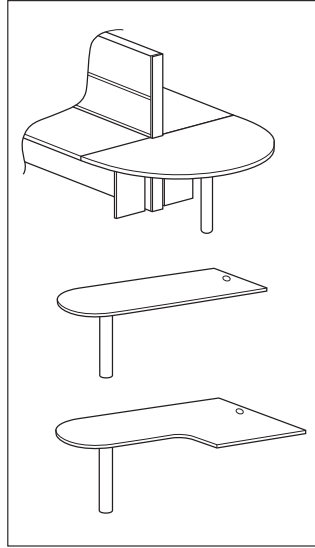

D-Shaped, Peninsula and Jetty worksurfaces require support columns (ordered separately).

Countertops are available in straight or corner configurations.

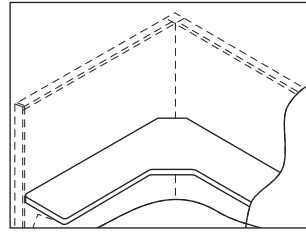

Corner shelves are available in Edgeband. Attachment brackets are included.

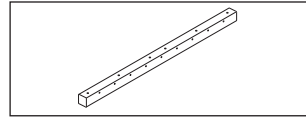

- Unsupported worksurface spans of 60"W-84"W require an external worksurface support channel. It is recommended for 48"W-60"W.

EXTERNAL CHANNEL SELECTION GUIDE

Support Combination		Rectangle Worksurface Width			
		Recommended		Required	
Worksurface End Support 1	Worksurface End Support 2	54	60	66	72
End Panel	End Panel	42"	48"	54"	60"
End Panel	Pedestal	NA	NA	NA	42"
End Panel	Worksurface Brackets	42"	48"	54"	60"
End Panel	Cantilever	42"	48"	54"	60"
End Panel	Open Leg	42"	48"	54"	60"
Pedestal	Pedestal	NA	NA	NA	NA
Pedestal	Worksurface Brackets	NA	NA	NA	42"
Pedestal	Cantilever	NA	NA	NA	42"
Pedestal	Open Leg	NA	NA	NA	42"
Worksurface Brackets	Worksurface Brackets	42"	48"	54"	60"
Worksurface Brackets	Cantilever	42"	48"	54"	60"
Worksurface Brackets	Open Leg	42"	48"	54"	60"
Height Adjustable Base	NA	42"	48"	54"	60"

See page 198 for External Channel models.

Supports above are recommended for worksurfaces 54"W or 60"W. For 66"-72" worksurfaces, the supports are required.



Icon Legend on page 19

SYSTEMS WORKSURFACES

Primary

WORKSTATIONS

DESCRIPTION	MODEL	SHIP WEIGHT	CUBE	L1	L2
				LIST PRICE	LIST PRICE
Primary and/or Return Worksurfaces					
24"W x 18"D	HWR1824P	23	2.1	\$330	\$340
30"W x 18"D	HWR1830P	28	2.1	\$342	\$352
36"W x 18"D	HWR1836P	35	2.5	\$355	\$365
42"W x 18"D	HWR1842P	39	2.8	\$366	\$376
48"W x 18"D	HWR1848P	44	3.2	\$405	\$415
54"W x 18"D	HWR1854P	48	4.0	\$451	\$466
60"W x 18"D	HWR1860P	53	4.0	\$463	\$478
66"W x 18"D	HWR1866P	65	4.7	\$497	\$512
72"W x 18"D	HWR1872P	67	4.7	\$509	\$524
24"W x 24"D	HWR2424P	31	2.2	\$338	\$348
30"W x 24"D	HWR2430P ☉	37	2.2	\$353	\$363
36"W x 24"D	HWR2436P ☉	46	2.5	\$382	\$397
42"W x 24"D	HWR2442P	52	2.5	\$419	\$434
48"W x 24"D	HWR2448P ☉	58	3.3	\$446	\$461
54"W x 24"D	HWR2454P	64	4.0	\$473	\$493
60"W x 24"D	HWR2460P ☉	70	4.0	\$526	\$546
66"W x 24"D	HWR2466P	86	4.8	\$565	\$585
72"W x 24"D	HWR2472P ☉	89	4.8	\$583	\$603
84"W x 24"D	HWR2484P	103	5.1	\$826	\$851

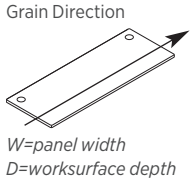

NOTES:

- Worksurfaces may be used with Accelerate®, Abound® and Voi® products.
- Worksurfaces are constructed of laminate on 1/8" solid core high-performance particleboard.
- Models up to 42"W are standard with one centered grommet. Models 48"W and wider are standard with two grommets.
- Accelerate® adds a "C" prefix and "T" suffix and Abound® adds a "B" prefix and "T" suffix to the Model Number for primary worksurfaces to span a TEE or EXTENDED STRAIGHT connection (adds 2 1/4" to width). Add upcharge of \$30 List per model.
- Add suffix "N" to Model Number for worksurfaces with no grommets. No upcharge.
- Woodgrain runs horizontally across surface.
- ! 18"D models are not available in Tee-Span but can be accommodated through Tailored Solutions.
- ! EXTENDED STRAIGHT worksurfaces are available with grommets only.
- ! 60"W, 66"W and 72"W worksurfaces require one or more of the following: worksurface support brackets, end panel, external channel universal support leg or pedestal support in conjunction with cantilever brackets.
- ! When a run of worksurfaces equals or exceeds 6 feet, a floor support is required for worksurface structural assurance.
- ! All worksurfaces load tested to BIFMA standards.

HOW TO SPECIFY

<p>Select Model Number</p> <p>For Tee-Span or Extended straight connection: Accelerate® adds a "C" prefix and "T" suffix (\$30 upcharge per model)</p> <p>Abound® adds a "B" prefix and "T" suffix (\$30 upcharge per model)</p> <p>No Grommet option: Add "N" suffix (no upcharge)</p> <p>HWR2424P .</p> <p>HCWR2424PT .</p> <p>HBWR2424PT .</p> <p>HWR2424PN .</p>	<p>Select Laminate</p> <p>See page 481</p> <p>A5 .</p> <p>A5 .</p> <p>A5 .</p> <p>A5 .</p>	<p>Select Edge Color</p> <p>See page 481</p> <p>K .</p> <p>K .</p> <p>K .</p> <p>K .</p>	<p>Select Grommet Color</p> <p>See page 481</p> <p>T1</p> <p>T1</p> <p>T1</p>
---	---	---	--

SYSTEMS WORKSURFACES

Primary

GSA SIN 33721



Icon Legend on page 19

WORKSTATIONS

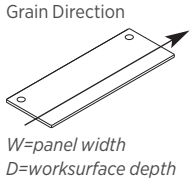

DESCRIPTION

Primary and/or Return Worksurfaces

24"W x 30"D
30"W x 30"D
36"W x 30"D
42"W x 30"D
48"W x 30"D
54"W x 30"D
60"W x 30"D
66"W x 30"D
72"W x 30"D
84"W x 30"D

MODEL

HWR3024P
HWR3030P
HWR3036P
HWR3042P
HWR3048P
HWR3054P
HWR3060P ☉
HWR3066P
HWR3072P ☉
HWR3084P

SHIP WEIGHT

47
56
62
64
68
80
101
105
105
127

CUBE

2.2
2.6
3.1
3.6
4.0
5.0
5.0
6.0
6.0
6.2

L1 LIST PRICE

\$353
\$405
\$429
\$456
\$481
\$517
\$573
\$612
\$653
\$881

L2 LIST PRICE

\$365
\$417
\$444
\$471
\$496
\$537
\$593
\$632
\$673
\$906

NOTES:

- Worksurfaces may be used with Accelerate®, Abound® and Voi® products.
- Worksurfaces are constructed of laminate on 1/8" solid core high-performance particleboard.
- Models up to 42"W are standard with one centered grommet. Models 48"W and wider are standard with two grommets.
- Accelerate® adds a "C" prefix and "T" suffix and Abound® adds a "B" prefix and "T" suffix to the Model Number for primary worksurfaces to span a TEE or EXTENDED STRAIGHT connection (adds 2 1/4" to width). Add upcharge of \$30 List per model.
- Add suffix "N" to Model Number for worksurfaces with no grommets. No upcharge.
- Woodgrain runs horizontally across surface.

- ! EXTENDED STRAIGHT worksurfaces are available with grommets only.
- ! 60"W, 66"W, 72"W, and 84"W worksurfaces require one or more of the following: worksurface support brackets, end panel, external channel universal support leg or pedestal support in conjunction with cantilever brackets.
- ! When a run of worksurfaces equals or exceeds 6 feet, a floor support is required for worksurface structural assurance.
- ! All worksurfaces load tested to BIFMA standards.

EXTERNAL CHANNEL SELECTION GUIDE

Support Combination		Rectangle Worksurface Width				
Worksurface End Support 1	Worksurface End Support 2	54	60	66	72	84
End Panel	End Panel	42"	48"	54"	60"	72"
End Panel	Pedestal	NA	NA	NA	42"	48"
End Panel	Worksurface Brackets	42"	48"	54"	60"	72"
End Panel	Cantilever	42"	48"	54"	60"	72"
End Panel	Open Leg	42"	48"	54"	60"	72"
Pedestal	Pedestal	NA	NA	NA	NA	NA
Pedestal	Worksurface Brackets	NA	NA	NA	42"	48"
Pedestal	Cantilever	NA	NA	NA	42"	48"
Pedestal	Open Leg	NA	NA	NA	42"	48"
Worksurface Brackets	Worksurface Brackets	42"	48"	54"	60"	72"
Worksurface Brackets	Cantilever	42"	48"	54"	60"	72"
Worksurface Brackets	Open Leg	42"	48"	54"	60"	72"
Height Adjustable Base	NA	42"	48"	54"	60"	72"

See page 198 for External Channel models.

HOW TO SPECIFY

Select Model Number

For Tee-Span or Extended straight connection: Accelerate® adds a "C" prefix and "T" suffix (\$30 upcharge per model)

Abound® adds a "B" prefix and "T" suffix (\$30 upcharge per model)

No Grommet option: Add "N" suffix (no upcharge)

HWR3024P .

HCWR3024PT .

HBWR3024PT .

HWR3024PN .

Select Laminate

See page 481

A5 .

A5 .

A5 .

A5 .

Select Edge Color

See page 481

K .

K .

K .

K .

Select Grommet Color

See page 481

T1

T1

T1



SYSTEMS WORKSURFACES

Wedge

	DESCRIPTION	MODEL	SHIP WEIGHT	CUBE	L1 LIST PRICE	L2 LIST PRICE
<p>Grain Direction</p>	Wedge Worksurfaces					
	48" A x 24" B x 30" C	HWD244830P	64	4.8	\$612	\$627
	54" A x 24" B x 30" C	HWD245430P	80	4.8	\$657	\$677
	60" A x 24" B x 30" C	HWD246030P	101	4.8	\$703	\$723
	66" A x 24" B x 30" C	HWD246630P	105	5.7	\$748	\$768
	72" A x 24" B x 30" C	HWD247230P	109	5.7	\$798	\$818
	Wedge Worksurfaces					
	48" A x 30" B x 24" C	HWD304824P	64	4.8	\$612	\$627
	54" A x 30" B x 24" C	HWD305424P	80	4.8	\$657	\$677
	60" A x 30" B x 24" C	HWD306024P	101	4.8	\$703	\$723
	66" A x 30" B x 24" C	HWD306624P	105	5.7	\$748	\$768
	72" A x 30" B x 24" C	HWD307224P	109	5.7	\$798	\$818

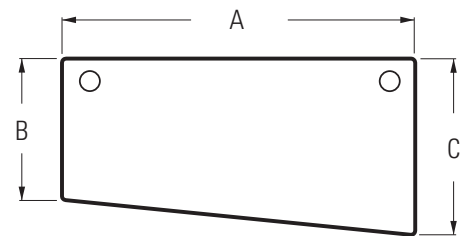
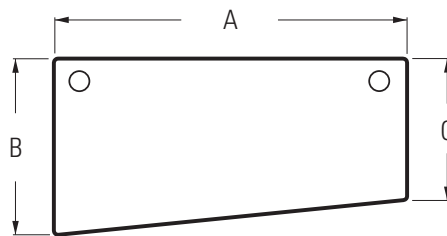

See matrix on page 618.

NOTES:

- Worksurfaces may be used with Accelerate®, Abound® and Voi® products.
 - Worksurfaces are constructed of laminate on 1½" solid core particleboard.
 - Refer to Worksurface Supports, pages 630-634.
 - Universal support leg can be used to share support when worksurfaces are placed side-by-side.
 - Add suffix "N" to Model Number for worksurfaces with no grommets. No upcharge.
 - Woodgrain runs horizontally across surface.
- ❗ 60"W, 66"W and 72"W worksurfaces require one or more of the following: worksurface support brackets, end panel, external channel universal support leg or pedestal support in conjunction with cantilever brackets. A full end panel can also be used for support in place of cantilever brackets.
- ❗ When a run of worksurfaces equals or exceeds 6 feet, a floor support is required for worksurface structural assurance.

HOW TO SPECIFY

<p>Select Model Number</p> <p>No Grommet option: Add "N" suffix (no upcharge)</p> <p>HWD244830P .</p> <p>HWD244830PN .</p>	<p>Select Laminate</p> <p>See page 481</p> <p>A5 .</p> <p>A5 .</p>	<p>Select Edge Color</p> <p>See page 481</p> <p>K .</p> <p>K .</p>	<p>Select Grommet Color</p> <p>See page 481</p> <p>T1</p>
---	---	---	--

SYSTEMS WORKSURFACES

Corner

GSA SIN 33721



Icon Legend on page 19

WORKSTATIONS

Grain Direction

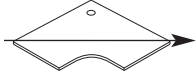

W=panel width

D=worksurface depth

DESCRIPTION

Corner Worksurfaces with Curved User Edge

36"W x 24"D

42"W x 24"D

48"W x 24"D

42"W x 30"D

48"W x 30"D

- HWC3624P will not accept the H4022, H4028, or H4029 keyboard platforms.
- One small worksurface bracket standard with each worksurface.

❗ Corner worksurfaces must match exactly the panel behind them, i.e.: a 36" panel must be used on the back two sides of model HWC3624P.

MODEL

HWC3624P

HWC4224P

HWC4824P

HWC4230P

HWC4830P

SHIP WEIGHT

53

65

76

72

77

CUBE

3.7

4.9

6.3

6.3

6.3

L1 LIST PRICE

\$597

\$631

\$710

\$741

\$800

L2 LIST PRICE

\$612

\$646

\$725

\$756

\$815

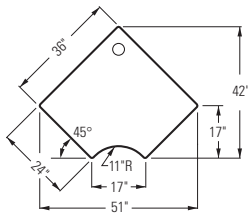

HWC3624P

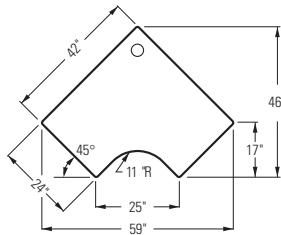

HWC4224P

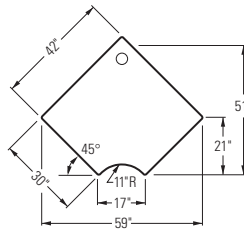

HWC4230P

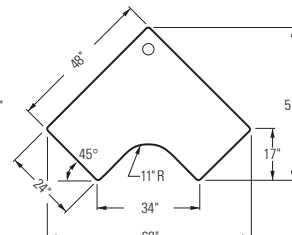

HWC4824P

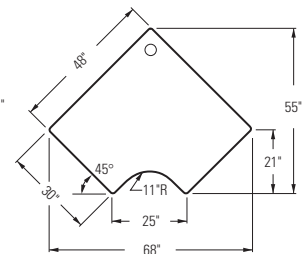

HWC4830P

NOTES:

- Worksurfaces may be used with Accelerate®, Abound® and Voi® products.
- Add suffix **"N"** to Model Number for worksurfaces with no grommets. No upcharge.
- Worksurfaces are constructed of laminate on 1/8" solid core high-performance particleboard.
- Refer to Worksurface Supports, pages 630-634.

HOW TO SPECIFY

Select Model Number

No Grommet option: Add **"N"** suffix (no upcharge)

HWC3624P

HWC3624PN

Select Laminate

See page 481

AS

AS

Select Edge Color

See page 481

K

K

Select Grommet Color

See page 481

T1



SYSTEMS WORKSURFACES

Corner

Grain Direction

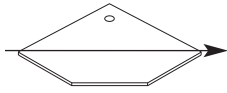

W=panel width
D=worksurface depth

DESCRIPTION

Corner Worksurfaces with Straight User Edge

- 36"W x 24"D
- 42"W x 24"D
- 48"W x 24"D
- 42"W x 30"D
- 48"W x 30"D

MODEL

- HWCS3624P** Ⓢ
- HWCS4224P**
- HWCS4824P**
- HWCS4230P**
- HWCS4830P**

SHIP WEIGHT

- 53
- 65
- 76
- 72
- 77

CUBE

- 3.7
- 4.9
- 6.3
- 6.3
- 6.3

L1 LIST PRICE

- \$575
- \$602
- \$664
- \$723
- \$736

L2 LIST PRICE

- \$590
- \$617
- \$679
- \$738
- \$751

- HWCS3624P will not accept the H4022, H4028, or H4029 keyboard platforms.
- One small worksurface bracket standard with each worksurface.

ⓘ Corner worksurfaces must match exactly the panel behind them, i.e.: a 36" panel must be used on the back two sides of model HWCS3624P.

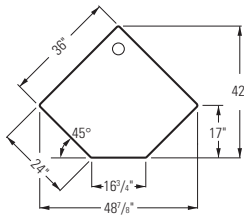

HWCS3624P

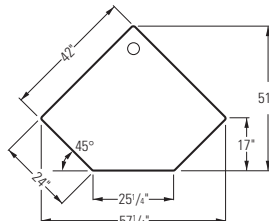

HWCS4224P

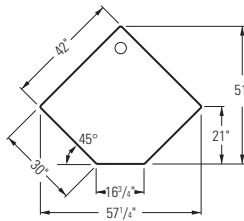

HWCS4230P

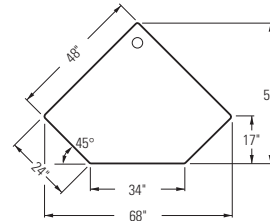

HWCS4824P

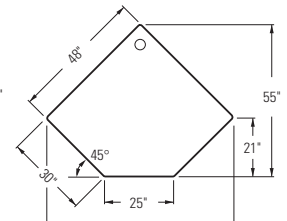

HWCS4830P

NOTES:

- Worksurfaces may be used with Accelerate®, Abound® and Voi® products.
- Add suffix **"N"** to Model Number for worksurfaces with no grommets. No upcharge.
- Worksurfaces are constructed of laminate on 1 1/8" solid core high-performance particleboard.
- Refer to Worksurface Supports, pages 630-634.

HOW TO SPECIFY

<p>Select Model Number</p> <p>No Grommet option: Add "N" suffix (no upcharge)</p> <p>HWCS3624P .</p> <p>HWCS3624PN .</p>	<p>Select Laminate</p> <p>See page 481</p> <p>AS .</p> <p>AS .</p>	<p>Select Edge Color</p> <p>See page 481</p> <p>K .</p> <p>K .</p>	<p>Select Grommet Color</p> <p>See page 481</p> <p>T1</p>
--	---	---	--

SYSTEMS WORKSURFACES

120 Degree Corner

GSA SIN 33721



Icon Legend on page 19

WORKSTATIONS

Grain Direction

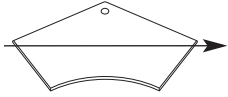

W=panel width

D=worksurface depth

DESCRIPTION

Abound® and Accelerate® 120 Degree Corner Worksurfaces with Curved User Edge

36"W x 24"D

42"W x 24"D

48"W x 24"D

42"W x 30"D

48"W x 30"D

- HBWCT3624P will not accept the H4022, HE4022, H4028, or H4029 keyboard platforms.
- One small work surface bracket standard with each work surface.

- ❗ Corner work surfaces must match exactly the panel behind them, i.e.: a 36" panel must be used on the back two sides of model HBWCT3624P.

MODEL

HBWCT3624P

HBWCT4224P

HBWCT4824P

HBWCT4230P

HBWCT4830P

SHIP WEIGHT

75

96

107

102

112

CUBE

7.7

9.2

9.2

11.4

11.4

L1 LIST PRICE

\$856

\$917

\$1063

\$1205

\$1282

L2 LIST PRICE

\$871

\$932

\$1078

\$1220

\$1297

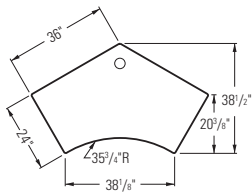

HBWCT3624P

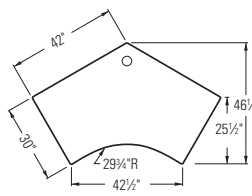

HBWCT4230P

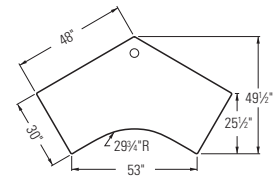

HBWCT4830P

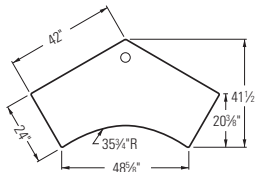

HBWCT4224P

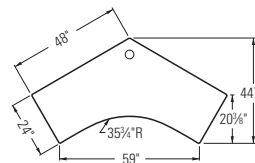

HBWCT4824P

NOTES:

- Worksurfaces are constructed of laminate on 1/8" solid core high-performance particleboard.
- Add suffix "N" to Model Number for worksurfaces with no grommets. No upcharge.
- Refer to Worksurface Supports, pages 630-634.
- If used at an end of run, full end panel needs to be ordered — see page 630.

HOW TO SPECIFY

Select Model Number

No Grommet option: Add "N" suffix (no upcharge)

HBWCT3624P

HBWCT3624PN

Select Laminate

See page 481

AS

AS

Select Edge Color

See page 481

K

K

Select Grommet Color

See page 481

T1



SYSTEMS WORKSURFACES

Corner Cove

DESCRIPTION	MODEL	SHIP WEIGHT	CUBE	L1	L2
				LIST PRICE	LIST PRICE
<p>Corner Cove Worksurfaces, Left Hand</p> <p>60" A x 36" B x 24" C x 24" D 60" A x 36" B x 30" C x 24" D</p> <p>60" A x 48" B x 24" C x 24" D 60" A x 48" B x 24" C x 30" D 60" A x 48" B x 30" C x 24" D 60" A x 48" B x 30" C x 30" D</p> <p>72" A x 36" B x 24" C x 24" D 72" A x 36" B x 30" C x 24" D</p> <p>72" A x 48" B x 24" C x 24" D 72" A x 48" B x 24" C x 30" D 72" A x 48" B x 30" C x 24" D 72" A x 48" B x 30" C x 30" D</p>	HWV73AALP	67	5.9	\$673	\$698
	HWV73BALP	76	5.9	\$695	\$720
	HWV75AALP	85	7.7	\$736	\$766
	HWV75ABLP	94	7.7	\$762	\$792
	HWV75BALP	92	7.7	\$762	\$792
	HWV75BBLP	99	7.7	\$790	\$820
	HWV93AALP	75	7.0	\$736	\$766
	HWV93BALP	83	7.0	\$762	\$792
	HWV95AALP	96	9.2	\$918	\$953
	HWV95ABLP	107	9.2	\$944	\$979
	HWV95BALP	102	9.2	\$944	\$979
	HWV95BBLP	112	9.2	\$974	\$1009

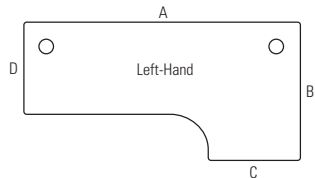
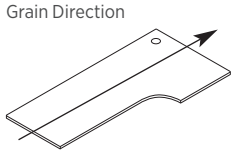

NOTES:

- Worksurfaces may be used with Accelerate®, Abound® and Voi® products.
- Worksurfaces are constructed of laminate on 1/8" solid core high-performance particleboard.
- Includes a rear-support bracket in Charcoal only.
- Add suffix **"N"** to Model Number for worksurfaces with no grommets. No upcharge.
- Refer to Worksurface Supports, pages 630-634.
- ❗ Panel-hung application requires two panels of corresponding width joined at 90°.
- ❗ When a run of worksurfaces equals or exceeds 6 feet, a floor support is required for worksurface structural assurance.
- ❗ 60"W, 66"W and 72"W worksurfaces require one or more of the following: worksurface support brackets, end panel, external channel universal support leg or pedestal support in conjunction with cantilever brackets.

HOW TO SPECIFY

<p>Select Model Number</p> <p>No Grommet option: Add "N" suffix (no upcharge)</p> <p>HWV73AALP .</p> <p>HWV73AALPN .</p>	<p>Select Laminate</p> <p>See page 481</p> <p>AS .</p> <p>AS .</p>	<p>Select Edge Color</p> <p>See page 481</p> <p>K .</p> <p>K .</p>	<p>Select Grommet Color</p> <p>See page 481</p> <p>T1</p>
--	---	---	--

SYSTEMS WORKSURFACES

Corner Cove

GSA SIN 33721



Icon Legend on page 19

WORKSTATIONS

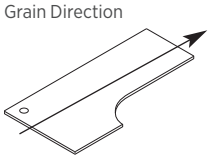

DESCRIPTION	MODEL	SHIP WEIGHT	CUBE	L1 LIST PRICE	L2 LIST PRICE
Corner Cove Worksurfaces, Right Hand					
60" A x 36" B x 24" C x 24" D	HWV73AARP	67	5.9	\$673	\$698
60" A x 36" B x 30" C x 24" D	HWV73BARP	76	5.9	\$695	\$720
60" A x 48" B x 24" C x 24" D	HWV75AARP	85	7.7	\$736	\$766
60" A x 48" B x 24" C x 30" D	HWV75ABRP	94	7.7	\$762	\$792
60" A x 48" B x 30" C x 24" D	HWV75BARP	92	7.7	\$762	\$792
60" A x 48" B x 30" C x 30" D	HWV75BBRP	99	7.7	\$790	\$820
72" A x 36" B x 24" C x 24" D	HWV93AARP	75	7.0	\$736	\$766
72" A x 36" B x 30" C x 24" D	HWV93BARP	83	7.0	\$762	\$792
72" A x 48" B x 24" C x 24" D	HWV95AARP	96	9.2	\$918	\$953
72" A x 48" B x 24" C x 30" D	HWV95ABRP	107	9.2	\$944	\$979
72" A x 48" B x 30" C x 24" D	HWV95BARP	102	9.2	\$944	\$979
72" A x 48" B x 30" C x 30" D	HWV95BBRP	112	9.2	\$974	\$1009

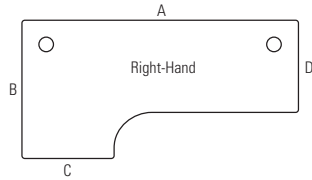

NOTES:

- Worksurfaces may be used with Accelerate®, Abound® and Voi® products.
- Worksurfaces are constructed of laminate on 1/8" solid core high-performance particleboard.
- Includes a rear-support bracket in Charcoal only.
- Add suffix **"N"** to Model Number for worksurfaces with no grommets. No upcharge.
- Refer to Worksurface Supports, pages 630-634.
- ! Panel-hung application requires two panels of corresponding width joined at 90°.
- ! When a run of worksurfaces equals or exceeds 6 feet, a floor support is required for worksurface structural assurance.
- ! 60"W, 66"W and 72"W worksurfaces require one or more of the following: worksurface support brackets, end panel, external channel universal support leg or pedestal support in conjunction with cantilever brackets.

HOW TO SPECIFY

<p>Select Model Number</p> <p>No Grommet option: Add "N" suffix (no upcharge)</p> <p>HWV73AARP .</p> <p>HWV73AARP N .</p>	<p>Select Laminate</p> <p>See page 481</p> <p>AS .</p> <p>AS .</p>	<p>Select Edge Color</p> <p>See page 481</p> <p>K .</p> <p>K .</p>	<p>Select Grommet Color</p> <p>See page 481</p> <p>T1</p>
---	---	---	--



SYSTEMS WORKSURFACES

Jetty / Peninsula

	DESCRIPTION	MODEL	SHIP WEIGHT	CUBE	L1 LIST PRICE	L2 LIST PRICE
	Jetty Worksurfaces, Left Hand					
	48" A x 66" B x 24" C x 30" D	HWJ58ABLP	84	9.2	\$923	\$953
	48" A x 66" B x 30" C x 30" D	HWJ58BBLP	91	9.2	\$924	\$954
	48" A x 72" B x 24" C x 30" D	HWJ59ABLP	88	9.2	\$929	\$959
	48" A x 72" B x 30" C x 30" D	HWJ59BBLP	94	9.2	\$925	\$955
	! Requires support column — see page 632. Order support column separately.					
	Jetty Worksurfaces, Right Hand					
	48" A x 66" B x 24" C x 30" D	HWJ58ABRP	84	9.2	\$923	\$953
	48" A x 66" B x 30" C x 30" D	HWJ58BBRP	91	9.2	\$924	\$954
	48" A x 72" B x 24" C x 30" D	HWJ59ABRP	88	9.2	\$929	\$959
	48" A x 72" B x 30" C x 30" D	HWJ59BBRP	94	9.2	\$925	\$955
	! Requires support column — see page 632. Order support column separately.					
	Peninsula Worksurfaces					
	60" W x 24" D	HWP2460P	65	4.9	\$433	\$453
	66" W x 24" D	HWP2466P	72	4.6	\$528	\$548
	72" W x 24" D	HWP2472P	95	5.5	\$594	\$614
	60" W x 30" D	HWP3060P	68	5.0	\$693	\$713
	66" W x 30" D	HWP3066P	75	6.0	\$761	\$781
	72" W x 30" D	HWP3072P	98	6.0	\$837	\$857
	! Peninsula worksurface width must correspond to the width of its support panel. Requires support column — see page 632. Order support column separately.					

NOTES:

- Worksurfaces may be used with Accelerate®, Abound® and Voi® products.
- Worksurfaces are constructed of laminate on 1½" solid core high-performance particleboard.
- Order support column separately — see page 632.
- Can also be attached perpendicular to a primary worksurface using Flat Brackets. Do not attach to a worksurface supported with Cantilever Brackets.
- Add suffix "N" to Model Number for worksurfaces with no grommets. No upcharge.
- Refer to Worksurface Supports, pages 630-634.
- ! Not designed to be used freestanding.

HOW TO SPECIFY

<p>Select Model Number</p> <p>No Grommet option: Add "N" suffix (no upcharge)</p> <p>HWJ58ABLP .</p> <p>HWJ58ABLPN .</p>	<p>Select Laminate</p> <p>See page 481</p> <p>AS .</p> <p>AS .</p>	<p>Select Edge Color</p> <p>See page 481</p> <p>K .</p> <p>K .</p>	<p>Select Grommet Color</p> <p>See page 481</p> <p>T1</p>
---	---	---	--

SYSTEMS WORKSURFACES

Half-Round / Quarter Round / 60° Wedge

GSA SIN 33721



Icon Legend on page 19

WORKSTATIONS

Grain Direction

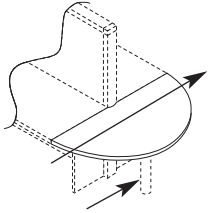

Requires Support Column — see page 632.

DESCRIPTION

Abound® Half-Round Worksurfaces

50"W x 30"D Connects to two 24"D Worksurfaces
62"W x 36"D Connects to two 30"D Worksurfaces

MODEL

HBWD2450P
HBWD3062P

SHIP WEIGHT

52
58

CUBE

5.0
6.1

L1 LIST PRICE

\$684
\$798

L2 LIST PRICE

\$699
\$818

Accelerate® Half-Round Worksurfaces

50"W x 30"D Connects to two 24"D Worksurfaces
62"W x 36"D Connects to two 30"D Worksurfaces

HCWD2450P
HCWD3062P

52
58

5.0
6.1

\$684
\$798

\$699
\$818

NOTES: Order one Support Column and two Universal Support Legs or Full End Panel — see pages 630-632.

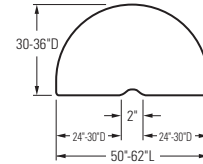

Grain Direction

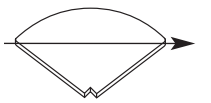

Abound® Quarter-Round Worksurfaces

24"W x 24"W Connects to two 24"D Worksurfaces
30"W x 30"W Connects to two 30"D Worksurfaces

HBWQ2424P
HBWQ3030P

18
25

2.6
3.7

\$393
\$492

\$408
\$512

Accelerate® Quarter-Round Worksurfaces

24"W x 24"W Connects to two 24"D Worksurfaces
30"W x 30"W Connects to two 30"D Worksurfaces

HCWQ2424P
HCWQ3030P

18
25

2.6
3.7

\$393
\$492

\$408
\$512

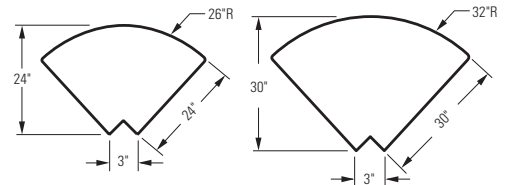

HBWQ2424P
HCWQ2424P

HBWQ3030P
HCWQ3030P

Grain Direction

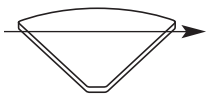

Abound® 60° Wedge Worksurfaces for use with 120 degree Universal Connector

24"W x 24"W Abound® Only
30"W x 30"W Abound® Only

HBWQT2424P
HBWQT3030P

18
25

2.6
3.7

\$436
\$506

\$451
\$526

Accelerate® 60° Wedge Worksurfaces for use with 120 degree Universal Connector

24"W x 24"W Accelerate® Only
30"W x 30"W Accelerate® Only

HCWQT2424P
HCWQT3030P

17
25

2.4
2.9

\$433
\$503

\$448
\$523

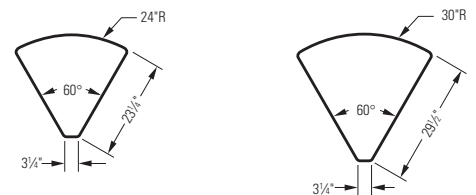

HBWQT2424P
HCWQT2424P

HBWQT3030P
HCWQT3030P

NOTES:

• Worksurfaces are constructed of laminate on 1½" solid core high-performance particleboard.

Half-Round Worksurfaces

• Order Support Column and End Panels separately.

Quarter Round Worksurfaces

• Two Flat Brackets and one Tie Bracket included.

60° Wedge Worksurfaces

• Two flat brackets and one tie bracket included.
• Refer to Worksurface Supports, pages 630-634.

HOW TO SPECIFY

Select Model Number	Select Laminate	Select Edge Color
<div style="display: flex; gap: 5px;"> HBWD2450P </div> <div style="display: flex; gap: 5px;"> HCWD2450P </div>	<p>See page 481</p> <div style="display: flex; gap: 5px;"> A5 </div> <div style="display: flex; gap: 5px;"> A5 </div>	<p>See page 481</p> <div style="display: flex; gap: 5px;"> K </div> <div style="display: flex; gap: 5px;"> K </div>



SYSTEMS COUNTERTOPS

Straight and Corner

	DESCRIPTION	MODEL	SHIP WEIGHT	CUBE	L1 LIST PRICE	L2 LIST PRICE
Grain Direction 	Abound® and Accelerate® 15"D Straight Countertops					
	24"W x 15"D	HBCSR1524P	19	1.4	\$245	\$255
	30"W x 15"D	HBCSR1530P	25	1.4	\$271	\$281
	36"W x 15"D	HBCSR1536P ⓘ	27	1.6	\$303	\$313
	42"W x 15"D	HBCSR1542P	32	1.8	\$311	\$321
	48"W x 15"D	HBCSR1548P ⓘ	38	2.1	\$329	\$339
	60"W x 15"D	HBCSR1560P ⓘ	48	2.6	\$417	\$432
	66"W x 15"D	HBCSR1566P	53	2.7	\$431	\$446
	72"W x 15"D	HBCSR1572P ⓘ	59	3.1	\$448	\$463
Grain Direction 	Abound® and Accelerate® 15"D Corner Countertops					
	24"W x 24"D	HBCSR2424P	44	1.4	\$468	\$483
	30"W x 30"D	HBCSR3030P	51	1.4	\$543	\$558
	36"W x 36"D	HBCSR3636P	58	1.6	\$605	\$625

NOTES:

- Countertops constructed with high-pressure laminate.
- Specify laminate and Edgeband options color.

HOW TO SPECIFY

<p>Select Model Number</p> <p>H B C S R 1 5 2 4 P .</p>	<p>Select Laminate</p> <p>See page 481</p> <p>A 5 .</p>	<p>Select Edge Color</p> <p>See page 481</p> <p>K</p>
--	--	--

SYSTEMS COUNTERTOPS

Straight and Corner

GSA SIN 33721



Icon Legend on page 19

WORKSTATIONS

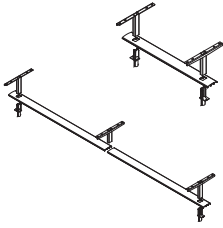

DESCRIPTION	FLAT MODEL	CHAMFERED MODEL	SHIP WEIGHT	CUBE	LIST PRICE BY PAINT GRADE	
					P1	P2
Abound® Raised Straight Countertop Kits						
24"W	HRVBR1524F	HRVBR1524	5	1.0	\$148	\$165
30"W	HRVBR1530F	HRVBR1530	5	1.0	\$155	\$172
36"W	HRVBR1536F	HRVBR1536	6	2.0	\$164	\$181
42"W	HRVBR1542F	HRVBR1542	6	2.0	\$169	\$186
48"W	HRVBR1548F	HRVBR1548	7	2.0	\$176	\$193
60"W	HRVBR1560F	HRVBR1560	8	2.0	\$209	\$226
66"W	HRVBR1566F	HRVBR1566	8	3.0	\$223	\$240
72"W	HRVBR1572F	HRVBR1572	9	3.0	\$240	\$257

! Do not order top caps for the panels the Countertop Kits will be installed on. Countertop Kits come with the necessary top caps and hardware.

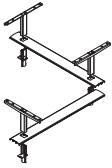

Abound® Raised Corner Countertop Kits						
24"W	HRVBR1524PF	HRVBR1524P	5	1.0	\$184	\$201
30"W	HRVBR1530PF	HRVBR1530P	6	1.0	\$193	\$210
36"W	HRVBR1536PF	HRVBR1536P	6	2.0	\$202	\$219

! Do not order top caps for the panels the Countertop Kits will be installed on. Countertop Kits come with the necessary top caps and hardware.

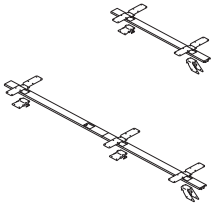

Abound® Straight Countertop Kits						
24"W	HBCKIT24F	HBCKIT24	5	0.7	\$57	\$62
30"W	HBCKIT30F	HBCKIT30	5	0.9	\$60	\$66
36"W	HBCKIT36F	HBCKIT36	6	0.9	\$62	\$68
42"W	HBCKIT42F	HBCKIT42	6	1.2	\$64	\$70
48"W	HBCKIT48F	HBCKIT48	7	1.4	\$66	\$72
60"W	HBCKIT60F	HBCKIT60	8	1.8	\$69	\$76
66"W	HBCKIT66F	HBCKIT66	8	1.8	\$72	\$79
72"W	HBCKIT72F	HBCKIT72	9	1.9	\$74	\$81

! Straight Countertop Kits must match the width of the corresponding panel onto which they are installed.

! 66"W kit must be used with 30" and 36"W frames.

! 72"W kit must be used with two 36"W frames.

! Do not order top caps for the panels onto which the Countertop Kits are installed. Countertop Kits come with the necessary top caps and hardware.

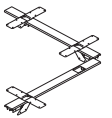

Abound® Corner Countertop Kits						
24"W	HBCKIT24F	HBCKIT24	5	0.7	\$68	\$74
30"W	HBCKIT30F	HBCKIT30	6	1.0	\$76	\$83
36"W	HBCKIT36F	HBCKIT36	6	1.0	\$78	\$85

! Do not order top caps for the panels the Countertop Kits will be installed on. Countertop Kits come with the necessary top caps and hardware.

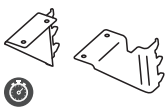

Accelerate® Countertop Bracket Kit	HECB01	1	0.1	\$60	\$63
---	---------------	----------	------------	-------------	-------------

! For use with all panel heights, except 42½".

! Top caps required and specified separately from Accelerate® Countertop Bracket Kits.

Accelerate® Countertop Bracket Kit for 42½"H Panels	HECB42	1	0.1	\$60	\$63
--	---------------	----------	------------	-------------	-------------

! For use with 42½"H Panels only.

! Top caps required and specified separately from Accelerate® Countertop Bracket Kits.

! Bracket kits include one right and one left hand bracket. Order two sets of brackets for the straight countertop models and three sets for the corner countertop models. To be used on Accelerate® panels only.

SPECIFYING EXAMPLE: HECB01.LOFT

HOW TO SPECIFY

Select Model Number

Select Paint Color

See page 481

HRVBR1524

A5



Icon Legend on page 19

SYSTEMS SHELVES

Corner Shelves

DESCRIPTION	MODEL	SHIP WEIGHT	CUBE	L1	L2
				LIST PRICE	LIST PRICE
Corner Shelves 36" x 36" x 12"D 42" x 42" x 12"D	HCS3636P	33	3.6	\$445	\$465
	HCS4242P	33	3.6	\$466	\$491

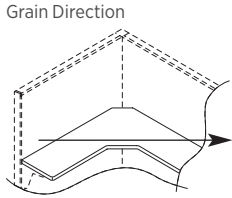

NOTES:

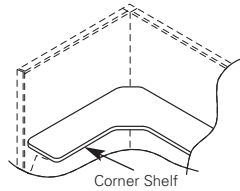

- Corner Shelves may be used with both Abound® and Accelerate® systems products.
- Diagonal leading edge = 10½"
- Diagonal depth = 22½"
- Includes panel attachment brackets.

HOW TO SPECIFY

Select Model Number HCS3636P	Select Laminate See page 481 A5	Select Edge Color See page 481 K	Select Paint Color See page 481 T1
--	--	---	---

DESCRIPTION	MODEL	SHIP WEIGHT	CUBE	LIST PRICE BY PAINT GRADE
				P1
Power Hub, 3" Grommet Mount, 6' Cord • Fits in 3" round grommet holes on the following product lines: 10500, 10700, Coordinate and Voi desks; Systems Worksurfaces; Huddle and Motivate tables and SmartLink. • Two grounded AC power outlets. • Includes 6' cord with three-prong plug. • Field installed with Plug-and-play ease.	HGRMTAC	1.3	0.2	\$126

NOTES: For additional information see the Workplace Tools section in the 2021 Shared Spaces Pricer.

ⓘ Available in black only (no color designation so use .X - Specify: HGRMTAC.X).

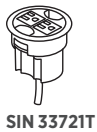

SYSTEMS Worksurface Supports

GSA SIN 33721



Icon Legend on page 19

WORKSTATIONS

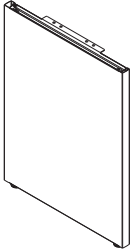

Specify paint

DESCRIPTION	MODEL	SHIP WEIGHT	CUBE	LIST PRICE BY PAINT GRADE	
				P1	P2
Abound® and Accelerate® Full End Panel*					
29½"H x 11"D — Right — Panel Mount	HRVEP1129R	16	1.4	\$228	\$257
29½"H x 11"D — Left — Panel Mount	HRVEP1129L	16	1.4	\$228	\$257
29½"H x 24"D — Right — Panel Mount	HRVEP2429R	21	1.4	\$246	\$275
29½"H x 24"D — Left — Panel Mount	HRVEP2429L	21	1.4	\$246	\$275
29½"H x 30"D — Right — Panel Mount	HRVEP3029R	23	1.4	\$268	\$297
29½"H x 30"D — Left — Panel Mount	HRVEP3029L	23	1.4	\$268	\$297

NOTES: The use of an end panel at the end of a worksurface will increase the rigidity of the workstation. If the panel is a greater dimension than the worksurface, an end panel is required if the run of the worksurfaces is 8 feet or greater. Levelers provide 1½" vertical adjustment.

- ! *Must be connected into panel slots. When an installation of worksurfaces is 8 feet or greater, a full end panel or universal support leg must be used at 90 degree panel junctions or in a shared position to support adjoining worksurfaces.
- ! End panel support with bracket will attach to both Accelerate® and Abound® panels.

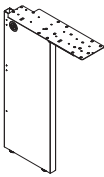

Non-handed unit
Specify paint

Abound® and Accelerate® Universal Support Leg*					
29½"H to support 24"D	HRVCLG24	16	1.4	\$218	\$247
29½"H to support 30"D	HRVCLG30	17	1.4	\$238	\$267

NOTES: Use at 90° panel junctions or in a shared position to support adjoining worksurfaces. Provided with flat bracket. Levelers provide 1½" vertical adjustment.

- ! *Must be connected into panel slots. When an installation of worksurfaces is 8 feet or greater, a full end panel or universal support leg must be used at 90 degree panel junctions or in a shared position to support adjoining worksurfaces.

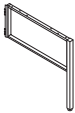

Open Leg Models*					
29½"H x 12"D	HOLEG12	7	0.5	\$163	\$192
29½"H x 18"D	HOLEG18	9	1.4	\$188	\$217
29½"H x 24"D	HOLEG24	11	1.2	\$228	\$257
29½"H x 30"D	HOLEG30	15	1.8	\$249	\$278

NOTES: Open leg includes attaching hardware and leveling glides. Leveling glides provide 2¼" of adjustment. Open leg is universal shared with a left- and right-hand attachment bracket.

- ! *Must be connected into frame slots. Specify paint.

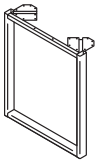

O-Leg Support for Worksurfaces					
20"D x 28½"H	HLSL2028O	15	3.7	\$328	\$332
24"D x 28½"H	HLSL2428O	17	3.7	\$357	\$361
30"D x 28½"H	HLSL3028O	19	5.4	\$395	\$399

NOTES: Ship fully assembled, 1/pack. Non-handed. Use the anti-dislodgement bracket when using a worksurface in a peninsula application with a post or O-leg.



DESCRIPTION	MODEL	SHIP WEIGHT	CUBE	LIST PRICE BY PAINT GRADE		
				P1	P2	P3
Voi® for Systems O-Leg-to-Panel Attachment Bracket						
Left handed bracket (quantity 1)	HLSLPBL	3	0.4	\$111	\$115	N/A
Right handed bracket (quantity 1)	HLSLPBR	3	0.4	\$111	\$115	N/A

NOTES: Used to connect Voi O-Leg to a systems panel for additional workstation rigidity. Bracket designed to work with edgeband worksurfaces only. Brackets are handed, come one per package and include self-tapping screws. Specify paint.

NOTES:

- The supports included on this page can be used with Systems and Worksurfaces.

HOW TO SPECIFY

Select
Model Number

Select
Paint Color

See page 183

HRVEP1129R.

T1



SYSTEMS Worksurface Supports

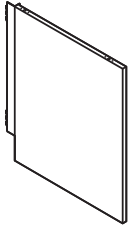

DESCRIPTION	MODEL	SHIP WEIGHT	CUBE	LIST PRICE BY PAINT GRADE	
				P1	P2
Laminate End Panel Support with Panel Bracket					
29½”H x 24”D, Left handed	HLSL2428EBL	3	2.2	\$290	\$294
29½”H x 24”D, Right handed	HLSL2428EBR	3	2.2	\$290	\$294
29½”H x 30”D, Left handed	HLSL3028EBL	3	3.2	\$308	\$312
29½”H x 30”D, Right handed	HLSL3028EBR	3	3.2	\$308	\$312

NOTES: Includes laminate end panel and brackets to attach end panel support to a panel. Order to correspond to worksurface depth. Specify laminate and paint. Can be used with Abound® and Accelerate® Systems products.

NOTES:

- The supports included on this page and on previous page can be used with Systems and Worksurfaces.

HOW TO SPECIFY

<p>Select Model Number</p> <p>H L S L 2 4 2 8 E B L .</p>	<p>Select Laminate</p> <p>L2 Laminate Upcharge \$10 See page 481</p> <p>H .</p>	<p>Select Paint Color</p> <p>See page 481</p> <p>T 1</p>
--	--	---

SYSTEMS Worksurface Supports

GSA SIN 33721



Icon Legend on page 19

WORKSTATIONS

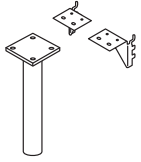

Non-handed unit
Specify paint

DESCRIPTION

Support Column*

For 29½" Height. 3" diameter.

NOTES: Used to support one end of a peninsula, round or half-round worksurface. (Includes panel support brackets.) Levelers provide 1½" vertical adjustment.

! *Brackets must be connected into panel slots.

MODEL

SHIP WEIGHT

CUBE

LIST PRICE BY PAINT GRADE

P1

P2

HCNLEG29

13

1.1

\$240

\$267



Post Leg Base

• Single Post Leg with Hardware Pack

HMBPOST1

18

2.3

\$325

\$337

• Requires hardware bracket model HWSA2. Please see below for HWSA2 bracket ordering information.

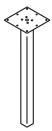

Post Leg Base

28½"H x 2" square

HLSL28P

15

1.0

\$321

\$325

NOTES: Requires hardware bracket model HWSA2 when used to support a peninsula.

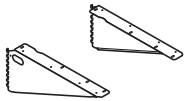

Specify paint

Accessory Cantilever*

18"D Pair

HCTL182

4

0.3

\$74

\$84

24"D Pair

HCTL242

5

0.3

\$93

\$103

18"D Right-Hand Cantilever

HCTL181R

3.2

0.2

\$40

\$50

18"D Left-Hand Cantilever

HCTL181L

3.2

0.2

\$40

\$50

24"D Right-Hand Cantilever

HCTL241R

3.7

0.6

\$50

\$60

24"D Left-Hand Cantilever

HCTL241L

3.7

0.6

\$50

\$60

! *Must be connected into panel slots.

! Accelerate® only: Cantilevers only to be used on worksurface runs 72"W or less.

! Use with runs 72" or less – avoid installation on only one side of a straight connection except to support corner worksurfaces. Floor support is required for runs longer than 72".

! DO NOT position at the end of a panel run where no 90 degree return panel is positioned.

! DO NOT use to support worksurfaces from which a hanging pedestal is suspended, or to which a peninsula worksurface is attached.

! DO NOT use cantilever brackets to support worksurfaces supported with permanent wall hanger kit.

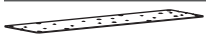

Flat Bracket

18"D

HHN831118

3

0.2

\$70

N/A

24"D

HHN831124

3

0.3

\$72

N/A

30"D

HHN831130

3

0.4

\$72

N/A

NOTES: Flat Brackets can be used to connect one worksurface perpendicular to another worksurface.

! Charcoal only.

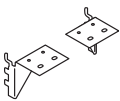

Specify paint

Worksurface Bracket Kit*

One Pair

HWSB2

1

0.1

\$52

\$55

NOTES: Used to connect the end of a worksurface to a panel of the same width.

! Always use when the depth side of a worksurface is against a panel (return/wing panel) of the same dimension. This will increase the sturdiness of the workstation.

! *Must be connected into panel slots.

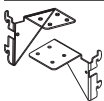

Anti-Dislodgement Bracket Kit

HWSA2

1

0.1

\$50

\$53

NOTES: To be used with models HMBPOST1 and HLSL28P Post Leg Base.

NOTES:







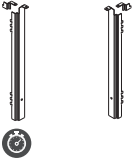

• The supports included on this page can be used with Systems Worksurfaces.

HOW TO SPECIFY

<p>Select Model Number</p> <p>H C T L 2 4 2 .</p>	<p>Select Paint Color</p> <p>See page 481</p> <p>T 1</p>
--	---



WORKSURFACE BRACKETS

	DESCRIPTION	MODEL	SHIP		LIST PRICE BY PAINT GRADE		
			WEIGHT	CUBE	P1	P2	P3
	Flagship® Pedestal to Panel Bracket Kit, Left	HPD2PNBRK2L	3.0 	0.3	\$122	\$130	\$132
	Flagship® Pedestal to Panel Bracket Kit, Right	HPD2PNBRK2R	3.0 	0.3	\$122	\$130	\$132
NOTES: Bracket to attach 22 ⁷ / ₈ "D pedestals to 24"D worksurface or 28 ⁷ / ₈ "D pedestals to 30"D worksurface.							
	Worksurface to Tower Bracket Kit						
	Bracket to attach storage towers to worksurfaces.	HSTB2W1	4.0 	0.6	\$88	\$101	\$103
NOTES: Replaces the need for a panel attached end panel. Standard with hardware to attach bracket to panel and worksurface.							
 Bracket cannot be used as a support when placing Stack-on Storage on worksurface over bracket. Must use two full-sized supports when using Stack-on Storage.							
 Not for use with systems support pedestals.							
	Worksurface-to-Wing Panel Bracket						
	24"W	HWSR24	2.5	0.4	\$65	N/A	N/A
	30"W	HWSR30	3.0	0.4	\$65	N/A	N/A
	36"W	HWSR36	3.5	0.5	\$65	N/A	N/A
	42"W	HWSR42	4.0	0.5	\$65	N/A	N/A
	48"W	HWSR48	4.5	0.6	\$65	N/A	N/A
NOTES:							
<ul style="list-style-type: none"> To be used when the adjacent wing panel is wider than the worksurface depth. Specify support to the same width as your adjacent wing panel, not the depth of your worksurface. Support spans the entire width of the wing panel. Supports are non-handed. 							

HOW TO SPECIFY

<p>Select Model Number</p> <p>HPD2PNBRK2L . T1</p>	<p>Select Paint Color</p> <p>See page 481</p>
--	---

SYSTEMS

Worksurface Supports

GSA SIN 33721



Icon Legend on page 19

WORKSTATIONS

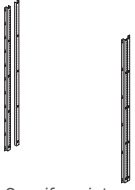

Specify paint

DESCRIPTION	MODEL	SHIP WEIGHT	CUBE	LIST PRICE BY PAINT GRADE	
				P1	P2
Abound® and Accelerate® Permanent-Wall Hanger Kit Wall Hanger Kit (2 pieces) 2½"W x ⅞"D x 66"H	HRVC35PCE	6	0.7	\$243	\$263
Wall Hanger Kit 4¼"W x ⅞"D x 66"H	HRVC35PCM	3	0.7	\$128	\$138

NOTES: Anchor devices are not supplied with these models. Refer to Abound® or Accelerate® Installation instructions for appropriate hardware. Used to hang storage cabinets and bookshelves from permanent wall, and/or to attach worksurfaces to permanent wall.

- ⓘ Attachment to masonry walls is not recommended.
- ⓘ Worksurfaces should not be supported with Cantilever brackets when using Permanent-Wall Hanger Kit.

NOTES:

- Wall track has ⅛" x ½" slots on 1" centers.
- Customer to furnish connecting hardware. (Refer to Installation Instructions for appropriate hardware.)
- Includes a cover for top of channel.

HOW TO SPECIFY

<p>Select Model Number</p> <p>HRVC35PCE</p>	<p>Select Paint Color</p> <p>See page 481</p> <p>T1</p>
---	---



STANDING-HEIGHT WORKSURFACE SUPPORTS

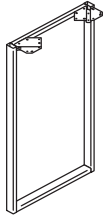

DESCRIPTION

Standing-Height O-Leg Support for Worksurfaces

24”D x 41”H
30”D x 41”H

NOTES: Ship fully assembled, 1/package. Non-handed.

MODEL	SHIP WEIGHT	CUBE	LIST PRICE BY PAINT GRADE	
			P1	P2
HLSL2441O	16	5.3	\$476	\$482
HLSL3041O	17	6.5	\$533	\$539

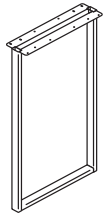

Standing-Height O-Leg Shared Support for Worksurfaces

24”D x 41”H
30”D x 41”H

NOTES: Ship fully assembled, 1/package. Non-handed.

HLSL2441SL	16	5.3	\$537	\$543
HLSL3041SL	17	6.5	\$593	\$599

NOTES:

- O-leg glides have 2” adjustability.
- Shared O-legs create a cleaner aesthetic in all applications where two legs are used side-by-side.
- O-Leg to Panel Attachment Brackets are used to connect Voi® O-Legs to a systems panel for additional worksurface rigidity.

! O-legs may only be attached to worksurfaces, not storage units.

HOW TO SPECIFY

<p>Select Model Number</p> <p>H L S L 2 4 4 1 O</p>	<p>Select Paint Color</p> <p>See page 183</p> <p>T 1</p>
--	---

SYSTEMS

Standard Height Support Pedestals

GSA SIN 33721



Icon Legend on page 19

WORKSTATIONS

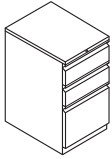

DESCRIPTION

Standard Height Freestanding Support Pedestals — Box/Box/File
 15"W x 19⁷/₈"D x 28"H
 15"W x 22⁷/₈"D x 28"H

MODEL

HVFB20R
HVFB23R

SHIP WEIGHT

89.0
 95.0

CUBE

7.0
 8.0

LIST PRICE BY PAINT GRADE

P1	P2	P3
\$597	\$625	\$641
\$614	\$642	\$659

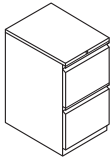

Standard Height Freestanding Support Pedestals — File/File
 15"W x 19⁷/₈"D x 28"H
 15"W x 22⁷/₈"D x 28"H

HVFF20R
HVFF23R

88.0
 94.0

7.0
 8.0

P1	P2	P3
\$591	\$619	\$635
\$609	\$637	\$654

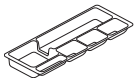

Optional Pencil Tray

HV-UT1

0.5

0.1

\$77

N/A

N/A

NOTES: For additional information see the Workplace Tools section in the 2021 Shared Pricer.

For use with mobile and freestanding pedestal models shown above.

NOTES:

- 28"H fits under all HON worksurfaces and desk shells.
- Ball-bearing suspension on file drawer (90% extension), and box drawer (90% extension on both drawers).
- File drawers have high sides for filing front-to-back.
- Available in "R" pull only.
- Pencil tray standard in top box drawer.
- One box divider standard in each box drawer.
- One crossrail standard in each file drawer.

Freestanding models must be used under a worksurface only.

HOW TO SPECIFY

<p>Select Model Number</p> <p>H V F B 2 0 R .</p>	<p>Select Lock Option</p> <p>L Lock (no upcharge)</p> <p>L .</p>	<p>Select Paint Color</p> <p>See page 481</p> <p>P</p>
--	---	---

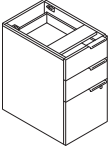
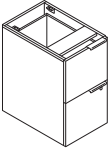
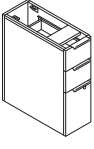

Laminate Support Pedestals

	DESCRIPTION	MODEL	SHIP WEIGHT	CUBE	L1 LIST	L2 UPCHARGES	
						CHASSIS	FRONTS
	Support Pedestals — Box/Box/File						
	16"W x 20"D x 28½"H	HLSL2028B	73	7.3	\$773	\$15	\$10
	16"W x 24"D x 28½"H	HLSL2428B	85	8.5	\$855	\$20	\$10
	16"W x 30"D x 28½"H	HLSL3028B	105	10.5	\$962	\$25	\$10
	NOTES: Top box drawer does not lock.						
	Support Pedestals — File/File						
	16"W x 20"D x 28½"H	HLSL2028F	72	7.3	\$773	\$15	\$10
	16"W x 24"D x 28½"H	HLSL2428F	84	8.5	\$855	\$20	\$10
	16"W x 30"D x 28½"H	HLSL3028F	104	10.5	\$962	\$25	\$10
	Slim Profile Pedestals — Box/Box/File						
	9½"W x 24"D x 28½"H	HLSL2428S	69	6.9	\$848	\$20	\$10
	9½"W x 30"D x 28½"H	HLSL3028S	56	5.6	\$931	\$25	\$10
	NOTES: Top box drawer does not lock.						

NOTES:

- Please see Voi® section of the pricer for full Voi® laminate offering, which is compatible with all HON systems series.
 - Voi® Support and Power-Ready Pedestals can be used with worksurfaces.
 - A variety of pedestals, end panels, and O-legs can be combined to create a conventional or contemporary desk.
 - Chassis and drawer front woodgrain and solid laminates are specified separately (see SIF options below).
 - File drawers accept hanging folders in letter or legal size.
 - Multiple handle locations possible per customer preference.
 - Ships with one handle per drawer.
 - Drawer Organizer model HLSLDRWORG works with box drawers.
 - Box and file drawers operate on ball-bearing suspension with full extension.
 - Adjustable hex leveling glides allow floor-standing furniture to be easily leveled without lifting the unit; glides have 1¼" adjustable range.
- ① Pedestals ship fully assembled but must attach to a worksurface with a quick release bracket, provided. Pedestals are non-handed and are interchangeable.
- ① Locking units equipped with HON "One Key" interchangeable core removable locks. Keyed alike core must be ordered separately.

HOW TO SPECIFY

<p>Select Model Number</p> <p>H L S L 2 0 2 8 B</p>	<p>Select Chassis Laminate</p> <p>See page 183</p> <p>N</p>	<p>Select Drawer Front Laminate</p> <p>See page 183</p> <p>N</p>	<p>Select Pull Color</p> <p>P Black T4 Champagne T1 Platinum PJW Designer White PR6 Silver P8X Solar Black</p> <p>T 4</p>
--	--	---	---

VOI® Laminate Support Storage

GSA SIN 33721



Icon Legend on page 19

WORKSTATIONS

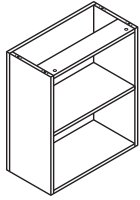

DESCRIPTION

Bookcase Support
24"W x 12"D x 28½"H
30"W x 12"D x 28½"H

MODEL	SHIP WEIGHT	CUBE	L1 LIST	L2 UPCHARGES	
				CHASSIS	FRONTS
HLSL240BC	60	3.0	\$574	\$20	N/A
HLSL300BC	75	3.0	\$600	\$25	N/A

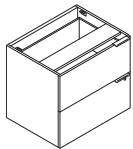

Lateral File — 2 Drawer
31⅜"W x 24"D x 28½"H

HLSL2430L	121	15.6	\$1325	\$35	\$20
------------------	-----	------	---------------	-------------	-------------

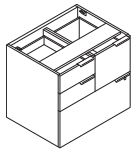

Multi File Lateral File
31⅜"W x 24"D x 28½"H
NOTES: Box drawers do not lock.

HLSL2430MF	163	15.6	\$1574	\$35	\$20
-------------------	-----	------	---------------	-------------	-------------

NOTES:

- Voi® Support and Power-Ready Storage can be used with Systems Worksurfaces.
- Ships with one handle per drawer on all units.
- A variety of pedestals, end panels, and O-legs can be combined to create a conventional or contemporary desk.
- Bookcase can only mount exterior facing under a worksurface.
- Chassis and drawer front woodgrain and solid laminates are specified separately (see SIF options below).
- File drawers accept hanging folders in letter or legal size.
- Multiple handle locations possible per customer preference.
- Storage accessory model HLSLDRWORG works with box doors.
- Standard box drawers operate on ball-bearing suspension with full extension. File, lateral, and wide box drawers operate on ball-bearing suspension with full extension.
- Adjustable hex leveling glides allow floor-standing furniture to be easily leveled without lifting the unit; glides have 2" adjustable range.
- When using two lateral files, a 60" worksurface cannot be used, a 66" worksurface must be specified, which will show a gap.

- ❗ Cannot fit binders on both shelves of bookcase model HLSL240BC and HLSL300BC.
- ❗ Must be specified under a worksurface 60"W or wider.
- ❗ Locking units equipped with HON "One Key" interchangeable core removable locks. Keyed alike core must be ordered separately.

HOW TO SPECIFY

<p>Select Model Number</p> <p>H L S L 2 4 3 0 L</p>	<p>Select Chassis Laminate</p> <p>See page 183</p> <p>N</p>	<p>Select Laminate</p> <p>See page 183</p> <p>N</p>	<p>Select Pull Color</p> <p>P Black T4 Champagne T1 Platinum PJW Designer White PR6 Silver P8X Solar Black</p> <p>T 4</p>
--	--	--	--

	DESCRIPTION	MODEL	SHIP WEIGHT	CUBE	LIST PRICE BY PAINT GRADE		
					P1	P2	P3
	Paper Management Support Bars						
	24"W x 5"H	HNPBMSW24	1.3	0.4	\$210	\$222	\$232
	30"W x 5"H	HNPBMSW30	1.5	0.5	\$224	\$236	\$246
	36"W x 5"H	HNPBMSW36	2.0	0.6	\$232	\$244	\$254
	42"W x 5"H	HNPBMSW42	5.0	0.7	\$244	\$256	\$266
	48"W x 5"H	HNPBMSW48	7.0	0.8	\$254	\$266	\$276
	60"W x 5"H	HNPBMSW60	9.0	0.9	\$289	\$301	\$311
	Recommended weight capacity not to exceed 80 pounds. Paper management bar attaches to Systems panels/frames to accommodate work flow accessories.						
	Paper Shelf 15"W x 9 1/2"D x 2"H	HPPMPS	2.0	0.3	\$110	\$122	\$133
	NOTES: Holds letter size paper and inter-office envelopes.						
	Accessory Shelf 21 3/4"W x 7"D x 2"H	HPPMAS	2.0	0.3	\$114	\$126	\$137
	NOTES: Holds office supplies and personal effects.						
	Phone Tray 9"W x 10 3/4"D x 2"H	HPPMPT	2.0	0.3	\$139	\$151	\$162
	NOTES: Holds telephone at optimum ergonomic angle.						
	CD/Pencil Holder 5 1/4"W x 1 1/2"D x 5"H	HPPMPB	1.0	0.2	\$114	\$126	\$137
	NOTES: Can store up to 3 CD jewel cases; sticky pads or writing instruments.						
	Sorter Tray 6"W x 10"D x 2 1/2"H	HPPMST	2.0	0.3	\$150	\$162	\$173
	NOTES: Provides 3 slots for organizing files.						
	Folder Bin 12 1/4"W x 1 1/4"D x 9"H	HPPMFB	2.0	0.3	\$114	\$126	\$137
	NOTES: Accommodates manila envelopes and can be hung from other folder binds to maximize storage.						
	DESCRIPTION	MODEL	SHIP WEIGHT	CUBE	LIST PRICE		
	Markerboards						
	36"W x 24"H	HHMRK36	15.0	3.2	\$546		
	42"W x 24"H	HHMRK42	17.0	4.0	\$591		
	48"W x 24"H	HHMRK48	19.0	4.6	\$637		
	No color specification required.						
	Back Pack Hook (10 per carton) 12"W x 14 1/2"D x 1 1/2"H	HCLA65	10.0	0.1	\$101		
	NOTES: Assembly; attaches to bottom of desk with (2) screws, included.						
	Available in Titanium finish only, no specification needed.						
OPEN MARKET 							

HOW TO SPECIFY

Select Model Number H N P M B S W 2 4	Select Paint Color See page 481 P 8 S
---	--

SYSTEMS

Accessories — Task Lights

GSA SIN 33721



Icon Legend on page 19

WORKSTATIONS



DESCRIPTION

Articulating Desk Lamp Articulating Desk Lamp w/ Occupancy Sensor

- Color: Matte Silver.
- Full-range dimming from 10% to 100%.
- Designed for 50,000 hours of life.
- Occupancy sensor is built into the head of the lamp and will automatically shut the lamp off after 6 minutes of undetected movement.
- Base swivel is 180 degrees.
- Uses only 5 watts of energy.
- Light comes with a silver 9' 4" power cord.
- Base diameter is 7.5".
- 3500K Color Temperature.
- 80 Color Rendering Index.
- TAA Compliant.

MODEL SHIP WEIGHT CUBE LIST PRICE

HLED1	1.2	6.5	\$430
HLED1OC	1.2	6.5	\$524



Task Desk Lamp

- Color: Brushed Nickel.
- Full-range dimming from 10% to 100%.
- Designed for 50,000 hours of life.
- Lamp is 15.83" tall.
- Desk lamp does not articulate at base. The pivoting head provides custom positioning, as it can be twisted 360 degrees.
- Uses only 5 watts of energy.
- Light comes with a silver 9' 4" power cord.
- Base diameter is 6.7".
- 3500K Color Temperature.
- 80 Color Rendering Index.
- TAA Compliant.

HLED2	0.7	3.0	\$373
--------------	-----	-----	--------------









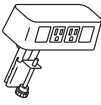

NOTES:

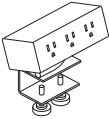
- For additional information see the Workplace Tools section in the 2021 Shared Spaces Pricer.

HOW TO SPECIFY

Select Model Number

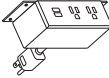
HLED1

	DESCRIPTION	MODEL	SHIP WEIGHT	CUBE	LIST PRICE
	<p>Power & Data Center</p> <p>2 Receptacles 2 Data Accessory</p> <ul style="list-style-type: none"> Standard with two receptacles and openings for two data ports. 6' power cord with standard three-prong plug. Fits on any worksurface with a 4" overhang. UL Listed. <p>! Color finish coordinates with HON's Loft. <i>Specify LOFT when ordering. Example: HCOMDOME2.LOFT</i></p>	HCOMDOME2	2.5 	0.2	\$327
	<p>Power Modules</p> <p>3 Receptacles with Worksurface Clamp</p> <p>3 Receptacles with Under-Worksurface Mounting Bracket</p> <p>2 Receptacles 2 USB with Worksurface Clamp</p> <p>2 Receptacles 2 USB with Under-Worksurface Mounting Bracket</p> <ul style="list-style-type: none"> 6' power cord with standard three-prong plug. Under-worksurface mounting bracket models work with any top that has a 5" x 5" square clearance. Worksurface clamp models work on any top with a 4" overhang. UL Listed. <p>! Color finish coordinates with HON's Charcoal or White. <i>Specify STRM for Storm and SNW for Snow when ordering. Example: HPWRMOD3WC.STRM</i></p>	<p>HPWRMOD3WC </p> <p>HPWRMOD3UWM</p> <p>HPWRMOD2WC </p> <p>HPWRMOD2UWM</p>	<p>2.3 </p> <p>2.3 </p> <p>2.3 </p> <p>2.3 </p>	<p>0.2</p> <p>0.2</p> <p>0.2</p> <p>0.2</p>	<p>\$342</p> <p>\$342</p> <p>\$546</p> <p>\$546</p>
 Model HPWRMOD2UWM shown	<p>Under Worksurface Power Module — 4 Outlets, 10' Cord</p> <ul style="list-style-type: none"> Includes 10' cord with three-prong plug. Fits in cable management troughs. See page 613. 4 outlets on side create easy access. <p>NOTES: Power Modules will also work with standing-height applications for 10500 Series™ and Voi® desks.</p> <p>! Available in black finish only, no specification needed.</p>	HPWRMOD2	1.5	0.2	\$441
 	<p>Vertebrae</p> <p>NOTES: 30"H x 3 1/8"W x 1 1/2"D. Ships unassembled.</p> <p>! Clear finish. Specify "X" for finish option.</p> <p>SPECIFYING EXAMPLE: HMPVWM28.X</p>	HMPVWM28	3.0	0.3	\$246

NOTES:

- For additional information see the Workplace Tools section in the 2021 Shared Spaces Pricer.

SYSTEMS

Accessories — Monitor Arms

OPEN MARKET EXCEPT AS NOTED

ABI

Icon Legend on page 19

WORKSTATIONS

DESCRIPTION

MODEL SHIP WEIGHT CUBE LIST PRICE

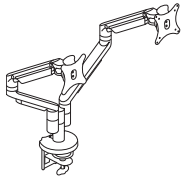

Dual Dynamic Monitor Arm

- 150° of rotation at base with optional 360° rotation.
- Arms extend 22" and retract up to 3".
- Monitor mount rotates 180° and tilts +/-30°.
- Monitor can be rotated from landscape to portrait position.

! Arms hold monitors from 6.2-18 lbs. Optional counterweight HPACW available to support monitors as low as 5 lbs. (see the Workplace Tools section in the 2021 Shared Spaces Pricer).

HMASD 17.0 1.1 \$962

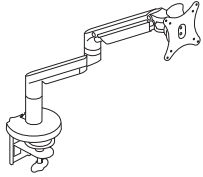

Single Dynamic Monitor Arm

- 180° of rotation at base with optional 360° rotation.
- Arms extend 22" and retract up to 3".
- Monitor mount rotates 180° and tilts +/-30°.
- Monitor can be rotated from landscape to portrait position.

! Arms hold monitors from 6.2-18 lbs. Optional counterweight HPACW available to support monitors as low as 5 lbs. (see the Workplace Tools section in the 2021 Shared Spaces Pricer).

HMASTS 11.5 0.8 \$501

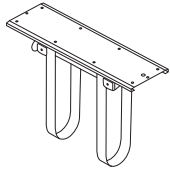

360° Swivel CPU Holder with Adjustable Straps

- Supports CPUs 3 3/4" wide up to 64" perimeter and holds up to 75 lbs.
- 360° rotation.
- Ships complete and includes necessary mounting hardware and instruction sheet.

! Available in Black only, no specification needed.

HCPUI 7.0 0.2 \$260

SIN 33721

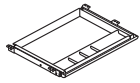

Polymer Center Drawer

- Color: Black.
- Material: ABS.
- Minimum clearance for mounting: 23"W x 16 1/4"D x 2"H.
- Retracts on 16" ball-bearing slides.
- Can be used on worksurfaces with Coordinate™ Height Adjustable Bases as long as it is attached with spacer model HKBS.
- Can store up to 25 lbs.

! Black finish only, no specification needed.

HCD1 7.0 0.5 \$126

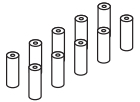

Keyboard Spacer

- For use when attaching a keyboard tray to Coordinate™ and Voi® or Systems Worksurface with an external channel.
- The kit includes ten cylinder spacers and ten screws.
- Spacers are 3/4"W x 2 1/8"H.
- Specify one kit per keyboard tray.

NOTES: For additional information see the Workplace Tools section in the 2021 Shared Spaces Pricer.

HKBS 1.0 0.8 \$100

NOTES:

- See the Workplace Tools section in the 2021 Shared Spaces Pricer for additional monitor arm models.

HOW TO SPECIFY

Select Model Number

Select Finish

Specify for models HMASD and HMASTS only

SVR Silver
BLK Black

HMASD.

SVR

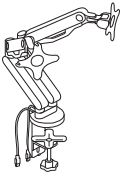

	DESCRIPTION	MODEL	SHIP WEIGHT	CUBE	LIST PRICE
	<p>Coordinate™ Portable Desktop Riser 31"D x 5"-16½"H x 35"W</p> <p>NOTES: Available in Black (BLK) or White (WHT) finish. Desktop riser dimensions (without keyboard tray): 22"D x 5"-16½"H x 35"W. Keyboard tray dimensions: 9"D x 30"W. Max loading capacity is 33 lbs for the desktop riser surface and 4 lbs for the keyboard tray. Easily transition from seated to standing positions throughout the workday. Sits atop an existing desk to create sit-to-stand functionality by raising the computer. Includes keyboard tray and surface for computer monitors. HON 5-Year Limited Warranty.</p> <p>⚠ Not intended for use on mobile workstations.</p>	HBXRISER	54.0	4.1	\$657
	<p>Dual Monitor Arm with 2 USB Ports</p> <p>NOTES: Easy adjustment. Height adjusts to 17" tall. Monitor tilt and swivel capability. Enclosed cable management. Grommet or desktop mounting. Clean appearance. In some applications the Monitor Arms may extend 12 or more inches into the worksurface. For additional information see the Workplace Tools section in the 2021 Shared Spaces Pricer. HON 5-Year Limited Warranty.</p> <p>⚠ No specification needed.</p> <p>⚠ Cannot be used with Empower® height adjustable models.</p>	HBDMAUSB	41.9	2.6	\$410

HOW TO SPECIFY

<p>Select Model Number</p> <p>H B X R I S E R .</p>	<p>Select Finish</p> <p>BLK Black WHT White</p> <p>B L K</p>
--	---

SYSTEMS

Accessories

OPEN MARKET



Icon Legend on page 19

WORKSTATIONS

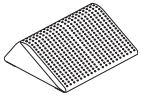

DESCRIPTION

Footrest — Anti-Slip Cover
13¾"D x 5½"H x 16"W

ⓘ Available in Black (T) finish ONLY. Recommended weight capacity not to exceed 250 pounds. **HON 5-Year Limited Warranty.**
SPECIFYING EXAMPLE: HVL991.T — isolated, dedicated circuit

MODEL

HVL991

SHIP WEIGHT

7 ⓘ

CUBE

0.9

LIST PRICE

\$89

HOW TO SPECIFY

Select Model Number

Select Finish

T Black

H V L 9 9 1 .

T



Versé® Panels shown with SmartLink® Value Mobile Storage, Between™ Multi-Purpose Table, Motivate® Stacking Chair, and Hand Sanitizer Station.

VERSÉ®

Create more personal space in open areas with the Versé panel system. Easily connected and endlessly reconfigurable, Versé panels can maintain sightlines or maximize privacy, and keep frequently used items conveniently within reach. It's the smart long-term investment to support short-term work environments that are constantly changing.



FEATURES

- A variety of Versé panel widths and heights easily connect to one another to form workstations or offer privacy as space dividers. Available in sizes ranging from 24"-72"W and 42"-72"H.
- Steel hanging shelf hangs off the top of a Versé panel.
- Choose from three paint options to customize your office space.

VERSÉ® Panel System

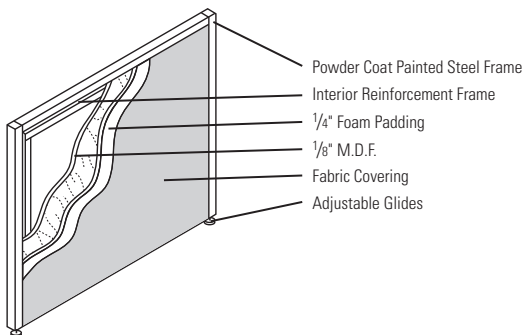
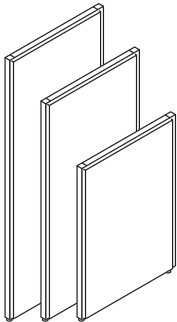
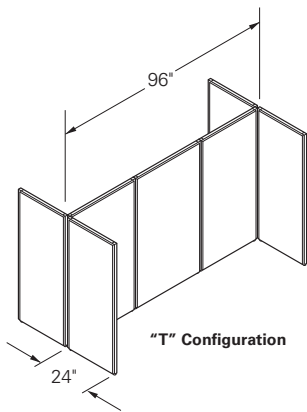
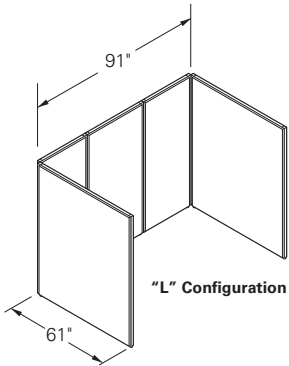

FEATURES

Panels

- Use Versé as a privacy panel (stand-alone) to create space division.

QuickConnect

(See page 649 for more details on this hardware.)

- Our QuickConnect connectors allow for easy installation. Simply snap on the connectors at the top and bottom of the panel and slide the panels together. There are only two connectors to specify for almost all configurations.

Storage

- Shelving capabilities. Each shelf width must match width of panel.

PANEL DIMENSIONS AND GROWTH ALLOWANCES

- All panel runs must be supported at each end of the panel run and supported at least every 8' within the panel run (maximum of 8' between supports).
- Support can be in the form of an adjustable wall bracket or return panel at 90° to the run.
- When using an "L" configuration, the return panel must measure at least 60% (minimum 36") of the unsupported run.
- When using a "T" configuration, each return panel must measure at least 20% of the unsupported run.
- Return panels can be no more than 24" lower than the panel height in the unsupported run.
- When used in conjunction with hanging shelves, panel width must match width of shelf.

VERSÉ PANELS

Includes

- Adjustable glides with all panels.

What Do I Need?

- QuickConnect Connectors.

Special Notes

- Versé panels feature a soft, padded look.
- Panels packed two per carton when possible.

Connection Type	Connectors Needed
Straight	1 pair – 180°
2-way (L)	1 pair – 90°
3-way (T)	2 pair – 90°
4-way (X)	3 pair – 90°

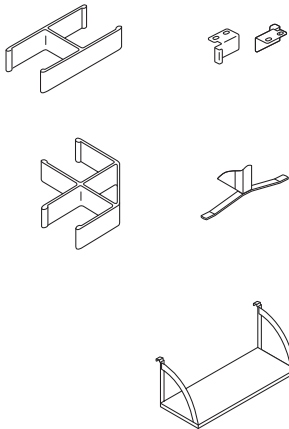

CONNECTING HARDWARE

Versé QuickConnect User Instructions

- Versé QuickConnect is easy to install. Simply snap on the connectors at the top and bottom of the panel and slide the panels together. There are only two connectors to specify for almost all configurations, including multi-height connections.
- 180° Straight Connector – use when connecting two panels together for a straight connection or for multi-height straight connections.
- 90° Corner Connector – use for 2-way, 3-way and 4-way corner connections. Only one pair is needed per corner connection or for multi-height corner connections.

HARDWARE

Special Notes

- Connectors add to the overall dimensions of the panel installation.
- These connector dimensions are important when space planning and sizing your panel layout.
- All hardware items may ship by a parcel service.
- Use HBV-PBS bracket with freestanding furniture for optimal workstation rigidity.

SHELVES

- Steel shelves are 14½" high.
- End brackets included.
- Must match panel width.
- Easy assembly; no tools required.

PANEL FABRIC & PAINT ORDERING CODES

PRICE CODE A	
CENTURION*	CU
◆ Apricot	CU47
◆ Bark	CU25
◆ Black	CU10
◆ Espresso	CU49
◆ Fog	CU03
◆ Frost	CU22
◆ Goldenrod	CU27
◆ Indigo	CU06
◆ Iris	CU50
◆ Iron Ore	CU19
◆ Jade	CU83
◆ Marsala	CU63
◆ Morel	CU24
◆ Navy	CU98
◆ Peacock	CU97
◆ Pear	CU84
◆ Ruby	CU67
◆ Sapphire	CU09

PRICE CODE A <i>continued</i>	
CONTOURETT POLYURETHANE*	VUR
◆ Baltic	VUR94
◆ Beach	VUR23
◆ Black	VUR10
◆ Bordeaux	VUR63
◆ Buff	VUR22
◆ Cloud	VUR18
◆ Coffee Bean	VUR49
◆ Crater	VUR51
◆ Flame	VUR62
◆ Graphite	VUR19
◆ Iron	VUR20
◆ Luggage	VUR26
◆ Marine	VUR92
◆ Navy	VUR95
◆ Nimbus	VUR93
◆ Ocean	VUR96
◆ Pumpkin	VUR42

PRICE CODE A <i>continued</i>	
CONTOURETT POLYURETHANE*	VUR
◆ Quarry	VUR24
◆ Red	VUR64
◆ Safari	VUR27
◆ Sage	VUR82
◆ Steel	VUR21
◆ Storm	VUR17
◆ Taupe	VUR28
◆ Trunk	VUR50

PRICE CODE A <i>continued</i>	
SEAWAY	2310
◆ Grey	2310GRE

PAINTS ORDERING CODES (Panel, T-base, Shelf and Connectors)	
Black	P
Light Gray	Q
Putty	L

* Centurion and Contourett fabrics are only able to exceed 54" in one direction (vertically or horizontally), not both directions.

! To clean Versé Panels with Contourett use a 1:5 diluted bleach and water mixture or Virex II 256. Leave cleaning solution on for at least 30 seconds but no longer than two minutes. Thoroughly remove the solution from the surface with a clean cloth and warm water. May cause discoloration if left on the surface longer than the suggested time or not removed after sanitizing.

◆◆◆ For lead time information see page 19.

VERSÉ® Panel System

OPEN MARKET

WORKSTATIONS

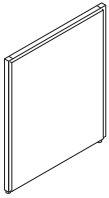

DESCRIPTION

42" H Panel

42" H x 24" W
42" H x 30" W
42" H x 36" W
42" H x 42" W
42" H x 48" W
42" H x 60" W
42" H x 72" W

MODEL

HBV-P4224
HBV-P4230
HBV-P4236
HBV-P4242
HBV-P4248
HBV-P4260
HBV-P4272

SHIP WEIGHT

18
22
24
33
34
36
48

CUBE

1.8
2.2
2.7
3.1
3.6
4.4
5.3

LIST PRICE

\$339
\$351
\$356
\$358
\$374
\$402
\$462

NOTES: All panels include adjustable glides.

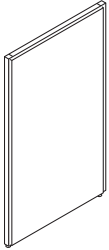

60" H Panel

60" H x 24" W
60" H x 30" W
60" H x 36" W
60" H x 42" W
60" H x 48" W
60" H x 60" W
60" H x 72" W

HBV-P6024
HBV-P6030
HBV-P6036
HBV-P6042
HBV-P6048
HBV-P6060
HBV-P6072

30
33
35
37
42
54
60

2.5
3.2
3.8
4.4
5.0
6.4
7.5

\$376
\$390
\$391
\$410
\$416
\$434
\$508

NOTES: All panels include adjustable glides.

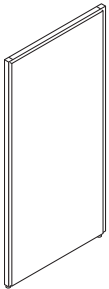

72" H Panel

72" H x 24" W
72" H x 30" W
72" H x 36" W
72" H x 42" W
72" H x 48" W
72" H x 60" W

HBV-P7224
HBV-P7230
HBV-P7236
HBV-P7242
HBV-P7248
HBV-P7260

39
40
44
46
50
62

3.0
3.8
4.5
5.2
6.0
7.5

\$423
\$432
\$453
\$474
\$485
\$537

NOTES: All panels include adjustable glides.



NOTES:

- **HON 5-Year Limited Warranty.**
- Panels offer privacy as room dividers or in desk-wrap applications.
- Panels feature 1" powder coat painted steel frame construction with interior reinforcement, 1/4" foam padding and 1/8" M.D.F.
- All panels include adjustable glides.
- To free-stand a single Versé panel or to stabilize the end of a panel run, order T-base stabilizing foot shown on page 649.
- See page 647 for available fabrics and finishes.

HOW TO SPECIFY

<p>Select Model Number</p> <p>HBV - P 4 2 2 4 .</p>	<p>Select Upholstery</p> <p>See page 647</p> <p>2 3 1 0 G R E .</p>	<p>Select Trim Color</p> <p>P Black Q Light Gray L Putty</p> <p>See page 647</p> <p>P</p>
---	---	---

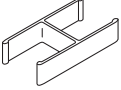
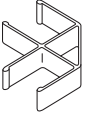

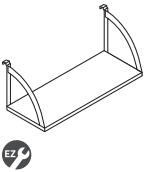
	DESCRIPTION	MODEL	SHIP WEIGHT	CUBE	LIST PRICE
	180° QuickConnect Straight Panel Connector Pair NOTES: 180° connector to be used to connect two panels in a straight connection or for multi-height straight connections.	HBV-QC180	0.1	0.3	\$27
	90° QuickConnect Panel Connector Pair NOTES: 90° connector to be used for 2-way, 3-way or 4-way corner connections, or for multi-height connections.	HBV-QC90	0.1	0.3	\$27
	Wall Bracket	HBV-PWB1	0.2	0.3	\$58
	Panel-to-Worksurface Bracket Pair	HBV-PBS	0.3	0.3	\$49
	T-Base Stabilizing Foot 18¾" long NOTES: Adds 1¼" to the height of the panel.	HBV-TBASE	6.0	0.3	\$53
	Hanging Shelves 24"W x 12¾"D 30"W x 12¾"D 36"W x 12¾"D 42"W x 12¾"D 48"W x 12¾"D 60"W x 12¾"D NOTES: Shelves hang over the top of panels. Supporting panel must match the width of the shelf.	HBV-VSH24 HBV-VSH30 HBV-VSH36 HBV-VSH42 HBV-VSH48 HBV-VSH60	9.0 10.0 12.0 13.0 14.0 19.0	1.2 1.5 1.8 2.0 2.3 2.9	\$216 \$240 \$262 \$282 \$323 \$367

NOTES:

- **HON 5-Year Limited Warranty.**
- T-base stabilizing foot optional.
- Extruded aluminum connectors are sold in pairs and are used at top and bottom of panels.
- Shelves hang over the top of panels; the supporting panel must match the width of the shelf.
- Shelves feature steel construction with powder coat paint finish.
- Shelves ship easy to assemble – no tools required.
- See page 647 for available fabrics and finishes.

HOW TO SPECIFY

<p>Select Model Number</p> <p>HBV - QC180</p>	<p>Select Trim Color</p> <p>See page 647</p> <p>P</p>
--	--

OVERVIEW OF PERSONAL STORAGE AND PEDESTALS

LATERAL FILES

Advantages:

a) The most efficient means of conventional filing; b) Ideal for active filing in workstations, where higher volume capacity is necessary and retrieval is frequent

Considerations:

2-drawer steel lateral files fit under standard-height worksurfaces when using panel systems.

VERTICAL FILES

Advantages:

a) Economical; b) The most widely used filing method; c) requires minimal floor space

Considerations:

Vertical files are best suited for long-term storage, where retrieval is less frequent. For larger banks of files, lateral files are more space-efficient than vertical files.

BOOKCASES

Advantages:

a) These units are ideal for binders, reference books or other items; b) Available with your choice of fixed or movable shelves

Considerations:

If working with panel systems, it is more attractive to specify units that are lower than the panel height.

FILING TECHNIQUES

Type	Standing Files	Hanging Files
Advantages	Inexpensive. Uses existing file folders.	Easier organization and identification of the file folders. Files viewed from top. Remaining files hold their place when folders are removed. Easier to re-stock.
Requirements	Follower block or Dividers	Hangrails or high-drawer sides
Can be used in	<ul style="list-style-type: none"> Vertical files (front-to-back only) Lateral files (side-to-side only in drawers) Shelf files (side-to-side only) 	<ul style="list-style-type: none"> Vertical files (front-to-back only) Lateral files (front-to-back or side-to-side in drawers)

Contain*/Flagship*/Brigade* Series Pedestals Utilization with 38000 Series.

Pedestal Depths	Abound* and Accelerate* Panel-Hung Worksurfaces			38000 Series Modular Desks		
	18" Deep	24" Deep	30" Deep	24" Deep	30" Deep	36" Deep
16 ³ / ₄ " Deep	•	•	•	•	•	•
22 ⁷ / ₈ " Deep		•	•	•*	•	•
28 ⁷ / ₈ " Deep			•		•	•

* Cannot attach 22⁷/₈"D Hanging Pedestal.

WORKING WITH STORAGE PEDESTALS

Storage Pedestals are available in 5 styles:

- Box/File Mobile.....(Model Nos. beginning with HSPM)
- Freestanding(Model Nos. beginning with HSPF)
- Hanging(Model Nos. beginning with HSPH)
- Worksurface Supporting**(Model Nos. beginning with HSPS)
- Under Worksurface Mobile.....(Model Nos. beginning with HSPM)

Worksurface height supporting pedestals have a taller base plate, resulting in a taller overall cabinet height. Consideration must be made to ensure that units align visually with each other. The accompanying chart will help you select the correct pedestal for your application.

Pedestal Models (Nos. begin with)	Style	Overall Height	Base Height	Spacer Required Below Worksurface
HSPM or H15	Box/File mobile	22 ⁵ / ₈ "	N/A	N/A
HSPF	Freestanding	28"	3 ¹ / ₂ "	NO
HSPH or H14	Hanging	19 ¹ / ₂ "	N/A	N/A
HSPS or H19 or H36	Worksurface supporting**	28"	3 ¹ / ₈ "	NO
HSPM or H18 or H33	Under Worksurface mobile	28"	3 ¹ / ₈ "	NO

** Units will support conventional 29¹/₂"H worksurfaces, WITHOUT SPACERS.

LATERAL FILING OPTIONS

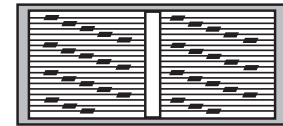

Front-to-back filing:

30" wide files:** 30¹/₂" of filing with letter/letter rows.

36" wide files:** 30¹/₂" of filing with letter/letter, legal/legal, or letter/legal rows.

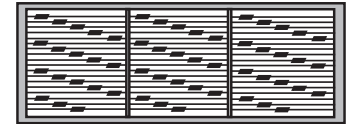

42" wide files:** 45³/₄" of filing with 3 rows letter or 30¹/₂" of 2 rows legal, or 2 standard printout rows.

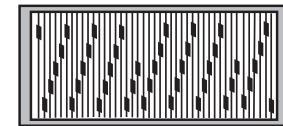

Side-to-side filing:

30" wide files: 27" of filing with letter or legal.

36" wide files: 33" of filing with letter or legal.

42" wide files: 39" of filing with letter or legal.

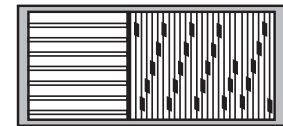

Combination filing:

(front-to-back with side-to-side in one drawer)

30" wide files: not recommended.

36" wide files: 15¹/₄" of front-to-back filing and 20¹/₄" of side-to-side legal filing.

42" wide files: 15¹/₄" of front-to-back filing and 26¹/₄" of side-to-side legal filing.

* Requires H919491 optional hangrails.

** Requires H919492 optional hangrails.

HON LATERAL FILES AT A GLANCE

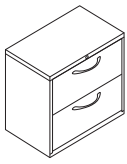

Flagship®

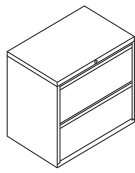

**Brigade®
Model H872L**

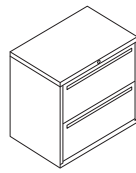

**Brigade®
Model H772L**

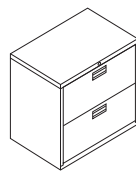

**Brigade®
Model H672L**

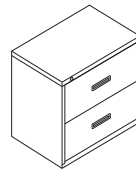

400 Series

Flagship Series lateral files are 18"D.

Brigade® 800, 700, 600 and 500 Series lateral files are all 18"D.

Series	Widths Available	Heights Available	Suspension Style	Usage	Pull	Safety Interlock	Lock	Features
Flagship, Brigade® 800, 700, 600	30" 36" 42"	2 dwr 3 dwr 4 dwr 5 dwr	Heavy-Duty ball-bearing (telescoping)	Intensive	Flagship Series 3 Pulls available. See page 653. Brigade® 800 Series Full-width radius designer style Brigade® 700 Series Full-width designer style Brigade® 600 Series Anodized Aluminum	Positive Mechanical	Core removable	<ul style="list-style-type: none"> • 4 leveling glides • 2 hangrails per drawer • Rack resistant case reinforcement • Flagship® and Brigade® can be used with Storage Islands
400	30" 36"	2 dwr 4 dwr	Ball-bearing	Moderate	Color-matched polymer Monochromatic drawer pulls	Positive Mechanical	Core removable	<ul style="list-style-type: none"> • 2 leveling glides

All products meet or exceed ANSI/BIFMA and ISTA performance standards.

STORAGE

HON VERTICAL FILES AT A GLANCE

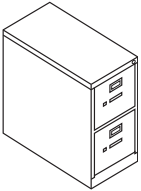

Model H212

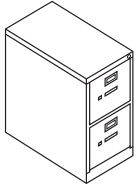

Model H312



Model H512

Vertical files listed below meet or exceed ANSI/BIFMA and ISTA performance standards. They are available in 15"W letter and 18¼"W legal widths.

Series	Depth	Heights Available	Suspension Style	Lock	Accepts Hanging Files	Features
210 Series	28½"	2 dwr 4 dwr 5 dwr	Three-part telescoping, ball-bearing steel suspension	INCLUDED core removable	YES (Hangrails not required)	Follower Block standard
310 Series	26½"	2 dwr 4 dwr 5 dwr	Three-part telescoping, ball-bearing steel suspension	INCLUDED core removable	YES (Hangrails not required)	Follower Block standard
510 Series	25"	2 dwr 4 dwr	Three-part telescoping, ball-bearing steel suspension	INCLUDED core removable	YES (Hangrails not required)	Adjustable wire follower

STORAGE

STORAGE AND FILES ORDERING INFORMATION

CONTAIN® PRODUCT

L1 LAMINATES CODES

Woodgrain

- ◆ Bourbon Cherry H
- ◆ Cognac COGN
- ◆ Florence Walnut LFW1
- ◆ Harvest C
- ◆ Kingswood Walnut LK11
- ◆ Mahogany N
- ◆ Mocha MOCH
- ◆ Natural Maple D
- ◆ Pinnacle PINC
- ◆ Shaker Cherry F
- ◆ Sterling Ash LSA1

L2 LAMINATES CODES

Woodgrain

- ◆ Lowell Ash LLA1
- ◆ Natural Recon LNR1
- ◆ Phantom Ecru LPE1
- ◆ Portico Teak LPT1
- ◆ Skyline Walnut LSW1

OPTIONAL LAMINATE TOPS FOR LATERAL FILES AND CONTAIN® CREDENZAS

L1 LAMINATES CODES

Woodgrain

- ◆ Bourbon Cherry H
- ◆ Cognac COGN
- ◆ Florence Walnut LFW1
- ◆ Harvest C
- ◆ Kingswood Walnut LK11
- ◆ Mahogany N
- ◆ Mocha MOCH
- ◆ Natural Maple D
- ◆ Pinnacle PINC
- ◆ Shaker Cherry F
- ◆ Sterling Ash LSA1

Solid

- ◆ Charcoal S
- ◆ Designer White LDW1
- ◆ Loft LOFT

Patterned

- ◆ Handspun Chestnut LAHC
- ◆ Handspun Dove LAHD
- ◆ Handspun Pearl LAHP
- ◆ Handspun Slate LAHS
- ◆ Sheer Mesh* A5
- ◆ Silver Mesh* B9
- ◆ Steel Mesh* A9
- ◆ Canyon Zephyr* K9
- ◆ Desert Zephyr* K8
- ◆ Shadow Zephyr* K1
- ◆ Gray* G2
- ◆ White* G1

L2 LAMINATES CODES

Woodgrain

- ◆ Lowell Ash LLA1
- ◆ Natural Recon LNR1
- ◆ Phantom Ecru LPE1
- ◆ Portico Teak LPT1
- ◆ Skyline Walnut LSW1

OPTIONAL LAMINATE TOPS FOR STEEL BOOKCASES

L1 LAMINATES CODES

Woodgrain

- ◆ Bourbon Cherry H
- ◆ Florence Walnut LFW1
- ◆ Harvest C
- ◆ Kingswood Walnut LK11
- ◆ Mahogany N
- ◆ Natural Maple D
- ◆ Shaker Cherry F
- ◆ Sterling Ash LSA1

Solid

- ◆ Charcoal S
- ◆ Designer White LDW1

Patterned

- ◆ Handspun Chestnut LAHC
- ◆ Handspun Dove LAHD
- ◆ Handspun Pearl LAHP
- ◆ Handspun Slate LAHS
- ◆ Sheer Mesh* A5
- ◆ Silver Mesh* B9
- ◆ Steel Mesh* A9
- ◆ Canyon Zephyr* K9
- ◆ Desert Zephyr* K8
- ◆ Shadow Zephyr* K1
- ◆ Gray* G2
- ◆ White* G1

1870 SERIES BOOKCASES

L1 LAMINATES CODES

Woodgrain

- ◆ Cognac COGN
- ◆ Harvest C
- ◆ Mahogany N

FLAGSHIP®, CONTAIN® PRODUCT, BRIGADE PEDESTALS, BRIGADE 800, 700, 600 LATERAL FILES, 210, 310/H320, AND 510 SERIES VERTICAL FILES, BRIGADE STORAGE CABINETS, BRIGADE STEEL BOOKCASES

PAINTS CODES

P1

- ◆ Black P
- ◆ Brownstone P7D
- ◆ Charcoal S
- ◆ Designer White PJW
- ◆ Fossil P28
- ◆ Greige T5
- ◆ Light Gray Q
- ◆ Loft LOFT
- ◆ Muslin T3
- ◆ Putty L
- ◆ Shadow* SHDW
- ◆ Titanium P8T

P2

- ◆ Champagne Metallic T4
- ◆ Platinum Metallic T1
- ◆ Silver** PR6
- ◆ Solar Black** P8X

400 SERIES LATERAL, FLAMESAFE FILES

PAINTS CODES

P1

- ◆ Black P
- ◆ Light Gray Q
- ◆ Loft LOFT
- ◆ Putty L

PULL OPTIONS FOR CONTAIN® AND FLAGSHIP® STORAGE

Suffix "A"



Satin Chrome Arch Pull

Suffix "N"



Full Face Integral Drawer Pull

Suffix "R"



Full Radius Drawer Pull

NOTES: Arch pulls available in Satin Chrome only.

* Laminate colors will have the following pre-set edgeband colors:

** Only available on Flagship® Pedestals and Contain®.

Laminate	Edge
Sheer Mesh	Muslin
Silver Mesh	Loft
Steel Mesh	Charcoal
Gray	Charcoal
White	Charcoal

Edgeband matches top except as noted.

For Champagne Metallic Paint, Muslin is the suggested edgeband color. When Champagne Metallic Paint is selected, pulls are standard in Muslin.

- The HON Company has elected to discontinue the HON Choice paint program, as of 12/31/2018, and roll it into our standard specials process.
- A special request will need to be submitted to receive pricing and order information.

◆◆◆ For lead time information see page 19.

* De-emphasized



Brigade® Storage.

BRIGADE®

You don't need an army to bring order to your office. Just a brigade. Sturdily built to rigorous specifications, our Brigade storage is ready to serve any organization needing top-quality storage. With welded construction and features like heavy-duty steel ball-bearing suspensions, it outlasts and outperforms most build-it-yourself options. Brigade was built to soldier on.



FEATURES

- Clean, straightforward design complements and blends in with any workspace.
- Optional Storage Islands laminate tops provide extra surface area for technology tools, collating or stand-up work.
- With a combination of reasonable pricing and high quality, Brigade is a value that's hard to beat.
- Heavy-duty Steel ball-bearing drawer suspensions operate easily and quietly.
- Mechanical interlock prevents more than one drawer from being opened at a time, for stability.

BRIGADE® ORDERING INFORMATION

BRIGADE PRODUCTS

PAINTS CODES

P1

- ◆ Black P
- ◆ Brownstone P7D
- ◆ Charcoal S
- ◆ Designer White PJW
- ◆ Fossil P28
- ◆ Greige T5
- ◆ Light Gray Q
- ◆ Loft LOFT
- ◆ Muslin T3
- ◆ Putty L
- ◆ Shadow * SHDW
- ◆ Titanium P8T

P2

- ◆ Champagne Metallic T4
- ◆ Platinum Metallic T1

OPTIONAL LAMINATE TOPS FOR LATERAL FILES AND CONTAIN® CREDENZAS

L1 LAMINATES CODES

Woodgrain

- ◆ Bourbon Cherry H
- ◆ Cognac COGN
- ◆ Florence Walnut LFW1
- ◆ Harvest C
- ◆ Kingswood Walnut LK11
- ◆ Mahogany N
- ◆ Mocha MOCH
- ◆ Natural Maple D
- ◆ Pinnacle PINC
- ◆ Shaker Cherry F
- ◆ Sterling Ash LSA1

Solid

- ◆ Charcoal S
- ◆ Designer White LDW1
- ◆ Loft LOFT

Patterned

- ◆ Handspun Chestnut LAHC
- ◆ Handspun Dove LAHD
- ◆ Handspun Pearl LAHP
- ◆ Handspun Slate LAHS
- ◆ Sheer Mesh* * A5
- ◆ Silver Mesh* B9
- ◆ Steel Mesh* * A9
- ◆ Canyon Zephyr * K9
- ◆ Desert Zephyr * K8
- ◆ Shadow Zephyr * K1
- ◆ Gray* G2
- ◆ White* G1

L2 LAMINATES CODES

Woodgrain

- ◆ Lowell Ash LLA1
- ◆ Natural Recon LNRI
- ◆ Phantom Ecru LPE1
- ◆ Portico Teak LPT1
- ◆ Skyline Walnut LSW1

For Champagne Metallic Paint, Muslin is the suggested edgeband color.

- The HON Company has elected to discontinue the HON Choice paint program, as of 12/31/2018, and roll it into our standard specials process.
- A special request will need to be submitted to receive pricing and order information.

* Laminate colors will have the following pre-set edgeband colors:

Laminate	Edge
Sheer Mesh	Muslin
Silver Mesh	Loft
Steel Mesh	Charcoal
Gray	Charcoal
White	Charcoal

Edgeband matches top except as noted.

◆◆◆ For lead time information see page 19.

* De-emphasized





BRIGADE® Standard Height Pedestals

GSA SIN 33721

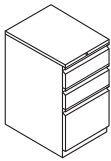

Icon Legend on page 19

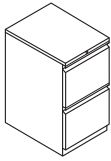
STORAGE

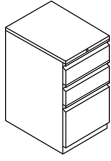
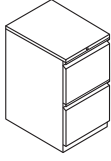
	DESCRIPTION	MODEL	SHIP WEIGHT	CUBE	LIST PRICE BY PAINT GRADE		
					P1	P2	P3
	Standard Height Mobile Pedestals — Box/Box/File						
	15"W x 19 ⁷ / ₈ "D x 28"H	H33720(?)	73	6.6	\$676	\$704	\$732
	15"W x 22 ⁷ / ₈ "D x 28"H	H33723(?) 	77	7.5	\$696	\$724	\$752
	Standard Height Mobile Pedestals — File/File						
	15"W x 19 ⁷ / ₈ "D x 28"H	H33820(?)	73	6.6	\$676	\$704	\$732
	15"W x 22 ⁷ / ₈ "D x 28"H	H33823(?) 	77	7.5	\$696	\$724	\$752
	Standard Height Freestanding Support Pedestals — Box/Box/File						
	15"W x 19 ⁷ / ₈ "D x 28"H	H36720(?)	61	6.6	\$663	\$691	\$719
	15"W x 22 ⁷ / ₈ "D x 28"H	H36723(?)	83	7.5	\$687	\$715	\$743
	Standard Height Freestanding Support Pedestals — File/File						
	15"W x 19 ⁷ / ₈ "D x 28"H	H36820(?)	61	6.6	\$663	\$691	\$719
	15"W x 22 ⁷ / ₈ "D x 28"H	H36823(?)	83	7.5	\$687	\$715	\$743

NOTES:

- 28"H fits under all HON worksurfaces and desk shells.
 - Pencil tray standard in top box drawer.
 - One box divider standard in each box drawer.
 - One crossrail standard in each file drawer.
 - Ball-bearing suspension on file and box drawers with 90% extension.
 - File drawers have high sides for filing front-to-back.
 - See pages 750-751 for accessories and pedestal utilization information.
 - Equipped with HON "One Key" interchangeable core removable locks.
 - Front casters are fixed, rear casters swivel on mobile pedestals.
 - "N" Pull matches Brigade 700 Series lateral file pull.
 - "R" pull matches Brigade 800 Series Lateral Pull.
 - See pages 750-751 for Pedestal Accessories. Additional Flagship pedestal models on pages 707-708.
-  Freestanding support pedestals that are not positioned and attached under a worksurface, require a counterweight kit found on page 750.

HOW TO SPECIFY

<p>Select Model Number</p> <p>Select the Pull</p> <p>N Full Face Integral R Full Radius</p> <p>H 3 3 7 2 0 R</p>	<p>Select Lock Option</p> <p>L Lock</p> <p>L</p>	<p>Select Paint Color</p> <p>See page 655</p> <p>P</p>
---	--	--



Icon Legend on page 19

BRIGADE® 800 SERIES

Lateral Files w/Drawers

	DESCRIPTION	MODEL	SHIP WEIGHT	CUBE	LIST PRICE BY PAINT GRADE		
					P1	P2	P3
	Lateral File — 2 Drawer						
	30"W x 18"D x 28"H	H872	121	12.2	\$892	\$925	\$959
	36"W x 18"D x 28"H	H882	131	14.3	\$996	\$1029	\$1063
	42"W x 18"D x 28"H	H892	141	16.7	\$1152	\$1185	\$1219
	Lateral File — 3 Drawer						
	30"W x 18"D x 39½"H	H873	158	16.4	\$1267	\$1300	\$1334
	36"W x 18"D x 39½"H	H883	175	19.1	\$1412	\$1445	\$1479
	42"W x 18"D x 39½"H	H893	190	22.4	\$1637	\$1670	\$1704
	Lateral File — 4 Drawer						
	30"W x 18"D x 52½"H	H874	197	21.4	\$1534	\$1601	\$1667
	36"W x 18"D x 52½"H	H884	217	25.1	\$1740	\$1807	\$1873
	42"W x 18"D x 52½"H	H894	232	29.4	\$1998	\$2065	\$2131
	Lateral File — 5 Drawer						
	30"W x 18"D x 64¼"H	H875	199	25.8	\$2038	\$2105	\$2171
	36"W x 18"D x 64¼"H	H885	215	30.1	\$2294	\$2361	\$2427
	42"W x 18"D x 64¼"H	H895	244	35.3	\$2649	\$2716	\$2782

NOTES:

- 30", 36" & 42" case widths with drawers, 18" case depth.
- Flush top and sides.
- Reinforced case construction.
- Four adjustable leveling glides.
- Full-width radius designer style pull.
- Features drawer extension restraint; mechanical interlock inhibits the extension of more than one drawer at a time.
- Three-part, telescoping, steel ball-bearing suspension.
- Two adjustable hangrails per drawer for side-to-side filing.
- Counterweight included where applicable to meet ANSI/BIFMA stability requirements.
- Lock mechanism secures both sides of drawer.
- Baked enamel finish over rust-inhibiting phosphate pre-treatment.
- Equipped with HON "One Key" interchangeable core removable locks.
- Optional laminate tops and accessories — see page 747.
- See page 747 for Lateral File Accessories.

Keyed alike cores must be ordered separately — see page 773.

HOW TO SPECIFY

Select Model Number 	Select Lock Option L Lock 	Select Paint Color See page 655
--------------------------------	---	---

BRIGADE® 800 SERIES Lateral Files w/Storage

GSA SIN 33721



Icon Legend on page 19

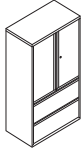

DESCRIPTION

Lateral File w/Storage — 2 Drawer

30"W x 18"D x 64¼"H

36"W x 18"D x 64¼"H

42"W x 18"D x 64¼"H

MODEL	SHIP WEIGHT	CUBE	LIST PRICE BY PAINT GRADE		
			P1	P2	P3
H875LS	174	27.5	\$1636	\$1703	\$1769
H885LS	210	32.9	\$1802	\$1869	\$1935
H895LS	228	38.0	\$2060	\$2127	\$2193

NOTES:

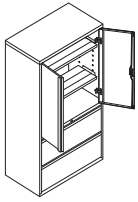

- 30", 36" & 42" case widths, 18" case depth.
- 46¼"H case - matches height of 800 Series 5 Drawer laterals.
- Bottom two openings are lateral drawers, remainder of case is storage shelves.
- Lateral file drawer features are same as 800 Series Laterals shown on previous page.
- Inside dimension of storage case is 36¼"H. Includes 2 adjustable shelves, adjustable in 2" increments. Bottom shelves accept two rows of 3-ring binders; top opening measures: 10¼".
- Storage case is standard with 2 hinged doors. Door pulls match lateral file drawer pulls.
- Equipped with HON "One Key" interchangeable core removable locks. Locks on storage case and lateral file are keyed alike. Lateral file drawers lock independently from storage case.
- Four adjustable leveling glides.
- See page 747 for Lateral File Accessories and page 662 for Wire Dividers.

STORAGE

HOW TO SPECIFY

Select Model Number

H 8 7 5 L S .

Select Lock Option

L Lock

L .

Select Paint Color

See page 655

T 1



BRIGADE® 700 SERIES

Lateral Files w/Drawers

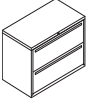
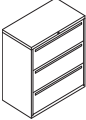
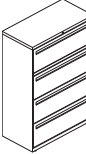
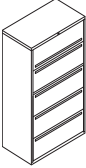
	DESCRIPTION	MODEL	SHIP WEIGHT	CUBE	LIST PRICE BY PAINT GRADE		
					P1	P2	P3
	Lateral File — 2 Drawer (locking)						
	30"W x 18"D x 28"H	H772	121	12.2	\$892	\$925	\$959
	36"W x 18"D x 28"H	H782	131	14.3	\$996	\$1029	\$1063
	42"W x 18"D x 28"H	H792	141	16.7	\$1152	\$1185	\$1219
	Lateral File — 3 Drawer (locking)						
	30"W x 18"D x 39 ¹ / ₈ "H	H773	158	16.4	\$1267	\$1300	\$1334
	36"W x 18"D x 39 ¹ / ₈ "H	H783	175	19.1	\$1412	\$1479	\$1545
	42"W x 18"D x 39 ¹ / ₈ "H	H793	190	22.4	\$1637	\$1670	\$1704
	Lateral File — 4 Drawer (locking)						
	30"W x 18"D x 52 ¹ / ₂ "H	H774	197	21.4	\$1534	\$1601	\$1667
	36"W x 18"D x 52 ¹ / ₂ "H	H784	217	25.1	\$1740	\$1807	\$1873
	42"W x 18"D x 52 ¹ / ₂ "H	H794	232	29.4	\$1998	\$2065	\$2131
	Lateral File — 5 Drawer (locking)						
	30"W x 18"D x 64 ¹ / ₄ "H	H775	199	25.8	\$2038	\$2105	\$2171
	36"W x 18"D x 64 ¹ / ₄ "H	H785	215	30.1	\$2294	\$2361	\$2427
	42"W x 18"D x 64 ¹ / ₄ "H	H795	244	35.3	\$2649	\$2716	\$2782



NOTES: Top drawer is a roll-out shelf.

NOTES:

- 30", 36" & 42" case widths with drawers, 18" case depth.
- Flush top and sides.
- Reinforced case construction.
- Four adjustable leveling glides.
- Full-face integral drawer pulls.
- Features drawer extension restraint; mechanical interlock inhibits the extension of more than one drawer at a time.
- Three-part, telescoping, steel ball-bearing suspension.
- Two adjustable hangrails per drawer/rollout shelf for side-to-side filing.
- Counterweight included where applicable to meet ANSI/BIFMA stability requirements.
- Lock mechanism secures both sides of drawer.
- Baked enamel finish over rust-inhibiting phosphate pre-treatment.
- Optional laminate tops and accessories — see page 747.
- Equipped with HON "One Key" interchangeable core removable locks.
- See page 747 for Lateral File Accessories.

! Keyed alike cores must be ordered separately — see page 773.

HOW TO SPECIFY

Select Model Number 	Select Lock Option L Lock 	Select Paint Color See page 655 
---	--	--

BRIGADE® 700 SERIES

Lateral Files w/Storage

GSA SIN 33721



Icon Legend on page 19

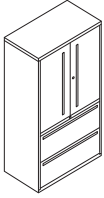

DESCRIPTION

Lateral File w/Storage — 2 Drawer

30"W x 18"D x 64¼"H

36"W x 18"D x 64¼"H

42"W x 18"D x 64¼"H

MODEL	SHIP WEIGHT	CUBE	LIST PRICE BY PAINT GRADE		
			P1	P2	P3
H775LS	175	27.5	\$1636	\$1703	\$1769
H785LS	211	32.9	\$1802	\$1869	\$1935
H795LS	230	38.0	\$2060	\$2127	\$2193

NOTES:

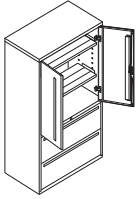

- 30", 36" & 42" case widths, 18" case depth.
- 64¼"H case - matches height of 700 Series 5 Drawer laterals.
- Bottom two openings are lateral drawers, remainder of case is storage shelves.
- Lateral file drawer features are same as 700 Series Laterals shown on previous page.
- Inside dimension of storage case is 36¼"H. Includes 2 adjustable shelves, adjustable in 2" increments. Bottom shelves accept two rows of 3-ring binders; top opening measures: 10¼".
- Storage case is standard with 2 hinged doors. Door pulls match lateral file drawer pulls.
- Equipped with HON "One Key" interchangeable core removable locks. Locks on storage case and lateral file are keyed alike. Lateral file drawers lock independently from storage case.
- Four adjustable leveling glides.
- See page 747 for Lateral File Accessories and page 662 for Wire Dividers.

STORAGE

HOW TO SPECIFY

Select Model Number

H 7 7 5 L S .

Select Lock Option

L Lock

L .

Select Paint Color









See page 655

T 1

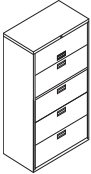

BRIGADE® 600 SERIES

Lateral Files w/Drawers



	DESCRIPTION	MODEL	SHIP WEIGHT	CUBE	LIST PRICE BY PAINT GRADE		
					P1	P2	P3
	Lateral File — 2 Drawer						
	30"W x 18"D x 28"H	H672	121	12.2	\$823	\$890	\$956
	36"W x 18"D x 28"H	H682 	131	14.3	\$885	\$918	\$952
	42"W x 18"D x 28"H	H692	141	16.7	\$1044	\$1077	\$1111
	Lateral File — 3 Drawer						
	30"W x 18"D x 39 ¹ / ₈ "H	H673	158	16.4	\$1129	\$1196	\$1262
	36"W x 18"D x 39 ¹ / ₈ "H	H683 	175	19.1	\$1235	\$1268	\$1302
	42"W x 18"D x 39 ¹ / ₈ "H	H693	190	22.4	\$1451	\$1484	\$1518
	Lateral File — 4 Drawer						
	30"W x 18"D x 52 ¹ / ₂ "H	H674	197	21.4	\$1403	\$1470	\$1536
	36"W x 18"D x 52 ¹ / ₂ "H	H684 	217	25.1	\$1533	\$1600	\$1666
	42"W x 18"D x 52 ¹ / ₂ "H	H694	232	29.4	\$1818	\$1885	\$1951
	Lateral File — 5 Drawer						
	30"W x 18"D x 64 ¹ / ₄ "H	H675	199	25.8	\$1864	\$1931	\$1997
	36"W x 18"D x 64 ¹ / ₄ "H	H685 	215	30.1	\$1991	\$2058	\$2124
	42"W x 18"D x 64 ¹ / ₄ "H	H695	244	35.3	\$2402	\$2469	\$2535

NOTES:

- 30", 36" & 42" case widths with drawers, 18" case depth.
- Flush top and sides.
- Reinforced case construction.
- Four adjustable leveling glides.
- Features drawer extension restraint; mechanical interlock inhibits the extension of more than one drawer at a time.
- Three-part, telescoping, steel ball-bearing suspension.
- Two adjustable hangrails per drawer/roll-out shelf for side-to-side filing.
- Counterweight included where applicable to meet ANSI/BIFMA stability requirements.
- Lock mechanism secures both sides of drawer.
- Baked enamel finish over rust-inhibiting phosphate pre-treatment.
- Bright anodized aluminum recessed drawer pull.
- Equipped with HON "One Key" interchangeable core removable locks.
- Optional laminate tops and accessories — see page 747.
- See page 747 for Lateral File Accessories.

 Keyed alike cores must be ordered separately — see page 773.

HOW TO SPECIFY

Select Model Number 	Select Lock Option L Lock 	Select Paint Color See page 655 
---	--	--

BRIGADE[®] Metal Dividers

GSA SIN 33721

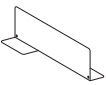
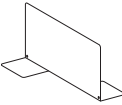

Icon Legend on page 19

	DESCRIPTION	MODEL	SHIP WEIGHT	CUBE	LIST PRICE P1
	Metal Box Divider				
	10 pack	HSCABD10	7	0.7	\$189
	2 pack	HSCABD02	2	0.7	\$48
<p>! Metal dividers available in Black only. No need to specify.</p>					
	Metal File Divider				
	10 pack	HSCAFD10	12	0.7	\$224
	2 pack	HSCAFD02	3	0.7	\$60
<p>! Metal dividers available in Black only. No need to specify.</p>					

STORAGE

HOW TO SPECIFY

Select
Model Number

H S C A B D 1 0



BRIGADE® Steel Bookcases

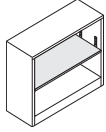

Shaded shelves are adjustable.

DESCRIPTION

Steel Bookcase
 34½"W x 12⅝"D x 29"H, 2-Shelf
 34½"W x 12⅝"D x 41"H, 3-Shelf
 34½"W x 12⅝"D x 59"H, 4-Shelf
 34½"W x 12⅝"D x 71"H, 5-Shelf
 34½"W x 12⅝"D x 81⅝"H, 6-Shelf

MODEL	SHIP WEIGHT	CUBE	LIST PRICE BY PAINT GRADE		
			P1	P2	P3
HS30ABC	44	9.6	\$290	\$323	\$357
HS42ABC	57	13.3	\$347	\$380	\$414
HS60ABC	77	18.9	\$518	\$585	\$651
HS72ABC	87	22.6	\$590	\$657	\$723
HS82ABC	97	27.5	\$853	\$920	\$986

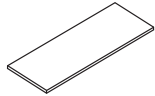

Extra Shelf for all Models

NOTES: Edge is ¼" thick. Specify: Paint

HB9	7 Ⓞ	0.3	\$98	\$111	\$121
------------	-----	-----	-------------	--------------	--------------

NOTES:

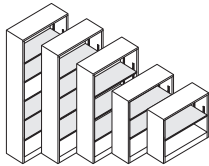

- Available in 2, 3, 4, 5, and 6 shelf models.
- Inside shelf depth is 12⅝".
- Bookcase shelves easily adjust in ½" increments (shaded shelves are adjustable).
- Optional laminate tops available.
- Baked enamel finish over rust-inhibiting phosphate pre-treatment.

HOW TO SPECIFY

<p>Select Model Number</p> <p>HS30ABC .</p>	<p>Select Paint Color</p> <p>See page 655</p> <p>P</p>
--	---

DESCRIPTION

Laminate Top for all Models
 NOTES: Specify: Laminate

MODEL	SHIP WEIGHT	CUBE	LIST PRICE
H511596	16 Ⓞ	0.7	\$293

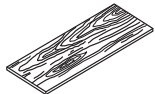

HOW TO SPECIFY

<p>Select Model Number</p> <p>H511596 .</p>	<p>Select Laminate</p> <p>See page 655</p> <p>N</p>
--	--

STORAGE

BRIGADE® Storage Cabinets

GSA SIN 33721



Icon Legend on page 19

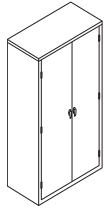

71 3/4" High

DESCRIPTION

Storage Cabinets

36"W x 18 1/8"D x 72"H
36"W x 24 1/8"D x 72"H

NOTES: Includes 5 adjustable shelves.

MODEL	SHIP WEIGHT	CUBE	LIST PRICE BY PAINT GRADE		
			P1	P2	P3
HSC1872	131	36.5	\$1140	\$1207	\$1273
HSC2472	149	46.7	\$1429	\$1496	\$1562

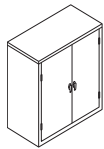

41 1/4" High

Storage Cabinet

36"W x 18 1/8"D x 41 1/4"H

NOTES: Includes 2 adjustable shelves.

HSC1842	82	21.8	\$963	\$1008	\$1052
----------------	----	------	--------------	---------------	---------------

Additional Shelves

36"W x 18"D
36"W x 24"D

HAS18	6	0.6	\$136	\$149	\$159
HAS24	8	0.7	\$169	\$182	\$192

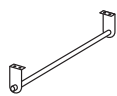

Conversion Kit

Hanging Bar and brackets to convert a Storage Cabinet into a Wardrobe Cabinet.

HWC72	5	0.4	\$126		
--------------	---	-----	--------------	--	--

NOTES: Necessary hardware included to screw into shelf.

For use on 72"H HSC Model Storage Cabinets shown above, only.

Aluminum finish only. No need to specify paint color.

SPECIFY: HWC72

NOTES:

- Product shipped fully assembled.
- All shelves are adjustable in 2" increments.
- Stretch-wrap cartoning.
- Flush top.
- Two adjustable leveling glides standard.
- Reinforced base.
- One locking handle, one fixed handle.
- Adjustable shelves.
- Doors have vertical stiffener standard.
- Positive door stops.
- Equipped with HON "One Key" interchangeable core removable locks.

Keyed alike cores must be ordered separately – see page 773.

HOW TO SPECIFY

Select Model Number <input type="text" value="HSC2472"/>	Select Lock Option <input type="text" value="L"/>	Select Paint Color <input type="text" value="P"/> See page 655
--	---	--



Contain® Lockers with
Electronic Locks.

STORAGE

CONTAIN®

Harder-working storage. That's what you need. So we re-examined it from the inside out and developed our new Contain storage solutions. With a variety of shapes and sizes, functions and configurations, Contain can help you expand your capabilities for storage, efficiency, and collaboration — and elevate your aesthetic too.



FEATURES

- Contain® provides the storage solutions you need, where you need them. Personal workstations, private offices, shared spaces, Contain® has you covered.
- Combine metal and laminate to create a unique and unified look for your office.
- Add a pop of color with standard HON paint or Colorway paint options.
- Punch up the personality of your storage with dual paint options, available in traditional HON colors or vibrant Colorway hues.
- Choose between a footed base to create a stand-alone furniture aesthetic, a recessed kickplate that matches both the drawer fronts, or an optional flush kickplate.
- Pair low credenzas and pedestals with seat cushions to turn any space into a collaborative hub.
- Leave the key in the past with our digital keypad or RFID lock options.
- Incorporate Contain® lockers and wardrobes into Storage Islands to create simple touchdown spaces throughout the office.

CONTAIN® ORDERING INFORMATION

STORAGE

CONTAIN® PRODUCTS CASE PAINT

PAINTS	CODES
P1	
◆ Black	P
◆ Brownstone	P7D
◆ Charcoal	S
◆ Designer White	PJW
◆ Fossil	P28
◆ Greige	T5
◆ Light Gray	Q
◆ Loft	LOFT
◆ Muslin	T3
◆ Putty	L
◆ Shadow *	SHDW
◆ Titanium	P8T
P2	
◆ Champagne Metallic	T4
◆ Platinum Metallic	T1
◆ Silver	PR6
◆ Solar Black	P8X
P3	
◆ Atom	P8S
◆ Bullseye	PJF
◆ Ember	P8P
◆ Ion	P8N
◆ Iris	P8J
◆ Krypton	P8F
◆ Regatta	P8M

CONTAIN® PRODUCTS

L1 LAMINATES	CODES
Woodgrain	
◆ Bourbon Cherry	H
◆ Cognac	COGN
◆ Florence Walnut	LFW1
◆ Harvest	C
◆ Kingswood Walnut	LK11
◆ Mahogany	N
◆ Mocha	MOCH
◆ Natural Maple	D
◆ Pinnacle	PINC
◆ Shaker Cherry	F
◆ Sterling Ash	LSA1
L2 LAMINATES	CODES
Woodgrain	
◆ Lowell Ash	LLA1
◆ Natural Recon	LNRI
◆ Phantom Ecru	LPE1
◆ Portico Teak	LPT1
◆ Skyline Walnut	LSW1

OPTIONAL LAMINATE TOPS FOR LATERAL FILES AND CONTAIN® CREDENZAS





L1 LAMINATES	CODES
Woodgrain	
◆ Bourbon Cherry	H
◆ Cognac	COGN
◆ Florence Walnut	LFW1
◆ Harvest	C
◆ Kingswood Walnut	LK11
◆ Mahogany	N
◆ Mocha	MOCH
◆ Natural Maple	D
◆ Pinnacle	PINC
◆ Shaker Cherry	F
◆ Sterling Ash	LSA1
Solid	
◆ Charcoal	S
◆ Designer White	LDW1
◆ Loft	LOFT
Patterned	
◆ Handspun Chestnut	LAHC
◆ Handspun Dove	LAHD
◆ Handspun Pearl	LAHP
◆ Handspun Slate	LAHS
◆ Sheer Mesh* *	A5
◆ Silver Mesh* *	B9
◆ Steel Mesh* *	A9
◆ Canyon Zephyr *	K9
◆ Desert Zephyr *	K8
◆ Shadow Zephyr *	K1
◆ Gray*	G2
◆ White*	G1
L2 LAMINATES	CODES
Woodgrain	
◆ Lowell Ash	LLA1
◆ Natural Recon	LNRI
◆ Phantom Ecru	LPE1
◆ Portico Teak	LPT1
◆ Skyline Walnut	LSW1

CONTAIN® PRODUCTS FRONT PAINT

PAINTS	CODES
P1	
◆ Black	P
◆ Brownstone	P7D
◆ Charcoal	S
◆ Designer White	PJW
◆ Fossil	P28
◆ Greige	T5
◆ Light Gray	Q
◆ Loft	LOFT
◆ Muslin	T3
◆ Putty	L
◆ Shadow *	SHDW
◆ Titanium	P8T
P2	
◆ Champagne Metallic	T4
◆ Platinum Metallic	T1
◆ Silver	PR6
◆ Solar Black	P8X
P3	
◆ Atom	P8S
◆ Bullseye	PJF
◆ Ember	P8P
◆ Ion	P8N
◆ Iris	P8J
◆ Krypton	P8F
◆ Regatta	P8M

NOTES: L2 laminate front upcharge is \$35 per list unit.

PULL OPTIONS FOR CONTAIN® AND FLAGSHIP® STORAGE

"A"	"N"	"R"	"S"
			
Satin Chrome Arch Pull	Full Face Integral Drawer Pull	Full Radius Drawer Pull	Square Drawer Pull

NOTES: Arch Pulls available in Satin Chrome only. Linear Pull coming soon.

* Laminate colors will have the following pre-set edgeband colors:

Laminate	Edge
Sheer Mesh	Muslin
Silver Mesh	Loft
Steel Mesh	Charcoal
Gray	Charcoal
White	Charcoal

Edgeband matches top except as noted.

For Champagne Metallic Paint, Muslin is the suggested edgeband color. When Champagne Metallic Paint is selected, pulls are standard in Muslin.

◆◆◆ For lead time information see page 19.

* De-emphasized

METAL CRENZAS WITH PANEL FRAMES

Guidelines for using Contain[®] Credenzas in place of standard panel systems configurations

Side-mounted Credenzas

Use 1 storage-to-panel bracket set.

The minimum credenza size is 22"H x 36"W x 18"D.

With a mid-run floor support, the maximum panel run is 144".

Without a mid-run panel attached floor support, the maximum panel run is 96".

Overheads and shelves cannot be used with 22"H side mounted credenzas.

Worksurfaces (if specified) must be mounted on the same side of the parent run as the credenzas.

Panel frame maximum height is 68".

Counterweight is required, if using unit with drawers.

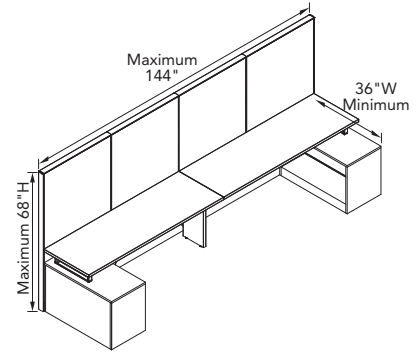

Back-mounted Credenzas — Modular

Use 2 storage-to-panel bracket sets per Credenza — 2 LH and 2 RH.

The minimum credenza size is 22"H x 36"W x 18"D.

The maximum panel run between back-mounted credenzas is 60".

Overheads and shelves cannot be used with 22"H back mounted credenzas.

Worksurfaces (if specified) must be mounted on the same side of the parent run as the credenzas.

Panel frame maximum height is 68".

Counterweights are required in a single side run configuration as shown.

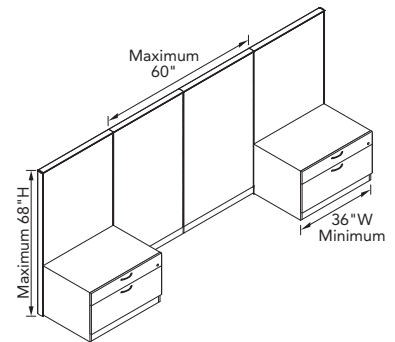

Side-mounted Credenzas — with Return Panel

Use 1 storage-to-panel bracket on Credenza LH or RH of set.

The minimum credenza size is 22"H x 36"W x 18"D.

The minimum size for panel return is 35"H x 36"W.

With a mid-run panel attached floor support, the maximum panel run is 144".

Without a mid-run floor support, the maximum panel run is 96".

Overheads and shelves cannot be used with 22"H side mounted credenzas.

Worksurfaces (if specified) must be mounted on the same side of the parent run as the credenzas.

Panel frame maximum height is 68".

Counterweight is required, if using unit with drawers.

Mid-run floor support options include:

Back-to-Back Credenzas

Panel Attached O-legs

Panel Attached Support Legs

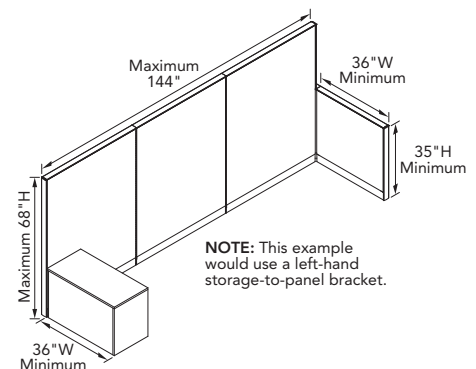

COUNTERWEIGHT REQUIREMENTS FOR CONTAIN[®] CRENZAS

Series	24"W Box/File Unit	30"W Box/File Unit	36"W Box/File Unit	42"W Combo Unit	48"W Combo Unit	60"W Combo Unit	72"W Combo Unit
18"D	HSCACW35 35 lbs. (two 12½ lb. and two 5 lb. counterweights)	HSCACW50 50 lbs. (four 12½ lb. counterweights)	HSCACW50 50 lbs. (four 12½ lb. counterweights)	HSCACW25 25 lbs. (two 12½ lb. counterweights)	HSCACW25 25 lbs. (two 12½ lb. counterweights)	HSCACW35 35 lbs. (two 12½ lb. and two 5 lb. counterweights)	HSCACW35 35 lbs. (two 12½ lb. and two 5 lb. counterweights)

Counterweight is not required if credenzas are used within a standard Systems set up and attached with the Credenza Storage-to-Panel Brackets.

CONTAIN[®] Metal Credenzas

GSA SIN 33721



Icon Legend on page 19

STORAGE

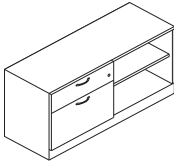
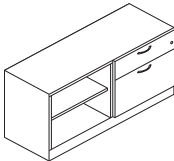
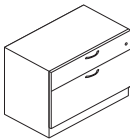
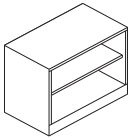
	DESCRIPTION	MODEL	SHIP WEIGHT	CUBE	LIST PRICE BY PAINT GRADE		
					P1	P2	P3
	Low Credenza, Box/Lateral Left, Open Shelf Right						
	72"W x 18"D x 22"H	HSCP227218RBFOM	150	20.7	\$2154	\$2221	\$2289
	60"W x 18"D x 22"H	HSCP226018RBFOM	130	17.3	\$1943	\$2010	\$2078
	48"W x 18"D x 22"H	HSCP224818RBFOM	111	14.0	\$1792	\$1859	\$1927
	Low Credenza, Box/Lateral Right, Open Shelf Left						
	72"W x 18"D x 22"H	HSCP227218LBFOM	150	20.7	\$2154	\$2221	\$2289
	60"W x 18"D x 22"H	HSCP226018LBFOM	130	17.3	\$1943	\$2010	\$2078
	48"W x 18"D x 22"H	HSCP224818LBFOM	111	14.0	\$1792	\$1859	\$1927
	Low Credenza, Box/Lateral						
	36"W x 18"D x 22"H	HSCP223618BFM	87	10.6	\$1318	\$1351	\$1386
	30"W x 18"D x 22"H	HSCP223018BFM	76	9.0	\$1263	\$1296	\$1331
	Open Shelf						
	36"W x 18"D x 22"H	HSCP223618O	66	10.6	\$939	\$972	\$1007
	30"W x 18"D x 22"H	HSCP223018O	60	9.0	\$865	\$898	\$933

NOTES:

- Metal chassis and drawer fronts.
- Lateral and wide box drawers operate on ball-bearing suspension with full extension.
- Steel ball-bearing drawer suspensions.
- Ships complete with standard kickplate.
- Field installable counterweight sold separately.
- File drawers accept hanging folders in letter or legal size.
- Steel frame provides durability.
- Use with laminate tops and credenza seat cushions. Order separately — see pages 675-676.

⚠ Locking units equipped with HON "One Key" interchangeable core removable locks. Keyed alike core model HF23S, in Satin, must be ordered separately. See page 675.



HOW TO SPECIFY

Select Model Number H S C P 2 2 3 6 1 8 O .	Select Base BK Flush Plinth BX Recessed Plinth B K .	Select Case Paint See page 666 P J W .	Select Shelf Paint See page 666 P J W .			
Select Model Number H S C P 2 2 7 2 1 8 R B F O M .	Select Base BK Flush Plinth BX Recessed Plinth B K .	Select Pull A Arch PRO Silver R Radius N Integral S Square PR6 Silver A P R O .	Select Case Paint See page 666 P J W .	Select Front Paint NA Matches Case N A .	Select Shelf Paint See page 666 Not specified for models HSCP223018BFM and HSCP223618BFM P J W .	Select Lock L Standard Lock X Omit Lock (- \$20) Not specified for models HSCP223618O and HSCP223018O L

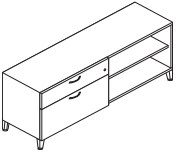
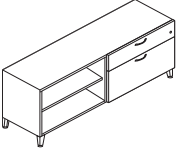

Icon Legend on page 19

CONTAIN® Footed Metal Credenzas

	DESCRIPTION	MODEL	SHIP WEIGHT	CUBE	LIST PRICE BY PAINT GRADE		
					P1	P2	P3
	Footed Low Credenza, Box/Lateral Left, Open Shelf Right						
	72"W x 18"D x 22"H	HSCF227218RBFOM	150	17.7	\$2327	\$2394	\$2462
	60"W x 18"D x 22"H	HSCF226018RBFOM	130	14.9	\$2118	\$2185	\$2253
	48"W x 18"D x 22"H	HSCF224818RBFOM	111	12.0	\$1932	\$1999	\$2067
	Footed Low Credenza, Box/Lateral Right, Open Shelf Left						
	72"W x 18"D x 22"H	HSCF227218LBFOM	150	17.7	\$2327	\$2394	\$2462
	60"W x 18"D x 22"H	HSCF226018LBFOM	130	14.9	\$2118	\$2185	\$2253
	48"W x 18"D x 22"H	HSCF224818LBFOM	111	12.0	\$1932	\$1999	\$2067
	Footed Low Credenza, Box/Lateral						
	36"W x 18"D x 22"H	HSCF223618BFM	87	9.1	\$1457	\$1490	\$1525
	30"W x 18"D x 22"H	HSCF223018BFM	76	7.7	\$1401	\$1434	\$1469
	Footed Open Shelf						
	36"W x 18"D x 22"H	HSCF223618O	66	9.1	\$1079	\$1112	\$1147
	30"W x 18"D x 22"H	HSCF223018O	60	7.7	\$1004	\$1037	\$1072

STORAGE

NOTES:

- Lateral and wide box drawers operate on ball-bearing suspension with full extension.
 - Steel ball-bearing drawer suspensions.
 - Ships complete with standard footed base.
 - Field installable counterweight sold separately.
 - File drawers accept hanging folders in letter or legal size.
 - Steel frame provides durability.
 - Feet are shipped with the credenza unit and are easily assembled.
 - Use with laminate tops and credenza seat cushions. Order separately — see pages 675-676.
- ⓘ Locking units equipped with HON "One Key" interchangeable core removable locks. Keyed alike core model HF23S, in Satin, must be ordered separately. See page 675.

HOW TO SPECIFY

<p>Select Model Number</p> <p>HSCF223618O</p>	<p>Select Foot</p> <p>SF Contain Foot T1 Platinum Metallic PR6 Silver</p> <p>SFT1</p>	<p>Select Case Paint</p> <p>See page 666</p> <p>PJW</p>	<p>Select Shelf Paint</p> <p>See page 666</p> <p>PJW</p>			
<p>Select Model Number</p> <p>HSCF227218RBFOM</p>	<p>Select Foot</p> <p>SF Contain Foot T1 Platinum Metallic PR6 Silver</p> <p>SFT1</p>	<p>Select Pull</p> <p>A Arch PRO Silver R Radius N Integral S Square PR6 Silver</p> <p>APRO</p>	<p>Select Case Paint</p> <p>See page 666</p> <p>PJW</p>	<p>Select Front Paint</p> <p>NA Matches Case</p> <p>NA</p>	<p>Select Shelf Paint</p> <p>See page 666 Not specified for models HSCF223618BFM and HSCF223018BFM</p> <p>PJW</p>	<p>Select Lock</p> <p>L Standard Lock X Omit Lock (- \$20) Not specified for models HSCF223618O and HSCF223018O</p> <p>L</p>

CONTAIN[®] Metal Credenzas with Laminate Fronts

GSA SIN 33721

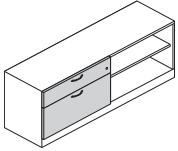
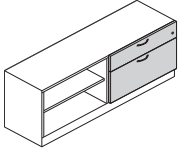
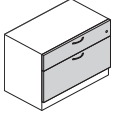

Icon Legend on page 19

	DESCRIPTION	MODEL	SHIP WEIGHT	CUBE	LIST PRICE BY PAINT GRADE		
					P1	P2	P3
	Metal Low Credenza, Laminate Front, Box/Lateral Left, Open Shelf Right						
	72"W x 18"D x 22"H	HSCP227218RBFOL	152	20.7	\$2389	\$2456	\$2524
	60"W x 18"D x 22"H	HSCP226018RBFOL	132	17.3	\$2179	\$2246	\$2314
	48"W x 18"D x 22"H	HSCP224818RBFOL	113	14.0	\$2027	\$2094	\$2162
	Metal Low Credenza, Laminate Front, Box/Lateral Right, Open Shelf Left						
	72"W x 18"D x 22"H	HSCP227218LBFOL	152	20.7	\$2389	\$2456	\$2524
	60"W x 18"D x 22"H	HSCP226018LBFOL	132	17.3	\$2179	\$2246	\$2314
	48"W x 18"D x 22"H	HSCP224818LBFOL	113	14.0	\$2027	\$2094	\$2162
	Metal Low Credenza, Laminate Front Box/Lateral						
	36"W x 18"D x 22"H	HSCP223618BFL	89	10.6	\$1553	\$1586	\$1621
	30"W x 18"D x 22"H	HSCP223018BFL	76	9.0	\$1497	\$1530	\$1565

STORAGE

NOTES:

- Lateral and wide box drawers operate on ball-bearing suspension with full extension.
- Steel ball-bearing drawer suspensions.
- Ships complete with standard kickplate.
- Field installable counterweight sold separately.
- File drawers accept hanging folders in letter or legal size.
- Steel frame provides durability.
- Use with laminate tops and credenza seat cushions. Order separately — see pages 675-676.

ⓘ Locking units equipped with HON "One Key" interchangeable core removable locks. Keyed alike core model HF23S, in Satin, must be ordered separately. See page 675.

HOW TO SPECIFY

Select Model Number	Select Base	Select Pull	Select Case Paint	Select Laminate	Select Shelf Paint	Select Lock
	BX Recessed Plinth	A Arch PRO Silver S Square PR6 Silver	See page 666	See page 666	See page 666 Not specified for models HSCP223618BFL and HSCP223018BFL	L Standard Lock X Omit Lock (- \$20)
H S C P 2 2 7 2 1 8 R B F O L .	B X .	A P R O .	P J W .	L S A 1 .	P J W .	L



Icon Legend on page 19

Footed Metal Credenzas with Laminate Fronts

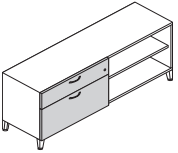
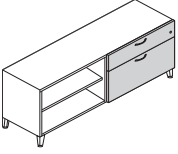
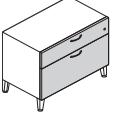
	DESCRIPTION	MODEL	SHIP WEIGHT	CUBE	LIST PRICE BY PAINT GRADE		
					P1	P2	P3
	Footed Low Credenza, Laminated Front, Box/Lateral Left, Open Shelf Right						
	72"W x 18"D x 22"H	HSCF227218RBFOL	152	17.7	\$2564	\$2631	\$2699
	60"W x 18"D x 22"H	HSCF226018RBFOL	132	14.9	\$2352	\$2419	\$2487
	48"W x 18"D x 22"H	HSCF224818RBFOL	113	12.0	\$2167	\$2234	\$2302
	Footed Low Credenza, Laminated Front, Box/Lateral Right, Open Shelf Left						
	72"W x 18"D x 22"H	HSCF227218LBFOL	152	17.7	\$2564	\$2631	\$2699
	60"W x 18"D x 22"H	HSCF226018LBFOL	132	14.9	\$2352	\$2419	\$2487
	48"W x 18"D x 22"H	HSCF224818LBFOL	113	12.0	\$2167	\$2234	\$2302
	Footed Low Credenza, Laminated Front Box/Lateral						
	36"W x 18"D x 22"H	HSCF223618BFL	89	9.1	\$1692	\$1725	\$1760
	30"W x 18"D x 22"H	HSCF223018BFL	78	7.7	\$1638	\$1671	\$1706

NOTES:

- Lateral and wide box drawers operate on ball-bearing suspension with full extension.
- Steel ball-bearing drawer suspensions.
- Ships complete with standard footed base.
- Field installable counterweight sold separately.
- File drawers accept hanging folders in letter or legal size.
- Steel frame provides durability.
- Feet are shipped with the credenza unit and are easily assembled.
- Use with laminate tops and credenza seat cushions. Order separately — see pages 675-676.

! Locking units equipped with HON "One Key" interchangeable core removable locks. Keyed alike core model HF23S, in Satin, must be ordered separately. See page 675.

STORAGE

HOW TO SPECIFY



Select Model Number	Select Foot	Select Pull	Select Case Paint	Select Laminate	Select Shelf Paint	Select Lock
	SF Contain Foot T1 Platinum Metallic PR6 Silver	A Arch PRO Silver S Square PR6 Silver	See page 666	See page 666	See page 666 Not specified for models HSCF223618BFL and HSCF223018BFL	L Standard Lock X Omit Lock (- \$20)
HSCF227218RBFOL	SFT1	APRO	PJW	LSA1	PJW	L

CONTAIN® Personal Files

OPEN MARKET

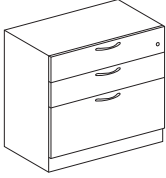

Icon Legend on page 19

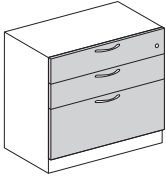
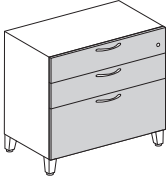
	DESCRIPTION	MODEL	SHIP WEIGHT	CUBE	LIST PRICE BY PAINT GRADE		
					P1	P2	P3
	Box/Box/File 30"W x 18"D x 28"H	HSFCP283018BBFM	90	11.3	\$1459	\$1492	\$1527
	Footed, Box/Box/File 30"W x 18"D x 28"H	HSFCF283018BBFM	90	11.3	\$1604	\$1637	\$1672
	Box/Box/File, Laminate Front Base 30"W x 18"D x 28"H	HSFCP283018BBFL	90	11.3	\$1677	\$1710	\$1745
	Footed, Box/Box/File, Laminate Front 30"W x 18"D x 28"H	HSFCF283018BBFL	90	11.3	\$1824	\$1857	\$1892

STORAGE

NOTES:

- Lateral and wide box drawers operate on ball-bearing suspension with full extension.
- Steel ball-bearing drawer suspensions.
- Field installable counterweight sold separately.
- File drawers accept hanging folders in letter or legal size.
- Steel frame provides durability.

! Locking units equipped with HON "One Key" interchangeable core removable locks.

HOW TO SPECIFY

Select Model Number HSFCP283018BBFM	Select Base BK Flush Plinth BX Recessed Plinth BK	Select Pull A Arch PRO Silver R Radius N Integral S Square PR6 Silver APRO	Select Case Paint See page 666 PJW	Select Front Paint NA Matches Case NA	Select Lock L Standard Lock X Omit Lock (- \$20) L
---	---	--	---	--	--

Select Model Number HSFCF283018BBFL	Select Foot SF Contain Foot T1 Platinum Metallic PR6 Silver SFT1	Select Pull A Arch PRO Silver S Square PR6 Silver APRO	Select Case Paint See page 666 PJW	Select Laminate See page 666 LSA1	Select Lock L Standard Lock X Omit Lock (- \$20) L
---	---	--	---	--	--



Icon Legend on page 19

CONTAIN® Lateral Files

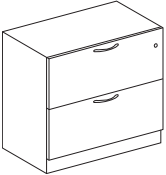
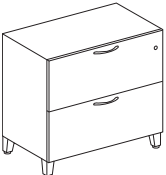
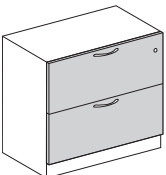
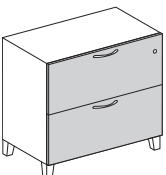
	DESCRIPTION	MODEL	SHIP WEIGHT	CUBE	LIST PRICE BY PAINT GRADE		
					P1	P2	P3
	2 Drawer Lateral						
	30"W x 18"D x 28"H 36"W x 18"D x 28"H	HSLP283018FFM HSLP283618FFM	90 101	11.3 13.4	\$1136 \$1335	\$1169 \$1368	\$1204 \$1403
	Footed 2 Drawer Lateral						
	30"W x 18"D x 28"H 36"W x 18"D x 28"H	HSLF283018FFM HSLF283618FFM	90 101	11.3 13.4	\$1329 \$1468	\$1362 \$1501	\$1397 \$1536
	2 Drawer Lateral, Laminate Front						
	30"W x 18"D x 28"H 36"W x 18"D x 28"H	HSLP283018FFL HSLP283618FFL	98 109	11.3 13.4	\$1405 \$1533	\$1438 \$1566	\$1473 \$1601
	Footed 2 Drawer Lateral, Laminate Front						
	30"W x 18"D x 28"H 36"W x 18"D x 28"H	HSLF283018FFL HSLF283618FFL	98 109	11.3 13.4	\$1533 \$1687	\$1566 \$1720	\$1601 \$1755

STORAGE

NOTES:

- Lateral and wide box drawers operate on ball-bearing suspension with full extension.
- Steel ball-bearing drawer suspensions.
- Field installable counterweight sold separately.
- File drawers accept hanging folders in letter or legal size.
- Steel frame provides durability.
- Contain® Laterals can be used with Storage Islands.

! Locking units equipped with HON "One Key" interchangeable core removable locks.

HOW TO SPECIFY

Select Model Number	Select Base BK Flush Plinth BX Recessed Plinth	Select Pull A Arch PRO Silver R Radius N Integral S Square PR6 Silver	Select Case Paint See page 666	Select Front Paint NA Matches Case	Select Lock L Standard Lock X Omit Lock (- \$20)
H S L P 2 8 3 0 1 8 F F M .	B K .	A P R O .	P J W .	N A .	L .

Select Model Number	Select Foot SF Contain Foot T1 Platinum Metallic PR6 Silver	Select Pull A Arch PRO Silver S Square PR6 Silver	Select Case Paint See page 666	Select Laminate See page 666	Select Lock L Standard Lock X Omit Lock (- \$20)
H S L F 2 8 3 0 1 8 F F L .	S F T 1 .	A P R O .	P J W .	L S A 1 .	L .

CONTAIN[®] Lateral File Accessories

GSA SIN AS NOTED



Icon Legend on page 19

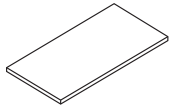

SIN 33721

DESCRIPTION

Credenza Laminate Top — Square Edge

72"W x 18"D x 1/8" Thick
60"W x 18"D x 1/8" Thick
48"W x 18"D x 1/8" Thick
36"W x 18"D x 1/8" Thick
30"W x 18"D x 1/8" Thick

MODEL	SHIP WEIGHT	CUBE	LIST PRICE BY LAMINATE GRADE	
			L1	L2
H919472	48	3.5	\$915	\$930
H919460	32	3.0	\$780	\$795
H919448	31	2.6	\$684	\$694
H919436	25	1.8	\$565	\$575
H919430	20	1.6	\$451	\$461

NOTES: Square-edge laminate tops provide a finished look to credenzas. See Storage Islands on page 729 for full laminate solution.

Specify laminate only.

SPECIFYING EXAMPLE: H919448.C

DESCRIPTION

Front-to-Back Hangrail Kits

15"D for 24"D Credenza or 18"D Lateral

No specification needed.

MODEL	SHIP WEIGHT	CUBE	LIST PRICE
HSCAHR15	0.1	0.2	\$22



OPEN MARKET

Counterweight for Contain 28"H Laterals

50 lbs for 30" Lateral
57½ lbs for 36" Lateral

HSLACW50	2.0	55.0	\$229
HSLACW57	2.0	63.0	\$240



OPEN MARKET

Field Installable Drawer/Door Handle Kits

Field Installable Pull, 2 Pack
Field Installable Pull, 3 Pack

HPULL2	0.4	0.3	\$60
HPULL3	0.5	0.3	\$68

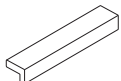

Linear



Square

NOTES: Square and Linear pull packs provide the option to coordinate with Fuse™ Storage. Pull packs are field installable on all Contain® Storage Products, excluding electronic locking units.

STORAGE

HOW TO SPECIFY

Select Model Number

H 9 1 9 4 7 2 .

Select Laminate Color

See page 666

C

Select Model Number

H S L A C W 5 0 .

Select Paint Color

See page 666

S

Select Model Number

H P U L L 2 .

Select Pull Style and Color

LP Linear Black
LPR6 Linear Silver
SPR6 Square Silver

L P R 6



CONTAIN® Metal Credenzas Accessories

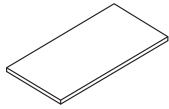

DESCRIPTION	MODEL	SHIP WEIGHT	CUBE	LIST PRICE BY LAMINATE GRADE	
				L1	L2
Credenza Laminate Top — Square Edge					
72"W x 18"D x 1/8" Thick	H919472	48.0	3.5	\$915	\$930
60"W x 18"D x 1/8" Thick	H919460	32.0	3.0	\$780	\$795
48"W x 18"D x 1/8" Thick	H919448	31.0	2.6	\$684	\$694
36"W x 18"D x 1/8" Thick	H919436	25.0 Ⓔ	1.8	\$565	\$575
30"W x 18"D x 1/8" Thick	H919430	20.0 Ⓔ	1.6	\$451	\$461

NOTES: Square-edge laminate tops provide a finished look to credenzas.

! Specify laminate only.

SPECIFYING EXAMPLE: H919448.C

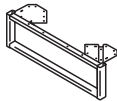

DESCRIPTION	MODEL	SHIP WEIGHT	CUBE	LIST PRICE BY PAINT GRADE		
				P1	P2	P3
Worksurface O-Leg						
30"W x 6 1/2"H	HSCAWS6530	7.0	1.0	\$254	\$264	\$269
24"W x 6 1/2"H	HSCAWS6524	6.0	1.0	\$212	\$222	\$227
20"W x 6 1/2"H	HSCAWS6520	5.0	1.0	\$184	\$194	\$199

NOTES: Worksurfaces with O-Legs may be placed upon Low Credenzas to create layering.

! Specify paint only.

SPECIFYING EXAMPLE: HSCAWS6530.S



Credenza Kickplates						
For 36" Box/File Model	HSCCK36BF	3.0	0.5	\$146	\$156	\$171
For 30" Box/File Model	HSCCK30BF	2.0	0.4	\$135	\$145	\$160
For 24" Box/File Model	HSCCK24BF	2.0	0.4	\$120	\$130	\$145
For 36" Open File Model	HSCCK36O	3.0	0.5	\$146	\$156	\$171
For 30" Open File Model	HSCCK30O	2.0	0.4	\$135	\$145	\$160

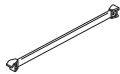

Credenza Hangrail Kits						
12" for front-to-back filing	HSCAHR12	1.0 Ⓔ	0.4	\$20	N/A	N/A

NOTES: For legal filing, hangrail kit hooks on the front hangrail and the side-to-side hangrail.

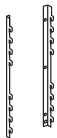

Credenza Storage-to-Panel Bracket	HSCAPB	0.2 Ⓔ	0.4	\$220	\$232	\$240
--	---------------	--------------	-----	--------------	--------------	--------------

Credenza Counterweight Kit

HSCACW50	55.0 Ⓔ	2.0	\$244	N/A	N/A
HSCACW35	40.0 Ⓔ	2.0	\$221	N/A	N/A
HSCACW25	30.0 Ⓔ	2.0	\$197	N/A	N/A

NOTES: Field installable counterweight sold separately.

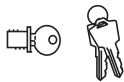

Removable Lock Core Kit—Satin	HF23S	0.2 Ⓔ	0.1	\$47	N/A	N/A
--------------------------------------	--------------	--------------	-----	-------------	------------	------------

- Use when specifying omit lock application.
- Specify quantity of each key number from 101E-225E.
- Includes: 1-core, 2-keys, 1-core removal tool and instructions.
- Removable lock core kits with specific key number must be ordered to facilitate keying alike in the field.
- For specific models, look for the Omit Lock Core icon throughout this publication.

NOTES: If key number isn't specified, number will be at random. Core matches manufactured lock on Contain® product but can be used with Contain® metal casegoods and laminate product.

HOW TO SPECIFY

<p>Select Model Number</p> <p>H 9 1 9 4 4 8 .</p>	<p>Select Laminate Color</p> <p>See page 666</p> <p>C</p>
<p>Select Model Number</p> <p>H S C A W S 6 5 3 0 .</p>	<p>Select Paint Color</p> <p>See page 666</p> <p>S</p>

STORAGE

CONTAIN[®] Metal Credenzas Accessories

GSA SIN 33721



Icon Legend on page 19

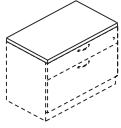

DESCRIPTION	MODEL	SHIP WEIGHT	CUBE	SHIP											
				1	2	3	4	5	6	7	8	9	10	11	12
Credenza Cushion 36"W x 18"D for 36", 60", and 72" Credenzas	HSCAUC1836	16.3	1.6	\$313	\$351	\$389	\$428	\$477	\$527	\$577	\$626	\$676	\$725	\$775	\$825
30"W x 18"D for 30", 48", and 60" Credenzas	HSCAUC1830	16.3	1.6	\$292	\$330	\$368	\$407	\$456	\$506	\$556	\$605	\$655	\$704	\$754	\$804
24"W x 18"D for 48" Credenzas	HSCAUC1824	16.3	1.9	\$273	\$311	\$349	\$388	\$437	\$487	\$537	\$586	\$636	\$685	\$735	\$785

NOTES: See pages 22-24 for available fabrics.
SPECIFYING EXAMPLE: HSCAUC1836.APN23

NOTES:

- For matching Pedestal Seats, see page 701.
- Credenza Cushions are available in 24", 30" and 36" size options.
- Choose from multiple upholstery options, see pages 22-24.

STORAGE

HOW TO SPECIFY

Select Model Number	Select Fabric
H S C A U C 1 8 3 6 .	See pages 22-24
	C U 1 0

	DESCRIPTION	MODEL	SHIP WEIGHT	CUBE	LIST PRICE
					P1
	Metal Box Divider 10 pack	HSCABD10	7	0.7	\$189
	2 pack	HSCABD02	2	0.7	\$48
! Metal dividers available in Black only. No need to specify.					
	Metal File Divider 10 pack	HSCAFD10	12	0.7	\$224
	2 pack	HSCAFD02	3	0.7	\$60
! Metal dividers available in Black only. No need to specify.					

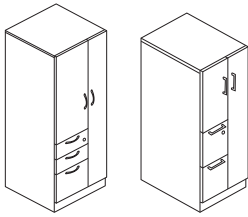

Metal Personal Towers with Plinth Base

65", 50", 42"H
24", 18"W
24"D

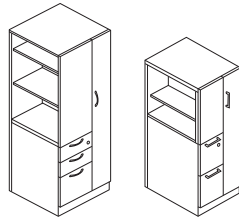

Metal Side-Access Personal Towers with Plinth Base

65", 50", 42"H
24", 18"W
24"D

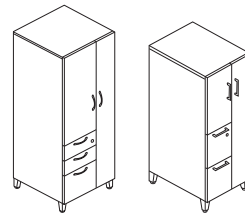

Metal Personal Towers with Footed Base

65", 50", 42"H
24", 18"W
24"D

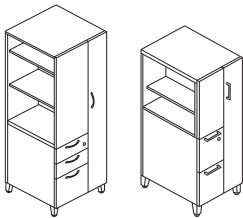

Metal Personal Towers with Footed Base

65", 50", 42"H
24", 18"W
24"D

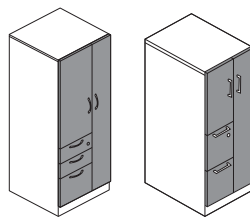

Metal Personal Towers with Laminate Fronts, Plinth Base

65", 50", 42"H
24", 18"W
24"D

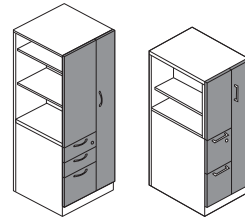

Metal Side-Access Personal Towers with Laminate Fronts, Plinth Base

65", 50", 42"H
24", 18"W
24"D

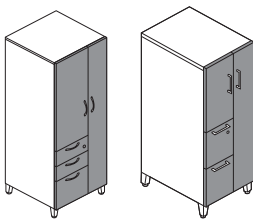

Metal Personal Towers with Laminate Fronts, Footed Base

65", 50", 42"H
24", 18"W
24"D

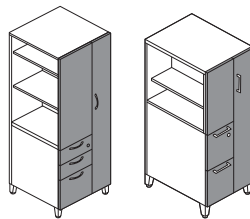

Metal Side-Access Towers with Laminate Fronts, Footed Base

65", 50", 42"H
24", 18"W
24"D

NOTES:

- ❗ 18"W Tower models available in File/File configuration only.
- ❗ 24"W Tower models available in both Box/Box/File and File/File configurations.

CONTAIN[®] Lockers & Wardrobes

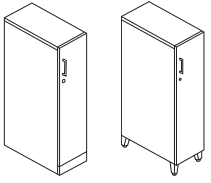

Wardrobe Tower with Metal Front

65", 50", 42"H
12"W
24", 18"D

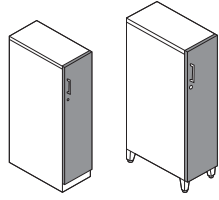

Wardrobe Tower with Laminate Front

65", 50", 42"H
12"W
24", 18"D

NOTES:

- Available with Plinth Base or Footed.
- Doors available hinged left or right.

STORAGE

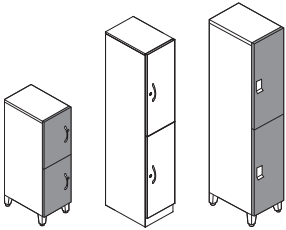

Double Locker, Metal or Laminate Fronts

65"H x 12"W x 18"D, Two Doors
45"H x 12"W x 18"D, Two Doors

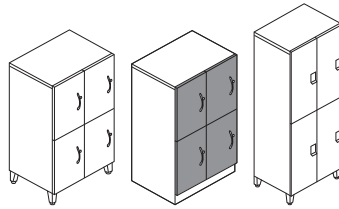

Quad Locker, Metal or Laminate Fronts

65"H x 24"W x 18"D, Four Doors
45"H x 24"W x 18"D, Four Doors

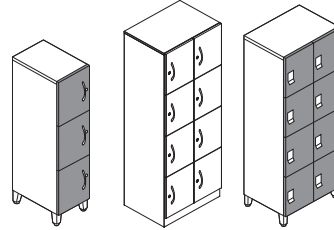

Cubby Locker, Metal or Laminate Fronts

65"H x 12"W x 18"D, Four Doors
50"H x 12"W x 18"D, Three Doors
65"H x 24"W x 18"D, Eight Doors
50"H x 24"W x 18"D, Six Doors

NOTES:

- Available with Flush or Recessed Plinth, or Footed.
- Doors available hinged left or right.
- Electronic Keypad or RFID Lock Pulls available to be specified on all sizes (upcharges apply).

CONTAIN® DIGITAL LOCK SPECIFICATIONS

Digital Keypad & RFID Lock Specification Information for Contain® Lockers

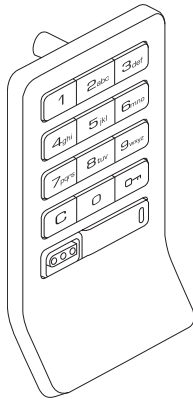

Keypad Lock Pull

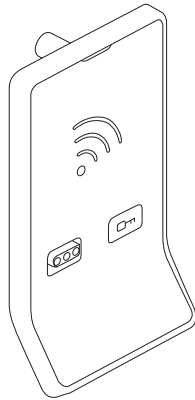

RFID Lock Pull

The digital keypad and RFID lock options support applications where workstations or storage areas are shared by multiple users. This is an alternative to a standard lock and key. This feature facilitates the use of storage by multiple users through eliminating the need to keep and hand-off physical keys. These locks ship in “shared mode” by default; shared mode indicates that the lock will “forget” the paired 4-digit code or RFID badge after the lock is opened, allowing the unit to be used by multiple users.

❗ Order at least one Programming Key and Manager Key per install.

Digital Keypad & RFID Locks:

- Offered on Contain® lockers.
- Ship factory installed.
- Integral Pull/Lock design replaces a specified pull on eLock models.
- Offered in a polished silver finish.
- Digital keypad lock requires input of a user-selected 4-digit code.
- RFID lock requires a compatible RFID card or sticker.
- Digital keypad locks and RFID locks are powered using 4 premium AA batteries.
- Battery life is dependent on the frequency of operation but can last up to 5-7 years.

RFID locks require user to present a compatible RFID card or sticker to the lock in order to gain access. This is the same technology as “badge” systems that allows employers to grant employees with cards that can be scanned to gain access to entrances and buildings. HON locks *may or may not be* compatible with these existing badge systems.

- For existing RFID badge system compatibility, badges must operate on a 13.56 MHz frequency with both iClass (ISO 15693) and Mifare (ISO 14443).
- If existing badge system is not compatible with 13.56 MHz frequency, compatible RFID badges or RFID stickers are sold separately as an accessory model.

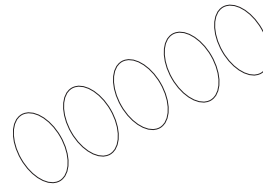

RFID Lock Pull

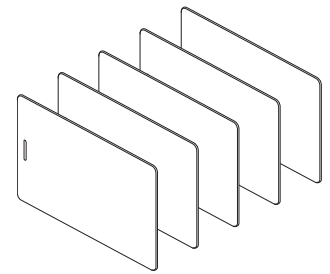

RFID Cards

Digital Lock Accessory Models (page 698)

- RFID-compatible cards and stickers are sold as accessory models in increments of 5, 25, or 100.
- RFID cards are plain white and have a lanyard cut.
- RFID stickers are plain white, approximately 1” in diameter and may be added to the back of an existing badge or employee identification card.
- **Every digital keypad or RFID installation site will require one Programming Key and at least one Manager Key, sold separately.**

Programming Key

- A Programming Key is a device used to initialize locks out of factory default mode and register Manager Keys to the locks.
- Only one Programming Key should be specified per installation site because multiple Programming Keys are not compatible with each other.
- Add-on digital lock orders should be programmed with the original Programming Key.
- Programming Key is the same key as Fuse™ Digilocks and can work across both Contain® and Fuse™.

Manager Key

- A Manager Key is used to bypass a locked unit; this operates as the “master key” and it is recommended that building facilitators have at least one Manager Key.
- Up to 6 Manager Keys may be registered to each lock.
- Manager Keys provide external power to locks in case of battery failure.

Digital Lock Keys and Accessories		
Description	Model	List Price
Programming Key	HSLDIGPRG	\$160
Manager Key	HSLDIGMGR	\$125
5 pk RFID Cards	HSLRFID5C	\$105
25 pk RFID Cards	HSLRFID25C	\$500
100 pk RFID Cards	HSLRFID100C	\$1,900
5 pk RFID Stickers	HSLRFID5S	\$55
25 pk RFID Stickers	HSLRFID25S	\$250
100 pk RFID Stickers	HSLRFID5100S	\$950

CONTAIN[®] Metal Personal Towers

GSA SIN 33721



Icon Legend on page 19

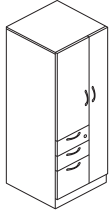

DESCRIPTION	MODEL	SHIP WEIGHT	CUBE	LIST PRICE BY CASE PAINT GRADE		
				P1	P2	P3
Personal Tower with Metal Fronts, Door/Box/Box/File						
65"H x 24"W x 24"D, Wardrobe Left	HSTP652424LBBFM	178	27.2	\$2266	\$2343	\$2411
65"H x 24"W x 24"D, Wardrobe Right	HSTP652424RBBFM	178	27.2	\$2266	\$2343	\$2411
50"H x 24"W x 24"D, Wardrobe Left	HSTP502424LBBFM	146	21.2	\$2120	\$2197	\$2265
50"H x 24"W x 24"D, Wardrobe Right	HSTP502424RBBFM	146	21.2	\$2120	\$2197	\$2265
42"H x 24"W x 24"D, Wardrobe Left	HSTP422424LBBFM	132	16.8	\$1822	\$1872	\$1947
42"H x 24"W x 24"D, Wardrobe Right	HSTP422424RBBFM	132	16.8	\$1822	\$1872	\$1947

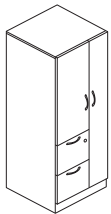

Personal Tower with Metal Fronts, Door/File/File						
65"H x 24"W x 24"D, Wardrobe Left	HSTP652424LFFM	178	27.2	\$2208	\$2285	\$2353
65"H x 24"W x 24"D, Wardrobe Right	HSTP652424RFFM	178	27.2	\$2208	\$2285	\$2353
50"H x 24"W x 24"D, Wardrobe Left	HSTP502424LFFM	146	21.1	\$2065	\$2142	\$2210
50"H x 24"W x 24"D, Wardrobe Right	HSTP502424RFFM	146	21.1	\$2065	\$2142	\$2210
42"H x 24"W x 24"D, Wardrobe Left	HSTP422424LFFM	132	16.8	\$1765	\$1815	\$1890
42"H x 24"W x 24"D, Wardrobe Right	HSTP422424RFFM	132	16.8	\$1765	\$1815	\$1890

NOTES:

- Metal chassis and drawer fronts.
- Steel frame provides durability.
- Leveling glides can be adjusted from outside or inside the case.
- Heavy-duty, telescoping ball-bearing slides.
- Baked, epoxy/polyester, powder coating finish.
- One lock secures doors and drawers.
- Pencil tray standard in top box drawer.
- One box divider standard in each box drawer.
- One crossrail standard in each file drawer.

! Locking units equipped with HON "One Key" interchangeable core removable locks. Keyed alike core model HF23S, in Satin, must be ordered separately. See page 675.

HOW TO SPECIFY

Select Model Number	Select Base	Select Pull	Select Case Paint	Select Front Paint	Select Lock
	BK Flush Plinth BX Recessed Plinth	A Arch PRO Silver R Radius N Integral S Square PR6 Silver	See page 666	See page 666 NA Matches Case (+ \$0) P1 upcharge (+ \$150) P2 upcharge (+ \$170) P3 upcharge (+ \$190)	L Standard Lock X Omit Lock (- \$20)
H S T P 6 5 2 4 2 4 L F F M .	B X .	S P R 6 .	P 7 T .	N A .	L



Icon Legend on page 19

CONTAIN[®] Metal Side Access Towers

	DESCRIPTION	MODEL	SHIP WEIGHT	CUBE	LIST PRICE BY CASE PAINT GRADE		
					P1	P2	P3
	Side Access Tower with Metal Fronts, Shelves/Box/Box/File						
	65”H x 24”W x 24”D, Wardrobe Left	HSTSP652424LBBFM	178	27.2	\$2399	\$2476	\$2544
	65”H x 24”W x 24”D, Wardrobe Right	HSTSP652424RBBFM	178	27.2	\$2399	\$2476	\$2544
	50”H x 24”W x 24”D, Wardrobe Left	HSTSP502424LBBFM	146	21.2	\$2247	\$2324	\$2392
	50”H x 24”W x 24”D, Wardrobe Right	HSTSP502424RBBFM	146	21.2	\$2247	\$2324	\$2392
	42”H x 24”W x 24”D, Wardrobe Left	HSTSP422424LBBFM	132	16.8	\$2027	\$2077	\$2152
	42”H x 24”W x 24”D, Wardrobe Right	HSTSP422424RBBFM	132	16.8	\$2027	\$2077	\$2152
	Side Access Tower with Metal Fronts, Shelves/File/File						
	65”H x 24”W x 24”D, Wardrobe Left	HSTSP652424LFFM	178	27.2	\$2344	\$2421	\$2489
	65”H x 24”W x 24”D, Wardrobe Right	HSTSP652424RFFM	178	27.2	\$2344	\$2421	\$2489
	50”H x 24”W x 24”D, Wardrobe Left	HSTSP502424LFFM	146	21.2	\$2190	\$2267	\$2335
	50”H x 24”W x 24”D, Wardrobe Right	HSTSP502424RFFM	146	21.2	\$2190	\$2267	\$2335
	42”H x 24”W x 24”D, Wardrobe Left	HSTSP422424LFFM	132	16.8	\$1971	\$2021	\$2096
	42”H x 24”W x 24”D, Wardrobe Right	HSTSP422424RFFM	132	16.8	\$1971	\$2021	\$2096

NOTES:

- Towers can be used to support a worksurface. In order to do so, order bracket model HSTB2W1.
- Metal chassis and drawer fronts.
- Steel frame provides durability.
- Leveling glides can be adjusted from outside or inside the case.
- Heavy-duty, telescoping ball-bearing slides.
- Baked, epoxy/polyester, powder coating finish.
- One lock secures doors and drawers.
- Pencil tray standard in top box drawer.
- One box divider standard in each box drawer.
- One crossrail standard in each file drawer.

! Locking units equipped with HON “One Key” interchangeable core removable locks. Keyed alike core model HF23S, in Satin, must be ordered separately. See page 675.

STORAGE

HOW TO SPECIFY

Select Model Number	Select Base	Select Pull	Select Case Paint	Select Front Paint	Select Panel Paint	Select Lock
	BK Flush Plinth BX Recessed Plinth	A Arch PRO Silver R Radius N Integral S Square PR6 Silver	See page 666	See page 666 NA Matches Case (+ \$0) P1 upcharge (+ \$150) P2 upcharge (+ \$170) P3 upcharge (+ \$190)	NA Matches Case	L Standard Lock X Omit Lock (- \$20)
H S T S P 6 5 2 4 2 4 L F F M	B X	S P R 6	P 7 T	N A	N A	L

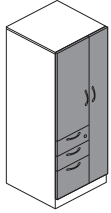

DESCRIPTION	MODEL	SHIP WEIGHT	CUBE	LIST PRICE BY PAINT GRADE		
				P1	P2	P3
Personal Tower with Laminate Fronts, Door/Box/Box/File						
65"H x 24"W x 24"D, Wardrobe Left	HSTP652424LBBFL	178	27.2	\$2595	\$2672	\$2740
65"H x 24"W x 24"D, Wardrobe Right	HSTP652424RBBFL	178	27.2	\$2595	\$2672	\$2740
50"H x 24"W x 24"D, Wardrobe Left	HSTP502424LBBFL	146	21.2	\$2430	\$2507	\$2575
50"H x 24"W x 24"D, Wardrobe Right	HSTP502424RBBFL	146	21.2	\$2430	\$2507	\$2575
42"H x 24"W x 24"D, Wardrobe Left	HSTP422424LBBFL	132	16.8	\$2086	\$2136	\$2211
42"H x 24"W x 24"D, Wardrobe Right	HSTP422424RBBFL	132	16.8	\$2086	\$2136	\$2211

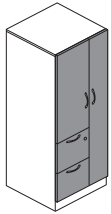

DESCRIPTION	MODEL	SHIP WEIGHT	CUBE	LIST PRICE BY PAINT GRADE		
				P1	P2	P3
Personal Tower with Laminate Fronts, Door/File/File						
65"H x 24"W x 24"D, Wardrobe Left	HSTP652424LFFL	178	27.2	\$2539	\$2616	\$2684
65"H x 24"W x 24"D, Wardrobe Right	HSTP652424RFFL	178	27.2	\$2539	\$2616	\$2684
50"H x 24"W x 24"D, Wardrobe Left	HSTP502424LFFL	146	21.2	\$2374	\$2451	\$2519
50"H x 24"W x 24"D, Wardrobe Right	HSTP502424RFFL	146	21.2	\$2374	\$2451	\$2519
42"H x 24"W x 24"D, Wardrobe Left	HSTP422424LFFL	132	16.8	\$2029	\$2079	\$2154
42"H x 24"W x 24"D, Wardrobe Right	HSTP422424RFFL	132	16.8	\$2029	\$2079	\$2154

STORAGE

NOTES:

- Metal chassis with laminate drawer/door fronts.
- Steel frame provides durability.
- Leveling glides can be adjusted from outside or inside the case.
- Heavy-duty, telescoping ball-bearing slides.
- Baked, epoxy/polyester, powder coating finish.
- One lock secures doors and drawers.
- Pencil tray standard in top box drawer.
- One box divider standard in each box drawer.
- One crossrail standard in each file drawer.

! Locking units equipped with HON "One Key" interchangeable core removable locks. Keyed alike core model HF23S, in Satin, must be ordered separately. See page 675.

HOW TO SPECIFY

<p>Select Model Number</p> <p>HSTP652424LFFL</p>	<p>Select Base</p> <p>BX Recessed Plinth</p> <p>BX</p>	<p>Select Pull</p> <p>A Arch PRO Silver S Square PR6 Silver</p> <p>SPR6</p>	<p>Select Case Paint</p> <p>See page 666</p> <p>P7T</p>	<p>Select Laminate</p> <p>See page 666</p> <p>LSA1</p>	<p>Select Lock</p> <p>L Standard Lock X Omit Lock (- \$20)</p> <p>L</p>
---	---	--	--	---	--



Icon Legend on page 19

Metal Side Access Towers with Laminate Fronts

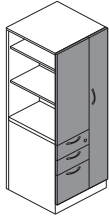

DESCRIPTION	MODEL	SHIP WEIGHT	CUBE	LIST PRICE BY PAINT GRADE		
				P1	P2	P3
Side Access Tower with Laminate Fronts, Shelves/Box/Box/File						
65”H x 24”W x 24”D, Wardrobe Left	HSTSP652424LBBFL	178	27.2	\$2750	\$2827	\$2895
65”H x 24”W x 24”D, Wardrobe Right	HSTSP652424RBBFL	178	27.2	\$2750	\$2827	\$2895
50”H x 24”W x 24”D, Wardrobe Left	HSTSP502424LBBFL	146	21.2	\$2574	\$2651	\$2719
50”H x 24”W x 24”D, Wardrobe Right	HSTSP502424RBBFL	146	21.2	\$2574	\$2651	\$2719
42”H x 24”W x 24”D, Wardrobe Left	HSTSP422424LBBFL	132	16.8	\$2322	\$2372	\$2447
42”H x 24”W x 24”D, Wardrobe Right	HSTSP422424RBBFL	132	16.8	\$2322	\$2372	\$2447

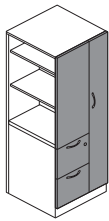

Side Access Tower with Laminate Fronts, Shelves/File/File						
65”H x 24”W x 24”D, Wardrobe Left	HSTSP652424LFFL	178	27.2	\$2695	\$2772	\$2840
65”H x 24”W x 24”D, Wardrobe Right	HSTSP652424RFFL	178	27.2	\$2695	\$2772	\$2840
50”H x 24”W x 24”D, Wardrobe Left	HSTSP502424LFFL	146	21.2	\$2519	\$2596	\$2664
50”H x 24”W x 24”D, Wardrobe Right	HSTSP502424RFFL	146	21.2	\$2519	\$2596	\$2664
42”H x 24”W x 24”D, Wardrobe Left	HSTSP422424LFFL	132	16.8	\$2267	\$2317	\$2392
42”H x 24”W x 24”D, Wardrobe Right	HSTSP422424RFFL	132	16.8	\$2267	\$2317	\$2392

NOTES:

- Towers can be used to support a worksurface. In order to do so, order bracket model HSTB2W1.
- Metal chassis with laminate drawer/door fronts.
- Steel frame provides durability.
- Leveling glides can be adjusted from outside or inside the case.
- Heavy-duty, telescoping ball-bearing slides.
- Baked, epoxy/polyester, powder coating finish.
- One lock secures doors and drawers.
- Pencil tray standard in top box drawer.
- One box divider standard in each box drawer.
- One crossrail standard in each file drawer.

! Locking units equipped with HON “One Key” interchangeable core removable locks. Keyed alike core model HF23S, in Satin, must be ordered separately. See page 675.

STORAGE

HOW TO SPECIFY

<p>Select Model Number</p> <p>H S T S P 6 5 2 4 2 4 L F F L .</p>	<p>Select Base</p> <p>BX Recessed Plinth</p> <p>B X .</p>	<p>Select Pull</p> <p>A Arch PRO Silver S Square PR6 Silver</p> <p>S P R 6 .</p>	<p>Select Case Paint</p> <p>See page 666</p> <p>P 7 T .</p>	<p>Select Laminate</p> <p>See page 666</p> <p>L S A 1 .</p>	<p>Select Lock</p> <p>L Standard Lock X Omit Lock (- \$20)</p> <p>L</p>
--	--	--	--	--	---

CONTAIN[®] Footed Metal Personal Towers

GSA SIN 33721



Icon Legend on page 19

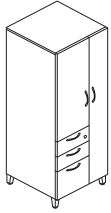

DESCRIPTION	MODEL	SHIP WEIGHT	CUBE	LIST PRICE BY CASE PAINT GRADE		
				P1	P2	P3
Footed Personal Tower with Metal Fronts, Door/Box/Box/File						
65"H x 24"W x 24"D, Wardrobe Left	HSTF652424LBBFM	178	25.8	\$2399	\$2476	\$2544
65"H x 24"W x 24"D, Wardrobe Right	HSTF652424RBBFM	178	25.8	\$2399	\$2476	\$2544
50"H x 24"W x 24"D, Wardrobe Left	HSTF502424LBBFM	146	19.8	\$2255	\$2332	\$2400
50"H x 24"W x 24"D, Wardrobe Right	HSTF502424RBBFM	146	19.8	\$2255	\$2332	\$2400
42"H x 24"W x 24"D, Wardrobe Left	HSTF422424LBBFM	132	18.2	\$1955	\$2005	\$2080
42"H x 24"W x 24"D, Wardrobe Right	HSTF422424RBBFM	132	18.2	\$1955	\$2005	\$2080

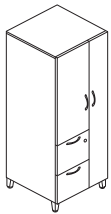

DESCRIPTION	MODEL	SHIP WEIGHT	CUBE	LIST PRICE BY CASE PAINT GRADE		
				P1	P2	P3
Footed Personal Tower with Metal Fronts, Door/File/File						
65"H x 24"W x 24"D, Wardrobe Left	HSTF652424LFFM	178	25.8	\$2344	\$2421	\$2489
65"H x 24"W x 24"D, Wardrobe Right	HSTF652424RFFM	178	25.8	\$2344	\$2421	\$2489
50"H x 24"W x 24"D, Wardrobe Left	HSTF502424LFFM	146	19.8	\$2199	\$2276	\$2344
50"H x 24"W x 24"D, Wardrobe Right	HSTF502424RFFM	146	19.8	\$2199	\$2276	\$2344
42"H x 24"W x 24"D, Wardrobe Left	HSTF422424LFFM	132	18.2	\$1900	\$1950	\$2025
42"H x 24"W x 24"D, Wardrobe Right	HSTF422424RFFM	132	18.2	\$1900	\$1950	\$2025

NOTES:

- Metal chassis and drawer fronts.
- Steel frame provides durability.
- Leveling glides can be adjusted from outside or inside the case.
- Heavy-duty, telescoping ball-bearing slides.
- Baked, epoxy/polyester, powder coating finish.
- One lock secures doors and drawers.
- Pencil tray standard in top box drawer.
- One box divider standard in each box drawer.
- One crossrail standard in each file drawer.

ⓘ Locking units equipped with HON "One Key" interchangeable core removable locks. Keyed alike core model HF23S, in Satin, must be ordered separately. See page 675.

HOW TO SPECIFY

Select Model Number H S T F 4 2 2 4 2 4 L B B F M .	Select Foot SF Contain Foot T1 Platinum Metallic PR6 Silver	Select Pull A Arch PRO Silver R Radius N Integral S Square PR6 Silver	Select Paint Color See page 666 P 7 T .	Select Front Paint See page 666 NA Matches Case (+ \$0) P1 upcharge (+ \$150) P2 upcharge (+ \$170) P3 upcharge (+ \$190)	Select Lock L Standard Lock X Omit Lock (- \$20) L
---	---	--	--	---	--



Icon Legend on page 19

Footed Metal Side Access Towers

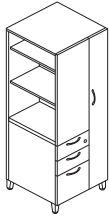

DESCRIPTION	MODEL	SHIP WEIGHT	CUBE	LIST PRICE BY CASE PAINT GRADE		
				P1	P2	P3
Footed Side Access Tower with Metal Fronts, Shelves/Box/Box/File						
65”H x 24”W x 24”D, Wardrobe Left	HSTSF652424LBBFM	178	25.8	\$2534	\$2611	\$2679
65”H x 24”W x 24”D, Wardrobe Right	HSTSF652424RBBFM	178	25.8	\$2534	\$2611	\$2679
50”H x 24”W x 24”D, Wardrobe Left	HSTSF502424LBBFM	146	19.8	\$2380	\$2457	\$2525
50”H x 24”W x 24”D, Wardrobe Right	HSTSF502424RBBFM	146	19.8	\$2380	\$2457	\$2525
42”H x 24”W x 24”D, Wardrobe Left	HSTSF422424LBBFM	132	18.2	\$2162	\$2212	\$2287
42”H x 24”W x 24”D, Wardrobe Right	HSTSF422424RBBFM	132	18.2	\$2162	\$2212	\$2287

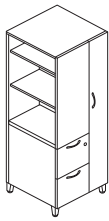

DESCRIPTION	MODEL	SHIP WEIGHT	CUBE	LIST PRICE BY CASE PAINT GRADE		
				P1	P2	P3
Footed Side Access Tower with Metal Fronts, Shelves/File/File						
65”H x 24”W x 24”D, Wardrobe Left	HSTSF652424LFFM	178	25.8	\$2478	\$2555	\$2623
65”H x 24”W x 24”D, Wardrobe Right	HSTSF652424RFFM	178	25.8	\$2478	\$2555	\$2623
50”H x 24”W x 24”D, Wardrobe Left	HSTSF502424LFFM	146	19.8	\$2324	\$2401	\$2469
50”H x 24”W x 24”D, Wardrobe Right	HSTSF502424RFFM	146	19.8	\$2324	\$2401	\$2469
42”H x 24”W x 24”D, Wardrobe Left	HSTSF422424LFFM	132	18.2	\$2106	\$2156	\$2231
42”H x 24”W x 24”D, Wardrobe Right	HSTSF422424RFFM	132	18.2	\$2106	\$2156	\$2231

NOTES:

- Towers can be used to support a worksurface. In order to do so, order bracket model HSTB2W1.
- Metal chassis and drawer fronts.
- Steel frame provides durability.
- Leveling glides can be adjusted from outside or inside the case.
- Heavy-duty, telescoping ball-bearing slides.
- Baked, epoxy/polyester, powder coating finish.
- One lock secures doors and drawers.
- Pencil tray standard in top box drawer.
- One box divider standard in each box drawer.
- One crossrail standard in each file drawer.

! Locking units equipped with HON “One Key” interchangeable core removable locks. Keyed alike core model HF23S, in Satin, must be ordered separately. See page 675.

STORAGE

HOW TO SPECIFY

Select Model Number	Select Foot	Select Pull	Select Paint Color	Select Front Paint	Select Panel Paint	Select Lock
	SF Contain Foot T1 Platinum Metallic PR6 Silver	A Arch PRO Silver R Radius N Integral S Square PR6 Silver	See page 666	See page 666 NA Matches Case (+ \$0) P1 upcharge (+ \$150) P2 upcharge (+ \$170) P3 upcharge (+ \$190)	NA Matches Case	L Standard Lock X Omit Lock (- \$20)
HSTSF422424RBBFM	SFT1	SPR6	P7T	NA	NA	L

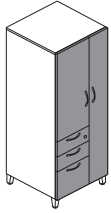

DESCRIPTION	MODEL	SHIP WEIGHT	CUBE	LIST PRICE BY PAINT GRADE		
				P1	P2	P3
Footed Personal Tower with Laminate Fronts, Door/Box/Box/File						
65"H x 24"W x 24"D, Wardrobe Left	HSTF652424LBBFL	178	25.8	\$2730	\$2807	\$2875
65"H x 24"W x 24"D, Wardrobe Right	HSTF652424RBBFL	178	25.8	\$2730	\$2807	\$2875
50"H x 24"W x 24"D, Wardrobe Left	HSTF502424LBBFL	146	19.8	\$2564	\$2641	\$2709
50"H x 24"W x 24"D, Wardrobe Right	HSTF502424RBBFL	146	19.8	\$2564	\$2641	\$2709
42"H x 24"W x 24"D, Wardrobe Left	HSTF422424LBBFL	132	18.2	\$2220	\$2270	\$2345
42"H x 24"W x 24"D, Wardrobe Right	HSTF422424RBBFL	132	18.2	\$2220	\$2270	\$2345

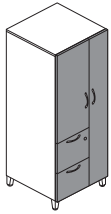

DESCRIPTION	MODEL	SHIP WEIGHT	CUBE	LIST PRICE BY PAINT GRADE		
				P1	P2	P3
Footed Personal Tower with Laminate Fronts, Door/File/File						
65"H x 24"W x 24"D, Wardrobe Left	HSTF652424LFFL	178	25.8	\$2674	\$2751	\$2819
65"H x 24"W x 24"D, Wardrobe Right	HSTF652424RFFL	178	25.8	\$2674	\$2751	\$2819
50"H x 24"W x 24"D, Wardrobe Left	HSTF502424LFFL	146	19.8	\$2507	\$2584	\$2652
50"H x 24"W x 24"D, Wardrobe Right	HSTF502424RFFL	146	19.8	\$2507	\$2584	\$2652
42"H x 24"W x 24"D, Wardrobe Left	HSTF422424LFFL	132	18.2	\$2165	\$2215	\$2290
42"H x 24"W x 24"D, Wardrobe Right	HSTF422424RFFL	132	18.2	\$2165	\$2215	\$2290

STORAGE

NOTES:

- Metal chassis with laminate drawer/door fronts.
- Steel frame provides durability.
- Leveling glides can be adjusted from outside or inside the case.
- Heavy-duty, telescoping ball-bearing slides.
- Baked, epoxy/polyester, powder coating finish.
- One lock secures doors and drawers.
- Pencil tray standard in top box drawer.
- One box divider standard in each box drawer.
- One crossrail standard in each file drawer.

! Locking units equipped with HON "One Key" interchangeable core removable locks. Keyed alike core model HF23S, in Satin, must be ordered separately. See page 675.

HOW TO SPECIFY

Select Model Number	Select Foot	Select Pull	Select Case Paint	Select Laminate	Select Lock
SF Contain Foot T1 Platinum Metallic PR6 Silver	A Arch PRO Silver S Square PR6 Silver	See page 666	See page 666	L Standard Lock X Omit Lock (- \$20)	
HSTF652424LBBFL	SFT1	SPR6	P7T	LSA1	L



Icon Legend on page 19

Footed Metal Side Access Towers with Laminate Fronts

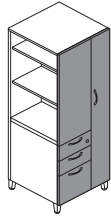

DESCRIPTION	MODEL	SHIP WEIGHT	CUBE	LIST PRICE BY PAINT GRADE		
				P1	P2	P3
Footed Side Access Tower with Laminate Fronts, Shelves/Box/Box/File						
65”H x 24”W x 24”D, Wardrobe Left	HSTSF652424LBBFL	178	25.8	\$2885	\$2962	\$3030
65”H x 24”W x 24”D, Wardrobe Right	HSTSF652424RBBFL	178	25.8	\$2885	\$2962	\$3030
50”H x 24”W x 24”D, Wardrobe Left	HSTSF502424LBBFL	146	19.8	\$2709	\$2786	\$2854
50”H x 24”W x 24”D, Wardrobe Right	HSTSF502424RBBFL	146	19.8	\$2709	\$2786	\$2854
42”H x 24”W x 24”D, Wardrobe Left	HSTSF422424LBBFL	132	18.2	\$2457	\$2507	\$2582
42”H x 24”W x 24”D, Wardrobe Right	HSTSF422424RBBFL	132	18.2	\$2457	\$2507	\$2582

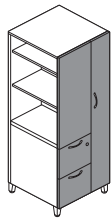

DESCRIPTION	MODEL	SHIP WEIGHT	CUBE	LIST PRICE BY PAINT GRADE		
				P1	P2	P3
Footed Side Access Tower with Laminate Fronts, Shelves/File/File						
65”H x 24”W x 24”D, Wardrobe Left	HSTSF652424LFFL	178	25.8	\$2829	\$2906	\$2974
65”H x 24”W x 24”D, Wardrobe Right	HSTSF652424RFFL	178	25.8	\$2829	\$2906	\$2974
50”H x 24”W x 24”D, Wardrobe Left	HSTSF502424LFFL	146	19.8	\$2653	\$2730	\$2798
50”H x 24”W x 24”D, Wardrobe Right	HSTSF502424RFFL	146	19.8	\$2653	\$2730	\$2798
42”H x 24”W x 24”D, Wardrobe Left	HSTSF422424LFFL	132	18.2	\$2400	\$2450	\$2525
42”H x 24”W x 24”D, Wardrobe Right	HSTSF422424RFFL	132	18.2	\$2400	\$2450	\$2525



DESCRIPTION	MODEL	SHIP WEIGHT	CUBE	LIST PRICE BY PAINT GRADE		
				P1	P2	P3
Tower Kickplates (Field Installable)						
For 24” Tower, Left	HSTAKL	2	0.3	\$179	\$187	\$192
For 24” Tower, Right	HSTAKR	2	0.3	\$179	\$187	\$192
Specify: Model.Paint						
SPECIFYING EXAMPLE: HSATKL.P						

STORAGE

NOTES:

- Towers can be used to support a worksurface. In order to do so, order bracket model HSTB2W1.
 - Metal chassis with laminate drawer/door fronts.
 - Steel frame provides durability.
 - Leveling glides can be adjusted from outside or inside the case.
 - Heavy-duty, telescoping ball-bearing slides.
 - Baked, epoxy/polyester, powder coating finish.
 - One lock secures doors and drawers.
 - Pencil tray standard in top box drawer.
 - One box divider standard in each box drawer.
 - One crossrail standard in each file drawer.
- ⚠ Locking units equipped with HON “One Key” interchangeable core removable locks. Keyed alike core model HF23S, in Satin, must be ordered separately. See page 675.

HOW TO SPECIFY

Select Model Number	Select Foot	Select Pull	Select Case Paint	Select Laminate	Select Lock
	SF Contain Foot T1 Platinum Metallic PR6 Silver	A Arch PRO Silver S Square PR6 Silver	See page 666	See page 666	L Standard Lock X Omit Lock (- \$20)
H S T S F 6 5 2 4 2 4 L B B F L	S F T 1	S P R 6	P 7 T	L S A 1	L

CONTAIN[®] 18"W Slim Metal Personal Towers

GSA SIN 33721



Icon Legend on page 19

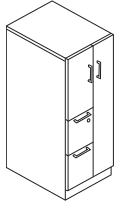

DESCRIPTION	MODEL	SHIP WEIGHT	CUBE	LIST PRICE BY CASE PAINT GRADE		
				P1	P2	P3
18"W Slim Personal Tower, Plinth w/Metal Fronts						
65"H x 18"W x 24"D, Left Hand	HSTP651824LFFM	148	19.4	\$1945	\$2022	\$2090
65"H x 18"W x 24"D, Right Hand	HSTP651824RFFM	148	19.4	\$1945	\$2022	\$2090
50"H x 18"W x 24"D, Left Hand	HSTP501824LFFM	121	16.0	\$1817	\$1894	\$1962
50"H x 18"W x 24"D, Right Hand	HSTP501824RFFM	121	16.0	\$1817	\$1894	\$1962
42"H x 18"W x 24"D, Left Hand	HSTP421824LFFM	109	13.7	\$1553	\$1603	\$1678
42"H x 18"W x 24"D, Right Hand	HSTP421824RFFM	109	13.7	\$1553	\$1603	\$1678

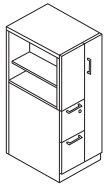

DESCRIPTION	MODEL	SHIP WEIGHT	CUBE	LIST PRICE BY CASE PAINT GRADE		
				P1	P2	P3
18"W Slim Side Access Tower, Plinth, Metal Fronts						
65"H x 18"W x 24"D, Left Hand	HSTSP651824LFFM	148	19.4	\$2061	\$2138	\$2206
65"H x 18"W x 24"D, Right Hand	HSTSP651824RFFM	148	19.4	\$2061	\$2138	\$2206
50"H x 18"W x 24"D, Left Hand	HSTSP501824LFFM	121	16.0	\$1928	\$2005	\$2073
50"H x 18"W x 24"D, Right Hand	HSTSP501824RFFM	121	16.0	\$1928	\$2005	\$2073
42"H x 18"W x 24"D, Left Hand	HSTSP421824LFFM	109	13.7	\$1735	\$1785	\$1860
42"H x 18"W x 24"D, Right Hand	HSTSP421824RFFM	109	13.7	\$1735	\$1785	\$1860

NOTES:

- Towers can be used to support a worksurface. In order to do so, order bracket model HSTB2W1.
- Metal chassis and drawer fronts.
- Steel frame provides durability.
- Leveling glides can be adjusted from outside or inside the case.
- Heavy-duty, telescoping ball-bearing slides.
- Baked, epoxy/polyester, powder coating finish.
- One lock secures doors and drawers.
- One crossrail standard in each file drawer.

! Locking units equipped with HON "One Key" interchangeable core removable locks. Keyed alike core model HF23S, in Satin, must be ordered separately. See page 675.

HOW TO SPECIFY

Select Model Number H S T P 6 5 1 8 2 4 L F F M .	Select Base BK Flush Plinth BX Recessed Plinth BX .	Select Pull A Arch PRO Silver S Square PR6 Silver S P R 6 .	Select Paint Color See page 666 P 7 T .	Select Front Paint See page 666 NA Matches Case (+ \$0) P1 upcharge (+ \$150) P2 upcharge (+ \$170) P3 upcharge (+ \$190) NA .	Select Lock L Standard Lock X Omit Lock (- \$20) L
---	---	---	--	---	--

Select Model Number H S T S P 6 5 1 8 2 4 L F F M .	Select Base BK Flush Plinth BX Recessed Plinth BX .	Select Pull A Arch PRO Silver S Square PR6 Silver S P R 6 .	Select Case Paint See page 666 P 7 T .	Select Front Paint See page 666 NA Matches Case (+ \$0) P1 upcharge (+ \$150) P2 upcharge (+ \$170) P3 upcharge (+ \$190) NA .	Select Panel Paint NA Matches Case NA .	Select Lock L Standard Lock X Omit Lock (- \$20) L
---	---	---	---	---	--	--



Icon Legend on page 19

18"W Slim Metal Personal Towers

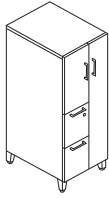

DESCRIPTION	MODEL	SHIP WEIGHT	CUBE	LIST PRICE BY CASE PAINT GRADE		
				P1	P2	P3
18"W Slim Personal Tower, Footed w/Metal Fronts						
65"H x 18"W x 24"D, Left Hand	HSTF651824LFFM	148	19.4	\$2079	\$2156	\$2224
65"H x 18"W x 24"D, Right Hand	HSTF651824RFFM	148	19.4	\$2079	\$2156	\$2224
50"H x 18"W x 24"D, Left Hand	HSTF501824LFFM	121	14.9	\$1951	\$2028	\$2096
50"H x 18"W x 24"D, Right Hand	HSTF501824RFFM	121	14.9	\$1951	\$2028	\$2096
42"H x 18"W x 24"D, Left Hand	HSTF421824LFFM	109	12.6	\$1688	\$1738	\$1813
42"H x 18"W x 24"D, Right Hand	HSTF421824RFFM	109	12.6	\$1688	\$1738	\$1813

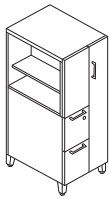

18"W Slim Side Access Tower, Footed w/Metal Fronts						
65"H x 18"W x 24"D, Left Hand	HSTSF651824LFFM	148	19.4	\$2197	\$2274	\$2342
65"H x 18"W x 24"D, Right Hand	HSTSF651824RFFM	148	19.4	\$2197	\$2274	\$2342
50"H x 18"W x 24"D, Left Hand	HSTSF501824LFFM	121	14.9	\$2061	\$2138	\$2206
50"H x 18"W x 24"D, Right Hand	HSTSF501824RFFM	121	14.9	\$2061	\$2138	\$2206
42"H x 18"W x 24"D, Left Hand	HSTSF421824LFFM	109	12.6	\$1869	\$1919	\$1994
42"H x 18"W x 24"D, Right Hand	HSTSF421824RFFM	109	12.6	\$1869	\$1919	\$1994

NOTES:

- Towers can be used to support a worksurface. In order to do so, order bracket model HSTB2W1.
- Metal chassis and drawer fronts.
- Steel frame provides durability.
- Leveling glides can be adjusted from outside or inside the case.
- Heavy-duty, telescoping ball-bearing slides.
- Baked, epoxy/polyester, powder coating finish.
- One lock secures doors and drawers.
- One crossrail standard in each file drawer.

ⓘ Locking units equipped with HON "One Key" interchangeable core removable locks. Keyed alike core model HF23S, in Satin, must be ordered separately. See page 675.

STORAGE

HOW TO SPECIFY

<p>Select Model Number</p> <p>H S T F 6 5 1 8 2 4 L F F M .</p>	<p>Select Foot</p> <p>SF Contain Foot T1 Platinum Metallic PR6 Silver</p> <p>S F T 1 .</p>	<p>Select Pull</p> <p>A Arch PRO Silver S Square PR6 Silver</p> <p>S P R 6 .</p>	<p>Select Paint Color</p> <p>See page 666</p> <p>P 7 T .</p>	<p>Select Front Paint</p> <p>See page 666 NA Matches Case (+ \$0) P1 upcharge (+ \$150) P2 upcharge (+ \$170) P3 upcharge (+ \$190)</p> <p>N A .</p>	<p>Select Lock</p> <p>L Standard Lock X Omit Lock (- \$20)</p> <p>L</p>
--	---	---	---	---	--

<p>Select Model Number</p> <p>H S T S F 6 5 1 8 2 4 L F F M .</p>	<p>Select Foot</p> <p>SF Contain Foot T1 Platinum Metallic PR6 Silver</p> <p>S F T 1 .</p>	<p>Select Pull</p> <p>A Arch PRO Silver S Square PR6 Silver</p> <p>S P R 6 .</p>	<p>Select Case Paint</p> <p>See page 666</p> <p>P 7 T .</p>	<p>Select Front Paint</p> <p>See page 666 NA Matches Case (+ \$0) P1 upcharge (+ \$150) P2 upcharge (+ \$170) P3 upcharge (+ \$190)</p> <p>N A .</p>	<p>Select Panel Paint</p> <p>NA Matches Case</p> <p>N A .</p>	<p>Select Lock</p> <p>L Standard Lock X Omit Lock (- \$20)</p> <p>L</p>
--	---	---	--	---	--	--

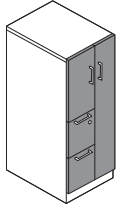

DESCRIPTION	MODEL	SHIP WEIGHT	CUBE	LIST PRICE BY PAINT GRADE		
				P1	P2	P3
18"W Slim Personal Tower, Plinth w/Laminate Fronts						
65"H x 18"W x 24"D, Left Hand	HSTP651824LFFL	148	19.4	\$2235	\$2312	\$2380
65"H x 18"W x 24"D, Right Hand	HSTP651824RFFL	148	19.4	\$2235	\$2312	\$2380
50"H x 18"W x 24"D, Left Hand	HSTP501824LFFL	121	16.0	\$2090	\$2167	\$2235
50"H x 18"W x 24"D, Right Hand	HSTP501824RFFL	121	16.0	\$2090	\$2167	\$2235
42"H x 18"W x 24"D, Left Hand	HSTP421824LFFL	109	13.7	\$1786	\$1836	\$1911
42"H x 18"W x 24"D, Right Hand	HSTP421824RFFL	109	13.7	\$1786	\$1836	\$1911

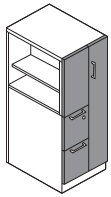

DESCRIPTION	MODEL	SHIP WEIGHT	CUBE	LIST PRICE BY PAINT GRADE		
				P1	P2	P3
18"W Slim Side Access Tower, Plinth, Laminate Fronts						
65"H x 18"W x 24"D, Left Hand	HSTSP651824LFFL	148	19.4	\$2372	\$2449	\$2517
65"H x 18"W x 24"D, Right Hand	HSTSP651824RFFL	148	19.4	\$2372	\$2449	\$2517
50"H x 18"W x 24"D, Left Hand	HSTSP501824LFFL	121	16.0	\$2216	\$2293	\$2361
50"H x 18"W x 24"D, Right Hand	HSTSP501824RFFL	121	16.0	\$2216	\$2293	\$2361
42"H x 18"W x 24"D, Left Hand	HSTSP421824LFFL	109	13.7	\$1995	\$2045	\$2120
42"H x 18"W x 24"D, Right Hand	HSTSP421824RFFL	109	13.7	\$1995	\$2045	\$2120

STORAGE

NOTES:

- Towers can be used to support a worksurface. In order to do so, order bracket model HSTB2W1.
- Metal chassis with laminate drawer/door fronts.
- Steel frame provides durability.
- Leveling glides can be adjusted from outside or inside the case.
- Heavy-duty, telescoping ball-bearing slides.
- Baked, epoxy/polyester, powder coating finish.
- One lock secures doors and drawers.
- One crossrail standard in each file drawer.

ⓘ Locking units equipped with HON "One Key" interchangeable core removable locks. Keyed alike core model HF23S, in Satin, must be ordered separately. See page 675.

HOW TO SPECIFY

Select Model Number H S T S P 6 5 1 8 2 4 L F F L .	Select Base B X .	Select Pull A Arch PRO Silver S Square PR6 Silver	Select Case Paint See page 666	Select Laminate See page 666	Select Lock L Standard Lock X Omit Lock (- \$20)
H S T S P 6 5 1 8 2 4 L F F L .	B X .	S P R 6 .	P 7 T .	L S A 1 .	L



Icon Legend on page 19

18"W Slim Personal Towers with Laminate Fronts

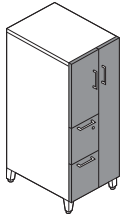

DESCRIPTION

MODEL

SHIP WEIGHT CUBE

LIST PRICE BY PAINT GRADE
P1 P2 P3

18"W Slim Personal Tower, Footed w/Laminate Fronts

65"H x 18"W x 24"D, Left Hand	HSTF651824LFFL	148	19.4	\$2371	\$2448	\$2516
65"H x 18"W x 24"D, Right Hand	HSTF651824RFFL	148	19.4	\$2371	\$2448	\$2516
50"H x 18"W x 24"D, Left Hand	HSTF501824LFFL	121	16.0	\$2223	\$2300	\$2368
50"H x 18"W x 24"D, Right Hand	HSTF501824RFFL	121	16.0	\$2223	\$2300	\$2368
42"H x 18"W x 24"D, Left Hand	HSTF421824LFFL	109	13.7	\$1921	\$1971	\$2046
42"H x 18"W x 24"D, Right Hand	HSTF421824RFFL	109	13.7	\$1921	\$1971	\$2046

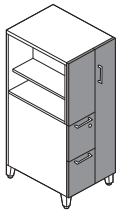

18"W Slim Side Access Tower, Footed, Laminate Fronts

65"H x 18"W x 24"D, Left Hand	HSTSF651824LFFL	148	19.4	\$2505	\$2582	\$2650
65"H x 18"W x 24"D, Right Hand	HSTSF651824RFFL	148	19.4	\$2505	\$2582	\$2650
50"H x 18"W x 24"D, Left Hand	HSTSF501824LFFL	121	14.9	\$2351	\$2428	\$2496
50"H x 18"W x 24"D, Right Hand	HSTSF501824RFFL	121	14.9	\$2351	\$2428	\$2496
42"H x 18"W x 24"D, Left Hand	HSTSF421824LFFL	109	12.6	\$2129	\$2179	\$2254
42"H x 18"W x 24"D, Right Hand	HSTSF421824RFFL	109	12.6	\$2129	\$2179	\$2254

NOTES:

- Towers can be used to support a worksurface. In order to do so, order bracket model HSTB2W1.
- Metal chassis with laminate drawer/door fronts.
- Steel frame provides durability.
- Leveling glides can be adjusted from outside or inside the case.
- Heavy-duty, telescoping ball-bearing slides.
- Baked, epoxy/polyester, powder coating finish.
- One lock secures doors and drawers.
- One crossrail standard in each file drawer.

ⓘ Locking units equipped with HON "One Key" interchangeable core removable locks. Keyed alike core model HF23S, in Satin, must be ordered separately. See page 675.

STORAGE

HOW TO SPECIFY

<p>Select Model Number</p> <p>H S T S F 6 5 1 8 2 4 L F F L .</p>	<p>Select Foot</p> <p>SF Contain Foot T1 Platinum Metallic PR6 Silver</p> <p>S F T 1 .</p>	<p>Select Pull</p> <p>A Arch PRO Silver S Square PR6 Silver</p> <p>S P R 6 .</p>	<p>Select Case Paint</p> <p>See page 666</p> <p>P 7 T .</p>	<p>Select Laminate</p> <p>See page 666</p> <p>L S A 1 .</p>	<p>Select Lock</p> <p>L Standard Lock X Omit Lock (- \$20)</p> <p>L</p>
--	---	---	--	--	--

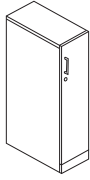

DESCRIPTION	MODEL	SHIP WEIGHT	CUBE	LIST PRICE BY CASE PAINT GRADE		
				P1	P2	P3
Wardrobe Tower, Plinth w/Metal Fronts						
65"H x 12"W x 24"D, Right Hand	HSWP651224RM	108	14.8	\$1248	\$1325	\$1393
65"H x 12"W x 24"D, Left Hand	HSWP651224LM	108	14.8	\$1248	\$1325	\$1393
50"H x 12"W x 24"D, Right Hand	HSWP501224RM	87	11.5	\$1155	\$1232	\$1300
50"H x 12"W x 24"D, Left Hand	HSWP501224LM	87	11.5	\$1155	\$1232	\$1300
42"H x 12"W x 24"D, Right Hand	HSWP421224RM	77	9.9	\$964	\$1014	\$1089
42"H x 12"W x 24"D, Left Hand	HSWP421224LM	77	9.9	\$964	\$1014	\$1089
Wardrobe Tower, Footed w/Metal Fronts						
65"H x 12"W x 18"D, Right Hand	HSWP651218RM	108	14.8	\$1145	\$1222	\$1290
65"H x 12"W x 18"D, Left Hand	HSWP651218LM	108	14.8	\$1145	\$1222	\$1290
50"H x 12"W x 18"D, Right Hand	HSWP501218RM	87	11.5	\$1060	\$1137	\$1205
50"H x 12"W x 18"D, Left Hand	HSWP501218LM	87	11.5	\$1060	\$1137	\$1205
42"H x 12"W x 18"D, Right Hand	HSWP421218RM	77	9.9	\$885	\$935	\$1010
42"H x 12"W x 18"D, Left Hand	HSWP421218LM	77	9.9	\$885	\$935	\$1010

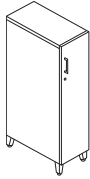

Wardrobe Tower, Footed w/Metal Fronts						
65"H x 12"W x 24"D, Right Hand	HSWF651224RM	108	14.1	\$1383	\$1460	\$1528
65"H x 12"W x 24"D, Left Hand	HSWF651224LM	108	14.1	\$1383	\$1460	\$1528
50"H x 12"W x 24"D, Right Hand	HSWF501224RM	87	10.8	\$1291	\$1368	\$1436
50"H x 12"W x 24"D, Left Hand	HSWF501224LM	87	10.8	\$1291	\$1368	\$1436
42"H x 12"W x 24"D, Right Hand	HSWF421224RM	77	9.1	\$1099	\$1149	\$1224
42"H x 12"W x 24"D, Left Hand	HSWF421224LM	77	9.1	\$1099	\$1149	\$1224
Wardrobe Tower, Footed w/Metal Fronts						
65"H x 12"W x 18"D, Right Hand	HSWF651218RM	108	11.0	\$1280	\$1357	\$1425
65"H x 12"W x 18"D, Left Hand	HSWF651218LM	108	11.0	\$1280	\$1357	\$1425
50"H x 12"W x 18"D, Right Hand	HSWF501218RM	87	8.4	\$1195	\$1272	\$1340
50"H x 12"W x 18"D, Left Hand	HSWF501218LM	87	8.4	\$1195	\$1272	\$1340
42"H x 12"W x 18"D, Right Hand	HSWF421218RM	77	7.1	\$1019	\$1069	\$1144
42"H x 12"W x 18"D, Left Hand	HSWF421218LM	77	7.1	\$1019	\$1069	\$1144

NOTES: Wardrobes come installed with a rod accessory to accept clothing hangars or a Fuse™ work tool coat hook can be added (sold separately). Wardrobes have slots cut into the inner liner that allow the user to hang Fuse™ work tool accessories inside the unit. 42"H wardrobes have 2 slots; 50"H and 65"H wardrobes have 4 slots. Wardrobes ship with one adjustable shelf. 42"H and 50"H wardrobes have 3 shelf locations; 65"H wardrobes have 6 shelf locations.

NOTES:

- 1 18"D Wardrobes: 42"H and 50"H plinth wardrobes can be freestanding. 18"D footed units must be attached to a panel, worksurface, or ganged to another unit.
- 1 24"D Wardrobes: 42"H and 50"H plinth and footed wardrobes can be freestanding.
- 1 65"H Wardrobes: 18"D and 24"D must be attached to a panel, worksurface, or ganged to another unit.

HOW TO SPECIFY

<p>Select Model Number</p> <p>HSWF651224RM</p>	<p>Select Base/Foot</p> <p>BK Flush Plinth Base BX Recessed Plinth Base SF Contain Foot T1 Platinum Metallic PR6 Silver</p> <p>SFT1</p>	<p>Select Pull</p> <p>A Arch PRO Silver R Radius N Integral S Square PR6 Silver</p> <p>SPR6</p>	<p>Select Paint Color</p> <p>See page 666</p> <p>PJW</p>	<p>Select Front Paint</p> <p>See page 666 NA Matches Case (+ \$0) P1 upcharge (+ \$150) P2 upcharge (+ \$170) P3 upcharge (+ \$190)</p> <p>NA</p>	<p>Select Lock</p> <p>L Standard Lock X Omit Lock (- \$20)</p> <p>L</p>
---	--	---	---	--	---



Icon Legend on page 19

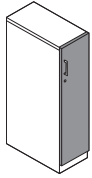

DESCRIPTION	MODEL	SHIP WEIGHT	CUBE	LIST PRICE BY PAINT GRADE		
				P1	P2	P3
Wardrobe Tower, Plinth w/Laminate Fronts						
65”H x 12”W x 24”D, Right Hand	HSWP651224RL	108	14.8	\$1436	\$1513	\$1581
65”H x 12”W x 24”D, Left Hand	HSWP651224LL	108	14.8	\$1436	\$1513	\$1581
50”H x 12”W x 24”D, Right Hand	HSWP501224RL	87	11.5	\$1329	\$1406	\$1474
50”H x 12”W x 24”D, Left Hand	HSWP501224LL	87	11.5	\$1329	\$1406	\$1474
42”H x 12”W x 24”D, Right Hand	HSWP421224RL	77	9.9	\$1109	\$1159	\$1234
42”H x 12”W x 24”D, Left Hand	HSWP421224LL	77	9.9	\$1109	\$1159	\$1234
Wardrobe Tower, Footed w/Laminate Fronts						
65”H x 12”W x 18”D, Right Hand	HSWF651218RL	108	11.6	\$1317	\$1394	\$1462
65”H x 12”W x 18”D, Left Hand	HSWF651218LL	108	11.6	\$1317	\$1394	\$1462
50”H x 12”W x 18”D, Right Hand	HSWF501218RL	87	9.0	\$1219	\$1296	\$1364
50”H x 12”W x 18”D, Left Hand	HSWF501218LL	87	9.0	\$1219	\$1296	\$1364
42”H x 12”W x 18”D, Right Hand	HSWF421218RL	77	7.7	\$1017	\$1067	\$1142
42”H x 12”W x 18”D, Left Hand	HSWF421218LL	77	7.7	\$1017	\$1067	\$1142

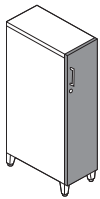

65”H x 12”W x 24”D, Right Hand	HSWF651224RL	108	14.1	\$1570	\$1647	\$1715
65”H x 12”W x 24”D, Left Hand	HSWF651224LL	108	14.1	\$1570	\$1647	\$1715
50”H x 12”W x 24”D, Right Hand	HSWF501224RL	87	10.8	\$1464	\$1541	\$1609
50”H x 12”W x 24”D, Left Hand	HSWF501224LL	87	10.8	\$1464	\$1541	\$1609
42”H x 12”W x 24”D, Right Hand	HSWF421224RL	77	9.1	\$1243	\$1293	\$1368
42”H x 12”W x 24”D, Left Hand	HSWF421224LL	77	9.1	\$1243	\$1293	\$1368
65”H x 12”W x 18”D, Right Hand	HSWF651218RL	108	11.0	\$1452	\$1529	\$1597
65”H x 12”W x 18”D, Left Hand	HSWF651218LL	108	11.0	\$1452	\$1529	\$1597
50”H x 12”W x 18”D, Right Hand	HSWF501218RL	87	8.4	\$1354	\$1431	\$1499
50”H x 12”W x 18”D, Left Hand	HSWF501218LL	87	8.4	\$1354	\$1431	\$1499
42”H x 12”W x 18”D, Right Hand	HSWF421218RL	77	7.1	\$1151	\$1201	\$1276
42”H x 12”W x 18”D, Left Hand	HSWF421218LL	77	7.1	\$1151	\$1201	\$1276

NOTES: Wardrobes come installed with a rod accessory to accept clothing hangars or a Fuse™ work tool coat hook can be added (sold separately). Wardrobes have slots cut into the inner liner that allow the user to hang Fuse™ work tool accessories inside the unit. 42”H wardrobes have 2 slots; 50”H and 65”H wardrobes have 4 slots. Wardrobes ship with one adjustable shelf. 42”H and 50”H wardrobes have 3 shelf locations; 65”H wardrobes have 6 shelf locations.

NOTES:

- ① 18”D Wardrobes: 42”H and 50”H plinth wardrobes can be freestanding. 18”D footed units must be attached to a panel, worksurface, or ganged to another unit.
- ① 24”D Wardrobes: 42”H and 50”H plinth and footed wardrobes can be freestanding.
- ① 65”H Wardrobes: 18”D and 24”D must be attached to a panel, worksurface, or ganged to another unit.

HOW TO SPECIFY

<p>Select Model Number</p> <p>BX Recessed Plinth Base SF Contain Foot T1 Platinum Metallic PR6 Silver</p>	<p>Select Base/Foot</p> <p>A Arch PRO Silver S Square PR6 Silver</p>	<p>Select Pull</p> <p>See page 666</p>	<p>Select Case Paint</p> <p>See page 666</p>	<p>Select Laminate</p> <p>See page 666</p>	<p>Select Lock</p> <p>L Standard Lock X Omit Lock (- \$20)</p>
H S W F 6 5 1 2 2 4 R L .	S F T 1 .	S P R 6 .	P J W .	L S A 1 .	L

CONTAIN® Metal Lockers

GSA SIN 33721



Icon Legend on page 19

STORAGE

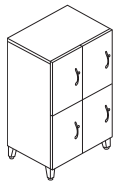
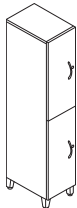

DESCRIPTION	MODEL	SHIP WEIGHT	CUBE	LIST PRICE BY CASE PAINT GRADE		
				P1	P2	P3
Double Lockers, Plinth w/Metal Front 65"H x 12"W x 18"D, Right Hand, 2 Door 65"H x 12"W x 18"D, Left Hand, 2 Door 42"H x 12"W x 18"D, Right Hand, 2 Door 42"H x 12"W x 18"D, Left Hand, 2 Door	HSDLP651218RM HSDLP651218LM HSDLP421218RM HSDLP421218LM	108 108 77 77	11.6 11.6 7.7 7.7	\$1377 \$1377 \$1251 \$1251	\$1454 \$1454 \$1301 \$1301	\$1522 \$1522 \$1376 \$1376
Quad Lockers, Plinth w/Metal Front 65"H x 24"W x 18"D, Right Hand, 4 Door 65"H x 24"W x 18"D, Left Hand, 4 Door 42"H x 24"W x 18"D, Right Hand, 4 Door 42"H x 24"W x 18"D, Left Hand, 4 Door	HSQLP652418RM HSQLP652418LM HSQLP422418RM HSQLP422418LM	148 148 109 109	20.5 20.5 13.7 13.7	\$2062 \$2062 \$1651 \$1651	\$2139 \$2139 \$1701 \$1701	\$2207 \$2207 \$1776 \$1776
Cubby Lockers, Plinth w/Metal Front 65"H x 12"W x 18"D, Right Hand, 4 Door 65"H x 12"W x 18"D, Left Hand, 4 Door 50"H x 12"W x 18"D, Right Hand, 3 Door 50"H x 12"W x 18"D, Left Hand, 3 Door	HSCLP651218RM HSCLP651218LM HSCLP501218RM HSCLP501218LM	92 92 81 81	11.6 11.6 9.0 9.0	\$1400 \$1400 \$1188 \$1188	\$1477 \$1477 \$1238 \$1238	\$1545 \$1545 \$1313 \$1313
65"H x 24"W x 18"D, Right Hand, 8 Door 65"H x 24"W x 18"D, Left Hand, 8 Door 50"H x 24"W x 18"D, Right Hand, 6 Door 50"H x 24"W x 18"D, Left Hand, 6 Door	HSCLP652418RM HSCLP652418LM HSCLP502418RM HSCLP502418LM	148 148 121 121	20.5 20.5 16.0 16.0	\$2186 \$2186 \$1739 \$1739	\$2263 \$2263 \$1789 \$1789	\$2331 \$2331 \$1864 \$1864
Double Lockers, Footed w/Metal Front 65"H x 12"W x 18"D, Right Hand, 2 Door 65"H x 12"W x 18"D, Left Hand, 2 Door 42"H x 12"W x 18"D, Right Hand, 2 Door 42"H x 12"W x 18"D, Left Hand, 2 Door	HSDLF651218RM HSDLF651218LM HSDLF421218RM HSDLF421218LM	92 92 74 74	11.0 11.0 7.1 7.1	\$1512 \$1512 \$1387 \$1387	\$1589 \$1589 \$1437 \$1437	\$1657 \$1657 \$1512 \$1512
Quad Lockers, Footed w/Metal Front 65"H x 24"W x 18"D, Right Hand, 4 Door 65"H x 24"W x 18"D, Left Hand, 4 Door 42"H x 24"W x 18"D, Right Hand, 4 Door 42"H x 24"W x 18"D, Left Hand, 4 Door	HSQLF652418RM HSQLF652418LM HSQLF422418RM HSQLF422418LM	148 148 109 109	19.4 19.4 12.6 12.6	\$2198 \$2198 \$1784 \$1784	\$2275 \$2275 \$1834 \$1834	\$2343 \$2343 \$1909 \$1909
Cubby Lockers, Footed w/Metal Front 65"H x 12"W x 18"D, Right Hand, 4 Door 65"H x 12"W x 18"D, Left Hand, 4 Door 50"H x 12"W x 18"D, Right Hand, 3 Door 50"H x 12"W x 18"D, Left Hand, 3 Door	HSCLF651218RM HSCLF651218LM HSCLF501218RM HSCLF501218LM	92 92 81 81	11.0 11.0 8.4 8.4	\$1534 \$1534 \$1321 \$1321	\$1611 \$1611 \$1371 \$1371	\$1679 \$1679 \$1446 \$1446
65"H x 24"W x 18"D, Right Hand, 8 Door 65"H x 24"W x 18"D, Left Hand, 8 Door 50"H x 24"W x 18"D, Right Hand, 6 Door 50"H x 24"W x 18"D, Left Hand, 6 Door	HSCLF652418RM HSCLF652418LM HSCLF502418RM HSCLF502418LM	148 148 121 121	19.4 19.4 14.9 14.9	\$2626 \$2626 \$2247 \$2247	\$2703 \$2703 \$2297 \$2297	\$2771 \$2771 \$2372 \$2372

NOTES:

- Lockers can be ganged either side-to-side or back-to-back.
- "Double" and "Quad" lockers include two double coat hooks in each compartment.
- Contain® Lockers can be used with Storage Islands, see page 733.

ⓘ Lockers: 42"H x 12"W and 50"H x 12"W plinth lockers can be freestanding. 65"H x 12"W plinth lockers and all heights of 12"W footed lockers must be attached to a panel, worksurface, or ganged to another unit.

HOW TO SPECIFY

<p>Select Model Number</p> <p>H S Q L P 6 5 2 4 1 8 R M .</p>	<p>Select Base/Foot</p> <p>BK Flush Plinth Base BX Recessed Plinth Base SF Contain Foot T1 Platinum Metallic PR6 Silver</p> <p>B X .</p>	<p>Select Pull</p> <p>A Arch PRO Silver N Integral S Square PR6 Silver</p> <p>S P R 6 .</p>	<p>Select Paint Color</p> <p>See page 666</p> <p>P J W .</p>	<p>Select Front Paint</p> <p>See page 666 NA Matches Case (+ \$0) P1 upcharge (+ \$150) P2 upcharge (+ \$170) P3 upcharge (+ \$190)</p> <p>N A .</p>	<p>Select Lock</p> <p>L Standard Lock X Omit Lock - \$40 (2 Doors) - \$60 (3 Doors) - \$80 (4 Doors) - \$120 (6 Doors) - \$160 (8 Doors)</p> <p>L</p>
--	---	--	---	---	--



Icon Legend on page 19

Metal Lockers with Laminate Fronts

STORAGE

DESCRIPTION	MODEL	SHIP WEIGHT	CUBE	LIST PRICE BY PAINT GRADE			
				P1	P2	P3	
Double Lockers, Plinth w/Laminate Front 65"H x 12"W x 18"D, Right Hand, 2 Door 65"H x 12"W x 18"D, Left Hand, 2 Door 42"H x 12"W x 18"D, Right Hand, 2 Door 42"H x 12"W x 18"D, Left Hand, 2 Door	HSDLP651218RL	108	11.6	\$1583	\$1660	\$1728	
	HSDLP651218LL	108	11.6	\$1583	\$1660	\$1728	
	HSDLP421218RL	77	7.7	\$1440	\$1490	\$1565	
	HSDLP421218LL	77	7.7	\$1440	\$1490	\$1565	
Quad Lockers, Plinth w/Laminate Front 65"H x 24"W x 18"D, Right Hand, 4 Door 65"H x 24"W x 18"D, Left Hand, 4 Door 42"H x 24"W x 18"D, Right Hand, 4 Door 42"H x 24"W x 18"D, Left Hand, 4 Door	HSQLP652418RL	148	20.5	\$2373	\$2450	\$2518	
	HSQLP652418LL	148	20.5	\$2373	\$2450	\$2518	
	HSQLP422418RL	109	13.7	\$1899	\$1949	\$2024	
	HSQLP422418LL	109	13.7	\$1899	\$1949	\$2024	
Cubby Lockers, Plinth w/Laminate Front 65"H x 12"W x 18"D, Right Hand, 4 Door 65"H x 12"W x 18"D, Left Hand, 4 Door 50"H x 12"W x 18"D, Right Hand, 3 Door 50"H x 12"W x 18"D, Left Hand, 3 Door 65"H x 24"W x 18"D, Right Hand, 8 Door 65"H x 24"W x 18"D, Left Hand, 8 Door 50"H x 24"W x 18"D, Right Hand, 6 Door 50"H x 24"W x 18"D, Left Hand, 6 Door	HSCLP651218RL	92	11.6	\$1610	\$1687	\$1755	
	HSCLP651218LL	92	11.6	\$1610	\$1687	\$1755	
	HSCLP501218RL	81	9.0	\$1366	\$1416	\$1491	
	HSCLP501218LL	81	9.0	\$1366	\$1416	\$1491	
	HSCLP652418RL	148	20.5	\$2865	\$2942	\$3010	
	HSCLP652418LL	148	20.5	\$2865	\$2942	\$3010	
	HSCLP502418RL	121	16.0	\$2429	\$2479	\$2554	
	HSCLP502418LL	121	16.0	\$2429	\$2479	\$2554	
	Double Lockers, Footed w/Laminate Front 65"H x 12"W x 18"D, Right Hand, 2 Door 65"H x 12"W x 18"D, Left Hand, 2 Door 42"H x 12"W x 18"D, Right Hand, 2 Door 42"H x 12"W x 18"D, Left Hand, 2 Door	HSDLF651218RL	92	11.0	\$1719	\$1796	\$1864
		HSDLF651218LL	92	11.0	\$1719	\$1796	\$1864
		HSDLF421218RL	74	7.1	\$1574	\$1624	\$1699
		HSDLF421218LL	74	7.1	\$1574	\$1624	\$1699
Quad Lockers, Footed w/Laminate Front 65"H x 24"W x 18"D, Right Hand, 4 Door 65"H x 24"W x 18"D, Left Hand, 4 Door 42"H x 24"W x 18"D, Right Hand, 4 Door 42"H x 24"W x 18"D, Left Hand, 4 Door	HSQLF652418RL	148	19.4	\$2506	\$2583	\$2651	
	HSQLF652418LL	148	19.4	\$2506	\$2583	\$2651	
	HSQLF422418RL	109	12.6	\$2033	\$2083	\$2158	
	HSQLF422418LL	109	12.6	\$2033	\$2083	\$2158	
Cubby Lockers, Footed w/Laminate Front 65"H x 12"W x 18"D, Right Hand, 4 Door 65"H x 12"W x 18"D, Left Hand, 4 Door 50"H x 12"W x 18"D, Right Hand, 3 Door 50"H x 12"W x 18"D, Left Hand, 3 Door 65"H x 24"W x 18"D, Right Hand, 8 Door 65"H x 24"W x 18"D, Left Hand, 8 Door 50"H x 24"W x 18"D, Right Hand, 6 Door 50"H x 24"W x 18"D, Left Hand, 6 Door	HSCLF651218RL	92	11.0	\$1745	\$1822	\$1890	
	HSCLF651218LL	92	11.0	\$1745	\$1822	\$1890	
	HSCLF501218RL	81	8.4	\$1499	\$1549	\$1624	
	HSCLF501218LL	81	8.4	\$1499	\$1549	\$1624	
	HSCLF652418RL	148	19.4	\$3000	\$3077	\$3145	
	HSCLF652418LL	148	19.4	\$3000	\$3077	\$3145	
	HSCLF502418RL	121	14.9	\$2563	\$2613	\$2688	
	HSCLF502418LL	121	14.9	\$2563	\$2613	\$2688	

NOTES:

- Lockers can be ganged either side-to-side or back-to-back.
- "Double" and "Quad" lockers include two double coat hooks in each compartment.
- Contain® Lockers can be used with Storage Islands, see page 733.

ⓘ Lockers: 42"H x 12"W and 50"H x 12"W plinth lockers can be freestanding. 65"H x 12"W plinth lockers and all heights of 12"W footed lockers must be attached to a panel, worksurface, or ganged to another unit.

HOW TO SPECIFY

<p>Select Model Number</p> <p>H S Q L P 6 5 2 4 1 8 R L .</p>	<p>Select Base/Foot</p> <p>BX Recessed Plinth Base SF Contain Foot T1 Platinum Metallic PR6 Silver</p> <p>B X .</p>	<p>Select Pull</p> <p>A Arch PRO Silver S Square PR6 Silver</p> <p>S P R 6 .</p>	<p>Select Case Paint</p> <p>See page 666</p> <p>P J W .</p>	<p>Select Front Laminate</p> <p>See page 666</p> <p>L S A 1 .</p>	<p>Select Lock</p> <p>L Standard Lock X Omit Lock - \$40 (2 Doors) - \$60 (3 Doors) - \$80 (4 Doors) - \$120 (6 Doors) - \$160 (8 Doors)</p> <p>L</p>
--	---	--	--	--	--

CONTAIN® Metal Lockers with eLock

GSA SIN 33721



Icon Legend on page 19

STORAGE

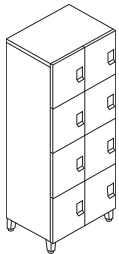
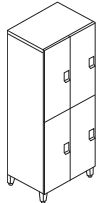
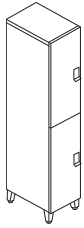
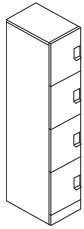
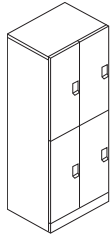
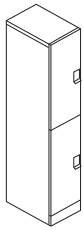

DESCRIPTION	MODEL	SHIP WEIGHT	CUBE	LIST PRICE BY CASE PAINT GRADE		
				P1	P2	P3
Double Lockers, Plinth w/Metal Front, eLock						
65"H x 12"W x 18"D, Right Hand, 2 Door	HSDLP651218RME	92	11.6	\$1994	\$2071	\$2139
65"H x 12"W x 18"D, Left Hand, 2 Door	HSDLP651218LME	92	11.6	\$1994	\$2071	\$2139
42"H x 12"W x 18"D, Right Hand, 2 Door	HSDLP421218RME	74	7.7	\$1868	\$1918	\$1993
42"H x 12"W x 18"D, Left Hand, 2 Door	HSDLP421218LME	74	7.7	\$1868	\$1918	\$1993
Quad Lockers, Plinth w/Metal Front, eLock						
65"H x 24"W x 18"D, Right Hand, 4 Door	HSQLP652418RME	148	20.5	\$3295	\$3372	\$3440
65"H x 24"W x 18"D, Left Hand, 4 Door	HSQLP652418LME	148	20.5	\$3295	\$3372	\$3440
42"H x 24"W x 18"D, Right Hand, 4 Door	HSQLP422418RME	109	13.7	\$2884	\$2934	\$3009
42"H x 24"W x 18"D, Left Hand, 4 Door	HSQLP422418LME	109	13.7	\$2884	\$2934	\$3009
Cubby Lockers, Plinth w/Metal Front, eLock						
65"H x 12"W x 18"D, Right Hand, 4 Door	HSCLP651218RME	92	11.6	\$2632	\$2709	\$2777
65"H x 12"W x 18"D, Left Hand, 4 Door	HSCLP651218LME	92	11.6	\$2632	\$2709	\$2777
50"H x 12"W x 18"D, Right Hand, 3 Door	HSCLP501218RME	81	9.0	\$2111	\$2161	\$2236
50"H x 12"W x 18"D, Left Hand, 3 Door	HSCLP501218LME	81	9.0	\$2111	\$2161	\$2236
65"H x 24"W x 18"D, Right Hand, 8 Door	HSCLP652418RME	148	20.5	\$4957	\$5034	\$5102
65"H x 24"W x 18"D, Left Hand, 8 Door	HSCLP652418LME	148	20.5	\$4957	\$5034	\$5102
50"H x 24"W x 18"D, Right Hand, 6 Door	HSCLP502418RME	121	16.0	\$3961	\$4011	\$4086
50"H x 24"W x 18"D, Left Hand, 6 Door	HSCLP502418LME	121	16.0	\$3961	\$4011	\$4086
Double Lockers, Footed w/Metal Front, eLock						
65"H x 12"W x 18"D, Right Hand, 2 Door	HSDLF651218RME	92	11.0	\$2128	\$2205	\$2273
65"H x 12"W x 18"D, Left Hand, 2 Door	HSDLF651218LME	92	11.0	\$2128	\$2205	\$2273
42"H x 12"W x 18"D, Right Hand, 2 Door	HSDLF421218RME	74	7.1	\$2003	\$2053	\$2128
42"H x 12"W x 18"D, Left Hand, 2 Door	HSDLF421218LME	74	7.1	\$2003	\$2053	\$2128
Quad Lockers, Footed w/Metal Front, eLock						
65"H x 24"W x 18"D, Right Hand, 4 Door	HSQLF652418RME	148	19.4	\$3431	\$3508	\$3576
65"H x 24"W x 18"D, Left Hand, 4 Door	HSQLF652418LME	148	19.4	\$3431	\$3508	\$3576
42"H x 24"W x 18"D, Right Hand, 4 Door	HSQLF422418RME	109	12.6	\$3017	\$3067	\$3142
42"H x 24"W x 18"D, Left Hand, 4 Door	HSQLF422418LME	109	12.6	\$3017	\$3067	\$3142
Cubby Lockers, Footed w/Metal Front, eLock						
65"H x 12"W x 18"D, Right Hand, 4 Door	HSCLF651218RME	92	11.0	\$2766	\$2843	\$2911
65"H x 12"W x 18"D, Left Hand, 4 Door	HSCLF651218LME	92	11.0	\$2766	\$2843	\$2911
50"H x 12"W x 18"D, Right Hand, 3 Door	HSCLF501218RME	81	8.4	\$2247	\$2297	\$2372
50"H x 12"W x 18"D, Left Hand, 3 Door	HSCLF501218LME	81	8.4	\$2247	\$2297	\$2372
65"H x 24"W x 18"D, Right Hand, 8 Door	HSCLF652418RME	148	20.5	\$5091	\$5168	\$5236
65"H x 24"W x 18"D, Left Hand, 8 Door	HSCLF652418LME	148	20.5	\$5091	\$5168	\$5236
50"H x 24"W x 18"D, Right Hand, 6 Door	HSCLF502418RME	121	16.0	\$4094	\$4144	\$4219
50"H x 24"W x 18"D, Left Hand, 6 Door	HSCLF502418LME	121	16.0	\$4094	\$4144	\$4219

NOTES:

- Lockers can be ganged either side-to-side or back-to-back.
- "Double" and "Quad" lockers include two double coat hooks in each compartment.
- Contain® Lockers can be used with Storage Islands, see page 733.

ⓘ Lockers: 42"H x 12"W and 50"H x 12"W plinth lockers can be freestanding. 65"H x 12"W plinth lockers and all heights of 12"W footed lockers must be attached to a panel, worksurface, or ganged to another unit.



ⓘ Every digital keypad or RFID installation site will require one Programming Key and at least one Manager Key, sold separately.

HOW TO SPECIFY

<p>Select Model Number</p> <p>H S Q L P 6 5 2 4 1 8 R M E .</p>	<p>Select Base/Foot</p> <p>BK Flush Plinth Base BX Recessed Plinth Base SF Contain Foot T1 Platinum Metallic PR6 Silver</p> <p>B X .</p>	<p>Select Pull</p> <p>E Keypad Electronic Lock D RFID Electronic Lock Pull + \$200 (2 Doors) + \$300 (3 Doors) + \$400 (4 Doors) + \$600 (6 Doors) + \$800 (8 Doors)</p> <p>D .</p>	<p>Select Paint Color</p> <p>See page 666</p> <p>P J W .</p>	<p>Select Front Paint</p> <p>See page 666</p> <p>NA Matches Case (+ \$0) P1 upcharge (+ \$150) P2 upcharge (+ \$170) P3 upcharge (+ \$190)</p> <p>N A</p>
--	---	--	---	---

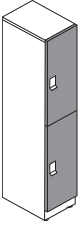
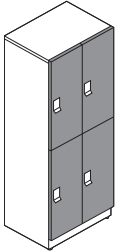
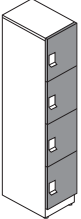

Metal Lockers with Laminate Fronts and eLock

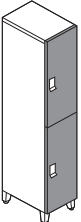
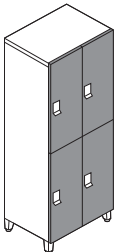
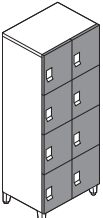
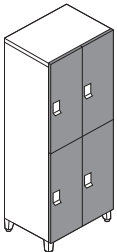
DESCRIPTION	MODEL	SHIP WEIGHT	CUBE	LIST PRICE BY PAINT GRADE			
				P1	P2	P3	
 Double Lockers, Plinth w/Laminate Front, eLock 65"H x 12"W x 18"D, Right Hand, 2 Door 65"H x 12"W x 18"D, Left Hand, 2 Door 42"H x 12"W x 18"D, Right Hand, 2 Door 42"H x 12"W x 18"D, Left Hand, 2 Door	HSDLP651218RLE	92	11.6	\$2200	\$2277	\$2345	
	HSDLP651218LLE	92	11.6	\$2200	\$2277	\$2345	
	HSDLP421218RLE	74	7.7	\$2055	\$2105	\$2180	
	HSDLP421218LLE	74	7.7	\$2055	\$2105	\$2180	
 Quad Lockers, Plinth w/Laminate Front, eLock 65"H x 24"W x 18"D, Right Hand, 4 Door 65"H x 24"W x 18"D, Left Hand, 4 Door 42"H x 24"W x 18"D, Right Hand, 4 Door 42"H x 24"W x 18"D, Left Hand, 4 Door	HSQLP652418RLE	148	20.5	\$3606	\$3683	\$3751	
	HSQLP652418LLE	148	20.5	\$3606	\$3683	\$3751	
	HSQLP422418RLE	109	13.7	\$3131	\$3181	\$3256	
	HSQLP422418LLE	109	13.7	\$3131	\$3181	\$3256	
  Cubby Lockers, Plinth w/Laminate Front, eLock 65"H x 12"W x 18"D, Right Hand, 4 Door 65"H x 12"W x 18"D, Left Hand, 4 Door 50"H x 12"W x 18"D, Right Hand, 3 Door 50"H x 12"W x 18"D, Left Hand, 3 Door 65"H x 24"W x 18"D, Right Hand, 8 Door 65"H x 24"W x 18"D, Left Hand, 8 Door 50"H x 24"W x 18"D, Right Hand, 6 Door 50"H x 24"W x 18"D, Left Hand, 6 Door	HSCLP651218RLE	92	11.6	\$2842	\$2919	\$2987	
	HSCLP651218LLE	92	11.6	\$2842	\$2919	\$2987	
	HSCLP501218RLE	81	9.0	\$2289	\$2339	\$2414	
	HSCLP501218LLE	81	9.0	\$2289	\$2339	\$2414	
	HSCLP652418RLE	148	20.5	\$5330	\$5407	\$5475	
	HSCLP652418LLE	148	20.5	\$5330	\$5407	\$5475	
	HSCLP502418RLE	121	16.0	\$4278	\$4328	\$4403	
	HSCLP502418LLE	121	16.0	\$4278	\$4328	\$4403	
	 Double Lockers, Footed w/Laminate Front, eLock 65"H x 12"W x 18"D, Right Hand, 2 Door 65"H x 12"W x 18"D, Left Hand, 2 Door 42"H x 12"W x 18"D, Right Hand, 2 Door 42"H x 12"W x 18"D, Left Hand, 2 Door	HSDLF651218RLE	92	11.0	\$2335	\$2412	\$2480
		HSDLF651218LLE	92	11.0	\$2335	\$2412	\$2480
		HSDLF421218RLE	74	7.1	\$2190	\$2240	\$2315
		HSDLF421218LLE	74	7.1	\$2190	\$2240	\$2315
 Quad Lockers, Footed w/Laminate Front, eLock 65"H x 24"W x 18"D, Right Hand, 4 Door 65"H x 24"W x 18"D, Left Hand, 4 Door 42"H x 24"W x 18"D, Right Hand, 4 Door 42"H x 24"W x 18"D, Left Hand, 4 Door	HSQLF652418RLE	148	19.4	\$3739	\$3816	\$3884	
	HSQLF652418LLE	148	19.4	\$3739	\$3816	\$3884	
	HSQLF422418RLE	109	12.6	\$3265	\$3315	\$3390	
	HSQLF422418LLE	109	12.6	\$3265	\$3315	\$3390	
  Cubby Lockers, Footed w/Laminate Front, eLock 65"H x 12"W x 18"D, Right Hand, 4 Door 65"H x 12"W x 18"D, Left Hand, 4 Door 50"H x 12"W x 18"D, Right Hand, 3 Door 50"H x 12"W x 18"D, Left Hand, 3 Door 65"H x 24"W x 18"D, Right Hand, 8 Door 65"H x 24"W x 18"D, Left Hand, 8 Door 50"H x 24"W x 18"D, Right Hand, 6 Door 50"H x 24"W x 18"D, Left Hand, 6 Door	HSCLF651218RLE	92	11.0	\$2978	\$3055	\$3123	
	HSCLF651218LLE	92	11.0	\$2978	\$3055	\$3123	
	HSCLF501218RLE	81	8.4	\$2425	\$2475	\$2550	
	HSCLF501218LLE	81	8.4	\$2425	\$2475	\$2550	
	HSCLF652418RLE	148	19.4	\$5465	\$5542	\$5610	
	HSCLF652418LLE	148	19.4	\$5465	\$5542	\$5610	
	HSCLF502418RLE	121	14.9	\$4412	\$4462	\$4537	
	HSCLF502418LLE	121	14.9	\$4412	\$4462	\$4537	

STORAGE

NOTES:

- Lockers can be ganged either side-to-side or back-to-back.
- "Double" and "Quad" lockers include two double coat hooks in each compartment.
- Contain® Lockers can be used with Storage Islands, see page 733.
- ⓘ Lockers: 42"H x 12"W and 50"H x 12"W plinth lockers can be freestanding. 65"H x 12"W plinth lockers and all heights of 12"W footed lockers must be attached to a panel, worksurface, or ganged to another unit.
- ⓘ Every digital keypad or RFID installation site will require one Programming Key and at least one Manager Key, sold separately.

HOW TO SPECIFY

<p>Select Model Number</p> <p>H S Q L P 6 5 2 4 1 8 R L E .</p>	<p>Select Base/Foot</p> <p>BX Recessed Plinth Base SF Contain Foot T1 Platinum Metallic PR6 Silver</p> <p>B X .</p>	<p>Select Pull</p> <p>E Keypad Electronic Lock D RFID Electronic Lock Pull + \$200 (2 Doors) + \$300 (3 Doors) + \$400 (4 Doors) + \$600 (6 Doors) + \$800 (8 Doors)</p> <p>D .</p>	<p>Select Case Paint</p> <p>See page 666</p> <p>P J W .</p>	<p>Select Laminate</p> <p>See page 666</p> <p>L S A 1</p>
--	---	--	--	--

CONTAIN[®] eLock Accessories

GSA SIN 33721



Icon Legend on page 19

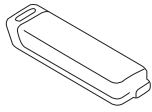

DESCRIPTION

MODEL

SHIP WEIGHT

CUBE

LIST PRICE

Digital Keys

Digilock Programming Key
Digilock Manager Key

HSLDIGPRG
HSLDIGMGR

0.8
0.8

0.0
0.0

\$181
\$141

NOTES: A Programming Key is used to initialize locks out of factory default mode and register Manager Keys to the locks. Manager Keys are used to bypass a locked unit, operating as the “master key” and it is recommended that building facilitators have at least one Manager Key. Up to 6 Manager Keys may be registered to each lock. Manager Keys provide external power to locks in case of battery failure. Programming Key is the same key as Fuse™ Digilocks and can work across both Contain® and Fuse™.

- ⓘ Only one Programming Key should be specified per installation and multiple Programming Keys are not compatible with each other.
- ⓘ Add-on digital lock orders should be programmed with the original Programming Key.

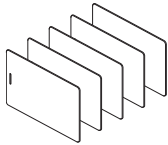

RFID Cards

Digilock RFID Cards, Pack of 5
Digilock RFID Cards, Pack of 25
Digilock RFID Cards, Pack of 100

HSLRFID5C
HSLRFID25C
HSLRFID100C

0.3
0.5
1.9

0.0
0.0
0.0

\$119
\$562
\$2130

NOTES: RFID cards are plain white and have a lanyard cutout.

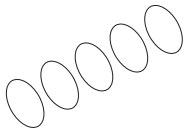

RFID Stickers

Digilock RFID Stickers, Pack of 5
Digilock RFID Stickers, Pack of 25
Digilock RFID Stickers, Pack of 100

HSLRFID5S
HSLRFID25S
HSLRFID100S

0.3
0.5
1.9

0.0
0.0
0.0

\$63
\$282
\$1066

NOTES: RFID stickers are plain white, approximately 1” in diameter and may be added to the back of an existing employee badge or identification card.

STORAGE

HOW TO SPECIFY

Select
Model Number

H S L R F I D 2 5 C



Icon Legend on page 19

CONTAIN[®] Metal Pedestals

	DESCRIPTION	MODEL	SHIP WEIGHT	CUBE	LIST PRICE BY PAINT GRADE		
					P1	P2	P3
	Hanging Pedestal with Metal Fronts, Box/File						
	18"H x 15"W x 18"D	HSPH181518BFM(?)	35.8	4.4	\$627	\$655	\$683
	18"H x 15"W x 24"D	HSPH181524BFM(?)	39.3	5.7	\$668	\$696	\$724
	18"H x 15"W x 30"D	HSPH181530BFM(?)	45.6	6.4	\$706	\$734	\$762
	Mobile Pedestal with Metal Fronts, Box/File						
	21"H x 15"W x 18"D	HSPM211518BFM(?)	63.5	4.4	\$627	\$655	\$683
	21"H x 15"W x 24"D	HSPM211524BFM(?)	61.9	5.7	\$673	\$701	\$729
	Mobile Pedestal with Metal Fronts, Box/Box/File						
	27"H x 15"W x 18"D	HSPM271518BBFM(?)	63.4	5.3	\$812	\$840	\$868
	27"H x 15"W x 24"D	HSPM271524BBFM(?)	71.9	6.6	\$857	\$885	\$913
	27"H x 15"W x 30"D	HSPM271530BBFM(?)	83.6	8.2	\$901	\$929	\$957
	Mobile Pedestal with Metal Fronts, File/File						
	27"H x 15"W x 18"D	HSPM271518FFM(?)	60.9	5.3	\$812	\$840	\$868
	27"H x 15"W x 24"D	HSPM271524FFM(?)	65.7	6.6	\$857	\$885	\$913
	27"H x 15"W x 30"D	HSPM271530FFM(?)	75.2	8.2	\$901	\$929	\$957
	Plinth Support Pedestal with Metal Fronts, Box/Box/File						
	28"H x 15"W x 18"D	HSPSBX281518BBFM(?)	50.4	5.9	\$785	\$813	\$841
	28"H x 15"W x 24"D	HSPSBX281524BBFM(?)	58.6	7.5	\$828	\$856	\$884
	28"H x 15"W x 30"D	HSPSBX281530BBFM(?)	69.8	9.3	\$873	\$901	\$929
	Plinth Support Pedestal with Metal Fronts, File/File						
	28"H x 15"W x 18"D	HSPSBX281518FFM(?)	45.1	5.9	\$785	\$813	\$841
	28"H x 15"W x 24"D	HSPSBX281524FFM(?)	52.1	7.5	\$828	\$856	\$884
	28"H x 15"W x 30"D	HSPSBX281530FFM(?)	61.1	9.3	\$873	\$901	\$929

STORAGE

NOTES:

- Ball-bearing suspension on box and file drawer. (100%)
- Drawers color to be interior gray steel.
- See page 701 for Pedestal Seat.
- File drawer has high sides and back for filing front to back and side to side.
- Counterweight standard on all mobile peds.
- Pencil tray standard in top box drawer.
- One box divider standard in each box drawer.

- One crossrail standard in each file drawer.
- 24"D and 30"D pedestals accommodate legal files side to side.
- ! A-Pull available in Satin Chrome only.
- ! Locking units equipped with HON "One Key" interchangeable core removable locks. Keyed alike core model HF23S, in Satin, must be ordered separately. See page 675.
- ! **NEW MODELS LAUNCHING Q4 2021. SEE DIGITAL PRICER FOR UPDATES.**

HOW TO SPECIFY

Select Model Number Replace (?) with handle choice A Satin Chrome Arch N Full Face Integral R Full Radius	Select Paint Color See page 666	Select Lock Option L Standard Lock X Omit Lock (deduct \$20)
H S P H 1 8 1 5 1 8 B F M A .	P .	L

CONTAIN[®] Footed Metal Pedestals

GSA SIN 33721



Icon Legend on page 19

	DESCRIPTION	MODEL	SHIP WEIGHT	CUBE	LIST PRICE BY PAINT GRADE		
					P1	P2	P3
	Footed Freestanding Pedestal with Metal Fronts, Box/File						
	22"H x 15"W x 18"D 22"H x 15"W x 24"D	HSPFSF221518BFM(?) HSPFSF221524BFM(?)	66.8 73.1	4.4 5.7	\$737 \$779	\$765 \$807	\$793 \$835
	Footed Support Pedestal with Metal Fronts, Box/Box/File						
	28"H x 15"W x 18"D 28"H x 15"W x 24"D 28"H x 15"W x 30"D	HSPSSF281518BBFM(?) HSPSSF281524BBFM(?) HSPSSF281530BBFM(?)	49.8 57.4 68.3	5.3 6.6 8.2	\$922 \$963 \$1010	\$950 \$991 \$1038	\$978 \$1019 \$1066
	Footed Support Pedestal with Metal Fronts, File/File						
	28"H x 15"W x 18"D 28"H x 15"W x 24"D 28"H x 15"W x 30"D	HSPSSF281518FFM(?) HSPSSF281524FFM(?) HSPSSF281530FFM(?)	47.3 54.3 60.0	5.3 6.6 8.2	\$922 \$963 \$1010	\$950 \$991 \$1038	\$978 \$1019 \$1066
	Flush Pedestal Kickplates (Field Installable)	HSPAK15	2.0	0.2	\$122	\$130	\$135
	Specify: Model.Paint SPECIFYING EXAMPLE: HSPAK.P						

STORAGE

NOTES:

- Ball-bearing suspension on box and file drawer. (100%)
- Drawers color to be interior gray steel.
- File drawer has high sides and back for filing front-to-back and side-to-side.
- Counterweight standard on all mobile peds.
- See page 701 for Pedestal Seat.
- Pencil tray standard in top box drawer.
- One box divider standard in each box drawer.
- One crossrail standard in each file drawer.
- 24"D and 30"D pedestals accommodate legal files side-to-side.
- ! A-Pull available in Satin Chrome only.
- ! Locking units equipped with HON "One Key" interchangeable core removable locks. Keyed alike core model HF23S, in Satin, must be ordered separately. See page 675.
- ! **NEW MODELS LAUNCHING Q4 2021. SEE DIGITAL PRICER FOR UPDATES.**

HOW TO SPECIFY



Select Model Number Replace (?) with handle choice A Satin Chrome Arch N Full Face Integral R Full Radius	Select Paint Color See page 666	Select Lock Option L Standard Lock X Omit Lock (deduct \$20)	Select Foot Color T1 Platinum Metallic PR6 Silver
H S P F S F 2 2 1 5 1 8 B F M A .	P .	L .	T 1



Icon Legend on page 19

CONTAIN[®] Footed Metal Pedestals

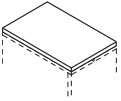
	DESCRIPTION	MODEL	SHIP WEIGHT	CUBE	LIST PRICE
SIN 33721	Counterweight — Freestanding Support Pedestals or Systems Support and Mobile Pedestals	HPCW1	18	0.1	\$223

	DESCRIPTION	MODEL	SHIP WEIGHT	CUBE	FABRIC PRICE CODES			
 OPEN MARKET 	Pedestal Seat 15"W x 22 ⁷ / ₈ "D x 2"H NOTES: For seating fabrics, see pages 22-24. SPECIFYING EXAMPLE: HPSEAT24ND.APN23	HPSEAT24ND	10 	1.2	1	\$222	8	\$418
					2	\$246	9	\$449
					3	\$270	10	\$480
					4	\$294	11	\$511
					5	\$325	12	\$542
					6	\$356	L	—
					7	\$387		

STORAGE

HOW TO SPECIFY

Select Model Number HPSEAT24.	Select Fabric See pages 22-24 for seating fabric options APN23
---	---

CONTAIN[®] Metal Pedestals with Laminate Fronts

GSA SIN 33721



Icon Legend on page 19

	DESCRIPTION	MODEL	SHIP WEIGHT	CUBE	LIST PRICE BY PAINT GRADE		
					P1	P2	P3
	Hanging Pedestal with Laminate Fronts, Box/File						
	18"H x 15"W x 18"D, Arch Pull	HSPH181518BFL(?)	37.6	4.4	\$802	\$830	\$858
	18"H x 15"W x 24"D, Arch Pull	HSPH181524BFL(?)	43.9	5.7	\$842	\$870	\$898
	18"H x 15"W x 30"D, Arch Pull	HSPH181530BFL(?)	53.0	6.4	\$880	\$908	\$936
	Mobile Pedestal with Laminate Fronts, Box/File						
	21"H x 15"W x 18"D, Arch Pull	HSPM211518BFL(?)	65.3	4.4	\$802	\$830	\$858
	21"H x 15"W x 24"D, Arch Pull	HSPM211524BFL(?)	63.7	5.7	\$847	\$875	\$903
	Mobile Pedestal with Laminate Fronts, Box/Box/File						
	27"H x 15"W x 18"D, Arch Pull	HSPM271518BBFL(?)	65.0	5.3	\$1041	\$1069	\$1097
	27"H x 15"W x 24"D, Arch Pull	HSPM271524BBFL(?)	73.5	6.6	\$1085	\$1113	\$1141
	27"H x 15"W x 30"D, Arch Pull	HSPM271530BBFL(?)	85.2	8.2	\$1130	\$1158	\$1186
	Mobile Pedestal with Laminate Fronts, File/File						
	27"H x 15"W x 18"D, Arch Pull	HSPM271518FFL(?)	63.4	5.3	\$1041	\$1069	\$1097
	27"H x 15"W x 24"D, Arch Pull	HSPM271524FFL(?)	68.1	6.6	\$1085	\$1113	\$1141
	27"H x 15"W x 30"D, Arch Pull	HSPM271530FFL(?)	77.6	8.2	\$1130	\$1158	\$1186
	Plinth Support Pedestal with Laminate Fronts, Box/Box/File						
	28"H x 15"W x 18"D, Arch Pull	HSPSBX281518BBFL(?)	51.7	5.9	\$1015	\$1043	\$1071
	28"H x 15"W x 24"D, Arch Pull	HSPSBX281524BBFL(?)	59.9	7.5	\$1056	\$1084	\$1112
	28"H x 15"W x 30"D, Arch Pull	HSPSBX281530BBFL(?)	71.1	9.3	\$1103	\$1131	\$1159
	Plinth Support Pedestal with Laminate Fronts, File/File						
	28"H x 15"W x 18"D, Arch Pull	HSPSBX281518FFL(?)	47.6	5.9	\$1015	\$1043	\$1071
	28"H x 15"W x 24"D, Arch Pull	HSPSBX281524FFL(?)	54.6	7.5	\$1056	\$1084	\$1112
	28"H x 15"W x 30"D, Arch Pull	HSPSBX281530FFL(?)	63.6	9.3	\$1103	\$1131	\$1159

STORAGE

NOTES:

- Ball-bearing suspension on box and file drawer. (100%)
- Drawers color to be interior gray steel.
- File drawer has high sides and back for filing front-to-back and side-to-side.
- Counterweight standard on all mobile peds.
- See page 701 for Pedestal Seat.
- Pencil tray standard in top box drawer.
- One box divider standard in each box drawer.
- One crossrail standard in each file drawer.
- 24"D and 30"D pedestals accommodate legal files side-to-side.
- ! Drawer Fronts available with Satin Chrome Arch only.
- ! Locking units equipped with HON "One Key" interchangeable core removable locks. Keyed alike core model HF23S, in Satin, must be ordered separately. See page 675.
- ! **NEW MODELS LAUNCHING Q4 2021. SEE DIGITAL PRICER FOR UPDATES.**

HOW TO SPECIFY

<p>Select Model Number</p> <p>Replace (?) with handle choice</p> <p>A Satin Chrome Arch</p> <p>H S P H 1 8 1 5 1 8 B F L A .</p>	<p>Select Paint Color</p> <p>See page 666</p> <p>P .</p>	<p>Select Lock Option</p> <p>L Standard Lock X Omit Lock (deduct \$20)</p> <p>L .</p>	<p>Select Laminate Option</p> <p>See page 666</p> <p>C</p>
---	--	---	--



Icon Legend on page 19

Footed Metal Pedestals with Laminate Fronts

	DESCRIPTION	MODEL	SHIP WEIGHT	CUBE	LIST PRICE BY PAINT GRADE		
					P1	P2	P3
	Footed Freestanding Pedestal with Laminate Fronts, Box/File						
	22”H x 15”W x 18”D, Arch Pull	HSPFSF221518BFL(?)	69.0	4.4	\$912	\$940	\$968
	22”H x 15”W x 24”D, Arch Pull	HSPFSF221524BFL(?)	75.3	5.7	\$953	\$981	\$1009
	Footed Support Pedestal with Laminate Fronts, Box/Box/File						
	28”H x 15”W x 18”D, Arch Pull	HSPSSF281518BBFL(?)	51.4	5.3	\$1148	\$1176	\$1204
	28”H x 15”W x 24”D, Arch Pull	HSPSSF281524BBFL(?)	59.0	6.6	\$1193	\$1221	\$1249
	28”H x 15”W x 30”D, Arch Pull	HSPSSF281530BBFL(?)	69.9	8.2	\$1236	\$1264	\$1292
	Footed Support Pedestal with Laminate Fronts, File/File						
	28”H x 15”W x 18”D, Arch Pull	HSPSSF281518FFL(?)	49.7	5.3	\$1148	\$1176	\$1204
	28”H x 15”W x 24”D, Arch Pull	HSPSSF281524FFL(?)	56.7	6.6	\$1193	\$1221	\$1249
	28”H x 15”W x 30”D, Arch Pull	HSPSSF281530FFL(?)	62.4	8.2	\$1236	\$1264	\$1292

NOTES:

- Ball-bearing suspension on box and file drawer. (100%)
- Drawers color to be interior gray steel.
- File drawer has high sides and back for filing front-to-back and side-to-side.
- Counterweight standard on all mobile peds.
- See page 701 for Pedestal Seat.
- Pencil tray standard in top box drawer.
- One box divider standard in each box drawer.
- One crossrail standard in each file drawer.
- 24”D and 30”D pedestals accommodate legal files side-to-side.

! Drawer Fronts available with Satin Chrome Arch only.

! Locking units equipped with HON “One Key” interchangeable core removable locks. Keyed alike core model HF23S, in Satin, must be ordered separately. See page 675.

! NEW MODELS LAUNCHING Q4 2021. SEE DIGITAL PRICER FOR UPDATES.

STORAGE

HOW TO SPECIFY

<p>Select Model Number</p> <p>Replace (?) with handle choice</p> <p>A Satin Chrome Arch</p> <p>H S P F S F 2 2 1 5 1 8 B F L A .</p>	<p>Select Paint Color</p> <p>See page 666</p> <p>P .</p>	<p>Select Lock Option</p> <p>L Standard Lock X Omit Lock (deduct \$20)</p> <p>L .</p>	<p>Select Laminate Option</p> <p>See page 666</p> <p>C .</p>	<p>Select Foot Color</p> <p>T1 Platinum Metallic PR6 Silver</p> <p>T 1</p>
--	---	--	---	---

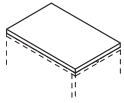

DESCRIPTION

Pedestal Seat

15"W x 22⁷/₈"D x 2"H

NOTES: For seating fabrics, see pages 22-24.

SPECIFYING EXAMPLE: HPSEAT24ND.APN23

MODEL

HPSEAT24ND

SHIP WEIGHT

10

CUBE

1.2

FABRIC PRICE CODES

1	\$222	8	\$418
2	\$246	9	\$449
3	\$270	10	\$480
4	\$294	11	\$511
5	\$325	12	\$542
6	\$356	L	—
7	\$387		

NOTES:

- See Brigade[®] pedestals on page 656 for additional pedestal options. See pages 750-751 for Pedestal Accessories.

STORAGE

HOW TO SPECIFY

<p>Select Model Number</p>	<p>Select Fabric</p> <p>See pages 22-24 for seating fabric options</p>
<p>HPSEAT24.</p>	<p>APN23</p>



Flagship® Modular Storage.

FLAGSHIP®

Pedestals in more than 40 styles. Lateral files in 15 sizes. These are just some of the reasons why Flagship is one of HON's top metal storage collections, and why HON is America's filing and storage leader. Today's offices run on information, and Flagship helps them sort, store and share every bit of it — plus all of the personal items and daily supplies employees depend on. It's the best-built storage available from any manufacturer at any price.



FEATURES

- Rugged, high-quality construction makes HON America's leader in filing and storage.
- ColorCorrect® lets you match your Flagship storage to many office furniture manufacturers.
- Add seat cushions to mobile pedestals for short-term, stow-away guest seating.
- Modular Storage with bins for easy access and customization.
- Lateral files with storage cabinets not only corral all your info, they double as collaborative hubs.
- Squeeze more storage capacity into a smaller workstation footprint by using pedestals as worksurface supports.
- Archival filing doesn't have to be stuffy. Outfit any open space with a wall full of storage, available at a moment's notice.

FLAGSHIP® ORDERING INFORMATION

FLAGSHIP® PRODUCTS

PAINTS CODES

- P1**
- ◆ Black **P**
 - ◆ Brownstone **P7D**
 - ◆ Charcoal **S**
 - ◆ Designer White **PJW**
 - ◆ Fossil **P28**
 - ◆ Greige **T5**
 - ◆ Light Gray **Q**
 - ◆ Loft **LOFT**
 - ◆ Muslin **T3**
 - ◆ Putty **L**
 - ◆ Shadow * **SHDW**
 - ◆ Titanium **P8T**

- P2**
- ◆ Champagne Metallic **T4**
 - ◆ Platinum Metallic **T1**

OPTIONAL LAMINATE TOPS FOR LATERAL FILES

L1 LAMINATES CODES

- Woodgrain**
- ◆ Bourbon Cherry **H**
 - ◆ Cognac **COGN**
 - ◆ Florence Walnut **LFW1**
 - ◆ Harvest **C**
 - ◆ Kingswood Walnut **LK11**
 - ◆ Mahogany **N**
 - ◆ Mocha **MOCH**
 - ◆ Natural Maple **D**
 - ◆ Pinnacle **PINC**
 - ◆ Shaker Cherry **F**
 - ◆ Sterling Ash **LSA1**

- Solid**
- ◆ Charcoal **S**
 - ◆ Designer White **LDW1**
 - ◆ Loft **LOFT**

- Patterned**
- ◆ Handspun Chestnut **LAHC**
 - ◆ Handspun Dove **LAHD**
 - ◆ Handspun Pearl **LAHP**
 - ◆ Handspun Slate **LAHS**
 - ◆ Sheer Mesh* **A5**
 - ◆ Silver Mesh* **B9**
 - ◆ Steel Mesh* **A9**
 - ◆ Canyon Zephyr * **K9**
 - ◆ Desert Zephyr * **K8**
 - ◆ Shadow Zephyr * **K1**
 - ◆ Gray* **G2**
 - ◆ White* **G1**

L2 LAMINATES CODES

- Woodgrain**
- ◆ Lowell Ash **LLA1**
 - ◆ Natural Recon **LNRI**
 - ◆ Phantom Ecrú **LPE1**
 - ◆ Portico Teak **LPT1**
 - ◆ Skyline Walnut **LSW1**

PULL OPTIONS FOR CONTAIN® AND FLAGSHIP® STORAGE

Suffix "A"



Satin Chrome
Arch Pull

Suffix "N"



Full Face Integral
Drawer Pull

Suffix "R"



Full Radius
Drawer Pull

NOTES: Arch pulls available in Satin Chrome only.

* Laminate colors will have the following pre-set edgeband colors:

Laminate	Edge
Sheer Mesh	Muslin
Silver Mesh	Loft
Steel Mesh	Charcoal
Gray	Charcoal
White	Charcoal

Edgeband matches top except as noted.

For Champagne Metallic Paint, Muslin is the suggested edgeband color. When Champagne Metallic Paint is selected, pulls are standard in Muslin.



◆◆◆ For lead time information see page 19.

* De-emphasized

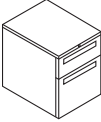

Icon Legend on page 19

Hanging and Standard Height Pedestals

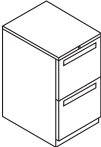
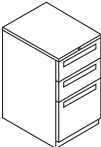
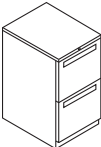
	DESCRIPTION	MODEL	SHIP WEIGHT	CUBE	LIST PRICE BY PAINT GRADE		
					P1	P2	P3
	Hanging Pedestals — Box/File						
	15"W x 16 ⁷ / ₈ "D x 19 ¹ / ₂ "H	H14917(?)	41	4.4	\$617	\$645	\$673
	15"W x 22 ⁷ / ₈ "D x 19 ¹ / ₂ "H	H14923(?)	48	6.0	\$657	\$685	\$713
	Standard Height Mobile Pedestals — Box/Box/File						
	15"W x 16 ⁷ / ₈ "D x 28"H	H18717(?)	76	5.9	\$790	\$818	\$846
	15"W x 22 ⁷ / ₈ "D x 28"H	H18723(?)	88	8.0	\$851	\$879	\$907
	15"W x 28 ⁷ / ₈ "D x 28"H	H18730(?)	102	9.8	\$913	\$941	\$969
	Standard Height Mobile Pedestals — File/File						
	15"W x 16 ⁷ / ₈ "D x 28"H	H18817(?)	72	5.9	\$790	\$818	\$846
	15"W x 22 ⁷ / ₈ "D x 28"H	H18823(?)	85	8.0	\$851	\$879	\$907
	15"W x 28 ⁷ / ₈ "D x 28"H	H18830(?)	98	9.8	\$913	\$941	\$969
	Standard Height Freestanding Support Pedestals — Box/Box/File						
	15"W x 16 ⁷ / ₈ "D x 28"H	H19717(?)	59	5.9	\$779	\$807	\$835
	15"W x 22 ⁷ / ₈ "D x 28"H	H19723(?)	73	8.0	\$837	\$865	\$893
	15"W x 28 ⁷ / ₈ "D x 28"H	H19730(?)	87	9.8	\$900	\$928	\$956
	Standard Height Freestanding Support Pedestals — File/File						
	15"W x 16 ⁷ / ₈ "D x 28"H	H19817(?)	55	5.9	\$779	\$807	\$835
	15"W x 22 ⁷ / ₈ "D x 28"H	H19823(?)	70	8.0	\$837	\$865	\$893
	15"W x 28 ⁷ / ₈ "D x 28"H	H19830(?)	83	9.8	\$900	\$928	\$956

STORAGE

NOTES:

- 28"H fits under all HON worksurfaces and desk shells.
- 22⁷/₈"D and 28⁷/₈"D pedestals accommodate legal files side-to-side.
- Pencil tray standard in top box drawer.
- One box divider standard in each box drawer.
- One crossrail standard in each file drawer.
- Steel ball-bearing suspension on file and box drawers.
- Full extension on all drawers.
- File drawers have high sides for filing front-to-back.
- See pages 750-751 for accessories and pedestal utilization information.
- Equipped with HON "One Key" interchangeable core removable locks.
- Hanging units are mounted using keyhole slots in top of pedestals; all hardware provided.
- Arch pull available in Satin Chrome only.
- Available in Arch (A), Full Face Integral (N) and Full Radius (R) Drawer Pulls. See page 706 for pull options.
- Choose from any of three pull options with no upcharge.
- Counterweight standard in mobile pedestals.
- Omit lock-option available. See page 773 for ordering instructions.
- See Brigade® pedestals on page 656 for additional pedestal options. See pages 750-751 for Pedestal Accessories.

! Freestanding support pedestals that are not positioned and attached under a worksurface require a counterweight kit found on page 750.

HOW TO SPECIFY

Select Model Number A Satin Chrome Arch N Full Face Integral R Full Radius H14917A	Select Lock Option L Lock (no upcharge) X Omit Lock (deduct \$20) L	Select Paint Color See page 706 P
---	--	---

FLAGSHIP® Mobile Pedestals

GSA SIN AS NOTED



Icon Legend on page 19

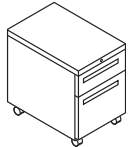

H15923N

SIN 33721

DESCRIPTION

Mobile Pedestals — Box/File
15"W x 22⁷/₈"D x 22"H

MODEL	SHIP WEIGHT	CUBE	LIST PRICE BY PAINT GRADE		
			P1	P2	P3
H15923(?)	92	6.0	\$663	\$691	\$719

NOTES:

- Pencil tray standard in top box drawer.
- One box divider standard in each box drawer.
- One crossrail standard in each file drawer.
- File drawers have high sides for filing front-to-back.
- Steel ball-bearing suspension on file drawer, and box drawer.
- See pages 750-751 for accessories and pedestal utilization information.
- Arch pull available in Satin Chrome only.
- Choose from any of three pull options with no upcharge.
- Available in Arch (A), Full Face Integral (N) and Full Radius (R) Drawer Pulls. See page 706 for pull options.
- Equipped with HON "One Key" interchangeable core removable locks.
- Counterweight standard.
- Omit lock-option available. See page 773 for ordering instructions.

STORAGE

HOW TO SPECIFY

Select Model Number A Satin Chrome Arch N Full Face Integral R Full Radius H 1 5 9 2 3 A	Select Lock Option L Lock (no upcharge) X Omit Lock (deduct \$20) X	Select Paint Color See page 706 T 1
---	---	--

DESCRIPTION

Pedestal Seat
15"W x 22⁷/₈"D x 2"H

NOTES: For seating fabrics, see pages 22-24.

MODEL	SHIP WEIGHT	CUBE	FABRIC PRICE CODES			
HPSEAT24ND	10 Ⓞ	1.2	1	\$222	8	\$418
			2	\$246	9	\$449
			3	\$270	10	\$480
			4	\$294	11	\$511
			5	\$325	12	\$542
			6	\$356	L	—
			7	\$387		

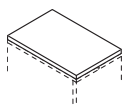

OPEN MARKET

NOTES:

- See Brigade® pedestals on page 656 for additional pedestal options. See pages 750-751 for Pedestal Accessories.

HOW TO SPECIFY

Select Model Number H P S E A T 2 4	Select Fabric See pages 22-24 for seating fabric options A P N 2 3
---	---



Icon Legend on page 19

18" Deep Lateral Files with Drawers

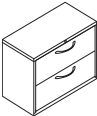
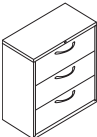
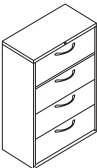
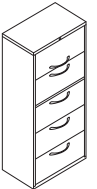
	DESCRIPTION	MODEL	SHIP WEIGHT	CUBE	LIST PRICE BY PAINT GRADE		
					P1	P2	P3
 <p>Standard Height</p>	Standard Height Lateral File — 2 Drawer						
	30"W x 18"D x 28"H	H9170(?)	138	12.3	\$1116	\$1149	\$1183
	36"W x 18"D x 28"H	H9180(?)	156	14.5	\$1233	\$1266	\$1300
	42"W x 18"D x 28"H	H9190(?)	177	16.8	\$1426	\$1459	\$1493
	Lateral File — 3 Drawer						
	30"W x 18"D x 39 ¹ / ₈ "H	H9173(?)	150	16.9	\$1461	\$1494	\$1528
	36"W x 18"D x 39 ¹ / ₈ "H	H9183(?)	174	20.0	\$1640	\$1673	\$1707
	42"W x 18"D x 39 ¹ / ₈ "H	H9193(?)	197	23.2	\$1898	\$1931	\$1965
	Lateral File w/o Posting Shelf — 4 Drawer						
	30"W x 18"D x 52 ¹ / ₂ "H	H9174(?)	176	22.1	\$1841	\$1908	\$1974
	36"W x 18"D x 52 ¹ / ₂ "H	H9184(?)	198	26.2	\$2090	\$2157	\$2223
	42"W x 18"D x 52 ¹ / ₂ "H	H9194(?)	213	30.3	\$2397	\$2464	\$2530
	Lateral File w/o Posting Shelf — 5 Drawer						
	30"W x 18"D x 64 ¹ / ₄ "H	H9175(?)	203	26.8	\$2351	\$2418	\$2484
	36"W x 18"D x 64 ¹ / ₄ "H	H9185(?)	238	31.8	\$2647	\$2714	\$2780
	42"W x 18"D x 64 ¹ / ₄ "H	H9195(?)	264	36.8	\$3068	\$3135	\$3201

NOTES: Top drawer is a roll-out shelf.

NOTES:

- 28"H lateral fit under standard 38000 Series and worksurfaces.
- Flush top and sides.
- Reinforced case construction.
- Lock mechanism serves both sides of drawer.
- Equipped with HON "One Key" interchangeable core removable locks.
- Counterweight included where applicable to meet ANSI/BIFMA stability requirements.
- Three-part, telescoping, steel ball-bearing suspension.
- Features drawer extension restraint; mechanical interlock inhibits the extension of more than one drawer at a time.
- Optional laminate tops and accessories — see page 747.
- Matching Pedestals — see page 707.
- Omit lock-option available. See page 773 for ordering instructions.
- Arch pull available in Satin Chrome only.
- Choose from any of three pull options with no upcharge.
- Available in Arch (A), Full Face Integral (N) and Full Radius (R) Drawer Pulls. See below and page 706 for pull options.
- See page 747 for Lateral File Accessories.
- Flagship® laterals can be used with Storage Islands, see page 733.

HOW TO SPECIFY

Select Model Number Select the Pull A Satin Chrome Arch N Full Face Integral R Full Radius	Select Lock Option L Lock (no upcharge) X Omit Lock (deduct \$20)	Select Paint Color See page 706
H 9 1 7 0 A	L	P

FLAGSHIP® Lateral File with Storage

GSA SIN 33721



Icon Legend on page 19

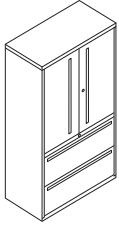

Model H9185LSN shown

DESCRIPTION

Lateral Files with Storage and Hinged Doors
36"W x 18"D x 64¼"H

NOTES: Lateral File drawers lock independently from storage case.

MODEL

H9185LS(?)

SHIP WEIGHT

203

CUBE

31.8

LIST PRICE BY PAINT GRADE

P1

\$2537

P2

\$2604

P3

\$2670

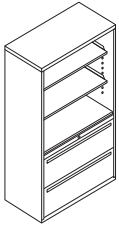

Model H9185LSNN shown

DESCRIPTION

Lateral Files with Open Shelves, No Doors
36"W x 18"D x 64¼"H

H9185LSN(?)

184

31.8

\$2314

\$2381

\$2447

STORAGE

NOTES:

- 64¼"H models complement Flagship lateral file heights.
- Equipped with HON "One Key" interchangeable core removable locks. Locks on storage cabinet doors and lateral file are keyed alike.
- Three-part, telescoping, steel ball-bearing suspension.
- Includes two adjustable shelves, adjustable in 2" increments.
- Lock mechanism serves both sides of drawer.
- Features drawer extension restraint; mechanical interlock inhibits the extension of more than one drawer at a time.
- Wire management grommet in back of unit.
- Omit lock-option available. See page 773 for ordering instructions.
- Flush top and sides.
- Choose from any of three pull options with no upcharge.
- Arch pull available in Satin Chrome only.
- Available in Arch (A), Full Face Integral (N) and Full Radius (R) Drawer Pulls. See page 706 for pull options.

HOW TO SPECIFY

Select Model Number

Select the Pull

- A** Satin Chrome Arch
- N** Full Face Integral
- R** Full Radius

H 9 1 8 5 L S A .

Select Lock Option

- L** Lock (no upcharge)
- X** Omit Lock
(deduct \$40 for models H91756LS and H9185LS)
(deduct \$20 for models H9175LSN and H9185LSN)

X .

Select Paint Color

See page 706

P



Icon Legend on page 19

FLAGSHIP® Modular Storage

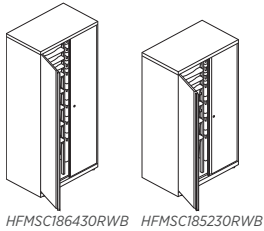

HFMSC186430RWB HFMSC185230RWB

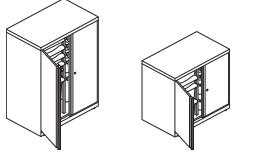

HFMSC183930RWB HFMSC182830RWB

DESCRIPTION

Modular Storage Cabinet
 18"D x 28"H x 30"W
 18"D x 39 1/8"H x 30"W
 18"D x 52 1/2"H x 30"W
 18"D x 64 1/4"H x 30"W

MODEL	SHIP WEIGHT	CUBE	LIST PRICE BY PAINT GRADE		
			P1	P2	P3
HFMSC182830RWB	119	12.0	\$1179	\$1212	\$1246
HFMSC183930RWB	138	16.2	\$1429	\$1462	\$1496
HFMSC185230RWB	176	22.4	\$1725	\$1792	\$1858
HFMSC186430RWB	184	28.2	\$2011	\$2078	\$2144

NOTES:

- Shipped fully assembled.
- Pre-configured trays and rails are included, see chart below.
- Additional Tray Kits may be purchased separately.
- Full radius handle on both doors.
- Four adjustable leveling glides standard.
- Reinforced top and base.
- Equipped with HON "One Key" interchangeable core removable locks standard.
- Doors have vertical stiffener standard.
- Positive door stops.
- Meets or exceeds ANSI/BIFMA and ISTA standards.
- Certified SCS Indoor Advantage Gold.

STORAGE

Pre-Configured Cabinets/Tray Kits

64" High Cabinet		52" High Cabinet		39" High Cabinet		28" High Cabinet	
1	2	1	2	1	2	1	2
3	4	3	4	3	4	3	4
5	6	5	6	5	6	5	6
7	8	7	8	7	8	7	8
1	2	1	2	1	2	1	2
3	4	3	4	3	4	3	4
5	6	5	6	5	6	5	6
7	8	7	8	7	8	7	8
1	2	1	2	1	2	1	2

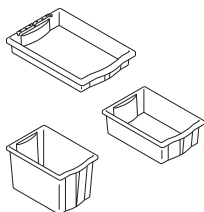

DESCRIPTION

Accessories — Tray Kit
 3"H, 2 bins and 4 rails
 6"H, 2 bins and 4 rails
 12"H, 2 bins and 4 rails

MODEL	SHIP WEIGHT	CUBE	LIST PRICE
HFMBIN3	7 Ⓞ	4.0	\$59
HFMBIN6	10 Ⓞ	4.5	\$72
HFMBIN12	12 Ⓞ	5.0	\$84

NOTES: Modular Storage Cabinets come with rails and bins. Additional bins and rails may be ordered in sets of 2. Availability and usage are outlined below.

NOTES:

- Tray height options include: 3", 6", 12".
- Trays may only be used in 12" width single column/section only.
- All trays are suspended off a pair of storage rails, trays slide easily in and out and are removable.
- Trays and storage rails are field installed and may be easily reconfigured.
- Front and rear handles are integrated for easy handling/transport.
- Translucent material provides visibility to contents.

HOW TO SPECIFY

<p>Select Model Number</p> <p>H F M S C 1 8 6 4 3 0 R W B .</p>	<p>Select Lock Option</p> <p>L Lock (no upcharge) X Omit Lock (deduct \$20) See page 773 for omit lock ordering instructions</p> <p>L .</p>	<p>Select Glide</p> <p>G Glide</p> <p>G .</p>	<p>Select Paint Color</p> <p>See page 706</p> <p>L D W 1</p>
--	--	--	---

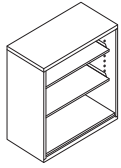

DESCRIPTION

3 Shelf
36"W x 18"D x 39½"H

MODEL	SHIP WEIGHT	CUBE	LIST PRICE BY PAINT GRADE		
			P1	P2	P3
HFSC183640W	100	20.0	\$976	\$1043	\$1109

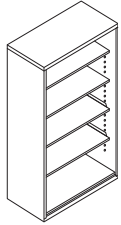

5 Shelf
36"W x 18"D x 64¼"H

NOTES: 64¼"H models complement Flagship lateral file heights.

HFSC183664W	148	31.8	\$1445	\$1512	\$1578
--------------------	-----	------	---------------	---------------	---------------

STORAGE

NOTES:

- Flush top and sides.
- Reinforced case construction.
- Shelves adjust in 2" increments.
- Wire management grommet in back of unit.

HOW TO SPECIFY

<p>Select Model Number</p> <p>HFSC183640W . P</p>	<p>Select Paint Color</p> <p>See page 706</p>
--	--



Icon Legend on page 19

FLAGSHIP® Storage Cabinets

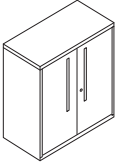
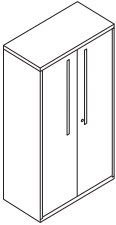
	DESCRIPTION	MODEL	SHIP WEIGHT	CUBE	LIST PRICE BY PAINT GRADE		
					P1	P2	P3
 <p>Model HFSC183640N shown</p>	<p>Storage Cabinets 36"W x 18"D x 39 7/8"H (with lock) 2 adjustable shelves</p>	HFSC183640(?)	119	20.0	\$1209	\$1276	\$1342
 <p>Model HFSC183664N shown</p>	<p>36"W x 18"D x 64 1/4"H (with lock) 4 adjustable shelves NOTES: 64 1/4"H models complement Flagship lateral file heights.</p>	HFSC183664(?)	184	31.8	\$1761	\$1828	\$1894

NOTES:

- Flush top and sides.
- Reinforced case construction.
- Includes adjustable shelves, adjustable in 2" increments.
- Arch pull available in Satin Chrome only.
- Choose from any of three pull options with no upcharge.
- Available in Arch (A), Full Face Integral (N) and Full Radius (R) Drawer Pulls. See below and page 706 for pull options.
- Four adjustable leveling glides are standard.
- Equipped with HON "One Key" interchangeable core removable locks.
- Wire management grommet in back of unit.
- Omit lock-option available. See page 773 for ordering instructions.

STORAGE

HOW TO SPECIFY

<p>Select Model Number</p> <p>Select the Pull</p> <p>A Satin Chrome Arch N Full Face Integral R Full Radius</p>	<p>Select Lock Option</p> <p>L Lock (no upcharge) X Omit Lock (deduct \$20)</p>	<p>Select Paint Color</p> <p>See page 706</p>
<div style="display: flex; justify-content: space-around;"> <div style="border: 1px solid black; padding: 2px;">H</div> <div style="border: 1px solid black; padding: 2px;">F</div> <div style="border: 1px solid black; padding: 2px;">S</div> <div style="border: 1px solid black; padding: 2px;">C</div> <div style="border: 1px solid black; padding: 2px;">1</div> <div style="border: 1px solid black; padding: 2px;">8</div> <div style="border: 1px solid black; padding: 2px;">3</div> <div style="border: 1px solid black; padding: 2px;">6</div> <div style="border: 1px solid black; padding: 2px;">4</div> <div style="border: 1px solid black; padding: 2px;">0</div> <div style="border: 1px solid black; padding: 2px;">A</div> </div>	<div style="border: 1px solid black; padding: 2px;">L</div>	<div style="border: 1px solid black; padding: 2px;">P</div>

FLAMESAFE™ ORDERING INFORMATION

FLAMESAFE™ PRODUCTS

PAINTS CODES

P1

- ◆ Black P
- ◆ Light Gray Q
- ◆ Putty L

STORAGE

◆◆◆ For lead time information see page 19.



FLAMESAFE™ Fire-Resistant Files

	DESCRIPTION	MODEL	SHIP WEIGHT	CUBE	LIST PRICE
	Vertical File — 2-Drawer, Letter 17¾"W x 25"D x 27¾"H	H52	304	10.0	\$4010
	Vertical File — 2-Drawer, Legal 20¾"W x 25"D x 27¾"H	H52C	330	13.0	\$4112
	Vertical File — 4-Drawer, Letter 17¾"W x 25"D x 52¾"H	H54	531	17.0	\$6173
	Vertical File — 4-Drawer, Legal 20¾"W x 25"D x 52¾"H	H54C	561	21.0	\$6302

NOTES:

- Full suspension.
- Non-asbestos.
- Follower block comes standard.
- Chrome drawer pulls, thumb latch and label holder.
- Rated: Filing Device Class 350, 1700° for one hour with drop test.
- UL listed.
- High drawer sides.
- Available in Putty, Black and Gray only; see page 714.
- Insulated in drawer face and between drawers.
- **Full Lifetime Warranty.**

⚠ Lock is NOT core removable.

HOW TO SPECIFY

<p>Select Model Number</p> <p>H 5 2 .</p>	<p>Select Lock Option</p> <p>P Lock</p> <p>P .</p>	<p>Select Paint Color</p> <p>See page 714</p> <p>P</p>
--	---	---

	DESCRIPTION	MODEL	SHIP WEIGHT	CUBE	LIST PRICE
	Lateral File — 2-Drawer 31⅞"W x 22⅞"D x 27¾"H	H32	470	11.0	\$5905
	Lateral File — 4-Drawer 31⅞"W x 22⅞"D x 52¾"H NOTES: Lateral Drawer inside dimensions: 25⅜"W x 15⅞"D x 10⅜"H	H34	795	26.0	\$8911

NOTES:

- Telescoping suspension.
- Non-asbestos.
- Available in Putty, Black and Gray only; see page 714.
- Rated: Filing Device Class 350, 1700° for one hour with drop test.
- Insulated in drawer face and between drawers.
- UL listed.
- 4 hangrails per opening, standard.
- Black, plastic recessed drawer pulls.
- **Full Lifetime Warranty.**

⚠ Lock is NOT core removable.

HOW TO SPECIFY

<p>Select Model Number</p> <p>H 3 2 .</p>	<p>Select Lock Option</p> <p>P Lock</p> <p>P .</p>	<p>Select Paint Color</p> <p>P Black Q Light Gray L Putty</p> <p>P</p>
--	---	---

STORAGE



Fuse™ Mobile Pedestal shown with Solve® Seating and Empower®.

FUSE™

Who says storage has to be boring? With a completely modern take on form and function, not to mention an ultra-cool color palette, Fuse storage adds personality to any home office or corporate workspace. With personal storage space for just about everything, Fuse keeps you organized even in small spaces.



FEATURES

- Designed to make the most of the compressed footprint of desking, benching and height-adjustable workstations.
- Extra thick, low profile case provides increased strength and durability while providing a modern 360-degree aesthetic for your storage needs.
- Extended height drawers give you the extra capacity to neatly store what matters most to you.
- Add a pop of color with an optional two-tone design to give new meaning to personal space.
- Alcove for stowing backpack, purse, bag, or other personal items.
- Rear casters swivel and front casters are fixed for easier mobility.
- Casters are designed to clear the top of Coordinate™ feet.
- File drawer has high sides to allow front-to-back filing for 15" wide models.
- Side-to-side filing uses file bars for support for 10" wide models.
- Standard core removable locks make rekeying a breeze.
- Electronic keypad lock option allows for ease of locking and unlocking personal items with your Fuse™ unit.

FUSE™ ORDERING INFORMATION

FUSE™ PRODUCTS

PAINTS CODES

P1

- ◆ Black P
- ◆ Brownstone P7D
- ◆ Designer White PJW
- ◆ Charcoal P02
- ◆ Fossil*** P28
- ◆ Greige T5
- ◆ Loft LOFT
- ◆ Muslin T3
- ◆ Titanium P8T

P2*

- ◆ Champagne Metallic T4
- ◆ Silver PR6
- ◆ Solar Black P8X

P3**

- ◆ Amethyst P091
- ◆ Atom P8S
- ◆ Blossom*** P8K
- ◆ Bullseye PJF
- ◆ Cabernet*** * P7T
- ◆ Cobalt Mica P090
- ◆ Conifer*** * P8H
- ◆ Ember P8P
- ◆ Ion P8N
- ◆ Iris P8J
- ◆ Krypton P8F
- ◆ Ochre P093
- ◆ Regatta P8M
- ◆ Sienna P092
- ◆ Succulent*** P8A

PULLS

- ◆ Square Silver SPR6
- ◆ Linear Silver LPR6
- ◆ Linear Black LP

WORKPLACE TOOLS

- ◆ Designer White DW

PULL OPTIONS FOR FUSE™ STORAGE



Square

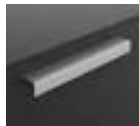

Linear

*P2 upcharges \$18 for each dot option selected.

**P3 upcharges \$40 for each dot option selected.

***TREND COLORS: These colors are intended to be an inspirational option for the trending market. Product application is limited and color availability is approximately two years to coincide with evolving workplace trends.

- The HON Company has elected to discontinue the HON Choice paint program, as of 12/31/2018, and roll it into our standard specials process.
- A special request will need to be submitted to receive pricing and order information.

◆◆◆ For lead time information see page 19.

* De-emphasized

FUSE™ Pedestals

Fuse Pedestal Functionality with Workplace Tools

STORAGE

Large & Slim Trays

- Ships in 9" and/or 15" bin drawers where applicable
- Organizes notepads, rulers, pens, pencils, paper clips, sticky notes, etc
- Radiused compartments allow for easy pick up of those small items
- Versatile tray can be utilized on top of your pedestal, drawers, or on the worksurface

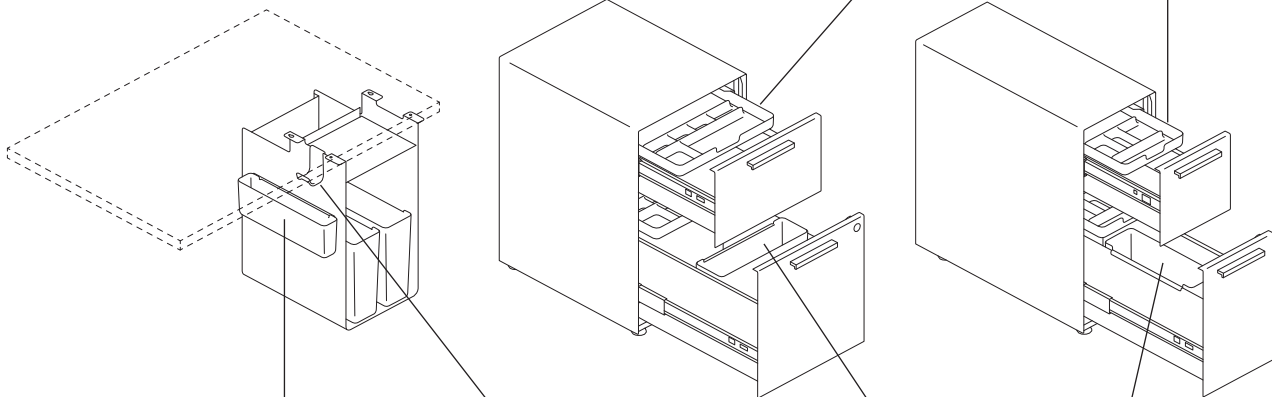

Side Saddle

- Stores small personal items such as your phone, tablet, and other organizational items
- Hangs on the drawer side, sits on the drawer bottom, undermount side slot and case top.
- Division in the bottom creates two storage areas
- Also hangs on the paper management support bars on page 465

Hook

- Used to hang backpacks, coats, headphones, umbrellas, and other personal items
- Can be used only in the undermount side slot or case top lip
- Thoughtfully designed to stay in place
- Supports up to 20 pounds

Hot File

- Take multiple project folders with you to your next meeting
- Ridges in the bottom keep files upright
- Hangs on the drawer side, undermount or sit in the drawer bottom to subdivide space
- Makes files accessible without having to even open a drawer
- Also hangs on the paper management support bars on page 465

Configuration Options - Fuse

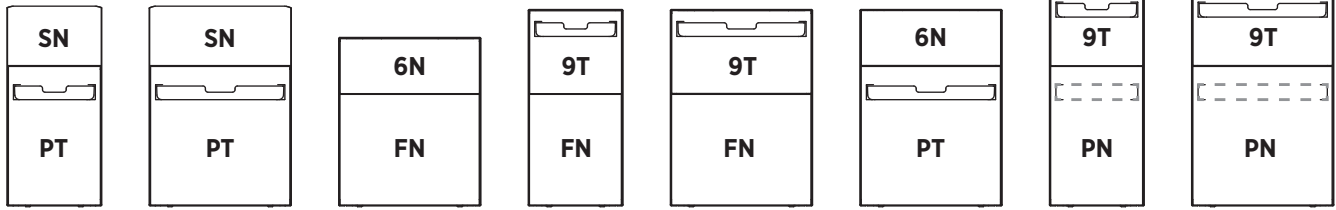

Legend

6N = 6" Box No Tray
 9T = 9" Box Bin with Tray
 SN = Alcove
 FN = 12" File No Tray
 PN = 15" File No Tray
 PT = 15" Bin with Tray

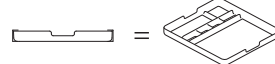
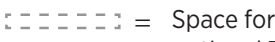
 = Tray
 = Space for optional Tray

FUSE™ DIGITAL LOCK SPECIFICATIONS

Digital Keypad Lock Specification Information for Fuse™ Pedestals

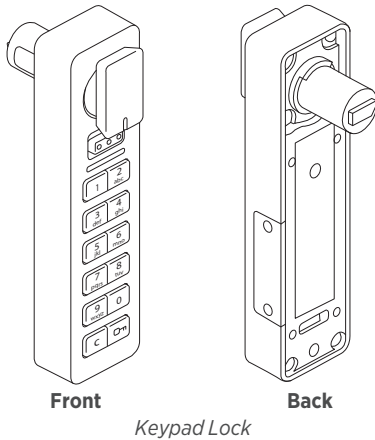

Keypad Lock

The digital keypad lock option helps modernize the workspace by eliminating the need to carry physical keys. The digital lock feature provides an alternative to standard lock and key, allowing users to simply input a code to unlock their Fuse™ storage unit. The digital keypad also supports shared applications where workstations or storage units support multiple users. These locks ship in “shared mode” by default; shared mode indicates that the lock will “forget” the paired 4-digit code after the lock is opened, allowing the unit to be used by multiple users.

❗ Order at least one Programming Key and Manager Key per install.

Digital Keypad Locks:

- Offered on all Fuse™ pedestal and undermount models.
- Ship factory installed.
- Offered in a brushed nickel finish.
- Digital keypad lock requires input of a user-selected 4-digit code.
- Digital keypad locks are powered using 2 premium lithium CR2032 batteries.
- Battery life is dependent on the frequency of operation but can last up to 5-7 years.
- **Every digital keypad installation site will require *one* Programming Key and *at least one* Manager Key, sold separately.**

Programming Key

- A Programming Key is a device used to initialize locks out of factory default mode and register Manager Keys to the locks.
- Only one Programming Key should be specified per installation site because multiple Programming Keys are not compatible with each other.
- Add-on digital lock orders should be programmed with the original Programming Key.
- Programming Key is the same key as Contain® Digilocks and can work across both Contain® and Fuse™.

Manager Key

- A Manager Key is used to bypass a locked unit; this operates as the “master key” and it is recommended that building facilitators have at least one Manager Key.
- Up to 6 Manager Keys may be registered to each lock.
- Manager Keys provide external power to locks in case of battery failure.

Digital Lock Keys and Accessories		
Description	Model	List Price
Programming Key	HSLDIGPRG	\$160
Manager Key	HSLDIGMGR	\$125

FUSE™ Mobile Pedestals

OPEN MARKET



Icon Legend on page 19

STORAGE

	DESCRIPTION	MODEL	SHIP WEIGHT	CUBE	LIST PRICE
	Mobile Pedestal, 6" Box/12" File 15"W x 19"D x 20 3/8"H 15"W x 23"D x 20 3/8"H	HAPMAP196NFN	48	5.0	\$668
		HAPMAP236NFN	54	5.9	\$717
	NOTES: No tray, Specification of tray color not required.				
	Mobile Pedestal, 9" Bin with Tray/12" File 15"W x 19"D x 23 3/8"H 15"W x 23"D x 23 3/8"H	HAPMBP199TFN	53	5.7	\$753
		HAPMBP239TFN	58	6.7	\$806
	Mobile Pedestal, 6" Box/15" Bin with Tray 15"W x 19"D x 23 3/8"H 15"W x 23"D x 23 3/8"H	HAPMBP196NPT	53	5.7	\$753
		HAPMBP236NPT	58	6.7	\$806
	Mobile Pedestal, 9" Bin with Tray/15" Bin 15"W x 19"D x 26 3/8"H 15"W x 23"D x 26 3/8"H	HAPMCP199TPN	58	6.4	\$811
		HAPMCP239TPN	62	7.5	\$862
	Mobile Pedestal, Alcove/15" File with Tray 15"W x 19"D x 21 1/2"H	HAPMBP195NPT	58	5.7	\$701
	NOTES: Top matches drawer color.				
	Slim Mobile Pedestal, 9" Bin with Tray/12" File 10"W x 23"D x 23 3/8"H	HAPMBS239TFN	47	4.9	\$767
	Slim Mobile Pedestal, 9" Bin with Tray/15" Bin 10"W x 23"D x 26 3/8"H	HAPMCS239TPN	52	5.4	\$825
	Slim Mobile Pedestal, Alcove/15" Bin with Tray 10"W x 23"D x 21 1/2"H	HAPMBS235NPT	43	4.9	\$714
	NOTES: Top matches drawer color.				

HOW TO SPECIFY

Select Model Number	Select Pull Option	Select Case Color	Select Drawer Color	Select Tray Color	Select Lock Option
	SPR6 Square Silver LPR6 Linear Silver LP Linear Black	See page 717 P2 upcharge (+ \$18) P3 upcharge (+ \$40)	See page 717 P2 upcharge (+ \$18) P3 upcharge (+ \$40)	DW Designer White	L Standard Lock X Omit Lock (deduct \$20)
H A P M A P 1 9 6 N F N .	S P R 6 .	P .	S .	D W .	L .



Icon Legend on page 19

Mobile Pedestals with eLock

	DESCRIPTION	MODEL	SHIP WEIGHT	CUBE	LIST PRICE
	Mobile Pedestal, 6" Box/12" File, eLock 15"W x 19"D x 20 3/8"H 15"W x 23"D x 20 3/8"H NOTES: No tray, Specification of tray color not required.	HAPMAP196NFNE	48	5.0	\$909
		HAPMAP236NFNE	54	5.9	\$956
	Mobile Pedestal, 9" Box/12" File, eLock 15"W x 19"D x 23 3/8"H 15"W x 23"D x 23 3/8"H	HAPMBP199TFNE	53	5.7	\$991
		HAPMBP239TFNE	58	6.7	\$1039
	Mobile Pedestal, 6" Box/15" File, eLock 15"W x 19"D x 23 3/8"H 15"W x 23"D x 23 3/8"H	HAPMBP196NPTE	53	5.7	\$991
		HAPMBP236NPTE	58	6.7	\$1039
	Mobile Pedestal, 9" Box/15" File, eLock 15"W x 19"D x 26 3/8"H 15"W x 23"D x 26 3/8"H	HAPMCP199TPNE	58	6.4	\$1045
		HAPMCP239TPNE	62	7.5	\$1094
	Mobile Pedestal, Alcove/15" File, eLock 15"W x 19"D x 21 1/2"H NOTES: Top matches drawer color.	HAPMBP19SNPTE	45	5.7	\$940
	Slim Mobile Pedestal, 9" Box/12" File, eLock 10"W x 23"D x 23 3/8"H	HAPMBS239TFNE	47	4.9	\$1002
	Slim Mobile Pedestal, 9" Box/15" File, eLock 10"W x 23"D x 26 3/8"H	HAPMCS239TPNE	52	5.4	\$1058
	Slim Mobile Pedestal, Alcove/15" File, eLock 10"W x 23"D x 21 1/2"H NOTES: Top matches drawer color.	HAPMBS23SNPTE	43	4.9	\$952

STORAGE

NOTES:

ⓘ Every installation will require one Programming Key and at least one Manager Key.

HOW TO SPECIFY

Select Model Number	Select Pull Option	Select Case Color	Select Drawer Color	Select Tray Color	Select Lock Option
SPR6	SPR6 Square Silver LPR6 Linear Silver LP Linear Black	See page 717 P2 upcharge (+ \$18) P3 upcharge (+ \$40)	See page 717 P2 upcharge (+ \$18) P3 upcharge (+ \$40)	DW Designer White	EBNL eLock Brushed Nickel
HAPMAP196NFNE	SPR6	P	S	DW	EBNL

FUSE™ Freestanding Pedestals

OPEN MARKET



Icon Legend on page 19

STORAGE

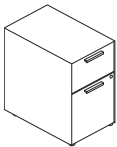
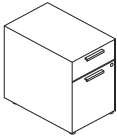
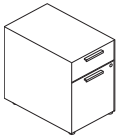
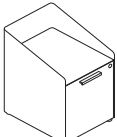
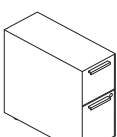
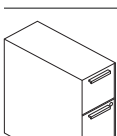
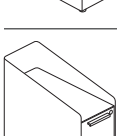
	DESCRIPTION	MODEL	SHIP WEIGHT	CUBE	LIST PRICE
	Freestanding Pedestal, 9" Bin with Tray/12" File 15"W x 19"D x 21"H	HAPGBP199TFN	53	5.7	\$732
	15"W x 23"D x 21"H	HAPGBP239TFN	58	5.7	\$782
	Freestanding Pedestal, 6" Box/15" Bin with Tray 15"W x 19"D x 21"H	HAPGBP196NPT	53	5.7	\$732
	15"W x 23"D x 21"H	HAPGBP236NPT	58	5.7	\$782
	Freestanding Pedestal, 9" Bin with Tray/15" Bin 15"W x 19"D x 24"H	HAPGCP199TPN	58	5.7	\$787
	15"W x 23"D x 24"H	HAPGCP239TPN	62	5.7	\$838
	Freestanding Pedestal, Alcove/15" Bin with Tray 15"W x 19"D x 21"H NOTES: Top matches drawer color.	HAPGBP195NPT	45	5.7	\$681
	Slim Freestanding Pedestal, 9" Bin with Tray/12" File 10"W x 23"D x 21"H	HAPGBS239TFN	47	5.7	\$745
	Slim Freestanding Pedestal, 9" Bin with Tray/15" Bin 10"W x 23"D x 24"H	HAPGCS239TPN	52	5.4	\$800
	Slim Freestanding Pedestal, Alcove/15" Bin with Tray 10"W x 23"D x 21"H NOTES: Top matches drawer color.	HAPGBS235NPT	43	4.9	\$694

HOW TO SPECIFY

Select Model Number H A P G B P 1 9 9 T F N .	Select Pull Option SPR6 Square Silver LPR6 Linear Silver LP Linear Black	Select Case Color See page 717 P2 upcharge (+ \$18) P3 upcharge (+ \$40)	Select Drawer Color See page 717 P2 upcharge (+ \$18) P3 upcharge (+ \$40)	Select Tray Color DW Designer White	Select Lock Option L Standard Lock X Omit Lock (deduct \$20)
---	--	--	--	---	---



Icon Legend on page 19

Freestanding Pedestals with eLock

	DESCRIPTION	MODEL	SHIP WEIGHT	CUBE	LIST PRICE
	Freestanding Pedestal, 9" Box/12" File, eLock				
	15"W x 19"D x 21"H 15"W x 23"D x 21"H	HAPGBP199TFNE HAPGBP239TFNE	53 58	5.7 6.7	\$969 \$1017
	Freestanding Pedestal, 6" Box/15" File, eLock				
	15"W x 19"D x 21"H 15"W x 23"D x 21"H	HAPGBP196NPTE HAPGBP236NPTE	53 58	5.7 6.7	\$969 \$1017
	Freestanding Pedestal, 9" Box/15" File, eLock				
	15"W x 19"D x 24"H 15"W x 23"D x 24"H	HAPGCP199TPNE HAPGCP239TPNE	58 62	6.4 7.5	\$1022 \$1071
	Freestanding Pedestal, Alcove/15" File, eLock 15"W x 19"D x 21"H NOTES: Top matches drawer color.	HAPGBP19SNPTE	45	5.7	\$920
	Slim Freestanding Pedestal, 9" Box/12" File, eLock				
	10"W x 23"D x 24"H	HAPGBS239TFNE	47	4.9	\$981
	Slim Freestanding Pedestal, 9" Box/15" File, eLock				
	10"W x 23"D x 24"H	HAPGCS239TPNE	52	5.4	\$1034
	Slim Freestanding Pedestal, Alcove/15" File				
	10"W x 23"D x 24"H NOTES: Top matches drawer color.	HAPGBS23SNPTE	43	4.9	\$932

STORAGE

NOTES:

! Every installation will require one Programming Key and at least one Manager Key.

HOW TO SPECIFY

Select Model Number	Select Pull Option	Select Case Color	Select Drawer Color	Select Tray Color	Select Lock Option
	SPR6 Square Silver LPR6 Linear Silver LP Linear Black	See page 717 P2 upcharge (+ \$18) P3 upcharge (+ \$40)	See page 717 P2 upcharge (+ \$18) P3 upcharge (+ \$40)	DW Designer White	EBNL eLock Brushed Nickel
H A P G B P 1 9 9 T F N E .	S P R 6 .	P .	S .	D W .	E B N L

FUSE™ Pedestal Cushion

OPEN MARKET



Icon Legend on page 19

	DESCRIPTION	MODEL	SHIP WEIGHT	CUBE	FABRIC PRICE CODES			
	Seat Cushion For 19"D Pedestal	HAESC19	6	1.0	1	\$208	8	\$346
					2	\$232	9	\$364
					3	\$256	10	\$382
					4	\$274	11	\$400
					5	\$292	12	\$418
					6	\$310	L	—
					7	\$328		
						Seat Cushion For 23"D Pedestal	HPSEAT24ND	10
2	\$246	9	\$449					
3	\$270	10	\$480					
4	\$294	11	\$511					
5	\$325	12	\$542					
6	\$356	L	—					
7	\$387							





STORAGE

HOW TO SPECIFY

<p>Select Model Number</p> <p>HAESC19 .</p>	<p>Select Fabric</p> <p>See pages 22-24 for seating fabric options</p> <p>CU10</p>
--	---

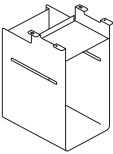
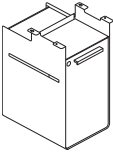

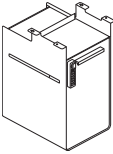
Undermount Storage

	DESCRIPTION	MODEL	SHIP WEIGHT	CUBE	LIST PRICE
	Undermount Storage Cubby NOTES: No need to specify door color or lock option.	HAUFO15N	19	3.3	\$403
	Undermount Storage Cubby with Locking Door Right-Hinged Left-Hinged NOTES: Right-Hinged shown.	HAUFHR15N  HAUFHL15N	24 24	3.3 3.3	\$477 \$477
	Undermount Storage Cubby with Locking Door, eLock Right-Hinged Left-Hinged  Every installation will require one Programming Key and at least one Manager Key.	HAUFHR15NE HAUFHL15NE	24 24	3.3 3.3	\$730 \$730

NOTES:

- Compatible with all HON benching, desking, and height adjustable tables, except where required space is unavailable.
- Ensure weight limit of height adjustable table system is considered before adding undermount storage.
- Open and hinged door units contain a side slot on each side which can be used to hang Workplace Tools.
- Can accommodate two Hot Files, HAEHF, side-by-side.
- 42 lb. storage capacity based on BIFMA loading standards.

 Workplace Tools trays will not fit in cubby.

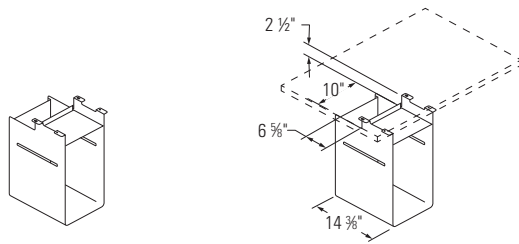

HAUFO15N
Undermount Open Cubby

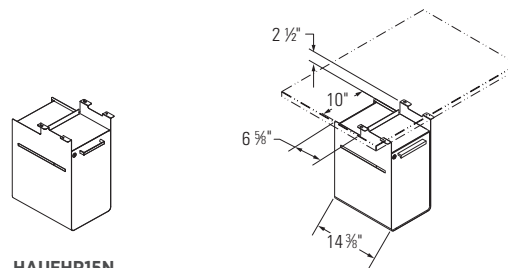

HAUFHR15N
Undermount Storage Cubby
with Locking Door

HOW TO SPECIFY

<p>Select Model Number</p> <p>HAUFO15N</p>	<p>Select Case Color</p> <p>See page 717 P2 upcharge (+ \$18) P3 upcharge (+ \$40)</p> <p>P</p>	<p>Select Door Color</p> <p>See page 717 P2 upcharge (+ \$18) P3 upcharge (+ \$40)</p> <p>S</p>	<p>Select Lock Option</p> <p>L Standard Lock X Omit Lock (deduct \$20) EBNL Digital Lock Brushed Nickel (Specify for eLock models only)</p> <p>L</p>
---	--	--	---

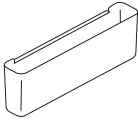
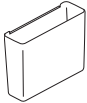
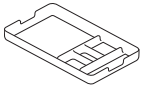
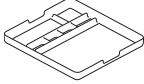

	DESCRIPTION	MODEL	SHIP WEIGHT	CUBE	LIST PRICE
	Side Saddle 12¼"W x 2½"D x 4"H	HAESS	0.6	0.1	\$42
	Hook 1⅝"W x 2¼"D x 3¼"H	HAECBH	0.1	0.1	\$28
	Hot File 12¼"W x 3⅞"D x 9½"H	HAEHF	0.7	1.5	\$62
	Slim Tray 8½"W x 14⅞"D x 1½"H	HAEST	1.0	0.2	\$55
	Large Tray 13½"W x 14⅞"D x 1½"H	HAELT	1.5	0.2	\$62

NOTES:

- Side Saddle and Hot File work on Paper Management Support Bars on page 465.
- Hook weight limit 20 lbs.

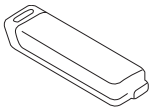
	DESCRIPTION	MODEL	SHIP WEIGHT	CUBE	LIST PRICE
	Digital Keys Digilock Programming Key	HSLDIGPRG	0.8	0.0	\$181
	Digilock Manager Key	HSLDIGMGR	0.8	0.0	\$141
	<p>NOTES: A Programming Key is used to initialize locks out of factory default mode and register Manager Keys to the locks. Manager Keys are used to bypass a locked unit, operating as the "master key" and it is recommended that building facilitators have at least one Manager Key. Up to 6 Manager Keys may be registered to each lock. Manager Keys provide external power to locks in case of battery failure. Programming Key is the same key as Contain® Digilocks and can work across both Contain® and Fuse™.</p> <ul style="list-style-type: none"> ! Only one Programming Key should be specified per installation and multiple Programming Keys are not compatible with each other. ! Add-on digital lock orders should be programmed with the original Programming Key. ! Digital lock user guides and manager programming instructions included. 				

HOW TO SPECIFY

Select Model Number	Select Color
HAESS.	DW Designer White

STORAGE ISLANDS

Want to see more? Scan here
to check out hon.com.



Storage Islands shown with Contain[®] Cubby Lockers, Preside[®] Table, and Cliq[™] Seating.

STORAGE

STORAGE ISLANDS

Time to pack your bags and take flight for an organizational oasis. Storage Islands don't just offer intuitive design and unsurpassed efficiency, they create flexible work suites that will make any project feel like a vacation. Whether you're a creative collaborator or intensely focused on a singular project, these dynamic units are easily customizable with a variety of vibrant color options and offer seamless adaptability to meet the demands of any work day.



FEATURES

- Storage Islands promotes dual-purpose spaces, where functional storage and impromptu collaboration occur simultaneously.
- Clean, straightforward design complements and blends in with any workspace.
- Combine metal, laminate, and color to create a unique and unified look for your office.
- Storage Islands works best with Contain[®] lockers, wardrobes, and Flagship[®] and Brigade[®] laterals.
- Will work with 3-high Flagship[®] and Brigade[®] laterals, bookcases, and storage cabinets along with Contain[®] 42½" lockers and wardrobes.
- Add Storage Islands to existing HON Storage banks or specify in new office configurations.
- Pair storage options to consolidate storage away from the workspace, allowing more room for people to interact, work, and move freely.

STORAGE ISLANDS ORDERING INFORMATION

WORKSURFACES

L1 LAMINATES CODES

Woodgrain

- ◆ Bourbon Cherry H
- ◆ Cognac COGN
- ◆ Florence Walnut LFW1
- ◆ Harvest C
- ◆ Kingswood Walnut LK11
- ◆ Mahogany N
- ◆ Mocha MOCH
- ◆ Natural Maple D
- ◆ Pinnacle PINC
- ◆ Shaker Cherry F
- ◆ Sterling Ash LSA1

Solid

- ◆ Black P
- ◆ Charcoal S
- ◆ Designer White LDW1
- ◆ Loft LOFT

L2 LAMINATES CODES

Woodgrain

- ◆ Lowell Ash LLA1
- ◆ Natural Recon LNR1
- ◆ Phantom Ecru LPE1
- ◆ Portico Teak LPT1
- ◆ Skyline Walnut LSW1

WORKSURFACE EDGE BAND

Woodgrain

- ◆ Bourbon Cherry H
- ◆ Cognac COGN
- ◆ Florence Walnut FW
- ◆ Harvest C
- ◆ Kingswood Walnut KI
- ◆ Lowell Ash DL
- ◆ Mahogany N
- ◆ Mocha MOCH
- ◆ Natural Maple D
- ◆ Natural Recon NR
- ◆ Phantom Ecru PE
- ◆ Pinnacle PINC
- ◆ Portico Teak DP
- ◆ Shaker Cherry F
- ◆ Skyline Walnut SW
- ◆ Sterling Ash SA

Solid

- ◆ Black P
- ◆ Brownstone EY
- ◆ Charcoal S
- ◆ Designer White DW
- ◆ Fossil EH
- ◆ Loft LOFT

O-LEGS

PAINTS CODES

P1

- ◆ Black P
- ◆ Brownstone P7D
- ◆ Charcoal S
- ◆ Designer White PJW
- ◆ Fossil P28
- ◆ Greige T5
- ◆ Loft LOFT
- ◆ Muslin T3
- ◆ Shadow* SHDW
- ◆ Titanium P8T

P2

- ◆ Champagne Metallic T4
- ◆ Platinum Metallic T1
- ◆ Silver PR6
- ◆ Solar Black P8X

P3

- ◆ Amethyst P091
- ◆ Atom P8S
- ◆ Blossom* P8K
- ◆ Bullseye PJF
- ◆ Cabernet* P7T
- ◆ Cobalt Mica P090
- ◆ Conifer* P8H
- ◆ Ember P8P
- ◆ Ion P8N
- ◆ Iris P8J
- ◆ Krypton P8F
- ◆ Ochre P093
- ◆ Regatta P8M
- ◆ Sienna P092
- ◆ Succulent* P8A

* TREND COLORS: These colors are intended to be an inspirational option for the trending market. Product application is limited and color availability is approximately two years to coincide with evolving workplace trends.

◆◆◆ For lead time information see page 19.

* De-emphasized

STORAGE ISLANDS SPECIFYING GUIDE

Top

Available in single depth (18") or double depth (36") surface.

- Select dimensionality based on configuration and the number of undersurface units being spanned.

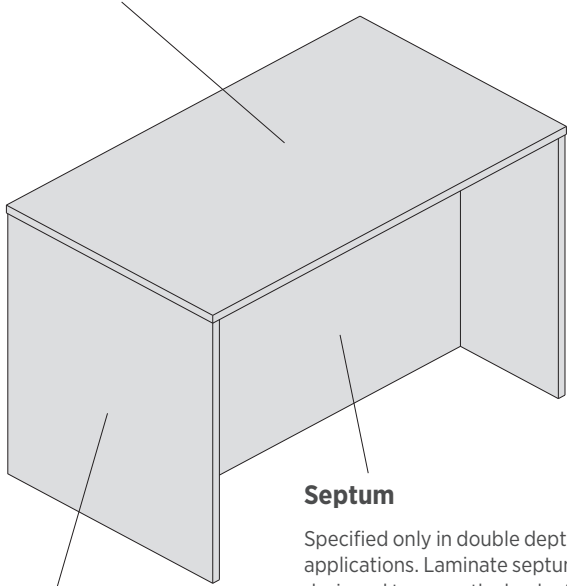

End Panel

Specified in both 18"D and 36"D applications to conceal the sides of storage units.

Septum

Specified only in double depth (36") applications. Laminate septum designed to cover the back of storage units and create a clean countertop application. Septum must be connected to end panels or an adjacent septum.

Back

Specified only in 18"D configurations to conceal the back of storage units.

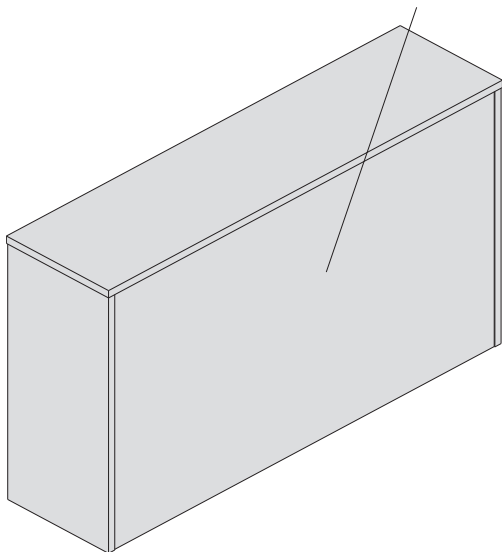

Specifying Islands Top

1. Select top depth.
 - Single (18") or double (36")
2. Select desired Islands configuration.
 - Top only
 - Top + End Panels
 - Top + End Panels + Back or Septum
3. Determine top width.
 - Identify the number of side-to-side storage units the top will cover. This number represents the number of **spans**.

* Note: Front-to-back units do not factor into number of spans. Although top or end panels accept a septum, it is not required to add septum based on application.

Specifying End Panels, Back, or Septum

4. Identify storage units Islands will wrap. This determines correct height.
 - Contain® Height = 40¹/₂"
 - Flagship®/Brigade® Height = 38¹/₂"
5. Specify additional components to complete your Islands configuration.
 - End panels, back, or septum
 - The width and number of units spanned on the septum must match the width and number of units spanned on the top.

Peninsula Applications

Specify an O-Leg or laminate return panel to create an open span collaboration space.

* Note: Under-surface storage must support at least one side of the open span.

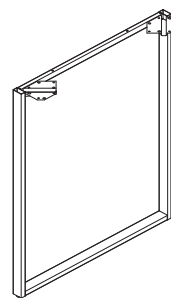

O-Leg

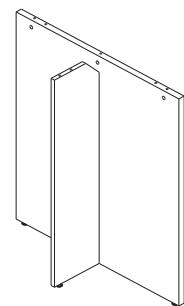

Return Panel

O-Leg & Return Panel

Specified to support open span top in Islands peninsula configuration.

STORAGE ISLANDS SPECIFYING GUIDE

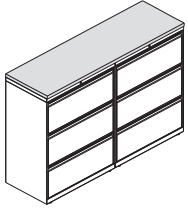

18"D - Single Depth

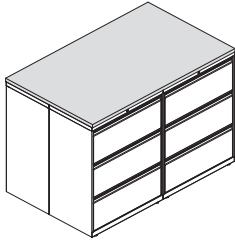

36"D - Double Depth

Light Configuration

Top Only
See page 734 to specify top only.

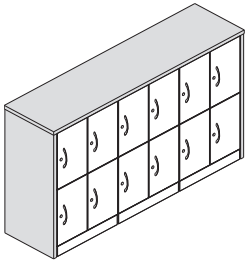

18"D - Single Depth

Medium Configuration

Top + 2 End Panels
See page 735 to specify top designed for end panel configuration.

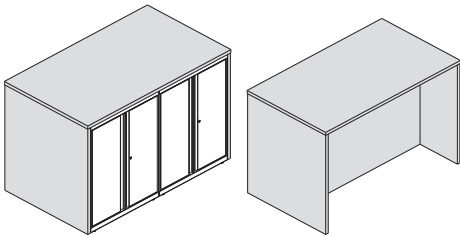

36"D - Double Depth

Heavy Configuration

Top + 2 End Panels + Back (18"D)
Top + 2 End Panels + Septum (36"D)

See page 736 to specify top designed for end panel and back/septum configuration.

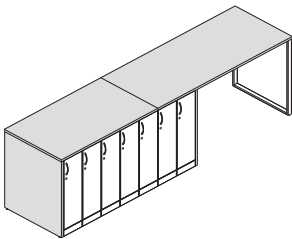

Joined Configuration

Top + 1 End Panel + Septum (36"D)

See page 737 to specify top designed for single end panel and septum configuration.

⚠ This application is designed to join worksurfaces to create a run greater than 84".

NOTES: End panels, backs, septums, and support legs specified separately from tops. See pages 738-739 for specification options.

STORAGE ISLANDS

Planning Typical

QTY	DESCRIPTION	MODEL	LIST PRICE	PRICE EXTENSION
1	Islands Top, Double Depth, Span 2 36"D x 60"W	HSISLAUTNPNB6036S2	\$593	\$593
4	Brigade® Lateral File, 3 Drawer 30"W x 18"D x 39 1/8"H	H873	\$1,267	\$5,068
TOTAL:			\$5,661	

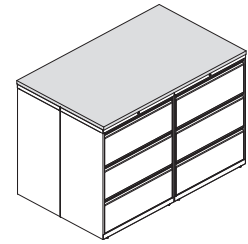

QTY	DESCRIPTION	MODEL	LIST PRICE	PRICE EXTENSION
1	Islands Top for Use w/2 End Panels and Back, Span 3 18"D x 72"W	HSISLAUT2PYB7218S3	\$458	\$458
1	Islands End Panels, Contain® Height, Back, Left 42"H x 18"W	HSISLACEYB1842L	\$220	\$220
1	Islands End Panels, Contain® Height, Back, Right 42"H x 18"W	HSISLACEYB1842R	\$220	\$220
1	Islands Back, Contain® Height, 2 End Panels, Span 3 42"H x 72"W	HSISLACB2P7242S3	\$475	\$475
3	Contain® Quad Locker, Plinth Base 42"H x 24"W x 18"D	HSQLP422418RM	\$1,651	\$4,953
TOTAL:			\$6,326	

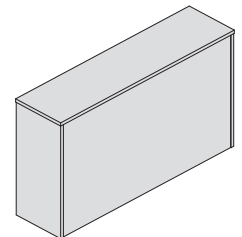
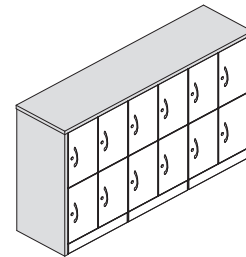

STORAGE

QTY	DESCRIPTION	MODEL	LIST PRICE	PRICE EXTENSION
1	Islands Top for Use w/2 End Panels & Septum, Span 2 36"D x 60"W	HSISLAUT2PYB6036S2	\$711	\$711
2	Islands End Panel, Flagship® Height, Septum 42"H x 36"W	HSISLAFEB3642	\$385	\$770
1	Islands Septum, Flagship® Height, 2 End Panels, Span 2 42"H x 60"W	HSISLAFB2P6042S2	\$405	\$405
2	Flagship® Modular Storage Cabinet 39 1/8"H x 30"W x 18"D	HFMSC183930RWB	\$1,429	\$2,858
TOTAL:			\$4,744	

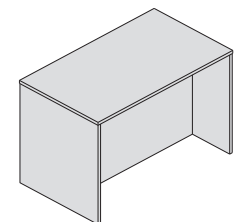
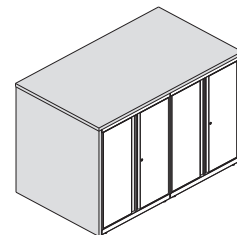

STORAGE ISLANDS

Planning Typical

QTY	DESCRIPTION	MODEL	LIST PRICE	PRICE EXTENSION
1	Islands Top for Use w/2 End Panels and Septum, Span 2 36"D x 84"W	HSISLAUT2PYB8436S2	\$827	\$827
1	Islands End Panel, Flagship® Height, Back 42"H x 36"W	HSISLAFESP3642	\$385	\$385
1	Flagship® Height, Return Panel 42"H x 36"W	HSISLAFESP3642	\$385	\$385
2	Flagship® Bookcase, 3-Shelves 39 1/8"H x 30"W x 18"D	HFSC183640W	\$976	\$1,952
TOTAL:			\$3,549	

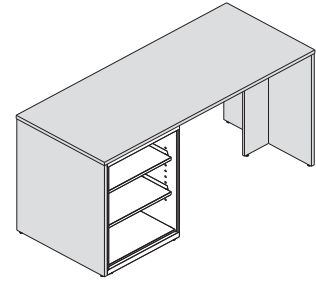

STORAGE

QTY	DESCRIPTION	MODEL	LIST PRICE	PRICE EXTENSION
2	Islands Top for Use w/1 End Panel & Septum, Span 2 36"D x 60"W	HSISLAUT1PYB6036S2	\$681	\$1,362
2	Islands Septum, Flagship® Height, 2 End Panels, Span 2 42"H x 60"W	HSISLAFB2P6042S2	\$405	\$810
2	Islands End Panel, Flagship® Height, Septum 42"H x 36"W	HSISLAFEYB3642	\$385	\$770
4	Flagship® Lateral File, 3 Drawer 39 1/8"H x 30"W x 18"D	H9173(?)	\$1,461	\$5,844
1	Flat Bracket 18"D	HHN831118	\$70	\$70
TOTAL:			\$8,856	

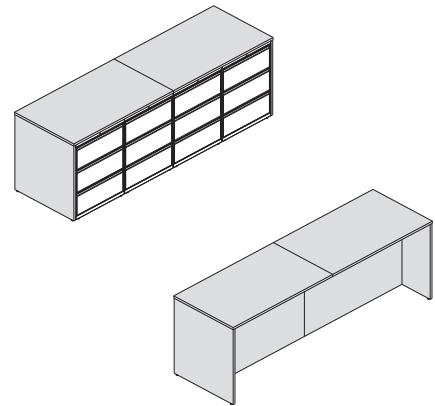

QTY	DESCRIPTION	MODEL	LIST PRICE	PRICE EXTENSION
1	Islands Top, 1 End Panel and Septum, Span 5 36"D x 60"W	HSISLAUT1PYB6036S5	\$681	\$681
2	Islands End Panel, Contain® Height, Back, No Septum 42"H x 36"W	HSISLACEYB3642	\$385	\$770
1	Islands Top, 1 End Panel and Septum, Span 2 36"D x 84"W	HSISLAUT1PYB8436S2	\$792	\$792
1	Islands O-Leg, Contain® Height 42"H x 36"W	HSISLACO3642	\$555	\$555
2	External Stiffener Channel 48"W, for 60" Worksurface	HLSLZ5SC60	\$106	\$212
14	Contain® Wardrobe, Plinth Base 42"H x 12"W x 18"D	HSWP421224RM	\$964	\$13,496
TOTAL:			\$16,506	

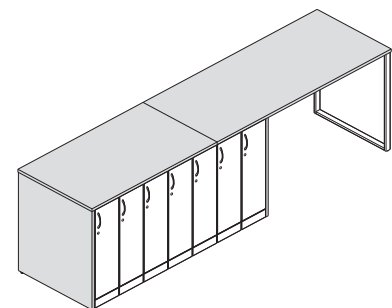

! On joined application, top seam only allowed when supported by storage underneath seam.

STORAGE ISLANDS SPECIFYING GUIDE

WORKING WITH STORAGE ISLANDS WITH CONTAIN® OR FLAGSHIP®/BRIGADE® PRODUCT LINES

Storage Islands come in 2" height variances designed to be used with Contain® or Flagship®/Brigade® product lines. Worksurfaces and end supports are made of 1¼" particleboard with 2mm edgeband and laminate on both sides of all surfaces. Center septums are made of ¾" particleboard with 0.5mm edgeband and laminate on both sides.



	Depths
18"D No Back, No End Panels	18.19
18"D No Back, With End Panels	18.44
18"D Back and End Panels	19.455
36"D No Back, No End Panels	36.69
36"D End Panels	

End Panel Sizes		
	Depths	Height
18"D No Back, Contain®	18.19	40.8
18"D No Back, Flagship®		38.8
18"D With Back, Contain®	19.20	40.8
18"D With Back, Flagship®		38.8
36"D End Panels, Contain®	36.44	40.8
36"D End Panels, Flagship®		38.8

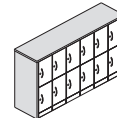
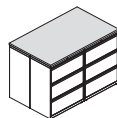

	Width Sizes						
	S1	S2	S3	S4	S5	S6	S7
No End Panels	84.00"	S1 + 0.125	S1 + 0.25	S1 + 0.375	S1 + 0.5	S1 + 0.625	S1 + 0.75
1 End Panel	85.372"						
2 End Panels	86.744"						

*S1 spans a single storage unit, which is noted at the end of the model number. Start with the S1 number displayed in the table above. Depending on your Islands configuration, the top width increases accordingly based on the 2 factors below.

- 1). The number of end panels you attach to the worksurface.
- 2). The number of side-to-side storage units the surface spans.

NOTES:

- Use the width of the worksurface you select. Models correspond to the correct surface width.
- Span represents the total number of side-to-side units. Front-to-back units do not factor into number of units spanned.

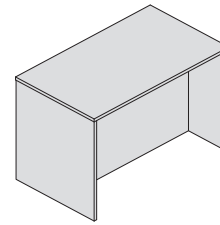

Countertop Application

- When specifying a countertop application, the end of a septum cannot be left open. The septum must connect to an end panel or adjacent septum.

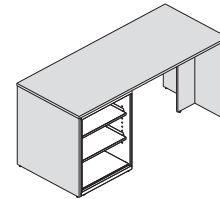

Peninsula Application

- Peninsula applications can only be completed with 36"D worksurfaces and end panels.
- Back-to-back storage specified without an end panel will result in an ~3/8" gap between storage units.
- In a peninsula application, one end of the worksurface must be supported by undersurface storage. The opposing end can be supported with an O-leg or laminate end panel.

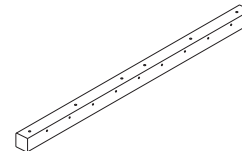

- Unsupported surface runs greater than 54"W require the installation of an external stiffener.
- External stiffener extends 1½" below the worksurface.
- For 36"W surfaces, 2 external stiffeners are needed on the underneath side of the worksurface.

STORAGE ISLANDS

Top Only Applications

OPEN MARKET



Icon Legend on page 19

STORAGE

	DESCRIPTION	MODEL	SHIP WEIGHT	CUBE	LIST PRICE BY LAMINATE GRADE	
					L1	L2
	Islands Tops, Single Depth					
	18"D x 24"W, Spans 1	HSISLAUTNPB2418S1	15	2.0	\$217	\$227
	18"D x 30"W, Spans 1	HSISLAUTNPB3018S1	18	2.5	\$244	\$255
	18"D x 36"W, Spans 1	HSISLAUTNPB3618S1	22	2.9	\$267	\$279
	18"D x 36"W, Spans 3	HSISLAUTNPB3618S3	22	2.9	\$284	\$297
	18"D x 42"W, Spans 1	HSISLAUTNPB4218S1	25	3.3	\$300	\$314
	18"D x 48"W, Spans 1	HSISLAUTNPB4818S1	28	3.8	\$323	\$338
	18"D x 48"W, Spans 2	HSISLAUTNPB4818S2	28	3.8	\$323	\$338
	18"D x 48"W, Spans 4	HSISLAUTNPB4818S4	28	3.8	\$323	\$338
	18"D x 60"W, Spans 1	HSISLAUTNPB6018S1	35	4.7	\$339	\$354
	18"D x 60"W, Spans 2	HSISLAUTNPB6018S2	35	4.7	\$339	\$354
	18"D x 60"W, Spans 5	HSISLAUTNPB6018S5	35	4.7	\$339	\$354
	18"D x 72"W, Spans 1	HSISLAUTNPB7218S1	42	5.6	\$366	\$383
	18"D x 72"W, Spans 2	HSISLAUTNPB7218S2	42	5.6	\$366	\$383
	18"D x 72"W, Spans 3	HSISLAUTNPB7218S3	42	5.6	\$366	\$383
18"D x 72"W, Spans 6	HSISLAUTNPB7218S6	42	5.6	\$366	\$383	
18"D x 84"W, Spans 1	HSISLAUTNPB8418S1	48	6.4	\$394	\$412	
18"D x 84"W, Spans 2	HSISLAUTNPB8418S2	48	6.4	\$394	\$412	
18"D x 84"W, Spans 7	HSISLAUTNPB8418S7	49	6.5	\$394	\$412	
	Islands Tops, Double Depth					
	36"D x 24"W, Spans 1	HSISLAUTNPB2436S1	29	3.8	\$379	\$396
	36"D x 30"W, Spans 1	HSISLAUTNPB3036S1	35	4.6	\$428	\$447
	36"D x 36"W, Spans 1	HSISLAUTNPB3636S1	42	5.3	\$466	\$487
	36"D x 36"W, Spans 3	HSISLAUTNPB3636S3	42	5.4	\$496	\$518
	36"D x 42"W, Spans 1	HSISLAUTNPB4236S1	49	6.2	\$525	\$549
	36"D x 48"W, Spans 1	HSISLAUTNPB4836S1	56	7.0	\$563	\$588
	36"D x 48"W, Spans 2	HSISLAUTNPB4836S2	56	7.0	\$563	\$588
	36"D x 48"W, Spans 4	HSISLAUTNPB4836S4	56	7.0	\$563	\$588
	36"D x 60"W, Spans 1	HSISLAUTNPB6036S1	69	8.6	\$593	\$620
	36"D x 60"W, Spans 2	HSISLAUTNPB6036S2	69	8.6	\$593	\$620
	36"D x 60"W, Spans 5	HSISLAUTNPB6036S5	70	8.7	\$593	\$620
	36"D x 72"W, Spans 1	HSISLAUTNPB7236S1	83	10.3	\$642	\$671
	36"D x 72"W, Spans 2	HSISLAUTNPB7236S2	83	10.3	\$642	\$671
	36"D x 72"W, Spans 3	HSISLAUTNPB7236S3	83	10.3	\$642	\$671
36"D x 72"W, Spans 6	HSISLAUTNPB7236S6	83	10.3	\$642	\$671	
36"D x 84"W, Spans 1	HSISLAUTNPB8436S1	96	11.9	\$688	\$719	
36"D x 84"W, Spans 2	HSISLAUTNPB8436S2	96	11.9	\$688	\$719	
36"D x 84"W, Spans 7	HSISLAUTNPB8436S7	97	12.0	\$688	\$719	

NOTES:

- Top specified to create "light" configuration . See page 730.
- Worksurfaces are made of 1/8" high-performance particleboard with 2mm edgeband and laminate on both sides of all surfaces.
- Grain direction on all worksurfaces runs horizontal.

HOW TO SPECIFY

<p>Select Model Number</p> <p>HSISLAUTNPB6036S5</p>	<p>Select Laminate</p> <p>See page 728</p> <p>LKI1</p>	<p>Select Edge</p> <p>See page 728</p> <p>KI</p>
---	--	--



STORAGE ISLANDS

Tops for Use with 2 End Panels

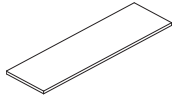

DESCRIPTION	MODEL	SHIP WEIGHT	CUBE	LIST PRICE BY LAMINATE GRADE	
				L1	L2
Islands Tops for use with End Panels 18"D x 24"W, 2 End Panels, Spans 1	HSISLAUT2PNB2418S1	17	2.2	\$260	\$272
18"D x 30"W, 2 End Panels, Spans 1	HSISLAUT2PNB3018S1	20	2.6	\$293	\$306
18"D x 36"W, 2 End Panels, Spans 1	HSISLAUT2PNB3618S1	23	3.1	\$320	\$334
18"D x 36"W, 2 End Panels, Spans 3	HSISLAUT2PNB3618S3	23	3.1	\$326	\$341
18"D x 42"W, 2 End Panels, Spans 1	HSISLAUT2PNB4218S1	27	3.5	\$360	\$376
18"D x 48"W, 2 End Panels, Spans 2	HSISLAUT2PNB4818S2	30	4.0	\$386	\$403
18"D x 48"W, 2 End Panels, Spans 4	HSISLAUT2PNB4818S4	30	4.0	\$386	\$403
18"D x 60"W, 2 End Panels, Spans 2	HSISLAUT2PNB6018S2	37	4.9	\$406	\$424
18"D x 60"W, 2 End Panels, Spans 5	HSISLAUT2PNB6018S5	37	4.9	\$406	\$424
18"D x 72"W, 2 End Panels, Spans 2	HSISLAUT2PNB7218S2	44	5.8	\$439	\$459
18"D x 72"W, 2 End Panels, Spans 3	HSISLAUT2PNB7218S3	44	5.8	\$439	\$459
18"D x 72"W, 2 End Panels, Spans 6	HSISLAUT2PNB7218S6	44	5.8	\$403	\$421
18"D x 84"W, 2 End Panels, Spans 2	HSISLAUT2PNB8418S2	51	6.6	\$473	\$494
18"D x 84"W, 2 End Panels, Spans 7	HSISLAUT2PNB8418S7	51	6.7	\$473	\$494

NOTES:

- Top specified to create "medium" configuration . See page 730.
- Worksurfaces are made of 1 1/8" high-performance particleboard with 2mm edgeband and laminate on both sides of all surfaces.
- Grain direction on all worksurfaces runs horizontal.

STORAGE

HOW TO SPECIFY

<p>Select Model Number</p> <p>HSISLAUT2PNB3618S3</p>	<p>Select Laminate</p> <p>See page 728</p> <p>LKI1</p>	<p>Select Edge</p> <p>See page 728</p> <p>KI</p>
---	---	---

STORAGE ISLANDS

Tops for Use with 2 End Panels and Back/Septum

OPEN MARKET



Icon Legend on page 19

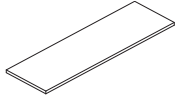

DESCRIPTION	MODEL	SHIP WEIGHT	CUBE	LIST PRICE BY LAMINATE GRADE	
				L1	L2
Islands Tops for Use with 2 End Panels and Back/Septum					
18"D x 48"W, 2 End Panels and Back, Spans 2	HSISLAUT2PYB4818S2	32	4.4	\$403	\$421
18"D x 48"W, 2 End Panels and Back, Spans 4	HSISLAUT2PYB4818S4	32	4.4	\$403	\$421
18"D x 60"W, 2 End Panels and Back, Spans 2	HSISLAUT2PYB6018S2	39	5.4	\$423	\$442
18"D x 60"W, 2 End Panels and Back, Spans 5	HSISLAUT2PYB6018S5	39	5.4	\$423	\$442
18"D x 72"W, 2 End Panels and Back, Spans 2	HSISLAUT2PYB7218S2	46	6.3	\$458	\$479
18"D x 72"W, 2 End Panels and Back, Spans 3	HSISLAUT2PYB7218S3	46	6.3	\$458	\$479
18"D x 72"W, 2 End Panels and Back, Spans 6	HSISLAUT2PYB7218S6	46	6.3	\$458	\$479
18"D x 84"W, 2 End Panels and Back, Spans 2	HSISLAUT2PYB8418S2	53	7.3	\$492	\$514
18"D x 84"W, 2 End Panels and Back, Spans 7	HSISLAUT2PYB8418S7	54	7.3	\$492	\$514
<hr/>					
36"D x 48"W, 2 End Panels and Septum, Spans 2	HSISLAUT2PYB4836S2	59	7.4	\$676	\$706
36"D x 48"W, 2 End Panels and Septum, Spans 4	HSISLAUT2PYB4836S4	59	7.4	\$676	\$706
36"D x 60"W, 2 End Panels and Septum, Spans 2	HSISLAUT2PYB6036S2	72	9.0	\$711	\$743
36"D x 60"W, 2 End Panels and Septum, Spans 5	HSISLAUT2PYB6036S5	73	9.0	\$711	\$743
36"D x 72"W, 2 End Panels and Septum, Spans 2	HSISLAUT2PYB7236S2	86	10.6	\$769	\$804
36"D x 72"W, 2 End Panels and Septum, Spans 3	HSISLAUT2PYB7236S3	86	10.6	\$769	\$804
36"D x 72"W, 2 End Panels and Septum, Spans 6	HSISLAUT2PYB7236S6	86	10.7	\$769	\$804
36"D x 84"W, 2 End Panels and Septum, Spans 2	HSISLAUT2PYB8436S2	99	12.3	\$827	\$864
36"D x 84"W, 2 End Panels and Septum, Spans 7	HSISLAUT2PYB8436S7	100	12.4	\$827	\$864

NOTES:

- Top specified to create "heavy" configuration . See page 730.
- Worksurfaces are made of 1½" high-performance particleboard with 2mm edgeband and laminate on both sides of all surfaces.
- Grain direction on all worksurfaces runs horizontal.

HOW TO SPECIFY

<p>Select Model Number</p> <p>HSISLAUT2PYB6036S2</p>	<p>Select Laminate</p> <p>See page 728</p> <p>LKI1</p>	<p>Select Edge</p> <p>See page 728</p> <p>KI</p>
--	--	--



STORAGE ISLANDS

Islands Tops for Use with 1 End Panel and Septum

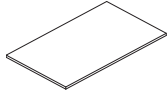

DESCRIPTION	MODEL	SHIP WEIGHT	CUBE	LIST PRICE BY LAMINATE GRADE	
				L1	L2
Islands Tops for Use with One End Panel & Septum					
36"D x 48"W, 1 End Panel and Septum, Spans 2	HSISLAUTIPYB4836S2	57	7.2	\$648	\$677
36"D x 48"W, 1 End Panel and Septum, Spans 4	HSISLAUTIPYB4836S4	57	7.2	\$648	\$677
36"D x 60"W, 1 End Panel and Septum, Spans 2	HSISLAUTIPYB6036S2	71	8.8	\$681	\$712
36"D x 60"W, 1 End Panel and Septum, Spans 5	HSISLAUTIPYB6036S5	71	8.9	\$681	\$712
36"D x 72"W, 1 End Panel and Septum, Spans 2	HSISLAUTIPYB7236S2	84	10.5	\$736	\$769
36"D x 72"W, 1 End Panel and Septum, Spans 3	HSISLAUTIPYB7236S3	84	10.5	\$736	\$769
36"D x 72"W, 1 End Panel and Septum, Spans 6	HSISLAUTIPYB7236S6	85	10.5	\$736	\$769
36"D x 84"W, 1 End Panel and Septum, Spans 2	HSISLAUTIPYB8436S2	98	12.1	\$792	\$828
36"D x 84"W, 1 End Panel and Septum, Spans 7	HSISLAUTIPYB8436S7	98	12.2	\$792	\$828

NOTES:

- Worksurfaces are made of 1½" high-performance particleboard with 2mm edgeband and laminate on both sides of all surfaces.
- Grain direction on all worksurfaces runs horizontal.
- Single end panel application designed to join worksurfaces to create run greater than 84".

DESCRIPTION	MODEL	SHIP WEIGHT	CUBE	LIST PRICE
 <p>Flat Bracket 18"D</p> <p>NOTES: Use the flat bracket in countertop applications where 2 worksurfaces come together and there is not a storage unit or end panel connecting them.</p> <p>ⓘ Available in Charcoal only.</p>	HHN831118	3 ⓘ	0.2	\$70

NOTES:

- Top specified to create "joint" configuration. See page 730.
- ⓘ 36"W with back-to-back storage without an end panel will result in approximately ⅜" exposed gap between storage units.

HOW TO SPECIFY

<p>Select Model Number</p> <p>HSISLAUT1PYB6036S5</p>	<p>Select Laminate</p> <p>See page 728</p> <p>LK11</p>	<p>Select Edge</p> <p>See page 728</p> <p>KI</p>
--	--	--

STORAGE ISLANDS

Islands Septum/Back and End Panels

OPEN MARKET



Icon Legend on page 19

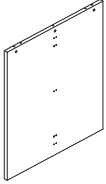

DESCRIPTION	MODEL	SHIP WEIGHT	CUBE	LIST PRICE BY LAMINATE GRADE	
				L1	L2
Islands End Panels, Contain® Height					
42"H x 18"W, Contain® Height, No Back	HSISLACENB1842	24	3.3	\$220	\$230
42"H x 18"W, Contain® Height, Back, Left-Hand	HSISLACEYB1842L	26	3.3	\$220	\$230
42"H x 18"W, Contain® Height, Back, Right-Hand	HSISLACEYB1842R	26	3.3	\$220	\$230
42"H x 36"W, Contain® Height, No Septum	HSISLACEYB3642	45	6.0	\$385	\$402
42"H x 36"W, Contain® Height, Septum	HSISLACESP3642	45	6.0	\$385	\$402
Islands End Panels, Flagship® Height					
42"H x 18"W, Flagship® Height, No Back	HSISLAFENB1842	24	3.1	\$220	\$230
42"H x 18"W, Flagship® Height, Back, Left-Hand	HSISLAFEYB1842L	24	3.1	\$220	\$230
42"H x 18"W, Flagship® Height, Back, Right-Hand	HSISLAFEYB1842R	24	3.1	\$220	\$230
42"H x 36"W, Flagship® Height, No Septum	HSISLAFEYB3642	47	5.7	\$385	\$402
42"H x 36"W, Flagship® Height, Septum	HSISLAFESP3642	47	5.7	\$385	\$402

NOTES: Panels are made of 1/8" high-performance particleboard with 2mm edgeband and laminate on both sides of all surfaces. Grain direction on all End Panels runs vertical. 18"W end panels require selection of right or left model numbers for installation purposes.

! Models HSISLACESP3642 and HSISLAFESP3642 come with short end panel which can be discarded when used as an end panel.

STORAGE

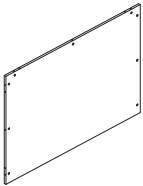

Islands Septum/Back, Contain® Height					
42"H x 48"W, 2 End Panels, Spans 2	HSISLACB2P4842S2	42	8.1	\$368	\$385
42"H x 72"W, 2 End Panels, Spans 3	HSISLACB2P7242S3	63	11.9	\$475	\$496
42"H x 48"W, 2 End Panels, Spans 4	HSISLACB2P4842S4	42	8.1	\$368	\$385
42"H x 60"W, 2 End Panels, Spans 5	HSISLACB2P6042S5	53	10.0	\$405	\$423
42"H x 72"W, 2 End Panels, Spans 6	HSISLACB2P7242S6	63	11.9	\$475	\$496
42"H x 84"W, 2 End Panels, Spans 7	HSISLACB2P8442S7	73	13.8	\$577	\$603
Islands Septum/Back, Flagship® Height					
42"H x 60"W, 2 End Panels, Spans 2	HSISLAFB2P6042S2	50	10.0	\$405	\$423
42"H x 72"W, 2 End Panels, Spans 2	HSISLAFB2P7242S2	59	11.9	\$475	\$496
42"H x 84"W, 2 End Panels, Spans 2	HSISLAFB2P8442S2	69	13.7	\$577	\$603

NOTES: Septums/Backs are made of 3/4" high-performance particleboard with 0.5mm edgeband and laminate on both sides of all surfaces. Grain direction on all Septums/Backs runs horizontal.

NOTES:

- End panels and septum are shipped with mounting hardware included, 1/pack.

HOW TO SPECIFY

<p>Select Model Number</p> <p>HSISLACB2P6042S5</p>	<p>Select Laminate</p> <p>See page 728</p> <p>LK11</p>
--	--



STORAGE ISLANDS

Peninsula Supports

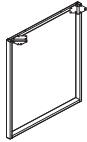

DESCRIPTION

Islands O-Leg
 42”H x 36”W, Contain® Height
 42”H x 36”W, Flagship® Height

MODEL	SHIP WEIGHT	CUBE	LIST PRICE BY PAINT GRADE		
			P1	P2	P3
HSISLACO3642	21	6.8	\$555	\$563	\$575
HSISLAF03642	21	6.8	\$555	\$563	\$575

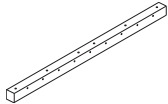

DESCRIPTION

External Support Channel
 42”W for a 54” Open Worksurface Run
 48”W for a 60” Open Worksurface Run
 54”W for a 66” Open Worksurface Run
 60”W for a 72” Open Worksurface Run
 72”W for an 84” Open Worksurface Run

MODEL	SHIP WEIGHT	CUBE	LIST PRICE
HLSLZ5SC54	5	0.5	\$101
HLSLZ5SC60	6	0.5	\$106
HLSLZ5SC66	7	0.5	\$110
HLSLZ5SC72	7	0.5	\$119
HLSLZ5SC84	12	0.7	\$119

NOTES: 36”W surfaces will need 2 external stiffeners on either side of the worksurface.

ⓘ Available in Graphite paint only.

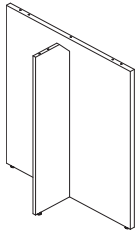

DESCRIPTION

Islands Return Panels
 42”H x 36”W, Contain® Height, Return Panel
 42”H x 36”W, Flagship® Height, Return Panel

MODEL	SHIP WEIGHT	CUBE	LIST PRICE BY LAMINATE GRADE	
			L1	L2
HSISLACESP3642	56	4.6	\$385	\$402
HSISLAFESP3642	58	4.6	\$385	\$402

NOTES:

- Voi® O-legs installed in peninsula application are centered front-to-back on the worksurface. The O-leg will be 1/2” inset from the edge of the worksurface.
- ⓘ When specifying a peninsula application, at least one side of the open worksurface span must be supported with undersurface storage. Islands tops cannot be specified with only O-leg or Laminate Return Panel supports.

HOW TO SPECIFY

<p>Select Model Number</p> <p>H S I S L A C O 3 6 4 2 . T 1</p>	<p>Select Paint/Laminate</p> <p>See page 728</p>
--	--

400 SERIES

Want to see more? Scan here
to check out hon.com.



STORAGE



400 Series Lateral Files.

400 SERIES

Economical 400 Series lateral files from HON offer features not often found on competitors' files, such as a tamper-resistant enclosed base and factory-installed counterweights on two- and four-drawer cabinets to stabilize the center of gravity when a drawer is opened. Even the removable lock core system stands out among higher-priced rivals.



FEATURES

- Lateral files have counterweights for stability and a two-sided lock mechanism that resists tampering.
- Removable lock core can be changed as security needs require.
- Leveling glides compensate for uneven floors.
- Heavy-duty Steel ball-bearing drawer suspensions operate easily and quietly.
- Four vertical reinforcements keep the cabinet sturdy and the drawers gliding smoothly.
- Drawer handle design coordinates with HON Metro Classic Steel desks.

400 SERIES Lateral Files

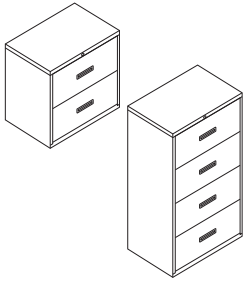

DESCRIPTION

Steel Lateral Files

- 30"W x 18"D x 28"H — 2 Drawer
- 30"W x 18"D x 53½"H — 4 Drawer
- 36"W x 18"D x 28"H — 2 Drawer
- 36"W x 18"D x 53½"H — 4 Drawer

NOTES: Drawers lock. Features ball-bearing slide suspensions.

MODEL	SHIP WEIGHT	CUBE	LIST PRICE
H432	109	12.4	\$864
H434	169	22.1	\$1274
H482	124	12.4	\$903
H484	185	22.1	\$1454

NOTES:

- Reinforced case construction.
- Two adjustable leveling glides in front corners.
- Baked enamel finish.
- Monochromatic drawer pulls.
- **HON 5-Year Limited Warranty.**

STORAGE

HOW TO SPECIFY

<p>Select Model Number</p> <p>H 4 3 2 .</p>	<p>Select Lock Option</p> <p>L Lock</p> <p>L .</p>	<p>Select Paint Color</p> <p>P Black Q Light Gray LOFT Loft L Putty</p> <p>P</p>
--	---	---

VERTICAL FILES

Want to see more? Scan here
to check out hon.com.



310 Series Verticals with Perpetual® Seating.

STORAGE

VERTICAL FILES

Have lots to store but not a lot to spend? HON has a lot of filing solutions to fit your budget. Perfect for small businesses, home and professional offices, schools and more, HON's vertical files are value priced and available in multiple styles and sizes.



FEATURES

- Our vertical filing cabinets offer both legal and letter drawer sizes to accommodate all your filing needs.
- HON One Key core removable locks can be changed or interchanged as security demands change.
- Double-walled front kickplate stands up to impact.
- High drawer sides support hanging file folders, eliminating the need for extra-cost hangrails.

VERTICAL FILES ORDERING INFORMATION

210, 310, H320 & 510 VERTICAL FILES

PAINTS CODES

P1

◆ Black	P
◆ Brownstone	P7D
◆ Charcoal	S
◆ Designer White	PJW
◆ Fossil	P28
◆ Greige	T5
◆ Light Gray	Q
◆ Loft	LOFT
◆ Muslin	T3
◆ Putty	L
◆ Shadow *	SHDW
◆ Titanium	P8T

P2

◆ Champagne Metallic	T4
◆ Platinum Metallic	T1

STORAGE

For Champagne Metallic Paint, Muslin is the suggested edgeband color.

◆◆◆ For lead time information see page 19.

* De-emphasized

210 SERIES Vertical Files

GSA SIN 33721



Icon Legend on page 19



DESCRIPTION

Vertical File — 2 Drawer
15"W x 28½"D x 29"H, Letter
18¼"W x 28½"D x 29"H, Legal

MODEL	SHIP WEIGHT	CUBE	LIST PRICE BY PAINT GRADE		
			P1	P2	P3
H212	65	11.92	\$915	\$943	\$971
H212C	71	14.06	\$1111	\$1139	\$1167

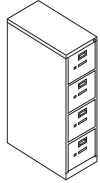

Vertical File — 4 Drawer
15"W x 28½"D x 52"H, Letter
18¼"W x 28½"D x 52"H, Legal

H214	114	19.64	\$1189	\$1234	\$1278
H214C	123	23.18	\$1411	\$1456	\$1500

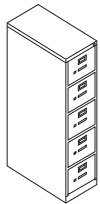

Vertical File — 5 Drawer
15"W x 28½"D x 60"H, Letter
18¼"W x 28½"D x 60"H, Legal

H215	136	22.31	\$1588	\$1633	\$1677
H215C	145	26.33	\$1886	\$1931	\$1975

STORAGE

NOTES:

- High capacity file, 28½" Case depth with 27 front-to-back filing inches per drawer.
- Letter or legal sizes available.
- Three-part, telescoping, steel ball-bearing suspension.
- Bright aluminum drawer pulls, label holders and thumb latch.
- Standard interchangeable core removable locks. Equipped with HON "One Key" system.
- Accepts hanging files. High drawer sides hold hanging file folders without use of hangrails.
- Follower block comes standard.
- Baked enamel finish over rust-inhibiting phosphate pre-treatment.
- See page 748 for Vertical File Accessories.

ⓘ Keyed alike cores must be ordered separately — see page 773.





HOW TO SPECIFY

Select Model Number <div style="border: 1px solid black; padding: 2px; display: inline-block;">H 2 1 2 .</div>	Select Lock Option P Lock <div style="border: 1px solid black; padding: 2px; display: inline-block;">P .</div>	Select Paint Color See page 743 <div style="border: 1px solid black; padding: 2px; display: inline-block;">T 1</div>
--	---	---



Icon Legend on page 19

310 SERIES Vertical Files

	DESCRIPTION	MODEL	SHIP WEIGHT	CUBE	LIST PRICE BY PAINT GRADE		
					P1	P2	P3
	Vertical File — 2 Drawer 15"W x 26½"D x 29"H, Letter 18¼"W x 26½"D x 29"H, Legal	H312  H312C	60 66	9.2 13.2	\$546 \$696	\$574 \$724	\$602 \$752
	Vertical File — 4 Drawer 15"W x 26½"D x 52"H, Letter 18¼"W x 26½"D x 52"H, Legal	H314  H314C	107 116	16.03 21.76	\$742 \$911	\$787 \$956	\$831 \$1000
	Vertical File — 5 Drawer 15"W x 26½"D x 60"H, Letter 18¼"W x 26½"D x 60"H, Legal	H315  H315C	128 137	20.94 24.72	\$1088 \$1300	\$1133 \$1345	\$1177 \$1389

STORAGE

NOTES:

- 26½" Case depth with 25 front-to-back filing inches per drawer.
- Letter or legal sizes available.
- Three-part, telescoping, steel ball-bearing suspension.
- Bright aluminum drawer pulls, label holders and thumb latch.
- Standard interchangeable core removable locks. Equipped with HON "One Key" system.
- Accepts hanging files. High drawer sides hold hanging file folders without use of hangrails.
- Follower block comes standard.
- Baked enamel finish over rust-inhibiting phosphate pre-treatment.
- See page 748 for Vertical File Accessories.

 Keyed alike cores must be ordered separately — see page 773.

HOW TO SPECIFY

<p>Select Model Number</p> <p>H 3 1 2 .</p>	<p>Select Lock Option</p> <p>P Lock</p> <p>P .</p>	<p>Select Paint Color</p> <p>See page 743</p> <p>T 1</p>
--	---	---

510 SERIES Vertical Files

GSA SIN 33721



Icon Legend on page 19



DESCRIPTION

Vertical File — 2 Drawer
15"W x 25"D x 29"H, Letter
18¼"W x 25"D x 29"H, Legal

MODEL	SHIP WEIGHT	CUBE	LIST PRICE BY PAINT GRADE		
			P1	P2	P3
H512	58	8.12	\$479	\$507	\$535
H512C	63	9.71	\$612	\$640	\$668

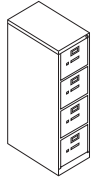

Vertical File — 4 Drawer
15"W x 25"D x 52"H, Letter
18¼"W x 25"D x 52"H, Legal

MODEL	SHIP WEIGHT	CUBE	LIST PRICE BY PAINT GRADE		
			P1	P2	P3
H514	102	17.42	\$645	\$690	\$734
H514C	112	20.65	\$791	\$836	\$880

NOTES:

- 25" Case depth with 23½" front-to-back filing inches per drawer.
- Letter and legal sizes are available.
- Three-part telescoping, ball-bearing steel suspension.
- Bright aluminum drawer pulls, label holders and thumb latch.
- Standard interchangeable core removable locks. Equipped with HON "One Key" system.
- Accepts hanging files. High drawer sides hold hanging file folders without use of hangrails.
- Adjustable wire follower.
- Baked enamel finish over rust-inhibiting phosphate pre-treatment.

Keyed alike cores must be ordered separately — see page 773.





STORAGE

HOW TO SPECIFY

<p>Select Model Number</p> <p>H 5 1 2 .</p>	<p>Select Lock Option</p> <p>P Lock</p> <p>P .</p>	<p>Select Paint Color</p> <p>See page 743</p> <p>T 1</p>
--	---	---

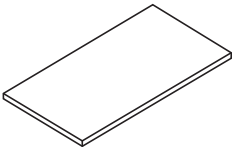
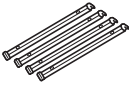

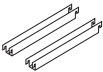
LATERAL FILE ACCESSORIES

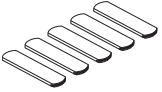

	DESCRIPTION	MODEL	SHIP WEIGHT	CUBE	LIST PRICE
	Square Edge Laminate Top				
	30"W x 18"D x 1/8" Thick	H919430	20.0	1.6	\$451
	36"W x 18"D x 1/8" Thick	H919436	25.0	1.8	\$565
	42"W x 18"D x 1/8" Thick	H919442	30.0	2.1	\$617
	60"W x 18"D x 1/8" Thick	H919460	32.0	3.0	\$780
	66"W x 18"D x 1/8" Thick	H919466	40.0	3.2	\$892
	72"W x 18"D x 1/8" Thick	H919472	48.0	3.5	\$915
NOTES: Compatible with Flagship® and Brigade® 18"D Lateral Files only. Laminate tops are abrasion- and stain-resistant laminate. See Storage Islands pages for broad offering of laminate top options compatible with Contain®, Flagship®, and Brigade®.					
 	Single Rail Hanging File Racks (4/pack)	H919491	1.0	0.4	\$75
	NOTES: For front-to-back filing — 30"W, 36"W and 42"W files. Order one package per drawer for 42"W files. One package will do two 30"W or 36"W file drawers. Racks span between 15 1/4"W rails. Hanging file racks and dividers available in Gray only.				
 Gray only.					
 	Double-Rail Hanging File Racks (2/pack)	H919492	1.5	0.4	\$75
	NOTES: For 3 rows front-to-back — 42"W files. Order one package per drawer. Racks span between 15 1/4"W rails. Hanging file racks and dividers available in Gray only.				
 Gray only.					
	Magnetic Label Holder	H919493	1.6	0.1	\$22
	5 pack				

NOTES:

- Compatible with Flagship®, Brigade® 800, 700, 600, and 500 Series Lateral Files.
- See Contain® Accessories for hanging file racks compatible with Contain® Storage Products.

HOW TO SPECIFY

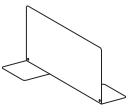

Select Model Number <input type="text" value="H"/> <input type="text" value="9"/> <input type="text" value="1"/> <input type="text" value="9"/> <input type="text" value="4"/> <input type="text" value="3"/> <input type="text" value="0"/> <input type="text" value="."/>	Select Laminate See page 653 <input type="text" value="N"/>
---	--

	DESCRIPTION	MODEL	SHIP WEIGHT	CUBE	LIST PRICE
					P1
	Metal File Divider				
	10 pack	HSCAFD10	12	0.7	\$224
	2 pack	HSCAFD02	3	0.7	\$60
 Metal dividers available in Black only. No need to specify.					

VERTICAL FILE ACCESSORIES



Icon Legend on page 19

	DESCRIPTION	MODEL	SHIP WEIGHT	CUBE	LIST PRICE
 SIN 33721	Follower Block (4/pack)				
	Legal	HF60	8.0	0.6	\$117
	Letter	HF50	7.0	0.5	\$111
  Lock info page 773.	Chrome Core Removable Lock Kit (Field installable)	HF24	0.2	0.2	\$67
	Bulk Package — 6 HF24 Lock Kits (Individually shrink wrapped)	HF246	1.2	0.2	\$310
OPEN MARKET					

STORAGE

HOW TO SPECIFY

Select
Model Number

HF60



Icon Legend on page 19

MOBILE PEDESTALS

	DESCRIPTION	MODEL	SHIP WEIGHT	CUBE	LIST PRICE
	Mobile Pedestal 15"W x 20"D x 28"H, Box/Box/File 15"W x 20"D x 28"H, File/File	HBMP2B HBMP2F	60 60	6.9 6.9	\$579 \$579

NOTES:

- Pencil tray standard in top box drawer.
- One box divider standard in each box drawer.
- One crossrail standard in each file drawer.
- Ball-bearing suspension with 90% extension.
- Steel frame construction for everyday use.
- **HON 5-Year Limited Warranty.**

STORAGE

HOW TO SPECIFY

<p>Select Model Number</p> <p>H B M P 2 B . P</p>	<p>Select Paint Color</p> <p>P Black Q Light Gray L Putty</p> <p>P</p>
--	---



PEDESTAL ACCESSORIES

Icon Legend on page 19

STORAGE

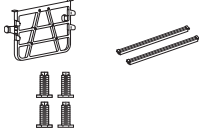
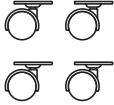
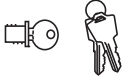

	DESCRIPTION	MODEL	SHIP WEIGHT	CUBE	LIST PRICE
	Counterweight — Freestanding Support Pedestals or Systems Support and Mobile Pedestals	HPCW1	18.0	0.1	\$223
	Follower Block — 1-Pack. Gray only. Double-Rail Hanging File Racks — 2-Pack. Gray only (for side-to-side). Adjustable Glides — 4-Pack Field installable, used to convert mobile pedestals to freestanding support pedestals. NOTES: Hardware included. Compatible with Contain®.	HF80 H519495 H20040AG	1.0 0.5 1.0	0.3 0.5 0.6	\$55 \$39 \$72
	Caster Package — Field Installable Four Casters (2 swivel, 2 fixed) NOTES: Used to convert Freestanding Support Pedestals to Mobile Pedestals. Does not work on Contain® or Flagship® B/F mobile pedestals. ! Not designed to be used on pedestals without a counterweight.	H1050CST	1.0 Ⓢ	0.6	\$51
	Lock Core Replacement Kit — Chrome (Specify quantity of each key number from 101E-225E.) Contains one core, two keys, one core removable tool and instructions. Refer to page 773. SIN 33721 Master Key (one key) — Available to authorized dealers only. OPEN MARKET	HF23C HF22	0.1 Ⓢ 0.1 Ⓢ	0.1 0.1	\$49 \$30

NOTES:
• Compatible with Flagship®, Brigade® and Systems Support Pedestals.

HOW TO SPECIFY

Select Model Number

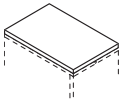
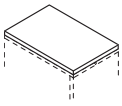
H F 2 3 C

	DESCRIPTION	MODEL	SHIP WEIGHT	CUBE	FABRIC PRICE CODES																												
 OPEN MARKET	Pedestal Seat 15"W x 18"D x 2"H NOTES: For seating fabrics, see pages 22-24. Works with Contain® and Flagship® Pedestals and Mobile Pedestals.	HPSEAT18ND	16.3 Ⓢ	0.9	<table border="0"> <tr><td>1</td><td>\$189</td><td>8</td><td>\$385</td></tr> <tr><td>2</td><td>\$213</td><td>9</td><td>\$416</td></tr> <tr><td>3</td><td>\$237</td><td>10</td><td>\$447</td></tr> <tr><td>4</td><td>\$261</td><td>11</td><td>\$478</td></tr> <tr><td>5</td><td>\$292</td><td>12</td><td>\$509</td></tr> <tr><td>6</td><td>\$323</td><td>L</td><td>—</td></tr> <tr><td>7</td><td>\$354</td><td></td><td></td></tr> </table>	1	\$189	8	\$385	2	\$213	9	\$416	3	\$237	10	\$447	4	\$261	11	\$478	5	\$292	12	\$509	6	\$323	L	—	7	\$354		
1	\$189	8	\$385																														
2	\$213	9	\$416																														
3	\$237	10	\$447																														
4	\$261	11	\$478																														
5	\$292	12	\$509																														
6	\$323	L	—																														
7	\$354																																
 OPEN MARKET 	Pedestal Seat 15"W x 22 7/8"D x 2"H NOTES: For seating fabrics, see pages 22-24. Works with Contain® and Flagship® Pedestals and Mobile Pedestals.	HPSEAT24ND	10.0 Ⓢ	1.2	<table border="0"> <tr><td>1</td><td>\$222</td><td>8</td><td>\$418</td></tr> <tr><td>2</td><td>\$246</td><td>9</td><td>\$449</td></tr> <tr><td>3</td><td>\$270</td><td>10</td><td>\$480</td></tr> <tr><td>4</td><td>\$294</td><td>11</td><td>\$511</td></tr> <tr><td>5</td><td>\$325</td><td>12</td><td>\$542</td></tr> <tr><td>6</td><td>\$356</td><td>L</td><td>—</td></tr> <tr><td>7</td><td>\$387</td><td></td><td></td></tr> </table>	1	\$222	8	\$418	2	\$246	9	\$449	3	\$270	10	\$480	4	\$294	11	\$511	5	\$325	12	\$542	6	\$356	L	—	7	\$387		
1	\$222	8	\$418																														
2	\$246	9	\$449																														
3	\$270	10	\$480																														
4	\$294	11	\$511																														
5	\$325	12	\$542																														
6	\$356	L	—																														
7	\$387																																

HOW TO SPECIFY

Select Model Number

Select Fabric

See pages 22-24 for seating fabric options

H P S E A T 2 4 . A P N 2 3



PEDESTAL ACCESSORIES

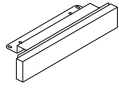

DESCRIPTION

Flush Front Kick Plate
For 28"H Flagship® Pedestals

MODEL	SHIP WEIGHT	CUBE	LIST PRICE BY PAINT GRADE		
			P1	P2	P3
HKP2800	3 Ⓞ	0.2	\$130	\$138	\$143

NOTES:

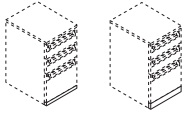

- Mounts to base of pedestal to provide a flush appearance to coordinate with laterals, file centers and storage towers.
- Kick plate is field installable.

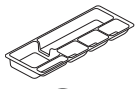

DESCRIPTION

Optional Pencil Tray

NOTES: For additional information see the Workplace Tools section in the 2021 Shared Spaces Pricer.

- ⓘ For use with mobile and freestanding pedestal models.
- ⓘ No specification required.

MODEL	SHIP WEIGHT	CUBE	LIST PRICE
HV-UT1	0.5	0.1	\$77

STORAGE

HOW TO SPECIFY

Select Model Number

H K P 2 8 0 0 .

Select Paint Color

See page 653

P

LAMINATE BOOKCASES

Want to see more? Scan here
to check out hon.com.



STORAGE

1870 Series Bookcases.



LAMINATE BOOKCASES

These sturdy laminate bookcases coordinate with most HON laminate desks. The scratch-, spill- and stain-resistant laminate will ensure that they keep their good looks.

1870 SERIES FEATURES

- Shelves adjust on 1/4" increments.
- Leveling glides keep them nicely aligned, even if the floor isn't.
- Easy to assemble, using high-precision cam-locks and wood dowels, with no glue needed.



10500 SERIES FEATURES

- Ship fully assembled and ready to use.
- Adjustable leveling glides compensate for uneven floors.
- Available in a broad palette of laminate colors.



BOOKCASES ORDERING INFORMATION

10500 SERIES™ BOOKCASES

L1 LAMINATES CODES

Woodgrain

- ◆ Bourbon Cherry H
- ◆ Cognac COGN
- ◆ Florence Walnut LFW1
- ◆ Harvest C
- ◆ Kingswood Walnut LK11
- ◆ Mahogany N
- ◆ Mocha MOCH
- ◆ Natural Maple D
- ◆ Pinnacle PINC
- ◆ Shaker Cherry F
- ◆ Sterling Ash LSA1

Solid

- ◆ Black P
- ◆ Charcoal S
- ◆ Designer White LDW1
- ◆ Loft LOFT

Patterned Top*

- ◆ Handspun Chestnut LAHC
- ◆ Handspun Dove LAHD
- ◆ Handspun Pearl LAHP
- ◆ Handspun Slate LAHS
- ◆ Sheer Mesh * A5
- ◆ Silver Mesh B9
- ◆ Canyon Zephyr * K9
- ◆ Desert Zephyr * K8
- ◆ Grey Tigris * L6

L2 LAMINATES CODES

Woodgrain

- ◆ Lowell Ash LLA1
- ◆ Natural Recon LNR1
- ◆ Phantom Ecru LPE1
- ◆ Portico Teak LPT1
- ◆ Skyline Walnut LSW1

1870 SERIES BOOKCASES

L1 LAMINATES CODES

Woodgrain

- ◆ Cognac COGN
- ◆ Harvest C
- ◆ Mahogany N

10500 Series™ Laminate Bookcases

- Available Laminate Colors:

Woodgrain	Solid	Patterned Top*	Two-Tone (Top/Chassis)
Top and edgingband are the same, chassis is different laminate color:			
L1 Laminates: Bourbon Cherry (HH) Cognac (COGNCOGN) Florence Walnut (LFWILFW1) Harvest (CC) Kingswood Walnut (LK11LK11) Mahogany (NN) Mocha (MOCHMOCH) Natural Maple (DD) Pinnacle (PINCPINC) Shaker Cherry (FF) Sterling Ash (LSA1LSA1)	Black (PP) Charcoal (SS) Designer White (LDWILDW1) Loft (LOFTLOFT)	Canyon Zephyr (K9) Desert Zephyr (K8) Grey Tigris (L6) Handspun Chestnut (LAHC) Handspun Dove (LAHD) Handspun Pearl (LAHP) Handspun Slate (LAHS) Sheer Mesh (A5) Silver Mesh (B9)	Black/Charcoal (PS) Black/Designer White (PLDW1) Black/Loft (PLOFT) Bourbon Cherry/Black (HP) Bourbon Cherry/Charcoal (HS) Bourbon Cherry/Designer White (HLDW1) Bourbon Cherry/Loft (HLOFT) Charcoal/Black (SP) Charcoal/Designer White (SLDW1) Cognac/Black (COGNP) Cognac/Charcoal (COGNS) Cognac/Designer White (COGNLDW1) Cognac/Loft (COGNLOFT) Designer White/Black (LDWIP) Designer White/Bourbon Cherry (LDW1H) Designer White/Charcoal (LDW1S) Designer White/Cognac (LDW1COGN) Designer White/Harvest (LDW1C) Designer White/Loft (LDW1LOFT) Designer White/Lowell Ash (LDW1LLA1O) Designer White/Mahogany (LDW1N) Designer White/Mocha (LDW1MOCH) Designer White/Natural Maple (LDW1D) Designer White/Natural Recon (LDW1LNR1) Designer White/Phantom Ecru (LDW1LPE1) Designer White/Pinnacle (LDW1PIN) Designer White/Portico Teak (LDW1LPT1) Designer White/Shaker Cherry (LDW1F) Designer White/Skyline Walnut (LDW1LSW1) Florence Walnut/Black (LFW1P) Florence Walnut/Charcoal (LFW1S) Florence Walnut/Designer White (LFW1LDW1) Florence Walnut/Loft (LFW1LOFT) Harvest/Black (CP) Harvest/Charcoal (CS) Harvest/Designer White (CLDW1) Harvest/Loft (CLOFT) Kingswood Walnut/Black (LK11P) Kingswood Walnut/Charcoal (LK11S) Kingswood Walnut/Designer White (LK11LDW1) Kingswood Walnut/Loft (LK11LOFT) Loft/Black (LOFTP) Loft/Charcoal (LOFTS) Loft/Designer White (LOFTLDW1) Lowell Ash/Black (LLA1P) Lowell Ash/Charcoal (LLA1S) Lowell Ash/Designer White (LLA1LDW1) Lowell Ash/Loft (LLA1LOFT)
L2 Laminates: Lowell Ash (LLA1) Natural Recon (LNR1) Phantom Ecru (LPE1) Portico Teak (LPT1) Skyline Walnut (LSW1)		*Patterned Laminates are available with the following chassis/edgingband laminate selection: Black (P) Bourbon Cherry (H) Charcoal (S) Designer White (LDW1) Florence Walnut (LFW1) Harvest (CC) Kingswood Walnut (LK11) Loft (LOFT) Mahogany (N) Natural Maple (D) Shaker Cherry (F) Sterling Ash (LSA1)	Edgebanding around top will match chassis laminate color selected.

Patterned Top

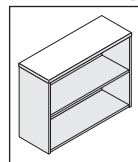

Edgeband Around Top/Laminate Base

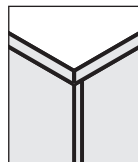

Two-Tone Laminate Top/Edgebanding

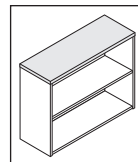

Laminate Base

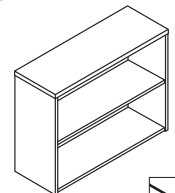
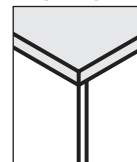

Square Corner Edge Detail



* NOTE: For patterned top laminates, select one of the following for the edgeband around the top, the shelves and vertical panels — Black (P), Bourbon Cherry (H), Charcoal (S), Cognac (COGN), Designer White (DW), Florence Walnut (LFW1), Harvest (C), Kingswood Walnut (LK11), Mahogany (N), Mocha (MOCH), Natural Maple (D), Pinnacle (PIN), Shaker Cherry (F), and Sterling Ash (LSA1).

◆◆◆ For lead time information see page 19.

* De-emphasized

10500 SERIES™ Laminate Bookcases

GSA SIN 33721



Icon Legend on page 19

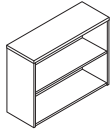

DESCRIPTION

Laminate Bookcase

- 36"W x 13¹/₈"D x 29³/₈"H, 2-Shelf
- 36"W x 13¹/₈"D x 43³/₈"H, 3-Shelf
- 36"W x 13¹/₈"D x 57¹/₈"H, 4-Shelf
- 36"W x 13¹/₈"D x 71"H, 5-Shelf

MODEL	SHIP WEIGHT	CUBE	L1 LIST PRICE	L2 LIST PRICE
H105532	90	11.0	\$503	\$518
H105533	122	15.6	\$639	\$659
H105534	156	20.2	\$753	\$778
H105535	187	25.1	\$875	\$905

NOTES: Ships fully assembled. Fixed shelves. Inside shelf dimensions on all units are 33¹/₈"W x 11¹⁵/₁₆"D x 12¹⁵/₁₆"H.

NOTES:

- 10500 Series™ Caseloads smooth, flat edge detail (see pages 274-325) complements many furniture designs.
- Fully finished back.
- Replaces 1980 Series Laminate Bookcases.
- Bottom shelf, top and end panels are 1¹/₈" thick. Interior shelves are 3³/₄" thick.
- All surfaces finished in abrasion- and stain-resistant thermal-fused laminate over solid core high-performance particleboard.
- Adjustable hex leveling glides allow floor-standing bookcases to be easily leveled without lifting the unit; glides have 3³/₄" adjustable range.

STORAGE

HOW TO SPECIFY

<p>Select Model Number</p> <p>H 1 0 5 5 3 2 .</p>	<p>Select Laminate</p> <p>See page 753</p> <p>N N</p>
---	---



1870 SERIES Laminate Bookcases

	DESCRIPTION	MODEL	SHIP WEIGHT	CUBE	LIST PRICE
	Laminate Bookcase				
	36"W x 11½"D x 29⅞"H, 2-Shelf (1 adjustable)	H1871	48	1.5	\$268
	36"W x 11½"D x 36⅞"H, 3-Shelf (2 adjustable)	H1872	60	1.7	\$297
	36"W x 11½"D x 48¾"H, 4-Shelf (3 adjustable)	H1874	77	2.6	\$359
	36"W x 11½"D x 60⅞"H, 5-Shelf (3 adjustable)	H1875	92	2.8	\$421
	36"W x 11½"D x 72⅝"H, 6-Shelf (4 adjustable)	H1876	109	3.4	\$483
	36"W x 11½"D x 84"H, 6-Shelf (4 adjustable)	H1877	124	4.5	\$549
	Set of doors with hinges used to conceal lower shelf contents				
	36"W x 25¾"H	H1801	23 Ⓞ	1.0	\$222

NOTES:

- Square edge profile complements many different furniture designs.
- Abrasion- and stain-resistant laminate, over durable solid core, high-performance particleboard.
- ¾" thick shelves adjust in ¼" increments to suit a variety of storage needs (two shelves are fixed in 5- and 6-shelf units).
- Cam-lock fasteners and wood dowels ensure pieces go together easily and precisely.
- Equipped with four adjustable leveling glides.
- Shelves will deflect under large amounts of weight.
- ⅛" hardboard back panel.
- All bookcases are 36"W x 11½"D.
- Optional doors available to conceal lower shelf contents.
- Easy-to-assemble instructions included.

! Designed to be used in small office-home office applications.

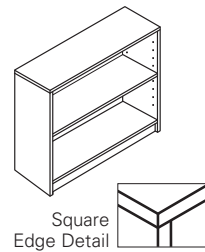

STORAGE

HOW TO SPECIFY

<p>Select Model Number</p> <p>H 1 8 7 1 . N</p>	<p>Select Laminate</p> <p>COGN Cognac C Harvest N Mahogany</p>
--	--

NOTES

STORAGE

ACOUSTIC SOLUTIONS

by unika vaev

Want to see more? Scan here
to check out hon.com.



**Drift ecoustic® Flat Surface Tiles shown
with Flock® Dual Fabric Square Chair.**

UNIKA VAEV

The workplace as we know it is evolving. With the increasing popularity of open concept layouts, the need for creative ways to divide space and absorb sound is greater than ever. Introducing HON acoustics by Unika Vaev. We've partnered with one of the most trusted brands in the acoustic industry to bring you several of their most popular models from their standard collection. This partnership will fulfill the growing need for sound absorption in the workplace by providing proven acoustic solutions sold by HON.

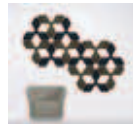

FEATURES

- Choose from wall, ceiling, and freestanding acoustic products.
- Unique shapes and designs allow for a functional and customized space.
- Freestanding and select hanging models allow for a creative way to divide your space.
- Blend in or stand out with multiple finish options.
- Products ship directly from Unika Vaev.
- Follows HON standard freight terms.
- Please see HON.com for care and installation guide.
- **HON 5-Year Limited Warranty.**

UNIVERSAL SCREENS

ACOUSTIC SOLUTIONS ORDERING INFORMATION

	ecoustic® Felt	Solid Core	Salsa	Dox	Fraster Felt
Wall Mounted Tiles					
e3 Collection		•			
ecoustic® Foliar	•				
ecoustic® Linear	•				
ecoustic® Matrix	•				
ecoustic® Torque	•				
Ceiling-Mounted Tiles					
ecoustic® Arbor Alto		•			
ecoustic® Ceiling Flats		•			
ecoustic® Matrix	•				
ecoustic® Torque	•				
ecoustic® Measure Baffles		•			
Hanging Screens					
ScreenTrak® Bass Collection	•				
ScreenTrak® Alto		•			
Free-standing Screens					
MixMax					•
Softline			•	•	

(02/2020)

ScreenTrak and ecoustic are registered trademarks of Unika Vaev.

ACOUSTIC SOLUTIONS ORDERING INFORMATION

ECOUSTIC*

Lemon*	EF15
Baltic*	EF36
Nautical**	EF41
Paprika*	EF53
Berry*	EF55
Aqua*	EF62
Field*	EF68
Aubergine*	EF76
Fossil*	EF78
Dove**	EF87
Oyster**	EF88
Quartz*	EF92
Spray**	EF63
Cameo**	EF19
Caper*	EF64
Charcoal*	EF79
Cobalt*	EF35
Cream**	EF94
Fresco**	EF65
Green*	EF67
Indigo*	EF40
Jet*	EF80
Light Grey*	EF81
Lime*	EF66
Natural**	EF95
Oatmeal**	EF89
Opal**	EF93
Orange*	EF52
Pewter*	EF91
Red*	EF54
Yellow*	EF10
White**	EF96
Taupe*	EF90
Sky**	EF39

SOLID CORE

Almond	DAL1
Arizona	DAZ1
Bluebell	DBB1
Cool	DCL1
Galaxy	DGX1
Iris	DRS1
Leaf	DLF1
Oxide	DXD1
Snowdrop	DSW1
Tungsten	DTG1
Venus	DVN1
Denim	DDM1
Fawn	DFN1
Horizon	DHN1
Olive	DLV1

SALSA

Light Grey	SL30
Blue	SL31
Dark Mid Grey	DL32
Yellow	SL33
Dark Yellow	SL34
Green	SL35
Mid Grey	SL36
Pink	SL39
Dark Blue	SL40
Light Pink	SL54
Green	SL55
Brown	SL56
Beige	SL57

DOX

Black	DOX50
Dark Grey	DOX51
Middle Grey	DOX52
Light Grey	DOX53

FRASTER FELT

Red	FF102
Orange	FF105
Ochre	FF130
Wine	FF136
Off White	FF150
Beige	FF160
Silver	FF170
Charcoal	FF175
Beaver	FF190
Deer	FF220
Truffle	FF250
Mint	FF262
Curry	FF274
Azur	FF312
Citrus	FF398
Banana	FF399
Dust Green	FF415
Black	FF426
Aubergine	FF437
Moss	FF448
Sepia	FF463
Tomato	FF484
Flamingo	FF534
Midnight	FF539
Ocean	FF540
Sky	FF541







To view these options in the HON Surface Materials Guide visit hon.com/fabrics-and-finishes.

* Applied over Black solid core on ScreenTrak® Bass Hanging Screens.
** Applied over White solid core on ScreenTrak® Bass Hanging Screens.

ACOUSTIC SOLUTIONS

Wall

OPEN MARKET

	DESCRIPTION	MODEL	SHIP WEIGHT	CUBE	LIST PRICE
	e3 Solid Core Parallelogram 8¾" x 7½" x ½", Box of 15	HUVPAWT	5.0	0.2	\$995
	e3 Solid Core Triangle 8¾" Equilateral Sides, Box of 30	HUVTRWT	5.2	0.6	\$995
	e3 Solid Core Rectangle 8¾" x 17½", Box of 7	HUVREWT	5.4	1.0	\$995
	e3 Solid Core Large Square 8¾" x 8¾", Box of 15	HUVLSWT	5.2	0.6	\$946
	e3 Solid Core Small Square 2¼" x 2¼", Box of 60	HUVSSWT	5.2	0.6	\$946
	e3 Solid Core Wave 17½" x 8½", Box of 8	HUVVWWT	5.2	0.6	\$995
	e3 Solid Core Hexagon 17½" x 15¼", Box of 5	HUVHEWT	5.2	0.6	\$995



NOTES:

- Tiles sold in sets of individual shapes. Tiles can be arranged and combined to form larger and more intricate shapes. Attaches to wall by adhesive backing that ships already applied to the tiles.

Content: 100% PET (>50% Recycled PET)

Application: Wall

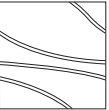
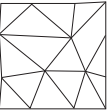
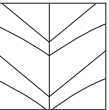
NRC: 0.40

	DESCRIPTION	MODEL	SHIP WEIGHT	CUBE	LIST PRICE
	Drift ecoustic® Wall Tiles 19¼"W x 19¼"H x 1¼"D, 8 per box NOTES: Attaches via wall clips. Content: 100% PET (>50% Recycled PET) Application: Wall NRC: 0.85	HUVDRT	13.2	4.3	\$3212
	Matrix ecoustic® Wall Tiles 19¼"W x 19¼"H x 1½"D, 8 per box NOTES: Attaches via wall clips. Content: 100% PET (>50% Recycled PET) Application: Wall NRC: 0.90	HUVMAWT	13.2	4.3	\$3212
	Torque ecoustic® Wall Tiles 22½"W x 22½"H x 1½"D, 8 per box NOTES: Attaches via wall clips. Content: 100% PET (>50% Recycled PET) Application: Wall NRC: 0.80	HUVTOWT	15.4	5.3	\$3212
	Foliar ecoustic® Wall Tiles 17½"W x 19¼"H x 2¾"D, 5 per box NOTES: Attachment plastic frame screws to the wall. Content: 100% PET (>50% Recycled PET) Application: Wall NRC: 0.80	HUVFOWT	9.0	3.0	\$2596

HOW TO SPECIFY

Select Model Number	Select Material
	See page 758 Specify ecoustic® Felt for Wall Tiles and PET Solid Core for e3 Tiles
H U V D R W T .	E F 5 2

ACOUSTIC SOLUTIONS

Ceiling Tiles and Screens

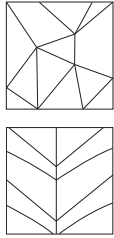

DESCRIPTION

Matrix ecoustic® Ceiling Tiles
 23⁷/₁₆"W x 23³/₁₆"H x 2⁹/₁₆"D, Pack of 8 tiles
 47¹/₁₆"W x 23⁷/₁₆"H x 2⁹/₁₆"D, Pack of 8 tiles

Torque ecoustic® Ceiling Tiles
 23³/₈"W x 23³/₈"H x 1⁷/₈"D, Pack of 8 tiles
 47¹/₁₆"W x 23³/₈"H x 1⁷/₈"D, Pack of 8 tiles

NOTES: Matrix and Torque tile packs contain groups of eight solid colors. Fits directly into 2' x 2' or 2' x 4' drop ceiling grid. Tiles replace ceiling tiles already in the grid. Tiles slide into grid at an angle and are held in by the edge of the tile. No hardware is needed.
 Content: 100% PET (>50% Recycled PET)
 Application: Ceiling
 NRC: 0.80 (Torque), 0.75 (Matrix)

MODEL SHIP WEIGHT CUBE LIST PRICE

HUVMAWT24	15.4	5.3	\$3277
HUVMAWT48	30.9	10.7	\$4932
HUVTOWT24	15.4	5.3	\$3277
HUVTOWT48	30.9	10.7	\$4932

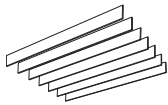

Measure Baffles

47"W x 10³/₄"H
 96"W x 10³/₄"H

NOTES: Ships 4 per box with 4' hanging cords. Attaches via ceiling brackets (not included). Attachment hardware to ceiling should be procured by installers.
 Content: 100% PET
 Application: Ceiling
 NRC: 0.80

HUVMBHS48	15.0	0.8	\$1258
HUVMBHS96	30.0	1.6	\$1580

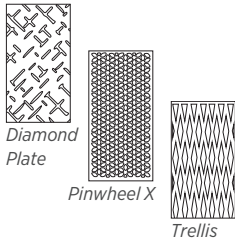

ScreenTrak® Bass Hanging Screen — Felt

95"H x 46"W x 1/2"D, Diamond Plate
 95"H x 46"W x 1/2"D, Pinwheel X
 95"H x 46"W x 1/2"D, Trellis

NOTES: Solid core with felt on top — black or white solid core is automatically assigned to each color. See page 758 for color/felt applications.

HUVSTBHS D	17.4	2.7	\$2587
HUVSTBHS P	17.4	2.7	\$2587
HUVSTBHS T	17.4	2.7	\$2587

ScreenTrak® Alto Hanging Screen — Solid Color Core

95"H x 46"W x 1/2"D, Diamond Plate
 95"H x 46"W x 1/2"D, Pinwheel X
 95"H x 46"W x 1/2"D, Trellis

NOTES: Ships with 10' hanging cords.

⚠ Ceiling attachment is not included due to many ceiling types and materials. Attachment hardware to ceiling should be procured by installers.
 Content: 100% PET (>50% Recycled PET)
 Application: Vertical Surfaces/Screens
 NRC: 0.20

HUVSTAHS D	17.4	2.7	\$2305
HUVSTAHS P	17.4	2.7	\$2305
HUVSTAHS T	17.4	2.7	\$2305

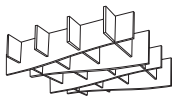

Arbor Alto ecoustic® Hanging Screen — Solid Color Core

48"H x 48"W x 4¹/₄"-7¹/₄"D

NOTES: Kit format contains 8 fins and 4' hanging cords.

⚠ Ceiling attachment is not included due to many ceiling types and materials. Attachment hardware to ceiling should be procured by installers.
 Content: 100% PET
 Application: Ceiling
 NRC: 0.80

HUVA AHS	15.0	0.8	\$1344
-----------------	------	-----	---------------



ecoustic® Ceiling Flats

24" x 24", Box of 16
 24" x 48", Box of 8

NOTES: Fits directly into 2' x 2' or 2' x 4' dropped ceiling grid. Flats replace ceiling tiles already in the grid. Tiles slide into grid at an angle and are held in by the edge of the tile. No hardware is needed.
 Content: 100% PET (>50% Recycled PET)
 Application: Ceiling
 NRC: 0.85
 Tiles are .47" thick.

HUVCFCT24	15.4	5.3	\$2355
HUVCFCT48	30.9	10.7	\$2503

HOW TO SPECIFY

<p>Select Model Number</p> <p>H U V S T A H S P</p>	<p>Select Felt/Solid Core</p> <p>See pages 758-759</p> <p>D L F 1</p>
--	--

UNIVERSAL SCREENS

ACOUSTIC SOLUTIONS

Floor Screens

OPEN MARKET

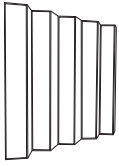

DESCRIPTION

MixMax
55"W x 59"H
63"W x 59"H

MODEL

HUVMF55
HUVMF63

SHIP WEIGHT

19.8
22.7

CUBE

24.4
24.4

LIST PRICE

\$3876
\$4282

NOTES:

- Available in one solid color. For multicolor options contact HON Tailored Solutions.
- Content: 100% 3mm Wool Felt exterior. 100% Foamed PVC Plate interior.
- Application: Floor Screen
- NRC: 0.80

UNIVERSAL SCREENS

HOW TO SPECIFY

Select
Model Number

Select
Fraster Felt

See pages 758-759

H U V M M F S 5 5 .

F F 1 3 0

ACOUSTIC SOLUTIONS Floor Screens

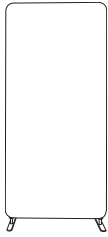

DESCRIPTION

Softline Floor Screen with Leg Set

32"W x 54"H
32"W x 59"H
32"W x 67"H

40"W x 54"H
40"W x 59"H
40"W x 67"H

47"W x 54"H
47"W x 59"H
47"W x 67"H

NOTES: Legs allow for screens to be freestanding.

Softline Floor Screen with Leg Set and Casters

32"W x 54"H
32"W x 59"H
32"W x 67"H

40"W x 54"H
40"W x 59"H
40"W x 67"H

47"W x 54"H
47"W x 59"H
47"W x 67"H

NOTES: Casters allow screens to be mobile.

MODEL

SHIP WEIGHT

CUBE

LIST PRICE

HUVSLFS3254L 25 12.5 **\$1392**
HUVSLFS3259L 30 12.5 **\$1629**
HUVSLFS3267L 35 12.5 **\$1798**

HUVSLFS4054L 27 10.4 **\$1551**
HUVSLFS4059L 33 10.4 **\$1749**
HUVSLFS4067L 38 10.4 **\$1928**

HUVSLFS4754L 30 7.8 **\$1681**
HUVSLFS4759L 36 7.8 **\$1871**
HUVSLFS4767L 43 7.8 **\$2022**

HUVSLFS3254LC 26 12.5 **\$1457**
HUVSLFS3259LC 31 12.5 **\$1692**
HUVSLFS3267LC 36 12.5 **\$1863**

HUVSLFS4054LC 28 10.4 **\$1616**
HUVSLFS4059LC 34 10.4 **\$1813**
HUVSLFS4067LC 39 10.4 **\$1992**

HUVSLFS4754LC 31 7.8 **\$1745**
HUVSLFS4759LC 37 7.8 **\$1936**
HUVSLFS4767LC 44 7.8 **\$2087**

NOTES:

- Softline is manufactured on the basis of technical, environmental, and production ethical requirements. There are no emissions to air, water, or land during the production of Softline. The sound-absorbent core of Softline contains recycled materials. Materials in Softline screens are recyclable, either as material recycling or energy recovery.
- Softline screens are 2" thick.
- Core Content: 100% Mineral Wool
- Frame Content: 100% Pine
- Base Content: 100% Steel lacquered in Black, Gray, or White
- Application: Floor Screen
- NRC: 0.75
- Each screen ships with one in-line connector.
- Screen legs prohibit screens from sitting directly at an L-, T-, or X-connection. Space must be provided to prevent legs from overlapping.

UNIVERSAL SCREENS

HOW TO SPECIFY

<p>Select Model Number</p> <p>H U V S L F S 4 0 5 4 L .</p>	<p>Select Fabric</p> <p>See page 759</p> <p>S L 4 0 .</p>	<p>Select Paint Color</p> <p><i>Specify on screens with legs and legs with casters only</i></p> <p>SVR Silver WHTT White Texture BLKT Black Texture</p> <p>W H T T</p>
--	--	--

DESKTOP SCREENS ORDERING INFORMATION

DESKTOP PET

PET	CODES
◆ Dark Blue	DDB1
◆ Green	DGN1
◆ Dark Gray	DGY4
◆ Medium Gray	DGY3

EMPOWER® SCREEN BRACKETS

PAINTS	CODES
P1	
◆ Black	P71
◆ Brownstone	P7D
◆ Charcoal	S
◆ Designer White	PJW
◆ Fossil	P28
◆ Greige	T5
◆ Light Gray	Q
◆ Loft	LOFT
◆ Muslin	T3
◆ Putty	L
◆ Shadow *	SHDW
◆ Titanium	P8T
P2	
◆ Champagne Metallic	T4
◆ Platinum Metallic	T1
◆ Silver	PR6
◆ Solar Black	P8X
P3	
◆ Atom	P8S
◆ Bullseye	PJF
◆ Ember	P8P
◆ Ion	P8N
◆ Iris	P8J
◆ Krypton	P8F
◆ Regatta	P8M

GRAVITATION™ SCREEN BRACKETS

PAINTS	CODES
P1	
◆ Black	P71
◆ Brownstone	P7D
◆ Charcoal	P02
◆ Designer White	PJW
◆ Fossil	P28
◆ Greige	T5
◆ Light Gray	Q
◆ Loft	LOFT
◆ Muslin	T3
◆ Putty	L
◆ Shadow *	SHDW
◆ Titanium	P8T
P2	
◆ Champagne Metallic	T4
◆ Silver	PR6
◆ Solar Black	P8X
P3	
◆ Atom	P8S
◆ Bullseye	PJF
◆ Ember	P8P
◆ Ion	P8N
◆ Iris	P8J
◆ Krypton	P8F
◆ Regatta	P8M

◆◆◆ For lead time information see page 19.

* De-emphasized



Icon Legend on page 19

DESKTOP SCREENS

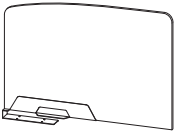
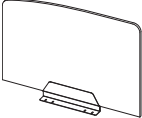
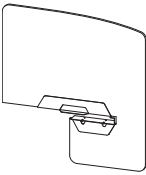
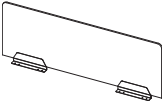
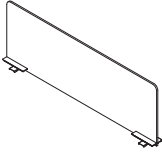
	DESCRIPTION	MODEL	SHIP WEIGHT	CUBE	LIST PRICE
	Coordinate™ Side/Middle Desktop PET Screens				
	23¼"W x 13"H	HUVDSSM1324	3.0	1.5	\$214
	29¼"W x 13"H	HUVDSSM1330	3.3	1.8	\$252
	23¼"W x 20"H	HUVDSSM2024	3.6	2.3	\$252
	29¼"W x 20"H	HUVDSSM2030	4.1	2.7	\$296
	Coordinate™ Side/End Desktop PET Screens				
	23¼"W x 13"H	HUVDSSE1324	3.0	1.5	\$239
	29¼"W x 13"H	HUVDSSE1330	3.0	1.8	\$278
	23¼"W x 20"H	HUVDSSE2024	3.5	2.3	\$278
	29¼"W x 20"H	HUVDSSE2030	4.1	2.7	\$315
NOTES: Screen attachment method involves screwing into the underside of the worksurface.					
	Coordinate™ Pacman PET Screens				
	23¼"W x 13"H, for 23"D Surfaces	HUVDPS1324	5.7	1.8	\$285
	29¼"W x 13"H, for 29"D Surfaces	HUVDPS1330	6.2	2.1	\$335
	23¼"W x 20"H, for 23"D Surfaces	HUVDPS2024	6.3	2.7	\$335
	29¼"W x 20"H, for 29"D Surfaces	HUVDPS2030	7.0	3.2	\$394
NOTES: Screen extends 6" from front of surface and 9" below surface.					
	Coordinate™ Above Desktop PET Screens				
	46"W x 13"H	HUVDSAO1348	5.0	2.7	\$401
	58"W x 13"H	HUVDSAO1360	5.6	3.3	\$445
	70"W x 13"H	HUVDSAO1372	6.2	4.0	\$494
	46"W x 20"H	HUVDSAO2048	6.2	4.1	\$501
	58"W x 20"H	HUVDSAO2060	7.1	5.0	\$556
	70"W x 20"H	HUVDSAO2072	8.0	5.9	\$617
NOTES: Screen attachment method involves screwing into the underside of the worksurface. Brackets can be positioned as needed to clear worksurface supports.					
	Empower® Desktop Screens				
	46"W x 13"H	HUVDSAOEM1348	5.0	2.7	\$511
	58"W x 13"H	HUVDSAOEM1360	5.6	3.3	\$555
	70"W x 13"H	HUVDSAOEM1372	6.2	4.0	\$605
	46"W x 20"H	HUVDSAOEM2048	6.2	4.1	\$611
	58"W x 20"H	HUVDSAOEM2060	7.1	5.0	\$666
	70"W x 20"H	HUVDSAOEM2072	8.0	5.9	\$728
NOTES: Specify PET and Bracket Paint, see page 764. P2 upcharge + \$4, P3 upcharge + \$20. Brackets can be positioned as needed to clear worksurface supports.					

NOTES:

- PET material is 12mm thick.
- Brackets painted in PR8 Silver.
- Brackets and screens ship in same box.
- PET material is tackable.

HOW TO SPECIFY

<p>Select Model Number</p> <p>H U V D S S M 1 3 3 0 .</p>	<p>Select PET Desktop</p> <p>See page 764</p> <p>D G Y 3 .</p>	<p>Select Paint Color</p> <p>PR6 Silver</p> <p>P R 6</p>
--	---	---

DESKTOP SCREENS

DESCRIPTION

MODEL

SHIP WEIGHT

CUBE

LIST PRICE

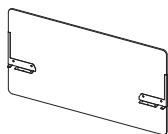

Coordinate™ Above/Below PET Screens

46"W x 32"H, 13"H Above
58"W x 32"H, 13"H Above
70"W x 32"H, 13"H Above

HUVDSHAB4813	9.7 Ⓢ	6.3	\$766
HUVDSHAB6013	11.0	7.7	\$851
HUVDSHAB7213	12.8	9.1	\$945

46"W x 32"H, 20"H Above
58"W x 32"H, 20"H Above
70"W x 32"H, 20"H Above

HUVDSHAB4820	9.7 Ⓢ	6.3	\$766
HUVDSHAB6020	11.0	7.7	\$851
HUVDSHAB7220	12.8	9.1	\$945

NOTES: Screen attachment method involves screwing into the underside of the worksurface.

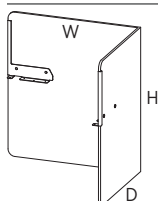

Coordinate™ Above/Below "L" PET Screens

23¼"D x 23"W x 32"H, 13"H Above, Right Hand
23¼"D x 29"W x 32"H, 13"H Above, Right Hand
23¼"D x 35"W x 32"H, 13"H Above, Right Hand

HUVABLS2424R	9.2	6.3	\$880
HUVABLS3024R	9.9	7.0	\$929
HUVABLS3624R	9.9	7.7	\$978

29¼"D x 23"W x 32"H, 20"H Above, Right Hand
29¼"D x 29"W x 32"H, 20"H Above, Right Hand
29¼"D x 35"W x 32"H, 20"H Above, Right Hand

HUVABLS2430R	10.6	6.3	\$1068
HUVABLS3030R	10.6	7.0	\$1124
HUVABLS3630R	10.6	7.7	\$1228

23¼"D x 23"W x 32"H, 13"H Above, Left Hand
23¼"D x 29"W x 32"H, 13"H Above, Left Hand
23¼"D x 35"W x 32"H, 13"H Above, Left Hand

HUVABLS2424L	9.2	6.3	\$880
HUVABLS3024L	9.9	7.0	\$929
HUVABLS3624L	9.9	7.7	\$978

29¼"D x 23"W x 32"H, 20"H Above, Left Hand
29¼"D x 29"W x 32"H, 20"H Above, Left Hand
29¼"D x 35"W x 32"H, 20"H Above, Left Hand

HUVABLS2430L	10.6	6.3	\$1068
HUVABLS3030L	10.6	7.0	\$1124
HUVABLS3630L	10.6	7.7	\$1228

NOTES: Screen attachment method includes screwing into the underside of the worksurface.

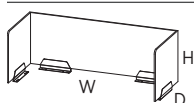

Coordinate™ Above "U" PET Screens

23¼"D x 46"W x 13"H
23¼"D x 58"W x 13"H
23¼"D x 70"W x 13"H

HUVAUS482413	12.0	4.0	\$988
HUVAUS602413	12.6	4.6	\$1039
HUVAUS722413	13.2	5.2	\$1095

23¼"D x 46"W x 20"H
23¼"D x 58"W x 20"H
23¼"D x 70"W x 20"H

HUVAUS482420	14.5	5.9	\$1235
HUVAUS602420	15.4	6.8	\$1299
HUVAUS722420	16.3	7.7	\$1370

29¼"D x 46"W x 13"H
29¼"D x 58"W x 13"H
29¼"D x 70"W x 13"H

HUVAUS483013	12.6	4.0	\$1082
HUVAUS603013	13.2	4.6	\$1133
HUVAUS723013	13.7	5.2	\$1189

29¼"D x 46"W x 20"H
29¼"D x 58"W x 20"H
29¼"D x 70"W x 20"H

HUVAUS483020	15.4	5.9	\$1351
HUVAUS603020	16.3	6.8	\$1415
HUVAUS723020	17.1	7.7	\$1486

NOTES: Screen attachment method involves screwing into the underside of the worksurface.

Ⓢ Screens are for use with Coordinate™ and Empower® Height Adjustable.

DESCRIPTION

MODEL

SHIP WEIGHT

CUBE

LIST PRICE BY PAINT GRADE

P1

P2

P3

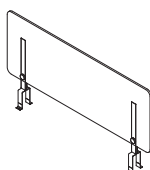

Gravitation™ Beam PET Screen

46"W x 20"H
58"W x 20"H
70"W x 20"H

HUVDSBS2048	3.5 Ⓢ	4.1	\$621	\$625	\$641
HUVDSBS2060	4.4 Ⓢ	5.0	\$679	\$683	\$699
HUVDSBS2072	5.3 Ⓢ	5.9	\$842	\$846	\$862

NOTES: Specify PET and Bracket Paint, see page 764. Brackets and screen ship in separate boxes.

NOTES:

- PET material is 12mm thick.
- Brackets painted in PR8 Silver.
- Brackets and screens ship in same box except for Gravitation™ Beam PET Screens.
- PET material is tackable.

HOW TO SPECIFY

Select Model Number H U V D S H A B 6 0 1 3	Select PET Desktop See page 764 D G Y 3	Select Paint Color PR6 Silver P R 6
---	--	--

UNIVERSAL SCREENS ORDERING INFORMATION

METAL TABLE SCREENS AND BRACKETS

PAINTS CODES

P1

◆ Black	P71
◆ Brownstone	P7D
◆ Charcoal	P02
◆ Designer White	PJW
◆ Fossil	P28
◆ Greige	T5
◆ Light Grey	Q
◆ Loft	LOFT
◆ Muslin	T3
◆ Putty	L
◆ Shadow *	SHDW
◆ Titanium	P8T

P2

◆ Champagne Metallic	T4
◆ Platinum Metallic	T1
◆ Silver	PR6
◆ Solar Black	P8X

P3

◆ Amethyst	P091
◆ Atom	P8S
◆ Blossom	P8K
◆ Bullseye	PJF
◆ Cabernet *	P7T
◆ Cobalt Mica	P090
◆ Conifer *	P8H
◆ Ember	P8P
◆ Ion	P8N
◆ Iris	P8J
◆ Krypton	P8F
◆ Ochre	P093
◆ Regatta	P8M
◆ Sienna	P092
◆ Succulent	P8A

P6

◆ Markerboard	MKB
---------------------	-----

* De-emphasized

UNIVERSAL SCREENS

Table Screens

OPEN MARKET

ABI

Icon Legend on page 19

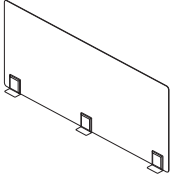
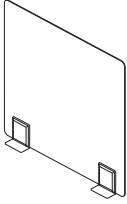
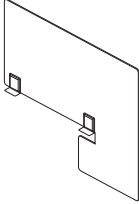
	DESCRIPTION	MODEL	SHIP WEIGHT	CUBE	LIST PRICE BY PAINT GRADE			
					P1	P2	P3	P6
	Metal Table Screen							
	20"H x 45½"W, for 48"W Surfaces	HMTLSCRN2048	36.4	5.5	\$684	\$704	\$724	\$784
	20"H x 51½"W, for 54"W Surfaces	HMTLSCRN2054	39.7	6.1	\$718	\$738	\$758	\$818
	20"H x 57½"W, for 60"W Surfaces	HMTLSCRN2060	43.1	6.7	\$755	\$775	\$795	\$855
	20"H x 63½"W, for 66"W Surfaces	HMTLSCRN2066	46.4	7.3	\$792	\$812	\$832	\$892
	25"H x 45½"W, for 48"W Surfaces	HMTLSCRN2548	42.8	6.7	\$752	\$772	\$792	\$852
	25"H x 51½"W, for 54"W Surfaces	HMTLSCRN2554	46.9	7.4	\$790	\$810	\$830	\$890
	25"H x 57½"W, for 60"W Surfaces	HMTLSCRN2560	51.1	8.2	\$829	\$849	\$869	\$929
	25"H x 63½"W, for 66"W Surfaces	HMTLSCRN2566	55.3	9.0	\$871	\$891	\$911	\$971
		Metal Lateral Screen						
20"H x 21"D, for 24"D Surfaces		HMTLSCRN2024	19.5	3.0	\$473	\$493	\$513	\$573
20"H x 25"D, for 27"-30"D Surfaces		HMTLSCRN2030	21.6	3.4	\$497	\$517	\$537	\$597
20"H x 36"D, for 36"D Surfaces		HMTLSCRN2036	26.6	4.3	\$521	\$541	\$561	\$621
25"H x 21"D, for 24"D Surfaces		HMTLSCRN2524	22.4	3.7	\$520	\$540	\$560	\$620
25"H x 25"D, for 30"D Surfaces		HMTLSCRN2530	25.0	4.2	\$547	\$567	\$587	\$647
25"H x 34"D, for 36"D Surfaces		HMTLSCRN2536	31.3	5.3	\$575	\$595	\$615	\$675
	Metal Extended Screen							
	20"H x 33½"D, for 24"D Surfaces	HMTLEXSCRN2036	61.2	5.7	\$629	\$649	\$669	\$729
	20"H x 37"D, for 30"D Surfaces	HMTLEXSCRN2042	65.9	6.3	\$661	\$681	\$701	\$761
	25"H x 33½"D, for 24"D Surfaces	HMTLEXSCRN2536	71.6	6.6	\$693	\$713	\$733	\$793
	25"H x 37"D, for 30"D Surfaces	HMTLEXSCRN2542	77.4	7.3	\$727	\$747	\$767	\$827

NOTES:

- Metal screens are single-piece steel construction.
- Screens mount by using double stick tape, which provides the ability to mount to any surface.
- Extended Screen can be used on all HON products including Voi®, Empower®, and Coordinate™ Height Adjustable Tables. Extended screen can also be used on any 2½" thick or under surface with 5"D clear space underneath.
- Minimum mounting clearance on top of worksurface at each bracket location is 3"W x 1½"D.

HOW TO SPECIFY

<p>Select Model Number</p> <p>HMTLSCRN2054</p>	<p>Select Frame Paint</p> <p>See page 767</p> <p>P8T</p>	<p>Select Bracket Paint</p> <p>NA No Specification Needed, matches Frame Paint</p> <p>NA</p>
--	--	--



UNIVERSAL SCREENS

Table Screens

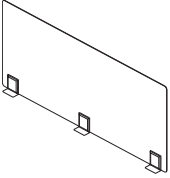
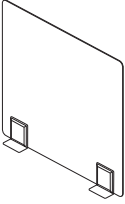
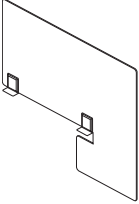
	DESCRIPTION	MODEL	SHIP WEIGHT	CUBE	LIST PRICE BY PAINT GRADE			
					P1	P2	P3	P6
	Acrylic Table Screen							
	20”H x 45½”W, for 48”W Surfaces	HACRYSCRN2048	8.0	5.5	\$616	\$628	\$634	N/A
	20”H x 51½”W, for 54”W Surfaces	HACRYSCRN2054	12.0	6.1	\$647	\$659	\$665	N/A
	20”H x 57½”W, for 60”W Surfaces	HACRYSCRN2060	14.0	6.7	\$679	\$691	\$697	N/A
	20”H x 63½”W, for 66”W Surfaces	HACRYSCRN2066	15.0	7.3	\$713	\$725	\$731	N/A
	25”H x 45½”W, for 48”W Surfaces	HACRYSCRN2548 ☹	15.0	6.7	\$678	\$690	\$696	N/A
	25”H x 51½”W, for 54”W Surfaces	HACRYSCRN2554 ☹	18.0	7.4	\$711	\$723	\$729	N/A
	25”H x 57½”W, for 60”W Surfaces	HACRYSCRN2560 ☹	20.0	8.2	\$747	\$759	\$765	N/A
	25”H x 63½”W, for 66”W Surfaces	HACRYSCRN2566 ☹	21.0	9.0	\$784	\$796	\$802	N/A
		Acrylic Lateral Screen						
20”H x 21”D, for 24”D Surfaces		HACRYSCRN2024	5.0	3.0	\$426	\$434	\$438	N/A
20”H x 25”D, for 27”-30”D Surfaces		HACRYSCRN2030	5.0	3.4	\$448	\$456	\$460	N/A
20”H x 36”D, for 36”D Surfaces		HACRYSCRN2036	6.0	4.3	\$470	\$478	\$482	N/A
25”H x 21”D, for 24”D Surfaces		HACRYSCRN2524 ☹	6.0	3.7	\$469	\$477	\$481	N/A
25”H x 25”D, for 30”D Surfaces		HACRYSCRN2530 ☹	8.0	4.2	\$491	\$499	\$503	N/A
25”H x 34”D, for 36”D Surfaces		HACRYSCRN2536 ☹	11.0	5.3	\$516	\$524	\$528	N/A
	Acrylic Extended Screen							
	20”H x 33½”D, for 24”D Surfaces	HACRYEXSCRN2036	7.0	5.7	\$568	\$576	\$580	N/A
	20”H x 37”D, for 30”D Surfaces	HACRYEXSCRN2042 ☹	9.0	6.3	\$595	\$603	\$607	N/A
	25”H x 33½”D, for 24”D Surfaces	HACRYEXSCRN2536	12.0	6.6	\$623	\$631	\$635	N/A
	25”H x 37”D, for 30”D Surfaces	HACRYEXSCRN2542	14.0	7.3	\$655	\$663	\$667	N/A

NOTES:

- Screens mount by using double stick tape, which provides the ability to mount to any surface.
- Extended Screen can be used on all HON products including Voi®, Empower®, and Coordinate™ Height Adjustable Tables. Extended screen can also be used on any 2½” thick or under surface with 5”D clear space underneath.
- Minimum mounting clearance on top of worksurface at each bracket location is 3”W x 1½”D.

HOW TO SPECIFY

<p>Select Model Number</p> <p>H A C R Y S C R N 2 0 5 4 .</p>	<p>Select Bracket Paint</p> <p>See page 767</p> <p>P 8 T</p>
--	---

UNIVERSAL SCREENS

Plexi-Glass Screens

OPEN MARKET



Icon Legend on page 19

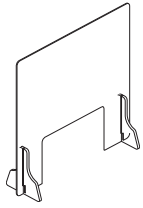

DESCRIPTION

Plexi-Glass Screens with Pass-Thru Opening

36''H x 30''W
36''H x 36''W
36''H x 48''W

MODEL

HHC-TASCRN3630 ⓘ
HHC-TASCRN3636 ⓘ
HHC-TASCRN3648

SHIP WEIGHT

13
15
19

CUBE

1.4
1.1
1.5

LIST PRICE

\$494
\$505
\$516

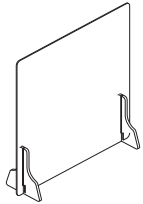

Plexi-Glass Screens without Pass-Thru Opening

24''H x 30''W
24''H x 36''W
24''H x 48''W

H-TASCRN2430
H-TASCRN2436
H-TASCRN2448

10
11
14

1.0
1.2
1.6

\$443
\$451
\$469

36''H x 30''W
36''H x 36''W
36''H x 48''W

H-TASCRN3630 ⓘ
H-TASCRN3636 ⓘ
H-TASCRN3648

13
15
19

1.4
1.1
1.5

\$494
\$505
\$516

NOTES:

- Screens ship with two black stands each.
- Screen stand is 11''D x 12''H.
- Pass-thru opening is 20''W x 12''H.

- ! Easy to assemble, no tools required.
- ! Unit is freestanding and does not need to be fixed to any surface.

UNIVERSAL SCREENS

HOW TO SPECIFY



Select
Model Number

H H C - T A S C R N 3 6 3 6



UNIVERSAL SCREENS

Floor Screens

	DESCRIPTION	MODEL	SHIP WEIGHT	CUBE	LIST PRICE BY PAINT GRADE		
					P1	P2	P3
	Freestanding Acrylic Floor Screens						
	60"H x 36"W	HFHACRYSCRN6036	55	6.1	\$1090	\$1106	\$1114
	60"H x 48"W	HFHACRYSCRN6048	60	8.0	\$1211	\$1227	\$1235
	72"H x 36"W	HFHACRYSCRN7236	62	7.4	\$1195	\$1211	\$1219
	72"H x 48"W	HFHACRYSCRN7248	65	9.6	\$1327	\$1343	\$1351
	Freestanding Twin-wall Polycarbonate Floor Screens						
	60"H x 48"W	HFHPCSCRN6048	62	8.0	\$909	\$925	\$933
	72"H x 48"W	HFHPCSCRN7248	65	9.6	\$992	\$1008	\$1016

NOTES:

- Screens ship in single cartons.
- Adjustable glides included.
- ! Screens are not made to accept casters.
- ! Twin-wall Polycarbonate is partially opaque, acrylic is clear.

HOW TO SPECIFY

<p>Select Model Number</p> <p>HFHACRYSCRN6048 .</p>	<p>Select Paint Color</p> <p>See page 767</p> <p>PR6</p>
---	--

UNIVERSAL SCREENS

Panel Stackers

OPEN MARKET



Icon Legend on page 19

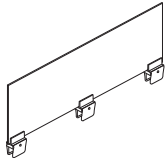

DESCRIPTION

Universal Panel Stackers

15"H x 22"W
15"H x 28"W
15"H x 34"W
15"H x 40"W
15"H x 46"W
15"H x 52"W
15"H x 58"W
15"H x 64"W
15"H x 70"W
15"H x 76"W
15"H x 82"W
15"H x 88"W
15"H x 94"W

MODEL

HPNLSTACK1524
HPNLSTACK1530
HPNLSTACK1536
HPNLSTACK1542
HPNLSTACK1548
HPNLSTACK1554
HPNLSTACK1560
HPNLSTACK1566
HPNLSTACK1572
HPNLSTACK1578
HPNLSTACK1584
HPNLSTACK1590
HPNLSTACK1596

SHIP WEIGHT

CUBE

LIST PRICE BY PAINT GRADE

P1 P2 P3

13.0 1.5 \$380 \$388 \$392
15.0 1.8 \$423 \$431 \$435
17.0 2.1 \$474 \$482 \$486
19.0 2.5 \$524 \$536 \$542
21.0 2.8 \$586 \$598 \$604
24.0 3.2 \$613 \$625 \$631
27.0 3.5 \$634 \$646 \$652
29.0 3.9 \$735 \$751 \$759
31.0 4.2 \$779 \$795 \$803
34.0 4.6 \$824 \$840 \$848
36.0 4.9 \$868 \$884 \$892
38.0 5.3 \$946 \$966 \$976
40.0 5.6 \$1007 \$1027 \$1037

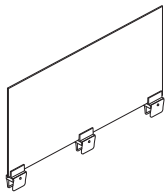

22"H x 22"W
22"H x 28"W
22"H x 34"W
22"H x 40"W
22"H x 46"W
22"H x 52"W
22"H x 58"W
22"H x 64"W
22"H x 70"W
22"H x 76"W
22"H x 82"W
22"H x 88"W
22"H x 94"W

HPNLSTACK2224 Ⓞ
HPNLSTACK2230 Ⓞ
HPNLSTACK2236 Ⓞ
HPNLSTACK2242 Ⓞ
HPNLSTACK2248 Ⓞ
HPNLSTACK2254 Ⓞ
HPNLSTACK2260 Ⓞ
HPNLSTACK2266
HPNLSTACK2272
HPNLSTACK2278
HPNLSTACK2284
HPNLSTACK2290
HPNLSTACK2296

17.0 1.9 \$428 \$436 \$440
20.0 2.4 \$479 \$487 \$491
23.0 2.9 \$535 \$543 \$547
26.0 3.3 \$592 \$604 \$610
29.0 3.8 \$660 \$672 \$678
32.0 4.3 \$693 \$705 \$711
35.0 4.7 \$717 \$729 \$735
38.0 5.2 \$830 \$846 \$854
41.0 5.6 \$880 \$896 \$904
44.0 6.1 \$931 \$947 \$955
47.0 6.6 \$980 \$996 \$1004
50.0 7.0 \$1069 \$1089 \$1099
53.0 7.5 \$1139 \$1159 \$1169

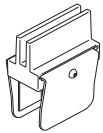

Universal Panel Stacker Bracket
1-Pack

HPNLSTACKBKT

2.5 Ⓞ

1.0

\$135

\$139

\$141

NOTES:

- Can be used on any panel system between 1.975" and 3.450" thick.
- Glass is undersized by 2".
- Stackers can span multiple panels.
- Panel stackers will work with both flat trim and radius trim.
- 1" gap between top cap and bottom of bracket.
- 6mm tempered glass.
- Cannot be used on top of glass stackers.

HOW TO SPECIFY

Select Model Number

HPNLSTACK2230

Select Glass

G Glass

G

Select Paint Color

P

Select Model Number





HPNLSTACKBKT

Select Paint Color

P

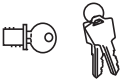
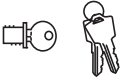
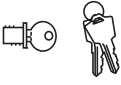
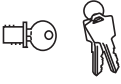

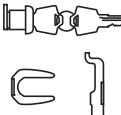
CORE REMOVABLE LOCK KITS

	DESCRIPTION	MODEL	SHIP WEIGHT	CUBE	LIST PRICE
 SIN 33721	Chrome Removable Lock Core Kit (for metal casegoods) • Use when specifying omit lock application. • Specify quantity of each key number from 101E-225E. • Includes: 1-core, 2-keys, 1-core removal tool and instructions. • Removable lock core kits with specific key number must be ordered to facilitate keying alike in the field. • For specific models, look for the Omit Lock Core icon throughout this publication. NOTES: If key number isn't specified, number will be at random. Core matches manufactured lock on metal casegoods product but can be used with Contain® and laminate product.	HF23C	0.1 Ⓔ	0.1	\$49
 SIN 33721	Satin Removable Lock Core Kit (for metal and laminate casegoods) • Use when specifying omit lock application. • Specify quantity of each key number from 101E-225E. • Includes: 1-core, 2-keys, 1-core removal tool and instructions. • Removable lock core kits with specific key number must be ordered to facilitate keying alike in the field. • For specific models, look for the Omit Lock Core icon throughout this publication. NOTES: If key number isn't specified, number will be at random. Core matches manufactured lock on metal casegoods product but can be used with metal casegoods and laminate product. For laminate stack-on and wall mounted storage models with locks, use HF27S.	HF23S	0.1 Ⓔ	0.1	\$47
 SIN 33721	Black Removable Lock Core Kit (for laminate products) Specify quantity of each key number from 101E-225E. Includes: 1-core, 2-keys, 1-core removal tool, and instructions. NOTES: If key number isn't specified, number will be at random. Core matches manufactured lock on laminate product but can be used with metal casegoods product. For laminate stack-on and wall mounted storage models with locks, use HF27B.	HF23B	0.1 Ⓔ	0.1	\$35
 OPEN MARKET	Removable Lock Core Kit Black Satin • For stack-on and wall mounted storage laminate models (with locks) in 10500, 10700, Valido, Voi, Concinnity, and 94000 Series. • Specify quantity of each key number from 101E to 225E. • Includes: 1-core, 2-keys, 1-core removal tool, and instructions. NOTES: If key number isn't specified, number will be at random.	HF27B HF27S	0.2 0.2	0.02 0.02	\$35 \$35
 OPEN MARKET	Master Key (one key) Will open all HON product with HON "One Key" interchangeable core removable locks. Available to authorized dealers only. Will open HF23B, HF23C, HF23S, HF24, HF27B, and HF27S locks numbered 101E-225E. Will open old HON style MB series locks.	HF22	0.1 Ⓔ	0.1	\$30
 OPEN MARKET	Chrome Core Removable Lock Kit for Vertical Files Field Installable. Specify key number from 101E-225E. Includes: 1-lock with core, 2-keys and attaching linkage. NOTES: If key number isn't specified, number will be at random.	HF24	0.2 Ⓔ	0.2	\$67
 OPEN MARKET	Bulk Package 6 HF24 Lock Kits (Individually shrink wrapped) NOTES: Bulk Package key numbers are at random and cannot be specified.	HF246	1.2 Ⓔ	0.2	\$310

NOTES:

- HON "One Key" interchangeable core removable locks are standard on most HON products. Look for the HON "One Key" icon.
- Keyed alike cores are listed above.
- If key number is not specified, number will be at random.
- For keyed alike locks:
 - Order standard product which will be shipped with factory installed locks and random numbered cores or omit lock option where offered.
 - Order the appropriate quantity of like numbered cores required for each workstation or keyed area.
 - Simply replace the factory installed cores with the replacement cores after product has been installed.
- To install new core:
 - Lock must be in the unlocked position.
 - Insert core removal key and pull core straight out.
 - Insert new core with core removable key, hold core into lock and withdraw core removal key.
 - Retain original core for future use.
- To provide normal lead times, key numbers cannot be specified on HON products at time of order. This also eliminates need for tagging and tracking each product's lock number during installation.
- Black removable lock core kit used on laminate casegoods.
- Chrome removable lock core kit used on metal casegoods.



HOW TO ORDER CORE REMOVABLE LOCK KITS:

Specify: Model Number.X
Key Number
Examples: HF23C.X121E
HF23C.X (Key number not specified)

NOTES: Key orders without numbers specified will be keyed at random.
Numbers 101E-225E are available.

SAMPLE ORDER:

Quantity	Model	Key Code
6	HF23C.	X121E
4	HF23B.	X121E
5	HF24.	X121E
1	HF22.	X
2	HF24.	X



Icon Legend on page 19

TOUCH-UP PAINT

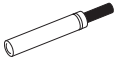

DESCRIPTION

MODEL

SHIP WEIGHT

CUBE

LIST PRICE BY PAINT GRADE

P1

P2

P3

1 Touch-up Paint (.6 oz.)

HPMARKER1

0.1

0.1

\$40

\$47

\$58

NOTES: Touch-up Paint available in P1, P2, and P3 colors.

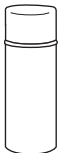

Spray Paint (12 oz.)

HSPRAY

0.5

0.1

\$40

\$47

\$58

NOTES: Touch-up Paint available in P1, P2, and P3 colors.

! Designer White Texture (PK7) for use with Solve base only.

NOTES:

- Allows minor repairs in the field.
- Shippable by small package carrier, ground only.
- Must specify color when ordering.

HOW TO SPECIFY

Select Model Number

Select Color

See page 156 in the 2021 Shared Spaces Pricer

HPMARKER1 . P

CROSS REFERENCE INDEX

MODEL	PAGE	MODEL	PAGE	MODEL	PAGE	MODEL	PAGE
H-TASCRN2430	770	H10530LEP	280	H10543	297	H105729	317
H-TASCRN2436	770	H10530TEP	280	H10544	297	H10573	296
H-TASCRN2448	770	H105310	312	H10545R	297	H10578	274
H-TASCRN3630	770	H105319	304	H10546L	297	H10578X	274
H-TASCRN3636	770	H105321	302	H10547R	300	H10579	274
H-TASCRN3648	770	H105321G	303	H10548L	300	H10579X	274
H10501	289, 340	H105321K	302	H105491	300	H105810	310
H105012	289	H105322	302	H105492	300	H105811	310
H105014	290	H105322G	303	H105493	300	H105815R	310
H10502	289, 340	H105322K	302	H105520	316	H105816L	310
H10503	291, 341	H105323	302	H105523	316	H105817R	310
H10504	290, 340	H105323G	303	H105524	316	H105818L	310
H10505	291, 341	H105323K	302	H105525R	316	H10583R	296
H105062	289	H105324	302	H105526L	316	H10584L	296
H105064	290	H105324G	303	H105527R	316	H105851	168, 305
H105076	291	H105324K	302	H105528L	316	H105852	168, 305
H105077	291	H105327	302	H105531	312	H105853	168, 305
H10508	291, 341	H105327G	303	H105532	316, 754	H105854	168, 305
H105093	289, 340	H105327K	302	H105533	316, 754	H105855	168, 305
H105098	155, 275, 337	H10533	302	H105534	316, 754	H105856	168, 305
H105099	155, 275, 337	H10533G	303	H105535	316, 754	H105857	168, 305
H1050CST	750	H10533K	302	H105581	275	H10585R	296
H105102	311, 350	H10534	302	H105581X	275	H10586L	296
H105104	311, 350	H105349	167, 303	H105582	275	H10587R	296
H105106	311, 350	H10534G	303	H105582X	275	H105885R	296
H105109	311, 350	H10534K	302	H105583	275	H10588L	296
H10511R	296	H10536	301	H105583X	275	H105890	292
H10512L	296	H105360	309	H105598	300	H105891	292
H10515R	296	H105361	309	H105599	300	H105892	292
H10516	311	H105362	309	H10560	300	H105893R	292
H10516L	296	H105363	309	H10561	278	H105894L	292
H10517	311	H105367	301	H10561X	278	H105895R	292
H105201RE	298	H105368	301	H10563	311	H105896L	292
H105202LE	298	H10537	301	H10564	275	H105897R	292
H105203RE	298	H105380	306	H10564X	275	H105898L	292
H105204LE	298	H105380G	309	H10565	297	H105899	292
H105205RE	299	H105380K	306	H10566	297	H105900	293
H105206LE	299	H105381	306	H105663	277	H105901	293
H105209E	298	H105381G	309	H105679	158, 291, 341	H105902	293
H10521E	298	H105381K	306	H10568	278	H105903R	293
H10522E	298	H105382	306	H105680	278	H105904L	293
H10523E	298	H105382G	309	H105680X	278	H105905R	293
H10524	290, 340	H105382K	306	H105681	278	H105906L	293
H1052441LEP	280	H105383	306	H105681X	278	H105907R	293
H10524LEP	280	H105383G	309	H105684	278	H105908L	293
H10524TEP	280	H105383K	306	H105684X	278	H105909	293
H10524TSUPP	280	H105386	301	H105686	278	H10592	274
H10525RE	298	H105388	301	H10568X	278	H10592X	274
H10526LE	298	H105392	277	H105686X	278	H10593	296
H10528	164, 299, 346	H105393	277	H105690	311	H10594	274
H105290	312	H105397	277	H105691	275	H10594X	274
H105291	312	H10541	275	H105691X	275	H10595	296
H105292	312	H105410	276	H105692	275	H10596	274
H105293	315	H105410X	276	H105692X	275	H10596X	274
H105295R	315	H105411	276	H105698	300	H105973R	293
H105296L	315	H105411X	276	H105699	300	H105974L	293
H105297R	315	H105412	276	H10570	300	H105975R	293
H105298L	315	H105412X	276	H10571	296	H105976L	293
H105299	315	H105413	276	H105720	317	H10598	274
H10530	315	H105413X	276	H105721	173, 317	H10598X	274
H105301R	315	H10541X	275	H105722	173, 317	H105B2460	279
H105302L	315	H10542	275	H105724	317	H105B3060	279
H1053041LEP	280	H10542X	275	H105726	317	H105B3066	279

CROSS REFERENCE INDEX

MODEL	PAGE	MODEL	PAGE	MODEL	PAGE	MODEL	PAGE
H105B3072	279	H105LT242450CBFL	313	H107191R	343	H10771	344
H105CT3020	295	H105LT242450CBFR	313	H107192L	343	H107720	353
H105CT3024	295	H105LT242450SBFL	313	H107193R	345	H107721R	353
H105CT3620	295	H105LT242450SBFR	313	H107194L	345	H107722L	353
H105CT3624	295	H105R2430	279	H10721E	346	H107725R	338
H105CTHAT3020	295	H105R2436	279	H10722E	346	H107726L	338
H105CTHAT6020R	295	H105R2442	279, 285	H107242	353	H107727R	338
H105CTHAT3620L	295	H105R2448	123, 279, 285	H107270X	339	H107727RX	339
H105CTHAT3620R	295	H105R2460	123, 279, 285	H107290	350	H107728L	338
H105CTHAT3624L	295	H105R2466	123, 279, 285	H107291	350	H107728LX	339
H105CTHAT3624R	295	H105R2472	123, 279, 285	H107292	350	H10773	342
H105CTHAT6020L	295	H105R2478	279	H107293	352	H10774	342
H105CTHAT6020R	295	H105R2484	279	H107295R	352	H10775	344
H105CTHAT6024L	295	H105R3048	123, 279, 285	H107296L	352	H107801R	338
H105CTHAT6024R	295	H105R3060	123, 279, 285	H107299	352	H107801RX	339
H105CTHAT6620L	295	H105R3066	123, 279, 285	H10730	352	H107802L	338
H105CTHAT6620R	295	H105R3072	123, 279, 285	H107301R	352	H107802LX	339
H105CTHAT6624L	295	H105R3078	279	H107302L	352	H107803R	338
H105CTHAT6624R	295	H105R3084	279	H107313	348	H107803RX	339
H105CTHAT7220L	295	H105ST122450L	312	H107313K	348	H107804L	338
H105CTHAT7220R	295	H105ST122450R	312	H107318	348	H107804LX	339
H105CTHAT7224L	295	H105ST123050L	312	H107318K	348	H107805R	338
H105CTHAT7224R	295	H105ST123050R	312	H10732	348	H107805RX	339
H105HLEG2428	282	H105WMH30	307	H10732K	348	H107806L	338
H105HLEG2441	282	H105WMH30C	307	H10733	348	H107806LX	339
H105HLEG3028	282	H105WMH36	307	H10733K	348	H107807R	338
H105HLEG3041	282	H105WMH36C	307	H10734	348	H107807RX	339
H105LC3020BF	294	H105WMH42	307	H10734G	348	H107808L	338
H105LC3020SF	294	H105WMH42C	307	H10734K	348	H107808LX	339
H105LC3024BF	294	H105WMH48	307	H107353	349	H107811	347
H105LC3024SF	294	H105WMH48C	307	H107358	349, 367	H107815	337
H105LC3620BF	294	H105WMH48P	307	H10736	349	H107815X	337
H105LC3620SF	294	H105WMH48PC	307	H10737	349	H107816	337
H105LC3624BF	294	H105WMH48PCG	308	H10738	349, 367	H107816X	337
H105LC3624SF	294	H105WMH48PG	308	H107398	347	H107817	337
H105LCHAT3020B	294	H105WMH60P	307	H107399	347	H107817X	337
H105LCHAT3020S	294	H105WMH60PC	307	H10741	343	H107824	336
H105LCHAT3024S	294	H105WMH60PCG	308	H10742	343	H107825	336
H105LCHAT3620B	294	H105WMH60PG	308	H10743	345	H107825X	336
H105LCHAT3620S	294	H105WMH66	307	H10744	345	H107826	336
H105LCHAT3624S	294	H105WMH66C	307	H10745R	345	H107827	336
H105LT182050BFL	313	H105WMH66P	307	H10746L	345	H107829	336
H105LT182050BFR	313	H105WMH66PC	307	H10747R	347	H107835	337
H105LT182050CBFL	313	H105WMH66PCG	308	H10748L	347	H107836	337
H105LT182050CBFR	313	H105WMH66PG	308	H107492	347	H107837	337
H105LT182050SBFL	313	H105WMH72P	307	H10751	347	H10783R	344
H105LT182050SBFR	313	H105WMH72PC	307	H10752	351	H10784L	344
H105LT182450BFL	313	H105WMH72PCG	308	H10753	351	H10785R	344
H105LT182450BFR	313	H105WMH72PG	308	H10754	351	H10786L	344
H105LT182450CBFL	313	H10701R	342	H10755	351	H10787R	342
H105LT182450CBFR	313	H10702L	342	H107569	351	H10787RG	342
H105LT182450SBFL	313	H10705R	343	H10760	347	H107885R	344
H105LT182450SBFR	313	H10706L	343	H10762	350	H10788L	342
H105LT182450SCBFL	314	H10707R	343	H10763R	345	H10788LG	342
H105LT182450SCBFR	314	H10708L	343	H10764L	345	H10791	344
H105LT242050BFL	313	H10709R	343	H10765	345	H10799	342
H105LT242050BFR	313	H10710L	343	H10766	345	H10799G	342
H105LT242050CBFL	313	H10711R	343	H10767	343	H11501	157
H105LT242050CBFR	313	H10712L	343	H10768	343	H115012	157
H105LT242050SBFL	313	H10715R	345	H107690	350	H115014	157
H105LT242050SBFR	313	H10716L	345	H107698	350	H11502	157
H105LT242450BFL	313	H10717R	345	H107699	350	H11503	158
H105LT242450BFR	313	H10718L	345	H10770	347	H11504	157

CROSS REFERENCE INDEX

MODEL	PAGE	MODEL	PAGE	MODEL	PAGE	MODEL	PAGE
H11505	158	H11541	155	H11578	154	H212	744
H11508	158	H11541X	155	H11579	154	H212C	744
H115093	157	H11542	155	H115811	169	H214	744
H115102	170	H11542X	155	H115815R	169	H214C	744
H115104	170	H11543	162	H115816L	169	H215	744
H115106	170	H11544	162	H11583R	161	H215C	744
H115109	170	H11545R	162	H11584L	161	H312	745
H11511R	161	H11546L	162	H11585R	161	H312C	745
H11512L	161	H11547R	165	H11586L	161	H314	745
H11515R	161	H11548L	165	H11587R	161	H314C	745
H11516	170	H115491	165	H115885R	161	H315	745
H11516L	161	H115492	165	H11588L	161	H315C	745
H11517	170	H115493	165	H115890	159	H32	715
H115201RE	163	H11552	172	H115891	159	H33720(?)	656
H115202LE	163	H115520	172	H115892	159	H33723(?)	656
H115203RE	163	H115523	172	H115893R	159	H33820(?)	656
H115204LE	163	H115524	172	H115894L	159	H33823(?)	656
H11521E	163	H115525R	172	H115895R	159	H34	715
H11522E	163	H115526L	172	H115896L	159	H34002R	389
H11523E	163	H115527R	172	H115897R	159	H34251	389
H11525RE	163	H115528L	172	H115898L	159	H34480	389
H11526LE	163	H11553	172	H115899	159	H34834R	389
H115290	170	H11554	172	H115900	160	H34835L	389
H115291	170	H11555	172	H115901	160	H34962	389
H115292	170	H115581	155	H115902	160	H34973R	389
H115293	171	H115581X	155	H115903R	160	H34974L	389
H115295R	171	H115582	155	H115904L	160	H36720(?)	656
H115296L	171	H115582X	155	H115905R	160	H36723(?)	656
H115297R	171	H115583	155	H115906L	160	H36820(?)	656
H115298L	171	H115583X	155	H115907R	160	H36823(?)	656
H115299	171	H115598	165	H115908L	160	H38155	399
H11530	171	H115599	165	H115909	160	H38170	399
H115301R	171	H11560	165	H11592	154	H38180	399
H115302L	171	H11561	156	H11593	161	H38210	401
H115321	166	H11561X	156	H11594	154	H38215R	399
H115321G	167	H11563	170	H11595	161	H38216L	399
H115321K	166	H11564	155	H11596	154	H38217R	399
H115322	166	H11564X	155	H11598	154	H38218L	399
H115322G	167	H11565	162	H14917(?)	707	H38220	401
H115322K	166	H11566	162	H14923(?)	707	H38251	399
H115323	166	H11568	156	H1522	104, 174, 237, 319, 356, 369	H38252L	399
H115323G	167	H115680	156	H1526	104, 174, 237, 319, 356, 369	H38291R	399
H115323K	166	H115680X	156	H15923(?)	569, 708	H38292L	399
H115324	166	H115681	156	H1801	755	H38293R	399
H115324G	167	H115681X	156	H1871	755	H38294L	399
H115324K	166	H115684	156	H18717(?)	707	H384815	405
H115327	166	H115684X	156	H1872	755	H386015	405
H115327G	167	H115686	156	H18723(?)	707	H386548N	383, 405
H115327K	166	H115686X	156	H18730(?)	707	H386560N	383, 405
H11533	166	H11568X	156	H1874	755	H386566N	383, 405
H11533G	167	H115690	170	H1875	755	H386572N	405
H11533K	166	H115691	155	H1876	755	H386615	405
H11534	166	H115691X	155	H1877	755	H387215	405
H11534G	167	H115692	155	H18817(?)	707	H38851	399
H11534K	166	H115692X	155	H18823(?)	707	H38852	399
H115380	168	H115698	165	H18830(?)	707	H38853	399
H115380K	168	H115699	165	H19717(?)	707	H38854	399
H115381	168	H11570	165	H19723(?)	707	H38855L	399
H115381K	168	H11571	161	H19730(?)	707	H38856R	399
H115382	168	H115720	173	H19817(?)	707	H38857L	399
H115382K	168	H115724	173	H19823(?)	707	H38858R	399
H115383	168	H115726	173	H19830(?)	707	H38921	400
H115383K	168	H11573	161	H20040AG	750	H38922	400

CROSS REFERENCE INDEX

MODEL	PAGE	MODEL	PAGE	MODEL	PAGE	MODEL	PAGE
H38923	400	H795	659	H919492	747	HAESC19	724
H38925	400	H795LS	660	H919493	747	HAESS	726
H38928	401	H80191	321	H9195(?)	709	HAEST	726
H38931	400	H80192	321	H94210	368	HAPGBP196NPT	722
H38932	400	H80193	321	H94211R	364	HAPGBP196NPTE	723
H38933	400	H872	657	H94212L	364	HAPGBP199TFN	722
H38934	400	H873	657	H94215R	364	HAPGBP199TFNE	723
H38935	400	H874	657	H94216L	364	HAPGBP19SNPT	722
H38941E	401	H875	657	H94220	368	HAPGBP19SNPTE	723
H38942E	401	H875LS	658	H94221	368	HAPGBP236NPT	722
H38943R	400	H882	657	H94222	368	HAPGBP236NPTE	723
H38944L	400	H88231	376	H94223	368	HAPGBP239TFN	722
H38945R	400	H88235R	376	H94224	368	HAPGBP239TFNE	723
H38946L	400	H88236L	376	H94225	368	HAPGBS239TFN	722
H38947R	400	H88251R	375	H94226	368	HAPGBS239TFNE	723
H38948L	400	H88263R	375	H94229	368	HAPGBS23SNPT	722
H38949R	400	H88265R	375	H94234	366	HAPGBS23SNPTE	723
H38950L	400	H88266L	375	H94234K	366	HAPGCP199TPN	722
H38966E	401	H883	657	H94236	366	HAPGCP199TPNE	723
H38SHFDV	406, 596	H884	657	H94237	366	HAPGCP239TPN	722
H4022	112, 174, 325, 357, 370, 401	H885	657	H94237K	366	HAPGCP239TPNE	723
H4028	112, 174, 325, 357, 401	H885LS	658	H94243	365	HAPGCS239TPN	722
H4029	112, 174, 325, 357, 401	H88962	375	H94244	365	HAPGCS239TPNE	723
H432	741	H88976	375	H94245R	365	HAPMAP196NFN	720
H434	741	H892	657	H94246L	365	HAPMAP196NFNE	721
H482	741	H893	657	H94247R	365	HAPMAP236NFN	720
H484	741	H894	657	H94248L	365	HAPMAP236NFNE	721
H511596	663	H895	657	H94251	364	HAPMBP196NPT	720
H512	746	H895LS	658	H94260	365	HAPMBP196NPTE	721
H51206	357, 401	H90031	349	H94270	365	HAPMBP199TFN	720
H512C	746	H90032	349	H94271	364	HAPMBP199TFNE	721
H514	746	H90033	349	H94276	364	HAPMBP19SNPT	720
H514C	746	H90034	349, 367	H94283R	364	HAPMBP19SNPTE	721
H519495	383, 389, 401, 750	H90035	349, 367	H94284L	364	HAPMBP236NPT	720
H52	715	H90050	57, 63, 305	H94285R	364	HAPMBP236NPTE	721
H52C	715	H90051	57, 63, 168, 305	H94286L	364	HAPMBP239TFN	720
H54	715	H90052	57, 63, 168, 305	H94291	368	HAPMBP239TFNE	721
H54C	715	H90053	57, 63, 168, 305	H94430	368	HAPMBS239TFN	720
H672	661	H90054	57, 63, 168, 305	H94435	368	HAPMBS239TFNE	721
H673	661	H90055	57, 63, 168, 305	H94720	369	HAPMBS23SNPT	720
H674	661	H90056	57, 63, 168, 305	H94721R	369	HAPMBS23SNPTE	721
H675	661	H90057	57, 63, 168, 305	H94722L	369	HAPMCP199TPN	720
H682	661	H9170(?)	709	HACRYEXSCRN2036	769	HAPMCP199TPNE	721
H683	661	H9173(?)	709	HACRYEXSCRN2042	769	HAPMCP239TPN	720
H684	661	H9174(?)	709	HACRYEXSCRN2536	769	HAPMCP239TPNE	721
H685	661	H9175(?)	709	HACRYEXSCRN2542	769	HAPMCS239TPN	720
H692	661	H9180(?)	709	HACRYSCRN2024	769	HAPMCS239TPNE	721
H693	661	H9183(?)	709	HACRYSCRN2030	769	HARCHA2	174, 322, 354
H694	661	H9184(?)	709	HACRYSCRN2036	769	HARCHA3	174, 322, 354
H695	661	H9185(?)	709	HACRYSCRN2048	769	HARCHC2	174, 322, 354
H772	659	H9185LS(?)	710	HACRYSCRN2054	769	HARCHC3	174, 322, 354
H773	659	H9185LSN(?)	710	HACRYSCRN2060	769	HAS18	664
H774	659	H9190(?)	709	HACRYSCRN2066	769	HAS24	664
H775	659	H9193(?)	709	HACRYSCRN2524	769	HAUFHL15N	725
H775LS	660	H9194(?)	709	HACRYSCRN2530	769	HAUFHL15NE	725
H782	659	H919430	674, 675, 747	HACRYSCRN2536	769	HAUFHR15N	725
H783	659	H919436	674, 675, 747	HACRYSCRN2548	769	HAUFHR15NE	725
H784	659	H919442	747	HACRYSCRN2554	769	HAUFO15N	725
H785	659	H919448	674, 675	HACRYSCRN2560	769	HB9	663
H785LS	660	H919460	674, 675, 747	HACRYSCRN2566	769	HB96PP	580
H792	659	H919466	747	HAECBH	726	HBCKKIT24	628
H793	659	H919472	674, 675, 747	HAEHF	726	HBCKKIT24F	628
H794	659	H919491	747	HAELT	726	HBCKKIT30	628

CROSS REFERENCE INDEX

MODEL	PAGE	MODEL	PAGE	MODEL	PAGE	MODEL	PAGE
HBCKKIT30F	628	HBV-P4260	648	HCTROUGH3610	107, 178, 242,	HECC15	596
HBCKKIT36	628	HBV-P4272	648		595, 613	HECPPP	610
HBCKKIT36F	628	HBV-P6024	648	HCWD2450P	626	HECPP156	610
HBCKKIT24	628	HBV-P6030	648	HCWD3062P	626	HECSI	498
HBCKKIT24F	628	HBV-P6036	648	HCWQ2424P	626	HECSL	498
HBCKKIT30	628	HBV-P6042	648	HCWQ3030P	626	HECSS	498
HBCKKIT30F	628	HBV-P6048	648	HCWQT2424P	626	HECST	498
HBCKKIT36	628	HBV-P6060	648	HCWQT3030P	626	HECSV	498
HBCKKIT36F	628	HBV-P6072	648	HD2	401	HECSX	498
HBCKKIT42	628	HBV-P7224	648	HD8	401	HECSY	498
HBCKKIT42F	628	HBV-P7230	648	HDPS1	108, 175, 236, 320, 355	HECVH07P	499
HBCKKIT48	628	HBV-P7236	648	HE4022	112, 174, 325, 357, 370	HECVH15P	499
HBCKKIT48F	628	HBV-P7242	648	HEABAC	500	HECVH22P	499
HBCKKIT60	628	HBV-P7248	648	HEBPLATE336	493, 607	HECVH30P	499
HBCKKIT60F	628	HBV-P7260	648	HEBPLATE342	493, 607	HEFEC35P	499
HBCKKIT66	628	HBV-PBS	649	HEBPLATE348	493, 607	HEFEC42P	499
HBCKKIT66F	628	HBV-PWB1	649	HEBPLATE360	493, 607	HEFEC50P	499
HBCKKIT72	628	HBV-QC180	649	HEBPLATE372	493, 607	HEFEC57P	499
HBCKKIT72F	628	HBV-QC90	649	HEC35P2N	497	HEFEC65P	499
HBCONU	579	HBV-TBASE	649	HEC35P3N	497	HEFEC72P	499
HBCSRI524P	627	HBV-VSH24	649	HEC35PLN	497	HEFEC80P	499
HBCSRI530P	627	HBV-VSH30	649	HEC35PSN	497	HEFGS0720	496
HBCSRI536P	627	HBV-VSH36	649	HEC35PTN	497	HEFGS0724	496
HBCSRI542P	627	HBV-VSH42	649	HEC35PXN	497	HEFGS0730	496
HBCSRI548P	627	HBV-VSH48	649	HEC42P2N	497	HEFGS0736	496
HBCSRI560P	627	HBV-VSH60	649	HEC42P3N	497	HEFGS0742	496
HBCSRI566P	627	HBVWM	580	HEC42PLN	497	HEFGS0748	496
HBCSRI572P	627	HBWCT3624P	531, 622	HEC42PSN	497	HEFGS0754	496
HBCSR2424P	627	HBWCT4224P	124, 531, 622	HEC42PTN	497	HEFGS0760	496
HBCSR3030P	627	HBWCT4230P	124, 531, 622	HEC42PXN	497	HEFGS0766	496
HBCSR3636P	627	HBWCT4824P	124, 531, 622	HEC50P2N	497	HEFGS0772	496
HBDMAUSB	113, 126, 180, 235, 326, 359, 371, 378, 385, 391, 403, 643	HBWCT4830P	124, 531, 622	HEC50P3N	497	HEFGS1520	496
		HBWD2450P	626	HEC50PLN	497	HEFGS1524	496
HBEAM48	578	HBWD3062P	626	HEC50PSN	497	HEFGS1530	496
HBEAM60	578	HBWQ2424P	626	HEC50PTN	497	HEFGS1536	496
HBEAM72	578	HBWQ3030P	626	HEC50PXN	497	HEFGS1542	496
HBENDCP	578	HBWQT2424P	626	HEC57P2N	497	HEFGS1548	496
HBEORH23	579	HBWQT3030P	626	HEC57P3N	497	HEFGS1554	496
HBEORL23	579	HBXRISER	113, 126, 180, 239, 326, 359, 371, 378, 385, 391, 403, 643	HEC57PLN	497	HEFGS1560	496
HBEORT23	579			HEC57PSN	497	HEFGS1566	496
HBFAB	580	HC14	383, 389	HEC57PTN	497	HEFGS1572	496
HBILNH23	579	HCD1	174, 237, 325, 356, 370, 401, 642	HEC57PXN	497	HEFTAC	500
HBILNT23	579	HCLA65	105, 176, 236, 325, 356, 639	HEC65P2N	497	HEOHRTA1524FD	587
HBILNX23	579	HCNLEG29	632	HEC65P3N	497	HEOHRTA1530FD	587
HBLEG23	578	HCOMDOME2	107, 122, 179, 243, 377, 384, 390, 402, 546, 612, 641	HEC65PLN	497	HEOHRTA1536FD	587
HBLPBRIDGE	143			HEC65PSN	497	HEOHRTA1542FD	587
HBLPCLASSIC	143	HCPU1	176, 235, 570, 642	HEC65PTN	497	HEOHRTA1548FD	587
HBLPCONTEMP	143	HCRESCENTA2	322, 354	HEC65PXN	497	HEOHRTA1560FD	587
HBMP2B	749	HCRESCENTA3	322, 354	HEC72P2N	497	HEOHRTA1572FD	587
HBMP2F	749	HCRESCENTC2	322, 354	HEC72P3N	497	HEP35	610
HBPPCK	580	HCRESCENTC3	322, 354	HEC72PLN	497	HEP65	610
HBPPEK	580	HCS3636P	629	HEC72PSN	497	HEPDMK42P	492
HBPPMK	580	HCS4242P	629	HEC72PTN	497	HERECPCVR	545, 610
HBPPSK	580	HCTL181L	632	HEC72PXN	497	HES1520F	494
HBPRTCV	579	HCTL181R	632	HEC80P2N	497	HES1520G	495
HBSCRAOMTL48	582	HCTL182	632	HEC80P3N	497	HES1524F	494
HBSCRAOMTL60	582	HCTL241L	632	HEC80PLN	497	HES1524G	495
HBSCRAOMTL72	582	HCTL241R	632	HEC80PSN	497	HES1530F	494
HBV-P4224	648	HCTL242	632	HEC80PTN	497	HES1530G	495
HBV-P4230	648	HCTROUGH17	107, 178, 242, 595, 613	HEC80PXN	497	HES1536F	494
HBV-P4236	648	HCTROUGH1710	107, 178, 242, 595, 613	HECB01	628	HES1536G	495
HBV-P4242	648	HCTROUGH36	107, 178, 242, 595, 613	HECB42	628	HES1542F	494
HBV-P4248	648			HECC10	596	HES1542G	495

CROSS REFERENCE INDEX

MODEL	PAGE	MODEL	PAGE	MODEL	PAGE	MODEL	PAGE
HES1548F	494	HETP5024DP	491	HFLDGRMT3	106, 177, 242, 324, 358	HH871224A	608
HES1548G	495	HETP5024FP	490	HFLDGRMT4	106	HH871230	608
HES1560F	494	HETP5030DP	491	HFMBIN12	711	HH871230A	608
HES1560G	495	HETP5030FP	490	HFMBIN3	711	HH871236	608
HES1572F	494	HETP5036DP	491	HFMBIN6	711	HH871236A	608
HES1572G	495	HETP5036FP	490	HFMSC182830RWB	711	HH871242	608
HES3020G	495	HETP5042DP	491	HFMSC183930RWB	711	HH871242A	608
HES3024G	495	HETP5042FP	490	HFMSC185230RWB	711	HH871248	544, 581, 608
HES3030G	495	HETP5048DP	491	HFMSC186430RWB	711	HH871248A	544, 581, 608
HES3036G	495	HETP5048FP	490	HFSC183640(?)	713	HH871260	544, 581, 608
HES3042G	495	HETP5060DP	491	HFSC183640W	712	HH871260A	544, 581, 608
HES3048G	495	HETP5060FP	490	HFSC183664(?)	713	HH871272	544, 581, 608
HES3060G	495	HETP5072DP	491	HFSC183664W	712	HH871272A	544, 581, 608
HESDMK30	492	HETP5072FP	490	HFTPD	121	HH871366	609
HESDMK36	492	HETP6520DP	491	HGRMTAC	106, 178, 241, 324, 358, 613, 629	HH871366A	609
HESDMK42	492	HETP6520FP	490	HGRMTAC2	106, 122, 178, 241, 324, 358	HH871400	545, 609
HESDMK48	492	HETP6524DP	491	HGRMTAC2	106, 122, 178, 241, 324, 358	HH871400A	545, 609
HESHRTA24	587	HETP6524FP	490	HGRMTDATA	241	HH871500	545, 609
HESHRTA30	587	HETP6530DP	491	HGRMTUSB2	106, 122, 178, 241, 324, 358, 613	HH871501	545, 611
HESHRTA36	587	HETP6530FP	490	HGRMTUSB2	106, 122, 178, 241, 324, 358, 613	HH871501A	545, 611
HESHRTA42	587	HETP6536DP	491	HH15042SD	451, 492	HH871502	545, 611
HESHRTA48	587	HETP6536FP	490	HH16542SD	451, 492	HH871502A	545, 611
HESHRTA60	587	HETP6542DP	491	HH18042SD	451, 492	HH871503	545, 611
HESHRTA72	587	HETP6542FP	490	HH870070	242, 580, 610	HH871503A	545, 611
HETB2018	594	HETP6548DP	491	HH870924(?)	595	HH871504	545, 611
HETB2418	594	HETP6548FP	490	HH870930	111, 177, 309	HH871506	545, 611
HETB3018	594	HETP6560DP	491	HH870930(?)	595	HH871601	545, 581, 611
HETB3618	594	HETP6560FP	490	HH870930CH	111	HH871601A	581, 611
HETB4218	594	HETP6572DP	491	HH870942	111, 177, 309, 357, 407	HH871912	544, 581, 609
HETB4818	594	HETP6572FP	490	HH870942(?)	595	HH871912A	581, 609
HETB6018	594	HEVHF07P	499	HH870942CH	111	HH871918	581, 609
HETB7218	594	HEVHF15P	499	HH870960	111, 177, 309, 357, 367, 407	HH871918A	581, 609
HETC20	493	HEVHF22P	499	HH870960(?)	595	HH873500	609
HETC24	493	HEVHF30P	499	HH870960CH	111, 367	HH873501	581, 611
HETC30	493	HEVHG07P	496	HH871024	544, 608	HH873501A	581, 611
HETC36	493	HEVHG15P	496	HH871024A	544, 608	HH873502	581, 611
HETC42	493	HEVHG22P	496	HH871030	608	HH873502A	581, 611
HETC48	493	HEVHG30P	496	HH871030A	608	HH873503	581, 611
HETC60	493	HEWS35P	499	HH871036	608	HH873503A	581, 611
HETC66	493	HEWS42P	499	HH871036A	608	HH873504	581, 611
HETC72	493	HEWS50P	499	HH871042	608	HH873506	581, 611
HETC78	493	HEWS57P	499	HH871042A	608	HH879072	609
HETC84	493	HEWS65P	499	HH871048	544, 608	HH879072A	609
HETC90	493	HEWS72P	499	HH871048A	544, 608	HH879168	609
HETC96	493	HEWS80P	499	HH871060	544, 608	HH879168A	609
HETP3520FP	490	HF22	750, 773	HH871060A	544, 608	HH8988EBN	613
HETP3524FP	490	HF23B	110, 174, 323, 356, 370, 773	HH871072	544, 608	HHABBT	121
HETP3530FP	490	HF23C	750, 773	HH871124	608	HHABCSTRPK	121
HETP3536FP	490	HF23S	110, 323, 675, 773	HH871124A	608	HHABETA2S2L	120
HETP3542FP	490	HF24	748, 773	HH871130	608	HHABGLIDE	121
HETP3548FP	490	HF246	748, 773	HH871130A	608	HHALGPT	479
HETP3560FP	490	HF27B	110, 323, 356, 773	HH871136	608	HHALRECG	479
HETP3572FP	490	HF27S	110, 323, 773	HH871136A	608	HHALRECL	479
HETP4220FP	490	HF50	748	HH871142	608	HHALRECR	479
HETP4224FP	490	HF60	748	HH871142A	608	HHALRETL	479
HETP4230FP	490	HF80	750	HH871148	544, 608	HHALRETR	479
HETP4236FP	490	HFHACRYSCRN6036	771	HH871148A	544, 608	HHATB2S2LC	117, 207
HETP4242FP	490	HFHACRYSCRN6048	771	HH871160	544, 608	HHATB2S2LT	95, 117, 207, 286
HETP4248FP	490	HFHACRYSCRN7236	771	HH871160A	544, 608	HHATB3S2LC	117, 207
HETP4260FP	490	HFHACRYSCRN7248	771	HH871172	544, 608	HHATB3S2LT	117, 207
HETP4272FP	490	HFHPCSCRN6048	771	HH871172A	544, 608	HHATB3S3LC	117, 207
HETP5020DP	491	HFHPCSCRN7248	771	HH871224	608	HHATB3S3LT	117, 207
HETP5020FP	490	HFLDGRMT	106, 177, 324, 358				

CROSS REFERENCE INDEX

MODEL	PAGE	MODEL	PAGE	MODEL	PAGE	MODEL	PAGE
HHATCC583422L	119	HHATW2876CT	118	HLCRPL4224WFH	129	HLPLDH72	142
HHATCC583422R	119	HHATW2882CT	118	HLCRPL4824WFH-PS	129	HLPLDR12MB	142
HHATCC584622L	119	HHATW2888CT	118	HLCRPL4824WFH-US	129	HLPLDR48GS	142
HHATCC584622R	119	HHATW2894CT	118	HLCRPL4824WFH	129	HLPLDR48LM	142
HHATCC584628L	119	HHATW2946EM	533	HLCRPL4830WFH-PS	129	HLPLDR60GS	142
HHATCC584628R	119	HHATW2958EM	533	HLCRPL4830WFH-US	129	HLPLDR60LM	142
HHATCC603624L	119	HHATW2970EM	533	HLCRPL4830WFH	129	HLPLDR66GS	142
HHATCC603624R	119	HHATW3042CT	118	HLCRPL5424WFH-PS	129	HLPLDR66LM	142
HHATCC604824L	119	HHATW3048CT	118	HLCRPL5424WFH-US	129	HLPLDR72GS	142
HHATCC604824R	119	HHATW3048EA	120	HLCRPL5424WFH	129	HLPLDR72LM	142
HHATCC604830L	119	HHATW3054CT	118	HLCRPL5430WFH-PS	129	HLPLDS4830	140
HHATCC604830R	119	HHATW3054EA	120	HLCRPL5430WFH-US	129	HLPLDS6030	140
HHATCC703422L	119	HHATW3060CT	118	HLCRPL5430WFH	129	HLPLDS6630	140
HHATCC703422R	119	HHATW3060EA	120	HLCWFH-PS	130	HLPLDS7230	140
HHATCC704622L	119	HHATW3066CT	118	HLCWFH-US	130	HLPLDS7236	140
HHATCC704622R	119	HHATW3072CT	118	HLDST1	108, 175, 236, 319, 355	HLPLDS7236B	140
HHATCC704628L	119	HHATW3078CT	118	HLED1	111, 177, 238, 325, 357, 407, 640	HLPLFB24	145
HHATCC704628R	119	HHATW3084CT	118	HLED17A	111, 177, 234, 309, 357, 407, 595	HLPLLEG24A	145
HHATCC723624L	119	HHATW3090CT	118	HLED17AS	111, 177, 234, 309, 357, 367, 407, 595	HLPLLEG24U	145
HHATCC723624R	119	HHATW3096CT	118	HLED17AS	111, 177, 234, 309, 357, 367, 407, 595	HLPLLEG30A	145
HHATCC724824L	119	HHC-TASCRN3630	770	HLED17AUO	111, 177, 234, 309, 357, 407, 595	HLPLLEG30U	145
HHATCC724824R	119	HHC-TASCRN3636	770	HLED17AUO	111, 177, 234, 309, 357, 407, 595	HLPLLF3620L2	144
HHATCC724830L	119	HHC-TASCRN3648	770	HLED10C	111, 177, 238, 325, 357, 407, 640	HLPLLF3620L3	144
HHATCC724830R	119	HHCTM24	613	HLED10C	111, 177, 238, 325, 357, 407, 640	HLPLLF3620L4	144
HHATM3S2LT	117, 207	HHCTM36	613	HLED2	111, 177, 238, 325, 357, 407, 640	HLPLS10	145
HHATW2240CT	118	HHEM620	613	HLED2	111, 177, 238, 325, 357, 407, 640	HLPLS23	145
HHATW2246CT	118	HHKDMK30	451	HLED31A	111, 177, 234, 309, 357, 407, 595	HLPLPEN6630E	141
HHATW2246EA	120	HHKDMK36	451	HLED31A	111, 177, 234, 309, 357, 407, 595	HLPLPEN7236E	141
HHATW2252CT	118	HHKDMK42	451	HLED31AS	111, 177, 234, 309, 357, 367, 407, 595	HLPLPHBF	143
HHATW2252EA	120	HHKDMK48	451	HLED31AS	111, 177, 234, 309, 357, 367, 407, 595	HLPLPMBBF	143
HHATW2258CT	118	HHMRK36	594, 639	HLED31AUO	111, 177, 234, 309, 357, 407, 595	HLPLPMBF	143
HHATW2258EA	120	HHMRK42	594, 639	HLED31AUO	111, 177, 234, 309, 357, 407, 595	HLPLPMBF	143
HHATW2264CT	118	HHMRK48	594, 639	HLEDOSA	111, 177, 234, 309, 357, 407, 595	HLPLPSBBF	143
HHATW2270CT	118	HHN831118	632, 737	HLEDOSA	111, 177, 234, 309, 357, 407, 595	HLPLPSEAT1520	143
HHATW2276CT	118	HHN831124	419, 632	HLINEARA2	174, 322, 354	HLPLPSFF	143
HHATW2282CT	118	HHN831130	419, 632	HLINEARA3	174, 322, 354	HLPLRCPNDS7230	148
HHATW2288CT	118	HHPMC6	469, 492	HLINEARC2	174, 322, 354	HLPLRCPNRS4225	148
HHATW2294CT	118	HHPS1	108, 175, 236, 320, 355	HLINEARC3	174, 322, 354	HLPLRCPNTPGS	148
HHATW2346EM	533	HHT2DP	611	HPLB3624	140	HLPLRCPNTPLM	148
HHATW2358EM	533	HHTADF3	581, 613	HPLB4224	140	HLPLRS3624	140
HHATW2370EM	533	HHTADF4	581, 613	HPLB4824	140	HLPLRS4224	140
HHATW2442CT	118	HHTADJ5	581, 613	HLPLBC3013B2	144	HLPLRS4824	140
HHATW2448CT	118	HHTADJ6	581, 613	HLPLBC3013B4	144	HLPLRW4824	145
HHATW2448EA	120	HICG12	450, 492	HLPLBC3013B5	144	HLPLRW4830	145
HHATW2454CT	118	HKBS	237, 642	HLPLCL3020BF	146	HLPLRW6024	145
HHATW2454EA	120	HKP2800	751	HLPLCL3020S	146	HLPLRW6030	145
HHATW2460CT	118	HLAM3348RR	66, 318	HLPLCL3020TOP	146	HLPLRW6624	145
HHATW2460EA	120	HLAM3772RD	66, 318	HLPLCL3620BF	146	HLPLRW6630	145
HHATW2466CT	118	HLAMMP6030	85, 288	HLPLCL3620S	146	HLPLRW7224	145
HHATW2472CT	118	HLAMMP7230	85, 288	HLPLCL3620TOP	146	HLPLRW7230	145
HHATW2478CT	118	HLAMSEAT3024	295	HLPLCL6020TOP	146	HLPLS3620	144
HHATW2484CT	118	HLAMSEAT3624	295	HLPLCL6620TOP	146	HLPLSL24	145
HHATW2490CT	118	HLAMSHB30	95, 286	HLPLCL7220TOP	146	HLPLSL30	145
HHATW2496CT	118	HLCP29WFH-PS	130	HLPLCS30	141	HLPLTACK48	142
HHATW2840CT	118	HLCP29WFH-US	130	HLPLCS36	141	HLPLTACK60	142
HHATW2846CT	118	HLCP29WFH	130	HLPLCS4824	140	HLPLTACK66	142
HHATW2846EA	120	HLCR2442WFH	130	HLPLCS6024	140	HLPLTACK72	142
HHATW2852CT	118	HLCR2448WFH	130	HLPLCS6624	140	HLPLTBL120BASE	147
HHATW2852EA	120	HLCR2454WFH	130	HLPLCS7224	140	HLPLTBL3672RCT	147
HHATW2858CT	118	HLCR3048WFH	130	HLPLCSEAT3020	146	HLPLTBL36BASE	147
HHATW2858EA	120	HLCR3054WFH	130	HLPLCSEAT3620	146	HLPLTBL36RND	147
HHATW2864CT	118	HLCRPL4224WFH-PS	129	HLPLDH60	142	HLPLTBL4296RCT	147
HHATW2870CT	118	HLCRPL4224WFH-US	129	HLPLDH66	142	HLPLTBL42BASE	147

CROSS REFERENCE INDEX

MODEL	PAGE	MODEL	PAGE	MODEL	PAGE	MODEL	PAGE
HLPLTBL42RND	147	HLSL1530SOMB	104, 217, 593	HLSL2070	202, 221	HLSL4814MM	85, 125, 211, 288
HLPLTBL4812ORCT	147	HLSL1536SOMB	104, 217, 593	HLSL207SL	202	HLSL4828O	92, 202, 283
HLPLTBL48BASE	147	HLSL154LSD	227	HLSL220SPL	217, 593	HLSL4831MB	234
HLPLTBL48RND	147	HLSL154LSO	227	HLSL2428B	208, 637	HLSL4835TS	213
HLPLTBL72BASE	147	HLSL1760SOL	217, 593	HLSL2428E	203	HLSL48TW	216, 218
HLPLTBL96BASE	147	HLSL1760SOR	217, 593	HLSL2428EBL	631	HLSL4AM2	203
HLPLW1824	144	HLSL1772SOL	217, 593	HLSL2428EBR	631	HLSL500S	218, 592
HLPLW2424	144	HLSL1772SOR	217, 593	HLSL2428F	208, 637	HLSL5414L	85, 125, 210, 287
HLPLWMH48	142	HLSL2016FP2	232	HLSL2428O	92, 202, 283, 630	HLSL5414MM	85, 125, 211, 288
HLPLWMH60	142	HLSL2016MP2	225, 549	HLSL2428S	208, 637	HLSL5435TS	213
HLPLWMH66	142	HLSL2016PH2	69, 225, 549	HLSL2428SL	92, 202, 284	HLSL6014L	85, 125, 210, 287
HLPLWMH72	142	HLSL2020TS	213	HLSL2430L	209, 638	HLSL6014MM	85, 125, 211, 288
HLPLXS60	145	HLSL2024TS	213	HLSL2430MF	209, 638	HLSL6028O	92, 202, 283
HLPLXS66	145	HLSL2028B	208, 637	HLSL2436L2	226	HLSL6035TS	213
HLPLXS72	145	HLSL2028E	203	HLSL2436L4	226	HLSL60TW	216, 218
HLSL1212	108, 175, 218, 234, 320, 355, 377, 384, 390, 402, 592	HLSL2028F	208, 637	HLSL2436SC	226	HLSL650S	218, 592
		HLSL2028O	202, 630	HLSL2441O	92, 204, 283, 635	HLSL6635TS	213
HLSL1220FS	214	HLSL2028SL	202	HLSL2441S	205	HLSL66TW	216, 218
HLSL1220GS	214	HLSL2030CH2	48, 69, 221, 225, 295, 547, 548, 549	HLSL2441SL	92, 204, 283, 635	HLSL7235TS	213
HLSL1220TS	213		HLSL2472LC	226	HLSL7265TE	219	
HLSL1224FS	96, 214	HLSL2030LDO	224, 548	HLSL2470	92, 202, 221, 284	HLSL72TW	216, 218
HLSL1224GS	96, 214	HLSL2030LD0F	222	HLSL247SL	202	HLSL78TW	216, 218
HLSL1224TS	213	HLSL2030LD1	224, 548	HLSL240BC	209, 638	HLSLDRWORG	234
HLSL1230	96, 212, 288, 344	HLSL2030LDIF	222	HLSL2814LM	86, 210	HLSLPBL	203, 630
HLSL1230FS	96, 214	HLSL2030LD2	224, 548	HLSL2828LM	86, 210	HLSLPBR	203, 630
HLSL1230GS	96, 214	HLSL2030LD2F	222	HLSL2830	96, 212	HLSLPMB	592
HLSL1230TS	213	HLSL2030MCO	225, 549	HLSL2836	96, 212	HLSLPMBSO42	217, 593
HLSL1236	96, 212, 288, 344	HLSL2030TS	213	HLSL2842	96, 212	HLSLPMBSOA	217, 593
HLSL1236FS	96, 214	HLSL2036CH2	48, 221, 295, 547, 548	HLSL2848	96, 212	HLSLPMBSOB	217, 593
HLSL1236GS	96, 214		HLSL2036L2	226	HLSL2854	96, 212	HLSLR1330
HLSL1236TS	213	HLSL2036L4	226	HLSL2860	96, 212	HLSLR1336	218, 227
HLSL1242	96, 212, 288, 344	HLSL2036LDO	224, 548	HLSL28AM2	203	HLSLR1345	218, 227
HLSL1248	96, 212, 288, 344	HLSL2036LD0F	222	HLSL28AW2	203	HLSLR2036	198
HLSL1254	96, 212, 288, 344	HLSL2036LD1	224, 548	HLSL28P	45, 93, 203, 281, 632	HLSLR2042	198
HLSL1260	96, 212, 288, 344	HLSL2036LDIF	222	HLSL3014L	85, 125, 210, 287	HLSLR2048	198
HLSL1336B2	233	HLSL2036LD2	224, 548	HLSL3014MM	85, 125, 211, 288	HLSLR2054	198
HLSL1336B3	233	HLSL2036LD2F	222	HLSL3028B	208, 637	HLSLR2060	198
HLSL1336B4	233	HLSL2036SC	226	HLSL3028E	203	HLSLR2066	198
HLSL1436BH	226	HLSL2036TS	213	HLSL3028EBL	631	HLSLR2072	198
HLSL1436D	215, 591	HLSL2060LDO	220, 547	HLSL3028EBR	631	HLSLR2436	198
HLSL1436S	215, 590	HLSL2060LD0F	222	HLSL3028F	208, 637	HLSLR2442	198
HLSL1442D	215, 591	HLSL2060LD2	220, 547	HLSL3028O	92, 202, 283, 630	HLSLR2448	198, 206
HLSL1442S	215, 590	HLSL2060LD2F	222	HLSL3028S	208, 637	HLSLR2448J	200
HLSL1448D	215, 591	HLSL2060LD4	220, 547	HLSL3028SL	92, 202, 284	HLSLR2454	198, 206
HLSL1448S	215, 590	HLSL2060LD4F	222	HLSL3041O	92, 204, 283, 635	HLSLR2460	198, 206
HLSL1460D	215, 591	HLSL2060LL2	220, 547	HLSL3041S	205	HLSLR2460J	200
HLSL1460LS	234	HLSL2060LL2F	223	HLSL3041SL	92, 204, 283, 635	HLSLR2466	198, 206
HLSL1460M	216, 592	HLSL2060LR2	220, 547	HLSL3070	92, 202, 221, 284	HLSLR2472	198, 206
HLSL1460S	215, 590	HLSL2060LR2F	223	HLSL307SL	202	HLSLR2472J	200
HLSL1466D	215, 591	HLSL2060S4	220, 547	HLSL300BC	209, 638	HLSLR2484	198
HLSL1466M	216, 592	HLSL2060S4F	223	HLSL3414LM	86, 210	HLSLR3036	199
HLSL1466S	215, 590	HLSL2072LDO	220, 547	HLSL3428LM	86, 210	HLSLR3042	199
HLSL1472D	215, 591	HLSL2072LD0F	222	HLSL3614L	85, 125, 210, 287	HLSLR3048	199, 206
HLSL1472DB	219	HLSL2072LD2	220, 547	HLSL3614MM	85, 125, 211, 288	HLSLR3048J	200
HLSL1472LS	234	HLSL2072LD2F	222	HLSL3635TS	213	HLSLR3054	199, 206
HLSL1472M	216, 592	HLSL2072LD4	220, 547	HLSL36TW	216, 218	HLSLR3060	199, 206
HLSL1472MB	216	HLSL2072LD4F	222	HLSL4014LM	86, 210	HLSLR3060J	200
HLSL1472S	215, 590	HLSL2072LL2	220, 547	HLSL4028LM	86, 210	HLSLR3066	199, 206
HLSL1472SB	219	HLSL2072LL2F	223	HLSL4214L	85, 125, 210, 287	HLSLR3072	199, 206
HLSL14OSPL	217, 593	HLSL2072LR2	220, 547	HLSL4214MM	85, 125, 211, 288	HLSLR3072J	200
HLSL1512LSCL	227	HLSL2072LR2F	223	HLSL4235TS	213	HLSLR3084	199
HLSL1512LSCR	227	HLSL2072S4	220, 547	HLSL42TW	216, 218	HLSLR3660	199
HLSL1512LSO	227	HLSL2072S4F	223	HLSL4814L	85, 125, 210, 287	HLSLR3666	199

CROSS REFERENCE INDEX

MODEL	PAGE	MODEL	PAGE	MODEL	PAGE	MODEL	PAGE
HLSLR3672	199	HMP2460PK6	538	HMPFGS7213	536	HMPSTROUGH72	528
HLSLSB	218	HMP2460PK8	538	HMPFGS7220	536	HMPSTROUGH48	528
HLSLSPBL	204	HMP2472PK2	538	HMPFSS3613	535	HMPSTROUGH60	528
HLSLSPBR	204	HMP2472PK4	538	HMPFSS3620	535	HMPSTROUGH72	528
HLSLW045L	229, 550	HMP2472PK6	538	HMPFSS4213	535	HMPUB148	527, 529
HLSLW045LF	231	HMP2472PK8	538	HMPFSS4220	535	HMPUB160	527, 529
HLSLW045R	229, 550	HMP3060PK2	538	HMPFSS4813	535	HMPUB172	527
HLSLW045RF	231	HMP3060PK4	538	HMPFSS4820	535	HMPUB248	527
HLSLW046L	229, 550	HMP3060PK6	538	HMPFSS5413	535	HMPUB260	527
HLSLW046R	229, 550	HMP3060PK8	538	HMPFSS5420	535	HMPUB272	527
HLSLW084L	231	HMP3072PK2	538	HMPFSS6013	535	HMPVWM28	107, 179, 243, 377, 384, 390, 402, 546, 612, 641
HLSLW084LF	231	HMP3072PK4	538	HMPFSS6020	535		
HLSLW084R	231	HMP3072PK6	538	HMPHA2460PK2	539	HMTLEXSCRN2036	768
HLSLW084RF	231	HMP3072PK8	538	HMPHA2460PK4	539	HMTLEXSCRN2042	768
HLSLW085L	230, 551	HMP3072PK2	538	HMPHA2460PK6	539	HMTLEXSCRN2536	768
HLSLW085LF	231	HMP3072PK4	538	HMPHA2460PK8	539	HMTLEXSCRN2542	768
HLSLW085R	230, 551	HMP3072PK6	538	HMPHA2472PK2	539	HMTLSCRN2024	768
HLSLW085RF	231	HMP3072PK8	538	HMPHA2472PK4	539	HMTLSCRN2030	768
HLSLW086L	230, 551	HMP3072PK2	538	HMPHA2472PK6	539	HMTLSCRN2036	768
HLSLW086R	230, 551	HMP3072PK4	538	HMPHA2472PK8	539	HMTLSCRN2048	121, 768
HLSLW1224L	205	HMP3072PK6	538	HMPHA2472PK2	539	HMTLSCRN2054	121, 768
HLSLW1224R	205	HMP3072PK8	538	HMPHA2S4C	532	HMTLSCRN2060	121, 768
HLSLW1230L	205	HMP3072PK2	538	HMPHA3060PK2	539	HMTLSCRN2066	121, 768
HLSLW1230R	205	HMP3072PK4	538	HMPHA3060PK4	539	HMTLSCRN2066	121, 768
HLSLW445L	229, 550	HMP3072PK6	538	HMPHA3060PK6	539	HMTLSCRN2524	768
HLSLW445LF	231	HMP3072PK8	538	HMPHA3060PK8	539	HMTLSCRN2530	768
HLSLW445R	229, 550	HMP3072PK2	538	HMPHA3072PK2	539	HMTLSCRN2536	768
HLSLW445RF	231	HMP3072PK4	538	HMPHA3072PK4	539	HMTLSCRN2548	121, 768
HLSLW446L	229, 550	HMP3072PK6	538	HMPHA3072PK6	539	HMTLSCRN2554	121, 768
HLSLW446LP	229, 550	HMP3072PK8	538	HMPHA3072PK8	539	HMTLSCRN2560	121, 768
HLSLW446R	229, 550	HMP3072PK2	538	HMPHABEORKIT	532	HMTLSCRN2566	121, 768
HLSLW446RP	229, 550	HMP3072PK4	538	HMPHASLID20	532	HN899900	450, 492
HLSLW485L	230, 551	HMP3072PK6	538	HMPHASLID48	532	HN899910	450, 492
HLSLW485LF	231	HMP3072PK8	538	HMPHASLID60	532	HNL11SUPP	91
HLSLW485R	230, 551	HMP3072PK2	538	HMPHASLID72	532	HNL122428BKE	100
HLSLW485RF	231	HMP3072PK4	538	HMPHATFWML	122, 546, 612	HNL123028BKE	100
HLSLW486L	230, 551	HMP3072PK6	538	HMPHATROUGH20	532	HNL123628BKE	100
HLSLW486R	230, 551	HMP3072PK8	538	HMPHATROUGH48	532	HNL1530BK2	75
HLSLZ5SC54	201, 279, 739	HMP3072PK2	538	HMPHATROUGH60	532	HNL1530BK3	75
HLSLZ5SC60	82, 201, 279, 739	HMP3072PK4	538	HMPHATROUGH72	532	HNL1530BK4	75
HLSLZ5SC66	82, 201, 279, 739	HMP3072PK6	538	HMPHAWTWML	546, 612	HNL1530BK5	75
HLSLZ5SC72	82, 201, 279, 739	HMP3072PK8	538	HMPJUMP	544	HNL1530BK6	75
HLSLZ5SC78	82	HMP3072PK2	538	HMPJGP4850	537	HNL1530FD	61
HLSLZ5SC84	82, 201, 279, 739	HMP3072PK4	538	HMPJGP6050	537	HNL1530LD	60
HLVPM1	108, 175, 236, 319, 355, 369	HMP3072PK6	538	HMPJGP6050	537	HNL1530LL	60
HLVPM2	108, 175, 319, 355	HMP3072PK8	538	HMPJGP6050	537	HNL1530FD	61
HMASD	112, 176, 235, 323, 570, 642	HMP3072PK2	538	HMPJGP6050	537	HNL1536LD	60
HMASTS	112, 176, 235, 323, 570, 642	HMP3072PK4	538	HMPJGP6050	537	HNL1536LL	60
HMBPOST	94	HMP3072PK6	538	HMPJGP6050	537	HNL1542FD	61
HMBPOST1	632	HMP3072PK8	538	HMPJGP6050	537	HNL1542LD	60
HMBTLEG24	94	HMP3072PK2	538	HMPJGP6050	537	HNL1542LL	60
HMP120EL4828	526	HMP3072PK4	538	HMPJGP6050	537	HNL1548FD	61
HMP120EL6028	526	HMP3072PK6	538	HMPJGP6050	537	HNL1548LD	60
HMP120POST	526	HMP3072PK8	538	HMPJGP6050	537	HNL1548LL	60
HMP120TROUGH36	528	HMP3072PK2	538	HMPJGP6050	537	HNL1548SD	61
HMP120TROUGH42	528	HMP3072PK4	538	HMPJGP6050	537	HNL1560FD	61
HMP120TROUGH48	528	HMP3072PK6	538	HMPJGP6050	537	HNL1560LD	60
HMP120UB236	527	HMP3072PK8	538	HMPJGP6050	537	HNL1560LL	60
HMP120UB242	527	HMP3072PK2	538	HMPJGP6050	537	HNL1560SD	61
HMP120UB248	527	HMP3072PK4	538	HMPJGP6050	537	HNL1566FD	61
HMP144	544, 581	HMP3072PK6	538	HMPJGP6050	537	HNL1566LD	60
HMP2460PK2	538	HMP3072PK8	538	HMPJGP6050	537	HNL1566LL	60
HMP2460PK4	538	HMP3072PK2	538	HMPJGP6050	537	HNL1566SD	61
		HMP3072PK4	538	HMPJGP6050	537	HNL1572FD	61

CROSS REFERENCE INDEX

MODEL	PAGE	MODEL	PAGE	MODEL	PAGE	MODEL	PAGE
HNL1572LD	60	HNL2436LD3	70	HNL3630TB	104	HNL4936BHLD	64
HNL1572LL	60	HNL2436LD4	70	HNL3630WB	104	HNL4936BHXD	64
HNL1572SD	61	HNL2442BF	50	HNL3636BHFD	65	HNL4936FD	56
HNL1578FD	61	HNL2442LP	49	HNL3636BHLD	64	HNL4936LD	55
HNL1578LD	60	HNL2442RP	49	HNL3636BHXD	64	HNL4936LL	55
HNL1578LL	60	HNL2448BF	50	HNL3636CU	46	HNL4936TB	104
HNL1578SD	61	HNL2448LP	49	HNL3636FD	53	HNL4936WB	104
HNL1772RT	67	HNL2448RP	49	HNL3636LD	53	HNL4942FD	56
HNL20302ID2	48	HNL2460DPK	47	HNL3636LL	53	HNL4942LD	55
HNL2030MSFC	69	HNL2466DPK	47	HNL3636TB	104	HNL4942LL	55
HNL20362ID2	48	HNL2472DPK	47	HNL3636WB	104	HNL4948FD	56
HNL20602ID4	48	HNL2472DPS	47	HNL3642FD	53	HNL4948LD	55
HNL20602ILD2	48	HNL2472LLC	47	HNL3642LD	53	HNL4948LL	55
HNL20602IRD2	48	HNL2472LP	47	HNL3642LL	53	HNL4948SD	57
HNL20722ID4	48	HNL2472RLC	47	HNL3648FD	53	HNL4960FD	56
HNL20722ILD2	48	HNL2472RP	47	HNL3648LD	53	HNL4960LD	55
HNL20722IRD2	48	HNL291028PBFF	99	HNL3648LL	53	HNL4960LL	55
HNL2116MBBF	69	HNL291028PFF	99	HNL3648SD	54	HNL4960SD	57
HNL2116MBF	69	HNL291041PBFF	101	HNL3660FD	53	HNL4966FD	56
HNL2116MFF	69	HNL291628PBFF	99	HNL3660LD	53	HNL4966LD	55
HNL231028PBFF	99	HNL291628PFF	99	HNL3660LL	53	HNL4966LL	55
HNL231028PFF	99	HNL291641PBFF	101	HNL3660SD	54	HNL4966SD	57
HNL231041PBFF	101	HNL291641PSBFF	101	HNL3666FD	53	HNL4972FD	56
HNL231628PBFF	99	HNL2930FD	62	HNL3666LD	53	HNL4972LD	55
HNL231628PFF	99	HNL2930LD	62	HNL3666LL	53	HNL4972LL	55
HNL231641PBFF	101	HNL2930LL	62	HNL3666SD	54	HNL4972SD	57
HNL231641PSBFF	101	HNL2936FD	62	HNL3672BUEP	44	HNL4978FD	56
HNL231828PBFF	99	HNL2936LD	62	HNL3672DPBB	41	HNL4978LD	55
HNL231828PFF	99	HNL2936LL	62	HNL3672DPBFF	41	HNL4978LL	55
HNL233028PBK	100	HNL2942FD	62	HNL3672DPBR	41	HNL4978SD	57
HNL233028PLF	99	HNL2942LD	62	HNL3672DPRB	41	HNL7872RLT	68
HNL233028PSC	100	HNL2942LL	62	HNL3672DPRBF	41	HNL7872RT	67
HNL233028PSL	100	HNL2948FD	62	HNL3672DPRR	41	HNL8472RLT	68
HNL233628PBK	100	HNL2948LD	62	HNL3672FD	53	HNL8472RT	67
HNL233628PLF	99	HNL2948LL	62	HNL3672LD	53	HNLBU3048	80
HNL233628PSC	100	HNL2948SD	63	HNL3672LL	53	HNLBU3060	80
HNL233628PSL	100	HNL2960FD	62	HNL3672LPBB	42	HNLBU3066	80
HNL241850TLL	74	HNL2960LD	62	HNL3672LPBFF	42	HNLBU3072	80
HNL241850TLR	74	HNL2960LL	62	HNL3672LPBR	42	HNLBU3078	80
HNL241865SFL	71	HNL2960SD	63	HNL3672LPRB	43	HNLBU3084	80
HNL241865SFLR	71	HNL2966FD	62	HNL3672LPRBF	43	HNLBW3672	80
HNL241865SFX	71	HNL2966LD	62	HNL3672LPRR	43	HNLBW3684	80
HNL241865WLL	73	HNL2966LL	62	HNL3672RPBB	42	HNLCDShelf	104
HNL241865WLR	73	HNL2966SD	63	HNL3672RPBFF	42	HNLECC367224L	81
HNL241879WLL	73	HNL2972FD	62	HNL3672RPBR	42	HNLECC367224R	81
HNL241879WLR	73	HNL2972LD	62	HNL3672RPRB	43	HNLECC487224L	81
HNL242465TLL	74	HNL2972LL	62	HNL3672RPRBF	43	HNLECC487224R	81
HNL242465TLR	74	HNL2972SD	63	HNL3672RPRR	43	HNLEP1128	89
HNL242479TLL	74	HNL2978FD	62	HNL3672SD	54	HNLEP1141	89
HNL242479TLR	74	HNL2978LD	62	HNL3678FD	53	HNLEP2428L	88
HNL2424BK5CL	75	HNL2978LL	62	HNL3678LD	53	HNLEP2428R	88
HNL2424BK5CR	75	HNL2978SD	63	HNL3678LL	53	HNLEP2441L	88
HNL243629SC	71	HNL301850TLL	74	HNL3678SD	54	HNLEP2441R	88
HNL243665SSC	71	HNL301850TLR	74	HNL4272JLEP	44	HNLEP247L	90, 280
HNL243665SLL	72	HNL3060DPRF	41	HNL4272JREP	44	HNLEP247R	90, 280
HNL243665WL	73	HNL3066BUEP	44	HNL4872JLEP	44	HNLEP3028L	88
HNL243665WLB	73	HNL3066DPRF	41	HNL4872JREP	44	HNLEP3028R	88
HNL243665WRBL	73	HNL3066LPRF	43	HNL4905SSEP	57	HNLEP3041L	88
HNL243679SC	71	HNL3066RPRF	43	HNL4930BHLD	64	HNLEP3041R	88
HNL243679WL	73	HNL3072BUEP	44	HNL4930BHXD	64	HNLEP307L	90, 280
HNL243679WLB	73	HNL3605SSEP	54	HNL4930TB	104	HNLEP307R	90, 280
HNL243679WRBL	73	HNL3630BHLD	64	HNL4930WB	104	HNLEP3628L	88
HNL2436LD2	70	HNL3630BHXD	64	HNL4936BHFD	65	HNLEP3628R	88

CROSS REFERENCE INDEX

MODEL	PAGE	MODEL	PAGE	MODEL	PAGE	MODEL	PAGE
HNLB1013	103	HNLRC2478	78	HPNLSTACK2272	772	HRVBPLATE342	449, 607
HNLB1018	103	HNLRC2484	78	HPNLSTACK2278	772	HRVBPLATE348	449, 607
HNLB1613	103	HNLRC2490	78	HPNLSTACK2284	772	HRVBPLATE360	449, 607
HNLB1618	103	HNLRC2496	78	HPNLSTACK2290	772	HRVBRI524	628
HNLB1818	103	HNLRC3048	78, 123	HPNLSTACK2296	772	HRVBRI524F	628
HNLB3018	103	HNLRC3060	78, 123	HPNLSTACKBKT	772	HRVBRI524P	628
HNLB3618	103	HNLRC3066	78, 123	HPPMAS	466, 639	HRVBRI524PF	628
HNLLEP2428L	90	HNLRC3072	78, 123	HPPMFB	466, 639	HRVBRI530	628
HNLLEP2428R	90	HNLRC3078	78	HPPMPB	466, 639	HRVBRI530F	628
HNLLEP2441L	90	HNLRC3084	78	HPPMPS	466, 639	HRVBRI530P	628
HNLLEP2441R	90	HNLRC3672	78	HPPMPT	466, 639	HRVBRI530PF	628
HNLLEP3028L	90	HNLRC3684	78	HPPMST	466, 639	HRVBRI536	628
HNLLEP3028R	90	HNLTEP2428	91	HPSEAT18ND	750	HRVBRI536F	628
HNLLEP3041L	90	HNLTEP3028	91	HPSEAT24ND	566, 568, 569, 701, 704, 708, 724, 750	HRVBRI536P	628
HNLLEP3041R	90	HNLTEP3628	91	HPULL2	674	HRVBRI536PF	628
HNLMP3010	84	HNPMBSW24	465, 639	HPULL3	674	HRVBRI542	628
HNLMP3028	84	HNPMBSW30	465, 639	HPWRMOD2	107, 122, 179, 243, 286, 546, 641	HRVBRI542F	628
HNLMP3610	84	HNPMBSW36	465, 639	HPWRMOD2UWM	107, 122, 179, 243, 546, 612, 641	HRVBRI548	628
HNLMP3628	84	HNPMBSW42	465, 639	HPWRMOD2WC	107, 122, 179, 243, 377, 384, 390, 402, 546, 612, 641	HRVBRI548F	628
HNLMP4210	84	HNPMBSW48	465, 639	HPWRMOD3UWM	107, 122, 179, 243, 546, 612, 641	HRVBRI560	628
HNLMP4228	84	HNPMBSW60	465, 639	HPWRMOD3WC	107, 122, 179, 243, 377, 384, 390, 402, 546, 612, 641	HRVBRI560F	628
HNLMP4810	84	HOLEG12	630	HPWRMOD4WC	122	HRVBRI566	628
HNLMP4828	84	HOLEG18	630	HRABAB	469	HRVBRI566F	628
HNLMP5410	84	HOLEG24	630	HRFF3524P	447	HRVBRI572	628
HNLMP5428	84	HOLEG30	630	HRFF3530P	447	HRVBRI572F	628
HNLMP6010	84	HP3231	383	HRFF3536P	447	HRVC15FFV	454
HNLMP6028	84	HP3235R	382	HRFF3542P	447	HRVC15FFVF	454
HNLMP6610	84	HP3236L	382	HRFF3548P	447	HRVC15PF	454
HNLMP6628	84	HP3251R	382	HRFF3560P	447	HRVC15PFF	454
HNLMP7210	84	HP3261	382	HRFF4224P	447	HRVC15PFT	454
HNLMP7228	84	HP3262	382	HRFF4230P	447	HRVC15PXF	452
HNLMP7810	84	HP3265R	382	HRFF4242P	447	HRVC22PFT	454
HNLMP7828	84	HP3266L	382	HRFF4248P	447	HRVC22PFV	454
HNLMP8410	84	HP3276	382	HRFF4260P	447	HRVC22PLF	452
HNLMP8428	84	HPC180G	45, 164, 299, 346	HRFF5024P	447	HRVC22PLF	452
HNLMP9010	84	HPC180W	45	HRFF5030P	447	HRVC22PS	452
HNLMP9028	84	HPC190X	44, 93, 281	HRFF5036P	447	HRVC22PSF	452
HNLMP9610	84	HPC191X	44, 93, 281	HRFF5042P	447	HRVC22PT	452
HNLMP9628	84	HPCW1	566, 701, 750	HRFF5048P	447	HRVC22PTF	452
HNLPB1028	103	HPD2PNBRK2L	633	HRFF5060P	447	HRVC22PTF	452
HNLPB1041	103	HPD2PNBRK2R	633	HRFF5724P	447	HRVC22PX	452
HNLPB1628	103	HPMARKER1	774	HRFF5730P	447	HRVC22PXF	452
HNLPB1641	103	HPNLSTACK1524	772	HRFF5736P	447	HRVC30PF	454
HNLPB1828	103	HPNLSTACK1530	772	HRFF5742P	447	HRVC30PFF	454
HNLPT2416	102	HPNLSTACK1536	772	HRFF5748P	447	HRVC30PFT	454
HNLPT2418	102	HPNLSTACK1542	772	HRFF5760P	447	HRVC30PFV	454
HNLPT3016	102	HPNLSTACK1548	772	HRFF6524P	447	HRVC30PFV	454
HNLRC2042V	79	HPNLSTACK1554	772	HRFF6530P	447	HRVC30PL	452
HNLRC2048V	79	HPNLSTACK1560	772	HRFF6536P	447	HRVC30PLF	452
HNLRC2430	78	HPNLSTACK1566	772	HRFF6542P	447	HRVC30PS	452
HNLRC2430V	79	HPNLSTACK1572	772	HRFF6548P	447	HRVC30PSF	452
HNLRC2436	78	HPNLSTACK1578	772	HRFF6560P	447	HRVC30PT	452
HNLRC2436V	79	HPNLSTACK1584	772	HRFTAB	469	HRVC30PTF	452
HNLRC2442	78	HPNLSTACK1590	772	HRVBPLATE336	449, 607	HRVC30PX	452
HNLRC2442V	79	HPNLSTACK1596	772				
HNLRC2448	78, 123	HPNLSTACK2224	772				
HNLRC2448V	79	HPNLSTACK2230	772				
HNLRC2454	78	HPNLSTACK2236	772				
HNLRC2454V	79	HPNLSTACK2242	772				
HNLRC2460	78, 123	HPNLSTACK2248	772				
HNLRC2460V	79	HPNLSTACK2254	772				
HNLRC2466	78, 123	HPNLSTACK2260	772				
HNLRC2472	78, 123	HPNLSTACK2266	772				

CROSS REFERENCE INDEX

MODEL	PAGE	MODEL	PAGE	MODEL	PAGE	MODEL	PAGE
HRVC30PXF	452	HRVC65PF	454	HRVF3524P	445	HRVG3527L	470
HRVC35GP	473	HRVC65PFF	454	HRVF3530P	445	HRVG3527LG	471
HRVC35PCE	454, 499, 634	HRVC65PL	452	HRVF3536P	445	HRVG353018GGNS	478
HRVC35PCM	454, 499, 634	HRVC65PLF	452	HRVF3542P	445	HRVG353018GGNSG	478
HRVC35PF	454	HRVC65PS	452	HRVF3548P	445	HRVG353024GGNS	478
HRVC35PFF	454	HRVC65PSF	452	HRVF3560P	445	HRVG353024GGNSG	478
HRVC35PL	452	HRVC65PT	452	HRVF4224P	445	HRVG3530GGL	476
HRVC35PLF	452	HRVC65PTF	452	HRVF4230P	445	HRVG3530GGLG	476
HRVC35PS	452	HRVC65PW	454	HRVF4236P	445	HRVG3530GGR	475
HRVC35PSF	452	HRVC65PWF	454	HRVF4242P	445	HRVG3530GGRG	475
HRVC35PT	452	HRVC65PX	452	HRVF4248P	445	HRVG3530L	470
HRVC35PTF	452	HRVC65PXF	452	HRVF4260P	445	HRVG3530LG	471
HRVC35PX	452	HRVC65PY2	453	HRVF5024P	445	HRVG3533L	470
HRVC35PXF	452	HRVC65PY2F	453	HRVF5030P	445	HRVG3533LG	471
HRVC35PY2	453	HRVC65PY3	453	HRVF5036P	445	HRVG3536GGL	476
HRVC35PY2F	453	HRVC65PY3F	453	HRVF5042P	445	HRVG3536GGLG	476
HRVC35PY3	453	HRVC7FFV	454	HRVF5048P	445	HRVG3536GGR	475
HRVC35PY3F	453	HRVC7FFVF	454	HRVF5060P	445	HRVG3536GGRG	475
HRVC42GP	473	HRVC7PFT	454	HRVF5724P	445	HRVG3536GGT	477
HRVC42PF	454	HRVC7PFV	454	HRVF5730P	445	HRVG3536GGTG	477
HRVC42PFF	454	HRVC7PFVF	454	HRVF5736P	445	HRVG3536L	470
HRVC42PL	452	HRVC7PL	452	HRVF5742P	445	HRVG3536LG	471
HRVC42PLF	452	HRVC7PLF	452	HRVF5748P	445	HRVG3539L	470
HRVC42PS	452	HRVC7PS	452	HRVF5760P	445	HRVG3539LG	471
HRVC42PSF	452	HRVC7PSF	452	HRVF6524P	445	HRVG3542GGL	476
HRVC42PT	452	HRVC7PT	452	HRVF6530P	445	HRVG3542GGLG	476
HRVC42PTF	452	HRVC7PTF	452	HRVF6536P	445	HRVG3542GGR	475
HRVC42PX	452	HRVC7PX	452	HRVF6542P	445	HRVG3542GGRG	475
HRVC42PXF	452	HRVC7PXF	452	HRVF6548P	445	HRVG3542GGT	477
HRVC42PY2	453	HRVC80PF	454	HRVF6560P	445	HRVG3542GGTG	477
HRVC42PY2F	453	HRVC80PFF	454	HRVF6560P	447	HRVG3542L	470
HRVC42PY3	453	HRVC80PL	452	HRVFSB24	448	HRVG3542LG	471
HRVC42PY3F	453	HRVC80PLF	452	HRVFSB30	448	HRVG3545L	470
HRVC50GP	473	HRVC80PS	452	HRVFSB36	448	HRVG3545LG	471
HRVC50PF	454	HRVC80PSF	452	HRVFSB42	448	HRVG3548GGL	476
HRVC50PFF	454	HRVC80PT	452	HRVFSB48	448	HRVG3548GGLG	476
HRVC50PL	452	HRVC80PTF	452	HRVFSB60	448	HRVG3548GGR	475
HRVC50PLF	452	HRVC80PX	452	HRVFSBW24	455	HRVG3548GGRG	475
HRVC50PS	452	HRVC80PXF	452	HRVFSBW30	455	HRVG3548GGT	477
HRVC50PSF	452	HRVCE	473	HRVFSBW36	455	HRVG3548GGTG	477
HRVC50PT	452	HRVCLG24	418, 630	HRVFSBW42	455	HRVG3548L	470
HRVC50PTF	452	HRVCLG30	418, 630	HRVFSBW48	455	HRVG3548LG	471
HRVC50PX	452	HRVCM	473	HRVFSBW60	455	HRVG3551L	470
HRVC50PXF	452	HRVD0742T	450	HRVG351824GGNS	478	HRVG3551LG	471
HRVC50PY2	453	HRVD9542P	450	HRVG351824GGNSG	478	HRVG3560GGL	476
HRVC50PY2F	453	HRVEP1129L	418, 630	HRVG351830GGNS	478	HRVG3560GGLG	476
HRVC50PY3	453	HRVEP1129R	418, 630	HRVG351830GGNSG	478	HRVG3560GGR	475
HRVC50PY3F	453	HRVEP2429L	418, 630	HRVG3518GGL	476	HRVG3560GGRG	475
HRVC57PF	454	HRVEP2429R	418, 630	HRVG3518GGLG	476	HRVG3560GGT	477
HRVC57PFF	454	HRVEP3029L	418, 630	HRVG3518GGR	475	HRVG3560GGTG	477
HRVC57PL	452	HRVEP3029R	418, 630	HRVG3518GGRG	475	HRVG3560L	470
HRVC57PLF	452	HRVFI524	448	HRVG3518GGT	477	HRVG3560LG	471
HRVC57PS	452	HRVFI530	448	HRVG3518GGTG	477	HRVG3563L	470
HRVC57PSF	452	HRVFI536	448	HRVG352418GGNS	478	HRVG3563LG	471
HRVC57PT	452	HRVFI542	448	HRVG352418GGNSG	478	HRVG3572GGT	477
HRVC57PTF	452	HRVFI548	448	HRVG352430GGNS	478	HRVG3572GGTG	477
HRVC57PX	452	HRVFI560	448	HRVG352430GGNSG	478	HRVG3575L	470
HRVC57PXF	452	HRVF3024	448	HRVG3524GGL	476	HRVG3575LG	471
HRVC57PY2	453	HRVF3030	448	HRVG3524GGLG	476	HRVG421824GGNS	478
HRVC57PY2F	453	HRVF3036	448	HRVG3524GGR	475	HRVG421824GGNSG	478
HRVC57PY3	453	HRVF3042	448	HRVG3524GGRG	475	HRVG421830GGNS	478
HRVC57PY3F	453	HRVF3048	448	HRVG3524L	470	HRVG421830GGNSG	478
HRVC65GP	473	HRVF3060	448	HRVG3524LG	471	HRVG4218GGL	476

CROSS REFERENCE INDEX

MODEL	PAGE	MODEL	PAGE	MODEL	PAGE	MODEL	PAGE
HRVG4218GGLG	476	HRVG4260GGT	477	HRVG5045LG	471	HRVSH72	586
HRVG4218GGR	475	HRVG4260GGTG	477	HRVG5048GGL	476	HRVSHV24	588
HRVG4218GGRG	475	HRVG4260L	470	HRVG5048GGLG	476	HRVSHV30	588
HRVG4218GGT	477	HRVG4260LG	471	HRVG5048GGR	475	HRVSHV36	588
HRVG4218GGTG	477	HRVG4263L	470	HRVG5048GGRG	475	HRVSHV42	588
HRVG422418GGNS	478	HRVG4263LG	471	HRVG5048GGT	477	HRVSHV48	588
HRVG422418GGNSG	478	HRVG4272GGT	477	HRVG5048GGTG	477	HRVSS24	449
HRVG422430GGNS	478	HRVG4272GGTG	477	HRVG5048L	470	HRVSS30	449
HRVG422430GGNSG	478	HRVG4275L	470	HRVG5048LG	471	HRVSS36	449
HRVG4224GGL	476	HRVG4275LG	471	HRVG5051L	470	HRVSS42	449
HRVG4224GGLG	476	HRVG501824GGNS	478	HRVG5051LG	471	HRVSS48	449
HRVG4224GGR	475	HRVG501824GGNSG	478	HRVG5060GGL	476	HRVSS60	449
HRVG4224GGRG	475	HRVG501830GGNS	478	HRVG5060GGGLG	476	HRVT0724F	463
HRVG4224L	470	HRVG501830GGNSG	478	HRVG5060GGR	475	HRVT0724FF	463
HRVG4224LG	471	HRVG5018GGL	476	HRVG5060GGRG	475	HRVT0724T	456, 464
HRVG4227L	470	HRVG5018GGLG	476	HRVG5060GGT	477	HRVT0730F	463
HRVG4227LG	471	HRVG5018GGR	475	HRVG5060GGTG	477	HRVT0730FF	463
HRVG423018GGNS	478	HRVG5018GGRG	475	HRVG5060L	470	HRVT0730T	456, 464
HRVG423018GGNSG	478	HRVG5018GGT	477	HRVG5060LG	471	HRVT0736F	463
HRVG423024GGNS	478	HRVG5018GGTG	477	HRVG5063L	470	HRVT0736FF	463
HRVG423024GGNSG	478	HRVG502418GGNS	478	HRVG5063LG	471	HRVT0736T	456, 464
HRVG4230GGL	476	HRVG502418GGNSG	478	HRVG5072GGT	477	HRVT0742F	463
HRVG4230GGLG	476	HRVG502430GGNS	478	HRVG5072GGTG	477	HRVT0742FF	463
HRVG4230GGR	475	HRVG502430GGNSG	478	HRVG5075L	470	HRVT0742T	456, 464
HRVG4230GGRG	475	HRVG5024GGL	476	HRVG5075LG	471	HRVT0748F	463
HRVG4230L	470	HRVG5024GGLG	476	HRVGLSK	473	HRVT0748FF	463
HRVG4230LG	471	HRVG5024GGR	475	HRVGMASK	473	HRVT0748T	456, 464
HRVG4233L	470	HRVG5024GGRG	475	HRVGTGG	479	HRVT0754F	463
HRVG4233LG	471	HRVG5024L	470	HRVOH1530RM	586	HRVT0754FF	463
HRVG4236GGL	476	HRVG5024LG	471	HRVOH1536RM	586	HRVT0760F	463
HRVG4236GGLG	476	HRVG5027L	470	HRVOH1542RM	586	HRVT0760FF	463
HRVG4236GGR	475	HRVG5027LG	471	HRVOH1548RM	586	HRVT0760T	456, 464
HRVG4236GGRG	475	HRVG503018GGNS	478	HRVOH1560RM	586	HRVT0766F	463
HRVG4236GGT	477	HRVG503018GGNSG	478	HRVOH24FM	586	HRVT0766FF	463
HRVG4236GGTG	477	HRVG503024GGNS	478	HRVOH30FM	586	HRVT0772F	463
HRVG4236L	470	HRVG503024GGNSG	478	HRVOH36FM	586	HRVT0772FF	463
HRVG4236LG	471	HRVG5030GGL	476	HRVOH42FM	586	HRVT0778F	463
HRVG4239L	470	HRVG5030GGLG	476	HRVOH48FM	586	HRVT0778FF	463
HRVG4239LG	471	HRVG5030GGR	475	HRVOH60FM	586	HRVT0784F	463
HRVG4242GGL	476	HRVG5030GGRG	475	HRVOH72FM	586	HRVT0784FF	463
HRVG4242GGLG	476	HRVG5030L	470	HRVOHV24HLA	589	HRVT0790F	463
HRVG4242GGR	475	HRVG5030LG	471	HRVOHV24HMA	588	HRVT0790FF	463
HRVG4242GGRG	475	HRVG5033L	470	HRVOHV30HLA	589	HRVT0796F	463
HRVG4242GGT	477	HRVG5033LG	471	HRVOHV30HMA	588	HRVT0796FF	463
HRVG4242GGTG	477	HRVG5036GGL	476	HRVOHV36HLA	589	HRVT1524CK	469
HRVG4242L	470	HRVG5036GGLG	476	HRVOHV36HMA	588	HRVT1524E	458
HRVG4242LG	471	HRVG5036GGR	475	HRVOHV42HLA	589	HRVT1524F	463
HRVG4245L	470	HRVG5036GGRG	475	HRVOHV42HMA	588	HRVT1524FF	463
HRVG4245LG	471	HRVG5036GGT	477	HRVOHV48HLA	589	HRVT1524G	461
HRVG4248GGL	476	HRVG5036GGTG	477	HRVOHV48HMA	588	HRVT1524HS2	460
HRVG4248GGLG	476	HRVG5036L	470	HRVOMOD	455	HRVT1524M	467
HRVG4248GGR	475	HRVG5036LG	471	HRVP24P	610	HRVT1524PM	468
HRVG4248GGRG	475	HRVG5039L	470	HRVP30P	610	HRVT1524R	462
HRVG4248GGT	477	HRVG5039LG	471	HRVP36P	610	HRVT1524T	456
HRVG4248GGTG	477	HRVG5042GGL	476	HRVP42P	610	HRVT1524W	465
HRVG4248L	470	HRVG5042GGLG	476	HRVP48P	610	HRVT1530CK	469
HRVG4248LG	471	HRVG5042GGRG	475	HRVP60P	610	HRVT1530E	458
HRVG4251L	470	HRVG5042GGTG	475	HRVSH24	586	HRVT1530F	463
HRVG4251LG	471	HRVG5042GGT	477	HRVSH30	586	HRVT1530FF	463
HRVG4260GGL	476	HRVG5042GGTG	477	HRVSH36	586	HRVT1530G	461
HRVG4260GGLG	476	HRVG5042L	470	HRVSH42	586	HRVT1530HS2	460
HRVG4260GGR	475	HRVG5042LG	471	HRVSH48	586	HRVT1530M	467
HRVG4260GGRG	475	HRVG5045L	470	HRVSH60	586	HRVT1530PM	468

CROSS REFERENCE INDEX

MODEL	PAGE	MODEL	PAGE	MODEL	PAGE	MODEL	PAGE
HRVT1530R	462	HRVT2236T	456	HRVT3730T	456	HRVTC60	446
HRVT1530T	456	HRVT2242T	456	HRVT3736E	458	HRVTC60F	446
HRVT1530W	465	HRVT2248T	456	HRVT3736HS2	460	HRVTC66	446
HRVT1536CK	469	HRVT2260T	456	HRVT3736T	456	HRVTC66F	446
HRVT1536E	458	HRVT3024CK	469	HRVT3742E	458	HRVTC72	446
HRVT1536F	463	HRVT3024E	458	HRVT3742HS2	460	HRVTC72F	446
HRVT1536FF	463	HRVT3024G	461	HRVT3742T	456	HRVTC78	446
HRVT1536G	461	HRVT3024HS2	460	HRVT3748E	458	HRVTC78F	446
HRVT1536HS2	460	HRVT3024M	467	HRVT3748HS2	460	HRVTC84	446
HRVT1536M	467	HRVT3024P	464	HRVT3748T	456	HRVTC84F	446
HRVT1536PM	468	HRVT3024PM	468	HRVT3760E	458	HRVTC90	446
HRVT1536R	462	HRVT3024R	462	HRVT3760HS2	460	HRVTC90F	446
HRVT1536T	456	HRVT3024T	456	HRVT3760T	456	HRVTC96	446
HRVT1536W	465	HRVT3030CK	469	HRVT4524E	459	HRVTC96F	446
HRVT1542CK	469	HRVT3030E	458	HRVT4524T	457	HRVTRAYM	467
HRVT1542E	458	HRVT3030G	461	HRVT4530E	459	HRVUP24	596
HRVT1542F	463	HRVT3030HS2	460	HRVT4530T	457	HRVUP30	596
HRVT1542FF	463	HRVT3030M	467	HRVT4536E	459	HRVUP36	596
HRVT1542G	461	HRVT3030P	464	HRVT4536T	457	HRVUP42	596
HRVT1542HS2	460	HRVT3030PM	468	HRVT4542E	459	HRVUP48	596
HRVT1542M	467	HRVT3030R	462	HRVT4542T	457	HRVUP60	596
HRVT1542PM	468	HRVT3030T	456	HRVT4548E	459	HS30ABC	663
HRVT1542R	462	HRVT3036CK	469	HRVT4548T	457	HS42ABC	663
HRVT1542T	456	HRVT3036E	458	HRVT4560E	459	HS60ABC	663
HRVT1542W	465	HRVT3036G	461	HRVT4560T	457	HS72ABC	663
HRVT1548CK	469	HRVT3036HS2	460	HRVT5224E	459	HS82ABC	663
HRVT1548E	458	HRVT3036M	467	HRVT5224T	457	HSC1842	664
HRVT1548F	463	HRVT3036P	464	HRVT5230E	459	HSC1872	664
HRVT1548FF	463	HRVT3036PM	468	HRVT5230T	457	HSC2472	664
HRVT1548G	461	HRVT3036R	462	HRVT5236E	459	HSCABD02	556, 662, 676
HRVT1548HS2	460	HRVT3036T	456	HRVT5236T	457	HSCABD10	556, 662, 676
HRVT1548M	467	HRVT3042CK	469	HRVT5242E	459	HSCACW25	675
HRVT1548PM	468	HRVT3042E	458	HRVT5242T	457	HSCACW35	675
HRVT1548R	462	HRVT3042G	461	HRVT5248E	459	HSCACW50	675
HRVT1548T	456	HRVT3042HS2	460	HRVT5248T	457	HSCAFD02	556, 662, 676, 747
HRVT1548W	465	HRVT3042M	467	HRVT5260E	459	HSCAFD10	556, 662, 676, 747
HRVT1554F	463	HRVT3042P	464	HRVT5260T	457	HSCAHR12	675
HRVT1554FF	463	HRVT3042PM	468	HRVT6024E	459	HSCAHR15	674
HRVT1560CK	469	HRVT3042R	462	HRVT6024T	457	HSCAPB	675
HRVT1560E	458	HRVT3042T	456	HRVT6030E	459	HSCAUC1824	556, 676
HRVT1560F	463	HRVT3048CK	469	HRVT6030T	457	HSCAUC1830	556, 676
HRVT1560FF	463	HRVT3048E	458	HRVT6036E	459	HSCAUC1836	556, 676
HRVT1560G	461	HRVT3048G	461	HRVT6036T	457	HSCAWS6520	675
HRVT1560HS2	460	HRVT3048HS2	460	HRVT6042E	459	HSCAWS6524	675
HRVT1560M	467	HRVT3048M	467	HRVT6042T	457	HSCAWS6530	675
HRVT1560PM	468	HRVT3048P	464	HRVT6048E	459	HSCF223018BFL	555, 671
HRVT1560R	462	HRVT3048PM	468	HRVT6048T	457	HSCF223018BFM	553, 669
HRVT1560T	456	HRVT3048R	462	HRVT6060E	459	HSCF223018O	553, 669
HRVT1560W	465	HRVT3048T	456	HRVT6060T	457	HSCF223618BFL	555, 671
HRVT1566F	463	HRVT3060CK	469	HRVTB11	474	HSCF223618BFM	553, 669
HRVT1566FF	463	HRVT3060E	458	HRVTB18	474	HSCF223618O	553, 669
HRVT1572F	463	HRVT3060G	461	HRVTC24	446	HSCF224818BFL	555, 671
HRVT1572FF	463	HRVT3060HS2	460	HRVTC24F	446	HSCF224818BFOM	553, 669
HRVT1578F	463	HRVT3060M	467	HRVTC30	446	HSCF224818BFL	555, 671
HRVT1578FF	463	HRVT3060P	464	HRVTC30F	446	HSCF224818BFOM	553, 669
HRVT1584F	463	HRVT3060PM	468	HRVTC36	446	HSCF226018BFL	555, 671
HRVT1584FF	463	HRVT3060R	462	HRVTC36F	446	HSCF226018BFOM	553, 669
HRVT1590F	463	HRVT3060T	456	HRVTC42	446	HSCF226018BFL	555, 671
HRVT1590FF	463	HRVT3724E	458	HRVTC42F	446	HSCF226018BFOM	553, 669
HRVT1596F	463	HRVT3724HS2	460	HRVTC48	446	HSCF227218BFL	555, 671
HRVT1596FF	463	HRVT3724T	456	HRVTC48F	446	HSCF227218BFOM	553, 669
HRVT2224T	456	HRVT3730E	458	HRVTC54	446	HSCF227218BFL	555, 671
HRVT2230T	456	HRVT3730HS2	460	HRVTC54F	446	HSCF227218BFOM	553, 669

CROSS REFERENCE INDEX

MODEL	PAGE	MODEL	PAGE	MODEL	PAGE	MODEL	PAGE
HSCK24BF	675	HSCLP652418LLE	697	HSDLP421218LM	694	HSISLAUTIPYB6036S2	737
HSCK30BF	675	HSCLP652418LM	694	HSDLP421218LME	696	HSISLAUTIPYB6036S5	737
HSCK300	675	HSCLP652418LME	696	HSDLP421218RL	695	HSISLAUTIPYB7236S2	737
HSCK36BF	675	HSCLP652418RL	695	HSDLP421218RLE	697	HSISLAUTIPYB7236S3	737
HSCK36O	675	HSCLP652418RLE	697	HSDLP421218RM	694	HSISLAUTIPYB7236S6	737
HSCKTPS	498	HSCLP652418RM	694	HSDLP421218RME	696	HSISLAUTIPYB8436S2	737
HSCLF501218LL	695	HSCLP652418RME	696	HSDLP651218LL	695	HSISLAUTIPYB8436S7	737
HSCLF501218LLE	697	HSCP223018BFL	554, 670	HSDLP651218LLE	697	HSISLAUT2PNB2418S1	735
HSCLF501218LM	694	HSCP223018BFM	552, 668	HSDLP651218LM	694	HSISLAUT2PNB3018S1	735
HSCLF501218LME	696	HSCP223018O	552, 668	HSDLP651218LME	696	HSISLAUT2PNB3618S1	735
HSCLF501218RL	695	HSCP223618BFL	554, 670	HSDLP651218RL	695	HSISLAUT2PNB3618S3	735
HSCLF501218RLE	697	HSCP223618BFM	552, 668	HSDLP651218RLE	697	HSISLAUT2PNB4218S1	735
HSCLF501218RM	694	HSCP223618O	552, 668	HSDLP651218RM	694	HSISLAUT2PNB4818S2	735
HSCLF501218RME	696	HSCP224818LBFOL	554, 670	HSDLP651218RME	696	HSISLAUT2PNB4818S4	735
HSCLF502418LL	695	HSCP224818LBFOM	552, 668	HSDMP244	421	HSISLAUT2PNB6018S2	735
HSCLF502418LLE	697	HSCP224818RBFOL	554, 670	HSDMP249	421	HSISLAUT2PNB6018S5	735
HSCLF502418LM	694	HSCP224818RBFOM	552, 668	HSDMP304	421	HSISLAUT2PNB7218S2	735
HSCLF502418LME	696	HSCP226018LBFOL	554, 670	HSDMP309	421	HSISLAUT2PNB7218S3	735
HSCLF502418RL	695	HSCP226018LBFOM	552, 668	HSDMP364	421	HSISLAUT2PNB7218S6	735
HSCLF502418RLE	697	HSCP226018RBFOL	554, 670	HSDMP369	421	HSISLAUT2PNB8418S2	735
HSCLF502418RM	694	HSCP226018RBFOM	552, 668	HSDMP424	421	HSISLAUT2PNB8418S7	735
HSCLF502418RME	696	HSCP227218LBFOL	554, 670	HSDMP429	421	HSISLAUT2PYB4818S2	736
HSCLF651218LL	695	HSCP227218RBFOL	552, 668	HSDMP484	421	HSISLAUT2PYB4818S4	736
HSCLF651218LLE	697	HSCP227218RBFOM	554, 670	HSDMP489	421	HSISLAUT2PYB4836S2	736
HSCLF651218LM	694	HSCP227218RBFOM	552, 668	HSDMP544	421	HSISLAUT2PYB4836S4	736
HSCLF651218LME	696	HSDBK29	420	HSDMP549	421	HSISLAUT2PYB6018S2	736
HSCLF651218RL	695	HSDCDPA29L	420	HSDMP604	421	HSISLAUT2PYB6018S5	736
HSCLF651218RLE	697	HSDCDPA29R	420	HSDMP609	421	HSISLAUT2PYB6036S2	736
HSCLF651218RM	694	HSDCMP3614	421	HSDMP664	421	HSISLAUT2PYB6036S5	736
HSCLF651218RME	696	HSDCMP3629	421	HSDMP669	421	HSISLAUT2PYB7218S2	736
HSCLF652418LL	695	HSDCMP4214	421	HSDMP724	421	HSISLAUT2PYB7218S3	736
HSCLF652418LLE	697	HSDCMP4229	421	HSDMP729	421	HSISLAUT2PYB7218S6	736
HSCLF652418LM	694	HSDCMP4814	421	HSDRK29	420	HSISLAUT2PYB7236S2	736
HSCLF652418LME	696	HSDCMP4829	421	HSDSL2429F	418	HSISLAUT2PYB7236S3	736
HSCLF652418RL	695	HSDCMP6014	421	HSDSL29	419	HSISLAUT2PYB7236S6	736
HSCLF652418RLE	697	HSDCMP6029	421	HSDSL3029F	418	HSISLAUT2PYB8418S2	736
HSCLF652418RM	694	HSDCMP7214	421	HSFCF283018BBFL	672	HSISLAUT2PYB8418S7	736
HSCLF652418RME	696	HSDCMP7229	421	HSFCF283018BBFM	672	HSISLAUT2PYB8436S2	736
HSCLP501218LL	695	HSDDL29	419	HSFCP283018BBFL	672	HSISLAUT2PYB8436S7	736
HSCLP501218LLE	697	HSDDPA29L	420	HSFCP283018BBFM	672	HSISLAUTNPNB2418S1	734
HSCLP501218LM	694	HSDDPA29R	420	HSISLACB2P4842S2	738	HSISLAUTNPNB2436S1	734
HSCLP501218LME	696	HSDEP1129F	418	HSISLACB2P4842S4	738	HSISLAUTNPNB3018S1	734
HSCLP501218RL	695	HSDEP2429F	418	HSISLACB2P6042S5	738	HSISLAUTNPNB3036S1	734
HSCLP501218RLE	697	HSDEP3029F	418	HSISLACB2P7242S3	738	HSISLAUTNPNB3618S1	734
HSCLP501218RM	694	HSDG	419	HSISLACB2P7242S6	738	HSISLAUTNPNB3618S3	734
HSCLP501218RME	696	HSDLF421218LL	695	HSISLACB2P8442S7	738	HSISLAUTNPNB3636S1	734
HSCLP502418LL	695	HSDLF421218LLE	697	HSISLACENB1842	738	HSISLAUTNPNB3636S3	734
HSCLP502418LME	696	HSDLF421218LM	694	HSISLACESP3642	738, 739	HSISLAUTNPNB4218S1	734
HSCLP502418RL	695	HSDLF421218LME	696	HSISLACEYB1842L	738	HSISLAUTNPNB4236S1	734
HSCLP502418RLE	697	HSDLF421218RLE	695	HSISLACEYB1842R	738	HSISLAUTNPNB4818S1	734
HSCLP502418RM	694	HSDLF421218RL	694	HSISLACEYB3642	738	HSISLAUTNPNB4818S2	734
HSCLP502418RME	696	HSDLF421218RME	696	HSISLACO3642	739	HSISLAUTNPNB4818S4	734
HSCLP651218LL	695	HSDLF421218RME	696	HSISLAFB2P6042S2	738	HSISLAUTNPNB4836S1	734
HSCLP651218LLE	697	HSDLF651218LL	695	HSISLAFB2P7242S2	738	HSISLAUTNPNB4836S2	734
HSCLP651218LM	694	HSDLF651218LLE	697	HSISLAFB2P8442S2	738	HSISLAUTNPNB4836S4	734
HSCLP651218LME	696	HSDLF651218LM	694	HSISLAFENB1842	738	HSISLAUTNPNB6018S1	734
HSCLP651218RL	695	HSDLF651218LME	696	HSISLAFESP3642	738, 739	HSISLAUTNPNB6018S2	734
HSCLP651218RLE	697	HSDLF651218RL	695	HSISLAFEB1842L	738	HSISLAUTNPNB6018S5	734
HSCLP651218RM	694	HSDLF651218RLE	697	HSISLAFEB1842R	738	HSISLAUTNPNB6036S1	734
HSCLP651218RME	696	HSDLF651218RM	694	HSISLAFEB3642	738	HSISLAUTNPNB6036S2	734
HSCLP651218RME	696	HSDLF651218RME	696	HSISLAFO3642	739	HSISLAUTNPNB6036S5	734
HSCLP651218RME	696	HSDLF651218RME	696	HSISLAUTIPYB4836S2	737	HSISLAUTNPNB7218S1	734
HSCLP652418LL	695	HSDLP421218LL	695	HSISLAUTIPYB4836S4	737	HSISLAUTNPNB7218S2	734

CROSS REFERENCE INDEX

MODEL	PAGE	MODEL	PAGE	MODEL	PAGE	MODEL	PAGE
HSISLAUTNPB7218S3	734	HSPSBX281524BBFM(?)	699	HSTF422424RBBFM	561, 684	HSTSF421824LFFL	691
HSISLAUTNPB7218S6	734	HSPSBX281524FFL(?)	702	HSTF422424RFFL	563, 686	HSTSF421824LFFM	689
HSISLAUTNPB7236S1	734	HSPSBX281524FFM(?)	699	HSTF422424RFFM	561, 684	HSTSF421824RFFL	691
HSISLAUTNPB7236S2	734	HSPSBX281530BBFL(?)	702	HSTF501824LFFL	691	HSTSF421824RFFM	689
HSISLAUTNPB7236S3	734	HSPSBX281530BBFM(?)	699	HSTF501824LFFM	689	HSTSF422424LBBFL	564, 687
HSISLAUTNPB7236S6	734	HSPSBX281530FFL(?)	702	HSTF501824RFFL	691	HSTSF422424LBBFM	562, 685
HSISLAUTNPB8418S1	734	HSPSBX281530FFM(?)	699	HSTF501824RFFM	689	HSTSF422424LFFL	564, 687
HSISLAUTNPB8418S2	734	HSPSSF281518BBFL(?)	703	HSTF502424LBBFL	563, 686	HSTSF422424LFFM	562, 685
HSISLAUTNPB8418S7	734	HSPSSF281518BBFM(?)	700	HSTF502424LBBFM	561, 684	HSTSF422424RBBFL	564, 687
HSISLAUTNPB8436S1	734	HSPSSF281518FFL(?)	703	HSTF502424LFFL	563, 686	HSTSF422424RBBFM	562, 685
HSISLAUTNPB8436S2	734	HSPSSF281518FFM(?)	700	HSTF502424LFFM	561, 684	HSTSF422424RFFL	564, 687
HSISLAUTNPB8436S7	734	HSPSSF281524BBFL(?)	703	HSTF502424RBBFL	563, 686	HSTSF422424RFFM	562, 685
HSLACW50	674	HSPSSF281524BBFM(?)	700	HSTF502424RBBFM	561, 684	HSTSF501824LFFL	691
HSLACW57	674	HSPSSF281524FFL(?)	703	HSTF502424RFFL	563, 686	HSTSF501824LFFM	689
HSLDIGMGR	698, 726	HSPSSF281524FFM(?)	700	HSTF502424RFFM	561, 684	HSTSF501824RFFL	691
HSLDIGPRG	698, 726	HSPSSF281530BBFL(?)	703	HSTF502424RFFM	691	HSTSF501824RFFM	689
HSLF283018FFL	673	HSPSSF281530BBFM(?)	700	HSTF651824LFFM	689	HSTSF502424LBBFL	564, 687
HSLF283018FFM	673	HSPSSF281530FFL(?)	703	HSTF651824RFFL	691	HSTSF502424LBBFM	562, 685
HSLF283618FFL	673	HSPSSF281530FFM(?)	700	HSTF651824RFFM	689	HSTSF502424LFFL	564, 687
HSLF283618FFM	673	HSQLF422418LL	695	HSTF652424LBBFL	563, 686	HSTSF502424LFFM	562, 685
HSLP283018FFL	673	HSQLF422418LLE	697	HSTF652424LBBFM	561, 684	HSTSF502424RBBFL	564, 687
HSLP283018FFM	673	HSQLF422418LM	694	HSTF652424LFFL	563, 686	HSTSF502424RBBFM	562, 685
HSLP283618FFL	673	HSQLF422418LME	696	HSTF652424LFFM	561, 684	HSTSF502424RFFL	564, 687
HSLP283618FFM	673	HSQLF422418RL	695	HSTF652424RBBFL	563, 686	HSTSF502424RFFM	562, 685
HSLRFID100C	698	HSQLF422418RLE	697	HSTF652424RBBFM	561, 684	HSTSF651824LFFL	691
HSLRFID100S	698	HSQLF422418RM	694	HSTF652424RFFL	563, 686	HSTSF651824LFFM	689
HSLRFID25C	698	HSQLF422418RME	696	HSTF652424RFFM	561, 684	HSTSF651824RFFL	691
HSLRFID25S	698	HSQLF652418LL	695	HSTP421824LFFL	690	HSTSF651824RFFM	689
HSLRFID5C	698	HSQLF652418LLE	697	HSTP421824LFFM	688	HSTSF652424LBBFL	564, 687
HSLRFID5S	698	HSQLF652418LM	694	HSTP421824RFFL	690	HSTSF652424LBBFM	562, 685
HSPAKI5	700	HSQLF652418LME	696	HSTP421824RFFM	688	HSTSF652424LFFL	564, 687
HSPFSF221518BBFL(?)	568, 703	HSQLF652418RL	695	HSTP422424LBBFL	559, 682	HSTSF652424LFFM	562, 685
HSPFSF221518BBFM(?)	566, 700	HSQLF652418RLE	697	HSTP422424LBBFM	557, 680	HSTSF652424RBBFL	564, 687
HSPFSF221524BFL(?)	568, 703	HSQLF652418RM	694	HSTP422424LFFL	559, 682	HSTSF652424RBBFM	562, 685
HSPFSF221524BFM(?)	566, 700	HSQLF652418RME	696	HSTP422424LFFM	557, 680	HSTSF652424RFFL	564, 687
HSPHI181518BFL(?)	702	HSQLP422418LL	695	HSTP422424RBBFL	559, 682	HSTSF652424RFFM	562, 685
HSPHI181518BFM(?)	699	HSQLP422418LLE	697	HSTP422424RBBFM	557, 680	HSTSP421824LFFL	690
HSPHI181524BFL(?)	702	HSQLP422418LM	694	HSTP422424RFFL	559, 682	HSTSP421824LFFM	688
HSPHI181524BFM(?)	699	HSQLP422418LME	696	HSTP422424RFFM	557, 680	HSTSP421824RFFL	690
HSPHI181530BFL(?)	702	HSQLP422418RL	695	HSTP501824LFFL	690	HSTSP421824RFFM	688
HSPHI181530BFM(?)	699	HSQLP422418RLE	697	HSTP501824LFFM	688	HSTSP422424LBBFL	560, 683
HSPM211518BFL(?)	567, 702	HSQLP422418RM	694	HSTP501824RFFL	690	HSTSP422424LBBFM	558, 681
HSPM211518BFM(?)	565, 699	HSQLP422418RME	696	HSTP501824RFFM	688	HSTSP422424LFFL	560, 683
HSPM211524BFL(?)	567, 702	HSQLP652418LL	695	HSTP502424LBBFL	559, 682	HSTSP422424LFFM	558, 681
HSPM211524BFM(?)	565, 699	HSQLP652418LLE	697	HSTP502424LBBFM	557, 680	HSTSP422424RBBFL	560, 683
HSPM211518BBFL(?)	702	HSQLP652418LM	694	HSTP502424LFFL	559, 682	HSTSP422424RBBFM	558, 681
HSPM211518BBFM(?)	699	HSQLP652418LME	696	HSTP502424LFFM	557, 680	HSTSP422424RFFL	560, 683
HSPM211518FFL(?)	702	HSQLP652418RL	695	HSTP502424RBBFL	559, 682	HSTSP422424RFFM	558, 681
HSPM211518FFM(?)	699	HSQLP652418RLE	697	HSTP502424RBBFM	557, 680	HSTSP501824LFFL	690
HSPM211524BBFL(?)	702	HSQLP652418RM	694	HSTP502424RFFL	559, 682	HSTSP501824LFFM	688
HSPM211524BFBM(?)	699	HSQLP652418RME	696	HSTP502424RFFM	557, 680	HSTSP501824RFFL	690
HSPM211524FFL(?)	702	HSTAKL	564, 687	HSTP651824LFFL	690	HSTSP501824RFFM	688
HSPM211524FFM(?)	699	HSTAKR	564, 687	HSTP651824LFFM	688	HSTSP502424LBBFL	560, 683
HSPM211530BBFL(?)	702	HSTB2W1	82, 229, 284, 633	HSTP651824RFFL	690	HSTSP502424LBBFM	558, 681
HSPM211530BBFM(?)	699	HSTF421824LFFL	691	HSTP651824RFFM	688	HSTSP502424LFFL	560, 683
HSPM211530FFL(?)	702	HSTF421824LFFM	689	HSTP652424LBBFL	559, 682	HSTSP502424LFFM	558, 681
HSPM211530FFM(?)	699	HSTF421824RFFL	691	HSTP652424LBBFM	557, 680	HSTSP502424RBBFL	560, 683
HSPRAY	774	HSTF421824RFFM	689	HSTP652424LFFL	559, 682	HSTSP502424RBBFM	558, 681
HSPSBX281518BBFL(?)	702	HSTF422424LBBFL	563, 686	HSTP652424LFFM	557, 680	HSTSP502424RFFL	560, 683
HSPSBX281518BBFM(?)	699	HSTF422424LBBFM	561, 684	HSTP652424RBBFL	559, 682	HSTSP502424RFFM	558, 681
HSPSBX281518BFL(?)	702	HSTF422424LFFL	563, 686	HSTP652424RBBFM	557, 680	HSTSP651824LFFL	690
HSPSBX281518FFM(?)	699	HSTF422424LFFM	561, 684	HSTP652424RFFL	559, 682	HSTSP651824LFFM	688
HSPSBX281524BBFL(?)	702	HSTF422424RBBFL	563, 686	HSTP652424RFFM	557, 680	HSTSP651824RFFL	690

CROSS REFERENCE INDEX

MODEL	PAGE	MODEL	PAGE	MODEL	PAGE	MODEL	PAGE
HSTSP651824RFFM	688	HT66ND	407	HUVDSSM2024	765	HWCS4824P	621
HSTSP652424LBBFL	560, 683	HT72ND	407	HUVDSSM2030	765	HWCS4830P	621
HSTSP652424LBBFM	558, 681	HTCOL52	68, 173, 317, 353, 369	HUVFOWT	760	HWD244830P	619
HSTSP652424LFFL	560, 683	HTWTH	588	HUVHEWT	760	HWD245430P	619
HSTSP652424LFFM	558, 681	HUVAABS	761	HUVLSWT	760	HWD246030P	619
HSTSP652424RBBFL	560, 683	HUVABLS2424L	766	HUVMAWT	760	HWD246630P	619
HSTSP652424RBBFM	558, 681	HUVABLS2424R	766	HUVMAWT24	761	HWD247230P	619
HSTSP652424RFFL	560, 683	HUVABLS2430L	766	HUVMAWT48	761	HWD304824P	619
HSTSP652424RFFM	558, 681	HUVABLS2430R	766	HUVMBHS48	761	HWD305424P	619
HSWEEPA2	322, 354	HUVABLS3024L	766	HUVMBHS96	761	HWD306024P	619
HSWEEPA3	322, 354	HUVABLS3024R	766	HUVMMFS55	762	HWD306624P	619
HSWEEPC2	322, 354	HUVABLS3030L	766	HUVMMFS63	762	HWD307224P	619
HSWEEPC3	322, 354	HUVABLS3030R	766	HUVPAWT	760	HWJ58ABLP	625
HSWF421218LL	693	HUVABLS3624L	766	HUVREWT	760	HWJ58ABRP	625
HSWF421218LM	692	HUVABLS3624R	766	HUVSLS3254L	763	HWJ58BBLP	625
HSWF421218RL	693	HUVABLS3630L	766	HUVSLS3254LC	763	HWJ58BBRP	625
HSWF421218RM	692	HUVABLS3630R	766	HUVSLS3259L	763	HWJ59ABLP	625
HSWF421224LL	693	HUVAUS482413	766	HUVSLS3259LC	763	HWJ59ABRP	625
HSWF421224LM	692	HUVAUS482420	766	HUVSLS3267L	763	HWJ59BBLP	625
HSWF421224RL	693	HUVAUS483013	766	HUVSLS3267LC	763	HWJ59BBRP	625
HSWF421224RM	692	HUVAUS483020	766	HUVSLS4054L	763	HWMCLIPLG	107, 242, 283
HSWF501218LL	693	HUVAUS602413	766	HUVSLS4054LC	763	HWMCLIPSM	107, 242
HSWF501218LM	692	HUVAUS602420	766	HUVSLS4059L	763	HWP2460P	625
HSWF501218RL	693	HUVAUS603013	766	HUVSLS4059LC	763	HWP2466P	625
HSWF501218RM	692	HUVAUS603020	766	HUVSLS4067L	763	HWP2472P	625
HSWF501224LL	693	HUVAUS722413	766	HUVSLS4067LC	763	HWP3060P	625
HSWF501224LM	692	HUVAUS722420	766	HUVSLS4754L	763	HWP3066P	625
HSWF501224RL	693	HUVAUS723013	766	HUVSLS4754LC	763	HWP3072P	625
HSWF501224RM	692	HUVAUS723020	766	HUVSLS4759L	763	HWR1824P	617
HSWF651218LL	693	HUVCFCT24	761	HUVSLS4759LC	763	HWR1830P	617
HSWF651218LM	692	HUVCFCT48	761	HUVSLS4767L	763	HWR1836P	617
HSWF651218RL	693	HUVDPS1324	765	HUVSLS4767LC	763	HWR1842P	617
HSWF651218RM	692	HUVDPS1330	765	HUVSSWT	760	HWR1848P	617
HSWF651224LL	693	HUVDPS2024	765	HUVSTAHSD	761	HWR1854P	617
HSWF651224LM	692	HUVDPS2030	765	HUVSTAHSP	761	HWR1860P	617
HSWF651224RL	693	HUVDRWT	760	HUVSTAHST	761	HWR1866P	617
HSWF651224RM	692	HUVDSAO1348	765	HUVSTBHSD	761	HWR1872P	617
HSWP421218LL	693	HUVDSAO1360	765	HUVSTBHSP	761	HWR2424P	617
HSWP421218LM	692	HUVDSAO1372	765	HUVSTBHST	761	HWR2430P	617
HSWP421218RL	693	HUVDSAO2048	765	HUVTOWT	760	HWR2436P	617
HSWP421218RM	692	HUVDSAO2060	765	HUVTOWT24	761	HWR2436PN	529
HSWP421224LL	693	HUVDSAO2072	765	HUVTOWT48	761	HWR2442P	617
HSWP421224LM	692	HUVDSAOEM1348	765	HUVTRWT	760	HWR2448P	617
HSWP421224RL	693	HUVDSAOEM1360	765	HUVVWVT	760	HWR2448PN	529, 530
HSWP421224RM	692	HUVDSAOEM1372	765	HV-UT1	566, 636, 751	HWR2454P	617
HSWP501218LL	693	HUVDSAOEM2048	765	HVFB20R	636	HWR2460P	617
HSWP501218LM	692	HUVDSAOEM2060	765	HVFB23R	636	HWR2460PN	530
HSWP501218RL	693	HUVDSAOEM2072	765	HVFF20R	636	HWR2466P	617
HSWP501218RM	692	HUVDSBS2048	582, 766	HVFF23R	636	HWR2472P	617
HSWP501224LL	693	HUVDSBS2060	582, 766	HVL991	114, 127, 181, 240, 327, 360, 372, 379, 386, 392, 404, 571, 644	HWR2472PN	530
HSWP501224LM	692	HUVDSBS2072	582, 766	HVPWLBK24	82, 284	HWR2484P	617
HSWP501224RL	693	HUVDSHAB4813	766	HVPWLBK30	82, 284	HWR3024P	618
HSWP501224RM	692	HUVDSHAB4820	766	HWC3624P	620	HWR3030P	618
HSWP651218LL	693	HUVDSHAB6013	766	HWC4224P	620	HWR3036P	618
HSWP651218LM	692	HUVDSHAB6020	766	HWC4230P	620	HWR3042P	618
HSWP651218RL	693	HUVDSHAB7213	766	HWC4824P	620	HWR3048P	618
HSWP651218RM	692	HUVDSHAB7220	766	HWC4830P	620	HWR3048PN	530
HSWP651224LL	693	HUVDSSEI324	765	HWC72	664	HWR3054P	618
HSWP651224LM	692	HUVDSSEI330	765	HWCS3624P	621	HWR3060P	618
HSWP651224RL	693	HUVDSSE2024	765	HWCS4224P	621	HWR3060PN	530
HSWP651224RM	692	HUVDSSE2030	765	HWCS4230P	621	HWR3066P	618
HT48ND	407	HUVDSSM1324	765			HWR3072P	618
HT60ND	407	HUVDSSM1330	765			HWR3072PN	530

CROSS REFERENCE INDEX

MODEL	PAGE	MODEL	PAGE	MODEL	PAGE	MODEL	PAGE
HWR3084P	618	HWWAST	264	HWWT3024L	259	HWWT4536V	260
HWSA2	632	HWWATS	264	HWWT3024P	261	HWWT4542F	257
HWSB2	632	HWWT1518F	256	HWWT3030F	257	HWWT4542M	258
HWSR24	633	HWWT1518L	259	HWWT3030L	259	HWWT4542V	260
HWSR30	633	HWWT1518P	261	HWWT3030M	258	HWWT4548F	257
HWSR36	633	HWWT1524F	256	HWWT3030P	261	HWWT4548M	258
HWSR42	633	HWWT1524L	259	HWWT3036F	257	HWWT4548V	260
HWSR48	633	HWWT1524P	261	HWWT3036L	259	HWWT4554F	257
HWV73AALP	623	HWWT1524T	262	HWWT3036M	258	HWWT4554M	258
HWV73AARP	624	HWWT1530F	256	HWWT3036P	261	HWWT4554V	260
HWV73BALP	623	HWWT1530L	259	HWWT3036V	260	HWWT4560F	257
HWV73BARP	624	HWWT1530M	258	HWWT3042F	257	HWWT4560M	258
HWV75AALP	623	HWWT1530P	261	HWWT3042V	260	HWWT718F	256
HWV75AARP	624	HWWT1530T	262	HWWT3048F	257	HWWT718L	259
HWV75ABLP	623	HWWT1536F	256	HWWT3048V	260	HWWT718P	261
HWV75ABRP	624	HWWT1536L	259	HWWT3054F	257	HWWT724F	256
HWV75BALP	623	HWWT1536M	258	HWWT3060F	257	HWWT724L	259
HWV75BARP	624	HWWT1536P	261	HWWT3718F	257	HWWT724P	261
HWV75BBLP	623	HWWT1536T	262	HWWT3718L	259	HWWT724T	262
HWV75BBRP	624	HWWT1542F	256	HWWT3724F	257	HWWT730F	256
HWV93AALP	623	HWWT1542T	262	HWWT3724L	259	HWWT730L	259
HWV93AARP	624	HWWT1548F	256	HWWT3730F	257	HWWT730P	261
HWV93BALP	623	HWWT1548T	262	HWWT3730L	259	HWWT730T	262
HWV93BARP	624	HWWT1554F	256	HWWT3730M	258	HWWT736F	256
HWV95AALP	623	HWWT1554T	262	HWWT3736F	257	HWWT736L	259
HWV95AARP	624	HWWT1560F	256	HWWT3736L	259	HWWT736P	261
HWV95ABLP	623	HWWT1560T	262	HWWT3736M	258	HWWT736T	262
HWV95ABRP	624	HWWT2218F	256	HWWT3736V	260	HWWT742F	256
HWV95BALP	623	HWWT2218L	259	HWWT3742F	257	HWWT742T	262
HWV95BARP	624	HWWT2218P	261	HWWT3742M	258	HWWT748F	256
HWV95BBLP	623	HWWT2224F	256	HWWT3742V	260	HWWT748T	262
HWV95BBRP	624	HWWT2224L	259	HWWT3748F	257	HWWT754F	256
HWWAC	264	HWWT2224P	261	HWWT3748M	258	HWWT754T	262
HWWAH	264	HWWT2230F	256	HWWT3748V	260	HWWT760F	256
HWWAP	264	HWWT2230L	259	HWWT3754F	257	HWWT760T	262
HWWAPH	264	HWWT2230M	258	HWWT3754M	258	SPLH-ABND-GALGLSS.M482171	472
HWWARAIL18	263	HWWT2230P	261	HWWT3754V	260	SPLH-ABND-GALGLSS.M482172	472
HWWARAIL24	263	HWWT2236F	256	HWWT3760F	257	SPLH-ABND-GALGLSS.M482173	472
HWWARAIL30	263	HWWT2236L	259	HWWT3760M	258	SPLH-ABND-GALGLSS.M482174	472
HWWARAIL36	263	HWWT2236M	258	HWWT4518F	257	SPLH-ABND-GALGLSS.M482175	472
HWWARAIL42	263	HWWT2236P	261	HWWT4518L	259	SPLH-ABND-GALGLSS.M482176	472
HWWARAIL48	263	HWWT2242F	256	HWWT4524F	257	SPLH-ABND-GALGLSS.M482177	472
HWWARAIL54	263	HWWT2248F	256	HWWT4524L	259	SPLH-ABND-GALGLSS.M482178	472
HWWARAIL60	263	HWWT2254F	256	HWWT4530F	257	SPLH-ABND-GALGLSS.M482179	472
HWWASB	264	HWWT2260F	256	HWWT4530L	259	SPLH-ABND-GALGLSS.M482180	472
HWWASHELF18	263	HWWT3018F	257	HWWT4530M	258	SPLH-ABND-GALGLSS.M482181	472
HWWASHELF24	263	HWWT3018L	259	HWWT4536F	257	SPLH-ABND-GALGLSS.M482182	472
HWWASHELF30	263	HWWT3018P	261	HWWT4536L	259	SPLH-ABND-GALGLSS.M482183	472
HWWASHELF36	263	HWWT3024F	257	HWWT4536M	258		

NOTES

NOTES

NOTES

INFORMATION ON ORDERING PARTS

When parts are needed to repair HON products, the following guidelines should be followed to expedite the process.

1. Warranty orders are submitted on HON Ready via the Quick Claim tool. To purchase repair parts, please visit HONAccessories.com which can be found on HON.com.
2. There are no discounts applied to parts. Pricing quoted is the net value. Parts pricing is subject to change without notice.
3. For a part not covered by warranty applicable shipping charges will apply.
4. All keys are \$6.00 each plus a shipping and handling fee of \$3.00 per shipping location.
5. Parts may be paid for with an approved credit card. Approved Cards: MasterCard, VISA and American Express.
6. Payment terms for invoiced parts are Net 30 days.
7. Due to short leadtimes on parts, no changes will be accepted after the order has been placed.
8. When placing a **warranty** parts order:

If the product is under warranty, the product serial number must be provided. Most finished goods products have a serial number placed on them at the factory. The label containing the serial number is located:

Vertical Files — right side of the uppermost drawer

Lateral Files — left side of the uppermost drawer or shelf

Desk Towers — outside of top drawer

Desks, Credenzas, & Returns — on the outside, kneespace side of the top drawer. Fully extend the drawer to find it.

Desks, Credenzas, Corner Units, Bridges, Peninsulas & Returns without drawers — underside of top

Tables and Stands — underside of the top

Table Trucks — underside of side rail

Cabinets & Bookcases — left inner side of the case

Modular Component Top and Backs — underside of top

Modular End Panels — top inside surface

Reception Stations — top inside surface of back panel

Organizers — top inside surface of left end panel near back panel

Vertical Paper Manager — back panel inside surface near top

Pedestals — bottom drawer right side exterior

Seating — underside of the seat

Panels — underside of the top cap

Hutches, Storage Units, Overhead Storage — underside of the shelf

Hanging Bookshelves — underside of shelf

NOTE: Removal of the serial number tag from the product voids the warranty.

An important note regarding Product Serial Numbers:

HON desks, tables, chairs, files and systems components are tagged with a serial number. This number helps us identify *when and where your product was made*, and to identify and correct the root causes for the problem. NEITHER THE DEALER NOR THE CONSUMER SHOULD REMOVE THIS TAG UNDER ANY CIRCUMSTANCES. To do so immediately voids your Warranty coverage for that particular item *and prevents us from further identifying it*. Instead, please transcribe the number and call your Dealer.