

SILEA^{EH}

DESIGN GUIDE

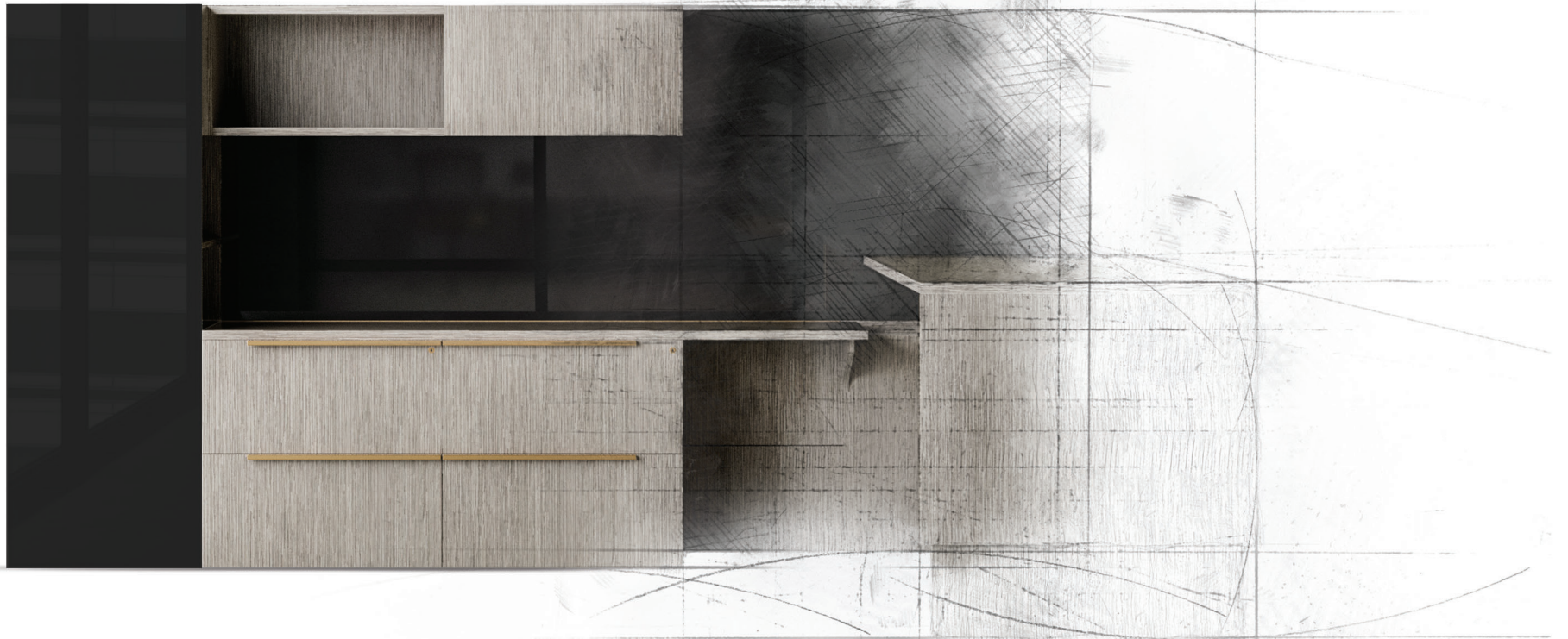

designing with SILEA^{EH}

Silea^{EH} is designed with an amazing array of new products and an enhanced range of styles, leg and foot options, materials, and finishes. We've expanded functionality, with height adjustability, technology management, and components to facilitate collaboration. The collection is stylish and agile, easily adapting to private offices, enclosed team spaces, and open settings. And because Silea^{EH} is so scalable, it works within a smaller office footprint. As always, every detail is considered and constructed with Gunlocke craftsmanship.

Integrate style, blend functionality and applications, and add exceptional features. Designing with Silea^{EH} magnifies your creativity.

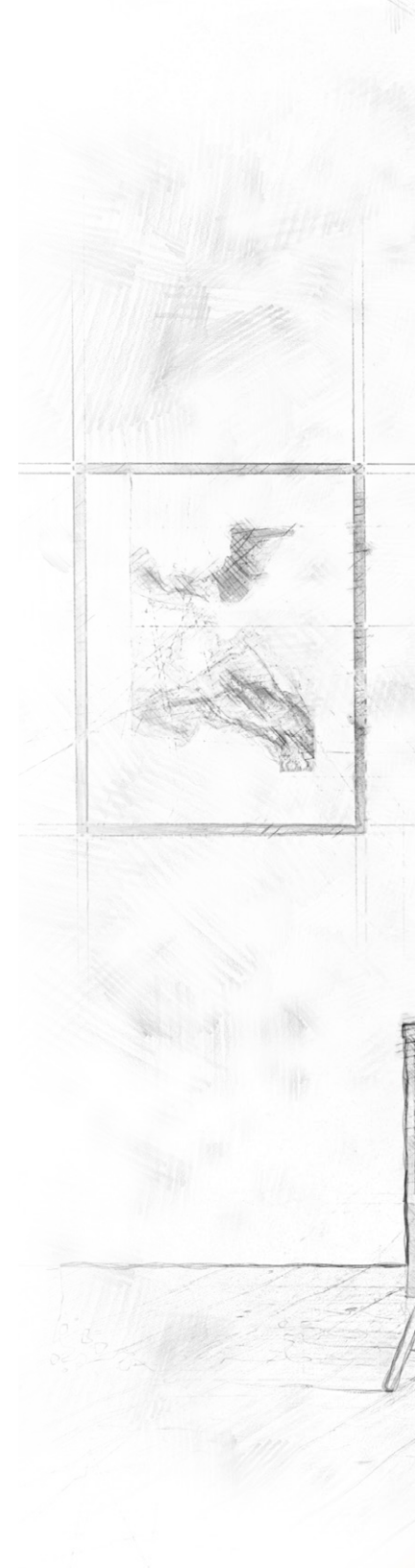



choose your STYLE

Style profiles.

Silea^{EH} is composed of carefully curated and compatible material and finish options to embrace diverse styling choices. Its versatility even extends to meeting the challenges of smaller space allocations while enabling design solutions with exceptional functionality and an unmatched array of finish options. One platform. Many choices. Unlimited outcomes.



CLASSIC CHARACTER



SLEEK SOPHISTICATION



MODERN SIMPLICITY



ESSENTIAL ELEMENTS

workplaces are CHANGING...

Choice, unlocked. Design potential, expanded.

Silea^{EH} unlocks more choice and more potential across the evolving workplace floorplate. The workplaces of today and tomorrow include a variety of space types to accommodate people's preferences and functional needs. These spaces may be designed for individual heads-down concentration, or for team collaborations, or for less-formal community gatherings. Silea^{EH} has you covered.



INDIVIDUAL



COMMUNITY



TEAM



INDIVIDUAL spaces

Unlock enclosed spaces.

Release the full potential for concentration and more private worksettings in today's office.

Silea^{EH} offers the flexibility to create enclosed offices, or even more open dedicated settings that signal sophistication and support personal performance. The scalability and range of choices is unmatched.

INDIVIDUAL spaces



APPLICATION VERSATILITY

A setting for concentrated work that displays, stores, and leverages enclosed spaces for solo work as well as meeting with others.

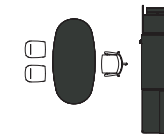

SIL-217 (10' X 12')

- VENEER: CLEAR SILVER OAK STRATAWOOD HORIZONTAL GRAIN
- BACK-PAINTED GLASS: FLINT
- TACKBOARD: FABRIC
- PULLS: SILEA
- METAL: MATTE GOLD
- SHOWN WITH GENESEE SEATING

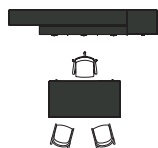

GEH-105 (15' X 15')

- VENEER: SUMATRA WALNUT NATURAL QUARTER CUT
- BACK-PAINTED GLASS: BEIGE
- PULLS: ARCH
- METAL: SILVER
- EDGE DETAIL: SQUARE
- SHOWN WITH AVOCA & CALIA SEATING

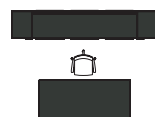

SIL-200 (12' X 12')

- VENEER: PHANTOM ECRU RIFT OAK
- TACKBOARD: FABRIC
- PULLS: SILEA
- METAL: BLACK
- SHOWN WITH GENEVA SEATING



SIL-218 (10' X 14')

- VENEER: PINNACLE WALNUT NATURAL QUARTER CUT
- BACK-PAINTED GLASS: MUSLIN
- TACKBOARD: FABRIC
- PULLS: SILEA
- METAL: PYRITE
- SHOWN WITH GENESEE & LIV SEATING

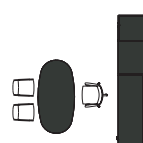

SIL-219 (10' X 12')

- VENEER: SKYLINE WALNUT NATURAL QUARTER CUT
- TACKBOARD: FABRIC
- SOLID SURFACE: DESIGNER WHITE
- PULLS: SILEA
- METAL: MATTE GOLD
- SHOWN WITH AVOCA & METTA SEATING

INDIVIDUAL spaces



APPLICATION VERSATILITY
Maximizing horizontal workspaces, integrating height adjustability, and creating an enclosed setting with enhanced privacy.

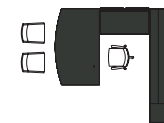

- GEH-101 (10' X 14')
- VENEER: NUTMEG WALNUT NATURAL FLAT CUT
 - TACKBOARD: FABRIC
 - PULLS: INTEGRAL
 - EDGE DETAIL: TRIOVAL
 - SHOWN WITH EDITION & SAVOR SEATING

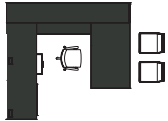

SIL-216 (8' X 12')

- VENEER: CLEAR SILVER OAK STRATAWOOD
- LAMINATE: DESIGNER WHITE 15051
- TACKBOARD: FABRIC
- PULLS: ARCH
- METAL: SILVER
- EDGE DETAIL: SQUARE
- SHOWN WITH GENEVA & TIA SEATING

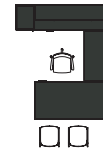

SIL-215 (12' X 14')

- LAMINATE: NATURAL RECON
- TACKBOARD: FABRIC
- PULLS: TRIO BAR
- METAL: BLACK
- EDGE DETAIL: SQUARE
- SHOWN WITH AVOCA & LIV SEATING

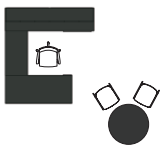

SIL-107 (12' X 12')

- VENEER: CLEAR MAPLE STRATAWOOD HORIZONTAL GRAIN
- BACK-PAINTED GLASS: ICE WHITE
- TACKBOARD: FABRIC
- PULLS: SILEA
- METAL: SILVER
- SHOWN WITH GENEVA SEATING, LIV SEATING & BRIEFING TABLE

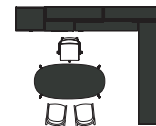

SIL-203 (12' X 14')

- LAMINATE: PORTICO TEAK
- BACK-PAINTED GLASS: LOFT
- TACKBOARD: FABRIC
- PULLS: MODERN
- METAL: BLACK
- EDGE DETAIL: SQUARE
- SOLID SURFACE: DESIGNER WHITE
- SHOWN WITH GENEVA SEATING, CALIA SEATING & BRIEFING TABLE

INDIVIDUAL spaces



APPLICATION VERSATILITY

Robust functionality blends with a crisp aesthetic, integrating multiple components. Rich material choices are designed with elegance and adaptability.

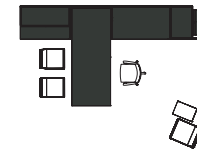

SIL-220 (10' X 12')

- VENEER: CLEAR SILVER OAK STRATAWOOD
- BACK-PAINTED GLASS: BLACK
- PULLS: SILEA
- METAL: PYRITE
- SHOWN WITH AVOCA SEATING, TIA SEATING & CALM OCCASIONAL TABLE

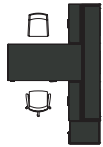

GEH-107 (10' X 10')

- LAMINATE: PINNACLE WALNUT
- BACK-PAINTED GLASS: ICE WHITE
- TACKBOARD: FABRIC
- PULLS: TRIO BAR
- METAL: SILVER
- EDGE DETAIL: SQUARE
- SHOWN WITH ATTRACT & CAMILLE SEATING

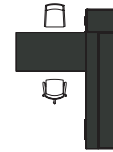

GEH-108 (10' X 12')

- VENEER: CLEAR CHERRY STRATAWOOD
- LAMINATE: DESIGNER WHITE 15051
- TACKBOARD: MAGNETIC VENEER
- PULLS: MODERN
- METAL: DESIGNER WHITE
- EDGE DETAIL: SQUARE
- SHOWN WITH AVOCA & CAMILLE SEATING

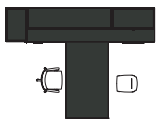

GEH-111 (10' X 10')

- LAMINATE: SKYLINE WALNUT
- TACKBOARD: FABRIC
- PULLS: MODERN
- METAL: BLACK
- EDGE DETAIL: SQUARE
- SHOWN WITH GENESEE SEATING



SIL-102 (10' X 12')

- VENEER: CLEAR SILVER STRATAWOOD HORIZONTAL GRAIN
- PAINT: DESIGNER WHITE
- BACK-PAINTED GLASS: ICE WHITE
- TACKBOARD: FABRIC
- PULLS: INTEGRAL
- SHOWN WITH ATTRACT SEATING



APPLICATION VERSATILITY

A setting for concentrated work that displays, stores, and supports conversations and collaboration.

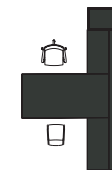

SIL-221 (8' X 10')

- LAMINATE: NATURAL RECON
- PAINT: SOFT WHITE
- BACK-PAINTED GLASS: ICE WHITE
- PULLS: INTEGRAL
- METAL: BLACK
- SHOWN WITH GENESEE & METTA SEATING



- GEH-112 (10' X 10')
- LAMINATE: PORTICO TEAK
 - TACKBOARD: FABRIC
 - PULLS: LINEAR
 - METAL: BLACK
 - EDGE DETAIL: SQUARE
 - SHOWN WITH GENEVA SEATING



- SIL-222 (10' X 12')
- VENEER: NUTMEG WALNUT NATURAL
 - QUARTER CUT
 - PAINT: SOFT WHITE
 - BACK-PAINTED GLASS: ICE WHITE
 - TACKBOARD: FABRIC
 - PULLS: MODERN
 - METAL: MATTE GOLD
 - SHOWN WITH GENEVA SEATING



- GEH-106 (12' X 12')
- VENEER: SKYLINE WALNUT NATURAL
 - FLAT CUT
 - LAMINATE: DESIGNER WHITE 15051
 - PAINT: SOFT WHITE
 - BACK-PAINTED GLASS: ICE WHITE
 - TACKBOARD: FABRIC
 - PULLS: LINEAR
 - METAL: BLACK
 - EDGE DETAIL: SQUARE
 - SHOWN WITH GENEVA SEATING & BRIEFING TABLE

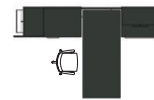

- SIL-106 (10' X 10')
- VENEER: LIGHT RIFT OAK
 - BACK-PAINTED GLASS: ICE WHITE
 - TACKBOARD: FABRIC
 - PULLS: INTEGRAL AND SILEA
 - METAL: BLACK
 - SHOWN WITH GENEESE SEATING



APPLICATION VERSATILITY

A simple pivot transitions concentrated work into an interactive setting, employing a visually engaging aesthetic, all in an economical footprint.

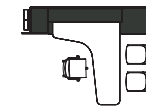

- SIL-201 (10' X 12')
- VENEER: SUMATRA WALNUT NATURAL QUARTER CUT
- BACK-PAINTED GLASS: ICE WHITE
- SOLID SURFACE: DESIGNER WHITE
- TACKBOARD: FABRIC
- PULLS: SILEA
- METAL: MATTE GOLD
- EDGE DETAIL: SQUARE
- SHOWN WITH GENEVA & LIV SEATING



- GEH-113 (9' X 12')
- LAMINATE: FAWN CYPRESS
 - TACKBOARD: FABRIC
 - PULLS: TRIO LINEAR
 - METAL: SILVER
 - EDGE DETAIL: SQUARE
 - SHOWN WITH GENEVA & TIA SEATING



- SIL-104 (10' X 12')
- VENEER: NUTMEG WALNUT NATURAL QUARTER CUT
 - BACK-PAINTED GLASS: ICE WHITE
 - TACKBOARD & PED CUSHION: FABRIC
 - PULLS: SILEA
 - METAL: MATTE GOLD
 - SHOWN WITH GENEVA SEATING

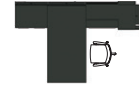

- SIL-202 (10' X 12')
- VENEER: PINNACLE WALNUT NATURAL FLAT CUT
 - PULLS: SILEA
 - METAL: SILVER
 - EDGE DETAIL: SQUARE
 - SHOWN WITH GENESEE SEATING

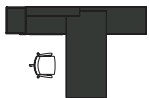

- SIL-214 (10' X 10')
- VENEER: SUMATRA WALNUT NATURAL FLAT CUT
 - PAINT: SOFT WHITE
 - TACKBOARD: FABRIC
 - PULLS: LINEAR
 - METAL: BLACK
 - EDGE DETAIL: SQUARE
 - SHOWN WITH GENEVA & CAMILLE SEATING

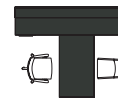

INDIVIDUAL spaces



APPLICATION VERSATILITY

Elegant functionality accommodates a variety of activities, showcasing a welcoming aesthetic and a high-performance setting.

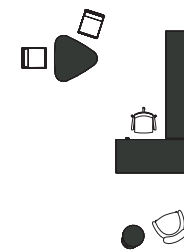

- SIL-223 (12' X 16')
- VENEER: PINNACLE WALNUT NATURAL QUARTER CUT
 - BACK-PAINTED GLASS: ICE WHITE
 - METAL: BLACK
 - SHOWN WITH GENESEE SEATING, TIA SEATING, IRIS SEATING & BRIEFING OCCASIONAL TABLE



SIL-113 (8' X 8')

- VENEER: NUTMEG WALNUT NATURAL QUARTER CUT
- PULLS: SILEA
- METAL: BLACK
- PED CUSHION: FABRIC
- SHOWN WITH GENESEE SEATING



SIL-204 (8' X 10')

- LAMINATE: FAWN CYPRESS
- PAINT: MUSLIN
- PULLS: SILEA
- METAL: PYRITE
- SHOWN WITH ATTRACT SEATING



SIL-111 (8' X 8')

- VENEER: PHANTOM ECRU MAPLE STRATAWOOD HORIZONTAL GRAIN
- BACK-PAINTED GLASS: BEIGE
- PULLS: SILEA
- METAL: PYRITE
- SHOWN WITH GENESEE SEATING



SIL-114 (8' X 8')

- LAMINATE: NATURAL MAPLE
- LAMINATE: DESIGNER WHITE 15051
- PULLS: SILEA
- METAL: SILVER
- SHOWN WITH GENESEE SEATING

INDIVIDUAL spaces



APPLICATION VERSATILITY

A compact space delivers expansive comfort, expressed in minimalist styling that promotes creative thinking.

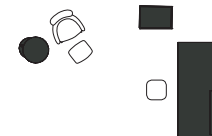

SIL-224 (9' X 12')

- LAMINATE: SKYLINE WALNUT
- PULLS: SILEA
- METAL: MATTE GOLD
- SHOWN WITH IRIS LOUNGE, TRILLIA STOOL & BRIEFING OCCASIONAL TABLE

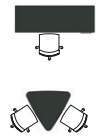

- SIL-115 (10' X 10')
- LAMINATE: NATURAL MAPLE
 - METAL: BLACK
 - PULL: SILEA
 - SHOWN WITH AVOCA SEATING

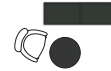

- SIL-117 (6' X 6')
- VENEER: NUTMEG WALNUT NATURAL QUARTER CUT
 - SHOWN WITH IRIS SEATING & BRIEFING OCCASIONAL TABLE

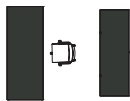

- SIL-225 (10' X 10')
- VENEER: NUTMEG WALNUT NATURAL QUARTER CUT
 - PULLS: SILEA
 - METAL: MATTE GOLD
 - SHOWN WITH GENEVA SEATING



- SIL-118 (10' X 10')
- LAMINATE: PORTICO TEAK
 - PULLS: SILEA
 - METAL: SILVER
 - SHOWN WITH ATTRACT SEATING

INDIVIDUAL spaces



APPLICATION VERSATILITY

Leverage a dual-office application for easy collaboration and ample storage with height adjustability to support ergonomic wellness.

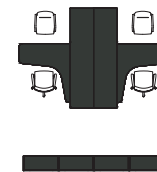

SIL-226 (12' X 14')

- VENEER: CLEAR SILVER STRATAWOOD VERTICAL GRAIN
- PULLS: SILEA
- METAL: BLACK
- SOLID SURFACE: DESIGNER WHITE
- SHOWN WITH GENESEE SEATING, AVOCA SEATING, CALM LOUNGE & CYLINDER OCCASIONAL TABLE

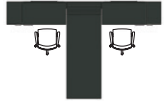

- SIL-135 (10' X 15')
- LAMINATE: PORTICO TEAK
 - PAINT: FLINT
 - TACKBOARD: FABRIC
 - PULLS: SILEA
 - METAL: MATTE GOLD
 - SHOWN WITH GENEVA SEATING

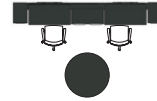

- SIL-137 (12' X 12')
- LAMINATE: PHANTOM ECRU RIFT OAK
 - BACK-PAINTED GLASS: ICE WHITE
 - TACKBOARD & PED CUSHION: FABRIC
 - PULLS: SILEA
 - METAL: PYRITE
 - SHOWN WITH GENESEE SEATING & SARANAC TABLE



- SIL-208 (10' X 12')
- LAMINATE: NEOWALNUT
 - BACK-PAINTED GLASS: BEIGE
 - PULLS: SILEA
 - METAL: BLACK
 - SHOWN WITH AVOCA SEATING



- SIL-227 (10' X 15')
- VENEER: CLEAR STRATAWOOD SILVER OAK HORIZONTAL GRAIN
 - LAMINATE: LOFT
 - TACKBOARD: FABRIC
 - METAL: PYRITE
 - SHOWN WITH ATTRACT SEATING



TEAM spaces

Configured agility.

Silea^{EH} matches the needs of today's workplace.

The collection is adaptable for enclosed team spaces as well as open settings, evolving with the needs of each group. Silea^{EH} adeptly supports a team for any duration... a day, a week, a month... enhancing the creative process with the integration of writable and tackable surfaces. Easy access to technology for idea sharing and video conferencing brings additional effectiveness.



APPLICATION VERSATILITY

A changing workplace requires furniture that supports new ways of working, balancing the needs of individual work and collaboration. The freestanding WorkWall brings it all together.

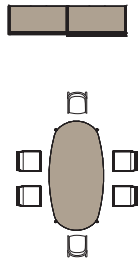

- SIL-228 (10' X 20')
- VENEER: NUTMEG WALNUT NATURAL QUARTER CUT
- BACK-PAINTED GLASS: ICE WHITE
- TACKBOARD: FABRIC
- SHOWN WITH CALIA SEATING, TIA SEATING & BRIEFING CONFERENCE TABLE

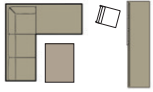

- SIL-121 (12' X 15')
- VENEER: PHANTOM ECRU MAPLE STRATAWOOD VERTICAL GRAIN
 - BACK-PAINTED GLASS: BEIGE
 - TACKBOARD: FABRIC
 - SHOWN WITH CALM LOUNGE & TIA SEATING

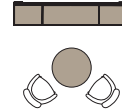

- SIL-212 (10' X 12')
- VENEER: PHANTOM ECRU RIFT OAK
 - PED CUSHION: FABRIC
 - METAL: MATTE GOLD
 - SHOWN WITH IRIS SEATING & BRIEFING TABLE

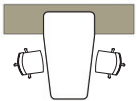

- SIL-123 (10' X 10')
- LAMINATE: PORTICO TEAK
 - METAL: BLACK
 - SOLID SURFACE: DESIGNER WHITE
 - SHOWN WITH AVOCA SEATING



- SIL-124 (10' X 10')
- VENEER: EBONY WALNUT NATURAL FLAT CUT
 - PAINT: SOFT WHITE
 - BACK-PAINTED GLASS: ICE WHITE
 - TACKBOARD: FABRIC
 - METAL: BLACK
 - SHOWN WITH GENEVA SEATING

TEAM spaces



APPLICATION VERSATILITY

Complement group collaborations with easy access to stored resources, supported by adjacent writable surfaces and shared displays.

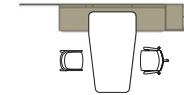

SIL-128 (10' X 15')

- VENEER: NUTMEG WALNUT NATURAL QUARTER CUT
- LAMINATE: DESIGNER WHITE 15051
- BACK-PAINTED GLASS: LOFT
- TACKBOARD: FABRIC
- PULLS: SILEA
- METAL: SILVER
- SHOWN WITH GENEVA & CALIA SEATING

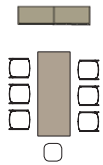

SIL-126 (10' X 15')

- VENEER: LIGHT RIFT OAK
- BACK-PAINTED GLASS: MUSLIN
- TACKBOARD: FABRIC
- SHOWN WITH LIV SEATING, TRILLIA SEATING & SARANAC TABLE

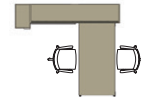

SIL-127 (10' X 12')

- VENEER: CLEAR MAPLE STRATAWOOD HORIZONTAL GRAIN
- LAMINATE: DESIGNER WHITE 15051
- BACK-PAINTED GLASS: ICE WHITE
- TACKBOARD: FABRIC
- PULLS: SILEA
- METAL: BLACK
- SHOWN WITH GENEVA SEATING

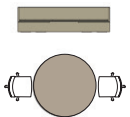

SIL-125 (12' X 13')

- VENEER: PORTICO TEAK SILVER OAK STRATAWOOD
- BACK-PAINTED GLASS: BEIGE
- PULLS: SILEA
- METAL: PYRITE
- SHOWN WITH GENESEE SEATING & SARANAC TABLE



SIL-129 (10' X 12')

- VENEER: PINNACLE WALNUT NATURAL QUARTER CUT
- BACK-PAINTED GLASS: BLACK
- TACKBOARD: FABRIC
- METAL: BLACK
- SOLID SURFACE: DESIGNER WHITE
- SHOWN WITH AVOCA & SAVOR SEATING

TEAM spaces



APPLICATION VERSATILITY

An easy transition from a personal space to a team setting, integrating display and versatile storage. Design spaces to blend individual work and collaboration within one setting to maximize team effectiveness.

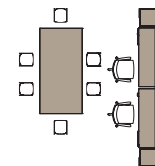

SIL-229 (14' X 16')

- VENEER: LOWELL ASH CHERRY NATURAL FLAT CUT
- PULLS: SILEA
- METAL: PYRITE
- SHOWN WITH GENESEE SEATING, CONVO SEATING & LETCHWORTH TABLE

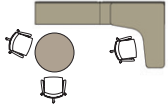

SIL-131 (10' X 12')

- VENEER: PINNACLE WALNUT NATURAL QUARTER CUT
- PAINT: SOFT WHITE
- BACK-PAINTED GLASS: FLINT
- PULLS: SILEA
- METAL: SILVER
- PED CUSHION: FABRIC
- SHOWN WITH GENEVA SEATING

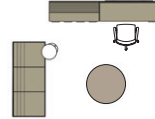

SIL-132 (12' X 15')

- VENEER: PHANTOM ECRU RIFT OAK
- BACK-PAINTED GLASS: ICE WHITE
- PULLS: SILEA
- METAL: PYRITE
- SHOWN WITH CIJI LOUNGE, GENESEE SEATING & BRIEFING OCCASIONAL TABLE

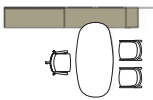

SIL-105 (10' X 15')

- VENEER: SUMATRA WALNUT STRATAWOOD VERTICAL GRAIN
- BACK-PAINTED GLASS: MUSLIN
- TACKBOARD: FABRIC
- PULLS: SILEA
- METAL: PYRITE
- SHOWN WITH GENEVA & CALIA SEATING

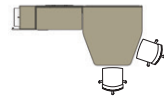

SIL-130 (10' X 15')

- LAMINATE: NATURAL RECON
- TACKBOARD: FABRIC
- PULLS: SILEA
- METAL: BLACK
- SHOWN WITH AVOCA SEATING



COMMUNITY spaces

Flex your office.

Make the most of multi-functional spaces with multi-purpose configurations. Suddenly, a common area becomes a project center or a meeting space that accommodates impromptu conversation and a space used to solve problems. These spaces provide a wide range of functionality and aesthetic excellence to welcome more spontaneous assembly throughout the workplace. Comfort and agile tools converge in spaces that blend style and performance.

COMMUNITY spaces



APPLICATION VERSATILITY

Comfort and functionality combine with inviting shapes, creating a place for fellow workers to quickly gather, collaborate, and create.

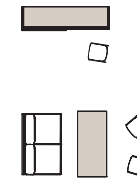

SIL-230 (10' X 14')

- VENEER: LIGHT RIFT OAK
- BACK-PAINTED GLASS: ICE WHITE
- TACKBOARD: FABRIC
- SHOWN WITH LIV SEATING, CALM LOUNGE, LETCHWORTH OCCASIONAL & BRIEFING COLLABORATIVE TABLES

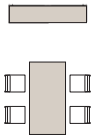

SIL-141 (10' X 12')

- VENEER: NUTMEG WALNUT NATURAL FLAT CUT
- BACK-PAINTED GLASS: MUSLIN
- TACKBOARD: FABRIC
- SHOWN WITH TIA SEATING & LETCHWORTH TABLE

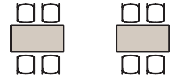

SIL-209 (20' X 20')

- VENEER: SUMARTA WALNUT NATURAL FLAT CUT
- METAL: SILVER
- SHOWN WITH LIV SEATING, CALM LOUNGE & CYLINDER OCCASIONAL TABLE

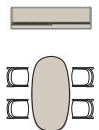

SIL-143 (10' X 15')

- VENEER: PHANTOM ECRU MAPLE STRATAWOOD HORIZONTAL GRAIN
- BACK-PAINTED GLASS: ICE WHITE
- TACKBOARD: FABRIC
- METAL: BLACK
- SHOWN WITH CALIA SEATING



SIL-210 (25' X 15')

- LAMINATE: VERANDA TEAK
- PULLS: SILEA
- METAL: WHITE
- SHOWN WITH LIV SEATING & UNIVERSAL BAR-HEIGHT TABLES



COMMUNITY spaces



APPLICATION VERSATILITY

A setting that beckons colleagues to gather, display, and exchange information, all in a space with robust tools and enlightened functionality.

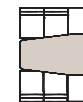

SIL-231 (6' X 8')

- VENEER: SKYLINE WALNUT NATURAL FLAT CUT
- TACKBOARD: FABRIC
- METAL: SILVER
- SOLID SURFACE: DESIGNER WHITE
- SHOWN WITH CIJI LOUNGE

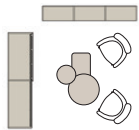

SIL-211 (10' X 12')

- VENEER: PINNACLE WALNUT NATURAL
- FLAT CUT
- BACK-PAINTED GLASS: BEIGE
- TACKBOARD & PED CUSHION: FABRIC
- METAL: PYRITE
- SHOWN WITH IRIS SEATING & BRIEFING OCCASIONAL TABLES

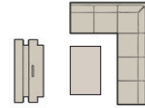

SIL-147 (12' X 15')

- VENEER: CLEAR CHERRY STRATAWOOD HORIZONTAL GRAIN
- SHOWN WITH CALM LOUNGE

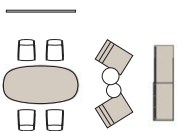

SIL-148 (10' X 20')

- VENEER: CLEAR MAPLE STRATAWOOD VERTICAL GRAIN
- BACK-PAINTED GLASS: ICE WHITE
- METAL: BLACK
- TACKBOARD: FABRIC
- SHOWN WITH CALM LOUNGE, METTA SEATING & BRIEFING OCCASIONAL TABLES

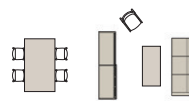

SIL-149 (12' X 24')

- VENEER: SKYLINE WALNUT NATURAL QUARTER CUT
- BACK-PAINTED GLASS: LOFT
- TACKBOARD: FABRIC
- SHOWN WITH CIJI LOUNGE, CALIA SEATING, CONVO STOOLS, LETCHWORTH & BRIEFING TABLES

COMMUNITY spaces



APPLICATION VERSATILITY

Adjacency and visibility converge to create an agile and attractive range of settings, all supporting an array of functional needs.



SIL-232 (8' X 8')

- VENEER: PHANTOM ECRU RIFT OAK
- TACKBOARD: FABRIC
- BACK-PAINTED GLASS: MUSLIN
- SHOWN WITH IRIS LOUNGE & TRILLIA STOOLS

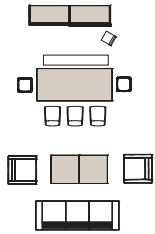

SIL-233 (16' X 20')

- VENEER: PORTICO TEAK SILVER OAK STRATAWOOD
- BACK-PAINTED GLASS: ICE WHITE
- SHOWN WITH URBANA LOUNGE, CIJI LOUNGE, METTA SEATING, TIA SEATING, TRILLIA STOOLS, CALM TABLE & SARANAC TABLE

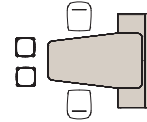

SIL-234 (8' X 8')

- VENEER: PORTICO TEAK SILVER OAK STRATAWOOD
- SOLID SURFACE: DESIGNER WHITE
- METAL: DESIGNER WHITE
- SHOWN WITH GENESSE SEATING & TRILLIA STOOLS

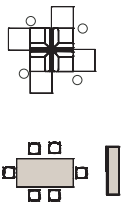

SIL-235 (24' X 20')

- VENEER: NUTMEG WALNUT NATURAL FLAT CUT
- BACK-PAINTED GLASS: ICE WHITE
- TACKBOARD: FABRIC
- SHOWN WITH CALM LOUNGE, CONVO STOOLS, LETCHWORTH & BRIEFING TABLES

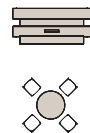

SIL-236 (10' X 12')

- VENEER: SKYLINE WALNUT NATURAL QUARTER CUT
- BACK-PAINTED GLASS: LOFT
- SHOWN WITH LIV SEATING & CYLINDER OCCASIONAL TABLE

MATERIALS & finishes

The beauty of choice.

Silea^{EH} material options offer high-end aesthetics and uncompromising quality. Veneer, painted wood, laminate, metal, glass, and solid surfaces provide endless options and design possibility to bring your style to life. Blend and integrate to create the tone and impact that reflects the personality of your workplace.

VENEER 1
STRATAWOOD

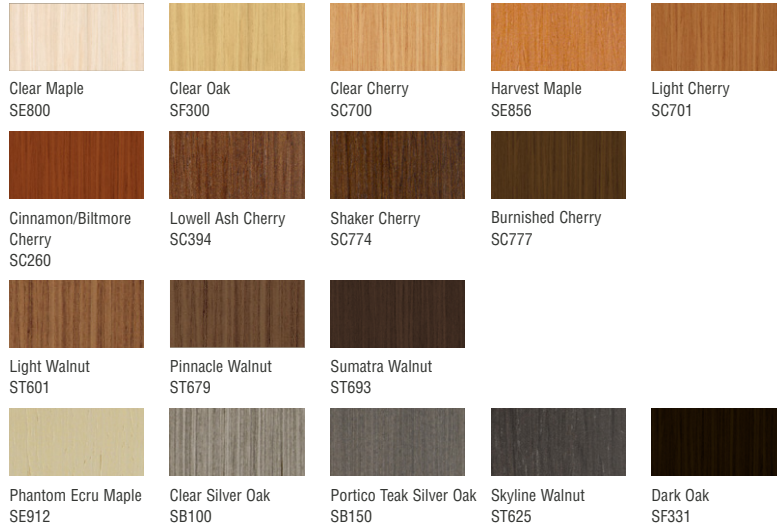

VENEER 2
PREMIUM

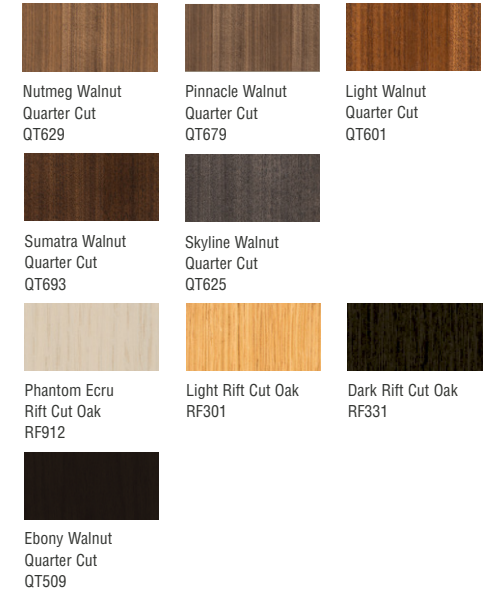

VENEER 1
FLAT CUT

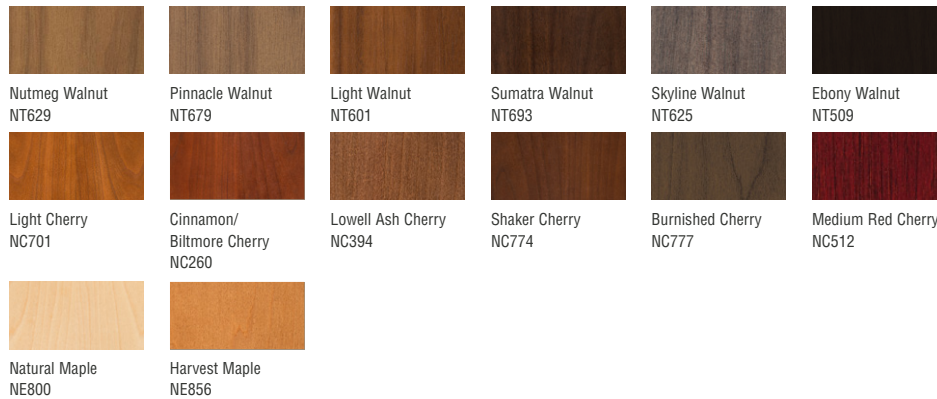

LAMINATE
SOLID

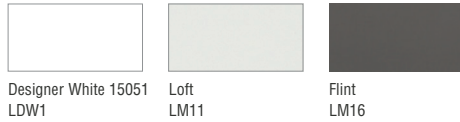

PAINTED
WOOD

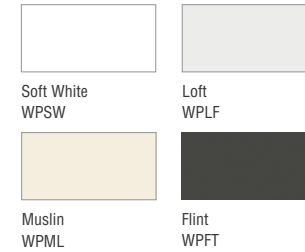

LAMINATE
WOODGRAIN

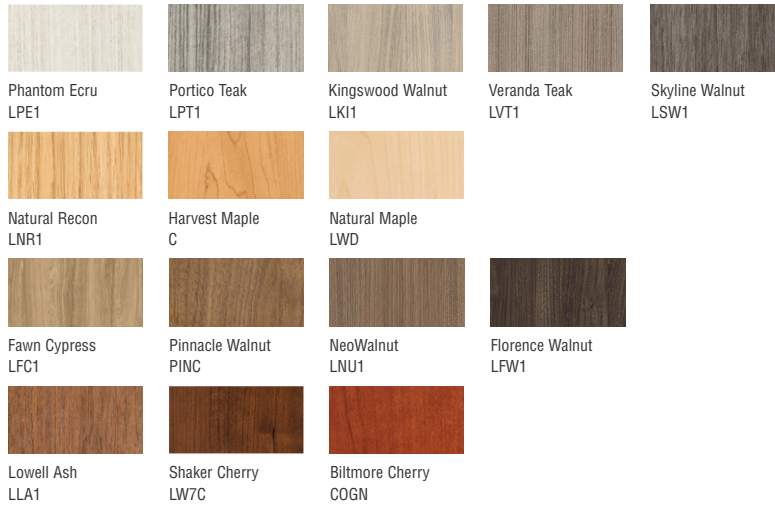

SOLID
SURFACE



METAL



BACK-PAINTED
GLASS

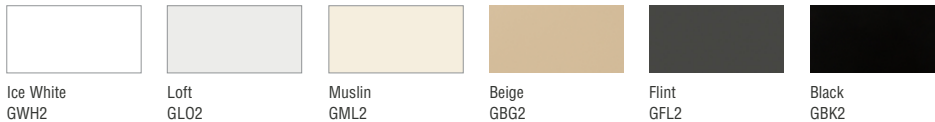

FEATURES & functionality

Powering performance.

Silea^{EH} from Gunlocke delivers the features and functionality that you expect for today's workplace.

COMPLEMENTING MATERIALS

Blend painted surfaces with the rich appeal of wood. Select from a variety of options that harmonize and adapt to create a unique design aesthetic.

STORAGE AGILITY

Select from storage components that align with your specific configuration needs. Standard soft-close doors and drawers deliver the quality you deserve and expect.

TACKZONES

Tackboard, magnetic, and writable surfaces further enhance functionality and user choices for any application. Specify to-the-floor options to increase collaboration in any space.



HEIGHT ADJUSTABILITY

Thoughtfully nested mechanisms for height-adjustable worksurfaces ensure attractive wellness options and deliver quiet and smoothly functioning electric adjustments.

FOOT OPTION

The vertical foot expands the options for planning and style preferences. Select your ideal storage configuration to complement your design statement.

PULLS & EDGE DETAILS

Select from five edge details and seven pull options to design a worksetting that reflects your design. The Silea pull position can be determined at the time of installation.

CHOOSE your base

Set the stage for the aesthetic and functionality. Give every worker their choice of workspace with thoughtful design intention that adapts to individual workstyles.

B.1
RUNOFF COLUMN BASE



B.2
PANEL LEG HOOP - ALUMINUM



B.3
SARANAC LEG



B.4
PANEL LEG HOOP - STEEL



B.5
ANGLED LEG



B.6
PANEL LEG WITH GLASS INSERT



B.7
POST LEG



B.8
PANEL LEG WITH PAINTED INSERT



B.9
PEDESTAL BASE



B.10
PANEL LEG WITH WOOD INSERT



CHOOSE your surface

From the shaping of new worksurfaces to the non-handed pulls, the graceful aesthetic of Silea^{EH} is intentionally designed to accommodate individual taste.

S.1
COCKPIT TOP

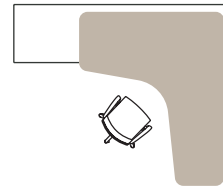

S.2
ARCH BOAT TABLE DESK

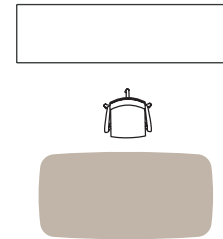

S.3
ARCH BOAT LAYERS RUNOFF

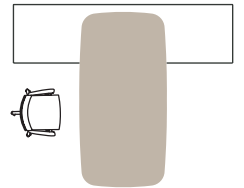

S.4
GUITAR PICK

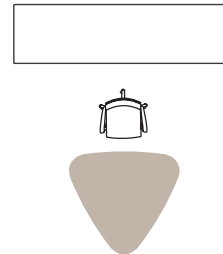

S.5
ELLIPSE TABLE DESK

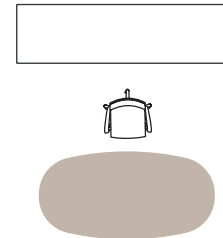

S.6
ELLIPSE LAYERS RUNOFF

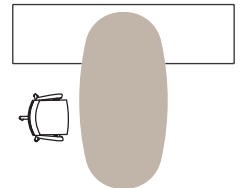

S.7
ROUND TABLE

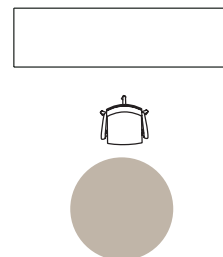

S.8
SIGHTLINE RUNOFF

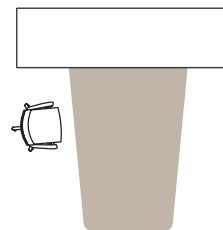

S.9
SIGHTLINE LAYERS RUNOFF

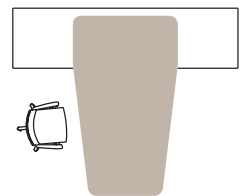

STATEMENT of line

Integrated options.

Silea^{EH} includes an array of integrated options that comprehensively address your needs for worksurfaces, storage, height adjustability, leg and foot options, and all the other elements of a high-performance worksetting.

UNITIZED

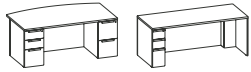

PEDESTAL DESKS
9" AND 15" PEDS
DOUBLE AND SINGLE PEDESTAL
BREAK FRONT AND FLUSH FRONT
RECTANGULAR AND BOWFRONT TOPS

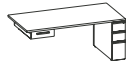

RUNOFF PEDESTALS
9" PEDS
STANDARD HEIGHT AND LAYERS
LAPTOP DRAWER OPTION
MODESTY OPTIONS

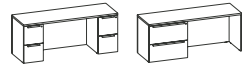

CREDENZAS
15" AND 30" PEDS
DOUBLE AND SINGLE PEDESTAL
FULL MODESTY

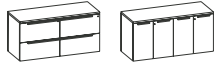

FULL BANK CREDENZAS
LATERAL FILE AND HINGED DOOR



RETURNS
CREDENZA DEPTH
15" PEDS
FULL MODESTY



TABLE DESKS
ANGLED LEGS
RECTANGULAR, ELLIPSE
AND ARCH BOAT TOPS



RUNOFF TABLE DESK
ANGLED LEGS
RECTANGULAR, ELLIPSE, ARCH BOAT,
SIGHTLINE AND COCKPIT TOPS
STANDARD HEIGHT AND LAYERS
LAPTOP DRAWER OPTION



MEDIA TOP
ANGLED LEGS
WALL ACCESS PANEL

HEIGHT
ADJUSTABLE



30" & 36" HEIGHT-ADJUSTABLE DESKS
FREESTANDING AND EXTENSIONS
FULL AND HALF MODESTY
TELESCOPING BASE
T-BASE
SHROUD FOR T-BASE

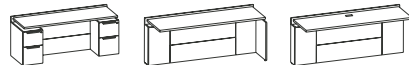

24" HEIGHT-ADJUSTABLE
CREDENZAS, RETURNS AND BRIDGES
SHROUD FOR T-BASE
LAYERS BOOKCASE FOR T-BASE

MODULAR

WORKSURFACES

36", 30", 24"
RECTANGULAR, BOWFRONT, RACETRACK,
B-SHAPE, D-SHAPE, J-SHAPE



PEDESTALS
9" 15" 18" 30" 36"



MODESTY PANELS



WALL ACCESS PANELS
CREDENZAS, RETURNS AND BRIDGES

TOP SHAPES

RECTANGULAR, ELLIPSE, ARCH BOAT, ROUND, GUITAR PICK, COCKPIT, SIGHTLINE



BASES

POST, POST WITH CASTERS, HOOP LEG, HOOP LEG WITH INFILLS,
ANGLED LEG, VERTICAL LEG, TRAPEZOID COLUMN, ROUND COLUMN, SARANAC

FOOTED
STORAGE
OPTION



PEDESTALS

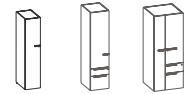

STORAGE



VERTICAL FOOT

For an unabridged listing of casegoods components, see the
Silea^{EH} | Medley^{EH} | Trio^{EH} price and specification guides on Gunlocke.com

STORAGE

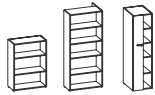

BOOKCASES
2H, 3H, 4H, 5H, 6H
30", 36"
BOOKCASE WITH COAT HOOK
BOOKCASE WITH CLOSET (18")



LATERAL FILES
2H WITH TOP
2H STORAGE CABINET WITH TOP
3H, 4H, 5H, 6H

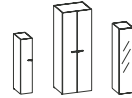

CLOSETS
5H, 6H
15", 18", 30"
GLASS DOOR OPTION

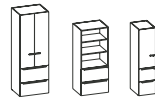

STORAGE BOXES
5H, 6H
18", 30"
CLOSED AND OPEN STORAGE



STORAGE LOCKERS
5H, 6H
24"
GLASS DOOR OPTION
STANDARD AND LAYERS HEIGHT



MOBILE PEDESTAL
CUSHION OPTION

STORAGE TOPS

AVAILABLE FOR VARIOUS STORAGE TYPES
FOR UNITS WITH AND WITHOUT DOORS

SURFACE MOUNT

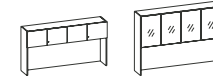

CABINETS
1H, 2H
OPEN
HINGED DOOR
HINGED GLASS DOOR



SURFACE-MOUNT TACKBOARDS
FABRIC TACKBOARD
MAGNETIC GLASS WHITEBOARD
MAGNETIC WOOD AND PAINT

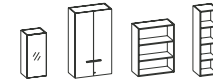

TOWERS
1H, 2H
15", 18" 30", 36"
OPEN
HINGED DOOR
HINGED GLASS DOOR

WALL MOUNT

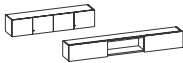

CABINETS
1H, 2H
OPEN
HINGED DOORS
HINGED GLASS DOORS
SLIDING DOORS
SLIDING GLASS DOORS



TACKZONES
MULTIPLE HEIGHT OPTIONS
FABRIC TACKBOARD
MAGNETIC GLASS WHITEBOARD
MAGNETIC WOOD AND PAINT



WALL-MOUNT WALLS
1H, 2H
OVERHEAD AND TACKZONE AREAS
STANDARD AND LAYERS HEIGHT
CLIP-IN SHELVING OPTIONS



FLOATING SHELVES
AVAILABLE IN ALL MATERIALS

WALL MOUNT TOPS
AVAILABLE FOR CABINETS FOR UNITS
WITH AND WITHOUT DOORS

WORKWALLS

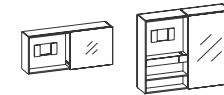

WORKWALLS
72", 90"
WALL MOUNT
WALL MOUNT WITH ACCESS PANEL
STACK-ON
FREESTANDING
FABRIC TACKBOARDS



LOUNGE-LEVEL MEDIA
WHITEBOARD OPTION

STYLE Choices

Creative configurations.

The Silea^{EH} collection brings an unmatched range of possibilities for blending aesthetic signatures with functional horsepower. The carefully curated and compatible material and finish options embrace the diverse style profiles and enable design solutions with exceptional functionality. Beauty meets performance.

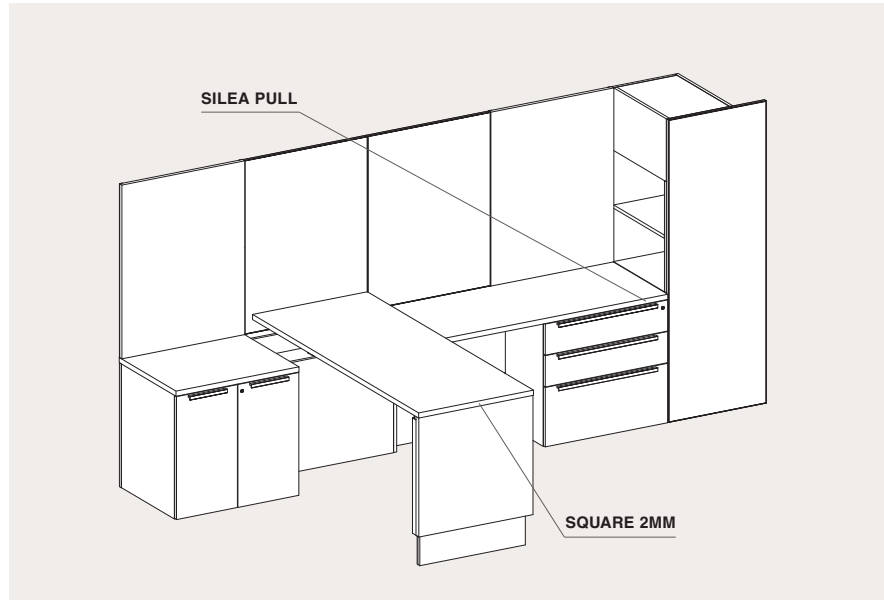

Sleek Sophistication

The versatility and creative integration of these components supports a variety of workplace configurations. This stunningly attractive profile is an invitation to productive work, and Gunlocke casegoods extend that welcome like no other. Choice, unlocked. Design potential, expanded.

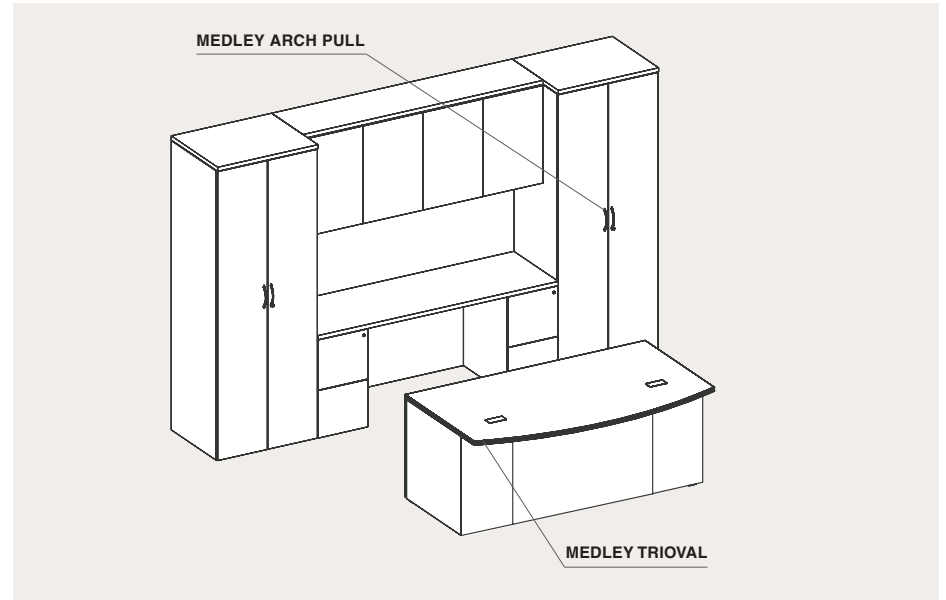

Classic Character

An array of features and options enable these casegoods to combine efficiency and style. Create a workplace that articulates classic elegance but also includes the latest in performance, including height adjustability.

PULLS

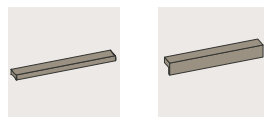

Modern

Silea

EDGE
DETAIL



Square*
2mm

*Laminate only available in Square 2mm edge detail.

PULLS



Medley
Arch

Medley
Arette

EDGE
DETAIL



Medley Square
1/2 Inch



Medley
Double Flute
1/2 Inch



Medley Trioval
1/2 Inch

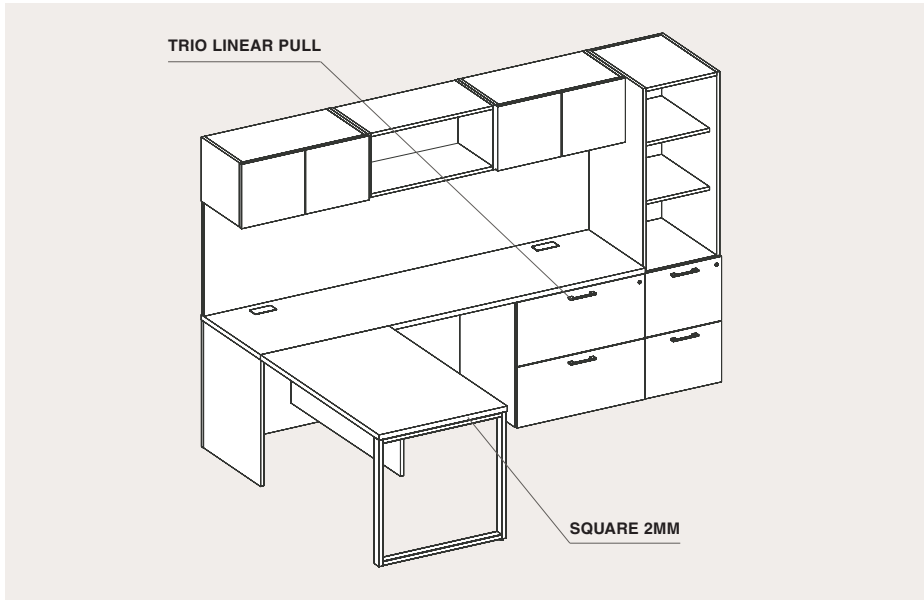

Essential Elements

The variety of options blended with the array of material possibilities makes a powerful design asset. The clean aesthetic conveys both efficiency and stature, while supplying the features and functionality that enable productivity.

PULLS



Trio Linear

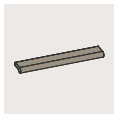

Trio Bar

EDGE DETAIL



Square* 2mm

*Laminate only available in Square 2mm edge detail.

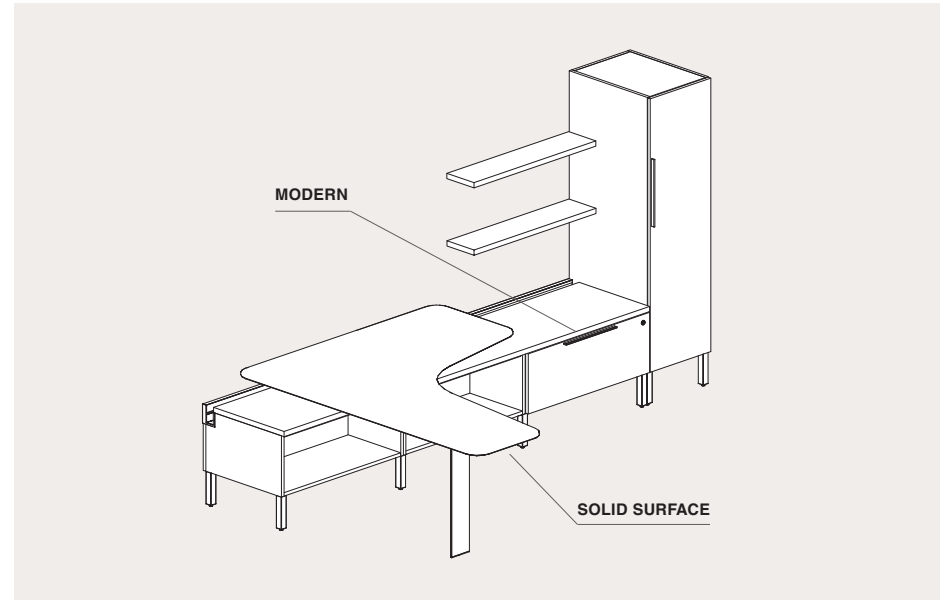

Modern Simplicity

Transform the conventional into the smartly simple by integrating an attractive foot option. A striking profile for today's tastes.

PULLS

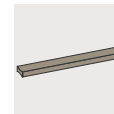

Modern

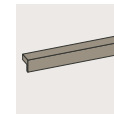

Silea

EDGE DETAIL

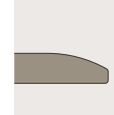

Solid Surface

FOOT DETAIL

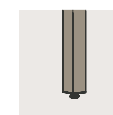

Vertical

HEIGHT adjustability

Sit-to-stand, concentrate, collaborate.

Silea^{EH} integrates height adjustability to enable the healthful rotation of working posture. The virtually concealed mechanism supports the quiet and easy transition to standing. Sit-to-stand, concentrate, collaborate. With Silea^{EH} height adjustability, a desk is more than a desk.

BRIDGE APPLICATION

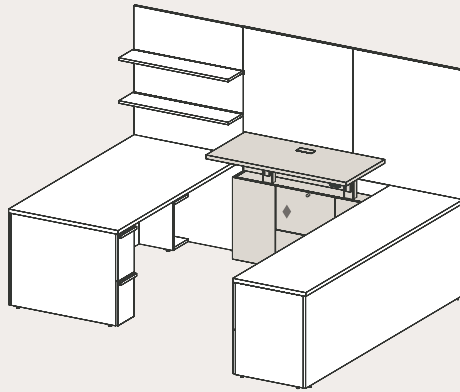

RETURN APPLICATION

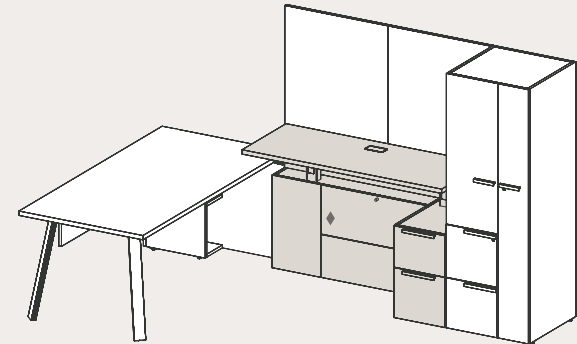

CREDENZA APPLICATION

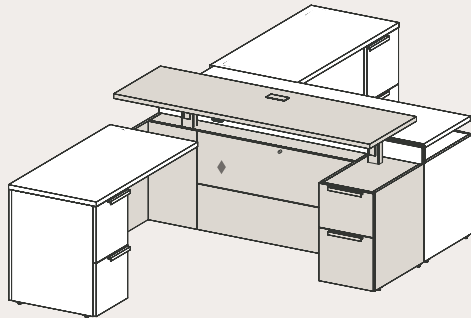

DESK/EXTENSION APPLICATION

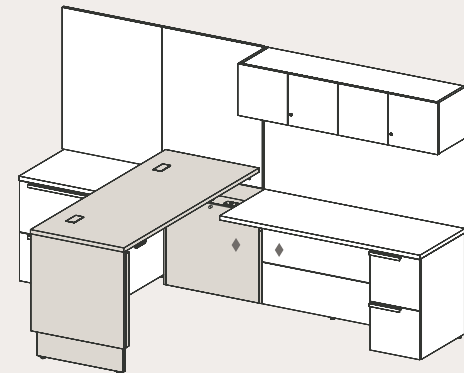

◆ WALL ACCESS PANEL

DESK OPTIONS

MIXED MATERIAL TELESCOPING

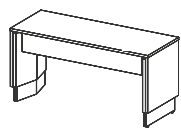

FREESTANDING DESK

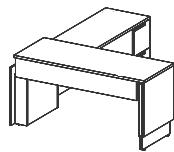

EXTENSION DESK

HALF

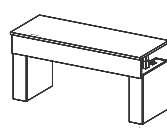

FREESTANDING DESK

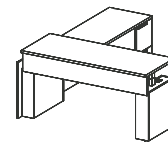

EXTENSION DESK

FULL

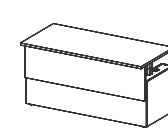

FREESTANDING DESK

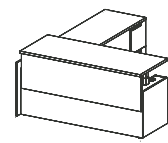

EXTENSION DESK

WORKWALL variations

The Silea^{EH} WorkWall powers the transformation of spaces, reshaping the way individuals and groups can gather and work. Expand options for the versatility of your progressive workplace.

FREESTANDING WORKWALL

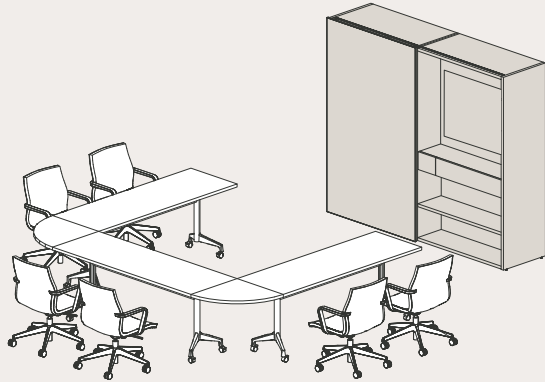

WALL-MOUNTED WORKWALL

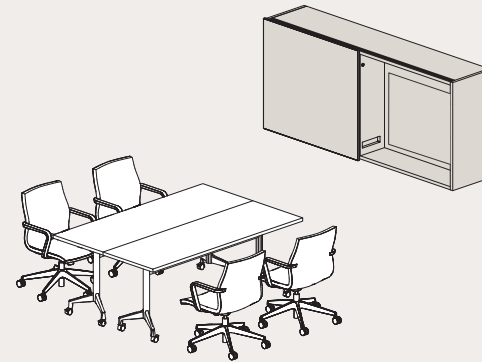

WORKWALL WITH ACCESS PANEL

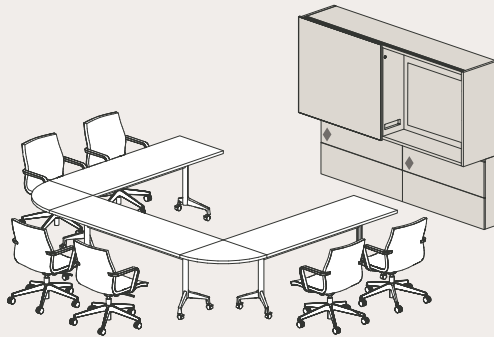

LOUNGE-LEVEL MEDIA

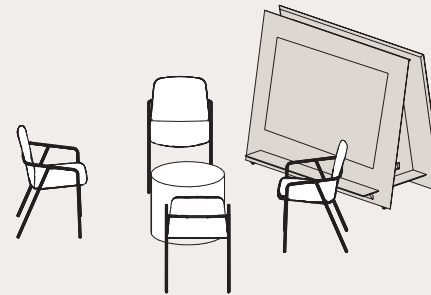

WORKWALLS

GATHER AND CREATE

WorkWalls include wall mounted, wall mounted with access panels, stack-on, and freestanding versions. Incorporating both a collaborative side and a personal side, WorkWalls utilize a back-painted glass sliding door that can serve as a whiteboard and be secured with a digital lock.

The application potential of the Silea^{EH} WorkWall supports productive group work or an office for one. When the needs shift or when the owner is away, it transforms the space to serve high-performing spaces.

LOUNGE-LEVEL MEDIA

PRESENT AND COLLABORATE

The lounge-level media unit brings the tools down to exactly where you need them. Use it to view a screen or write on the marker board surface. It's functional on both sides.

ACCESSORY details

Silea^{EH} provides versatile storage features, including convenient options for pull orientation and drawer configuration. The accessory drawer includes convenient internal compartments crafted with Gunlocke quality.

PULLS

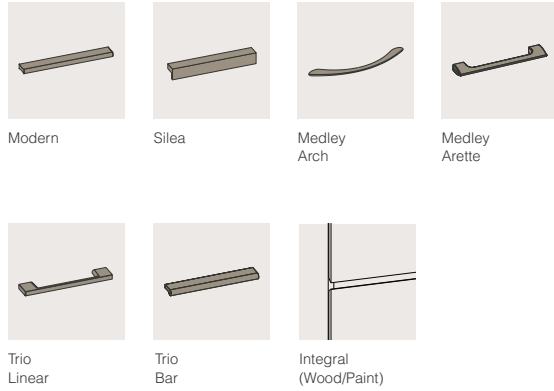

All metal pulls are available in Black and Silver.
Modern and Silea pulls are available in all five metal finishes.

EDGE DETAILS

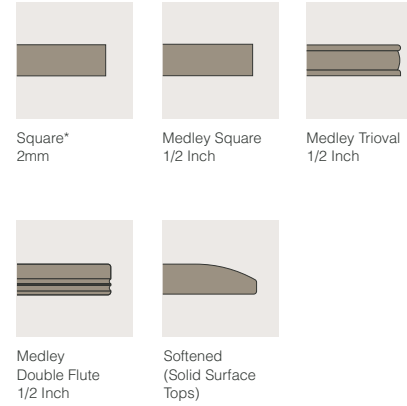

*Laminate only available in Square 2mm edge detail.

ACCESSORY DRAWER

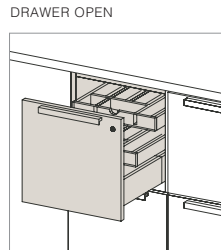

PULL ORIENTATION

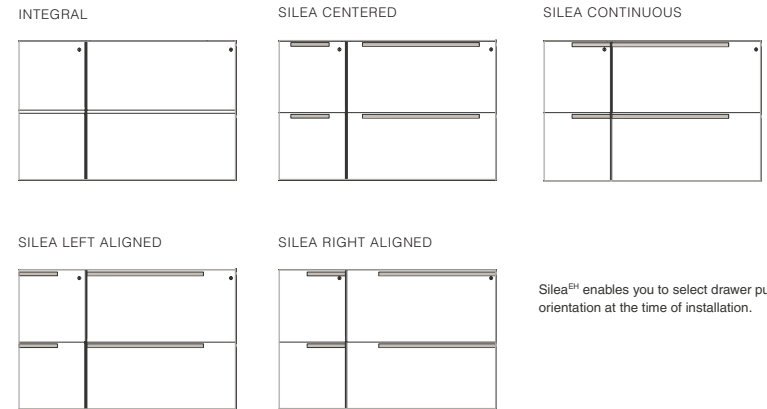

Silea^{EH} enables you to select drawer pull orientation at the time of installation.

WIRE management

Silea^{EH} thoughtfully channels and conceals wires and cables using a streamlined trough feature. Easy wall access and conveniently placed grommets deliver your power and data.

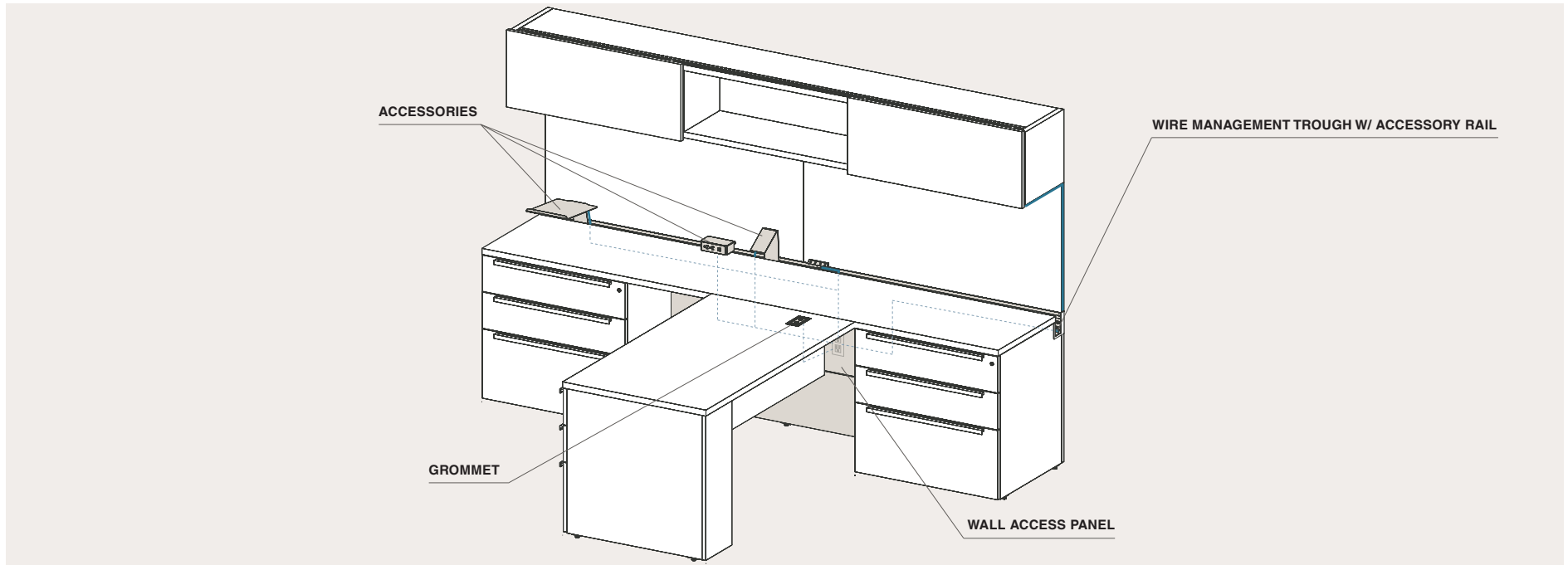

WALL ACCESS PANEL

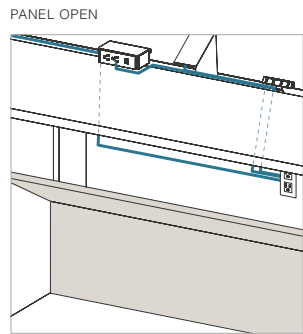

GROMMET

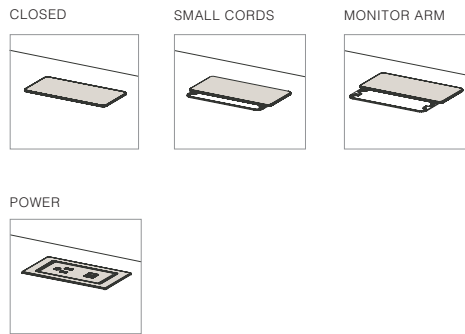

TROUGH

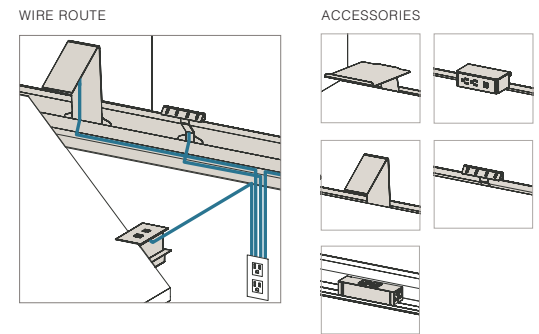

STORAGE elements

Silea^{EH} storage options provide a range of solutions from side-access towers, to storage closets, to overhead cabinets and surface-mounted components. Maximize space and usage in drawers that also provide guest power. A mix of open and closed storage provides the range and details you need to customize any application.

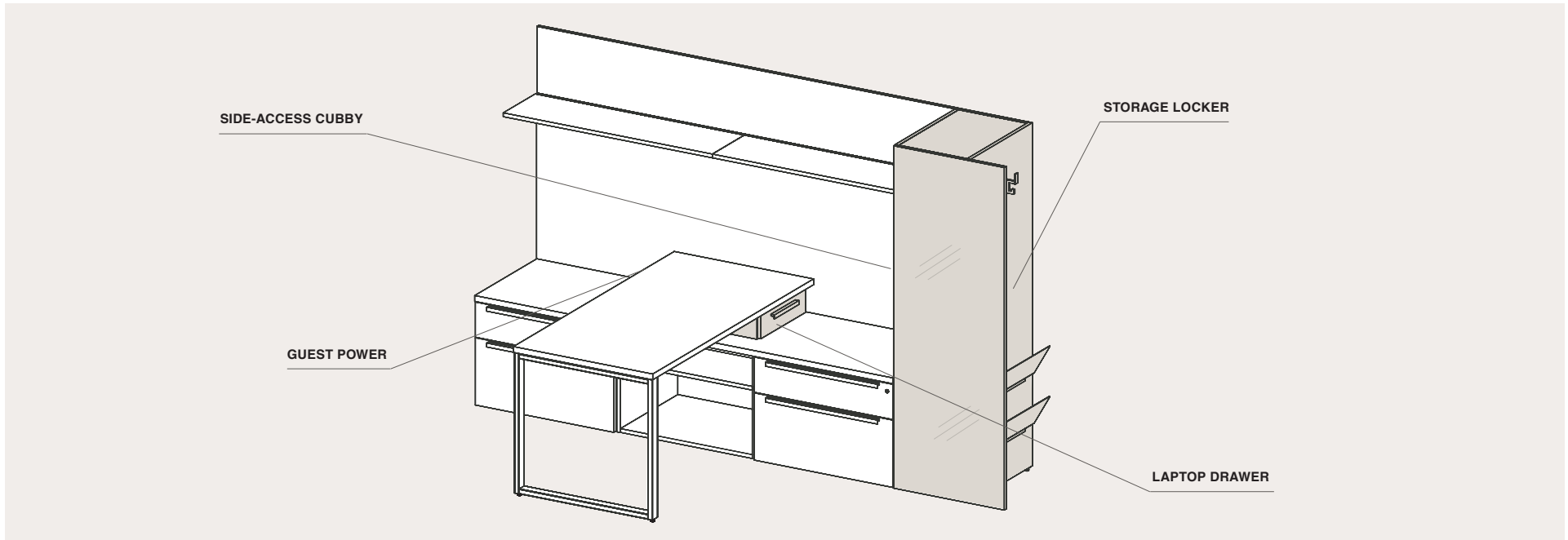

LAPTOP DRAWER

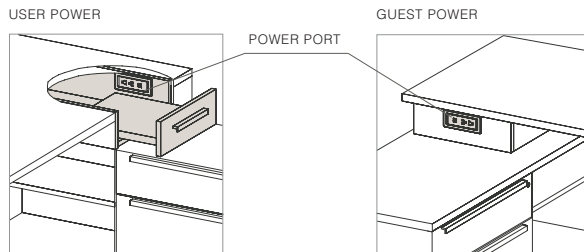

STORAGE LOCKER

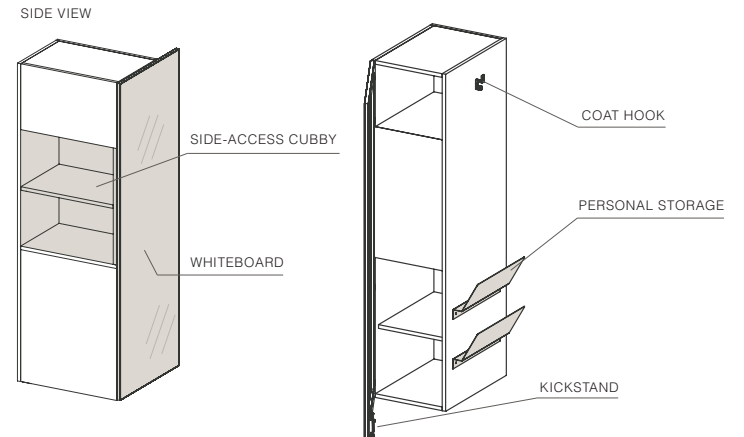

FOOT options

Choose components with the foot option to create a distinct design, enabling the creative coordination of finishes and the overall aesthetic.

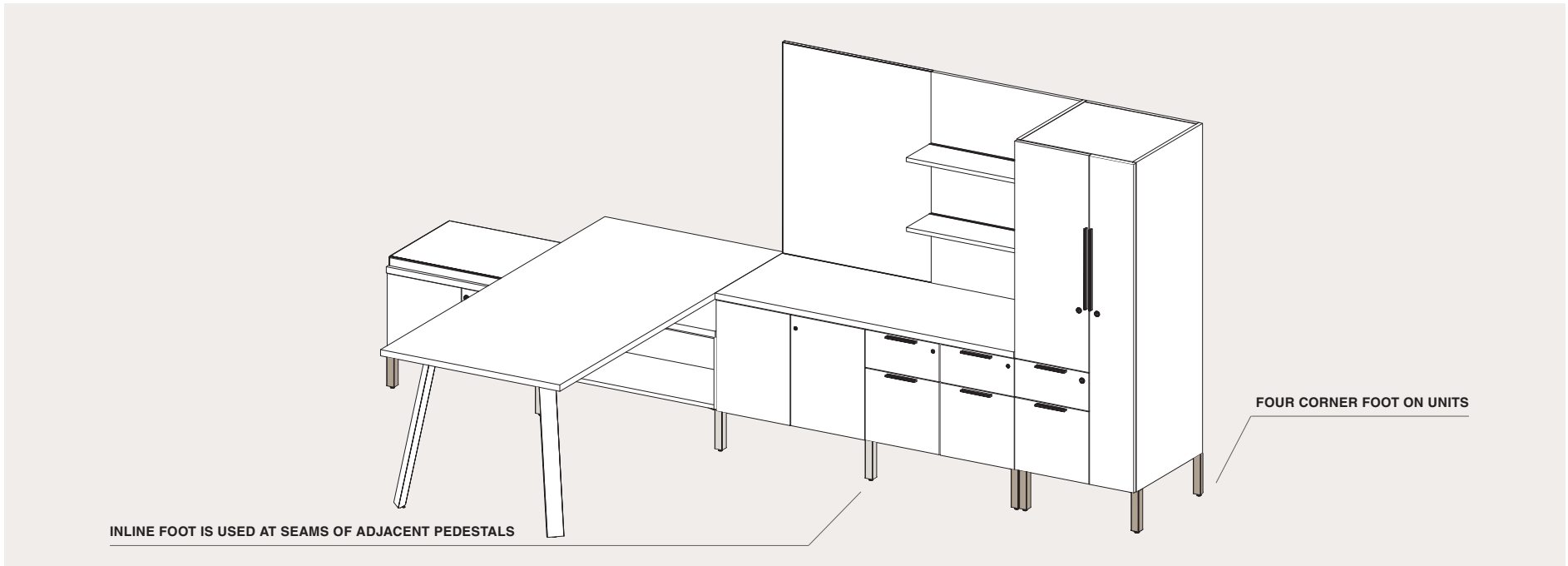

SPECIFYING FEET

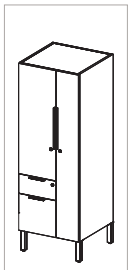

Corner Foot Kits are used on storage units or the four outside corners of a modular station.

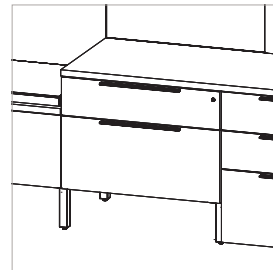
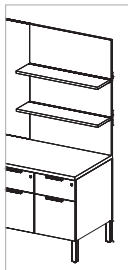

Inline Foot Kits are used at the seams of adjacent pedestals of a modular station.

GANGING UNITS

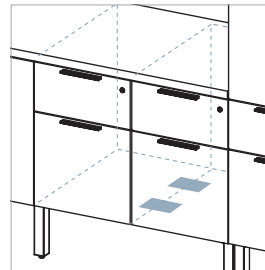

When planning with two or more 15" or 18" pedestals, pedestal ganging kits may be used. Reference the price and specification guide for more details.

ADAPTABLE AESTHETICS

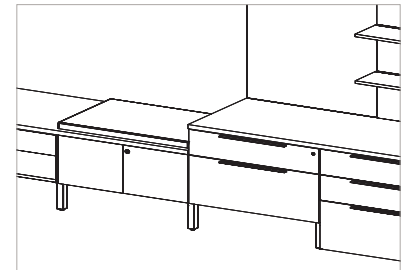

Incorporate pedestals that accommodate storage and aesthetic preferences. Silea™ offers a wide range of storage options that provides a mix of open and closed units and maximizes space usage in drawers. Configure storage to support functional and design requirements for any application across the floorplate.

Gunlocke®

One Gunlocke Drive
Wayland, NY 14572
800 828 6300

GUNLOCKE.COM

Our commitment to the environment. A vibrant, healthy planet yields the products we create and our future is dependent upon the commitment we make to stewardship and sustainability. Find out more at Gunlocke.com/environment

© 2019 The Gunlocke Company, LLC

G1011.A1