

HON Acoustics by Unika Vaev

Care + Install Guide



Table of Contents

ECOUSTIC® CEILING FLATS.....	3
ECOUSTIC® CEILING MATRIX.....	5
ECOUSTIC® DRIFT.....	7
ECOUSTIC® MEASURE BAFFLE.....	9
E3® PEEL + STICK TILES.....	11
ECOUSTIC® FOLIAR.....	13
ECOUSTIC® MATRIX WALL/CEILING.....	15
ECOUSTIC® TORQUE CEILING.....	17
ECOUSTIC® TORQUE WALL.....	19
ECOUSTIC® ARBOR ALTO.....	21
SCREENTRAK® ALTO BASS.....	23
ECOUSTIC® SOFTLINE.....	24
MIXMAX.....	27

ECOUSTIC® CEILING FLATS - INSTALLATION

ASSEMBLY INSTRUCTIONS

Supplied

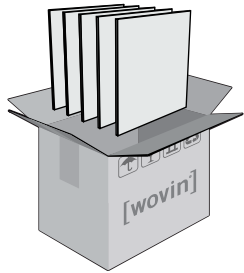

8x ecoustic® Ceiling Flats 24 Tiles
or
4x ecoustic® Ceiling Flats 48 Tiles

Sold as single color per box

Source



Pre-existing or newly installed drop ceiling T-frame

24" x 24" [centers]
or
48" x 24" [centers]

Essential

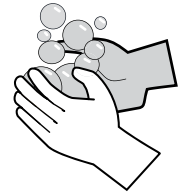

Clean hands
Handle with care
during installation

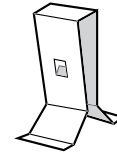

Hold down clip
4 per tile

Suitable for your grid system

INSTALLATION

Step 1

Check the pre-existing or newly installed frame in which to suspend the ecoustic® Ceiling Flats.

Ensure the frame has been correctly installed with a suitable sized aperture for the tiles and the frame is square and true.

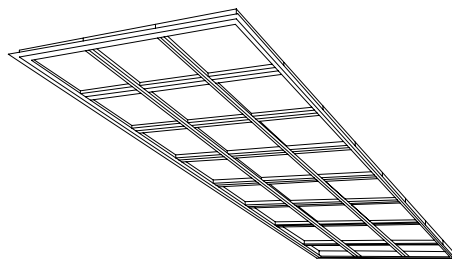

Step 2

The tiles can be dropped in place from the rear of the frame or slotted through from the visible side.

Take care not to bend the tile. The use of suitable hold down clips are mandatory on ecoustic® Ceiling Flats, 4 per tile.

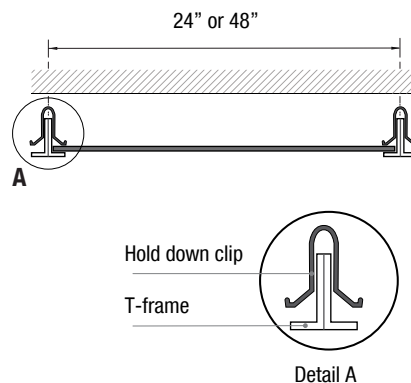

Step 3

Continue to fill the frame with ecoustic® Ceiling Flats.

Finish the installation in a discreet area as the last tile can remain unclipped to act as access to the plenum.

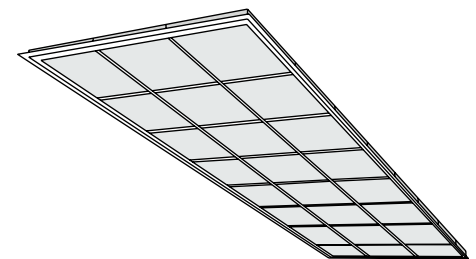

ECOUSTIC® CEILING FLATS CARE

Please Note

- Care must be taken when cleaning as these instructions apply to the fabric face only and the possible effect of the cleaning regime on underlying bases and ceiling surface must be considered
- For these reasons it is suggested to spot clean only and that it be carried out by a professional cleaner

Regular Care

- Protect from direct heat and sunlight
- To prevent dust build up, lightly dust with a soft cloth or vacuum with a soft brush attachment

Cleaning

- Professional cleaning is always recommended
- Always test any cleaning products on an inconspicuous area prior to commencing cleaning
- Blot any excess spills from the material with a dry clean sponge or cloth
- Treat all stains and spills as soon as possible
- Most marks can be spot cleaned by lightly wetting the affected area with a mild detergent and warm water solution
- Do not saturate the tile
- Do not scrub or abrade the tile surface as this will affect the surface finish
- Once the stain or mark has been loosened then blot the excess solution out with a dry clean sponge or cloth
- Sponge afterwards with clean warm water and dry any excess moisture with a dry clean sponge or cloth
- The product can also be spot cleaned with dry cleaning fluid, lightly sponge a small amount of dry cleaning fluid and blot
- Dry away from direct heat

ECOUSTIC® CEILING MATRIX INSTALLATION

Assembly View

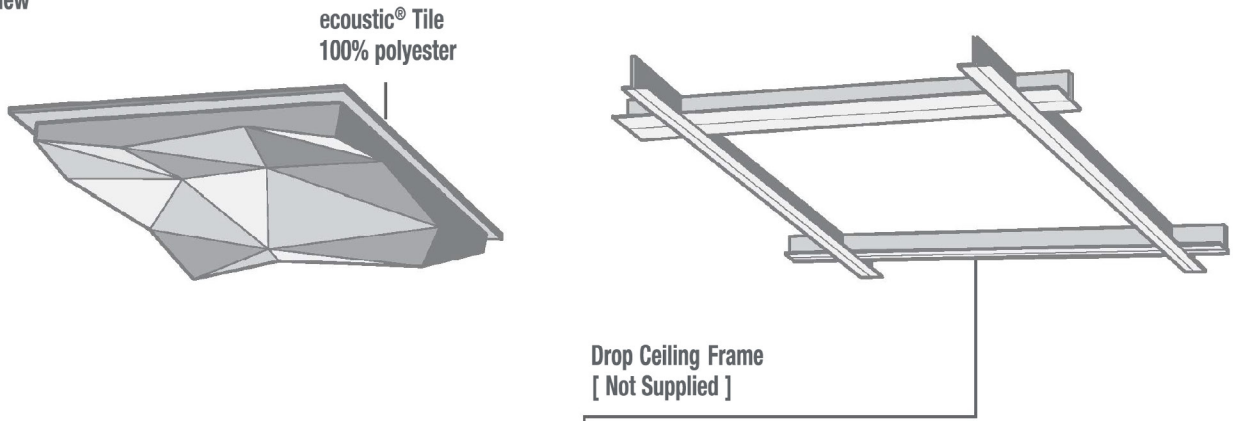

Supplied

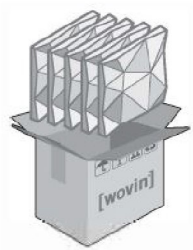

23 3/8" X 23 3/8":
8 x ecoustic® Ceiling Matrix

47 1/16" X 23 3/8":
8 x ecoustic® Ceiling Matrix

All sold as single color per pack

Source



Pre-existing or newly installed
drop ceiling T-Frame

24" x 24" [centers]
or
48" x 24" [centers]

Essential

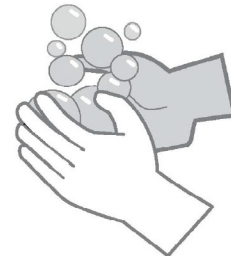

Clean Hands
Handle with care
during installation

Installation

Step 1:

Check the pre-existing or newly installed frame in which to suspend the ecoustic® Ceiling Matrix. Ensure the frame has been correctly installed with a suitable sized aperture for the tiles and the frame is square and true.



Step 2:

The return flange of the panel will locate onto the landing of the suspended ceiling frame. The tiles can be dropped in place from the rear of the frame or slotted through from the visible side. Be careful not to bend the tile. The use of suitable Hold Down Clips is mandatory on ecoustic® Ceiling Matrix, 4 per tile.

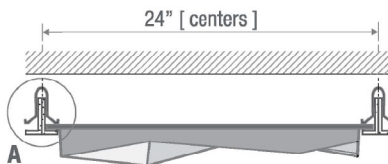

Hold Down Clip

T-Frame

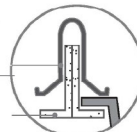

Detail - A

Step 3:

Continue to fill the frame with ecoustic® Ceiling Matrix. Finish the installation in a discreet area as the last tile can remain unclipped to act as access to the plenum.

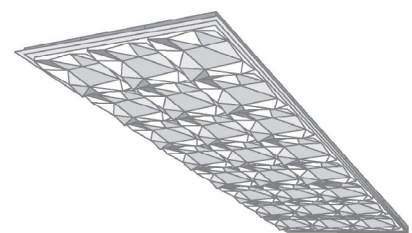

ECOUSTIC® CEILING MATRIX CARE

Please Note

- Care must be taken when cleaning as these instructions apply to the fabric face only and the possible effect of the cleaning regime on underlying bases and wall surface must be considered.
- For these reasons it is suggested to spot clean only and that it may be carried out by a professional cleaner.

Regular Care

- Protect from direct heat and sunlight.
- To prevent dust build up, lightly dust with a soft cloth or vacuum with a soft brush attachment.

Cleaning

- Professional cleaning is always recommended.
- Always test any cleaning products on an inconspicuous area prior to commencing cleaning.
- Blot any excess spills from the material with a dry clean sponge or cloth.
- Treat all stains as soon as possible.
- Most marks can be spot cleaned by lightly wetting the affected area with a mild detergent and warm water solution.
- Do not saturate the tile.
- Do not scrub or abrade the tile surface as this will affect the surface finish.
- Once the stain or mark has been loosened, blot the excess solution out with a dry clean sponge or cloth.
- Sponge afterwards with clean warm water and dry any excess solution out with a dry clean sponge or cloth.
- The fabric may also be spot cleaned with dry cleaning fluid. Lightly sponge a small amount of dry cleaning fluid and blot.
- Dry away from direct heat or sunlight.
- Do not use carpet shampoo.

ECOUSTIC® DRIFT INSTALLATION

ASSEMBLY INSTRUCTIONS

Supplied

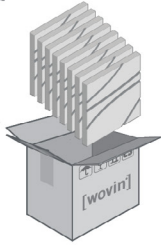

8 x Ecoustic Drift tiles
 Sold in packs of 8 per colour
 9 x 4-way joiner clips (inc. 1 spare)
 Clip template
 Installation instructions

Source

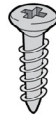

Flat-head c/sunk
 25mm (1") 10g
 [4-8 per tile]



Power drill

Essential



Clean hands
 Handle with care
 during installation

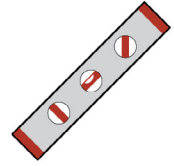

Spirit level

INSTALLATION

Step 1

In most situations it is best to measure up from the floor and mark a straight line along the base of the area, this line is your datum. On the datum mark your starting position in the bottom left hand corner.

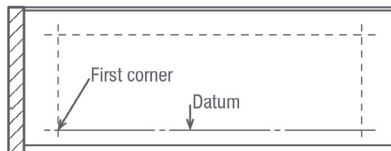

Step 2

Using fixings suitable for your substrate, fix the first corner in place.
 Note: Always use a mechanical means of fixing.

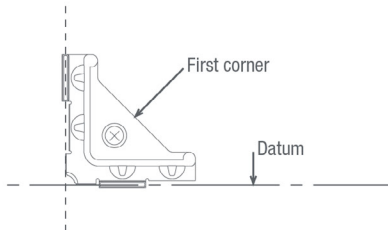

Step 3

Use the supplied template to fix the next 3 clips in place.

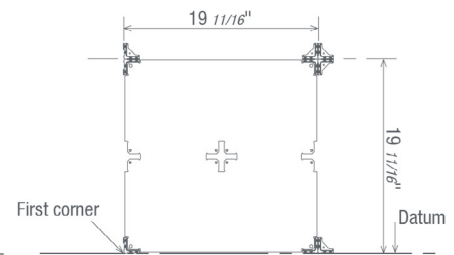

Step 4

Using the template work your way up the wall in columns. Finish the top with corner clips on corners + edge clips on straight joins.
 Note: never use the tiles to measure spacing.

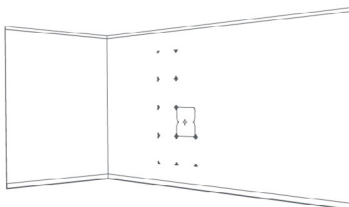

Step 5

Once you have two columns up, double check your spacing by installing the first column of tiles. Always stay one column ahead of the installed tiles so the tiles don't interfere with the spacing.

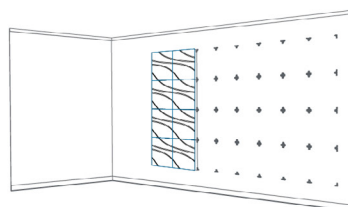

Step 6

Install the rest of your clips and put up the tiles to finish.
 For ceiling installations, we recommend the use of glue for additional fixing.

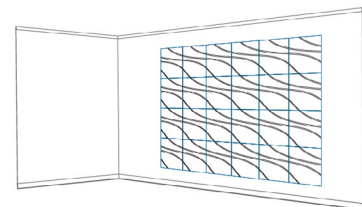

ECOUSTIC® DRIFT CARE

Please Note

- Care must be taken when cleaning as these instructions apply to the fabric face only and the possible effect of the cleaning regime on underlying bases and wall surface must be considered.
- For these reasons it is suggested to spot clean only and that it may be carried out by a professional cleaner.

Regular Care

- Protect from direct heat and sunlight.
- To prevent dust build up, lightly dust with a soft cloth or vacuum with a soft brush attachment.

Cleaning

- Professional cleaning is always recommended.
- Always test any cleaning products on an inconspicuous area prior to commencing cleaning.
- Blot any excess spills from the material with a dry clean sponge or cloth.
- Treat all stains as soon as possible.
- Most marks can be spot cleaned by lightly wetting the affected area with a mild detergent and warm water solution.
- Do not saturate the tile.
- Do not scrub or abrade the tile surface as this will affect the surface finish.
- Once the stain or mark has been loosened, blot the excess solution out with a dry clean sponge or cloth.
- Sponge afterwards with clean warm water and dry any excess solution out with a dry clean sponge or cloth.
- The fabric may also be spot cleaned with dry cleaning fluid. Lightly sponge a small amount of dry cleaning fluid and blot.
- Dry away from direct heat or sunlight.
- Do not use carpet shampoo.

ECOUSTIC® MEASURE BAFFLE INSTALLATION

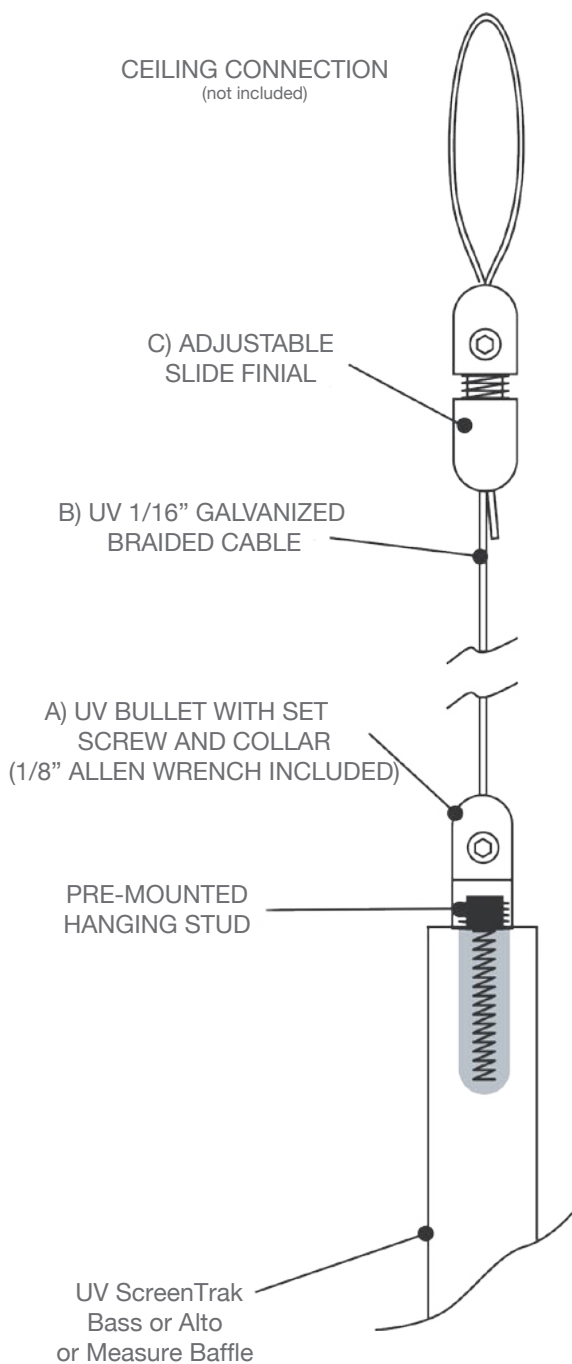

1

Unpack and inspect baffles, confirm location of pre-mounted hanging studs, and parts count.

2

Attach (A) UV Bullet to studs and loosen the set screws.

3

Measure and cut (B) UV cable to required length. Include allowance for hanging loop.

4

Thread cable through (C) UV adjustable slide finial and loop back through with the slide and set screw loosened.

a) If hanging hardware is an open hook the loop can be completed before hanging.

b) If cable is to be attached to a closed eye, or an architectural feature, loop cable around the feature and thread back through finial.

Adjust the overall length of the cable to the specified length, hand-tighten the twist feature of the finial to locate the specified length.

5

Insert hanging, bottom end of (B) UV cable into the mounted (A) ICF terminals and tighten the set screw -- tug to test connection.

6

Check position, height and level of baffles -- if adjustment is required -- loosen the twist feature (C) Adjustable slide finial and adjust to desired length. TIGHTEN SET SCREW.

ECOUSTIC® MEASURE BAFFLE CARE

Please Note

- ecooustic® Baffles should be removed from the ceiling or wall to ensure they can be cleaned safely.
- Disassemble ecooustic® Baffles in reverse sequence of the relevant assembly process mentioned above.
- It is recommended to spot clean only by a professional cleaner.

Regular Care

- Protect from direct heat and sunlight.
- To prevent dust build up, lightly dust with a soft cloth or vacuum with a soft brush attachment.

Cleaning

- Professional cleaning is always recommended.
- Always test any cleaning products on an inconspicuous area prior to commencing cleaning.
- Blot any excess spills from the material with a dry clean sponge or cloth.
- Treat all stains and spills as soon as possible.
- Most marks can be spot cleaned by lightly wetting the affected area with a mild detergent and warm water solution.
- Do not saturate the baffle panel.
- Do not scrub or abrade the fabric as this will affect the surface finish.
- Once the stain or mark has been loosened then blot the excess solution out with a dry clean cloth.
- Sponge afterwards with clean warm water and mop any excess moisture with a dry clean sponge or cloth.
- The surface can also be spot cleaned with dry cleaning fluid. Lightly sponge a small amount of dry cleaning fluid and blot.
- Dry away from direct heat and sunlight.
- Avoid the use of carpet shampoos.

E3® PEEL + STICK TILE INSTALLATION

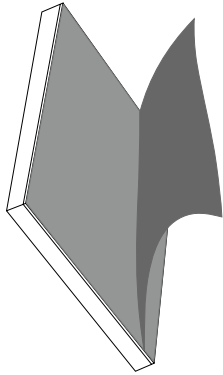

STEP 1: Peel backer from tile.

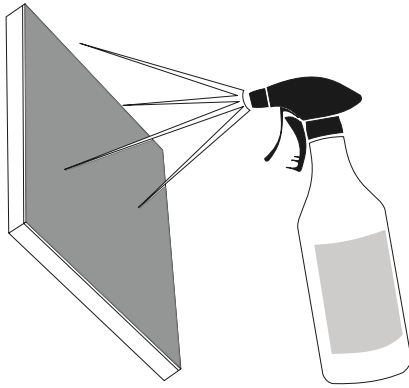

STEP 2: Lightly spray adhesive side of tile with mild soapy water, ensuring there are no dry spots.

BE CAREFUL TO NOT OVER-SPRAY

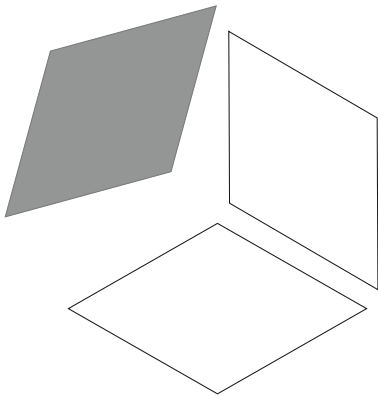

STEP 3: Place the tile in its approximate location.

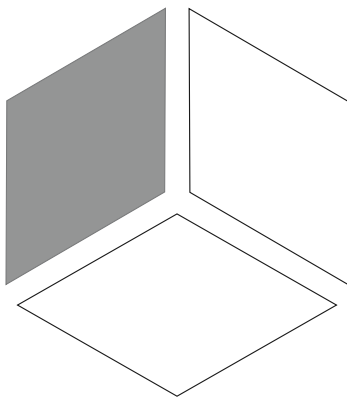

STEP 4: While the adhesive is moist with soapy water, the tile can be maneuvered into alignment. When the tile is in its desired location, press it firmly against the wall to set it into place. Allow 24 hours to dry for permanent bond.

E3® PEEL + STICK TILE CARE

CARE INSTRUCTIONS

Please Note

- The care instructions below are applicable to the Ecooustic® Solid Color Panel + Print products. Please Note Consideration must be given to any possible effect of the cleaning regime on the underlying glue or backing board. It is recommended that spot cleaning only is used and that it is carried out by a professional cleaner.

Regular Care

- Protect from direct heat and sunlight.
- To prevent dust build up, lightly dust with a soft cloth or vacuum with a soft brush attachment.
- Spot Cleaning
- Professional cleaning is always recommended.
- Always test any cleaning products on an inconspicuous area prior to commencing cleaning.
- Blot any excess spills from the material with a dry clean sponge or cloth.
- Treat all stains and spills as soon as possible.
- Most marks can be spot cleaned by lightly wetting the affected area with a mild detergent and warm water solution.
- Do not saturate the panel, screen or felt.
- Do not scrub or abrade the fabric as this will affect the surface finish.
- Once the stain or mark has been loosened then blot the excess solution out with a dry clean cloth.
- Sponge afterwards with clean warm water and mop any excess moisture with a dry clean sponge or cloth.
- The fabric can also be spot cleaned with dry cleaning fluid. Lightly sponge a small amount of dry cleaning fluid and blot.
- Dry away from direct heat and sunlight.
- Avoid the use carpet shampoos.

ECOUSTIC® FOLIAR INSTALLATION

ASSEMBLY INSTRUCTIONS

Supplied

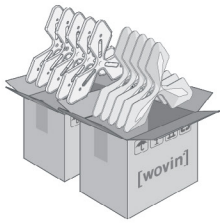

5 x Ecoustic® Foliar leaf tiles
Sold in packs of 5 per colour
Flat packed separately

5 x Ecoustic® Foliar base tiles
Sold in packs of 5 per colour
Flat packed separately

Source

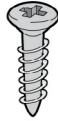

Flat-head c/sunk
25mm (1/4 ") 10g
[x 4 per tile]



Power drill

Essential



Clean hands
Handle with care
during installation



Spirit level

INSTALLATION

Step 1:

Insert the screw into centre of the base.
Insert the remaining 3 screws.

Step 2:

Fix Ecoustic Foliar leaf into the base. The leaf will self locate via magnet fasteners within the part.

Note:

For secure fixing between the leaf and the base, silicone or builders glue can be applied to the three contact points on the rear of the leaf.

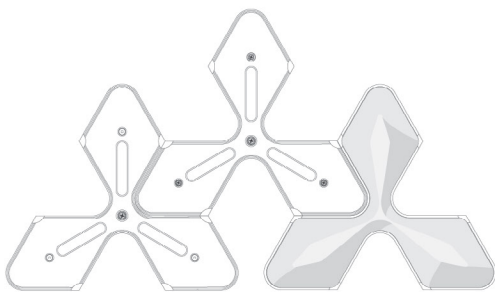

Tip:

If you wish for the bottom edge to be horizontal, use a spirit level to straighten the first base, then it is as easy as butting the next.

Ensure the following tile is firmly pushed up against the previous for a tight fit prior to screwing into place.

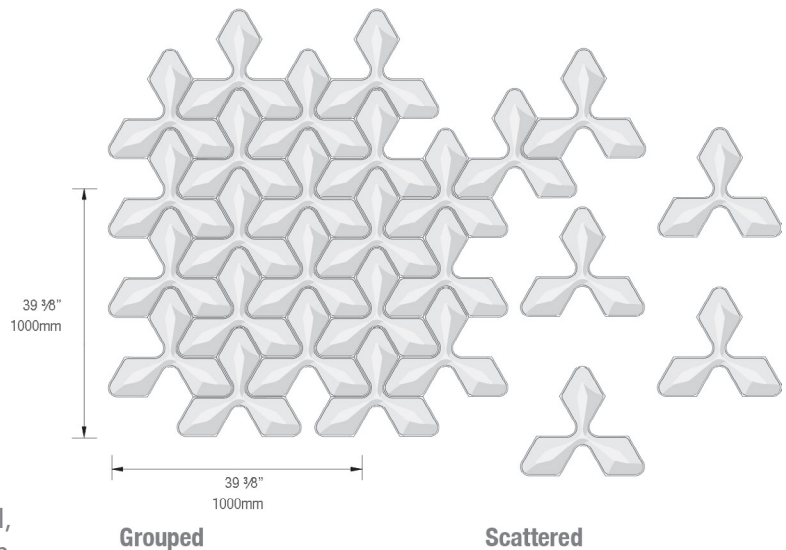

ECOUSTIC® FOLIAR CARE

Please Note

- Care must be taken when cleaning as these instructions apply to the fabric face only and the possible effect of the cleaning regime on underlying bases and wall surface must be considered.
- For these reasons it is suggested to spot clean only and that it may be carried out by a professional cleaner.

Regular Care

- Protect from direct heat and sunlight.
- To prevent dust build up, lightly dust with a soft cloth or vacuum with a soft brush attachment.

Cleaning

- Professional cleaning is always recommended.
- Always test any cleaning products on an inconspicuous area prior to commencing cleaning.
- Blot any excess spills from the material with a dry clean sponge or cloth.
- Treat all stains as soon as possible.
- Most marks can be spot cleaned by lightly wetting the affected area with a mild detergent and warm water solution.
- Do not saturate the tile.
- Do not scrub or abrade the tile surface as this will affect the surface finish.
- Once the stain or mark has been loosened, blot the excess solution out with a dry clean sponge or cloth.
- Sponge afterwards with clean warm water and dry any excess solution out with a dry clean sponge or cloth.
- The fabric may also be spot cleaned with dry cleaning fluid. Lightly sponge a small amount of dry cleaning fluid and blot.
- Dry away from direct heat or sunlight.
- Do not use carpet shampoo.

ECOUSTIC® MATRIX WALL INSTALLATION

ASSEMBLY INSTRUCTIONS

Supplied

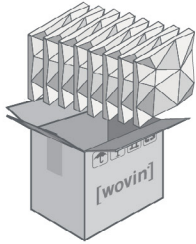

8 x Ecoustic Matrix tiles
 Sold in packs of 8 per color
 9 x 4-way joiner clips (inc. 1 spare)
 Clip template
 Installation instructions

Source

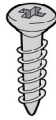

Flat-head c/sunk
 25mm (1") 10g
 [4-8 per tile]



Power drill

Essential



Clean hands
 Handle with care
 during installation

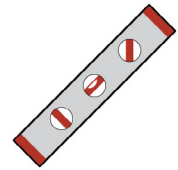

Spirit level

INSTALLATION

Step 1

In most situations it is best to measure up from the floor and mark a straight line along the base of the area, this line is your datum. On the datum mark your starting position in the bottom left hand corner.

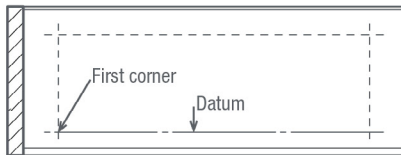

Step 2

Using fixings suitable for your substrate, fix the first corner in place.
 Note: Always use a mechanical means of fixing.

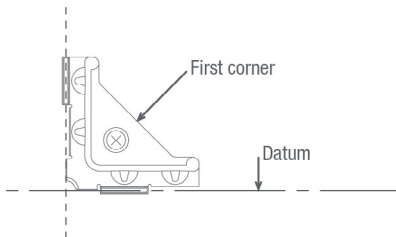

Step 3

Use the supplied template to fix the next 3 clips in place.

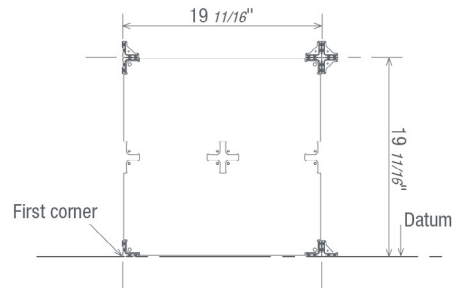

Step 4

Using the template work your way up the wall in columns. Finish the top with corner clips on corners + edge clips on straight joins.
 Note: never use the tiles to measure spacing.

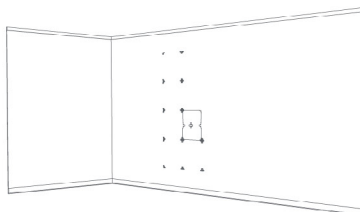

Step 5

Once you have two columns up, double check your spacing by installing the first column of tiles. Always stay one column ahead of the installed tiles so the tiles don't interfere with the spacing.

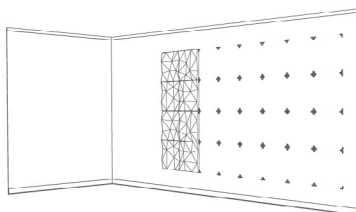

Step 6

Install the rest of your clips and put up the tiles to finish.
 For ceiling installations, we recommend the use of glue for additional fixing.

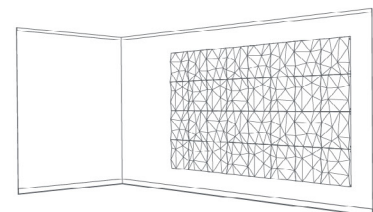

ECOUSTIC® MATRIX WALL/CEILING CARE

Please Note

- Care must be taken when cleaning as these instructions apply to the fabric face only and the possible effect of the cleaning regime on underlying bases and wall surface must be considered.
- For these reasons it is suggested to spot clean only and that it may be carried out by a professional cleaner.

Regular Care

- Protect from direct heat and sunlight.
- To prevent dust build up, lightly dust with a soft cloth or vacuum with a soft brush attachment.

Cleaning

- Professional cleaning is always recommended.
- Always test any cleaning products on an inconspicuous area prior to commencing cleaning.
- Blot any excess spills from the material with a dry clean sponge or cloth.
- Treat all stains as soon as possible.
- Most marks can be spot cleaned by lightly wetting the affected area with a mild detergent and warm water solution.
- Do not saturate the tile.
- Do not scrub or abrade the tile surface as this will affect the surface finish.
- Once the stain or mark has been loosened, blot the excess solution out with a dry clean sponge or cloth.
- Sponge afterwards with clean warm water and dry any excess solution out with a dry clean sponge or cloth.
- The fabric may also be spot cleaned with dry cleaning fluid. Lightly sponge a small amount of dry cleaning fluid and blot.
- Dry away from direct heat or sunlight.
- Do not use carpet shampoo.

ECOUSTIC® TORQUE CEILING INSTALLATION

ASSEMBLY INSTRUCTIONS

Supplied

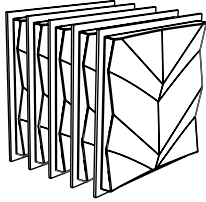

8 x ecoustic® Torque Ceiling tiles
(23.4" x 23.4" or 47" x 23.4")
Sold as single color per box

Source

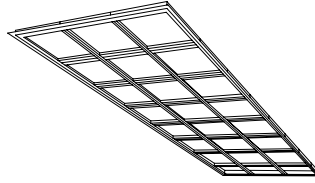

Pre-existing or newly installed drop
ceiling T-frame

23.6" x 23.6" [centered]
or
47.2" x 23.6" [centered]

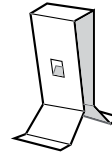

Hold down clip
4 per tile

Suitable for your grid
system

Essential

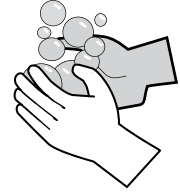

Clean hands
Handle with care
during installation

INSTALLATION

Step 1

Check the pre-existing or newly installed
frame in which to suspend the ecoustic®
Torque Ceiling Tile.

Ensure the frame has been correctly
installed with a suitable sized aperture for
the tiles and the frame is square and true.

Step 2

The return flange of the tile will locate onto
the landing of the suspended ceiling frame.
The tiles can be dropped in place from the
rear of the frame or slotted through from the
visible side.

Take care not to bend the tile. The use of
suitable Hold Down Clips is mandatory on
ecoustic® Torque Ceiling Tile, 4 per tile.

Step 3

Continue to fill the frame with ecoustic®
Torque Ceiling Tile.

Finish the installation in a discreet area as
the last tile can remain unclipped to act
as access to the plenum.

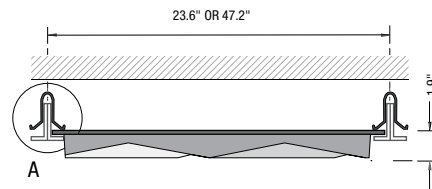
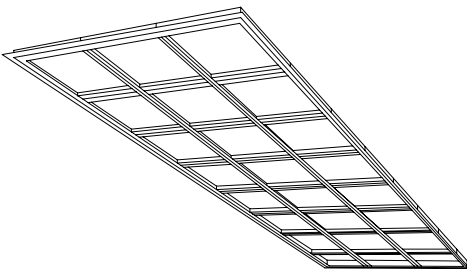

Hold Down Clip

T-Frame



Detail - A

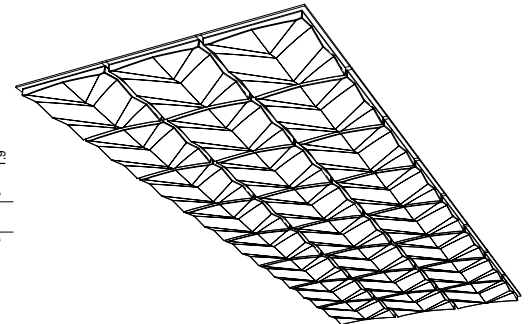

ECOUSTIC® TORQUE CEILING CARE

CARE INSTRUCTIONS

Please Note

- Care must be taken when cleaning as these instructions apply to the fabric face only and the possible effect of the cleaning regime on underlying bases and wall surface must be considered
- For these reasons it is suggested to spot clean only and that it be carried out by a professional cleaner.

Regular Care

- Protect from direct heat and sunlight
- To prevent dust build up, lightly dust with a soft cloth or vacuum with a soft brush attachment

Cleaning

- Professional cleaning is always recommended
- Always test any cleaning products on an inconspicuous area prior to commencing cleaning
- Blot any excess spills from the material with a dry clean sponge or cloth
- Treat all stains and spills as soon as possible
- Most marks can be spot cleaned by lightly wetting the affected area with a mild detergent and warm water solution
- Do not saturate the tile
- Do not scrub or abrade the tile surface as this will affect the surface finish
- Once the stain or mark has been loosened then blot the excess solution out with a dry clean sponge or cloth
- Sponge afterwards with clean warm water and dry any excess moisture with a dry clean sponge or cloth
- The product can also be spot cleaned with dry cleaning fluid, lightly sponge a small amount of dry cleaning fluid and blot.
- Dry away from direct heat and sunlight
- Do not use carpet shampoo

ECOUSTIC® TORQUE WALL INSTALLATION

ASSEMBLY INSTRUCTIONS

Supplied

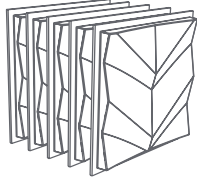

8x ecoustic® Torque tiles
 Sold in boxes of 8 per color
 17x 4-way joiner clips (inc. 1 spare)
 Clip template
 Installation instructions

Source

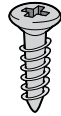

Flat-head c/sunk
 1" (25mm) 10g
 [4-8 per tile]



Power drill

Essential



Clean hands
 Handle with care
 during installation

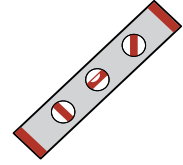

Spirit level

INSTALLATION

Step 1

In most situations it is best to measure up from the floor and mark a straight line along the base of the area, this line is your starting point. Use this mark and begin from the bottom left corner.

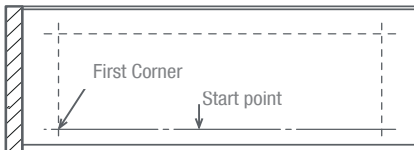

Step 4

Using the template work your way up the wall in columns. Finish the top with corner clips on corners + edge clips on straight joins.
 Note: never use the tiles to measure spacing.

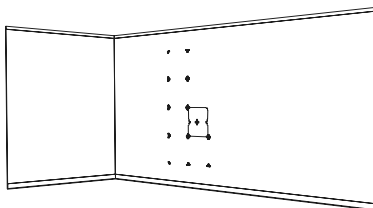

Step 2

Using screws suitable for your substrate, fix the first corner in place.
 Note: Always use a secure, mechanical means of fixing.

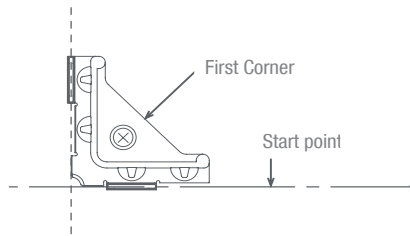

Step 5

Once you have two columns up, double check your spacing by installing the first column of tiles. Always stay one column ahead of the installed tiles so the tiles don't interfere with the spacing.

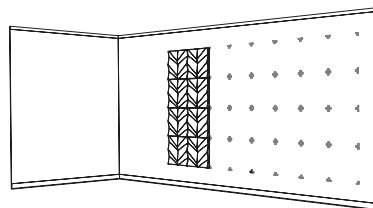

Step 3

Use the supplied template to fix additional clips necessary to support the tile, including clips at mid points of the tiles.

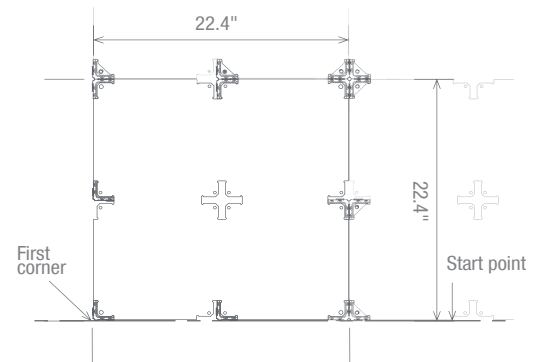

Step 6

Install the rest of your clips and put up the tiles to finish.

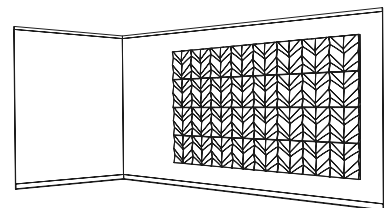

ECOUSTIC® TORQUE CARE

CARE INSTRUCTIONS

Please Note

- Care must be taken when cleaning as these instructions apply to the fabric face only and the possible effect of the cleaning regime on underlying bases and wall surface must be considered
- For these reasons it is suggested to spot clean only and that it be carried out by a professional cleaner.

Regular Care

- Protect from direct heat and sunlight
- To prevent dust build up, lightly dust with a soft cloth or vacuum with a soft brush attachment

Cleaning

- Professional cleaning is always recommended
- Always test any cleaning products on an inconspicuous area prior to commencing cleaning
- Blot any excess spills from the material with a dry clean sponge or cloth
- Treat all stains and spills as soon as possible
- Most marks can be spot cleaned by lightly wetting the affected area with a mild detergent and warm water solution
- Do not saturate the tile
- Do not scrub or abrade the tile surface as this will affect the surface finish
- Once the stain or mark has been loosened then blot the excess solution out with a dry clean sponge or cloth
- Sponge afterwards with clean warm water and dry any excess moisture with a dry clean sponge or cloth
- The product can also be spot cleaned with dry cleaning fluid, lightly sponge a small amount of dry cleaning fluid and blot.
- Dry away from direct heat and sunlight
- Do not use carpet shampoo

ECOUSTIC® ARBOR ALTO INSTALLATION

NOTE: HANDLE FINN WITH CARE DURING ASSEMBLY. ONCE ASSEMBLED THE STRUCTURE HAS INTEGRITY, HOWEVER INDIVIDUAL FINN ARE MORE SUSCEPTIBLE TO DAMAGE SUCH AS BENDING.

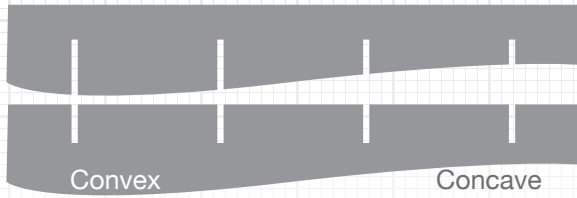

Each Arbor Kit Contains:

- (4) Top Finns (slots on bottom)
- (4) Bottom Finns (slots on top)
- Two of the Bottom Finns have hanging studs mounted. These finns are to be positioned in the first slot from each side of the Top Fin.
- (4) Hanging Hardware connections (see Hanging Hardware Instructions)

The Fin shape and Slot spacing are parametric which allow for several arrangements depending on the designers point-of-view.

In-Line



Alternating



Every other fin can alternate or in groups

Two Examples:

LEGEND



Convex

Concave

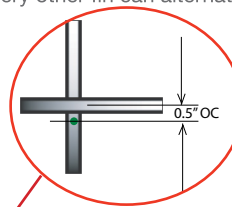

Diagonal (convex all to one corner)

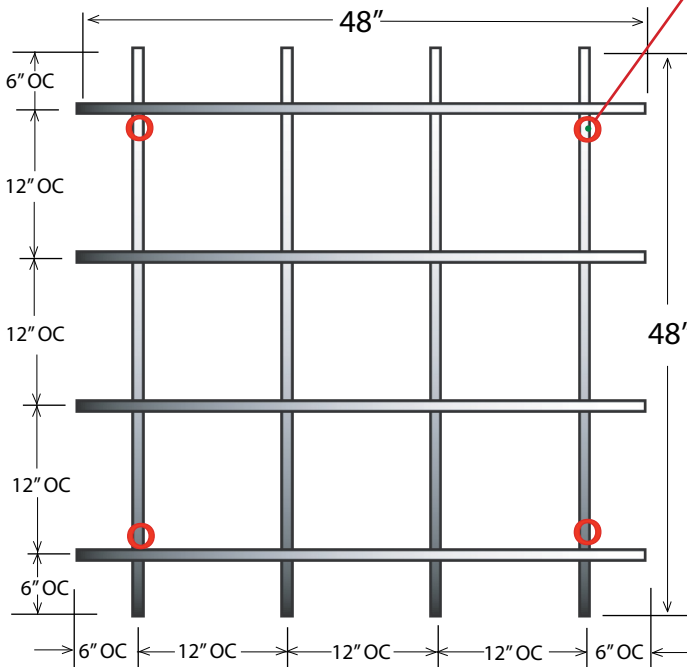

Basket Weave (convex and concave alternate)

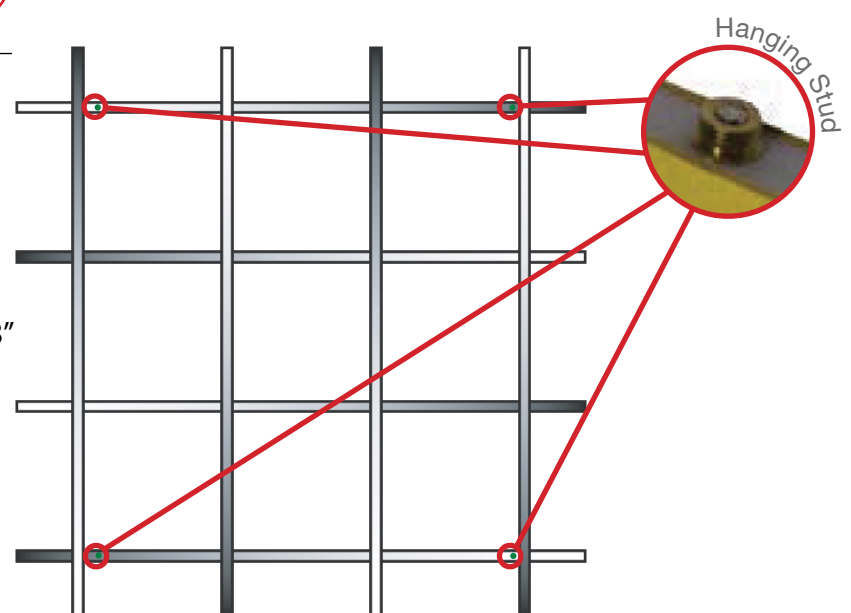

Hanging Stud

CARE INSTRUCTIONS

Please Note

- The care instructions below are applicable to the Ecoustic® Solid Color Panel + Print products. Please Note Consideration must be given to any possible effect of the cleaning regime on the underlying glue or backing board. It is recommended that spot cleaning only is used and that it is carried out by a professional cleaner.

Regular Care

- Protect from direct heat and sunlight.
- To prevent dust build up, lightly dust with a soft cloth or vacuum with a soft brush attachment.
- Spot Cleaning
- Professional cleaning is always recommended.
- Always test any cleaning products on an inconspicuous area prior to commencing cleaning.
- Blot any excess spills from the material with a dry clean sponge or cloth.
- Treat all stains and spills as soon as possible.
- Most marks can be spot cleaned by lightly wetting the affected area with a mild detergent and warm water solution.
- Do not saturate the panel, screen or felt.
- Do not scrub or abrade the fabric as this will affect the surface finish.
- Once the stain or mark has been loosened then blot the excess solution out with a dry clean cloth.
- Sponge afterwards with clean warm water and mop any excess moisture with a dry clean sponge or cloth.
- The fabric can also be spot cleaned with dry cleaning fluid. Lightly sponge a small amount of dry cleaning fluid and blot.
- Dry away from direct heat and sunlight.
- Avoid the use carpet shampoos.

SKREENTRAK® ALTO/BASS CARE

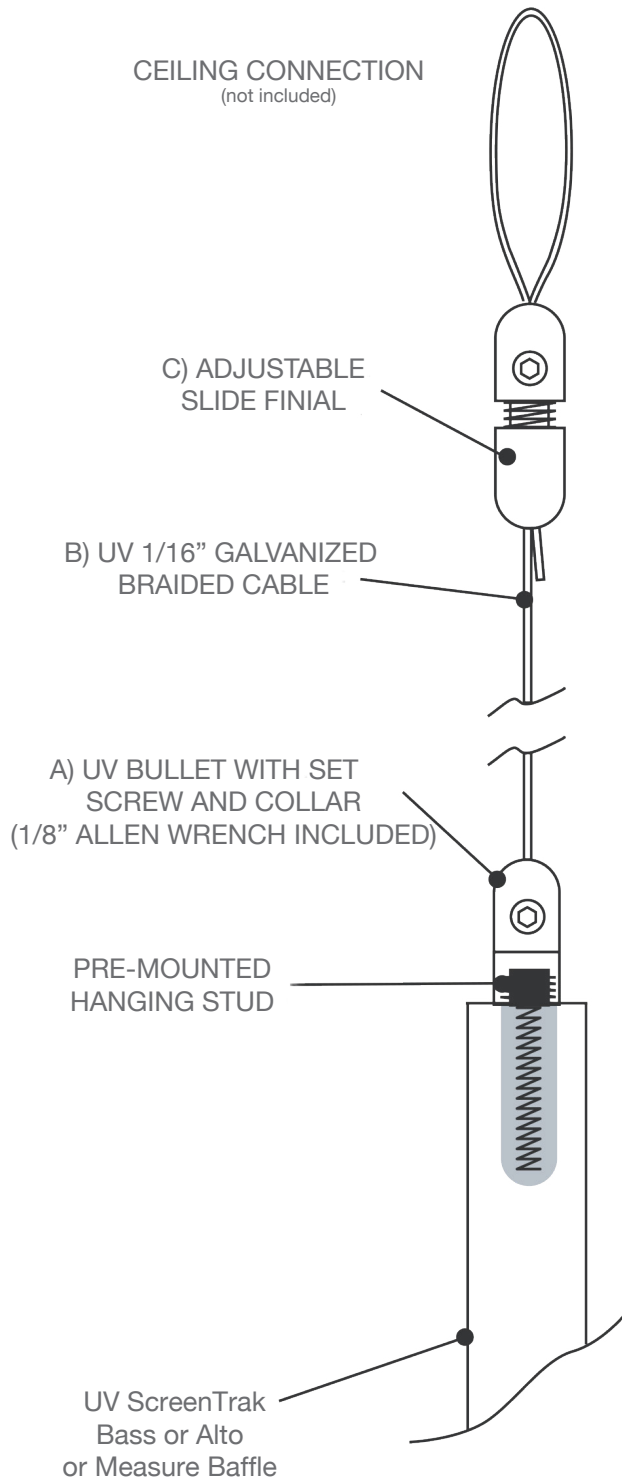

1. Unpack and inspect baffles, confirm location of pre-mounted hanging studs, and parts count.
 2. Attach (A) UV Bullet to studs and loosen the set screws.
 3. Measure and cut (B) UV cable to required length. Include allowance for hanging loop.
 4. Thread cable through (C) UV adjustable slide finial and loop back through with the slide and set screw loosened.
 - a) If hanging hardware is an open hook the loop can be completed before hanging.
 - b) If cable is to be attached to a closed eye, or an architectural feature, loop cable around the feature and thread back through finial.
- Adjust the overall length of the cable to the specified length, hand-tighten the twist feature of the finial to locate the specified length
- OPTION:** Trim hanging cable to specified length after hanging
5. Insert hanging, bottom end of (B) UV cable into the mounted (A) ICF terminals and tighten the set screw -- tug to test connection.
 6. Check position, height and level of baffles -- if adjustment is required -- loosen the twist feature (C) Adjustable slide finial and adjust to desire length. **TIGHTEN SET SCREW.**

SKREENTRAK® ALTO/BASS CARE

CARE INSTRUCTIONS

Please Note

- It is recommended that spot cleaning only is used and that it is carried out by a professional cleaner.

Regular Care

- Protect from direct heat and sunlight.
- To prevent dust build up, lightly dust with a soft cloth or vacuum with a soft brush attachment.

Spot Cleaning

- Professional cleaning is always recommended.
- Always test any cleaning products on an inconspicuous area prior to commencing cleaning.
- Blot any excess spills from the material with a dry clean sponge or cloth.
- Treat all stains and spills as soon as possible.
- Most marks can be spot cleaned by lightly wetting the affected area with a mild detergent and warm water solution.
- Do not saturate the panel, screen, or felt.
- Do not scrub or abrade the fabric as this will affect the surface finish.
- Once the stain or mark has been loosened then blot the excess solution out with a dry clean cloth.
- Sponge afterwards with clean warm water and mop any excess moisture with a dry clean sponge or cloth.
- The fabric can also be spot cleaned with dry cleaning fluid. Lightly sponge a small amount of dry cleaning fluid and blot.
- Dry away from direct heat and sunlight.
- Avoid the use of carpet shampoos.

SOFTLINE INSTALLATION

Assembly instructions

Softline Floor screen

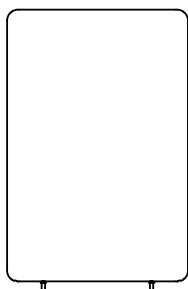
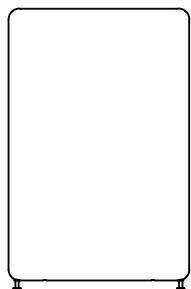

These holes are used for the transport

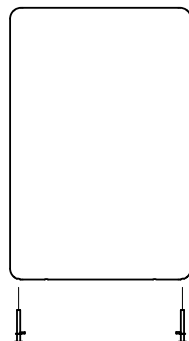
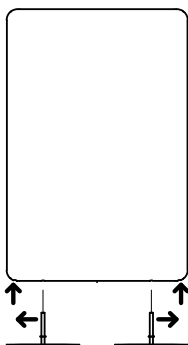

These holes are used for assembling

Assembly instructions

Softline Floor screen

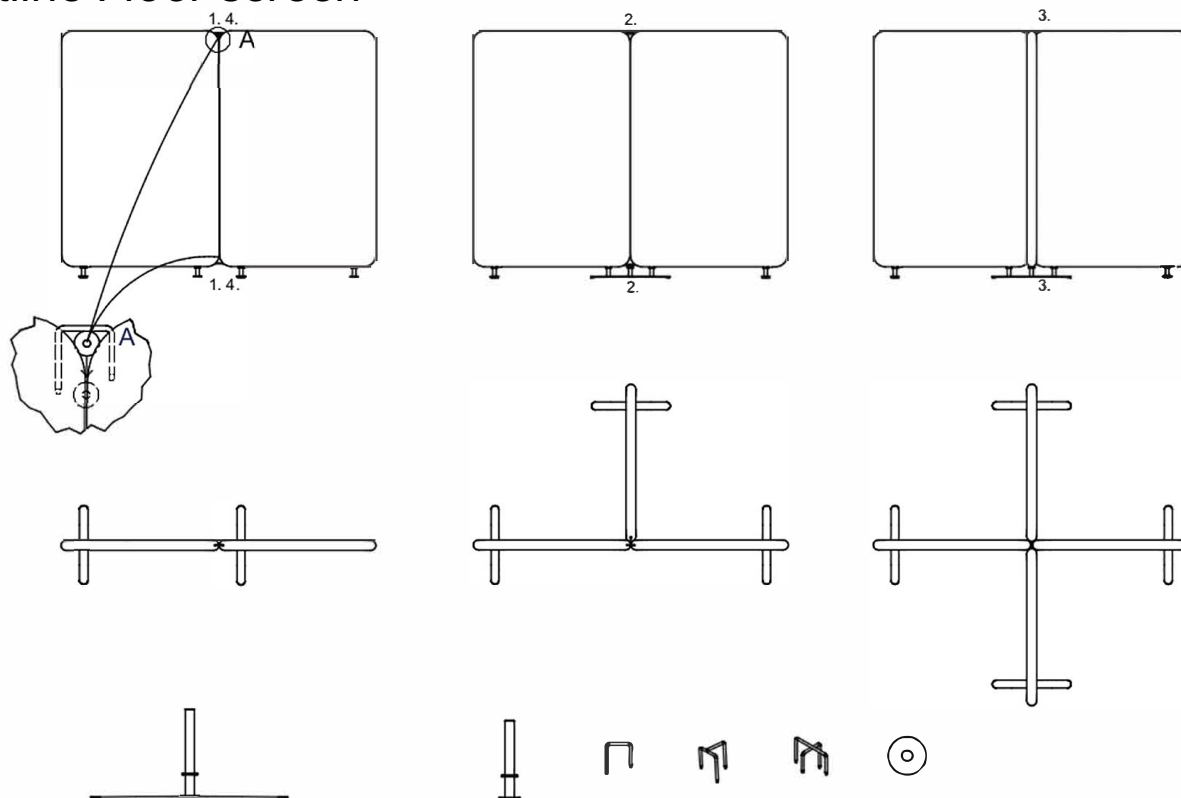

SOFTLINE CARE

CARE INSTRUCTIONS

Regular Care

- To preserve the fabric color and appearance of the fabric, Softline floor screen should be vacuumed regularly with a soft nozzle. Polyester Stain Removal: Use uncolored paper towel or cloth to soak up as much as possible of the stain. Dried stains should be vacuumed. Moisten the stain lightly with a clean white cotton cloth, lukewarm water and possibly a small amount of pH-neutral detergent. Press a dry cloth or uncolored paper towel against the fabric so that moisture and dirt are absorbed. Repeat moisten and soaking until the stain is gone. Use clean water without detergent at the last moistening. Finish with soaking. Wool Stain Removal: Dab or wipe gently with a moist cloth

MIXMAX CARE

CARE INSTRUCTIONS

Regular Care:

Excess wool: The loose wool can be easily removed with a vacuum cleaner. Always use a soft brush on the vacuum cleaner and avoid vacuum cleaner heads with rotating brushes.

Daily cleaning: The best thing you can do for your MixMax is to do as little as possible. Wool, so-to-speak, is a "self-cleaning" natural material, you can typically settle for vacuuming with a soft brush once a week.

Dry dirt: Brush away the dirt with a soft brush or vacuum the product gently. A third and very effective method is to remove the dirt with a self-adhesive lint roller.

Damp dirt: Never try to wipe or scrub soil, mud and similar dirt while it is still wet. You risk damaging the wool fibers or giving the dirt "foothold", turning it into a stain. If there is damp dirt on the product that you fear might set in and become a stain, follow the instructions on the following page for stain treatment.

Spilled liquids: The structure of felted merino wool fibers is liquid repellent. If you spill liquid on MixMax, you must quickly soak it up with a clean cloth or a paper towel. Do not rub, but blot gently for a few seconds at a time and allow the cloth or paper do the job for you. When the liquid is completely soaked up, you can either brush the carpet with a soft brush or remove any residue of dry dirt with a vacuum cleaner.

Stains: If you have accidentally spilled coffee, red wine, blood, ketchup or any other problematic liquids on MixMax, and it has set in in the wool fibers before you have managed to soak it up, we recommend the following:

1. Avoid rubbing the stain - it will only make matters worse.
2. Place a wet cloth on the stain, leave it there for about 15 min. until the stain is wet through. Do not use soap.
3. Once the stain is damp (not wet), blot gently with a clean, dry cloth. Press for 3-4 seconds at a time. It is important that you blot and release rather than rub. Work the stain from the outside in because otherwise you risk damaging the felt.
4. Repeat steps 2 and possibly 3 a few times.
5. Finally, dry the damp area with a hair dryer to avoid water stains. If the stain cannot be removed using the above method, we recommend that you contact a cleaning company that works with the carbonation method in order to avoid the use of soap and chemicals.

Stain removers: We do not recommend the use of stain removers, since the use of even mild soaps can allow the stain to set in.