



Request for Contract Update

Pursuant to the terms of contract number R191802 for Allsteel Inc. Contractor must notify and receive approval from Region 4 ESC when there is an update in the contract. No request will be officially approved without the prior authorization of Region 4 ESC. Region 4 ESC reserves the right to accept or reject any request.

Allsteel Inc. (Contractor) hereby provides notice of the following update on this date 8/25/2020.

Instructions: Contractor must check all that may apply and shall provide supporting documentation. Requests received without supporting documentation will be returned. This form is not intended for use if there is a material change in operations, such as assignment, bankruptcy, change of ownership, merger, etc. Material changes must be submitted on a "Notice of Material Change to Vendor Contract" form.

Authorized Distributors/Dealers
____ Addition
____ Deletion
____ Supporting Documentation

Price Update
____ Supporting Documentation

Products/Services
X New Addition
____ Update Only
X Supporting Documentation

Discontinued Products/Services
____ Supporting Documentation

States/Territories
____ Supporting Documentation

Other _____
____ Supporting Documentation

Notes: Contractor may include other notes regarding the contract update here: (attach another page if necessary). Allsteel Inc. is requesting to add new products to Contract R191804 effective immediately upon approval.

Submitted By: Cindy Hermann

Approved by Email: Date 8/31/2020 | 7:41 AM PDT

Title: Public Sector Contract Analyst

Denied by Email: Date _____

Email Address: allsteelgovcontracts@allsteeloffice.com

DocuSigned by:
Robert Engelmann
Region 4 ESC: _____
0B1D33BB0130490...



August 25, 2020

ATTN: Robert Zingelmann
Chief Financial Officer
Region 4 – Education Service Center
7145 West Tidwell Road
Houston, TX 77092

RE: Allsteel Inc. request for price adjustment for Region 4 Furniture, Installation and Related Services
Contract R191802

Dear Mr. Zingelmann:

Allsteel Inc. would like to add the following new products to our current Contract R191802 effective immediately upon approval:

- Gallery Panels – falls under the Systems product category already awarded on contract
- A6 Altitude Tables (expansion of the Altitude Tables currently on contract) – falls under the Systems product category already awarded on contract
- COVID Accessory products
 - Metal Table Screens – falls under the Systems product category already awarded on contract
 - Acrylic Table Screens – falls under the Systems product category already awarded on contract
 - Universal Panel Stacker – falls under the Systems product category already awarded on contract
 - Height-Adjustable Table Foot Control – falls under the Systems product category already awarded on contract
 - Hands Free Pulls – falls under the Accessories (Wand & Link Lights, Ergonomic Tools) product category already awarded on contract
 - Hand Sanitizer Solutions – falls under the Accessories (Wand & Link Lights, Ergonomic Tools) product category already awarded on contract
 - Wall Mounted Sanitizer Holder – falls under the Accessories (Wand & Link Lights, Ergonomic Tools) product category already awarded on contract
 - Acrylic Freestanding Screens – falls under the Accessories (Wand & Link Lights) Ergonomic Tools) product category already awarded on contract
- Recharge (expansion) – this product line is currently on contract and falls under the Gather Collection (nka Social Collaborative Seating/Tables/Conferencing) product category already awarded on contract
- Two-Thirds – falls under the Gather Collection (nka Social Collaborative Seating/Tables/Conferencing)



The price lists or pricer pages are included with the attached Request for Contract Update along with an updated Discount Matrix.

If you have any questions, please do not hesitate to contact me at 563-316-9655 or email at allsteelgovcontracts@allsteeloffice.com.

Sincerely,

A handwritten signature in black ink that reads "Cindy Hermann". The signature is written in a cursive, flowing style.

Cindy Hermann
Public Sector Contract Analyst

Enclosure

Allsteel®

Gallery Panels

SPECIFICATION & PRICE LIST 2019

prices effective July 29



PDF updated January 13, 2020

Gallery

Laminates and Paint Finishes

PAINT FINISHES

GRADE P1

Black.....	P71
Brownstone.....	P7D
Bungalow.....	P7C
Carob.....	P52
Cinder.....	P7Q
Designer White.....	PJW
Flint.....	P02
Fossil.....	P28
Loft.....	P7B
Muslin.....	P4J
Parchment.....	P93
Pebble.....	P8R
Pewter.....	P8D
Salt.....	P8C
Titanium.....	P8T

GRADE P2

Champagne Metallic.....	PR5
Gunmetal Metallic.....	PR3
Platinum Metallic.....	PR2
Pyrite.....	PJE
Silver.....	PR6
Solar Black.....	P8X

Metallic paints, due to varying reflectance, may appear to have less visual color consistency than other paint finishes, even when L/A/B values are exactly the same. (L/A/B — measurable aspects of color — values are maintained within a specified range, to ensure consistent appearance of paint colors.)

GRADE P3

Atom.....	P8S
Blossom***.....	P8K
Bullseye.....	PJF
Cabernet***.....	P7T
Conifer***.....	P8H
Ember.....	P8P
Ion.....	P8N
Iris.....	P8J
Krypton.....	P8F
Regatta.....	P8M
Succulent***.....	P8A

***These colors are intended to be an inspirational option for the trending market. Product application is limited and color availability is approximately two years to coincide with evolving workplace trends.

LAMINATES

GRADE L1

SOLID COLOR	
Brownstone.....	LM13
Bungalow.....	LM12
Designer White.....	LDW1
Flint.....	LM16
Fossil Shale.....	LEH1
Loft.....	LM11
Muslin.....	LM15
Titanium.....	LTI1

WOODGRAIN

Florence Walnut.....	LFW1
Kingswood Walnut.....	LK11
Natural Maple.....	LWD
NeoWalnut.....	LNU1
Shaker Cherry.....	LW7C

GRADE L2

Amber Cherry.....	LWAC
Beigewood.....	LWBE
Branded Oak.....	LBO1
Brazilwood.....	LWBR
Columbian Walnut.....	LWZ
Ebony Recon.....	LER1
Fawn Cypress.....	LFC1
Lowell Ash.....	LLA1
Mangalore Mango.....	LMM1
Natural Recon.....	LNR1
Phantom Charcoal.....	LPC1
Phantom Ecu.....	LPE1
Portico Teak.....	LPT1
Skyline Walnut.....	LSW1

GRADE L3

Cafelle.....	LWC
Charcoal Walnut.....	LWCW
Natural Walnut.....	LWNW

LAMINATE EDGE COLORS

Amber Cherry.....	DA
Beigewood.....	DE
Black.....	E4
Branded Oak.....	BO
Brazilwood.....	DB
Brownstone.....	EY
Bungalow.....	EX
Cafelle.....	DG
Carob.....	E8
Charcoal Walnut.....	DC
Columbian Walnut.....	DZ
Designer White.....	DW
Ebony Recon.....	DR
Fawn Cypress.....	FC
Flint.....	E9
Florence Walnut.....	FW
Fossil.....	EH
Kingswood Walnut.....	KI
Loft.....	EV
Lowell Ash.....	DL
Mangalore Mango.....	MM
Muslin.....	EU
Natural Maple.....	DD
Natural Recon.....	NR
Natural Walnut.....	DN
NeoWalnut.....	NU
Parchment.....	EN
Phantom Charcoal.....	PC
Phantom Ecu.....	PE
Portico Teak.....	DP
Shaker Cherry.....	DF
Skyline Walnut.....	SW
Titanium.....	TI

Forest Stewardship Council (FSC) is a non-profit organization devoted to encouraging the responsible management of the world's forests. FSC sets high standards that ensure forestry is practiced in an environmentally responsible, socially beneficial, and economically viable way. Allsteel received its FSC Chain of Custody certification in 2010 and can offer FSC Certified products. Select wood-based products can be ordered as FSC certified, either by choosing the FSC option or selecting an FSC laminate or veneer finish at the time of order. For more information, please contact Customer Support at 888-255-7833. (FSC Trademark license code: FSC-CO14704.)

NOTE: Refer to individual product pages for upcharges.

Gallery

Specification and Price List

Effective July 29, 2019

- Software support packages furnished to the customer, either by Allsteel® or by another source, which support the sale of Allsteel products are superseded by printed price lists.
- Prices are subject to change without notice. All orders are subject to prices in effect at the time of order.
- Please refer to your Allsteel Dealer Sales and Discount Policies for order placement information, terms and conditions.

- Ordering information appears at the bottom of each product page complete with examples on how to specify. Fabric and finish pages are referenced at the bottom of product pages.

This publication is available as a downloadable PDF on Allsteel websites.

Questions or Comments?

Please call us at: **888-ALLSTEEL**
888-255-7833

TABLE OF CONTENTS

Laminates and Paint Finishes	2	Terrace 50"H Application for Use with Glass	40
Table of Contents	3	Terrace 57½"H Application for Use with Glass	41
Limited Lifetime Warranty	4	Terrace Connector Kits.....	42
Programs	5	Further 30"H Application.....	43
Gallery Panels.....	6	Further 35"H Application.....	44
Basic Characteristics.....	7	Further 42"H Application.....	45
Dimensions.....	8	Further 50"H Application.....	46
Working with Integrated Glass.....	9	Further 30"H Application for Use with Glass.....	47
Stride System - T-Configuration	10	Further 35"H Application for Use with Glass.....	48
Stride System - L-Configuration	11	Further 42"H Application for Use with Glass.....	49
Stride System - Mid-Configuration.....	12	Further Connector Kits.....	50
Terrace System - T-Configuration.....	13	Stride Benching 30"H Application	51
Terrace System - L-Configuration.....	14	Stride Benching 35"H Application	52
Terrace System - Mid-Configuration	15	Stride Benching 42"H Application	53
(Single-Sided or Dual-Sided)		Stride Benching 50"H Application	54
Further - T-Configuration.....	16	Stride Benching 30"H Application for Use with Glass	55
Further - L-Configuration.....	17	Stride Benching 35"H Application for Use with Glass	56
Stride Benching.....	18	Stride Benching 42"H Application for Use with Glass	57
Storage and Worksurface Connectors.....	19	Stride Benching Connector Kits.....	58
Accessories - Tackboards.....	20	Panel Systems Gallery Glass	59
Stride 30"H Application.....	21		
Stride 35"H Application.....	22		
Stride 42"H Application.....	23		
Stride 50"H Application.....	24		
Stride 57½"H Application	25		
Stride 30"H Application for Use with Glass.....	26		
Stride 35"H Application for Use with Glass.....	27		
Stride 42"H Application for Use with Glass.....	28		
Stride 50"H Application for Use with Glass.....	29		
Stride 57½"H Application for Use with Glass	30		
Stride Connector Kits	31		
Terrace 30"H Application	32		
Terrace 35"H Application.....	33		
Terrace 42"H Application.....	34		
Terrace 50"H Application	35		
Terrace 57½"H Application.....	36		
Terrace 30"H Application for Use with Glass	37		
Terrace 35"H Application for Use with Glass	38		
Terrace 42"H Application for Use with Glass	39		

Limited Lifetime Warranty

Our unwavering commitment to our customers compels us to care, and our dedication to quality is just one of the ways we show our customers how much they mean to us.

We recognize that keeping up with the pace of change requires having products that work as hard as the people who use them. That's why each of our products is rigorously tested and certified to meet the highest industry standards.

In the unlikely event that any Allsteel product or component covered by the Allsteel Warranty should fail under normal workplace use because of defective material or workmanship, Allsteel promises to fix it. Because taking care of *people* is how Allsteel takes care of business.

For information on Allsteel's warranty coverage, visit AllsteelOffice.com.

Everyday Advantage[®]

Program Terms for Everyday Advantage

1. Orders must clearly state “Everyday Advantage Order” and include the appropriate Everyday Advantage contract number:
 - Everyday Concensys[®] Std-0131, Everyday Concensys Canada-0133
 - Everyday Optimize[™]/Terrace[®]/Further[™] Std-0125, Everyday Optimize/Terrace/Further Canada-0127
 - Everyday Concensys Gov-0132
2. Choose the correct contract in your electronic ordering system by selecting the panel system, (Concensys or Optimize/Terrace) then add other desired products. If no systems product is being ordered, either contract can be selected.
3. Everyday Advantage orders are not eligible for bid pricing.
4. The complete Concensys, Optimize, Further, and Terrace systems lines; and a private office solution, Approach[™]. This program also includes Access[™], Evo[™], Inspire[®], Lyric[™], Mimeo[™], Nimble[®], Quip[™], Relate[®], Scout[®], Seek[®], Tolleson, and Trooper[®] seating. Altitude[®], Aware[®], and Merge[®] tables are available, along with Align[™] Lockers and metal storage, and the complete Essentials[™] storage line. In addition, Extensions[™] ergonomic accessories and lighting are part of the offering.
5. All textiles and finishes are available, but some may have extended lead times.
6. Everyday Advantage orders are not limited to a minimum or maximum.
7. All orders ship based on standard lead times. Large-quantity orders of like products may be subject to longer lead times.
8. Standard freight terms apply.
9. If driver assistance is needed, standard driver assist charges will be added at time of order entry.

Allsteel Inc. reserves the right to amend or terminate this program at any time with 30 days written notice. Allsteel is not liable for service delays caused by force majeure (circumstances beyond Allsteel's control).

Gallery Panels

Gallery Panels are ideal for bringing natural wood elements to workstations and providing privacy. Allsteel Gallery Panels are designed to work universally across 4 product platforms. Please follow the product guidelines for proper specification.

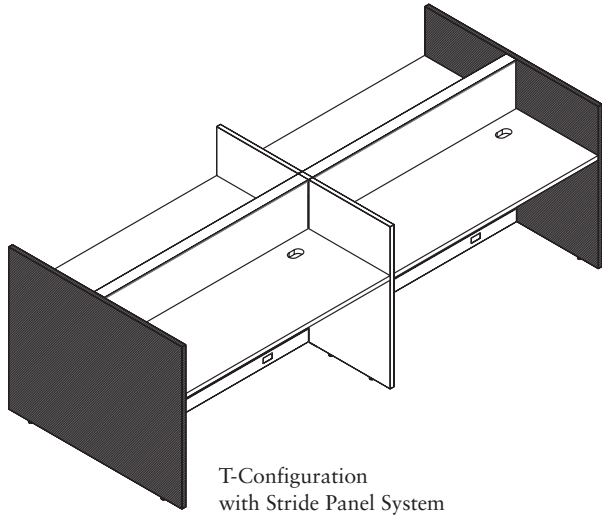

T-Configuration with Stride Panel System

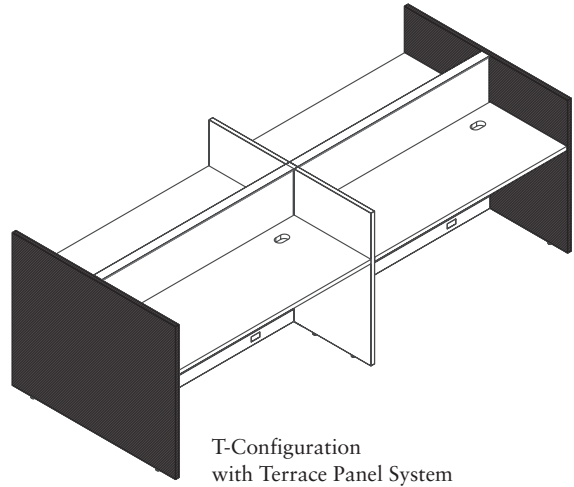

T-Configuration with Terrace Panel System

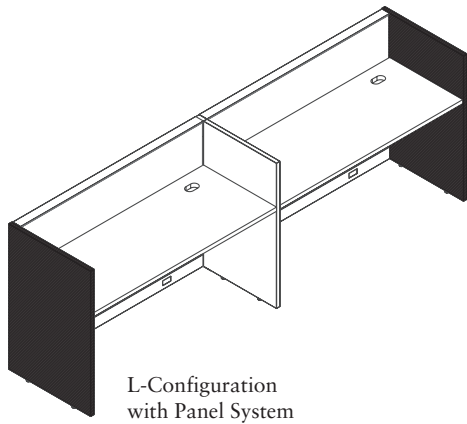

L-Configuration with Panel System

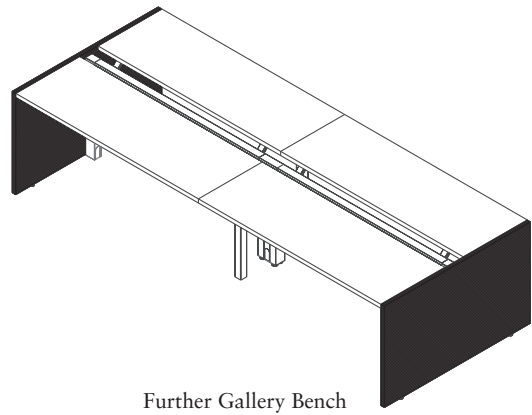

Further Gallery Bench

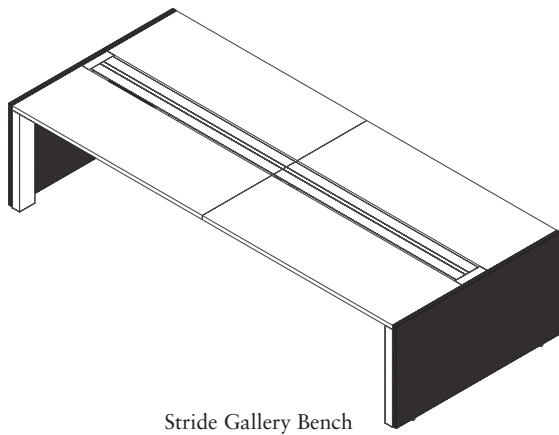

Stride Gallery Bench

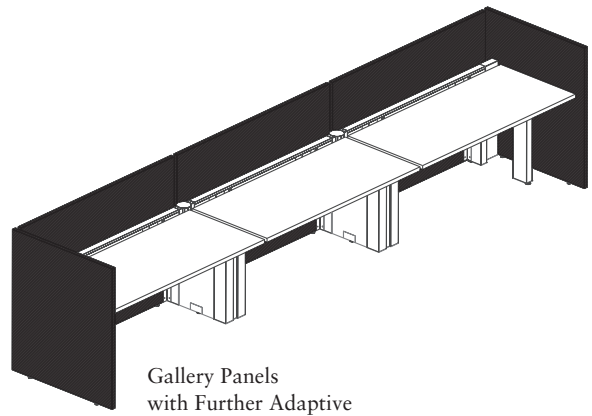

Gallery Panels with Further Adaptive

Gallery Panels

Basic Characteristics

GSA PENDING

- Available in L-, T- and Mid-configurations.
- Made of 1 1/8" board with HPL laminate.
- Use 1 1/8" thickness for space planning.
- Can be specified with matching or contrasting edge.
- Edge band is 2mm ABS.
- Available in woodgrain and solid laminates.
- Horizontal laminate available on all sizes. Vertical laminate is available on widths 18"W to 60"W, and 87"W to 117"W.
- Widths are available in 3" increments from 18"W to 87"W, in 6" increments from 87"W to 147"W.
- Sizes up to 84"W come as a single piece. Sizes 87"W though 147"W are split panels and come in two-pieces.
- Split panels can only be used in T-configurations with Stride panel systems.
- Grain matching is not available on split panels.
- Cannot be connected to another Gallery Panel.
- Gallery Panels offer 2 1/2" leveling capability.
- Overall heights line up with adjacent panel or benching systems.
- Gallery Panel widths are true to size.
- Available with and without the integrated glass option.
- Glass is specified separately.
- Gallery Panels for use with glass have separate model numbers.
- Can be used with Single Sided Further adaptive for privacy and stability along the beam.
- All configurations are non-handed and secured using hidden fasteners.
- Please adhere to all standard systems specification guidelines.

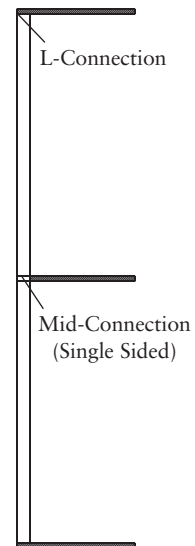
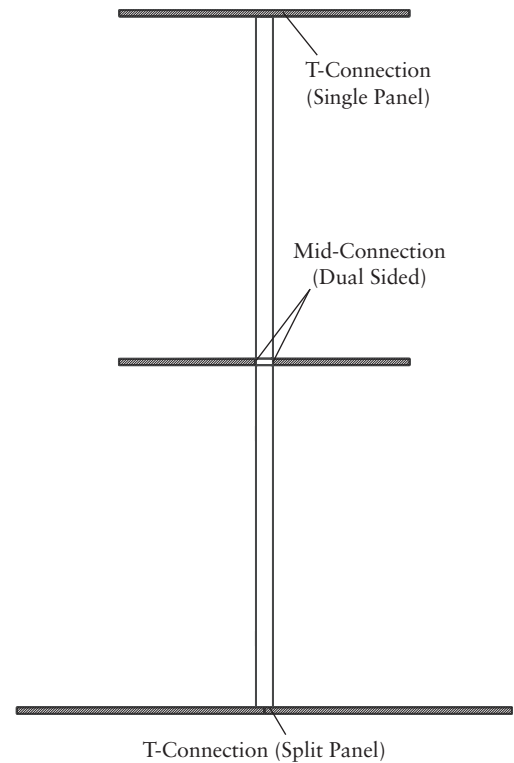

Gallery Panels

Dimensions

GSA PENDING

Gallery Panel Widths

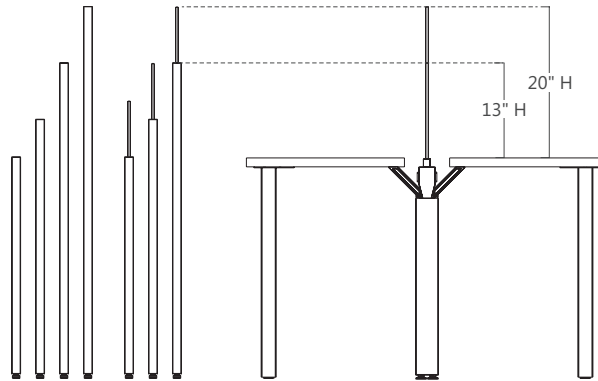
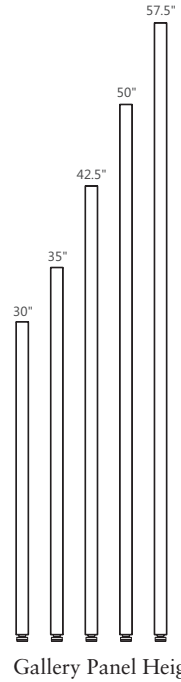
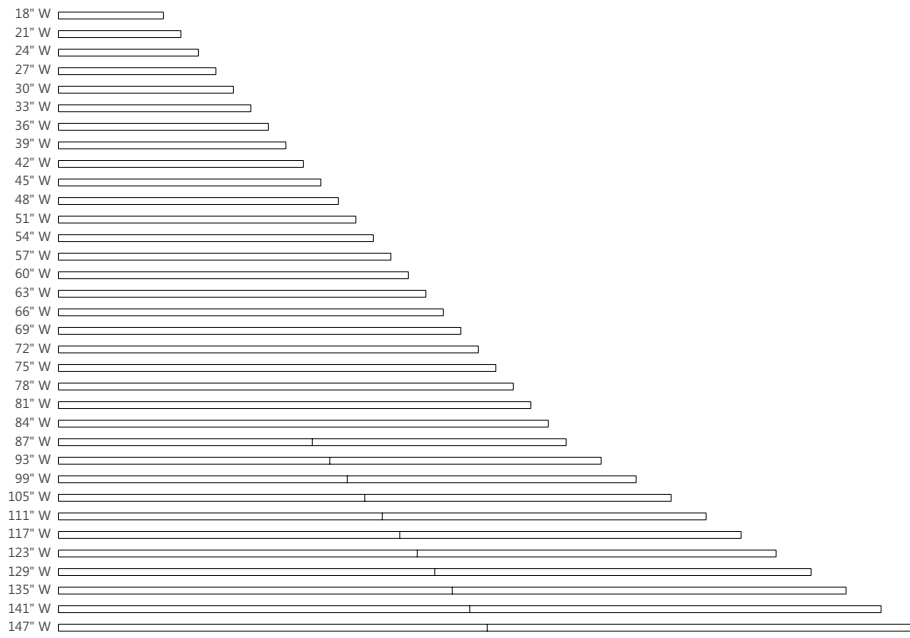

Gallery Panels

Working with Integrated Glass

GSA PENDING

- Gallery Panels for use with glass offer a routed top edge.
- Glass mounts directly into the Gallery Panel route via a gasket.
- The routing is inset 1½" from each end of the panel.
- Single-piece Gallery Panels for use with integrated glass require glass 3" shorter than the panel width.
- For split Gallery Panels, specify glass for each piece separately.
- Split Gallery Panels for use with integrated glass require glass that is 4½" shorter than panel width (individual piece).
- Glass is available in 3 colors: Clear, Frosted, Smoked (Available for order September 2019).
- Glass height is available in 7½"H.
- Glass is available on all Gallery Panel widths.
- For benching systems, maximum allowable benching height cannot exceed 50"H with or without glass. Overall Gallery Panel height includes the glass.
- Specify glass models separate from Gallery Panel models.

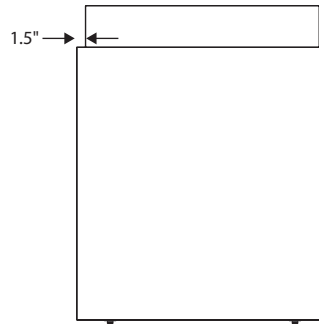

Single Panel with Glass

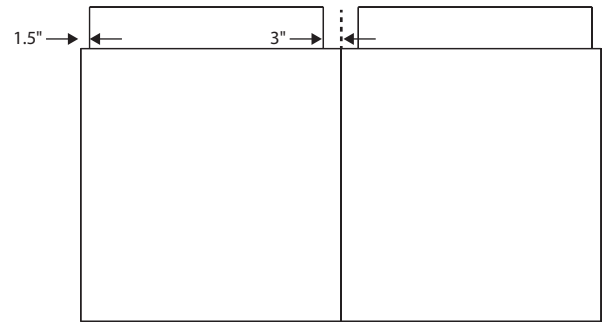

Split Panel with Glass

Find the Gallery Glass width appropriate for your Gallery Panel width.

Shaded example:
For the 18"W Gallery Panel, Gallery Glass should be ordered with width of 15".

Gallery Panel Width \ Gallery Glass Height	7.5"H	
	Gallery Glass Order Width	
18"W Gallery Panel	15"W	
21"W Gallery Panel	18"W	
24"W Gallery Panel	21"W	
27"W Gallery Panel	24"W	
30"W Gallery Panel	27"W	
33"W Gallery Panel	30"W	
36"W Gallery Panel	33"W	
39"W Gallery Panel	36"W	
42"W Gallery Panel	39"W	
45"W Gallery Panel	42"W	
48"W Gallery Panel	45"W	
51"W Gallery Panel	48"W	
54"W Gallery Panel	51"W	
57"W Gallery Panel	54"W	
60"W Gallery Panel	57"W	
63"W Gallery Panel	60"W	
66"W Gallery Panel	63"W	
69"W Gallery Panel	66"W	
72"W Gallery Panel	69"W	
75"W Gallery Panel	72"W	
78"W Gallery Panel	75"W	
81"W Gallery Panel	78"W	
84"W Gallery Panel	81"W	
87"W Split Panel	39"W	
93"W Split Panel	42"W	
99"W Split Panel	45"W	
105"W Split Panel	48"W	
111"W Split Panel	51"W	
117"W Split Panel	54"W	
123"W Split Panel	57"W	
129"W Split Panel	60"W	
135"W Split Panel	63"W	
141"W Split Panel	66"W	
147"W Split Panel	69"W	

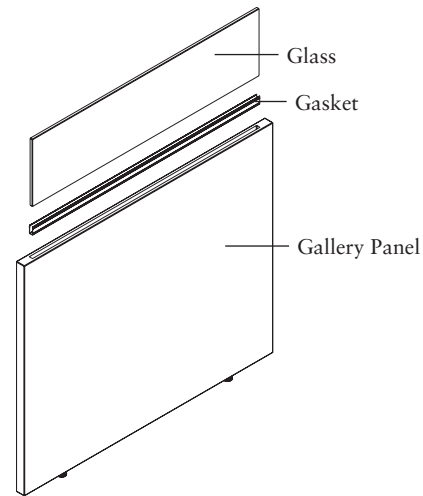

Gallery Panels

Stride System - T-Configuration

GSA PENDING

- Provides privacy to one or both ends of the system in a dual sided application.
- All T-configurations connect using GZCKP connector kit.
- Gallery Panel sizes 129"W or greater require storage or worksurface tie in on both sides of panel. Please reference storage and worksurface support sections for more details.
- When System panel is higher than the Gallery Panel, variable height System's trim must be specified to finish off exposed frame.
- 30"H Gallery Panel must only be used with 30"H panel frame.
- Stride 30"H panel frames can be ordered via the Standard Specials catalog until available as standard.
- Single piece T-configuration can be used for off-modular planning. GZCKP connector kit location must be field measured.
- Dual piece T-configuration panel seams must align with parent run.
- Dual piece T-configuration can be used for off-modular planning. Contact Allsteel Tailored Solutions Group for details.

Front edge of Gallery Panel will sit flush with front edge of worksurface on Stride system.

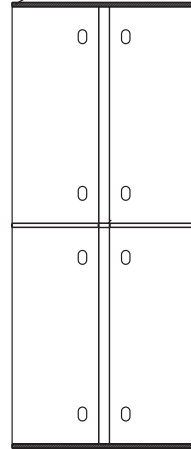

Single Panel Configuration

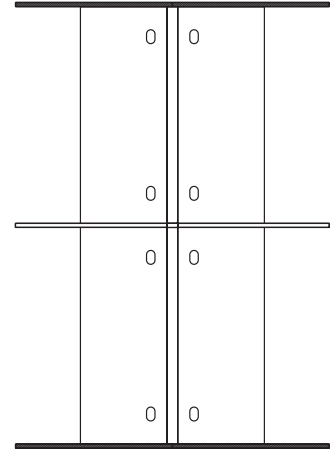

Split Panel Configuration

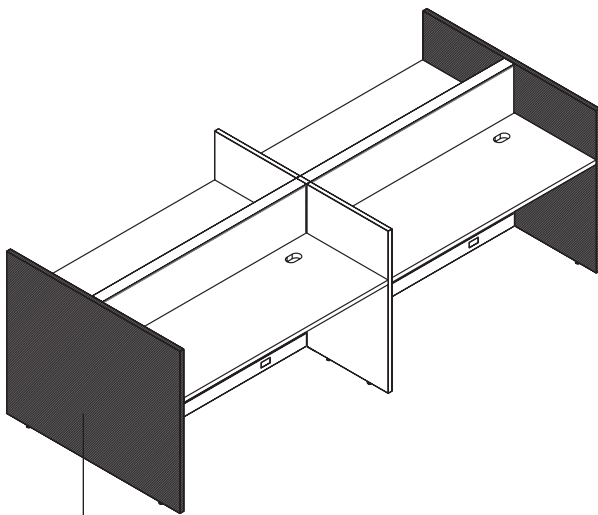

Single panel up to 84"W

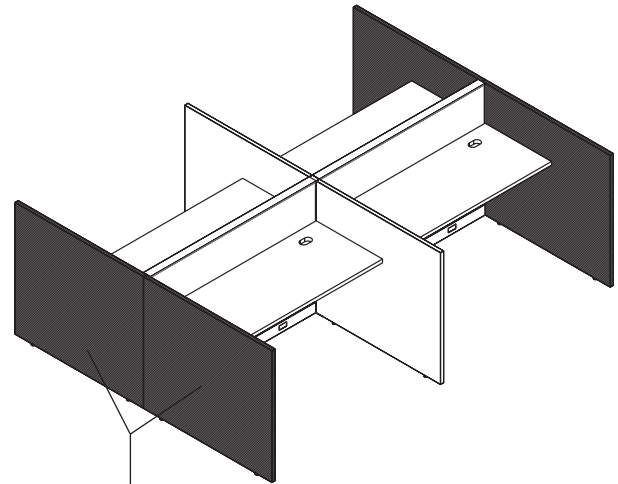

Split panel 87" W and greater

Gallery Panels

Stride System - L-Configuration

GSA PENDING

- Provides privacy to one or both ends of the system in a single sided application.
- L-configuration caps over the System panel. Accommodate for 3" frame thickness when planning with Stride panel system.
- All L-Configuration Gallery Panels require connector kit GZCKP to attach to parent run.
- Gallery Panel sizes 66"W or greater require storage or worksurface tie-in. Please reference storage and worksurface support sections for more details.
- When System panel is higher than the Gallery Panel, variable height system's trim must be specified to finish off exposed frame.
- 30"H Gallery Panel must only be used with 30"H panel frame.
- Stride 30"H panel frames can be ordered via the Standard Specials catalog until available as standard.

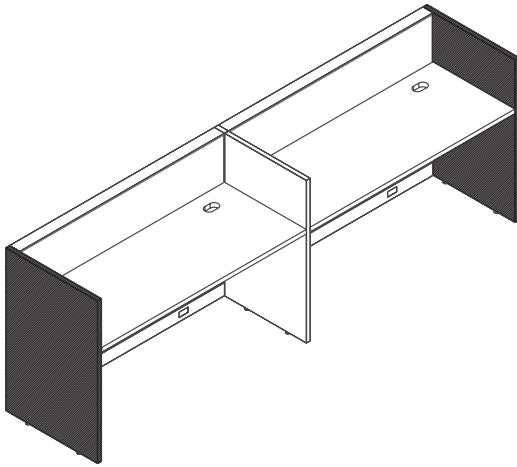
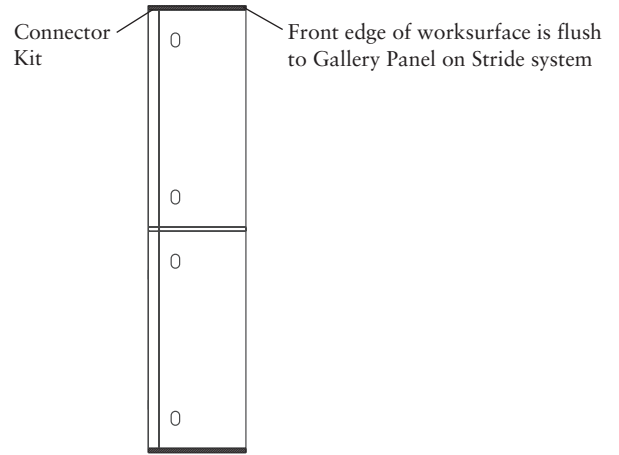

Gallery Panels

Stride System - Mid-Configuration

GSA PENDING

- Mid-configuration panel does not overlap parent system panel.
- When specifying mid-configuration panels, one gallery panel “block and trim” kit (GZ3CONxx) is required to space the System panels out 1 $\frac{1}{8}$ ". Kits include: Connector blocks, vertical trim and a top cap.
- “Block and trim” models must match the height of the parent run.
- Specify one mid-connector kit (GCKPM) per gallery panel to attach to parent run. Gallery panel and mid-connector kit attach over “block and trim” kit. Dual sided application requires two connector kit models.
- When using a mid-configuration Gallery Panel, both panel frames in spine must be of equal height.
- Mid-configuration Gallery Panel may not exceed height of parent run.
- Trims can be painted to match the System panel trims.
- Mid-configuration panels are available in 18"-84" widths in 3" increments.
- Gallery Panel sizes 63"W or greater require storage or worksurface tie-in. Please reference storage and worksurface support sections for more details.
- Spanning top cap available through Allsteel Tailored Solution Group.

Mid-panel must be 3" shorter than end panel due to panel frame thickness

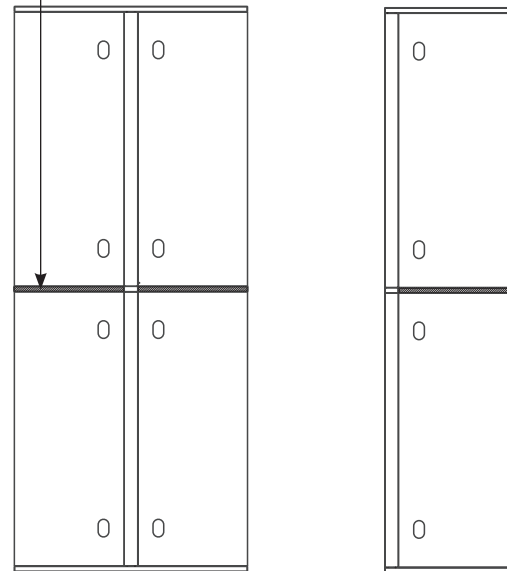

Dual-sided

Single-sided

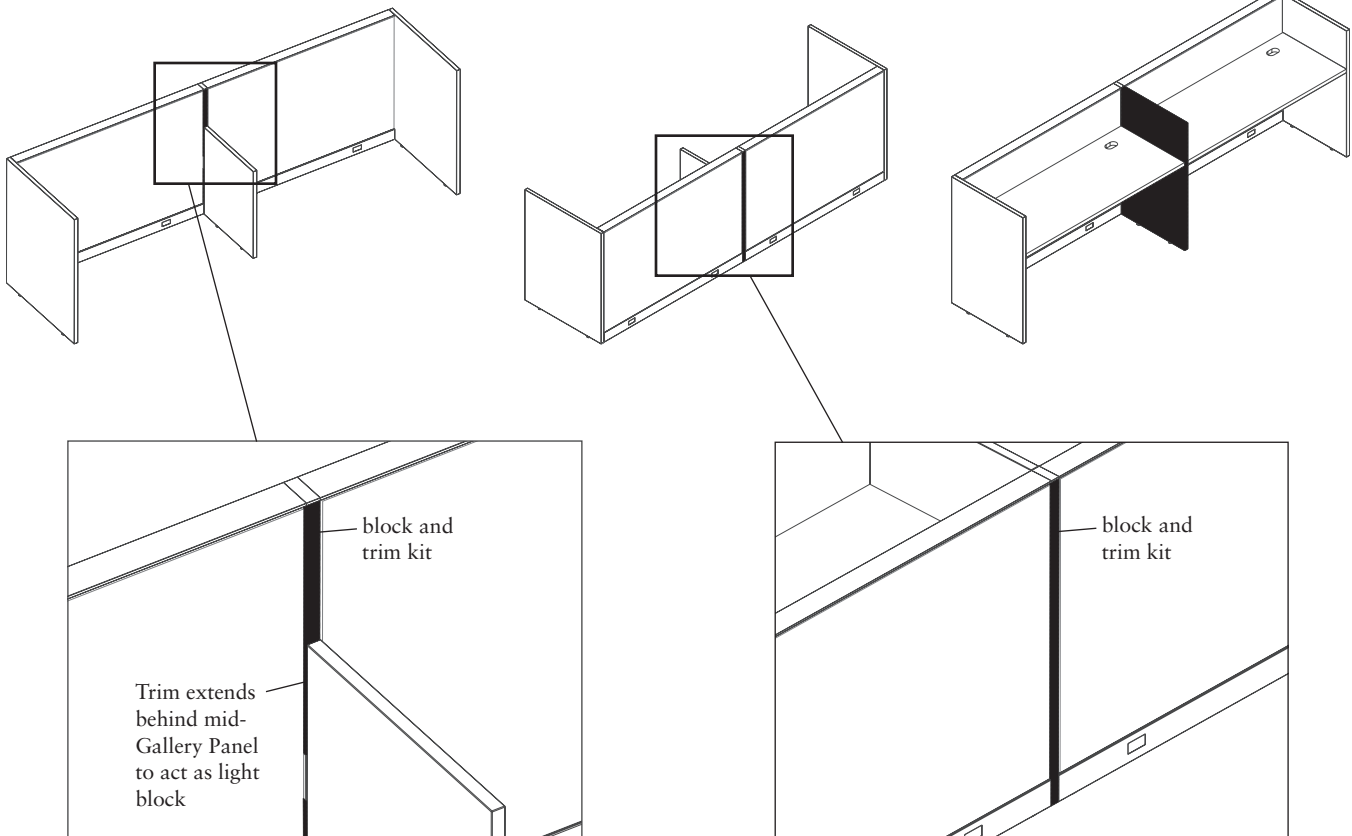

Gallery Panels

Terrace System - T-Configuration

GSA PENDING

- Provides privacy to one or both ends of the system in a dual-sided application.
- All T-configurations connect using GTKCKP connector kit.
- Two-piece Gallery Panels are not allowed in Terrace T-Configurations. Contact Tailored Products Group for a custom solution.
- When System panel is higher than the Gallery Panel, variable height System's trim must be specified to finish off exposed frame.
- 30"H Gallery Panel must only be used with 30"H panel frame. GTKGK30 is required when a 30"H Terrace panel with frameless glass is attached to a Gallery Panel in an end-of-run T- or L-configuration.
- Single piece T-configuration can be used for off-modular planning. GTKCKP connector kit location must be field measured.
- Accommodate for 2⁵/₈" frame thickness when planning with Terrace panel system.

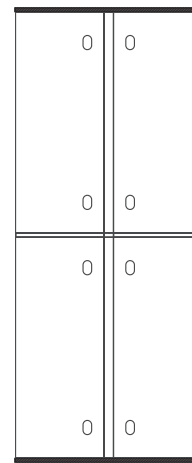

Front edge of Gallery Panel will sit 3/16" proud of front edge of worksurface on Terrace system

T-Configuration

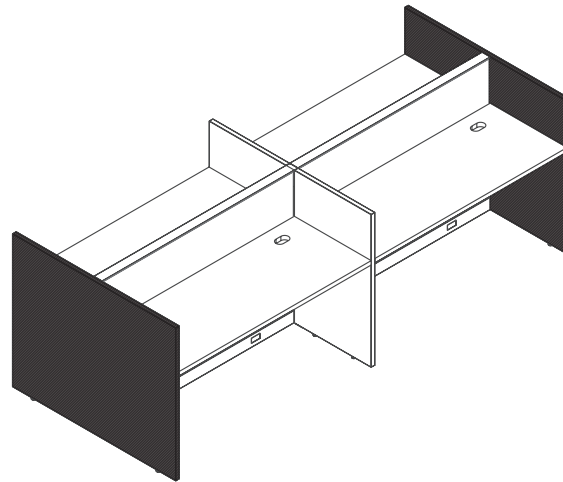

Gallery Panels

Terrace System - L-Configuration

GSA PENDING

- Provides privacy to one or both ends of the system in a single-sided application.
- L-configuration caps over the System panel.
- Due to thickness of the Terrace panel L-configuration overhangs by approximately $\frac{3}{16}$ " on both sides.
- Accommodate for $2\frac{5}{8}$ " frame thickness planning when with Terrace panel system.
- All L-Configuration Gallery Panels require connector kit GTKCKP to attach to parent run.
- Gallery Panel sizes 66"W or greater require storage or worksurface tie in. Please reference storage and worksurface support sections for more details.
- When System panel is higher than the Gallery Panel, variable height system's trim must be specified to finish off exposed frame.
- 30"H Gallery Panel must only be used with 30"H panel frame. GTKGK30 is required when a 30"H Terrace panel with frameless glass is attached to a Gallery Panel in an end-of-run T- or L-configuration.

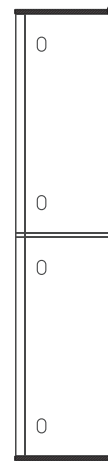

Front edge of Gallery Panel will sit $\frac{3}{16}$ " proud of front edge of worksurface on Terrace system

L-Configuration

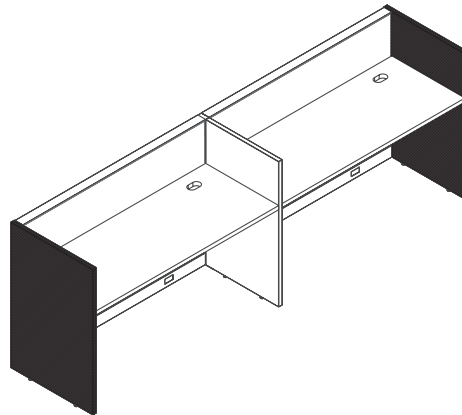

Gallery Panels

Terrace System - Mid-Configuration (Single-Sided or Dual-Sided)

GSA PENDING

- Mid-configuration panel does not overlap parent system panel.
- When specifying mid-configuration panels, one gallery panel “block and trim” kit (GTK3CONxx) is required to space the System panels out 1 1/8". Kits include: Connector blocks, vertical trim and a top cap.
- “Block and trim” models must match the height of the parent run.
- Specify one mid-connector kit (GCKPM) per gallery panel to attach to parent run. Gallery panel and mid-connector kit attach over “block and trim” kit. Dual sided application requires two connector kit models.
- When using a mid-configuration Gallery Panel, both panel frames in spine must be of equal height.
- Mid-configuration Gallery Panel may not exceed height of parent run.
- Trims can be painted to match the System panel trims.
- Mid-configuration panels are available in 18"-84" widths in 3" increments.
- Gallery Panel sizes 63"W or greater require storage or worksurface tie-in. Please reference storage and worksurface support sections for more details.
- Spanning top cap available through Allsteel Tailored Products Group.

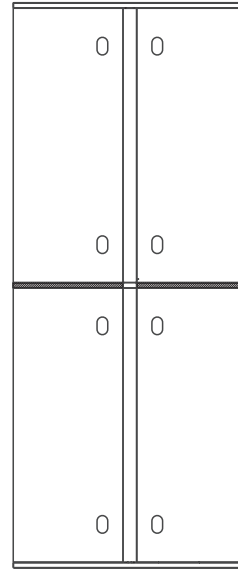

Dual-Sided Configuration

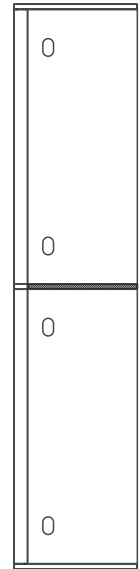

Single-Sided Configuration

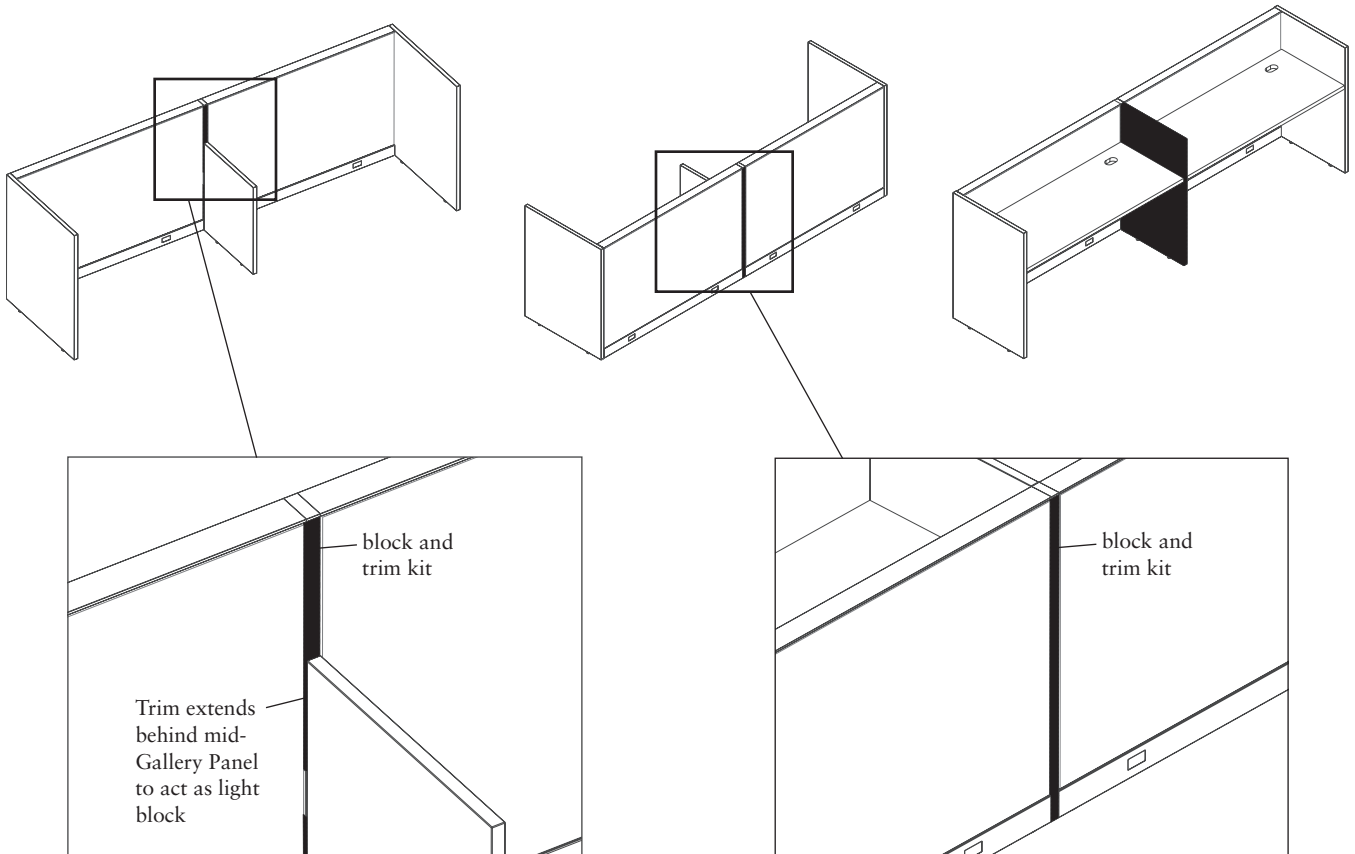

Gallery Panels

Further - T-Configuration

GSA PENDING

- Gallery Panels provide support for beam and worksurfaces.
- Provides privacy to one or both ends of the system in a dual-sided application.
- T-Configuration sizes are available from 48"W to 84"W.
- Maximum overall height is 50"H. Integrated glass is included in overall height.
- All T-configurations connect using one of the following connector kits:
 - GFCKSH - standard-height tethered applications
 - GFCKA - Adaptive or standard-height freestanding beam applications.
 - GFCKLH - low freestanding beam applications
- Connector kits are infed and data accessible.
- Connector kits do not accept power poles.
- T-configuration can be used for off-modular planning, connector kit location must be field-measured.
- In standard height tethered applications, use Z6LB bracket to tie worksurface to Gallery Panel.
- Gallery Panels line up with the edge of the worksurface.
- In tethered applications, the gallery panel must meet or exceed the depth of the worksurfaces.
- In a freestanding application, minimum beam run must total 98"W. This includes connector kit.

Front edge of worksurface is flush to Gallery Panel in T-configuration

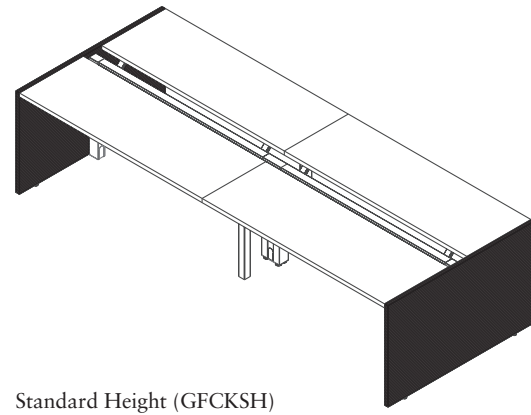
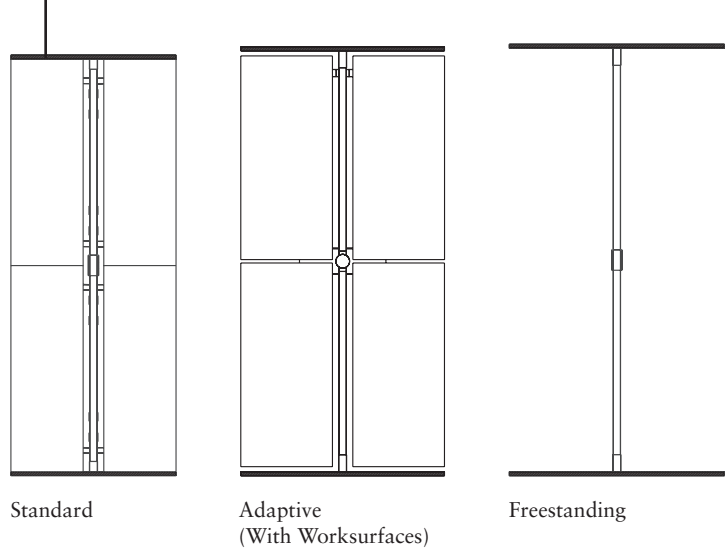

Standard Height (GFCKSH)

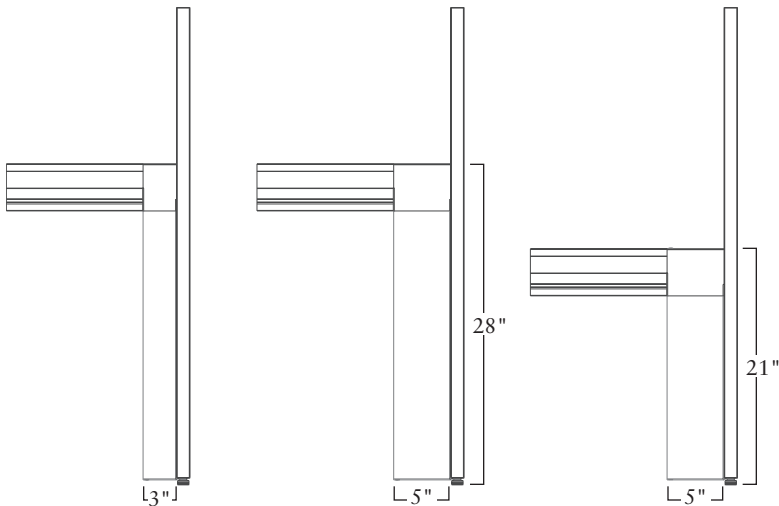

Standard Height (GFCKSH)

Adaptive and freestanding standard height (GFCKA)

Low Fence (GFCKLH)

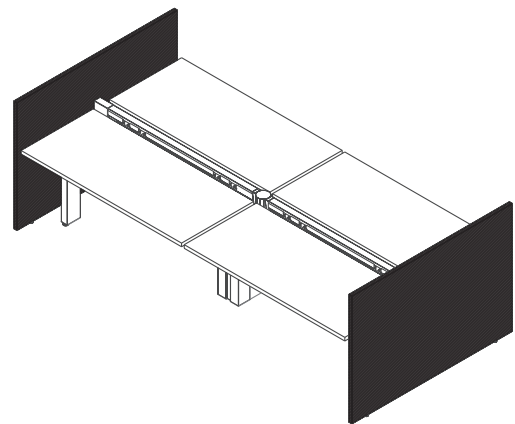

Gallery Panels

Further - L-Configuration

GSA PENDING

- Gallery Panels provide support for beam and worksurface.
- Provides privacy to one or both ends of the system in a single-sided application.
- L-Configuration sizes are available from 33"W to 84"W.
- Maximum overall height is 50"H. Integrated glass is included in overall height.
- All L-configurations connect using one of the following connector kits:
 - GFCKSH - standard-height tethered applications
 - GFCKA - Adaptive or standard-height freestanding beam applications.
 - GFCKLH - low freestanding beam applications
- Connector kits are infed and data accessible. Connector kits do not accept power poles.
- In standard height tethered applications, use Z6LB bracket to tie worksurface to Gallery Panel.
- Gallery Panels extend 1½" past front edge of the worksurface. Specify gallery panel 6" longer than the depth of worksurface.
- In tethered applications, the gallery panel must meet or exceed the depth of the workspaces.
- In a freestanding application, minimum beam run must total 98"W. This includes connector kit.
- L-configurations may not utilize a single beam between two gallery panels.
- Gallery Panel sizes 66"W or greater require storage or worksurface tie in. Please reference storage and worksurface support sections for more details.
- Single-sided Adaptive requires gallery panels along the beam run. Panel widths must match worksurface widths.
- One connector kit (U6GPSS) required for each gallery panel – ordered separately.
- Standard specification creates 1" gap between all gallery panels.
- End Gallery Panels may be specified to align with back panels.
- U3SSHAFa used to mount single-sided Adaptive supports to floor if Gallery panels are not desired.
- Kit includes brackets for 2 end supports and 2 mid-supports.
- Hardware for mounting to floor is not included.

Front edge of Gallery Panel sits 1½" proud of front edge of worksurface in L-configuration

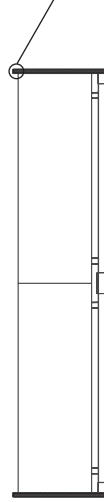

Standard

1" gap between end panel and spine panels



Single-Sided Adaptive

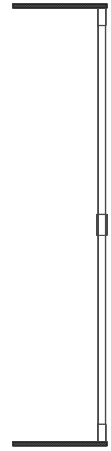

Freestanding

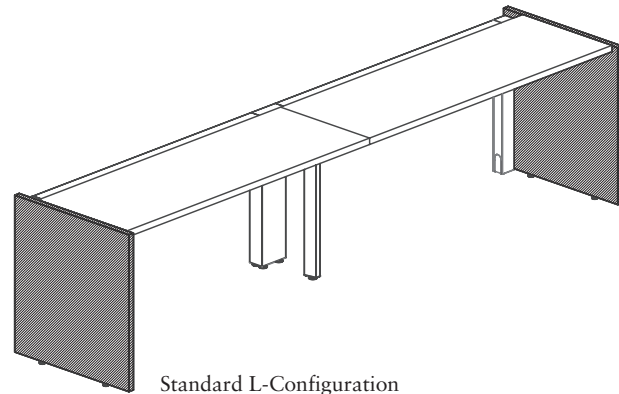

Standard L-Configuration

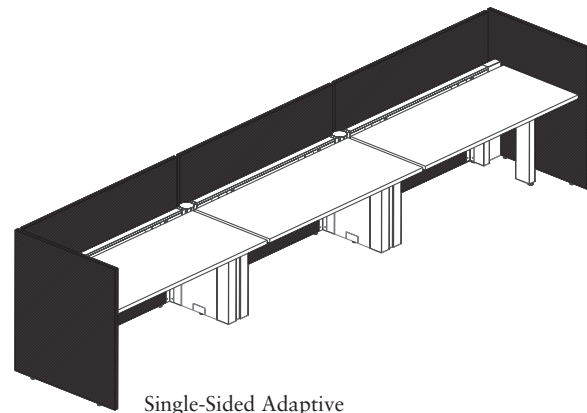

Single-Sided Adaptive

Gallery Panels

- Provides privacy to one or both ends of the system.
- T-Configuration sizes are available from 54"W to 84"W.
- L-Configuration sizes are available from 33"W to 84"W.
- Maximum overall height is 50"H. Integrated glass is included in overall height.
- Connect using one of the following connector kits:
 - GSBCKO – end connector for open leg
 - GSBCKC – end connector for closed leg

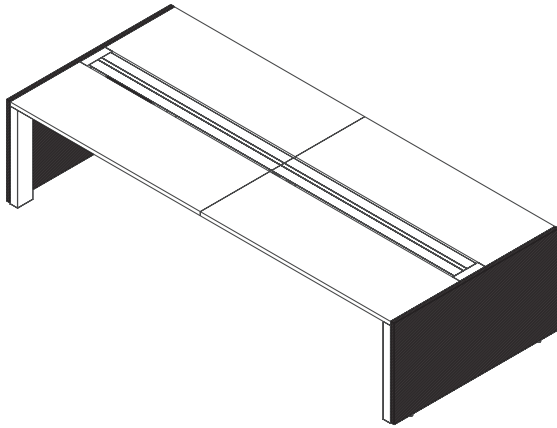

Front edge of panel sits 1¼" proud of worksurface in L-configuration

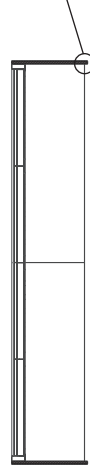

L-Configuration

Front edge of worksurface is flush to Gallery Panel in T-configuration

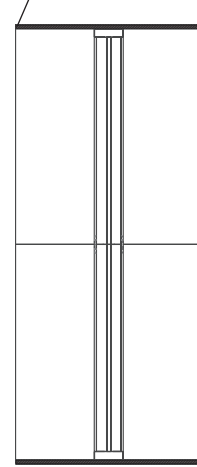

T-Configuration

Gallery Panels

Storage and Worksurface Connectors

GSA PENDING

- To connect to laminate storage use GSGKL or GSGKM for metal storage.
- To connect to worksurface use Z6LB bracket when used in perpendicular to parent run or use standard systems cantilever brackets when used in parallel to parent run in panel systems.
- Perpendicular surfaces connected to a Gallery Panel over 60"W require (2) Z6LB Brackets.

Panel Systems

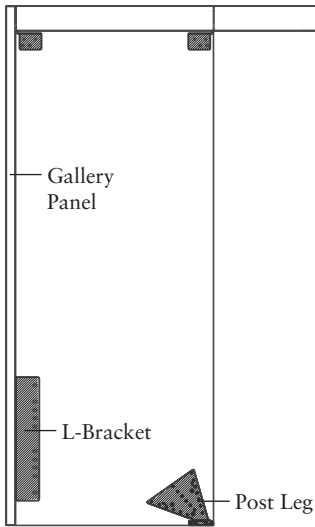

Perpendicular panel system with L-bracket (Z6LB) and post leg.

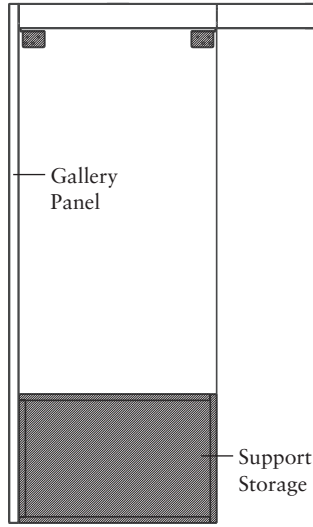

Perpendicular panel system with storage support.

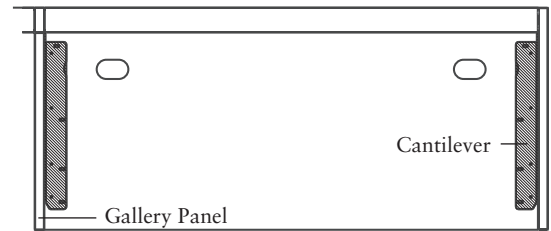

Panel system with cantilever support.

Further System

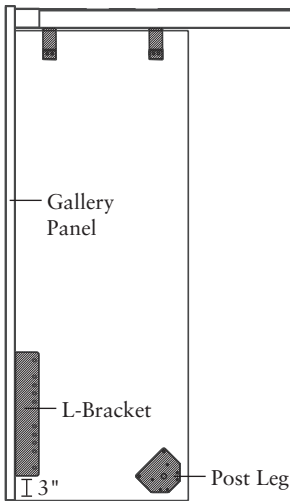

Further perpendicular with L-bracket (Z6LB), worksurface brackets, and post leg.

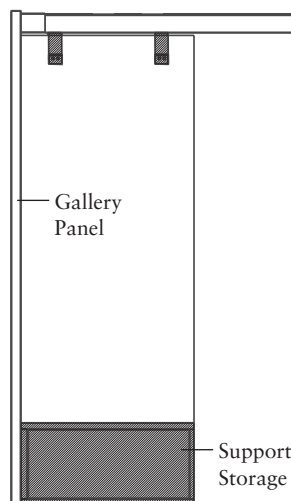

Further perpendicular with storage support and worksurface brackets.

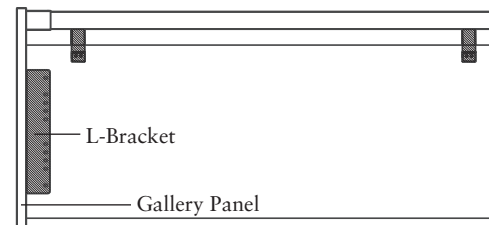

Further perpendicular with L-bracket (Z6LB) and worksurface brackets.

Gallery Panels

Accessories - Tackboards

GSA PENDING

- Provides tackable surface
- Comes with steel-painted trim
- Available in 36" W and in two heights: 11"H and 18½"H
- For use with a minimum 39" W Gallery Panel
- Mounts directly to Gallery Panel. Mounting hardware included.

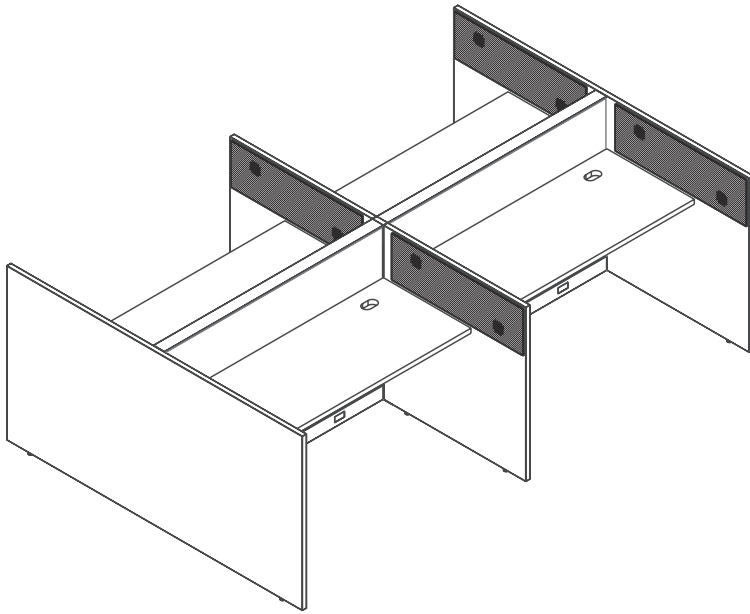

Tackboard Accessory on Mid- and T-Configuration Gallery Panels

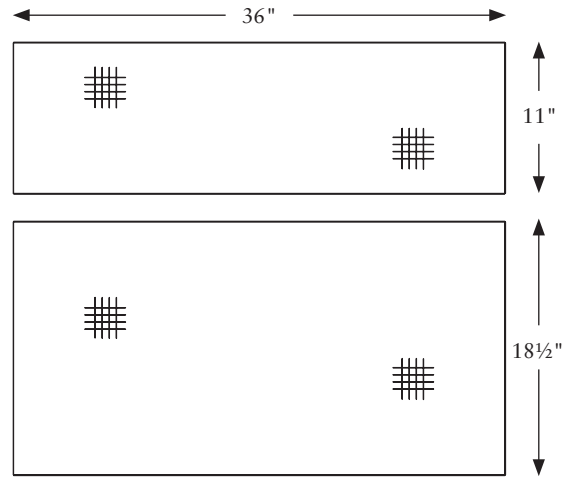

Tackboard Accessory dimensions

Gallery Panels

Stride 30"H Application

For Stride Gallery Panel connectors see page 31.

GSA PENDING

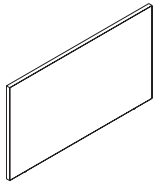

Description	Model	Configuration	List Price		
			L1	L2	L3
30"H Gallery Panels					
18"W	G3018	Mid	\$ 301	\$ 316	\$ 331
21"W	G3021	Mid	\$ 312	\$ 328	\$ 343
24"W	G3024	Mid	\$ 332	\$ 349	\$ 365
27"W	G3027	Mid	\$ 356	\$ 374	\$ 392
30"W	G3030	Mid	\$ 406	\$ 426	\$ 447
33"W	G3033	L, Mid	\$ 430	\$ 452	\$ 473
36"W	G3036	L, Mid	\$ 452	\$ 475	\$ 497
39"W	G3039	L, Mid	\$ 490	\$ 515	\$ 539
42"W	G3042	L, Mid	\$ 529	\$ 555	\$ 582
45"W	G3045	L, Mid	\$ 578	\$ 607	\$ 636
48"W	G3048	L, Mid	\$ 605	\$ 635	\$ 666
51"W	G3051	T, L, Mid	\$ 616	\$ 647	\$ 678
54"W	G3054	T, L, Mid	\$ 646	\$ 678	\$ 711
57"W	G3057	T, L, Mid	\$ 673	\$ 707	\$ 740
60"W	G3060	T, L, Mid	\$ 707	\$ 742	\$ 778
63"W	G3063	T, L, Mid	\$ 718	\$ 754	\$ 790
66"W	G3066	T, L, Mid	\$ 733	\$ 770	\$ 806
69"W	G3069	T, L, Mid	\$ 786	\$ 825	\$ 865
72"W	G3072	T, L, Mid	\$ 809	\$ 849	\$ 890
75"W	G3075	T, L, Mid	\$ 917	\$ 963	\$ 1009
78"W	G3078	T, L, Mid	\$ 953	\$ 1001	\$ 1048
81"W	G3081	T, L, Mid	\$ 986	\$ 1035	\$ 1085
84"W	G3084	T, L, Mid	\$ 1082	\$ 1136	\$ 1190

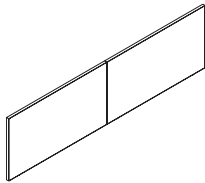

30"H Gallery Split Panels (model number includes two units)					
87"W	GS3087	T	\$ 1132	\$ 1189	\$ 1245
93"W	GS3093	T	\$ 1167	\$ 1225	\$ 1284
99"W	GS3099	T	\$ 1182	\$ 1241	\$ 1300
105"W	GS30105	T	\$ 1203	\$ 1263	\$ 1323
111"W	GS30111	T	\$ 1262	\$ 1325	\$ 1388
117"W	GS30117	T	\$ 1295	\$ 1360	\$ 1425
123"W	GS30123	T	\$ 1306	\$ 1371	\$ 1437
129"W	GS30129	T	\$ 1337	\$ 1404	\$ 1471
135"W	GS30135	T	\$ 1393	\$ 1463	\$ 1532
141"W	GS30141	T	\$ 1456	\$ 1529	\$ 1602
147"W	GS30147	T	\$ 1528	\$ 1604	\$ 1681

E All Gallery models are available in the **Everyday Advantage®** program, see page 5 for details.

<p>How to specify — Select the Model Number from above.</p>	<p>1st Option: FSC: F FSC Wood X Non-FSC Wood</p>	<p>2nd Option: Laminate: See inside front cover for finishes.</p>	<p>3rd Option: Edge: See inside front cover for finishes.</p>	<p>4th Option: Grain: VLG Horizontal grain or Solid only. VST Vertical Grain (available only for single panels 60"W or less, and for split panels between 87"W and 117"W).</p>	<p>5th Option: Glide:</p>
<p>G . .</p>				<p>V .</p>	<p>G </p>

Examples: G3018.X.LT11.TI.VLG.G GS3087.F.LLA1.TI.VST.G

Gallery Panels

Stride 35"H Application

For Stride Gallery Panel connectors see page 31.

GSA PENDING

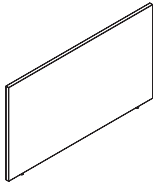

Description	Model	Configuration	List Price		
			L1	L2	L3
35"H Gallery Panels					
18"W	G3518	Mid	\$ 367	\$ 386	\$ 404
21"W	G3521	Mid	\$ 379	\$ 398	\$ 417
24"W	G3524	Mid	\$ 403	\$ 424	\$ 444
27"W	G3527	Mid	\$ 425	\$ 447	\$ 468
30"W	G3530	Mid	\$ 491	\$ 516	\$ 541
33"W	G3533	L, Mid	\$ 517	\$ 543	\$ 569
36"W	G3536	L, Mid	\$ 548	\$ 576	\$ 603
39"W	G3539	L, Mid	\$ 586	\$ 616	\$ 645
42"W	G3542	L, Mid	\$ 612	\$ 643	\$ 674
45"W	G3545	L, Mid	\$ 650	\$ 683	\$ 715
48"W	G3548	L, Mid	\$ 677	\$ 711	\$ 745
51"W	G3551	T, L, Mid	\$ 700	\$ 735	\$ 770
54"W	G3554	T, L, Mid	\$ 725	\$ 762	\$ 798
57"W	G3557	T, L, Mid	\$ 755	\$ 793	\$ 831
60"W	G3560	T, L, Mid	\$ 780	\$ 819	\$ 858
63"W	G3563	T, L, Mid	\$ 797	\$ 837	\$ 877
66"W	G3566	T, L, Mid	\$ 820	\$ 861	\$ 902
69"W	G3569	T, L, Mid	\$ 860	\$ 903	\$ 946
72"W	G3572	T, L, Mid	\$ 900	\$ 945	\$ 990
75"W	G3575	T, L, Mid	\$ 970	\$ 1019	\$ 1067
78"W	G3578	T, L, Mid	\$ 1020	\$ 1071	\$ 1122
81"W	G3581	T, L, Mid	\$ 1097	\$ 1152	\$ 1207
84"W	G3584	T, L, Mid	\$ 1200	\$ 1260	\$ 1320

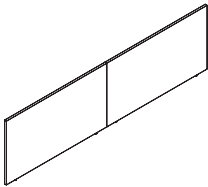

35"H Gallery Split Panels (model number includes two units)					
87"W	GS3587	T	\$ 1245	\$ 1308	\$ 1370
93"W	GS3593	T	\$ 1291	\$ 1356	\$ 1421
99"W	GS3599	T	\$ 1343	\$ 1411	\$ 1478
105"W	GS35105	T	\$ 1361	\$ 1430	\$ 1498
111"W	GS35111	T	\$ 1410	\$ 1481	\$ 1551
117"W	GS35117	T	\$ 1453	\$ 1526	\$ 1599
123"W	GS35123	T	\$ 1491	\$ 1566	\$ 1641
129"W	GS35129	T	\$ 1511	\$ 1587	\$ 1663
135"W	GS35135	T	\$ 1580	\$ 1659	\$ 1738
141"W	GS35141	T	\$ 1641	\$ 1724	\$ 1806
147"W	GS35147	T	\$ 1683	\$ 1768	\$ 1852

E All Gallery models are available in the **Everyday Advantage®** program, see page 5 for details.

<p>How to specify — Select the Model Number from above.</p>	<p>1st Option: FSC: F FSC Wood X Non-FSC Wood</p>	<p>2nd Option: Laminate: See inside front cover for finishes.</p>	<p>3rd Option: Edge: See inside front cover for finishes.</p>	<p>4th Option: Grain: VLG Horizontal grain or Solid only. VST Vertical Grain (available only for single panels 60"W or less, and for split panels between 87"W and 117"W).</p>	<p>5th Option: Glide:</p>
<p>G . .</p>				<p>V .</p>	<p>G </p>

Examples: G3518.X.LT11.TI.VLG.G GS3587.F.LLA1.TI.VST.G

Gallery Panels

Stride 42"H Application

For Stride Gallery Panel connectors see page 31.

GSA PENDING

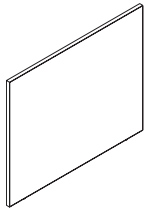

Description	Model	Configuration	List Price		
			L1	L2	L3
42"H Gallery Panels					
18"W	G4218	Mid	\$ 403	\$ 423	\$ 443
21"W	G4221	Mid	\$ 412	\$ 433	\$ 453
24"W	G4224	Mid	\$ 442	\$ 464	\$ 486
27"W	G4227	Mid	\$ 467	\$ 490	\$ 514
30"W	G4230	Mid	\$ 539	\$ 566	\$ 593
33"W	G4233	L, Mid	\$ 567	\$ 595	\$ 624
36"W	G4236	L, Mid	\$ 601	\$ 631	\$ 661
39"W	G4239	L, Mid	\$ 643	\$ 675	\$ 707
42"W	G4242	L, Mid	\$ 671	\$ 705	\$ 738
45"W	G4245	L, Mid	\$ 695	\$ 730	\$ 765
48"W	G4248	L, Mid	\$ 723	\$ 759	\$ 795
51"W	G4251	T, L, Mid	\$ 769	\$ 807	\$ 846
54"W	G4254	T, L, Mid	\$ 792	\$ 832	\$ 871
57"W	G4257	T, L, Mid	\$ 813	\$ 854	\$ 894
60"W	G4260	T, L, Mid	\$ 842	\$ 884	\$ 926
63"W	G4263	T, L, Mid	\$ 865	\$ 908	\$ 952
66"W	G4266	T, L, Mid	\$ 893	\$ 938	\$ 982
69"W	G4269	T, L, Mid	\$ 911	\$ 957	\$ 1002
72"W	G4272	T, L, Mid	\$ 963	\$ 1011	\$ 1059
75"W	G4275	T, L, Mid	\$ 997	\$ 1047	\$ 1097
78"W	G4278	T, L, Mid	\$ 1059	\$ 1112	\$ 1165
81"W	G4281	T, L, Mid	\$ 1183	\$ 1242	\$ 1301
84"W	G4284	T, L, Mid	\$ 1274	\$ 1338	\$ 1401

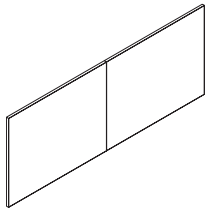

42"H Gallery Split Panels (model number includes two units)					
87"W	GS4287	T	\$ 1298	\$ 1363	\$ 1428
93"W	GS4293	T	\$ 1323	\$ 1389	\$ 1455
99"W	GS4299	T	\$ 1383	\$ 1452	\$ 1521
105"W	GS42105	T	\$ 1403	\$ 1473	\$ 1543
111"W	GS42111	T	\$ 1439	\$ 1511	\$ 1583
117"W	GS42117	T	\$ 1473	\$ 1547	\$ 1620
123"W	GS42123	T	\$ 1509	\$ 1584	\$ 1660
129"W	GS42129	T	\$ 1564	\$ 1642	\$ 1720
135"W	GS42135	T	\$ 1628	\$ 1709	\$ 1791
141"W	GS42141	T	\$ 1689	\$ 1773	\$ 1858
147"W	GS42147	T	\$ 1723	\$ 1809	\$ 1895

E All Gallery models are available in the **Everyday Advantage®** program, see page 5 for details.

<p>How to specify — Select the Model Number from above.</p>	<p>1st Option: FSC: F FSC Wood X Non-FSC Wood</p>	<p>2nd Option: Laminate: See inside front cover for finishes.</p>	<p>3rd Option: Edge: See inside front cover for finishes.</p>	<p>4th Option: Grain: VLG Horizontal grain or Solid only. VST Vertical Grain (available only for single panels 60"W or less, and for split panels between 87"W and 117"W).</p>	<p>5th Option: Glide:</p>
<p>G . .</p>				<p>V .</p>	<p>G </p>

Examples: G4218.X.LT11.TI.VLG.G GS4287.F.LLA1.TI.VST.G

Gallery Panels

Stride 50"H Application

For Stride Gallery Panel connectors see page 31.

GSA PENDING

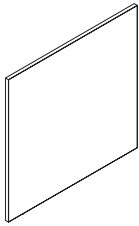

Description	Model	Configuration	List Price		
			L1	L2	L3
50"H Gallery Panels					
18"W	G5018	Mid	\$ 471	\$ 495	\$ 518
21"W	G5021	Mid	\$ 485	\$ 509	\$ 534
24"W	G5024	Mid	\$ 509	\$ 534	\$ 560
27"W	G5027	Mid	\$ 536	\$ 563	\$ 590
30"W	G5030	Mid	\$ 598	\$ 628	\$ 658
33"W	G5033	L, Mid	\$ 628	\$ 659	\$ 691
36"W	G5036	L, Mid	\$ 661	\$ 694	\$ 727
39"W	G5039	L, Mid	\$ 701	\$ 736	\$ 771
42"W	G5042	L, Mid	\$ 739	\$ 776	\$ 813
45"W	G5045	L, Mid	\$ 792	\$ 832	\$ 871
48"W	G5048	L, Mid	\$ 813	\$ 854	\$ 894
51"W	G5051	T, L, Mid	\$ 834	\$ 876	\$ 917
54"W	G5054	T, L, Mid	\$ 869	\$ 912	\$ 956
57"W	G5057	T, L, Mid	\$ 891	\$ 936	\$ 980
60"W	G5060	T, L, Mid	\$ 918	\$ 964	\$ 1010
63"W	G5063	T, L, Mid	\$ 937	\$ 984	\$ 1031
66"W	G5066	T, L, Mid	\$ 964	\$ 1012	\$ 1060
69"W	G5069	T, L, Mid	\$ 991	\$ 1041	\$ 1090
72"W	G5072	T, L, Mid	\$ 1019	\$ 1070	\$ 1121
75"W	G5075	T, L, Mid	\$ 1086	\$ 1140	\$ 1195
78"W	G5078	T, L, Mid	\$ 1193	\$ 1253	\$ 1312
81"W	G5081	T, L, Mid	\$ 1295	\$ 1360	\$ 1425
84"W	G5084	T, L, Mid	\$ 1384	\$ 1453	\$ 1522

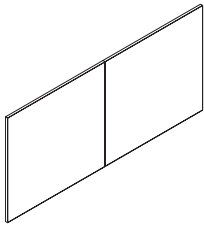

50"H Gallery Split Panels (model number includes two units)					
87"W	GS5087	T	\$ 1408	\$ 1478	\$ 1549
93"W	GS5093	T	\$ 1482	\$ 1556	\$ 1630
99"W	GS5099	T	\$ 1511	\$ 1587	\$ 1662
105"W	GS50105	T	\$ 1567	\$ 1645	\$ 1724
111"W	GS50111	T	\$ 1589	\$ 1668	\$ 1748
117"W	GS50117	T	\$ 1603	\$ 1683	\$ 1763
123"W	GS50123	T	\$ 1621	\$ 1702	\$ 1783
129"W	GS50129	T	\$ 1664	\$ 1747	\$ 1830
135"W	GS50135	T	\$ 1696	\$ 1781	\$ 1866
141"W	GS50141	T	\$ 1723	\$ 1809	\$ 1895
147"W	GS50147	T	\$ 1786	\$ 1875	\$ 1965

E All Gallery models are available in the **Everyday Advantage®** program, see page 5 for details.

<p>How to specify — Select the Model Number from above.</p>	<p>1st Option: FSC: F FSC Wood X Non-FSC Wood</p>	<p>2nd Option: Laminate: See inside front cover for finishes.</p>	<p>3rd Option: Edge: See inside front cover for finishes.</p>	<p>4th Option: Grain: VLG Horizontal grain or Solid only. VST Vertical Grain (available only for single panels 60"W or less, and for split panels between 87"W and 117"W).</p>	<p>5th Option: Glide:</p>
<p>G . .</p>				<p>V .</p>	<p>G </p>

Examples: G5018.X.LT11.TI.VLG.G GS5087.F.LLA1.TI.VST.G

Gallery Panels

Stride 57½"H Application

For Stride Gallery Panel connectors see page 31.

GSA PENDING

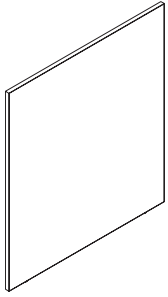

Description	Model	Configuration	List Price		
			L1	L2	L3
57½"H Gallery Panels					
18"W	G5718	Mid	\$ 573	\$ 602	\$ 630
21"W	G5721	Mid	\$ 587	\$ 616	\$ 646
24"W	G5724	Mid	\$ 611	\$ 642	\$ 672
27"W	G5727	Mid	\$ 638	\$ 670	\$ 702
30"W	G5730	Mid	\$ 700	\$ 735	\$ 770
33"W	G5733	L, Mid	\$ 730	\$ 767	\$ 803
36"W	G5736	L, Mid	\$ 763	\$ 801	\$ 839
39"W	G5739	L, Mid	\$ 803	\$ 843	\$ 883
42"W	G5742	L, Mid	\$ 841	\$ 883	\$ 925
45"W	G5745	L, Mid	\$ 894	\$ 939	\$ 983
48"W	G5748	L, Mid	\$ 915	\$ 961	\$ 1007
51"W	G5751	T, L, Mid	\$ 936	\$ 983	\$ 1030
54"W	G5754	T, L, Mid	\$ 971	\$ 1020	\$ 1068
57"W	G5757	T, L, Mid	\$ 993	\$ 1043	\$ 1092
60"W	G5760	T, L, Mid	\$ 1020	\$ 1071	\$ 1122
63"W	G5763	T, L, Mid	\$ 1039	\$ 1091	\$ 1143
66"W	G5766	T, L, Mid	\$ 1066	\$ 1119	\$ 1173
69"W	G5769	T, L, Mid	\$ 1093	\$ 1148	\$ 1202
72"W	G5772	T, L, Mid	\$ 1121	\$ 1177	\$ 1233
75"W	G5775	T, L, Mid	\$ 1188	\$ 1247	\$ 1307
78"W	G5778	T, L, Mid	\$ 1295	\$ 1360	\$ 1425
81"W	G5781	T, L, Mid	\$ 1397	\$ 1467	\$ 1537
84"W	G5784	T, L, Mid	\$ 1486	\$ 1560	\$ 1635

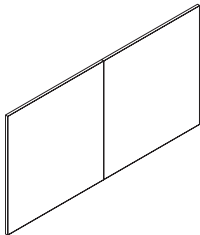

57½"H Gallery Split Panels (model number includes two units)					
87"W	GS5787	T	\$ 1510	\$ 1586	\$ 1661
93"W	GS5793	T	\$ 1584	\$ 1663	\$ 1742
99"W	GS5799	T	\$ 1613	\$ 1694	\$ 1774
105"W	GS57105	T	\$ 1669	\$ 1752	\$ 1836
111"W	GS57111	T	\$ 1691	\$ 1776	\$ 1860
117"W	GS57117	T	\$ 1705	\$ 1790	\$ 1876
123"W	GS57123	T	\$ 1723	\$ 1809	\$ 1895
129"W	GS57129	T	\$ 1766	\$ 1854	\$ 1943
135"W	GS57135	T	\$ 1798	\$ 1888	\$ 1978
141"W	GS57141	T	\$ 1825	\$ 1916	\$ 2008
147"W	GS57147	T	\$ 1888	\$ 1982	\$ 2077

E All Gallery models are available in the **Everyday Advantage®** program, see page 5 for details.

<p>How to specify — Select the Model Number from above.</p>	<p>1st Option: FSC: F FSC Wood X Non-FSC Wood</p>	<p>2nd Option: Laminate: See inside front cover for finishes.</p>	<p>3rd Option: Edge: See inside front cover for finishes.</p>	<p>4th Option: Grain: VLG Horizontal grain or Solid only. VST Vertical Grain (available only for single panels 60"W or less, and for split panels between 87"W and 117"W).</p>	<p>5th Option: Glide:</p>
<p>G . .</p>				<p>V .</p>	<p>G </p>

Examples: G5718.X.LT11.TI.VLG.G GS5787.F.LLA1.TI.VST.G

Gallery Panels

Terrace 30"H Application

For Terrace Gallery Panel connectors see page 42.

GSA PENDING

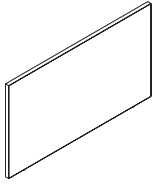

Description	Model	Configuration	List Price		
			L1	L2	L3
30"H Gallery Panels					
18"W	G3018	Mid	\$ 301	\$ 316	\$ 331
21"W	G3021	Mid	\$ 312	\$ 328	\$ 343
24"W	G3024	Mid	\$ 332	\$ 349	\$ 365
27"W	G3027	Mid	\$ 356	\$ 374	\$ 392
30"W	G3030	Mid	\$ 406	\$ 426	\$ 447
33"W	G3033	L, Mid	\$ 430	\$ 452	\$ 473
36"W	G3036	L, Mid	\$ 452	\$ 475	\$ 497
39"W	G3039	L, Mid	\$ 490	\$ 515	\$ 539
42"W	G3042	L, Mid	\$ 529	\$ 555	\$ 582
45"W	G3045	L, Mid	\$ 578	\$ 607	\$ 636
48"W	G3048	L, Mid	\$ 605	\$ 635	\$ 666
51"W	G3051	T, L, Mid	\$ 616	\$ 647	\$ 678
54"W	G3054	T, L, Mid	\$ 646	\$ 678	\$ 711
57"W	G3057	T, L, Mid	\$ 673	\$ 707	\$ 740
60"W	G3060	T, L, Mid	\$ 707	\$ 742	\$ 778
63"W	G3063	T, L, Mid	\$ 718	\$ 754	\$ 790
66"W	G3066	T, L, Mid	\$ 733	\$ 770	\$ 806
69"W	G3069	T, L, Mid	\$ 786	\$ 825	\$ 865
72"W	G3072	T, L, Mid	\$ 809	\$ 849	\$ 890
75"W	G3075	T, L, Mid	\$ 917	\$ 963	\$ 1009
78"W	G3078	T, L, Mid	\$ 953	\$ 1001	\$ 1048
81"W	G3081	T, L, Mid	\$ 986	\$ 1035	\$ 1085
84"W	G3084	T, L, Mid	\$ 1082	\$ 1136	\$ 1190

E All Gallery models are available in the **Everyday Advantage®** program, see page 5 for details.

<p>How to specify — Select the Model Number from above.</p> <p>G 3 0 .</p>	<p>1st Option: FSC: F FSC Wood X Non-FSC Wood</p> <p> .</p>	<p>2nd Option: Laminate: See inside front cover for finishes.</p> <p> .</p>	<p>3rd Option: Edge: See inside front cover for finishes.</p> <p> .</p>	<p>4th Option: Grain: VLG Horizontal grain or Solid only. VST Vertical Grain (available only for single panels 60"W or less, and for split panels between 87"W and 117"W).</p> <p>V .</p>	<p>5th Option: Glide:</p> <p>G </p>
---	--	--	--	---	--

Example: G3018.X.LT11.TI.VLG.G

Gallery Panels

Terrace 35"H Application

For Terrace Gallery Panel connectors see page 42.

GSA PENDING

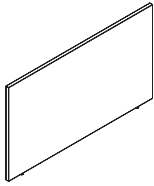

Description	Model	Configuration	List Price		
			L1	L2	L3
35"H Gallery Panels					
18"W	G3518	Mid	\$ 367	\$ 386	\$ 404
21"W	G3521	Mid	\$ 379	\$ 398	\$ 417
24"W	G3524	Mid	\$ 403	\$ 424	\$ 444
27"W	G3527	Mid	\$ 425	\$ 447	\$ 468
30"W	G3530	Mid	\$ 491	\$ 516	\$ 541
33"W	G3533	L, Mid	\$ 517	\$ 543	\$ 569
36"W	G3536	L, Mid	\$ 548	\$ 576	\$ 603
39"W	G3539	L, Mid	\$ 586	\$ 616	\$ 645
42"W	G3542	L, Mid	\$ 612	\$ 643	\$ 674
45"W	G3545	L, Mid	\$ 650	\$ 683	\$ 715
48"W	G3548	L, Mid	\$ 677	\$ 711	\$ 745
51"W	G3551	T, L, Mid	\$ 700	\$ 735	\$ 770
54"W	G3554	T, L, Mid	\$ 725	\$ 762	\$ 798
57"W	G3557	T, L, Mid	\$ 755	\$ 793	\$ 831
60"W	G3560	T, L, Mid	\$ 780	\$ 819	\$ 858
63"W	G3563	T, L, Mid	\$ 797	\$ 837	\$ 877
66"W	G3566	T, L, Mid	\$ 820	\$ 861	\$ 902
69"W	G3569	T, L, Mid	\$ 860	\$ 903	\$ 946
72"W	G3572	T, L, Mid	\$ 900	\$ 945	\$ 990
75"W	G3575	T, L, Mid	\$ 970	\$ 1019	\$ 1067
78"W	G3578	T, L, Mid	\$ 1020	\$ 1071	\$ 1122
81"W	G3581	T, L, Mid	\$ 1097	\$ 1152	\$ 1207
84"W	G3584	T, L, Mid	\$ 1200	\$ 1260	\$ 1320

E All Gallery models are available in the **Everyday Advantage®** program, see page 5 for details.

<p>How to specify — Select the Model Number from above.</p>	<p>1st Option: FSC: F FSC Wood X Non-FSC Wood</p>	<p>2nd Option: Laminate: See inside front cover for finishes.</p>	<p>3rd Option: Edge: See inside front cover for finishes.</p>	<p>4th Option: Grain: VLG Horizontal grain or Solid only. VST Vertical Grain (available only for single panels 60"W or less, and for split panels between 87"W and 117"W).</p>	<p>5th Option: Glide:</p>
<p>G 3 5 .</p>	<p> .</p>	<p> .</p>	<p> .</p>	<p>V .</p>	<p>G </p>

Example: G3518.X.LT11.TI.VLG.G

Gallery Panels

Terrace 42"H Application

For Terrace Gallery Panel connectors see page 42.

GSA PENDING

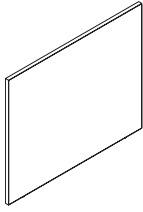

Description	Model	Configuration	List Price		
			L1	L2	L3
42"H Gallery Panels					
18"W	G4218	Mid	\$ 403	\$ 423	\$ 443
21"W	G4221	Mid	\$ 412	\$ 433	\$ 453
24"W	G4224	Mid	\$ 442	\$ 464	\$ 486
27"W	G4227	Mid	\$ 467	\$ 490	\$ 514
30"W	G4230	Mid	\$ 539	\$ 566	\$ 593
33"W	G4233	L, Mid	\$ 567	\$ 595	\$ 624
36"W	G4236	L, Mid	\$ 601	\$ 631	\$ 661
39"W	G4239	L, Mid	\$ 643	\$ 675	\$ 707
42"W	G4242	L, Mid	\$ 671	\$ 705	\$ 738
45"W	G4245	L, Mid	\$ 695	\$ 730	\$ 765
48"W	G4248	L, Mid	\$ 723	\$ 759	\$ 795
51"W	G4251	T, L, Mid	\$ 769	\$ 807	\$ 846
54"W	G4254	T, L, Mid	\$ 792	\$ 832	\$ 871
57"W	G4257	T, L, Mid	\$ 813	\$ 854	\$ 894
60"W	G4260	T, L, Mid	\$ 842	\$ 884	\$ 926
63"W	G4263	T, L, Mid	\$ 865	\$ 908	\$ 952
66"W	G4266	T, L, Mid	\$ 893	\$ 938	\$ 982
69"W	G4269	T, L, Mid	\$ 911	\$ 957	\$ 1002
72"W	G4272	T, L, Mid	\$ 963	\$ 1011	\$ 1059
75"W	G4275	T, L, Mid	\$ 997	\$ 1047	\$ 1097
78"W	G4278	T, L, Mid	\$ 1059	\$ 1112	\$ 1165
81"W	G4281	T, L, Mid	\$ 1183	\$ 1242	\$ 1301
84"W	G4284	T, L, Mid	\$ 1274	\$ 1338	\$ 1401

E All Gallery models are available in the **Everyday Advantage®** program, see page 5 for details.

<p>How to specify — Select the Model Number from above.</p> <p>G 4 2 .</p>	<p>1st Option: FSC: F FSC Wood X Non-FSC Wood</p> <p> .</p>	<p>2nd Option: Laminate: See inside front cover for finishes.</p> <p> .</p>	<p>3rd Option: Edge: See inside front cover for finishes.</p> <p> .</p>	<p>4th Option: Grain: VLG Horizontal grain or Solid only. VST Vertical Grain (available only for single panels 60"W or less, and for split panels between 87"W and 117"W).</p> <p>V .</p>	<p>5th Option: Glide:</p> <p>G </p>
---	--	--	--	---	--

Example: G4218.X.LT11.TI.VLG.G

Gallery Panels

Terrace 50"H Application

For Terrace Gallery Panel connectors see page 42.

GSA PENDING

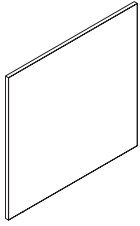

Description	Model	Configuration	List Price		
			L1	L2	L3
50"H Gallery Panels					
18"W	G5018	Mid	\$ 471	\$ 495	\$ 518
21"W	G5021	Mid	\$ 485	\$ 509	\$ 534
24"W	G5024	Mid	\$ 509	\$ 534	\$ 560
27"W	G5027	Mid	\$ 536	\$ 563	\$ 590
30"W	G5030	Mid	\$ 598	\$ 628	\$ 658
33"W	G5033	L, Mid	\$ 628	\$ 659	\$ 691
36"W	G5036	L, Mid	\$ 661	\$ 694	\$ 727
39"W	G5039	L, Mid	\$ 701	\$ 736	\$ 771
42"W	G5042	L, Mid	\$ 739	\$ 776	\$ 813
45"W	G5045	L, Mid	\$ 792	\$ 832	\$ 871
48"W	G5048	L, Mid	\$ 813	\$ 854	\$ 894
51"W	G5051	T, L, Mid	\$ 834	\$ 876	\$ 917
54"W	G5054	T, L, Mid	\$ 869	\$ 912	\$ 956
57"W	G5057	T, L, Mid	\$ 891	\$ 936	\$ 980
60"W	G5060	T, L, Mid	\$ 918	\$ 964	\$ 1010
63"W	G5063	T, L, Mid	\$ 937	\$ 984	\$ 1031
66"W	G5066	T, L, Mid	\$ 964	\$ 1012	\$ 1060
69"W	G5069	T, L, Mid	\$ 991	\$ 1041	\$ 1090
72"W	G5072	T, L, Mid	\$ 1019	\$ 1070	\$ 1121
75"W	G5075	T, L, Mid	\$ 1086	\$ 1140	\$ 1195
78"W	G5078	T, L, Mid	\$ 1193	\$ 1253	\$ 1312
81"W	G5081	T, L, Mid	\$ 1295	\$ 1360	\$ 1425
84"W	G5084	T, L, Mid	\$ 1384	\$ 1453	\$ 1522

E All Gallery models are available in the **Everyday Advantage®** program, see page 5 for details.

<p>How to specify — Select the Model Number from above.</p>	<p>1st Option: FSC: F FSC Wood X Non-FSC Wood</p>	<p>2nd Option: Laminate: See inside front cover for finishes.</p>	<p>3rd Option: Edge: See inside front cover for finishes.</p>	<p>4th Option: Grain: VLG Horizontal grain or Solid only. VST Vertical Grain (available only for single panels 60"W or less, and for split panels between 87"W and 117"W).</p>	<p>5th Option: Glide:</p>
<p>G 5 0 .</p>	<p> .</p>	<p> .</p>	<p> .</p>	<p>V .</p>	<p>G </p>

Example: G5018.X.LT11.TI.VLG.G

Gallery Panels

Terrace 57½"H Application

For Terrace Gallery Panel connectors see page 42.

GSA PENDING

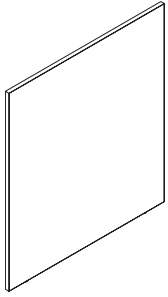

Description	Model	Configuration	List Price		
			L1	L2	L3
57½"H Gallery Panels					
18"W	G5718	Mid	\$ 573	\$ 602	\$ 630
21"W	G5721	Mid	\$ 587	\$ 616	\$ 646
24"W	G5724	Mid	\$ 611	\$ 642	\$ 672
27"W	G5727	Mid	\$ 638	\$ 670	\$ 702
30"W	G5730	Mid	\$ 700	\$ 735	\$ 770
33"W	G5733	L, Mid	\$ 730	\$ 767	\$ 803
36"W	G5736	L, Mid	\$ 763	\$ 801	\$ 839
39"W	G5739	L, Mid	\$ 803	\$ 843	\$ 883
42"W	G5742	L, Mid	\$ 841	\$ 883	\$ 925
45"W	G5745	L, Mid	\$ 894	\$ 939	\$ 983
48"W	G5748	L, Mid	\$ 915	\$ 961	\$ 1007
51"W	G5751	T, L, Mid	\$ 936	\$ 983	\$ 1030
54"W	G5754	T, L, Mid	\$ 971	\$ 1020	\$ 1068
57"W	G5757	T, L, Mid	\$ 993	\$ 1043	\$ 1092
60"W	G5760	T, L, Mid	\$ 1020	\$ 1071	\$ 1122
63"W	G5763	T, L, Mid	\$ 1039	\$ 1091	\$ 1143
66"W	G5766	T, L, Mid	\$ 1066	\$ 1119	\$ 1173
69"W	G5769	T, L, Mid	\$ 1093	\$ 1148	\$ 1202
72"W	G5772	T, L, Mid	\$ 1121	\$ 1177	\$ 1233
75"W	G5775	T, L, Mid	\$ 1188	\$ 1247	\$ 1307
78"W	G5778	T, L, Mid	\$ 1295	\$ 1360	\$ 1425
81"W	G5781	T, L, Mid	\$ 1397	\$ 1467	\$ 1537
84"W	G5784	T, L, Mid	\$ 1486	\$ 1560	\$ 1635

E All Gallery models are available in the **Everyday Advantage®** program, see page 5 for details.

<p>How to specify — Select the Model Number from above.</p>	<p>1st Option: FSC: F FSC Wood X Non-FSC Wood</p>	<p>2nd Option: Laminate: See inside front cover for finishes.</p>	<p>3rd Option: Edge: See inside front cover for finishes.</p>	<p>4th Option: Grain: VLG Horizontal grain or Solid only. VST Vertical Grain (available only for single panels 60" W or less, and for split panels between 87" W and 117" W).</p>	<p>5th Option: Glide:</p>
<p>G 5 7 .</p>	<p> .</p>	<p> .</p>	<p> .</p>	<p>V .</p>	<p>G </p>

Example: G5718.X.LT11.TI.VLG.G

Gallery Panels

Terrace 30"H Application for Use with Glass

For Gallery Panel Glass see page 59.
 For Gallery Panel connectors see page 42.

GSA PENDING

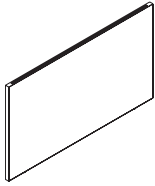

Description	Model	Configuration	List Price			Accepts Glass Models
			L1	L2	L3	7½"H
30"H Gallery Panels with Glass						
18"W	G3018G	Mid	\$ 454	\$ 477	\$ 499	G40715GS
21"W	G3021G	Mid	\$ 465	\$ 488	\$ 512	G40718GS
24"W	G3024G	Mid	\$ 485	\$ 509	\$ 534	G40721GS
27"W	G3027G	Mid	\$ 509	\$ 534	\$ 560	G40724GS
30"W	G3030G	Mid	\$ 559	\$ 587	\$ 615	G40727GS
33"W	G3033G	L, Mid	\$ 583	\$ 612	\$ 641	G40730GS
36"W	G3036G	L, Mid	\$ 605	\$ 635	\$ 666	G40733GS
39"W	G3039G	L, Mid	\$ 643	\$ 675	\$ 707	G40736GS
42"W	G3042G	L, Mid	\$ 682	\$ 716	\$ 750	G40739GS
45"W	G3045G	L, Mid	\$ 731	\$ 768	\$ 804	G40742GS
48"W	G3048G	L, Mid	\$ 758	\$ 796	\$ 834	G40745GS
51"W	G3051G	T, L, Mid	\$ 769	\$ 807	\$ 846	G40748GS
54"W	G3054G	T, L, Mid	\$ 799	\$ 839	\$ 879	G40751GS
57"W	G3057G	T, L, Mid	\$ 826	\$ 867	\$ 909	G40754GS
60"W	G3060G	T, L, Mid	\$ 860	\$ 903	\$ 946	G40757GS
63"W	G3063G	T, L, Mid	\$ 871	\$ 915	\$ 958	G40760GS
66"W	G3066G	T, L, Mid	\$ 886	\$ 930	\$ 975	G40763GS
69"W	G3069G	T, L, Mid	\$ 939	\$ 986	\$ 1033	G40766GS
72"W	G3072G	T, L, Mid	\$ 962	\$ 1010	\$ 1058	G40769GS
75"W	G3075G	T, L, Mid	\$ 1070	\$ 1124	\$ 1177	G40772GS
78"W	G3078G	T, L, Mid	\$ 1106	\$ 1161	\$ 1217	G40775GS
81"W	G3081G	T, L, Mid	\$ 1139	\$ 1196	\$ 1253	G40778GS
84"W	G3084G	T, L, Mid	\$ 1235	\$ 1297	\$ 1359	G40781GS

E All Gallery models are available in the **Everyday Advantage®** program, see page 5 for details.

<p>How to specify — Select the Model Number from above.</p>	<p>1st Option: FSC: F FSC Wood X Non-FSC Wood</p>	<p>2nd Option: Laminate: See inside front cover for finishes.</p>	<p>3rd Option: Edge: See inside front cover for finishes.</p>	<p>4th Option: Grain: VLG Horizontal grain or Solid only. VST Vertical Grain (available only for single panels 60"W or less, and for split panels between 87"W and 117"W).</p>	<p>5th Option: Glide:</p>
G 3 0 	V .	G

Example: G3018G.X.LT11.TI.VLG.G

Gallery Panels

Terrace 42"H Application for Use with Glass

For Gallery Panel Glass see page 59.
 For Gallery Panel connectors see page 42.

GSA PENDING

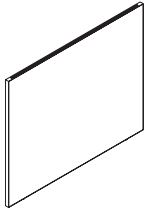

Description	Model	Configuration	List Price			Accepts Glass Models
			L1	L2	L3	7½"H
42"H Gallery Panels with Glass						
18"W	G4218G	Mid	\$ 556	\$ 584	\$ 612	G40715GS
21"W	G4221G	Mid	\$ 565	\$ 593	\$ 622	G40718GS
24"W	G4224G	Mid	\$ 595	\$ 625	\$ 655	G40721GS
27"W	G4227G	Mid	\$ 620	\$ 651	\$ 682	G40724GS
30"W	G4230G	Mid	\$ 692	\$ 727	\$ 761	G40727GS
33"W	G4233G	L, Mid	\$ 720	\$ 756	\$ 792	G40730GS
36"W	G4236G	L, Mid	\$ 754	\$ 792	\$ 829	G40733GS
39"W	G4239G	L, Mid	\$ 796	\$ 836	\$ 876	G40736GS
42"W	G4242G	L, Mid	\$ 824	\$ 865	\$ 906	G40739GS
45"W	G4245G	L, Mid	\$ 848	\$ 890	\$ 933	G40742GS
48"W	G4248G	L, Mid	\$ 876	\$ 920	\$ 964	G40745GS
51"W	G4251G	T, L, Mid	\$ 922	\$ 968	\$ 1014	G40748GS
54"W	G4254G	T, L, Mid	\$ 945	\$ 992	\$ 1040	G40751GS
57"W	G4257G	T, L, Mid	\$ 966	\$ 1014	\$ 1063	G40754GS
60"W	G4260G	T, L, Mid	\$ 995	\$ 1045	\$ 1095	G40757GS
63"W	G4263G	T, L, Mid	\$ 1018	\$ 1069	\$ 1120	G40760GS
66"W	G4266G	T, L, Mid	\$ 1046	\$ 1098	\$ 1151	G40763GS
69"W	G4269G	T, L, Mid	\$ 1064	\$ 1117	\$ 1170	G40766GS
72"W	G4272G	T, L, Mid	\$ 1116	\$ 1172	\$ 1228	G40769GS
75"W	G4275G	T, L, Mid	\$ 1150	\$ 1208	\$ 1265	G40772GS
78"W	G4278G	T, L, Mid	\$ 1212	\$ 1273	\$ 1333	G40775GS
81"W	G4281G	T, L, Mid	\$ 1336	\$ 1403	\$ 1470	G40778GS
84"W	G4284G	T, L, Mid	\$ 1427	\$ 1498	\$ 1570	G40781GS

E All Gallery models are available in the **Everyday Advantage®** program, see page 5 for details.

<p>How to specify — Select the Model Number from above.</p>	<p>1st Option: FSC: F FSC Wood X Non-FSC Wood</p>	<p>2nd Option: Laminate: See inside front cover for finishes.</p>	<p>3rd Option: Edge: See inside front cover for finishes.</p>	<p>4th Option: Grain: VLG Horizontal grain or Solid only. VST Vertical Grain (available only for single panels 60"W or less, and for split panels between 87"W and 117"W).</p>	<p>5th Option: Glide:</p>
<p>G 4 2 .</p>	<p> .</p>	<p> .</p>	<p> .</p>	<p>V .</p>	<p>G </p>

Example: G4218G.X.LT11.TI.VLG.G

Gallery Panels

Terrace 50"H Application for Use with Glass

For Gallery Panel Glass see page 59.
 For Gallery Panel connectors see page 42.

GSA PENDING

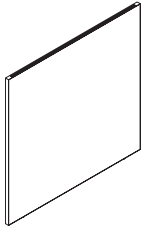

Description	Model	Configuration	List Price			Accepts Glass Models
			L1	L2	L3	7½"H
50"H Gallery Panels with Glass						
18"W	G5018G	Mid	\$ 624	\$ 655	\$ 686	G40715GS
21"W	G5021G	Mid	\$ 638	\$ 670	\$ 702	G40718GS
24"W	G5024G	Mid	\$ 662	\$ 695	\$ 728	G40721GS
27"W	G5027G	Mid	\$ 689	\$ 723	\$ 758	G40724GS
30"W	G5030G	Mid	\$ 751	\$ 789	\$ 826	G40727GS
33"W	G5033G	L, Mid	\$ 781	\$ 820	\$ 859	G40730GS
36"W	G5036G	L, Mid	\$ 814	\$ 855	\$ 895	G40733GS
39"W	G5039G	L, Mid	\$ 854	\$ 897	\$ 939	G40736GS
42"W	G5042G	L, Mid	\$ 892	\$ 937	\$ 981	G40739GS
45"W	G5045G	L, Mid	\$ 945	\$ 992	\$ 1040	G40742GS
48"W	G5048G	L, Mid	\$ 966	\$ 1014	\$ 1063	G40745GS
51"W	G5051G	T, L, Mid	\$ 987	\$ 1036	\$ 1086	G40748GS
54"W	G5054G	T, L, Mid	\$ 1022	\$ 1073	\$ 1124	G40751GS
57"W	G5057G	T, L, Mid	\$ 1044	\$ 1096	\$ 1148	G40754GS
60"W	G5060G	T, L, Mid	\$ 1071	\$ 1125	\$ 1178	G40757GS
63"W	G5063G	T, L, Mid	\$ 1090	\$ 1145	\$ 1199	G40760GS
66"W	G5066G	T, L, Mid	\$ 1117	\$ 1173	\$ 1229	G40763GS
69"W	G5069G	T, L, Mid	\$ 1144	\$ 1201	\$ 1258	G40766GS
72"W	G5072G	T, L, Mid	\$ 1172	\$ 1231	\$ 1289	G40769GS
75"W	G5075G	T, L, Mid	\$ 1239	\$ 1301	\$ 1363	G40772GS
78"W	G5078G	T, L, Mid	\$ 1346	\$ 1413	\$ 1481	G40775GS
81"W	G5081G	T, L, Mid	\$ 1448	\$ 1520	\$ 1593	G40778GS
84"W	G5084G	T, L, Mid	\$ 1537	\$ 1614	\$ 1691	G40781GS

E All Gallery models are available in the **Everyday Advantage®** program, see page 5 for details.

<p>How to specify — Select the Model Number from above.</p>	<p>1st Option: FSC: F FSC Wood X Non-FSC Wood</p>	<p>2nd Option: Laminate: See inside front cover for finishes.</p>	<p>3rd Option: Edge: See inside front cover for finishes.</p>	<p>4th Option: Grain: VLG Horizontal grain or Solid only. VST Vertical Grain (available only for single panels 60"W or less, and for split panels between 87"W and 117"W).</p>	<p>5th Option: Glide:</p>
G 5 0 	V .	G

Example: G5018G.X.LT11.TI.VLG.G

Gallery Panels

Terrace 57½"H Application for Use with Glass

For Gallery Panel Glass see page 59.
For Gallery Panel connectors see page 42.

GSA PENDING

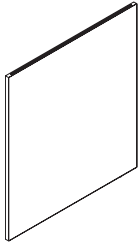

Description	Model	Configuration	List Price			Accepts Glass Models
			L1	L2	L3	7½"H
57½"H Gallery Panels with Glass						
18"W	G5718G	Mid	\$ 726	\$ 762	\$ 799	G40715GS
21"W	G5721G	Mid	\$ 740	\$ 777	\$ 814	G40718GS
24"W	G5724G	Mid	\$ 764	\$ 802	\$ 840	G40721GS
27"W	G5727G	Mid	\$ 791	\$ 831	\$ 870	G40724GS
30"W	G5730G	Mid	\$ 853	\$ 896	\$ 938	G40727GS
33"W	G5733G	L, Mid	\$ 883	\$ 927	\$ 971	G40730GS
36"W	G5736G	L, Mid	\$ 916	\$ 962	\$ 1008	G40733GS
39"W	G5739G	L, Mid	\$ 956	\$ 1004	\$ 1052	G40736GS
42"W	G5742G	L, Mid	\$ 994	\$ 1044	\$ 1093	G40739GS
45"W	G5745G	L, Mid	\$ 1047	\$ 1099	\$ 1152	G40742GS
48"W	G5748G	L, Mid	\$ 1068	\$ 1121	\$ 1175	G40745GS
51"W	G5751G	T, L, Mid	\$ 1089	\$ 1143	\$ 1198	G40748GS
54"W	G5754G	T, L, Mid	\$ 1124	\$ 1180	\$ 1236	G40751GS
57"W	G5757G	T, L, Mid	\$ 1146	\$ 1203	\$ 1261	G40754GS
60"W	G5760G	T, L, Mid	\$ 1173	\$ 1232	\$ 1290	G40757GS
63"W	G5763G	T, L, Mid	\$ 1192	\$ 1252	\$ 1311	G40760GS
66"W	G5766G	T, L, Mid	\$ 1219	\$ 1280	\$ 1341	G40763GS
69"W	G5769G	T, L, Mid	\$ 1246	\$ 1308	\$ 1371	G40766GS
72"W	G5772G	T, L, Mid	\$ 1274	\$ 1338	\$ 1401	G40769GS
75"W	G5775G	T, L, Mid	\$ 1341	\$ 1408	\$ 1475	G40772GS
78"W	G5778G	T, L, Mid	\$ 1448	\$ 1520	\$ 1593	G40775GS
81"W	G5781G	T, L, Mid	\$ 1550	\$ 1628	\$ 1705	G40778GS
84"W	G5784G	T, L, Mid	\$ 1639	\$ 1721	\$ 1803	G40781GS

E All Gallery models are available in the **Everyday Advantage®** program, see page 5 for details.

<p>How to specify — Select the Model Number from above.</p>	<p>1st Option: FSC: F FSC Wood X Non-FSC Wood</p>	<p>2nd Option: Laminate: See inside front cover for finishes.</p>	<p>3rd Option: Edge: See inside front cover for finishes.</p>	<p>4th Option: Grain: VLG Horizontal grain or Solid only. VST Vertical Grain (available only for single panels 60"W or less, and for split panels between 87"W and 117"W).</p>	<p>5th Option: Glide:</p>
<p>G 5 7 .</p>	<p> .</p>	<p> .</p>	<p> .</p>	<p>V .</p>	<p>G </p>

Example: G5718G.X.LT11.TI.VLG.G

Gallery Panel Connectors

Terrace Connector Kits

GSA PENDING

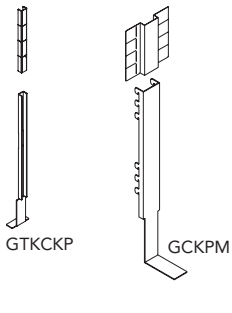

Description	Model	List Price		
		P1	P2	P3
Terrace Connector Kit				
T&L Connector Kit for Terrace System	GTKCKP	\$ 91	\$ 100	\$ 114
Intermediate Mid connector	GCKPM	\$ 105	\$ 116	\$ 131
Panel Glass Kit for 30"H Panel	GTKGK30	\$ 50	N/A	N/A

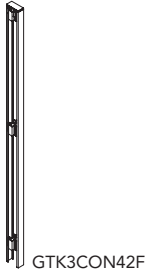

Terrace Connector Kit for Flat Trim				
30" – Flat Trim	GTK3CON30F	\$ 135	\$ 149	\$ 169
35" – Flat Trim	GTK3CON35F	\$ 141	\$ 155	\$ 176
42" – Flat Trim	GTK3CON42F	\$ 162	\$ 178	\$ 203
50" – Flat Trim	GTK3CON50F	\$ 168	\$ 185	\$ 210
57½" – Flat Trim	GTK3CON57F	\$ 174	\$ 190	\$ 216
65" – Flat Trim	GTK3CON65F	\$ 191	\$ 199	\$ 226
72½" – Flat Trim	GTK3CON72F	\$ 210	\$ 231	\$ 263
80" – Flat Trim	GTK3CON80F	\$ 227	\$ 243	\$ 276
87½" – Flat Trim	GTK3CON87F	\$ 231	\$ 257	\$ 293

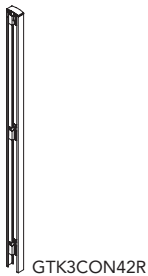

Terrace Connector Kit for Radius Trim				
30" – Radius Trim	GTK3CON30R	\$ 135	\$ 149	\$ 169
35" – Radius Trim	GTK3CON35R	\$ 141	\$ 155	\$ 176
42" – Radius Trim	GTK3CON42R	\$ 162	\$ 178	\$ 203
50" – Radius Trim	GTK3CON50R	\$ 168	\$ 185	\$ 210
57½" – Radius Trim	GTK3CON57R	\$ 174	\$ 190	\$ 216
65" – Radius Trim	GTK3CON65R	\$ 191	\$ 199	\$ 226
72½" – Radius Trim	GTK3CON72R	\$ 210	\$ 231	\$ 263
80" – Radius Trim	GTK3CON80R	\$ 227	\$ 243	\$ 276
87½" – Radius Trim	GTK3CON87R	\$ 231	\$ 257	\$ 293

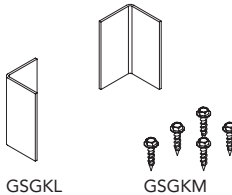

Storage Mounting Brackets				
Gallery Laminate Storage Ganging Kit	GSGKL	\$ 50	N/A	N/A
Gallery Metal Storage Ganging Kit	GSGKM	\$ 11	N/A	N/A

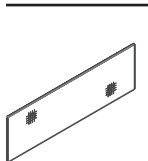

Description	Model	List Price					
		Grade A	Grade B	Grade C	Grade D	Grade E	Grade F
Tackable Cantilever Storage Accessory							
Cantilever Unit for use with 50"H Single Sided Cantilever Unit	ZS42SF S	\$ 292	\$ 318	\$ 344	\$ 386	\$ 429	\$ 472
Cantilever Unit	ZS50SF	\$ 347	\$ 387	\$ 426	\$ 492	\$ 558	\$ 624

E All Gallery models are available in the **Everyday Advantage®** program, see page 5 for details.

S **Shippable by small-package carrier.**

<p>How to specify — Select the Model Number from above.</p>	<p><i>1st Option:</i> Paint for Connector Kits and Brackets (if available): P1 P2 P3 See inside front cover for finishes.</p>	<p><i>1st Option:</i> Fabric for Cantilevered Storage Accessory: See inside back cover for fabrics.</p>	<p><i>2nd Option:</i> Trim Paint for Cantilevered Storage Accessory: P1 P2 P3 See inside front cover for finishes.</p>
--	--	--	---

Examples: GZCKP.P71 GCKPM.P71 GZ3CON30.P71 GSGKL GSGKM ZS50SF.EXG903.P27

Gallery Panels

Further 30"H Application

For Further Gallery Benching connectors see page 50.

GSA PENDING

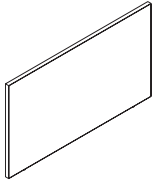

Description	Model	Configuration	List Price		
			L1	L2	L3
30"H Gallery Panels					
33"W	G3033	L	\$ 430	\$ 452	\$ 473
36"W	G3036	L	\$ 452	\$ 475	\$ 497
39"W	G3039	L	\$ 490	\$ 515	\$ 539
42"W	G3042	L	\$ 529	\$ 555	\$ 582
45"W	G3045	L	\$ 578	\$ 607	\$ 636
48"W	G3048	T, L	\$ 605	\$ 635	\$ 666
51"W	G3051	T, L	\$ 616	\$ 647	\$ 678
54"W	G3054	T, L	\$ 646	\$ 678	\$ 711
57"W	G3057	T, L	\$ 673	\$ 707	\$ 740
60"W	G3060	T, L	\$ 707	\$ 742	\$ 778
63"W	G3063	T, L	\$ 718	\$ 754	\$ 790
66"W	G3066	T, L	\$ 733	\$ 770	\$ 806
69"W	G3069	T, L	\$ 786	\$ 825	\$ 865
72"W	G3072	T, L	\$ 809	\$ 849	\$ 890
75"W	G3075	T, L	\$ 917	\$ 963	\$ 1009
78"W	G3078	T, L	\$ 953	\$ 1001	\$ 1048
81"W	G3081	T, L	\$ 986	\$ 1035	\$ 1085
84"W	G3084	T, L	\$ 1082	\$ 1136	\$ 1190

E All Gallery models are available in the **Everyday Advantage®** program, see page 5 for details.

<p>How to specify — Select the Model Number from above.</p>	<p>1st Option: FSC: F FSC Wood X Non-FSC Wood</p>	<p>2nd Option: Laminate: See inside front cover for finishes.</p>	<p>3rd Option: Edge: See inside front cover for finishes.</p>	<p>4th Option: Grain: VLG Horizontal grain or Solid only. VST Vertical Grain (available only for single panels 60"W or less.</p>	<p>5th Option: Glide:</p>
<p>G 3 0 .</p>	<p> .</p>	<p> .</p>	<p> .</p>	<p>V .</p>	<p>G </p>

Example: G3033.X.LT11.TI.VLG.G

Gallery Panels

Further 35"H Application

For Further Gallery Benching connectors see page 50.

GSA PENDING

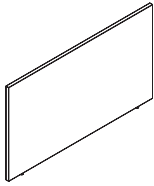

Description	Model	Configuration	List Price		
			L1	L2	L3
35"H Gallery Panels					
33"W	G3533	L	\$ 517	\$ 543	\$ 569
36"W	G3536	L	\$ 548	\$ 576	\$ 603
39"W	G3539	L	\$ 586	\$ 616	\$ 645
42"W	G3542	L	\$ 612	\$ 643	\$ 674
45"W	G3545	L	\$ 650	\$ 683	\$ 715
48"W	G3548	T, L	\$ 677	\$ 711	\$ 745
51"W	G3551	T, L	\$ 700	\$ 735	\$ 770
54"W	G3554	T, L	\$ 725	\$ 762	\$ 798
57"W	G3557	T, L	\$ 755	\$ 793	\$ 831
60"W	G3560	T, L	\$ 780	\$ 819	\$ 858
63"W	G3563	T, L	\$ 797	\$ 837	\$ 877
66"W	G3566	T, L	\$ 820	\$ 861	\$ 902
69"W	G3569	T, L	\$ 860	\$ 903	\$ 946
72"W	G3572	T, L	\$ 900	\$ 945	\$ 990
75"W	G3575	T, L	\$ 970	\$ 1019	\$ 1067
78"W	G3578	T, L	\$ 1020	\$ 1071	\$ 1122
81"W	G3581	T, L	\$ 1097	\$ 1152	\$ 1207
84"W	G3584	T, L	\$ 1200	\$ 1260	\$ 1320

E All Gallery models are available in the **Everyday Advantage®** program, see page 5 for details.

<p>How to specify — Select the Model Number from above.</p>	<p>1st Option: FSC: F FSC Wood X Non-FSC Wood</p>	<p>2nd Option: Laminate: See inside front cover for finishes.</p>	<p>3rd Option: Edge: See inside front cover for finishes.</p>	<p>4th Option: Grain: VLG Horizontal grain or Solid only. VST Vertical Grain (available only for single panels 60"W or less.</p>	<p>5th Option: Glide:</p>
<p>G 3 5 .</p>	<p> .</p>	<p> .</p>	<p> .</p>	<p>V .</p>	<p>G </p>

Example: G3533.X.LT11.TI.VLG.G

Gallery Panels

Further 42"H Application

For Further Gallery Benching connectors see page 50.

GSA PENDING

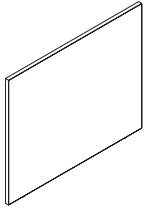

Description	Model	Configuration	List Price		
			L1	L2	L3
42"H Gallery Panels					
33"W	G4233	L	\$ 567	\$ 595	\$ 624
36"W	G4236	L	\$ 601	\$ 631	\$ 661
39"W	G4239	L	\$ 643	\$ 675	\$ 707
42"W	G4242	L	\$ 671	\$ 705	\$ 738
45"W	G4245	L	\$ 695	\$ 730	\$ 765
48"W	G4248	T, L	\$ 723	\$ 759	\$ 795
51"W	G4251	T, L	\$ 769	\$ 807	\$ 846
54"W	G4254	T, L	\$ 792	\$ 832	\$ 871
57"W	G4257	T, L	\$ 813	\$ 854	\$ 894
60"W	G4260	T, L	\$ 842	\$ 884	\$ 926
63"W	G4263	T, L	\$ 865	\$ 908	\$ 952
66"W	G4266	T, L	\$ 893	\$ 938	\$ 982
69"W	G4269	T, L	\$ 911	\$ 957	\$ 1002
72"W	G4272	T, L	\$ 963	\$ 1011	\$ 1059
75"W	G4275	T, L	\$ 997	\$ 1047	\$ 1097
78"W	G4278	T, L	\$ 1059	\$ 1112	\$ 1165
81"W	G4281	T, L	\$ 1183	\$ 1242	\$ 1301
84"W	G4284	T, L	\$ 1274	\$ 1338	\$ 1401

E All Gallery models are available in the **Everyday Advantage®** program, see page 5 for details.

<p>How to specify — Select the Model Number from above.</p>	<p>1st Option: FSC: F FSC Wood X Non-FSC Wood</p>	<p>2nd Option: Laminate: See inside front cover for finishes.</p>	<p>3rd Option: Edge: See inside front cover for finishes.</p>	<p>4th Option: Grain: VLG Horizontal grain or Solid only. VST Vertical Grain (available only for single panels 60"W or less.</p>	<p>5th Option: Glide:</p>
<p>G 4 2 .</p>	<p> .</p>	<p> .</p>	<p> .</p>	<p>V .</p>	<p>G </p>

Example: G4233.X.LT11.TI.VLG.G

Gallery Panels

Further 50"H Application

For Further Gallery Benching connectors see page 50.

GSA PENDING

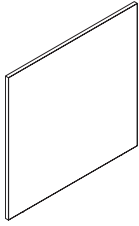

Description	Model	Configuration	List Price		
			L1	L2	L3
50"H Gallery Panels					
33"W	G5033	L	\$ 628	\$ 659	\$ 691
36"W	G5036	L	\$ 661	\$ 694	\$ 727
39"W	G5039	L	\$ 701	\$ 736	\$ 771
42"W	G5042	L	\$ 739	\$ 776	\$ 813
45"W	G5045	L	\$ 792	\$ 832	\$ 871
48"W	G5048	T, L	\$ 813	\$ 854	\$ 894
51"W	G5051	T, L	\$ 834	\$ 876	\$ 917
54"W	G5054	T, L	\$ 869	\$ 912	\$ 956
57"W	G5057	T, L	\$ 891	\$ 936	\$ 980
60"W	G5060	T, L	\$ 918	\$ 964	\$ 1010
63"W	G5063	T, L	\$ 937	\$ 984	\$ 1031
66"W	G5066	T, L	\$ 964	\$ 1012	\$ 1060
69"W	G5069	T, L	\$ 991	\$ 1041	\$ 1090
72"W	G5072	T, L	\$ 1019	\$ 1070	\$ 1121
75"W	G5075	T, L	\$ 1086	\$ 1140	\$ 1195
78"W	G5078	T, L	\$ 1193	\$ 1253	\$ 1312
81"W	G5081	T, L	\$ 1295	\$ 1360	\$ 1425
84"W	G5084	T, L	\$ 1384	\$ 1453	\$ 1522

E All Gallery models are available in the **Everyday Advantage®** program, see page 5 for details.

<p>How to specify — Select the Model Number from above.</p>	<p>1st Option: FSC: F FSC Wood X Non-FSC Wood</p>	<p>2nd Option: Laminate: See inside front cover for finishes.</p>	<p>3rd Option: Edge: See inside front cover for finishes.</p>	<p>4th Option: Grain: VLG Horizontal grain or Solid only. VST Vertical Grain (available only for single panels 60"W or less.</p>	<p>5th Option: Glide:</p>
<p>G 5 0 .</p>	<p> .</p>	<p> .</p>	<p> .</p>	<p>V .</p>	<p>G </p>

Example: G5033.X.LT11.TI.VLG.G

Gallery Panels

Further 30"H Application for Use with Glass

For Gallery Panel Glass see page 59.
For Gallery Panel connectors see page 50.

GSA PENDING

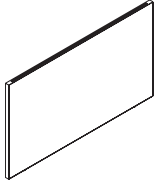

Description	Model	Configuration	List Price			Accepts Glass Models
			L1	L2	L3	7½"H
30"H Gallery Panels with Glass						
33"W	G3033G	L	\$ 583	\$ 612	\$ 641	G40730GS
36"W	G3036G	L	\$ 605	\$ 635	\$ 666	G40733GS
39"W	G3039G	L	\$ 643	\$ 675	\$ 707	G40736GS
42"W	G3042G	L	\$ 682	\$ 716	\$ 750	G40739GS
45"W	G3045G	L	\$ 731	\$ 768	\$ 804	G40742GS
48"W	G3048G	T, L	\$ 758	\$ 796	\$ 834	G40745GS
51"W	G3051G	T, L	\$ 769	\$ 807	\$ 846	G40748GS
54"W	G3054G	T, L	\$ 799	\$ 839	\$ 879	G40751GS
57"W	G3057G	T, L	\$ 826	\$ 867	\$ 909	G40754GS
60"W	G3060G	T, L	\$ 860	\$ 903	\$ 946	G40757GS
63"W	G3063G	T, L	\$ 871	\$ 915	\$ 958	G40760GS
66"W	G3066G	T, L	\$ 886	\$ 930	\$ 975	G40763GS
69"W	G3069G	T, L	\$ 939	\$ 986	\$ 1033	G40766GS
72"W	G3072G	T, L	\$ 962	\$ 1010	\$ 1058	G40769GS
75"W	G3075G	T, L	\$ 1070	\$ 1124	\$ 1177	G40772GS
78"W	G3078G	T, L	\$ 1106	\$ 1161	\$ 1217	G40775GS
81"W	G3081G	T, L	\$ 1139	\$ 1196	\$ 1253	G40778GS
84"W	G3084G	T, L	\$ 1235	\$ 1297	\$ 1359	G40781GS

E All Gallery models are available in the **Everyday Advantage®** program, see page 5 for details.

<p>How to specify — Select the Model Number from above.</p>	<p>1st Option: FSC: F FSC Wood X Non-FSC Wood</p>	<p>2nd Option: Laminate: See inside front cover for finishes.</p>	<p>3rd Option: Edge: See inside front cover for finishes.</p>	<p>4th Option: Grain: VLG Horizontal grain or Solid only. VST Vertical Grain (available only for single panels 60"W or less.</p>	<p>5th Option: Glide:</p>
<p>G 3 0 .</p>	<p> .</p>	<p> .</p>	<p> .</p>	<p>V .</p>	<p>G </p>

Example: G3033G.X.LT11.TI.VLG.G

Gallery Panels

Further 35"H Application for Use with Glass

For Gallery Panel Glass see page 59.
For Gallery Panel connectors see page 50.

GSA PENDING

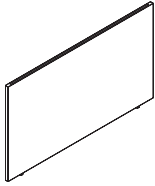

Description	Model	Configuration	List Price			Accepts Glass Models
			L1	L2	L3	7½"H
35"H Gallery Panels with Glass						
33"W	G3533G	L	\$ 670	\$ 704	\$ 737	G40730GS
36"W	G3536G	L	\$ 701	\$ 737	\$ 772	G40733GS
39"W	G3539G	L	\$ 739	\$ 776	\$ 813	G40736GS
42"W	G3542G	L	\$ 765	\$ 804	\$ 842	G40739GS
45"W	G3545G	L	\$ 803	\$ 844	\$ 884	G40742GS
48"W	G3548G	T, L	\$ 830	\$ 872	\$ 913	G40745GS
51"W	G3551G	T, L	\$ 853	\$ 896	\$ 939	G40748GS
54"W	G3554G	T, L	\$ 880	\$ 924	\$ 968	G40751GS
57"W	G3557G	T, L	\$ 903	\$ 949	\$ 994	G40754GS
60"W	G3560G	T, L	\$ 935	\$ 982	\$ 1029	G40757GS
63"W	G3563G	T, L	\$ 952	\$ 1000	\$ 1048	G40760GS
66"W	G3566G	T, L	\$ 975	\$ 1024	\$ 1073	G40763GS
69"W	G3569G	T, L	\$ 1010	\$ 1061	\$ 1111	G40766GS
72"W	G3572G	T, L	\$ 1048	\$ 1101	\$ 1153	G40769GS
75"W	G3575G	T, L	\$ 1118	\$ 1174	\$ 1230	G40772GS
78"W	G3578G	T, L	\$ 1168	\$ 1227	\$ 1285	G40775GS
81"W	G3581G	T, L	\$ 1250	\$ 1313	\$ 1375	G40778GS
84"W	G3584G	T, L	\$ 1353	\$ 1421	\$ 1489	G40781GS

E All Gallery models are available in the Everyday Advantage® program, see page 5 for details.

<p>How to specify — Select the Model Number from above.</p> <p>G 3 5 . .</p>	<p>1st Option: FSC: F FSC Wood X Non-FSC Wood</p>	<p>2nd Option: Laminate: See inside front cover for finishes.</p>	<p>3rd Option: Edge: See inside front cover for finishes.</p>	<p>4th Option: Grain: VLG Horizontal grain or Solid only. VST Vertical Grain (available only for single panels 60"W or less).</p>	<p>5th Option: Glide:</p> <p>G .</p>
---	---	---	---	---	--

Example: G3533G.X.LT11.TI.VLG.G

Gallery Panels

Further 42"H Application for Use with Glass

For Gallery Panel Glass see page 59.
For Gallery Panel connectors see page 50.

GSA PENDING

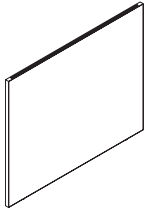

Description	Model	Configuration	List Price			Accepts Glass Models
			L1	L2	L3	7½"H
42"H Gallery Panels with Glass						
33"W	G4233G	L	\$ 720	\$ 756	\$ 792	G40730GS
36"W	G4236G	L	\$ 754	\$ 792	\$ 829	G40733GS
39"W	G4239G	L	\$ 796	\$ 836	\$ 876	G40736GS
42"W	G4242G	L	\$ 824	\$ 865	\$ 906	G40739GS
45"W	G4245G	L	\$ 848	\$ 890	\$ 933	G40742GS
48"W	G4248G	T,L	\$ 876	\$ 920	\$ 964	G40745GS
51"W	G4251G	T,L	\$ 922	\$ 968	\$ 1014	G40748GS
54"W	G4254G	T,L	\$ 945	\$ 992	\$ 1040	G40751GS
57"W	G4257G	T,L	\$ 966	\$ 1014	\$ 1063	G40754GS
60"W	G4260G	T,L	\$ 995	\$ 1045	\$ 1095	G40757GS
63"W	G4263G	T,L	\$ 1018	\$ 1069	\$ 1120	G40760GS
66"W	G4266G	T,L	\$ 1046	\$ 1098	\$ 1151	G40763GS
69"W	G4269G	T,L	\$ 1064	\$ 1117	\$ 1170	G40766GS
72"W	G4272G	T,L	\$ 1116	\$ 1172	\$ 1228	G40769GS
75"W	G4275G	T,L	\$ 1150	\$ 1208	\$ 1265	G40772GS
78"W	G4278G	T,L	\$ 1212	\$ 1273	\$ 1333	G40775GS
81"W	G4281G	T,L	\$ 1336	\$ 1403	\$ 1470	G40778GS
84"W	G4284G	T,L	\$ 1427	\$ 1498	\$ 1570	G40781GS

E All Gallery models are available in the **Everyday Advantage®** program, see page 5 for details.

<p>How to specify — Select the Model Number from above.</p>	<p>1st Option: FSC: F FSC Wood X Non-FSC Wood</p>	<p>2nd Option: Laminate: See inside front cover for finishes.</p>	<p>3rd Option: Edge: See inside front cover for finishes.</p>	<p>4th Option: Grain: VLG Horizontal grain or Solid only. VST Vertical Grain (available only for single panels 60"W or less.</p>	<p>5th Option: Glide:</p>
<p>G 4 2 .</p>	<p> .</p>	<p> .</p>	<p> .</p>	<p>V .</p>	<p>G </p>

Example: G4233G.X.LT11.TI.VLG.G

Gallery Panel Connectors

Further Connector Kits

GSA PENDING

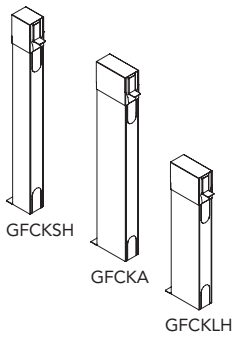

Description	Model	List Price		
		P1	P2	P3
Further Benching Connector Kit				
Further Tethered Standard Height Connector	GFCKSH	\$ 323	\$ 355	\$ 404
Further Adaptive and Freestanding Standard Height Connector	GFCKA	\$ 318	\$ 350	\$ 398
Further Low Height Connector (Freestanding)	GFCKLH	\$ 364	\$ 400	\$ 455

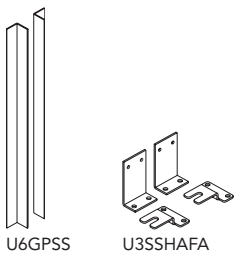

Single-Sided Adaptive Kits				
For Adaptive Gallery Panel in Single Sided Applications	U6GPSS	\$ 100	\$ 111	\$ 125
For Single Sided applications without Gallery Panels	U3SSHAFA	\$ 46	\$ 52	\$ 58

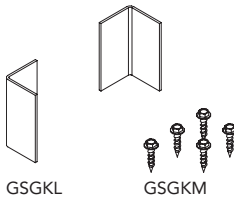

Storage Mounting Brackets				
Gallery Laminate Storage Ganging Kit	GSGKL	\$ 50	N/A	N/A
Gallery Metal Storage Ganging Kit	GSGKM	\$ 11	N/A	N/A

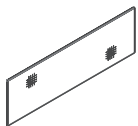

Description	Model	List Price					
		Grade A	Grade B	Grade C	Grade D	Grade E	Grade F
Tackable Cantilever Storage Accessory							
Cantilever Unit for use with 50"H Single Sided	ZS425F S	\$ 292	\$ 318	\$ 344	\$ 386	\$ 429	\$ 472
Cantilever Unit	ZS505F	\$ 347	\$ 387	\$ 426	\$ 492	\$ 558	\$ 624

E All Gallery models are available in the **Everyday Advantage®** program, see page 5 for details.

S Shippable by small-package carrier.

<p>How to specify — Select the Model Number from above.</p>	<p><i>1st Option:</i> Paint for Connector Kits and Brackets (if available): P1 P2 P3 See inside front cover for finishes.</p>	<p><i>1st Option:</i> Fabric for Cantilevered Storage Accessory: See inside back cover for fabrics.</p>	<p><i>2nd Option:</i> Trim Paint for Cantilevered Storage Accessory: P1 P2 P3 See inside front cover for finishes.</p>
<p>_____ .</p>	<p>_____</p>	<p>_____ .</p>	<p>P _____</p>

Examples: GZCKP.P71 GCKPM.P71 GZ3CON30.P71 GSGKL GSGKM ZS505F.EXG903.P27

Gallery Panels

Stride Benching 30"H Application

For Stride Gallery Benching connectors see page 58.

GSA PENDING

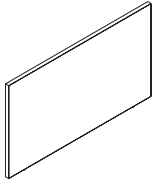

Description	Model	Configuration	List Price		
			L1	L2	L3
30"H Gallery Panels					
33"W	G3033	L	\$ 430	\$ 452	\$ 473
36"W	G3036	L	\$ 452	\$ 475	\$ 497
39"W	G3039	L	\$ 490	\$ 515	\$ 539
42"W	G3042	L	\$ 529	\$ 555	\$ 582
45"W	G3045	L	\$ 578	\$ 607	\$ 636
48"W	G3048	T, L	\$ 605	\$ 635	\$ 666
51"W	G3051	T, L	\$ 616	\$ 647	\$ 678
54"W	G3054	T, L	\$ 646	\$ 678	\$ 711
57"W	G3057	T, L	\$ 673	\$ 707	\$ 740
60"W	G3060	T, L	\$ 707	\$ 742	\$ 778
63"W	G3063	T, L	\$ 718	\$ 754	\$ 790
66"W	G3066	T, L	\$ 733	\$ 770	\$ 806
69"W	G3069	T, L	\$ 786	\$ 825	\$ 865
72"W	G3072	T, L	\$ 809	\$ 849	\$ 890
75"W	G3075	T, L	\$ 917	\$ 963	\$ 1009
78"W	G3078	T, L	\$ 953	\$ 1001	\$ 1048
81"W	G3081	T, L	\$ 986	\$ 1035	\$ 1085
84"W	G3084	T, L	\$ 1082	\$ 1136	\$ 1190

E All Gallery models are available in the **Everyday Advantage®** program, see page 5 for details.

<p>How to specify — Select the Model Number from above.</p>	<p>1st Option: FSC: F FSC Wood X Non-FSC Wood</p>	<p>2nd Option: Laminate: See inside front cover for finishes.</p>	<p>3rd Option: Edge: See inside front cover for finishes.</p>	<p>4th Option: Grain: VLG Horizontal grain or Solid only. VST Vertical Grain (available only for single panels 60"W or less.</p>	<p>5th Option: Glide:</p>
<p>G 3 0 . .</p>				<p>V .</p>	<p>G </p>

Example: G3033.X.LT11.TI.VLG.G

Gallery Panels

Stride Benching 35"H Application

For Stride Gallery Benching connectors see page 58.

GSA PENDING

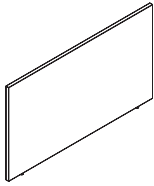

Description	Model	Configuration	List Price		
			L1	L2	L3
35"H Gallery Panels					
33"W	G3533	L	\$ 517	\$ 543	\$ 569
36"W	G3536	L	\$ 548	\$ 576	\$ 603
39"W	G3539	L	\$ 586	\$ 616	\$ 645
42"W	G3542	L	\$ 612	\$ 643	\$ 674
45"W	G3545	L	\$ 650	\$ 683	\$ 715
48"W	G3548	T, L	\$ 677	\$ 711	\$ 745
51"W	G3551	T, L	\$ 700	\$ 735	\$ 770
54"W	G3554	T, L	\$ 725	\$ 762	\$ 798
57"W	G3557	T, L	\$ 755	\$ 793	\$ 831
60"W	G3560	T, L	\$ 780	\$ 819	\$ 858
63"W	G3563	T, L	\$ 797	\$ 837	\$ 877
66"W	G3566	T, L	\$ 820	\$ 861	\$ 902
69"W	G3569	T, L	\$ 860	\$ 903	\$ 946
72"W	G3572	T, L	\$ 900	\$ 945	\$ 990
75"W	G3575	T, L	\$ 970	\$ 1019	\$ 1067
78"W	G3578	T, L	\$ 1020	\$ 1071	\$ 1122
81"W	G3581	T, L	\$ 1097	\$ 1152	\$ 1207
84"W	G3584	T, L	\$ 1200	\$ 1260	\$ 1320

E All Gallery models are available in the **Everyday Advantage®** program, see page 5 for details.

<p>How to specify — Select the Model Number from above.</p>	<p>1st Option: FSC: F FSC Wood X Non-FSC Wood</p>	<p>2nd Option: Laminate: See inside front cover for finishes.</p>	<p>3rd Option: Edge: See inside front cover for finishes.</p>	<p>4th Option: Grain: VLG Horizontal grain or Solid only. VST Vertical Grain (available only for single panels 60"W or less.</p>	<p>5th Option: Glide:</p>
<p>G 3 5 . .</p>		<p> .</p>	<p> .</p>	<p>V .</p>	<p>G </p>

Example: G3533.X.LT11.TI.VLG.G

Gallery Panels

Stride Benching 42"H Application

For Stride Gallery Benching connectors see page 58.

GSA PENDING

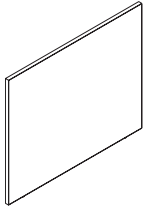

Description	Model	Configuration	List Price		
			L1	L2	L3
42"H Gallery Panels					
33"W	G4233	L	\$ 567	\$ 595	\$ 624
36"W	G4236	L	\$ 601	\$ 631	\$ 661
39"W	G4239	L	\$ 643	\$ 675	\$ 707
42"W	G4242	L	\$ 671	\$ 705	\$ 738
45"W	G4245	L	\$ 695	\$ 730	\$ 765
48"W	G4248	T, L	\$ 723	\$ 759	\$ 795
51"W	G4251	T, L	\$ 769	\$ 807	\$ 846
54"W	G4254	T, L	\$ 792	\$ 832	\$ 871
57"W	G4257	T, L	\$ 813	\$ 854	\$ 894
60"W	G4260	T, L	\$ 842	\$ 884	\$ 926
63"W	G4263	T, L	\$ 865	\$ 908	\$ 952
66"W	G4266	T, L	\$ 893	\$ 938	\$ 982
69"W	G4269	T, L,	\$ 911	\$ 957	\$ 1002
72"W	G4272	T, L	\$ 963	\$ 1011	\$ 1059
75"W	G4275	T, L	\$ 997	\$ 1047	\$ 1097
78"W	G4278	T, L	\$ 1059	\$ 1112	\$ 1165
81"W	G4281	T, L	\$ 1183	\$ 1242	\$ 1301
84"W	G4284	T, L	\$ 1274	\$ 1338	\$ 1401

E All Gallery models are available in the **Everyday Advantage®** program, see page 5 for details.

<p>How to specify — Select the Model Number from above.</p>	<p>1st Option: FSC: F FSC Wood X Non-FSC Wood</p>	<p>2nd Option: Laminate: See inside front cover for finishes.</p>	<p>3rd Option: Edge: See inside front cover for finishes.</p>	<p>4th Option: Grain: VLG Horizontal grain or Solid only. VST Vertical Grain (available only for single panels 60"W or less.</p>	<p>5th Option: Glide:</p>
<p>G 4 2 . .</p>				<p>V .</p>	<p>G </p>

Example: G4233.X.LT11.TI.VLG.G

Gallery Panels

Stride Benching 50"H Application

For Stride Gallery Benching connectors see page 58.

GSA PENDING

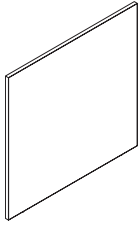

Description	Model	Configuration	List Price		
			L1	L2	L3
50"H Gallery Panels					
33"W	G5033	L	\$ 628	\$ 659	\$ 691
36"W	G5036	L	\$ 661	\$ 694	\$ 727
39"W	G5039	L	\$ 701	\$ 736	\$ 771
42"W	G5042	L	\$ 739	\$ 776	\$ 813
45"W	G5045	L	\$ 792	\$ 832	\$ 871
48"W	G5048	T, L	\$ 813	\$ 854	\$ 894
51"W	G5051	T, L	\$ 834	\$ 876	\$ 917
54"W	G5054	T, L	\$ 869	\$ 912	\$ 956
57"W	G5057	T, L	\$ 891	\$ 936	\$ 980
60"W	G5060	T, L	\$ 918	\$ 964	\$ 1010
63"W	G5063	T, L	\$ 937	\$ 984	\$ 1031
66"W	G5066	T, L	\$ 964	\$ 1012	\$ 1060
69"W	G5069	T, L	\$ 991	\$ 1041	\$ 1090
72"W	G5072	T, L	\$ 1019	\$ 1070	\$ 1121
75"W	G5075	T, L	\$ 1086	\$ 1140	\$ 1195
78"W	G5078	T, L	\$ 1193	\$ 1253	\$ 1312
81"W	G5081	T, L	\$ 1295	\$ 1360	\$ 1425
84"W	G5084	T, L	\$ 1384	\$ 1453	\$ 1522

E All Gallery models are available in the **Everyday Advantage®** program, see page 5 for details.

<p>How to specify — Select the Model Number from above.</p>	<p>1st Option: FSC: F FSC Wood X Non-FSC Wood</p>	<p>2nd Option: Laminate: See inside front cover for finishes.</p>	<p>3rd Option: Edge: See inside front cover for finishes.</p>	<p>4th Option: Grain: VLG Horizontal grain or Solid only. VST Vertical Grain (available only for single panels 60"W or less.</p>	<p>5th Option: Glide:</p>
<p>G 5 0 . .</p>		<p> .</p>	<p> .</p>	<p>V .</p>	<p>G </p>

Example: G5033.X.LT11.TI.VLG.G

Gallery Panels

Stride Benching 30"H Application for Use with Glass

For Gallery Panel Glass see page 59.

For Stride Gallery Benching connectors see page 58.

GSA PENDING

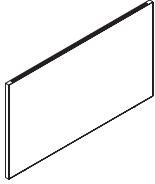

Description	Model	Configuration	List Price			Accepts Glass Models 7½"H
			L1	L2	L3	
30"H Gallery Panels with Glass						
33"W	G3033G	L	\$ 583	\$ 612	\$ 641	G40730GS
36"W	G3036G	L	\$ 605	\$ 635	\$ 666	G40733GS
39"W	G3039G	L	\$ 643	\$ 675	\$ 707	G40736GS
42"W	G3042G	L	\$ 682	\$ 716	\$ 750	G40739GS
45"W	G3045G	L	\$ 731	\$ 768	\$ 804	G40742GS
48"W	G3048G	T, L	\$ 758	\$ 796	\$ 834	G40745GS
51"W	G3051G	T, L	\$ 769	\$ 807	\$ 846	G40748GS
54"W	G3054G	T, L	\$ 799	\$ 839	\$ 879	G40751GS
57"W	G3057G	T, L	\$ 826	\$ 867	\$ 909	G40754GS
60"W	G3060G	T, L	\$ 860	\$ 903	\$ 946	G40757GS
63"W	G3063G	T, L	\$ 871	\$ 915	\$ 958	G40760GS
66"W	G3066G	T, L	\$ 886	\$ 930	\$ 975	G40763GS
69"W	G3069G	T, L	\$ 939	\$ 986	\$ 1033	G40766GS
72"W	G3072G	T, L	\$ 962	\$ 1010	\$ 1058	G40769GS
75"W	G3075G	T, L	\$ 1070	\$ 1124	\$ 1177	G40772GS
78"W	G3078G	T, L	\$ 1106	\$ 1161	\$ 1217	G40775GS
81"W	G3081G	T, L	\$ 1139	\$ 1196	\$ 1253	G40778GS
84"W	G3084G	T, L	\$ 1235	\$ 1297	\$ 1359	G40781GS

E All Gallery models are available in the **Everyday Advantage®** program, see page 5 for details.

How to specify — Select the Model Number from above.	1st Option: FSC: F FSC Wood X Non-FSC Wood	2nd Option: Laminate: See inside front cover for finishes.	3rd Option: Edge: See inside front cover for finishes.	4th Option: Grain: VLG Horizontal grain or Solid only. VST Vertical Grain (available only for single panels 60"W or less.	5th Option: Glide:
G 3 0 	V .	G

Example: G3033G.X.LT11.TI.VLG.G

Gallery Panels

Stride Benching 35"H Application for Use with Glass

For Gallery Panel Glass see page 59.

For Stride Gallery Benching connectors see page 58.

GSA PENDING

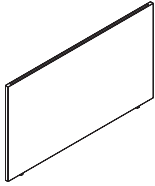

Description	Model	Configuration	List Price			Accepts Glass Models
			L1	L2	L3	7½"H
35"H Gallery Panels with Glass						
33"W	G3533G	L	\$ 670	\$ 704	\$ 737	G40730GS
36"W	G3536G	L	\$ 701	\$ 737	\$ 772	G40733GS
39"W	G3539G	L	\$ 739	\$ 776	\$ 813	G40736GS
42"W	G3542G	L	\$ 765	\$ 804	\$ 842	G40739GS
45"W	G3545G	L	\$ 803	\$ 844	\$ 884	G40742GS
48"W	G3548G	T, L	\$ 830	\$ 872	\$ 913	G40745GS
51"W	G3551G	T, L	\$ 853	\$ 896	\$ 939	G40748GS
54"W	G3554G	T, L	\$ 880	\$ 924	\$ 968	G40751GS
57"W	G3557G	T, L	\$ 903	\$ 949	\$ 994	G40754GS
60"W	G3560G	T, L	\$ 935	\$ 982	\$ 1029	G40757GS
63"W	G3563G	T, L	\$ 952	\$ 1000	\$ 1048	G40760GS
66"W	G3566G	T, L	\$ 975	\$ 1024	\$ 1073	G40763GS
69"W	G3569G	T, L	\$ 1010	\$ 1061	\$ 1111	G40766GS
72"W	G3572G	T, L	\$ 1048	\$ 1101	\$ 1153	G40769GS
75"W	G3575G	T, L	\$ 1118	\$ 1174	\$ 1230	G40772GS
78"W	G3578G	T, L	\$ 1168	\$ 1227	\$ 1285	G40775GS
81"W	G3581G	T, L	\$ 1250	\$ 1313	\$ 1375	G40778GS
84"W	G3584G	T, L	\$ 1353	\$ 1421	\$ 1489	G40781GS

E All Gallery models are available in the **Everyday Advantage®** program, see page 5 for details.

<p>How to specify — Select the Model Number from above.</p>	<p>1st Option: FSC: F FSC Wood X Non-FSC Wood</p>	<p>2nd Option: Laminate: See inside front cover for finishes.</p>	<p>3rd Option: Edge: See inside front cover for finishes.</p>	<p>4th Option: Grain: VLG Horizontal grain or Solid only. VST Vertical Grain (available only for single panels 60"W or less).</p>	<p>5th Option: Glide:</p>
<p>G 3 5 . .</p>		<p> .</p>	<p> .</p>	<p>V .</p>	<p>G </p>

Example: G3533G.X.LT11.TI.VLG.G

Gallery Panels

Stride Benching 42"H Application for Use with Glass

For Gallery Panel Glass see page 59.

For Stride Gallery Benching connectors see page 58.

GSA PENDING

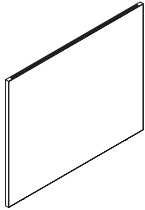

Description	Model	Configuration	List Price			Accepts Glass Models
			L1	L2	L3	7½"H
42"H Gallery Panels with Glass						
33"W	G4233G	L	\$ 720	\$ 756	\$ 792	G40730GS
36"W	G4236G	L	\$ 754	\$ 792	\$ 829	G40733GS
39"W	G4239G	L	\$ 796	\$ 836	\$ 876	G40736GS
42"W	G4242G	L	\$ 824	\$ 865	\$ 906	G40739GS
45"W	G4245G	L	\$ 848	\$ 890	\$ 933	G40742GS
48"W	G4248G	T, L	\$ 876	\$ 920	\$ 964	G40745GS
51"W	G4251G	T, L	\$ 922	\$ 968	\$ 1014	G40748GS
54"W	G4254G	T, L	\$ 945	\$ 992	\$ 1040	G40751GS
57"W	G4257G	T, L	\$ 966	\$ 1014	\$ 1063	G40754GS
60"W	G4260G	T, L	\$ 995	\$ 1045	\$ 1095	G40757GS
63"W	G4263G	T, L	\$ 1018	\$ 1069	\$ 1120	G40760GS
66"W	G4266G	T, L	\$ 1046	\$ 1098	\$ 1151	G40763GS
69"W	G4269G	T, L	\$ 1064	\$ 1117	\$ 1170	G40766GS
72"W	G4272G	T, L	\$ 1116	\$ 1172	\$ 1228	G40769GS
75"W	G4275G	T, L	\$ 1150	\$ 1208	\$ 1265	G40772GS
78"W	G4278G	T, L	\$ 1212	\$ 1273	\$ 1333	G40775GS
81"W	G4281G	T, L	\$ 1336	\$ 1403	\$ 1470	G40778GS
84"W	G4284G	T, L	\$ 1427	\$ 1498	\$ 1570	G40781GS

E All Gallery models are available in the **Everyday Advantage®** program, see page 5 for details.

<p>How to specify — Select the Model Number from above.</p>	<p>1st Option: FSC: F FSC Wood X Non-FSC Wood</p>	<p>2nd Option: Laminate: See inside front cover for finishes.</p>	<p>3rd Option: Edge: See inside front cover for finishes.</p>	<p>4th Option: Grain: VLG Horizontal grain or Solid only. VST Vertical Grain (available only for single panels 60"W or less.</p>	<p>5th Option: Glide:</p>
<p>G 4 2 . .</p>				<p>V .</p>	<p>G </p>

Example: G4233G.X.LT11.TI.VLG.G

Gallery Panel Connectors

Stride Benching Connector Kits

GSA PENDING

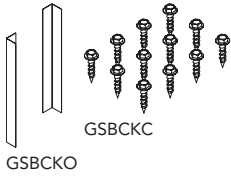

Description	Model	List Price		
		P1	P2	P3
Stride Benching Connectors				
Gallery End Connector for Stride Bench Open Leg	GSBCKO	\$ 103	\$ 113	\$ 129
Gallery Kit for Stride Bench Closed Leg	GSBCKC	\$ 11	N/A	N/A

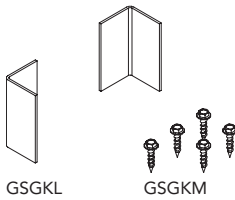

Description	Model	List Price		
		P1	P2	P3
Storage Mounting Brackets				
Gallery Laminate Storage Ganging Kit	GSGKL	\$ 50	N/A	N/A
Gallery Metal Storage Ganging Kit	GSGKM	\$ 11	N/A	N/A

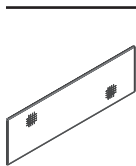

Description	Model	List Price					
		Grade A	Grade B	Grade C	Grade D	Grade E	Grade F
Tackable Cantilever Storage Accessory							
Cantilever Unit for use with 50"H Single Sided	ZS425F S	\$ 292	\$ 318	\$ 344	\$ 386	\$ 429	\$ 472
Cantilever Unit	ZS50SF	\$ 347	\$ 387	\$ 426	\$ 492	\$ 558	\$ 624

E All Gallery models are available in the **Everyday Advantage®** program, see page 5 for details.

S **Shippable by small-package carrier.**

<p><i>How to specify —</i> Select the Model Number from above.</p>	<p><i>1st Option:</i> Paint for Connector Kits and Brackets (if available): P1 P2 P3 See inside front cover for finishes.</p>	<p><i>1st Option:</i> Fabric for Cantilevered Storage Accessory: See inside back cover for fabrics.</p>	<p><i>2nd Option:</i> Trim Paint for Cantilevered Storage Accessory: P1 P2 P3 See inside front cover for finishes.</p>
<div style="display: flex; justify-content: space-between;"> </div>	<div style="display: flex; justify-content: space-between;"> </div>	<div style="display: flex; justify-content: space-between;"> </div>	<div style="display: flex; justify-content: space-between;"> P </div>

Examples: GZCKP.P71 GCKPM.P71 GZ3CON30.P71 GSGKL GSGKM ZS50SF.EXG903.P27

Gallery Glass

Panel Systems Gallery Glass

GSA PENDING

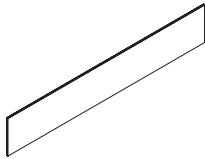

Description	Model	List Price		
		Clear Glass	Frosted Glass	Smoked Glass
7½"H Gallery Glass — Single Panel				
15"W	G40715GS	\$ 122	\$ 140	\$ 146
18"W	G40718GS	\$ 125	\$ 144	\$ 150
21"W	G40721GS	\$ 128	\$ 147	\$ 154
24"W	G40724GS	\$ 131	\$ 151	\$ 157
27"W	G40727GS	\$ 141	\$ 162	\$ 169
30"W	G40730GS	\$ 152	\$ 175	\$ 182
33"W	G40733GS	\$ 166	\$ 191	\$ 199
36"W	G40736GS	\$ 187	\$ 215	\$ 224
39"W	G40739GS	\$ 203	\$ 233	\$ 244
42"W	G40742GS	\$ 226	\$ 260	\$ 271
45"W	G40745GS	\$ 246	\$ 283	\$ 295
48"W	G40748GS	\$ 267	\$ 307	\$ 320
51"W	G40751GS	\$ 273	\$ 314	\$ 328
54"W	G40754GS	\$ 295	\$ 339	\$ 354
57"W	G40757GS	\$ 327	\$ 376	\$ 392
60"W	G40760GS	\$ 383	\$ 440	\$ 460
63"W	G40763GS	\$ 445	\$ 512	\$ 534
66"W	G40766GS	\$ 481	\$ 553	\$ 577
69"W	G40769GS	\$ 527	\$ 606	\$ 632
72"W	G40772GS	\$ 564	\$ 649	\$ 677
75"W	G40775GS	\$ 603	\$ 693	\$ 724
78"W	G40778GS	\$ 663	\$ 762	\$ 796
81"W	G40781GS	\$ 697	\$ 802	\$ 836

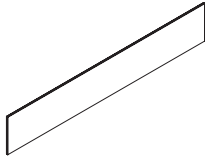

7½"H Gallery Glass — Split Panels (order quantity must be in multiples of 2)				
39"W	G40739GS	\$ 406	\$ 467	\$ 487
42"W	G40742GS	\$ 452	\$ 520	\$ 542
45"W	G40745GS	\$ 492	\$ 566	\$ 590
48"W	G40748GS	\$ 534	\$ 614	\$ 641
51"W	G40751GS	\$ 546	\$ 628	\$ 655
54"W	G40754GS	\$ 590	\$ 679	\$ 708
57"W	G40757GS	\$ 654	\$ 752	\$ 785
60"W	G40760GS	\$ 766	\$ 881	\$ 919
63"W	G40763GS	\$ 890	\$ 1024	\$ 1068
66"W	G40766GS	\$ 962	\$ 1106	\$ 1154
69"W	G40769GS	\$ 1054	\$ 1212	\$ 1265

E All Further models are available in the **Everyday Advantage®** program, see page 5 for details.

<p>How to specify — Select the Model Number from above.</p>	<p><i>1st Option:</i> Glass: LC Clear Glass LF Frosted Glass GSM1 Smoked Glass (Available for order September 2019)</p>
<p>G 4 0 7 .</p>	<p> .</p>

Examples: G40715GS.LC G40739GS.GSM1

Showrooms

Atlanta
Boston
Chicago
Dallas
Los Angeles
New York
San Francisco
Washington, DC

Allsteel®

Allsteel Inc.
Muscatine, Iowa 52761

allsteeloffice.com

Form # A8605.A6 (1/20)

©2020 Allsteel Inc.
All registered trademarks and trademarks
are the property of Allsteel Inc.



Base Style: Dimension Location:	A6-T Base				A6-C Base			
	E1	W1	W2	E2	E1	W1	W2	E2
Altitude Top: (Surface dimensions are nominal. Actual widths are reduced by 2")	Edge of table to outside of leg	Between legs	Between legs	Edge of table to the outside of leg	Edge of table to outside of leg	Between legs	Between legs	Edge of table to the outside of leg
24" x 48" Rectangle*	2½"	35¼"	—	10⅝"	2½"	35¼"	—	14⅞"
24" x 54" Rectangle	2½"	41¼"	—	10⅝"	2½"	41¼"	—	14⅞"
24" x 60" Rectangle	2½"	47¼"	—	10⅝"	2½"	47¼"	—	14⅞"
24" x 66" Rectangle	2½"	53¼"	—	10⅝"	2½"	53¼"	—	14⅞"
24" x 72" Rectangle	2½"	59¼"	—	10⅝"	2½"	59¼"	—	14⅞"
30" x 48" Rectangle	2½"	35¼"	—	13⅝"	2½"	35¼"	—	17⅞"
30" x 54" Rectangle	2½"	41¼"	—	13⅝"	2½"	41¼"	—	17⅞"
30" x 60" Rectangle	2½"	47¼"	—	13⅝"	2½"	47¼"	—	17⅞"
30" x 66" Rectangle	2½"	53¼"	—	13⅝"	2½"	53¼"	—	17⅞"
30" x 72" Rectangle	2½"	59¼"	—	13⅝"	2½"	59¼"	—	17⅞"
60" x 36" Corner Cove	2½"	43"	26"	10⅝"	2½"	43"	29½"	14⅞"
60" x 48" Corner Cove	2½"	43"	32"	10⅝"	2½"	43"	35½"	14⅞"
72" x 36" Corner Cove	2½"	55"	26"	10⅝"	2½"	55"	29½"	14⅞"
72" x 48" Corner Cove	2½"	55"	32"	10⅝"	2½"	55"	35½"	14⅞"

Bottom Views

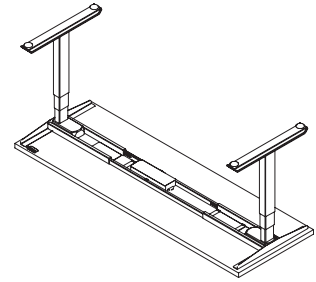

A6-T Base

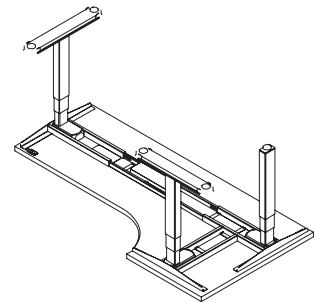

A6-C Base

Feature	A6	A8	A3	A5
Range Adjustment	2-Stage 27¼" - 47⅞" 3-Stage 22¼" - 48½"	27¼" - 47⅞"	• 22¼" - 48½" for Extended Travel • 27¼" - 47⅞" for Standard Travel	27¼" - 47⅞"
Foot Configuration	• T Foot or C Foot • Standard leveling glide. Casters available as a special • Foot Control	• C Foot • Standard options include leveling glide, slide glides, and casters	• T Foot • Standard leveling glide. Casters available as a special • Foot Control	• C Foot • Standard leveling glide. Casters available as a special
Leg Options	2 and 3 leg	2 leg	2 and 3 leg	2 and 3 leg
Weight Rating	• 250 lbs for 2 leg • 375 lbs for 3 leg • 350 lbs for Max models	300 lbs	• 250 lbs for 2 leg • 375 lbs for 3 leg	• 300 lbs for 2 leg • 450 lbs for 3 leg
Cross Bar Design	Yes	No, however wire management Utility bay is standard	Yes	No
Colors	Black, Nickel, White	Black, Designer White, Silver	Black, Nickel, White	Black, Designer White, Silver
Control Pad	Basic up/down, memory preset, paddle, rotating, foot pedal	• Up/Down user intuitive paddle standard • 4 programmable position paddle with Bluetooth, LED readout, Autodrive, and Reminder feature optional	4 programmable position memory keypad with LED readout standard	• Up/Down user intuitive paddle standard • 4 programmable position paddle with Bluetooth, LED readout, Autodrive, and Reminder feature optional
Wire Management	Allsteel standard options available Hinged trough not recommended	Unique Utility Bay is integrated with the height adjustable table to provide a clean aesthetic and ample wire management capabilities	Allsteel standard options available Hinged trough not recommended	Allsteel standard options available
Power Access	Desktop power modules available	Concealed power module sits within the Utility Bay and provides access to ample power outlets and USB chargers at the users fingertips.	Desktop power modules available	Desktop power modules available
Warranty	10 years metal base, 7 years electronic base	7 Years	10 years metal base, 7 years electronic base	7 Years

Height-Adjustable Worksurfaces, Bases, and Controls

Height-Adjustable Worksurfaces (page 27)

- Height-adjustable worksurfaces are available in laminate with flat edge and rectangular veneer with matching square edge.
- T-mold is used on the edge of curved worksurfaces. This will have a noticeable visual difference when directly adjacent to straight worksurfaces.
- Worksurface dimensions are nominal. Actual widths are reduced by 2" (1" each side) and worksurface depths are reduced by ¼". Corner cove depth is nominal, actual is 1" less.
- Altitude worksurfaces are pre-drilled with mounting location for bases.
- Rectangular worksurface grommet location is limited to center location due to mounting of worksurface supports at each end of the worksurface.
- A6 Load capacity is 250 lbs for 2-leg models, 375 lbs for 3-leg models, and 350 lbs for Max models. This includes weight of worksurface.

Height-Adjustable Bases (page 7-8)

- Electronic height-adjustable base units are available in six styles: A6-T Base with 2 legs, A6-C Base with 2 legs, A6-T Base with 3 legs, A6-C Base with 3 legs, A6-T Max Base with 2 legs, and A6-C Max Base with 2 legs.
- A5 models travel at 1.5" per second, A6 2-stage 1.2"/sec, A6 3-stage 1.4"/sec, A6 Max .8"/sec. Motor devices have a continuous cycle time of 2 minutes with an 18 minute rest period before it can be cycled again.
- Control box is powered by 110-120V/60Hz/4A. Standby power is < 0.1 Watts. Power cords on A6-T models are 10'.
- Pedestals taller than 24½" for 2-stage models and 19½" for 3-stage models when placed under table will limit range in lowest position.
- Mobile box/file pedestals will clear feet on height adjustable base but will extend past edge of worksurface in that position. See chart on page 5.
- Moving worksurfaces can collide with other components. It is important to ensure free range of motion prior to operating the table.
- All tables have adjustable glides providing ½" adjustment on A6.
- 3-Leg bases can accommodate worksurface configurations from 24"D x 48"W x 48"W to 30"D x 72"W x 72"W and 36"D x 48"W x 48"W to 36"D x 72"W x 72"W.

Memory Controls (page 30)

- Memory Controls are now a .option.
- Up/Down: Basic Up/Down control.
- Memory Control: 4 memory pre-set options allow the user to adjust their height to their preferred heights.
- Paddle: Simple, aesthetic control with 1 memory pre-set option and reminder mode.
- Rotating: 3 memory pre-set options and a rotating, dial-like control.
- Foot Control: Basic up/down wireless, hands free control. Can be paired with hand controls for multi-control option.

Foot Controls

- Available as a .option on A6 and as model.
- Wireless, hands free control.
- Can be paired with hand control for multi-control option.
- Compatible with A6 and A3 tables.
- 2 AAA batteries needed. Batteries not included.

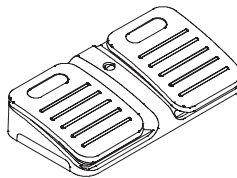

Cross-sectional Area Inside Under Worksurface Troughs

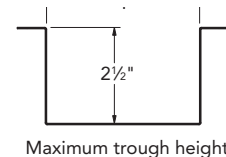
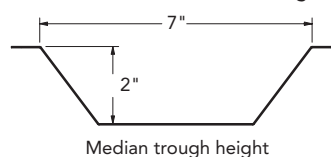
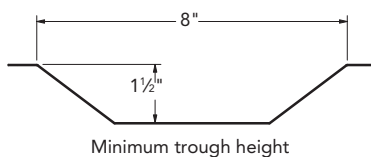

Cable & Wire Management

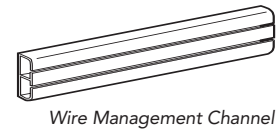
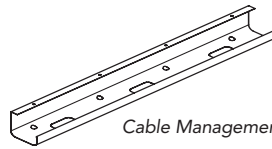

Cable Management Tray (page 28)

- Attaches under the worksurface to contain cables.
- Metal tray shelf is 4" deep. Can hold electrical power strip and/or surge protector.
- 24" and 36" lengths, use multiple units for larger worksurfaces.
- Attachment hardware included, specify paint color.

Wire Management Channel (page 28)

- Self adhesive backing to attach to panels and underside of worksurfaces.
- Flexible strips allow cabling to enter/exit and can be contained inside the 2-cavity profile.
- Each cavity provides space for a maximum of six .22" dia. cables. Total capacity = 1 sq. in.

Cord Management Chain (page 28)

- Works with Approach and Altitude A5 and A3-T units.
- Used to route and conceal power/data cables from control box and other devices. Includes all mounting hardware and a plate to secure to a leveling glide.
- Houses 6 cables @ 0.300" diameter.
- Made of plastic chain with plastic attachment brackets at each end. Only comes in Black finish.

Under Worksurface Trough (page 28)

- Used to conceal wires and control box below worksurfaces. Trough can be configured at various height/width combinations to meet capacity needs — see illustrations below.
- On 48"W and 54"W worksurfaces use one 17"W trough. 54"W has space to use 2 – 17"W, if necessary.
- On 60"W, 66"W, and 72"W worksurfaces use the 36" trough.
- On 84"W worksurface use 2 – 17"W troughs.

Quad Tap (page 28)

- Under surface mounting, used on any worksurface.
- 10' Power cord. UL Listed
- 4 Simplex receptacles.
- May be used in conjunction with hinged trough to reduce the number of cords routed from a worksurface to a beam.

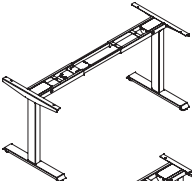
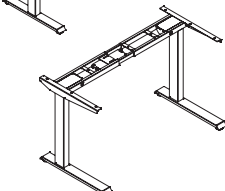
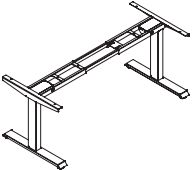
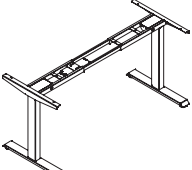
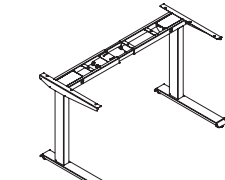
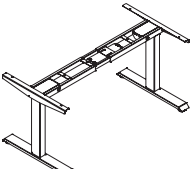
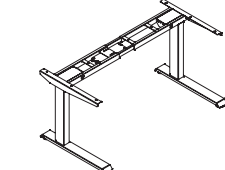
	Description	D	W	H	Model	
	2-Stage 2 Stage, 2 Leg Rectangle T Foot	9.4	10.6	41.7	A6REC2S2LTF	\$ 1535
	*For 24"D-30"D Rectangular Worksurfaces 48"W-72"W					
	2 Stage, 2 Leg Rectangle C Foot	9.4	10.6	41.7	A6REC2S2LCF	\$ 1535
	*For 24"D-30"D Rectangular Worksurfaces 48"W-72"W					
	3-Stage Altitude 2 Leg, 3 Stage for GSA	9.45	10.63	41.72	ABJ3S2L-G	\$ 1795
	*For 24"D-30"D Rectangular Worksurfaces 48"W-72"W *Comes with control box with 4 memory set user heights. **Not an Open Market item.					
	A6 3 Stage, 2 Leg Rectangle T Foot	9.4	10.6	41.7	A6REC3S2LTF	\$ 1721
	*For 24"D-30"D Rectangular Worksurfaces 48"W-72"W					
	A6 3 Stage, 2 Leg Rectangle C Foot	9.4	10.6	41.7	A6REC3S2LCF	\$ 1721
	*For 24"D-30"D Rectangular Worksurfaces 48"W-72"W					
	A6 Max 3 Stage, 2 Leg T Foot	9.4	10.6	41.7	A6MREC3S2LTF	\$ 2389
	*For 24"D-30"D Rectangular Worksurfaces 48"W-96"W *350 LB Max Lift Capacity					
	A6 Max 3 Stage, 2 Leg C Foot	9.4	10.6	41.7	A6MREC3S2LCF	\$ 2389
	*For 24"D-30"D Rectangular Worksurfaces 48"W-96"W *350 LB Max Lift Capacity					

<p>How to specify — Select the Model Number from above.</p> <p>_____ .</p>	<p>1st Option: Select the Base Paint Color (if applicable):</p> <p>P1 P2 P3 P8L Nickel PD8 White P71 Black</p> <p>_____ .</p>	<p>2nd Option: Select Feet Options (if applicable):</p> <p>X Standard Glides</p> <p>_____ .</p>	<p>3rd Option: Select the Keypad (if applicable):</p> <p>UD Basic Up/Down MEM Memory Preset PDL Paddle RTG Rotating (\$125 extra) FPD Foot Control (\$240 extra)</p> <p>_____ .</p>
---	---	--	--

Example: A6RND3S2LCF.P8L.X.PDL

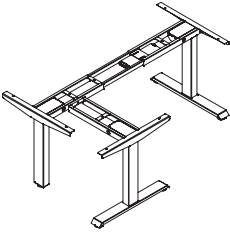
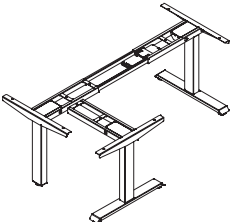
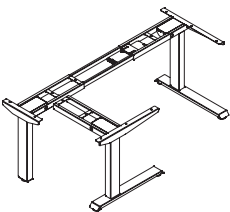
	Description	D	W	H	Model	
	3-Stage Altitude 3 Leg, 3 Stage for GSA	9.45	15.75	41.72	ABJ3S3L-G	\$ 2822
	*For 24"D-30"D Corner Cove Worksurfaces 48"W-84"W or 36"D x 48"W-72"W *Comes with control box with 4 memory set user heights. **Not an Open Market item.					
	A6 3 Stage, 3 Leg Rectangle T Foot	9.45	15.75	41.73	A6REC3S3LTF	\$ 2705
	*For 24"D-30"D Corner Cove Worksurfaces 48"W-84"W or 36"D x 48"W-72"W					
	A6 3 Stage, 3 Leg Rectangle C Foot	9.45	15.75	41.73	A6REC3S3LCF	\$ 2705
	*For 24"D-30"D Corner Cove Worksurfaces 48"W-84"W or 36"D x 48"W-72"W					

<p>How to specify — Select the Model Number from above.</p>	<p><i>1st Option:</i> Select the Base Paint Color (if applicable):</p> <p>P1 P2 P3</p> <p>P8L Nickel PD8 White P71 Black</p>	<p><i>2nd Option:</i> Select Feet Options (if applicable):</p> <p>X Standard Glides</p>	<p><i>3rd Option:</i> Select the Keypad (if applicable):</p> <p>UD Basic Up/Down MEM Memory Preset PDL Paddle RTG Rotating (\$125 extra) FPD Foot Control (\$240 extra)</p>
--	---	---	---

Example: A6RND3S3LCF.P8L.X.PDL

Metal Table Screens

Now Open for Orders
3-4 Week Lead Time



Allsteel universal metal table-mounted screens offer a cleanable, easily retrofitted solution to create boundaries within the workplace. Available in 20"H and 25"H, metal screens offer users a sense of privacy while also providing a magnetic surface for posting notes or an optional marker board finish as a writable surface. Extended lateral screens offer an additional 12" boundary between users.

Description	SPLA Model	List Price
Mtl Table Screen, 20"H x 45½"W (for 48"W)	ASIMTLSCRN2048	\$780
Mtl Table Screen, 20"H x 51½"W (for 54"W)	ASIMTLSCRN2054	\$818
Mtl Table Screen, 20"H x 57½"W (for 60"W)	ASIMTLSCRN2060	\$859
Mtl Table Screen, 20"H x 63½"W (for 66"W)	ASIMTLSCRN2066	\$902
Mtl Table Screen, 25"H x 45½"W (for 48"W)	ASIMTLSCRN2548	\$896
Mtl Table Screen, 25"H x 51½"W (for 54"W)	ASIMTLSCRN2554	\$941
Mtl Table Screen, 25"H x 57½"W (for 60"W)	ASIMTLSCRN2560	\$988
Mtl Lat Screen 20"H x 21"D (for 24"D)	ASIMTLSCRN2024	\$673
Mtl Lat Screen 20"H x 25"D (for 27"-30"D)	ASIMTLSCRN2030	\$707
Mtl Lat Screen 20"H x 34"D (for 36"D)	ASIMTLSCRN2036	\$742
Mtl Lat Screen 25"H x 21"D (for 24"D)	ASIMTLSCRN2524	\$774
Mtl Lat Screen 25"H x 25"D (for 30"D)	ASIMTLSCRN2530	\$813
Mtl Lat Screen 25"H x 34"D (for 36"D)	ASIMTLSCRN2536	\$853
Mtl Extended Screen 20"H x 33¾"D (for 24"D)	ASIMTLEXSCRN2036	\$757
Mtl Extended Screen 20"H x 37¾"D (for 30"D)	ASIMTLEXSCRN2042	\$795
Mtl Extended Screen 25"H x 33¾"D (for 24"D)	ASIMTLEXSCRN2536	\$870
Mtl Extended Screen 25"H x 37"D (for 30"D)	ASIMTLEXSCRN2542	\$914

- Screens are offered as extended lateral (for 24" or 30"D worksurfaces), lateral (for 24", 30", or 36"D surfaces), or table-mounted configurations (for 48" through 66"W worksurfaces).
- Screen depths are undersized to accommodate Further™ or Altitude® worksurface depths but can also be added to panel systems or tables products.
- Brackets attach to the top of the worksurface using an industrial grade adhesive. Installation does not require any drilling or defacing of the worksurface. Screens and brackets may be removed in the future, if desired.
- The front of the bracket has a beveled zinc cap, and the back of the bracket has exposed hardware. Brackets are non-handed so that the front and back can be oriented either direction, based on the application.
- Screens meet or exceed ANSI/BIFMA X5.5-2014 Sections 4.6 and 9.

Offered in 32 standard Allsteel powder-coat paint finishes, including a marker board finish. P2 is \$20 upcharge, P3 is \$40 upcharge, P6 (marker board) is a \$100 upcharge. Bracket will match the finish of the screen.

Now available with Further Everyday Advantage® at 76% off!



Allsteel®

Allsteel Inc.
Muscatine, Iowa 52761
allsteeloffice.com

Acrylic Table Screens

Now Open for Orders
3-4 Week Lead Time



Allsteel universal acrylic table mounted screens offer a cleanable, easily retrofitted solution to create boundaries within the workplace. Available in 20"H and 25"H, acrylic screens offer users protection and personal division within a workspace. Extended lateral screens offer an additional 12" boundary between users.

Description	SPLA Model	List Price
Acry Table Screen, 20"H x 45½"W (for 48"W)	ASIACRYSCRN2048	\$780
Acry Table Screen, 20"H x 51½"W (for 54"W)	ASIACRYSCRN2054	\$818
Acry Table Screen, 20"H x 57½"W (for 60"W)	ASIACRYSCRN2060	\$859
Acry Table Screen, 20"H x 63½"W (for 66"W)	ASIACRYSCRN2066	\$902
Acry Table Screen, 25"H x 45½"W (for 48"W)	ASIACRYSCRN2548	\$896
Acry Table Screen, 25"H x 51½"W (for 54"W)	ASIACRYSCRN2554	\$941
Acry Table Screen, 25"H x 57½"W (for 60"W)	ASIACRYSCRN2560	\$988
Acry Table Screen, 25"H x 63½"W (for 66"W)	ASIACRYSCRN2566	\$1,037
Acry Lat Screen 20"H x 21"D (for 24"D)	ASIACRYSCRN2024	\$673
Acry Lat Screen 20"H x 25"D (for 30"D)	ASIACRYSCRN2030	\$707
Acry Lat Screen 20"H x 34"D (for 36"D)	ASIACRYSCRN2036	\$742
Acry Lat Screen 25"H x 21"D (for 24"D)	ASIACRYSCRN2524	\$774
Acry Lat Screen 25"H x 25"D (for 30"D)	ASIACRYSCRN2530	\$813
Acry Lat Screen 25"H x 34"D (for 36"D)	ASIACRYSCRN2536	\$853
Acry Extended Screen 20"H x 33¾"D (for 24"D)	ASIACRYEXSCRN2036	\$757
Acry Extended Screen 20"H x 33¾"D (for 24"D)	ASIACRYEXSCRN2042	\$795
Acry Extended Screen 20"H x 37"D (for 30"D)	ASIACRYEXSCRN2536	\$870
Acry Extended Screen 25"H x 37"D (for 30"D)	ASIACRYEXSCRN2542	\$914

- Screens are offered as extended lateral (for 24" or 30"D worksurfaces), lateral (for 24", 30", or 36"D surfaces), or table-mounted configurations (for 48" through 66"W worksurfaces).
- Screen depths are undersized to accommodate Further™ or Altitude® worksurface depths but can also be added to panel systems or tables products.
- Brackets attach to the top of the worksurface using an industrial grade adhesive. Installation does not require any drilling or defacing of the worksurface. Screens and brackets may be removed in the future, if desired.
- The front of the bracket has a beveled zinc cap, and the back of the bracket has exposed hardware. Brackets are non-handed so that the front and back can be oriented either direction, based on the application.
- Screens are made of 0.170" thick high-impact clear acrylic.
- Screens meet or exceed ANSI/BIFMA X5.5-2014 Sections 4.6 and 9.

Bracket color must be specified. Available in Allsteel Standard Paints. P2 is \$10 upcharge, P3 is \$15 upcharge.

Now available with Further Everyday Advantage® at 76% off!

Allsteel®

Allsteel Inc.
Muscatine, Iowa 52761
allsteeloffice.com

(06/20)

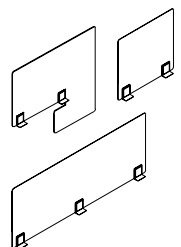
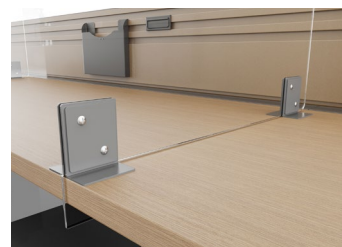

Acrylic Freestanding Screens

Now Open for Orders
3-4 Week Lead Time



Acrylic Freestanding Screens offer a cleanable, transparent solution to create a protective barrier between users. Models with a transaction cut-out are a solution for reception and other front-desk applications. Varying screen sizes provide solutions for different types of spaces. From a large reception desk to a smaller check-in space, this screen solution blocks germs without interrupting communication.

- Screens are supported by two black feet. Feet are only available in a black finish.
- Feet dimensions are 12"H x 10⁵/₈"W.
- Screens are offered as a freestanding solution and do not adhere or mount to a worksurface or tabletop.
- Transaction cut-out screens stand 36"H and are offered in 30", 36", and 48"W.
- Freestanding screen without a cut-out is available in 24" or 30"H and 30", 36", or 48"W.
- Screens are made of 0.220" thick high-impact clear acrylic.



Description	SPLA Model	List Price
Acry Freestanding Screen Cutout 36"H x 30"W	ASIACRYFSSCRNC3630	\$368
Acry Freestanding Screen Cutout 36"H x 36"W	ASIACRYFSSCRNC3636	\$376
Acry Freestanding Screen Cutout 36"H x 48"W	ASIACRYFSSCRNC3648	\$384
Acry Freestanding Screen 24"H x 30"W	ASIACRYFSSCRNX2430	\$329
Acry Freestanding Screen 24"H x 36"W	ASIACRYFSSCRNX2436	\$335
Acry Freestanding Screen 24"H x 48"W	ASIACRYFSSCRNX2448	\$350
Acry Freestanding Screen 36"H x 30"W	ASIACRYFSSCRNX3630	\$368
Acry Freestanding Screen 36"H x 36"W	ASIACRYFSSCRNX3630	\$376
Acry Freestanding Screen 36"H x 48"W	ASIACRYFSSCRNX3648	\$384

Now available with Accessories Everyday Advantage® at 65% off!

Allsteel®

Allsteel Inc.
Muscatine, Iowa 52761
allsteeloffice.com

(06/20)

Hands-Free Pulls

Now Open for Orders
3-4 Week Lead Time



Allsteel foot and arm pulls allow for hands-free entry on any latch-less door. A hands-free operation helps to prevent cross-contamination in high traffic areas. The hands-free pulls are shipped with mounting hardware to accommodate either metal or solid wood doors and are offered in either a pack of 5 or 15.

- Hands-free pulls are ideal for high-traffic areas.
- Hands-free pulls can be installed in minutes using the included mounting hardware.
- Toothed edge on foot pull ensures a no-slip grip.
- Offered in Textured Titanium (P8V) and Textured Black (P6P).

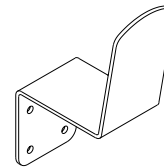

Arm Pull

7 3/8" H x 2 1/2" W x 4 1/2" D

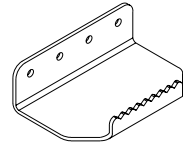

Foot Pull

1 5/8" H x 5" W x 3 1/4" D

Description	SPLA Model	List Price
Allsteel Door Foot Pull 5 PACK	ASIFOOTPULL5	\$255
Allsteel Door Foot Pull 15 PACK	ASIFOOTPULL15	\$720
Allsteel Hands Free Door Arm Pull 5 PACK	ASIARMPULL5	\$255
Allsteel Hands Free Door Arm Pull 15 PACK	ASIARMPULL15	\$720

Now available with Accessories Everyday Advantage at 65% off!

Allsteel®

Allsteel Inc.
Muscatine, Iowa 52761
allsteeloffice.com

(06/20)

Height-Adjustable Table Foot Control

Now Open for Orders
3-4 Week Lead Time

The Allsteel height-adjustable table foot control allows for hands-free adjustment at any Altitude® A6 or A3 table. Hands-free operation helps prevent the spread of germs, making this control a great solution for individual or shared workspaces.

- Compatible with the existing Altitude A3 and the new Altitude A6 height-adjustable tables.
- Available in grey only.
- Wireless design offers clean and functional solution.
- Can be paired with a standard control pad for dual control function.
- Easy to install instructions for retrofitting current workstations or adding on to new Altitude A6 workstations.
- Requires 2 AAA batteries. Batteries not included.

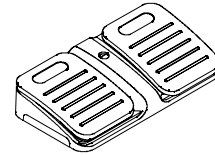

1 5/8" x 7 7/8" W x 4 1/8" D

Description	SPLA Model	List Price
A3/A6 Wireless Foot Control Pad	A6FOOTCNTL	\$240

Hand Sanitizer Solutions

Now Open for Orders
3-4 Week Lead Time



Allsteel offers an easy and accessible sanitizing solution, helping employees stay bacteria-free while moving throughout the office. Incorporating freestanding stations within the facility aids in preventing the transfer of germs between meetings and high-traffic areas. Bottle holders at individual workstations free up valuable workspace to allow for easy surface cleaning while promoting more frequent sanitizing.

- Ideal for high-traffic areas and workstations.
- Available freestanding on base and mounted to panel wall or tool rail and tile.
- Metal freestanding base for added stability. Drip tray prevents sanitizer spills.
- Holder is compatible with most standard hand sanitizer dispensers.
- Easy installation: holder for panel or tool rail and tile can be attached through the pre-drilled holes or via double-sided tape. Additional mounting holes can be drilled to fit a non-standard dispenser.
- Velcro attachment can be used to hold other disinfectants.
- Hand sanitizer dispenser sold separately.

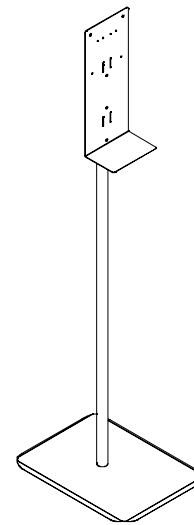

Free Standing

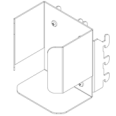

Panel Mount



Tool Rail / Tile Mount

Description	SPLA Model	List Price
Freestanding Hand Sanitizer Stand with Drip Tray	ASISANSTND	\$315
Panel Mount / Wall Mount Hand Sanitizer Bottle Holder	SPLA-HC-ACCYHRDWP.M505015.PAINT	\$94
Tool Tile / Tool Rail Mounted Hand Sanitizer Bottle Holder	SPLA-HC-ACCYHRDWP.M505017.PAINT	\$94

Offered in 32 standard Allsteel powder-coat paint finishes. P2 is \$13 upcharge; P3 is \$22 upcharge.

Now available with Accessories Everyday Advantage® at 65% off!

Allsteel®

Allsteel Inc.
Muscatine, Iowa 52761
allsteeloffice.com

(06/20)

Wall Mounted Sanitizer Holder

Now Open for Orders
3-4 Week Lead Time

Having a place to hold hand sanitizers either on panels or architectural walls, keeps items in consistent locations and prevents cluttering a table or worksurface. The hand sanitizer holder can be inserted into Beyond's slotted standards between panels. The holder is designed to fit most 8 oz bottles of hand sanitizer.

This model contains the following parts: a left-hand and a right-hand bracket that fit into Beyond's $\frac{5}{8}$ " slotted standards, a metal holder that screws into the bracket, and a hardware pack with 4 screws. Only one bracket is needed for installation and the holder can be positioned in a right, left or centered location.

- The metal mount can be finished in any Beyond or Aspect standard painted metal finishes. It will be painted in an anodized-like silver powder coat if anodized clear is selected.
- To attach the mount to Aspect, no bracket is needed. Simply screw the bracket into Aspect between the door jamb and panel vertical.
- If mounting into a panel system, a different bracket is needed to work with furniture's $\frac{1}{2}$ " slotted standards (see Hand Sanitizer Solutions).
- The mount can also be screwed into drywall with no bracket needed.

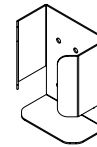

Metal Holder

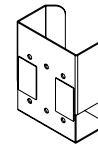

Beyond Bracket

Description	SPLA Model	List Price
Hand Sanitizer Holder – Clear Anodized*	SPLW-SANITIZER.M505403.AALCLR	\$75
Hand Sanitizer Holder – Painted	SPLW-SANITIZER.M505403.PNT_ _ _**	\$75

*Note: Holder will be painted in a light silver powder coat to match anodized.

**Choose from 30 Beyond and Aspect standard painted metal options. See Beyond and Aspect specification guides for full listing of finishes.

4-5 week lead time when ordered with Aspect finishes. 6-8 week lead time when ordered with Beyond finishes.

Altitude® A8 Screens Now Available in Contourett

A Durable & Easy-to-Clean Polyurethane
Now Open for Orders



Altitude A8 screens create a natural privacy barrier above and below the worksurface. The A8 screen extends 21¾" above and 10" below the worksurface, creating a boundary around your personal workspace in a clean and attractive way. As workspace design evolves, creating a sense of physical privacy and personal space can help promote individual well-being. Adding a privacy screen, like an A8 screen, to compatible work surfaces offers the much-needed personal perimeter we now look for in our workspace.

A8 screen kits (U, Rectangle) are now available in Contourett, a non-tackable 100% polyurethane, a durable and easy-to-clean surface that allows for the use of a variety of cleaning agents.

[Material Cleaning Resources →](#)

Statement of Line

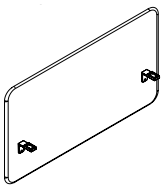

48" 54" 60" 66" 72"
Rectangle Screen Kit

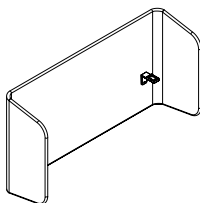

48" 54" 60" 66" 72"
U Screen Kit

Available to order as a Standard Special in Contourett colors



Crater Taupe Luggage Sage Graphite



Steel Cloud Nimbus Marine Ocean Navy

Size / Shape	SPLA Model
48" U	SPLA-A8-FABSCRNPNTA.M505257.FABRIC.PAINT
54" U	SPLA-A8-FABSCRNPNTA.M505258.FABRIC.PAINT
60" U	SPLA-A8-FABSCRNPNTB.M505259.FABRIC.PAINT
66" U	SPLA-A8-FABSCRNPNTB.M505260.FABRIC.PAINT
72" U	SPLA-A8-FABSCRNPNTB.M505261.FABRIC.PAINT
48" Rectangle	SPLA-A8-FABSCRNPNTA.M505262.FABRIC.PAINT
54" Rectangle	SPLA-A8-FABSCRNPNTA.M505263.FABRIC.PAINT
60" Rectangle	SPLA-A8-FABSCRNPNTB.M505264.FABRIC.PAINT
66" Rectangle	SPLA-A8-FABSCRNPNTB.M505265.FABRIC.PAINT
72" Rectangle	SPLA-A8-FABSCRNPNTB.M505266.FABRIC.PAINT

Specifying for Freestanding Worksurfaces

Altitude A8 screens are designed to fit on Altitude worksurfaces, which are undersized by 2" to allow for height-adjustable motion. This is a common design for height-adjustable worksurfaces, but there are a few steps to take to verify non-Altitude worksurfaces are compatible.

1. Understand measurements of worksurface
2. Match with correct A8 screen size
3. Consider clearance of modesty screen and mounting brackets

Example: 48" Altitude Worksurface (AF5RS4824) is actually 46". A 48" U-Screen kit would be the correct screen size to specify with this worksurface.

Allsteel Customer Support is available to verify when needed.

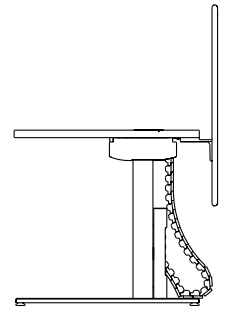
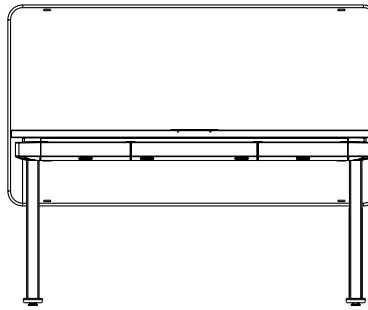
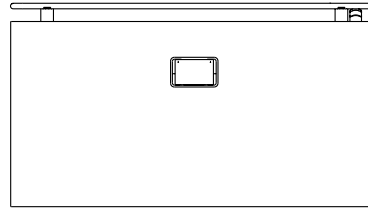

How to Clean

Contourett

- For wet spills, gently blot with dry cloth to remove spill.
- For dried spills, gently work the spill in a non-aggressive circular motion using a damp cloth, making sure to not oversaturate the fabric.
- For dried stains, use a mixture of Tide or Oxiclean and warm water (1 teaspoon of soap for every 16 ounces of water). Follow instructions for dried spills above. Make sure to wipe away any excess soap left behind and remove any moisture with a dry cloth.
- For non-liquid spills, always remove excess contaminant from surface before cleaning. The use of a soft brush or soft abrasive can be used to remove dried contaminants before performing liquid cleaning.
- For healthcare related stains, a water-to-bleach solution of 5:1 is recommended. Rinse cleaned area with water.
- For stains requiring the use of a solvent, spray the solvent directly onto the stain and allow it to sit for 2-3 minutes, avoiding over saturating the fabric. Follow directions for dried stains above.
- Always allow fabric to air dry.

Approved Cleaners for Contourett

It is important to remember that after use of any cleaning agent, the fabric should be rinsed with water and wiped dry to remove any remaining residue or moisture. Approved cleaning agents include Shockwave, Recon, Benefect, Microban, Greased Lightning Degreaser, Lysol Wipes, Diluted bleach solution (5:1 water to bleach), Dispatch Disinfectant Towels with bleach, PDI Sani-Hands Wipes, PDI Super Sani-Cloth Germicidal Disposable Wipes, Diversity Morning Mist Neutral Disinfectant Cleaner, Virex 256, Fantastik, Oxycide, Formula 409.

Recharge™ Modular Lounge

Tables — Connector, Lounge, Laptop

GSA SIN 711-11/711-16

Description	Model Number	Power Location	Ship Weight	Cubes	L1	Laminate L2	L3
Straight Connector Table 14½"W x 28½"D x 17"H							
Power Cutout Right	MLMR15		28	6.8	\$ 1715	\$ 1818	\$ 1887
Power Cutout Left	MLML15		28	6.8	\$ 1715	\$ 1818	\$ 1887
No Power Cutout	MLM15N		28	6.8	\$ 1715	\$ 1818	\$ 1887

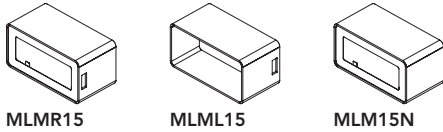

GSA SIN 711-16

120° x 2 Connector Table 35¾"W x 24¾"D x 17"H	One Power Cutout	MLM16	30	12.3	\$ 2050	\$ 2173	\$ 2255
	No Power Cutout	MLM16N	30	12.3	\$ 2050	\$ 2173	\$ 2255



GSA SIN 711-16

120° x 3 Connector Table 35¾"W x 31"D x 17"H	Three Power Cutouts	MLM17	35	14.1	\$ 3050	\$ 3233	\$ 3355
	No Power Cutouts	MLM17N	35	14.1	\$ 3050	\$ 3233	\$ 3355



GSA SIN 711-16

Coffee Table 48"L x 27"W x 17"H	No Power	MLM19	145	24.9	\$ 1150	\$ 1208	\$ 1265
---------------------------------	----------	--------------	-----	------	---------	---------	---------



GSA SIN 711-11

Work Table 48"L x 27"W x 28"H	No Power	MLM22	150	29.0	\$ 1255	\$ 1313	\$ 1370
-------------------------------	----------	--------------	-----	------	---------	---------	---------



GSA SIN 711-11

Corner Table 29"L x 29"W x 17"H	No Power	MLM26	73	14.7	\$ 1100	\$ 1155	\$ 1210
---------------------------------	----------	--------------	----	------	---------	---------	---------



GSA SIN 711-11



Laptop Table 22"L x 17"W x 28"H	No Power	MLM18	37	11.8	\$ 570	\$ 599	\$ 627
---------------------------------	----------	--------------	----	------	--------	--------	--------



GSA SIN 711-11

<p>How to specify — Select the Model Number from above.</p> <p>MLM .</p>	<p>1st Option: Select the Laminate Color (if applicable): See page 2 for selections and color codes. Connector Tables limited to: LDW1 Designer White LM16 Flint</p> <p> .</p>	<p>2nd Option: Select the Laminate Edge Color (if applicable): See page 2 for selections and color codes. Connector Tables do not require an edge color.</p> <p> .</p>	<p>3rd Option: Select the Table Base Paint Color (if applicable): See page 2 for selections and color codes.</p> <p> .</p>
---	---	--	--

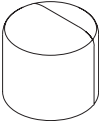
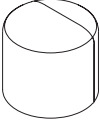
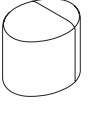
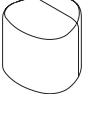
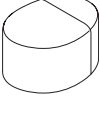
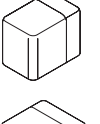
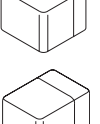
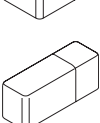
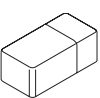
Examples: MLMR15.LDW1 MLM22.LWZ.DZ.PR8 MLM18.LM16.E9.P7A

Description	Model Number	Base	Upcharge List Price — Add to Base Price								L1 Leather
		List Price	2	3	4	5	6	7	8		
Pouf Single Upholstery Models											
 18" Round Pouf	EPR18S	\$ 550	\$ 24	\$ 47	\$ 71	\$ 102	\$ 134	\$ 165	\$ 196	\$ 440	
 18" Round Wobble Pouf	EPW18S <i>COMING SOON!</i>	\$ 600	\$ 24	\$ 47	\$ 71	\$ 102	\$ 134	\$ 165	\$ 196	\$ 440	
 17" x 22" Pebble Pouf	EPP1722S	\$ 700	\$ 27	\$ 53	\$ 80	\$ 116	\$ 151	\$ 187	\$ 223	\$ 499	
 18" x 20" Pebble Pouf	EPP1820S	\$ 750	\$ 25	\$ 50	\$ 75	\$ 109	\$ 142	\$ 176	\$ 210	\$ 469	
 21" x 28" Pebble Pouf	EPP2128S	\$ 800	\$ 30	\$ 60	\$ 90	\$ 129	\$ 169	\$ 209	\$ 249	\$ 557	
 14" x 21" Block Pouf	EPB1421S	\$ 600	\$ 36	\$ 72	\$ 108	\$ 157	\$ 205	\$ 253	\$ 301	\$ 675	
 21" x 21" Block Pouf	EPB2121S	\$ 650	\$ 36	\$ 72	\$ 108	\$ 157	\$ 205	\$ 253	\$ 301	\$ 675	
 21" x 28" Block Pouf	EPB2128S	\$ 700	\$ 46	\$ 91	\$ 137	\$ 197	\$ 258	\$ 319	\$ 380	\$ 851	
 14" x 42" Block Pouf	EPB1442S	\$ 875	\$ 46	\$ 91	\$ 137	\$ 197	\$ 258	\$ 319	\$ 380	\$ 851	
 21" x 42" Block Pouf	EPB2142S	\$ 950	\$ 46	\$ 91	\$ 137	\$ 197	\$ 258	\$ 319	\$ 380	\$ 851	

<p>How to specify — Select the Model Number from above.</p> <p>E P .</p>	<p><i>1st Option:</i> FSC Certified Wood FSC Select for FSC Certified Wood</p> <p>F S C .</p>	<p><i>2nd Option:</i> Select the Upholstery See pages 14-19 for selections.</p> <p> </p>
---	---	--

Example: EPB2128S.FSC.ARR07

Model Number	Overall					
	Ship Weight	Cubes	COM Yardage*	Height	Width	Depth
EPR18S	11	5.4	1.6	17.25"	18.5"	18.5"
EPW18S COMING SOON!	13	6.5	1.6	18.5"	18.5"	18.5"
EPP1722S	25	5.4	1.7	17.25"	22"	17"
EPP1820S	28	6.0	1.7	19.5"	20"	18"
EPP2128S	33	8.0	1.8	16.5"	28"	21"
EPB1421S	21	5.4	1.7	17.25"	21"	14"
EPB2121S	29	6.0	2.1	17.25"	21"	21"
EPB2128S	37	8.0	2.3	17.25"	28"	21"
EPB1442S	39	12.0	2.9	17.25"	42"	14"
EPB2142S	50	12.0	2.9	17.25"	42"	21"

*COM Yardage is listed for total yardage/feet required for a model, with applicable yardage/feet for individual components listed.

Description	Model Number	Base List Price	Upcharge List Price — Add to Base Price									
			2	3	4	5	6	7	8	L1 Leather		
Pouf Multi-Upholstery Models												
	18" Round Pouf	EPR18M	\$ 625	1/3 Upholstery	\$ 13	\$ 25	\$ 38	\$ 54	\$ 71	\$ 88	\$ 105	\$ 235
				2/3 Upholstery	\$ 20	\$ 41	\$ 61	\$ 89	\$ 116	\$ 143	\$ 170	\$ 381
	18" Round Wobble Pouf	EPW18M COMING SOON!	\$ 675	1/3 Upholstery	\$ 13	\$ 25	\$ 38	\$ 54	\$ 71	\$ 88	\$ 105	\$ 235
				2/3 Upholstery	\$ 20	\$ 41	\$ 61	\$ 89	\$ 116	\$ 143	\$ 170	\$ 381
	17" x 22" Pebble Pouf	EPP1722M	\$ 775	1/3 Upholstery	\$ 13	\$ 25	\$ 38	\$ 54	\$ 71	\$ 88	\$ 105	\$ 235
				2/3 Upholstery	\$ 24	\$ 47	\$ 71	\$ 102	\$ 134	\$ 165	\$ 196	\$ 440
	18" x 20" Pebble Pouf	EPP1820M	\$ 825	1/3 Upholstery	\$ 13	\$ 25	\$ 38	\$ 54	\$ 71	\$ 88	\$ 105	\$ 235
				2/3 Upholstery	\$ 24	\$ 47	\$ 71	\$ 102	\$ 134	\$ 165	\$ 196	\$ 440
	21" x 28" Pebble Pouf	EPP2128M	\$ 875	1/3 Upholstery	\$ 13	\$ 25	\$ 38	\$ 54	\$ 71	\$ 88	\$ 105	\$ 235
				2/3 Upholstery	\$ 24	\$ 47	\$ 71	\$ 102	\$ 134	\$ 165	\$ 196	\$ 440
	14" x 21" Block Pouf	EPB1421M	\$ 675	1/3 Upholstery	\$ 16	\$ 31	\$ 47	\$ 68	\$ 89	\$ 110	\$ 131	\$ 293
				2/3 Upholstery	\$ 25	\$ 50	\$ 75	\$ 109	\$ 142	\$ 176	\$ 210	\$ 469
	21" x 21" Block Pouf	EPB2121M	\$ 725	1/3 Upholstery	\$ 16	\$ 31	\$ 47	\$ 68	\$ 89	\$ 110	\$ 131	\$ 293
				2/3 Upholstery	\$ 25	\$ 50	\$ 75	\$ 109	\$ 142	\$ 176	\$ 210	\$ 469
	21" x 28" Block Pouf	EPB2128M	\$ 775	1/3 Upholstery	\$ 16	\$ 31	\$ 47	\$ 68	\$ 89	\$ 110	\$ 131	\$ 293
				2/3 Upholstery	\$ 25	\$ 50	\$ 75	\$ 109	\$ 142	\$ 176	\$ 210	\$ 469
	14" x 42" Block Pouf	EPB1442M	\$ 950	1/3 Upholstery	\$ 25	\$ 50	\$ 75	\$ 109	\$ 142	\$ 176	\$ 210	\$ 469
				2/3 Upholstery	\$ 36	\$ 72	\$ 108	\$ 157	\$ 205	\$ 253	\$ 301	\$ 675
	21" x 42" Block Pouf	EPB2142M	\$ 1025	1/3 Upholstery	\$ 25	\$ 50	\$ 75	\$ 109	\$ 142	\$ 176	\$ 210	\$ 469
				2/3 Upholstery	\$ 36	\$ 72	\$ 108	\$ 157	\$ 205	\$ 253	\$ 301	\$ 675

Multi-upholstery Pricing Example:	Model/Options	Base Price/Upcharges
Step 1: Select Model	EPB1421M	\$ 675
Step 2: Select 1/3 Upholstery	Grade 6 Arris	\$ 89 upcharge
Step 3: Select 2/3 Upholstery	Grade 3 Purl	\$ 50 upcharge
Add Base + applicable Upcharges for Total List Price =		\$ 814

<p>How to specify — Select the Model Number from above.</p> <p>E P .</p>	<p>1st Option: FSC Certified Wood (if applicable): FSC Select for FSC Certified Wood</p> <p>F S C .</p>	<p>2nd Option: Select the 1/3 Upholstery: See pages 14-19 for selections.</p> <p> </p>	<p>3rd Option: Select the 2/3 Upholstery: See pages 14-19 for selections.</p> <p> </p>
---	--	---	---

Example: EPB2128M.FSC.QUL05.PURL11



Model Number		Ship Weight	Cubes	COM Yardage*	Overall		
					Height	Width	Depth
EPR18M		11	5.4		17.25"	18.5"	18.5"
	1/3 Upholstery			0.9			
	2/3 Upholstery			1.3			
EPW18M <i>COMING SOON!</i>		13	6.5		18.5"	18.5"	18.5"
	1/3 Upholstery			0.9			
	2/3 Upholstery			1.3			
EPP1722M		25	5.4		17.25"	22"	17"
	1/3 Upholstery			0.8			
	2/3 Upholstery			1.3			
EPP1820M		28	6.0		19.5"	20"	18"
	1/3 Upholstery			0.9			
	2/3 Upholstery			1.4			
EPP2128M		33	8.0		16.5"	28"	21"
	1/3 Upholstery			0.8			
	2/3 Upholstery			1.5			
EPB1421M		21	5.4		17.25"	21"	14"
	1/3 Upholstery			0.9			
	2/3 Upholstery			1.4			
EPB2121M		29	6.0		17.25"	21"	21"
	1/3 Upholstery			1.2			
	2/3 Upholstery			1.4			
EPB2128M		37	8.0		17.25"	28"	21"
	1/3 Upholstery			1.2			
	2/3 Upholstery			1.6			
EPB1442M		39	12.0		17.25"	42"	14"
	1/3 Upholstery			1.4			
	2/3 Upholstery			1.9			
EPB2142M		50	12.0		17.25"	42"	21"
	1/3 Upholstery			1.4			
	2/3 Upholstery			1.9			

*COM Yardage is listed for total yardage/feet required for a model, with applicable yardage/feet for individual components listed.

Two Thirds™ — Social Collaborative



Two Thirds Benches

GSA PENDING

Description	Model Number	Base List Price	Upcharge List Price — Add to Base Price								P2 Paint	L1 Leather
			2	3	4	5	6	7	8			
Bench Single Upholstery Models <i>COMING SOON!</i>												
 39" Round Bench	EB39S	\$ 1500	\$ 36	\$ 72	\$ 108	\$ 157	\$ 205	\$ 253	\$ 301	\$ 80	\$ 675	
 21" x 42" Bench	EB2142S	\$ 1200	\$ 25	\$ 50	\$ 75	\$ 109	\$ 142	\$ 176	\$ 210	\$ 65	\$ 469	
 42" x 42" Bench	EB4242S	\$ 1500	\$ 44	\$ 88	\$ 132	\$ 191	\$ 249	\$ 308	\$ 367	\$ 80	\$ 821	

How to specify — Select the Model Number from above.	1st Option: FSC Certified Wood FSC Select for FSC Certified Wood	2nd Option: Select the Upholstery See pages 14-19 for selections.	3rd Option: Select the Paint P8Z Textured Salt P8X Solar Black (add P2 Paint upcharge)
E B .	F S C .		

Example: EB39S.FSC.ARR.P8Z

Description	Model Number	Base List Price	Upcharge List Price — Add to Base Price								P2 Paint	L1 Leather
			2	3	4	5	6	7	8			
Bench Multi-Upholstery Models												
 39" Round Bench	EB39M	\$ 1600	1/3 Upholstery	\$ 22	\$ 44	\$ 66	\$ 95	\$ 125	\$ 154	\$ 183	\$ 80	\$ 411
			2/3 Upholstery	\$ 28	\$ 57	\$ 85	\$ 123	\$ 160	\$ 198	\$ 236	\$ 528	
 21" x 42" Bench	EB2142M	\$ 1300	1/3 Upholstery	\$ 19	\$ 38	\$ 57	\$ 82	\$ 107	\$ 132	\$ 157	\$ 65	\$ 352
			2/3 Upholstery	\$ 22	\$ 44	\$ 66	\$ 95	\$ 125	\$ 154	\$ 183	\$ 411	
 42" x 42" Bench	EB4242M	\$ 1600	1/3 Upholstery	\$ 35	\$ 69	\$ 104	\$ 150	\$ 196	\$ 242	\$ 288	\$ 80	\$ 645
			2/3 Upholstery	\$ 38	\$ 75	\$ 113	\$ 163	\$ 214	\$ 264	\$ 314	\$ 704	

Multi-upholstery Pricing Example:	Model/Options	Base Price/Upcharges
Step 1: Select Model	EB4242M	\$ 1600
Step 2: Select 1/3 Upholstery	Grade 6 Arris	\$ 196 upcharge
Step 3: Select 2/3 Upholstery	Grade 4 Mode	\$ 113 upcharge
Step 4: Select Paint	Grade 2 P8X	\$ 80 upcharge
Add Base + applicable Upcharges for Total List Price =		\$ 1989

How to specify — Select the Model Number from above.	1st Option: FSC Certified Wood (if applicable): FSC Select for FSC Certified Wood	2nd Option: Select the 1/3 Upholstery See pages 14-19 for selections.	3rd Option: Select the 2/3 Upholstery See pages 14-19 for selections.	4th Option: Select the Paint P8Z Textured Salt P8X Solar Black (add P2 Paint upcharge)
E B .	F S C .			

Example: EB4242M.FSC.ARR.MOD.P8X

Model Number	Overall					
	Ship Weight	Cubes	COM Yardage*	Height	Width	Depth
EB39S	36	21.0	2.7	17.25"	39"	39"
EB2142S	33	10.3	1.9	17.25"	42"	21"
EB4242S	47	21.2	3.2	17.25"	42"	42"

*COM Yardage is listed for total yardage/feet required for a model, with applicable yardage/feet for individual components listed.

Model Number	Overall					
	Ship Weight	Cubes	COM Yardage*	Height	Width	Depth
EB39M		36	21.0	17.25"	39"	39"
	1/3 Upholstery		1.5			
	2/3 Upholstery		1.8			
EB2142M		33	10.3	17.25"	42"	21"
	1/3 Upholstery		0.9			
	2/3 Upholstery		1.1			
EB4242M		47	21.2	17.25"	42"	42"
	1/3 Upholstery		1.7			
	2/3 Upholstery		1.7			

*COM Yardage is listed for total yardage/feet required for a model, with applicable yardage/feet for individual components listed.

Description	Model Number	Base List Price	Upcharge List Price — Add to Base Price		P2 Paint
			L2	L3	
Laminate Tables COMING SOON!					
 20" Round Side Table	ET20	\$ 600	\$ 10	\$ 20	\$ 40
 39" Round Table	ET39	\$ 1350	\$ 28	\$ 55	\$ 80
 14" x 21" Side Table	ET1421	\$ 850	\$ 15	\$ 30	\$ 55
 21" x 42" Table	ET2142	\$ 1150	\$ 25	\$ 50	\$ 65
 42" x 42" Table	ET4242	\$ 1400	\$ 30	\$ 60	\$ 80

Table Pricing Example:	Model/Options	Base Price/Upcharges
Step 1: Select Model	ET1421	\$ 850
Step 2: Select Laminate	LWCW Charcoal Walnut	\$ 30 upcharge
Step 3: Select Edgeband	DG Cafelle	\$ 0 upcharge
Step 4: Select Paint	P8X Solar Black	\$ 55 upcharge
Add Base + applicable Upcharges for Total List Price =		\$ 935

<p>How to specify — Select the Model Number from above.</p> <p>E T .</p>	<p>1st Option: FSC Certified Wood (if applicable):</p> <p>FSC Select for FSC Certified Wood</p> <p>F S C .</p>	<p>2nd Option: Select the Laminate</p> <p>See inside front cover for options.</p> <p> .</p>	<p>3rd Option: Select the Edge Band</p> <p>See inside front cover for options.</p> <p> .</p>	<p>4th Option: Select the Paint</p> <p>P8Z Textured Salt P8X Solar Black (add P2 Paint upcharge)</p> <p> .</p>
---	---	---	--	--

Example: ET39.FSC.LWCW.DA.P8X

Model Number	Overall				
	Ship Weight	Cubes	Height	Width	Depth
ET20	14	3.4	17.25"	20"	20"
ET39	38	19.4	15"	39"	39"
ET1421	14	3.4	17.25"	21"	14"
ET2142	35	9.1	15"	42"	21"
ET4242	53	18.8	15"	42"	21"

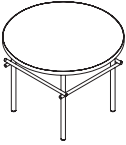
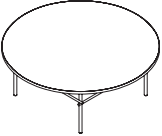
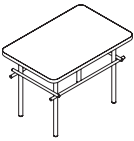
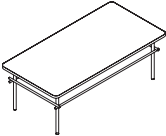
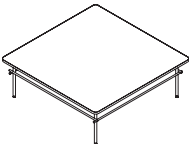
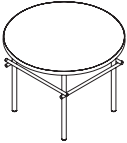
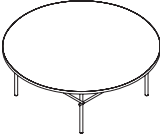
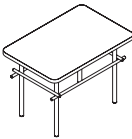
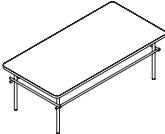
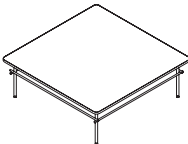
	Description	Model Number	Base List Price	Upcharge List Price — Add to Base Price		P2 Paint
				V3	V5	
	Veneer Tables COMING SOON! 20" Round Side Table	EV20	\$ 1015	\$ 31	\$ 62	\$ 40
	39" Round Table	EV39	\$ 1635	\$ 42	\$ 84	\$ 80
	14" x 21" Veneer Side Table	EV1421	\$ 1150	\$ 30	\$ 60	\$ 55
	21" x 42" Veneer Table	EV2142	\$ 1380	\$ 37	\$ 73	\$ 65
	42" x 42" Veneer Table	EV4242	\$ 1700	\$ 45	\$ 90	\$ 80

<p>How to specify — Select the Model Number from above.</p> <p>EV .</p>	<p><i>1st Option:</i> FSC Certified Wood (if applicable): FSC Select for FSC Certified Wood</p> <p>F S C .</p>	<p><i>2nd Option:</i> Select the Veneer See inside front cover for options.</p> <p> .</p>	<p><i>3rd Option:</i> Select the Veneer Finish OP Open Pore Low Sheen FF Full Fill Cleartech (add \$200)</p> <p> .</p>	<p><i>4th Option:</i> Select the Paint P8Z Textured Salt P8X Solar Black (add P2 Paint upcharge)</p> <p> </p>
--	---	---	--	--

Example: EV39.FSC.NC701.FF.P8X

Model Number	Overall				
	Ship Weight	Cubes	Height	Width	Depth
EV20	22	3.4	17.25"	20"	20"
EV39	53	19.4	15"	39"	39"
EV1421	22	3.4	17.25"	21"	14"
EV2142	45	9.1	15"	42"	21"
EV4242	65	18.8	15"	42"	21"