

# Standard Specials

## **Price & Specification Guide 2024**

Prices effective February 1, 2024

## PAINTED METAL FINISHES

### GRADE P1

Black	P27
Brownstone	P7D
Bungalow	P7C
Cinder	P7Q
Designer White	PJW
Flint	P02
Fossil	P28
Loft	P7B
Muslin	P4J
Parchment	P93
Pebble	P8R
Pewter	P8D
Salt	P8C
Titanium	P8T

### GRADE P2

Champagne Metallic	PR5
Gunmetal Metallic	PR3
Platinum Metallic	PR2
Silver**	PR6
Solar Black	P8X

\*\*PR6 no upcharge on Involve; available as a Grade P2 color on stanchions; is not available on Concensys, Essentials, and vertical files. PQ8 is not available on vertical files.

### GRADE P3

Atom	P8S
Blossom***	P8K
Bullseye	PJF
Cabernet***	P7T
Conifer***	P8H
Ember	P8P
Ion	P8N
Iris	P8J
Krypton	P8F
Regatta	P8M
Succulent***	P8A

\*\*\* These colors are intended to be an inspirational option for the trending market. Product application is limited and color availability is approximately two years to coincide with evolving workplace trends.

*Metallic paints, due to varying reflectance, may appear to have less visual color consistency than other paint finishes, even when L/A/B values are exactly the same. (L/A/B — measurable aspects of color — values are maintained within a specified range, to ensure consistent appearance of paint colors.)*

## METAL STORAGE PULLS

Black	E4
Bronze (for veneer only)	EZ
Matte Silver	EL

## PAINTED WOOD FINISHES

Brownstone	M13
Bungalow	M12
Designer White	M17
Flint	M16
Loft	M11
Muslin	M15

## ELECTRICAL AND DATA COMPONENTS

Black	E4
Brownstone	EY
Designer White	DW
Flint	E9
Loft	EV
Muslin	EU
Silver	ES

Recommended Coordinate Colors:  
 Bungalow use Muslin EU  
 Carob use Black E4  
 Champagne Metallic use Muslin EU  
 Cinder use Brownstone EY  
 Fossil use Flint E9  
 Gunmetal Metallic use Brownstone EY  
 Parchment use Muslin EU  
 Pebble use Loft EV  
 Pewter use Flint E9  
 Platinum Metallic use Loft EV  
 Salt use Silver ES  
 Titanium use Silver ES

## LAMINATES

### GRADE L1

<b>CORE</b>	
Ash	LT3B
Brownstone*	LM13
Bungalow*	LM12
Camelstone	LT6A
Canyon Zephyr	LT5B
Desert Zephyr	LT5A
Designer White	LDW1
Flint*	LM16
Fossil Shale*	LEH1
Grey Mesh	LT8A
Greystone	TM65
Loft*	LM11
Muslin*	LM15
Parchment	TM20
Pewter Mesh	LT8C
Sheer Mesh	LT8B
Silver Mesh	LT8D
Titanium	LT11
White Tigris	LT2A
Whitestone	TM33

### WOODGRAIN

Florence Walnut*	LFW1
Kingswood Walnut*	LK11
Natural Maple*	LWD
NeoWalnut*	LNU1
Shaker Cherry*	LW7C

### GRADE L2

Amber Cherry*	LWAC
Beigewood*	LWBE
Branded Oak*	LBO1
Brazilwood*	LWBR
Columbian Walnut*	LWZ
Ebony Recon*	LER1
Fawn Cypress*	LFC1
Lowell Ash*	LLA1
Mangalore Mango*	LMM1
Natural Recon*	LNR1
Phantom Charcoal*	LPC1
Phantom Ecru*	LPE1
Portico Teak*	LPT1
Skyline Walnut*	LSW1

### GRADE L3

Cafelle*	LWC
Charcoal Walnut*	LWCW
Natural Walnut*	LWNW

\* Storage available in these 29 laminates.

## LAMINATE AND PAINTED WOOD STORAGE PULLS

Silver	PR6
--------	-----

## LAMINATE EDGE COLORS

Amber Cherry	DA
Beigewood	DE
Black	E4
Branded Oak	BO
Brazilwood	DB
Brownstone	EY
Bungalow	EX
Cafelle	DG
Charcoal Walnut	DC
Columbian Walnut	DZ
Designer White	DW
Ebony Recon	DR
Fawn Cypress	FC
Flint	E9
Florence Walnut	FW
Fossil	EH
Kingswood Walnut	KI
Loft	EV
Lowell Ash	DL
Mangalore Mango	MM
Muslin	EU
Natural Maple	DD
Natural Recon	NR
Natural Walnut	DN
NeoWalnut	NU
Parchment	EN
Phantom Charcoal	PC
Phantom Ecru	PE
Platinum Metallic	EP
Plyband ♦	PL
Portico Teak	DP
Shaker Cherry	DF
Skyline Walnut	SW
Titanium	TI

♦ Edge is limited to flat edge surfaces: rectangle, square, trapezoid, polygon, or round. No curvilinear or combination curve and straight.

## METAL GROMMETS

### FOR LAMINATE WORKSURFACES

Oval/Square:	
Matte Silver	EL

### FOR VENEER WORKSURFACES

Oval:	
Black	E4
Bronze	EZ
Matte Silver	EL
Square:	
Matte Silver	EL

## PLASTIC GROMMETS

### FOR WORKSURFACES

Black	E4
Brownstone	EY
Bungalow	EX
Designer White	DW
Flint	E9
Fossil	EH
Loft	EV
Muslin	EU
Parchment	EN

### PLASTIC GROMMETS WITH WOODGRAIN EDGE

If woodgrain edge is specified, the plastic grommet color is predetermined, based on finish selection.

Beigewood, Fawn Cypress, Natural Maple, and Natural Recon	Muslin EU
Branded Oak	Brownstone EY
Phantom Charcoal	Flint E9
Phantom Ecru	Loft EV
Portico Teak	Fossil EH
Skyline Walnut	Flint E9
All other woodgrain options	Black E4

## STRATAWOOD VENEERS

### GRADE V1

Add FSC prefix to Stratawood colors listed below for Stratawood veneer trim on Stride and Terrace.  
 Example: **FSCSC777**

### CHERRY

Burnished Cherry	SC777
Light Cherry	SC701
Wheat Cherry	SC706

### MAPLE

Clear Maple***	SE800
----------------	-------

### OAK

Clear Oak	SF300
Dark Rift Oak	SF331

### WALNUT

Coffee Walnut	ST615
Dark Roast Walnut	ST684
Light Walnut	ST601

## NATURAL VENEERS — NATURAL-1

### GRADE V3

### CHERRY

Burnished Cherry	NC777
Light Cherry	NC701
Medium Wheat Cherry	NC706

### MAPLE

Natural Maple***	NE800
------------------	-------

### WALNUT

Coffee Walnut	NT615
Dark Roast Walnut	NT684
Light Walnut	NT601

## NATURAL VENEERS — NATURAL-2

### GRADE V5

Dark Rift Oak	RF331
---------------	-------

\*\*\* SE800 and NE800 are not available on Stride trim.

*The beauty of wood is the natural variation of grain patterns and colors that make each piece unique. This variation is also influenced by lighting conditions, orientation of mated parts, and varying acceptance of the finishing process. The varying colors and physical characteristics naturally occur in all wood species but are most pronounced in lighter colored woods, and are especially evident in natural finishes.*

## GROMMETS ON VENEER WORKSURFACES

Wire management grommets come standard on most veneer worksurfaces. Choose between metal or plastic grommet option. Note: Plastic grommet color is predetermined based on finish selection. All Maple veneers.....Muslin EU  
 All other veneers .....Black E4

## LOCKS

Black	E4
Chrome	ordered by base model
Matte Silver	EL

**NOTE:** Refer to individual product pages for upcharges.

- Software support packages furnished to the customer, either by Allsteel® or by another source, which support the sale of Allsteel products are superseded by printed price lists.
- Prices are subject to change without notice. All orders are subject to prices in effect at the time of order.
- Please refer to your Allsteel Dealer Sales and Discount Policies for order placement information, terms and conditions.
- Additional copies of this Specification and Price List are available to Allsteel Dealers on Synergy as a PDF.

- Ordering information appears at the bottom of each product page complete with examples on how to specify. Fabric and finish pages are referenced at the bottom of product pages.

This publication is available as an interactive or downloadable PDF at [www.allsteeloffice.com/pricers](http://www.allsteeloffice.com/pricers).

### Questions or Comments?

Please call us at: **888-ALLSTEEL**  
**888-255-7833**

Standard Finishes .....	2
Table of Contents .....	3
<b>WORKSURFACES</b>	
Primary Rectangle .....	4-5
Stride Linear Corner Asymmetrical .....	6
Stride Linear Corner Cove.....	6
Wave.....	7
Reef .....	7
Peninsula .....	8
Boomerang .....	9
Stride 120 Degree Countertop.....	9
Countertops - T-Mold Edge.....	10
Full Depth Lateral Divider Screens.....	11-13
20"H Stride Benching Lateral Divider Screens .....	14
Corner .....	15
<b>STRIDE®</b>	
Stride 30"H Panels .....	16
Stride Feet.....	17
Stride Power Pole Splice .....	17
Stride Trim .....	18
Stride 25"H Fabric, Steel, and Laminate Tiles .....	19
22½"H Frameless Glass Specification Rules.....	20
Frameless Glass Alignment Brackets.....	21
Stride 22½"H Frameless Glass with Top Cap.....	22
Stride COM Insert Spec.....	23
Grooved Top Cap For Frameless COM Insert.....	24
22½"H & 30"H Low Profile Glass Stackers.....	25
Stride Tackable Acoustical Ported-Below-Worksurface Tiles ....	26
Stride Steel Ported Tiles .....	27
Stride Electrical Components .....	28-29
<b>TERRACE®</b>	
Terrace Feet .....	30
Terrace Power Pole Splice.....	30
Steel to-the-Floor Tiles.....	30
Terrace 22½"H Frameless Glass with Flat Top Cap .....	31
Terrace 22½"H Frameless Glass with Radius Top Cap .....	31
Terrace Flat & Radius Trim COM Insert Specs.....	32
Grooved Top Cap for Frameless COM Insert.....	33
Terrace Fabric Tiles to-the-Floor .....	34
Terrace Fabric Below-Worksurface Tiles — Ported .....	35
Terrace Steel Ported Tiles.....	36
Terrace Pass Thru Kits.....	37
Terrace Electrical Components.....	38

<b>FURTHER®</b>	
Further 28"H Triangle Base Beam Mounted Glass Screens.....	39
28"H Triangle Base Beam Mounted Fabric Screens .....	40
Further Electrical .....	41
<b>APPROACH™</b>	
Approach End Cap.....	42
<b>OPTIMIZE®</b>	
Optimize 22½"H Frameless Glass with Top Cap .....	43
Optimize Trim COM Insert Spec.....	44
Top Cap For Frameless COM Insert .....	45
Optimize Electrical .....	46
<b>ALTITUDE®</b>	
Wire Manager Chain.....	47
HAT Base & Worksurface Spec Rules .....	48
Height-Adjustable Bases.....	49-58
Screen Kits in Contourett .....	59
Altitude A8 Screen Kits - Extended Wing Specification Notes....	60
Altitude A8 Screen Kits - Extended Wing .....	61
<b>INVOLVE®</b>	
Involve® Desk Mount Screens, Glass .....	62
Involve® Towers.....	63-64
Involve® Credenzas .....	65-66
Involve® Two-Tone Banquette Cushion .....	67
<b>ENERGY MANAGEMENT SYSTEM</b>	
EMS.....	68-69
<b>ELECTRICAL TITLE 24</b>	
Electrical — Title 24 .....	70-71
<b>ACCESSORIES</b>	
Panel / Wall Mount Hand Sanitizer Bottle Holder.....	72
Tool Tile / Tool Rail Mount Hand Sanitizer Bottle Holder.....	72
Aware Mobile Markerboards.....	72
Panel Fabrics .....	73



Description	Laminate Model w/T-Mold Edge	Laminate w/T-Mold Edge		
		L1 List Price	L2 Upcharge	L3 Upcharge
<b>24"D Primary Worksurfaces</b>				
24"W	832424A	\$ 431	\$ 24	\$ 42
30"W	832430A	\$ 454	\$ 25	\$ 44
36"W	832436A	\$ 513	\$ 26	\$ 49
42"W	832442A	\$ 573	\$ 27	\$ 52
48"W	832448A	\$ 623	\$ 29	\$ 55
54"W	832454A	\$ 670	\$ 37	\$ 61
60"W	832460A	\$ 761	\$ 39	\$ 66
66"W	832466A	\$ 829	\$ 41	\$ 73
72"W	832472A	\$ 864	\$ 42	\$ 74



<b>30"D Primary Worksurfaces</b>				
24"W	833024A	\$ 454	\$ 25	\$ 44
30"W	833030A	\$ 546	\$ 27	\$ 51
36"W	833036A	\$ 588	\$ 28	\$ 53
42"W	833042A	\$ 638	\$ 29	\$ 58
48"W	833048A	\$ 670	\$ 37	\$ 61
54"W	833054A	\$ 748	\$ 39	\$ 66
60"W	833060A	\$ 835	\$ 41	\$ 73
66"W	833066A	\$ 900	\$ 44	\$ 80
72"W	833072A	\$ 975	\$ 48	\$ 84



**Note:** Add Suffix "N" to model number for no grommet, no upcharge. Example: **832424AN**

<p><b>How to specify —</b> Select the Model Number from above. <b>Suffix</b> N No Grommets</p>	<p><b>1st Option:</b> <b>Laminate:</b> See <a href="#">inside front cover</a> for finishes.</p>	<p><b>2nd Option:</b> <b>Edge Trim Color:</b> See <a href="#">inside front cover</a> for finishes.</p>	<p><b>3rd Option:</b> <b>Grommet Type:</b> P Oval Plastic (will match edge trim) M Oval Metal (Add \$13 per grommet) S Square Metal (Add \$13 per grommet)</p>	<p><b>4th Option:</b> <b>Grommet Color (Metal only):</b> <b>Oval:</b> EL Matte Silver <b>Square:</b> EL Matte Silver</p>
--	---	--	--	--

Example: 832424A.LT3B.E9.P

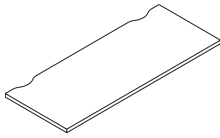

Description	Laminate Model w/Flat Edge & Scallops	Laminate w/Flat Edge & Scallops		
		L1 List Price	L2 Upcharge	L3 Upcharge
<b>24"D Primary Worksurfaces</b>				
24"W	T52424SS	\$ 570	\$ 22	\$ 41
30"W	T52430SS	\$ 594	\$ 24	\$ 42
36"W	T52436SS	\$ 651	\$ 25	\$ 48
42"W	T52442SS	\$ 713	\$ 26	\$ 51
48"W	T52448SS	\$ 763	\$ 29	\$ 53
54"W	T52454SS	\$ 814	\$ 36	\$ 58
60"W	T52460SS	\$ 908	\$ 38	\$ 63
66"W	T52466SS	\$ 972	\$ 40	\$ 70
72"W	T52472SS	\$ 1010	\$ 41	\$ 71
78"W	T52478SS	\$ 1266	\$ 50	\$ 93
84"W	T52484SS	\$ 1320	\$ 52	\$ 99
90"W	T52490SS	\$ 1540	\$ 59	\$ 116
96"W	T52496SS	\$ 1603	\$ 62	\$ 124
<b>30"D Primary Worksurfaces</b>				
24"W	T53024SS	\$ 594	\$ 24	\$ 42
30"W	T53030SS	\$ 688	\$ 26	\$ 50
36"W	T53036SS	\$ 729	\$ 27	\$ 52
42"W	T53042SS	\$ 775	\$ 29	\$ 55
48"W	T53048SS	\$ 814	\$ 36	\$ 58
54"W	T53054SS	\$ 891	\$ 38	\$ 63
60"W	T53060SS	\$ 979	\$ 40	\$ 70
66"W	T53066SS	\$ 1044	\$ 42	\$ 74
72"W	T53072SS	\$ 1122	\$ 47	\$ 81
78"W	T53078SS	\$ 1418	\$ 55	\$ 108
84"W	T53084SS	\$ 1475	\$ 57	\$ 113
90"W	T53090SS	\$ 1735	\$ 66	\$ 132
96"W	T53096SS	\$ 1787	\$ 68	\$ 137

<p><b>How to specify —</b> Select the Model Number from above.</p>	<p><b>1st Option:</b> <b>Laminate:</b> See <a href="#">inside front cover</a> for finishes.</p>	<p><b>2nd Option:</b> <b>Edge Trim Color:</b> See <a href="#">inside front cover</a> for finishes.</p>
<input type="text"/>	<input type="text"/>	<input type="text"/>

Example: T52424SS.LT3B.E9









# Worksurfaces

## Boomerang and 120° Countertops

For specification information see applicable system's specification book.

Laminate

Description	Laminate w/Flat Edge Model	Laminate w/Flat Edge		
		L1 List Price	L2 Upcharge	L3 Upcharge
<b>Boomerang Worksurfaces — Left Hand 90°</b>				
48" A x 72" B x 24" C	T547229BL	\$ 1770	\$ 80	\$ 159
48" A x 72" B x 30" C	T547239BL	\$ 1845	\$ 82	\$ 166
<b>Boomerang Worksurfaces — Left Hand 110°</b>				
36" A x 72" B x 24" C	T547221BL	\$ 1770	\$ 80	\$ 159
36" A x 72" B x 30" C	T547231BL	\$ 1845	\$ 82	\$ 166
<b>Boomerang Worksurfaces — Right Hand 90°</b>				
48" A x 72" B x 24" C	T547229BR	\$ 1770	\$ 80	\$ 159
48" A x 72" B x 30" C	T547239BR	\$ 1845	\$ 82	\$ 166
<b>Boomerang Worksurface — Right Hand 110°</b>				
36" A x 72" B x 24" C	T547221BR	\$ 1770	\$ 80	\$ 159
36" A x 72" B x 30" C	T547231BR	\$ 1845	\$ 82	\$ 166

**Note:** Add Suffix "N" to model number for no grommets, no upcharge. *Example:* T547239BLN

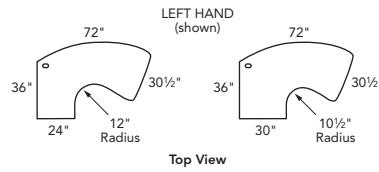
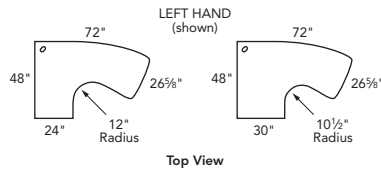
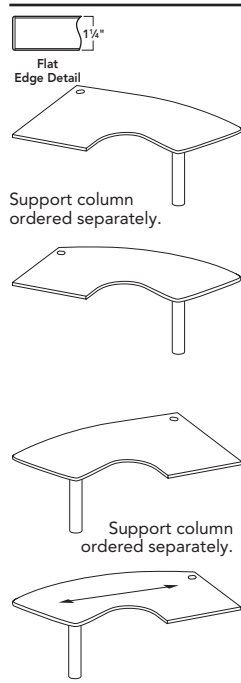

Arrows indicate grain direction for woodgrain laminates

<b>15"D 120° Corner Countertops</b>				
30" W x 30" W	Z53030CSB	\$ 1121	\$ 48	\$ 86
36" W x 36" W	Z53636CSB	\$ 1241	\$ 52	\$ 99
42" W x 42" W	Z54242CSB	\$ 1336	\$ 55	\$ 107
48" W x 48" W	Z54848CSB	\$ 1456	\$ 59	\$ 117

<p><b>How to specify —</b> Select the Model Number from above. Add suffix if applicable: "N" for No Grommets — no upcharge</p>	<p><b>1st Option:</b> <b>Laminate:</b> See <a href="#">inside front cover</a> for finishes.</p>	<p><b>2nd Option:</b> <b>Edge Trim Color (Laminate worksurfaces only):</b> See <a href="#">inside front cover</a> for finishes.</p>	<p><b>3rd Option:</b> <b>Grommet Type:</b> P Oval Plastic (will match edge trim on laminate) M Oval Metal (Add \$25 per grommet) S Square Metal (Add \$25 per grommet)</p>	<p><b>4th Option:</b> <b>Grommet Color (if applicable):</b> See <a href="#">inside front cover</a> for finishes.</p>
<p>_____ .</p>	<p>_____ .</p>	<p>_____ .</p>	<p>_____</p>	<p><b>E</b> _____</p>

Examples: T547221BR.LT3B.E9.P 5303030CSB.TM33.EV

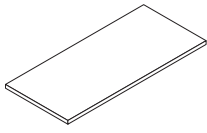

Description	Model	L1 List Price	L2 Upcharge	L3 Upcharge
<b>Straight Countertops</b>				
24"W x 15"D	851524	\$ 377	\$ 22	\$ 39
30"W x 15"D	851530	\$ 421	\$ 24	\$ 41
36"W x 15"D	851536	\$ 469	\$ 25	\$ 47
42"W x 15"D	851542	\$ 486	\$ 25	\$ 48
48"W x 15"D	851548	\$ 514	\$ 26	\$ 49
54"W x 15"D	851554	\$ 581	\$ 28	\$ 52
60"W x 15"D	851560	\$ 649	\$ 25	\$ 47
66"W x 15"D	851566	\$ 674	\$ 37	\$ 61
72"W x 15"D	851572	\$ 701	\$ 38	\$ 62

**Note:** Order mounting brackets separately; see Concensys Price & Spec Guide.



Description	Model	L1 List Price	L2 Upcharge	L3 Upcharge
<b>Corner Countertops</b>				
15"D x 24"W x 24"W	852424	\$ 736	\$ 39	\$ 64
15"D x 30"W x 30"W	853030	\$ 855	\$ 42	\$ 74
15"D x 36"W x 36"W	853636	\$ 950	\$ 47	\$ 83
15"D x 42"W x 42"W	854242	\$ 1029	\$ 49	\$ 93

**Note:** Order mounting brackets separately; see Concensys Price & Spec Guide.

**OPTIONS:**

SUFFIX	OPTION — Routed to fit Painted Variable Height Trim	UPCHARGE
RS	For routing one end of a straight countertop, when used in variable height panel applications.	None
RR*	For routing right end of corner countertops, when used in variable height panel applications.	None
RL*	For routing left end of corner countertops, when used in variable height panel applications.	None
RB*	For routing both ends of a straight or corner countertop when used in variable height panel applications.	None

**\*Note:** "Right end" and "left end" are determined by facing the inside radius of the corner countertop.

<p><b>How to specify —</b> Select the Concensys Model Number from above.</p> <p>8   5             .</p>	<p><b>1st Option:</b> <b>Laminate:</b> See <a href="#">inside front cover</a> for finishes.</p> <p>            .</p>	<p><b>2nd Option:</b> <b>Edge Trim Color:</b> See <a href="#">inside front cover</a> for finishes.</p> <p>     </p>
---	--	---

*Example:* 851524.LT3B.E4

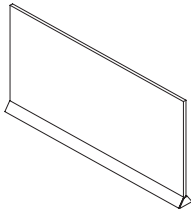
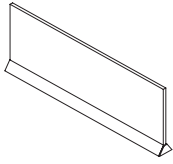

Description	Model		P1 List Price	P2 Upcharge	P3 Upcharge	Frosted Glass Upcharge	Smoked Glass Upcharge
<b>8"H Lateral Divider Screen — 3/8" Thick Glass</b>							
18"D	SPLA-SS-STR08HGDS1.M490854		\$ 845	\$ 28	\$ 55	\$ 42	\$ 111
20"D	SPLA-SS-STR08HGDS1.M490855		\$ 863	\$ 28	\$ 55	\$ 42	\$ 111
21"D	SPLA-SS-STR08HGDS1.M490856		\$ 880	\$ 28	\$ 55	\$ 42	\$ 111
24"D	SPLA-SS-STR08HGDS2.M490857		\$ 898	\$ 38	\$ 73	\$ 57	\$ 147
27"D	SPLA-SS-STR08HGDS2.M490858		\$ 916	\$ 38	\$ 73	\$ 57	\$ 147
30"D	SPLA-SS-STR08HGDS3.M490859		\$ 962	\$ 40	\$ 81	\$ 73	\$ 162
36"D	SPLA-SS-STR08HGDS3.M490860		\$ 1010	\$ 40	\$ 81	\$ 73	\$ 162

<b>13"H Lateral Divider Screen — 3/8" Thick Glass</b>							
18"D	SPLA-SS-STR13HGDS1.M490861		\$ 886	\$ 28	\$ 57	\$ 47	\$ 115
20"D	SPLA-SS-STR13HGDS1.M490862		\$ 905	\$ 28	\$ 57	\$ 47	\$ 115
21"D	SPLA-SS-STR13HGDS1.M490863		\$ 924	\$ 28	\$ 57	\$ 47	\$ 115
24"D	SPLA-SS-STR13HGDS2.M490864		\$ 941	\$ 39	\$ 76	\$ 59	\$ 155
27"D	SPLA-SS-STR13HGDS2.M490865		\$ 962	\$ 39	\$ 76	\$ 59	\$ 155
30"D	SPLA-SS-STR13HGDS3.M490866		\$ 1010	\$ 42	\$ 84	\$ 76	\$ 169
36"D	SPLA-SS-STR13HGDS3.M490867		\$ 1051	\$ 42	\$ 84	\$ 76	\$ 169

<b>20"H Lateral Divider Screen — 3/8" Thick Glass</b>							
18"D	SPLA-SS-STR20HGDS1.M490868		\$ 1099	\$ 44	\$ 86	\$ 71	\$ 177
20"D	SPLA-SS-STR20HGDS1.M490869		\$ 1121	\$ 44	\$ 86	\$ 71	\$ 177
21"D	SPLA-SS-STR20HGDS1.M490870		\$ 1145	\$ 44	\$ 86	\$ 71	\$ 177
24"D	SPLA-SS-STR20HGDS2.M490872		\$ 1167	\$ 59	\$ 118	\$ 92	\$ 238
27"D	SPLA-SS-STR20HGDS2.M490873		\$ 1157	\$ 59	\$ 118	\$ 92	\$ 238
30"D	SPLA-SS-STR20HGDS3.M490874		\$ 1217	\$ 66	\$ 130	\$ 118	\$ 261
36"D	SPLA-SS-STR20HGDS3.M490875		\$ 1278	\$ 66	\$ 130	\$ 118	\$ 261

**Notes:**

- Screen depths nominal sizes match actual sizes. \*Not for use with Stride Benching. See page 14.
- 13H screens are 12.6"H (to match standard Stride Lateral Screens).
- 8H screen nominal height matches actual.
- 20H screen nominal height matches actual, intending to align with 50H panels. These will not align with Stride Benching 20H Beam Mounted Screens or 20H Elevated table mounted screens.
- Screens used on Systems applications must be placed 3" from a seam with a cantilever or center support bracket. If necessary the alternative attachment kit, VHB Tape and End Cap, may be used. Order separately.
- Screens used on Further applications can be placed anywhere, however support brackets may need to be repositioned.

<p><b>How to specify —</b> Select the Model Number from above.</p> <div style="border: 1px solid black; height: 20px; width: 100%;"></div> <div style="border: 1px solid black; height: 20px; width: 100%;"></div>	<p><i>1st Option:</i> <b>Glass</b> (if applicable): LC Clear LF Frosted GSM1 Smoked</p>	<p><i>2nd Option:</i> <b>Paint</b> (if applicable):   See <a href="#">inside front cover</a> for finishes.</p>
<p>Example: SPLA-SS-STR08HGDS1.M490854.LC.P02</p>		

Shippable by small-package carrier.

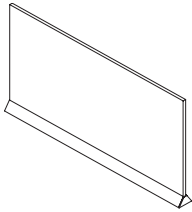
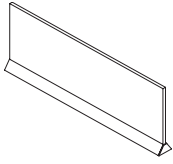

Description	Model	P1 List Price	P2 Upcharge	P3 Upcharge	Frosted Glass Upcharge	Smoked Glass Upcharge
<b>8"H Lateral Divider Screen — 3/8" Thick Glass</b>						
42"W	SPLA-SS-STR08HGDS4.M505525	\$ 1057	\$ 48	\$ 94	\$ 86	\$ 192
48"W	SPLA-SS-STR08HGDS4.M505526	\$ 1106	\$ 48	\$ 94	\$ 86	\$ 192
54"W	SPLA-SS-STR08HGDS5.M505527	\$ 1159	\$ 61	\$ 122	\$ 111	\$ 248
60"W	SPLA-SS-STR08HGDS5.M505528	\$ 1216	\$ 61	\$ 122	\$ 111	\$ 248
66"W	SPLA-SS-STR08HGDS6.M505529	\$ 1275	\$ 71	\$ 141	\$ 128	\$ 288
72"W	SPLA-SS-STR08HGDS7.M505530	\$ 1334	\$ 78	\$ 155	\$ 141	\$ 316

<b>13"H Lateral Divider Screen — 3/8" Thick Glass</b>						
42"W	SPLA-SS-STR13HGDS4.M505531	\$ 1101	\$ 62	\$ 125	\$ 113	\$ 248
48"W	SPLA-SS-STR13HGDS4.M505532	\$ 1153	\$ 62	\$ 125	\$ 113	\$ 248
54"W	SPLA-SS-STR13HGDS5.M505533	\$ 1207	\$ 78	\$ 156	\$ 140	\$ 307
60"W	SPLA-SS-STR13HGDS5.M505534	\$ 1264	\$ 78	\$ 156	\$ 140	\$ 307
66"W	SPLA-SS-STR13HGDS6.M505535	\$ 1325	\$ 85	\$ 171	\$ 153	\$ 338
72"W	SPLA-SS-STR13HGDS7.M505536	\$ 1387	\$ 94	\$ 186	\$ 169	\$ 371

**Notes:**

- Screen depths nominal sizes match actual sizes and not for use with Stride Benching. See page 14.
- 13H screens are 12.6"H (to match standard Stride Lateral Screens).
- 8H screen nominal height matches actual.
- 20H screen nominal height matches actual, intending to align with 50H panels. These will not align with Stride Benching 20H Beam Mounted Screens or 20H Elevated table mounted screens.
- Screens used on Systems applications must be placed 3" from a seam with a cantilever or center support bracket. If necessary the alternative attachment kit, VHB Tape and End Cap, may be used. Order separately.
- Screens used on Further applications can be placed anywhere, however support brackets may need to be repositioned.

**Bracket-less Alternative Attachment Kit**

SPLA-STR-SPLSCRNGLAS.M505831	\$ 66	\$ 18
SPLA-STR-SPLSCRNGLAS.M506260	\$ 74	\$ 18

**Notes:**

- Bracket-less alternative attachment kit for Stride Lateral Divider Screens up to 36"W SPLA-STR-SPLSCRNGLAS.M505831.
- Bracket-less alternative attachment kit for Stride Lateral Divider Screens 42"W–72"W SPLA-STR-SPLSCRNGLAS.M506260.

**How to specify —**  
Select the Model Number from above.

\_\_\_\_\_ . **L** \_\_\_\_\_ .

*Example:*

**1st Option:**  
Glass  
(if applicable):  
LC Clear  
LF Frosted  
GSM1 Smoked

**2nd Option:**  
Paint  
(if applicable):  
P1 P2  
See [inside front cover](#) for finishes.

**S** Shippable by small-package carrier.

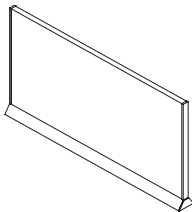
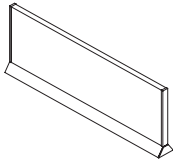

Description	Model	P1 List Price	P2 Upcharge	P3 Upcharge	Upholstery Upcharge				
					Grade A	Grade B	Grade C	Grade D	
<b>8"H Lateral Divider Screen — ¾" Thick Tackable Fabric</b>									
18"D	SPLA-SS-STR08HFDS1.M490833	\$ 754	\$ 26	\$ 50	\$ 0	\$ 10	\$ 19	\$ 33	
20"D	SPLA-SS-STR08HFDS1.M490834	\$ 772	\$ 26	\$ 50	\$ 0	\$ 10	\$ 19	\$ 33	
21"D	SPLA-SS-STR08HFDS1.M490835	\$ 786	\$ 26	\$ 50	\$ 0	\$ 10	\$ 19	\$ 33	
24"D	SPLA-SS-STR08HFDS2.M490836	\$ 804	\$ 33	\$ 64	\$ 0	\$ 13	\$ 25	\$ 44	
27"D	SPLA-SS-STR08HFDS2.M490837	\$ 821	\$ 33	\$ 64	\$ 0	\$ 13	\$ 25	\$ 44	
30"D	SPLA-SS-STR08HFDS3.M490838	\$ 846	\$ 38	\$ 74	\$ 0	\$ 15	\$ 29	\$ 58	
36"D	SPLA-SS-STR08HFDS3.M490839	\$ 937	\$ 38	\$ 74	\$ 0	\$ 15	\$ 29	\$ 58	
42"W	SPLA-SS-STR08HFDS4.M506668	\$ 955	\$ 38	\$ 74	\$ 0	\$ 15	\$ 29	\$ 58	
48"W	SPLA-SS-STR08HFDS4.M506670	\$ 974	\$ 38	\$ 74	\$ 0	\$ 15	\$ 29	\$ 58	
54"W	SPLA-SS-STR08HFDS4.M506672	\$ 993	\$ 38	\$ 74	\$ 0	\$ 15	\$ 29	\$ 58	
60"W	SPLA-SS-STR08HFDS4.M506673	\$ 1012	\$ 38	\$ 74	\$ 0	\$ 15	\$ 29	\$ 58	
66"W	SPLA-SS-STR08HFDSRR.M506674	\$ 1033	\$ 18	\$ 29	\$ 0	\$ 68	\$ 139	\$ 209	
72"W	SPLA-SS-STR08HFDSRR.M506774	\$ 1053	\$ 18	\$ 29	\$ 0	\$ 68	\$ 139	\$ 209	

<b>13"H Lateral Divider Screen — ¾" Thick Tackable Fabric</b>									
18"D	SPLA-SS-STR13HFDS1.M490840	\$ 798	\$ 26	\$ 52	\$ 0	\$ 15	\$ 27	\$ 50	
20"D	SPLA-SS-STR13HFDS1.M490841	\$ 817	\$ 26	\$ 52	\$ 0	\$ 15	\$ 27	\$ 50	
21"D	SPLA-SS-STR13HFDS1.M490842	\$ 833	\$ 26	\$ 52	\$ 0	\$ 15	\$ 27	\$ 50	
24"D	SPLA-SS-STR13HFDS2.M490843	\$ 849	\$ 36	\$ 70	\$ 0	\$ 19	\$ 37	\$ 64	
27"D	SPLA-SS-STR13HFDS2.M490844	\$ 916	\$ 36	\$ 70	\$ 0	\$ 19	\$ 37	\$ 64	
30"D	SPLA-SS-STR13HFDS3.M490845	\$ 892	\$ 40	\$ 80	\$ 0	\$ 25	\$ 49	\$ 86	
36"D	SPLA-SS-STR13HFDS3.M490846	\$ 986	\$ 40	\$ 80	\$ 0	\$ 25	\$ 49	\$ 86	
42"W	SPLA-SS-STR13HFDS4.M506775	\$ 1005	\$ 38	\$ 74	\$ 0	\$ 15	\$ 29	\$ 58	
48"W	SPLA-SS-STR13HFDS4.M506776	\$ 1026	\$ 38	\$ 74	\$ 0	\$ 15	\$ 29	\$ 58	
54"W	SPLA-SS-STR13HFDS4.M506777	\$ 1046	\$ 38	\$ 74	\$ 0	\$ 15	\$ 29	\$ 58	
60"W	SPLA-SS-STR13HFDS4.M506786	\$ 1068	\$ 38	\$ 74	\$ 0	\$ 15	\$ 29	\$ 58	
66"W	SPLA-SS-STR13HFDSRR.M506778	\$ 1087	\$ 18	\$ 29	\$ 0	\$ 68	\$ 139	\$ 209	
72"W	SPLA-SS-STR13HFDSRR.M506779	\$ 1111	\$ 18	\$ 29	\$ 0	\$ 68	\$ 139	\$ 209	

<b>20"H Lateral Divider Screen — ¾" Thick Tackable Fabric</b>									
18"D	SPLA-SS-STR20HFDS1.M490847	\$ 957	\$ 40	\$ 81	\$ 0	\$ 24	\$ 42	\$ 76	
20"D	SPLA-SS-STR20HFDS1.M490848	\$ 975	\$ 40	\$ 81	\$ 0	\$ 24	\$ 42	\$ 76	
21"D	SPLA-SS-STR20HFDS1.M490849	\$ 994	\$ 40	\$ 81	\$ 0	\$ 24	\$ 42	\$ 76	
24"D	SPLA-SS-STR20HFDS2.M490850	\$ 1015	\$ 52	\$ 108	\$ 0	\$ 28	\$ 55	\$ 99	
27"D	SPLA-SS-STR20HFDS2.M490851	\$ 1035	\$ 52	\$ 108	\$ 0	\$ 28	\$ 55	\$ 99	
30"D	SPLA-SS-STR20HFDS3.M490852	\$ 1059	\$ 62	\$ 124	\$ 0	\$ 39	\$ 74	\$ 136	
36"D	SPLA-SS-STR20HFDS3.M490853	\$ 1095	\$ 62	\$ 124	\$ 0	\$ 39	\$ 74	\$ 136	

**Notes:**

- Screen depths nominal sizes match actual sizes.\*Not for use with Stride Benching. See page 14.
- 13H screens are 12.6"H (to match standard Stride Lateral Screens).
- 8H screen nominal height matches actual.
- 20H screen nominal height matches actual, intending to align with 50H panels. These will not align with Stride Benching 20H Beam Mounted Screens or 20H Elevated table mounted screens.
- Screens used on Systems applications must be placed 3" from a seam with a cantilever or center support bracket. If necessary the alternative attachment kit, VHB Tape and End Cap, may be used. Order separately.
- Screens used on Further applications can be placed anywhere, however support brackets may need to be repositioned.
- Bracket-less alternative attachment kit for Stride Lateral Divider Screens up to 36"W SPLA-STR-SPLSCRNGLAS.M505831.
- Bracket-less alternative attachment kit for Stride Lateral Divider Screens 42"W–72"W SPLA-STR-SPLSCRNGLAS.M506260.

<p><b>How to specify —</b> Select the Model Number from above.</p> <div style="border: 1px solid black; height: 20px; width: 100%;"></div>	<p><b>1st Option:</b> <b>Fabric</b> (if applicable): See <a href="#">inside back cover</a> for fabrics.</p>	<p><b>2nd Option:</b> <b>Paint</b> (if applicable): <b>P1 P2</b> See <a href="#">inside front cover</a> for finishes.</p>
<p><b>Example:</b></p>	<p><b>P</b></p>	

**S** Shippable by small-package carrier.

# Stride® Benching Worksurfaces

## 20"H Stride Benching Lateral Divider Screens

FINISHES

TABLE OF CONTENTS

WORKSURFACES

STRIDE

TERRACE

FURTHER

APPROACH

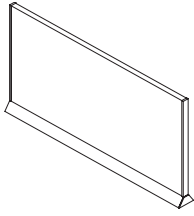

Description	Model	P1 List Price	P2 Upcharge	P3 Upcharge	Frosted Glass Upcharge	Smoked Glass Upcharge
<b>20"H Lateral Divider Screen — Glass</b>						
27"D	SPLA-SS-STR20HGDS2.M518445	\$ 1192	\$ 59	\$ 118	\$ 92	\$ 238
30"D	SPLA-SS-STR20HGDS3.M518446	\$ 1217	\$ 66	\$ 130	\$ 118	\$ 261
36"D	SPLA-SS-STR20HGDS3.M518447	\$ 1278	\$ 66	\$ 130	\$ 118	\$ 261

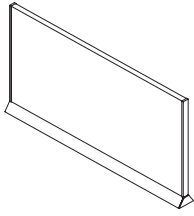

Description	Model	P1 List Price	P2 Upcharge	P3 Upcharge	Upholstery Upcharge			
					Grade A	Grade B	Grade C	Grade D
<b>20"H Lateral Divider Screen — Fabric</b>								
27"D	SPLA-SS-STR20HFDS2.M518448	\$ 1035	\$ 52	\$ 108	\$ 0	\$ 28	\$ 55	\$ 99
30"D	SPLA-SS-STR20HFDS3.M518449	\$ 1059	\$ 62	\$ 124	\$ 0	\$ 39	\$ 74	\$ 136
36"D	SPLA-SS-STR20HFDS3.M518450	\$ 1095	\$ 62	\$ 124	\$ 0	\$ 39	\$ 74	\$ 136

**Notes:**

- Screen depths nominal sizes match Stride Benching surface depth.
- Nominal depths are 27", 30", and 36".
- Actual depths are 22¾", 25¾", and 31¾".
- 20"H screen nominal height matches actual, intending to align with 50"H panels. These will not align with Stride Benching 20"H Beam Mounted Screens or 20"H Elevated table mounted screens.

<p><b>How to specify —</b> Select the Model Number from above.</p>	<p><b>1st Option:</b> <b>Fabric/Glass</b> (if applicable): See <a href="#">inside back cover</a> for fabrics.</p>	<p><b>2nd Option:</b> <b>Paint</b> (if applicable): <b>P1 P2</b> See <a href="#">inside front cover</a> for finishes.</p>
<p><i>Example:</i></p>		

Shippable by small-package carrier.

Standard Specials – 02/2024

# Worksurfaces

## Corner — Flat Edge

For specification information see applicable System's Price & Specification Guide.

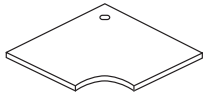
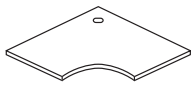

Description	Laminate w/Flat Edge Model	Old Model For Reference	Laminate w/Flat Edge		
			L1 List Price	L2 Upcharge	L3 Upcharge
<b>24"D Corner Worksurfaces w/Radial Leading Edge</b>					
36"W x 24"D	T53624CR	833624RM	\$ 790	\$ 33	\$ 58
42"W x 24"D	T54224CR	834224RM	\$ 842	\$ 34	\$ 63
48"W x 24"D	T54824CR	834824RM	\$ 958	\$ 39	\$ 71
<b>30"D Corner Worksurfaces w/Radial Leading Edge</b>					
42"W x 30"D	T54230CR	834230RM	\$ 1018	\$ 40	\$ 75
48"W x 30"D	T54830CR	834830RM	\$ 1099	\$ 42	\$ 82

**Notes:**

- Add Suffix "N" to model number for no grommet, no upcharge.
- Corner cove worksurfaces do NOT include rear support bracket. Order brackets separately, T6BK for Terrace, Stride and Optimize, 831099 for Concensus.

Corner Worksurfaces with Radial Leading Edge

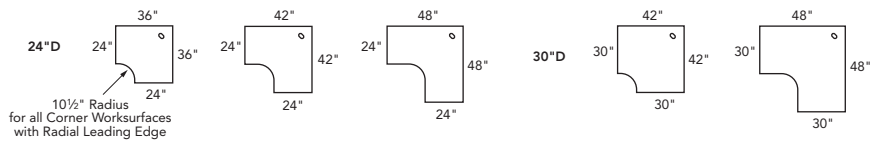

Corner Worksurfaces with Straight Leading Edge

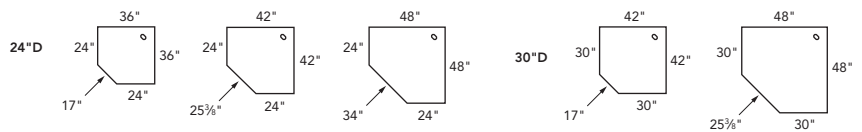

<p><b>How to specify —</b> Select the Model Number from above.</p>	<p><b>1st Option:</b> <b>Laminate:</b> See <a href="#">inside front cover</a> for finishes.</p>	<p><b>2nd Option:</b> <b>Paint (Corner Shelves only):</b> P1 P2 See <a href="#">inside front cover</a> for finishes.</p>	<p><b>2nd Option:</b> <b>Edge Trim Color:</b> See <a href="#">inside front cover</a> for finishes.</p>	<p><b>3rd Option:</b> <b>Grommet Type:</b> P Plastic M Metal (Add \$12 per grommet) S Square Metal (Add \$12 per grommet)</p>	<p><b>4th Option:</b> <b>Grommet Color (Metal only):</b> EL Matte Silver <b>Note:</b> Plastic grommet color matches trim selection.</p>
<p>Example: T53624CR.LT3B.EV.MEL</p>					







For specification information see Stride system specification book.

FINISHES  
TABLE OF CONTENTS  
WORKSURFACES  
STRIDE  
TERRACE  
FURTHER  
APPROACH

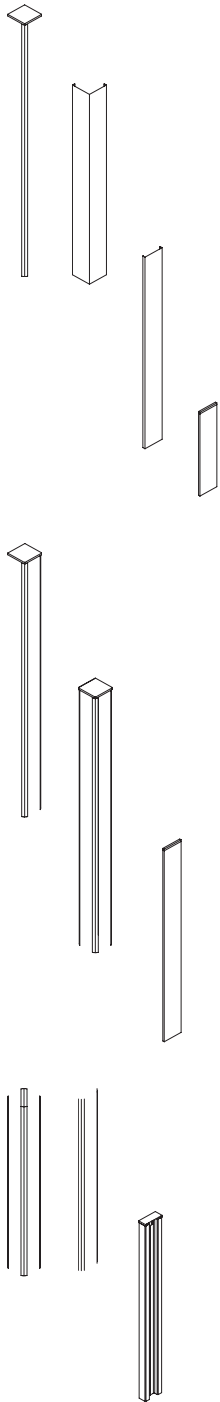

Description	Model	List Price P1	Upcharge P2
<b>2-Way 90° Light Block Kit with Top Cap Transition Piece</b>			
L-90 Light Block Kit with "L" Top Cap (for 30"H Panel)	Z330LLSS.M376721	\$ 871	\$ 18
<b>"L" 90° Vertical Filler Trim</b>			
30"H L-90 Degree Trim (for 30"H Panel)	Z330PLSS.M376714	\$ 988	\$ 29
5"H L-90 Degree Trim (for 30"H to 35"H Panel)	SPLA-STR-TRIM.M430113	\$ 110	\$ 18
12½"H L-90 Degree Trim (for 30"H to 42½"H Panel)	SPLA-STR-TRIM.M430114	\$ 117	\$ 18
20"H L-90 Degree Trim (for 30"H to 50"H Panel)	SPLA-STR-TRIM.M430115	\$ 125	\$ 18
27½"H L-90 Degree Trim (for 30"H to 57½"H Panel)	SPLA-STR-TRIM.M523058	\$ 134	\$ 18
<b>"F" Flat Vertical Filler Trim</b>			
5"H Filler Trim (for 30"H to 35"H Panel)	SPLA-STR-TRIM.M430107	\$ 86	\$ 18
12½"H Filler Trim (for 30"H to 42½"H Panel)	SPLA-STR-TRIM.M430108	\$ 94	\$ 18
20"H Filler Trim (for 30"H to 50"H Panel)	SPLA-STR-TRIM.M430109	\$ 105	\$ 18
27½"H Filler Trim (for 30"H to 57½"H Panel)	SPLA-STR-TRIM.M523060	\$ 117	\$ 18
30"H Filler Trim (for 30"H Panel)	Z330PFSS.M376713	\$ 966	\$ 29
<b>"VH" Variable Height Vertical End Trim</b>			
5"H "E" Variable Height Trim (for 30"H to 35"H Panel)	SPLA-STR-TRIM.M430110	\$ 86	\$ 18
12½"H "E" Variable Height Trim (for 30"H to 42½"H Panel)	SPLA-STR-TRIM.M430111	\$ 94	\$ 18
20"H "E" Variable Height Trim (for 30"H to 50"H Panel)	SPLA-STR-TRIM.M430112	\$ 105	\$ 18
27½"H "E" Variable Height Trim (for 30"H to 57½"H Panel)	SPLA-STR-TRIM.M523059	\$ 117	\$ 18
<b>3-Way Light Block Kit with Top Cap Transition Piece</b>			
3-Way Light Block Kit for "S" Top Cap (for 30"H Panel)	Z330TSSS.M376722	\$ 954	\$ 18
3-Way Light Block Kit for "L" Top Cap (for 30"H Panel)	Z330TLSS.M376719	\$ 963	\$ 18
3-Way Light Block Kit for "T" Top Cap (for 30"H Panel)	Z330TTSS.M376720	\$ 963	\$ 18
<b>4-Way Light Block Kit with Top Cap Transition Piece</b>			
4-Way Light Block Kit for "S" Top Cap (for 30"H Panel)	Z330XSSS.M376715	\$ 970	\$ 18
4-Way Light Block Kit for "L" Top Cap (for 30"H Panel)	Z330XLSS.M376716	\$ 970	\$ 18
4-Way Light Block Kit for "T" Top Cap (for 30"H Panel)	Z330XTSS.M376717	\$ 970	\$ 18
4-Way Light Block Kit for "X" Top Cap (for 30"H Panel)	Z330XXSS.M376718	\$ 970	\$ 18
<b>Vertical End Trim</b>			
30"H "E" End Trim for 30"H Raceway Panel	Z330PESS.M376712	\$ 966	\$ 29
30"H "EF" End Trim for 30"H Footed Panel	SPLA-STR-TRIM.M430106	\$ 122	\$ 18
<b>Light Block Kits without Top Cap Transition Piece</b>			
30"H 3-Way Light Block Kit w/o Top Cap	SPLA-STR-TRIM.M430116	\$ 87	\$ 18
30"H 4-Way Light Block Kit w/o Top Cap	SPLA-STR-TRIM.M430117	\$ 100	\$ 18
<b>"W" Wall Mount Kit</b>			
30"H Wall Mount (for 30"H Panel)	SPLA-STR-TRIM.M430118	\$ 199	\$ 18

**How to specify —**  
Select the Model Number from above.

**1st Option:**  
**Paint Color**  
(if applicable):  
P1 P2  
See inside front cover for finishes.

Examples: Z330LLSS.M376721.P52 SPLA-STR-TRIM.M430110.P02

For specification information see *Stride system specification book*.

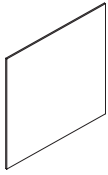

Description	Model	List Price		Upcharge		
		Grade A	Grade B	Grade C	Grade D	Grade E
<b>25"H Tackable Acoustical Tiles (monolithic tiles for 30"H Stride frames) — specify fabric</b>						
18"W	Z42518TSS.M376723	\$ 1213	\$ 20	\$ 50	\$ 80	\$ 129
20"W	Z42520TSS.M376724	\$ 1213	\$ 20	\$ 48	\$ 73	\$ 124
24"W	Z42524TSS.M376725	\$ 1231	\$ 20	\$ 48	\$ 74	\$ 126
30"W	Z42530TSS.M376726	\$ 1243	\$ 28	\$ 52	\$ 82	\$ 129
36"W	Z42536TSS.M376727	\$ 305	\$ 29	\$ 55	\$ 88	\$ 133
42"W	Z42542TSS.M376728	\$ 325	\$ 37	\$ 61	\$ 93	\$ 137
48"W	Z42548TSS.M376729	\$ 344	\$ 39	\$ 64	\$ 99	\$ 142
60"W	Z42560TSS.M376730	\$ 380	\$ 48	\$ 73	\$ 109	\$ 151

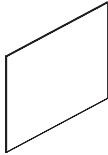

Description	Model	List Price	Upcharge	Upcharge
		P1	P2	P3
<b>25"H Steel Tiles (monolithic tiles for 30"H Stride frames) — specify paint</b>				
18"W	Z42518SSS.M376731	\$ 1402	\$ 33	\$ 62
20"W	Z42520SSS.M376732	\$ 1530	\$ 33	\$ 62
24"W	Z42524SSS.M376733	\$ 1552	\$ 33	\$ 62
30"W	Z42530SSS.M376734	\$ 1587	\$ 33	\$ 62
36"W	Z42536SSS.M376735	\$ 1643	\$ 33	\$ 62
42"W	Z42542SSS.M376736	\$ 730	\$ 33	\$ 62
48"W	Z42548SSS.M376737	\$ 774	\$ 33	\$ 62
60"W	Z42560SSS.M376738	\$ 867	\$ 33	\$ 62

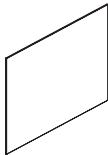

Description	Model	List Price	Upcharge	Upcharge
		L1	L2	L3
<b>25"H Laminate Tiles (monolithic tiles for 30"H Stride frames) — specify laminate &amp; edge</b>				
18"W	SPLA-STR-LMTILE30.M430119	\$ 698	\$ 53	\$ 124
20"W	SPLA-STR-LMTILE30.M430120	\$ 698	\$ 53	\$ 124
24"W	SPLA-STR-LMTILE30.M430121	\$ 698	\$ 53	\$ 124
30"W	SPLA-STR-LMTILE30.M430122	\$ 750	\$ 53	\$ 124
36"W	SPLA-STR-LMTILE30.M430123	\$ 806	\$ 53	\$ 124
42"W	SPLA-STR-LMTILE30.M430124	\$ 877	\$ 53	\$ 124
48"W	SPLA-STR-LMTILE30.M430125	\$ 948	\$ 53	\$ 124
60"W	SPLA-STR-LMTILE30.M430126	\$ 1083	\$ 53	\$ 124

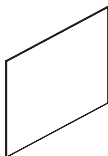

<b>25"H Laminate Tiles to-the-Floor (monolithic tiles for 30"H Stride frames) — specify laminate &amp; edge</b>				
18"W	SPLA-STR-LMTILE30.M430127	\$ 971	\$ 53	\$ 124
20"W	SPLA-STR-LMTILE30.M430128	\$ 971	\$ 53	\$ 124
24"W	SPLA-STR-LMTILE30.M430129	\$ 971	\$ 53	\$ 124
30"W	SPLA-STR-LMTILE30.M430130	\$ 1063	\$ 53	\$ 124
36"W	SPLA-STR-LMTILE30.M430131	\$ 1125	\$ 53	\$ 124
42"W	SPLA-STR-LMTILE30.M430132	\$ 1206	\$ 53	\$ 124
48"W	SPLA-STR-LMTILE30.M430133	\$ 1281	\$ 53	\$ 124
60"W	SPLA-STR-LMTILE30.M430134	\$ 1480	\$ 53	\$ 124

**Note:** For to-the-Floor models please order the to-the-Floor Bracket Kit Z4TFB separately.

<p><b>How to specify —</b> Select the Model Number from above.</p> <p>_____</p> <p>_____ .</p>	<p><i>1st Option:</i> <b>Fabric</b> (if applicable): See <i>inside back cover</i> for fabrics.</p> <p>_____</p>	<p><i>2nd Option:</i> <b>Paint Color</b> (if applicable): P1 P2 See <i>inside front cover</i> for finishes.</p> <p>_____</p>	<p><i>3rd Option:</i> <b>Laminate Color</b> (if applicable): See <i>inside front cover</i> for finishes.</p> <p>_____ .</p>	<p><i>4th Option:</i> <b>Edge Color</b> (if applicable): See <i>inside front cover</i> for finishes.</p> <p>_____</p>
--	---	--	---	---

*Example:* Z42518TSS.M376723.APN911

## 22½"H Frameless Glass Specification Rules

Connector brackets are required to connect all glass screens together.

Every run of glass must have perpendicular support. Must use an L, T, or X connector brackets.

See page 21 for models.

Models are universal and are to be used for Stride, Terrace and Optimize.

Brackets connect to top corners of the glass.

Inline

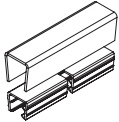
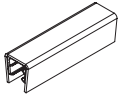

“S” Ext. Straight

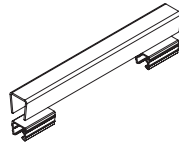
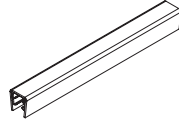

“T”

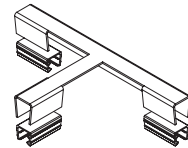
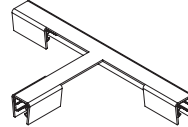

“L”

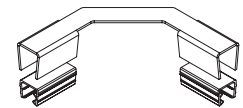

120° — 2 Way

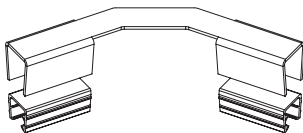
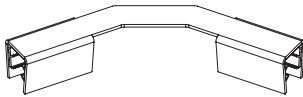

120° — 3 Way

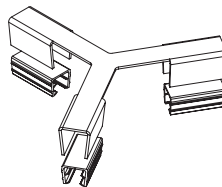
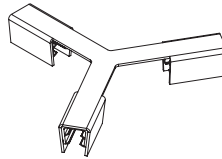

“X”

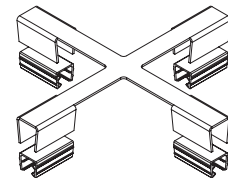
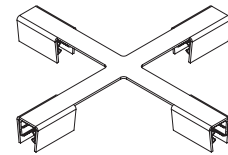

For specification information please see page 20.

Model	P1 List Price	P2 Upcharge	P3 Upcharge
Panel Mounted Frameless Glass Screen Alignment Bracket for an In-Line application SPLA-ACC-BRACKET.M508476	\$ 90	\$ 18	\$ 29
Panel Mounted Frameless Glass Screen Alignment Bracket for an "L" application SPLA-ACC-BRACKET.M508479	\$ 90	\$ 18	\$ 29
Panel Mounted Frameless Glass Screen Alignment Bracket for a "T" application SPLA-ACC-BRACKET.M508480	\$ 90	\$ 18	\$ 29
Panel Mounted Frameless Glass Screen Alignment Bracket for a 120° — 2 Way application SPLA-ACC-BRACKET.M508481	\$ 90	\$ 18	\$ 29
Panel Mounted Frameless Glass Screen Alignment Bracket for a 120° — 3 Way application SPLA-ACC-BRACKET.M508482	\$ 90	\$ 18	\$ 29
Panel Mounted Frameless Glass Screen Alignment Bracket for an "X" application SPLA-ACC-BRACKET.M508484	\$ 90	\$ 18	\$ 29
Panel Mounted Frameless Glass Screen Alignment Bracket for an "S" application SPLA-ACC-BRACKET.M508485	\$ 90	\$ 18	\$ 29

<p><b>How to specify —</b> Select the Model Number from above.</p> <p>_____ .</p> <p><i>Example:</i></p>	<p><i>1st Option:</i> <b>Paint</b> (if applicable): P1 P2 See <a href="#">inside front cover</a> for finishes.</p> <p>P      </p>
--	---

For specification information please see page 20.

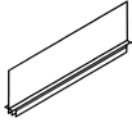

Description	Model	P1 List Price	P2 Upcharge	Frosted Glass Upcharge	Smoked Glass Upcharge
<b>22½"H Frameless Glass with Top Cap</b>					
42"W	SPLA-STR-SCRNGLSSM.M511269	\$ 1053	\$ 18	\$ 114	\$ 171
48"W	SPLA-STR-SCRNGLSSM.M511270	\$ 1140	\$ 18	\$ 114	\$ 171
54"W	SPLA-STR-SCRNGLSSM.M511271	\$ 1260	\$ 18	\$ 114	\$ 171
60"W	SPLA-STR-SCRNGLSSM.M511272	\$ 1386	\$ 18	\$ 114	\$ 171
66"W	SPLA-STR-SCRNGLSSM.M511273	\$ 1521	\$ 18	\$ 114	\$ 171
72"W	SPLA-STR-SCRNGLSSL.M511274	\$ 1658	\$ 18	\$ 170	\$ 257
78"W	SPLA-STR-SCRNGLSSL.M511275	\$ 1873	\$ 18	\$ 170	\$ 257
84"W	SPLA-STR-SCRNGLSSL.M511276	\$ 2091	\$ 18	\$ 170	\$ 257
90"W	SPLA-STR-SCRNGLSSL.M511278	\$ 2159	\$ 18	\$ 170	\$ 257
96"W	SPLA-STR-SCRNGLSSL.M511279	\$ 2230	\$ 18	\$ 170	\$ 257

**Note:** Due to increased height of the glass, there will be noticeable side-to-side movement on the screen.  
Please contact TPG prior to placing your order to review your layout if you have questions.  
Alignment brackets are required. See page 21.



<b>22½"H Grooved End Trim for ⅜" Glass Panel Mounted Screens</b>					
	SPLA-STR-TRIM.M507357	\$ 138	\$ 18		

<p><b>How to specify —</b> Select the Model Number from above.</p> <p>_____ . _____ . _____</p>	<p><b>1st Option:</b> <b>Glass</b> (if applicable): LC Clear LF Frosted GSM1 Smoked</p> <p>_____ . _____ . _____</p>	<p><b>2nd Option:</b> <b>Paint</b> (if applicable): P1 P2 See <a href="#">inside front cover</a> for finishes.</p> <p>P _____</p>
---	--	---

Example: SPLA-SS-STR08HGDS1.M490854.LC.P02

**S** Shippable by small-package carrier.

## Stride COM Insert Spec

Custom material used in grooved top cap trim should be sized according to these dimensions:

Standard Height	Actual Dimensions	Standard Width	Actual Dimensions
7½"H	8.460"H	24"W	23.866"W
15"H	15.960"H	30"W	29.866"W
22½"H	23.460"H	36"W	35.866"W
		42"W	41.866"W
		48"W	47.866"W
		54"W	53.866"W
		60"W	59.866"W
		66"W	65.866"W
		72"W	71.866"W
		78"W	77.866"W
		84"W	83.866"W
		90"W	89.866"W
		96"W	95.866"W

Height tolerance should be +0.000" / -0.188"

Width tolerance should be +/- 0.094"

Thickness of custom material must be 10MM thick -0.120MM / +0.890MM

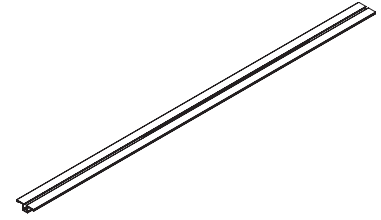

For COM material heights taller than 15"H.

Connector brackets are required to connect all screens together.

Every run of glass must have perpendicular support. Must use an L, T, or X connector brackets.

See page 21 for models





For specification information please see page 23.

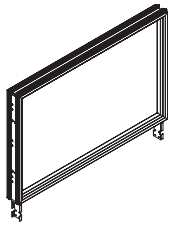

Description	Model	P1 List Price	P2 Upcharge	P3 Upcharge	Frosted Glass Upcharge
<b>22½"H Low Profile Glass Stacker</b>					
24"W	SPLA-SS-STR022GDS1.M506787	\$ 1033	\$ 80	\$ 155	\$ 106
30"W	SPLA-SS-STR022GDS1.M506788	\$ 1125	\$ 80	\$ 155	\$ 106
36"W	SPLA-SS-STR022GDS1.M506789	\$ 1228	\$ 80	\$ 155	\$ 106
42"W	SPLA-SS-STR022GDS2.M506790	\$ 1337	\$ 80	\$ 155	\$ 191
48"W	SPLA-SS-STR022GDS2.M506791	\$ 1460	\$ 80	\$ 155	\$ 191
<b>22½ "H x 60"W Low Profile Glass Stacker For 30+30 or 24+36 Frames</b>					
60"W	SPLA-SS-STR022GDS2.M506792	\$ 1621	\$ 80	\$ 155	\$ 191
<b>22½ "H x 72"W Low Profile Glass Stacker For 36+36 or 24+48 Frames</b>					
72"W	SPLA-SS-STR022GDS3.M506793	\$ 1800	\$ 80	\$ 155	\$ 294
<b>22½ "H x 84"W Low Profile Glass Stacker For 36+48 Frames</b>					
84"W	SPLA-SS-STR022GDS3.M506794	\$ 1998	\$ 80	\$ 155	\$ 294
<b>22½ "H x 90"W Low Profile Glass Stacker For 42+48 or 30+30+30 Frames</b>					
90"W	SPLA-SS-STR022GDS3.M506795	\$ 2219	\$ 80	\$ 155	\$ 294
<b>22½ "H x 96"W Low Profile Glass Stacker For 48+48 or 30+30+36 Frames</b>					
96"W	SPLA-SS-STR022GDS3.M506796	\$ 2463	\$ 80	\$ 155	\$ 294

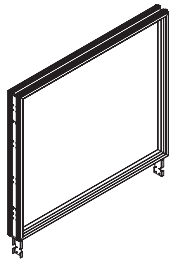

<b>30 "H Low Profile Glass Stacker</b>					
24"W	SPLA-SS-STR030GDS1.M506797	\$ 1093	\$ 80	\$ 155	\$ 181
30"W	SPLA-SS-STR030GDS1.M506798	\$ 1193	\$ 80	\$ 155	\$ 181
36"W	SPLA-SS-STR030GDS1.M506799	\$ 1299	\$ 80	\$ 155	\$ 181
42"W	SPLA-SS-STR030GDS2.M506800	\$ 1416	\$ 80	\$ 155	\$ 253
48"W	SPLA-SS-STR030GDS2.M506801	\$ 1545	\$ 80	\$ 155	\$ 253
<b>30 "H x 60"W Low Profile Glass Stacker For 30+30 or 24+36 Frames</b>					
60"W	SPLA-SS-STR030GDS2.M506802	\$ 1713	\$ 80	\$ 155	\$ 253
<b>30 "H x 72"W Low Profile Glass Stacker For 36+36 or 24+48 Frames</b>					
72"W	SPLA-SS-STR030GDS3.M506803	\$ 1902	\$ 80	\$ 155	\$ 393
<b>30 "H x 84"W Low Profile Glass Stacker For 36+48 Frames</b>					
84"W	SPLA-SS-STR030GDS3.M506804	\$ 2111	\$ 80	\$ 155	\$ 393
<b>30 "H x 90"W Low Profile Glass Stacker For 42+48 or 30+30+30 Frames</b>					
90"W	SPLA-SS-STR030GDS3.M506805	\$ 2346	\$ 80	\$ 155	\$ 393
<b>30 "H x 96"W Low Profile Glass Stacker For 48+48 or 30+30+36 Frames</b>					
96"W	SPLA-SS-STR030GDS3.M506806	\$ 2603	\$ 80	\$ 155	\$ 393

<p><b>How to specify —</b> Select the Model Number from above.</p> <p>_____ .</p> <p>_____ .</p>	<p><b>1st Option:</b> Glass (if applicable): LC Clear LF Frosted</p> <p>_____ .</p>	<p><b>2nd Option:</b> Paint (if applicable): P1 P2 See inside front cover for finishes.</p> <p>P _____</p>
--	---	--

Example:

For specification information see current Stride Price & Specification Guide.

FINISHES  
TABLE OF CONTENTS  
WORKSURFACES  
STRIDE  
TERRACE  
FURTHER  
APPROACH

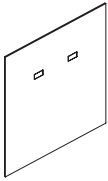

Description	Model		List Price		Upcharge		
			Grade A	Grade B	Grade C	Grade D	Grade E
<b>37½"H Tackable Acoustical Port Tiles</b> (Monolithic tile for 42½"H frame)							
18"W	SPLA-SS-STRETILE38HS.M425572		\$ 434	\$ 27	\$ 53	\$ 96	\$ 142
20"W	SPLA-SS-STRETILE38HS.M425573		\$ 434	\$ 27	\$ 53	\$ 96	\$ 142
24"W	SPLA-SS-STRETILE38HS.M425574		\$ 434	\$ 27	\$ 53	\$ 96	\$ 142
30"W	SPLA-SS-STRETILE38HM.M425575		\$ 457	\$ 40	\$ 81	\$ 147	\$ 215
36"W	SPLA-SS-STRETILE38HM.M425576		\$ 479	\$ 40	\$ 81	\$ 147	\$ 215
42"W	SPLA-SS-STRETILE38HM.M425577		\$ 509	\$ 40	\$ 81	\$ 147	\$ 215
48"W	SPLA-SS-STRETILE38HL.M425578		\$ 552	\$ 66	\$ 133	\$ 245	\$ 357
60"W	SPLA-SS-STRETILE38HL.M425579		\$ 587	\$ 66	\$ 133	\$ 245	\$ 357

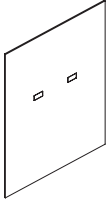

<b>45"H Tackable Acoustical Port Tiles</b> (Monolithic tile for 50"H frame)							
18"W	SPLA-SS-STRETILE45HS.M425580		\$ 468	\$ 33	\$ 63	\$ 117	\$ 170
20"W	SPLA-SS-STRETILE45HS.M425581		\$ 468	\$ 33	\$ 63	\$ 117	\$ 170
24"W	SPLA-SS-STRETILE45HS.M425582		\$ 468	\$ 33	\$ 63	\$ 117	\$ 170
30"W	SPLA-SS-STRETILE45HM.M425583		\$ 499	\$ 49	\$ 95	\$ 177	\$ 256
36"W	SPLA-SS-STRETILE45HM.M425584		\$ 524	\$ 49	\$ 95	\$ 177	\$ 256
42"W	SPLA-SS-STRETILE45HM.M425585		\$ 554	\$ 49	\$ 95	\$ 177	\$ 256
48"W	SPLA-SS-STRETILE45HL.M425586		\$ 592	\$ 81	\$ 159	\$ 294	\$ 427
60"W	SPLA-SS-STRETILE45HL.M425587		\$ 641	\$ 81	\$ 159	\$ 294	\$ 427

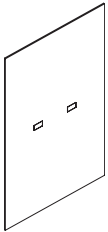

<b>52½"H Tackable Acoustical Port Tiles</b> (Monolithic tile for 57½"H frame)							
18"W	SPLA-SS-STRETILE53HS.M425588		\$ 511	\$ 38	\$ 74	\$ 137	\$ 199
20"W	SPLA-SS-STRETILE53HS.M425589		\$ 511	\$ 38	\$ 74	\$ 137	\$ 199
24"W	SPLA-SS-STRETILE53HS.M425590		\$ 511	\$ 38	\$ 74	\$ 137	\$ 199
30"W	SPLA-SS-STRETILE53HM.M425591		\$ 539	\$ 57	\$ 113	\$ 205	\$ 300
36"W	SPLA-SS-STRETILE53HM.M425592		\$ 574	\$ 57	\$ 113	\$ 205	\$ 300
42"W	SPLA-SS-STRETILE53HM.M425593		\$ 606	\$ 57	\$ 113	\$ 205	\$ 300
48"W	SPLA-SS-STRETILE53HL.M425594		\$ 641	\$ 93	\$ 186	\$ 343	\$ 499
60"W	SPLA-SS-STRETILE53HL.M425595		\$ 705	\$ 93	\$ 186	\$ 343	\$ 499

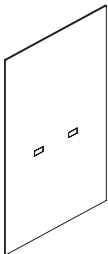

<b>60"H Tackable Acoustical Port Tiles</b> (Monolithic tile for 65"H frame)							
18"W	SPLA-SS-STRETILE60HS.M425596		\$ 547	\$ 42	\$ 84	\$ 156	\$ 227
20"W	SPLA-SS-STRETILE60HS.M425597		\$ 547	\$ 42	\$ 84	\$ 156	\$ 227
24"W	SPLA-SS-STRETILE60HS.M425598		\$ 547	\$ 42	\$ 84	\$ 156	\$ 227
30"W	SPLA-SS-STRETILE60HM.M425599		\$ 587	\$ 63	\$ 128	\$ 235	\$ 341
36"W	SPLA-SS-STRETILE60HM.M425600		\$ 664	\$ 63	\$ 128	\$ 235	\$ 341
42"W	SPLA-SS-STRETILE60HM.M425601		\$ 698	\$ 63	\$ 128	\$ 235	\$ 341
48"W	SPLA-SS-STRETILE60HL.M425602		\$ 724	\$ 106	\$ 214	\$ 391	\$ 569
60"W	SPLA-SS-STRETILE60HL.M425603		\$ 764	\$ 106	\$ 214	\$ 391	\$ 569

**Note:** Electrical mounts with 8988EBZ (ordered separately) mounted to underside of beltline horizontal (segment bar not required).

























**Note:** Should not be used with low storage as port access will be blocked.

<p><b>How to specify —</b> Select the Model Number from above.</p>	<p><b>1st Option:</b> <b>Fabric:</b> See <a href="#">inside back cover</a> for fabrics.</p>	<p><b>2nd Option:</b> <b>Electrical Grommet Color:</b> See <a href="#">inside front cover</a> for finishes.</p>
<p><b>S P L A - S S - S T R E T I L E</b></p> <p>_____ .</p>	<p>_____ .</p>	<p>_____ .</p>

Example: SPLA-SS-STRETILE38HS.M425572.APN927.E4

Shippable by small-package carrier.

For specification information see *Stride Price & Specification Guide*.

Description	Model	P1 Paint List Price	P2 Paint Upcharge	P3 Paint Upcharge
<b>7"H Steel Tiles</b>				
24"W	SPLA-SS-STRSTILE7HSM.M516892 	\$ 170	\$ 27	\$ 50
30"W	SPLA-SS-STRSTILE7HSM.M516891 	\$ 176	\$ 27	\$ 50
36"W	SPLA-SS-STRSTILE7HSM.M516890 	\$ 190	\$ 27	\$ 50
42"W	SPLA-SS-STRSTILE7HLG.M516889 	\$ 211	\$ 27	\$ 50
48"W	SPLA-SS-STRSTILE7HLG.M516888 	\$ 223	\$ 27	\$ 50
60"W	SPLA-SS-STRSTILE7HLG.M516887 	\$ 252	\$ 27	\$ 50
<b>15"H Steel Tiles</b>				
24"W	SPLA-SS-STRSTILE15HS.M516886 	\$ 197	\$ 27	\$ 50
30"W	SPLA-SS-STRSTILE15HS.M516885 	\$ 210	\$ 27	\$ 50
36"W	SPLA-SS-STRSTILE15HS.M516884 	\$ 229	\$ 27	\$ 50
42"W	SPLA-SS-STRSTILE15HL.M516883 	\$ 247	\$ 27	\$ 50
48"W	SPLA-SS-STRSTILE15HL.M516882 	\$ 272	\$ 27	\$ 50
60"W	SPLA-SS-STRSTILE15HL.M516881 	\$ 304	\$ 27	\$ 50
<b>22½"H Steel Tiles</b>				
24"W	SPLA-SS-STRSTILE22HS.M516880 	\$ 291	\$ 27	\$ 50
30"W	SPLA-SS-STRSTILE22HS.M516879 	\$ 316	\$ 27	\$ 50
36"W	SPLA-SS-STRSTILE22HS.M516878 	\$ 338	\$ 27	\$ 50
42"W	SPLA-SS-STRSTILE22HL.M516877 	\$ 367	\$ 27	\$ 50
48"W	SPLA-SS-STRSTILE22HL.M516876 	\$ 393	\$ 27	\$ 50
60"W	SPLA-SS-STRSTILE22HL.M516875 	\$ 458	\$ 27	\$ 50
<b>30"H Steel Tiles</b>				
24"W	SPLA-SS-STRSTILE30HS.M516874 	\$ 350	\$ 27	\$ 50
30"W	SPLA-SS-STRSTILE30HS.M516873 	\$ 378	\$ 27	\$ 50
36"W	SPLA-SS-STRSTILE30HS.M516872 	\$ 409	\$ 27	\$ 50
42"W	SPLA-SS-STRSTILE30HL.M516871 	\$ 444	\$ 27	\$ 50
48"W	SPLA-SS-STRSTILE30HL.M516870 	\$ 477	\$ 27	\$ 50
60"W	SPLA-SS-STRSTILE30HL.M516869 	\$ 547	\$ 27	\$ 50

**Note:** Order special UTP KIT separately below.



**Note:** 24"W tiles require 1 UTP kit.

30"W - 60"W tiles require 2 UTP kits.

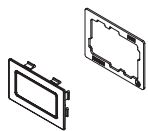
Description	Model	List Price
<b>Data/Electrical Port Kit</b> (specify color)		
Tile Port Kit for Steel Tiles	SPLA-UTP.M456004 	\$ 42



**How to specify —**  
Select the Model Number from above.

**1st Option:**  
**Paint Color:**  
   
See [inside front cover](#) for finishes.

\_\_\_\_\_ . **P** \_\_\_\_\_

Example: SPLA-SS-STRSTILE7HSM.M455956.P4J

 Shippable by small-package carrier.



For specification information see Stride Price & Specification Guide.

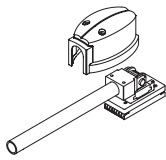

Description	Four-circuit 3 + 1 2 + 2		Three-circuit Separate Neutrals	
		List Price		List Price
<b>Base Electrical In-feed Cable (Black only)</b>				
12' Sealtight	SPLA-TP-ELEC-BYR.M489306	\$ 549	SPLA-TP-ELEC-BYR.M489309	\$ 793
18' Sealtight	SPLA-TP-ELEC-BYR.M489307	\$ 1045	SPLA-TP-ELEC-BYR.M489310	\$ 1075
24' Sealtight	SPLA-TP-ELEC-BYR.M489308	\$ 1395	SPLA-TP-ELEC-BYR.M489311	\$ 1431

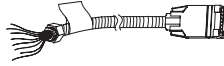

<b>Ceiling Electrical In-Feed Cables</b>				
6' Flex Cable	SPLA-TP-ELEC-BYR.M489324	\$ 500	N/A	
24' Flex Cable	SPLA-TP-ELEC-BYR.M489325	\$ 761	N/A	

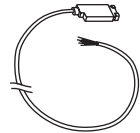

<b>Electrical Base In-Feed Cable</b>				
6' Sealtight Cable Power In-Feed	SPLA-TP-ELEC-BYR.M489326	\$ 606	N/A	
18' Sealtight Cable Power In-Feed	SPLA-TP-ELEC-BYR.M489327	\$ 836	N/A	
24' Sealtight Cable Power In-Feed	SPLA-TP-ELEC-BYR.M489328	\$ 1043	N/A	

**How to specify —**  
Select the Model Number from above.

\_\_\_\_\_ .

*Example: SPLA-TP-ELEC-BYR.M489306*

**[S]** Shippable by small-package carrier.

For specification information see Terrace system specification book.

Description	Model	List Price	Upcharge
		P1	P2
<b>Terrace Blade Feet and Glide Cover Kits — specify paint color</b>			
End Blade Foot* — Dual Sided	SPLA-ACC-SUPPORT.M375836	\$ 685	\$ 18
Mid Blade Foot* — Dual-Sided	SPLA-ACC-SUPPORT.M375837	\$ 685	\$ 18
Glide Tower Cover Kit for Blade Foot** — Single	SPLA-ACC-SUPPORT.M375840	\$ 78	\$ 18
Glide Tower Cover Kit for Blade Feet** — Pair	SPLA-ACC-SUPPORT.M375841	\$ 156	\$ 18

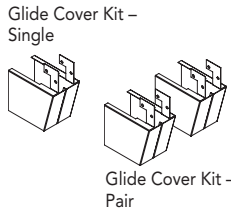
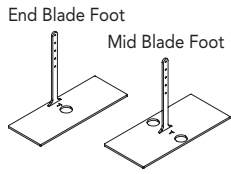

**\*Blade Feet**

- Blade Feet to be used with Raceway panels only – not compatible with Footed panels
- Glide tower cover kit includes parts to hide glide tower and give “footed” appearance. Will not exactly match standard footed aesthetic.
- Terrace panels must be ordered separately
- Blade feet are intended to be used to create free-standing panel runs
- Panels supported by Blade feet cannot contain hanging elements (shelves; overheads; shared storage)
- Panels supported by Blade feet cannot support worksurfaces
- Maximum height panels: Panels supported by blade bases can be no taller than 50”H (including stackers).
- Minimum quantity of supports: A blade base is required AT LEAST every 96” (8 feet), or every other panel connection, whichever condition happens first. A blade foot must be used at the ends of the panel run.
- Maximum length of run: A freestanding panel run supported by blade bases cannot be longer than 192” (16 feet).
- Note on Leveling: The special bases are designed to screw directly to the panel frame verticals. Therefore, there is no height adjustability once installed.
- Contact TPG to review layouts for potential exceptions or applications outside of free-standing panel runs

**\*\*Glide Tower**

- Includes parts to hide glide tower(s) and give “footed” appearance. Will not exactly match standard footed aesthetic.

**Terrace Power Pole Accessories — specify paint color**

Power Pole Splice Kit — use with 2 Standard			
Power Poles (order Terrace Power Poles separately)	SPLA-DNA-TRIM.M375864	\$ 333	\$ 18



Description	Model	List Price	Upcharge	Upcharge
		P1	P2	P3
<b>22½”H Steel Base Tiles to-the-Floor — specify paint color</b>				
24”W	TKG42224FSF	\$ 481	\$ 30	\$ 57
30”W	TKG42230FSF	\$ 520	\$ 30	\$ 57
36”W	TKG42236FSF	\$ 558	\$ 30	\$ 57
42”W	TKG42242FSF	\$ 595	\$ 30	\$ 57
48”W	TKG42248FSF	\$ 640	\$ 30	\$ 57
60”W	TKG42260FSF	\$ 726	\$ 30	\$ 57

**30”H Steel Base Tiles to-the-Floor — specify paint color**

24”W	TKG43024FSF	\$ 645	\$ 30	\$ 57
30”W	TKG43030FSF	\$ 702	\$ 30	\$ 57
36”W	TKG43036FSF	\$ 749	\$ 30	\$ 57
42”W	TKG43042FSF	\$ 800	\$ 30	\$ 57
48”W	TKG43048FSF	\$ 851	\$ 30	\$ 57
60”W	TKG43060FSF	\$ 983	\$ 30	\$ 57

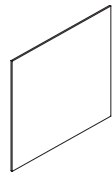
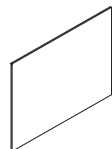

**How to specify —**

Select the Model Number from above.

**1st Option:**

Select the Paint Color:



See inside front cover for paints.

\_\_\_\_\_ . P \_\_\_\_\_

Examples: SPLA-ACC-SUPPORT.M375836.P7C TKG42224FSF.PR5

For specification information please see page 20.

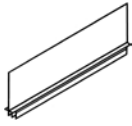

Description	Model	P1 List Price	P2 Upcharge	Frosted Glass Upcharge	Smoked Glass Upcharge
<b>22½"H Frameless Glass with Flat Top Cap</b>					
24"W	SPLA-DNA-SCRNGLSSFA.M511280	\$ 774	\$ 40	\$ 73	\$ 111
30"W	SPLA-DNA-SCRNGLSSFA.M511281	\$ 828	\$ 40	\$ 73	\$ 111
36"W	SPLA-DNA-SCRNGLSSFA.M511282	\$ 956	\$ 40	\$ 73	\$ 111
42"W	SPLA-DNA-SCRNGLSSFB.M511283	\$ 1020	\$ 48	\$ 114	\$ 171
48"W	SPLA-DNA-SCRNGLSSFB.M511284	\$ 1092	\$ 48	\$ 114	\$ 171
54"W	SPLA-DNA-SCRNGLSSFC.M511285	\$ 1210	\$ 48	\$ 170	\$ 257
60"W	SPLA-DNA-SCRNGLSSFC.M511286	\$ 1334	\$ 48	\$ 170	\$ 257
66"W	SPLA-DNA-SCRNGLSSFC.M511287	\$ 1458	\$ 48	\$ 170	\$ 257
72"W	SPLA-DNA-SCRNGLSSFC.M511288	\$ 1588	\$ 48	\$ 170	\$ 257
78"W	SPLA-DNA-SCRNGLSSFC.M511289	\$ 1788	\$ 48	\$ 170	\$ 257
84"W	SPLA-DNA-SCRNGLSSFC.M511290	\$ 2020	\$ 48	\$ 170	\$ 257
90"W	SPLA-DNA-SCRNGLSSFC.M511291	\$ 2074	\$ 48	\$ 170	\$ 257
96"W	SPLA-DNA-SCRNGLSSFC.M511292	\$ 2138	\$ 48	\$ 170	\$ 257



<b>22½"H Grooved High/Low Flat Connector Kit</b>					
	SPLA-DNA-TRIM.M507358	\$ 128	\$ 18		

Description	Model	P1 List Price	P2 Upcharge	Frosted Glass Upcharge	Smoked Glass Upcharge
<b>22½"H Frameless Glass with Radius Top Cap</b>					
24"W	SPLA-DNA-SCRNGLSSRA.M511293	\$ 774	\$ 40	\$ 73	\$ 111
30"W	SPLA-DNA-SCRNGLSSRA.M511294	\$ 828	\$ 40	\$ 73	\$ 111
36"W	SPLA-DNA-SCRNGLSSRA.M511295	\$ 956	\$ 40	\$ 73	\$ 111
42"W	SPLA-DNA-SCRNGLSSRB.M511296	\$ 1020	\$ 48	\$ 114	\$ 171
48"W	SPLA-DNA-SCRNGLSSRB.M511297	\$ 1092	\$ 48	\$ 114	\$ 171
54"W	SPLA-DNA-SCRNGLSSRC.M511298	\$ 1210	\$ 48	\$ 170	\$ 257
60"W	SPLA-DNA-SCRNGLSSRC.M511299	\$ 1334	\$ 48	\$ 170	\$ 257
66"W	SPLA-DNA-SCRNGLSSRC.M511300	\$ 1458	\$ 48	\$ 170	\$ 257
72"W	SPLA-DNA-SCRNGLSSRC.M511301	\$ 1588	\$ 48	\$ 170	\$ 257
78"W	SPLA-DNA-SCRNGLSSRC.M511302	\$ 1788	\$ 48	\$ 170	\$ 257
84"W	SPLA-DNA-SCRNGLSSRC.M511303	\$ 2020	\$ 48	\$ 170	\$ 257
90"W	SPLA-DNA-SCRNGLSSRC.M511304	\$ 2074	\$ 48	\$ 170	\$ 257
96"W	SPLA-DNA-SCRNGLSSRC.M511305	\$ 2138	\$ 48	\$ 170	\$ 257



<b>22½"H Grooved Painted High/Low Radius Connector Kit</b>					
	SPLA-DNA-TRIM.M507359	\$ 128	\$ 18		

**Note:** Due to increased height of the glass, there will be noticeable side-to-side movement on the screen. Please contact TPG prior to placing your order to review your layout if you have questions. Alignment brackets are required. See page 21.

<p><b>How to specify —</b> Select the Model Number from above.</p> <p>_____ .</p> <p>_____ .</p>	<p><b>1st Option:</b> Glass (if applicable): LC Clear LF Frosted GSM1 Smoked</p> <p>_____ .</p>	<p><b>2nd Option:</b> Paint (if applicable): P1 P2 See inside front cover for finishes.</p> <p>P _____</p>
--	---	--

Example:

5 Shippable by small-package carrier.

## Terrace Flat Trim COM Insert Spec

Custom material used in grooved top cap trim should be sized according to these dimensions:

Standard Height	Actual Dimensions	Standard Width	Actual Dimensions
7½"H	8.460"H	24"W	23.866"W
15"H	15.960"H	30"W	29.866"W
22½"H	23.460"H	36"W	35.866"W
		42"W	41.866"W
		48"W	47.866"W
Height tolerance should be +0.000" / -0.188"		54"W	53.866"W
		60"W	59.866"W
Width tolerance should be +/- 0.094"		66"W	65.866"W
		72"W	71.866"W
Thickness of custom material must be 10MM thick -0.120MM / +0.890MM		78"W	77.866"W
		84"W	83.866"W
		90"W	89.866"W
		96"W	95.866"W

For COM material heights taller than 15"H.

Connector brackets are required to connect all screens together.

Every run of glass must have perpendicular support. Must use an L, T, or X connector brackets.

See page 21 for models

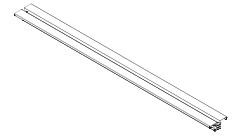

## Terrace Radius Trim COM Insert Spec

Custom material used in grooved top cap trim should be sized according to these dimensions:

Standard Height	Actual Dimensions	Standard Width	Actual Dimensions
7½"H	8.460"H	24"W	23.866"W
15"H	15.960"H	30"W	29.866"W
22½"H	23.460"H	36"W	35.866"W
		42"W	41.866"W
		48"W	47.866"W
Height tolerance should be +0.000" / -0.188"		54"W	53.866"W
		60"W	59.866"W
Width tolerance should be +/- 0.094"		66"W	65.866"W
		72"W	71.866"W
Thickness of custom material must be 10MM thick -0.120MM / +0.890MM		78"W	77.866"W
		84"W	83.866"W
		90"W	89.866"W
		96"W	95.866"W

For COM material heights taller than 15"H.

Connector brackets are required to connect all screens together.

Every run of glass must have perpendicular support. Must use an L, T, or X connector brackets.

See page 21 for models

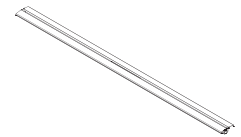







For specification information see current Terrace Price & Specification Guide.

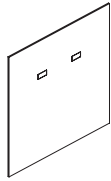

Description	Model	List Price					Upcharge				
		Grade A	Grade B	Grade C	Grade D	Grade E	Grade A	Grade B	Grade C	Grade D	Grade E
<b>30"H Tackable Acoustical Port Tiles</b>											
18"W	SPLA-SS-TER30HFT1.M425613	\$ 286	\$ 15	\$ 33	\$ 59	\$ 85					
20"W	SPLA-SS-TER30HFT1.M425614	\$ 286	\$ 15	\$ 33	\$ 59	\$ 85					
24"W	SPLA-SS-TER30HFT1.M425615	\$ 286	\$ 15	\$ 33	\$ 59	\$ 85					
30"W	SPLA-SS-TER30HFT2.M425616	\$ 299	\$ 25	\$ 49	\$ 88	\$ 129					
36"W	SPLA-SS-TER30HFT2.M425617	\$ 330	\$ 25	\$ 49	\$ 88	\$ 129					
42"W	SPLA-SS-TER30HFT2.M425618	\$ 346	\$ 25	\$ 49	\$ 88	\$ 129					
48"W	SPLA-SS-TER30HFT3.M425619	\$ 363	\$ 41	\$ 82	\$ 150	\$ 218					
60"W	SPLA-SS-TER30HFT3.M425620	\$ 383	\$ 41	\$ 82	\$ 150	\$ 218					

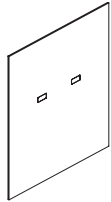

<b>42½"H Tackable Acoustical Port Tiles</b>											
18"W	SPLA-SS-TER42HFT1.M425621	\$ 355	\$ 27	\$ 53	\$ 96	\$ 141					
20"W	SPLA-SS-TER42HFT1.M425622	\$ 355	\$ 27	\$ 53	\$ 96	\$ 141					
24"W	SPLA-SS-TER42HFT1.M425623	\$ 355	\$ 27	\$ 53	\$ 96	\$ 141					
30"W	SPLA-SS-TER42HFT2.M425624	\$ 375	\$ 40	\$ 81	\$ 147	\$ 214					
36"W	SPLA-SS-TER42HFT2.M425625	\$ 414	\$ 40	\$ 81	\$ 147	\$ 214					
42"W	SPLA-SS-TER42HFT2.M425626	\$ 441	\$ 40	\$ 81	\$ 147	\$ 214					
48"W	SPLA-SS-TER42HFT3.M425627	\$ 501	\$ 66	\$ 132	\$ 245	\$ 357					
60"W	SPLA-SS-TER42HFT3.M425628	\$ 523	\$ 66	\$ 132	\$ 245	\$ 357					

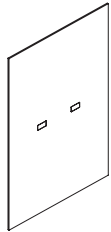

<b>50"H Tackable Acoustical Port Tiles</b>											
18"W	SPLA-SS-TER50HFT1.M425629	\$ 375	\$ 29	\$ 63	\$ 116	\$ 167					
20"W	SPLA-SS-TER50HFT1.M425630	\$ 375	\$ 29	\$ 63	\$ 116	\$ 167					
24"W	SPLA-SS-TER50HFT1.M425631	\$ 387	\$ 29	\$ 63	\$ 116	\$ 167					
30"W	SPLA-SS-TER50HFT2.M425632	\$ 430	\$ 48	\$ 94	\$ 174	\$ 253					
36"W	SPLA-SS-TER50HFT2.M425633	\$ 464	\$ 48	\$ 94	\$ 174	\$ 253					
42"W	SPLA-SS-TER50HFT2.M425634	\$ 511	\$ 48	\$ 94	\$ 174	\$ 253					
48"W	SPLA-SS-TER50HFT3.M425635	\$ 556	\$ 80	\$ 158	\$ 292	\$ 423					
60"W	SPLA-SS-TER50HFT3.M425636	\$ 608	\$ 80	\$ 158	\$ 292	\$ 423					

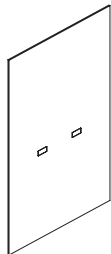

<b>57½"H Tackable Acoustical Port Tiles</b>											
18"W	SPLA-SS-TER57HFT1.M425637	\$ 432	\$ 38	\$ 73	\$ 133	\$ 195					
20"W	SPLA-SS-TER57HFT1.M425638	\$ 432	\$ 38	\$ 73	\$ 133	\$ 195					
24"W	SPLA-SS-TER57HFT1.M425639	\$ 432	\$ 38	\$ 73	\$ 133	\$ 195					
30"W	SPLA-SS-TER57HFT2.M425640	\$ 432	\$ 55	\$ 109	\$ 202	\$ 294					
36"W	SPLA-SS-TER57HFT2.M425641	\$ 479	\$ 55	\$ 109	\$ 202	\$ 294					
42"W	SPLA-SS-TER57HFT2.M425642	\$ 517	\$ 55	\$ 109	\$ 202	\$ 294					
48"W	SPLA-SS-TER57HFT3.M425643	\$ 559	\$ 92	\$ 184	\$ 334	\$ 488					
60"W	SPLA-SS-TER57HFT3.M425644	\$ 612	\$ 92	\$ 184	\$ 334	\$ 488					

<b>65"H Tackable Acoustical Port Tiles</b>											
18"W	SPLA-SS-TER65HFT1.M425645	\$ 448	\$ 41	\$ 82	\$ 150	\$ 218					
20"W	SPLA-SS-TER65HFT1.M425646	\$ 448	\$ 41	\$ 82	\$ 150	\$ 218					
24"W	SPLA-SS-TER65HFT1.M425647	\$ 448	\$ 41	\$ 82	\$ 150	\$ 218					
30"W	SPLA-SS-TER65HFT2.M425648	\$ 498	\$ 62	\$ 124	\$ 226	\$ 329					
36"W	SPLA-SS-TER65HFT2.M425649	\$ 545	\$ 62	\$ 124	\$ 226	\$ 329					
42"W	SPLA-SS-TER65HFT2.M425650	\$ 594	\$ 62	\$ 124	\$ 226	\$ 329					
48"W	SPLA-SS-TER65HFT3.M425651	\$ 650	\$ 102	\$ 204	\$ 377	\$ 549					
60"W	SPLA-SS-TER65HFT3.M425652	\$ 677	\$ 102	\$ 204	\$ 377	\$ 549					

**Note:** Electrical mounts with 8989EB (ordered separately) mounted to the underside of the beltline horizontal (segment bar not required.)

**Note:** Should not be used with low storage because port access will be blocked.

<p><b>How to specify —</b> Select the Model Number from above.</p>	<p><i>1st Option:</i> <b>Fabric:</b> See <a href="#">inside back cover</a> for fabrics.</p>	<p><i>2nd Option:</i> <b>Electrical Grommet Color:</b> See <a href="#">inside front cover</a> for finishes.</p>
--	---	---

Example: SPLA-SS-TER30HFT1.M425613.ECH901.E9

**[S]** Shippable by small-package carrier.

For specification information see *Terrace Price & Specification Guide*.

Description	Model	P1 Paint List Price	P2 Paint Upcharge	P3 Paint Upcharge
<b>7½"H Steel Tiles</b>				
24"W	SPLA-SS-TER07HST1.M455980 <span>S</span>	\$ 168	\$ 38	\$ 71
30"W	SPLA-SS-TER07HST1.M455981 <span>S</span>	\$ 176	\$ 38	\$ 71
36"W	SPLA-SS-TER07HST1.M455982 <span>S</span>	\$ 190	\$ 38	\$ 71
42"W	SPLA-SS-TER07HST2.M455983 <span>S</span>	\$ 214	\$ 38	\$ 71
48"W	SPLA-SS-TER07HST2.M455984 <span>S</span>	\$ 229	\$ 38	\$ 71
60"W	SPLA-SS-TER07HST2.M455985 <span>S</span>	\$ 256	\$ 38	\$ 71
<b>15"H Steel Tiles</b>				
24"W	SPLA-SS-TER15HST1.M455986 <span>S</span>	\$ 175	\$ 38	\$ 71
30"W	SPLA-SS-TER15HST1.M455987 <span>S</span>	\$ 183	\$ 38	\$ 71
36"W	SPLA-SS-TER15HST1.M455988 <span>S</span>	\$ 199	\$ 38	\$ 71
42"W	SPLA-SS-TER15HST2.M455989 <span>S</span>	\$ 219	\$ 38	\$ 71
48"W	SPLA-SS-TER15HST2.M455990 <span>S</span>	\$ 236	\$ 38	\$ 71
60"W	SPLA-SS-TER15HST2.M455991 <span>S</span>	\$ 266	\$ 38	\$ 71
<b>22½"H Steel Tiles</b>				
24"W	SPLA-SS-TER22HST1.M455992 <span>S</span>	\$ 222	\$ 38	\$ 71
30"W	SPLA-SS-TER22HST1.M455993 <span>S</span>	\$ 230	\$ 38	\$ 71
36"W	SPLA-SS-TER22HST1.M455994 <span>S</span>	\$ 246	\$ 38	\$ 71
42"W	SPLA-SS-TER22HST2.M455995 <span>S</span>	\$ 266	\$ 38	\$ 71
48"W	SPLA-SS-TER22HST2.M455996 <span>S</span>	\$ 285	\$ 38	\$ 71
60"W	SPLA-SS-TER22HST2.M455997 <span>S</span>	\$ 315	\$ 38	\$ 71
<b>30"H Steel Tiles</b>				
24"W	SPLA-SS-TER30HST1.M455998 <span>S</span>	\$ 256	\$ 53	\$ 108
30"W	SPLA-SS-TER30HST1.M455999 <span>S</span>	\$ 281	\$ 53	\$ 108
36"W	SPLA-SS-TER30HST1.M456000 <span>S</span>	\$ 317	\$ 53	\$ 108
42"W	SPLA-SS-TER30HST2.M456001 <span>S</span>	\$ 337	\$ 53	\$ 108
48"W	SPLA-SS-TER30HST2.M456002 <span>S</span>	\$ 376	\$ 53	\$ 108
60"W	SPLA-SS-TER30HST2.M456003 <span>S</span>	\$ 427	\$ 53	\$ 108

**Note:** Order special UTP KIT separately below.

**Note:** 24"W tiles require 1 UTP kit.

30"W - 60"W tiles require 2 UTP kits.

Description	Model	List Price
<b>Data/Electrical Port Kit (specify color)</b>		
Tile Port Kit for Steel Tiles	SPLA-UTP.M456004 <span>S</span>	\$ 42

**How to specify —**  
Select the Model Number from above.

*1st Option:*  
**Paint Color:**  
P1 P2  
See [inside front cover](#) for finishes.

Example: SPLA-SS-STRSTILE7HSM.M455956.P4J P

S Shippable by small-package carrier.



For specification information see current Terrace Price & Specification Guide.

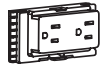

Duplex Receptacle

Description	Four-circuit 3 + 1 2 + 2	List Price	Three-circuit Separate Neutrals	List Price
<b>Duplex Receptacle</b>				
Circuit 2 - 20 AMP	SPLA-TP-PELEC-BYR.M487355	\$ 87	SPLA-TP-PELEC-BYR.M487372	\$ 87
Circuit 3 - 20 AMP (3 + 1)	SPLA-TP-PELEC-BYR.M487356	\$ 87	SPLA-TP-PELEC-BYR.M487373	\$ 87
Circuit 3 - 20 AMP (2 + 2)	SPLA-TP-PELEC-BYR.M487358	\$ 87	N/A	
Circuit 4 - 20 AMP (Four Circuit - ISO/DEDICATED)	SPLA-TP-PELEC-BYR.M487359	\$ 87	N/A	

**Note:** Duplex receptacles are 1 1/8"D and will sit proud of the panel frame.

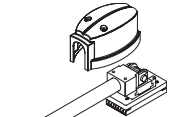

Base Electrical Infeed

<b>Base Electrical In-Feed Cable: Sealtight cable for Terrace receptacle</b>				
12' Sealtight	SPLA-TP-ELEC-BYR.M489312	\$ 749	SPLA-TP-ELEC-BYR.M489315	\$ 722
18' Sealtight	SPLA-TP-ELEC-BYR.M489313	\$ 1012	SPLA-TP-ELEC-BYR.M489316	\$ 1012
24' Sealtight	SPLA-TP-ELEC-BYR.M489314	\$ 1352	SPLA-TP-ELEC-BYR.M489317	\$ 1201

<b>Base Electrical In-Feed Cable: Flex Cable</b>				
12' Flex Cable	SPLA-TP-ELEC-BYR.M489318	\$ 477	SPLA-TP-ELEC-BYR.M489321	\$ 576
18' Flex Cable	SPLA-TP-ELEC-BYR.M489319	\$ 1045	SPLA-TP-ELEC-BYR.M489322	\$ 980
24' Flex Cable	SPLA-TP-ELEC-BYR.M489320	\$ 1111	SPLA-TP-ELEC-BYR.M489323	\$ 1208



Ceiling Electrical Infeed

<b>Ceiling Electrical In-Feed Cables</b>				
6' Flex Cable	SPLA-TP-ELEC-BYR.M489324	\$ 500	N/A	
24' Flex Cable	SPLA-TP-ELEC-BYR.M489325	\$ 761	N/A	

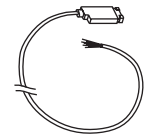

Electrical Infeed Cable

<b>Electrical Base In-Feed Cables (for use with footed panels)</b>				
6' Sealtight Ceiling	SPLA-TP-ELEC-BYR.M489326	\$ 606	N/A	
18' Sealtight Ceiling	SPLA-TP-ELEC-BYR.M489327	\$ 836	N/A	
24' Sealtight Ceiling	SPLA-TP-ELEC-BYR.M489328	\$ 1043	N/A	

**How to specify —**  
Select the Model Number from above.

*1st Option:*  
**Electrical Receptacle Color (if applicable):**  
See [inside front cover](#) for finishes.

*1st Option:*  
**Color (if applicable):**  
P Black

\_\_\_\_\_ . **E**

*Example:* SPLA-TP-PELEC-BYR.M487355.E4

**S** Shippable by small-package carrier.

For specification information see current Further Price & Specification Guide.

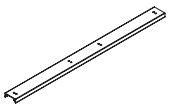
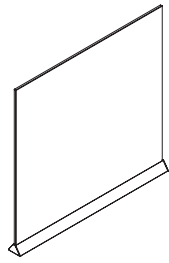

Description	Model	P1 List Price	P2 Upcharge	P3 Upcharge	Frosted Glass Upcharge	Smoked Glass Upcharge
<b>28"H Triangle Base Beam Mounted Glass Screens</b>						
24"W	SPLA-FTR-GSCRN2040.M511316	\$ 975	\$ 18	\$ 29	\$ 120	\$ 242
30"W	SPLA-FTR-GSCRN2040.M511317	\$ 1137	\$ 18	\$ 29	\$ 120	\$ 242
36"W	SPLA-FTR-GSCRN2040.M511319	\$ 1269	\$ 18	\$ 29	\$ 120	\$ 242
42"W	SPLA-FTR-GSCRN2040.M511321	\$ 1440	\$ 18	\$ 29	\$ 120	\$ 242
48"W	SPLA-FTR-GSCRN4060.M511322	\$ 1558	\$ 18	\$ 29	\$ 152	\$ 307
54"W	SPLA-FTR-GSCRN4060.M511323	\$ 1687	\$ 18	\$ 29	\$ 152	\$ 307
60"W	SPLA-FTR-GSCRN4060.M511325	\$ 1802	\$ 18	\$ 29	\$ 152	\$ 307
66"W	SPLA-FTR-GSCRN4060.M511326	\$ 2135	\$ 18	\$ 29	\$ 152	\$ 307
72"W	SPLA-FTR-GSCRN6080.M511327	\$ 2296	\$ 18	\$ 29	\$ 209	\$ 424
78"W	SPLA-FTR-GSCRN6080.M511328	\$ 2493	\$ 18	\$ 29	\$ 209	\$ 424
84"W	SPLA-FTR-GSCRN6080.M511329	\$ 2700	\$ 18	\$ 29	\$ 209	\$ 424
90"W	SPLA-FTR-GSCRN6080.M511331	\$ 2842	\$ 18	\$ 29	\$ 209	\$ 424
96"W	SPLA-FTR-GSCRN6080.M511332	\$ 3051	\$ 18	\$ 29	\$ 209	\$ 424

**Beam Trim For Triangle Base Screens**

24"W	SPLA-FTR-CAP2040.M511333	\$ 346	\$ 14	\$ 22
30"W	SPLA-FTR-CAP2040.M511334	\$ 358	\$ 14	\$ 22
36"W	SPLA-FTR-CAP2040.M511335	\$ 368	\$ 14	\$ 22
42"W	SPLA-FTR-CAP2040.M511336	\$ 389	\$ 14	\$ 22
48"W	SPLA-FTR-CAP2040.M511337	\$ 439	\$ 14	\$ 22
54"W	SPLA-FTR-CAP4060.M511338	\$ 485	\$ 19	\$ 33
60"W	SPLA-FTR-CAP4060.M511339	\$ 505	\$ 19	\$ 33
66"W	SPLA-FTR-CAP4060.M511340	\$ 528	\$ 19	\$ 33
72"W	SPLA-FTR-CAP4060.M511341	\$ 541	\$ 19	\$ 33
78"W	SPLA-FTR-CAP6080.M511342	\$ 559	\$ 27	\$ 50
84"W	SPLA-FTR-CAP6080.M511343	\$ 596	\$ 27	\$ 50
90"W	SPLA-FTR-CAP6080.M511344	\$ 630	\$ 27	\$ 50
96"W	SPLA-FTR-CAP6080.M511345	\$ 701	\$ 27	\$ 50

**Notes:**

- 28"H Beam Mounted Screens will align with 57½"H Storage when used with 28"H Further Beams.
- Beam Mount component must be ordered separately.
- Beam Mount models will not be visible in specifying software, but are visible on Allsteel Synergy quoting and ordering tools.

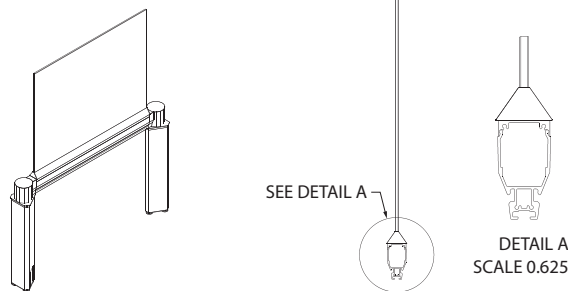

**Specification Rules:**

- This solution is for New Further Beams only.
- Triangle Base will slightly overhang the beam.
- Special Beam trim to be ordered separately. See detail A.
- Installation requires clamping of the top cap to get it to "snap" on.
- Top cap pressure fit will be tight so the data or electrical in the beam will be more difficult to access after special top cap and screen is installed.

<p><b>How to specify —</b> Select the Model Number from above.</p>	<p><b>1st Option:</b> Glass (if applicable): LC Clear LF Frosted GSM1 Smoked</p>	<p><b>2nd Option:</b> Paint (if applicable): P1 P2 P3 See <a href="#">inside front cover</a> for finishes.</p>
<p>Example:</p>		

5 Shippable by small-package carrier.





For specification information see current Further Price & Specification Guide.



Description	Max. Receptacles Per Side	Model	List Price
<b>Duplex Receptacles for Further Dual-Sided Power Kits</b>			
Receptacle - 20 AMP Circuit 2 - Further		SPLA-TP-PELEC-BYR.M487360 <span style="border: 1px solid black; padding: 0 2px;">S</span>	\$ 87
Receptacle - 20 AMP Circuit 1 - Further		SPLA-TP-PELEC-BYR.M496568 <span style="border: 1px solid black; padding: 0 2px;">S</span>	\$ 87
Receptacle - 20 AMP Circuit 3 - Further (2+2)		SPLA-TP-PELEC-BYR.M487362 <span style="border: 1px solid black; padding: 0 2px;">S</span>	\$ 87
Receptacle - 20 AMP Circuit 3 - Further (3+1)		SPLA-TP-PELEC-BYR.M487361 <span style="border: 1px solid black; padding: 0 2px;">S</span>	\$ 87
Receptacle - 20 AMP Circuit 4 - Further (ISOLATED/DEDICATED)		SPLA-TP-PELEC-BYR.M487363 <span style="border: 1px solid black; padding: 0 2px;">S</span>	\$ 87

**Note:** 20 AMP receptacles not compatible with old style beams.

**Note:** Further 20 AMP receptacles extend from beam 1/8" more than standard Further receptacles.

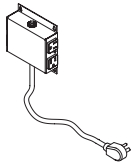

Description	Max. Receptacles Per Side	Model	List Price
<b>Power/Data Modules — Under Worksurface Mount</b>			
FURTHER QUAD TAP POWER MODULE with 6' cord		SPLA-TP-ELEC-BYR.M454877 <span style="border: 1px solid black; padding: 0 2px;">S</span>	\$ 541

**How to specify —**  
Select the Model Number from above.

*1st Option:*  
**Electrical Receptacle Color**  
(if applicable):  
See [inside front cover](#) for finishes.

\_\_\_\_\_ . **E**

*Examples:* SPLA-TP-ELEC-BYR.M454877  
SPLA-TP-PELEC-BYR.M496568.E4

S Shippable by small-package carrier.



For specification information please see page 20.

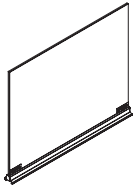

Description	Model	P1 List Price	P2 Upcharge	P3 Upcharge	Frosted Glass Upcharge	Smoked Glass Upcharge
<b>22½"H Frameless Glass with Top Cap</b>						
24"W	SPLA-SS-OPTSCRGLSS.M511306	\$ 856	\$ 18	\$ 29	\$ 73	\$ 111
30"W	SPLA-SS-OPTSCRGLSS.M511307	\$ 945	\$ 18	\$ 29	\$ 73	\$ 111
36"W	SPLA-SS-OPTSCRGLSS.M511308	\$ 1068	\$ 18	\$ 29	\$ 73	\$ 111
42"W	SPLA-SS-OPTSCRGLSM.M511309	\$ 1136	\$ 18	\$ 29	\$ 114	\$ 171
48"W	SPLA-SS-OPTSCRGLSM.M511310	\$ 1250	\$ 18	\$ 29	\$ 114	\$ 171
54"W	SPLA-SS-OPTSCRGLSM.M511311	\$ 1366	\$ 18	\$ 29	\$ 114	\$ 171
60"W	SPLA-SS-OPTSCRGLSM.M511312	\$ 1467	\$ 18	\$ 29	\$ 114	\$ 171
66"W	SPLA-SS-OPTSCRGLSM.M511313	\$ 1584	\$ 18	\$ 29	\$ 114	\$ 171
72"W	SPLA-SS-OPTSCRGLSL.M511314	\$ 1671	\$ 18	\$ 29	\$ 170	\$ 257

**Note:** Due to increased height of the glass, there will be noticeable side-to-side movement on the screen.

Please contact TPG prior to placing your order to review your layout if you have questions.

**Note:** The height of these models are NOT compatible with new frameless glass models (ie: P21536FGS) launched 7/1/21. If 22½"H frameless glass is needed for NEW model design, please contact TPG as product modification requests will be needed.

<p><b>How to specify —</b> Select the Model Number from above.</p>          <div style="border-bottom: 1px solid black; width: 100%; height: 10px;"></div> <div style="border-bottom: 1px solid black; width: 100%; height: 10px;"></div>	<p><b>1st Option:</b> <b>Glass</b> (if applicable): LC Clear LF Frosted GSM1 Smoked</p>          <div style="border-bottom: 1px solid black; width: 100%; height: 10px;"></div>	<p><b>2nd Option:</b> <b>Paint</b> (if applicable): P1 P2 See <a href="#">inside front cover</a> for finishes.</p>          <div style="border-bottom: 1px solid black; width: 100%; height: 10px;"></div>
---	---	--

Example:

**S** Shippable by small-package carrier.

## Optimize Trim COM Insert Spec

Custom material used in grooved top cap trim should be sized according to these dimensions:

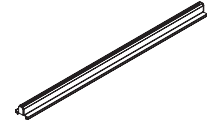

Standard Height	Actual Dimensions	Standard Width	Actual Dimensions
7½"H	8.460"H	24"W	23.866"W
15"H	15.960"H	30"W	29.866"W
22½"H	23.460"H	36"W	35.866"W
		42"W	41.866"W
		48"W	47.866"W
		54"W	53.866"W
		60"W	59.866"W
		66"W	65.866"W
		72"W	71.866"W

Height tolerance should be +0.000" / -0.188"

Width tolerance should be +/- 0.094"

Thickness of custom material must be 10MM thick -0.120MM / +0.890MM

For COM material heights taller than 15"H.  
 Connector brackets are required to connect all screens together.  
 Every run of glass must have perpendicular support. Must use an L, T, or X connector brackets.  
 See page 21 for models

**Note:** The dimensions referenced are NOT compatible with new frameless glass models (ie: P21536FGS) launched 7/1/21.



For specification information see current Optimize Price & Specification Guide.



Description	Four-circuit 3 + 1 2 + 2	List Price	Three-circuit Separate Neutrals	List Price
<b>Duplex Receptacle</b>				
Circuit 2 - 20 AMP	SPLA-TP-PELEC-BYR.M487364	\$ 87	SPLA-TP-PELEC-BYR.M487368	\$ 87
Circuit 3 - 20 AMP (3 + 1)	SPLA-TP-PELEC-BYR.M487365	\$ 87	SPLA-TP-PELEC-BYR.M487369	\$ 87
Circuit 3 - 20 AMP (2 + 2)	SPLA-TP-PELEC-BYR.M487366	\$ 87		
Circuit 4 - 20 AMP (Four Circuit - ISO/DEDICATED)	SPLA-TP-PELEC-BYR.M487367	\$ 87		

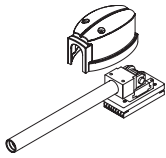

<b>Base Electrical In-Feed Cable: Sealight Cable for Optimize Receptacle</b>				
12' Sealight	SPLA-TP-ELEC-BYR.M489329	\$ 749	SPLA-TP-ELEC-BYR.M489332	\$ 768
18' Sealight	SPLA-TP-ELEC-BYR.M489330	\$ 1012	SPLA-TP-ELEC-BYR.M489333	\$ 1042
24' Sealight	SPLA-TP-ELEC-BYR.M489331	\$ 1326	SPLA-TP-ELEC-BYR.M489334	\$ 1387

<b>Base Electrical In-Feed Cable: Flex Cable</b>				
12' Flex Cable	SPLA-TP-ELEC-BYR.M489318	\$ 477	SPLA-TP-ELEC-BYR.M489321	\$ 576
18' Flex Cable	SPLA-TP-ELEC-BYR.M489319	\$ 1045	SPLA-TP-ELEC-BYR.M489322	\$ 980
24' Flex Cable	SPLA-TP-ELEC-BYR.M489320	\$ 1111	SPLA-TP-ELEC-BYR.M489323	\$ 1208

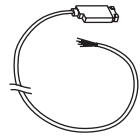

<b>Ceiling Electrical In-Feed Cables</b>				
6' Flex Cable	SPLA-TP-ELEC-BYR.M489324	\$ 500		
24' Flex Cable	SPLA-TP-ELEC-BYR.M489325	\$ 761		

**How to specify —**  
Select the  
Model Number  
from above.

*1st Option:*  
**Electrical Receptacle**  
**Color (if applicable):**  
See [inside front](#)  
[cover](#) for finishes.

*1st Option:*  
**Color**  
*(if applicable):*  
P Black

Example: SPLA-TP-PELEC-BYR.M487364.E4

Shippable by small-package carrier.



120 Degree Surfaces

	Depth	36	42	48	54
Base Type	Width				
A6 T- or C-Base	36				
	42				
	48				
	54				

Corner Covers

	Depth	36	42	48	54	60
Base Type	Width					
A6 T- or C-Base	54	A6REC3S3LTF or A6REC3S3LCF				
	60					
	66					
	72					
	78	For A6 T- or C-Base to support these size corner covers, please submit a modification request on the Tailored Solutions App on Allsteel Synergy.				
	84					
	90					
	96					

Rectangular Tops

	Depth	24	27	30	36		
Base Type	Width						
A6 T- or C-Base NOTE: Bases for 36D tops are "old style" T-Base only. If New Style A6 T- or C-Bases is needed please submit a modification request through the Tailored Solutions App.	36						
	42	A6REC3S2LTF or A6REC3S2LCF			BLACK-M490245	Standard Special SILVER-M490243	WHITE-M490247
	78	A6MREC3S2LTF or A6MREC3S2LCF			BLACK-M490245	Standard Special SILVER-M490243	WHITE-M490247
	84	A6MREC3S2LTF or A6MREC3S2LCF			BLACK-M490245	Standard Special SILVER-M490243	WHITE-M490247
	90	A6MREC3S2LTF or A6MREC3S2LCF			BLACK-M490245	Standard Special SILVER-M490243	WHITE-M490247
	96				BLACK-M490245	Standard Special SILVER-M490243 Special Stretcher Bar M501803	WHITE-M490247



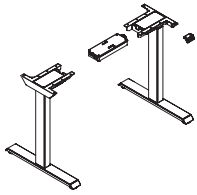

Open Market

Description	Model	List Price
<b>T-Base Height-Adjustable</b>		
Adjustable 2 leg - black paint - 800mm feet	SPLA-ALT-TLEGBASE.M490245	\$ 2712
Adjustable 2 leg - silver paint - 800mm feet	SPLA-ALT-TLEGBASE.M490243	\$ 2712
Adjustable 2 leg - white paint - 800mm feet	SPLA-ALT-TLEGBASE.M490247	\$ 2712

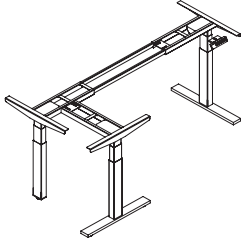

Open Market

Adjustable 3 leg - black paint - 800mm feet	SPLA-ALT-TLEGBASE.M490246	\$ 4504
Adjustable 3 leg - silver paint - 800mm feet	SPLA-ALT-TLEGBASE.M490244	\$ 4504
Adjustable 3 leg - white paint - 800mm feet	SPLA-ALT-TLEGBASE.M490248	\$ 4504

**T-leg Stretcher Bars**

Two 51" stretcher bars to support surfaces 85"-96"	SPLA-ALT-TLEGBASE.M501803	\$ 74
--	---------------------------	-------

*How to specify —*  
 Select the  
 Model Number  
 from above.

Example: SPLA-ALT-TLEGBASE.M490245











Note: For specification rules see page 48.

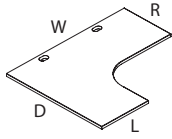

Description	Model	L1	L2	L3
		List Price	Upcharge	Upcharge
<b>Corner Cove Worksurfaces — Extended Right</b>				
54"W x 36"D - 24"L x 24"R	SPLA-ALT-3660MIXLEG.M490339	\$ 996	\$ 51	\$ 94
54"W x 36"D - 24"L x 30"R	SPLA-ALT-3660MIXLEG.M490522	\$ 996	\$ 51	\$ 94
54"W x 36"D - 30"L x 24"R	SPLA-ALT-3660MIXLEG.M490604	\$ 996	\$ 51	\$ 94
54"W x 36"D - 30"L x 30"R	SPLA-ALT-3660MIXLEG.M490438	\$ 996	\$ 51	\$ 94
54"W x 42"D - 24"L x 24"R	SPLA-ALT-4860MIXLEG.M490340	\$ 1093	\$ 66	\$ 129
54"W x 42"D - 24"L x 30"R	SPLA-ALT-4860MIXLEG.M490523	\$ 1093	\$ 66	\$ 129
54"W x 42"D - 30"L x 24"R	SPLA-ALT-4860MIXLEG.M490605	\$ 1093	\$ 66	\$ 129
54"W x 42"D - 30"L x 30"R	SPLA-ALT-4860MIXLEG.M490439	\$ 1093	\$ 66	\$ 129
54"W x 48"D - 24"L x 24"R	SPLA-ALT-4860MIXLEG.M490341	\$ 1093	\$ 66	\$ 129
54"W x 48"D - 24"L x 30"R	SPLA-ALT-4860MIXLEG.M490524	\$ 1093	\$ 66	\$ 129
54"W x 48"D - 30"L x 24"R	SPLA-ALT-4860MIXLEG.M490606	\$ 1093	\$ 66	\$ 129
54"W x 48"D - 30"L x 30"R	SPLA-ALT-4860MIXLEG.M490440	\$ 1093	\$ 66	\$ 129
54"W x 54"D - 24"L x 24"R	SPLA-ALT-6197MIXLEG.M490342	\$ 1530	\$ 97	\$ 195
54"W x 54"D - 24"L x 30"R	SPLA-ALT-6197MIXLEG.M490525	\$ 1530	\$ 97	\$ 195
54"W x 54"D - 30"L x 24"R	SPLA-ALT-6197MIXLEG.M490608	\$ 1530	\$ 97	\$ 195
54"W x 54"D - 30"L x 30"R	SPLA-ALT-6197MIXLEG.M490441	\$ 1530	\$ 97	\$ 195
60"W x 36"D - 24"L x 30"R	SPLA-ALT-3660MIXLEG.M490526	\$ 996	\$ 51	\$ 94
60"W x 36"D - 30"L x 24"R	SPLA-ALT-3660MIXLEG.M490610	\$ 996	\$ 51	\$ 94
60"W x 36"D - 30"L x 30"R	SPLA-ALT-3660MIXLEG.M490442	\$ 996	\$ 51	\$ 94
60"W x 42"D - 24"L x 24"R	SPLA-ALT-4860MIXLEG.M490344	\$ 1093	\$ 66	\$ 129
60"W x 42"D - 24"L x 30"R	SPLA-ALT-4860MIXLEG.M490527	\$ 1093	\$ 66	\$ 129
60"W x 42"D - 30"L x 24"R	SPLA-ALT-4860MIXLEG.M490611	\$ 1093	\$ 66	\$ 129
60"W x 42"D - 30"L x 30"R	SPLA-ALT-4860MIXLEG.M490443	\$ 1093	\$ 66	\$ 129
60"W x 48"D - 24"L x 30"R	SPLA-ALT-4860MIXLEG.M490528	\$ 1093	\$ 66	\$ 129
60"W x 48"D - 30"L x 24"R	SPLA-ALT-4860MIXLEG.M490612	\$ 1093	\$ 66	\$ 129
60"W x 48"D - 30"L x 30"R	SPLA-ALT-4860MIXLEG.M490444	\$ 1093	\$ 66	\$ 129
60"W x 54"D - 24"L x 24"R	SPLA-ALT-6197MIXLEG.M490346	\$ 1530	\$ 97	\$ 195
60"W x 54"D - 24"L x 30"R	SPLA-ALT-6197MIXLEG.M490529	\$ 1530	\$ 97	\$ 195
60"W x 54"D - 30"L x 24"R	SPLA-ALT-6197MIXLEG.M490613	\$ 1530	\$ 97	\$ 195
60"W x 54"D - 30"L x 30"R	SPLA-ALT-6197MIXLEG.M490445	\$ 1530	\$ 97	\$ 195
60"W x 60"D - 24"L x 24"R	SPLA-ALT-6197MIXLEG.M490347	\$ 1530	\$ 97	\$ 195
60"W x 60"D - 24"L x 30"R	SPLA-ALT-6197MIXLEG.M490530	\$ 1530	\$ 97	\$ 195
60"W x 60"D - 30"L x 24"R	SPLA-ALT-6197MIXLEG.M490614	\$ 1530	\$ 97	\$ 195
60"W x 60"D - 30"L x 30"R	SPLA-ALT-6197MIXLEG.M490446	\$ 1530	\$ 97	\$ 195
66"W x 36"D - 24"L x 24"R	SPLA-ALT-3672MIXLEG.M490348	\$ 1093	\$ 59	\$ 118
66"W x 36"D - 24"L x 30"R	SPLA-ALT-3672MIXLEG.M490531	\$ 1093	\$ 59	\$ 118
66"W x 36"D - 30"L x 24"R	SPLA-ALT-3672MIXLEG.M490615	\$ 1093	\$ 59	\$ 118
66"W x 36"D - 30"L x 30"R	SPLA-ALT-3672MIXLEG.M490447	\$ 1093	\$ 59	\$ 118
66"W x 42"D - 24"L x 24"R	SPLA-ALT-4872MIXLEG.M490349	\$ 1217	\$ 82	\$ 130
66"W x 42"D - 24"L x 30"R	SPLA-ALT-4872MIXLEG.M490532	\$ 1217	\$ 82	\$ 130
66"W x 42"D - 30"L x 24"R	SPLA-ALT-4872MIXLEG.M490616	\$ 1217	\$ 82	\$ 130
66"W x 42"D - 30"L x 30"R	SPLA-ALT-4872MIXLEG.M490448	\$ 1217	\$ 82	\$ 130
66"W x 48"D - 24"L x 24"R	SPLA-ALT-4872MIXLEG.M490350	\$ 1374	\$ 82	\$ 130
66"W x 48"D - 24"L x 30"R	SPLA-ALT-4872MIXLEG.M490533	\$ 1374	\$ 82	\$ 130
66"W x 48"D - 30"L x 24"R	SPLA-ALT-4872MIXLEG.M490617	\$ 1374	\$ 82	\$ 130
66"W x 48"D - 30"L x 30"R	SPLA-ALT-4872MIXLEG.M490449	\$ 1374	\$ 82	\$ 130
66"W x 54"D - 24"L x 24"R	SPLA-ALT-6197MIXLEG.M490351	\$ 1812	\$ 97	\$ 195
66"W x 54"D - 24"L x 30"R	SPLA-ALT-6197MIXLEG.M490534	\$ 1812	\$ 97	\$ 195
66"W x 54"D - 30"L x 24"R	SPLA-ALT-6197MIXLEG.M490618	\$ 1812	\$ 97	\$ 195
66"W x 54"D - 30"L x 30"R	SPLA-ALT-6197MIXLEG.M490450	\$ 1812	\$ 97	\$ 195
66"W x 60"D - 24"L x 24"R	SPLA-ALT-6197MIXLEG.M490353	\$ 1812	\$ 97	\$ 195

Note: Dimensions are nominal. "W" and "D" are undersized by 2" for all sizes except 36" which is undersized by 1½" due to base limitations. "L" and "R" are undersized by ¾".  
 Note: Worksurfaces over 60" W require external stiffener (order separately): Z5SC48 for 66" W, Z5SC54 for 72" W, Z5SC60 for 78" W, Z5SC66 for 84" W, Z5SC72 for 90" W and 96" W.

<b>How to specify —</b> Select the Model Number from above. _____ _____ _____	<b>1st Option:</b> <b>Laminate:</b> See <i>inside front cover</i> for finishes.	<b>2nd Option:</b> <b>Laminate Edge Color:</b> See <i>inside front cover</i> for finishes.	<b>3rd Option:</b> <b>Grommet Location (if applicable):</b> GB Grommet LH and RH GO No Grommet	<b>4th Option:</b> <b>Grommet Type (if applicable):</b> P Oval Plastic M Oval Metal S Square Metal  (Add \$13 per grommet for metal.)	<b>5th Option:</b> <b>Grommet Color (if applicable):</b> _____
	_____	_____	_____	_____	_____

Example: SPLA-ALT-3660MIXLEG.M490339.LDW1.DW.GO

OPTIMIZE ALTITUDE INVOLVE TITLE 24 ACCESSORIES PANEL FABRICS







Note: For specification rules see page 48.



Description	Model	L1	L2	L3
		List Price	Upcharge	Upcharge
36"W x 24"L x 24"R	SPLA-ALT-36CNRMIXLEG.M490665	\$ 901	\$ 37	\$ 63
36"W x 24"L x 30"R	SPLA-ALT-36CNRMIXLEG.M490675	\$ 901	\$ 37	\$ 63
36"W x 30"L x 24"R	SPLA-ALT-36CNRMIXLEG.M490679	\$ 901	\$ 37	\$ 63
36"W x 30"L x 30"R	SPLA-ALT-36CNRMIXLEG.M490671	\$ 926	\$ 37	\$ 63
42"W x 24"L x 24"R	SPLA-ALT-42CNRMIXLEG.M490666	\$ 956	\$ 42	\$ 81
42"W x 24"L x 30"R	SPLA-ALT-42CNRMIXLEG.M490676	\$ 1141	\$ 42	\$ 81
42"W x 30"L x 24"R	SPLA-ALT-42CNRMIXLEG.M490680	\$ 1141	\$ 42	\$ 81
42"W x 30"L x 30"R	SPLA-ALT-42CNRMIXLEG.M490672	\$ 1141	\$ 42	\$ 81
48"W x 24"L x 24"R	SPLA-ALT-48CNRMIXLEG.M490668	\$ 1078	\$ 51	\$ 96
48"W x 24"L x 30"R	SPLA-ALT-48CNRMIXLEG.M490677	\$ 1224	\$ 51	\$ 96
48"W x 30"L x 24"R	SPLA-ALT-48CNRMIXLEG.M490681	\$ 1224	\$ 51	\$ 96
48"W x 30"L x 30"R	SPLA-ALT-48CNRMIXLEG.M490673	\$ 1224	\$ 51	\$ 96
54"W x 24"L x 24"R	SPLA-ALT-54CNRMIXLEG.M490669	\$ 1585	\$ 97	\$ 195
54"W x 24"L x 30"R	SPLA-ALT-54CNRMIXLEG.M490678	\$ 1731	\$ 97	\$ 195
54"W x 30"L x 24"R	SPLA-ALT-54CNRMIXLEG.M490682	\$ 1731	\$ 97	\$ 195
54"W x 30"L x 30"R	SPLA-ALT-54CNRMIXLEG.M490674	\$ 1731	\$ 97	\$ 195
60"W x 24"L x 24"R	SPLA-ALT-60CNRMIXLEG.M490670	\$ 1806	\$ 97	\$ 195
60"W x 24"L x 30"R	SPLA-ALT-60CNRMIXLEG.M501497	\$ 1806	\$ 97	\$ 195
60"W x 30"L x 24"R	SPLA-ALT-60CNRMIXLEG.M501498	\$ 1806	\$ 97	\$ 195
60"W x 30"L x 30"R	SPLA-ALT-60CNRMIXLEG.M501499	\$ 1806	\$ 97	\$ 195

Note: Dimensions are nominal. "W" and "D" are undersized by 2" for all sizes except 36" which is undersized by 1½" due to base limitations. "L" and "R" are undersized by ¾".

<p><b>How to specify —</b> Select the Model Number from above.</p>	<p><b>1st Option:</b> <b>Laminate:</b> See <a href="#">inside front cover</a> for finishes.</p>	<p><b>2nd Option:</b> <b>Laminate Edge Color:</b> See <a href="#">inside front cover</a> for finishes.</p>	<p><b>3rd Option:</b> <b>Grommet Type</b> (if applicable): P Oval Plastic M Oval Metal S Square Metal  (Add \$13 per grommet for metal.)</p>	<p><b>4th Option:</b> <b>Grommet Color</b> (if applicable):</p>
<p>_____ .</p>	<p>_____ .</p>	<p>_____ .</p>	<p>_____</p>	<p>_____</p>

Example: SPLA-ALT-36CNRMIXLEG.M490665.LDW1.DW.PDW



For specification information see standard Altitude pricer and specification guide.

Open Market

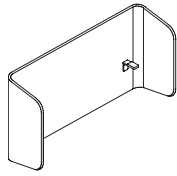

Description	Model	P1 Clear List Price	P2 Upcharge
<b>U Screen Kit</b>			
48"	SPLA-A8-FABSCRNPNTA.M505257	\$ 2042	\$ 18
54"	SPLA-A8-FABSCRNPNTA.M505258	\$ 2111	\$ 18
60"	SPLA-A8-FABSCRNPNTB.M505259	\$ 2172	\$ 18
66"	SPLA-A8-FABSCRNPNTB.M505260	\$ 2301	\$ 18
72"	SPLA-A8-FABSCRNPNTB.M505261	\$ 2473	\$ 18

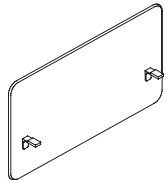

<b>Rectangular Screen Kit</b>			
48"	SPLA-A8-FABSCRNPNTA.M505262	\$ 1433	\$ 18
54"	SPLA-A8-FABSCRNPNTA.M505263	\$ 1469	\$ 18
60"	SPLA-A8-FABSCRNPNTB.M505264	\$ 1517	\$ 18
66"	SPLA-A8-FABSCRNPNTB.M505265	\$ 1624	\$ 18
72"	SPLA-A8-FABSCRNPNTB.M505266	\$ 1729	\$ 18

**Note:** These screens ARE NOT TACKABLE. The properties of Contourett fabric do not allow this feature.

Note: Installation brackets are now attached to the screen from the factory.

<p><b>How to specify —</b> Select the Model Number from above.</p> <p>_____ .</p>	<p><b>1st Option:</b> Select the Screen Fabric: See <a href="#">inside back cover</a> for selections and color codes.</p> <p>_____ .</p>	<p><b>2nd Option:</b> Select the Screen Bracket Paint: <b>P1</b> <b>P2</b> See <a href="#">inside front cover</a> for selections and color codes.* <b>P2</b> (\$18 extra)</p> <p>_____</p>
---	--	--

Examples:

### Specification Notes:

- Interior wing dimension is 27.825"
- On a 30"D Altitude work surface (true depth is 29.25") the extended wing screen will not extend to the front edge of the work surface, the screen will end 1.5" before the front edge of the work surface.
- On a 24"D Altitude work surface (true depth is 23.25") the extended wing screen will extend 4.5" past the front edge of the work surface.

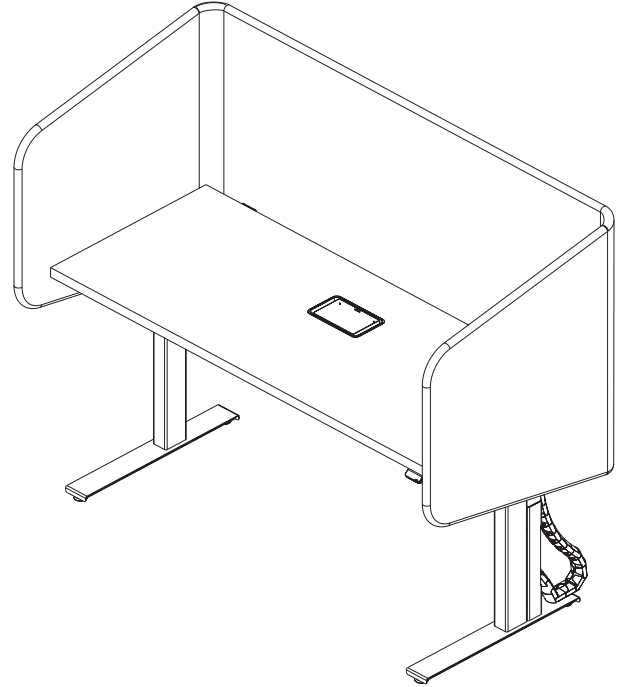
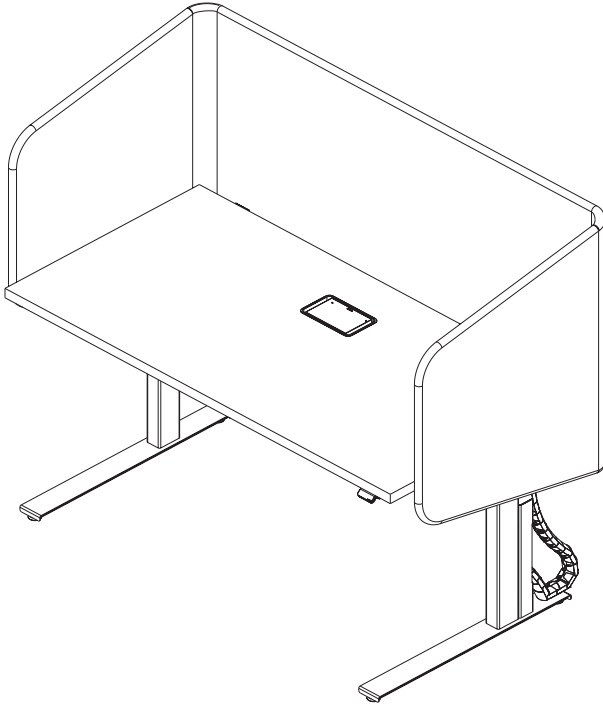

- Adding a screen adds 1" to the width of the table per return wing.
- All Altitude worksurfaces are 2" under nominal width to accommodate screens.
- RH L-screens have return wing on user's right; LH opposite.
- Textile offering is limited to Nobel.

For specification information see page 60.

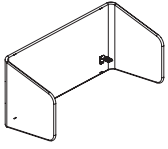

Description	Model	P1 Paint List Price	P2 Paint Upcharge	P3 Paint Upcharge
<b>Extended Wing U Screen</b>				
48"W	SPLA-A8-EXTSCRNPNTA.M519714	\$ 2352	\$ 18	\$ 42
54"W	SPLA-A8-EXTSCRNPNTA.M519715	\$ 2461	\$ 18	\$ 42
60"W	SPLA-A8-EXTSCRNPNTB.M519716	\$ 2504	\$ 18	\$ 42
66"W	SPLA-A8-EXTSCRNPNTB.M519717	\$ 2654	\$ 18	\$ 42
72"W	SPLA-A8-EXTSCRNPNTB.M519718	\$ 2855	\$ 18	\$ 42

OPTIMIZE

ALTITUDE

INVOLVE

TITLE 24

ACCESSORIES

PANEL FABRICS

<p><b>How to specify —</b> Select the Model Number from above.</p> <p>_____</p> <p>_____ .</p>	<p><b>1st Option:</b> <b>Fabric</b> (if applicable): See <a href="#">inside back cover</a> for fabrics.</p> <p>_____ .</p>	<p><b>2nd Option:</b> <b>Paint</b> (if applicable): <b>P1 P2</b> See <a href="#">inside front cover</a> for finishes.</p> <p>_____ . <b>P</b> _____</p>
--	--	---

Example:

For specification information see current Involve Price & Specification Guide.

Description	Model	P1 Clear List Price	P2 Upcharge	Frosted Glass Upcharge	Smoked Glass Upcharge
<b>32"H</b>					
36"W	SPLA-IN-SCRNGLSS.M505543	\$ 1262	\$ 18	\$ 315	\$ 478
42"W	SPLA-IN-SCRNGLSS.M505544	\$ 1415	\$ 18	\$ 315	\$ 478
48"W	SPLA-IN-SCRNGLSS.M505545	\$ 1564	\$ 18	\$ 315	\$ 478
54"W	SPLA-IN-SCRNGLSS.M505546	\$ 1736	\$ 18	\$ 315	\$ 478
60"W	SPLA-IN-SCRNGLSS.M505547	\$ 1902	\$ 18	\$ 315	\$ 478

**Note:** 32"H Involve Desk Mount Screens will align with 50"H Storage.

**Note:** Not for use with Height Adjustable Tables.

OPTIMIZE

ALTITUDE

INVOLVE

TITLE 24

ACCESSORIES

PANEL FABRICS

<p><b>How to specify —</b> Select the Model Number from above.</p>          <p>Example: _____ .</p>	<p><b>1st Option:</b> <b>Glass</b> (if applicable): LC Clear LF Frosted GSM1 Smoked</p>          <p>_____ .</p>	<p><b>2nd Option:</b> <b>Paint</b> (if applicable): P1 P2 See <a href="#">inside front cover</a> for finishes.</p>          <p>P _____</p>
---	---	--

**S** Shippable by small-package carrier.

For specification information see below and the Involve section of the Casegoods & Storage Price and Specification Guide.

THESE MODELS ARE NEW (HAVING NEW MODEL NUMBERS) AND HAVE A FLUSH TOP DESIGN (TOP CAPS OVER THE SIDES). PREVIOUS STANDARD SPECIALS WITH AN INSET TOP (SIDES WERE FULL HEIGHT) ARE STILL AVAILABLE WITH THE OLD MODEL NUMBER. CONTACT TPG FOR ASSISTANCE.

Description	Model	L1		L2 Upcharge		L3 Upcharge	
		List Price	Case	Front	Case	Front	
<b>42½"H Pull Out Tower — 12"W</b>							
24"D LH	SPLA-IN-PLSTG12A.M475881	\$ 3972	\$ 88	\$ 42	\$ 178	\$ 78	
24"D RH	SPLA-IN-PLSTG12A.M475880	\$ 3972	\$ 88	\$ 42	\$ 178	\$ 78	
27"D LH	SPLA-IN-PLSTG12A.M488732	\$ 4208	\$ 88	\$ 42	\$ 178	\$ 78	
27"D RH	SPLA-IN-PLSTG12A.M488731	\$ 4208	\$ 88	\$ 42	\$ 178	\$ 78	
<b>Note:</b> Towers are freestanding.							
Contains:							
<ul style="list-style-type: none"> <li>Removable file bar</li> <li>1 – Adjustable shelf</li> <li>1 – Fixed shelf</li> <li>2 – Coat hooks</li> </ul>							
Wardrobe on 24"D model is 6"D							
<b>50"H Pull Out Tower — 12"W</b>							
24"D LH	SPLA-IN-PLSTG12A.M475886	\$ 4730	\$ 88	\$ 42	\$ 178	\$ 78	
24"D RH	SPLA-IN-PLSTG12A.M475885	\$ 4730	\$ 88	\$ 42	\$ 178	\$ 78	
27"D LH	SPLA-IN-PLSTG12A.M488734	\$ 5015	\$ 88	\$ 42	\$ 178	\$ 78	
27"D RH	SPLA-IN-PLSTG12A.M488733	\$ 5015	\$ 88	\$ 42	\$ 178	\$ 78	
<b>Note:</b> Towers are freestanding.							
Contains:							
<ul style="list-style-type: none"> <li>Removable file bar</li> <li>2 – Adjustable shelves</li> <li>1 – Fixed shelf</li> <li>2 – Coat hooks</li> </ul>							
Wardrobe on 24"D model is 6"D							

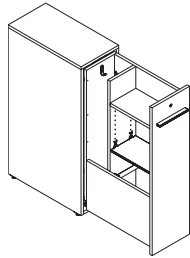

RH

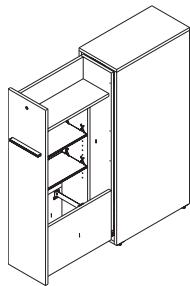

LH

<p><b>How to specify —</b> Select the Model Number from above.</p> <p><b>S</b>   <b>P</b>   <b>L</b>   <b>A</b>   <b>-</b>   <b>I</b>   <b>N</b>   <b>-</b> <b>P</b>   <b>L</b>   <b>S</b>   <b>T</b>   <b>G</b>   <b>1</b>   <b>2</b>   <b>A</b> . <b>M</b>   <b>4</b>                     .          </p>	<p><b>1st Option:</b> <b>Pull Type (if applicable):</b> <b>MP</b> Beam <b>OP</b> Halo <b>SP</b> Square <b>AP</b> Arch</p>	<p><b>2nd Option:</b> <b>Pull Color (if applicable):</b> <b>MP</b> Beam / <b>OP</b> Halo <b>PJW</b> Designer White <b>PR6</b> Silver <b>PJE</b> Pyrite <b>P8X</b> Solar Black P2 upcharge +\$18/pull</p>	<p><b>3rd Option:</b> <b>Metal Shelf Color:</b> See <a href="#">inside front cover</a> for finishes. Add \$40 for P2 or \$76 for P3 Paints.</p> <p><b>P</b>           .</p>
---	---	--	---

Continued below ▼

<p><b>4th Option:</b> <b>FSC Certified Wood:</b> <b>FSC</b> Select for FSC Certified Wood <b>X</b> No FSC</p> <p>          .</p>	<p><b>5th Option:</b> <b>Laminate Color (Case):</b> See <a href="#">inside front cover</a> for finishes.</p> <p>         </p>	<p><b>6th Option:</b> <b>Matching Edge:</b> See <a href="#">inside front cover</a> for finishes.</p> <p>          .</p>	<p><b>7th Option:</b> <b>2nd Laminate Color (Front):</b> See <a href="#">inside front cover</a> for finishes.</p> <p>         </p>	<p><b>8th Option:</b> <b>Matching Edge:</b> See <a href="#">inside front cover</a> for finishes.</p> <p>          .</p>	<p><b>9th Option:</b> <b>Lock Option:</b> <b>STD</b> Standard <b>OMT</b> Omit Lock Core (deduct \$18 per lock)</p> <p>         </p>	<p><b>10th Option:</b> <b>Lock Color (if applicable):</b> <b>EL</b> Silver</p> <p><b>E</b>   <b>L</b>        </p>
--	---	---	--	---	---	---

Example: SPLA-IN-PLSTG12A.M475881.APPR6.P7D.X.LWCWEDCW.LWCWEDCW.STDEL

Description	Model	L1		L2 Upcharge		L3 Upcharge	
		List Price	Case	Front	Case	Front	
<b>42½"H Wardrobe Tower — 12"W</b>							
30"D LH Footed 2-Tone	SPLA-SS-IN42H2TTFB.M490878	\$ 3788	\$ 88	\$ 42	\$ 178	\$ 78	
30"D LH Plinth 2-Tone	SPLA-SS-IN42H2TTPB.M490880	\$ 3788	\$ 88	\$ 42	\$ 178	\$ 78	
30"D RH Footed 2-Tone	SPLA-SS-IN42H2TTFB.M490877	\$ 3788	\$ 88	\$ 42	\$ 178	\$ 78	
30"D RH Plinth 2-Tone	SPLA-SS-IN42H2TTPB.M490879	\$ 3788	\$ 88	\$ 42	\$ 178	\$ 78	
<b>50"H Wardrobe Tower — 12"W</b>							
30"D LH Footed 2-Tone	SPLA-SS-IN50H2TTFB.M490882	\$ 3931	\$ 94	\$ 44	\$ 191	\$ 80	
30"D LH Plinth 2-Tone	SPLA-SS-IN50H2TTPB.M490884	\$ 3931	\$ 94	\$ 44	\$ 191	\$ 80	
30"D RH Footed 2-Tone	SPLA-SS-IN50H2TTFB.M490881	\$ 3931	\$ 94	\$ 44	\$ 191	\$ 80	
30"D RH Plinth 2-Tone	SPLA-SS-IN50H2TTPB.M490883	\$ 3931	\$ 94	\$ 44	\$ 191	\$ 80	
<b>57½"H Wardrobe Tower — 12"W</b>							
30"D LH Footed 2-Tone	SPLA-SS-IN57H2TTFB.M490886	\$ 4043	\$ 95	\$ 44	\$ 194	\$ 82	
30"D LH Plinth 2-Tone	SPLA-SS-IN57H2TTPB.M490888	\$ 4043	\$ 95	\$ 44	\$ 194	\$ 82	
30"D RH Footed 2-Tone	SPLA-SS-IN57H2TTFB.M490885	\$ 4043	\$ 95	\$ 44	\$ 194	\$ 82	
30"D RH Plinth 2-Tone	SPLA-SS-IN57H2TTPB.M490887	\$ 4043	\$ 95	\$ 44	\$ 194	\$ 82	
<b>65"H Wardrobe Tower — 12"W</b>							
30"D LH Footed 2-Tone	SPLA-SS-IN65H2TTFB.M490890	\$ 4088	\$ 96	\$ 44	\$ 197	\$ 82	
30"D LH Plinth 2-Tone	SPLA-SS-IN65H2TTPB.M490892	\$ 4088	\$ 96	\$ 44	\$ 197	\$ 82	
30"D RH Footed 2-Tone	SPLA-SS-IN65H2TTFB.M490889	\$ 4088	\$ 96	\$ 44	\$ 197	\$ 82	
30"D RH Plinth 2-Tone	SPLA-SS-IN65H2TTPB.M490891	\$ 4088	\$ 96	\$ 44	\$ 197	\$ 82	

**Note:** Wardrobe includes coat rod and adjustable shelf.  
 \*Upcharges are added to solid laminate list price depending on woodgrain laminate selection.

<b>How to specify —</b> Select the Model Number from above.  S   P   L   A   -   S   S   -   I   N   .	<b>1st Option:</b> <b>Foot Type</b> (if applicable): TF Terrace Foot ZF Stride Foot (Add \$95)	<b>2nd Option:</b> <b>Foot Paint Color</b> (if applicable): P1 P2 See inside front cover for finishes. Stride is limited to PR6 Silver.	<b>3rd Option:</b> <b>Pull Type</b> (if applicable): MP Beam OP Halo SP Square AP Arch	<b>4th Option:</b> <b>Pull Color (if applicable):</b> MP Beam / OP Halo PJW Designer White PR6 Silver PJE Pyrite P8X Solar Black P2 upcharge +\$18/pull SP Square PJW Designer White EL Matte Silver P02 Flint P7B Loft PJE Pyrite P8X Solar Black AP Arch PRO Anodized Silver P2 upcharge +\$18/pull
	Continued below ▼			

<b>5th Option:</b> <b>Metal Shelf Color:</b> P1 P2 P3 See inside front cover for finishes. Add \$18 for P2 (except PR6) or \$29 for P3 Paints.	<b>6th Option:</b> <b>FSC Certified Wood</b> (if applicable): FSC Select for FSC Certified Wood X No FSC	<b>7th Option:</b> <b>Laminate Color</b> (if applicable): See inside front cover for finishes. (If two-tone list case color here.)	<b>8th Option:</b> <b>Matching Edge</b> (if applicable): See inside front cover for finishes.	<b>9th Option:</b> <b>2nd Laminate Color (Front)</b> (if applicable): See inside front cover for finishes.	<b>10th Option:</b> <b>Matching Edge</b> (if applicable): See inside front cover for finishes.	<b>11th Option:</b> <b>Lock</b> (if applicable): STD Standard Core (Deduct \$18) OMT Omit Lock Core (Deduct \$18)	<b>12th Option:</b> <b>Lock Color</b> (if applicable): EL Silver
Example: SPLA-SS-IN42H2TTFB.M490878.APPR6.P7D.X.LM13EY.LM15EU.STDEL							E   L







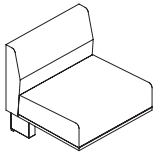

Description	Model Number	Base List Price	Upcharge List Price — Add to Base Price								
			1	2	3	4	5	6	7	8	
<b>Two-Tone Banquette Cushion</b> — 24"D x 19"H Back for use on 11"H seat bases											
24"W	SPLA-IN-BANCUSH.										
	M490800	\$ 1483	Back Fabric	\$ 0	\$ 19	\$ 27	\$ 41	\$ 58	\$ 76	\$ 93	\$ 111
			Seat Fabric	\$ 0	\$ 19	\$ 27	\$ 41	\$ 58	\$ 76	\$ 93	\$ 111
24"W	SPLA-IN-BANCUSHFC.										
Fire Code	M490802	\$ 1689	Back Fabric	\$ 0	\$ 19	\$ 27	\$ 41	\$ 58	\$ 76	\$ 93	\$ 111
			Seat Fabric	\$ 0	\$ 19	\$ 27	\$ 41	\$ 58	\$ 76	\$ 93	\$ 111
36"W	SPLA-IN-BANCUSH36.										
	M490801	\$ 1904	Back Fabric	\$ 0	\$ 32	\$ 65	\$ 109	\$ 152	\$ 197	\$ 244	\$ 288
			Seat Fabric	\$ 0	\$ 32	\$ 65	\$ 109	\$ 152	\$ 197	\$ 244	\$ 288
36"W	SPLA-IN-BANCUSHFC36.										
Fire Code	M490803	\$ 2115	Back Fabric	\$ 0	\$ 32	\$ 65	\$ 109	\$ 152	\$ 197	\$ 244	\$ 288
			Seat Fabric	\$ 0	\$ 32	\$ 65	\$ 109	\$ 152	\$ 197	\$ 244	\$ 288

**Note:** Due to the design of the cushion, pattern matching is not possible on Involve cushion backs. Large scale patterns and stripes are to be avoided, unless approved by the customer.

	<b>24"W Models</b>	<b>36"W Models</b>
COM Yardage (Back)	1.6 yards	1.6 yards
COM Yardage (Seat)	1.3 yards	1.3 yards

**How to specify Cushions —**

Select the Model Number from above.

**1st Option:**

**Back Upholstery:**

Specify back upholstery — see Casegoods & Storage price list pages 9-13.

**2nd Option:**

**Seat Upholstery:**

Specify seating upholstery — see Casegoods & Storage price list pages 9-13.

Example: SPLA-IN-BANCUSH.M490800.CU40.CU98

**S** Shippable by small-package carrier.

## EMS ENERGY MANAGEMENT SYSTEM

### Summary of Title 24

The 2014 California Title 24, addresses building energy efficiency standards with an objective to reduce energy use in California. The owner or tenant is responsible to meet these specific requirements. This impacts:

- All building permits, new or renovation
- Office improvements, including moving or reconfiguring existing furniture

### Office Furniture Impact

In Subchapter 4, Section 130.5(d), controlled duplex receptacles are required and non-controlled duplex receptacles are allowed. A factory-marked controlled duplex receptacle is required within 6 feet of any non-controlled receptacle. Circuit controls for 120 volt duplex receptacles will run on timers, sensors, or both. A power strip or surge bar does not meet the standard. These requirements are for new spaces and retrofits, with all building permits, and any time furniture with electrical is moved. A post-installation inspection is also required. Controlling duplex receptacles can be accomplished at the building power controls or within the furniture power system.

### FAQ

#### Q. What should I discuss with customers now?

A. Ask if Title 24 compliance will be necessary on the project, and how they intend to comply. Be ready to discuss options.

#### Q. How will this affect planning and specification?

A. Plan for the 6' rule when placing controlled and non-controlled duplex receptacles. The Allsteel IDS team is versed in Title 24 and ready to help you with your planning needs.

#### Q. Does this work with existing Allsteel electrical?

A. Yes, the infeed must be the EMS version but the other electrical components downstream from the infeed will remain Allsteel standard electrical components. Please see notes below for more information.

#### Q. When will the EMS (Energy Management System) be orderable?

A. Components are available now through Tailored Solutions.

#### Q. Can you sync more than 1 occupancy sensor to a Monitor Controlled Device (MCD)?

A. Yes, you can sync multiple occupancy sensors to each MCD.

#### Q. How do I know whether to specify the base/ceiling infeed or power harness MCD?

A. The MCD needs to be as close to the power input as possible. If your last panel in a run needs to have powered duplex receptacles, the base/ceiling in-feed version must be used. If not, it is recommended to use the power harness MCD. (Context: The power harness MCD is concealed within the panel kickplate. The base/ceiling in-feed is mounted to the outside of the kickplate on the panel.)

## Furniture Controls

Specify Allsteel EMS Base/ceiling in-feed or power harness. Each Monitor/ Controlled Device (MCD) includes programming instructions. Controlled labels for duplex receptacles are available as well as duplex receptacles marked with 'controlled'. Occupancy sensor is specified separately.

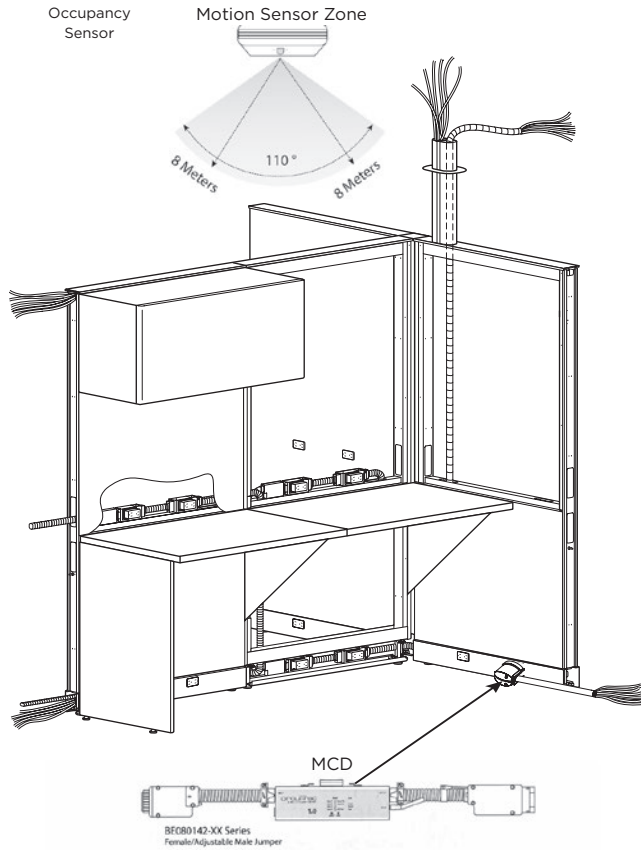

- Follow 6' rule when placing controlled receptacles
- Label controlled receptacles

Allsteel EMS, features "CircuiTrac™ by Byrne" energy management system. EMS is compatible with new installations or can easily retrofit to existing Allsteel electrical systems. Simply program the circuits at the time of installation and sync to the occupancy sensor(s).

### Key components:

- Monitor/Control Device (MCD) (Base/ceiling in-feed or power harness)
- Occupancy Sensor
- Label controlled duplex receptacles with stickers or order pre-marked, "controlled", duplex receptacles

## Building Controls

A certified electrician wires in-feeds for select circuits to be controlled using an occupancy sensor or timer. All controlled duplex receptacles must be labeled as such.

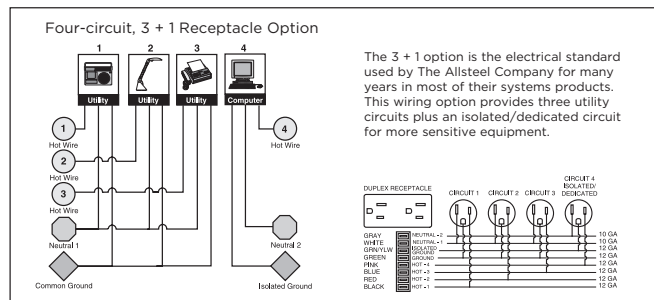
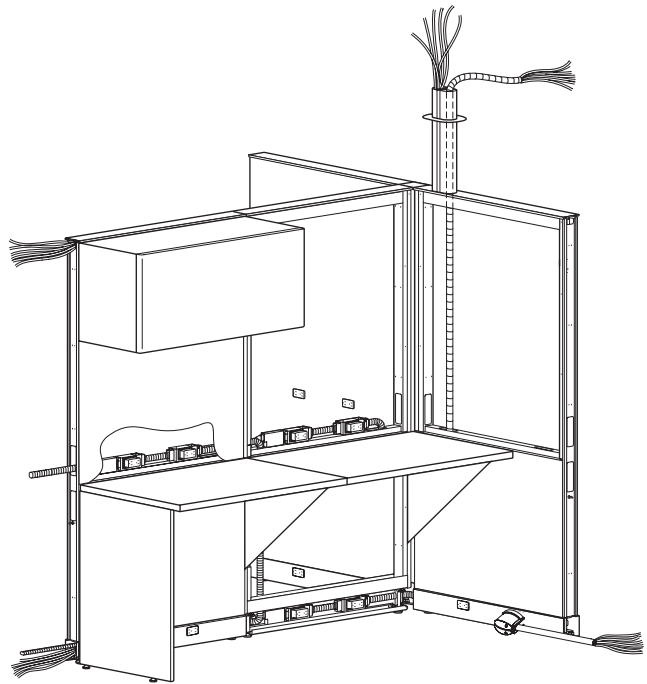

- Follow 6' rule when placing controlled duplex receptacles
- Label controlled duplex receptacles
- Use standard electrical components
- Coordinate with electrician on which circuit(s) to control
- Electrician provides controlled circuits

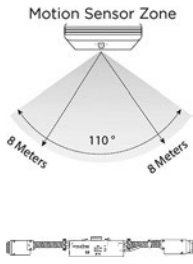

Description	Four-circuit 3 + 1 2 + 2	List Price	Three-circuit Separate Neutrals	List Price
<b>Title 24 Electrical</b>				
30"W Pass-through w/ MCD, No Power Block (Four Circuit) (no duplexes with 30"W frame)	SPLA-TP-ELEC-BYR.M490906	\$ 5427	N/A	
30"W Pass-through w/ MCD, No Power Block (no duplexes with 30"W frame)	SPLA-TP-ELEC-BYR.M490916	\$ 5427	N/A	
36"W Power Harness w/ MDC, One Power Block	SPLA-TP-ELEC-BYR.M490908	\$ 5747	SPLA-TP-ELEC-BYR.M490917	\$ 5747
42"W Power Harness w/ MDC, One Power Block	SPLA-TP-ELEC-BYR.M490909	\$ 5763	SPLA-TP-ELEC-BYR.M490918	\$ 5763
48"W Power Harness w/ MDC, One Power Block	SPLA-TP-ELEC-BYR.M490910	\$ 5778	SPLA-TP-ELEC-BYR.M490919	\$ 5778
60"W Power Harness w/ MDC, One Power Block	SPLA-TP-ELEC-BYR.M490911	\$ 5807	SPLA-TP-ELEC-BYR.M490920	\$ 5807
Occupancy Sensor for Energy Management System	SPLA-TP-ELEC-BYR.M490915	\$ 812	N/A	

**How to specify —**  
Select the  
Model Number  
from above.

*1st Option:*  
**Electrical Receptacle**  
**Color (if applicable):**  
See [inside front cover](#) for finishes.

*1st Option:*  
**Color**  
**(if applicable):**  
P Black

Example: SPLA-TP-ELEC-BYR.M490906.P

**S** Shippable by small-package carrier.



Description	Model	List Price
<b>Title 24 Electrical — Further</b>		
Receptacle - CONTROLLED STAMP Circuit 1 - Further	SPLA-TP-PELEC-BYR.M490934	\$ 87
Receptacle - CONTROLLED STAMP Circuit 2 - Further	SPLA-TP-PELEC-BYR.M490935	\$ 87
Receptacle - CONTROLLED STAMP Circuit 3 - Further (2+2)	SPLA-TP-PELEC-BYR.M490937	\$ 87
Receptacle - CONTROLLED STAMP Circuit 3 - Further (3+1)	SPLA-TP-PELEC-BYR.M490936	\$ 87
Receptacle - CONTROLLED STAMP Circuit 4 - Further (Four-Circuit - ISO/DEDICATED)	SPLA-TP-PELEC-BYR.M490938	\$ 87



<b>Title 24 Electrical — Optimize</b>		
BASE ELEC IN-FEED 6FT SEALTIGHT CABLE w/ screw mount MDC, SN/Ap fit to power block out (Four Circuit)	SPLA-TP-ELEC-BYR.M490914	\$ 4736
BASE ELEC IN-FEED 6FT SEALTIGHT CABLE w/ screw mount MDC, SN/Ap fit to power block out (Three Circuit)	SPLA-TP-ELEC-BYR.M490923	\$ 4736
Receptacle - CONTROLLED STAMP Circuit 1 - Optimize (Four Circuit)	SPLA-TP-PELEC-BYR.M490939	\$ 87
Receptacle - CONTROLLED STAMP Circuit 1 - Optimize (Three Circuit)	SPLA-TP-PELEC-BYR.M490950	\$ 87
Receptacle - CONTROLLED STAMP Circuit 2 - Optimize (Four Circuit)	SPLA-TP-PELEC-BYR.M490940	\$ 87
Receptacle - CONTROLLED STAMP Circuit 2 - Optimize (Three Circuit)	SPLA-TP-PELEC-BYR.M490951	\$ 87
Receptacle - CONTROLLED STAMP Circuit 3 - Optimize (Four Circuit 2+2)	SPLA-TP-PELEC-BYR.M490942	\$ 87
Receptacle - CONTROLLED STAMP Circuit 3 - Optimize (Four Circuit 3+1)	SPLA-TP-PELEC-BYR.M490941	\$ 87
Receptacle - CONTROLLED STAMP Circuit 3 - Optimize (Three Circuit 3+1)	SPLA-TP-PELEC-BYR.M490952	\$ 87
Receptacle - CONTROLLED STAMP Circuit 4 - Optimize (Four Circuit ISO/DEDICATED)	SPLA-TP-PELEC-BYR.M490943	\$ 87



<b>Title 24 Electrical — Stride</b>		
BASE ELEC IN-FEED 6FT SEALTIGHT CABLE w/ screw mount MDC, SN/Ap fit to power block out (Four Circuit)	SPLA-TP-ELEC-BYR.M490912	\$ 4736
BASE ELEC IN-FEED 6FT SEALTIGHT CABLE w/ screw mount MDC, SN/Ap fit to power block out (Three Circuit)	SPLA-TP-ELEC-BYR.M490921	\$ 4736
Receptacle - CONTROLLED STAMP Circuit 1 - Stride (Four Circuit)	SPLA-TP-PELEC-BYR.M490924	\$ 87
Receptacle - CONTROLLED STAMP Circuit 1 - Stride (Three Circuit)	SPLA-TP-PELEC-BYR.M490944	\$ 87
Receptacle - CONTROLLED STAMP Circuit 2 - Stride (Four Circuit)	SPLA-TP-PELEC-BYR.M490925	\$ 87
Receptacle - CONTROLLED STAMP Circuit 2 - Stride (Three Circuit)	SPLA-TP-PELEC-BYR.M490945	\$ 87
Receptacle - CONTROLLED STAMP Circuit 3 - Stride (Four Circuit 2+2)	SPLA-TP-PELEC-BYR.M490927	\$ 87
Receptacle - CONTROLLED STAMP Circuit 3 - Stride (Four Circuit 3+1)	SPLA-TP-PELEC-BYR.M490926	\$ 87
Receptacle - CONTROLLED STAMP Circuit 3 - Stride (Three Circuit)	SPLA-TP-PELEC-BYR.M490946	\$ 87
Receptacle - CONTROLLED STAMP Circuit 4 - Stride (Four Circuit - ISO/DEDICATED)	SPLA-TP-PELEC-BYR.M490928	\$ 87



<b>Title 24 Electrical — Terrace</b>		
BASE ELEC IN-FEED 6FT SEALTIGHT CABLE w/ screw mount MDC, SN/Ap fit to power block out (Four Circuit)	SPLA-TP-ELEC-BYR.M490913	\$ 4736
BASE ELEC IN-FEED 6FT SEALTIGHT CABLE w/ screw mount MDC, SN/Ap fit to power block out (Three Circuit)	SPLA-TP-ELEC-BYR.M490922	\$ 4736
Receptacle - CONTROLLED STAMP Circuit 1 - Terrace (Four Circuit)	SPLA-TP-PELEC-BYR.M490929	\$ 87
Receptacle - CONTROLLED STAMP Circuit 1 - Terrace (Three Circuit)	SPLA-TP-PELEC-BYR.M490947	\$ 87
Receptacle - CONTROLLED STAMP Circuit 2 - Terrace (Four Circuit)	SPLA-TP-PELEC-BYR.M490930	\$ 87
Receptacle - CONTROLLED STAMP Circuit 2 - Terrace (Three Circuit)	SPLA-TP-PELEC-BYR.M490948	\$ 87
Receptacle - CONTROLLED STAMP Circuit 3 - Terrace (Four Circuit 2+2)	SPLA-TP-PELEC-BYR.M490932	\$ 87
Receptacle - CONTROLLED STAMP Circuit 3 - Terrace (Four Circuit 3+1)	SPLA-TP-PELEC-BYR.M490931	\$ 87
Receptacle - CONTROLLED STAMP Circuit 3 - Terrace (Three Circuit)	SPLA-TP-PELEC-BYR.M490949	\$ 87
Receptacle - CONTROLLED STAMP Circuit 4 - Terrace (Four Circuit - ISO/DEDICATED)	SPLA-TP-PELEC-BYR.M490933	\$ 87

<p><b>How to specify —</b> Select the Model Number from above.</p>	<p><i>1st Option:</i> <b>Electrical Receptacle Color (if applicable):</b> See <a href="#">inside front cover</a> for finishes.</p>	<p><i>1st Option:</i> <b>Color (if applicable):</b> P Black</p>
<p>Example: SPLA-TP-ELEC-BYR.M490929.E4</p>		

Shippable by small-package carrier.





## GRADE A

### APPOINT PANEL

100% Polyester

Artichoke.....	APN911
Blackberry.....	APN932
Bronze.....	APN922
Carbon.....	APN928
Chai.....	APN912
Cherry.....	APN930
Dark Pewter.....	APN917
Dune.....	APN915
Espresso.....	APN923
Framboise.....	APN931
Frost.....	APN934
Jet.....	APN927
Lawn.....	APN925
Mandarin.....	APN929
Morel.....	APN909
Nimbus.....	APN916
Platinum.....	APN924
Turquoise.....	APN926

### BINARY

100% Recycled Polyester

Blush.....	BNRY12
Coal.....	BNRY06
Cream.....	BNRY01
Denim.....	BNRY08
Diamond.....	BNRY03
Graphite.....	BNRY05
Juniper.....	BNRY10
Lagoon.....	BNRY07
Lavendar.....	BNRY11
Mineral.....	BNRY04
Reef.....	BNRY09
Sand Dollar.....	BNRY02

### CENTURION\*

(Nanotex™ Stain-Resistant finish)

Apricot.....	CU47
Bark.....	CU25
Black.....	CU10
Espresso.....	CU49
Fog.....	CU03
Frost.....	CU22
Goldenrod.....	CU27
Indigo.....	CU06
Iris.....	CU50
Iron Ore.....	CU19
Jade.....	CU83
Marsala.....	CU63
Morel.....	CU24
Navy.....	CU98
Peacock.....	CU97
Pear.....	CU84
Ruby.....	CU67
Sapphire.....	CU09

### CIRCUIT

Atlas.....	CIRC35
Dolphin.....	CIRC63
Island White.....	CIRC14
Moon.....	CIRC07
Night.....	CIRC49
Pacific.....	CIRC28
Quartz.....	CIRC01
Sienna.....	CIRC56
Silk.....	CIRC21
Snap Pea.....	CIRC42

### ETCH

100% Polyester

Axis.....	ECH913
Blend.....	ECH914
Cast.....	ECH912
Highlight.....	ECH910
Midtone.....	ECH911
Outline.....	ECH908
Shade.....	ECH909
Tonal.....	ECH916
Vanish.....	ECH915

## GRADE A – continued

### EXCHANGE

100% Polyester

Iron.....	EXG916
Nickel.....	EXG914
Pistachio.....	EXG910
Root.....	EXG913
Rupee.....	EXG903
Shadow.....	EXG911
Silver.....	EXG915
Sisal.....	EXG917
Stone.....	EXG912

### LANDSCAPE

100% Polyester

Corn silk.....	LN15
Drift.....	LN05
Khaki.....	LN20
Sheen.....	LN10
Slate.....	LN35
Umber.....	LN25
Urban.....	LN30

### LUCY

100% Recycled Polyester

Aspen.....	LC932
Corn silk.....	LC930
Dusk.....	LC922
Fawn.....	LC933
Graphite.....	LC934
Mist.....	LC920
Neutra.....	LC924
Pewter.....	LC935
Snowdrop.....	LC928

### REFLECTIONS

100% Recycled Polyester

Galvanized.....	REF929
Ice.....	REF920
Loggia.....	REF921
Mistral.....	REF928
Moonstone.....	REF923
Pewter.....	REF922
Stainless.....	REF924
Vanilla.....	REF925
Winter.....	REF927

### REFUGE

64% Recycled Polyester  
36% Polyester

Artesian.....	RFG996
Dune.....	RFG992
Eclipse.....	RFG990
Frost †.....	RFG993
Glacier †.....	RFG991
Mineral.....	RFG991
Tidal.....	RFG994

### SARTO

100% Polyester (45% Recycled)

Ash.....	SRT988
Fog.....	SRT914
Lemongrass.....	SRT949
Mist.....	SRT945
Mushroom.....	SRT976
Oyster.....	SRT918
Reef.....	SRT964
Sesame.....	SRT993
Shale.....	SRT952

### TEMPEST

100% Recycled Polyester

Dragonfly.....	TP930
Frost.....	TP915
Full Stream.....	TP980
Gold Rush.....	TP910
Slate.....	TP945
Tumbleweed.....	TP970
Wind Chill.....	TP940
Zebra.....	TP935

## GRADE B

### \*ANALOG

Album.....	ANLG06
Cartridge.....	ANLG04
Cassette.....	ANLG09
Dial.....	ANLG02
Media.....	ANLG08
Reel.....	ANLG07
Signal.....	ANLG03
Stereo.....	ANLG01
Track.....	ANLG05

### COAST

100% Antimony-Free Polyester

Channel.....	COA914
Dune.....	COA903
Headlands.....	COA910
Marsh.....	COA902
Pebble.....	COA912
Pier.....	COA913
Shoal.....	COA901
Silt.....	COA906
Tide.....	COA908

### DISPERSE

100% Polyester

Autumn.....	DISP03
Branch.....	DISP10
Coffee Bean.....	DISP13
Dusk.....	DISP09
Emerald City.....	DISP08
Gold Rush.....	DISP02
Igloo.....	DISP11
Ink.....	DISP06
Mist.....	DISP12
Oatmeal.....	DISP15
Prince.....	DISP07
Reservoir.....	DISP01
Rose.....	DISP04
Spring.....	DISP05
Steel.....	DISP16
Taupe.....	DISP14

### MICA

100% Recycled Polyester

Anthracite.....	MCA911
Breeze.....	MCA918
Bronze.....	MCA913
Buff.....	MCA914
Cremini.....	MCA917
Crystal †.....	MCAWIT
Dew.....	MCA920
Dove.....	MCA912
Fresh.....	MCA916
Mineral.....	MCA915
Nectar.....	MCA919
Shale.....	MCA910

### SPIN PANEL

46% Recycled Polyester,  
56% Polyester

Alabaster.....	SPIN02
Cavern.....	SPIN03
Cobblestone.....	SPIN04
Ember.....	SPIN06
Flame.....	SPIN07
Heron.....	SPIN13
Oat.....	SPIN01
Ocean.....	SPIN12
Plum.....	SPIN15
Pool.....	SPIN11
Raven.....	SPIN10
Rhubarb.....	SPIN14
Tropic.....	SPIN08
Willow.....	SPIN05

## GRADE B – continued

### TERRAIN

52% Recycled Polyester,  
48% Polyester

Bay.....	TRRN05
Bayou.....	TRRN35
Canyon.....	TRRN30
Cliff.....	TRRN45
Crest.....	TRRN25
Delta.....	TRRN10
Plateau.....	TRRN15
Ridge.....	TRRN20
Valley.....	TRRN40

## ALLSTEEL PARTNERSHIP PROGRAM

Allsteel understands that customers may want to specify panel and seating textiles outside of Allsteel's standard offering. Allsteel's **Partnership Program** consists of on-trend and design-forward patterns that have been tested and approved by Allsteel for use on Allsteel products. A subset of these approved patterns is available on cards in the textile binder, while numerous others are available on our website, [allsteeloffice.com](http://allsteeloffice.com).

**For memo samples, please contact our partners:**

- Camira, [memos@camirafabrics.com](mailto:memos@camirafabrics.com)  
1.616.288.0655
- Carnegie, [carnegiefabrics.com](http://carnegiefabrics.com)  
1.800.727.6770
- CF Stinson, [cfstinson.com](http://cfstinson.com)  
1.800.841.6279
- HBF Textiles, [hbftextiles.com](http://hbftextiles.com)  
1.877.494.5727
- Maharam, [maharam.com](http://maharam.com)  
1.800.645.3943
- Ultrafabrics, [ultrafabricsllc.com](http://ultrafabricsllc.com)  
1.877.309.6648

The intent of the **Partnership Program** is to offer a wide variety of on-trend textiles to meet your varied needs, but since these textiles are not part of our standard offering they may be subject to extended lead times. Because new materials will be introduced regularly, Allsteel reserves the right to change the offering at any time.

\* Limited to product 48" W or less.

Multi-use fabrics are seating fabrics that can be used on specific Allsteel panels systems, providing more color and pattern options. The applicable Allsteel multi-use fabrics are noted with System designators in the Seating, Collaboration, and Tables Price List.



Allsteel®

Allsteel Inc.  
Muscatine, Iowa 52761

[allsteeloffice.com](http://allsteeloffice.com)

Form # A8751 (02/24)