

# Casegoods & Storage

## Price & Specification Guide 2023

Prices effective March 1, 2023

PDF updated December 14, 2023

# Limited Lifetime Warranty

Our unwavering commitment to our customers compels us to care, and our dedication to quality is just one of the ways we show our customers how much they mean to us.

We recognize that keeping up with the pace of change requires having products that work as hard as the people who use them. That's why each of our products is rigorously tested and certified to meet the highest industry standards.

In the unlikely event that any Allsteel product or component covered by the Allsteel Warranty should fail under normal workplace use because of defective material or workmanship, Allsteel promises to fix it. Because taking care of *people* is how Allsteel takes care of business.

For information on Allsteel's warranty coverage, visit [AllsteelOffice.com](http://AllsteelOffice.com).

Government Support – [GovernmentSupport@hniworkplacefurnishings.com](mailto:GovernmentSupport@hniworkplacefurnishings.com)  
Product, Parts, Non-Warranty Parts Orders – [ProductSupport@hniworkplacefurnishings.com](mailto:ProductSupport@hniworkplacefurnishings.com)  
Quick Ship Orders – [QuickShip@hniworkplacefurnishings.com](mailto:QuickShip@hniworkplacefurnishings.com)  
Order Status – [OrderStatus@hniworkplacefurnishings.com](mailto:OrderStatus@hniworkplacefurnishings.com)  
General Inquiries – [GeneralSupport@hniworkplacefurnishings.com](mailto:GeneralSupport@hniworkplacefurnishings.com)

- Software support packages furnished to the customer, either by Allsteel® or by another source, which support the sale of Allsteel products are superseded by printed price lists.
- Prices are subject to change without notice. All orders are subject to prices in effect at the time of order.
- Please refer to your Allsteel Dealer Sales and Discount Policies for order placement information and terms and conditions.
- Additional copies of this Specification and Price List are available upon request from Allsteel Literature Fulfillment at 1-866-255-7833.

- Ordering information appears at the bottom of each product page complete with examples on how to specify. Fabric and finish pages are referenced at the bottom of product pages.

This publication is available as an interactive or downloadable PDF at [www.allsteeloffice.com](http://www.allsteeloffice.com).

### Questions or Comments?

Please call us at: **888-ALLSTEEL**  
**888-255-7833**

Warranty .....	Inside Front Cover
New, Revised, and Discontinued Products .....	4
COM, Specials Policies, and Programs .....	5-8
Upholstery and Finishes .....	9-19
Storage Introduction and Pull Option Matrix .....	20-21
Working with Digital Lock .....	22-23
<b>ALIGN™ METAL STORAGE</b>	
Statement of Line .....	25-26
Finishes .....	28
Working with Align Metal Storage .....	29-31
Dimensions .....	32
File/Load Capacities .....	33-34
Align Metal Pedestal Specifications .....	35-36
Credenzas and Accessories .....	37-38
Metal Credenzas with Panel Frames .....	39
Lateral/Personal/Laminate Top Specifications .....	40
Tower Specifications .....	41-42
Locker Specifications .....	43
Support, Mobile, and Freestanding Pedestals .....	44-47
Pedestal Tops and Accessories .....	48
22" H Credenzas .....	49-52.5
22" H Pedestals .....	52.6
Open Shelf & HAT Credenzas .....	52.7
Wire Management .....	52.8
Align Accessories .....	53-55
28" H Laterals, Personal Files, and Bookcases .....	56
Align Metal Towers .....	57-68
Align Lockers, Wardrobes, and Accessories .....	69-77
Digital Lock Keys and Accessories .....	78
Storage Islands .....	79-89
<b>ESSENTIALS™ METAL</b>	
Finishes .....	92
Working with Essentials Metal Storage .....	93-98
Essentials Metal Pedestals and Accessories .....	99-101
Essentials Metal Lateral Files .....	102
Essentials Metal Combination Files .....	103
Essentials Metal Storage Cabinets .....	104
Essentials Metal Bookcases .....	105
<b>VERTICAL METAL STORAGE</b>	
Finishes .....	108
Working with Vertical Files .....	109
A990 / A940 Series Vertical Files .....	110
<b>METAL OVERHEADS &amp; SHELVES</b>	
Finishes .....	112
Working with Terrace Overheads, Shelves, and Hutches .....	113-116
Overhead Cabinets, Shelves, and Up-mount Kits .....	117-118
Hutches, Tackboards, and Accessories .....	119
<b>RADII™ STORAGE</b>	
Finishes .....	122
Digital Lock Specifications .....	123
Pedestal Functionality with Work Tools .....	124
Freestanding and Mobile Pedestals .....	125-128
Pedestal Functionality with Work Tools .....	129
Undermount, L-Cube, and Work Tools .....	130-132
Caddy .....	133
Digital Lock Keys and Accessories .....	134

<b>APPROACH™</b>	
Overview .....	135-160
Approach Statement of Line .....	137-140
Finishes .....	161
Laminate Storage Brackets .....	162
Approach and Involve Laminate Wood Storage .....	163-164
Storage Open Plan Supports .....	165-166
Working with Approach .....	167-189
Desks .....	191-193
Pedestals .....	194-195
Credenzas .....	196-206
Storage Back Panels .....	207
Lateral Files .....	208
Bookcases .....	209
False Peds / Height-Adjustable Shrouds / Wall Access Panels / Bridges .....	210
Table Tops .....	211
Worksurfaces and Supports .....	212-215
Modesty Panels — Laminate .....	216
Towers and Wardrobes .....	217-226
Overheads and Stack on Storage .....	227-230
Tackboards & Writable Boards .....	231-232
Counterweights & Accessories .....	233
Altitude Height-Adjustable .....	234-237
<b>INVOLVE®</b>	
Finishes .....	240
Involve® Overview .....	241-242
Working with Involve® .....	243-262
Pedestals, Credenzas, and Bookcases .....	263-270
Soft Seating .....	271-276
Storage Towers .....	277-281
Stacking Storage .....	282
Overheads, Shelves, Stanchions, Hutches, and Tackboards .....	283-288
Worksurfaces — 18"D / Linear Taper / EZ View .....	289
Worksurface Supports .....	290-291
Screens .....	292-295
<b>FURTHER™</b>	
Finishes .....	298
Statement of Line .....	299
Working with Storage .....	300-303
Pedestals and Credenzas .....	305
Storage Towers .....	306
<b>AWARE®</b>	
Credenzas .....	307-308
<b>EXTENSIONS™</b>	
Working with Ergonomic Accessories .....	310-311
Working with Organization Tools .....	312-317
Working with Illumination .....	318-321
Power/Data Modules .....	322
<b>ACCESSORIES</b>	
Working with Pivot Monitor Arms .....	324-327
<b>APPENDIX AND INDEX</b>	
Locking Specification/Easy Lock .....	328-330
Touch-Up Paint .....	331
Fabric Grades G-J and Upholstery Grades 9-23 .....	332-333
Index — Model Numbers with Page Reference .....	334-341

**NEW FINISHES**

## Studio Paints

- Ochre – P093
- Sienna – P092
- Cove – P096
- Harbor – P097
- Sage – P095
- Dune – P094

Stratawood Beigewood Maple SE878

Stratawood Field Elm Maple SE599

Stratawood Belair Maple SE934

Stratawood Florence Walnut ST579

Natural Florence Walnut NT579

Quarter Florence Walnut QT579

Fawn Cypress Rift Oak RF108

Beigewood LWBE

Field Elm LWFE

**NEW TEXTILES**

Taylor

Livi with Supreen

Oxford with Supreen

Hamilton

Rush

**DE-EMPHASIZED FINISHES:**

Amethyst — P091

Cobalt Mica — P090

**DE-EMPHASIZED PRODUCTS**

Lock Core Kits: 6, 7, and 8 cores — 12/31/2023

Cable Management Trays: 24" and 36" — 12/31/2023

Gripper Clip — 12/31/2023

**DISCONTINUED FINISHES:**

Charcoal Walnut laminate — LWCW Disco 6/30/2022

Columbian Walnut laminate — LWZ Disco 6/30/2022

Amber Cherry laminate — LWAC Disco 6/30/2022

Charcoal Walnut edge — DC Disco 6/30/2022

Columbian Walnut edge — DZ Disco 6/30/2022

Amber Cherry edge — DA Disco 6/30/2022

Canyon Zephyr laminate — LT5B Disco 6/30/2022

Desert Zephyr laminate — LT5A Disco 6/30/2022

Ebony laminate — LT3E Disco 6/30/2022

Grey Mesh laminate — LT8A Disco 6/30/2022

Parchment laminate — TM20 Disco 6/30/2022

Pewter Mesh laminate — LT8C Disco 6/30/2022

Sheer Mesh laminate — LT8B Disco 6/30/2022

White Tigris laminate — LT2A Disco 6/30/2022

**DISCONTINUED TEXTILES**

In Season — 12/31/2022

Attire — 12/31/2022

Seed — 12/31/2022

Dapper — Azalea, Emerald, Peony, Pool, Rose, Spice — 12/31/2022

Analog — 12/31/2023

Whisper — Brick Red, Carotene, Cucumber, Forest, Merlot, Ochre,

Putty, Sangre, Zest — 12/31/2023

**COM Program**

Allsteel understands that customers may at times want to specify fabrics outside of Allsteel's standard fabric offering. Our COM program was designed to make specifying COMs on Allsteel products a simpler, friendlier, and hassle-free process. This process is simple and easy to use, and is described below under "Allsteel to Supply (ATS)." If a Dealer wishes to manage the COM process themselves, they can do so by following guidelines under "Dealer to Supply (DTS)". **ATS is the preferred method for all COM fabrics.** With ATS, Company will provide acknowledgment based upon planned date of receipt of COM fabric and manage the entire process. DTS is allowed if it is not a partnership fabric or if Company does not have access to the supplier. **DTS may cause order delays and is strongly discouraged.** Find out more about Allsteel's COM process by emailing our COM Department at [allsteelcomteam@allsteeloffice.com](mailto:allsteelcomteam@allsteeloffice.com).

**Allsteel to Supply (ATS):**

1. Select the fabric you wish to use and check the COM Search on Synergy at: [Allsteelsynergy/Design Resources/Textiles & Finishes/COM Search](#) or [COM Search quick link](#). You will need to have the COM supplier's name, fabric pattern name, and color name to search for approved fabrics.
2. If your fabric is listed as an approved fabric, you may place your order directly with Allsteel Customer Support. Please use the fabric code (e.g., S216426XP) from the COM Test Request on your order in the place of the standard fabric code.  
If your fabric is not listed as approved, you will need to select the "Request COM Test" link on the COM Search website. If your fabric is not listed as approved, and it is not a Partnership fabric you may request a "Dealer to Supply" code. Select the "Request COM Test" link on the COM Search website. Your name, company name and email will be prepopulated fields. The secondary email, project name, and bid/contract number are optional information. The supplier, pattern, and color will show a list by clicking in the box and entering the first letter of the name and these are free form text boxes. Once that information is entered click add. (Multiple series can be added to the same request if they are the same supplier, pattern, and color.) Then click submit.
3. An email will be sent to the to the requestor stating the COM Request was successfully submitted. Up to four emails could be received: Testing materials requested, in testing, and final approval/denial with price grade and fabric code. It's rare actual test yardage is required. Testing is mainly done by reviewing the attributes of the fabric. The testing process takes approximately 48 hours. Written COM price quotes hold pricing for 90 days after issue date.
4. Once the fabric has been approved by Allsteel, enter your order directly with Allsteel Customer Support. Allsteel will purchase all COM fabric directly from the COM suppliers and schedule for production.

In the event that the Dealer decides to cancel a COM fabric order, the Dealer is responsible for the cost of the fabric plus a handling charge that is equal to 10% of the fabric cost.

**Dealer to Supply (DTS):**

1. Select the fabric you wish to use and check the COM Search on Synergy at: [Allsteelsynergy/Design Resources/Textiles & Finishes/COM Search](#) or [COM Search quick link](#). Or call Allsteel Customer Support to see if the fabric you have chosen has already been tested and approved on the product you are interested in.  
You will need to have the COM supplier's name, fabric pattern name, and color name for this inquiry.
2. If your fabric is not listed as approved, and it is not a Partnership fabric you may request a "Dealer to Supply" code. Select the "Request COM Test" link on the COM Search website. Your name, company name and email will be prepopulated fields. The secondary email, project name, and bid/contract number are optional information. The supplier, pattern, and color will show a list by clicking in the box and entering the first letter of the name and these are free form text boxes. Once that information is entered click add. (Multiple series can be added to the same request if they are the same supplier, pattern, and color.) Then click submit.
3. An email will be sent to the to the requestor stating the COM Request was successfully submitted. Up to four emails could be received: Testing materials requested, in testing, and final approval/denial with price grade and fabric code. It's rare actual test yardage is required. Testing is mainly done by reviewing the attributes of the fabric. The testing process takes approximately 48 hours.
4. Make sure to use a "Dealer to Supply" COM code (e.g., S216426ZP) and place your order directly with Allsteel Customer Support.
5. All "Dealer to Supply" orders will be charged Grade 4 pricing for seating, Grade 3 for Gather, and Grade D pricing for panels. Dealers will pay for the COM fabric separately.
6. All "Dealer to Supply" fabric must be sent on a fabric roll. Estimate the yardage required by using the yardage requirements listed in the price list by model. For questions please contact Allsteel Customer Support.
7. Place your fabric order directly with the COM Supplier with instructions for the fabric to be sent on a fabric roll to:

**HNI Textile Distribution Center****COM Production Yardage — PO Number**

Docks 20-22  
301 Mulberry Avenue  
Muscatine, IA 52761

Information that **MUST** be included in the packing slip attached to the DTS fabric:

1. Dealer's Purchase Order number to Allsteel
2. Allsteel's Tracking number for the COM fabric
3. Dealer Name
4. Yards of Fabric

If the fabric shipment does not match the correct fabric and yardage, Allsteel will notify the Dealer for resolution.

If Allsteel receives fabric with incorrect labeling or fabric yardage that cannot be linked to an Allsteel furniture order, Allsteel will hold the fabric for up to 4 weeks. After 4 weeks Allsteel will dispose of the fabric. There are no exceptions to this policy.

Specific to DTS orders - The customer should send only the amount needed for the order. Excess yardage, or yardage not attached to an order will be disposed of at Allsteel's discretion.

Any canceled orders are subject to cancellation charges up to the full value of the Allsteel product canceled. Allsteel will determine the actual cancellation charge at the time the cancellation is requested.

8. For additional details on "Dealer to Supply" fabric refer to your Allsteel terms and conditions.

#### Additional Policy Information:

The company assumes no responsibility for the overall appearance, flammability, normal durability, colorfastness, or any other quality standards. The company reserves the right to reject a COM if the quality of the COM is not satisfactory for the product. Should this occur, the customer will be notified with an explanation when the issue is found.

The company is not responsible for fabric that has become obsolete at the COM supplier, that is of poor quality, or that is delivered late to the manufacturer from the COM supplier.

All cancellations or changes to COM orders are subject to Company approval. Because of the nature of COM, special fabrics, finishes, and structural modifications, products ordered as specials and then canceled prior to shipment are subject to cancellation costs up to the full value of the product canceled. The company determines the actual cancellation charge at the time the cancellation is requested. Upon approval, a cancellation number is issued to the Customer.

Purchase orders will not be accepted or entered unless the testing process is complete with positive results.

If all testing has been previously completed, re-testing is only necessary if fabric is to be used on a different product, or pattern direction has changed from that previously approved.

Previous test results can be obtained by a customer on the COM Search on Synergy or by calling Allsteel Customer Support.

All COM fabric will be applied to seating and panel systems Pattern Cut unless Railroad Cut is requested and approved on the COM Test Request. Any fabrics approved as a width pass, the dealer is responsible for clarifying Railroad Cut on orders containing items that are too large to support the Pattern Cut of a fabric application (any items larger than 48" high or wide).

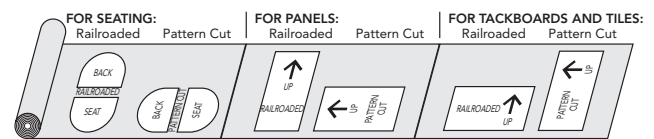

#### Fire Retardant

The Dealer is responsible for ensuring that the COM fabric is certified to meet all flame retardant requirements.

*For more information, please contact Allsteel Customer Support.*

#### YARDAGE REQUIREMENTS FOR FABRIC WITH REPEATS — FOR USE ON GATHER™ PRODUCTS

Fabric Width	Plain Fabric	2"– 14" Repeat	15"– 19" Repeat	20"– 27" Repeat	28"– 36" Repeat
54"	0	+15%	+20%	+25%	+30%
53"	+6%	+19%	+24%	+28%	+36%
52"	+13%	+23%	+28%	+33%	+38%
51"	+19%	+26%	+31%	+36%	+41%
50"	+25%	+30%	+35%	+40%	+45%
49"	+30%	+35%	+40%	+45%	+50%
48"	+35%	+40%	+45%	+50%	+55%
47"	+45%	+50%	+55%	+58%	+65%

Depending upon the pattern repeat, it may be necessary to pattern cut the fabric. This will require 10% additional fabric.

To calculate multiple repeats (vertical and horizontal), add each repeat for total yardage required. For example for a fabric width of 54": 7" vertical requires 15%, 15" horizontal requires 20% total additional yardage required equals 35% (15% + 20%). Therefore, if your chair requires 2 yards of fabric, multiply 2 by 35%. Then 2.7 yards will be yardage required.

### Special Paint & Stain Policy

Allsteel at its own discretion may modify its standard products with non-standard paint and stain colors to meet specific needs. Dealer is required to submit a special paint or stain request via the COM Search on Synergy. A sample of the non-standard paint or stain color desired will be required for matching. Pricing, lead time, and order information will be provided at the time of approval.

- For each new requested stain or paint, there will be a \$500 net fee to cover supplier costs to match the special item.
- For existing, previously-approved stains or paints, there is no \$500 matching fee, however, there is a sample chip fee of \$175 net for stains and \$100 net for paints.
- Samples, preferably at least 3" x 5" chips, of the exact color desired should be sent to the Allsteel Tailored Products Group. Paint matches require (3) sample chips and stain matches require (3) sample chips. Please mail these sample chips to the address below and reference the Special Item Request Number from Tailored Solutions.

#### Allsteel Inc.

Attn: COM Team  
200 Oak St.  
Muscatine, IA 52761

- Allsteel will color match the sample and send control samples to the address provided in the request. Dealer will review Allsteel's color match and approve by signing the back of the sample chip. Send the signed sample back to the Allsteel Tailored Products Group.
- Special paints will be assigned a paint price grade.
- Orders will not be accepted until Allsteel receives the Dealer's written approval on the color match.
- Extended lead times will apply on orders containing special paints or stains.
- Due to manufacturing techniques, materials, and quality issues, some exclusions will apply and some matches may be declined.

#### Important Notes

- Natural veneer is subject to nature's quality control. Differences in grain and color are naturally occurring variations and cannot be controlled by the manufacturer and cannot be considered as product defects. Natural veneer has the characteristics and beauty of a living organism; with its own variations of grain, growth, and color patterns. For these reasons, Natural veneer is preferred by many for its warmth and personal characteristics.
- Color changes will occur over time when wood is exposed to light. For this reason, when new product is ordered as an addition to existing product, there will be color variances between the old and new product. Please remember when specifying new product that although the species of veneer will be the same, additional product is being manufactured from a different tree. It may take several months for the new furniture to mature to the color level of existing product. Even with this maturation process the additional product will not be an exact match.

### Special Laminate Policy

The Company at its own discretion may modify its standard products with non-standard laminates to meet specific needs. Contact the Allsteel Tailored Products Group for pre-approved Wilsonart, Formica, Nevamar and Pionite laminates and pricing for special laminates. When requesting a special laminate please supply manufacturer, along with name and pattern number of laminate.

- Extended lead times will apply on orders containing special laminates.
- Due to manufacturing techniques, materials, and quality issues, some product exclusions will apply and some requests may be declined.

### Veneer Care Instructions

Veneer worksurfaces feature the Gunlocke® finishing system. The finishing system is a process that begins with the application of stains, which promote exceptional depth and clarity. Next the worksurface receives a specialized coating that provides exceptional durability and chemical resistance. The remaining surfaces receive a top coat. These finishing processes ensure depth, clarity, color consistency and durability throughout the product.

Veneer worksurfaces have exceptional resistance to:

- Heat and moisture (hot beverages, pizza boxes)
- Chemicals (liquid paper, nail polish)
- Stains (permanent markers)
- Scratches and impact (everyday wear and tear)

#### Caring for your veneer finish:

- General maintenance procedures entail wiping clean the entire surface with a clean, water dampened soft cloth once per week (be sure to wipe with the grain)
- Murphy's® Oil Soap may be used as a general purpose type cleaner with warm water to clean tops.
- The finish may also be polished with Guardsman® Furniture Polish (contains no waxes or silicones) to provide renewed luster.
- Be sure to wipe up all spills immediately. Do not allow spills to dry.

Wood owes its inherent beauty to variations in color, grain and texture, and therefore, these variations are not considered defects. There may be minor variations from one piece of furniture to the next even though they are finished at the same time. Exposure to light and the aging process will cause a darkening of natural wood products. Light finishes on wood products do not mask the natural characteristics of wood. Allsteel does not guarantee the exact matching of grain, pattern and color.

### Allsteel Open Line Laminate Program

The Open Line Laminate (OLL) program makes it even easier for a customer to tailor their Allsteel product for a custom look. Select Allsteel furniture products accommodate hundreds of graded-in high-pressure laminates (HPL) from the leading laminate manufacturers' open lines.

Laminates that are currently available in the program can be viewed in specification tools.

Requests to add laminates to the standard specials program can be submitted through the CET Specials Integration tool as well as Community.

Matching edge options are not available offered for laminates in the OLL program. When selecting a laminate please select an edge option from the Allsteel standard offering. If a matching edge is required a modification request can be submitted through the CET Specials Integration tool as well as Community.

Due to manufacturing techniques, materials, quality issues of varying laminates, and minimum order quantities some product exclusions will apply, and some requests may be declined.

Extended lead times may apply on orders containing special laminates.

Contact the Tailored Products Group for questions or additional information regarding pre-approved laminates and pricing.

Allsteel

Phone: 888-255-7833 Option 4.2

Email: [ASITPG@allsteeloffice.com](mailto:ASITPG@allsteeloffice.com)

For edge band recommendations from the Allsteel standard offering, please email the HNI Workplace Colors, Materials and Finishes team at [allsteel finishes@allsteeloffice.com](mailto:allsteel finishes@allsteeloffice.com).

Allsteel edge samples can be ordered through the Allsteel Synergy literature site, <https://www.allsteelsynergy.com>.

For laminate samples, please contact the manufacturer directly:

Wilsonart

<https://www.wilsonart.com/>

1-800-433-3222

Formica

<https://www.formica.com/en-us/>

1-800-FORMICA (367-6422)

Nevamar and Pionite

<https://www.panolam.com>

877-726-6526



# Everyday Advantage<sup>®</sup>

## New terms and conditions for EDA:

1. Orders must clearly state “Everyday Advantage Order” and include the appropriate Everyday Advantage contract number:
  - Everyday Advantage Std-0125, Everyday Advantage Canada-0127
2. Everyday Advantage orders are not eligible for bid pricing.
3. Program discounting includes the complete Optimize, Further, Terrace, and Stride systems lines, private office solution, Approach and Involve storage. This program also includes Acuity, Access, Evo, Inspire, Lyric, Mimeo, Nimble, Quip, Relate, Seek, and Svelte, seating. Altitude, Aware, and Structure tables are also available, along with Align pedestals, lockers and metal storage and Essentials pedestals, and Radii storage lines. In addition, Extensions ergonomic accessories and lighting are part of the standard offering. All other product not called out is available for order on the contract but will receive standard discounting of 55%–65%.
4. All textiles and finishes except for veneer and some wood finishes are available, depending on quantity and selection, and may have extended lead times.
5. Everyday Advantage orders are not limited to a minimum or maximum.
6. All orders ship based on standard lead times. Large-quantity orders of like products may be subject to longer lead times.
7. Standard freight terms apply.
8. If driver assistance is needed, standard driver assist charges will be added at time of order entry.

*Allsteel Inc. reserves the right to amend or terminate this program at anytime with 30 days written notice. Allsteel is not liable for service delays caused by force majeure (circumstances beyond Allsteel's control).*

Refer to page 12 for current upholstery availability by model/series.

GSA Reference Page

ALLSTEEL MATERIALS PARTNERSHIP PROGRAM — See program explanation at bottom of page.

GRADE 2	GRADE 4	GRADE 4 – continued	GRADE 4 – continued	GRADE 4 – continued
<b>Maharam MELD</b>	<b>HBF Textiles BLINK</b>	<b>Maharam MANNER</b>	<b>Maharam MERIT</b>	<b>Maharam METRIC</b>
Amethyst.....SMHMMLD18	Bright Blue..... 1048-59	Ablaze..... SMHMMAN13	Aegean..... SMHMMER15	Admiral..... SMHMMET26
Antler.....SMHMMLD13	Dark Violet..... 1048-77	Aquatic..... SMHMMAN22	Alert..... SMHMMER37	Alligator..... SMHMMET20
Bare.....SMHMMLD26	Dove Grey*..... 1048-83	Atmospheric*.. SMHMMAN36	Armada..... SMHMMER16	Anchor..... SMHMMET24
Blonde.....SMHMMLD27	Lemon Yellow*..... 1048-22	Baroness*..... SMHMMAN53	Arrow*..... SMHMMER33	Arabica*..... SMHMMET09
Bride.....SMHMMLD10	Ocean Blue*..... 1048-56	Basin..... SMHMMAN26	Bellini*..... SMHMMER24	Aztec*..... SMHMMET41
Bulb.....SMHMMLD09	Peppery..... 1048-90	Butterscotch*... SMHMMAN16	Beluga*..... SMHMMER02	Bittersweet*.... SMHMMET08
Clementine.....SMHMMLD23	Red Orange..... 1048-44	Caper*..... SMHMMAN19	Blackout*..... SMHMMER04	Bonsai*..... SMHMMET22
Comet.....SMHMMLD29	Sea Green*..... 1048-67	Carob*..... SMHMMAN02	Blizzard*..... SMHMMER10	Brick*..... SMHMMET11
Crater.....SMHMMLD14	Silvery..... 1048-80	Charisma*..... SMHMMAN49	Brass..... SMHMMER32	Canary*..... SMHMMET39
Creek.....SMHMMLD40		Citronella*..... SMHMMAN45	Cabernet..... SMHMMER39	Caramel*..... SMHMMET17
Fox.....SMHMMLD24	<b>Maharam CAPER</b>	Cloudburst*.... SMHMMAN37	Eggplant*..... SMHMMER40	Cardinal..... SMHMMET12
Fuchsia.....SMHMMLD17	Bliss.....SMHMCAP09	Cocoa*..... SMHMMAN08	Farro*..... SMHMMER29	Cedar*..... SMHMMET15
Globe.....SMHMMLD42	Cactus*.....SMHMCAP08	Cola*..... SMHMMAN10	Gator..... SMHMMER19	Cerise*..... SMHMMET10
Gloss.....SMHMMLD08	Cameo*.....SMHMCAP10	Comfort*..... SMHMMAN42	Gelato*..... SMHMMER34	Downpour*.... SMHMMET33
Grate.....SMHMMLD07	Cinnamon*.....SMHMCAP04	Cottage..... SMHMMAN23	Goji..... SMHMMER38	Driftwood*.... SMHMMET06
Heat.....SMHMMLD22	Cougar*.....SMHMCAP03	Cruise..... SMHMMAN35	Gunmetal..... SMHMMER03	Envy*..... SMHMMET21
Honeydew..... SMHMMLD30	Note.....SMHMCAP06	Dahlia*..... SMHMMAN24	Hawk..... SMHMMER41	Film..... SMHMMET31
Isle.....SMHMMLD39	Paprika.....SMHMCAP05	Dill..... SMHMMAN43	Hedera*..... SMHMMER17	Fleece*..... SMHMMET03
Kale.....SMHMMLD34	Ribbon*.....SMHMCAP11	Ember*..... SMHMMAN11	Highborn*..... SMHMMER07	Fog*..... SMHMMET02
Kiss.....SMHMMLD25	Sidekick.....SMHMCAP12	Firth*..... SMHMMAN39	Immersed..... SMHMMER08	Fruit*..... SMHMMET42
Knight.....SMHMMLD04	Silverback.....SMHMCAP07	Flint..... SMHMMAN04	Kiwi..... SMHMMER22	Galah..... SMHMMET43
Magma.....SMHMMLD20	Smolder*.....SMHMCAP13	Grandeur*..... SMHMMAN41	Kookaburra.... SMHMMER23	Hedgerow*.... SMHMMET36
Mariner.....SMHMMLD41	Whim*.....SMHMCAP01	Greenway*..... SMHMMAN21	Lynx*..... SMHMMER28	Highway*..... SMHMMET38
Merlot.....SMHMMLD19	Wise*.....SMHMCAP02	Harvest*..... SMHMMAN17	Macaron..... SMHMMER36	Hopscoth..... SMHMMET30
Mimosa.....SMHMMLD28		Hush..... SMHMMAN05	Manila*..... SMHMMER30	Kiln*..... SMHMMET44
Mulberry.....SMHMMLD16	<b>Stinson LATERAL</b>	Kimono..... SMHMMAN51	Mudder*..... SMHMMER27	Lava..... SMHMMET13
Nordic.....SMHMMLD36	Calypto.....SCFSLAT43	Lattice*..... SMHMMAN30	Nectarine*.... SMHMMER35	Middy..... SMHMMET34
Panda.....SMHMMLD02	Citrine.....SCFSLAT41	Lioness*..... SMHMMAN18	Ocean..... SMHMMER06	Mineral*..... SMHMMET07
Perennial.....SMHMMLD15	Horizon.....SCFSLAT42	Magic*..... SMHMMAN01	Overcast..... SMHMMER43	Moth*..... SMHMMET45
Pipe.....SMHMMLD06	Mist.....SCFSLAT40	Magnetic..... SMHMMAN32	Pine..... SMHMMER21	Oriole*..... SMHMMET14
Quill.....SMHMMLD05	Papaya.....SCFSLAT45	Nuance*..... SMHMMAN06	Pine..... SMHMMER21	Phantom*..... SMHMMET01
Reef.....SMHMMLD37	Peppercorn*.....SCFSLAT46	Oceanside..... SMHMMAN40	Poolside*..... SMHMMER11	Pollen*..... SMHMMET18
Rooster.....SMHMMLD21	Sangria.....SCFSLAT47	Parakeet..... SMHMMAN20	Rainfall..... SMHMMER09	Scuba*..... SMHMMET28
Seashell.....SMHMMLD12	Skyline*.....SCFSLAT48	Passerine..... SMHMMAN46	Rainforest*.... SMHMMER18	Seaport..... SMHMMET27
Seed.....SMHMMLD33	Sterling.....SCFSLAT14	Pathway*..... SMHMMAN09	Ripple*..... SMHMMER14	Skate..... SMHMMET29
Skyline.....SMHMMLD03		Peel..... SMHMMAN14	Sandstorm*.... SMHMMER26	Snorkel*..... SMHMMET37
Spa.....SMHMMLD43	<b>HBF Textiles LOOK-SEE</b>	Penny*..... SMHMMAN15	Stag*..... SMHMMER42	Sourdough*.... SMHMMET04
Stark.....SMHMMLD11	Electric*..... 1044-77	Poplar*..... SMHMMAN44	Starfish*..... SMHMMER31	Sunny..... SMHMMET40
Vast.....SMHMMLD01	Foggy..... 1044-85	Porpoise..... SMHMMAN03	Steel*..... SMHMMER12	Talisman..... SMHMMET35
Vine.....SMHMMLD32	Foliage..... 1044-67	Resolute*..... SMHMMAN34	Sunflower*.... SMHMMER25	Tar*..... SMHMMET23
Waterfall.....SMHMMLD35	Lava..... 1044-44	Roseate..... SMHMMAN48	Superior..... SMHMMER05	Toffee*..... SMHMMET05
Wave.....SMHMMLD38	Midnight..... 1044-59	Schooner..... SMHMMAN27	Trickle..... SMHMMER01	Tupelo*..... SMHMMET19
Wild.....SMHMMLD31	Plum..... 1044-75	Siltstone..... SMHMMAN50	Vineyard..... SMHMMER20	Twilight*..... SMHMMET25
	Shady..... 1044-80	Silverpoint..... SMHMMAN29	Zircon..... SMHMMER13	Whale*..... SMHMMET32
	Snowy..... 1044-11	Slope*..... SMHMMAN28		
	Stone..... 1044-89	Smoky*..... SMHMMAN31		
	Terra Cotta*..... 1044-46	Southwest*.... SMHMMAN47		
	Ultramarine..... 1044-57	Thicket*..... SMHMMAN07		
	Wavelet*..... 1044-56	Tidewater..... SMHMMAN38		
	Wine*..... 1044-74	Valiant..... SMHMMAN52		
		Vivid*..... SMHMMAN25		
		Wagon*..... SMHMMAN12		
		Woad..... SMHMMAN33		

UPHOLSTERY

Multi-use fabrics are noted with the following designators: **B** – Tackboards, **C** – Concensys®, **O** – Optimize™, **S** – Stride®, **T** – Terrace®, **F** – Further™.

\* Colorway not shown on Textiles card; all Partnership Program memo samples are available from supplier. See contact information below.

### ALLSTEEL PARTNERSHIP PROGRAM

Allsteel understands that customers may want to specify panel and seating textiles outside of Allsteel's standard offering. Allsteel's Partnership Program consists of on-trend and design-forward patterns that have been tested and approved by Allsteel for use on Allsteel products. A subset of these approved patterns is available on cards in the textile binder, while numerous others are available on our website, [allsteeloffice.com](http://allsteeloffice.com).

For memo samples, please contact our partners:

- Camira, [memos@camirafabrics.com](mailto:memos@camirafabrics.com) 1.616.288.0655
- CF Stinson, [cfstinson.com](http://cfstinson.com) 1.800.841.6279
- HBF Textiles, [hbftextiles.com](http://hbftextiles.com) 1.877.494.5727
- Maharam, [maharam.com](http://maharam.com) 1.800.645.3943
- Ultrafabrics, [ultrafabricsinc.com](http://ultrafabricsinc.com) 1.877.309.6648

The intent of the **Partnership Program** is to offer a wide variety of on-trend textiles to meet your varied needs, but since these textiles are not part of our standard offering they may be subject to extended lead times. Because new materials will be introduced regularly, Allsteel reserves the right to change the offering at any time.

Refer to page 12 for current upholstery availability by model/series.

GSA Reference Page

ALLSTEEL MATERIALS PARTNERSHIP PROGRAM — SEE PROGRAM EXPLANATION AT BOTTOM OF PAGE 9.

UPHOLSTERY

**GRADE 4 – continued**

<b>Maharam MODE</b>	
Alder*	SMHMMOD23
Angelfish*	SMHMMOD32
Ballpoint*	SMHMMOD29
Barberry*	SMHMMOD25
Billygoat*	SMHMMOD10
Blush*	SMHMMOD21
Bonsai*	SMHMMOD40
Carotene*	SMHMMOD20
Celtic*	SMHMMOD38
Clavicle*	SMHMMOD09
Cottontail*	SMHMMOD16
Crush*	SMHMMOD34
Denim*	SMHMMOD33
Eucalyptus*	SMHMMOD39
Goldenrod*	SMHMMOD15
Henge*	SMHMMOD14
Hollow*	SMHMMOD07
Intaglio*	SMHMMOD02
Jetty*	SMHMMOD35
Kermes*	SMHMMOD24
Lemon*	SMHMMOD12
Lichen*	SMHMMOD43
Lioness*	SMHMMOD17
Machine*	SMHMMOD04
Mallard*	SMHMMOD37
Marsh*	SMHMMOD06
Odyssey*	SMHMMOD28
Ominous*	SMHMMOD03
Oriole*	SMHMMOD18
Oxeye*	SMHMMOD13
Paradise*	SMHMMOD31
Petal*	SMHMMOD26
Rust*	SMHMMOD19
Saltwater*	SMHMMOD36
Sassafras*	SMHMMOD41
Spindle*	SMHMMOD11
Stroll*	SMHMMOD01
Sycamore*	SMHMMOD08
Talus*	SMHMMOD05
Toile*	SMHMMOD30
Valley*	SMHMMOD27
Vermilion*	SMHMMOD22
Yucca*	SMHMMOD42
<b>Maharam MULTIPLY</b>	
Contrast*	SMHMMMLT04
Craft*	SMHMMMLT11
Daze*	SMHMMMLT06
Deep*	SMHMMMLT10
Encore*	SMHMMMLT02
Limit*	SMHMMMLT13
Mystique*	SMHMMMLT09
Sailor*	SMHMMMLT08
Sterling*	SMHMMMLT05
Sway*	SMHMMMLT07
Swing*	SMHMMMLT03
Tamale*	SMHMMMLT14
Town*	SMHMMMLT12
Winter*	SMHMMMLT01
<b>Maharam MURMUR</b>	
Argan*	SMHMMUR17
Baby*	SMHMMUR10
Biome*	SMHMMUR15
Canopy*	SMHMMUR03
Cask*	SMHMMUR16
Cauldron*	SMHMMUR06
Conquer*	SMHMMUR07
Dim*	SMHMMUR04
Elderberry*	SMHMMUR11
Gust*	SMHMMUR01
Harmonica*	SMHMMUR02
Iceberg*	SMHMMUR12
Ignite*	SMHMMUR19
Peppercorn*	SMHMMUR05
Rapids*	SMHMMUR08
Sangria*	SMHMMUR21
Seawater*	SMHMMUR09
Sultry*	SMHMMUR20
Sundown*	SMHMMUR18
Tallgrass*	SMHMMUR13
Underground*	SMHMMUR14

**GRADE 4 – continued**

<b>Maharam MUSE</b>	
Ascend	SMHMMUS04
Bergamot*	SMHMMUS11
Celebrate	SMHMMUS30
Clear	SMHMMUS07
Compass	SMHMMUS10
Crescendo	SMHMMUS01
Fantasy*	SMHMMUS08
Heat*	SMHMMUS16
Goal	SMHMMUS13
Grasshopper	SMHMMUS12
Haven*	SMHMMUS24
Jovial	SMHMMUS27
Mead*	SMHMMUS25
Miso*	SMHMMUS09
Mistletoe	SMHMMUS14
Neat	SMHMMUS26
Noble	SMHMMUS18
Poinsettia	SMHMMUS29
Pulsar	SMHMMUS19
Refresh	SMHMMUS06
Resonate	SMHMMUS02
Riverbend	SMHMMUS17
Runway	SMHMMUS03
Sailboat*	SMHMMUS21
Seaglass*	SMHMMUS15
Sparse*	SMHMMUS22
Spectacle	SMHMMUS31
Theater	SMHMMUS28
Vase	SMHMMUS23
Veil*	SMHMMUS05
Velella*	SMHMMUS20
<b>Maharam TRUNDLE</b>	
Aloe	SMHMTRN05
Cabana*	SMHMTRN06
Confetti*	SMHMTRN09
Crabapple*	SMHMTRN10
Element	SMHMTRN02
Hibernate*	SMHMTRN04
Magnet	SMHMTRN11
Rainstorm*	SMHMTRN07
Ray	SMHMTRN03
Ski*	SMHMTRN01
Wake	SMHMTRN08
<b>HBF Textiles WALKABOUT</b>	
Alluring Aqua*	1046-56
Bewitched Blue	1046-59
Bold Burgundy*	1046-74
Classic Cobalt*	1046-55
Cool Carbon	1046-87
Gallant Green*	1046-67
Gutsy Grey	1046-85
Jungly Jade	1046-64
Noble Navy	1046-58
Peaceful Pewter	1046-89
Reliable Red	1046-44
Swanky Silver	1046-80
Wistful White	1046-11

**GRADE 5**

<b>HBF Textiles CHECKMATE</b>	
Aqua Sky	1043-56
Blue Green*	1043-63
Charcoal Black*	1043-89
Forest Mint	1043-66
Golden Grey*	1043-22
Purple Indigo	1043-77
Red Brick	1043-44
Royal Navy	1043-58
Rust	1043-43
Smoke Slate	1043-80
Tanned Umber	1043-25
<b>Camira MAIN LINE FLAX</b>	
Aldgate	SCAMMLF01
Archway*	SCAMMLF02
Bank*	SCAMMLF23
Barbican	SCAMMLF03
Bayswater	SCAMMLF24
Bethnal	SCAMMLF25
Brompton*	SCAMMLF35
Camden*	SCAMMLF26
Charing	SCAMMLF27
Edgware*	SCAMMLF28
Euston	SCAMMLF04
Farringdon	SCAMMLF29
Finsbury	SCAMMLF30
Goldhawk*	SCAMMLF31
Greenford	SCAMMLF32
Highgate*	SCAMMLF33
Hillingdon*	SCAMMLF41
Holborn*	SCAMMLF05
Kensington	SCAMMLF07
Kilburn*	SCAMMLF06
Lambeth	SCAMMLF08
Leyton*	SCAMMLF13
Monument	SCAMMLF09
Mordor*	SCAMMLF12
Newbury	SCAMMLF10
Northfields*	SCAMMLF40
Paddington*	SCAMMLF39
Parsons*	SCAMMLF14
Pimlico*	SCAMMLF34
Russell*	SCAMMLF38
Stanmore	SCAMMLF37
Stockwell*	SCAMMLF15
Temple*	SCAMMLF16
Tooting	SCAMMLF17
Tower*	SCAMMLF36
Tufnell	SCAMMLF18
Upminster*	SCAMMLF20
Victoria*	SCAMMLF19
Waterloo*	SCAMMLF21
Wembley	SCAMMLF11
Westminster	SCAMMLF22
<b>HBF Textiles ZIPPY</b>	
Dark Grey	1045-89
Deep Red	1045-44
Denim Blue*	1045-58
Grey	1045-80
Navy*	1045-59
Pine	1045-67
School Blue	1045-55
Winter White*	1045-10

**GRADE 6**

<b>Camira BLAZER</b>	
Aberlour*	SCAMBLZ15
Aberarty	SCAMBLZ36
Aston	SCAMBLZ02
Barlborough*	SCAMBLZ40
Barnard	SCAMBLZ27
Bromsgrove*	SCAMBLZ35
Bryanston	SCAMBLZ53
Camphill	SCAMBLZ16
Cardiff*	SCAMBLZ04
Dartmouth	SCAMBLZ24
Dunhurst*	SCAMBLZ58
Edge Hill*	SCAMBLZ90
Edinburgh*	SCAMBLZ23
Eynesbury*	SCAMBLZ44
Fairfield	SCAMBLZ47
Glasgow*	SCAMBLZ01
Glenalmond	SCAMBLZ62
Goldsmith	SCAMBLZ39
Handcross*	SCAMBLZ63
Holyoke*	SCAMBLZ43
Hull*	SCAMBLZ19
Kingsmead*	SCAMBLZ67
Knightsbridge*	SCAMBLZ26
Latimer*	SCAMBLZ33
Magdalene*	SCAMBLZ42
Manchester	SCAMBLZ21
Marymount*	SCAMBLZ38
Montcrest*	SCAMBLZ37
Napier	SCAMBLZ08
Newcastle	SCAMBLZ22
Newport*	SCAMBLZ17
Oriel*	SCAMBLZ18
Oxford*	SCAMBLZ09
Penola*	SCAMBLZ45
Plymouth	SCAMBLZ20
Scottsdale*	SCAMBLZ41
Sheffield*	SCAMBLZ03
Silcoates	SCAMBLZ30
Silverdale	SCAMBLZ28
St. Andrews	SCAMBLZ86
Stanford	SCAMBLZ25
Surrey	SCAMBLZ10
Trevelyan	SCAMBLZ31
Tyndale*	SCAMBLZ46
Ulster*	SCAMBLZ11
Vassar	SCAMBLZ34
Wellington	SCAMBLZ13
Wesley*	SCAMBLZ82
Winchester*	SCAMBLZ12
Woodcroft*	SCAMBLZ48
<b>Camira HEMP</b>	
Acre	SCAMHMP19
Alec*	SCAMHMP12
Arable	SCAMHMP04
Ashworth*	SCAMHMP26
Bale	SCAMHMP02
Barn*	SCAMHMP23
Dale*	SCAMHMP18
Dew	SCAMHMP16
Fallow	SCAMHMP28
Gorse*	SCAMHMP03
Grain	SCAMHMP27
Heath*	SCAMHMP07
Hectare*	SCAMHMP21
Hedgerow*	SCAMHMP09
Oat	SCAMHMP05
Plough	SCAMHMP01
Pollen	SCAMHMP08
Root	SCAMHMP06
Seed	SCAMHMP13
Sickle	SCAMHMP30
Trough*	SCAMHMP20

**GRADE 6 – continued**

<b>HBF Textiles POPPY</b>	
Flame	1047-44
Graphite	1047-85
Ink	1047-89
Khaki	1047-35
Limelight	1047-63
Natural	1047-16
Neutral	1047-83
Night*	1047-59
Pool	1047-56
Punch	1047-45
<b>GRADE 7</b>	
<b>Camira SILK</b>	
Arabia*	SCAMSLK02
Assam*	SCAMSLK11
Brunei	SCAMSLK08
Byzantine*	SCAMSLK03
Chancellor	SCAMSLK19
Divine*	SCAMSLK13
Dynasty	SCAMSLK17
Emperor	SCAMSLK16
Empress*	SCAMSLK05
Forbidden*	SCAMSLK07
Imeon	SCAMSLK20
Incense*	SCAMSLK06
Kingdom*	SCAMSLK10
Monarch	SCAMSLK15
Oriental*	SCAMSLK12
Pamir*	SCAMSLK14
Parthian*	SCAMSLK09
Persia	SCAMSLK04
Sahara*	SCAMSLK01
Sovereign	SCAMSLK18
Tussah	SCAMSLK21

\* Colorway not shown on Textiles card; all Partnership Program memo samples are available from supplier. See contact information on page 9.

Refer to page 12 for current upholstery availability by model/series.

ALLSTEEL MATERIALS PARTNERSHIP PROGRAM — SEE PROGRAM EXPLANATION AT BOTTOM OF PAGE 9.

## GRADE 8

*Ultrafabrics*  
**BRISA\*** ▲

Abyss*	RS78
Apple Green	RS25
Ash	RS05
Aztec*	RS16
Bark*	RS18
Beet Root*	RS361
Birch	RS64
Black Onyx	RS01
Blossom*	RS74
Blue Sea	RS621
Bone	RS31
Cabernet	RS99
Cambridge Blue	RS17
Canyon*	RS07
Caramel	RS91
Celery	RS87
Cinnabar*	RS36
Coffee Bean*	RS33
Cookie Dough*	RS234
Cream*	RS63
Desert Clay*	RS19
Esmeralda	RS302
Evening Blue	RS620
Flamingo	RS203
French Vanilla	RS66
Ginger*	RS51
Golden*	RS67
Gravel*	RS275
Hazy Lilac*	RS310
Honeycomb*	RS233
Iceberg	RS272
Indigo	RS14
Koi	RS202
Mineral*	RS97
Moon	RS277
New Sand*	RS20
Night Navy*	RS94
Olive*	RS02
Peat*	RS00
Pompeian Red	RS83
Putty	RS08
Quicksilver	RS30
Rose Red*	RS43
Sage	RS10
Salsa	RS15
Seaweed	RS303
Shiitake*	RS22
Skyway*	RS96
Sterling Blue	RS98
Strawberry	RS359
Truffle	RS12
Turq	RS23
White	RS47
Wishbone*	RS276
Wrought Iron*	RS27

## GRADE 8 – continued

*Camira ZAP*

Argh	SCAMZAP11
Awesome*	SCAMZAP14
Boing	SCAMZAP21
Bonza	SCAMZAP25
Clang*	SCAMZAP19
Clobber*	SCAMZAP12
Cool*	SCAMZAP30
Crackle*	SCAMZAP05
Crash*	SCAMZAP16
Flump	SCAMZAP17
Gasp*	SCAMZAP15
Hahaha*	SCAMZAP09
Kapow*	SCAMZAP06
Omg	SCAMZAP13
Power*	SCAMZAP18
Puff	SCAMZAP26
Screech	SCAMZAP08
Snap*	SCAMZAP01
Splash	SCAMZAP27
Splat	SCAMZAP20
Thud*	SCAMZAP29
Wham	SCAMZAP23
Whirr	SCAMZAP03
Whomp*	SCAMZAP28
Whoosh*	SCAMZAP02
Wowzers*	SCAMZAP07
Yeah*	SCAMZAP04
Yikes	SCAMZAP10
Zoink	SCAMZAP24
Zoom	SCAMZAP22

## GRADE 9

*Ultrafabrics*  
**ULTRALEATHER PRO**

Aubergine	SUF554336
Blue Bird	SUF554661
Blueberry	SUF554711
Blush	SUF554200
Butterfly	SUF554216
Butternut*	SUF554241
Campfire	SUF554229
Capri*	SUF554522
Char	SUF554626
Chestnut	SUF554214
Cloud	SUF554648
Coastal	SUF554450
Cork	SUF554595
Cougar*	SUF554209
Cranberry	SUF554357
Dark Chocolate	SUF554376
Dark Knight	SUF554618
Ember	SUF554649
Laurel	SUF554443
Mortar	SUF554733
Parfait	SUF554803
Persian Green	SUF554453
Rhubarb	SUF554329
Sailor	SUF554547
Sea Mist	SUF554478
Shore	SUF554352
Sky	SUF554530
Swan	SUF554811
Toasted Bagel*	SUF554444
Tundra	SUF554353
Violet	SUF554395
White Wash	SUF554008
Woodcres	SUF554087

*Camira YOREDALE*

Askrigg*	SCAMYDL03
Buckden	SCAMYDL01
Burnsall	SCAMYDL22
Carperby	SCAMYDL07
Cracoe	SCAMYDL23
Cray	SCAMYDL10
Dacre	SCAMYDL21
Darley	SCAMYDL20
Fossdale	SCAMYDL11
Gayle	SCAMYDL08
Hardraw	SCAMYDL04
Kidstone	SCAMYDL02
Leyburn	SCAMYDL25
Litton	SCAMYDL15
Nidd*	SCAMYDL16
Ribble	SCAMYDL17
Ripley*	SCAMYDL19
Sedbusk	SCAMYDL14
Simonstone*	SCAMYDL05
Thoralby	SCAMYDL06
Thornton	SCAMYDL09
Walden	SCAMYDL13
Warfe*	SCAMYDL18
Woden*	SCAMYDL24
Woodale*	SCAMYDL12

\* Colorway not shown on Textiles card; all Partnership Program memo samples are available from supplier. See contact information on page 9.

### Upholstery Selections for Storage by Model/Series

Upholstery colors and codes for standard fabrics are listed on page 13. Partnership (⊕) upholstery colors and codes are listed in the Seating, Social Collaborative & Tables Price List.

Banquette/Seat Cushions  
Radin Ped Topper  
Align, Essentials, Involve  
Ped Topper

Banquette/Seat Cushions  
Radin Ped Topper  
Align, Essentials, Involve  
Ped Topper

UPHOLSTERY

#### GRADE 1

Apex	APX	•	•	•
Centurion	CU	◆	•	◆
Contourett	UR	◆	•	•
Dapper	DAPR	◆	•	◆
Ensemble	ENSB	•	•	•
Hamilton	HAML	◆	•	◆
Inertia	NR	◆	•	◆
Optic	OP	•	•	•

#### GRADE 2

Appoint Seating	PNS	◆	•	◆
Blume	BLME	•	•	•
Clyde	CLYD	•	•	•
Dotty	DOT	◆	•	•
Meld ⊕	SMHMMLD	•	•	•
Rush	RUSH	◆	•	•
Spin Seating	SPNN	◆	•	•
Taylor	TAY			

#### GRADE 3

Parker ⊕	PRKR		•	•
Purl	PURL	◆	•	•
Quill	QUL	◆	•	•
Lateral ⊕	SCFSLAT		•	•

#### GRADE 4

Blink ⊕	1048	•	•	•
Caper ⊕	SMHMCAP	•	•	•
Look-See ⊕	1044	•	•	•
Manner ⊕	SMHMMAN	◆	•	•
Merit ⊕	SMHMMER	•	•	•
Metric ⊕	SMHMMET	◆	•	•
Mode ⊕	SMHMMOD	•	•	•
Multiply ⊕	SMHMMLT	•	•	•
Murmur ⊕	SMHMMUR		•	•
Muse ⊕	SMHMMUS	•	•	•
Trundle ⊕	SMHMTRN	•	•	•
Walkabout ⊕	1046	•	•	•

#### GRADE 5

Blazer ⊕	SCAMBLZ	• <sup>s</sup>	•	•
Checkmate ⊕	1043	•	•	•
Main Line Flax ⊕	SCAMMLF	•	•	•
Zippy ⊕	1045	•	•	•

#### GRADE 6

Arris	ARR	•		
Hemp ⊕	SCAMHMP	•	•	•
Poppy ⊕	1047	•	•	•

#### GRADE 7

Silk ⊕	SCAMSLK		•	•
--------	---------	--	---	---

#### GRADE 8

Brisa ⊕	RS			
Zap ⊕	SCAMZAP	•	•	•

#### GRADE 9

Ultraleather Pro ⊕	SUF554		•	•
Yoredale ⊕	SCAMYDL	•	•	•

<sup>s</sup>Seat Only

• Available upholstery option

◆ Available upholstery option with CTB133 approval — requires FC suffix added to model (FC extra, \$ varies by series)

⊕ Partnership Program — See page 9 for details. Partnership colors and codes are listed in the Seating, Collaboration and Tables Price List.

Refer to page 12 for current upholstery availability by model/series.

### GRADE 1

<b>APEX</b>	
Basalt.....	APX25
Beet.....	APX12
Blackberry.....	APX20
Chive.....	APX05
Iris.....	APX03
Kiwi.....	APX06
Lemonade.....	APX08
Navy.....	APX13
Papaya.....	APX09
Pumice.....	APX23
Rain.....	APX19
Resort.....	APX15
Royal.....	APX14
Tiki.....	APX29
Tomato.....	APX11
<b>*CENTURION B, C, F, O, S, T</b>	
Apricot.....	CU47
Bark.....	CU25
Black.....	CU10
Espresso.....	CU49
Fog.....	CU03
Frost.....	CU22
Goldenrod.....	CU27
Indigo.....	CU06
Iris.....	CU50
Iron Ore.....	CU19
Jade.....	CU83
Marsala.....	CU63
Morel.....	CU24
Navy.....	CU98
Peacock.....	CU97
Pear.....	CU84
Ruby.....	CU67
Sapphire.....	CU09
<b>CONTOURETT</b>	
Baltic.....	UR94
Beach.....	UR23
Black.....	UR10
Bordeaux.....	UR63
Buff.....	UR22
Cloud.....	UR18
Coffee Bean.....	UR49
Crater.....	UR51
Flame.....	UR62
Graphite.....	UR19
Iron.....	UR20
Luggage.....	UR26
Marine.....	UR92
Navy.....	UR95
Nimbus.....	UR93
Ocean.....	UR96
Pumpkin.....	UR42
Quarry.....	UR24
Red.....	UR64
Safari.....	UR27
Sage.....	UR82
Steel.....	UR21
Storm.....	UR17
Taupe.....	UR28
Trunk.....	UR50

Multi-use fabrics are noted with the following designators:

**B** – Tackboards

**C** – Concensys®

**F** – Further™

**O** – Optimize™

**S** – Stride®

**T** – Terrace®

<sup>w</sup> limited to 48" W or less

\* Not available on 72" W.

### GRADE 1

– continued

<b>DAPPER B<sup>w</sup>, F<sup>w</sup>, S<sup>w</sup>, T<sup>w</sup></b>	
Ash.....	DAPR20
Breeze.....	DAPR06
Canvas.....	DAPR25
Charcoal.....	DAPR01
Clover.....	DAPR22
Currant.....	DAPR00
Fawn.....	DAPR35
Fern.....	DAPR85
Gerbera.....	DAPR16
Grape.....	DAPR33
Jewel.....	DAPR08
Marigold.....	DAPR65
Onyx.....	DAPR10
Orchid.....	DAPR90
Parrot.....	DAPR59
Poppy.....	DAPR19
Sapphire.....	DAPR07
Scarlet.....	DAPR45
Sepia.....	DAPR30
Slate.....	DAPR15
Sky.....	DAPR44
Sorbet.....	DAPR55
Spring.....	DAPR80
Terracotta.....	DAPR13
Titanium.....	DAPR17
Varsity.....	DAPR09
Zest.....	DAPR70
<b>ENSEMBLE</b>	
Aquamarine.....	ENSB30
Ash.....	ENSB39
Greige.....	ENSB36
Harbor.....	ENSB34
Navy.....	ENSB35
Oat.....	ENSB37
Pear.....	ENSB33
Sand.....	ENSB38
Scarlet.....	ENSB32
Slate.....	ENSB31
Stone.....	ENSB40
<b>HAMILTON</b>	
Azure.....	HAML10
Biscotti.....	HAML11
Cabernet.....	HAML08
Carolina.....	HAML21
Charcoal.....	HAML17
Chocolate.....	HAML13
Cloud.....	HAML18
Dane.....	HAML16
Dusty Rose.....	HAML07
Esmeralda.....	HAML06
Fern.....	HAML04
Fresh.....	HAML03
Granola.....	HAML19
Lilac.....	HAML14
Lime.....	HAML05
Lipstick.....	HAML09
Oxford.....	HAML20
Passion Fruit.....	HAML02
Pepper.....	HAML15
Powder.....	HAML12
Sunrise.....	HAML01
<b>INERTIA</b>	
Amethyst.....	NR61
Calypso.....	NR98
Cherry.....	NR66
Cobalt.....	NR91
Coffee.....	NR49
Fog.....	NR19
Fuchsia.....	NR63
Gecko.....	NR76
Glow.....	NR27
Leaf.....	NR75
Lime.....	NR82
Loft.....	NR22
Mandarin.....	NR47
Meteor.....	NR30
Mustard.....	NR26
Nickel.....	NR23
Onyx.....	NR10
Regatta.....	NR90
Shadow.....	NR20
Surf.....	NR96
Tangelo.....	NR46

### GRADE 1

– continued

<b>OPTIC</b>	
Aurora.....	OP72
Bark.....	OP24
Canopy.....	OP84
Char.....	OP49
Ruby.....	OP42
Sand.....	OP17
Sky.....	OP83
Slate.....	OP19
Sprout.....	OP74
Starry Night.....	OP11
Storm.....	OP56
Wildfire.....	OP66

### GRADE 2

**APPOINT SEATING**

Blackberry.....	PNS012
Bronze.....	PNS002
Carbon.....	PNS008
Cherry.....	PNS010
Espresso.....	PNS003
Framboise.....	PNS011
Jet.....	PNS007
Lawn.....	PNS005
Mandarin.....	PNS009
Morel.....	PNS001
Platinum.....	PNS004
Turquoise.....	PNS006

**BLUME**

Chalk.....	BLME03
Char.....	BLME00
Coin.....	BLME02
Driftwood.....	BLME05
Emerald City.....	BLME07
Fir.....	BLME09
Harvest.....	BLME04
Haze.....	BLME08
Hyacinth.....	BLME14
Jasper.....	BLME13
Merlot.....	BLME10
Moonstone.....	BLME01
Opal.....	BLME06
Scarlet.....	BLME11
Slate.....	BLME12

**CLYDE**

Antique.....	CLYD04
Artifact.....	CLYD01
Blacksmith.....	CLYD10
Claret.....	CLYD13
Craftsman.....	CLYD08
Crate.....	CLYD12
Fossil.....	CLYD02
Heirloom.....	CLYD05
Iron.....	CLYD11
Linen.....	CLYD14
Relic.....	CLYD06
Seasoned.....	CLYD03
Trestle.....	CLYD07

**DOTTY**

Candy.....	DOT63
Gelato.....	DOT34
Indigo.....	DOT31
Onyx.....	DOT35
Park.....	DOT83
Peat.....	DOT24
Peony.....	DOT32
Suit.....	DOT20
Sunflower.....	DOT33
Tailor.....	DOT21
Tide.....	DOT90
Velum.....	DOT29
Violet.....	DOT30

### GRADE 2

– continued

<b>RUSH</b>	
Anchor.....	RUSH07
Basil.....	RUSH16
Blueberry.....	RUSH10
Flamingo.....	RUSH21
Greenery.....	RUSH15
Greyhound.....	RUSH06
Marina.....	RUSH13
Merlot.....	RUSH19
Midnight.....	RUSH11
Mint.....	RUSH09
Mulberry.....	RUSH18
Pumice.....	RUSH01
Punch.....	RUSH20
Sage.....	RUSH14
Salsa.....	RUSH24
Sand.....	RUSH05
Seal.....	RUSH08
Soot.....	RUSH02
Stout.....	RUSH03
Sunshine.....	RUSH23
Tapestry.....	RUSH04
Tiger.....	RUSH22
Vintage.....	RUSH17
Wave.....	RUSH12

**SPIN SEATING**

Alabaster.....	SPNN02
Cavern.....	SPNN03
Cobblestone.....	SPNN04
Ember.....	SPNN06
Flame.....	SPNN07
Heron.....	SPNN13
Oat.....	SPNN01
Ocean.....	SPNN12
Plum.....	SPNN15
Pool.....	SPNN11
Raven.....	SPNN10
Rhubarb.....	SPNN14
Tropic.....	SPNN08
Willow.....	SPNN05

**TAYLOR**

Autumn.....	TAY43
Daffodil.....	TAY20
Deep Lilac.....	TAY75
Dreamy.....	TAY80
Envious.....	TAY58
Handkerchief.....	TAY90
Luxe.....	TAY50
Malbec.....	TAY40
Martini.....	TAY60
Mink.....	TAY30
Pearl.....	TAY15
Spritz.....	TAY45
Tungsten.....	TAY85

### GRADE 3

**PARKER**

Aloe.....	PRKR01
Cumulus.....	PRKR05
Cyan.....	PRKR06
Domino.....	PRKR07
Fossil.....	PRKR10
Graphite.....	PRKR11
Grass.....	PRKR12
Grenadine.....	PRKR13
Griffin.....	PRKR14
Kiln.....	PRKR16
Magnesium.....	PRKR18
Magnet.....	PRKR19
Mica.....	PRKR20
Mink.....	PRKR21
Nightfall.....	PRKR22
Paprika.....	PRKR24
Pine.....	PRKR25
Rapids.....	PRKR28
Rioja.....	PRKR30

**PURL**

Alpaca.....	PURL08
Braid.....	PURL10
Deep.....	PURL12
Graze.....	PURL05
Loom.....	PURL06
Needle.....	PURL07
Pasture.....	PURL02
Ranch.....	PURL04
Shuttle.....	PURL09
Skein.....	PURL01
Thistle.....	PURL11
Yearling.....	PURL03

**QUILL**

Aviary.....	QUL03
Feather.....	QUL02
Fountain.....	QUL06
Ink.....	QUL05
Metal.....	QUL04
Reed.....	QUL08
Scroll.....	QUL01
Well.....	QUL07

### GRADE 6

**ARRIS**

Artisan.....	ARR01
Baroque.....	ARR07
Noble.....	ARR02
Rattan.....	ARR05
Rich.....	ARR04
Tapestry.....	ARR03
Weft.....	ARR06

### GRADE A

#### APPOINT PANEL

Artichoke.....	APN911
Blackberry.....	APN932
Bronze.....	APN922
Carbon.....	APN928
Chai.....	APN912
Cherry.....	APN930
Dark Pewter.....	APN917
Dune.....	APN915
Espresso.....	APN923
Framboise.....	APN931
Frost.....	APN934
Jet.....	APN927
Lawn.....	APN925
Mandarin.....	APN929
Morel.....	APN909
Nimbus.....	APN916
Platinum.....	APN924
Turquoise.....	APN926

#### BINARY †

Blush.....	BNRY12
Coal.....	BNRY06
Cream.....	BNRY01
Denim.....	BNRY08
Diamond.....	BNRY03
Graphite.....	BNRY05
Juniper.....	BNRY10
Lagoon.....	BNRY07
Lavendar.....	BNRY11
Mineral.....	BNRY04
Reef.....	BNRY09
Sand Dollar.....	BNRY02

#### CENTURION<sup>w</sup>

Apricot.....	CU47
Bark.....	CU25
Black.....	CU10
Espresso.....	CU49
Fog.....	CU03
Frost.....	CU22
Goldenrod.....	CU27
Indigo.....	CU06
Iris.....	CU50
Iron Ore.....	CU19
Jade.....	CU83
Marsala.....	CU63
Morel.....	CU24
Navy.....	CU98
Peacock.....	CU97
Pear.....	CU84
Ruby.....	CU67
Sapphire.....	CU09

#### CIRCUIT † ♣

Atlas.....	CIRC35
Dolphin.....	CIRC63
Island White.....	CIRC14
Moon.....	CIRC07
Night.....	CIRC49
Pacific.....	CIRC28
Quartz.....	CIRC01
Sienna.....	CIRC56
Silk.....	CIRC21
Snap Pea.....	CIRC42

#### ETCH

Axis.....	ECH913
Blend.....	ECH914
Cast.....	ECH912
Highlight.....	ECH910
Midtone.....	ECH911
Outline.....	ECH908
Shade.....	ECH909
Tonal.....	ECH916
Vanish.....	ECH915

### GRADE A – continued

#### LANDSCAPE

Cornsilk.....	LN15
Drift.....	LN05
Khaki.....	LN20
Sheen.....	LN10
Slate.....	LN35
Umber.....	LN25
Urban.....	LN30

#### LUCY

Aspen.....	LC932
Cornsilk.....	LC930
Dusk.....	LC922
Fawn.....	LC933
Graphite.....	LC934
Mist.....	LC920
Neutra.....	LC924
Pewter.....	LC935
Snowdrop.....	LC928

#### NOBLE

Aspen.....	NBLE14
Bordeaux.....	NBLE01
Brick.....	NBLE02
Chambray.....	NBLE10
Clementine.....	NBLE04
Dawn.....	NBLE13
Denim.....	NBLE09
Grass.....	NBLE07
Gunmetal.....	NBLE15
Harvest.....	NBLE12
Jade.....	NBLE06
Knight.....	NBLE17
Mesa.....	NBLE03
Pacific.....	NBLE08
Rainforest.....	NBLE05
Regal.....	NBLE11
Stormy.....	NBLE16

#### REFLECTIONS

Galvanized.....	REF929
Ice.....	REF920
Loggia.....	REF921
Mistral.....	REF928
Moonstone.....	REF923
Pewter.....	REF922
Stainless.....	REF924
Vanilla.....	REF925
Winter.....	REF927

#### REFUGE

Artesian.....	RFG996
Dune.....	RFG992
Eclipse.....	RFG990
Frost †.....	RFG993
Glacier †.....	RFG991
Mineral.....	RFG998
Tidal.....	RFG994

#### TEMPEST

Dragonfly.....	TP930
Frost.....	TP915
Full Stream.....	TP980
Gold Rush.....	TP910
Slate.....	TP945
Tumbleweed.....	TP970
Wind Chill.....	TP940
Zebra.....	TP935

### GRADE B

#### \*ANALOG (De-emphasized)

Album.....	ANLG06
Cartridge.....	ANLG04
Cassette.....	ANLG09
Dial.....	ANLG02
Media.....	ANLG08
Reel.....	ANLG07
Signal.....	ANLG03
Stereo.....	ANLG01
Track.....	ANLG05

#### COAST † ♣

Channel.....	COA914
Dune.....	COA903
Headlands.....	COA910
Marsh.....	COA902
Pebble.....	COA912
Pier.....	COA913
Shoal.....	COA901
Silt.....	COA906
Tide.....	COA908

#### DISPERSE †

Autumn.....	DISP03
Branch.....	DISP10
Coffee Bean.....	DISP13
Dusk.....	DISP09
Emerald City.....	DISP08
Gold Rush.....	DISP02
Igloo.....	DISP11
Ink.....	DISP06
Mist.....	DISP12
Oatmeal.....	DISP15
Prince.....	DISP07
Reservoir.....	DISP01
Rose.....	DISP04
Spring.....	DISP05
Steel.....	DISP16
Taupe.....	DISP14

#### MICA

Anthracite.....	MCA911
Breeze.....	MCA918
Bronze.....	MCA913
Buff.....	MCA914
Cremini.....	MCA917
Crystal.....	MCAWIT
Dew.....	MCA920
Dove.....	MCA912
Fresh.....	MCA916
Mineral.....	MCA915
Nectar.....	MCA919
Shale.....	MCA910

#### SPIN PANEL

Alabaster.....	SPIN02
Cavern.....	SPIN03
Cobblestone.....	SPIN04
Ember.....	SPIN06
Flame.....	SPIN07
Heron.....	SPIN13
Oat.....	SPIN01
Ocean.....	SPIN12
Plum.....	SPIN15
Pool.....	SPIN11
Raven.....	SPIN10
Rhubarb.....	SPIN14
Tropic.....	SPIN08
Willow.....	SPIN05

#### TERRAIN

Bay.....	TRRN05
Bayou.....	TRRN35
Canyon.....	TRRN30
Cliff.....	TRRN45
Crest.....	TRRN25
Delta.....	TRRN10
Plateau.....	TRRN15
Ridge.....	TRRN20
Valley.....	TRRN40

<sup>w</sup> Limited to product 48"W or less.

▼ Panel fabric is not available on Further<sup>™</sup>.

♣ Panel fabric is not available on Optimize<sup>®</sup>.

† Panel fabric is not available on Concensys<sup>®</sup>.

◆ Panel fabric is not available on Involve<sup>®</sup>.

## GRADE A

### APPOINT PANEL

Artichoke.....	APN911
Blackberry.....	APN932
Bronze.....	APN922
Carbon.....	APN928
Chai.....	APN912
Cherry.....	APN930
Dark Pewter.....	APN917
Dune.....	APN915
Espresso.....	APN923
Frost.....	APN934
Framboise.....	APN931
Jet.....	APN927
Lawn.....	APN925
Mandarin.....	APN929
Morel.....	APN909
Nimbus.....	APN916
Platinum.....	APN924
Turquoise.....	APN926

### BINARY †

Blush.....	BNRY12
Coal.....	BNRY06
Cream.....	BNRY01
Denim.....	BNRY08
Diamond.....	BNRY03
Graphite.....	BNRY05
Juniper.....	BNRY10
Lagoon.....	BNRY07
Lavender.....	BNRY11
Mineral.....	BNRY04
Reef.....	BNRY09
Sand Dollar.....	BNRY02

### CENTURION<sup>w</sup>

Apricot.....	CU47
Bark.....	CU25
Black.....	CU10
Espresso.....	CU49
Fog.....	CU03
Frost.....	CU22
Goldenrod.....	CU27
Indigo.....	CU06
Iris.....	CU50
Iron Ore.....	CU19
Jade.....	CU83
Marsala.....	CU63
Morel.....	CU24
Navy.....	CU98
Peacock.....	CU97
Pear.....	CU84
Ruby.....	CU67
Sapphire.....	CU09

### CIRCUIT † ♣

Atlas.....	CIRC35
Dolphin.....	CIRC63
Island White.....	CIRC14
Moon.....	CIRC07
Night.....	CIRC49
Pacific.....	CIRC28
Quartz.....	CIRC01
Sienna.....	CIRC56
Silk.....	CIRC21
Snap Pea.....	CIRC42

### ETCH

Axis.....	ECH913
Blend.....	ECH914
Cast.....	ECH912
Highlight.....	ECH910
Midtone.....	ECH911
Outline.....	ECH908
Shade.....	ECH909
Tonal.....	ECH916
Vanish.....	ECH915

## GRADE A – continued

### LANDSCAPE

Cornsilk.....	LN15
Drift.....	LN05
Khaki.....	LN20
Sheen.....	LN10
Slate.....	LN35
Umber.....	LN25
Urban.....	LN30

### LUCY

Aspen.....	LC932
Cornsilk.....	LC930
Dusk.....	LC922
Fawn.....	LC933
Graphite.....	LC934
Mist.....	LC920
Neutra.....	LC924
Pewter.....	LC935
Snowdrop.....	LC928

### NOBLE

Aspen.....	NBLE14
Bordeaux.....	NBLE01
Brick.....	NBLE02
Chambray.....	NBLE10
Clementine.....	NBLE04
Dawn.....	NBLE13
Grass.....	NBLE07
Gunmetal.....	NBLE15
Harvest.....	NBLE12
Jade.....	NBLE06
Knight.....	NBLE17
Mesa.....	NBLE03
Pacific.....	NBLE08
Rainforest.....	NBLE05
Regal.....	NBLE11
Stormy.....	NBLE16

### REFLECTIONS

Galvanized.....	REF929
Ice.....	REF920
Loggia.....	REF921
Mistral.....	REF928
Moonstone.....	REF923
Pewter.....	REF922
Stainless.....	REF924
Vanilla.....	REF925
Winter.....	REF927

### REFUGE

Artesian.....	RFG996
Dune.....	RFG992
Eclipse.....	RFG990
Frost †.....	RFG993
Glacier †.....	RFG991
Hemp.....	RFG997
Mineral.....	RFG998
Sandbar.....	RFG995
Tidal.....	RFG994

### SARTO ▼

Ash.....	SRT988
Fog.....	SRT914
Lemongrass.....	SRT949
Mist.....	SRT945
Mushroom.....	SRT976
Oyster.....	SRT918
Reef.....	SRT964
Sesame.....	SRT993
Shale.....	SRT952

### TEMPEST

Dragonfly.....	TP930
Frost.....	TP915
Full Stream.....	TP980
Gold Rush.....	TP910
Slate.....	TP945
Tumbleweed.....	TP970
Wind Chill.....	TP940
Zebra.....	TP935

## GRADE B

### ANALOG (De-emphasized)

Album.....	ANLG06
Cartridge.....	ANLG04
Cassette.....	ANLG09
Dial.....	ANLG02
Media.....	ANLG08
Reel.....	ANLG07
Signal.....	ANLG03
Stereo.....	ANLG01
Track.....	ANLG05

### COAST † ♣

Channel.....	COA914
Dune.....	COA903
Headlands.....	COA910
Marsh.....	COA902
Pebble.....	COA912
Pier.....	COA913
Shoal.....	COA901
Silt.....	COA906
Tide.....	COA908

### DISPERSE †

Autumn.....	DISP03
Branch.....	DISP10
Coffee Bean.....	DISP13
Dusk.....	DISP09
Emerald City.....	DISP08
Gold Rush.....	DISP02
Igloo.....	DISP11
Ink.....	DISP06
Mist.....	DISP12
Oatmeal.....	DISP15
Prince.....	DISP07
Reservoir.....	DISP01
Rose.....	DISP04
Spring.....	DISP05
Steel.....	DISP16
Taupe.....	DISP14

### MICA

Anthracite.....	MCA911
Breeze.....	MCA918
Bronze.....	MCA913
Buff.....	MCA914
Cremini.....	MCA917
Crystal †.....	MCAWIT
Dew.....	MCA920
Dove.....	MCA912
Fresh.....	MCA916
Mineral.....	MCA915
Nectar.....	MCA919
Shale.....	MCA910

### SPIN PANEL

Alabaster.....	SPIN02
Cavern.....	SPIN03
Cobblestone.....	SPIN04
Ember.....	SPIN06
Flame.....	SPIN07
Heron.....	SPIN13
Oat.....	SPIN01
Ocean.....	SPIN12
Plum.....	SPIN15
Pool.....	SPIN11
Raven.....	SPIN10
Rhubarb.....	SPIN14
Tropic.....	SPIN08
Willow.....	SPIN05

### TERRAIN

Bay.....	TRRN05
Bayou.....	TRRN35
Canyon.....	TRRN30
Cliff.....	TRRN45
Crest.....	TRRN25
Delta.....	TRRN10
Plateau.....	TRRN15
Ridge.....	TRRN20
Valley.....	TRRN40

<sup>w</sup> Limited to 48"W or less

▼ Panel fabric is not available on Further.

♣ Panel fabric is not available on Optimize®.

† Panel fabric is not available on Concensys®.

◆ Panel fabric is not available on Involve.

\* Not available on 72"W

Multi-use fabrics are seating fabrics that can be used on specific Allsteel panels systems, providing more color and pattern options. The applicable Allsteel multi-use fabrics are noted with System designators in the Seating, Collaboration, and Tables Price List.



# Finishes

FINISHES

Paint Name	Allsteel Paint Code	Grade	Cadence	Universal Hutches & Universal Overhead Storage	Essentials Storage	Essentials Bookcases & Shelf	Vertical Metal Storage	Metal Center Drawers	Align Storage & Shelf Option	Stride Storage Foot	Involve	Radji	Approach O'Legs & Supports
Black	P27	1	•	•	•	•	•	•	•	•	•	•	•
Black	P71	1	•	•	•	•	•	•	•	•	•	•	•
Brownstone	P7D	1	•	•	•	•	•	•	•	•	•	•	•
Bungalow	P7C	1	•	•	•	•	•	•	•	•	•	•	•
Charblack	CBK	1	•	•	•	•	•	•	•	•	•	•	•
Cinder	P7Q	1	•	•	•	•	•	•	•	•	•	•	•
Designer White	PJW	1	•	•	•	•	•	•	•	•	•	•	•
Flint	P02	1	•	•	•	•	•	•	•	•	•	•	•
Fossil	P28	1	•	•	•	•	•	•	•	•	•	•	•
Loft	P7B	1	•	•	•	•	•	•	•	•	•	•	•
Muslin	P4J	1	•	•	•	•	•	•	•	•	•	•	•
Parchment	P93	1	•	•	•	•	•	•	•	•	•	•	•
Pebble	P8R	1	•	•	•	•	•	•	•	•	•	•	•
Pewter	P8D	1	•	•	•	•	•	•	•	•	•	•	•
Salt	P8C	1	•	•	•	•	•	•	•	•	•	•	•
Textured Brownstone	P7J	1											
Textured Designer White	PK7	1											
Textured Flint	P7A	1											
Textured Loft	P7L	1											
Textured Muslin	P7M	1											
Textured Pebble	P8Y	1											
Textured Salt	P8Z	1											
Textured Titanium	P8V	1											
Titanium	P8T / T	1	•	•	•	•	•	•	•	•	•	•	•
Champagne Metallic	PR5	2	•	•	•	•	•	•	•	•	•	•	•
Gunmetal Metallic	PR3	2	•	•	•	•	•	•	•	•	•	•	•
Night Bronze	P8B	2											•
Platinum Metallic	PR2	2	•	•	•	•	•	•	•	•	•	•	•
Pyrite	PJE	2											•
Silver	PR6**	2	•	•	•			•	•	•	•	•	•
Silver Texture	PR8	2	•	•	•								•
Solar Black	P8X	2	•	•	•			•		•	•	•	•
Atom	P8S	3	•	•	•			•		•	•	•	•
Blossom	P8K	3	•	•	•			•		•	•	•	•
Bullseye	PJF	3	•	•	•			•		•	•	•	•
Ember	P8P	3	•	•	•			•		•	•	•	•
Ion	P8N	3	•	•	•			•		•	•	•	•
Iris	P8J	3	•	•	•			•		•	•	•	•
Krypton	P8F	3	•	•	•			•		•	•	•	•
Regatta	P8M	3	•	•	•			•		•	•	•	•
Succulent	P8A	3	•	•	•			•		•	•	•	•

\*\*PR6 no upcharge on storage hardware

# Finishes

Paint Name	Allsteel Paint Code	Grade	Approach Splay Leg	Approach Post Foot	Approach Back Panels	Approach End Cap	Approach Wall Mount Kit	Approach Foot
Black	P27	1	•		•	•	•	•
Black	P71	1	•					
Brownstone	P7D	1	•					
Bungalow	P7C	1	•					
Charblack	CBK	1						
Cinder	P7Q	1	•					
Designer White	PJW	1	•	•	•	•	•	•
Flint	P02	1	•	•				
Fossil	P28	1	•					
Loft	P7B	1	•	•				
Muslin	P4J	1	•					
Parchment	P93	1	•					
Pebble	P8R	1	•					
Pewter	P8D	1	•					
Salt	P8C	1	•					
Textured Brownstone	P7J	1	•					
Textured Designer White	PK7	1	•					
Textured Flint	P7A	1	•					
Textured Loft	P7L	1	•					
Textured Muslin	P7M	1	•					
Textured Pebble	P8Y	1	•					
Textured Salt	P8Z	1	•					
Textured Titanium	P8V	1	•					
Titanium	P8T / T	1	•					
Champagne Metallic	PR5	2	•					
Gunmetal Metallic	PR3	2	•					
Night Bronze	P8B	2	•					
Platinum Metallic	PR2	2	•					
Pyrite	PJE	2	•	•				
Silver	PR6**	2	•	•	•	•	•	•
Silver Texture	PR8	2	•					
Solar Black	P8X	2	•	•				
Atom	P8S	3	•					
Blossom	P8K	3	•					
Bullseye	PJF	3	•					
Ember	P8P	3	•					
Ion	P8N	3	•					
Iris	P8J	3	•					
Krypton	P8F	3	•					
Regatta	P8M	3	•					
Succulent	P8A	3	•					

\*\*PR6 no upcharge on storage hardware

# Finishes

## LAMINATES

### GRADE L1

#### SOLID COLORS

Black	..... P
Brownstone*	.....LM13
Bungalow*	.....LM12
Designer White*	.....LDW1
Flint*	.....LM16
Fossil Shale*	.....LEH1
Loft*	.....LM11
Muslin*	.....LM15
Titanium*	.....LTI1

#### ABSTRACT

Ash	.....LT3B
Handspun Pearl	.....LAHP
Handspun Dove	.....LAHD
Handspun Slate	.....LAHS
Handspun Chestnut	.....LAHC
Silver Mesh	.....LT8D

#### WOODGRAIN

Belair	.....LWBA
Bourbon Cherry	..... H
Field Elm	.....LWFE
Florence Walnut*	.....LFW1
Kingswood Walnut*	..... LK11
Natural Maple*	.....LWD
NeoWalnut*	.....LNU1
Pinnacle	.....PINC
Shaker Cherry*	.....LW7C

### GRADE L2

Beigewood*	.....LWBE
Fawn Cypress*	.....LFC1
Lowell Ash*	.....LLA1
Mangalore Mango*	.....LMM1
Natural Recon*	.....LNR1
Phantom Charcoal*	.....LPC1
Phantom Ecru*	.....LPE1
Portico Teak*	.....LPT1
Skyline Walnut*	.....LSW1
Veranda Teak	.....LVT1

### GRADE L3

Natural Walnut*	.....LWNW
-----------------	-----------

\* Storage available in these 30 laminates.

## LAMINATE AND PAINTED WOOD STORAGE PULLS

Silver	.....PR6
--------	----------

### LAMINATE EDGE COLORS

Beigewood	..... DE
Belair	.....BA
Black	..... E4
Bourbon Cherry	..... H
Brownstone	.....EY
Bungalow	..... EX
Designer White	..... DW
Fawn Cypress	.....FC
Field Elm	..... FE
Flint	..... E9
Florence Walnut	.....FW
Fossil	..... EH
Kingswood Walnut	.....KI
Loft	.....EV
Lowell Ash	..... DL
Mangalore Mango	..... MM
Muslin	.....EU
Natural Maple	.....DD
Natural Recon	.....NR
Natural Walnut	.....DN
NeoWalnut	.....NU
Parchment	.....EN
Phantom Charcoal	.....PC
Phantom Ecru	..... PE
Pinnacle	.....PI
Platinum Metallic†	..... EP
Plyband ♦	..... PL
Portico Teak	.....DP
Shaker Cherry	.....DF
Skyline Walnut	.....SW
Titanium	.....TI
Veranda Teak	..... VT

† Not available on Aware table tops.

♦ Edge is limited to flat edge surfaces: rectangle, square, trapezoid, polygon, or round. No curvilinear or combination curve and straight.

**NOTE:** Refer to individual product pages for upcharges.

**FSC Certified Wood at Allsteel**  
See page 332 for more information.

# Finishes

Pattern Name	Code	Grade	Align	Involve Storage Screens & Desking	Approach
Belair	LWBA	1	•		
Bourbon Cherry	H	1	•		•
Brownstone	LM13	1	•	•	
Bungalow	LM12	1	•	•	
Designer White 15051	LDW1	1	•	•	•
Field Elm	LWFE	1	•		•
Flint	LM16	1	•	•	•
Fossil Shale	LEH1	1	•	•	
Loft	LM11	1	•	•	•
Muslin	LM15	1	•	•	
Titanium	LT11	1	•	•	
Florence Walnut	LFW1	1	•	•	•
Kingswood Walnut	LK11	1	•	•	•
Natural Maple	LWD	1	•	•	
NeoWalnut	LNU1	1	•	•	•
Pinnacle	PINC	1	•		•
Shaker Cherry	LW7C	1	•	•	
Beigewood	LWBE	2	•	•	
Fawn Cypress	LFC1	2	•	•	•
Lowell Ash	LLA1	2	•	•	•
Mangalore Mango	LMM1	2	•	•	
Natural Recon	LNR1	2	•	•	•
Phantom Charcoal	LPC1	2	•	•	
Phantom Ecrú	LPE1	2	•	•	•
Portico Teak	LPT1	2	•	•	•
Skyline Walnut	LSW1	2	•	•	•
Veranda Teak	LVT1	2	•	•	•
Natural Walnut	LWNW	3	•	•	

Pattern Name	Code	Grade	Beam	Half	Square	Bar	Arch
Designer White	PJW	1	•	•	•	•	
Silver	PR6	1	•	•		•	
Black	P27	1				•	
Flint	P02	1			•		
Loft	P7B	1			•		
Matte Silver	EL	1			•		
Anodized Silver	PR0	1					•
Pyrite	PJE	2	•	•	•		
Solar Black	P8X	2	•	•	•		

**Storage is an essential part of the productive workplace.**

Make storage a matter of personal choice as well as necessity. Choose from metal, laminate, or veneer with features like multiple pull styles, drawer sizes, finishes, and more. It's your workspace. Shouldn't it look like it?

**PERSONAL STORAGE**

- 1. Pedestal.**  
Support, mobile, or suspended, with three drawer sizes.
- 2. Personal file.**  
Combines pedestal and lateral storage to create a personal filing solution for letter and legal size documents.







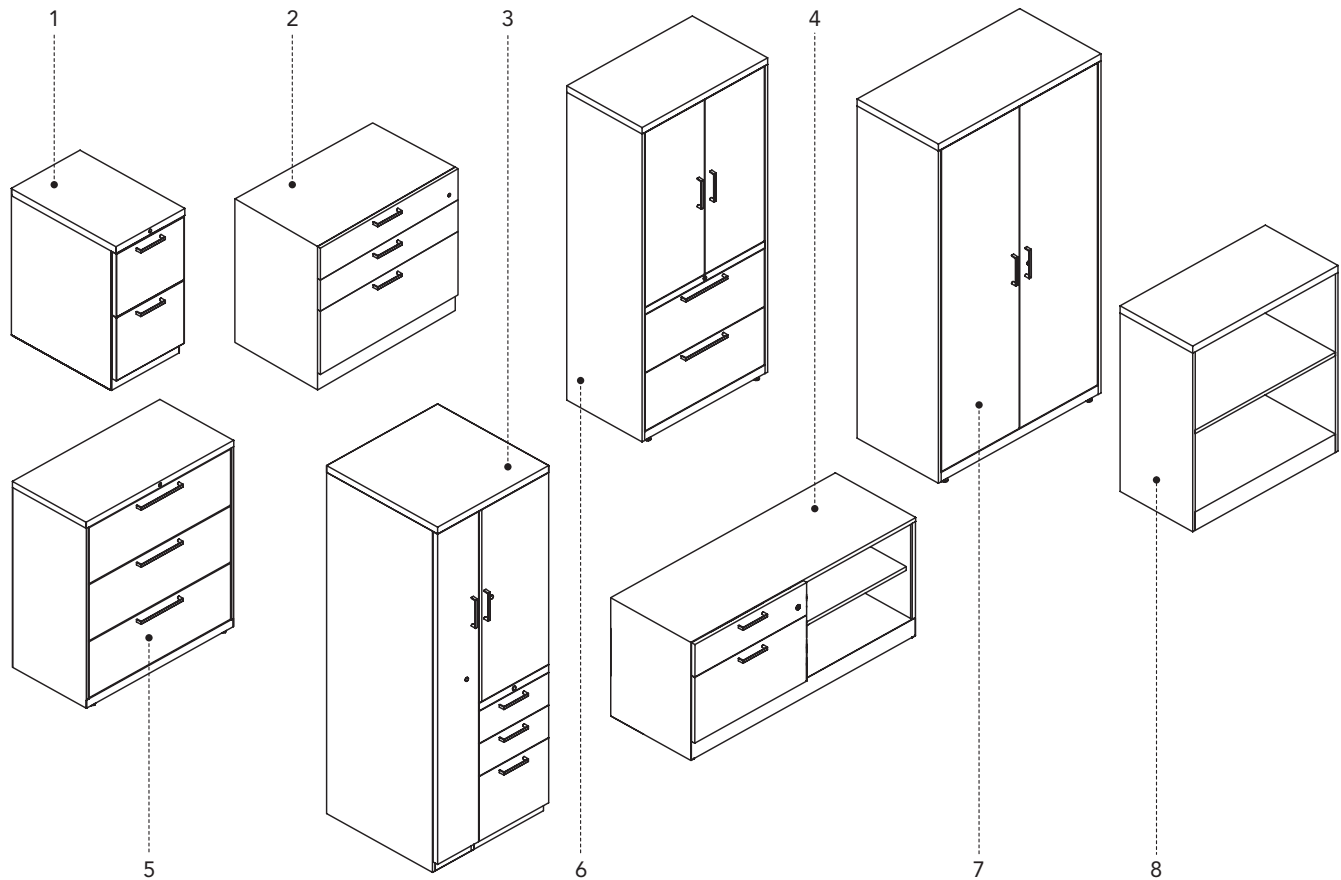

- 3. Personal tower.**  
Versatile storage with a small footprint. It's storage that goes up, not out. Combine drawers, personal storage, and wardrobe options for the right solution.
- 4. Low credenza.**  
Active storage that creates a layered look in any workspace.

**LATERALS AND SHARED STORAGE**

- 5. Lateral file.**  
The storage workhorse, in multiple heights and widths. Works with systems furniture or by itself.
- 6. Combination file.**  
The perfect combination of file storage and shelf storage, with concealed or open shelves.
- 7. Storage cabinet.**  
Equipped with hinged, locking doors and adjustable shelves to conceal and secure supplies.
- 8. Bookcases.**  
Quick access to information, in depths to match laterals or narrower profiles to stand on their own.



STORAGE OVERVIEW

PULL OPTIONS AVAILABLE									
Beam and Halo Pulls available Q1 of 2021									
STORAGE SOLUTIONS	Arch	Bar	Beam	Halo	Straight	Square	Beveled	Linear	Integral
Pull Letter Designator:	A				H	S	B	(None)	I
Pull Reference: (Pedestal Drawer Fronts)									
<b>Align Metal</b>	•		•	•	•	•	•		•
<i>Align 12" W Metal Towers*</i>									
<i>Align Metal Lockers*</i>									
<b>Align Metal Storage with Laminate Fronts</b>	•		•	•	•	•			
<b>Align Veneer</b>	•		•	•		•			
<i>Align Veneer Hutch*</i>									
<i>Align All Veneer Overhead w/hinged doors*</i>									
<i>Align All Veneer Bookcases</i>									
<b>Essentials</b>	•					•	•		•
<i>Essentials Bookcases*</i>									
<i>Essentials Overfile*</i>									
<b>Radii</b>		•	•	•		•			
<b>All Metal Overheads</b>	•					•			
<i>All Metal Overhead w/single sliding door</i>									
<b>Approach</b>	•	•	•	•		•			
<b>Involve</b>	•		•	•	•	•			
<i>Involve Overheads*</i>									
<b>Further</b>	•		•	•	•	•		•	

**Exceptions:**

Align 12" W Metal Towers not available with Integral Pull

Align Metal Lockers not available with Bevel Pull

Align Veneer Hutch (no pull required)

Align All Veneer Overhead (no pull required)

Align All Veneer Bookcases (no pull required)

Involve Overheads (no pull required)

Essentials Bookcases (no pull required)

Essentials Overfile (no pull required)

All Metal Overhead with single sliding door (no pull required)

**Note:** Beam and Halo pulls available on Radii, Approach, Involve, and Further casegoods March 15, 2021 with retrofit pull pack models for Align until Q4 2021

FOOT OPTIONS AVAILABLE							
	Blade Foot	Mobile	Plinth/No Foot	Post Foot	Stride Foot	Terrace Foot	Pier Foot
<b>Align Metal Storage</b>		•	•		•	•	•
<b>Align Veneer</b>			•				
<b>Approach</b>	•		•	•			
<b>Essentials</b>		•	•				
<b>Further</b>		•	•				
<b>Involve</b>			•		•	•	
<b>Radii</b>		•	•				

Available on Align Lockers and Wardrobes (pages 69-78)

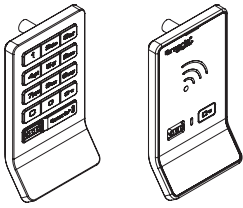

Keypad lock, left  
RFID lock, right

The digital keypad & RFID lock options support applications where workstations or storage banks are shared by multiple users. This is an alternative to a standard key lock. This feature facilitates the use of storage by multiple users through eliminating the need to keep and hand-off physical keys. These locks ship in “shared mode” by default; shared mode indicates that the lock will “forget” the paired 4-digit code or RFID badge after the lock is opened, allowing the unit to be used by multiple users.

### Digital keypad & RFID locks:

- Offered on Align™ lockers and wardrobes
- Ship factory installed
- Offered in a polished silver finish
- Digital keypad lock requires input of a user-selected 4-digit code
- RFID lock requires a compatible RFID card or sticker
- Digital keypad and RFID locks are powered using 4 premium AA batteries.
- Battery life is dependent on the frequency of operation but can last up to 5-7 years
- To order Align wardrobes or lockers with a digital lock option, add "E" suffix to base model number. The digital lock has an integrated pull, so no pull will be specified.

RFID locks require user to present a compatible RFID card or sticker to the lock in order to gain access. This is the same technology as “badge” systems that allows employers to grant employee with cards that can be scanned to gain access to entrances and buildings. Allsteel locks *may or may not be* compatible with these existing badge systems.

- For existing RFID badge system compatibility, badges must operate on a 13.56 MHz frequency with both iClass (ISO 15693) and Mifare (ISO 14443).
- If existing badge system is not compatible with 13.56 MHz frequency, compatible RFID badges or RFID stickers are sold separately as an accessory model.

Additional information about setup and common troubleshooting problems can be found here: [Digital Lock Overview](#).

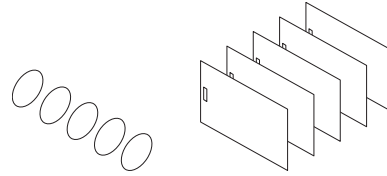

### Digital Lock Accessory Models (page 78)

- RFID-compatible cards and stickers are sold as accessory models in increments of 5, 25, or 100.
- RFID cards are plain white and have a lanyard cut in them.
- RFID stickers are plain white, approximately 1" in diameter, and may be added to the back of an existing badge or employee identification card.
- Every digital keypad or RFID installation site will require *one* Programming Key and *at least one* Manager Key, sold separately.

### Programming Key

- A Programming Key is a device used to initialize locks out of factory default mode and register Manager Keys to the locks.
- Only one Programming Key should be specified per installation site because multiple Programming Keys are not compatible with each other.
- Once a programming key is used with a unit, it is tied to that lock. Another programming key can not be used.
- Add-on digital lock orders should be programmed with the original programming key.

### Manager Key

- A Manager Key is used to bypass a locked unit; this operates as the “master” key and it is recommended that building facilitators have at least one Manager Key.
- Up to 6 Manager Keys may be registered to each lock.
- Manager Keys provide external power to locks in case of battery failure.

Description	Model	List Price
<b>Digital Lock Keys and Accessories</b>		
Programming Key	YPLDIGPRG	\$ 330
Manager Key	YPLDIGMGR	\$ 255
5pk RFID Stickers	YPLRFID5S	\$ 109
5pk RFID Cards	YPLRFID5C	\$ 219
25pk RFID Stickers	YPLRFID25S	\$ 521
25pk RFID Cards	YPLRFID25C	\$ 1042

\*Digital Lock users must purchase a programming key to operate. Programming keys and manager keys are purchased separately from locks.

### Available on Align (Pedestals, Credenzas, Towers) and Radii Products

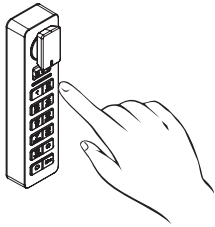

The digital keypad lock options support applications where workstations or storage banks are shared by multiple users. This is an alternative to a standard key lock. This feature facilitates the use of storage by multiple users through eliminating the need to keep and hand-off physical keys. These locks ship in “shared mode” by default; shared mode indicates that the lock will “forget” the paired 4-digit code, allowing the unit to be used by multiple users.

#### Digital keypad locks:

- Ship factory installed
- Offered in a polished silver finish
- Digital keypad lock requires input of a user-selected 4-digit code
- Digital keypad powered using 2 premium lithium CR2450 batteries
- Battery life is dependent on the frequency of operation but can last up to 5-7 years
- Digital keypad locks are installed horizontally on Align pedestals, credenzas, and towers

Additional information about setup and common troubleshooting problems can be found here: [Digital Lock Overview](#).

#### Programming Key

- A Programming Key is a device used to initialize locks out of factory default mode and register Manager Keys to the locks.
- Only one Programming Key should be specified per installation site because multiple Programming Keys are not compatible with each other.
- Once a programming key is used with a unit, it is tied to that lock. Another programming key can not be used.
- Add-on digital lock orders should be programmed with the original programming key.

#### Manager Key

- A Manager Key is used to bypass a locked unit; this operates as the “master” key and it is recommended that building facilitators have at least one Manager Key.
- Up to 6 Manager Keys may be registered to each lock.
- Manager Keys provide external power to locks in case of battery failure.

Description	Model	List Price
<b>Digital Lock Keys and Accessories</b>		
Programming Key	YPLDIGPRG	\$ 330
Manager Key	YPLDIGMGR	\$ 255

\*Digital Lock users must purchase a programming key to operate. Programming keys and manager keys are purchased separately from locks.



# Notes

---

STORAGE OVERVIEW

### Align Metal Pedestals — support or mobile



**File/File**  
28½"H x 15"W  
18", 23¼", 29¼"D



**Box/Box/File**  
28½"H x 15"W  
18", 23¼", 29¼"D



**File/File**  
26½"H x 15"W  
18", 23¼", 29¼"D



**Box/Box/File**  
26½"H x 15"W  
18", 23¼", 29¼"D



**Box/File**  
20½"H Mobile,  
22"H Freestanding  
18", 23¼", 29¼"D x 15"W

Plinth base shown, models available with Stride or Terrace feet. Choice of metal or laminate fronts.

### Align Low Metal Storage — credenzas, right and left configurations available

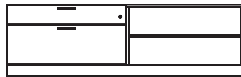

**Box/Lateral/Open**  
72"W  
22"H x 18", 24"D

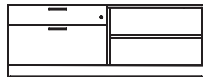

**Box/Lateral/Open**  
60"W  
22"H x 18", 24"D



**Box/Lateral/Open**  
48"W  
22"H x 18", 24"D



**Box/Lateral/Open**  
42"W  
22"H x 18", 24"D



**Box/Lateral**  
24", 30", 36", 42"W  
22"H x 18", 24"D

Plinth base shown, models available with Stride or Terrace feet. Choice of metal or laminate fronts.

### Align Metal Lateral and Personal Files



**2-High**  
28"H  
30", 36", 42"W  
18"D



**2-High**  
28"H  
30"W  
18"D



**2-High**  
28"H  
24", 30", 36"W  
18"D



**Open**  
24", 30", 36", 42"W  
22"H x 18", 24"D

Plinth base shown, models available with Stride or Terrace feet. Choice of metal or laminate fronts.

### Align Metal Personal Towers — Stride®/Terrace®/Optimize™ Height — left configuration shown, also available right

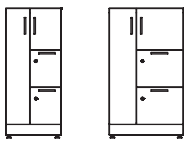

42½"H  
18", 24"W  
24"D

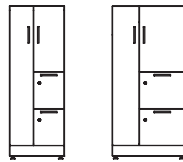

50"H  
18", 24"W  
24"D

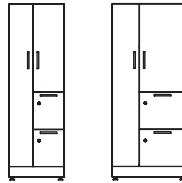

57½"H  
18", 24"W  
24"D



65"H  
18", 24"W  
24"D

Plinth base shown, models available with Stride or Terrace feet. Choice of metal or laminate fronts.

### Align Lockers — Overview — Left configurations shown, also available right

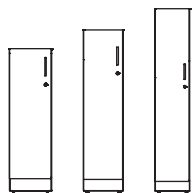

**Single 12"W**  
42½", 50", 65"H / 18", 24"D

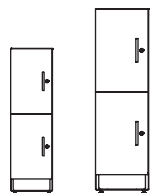

**Double 12"W**  
42½", 65"H / 18"D

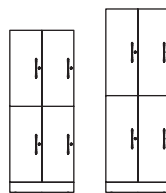

**Quad 24"W**  
42½", 65"H / 18"D

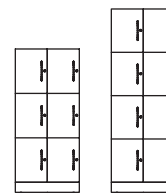

**Cubby 24"W**  
50", 65"H / 18"D

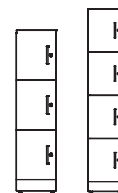

**Cubby 12"W**  
50", 65"H / 18"D

Plinth base shown, models available with Stride or Terrace feet. Choice of metal or laminate fronts.

### Essentials Pedestals — Ball-Bearing Slides

#### Support



File/File  
28"H x 15"W  
18", 22½", 28¾"D



Box/Box/File  
28"H x 15"W  
18", 22½", 28¾"D

#### Suspended



Box/File  
19½"H x 15"W  
18", 22½"D

#### Basic Support



File/File  
28" x 15"W  
19½", 22½"



Box/Box/File  
28"H x 15"W  
19½", 22½"

#### Mobile



File/File  
28"H x 15"W  
18", 22½", 28¾"D



Box/Box/File  
28"H x 15"W  
18", 22½", 28¾"D



Box/File  
22½"H x 15"W  
22½"D

#### Basic Mobile



File/File  
28"H x 15"W  
19½", 22½"



Box/Box/File  
28"H x 15"W  
19½", 22½"

### Essentials Lateral Files

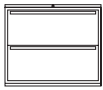

2-High  
28"H  
30", 36", 42"W  
18"D

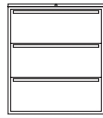

3-High  
39½"H  
30", 36", 42"W  
18"D

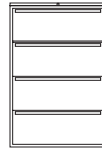

4-High  
52½"H  
30", 36", 42"W  
18"D



5-High  
64¼"H  
30", 36", 42"W  
18"D

### Essentials Combination Files



Without Doors  
64¼"H  
30", 36"W  
18"D

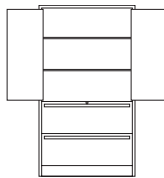

Hinged Doors  
64¼"H  
30", 36"W  
18"D

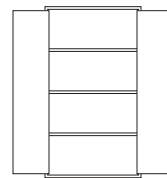

Hinged Doors  
28", 39½", 52½", 64¼"H  
30", 36"W  
18"D

### Essentials Cabinets

### Essentials Bookcases



28", 39½"H  
30", 36"W  
18"D



52½", 64¼"H  
30", 36"W  
18"D

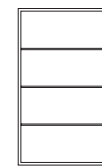

29", 41", 59",  
71", 81"H  
34½"W  
12½"D

Finishes .....	28
Working with Align Metal Storage.....	29-31
Dimensions .....	32
File/Load Capacities.....	33-34
Align Metal Pedestal Specifications.....	35-36
Credenzas and Accessories .....	37-38
Metal Credenzas with Panel Frames .....	39
Lateral/Personal/Laminate Top Specifications .....	40
Tower Specifications .....	41-42
Locker Specifications.....	43
Support, Mobile, and Freestanding Pedestals .....	44-47
Pedestal Tops and Accessories .....	48
22"H Credenzas.....	49-52.5
22"H Pedestals.....	52.6
Open Shelf & HAT Credenzas.....	52.7
Wire Management.....	52.8
Align Accessories.....	53-55
28"H Laterals, Personal Files, and Bookcases .....	56
Align Metal Towers.....	57-68
Align Lockers, Wardrobes, and Accessories.....	69-77
Digital Lock Keys and Accessories .....	78
Storage Islands .....	79-89

## PAINTED METAL FINISHES

### GRADE P1

Black.....	P27
Brownstone.....	P7D
Bungalow.....	P7C
Cinder.....	P7Q
Cove.....	P096
Designer White.....	PJW
Dune.....	P094
Flint.....	P02
Fossil.....	P28
Harbor.....	P097
Loft.....	P7B
Muslin.....	P4J
Parchment.....	P93
Pebble.....	P8R
Pewter.....	P8D
Sage.....	P095
Salt.....	P8C
Textured Designer White.....	PK7
Textured Flint.....	P7A
Titanium.....	P8T

### GRADE P2

Champagne Metallic.....	PR5
Gunmetal Metallic.....	PR3
Platinum Metallic.....	PR2
Silver***.....	PR6
Solar Black.....	PRX

\*\*\*PR6 no upcharge on Involve; available as a Grade P2 color on stanchions. PR6 & PRX are not available on Concensys, Essentials bookcase, and vertical files.

### GRADE P3

Amethyst*** (De-emphasized).....	P091
Atom.....	P8S
Blossom***.....	P8K
Bullseye.....	PJF
Cobalt Mica*** (De-emphasized).....	P090
Ember.....	P8P
Ion.....	P8N
Iris.....	P8J
Krypton.....	P8F
Ochre***.....	P093
Regatta.....	P8M
Sienna***.....	P092
Succulent***.....	P8A

*Metallic paints, due to varying reflectance, may appear to have less visual color consistency than other paint finishes, even when L/A/B values are exactly the same. (L/A/B — measurable aspects of color — values are maintained within a specified range, to ensure consistent appearance of paint colors.)*

\*\*\*These colors are intended to be an inspirational option for the trending market. Product application is limited and color availability is approximately two years to coincide with evolving workplace trends.

## METAL STORAGE PULLS

Black (Bar or Arch Pull).....	E4/P71
Designer White (Bar pull only).....	PJW
Silver.....	EL/PR6

## LAMINATES

### GRADE L1

<b>SOLID</b>	
Black.....	P
Brownstone.....	LM13
Bungalow.....	LM12
Designer White.....	LDW1
Flint.....	LM16
Fossil Shale.....	LEH1
Loft.....	LM11
Muslin.....	LM15
Titanium.....	LTI1

### WOODGRAIN

Belair.....	LWBA
Bourbon Cherry.....	H
Field Elm.....	LWFE
Florence Walnut.....	LFW1
Kingswood Walnut.....	LK11
Natural Maple.....	LWD
NeoWalnut.....	LNU1
Pinnacle.....	PINC
Shaker Cherry.....	LW7C

### GRADE L2

Beigewood.....	LWBE
Fawn Cypress.....	LFC1
Lowell Ash.....	LLA1
Mangalore Mango.....	LMM1
Natural Recon.....	LNR1
Phantom Charcoal.....	LPC1
Phantom Ecu.....	LPE1
Portico Teak.....	LPT1
Skyline Walnut.....	LSW1
Veranda Teak.....	LVT1

### GRADE L3

Natural Walnut.....	LWNW
---------------------	------

## LAMINATE EDGE COLORS

Beigewood.....	DE
Belair.....	BA
Black.....	E4
Bourbon Cherry.....	H
Brownstone.....	EY
Bungalow.....	EX
Designer White.....	DW
Fawn Cypress.....	FC
Field Elm.....	FE
Flint.....	E9
Florence Walnut.....	FW
Fossil.....	EH
Kingswood Walnut.....	KI
Loft.....	EV
Lowell Ash.....	DL
Mangalore Mango.....	MM
Muslin.....	EU
Natural Maple.....	DD
Natural Recon.....	NR
Natural Walnut.....	DN
NeoWalnut.....	NU
Phantom Charcoal.....	PC
Phantom Ecu.....	PE
Pinnacle.....	PI
Portico Teak.....	DP
Shaker Cherry.....	DF
Skyline Walnut.....	SW
Titanium.....	TI
Veranda Teak.....	VT

## STRATAWOOD VENEERS

### GRADE V1

Add FSC prefix to Stratawood codes listed below for Stratawood veneer trim on Stride and Terrace.  
Example: **FSCSC777**

### CHERRY

Cinnamon/Biltmore Cherry.....	SC260
Lowell Ash Cherry.....	SC394
Clear Cherry.....	SC700
Light Cherry.....	SC701
Shaker Cherry.....	SC774
Burnished Cherry.....	SC777

### MAPLE

Field Elm.....	SE599
Clear Maple***.....	SE800
Harvest Maple.....	SE856
Beigewood.....	SE878
Phantom Ecu.....	SE912
Belair.....	SE934

### OAK

Clear Silver Oak****.....	SB100
Portico Teak Silver Oak.....	SB150
Clear Oak.....	SF300
Dark Rift Oak.....	SF331

\*\*\*\*No FSC available

### WALNUT

Florence Walnut.....	ST579
Light Walnut.....	ST601
Skyline Walnut.....	ST625
Pinnacle Walnut.....	ST679
Sumatra Walnut.....	ST693

## NATURAL VENEERS — FLAT CUT

### GRADE V1

### CHERRY

Cinnamon/Biltmore Cherry.....	NC260
Lowell Ash.....	NC394
Medium Red Cherry.....	NC512
Light Cherry.....	NC701
Shaker Cherry.....	NC774
Burnished Cherry.....	NC777

### MAPLE

Clear Maple.....	NE800
Harvest Maple.....	NE856

### WALNUT

Ebony Walnut.....	NT509
Florence Walnut.....	NT579
Light Walnut.....	NT601
Skyline Walnut.....	NT625
Nutmeg Walnut.....	NT629
Pinnacle Walnut.....	NT679
Sumatra Walnut.....	NT693

## NATURAL VENEERS — RIFT CUT

### GRADE V2

Fawn Cypress Rift Cut Oak.....	RF108
Light Rift Cut Oak.....	RF301
Dark Rift Cut Oak.....	RF331
Phantom Ecu Rift Cut Oak.....	RF912

*The beauty of wood is the natural variation of grain patterns and colors that make each piece unique. This variation is also influenced by lighting conditions, orientation of mated parts, and varying acceptance of the finishing process. The varying colors and physical characteristics naturally occur in all wood species but are most pronounced in lighter colored woods, and are especially evident in natural finishes.*

## GROMMETS ON VENEER WORKSURFACES

Wire management grommets come standard on most veneer worksurfaces. Choose between metal or plastic grommet option. Note: Plastic grommet color is predetermined based on finish selection. All Maple veneers.....Muslin EU  
All other veneers.....Black E4

## LOCKS

Black.....	E4
Chrome.....	ordered by base model
Matte Silver.....	EL

**NOTE:** Refer to individual product pages for upcharges.

## FABRIC WIRE MANAGER

### GRADE 1

<b>DAPPER</b>	
Ash.....	DAPR20
Breeze.....	DAPR06
Canvas.....	DAPR25
Charcoal.....	DAPR01
Clover.....	DAPR22
Currant.....	DAPR00
Fawn.....	DAPR35
Fern.....	DAPR85
Gerbera.....	DAPR16
Grape.....	DAPR33
Jewel.....	DAPR08
Marigold.....	DAPR65
Onyx.....	DAPR10
Orchid.....	DAPR90
Parrot.....	DAPR59
Poppy.....	DAPR19
Sapphire.....	DAPR07
Scarlet.....	DAPR45
Sepia.....	DAPR30
Sky.....	DAPR44
Slate.....	DAPR15
Sorbet.....	DAPR55
Spring.....	DAPR80
Terracotta.....	DAPR13
Titanium.....	DAPR17
Varsity.....	DAPR09
Zest.....	DAPR70

### HAMILTON

Biscotti.....	HAML11
Cabernet.....	HAML08
Carolina.....	HAML21
Charcoal.....	HAML17
Chocolate.....	HAML13
Cloud.....	HAML18
Dane.....	HAML16
Dusty Rose.....	HAML07
Esmeralda.....	HAML06
Fern.....	HAML04
Fresh.....	HAML03
Granola.....	HAML19
Lilac.....	HAML14
Lime.....	HAML05
Lipstick.....	HAML09
Oxford.....	HAML20
Passion Fruit.....	HAML02
Pepper.....	HAML15
Powder.....	HAML12
Sunrise.....	HAML01

## FABRIC WIRE MANAGER

### — cont'd

### GRADE 3

<b>MOXIE</b>	
Barnwood.....	SX09
Basalt.....	SX23
Bayou.....	SX02
Bermuda.....	SX52
Biscotti.....	SX08
Blackberry.....	SX48
Blarney.....	SX49
Blueberry.....	SX05
Bonsai.....	SX20
Brigade.....	SX53
Butterscotch.....	SX54
Carob.....	SX24
Chalk.....	SX50
Chartreuse.....	SX34
Cherry.....	SX38
Cinnamon.....	SX13
Cobalt.....	SX01
Coconut.....	SX06
Concrete.....	SX43
Cozumel.....	SX55
Cumin.....	SX32
Dragonfly.....	SX44
Dover.....	SX56
Earl Grey.....	SX40
Elysian.....	SX04
Evergreen.....	SX21
Fatigue.....	SX18
Fawn.....	SX30
Flint.....	SX39
Forsythia.....	SX57
Grenache.....	SX58
Hazel.....	SX31
Hemp.....	SX45
Hickory.....	SX25
Holly.....	SX51
Jam.....	SX16
Kelly.....	SX33
Lemongrass.....	SX19
Lime.....	SX41
Macintosh.....	SX12
Midnight.....	SX59
Mulberry.....	SX15
Muslin.....	SX60
Pacifica.....	SX61
Parchment.....	SX07
Peacock.....	SX03
Phantom.....	SX62
Pineapple.....	SX42
Plum.....	SX17
Punch.....	SX46
Riverstone.....	SX47
Russet.....	SX14
Smokestack.....	SX22
Tangerine.....	SX37
Terracotta.....	SX11
Thicket.....	SX35
Walnut.....	SX10
Whirlwind.....	SX63

### PURL

(80% Polyester, 20% Acrylic)

Alpaca.....	PURL08
Braid.....	PURL10
Deep.....	PURL12
Graze.....	PURL05
Loom.....	PURL06
Needle.....	PURL07
Pasture.....	PURL02
Ranch.....	PURL04
Shuttle.....	PURL09
Skein.....	PURL01
Thistle.....	PURL11
Yearling.....	PURL03

## FABRIC WIRE MANAGER

### — cont'd

### QUILL

Aviary.....	QUL03
Feather.....	QUL02
Fountain.....	QUL06
Ink.....	QUL05
Metal.....	QUL04
Reed.....	QUL08
Scroll.....	QUL01
Well.....	QUL07

### "O" Frame Construction

Heavy duty outer shell and front and rear perimeter frames provides significant strength; helps keep the cabinet true to square.

### File and Box Drawers

Full extension file and box drawers glide easily on steel ball-bearing suspensions; allows complete access to drawer contents with a quiet drawer motion.

### Filing

File drawers can accommodate front-to-back and side-to-side filing. Order hanging frames separately.

### Full Front Drawer Design

Drawer front is square and extends fully across the case.

### Counterweight

Counterweights (standard on mobile pedestal units) inhibit tipping when drawers are opened. Optional counterweight kits.

### Aesthetic Alignment

Drawer alignment matches across Align storage offering. Base height matches Stride® and Terrace® panel base.

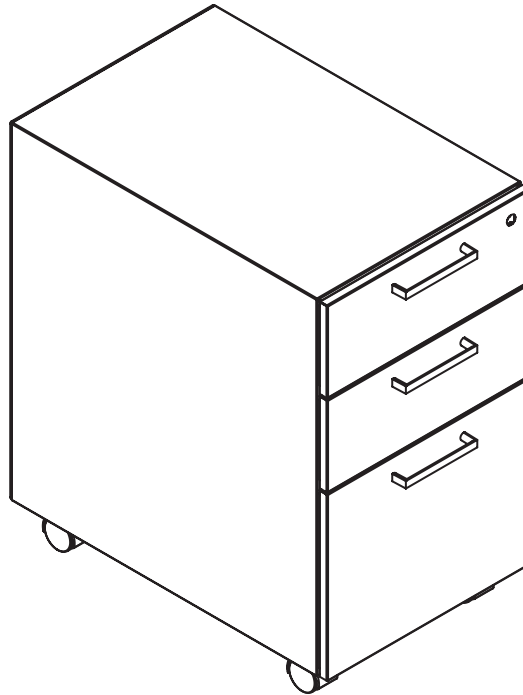

### Locking System

Robust lock system for security and reliability.

### Core Removable Locks

Master-keyed core removable lock feature allows key numbers to be easily changed in the field and facilitates one-key access.

### Omit Lock Core

Units can be shipped with lock cores removed; cores can then be installed after units are placed. Different storage components can be keyed alike within a workstation.

### Mobile Pedestals

Mobile pedestals provide flexible storage and can be nested under worksurfaces. (Take into consideration when planning offices which may have uneven floors.)

### Support Pedestals

Support pedestals can support one end of a panel-attached worksurface, in lieu of other worksurface supports, and can be used to support worksurfaces in desking applications. Drawers align with laterals.

### Freestanding Pedestals

Freestanding pedestal drawers align with credenzas.

### Depth

Pedestals are 18", 23¼", and 29¼"D, and credenzas are 18" and 24"D, both can be used with systems worksurfaces. Placement may affect access to receptacles in base pathway and worksurface grommets.

### Pull Styles

Choice of pull styles, available on pedestals, credenzas, towers, and laterals, allows for total design coordination on projects.

### Veneer and Landscape Fronts

Contact Allsteel Tailored Products Group for availability.

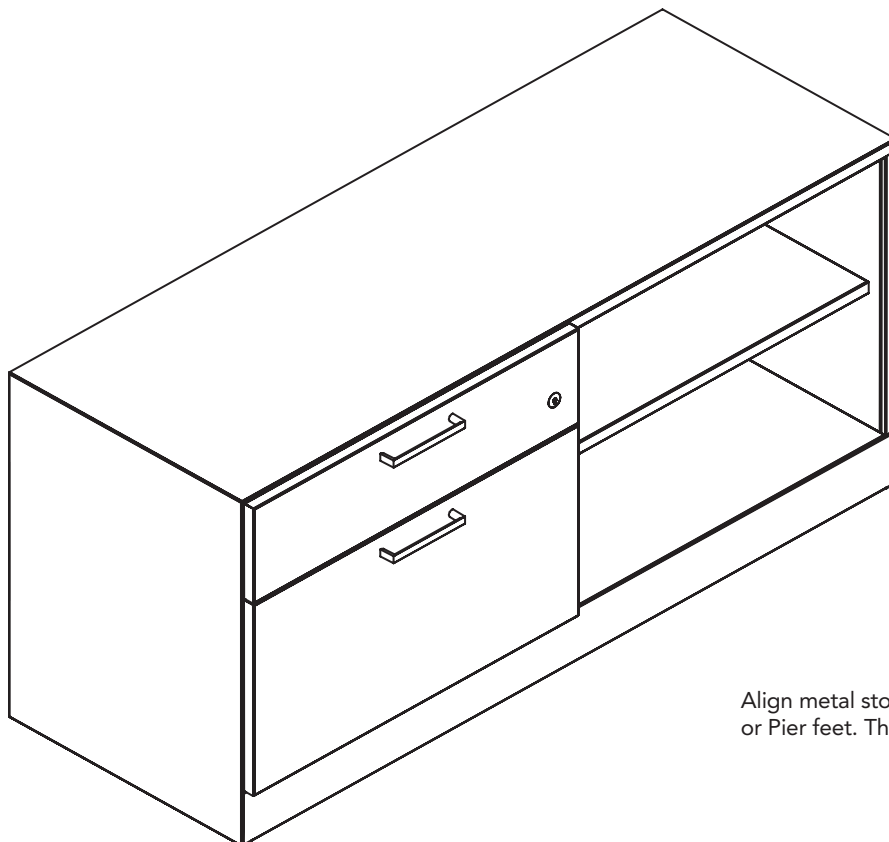

Align metal storage models are available with Terrace, Stride, or Pier feet. There is also a laminate front option.

### Seven-formation

#### Front Post Design

Steel front posts are formed with seven formations to provide unparalleled stability and strength. This unique design allows unmatched longevity for Allsteel files.

### Dual-side Locking

Drawers and doors lock on both sides to prevent being pried open. The locking system is enclosed within the case to hide mechanisms which can snag and scratch. This feature is not found on most other manufacturers' files.

### Dual Interlock

This mechanism inhibits roll out of more than one drawer, either sequentially or simultaneously.

### Adjustable Drawer Backs

Backs are adjustable to three depths to accommodate letter, A4, and legal documents side to side without the need for extra components.

### Infinitely Adjustable Divider

This Allsteel exclusive design allows the divider to also function as a compressor in that it can be located where it is needed versus being limited to pre-set positions.

### Offset Construction

As a result of the back and the top of the case sides being offset, the file case has a finished appearance with smooth seams and no overlaps.

### Fully Enclosed Bottom

Unlike many files, the Allsteel file features a fully enclosed steel bottom to help prevent moisture and dust from affecting the filed documents. Double bottoms are welded into all files for added rigidity.

### Side Knockouts

Files have two knockouts on each side to allow easy ganging of freestanding units to inhibit tipping.

### Four Hex-head Leveling Glides

Leveling glides can be adjusted from outside or inside the case. Because of the hex-head design of the stem, leveling can be done even when the file is fully loaded. Range is 1½".

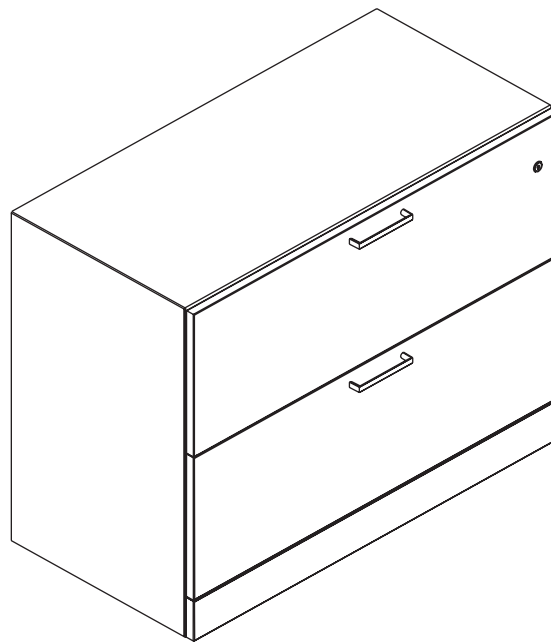

### Suspension

Extra heavy-duty, telescoping, ball-bearing slides.

### Hanging Frames

Front-to-back and side-to-side are both standard. For front-to-back filing, backs should be set on rear position for maximum storage capacity.

### Core Removable Lock

Core removable lock feature allows key numbers to be easily changed in the field. It also facilitates installation.

### Omit Lock Core

Files can be shipped with lock cores removed; cores can then be installed after files are placed. Laterals can be keyed alike with pedestals, laterals, credenzas, towers, and overhead cabinets.

### Full Front Drawer Style

Features core removable lock located in top drawer on the right.

### Front Drawer Options

Optional veneer and Landscape™ fronts available on laterals, contact Allsteel Tailored Products Group.

### Pull Styles

Choice of pull styles, available on pedestals, credenzas, towers, lockers, wardrobes and laterals, allows for total design coordination on projects.

### Double-wall Drawer Front Construction

Drawer fronts are fully lined to reduce noise and to prevent damage from drawer contents.

### Counterweight Kit

The unique design of the counterweight allows easy installation because, unlike some files, the drawers and shelves in Allsteel files do not have to be removed to install the required counterweights.

### Drawer Interiors

Painted same color as case.

### Paint Finish

Durable baked enamel finish is applied over rust-inhibiting phosphate pre-treatment.



#### Four Hex-head Leveling Glides

Hex-head design of the stem allows leveling to be done even when the cabinet is fully loaded (plinth units only). Plinth units include leveling glides that can be adjusted 1½" from outside or inside the case. Footed units include leveling glides that can be adjusted 2¼" from outside the case only.

#### Aesthetic Alignment

Drawer alignment matches other Align storage.

#### Full Front Design

Drawer and door fronts extend fully across the case.

#### Pull Styles

Choice of pull styles, available on pedestals, credenzas, towers, lockers, wardrobes and laterals, allows for total design coordination on projects.

#### Suspension

Heavy-duty, telescoping ball-bearing slides.

#### Omit Lock Core

Units can be shipped with lock cores removed; cores can then be installed after storage units are placed. Laterals can be keyed alike with pedestals, towers, and overhead cabinets.

#### Core Removable Locks

Core removable lock feature allows key numbers to be easily changed in the field. It also facilitates installation.

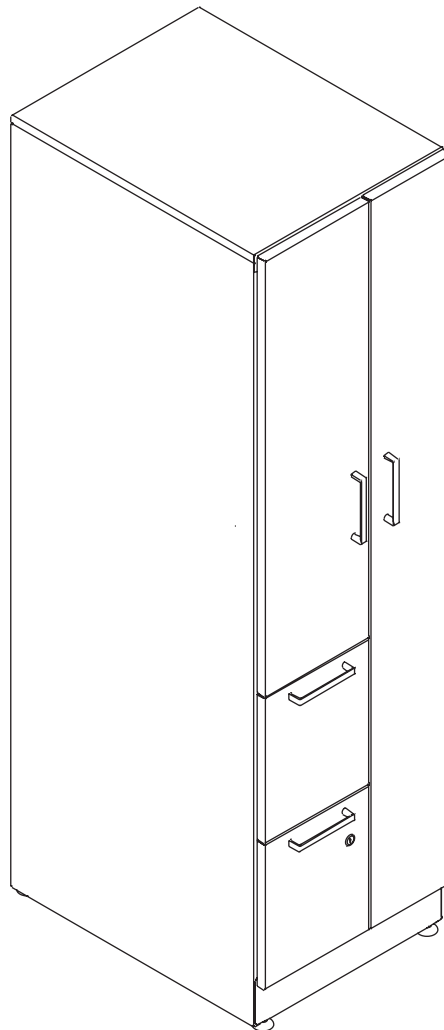

#### Locking

All door & drawer locks are controlled by one lock core located on the top drawer. Standard core removable locks, see page 54.

#### European Hinges

Wardrobe and cabinet door both contain European-style hinged door.

#### Filing

File drawers in 24"W towers accommodate front-to-back and side-to-side filing. Order file rails for side-to-side separately. File drawers in 18"W slim towers accommodate side-to-side filing only, hang rails are included.

#### Counterweight

Towers are factory-installed with counterweights to allow them to be freestanding.

### Interior Dimensions for Credenzas

Description	Height	Depth	Width	
CREDENZAS	Open	22"H – 17¼"	18"D — 17½" – 17" interior Shelf 15¼"	24" exterior – 22½" interior 30" exterior – 28½" interior
		1 Adj. Shelf ¾"	24"D — 23½" – 23" interior Shelf 21¼"	36" exterior – 34½" interior 42" exterior – 40½" interior
		8¼" Shelf 8¼" or 12" Shelf 4½"		
	Box/Lateral	Box – 3⅞"	Box – 13¼"	24" exterior – 21" interior 30" exterior – 27" interior 36" exterior – 33" interior
		Lateral – 10½"	18"D — Lateral – 13¼" 24"D — Lateral – 15½"	24" exterior – 20½" interior 30" exterior – 26½" interior 36" exterior – 32½" interior
	Box/Lateral w/Open Side	Box – 3⅞"	Box – 13¼"	42" exterior – 21" interior 48" exterior – 21" interior 60" exterior – 27" interior 72" exterior – 33" interior
		Lateral – 10½"	18"D — Lateral – 13¼" 24"D — Lateral – 15½"	42" exterior – 20½" interior 48" exterior – 20½" interior 60" exterior – 26½" interior 72" exterior – 32½" interior
		Open – 17¼" 1 Adj. Shelf ¾" 8¼", Shelf, 8¼" or 12", Shelf, 4½"	18"D — 17½" – 17" interior Shelf 15¼" 24"D — 23½" – 23" interior Shelf 21¼"	42" exterior – 16½" interior 48" exterior – 22½" interior 60" exterior – 28½" interior 72" exterior – 34½" interior
	LATERALS	Lateral – 10½"	18"D — Lateral – 13¼" 24"D — Lateral – 15½"	30" exterior – 26½" interior 36" exterior – 32½" interior 42" exterior – 38½" interior

### LOW STORAGE CREDENZAS — LATERAL FILE WIDTH:

24", 42", or 48"W

30" or 60"W

36" or 72"W

(42", 48", 60", and 72" credenzas are half lateral drawer/half open shelf)

#### Front-to-Back Filing\*

Outside tabs of folders rest on drawer sides.

Letter Size Hanging File Folders  
(8½ x 11" documents)



18"D – 11¼" of letter filing  
24"D – 14¾" of letter filing



18"D – 23½" of letter filing  
24"D – 29½" of letter filing



18"D – 23½" of letter filing  
24"D – 29½" of letter filing

A4 Hanging File Folders  
(8¼ x 11⅝" documents)



18"D – 11¼" of A4 filing  
24"D – 14¾" of A4 filing



18"D – 23½" of A4 filing  
24"D – 29½" of A4 filing



18"D – 23½" of A4 filing  
24"D – 29½" of A4 filing

Legal Size Hanging File Folders  
(8½ x 14" documents)

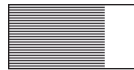

18"D – 11¼" of legal filing  
24"D – 14¾" of legal filing



18"D – 11¼" of legal filing  
24"D – 29½" of legal filing



18"D – 23½" of legal filing  
24"D – 29½" of legal filing

#### Side-to-Side Filing

Letter or A4 Hanging File Folders

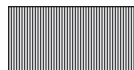

18"D – 20¼" of letter or A4 filing  
24"D – 20¼" of letter, A4, or legal filing

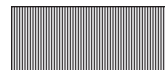

18"D – 26¼" of letter or A4 filing  
24"D – 26¼" of letter, A4, or legal filing

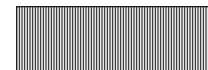

18"D – 32¼" of letter or A4 filing  
24"D – 32¼" of letter, A4, or legal filing

\* Front-to-back filing requires optional front-to-back filing bars **YPCAHR12** for 18"D units (except 2H lateral files use filing bar **YPCAHR15**) or **YPCAHR15** for 24"D units, one bar per row of filing. Order bars separately, see pages 53-55.

LATERAL FILE WIDTH

30"W

36"W

42"W

**Front-to-Back Filing — outside tabs of folders rest on drawer sides**

Letter Size  
(8½ x 11")

SHADED BOX INDICATES  
MAXIMUM FILING EFFICIENCY

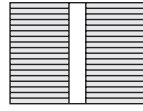

Filing Volume:  
29½" (Align™)  
30" (Essentials™)

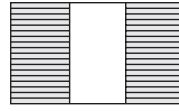

Filing Volume:  
29½" (Align)  
30" (Essentials)

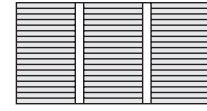

Filing Volume:  
44¼" (Align)  
45" (Essentials)

A4  
(8¼ x 11¾")



Filing Volume:  
14¾" (Align)  
15" (Essentials)

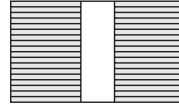

Filing Volume:  
29½" (Align)  
30" (Essentials)

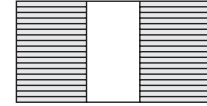

Filing Volume:  
29½" (Align)  
30" (Essentials)

Legal Size  
(8½ x 14")



Filing Volume:  
14¾" (Align)  
15" (Essentials)

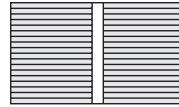

Filing Volume:  
29½" (Align)  
30" (Essentials)

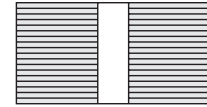

Filing Volume:  
29½" (Align)  
30" (Essentials)

EDP

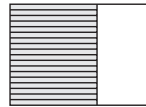

Filing Volume:  
14¾" (Align)

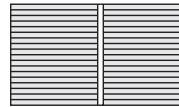

Filing Volume:  
29½" (Align)

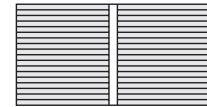

Filing Volume:  
29½" (Align)

**Side-to-Side Filing**

Letter, A4 and Legal

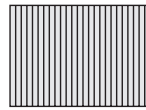

Filing Volume: 26¼"

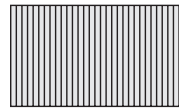

Filing Volume: 32¼"

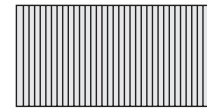

Filing Volume: 38¼"

**Load Capacities (per current ANSI/BIFMA standards)**

Align™	30" Wide	36" Wide	42" Wide
Opening Height			
12"	87 lbs. (Metal)	107 lbs. (Metal)	126 lbs.

**ANSI/BIFMA Standards**  
Allsteel lateral files, incorporating the **required counterweights** in freestanding situations, meet or exceed the applicable ANSI/BIFMA Storage Unit Test Standards X5.9-2012.

## Align Metal Support, Freestanding, and Mobile Pedestals

- Heavy-duty steel O-frame.
- Steel, ball-bearing slide suspension with full-extension drawers.
- Support pedestals are available with flush or recessed plinth base, and Terrace, Stride, or Pier feet.
- Full front drawers are available as metal or laminate.
- Box drawers have an adjustable divider.
- Standard core removable locks, see page 54.
- For locking specification, see pages 328-330.

**Align Metal Support Pedestals** (pages 44-48)

- Support pedestals have a fully enclosed top with exposed pre-drilled holes for top attachment. An additional top is required.
- Available as box/box/file or file/file drawers.
- Pencil trays included — one per pedestal with a box drawer.
- File drawer front reveals of support pedestals will align with Align metal laterals, towers, and credenzas.
- Leveling glides standard on freestanding pedestals.
- Hardware for attaching pedestal to worksurface is included
- 28 $\frac{1}{8}$ " H pedestals can be used to support worksurface at 29 $\frac{1}{2}$ " H.
- Align metal support pedestals are available with flush or recessed base, and Terrace, Stride, or Pier feet.

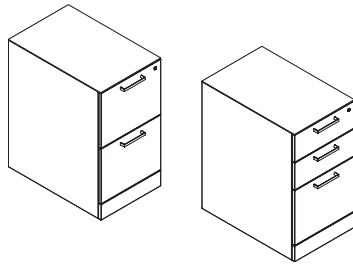
**Align Metal Freestanding Pedestals** (page 46)

- Available as box/file drawers.
- Pencil tray included in box drawer.
- Drawer reveals of freestanding pedestals will align with Align credenzas.
- Leveling glides standard on freestanding pedestals.
- Align metal freestanding pedestals are available with Terrace, Stride, or Pier feet.

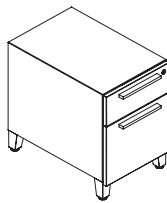
**Align Metal Mobile Pedestals** (pages 44-48)

- Available as box/file, box/box/file or file/file drawers.
- To allow clearance under worksurfaces, an Align mobile pedestal is 1 $\frac{1}{2}$ " shorter than an equivalent Align support pedestal. This, combined with the leveling range of Align support pedestals, personal files, towers, laterals, and credenzas will result in an offset of horizontal drawer reveals of 1 $\frac{1}{2}$ " to 3".
- Counterweight is standard in mobile pedestals.
- Four casters.
- Pencil trays included — one per pedestal with a box drawer.

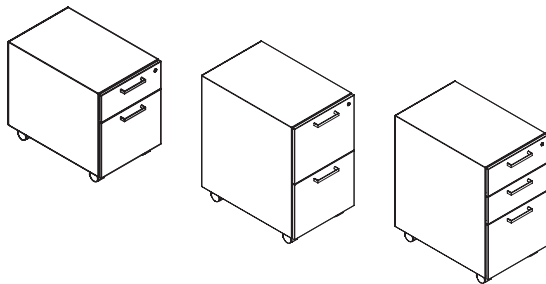

**NEW models launching October 2021 as part of a model logic update. The new model logic will allow future flexibility to add additional pull and foot options. Existing models will discontinue November 1, 2021.**

### Align Metal Support and Mobile Pedestal Tops and Accessories

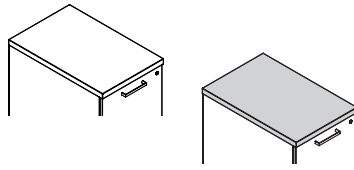

#### Align Pedestal Tops (page 48)

Field installed tops create additional storage and work areas on metal support or mobile pedestals.

- Laminate and veneer tops are 1/4" thick.
- Seat cushion provides quick and convenient additional seating on box/file pedestals.
- Seat cushion adds approximately 2"H to pedestal.
- YPPA prefix models have stitched corners and bumpers on bottom.
- Seat cushion to be used on steel (mobile) pedestal top only.
- COM yardage for seat cushion is 0.9 yards.

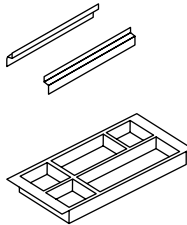

#### Align Pedestal Accessories (page 48)

- Accessories are for use with Align metal: pedestals, personal files, and personal towers.

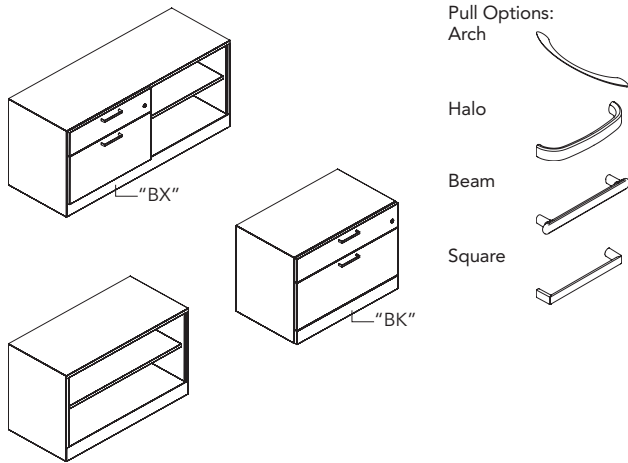

### Load Capacities (per current ANSI/BIFMA standards)

Align 22"H Credenzas	24" Wide	30" Wide	36" Wide
3 7/8" H Box Drawer	19 lbs.	24 lbs.	30 lbs.
10 1/2" H Box Drawer	50 lbs.	64 lbs.	78 lbs.

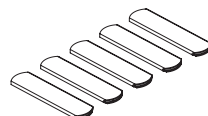
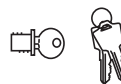
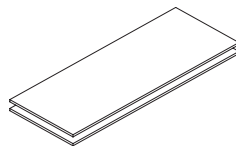
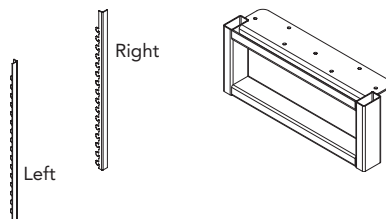

### Credenzas (pages 49-55)

- Full metal construction with finished top and back.
- Welded case with "O" frame construction for added strength.
- Full front design with proud, double wall drawer fronts.
- Units are 18"D or 24"D, 17 1/4"D or 23 1/4"D on open bookcases.
- Interlock and full extension ball bearing slides on all drawers.
- Enclosed bottom pan on open bookcase and on box/lateral/open units.
- Available with Terrace, Stride, or Pier feet. Also available with plinth base, either flush or recessed.
- Drawer fronts are available as metal or laminate.
- Plinth base option on drawer only units: recessed or flush.
- Leveling glides can be extended 1 1/2".
- Side-to-side filing bar included. Front-to-back filing with optional filing bar. Two rows of front to back letter filing on drawers 30"W or wider drawers, order 2 filing bars. See page 33.
- Accessories include: seat cushions, laminate tops.
- Planning: requires panel bracket, worksurface stanchion, or counterweight (sold separately) for units with drawers. See page 39 for specification examples.

### Storage-to-Panel Bracket (page 53)

- Used to attach the back or side of storage to a panel frame to provide stability when used with Stride, Terrace, or Optimize panel frames.
- Handedness is determined by side of storage that attaches to panel when facing panel run.

### Worksurface Support Stanchions (page 53)

- Worksurface stanchions are PR6 Silver and made of aluminum.
- Use 5"H stanchions for 22"H Align credenza with worksurface, or 6"H stanchions for credenza without a worksurface.
- Available in depths of 12" and 18". 12" is designed to work with 18"D worksurfaces and 18" with 24"D worksurfaces. Use two stanchions when mounting a 30"D or deeper worksurface.
- Stanchion orientation should run perpendicular to the length of the worksurface it is supporting.

### Front-to-Back Filing Bar (page 54)

- Front-to-back filing bar can be positioned to accommodate letter, A4, or legal size documents. 30"W and wider drawers can accommodate two rows requiring two bars. See page 33.

### Counterweight Kits for 22"H Credenzas (page 54)

- Metal weight attached to back of freestanding files to inhibit tipping; field installed only. The use of a storage-to-panel bracket and worksurface stanchion may eliminate the need for counterweight, see page 39.
- Counterweight kit required for freestanding files:
  - 42"W and 48"W Credenzas..... 25 LB kit
  - 24"W, 60"W, and 72"W Credenzas..... 35 LB kit
  - 30"W and 36"W Credenzas..... 50 LB kit

### Matte Silver Removable Lock Core Kit (page 54)

- Matte Silver used on Align credenzas with drawers. Includes one core, two keys, one core removal tool, adapter and instructions.
- The Allsteel Easy Lock Program simplifies the lock-core ordering process when multiple cores are being specified. To ensure ease of ordering in different situations the Easy Lock cores can be specified in three different ways — Random, Specified or Sequential. See page 330 for complete details and examples on the Allsteel Easy Lock program.

### Magnetic Label Holder - Available July 2021 (page 54)

- 5 pack of magnetic label holders.

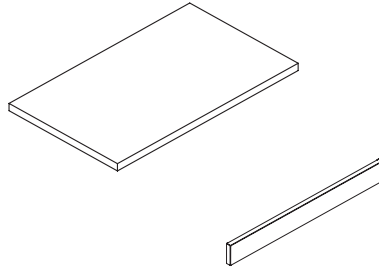

### Credenza Cushions (page 55)

- Cushions are for use on 22"H Align credenzas to create additional seating.
- Cushions can be placed directly on metal top of unit or on laminate top.
- Freestanding applications require counterweights — see page 37.

### Base Kick Plates for Align Credenzas (page 55)

- Allows field conversion of recessed plinth base unit to be flush with drawer front.



Plinth Base models available.

GSA Reference Page

### Side-mounted Credenzas

#### Use 1 storage-to-panel bracket per Credenza — 1 LH and 1 RH.

The minimum credenza size is 22"H x 36"W x 18"D or 24"D.

With a mid-run floor support, the maximum panel run is 144".

Without a mid-run floor support, the maximum panel run is 96".

Overheads and shelves cannot be used with 22"H side mounted credenzas.

Worksurfaces (if specified) must be mounted on the same side of the parent run as the credenzas.

Panel frame maximum height is 65".

Counterweight is required.

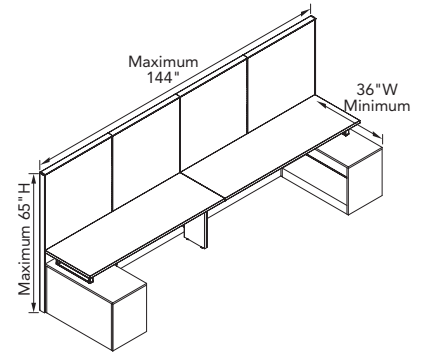

### Back-mounted Credenzas — Modular

#### Use 2 storage-to-panel brackets per Credenza — 2 LH and 2 RH.

The minimum Credenza size is 22"H x 42"W x 18"D or 24"D.

The maximum panel run between back-mounted Credenzas is 60".

Overheads and shelves cannot be used with 22"H back mounted Credenzas.

Worksurfaces (if specified) must be mounted on the same side of the parent run as the Credenzas.

Panel frame maximum height is 65".

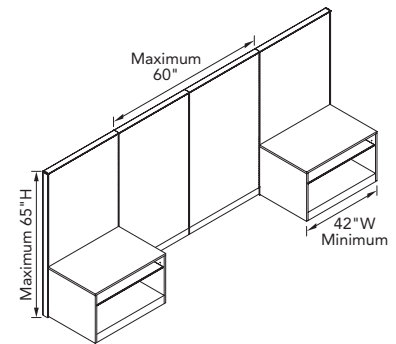

### Back-mounted Credenzas — Off-Modular Ends

#### Use 1 storage-to-panel bracket per Credenza — 1 LH and 1 RH.

The minimum Credenza size is 22"H x 42"W x 18"D or 24"D.

With a mid-run floor support, the maximum panel run is 144".

Without a mid-run floor support, the maximum panel run is 96".

Overheads and shelves cannot be used with 22"H back mounted Credenzas.

Worksurfaces (if specified) must be mounted on the same side of the parent run as the Credenzas.

Panel frame maximum height is 65".

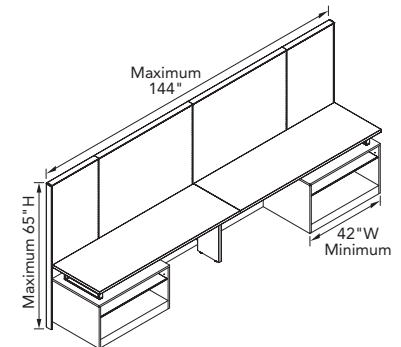

### Side-mounted Credenzas — with Return Panel

#### Use 1 storage-to-panel bracket on Credenza.

The minimum Credenza size is 22"H x 36"W x 18"D or 24"D.

The minimum size for panel return is 35"H x 36"W.

With a mid-run floor support, the maximum panel run is 144".

Without a mid-run floor support, the maximum panel run is 96".

Overheads and shelves cannot be used with 22"H side mounted Credenzas.

Worksurfaces (if specified) must be mounted on the same side of the parent run as the Credenzas.

Panel frame maximum height is 65".

Counterweight is required.

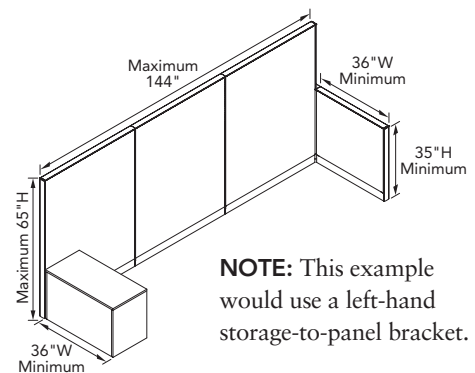

**NOTE:** This example would use a left-hand storage-to-panel bracket.

Align Lateral Files, Personal Files, and Accessories

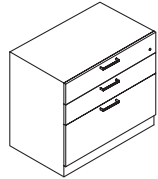
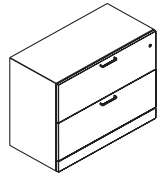

**28"H Align Lateral Files, Personal Files, and Bookcases** (page 56)

- Square edge full front.
- Beam, Halo, Square, and Arch metal pulls are customer installed.
- All files are 18"D.
- Files ship with glides fully recessed. Extend glides on 2-high files 3/4" to align with support pedestals.
- Hanging frames and dividers installed on-site.
- 2-high units have one lock.
- For locking specifications, see pages 328-330.
- Tops are available — order separately.
- 28"H Bookcases include one adjustable shelf.
- Adjustable shelf has 3 locations in 3.75" increments:
  - Bottom shelf location is 6.9" from bottom of case.
  - Middle shelf location is centered in case.
  - Top shelf location is 6.9" from top of case.
- Lateral Files come with file bars to accommodate either front-to-back or side-to-side filing. Personal files come with file bars to accommodate side-to-side filing only; front-to-back filing bars may be purchased separately.

**Note:** Counterweight kits are required for freestanding lateral files (i.e., files that are not positioned under a worksurface, ganged to an adjacent file, or bolted to the floor or wall.)

**Align Accessories**

**Counterweight kit(s) for 28"H Credenzas** (page 55)

- Counterweight kit(s) required for freestanding files:
 

2-high 30"W file.....	50 lbs.
2-high 36"W files .....	57½ lbs.
2-high 42"W files .....	70 lbs.
- Metal weight placed in bottom of freestanding files to inhibit tipping; field installed only.

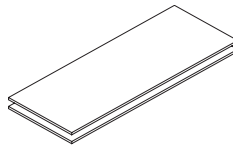

**Front-to-back Filing Bar** (page 54)

- Front-to-back filing bar can be positioned to accommodate letter, A4, legal or EDP size documents. See page 34 for complete filing information. Front-to-back filing bar must be used with side-to-side hanging frame.
- For 12"H interiors.

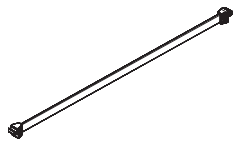

### Plinth Base – Flush or Recessed

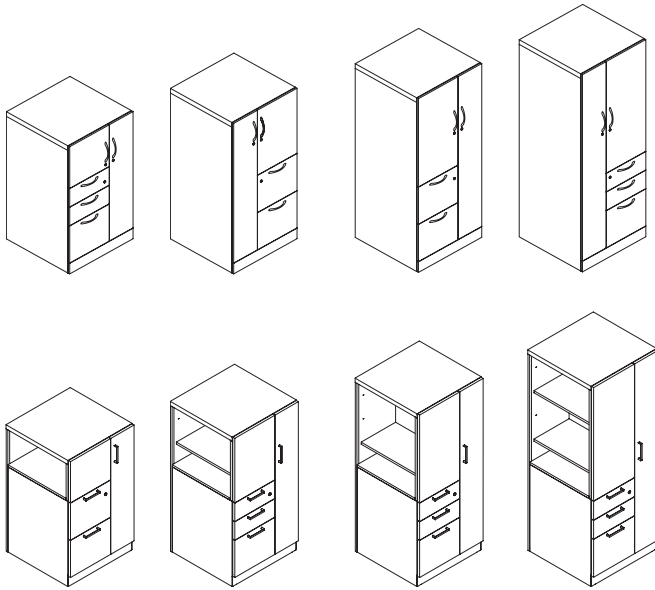

### Foot Base – Stride®, Pier or Terrace DNA®

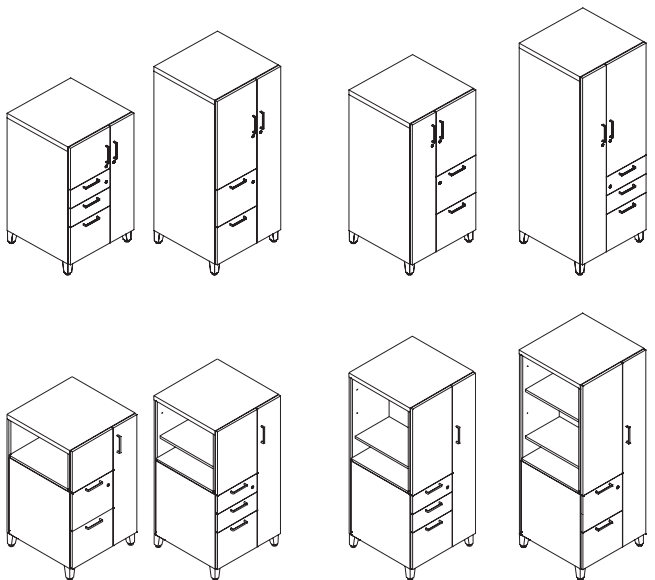

### NEW & IMPROVED 18"W and 24"W Align Metal Towers

(pages 57-68)

*This specification information is for Align tower models with the new model logic, ordered & produced after March 2020.*

- Front-access personal towers include locking cabinet section, locking wardrobe section, and locking drawer section. Side-access personal towers include open side access bookcase, locking wardrobe section, and locking drawer section.
- 24"W towers offer the option of box/box/file or file/file drawer configuration. 18"W tower offers file/file drawer configuration only.
- Available with Terrace, Stride, or Pier feet. Also available with plinth base, either flush or recessed. Plinth is approximately 3.35"H and matches other Align storage. 18"W tower is also available as a mobile tower with casters.
- 18"W Mobile towers have two locking casters (in front) and two non-locking casters.
- Full front drawers and doors are available as metal or laminate. Laminate fronts have grain running vertically and are grain-matched.
- Optional markerboard finish is available only on side-access units with metal fronts. Only the front panel of the side-access portion will be finished with markerboard paint, the remaining drawer and door fronts will be painted to match the chassis. Markerboard finish is white.
- 24"W tower wardrobe portion is approximately 9"W. 18"W tower wardrobe portion is approximately 8 $\frac{1}{3}$ "W.
- The wardrobe portion of each tower comes installed with a rod accessory to accept clothing hanger(s) or a Radian work tool coat hook can be added. Radian coat hook is sold separately.
- Units can be shipped with lock cores removed; cores can then be installed after storage units are placed. Towers can be keyed alike with pedestals, credenzas, laterals, and overhead cabinets.
- Towers can be used to support a work surface. In order to bracket a work surface to a tower, order bracket model YPWTAWSBKT24.
- All drawers use heavy-duty, telescoping ball-bearing slides. All drawers feature 100% drawer extension.
- Case has a finished appearance with smooth seams and no overlaps.
- Drawer alignment matches other Align storage.
- 24"W tower is available with all pull styles. 18"W tower is available only with arch and square pull styles due to slim width of drawer.
- Cabinet door on 50"H and 57 $\frac{1}{2}$ "H units include one adjustable shelf. 65"H units include two adjustable shelves in this area. 42 $\frac{1}{2}$ "H unit does not include an adjustable shelf in the cabinet section.
- Side access portion door on 50"H and 57 $\frac{1}{2}$ "H units include one adjustable shelf. 65"H units include two adjustable shelves in this area. 42 $\frac{1}{2}$ "H unit does not include an adjustable shelf in the side-access portion.

## Plinth or Foot Base — 12"W Wardrobe / Locker

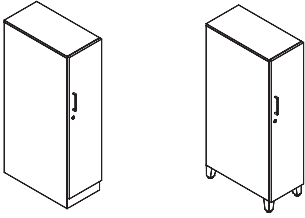
**NEW & IMPROVED 12"W Align Metal Wardrobe/Single Door Locker** (pages 69-71)

*This specification information is for Align wardrobe models with the new model logic, ordered & produced after March 2020.*

- Available in 42½", 50", and 65"H. Available in 18" or 24"D.
- Available with Terrace, Stride, or Pier feet. Also available with plinth base, either flush or recessed. Plinth is approximately 3.35"H and matches other Align storage.
- Full front doors are available as metal or laminate. Laminate fronts have grain running vertically.
- 18"D Wardrobes: 42"H and 50"H plinth wardrobes can be freestanding. 18" D footed units must be attached to a panel, worksurface, or ganged to another unit.
- 24"D Wardrobes: 42"H and 50"H plinth and footed wardrobes can be freestanding.
- 65"H wardrobes: 18"D and 24"D wardrobes must be attached to a panel, worksurface, or ganged to another unit.
- To attach wardrobes to a panel, use brackets AP22PBKLN or AP22PBKRH.
- Wardrobes can be used to support a work surface. In order to bracket a work surface to a tower, order bracket model YPWTAWSBKT18 or YPWTAWSBKT24.
- Wardrobes come installed with a rod accessory to accept clothing hanger(s) or a Ralii work tool coat hook can be added. Ralii coat hook is sold separately.
- Wardrobes have slots cut into the inner liner that allow the user to hang Ralii work tool accessories inside the unit. 42"H wardrobes have 2 slots, 50"H and 65"H wardrobes have 4 slots.
- Wardrobes are shipped with one adjustable shelf. 42"H and 50"H wardrobes have 3 shelf locations; 65"H wardrobes have 6 shelf locations.
- Units can be shipped with lock cores removed; cores can then be installed after storage units are placed. Towers can be keyed alike with pedestals, credenzas, laterals, and overhead cabinets.
- Wardrobes are also offered with a digital locking option. Digital lock replaces the pull. For digital lock specification information, see page 22.

[GSA Reference Page](#)

### SINGLE LOCKERS

Plinth Base – Flush or Recessed

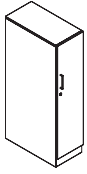

Foot Base – Stride, Terrace, or Pier

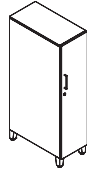

Align lockers provide a comprehensive solution of secure storage outside the primary workstation. Whether you're minimizing the overall workstation footprint or have mobile workers needing a place for their personal belongings, lockers provide the right amount of storage.

Align lockers include single, double, and quad locker variations, as well as an additional cubby solution. Designers have the freedom to select from a variety of aesthetic options including plinth or footed based, painted and laminate fronts, and a variety of pull options, to reflect any company culture.

### DOUBLE LOCKERS

Plinth Base – Flush or Recessed

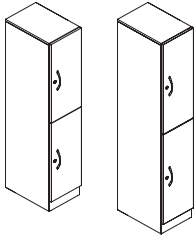

Foot Base – Stride, Terrace, or Pier

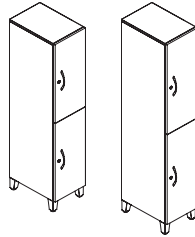

### NEW & IMPROVED Align Lockers (pages 69-77)

*This specification information is for Align locker models with the new model logic, ordered & produced after March 2020.*

### Align Lockers (pages 69-77)

- Available in 42½", 50", and 65"H. Available in 18"D.
- Available with Terrace, Stride, or Pier feet. Also available with plinth base, either flush or recessed. Plinth is approximately 3.35"H and matches other Align storage.
- Full front doors are available as metal or laminate. Laminate fronts have grain running vertically and are grain-matched.
- Units can be shipped with lock cores removed; cores can then be installed after storage units are placed. Towers can be keyed alike with pedestals, credenzas, laterals, and overhead cabinets.
- Lockers can be ganged either side-to-side or back-to-back.
- "Double" and "Quad" lockers include two double coat hooks in each compartment.
- 42"H x 12"W and 50"H x 12"W plinth lockers can be freestanding. 65"H x 12"W plinth lockers and all heights of 12"W footed lockers must be attached to a panel, worksurface, or ganged to another unit.

### QUAD LOCKERS

Plinth Base – Flush or Recessed

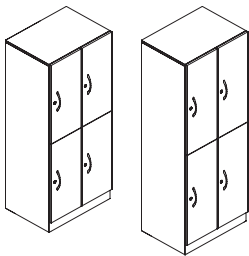

Foot Base – Stride, Terrace, or Pier

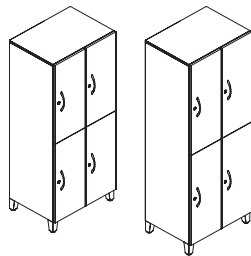

### CUBBY LOCKERS

Plinth Base – Flush or Recessed

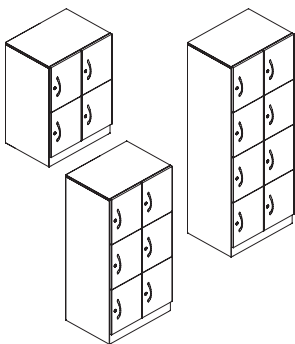

Foot Base – Stride, Terrace, or Pier

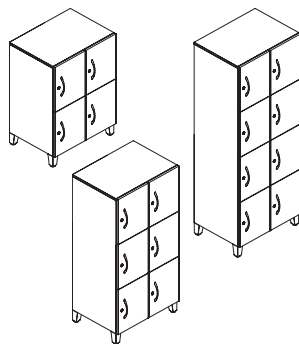

# Align™ Metal Storage

## Support and Mobile Pedestals

For specification information see pages 29 and 35-36.

Metal Fronts with Plinth Base

GSA SIN 33721

	Description	Model	P1 Paint List Price
	<b>Support Pedestal 28½"H — File/File — Metal Case/Metal Fronts</b>		
	17"D x 15"W*	YPPSP281518FFM	\$ 1128
	23"D x 15"W	YPPSP281524FFM	\$ 1175
	29"D x 15"W	YPPSP281530FFM	\$ 1212
	<b>Support Pedestal 28½"H — Box/Box/File — Metal Case/Metal Fronts</b>		
	17"D x 15"W*	YPPSP281518BBFM	\$ 1128
	23"D x 15"W	YPPSP281524BBFM	\$ 1175
	29"D x 15"W	YPPSP281530BBFM	\$ 1212
	<b>Mobile Pedestal 26½"H — File/File — Metal Case/Metal Fronts</b>		
	17"D x 15"W*	YPPM271518FFM	\$ 1142
	23"D x 15"W	YPPM271524FFM	\$ 1189
	29"D x 15"W	YPPM271530FFM	\$ 1227
	<b>Mobile Pedestal 26½"H — Box/Box/File — Metal Case/Metal Fronts</b>		
	17"D x 15"W*	YPPM271518BBFM	\$ 1142
	23"D x 15"W	YPPM271524BBFM	\$ 1189
	29"D x 15"W	YPPM271530BBFM	\$ 1226
	<b>Mobile Pedestal 20½"H — Box/File — Metal Case/Metal Fronts</b>		
	17"D x 15"W*	YPPM211518BFM	\$ 955
	23"D x 15"W	YPPM211524BFM	\$ 998
	29"D x 15"W	YPPM211530BFM	\$ 1045

Square Pulls shown

\*17"D Pedestals do not accommodate legal size filing.

METAL STORAGE

How to specify — Select the Model Number from above.	1st Option: Base Option (if applicable):	2nd Option: Pull Option:	3rd Option: Pull Color (if applicable):	4th Option: Paint Case:	5th Option: Paint Fronts:	6th Option: Lock:	7th Option: Digital Lock Color (if applicable):
Y P P	BK Flush Kickplate BX Recessed Kickplate	A Arch B Bevel M Beam O Halo S Square I Integral	M Beam / O Halo PJW Designer White PR6 Silver PJE Pyrite P8X Solar Black AP Arch PRO Anodized Silver SP Square PJW Designer White EL Matte Silver P02 Flint P7B Loft PJE Pyrite P8X Solar Black P2 upcharge +\$17/pull	P1 P2 P3 See page 28 for finishes. P2 upcharge \$22 P3 upcharge \$44	NA Match Case P1 \$55 P2 \$77 P3 \$99	L Standard Lock X Omit Lock Core (Deduct \$20 per lock) E Digital Lock (Add \$409 per lock) See page 23 for specification information.	BNL Brushed Nickel
_____ .	B _____ .	_____ .	_____ .	P _____ .	_____ .	_____ .	_____ .

Example: YPPSP281518FFM.BX.APRO.PJW.NA.L





# Align™ Metal Storage

## Support and Mobile Pedestals

For specification information see pages 29 and 35-36.

Laminate Fronts with Plinth Base

GSA SIN 33721

	Width	Model	P1 Paint		
			L1	L2	L3
	<b>Support Pedestal 28½"H — File/File — Metal Case/Laminate Fronts</b>				
	17"D x 15"W*	YPPSP281518FFL	\$ 1505	\$ 1562	\$ 1612
	23"D x 15"W	YPPSP281524FFL	\$ 1551	\$ 1622	\$ 1692
	29"D x 15"W	YPPSP281530FFL	\$ 1590	\$ 1662	\$ 1733
	<b>Support Pedestal 28½"H — Box/Box/File — Metal Case/Laminate Fronts</b>				
	17"D x 15"W*	YPPSP281518BBFL	\$ 1570	\$ 1638	\$ 1699
	23"D x 15"W	YPPSP281524BBFL	\$ 1622	\$ 1696	\$ 1767
	29"D x 15"W	YPPSP281530BBFL	\$ 1657	\$ 1732	\$ 1806
	<b>Mobile Pedestal 26½"H — File/File — Metal Case/Laminate Fronts</b>				
	17"D x 15"W*	YPPM271518FFL	\$ 1523	\$ 1594	\$ 1656
	23"D x 15"W	YPPM271524FFL	\$ 1571	\$ 1647	\$ 1722
	29"D x 15"W	YPPM271530FFL	\$ 1609	\$ 1686	\$ 1763
	<b>Mobile Pedestal 26½"H — Box/Box/File — Metal Case/Laminate Fronts</b>				
	17"D x 15"W*	YPPM271518BBFL	\$ 1589	\$ 1663	\$ 1727
	23"D x 15"W	YPPM271524BBFL	\$ 1640	\$ 1719	\$ 1795
	29"D x 15"W	YPPM271530BBFL	\$ 1677	\$ 1757	\$ 1838
	<b>Mobile Pedestal 20½"H — Box/File — Metal Case/Laminate Fronts</b>				
	17"D x 15"W*	YPPM211518BFL	\$ 1296	\$ 1362	\$ 1432
	23"D x 15"W	YPPM211524BFL	\$ 1305	\$ 1372	\$ 1437
	29"D x 15"W	YPPM211530BFL	\$ 1350	\$ 1419	\$ 1488

Square Pulls shown

\*17"D Pedestals do not accommodate legal size filing.

How to specify — Select the Model Number from above.	1st Option: Base Option (if applicable):	2nd Option: Pull Option:	3rd Option: Pull Color (if applicable):	4th Option: Paint Case:	5th Option: Laminate Fronts: Laminate & Edge:	6th Option: Lock:	7th Option: Digital Lock Color (if applicable):
Y P P	BX Recessed Kickplate	A Arch M Beam O Halo S Square	M Beam / O Halo P JW Designer White P R6 Silver P JE Pyrite P BX Solar Black AP Arch P R0 Anodized Silver SP Square P JW Designer White EL Matte Silver P O2 Flint P 7B Loft P JE Pyrite P BX Solar Black P2 upcharge +\$17/pull	P1 P2 P3 See page 28 for finishes. P2 upcharge \$22 P3 upcharge \$44	See page 28 for finishes. L2 upcharge \$164 L3 upcharge \$327	L Standard Lock X Omit Lock Core (Deduct \$20 per lock) E Digital Lock (Add \$409 per lock) See page 23 for specification information.	BNL Brushed Nickel
.	BX   .	.	.	P           .	.	.	

Example: YPPSP281518FFL.BK.APR0.PJW.LVT1VT.L



# Align™ Metal Storage

## Support and Freestanding Pedestals

For specification information see pages 29 and 35-36.

Metal Fronts Footed

GSA SIN 33721

	Description	Model	P1 Paint List Price
	<b>Support Pedestal 28½"H — File/File — Metal Case/Metal Fronts</b>		
	17"D x 15"W*	YPPSF281518FFM	\$ 1333
	23"D x 15"W	YPPSF281524FFM	\$ 1376
	29"D x 15"W	YPPSF281530FFM	\$ 1415
	<b>Support Pedestal 28½"H — Box/Box/File — Metal Case/Metal Fronts</b>		
	17"D x 15"W*	YPPSF281518BBFM	\$ 1333
	23"D x 15"W	YPPSF281524BBFM	\$ 1376
	29"D x 15"W	YPPSF281530BBFM	\$ 1415
	<b>Freestanding Pedestal 22"H — Box/File — Metal Case/Metal Fronts</b>		
	17"D x 15"W*	YPPFF221518BFM	\$ 1290
	23"D x 15"W	YPPFF221524BFM	\$ 1338



\*17"D Pedestals do not accommodate legal size filing.

METAL STORAGE

How to specify — Select the Model Number from above.	1st Option: Base Option:	2nd Option: Foot Finish:	3rd Option: Pull Option:	4th Option: Pull Color (if applicable):	5th Option: Paint Case:	6th Option: Paint Fronts:	7th Option: Lock:	8th Option: Digital Lock Color (if applicable):
Y   P   P	TF Terrace Foot ZF Stride Foot (+\$82) Pier PF Foot (+\$126)	Terrace, Stride PR6 Silver Pier PR6 Silver P8X Solar Black PJE Pyrite (+\$88) P02 Flint (+\$88) P7B Loft PJW Designer White	A Arch B Bevel M Beam O Halo S Square I Integral	M Beam / O Halo PJW Designer White PR6 Silver PJE Pyrite P8X Solar Black AP Arch PRO Anodized Silver SP Square PJW Designer White EL Matte Silver P02 Flint P7B Loft PJE Pyrite P8X Solar Black P2 upcharge +\$17/pull	P1 P2 P3 See page 28 for finishes. P2 upcharge \$22 P3 upcharge \$44	NA Match Case P1 \$55 P2 \$77 P3 \$99	L Standard Lock X Omit Lock Core (Deduct \$20 per lock) E Digital Lock (Add \$409 per lock) See page 23 for specification information.	BNL Brushed Nickel
Y   P   P	F	PR6			P			

Example: YPPSF281518FFM.TFPR6.APRO.PJW.NA.L



	Width	Model	P1 Paint		
			L1	L2	L3
	<b>Support Pedestal 28 1/2"H — File/File — Metal Case/Laminate Fronts</b>				
	17"D x 15"W*	YPPSF281518FFL	\$ 1475	\$ 1532	\$ 1582
	23"D x 15"W	YPPSF281524FFL	\$ 1526	\$ 1597	\$ 1658
	29"D x 15"W	YPPSF281530FFL	\$ 1568	\$ 1642	\$ 1704
	<b>Support Pedestal 28 1/2"H — Box/Box/File — Metal Case/Laminate Fronts</b>				
	17"D x 15"W*	YPPSF281518BBFL	\$ 1561	\$ 1618	\$ 1668
	23"D x 15"W	YPPSF281524BBFL	\$ 1615	\$ 1687	\$ 1754
	29"D x 15"W	YPPSF281530BBFL	\$ 1658	\$ 1733	\$ 1800
	<b>Freestanding Pedestal 22"H — Box/File — Metal Case/Laminate Fronts</b>				
	17"D x 15"W*	YPPFF221518BFL	\$ 1735	\$ 1809	\$ 1873
	23"D x 15"W	YPPFF221524BFL	\$ 1762	\$ 1844	\$ 1927

\*17"D Pedestals do not accommodate legal size filing.

How to specify — Select the Model Number from above.	1st Option: Base Option:	2nd Option: Foot Finish:	3rd Option: Pull Option:	4th Option: Pull Color (if applicable):	5th Option: Paint Case:	6th Option: Laminate Fronts: Laminate & Edge:	7th Option: Lock:	8th Option: Digital Lock Color (if applicable):
Y P P	TF Terrace Foot ZF Stride Foot (+\$82) PF Pier Foot (+\$126)	Terrace, Stride PR6 Silver  Pier PR6 Silver P8X Solar Black PJE Pyrite (+\$88) P02 Flint (+\$88) P7B Loft PJW Designer White	A Arch M Beam O Halo S Square	M Beam / O Halo PJW Designer White PR6 Silver PJE Pyrite P8X Solar Black AP Arch PR0 Anodized Silver SP Square PJW Designer White EL Matte Silver P02 Flint P7B Loft PJE Pyrite P8X Solar Black P2 upcharge +\$17/pull	P1 P2 P3 See page 28 for finishes. P2 upcharge \$22 P3 upcharge \$44	See page 28 for finishes. L2 upcharge \$150 L3 upcharge \$300	L Standard Lock X Omit Lock Core (Deduct \$20 per lock) E Digital Lock (Add \$409 per lock) See page 23 for specification information.	BNL Brushed Nickel
.	F	PR6		.	P       .	.		

Example: YPPSF281518FFL.ZFPR6.APR0.PJW.LVT1VT.L

For specification information see pages 29 and 35-36.

GSA SIN 33721

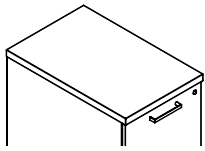

Description	Model	L1	L2	L3
		List Price	List Price	List Price
<b>Laminate Top — Flat Edge (for metal pedestal case)</b>				
23½"D	ASPTP-24LL <span style="border: 1px solid black; padding: 0 2px;">S</span>	\$ 331	\$ 346	\$ 358
29½"D	ASPTP-30LL <span style="border: 1px solid black; padding: 0 2px;">S</span>	\$ 410	\$ 428	\$ 442

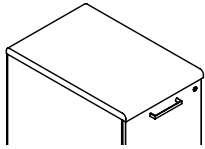

Description	Model	List Price							
		Grade 1	Grade 2	Grade 3	Grade 4	Grade 5	Grade 6	Grade 7	Grade 8
<b>Seat Cushion — For Metal Mobile Pedestals only (specify seating upholstery — no leathers)</b>									
17"D	YPPA1815SC <span style="border: 1px solid black; padding: 0 2px;">S</span>	\$ 255	\$ 270	\$ 284	\$ 298	\$ 318	\$ 336	\$ 355	\$ 374
23"D	YPPA2415SC <span style="border: 1px solid black; padding: 0 2px;">S</span>	\$ 304	\$ 319	\$ 333	\$ 347	\$ 367	\$ 385	\$ 404	\$ 423
29"D	YPPA3015SC <span style="border: 1px solid black; padding: 0 2px;">S</span>	\$ 319	\$ 334	\$ 348	\$ 362	\$ 382	\$ 400	\$ 419	\$ 438

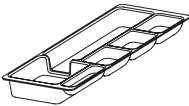

Description	Model	List Price
<b>Box Drawer Accessories</b>		
Pencil Tray (Black only)	A2280-000 <span style="border: 1px solid black; padding: 0 2px;">S</span>	\$ 48

### Counterweights

For 20½"H Pedestals produced prior to 11/1/2015 ( <i>De-emphasized</i> )	2282-300 <span style="border: 1px solid black; padding: 0 2px;">S</span>	\$ 246
For 28½"H Pedestals produced prior to 11/1/2015 ( <i>De-emphasized</i> )	2282-400 <span style="border: 1px solid black; padding: 0 2px;">S</span>	\$ 269

<p><b>How to specify —</b> Select the Model Number from above.</p>	<p><i>1st Option:</i> <b>Laminate or Veneer Type and Finish (if applicable):</b> See page 28 for finishes.</p>	<p><i>1st Option:</i> <b>Paint (if applicable):</b> See page 28 for finishes.</p>	<p><i>2nd Option:</i> <b>Edge (if applicable):</b> Laminate Flat Edge Tops only. See page 28 for finishes.</p>	<p><i>Only Option for Seat Cushion:</i> <b>Upholstery:</b> Specify seating upholstery.</p>
--	--	---	--	--

Examples: ASPTP-24LL.TM20.E2 YPPA2415SC.PNS012 2282-400

S Shippable by small-package carrier.

# Align™ Metal Storage

## 22"H Credenzas

For specification information see pages 29-34 and 37-40.

Metal Fronts with Plinth Base

GSA SIN 33721

	Description	Model	Recessed Base "BX"	
				P1 Paint
	<b>22"H Box/Lateral and Right Open w/Metal Shelf</b>			
	42"W x 18"D	YPCP224218RBFOM		\$ 3198
	42"W x 24"D	YPCP224224RBFOM		\$ 3405
	48"W x 18"D	YPCP224818RBFOM (shown)		\$ 3305
	48"W x 24"D	YPCP224824RBFOM		\$ 3520
	60"W x 18"D	YPCP226018RBFOM		\$ 3501
	60"W x 24"D	YPCP226024RBFOM		\$ 3729
	72"W x 18"D	YPCP227218RBFOM		\$ 3825
72"W x 24"D	YPCP227224RBFOM		\$ 4071	
	<b>22"H Left Open w/Metal Shelf and Box/Lateral</b>			
	42"W x 18"D	YPCP224218LBFOM		\$ 3198
	42"W x 24"D	YPCP224224LBFOM		\$ 3405
	48"W x 18"D	YPCP224818LBFOM (shown)		\$ 3305
	48"W x 24"D	YPCP224824LBFOM		\$ 3520
	60"W x 18"D	YPCP226018LBFOM		\$ 3501
	60"W x 24"D	YPCP226024LBFOM		\$ 3729
	72"W x 18"D	YPCP227218LBFOM		\$ 3825
72"W x 24"D	YPCP227224LBFOM		\$ 4071	
	<b>22"H Box/Lateral</b>			
	24"W x 18"D	YPCP222418BFM		\$ 2097
	24"W x 24"D	YPCP222424BFM		\$ 2235
	30"W x 18"D	YPCP223018BFM (shown)		\$ 2141
	30"W x 24"D	YPCP223024BFM		\$ 2282
	36"W x 18"D	YPCP223618BFM		\$ 2385
	36"W x 24"D	YPCP223624BFM		\$ 2538
	42"W x 18"D	YPCP224218BFM		\$ 2627
42"W x 24"D	YPCP224224BFM		\$ 2797	
	<b>22"H Open Binder w/Metal Shelf</b>			
	24"W x 17¼"D	YPCP222418O		\$ 1488
	24"W x 23¼"D	YPCP222424O		\$ 1588
	30"W x 17¼"D	YPCP223018O		\$ 1517
	30"W x 23¼"D	YPCP223024O		\$ 1612
	36"W x 17¼"D	YPCP223618O (shown)		\$ 1654
	36"W x 23¼"D	YPCP223624O		\$ 1759
	42"W x 17¼"D	YPCP224218O		\$ 1830
42"W x 23¼"D	YPCP224224O		\$ 1949	

How to specify — Select the Model Number from above.	1st Option: Base Option (if applicable):	2nd Option: Pull Option:	3rd Option: Pull Color (if applicable):	4th Option: Paint Case:	5th Option: Paint Fronts:	6th Option: Paint Shelf:	7th Option: Lock:	8th Option: Digital Lock Color (if applicable):
Y P C	BK Flush BX Kickplate BX Recessed Kickplate	A Arch B Bevel M Beam O Halo S Square I Integral	M Beam / O Halo P JW Designer White P R6 Silver P JE Pyrite P B X Solar Black AP Arch P R O Anodized Silver SP Square P JW Designer White EL Matte Silver P O 2 Flint P 7 B Loft P JE Pyrite P B X Solar Black P 2 upcharge +\$17/pull	P1 P2 P3 See inside front cover for finishes. P2 upcharge \$55 P3 upcharge \$131	NA Match Case P1 \$246 P2 \$322 P3 \$393	Specify "NA" for shelf color to match case color; or specify a different color and add \$0 for P1, \$17 for P2, or \$39 for P3.	L Standard Lock X Omit Lock Core (Deduct \$20 per lock) E Digital Lock (Add \$409 per lock) See page 23 for specification information.	BNL Brushed Nickel
.	B     .	.	.	P       .	N A   .	.	.	.

Example: YPCP224818RBFOM.BX.APR0.PJW.NA.P7B.L

# Align™ Metal Storage

22"H Credenzas

For specification information see pages 29-34 and 37-40.

Laminate Fronts with Plinth Base

GSA SIN 33721

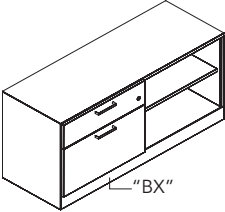

Width	Model	Base List Price L1
<b>22"H Box/Lateral w/Laminate Fronts and Right Open w/Metal Shelf</b>		
42"W x 18"D	YPCP224218BFFOL	\$ 3501
42"W x 24"D	YPCP224224BFFOL	\$ 3729
48"W x 18"D	YPCP224818BFFOL (shown)	\$ 3609
48"W x 24"D	YPCP224824BFFOL	\$ 3843
60"W x 18"D	YPCP226018BFFOL	\$ 3841
60"W x 24"D	YPCP226024BFFOL	\$ 4089
72"W x 18"D	YPCP227218BFFOL	\$ 4236
72"W x 24"D	YPCP227224BFFOL	\$ 4511

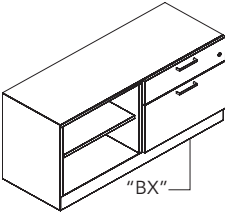

Width	Model	Base List Price L1
<b>22"H Left Open w/Metal Shelf and Box/Lateral w/Laminate Fronts</b>		
42"W x 18"D	YPCP224218LBFOL	\$ 3501
42"W x 24"D	YPCP224224LBFOL	\$ 3729
48"W x 18"D	YPCP224818LBFOL (shown)	\$ 3609
48"W x 24"D	YPCP224824LBFOL	\$ 3843
60"W x 18"D	YPCP226018LBFOL	\$ 3841
60"W x 24"D	YPCP226024LBFOL	\$ 4089
72"W x 18"D	YPCP227218LBFOL	\$ 4236
72"W x 24"D	YPCP227224LBFOL	\$ 4511



Width	Model	Base List Price L1
<b>22"H Box/Lateral w/Laminate Fronts</b>		
24"W x 18"D	YPCP222418BFL	\$ 2405
24"W x 24"D	YPCP222424BFL	\$ 2558
30"W x 18"D	YPCP223018BFL (shown)	\$ 2485
30"W x 24"D	YPCP223024BFL	\$ 2644
36"W x 18"D	YPCP223618BFL	\$ 2797
36"W x 24"D	YPCP223624BFL	\$ 2976
42"W x 18"D	YPCP224218BFL	\$ 3074
42"W x 24"D	YPCP224224BFL	\$ 3269

METAL STORAGE

How to specify — Select the Model Number from above.	1st Option: Base Option (if applicable): BX Recessed Kickplate	2nd Option: Pull Option: A Arch M Beam O Halo S Square	3rd Option: Pull Color (if applicable): M Beam / O Halo PJW Designer White PR6 Silver PJE Pyrite P8X Solar Black AP Arch PRO Anodized Silver SP Square PJW Designer White EL Matte Silver P02 Flint P7B Loft PJE Pyrite P8X Solar Black P2 upcharge +\$17/pull	4th Option: Paint Case: (if applicable): P1 P2 P3 See page 28 for finishes. P2 upcharge \$55 P3 upcharge \$131	5th Option: Laminate Fronts: Laminate & Edge: See page 28 for finishes. L2 upcharge \$109 L3 upcharge \$218	6th Option: Paint Shelf: Specify "NA" for shelf color to match case color; or specify a different color and add \$0 for P1, \$17 for P2, or \$39 for P3.	7th Option: Lock: L Standard Lock X Omit Lock Core (Deduct \$20 per lock) E Digital Lock (Add \$409 per lock) See page 23 for specification information.	8th Option: Digital Lock Color (if applicable): BNL Brushed Nickel
Y P C	B X   .		.	P           .	.	.	.	.

Example: YPCP226018LBFOL.BX.APR0.P7B.LVT1VT.P7B.X

Shippable by small-package carrier.

# Align™ Metal Storage

## 22"H Credenzas

For specification information see pages 29-34 and 37-40.

Metal Fronts Footed

GSA SIN 33721

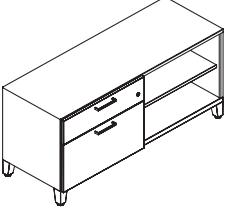
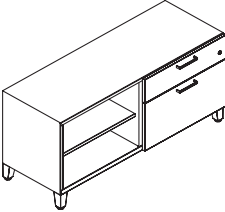
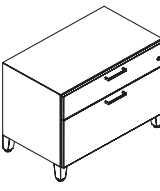
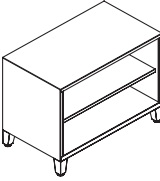
	Description	Model	P1 Paint List Price
	<b>22"H Box/Lateral and Right Open w/Metal Shelf</b>		
	42"W x 18"D	YPCF224218RBFOM	\$ 3421
	42"W x 24"D	YPCF224224RBFOM	\$ 3644
	48"W x 18"D	YPCF224818RBFOM (shown)	\$ 3528
	48"W x 24"D	YPCF224824RBFOM	\$ 3757
	60"W x 18"D	YPCF226018RBFOM	\$ 3782
	60"W x 24"D	YPCF226024RBFOM	\$ 4025
	72"W x 18"D	YPCF227218RBFOM	\$ 4103
	72"W x 24"D	YPCF227224RBFOM	\$ 4368
	<b>22"H Left Open w/Metal Shelf and Box/Lateral</b>		
	42"W x 18"D	YPCF224218LBFOM	\$ 3421
	42"W x 24"D	YPCF224224LBFOM	\$ 3644
	48"W x 18"D	YPCF224818LBFOM (shown)	\$ 3528
	48"W x 24"D	YPCF224824LBFOM	\$ 3757
	60"W x 18"D	YPCF226018LBFOM	\$ 3782
	60"W x 24"D	YPCF226024LBFOM	\$ 4025
	72"W x 18"D	YPCF227218LBFOM	\$ 4103
	72"W x 24"D	YPCF227224LBFOM	\$ 4368
	<b>22"H Box/Lateral</b>		
	24"W x 18"D	YPCF222418BFM	\$ 2324
	24"W x 24"D	YPCF222424BFM	\$ 2473
	30"W x 18"D	YPCF223018BFM (shown)	\$ 2366
	30"W x 24"D	YPCF223024BFM	\$ 2519
	36"W x 18"D	YPCF223618BFM	\$ 2608
	36"W x 24"D	YPCF223624BFM	\$ 2778
	42"W x 18"D	YPCF224218BFM	\$ 2850
	42"W x 24"D	YPCF224224BFM	\$ 3034
	<b>22"H Open Binder w/Metal Shelf</b>		
	24"W x 17¼"D	YPCF222418O	\$ 1714
	24"W x 23¼"D	YPCF222424O	\$ 1825
	30"W x 17¼"D	YPCF223018O (shown)	\$ 1739
	30"W x 23¼"D	YPCF223024O	\$ 1852
	36"W x 17¼"D	YPCF223618O	\$ 1875
	36"W x 23¼"D	YPCF223624O	\$ 1995
	42"W x 17¼"D	YPCF224218O	\$ 2052
	42"W x 23¼"D	YPCF224224O	\$ 2184

<p><b>How to specify —</b> Select the Model Number from above.</p> <p>Y P C                </p>	<p><b>1st Option:</b> <b>Base Option:</b> TF Terrace Foot ZF Stride Foot (+\$82) PF Pier Foot (+\$126)</p>	<p><b>2nd Option:</b> <b>Foot Finish:</b> Terrace, Stride PR6 Silver  Pier PR6 Silver P8X Solar Black PJE Pyrite (+\$88) P02 Flint (+\$88) P7B Loft PJW Designer White</p>	<p><b>3rd Option:</b> <b>Pull Option:</b> A Arch B Bevel M Beam O Halo S Square I Integral</p>	<p><b>4th Option:</b> <b>Pull Color (if applicable):</b> M Beam / O Halo PJW Designer White PR6 Silver PJE Pyrite P8X Solar Black AP Arch PRO Anodized Silver P2 upcharge +\$17/pull</p>	<p><b>5th Option:</b> SP Square PJW Designer White EL Matte Silver P02 Flint P7B Loft PJE Pyrite P8X Solar Black P2 upcharge +\$17/pull</p>
	<p>TF</p>	<p>PR6</p>	<p>A</p>	<p>PJW</p>	<p>SP</p>
	<p>F</p>	<p>R6</p>	<p> </p>	<p> </p>	<p> </p>

Continued below ▼

<p><b>5th Option:</b> <b>Paint Case:</b> P1 P2 P3 See page 28 for finishes. P2 upcharge \$55 P3 upcharge \$131</p>	<p><b>6th Option:</b> <b>Paint Fronts:</b> NA Match Case P1 \$246 P2 \$322 P3 \$393</p>	<p><b>7th Option:</b> <b>Paint Shelf:</b> Specify "NA" for shelf color to match case color; or specify a different color and add \$0 for P1, \$17 for P2, or \$39 for P3.</p>	<p><b>8th Option:</b> <b>Lock:</b> L Standard Lock X Omit Lock Core (Deduct \$20 per lock) E Digital Lock (Add \$409 per lock) See page 23 for specification information.</p>	<p><b>9th Option:</b> <b>Digital Lock Color (if applicable):</b> BNL Brushed Nickel</p>
<p>P       .</p>	<p>NA   .</p>	<p>      .</p>	<p>      .</p>	<p>      .</p>

Example: YPCF226018LBFOM.TFPR6.APR0.PJW.NA.P7B.L

METAL STORAGE

# Align™ Metal Storage

22"H Credenzas

For specification information see pages 29-34 and 37-40.

Laminate Fronts Footed

GSA SIN 33721

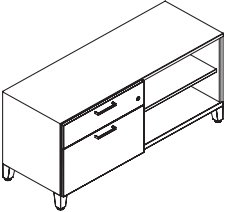

Description	Model	Base List Price L1
<b>22"H Box/Lateral w/Laminate Fronts and Right Open w/Metal Shelf</b>		
42" W x 18" D	YPCF224218RBFOL	\$ 3727
42" W x 24" D	YPCF224224RBFOL	\$ 3968
48" W x 18" D	YPCF224818RBFOL (shown)	\$ 3834
48" W x 24" D	YPCF224824RBFOL	\$ 4082
60" W x 18" D	YPCF226018RBFOL	\$ 4119
60" W x 24" D	YPCF226024RBFOL	\$ 4385
72" W x 18" D	YPCF227218RBFOL	\$ 4513
72" W x 24" D	YPCF227224RBFOL	\$ 4808

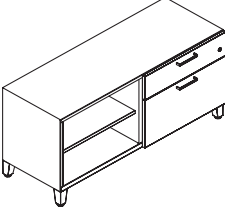

Description	Model	Base List Price L1
<b>22"H Left Open w/Metal Shelf and Box/Lateral w/Laminate Fronts</b>		
42" W x 18" D	YPCF224218LBFOL	\$ 3727
42" W x 24" D	YPCF224224LBFOL	\$ 3968
48" W x 18" D	YPCF224818LBFOL (shown)	\$ 3834
48" W x 24" D	YPCF224824LBFOL	\$ 4082
60" W x 18" D	YPCF226018LBFOL	\$ 4119
60" W x 24" D	YPCF226024LBFOL	\$ 4385
72" W x 18" D	YPCF227218LBFOL	\$ 4513
72" W x 24" D	YPCF227224LBFOL	\$ 4808

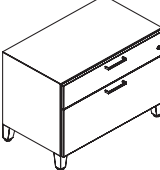

Description	Model	Base List Price L1
<b>22"H Box/Lateral w/Laminate Fronts</b>		
24" W x 18" D	YPCF222418BFL	\$ 2627
24" W x 24" D	YPCF222424BFL	\$ 2797
30" W x 18" D	YPCF223018BFL (shown)	\$ 2707
30" W x 24" D	YPCF223024BFL	\$ 2885
36" W x 18" D	YPCF223618BFL	\$ 3020
36" W x 24" D	YPCF223624BFL	\$ 3213
42" W x 18" D	YPCF224218BFL	\$ 3296
42" W x 24" D	YPCF224224BFL	\$ 3507

**How to specify —**

Select the Model Number from above.

Y P C

**1st Option:**

**Base Option:**

**TF** Terrace Foot  
**ZF** Stride Foot (+\$82)  
**PF** Pier Foot (+\$126)

F

**2nd Option:**

**Foot Finish:**

**Terrace, Stride**  
**PR6** Silver  
  
**Pier**  
**PR6** Silver  
**P8X** Solar Black  
**PJE** Pyrite (+\$88)  
**P02** Flint (+\$88)  
**P7B** Loft  
**PJW** Designer White

P R 6

**3rd Option:**

**Pull Option:**

**A** Arch  
**M** Beam  
**O** Halo  
**S** Square

**4th Option:**

**Pull Color (if applicable):**

**M** Beam / **O** Halo  
**PJW** Designer White  
**PR6** Silver  
**PJE** Pyrite  
**P8X** Solar Black  
**AP** Arch  
**PRO** Anodized Silver  
P2 upcharge +\$17/pull

**SP** Square  
**PJW** Designer White  
**EL** Matte Silver  
**P02** Flint  
**P7B** Loft  
**PJE** Pyrite  
**P8X** Solar Black  
P2 upcharge +\$17/pull

Continued below ▼

**5th Option:**

**Paint Case:**

P1 P2 P3

See page 28 for finishes.  
P2 upcharge \$55  
P3 upcharge \$131

P

**6th Option:**

**Laminate Fronts: Laminate & Edge:**

See page 28 for finishes.  
L2 upcharge \$109  
L3 upcharge \$218

**7th Option:**

**Paint Shelf:**

Specify "NA" for shelf color to match case color; or specify a different color and add \$0 for P1, \$17 for P2, or \$39 for P3.

**8th Option:**

**Lock:**

**L** Standard Lock  
**X** Omit Lock Core (Deduct \$20 per lock)  
**E** Digital Lock (Add \$409 per lock)  
See page 23 for specification information.

**9th Option:**

**Digital Lock Color (if applicable):**

**BNL** Brushed Nickel

*Example:* YPCF226018LBFOL.TFPR6.APRO.P7B.LVT1VT.P7B.L

	Description	Model	Base List Price
	<b>Footed, Metal Front Integrated HAT Combo Unit Credenzas</b>		
	22"H x 48"W x 18"D	YPCF224818RBFOMHAT (shown)	\$ 3434
	22"H x 60"W x 18"D	YPCF226018RBFOMHAT	\$ 3639
	22"H x 72"W x 18"D	YPCF227218RBFOMHAT	\$ 3977
	22"H x 48"W x 18"D	YPCF224818LBFOMHAT (shown)	\$ 3434
	22"H x 60"W x 18"D	YPCF226018LBFOMHAT	\$ 3639
	22"H x 72"W x 18"D	YPCF227218LBFOMHAT	\$ 3977
	<b>Footed, Metal Front Low Credenza Box / Open Bottom</b>		
	22"H x 24"W x 18"D	YPCF222418BOM (shown)	\$ 1956
	22"H x 30"W x 18"D	YPCF223018BOM	\$ 1991
	22"H x 36"W x 18"D	YPCF223618BOM	\$ 2197
	22"H x 42"W x 18"D	YPCF224218BOM	\$ 2403
	<b>Footed, Metal Front Combo Unit Credenzas w/ Open Shelf</b>		
	22"H x 36"W x 18"D	YPCF223618RBFOM (shown)	\$ 2782
	22"H x 36"W x 18"D	YPCF223618LBFOM	\$ 2782
	<b>Footed, Metal Front Low Credenza Open / File Drawer Bottom</b>		
	22"H x 24"W x 18"D	YPCF222418OFM	\$ 2072
	22"H x 30"W x 18"D	YPCF223018OFM	\$ 2110
	22"H x 36"W x 18"D	YPCF223618OFM	\$ 2327
	22"H x 42"W x 18"D	YPCF224218OFM (shown)	\$ 2546
	<b>Footed, Metal Front, Open/File Drawer Bottom</b>		
	28"H x 30"W x 18"D	YPLF283018OFM	\$ 1976
	28"H x 36"W x 18"D	YPLF283618OFM (shown)	\$ 1822
	28"H x 42"W x 18"D	YPLF284218OFM	\$ 1666

**Notes:** For use with A6 2-stage C and T bases, 24"D or 30"D.  
**Install Tip:** will not accommodate pre-drilled Altitude A6 top locations in captured panel systems setups due to offset position in credenza and will require field location from Credenza leg to bottom of top.  
 Recommended to use vertical fabric wire manager model FBRZPWM to manage cords from worksurface to inside credenza through grommet opening. See page 52.8.

<p><b>How to specify —</b> Select the Model Number from above.</p> <p>Y P C               .</p>	<p><b>1st Option:</b> <b>Base Option:</b></p> <p>TF Terrace Foot                  ZF Stride Foot (+\$82)                  PF Pier Foot (+\$126)</p>	<p><b>2nd Option:</b> <b>Foot Finish:</b></p> <p>Terrace, Stride                  PR6 Silver</p> <p>Pier                  PR6 Silver                  P8X Solar Black                  PJE Pyrite (+\$88)                  P02 Flint (+\$88)                  P7B Loft                  PJW Designer White</p>	<p><b>3rd Option:</b> <b>Pull Option:</b></p> <p>A Arch                  B Bevel                  M Beam                  O Halo                  S Square                  I Integral</p>	<p><b>4th Option:</b> <b>Pull Color (if applicable):</b></p> <p>M Beam / O Halo                  PJW Designer White                  PR6 Silver                  PJE Pyrite                  P8X Solar Black                  AP Arch                  PR0 Anodized Silver                  P2 upcharge +\$17/pull</p> <p>SP Square                  PJW Designer White                  EL Matte Silver                  P02 Flint                  P7B Loft                  PJE Pyrite                  P8X Solar Black                  P2 upcharge +\$17/pull</p>
	<p>P         .</p>	<p>F     .</p>	<p>P       .</p>	<p>      .</p>

Continued below ▼

<p><b>5th Option:</b> <b>Paint Case:</b></p> <p>P1 P2 P3                  See page 28 for finishes.                  P2 upcharge \$55                  P3 upcharge \$131</p>	<p><b>6th Option:</b> <b>Paint Fronts:</b></p> <p>NA Match Case                  P1 \$246                  P2 \$322                  P3 \$393</p>	<p><b>7th Option:</b> <b>Paint Shelf:</b></p> <p>Specify "NA" for shelf color to match case color; or specify a different color and add \$0 for P1, \$17 for P2, or \$39 for P3.                  Not needed on models ending in OFM</p>	<p><b>8th Option:</b> <b>Lock:</b></p> <p>L Standard Lock                  X Omit Lock Core (Deduct \$20 per lock)                  E Digital Lock (Add \$409 per lock)                  See page 23 for specification information.</p>	<p><b>9th Option:</b> <b>Digital Lock Color (if applicable):</b></p> <p>BNL Brushed Nickel</p>
<p>P         .</p>	<p>        .</p>	<p>        .</p>	<p>        .</p>	<p>        .</p>

**Example:** YPCF222418OFM.PFPJE.APR0.P27.PJW.PJW.EBNL

	Description	Model	List Price
	<b>Plinth, Metal Front Integrated HAT Combo Unit Credenzas</b>		
	22"H x 48"W x 18"D	YPCP224818RBFOMHAT (shown)	\$ 3434
	22"H x 60"W x 18"D	YPCP226018RBFOMHAT	\$ 3639
	22"H x 72"W x 18"D	YPCP227218RBFOMHAT	\$ 3977
	22"H x 48"W x 18"D	YPCP224818LBFOMHAT (shown)	\$ 3434
	22"H x 60"W x 18"D	YPCP226018LBFOMHAT	\$ 3639
	<b>Plinth, Metal Front Low Credenza Box / Open Bottom</b>		
	22"H x 24"W x 18"D	YPCP222418BOM	\$ 1762
	22"H x 30"W x 18"D	YPCP223018BOM	\$ 1800
	<b>Plinth, Metal Front Low Credenza Open / File Drawer Bottom</b>		
	22"H x 24"W x 18"D	YPCP222418OFM	\$ 1867
	22"H x 30"W x 18"D	YPCP223018OFM	\$ 1907
	<b>Plinth, Metal Front, Open Shelf, File Drawer Bottom Personal File</b>		
	28"H x 30"W x 18"D	YPLP283018OFM	\$ 1697
	28"H x 36"W x 18"D	YPLP283618OFM (shown)	\$ 1882
	<b>Plinth, Metal Front Combo Unit Credenzas w/ Open Shelf</b>		
	22"H x 36"W x 18"D	YPCP223618RBFOM (shown)	\$ 2599
	22"H x 36"W x 18"D	YPCP223618LBFOM	\$ 2599

**Notes:** For use with A6 2-stage C and T bases, 24"D or 30"D.

**Install Tip:** will not accommodate pre-drilled Altitude A6 top locations in captured panel systems setups due to offset position in credenza and will require field location from Credenza leg to bottom of top.

Recommended to use vertical fabric wire manager model FBRZPWM to manage cords from worksurface to inside credenza through grommet opening. See page 52.8.

**Plinth, Metal Front Low Credenza Box / Open Bottom**

22"H x 24"W x 18"D	YPCP222418BOM	\$ 1762
22"H x 30"W x 18"D	YPCP223018BOM	\$ 1800
22"H x 36"W x 18"D	YPCP223618BOM (shown)	\$ 2007
22"H x 42"W x 18"D	YPCP224218BOM	\$ 2213

**Plinth, Metal Front Low Credenza Open / File Drawer Bottom**

22"H x 24"W x 18"D	YPCP222418OFM	\$ 1867
22"H x 30"W x 18"D	YPCP223018OFM	\$ 1907
22"H x 36"W x 18"D	YPCP223618OFM	\$ 2127
22"H x 42"W x 18"D	YPCP224218OFM (shown)	\$ 2344

**Plinth, Metal Front, Open Shelf, File Drawer Bottom Personal File**

28"H x 30"W x 18"D	YPLP283018OFM	\$ 1697
28"H x 36"W x 18"D	YPLP283618OFM (shown)	\$ 1882
28"H x 42"W x 18"D	YPLP284218OFM	\$ 2062

**Note:** Drawers on these 3 models are letter depth.

**Plinth, Metal Front Combo Unit Credenzas w/ Open Shelf**



22"H x 36"W x 18"D	YPCP223618RBFOM (shown)	\$ 2599
22"H x 36"W x 18"D	YPCP223618LBFOM	\$ 2599

METAL STORAGE

How to specify — Select the Model Number from above.	1st Option: Base Option (if applicable):	2nd Option: Pull Option:	3rd Option: Pull Color (if applicable):	4th Option: Paint Case:	5th Option: Paint Fronts:	6th Option: Paint Shelf:	7th Option: Lock:	8th Option: Digital Lock Color (if applicable):
Y P C	BK Flush BX Kickplate BX Recessed BX Kickplate	A Arch B Bevel M Beam O Halo S Square I Integral	M Beam / O Halo PJW Designer White PR6 Silver PJE Pyrite P8X Solar Black AP Arch PRO Anodized Silver SP Square PJW Designer White EL Matte Silver P02 Flint P7B Loft PJE Pyrite P8X Solar Black P2 upcharge +\$17/pull	P1 P2 P3 See inside front cover for finishes. P2 upcharge \$55 P3 upcharge \$131	NA Match Case P1 \$246 P2 \$322 P3 \$393	Specify "NA" for shelf color to match case color; or specify a different color and add \$0 for P1, \$17 for P2, or \$39 for P3. Only needed on model ending in L/RBFOM and L/RBFOMHAT	L Standard Lock X Omit Lock Core (Deduct \$20 per lock) E Digital Lock (Add \$409 per lock) See page 23 for specification information.	BNL Brushed Nickel
.	B     .		.	P       .	.	.		

Example: YPCP222418BOM.BX.APR0.PJW.NA.P7B.L

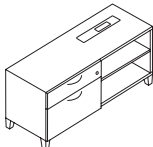
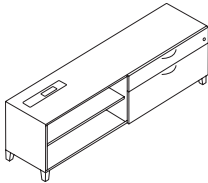

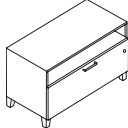
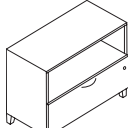
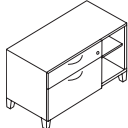
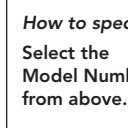
	Description	Model	Base List Price L1
	<b>Footed, Laminate Front Integrated HAT Combo Unit Credenzas</b>		
	22"H x 48"W x 18"D	YPCF224818RBFOLHAT (shown)	\$ 3986
	22"H x 60"W x 18"D	YPCF226018RBFOLHAT	\$ 4283
	22"H x 72"W x 18"D	YPCF227218RBFOLHAT	\$ 4696
	22"H x 48"W x 18"D	YPCF224818LBFOLHAT	\$ 3986
	22"H x 60"W x 18"D	YPCF226018LBFOLHAT	\$ 4283
	22"H x 72"W x 18"D	YPCF227218LBFOLHAT (shown)	\$ 4696
	<b>Notes:</b> For use with A6 2-sage C and T bases, 24"D or 30"D.		
	Install Tip: will not accommodate pre-drilled Altitude A6 top locations in captured panel systems setups due to offset position in credenza and will require field location from Credenza leg to bottom of top. Recommended to use vertical fabric wire manager model FBRZPWM to manage cords from work surface to inside credenza through grommet opening. See page 52.8.		
	<b>Footed, Laminate Front Low Credenza Open / File Drawer Bottom</b>		
	22"H x 24"W x 18"D	YPCF222418BOL	\$ 2213
	22"H x 30"W x 18"D	YPCF223018BOL	\$ 2281
	22"H x 36"W x 18"D	YPCF223618BOL (shown)	\$ 2548
	22"H x 42"W x 18"D	YPCF224218BOL	\$ 2782
	<b>Footed, Laminate Front Low Credenza Box / Open Bottom</b>		
	22"H x 24"W x 18"D	YPCF222418OFL	\$ 2344
	22"H x 30"W x 18"D	YPCF223018OFL	\$ 2416
	22"H x 36"W x 18"D	YPCF223618OFL (shown)	\$ 2698
	22"H x 42"W x 18"D	YPCF224218OFL	\$ 2947
	<b>Footed, Laminate Front, Open Shelf, File Drawer Bottom Personal File</b>		
	28"H x 30"W x 18"D	YPLF283018OFL	\$ 2073
	28"H x 36"W x 18"D	YPLF283618OFL (shown)	\$ 2285
	28"H x 42"W x 18"D	YPLF284218OFL	\$ 2481
	<b>Footed, Laminate Front Combo Unit Credenzas w/ Open Shelf</b>		
	22"H x 36"W x 18"D	YPCF223618RBFOL (shown)	\$ 3033
	22"H x 36"W x 18"D	YPCF223618LBFOL	\$ 3033

How to specify — Select the Model Number from above.	1st Option: Base Option:	2nd Option: Foot Finish:	3rd Option: Pull Option:	4th Option: Pull Color (if applicable):
Y P	TF Terrace Foot ZF Stride Foot (+\$82) PF Pier Foot (+\$126)	Terrace, Stride PR6 Silver  Pier PR6 Silver P8X Solar Black PJE Pyrite (+\$88) P02 Flint (+\$88) P7B Loft PJW Designer White	A Arch M Beam O Halo S Square	M Beam / O Halo PJW Designer White PR6 Silver PJE Pyrite (+\$30) P8X Solar Black (+\$30) A Arch PR0 Anodized Silver
	F	P		S Square PJW Designer White EL Matte Silver P02 Flint P7B Loft PJE Pyrite (+\$30) P8X Solar Black (+\$30)

Continued below ▼

<b>5th Option: Paint Case:</b> P1 P2 P3 See page 28 for finishes. P2 upcharge \$55 P3 upcharge \$131	<b>6th Option: Laminate Fronts: Laminate &amp; Edge:</b> See page 28 for finishes. L2 upcharge \$109 L3 upcharge \$218	<b>7th Option: Paint Shelf:</b> Specify "NA" for shelf color to match case color; or specify a different color and add \$0 for P1, \$17 for P2, or \$39 for P3.  Only needed on products ending in FOL/FOLHAT	<b>8th Option: Lock:</b> L Standard Lock X Omit Lock Core (Deduct \$20 per lock) E Digital Lock (Add \$409 per lock) See page 23 for specification information.	<b>9th Option: Digital Lock Color (if applicable):</b> BNL Brushed Nickel
P				

Example: YPLF283018OFL.PFPJE.APR0.P27.P.NA.EBNL

# Align™ Metal Storage

Credenzas

For specification information see pages 29-34 and 37-40.

Laminate Fronts with Plinth Base

Open Market

Description	Model	Base List Price L1
<b>Plinth, Laminate Front Integrated HAT Combo Unit Credenzas</b>		
22"H x 48"W x 18"D	YPCP224818RBFOLHAT (shown)	\$ 3752
22"H x 60"W x 18"D	YPCP226018RBFOLHAT	\$ 3995
22"H x 72"W x 18"D	YPCP227218RBFOLHAT	\$ 4407
<hr/>		
22"H x 48"W x 18"D	YPCP224818LBFOLHAT (shown)	\$ 3752
22"H x 60"W x 18"D	YPCP226018LBFOLHAT	\$ 3995
22"H x 72"W x 18"D	YPCP227218LBFOLHAT	\$ 4407
<b>Notes:</b> For use with A6 2-stage C and T bases, 24"D or 30"D. Install Tip: will not accommodate pre-drilled Altitude A6 top locations in captured panel systems setups due to offset position in credenza and will require field location from Credenza leg to bottom of top. Recommended to use vertical fabric wire manager model FBRZPWM to manage cords from worksurface to inside credenza through grommet opening. See page 52.8.		
<hr/>		
<b>Plinth, Laminate Front Low Credenza Box / Open Bottom</b>		
22"H x 36"W x 18"D	YPCP223618RBFOL (shown)	\$ 2848
22"H x 36"W x 18"D	YPCP223618LBFOL	\$ 2848
<hr/>		
<b>Plinth, Laminate Front Low Credenza Box / Open Bottom</b>		
22"H x 24"W x 18"D	YPCP222418BOL	\$ 2025
22"H x 30"W x 18"D	YPCP223018BOL (shown)	\$ 2092
22"H x 36"W x 18"D	YPCP223618BOL	\$ 2358
22"H x 42"W x 18"D	YPCP224218BOL	\$ 2593
<hr/>		
<b>Plinth, Laminate Front Low Credenza Open / File Drawer Bottom</b>		
22"H x 24"W x 18"D	YPCP222418OFL	\$ 2145
22"H x 30"W x 18"D	YPCP223018OFL (shown)	\$ 2216
22"H x 36"W x 18"D	YPCP223618OFL	\$ 2497
22"H x 42"W x 18"D	YPCP224218OFL	\$ 2746
<hr/>		
<b>Plinth, Laminate Front, Open Shelf, File Drawer Bottom Personal File</b>		
28"H x 30"W x 18"D	YPLP283018OFL	\$ 1885
28"H x 36"W x 18"D	YPLP283618OFL (shown)	\$ 2097
28"H x 42"W x 18"D	YPLP284218OFL	\$ 2295

**Note:** Drawers on these 3 models are letter depth.

<b>How to specify —</b> Select the Model Number from above.  Y P                     .	<b>1st Option:</b> <b>Base Option</b> (if applicable): BX Recessed Kickplate	<b>2nd Option:</b> <b>Pull Option:</b> A Arch M Beam O Halo S Square	<b>3rd Option:</b> <b>Pull Color (if applicable):</b> M Beam / O Halo PJW Designer White PR6 Silver PJE Pyrite (+\$30) P8X Solar Black (+\$30) A Arch PRO Anodized Silver S Square PJW Designer White EL Matte Silver P02 Flint P7B Loft PJE Pyrite (+\$30) P8X Solar Black (+\$30)
	B X                     .	.	.

Continued below ▼

<b>4th Option:</b> <b>Paint Case:</b> P1 P2 P3 See page 28 for finishes. P2 upcharge \$55 P3 upcharge \$131  P           .	<b>5th Option:</b> <b>Laminate Fronts:</b> <b>Laminate &amp; Edge:</b> See page 28 for finishes. L2 upcharge \$109 L3 upcharge \$218            .	<b>6th Option:</b> <b>Paint Shelf:</b> Specify "NA" for shelf color to match case color; or specify a different color and add \$0 for P1, \$17 for P2, or \$39 for P3.  Only available on models ending in FOL/FOLHAT            .	<b>7th Option:</b> <b>Lock:</b> L Standard Lock X Omit Lock Core (Deduct \$20 per lock) E Digital Lock (Add \$409 per lock) See page 23 for specification information.            .	<b>8th Option:</b> <b>Digital Lock Color (if applicable):</b> BNL Brushed Nickel            .
---	--	--	--	---

**Example:** YPCP222418BOL.BXA.PRO.P27.P.NA.EBNL

METAL STORAGE

# Align™ Metal Storage

For specification information see pages 29-34 and 37-40.

Open Market

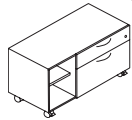
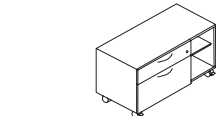
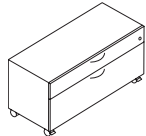
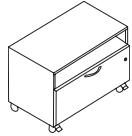
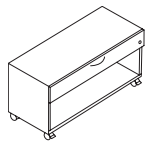

Description	Model	P1 Paint List Price
<b>Mobile, Metal Front Low Credenza Box / Open Bottom</b>		
22"H x 24"W x 18"D	YPCM222418BOM	\$ 2166
22"H x 30"W x 18"D	YPCM223018BOM	\$ 2201
22"H x 36"W x 18"D	YPCM223618BOM	\$ 2407
22"H x 42"W x 18"D	YPCM224218BOM (shown)	\$ 2613
<b>Mobile Laminate Front Low Credenza Box / Open Bottom</b>		
22"H x 24"W x 18"D	YPCM222418OFM	\$ 2397
22"H x 30"W x 18"D	YPCM223018OFM	\$ 2438
22"H x 36"W x 18"D	YPCM223618OFM (shown)	\$ 2665
22"H x 42"W x 18"D	YPCM224218OFM	\$ 2896
<b>Mobile, Metal Front Low Credenza Box/ File Drawer</b>		
22"H x 24"W x 18"D	YPCM222418BFM	\$ 2515
22"H x 30"W x 18"D	YPCM223018BFM	\$ 2558
22"H x 36"W x 18"D	YPCM223618BFM	\$ 2799
22"H x 42"W x 18"D	YPCM224218BFM (shown)	\$ 3042
<b>Mobile, Metal Front Combo Unit Credenzas w/ Open Shelf</b>		
22"H x 36"W x 18"D	YPCM223618RBFOM (shown)	\$ 2877
22"H x 42"W x 18"D	YPCM224218RBFOM	\$ 3138
22"H x 36"W x 18"D	YPCM223618LBFOM (shown)	\$ 2877
22"H x 42"W x 18"D	YPCM224218LBFOM	\$ 3138

<b>How to specify —</b> <b>Select the Model Number from above.</b>	<b>1st Option:</b> <b>Casters:</b> H Hard Casters	<b>2nd Option:</b> <b>Pull Option:</b> A Arch B Bevel M Beam O Halo S Square I Integral	<b>3rd Option:</b> <b>Pull Color (if applicable):</b> M Beam / O Halo P <sup>JW</sup> Designer White P <sup>R6</sup> Silver P <sup>JE</sup> Pyrite P <sup>8X</sup> Solar Black AP Arch P <sup>RO</sup> Anodized Silver P2 upcharge +\$17/pull	SP Square P <sup>JW</sup> Designer White EL Matte Silver P <sup>02</sup> Flint P <sup>7B</sup> Loft P <sup>JE</sup> Pyrite P <sup>8X</sup> Solar Black P2 upcharge +\$17/pull
	<b>4th Option:</b> <b>Paint Case:</b> P <sup>1</sup> P <sup>2</sup> P <sup>3</sup> See page 28 for finishes. P2 upcharge \$55 P3 upcharge \$131	<b>5th Option:</b> <b>Paint Fronts:</b> NA Match Case P <sup>1</sup> \$246 P <sup>2</sup> \$322 P <sup>3</sup> \$393	<b>6th Option:</b> <b>Paint Shelf:</b> Specify "NA" for shelf color to match case color; or specify a different color and add \$0 for P1, \$17 for P2, or \$39 for P3.  Only available on options ending in RBFOM/LBFOM	<b>7th Option:</b> <b>Lock:</b> L Standard Lock X Omit Lock Core (Deduct \$20 per lock) E Digital Lock (Add \$409 per lock) See page 23 for specification information.

Continued below ▼

Example: YPCM222418BFM.H.AP<sup>RO</sup>.P27.NA.NA.EBNL

# Align™ Metal Storage

For specification information see pages [29-34](#) and [37-40](#).

22"H Pedestal

Laminate Fronts Mobile

Open Market

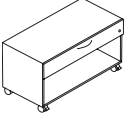
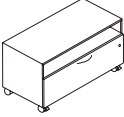
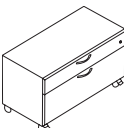
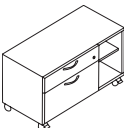
	Description	Model	Base List Price L1
	<b>Mobile Laminate Front Low Credenza Box / Open Bottom</b>		
	22"H x 24"W x 18"D	YPCM222418BOL	\$ 2423
	22"H x 30"W x 18"D	YPCM223018BOL	\$ 2491
	22"H x 36"W x 18"D	YPCM223618BOL (shown)	\$ 2758
	22"H x 42"W x 18"D	YPCM224218BOL	\$ 2992
	<b>Mobile, Laminate Front Low Credenza Open / File Drawer Bottom</b>		
	22"H x 24"W x 18"D	YPCM222418OFL	\$ 2555
	22"H x 30"W x 18"D	YPCM223018OFL	\$ 2628
	22"H x 36"W x 18"D	YPCM223618OFL (shown)	\$ 2909
	22"H x 42"W x 18"D	YPCM224218OFL	\$ 3159
	<b>Mobile, Laminate Front Low Credenza Box / File Drawer</b>		
	22"H x 24"W x 18"D	YPCM222418BFL	\$ 2818
	22"H x 30"W x 18"D	YPCM223018BFL	\$ 2899
	22"H x 36"W x 18"D	YPCM223618BFL (shown)	\$ 3212
	22"H x 42"W x 18"D	YPCM224218BFL	\$ 3489
	<b>Mobile, Laminate Front Combo Unit Credenzas w/ Open Shelf</b>		
	22"H x 36"W x 18"D	YPCM223618RBFOL (shown)	\$ 3128
	22"H x 42"W x 18"D	YPCM224218RBFOL	\$ 3410
	22"H x 36"W x 18"D	YPCM223618LBFOL	\$ 3128
	22"H x 42"W x 18"D	YPCM224218LBFOL	\$ 3410

METAL STORAGE

<p><b>How to specify —</b> Select the Model Number from above.</p> <p>Y P C                 . H   .</p>	<p><b>1st Option:</b> <b>Casters:</b> H Hard Casters</p>	<p><b>2nd Option:</b> <b>Pull Option:</b> A Arch M Beam O Halo S Square</p>	<p><b>3rd Option:</b> <b>Pull Color (if applicable):</b> M Beam / O Halo P JW Designer White P R6 Silver P J E Pyrite P 8 X Solar Black A P Arch P R O Anodized Silver P2 upcharge +\$17/pull</p>	<p>SP Square P JW Designer White E L Matte Silver P O2 Flint P 7 B Loft P J E Pyrite P 8 X Solar Black P2 upcharge +\$17/pull</p>
	<p><b>4th Option:</b> <b>Paint Case:</b> P1 P2 P3 See page 28 for finishes. P2 upcharge \$55 P3 upcharge \$131</p> <p>P       .</p>	<p><b>5th Option:</b> <b>Laminate Fronts:</b> <b>Laminate &amp; Edge:</b> See page 28 for finishes. L2 upcharge \$109 L3 upcharge \$218</p> <p>            .</p>	<p><b>6th Option:</b> <b>Paint Shelf:</b> Specify "NA" for shelf color to match case color; or specify a different color and add \$0 for P1, \$17 for P2, or \$39 for P3.</p> <p>      .</p>	<p><b>7th Option:</b> <b>Lock:</b> L Standard Lock X Omit Lock Core (Deduct \$20 per lock) E Digital Lock (Add \$409 per lock) See page 23 for specification information.</p>

Continued below ▼

Example: YPCM222418BFL.H.APRO.P27.P.NA.EBNL

# Align™ Metal Storage

For specification information see pages 29-34 and 37-40.

Open Market

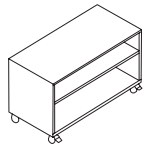

Description	Model	Base List Price L1
<b>Mobile, Open Shelf Credenzas</b>		
22"H x 24"W x 18"D	YPCM222418O	\$ 1924
22"H x 30"W x 18"D	YPCM223018O	\$ 1949
22"H x 36"W x 18"D	YPCM223618O (shown)	\$ 2085
22"H x 42"W x 18"D	YPCM224218O	\$ 2262

<p><b>How to specify —</b> Select the Model Number from above.</p> <p>Y P C  </p> <p>   </p>	<p><b>1st Option:</b> <b>Casters:</b> H Hard Casters</p>	<p><b>2nd Option:</b> <b>Paint Case:</b> P1 P2 P3 See page 28 for finishes. P2 upcharge \$55 P3 upcharge \$131</p>	<p><b>3rd Option:</b> <b>Paint Shelf:</b> Specify "NA" for shelf color to match case color; or specify a different color and add \$0 for P1, \$17 for P2, or \$39 for P3.</p>
	<p><b>Example:</b> YPCM222418O.H.P27.NA</p>		

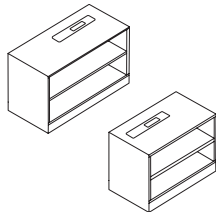

Description	Model	Base List Price L1
<b>Plinth, Integrated HAT Open Shelf Credenzas</b>		
22"H x 30"W x 18"D	YPCP223018ROHAT	\$ 1668
22"H x 36"W x 18"D	YPCP223618ROHAT (shown)	\$ 1820
22"H x 42"W x 18"D	YPCP224218ROHAT	\$ 2012
22"H x 30"W x 18"D	YPCP223018LOHAT (shown)	\$ 1668
22"H x 36"W x 18"D	YPCP223618LOHAT	\$ 1820
22"H x 42"W x 18"D	YPCP224218LOHAT	\$ 2012

<p><b>How to specify —</b> Select the Model Number from above.</p> <p>Y P C  </p> <p>   </p>	<p><b>1st Option:</b> <b>Base Option:</b> BK Flush Plinth BX Recessed Plinth</p>	<p><b>2nd Option:</b> <b>Paint Case:</b> P1 P2 P3 See page 28 for finishes. P2 upcharge \$55 P3 upcharge \$131</p>	<p><b>3rd Option:</b> <b>Paint Shelf:</b> Specify "NA" for shelf color to match case color; or specify a different color and add \$0 for P1, \$17 for P2, or \$39 for P3.</p>
	<p><b>Example:</b> YPCP223018ROHAT.BX.P27.NA</p>		

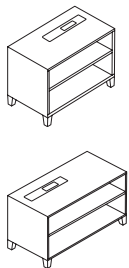

Description	Model	Base List Price L1
<b>Footed, Integrated HAT Open Shelf Credenzas</b>		
22"H x 30"W x 18"D	YPCF223018ROHAT (shown)	\$ 1914
22"H x 36"W x 18"D	YPCF223618ROHAT	\$ 2063
22"H x 42"W x 18"D	YPCF224218ROHAT	\$ 2257
22"H x 36"W x 18"D	YPCF223018LOHAT	\$ 1914
22"H x 36"W x 18"D	YPCF223618LOHAT (shown)	\$ 2063
22"H x 42"W x 18"D	YPCF224218LOHAT	\$ 2257

**Notes:** For use with A6 2-stage C and T bases, 24"D or 30"D.  
 Install Tip: will not accommodate pre-drilled Altitude A6 top locations in captured panel systems setups due to offset position in credenza and will require field location from Credenza leg to bottom of top.  
 Recommended to use vertical fabric wire manager model FBRZPWM to manage cords from worksurface to inside credenza through grommet opening. See page 52.8.

<p><b>How to specify —</b> Select the Model Number from above.</p> <p>Y P C  </p> <p>   </p>	<p><b>1st Option:</b> <b>Base Option:</b> TF Terrace Foot ZF Stride Foot (+\$82) PF Pier Foot (+\$126)</p>	<p><b>2nd Option:</b> <b>Foot Finish:</b> Terrace, Stride PR6 Silver  Pier PR6 Silver P8X Solar Black PJE Pyrite (+\$88) P02 Flint (+\$88) P7B Loft PJW Designer White</p>	<p><b>3rd Option:</b> <b>Paint Case:</b> P1 P2 P3 See page 28 for finishes. P2 upcharge \$55 P3 upcharge \$131</p>	<p><b>4th Option:</b> <b>Paint Shelf:</b> Specify "NA" for shelf color to match case color; or specify a different color and add \$0 for P1, \$17 for P2, or \$39 for P3.</p>
	<p><b>Example:</b> YPCF223018ROHAT.PFPJE.P27.NA</p>			



Description	Model	List Price
Fabric Wire Manager (Pack of 2) *Metal Hook attachments available in black only.	FBRZPWM	\$ 350

*How to specify —*  
Select the Model Number from above.

*1st Option:*  
**Fabric:**  
See page 28.1 for fabrics.

F | B | R | Z | P | W | M | .



*Example:* FBRZPWM.DAPR20

For specification information see pages 37-40.

GSA SIN 33721

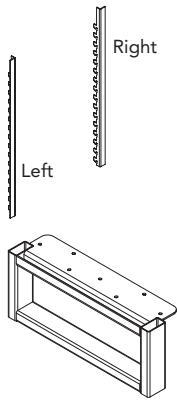

Description	Model	P1 Paint List Price	P2 Paint List Price	P3 Paint List Price
<b>Storage-to-Panel Bracket Kits for 22"H Credenzas</b>				
Left	AP22PBKLH	\$ 167	\$ 184	\$ 200
Right	AP22PBKRH	\$ 167	\$ 184	\$ 200
<b>Worksurface Support Stanchions for use with 22"H Align Credenzas</b>				
12"D x 5"H for use on credenza with laminate top	APOLG0512	\$ 403	\$ 431	\$ 453
12"D x 6"H for use on credenza without laminate top	APOLG0612	\$ 403	\$ 431	\$ 453
18"D x 5"H for use on credenza with laminate top	APOLG0518	\$ 439	\$ 467	\$ 489
18"D x 6"H for use on credenza without laminate top	APOLG0618	\$ 439	\$ 467	\$ 489

<p><b>How to specify —</b> Select the Model Number from above.</p>	<p><i>1st Option:</i> <b>Paint</b> (if applicable): P1 P2 P3</p>	<p><i>1st Option:</i> <b>Key Type</b> (if applicable): X Random X□□□ Number Specified SEQ /□□□ Sequential Keying</p>	<p><i>2nd Option:</i> <b>Quantity of Core Lock Kits</b> (if applicable): See page 330 for details.</p>
<p>Examples: AP22PBKLH.P7B YPCAHR12 YPCACW25 ALKF26EL LKFE4MTS.X202.3</p>	<p> Shippable by small-package carrier.</p>		

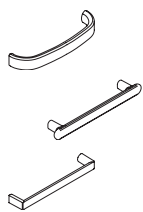

Description	Model	List Price
<b>Pull Packs – Hardware Included</b>		
Align Ped 2 QTY Pull Pack	YPPULL2	\$ 71
Align Ped 3 QTY Pull Pack	YPPULL3	\$ 105
Utilize as retrofit, samples, replacements, etc. Not compatible with Involve Straight Pull Pyrite and Solar Black finish will assume +\$17/per pull upcharge. Ex: YPPULL2.M.P8X +\$34 upcharge		

<p><b>How to specify —</b> Select the Model Number from above.</p>	<p><i>1st Option:</i> <b>Pull Type</b> (if applicable): M Beam O Halo S Square See matrix on page 19.</p>	<p><i>2nd Option:</i> <b>Pull Color</b> (if applicable): <b>M Beam/O Halo</b> PR6 Silver PJW Designer White PJE Pyrite +\$17/pull upcharge P8X Solar +\$17/pull upcharge <b>S Square</b> EL Matte Silver PJW Designer White P02 Flint P7B Loft PJE Pyrite +\$17/pull upcharge P8X Solar Black +\$17/pull upcharge</p>	
<p>Example: YPPULL2.S.PJW</p>	<p> Shippable by small-package carrier.</p>		

For specification information see pages 37-40.

GSA SIN 33721



Description	Model	List Price
<b>Front-to-Back Filing Bar for Credenzas</b>		
12"D Hangrail Kit for 18"D Credenzas and 18"D Personal Files	YPCAHR12	\$ 31
15"D Hangrail Kit for 24"D Credenzas or 18"D 2H Lateral Files	YPCAHR15	\$ 48

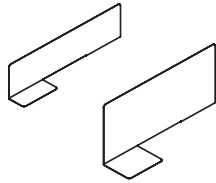

Description	Model	List Price
<b>Dividers for Credenzas</b>		
Box Drawer Dividers — 2 pack	YPCABD02	\$ 72
Box Drawer Dividers — 10 pack	YPCABD10	\$ 288
File Drawer Dividers — 2 pack	YPCAFD02	\$ 88
File Drawer Dividers — 10 pack	YPCAFD10	\$ 341

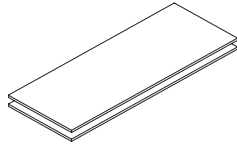

Description	Model	List Price
<b>Counterweight Kits for Align 22"H Credenzas w/Drawers</b>		
25 lbs. for 42"W and 48"W Box/Lateral/Open unit	YPCACW25	\$ 332
35 lbs. for 24"W, 60"W, and 72"W Box/Lateral/Open unit	YPCACW35	\$ 443
50 lbs. for 30"W and 36"W Box/Lateral unit	YPCACW50	\$ 493
65 lbs. for 42"W Box/Lateral unit	YPCACW65	\$ 540

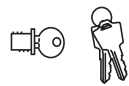

Description	Model	List Price
<b>Matte Silver Removable Lock Core Kit</b> Key Numbers 101E-225E		
Used on Align metal pedestals, credenzas, and towers. Includes one core, two keys, one core removal tool, adapter and instructions.	ALKF26EL	\$ 29

<b>Easy Lock Lock-Core</b> — Reference Appendix page 330 for Easy Lock specification details.		
Lock Core Kit Matte Silver — 1 core, 2 keys	LKFE1MTS	\$ 29
Lock Core Kit Matte Silver — 2 cores, 2 keys	LKFE2MTS	\$ 59
Lock Core Kit Matte Silver — 3 cores, 2 keys	LKFE3MTS	\$ 88
Lock Core Kit Matte Silver — 4 cores, 2 keys	LKFE4MTS	\$ 117
Lock Core Kit Matte Silver — 5 cores, 2 keys	LKFE5MTS	\$ 146
Lock Core Kit Matte Silver — 6 cores, 2 keys	LKFE6MTS (De-emphasized)	\$ 176
Lock Core Kit Matte Silver — 7 cores, 2 keys	LKFE7MTS (De-emphasized)	\$ 205
Lock Core Kit Matte Silver — 8 cores, 2 keys	LKFE8MTS (De-emphasized)	\$ 235

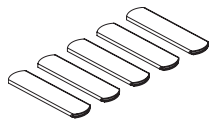

Description	Model	List Price
<b>Magnetic Label Holder (5 Pack)</b>	ASISLABEL5	\$ 36

METAL STORAGE

<p><b>How to specify —</b> Select the Model Number from above.</p>	<p><b>1st Option:</b> <b>Paint</b> (if applicable): P1 P2 P3</p>	<p><b>1st Option:</b> <b>Key Type</b> (if applicable): X Random X□□□ Number Specified SEQ / □□□ Sequential Keying</p>	<p><b>2nd Option:</b> <b>Quantity of Core Lock Kits</b> (if applicable): See page 330 for details.</p>
<p>_____ . P _____</p>			

Examples: AP22PBKLN.P7B YPCAHR12 YPCACW25  
ALKF26EL LKFE4MTS.X202.3

Shippable by small-package carrier.



For specification information see pages 37-40.

GSA SIN 33721

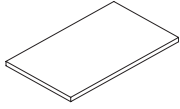

Description	Model	List Price											
		Grade 1	Grade 2	Grade 3	Grade 4	Grade 5	Grade 6	Grade 7	Grade 8	Grade L1	Grade L2		
<b>Credenza Cushions for 18"D Credenzas</b>													
24"W	[S] K5CT1824SC	\$ 396	\$ 425	\$ 453	\$ 482	\$ 520	\$ 558	\$ 596	\$ 633	\$ 613	\$ 768		
30"W	[S] K5CT1830SC	\$ 427	\$ 456	\$ 484	\$ 513	\$ 551	\$ 589	\$ 627	\$ 664	\$ 644	\$ 799		
36"W	K5CT1836SC	\$ 481	\$ 510	\$ 538	\$ 567	\$ 605	\$ 643	\$ 681	\$ 718	\$ 698	\$ 853		
42"W	K5CT1842SC	\$ 479	\$ 508	\$ 536	\$ 565	\$ 603	\$ 641	\$ 679	\$ 716	\$ 696	\$ 851		
48"W	K5CT1848SC	\$ 496	\$ 525	\$ 553	\$ 582	\$ 620	\$ 658	\$ 696	\$ 733	\$ 713	\$ 868		

COM Yardage: 0.7 yards (no vinyls), COL 7 sq.ft.

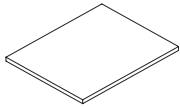

Description	Model	List Price											
		Grade 1	Grade 2	Grade 3	Grade 4	Grade 5	Grade 6	Grade 7	Grade 8	Grade 9	Grade 10	Grade 11	Grade 12
<b>Credenza Cushions for 24"D Credenzas</b>													
24"W	K5CT2424SC	\$ 413	\$ 451	\$ 487	\$ 524	\$ 572	\$ 621	\$ 670	\$ 719	\$ 693	\$ 892		
30"W	K5CT2430SC	\$ 444	\$ 482	\$ 518	\$ 555	\$ 603	\$ 652	\$ 701	\$ 750	\$ 724	\$ 923		
36"W	K5CT2436SC	\$ 481	\$ 519	\$ 555	\$ 592	\$ 640	\$ 689	\$ 738	\$ 787	\$ 761	\$ 960		
48"W	K5CT2448SC	\$ 538	\$ 576	\$ 612	\$ 649	\$ 697	\$ 746	\$ 795	\$ 844	\$ 818	\$ 1017		

COM Yardage: 0.9 yards (no vinyls), COL 8 sq.ft.

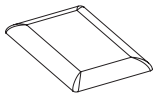

ASPT-24SC

Description	Model	List Price											
		Grade 1	Grade 2	Grade 3	Grade 4	Grade 5	Grade 6	Grade 7	Grade 8	Grade 9	Grade 10	Grade 11	Grade 12
<b>Seat Cushion — For Metal Mobile Pedestals only (Specify seating fabric — no leathers)</b>													
23½"D	ASPT-24SC	\$ 300	\$ 315	\$ 329	\$ 343	\$ 363	\$ 381	\$ 400	\$ 419	\$ 438	\$ 456	\$ 476	\$ 495
29½"D	ASPT-30SC	\$ 313	\$ 328	\$ 342	\$ 356	\$ 376	\$ 394	\$ 413	\$ 432	\$ 451	\$ 469	\$ 489	\$ 508

ASPT- cushions have a rounded corner and the YPPA-cushions have a square corner.

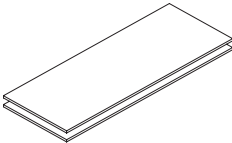

Description	Model	List Price
<b>Counterweight Kits for Align 28"H Lateral and Personal Files</b>		
50 lbs. for 30"W Lateral or Personal File	YPLACW50	\$ 461
57½ lbs. for 36"W Lateral	YPLACW57 [S]	\$ 481
70 lbs. for 42"W Lateral	YPLACW70	\$ 516

METAL STORAGE

<p><b>How to specify —</b> Select the Model Number from above.</p>	<p><i>1st Option:</i> <b>Upholstery</b> (if applicable): Specify seating upholstery. See Seating, Collaboration, and Tables Price List for available upholstery selection.</p>	<p><i>1st Option:</i> <b>Paint</b> (if applicable): P1 P2 P3 P2 upcharge \$66 P3 upcharge \$131</p>
<p>_____ . _____</p>	<p>_____</p>	<p>P _____</p>

Examples: K5CT1824SC.PNS012

[S] Shippable by small-package carrier.

# Align™ Metal Storage

28"H Laterals, Personal Files, and Bookcases

For specification information see pages 30, 34, and 40.

GSA SIN 33721

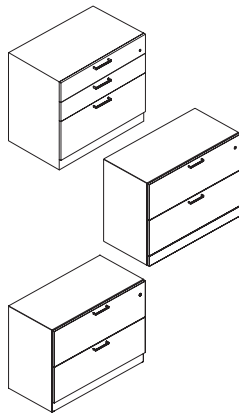

Description	Model	P1 Paint List Price
<b>28"H Metal Case / Metal Fronts</b>		
30"W x 18"D Box/Box/File	YPFCP283018BBFM (shown)	\$ 2157
30"W x 18"D File/File	YPLP283018FFM	\$ 1837
36"W x 18"D File/File	YPLP283618FFM (shown)	\$ 2034
42"W x 18"D File/File	YPLP284218FFM	\$ 2226

Width	Model	Base List Price L1
<b>28"H Metal Case / Laminate Fronts</b>		
30"W x 18"D Box/Box/File	YPFCP283018BBFL	\$ 2631
30"W x 18"D File/File	YPLP283018FFL	\$ 2241
36"W x 18"D File/File	YPLP283618FFL (shown)	\$ 2491
42"W x 18"D File/File	YPLP284218FFL	\$ 2723

**Note:** Laminate front pull selection is limited to Arch, Square, or Straight pulls.

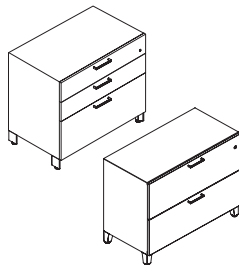

Description	Model	P1 Paint List Price
<b>28"H Metal Case / Metal Fronts / Feet</b>		
30"W x 18"D Box/Box/File	YPFCF283018BBFM (shown)	\$ 2414
30"W x 18"D File/File	YPLF283018FFM	\$ 2058
36"W x 18"D File/File	YPLF283618FFM (shown)	\$ 2251
42"W x 18"D File/File	YPLF284218FFM	\$ 2442

Width	Model	Base List Price L1
<b>28"H Metal Case / Laminate Fronts / Feet</b>		
30"W x 18"D Box/Box/File	YPFCF283018BBFL	\$ 2888
30"W x 18"D File/File	YPLF283018FFL	\$ 2463
36"W x 18"D File/File	YPLF283618FFL (shown)	\$ 2712
42"W x 18"D File/File	YPLF284218FFL	\$ 2942

**Note:** Laminate front pull selection is limited to Arch, Square, or Straight pulls.

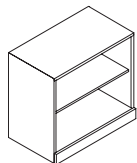

Description	Model	P1 Paint List Price
<b>28"H Bookcase, Metal Case / Plinth</b>		
24"W x 18"D Open Shelf	YPCP282418O	\$ 1371
30"W x 18"D Open Shelf	YPCP283018O	\$ 1487
36"W x 18"D Open Shelf	YPCP283618O	\$ 1622

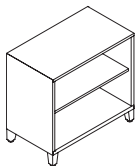

Description	Model	P1 Paint List Price
<b>28"H Bookcase, Metal Case / Feet</b>		
24"W x 18"D Open Shelf	YPCF282418O	\$ 1592
30"W x 18"D Open Shelf	YPCF283018O	\$ 1708
36"W x 18"D Open Shelf	YPCF283618O	\$ 1840

<b>How to specify —</b> Select the Model Number from above.  Y P C <span style="border-bottom: 1px solid black; display: inline-block; width: 20px; height: 10px;"></span> <span style="border-bottom: 1px solid black; display: inline-block; width: 20px; height: 10px;"></span> <span style="border-bottom: 1px solid black; display: inline-block; width: 20px; height: 10px;"></span> <span style="border-bottom: 1px solid black; display: inline-block; width: 20px; height: 10px;"></span> <span style="border-bottom: 1px solid black; display: inline-block; width: 20px; height: 10px;"></span> <span style="border-bottom: 1px solid black; display: inline-block; width: 20px; height: 10px;"></span> <span style="border-bottom: 1px solid black; display: inline-block; width: 20px; height: 10px;"></span> <span style="border-bottom: 1px solid black; display: inline-block; width: 20px; height: 10px;"></span> <span style="border-bottom: 1px solid black; display: inline-block; width: 20px; height: 10px;"></span> <span style="border-bottom: 1px solid black; display: inline-block; width: 20px; height: 10px;"></span> <span style="border-bottom: 1px solid black; display: inline-block; width: 20px; height: 10px;"></span> <span style="border-bottom: 1px solid black; display: inline-block; width: 20px; height: 10px;"></span> <span style="border-bottom: 1px solid black; display: inline-block; width: 20px; height: 10px;"></span> <span style="border-bottom: 1px solid black; display: inline-block; width: 20px; height: 10px;"></span>	<b>1st Option:</b> <b>Base Option:</b> TF Terrace Foot ZF Stride Foot (+\$82) BK Flush Kickplate BX Recessed Kickplate PF Pier Foot (+\$126)	<b>2nd Option:</b> <b>Foot Finish (if applicable):</b> Terrace, Stride PR6 Silver  Pier PR6 Silver P8X Solar Black PJE Pyrite (+\$88) P02 Flint (+\$88) P7B Loft PJW Designer White	<b>3rd Option:</b> <b>Pull Option:</b> A Arch B Bevel M Beam O Halo S Square I Integral	<b>4th Option:</b> <b>Pull Color (if applicable):</b> M Beam / O Halo PJW Designer White PR6 Silver PJE Pyrite P8X Solar Black AP Arch PRO Anodized Silver P2 upcharge +\$17/pull  SP Square PJW Designer White EL Matte Silver P02 Flint P7B Loft PJE Pyrite P8X Solar Black P2 upcharge +\$17/pull
	. <span style="border: 1px solid black; padding: 2px;">F</span> <span style="border: 1px solid black; padding: 2px;">P</span> <span style="border: 1px solid black; padding: 2px;">R</span> <span style="border: 1px solid black; padding: 2px;">6</span> .	Continued below ▼		

<b>5th Option:</b> <b>Paint Case:</b> P1 P2 P3 See page 28 for finishes. P2 upcharge \$55 P3 upcharge \$131  P <span style="border-bottom: 1px solid black; display: inline-block; width: 20px; height: 10px;"></span> <span style="border-bottom: 1px solid black; display: inline-block; width: 20px; height: 10px;"></span> .	<b>6th Option:</b> <b>Paint Fronts:</b> NA Match Case P1 \$246 P2 \$322 P3 \$393  N <span style="border-bottom: 1px solid black; display: inline-block; width: 20px; height: 10px;"></span> <span style="border-bottom: 1px solid black; display: inline-block; width: 20px; height: 10px;"></span> <span style="border-bottom: 1px solid black; display: inline-block; width: 20px; height: 10px;"></span> .	<b>7th Option:</b> <b>Laminate Fronts (if applicable):</b> <b>Laminate &amp; Edge:</b> See page 28 for finishes. L2 upcharge \$109 L3 upcharge \$218  <span style="border-bottom: 1px solid black; display: inline-block; width: 20px; height: 10px;"></span> <span style="border-bottom: 1px solid black; display: inline-block; width: 20px; height: 10px;"></span> <span style="border-bottom: 1px solid black; display: inline-block; width: 20px; height: 10px;"></span> <span style="border-bottom: 1px solid black; display: inline-block; width: 20px; height: 10px;"></span> .	<b>8th Option:</b> <b>Paint Shelf:</b> Specify "NA" for shelf color to match case color; or specify a different color and add \$0 for P1, \$17 for P2, or \$39 for P3.  <span style="border-bottom: 1px solid black; display: inline-block; width: 20px; height: 10px;"></span> <span style="border-bottom: 1px solid black; display: inline-block; width: 20px; height: 10px;"></span> <span style="border-bottom: 1px solid black; display: inline-block; width: 20px; height: 10px;"></span> .	<b>9th Option:</b> <b>Lock:</b> L Standard Lock X Omit Lock Core (Deduct \$20 per lock) E Digital Lock (Add \$409 per lock) See page 23 for specification information.  <span style="border-bottom: 1px solid black; display: inline-block; width: 20px; height: 10px;"></span> <span style="border-bottom: 1px solid black; display: inline-block; width: 20px; height: 10px;"></span> <span style="border-bottom: 1px solid black; display: inline-block; width: 20px; height: 10px;"></span> .	<b>10th Option:</b> <b>Digital Lock Color (if applicable):</b> BNL Brushed Nickel  <span style="border-bottom: 1px solid black; display: inline-block; width: 20px; height: 10px;"></span> <span style="border-bottom: 1px solid black; display: inline-block; width: 20px; height: 10px;"></span> <span style="border-bottom: 1px solid black; display: inline-block; width: 20px; height: 10px;"></span> .
---	--	--	---	--	--

Example: YPLP283618FFM.BK.B.P8T.NA.X

S Shippable by small-package carrier.

# Align™ Metal Storage

## Front and Side Access Towers

For specification information see pages 31 and 41-42.

Metal Fronts with Plinth Base

GSA SIN 33721

	Description	Model	P1 Paint List Price
	<b>42½"H Personal Towers — 24"W x 24"D – Metal Case/Metal Fronts</b>		
	Wardrobe Left / Door/File/File	YPTP422424LFFM	\$ 3132
	Wardrobe Right / Door/File/File	YPTP422424RFFM	\$ 3132
	Wardrobe Left / Door/Box/Box/File	YPTP422424LBBFM	\$ 3434
	Wardrobe Right / Door/Box/Box/File (shown)	YPTP422424RBBFM	\$ 3434
	<b>50"H Personal Towers — 24"W x 24"D – Metal Case/Metal Fronts</b>		
	Wardrobe Left / Door/File/File (shown)	YPTP502424LFFM	\$ 3242
	Wardrobe Right / Door/File/File	YPTP502424RFFM	\$ 3242
	Wardrobe Left / Door/Box/Box/File	YPTP502424LBBFM	\$ 3541
	Wardrobe Right / Door/Box/Box/File	YPTP502424RBBFM	\$ 3541
	<b>57½"H Personal Towers — 24"W x 24"D – Metal Case/Metal Fronts</b>		
	Wardrobe Left / Door/File/File	YPTP572424LFFM	\$ 3355
Wardrobe Right / Door/File/File (shown)	YPTP572424RFFM	\$ 3355	
Wardrobe Left / Door/Box/Box/File	YPTP572424LBBFM	\$ 3656	
Wardrobe Right / Door/Box/Box/File	YPTP572424RBBFM	\$ 3656	
<b>65"H Personal Towers — 24"W x 24"D – Metal Case/Metal Fronts</b>			
Wardrobe Left / Door/File/File	YPTP652424LFFM	\$ 3472	
Wardrobe Right / Door/File/File	YPTP652424RFFM	\$ 3472	
Wardrobe Left / Door/Box/Box/File (shown)	YPTP652424LBBFM	\$ 3773	
Wardrobe Right / Door/Box/Box/File	YPTP652424RBBFM	\$ 3773	
<b>42½"H Side Access Personal Towers — 24"W x 24"D – Metal Case/Metal Fronts</b>			
Wardrobe Left / File/File	YPTSP422424LFFM	\$ 3433	
Wardrobe Right / File/File (shown)	YPTSP422424RFFM	\$ 3433	
Wardrobe Left / Box/Box/File	YPTSP422424LBBFM	\$ 3732	
Wardrobe Right / Box/Box/File	YPTSP422424RBBFM	\$ 3732	
<b>50"H Side Access Personal Towers — 24"W x 24"D – Metal Case/Metal Fronts</b>			
Wardrobe Left / File/File	YPTSP502424LFFM	\$ 3551	
Wardrobe Right / File/File	YPTSP502424RFFM	\$ 3551	
Wardrobe Left / Box/Box/File	YPTSP502424LBBFM	\$ 3851	
Wardrobe Right / Box/Box/File (shown)	YPTSP502424RBBFM	\$ 3851	
<b>57½"H Side Access Personal Towers — 24"W x 24"D – Metal Case/Metal Fronts</b>			
Wardrobe Left / File/File	YPTSP572424LFFM	\$ 3675	
Wardrobe Right / File/File	YPTSP572424RFFM	\$ 3675	
Wardrobe Left / Box/Box/File	YPTSP572424LBBFM	\$ 3976	
Wardrobe Right / Box/Box/File (shown)	YPTSP572424RBBFM	\$ 3976	
<b>65"H Side Access Personal Towers — 24"W x 24"D – Metal Case/Metal Fronts</b>			
Wardrobe Left / File/File	YPTSP652424LFFM	\$ 3805	
Wardrobe Right / File/File	YPTSP652424RFFM	\$ 3805	
Wardrobe Left / Box/Box/File	YPTSP652424LBBFM	\$ 4105	
Wardrobe Right / Box/Box/File (shown)	YPTSP652424RBBFM	\$ 4105	

How to specify — Select the Model Number from above.	1st Option: Base Option (if applicable):	2nd Option: Pull Option:	3rd Option: Pull Color (if applicable):	4th Option: Paint Case:	5th Option: Paint Fronts:	6th Option: Markerboard Front:	7th Option: Lock:	8th Option: Digital Lock Color (if applicable):
Y   P   T	BK Flush BX Kickplate BX Recessed BX Kickplate	A Arch B Bevel M Beam O Halo S Square I Integral	M Beam / O Halo PJW Designer White PR6 Silver PJE Pyrite P8X Solar Black AP Arch PRO Anodized Silver SP Square PJW Designer White EL Matte Silver P02 Flint P7B Loft PJE Pyrite P8X Solar Black P2 upcharge +\$17/pull	P1 P2 P3 See inside front cover for finishes. P2 upcharge \$109 P3 upcharge \$218	NA Match Case P1 \$246 P2 \$322 P3 \$393	NA No Offered on front panel of side access models only MKB Yes (+\$109) NA No	L Standard Lock X Omit Lock Core (Deduct \$20 per lock) E Digital Lock (Add \$409 per lock) See page 23 for specification information.	BNL Brushed Nickel
Y   P   T	B			P	N   A			

Example: YPTP652424RBBFM.BK.APRO.PJW.NA.L

Shippable by small-package carrier.

For specification information see pages 31 and 41-42.

Laminate Fronts with Plinth Base

GSA SIN 33721

Width	Model	P1 Paint List Price
<b>42½"H Personal Towers — 24"W x 24"D – Metal Case/Laminate Fronts</b>		
Wardrobe Left / Door/File/File	YPTP422424LFFL	\$ 3852
Wardrobe Right / Door/File/File	YPTP422424RFFL	\$ 3852
Wardrobe Left / Door/Box/Box/File	YPTP422424LBBFL	\$ 4224
Wardrobe Right / Door/Box/Box/File (shown)	YPTP422424RBBFL	\$ 4224
<b>50"H Personal Towers — 24"W x 24"D – Metal Case/Laminate Fronts</b>		
Wardrobe Left / Door/File/File (shown)	YPTP502424LFFL	\$ 3986
Wardrobe Right / Door/File/File	YPTP502424RFFL	\$ 3986
Wardrobe Left / Door/Box/Box/File	YPTP502424LBBFL	\$ 4358
Wardrobe Right / Door/Box/Box/File	YPTP502424RBBFL	\$ 4358
<b>57½"H Personal Towers — 24"W x 24"D – Metal Case/Laminate Fronts</b>		
Wardrobe Left / Door/File/File	YPTP572424LFFL	\$ 4127
Wardrobe Right / Door/File/File (shown)	YPTP572424RFFL	\$ 4127
Wardrobe Left / Door/Box/Box/File	YPTP572424LBBFL	\$ 4498
Wardrobe Right / Door/Box/Box/File	YPTP572424RBBFL	\$ 4498
<b>65"H Personal Towers — 24"W x 24"D – Metal Case/Laminate Fronts</b>		
Wardrobe Left / Door/File/File	YPTP652424LFFL	\$ 4272
Wardrobe Right / Door/File/File	YPTP652424RFFL	\$ 4272
Wardrobe Left / Door/Box/Box/File (shown)	YPTP652424LBBFL	\$ 4640
Wardrobe Right / Door/Box/Box/File	YPTP652424RBBFL	\$ 4640
<b>42½"H Side Access Personal Towers — 24"W x 24"D – Metal Case/Laminate Fronts</b>		
Wardrobe Left / File/File	YPTSP422424LFFL	\$ 4221
Wardrobe Right / File/File (shown)	YPTSP422424RFFL	\$ 4221
Wardrobe Left / Box/Box/File	YPTSP422424LBBFL	\$ 4591
Wardrobe Right / Box/Box/File	YPTSP422424RBBFL	\$ 4591
<b>50"H Side Access Personal Towers — 24"W x 24"D – Metal Case/Laminate Fronts</b>		
Wardrobe Left / File/File	YPTSP502424LFFL	\$ 4368
Wardrobe Right / File/File	YPTSP502424RFFL	\$ 4368
Wardrobe Left / Box/Box/File	YPTSP502424LBBFL	\$ 4738
Wardrobe Right / Box/Box/File (shown)	YPTSP502424RBBFL	\$ 4738
<b>57½"H Side Access Personal Towers — 24"W x 24"D – Metal Case/Laminate Fronts</b>		
Wardrobe Left / File/File	YPTSP572424LFFL	\$ 4520
Wardrobe Right / File/File	YPTSP572424RFFL	\$ 4520
Wardrobe Left / Box/Box/File	YPTSP572424LBBFL	\$ 4890
Wardrobe Right / Box/Box/File (shown)	YPTSP572424RBBFL	\$ 4890
<b>65"H Side Access Personal Towers — 24"W x 24"D – Metal Case/Laminate Fronts</b>		
Wardrobe Left / File/File	YPTSP652424LFFL	\$ 4681
Wardrobe Right / File/File	YPTSP652424RFFL	\$ 4681
Wardrobe Left / Box/Box/File	YPTSP652424LBBFL	\$ 5051
Wardrobe Right / Box/Box/File (shown)	YPTSP652424RBBFL	\$ 5051

<p><b>How to specify —</b> Select the Model Number from above.</p> <p>Y P I T . . . . .</p> <p>. . . . .</p> <p>. . . . .</p> <p>. . . . .</p>	<p><b>1st Option:</b> Base Option (if applicable):</p> <p>BX Recessed Kickplate</p>	<p><b>2nd Option:</b> Pull Option:</p> <p>A Arch M Beam O Halo S Square</p>	<p><b>3rd Option:</b> Pull Color (if applicable):</p> <p>M Beam / O Halo PJW Designer White PR6 Silver PJE Pyrite P8X Solar Black AP Arch PRO Anodized Silver SP Square PJW Designer White EL Matte Silver P02 Flint P7B Loft PJE Pyrite P8X Solar Black P2 upcharge +\$17/pull</p>	<p><b>4th Option:</b> Paint Case:</p> <p>P1 P2 P3</p> <p>See page 28 for finishes. P2 upcharge \$109 P3 upcharge \$218</p>	<p><b>5th Option:</b> Laminate Fronts: Laminate &amp; Edge:</p> <p>See page 28 for finishes. L2 upcharge \$164 L3 upcharge \$327</p>	<p><b>6th Option:</b> Lock:</p> <p>L Standard Lock X Omit Lock Core (Deduct \$20 per lock) E Digital Lock (Add \$409 per lock) See page 23 for specification information.</p>	<p><b>7th Option:</b> Digital Lock Color (if applicable):</p> <p>BNL Brushed Nickel</p>
	<p>B X . . . . .</p>	<p>. . . . .</p>	<p>. . . . .</p>	<p>P . . . . .</p>	<p>. . . . .</p>	<p>. . . . .</p>	<p>. . . . .</p>

Example: YPTP652424RBBFL.BK.APRO.PJW.LVT1VT.L

METAL STORAGE

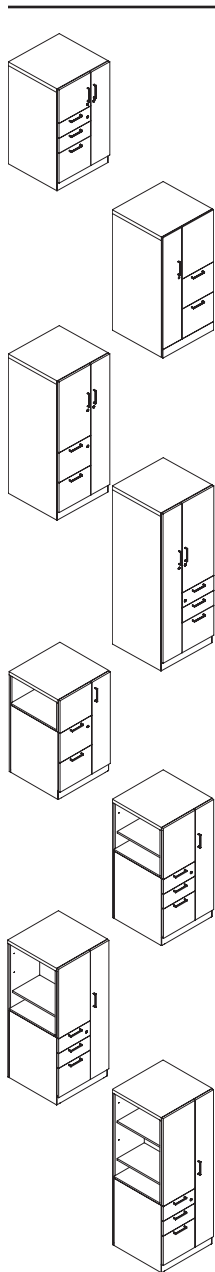

# Align™ Metal Storage

## Front Access Towers

For specification information see pages 31 and 41-42.

Metal Fronts Footed

GSA SIN 33721

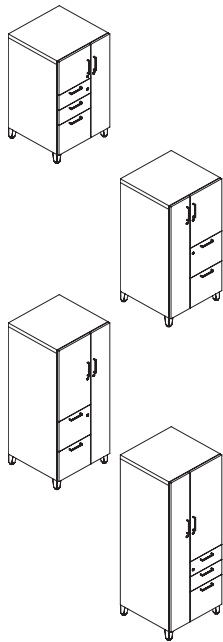

Description	Model	P1 Paint List Price
<b>42½"H Personal Towers — 24"W x 24"D – Metal Case/Metal Fronts</b>		
Wardrobe Left / Door/File/File	YPTF422424LFFM	\$ 3394
Wardrobe Right / Door/File/File	YPTF422424RFFM	\$ 3394
Wardrobe Left / Door/Box/Box/File	YPTF422424LBBFM	\$ 3695
Wardrobe Right / Door/Box/Box/File (shown)	YPTF422424RBBFM	\$ 3695
<b>50"H Personal Towers — 24"W x 24"D – Metal Case/Metal Fronts</b>		
Wardrobe Left / Door/File/File (shown)	YPTF502424LFFM	\$ 3503
Wardrobe Right / Door/File/File	YPTF502424RFFM	\$ 3503
Wardrobe Left / Door/Box/Box/File	YPTF502424LBBFM	\$ 3805
Wardrobe Right / Door/Box/Box/File	YPTF502424RBBFM	\$ 3805
<b>57½"H Personal Towers — 24"W x 24"D – Metal Case/Metal Fronts</b>		
Wardrobe Left / Door/File/File	YPTF572424LFFM	\$ 3618
Wardrobe Right / Door/File/File (shown)	YPTF572424RFFM	\$ 3618
Wardrobe Left / Door/Box/Box/File	YPTF572424LBBFM	\$ 3918
Wardrobe Right / Door/Box/Box/File	YPTF572424RBBFM	\$ 3918
<b>65"H Personal Towers — 24"W x 24"D – Metal Case/Metal Fronts</b>		
Wardrobe Left / Door/File/File	YPTF652424LFFM	\$ 3735
Wardrobe Right / Door/File/File	YPTF652424RFFM	\$ 3735
Wardrobe Left / Door/Box/Box/File (shown)	YPTF652424LBBFM	\$ 4037
Wardrobe Right / Door/Box/Box/File	YPTF652424RBBFM	\$ 4037

<p><b>How to specify —</b> Select the Model Number from above.</p> <p>Y P T F</p>	<p><b>1st Option:</b> <b>Base Option:</b> TF Terrace Foot ZF Stride Foot (+\$82) PF Pier Foot (+\$126)</p>	<p><b>2nd Option:</b> <b>Foot Finish:</b> Terrace, Stride PR6 Silver  Pier PR6 Silver P8X Solar Black PJE Pyrite (+\$88) P02 Flint (+\$88) P7B Loft P JW Designer White</p>	<p><b>3rd Option:</b> <b>Pull Option:</b> A Arch B Bevel M Beam O Halo S Square I Integral</p>	<p><b>4th Option:</b> <b>Pull Color (if applicable):</b> M Beam / O Halo P JW Designer White PR6 Silver PJE Pyrite P8X Solar Black AP Arch PRO Anodized Silver P2 upcharge +\$17/pull  SP Square P JW Designer White EL Matte Silver P02 Flint P7B Loft PJE Pyrite P8X Solar Black P2 upcharge +\$17/pull</p>
	<p>_____ .</p>	<p>_____ F _____ .</p>	<p>_____ P R 6 _____ .</p>	<p>_____ .</p>

Continued below ▼

<p><b>5th Option:</b> <b>Paint Case:</b> P1 P2 P3 See inside front cover for finishes. P2 upcharge \$109 P3 upcharge \$218</p>	<p><b>6th Option:</b> <b>Paint Fronts:</b> NA Match Case P1 \$246 P2 \$322 P3 \$393</p>	<p><b>7th Option:</b> <b>Markerboard Front:</b> Offered on front panel of side access models only MKB Yes (+\$109) NA No</p>	<p><b>8th Option:</b> <b>Lock:</b> L Standard Lock X Omit Lock Core (Deduct \$20 per lock) E Digital Lock (Add \$409 per lock) See page 23 for specification information.</p>	<p><b>9th Option:</b> <b>Digital Lock Color (if applicable):</b> BNL Brushed Nickel</p>
<p>P _____ .</p>	<p>NA _____ .</p>	<p>_____ .</p>	<p>_____ .</p>	<p>_____ .</p>

Example: YPTF652424RBBFM.TFPR6.APRO.P JW.NA.X

# Align™ Metal Storage

## Side Access Towers

For specification information see pages 31 and 41-42.

Metal Fronts Footed

GSA SIN 33721

Description	Model	P1 Paint List Price
<b>42½"H Side Access Personal Towers — 24"W x 24"D – Metal Case/Metal Fronts</b>		
Wardrobe Left / File/File	YPTSF422424LFFM	\$ 3694
Wardrobe Right / File/File (shown)	YPTSF422424RFFM	\$ 3694
Wardrobe Left / Box/Box/File	YPTSF422424LBBFM	\$ 3995
Wardrobe Right / Box/Box/File	YPTSF422424RBBFM	\$ 3995
<b>50"H Side Access Personal Towers — 24"W x 24"D – Metal Case/Metal Fronts</b>		
Wardrobe Left / File/File	YPTSF502424LFFM	\$ 3813
Wardrobe Right / File/File	YPTSF502424RFFM	\$ 3813
Wardrobe Left / Box/Box/File	YPTSF502424LBBFM	\$ 4114
Wardrobe Right / Box/Box/File (shown)	YPTSF502424RBBFM	\$ 4114
<b>57½"H Side Access Personal Towers — 24"W x 24"D – Metal Case/Metal Fronts</b>		
Wardrobe Left / File/File	YPTSF572424LFFM	\$ 3937
Wardrobe Right / File/File	YPTSF572424RFFM	\$ 3937
Wardrobe Left / Box/Box/File	YPTSF572424LBBFM	\$ 4239
Wardrobe Right / Box/Box/File (shown)	YPTSF572424RBBFM	\$ 4239
<b>65"H Side Access Personal Towers — 24"W x 24"D – Metal Case/Metal Fronts</b>		
Wardrobe Left / File/File	YPTSF652424LFFM	\$ 4069
Wardrobe Right / File/File (shown)	YPTSF652424RFFM	\$ 4069
Wardrobe Left / Box/Box/File	YPTSF652424LBBFM	\$ 4370
Wardrobe Right / Box/Box/File	YPTSF652424RBBFM	\$ 4370

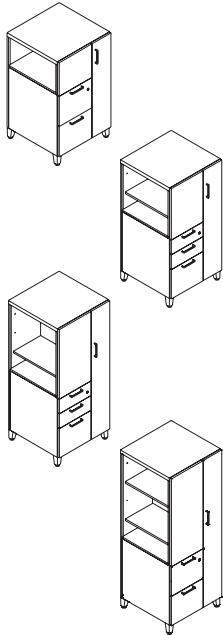

METAL STORAGE

<p><b>How to specify —</b> Select the Model Number from above.</p> <p>Y P T S                </p> <p>                .</p>	<p><b>1st Option:</b> <b>Base Option:</b> TF Terrace Foot ZF Stride Foot (+\$82) PF Pier Foot (+\$126)</p>	<p><b>2nd Option:</b> <b>Foot Finish:</b> Terrace, Stride PR6 Silver  Pier PR6 Silver P8X Solar Black PJE Pyrite (+\$88) P02 Flint (+\$88) P7B Loft P JW Designer White</p>	<p><b>3rd Option:</b> <b>Pull Option:</b> A Arch B Bevel M Beam O Halo S Square I Integral</p>	<p><b>4th Option:</b> <b>Pull Color (if applicable):</b> M Beam / O Halo P JW Designer White PR6 Silver PJE Pyrite P8X Solar Black AP Arch PRO Anodized Silver P2 upcharge +\$17/pull</p>	<p><b>SP Square</b> P JW Designer White EL Matte Silver P02 Flint P7B Loft PJE Pyrite P8X Solar Black P2 upcharge +\$17/pull</p>
	<p>  F  </p>	<p>  P   R   6   .</p>	<p>          .</p>	<p>          .</p>	<p>          .</p>

Continued below ▼

<p><b>5th Option:</b> <b>Paint Case:</b> P1 P2 P3 See inside front cover for finishes. P2 upcharge \$109 P3 upcharge \$218</p>	<p><b>6th Option:</b> <b>Paint Fronts:</b> NA Match Case P1 \$246 P2 \$322 P3 \$393</p>	<p><b>7th Option:</b> <b>Markerboard Front:</b> Offered on front panel of side access models only MKB Yes (+\$109) NA No</p>	<p><b>8th Option:</b> <b>Lock:</b> L Standard Lock X Omit Lock Core (Deduct \$20 per lock) E Digital Lock (Add \$409 per lock) See page 23 for specification information.</p>	<p><b>9th Option:</b> <b>Digital Lock Color (if applicable):</b> BNL Brushed Nickel</p>
<p>  P         .</p>	<p>  N A   .</p>	<p>          .</p>	<p>          .</p>	<p>          .</p>

Example: YPTS652424RBBFM.TFPR6.APRO.PJW.NA.X

# Align™ Metal Storage

For specification information see pages 31 and 41-42.

## Front Access Towers

Laminate Fronts Footed

GSA SIN 33721

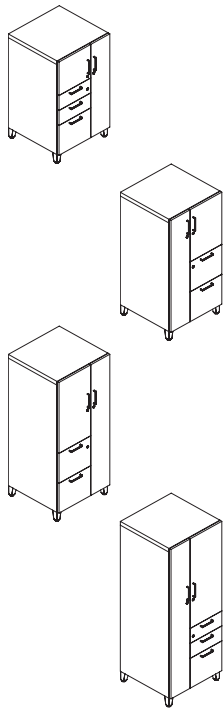

Width	Model	P1 Paint List Price
<b>42½"H Personal Towers — 24"W x 24"D – Metal Case/Laminate Fronts</b>		
Wardrobe Left / Door/File/File	YPTF422424LFFL	\$ 4116
Wardrobe Right / Door/File/File	YPTF422424RFLL	\$ 4116
Wardrobe Left / Door/Box/Box/File	YPTF422424LBBFL	\$ 4486
Wardrobe Right / Door/Box/Box/File (shown)	YPTF422424RBBFL	\$ 4486
<b>50"H Personal Towers — 24"W x 24"D – Metal Case/Laminate Fronts</b>		
Wardrobe Left / Door/File/File (shown)	YPTF502424LFFL	\$ 4249
Wardrobe Right / Door/File/File	YPTF502424RFLL	\$ 4249
Wardrobe Left / Door/Box/Box/File	YPTF502424LBBFL	\$ 4619
Wardrobe Right / Door/Box/Box/File	YPTF502424RBBFL	\$ 4619
<b>57½"H Personal Towers — 24"W x 24"D – Metal Case/Laminate Fronts</b>		
Wardrobe Left / Door/File/File	YPTF572424LFFL	\$ 4392
Wardrobe Right / Door/File/File (shown)	YPTF572424RFLL	\$ 4392
Wardrobe Left / Door/Box/Box/File	YPTF572424LBBFL	\$ 4760
Wardrobe Right / Door/Box/Box/File	YPTF572424RBBFL	\$ 4760
<b>65"H Personal Towers — 24"W x 24"D – Metal Case/Laminate Fronts</b>		
Wardrobe Left / Door/File/File	YPTF652424LFFL	\$ 4533
Wardrobe Right / Door/File/File	YPTF652424RFLL	\$ 4533
Wardrobe Left / Door/Box/Box/File (shown)	YPTF652424LBBFL	\$ 4906
Wardrobe Right / Door/Box/Box/File	YPTF652424RBBFL	\$ 4906

How to specify — Select the Model Number from above.	1st Option: Base Option:	2nd Option: Foot Finish:	3rd Option: Pull Option:	4th Option: Pull Color (if applicable):	5th Option: Paint Case:	6th Option: Laminate Fronts: Laminate & Edge:	7th Option: Lock:	8th Option: Digital Lock Color (if applicable):
Y P T   F	TF Terrace Foot ZF Stride Foot (+\$82) PF Pier Foot (+\$126)	PR6 Silver  Pier PR6 Silver P8X Solar Black PJE Pyrite (+\$88) P02 Flint (+\$88) P7B Loft PJW Designer White	A Arch M Beam O Halo S Square	M Beam / O Halo PJW Designer White PR6 Silver PJE Pyrite P8X Solar Black  AP Arch PRO Anodized Silver  SP Square PJW Designer White EL Matte Silver P02 Flint P7B Loft PJE Pyrite P8X Solar Black P2 upcharge +\$17/pull	P1 P2 P3 See page 28 for finishes. P2 upcharge \$109 P3 upcharge \$218	L2 upcharge \$164 L3 upcharge \$327	L Standard Lock X Omit Lock Core (Deduct \$20 per lock) E Digital Lock (Add \$409 per lock) See page 23 for specification information.	BNL Brushed Nickel
Y P T   F	F	P R 6			P			

Example: YPTF652424RBBFL.ZFPR6.APRO.PJW.LVT1VT.L

# Align™ Metal Storage

For specification information see pages 31 and 41-42.

## Side Access Towers

### Laminate Fronts Footed

GSA SIN 33721

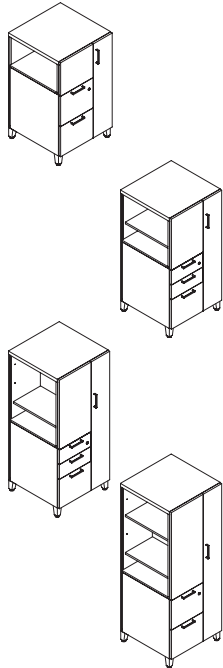

Width	Model	P1 Paint List Price
<b>42½"H Side Access Personal Towers — 24"W x 24"D – Metal Case/Laminate Fronts</b>		
Wardrobe Left / File/File	YPTSF422424LFFL	\$ 4484
Wardrobe Right / File/File (shown)	YPTSF422424RFFL	\$ 4484
Wardrobe Left / Box/Box/File	YPTSF422424LBBFL	\$ 4856
Wardrobe Right / Box/Box/File	YPTSF422424RBBFL	\$ 4856
<b>50"H Side Access Personal Towers — 24"W x 24"D – Metal Case/Laminate Fronts</b>		
Wardrobe Left / File/File	YPTSF502424LFFL	\$ 4631
Wardrobe Right / File/File	YPTSF502424RFFL	\$ 4631
Wardrobe Left / Box/Box/File	YPTSF502424LBBFL	\$ 5001
Wardrobe Right / Box/Box/File (shown)	YPTSF502424RBBFL	\$ 5001
<b>57½"H Side Access Personal Towers — 24"W x 24"D – Metal Case/Laminate Fronts</b>		
Wardrobe Left / File/File	YPTSF572424LFFL	\$ 4784
Wardrobe Right / File/File	YPTSF572424RFFL	\$ 4784
Wardrobe Left / Box/Box/File	YPTSF572424LBBFL	\$ 5154
Wardrobe Right / Box/Box/File (shown)	YPTSF572424RBBFL	\$ 5154
<b>65"H Side Access Personal Towers — 24"W x 24"D – Metal Case/Laminate Fronts</b>		
Wardrobe Left / File/File	YPTSF652424LFFL	\$ 4944
Wardrobe Right / File/File (shown)	YPTSF652424RFFL	\$ 4944
Wardrobe Left / Box/Box/File	YPTSF652424LBBFL	\$ 5312
Wardrobe Right / Box/Box/File	YPTSF652424RBBFL	\$ 5312

METAL STORAGE

How to specify — Select the Model Number from above.	1st Option: Base Option:	2nd Option: Foot Finish: Terrace, Stride PR6 Silver Pier PR6 Silver P8X Solar Black PJE Pyrite (+\$88) P02 Flint (+\$88) P7B Loft PJW Designer White	3rd Option: Pull Option: A Arch M Beam O Halo S Square	4th Option: Pull Color (if applicable): M Beam / O Halo PJW Designer White PR6 Silver PJE Pyrite P8X Solar Black AP Arch PRO Anodized Silver SP Square PJW Designer White EL Matte Silver P02 Flint P7B Loft PJE Pyrite P8X Solar Black P2 upcharge +\$17/pull	5th Option: Paint Case: P1 P2 P3 See page 28 for finishes. P2 upcharge \$109 P3 upcharge \$218	6th Option: Laminate Fronts: Laminate & Edge: See page 28 for finishes. L2 upcharge \$164 L3 upcharge \$327	7th Option: Lock: L Standard Lock X Omit Lock Core (Deduct \$20 per lock) E Digital Lock (Add \$409 per lock) See page 23 for specification information.	8th Option: Digital Lock Color (if applicable): BNL Brushed Nickel
Y P T S	F	P R 6   .	.	.	P         .			

Example: YPTSF652424RBBFL.ZFPR6.APRO.PJW.LVT1VT.L



# Align™ Metal Storage

## 18"W Front and Side Access Towers

For specification information see pages 31 and 41-42.

Metal Fronts with Plinth Base

GSA SIN 33721

Description	Model	P1
		Paint List Price
<b>42½"H Personal Tower — 18"W x 24"D – Metal Case/Metal Fronts</b>		
Wardrobe Left / Door/File/File (shown)	YPTP421824LFFM	\$ 2881
Wardrobe Right / Door/File/File	YPTP421824RFFM	\$ 2881
<b>50"H Personal Tower — 18"W x 24"D – Metal Case/Metal Fronts</b>		
Wardrobe Left / Door/File/File	YPTP501824LFFM	\$ 2981
Wardrobe Right / Door/File/File	YPTP501824RFFM	\$ 2981
<b>57½"H Personal Tower — 18"W x 24"D – Metal Case/Metal Fronts</b>		
Wardrobe Left / Door/File/File (shown)	YPTP571824LFFM	\$ 3086
Wardrobe Right / Door/File/File (shown)	YPTP571824RFFM	\$ 3086
<b>65"H Personal Tower — 18"W x 24"D – Metal Case/Metal Fronts</b>		
Wardrobe Left / Door/File/File	YPTP651824LFFM	\$ 3191
Wardrobe Right / Door/File/File (shown)	YPTP651824RFFM	\$ 3191
<b>42½"H Side Access Tower — 18"W x 24"D – Metal Case/Metal Fronts</b>		
Wardrobe Left / Door/File/File	YPTSP421824LFFM	\$ 3156
Wardrobe Right / Door/File/File (shown)	YPTSP421824RFFM	\$ 3156
<b>50"H Side Access Tower — 18"W x 24"D – Metal Case/Metal Fronts</b>		
Wardrobe Left / Door/File/File	YPTSP501824LFFM	\$ 3266
Wardrobe Right / Door/File/File (shown)	YPTSP501824RFFM	\$ 3266
<b>57½"H Side Access Tower — 18"W x 24"D – Metal Case/Metal Fronts</b>		
Wardrobe Left / Door/File/File	YPTSP571824LFFM	\$ 3380
Wardrobe Right / Door/File/File (shown)	YPTSP571824RFFM	\$ 3380
<b>65"H Side Access Tower — 18"W x 24"D – Metal Case/Metal Fronts</b>		
Wardrobe Left / Door/File/File	YPTSP651824LFFM	\$ 3500
Wardrobe Right / Door/File/File (shown)	YPTSP651824RFFM	\$ 3500

How to specify	1st Option:	2nd Option:	3rd Option:	4th Option:	5th Option:	6th Option:	7th Option:	8th Option:
Select the Model Number from above.	<b>Base Option</b> (if applicable):	<b>Pull Option:</b>	<b>Pull Color</b> (if applicable):	<b>Paint Case:</b>	<b>Paint Fronts:</b>	<b>Markerboard Front:</b>	<b>Lock:</b>	<b>Digital Lock Color</b> (if applicable):
	BK Flush BX Recessed Kickplate	A Arch B Bevel M Beam O Halo S Square	M Beam / O Halo PJW Designer White PR6 Silver PJE Pyrite P8X Solar Black AP Arch PRO Anodized Silver SP Square PJW Designer White EL Matte Silver P02 Flint P7B Loft PJE Pyrite P8X Solar Black P2 upcharge +\$17/pull	P1 P2 P3 See inside front cover for finishes. P2 upcharge \$109 P3 upcharge \$218	NA Match Case P1 \$246 P2 \$322 P3 \$393	Offered on front panel of side access models only MKB Yes (+\$109) NA No	L Standard Lock X Omit Lock Core (Deduct \$20 per lock) E Digital Lock (Add \$409 per lock) See page 23 for specification information.	BNL Brushed Nickel
Y   P   T	. B   .		.	P     .	. N   A   .	.		

Example: YPTP651824RFFM.BK.APRO.PJW.NA.L

# Align™ Metal Storage

## 18"W Front and Side Access Towers

For specification information see pages 31 and 41-42.

Laminate Fronts with Plinth Base

GSA SIN 33721

Description	Model	P1
		Paint List Price
<b>42½"H Personal Tower — 18"W x 24"D – Metal Case/Laminate Fronts</b>		
Wardrobe Left / Door/File/File (shown)	YPTP421824LFFL	\$ 3542
Wardrobe Right / Door/File/File	YPTP421824RFFL	\$ 3542
<b>50"H Personal Tower — 18"W x 24"D – Metal Case/Laminate Fronts</b>		
Wardrobe Left / Door/File/File	YPTP501824LFFL	\$ 3667
Wardrobe Right / Door/File/File	YPTP501824RFFL	\$ 3667
<b>57½"H Personal Tower — 18"W x 24"D – Metal Case/Laminate Fronts</b>		
Wardrobe Left / Door/File/File (shown)	YPTP571824LFFL	\$ 3795
Wardrobe Right / Door/File/File (shown)	YPTP571824RFFL	\$ 3795
<b>65"H Personal Tower — 18"W x 24"D – Metal Case/Laminate Fronts</b>		
Wardrobe Left / Door/File/File	YPTP651824LFFL	\$ 3929
Wardrobe Right / Door/File/File (shown)	YPTP651824RFFL	\$ 3929
<b>42½"H Side Access Tower — 18"W x 24"D – Metal Case/Laminate Fronts</b>		
Wardrobe Left / Door/File/File	YPTSP421824LFFL	\$ 3880
Wardrobe Right / Door/File/File (shown)	YPTSP421824RFFL	\$ 3880
<b>50"H Side Access Tower — 18"W x 24"D – Metal Case/Laminate Fronts</b>		
Wardrobe Left / Door/File/File	YPTSP501824LFFL	\$ 4017
Wardrobe Right / Door/File/File (shown)	YPTSP501824RFFL	\$ 4017
<b>57½"H Side Access Tower — 18"W x 24"D – Metal Case/Laminate Fronts</b>		
Wardrobe Left / Door/File/File	YPTSP571824LFFL	\$ 4157
Wardrobe Right / Door/File/File (shown)	YPTSP571824RFFL	\$ 4157
<b>65"H Side Access Tower — 18"W x 24"D – Metal Case/Laminate Fronts</b>		
Wardrobe Left / Door/File/File	YPTSP651824LFFL	\$ 4304
Wardrobe Right / Door/File/File (shown)	YPTSP651824RFFL	\$ 4304

How to specify — Select the Model Number from above.	1st Option: Base Option (if applicable):	2nd Option: Pull Option:	3rd Option: Pull Color (if applicable):	4th Option: Paint Case:	5th Option: Laminate Fronts: Laminate & Edge:	6th Option: Lock:	7th Option: Digital Lock Color (if applicable):
Y P T	BK BX	A M O S	M P P P P A P S	P1 P2 P3		L X E	BNL

Example: YPTP651824RFFL.BK.APR0.PJW.LVT1VT.L

METAL STORAGE

# Align™ Metal Storage

## 18"W Front and Side Access Towers

For specification information see pages 31 and 41-42.

Metal Fronts Footed

GSA SIN 33721

	Description	Model	P1 Paint List Price
	<b>42½"H Personal Tower — 18"W x 24"D – Metal Case/Metal Fronts</b>		
	Wardrobe Left / Door/File/File (shown)	YPTF421824LFFM	\$ 3157
	Wardrobe Right / Door/File/File	YPTF421824RFFM	\$ 3157
	<b>50"H Personal Tower — 18"W x 24"D – Metal Case/Metal Fronts</b>		
	Wardrobe Left / Door/File/File (shown)	YPTF501824LFFM	\$ 3257
	Wardrobe Right / Door/File/File (shown)	YPTF501824RFFM	\$ 3257
	<b>57½"H Personal Tower — 18"W x 24"D – Metal Case/Metal Fronts</b>		
	Wardrobe Left / Door/File/File (shown)	YPTF571824LFFM	\$ 3360
	Wardrobe Right / Door/File/File (shown)	YPTF571824RFFM	\$ 3360
	<b>65"H Personal Tower — 18"W x 24"D – Metal Case/Metal Fronts</b>		
	Wardrobe Left / Door/File/File	YPTF651824LFFM	\$ 3470
	Wardrobe Right / Door/File/File (shown)	YPTF651824RFFM	\$ 3470
	<b>42½"H Side Access Tower — 18"W x 24"D – Metal Case/Metal Fronts</b>		
	Wardrobe Left / Door/File/File	YPTSF421824LFFM	\$ 3434
	Wardrobe Right / Door/File/File (shown)	YPTSF421824RFFM	\$ 3434
	<b>50"H Side Access Tower — 18"W x 24"D – Metal Case/Metal Fronts</b>		
	Wardrobe Left / Door/File/File	YPTSF501824LFFM	\$ 3541
	Wardrobe Right / Door/File/File (shown)	YPTSF501824RFFM	\$ 3541
	<b>57½"H Side Access Tower — 18"W x 24"D – Metal Case/Metal Fronts</b>		
	Wardrobe Left / Door/File/File	YPTSF571824LFFM	\$ 3658
	Wardrobe Right / Door/File/File (shown)	YPTSF571824RFFM	\$ 3658
	<b>65"H Side Access Tower — 18"W x 24"D – Metal Case/Metal Fronts</b>		
	Wardrobe Left / Door/File/File	YPTSF651824LFFM	\$ 3777
	Wardrobe Right / Door/File/File (shown)	YPTSF651824RFFM	\$ 3777

<b>How to specify —</b> Select the Model Number from above.  Y P T	<b>1st Option:</b> <b>Base Option:</b> TF Terrace Foot ZF Stride Foot (+\$82) PF Pier Foot (+\$126)	<b>2nd Option:</b> <b>Foot Finish:</b> Terrace, Stride PR6 Silver  Pier PR6 Silver P8X Solar Black PJE Pyrite (+\$88) P02 Flint (+\$88) P7B Loft PJW Designer White	<b>3rd Option:</b> <b>Pull Option:</b> A Arch B Bevel M Beam O Halo S Square	<b>4th Option:</b> <b>Pull Color (if applicable):</b> M Beam / O Halo PJW Designer White PR6 Silver PJE Pyrite P8X Solar Black AP Arch PRO Anodized Silver P2 upcharge +\$17/pull  SP Square PJW Designer White EL Matte Silver P02 Flint P7B Loft PJE Pyrite P8X Solar Black P2 upcharge +\$17/pull
	F	P R 6		

<b>5th Option:</b> <b>Paint Case:</b> P1 P2 P3 See inside front cover for finishes. P2 upcharge \$109 P3 upcharge \$218  P	<b>6th Option:</b> <b>Paint Fronts:</b> NA Match Case P1 \$246 P2 \$322 P3 \$393	<b>7th Option:</b> <b>Markerboard Front:</b> Offered on front panel of side access models only  MKB Yes (+\$109) NA No	<b>8th Option:</b> <b>Lock:</b> L Standard Lock X Omit Lock Core (Deduct \$20 per lock) E Digital Lock (Add \$409 per lock) See page 23 for specification information.	<b>9th Option:</b> <b>Digital Lock Color (if applicable):</b> BNL Brushed Nickel
P	NA			

Example: YPTF651824RFFM.TFPR6.APRO.PJW.NA.L

METAL STORAGE

# Align™ Metal Storage

## 18"W Front and Side Access Towers

For specification information see pages 31 and 41-42.

Laminate Fronts Footed

GSA SIN 33721

	Description	Model	P1 Paint List Price
	<b>42½"H Personal Tower — 18"W x 24"D – Metal Case/Laminate Fronts</b>		
	Wardrobe Left / Door/File/File (shown)	YPTF421824LFFL	\$ 3821
	Wardrobe Right / Door/File/File	YPTF421824RFFL	\$ 3821
	<b>50"H Personal Tower — 18"W x 24"D – Metal Case/Laminate Fronts</b>		
	Wardrobe Left / Door/File/File (shown)	YPTF501824LFFL	\$ 3944
	Wardrobe Right / Door/File/File (shown)	YPTF501824RFFL	\$ 3944
	<b>57½"H Personal Tower — 18"W x 24"D – Metal Case/Laminate Fronts</b>		
	Wardrobe Left / Door/File/File (shown)	YPTF571824LFFL	\$ 4071
	Wardrobe Right / Door/File/File (shown)	YPTF571824RFFL	\$ 4071
	<b>65"H Personal Tower — 18"W x 24"D – Metal Case/Laminate Fronts</b>		
	Wardrobe Left / Door/File/File	YPTF651824LFFL	\$ 4205
	Wardrobe Right / Door/File/File (shown)	YPTF651824RFFL	\$ 4205
	<b>42½"H Side Access Tower — 18"W x 24"D – Metal Case/Laminate Fronts</b>		
	Wardrobe Left / Door/File/File	YPTSF421824LFFL	\$ 4157
	Wardrobe Right / Door/File/File (shown)	YPTSF421824RFFL	\$ 4157
	<b>50"H Side Access Tower — 18"W x 24"D – Metal Case/Laminate Fronts</b>		
	Wardrobe Left / Door/File/File	YPTSF501824LFFL	\$ 4294
	Wardrobe Right / Door/File/File (shown)	YPTSF501824RFFL	\$ 4294
	<b>57½"H Side Access Tower — 18"W x 24"D – Metal Case/Laminate Fronts</b>		
	Wardrobe Left / Door/File/File	YPTSF571824LFFL	\$ 4433
	Wardrobe Right / Door/File/File (shown)	YPTSF571824RFFL	\$ 4433
	<b>65"H Side Access Tower — 18"W x 24"D – Metal Case/Laminate Fronts</b>		
	Wardrobe Left / Door/File/File	YPTSF651824LFFL	\$ 4581
	Wardrobe Right / Door/File/File (shown)	YPTSF651824RFFL	\$ 4581

METAL STORAGE

How to specify — Select the Model Number from above.	1st Option: Base Option:	2nd Option: Foot Finish:	3rd Option: Pull Option:	2nd Option: Pull Color (if applicable):	5th Option: Paint Case:	6th Option: Laminate Fronts: Laminate & Edge:	7th Option: Lock:	8th Option: Digital Lock Color (if applicable):
Y P T	TF Terrace Foot (+\$82) ZF Stride Foot (+\$126) PF Pier Foot (+\$126)	Terrace, Stride PR6 Silver  Pier PR6 Silver P8X Solar Black PJE Pyrite (+\$88) P02 Flint (+\$88) P7B Loft PJW Designer White	A Arch M Beam O Halo S Square	M Beam / O Halo PJW Designer White  PR6 Silver PJE Pyrite P8X Solar Black AP Arch PRO Anodized Silver  SP Square PJW Designer White EL Matte Silver P02 Flint P7B Loft PJE Pyrite P8X Solar Black P2 upcharge +\$17/pull	P1 P2 P3 See page 28 for finishes. P2 upcharge \$109 P3 upcharge \$218	See page 28 for finishes. L2 upcharge \$164 L3 upcharge \$327	L Standard Lock X Omit Lock Core (Deduct \$20 per lock) E Digital Lock (Add \$409 per lock) See page 23 for specification information.	BNL Brushed Nickel
.	F	P R 6 .	.	.	P       .	.	.	.

Example: YPTF651824RFFL.ZFPR6.APRO.PJW.LVT1VT.L

# Align™ Metal Storage

## 18"W Front and Side Access Towers

For specification information see pages 31 and 41-42.

Metal Fronts with Casters

GSA SIN 33721

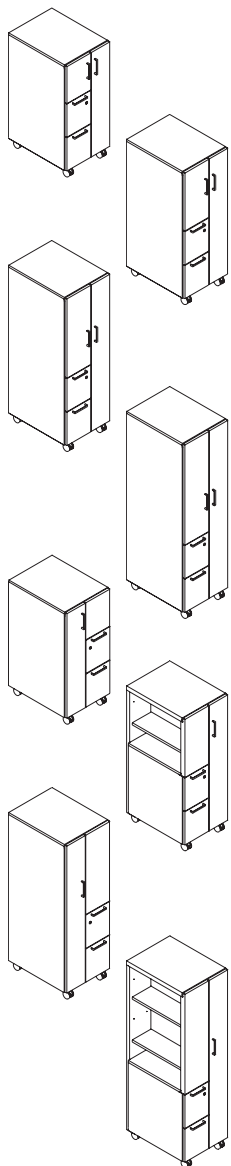

Description	Model	P1 Paint List Price
<b>42½"H Personal Tower — 18"W x 24"D – Metal Case/Metal Fronts</b>		
Wardrobe Left / Door/File/File	YPTM421824LFFM	\$ 3144
Wardrobe Right / Door/File/File (shown)	YPTM421824RFFM	\$ 3144
<b>50"H Personal Tower — 18"W x 24"D – Metal Case/Metal Fronts</b>		
Wardrobe Left / Door/File/File	YPTM501824LFFM	\$ 3244
Wardrobe Right / Door/File/File (shown)	YPTM501824RFFM	\$ 3244
<b>57½"H Personal Tower — 18"W x 24"D – Metal Case/Metal Fronts</b>		
Wardrobe Left / Door/File/File	YPTM571824LFFM	\$ 3348
Wardrobe Right / Door/File/File (shown)	YPTM571824RFFM	\$ 3348
<b>65"H Personal Tower — 18"W x 24"D – Metal Case/Metal Fronts</b>		
Wardrobe Left / Door/File/File	YPTM651824LFFM	\$ 3455
Wardrobe Right / Door/File/File (shown)	YPTM651824RFFM	\$ 3455
<b>42½"H Side Access Tower — 18"W x 24"D – Metal Case/Metal Fronts</b>		
Wardrobe Left / Door/File/File (shown)	YPTSM421824LFFM	\$ 3695
Wardrobe Right / Door/File/File	YPTSM421824RFFM	\$ 3695
<b>50"H Side Access Tower — 18"W x 24"D – Metal Case/Metal Fronts</b>		
Wardrobe Left / Door/File/File	YPTSM501824LFFM	\$ 3807
Wardrobe Right / Door/File/File (shown)	YPTSM501824RFFM	\$ 3807
<b>57½"H Side Access Tower — 18"W x 24"D – Metal Case/Metal Fronts</b>		
Wardrobe Left / Door/File/File (shown)	YPTSM571824LFFM	\$ 3921
Wardrobe Right / Door/File/File	YPTSM571824RFFM	\$ 3921
<b>65"H Side Access Tower — 18"W x 24"D – Metal Case/Metal Fronts</b>		
Wardrobe Left / Door/File/File	YPTSM651824LFFM	\$ 4039
Wardrobe Right / Door/File/File (shown)	YPTSM651824RFFM	\$ 4039

<p><b>How to specify — Select the Model Number from above.</b></p> <p>Y   P   T        </p> <p>             </p> <p>             </p>	<p><b>1st Option:</b></p> <p><b>Pull Option:</b></p> <p>A Arch B Bevel M Beam O Halo S Square</p>	<p><b>2nd Option:</b></p> <p><b>Pull Color (if applicable):</b></p> <p>M Beam / O Halo PJW Designer White PR6 Silver PJE Pyrite P8X Solar Black AP Arch PRO Anodized Silver SP Square PJW Designer White EL Matte Silver P02 Flint P7B Loft PJE Pyrite P8X Solar Black P2 upcharge +\$17/pull</p>	<p><b>3rd Option:</b></p> <p><b>Paint Case:</b></p> <p>P1 P2 P3 See inside front cover for finishes. P2 upcharge \$109 P3 upcharge \$218</p>	<p><b>4th Option:</b></p> <p><b>Paint Fronts:</b></p> <p>NA Match Case P1 \$246 P2 \$322 P3 \$393</p>	<p><b>5th Option:</b></p> <p><b>Markerboard Front:</b></p> <p>Offered on front panel/door MKB Yes (+\$109) NA No</p>	<p><b>6th Option:</b></p> <p><b>Lock:</b></p> <p>L Standard Lock X Omit Lock Core (Deduct \$20 per lock) E Digital Lock (Add \$409 per lock) See page 23 for specification information.</p>	<p><b>7th Option:</b></p> <p><b>Digital Lock Color (if applicable):</b></p> <p>BNL Brushed Nickel</p>
	<p>Example: YPTM651824RFFM.AP0.PJW.NA.L</p>						

# Align™ Metal Storage

## 18"W Front and Side Access Towers

For specification information see pages 31 and 41-42.

Laminate Fronts with Casters

GSA SIN 33721

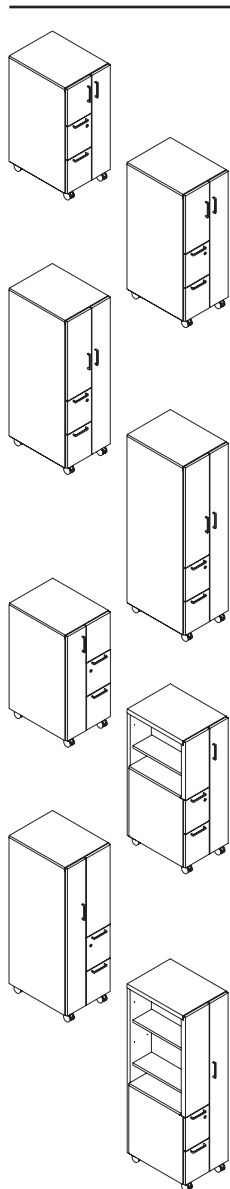

Description	Model	P1 Paint List Price
<b>42½"H Personal Tower — 18"W x 24"D – Metal Case/Laminate Fronts</b>		
Wardrobe Left / Door/File/File	YPTM421824LFFL	\$ 3808
Wardrobe Right / Door/File/File (shown)	YPTM421824RFFL	\$ 3808
<b>50"H Personal Tower — 18"W x 24"D – Metal Case/Laminate Fronts</b>		
Wardrobe Left / Door/File/File	YPTM501824LFFL	\$ 3931
Wardrobe Right / Door/File/File (shown)	YPTM501824RFFL	\$ 3931
<b>57½"H Personal Tower — 18"W x 24"D – Metal Case/Laminate Fronts</b>		
Wardrobe Left / Door/File/File	YPTM571824LFFL	\$ 4058
Wardrobe Right / Door/File/File (shown)	YPTM571824RFFL	\$ 4058
<b>65"H Personal Tower — 18"W x 24"D – Metal Case/Laminate Fronts</b>		
Wardrobe Left / Door/File/File	YPTM651824LFFL	\$ 4191
Wardrobe Right / Door/File/File (shown)	YPTM651824RFFL	\$ 4191
<b>42½"H Side Access Tower — 18"W x 24"D – Metal Case/Laminate Fronts</b>		
Wardrobe Left / Door/File/File (shown)	YPTSM421824LFFL	\$ 4420
Wardrobe Right / Door/File/File	YPTSM421824RFFL	\$ 4420
<b>50"H Side Access Tower — 18"W x 24"D – Metal Case/Laminate Fronts</b>		
Wardrobe Left / Door/File/File	YPTSM501824LFFL	\$ 4557
Wardrobe Right / Door/File/File (shown)	YPTSM501824RFFL	\$ 4557
<b>57½"H Side Access Tower — 18"W x 24"D – Metal Case/Laminate Fronts</b>		
Wardrobe Left / Door/File/File (shown)	YPTSM571824LFFL	\$ 4696
Wardrobe Right / Door/File/File	YPTSM571824RFFL	\$ 4696
<b>65"H Side Access Tower — 18"W x 24"D – Metal Case/Laminate Fronts</b>		
Wardrobe Left / Door/File/File	YPTSM651824LFFL	\$ 4844
Wardrobe Right / Door/File/File (shown)	YPTSM651824RFFL	\$ 4844

METAL STORAGE

<p><b>How to specify —</b> Select the Model Number from above.</p> <p>Y P T          </p> <p>         </p> <p>          .</p>	<p><b>1st Option:</b> <b>Pull Option:</b> A Arch M Beam O Halo S Square</p>	<p><b>2nd Option:</b> <b>Pull Color</b> (if applicable): M Beam / O Halo P JW Designer White P R6 Silver P JE Pyrite P 8X Solar Black AP Arch P RO Anodized Silver SP Square P JW Designer White EL Matte Silver P O2 Flint P 7B Loft P JE Pyrite P 8X Solar Black P2 upcharge +\$17/pull</p>	<p><b>3rd Option:</b> <b>Paint Case:</b> P1 P2 P3 See page 28 for finishes. P2 upcharge \$109 P3 upcharge \$218</p>	<p><b>4th Option:</b> <b>Laminate Fronts:</b> <b>Laminate &amp; Edge:</b> See page 28 for finishes. L2 upcharge \$164 L3 upcharge \$327</p>	<p><b>5th Option:</b> <b>Lock:</b> L Standard Lock X Omit Lock Core (Deduct \$20 per lock) E Digital Lock (Add \$409 per lock) See page 23 for specification information.</p>	<p><b>6th Option:</b> <b>Digital Lock Color</b> (if applicable): BNL Brushed Nickel</p>
	<p>          .</p> <p>          .</p> <p>          .</p>	<p>          .</p> <p>          .</p> <p>          .</p>	<p>          .</p> <p>          .</p> <p>          .</p>	<p>          .</p> <p>          .</p> <p>          .</p>	<p>          .</p> <p>          .</p> <p>          .</p>	<p>          .</p> <p>          .</p> <p>          .</p>

Example: YPTM651824RFFL.APRO.PJW.LVT1VT.L

For specification information see pages 31 and 43.

Metal Fronts with Plinth Base

GSA SIN 33721

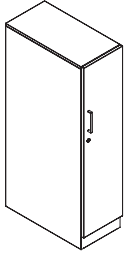

Description	Model	P1 Paint List Price
<b>42½"H Wardrobe / Lockers — 12"W – Metal Case/Metal Front</b>		
18"D Wardrobe Hinges on Left	YPWP421218LM	\$ 1898
18"D Wardrobe Hinges on Right	YPWP421218RM	\$ 1898
24"D Wardrobe Hinges on Left	YPWP421224LM	\$ 2050
24"D Wardrobe Hinges on Right (shown)	YPWP421224RM	\$ 2050
<b>50"H Wardrobe / Lockers — 12"W – Metal Case/Metal Front</b>		
18"D Wardrobe Hinges on Left	YPWP501218LM	\$ 2126
18"D Wardrobe Hinges on Right	YPWP501218RM	\$ 2126
24"D Wardrobe Hinges on Left	YPWP501224LM	\$ 2430
24"D Wardrobe Hinges on Right	YPWP501224RM	\$ 2430
<b>65"H Wardrobe / Lockers — 12"W – Metal Case/Metal Front/Plinth Base</b>		
18"D Wardrobe Hinges on Left	YPWP651218LM	\$ 2352
18"D Wardrobe Hinges on Right	YPWP651218RM	\$ 2352
24"D Wardrobe Hinges on Left	YPWP651224LM	\$ 2657
24"D Wardrobe Hinges on Right	YPWP651224RM	\$ 2657

**Note:** To order Align wardrobes or lockers with a digital lock option, add suffix "E" to base model number.

To order Align wardrobes or lockers with a digital lock option, add "E" suffix to base model number. The digital lock has an integrated pull, so no pull will be specified.

How to specify — Select the Model Number from above.	1st Option: Base Option (if applicable):	2nd Option: Pull Option:	3rd Option: Pull Color (if applicable):	4th Option: Paint Case:	5th Option: Paint Fronts:	6th Option: Lock:
Y   P   W	BK Flush Kickplate BX Recessed Kickplate	A Arch B Bevel M Beam O Halo S Square I Integral Pull Option (Digital Lock): E Keypad (+\$464) D RFID (+\$573)	M Beam / O Halo P JW Designer White P R6 Silver P JE Pyrite P 8X Solar Black AP Arch P RO Anodized Silver SP Square P JW Designer White EL Matte Silver P O2 Flint P 7B Loft P JE Pyrite P 8X Solar Black P2 upcharge +\$17/pull	P1 P2 P3 See inside front cover for finishes. P2 upcharge \$50 P3 upcharge \$109	NA Match Case P1 \$246 P2 \$322 P3 \$393	L Standard Lock X Omit Lock Core (Deduct \$20 per lock)
	B			P	N   A	

Example: YPWP421218RME.BX.E.PJW.NA

For specification information see pages 31 and 43.

Metal Fronts Footed

GSA SIN 33721

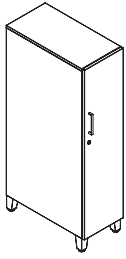

Description	Model	P1 Paint List Price
<b>42½"H Wardrobe / Lockers — 12"W – Metal Case/Metal Front</b>		
18"D Wardrobe Hinges on Left	YPWF421218LM	\$ 2163
18"D Wardrobe Hinges on Right	YPWF421218RM	\$ 2163
24"D Wardrobe Hinges on Left	YPWF421224LM	\$ 2316
24"D Wardrobe Hinges on Right (shown)	YPWF421224RM	\$ 2316
<b>50"H Wardrobe / Lockers — 12"W – Metal Case/Metal Front</b>		
18"D Wardrobe Hinges on Left	YPWF501218LM	\$ 2390
18"D Wardrobe Hinges on Right	YPWF501218RM	\$ 2390
24"D Wardrobe Hinges on Left	YPWF501224LM	\$ 2695
24"D Wardrobe Hinges on Right	YPWF501224RM	\$ 2695
<b>65"H Wardrobe / Lockers — 12"W – Metal Case/Metal Front/Footed Base</b>		
18"D Wardrobe Hinges on Left	YPWF651218LM	\$ 2618
18"D Wardrobe Hinges on Right	YPWF651218RM	\$ 2618
24"D Wardrobe Hinges on Left	YPWF651224LM	\$ 2922
24"D Wardrobe Hinges on Right	YPWF651224RM	\$ 2922

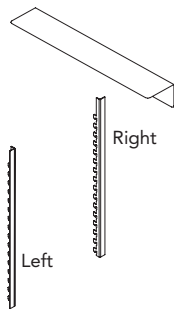

Description	Model	P1 Paint List Price	P2 Paint List Price	P3 Paint List Price
<b>Accessories for 12"W Wardrobe / Lockers</b>				
18"D Wardrobe Tower to Worksurface Bracket	YPWTAWSBKT18	\$ 105	\$ 116	\$ 122
24"D Wardrobe Tower to Worksurface Bracket	YPWTAWSBKT24	\$ 109	\$ 120	\$ 126
Panel Mounting Bracket — Left-Hand	AP22PBKLN	\$ 167	\$ 184	\$ 200
Panel Mounting Bracket — Right-Hand	AP22PBKRH	\$ 167	\$ 184	\$ 200

**Note:** To order Align wardrobes or lockers with a digital lock option, add suffix "E" to base model number.

To order Align wardrobes or lockers with a digital lock option, add "E" suffix to base model number. The digital lock has an integrated pull, so no pull will be specified.

METAL STORAGE

How to specify — Select the Model Number from above.	1st Option: Base Option:	2nd Option: Foot Finish:	3rd Option: Pull Option (Standard Lock):	4th Option: Pull Color (if applicable):	5th Option: Paint Case:	6th Option: Paint Fronts:	7th Option: Lock:
Y P W	TF Terrace Foot (+\$82) ZF Stride Foot (+\$126) PF Pier Foot (+\$126)	Terrace, Stride PR6 Silver  Pier PR6 Silver P8X Solar Black PJE Pyrite (+\$88) P02 Flint (+\$88) P7B Loft P JW Designer White	A Arch B Bevel M Beam O Halo S Square I Integral  Pull Option (Digital Lock): E Keypad (+\$464) D RFID (+\$573)	M Beam / O Halo P JW Designer White PR6 Silver PJE Pyrite P8X Solar Black AP Arch PRO Anodized Silver SP Square P JW Designer White EL Matte Silver P02 Flint P7B Loft PJE Pyrite P8X Solar Black P2 upcharge +\$17/pull	P1 P2 P3 See inside front cover for finishes. P2 upcharge \$50 P3 upcharge \$109	NA Match Case P1 \$246 P2 \$322 P3 \$393	L Standard Lock X Omit Lock Core (Deduct \$20 per lock)
Y P W	F	P R 6   .	.	.	P       .	N A   .	.

Example: YPWF421218RM.TFPR6.APRO.PJW.NA.L



# Align™ Metal Storage

## 12"W Wardrobe / Single Lockers

For specification information see pages 31 and 43.

Laminate Fronts with Plinth Base or Footed

GSA SIN 33721

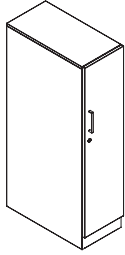

Width	Model	P1 Paint List Price
<b>42½" H Wardrobe / Locker — 12"W – Metal Case/Laminate Front/Recessed Base</b>		
18"D Hinges on Left	YPWP421218LL	\$ 2230
18"D Hinges on Right	YPWP421218RL	\$ 2230
24"D Hinges on Left	YPWP421224LL	\$ 2408
24"D Hinges on Right (shown)	YPWP421224RL	\$ 2408
<b>50" H Wardrobe / Locker — 12"W – Metal Case/Laminate Front/Recessed Base</b>		
18"D Hinges on Left	YPWP501218LL	\$ 2498
18"D Hinges on Right	YPWP501218RL	\$ 2498
24"D Hinges on Left	YPWP501224LL	\$ 2855
24"D Hinges on Right	YPWP501224RL	\$ 2855
<b>65"H Wardrobe / Lockers — 12"W – Metal Case/Laminate Front/Plinth Base</b>		
18"D Wardrobe Hinges on Left	YPWP651218LL	\$ 2764
18"D Wardrobe Hinges on Right	YPWP651218RL	\$ 2764
24"D Wardrobe Hinges on Left	YPWP651224LL	\$ 3122
24"D Wardrobe Hinges on Right	YPWP651224RL	\$ 3122

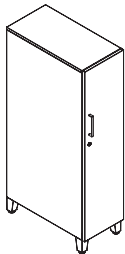

Width	Model	P1 Paint List Price
<b>42½" H Wardrobe / Locker — 12"W – Metal Case/Laminate Front/Recessed Base</b>		
18"D Hinges on Left	YPWF421218LL	\$ 2543
18"D Hinges on Right	YPWF421218RL	\$ 2543
24"D Hinges on Left	YPWF421224LL	\$ 2722
24"D Hinges on Right (shown)	YPWF421224RL	\$ 2722
<b>50" H Wardrobe / Locker — 12"W – Metal Case/Laminate Front/Recessed Base</b>		
18"D Hinges on Left	YPWF501218LL	\$ 2811
18"D Hinges on Right	YPWF501218RL	\$ 2811
24"D Hinges on Left	YPWF501224LL	\$ 3167
24"D Hinges on Right	YPWF501224RL	\$ 3167
<b>65"H Wardrobe / Lockers — 12"W – Metal Case/Laminate Front/Footed Base</b>		
18"D Wardrobe Hinges on Left	YPWF651218LL	\$ 3077
18"D Wardrobe Hinges on Right	YPWF651218RL	\$ 3077
24"D Wardrobe Hinges on Left	YPWF651224LL	\$ 3435
24"D Wardrobe Hinges on Right	YPWF651224RL	\$ 3435

To order Align wardrobes or lockers with a digital lock option, add "E" suffix to base model number. The digital lock has an integrated pull, so no pull will be specified.

<b>How to specify —</b> Select the Model Number from above.  Y P W	<b>1st Option:</b> <b>Plinth Base Options</b> (if applicable): BX Recessed Kickplate  <b>Footed Base Options:</b> TF Terrace Foot ZF Stride Foot (+\$82) PF Pier Foot (+\$126)	<b>2nd Option:</b> <b>Foot Finish:</b> Terrace, Stride PR6 Silver  Pier PR6 Silver P8X Solar Black PJE Pyrite (+\$88) P02 Flint (+\$88) P7B Loft PJW Designer White	<b>3rd Option:</b> <b>Pull Option (Standard Lock):</b> A Arch M Beam O Halo S Square  <b>Pull Option (Digital Lock):</b> E Keypad (+\$464) D RFID (+\$573)	<b>4th Option:</b> <b>Pull Color</b> (if applicable): M Beam / O Halo PJW Designer White PR6 Silver PJE Pyrite P8X Solar Black  AP Arch PRO Anodized Silver SP Square PJW Designer White EL Matte Silver P02 Flint P7B Loft PJE Pyrite P8X Solar Black P2 upcharge +\$17/pull	<b>5th Option:</b> <b>Paint Case:</b> P1 P2 P3 See page 28 for finishes. P2 upcharge \$50 P3 upcharge \$109	<b>6th Option:</b> <b>Laminate Fronts: Laminate &amp; Edge:</b> See page 28 for finishes. L2 upcharge \$164 L3 upcharge \$327	<b>7th Option:</b> <b>Lock:</b> L Standard Lock X Omit Lock Core (Deduct \$20 per lock)
	.	.	P   R   6   .	.	P           .	.	.

Example: YPWP421218RL.BX.APR0.PJW.LVT1VT.X

# Align™ Metal Storage

## 12"W Double Lockers

For specification information see pages 31 and 43.

Metal Fronts with Plinth Base or Footed

GSA SIN 33721

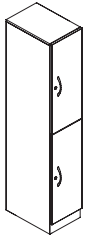

Description	Model	P1 Paint List Price
<b>65"H Double Locker — 12"W – Metal Case/Metal Fronts</b>		
18"D Hinges on Left	YPDLP651218LM	\$ 2694
18"D Hinges on Right (shown)	YPDLP651218RM	\$ 2694

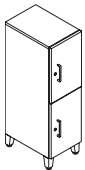

Description	Model	P1 Paint List Price
<b>42 1/2" H Double Locker — 12"W – Metal Case/Metal Fronts/Footed Base</b>		
18"D Hinges on Left	YPDLF421218LM	\$ 2357
18"D Hinges on Right (shown)	YPDLF421218RM	\$ 2357

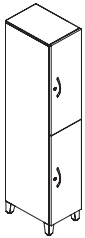

Description	Model	P1 Paint List Price
<b>65"H Double Locker — 12"W – Metal Case/Metal Fronts</b>		
18"D Hinges on Left	YPDLF651218LM	\$ 2955
18"D Hinges on Right (shown)	YPDLF651218RM	\$ 2955

To order Align wardrobes or lockers with a digital lock option, add "E" suffix to base model number. The digital lock has an integrated pull, so no pull will be specified.

METAL STORAGE

How to specify — Select the Model Number from above.	1st Option: Plinth Base Options (if applicable):	2nd Option: Foot Finish:	3rd Option: Pull Option (Standard Lock):	4th Option: Pull Color (if applicable):	5th Option: Paint Case:	6th Option: Paint Fronts:	7th Option: Lock:
Y P	<b>BK</b> Flush Kickplate <b>BX</b> Recessed Kickplate <b>Footed Base Options:</b> <b>TF</b> Terrace Foot (+\$82) <b>ZF</b> Stride Foot (+\$82) <b>PF</b> Pier Foot (+\$126)	<b>Terrace, Stride</b> <b>PR6</b> Silver <b>Pier</b> <b>PR6</b> Silver <b>P8X</b> Solar Black <b>PJE</b> Pyrite (+\$88) <b>P02</b> Flint (+\$88) <b>P7B</b> Loft <b>PJW</b> Designer White	<b>A</b> Arch <b>B</b> Bevel <b>M</b> Beam <b>O</b> Halo <b>S</b> Square <b>I</b> Integral <b>Pull Option (Digital Lock):</b> <b>E</b> Keypad (+\$464 per door) <b>D</b> RFID (+\$573 per door)	<b>M</b> Beam / <b>O</b> Halo <b>PJW</b> Designer White <b>PR6</b> Silver <b>PJE</b> Pyrite <b>P8X</b> Solar Black <b>AP</b> Arch <b>PRO</b> Anodized Silver <b>SP</b> Square <b>PJW</b> Designer White <b>EL</b> Matte Silver <b>P02</b> Flint <b>P7B</b> Loft <b>PJE</b> Pyrite <b>P8X</b> Solar Black P2 upcharge +\$17/pull	<b>P1 P2 P3</b> See page 28 for finishes. P2 upcharge \$82 P3 upcharge \$186	<b>NA</b> Match Case <b>P1</b> \$246 <b>P2</b> \$322 <b>P3</b> \$393	<b>L</b> Standard Lock <b>X</b> Omit Lock Core (Deduct \$20 per lock)
Y P		<b>P R 6</b> .		.	<b>P</b>       .	<b>N A</b> .	

Example: YPDLP651218LM.BX.E.PJW.NA

# Align™ Metal Storage

## 12"W Double Lockers

For specification information see pages 31 and 43.

Laminate Fronts with Plinth Base or Footed

GSA SIN 33721

Width	Model	P1 Paint List Price
<b>42½" H Double Locker — 12"W – Metal Case/Laminate Fronts/Plinth Base</b>		
18"D Hinges on Left	YPDLP421218LL	\$ 2463
18"D Hinges on Right (shown)	YPDLP421218RL	\$ 2463
<b>65"H Double Locker — 12"W – Metal Case/Laminate Fronts</b>		
18"D Hinges on Left	YPDLP651218LL	\$ 3164
18"D Hinges on Right (shown)	YPDLP651218RL	\$ 3164

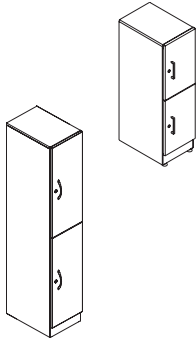

Width	Model	P1 Paint List Price
<b>42½" H Double Locker — 12"W – Metal Case/Laminate Fronts/Footed Base</b>		
18"D Hinges on Left	YPDLF421218LL	\$ 2771
18"D Hinges on Right (shown)	YPDLF421218RL	\$ 2771

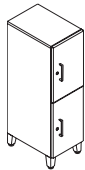

To order Align wardrobes or lockers with a digital lock option, add "E" suffix to base model number. The digital lock has an integrated pull, so no pull will be specified.

How to specify — Select the Model Number from above.	1st Option: Plinth Base Options (if applicable): BX Recessed Kickplate Footed Base Options: TF Terrace Foot ZF Stride Foot (+\$82) PF Pier Foot (+\$126)	2nd Option: Foot Finish: Terrace, Stride PR6 Silver Pier PR6 Silver P8X Solar Black PJE Pyrite (+\$88) P02 Flint (+\$88) P7B Loft PJW Designer White	3rd Option: Pull Option (Standard Lock): A Arch M Beam O Halo S Square Pull Option (Digital Lock): E Keypad (+\$464 per door) D RFID (+\$573 per door)	4th Option: Pull Color (if applicable): M Beam / O Halo PJW Designer White PR6 Silver PJE Pyrite P8X Solar Black AP Arch PRO Anodized Silver SP Square PJW Designer White EL Matte Silver P02 Flint P7B Loft PJE Pyrite P8X Solar Black P2 upcharge +\$17/pull	5th Option: Paint Case: P1 P2 P3 See page 28 for finishes. P2 upcharge \$82 P3 upcharge \$186	6th Option: Laminate Fronts: Laminate & Edge: See page 28 for finishes. L2 upcharge \$164 L3 upcharge \$327	7th Option: Lock: L Standard Lock X Omit Lock Core (Deduct \$20 per lock)
Y P .		PR6 .			P .		

Example: YPDLP651218LL.BX.APR0.PJW.LVT1VT.X

# Align™ Metal Storage

## 24"W Quad Lockers

For specification information see pages 31 and 43.

Metal Fronts with Plinth Base or Footed

GSA SIN 33721

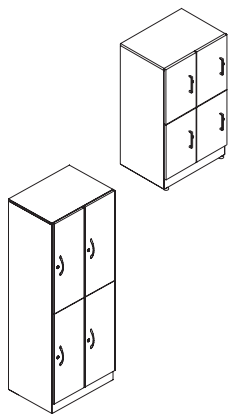

Description	Model	P1 Paint List Price
<b>42½" H Quad Locker — 24"W – Metal Case/Metal Fronts/Plinth Base</b>		
18"D Hinges on Left	YPQLP422418LM	\$ 3292
18"D Hinges on Right (shown)	YPQLP422418RM	\$ 3292
<b>65"H Quad Locker — 24"W – Metal Case/Metal Fronts</b>		
18"D Hinges on Left	YPQLP652418LM	\$ 3741
18"D Hinges on Right (shown)	YPQLP652418RM	\$ 3741

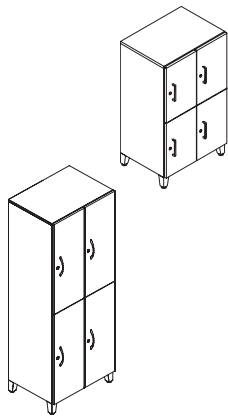

Description	Model	P1 Paint List Price
<b>42½"H Quad Locker — 24"W – Metal Case/Metal Fronts/Footed Base</b>		
18"D Hinges on Left	YPQLF422418LM	\$ 3556
18"D Hinges on Right (shown)	YPQLF422418RM	\$ 3556
<b>65"H Quad Locker — 24"W – Metal Case/Metal Fronts</b>		
18"D Hinges on Left	YPQLF652418LM	\$ 4003
18"D Hinges on Right (shown)	YPQLF652418RM	\$ 4003

To order Align wardrobes or lockers with a digital lock option, add "E" suffix to base model number. The digital lock has an integrated pull, so no pull will be specified.

METAL STORAGE

How to specify — Select the Model Number from above.	1st Option: Plinth Base Options (if applicable): BK Flush Kickplate BX Recessed Kickplate  Footed Base Options: TF Terrace Foot (+\$82) ZF Stride Foot (+\$82) PF Pier Foot (+\$126)	2nd Option: Foot Finish: Terrace, Stride PR6 Silver  Pier PR6 Silver P8X Solar Black PJE Pyrite (+\$88) P02 Flint (+\$88) P7B Loft PJW Designer White	3rd Option: Pull Option (Standard Lock): A Arch B Bevel M Beam O Halo S Square I Integral  Pull Option (Digital Lock): E Keypad (+\$464 per door) D RFID (+\$573 per door)	4th Option: Pull Color (if applicable): M Beam / O Halo PJW Designer White PR6 Silver PJE Pyrite P8X Solar Black  AP Arch PRO Anodized Silver  SP Square PJW Designer White EL Matte Silver P02 Flint P7B Loft PJE Pyrite P8X Solar Black P2 upcharge +\$17/pull	5th Option: Paint Case: P1 P2 P3 See page 28 for finishes. P2 upcharge \$109 P3 upcharge \$246	6th Option: Paint Fronts: NA Match Case P1 \$246 P2 \$322 P3 \$393	7th Option: Lock: L Standard Lock X Omit Lock Core (Deduct \$20 per lock)
Y P . . . . .	. . . . .	P R 6 . . . . .	. . . . .	. . . . .	P . . . . .	N A . . . . .	. . . . .

Example: YPQLP422418RM.BK.APR0.PJW.NA.L

For specification information see pages 31 and 43.

Laminate Fronts with Plinth Base or Footed

GSA SIN 33721

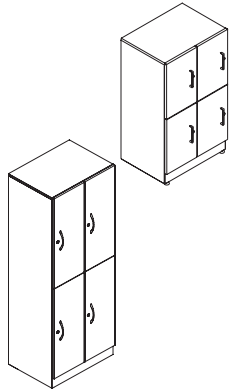

Width	Model	P1 Paint List Price
<b>42½"H Quad Locker — 24"W – Metal Case/Laminate Fronts/Plinth Base</b>		
18"D Hinges on Left	YPQLP422418LL	\$ 3869
18"D Hinges on Right (shown)	YPQLP422418RL	\$ 3869
<b>65"H Quad Locker — 24"W – Metal Case/Laminate Fronts</b>		
18"D Hinges on Left	YPQLP652418LL	\$ 4397
18"D Hinges on Right (shown)	YPQLP652418RL	\$ 4397

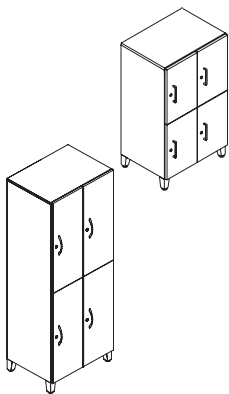

Width	Model	P1 Paint List Price
<b>42½"H Quad Locker — 24"W – Metal Case/Laminate Fronts/Footed Base</b>		
18"D Hinges on Left	YPQLF422418LL	\$ 4176
18"D Hinges on Right (shown)	YPQLF422418RL	\$ 4176
<b>65"H Quad Locker — 24"W – Metal Case/Laminate Fronts</b>		
18"D Hinges on Left	YPQLF652418LL	\$ 4704
18"D Hinges on Right (shown)	YPQLF652418RL	\$ 4704

To order Align wardrobes or lockers with a digital lock option, add "E" suffix to base model number. The digital lock has an integrated pull, so no pull will be specified.

<b>How to specify — Select the Model Number from above.</b>  <table border="1" style="width: 100%; height: 40px;"> <tr> <td style="width: 20px; height: 20px;">Y</td> <td style="width: 20px; height: 20px;">P</td> <td style="width: 20px; height: 20px;"></td> <td style="width: 20px; height: 20px;"></td> </tr> <tr> <td style="width: 20px; height: 20px;"></td> <td style="width: 20px; height: 20px;"></td> <td style="width: 20px; height: 20px;"></td> <td style="width: 20px; height: 20px;"></td> </tr> <tr> <td style="width: 20px; height: 20px;"></td> <td style="width: 20px; height: 20px;"></td> <td style="width: 20px; height: 20px;"></td> <td style="width: 20px; height: 20px;"></td> </tr> <tr> <td style="width: 20px; height: 20px;"></td> <td style="width: 20px; height: 20px;"></td> <td style="width: 20px; height: 20px;"></td> <td style="width: 20px; height: 20px;"></td> </tr> <tr> <td style="width: 20px; height: 20px;"></td> <td style="width: 20px; height: 20px;"></td> <td style="width: 20px; height: 20px;"></td> <td style="width: 20px; height: 20px;"></td> </tr> </table>	Y	P																			<b>1st Option:</b> <b>Plinth Base Options</b> <i>(if applicable):</i> BX Recessed Kickplate  <b>Footed Base Options:</b> TF Terrace Foot ZF Stride Foot (+\$82) PF Pier Foot (+\$126)	<b>2nd Option:</b> <b>Foot Finish:</b> Terrace, Stride PR6 Silver  Pier PR6 Silver P8X Solar Black PJE Pyrite (+\$88) P02 Flint (+\$88) P7B Loft PJW Designer White	<b>3rd Option:</b> <b>Pull Option (Standard Lock):</b> A Arch M Beam O Halo S Square  <b>Pull Option (Digital Lock):</b> E Keypad (+\$464 per door) D RFID (+\$573 per door)	<b>4th Option:</b> <b>Pull Color (if applicable):</b> M Beam / O Halo PJW Designer White PR6 Silver PJE Pyrite P8X Solar Black  AP Arch PRO Anodized Silver SP Square PJW Designer White EL Matte Silver P02 Flint P7B Loft PJE Pyrite P8X Solar Black P2 upcharge +\$17/pull	<b>5th Option:</b> <b>Paint Case:</b> P1 P2 P3 See page 28 for finishes. P2 upcharge \$109 P3 upcharge \$246	<b>6th Option:</b> <b>Laminate Fronts: Laminate &amp; Edge:</b> See page 28 for finishes. L2 upcharge \$164 L3 upcharge \$327	<b>7th Option:</b> <b>Lock:</b> L Standard Lock X Omit Lock Core (Deduct \$20 per lock)
Y	P																										
		<b>P R 6</b>			<b>P</b>																						

Example: YPQLP652418LL.BX.APRO.PJW.LVT1VT.X

# Align™ Metal Storage

## 12"W Cubby Lockers

For specification information see pages 31 and 43.

Metal Fronts with Plinth Base or Footed

GSA SIN 33721

		Description	Model Numbers	P1 Paint List Price
	<b>50"H Cubby Locker — 12"W – Metal Case/Metal Fronts/Plinth Base</b>			
		18"D Hinges on Left	YPCLP501218LM	\$ 2171
		18"D Hinges on Right	YPCLP501218RM	\$ 2171
	<b>50"H Cubby Locker — 12"W – Metal Case/Metal Fronts/Footed Base</b>			
		18"D Hinges on Left	YPCLF501218LM	\$ 2432
		18"D Hinges on Right	YPCLF501218RM	\$ 2432
<b>65"H Cubby Locker — 12"W – Metal Case/Metal Fronts/Footed Base</b>				
	18"D Hinges on Left	YPCLF651218LM	\$ 2881	
	18"D Hinges on Right	YPCLF651218RM	\$ 2881	

To order Align wardrobes or lockers with a digital lock option, add "E" suffix to base model number. The digital lock has an integrated pull, so no pull will be specified.

METAL STORAGE

How to specify — Select the Model Number from above.	1st Option: Plinth Base Options (if applicable):	2nd Option: Foot Finish:	3rd Option: Pull Option (Standard Lock):	4th Option: Pull Color (if applicable):	5th Option: Paint Case:	6th Option: Paint Fronts:	7th Option: Lock:
Y P	BK Flush Kickplate BX Recessed Kickplate	Terrace, Stride PR6 Silver	A Arch B Bevel M Beam O Halo S Square I Integral	M Beam / O Halo P JW Designer White PR6 Silver P JE Pyrite P8X Solar Black	AP Arch PRO Anodized Silver SP Square P JW Designer White EL Matte Silver P02 Flint P7B Loft P JE Pyrite P8X Solar Black P2 upcharge +\$17/pull	NA Match Case P1 \$246 P2 \$322 P3 \$393	L Standard Lock X Omit Lock Core (Deduct \$20 per lock)
TF Terrace Foot (+\$82) ZF Stride Foot (+\$82) PF Pier Foot (+\$126)	Footed Base Options:	Pier PR6 Silver P8X Solar Black P JE Pyrite (+\$88) P02 Flint (+\$88) P7B Loft P JW Designer White	Pull Option (Digital Lock): E Keypad (+\$464 per door) D RFID (+\$573 per door)		See page 28 for finishes. P2 upcharge \$109 P3 upcharge \$246		
.		P R 6   .	.	P       .	N A   .		

Example: YPCLP501218LM.BX.APRO.PJW.NA.X

For specification information see pages 31 and 43.

Laminate Fronts with Plinth Base or Footed

GSA SIN 33721

Width	Model Numbers	P1 Paint List Price
<b>50"H Cubby Locker — 12"W – Metal Case/Laminate Fronts/Plinth Base</b>		
18"D Hinges on Left	YPCLP501218LL	\$ 2550
18"D Hinges on Right	YPCLP501218RL	\$ 2550
<b>50"H Cubby Locker — 12"W – Metal Case/Laminate Fronts/Footed Base</b>		
18"D Hinges on Left	YPCLF501218LL	\$ 2858
18"D Hinges on Right	YPCLF501218RL	\$ 2858
<b>65"H Cubby Locker — 12"W – Metal Case/Laminate Fronts/Plinth Base</b>		
18"D Hinges on Left	YPCLP651218LL	\$ 3076
18"D Hinges on Right	YPCLP651218RL	\$ 3076
<b>65"H Cubby Locker — 12"W – Metal Case/Laminate Fronts/Footed Base</b>		
18"D Hinges on Left	YPCLF651218LL	\$ 3385
18"D Hinges on Right	YPCLF651218RL	\$ 3385

To order Align wardrobes or lockers with a digital lock option, add "E" suffix to base model number. The digital lock has an integrated pull, so no pull will be specified.

How to specify — Select the Model Number from above.	1st Option: Plinth Base Options (if applicable): BX Recessed Kickplate Footed Base Options: TF Terrace Foot ZF Stride Foot (+\$82) PF Pier Foot (+\$126)	2nd Option: Foot Finish: Terrace, Stride PR6 Silver Pier PR6 Silver P8X Solar Black PJE Pyrite (+\$88) P02 Flint (+\$88) P7B Loft PJW Designer White	3rd Option: Pull Option (Standard Lock): A Arch M Beam O Halo S Square Pull Option (Digital Lock): E Keypad (+\$464 per door) D RFID (+\$573 per door)	4th Option: Pull Color (if applicable): M Beam / O Halo PJW Designer White PR6 Silver PJE Pyrite P8X Solar Black AP Arch PRO Anodized Silver SP Square PJW Designer White EL Matte Silver P02 Flint P7B Loft PJE Pyrite P8X Solar Black P2 upcharge +\$17/pull	5th Option: Paint Case: P1 P2 P3 See page 28 for finishes. P2 upcharge \$109 P3 upcharge \$246	6th Option: Laminate Fronts: Laminate & Edge: See page 28 for finishes. L2 upcharge \$164 L3 upcharge \$327	7th Option: Lock: L Standard Lock X Omit Lock Core (Deduct \$20 per lock)
Y P . . . . .	. . . . .	P R 6 . . . . .	. . . . .	. . . . .	P . . . . .	. . . . .	. . . . .

Example: YPCLP501218LL.BX.APR0.PJW.LVT1VT.X

# Align™ Metal Storage

## 24"W Cubby Lockers

For specification information see pages 31 and 43.

Metal Fronts with Plinth Base or Footed

GSA SIN 33721

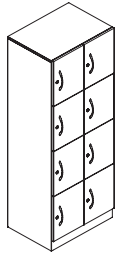

Description	Model	P1 Paint List Price
<b>65"H Cubby Locker — 24"W – Metal Case/Metal Fronts</b>		
18"D Hinges on Left	YPCLP652418LM	\$ 4639
18"D Hinges on Right (shown)	YPCLP652418RM	\$ 4639

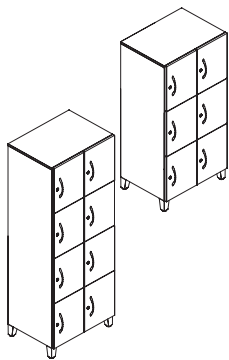

Description	Model	P1 Paint List Price
<b>50"H Cubby Locker — 24"W – Metal Case/Metal Fronts</b>		
18"D Hinges on Left	YPCLF502418LM	\$ 4154
18"D Hinges on Right (shown)	YPCLF502418RM	\$ 4154
<b>65"H Cubby Locker — 24"W – Metal Case/Metal Fronts</b>		
18"D Hinges on Left	YPCLF652418LM	\$ 4902
18"D Hinges on Right (shown)	YPCLF652418RM	\$ 4902

To order Align wardrobes or lockers with a digital lock option, add "E" suffix to base model number. The digital lock has an integrated pull, so no pull will be specified.

METAL STORAGE

<p><b>How to specify — Select the Model Number from above.</b></p> <p>Y P        </p> <p>         </p> <p>         </p> <p>         </p> <p>  .</p>	<p><i>1st Option:</i></p> <p><b>Plinth Base Options</b> (if applicable):</p> <p>BK Flush Kickplate</p> <p>BX Recessed Kickplate</p> <p><b>Footed Base Options:</b></p> <p>TF Terrace Foot (+\$82)</p> <p>ZF Stride Foot (+\$82)</p> <p>PF Pier Foot (+\$126)</p>	<p><i>2nd Option:</i></p> <p><b>Foot Finish:</b></p> <p><b>Terrace, Stride</b></p> <p>PR6 Silver</p> <p><b>Pier</b></p> <p>PR6 Silver</p> <p>P8X Solar Black</p> <p>PJE Pyrite (+\$88)</p> <p>P02 Flint (+\$88)</p> <p>P7B Loft</p> <p>PJW Designer White</p>	<p><i>3rd Option:</i></p> <p><b>Pull Option (Standard Lock):</b></p> <p>A Arch</p> <p>B Bevel</p> <p>M Beam</p> <p>O Halo</p> <p>S Square</p> <p>I Integral</p> <p><b>Pull Option (Digital Lock):</b></p> <p>E Keypad (+\$464 per door)</p> <p>D RFID (+\$573 per door)</p>	<p><i>4th Option:</i></p> <p><b>Pull Color</b> (if applicable):</p> <p>M Beam / O Halo</p> <p>PJW Designer White</p> <p>PR6 Silver</p> <p>PJE Pyrite</p> <p>P8X Solar Black</p> <p>AP Arch</p> <p>PRO Anodized Silver</p> <p>SP Square</p> <p>PJW Designer White</p> <p>EL Matte Silver</p> <p>P02 Flint</p> <p>P7B Loft</p> <p>PJE Pyrite</p> <p>P8X Solar Black</p> <p>P2 upcharge +\$17/pull</p>	<p><i>5th Option:</i></p> <p><b>Paint Case:</b></p> <p>P1 P2 P3</p> <p>See page 28 for finishes.</p> <p>P2 upcharge \$109</p> <p>P3 upcharge \$246</p>	<p><i>6th Option:</i></p> <p><b>Paint Fronts:</b></p> <p>NA Match Case</p> <p>P1 \$246</p> <p>P2 \$322</p> <p>P3 \$393</p>	<p><i>7th Option:</i></p> <p><b>Lock:</b></p> <p>L Standard Lock</p> <p>X Omit Lock Core (Deduct \$20 per lock)</p>
	<p>P R 6 .</p>	<p>P .</p>	<p>N A .</p>	<p>. . . . .</p>	<p>. . . . .</p>	<p>. . . . .</p>	<p>. . . . .</p>

Example: YPCLP652418LM.BX.APRO.PJW.NA.X



# Align™ Metal Storage

## 24"W Cubby Lockers

For specification information see pages 31 and 43.

Laminate Fronts with Plinth Base or Footed

GSA SIN 33721

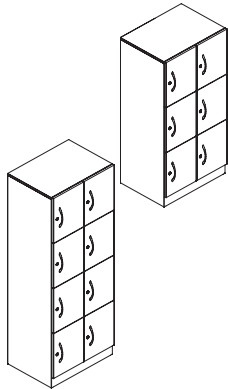

Width	Model	P1 Paint List Price
<b>50"H Cubby Locker — 24"W – Metal Case/Laminate Fronts</b>		
18"D Hinges on Left	YPCLP502418LL	\$ 4572
18"D Hinges on Right (shown)	YPCLP502418RL	\$ 4572
<b>65"H Cubby Locker — 24"W – Metal Case/Laminate Fronts</b>		
18"D Hinges on Left	YPCLP652418LL	\$ 5453
18"D Hinges on Right (shown)	YPCLP652418RL	\$ 5453

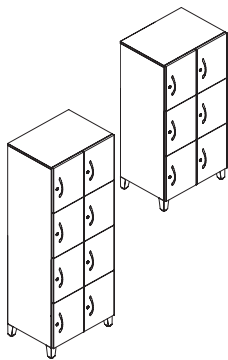

Width	Model	P1 Paint List Price
<b>50"H Cubby Locker — 24"W – Metal Case/Laminate Fronts</b>		
18"D Hinges on Left	YPCLF502418LL	\$ 4880
18"D Hinges on Right (shown)	YPCLF502418RL	\$ 4880
<b>65"H Cubby Locker — 24"W – Metal Case/Laminate Fronts</b>		
18"D Hinges on Left	YPCLF652418LL	\$ 5759
18"D Hinges on Right (shown)	YPCLF652418RL	\$ 5759

To order Align wardrobes or lockers with a digital lock option, add "E" suffix to base model number. The digital lock has an integrated pull, so no pull will be specified.

How to specify — Select the Model Number from above.	1st Option: Plinth Base Options (if applicable): BX Recessed Kickplate Footed Base Options: TF Terrace Foot ZF Stride Foot (+\$82) PF Pier Foot (+\$126)	2nd Option: Foot Finish: Terrace, Stride PR6 Silver Pier PR6 Silver P8X Solar Black PJE Pyrite (+\$88) P02 Flint (+\$88) P7B Loft P JW Designer White	3rd Option: Pull Option (Standard Lock): A Arch M Beam O Halo S Square Pull Option (Digital Lock): E Keypad (+\$464 per door) D RFID (+\$573 per door)	4th Option: Pull Color (if applicable): M Beam / O Halo P JW Designer White PR6 Silver PJE Pyrite P8X Solar Black AP Arch PRO Anodized Silver SP Square P JW Designer White EL Matte Silver P02 Flint P7B Loft PJE Pyrite P8X Solar Black P2 upcharge +\$17/pull	5th Option: Paint Case: P1 P2 P3 See page 28 for finishes. P2 upcharge \$109 P3 upcharge \$246	6th Option: Laminate Fronts: Laminate & Edge: See page 28 for finishes. L2 upcharge \$164 L3 upcharge \$327	7th Option: Lock: L Standard Lock X Omit Lock Core (Deduct \$20 per lock)
Y P . . . . .	. . . . .	P R 6 . . . . .	. . . . .	. . . . .	P . . . . .	. . . . .	. . . . .

Example: YPCLP652418LL.BX.APR0.P JW.LVT1VT.X

For specification information see page 22.

GSA SIN PENDING



00000

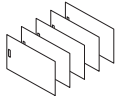

Description	Model	List Price
<b>Digital Lock Keys and Accessories</b>		
Programming Key	YPLDIGPRG	\$ 330
Manager Key	YPLDIGMGR	\$ 255
5pk RFID Stickers	YPLRFID5S	\$ 109
5pk RFID Cards	YPLRFID5C	\$ 219
25pk RFID Stickers	YPLRFID25S	\$ 521
25pk RFID Cards	YPLRFID25C	\$ 1042

**How to specify —**

Select the Model Number from above.

Y | P | L | | | | | | | | | |

Examples: YPLDIGPRG YPLRFID5S

TOPS	CHASSIS	EDGE
<b>GRADE L1</b>	<b>GRADE L1</b>	
<b>ABSTRACTS</b>	<b>SOLID</b>	Beigewood..... DE
Ash..... LT3B	Black..... P	Belair..... BA
Silver Mesh..... LT8D	Brownstone..... LM13	Black..... E4
Handspun Pear..... LAHP	Designer White 15051..... LDW1	Bourbon Cherry..... H
Handspun Dove..... LAHD	Flint..... LM16	Brownstone..... EY
Handspun Slate..... LAHS	Fossil Shale..... LEH1	Designer White..... DW
Handspun Chestnut..... LAHC	Loft..... LM11	Fawn Cypress..... FC
<b>SOLID</b>	Muslin..... LM15	Field Elm..... FE
Black..... P	<b>WOODGRAIN</b>	Flint..... E9
Brownstone..... LM13	Belair..... LWBA	Florence Walnut..... FW
Designer White 15051..... LDW1	Bourbon Cherry..... H	Fossil..... EH
Flint..... LM16	Field Elm..... LWFE	Kingswood Walnut..... KI
Fossil Shale..... LEH1	Florence Walnut..... LFW1	Loft..... EV
Loft..... LM11	Kingswood Walnut..... LK11	Lowell Ash..... DL
Muslin..... LM15	Natural Maple..... LWD	Mangalore Mango..... MM
Titanium..... LTI1	NeoWalnut..... LNU1	Muslin..... EU
<b>WOODGRAIN</b>	Pinnacle..... PINC	Natural Maple..... DD
Belair..... LWBA	Shaker Cherry..... LW7C	Natural Recon..... NR
Bourbon Cherry..... H	<b>GRADE L2</b>	Natural Walnut..... DN
Field Elm..... LWFE	Beigewood..... LWBE	NeoWalnut..... NU
Florence Walnut..... LFW1	Fawn Cypress..... LFC1	Phantom Charcoal..... PC
Kingswood Walnut..... LK11	Lowell Ash..... LLA1	Phantom Ecru..... PE
Natural Maple..... LWD	Mangalore Mango..... LMM1	Pinnacle..... PI
NeoWalnut..... LNU1	Natural Recon..... LNR1	Portico Teak..... DP
Pinnacle..... PINC	Phantom Charcoal..... LPC1	Shaker Cherry..... DF
Shaker Cherry..... LW7C	Phantom Ecru..... LPE1	Skyline Walnut..... SW
<b>GRADE L2</b>	Portico Teak..... LPT1	Veranda Teak..... VT
Beigewood..... LWBE	Skyline Walnut..... LSW1	
Fawn Cypress..... LFC1	Veranda Teak..... LVT1	
Lowell Ash..... LLA1	<b>GRADE L3</b>	
Mangalore Mango..... LMM1	Natural Walnut..... LWNW	
Natural Recon..... LNR1		
Phantom Charcoal..... LPC1		
Phantom Ecru..... LPE1		
Portico Teak..... LPT1		
Skyline Walnut..... LSW1		
Veranda Teak..... LVT1		
<b>GRADE L3</b>		
Natural Walnut..... LWNW		

Storage Islands are a new application for Align and Essentials Storage Lines.

**\*Essentials 3H Storage and Align 42½"H Lockers and Wardrobes**

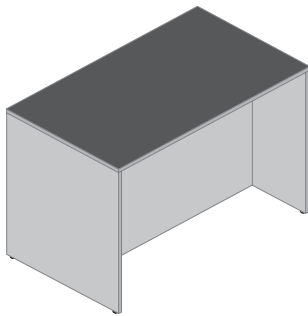

**Top:** (pages 83-86)

- Available in 18"D and 36"D.
- Tops made of 1¼" particle board with 2mm edgeband, High Pressure laminate on one side and paper back on the other. Grain direction on all tops runs horizontal.
- Tops specified specific to the application.  
*Example:* Storage island tops with end panels will have proper pilot holes in the top to accept attachment hardware.
- External Support Channel should be used in applications where +48"W tops are unsupported.

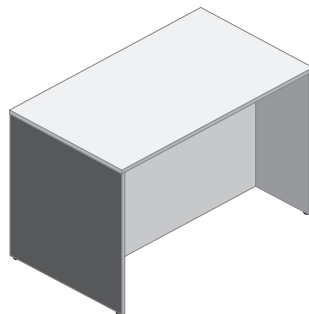

**End Panel:** (page 87)

- Panels made of 1¼" particle board with 2mm edgeband and High-Pressure Laminate on both sides.
- Grain direction on all End Panels runs vertical.
- End Panels are shipped with mounting hardware.
- All 36"D End Panels and Tops accept a septum, however, it is not necessary to put one in for all applications.

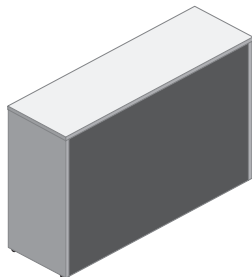

**Back/Septum:** (page 87)

- Model is considered a back when used in 18"D configurations to encase back of storage units.
- Model is considered septum when used in 36"D configurations to create division down the center of 36"D top.
- Backs/septums are made of ¾" particle board with 0.5mm edgeband and High-Pressure Laminate on both sides.
- Grain direction on all backs/septums runs horizontal.
- Ship with mounting hardware.
- The width and number of units spanned on the septum must match the width and number of units spanned on the top.

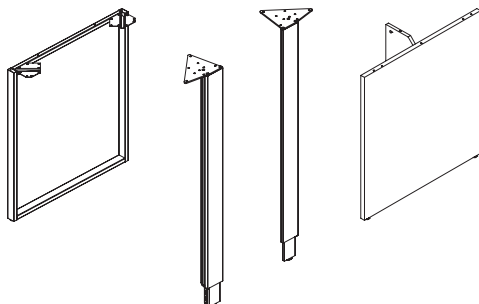
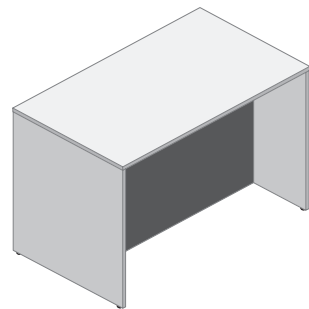

**End of Run Supports:** (pages 88-89)

- O-legs installed in peninsula application are centered front to back on the worksurface. The O-leg will be ½" inset from the edge of the worksurface.
- When specifying a peninsula application, at least one side of the open worksurface span must be supported with undersurface storage. Island tops cannot be specified with only O-leg, Stride Post Legs, or Laminate Return Panel supports.
- Stride Legs are height-adjustable and able to be used with Align or Essentials platforming.
- End of Run laminate supports can be specified as a "waterfall" return on peninsula applications.

### Working with Storage Islands

#### Top Sizes: (pages 83-86)

Top models are decided by what is needed in the application. If a storage island is specifying end panels, a different top model is needed than when a non-paneled island is configured. Storage Island Tops for use with End Panels are dimensionally larger to accommodate the needed attachment. The below chart highlights how the depth changes when panels and backs are specified.

<div style="display: flex; align-items: center; justify-content: center;"> <div style="border: 1px solid black; width: 150px; height: 100px; margin-right: 10px;"></div> <div style="text-align: center;"> <p>Width</p> <p>Depth</p> </div> </div>	Depths	
	18"D No Back, No End panels	18.190
	18"D No Back, With End panels	18.440
	18"D Back and End Panels	19.455
	36"D No Back, No End Panels	36.690
	36"D End Panels	

#### End Panel sizes: (pages 87-89)

Storage islands can be designed using Essentials and Align. These storage platforms have a 2" variance making storage island dimensions different depending on storage platform used. See the chart to the right for dimensions of end panels.

\*Recommend usage of panels when top is specified and storage sides are exposed. Storage will have gap between back-to-back units if top is flush with storage units.

	Depths	Height
18"D No Back, Align	18.190	40.8
18"D No Back, Essentials		38.8
18"D With Back, Align	19.204	40.8
18"D With Back, Essentials		38.8
36"D End Panels, Align	36.440	40.8
36"D End Panels, Essentials		38.8

As the storage island configuration grows, the top width also increases. The below chart outlines how to calculate these dimensions when considering how many units are spanned and if end panels are specified. When specifying your model for the storage island top, the model will end with the correlating span. These spanning guidelines assume all storage units are the same model and does not take into account mixing and matching of units. When mixing and matching of storage units, use the below chart to find required top dimensions and pick top model with this information. Spanning indicated on model may not be indicative of configuration when mixing and matching.

	Width Sizes						
	Span 1	Span 2	Span 3	Span 4	Span 5	Span 6	Span 7
No End Panels	Listed Model Dimensions	Span 1 + 0.125	Span 1 + 0.25	Span 1 + 0.375	Span 1 + 0.5	Span 1 + 0.625	Span 1 + 0.75
1 End Panel	Listed Model Dimensions + 1.372						
2 End Panels	Listed Model Dimensions + 2.744						

Span 1 tops indicate it will only cover a single storage unit. Start with the span 1 number displayed in the table above. Depending on your Islands configuration, the top width increases accordingly based on the 2 factors below.

- 1). The number of end panels you attach to the worksurface. As you add end panels, 1.372" is also added to the top dimensions per end panel specified.
- 2). The number of side-to-side storage units the surface spans. The spanning from one unit to another takes into account .125" gap between each storage unit.

\*Be sure to use the width of the worksurface you select. Models correspond to the correct surface width.

\*Span represents the total number of side-to-side units. Front-to-back units do not factor into number of units spanned.

**Example:** Two 24" W laterals are specified side-to-side. The top will span across two units making it a "S2." The configuration will also include two end panels, so the overall width of the configuration is 48" + 2.744" + .125" = 50.869" W.

### Working with Storage Islands

#### Application Overview

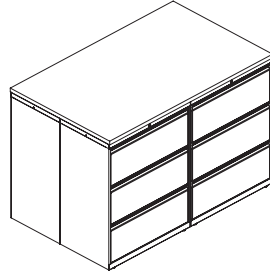

#### Simple Storage Island:

Simple Storage Islands only consist of adding a top to Align or Essentials storage configurations. Simple Storage Islands allow users to flex storage spaces into usable spaces.

#### Fully Shrouded Storage Island:

Fully Shrouded Storage Islands consist of adding a top, back/septum, and end panels. Single- (18"D top) or double-sided (36"D top) applications can be specified as fully shrouded. By adding these additional parts and pieces to Essentials or Align Storage platforms users can create more permanent and visually appealing storage spaces.

- When specifying like applications, both end panels must be specified with the back. The back piece cannot connect to another back.
- In a counter top application, the unsupported 18"D surface will require an external stiffener based on the unsupported width.

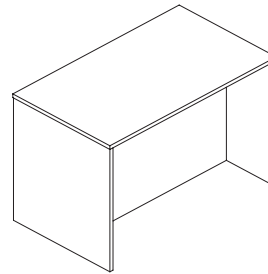

#### Collaborative Storage Peninsula:

Collaborative Storage Peninsulas consist of tops, septum, end panels, and end of run supports. Peninsulas create usable storage spaces and collaborative work areas all in one configuration.

- Peninsula applications can only be completed with 36"D worksurfaces and end panels.
- Back to back storage specified without an end panel will result in a  $\sim\frac{3}{8}$ " gap between storage units.
- In a peninsula application, one end of the worksurface must be supported by undersurface storage. The opposing end can be supported with an O-leg, Stride Post Legs, or laminate return panel.

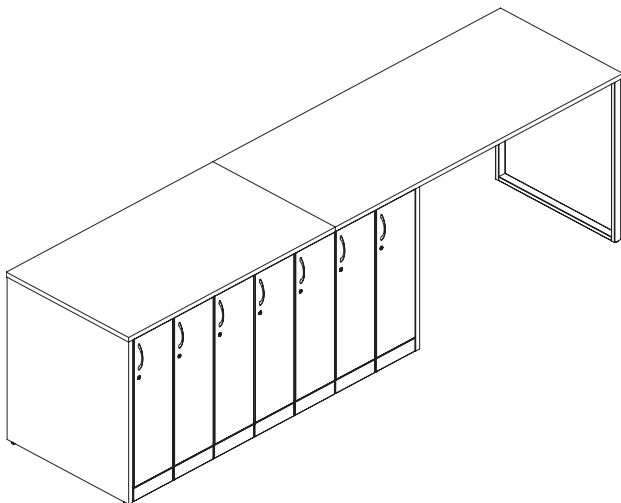

For specification information see pages 80-82.

GSA SIN 33721

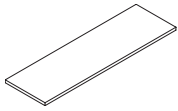

Description	Model	L1 List Price	L2 List Price	L3 List Price
<b>18" D Storage Island Tops:</b> For use with non-paneled storage island				
24" W S1	ISLAUTNPB2418S1	\$ 265	\$ 276	\$ 286
30" W S1	ISLAUTNPB3018S1	\$ 291	\$ 302	\$ 314
36" W S1	ISLAUTNPB3618S1	\$ 330	\$ 344	\$ 357
36" W S3	ISLAUTNPB3618S3	\$ 349	\$ 364	\$ 377
42" W S1	ISLAUTNPB4218S1	\$ 357	\$ 372	\$ 386
48" W S1	ISLAUTNPB4818S1	\$ 388	\$ 404	\$ 419
48" W S2	ISLAUTNPB4818S2	\$ 398	\$ 414	\$ 430
48" W S4	ISLAUTNPB4818S4	\$ 405	\$ 422	\$ 437
60" W S1	ISLAUTNPB6018S1	\$ 411	\$ 428	\$ 444
60" W S2	ISLAUTNPB6018S2	\$ 423	\$ 440	\$ 456
60" W S5	ISLAUTNPB6018S5	\$ 438	\$ 456	\$ 472
72" W S1	ISLAUTNPB7218S1	\$ 447	\$ 465	\$ 482
72" W S2	ISLAUTNPB7218S2	\$ 492	\$ 512	\$ 531
72" W S3	ISLAUTNPB7218S3	\$ 508	\$ 528	\$ 548
72" W S6	ISLAUTNPB7218S6	\$ 548	\$ 570	\$ 591
84" W S1	ISLAUTNPB8418S1	\$ 588	\$ 611	\$ 634
84" W S2	ISLAUTNPB8418S2	\$ 601	\$ 625	\$ 648
84" W S7	ISLAUTNPB8418S7	\$ 648	\$ 674	\$ 699
90" W S1	ISLAUTNPB9018S1	\$ 671	\$ 698	\$ 724
90" W S3	ISLAUTNPB9018S3	\$ 697	\$ 725	\$ 752

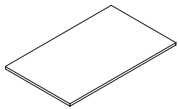

<b>36" D Storage Island Tops:</b> For use with non-paneled storage island				
24" W S1	ISLAUTNPB2436S1	\$ 445	\$ 463	\$ 480
30" W S1	ISLAUTNPB3036S1	\$ 492	\$ 512	\$ 531
36" W S1	ISLAUTNPB3636S1	\$ 555	\$ 577	\$ 599
36" W S3	ISLAUTNPB3636S3	\$ 585	\$ 608	\$ 631
42" W S1	ISLAUTNPB4236S1	\$ 601	\$ 625	\$ 648
48" W S1	ISLAUTNPB4836S1	\$ 654	\$ 680	\$ 706
48" W S2	ISLAUTNPB4836S2	\$ 670	\$ 697	\$ 723
48" W S4	ISLAUTNPB4836S4	\$ 682	\$ 709	\$ 736
60" W S1	ISLAUTNPB6036S1	\$ 693	\$ 721	\$ 748
60" W S2	ISLAUTNPB6036S2	\$ 712	\$ 741	\$ 768
60" W S5	ISLAUTNPB6036S5	\$ 738	\$ 767	\$ 796
72" W S1	ISLAUTNPB7236S1	\$ 752	\$ 782	\$ 811
72" W S2	ISLAUTNPB7236S2	\$ 830	\$ 863	\$ 895
72" W S3	ISLAUTNPB7236S3	\$ 854	\$ 888	\$ 921
72" W S6	ISLAUTNPB7236S6	\$ 921	\$ 957	\$ 993
84" W S1	ISLAUTNPB8436S1	\$ 989	\$ 1028	\$ 1067
84" W S2	ISLAUTNPB8436S2	\$ 1013	\$ 1053	\$ 1093
84" W S7	ISLAUTNPB8436S7	\$ 1089	\$ 1132	\$ 1175
90" W S1	ISLAUTNPB9036S1	\$ 1131	\$ 1176	\$ 1220
90" W S3	ISLAUTNPB9036S3	\$ 1173	\$ 1219	\$ 1265

<p><b>How to specify —</b> Select the Model Number from above.</p>	<p><b>1st Option:</b> FSC Certified Wood: F FSC Certified X No FSC</p>	<p><b>2nd Option:</b> Laminate (if applicable): See page 79 for finishes.</p>	<p><b>3rd Option:</b> Edgeband (if applicable): See page 79 for finishes.</p>
<p>Example: ISLAUTNPB2418S1.LM16.E9</p>			

For specification information see pages 80-82.

GSA SIN 33721

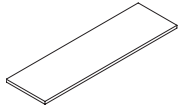

Description	Model	L1 List Price	L2 List Price	L3 List Price
<b>18" D Storage Island Tops:</b> For use with 2 end panels				
24" W S1	ISLAUT2PNB2418S1	\$ 291	\$ 302	\$ 314
30" W S1	ISLAUT2PNB3018S1	\$ 321	\$ 335	\$ 347
36" W S1	ISLAUT2PNB3618S1	\$ 364	\$ 379	\$ 393
36" W S3	ISLAUT2PNB3618S3	\$ 384	\$ 400	\$ 415
42" W S1	ISLAUT2PNB4218S1	\$ 393	\$ 409	\$ 424
48" W S2	ISLAUT2PNB4818S2	\$ 438	\$ 456	\$ 472
48" W S4	ISLAUT2PNB4818S4	\$ 445	\$ 463	\$ 480
60" W S2	ISLAUT2PNB6018S2	\$ 465	\$ 484	\$ 501
60" W S5	ISLAUT2PNB6018S5	\$ 481	\$ 500	\$ 520
72" W S2	ISLAUT2PNB7218S2	\$ 540	\$ 561	\$ 583
72" W S3	ISLAUT2PNB7218S3	\$ 559	\$ 581	\$ 603
72" W S6	ISLAUT2PNB7218S6	\$ 601	\$ 625	\$ 648
84" W S2	ISLAUT2PNB8418S2	\$ 662	\$ 689	\$ 714
84" W S7	ISLAUT2PNB8418S7	\$ 712	\$ 741	\$ 768
90" W S3	ISLAUT2PNB9018S3	\$ 766	\$ 796	\$ 826

<p><b>How to specify —</b> Select the Model Number from above.</p>	<p><b>1st Option:</b> <b>FSC Certified Wood:</b> F FSC Certified X No FSC</p>	<p><b>2nd Option:</b> <b>Laminate (if applicable):</b> See page 79 for finishes.</p>	<p><b>3rd Option:</b> <b>Edgeband (if applicable):</b> See page 79 for finishes.</p>
<p>_____ . _____ .</p>	<p>_____ .</p>	<p>_____ .</p>	<p>_____ .</p>

Example: ISLAUT2PNB2418S1.LM16.E9



For specification information see pages 80-82.

GSA SIN 33721

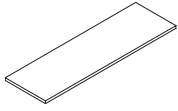

Description	Model	L1 List Price	L2 List Price	L3 List Price
<b>18"D Storage Island Tops:</b> For use with 2 end panels and back panel				
48"W S2	ISLAUT2PYB4818S2	\$ 481	\$ 500	\$ 520
48"W S4	ISLAUT2PYB4818S4	\$ 490	\$ 510	\$ 529
60"W S2	ISLAUT2PYB6018S2	\$ 511	\$ 531	\$ 552
60"W S5	ISLAUT2PYB6018S5	\$ 530	\$ 551	\$ 572
72"W S2	ISLAUT2PYB7218S2	\$ 595	\$ 618	\$ 642
72"W S3	ISLAUT2PYB7218S3	\$ 615	\$ 639	\$ 663
72"W S6	ISLAUT2PYB7218S6	\$ 662	\$ 689	\$ 714
84"W S2	ISLAUT2PYB8418S2	\$ 728	\$ 757	\$ 785
84"W S7	ISLAUT2PYB8418S7	\$ 784	\$ 815	\$ 846
90"W S3	ISLAUT2PYB9018S3	\$ 843	\$ 876	\$ 909

<p><b>How to specify —</b> Select the Model Number from above.</p>	<p><b>1st Option:</b> <b>FSC Certified Wood:</b> F FSC Certified X No FSC</p>	<p><b>2nd Option:</b> <b>Laminate</b> (if applicable): See page 79 for finishes.</p>	<p><b>3rd Option:</b> <b>Edgeband</b> (if applicable): See page 79 for finishes.</p>
<p>Example: ISLAUT2PYB4818S2.LM16.E9</p>			

For specification information see pages 80-82.

GSA SIN 33721

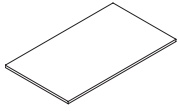

Description	Model	L1 List Price	L2 List Price	L3 List Price
<b>36"D Storage Island Tops:</b> For use with 1 end panel and septum				
48"W S2	ISLAUT1PYB4836S2	\$ 803	\$ 835	\$ 867
48"W S4	ISLAUT1PYB4836S4	\$ 818	\$ 850	\$ 883
60"W S2	ISLAUT1PYB6036S2	\$ 854	\$ 888	\$ 921
60"W S5	ISLAUT1PYB6036S5	\$ 884	\$ 919	\$ 953
72"W S2	ISLAUT1PYB7236S2	\$ 996	\$ 1036	\$ 1074
72"W S3	ISLAUT1PYB7236S3	\$ 1023	\$ 1064	\$ 1103
72"W S6	ISLAUT1PYB7236S6	\$ 1104	\$ 1148	\$ 1191
84"W S2	ISLAUT1PYB8436S2	\$ 1215	\$ 1263	\$ 1310
84"W S7	ISLAUT1PYB8436S7	\$ 1305	\$ 1357	\$ 1408
90"W S3	ISLAUT1PYB9036S3	\$ 1404	\$ 1459	\$ 1515
<b>36"D Storage Island Tops:</b> For use with 2 end panels and septum				
48"W S2	ISLAUT2PYB4836S2	\$ 811	\$ 843	\$ 875
48"W S4	ISLAUT2PYB4836S4	\$ 828	\$ 861	\$ 893
60"W S2	ISLAUT2PYB6036S2	\$ 864	\$ 898	\$ 932
60"W S5	ISLAUT2PYB6036S5	\$ 890	\$ 925	\$ 960
72"W S2	ISLAUT2PYB7236S2	\$ 1006	\$ 1046	\$ 1085
72"W S3	ISLAUT2PYB7236S3	\$ 1033	\$ 1074	\$ 1114
72"W S6	ISLAUT2PYB7236S6	\$ 1115	\$ 1159	\$ 1203
84"W S2	ISLAUT2PYB8436S2	\$ 1229	\$ 1277	\$ 1325
84"W S7	ISLAUT2PYB8436S7	\$ 1318	\$ 1370	\$ 1421
90"W S3	ISLAUT2PYB9036S3	\$ 1419	\$ 1475	\$ 1531

METAL STORAGE

<p><b>How to specify —</b> Select the Model Number from above.</p>	<p><b>1st Option:</b> <b>FSC Certified Wood:</b> F FSC Certified X No FSC</p>	<p><b>2nd Option:</b> <b>Laminate (if applicable):</b> See page 79 for finishes.</p>	<p><b>3rd Option:</b> <b>Edgeband (if applicable):</b> See page 79 for finishes.</p>
<input type="text"/>	<input type="text"/>	<input type="text"/>	<input type="text"/>

Example: ISLAUT1PYB4836S2.LM16.E9

For specification information see pages 80-82.

GSA SIN 33721

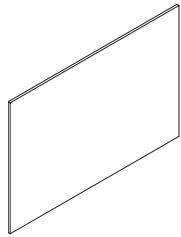

Description	Model	L1 List Price	L2 List Price	L3 List Price
<b>42"H Storage Island Septum/Back:</b> For use with Align Storage				
48"W S2	ISLAAB2P4842S2	\$ 662	\$ 689	\$ 714
48"W S4	ISLAAB2P4842S4	\$ 662	\$ 689	\$ 714
60"W S5	ISLAAB2P6042S5	\$ 712	\$ 741	\$ 768
72"W S3	ISLAAB2P7242S3	\$ 765	\$ 795	\$ 825
72"W S6	ISLAAB2P7242S6	\$ 822	\$ 854	\$ 887
84"W S7	ISLAAB2P8442S7	\$ 885	\$ 920	\$ 954

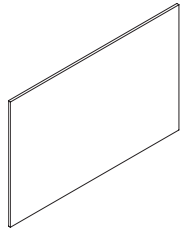

<b>40"H Storage Island Septum/Back:</b> For use with Essential Storage				
60"W S2	ISLAEB2P6040S2	\$ 712	\$ 741	\$ 768
72"W S2	ISLAEB2P7240S2	\$ 765	\$ 795	\$ 825
84"W S2	ISLAEB2P8440S2	\$ 885	\$ 920	\$ 954
90"W S3	ISLAEB2P9040S3	\$ 951	\$ 989	\$ 1026

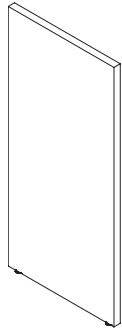

<b>42"H Storage Island End Panel:</b> For use with Align Storage				
18"D	ISLAAENB1842	\$ 441	\$ 459	\$ 476
18"D LH (Use with back)	ISLAAEYB1842L	\$ 441	\$ 459	\$ 476
18"D RH (Use with back)	ISLAAEYB1842R	\$ 441	\$ 459	\$ 476
36"D (Use with septum)	ISLAAEYB3642	\$ 616	\$ 640	\$ 664

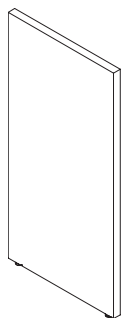

<b>40"H Storage Island End Panel:</b> For use with Essential Storage				
18"D	ISLAEENB1842	\$ 441	\$ 459	\$ 476
18"D LH (Use with back)	ISLAEYB1842L	\$ 441	\$ 459	\$ 476
18"D RH (Use with back)	ISLAEYB1842R	\$ 441	\$ 459	\$ 476
36"D (Use with septum)	ISLAEYB3642	\$ 616	\$ 640	\$ 664

<p><b>How to specify —</b> Select the Model Number from above.</p>	<p><i>1st Option:</i> <b>FSC Certified Wood:</b> F FSC Certified X No FSC</p>	<p><i>2nd Option:</i> <b>Laminate (if applicable):</b> See page 79 for finishes.</p>	<p><i>3rd Option:</i> <b>Edgeband (if applicable):</b> See page 79 for finishes.</p>
<p>Example: ISLAAB2P4842S2.LM16.E9</p>			

# Align™ Metal Storage

## Storage Island End of Run Supports

For specification information see pages 80-82.

GSA SIN 33721

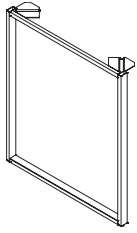

O-Leg

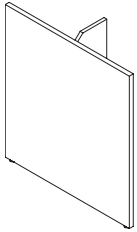

Support End Panel

Description	Model	L1 List Price	L2 List Price	L3 List Price
<b>For use with Align Storage, 36"D x 42"H</b>				
End Panel, Use w/supp	ISLAAESP3642	\$ 616	\$ 640	\$ 664
O-leg	ISLAAO3642	\$ 1308		
<b>For use with Essential Storage, 36"D x 40"H</b>				
End Panel, Use w/supp	ISLAEESP3642	\$ 616	\$ 640	\$ 664
O-leg	ISLAEO3642	\$ 1308		

<p><b>How to specify —</b> Select the Model Number from above.</p>	<p><b>1st Option:</b> <b>FSC Certified Wood:</b> F FSC Certified X No FSC</p>	<p><b>2nd Option:</b> <b>Laminate</b> (if applicable): See page 79 for finishes.</p>	<p><b>3rd Option:</b> <b>Edgeband</b> (if applicable): See page 79 for finishes.</p>	<p><b>4th Option:</b> <b>Paint:</b> P1 P2 P3 See page 28 for finishes. P2 upcharge \$22 P3 upcharge \$28</p>
--	---	--	--	--

Example: ISLAAESP3642.LM16.E9

Description	Model	P1 List Price	P2 List Price	P3 List Price
<b>For use with Essentials or Align Storage</b> 37½"H-43½"H Post Legs — Height Adjustable for Flat/Square Edge Worksurfaces — Pair	Z6PL40HP	\$ 1046	\$ 1094	\$ 1142



<p><b>How to specify —</b> Select the Model Number from above.</p>	<p><b>1st Option:</b> <b>Paint:</b> P1 P2 P3 See page 28 for finishes. P2 upcharge \$48 P3 upcharge \$96</p>
--	--

Example:

For specification information see pages 80-82.

GSA SIN PENDING

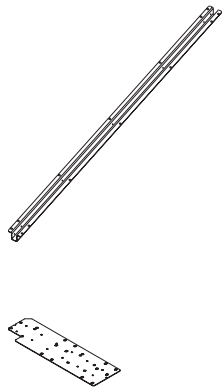

Description	Model	List Price
<b>For use with open, non-supported tops</b>		
<b>External Worksurface Support Channel (no color option for stiffener) — 1½"H</b>		
• You must specify external worksurface support channel when an unsupported 48"W Worksurface is specified.		
30"W for use on 42"W Worksurface	Z5SC42 <span style="border: 1px solid black; padding: 0 2px;">S</span>	\$ 83
36"W for use on 48"W Worksurface	Z5SC48 <span style="border: 1px solid black; padding: 0 2px;">S</span>	\$ 86
42"W for use on 54"W Worksurface	Z5SC54 <span style="border: 1px solid black; padding: 0 2px;">S</span>	\$ 99
48"W for use on 60"W Worksurface	Z5SC60	\$ 106
54"W for use on 66"W Worksurface	Z5SC66	\$ 124
60"W for use on 72"W Worksurface	Z5SC72	\$ 133
66"W for use on 78"W Worksurface	Z5SC78	\$ 145
72"W for use on 84"W Worksurface	Z5SC84	\$ 160
<b>Flat Brackets (no color option)</b>		
For 12"D	T612FB <span style="border: 1px solid black; padding: 0 2px;">S</span>	\$ 67

METAL STORAGE

**How to specify —**  
 Select the Model Number from above.

Example: Z6PL40HP

# Notes

---

METAL STORAGE

# Essentials™ Metal Storage

---

- Finishes ..... 92
- Working with Essentials Metal Storage ..... 93-98
- Essentials Metal Pedestals and Accessories..... 99-101
- Essentials Metal Lateral Files ..... 102
- Essentials Metal Combination Files ..... 103
- Essentials Metal Storage Cabinets..... 104
- Essentials Metal Bookcases ..... 105



# Essentials Metal Storage

## PAINTED METAL FINISHES

### GRADE P1

Black.....	P27
Brownstone.....	P7D
Bungalow.....	P7C
Cinder.....	P7Q
Cove.....	P096
Designer White.....	PJW
Dune.....	P094
Flint.....	P02
Fossil.....	P28
Harbor.....	P097
Loft.....	P7B
Muslin.....	P4J
Parchment.....	P93
Pebble.....	P8R
Pewter.....	P8D
Sage.....	P095
Salt.....	P8C
Titanium.....	P8T

### GRADE P2

Champagne Metallic.....	PR5
Gunmetal Metallic.....	PR3
Platinum Metallic.....	PR2
Silver***.....	PR6
Solar Black.....	P8X

\*\*\*PR6 no upcharge on Involve; available as a Grade P2 color on stanchions. PR6 & P8X are not available on Concensys, Essentials bookcase, and vertical files.

### GRADE P3

Amethyst*** (De-emphasized).....	P091
Atom.....	P8S
Blossom***.....	P8K
Bullseye.....	PJF
Cobalt Mica*** (De-emphasized).....	P090
Ember.....	P8P
Ion.....	P8N
Iris.....	P8J
Krypton.....	P8F
Ochre***.....	P093
Regatta.....	P8M
Sienna***.....	P092
Succulent***.....	P8A

*Metallic paints, due to varying reflectance, may appear to have less visual color consistency than other paint finishes, even when LJA/B values are exactly the same. (LJA/B — measurable aspects of color — values are maintained within a specified range, to ensure consistent appearance of paint colors.)*

\*\*\*These colors are intended to be an inspirational option for the trending market. Product application is limited and color availability is approximately two years to coincide with evolving workplace trends.

## METAL STORAGE PULLS

Black (Bar or Arch Pull) ... E4/P71 (Radii)
Designer White (Bar pull only) .....
.....PJW (Radii only)
Silver..... EL/PR6

## LAMINATES

### GRADE L1

<b>SOLID COLORS</b>	P
Black.....	P
Brownstone.....	LM13
Bungalow.....	LM12
Designer White.....	LDW1
Flint.....	LM16
Fossil Shale.....	LEH1
Loft.....	LM11
Muslin.....	LM15
Titanium.....	LT11

### ABSTRACT

Ash.....	LT3B
Handspun Pearl.....	LAHP
Handspun Dove.....	LAHD
Handspun Slate.....	LAHS
Handspun Chestnut.....	LAHC
Silver Mesh.....	LT8D

### WOODGRAIN

Belair.....	LWBA
Bourbon Cherry.....	H
Field Elm.....	LWFE
Florence Walnut.....	LFW1
Kingswood Walnut.....	LK11
Natural Maple.....	LWD
NeoWalnut.....	LNU1
Pinnacle.....	PINC
Shaker Cherry.....	LW7C

### GRADE L2

Beigewood.....	LWBE
Fawn Cypress.....	LFC1
Lowell Ash.....	LLA1
Mangalore Mango.....	LMM1
Natural Recon.....	LNR1
Phantom Charcoal.....	LPC1
Phantom Ecu.....	LPE1
Portico Teak.....	LPT1
Skyline Walnut.....	LSW1
Veranda Teak.....	LVT1

### GRADE L3

Natural Walnut.....	LWNW
---------------------	------

## LAMINATE EDGE COLORS

Beigewood.....	DE
Belair.....	BA
Black.....	E4
Bourbon Cherry.....	H
Brownstone.....	EY
Bungalow.....	EX
Designer White.....	DW
Fawn Cypress.....	FC
Field Elm.....	FE
Flint.....	E9
Florence Walnut.....	FW
Fossil.....	EH
Kingswood Walnut.....	KI
Loft.....	EV
Lowell Ash.....	DL
Mangalore Mango.....	MM
Muslin.....	EU
Natural Maple.....	DD
Natural Recon.....	NR
Natural Walnut.....	DN
NeoWalnut.....	NU
Parchment.....	EN
Phantom Charcoal.....	PC
Phantom Ecu.....	PE
Pinnacle.....	PI
Platinum Metallic.....	EP
Plyband.....	PL
Portico Teak.....	DP
Shaker Cherry.....	DF
Skyline Walnut.....	SW
Titanium.....	TI
Veranda Teak.....	VT



[GSA Reference Page](#)

### Essentials Pedestals

- File drawers can accommodate front-to-back filing on all models, and side-to-side filing on 22 $\frac{1}{2}$ "D and 28 $\frac{1}{2}$ "D models.
- Support pedestals of a maximum depth, relative to the worksurface depth, result in one panel receptacle position being inaccessible.
- 22 $\frac{1}{2}$ "D units cannot be used with 24"D Concensys® Freestanding.
- 28 $\frac{1}{2}$ "D units cannot be used with any 30"D Concensys Freestanding or any 24"D panel-hung worksurface.
- For locking specifications, see pages [328-330](#).
- Leveling capacity is 2" on 28"H pedestals.

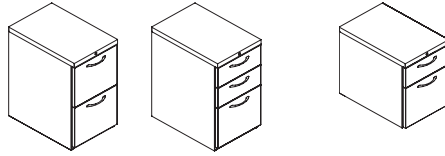

**Support pedestals** can support one end of a panel-attached worksurface, in lieu of other worksurface supports by using a 28"H support pedestal but cannot be used to support freestanding desking without an end panel.

**Suspended pedestals** mount to the underside of the worksurface using keyhole slots in top of pedestals. Do not mount suspended pedestals on bridges or peninsulas. Always mount suspended pedestals at end of worksurfaces.

When using suspended units on systems, a return panel should extend 18" minimum beyond leading edge of worksurface on which unit(s) is mounted.

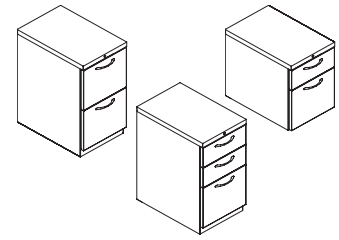

**Mobile Pedestals** can be used to provide flexible storage. The nominal height of a mobile pedestal is equal to that of a freestanding pedestal of equivalent design. There is no need to add extra height for the casters.

Both 26 $\frac{1}{2}$ "H and 28"H mobile pedestals can be nested under worksurfaces mounted at 29 $\frac{1}{2}$ "H. If using 28"H Essentials mobile pedestals underneath a panel mounted worksurface on Stride®, Terrace®, or Optimize™ the panel glides will need to be extended a minimum of  $\frac{3}{4}$ " to allow for the mobile pedestals to slide underneath the worksurface.

Mobile pedestals cannot be leveled. Take this into consideration when planning offices which may have uneven floors.

### Pedestal Compatibility with Cadence® Desking and Systems Worksurfaces

Pedestal Depth	Freestanding		Systems Panel-hung Worksurfaces	
	24" Deep	30" Deep	24" Deep	30" Deep
18"	Yes	Yes	Yes	Yes
19 $\frac{1}{2}$ "	Yes*	Yes	Yes*	Yes
22 $\frac{1}{2}$ "		Yes	Yes*	Yes
28 $\frac{1}{2}$ "				Yes*

\*Wire management grommet is blocked in these applications.

**Note:** Pedestal placement may affect access to receptacles in base pathway.

### Essentials storage pedestals are available in 5 styles:



Worksurface height mobile and worksurface supporting pedestals have a taller base plate, resulting in a taller overall cabinet height. Consideration must be made to ensure that units align visually with each other and with selected Essentials lateral files. The accompanying chart will help you select the correct pedestal for your application.

Essentials Pedestal Model begins with	Style	Overall Height	Base Height	Spacer required below worksurface	Units align with these Essentials Lateral Models begin with
xx11	Seat height	22 $\frac{1}{2}$ "	2"	N/A	N/A
xx14	Suspended	19 $\frac{1}{2}$ "	N/A	N/A	N/A
xx18, xx38	Worksurface height mobile	28" **	3 $\frac{1}{4}$ "	N/A	ELF8 (2-high only)
xx19, xx39	Worksurface supporting*	28"	3 $\frac{1}{4}$ "	No	ELF8 (2-high only)

\*Units will support conventional 29 $\frac{1}{2}$ " high worksurfaces.

\*\*When using 28"H Essentials mobile pedestals underneath a panel mounted worksurface on Stride or Terrace, the panel glides need to be extended a minimum of  $\frac{3}{4}$ " to allow for the mobile pedestals to slide underneath the worksurface.

### Essentials™ Pedestals

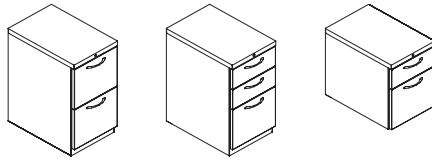

#### Essentials Support and Suspended Pedestals (page 99)

- Steel, ball-bearing slide suspension with full-extension on file drawers.
- File drawer has high sides to allow front-to-back filing.
- Side-to-side filing utilizes follower block and cross rail.
- Follower block (APFB80) sold separately.
- Cross rail is standard in all pedestals.
- Pencil tray included — one per pedestal with box drawers.
- For improved aesthetics on 28"H pedestals, order flush mount kick plates.
- Support units have four leveling glides.
- Counterweight is standard in mobile pedestals.
- Support pedestals not used to support a worksurface require a counterweight kit — order separately.
- Box drawers have adjustable divider.
- Caster package available to field convert support pedestals to mobile.
- Standard core removable locks.

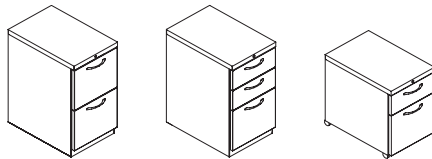

#### Essentials Mobile Pedestals (page 99)

- Steel, ball-bearing slide suspension with full-extension on file drawers.
- File drawer has high sides to allow front-to-back filing.
- Side-to-side filing utilizes follower block and cross rail.
- Follower block (APFB80) sold separately.
- Cross rail is standard in all pedestals.
- Pencil tray included — one per pedestal with box drawers.
- Counterweight is standard in mobile pedestals.
- Box drawers have adjustable divider.
- Rear casters swivel, front casters are fixed.
- Standard core removable locks.
- If using 28"H Essentials mobile pedestals underneath a panel mounted worksurface on Stride®, Terrace®, or Optimize™ the panel glides will need to be extended a minimum of 3/4" to allow for the mobile pedestals to slide underneath the worksurface.
- Adjustable glide kit available to field convert mobile pedestals to freestanding.
- Casters on box/file mobile pedestal require installation.
- For improved aesthetics on 28"H pedestals, order flush mount kick plates.

### Essentials™ Pedestals

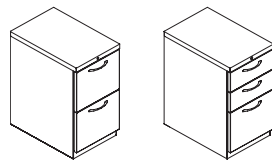
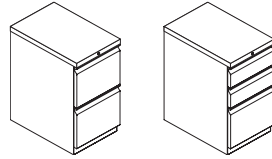
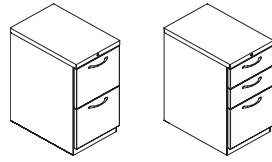

#### Essentials Basic Support Pedestals (page 100)

- Support pedestals have fully enclosed tops.
- Steel, ball-bearing slide suspension with full extension.
- Follower block (APFB80), pencil tray (A2280-000), and adjustable divider (PD80) for box drawers sold separately.
- Side-to-side filing utilizes two cross rails (AP519495) sold separately.
- File drawer has high sides to allow front-to-back filing.
- Support pedestals not used to support a worksurface require a counterweight kit sold separately.
- Caster package available to field convert support pedestals to mobile.
- Standard core removable locks.
- Adjustable Glide Kit available to field convert mobile pedestals to freestanding.
- For improved aesthetics on 28" H pedestals, order flush mount kick plates.

#### Essentials Basic Mobile Pedestals (page 100)

- Steel, ball-bearing slide suspension with full extension.
- Follower Block (APFB80), pencil tray (A2280-000), and adjustable divider (PD80) for box drawers sold separately.
- Side-to-side filing utilizes two cross rails (AP519495) sold separately.
- File drawer has high sides to allow front-to-back filing.
- Counterweight is standard in mobile pedestals.
- Support pedestals not used to support a worksurface require a counterweight kit sold separately.
- Caster package available to field convert support pedestals to mobile.
- Standard core removable locks.
- If using 28" H Essentials mobile pedestals underneath a panel mounted worksurface on Stride®, Terrace®, or Optimize™ the panel glides will need to be extended a minimum of ¼" to allow for the mobile pedestals to slide underneath the worksurface.
- Adjustable glide kit available to field convert 26½" H – 28" H mobile pedestals to freestanding.
- For improved aesthetics on 28" H pedestals, order flush mount kick plates.

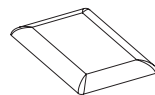
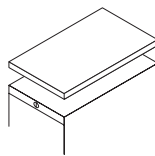

ASPT-24SC

#### Essentials Seat Cushion (page 101)

- Seat cushion provides quick and convenient additional seating.
- Seat cushion adds approximately 2" H to pedestal.
- YPPA prefix models have stitched corners and bumpers on bottom.
- ASPT prefix models have wrap around corners and attach with double-sided tape.
- COM yardage for seat cushion is ⅔ yard.

### Dual-side Locking

Drawers and doors lock on both sides to prevent being pried open.

### Interlock System

This mechanism inhibits roll-out of more than one drawer or shelf, either sequentially or simultaneously.

### Fully Enclosed Bottom

Double bottoms are welded into all files for added rigidity.

### Four Hex-head Leveling Glides

Leveling glides can be adjusted from outside or inside the case. Because of the hex-head design of the stem, leveling can be done even when the file is fully loaded. Range is 1".

### Suspension

Telescoping, ball-bearing slides.

### Core Removable Locks

Core removable lock feature allows key numbers to be easily changed in the field which facilitates installation.

### Omit Lock Core

Files can be shipped with lock cores removed; cores can then be installed after files are placed. Laterals can be keyed alike with pedestals and overhead cabinets.

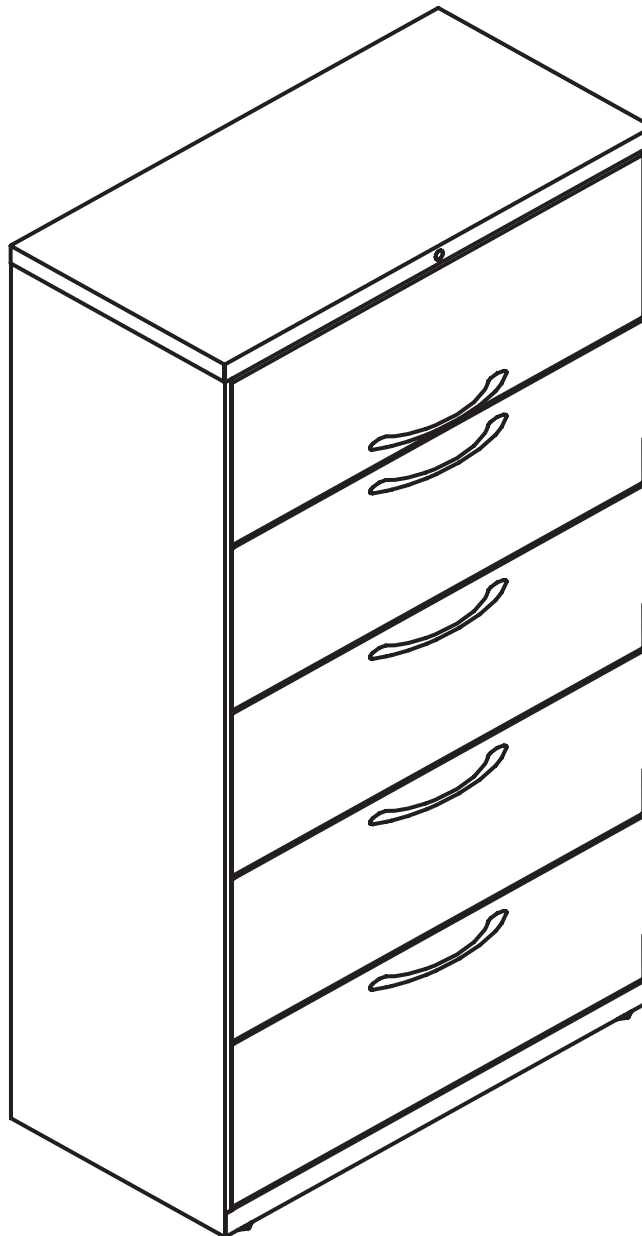

### Four Pull Styles

Choice of four pull styles, also available on Essentials pedestals, allows for total design coordination on projects.

### Side Knockouts

Files have knockouts on each side to allow easy ganging of freestanding units to inhibit tipping.

### Inset Drawer Design

Drawers are inset inside the case. Base plate is flush with drawer fronts.

### Paint Finish

Durable baked enamel finish is applied over rust-inhibiting phosphate pre-treatment.

### Hanging Frames

Side-to-side come standard. Front-to-back filing option — hang rails are required.

### Counterweights

Counterweights included and factory installed as required.

### Drawer Interiors

Interiors and all accessories painted gray.

### Essentials Lateral Files and Combination Files

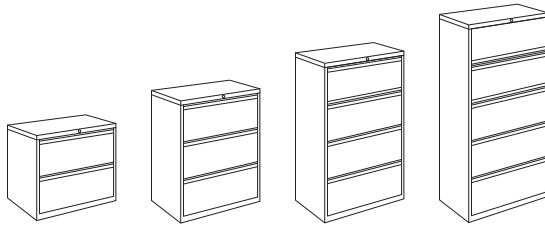

#### Essentials Lateral Files (page 102)

- Available in four pull options — arch, square, integral, and beveled pulls.
- Load capacities per 12" opening per current ANSI/BIFMA Standards:
  - 30" W..... 86 lbs.
  - 36" W..... 105 lbs.
  - 42" W..... 124 lbs.
- Clearance Dimensions – H x W 30 / 36 / 42" x D
  - Roll-out drawer..... 11¼" x 27⅞" / 33⅞" / 39⅞" x 16½"
  - Roll-out shelf..... 10½" x 27⅞" / 33⅞" / 39⅞" x 16½"
- For locking specifications, see pages 328-330.
- All files are 18" deep.
- Laminate and veneer tops are available — order separately.
- Support-only 2H Lateral does not include a counterweight and must be positioned under a panel-attached worksurface, ganged to an adjacent file, bracketed to a panel, or bolted to the floor or wall. It may not be used in a freestanding manner.

**Note:** Counterweights are included and factory installed as required except in the case of the 2H support-only lateral.

- Starting in July — Magnetic Label Holders available as an accessory model. Units will no longer include label holders.

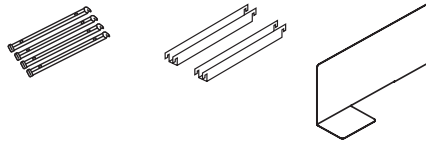

#### Essentials Accessories (page 102)

- All accessories are gray.
- Model L919491 used for front-to-back filing of all paper sizes in all drawer sizes except — letter in a 42" W case.
- Model L919492 for use in 42" W case for front-to-back filing of letter paper size

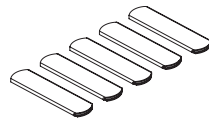

#### Magnetic Label Holder - Available July 2021 (page 102)

- 5 pack of magnetic label holders.

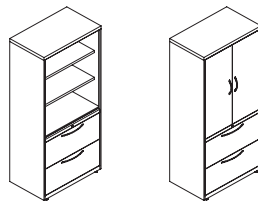

#### Essentials Combination Files (page 103)

- Combination cabinets match height of Essentials 5H laterals and storage cabinets.
- Combination cabinets are 30" W or 36" W and available as open shelves or hinged doors.
- Shelves are adjustable in 2" increments and are 15¼" D.
- Available in four pull styles — arch, square, integral, and beveled pulls.
- 64¼" combination cabinet has one fixed shelf and two adjustable shelves.
- Cabinets are fully assembled.
- Drawers feature three-part, telescoping, steel ball-bearing slides.
- Mechanical interlock inhibits opening more than one drawer at a time.
- For locking specifications, see pages 328-330.

### Essentials Storage Cabinets and Bookcases

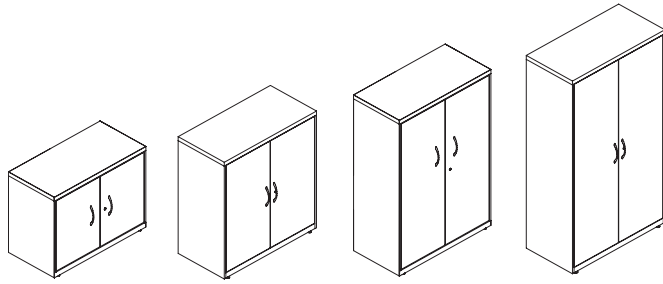

#### Essentials Storage Cabinets (page 104)

- Storage cabinet matches height of Essentials laterals and combination files.
- Cabinets are 30"W or 36"W and are available in four heights.
- Shelves are adjustable in 2" increments and are 15¼"D.
- Available in four pull styles — arch, square, integral, and beveled pulls.
- Storage cabinets have the following number of adjustable shelves:
 

27¼"H.....	1	52½"H.....	3
39¾"H.....	2	64¼"H.....	4
- Cabinets are fully assembled.
- For locking specifications, see pages 328-330.

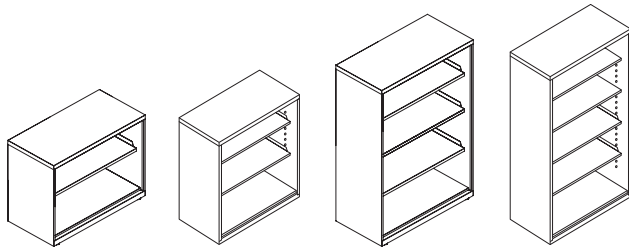

#### Essentials 18"D Bookcases (page 105)

- Essentials 18"D bookcases are same height as 2H, 3H, 4H, or 5H Essentials laterals and storage cabinets.
- Essentials 18"D Bookcases are 30"W or 36"W with open shelves.
- Shelves are 1" thick. Interior height 34½"H or 59"H.
- Shelves adjust in 2" increments. Shelf load capacity 107 lbs.
- 27¼"H units have 1 adjustable shelf. 39¾"H units have 2 adjustable shelves. 52½"H units have 3 adjustable shelves. 64¼"H units have 4 adjustable shelves.
- Inside shelf dimension 34½"W x 15½"D.
- Bookcases are fully assembled.
- Bookcases include leveling glides with 1" of adjustment.

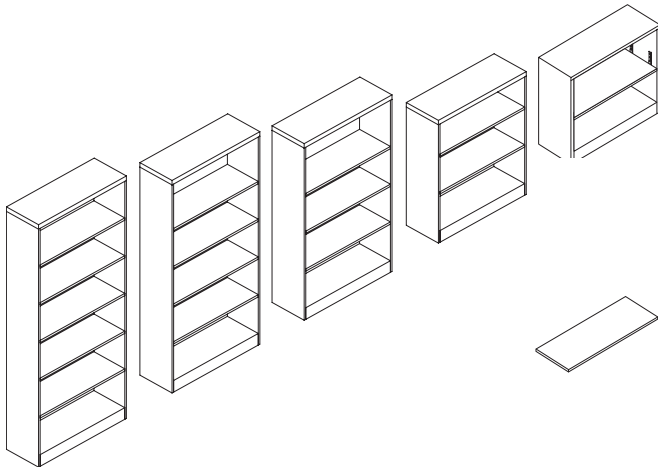

#### Essentials 12½"D Bookcases (page 105)

- Available in five heights from 29" to 81".
- All units case dimensions are 33⅞"W x 12⅞"D.
- Inside shelf dimension depth is 12⅞"D.
- Shelves adjust in ½" increments. Shelf load capacity 87 lbs.
- Bookcases have the following number of adjustable shelves:
 

29" high .....	1	71" high .....	4
41" high .....	2	81" high .....	4
59" high .....	3		
- Shelves are ¾" thick. Interior 4¼" less than height.
- Meets or exceeds ANSI/BIFMA and ISTA performance standards.
- Bookcases do not include leveling glides.

# Essentials™ Metal Storage

## Support, Suspended, and Mobile Pedestals

For specification information see pages 93-95.

### Ball-Bearing Suspension

GSA SIN 33721

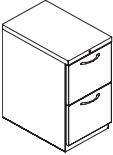
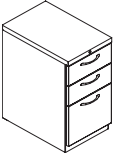
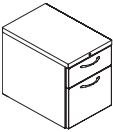
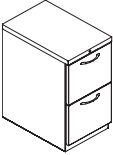
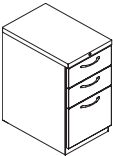
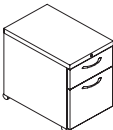
	Description	Model	P1 Paint List Price
	<b>Support Pedestals 28"H — File/File</b>		
	18"D x 15"W*	PF198-182 □	\$ 1175
	22½"D x 15"W	PF198-232 □	\$ 1232
	28¾"D x 15"W	PF198-302 □	\$ 1269
	<b>Note:</b> 28"H pedestals have a higher base plate resulting in a taller overall cabinet height. Consideration must be given to ensure that units align visually with each other and selected laterals.		
	<b>Support Pedestals 28"H — Box/Box/File</b>		
	18"D x 15"W*	PF197-183 □	\$ 1175
	22½"D x 15"W	PF197-233 □	\$ 1232
	28¾"D x 15"W	PF197-303 □	\$ 1269
	<b>Suspended Pedestals 19½"H — Box/File</b>		
	22½"D x 15"W	PH149-232 □	\$ 1029
	<b>Mobile Pedestal 28"H — File/File</b>		
	18"D x 15"W*	PM188-182 □	\$ 1225
	22½"D x 15"W	PM188-232 □	\$ 1277
	28¾"D x 15"W	PM188-302 □	\$ 1315
	<b>Mobile Pedestal 28"H — Box/Box/File</b>		
	18"D x 15"W*	PM187-183 □	\$ 1232
	22½"D x 15"W	PM187-233 □	\$ 1277
	28¾"D x 15"W	PM187-303 □	\$ 1315
	<b>Note:</b> 28"H pedestals have a higher base plate resulting in a taller overall cabinet height. Consideration must be given to ensure that units align visually with each other and selected laterals.		
	<b>Mobile Pedestal 22½"H — Box/File</b>		
	22½"D x 15"W	PM119-232 □	\$ 1045

\*18"D Pedestals do not accommodate legal size filing.

<p><b>How to specify —</b> Select the Model Number from above.</p>	<p><b>1st Option:</b> <b>Drawer Pull:</b> A Arch B Beveled I Integral S Square</p>	<p><b>2nd Option:</b> <b>Paint:</b> P1 P2 P3 See page 92 for finishes. P2 upcharge \$66 P3 upcharge \$88</p>	<p><b>3rd Option:</b> <b>Pull Color:</b> Arch Pull EL Matte Silver E4 Black Square Pull EL Matte Silver</p>	<p><b>4th Option:</b> <b>Lock Option:</b> STD Standard OMT Omit Lock Core (Deduct \$20)</p>
	<p>P 1 - .</p>	<p>. P .</p>	<p>. P .</p>	<p>. . . .</p>

Examples: PH149-232B.P02.STD PF197-233A.P27.EL.STD

Casegoods & Storage – 03/2023 PM187-233B.P02.STD PM187-233A.P4J.E4.STD

# Essentials™ Metal Storage

## Basic Support and Mobile Pedestals

For specification information see pages 93-95.

GSA SIN 33721

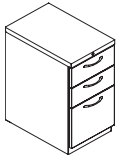
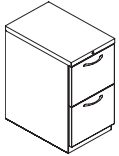
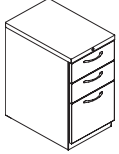
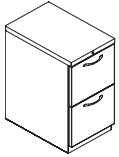

Description	Model	P1 Paint List Price
<b>Support Pedestals 28"H — File/File</b>		
19 7/8"D x 15"W	AF398-202 □	\$ 1063
22 7/8"D x 15"W	AF398-232 □	\$ 1100
<b>Support Pedestals 28"H — Box/Box/File</b>		
19 7/8"D x 15"W	AF397-203 □	\$ 1063
22 7/8"D x 15"W	AF397-233 □	\$ 1100
<b>Mobile Pedestal 28"H — File/File</b>		
19 7/8"D x 15"W	AM388-202 □	\$ 1081
22 7/8"D x 15"W	AM388-232 □	\$ 1123
<b>Mobile Pedestal 28"H — Box/Box/File</b>		
19 7/8"D x 15"W	AM387-203 □	\$ 1081
22 7/8"D x 15"W	AM387-233 □	\$ 1123

**How to specify —**  
Select the Model Number from above.

**1st Option:**

**Drawer Pull:**

- A Arch
- B Beveled
- I Integral
- S Square

Partial top models limited to "B" Beveled pulls.

**2nd Option:**

**Paint:**

P1 P2 P3

See page 92 for finishes.

P2 upcharge \$66  
P3 upcharge \$88

**3rd Option:**

**Pull Color:**

**Arch Pull**

EL Matte Silver  
E4 Black

**Square Pull**

EL Matte Silver

**4th Option:**

**Lock Option:**

STD Standard  
OMT Omit Lock Core (Deduct \$20)

\_\_\_\_\_ .

\_\_\_\_\_ .

P \_\_\_\_\_ .

\_\_\_\_\_ .

\_\_\_\_\_ .

Examples: AF397-203B.P27.STD  
AM387-203I.P27.STD

AF398-232A.P02.E4.STD  
AM388-232A.P02.EL.STD



# Essentials™ Metal Storage

## Tops and Accessories

For specification information see pages 93-95.  
(See page 332 for COM pricing on upholstery grades 13-22.)

GSA SIN 33721

Description	Model	List Price
<b>Accessories</b>		
Pencil Tray (Black only)	A2280-000 <input type="checkbox"/>	\$ 48
Follower Block — 1 Pack	APFB80 <input type="checkbox"/>	\$ 50
Box Drawer Divider — 2 Pack	PD80 <input type="checkbox"/>	\$ 41
Hanging File Cross Rails — 2 Pack (for side-to-side filing)	AP519495 <input type="checkbox"/>	\$ 39
Adjustable Glides — 4 Pack for 26 1/2"H – 28"H Mobile Pedestals	AP20040AG <input type="checkbox"/>	\$ 76
Field-installable Hardware included		
Caster Package — Field Installable Four Casters (2 swivel, 2 fixed)	AP1050CST <input type="checkbox"/>	\$ 50
Counterweights for 22 1/2"H and 26 1/2"H Pedestals (do not specify color)	2282-300	\$ 246
Counterweights for 28"H Pedestals (do not specify color)	2282-400	\$ 269
Flush Front Kick Plate for 28"H Pedestals	ETKP28H	\$ 134

Description	Model	L1 List Price	L2 List Price	L3 List Price
<b>Laminate Tops – Flat Edge (for mobile and freestanding pedestals)</b>				
19 1/2"D x 15"W x 1 1/4" Thick	PT17-20TTP <input type="checkbox"/>	\$ 280	\$ 292	\$ 302
22 1/2"D x 15"W x 1 1/4" Thick	PT17-23TTP <input type="checkbox"/>	\$ 321	\$ 335	\$ 345
28 1/2"D x 15"W x 1 1/4" Thick	PT17-29TTP <input type="checkbox"/>	\$ 377	\$ 394	\$ 406

Description	Model	List Price											
		Grade 1	Grade 2	Grade 3	Grade 4	Grade 5	Grade 6	Grade 7	Grade 8	Grade 9	Grade 10	Grade 11	Grade 12
<b>Seat Cushion — For Metal Mobile Pedestals only (Specify seating fabric — no leathers)</b>													
23 1/2"D	ASPT-24SC	\$ 300	\$ 315	\$ 329	\$ 343	\$ 363	\$ 381	\$ 400	\$ 419	\$ 438	\$ 456	\$ 476	\$ 495
29 1/2"D	ASPT-30SC	\$ 313	\$ 328	\$ 342	\$ 356	\$ 376	\$ 394	\$ 413	\$ 432	\$ 451	\$ 469	\$ 489	\$ 508
17"D	YPPA1815SC	\$ 255	\$ 270	\$ 284	\$ 298	\$ 318	\$ 336	\$ 355	\$ 374	\$ 393	\$ 411	\$ 431	\$ 450
23"D	YPPA2415SC	\$ 304	\$ 319	\$ 333	\$ 347	\$ 367	\$ 385	\$ 404	\$ 423	\$ 442	\$ 460	\$ 480	\$ 499
29"D	YPPA3015SC	\$ 319	\$ 334	\$ 348	\$ 362	\$ 382	\$ 400	\$ 419	\$ 438	\$ 457	\$ 475	\$ 495	\$ 514

ASPT- cushions have a rounded corner and the YPPA-cushions have a square corner.

<p><b>How to specify —</b> Select the Model Number from above.</p>	<p><b>1st Option:</b> <b>Laminate (Tops only):</b> See page 92 for finishes.</p>	<p><b>2nd Option:</b> <b>Edge Color (Flat and T-Mold Edge only):</b> See page 92 for finishes.</p>	<p><b>3rd Option:</b> <b>Paint:</b> <input type="checkbox"/> P1 <input type="checkbox"/> P2 <input type="checkbox"/> P3 Kick Plate only.  See page 92 for finishes. P2 upcharge \$11 P3 upcharge \$22</p>	<p><b>Only Option for Seat Cushion:</b> <b>Upholstery:</b> Specify seating upholstery.</p>
<p>Examples: PT17-20TTP.TM20.E4 YPPA2415SC.CU62</p>	<p><input type="checkbox"/> Shippable by small-package carrier.</p>			

# Essentials™ Metal Storage

Lateral Files

For specification information see pages 96-97.

GSA SIN 33721



Exterior Width	Model	P1 Paint List Price	P2 Paint List Price	P3 Paint List Price
<b>28"H; two 12" drawers with hanging frames side-to-side — 2-High Support-Only Lateral (No Counterweight)</b>				
30"W x 18"D	ELF830S □	\$ 1327	\$ 1382	\$ 1458
36"W x 18"D	ELF836S □	\$ 1475	\$ 1530	\$ 1606
42"W x 18"D	ELF842S □	\$ 1718	\$ 1773	\$ 1849

**Note:** 28"H worksurface supporting laterals have a taller base plate resulting in a taller overall cabinet height. Consideration must be made to ensure that units align visually within the workstation.



<b>28"H; two 12" drawers with hanging frames side-to-side — 2-High Freestanding Lateral</b>				
30"W x 18"D	ELF830N □	\$ 1468	\$ 1523	\$ 1599
36"W x 18"D	ELF836N □	\$ 1624	\$ 1679	\$ 1755
42"W x 18"D	ELF842N □	\$ 1882	\$ 1937	\$ 2013

**Note:** 28"H worksurface supporting laterals have a taller base plate resulting in a taller overall cabinet height. Consideration must be made to ensure that units align visually within the workstation.



<b>39 1/2"H; three 12" drawers with hanging frames side-to-side — 3-High</b>				
30"W x 18"D	ELF330N □	\$ 1814	\$ 1869	\$ 1945
36"W x 18"D	ELF336N □	\$ 2049	\$ 2104	\$ 2180
42"W x 18"D	ELF342N □	\$ 2366	\$ 2421	\$ 2497

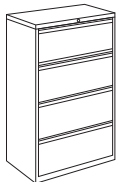

<b>52 1/2"H; four 12" drawers with hanging frames side-to-side — 4-High</b>				
30"W x 18"D – No posting shelf	ELF430N □	\$ 2310	\$ 2419	\$ 2556
36"W x 18"D – No posting shelf	ELF436N □	\$ 2625	\$ 2734	\$ 2871
42"W x 18"D – No posting shelf	ELF442N □	\$ 3009	\$ 3118	\$ 3255

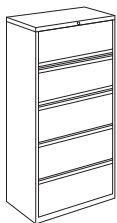

<b>64 1/4"H; 12" roll-out shelf with receding door top opening, balance 12" drawers and hanging frames side-to-side — 5-High</b>				
30"W x 18"D – No posting shelf	ELF530N □	\$ 2924	\$ 3033	\$ 3170
36"W x 18"D – No posting shelf	ELF536N □	\$ 3291	\$ 3400	\$ 3537
42"W x 18"D – No posting shelf	ELF542N □	\$ 3829	\$ 3938	\$ 4075

## ESSENTIALS

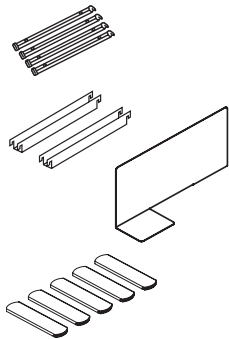

Description	Model	List Price
Single-Rail Hanging File Racks (4/pack)	L919491	\$ 65
Double-Rail Hanging File Racks (2/pack)	L919492	\$ 65
File Drawer Dividers — 2 pack	YPCAFD02	\$ 88
File Drawer Dividers — 10 pack	YPCAFD10	\$ 341
Magnetic Label Holder (5 pack)	ASISLABEL5	\$ 36

**How to specify —**  
Select the Model Number from above.

**1st Option:**  
**Pull**  
(if applicable):  
A Arch  
B Beveled  
I Integral  
S Square

**2nd Option:**  
**Paint**  
(if applicable):  
   
See page 92 for finishes.

**3rd Option:**  
**Pull Color**  
(if applicable):  
Arch Pull  
EL Matte Silver  
E4 Black  
Square Pull  
EL Matte Silver

**4th Option:**  
**Lock Option**  
(if applicable):  
STD Standard —  
Random Keyed  
OMT Omit Lock Core  
(Deduct \$20 per lock)

Examples: ELF830NB.P02.STD L919491

For specification information see pages 97-98.

GSA SIN 33721

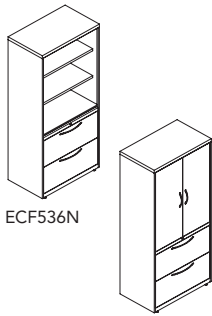

Description	Model	Number of Adj. Shelves	P1 Paint List Price
<b>64 1/4" H Combination Files w/Open Shelves — 18"D — 5-High</b>			
30"W	ECF530N □	2	\$ 2509
36"W	ECF536N □	2	\$ 2849
<b>64 1/4" H Combination Files w/Hinged Doors — 18"D — 5-High</b>			
30"W	ECF530H □	2	\$ 2741
36"W	ECF536H □	2	\$ 3113

<p><b>How to specify —</b> Select the Model Number from above.</p> <p>_____</p>	<p><b>1st Option:</b> <b>Drawer Pull</b> (if applicable):</p> <p>A Arch B Beveled I Integral S Square</p> <p>_____ .</p>	<p><b>2nd Option:</b> <b>Paint:</b></p> <p><b>P1 P2 P3</b></p> <p>See page 92 for finishes. P2 upcharge \$109 P3 upcharge \$246</p> <p><b>P</b> _____ .</p>	<p><b>3rd Option:</b> <b>Pull Color</b> (if applicable):</p> <p><b>Arch Pull only</b> EL Matte Silver E4 Black</p> <p><b>Square Pull</b> EL Matte Silver</p> <p>_____ .</p>	<p><b>4th Option:</b> <b>Lock Type</b> (if applicable):</p> <p>STD Standard OMT Omit Lock Core, not available on overfile cabinets (Deduct \$20 per lock)</p> <p>_____</p>
---	--	---	---	--

Examples: ECF530NA.P02.EL.STD EOF3018.P27

# Essentials™ Metal Storage

## Storage Cabinets

For specification information see pages 97-98.

GSA SIN 33721

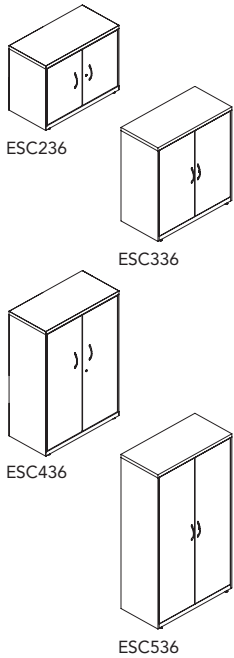

Description	Model	Number of Adj. Shelves	P1 Paint List Price	P2 Paint List Price	P3 Paint List Price
<b>28"H Storage Cabinets</b>					
30"W x 18"D	ESC230 □	1	\$ 1275	\$ 1330	\$ 1406
36"W x 18"D	ESC236 □	1	\$ 1419	\$ 1474	\$ 1550
<b>39½"H Storage Cabinets</b>					
30"W x 18"D	ESC330 □	2	\$ 1528	\$ 1583	\$ 1659
36"W x 18"D	ESC336 □	2	\$ 1609	\$ 1664	\$ 1740
<b>52½"H Storage Cabinets</b>					
36"W x 18"D	ESC436 □	3	\$ 1976	\$ 2085	\$ 2222
<b>64½"H Storage Cabinets</b>					
30"W x 18"D	ESC530 □	4	\$ 2140	\$ 2249	\$ 2386
36"W x 18"D	ESC536 □	4	\$ 2355	\$ 2464	\$ 2601

**How to specify —**  
Select the Model Number from above.

**1st Option: Pull**  
(if applicable):  
A Arch  
B Beveled  
I Integral  
S Square

**2nd Option: Paint:**  
P1 P2 P3  
See page 92 for finishes.

**3rd Option: Pull Color**  
(if applicable):  
**Arch Pull only**  
EL Matte Silver  
E4 Black  
**Square Pull**  
EL Matte Silver

**4th Option: Lock Type**  
(if applicable):  
STD Standard  
OMT Omit Lock Core, not available on overfile cabinets (Deduct \$20)

\_\_\_\_\_

\_\_\_\_\_ .

P \_\_\_\_\_ .

\_\_\_\_\_ .

\_\_\_\_\_

Example: ESC336A.P27.E4.STD

# Essentials™ Metal Storage

## Bookcases

For specification information see pages 97-98.

GSA SIN 33721

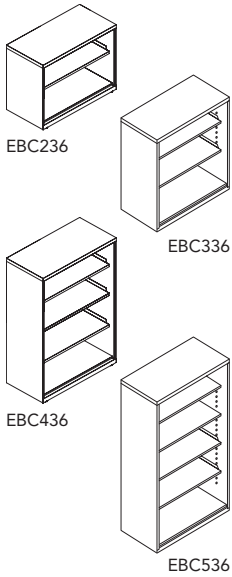

Description	Model	Number of Adj. Shelves	P1 Paint List Price	P2 Paint List Price
<b>28"H Bookcases</b>				
30"W x 18"D	EBC230	1	\$ 1029	\$ 1062
36"W x 18"D	EBC236	1	\$ 1157	\$ 1190
<b>39½"H Bookcases</b>				
30"W x 18"D	EBC330	2	\$ 1104	\$ 1137
36"W x 18"D	EBC336	2	\$ 1245	\$ 1278
<b>52½"H Bookcases</b>				
36"W x 18"D	EBC436	3	\$ 1500	\$ 1550
<b>64¾"H Bookcases</b>				
30"W x 18"D	EBC530	4	\$ 1581	\$ 1631
36"W x 18"D	EBC536	4	\$ 1790	\$ 1840

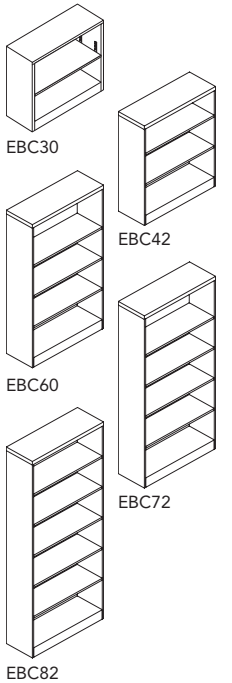

<b>Bookcases — 34½"W x 12¾"D</b>				
29"H	EBC30	1	\$ 987	\$ 1020
41"H	EBC42	2	\$ 1190	\$ 1223
59"H	EBC60	3	\$ 1472	\$ 1522
71"H	EBC72	4	\$ 1538	\$ 1588
81"H	EBC82	4	\$ 1592	\$ 1642

**How to specify —**  
Select the Model Number from above.

*1st Option:*

**Paint:**



See page 92 for finishes.

**P** | | | | |

Examples: EBC230.P02 EBC30.P27

# Notes

---

# Vertical Metal Storage

---

Finishes .....	108
Working with Vertical Files .....	109
A990 / A940 Series Vertical Files.....	110

# Vertical Metal Storage

## PAINTED METAL FINISHES

### GRADE P1

Black .....	P27
Brownstone .....	P7D
Bungalow .....	P7C
Cinder .....	P7Q
Designer White .....	PJW
Flint .....	P02
Fossil .....	P28
Loft .....	P7B
Muslin .....	P4J
Parchment .....	P93
Pebble .....	P8R
Pewter .....	P8D
Salt .....	P8C
Titanium .....	P8T

### GRADE P2

Champagne Metallic .....	PR5
Gunmetal Metallic .....	PR3
Platinum Metallic .....	PR2

## LOCKS

Black .....	E4
Chrome .....	ordered by base model
Matte Silver .....	EL

**NOTE:** Refer to individual product pages for upcharges.



### Vertical Files

The A990 and A940 vertical files offer two contemporary solutions to your filing needs. Both series are built to handle the demands of today's busy office. From rugged, full-extension, ball-bearing suspensions, to reinforced frames and kickplates, these files set the standard for reliability, efficiency, and durability. Whisper-like drawer action is quiet testimony to the three-part telescoping, ball-bearing slide suspension, which generate almost effortless movement. Locks can be keyed alike (optional). See pages [328-330](#).

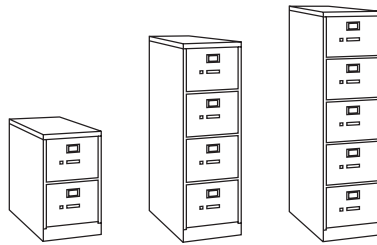

#### A990 Series Vertical Files (page 110)

- High capacity files with heavy-duty suspensions.
- 28½" D case depth with 27 front-to-back filing inches per drawer.
- Letter or legal sizes available.
- Three-part telescoping, ball-bearing slide suspension.
- Bright aluminum drawer pulls, label holders, and thumb latch.
- Standard interchangeable core removable locks.
- Accepts hanging files. High drawer sides hold hanging file folders without use of hangrails.
- Adjustable follower block.
- 7-point case reinforcement (6 vertical uprights, plus kickplate).
- Baked enamel finish over rust-inhibiting phosphate pre-treatment.
- Models meet or exceed ANSI/BIFMA 5.3-2012 and ISTA performance standards.

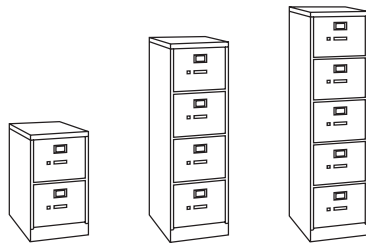

#### A940 Series Vertical Files (page 110)

- Files with heavy-duty suspensions.
- 26½" D case depth with 25 front-to-back filing inches per drawer.
- Letter or legal sizes available.
- Three-part telescoping, ball-bearing slide suspension.
- Bright aluminum drawer pulls, label holders, and thumb latch.
- Baked enamel finish over rust-inhibiting phosphate pre-treatment.
- Models meet or exceed ANSI/BIFMA 5.3-2012 and ISTA performance standards.
- Standard interchangeable core removable locks.
- Accepts hanging files. High drawer sides hold hanging file folders without use of hangrails.
- Adjustable follower block.
- 5-point case reinforcement (4 vertical uprights, plus kickplate).

# Vertical Metal Storage

A990 / A940 Series Vertical Files

For specification information see page 109.

GSA SIN 33721

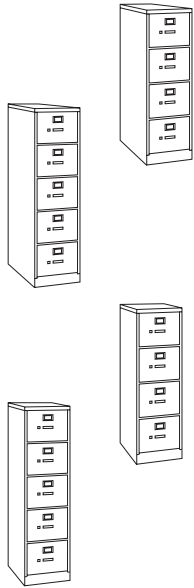

Exterior Width	Model	P1 Paint List Price	P2 Paint List Price
<b>52"H 4 Drawer, 28½"D — A990 Series</b>			
15"W Letter	A994	\$ 1662	\$ 1728
<b>60"H 5 Drawer, 28½"D — A990 Series</b>			
15"W Letter	A995	\$ 2215	\$ 2281
18¼"W Legal	A995C	\$ 2463	\$ 2529
<b>52"H 4-Drawer, 26½"D — A940 Series</b>			
15"W Letter	A944	\$ 1031	\$ 1097
<b>60"H 5-Drawer, 26½"D — A940 Series</b>			
15"W Letter	A945	\$ 1503	\$ 1569

**How to specify —**  
Select the Model Number from above.

**1st Option:**  
**Paint:**  
P1 P2  
See page 108 for finishes.

\_\_\_\_\_ .

P \_\_\_\_\_ .

Example: A994.P27

Shippable by small-package carrier.

# Metal Overheads & Shelves

---

- Finishes ..... 112
- Working with Terrace Overheads, Shelves, and Hutches.....113-116
- Overhead Cabinets, Shelves, and Up-mount Kits .....117-118
- Hutches, Tackboards, and Accessories ..... 119

# Metal Overheads & Shelves

## PAINTED METAL FINISHES

### GRADE P1

Black .....	P27
Brownstone .....	P7D
Bungalow .....	P7C
Cinder .....	P7Q
Designer White .....	PJW
Flint .....	P02
Fossil .....	P28
Loft .....	P7B
Muslin .....	P4J
Parchment .....	P93
Pebble .....	P8R
Pewter .....	P8D
Salt .....	P8C
Titanium .....	P8T

### GRADE P2

Champagne Metallic .....	PR5
Gunmetal Metallic .....	PR3
Platinum Metallic .....	PR2
Silver** .....	PR6
Solar Black .....	P8X

\*\*PR6 no upcharge on Involve; available as a Grade P2 color on stanchions. PR6 & P8X are not available on Concensys, Essentials bookcase, and vertical files.

### GRADE P3

Amethyst*** (De-emphasized) .....	P091
Atom .....	P8S
Blossom*** .....	P8K
Bullseye .....	PJF
Cobalt Mica*** (De-emphasized) ...	P090
Ember .....	P8P
Ion .....	P8N
Iris .....	P8J
Krypton .....	P8F
Ochre*** .....	P093
Regatta .....	P8M
Sienna*** .....	P092
Succulent*** .....	P8A

*Metallic paints, due to varying reflectance, may appear to have less visual color consistency than other paint finishes, even when L/A/B values are exactly the same. (L/A/B — measurable aspects of color — values are maintained within a specified range, to ensure consistent appearance of paint colors.)*

*\*\*\*These colors are intended to be an inspirational option for the trending market. Product application is limited and color availability is approximately two years to coincide with evolving workplace trends.*

## METAL STORAGE PULLS

Black (Bar or Arch Pull) .....	E4/P71
Designer White (Bar pull only) .....	PJW
Silver .....	EL/PR6

## PAINTED WOOD FINISHES

Brownstone .....	M13
Bungalow .....	M12
Designer White .....	M17
Flint .....	M16
Loft .....	M11
Muslin .....	M15

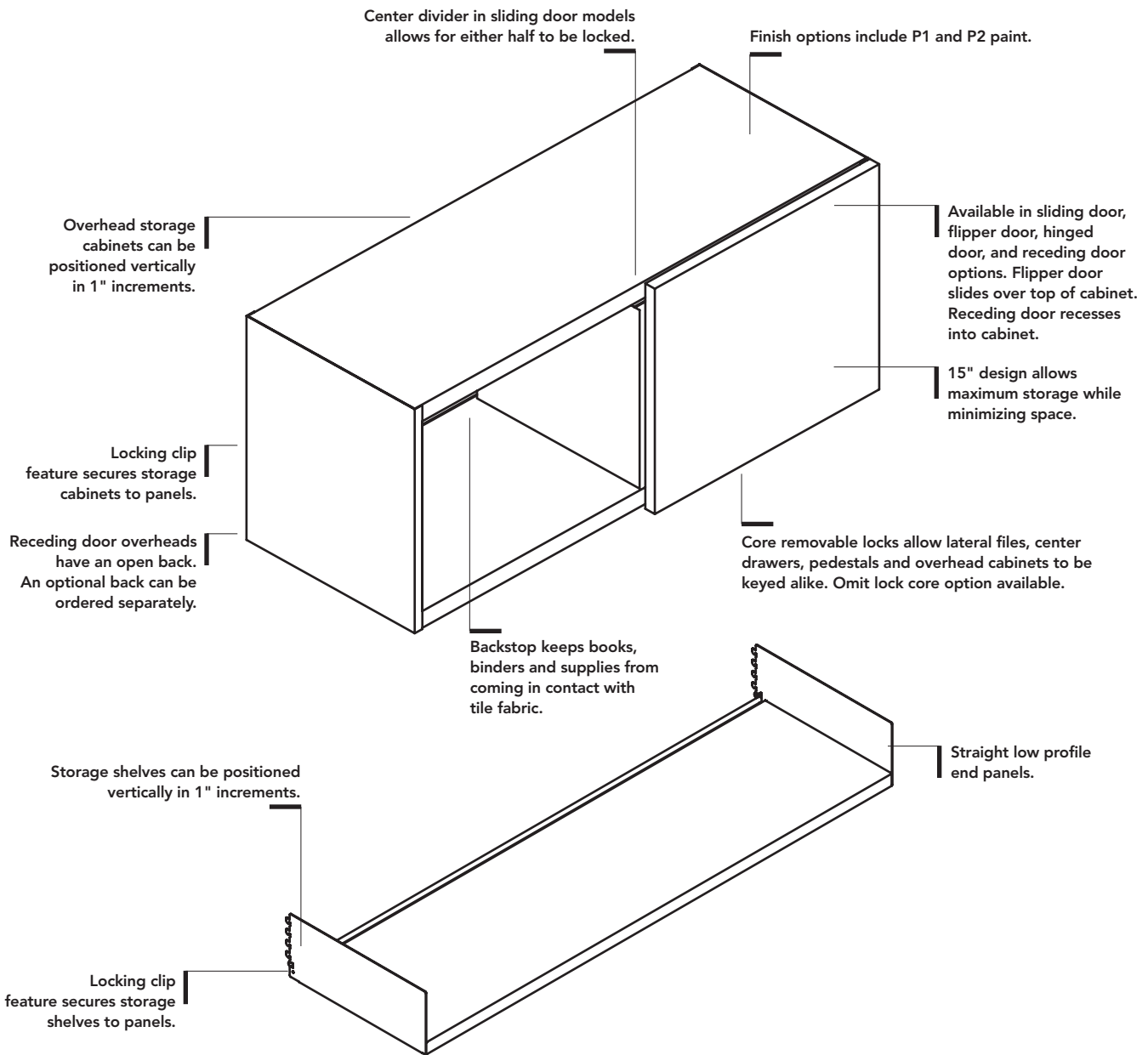

### Product dimensions

#### Overhead Storage Cabinet

**Width** 24", 30", 36", 42", 48", 60"

**Inside width** Flipper or 24"-36" W Hinged door —  $\frac{1}{8}$ " less than width  
42"-48" W Hinged or Sliding door — two compartments that are half of  $\frac{1}{8}$ " less than width

**Depth** 14 $\frac{1}{4}$ " RTA models 12"

**Inside depth** 12 $\frac{7}{8}$ " Receding door 12 $\frac{1}{2}$ " RTA models 11 $\frac{5}{8}$ "

**Height** 15"

**Inside height** 12 $\frac{3}{4}$ " Receding door 11 $\frac{5}{8}$ " RTA models 12 $\frac{3}{4}$ "

#### Open Shelf

**Width** 24", 30", 36", 42", 48", 60"

**Depth** 12 $\frac{7}{8}$ " RTA models 11 $\frac{1}{2}$ "

**Height** 4 $\frac{5}{8}$ " RTA models 5 $\frac{5}{8}$ "

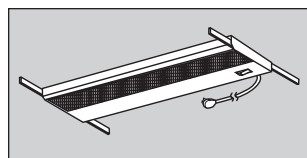

- **Task lights** can be mounted beneath storage shelves and overhead storage cabinets.
- Additional panel hung and freestanding lighting options are available.

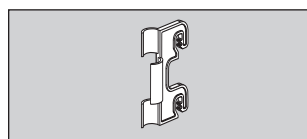

- **Cord retainer clips** fasten into panel slots to anchor power cords.
- Available in black only.
- Clips are provided with under-shelf mounted task lights. Additional clips can be purchased separately.

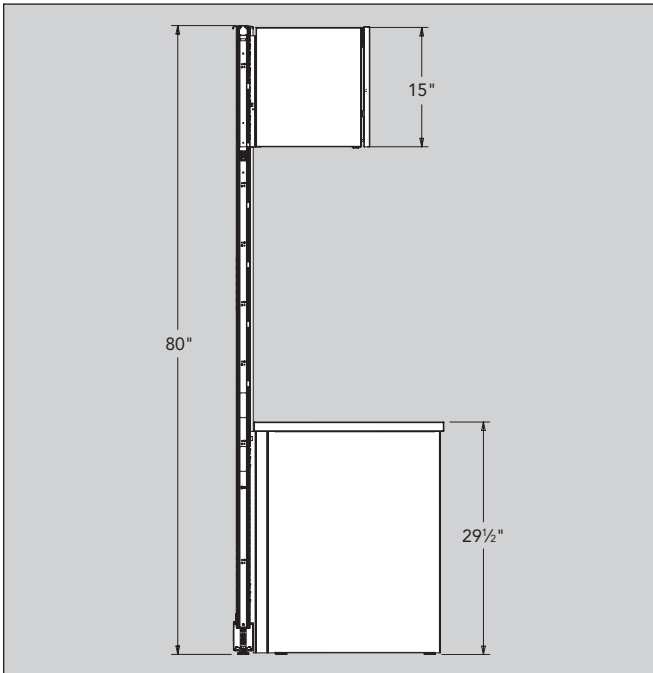
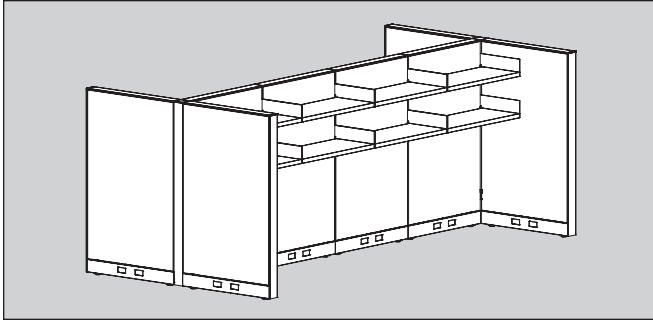

### Specification Guidelines

- In a panel run, only two overhead storage cabinets or open storage shelves are recommended per panel side.
- Do not suspend more than one overhead storage unit per side from panels in a panel run which is mounted, at one or both ends, with an off-module connector kit.
- Overhead storage cabinets and open storage shelves can be mounted on Terrace structural and stacking panels to a maximum height of 80"H.
- When mounting an overhead on a 57½"H base panel frame, select the option for Z57 bracket.
- For all other base panel frame and base panel frames with stacking frames the YZ bracket should be selected.
- Base panel frames with stacking frames that have an overall height of 57½" also use the YZ bracket.

**When overhead storage units are suspended from stacking frames,** the following guidelines should be adhered to:

- Stacking frames should be added to all the parent run panels, and to, at least the first panel of each return-panel run. Stacking panels added to return panel must match the parent run configuration.
- A maximum of two overhead storage units should be suspended from each side of stacking frames on any given panel.
- With Terrace, a full height panel end cover is required for adequate stability when using overhead storage on the end of a run, or on a return panel.

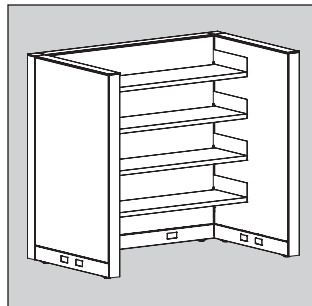

- No limitation to the number of units on structural frames when run is supported with return panels on each side of storage shelves or overhead storage cabinets.

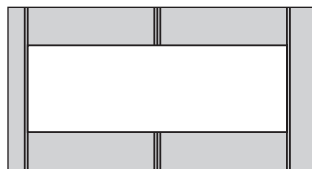

- **Storage shelf, receding door overhead, RTA overhead, and RTA shelf width** must correspond with width of panel(s).
- It is possible to span two panels when combined panel width equals cabinet or shelf width.

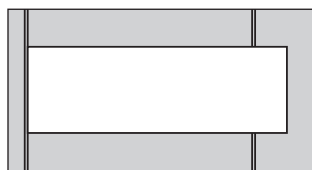

- **Terrace assembled metal overhead cabinets** can be mounted on a panel equal to or up to 18" narrower than cabinet using provided panel attachment brackets. Overhead cabinets can also be mounted on panels wider than the overhead cabinet when using off-module kit Z2MN. One side of overhead must be held on-module.

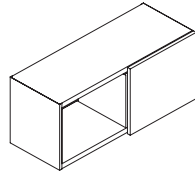

Sliding Door Overhead

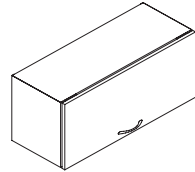

Flipper Door Overhead

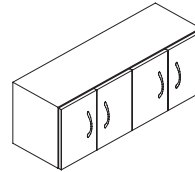

Hinged Door Overhead

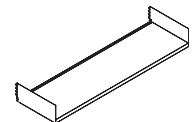

Open Shelf

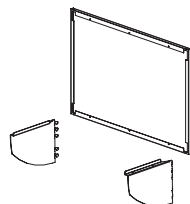

Upmount Kit for Overhead Cabinets

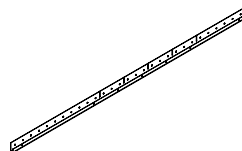

Horizontal Wall Track

### Overhead Storage Cabinet (page 117)

- Steel cabinet with backstop.
- Available with sliding, hinged, or flipper door(s).
- Easy-Assist flipper door optional — requires minimal assistance in opening and closing. Not available on 60"W cabinets, specify 2–30"W cabinets with Easy-Assist.
- Self-engaging safety latch to secure cabinet to panel.
- Width can correspond with width of panel, or 2 panels joined without a connector.
- Arch or square pull optional on flipper and hinged doors.
- 60"W flipper door cabinet has 2–30"W doors with 2 independent locks.
- 24"-36"W hinged door cabinets have 1 lock and 2 optional pulls, 42"-48"W have 2 locks and 4 optional pulls.
- Accommodates recessed task lighting (specified separately).
- For locking specifications, see pages 328-330.
- Cabinets are 14¼"D x 15"H.
- 15"H cabinets can also be mounted on a panel equal to or up to 18" narrower than cabinet using provided panel attachment brackets.
- Sliding doors have a built in pull.
- Sliding, hinged, and flipper door overhead weight limits:
 

24"W .....	59 lbs.	42"W .....	105 lbs.
30"W .....	74 lbs.	48"W .....	121 lbs.
36"W .....	90 lbs.	60"W .....	152 lbs.
- When mounting an overhead on a 57½"H base panel frame, select the option for Z57 bracket. For all other base panel frame and base panel frames with stacking frames the YZ bracket should be selected. Base panel frames with stacking frames that have an overall height of 57½"H also use the YZ bracket.

### Open Shelf (page 117)

- Metal shelf with back stop.
- Locking clips (2) standard.
- Will accommodate recessed task lighting — ordered separately.
- Weight Limits:
 

24"W .....	61 lbs.	42"W .....	108 lbs.
30"W .....	77 lbs.	48"W .....	124 lbs.
36"W .....	93 lbs.	60"W .....	155 lbs.

### Upmount Kits for Assembled Overhead Cabinets (page 117)

- Consists of two upmount brackets, full back panel and required installation hardware.
- Allows mounting of an assembled overhead cabinet up to 15" above height of panel.
- Specify "Z2" prefix model number upmount kits with 15"H, 30"H, 35"H, 50"H, or 65"H frames; and "Z4" prefix model numbers for use with 22½"H, 42½"H, or 57½"H frames.
- Brackets require a clearance of 6½" below bottom of overhead cabinet.
- Width must correspond with width of panel frame or 2 panel frames joined directly in-line.
- Full back panel adds ½" to depth of overhead case. Full back panel only used when upmounting cabinet.
- Cannot be used with RTA models.

### Horizontal Wall Track (page 117)

- Allows mounting overheads on permanent wall structures only.
- Cannot be used with RTA models.
- Track is 60"W and notched at 6" intervals as a guide for field cutting.
- For use with 15"H sliding door overhead, field modification is necessary.
- Available in Black only.
- Attachment hardware not included.

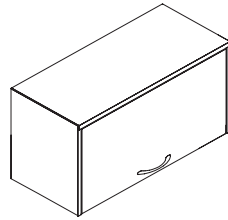

Receding Door Overhead

### Receding Door Overhead Storage Cabinet (page 118)

- Steel cabinet with open back. Optional back can be ordered separately.
- Arch or Square pull optional.
- 60"W cabinet has 2 30"W doors with 2 independent locks.
- Accommodates recessed task lighting — ordered separately.
- For locking specifications, see pages 328-330.
- Cabinets are 13¼"D x 15"H. When door is recessed, interior dimensions are 12⅝"D x 11⅝"H.

#### Weight Limits:

30"W .....	70 lbs.	48"W .....	110 lbs.
36"W .....	85 lbs.	60"W .....	138 lbs.
42"W .....	100 lbs.		

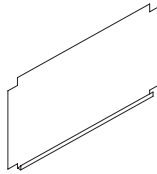

Receding Door Overhead Back

### Receding Door Overhead Back (page 118)

- Optional for use with receding door overhead.
- Order width to match overhead cabinet.

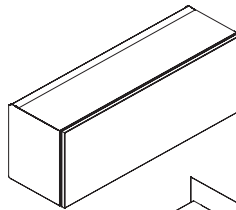

### Ready to Assemble (RTA) Flipper Door Overhead (page 118)

- Steel cabinet with open back.
- 60"W and 72"W cabinets have 2 doors with independent locks.
- Accommodates recessed task lighting — ordered separately.
- Random keying, for locking specifications see pages 328-330.
- Cabinets are 12"D x 15"H. Interior dimensions 11⅝"D x 12¾"H.

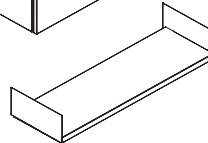

### Ready to Assemble (RTA) Shelf (page 118)

- Metal shelf with locking clips.
- Accommodates recessed task lighting — ordered separately.

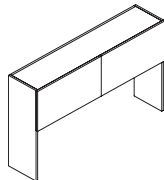

Stack-On Hutch

### Stack-on Hutch (page 119)

- Have flipper doors with square horizontal edges.
- Universal model can be converted to open hutch.
- Doors are standard with a core removable lock (60"W, 66"W and 72"W have two doors and two locks.)
- Attachment tape provided.
- Order hutch to match width of worksurface(s) it covers.
- Hutches have clearance of 19¼" for computers, etc.
- Ship easy to assemble.
- Depth dimensions shown includes thickness of door.
- Universal model inside depth dimension is 12¾"
- Stack-on hutches accommodate recessed task lighting.
- For locking specification see pages 328-330.
- Chicago task light cords cannot be routed through the Hutch end panels, due to the large size of the fused plugs.

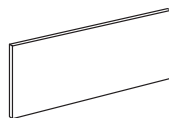

Tackboards for Hutches

### Tackboards (page 119)

- Use tackboard to close the back of stack-on or hutch below storage unit.
- Due to width of fabric roll, 72"W tackboards are available in railroad cut only.
- Back of tackboard is painted steel, a finished surface.



# Metal Overheads

## Terrace® — Overheads / Shelves and Mounting Kits

For specification information see pages 113-116.

GSA SIN 33721

METAL OVERHEADS & SHELVES

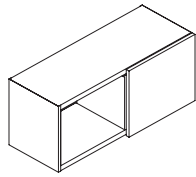

Description	Model	P1 Paint List Price	P2 Paint List Price	P3 Paint List Price
<b>15"H x 14½"D Sliding Single Door Overhead Cabinets</b>				
24"W	OH1524SD	\$ 1010	\$ 1086	\$ 1161
30"W	OH1530SD	\$ 1033	\$ 1109	\$ 1184
36"W	OH1536SD	\$ 1083	\$ 1159	\$ 1234
42"W	OH1542SD	\$ 1132	\$ 1208	\$ 1283
48"W	OH1548SD	\$ 1183	\$ 1259	\$ 1334
60"W	OH1560SD	\$ 1562	\$ 1638	\$ 1713

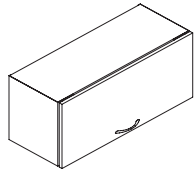

Description	Model	P1 Paint List Price	P2 Paint List Price	P3 Paint List Price
<b>15"H x 14½"D Flipper Door Overhead Cabinets</b>				
24"W	OH1524FD	\$ 1010	\$ 1086	\$ 1161
30"W	OH1530FD	\$ 1033	\$ 1109	\$ 1184
36"W	OH1536FD	\$ 1083	\$ 1159	\$ 1234
42"W	OH1542FD	\$ 1132	\$ 1208	\$ 1283
48"W	OH1548FD	\$ 1183	\$ 1259	\$ 1334
60"W	OH1560FD	\$ 1562	\$ 1638	\$ 1713

**Note:** Add suffix **A** for arch pull or **S** for square pull to model number — add \$41 per pull.  
For "Easy-Assist" on 24"W-48"W change FD suffix to FE – add \$233

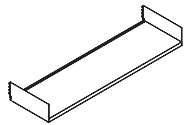

<b>Open Shelf (to line up with 15"H Overheads) — 12½"D</b>					
24"W	ZS24	<input type="checkbox"/> S	\$ 431	\$ 458	\$ 482
30"W	ZS30	<input type="checkbox"/> S	\$ 467	\$ 494	\$ 518
36"W	ZS36	<input type="checkbox"/> S	\$ 493	\$ 520	\$ 544
42"W	ZS42	<input type="checkbox"/> S	\$ 516	\$ 543	\$ 567
48"W	ZS48	<input type="checkbox"/> S	\$ 541	\$ 568	\$ 592
60"W	ZS60		\$ 659	\$ 686	\$ 710

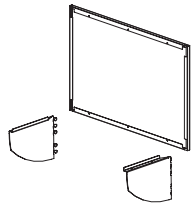

<b>Upmount Kits for Overhead Cabinets</b>				
Specify "Z4" prefix models with 22½"H, 42½"H, or 57½"H frames; "Z2" prefix for other heights.				
24"W	Z <input type="checkbox"/> UP24	\$ 261	\$ 289	\$ 314
30"W	Z <input type="checkbox"/> UP30	\$ 273	\$ 301	\$ 326
36"W	Z <input type="checkbox"/> UP36	\$ 281	\$ 309	\$ 334
42"W	Z <input type="checkbox"/> UP42	\$ 296	\$ 324	\$ 349
48"W	Z <input type="checkbox"/> UP48	\$ 310	\$ 338	\$ 363
60"W	Z <input type="checkbox"/> UP60	\$ 332	\$ 360	\$ 385



<b>Shelf Dividers</b>					
Package of 6	T7DV	<input type="checkbox"/> S	\$ 134	\$ 151	\$ 162

**Note:** Not compatible with RTA models.

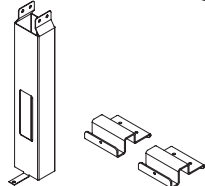

<b>Off-Modular Overhead Bracket Kit</b>					
Mounting Kit	Z2NM	<input type="checkbox"/> S	\$ 247	\$ 275	\$ 300

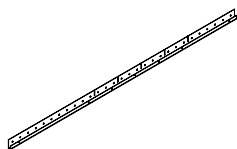

<b>Horizontal Wall Track</b>					
60"W Track	TWTH		\$ 131	N/A	N/A

How to specify — Select the Model Number from above.	1st Option: Pull (if applicable): A Arch pull, add \$41 per pull S Square pull, add \$41 per pull	2nd Option: System (if applicable): YZ Terrace, Stride®, or Optimize™ Z57 57"H Terrace or Stride	3rd Option: Paint: <input type="checkbox"/> P1 <input type="checkbox"/> P2 <input type="checkbox"/> P3 See page 112 for finishes.	4th Option: Pull Color (if applicable): Arch: E4 Black EL Matte Silver Square: EL Matte Silver	5th Option: Lock Type: STD Standard — Random Keyed OMT Omit Lock Core (Deduct \$20 per lock)
_____	_____	_____	P _____	E _____	_____

Examples: OH1536FEA.YZ.P01.E4.STD OH1548FDS.YZ.P27.EL.OMT  Shippable by small-package carrier.

# Metal Overheads

Terrace® — Overheads

For specification information see pages 113-116.

GSA SIN 33721

METAL OVERHEADS & SHELVES

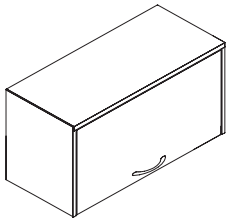

Description	Model	P1 Paint List Price	P2 Paint List Price	P3 Paint List Price
<b>15"H x 13 1/2"D Receding Door Overheads (Inside dimensions with door recessed — 11 1/8"H x 12 1/2"D)</b>				
30"W	OH1530RD	\$ 1185	\$ 1261	\$ 1336
36"W	OH1536RD	\$ 1250	\$ 1326	\$ 1401
42"W	OH1542RD	\$ 1328	\$ 1404	\$ 1479
48"W	OH1548RD	\$ 1439	\$ 1515	\$ 1590
60"W	OH1560RD	\$ 2177	\$ 2253	\$ 2328

**Note:** Add Suffix **A** for arch pull or **S** for square pull option — add \$41 per pull.

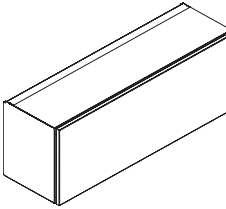

<b>15"H x 12"D Ready to Assemble (RTA) Flipper Door Overhead (Inside dimensions 12 3/4"H x 11 1/8"D)</b>				
36"W RTA — Flipper Door	POHRTA1536FD	\$ 849	\$ 925	\$ 1000
42"W RTA — Flipper Door	POHRTA1542FD	\$ 887	\$ 963	\$ 1038
48"W RTA — Flipper Door	POHRTA1548FD	\$ 925	\$ 1001	\$ 1076

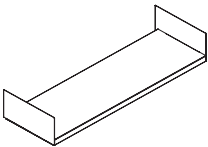

<b>5 1/2"H x 12"D Ready to Assemble (RTA) Shelf</b>				
36"W RTA — Shelf	POHRTA36S	\$ 442	\$ 468	\$ 490
48"W RTA — Shelf	POHRTA48S	\$ 486	\$ 512	\$ 534

<p><b>How to specify —</b> Select the Model Number from above.</p> <p>_____</p> <p>_____</p>	<p><b>1st Option:</b> <b>Receding Door Pull (if applicable):</b> A Arch Pull, add \$41 per pull S Square Pull, add \$41 per pull</p> <p>_____ .</p>	<p><b>2nd Option:</b> <b>System for Receding Door Overhead (if applicable):</b> YZ Terrace, Stride®, Optimize™, or Concensys® Z57 57 1/2"H Stride or Terrace</p> <p>_____ .</p>	<p><b>3rd Option:</b> <b>Paint:</b> P1 P2 P3 See page 112 for finishes.</p> <p>P _____</p>	<p><b>4th Option:</b> <b>Receding Door Pull Color (if applicable):</b> Arch: E4 Black EL Silver Square: EL Silver</p> <p>E _____ .</p>	<p><b>5th Option:</b> <b>Receding Door Lock (if applicable):</b> STD Standard OMT Omit Lock Core (Deduct \$20 per lock)</p> <p>_____</p>
--	---	---	--	--	--

Examples: OH1560RD.YZ.P7C.STD OH1536RDA.Z57.P27.E4.OMT POHRTA1536FD.P27

# Metal Hutches

## Terrace® — Hutches, Tackboards, and Accessories

For specification information see pages 113-116.

GSA SIN 33721

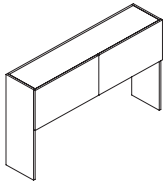

Description	Universal Hutch Model	P1 Paint List Price	P2 Paint List Price	P3 Paint List Price
<b>Hutch w/Square Flipper Doors and Lock — 14½"D, Universal 35"H</b>				
36"W	UH6536FD	\$ 1165	\$ 1244	\$ 1322
42"W	UH6542FD	\$ 1218	\$ 1297	\$ 1375
48"W	UH6548FD	\$ 1259	\$ 1338	\$ 1416
60"W	UH6560FD	\$ 1784	\$ 1863	\$ 1941
66"W	UH6566FD	\$ 1871	\$ 1950	\$ 2028
72"W	UH6572FD	\$ 1961	\$ 2040	\$ 2118

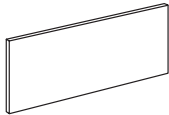

Description	Universal Hutch Model	P1 Paint List Price — Fabric			P2 Paint List Price — Fabric			P3 Paint List Price — Fabric		
		Grades A/B	Grades C/D	Grades E/F	Grades A/B	Grades C/D	Grades E/F	Grades A/B	Grades C/D	Grades E/F
<b>20"H Tackboards for Stack-on Hutches</b>										
36"W Tackboard	UHTB36	\$ 524	\$ 618	\$ 774	\$ 550	\$ 644	\$ 800	\$ 572	\$ 666	\$ 822
42"W Tackboard	UHTB42	\$ 550	\$ 649	\$ 812	\$ 576	\$ 675	\$ 838	\$ 598	\$ 697	\$ 860
48"W Tackboard	UHTB48	\$ 600	\$ 712	\$ 897	\$ 626	\$ 738	\$ 923	\$ 648	\$ 760	\$ 945
60"W Tackboard	UHTB60	\$ 671	\$ 811	\$ 1044	\$ 697	\$ 837	\$ 1070	\$ 719	\$ 859	\$ 1092
66"W Tackboard	UHTB66	\$ 706	\$ 859	\$ 1114	\$ 732	\$ 885	\$ 1140	\$ 754	\$ 907	\$ 1162
72"W Tackboard	UHTB72	\$ 744	\$ 896	\$ 1148	\$ 770	\$ 922	\$ 1174	\$ 792	\$ 944	\$ 1196



Description	Model	P1 Paint List Price	P2 Paint List Price	P3 Paint List Price
<b>Shelf Dividers</b>				
Package of 6	T7DV	\$ 134	\$ 151	\$ 162

**Note:** Not compatible with RTA models.

METAL OVERHEADS & SHELVES

<p><b>How to specify —</b> Select the Model Number from above.</p>	<p><b>1st Option:</b> <b>Pull</b> (if applicable): Add \$41 per pull. A Arch Pull S Square Pull</p>	<p><b>2nd Option:</b> <b>Paint:</b> P1 P2 P3 See page 112 for finishes.</p>	<p><b>3rd Option:</b> <b>Fabric</b> (if applicable): See page 14 for fabrics.</p>	<p><b>3rd Option:</b> <b>Lock Type</b> (if applicable): STD Standard — Random Keyed OMT Omit Lock Core (Deduct \$20 per lock)</p>	<p><b>4th Option:</b> <b>Railroad Cut</b> (Tackboard only): (Only applicable to 72"W Fabric Tackboards.)</p>
_____	_____	_____	_____	_____	_____

Examples: UH6536FDA.P27.STD UHTB66.P27.CS918.RR

Shippable by small-package carrier.

# Notes

---

METAL OVERHEADS & SHELVES

- Finishes ..... 122
- Digital Lock Specifications..... 123
- Pedestal Functionality with Work Tools ..... 124
- Freestanding and Mobile Pedestals ..... 125-128
- Pedestal Functionality with Work Tools ..... 129
- Undermount, L-Cube, and Work Tools ..... 130-132
- Caddy..... 133
- Digital Lock Keys and Accessories ..... 134

**PAINTED METAL FINISHES**

**GRADE P1**

Black .....	P71
Brownstone .....	P7D
Bungalow .....	P7C
Cinder .....	P7Q
Cove .....	P096
Designer White .....	PJW
Dune .....	P094
Flint .....	P02
Fossil .....	P28
Harbor .....	P097
Loft .....	P7B
Muslin .....	P4J
Parchment .....	P93
Pebble .....	P8R
Pewter .....	P8D
Sage .....	P095
Salt .....	P8C
Textured Designer White .....	PK7
Textured Flint .....	P7A
Titanium .....	P8T

**GRADE P2**

Champagne Metallic .....	PR5
Gunmetal Metallic .....	PR3
Silver** .....	PR6
Solar Black .....	P8X

\*\*PR6 no upcharge on Involve; available as a Grade P2 color on stanchions. PR6 & P8X are not available on Concensys, Essentials bookcase, and vertical files.

**GRADE P3**

Amethyst*** (De-emphasized) .....	P091
Atom .....	P8S
Blossom*** .....	P8K
Bullseye .....	PJF
Cobalt Mica*** (De-emphasized) .....	P090
Ember .....	P8P
Ion .....	P8N
Iris .....	P8J
Krypton .....	P8F
Ochre*** .....	P093
Regatta .....	P8M
Sienna*** .....	P092
Succulent*** .....	P8A

*Metallic paints, due to varying reflectance, may appear to have less visual color consistency than other paint finishes, even when L/A/B values are exactly the same. (L/A/B — measurable aspects of color — values are maintained within a specified range, to ensure consistent appearance of paint colors.)*

*\*\*\*These colors are intended to be an inspirational option for the trending market. Product application is limited and color availability is approximately two years to coincide with evolving workplace trends.*

**METAL STORAGE PULLS**

**BEAM**

Designer White .....	PJW
Silver .....	PR6
Pyrite .....	PJE
Solar Black .....	P8X

**HALO**

Designer White .....	PJW
Silver .....	PR6
Pyrite .....	PJE
Solar Black .....	P8X

**BAR**

Designer White .....	PJW
Black .....	P27
Silver .....	PR6

**SQUARE**

Designer White .....	PJW
Flint .....	P02
Loft .....	P7B
Matte Silver .....	EL
Pyrite .....	PJE
Solar Black .....	P8X

**RADII CONSOLE—POLY LINER**

Cool Grey .....	CGR
-----------------	-----

**RADII USB**

Designer White .....	DW
Flint .....	E9
Storm .....	STRM

**LOCKS**

Black .....	E4
Chrome .....	ordered by base model
Matte Silver .....	EL

**NOTE:** Refer to individual product pages for upcharges.

**RADII WORKTOOLS COLOR OPTIONS**

DW- Designer White
E9- Flint

### Available on Align (Pedestals, Credenzas, Towers) and Radii Products

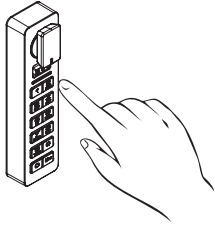

The digital keypad lock options support applications where workstations or storage banks are shared by multiple users. This is an alternative to a standard key lock. This feature facilitates the use of storage by multiple users through eliminating the need to keep and hand-off physical keys. These locks ship in “shared mode” by default; shared mode indicates that the lock will “forget” the paired 4-digit code, allowing the unit to be used by multiple users.

#### Digital keypad locks:

- Ship factory installed
- Offered in a polished silver finish
- Digital keypad lock requires input of a user-selected 4-digit code
- Digital keypad powered using 2 premium lithium CR2450 batteries
- Battery life is dependent on the frequency of operation but can last up to 5-7 years
- Digital keypad locks are installed horizontally on Align pedestals, credenzas, and towers

Additional information about setup and common troubleshooting problems can be found here: [Digital Lock Overview](#).

#### Programming Key

- A Programming Key is a device used to initialize locks out of factory default mode and register Manager Keys to the locks.
- Only one Programming Key should be specified per installation site because multiple Programming Keys are not compatible with each other.
- Once a programming key is used with a unit, it is tied to that lock. Another programming key can not be used.
- Add-on digital lock orders should be programmed with the original programming key.

#### Manager Key

- A Manager Key is used to bypass a locked unit; this operates as the “master” key and it is recommended that building facilitators have at least one Manager Key.
- Up to 6 Manager Keys may be registered to each lock.
- Manager Keys provide external power to locks in case of battery failure.

Description	Model	List Price
<b>Digital Lock Keys and Accessories</b>		
Programming Key	YPLDIGPRG	\$ 330
Manager Key	YPLDIGMGR	\$ 255

\*Digital Lock users must purchase a programming key to operate. Programming keys and manager keys are purchased separately from locks.

Radii is a new generation of metal storage pedestals, undermounts, and Work Tools designed to accommodate more personal items and less paper. In the evolving digital age, the need to store paper files dwindles, people archive fewer documents, while the need to stow personal belongings grows. Conventional storage options that were designed for lateral paper filing don't adequately accommodate items employees stow, such as a backpack, purse, gym shoes, office supplies, or other everyday essentials workers want to keep within reach.

The desire for products to do more with less is quickly becoming a necessity. Radii delivers efficiency that is obvious in a solution that succinctly stows today's objects in a user-customizable way.

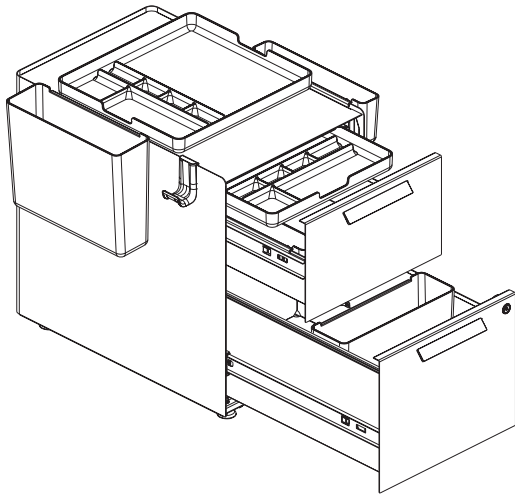

**Pedestals**

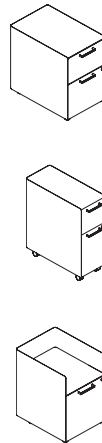

- Available with casters or glides
- Casters allow clearance for pedestal to straddle Altitude foot.
- Rear casters swivel, front casters are fixed, casters do not lock.
- Freestanding pedestals are not meant to support worksurfaces.
- Drawer slides are not full extension.
- Counterweight installed when required. No additional counterweight is required.
- Case wrapper creates a utility lip at top of case from which Work Tools can hang.
- 15"W pedestals can fit a Hot File Bin sideways in drawer to serve as a space divider.
- Hot File and Side Saddle can hang on inside file drawer lip.
- Alcove unit has a single drawer with open enclosure at top to stow backpack or other personal items.
- Drawers are labeled as "Box"/"Box +" and "File"/"File +"; see dimension table below.
- Drawers labeled as "+" have a taller drawer front and added space above the drawer body that can either accept the hidden Radii accessory tray or allow for the drawer to stow larger items, such as a backpack.
- All pedestals with a drawer marked "+" ship with one accessory tray, additional trays may be purchased separately (20<sup>3</sup>/<sub>8</sub>"H unit does not ship with or accept hidden tray).
- Radii pedestals offered with a digital locking option
- Slim peds (10"W) with digital locking only accept Square Pull.
- Manager and programming key purchased separately, see page 22.

Pedestal Functionality Represented by  
 Freestanding Pedestal 21½"H  
 15"W x 23"D Box with Tray/File.  
 Additional Work Tools ordered separately.

Drawer Type	Exterior Drawer Height	Accepts Tray	Filing	
			15"W Pedestal	10"W Pedestal
Box	6"	No	No	No
Box +	9"	Yes	No	No
File	12"	No	Front-to-Back Only, Letter Only	Side-to-Side Only, Letter or Legal
File +	15"	Yes	Front-to-Back Only, Letter Only	Side-to-Side Only, Letter or Legal

Drawer Type	Drawer Capacity*	
	15"W Pedestal	10"W Pedestal
Box	4¼"H x 12½"W x 17¾"D (19"D Pedestals) or 21¾"D (23"D Pedestals)	4¼"H x 7½"W x 21¾"D
Box +	7¼"H x 12½"W x 17¾"D (19"D Pedestals) or 21¾"D (23"D Pedestals)	7¼"H x 7½"W x 21¾"D
File	10¾"H x 12½"W x 17¾"D (19"D Pedestals) or 21¾"D (23"D Pedestals)	10¾"H x 7½"W x 21¾"D
File +	13⅝"H x 12½"W x 17¾"D (19"D Pedestals) or 21¾"D (23"D Pedestals)	13⅝"H x 7½"W x 21¾"D

\*If using hidden tray in + drawer, subtract approximately 3" from usable height

RADI STORAGE



For specification information see page 124.

GSA SIN 33721

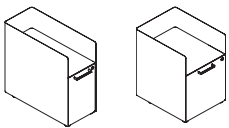
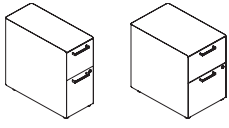
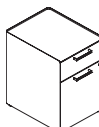
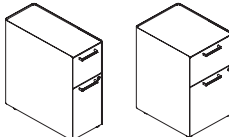
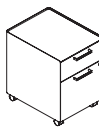
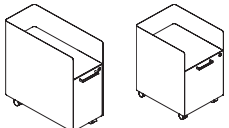
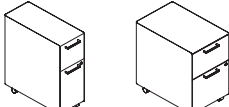
		Description	Model	P1 List Price
	<b>Freestanding Alcove and File + Pedestal 21½"H</b>			
		10"W x 23"D with Tray	APGBS24SNPT	\$ 923
		15"W x 19"D with Tray	APGBP18SNPT	\$ 955
	<b>Freestanding Box + and File Pedestal 21½"H</b>			
		10"W x 23"D with Tray	APGBS249TFN	\$ 985
		15"W x 19"D with Tray	APGBP189TFN	\$ 1013
		15"W x 23"D with Tray	APGBP249TFN	\$ 1078
	<b>Freestanding Box and File + Pedestal 21½"H</b>			
		15"W x 19"D with Tray	APGBP186NPT	\$ 1013
		15"W x 23"D with Tray	APGBP246NPT	\$ 1078
	<b>Freestanding Box + and File + Pedestal 24½"H</b>			
		10"W x 23"D with Tray	APGCS249TPN	\$ 1080
		15"W x 19"D with Tray	APGCP189TPN	\$ 1053
		15"W x 23"D with Tray	APGCP249TPN	\$ 1097
	<b>Mobile Box and File Pedestal 20½"H</b>			
		15"W x 19"D Does not accommodate Work Tool Tray	APMAP186NFN	\$ 944
		15"W x 23"D Does not accommodate Work Tool Tray	APMAP246NFN	\$ 1002
	<b>Mobile Alcove/File + Pedestal 23½"H</b>			
		10"W x 23"D Alcove/File with Tray	APMBS24SNPT	\$ 923
		15"W x 19"D Alcove/Tray-File	APMBP18SNPT	\$ 955
	<b>Mobile Box + and File Pedestal 23½"H</b>			
		10"W x 23"D with Tray	APMBS249TFN	\$ 985
		15"W x 19"D with Tray	APMBP189TFN	\$ 1013
		15"W x 23"D with Tray	APMBP249TFN	\$ 1078

RADI STORAGE

<p><b>How to specify —</b> Select the Model Number from above.</p> <p>A   P   .</p>	<p><b>1st Option:</b> <b>Pull Type</b> (if applicable):</p> <p>M Beam O Halo B Bar S Square</p> <p>See matrix on page 19.</p>	<p><b>2nd Option:</b> <b>Pull Color</b> (if applicable):</p> <p>M Beam / O Halo P JW Designer White P R6 Silver P J E Pyrite P 8 X Solar Black</p> <p>P2 upcharge +\$17/pull</p>	<p><b>3rd Option:</b> <b>Paint:</b></p> <p>P1 P2 P3</p> <p>See page 122 for finishes.</p> <p>P2 add \$44 P3 add \$88</p>
	<p>_____ .</p>		<p>_____ .</p>

Continued below ▼

<p><b>4th Option:</b> <b>Front Paint:</b></p> <p>P1 P2 P3</p> <p>See page 122 for finishes.</p> <p>NA Match Case P1 add \$11 P2 add \$33 P3 add \$55</p> <p>P       .</p>	<p><b>5th Option:</b> <b>Tray Color:</b></p> <p>DW Designer White E9 Flint</p> <p>DW   .</p>	<p><b>6th Option:</b> <b>Lock Option:</b></p> <p>STD Standard OMT Omit Lock Core (deduct \$20 per lock)</p> <p>       </p>
---	--	--

Examples: APGBS24SNPT.OPR6.PR3.PR3.DW.STD APMBP249TFN.BP27.P7B.P7B.DW.OMT

For specification information see page 124.

GSA SIN 33721



Description	Model	P1 List Price
<b>Mobile Box and File + Pedestal 23 1/2"H</b>		
15"W x 19"D with Tray	APMBP186NPT	\$ 1013
15"W x 23"D with Tray	APMBP246NPT	\$ 1078

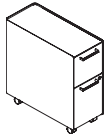

Description	Model	P1 List Price
<b>Mobile Box + and File + Pedestal 26 1/2"H</b>		
10"W x 23"D with Tray	APMCS249TPN	\$ 1080
15"W x 19"D with Tray	APMCP189TPN	\$ 1053
15"W x 23"D with Tray	APMCP249TPN	\$ 1097

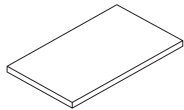

Description	Model	Base							
		List Price	2	3	4	5	6	7	8
<b>Seat Cushion</b>									
15"W x 19"D	AESC18	\$ 247	\$ 262	\$ 276	\$ 290	\$ 310	\$ 328	\$ 347	\$ 366
15"W x 23"D	AESC24	\$ 291	\$ 306	\$ 320	\$ 334	\$ 354	\$ 372	\$ 391	\$ 410

RADI STORAGE

<p><b>How to specify —</b></p> <p>Select the Model Number from above.</p>	<p><b>1st Option:</b></p> <p><b>Pull Type</b> (if applicable):</p> <p><b>M</b> Beam <b>O</b> Halo <b>B</b> Bar <b>S</b> Square See matrix on page 19.</p>	<p><b>2nd Option:</b></p> <p><b>Pull Color</b> (if applicable):</p> <p><b>M</b> Beam / O Halo <b>PJW</b> Designer White <b>PR6</b> Silver <b>PJE</b> Pyrite <b>P8X</b> Solar Black P2 upcharge +\$17/pull</p> <p><b>B</b> Bar <b>P27</b> Black <b>PJW</b> Designer White <b>PR6</b> Silver <b>S</b> Square <b>PJW</b> Designer White <b>EL</b> Matte Silver <b>P02</b> Flint <b>P7B</b> Loft <b>PJE</b> Pyrite <b>P8X</b> Solar Black P2 upcharge +\$17/pull</p>	<p><b>3rd Option:</b></p> <p><b>Paint:</b></p> <p><b>P1</b> <b>P2</b> <b>P3</b></p> <p>See page 122 for finishes. <b>P2</b> add \$44 <b>P3</b> add \$88</p>
A                     .		.           .	P         .

Continued below ▼

<p><b>4th Option:</b></p> <p><b>Front Paint:</b></p> <p><b>P1</b> <b>P2</b> <b>P3</b></p> <p>See page 122 for finishes. <b>NA</b> Match Case <b>P1</b> add \$11 <b>P2</b> add \$33 <b>P3</b> add \$55</p>	<p><b>5th Option:</b></p> <p><b>Tray Color:</b></p> <p><b>DW</b> Designer White <b>E9</b> Flint</p>	<p><b>6th Option:</b></p> <p><b>Lock Option:</b></p> <p><b>STD</b> Standard <b>OMT</b> Omit Lock Core (deduct \$20 per lock)</p>	
P         .	DW     .	.	

Examples: APGCS249TPN.BP27.PR6.PR6.DW.STD    APMCP189TPN.BP27.PJW.PJW.DW.OMT

<p><b>How to specify —</b></p> <p>Select the Seat Cushion Model Number from above.</p>	<p><b>1st Option:</b></p> <p><b>Upholstery:</b></p> <p>See page 12 for fabrics.</p>
A   E   S   C           .	.

Example: AESC18.CU10

For specification information see page 124.

GSA SIN 33721

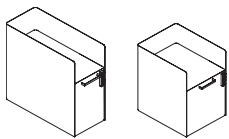
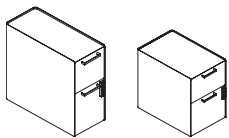
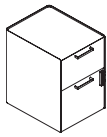
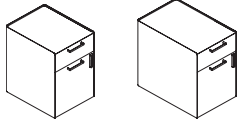
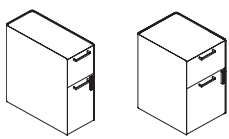
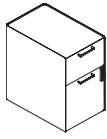
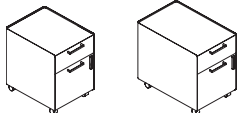
	Description	Model	P1 List Price
	<b>Freestanding Alcove and File + Pedestal 21½"H with Digital Lock</b>		
	10"W x 23"D with Tray	APGBS24SNPTE	\$ 923
	15"W x 19"D with Tray	APGBP18SNPTE	\$ 955
	<b>Freestanding Box + and File Pedestal 21½"H with Digital Lock</b>		
	10"W x 23"D with Tray	APGBS249TFNE	\$ 985
	15"W x 19"D with Tray	APGBP189TFNE	\$ 1013
			
	<b>Freestanding Box and File + Pedestal 21½"H with Digital Lock</b>		
	15"W x 19"D with Tray	APGBP186NPTE	\$ 1013
	15"W x 23"D with Tray	APGBP246NPTE	\$ 1078
	<b>Freestanding Box + and File + Pedestal 24½"H with Digital Lock</b>		
	10"W x 23"D with Tray	APGCS249TPNE	\$ 1080
	15"W x 19"D with Tray	APGCP189TPNE	\$ 1053
			
	<b>Mobile Box and File Pedestal 20½"H with Digital Lock</b>		
	15"W x 19"D Does not accommodate Work Tool Tray	APMAP186NFNE	\$ 944
	15"W x 23"D Does not accommodate Work Tool Tray	APMAP246NFNE	\$ 991

RADI STORAGE

<b>How to specify —</b> Select the Model Number from above.  A   P                             .	<b>1st Option:</b> <b>Pull Type</b> (if applicable): <b>M</b> Beam <b>O</b> Halo <b>B</b> Bar <b>S</b> Square See matrix on page 19.	<b>2nd Option:</b> <b>Pull Color</b> (if applicable): <b>M</b> Beam / <b>O</b> Halo <b>PJW</b> Designer White <b>PR6</b> Silver <b>PJE</b> Pyrite <b>P8X</b> Solar Black P2 upcharge +\$17/pull <b>B</b> Bar <b>P27</b> Black <b>PJW</b> Designer White <b>PR6</b> Silver <b>S</b> Square <b>PJW</b> Designer White <b>EL</b> Matte Silver <b>P02</b> Flint <b>P7B</b> Loft <b>PJE</b> Pyrite <b>P8X</b> Solar Black P2 upcharge +\$17/pull	<b>3rd Option:</b> <b>Paint:</b> <b>P1</b> <b>P2</b> <b>P3</b> See page 122 for finishes. <b>P2</b> add \$44 <b>P3</b> add \$88  P         .
---	---	---	---

Continued below ▼

<b>4th Option:</b> <b>Front Paint:</b> <b>P1</b> <b>P2</b> <b>P3</b> See page 122 for finishes. <b>NA</b> Match Case <b>P1</b> add \$11 <b>P2</b> add \$33 <b>P3</b> add \$55 <b>P</b>         .	<b>5th Option:</b> <b>Tray Color:</b> <b>DW</b> Designer White <b>E9</b> Flint	<b>6th Option:</b> <b>Lock Option:</b> <b>EBNL</b> Digital Lock add \$409 See page 134 for required programming key and manager key.             .
--	---	--

Example: APGBS24NPTE.SPR6.PDW.PDW.E9.EBNL

For specification information see page 124.

GSA SIN 33721

RADI STORAGE

Description		Model	P1 List Price
<b>Mobile Alcove/File + Pedestal 23 3/4"H with Digital Lock</b>			
10"W x 23"D Alcove/File with Tray		APMBS245NPTE	\$ 923
15"W x 19"D Alcove/Tray-File		APMBP185NPTE	\$ 955
<b>Mobile Box + and File Pedestal 23 3/4"H with Digital Lock</b>			
10"W x 23"D with Tray		APMBS249TFNE	\$ 985
15"W x 19"D with Tray		APMBP189TFNE	\$ 1013
15"W x 23"D with Tray		APMBP249TFNE	\$ 1078
<b>Mobile Box and File + Pedestal 23 3/4"H with Digital Lock</b>			
15"W x 19"D with Tray		APMBP186NPTE	\$ 1013
15"W x 23"D with Tray		APMBP246NPTE	\$ 1078
<b>Mobile Box + and File + Pedestal 26 3/4"H with Digital Lock</b>			
10"W x 23"D with Tray		APMCS249TPNE	\$ 1080
15"W x 19"D with Tray		APMCP189TPNE	\$ 1053
15"W x 23"D with Tray		APMCP249TPNE	\$ 1097

<p><b>How to specify —</b> Select the Model Number from above.</p> <p>A   P                                     .</p>	<p><b>1st Option:</b> Pull Type (if applicable):</p> <p>M Beam O Halo B Bar S Square</p> <p>See matrix on page 19.</p>	<p><b>2nd Option:</b> Pull Color (if applicable):</p> <p>M Beam / O Halo P JW Designer White P R6 Silver P J E Pyrite P 8 X Solar Black P2 upcharge +\$17/pull</p> <p>B Bar P 27 Black P JW Designer White P R 6 Silver S Square P JW Designer White E L Matte Silver P 0 2 Flint P 7 B Loft P J E Pyrite P 8 X Solar Black P2 upcharge +\$17/pull</p>	<p><b>3rd Option:</b> Paint:</p> <p>P1 P2 P3</p> <p>See page 122 for finishes.</p> <p>P2 add \$44 P3 add \$88</p> <p>P       .</p>
---	--	--	--

Continued below ▼

<p><b>4th Option:</b> Front Paint:</p> <p>P1 P2 P3</p> <p>See page 122 for finishes.</p> <p>NA Match Case P1 add \$11 P2 add \$33 P3 add \$55</p> <p>P       .</p>	<p><b>5th Option:</b> Tray Color:</p> <p>DW Designer White E9 Flint</p> <p>      .</p>	<p><b>6th Option:</b> Lock Option:</p> <p>EBNL Digital Lock add \$409</p> <p>See page 134 for required programming key and manager key.</p> <p>        .</p>
--	--	--

Example: APGBS24NPTE.SPR6.PDW.PDW.E9.EBNL

Representative Image

Space Claim

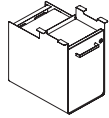

AUFD

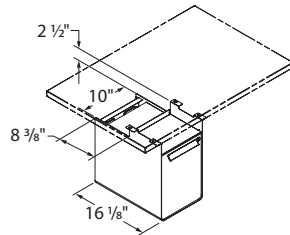

Flush Undermount  
Pull-Out Drawer

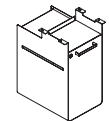

AUFH  
FH HD-Flush

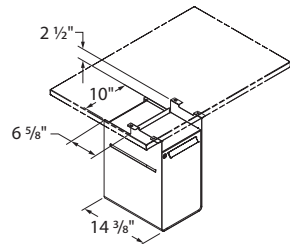

Flush Undermount  
RH Hinged Door

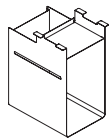

AUFO  
Open-Flush

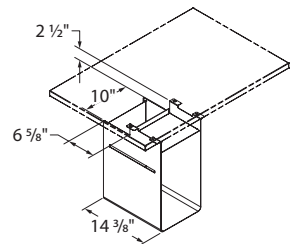

Flush Undermount  
Open Bin

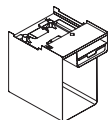

AUCL  
L Shelf-Console

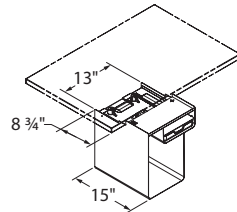

Console Undermount  
Open L-Cube

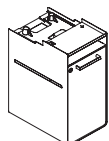

AUCH  
RH HD-Console

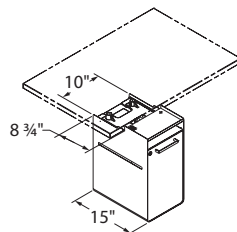

Console Undermount  
RH Hinged Door Bin

**Undermounts**

- Undermount units are mounted inset from the left or right edge of the worksurface dependent on table supports.
- Compatible with all Allsteel benching and desking applications, except where noted.
- Can accommodate 2 Hot File units within interior sitting side-by-side.
- Slim tray fits in the Drawer and Open L units only.
- Ensure weight limit of height adjustable table system is considered before adding undermount storage (see table for unit weight and storage capacity).
- Standard BIFMA loading standards based on open volume of storage area.
- For undermount applications with Altitude tables, see the matrix on page 131.
- Manager and programming key purchased separately, see page 123.
- Radii pedestals offered with a digital locking option.
- Slim peds (10" W) with digital locking only accept Square Pull.

**Flush Undermounts**

- Unit to be mounted under worksurface using hardware supplied with unit.
- Unit mounts flush to front edge of worksurface.
- Open and hinged door units contain side slot which can be used to hang Work Tools.
- Open and hinged door units do not fit Work Tool Trays.
- Drawer unit ships with hangrail to accommodate side-to-side filing.

**Console Undermounts**

- Open L unit comes with Work Tool Tray, console soft touch pad, and bottom soft touch liner.
- Hinged Door Console Unit comes with console soft touch pad ONLY.
- Unit available with or without USB. Either version ships with soft touch pad for console and contains a perforation for easy cord routing.
- Slots built into upper portion of case for Work Tools Hook to hang from.
- Unit mounts under worksurface with easy locating interface bracket. Bracket screws to worksurface, unit snaps onto bracket.
- Unit protrudes 6" from front of worksurface.

**Work Tools**

- Side Saddle and Hot File work on Stride and Terrace Tool Tiles and Tool Rails.
- Bag Hook weight limit 20 lbs.

RADI STORAGE

For specification information see page 124.

GSA SIN 33721

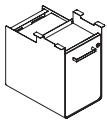
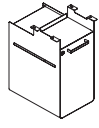
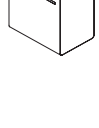
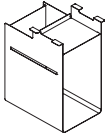
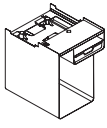
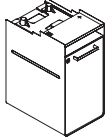
		Description	Model	P1 List Price
		<b>Flush Undermount Pull-Out Drawer 18"H</b> (Ships with Work Tool Tray)		
		10"W x 16½"D	AUFD15N	\$ 719
		<b>Flush Undermount Right-Hinged Door 20"H</b>		
		10"W x 14½"D	AUFH15N	\$ 676
		<b>Flush Undermount Left-Hinged Door 20"H</b>		
		10"W x 14½"D	AUFHL15N	\$ 676
		<b>Flush Undermount Open Bin 20"H</b>		
		10"W x 14½"D	AUFO15N	\$ 571
		<b>Console Undermount Open L-Cube 16"H</b> (Ships with Work Tool Tray)		
		13"W x 15"D with Non-USB Console	AUCL15N	\$ 769
		13"W x 15"D with USB Console	AUCL15U	\$ 918
		<b>Console Undermount Right Hinged Door Bin 20"H</b>		
		10"W x 15"D with Non-USB Console	AUCH15N	\$ 787
		10"W x 15"D with USB Console	AUCH15U	\$ 936
		<b>Console Undermount Left Hinged Door Bin 20"H</b>		
		10"W x 15"D with Non-USB Console	AUCHL15N	\$ 787
		10"W x 15"D with USB Console	AUCHL15U	\$ 936

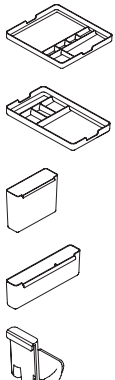
		Description	Model	List Price
	<b>Work Tools</b>	<b>Large Tray</b> for 15"W models		
		1½"H x 13½"W x 14¾"D	AELT	\$ 81
		<b>Small Tray</b> for 10"W models		
		1½"H x 8¾"W x 14¾"D	AEST	\$ 62
		<b>Hot File</b>		
		9½"H x 12¼"W x 3¾"D	AEHF	\$ 62
	<b>Side Saddle</b>			
		4"H x 12¼"W x 2½"D	AESS	\$ 51
	<b>Bag or Coat Hook</b>			
		3¼"H x 1¾"W x 2¼"D	AECH	\$ 39

<p><b>How to specify —</b> Select the Model Number from above.</p> <p>A           .</p>	<p><b>1st Option:</b> <b>Pull Type</b> (if applicable):</p> <p>M Beam O Halo B Bar S Square See matrix on page 19.</p>	<p><b>2nd Option:</b> <b>Pull Color</b> (if applicable):</p> <p>M Beam / O Halo P27 Designer White P6 Silver PJE Pyrite P8X Solar Black P2 upcharge +\$17/pull</p>	<p><b>3rd Option:</b> <b>Paint:</b> P1 P2 P3 See page 122 for finishes. P2 add \$33 P3 add \$66</p>	<p><b>4th Option:</b> <b>Front Paint:</b> P1 P2 P3 See page 122 for finishes. NA Match Case P1 add \$11 P2 add \$28 P3 add \$44</p>
			<p>B Bar P27 Black P6 Designer White P6 Silver S Square P27 Designer White EL Matte Silver P02 Flint P7B Loft PJE Pyrite P8X Solar Black P2 upcharge +\$17/pull</p>	<p>P       .</p>

Continued below ▼

<p><b>5th Option:</b> <b>Tray and Accessories Color</b> (if applicable): DW Designer White E9 Flint</p> <p>    .</p>	<p><b>6th Option:</b> <b>Console Poly Liner:</b> PL (if applicable)</p> <p>P   L</p>	<p><b>7th Option:</b> <b>Console Color</b> (if applicable): CGR Cool Grey</p> <p>C   G   R   .</p>	<p><b>8th Option:</b> <b>Lock Option:</b> STD Standard OMT Omit Lock Core (deduct \$20)</p> <p>       </p>	<p><b>9th Option:</b> <b>USB Color</b> (if applicable): STRM Storm</p> <p>S   T   R   M</p>
--	--	--	--	---

Examples: AUFH15N.OPR6.PJW.STD AUCL15U.PR6.DW.PLCGR.STRM AELT.DW

RADI STORAGE

Model Number	Unit Weight		Storage Capacity (lb.)	Weight + Capacity (added weight to table)		Internal	
				Height	Width	Depth	
AUFD15N	25	29	54	10"	7 $\frac{1}{8}$ "	14 $\frac{1}{8}$ "	
AUFH15N	22	42	64	16 $\frac{1}{4}$ "	9 $\frac{7}{8}$ "	13 $\frac{3}{8}$ "	
AUFHL15H	22	42	64	16 $\frac{1}{4}$ "	9 $\frac{7}{8}$ "	13 $\frac{3}{8}$ "	
AUFO15N	17	42	59	16 $\frac{1}{4}$ "	9 $\frac{7}{8}$ "	13 $\frac{3}{8}$ "	
AUCL15N	22	43	65	11 $\frac{1}{8}$ "	9 $\frac{7}{8}$ "	14 $\frac{1}{4}$ "	
AUCL15U	22	43	65	11 $\frac{1}{8}$ "	9 $\frac{7}{8}$ "	14 $\frac{1}{4}$ "	
AUCH15U	25	48	73	17"	9 $\frac{7}{8}$ "	14"	
AUCH15N	25	48	73	17"	9 $\frac{7}{8}$ "	14"	
AUCL15U	25	48	73	17"	9 $\frac{7}{8}$ "	14"	
AUCL15N	25	48	73	17"	9 $\frac{7}{8}$ "	14"	

		A6 (T-Leg)		A6 (C-Leg)	
		24"D	30"D	24"D	30"D
AUFD15N	Flush Undermount Pull-Out Drawer	○	○	○	●
AUFH15N/AUFHL15N	Flush Undermount RH/LH Hinge Door	○	○	○	●
AUFO15N	Flush Undermount Open Bin	○	○	○	●
AUCL15N/AUCL15U	Console Undermount L-Cube	○	○	○	○
AUCH15N/AUCH15U	Console Undermount RH Hinge Door	○	○	○	○
AUCL15N/AUCL15U	Console Undermount LH Hinge Door	○	○	○	○

Legend

●	Works, unit may sit flush to LH or RH edge of work surface
○	Works, unit must sit inset of height-adjustable leg
X	Does not work

For specification information see page 124.

GSA SIN 33721

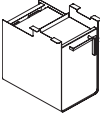
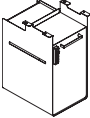
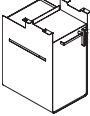
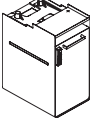
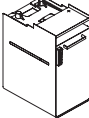
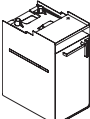
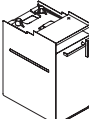
		Description	Model	P1 List Price
		Flush Undermount Pull-Out Drawer 18"H (Ships with Work Tool Tray) with Digital Lock 10"W x 16½"D	AUFD15NE	\$ 719
		Flush Undermount Right-Hinged Door 20"H with Digital Lock 10"W x 14½"D	AUFH15NE	\$ 676
		Flush Undermount Left-Hinged Door 20"H with Digital Lock 10"W x 14½"D	AUFHL15NE	\$ 676
		Console Undermount Right Hinged Door Bin 20"H with Digital Lock 10"W x 15"D, Non-USB Console 10"W x 15"D, USB Console	AUCH15NE AUCH15UE	\$ 787 \$ 936
		Console Undermount Left Hinged Door Bin 20"H with Digital Lock 10"W x 15"D, Non-USB Console 10"W x 15"D, USB Console	AUCHL15NE AUCHL15UE	\$ 787 \$ 936

RADI STORAGE

<p><b>How to specify —</b> Select the Model Number from above.</p>	<p><b>1st Option:</b> <b>Pull Type</b> (if applicable):</p> <p><b>M</b> Beam <b>O</b> Halo <b>B</b> Bar <b>S</b> Square  Slim Peds (10"W) only accept Square Pull.  See matrix on page 19.</p>	<p><b>2nd Option:</b> <b>Pull Color</b> (if applicable):</p> <table border="0"> <tr> <td><b>M</b> Beam / <b>O</b> Halo</td> <td><b>B</b> Bar</td> </tr> <tr> <td><b>PJW</b> Designer White</td> <td><b>P27</b> Black</td> </tr> <tr> <td><b>PR6</b> Silver</td> <td><b>PJW</b> Designer White</td> </tr> <tr> <td><b>PJE</b> Pyrite</td> <td><b>PR6</b> Silver</td> </tr> <tr> <td><b>P8X</b> Solar Black</td> <td><b>S</b> Square</td> </tr> <tr> <td>P2 upcharge +\$17/pull</td> <td><b>PJW</b> Designer White</td> </tr> <tr> <td></td> <td><b>EL</b> Matte Silver</td> </tr> <tr> <td></td> <td><b>P02</b> Flint</td> </tr> <tr> <td></td> <td><b>P7B</b> Loft</td> </tr> <tr> <td></td> <td><b>PJE</b> Pyrite</td> </tr> <tr> <td></td> <td><b>P8X</b> Solar Black</td> </tr> <tr> <td></td> <td>P2 upcharge +\$17/pull</td> </tr> </table>	<b>M</b> Beam / <b>O</b> Halo	<b>B</b> Bar	<b>PJW</b> Designer White	<b>P27</b> Black	<b>PR6</b> Silver	<b>PJW</b> Designer White	<b>PJE</b> Pyrite	<b>PR6</b> Silver	<b>P8X</b> Solar Black	<b>S</b> Square	P2 upcharge +\$17/pull	<b>PJW</b> Designer White		<b>EL</b> Matte Silver		<b>P02</b> Flint		<b>P7B</b> Loft		<b>PJE</b> Pyrite		<b>P8X</b> Solar Black		P2 upcharge +\$17/pull	<p><b>3rd Option:</b> <b>Paint:</b> <b>P1 P2 P3</b>  See page 122 for finishes.  <b>P2</b> add \$33 <b>P3</b> add \$66</p>	<p><b>4th Option:</b> <b>Front Paint:</b> <b>P1 P2 P3</b>  See page 122 for finishes.  <b>NA</b> Match Case <b>P1</b> add \$11 <b>P2</b> add \$28 <b>P3</b> add \$44</p>
	<b>M</b> Beam / <b>O</b> Halo	<b>B</b> Bar																										
<b>PJW</b> Designer White	<b>P27</b> Black																											
<b>PR6</b> Silver	<b>PJW</b> Designer White																											
<b>PJE</b> Pyrite	<b>PR6</b> Silver																											
<b>P8X</b> Solar Black	<b>S</b> Square																											
P2 upcharge +\$17/pull	<b>PJW</b> Designer White																											
	<b>EL</b> Matte Silver																											
	<b>P02</b> Flint																											
	<b>P7B</b> Loft																											
	<b>PJE</b> Pyrite																											
	<b>P8X</b> Solar Black																											
	P2 upcharge +\$17/pull																											
<p><b>A</b>                           .</p>	<p>                           </p>	<p>                           </p>	<p><b>P</b>                           .</p>																									

Continued below ▼

<p><b>5th Option:</b> <b>Tray and Accessories Color</b> (if applicable):</p> <p><b>DW</b> Designer White <b>E9</b> Flint</p>	<p><b>6th Option:</b> <b>Console Poly Liner:</b> <b>PL</b> (if applicable)</p>	<p><b>7th Option:</b> <b>Console Color</b> (if applicable):</p> <p><b>CGR</b> Cool Grey</p>	<p><b>8th Option:</b> <b>Lock Option:</b> <b>EBNL</b> Digital Lock add \$409  See page 134 for required programming key and manager key.</p>	<p><b>9th Option:</b> <b>USB Color</b> (if applicable):</p> <p><b>STRM</b> Storm</p>
<p>                            .</p>	<p><b>P   L</b>                          </p>	<p><b>C   G   R</b>                          </p>	<p>                           </p>	<p><b>S   T   R   M</b>                          </p>

Example: AUCHL15NE.SPR6.PDW.PDW.E9.PLCGR.EBNL



For specification information see page 124.

GSA SIN 33721

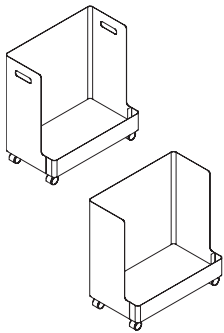

Description	Model	List Price
<b>Radii Caddy No Shelf</b> 22 $\frac{3}{4}$ "H x 12 $\frac{1}{2}$ "W x 21"D	ACMCM21O	\$ 740

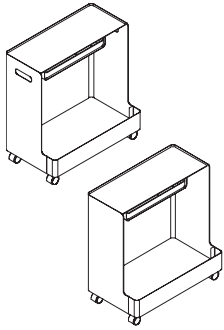

<b>Radii Caddy with Shelf</b> 22 $\frac{3}{4}$ "H x 12 $\frac{1}{2}$ "W x 21"D	ACMCM21T	\$ 887
---	----------	--------

**Notes:** Paint 1 for case color and Paint 2 for top and bottom shelf color  
 Handle options: YHDL for handle cutout and NHDL for no handle cutout  
 Radii work tools available in Designer White-DW or Flint-E9  
 Casters only  
 Accepts Radii work tools

RADI STORAGE

<p><b>How to specify —</b> Select the Model Number from above.</p> <p>ACMCM21     .</p>	<p><b>1st Option:</b> <b>Handle:</b> YHDL Handle Cutout NHDL No Handle Cutout</p> <p>        .</p>	<p><b>2nd Option:</b> <b>Case Color (if applicable):</b> P1 P2 See page 122 for finishes.</p> <p>    .</p>	<p><b>3rd Option:</b> <b>Top and Bottom Shelf Paint:</b> P1 P2 See page 122 for finishes.</p> <p>    .</p>	<p><b>4th Option:</b> <b>Tray and Accessories Color (if applicable):</b> DW Designer White E9 Flint</p> <p>   </p>
---	--	--	--	--

Examples: ACMCM21O.YHDL.PJW.P02 ACMCM21T.NHDL.PR6.PR6.DW

For specification information see page 123.

GSA SIN PENDING



Description	Model	List Price
<b>Digital Lock Keys and Accessories</b>		
Programming Key	YPLDIGPRG	\$ 330
Manager Key	YPLDIGMGR	\$ 255

*How to specify —*

Select the Model Number from above.

Y | P | L | | | | | | | |

*Examples:* YPLDIGPRG YPLRFID5S

Overview.....	135-160
Approach Statement of Line.....	137-140
Finishes .....	161
Laminate Storage Brackets.....	162
Approach and Involve Laminate Wood Storage.....	163-164
Storage Open Plan Supports.....	165-166
Working with Approach.....	167-189
Desks.....	191-193
Pedestals.....	194-195
Credenzas.....	196-206
Storage Back Panels.....	207
Lateral Files.....	208
Bookcases.....	209
False Peds / Height-Adjustable Shrouds / Wall Access Panels / Bridges .....	210
Table Tops.....	211
Worksurfaces and Supports.....	212-215
Modesty Panels — Laminate.....	216
Towers and Wardrobes.....	217-226
Overheads and Stack on Storage.....	227-230
Tackboards & Writable Boards.....	231-232
Counterweights & Accessories.....	233
Altitude Height-Adjustable .....	234-237

### A new way to optimize the private office.

Many executives spend more time outside their offices than in them. When they do touch down for focused work, they want to feel like they've reached home base. An office for the way they work. Confidential files stored securely, coffee mug in its rightful place.

Offices may be getting smaller, but they can't be less functional. Approach provides a portfolio of modular options that inspires you to rethink how the private office can be designed to address today's needs, change over time, and even serve more than one purpose.

### Approach complements Allsteel's open-plan solutions for a cohesive aesthetic throughout the space.

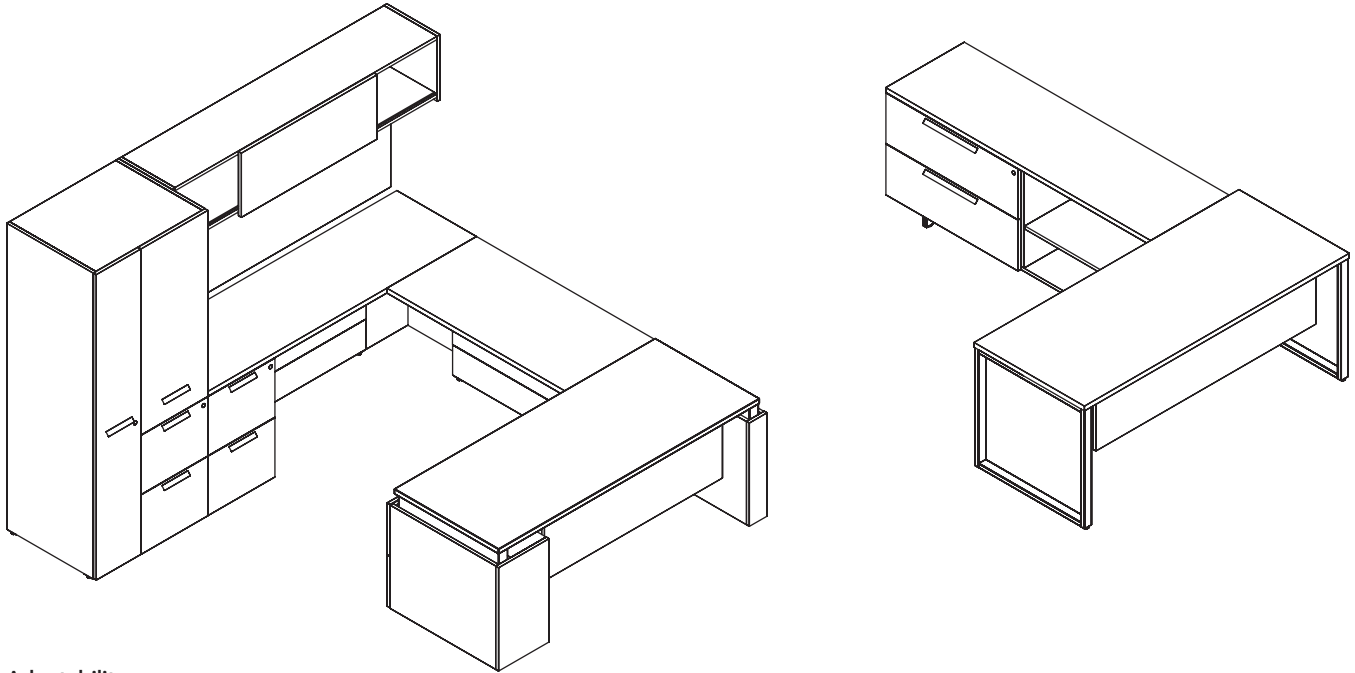

#### Adaptability

Two planning dimensions – 18" and 24" deep worksurfaces – allow you to design Approach to fit the space. Unique configurability options, like the ability to expand a simple "L" setup or change an "L" to a "U" setup, make it easy to efficiently use a single set of components throughout the workspace.

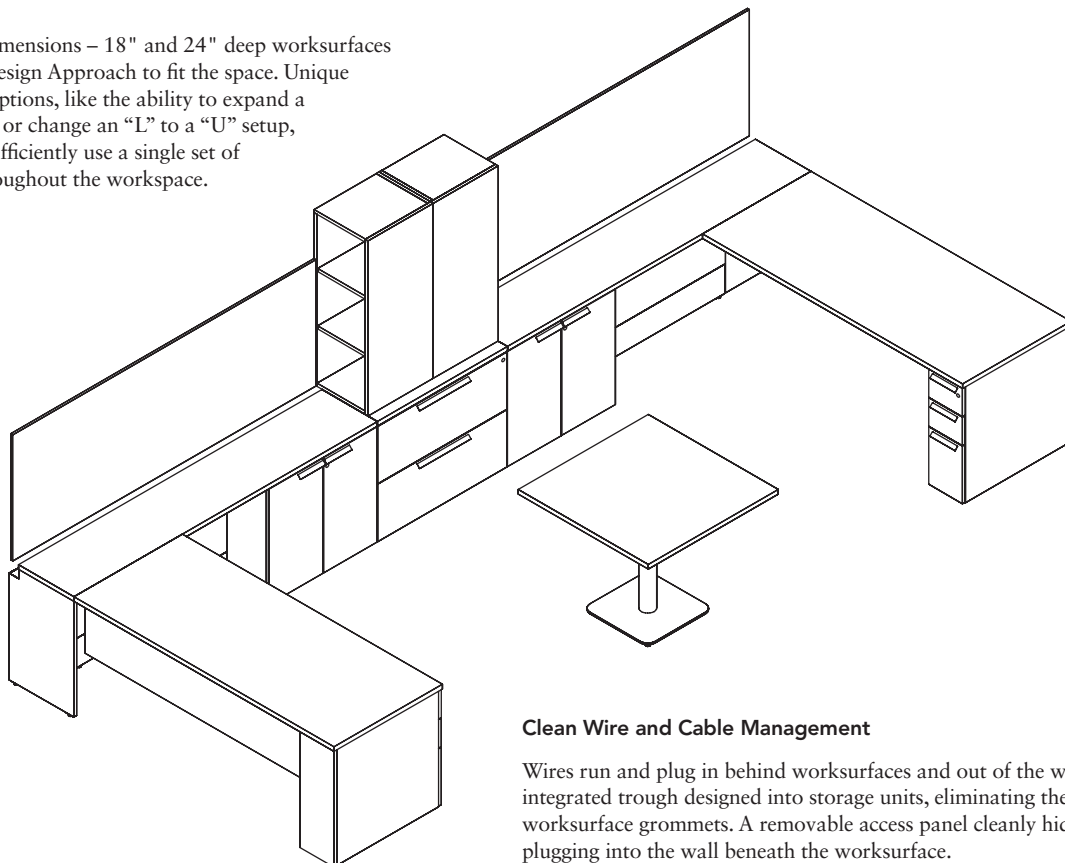

#### Clean Wire and Cable Management

Wires run and plug in behind worksurfaces and out of the way in an integrated trough designed into storage units, eliminating the need for worksurface grommets. A removable access panel cleanly hides cords plugging into the wall beneath the worksurface.

Approach Pre-configured Desks & Tables — height-adjustable 27¼"-47½"H, fixed height 29½"H, left and right configurations

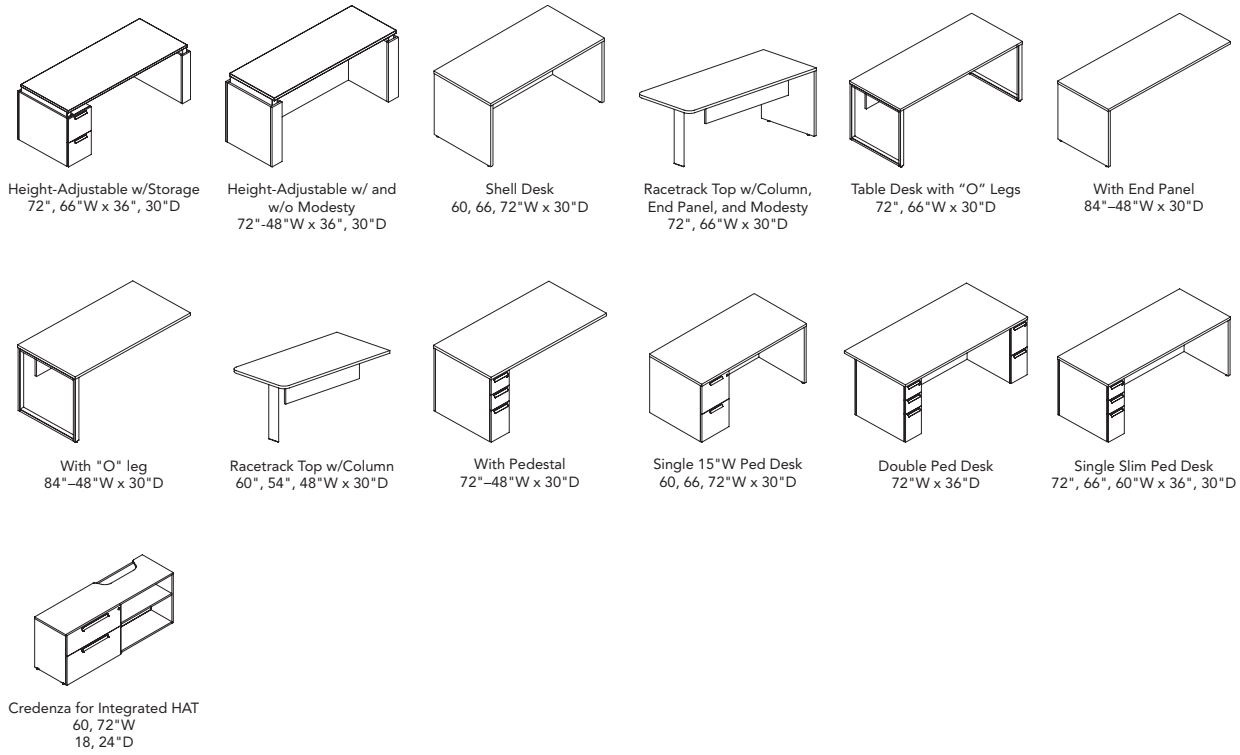

Approach Credenzas — 28"H (shown) x 18"D or 24"D, 24"H x 18"D; most available to-the-floor base or feet with or without troughs.

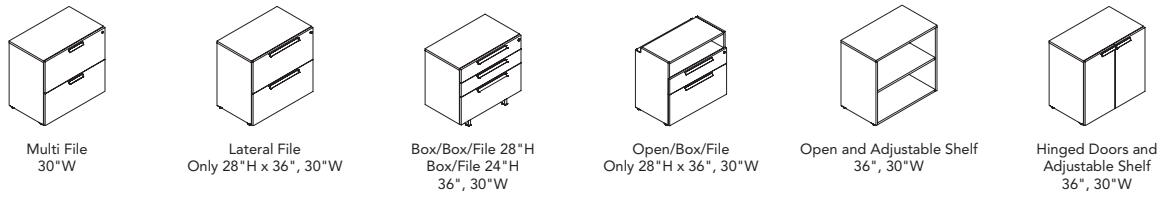

Approach 28"H Double Credenzas — 18" or 24"D, left and right configurations, available to-the-floor base or feet with or without troughs.

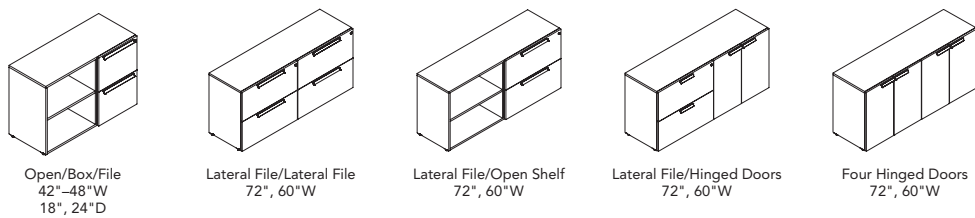

Approach 24"H Double Credenzas — 24"H x 18"D; left and right configurations, most available to-the-floor base or feet with or without troughs.

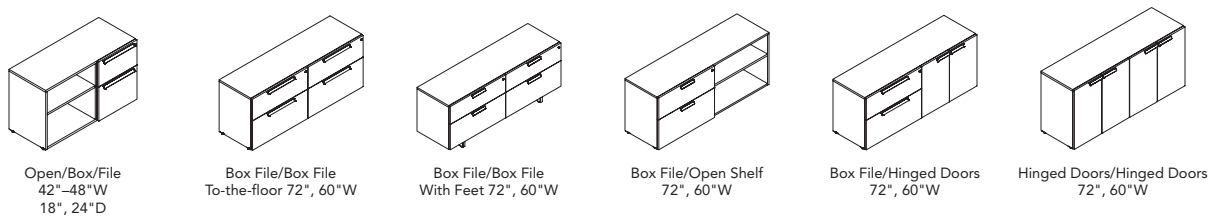

**Approach Pedestals** — Mobile models have recessed casters

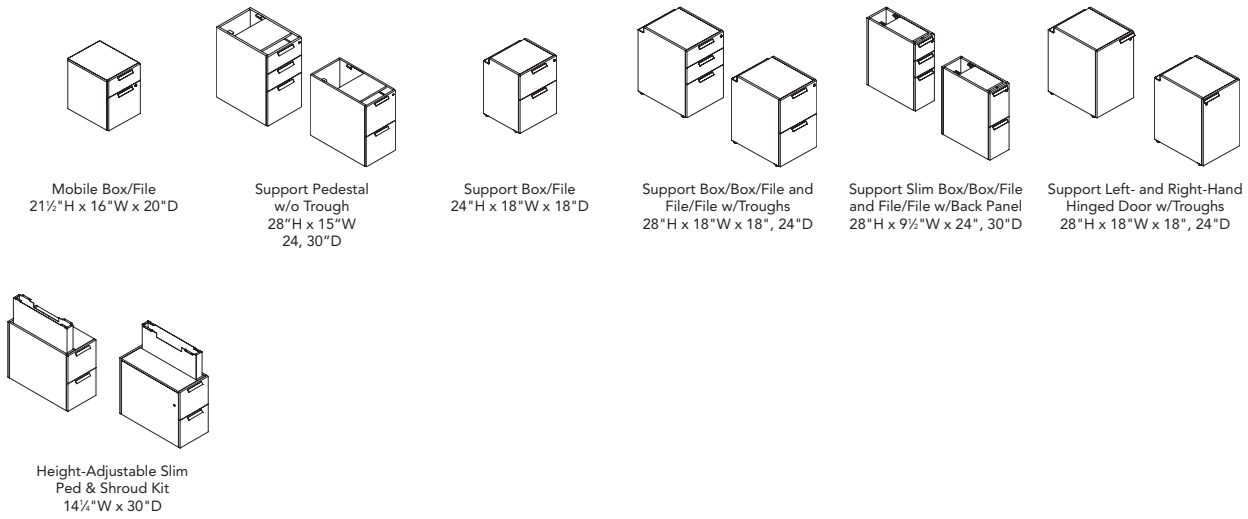

**Approach False Peds, Wall Access Panels, Bridges, and Back Panels**

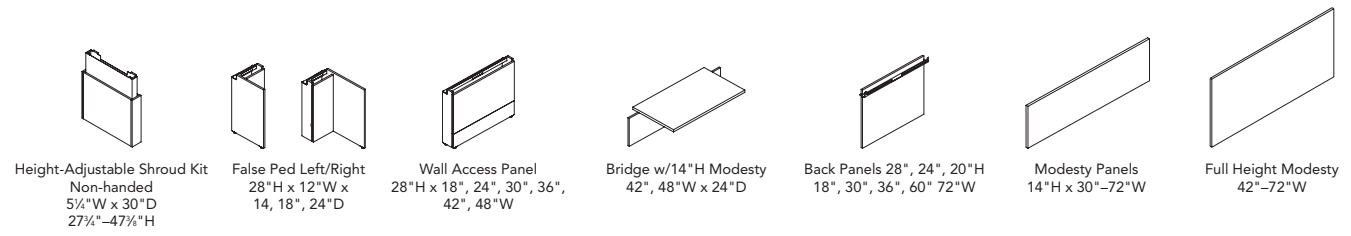

**Approach Tops, Worksurfaces, and Supports** — End Panels left- and right-handed

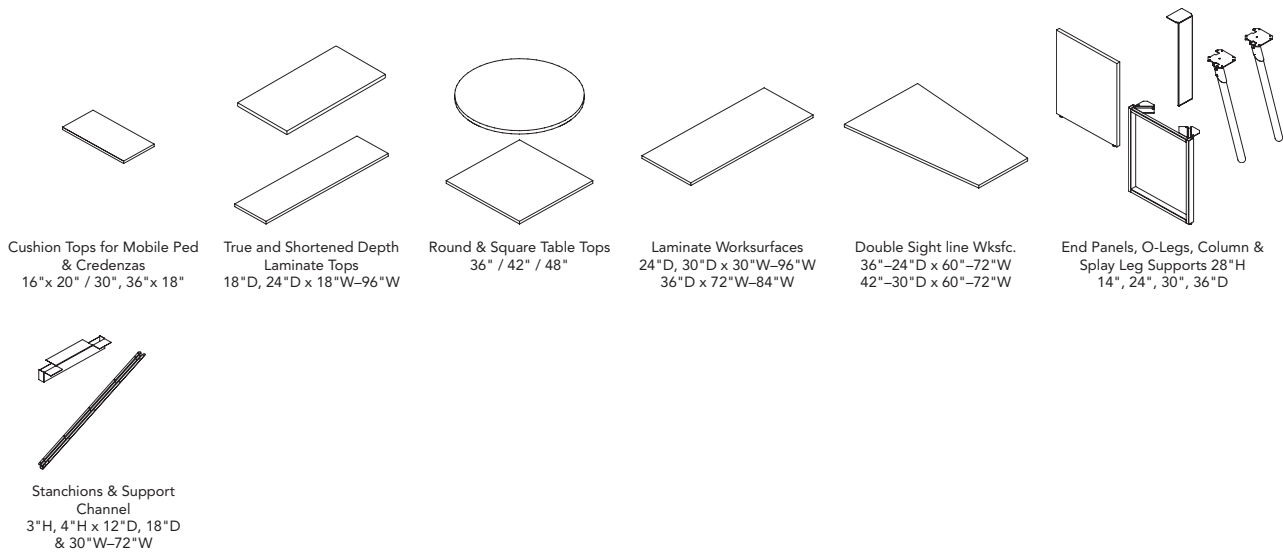

APPROACH

Approach Lateral Files, Bookcases, and Cubby — Laterals are 30" or 36"W x 18½"D, Bookcases are 30"W x 14¼"D, Cubby 7"H x 14"D

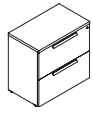

2-Drawer Lateral  
29½"H

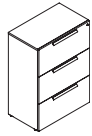

3-Drawer Lateral  
42¼"H

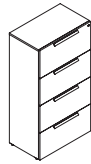

4-Drawer Lateral  
56½"H

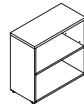

2-High Bookcase  
29½"H

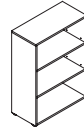

3-High Bookcase  
42¼"H



4-High Bookcase  
56½"H

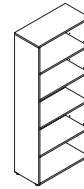

5-High Bookcase  
71½"H



Cubby Storage  
18", 24", 30"W



8"D Floating Shelf  
30"-78"

Approach Towers & Stack-On Storage — Towers 18"D, 24"D; Storage w/doors & Side Access 15"D, Open units 14½"D

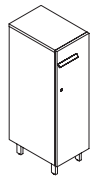

Wardrobe  
42"-72"H  
12", 18", 24"W  
18", 24"D

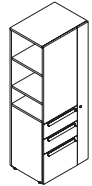

Side Access  
42"-72"H  
18", 24"W  
18", 24"D

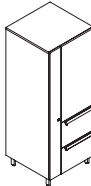

Combination  
42"-72"H  
18", 24"W  
18", 24"D

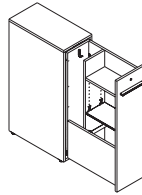

Pull Out Towers  
42", 50"H  
24", 30"D

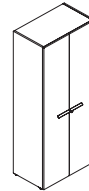

Tower w/Hinged Doors  
30"W x 57½", 72"H

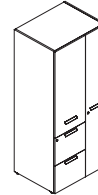

Combo Tower File/File  
L- and R-Handed  
30"W x 72"H

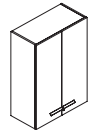

Stack-On w/Doors  
18", 30", 36"W  
x 29½, 42¼"H

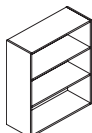

Stack-On Open  
18", 30", 36"W  
x 29½, 42¼"H

## Approach Overhead Storage — 15½"H x 15½"D with doors, open units 15½"D

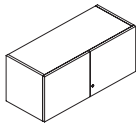

Hinged Doors  
30"-78"W

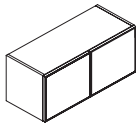

Writable Doors  
30", 36", 60", 72"W

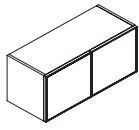

Frosted Glass Doors  
30"-78"W

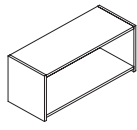

Open  
30", 36"W

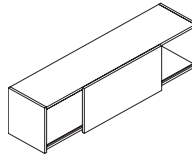

Sliding Door  
48"-78"W



Overhead Mounting Kit  
for Beyond Walls

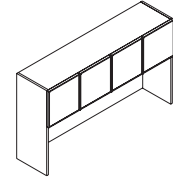

35"H Hutch  
Lam. or Frosty Doors  
48"-72"W

## Approach Tackboards, Writable Boards, and Accessories — Tackboards and Writable Boards 30", 34", 45", 49"H

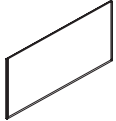

Tackboards for Hutches  
48"W-72"W

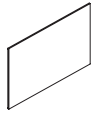

Tackboards  
30"W-96"W

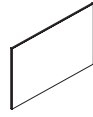

Writable Boards  
30"W-96"W

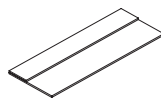

Counterweights  
25, 35, 50, 60 lbs.

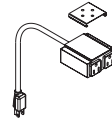

Mini Tap Power  
6' Cord



End Cap

## Altitude® Height-Adjustable Tops, Bases, and Accessories for Approach

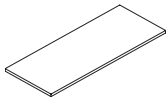

Altitude Tops  
24", 30", 36"D x  
48"-72"W

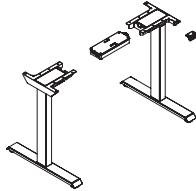

A6 T-leg Base 2-stage  
22½"H-48½"H for  
24"-30"D x 48"-84"W Tops

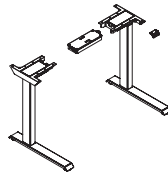

A6 C-leg Base 2-stage  
27½"H-47½"H for  
24"-30"D x 48"-72"W Tops

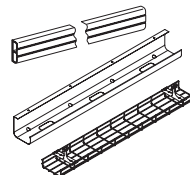

Cable Management  
Channel, Tray, and Trough

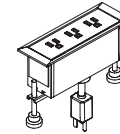

Power Modules  
Power & USB

## Extensions for Approach

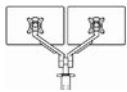

Monitor Arms  
21"

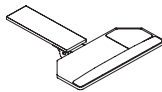

Articulating Keyboard  
25"W x 10½"D



CPU Hammock  
CPU 3-6"W x 16-23"H

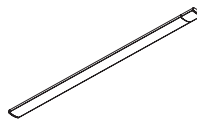

Under Cabinet LED Lights  
17" & 31"

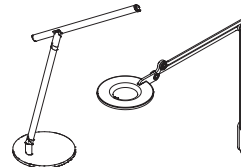

Link™ and Wand™ LED Lights  
Base or Clamp



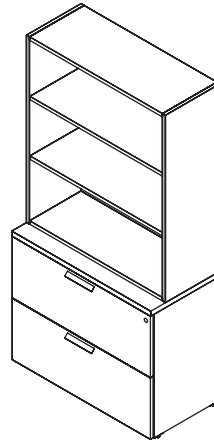
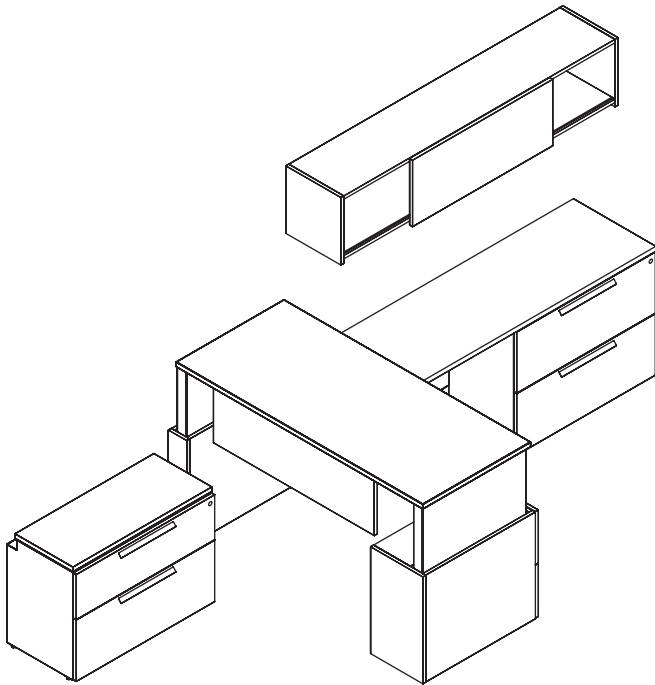

**Functional Design**

Sit-to-stand worksurfaces enable users to vary their posture throughout the day, while promoting wellness in the workplace. Height-adjustable legs are concealed within a shroud or pedestal storage. Smart storage, like a side-access tower, credenzas in multiple configurations at two heights, stack-ons and wall-mounted overheads with marker board fronts, and a slim pedestal, provide options for any storage need.

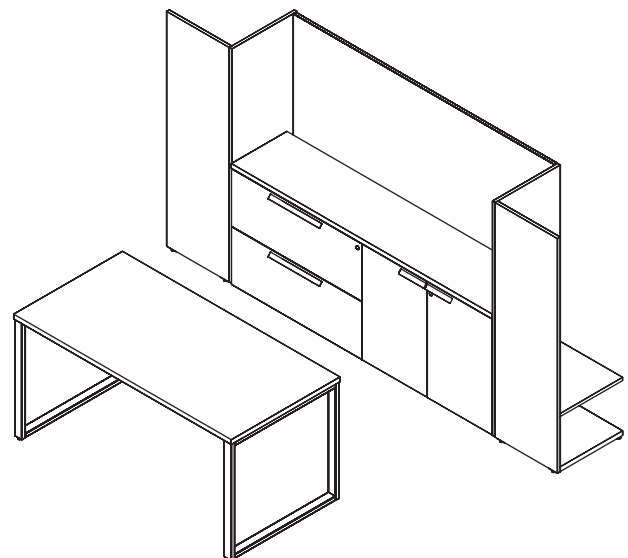
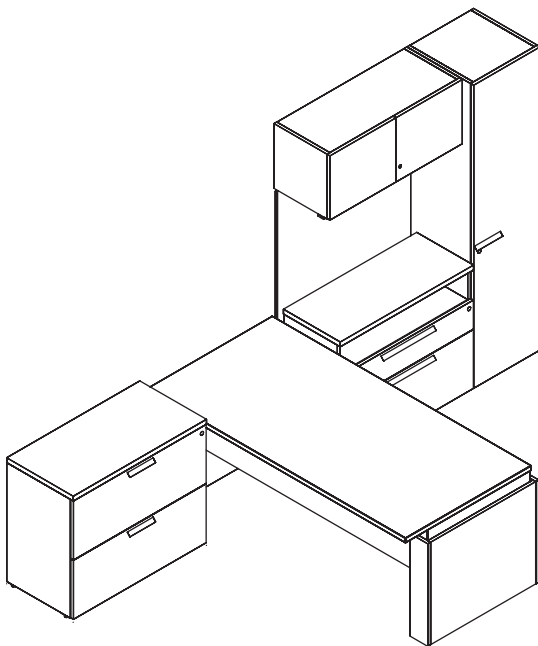
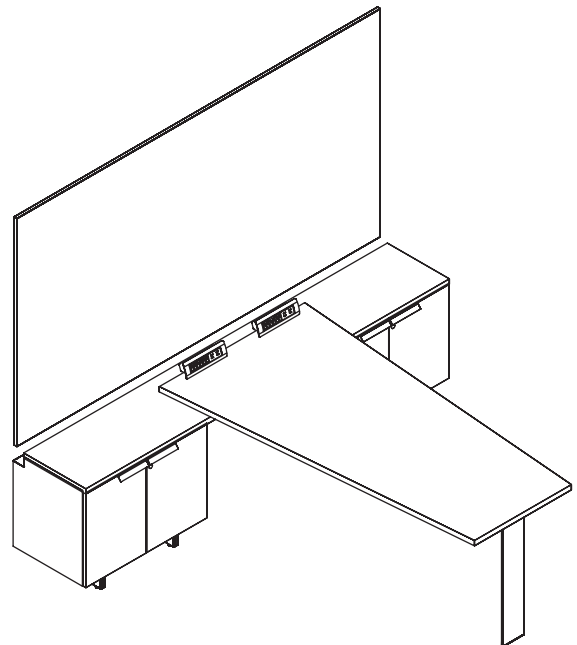

**Aesthetic Choices**

Approach offers a to-the-floor base or a lighter-scale footed design. Choose from eight solid and woodgrain laminate colors, numerous fabrics for tackboards and pedestal seat cushions, and five storage pull styles. Approach offers a mix of materials to support the design vision.

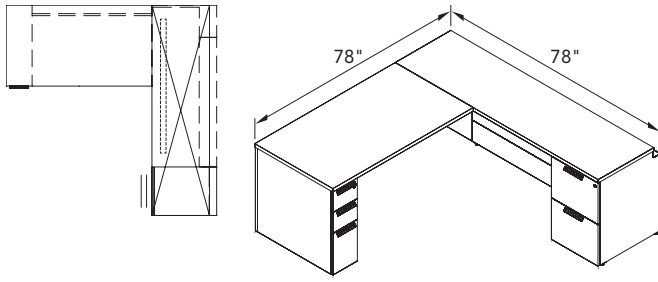

**Traditional L — Desking Runoff & Ped 78" x 78"**

Line Item	Product Description	Model Number	List Price
1	Desking Runoff 54"W x 30"D LH w/BBF Half Mod Panel	WKDRFN295430LH-BBF	\$ 3193
2	False Ped 12"W x 24"D LH	WKFPFN281224LH	\$ 994
3	Wall Access Panel 28"H x 48"W Full Height	WKHP2848	\$ 1184
4	Support Ped 18"W x 24"D FF w/Trough Cut No Bk Panel	WKPSFN281824-FF	\$ 2014
5	Credenza Top 78"W x 24"D for use w/Trough	WKWSCW7824	\$ 861
6	48"W External Support Channel for 60"W Worksurface	Z5SC60	\$ 106
<b>TOTAL</b>			<b>\$ 8,352</b>

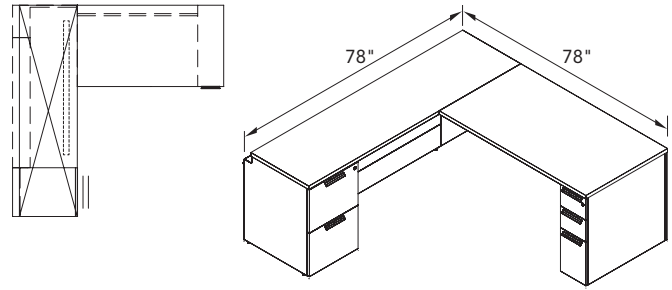

**Traditional L — Desking Runoff & Ped 78" x 78"**

Line Item	Product Description	Model Number	List Price
1	Desking Runoff 54"W x 30"D RH w/BBF Half Mod Panel	WKDRFN295430RH-BBF	\$ 3193
2	False Ped 12"W x 24"D RH	WKFPFN281224RH	\$ 994
3	Wall Access Panel 28"H x 48"W Full Height	WKHP2848	\$ 1184
4	Support Ped 18"W x 24"D FF w/Trough Cut No Bk Panel	WKPSFN281824-FF	\$ 2014
5	Credenza Top 78"W x 24"D for use w/Trough	WKWSCW7824	\$ 861
6	48"W External Support Channel for 60"W Worksurface	Z5SC60	\$ 106
<b>TOTAL</b>			<b>\$ 8,352</b>

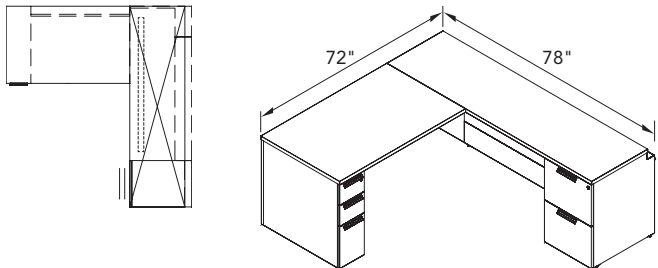

**Traditional L — Desking Runoff & Ped 72" x 78"**

Line Item	Product Description	Model Number	List Price
1	Desking Runoff 48"W x 30"D LH w/BBF Half Mod Panel	WKDRFN294830LH-BBF	\$ 3083
2	False Ped 12"W x 24"D LH	WKFPFN281224LH	\$ 994
3	Wall Access Panel 28"H x 48"W Full Height	WKHP2848	\$ 1184
4	Support Ped 18"W x 24"D FF w/Trough Cut No Bk Panel	WKPSFN281824-FF	\$ 2014
5	Credenza Top 78"W x 24"D for use w/Trough	WKWSCW7824	\$ 861
6	48"W External Support Channel for 60"W Worksurface	Z5SC60	\$ 106
<b>TOTAL</b>			<b>\$ 8,242</b>

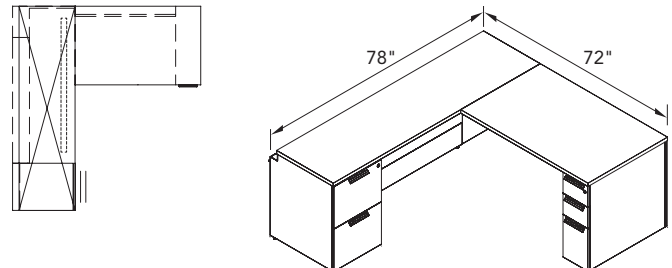

**Traditional L — Desking Runoff & Ped 78" x 72"**

Line Item	Product Description	Model Number	List Price
1	Desking Runoff 48"W x 30"D RH w/BBF Half Mod Panel	WKDRFN294830RH-BBF	\$ 3083
2	False Ped 12"W x 24"D RH	WKFPFN281224RH	\$ 994
3	Wall Access Panel 28"H x 48"W Full Height	WKHP2848	\$ 1184
4	Support Ped 18"W x 24"D FF w/Trough Cut No Bk Panel	WKPSFN281824-FF	\$ 2014
5	Credenza Top 78"W x 24"D for use w/Trough	WKWSCW7824	\$ 861
6	48"W External Support Channel for 60"W Worksurface	Z5SC60	\$ 106
<b>TOTAL</b>			<b>\$ 8,242</b>

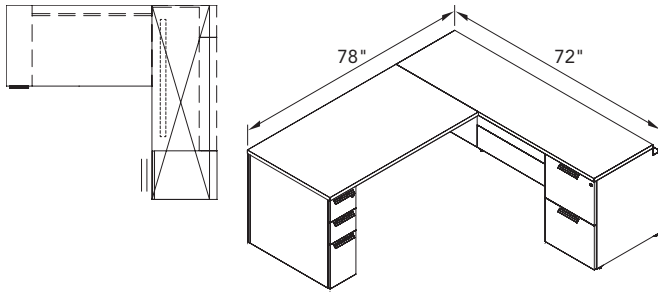

**Traditional L — Desking Runoff & Ped 78" x 72"**

Line Item	Product Description	Model Number	List Price
1	Desking Runoff 54"W x 30"D LH w/BBF Half Mod Panel	WKDRFN295430LH-BBF	\$ 3193
2	False Ped 12"W x 24"D LH	WKFPFN281224LH	\$ 994
3	Wall Access Panel 28"H x 42"W Full Height	WKHP2842	\$ 1138
4	Support Ped 18"W x 24"D FF w/Trough Cut No Bk Panel	WKPSFN281824-FF	\$ 2014
5	Credenza Top 72"W x 24"D for use w/Trough	WKWSCW7224	\$ 795
6	42"W External Support Channel for 54"W Worksurface	Z5SC54	\$ 99
<b>TOTAL</b>			<b>\$ 8,233</b>

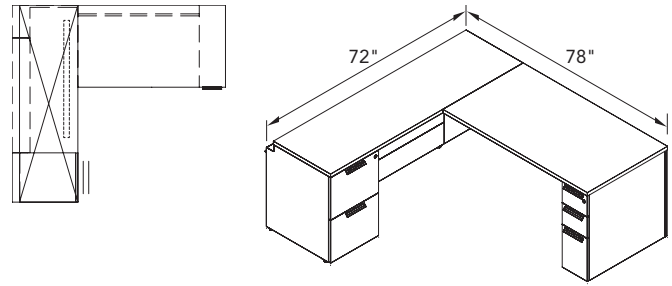

**Traditional L — Desking Runoff & Ped 72" x 78"**

Line Item	Product Description	Model Number	List Price
1	Desking Runoff 54"W x 30"D RH w/BBF Half Mod Panel	WKDRFN295430RH-BBF	\$ 3193
2	False Ped 12"W x 24"D RH	WKFPFN281224RH	\$ 994
3	Wall Access Panel 28"H x 42"W Full Height	WKHP2842	\$ 1138
4	Support Ped 18"W x 24"D FF w/Trough Cut No Bk Panel	WKPSFN281824-FF	\$ 2014
5	Credenza Top 72"W x 24"D for use w/Trough	WKWSCW7224	\$ 795
6	42"W External Support Channel for 54"W Worksurface	Z5SC54	\$ 99
<b>TOTAL</b>			<b>\$ 8,233</b>

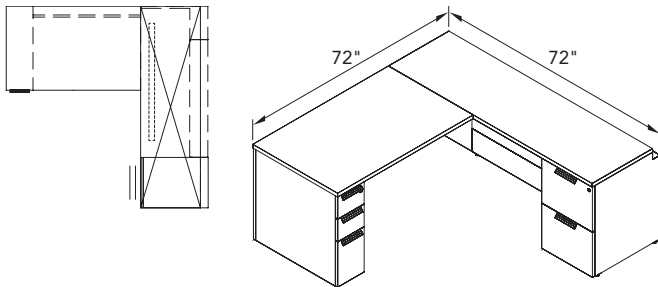

**Traditional L — Desking Runoff & Ped 72" x 72"**

Line Item	Product Description	Model Number	List Price
1	Desking Runoff 48"W x 30"D LH w/BBF Half Mod Panel	WKDRFN294830LH-BBF	\$ 3083
2	False Ped 12"W x 24"D LH	WKFPFN281224LH	\$ 994
3	Wall Access Panel 28"H x 42"W Full Height	WKHP2842	\$ 1138
4	Support Ped 18"W x 24"D FF w/Trough Cut No Bk Panel	WKPSFN281824-FF	\$ 2014
5	Credenza Top 72"W x 24"D for use w/Trough	WKWSCW7224	\$ 795
6	42"W External Support Channel for 54"W Worksurface	Z5SC54	\$ 99
<b>TOTAL</b>			<b>\$ 8,123</b>

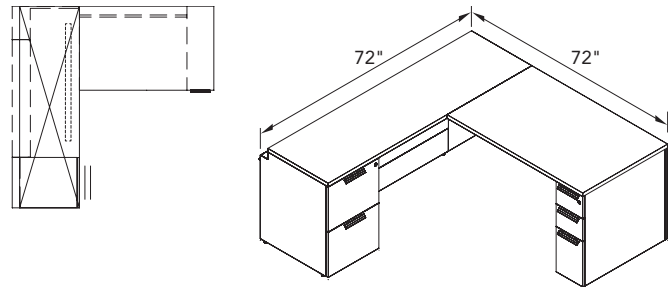

**Traditional L — Desking Runoff & Ped 72" x 72"**

Line Item	Product Description	Model Number	List Price
1	Desking Runoff 48"W x 30"D RH w/BBF Half Mod Panel	WKDRFN294830RH-BBF	\$ 3083
2	False Ped 12"W x 24"D RH	WKFPFN281224RH	\$ 994
3	Wall Access Panel 28"H x 42"W Full Height	WKHP2842	\$ 1138
4	Support Ped 18"W x 24"D FF w/Trough Cut No Bk Panel	WKPSFN281824-FF	\$ 2014
5	Credenza Top 72"W x 24"D for use w/Trough	WKWSCW7224	\$ 795
6	42"W External Support Channel for 54"W Worksurface	Z5SC54	\$ 99
<b>TOTAL</b>			<b>\$ 8,123</b>

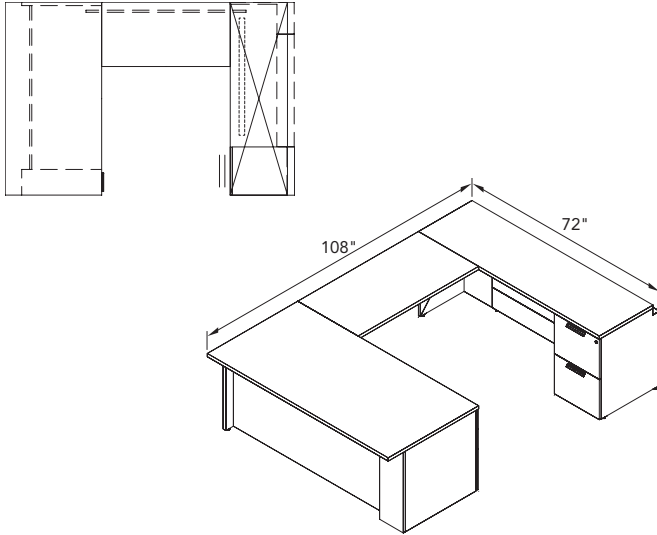

Traditional U — Single Ped Desk & Credenza 108" x 72"

Line Item	Product Description	Model Number	List Price
1	Single Ped Desk 72"W x 36"D LH BBF w/Mod Panel	WKDUFN297236LH-BBF	\$ 4248
2	Bridge 48"W x 24"D w/Half Mod Panel	WKAUBG4824	\$ 1256
3	Support Ped 18"W x 24"D FF w/Trough Cut No Back Panel	WKPSFN281824-FF	\$ 2014
4	False Ped 12"W x 24"D LH	WKFPFN281224LH	\$ 994
5	Wall Access Panel 28"H x 42"W Full Ht	WKHP2842	\$ 1138
6	Credenza Top 72"W x 24"D for use w/Trough	WKWSCW7224	\$ 795
7	42"W External Support Channel for 54"W Worksurface	Z5SC54	\$ 99
<b>TOTAL</b>			<b>\$ 10,544</b>

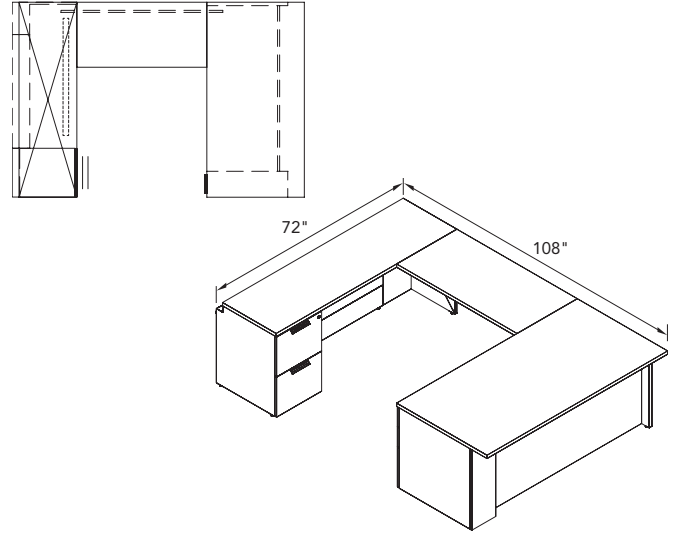

Traditional U — Single Ped Desk & Credenza 72" x 108"

Line Item	Product Description	Model Number	List Price
1	Single Ped Desk 72"W x 36"D RH BBF w/Mod Panel	WKDUFN297236RH-BBF	\$ 4248
2	Bridge 48"W x 24"D w/Half Mod Panel	WKAUBG4824	\$ 1256
3	Support Ped 18"W x 24"D FF w/Trough Cut No Back Panel	WKPSFN281824-FF	\$ 2014
4	False Ped 12"W x 24"D RH	WKFPFN281224RH	\$ 994
5	Wall Access Panel 28"H x 42"W Full Ht	WKHP2842	\$ 1138
6	Credenza Top 72"W x 24"D for use w/Trough	WKWSCW7224	\$ 795
7	42"W External Support Channel for 54"W Worksurface	Z5SC54	\$ 99
<b>TOTAL</b>			<b>\$ 10,544</b>

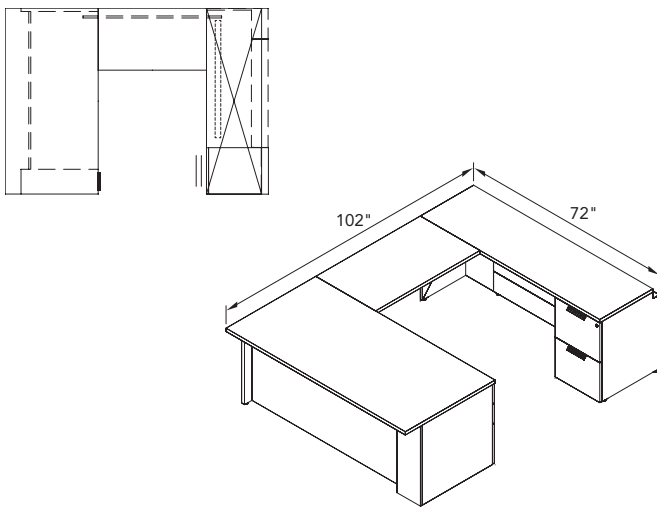

Traditional U — Single Ped Desk & Credenza 102" x 72"

Line Item	Product Description	Model Number	List Price
1	Single Ped Desk 72"W x 36"D LH BBF w/Mod Panel	WKDUFN297236LH-BBF	\$ 4248
2	Bridge 42"W x 24"D w/Half Mod Panel	WKAUBG4224	\$ 1209
3	Support Ped 18"W x 24"D FF w/Trough Cut No Back Panel	WKPSFN281824-FF	\$ 2014
4	False Ped 12"W x 24"D LH	WKFPFN281224LH	\$ 994
5	Wall Access Panel 28"H x 42"W Full Ht	WKHP2842	\$ 1138
6	Credenza Top 72"W x 24"D for use w/Trough	WKWSCW7224	\$ 795
7	42"W External Support Channel for 54"W Worksurface	Z5SC54	\$ 99
<b>TOTAL</b>			<b>\$ 10,497</b>

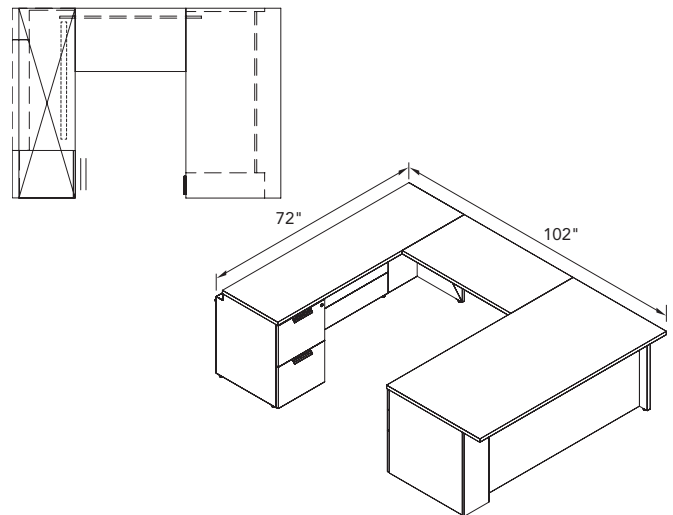

Traditional U — Single Ped Desk & Credenza 72" x 102"

Line Item	Product Description	Model Number	List Price
1	Single Ped Desk 72"W x 36"D RH BBF w/Mod Panel	WKDUFN297236RH-BBF	\$ 4248
2	Bridge 42"W x 24"D w/Half Mod Panel	WKAUBG4224	\$ 1209
3	Support Ped 18"W x 24"D FF w/Trough Cut No Back Panel	WKPSFN281824-FF	\$ 2014
4	False Ped 12"W x 24"D RH	WKFPFN281224RH	\$ 994
5	Wall Access Panel 28"H x 42"W Full Ht	WKHP2842	\$ 1138
6	Credenza Top 72"W x 24"D for use w/Trough	WKWSCW7224	\$ 795
7	42"W External Support Channel for 54"W Worksurface	Z5SC54	\$ 99
<b>TOTAL</b>			<b>\$ 10,497</b>

APPROACH

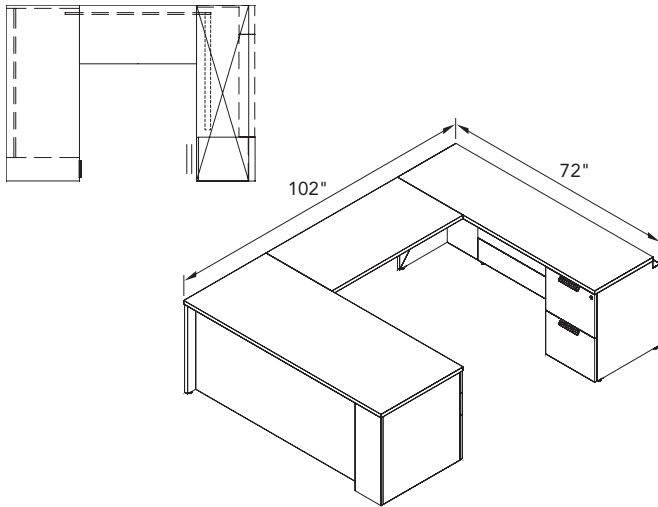

**Traditional U — Single Ped Desk & Credenza 102" x 72"**

Line Item	Product Description	Model Number	List Price
1	Single Ped Desk 72"W x 30"D LH BBF w/Mod Panel	WKDUFN297230LH-BBF	\$ 3979
2	Bridge 48"W x 24"D w/Half Mod Panel	WKAUBG4824	\$ 1256
3	Support Ped 18"W x 24"D FF w/Trough Cut No Back Panel	WKPSFN281824-FF	\$ 2014
4	False Ped 12"W x 24"D LH	WKFPFN281224LH	\$ 994
5	Wall Access Panel 28"H x 42"W Full Ht	WKHP2842	\$ 1138
6	Credenza Top 72"W x 24"D for use w/Trough	WKWSCW7224	\$ 795
7	42"W External Support Channel for 54"W Worksurface	Z5SC54	\$ 99
<b>TOTAL</b>			<b>\$ 10,275</b>

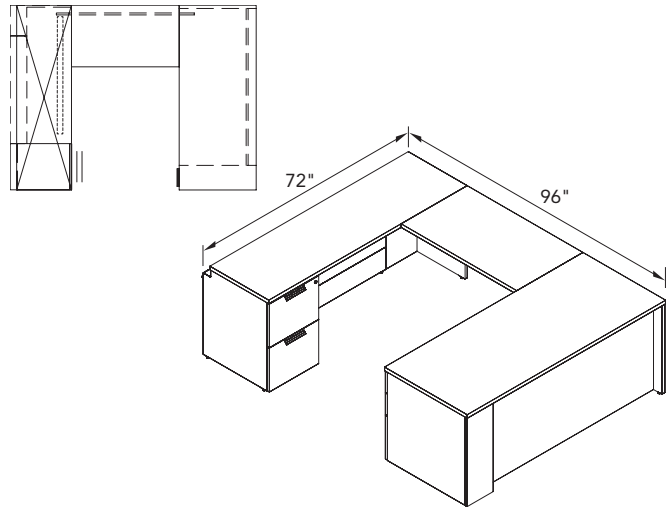

**Traditional U — Single Ped Desk & Credenza 72" x 96"**

Line Item	Product Description	Model Number	List Price
1	Single Ped Desk 72"W x 30"D RH BBF w/Mod Panel	WKDUFN297230RH-BBF	\$ 3979
2	Bridge 42"W x 24"D w/Half Mod Panel	WKAUBG4224	\$ 1209
3	Support Ped 18"W x 24"D FF w/Trough Cut No Back Panel	WKPSFN281824-FF	\$ 2014
4	False Ped 12"W x 24"D RH	WKFPFN281224RH	\$ 994
5	Wall Access Panel 28"H x 42"W Full Ht	WKHP2842	\$ 1138
6	Credenza Top 72"W x 24"D for use w/Trough	WKWSCW7224	\$ 795
7	42"W External Support Channel for 54"W Worksurface	Z5SC54	\$ 99
<b>TOTAL</b>			<b>\$ 10,228</b>

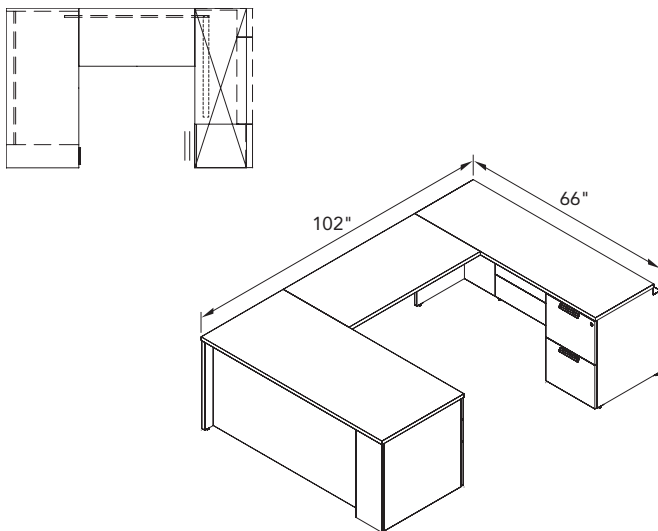

**Traditional U — Single Ped Desk & Credenza 102" x 66"**

Line Item	Product Description	Model Number	List Price
1	Single Ped Desk 66"W x 30"D LH BBF w/Mod Panel	WKDUFN296630LH-BBF	\$ 3921
2	Bridge 48"W x 24"D w/Half Mod Panel	WKAUBG4824	\$ 1256
3	Support Ped 18"W x 24"D FF w/Trough Cut No Back Panel	WKPSFN281824-FF	\$ 2014
4	False Ped 12"W x 24"D LH	WKFPFN281224LH	\$ 994
5	Wall Access Panel 28"H x 36"W Full Ht	WKHP2836	\$ 1102
6	Credenza Top 66"W x 24"D for use w/Trough	WKWSCW6624	\$ 750
7	36"W External Support Channel for 48"W Worksurface	Z5SC48	\$ 86
<b>TOTAL</b>			<b>\$ 10,123</b>

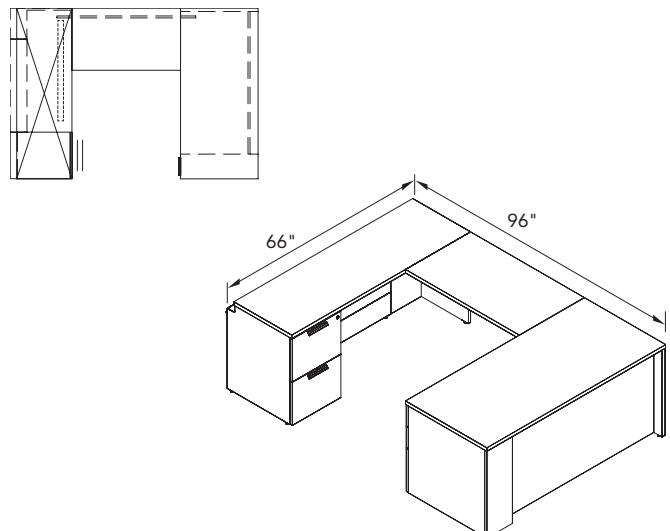

**Traditional U — Single Ped Desk & Credenza 96" x 66"**

Line Item	Product Description	Model Number	List Price
1	Single Ped Desk 66"W x 30"D RH BBF w/Mod Panel	WKDUFN296630RH-BBF	\$ 3921
2	Bridge 42"W x 24"D w/Half Mod Panel	WKAUBG4224	\$ 1209
3	Support Ped 18"W x 24"D FF w/Trough Cut No Back Panel	WKPSFN281824-FF	\$ 2014
4	False Ped 12"W x 24"D RH	WKFPFN281224RH	\$ 994
5	Wall Access Panel 28"H x 36"W Full Ht	WKHP2836	\$ 1102
6	Credenza Top 66"W x 24"D for use w/Trough	WKWSCW6624	\$ 750
7	36"W External Support Channel for 48"W Worksurface	Z5SC48	\$ 86
<b>TOTAL</b>			<b>\$ 10,076</b>

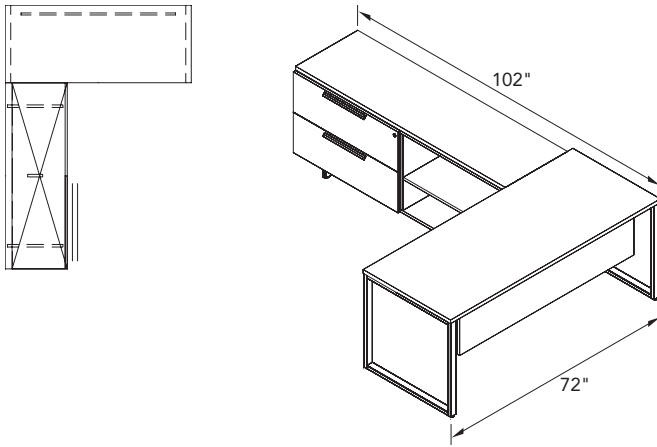

Light Scale L — Table Desk & Credenza 102" x 72"

Line Item	Product Description	Model Number	List Price
1	Table Desk 72"W x 30"D with O-Legs	WKTDOL297230	\$ 3113
2	Credenza 72"W x 24"D Lateral File / Open Shelf w/Trough	WKCUFY287224-LFOS	\$ 4398
3	Credenza Top 72"W x 24"D for use w/Trough	WKWSCW7224	\$ 795
TOTAL			\$ 8,306

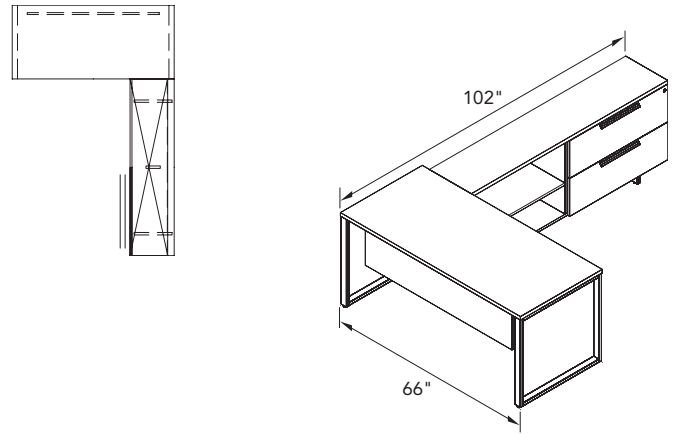

Light Scale L — Table Desk & Credenza 66" x 102"

Line Item	Product Description	Model Number	List Price
1	Table Desk 66"W x 30"D with O-Legs	WKTDOL296630	\$ 3026
2	Credenza 72"W x 18"D Open Shelf / Lateral File w/Trough	WKCUFY287218-OSLF	\$ 4294
3	Credenza Top 72"W x 18"D for use w/Trough	WKWSCW7218	\$ 750
TOTAL			\$ 8,070

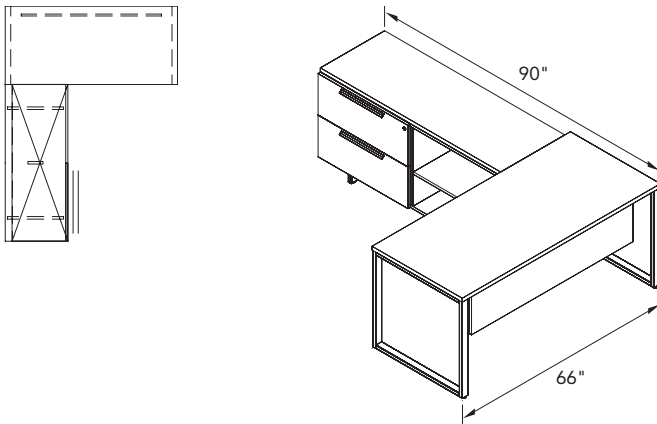

Light Scale L — Table Desk & Credenza 90" x 66"

Line Item	Product Description	Model Number	List Price
1	Table Desk 66"W x 30"D with O-Legs	WKTDOL296630	\$ 3026
2	Credenza 60"W x 24"D Lateral File / Open Shelf w/Trough	WKCUFY286024-LFOS	\$ 4249
3	Credenza Top 60"W x 24"D for use w/Trough	WKWSCW6024	\$ 721
TOTAL			\$ 7,996

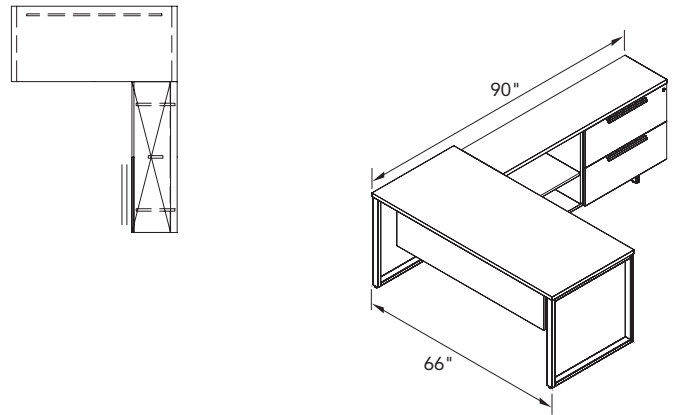

Light Scale L — Table Desk & Credenza 66" x 90"

Line Item	Product Description	Model Number	List Price
1	Table Desk 66"W x 30"D with O-Legs	WKTDOL296630	\$ 3026
2	Credenza 60"W x 18"D Open Shelf / Lateral File w/Trough	WKCUFY286018-OSLF	\$ 4147
3	Credenza Top 60"W x 18"D for use w/Trough	WKWSCW6018	\$ 683
TOTAL			\$ 7,856

Grain direction of woodgrain laminate is indicated below.

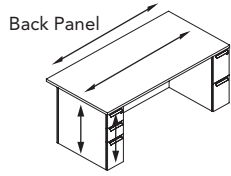

Desks

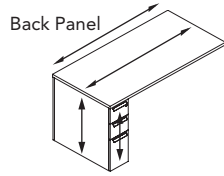

Desking Runoff

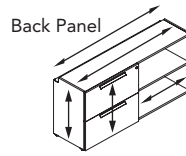

Credenzas

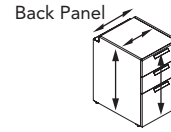

Pedestals

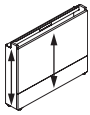

Wall Access Panel

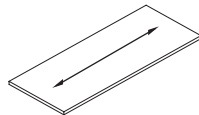

Tops & Shelf

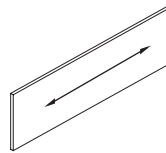

Modesty Panels & Finished Backs

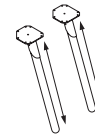

Wood Splay Legs

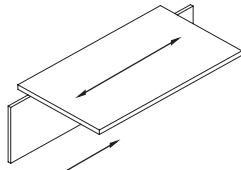

Bridges

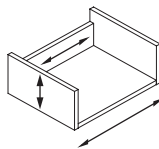

Cubby Storage

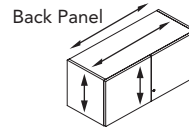

Wall Cabinet Overheads

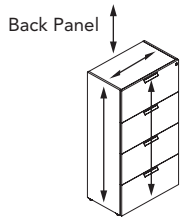

Lateral Files

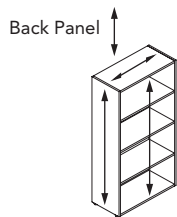

Bookcases

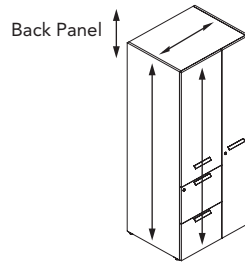

Towers

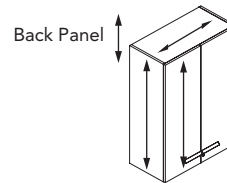

Stack-On Storage

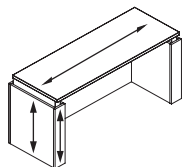

Height-Adjustable Shrouded Desk

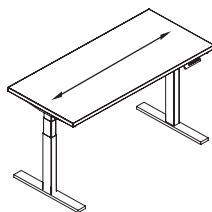

Height-Adjustable Table

APPROACH DIMENSIONS		EXTERNAL DIMENSIONS			INTERNAL DIMENSIONS							
Description	Style	Height	Width	Depth	Location	Height	Width	Depth				
Shell Desk		29"	60"	30"		57½"	27⅞"	26⅞"				
		29"	66"	30"		63½"	27⅞"	26⅞"				
		29"	72"	30"		69½"	27⅞"	26⅞"				
Credenza Full Height Non-footed	Open/Hinged Door	28⅞"	30" / 60"*	17¼" / 18"	Total	26⅞"	28⅞"	14⅞"				
				23¼" / 24"	Above shelf	12⅞"	34⅞"	19"				
					Below shelf	12¼"						
		28⅞"	42"*	18"	Total	26⅞"	22½"	16⅞"				
					Above Shelf	12¼"						
					Below Shelf	12¼"						
							24"		22⅞"			
							48"*	18"	Total	26⅞"	28½"	16⅞"
									Above Shelf	12¼"		
					Below Shelf	12¼"						
	Lateral File		28⅞"	30" / 60"*	18"	Top Drawer (Lat)	12⅞"	26⅞"	12⅞"			
					24"	Bottom Drawer (Lat)	12⅞"	32⅞"	15"			
					18" / 24"	Top Drawer (File)	8¾"	14⅞"	12⅞"			
						Bottom Drawer (File)	8¾"	14⅞"	12⅞"			
	Multi File		28⅞"	30" (Shelf)	18" (Shelf)	Cubby Shelf	6⅞"	13⅞"	14⅞"			
24" (Shelf)								19"				
30" (Drawers)					Box	Top Drawer (Box)	5⅞"	26⅞"	13"			
					18" (Lat)	Bottom Drawer (Lat)	12⅞"		12⅞"			
24" (Lat)									15"			
Open shelf/Box/File		28⅞"	30" (Shelf)	18" (Shelf)	Top shelf	6⅞"	28½"	14½"				
				24" (Shelf)				19"				
				30" (Drawers)	Box	Top Drawer (Box)	5⅞"	26⅞"	13"			
				36" (Drawers)	18" (Lat)	Bottom Drawer (Lat)	12⅞"	32⅞"	12"			
				24" (Lat)				15"				
Credenza Full Height Footed	Open/Hinged Door	28⅞"	30" / 60"*	17¼" / 18"	Total	22½"	28½"	14½"				
				23¼" / 24"	Above shelf	10⅞"	34½"	19"				
					Below shelf	10⅞"						
		28⅞"	42"*	18"	Total	22⅞"	22½"	16⅞"				
					Above Shelf	11"						
					Below Shelf	11"						
							24"		22⅞"			
							18"	Total	22⅞"	28½"	16⅞"	
								Above Shelf	11"			
				Below Shelf	11"							
	Lateral File		28⅞"	30" / 60"*	18"	Top Drawer (Lat)	10⅞"	26⅞"	12"			
					24"	Bottom Drawer (Lat)	10⅞"	32⅞"	15"			
					18" / 24"	Top Drawer (File)	8¾"	14⅞"	12⅞"			
						Bottom Drawer (File)	8¾"	14⅞"	12⅞"			
	Box/Box/File		28⅞"	30"	Box	Top Drawer (Box)	4⅞"	26⅞"	13"			
36"					Middle Drawer (Box)	4⅞"	32⅞"					
18" (Lat)					Bottom Drawer (Lat)	10⅞"		12"				
				24" (Lat)				15"				
Multi File		28⅞"	30" (Shelf)	18" (Shelf)	Cubby Shelf	4⅞"	13⅞"	14½"				
				24" (Shelf)				19"				
				30" (Drawers)	Box	Top Drawer (Box)	4⅞"	26⅞"	13"			
					18" (Lat)	Bottom Drawer (Lat)	10⅞"		12"			
				24" (Lat)				15"				

\*On 42"W, 48"W, 60"W, & 72"W units internal dimensions apply to each side of center support.



APPROACH DIMENSIONS		EXTERNAL DIMENSIONS			INTERNAL DIMENSIONS					
Description	Style	Height	Width	Depth	Location	Height	Width	Depth		
Credenza Layered Height Non-Footed	Open/Hinged Door	24¾"	30" / 60"*	17¼" / 18"	Total	22½"	28½"	14½"		
					Above shelf	9"	34½"			
			24¾"	42"*	18"	Total	22⅝"	22½"	16⅝"	
						Above Shelf	9⅝"			
						24"	Below Shelf	12¼"		
							Total			22⅝"
					48"*	18"	Total	22⅝"	28½"	16⅝"
							Above Shelf	9⅝"		
							Below Shelf	12¼"		
							Total			22⅝"
		Lateral File		24¾"	42"* / 48"*	18"	Top Drawer (Box)	2⅞"	14⅝"	12⅞"
							Bottom Drawer (File)	8¼"	14⅝"	12⅞"
Box/File		24¾"	30" / 60"* (Drawers)	Box	Top Drawer (Box)	8⅞"	26⅞"	13"		
					Bottom Drawer (Lat)	12⅞"	32⅞"	12"		
Multi File		24¾"	30" (Shelf)	18" (Shelf)	Cubby Shelf	4⅞"	13¼"	14⅞"		
					Top Drawer (Box)	3¼"	26⅞"	13"		
			30" (Drawers)	Depth	Bottom Drawer (Lat)	12⅞"		12"		
					Bottom Drawer (Lat)	12⅞"		12"		
Box/File / Pullout drawer		24¾"	30"	18"	Top Drawer (Box)	8⅞"	14¼"	12"		
					Bottom Drawer (File)	12"	14¼"	12"		
					Pullout Drawer	21½"	8"	15"		
					Top Drawer (Box)	8⅞"	19¼"	12"		
					Bottom Drawer (File)	12"	19¼"	12"		
					Pullout Drawer	21½"	8"	15"		
Open Shelf / Pullout Drawer		24¾"	30"	18"	Total	22½"	16½"	16¼"		
					Above Shelf	9¼"	16½"	16¼"		
					Below Shelf	12½"	16½"	16¼"		
					Pullout Drawer	21½"	8"	15"		
		24¾"	36"	18"	Total	22½"	22½"	16¼"		
					Above Shelf	9⅞"	22½"	16¼"		
					Below Shelf	12½"	22½"	16¼"		
					Pullout Drawer	21½"	8"	15"		
Box/File / Hinged Door		24¾"	30"	18"	Top Drawer (Box)	8⅞"	14¼"	12"		
					Bottom Drawer (File)	12"	14¼"	12"		
					Hinged Door	22½"	10½"	14¼"		
					Top Drawer (Box)	8⅞"	19¼"	12"		
					Bottom Drawer (File)	12"	19¼"	12"		
					Hinged Door	22½"	10½"	14¼"		
Open Shelf / Hinged Door		24¾"	30"	18"	Total	22½"	16½"	14¼"		
					Above Shelf	9¼"	16½"	14¼"		
					Below Shelf	12½"	16½"	14¼"		
					Hinged Door	22½"	10½"	14¼"		
		24¾"	36"	18"	Total	22½"	22½"	14¼"		
					Above Shelf	9⅞"	22½"	14¼"		
					Below Shelf	12½"	22½"	14¼"		
					Hinged Door	22½"	10½"	14¼"		
Box/File / Open Cubby		24¾"	30"	18"	Top Drawer (Box)	8⅞"	14¼"	12"		
					Bottom Drawer (File)	12"	14¼"	12"		
					Open Cubby	22½"	10½"	14¼"		
					Top Drawer (Box)	8⅞"	19¼"	12"		
					Bottom Drawer (File)	12"	19¼"	12"		
					Open Cubby	22½"	10½"	14¼"		
Open Shelf / Open Cubby		24¾"	30"	17¼"	Total	22½"	16½"	14¼"		
					Above Shelf	9¼"	16½"	14¼"		
					Below Shelf	12½"	16½"	14¼"		
					Open Cubby	22½"	10½"	14¼"		
		24¾"	36"	17¼"	Total	22½"	22½"	14¼"		
					Above Shelf	9¼"	22½"	14¼"		
					Below Shelf	12½"	22½"	14¼"		
					Open Cubby	22½"	10½"	14¼"		
					Total	22½"	22½"	14¼"		
					Above Shelf	9¼"	22½"	14¼"		
					Below Shelf	12½"	22½"	14¼"		
					Open Cubby	22½"	10½"	14¼"		

\*On 42"W, 48"W, 60"W, & 72"W units internal dimensions apply to each side of center support.

APPROACH DIMENSIONS		EXTERNAL DIMENSIONS			INTERNAL DIMENSIONS				
Description	Style	Height	Width	Depth	Location	Height	Width	Depth	
Credenza Layered Height Footed	Open/Hinged Door	24¾"	30" / 60"*	17¼" / 18"	Total	19"	28½"	14⅞"	
			36" / 72"*		Above shelf	7¼"	34½"		
					Below shelf	10⅞"			
			24¾"	42"*	18"	Total	19"	22½"	16⅞"
						Above Shelf	7¼"		
						Below Shelf	11"		
					24"				22⅜"
				48"*	18"	Total	19"	28½"	16⅞"
						Above Shelf	7¼"		
						Below Shelf	11"		
					24"				22⅜"
	Lateral File		24¾"	42"* / 48"*	18"	Top Drawer (Box)	2⅞"	14⅞"	12⅞"
					Bottom Drawer (File)	8¾"	14⅞"	12⅞"	
Box/File		24¾"	30" / 60"*(Drawers)	Box	Top Drawer (Box)	6"	26⅞"	13"	
			36" / 72"* (Drawers)	18" (Lat)	Bottom Drawer (Lat)	10⅞"	32⅞"	12"	
Credenza for Integrated HAT Full Height Non-footed	Open Shelf Portion	24¾"	60"*	18"	Open Shelf Total	21⅞"	28½"	10½"	
					Above Shelf	8"			
					Below Shelf	12 3/8"			
				24"				16½"	
			72"*	18"	Open Shelf Total	21⅞"	34½"	10½"	
					Above Shelf	8"			
					Below Shelf	12⅞"			
				24"				16½"	
	Box/File Portion	24¾"	60"*	18"/24"	Top Drawer (Box)	2⅞"	26⅞"	13"	
					Bottom Drawer (File)	8⅞"	25⅞"	12"	
		72"*	18"/24"	Top Drawer (Box)	2⅞"	32⅞"	13"		
				Bottom Drawer (File)	8⅞"	31⅞"	12"		
Approach Dimensions	Pullout Drawer	24¾"	18"	17¼"	Pullout Drawer	21½"	8"	15"	
	Hinged Door	24¾"	18"	17¼"	Hinged Door	22½"	10½"	14¼"	
	12"W Pedestal	24¾"	18"	17¼"	Open Cubby	22½"	10½"	14¼"	
Skinny Pedestals	File/File	28⅞"	9½"	23¼" (File)	Top Drawer (File)	11½"	5¼"	15½"	
				29¾" (File)	Bottom Drawer (File)	12¾"		25⅜"	
	Box/Box/File	28⅞"	9½"	Box	Top Drawer (Box)	5¼"	5¼"	15½"	
				23¼" (File)	Middle Drawer (Box)	6"		15½"	
				29¾" (File)	Bottom Drawer (File)	12¾"		25⅜"	
15"W Support Ped	File/File - Non-Footed	28"	15"	24"	Top Drawer (File)	12⅞"	12"	15"	
		28"	15"	30"	Bottom Drawer (File)	12⅞"	12"	15"	
	File/File - Footed	24"	15"	24"	Top Drawer (File)	10⅞"	12"	15"	
		24"	15"	30"	Bottom Drawer (File)	10⅞"	12"	15"	
	Box/Box/File Non-Footed	28"	15"	24"	Top Drawer (Box)	5¼"	12"	15"	
		28"	15"	30"	Mid Drawer (Box)	6"	12"	15"	
					Bottom Drawer (File)	12⅞"	12"	15"	
	Box/Box/File Footed	24"	15"	24"	Top Drawer (Box)	4⅞"	12"	15"	
	24"	15"	30"	Mid Drawer (Box)	5"	12"	15"		
				Bottom Drawer (File)	10⅞"	12"	15"		

\*On 42"W, 48"W, 60"W, & 72"W units internal dimensions apply to each side of center support.

APPROACH DIMENSIONS		EXTERNAL DIMENSIONS			INTERNAL DIMENSIONS			
Description	Style	Height	Width	Depth	Location	Height	Width	Depth
Height-Adjustable	File/File	24"	14¼"	30"	See Skinny Ped			
Fixed Laminate	48"W Modesty	24"	37.359"					
Modesty and	54"W Modesty		43.359"					
Metal Hanging	60"W Modesty		49.359"					
Modesty for HAT	66"W Modesty		55.359"					
	72"W Modesty		61.359"					
<b>Note:</b> Metal modesty is ½" less in width than shown above.								
Ped Desk w/ 15"W Ped		29"	60" 66" 72"	30"	See 15"W Pedestal for Configuration	27⅞" 42⅞" 54⅞"	42⅞" 48⅞" 54⅞"	26⅞" 19"
Pedestals 18"W – Full Height	Hinged Door	28⅞"	18"	18" 24"	Total Above shelf Below shelf	26¼" 12⅞" 12¾"	16½"	14⅞" 19"
	File/File	28⅞"	18"	18" 24"	Top Drawer (File) Bottom Drawer (File)	12⅞" 12¼"	14⅞"	12" 15"
	Box/Box/File	28⅞"	18"	18" (Box) 24" (Box) 18" (File) 24" (File)	Top Drawer (Box) Middle Drawer (Box) Bottom Drawer (File)	5⅞" 6" 12¼"	14⅞"	12" 15" 12" 15"
Ped 18"W – Layered Height	Box/File	24¾"	18"	18" (Box) 18" (File)	Top Drawer (Box) Bottom Drawer (File)	8½" 12¼"	14⅞"	12" 12"
Mobile Ped	Box/File	21½"	15¾"	20⅞" (Box) 20¼" (File)	Top Drawer (Box) Bottom Drawer (File)	4½" 10⅞"	12"	14⅞" 15"
Full-Height Modesty	¾" Thick	28"	48" 54" 60" 66" 72"	¾"				
Pull-Out Tower		42"	12"	24"	Wardrobe File Bottom Shelf (Adjustable) Top Shelf (Fixed)	35¼" 10⅞" 12" 6"	8⅞" 7½" 8⅞" 8⅞"	6" 12⅞" 15½" 15½"
		50"			Wardrobe File Bottom Shelf (Adjustable) Mid Shelf (Adjustable) Top Shelf (Fixed)	36" 10⅞" 8" 8" 6"	8⅞" 7½" 8⅞" 8⅞" 8⅞"	6" 12⅞" 15½" 15½" 21¼"
		42"		30"	Wardrobe File Bottom Shelf (Adjustable) Top Shelf (Adjustable)	35¼" 10⅞" 12" 6"	8⅞" 7½" 8⅞" 8⅞"	8" 12⅞" 19¼" 19¼"
		50"			Wardrobe File Bottom Shelf (Adjustable) Mid Shelf (Adjustable) Top Shelf (Fixed)	36" 10⅞" 8" 8" 6"	8⅞" 7½" 8⅞" 8⅞" 8⅞"	8" 12⅞" 19¼" 19¼" 27¼"

APPROACH DIMENSIONS		EXTERNAL DIMENSIONS			INTERNAL DIMENSIONS			
Description	Style	Height	Width	Depth	Location	Height	Width	Depth
Towers	Non-footed	42½"	12"	18"	3H - Bottom Shelf	14⅞"	10⅞"	16⅝"
Hinged Door		42½"	18"	18"	3H - Second Shelf (Adjustable)	12⅜"	16⅜"	16⅝"
		42½"	24"	18"	3H - Top Shelf (Fixed)	11"	22⅝"	16⅝"
		42½"	12"	24"			10⅞"	22⅝"
		42½"	18"	24"			16⅜"	22⅝"
		42½"	24"	24"			22⅝"	22⅝"
		50"	12"	18"	3H - Bottom Shelf	17⅞"	10⅞"	16⅝"
		50"	18"	18"	3H - Second Shelf (Adjustable)	12⅜"	16⅜"	16⅝"
		50"	24"	18"	3H - Top Shelf (Fixed)	15"	22⅝"	16⅝"
		50"	12"	24"			10⅞"	22⅝"
		50"	18"	24"			16⅜"	22⅝"
		50"	24"	24"			22⅝"	22⅝"
		57½"	12"	18"	4H - Bottom Shelf	17½"	10⅞"	16⅝"
		57½"	18"	18"	4H - Second Shelf (Adjustable)	11⅜"	16⅜"	16⅝"
		57½"	24"	18"	4H - Third Shelf (Adjustable)	11⅜"	22⅝"	16⅝"
		57½"	12"	24"	4H - Top Shelf (Fixed)	11"	10⅞"	22⅝"
		57½"	18"	24"			16⅜"	22⅝"
		57½"	24"	24"			22⅝"	22⅝"
		65"	12"	18"	5H - Bottom Shelf	17½"	10⅞"	16⅝"
		65"	18"	18"	5H - Second Shelf (Adjustable)	11⅜"	16⅜"	16⅝"
		65"	24"	18"	5H - Third Shelf (Adjustable)	11⅜"	22⅝"	16⅝"
		65"	12"	24"	5H - Fourth Shelf (Fixed)	7⅞"	10⅞"	22⅝"
		65"	18"	24"	5H - Top Shelf (Adjustable)	11"	16⅜"	22⅝"
		65"	24"	24"			22⅝"	22⅝"
		72½"	12"	18"	5H - Bottom Shelf	17½"	10⅞"	16⅝"
		72½"	18"	18"	5H - Second Shelf (Adjustable)	11⅜"	16⅜"	16⅝"
		72½"	24"	18"	5H - Third Shelf (Adjustable)	11⅜"	22⅝"	16⅝"
		72½"	12"	24"	5H - Fourth Shelf (Fixed)	11⅜"	10⅞"	22⅝"
	72½"	18"	24"	5H - Top Shelf (Adjustable)	11"	16⅜"	22⅝"	
	72½"	24"	24"			22⅝"	22⅝"	
Footed		42½"	12"	18"	3H - Bottom Shelf	10¾"	10⅞"	16⅝"
		42½"	18"	18"	3H - Second Shelf (Adjustable)	12⅜"	16⅜"	16⅝"
		42½"	24"	18"	3H - Top Shelf (Fixed)	11"	22⅝"	16⅝"
		42½"	12"	24"			10⅞"	22⅝"
		42½"	18"	24"			16⅜"	22⅝"
		42½"	24"	24"			22⅝"	22⅝"
		50"	12"	18"	3H - Bottom Shelf	14¼"	10⅞"	16⅝"
		50"	18"	18"	3H - Second Shelf (Adjustable)	12⅜"	16⅜"	16⅝"
		50"	24"	18"	3H - Top Shelf (Fixed)	14⅞"	22⅝"	16⅝"
		50"	12"	24"			10⅞"	22⅝"
		50"	18"	24"			16⅜"	22⅝"
		50"	24"	24"			22⅝"	22⅝"
		57½"	12"	18"	4H - Bottom Shelf	13⅞"	10⅞"	16⅝"
		57½"	18"	18"	4H - Second Shelf (Adjustable)	11⅜"	16⅜"	16⅝"
		57½"	24"	18"	4H - Third Shelf (Adjustable)	11⅜"	22⅝"	16⅝"
		57½"	12"	24"	4H - Top Shelf (Fixed)	11"	10⅞"	22⅝"
		57½"	18"	24"			16⅜"	22⅝"
		57½"	24"	24"			22⅝"	22⅝"
		65"	12"	18"	5H - Bottom Shelf	13⅞"	10⅞"	16⅝"
		65"	18"	18"	5H - Second Shelf (Adjustable)	11⅜"	16⅜"	16⅝"
		65"	24"	18"	5H - Third Shelf (Adjustable)	11⅜"	22⅝"	16⅝"
		65"	12"	24"	5H - Fourth Shelf (Fixed)	6⅞"	10⅞"	22⅝"
		65"	18"	24"	5H - Top Shelf (Adjustable)	13"	16⅜"	22⅝"
		65"	24"	24"			22⅝"	22⅝"
		72½"	12"	18"	5H - Bottom Shelf	13⅞"	10⅞"	16⅝"
		72½"	18"	18"	5H - Second Shelf (Adjustable)	11⅜"	16⅜"	16⅝"
		72½"	24"	18"	5H - Third Shelf (Adjustable)	11⅜"	22⅝"	16⅝"
	72½"	12"	24"	5H - Fourth Shelf (Fixed)	11⅜"	10⅞"	22⅝"	
	72½"	18"	24"	5H - Top Shelf (Adjustable)	13"	16⅜"	22⅝"	
	72½"	24"	24"			22⅝"	22⅝"	

\*Blanks are replicas of the same tower height 18"D model above.

APPROACH DIMENSIONS		EXTERNAL DIMENSIONS			INTERNAL DIMENSIONS				
Description	Style	Height	Width	Depth	Location	Height	Width	Depth	
Towers	Combination Non-Footed	50"	18"	18"	Fixed Shelf	6 <sup>3</sup> / <sub>8</sub> "	16 <sup>3</sup> / <sub>8</sub> "	16 <sup>3</sup> / <sub>8</sub> "	
		50"	18"	24"				22 <sup>3</sup> / <sub>8</sub> "	
	File/File & Box/Box/File available, see ped specs for details	Adjustable Shelf	50"	24"	18"		12 <sup>3</sup> / <sub>8</sub> "	16 <sup>3</sup> / <sub>8</sub> "	16 <sup>3</sup> / <sub>8</sub> "
			50"	24"	24"				22 <sup>3</sup> / <sub>8</sub> "
		Wardrobe (24" W ONLY)					47"	5 <sup>1</sup> / <sub>4</sub> "	16 <sup>3</sup> / <sub>8</sub> "
									22 <sup>3</sup> / <sub>8</sub> "
	LH/RH Versions available	Fixed Shelf	57 <sup>1</sup> / <sub>2</sub> "	18"	18"		14 <sup>3</sup> / <sub>8</sub> "	16 <sup>3</sup> / <sub>8</sub> "	16 <sup>3</sup> / <sub>8</sub> "
			57 <sup>1</sup> / <sub>2</sub> "	18"	24"				22 <sup>3</sup> / <sub>8</sub> "
		Adjustable Shelf	57 <sup>1</sup> / <sub>2</sub> "	24"	18"		12 <sup>3</sup> / <sub>8</sub> "	16 <sup>3</sup> / <sub>8</sub> "	16 <sup>3</sup> / <sub>8</sub> "
			57 <sup>1</sup> / <sub>2</sub> "	24"	24"				22 <sup>3</sup> / <sub>8</sub> "
	Footed	Wardrobe (24" W ONLY)					54 <sup>1</sup> / <sub>2</sub> "	5 <sup>1</sup> / <sub>4</sub> "	16 <sup>3</sup> / <sub>8</sub> "
									22 <sup>3</sup> / <sub>8</sub> "
		Fixed Shelf	65"	18"	18"		8 <sup>3</sup> / <sub>8</sub> "	16 <sup>3</sup> / <sub>8</sub> "	16 <sup>3</sup> / <sub>8</sub> "
			65"	18"	24"				22 <sup>3</sup> / <sub>8</sub> "
		Lower Adjustable Shelf	65"	24"	18"		12 <sup>3</sup> / <sub>4</sub> "	16 <sup>3</sup> / <sub>8</sub> "	16 <sup>3</sup> / <sub>8</sub> "
			65"	24"	24"				22 <sup>3</sup> / <sub>8</sub> "
		Upper Adjustable Shelf					12 <sup>3</sup> / <sub>8</sub> "	16 <sup>3</sup> / <sub>8</sub> "	16 <sup>3</sup> / <sub>8</sub> "
									22 <sup>3</sup> / <sub>8</sub> "
		Wardrobe (24" W ONLY)					62"	5 <sup>1</sup> / <sub>4</sub> "	16 <sup>3</sup> / <sub>8</sub> "
									22 <sup>3</sup> / <sub>8</sub> "
Fixed Shelf		72 <sup>1</sup> / <sub>2</sub> "	18"	18"		16 <sup>3</sup> / <sub>8</sub> "	16 <sup>3</sup> / <sub>8</sub> "	16 <sup>3</sup> / <sub>8</sub> "	
		72 <sup>1</sup> / <sub>2</sub> "	18"	24"				22 <sup>3</sup> / <sub>8</sub> "	
		Lower Adjustable Shelf	72 <sup>1</sup> / <sub>2</sub> "	24"	18"		12 <sup>3</sup> / <sub>4</sub> "	16 <sup>3</sup> / <sub>8</sub> "	16 <sup>3</sup> / <sub>8</sub> "
			72 <sup>1</sup> / <sub>2</sub> "	24"	24"				22 <sup>3</sup> / <sub>8</sub> "
		Upper Adjustable Shelf					12 <sup>3</sup> / <sub>8</sub> "	16 <sup>3</sup> / <sub>8</sub> "	16 <sup>3</sup> / <sub>8</sub> "
									22 <sup>3</sup> / <sub>8</sub> "
	Wardrobe (24" W ONLY)					69 <sup>1</sup> / <sub>2</sub> "	5 <sup>1</sup> / <sub>4</sub> "	16 <sup>3</sup> / <sub>8</sub> "	
								22 <sup>3</sup> / <sub>8</sub> "	

\*Blanks are replicas of the same tower height 18"D model above.

APPROACH DIMENSIONS		EXTERNAL DIMENSIONS			INTERNAL DIMENSIONS				
Description	Style	Height	Width	Depth	Location	Height	Width	Depth	
Side Access	Non-Footed	50"	18"	18"	Worksurface Height Shelf	5½"	17¼"	16⅜"	
Towers	File/File & Box/Box/File available, see ped specs for details	50"	18"	24"				22⅜"	
		50"	24"	18"	Adjustable Shelf	12⅝"	17¼"	16⅜"	
		50"	24"	24"				22⅜"	
					Wardrobe (24" W ONLY)	47"	5¼"	16⅜"	
							22⅜"		
	LH/RH Versions available	57½"	18"	18"	Worksurface Height Shelf	13"	17¼"	16⅜"	
		57½"	18"	24"				22⅜"	
		57½"	24"	18"	Adjustable Shelf	12⅝"	17¼"	16⅜"	
		57½"	24"	24"				22⅜"	
				Wardrobe (24" W ONLY)	54½"	5¼"	16⅜"		
							22⅜"		
			65"	18"	18"	Worksurface Height Shelf	7½"	17¼"	16⅜"
			65"	18"	24"			22⅜"	
			65"	24"	18"	Lower Adjustable Shelf	12¼"	17¼"	16⅜"
			65"	24"	24"			22⅜"	
						Upper Adjustable Shelf	12⅝"	17¼"	16⅜"
								22⅜"	
						Wardrobe (24" W ONLY)	62"	5¼"	16⅜"
								22⅜"	
			72½"	18"	18"	Worksurface Height Shelf	15"	17¼"	16⅜"
		72½"	18"	24"			22⅜"		
		72½"	24"	18"	Lower Adjustable Shelf	12¼"	17¼"	16⅜"	
		72½"	24"	24"			22⅜"		
					Upper Adjustable Shelf	12⅝"	17¼"	16⅜"	
							22⅜"		
					Wardrobe (24" W ONLY)	69½"	5¼"	16⅜"	
							22⅜"		
Footed	File/File & Box/Box/File available, see ped specs for details	50"	18"	18"	Worksurface Height Shelf	5½"	17¼"	16⅜"	
		50"	18"	24"				22⅜"	
		50"	24"	18"	Adjustable Shelf	12⅝"	17¼"	16⅜"	
		50"	24"	24"				22⅜"	
				Wardrobe (24" W ONLY)	47"	5¼"	16⅜"		
							22⅜"		
	RH/LH Models available	57½"	18"	18"	Worksurface Height Shelf	13"	17¼"	16⅜"	
		57½"	18"	24"				22⅜"	
		57½"	24"	18"	Adjustable Shelf	12⅝"	17¼"	16⅜"	
		57½"	24"	24"				22⅜"	
				Wardrobe (24" W ONLY)	54½"	5¼"	16⅜"		
							22⅜"		
			65"	18"	18"	Worksurface Height Shelf	7½"	17¼"	16⅜"
			65"	18"	24"			22⅜"	
			65"	24"	18"	Lower Adjustable Shelf	12¼"	17¼"	16⅜"
			65"	24"	24"			22⅜"	
						Upper Adjustable Shelf	12⅝"	17¼"	16⅜"
								22⅜"	
						Wardrobe (24" W ONLY)	62"	5¼"	16⅜"
								22⅜"	
		72½"	18"	18"	Worksurface Height Shelf	15"	17¼"	16⅜"	
		72½"	18"	24"			22⅜"		
		72½"	24"	18"	Lower Adjustable Shelf	12¼"	17¼"	16⅜"	
		72½"	24"	24"			22⅜"		
					Upper Adjustable Shelf	12⅝"	17¼"	16⅜"	
							22⅜"		
					Wardrobe (24" W ONLY)	69½"	5¼"	16⅜"	
							22⅜"		
Stack-On Storage		29⅝"	18"	15"	4H – Top Shelf	12⅝"	16½"	13⅝"	
			30"		4H – Bottom Shelf	12⅝"	28½"		
Hinged Door		42⅝"	36"		5H – Top Shelf	12⅝"	34½"		
				5H – Middle Shelf	12⅝"				
				5H – Bottom Shelf	13¼"				

\*Blanks are replicas of the same tower height 18"D model above.

APPROACH DIMENSIONS		EXTERNAL DIMENSIONS			INTERNAL DIMENSIONS				
Description	Style	Height	Width	Depth	Location	Height	Width	Depth	
Stack-On		29 <sup>7</sup> / <sub>8</sub> "	18"	14 <sup>1</sup> / <sub>4</sub> "	4H – Top Shelf	12 <sup>7</sup> / <sub>8</sub> "	16 <sup>1</sup> / <sub>2</sub> "	13 <sup>3</sup> / <sub>8</sub> "	
Storage					4H – Bottom Shelf	12 <sup>7</sup> / <sub>8</sub> "	28 <sup>1</sup> / <sub>2</sub> "		
Open Shelf		42 <sup>1</sup> / <sub>8</sub> "	36"		5H – Top Shelf	12 <sup>7</sup> / <sub>8</sub> "	34 <sup>1</sup> / <sub>2</sub> "		
					5H – Middle Shelf	12 <sup>7</sup> / <sub>8</sub> "			
					5H – Bottom Shelf	13 <sup>3</sup> / <sub>4</sub> "			
Stack-On		29 <sup>7</sup> / <sub>8</sub> "	18"	15"	4H – Top Shelf	13"	17 <sup>1</sup> / <sub>4</sub> "	13 <sup>3</sup> / <sub>8</sub> "	
Storage					4H – Bottom Shelf	11 <sup>1</sup> / <sub>4</sub> "			
Side Access		42 <sup>1</sup> / <sub>8</sub> "			5H – Top Shelf	13"			
					5H – Middle Shelf	13"			
					5H – Bottom Shelf	13"			
Hutch	Hinged Doors Available in Laminate and Frosted Glass Doors	35"	48"	14"	Workspace Clearance	20"	46 <sup>3</sup> / <sub>8</sub> "	13 <sup>3</sup> / <sub>8</sub> "	
					Left Storage Area	12 <sup>7</sup> / <sub>8</sub> "	30 <sup>3</sup> / <sub>8</sub> "	13 <sup>3</sup> / <sub>8</sub> "	
						Right Storage Area	12 <sup>7</sup> / <sub>8</sub> "	14 <sup>5</sup> / <sub>8</sub> "	13 <sup>3</sup> / <sub>8</sub> "
					Workspace Clearance	20"	58 <sup>3</sup> / <sub>8</sub> "	13 <sup>3</sup> / <sub>8</sub> "	
					Left Storage Area	12 <sup>7</sup> / <sub>8</sub> "	28 <sup>3</sup> / <sub>8</sub> "	13 <sup>3</sup> / <sub>8</sub> "	
					Right Storage Area	12 <sup>7</sup> / <sub>8</sub> "	28 <sup>3</sup> / <sub>8</sub> "	13 <sup>3</sup> / <sub>8</sub> "	
			35"	66"	14"	Workspace Clearance	20"	64 <sup>3</sup> / <sub>8</sub> "	13 <sup>3</sup> / <sub>8</sub> "
						Left Storage Area	12 <sup>7</sup> / <sub>8</sub> "	31 <sup>3</sup> / <sub>8</sub> "	13 <sup>3</sup> / <sub>8</sub> "
						Right Storage Area	12 <sup>7</sup> / <sub>8</sub> "	31 <sup>3</sup> / <sub>8</sub> "	13 <sup>3</sup> / <sub>8</sub> "
			35"	72"	14"	Workspace Clearance	20"	70 <sup>3</sup> / <sub>8</sub> "	13 <sup>3</sup> / <sub>8</sub> "
					Left Storage Area	12 <sup>7</sup> / <sub>8</sub> "	34 <sup>3</sup> / <sub>8</sub> "	13 <sup>3</sup> / <sub>8</sub> "	
					Right Storage Area	12 <sup>7</sup> / <sub>8</sub> "	34 <sup>3</sup> / <sub>8</sub> "	13 <sup>3</sup> / <sub>8</sub> "	
Floating Shelf	Laminate shelf without exposed brackets	1 <sup>1</sup> / <sub>8</sub> "	30"	8"					
		1 <sup>1</sup> / <sub>8</sub> "	36"	8"					
		1 <sup>1</sup> / <sub>8</sub> "	42"	8"					
		1 <sup>1</sup> / <sub>8</sub> "	48"	8"					
		1 <sup>1</sup> / <sub>8</sub> "	54"	8"					
		1 <sup>1</sup> / <sub>8</sub> "	60"	8"					
		1 <sup>1</sup> / <sub>8</sub> "	66"	8"					
		1 <sup>1</sup> / <sub>8</sub> "	72"	8"					
		1 <sup>1</sup> / <sub>8</sub> "	78"	8"					
Lateral Files	2H	29 <sup>1</sup> / <sub>2</sub> "	30"	18 <sup>3</sup> / <sub>8</sub> "	2H – Top Drawer	13"	26 <sup>3</sup> / <sub>8</sub> "	12"	
					2H – Top Drawer	12 <sup>3</sup> / <sub>8</sub> "	32 <sup>3</sup> / <sub>8</sub> "	15"	
	3H	42 <sup>1</sup> / <sub>4</sub> "	30"	18"	3H – Top Drawer	12 <sup>1</sup> / <sub>4</sub> "	26 <sup>3</sup> / <sub>8</sub> "	12"	
					3H – Middle Drawer	12 <sup>3</sup> / <sub>8</sub> "	32 <sup>3</sup> / <sub>8</sub> "	15"	
					3H – Bottom Shelf	12 <sup>3</sup> / <sub>8</sub> "			
	4H	56 <sup>3</sup> / <sub>8</sub> "	30"	18"	4H – Top Drawer	12 <sup>3</sup> / <sub>8</sub> "	26 <sup>3</sup> / <sub>8</sub> "	12"	
4H – 2nd Drawer					12 <sup>3</sup> / <sub>8</sub> "	32 <sup>3</sup> / <sub>8</sub> "	15"		
4H – 3rd Drawer					13"				
				4H – Bottom Drawer	12 <sup>3</sup> / <sub>8</sub> "				
Bookcases Open Shelf	2H	29 <sup>1</sup> / <sub>2</sub> "	30"	14 <sup>1</sup> / <sub>4</sub> "	2H – Top Shelf	13 <sup>3</sup> / <sub>8</sub> "	28 <sup>1</sup> / <sub>2</sub> "	13 <sup>3</sup> / <sub>8</sub> "	
					2H – Bottom Shelf	13 <sup>3</sup> / <sub>8</sub> "			
	3H	42 <sup>1</sup> / <sub>4</sub> "	30"	14 <sup>1</sup> / <sub>4</sub> "	3H – Top Shelf	11 <sup>7</sup> / <sub>8</sub> "	28 <sup>1</sup> / <sub>2</sub> "	13 <sup>3</sup> / <sub>8</sub> "	
					3H – Middle Shelf	13 <sup>1</sup> / <sub>2</sub> "			
					3H – Bottom Shelf	13 <sup>3</sup> / <sub>8</sub> "			
	4H	56 <sup>3</sup> / <sub>8</sub> "	30"	14 <sup>1</sup> / <sub>4</sub> "	4H – Top Shelf	12 <sup>3</sup> / <sub>8</sub> "	28 <sup>1</sup> / <sub>2</sub> "	13 <sup>3</sup> / <sub>8</sub> "	
					4H – 2nd Shelf	12 <sup>7</sup> / <sub>8</sub> "			
					4H – 3rd Shelf	13 <sup>1</sup> / <sub>2</sub> "			
					4H – Bottom Shelf	13 <sup>3</sup> / <sub>8</sub> "			
	5H	71 <sup>1</sup> / <sub>8</sub> "	30"	14 <sup>1</sup> / <sub>4</sub> "	5H – Top Shelf	12 <sup>3</sup> / <sub>8</sub> "	28 <sup>1</sup> / <sub>2</sub> "	13 <sup>3</sup> / <sub>8</sub> "	
5H – 2nd Shelf					12 <sup>3</sup> / <sub>8</sub> "				
5H – 3rd Shelf					14 <sup>1</sup> / <sub>2</sub> "				
5H – 4th Shelf					13 <sup>1</sup> / <sub>2</sub> "				
5H – Bottom Shelf					13 <sup>3</sup> / <sub>8</sub> "				
Overheads Hinged Door & Open Shelf	Hinged 15"D	15"	30"	See depth dimensions by style at left		12 <sup>3</sup> / <sub>8</sub> "	28 <sup>3</sup> / <sub>8</sub> "	13 <sup>3</sup> / <sub>8</sub> "	
	Glass 15 <sup>1</sup> / <sub>4</sub> "D		36"			34 <sup>3</sup> / <sub>8</sub> "			
	Open 14 <sup>3</sup> / <sub>8</sub> "D		42"			40 <sup>3</sup> / <sub>8</sub> "			
			48"			45 <sup>1</sup> / <sub>4</sub> "			
			60"*			28 <sup>1</sup> / <sub>2</sub> "			
			66"*			31 <sup>1</sup> / <sub>2</sub> "			
			72"*			34 <sup>1</sup> / <sub>2</sub> "			
	78"*		37 <sup>1</sup> / <sub>2</sub> "						

\*Blanks are replicas of the same tower height 18"D model above.

APPROACH DIMENSIONS		EXTERNAL DIMENSIONS				INTERNAL DIMENSIONS		
Description	Style	Height	Width	Depth	Location	Height	Width	Depth
Sliding Door	Sliding 15"D	15"	48"*			12 <sup>5</sup> / <sub>8</sub> "	22 <sup>3</sup> / <sub>4</sub> "	12 <sup>1</sup> / <sub>4</sub> "
			60"*				28 <sup>3</sup> / <sub>4</sub> "	
			66"*				31 <sup>3</sup> / <sub>4</sub> "	
			72"*				34 <sup>3</sup> / <sub>4</sub> "	
			78"*				37 <sup>3</sup> / <sub>4</sub> "	

\*Wider units internal dimensions apply to each side of center support.



### Load Capacity for Approach Laminate Wood Storage

Unit	Style	Height	Width	Depth	Load Capacity	Location	
<b>28"H Credenza Non-Footed</b>	Open/ Hinged Door	28	30	18	88 lbs.	Shelf	
				24	117 lbs.	Shelf	
			36	18	107 lbs.	Shelf	
				24	142 lbs.	Shelf	
			42	18	79 lbs.	Top Shelf	
				24	109 lbs.	Top Shelf	
		48	18	101 lbs.	Top Shelf		
			24	138 lbs.	Top Shelf		
		Lateral File	28	30	18	66 lbs.	File
					24	82 lbs.	File
				36	18	81 lbs.	File
			42	24	100 lbs.	File	
	18			36 lbs.	File		
	24			36 lbs.	File		
	Multi-File	28	30	18	21 lbs.	Cubby shelf	
				24	28 lbs.	Cubby shelf	
			18	30 lbs.	Box		
				24	30 lbs.	Box	
			18	67 lbs.	File		
				24	83 lbs.	File	
		30	28	30	18	43 lbs.	Top Shelf
					24	57 lbs.	Top Shelf
			36	18	52 lbs.	Top Shelf	
				24	69 lbs.	Top Shelf	
30			18	30 lbs.	Box		
			24	30 lbs.	Box		
Open Shelf/ Box/File	28	30	18	37 lbs.	Box		
			24	37 lbs.	Box		
		30	18	67 lbs.	File		
			24	83 lbs.	File		
		36	18	82 lbs.	File		
			24	102 lbs.	File		
	Open/ Hinged Door	28	30	18	75 lbs.	Shelf	
				24	100 lbs.	Shelf	
			36	18	91 lbs.	Shelf	
				24	121 lbs.	Shelf	
			42	18	68 lbs.	Top Shelf	
				24	93 lbs.	Top Shelf	
48		18	86 lbs.	Top Shelf			
		24	118 lbs.	Top Shelf			
Lateral File		28	30	18	56 lbs.	File	
				24	70 lbs.	File	
			36	18	69 lbs.	File	
				24	86 lbs.	File	
	42		18	31 lbs.	File		
			24	31 lbs.	File		
	48	18	31 lbs.	File			
		24	31 lbs.	File			
	Box/Box/File	28	30	18	25 lbs.	Box	
				24	25 lbs.	Box	
			36	18	31 lbs.	Box	
				24	31 lbs.	Box	
30			18	56 lbs.	File		
			24	70 lbs.	File		
36		18	69 lbs.	File			
		24	86 lbs.	File			
Multi-File		28	30	18	15 lbs.	Cubby Shelf	
				24	20 lbs.	Cubby shelf	
			18	26 lbs.	Box		
		24	26 lbs.	Box			
	18		56 lbs.	File			
	24		70 lbs.	File			

Unit	Style	Height	Width	Depth	Load Capacity	Location	
<b>24"H Credenza Non-Footed</b>	Open/ Hinged Door	24	30	18	63 lbs.	Shelf	
				18	76 lbs.	Shelf	
			36	18	57 lbs.	Shelf	
				48	18	72 lbs.	Shelf
			24	30	18	50 lbs.	Box
				36	18	61 lbs.	Box
		42	18	25 lbs.	Box		
			48	18	25 lbs.	Box	
		Box/File	24	30	18	67 lbs.	File
					36	18	82 lbs.
				42	18	36 lbs.	File
			24	30	18	36 lbs.	File
	48				18	36 lbs.	File
	30			18	36 lbs.	File	
	Multi-File	24	30	18	15 lbs.	Cubby Shelf	
				18	19 lbs.	Box	
			18	67 lbs.	File		
		24	30	18	50 lbs.	Shelf	
				36	18	61 lbs.	Shelf
			42	18	45 lbs.	Shelf	
	<b>24"H Credenza Footed</b>	Box/File	24	30	18	35 lbs.	Box
					36	18	43 lbs.
				42	18	20 lbs.	Box
			24	30	18	20 lbs.	Box
36					18	56 lbs.	File
42				18	69 lbs.	File	
Open Shelf/ Hinged Door		24	30	18	57 lbs.	Shelf	
				48	18	57 lbs.	Shelf
			24	30	18	31 lbs.	File
		48			18	31 lbs.	File
		Slim 28"H File/File		28	9.5	24	18 lbs.
			30			29 lbs.	File
28	9.5		24		8 lbs.	Box	
			30	31 lbs.	File		
	Pedestals		18"W x 28"H Hinged Door	28	18	18	51 lbs.
24						68 lbs.	Shelf
18"W x 28"H File/File		28		18	18	36 lbs.	File
			24		45 lbs.	File	
		28	18	18	15 lbs.	Box	
24				19 lbs.	Box		
18	36 lbs.		File				
<b>Overheads and Stack-Ons</b>	Hinged Door & Open Shelf	15	30	15	81 lbs.		
				36	15	98 lbs.	
			42	15	115 lbs.		
		48		15	66 lbs.		
		60	15	82 lbs.			
			66	15	90 lbs.		
	Sliding Door	15	48	15	60 lbs.		
				60	15	76 lbs.	
			66	15	84 lbs.		
		72		15	92 lbs.		
		78	15	99 lbs.			
			78	15	99 lbs.		
<b>Cubby</b>	7		18	14	23 lbs.		
		24	14	31 lbs.			
		30	14	39 lbs.			

Unit	Style	Height	Width	Depth	Load Capacity	Location		
HAT Integrated Credenzas	Open Shelf	24	30	18	42 lbs.	Shelf		
			36	18	51 lbs.	Shelf		
			30	24	66 lbs.	Shelf		
			36	24	80 lbs.	Shelf		
	Box/File	24	30	18	45 lbs.	Box		
			36	18	57 lbs.	Box		
			30	18	31 lbs.	File		
			36	18	80 lbs.	File		
			30	24	31 lbs.	Box		
			36	24	57 lbs.	Box		
			30	24	45 lbs.	File		
			36	24	80 lbs.	File		
Wardrobe Towers		42½	12	18	34 lbs.	Fixed & Adjustable Shelf		
		50		24	47 lbs.			
		57½	18	18	54 lbs.			
		65		24	74 lbs.			
		72½	24	18	74 lbs.			
Combo/Side Access Towers	Open Shelf		50	18	18	57 lbs.	Adjustable Shelf	
			57½		24	77 lbs.		
			65	24	18	57 lbs.		
			72½		24	77 lbs.		
	Box/File			18 & 24		18	36 lbs.	File
					24	45 lbs.	File	
					18	15 lbs.	Box	
					24	19 lbs.	Box	
					18	36 lbs.	File	
					24	45 lbs.	File	
Open Access Towers		57½	18	18	57 lbs.	Shelf		
		72½		24	77 lbs.			
Hutches	Left Storage	12⅝	48	13⅝	88 lbs.	Shelf		
	Right Storage	12⅝			42 lbs.	Shelf		
	Left Storage	12⅝	60	13⅝	82 lbs.	Shelf		
	Right Storage	12⅝			82 lbs.	Shelf		
	Left Storage	12⅝	66	13⅝	91 lbs.	Shelf		
	Right Storage	12⅝			91 lbs.	Shelf		
	Left Storage	12⅝	72	13⅝	99 lbs.	Shelf		
	Right Storage	12⅝			99 lbs.	Shelf		

Product	Style	9½"W	12"W	18"W	24"W	30"W	36"W	42"W	48"W	60"W	66"W	72"W	
<b>28"H Credenzas</b>	Open Shelves					N/A	N/A						
	Box/Box/File						1 lock						
	Hinged Door					1 lock	1 lock						
	Hinged Door / Hinged Door									2 locks		2 locks	
	Hinged Door / Lateral File									2 locks		2 locks	
	Lateral File					1 lock	1 lock						
	Lateral File / Hinged Door									2 locks		2 locks	
	Lateral File / Lateral File									2 locks		2 locks	
	Lateral File / Open Shelves								1 lock	1 lock	1 lock		1 lock
	Multi File						1 lock						
	Open Shelves / Box File						1 lock	1 lock					
	Open Shelves / Lateral File								1 lock	1 lock	1 lock		1 lock
<b>24"H Credenzas</b>	Open Shelves												
	Box/Box/File						1 lock						
	Box/File					1 lock	1 lock						
	Box File / Box File									2 locks		2 locks	
	Box File / Hinged Door									2 locks		2 locks	
	Box File / Open Shelves							1 lock	1 lock	1 lock		1 lock	
	Hinged Door					1 lock	1 lock						
	Hinged Door / Box File									2 locks		2 locks	
	Lateral File					1 lock	1 lock						
	Multi File					1 lock							
	Open Shelves / Box File								1 lock	1 lock	1 lock		1 lock
	Box/File / Pullout drawer					2 locks	2 locks						
	Open Shelf / Pullout Drawer					1 lock	1 lock						
	Box/File / Hinged Door					2 locks	2 locks						
	Open Shelf / Hinged Door					1 lock	1 lock						
Box/File / Open Cubby					1 lock	1 lock							
Open Shelf / Open Cubby													
<b>Desks</b>	Box/Box/File					1 lock							
	File/File					1 lock							
	Box Box File / File File					2 locks							
<b>Laterals</b>	2-High					1 lock	1 lock						
	3-High					1 lock	1 lock						
	4-High					1 lock	1 lock						
<b>24"H Pedestals</b>	Box/File			1 lock									
	Mobile Box/File		1 lock										
	Pullout Drawer		1 lock										
	Hinged Door		1 lock										
	Open Cubby												
<b>28"H Support Pedestals</b>	Box/Box/File	1 lock		1 lock									
	File/File	1 lock		1 lock									
	False Pedestal												
<b>Hinged Door Towers</b>	Hinged Door Laminate			1 lock	1 lock								
	Hinged Door Writable												
<b>Height – 42½", 50", 57½", 65½", 72½"</b>													
<b>Depth – 18", 24"</b>													
<b>Side Access and Combo Towers</b>	Side Access Laminate			1 lock	2 locks								
	Side Access Writable												
<b>Heights – 50", 57½", 65", 72½"</b>	Combo Tower Laminate												
	Combo Tower Writable												
<b>Depths – 18", 24"</b>													
<b>Hutches</b>	Laminate Door								1 lock	2 locks	2 locks	2 locks	
	Frosted Door												
<b>Heights – 35"</b>													
<b>Widths – 48", 60", 66", 72"</b>													

Product	Style	30"W	36"W	42"W	48"W	60"W	66"W	72"W	78"W
<b>Overheads</b>	Hinged Door Laminate (HDL)	1 lock	1 lock	1 lock	1 lock	2 locks	2 locks	2 locks	2 locks
	Hinged Door Writable (HDM)								
	Hinged Door Glass Front (HDG)								
	Open Shelf, No Door Laminate (NDL)								
	Sliding Door Laminate (SDL)				1 lock	1 lock	1 lock	1 lock	1 lock

## CREDENZAS

30"W or 60" W (2-30"W columns)

36"W or 72"W (2-36"W columns)

### Front-to-Back Filing\*

Outside tabs of folders rest on drawer sides.  
Inside tabs of folders rest on filing bars included with unit.

Letter Size Hanging File Folders  
(8½ x 11" documents)

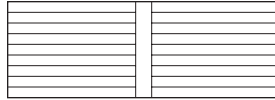

18"D Units – 24" of letter filing.  
24"D Units – 30" of letter filing.

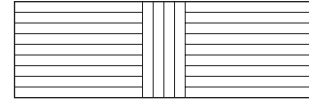

18"D Units – 24" of letter front-to-back filing, plus 8" of letter side-to-side filing.  
24"D Units – 30" of letter front-to-back filing, plus 8" of legal side-to-side filing.

Legal Size Hanging File Folders  
(8½ x 14" documents)

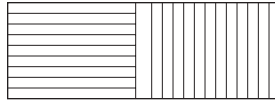

18"D Units – 12" of legal filing, plus 11" of letter side-to-side filing.  
24"D Units – 26" of legal filing both front-to-back and side-to-side.

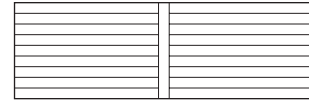

18"D Units – 24" of legal filing.  
24"D Units – 30" of legal filing.

### Side-to-Side Filing

Front folder tabs rest on drawer front. Back folder tabs rest on back of drawer on 18"D units for letter and 24"D units for legal; letter filing on 24"D, tabs rest on 2-12" filing bars resting on front-to-back bars (all 4 filing bars included with unit).

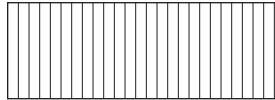

18"D Units – 26⅔" of letter filing.  
24"D Units – 24" of letter or 26⅔" of legal filing.

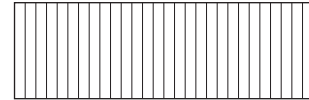

18"D Units – 32⅔" of letter filing.  
24"D Units – 24" of letter or 32⅔" of legal filing.

## PEDESTALS

### Side-to-Side Filing

15" W

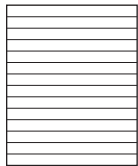

Letter Front-to-Back  
18"D Mobile – 14½" of filing  
24"D Support – 19" of filing

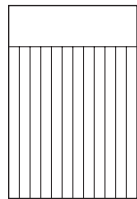

Legal Side-to-Side  
24"D Support – 12" of filing

### Slim 24"D

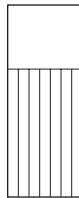

5¼" of letter filing  
5¼" of legal filing

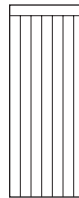

18"W x 18"D

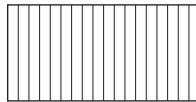

18"D Units – 14⅔" of letter filing

### Slim 30"D



11½" of letter filing  
5¼" of legal filing

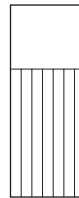

18"W x 24"D

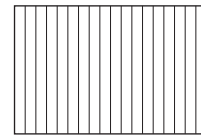

24"D Units – 14⅔" of letter or legal filing

### Front-to-Back Filing

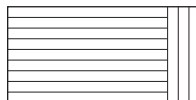

18"D Units – 12" of letter filing,  
plus 2" of side-to-side letter filing

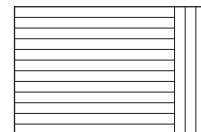

24"D Units – 15" of letter filing,  
plus 2" of legal side-to-side filing

## PAINT FINISHES

### GRADE P1

Black*	P27
Brownstone	P7D
Bungalow	P7C
Cinder	P7Q
Designer White*	PJW
Flint	P02
Fossil	P28
Loft	P7B
Muslin	P4J
Parchment	P93
Pebble	P8R
Pewter	P8D
Salt	P8C
Titanium	P8T
White	PD8

### GRADE P2

Champagne Metallic	PR5
Gunmetal Metallic	PR3
Night Bronze	P8B
Platinum Metallic	PR2
Pyrite	PJE
Silver*	PR6
Solar Black	P8X

### GRADE P3

Amethyst ( <i>De-emphasized</i> )	P091
Atom	P85
Blossom***	P8K
Bullseye	PJF
Cobalt Mica ( <i>De-emphasized</i> )	P090
Ember	P8P
Ion	P8N
Iris	P8J
Krypton	P8F
Ochre	P093
Regatta	P8M
Sienna	P092
Succulent***	P8A

\*Column, End Cap, Foot, and Leg models are only available in these three colors.

\*\*\* These colors are intended to be an inspirational option for the trending market. Product application is limited and color availability is approximately two years to coincide with evolving workplace trends.

*Metallic paints, due to varying reflectance, may appear to have less visual color consistency than other paint finishes, even when L/A/B values are exactly the same. (L/A/B — measurable aspects of color — values are maintained within a specified range, to ensure consistent appearance of paint colors.)*

## FOOT

### FOOT TYPE

Blade Foot	BF
Black	P27
Designer White	PJW
Silver	PR6
Post Foot	PF
Designer White	PJW
Flint	P02
Loft	P7B
Silver	PR6
Pyrite	PJE
Solar Black	P8X

## LAMINATES

### SOLID COLORS

#### GRADE L1

Black	P
Designer White	LDW1
Flint	LM16
Loft	LM11

### WOODGRAIN

#### GRADE L1

Bourbon Cherry	H
Cognac	COGN
Field Elm	LWFE
Florence Walnut	LFW1
Harvest	C
Kingswood Walnut	LKI1
Mocha	MOCH
Natural Maple	LWD
Neo Walnut	LNU1
Pinnacle	PINC
Shaker Cherry	F
Sterling Ash	LSA1

#### GRADE L2

Beigewood	LWBE
Fawn Cypress	LFC1
Lowell Ash	LLA1
Natural Recon	LNR1
Phantom Ecu	LPE1
Portico Teak	LPT1
Skyline Walnut	LSW1
Veranda Teak	LVT1

## PLASTIC GROMMETS

### FOR WORKSURFACES

Black	E4
Brownstone	EY
Designer White	DW
Flint	E9
Fossil	EH
Loft	EV
Muslin	EU

### PLASTIC GROMMETS WITH WOODGRAIN EDGE

If woodgrain edge is specified, the plastic grommet color is predetermined, based on finish selection.

Kingswood Walnut and Neowalnut	Brownstone EY
Fawn Cypress and Natural Recon	Muslin EU
Phantom Ecu	Loft EV
Portico Teak	Fossil EH
Skyline Walnut	Flint E9
All other woodgrains options	Black E4

## LAMINATE EDGE COLORS



Beigewood	DE
Black	E4
Bourbon Cherry	H
Cognac	CN
Designer White	DW
Fawn Cypress	FC
Field Elm	FE
Flint	E9
Florence Walnut	FW
Harvest	XEDC
Kingswood Walnut	KI
Loft	EV
Lowell Ash	DL
Mocha	MO
Natural Maple	DD
Natural Recon	NR
Neo Walnut	NU
Phantom Ecu	PE
Pinnacle	PI
Portico Teak	DP
Shaker Cherry	DF
Skyline Walnut	SW
Sterling Ash	SA
Veranda Teak	VT

**NOTE:** Refer to individual product pages for upcharges.

**FSC Certified Wood at Allsteel**

See page 332 for more information.

# Laminate Storage Brackets

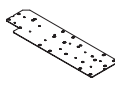
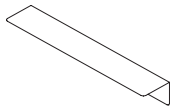
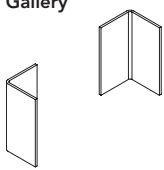
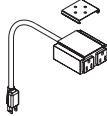
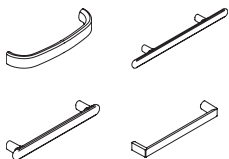
WORKING WITH LAMINATE BRACKETS		
Product Line	Brackets Which Work with All Laminate and Wood Storage	Model:
<b>Involve</b> 	Panel mounting kit – Compatible with all laminate storage with inset back	K6__PBK_
<b>Involve</b> 	O-Leg to Panel bracket – Compatible any 28"H O-Legs	KOLGBRK_FT
<b>Terrace</b> 	Flat Bracket 12D, 24D, or 30D – Compatible with all laminate storage	T6__FB
Product Line	Brackets Which Potentially Work with Multiple Lines	Model:
<b>Stride</b> 	"L" Bracket for Worksurface connections – Stride & Further have pilot holes, theoretically could be used with all laminate storage.	Z6LB
<b>Gallery</b> 	Storage to Gallery Panel ganging kit – Involve finished back units have pilot holes, theoretically could be used with all finished back laminate storage.	GSGKL
Product Line	Brackets Which Work with All Laminate and Wood Storage	Model:
<b>Involve</b>	Involve Tower to Overhead kit – Involve and Stride overheads as they have flat base panels, not Approach as it has a recessed bottom for integrated lighting.	K6TBK
<b>Approach</b> 	Approach mini tap bracket – Made for use with Approach Mini Tap – could be used to attach the Mini Tap to other storage products. <i>Note:</i> Any other storage units do not have pilot holes.	WKMTMB
	Individual pull packs include 2 or 3 pulls and hardware compatible with Approach, Involve, Further, Align, and Ralii.	YPPULL2/3

# Approach and Involve Laminate Wood Storage Storage with Panel Frames

Leg or plinth base models available. Leg base units are shown below.

## Side-mounted Credenzas

**Use 1 storage-to-panel bracket per credenza — 1 LH and 1 RH.**

The minimum credenza size is 24"H x 36"W x 18"D.

With a mid-run floor support, the maximum panel run is 144".

Without a mid-run floor support, the maximum panel run is 96".

Overheads and shelves cannot be used with 24"H side mounted credenzas.

Worksurfaces (if specified) must be mounted on the same side of the parent run as the credenzas.

Panel frame maximum height is 65".

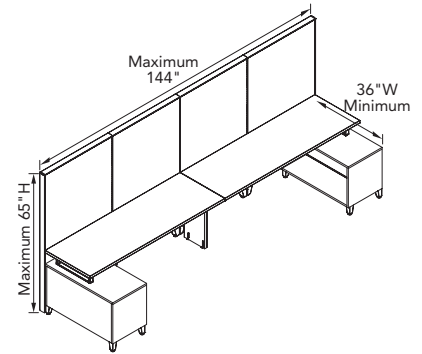

## Back-mounted Credenzas — Modular

**Use 2 storage-to-panel brackets per credenza — 1 LH and 1 RH.**

The minimum credenza size is 24"H x 36"W x 24"D.

The maximum panel run between back-mounted credenzas is 72".

Overheads and shelves cannot be used with 24"H back mounted credenzas.

Worksurfaces (if specified) must be mounted on the same side of the parent run as the credenzas.

Panel frame maximum height is 65".

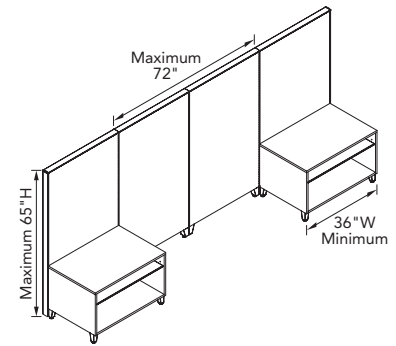

## Back-mounted Credenzas — Off-Modular Ends

**Use 1 storage-to-panel bracket per credenza — 1 LH and 1 RH.**

The minimum credenza size is 24"H x 36"W x 24"D.

With a mid-run floor support, the maximum panel run is 144"

Without a mid-run floor support, the maximum panel run is 96".

Overheads and shelves cannot be used with 24"H back mounted credenzas.

Worksurfaces (if specified) must be mounted on the same side of the parent run as the credenzas.

Panel frame maximum height is 65".

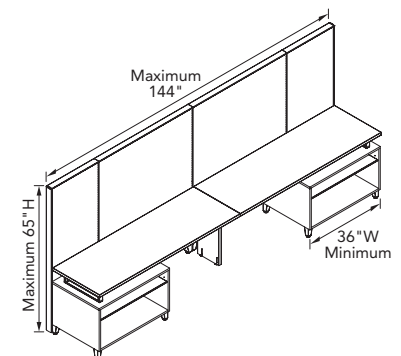

**Note:** Storage with unfinished metal backs require storage-to-panel bracket kit in order to mount to a panel. Left- or right-handed storage-to-panel bracket is determined by slots on panel — left-handed bracket required when attaching to left panel slots and right-handed bracket required when attaching to right panel slots.

Involve storage with unfinished backs require storage-to-panel bracket kit in order to mount to a panel.

Optional laminate back is available (ordered separately) for use when the back of the unit will be exposed.

Plinth base units require a different laminate back model than leg base units.

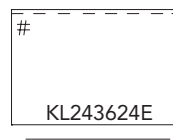
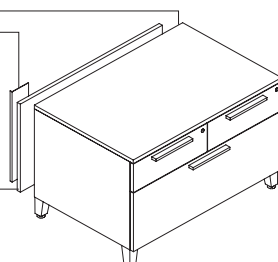

An example of a 2D CAD symbol for Involve is shown at left. Note the dashed line that represents the unfinished metal back. The pound sign indicates that counterweight kits may need to be added depending on the application. See page 256 for counterweight specification rules.

# Approach and Involve Laminate Wood Storage Storage with Panel Frames

Leg or Plinth Base models available. Leg base units are shown below.

GSA Reference Page

## Side-mounted Credenzas — Modular for Overheads and Worksurfaces

**Use 2 storage-to-panel brackets per credenza — 1 LH and 1 RH.**

The minimum credenza size is 28"H x 36"W x 24"D.

28"H side mounted credenzas must be mounted modular when using overheads and worksurfaces on panels.

With a mid-run floor support, the maximum panel run is 144".

Without a mid-run floor support, the maximum panel run is 96".

Overheads, shelves, and worksurfaces must be mounted on the same side of the parent run as the credenzas.

Maximum overhead height is 15".

Panel frame maximum height is 65".

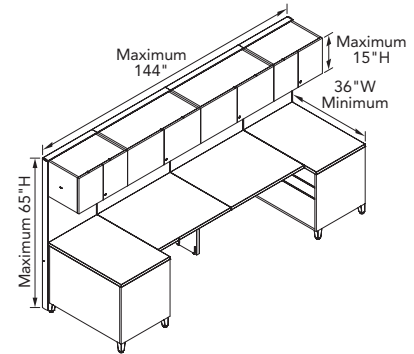

## Back-mounted Credenzas — Modular for Overheads and Worksurfaces

**Use 2 storage-to-panel brackets per credenza — 1 LH and 1 RH.**

The minimum credenza size is 28"H x 36"W x 24"D.

Full back units without trough due to stability, only troughless Approach or Involve allowed.

With a mid-run floor support, the maximum panel run is 144".

Without a mid-run floor support, the maximum panel run is 96".

The maximum panel run between back-mounted credenzas is 72".

Overheads, shelves, and worksurfaces must be mounted on the same side of the parent run as the credenzas.

Maximum overhead height is 15".

Panel frame maximum height is 65".

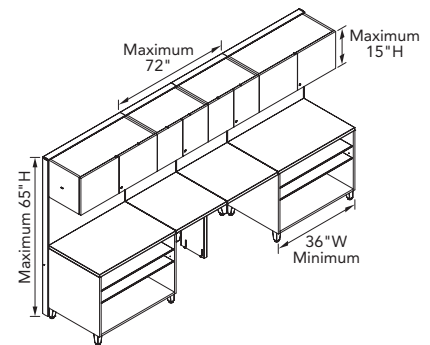

## Side-mounted Credenzas — with Return Panel

**Use 1 storage-to-panel bracket on credenza.**

The minimum credenza size is 24"H x 36"W x 18"D.

The minimum size for panel return is 35"H x 36"W.

With a mid-run floor support, the maximum panel run is 144".

Without a mid-run floor support, the maximum panel run is 96".

Overheads and shelves cannot be used with 24"H side mounted credenzas.

Worksurfaces (if specified) must be mounted on the same side of the parent run as the credenzas.

Panel frame maximum height is 65".

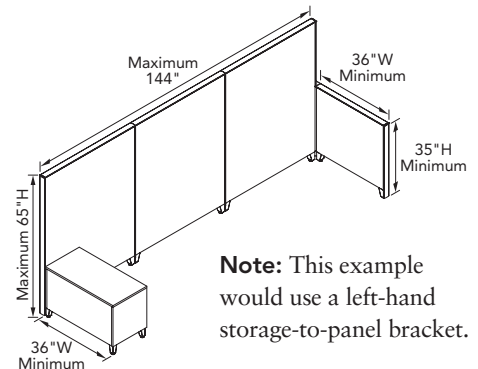

## Side-mounted Credenzas — Modular for Overheads and Worksurfaces

**Use 2 storage-to-panel brackets per credenza — 1 LH and 1 RH.**

The minimum credenza size is 28"H x 36"W x 24"D.

The minimum size for panel return is 50"H x 36"W.

28"H side mounted credenzas must be mounted modular when using overheads and worksurfaces on panels.

With a mid-run floor support, the maximum panel run is 144".

Without a mid-run floor support, the maximum panel run is 72".

Overheads, shelves, and worksurfaces must be mounted on the same side of the parent run as the credenzas.

Maximum overhead height is 15".

Panel frame maximum height is 65".

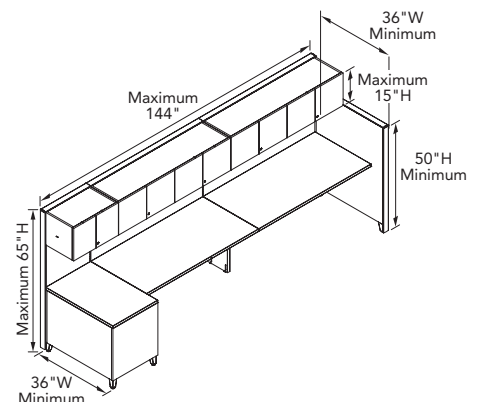



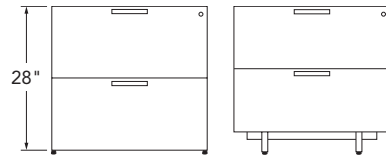

Approach components utilize Involve storage to panel brackets to tie storage into panel slotted standards. (Will not attach to Concensys panel system.)

### 28"H BACK-MOUNTED CRENZAS

28"H Plinth Base  
Finished Back  
No Trough  
K630PBKL + K630PBKR

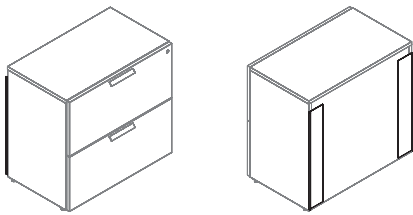

28"H Footed  
Finished Back  
No Trough  
K624PBKL + K624PBKR

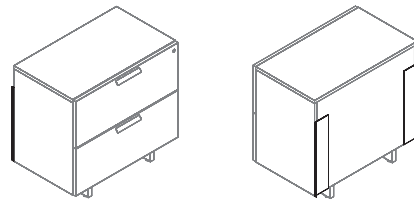

28"H Plinth Base  
Un-Finished Back  
With Trough  
K630PBKML + K630PBKMR

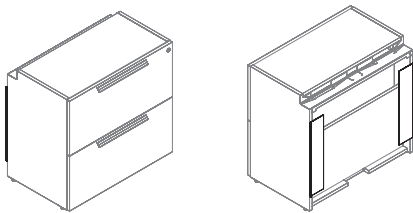
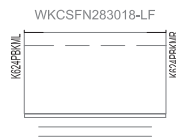

28"H Footed  
Un-Finished Back  
With Trough  
K624PBKML + K624PBKMR

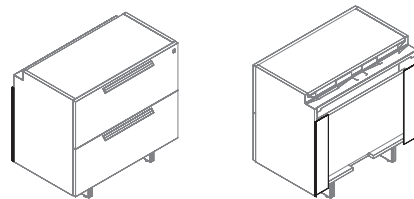
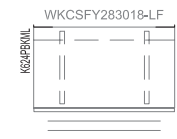

### 28"H SIDE-MOUNTED CRENZAS

28"H Plinth Base  
Finished Back  
With Trough  
K630PBKL + K630PBKR

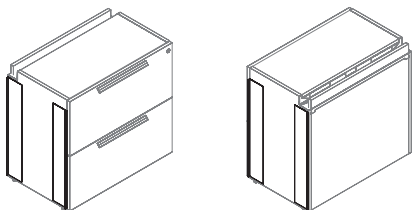
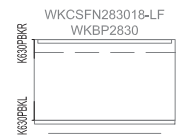

28"H Footed  
Finished Back  
With Trough  
K624PBKL + K624PBKR

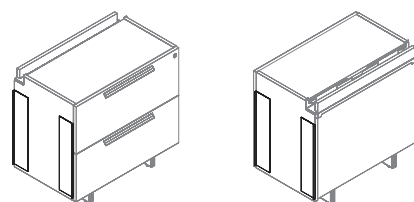
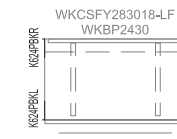

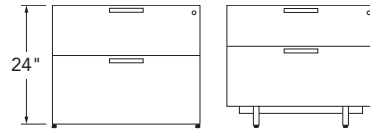

Approach components utilize Involve storage to panel brackets to tie storage into panel slotted standards. (Will not attach to Concensys panel system.)

### 24"H BACK-MOUNTED CREDENZAS

24"H Plinth Base  
Finished Back  
No Trough  
K624PBKL + K624PBKR

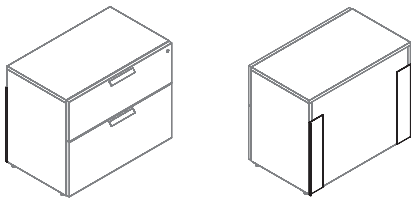

24"H Footed  
Finished Back  
No Trough  
K624PBKL + K624PBKR

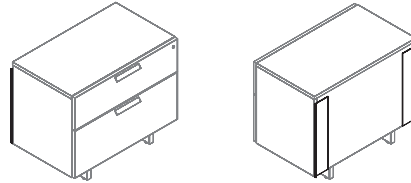
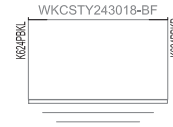

24"H Plinth Base  
Un-Finished Back  
With Trough  
K624PBKML + K624PBKMR

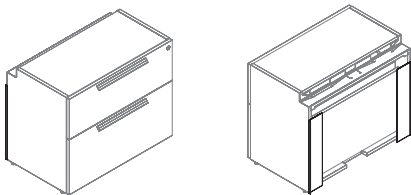

24"H Footed  
Un-Finished Back  
With Trough  
K624PBKML + K624PBKMR

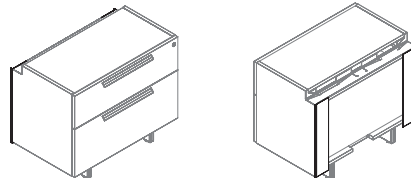
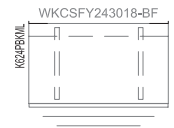

APPROACH

### 24"H SIDE-MOUNTED CREDENZAS

24"H Plinth Base  
Finished Back  
With Trough  
K624PBKL + K624PBKR

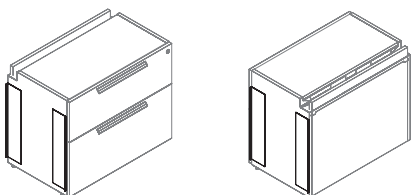
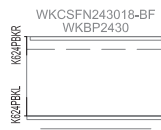

24"H Footed  
Finished Back  
With Trough  
K624PBKL + K624PBKR

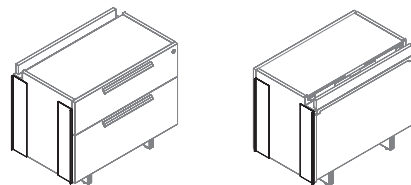
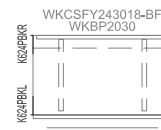

**Approach General Construction**

- Cases are made of ¾" particle board with 0.5mm edgeband. Worksurfaces and end supports are made of 1½" particle board with 2mm edgeband and laminate on both sides of all surfaces.
- Matching laminate fronts — all vertically stacked sets have grain matched parts. Horizontally adjacent units do not match.
- Box and file drawers are miter fold, ½" thick particle board.
- All Drawers lock
  - Lock is located in the top right corner of upper drawer on credenzas, desks, and skinny peds. Drawer locks all drawers in the vertical stack.
  - Mobile ped lock is in upper right corner of bottom drawer.
  - Omit core and keyed alike options. Omit core option ships with standard lock cores installed, customer is credited to order keyed alike cores to be replaced at installation.
  - Lock core color is Matte Silver.
- For door-locking, see product categories for details.
- All drawer units have holes drilled for pulls
  - User selects pull choice of beam, halo, square, arch, or bar. Beam and Halo available in Designer White, Silver, Pyrite, and Solar Black. Square pull available in Designer White, Flint, Loft, Matte Silver, Pyrite, and Solar Black. Bar pull available in Designer White, Silver, or Black.
  - Pulls are 1" to hole center from top of drawer.
  - Drawer bodies are light woodgrain finish with Black hangrails.
- Adjustable shelves are ¾" laminate and have 3 hole adjustable positions with 1¼" (32mm) hole spacing. One above and one below location specified in internal dimensioning table.
- Left-hand (LH) hinged units have hinges located on the left of the unit, right-hand (RH) hinged units have hinges on the right.
- Case end panels are the same depth regardless if fronts are assembled.
- Some models require counterweight — see specification table on pages [168-169](#).

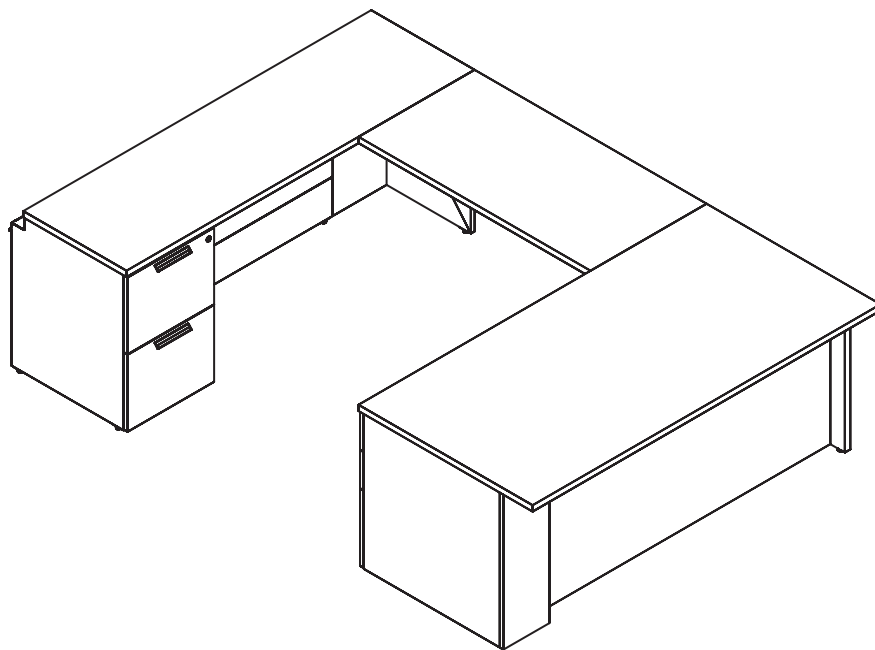

### Counterweights

Counterweight(s) may need to be added to Approach credenzas and storage depending on configuration and usage. Models that may require counterweights are flagged with a number sign # following the model number in the pricing section. Reference model and intended usage column in chart below. Some models require two counterweights. Open shelf and hinged door models do not require counterweights and are not listed.

### Approach Counterweight Kits — See page 233

Model	Description	List Price
WKCACW25	25 lb. Counterweight Kit	\$ 304
WKCACW35	35 lb. Counterweight Kit	\$ 407
WKCACW50	50 lb. Counterweight Kit	\$ 458
WKCACW65	65 lb. Counterweight Kit	\$ 542

Model #	*Freestanding Unit Needs	**Freestanding With Worksurface Needs	***Connected by Worksurface Needs
<b>Full-Height Single Credenzas (28"H x 30"W)</b>			
WKCST □ WKCSFN283018-LF	50	50	
WKCST □ WKCSFN283018-MF	50	35	
WKCST □ WKCSFN283018-OSBF	65	50	
WKCST □ WKCSFY283018-BBF	65+50	50+50	
WKCST □ WKCSFY283018-LF	50+50	50+35	
WKCST □ WKCSFY283018-MF	50	35	
WKCST □ WKCSFN283024-LF	65	50	
WKCST □ WKCSFN283024-MF	50	35	
WKCST □ WKCSFN283024-OSBF	65	50	
WKCST □ WKCSFY283024-BBF	50+35	50+25	
WKCST □ WKCSFY283024-LF	35	25	
WKCST □ WKCSFY283024-MF	50	35	
<b>Full-Height Single Credenzas (28"H x 36"W)</b>			
WKCST □ WKCSFN283618-LF	50	35	
WKCST □ WKCSFN283618-OSBF	50	35	
WKCST □ WKCSFY283618-BBF	65+50	50+50	
WKCST □ WKCSFY283618-LF	50	35	
WKCST □ WKCSFN283624-LF	60	50	
WKCST □ WKCSFN283624-OSBF	50	35	
WKCST □ WKCSFY283624-BBF	50+35	50+25	
WKCST □ WKCSFY283624-LF	65	50	
<b>Full-Height Double Credenzas (28"H x 60"W)</b>			
WKCUT/WKCUFN286018-HDLF	25	25	
WKCUT/WKCUFN286018-LFHD	25	25	
WKCUT/WKCUFN286018-LFLF	50+50	65	
WKCUT/WKCUFN286018-LFOS	25	25	
WKCUT/WKCUFN286018-OSLF	25	25	
WKCUT/WKCUFY286018-HDLF	35	25	
WKCUT/WKCUFY286018-LFHD	35	25	
WKCUT/WKCUFY286018-LFLF	50+50	50+35	25
WKCUT/WKCUFY286018-LFOS	35	25	
WKCUT/WKCUFY286018-OSLF	35	25	
WKCUT/WKCUFN286024-HDLF	25	25	
WKCUT/WKCUFN286024-LFHD	25	25	
WKCUT/WKCUFN286024-LFLF	65	50	
WKCUT/WKCUFN286024-LFOS	25	25	
WKCUT/WKCUFN286024-OSLF	25	25	
WKCUT/WKCUFY286024-HDLF	25		
WKCUT/WKCUFY286024-LFHD	25		
WKCUT/WKCUFY286024-LFLF	65+65	50+25	25
WKCUT/WKCUFY286024-LFOS	25		
WKCUT/WKCUFY286024-OSLF	25		

\* Freestanding unit is considered a unit only in contact with the floor via the glides/feet

\*\* Freestanding with worksurface is considered a freestanding unit with a worksurface the same width and depth as the unit itself. (i.e., 30W x 24D unit with a 30W x 24D credenza worksurface applied to the top.

\*\*\* Connected by worksurface refers to a 30/36W credenza unit, connected to another credenza unit that is non-drawerred via properly installed worksurface.

# For No-Trough Units (WKCSTXXXXXXXX-XXXX and WKCUTXXXXXXXX-XXXX), reduce counterweights by 25 lbs. Round up to closest counterweight set if needed, unless zero. Troughless 42" - 48" wide credenzas do not require counterweight.

Model #	*Freestanding Unit Needs	**Freestanding With Worksurface Needs	***Connected by Worksurface Needs
<b>Full-Height Double Credenzas (28"H x 72"W)</b>			
WKCUT/WKCUFN287218-HDLF	25	25	
WKCUT/WKCUFN287218-LFHD	25	25	
WKCUT/WKCUFN287218-LFLF	50+25	50	
WKCUT/WKCUFN287218-LFOS	25	25	
WKCUT/WKCUFN287218-OSLF	25	25	
WKCUT/WKCUFY287218-HDLF	25	25	
WKCUT/WKCUFY287218-LFHD	25	25	
WKCUT/WKCUFY287218-LFLF	65+65	50+50	25
WKCUT/WKCUFY287218-LFOS	25	25	
WKCUT/WKCUFY287218-OSLF	25	25	
WKCUT/WKCUFN287224-HDLF	25	25	
WKCUT/WKCUFN287224-LFHD	25	25	
WKCUT/WKCUFN287224-LFLF	50+25	50	
WKCUT/WKCUFN287224-LFOS	25	25	
WKCUT/WKCUFN287224-OSLF	25	25	
WKCUT/WKCUFY287224-HDLF	25	25	
WKCUT/WKCUFY287224-LFHD	25	25	
WKCUT/WKCUFY287224-LFLF	50+50	65	25
WKCUT/WKCUFY287224-LFOS	25	25	
WKCUT/WKCUFY287224-OSLF	25	25	
<b>Low-Height Single Credenzas (24"H x 30-36"W)</b>			
WKCST/WKCSFN243018-BF	50	35	
WKCST/WKCSFN243018-MF	65	50	
WKCST/WKCSFN243618-BF	50+25	65	
WKCST/WKCSFY243018-BF	35+25	50	
WKCST/WKCSFY243618-BF	35+25	50	
WKCUT/WKCUFY246018-OSBF	50	35	
WKPLTN241218RH-PD	25	25	
WKPLTN241218LH-PD	25	25	
WKCDTN243018-BFPD	25	25	
WKCDTN243618-BFPD	25	25	
WKCDTN243018-PDBF	25	25	
WKCDTN243618-PDBF	25	25	
<b>Low-Height Double Credenzas (24"H x 60"W)</b>			
WKCUT/WKCUFN246018-BFBF	50+50	65	25
WKCUT/WKCUFN246018-BFHD	35	25	
WKCUT/WKCUFN246018-BFOS	35	25	
WKCUT/WKCUFN246018-HDBF	35	25	
WKCUT/WKCUFN246018-OSBF	35	25	
WKCUT/WKCUFY246018-BFBF	65+65	50+50	25
WKCUT/WKCUFY246018-BFHD	50	35	
WKCUT/WKCUFY246018-BFOS	50	35	
WKCUT/WKCUFY246018-HDBF	50	35	
<b>Low-Height Double Credenzas (24"H x 72"W)</b>			
WKCUT/WKCUFN247218-BFBF	65+65	50+50	25
WKCUT/WKCUFN247218-BFHD	25	25	
WKCUT/WKCUFN247218-BFOS	25	25	
WKCUT/WKCUFN247218-HDBF	25	25	
WKCUT/WKCUFN247218-OSBF	25	25	
WKCUT/WKCUFY247218-BFBF	65+65	50+50	25
WKCUT/WKCUFY247218-BFHD	35	25	
WKCUT/WKCUFY247218-BFOS	35	25	
WKCUT/WKCUFY247218-HDBF	35	25	
WKCUT/WKCUFY247218-OSBF	35	25	
<b>Pedestals (28"H x 18"W)</b>			
WKPSFN281818-BBF	25		
WKPSFN281824-BBF	25		
WKPSFN281818-FF	25		
WKPSFN281824-FF	25		

\* Freestanding unit is considered a unit only in contact with the floor via the glides/feet

\*\* Freestanding with worksurface is considered a freestanding unit with a worksurface the same width and depth as the unit itself. (i.e., 30W x 24D unit with a 30W x 24D credenza worksurface applied to the top.

\*\*\* Connected by worksurface refers to a 30/36W credenza unit, connected to another credenza unit that is non-drawerred via properly installed worksurface.

# For No-Trough Units (WKCSTXXXXXXXX-XXXX and WKCUTXXXXXXXX-XXXX), reduce counterweights by 25 lbs. Round up to closest counterweight set if needed, unless zero. Troughless 42" - 48" wide credenzas do not require counterweight.

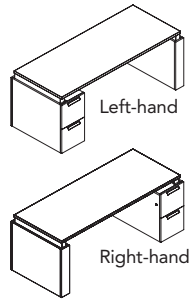

**Pedestal/Shroud Height-Adjustable Desk** (page 191)

- New models available April 2021 for A6 2 stage compatibility, see specification page for model transition.
- Available in RH and LH orientations, hand is determined by location of ped, RH Ped = RH Desk.
- 72"W x 36"D, 72"W x 30"D, and 66"W x 30"D desks available.
- Both depths include same 30"D support shroud and RH or LH pedestal shroud.
- Desk footprint dimensions are nominal. Example: 72"W x 30"D required for space planning. Worksurfaces are undersized by 1" on all sides to prevent pinch points when raising and lowering worksurface.
- Load capacity is 250 pounds, including the worksurface and metal shrouds.
- Laminate finish options include top, chassis, and front.
- User can specify grommet locations (L Left, R Right, B Both, C Centered, X None). See page 174.
- No slide glide option due to application.
- Single order desk models include HAT bases which are PR6 silver.
- Laminate shroud remains on the ground with 2" of leveling.
- Metal shroud, available in standard paint colors, attaches to and rises with worksurface.
- Laminate File/File ped is fixed with ¾" of leveling.
- Both drawers lock via side lock.
- Height-adjustable mechanism provides 27¼"-47⅞" min/max adjustability.
- Height-adjustable mechanism is same as used on A6 Altitude® tables. Reference the Altitude series in Desking and Tables price list for additional specification information.
- Standard up/down control shipped with unit.
- Memory Controls are now a .option.
- Up/Down: Basic Up/Down control.
- Memory Control: 4 memory pre-set options allow the user to adjust their height to their preferred heights.
- Paddle: Simple, aesthetic control with 1 memory pre-set option and reminder mode.
- Foot Control: Basic up/down wireless, hands free control. Can be paired with hand controls for multi-control option.
- Ships flat in multiple cartons for field assembly.
- Specify optional floating worksurface modesty panel 24" shorter than worksurface width.
- Modesties are non-handed and mount to the external stiffener included with the unit.
- Anti collision available on desking models April 2021.

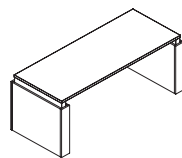

**Double Shroud Height-Adjustable Desk** (page 191)

- New models available April 2021 for A6 2 stage compatibility, see specification page for model transition.
- 72"W x 36"D, 72"W x 30"D, and 66"W x 30"D desks available.
- Both depths use same 30"D support shroud.
- Desk footprint dimensions are nominal. Example: 72"W x 30"D required for space planning. Worksurfaces are undersized by 1" on all sides to prevent pinch points when raising and lowering worksurface.
- Laminate finish options include top, chassis, and front.
- User can specify grommet locations (L Left, R Right, B Both, C Centered, X None). See page 174.
- Laminate shroud is fixed with 2" of leveling.
- Metal shrouds available in standard paint colors, attach to and rise with worksurface.
- Height-adjustable mechanism provides 27¼"-47⅞" min/max adjustability.
- Height-adjustable mechanism is same as used on A6 Altitude® tables. Reference the Altitude series in Tables and Desking price list for additional specification information.
- Standard up/down control shipped with unit.
- Memory Controls are now a .option.
- Up/Down: Basic Up/Down control.

- Memory Control: 4 memory pre-set options allow the user to adjust their height to their preferred heights.
- Paddle: Simple, aesthetic control with 1 memory pre-set option and reminder mode.
- Foot Control: Basic up/down wireless, hands free control. Can be paired with hand controls for multi-control option.
- Ships flat in multiple cartons for field assembly.
- Specify optional floating worksurface modesty panel 12" shorter than worksurface width.
- Modesties are non-handed and mount to the external stiffener included with the unit.
- Anti collision available on desking models April 2021.

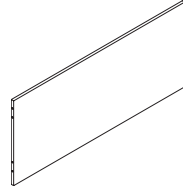

**Fixed Layered Height Modesty For Height Adjustable Desks:**

- Fixed laminate modesty for height adjustable table (24"H AFF) and metal hanging backdrop modesty compatible with double shroud height adjustable desks.
- Fixed laminate modesty for height adjustable tables is inset 3" between standard shrouds with a bracket visible under the work surface on the user side.
- Connection bracket is available in Allsteel standard paints.

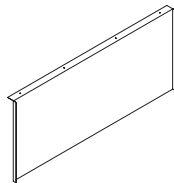

**Metal Hanging Modesty for Height Adjustable Desks:**

- Metal hanging modesty (offered in Flint) mounts to the worksurface nested to the stiffener and has 1" distance from fixed laminate modesty.
- Metal hanging modesty is 8¼" less in width than the worksurface to avoid interference has reveal on each side between shroud metal and metal modesty.
- Metal modesty has bent side folds for a clean curved aesthetic from the guest side.

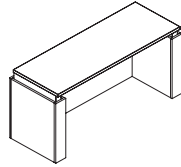

**24" D Height-Adjustable Work Wall Desk with Full-Height Modesty Panel (page 191)**

- New models available April 2021 for A6 2 stage compatibility, see specification page for model transition.
- Specifically designed for wall facing application to keep cords hidden from sight.
- True shroud depth of 22" and worksurface depth of 21".
- 48", 54", 60", 66", and 72"W desks available.
- Desk footprint dimensions are nominal. Example: 72"W x 24"D required for space planning. Worksurfaces are undersized by 1" on all sides to prevent pinch points when raising and lowering worksurface.
- Laminate finish options include top, chassis, and front.
- User can specify grommet locations (L Left, R Right, B Both, C Centered, X None). See page 174.
- Includes laminate shrouds fixed with 2" of leveling.
- Metal shrouds available in all standard Allsteel paint colors attach to and rise with worksurface.
- Laminate modesty ties into the laminate shrouds and remains on the ground. Modesty has unfinished back and is intended to be used against a wall.
- Metal modesty (Flint only) attaches and rises with the worksurface.
- Height-adjustable mechanism provides 27¾"-47¾" min/max adjustability.
- Height-adjustable mechanism is same as used on A6 Altitude® tables. Reference the Altitude series in Desking and Benching price list for additional specification information.
- Standard up/down control shipped with unit.
- Memory Controls are now a .option.
- Up/Down: Basic Up/Down control.
- Memory Control: 4 memory pre-set options allow the user to adjust their height to their preferred heights.
- Paddle: Simple, aesthetic control with 1 memory pre-set option and reminder mode.
- Foot Control: Basic up/down wireless, hands free control. Can be paired with hand controls for multi-control option.
- Ships flat in multiple cartons for field assembly.
- Anti collision available on desking models April 2021.

**Credenza for Integrated Height Adjustable Table (page 196)**

- 60"W and 72"W x 18"D and 24"D sizes available.
- Laminate finish options include top, chassis, and front.
- Credenzas for HAT are non-handed and configurable at installation. The three units included in these Credenzas are shipped separately (open credenza, box/file credenza, and top).
- User can adjust credenza orientation by reversing top and credenzas of base model at install. Example: Top scallop and open file on right side or top scallop and open file on left side.
- Credenzas for HAT compatible with 2-stage C and T base HAT tables to be ordered separately.
- Height-adjustable mechanism chosen should provide 27¾" as it's minimum.
- Altitude tables height-adjustable mechanism is compatible. Reference the Altitude series in Tables price list for additional specification information.
- Credenzas for HAT are non-footed with finished backs and no trough.
- Drawer stacked units have mechanical interlock, allowing only one drawer to open at a time.
- Shortest distance from edge of scallop is consistent across all tops. Scallop dimensions the same across all HAT tops. Depth of Scallop is 5".
- Compatible with A6
- Footed units come with a black recessed center foot.

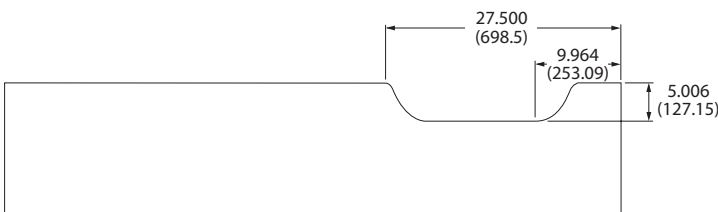
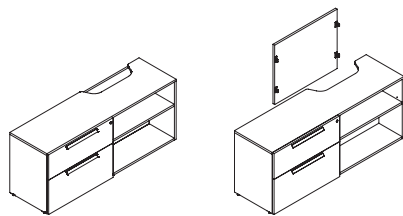



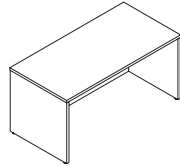

**Shell Desks (page 192)**

- Units ship knocked down for field assembly.
- Units are 29"H x 30"D, available in 60", 66" and 72"W.
- Laminate finish is the same for top, end panels and modesty.
- Only full-height modesty options available.
- Standard worksurface grommet options and placement.
- Full height laminate modesty is inset 3½" on guest side.

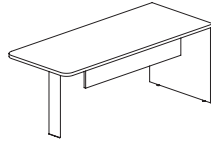

**Racetrack Top Desks with End Panel, Half-Height Modesty, and Column Base (page 192)**

- 30"D, non-handed.
- 72" and 66"W models have end panel support, 29½"H support column, and bracket to attach to a worksurface or desk.
- 48", 54", and 60"W models have 29½"H support column.
- Column support end has 3" round corners.
- Racetrack modesty is 18" shorter than worksurface length.
- Ships flat in multiple cartons for field assembly.

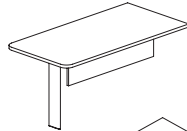

**O-leg Table Desks (page 192)**

- 30"D x 66" or 72"W.
- A variety of standard Allsteel paint colors.
- User can specify grommet locations (L Left, R Right, B Both, C Centered, X None). See page 174.
- O-legs installed on both ends of worksurface are inset ¼" from end of worksurface.
- See notes on O-leg for leveling and dimensions.
- 14"H half-height modesty is 12" shorter than worksurface width. Attaches to external stiffener on worksurface.
- Ships flat in multiple cartons for field assembly.

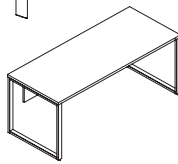

**Double Ped Desk (page 193)**

- 36"D x 72"W, ped base is 29¼"D.
- Laminate finish options include top, chassis, and front.
- User can specify grommet locations (L Left, R Right, B Both, C Centered, X None). See page 174.
- Box/Box/File on left and File/File on right from main user view.
- Full height modesty, ties into both ped end panels 9" from back of worksurface. Modesties go to the floor and match end panel height.

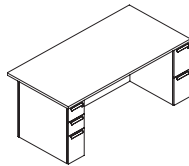

**Single Ped Desks (page 193)**

- Right- and left-hand versions
- RH = ped on right side from main user view
- LH = ped on left side from main user view
- Laminate finish options include top, chassis, and front.
- User can specify grommet locations (L Left, R Right, B Both, C Centered, X None). See page 174.
- Ped Desks available with 9"W and 15"W Ped Options.
- Box/Box/File only — slim peds (9½" width), see notes on slim peds for dimensions and leveling.
- Box/Box/File and File/File configurations available for the 15"W Pedestal.
- Panel base (1½" thick) is opposite the storage.
- 14"H half- or full-height modesty panel options, designated by dot option. Modesty panel ties into both end panel and pedestal.
- 30"D x 60", 66", or 72"W
  - Ped and panel base are both 29¼" in depth.
  - Modesty panel is 3" from back of worksurface.
- 36"D x 72"W
  - 36"D X 72"W available with 9"W Ped ONLY.
  - Ped base is 29¼" deep. Panel base is 35¼" deep.
  - Modesty panel is 9" from back of worksurface.

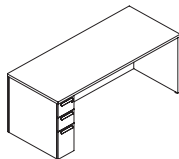

GROMMET SPECIFICATIONS

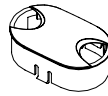

**Grommets**

Plastic grommets are made of durable ABS plastic and match edge color of laminate worksurfaces. Metal grommets are available in oval or square in Matte Silver.

**Grommet Position Option Codes**

- B** Both Left and Right — Pair of grommets each 10" from side edge – 5/8" from approach side to grommet edge; 7/4" from rear to grommet center.
- C** Centered Side-to-Side — One grommet 5/8" from approach side to grommet edge; 7/4" from approach side to grommet center.
- L** 10" from Left Side — 5/8" from approach side to grommet edge; 7/4" from approach side to grommet center.
- R** 10" from Right Side — 5/8" from approach side to grommet edge; 7/4" from approach side to grommet center.
- X** No grommet.

Note: On 36"D tops, approach side to grommets is 11 3/8". See 36"D illustration below.

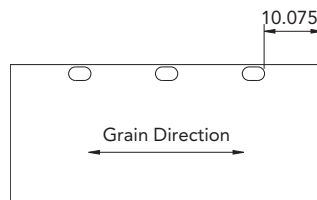
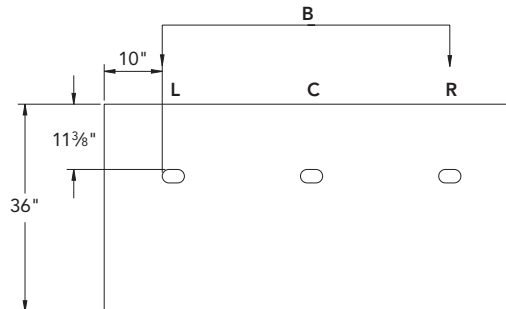
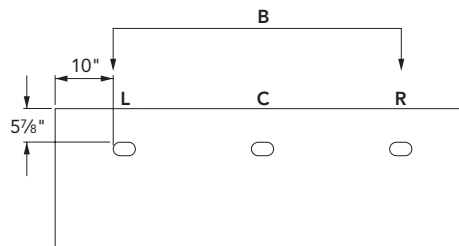

**Credenza Top**

Grommet positions other than those shown above are considered non-standard. Location allows ease of install for offered support, i.e. O-Leg, Column, and Panel.

APPROACH

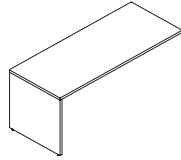

**Support Panel Run-off Desks** (page 192)

- 30"D x 48", 54", 60", 66", and 72"W
- Right- and left-hand models.
- Laminate finish options include top and chassis.
- User can specify grommet locations (L Left, R Right, B Both, C Centered, X None). See page 174.
- Support Panel is 1½" thick.
- 14"H half-height modesty attaches to end panel, 3" from back of worksurface. Modesty is ¼" short on opposite end of support.
- Run-off desks are able to attach to existing single ped desk or racetrack top desk with end panel.
- Ships flat in multiple cartons for field assembly.

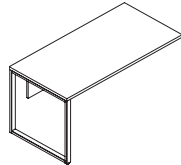

**O-leg Run-off Desks** (page 192)

- 30"D x 48", 54", 60", 66", 72", 78", and 84"W
- Non-handed, O-leg can be installed on either side of worksurface.
- Laminate finish options include top and chassis.
- User can specify grommet locations (L Left, R Right, B Both, C Centered, X None). See page 174.
- See notes on O-leg for leveling and dimensions.
- 14"H half-height modesty is 12" shorter than worksurface width. Attaches to external stiffener included with worksurface.
- Ships flat in multiple cartons for field assembly.

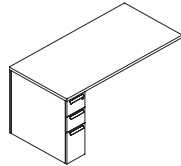

**Pedestal Run-off Desks** (page 193)

- 30"D x 48", 54", 60", 66", or 72"W
- Right- and left-hand models.
- Laminate finish options include top, chassis, and front.
- User can specify grommet locations (L Left, R Right, B Both, C Centered, X None). See page 174.
- Box/Box/File only — slim peds (9½" width), see notes on slim peds for dimensions and leveling.
- 14"H half-height modesty panel attaches to ped end of panel 3" in from back of worksurface. Modesty is ¼" short on opposite end of support.
- Run-off desk can attach to existing single ped desk or racetrack top desk with end panel.

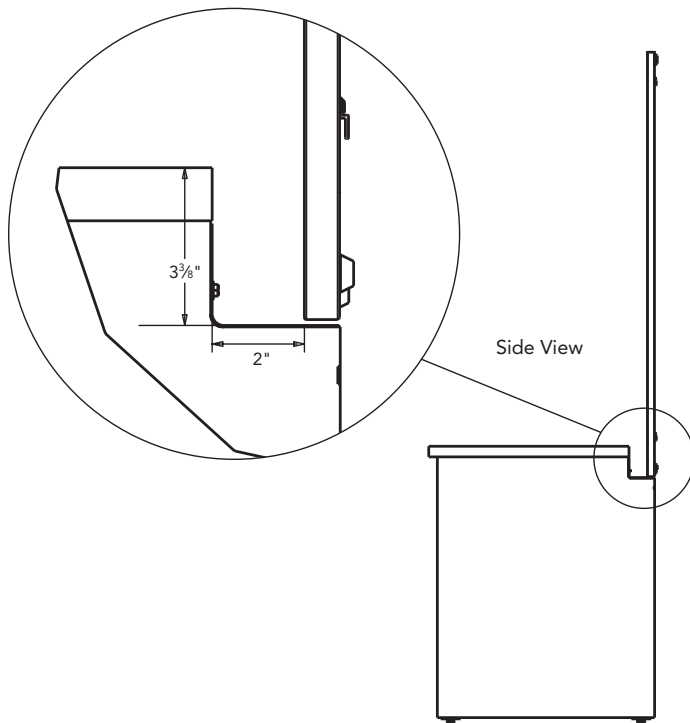
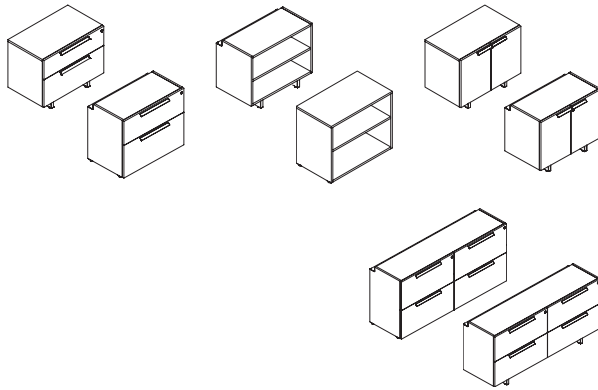

**Credenzas** (pages 196-204)

- 30" W and 36" W units contain single column of drawers, open cavity or hinged doors. 42", 48", 60", and 72" W units contain two columns of drawers, open cavities, hinged doors, or a combination of both.
- Full height 28 3/8" H, footed and non-footed, 18" D and 24" D. 29 1/2" H with added credenza worksurface.
- Layered height 24 3/4" H, footed and non-footed, 18" D. 25 5/8" H with added credenza worksurface.
- Trough credenzas have inset top construction where no-trough credenzas have top over construction.
- Laminate finish options include chassis and front.
- Multi File units feature a cubby at the top left of the top project drawer with lateral drawer front. This allows for many applications and concealed storage.
- All credenza units contain 1 1/2" adjustable glides
- All units can be standalone with or without credenza top.
- Full extension file drawers extend 13 1/4" on 18" D models, and 17 1/4" on 24" D models.
- Some models require counterweight – see specification table on pages 168-169.
- Vertically stacked units have mechanical interlock, allowing only one drawer to open at a time. Exception is Box/Box/File which allows bottom file drawer and top box drawers to open at the same time.
- Trough available for power application and no-trough available for open plan applications.
- Wire management trough
  - Trough is 2" D x 3 3/8" H with tackboard, see illustration at left.
  - Accessories available (ordered separately): Byrne mini tap, monitor arm, clamp style, light.
- No-trough credenzas have top over construction and have finished backs.
- Finish height is consistent across both trough and no-trough units, example both troughed and no-trough 28" H units are the same height.
- All other credenza models have a finished back option available for order. See page 207.
- Two styles of feet are available, post and blade feet.
  - Blade Feet are recessed 6" in from each side on 30" and 36" units, and 8 1/2"-9 1/2" in from each side on 42"-72" units.
  - Post feet are inset 1 1/8" from each side of unit across all units.
- Center stability foot is included on units 60" W and larger.
- No ganging option available.
- Unit's ship assembled except for feet and pulls.



**Mobile Pedestal** (page 194)

- 21 1/2" H x 15 3/4" W x 20" D.
- Laminate finish options include chassis and front.
- Box/File drawer configuration.
- Front-to-back filing capable without use of rails.
- Side-to-side filing available with use of file hangrails (included).
- Casters are recessed to provide clean aesthetic.
- Units ship assembled except casters and pulls.



**24" H Pedestal** (page 194)

- 24 3/4" H x 18" W x 18" D.
- 25 5/8" H with added laminate worksurface.
- Laminate finish options include chassis and front.
- Box/File drawer configuration.
- Front-to-back letter filing capable with use of file hangrail (included).
- Side-to-side letter filing available without use of rails.
- No interlock between drawers.
- Counterweight may be needed. See pages 168-169.
- Finished backs available, see page 207.
- Units ship assembled except pulls.

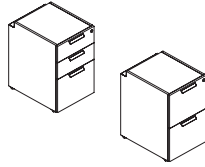

**Support Pedestals** (page 194)

- 28<sup>3</sup>/<sub>8</sub>"H x 18" W x 18" or 24"D.
- Box/Box/File and File/File drawer configurations.
- Laminate finish options include chassis and front.
- Same construction as credenza units.
- Support Pedestals with wire management trough do not have back panels.
- No interlock between drawers.
- Counterweight may be needed. See pages 168-169.
- Finished backs available, see page 207.
- Units ship assembled except pulls.

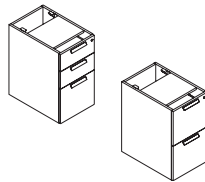

**15"W Support Pedestal** (page 195)

- 28<sup>3</sup>/<sub>8</sub>"H x 15" W x 24" or 30"D.
- Box/Box/File or File/File configurations available.
- Laminate finish options include chassis & front.
- Units must be mounted under worksurface, hardware included.
- Units have finished backs.
- Footed & Non-Footed configurations available. Overall Heights remain the same.
- No interlock between drawers.
- Glides provide 1<sup>1</sup>/<sub>2</sub>" adjustment.
- Units Ship assembled except pulls.

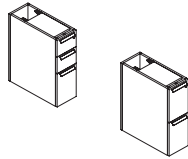

**Slim Pedestals for Freestanding Desks** (page 194)

- 28<sup>3</sup>/<sub>8</sub>"H x 9<sup>1</sup>/<sub>2</sub>" W x 24" or 30"D.
- Box/Box/File and File/File drawer configurations.
- Laminate finish options include chassis and front.
- Units must be mounted under worksurface, hardware included.
- Support Pedestals without wire management trough have back panels.
- Side-to-side filing available with hangrail (included). Narrow width does not permit front-to-back filing.
- Glides provide <sup>3</sup>/<sub>4</sub>" of adjustment
- Units ship assembled except pulls.

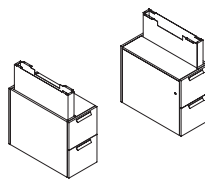

**Slim Pedestal Shroud Kits** (page 194)

- New models available April 2021 for A6 2 stage compatibility, see specification page for model transition.
- File/File only drawer configuration, available in left- and right-hand options determined from the primary user perspective.
- Both drawers lock via side lock.
- Includes laminate pedestal that remains on the ground and metal shroud, available in all standard Allsteel paint colors, that rises with the worksurface. Requires Altitude® 2-stage, A6 C-leg or A6 T-leg electric powered base purchased separately, see page 235.
- Pedestal is 14<sup>1</sup>/<sub>4</sub>"W x 30"D x 24"H with <sup>3</sup>/<sub>4</sub>" of leveling.
- Metal shroud elevates with worksurface 27<sup>3</sup>/<sub>4</sub>"–47<sup>3</sup>/<sub>8</sub>"H.
- Can be used in any combination of supports: Open T-Leg, C-Leg, Laminate Shroud, Slim Pedestal Shroud.
- The shroud fits over the height-adjustable leg of a 2" x 3" column.

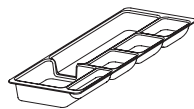

**15W Box Drawer Pedestals and Accessory** (page 195)

- Box drawers do not include pencil tray.
- Order pencil tray separately - A2280-000

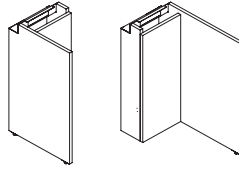

**False Ped (page 210)**

- 12" W x 28<sup>3</sup>/<sub>8</sub>" H
- End panel depth is 14", 18", or 24" D.
- LH and RH options.
- Designed to be used adjacent to wall access panel.
- Aligns with wall access panel.
- Used to continue wire trough and to support the end of credenza top.
- 14" D false ped worksurface must be supported on opposite end by a full-depth support.
- Maximum unsupported worksurface span is 48" with 14" D models, and 72" with 18" D and 24" D models.
- Metal wire trough ships separately and attaches directly to worksurface.

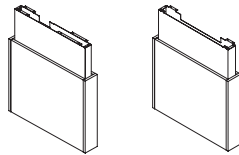

**Height-Adjustable Shroud Kits (page 235)**

- New models available April 2021 for A6 2 stage compatibility, see specification page for model transition.
- Available in non-handed for simple specification and optimal reconfigurability.
- Includes laminate shroud that remains on the ground and metal shroud, available in standard Allsteel paints, that rises with the worksurface. Requires Altitude® 2-stage, A6 C-leg or A6 T-leg electric powered base purchased separately, see page 235.
- Laminate shroud is 5<sup>5</sup>/<sub>8</sub>" x 30" D x 24" H with 2" of leveling.
- Metal shroud elevates with worksurface 27<sup>3</sup>/<sub>4</sub>"–47<sup>3</sup>/<sub>8</sub>" H.
- Can be used in any combination of supports: Open T-Leg, C-Leg, Laminate Shroud, Slim Pedestal Shroud.
- The shroud fits over the height-adjustable leg of a 2" x 3" column purchased separately.
- Models available April 2021 for A6 height adjustable 2-stage bases.

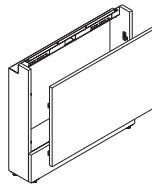

**Wall Access Panel (page 210)**

- Designed to be used adjacent to false ped or supported by another unit such as tower or credenza and is non-handed.
- 18-48" W x 6<sup>1</sup>/<sub>2</sub>" D x 28<sup>3</sup>/<sub>8</sub>" H.
- <sup>3</sup>/<sub>4</sub>" removable front.
- Metal wire trough ships separately and attaches directly to worksurface.

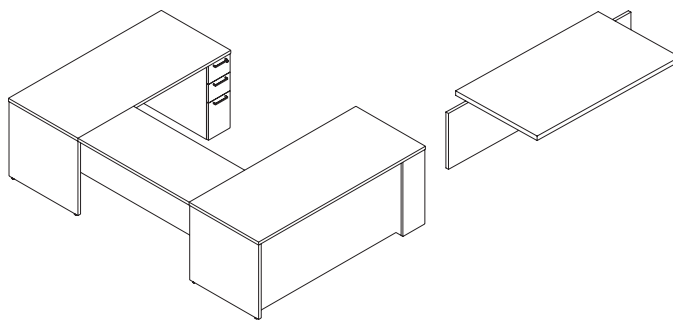

**Bridge (page 210)**

- 24" D x 42" W or 48" W.
- 48" W bridge ships with external support stiffener.
- Comes with 14" H half-height modesty panel, which is 12" wider than the worksurface.
- Flat brackets onto both sides of fixed height adjacent units.
- To mount, use a flat bracket on both sides fixed to an adjacent unit. Flat brackets are included for ease of installation.

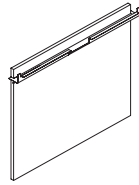

**Back Panels** (page 207)

- All credenzas have a finished back option available for order, see page 207.
  - All back panels are inset of credenza end panels.
  - Back panels include a filler piece for a clean back. Specify color options at time of order entry (colors are Black, Designer White and Silver to match pull or feet colors).
- 3 Heights available.
  - 20" is used on 24"H footed models, ex: **WKCSFY243018-BF**
  - 24" is used on 24"H non-footed models, ex: **WKCSFN243018-BF**
  - 24" is used on 28"H footed models, ex: **WKCSFY283624-LF**
  - 28" is used on 28"H non-footed models, ex: **WKCSFN283624-LF**

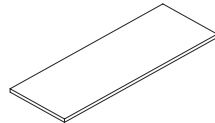

**Credenza and Pedestal Tops** (page 205)

- Tops are 1½" thick with 2mm Edgeband.
- Tops ship with double sided tape supplied in hardware packs.
- Double sided tape attach tops to top of credenza and pedestal units.
- Tops must cover at least one storage unit and may span multiple.
- External stiffeners need to be added to credenza tops if they are spanning a distance greater than 60".
- Shortened Tops for Trough Units
  - Depth is shortened by 2½" less than listed to accommodate wire management trough.
  - 18"D models are 15½"D (2½" less than actual).
  - 24"D models are 21½"D (2½" less than actual).
- Full Depth Tops
  - Width & Depth is nominal to size, (example 24"–24.0").
  - Optional Grommet locations allow user access to the trough.
  - 18"–36" W tops have center grommet option only.
  - 42"–96" W tops can specify grommet locations (L Left, R Right, B Both, C Center, X None).
  - Grommets available in Oval plastic, Square Metal, or Oval Metal.
  - Use for covering trough or top for troughless units.

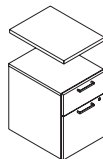

**Credenza and Pedestal Cushions** (page 205)

- A seat cushion can be placed on top of credenzas or 20"D mobile pedestals.
- Designed to fit flush with front of drawer fronts.
- Credenza cushions are undersized by 3" in depth to accommodate wire management trough, 18"D are actually 15"D.
- Seat cushion adds approximately 2"H to credenza or pedestal.

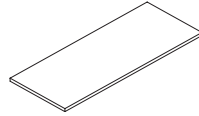

**Primary Worksurfaces** (page 213)

- All Worksurfaces are 1½" thick with 2MM edgeband.
- Width and depth are nominal to size, (example 24"W or 24"D = 24.000").
- Units 48"W or greater ship with external support stiffener.
- User can specify grommet locations (L Left, R Right, B Both, C Centered, X None). See page 174.
- User can specify grommet material (Plastic Oval, Metal Oval, Metal Rectangular).
- Plastic oval grommets automatically match worksurface edgeband selection.
- Includes pilot holes for standard supports and modesty panel locations.

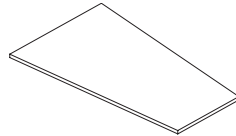

**Double Sightline Surfaces** (page 212)

- Double Sightline Surfaces: 6 sizes, measure as (Width, Depth 1, Depth 2).
- Reference the table base specifications in Seating, Collaboration & Tables price list for applicable models and size limitations
- Utilized mainly in team spaces, collaboration touch points, and/or a useful space division in the workplace if set with O-Leg or end-panel supports from a storage support.

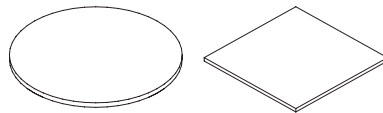

**Table Top Worksurfaces** (page 211)

- All Worksurfaces are 1½" thick with 2MM Edgeband
- Reference table base specifications in Seating, Collaboration & Tables price list for applicable models and size limitations
- Square Surfaces: 36", 42", and 48" available.
- Round Surfaces: 36", 42", and 48" available.
- Approved with splay legs.

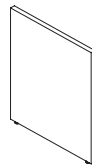

**End Panels** (page 216)

- 1½" particleboard with laminate on both surfaces.
- 2MM edge band on all edges.
- End panels are used to create run-off set-ups.
- 14", 24", 30", and 36" depths. Actual depths are 13¾", 23¾", 29¾", and 35¾"D.
- RH and LH options used separately. Model supports one side of a worksurface, not both unless using a full height modesty.
- 14"D end panels can only be used with 24"D primary worksurfaces.
- 24"D, 30"D and 36" end panels require primary worksurface depths to match the end panel.
- Maximum worksurface length is 48" with 14" end panel, and 72" with 24", 30" and 36" end panels.
- Attaches to worksurface with cam/pin/dowel mechanical fastener, providing strength and stability to desking application.
- Must order same hand modesty panel to tie into support and worksurface.

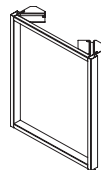
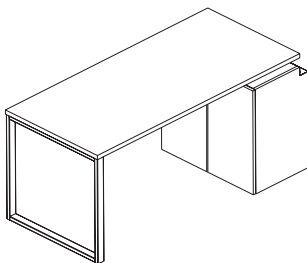

**O-legs** (page 214)

- 28¾"H x 24"D or 30"D.
- 1" x 2" steel tube construction welded to mounting brackets.
- Leveling glides with 2" of adjustability.
- Actual Depth is 23¾" and 29¾".
- Mounting plate width is 6", visual width is 2".

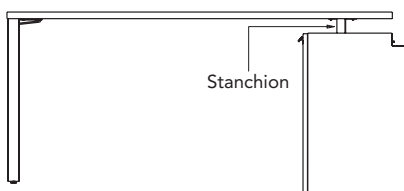

**Stanchions** (page 215)

- 12" and 18"D in two heights:
  - 24"D worksurface uses 12"D stanchion.
  - 30"D worksurface uses 18"D stanchion.
  - 36"D worksurface uses 2–12"D stanchions.
  - 4"H — credenza to primary worksurface
  - 3"H — credenza with top to primary worksurface
- Formed sheet metal construction, P02 Flint only.
- Attaches to upper worksurface with screws and industrial VHB tape to lower worksurface/credenza. See illustration at left. Stanchion is centered on credenza and when paired with a blade foot gives a floating aesthetic.



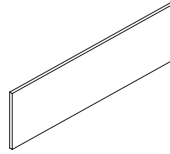

**Modesty Panels** (page 216)

- Horizontal Grain Direction:
  - 14"H x 30", 36", 42", 48", 54", 60", 66", and 72"W.
  - 28"H x 48", 54", 60", 66", 72"W.
  - 14"H Modular, RH modesty panel and LH modesty panel version for laminate end panel, non-handed 14"H modesties used in all other applications.
  - 14"H Modular mounts to worksurface stiffener with worksurface.
  - RH and LH modesty panels must attach to RH or LH laminate end panel. Specify same hand as end panel.
  - 28"H Modular, non-handed modesty panel version for laminate left and right end panel.

**Splay Legs**

**Wood Splay Legs** (page 214)

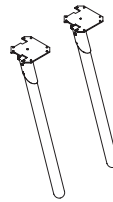

- Includes pair of legs (non-handed, mounted to top plate) and attaching hardware.
- Available in oak and walnut toned wood.
- Natural wood has variance between color and wood grain which is not the same visual as woodgrain laminate. Allsteel does not guarantee the exact matching of grain, pattern or color.
- Shroud available in standard paint selection.
- Used to support one corner of a worksurface or table.
- Standard worksurface support height
- Height adjustable legs provide a 1 7/8" range of adjustment.
- Splay legs are for use on worksurface spans up to 72"W.
- Height adjustable leveling feature requires common tools to adjust height.
- Optional push-pin glide and felt pad included in hardware pack.

**Metal Splay Legs** (page 214)

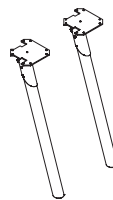

- Includes pair of legs (non-handed, mounted to top plate) and attaching hardware.
- Standard paint finish options include leg and shroud.
- Used to support one corner of a worksurface or table.
- Standard worksurface support height.
- Height adjustable legs provide a 1 7/8" range of adjustment.
- Splay legs are for use on worksurface spans up to 72"W.
- Height adjustable leveling feature requires common tools to adjust height.
- Floor protection provides 1/2" of additional adjustment.
- Approved for runoff or freestanding applications up to 72"W.

**Freestanding Laterals** (page 208)

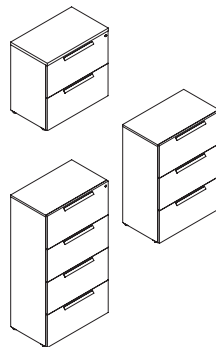

- Laminate finish options include chassis and front.
- Ships assembled except for pulls.
- No footed option available.
- Outside overall dimensions:
  - Heights: 2H = 29 1/2"H, 3H = 42 1/4"H, 4H = 56 1/8"H
  - Widths and Depths: 30"W and 36"W; 18"D and 24"D with the exception of 2H which is 18 3/8"D and 24 1/8"D.
- 2H has 1 1/8" top built-in to case construction. Cannot be used under a spanning top workwall of 28"H units.
- All units include interlock drawers.
- Inner drawer dimensions and filing configurations are the same as credenzas. See page 160.
- Full extension file drawers: 13 1/4"D on 18"D, and 17 1/4"D on 24"D models.
- Drawer unit ships with hangrail to accommodate side-to-side filing.

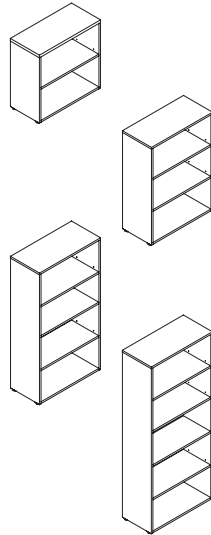

**Freestanding Bookcase** (page 209)

- Laminate finish options include chassis.
- Outside overall dimensions:
  - Width is nominal to dimension (i.e. 30"W = 30") with the exception of 2H which is 30.04"W
  - Heights: 2H = 29½"H, 3H = 42¼"H, 4H = 56⅝"H, 5H = 71⅝"H.
  - Depth: 15"D = 14¼"D actual.
- Shelves:
  - 2H – 1 adjustable shelf
  - 3H – 2 adjustable shelves
  - 4H – 2 adjustable, 1 fixed shelf at worksurface height
  - 5H – 3 adjustable, 1 fixed shelf at worksurface height
  - Internal shelves are ¾" laminate and adjustable to three levels.
- 2H bookcase has built-in 1⅝" top. Cannot be used under a spanning top workwall of 28"H units.
- 1½" adjustable glides
- Pin-and-cam fasteners visible from the front are covered with cam covers.
- No footed option available for bookcases.

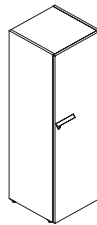

**All Towers** (page 226)

- Laminate finish options include chassis and front.
- Ships assembled except for pulls and side access towers which are assembled in field.
- 1½" adjustable glides on all except Open Access which have ½" adjustment.
- Footed and Non Footed Options Available.
  - Tower/Wardrobe models ending in HDL/H-HDL/CFL are available without feet only.
- 24"D x 24"W and 24"D x 30"W non-footed wardrobes and towers can be freestanding. Pullout towers can also be freestanding. All other wardrobes and towers are not for use in freestanding applications and must be ganged to adjoining units. All footed wardrobes and towers must be ganged to adjoining units.
  - Use included attachment hardware pack to attach through adjoining end panels utilizing the pilot holes underneath bottom-most shelf of wardrobe tower.
  - See instruction manual for installation steps.

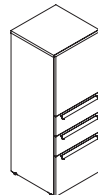

Left

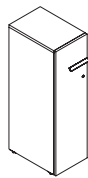

Left

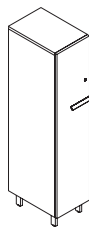

Left

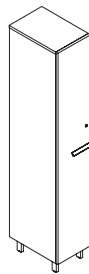

Left

- Hinged door
  - Sizes Available:
    - Heights – 42½", 50", 57½", 65½", 72"
    - Widths – 12", 18" & 24"
    - Depths – 18" & 24"
  - 18"D Towers have 2 coat hooks in unit
  - 24"D Towers have a coat rod in unit, except models ending in HDL
  - 12" & 18" Wide have RH and LH configurations
  - 12" & 18" Wide towers have single door, 24" Wide has two doors non-handed
  - Shelving:
    - 42½" & 50" – 1 adjustable, 1 fixed
    - 57½" – 2 adjustable, 1 fixed
    - 65" & 72" – 3 adjustable, 1 fixed
  - Refer to page 152 for interior dimensions.

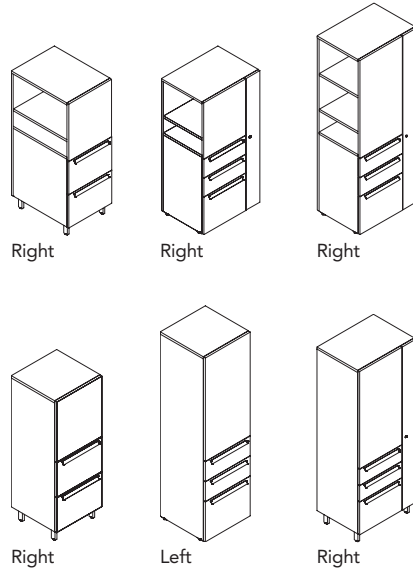

**Towers—continued (page 226)**

- Personal Combination and Side Access
  - Sizes:
    - Heights – 50", 57½", 65½", 72"
    - Widths – 18", 24"
    - Depths – 18", 24"
  - Personal combination and side access towers 24"W coat hanging options under fixed shelf are two coat hooks in 18"D models and a coat rod in 24"D units for hangers.
  - Available in right-hand and left-hand configurations
  - Push latch wardrobe door on 18 and 24 wide combo and side access units
  - Side access opening is at 29½" to line up with worksurface
  - 2 adjustable shelves behind hinged door
  - Shelving behind hinged door or in open cavity:
    - 50" & 57½" – 1 Shelf
    - 65½" & 72" – 2 shelves
  - Refer to pages 153-154 for interior dimensions.
  - Combo Towers have hinged door on front of unit
  - Side Access Towers have open shelving on side of unit
  - File drawer interior dimensions and filing are the same as 18"W ped
  - Box/Box/File and File/File configurations available
  - 30"W Combo tower has File/File configuration only with pulls on all doors and drawers
  - Interior Dimensions for Box/Box/File and File/File are the same as 18"W Ped
- 30"W Wardrobe
  - 5H only
  - Depth: 24"D.
  - Shelves:
    - 3 adjustable, 1 fixed
  - Refer to page 152 for interior dimensions.



**Cubby Storage (page 222)**

- 7"H x 14"D x 18", 24", or 30"W.
- Installs under a worksurface, hardware included.
- Ships flat for field assembly.

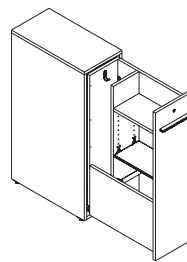

RH

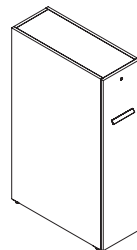

**Pullout Towers (page 217)**

- Tower ships fully assembled.
- Laminate finish options include chassis, front, and drawer.
  - Drawer finish options limited to Loft, Flint, and Designer White
- Sizes Available:
  - Heights – 42½", 50"
  - Widths – 12"
  - Depths – 24", 30"
- LH & RH configurations available.
- Tower Drawer contains two coat hooks.
- Shelving (See page 155 for specifications):
  - 42½"H – 1 adjustable & 1 fixed shelf
  - Adjustable shelf has 2½" height adjustment
  - 50"H – 2 adjustable & 1 fixed shelf
  - Bottom adjustable shelf has 4⅞" adjustment
  - Top adjustable shelf has 2½" adjustment
- Tower Drawer contains file capabilities (See page 151 for specifications).
- Case height contains 1½" adjustable glides.
- Tower Drawer contains 1½" adjustable caster.

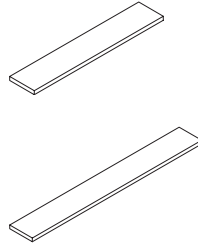

**Floating Shelf** (page 228)

- 30"-78" Widths available.
- Shelf is 8" in depth.
- Brackets ship with shelf.
- Maximum 10 lbs. per linear foot load capacity. Shelf can be mounted to any surface. Hardware to mount shelf not included and specified by contractor.

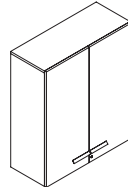

**Stack-On Storage** (pages 228-230)

- Ships assembled except for pulls.
- Outside overall dimensions:
  - Width is nominal to dimension (i.e. 18"W = 18")
  - Heights: 4H = 29 $\frac{1}{8}$ ", 5H = 42 $\frac{1}{8}$ "
  - Depths: 15"D = 15" from drawer front to rear edge of end panel. Open shelf units subtract  $\frac{3}{4}$ " for front thickness.
- Laminate finish options include chassis and front on hinged door units and chassis on open and side access units.
- Shelves:
  - 4H = 1 adjustable
  - 5H = 2 adjustable
- Pin-and-cam fasteners visible from the front are covered with cam covers
- 18"W hinged door available in right- and left-hand configurations.
- Side access available in right- and left-hand configurations.
- Writable front models available.
- Units must be placed on top of 1 $\frac{1}{4}$ " thick worksurface and are attached with industrial VHB tape.

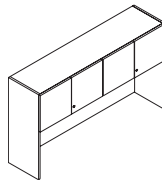
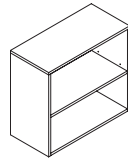

**Hutches** (page 230)

- Sizes:
  - Height - 35"
  - Width - 48", 60", 66", 72", 78"
  - Depth - 14"
- Fully enclosed back; includes a 1 $\frac{1}{4}$ ", full width pass-through for 3-prong electrical plugs; facilitates routing cords and reaching wall electrical outlets.
- Lower back panel can be attached with cord pass-through at bottom next to the worksurface or at top for close proximity to task light cord.
- Lower back panel can be removed to facilitate collaboration in teaming configurations.
- Valance hides task light.
- Vertical clearance for computer monitor is 20".
- Available with laminate or frosted glass/silver doors.
- Units are equipped with self-closing, adjustable hinges.
- Laminate hinged door units are available with or without a lock.
- For tackboards, see page 230.
- For task lights, see page 321.
- Units attach to worksurface using double sided tape.

**Overheads** (page 227)

- Ship fully assembled.
- Laminate finish options include chassis and front.
- Wall mounted - standard - ships with hardware for unit connection to bracket. Hardware for bracket connection to wall is not included.
- Outside overall dimensions:
  - Widths: 30"W = 29 $\frac{7}{8}$ ", 36"W = 35 $\frac{7}{8}$ ", 60"W = 59 $\frac{7}{8}$ ", 72"W = 71 $\frac{7}{8}$ ".
  - Heights: 15"H = 15 $\frac{1}{8}$ "
  - Depths: 15"H = 15 $\frac{1}{8}$ " open case depth; 15 $\frac{1}{8}$ " for overheads with doors.
- Pin-and-cam fasteners visible from the front are covered with cam covers

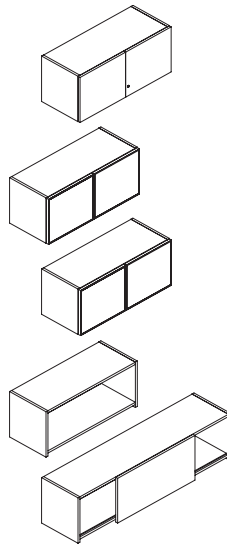

- Hinged door — laminate
  - 30"W, 36"W and 42"W (2 doors, 1 lock)
  - 48"W (3 doors, 1 lock)
  - 60"W, 66"W, 72"W and 78"W (4 doors, 2 locks)
  - Locking — standard, omit, and non-locking options.
- Writable front hinged doors
  - 30"W and 36"W (2 doors)
  - 60"W and 72"W (4 doors)
  - Non-locking
- Hinged door with frosted glass
  - 30"W, 36"W and 42"W (2 doors)
  - 48"W (3 doors)
  - 60"W, 66"W, 72"W and 78"W (4 doors)
  - Non-locking
- Open
  - 30"W and 36"W
- Sliding door — one half-width laminate door
  - 48"W, 60"W, 66"W, 72"W, and 78"W cabinets.
  - Locking on left side only.
- Specify low profile LED task lights to mount beneath laminate overhead cabinets. See pages [318-321](#).



**Overhead Mounting Kit for Beyond Walls** (page [227](#))

- Able to mount Approach overheads onto beyond frame wall.
- Need to order beyond slotted standard bracket, model **BFSFHB.L**.
- Able to mount off-modular, maximum 6" total for 30"–48"W units, and 12" total for 60"–78"W overheads.
- WKOHBW30AK includes 2 brackets.
- WKOHBW60AK includes 3 brackets. Required for 78" overheads and any setup that spans 2 or more glass sections.

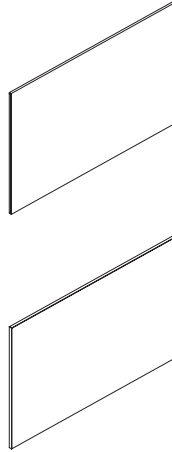

**Tackboards and Writable Boards** (pages 231-232)

- Available in upholstered tackboards and writable surface boards.
- Available to match 4H and 5H storage heights at layered and full height applications.
- Available 30"W - 96"W at 6" increments.
- Models greater than 60"W consist of multiple segments.
- If 4H tower unit is specified then use 4H board. Select height based on layered or full height credenza. See illustration at bottom.
- If 5H tower unit is specified then use 5H board. Select height based on layered or full height credenza. See illustration at bottom.
- If 5H tower unit is specified with an overhead unit then use 4H board. Select height based on layered or full height credenza. See illustration at bottom.
- Units are wall mounted using 'Z-Mounting' bracket.
- Tackboards and writable surface boards are not meant to be used with finished back credenza kits.
- Tackboards and writable board heights are in alignment with Trough heights.
- Troughless units are for open plan/workstations and will need tackboard to raise 3" or set behind credenza. Or contact tailored products group.

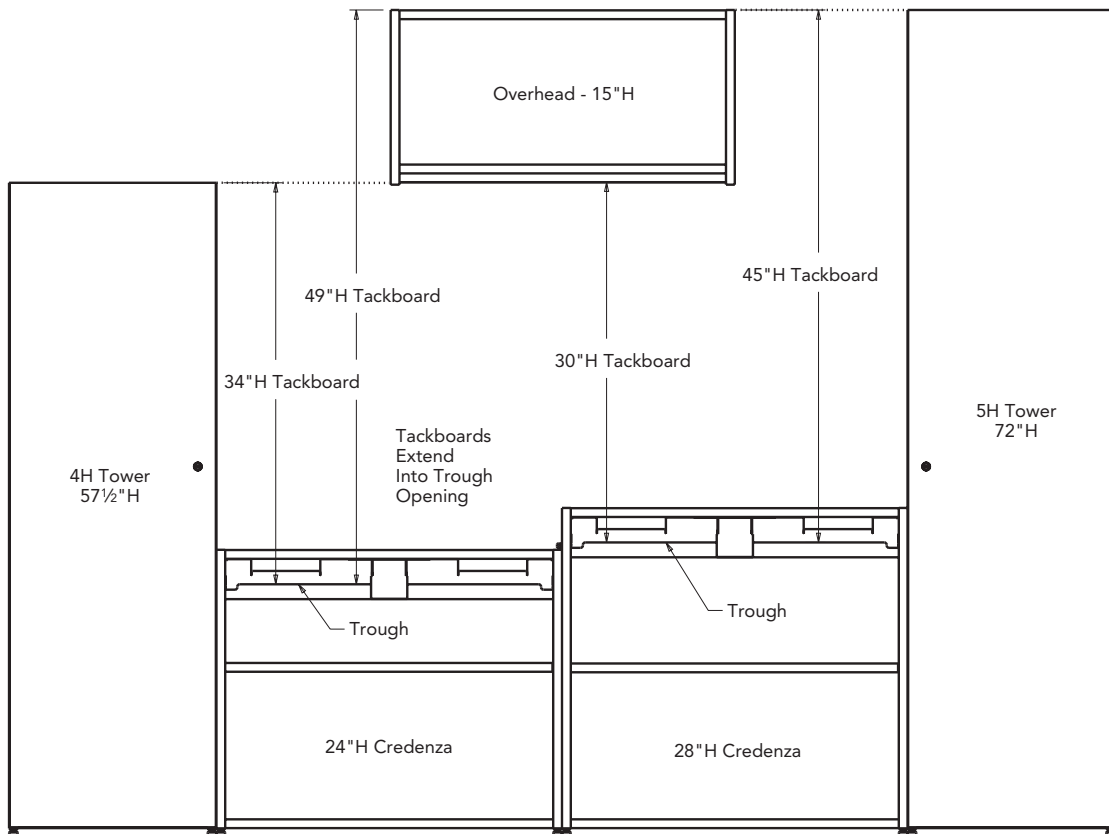

APPROACH

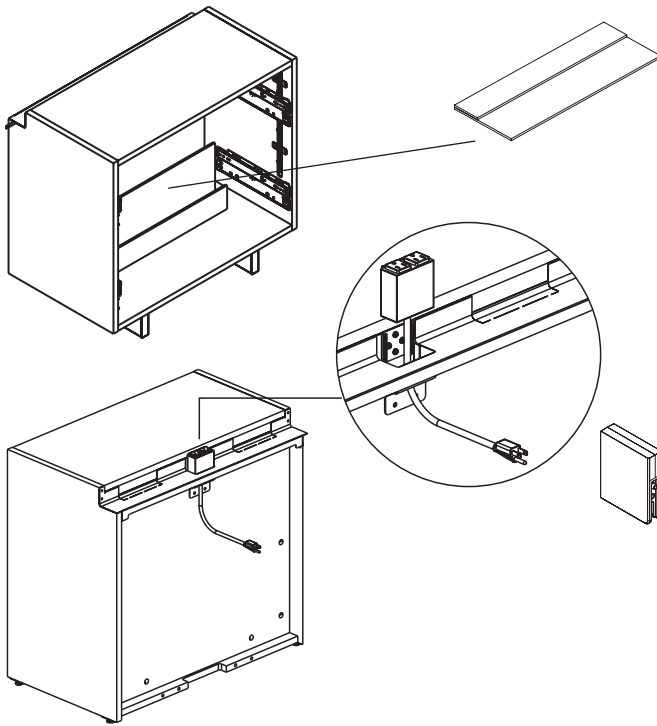

**Counterweight Kits (page 233)**

- Counterweight is attached to the back of a pedestal or credenza to inhibit tipping. See illustration at left.
- Kits must be ordered separately (see pages 168-169) based on type and depth of unit and are field-installed.
- Units that may require counterweight kits, depending on how they are configured, are flagged with a pound sign # after the model number listing on pages 194 and 202.

**Mini-tap Power (page 233)**

- Installs into back bracket of unit on 18"D models. See illustration at left. Includes 6' black power cord.
- Units available as 2 Power or 1 Power/1 USB.
- Requires additional mounting bracket WKMTMB (ordered separately) on 24"D models and wall access panels.
- 12"W, 18"W, 24"W, 30"W, and 36"W units have 1 knockout; 42"W, 48"W, 60"W, and 72"W units have 2 knockouts for mini-tap power modules.

**End Cap (page 233)**

- Used to finish trough at end of run.
  - Branded with Allsteel Logo.
  - Available in Black, Designer White, and Silver.
  - Specify Full Height or Enclosed Height end caps based on top specified.
  - **Credenza Top is required.**
  - For Open Trough Tops specify Full Height End Caps.
  - For Closed Trough Tops specify enclosed Shortened Height End Caps.
- \*Note: Top will cover top of end cap.

**Wire Manager for Height-Adjustable Trough (page 233)**

- 30"W, Flint only.
- Installs onto height-adjustable laminate shroud. See below.
- Spans two credenzas on either end of height-adjustable desk.
- Height-adjustable table must be perpendicular to wall.

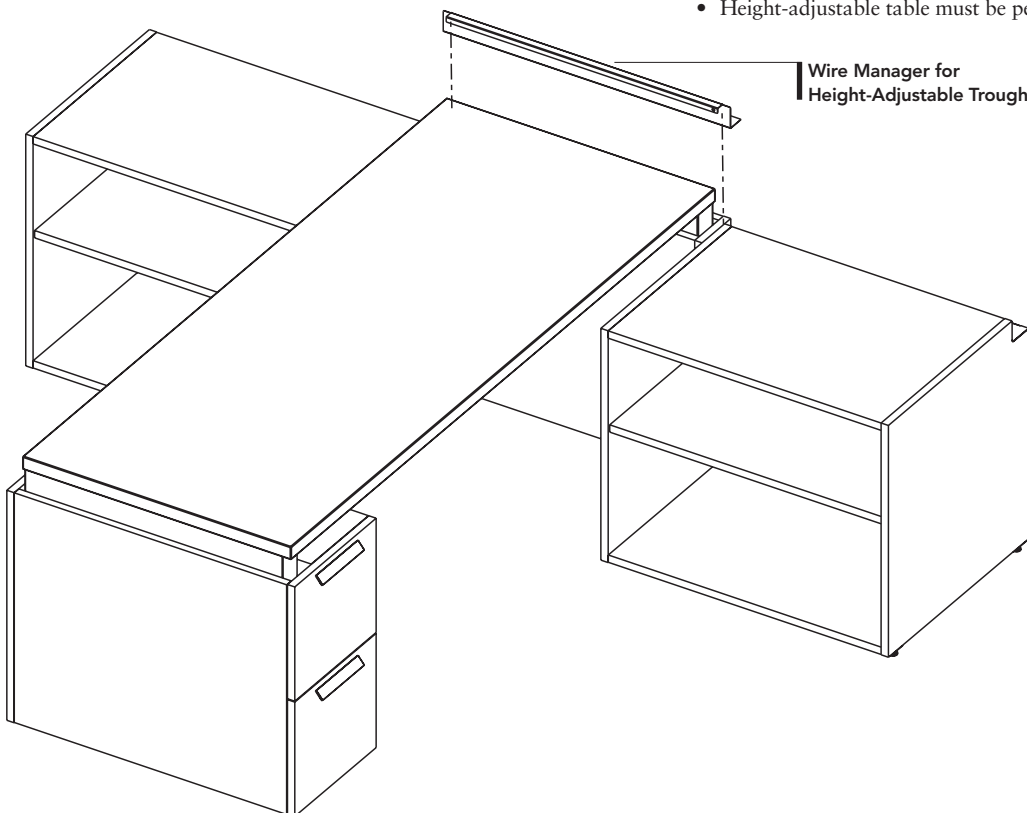

Altitude height-adjustable bases are available in two styles for Approach:

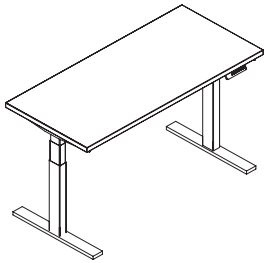

A6 T & C Electric Base  
with Rectangular Worksurface

Compatible with Credenza  
for Integrated leg new shroud  
models available April 2021

### Clearance Dimensions

Rectangle

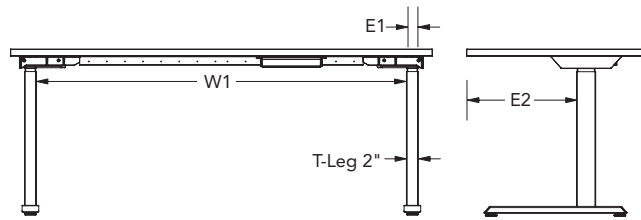

Bottom Views

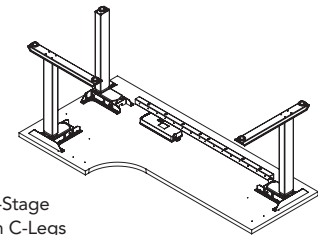
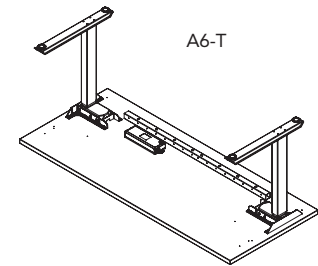

Base Style:	A6 T Base			A5 2-Stage C-Leg Base				
	Dimension Location:	E1	W	E2	E1	W1	W2	E2
<b>Altitude Top:</b> (Surface dimensions are nominal. Actual widths are reduced by 2")	Edge of table to outside of leg	Between legs	Edge of table to the outside of leg	Edge of table to outside of leg	Between legs	Between legs	Edge of table to the outside of leg	
24" x 48" Rectangle*	—	—	—	2"	38"	—	12 <sup>7</sup> / <sub>8</sub> "	
24" x 54" Rectangle	2 <sup>1</sup> / <sub>2</sub> "	41 <sup>1</sup> / <sub>4</sub> "	10 <sup>3</sup> / <sub>8</sub> "	2"	44"	—	12 <sup>7</sup> / <sub>8</sub> "	
24" x 60" Rectangle	2 <sup>1</sup> / <sub>2</sub> "	47 <sup>1</sup> / <sub>4</sub> "	10 <sup>3</sup> / <sub>8</sub> "	2"	50"	—	12 <sup>7</sup> / <sub>8</sub> "	
24" x 66" Rectangle	2 <sup>1</sup> / <sub>2</sub> "	53 <sup>1</sup> / <sub>4</sub> "	10 <sup>3</sup> / <sub>8</sub> "	2"	56"	—	12 <sup>7</sup> / <sub>8</sub> "	
24" x 72" Rectangle	2 <sup>1</sup> / <sub>2</sub> "	59 <sup>1</sup> / <sub>4</sub> "	10 <sup>3</sup> / <sub>8</sub> "	2"	62"	—	12 <sup>7</sup> / <sub>8</sub> "	
30" x 48" Rectangle	—	—	—	2"	38"	—	17 <sup>7</sup> / <sub>8</sub> "	
30" x 54" Rectangle	2 <sup>1</sup> / <sub>2</sub> "	41 <sup>1</sup> / <sub>4</sub> "	13 <sup>3</sup> / <sub>8</sub> "	2"	44"	—	17 <sup>7</sup> / <sub>8</sub> "	
30" x 60" Rectangle	2 <sup>1</sup> / <sub>2</sub> "	47 <sup>1</sup> / <sub>4</sub> "	13 <sup>3</sup> / <sub>8</sub> "	2"	50"	—	17 <sup>7</sup> / <sub>8</sub> "	
30" x 66" Rectangle	2 <sup>1</sup> / <sub>2</sub> "	53 <sup>1</sup> / <sub>4</sub> "	13 <sup>3</sup> / <sub>8</sub> "	2"	56"	—	17 <sup>7</sup> / <sub>8</sub> "	
30" x 72" Rectangle	2 <sup>1</sup> / <sub>2</sub> "	59 <sup>1</sup> / <sub>4</sub> "	13 <sup>3</sup> / <sub>8</sub> "	2"	62"	—	17 <sup>7</sup> / <sub>8</sub> "	

APPROACH



Height-Adjustable Worksurfaces, Bases, and Controls

Height-Adjustable Worksurfaces (page 234)

- Height-adjustable worksurfaces are available in laminate with flat edge and rectangular veneer with matching square edge.
- Worksurface dimensions are nominal. Actual widths are reduced by 2" (1" each side). Corner cove depth is nominal, actual is 1" less.
- Altitude worksurfaces are pre-drilled with mounting location for bases.
- Any open span 60" and greater requires an external support channel. Altitude 66"-72"W rectangular worksurfaces include an external support channel.
- Rectangular worksurface grommet location is limited to center location due to mounting of worksurface supports at each end of the worksurface.
- C-Leg load capacity is 300 pounds for 2-leg model including weight of worksurface. A3-T load capacity is 250 pounds for 2-leg model including weight of worksurface.

Height-Adjustable Bases (page 235)

- Electric height-adjustable base units are available in two styles for Approach: A6 with T-Leg or A6 with C-Leg.
- A6 models are available in Black, Brownstone, Cinder, Designer White, Flint, Fossil, Loft, Muslin, Nickel, Parchment, Pebble, Pewter, Salt, Titanium, Champagne Metallic, Gunmetal Metallic, Night Bronze, Platinum Metallic, and Silver.
- A6 models travel at 1.2" per second. Motor devices have a continuous cycle time of 2 minutes with an 18 minute rest period before it can be cycled again.
- Control box is powered by 110-120V/60Hz/4A. Standby power is <0.1 Watts. Power cords on A6-T models are 10'.
- Pedestals taller than 24½" for 2-stage models and 19½" for 3-stage models when placed under table will limit range in lower position.
- Mobile box/file pedestals will clear feet on height adjustable base but will extend past edge of worksurface in that position. See chart on page 151.
- Moving worksurfaces can collide with other components. It is important to ensure free range of motion prior to operating the table.
- All tables have adjustable glides providing ½" adjustment on A6.
- Altitude A6 tables feature anti-collision, a feature designed to stop table travel when the table detects an obstacle.
- Altitude A6 bases specified with a worksurface 60"W and greater require the use of an external stiffener. An external stiffener is included in Altitude worksurface models 60"W and greater. If a non-Altitude worksurface is being used, an external stiffener may need to be specified separately.
- A6 2-stage models (2-leg and 3-leg) can be used with shrouds.

Shrouds (page 235)

- A6 2-stage models (2-leg and 3-leg) can be used with shrouds.
- A6 3-stage standard and Max bases cannot be used with shrouds. The shrouds interfere with the reset of the base as it is not able to reach its lowest setting.

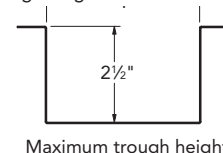
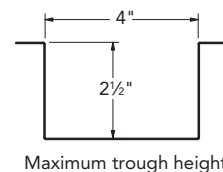
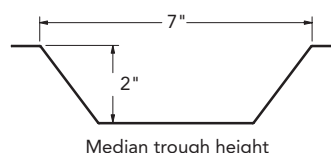
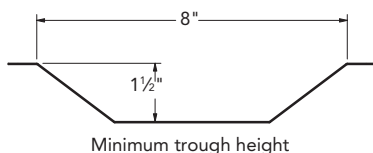

Cable & Wire Management

Cable Management Tray (page 234)

- Attaches under the worksurface to contain cables.
- Metal tray shelf is 4" deep. Can hold electrical power strip and/or surge protector.
- 24" and 36" lengths, use multiple units for larger worksurfaces.
- Attachment hardware included, paint option is black only.
- Zip tie attachment points located in base of tray. Zip ties not included.

Wire Management Channel (page 234)

- Self adhesive backing to attach to panels and underside of worksurfaces.
- Flexible strips allow cabling to enter/exit and can be contained inside the 2-cavity profile.
- Each cavity provides space for a maximum of six .22" dia. cables. Total capacity = 1 sq. in.

Cord Management Chain (page 234)

- Works with Approach and Altitude A3 and A5-Series product.
- Used to route and conceal power/data cables from control box and other devices. Includes all mounting hardware and a plate to secure to a leveling glide.
- Houses 6 cables @ 0.300" diameter.
- Made of plastic chain with plastic attachment brackets at each end. Only comes in Black finish.

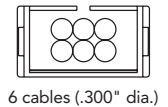

Under Worksurface Trough (page 234)

- Used to conceal wires and control box below worksurfaces. Trough can be configured at various height/width combinations to meet capacity needs — see illustrations below.
- On 48"W and 54"W worksurfaces use one 17"W trough. 54"W has space to use 2 – 17"W, if necessary.
- On 60"W, 66"W, and 72"W worksurfaces use the 36" trough.
- On 84"W worksurface use 2 – 17"W troughs.

Cross-sectional Area Inside Under Worksurface Troughs

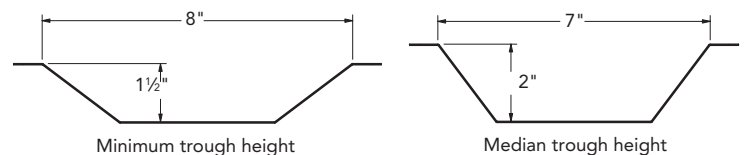



For specification information see pages 170-175.

GSA SIN 33721

Description	Model	Locks	L1 Laminate List Price	UPCHARGES*		
				Top	L2 Laminate Chassis	Front
<b>Desk w/Height-Adjustable Top (27¼"– 47½"H) and File/File Storage Left</b>						
72"W x 36"D	WKDAFNJ297236LH-FF	1	\$ 9208	\$ 184	\$ 94	\$ 45
72"W x 30"D (shown)	WKDAFNJ297230LH-FF	1	\$ 8939	\$ 181	\$ 94	\$ 45
66"W x 30"D	WKDAFNJ296630LH-FF	1	\$ 8877	\$ 180	\$ 94	\$ 45
*Half height modesty option only						
<b>Desk w/Height-Adjustable Top (27¼"– 47½"H) and File/File Storage Right</b>						
72"W x 36"D	WKDAFNJ297236RH-FF	1	\$ 9208	\$ 184	\$ 94	\$ 45
72"W x 30"D (shown)	WKDAFNJ297230RH-FF	1	\$ 8939	\$ 181	\$ 94	\$ 45
66"W x 30"D	WKDAFNJ296630RH-FF	1	\$ 8877	\$ 180	\$ 94	\$ 45
*Half height modesty option only						
<b>Desk w/Height-Adjustable Shrouds (27¼"– 47½"H) and No Modesty Panel</b>						
72"W x 36"D	WKDAFNJ297236	—	\$ 6845	\$ 184	\$ 55	N/A
72"W x 30"D (shown)	WKDAFNJ297230	—	\$ 6576	\$ 181	\$ 55	N/A
66"W x 30"D	WKDAFNJ296630	—	\$ 6514	\$ 180	\$ 55	N/A
*Half height modesty option within model or modular 24"H modesty see page 216						
<b>Wall Bridge w/Height-Adjustable Shrouds (27¼"– 47½"H) and Full-Height Modesty Panel Only</b>						
72"W x 24"D	WKDAFNJ297224	—	\$ 6770	\$ 96	\$ 57	N/A
66"W x 24"D	WKDAFNJ296624	—	\$ 6687	\$ 96	\$ 56	N/A
60"W x 24"D (shown)	WKDAFNJ296024	—	\$ 6584	\$ 94	\$ 55	N/A
54"W x 24"D	WKDAFNJ295424	—	\$ 6480	\$ 93	\$ 54	N/A
48"W x 24"D	WKDAFNJ294824	—	\$ 6400	\$ 92	\$ 53	N/A

\*Nominal depth of shroud is 22" and worksurface is 21" deep

\*Bridge models are for wall facing applications.

\*Upcharges are added to L1 Laminate List Price depending on woodgrain laminate selection.

\*New anti collision control on new models

How to specify — Select the Model Number from above.	1st Option: FSC Certified Wood: F FSC Certified X No FSC	2nd Option: Top Laminate and Predefined Edge (if applicable): See page 161 for finishes.	3rd Option: Chassis Laminate and Predefined Edge: See page 161 for finishes.	4th Option: Front Laminate and Predefined Edge (if applicable):	5th Option: Pull Type (if applicable): MP Beam OP Halo AP Arch BP Bar SP Square See matrix on page 19.
WKDAFNJ29					

<b>5th Option (continued):</b> <b>Pull Color (if applicable):</b> MP Beam / OP Halo PJW Designer White PR6 Silver PJE Pyrite P8X Solar Black AP Arch PRO Anodized Silver P2 upcharge +\$17/pull BP Bar P27 Black PJW Designer White PR6 Silver SP Square PJW Designer White EL Matte Silver P02 Flint P7B Loft PJE Pyrite P8X Solar Black P2 upcharge +\$17/pull	<b>6th Option:</b> <b>Grommet Location (if applicable):</b> See page 174. B Both Left and Right C Centered L Left R Right X No Grommet	<b>7th Option:</b> <b>Grommet Type (if applicable):</b> P Oval Plastic (will match edge trim) M Oval Metal (Add \$12 per grommet) S Square Metal (Add \$12 per grommet) <b>Grommet Color (Metal only) (if applicable):</b> EL Matte Silver	<b>8th Option:</b> <b>Metal Sleeve Paint (if applicable):</b> P1 P2 P3 See page 161 for finishes. P2 \$16/shroud P3 \$38/shroud	<b>9th Option:</b> <b>Height Adjustable Base (if applicable):</b> PR6	<b>10th Option:</b> <b>Height Adjustable Base Keypad (if applicable):</b> UD Basic Up/Down MEM Memory Preset PDL Paddle	<b>11th Option:</b> <b>Lock (if applicable):</b> STD Standard OMT Omit Lock Core (Deduct \$20 per lock)

Example: WKDAFNJ297236RH-FF.X.LM14EW.LSW1SW.OPP8X.STD



For specification information see pages 170-175.

GSA SIN 33721

Description	Model Add "L" for Left-hand model Add "R" for Right-hand model	Locks	L1 Laminate List Price	UPCHARGES*		
				Top	L2 Laminate Chassis	Front
<b>29½"H Desk with 15"W Box/Box/File Pedestal</b>						
30"D x 60"W Right Hand Ped Desk BBF (shown)	WKUP296030RH-BBF	1	\$ 3789	\$ 42	\$ 55	\$ 42
30"D x 60"W Left Hand Ped Desk BBF	WKUP296030LH-BBF	1	\$ 3789	\$ 42	\$ 55	\$ 42
30"D x 66"W Right Hand Ped Desk BBF	WKUP296630RH-BBF	1	\$ 3899	\$ 43	\$ 57	\$ 43
30"D x 66"W Left Hand Ped Desk BBF	WKUP296630LH-BBF	1	\$ 3899	\$ 43	\$ 57	\$ 43
30"D x 72"W Right Hand Ped Desk BBF	WKUP297230RH-BBF	1	\$ 4010	\$ 44	\$ 58	\$ 44
30"D x 72"W Left Hand Ped Desk BBF	WKUP297230LH-BBF	1	\$ 4010	\$ 44	\$ 58	\$ 44
<b>29½"H Desk with 15"W File/File Pedestal</b>						
30"D x 60"W Right Hand Ped Desk FF (shown)	WKUP296030RH-FF	1	\$ 3637	\$ 40	\$ 53	\$ 40
30"D x 60"W Left Hand Ped Desk FF	WKUP296030LH-FF	1	\$ 3637	\$ 40	\$ 53	\$ 40
30"D x 66"W Right Hand Ped Desk FF	WKUP296630RH-FF	1	\$ 3747	\$ 41	\$ 55	\$ 41
30"D x 66"W Left Hand Ped Desk FF	WKUP296630LH-FF	1	\$ 3747	\$ 41	\$ 55	\$ 41
30"D x 72"W Right Hand Ped Desk FF	WKUP297230RH-FF	1	\$ 3857	\$ 42	\$ 56	\$ 42
30"D x 72"W Left Hand Ped Desk FF	WKUP297230LH-FF	1	\$ 3857	\$ 42	\$ 56	\$ 42
<b>Double Ped Desk 29½"H — Box/Box/File Left and File/File Right with Full Height Modesty Panel</b>						
72"W x 36"D	WKDUFN297236-BBFFF	2	\$ 4910	\$ 51	\$ 68	\$ 51
<b>Single Ped Desk 29½"H — Box/Box/File with Full- or 14"H Half-Height Modesty Panel</b>						
72"W x 36"D	WKDUFN297236 □ H-BBF	1	\$ 4248	\$ 45	\$ 58	\$ 45
72"W x 30"D (shown)	WKDUFN297230 □ H-BBF	1	\$ 3979	\$ 42	\$ 55	\$ 42
66"W x 30"D	WKDUFN296630 □ H-BBF	1	\$ 3921	\$ 42	\$ 54	\$ 42
60"W x 30"D	WKDUFN296030 □ H-BBF	1	\$ 3853	\$ 41	\$ 54	\$ 41
Example of left-hand model shown: WKDUFN297230LH-BBF						
<b>Runoff 29½"H — Box/Box/File Pedestal with 14"H Half-Height Modesty Panel</b>						
72"W x 30"D	WKDRFN297230 □ H-BBF	1	\$ 3521	\$ 38	\$ 50	\$ 38
66"W x 30"D	WKDRFN296630 □ H-BBF	1	\$ 3407	\$ 36	\$ 47	\$ 36
60"W x 30"D (shown)	WKDRFN296030 □ H-BBF	1	\$ 3309	\$ 35	\$ 46	\$ 35
54"W x 30"D	WKDRFN295430 □ H-BBF	1	\$ 3193	\$ 34	\$ 45	\$ 34
48"W x 30"D	WKDRFN294830 □ H-BBF	1	\$ 3083	\$ 33	\$ 43	\$ 33
Example of left-hand model shown: WKDRFN296030LH-BBF						

<b>How to specify —</b> Select the Model Number from above.  WK                 .	<b>1st Option:</b> FSC Certified Wood: F FSC Certified X No FSC	<b>2nd Option:</b> Top Laminate and Predefined Edge (if applicable): See page 161 for finishes.	<b>3rd Option:</b> Chassis Laminate and Predefined Edge: See page 161 for finishes.	<b>4th Option:</b> Front Laminate and Predefined Edge:	<b>5th Option:</b> Pull Type (if applicable): MP Beam      BP Bar OP Halo      SP Square AP Arch See matrix on page 19.
	.	.	.	.	.

<b>6th Option:</b> Pull Color (if applicable): MP Beam / OP Halo PJW Designer White PR6 Silver PJE Pyrite P8X Solar Black AP Arch PRO Anodized Silver P2 upcharge +\$17/pull	<b>BP Bar</b> P27 Black PJW Designer White PR6 Silver SP Square PJW Designer White EL Matte Silver P02 Flint P7B Loft PJE Pyrite P8X Solar Black P2 upcharge +\$17/pull	<b>7th Option:</b> Grommet Location (if applicable): See page 174. B Both Left and Right C Centered L Left R Right X No Grommet	<b>8th Option:</b> Grommet Type (if applicable): P Oval Plastic (will match edge trim) M Oval Metal (Add \$12 per grommet) S Square Metal (Add \$12 per grommet) Grommet Color (Metal only) (if applicable): EL Matte Silver	<b>9th Option:</b> Modesty Panel Height: HM Half FM Full	<b>10th Option:</b> Lock (if applicable): STD Standard OMT Omit Lock Core (Deduct \$20 per lock)
.	.	.	.	.	.

*Example:* WKUP296630RH-BBF.X.LM14EW.LM14EW.LSW1SW.BPPR6.BP.STD

Description	Model	Locks	L1 Laminate List Price	UPCHARGES*	
				L2 Laminate Chassis	Front
<b>21½"H Mobile Pedestal — Box / File</b>					
16"W x 20"D	WKPMFN241620-BF	1	\$ 1939	\$ 47	\$ 22
<b>24"H Support Pedestal — Box / File</b>					
18"W x 18"D	WKPLFN241818-BF	1	\$ 1807	\$ 44	\$ 21
<b>28"H Support Pedestal — Box / Box / File with Trough (No Back Panel)</b>					
18"W x 18"D	WKPSFN281818-BBF #	1	\$ 1965	\$ 48	\$ 22
18"W x 24"D	WKPSFN281824-BBF #	1	\$ 2185	\$ 51	\$ 23
<b>28"H Support Pedestal — File / File with Trough (No Back Panel)</b>					
18"W x 18"D	WKPSFN281818-FF #	1	\$ 1931	\$ 47	\$ 22
18"W x 24"D	WKPSFN281824-FF #	1	\$ 2014	\$ 50	\$ 23
<b>28"H Support Slim Pedestal — Box / Box / File with Back Panel</b>					
9½"W x 24"D	WKPSFN28924-BBF	1	\$ 1729	\$ 41	\$ 19
9½"W x 30"D	WKPSFN28930-BBF	1	\$ 1773	\$ 44	\$ 20
<b>28"H Support Slim Pedestal — File / File with Back Panel</b>					
9½"W x 24"D	WKPSFN28924-FF	1	\$ 1699	\$ 41	\$ 19
9½"W x 30"D	WKPSFN28930-FF	1	\$ 1738	\$ 43	\$ 20
<b>Height-Adjustable* Slim Pedestal &amp; Shroud Kit — File / File</b>					
14¼"W x 30"D Left-hand	WKPSFNJ2830LH-HS	1	\$ 3401	\$ 67	\$ 45
14¼"W x 30"D Right-hand	WKPSFNJ2830RH-HS	1	\$ 3401	\$ 67	\$ 45
*27¼" – 47¾"H. Requires 2-Stage T-Leg Powered Base purchased separately. See page 235.					
*New models are compatible with A6 height adjustable bases					
<b>28"H Support Pedestal — Left Hand Hinged Door with Trough (No Back Panel)</b>					
18"W x 18"D	WKPSFN281818LH-HD	1	\$ 1791	\$ 44	\$ 21
18"W x 24"D	WKPSFN281824LH-HD	1	\$ 1910	\$ 45	\$ 21
<b>28"H Support Pedestal — Right Hand Hinged Door with Trough (No Back Panel)</b>					
18"W x 18"D	WKPSFN281818RH-HD	1	\$ 1791	\$ 44	\$ 21
18"W x 24"D	WKPSFN281824RH-HD	1	\$ 1910	\$ 45	\$ 21

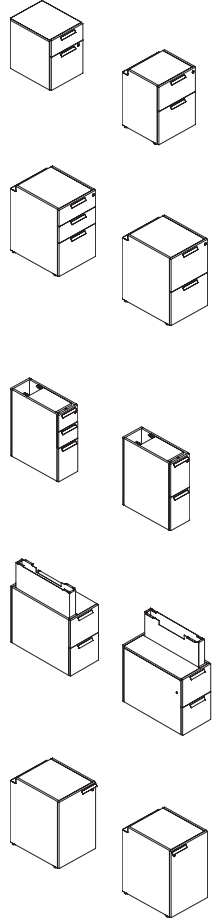

\*Upcharges are added to L1 Laminate List Price depending on woodgrain laminate selection.  
#Unit may require counterweight kits, see pages 168-169.

<b>How to specify —</b> Select the Model Number from above.  <b>WK</b>                     .   .                     .   .		<b>1st Option:</b> <b>FSC Certified Wood:</b> <b>F</b> FSC Certified <b>X</b> No FSC	<b>2nd Option:</b> <b>Chassis Laminate and Predefined Edge:</b> See inside front cover for finishes.	<b>3rd Option:</b> <b>Front Laminate and Predefined Edge:</b>	<b>4th Option:</b> <b>Pull Type</b> (if applicable): <b>MP</b> Beam <b>OP</b> Halo <b>AP</b> Arch <b>BP</b> Bar <b>SP</b> Square See matrix on page 19.	<b>5th Option:</b> <b>Pull Color</b> (if applicable): <b>MP</b> Beam / <b>OP</b> Halo <b>PJW</b> Designer White <b>PR6</b> Silver <b>PJE</b> Pyrite <b>P8X</b> Solar Black <b>AP</b> Arch <b>PRO</b> Anodized Silver P2 upcharge +\$17/pull <b>BP</b> Bar <b>P27</b> Black <b>PJW</b> Designer White <b>PR6</b> Silver <b>SP</b> Square <b>PJW</b> Designer White <b>EL</b> Matte Silver <b>P02</b> Flint <b>P7B</b> Loft <b>PJE</b> Pyrite <b>P8X</b> Solar Black P2 upcharge +\$17/pull	<b>6th Option:</b> <b>Metal Sleeve Paint</b> (if applicable): <b>P1</b> <b>P2</b> <b>P3</b> See page 161 for finishes. <b>P2</b> \$16/shroud <b>P3</b> \$38/shroud	<b>7th Option:</b> <b>Height Adjustable Base</b> (if applicable): <b>PIR6</b> .	<b>8th Option:</b> <b>Height Adjustable Base Keypad</b> (if applicable): <b>UD</b> Basic Up/Down <b>MEM</b> Memory Preset <b>PDL</b> Paddle	<b>9th Option:</b> <b>Lock</b> (if applicable): <b>STD</b> Standard <b>OMT</b> Omit Lock Core (Deduct \$20 per lock)
--	--	---	--	--	---	---	--	--	--	--

Example: WKPMFY241620-BF.F.LM14EW.LSW1SW.APPR6.STD

For specification information see pages 176-179.

First, select Trough (F) or Troughless (T). If trough, add \$100 from listed price.

Next, select Footed (Y) or Non-footed (N). If footed, add \$100 from listed price.

Description	Troughless only Model	Locks	L1 Laminate List Price	UPCHARGES*	
				L2 Laminate Chassis	Front
<b>Support Pedestal 28"H — Box / Box/File without a trough</b>					
15"W x 24"D BBF*	WK □ SP281524-BBF	1	\$ 1526	\$ 22	\$ 17
15"W x 30"D BBF*	WK □ SP281530-BBF	1	\$ 1833	\$ 20	\$ 20
*15W Box drawers compatible with A2280-000 pencil tray.					
<b>Support Pedestal 28"H — File / File without a trough</b>					
15"W x 24"D FF	WK □ SP281524-FF	1	\$ 1374	\$ 16	\$ 16
15"W x 30"D FF	WK □ SP281530-FF	1	\$ 1679	\$ 19	\$ 19
<b>24"H Support Pedestal — Pullout Drawer only troughless</b>					
12"W x 18"D (shown)	WKPLTN241218RH-PD	1	\$ 1970	\$ 51	\$ 22
12"W x 18"D	WKPLTN241218LH-PD	1	\$ 1970	\$ 51	\$ 22
<b>24"H Support Pedestal — Hinged Door</b>					
12"W x 18"D	WKPL □ N241218RH-HD	1	\$ 1487	\$ 39	\$ 17
12"W x 18"D	WKPL □ N241218LH-HD	1	\$ 1487	\$ 39	\$ 17
<b>24"H Support Pedestal — Open Cubby</b>					
12"W x 18"D	WKPL □ N241218-OC	1	\$ 1222	\$ 44	N/A
*Upcharges are added to L1 Laminate List Price depending on woodgrain laminate selection.					

Description	Model	List Price
<b>Box Drawer Accessories</b>		
Pencil Tray (Black only)	A2280-000	\$ 48

<p><b>How to specify —</b> Select the Model Number from above.</p> <p>WK                    </p>	<p><b>1st Option:</b> FSC Certified Wood:</p> <p>F FSC Certified X No FSC</p>	<p><b>2nd Option:</b> Chassis Laminate and Predefined Edge:</p> <p>See inside front cover for finishes.</p>	<p><b>3rd Option:</b> Front Laminate and Predefined Edge:</p>
--	---	---	---

<p><b>4th Option:</b> Pull Type (if applicable):</p> <p>MP Beam OP Halo AP Arch BP Bar SP Square</p> <p>See matrix on page 19.</p>	<p><b>5th Option:</b> Pull Color (if applicable):</p> <p>MP Beam / OP Halo P2 upcharge +\$17/pull</p> <p>PJW Designer White PR6 Silver PJE Pyrite P8X Solar Black</p>	<p><b>6th Option:</b> Foot Type (if applicable):</p> <p>PF Post Foot</p> <p><b>Foot Color (if applicable):</b> PJW Designer White PR6 Silver P02 Flint P7B Loft PJE Pyrite P8X Solar Black</p>	<p><b>7th Option:</b> Lock (if applicable):</p> <p>STD Standard OMT Omit Lock Core (Deduct \$20 per lock)</p>
--	---	--	---

Examples: WKYSP281530-BBF.X.LM14EW.LSW1SW.APPR6.PFPJE.STD

WKPLCDFN241218RH-HD.X.LSW1SW.LSW1SW.MPPJE.STD

For specification information see pages 176-179.

GSA SIN 33721

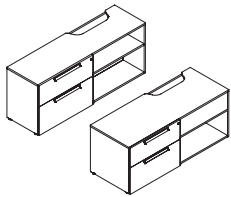

Description	Model	Locks	L1 Laminate List Price	UPCHARGES*		
				Top	L2 Laminate Chassis	Front
<b>24"H Credenza for Integrated HAT Leg Troughless and Non-Footed Available</b>						
60"W x 18"D (shown)	WKHATN246018	1	\$ 5036	\$ 91	\$ 62	\$ 24
60"W x 24"D (shown)	WKHATN246024	1	\$ 5191	\$ 93	\$ 63	\$ 26
72"W x 18"D	WKHATN247218	1	\$ 5237	\$ 94	\$ 64	\$ 26
72"W x 24"D	WKHATN247224	1	\$ 5398	\$ 98	\$ 65	\$ 26

\*Upcharges are added to L1 Laminate List Price depending on woodgrain laminate selection.

\*Compatible with 2-stage T-Leg A6 height adjustable tables. All height adjustable bases are purchased separately.

\*Universal top finished on both sides makes models non-handed.

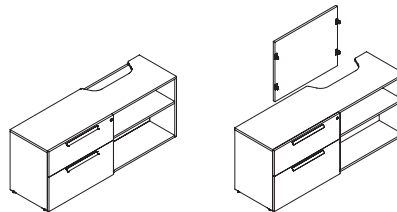
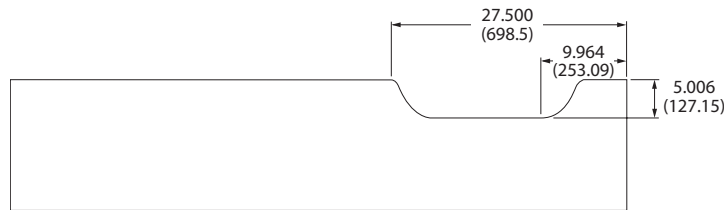

APPROACH

<p><b>How to specify —</b> Select the Model Number from above.</p> <p><b>WKHATN24</b></p> <p>_____ .</p>	<p><b>1st Option:</b> <b>FSC Certified Wood:</b> F FSC Certified X No FSC</p> <p>_____ .</p>	<p><b>2nd Option:</b> <b>Top Laminate and Predefined Edge</b> (if applicable): See page 161 for finishes.</p> <p>_____ .</p>	<p><b>3rd Option:</b> <b>Chassis Laminate and Predefined Edge</b> (if applicable): See page 161 for finishes.</p> <p>_____ .</p>
--	--	--	--

<p><b>4th Option:</b> <b>Front Laminate and Predefined Edge:</b></p> <p>_____ .</p>	<p><b>5th Option:</b> <b>Pull Type</b> (if applicable): MP Beam OP Halo AP Arch BP Bar SP Square See matrix on page 19.</p> <p>_____ .</p>	<p><b>6th Option:</b> <b>Pull Color</b> (if applicable): MP Beam / OP Halo PJV Designer White PR6 Silver PJE Pyrite P8X Solar Black AP Arch PRO Anodized Silver P2 upcharge +\$17/pull</p> <p>_____ .</p>	<p><b>7th Option:</b> <b>Lock</b> (if applicable): STD Standard OMT Omit Lock Core (Deduct \$20 per lock)</p> <p>_____ .</p>
---	--	---	--

Example: WKHATN247218.X.LM14EW.LM14EW.LSW1SW.BPPR6.STD



For specification information see pages 176-179.  
 First, select Trough (F) or Troughless (T). If trough, add \$100 from listed price.  
 Next, select Footed (Y) or Non-footed (N). If footed, add \$100 from listed price.

Description	Model	Lock	L1 Laminate List Price		UPCHARGES*	
			Non-Footed	Troughless	L2 Laminate Chassis	Front
<b>24"H Credenzas — Multi File</b>						
30"W x 18"D (shown)	WKCS □ N243018-MF	1	\$ 2557		\$ 29	\$ 29
<b>24"H Credenzas - Box/File</b>						
Non-Footed Troughless						
36"W x 18"D	WKCS □ □ 243618-BF	1	\$ 2281		\$ 26	\$ 26
30"W x 18"D (shown)	WKCS □ □ 243018-BF	1	\$ 2222		\$ 24	\$ 24
<b>24"H Credenzas — Open with Adjustable Shelf</b>						
36"W x 18"D	WKCS □ □ 243618-OS	—	\$ 1761		\$ 20	N/A
30"W x 18"D (shown)	WKCS □ □ 243018-OS	—	\$ 1717		\$ 19	N/A
<b>24"H Credenzas — Hinged Doors with Adjustable Shelf</b>						
36"W x 18"D	WKCS □ □ 243618-HD	1	\$ 2123		\$ 23	\$ 23
30"W x 18"D (shown)	WKCS □ □ 243018-HD	1	\$ 2069		\$ 23	\$ 23

\*Upcharges are added to L1 Laminate List Price depending on woodgrain laminate selection.

<p><b>How to specify —</b> Select the Model Number from above.</p> <p>WKCS                    </p> <p>                    .</p>	<p><b>1st Option:</b> FSC Certified Wood:</p> <p>F FSC Certified X No FSC</p> <p>                    .</p>	<p><b>2nd Option:</b> Chassis Laminate and Predefined Edge:</p> <p>See page 161 for finishes.</p> <p>                    .</p>	<p><b>3rd Option:</b> Front Laminate and Predefined Edge:</p> <p>                    .</p>
---	--	--	--

<p><b>4th Option:</b> Pull Type (if applicable):</p> <p>MP Beam OP Halo AP Arch BP Bar SP Square</p> <p>See matrix on page 19.</p> <p>                    .</p>	<p><b>5th Option:</b> Pull Color (if applicable):</p> <p>MP Beam / OP Halo P2 upcharge +\$17/pull</p> <p>PJW Designer White PR6 Silver PJE Pyrite P8X Solar Black</p> <p>BP Bar P27 Black PJW Designer White PR6 Silver SP Square PJW Designer White EL Matte Silver P02 Flint P7B Loft PJE Pyrite P8X Solar Black P2 upcharge +\$17/pull</p> <p>                    .</p>	<p><b>6th Option:</b> Blade Foot: BF Color:</p> <p>PJW Designer White P27 Black PR6 Silver</p> <p>Post Foot: PF (+\$109) Color:</p> <p>PJW Designer White P02 Flint P7B Loft PR6 Silver PJE Pyrite (+\$12) P8X Solar Black (+\$12)</p> <p>                    .</p>	<p><b>7th Option:</b> Lock (if applicable):</p> <p>STD Standard OMT Omit Lock Core (Deduct \$20 per lock)</p> <p>                    .</p>
---	--	---	--

Example: WKCSFY243618-BF.F.LM14EW.LSW1SW.APPR6.P27.STD



For specification information see pages 176-179.  
First, select Trough (F) or Troughless (T). If trough, add \$100 from listed price.

GSA SIN Pending

	Description	Model	Locks	L1 Laminate List Price Non-Footed Only	UPCHARGES*		
					L2 Laminate Chassis	Front	
	<b>24\"H Credenzas — Open Shelf / Hinged Door</b>						
	36\"W x 18\"D (shown)	WKCD □ N243618-OSHD	1	\$ 2317	\$ 59	26	
	30\"W x 18\"D	WKCD □ N243018-OSHD	1	\$ 2252	\$ 57	26	
	<b>24\"H Credenzas — Hinged Door / Open Shelf</b>						
	36\"W x 18\"D	WKCD □ N243618-HDOS	1	\$ 2317	\$ 59	26	
	30\"W x 18\"D (shown)	WKCD □ N243018-HDOS	1	\$ 2252	\$ 57	26	
	<b>24\"H Credenzas — Box/File / Open Cubby</b>						
	36\"W x 18\"D (shown)	WKCD □ N243618-BFOC	1	\$ 2531	\$ 64	28	
	30\"W x 18\"D	WKCD □ N243018-BFOC	1	\$ 2470	\$ 63	28	
	<b>24\"H Credenzas — Open Cubby / Box/File</b>						
	36\"W x 18\"D	WKCD □ N243618-OCBF	1	\$ 2531	\$ 64	28	
	30\"W x 18\"D (shown)	WKCD □ N243018-OCBF	1	\$ 2470	\$ 63	28	
	<b>24\"H Credenzas — Open Shelf / Open Cubby</b>						
	36\"W x 18\"D (shown)	WKCD □ N243618-OSOC		\$ 2046	\$ 74	N/A	
	30\"W x 18\"D	WKCD □ N243018-OSOC		\$ 1986	\$ 71	N/A	
	<b>24\"H Credenzas — Open Cubby / Open Shelf</b>						
	36\"W x 18\"D	WKCD □ N243618-OCOS		\$ 2046	\$ 74	N/A	
	30\"W x 18\"D (shown)	WKCD □ N243018-OCOS		\$ 1986	\$ 71	N/A	

\*Upcharges are added to L1 Laminate List Price depending on woodgrain laminate selection.

<p><b>How to specify —</b> Select the Model Number from above.</p> <p>WKCD                    </p> <p>          -                 .</p>	<p><b>1st Option:</b> FSC Certified Wood: F FSC Certified X No FSC</p>	<p><b>2nd Option:</b> Chassis Laminate and Predefined Edge: See page 161 for finishes.</p>	<p><b>3rd Option:</b> Front Laminate and Predefined Edge:</p>
---	--	--	---

<p><b>4th Option:</b> Pull Type (if applicable): MP Beam OP Halo AP Arch BP Bar SP Square See matrix on page 19.</p>	<p><b>5th Option:</b> Pull Color (if applicable): MP Beam / OP Halo P2 upcharge +\$17/pull BP Bar P27 Black PJE Pyrite P8X Solar Black SP Square P27 Black PJE Designer White PR6 Silver P8X Solar Black SP Square P27 Black PJE Designer White PR6 Silver SP Square P27 Black PJE Designer White EL Matte Silver P02 Flint P7B Loft PJE Pyrite P8X Solar Black P2 upcharge +\$17/pull</p>	<p><b>6th Option:</b> Lock (if applicable): STD Standard OMT Omit Lock Core (Deduct \$20 per lock)</p>
--	--	--

Example: WKYSP281530-BBF.X.LM14EW.LSW1SW.APPR6.PFPJE.STD

For specification information see pages 176-179.  
 First, select Trough (F) or Troughless (T). If trough, add \$100 from listed price.  
 Next, select Footed (Y) or Non-footed (N). If footed, add \$100 from listed price.

Description	Model	Locks	L1 Laminate List Price		UPCHARGES*	
			Non-footed	Troughless	L2 Laminate Chassis	Front
<b>24"H Credenzas — Box/File / Open Shelf</b>						
48"W x 18"D	WKCUT □ 244818-BFOS	1	\$ 3506		\$ 43	\$ 43
42"W x 18"D (shown)	WKCUT □ 244218-BFOS	1	\$ 3437		\$ 42	\$ 42
<b>24"H Credenzas — Open Shelf / Box/File</b>						
48"W x 18"D	WKCUT □ 244818-OSBF	1	\$ 3506		\$ 43	\$ 43
42"W x 18"D (shown)	WKCUT □ 244218-OSBF	1	\$ 3437		\$ 42	\$ 42
<b>24"H Credenzas — Box/File / Box/File</b>						
72"W x 18"D	WKCUC □ □ 247218-BFBF	2	\$ 4061		\$ 44	\$ 44
60"W x 18"D (shown)	WKCUC □ □ 246018-BFBF	2	\$ 3921		\$ 43	\$ 43
<b>24"H Credenzas — Box/File / Open Shelf</b>						
72"W x 18"D	WKCUC □ □ 247218-BFOS	1	\$ 3901		\$ 43	\$ 43
60"W x 18"D (shown)	WKCUC □ □ 246018-BFOS	1	\$ 3764		\$ 41	\$ 41

\*Upcharges are added to L1 Laminate List Price depending on woodgrain laminate selection.

<p><b>How to specify —</b> Select the Model Number from above.</p> <p>W K C U                </p>	<p><b>1st Option:</b> FSC Certified Wood:</p> <p>F FSC Certified X No FSC</p>	<p><b>2nd Option:</b> Chassis Laminate and Predefined Edge:</p> <p>See page 161 for finishes.</p>	<p><b>3rd Option:</b> Front Laminate and Predefined Edge:</p>
---	---	---	---

<p><b>4th Option:</b> Pull Type (if applicable):</p> <p>MP Beam OP Halo AP Arch BP Bar SP Square</p> <p>See matrix on page 19.</p>	<p><b>5th Option:</b> Pull Color (if applicable):</p> <p>MP Beam / OP Halo P2 upcharge +\$17/pull</p> <p>PJW Designer White PR6 Silver PJE Pyrite P8X Solar Black</p> <p>BP Bar P27 Black PJW Designer White PR6 Silver SP Square PJW Designer White EL Matte Silver P02 Flint P7B Loft PJE Pyrite P8X Solar Black P2 upcharge +\$17/pull</p>	<p><b>6th Option:</b> Blade Foot: BF Color:</p> <p>PJW Designer White P27 Black PR6 Silver</p> <p>Post Foot: PF (+\$109) Color:</p> <p>PJW Designer White P02 Flint P7B Loft PR6 Silver PJE Pyrite (+\$12) P8X Solar Black (+\$12)</p>	<p><b>7th Option:</b> Lock (if applicable):</p> <p>STD Standard OMT Omit Lock Core (Deduct \$20 per lock)</p>
--	---	--	---

Example: WKCUFY246018-BFBF.F.LM14EW.LSW1SW.BPPR6.P27.OMT

For specification information see pages 176-179.

First, select Trough (F) or Troughless (T). If trough, add \$100 from listed price.

Next, select Footed (Y) or Non-footed (N). If footed, add \$100 from listed price.

Description	Model	Locks	L1 Laminate List Price		UPCHARGES*	
			Non-footed	Troughless	Chassis	L2 Laminate Front
<b>24"H Credenzas — Open Shelf / Box/File</b>						
72"W x 18"D	WKCU □ □ 247218-OSBF	1	\$	3901	\$	43
60"W x 18"D (shown)	WKCU □ □ 246018-OSBF	1	\$	3764	\$	41
<b>24"H Credenzas — Box/File / Hinged Doors</b>						
72"W x 18"D	WKCU □ □ 247218-BFHD	2	\$	3987	\$	44
60"W x 18"D (shown)	WKCU □ □ 246018-BFHD	2	\$	3846	\$	42
<b>24"H Credenzas — Hinged Doors / Box/File</b>						
72"W x 18"D	WKCU □ □ 247218-HDBF	2	\$	3987	\$	44
60"W x 18"D (shown)	WKCU □ □ 246018-HDBF	2	\$	3846	\$	42
*Upcharges are added to L1 Laminate List Price depending on woodgrain laminate selection.						
<b>24"H Credenzas — Hinged Doors with Adjustable Shelves</b>						
72"W x 18"D	WKCU □ □ 247218-HDHD		\$	3895	\$	43
60"W x 18"D	WKCU □ □ 246018-HDHD		\$	3794	\$	42

<b>How to specify —</b> Select the Model Number from above.  WKCU	1st Option: <b>FSC Certified Wood:</b> F FSC Certified X No FSC	2nd Option: <b>Chassis Laminate and Predefined Edge:</b> See page 161 for finishes.	3rd Option: <b>Front Laminate and Predefined Edge:</b>

4th Option: <b>Pull Type</b> (if applicable): MP Beam OP Halo AP Arch BP Bar SP Square See matrix on page 19.	5th Option: <b>Pull Color</b> (if applicable): MP Beam / OP Halo PJW Designer White PR6 Silver PJE Pyrite P8X Solar Black AP Arch PRO Anodized Silver P2 upcharge +\$17/pull	6th Option: <b>Blade Foot: BF</b> <b>Color:</b> PJW Designer White P27 Black PR6 Silver  <b>Post Foot: PF</b> (+\$109) <b>Color:</b> PJW Designer White P02 Flint P7B Loft PR6 Silver PJE Pyrite (+\$12) P8X Solar Black (+\$12)	7th Option: <b>Lock</b> (if applicable): STD Standard OMT Omit Lock Core (Deduct \$20 per lock)

Example: WKCUFY246018-OSBF.F.LM14EW.LSW1SW.BPPR6.P27.OMT



For specification information see pages 176-179.  
 First, select Trough (F) or Troughless (T). If trough, add \$100 from listed price.  
 Next, select Footed (Y) or Non-footed (N). If footed, add \$100 from listed price.

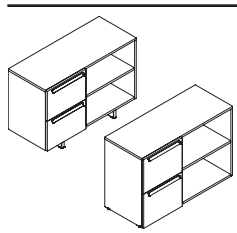

Description	Model	Locks	L1 Laminate List Price		UPCHARGES*	
			Non-footed	Troughless	L2 Laminate Chassis	Front
<b>28"H Credenzas — Lateral File Open Shelf</b>						
48"W x 18"D	WKCUT □ 284818-LFOS	1	\$	3619	\$	44
48"W x 24"D	WKCUT □ 284824-LFOS	1	\$	3727	\$	45
42"W x 18"D (shown)	WKCUT □ 284218-LFOS	1	\$	3511	\$	43
42"W x 24"D	WKCUT □ 284224-LFOS	1	\$	3628	\$	44

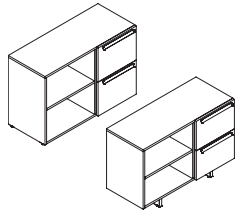

<b>28"H Credenzas — Open Shelf Lateral File</b>						
48"W x 18"D	WKCUT □ 284818-OSLF	1	\$	3619	\$	44
48"W x 24"D	WKCUT □ 284824-OSLF	1	\$	3727	\$	45
42"W x 18"D (shown)	WKCUT □ 284218-OSLF	1	\$	3511	\$	43
42"W x 24"D	WKCUT □ 284224-OSLF	1	\$	3628	\$	44

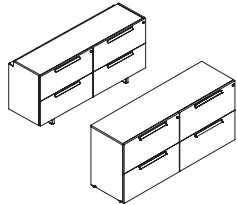

<b>28"H Credenzas — Lateral File Lateral File</b>						
72"W x 18"D	WKCUC □ □ 287218-LFLF	2	\$	4258	\$	46
72"W x 24"D	WKCUC □ □ 287224-LFLF	2	\$	4327	\$	47
60"W x 18"D (shown)	WKCUC □ □ 286018-LFLF	2	\$	4164	\$	45
60"W x 24"D	WKCUC □ □ 286024-LFLF	2	\$	4231	\$	46

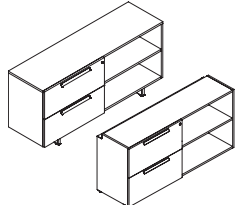

<b>28"H Credenzas — Lateral File Open Shelf</b>						
72"W x 18"D	WKCUC □ □ 287218-LFOS	1	\$	4076	\$	45
72"W x 24"D	WKCUC □ □ 287224-LFOS	1	\$	4180	\$	46
60"W x 18"D (shown)	WKCUC □ □ 286018-LFOS	1	\$	3929	\$	43
60"W x 24"D	WKCUC □ □ 286024-LFOS	1	\$	4031	\$	44

\*Upcharges are added to L1 Laminate List Price depending on woodgrain laminate selection.

<b>How to specify —</b> Select the Model Number from above.  WKCU                       .	<b>1st Option:</b> FSC Certified Wood: F FSC Certified X No FSC	<b>2nd Option:</b> Chassis Laminate and Predefined Edge: See page 161 for finishes.	<b>3rd Option:</b> Front Laminate and Predefined Edge:
--	--	---	---

<b>4th Option:</b> Pull Type (if applicable): MP Beam OP Halo AP Arch BP Bar SP Square See matrix on page 19.	<b>5th Option:</b> Pull Color (if applicable): MP Beam / OP Halo PJW Designer White PR6 Silver PJE Pyrite P8X Solar Black AP Arch PRO Anodized Silver P2 upcharge +\$17/pull	<b>6th Option:</b> Blade Foot: BF Color: PJW Designer White P27 Black PR6 Silver Post Foot: PF (+\$109) Color: PJW Designer White P02 Flint P7B Loft PR6 Silver PJE Pyrite (+\$12) P8X Solar Black (+\$12)	<b>7th Option:</b> Lock (if applicable): STD Standard OMT Omit Lock Core (Deduct \$20 per lock)
--	---	---	---

Example: WKCUFY286018-LFLF.F.LM14EW.LSW1SW.APPR6.P27.STD

For specification information see pages 176-179.

First, select Trough (F) or Troughless (T). If trough, add \$100 from listed price.

Next, select Footed (Y) or Non-footed (N). If footed, add \$100 from listed price.

GSA SIN 33721

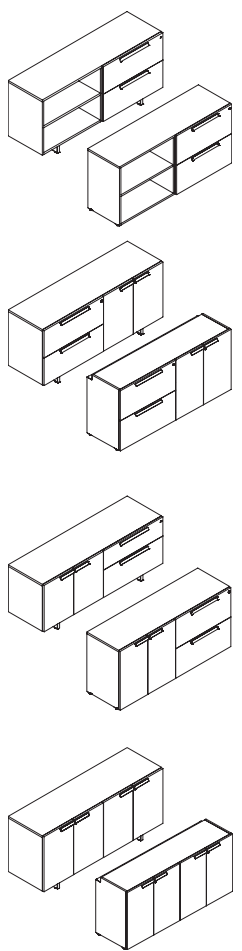

Description	Model	Locks	L1 Laminate List Price		UPCHARGES*	
			Non-footed	Troughless	L2 Laminate Chassis	Front
<b>28"H Credenzas — Open Shelf Lateral File</b>						
72" W x 18"D	WVCU □□ 287218-OSLF	1	\$ 4076		\$ 45	\$ 45
72" W x 24"D	WVCU □□ 287224-OSLF	1	\$ 4180		\$ 46	\$ 46
60" W x 18"D (shown)	WVCU □□ 286018-OSLF	1	\$ 3929		\$ 43	\$ 43
60" W x 24"D	WVCU □□ 286024-OSLF	1	\$ 4031		\$ 44	\$ 44
<b>28"H Credenzas — Lateral File Hinged Door</b>						
72" W x 18"D	WVCU □□ 287218-LFHD	2	\$ 4213		\$ 46	\$ 46
72" W x 24"D	WVCU □□ 287224-LFHD	2	\$ 4320		\$ 47	\$ 47
60" W x 18"D (shown)	WVCU □□ 286018-LFHD	2	\$ 4064		\$ 44	\$ 44
60" W x 24"D	WVCU □□ 286024-LFHD	2	\$ 4168		\$ 45	\$ 45
<b>28"H Credenzas — Hinged Door Lateral File</b>						
72" W x 18"D	WVCU □□ 287218-HDLF	2	\$ 4213		\$ 46	\$ 46
72" W x 24"D	WVCU □□ 287224-HDLF	2	\$ 4320		\$ 47	\$ 47
60" W x 18"D (shown)	WVCU □□ 286018-HDLF	2	\$ 4064		\$ 44	\$ 44
60" W x 24"D	WVCU □□ 286024-HDLF	2	\$ 4168		\$ 45	\$ 45
<b>28"H Credenzas — Hinged Door</b>						
72" W x 18"D	WVCU □□ 287218-HDHD	2	\$ 4013		\$ 44	\$ 44
72" W x 24"D	WVCU □□ 287224-HDHD	2	\$ 4076		\$ 45	\$ 45
60" W x 18"D (shown)	WVCU □□ 286018-HDHD	2	\$ 3923		\$ 43	\$ 43
60" W x 24"D	WVCU □□ 286024-HDHD	2	\$ 3987		\$ 44	\$ 44

\*Upcharges are added to L1 Laminate List Price depending on woodgrain laminate selection.

APPROACH

<p><b>How to specify —</b> Select the Model Number from above.</p> <p><b>WVCU</b>                                    </p>	<p><b>1st Option:</b> FSC Certified Wood: F FSC Certified X No FSC</p>	<p><b>2nd Option:</b> Chassis Laminate and Predefined Edge: See page 161 for finishes.</p>	<p><b>3rd Option:</b> Front Laminate and Predefined Edge:</p>
<p><b>4th Option:</b> Pull Type (if applicable): MP Beam OP Halo AP Arch BP Bar SP Square See matrix on page 19.</p>	<p><b>5th Option:</b> Pull Color (if applicable): MP Beam / OP Halo PJV Designer White PR6 Silver PJE Pyrite P8X Solar Black AP Arch PRO Anodized Silver P2 upcharge +\$17/pull</p> <p><b>BP Bar</b> P27 Black PJV Designer White PR6 Silver <b>SP Square</b> PJV Designer White EL Matte Silver P02 Flint P7B Loft PJE Pyrite P8X Solar Black P2 upcharge +\$17/pull</p>	<p><b>6th Option:</b> Blade Foot: BF Color: PJV Designer White P27 Black PR6 Silver Post Foot: PF (+\$109) Color: PJV Designer White P02 Flint P7B Loft PR6 Silver PJE Pyrite (+\$12) P8X Solar Black (+\$12)</p>	<p><b>7th Option:</b> Lock (if applicable): STD Standard OMT Omit Lock Core (Deduct \$20 per lock)</p>

Example: WVCUFY286018-OSLF.F.LM14EW.LSW1SW.APPR6.P27.STD



For specification information see pages 176-179.

GSA SIN 33721

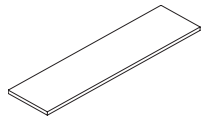

Description	Model	List Price	
		L1	L2
<b>18"D Laminate Tops for use with Trough (Actual 15 3/8"D)</b>			
18"W	WKWSPT1818	\$ 362	\$ 377
30"W	WKWSCW3018	\$ 470	\$ 488
36"W	WKWSCW3618	\$ 505	\$ 524
42"W	WKWSCW4218	\$ 538	\$ 558
48"W	WKWSCW4818	\$ 578	\$ 600
54"W	WKWSCW5418	\$ 622	\$ 645
60"W	WKWSCW6018	\$ 683	\$ 709
66"W	WKWSCW6618	\$ 708	\$ 734
72"W	WKWSCW7218	\$ 750	\$ 778
78"W	WKWSCW7818	\$ 814	\$ 843
84"W	WKWSCW8418	\$ 887	\$ 919
90"W	WKWSCW9018	\$ 954	\$ 988
96"W	WKWSCW9618	\$ 1028	\$ 1064

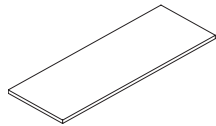

<b>24"D Laminate Tops for use with Trough (Actual 21 3/8"D)</b>			
18"W	WKWSPT1824	\$ 379	\$ 395
30"W	WKWSCW3024	\$ 499	\$ 518
36"W	WKWSCW3624	\$ 535	\$ 555
42"W	WKWSCW4224	\$ 571	\$ 592
48"W	WKWSCW4824	\$ 613	\$ 636
54"W	WKWSCW5424	\$ 663	\$ 687
60"W	WKWSCW6024	\$ 721	\$ 748
66"W	WKWSCW6624	\$ 750	\$ 778
72"W	WKWSCW7224	\$ 795	\$ 824
78"W	WKWSCW7824	\$ 861	\$ 892
84"W	WKWSCW8424	\$ 940	\$ 973
90"W	WKWSCW9024	\$ 1012	\$ 1047
96"W	WKWSCW9624	\$ 1087	\$ 1126

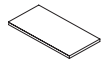

Description	Model	List Price by Upholstery Grade							
		1	2	3	4	5	6	7	8
<b>Seat Cushions — Specify Seating Upholstery</b> (Credenza models are for use with trough, actual 15"D)									
30"W x 18"D Credenza	WKFC3018	\$ 419	\$ 455	\$ 491	\$ 527	\$ 576	\$ 624	\$ 672	\$ 720
36"W x 18"D Credenza	WKFC3618	\$ 462	\$ 506	\$ 550	\$ 592	\$ 650	\$ 709	\$ 767	\$ 824
16"W x 20"D Mobile Pedestal	WKFC1620	\$ 343	\$ 365	\$ 387	\$ 409	\$ 437	\$ 467	\$ 495	\$ 524

\* Any unsupported span greater than 72" requires a floor support.

<p><b>How to specify —</b> Select the Model Number from above.</p>	<p>1st Option: <b>FSC Certified Wood</b> (if applicable): F FSC Certified X No FSC</p>	<p>2nd Option: <b>Top Laminate and Predefined Edge</b> (if applicable): See page 161 for finishes.</p>	<p>3rd Option: <b>Upholstery</b> (if applicable): Specify Seating Upholstery</p>
WK                     .   .			

Examples: WKWSCW3018.F.LM14EW WKWSCW3024.X.LM14EW WKFC1620.APN911

For specification information see pages 176-179.

GSA SIN 33721

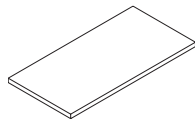

Description	Model	List Price	
		L1	L2
<b>18"D Laminate Full Depth Tops for use without Trough</b>			
18"W	WKWSCWFD1818	\$ 385	\$ 400
30"W	WKWSCWFD3018	\$ 499	\$ 518
36"W (shown)	WKWSCWFD3618	\$ 538	\$ 558
42"W	WKWSCWFD4218	\$ 574	\$ 595
48"W	WKWSCWFD4818	\$ 617	\$ 639
54"W	WKWSCWFD5418	\$ 659	\$ 683
60"W	WKWSCWFD6018	\$ 728	\$ 755
66"W	WKWSCWFD6618	\$ 755	\$ 783
72"W	WKWSCWFD7218	\$ 798	\$ 827
78"W	WKWSCWFD7818	\$ 866	\$ 897
84"W	WKWSCWFD8418	\$ 946	\$ 980
90"W	WKWSCWFD9018	\$ 1016	\$ 1052
96"W	WKWSCWFD9618	\$ 1096	\$ 1136

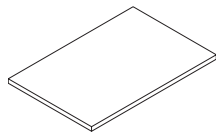

<b>24"D Laminate Tops for use without Trough</b>			
18"W	WKWSCWFD1824	\$ 403	\$ 418
30"W	WKWSCWFD3024	\$ 517	\$ 536
36"W (shown)	WKWSCWFD3624	\$ 559	\$ 579
42"W	WKWSCWFD4224	\$ 595	\$ 617
48"W	WKWSCWFD4824	\$ 639	\$ 662
54"W	WKWSCWFD5424	\$ 687	\$ 713
60"W	WKWSCWFD6024	\$ 753	\$ 781
66"W	WKWSCWFD6624	\$ 781	\$ 810
72"W	WKWSCWFD7224	\$ 827	\$ 857
78"W	WKWSCWFD7824	\$ 895	\$ 927
84"W	WKWSCWFD8424	\$ 978	\$ 1013
90"W	WKWSCWFD9024	\$ 1052	\$ 1090
96"W	WKWSCWFD9624	\$ 1133	\$ 1174

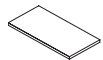

Description	Model	List Price by Upholstery Grade							
		1	2	3	4	5	6	7	8
<b>Credenza/Lateral Cushion — Specify Seating Upholstery</b>									
30"W x 24"D Credenza	WKFC3024	\$ 548	\$ 570	\$ 592	\$ 614	\$ 642	\$ 672	\$ 701	\$ 729
36"W x 24"D Credenza	WKFC3624	\$ 658	\$ 685	\$ 711	\$ 737	\$ 772	\$ 807	\$ 841	\$ 875

\* Any unsupported span greater than 72" requires a floor support.

<p><b>How to specify —</b> Select the Model Number from above.</p>	<p><b>1st Option:</b> FSC Certified Wood <i>(if applicable):</i> F FSC Certified X No FSC</p>	<p><b>2nd Option:</b> Top Laminate and Predefined Edge <i>(if applicable):</i> See page 161 for finishes.</p>	<p><b>3rd Option:</b> <b>Grommet Location</b> <i>(if applicable):</i> See page 174. B Both Left and Right C Centered L Left R Right X No Grommet  <b>Grommet Type</b> <i>(if applicable):</i> P Oval Plastic (will match edge trim) M Oval Metal (+ \$12 per grommet) S Square Metal (+ \$12 per grommet)  <b>Grommet Color</b> (Metal only) <i>(if applicable):</i> EL Matte Silver</p>	<p><b>4th Option:</b> <b>Upholstery</b> <i>(if applicable):</i> See page 161 for finishes.</p>
<p>WKW S CW                .     .</p>				

Examples: WKWSCW3018.F.LM14EW WKWSCW3024.X.LM14EW WKFC1620.APN911



For specification information see pages 181-185.

GSA SIN 33721

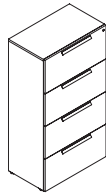
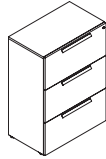
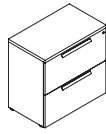

Description	Model	Locks	L1 Laminate List Price	UPCHARGES*		
				Top	L2 Laminate Chassis	Front
<b>29½"H Two Drawer Lateral File with Finished Back</b>						
30"W x 18½"D (shown)	WKLFFN2H3018	1	\$ 2270	\$ 24	\$ 53	\$ 24
30"W x 24½"D	WKLFFN2H3024	1	\$ 2333	\$ 26	\$ 54	\$ 26
36"W x 18½"D	WKLFFN2H3618	1	\$ 2306	\$ 24	\$ 54	\$ 24
36"W x 24½"D	WKLFFN2H3624	1	\$ 2396	\$ 27	\$ 56	\$ 26
<b>42¼"H Three Drawer Lateral File</b>						
30"W x 18½"D (shown)	WKLFFN3H3018	1	\$ 4097	N/A	\$ 98	\$ 43
30"W x 24½"D	WKLFFN3H3024	1	\$ 4219	N/A	\$ 102	\$ 44
36"W x 18½"D	WKLFFN3H3618	1	\$ 4224	N/A	\$ 102	\$ 44
36"W x 24½"D	WKLFFN3H3624	1	\$ 4350	N/A	\$ 104	\$ 45
<b>56¼"H Four Drawer Lateral File</b>						
30"W x 18½"D (shown)	WKLFFN4H3018	1	\$ 4508	N/A	\$ 108	\$ 48
30"W x 24½"D	WKLFFN4H3024	1	\$ 4636	N/A	\$ 113	\$ 50
36"W x 18½"D	WKLFFN4H3618	1	\$ 4876	N/A	\$ 117	\$ 51
36"W x 24½"D	WKLFFN4H3624	1	\$ 5019	N/A	\$ 120	\$ 52

\*Upcharges are added to L1 Laminate List Price depending on woodgrain laminate selection.

#Unit may require counterweight kits see pages 168-169.

<p><b>How to specify —</b> Select the Model Number from above.</p> <p>WK                    </p> <p>                    .</p>	<p><b>1st Option:</b> FSC Certified Wood:</p> <p>F FSC Certified X No FSC</p> <p>                    .</p>	<p><b>2nd Option:</b> Top Laminate and Predefined Edge (if applicable):</p> <p>                    .</p>	<p><b>3rd Option:</b> Chassis Laminate and Predefined Edge:</p> <p>                    .</p>	<p><b>4th Option:</b> Front Laminate and Predefined Edge:</p> <p>                    .</p>
---	--	--	--	--

<p><b>5th Option:</b> Pull Type (if applicable):</p> <p>MP Beam OP Halo AP Arch BP Bar SP Square</p> <p>See matrix on page 19.</p> <p>                    .</p>	<p><b>6th Option:</b> Pull Color (if applicable):</p> <table border="0"> <tr> <td>MP Beam / OP Halo</td> <td>BP Bar</td> </tr> <tr> <td>PJW Designer White</td> <td>P27 Black</td> </tr> <tr> <td>PR6 Silver</td> <td>PJW Designer White</td> </tr> <tr> <td>PJE Pyrite</td> <td>PR6 Silver</td> </tr> <tr> <td>P8X Solar Black</td> <td>SP Square</td> </tr> <tr> <td>AP Arch</td> <td>PJW Designer White</td> </tr> <tr> <td>PRO Anodized Silver</td> <td>EL Matte Silver</td> </tr> <tr> <td>P2 upcharge +\$17/pull</td> <td>P02 Flint</td> </tr> <tr> <td></td> <td>P7B Loft</td> </tr> <tr> <td></td> <td>PJE Pyrite</td> </tr> <tr> <td></td> <td>P8X Solar Black</td> </tr> <tr> <td></td> <td>P2 upcharge +\$17/pull</td> </tr> </table> <p>                    .</p>	MP Beam / OP Halo	BP Bar	PJW Designer White	P27 Black	PR6 Silver	PJW Designer White	PJE Pyrite	PR6 Silver	P8X Solar Black	SP Square	AP Arch	PJW Designer White	PRO Anodized Silver	EL Matte Silver	P2 upcharge +\$17/pull	P02 Flint		P7B Loft		PJE Pyrite		P8X Solar Black		P2 upcharge +\$17/pull	<p><b>7th Option:</b> Lock (if applicable):</p> <p>STD Standard OMT Omit Lock Core (Deduct \$20)</p> <p>                    .</p>
MP Beam / OP Halo	BP Bar																									
PJW Designer White	P27 Black																									
PR6 Silver	PJW Designer White																									
PJE Pyrite	PR6 Silver																									
P8X Solar Black	SP Square																									
AP Arch	PJW Designer White																									
PRO Anodized Silver	EL Matte Silver																									
P2 upcharge +\$17/pull	P02 Flint																									
	P7B Loft																									
	PJE Pyrite																									
	P8X Solar Black																									
	P2 upcharge +\$17/pull																									

Example: WKLFFN2H3018.F.LM14EW.LM14EW.LSW1SW.APPR6.STD

For specification information see pages 181-185.

GSA SIN 33721

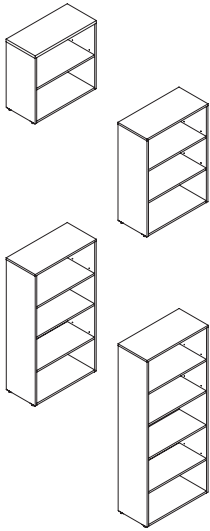

Description	Model	L1 Laminate List Price	UPCHARGES*		
			L2 Laminate Top	Chassis	Front
29½"H Bookcase with 1 Adjustable Shelf and Top Fin Back 30"W x 14¼"D (shown)	WKBKFN2H3015	\$ 1391	\$ 17	\$ 48	N/A
42½"H Bookcase with 2 Adjustable Shelves 30"W x 14¼"D (shown)	WKBKFN3H3015	\$ 1624	N/A	\$ 56	N/A
56⅝"H Bookcase with 1 Fixed and 2 Adjustable Shelves 30"W x 14¼"D (shown)	WKBKFN4H3015	\$ 1861	N/A	\$ 64	N/A
71½"H Bookcase with 1 Fixed and 3 Adjustable Shelves 30"W x 14¼"D (shown)	WKBKFN5H3015	\$ 2060	N/A	\$ 71	N/A

\*Upcharges are added to L1 Laminate List Price depending on woodgrain laminate selection.

<p><b>How to specify —</b> Select the Model Number from above.</p> <p>WK              </p> <p>                    .</p>	<p><b>1st Option:</b> FSC Certified Wood: F FSC Certified X No FSC</p> <p>    .</p>	<p><b>2nd Option:</b> Laminate and Predefined Edge:</p> <p>                   </p>
---	---	--

Example: WKLFFN2H3018.X.LM14EW

For specification information see pages [176-179](#).

GSA SIN 33721

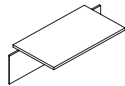
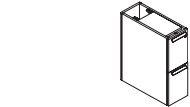
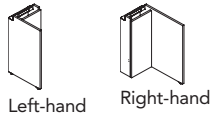

Description	Model	L1 Laminate List Price	UPCHARGES*		
			Top	L2 Laminate Chassis	Front
<b>False Ped 28"H</b>					
12"W x 14"D Left-hand	WKFFPN281214LH	\$ 956	N/A	\$ 35	N/A
12"W x 14"D Right-hand	WKFFPN281214RH	\$ 956	N/A	\$ 35	N/A
12"W x 18"D Left-hand (shown)	WKFFPN281218LH	\$ 975	N/A	\$ 35	N/A
12"W x 18"D Right-hand	WKFFPN281218RH	\$ 975	N/A	\$ 35	N/A
12"W x 24"D Left-hand	WKFFPN281224LH	\$ 994	N/A	\$ 35	N/A
12"W x 24"D Right-hand (shown)	WKFFPN281224RH	\$ 994	N/A	\$ 35	N/A
<b>28"H Support Slim Pedestal — File / File with Back Panel</b>					
9½"W x 24"D	WKPSFN28924-FF	1	\$ 1699	N/A	\$ 41 \$ 19
9½"W x 30"D	WKPSFN28930-FF	1	\$ 1738	N/A	\$ 43 \$ 20
<b>Wall Access Panel 28"H</b>					
18"W Full Height	WKHP2818	\$ 985	N/A	\$ 35	N/A
24"W Full Height	WKHP2824	\$ 1018	N/A	\$ 36	N/A
30"W Full Height	WKHP2830	\$ 1074	N/A	\$ 39	N/A
36"W Full Height (shown)	WKHP2836	\$ 1102	N/A	\$ 40	N/A
42"W Full Height	WKHP2842	\$ 1138	N/A	\$ 41	N/A
48"W Full Height	WKHP2848	\$ 1184	N/A	\$ 42	N/A
<b>Bridge 24"D with 14"H Half-Height Modesty Panel</b>					
42"W	WKAUBG4224	\$ 1209	N/A	\$ 44	\$ 44
48"W	WKAUBG4824	\$ 1256	N/A	\$ 47	\$ 47

APPROACH

<p><b>How to specify —</b> Select the Model Number from above.</p> <p>WK                     .   .</p>	<p><b>1st Option:</b> FSC Certified Wood:</p> <p>F FSC Certified X No FSC</p>	<p><b>2nd Option:</b> Top Laminate and Predefined Edge (if applicable):</p> <p>See page <a href="#">161</a> for finishes.</p>	<p><b>3rd Option:</b> Pull Type (if applicable):</p> <p>MP Beam OP Halo AP Arch BP Bar SP Square</p> <p>See matrix on page <a href="#">19</a>.</p>	<p><b>4th Option:</b> Pull Color (if applicable):</p> <p>MP Beam / OP Halo P27 Designer White PR6 Silver PJE Pyrite P8X Solar Black</p> <p>AP Arch PRO Anodized Silver P2 upcharge +\$17/pull</p> <p>BP Bar P27 Black P27 Designer White PR6 Silver SP Square P27 Designer White EL Matte Silver P02 Flint P7B Loft PJE Pyrite P8X Solar Black P2 upcharge +\$17/pull</p>
<p><b>5th Option:</b> Grommet Location (if applicable):</p> <p>See page <a href="#">174</a>.</p> <p>B Both Left and Right C Centered L Left R Right X No Grommet</p>	<p><b>6th Option:</b> Grommet Type (if applicable):</p> <p>P Oval Plastic (will match edge trim) M Oval Metal (Add \$12 per grommet) S Square Metal (Add \$12 per grommet)</p>	<p><b>7th Option:</b> Grommet Color (Metal only) (if applicable):</p> <p>EL Matte Silver</p>	<p><b>8th Option:</b> Chassis Laminate and Predefined Edge (if applicable):</p>	<p><b>9th Option:</b> Front Laminate and Predefined Edge (if applicable):</p>

Examples: WKFFPN281218LH.F.LM14EW WKAUBG4224.LM16E9.LM16E9







For specification information see pages 180-181. Grommet location information on page 174.

GSA SIN 33721

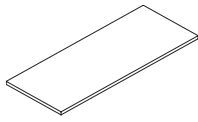

Description	Model	List Price	
		L1	L2
<b>24"D Laminate Worksurfaces with Grommets</b>			
30"W*	WKWSRS3024	\$ 542	\$ 562
36"W*	WKWSRS3624	\$ 561	\$ 582
42"W	WKWSRS4224	\$ 622	\$ 644
48"W	WKWSRS4824	\$ 643	\$ 667
54"W	WKWSRS5424	\$ 690	\$ 716
60"W	WKWSRS6024	\$ 757	\$ 785
66"W	WKWSRS6624	\$ 787	\$ 816
72"W	WKWSRS7224	\$ 833	\$ 863
78"W	WKWSRS7824	\$ 901	\$ 934
84"W	WKWSRS8424	\$ 987	\$ 1022
90"W	WKWSRS9024	\$ 1061	\$ 1099
96"W	WKWSRS9624	\$ 1188	\$ 1229

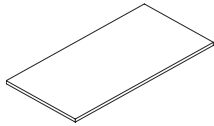

<b>30"D Laminate Worksurfaces with Grommets</b>			
30"W*	WKWSRS3030	\$ 565	\$ 587
36"W*	WKWSRS3630	\$ 639	\$ 662
42"W	WKWSRS4230	\$ 675	\$ 701
48"W	WKWSRS4830	\$ 758	\$ 785
54"W	WKWSRS5430	\$ 782	\$ 811
60"W	WKWSRS6030	\$ 833	\$ 863
66"W	WKWSRS6630	\$ 899	\$ 931
72"W	WKWSRS7230	\$ 960	\$ 994
78"W	WKWSRS7830	\$ 1036	\$ 1074
84"W	WKWSRS8430	\$ 1125	\$ 1165
90"W	WKWSRS9030	\$ 1204	\$ 1247
96"W	WKWSRS9630	\$ 1255	\$ 1299

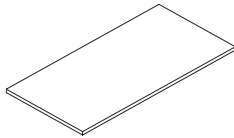

<b>36"D Laminate Worksurfaces with Grommets</b>			
72"W	WKWSRS7236	\$ 1280	\$ 1323
78"W	WKWSRS7836	\$ 1328	\$ 1374
84"W	WKWSRS8436	\$ 1444	\$ 1495

\* Grommet location on 30"W and 36"W worksurfaces is limited to C Center position.

\* Any unsupported span greater than 72" requires a floor support.

<p><b>How to specify —</b> Select the Model Number from above.</p>	<p><b>1st Option:</b> FSC Certified Wood: F FSC Certified X No FSC</p>	<p><b>2nd Option:</b> Top Laminate and Predefined Edge: See page 161 for finishes.</p>	<p><b>3rd Option:</b> Grommet Location (if applicable): See page 174. B Both Left and Right C Centered L Left R Right X No Grommet</p>	<p><b>4th Option:</b> Grommet Type (if applicable): P Oval Plastic (will match edge trim) M Oval Metal (Add \$12 per grommet) S Square Metal (Add \$12 per grommet)</p>	<p><b>5th Option:</b> Grommet Color (Metal only) (if applicable): EL Matte Silver</p>
<p>WKWS           .   .</p>					<p>EL</p>

Example: WKWSRS3024.F.LM14EW.C.MEL

For specification information see pages 180-181.

GSA SIN 33721

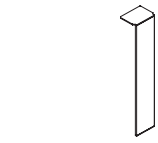

Description	Model	P1 Paint List Price	P2 Paint List Price	P3 Paint List Price
<b>Support Column</b>				
29"H	WKAUCB29	\$ 1199	\$ 1199	\$ 1199

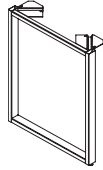

<b>O-Leg — 29"H (non-handed, painted metal)</b>				
24"D	WKTBTTL2824	\$ 709	\$ 736	\$ 759
30"D	WKTBTTL2830	\$ 770	\$ 799	\$ 823

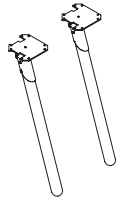

<b>Splay Leg (sold in pairs, 2 legs per model)</b>				
Approach Splay – Wood	WKSPLYWD	\$ 1222	\$ 1229	\$ 1239
Approach Splay Legs – Metal	WKSPLYMT	\$ 917	\$ 924	\$ 934

\*Natural wood has inherent variations in color, grain, and texture Allsteel does not guarantee the exact matching of grain, pattern and color.

\*\*Model includes a pair of legs with shroud included.

<p><b>How to specify —</b> Select the Model Number from above.</p>	<p><i>1st Option:</i> <b>Wood Toned Wood Legs</b> (if applicable): LL302 Natural Oak Wood LL500 Natural Walnut Wood</p>	<p><i>2nd Option:</i> <b>Shroud Paint:</b> P1 P2 P3 See page 161 for finishes. P2 paint upcharge \$7 (except PR6) P3 paint upcharge \$17</p>	<p><i>3rd Option:</i> <b>Metal Leg</b> (if applicable): P1 P2 P3 See page 161 for finishes. P2 paint upcharge \$14 P3 paint upcharge \$33</p>
--	---	--	---

Example: WKTBTTL2824.PJW

For specification information see pages 180-181.

GSA SIN 33721



Description	Model	List Price
<b>Worksurface Stanchions (non-handed; P02 Flint only, not specified)</b>		
3"H x 12"D	WKST312	\$ 362
3"H x 18"D	WKST318	\$ 401
4"H x 12"DZ6PL40H	WKST412	\$ 383
4"H x 18"D	WKST418	\$ 418

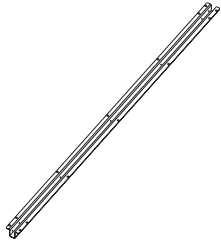

<b>For use with open, non-supported tops</b>		
<b>External Worksurface Support Channel (no color option for stiffener) — 1½"H</b>		
30"W for use on 42"W Worksurface	Z5SC42	\$ 83
36"W for use on 48"W Worksurface	Z5SC48	\$ 86
42"W for use on 54"W Worksurface	Z5SC54	\$ 99
48"W for use on 60"W Worksurface	Z5SC60	\$ 106
54"W for use on 66"W Worksurface	Z5SC66	\$ 124
60"W for use on 72"W Worksurface	Z5SC72	\$ 133
66"W for use on 78"W Worksurface	Z5SC78	\$ 145
72"W for use on 84"W Worksurface	Z5SC84	\$ 160

**Note:** Width of support channel may need to be reduced to accommodate width of storage.

**How to specify —**

Select the Model Number from above.

--	--	--	--	--	--	--	--	--	--	--

Examples: WKST312 Z5SC42

For specification information see pages 180-181.

GSA SIN 33721

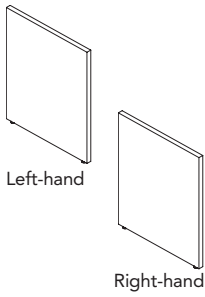

Description	Model	List Price	
		L1	L2
<b>End Panel Supports — 28"H</b>			
14"D Left-Hand	WKEP2814LH	\$ 565	\$ 587
14"D Right-Hand	WKEP2814RH	\$ 565	\$ 587
24"D Left-Hand	WKEP2824LH	\$ 592	\$ 614
24"D Right-Hand	WKEP2824RH	\$ 592	\$ 614
30"D Left-Hand	WKEP2830LH	\$ 652	\$ 676
30"D Right-Hand	WKEP2830RH	\$ 652	\$ 676
36"D Left-Hand	WKEP2836LH	\$ 758	\$ 786
36"D Right-Hand	WKEP2836RH	\$ 758	\$ 786

**Note:** Must order handed half modesty or full modesty panel. See below.

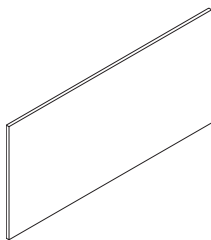

Description	Model	List Price	
		L1	L2
<b>28"H Full-Height Laminate Modesty Panels (non-handed)</b>			
<i>nominal height 27.861"</i>			
48" W	WKMP2848	\$ 880	\$ 912
54" W	WKMP2854	\$ 989	\$ 1025
60" W (shown)	WKMP2860	\$ 1098	\$ 1138
66" W	WKMP2866	\$ 1209	\$ 1253
72" W	WKMP2872	\$ 1318	\$ 1366

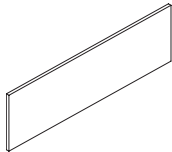

Description	MODEL – Handed Models: Add "L" for Left-hand model Add "R" for Right-hand model	List Price	
		L1	L2
<b>14"H Half-Height Laminate Modesty Panels (non-handed)</b>			
30"W*	WKMP1430	\$ 378	\$ 394
36"W*	WKMP1436	\$ 426	\$ 443
42"W	WKMP1442	\$ 479	\$ 498
48"W	WKMP1448	\$ 541	\$ 562
54"W	WKMP1454	\$ 587	\$ 609
60"W	WKMP1460	\$ 613	\$ 636
66"W	WKMP1466	\$ 641	\$ 665
72"W	WKMP1472	\$ 671	\$ 697

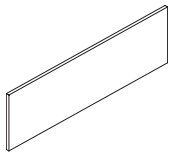

<b>14"H Half-Height Laminate Modesty Panels (handed)</b>			
36"W*	WKMP1436 □ H	\$ 439	\$ 457
42"W	WKMP1442 □ H	\$ 493	\$ 512
48"W	WKMP1448 □ H	\$ 553	\$ 574
54"W	WKMP1454 □ H	\$ 603	\$ 626
60"W	WKMP1460 □ H	\$ 632	\$ 656
66"W	WKMP1466 □ H	\$ 661	\$ 685
72"W	WKMP1472 □ H	\$ 689	\$ 715

Handed models are designed for use with laminate end panel supports, see above.

Example of left-hand model shown: **WKMP1448LH**

<p><b>How to specify —</b> Select the Model Number from above.</p>	<p><b>1st Option:</b> FSC Certified Wood (if applicable): F FSC Certified X No FSC</p>	<p><b>2nd Option:</b> Top Laminate and Predefined Edge (if applicable):</p>
<p>WK   .     .</p>		<p>   </p>

Examples: WKMP1430.F.LM14EW WKMP1436LH.X.LM14EW

For specification information see pages 182-185.

GSA SIN PENDING, GSA SIN 33721

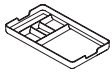
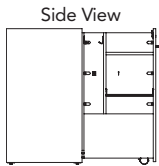
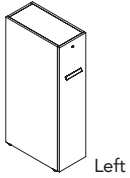
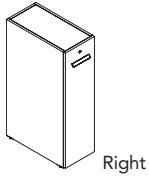

Description	Model	Lock	L1 Laminate List Price	UPCHARGES*	
				L2 Laminate Chassis	Front
<b>12"W Pullout Tower</b>					
42½"H x 24"D – Left	WKPT421224LH	1	\$ 3260	\$ 35	\$ 35
42½"H x 24"D – Right (shown)	WKPT421224RH	1	\$ 3260	\$ 35	\$ 35
42½"H x 30"D – Left	WKPT421230LH	1	\$ 3648	\$ 40	\$ 40
42½"H x 30"D – Right	WKPT421230RH	1	\$ 3648	\$ 40	\$ 40
<b>50"H Pullout Tower</b>					
50"H x 24"D – Left	WKPT501224LH	1	\$ 3881	\$ 42	\$ 42
50"H x 24"D – Right (shown)	WKPT501224RH	1	\$ 3881	\$ 42	\$ 42
50"H x 30"D – Left (shown)	WKPT501230LH	1	\$ 4345	\$ 46	\$ 46
50"H x 30"D – Right	WKPT501230RH	1	\$ 4345	\$ 46	\$ 46

Radii Small Tray for 10"W model available in Designer White (.DW) See page 130.

1½"H x 8½"W x 14¾"D	AEST	\$ 62
GSA SIN Pending		

How to specify — Select the Model Number from above.	1st Option: FSC Certified Wood: F FSC Certified X No FSC	2nd Option: Chassis Laminate and Predefined Edge:	3rd Option: Front Laminate and Predefined Edge:	4th Option: Drawer Laminate and Predefined Edge (if applicable): LM11 Loft LM16 Flint LDW1 Designer White
WK   P   T	.	.	.	.

<b>5th Option:</b> <b>Pull Type</b> (if applicable): MP Beam OP Halo AP Arch BP Bar SP Square See matrix on page 19.	<b>6th Option:</b> <b>Pull Color</b> (if applicable): MP Beam / OP Halo PJW Designer White PR6 Silver PJE Pyrite P8X Solar Black AP Arch PRO Anodized Silver P2 upcharge +\$17/pull	<b>7th Option:</b> <b>Lock</b> (if applicable): STD Standard OMT Omit Lock Core (Deduct \$20 per lock)
	.	

Examples: WKPT501224RH. X.LM14EW.LM14EW.LSW1SW.BPPJW.STD AEST.DW

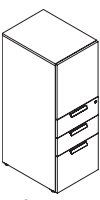
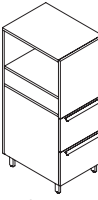
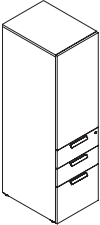
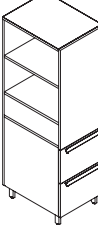
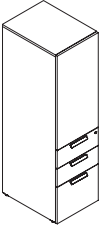
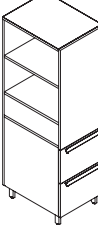
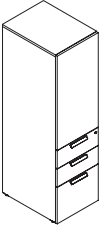
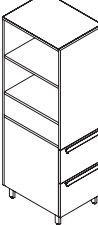

For specification information see pages 182-185.  
 First, select Post foot (Y) or Non-footed (N), if footed add \$100 to listed price.  
 Next, select Left (L) or Right (R) before configuration of tower.

	Description	Model	Lock	L1 Laminate List Price	UPCHARGES*		
					L2 Laminate Chassis	Front	
 Left  Right	<b>50"H Side Access Tower</b>						
	18"D Combination Tower L/R Door/Box/Box/File (shown)	WK □ ST501818 □ BBF	1	\$ 3589	\$ 40	\$ 40	
	18"D Combination Tower L/R Door/File/File	WK □ ST501818 □ FF	1	\$ 3511	\$ 39	\$ 39	
	24"D Combination Tower L/R Door/File/File (shown)	WK □ ST501824 □ FF	1	\$ 3742	\$ 41	\$ 41	
	24"D Combination Tower L/R Door/Box/Box/File	WK □ ST501824 □ BBF	1	\$ 3895	\$ 43	\$ 43	
 Left  Right	<b>57½"H Side Access Tower</b>						
	18"D Combination Tower L/R Door/Box/Box/File	WK □ ST571818 □ BBF	1	\$ 3818	\$ 42	\$ 42	
	18"D Combination Tower L/R Door/File/File	WK □ ST571818 □ FF	1	\$ 3666	\$ 40	\$ 40	
	24"D Combination Tower L/R Door/File/File	WK □ ST571824 □ FF	1	\$ 3895	\$ 43	\$ 43	
	24"D Combination Tower L/R Door/Box/Box/File	WK □ ST571824 □ BBF	1	\$ 4048	\$ 44	\$ 44	
 Left  Right	<b>65"H Side Access Tower</b>						
	18"D Combination Tower L/R Door/Box/Box/File (shown)	WK □ ST651818 □ BBF	1	\$ 4124	\$ 45	\$ 45	
	18"D Combination Tower L/R Door/File/File	WK □ ST651818 □ FF	1	\$ 3972	\$ 43	\$ 43	
	24"D Combination Tower L/R Door/File/File (shown)	WK □ ST651824 □ FF	1	\$ 4201	\$ 46	\$ 46	
	24"D Combination Tower L/R Door/Box/Box/File	WK □ ST651824 □ BBF	1	\$ 4353	\$ 47	\$ 47	
 Left  Right	<b>72"H Side Access Tower</b>						
	18"D Combination Tower L/R Door/Box/Box/File	WK □ ST721818 □ BBF	1	\$ 4431	\$ 48	\$ 48	
	18"D Combination Tower L/R Door/File/File	WK □ ST721818 □ FF	1	\$ 4431	\$ 48	\$ 48	
	24"D Combination Tower L/R Door/File/File	WK □ ST721824 □ FF	1	\$ 4658	\$ 51	\$ 51	
	24"D Combination Tower L/R Door/Box/Box/File	WK □ ST721824 □ BBF	1	\$ 4658	\$ 51	\$ 51	

All units ship with hardware to gang as individual models must be connected to an adjacent unit.

\*Upcharges are added to L1 Laminate List Price depending on woodgrain laminate selection.

<p><b>How to specify —</b> Select the Model Number from above.</p> <p>WK   S   T                     .</p>	<p><b>1st Option:</b> <b>FSC Certified Wood:</b> F FSC Certified X No FSC</p> <p>    .</p>	<p><b>2nd Option:</b> <b>Chassis Laminate and Predefined Edge:</b></p> <p>                        .</p>	<p><b>3rd Option:</b> <b>Front Laminate and Predefined Edge:</b></p> <p>                        .</p>
--	--	---	---

<p><b>4th Option:</b> <b>Pull Type</b> (if applicable):</p> <p>MP Beam OP Halo AP Arch BP Bar SP Square See matrix on page 19.</p> <p>       </p>	<p><b>5th Option:</b> <b>Pull Color</b> (if applicable):</p> <p>MP Beam / OP Halo PJV Designer White PR6 Silver PJE Pyrite P8X Solar Black AP Arch PRO Anodized Silver P2 upcharge +\$17/pull</p> <p>BP Bar P27 Black P JW Designer White PR6 Silver SP Square P JW Designer White EL Matte Silver P02 Flint P7B Loft PJE Pyrite P8X Solar Black P2 upcharge +\$17/pull</p> <p>        .</p>	<p><b>6th Option:</b> <b>Foot Type</b> (if applicable):</p> <p>PF Post Foot</p> <p><b>Foot Color</b> (if applicable):</p> <p>PJW Designer White PR6 Silver P02 Flint P7B Loft PJE Pyrite (+\$12) P8X Solar Black (+\$12)</p> <p>P   F   P       .</p>	<p><b>7th Option:</b> <b>Lock</b> (if applicable):</p> <p>STD Standard OMT Omit Lock Core (Deduct \$20 per lock)</p> <p>       </p>
---	--	---	---

Example: WKYST651824RBBF.X.LM14EW.LM14EW.BPPJW.PFP8X.STD

For specification information see pages 182-185.  
 First, select Post foot (Y) or Non-footed (N), if footed add \$100 to listed price.  
 Next, select Left (L) or Right (R) before configuration of tower.

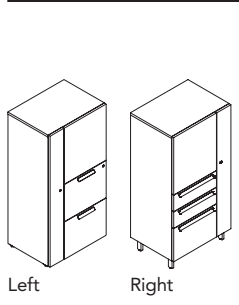

Left Right

Description	Model	Lock	L1 Laminate List Price	UPCHARGES*	
				L2 Laminate Chassis	Front
<b>50"H Personal Tower</b>					
18"D Combination Tower L/R Door/Box/Box/File (shown)	WK □ T502418 □ BBF	2	\$ 3818	\$ 42	\$ 42
18"D Combination Tower L/R Door/File/File	WK □ T502418 □ FF	2	\$ 3818	\$ 42	\$ 42
24"D Combination Tower L/R Door/File/File (shown)	WK □ T502424 □ FF	2	\$ 4124	\$ 45	\$ 45
24"D Combination Tower L/R Door/Box/Box/File	WK □ T502424 □ BBF	2	\$ 4235	\$ 46	\$ 46

<b>57½"H Personal Tower</b>					
18"D Combination Tower L/R Door/Box/Box/File	WK □ T572418 □ BBF	2	\$ 3972	\$ 43	\$ 43
18"D Combination Tower L/R Door/File/File	WK □ T572418 □ FF	2	\$ 3972	\$ 43	\$ 43
24"D Combination Tower L/R Door/File/File	WK □ T572424 □ FF	2	\$ 4275	\$ 46	\$ 46
24"D Combination Tower L/R Door/Box/Box/File	WK □ T572424 □ BBF	2	\$ 4431	\$ 48	\$ 48

<b>65"H Personal Tower</b>					
18"D Combination Tower L/R Door/Box/Box/File (shown)	WK □ T652418 □ BBF	2	\$ 4275	\$ 46	\$ 46
18"D Combination Tower L/R Door/File/File	WK □ T652418 □ FF	2	\$ 4275	\$ 46	\$ 46
24"D Combination Tower L/R Door/File/File (shown)	WK □ T652424 □ FF	2	\$ 4992	\$ 55	\$ 55
24"D Combination Tower L/R Door/Box/Box/File	WK □ T652424 □ BBF	2	\$ 5143	\$ 56	\$ 56

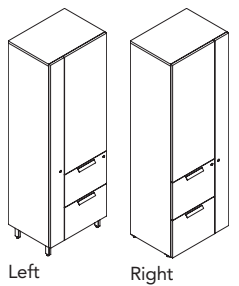

Left Right

<b>72"H Personal Tower</b>					
18"D Combination Tower L/R Door/Box/Box/File	WK □ T722418 □ BBF	2	\$ 4583	\$ 50	\$ 50
18"D Combination Tower L/R Door/File/File	WK □ T722418 □ FF	2	\$ 4737	\$ 52	\$ 52
24"D Combination Tower L/R Door/File/File	WK □ T722424 □ FF	2	\$ 5193	\$ 56	\$ 56
24"D Combination Tower L/R Door/Box/Box/File	WK □ T722424 □ BBF	2	\$ 5193	\$ 56	\$ 56

All units ship with hardware to gang as individual models must be connected to an adjacent unit. Exception: 24"D x 24"W non-footed units can be freestanding and do not require ganging.

\*Upcharges are added to L1 Laminate List Price depending on woodgrain laminate selection.  
 All towers have a hang feature included, 18"D units have coat hooks and 24"D units have coat rods.

APPROACH

<p><b>How to specify —</b>                  Select the Model Number from above.</p> <p>WK   T                         .</p>	<p><b>1st Option:</b>                  FSC Certified Wood:</p> <p>F FSC Certified                  X No FSC</p>	<p><b>2nd Option:</b>                  Chassis Laminate and Predefined Edge:</p>	<p><b>3rd Option:</b>                  Front Laminate and Predefined Edge:</p>
---	---	--	--

<p><b>4th Option:</b>                  Pull Type (if applicable):</p> <p>MP Beam                  OP Halo                  AP Arch                  BP Bar                  SP Square                  See matrix on page 19.</p>	<p><b>5th Option:</b>                  Pull Color (if applicable):</p> <p>MP Beam / OP Halo                  PJW Designer White                  PR6 Silver                  PJE Pyrite                  P8X Solar Black                  AP Arch                  PRO Anodized Silver                  P2 upcharge +\$17/pull</p>	<p><b>6th Option:</b>                  Foot Type (if applicable):</p> <p>PF Post Foot</p> <p><b>Foot Color (if applicable):</b>                  PJW Designer White                  PR6 Silver                  P02 Flint                  P7B Loft                  PJE Pyrite (+\$12)                  P8X Solar Black (+\$12)</p>	<p><b>7th Option:</b>                  Lock (if applicable):</p> <p>STD Standard                  OMT Omit Lock Core (Deduct \$20 per lock)</p>
---	--	---	---

Example: WKNT501824RBBF.X.LM14EW.LM14EW.LSW1SW.BPPJW.STD



For specification information see pages 182-185.  
 First, select Post foot (Y) or Non-footed (N), if footed add \$100 to listed price.  
 Next, select Left (L) or Right (R) before configuration of tower.

Description	Model	Lock	L1 Laminate List Price	UPCHARGES*	
				L2 Laminate Chassis	Front
<b>50"H Side Access Tower</b>					
18"D Combination Tower L/R Door/Box/Box/File (shown)	WK □ ST502418 □ BBF	2	\$ 3818	\$ 42	\$ 42
18"D Combination Tower L/R Door/File/File	WK □ ST502418 □ FF	2	\$ 3818	\$ 42	\$ 42
24"D Combination Tower L/R Door/File/File (shown)	WK □ ST502424 □ FF	2	\$ 4124	\$ 45	\$ 45
24"D Combination Tower L/R Door/Box/Box/File	WK □ ST502424 □ BBF	2	\$ 4235	\$ 46	\$ 46
<b>57½"H Side Access Tower</b>					
18"D Combination Tower L/R Door/Box/Box/File (shown)	WK □ ST572418 □ BBF	2	\$ 3972	\$ 43	\$ 43
18"D Combination Tower L/R Door/File/File	WK □ ST572418 □ FF	2	\$ 3972	\$ 43	\$ 43
24"D Combination Tower L/R Door/File/File (shown)	WK □ ST572424 □ FF	2	\$ 4275	\$ 46	\$ 46
24"D Combination Tower L/R Door/Box/Box/File	WK □ ST572424 □ BBF	2	\$ 4431	\$ 48	\$ 48
<b>65"H Side Access Tower</b>					
18"D Combination Tower L/R Door/Box/Box/File (shown)	WK □ ST652418 □ BBF	2	\$ 4275	\$ 46	\$ 46
18"D Combination Tower L/R Door/File/File	WK □ ST652418 □ FF	2	\$ 4275	\$ 46	\$ 46
24"D Combination Tower L/R Door/File/File (shown)	WK □ ST652424 □ FF	2	\$ 4583	\$ 50	\$ 50
24"D Combination Tower L/R Door/Box/Box/File	WK □ ST652424 □ BBF	2	\$ 4737	\$ 52	\$ 52
<b>72"H Side Access Tower</b>					
18"D Combination Tower L/R Door/Box/Box/File	WK □ ST722418 □ BBF	2	\$ 4583	\$ 50	\$ 50
18"D Combination Tower L/R Door/File/File	WK □ ST722418 □ FF	2	\$ 4737	\$ 52	\$ 52
24"D Combination Tower L/R Door/File/File	WK □ ST722424 □ FF	2	\$ 5193	\$ 56	\$ 56
24"D Combination Tower L/R Door/Box/Box/File	WK □ ST722424 □ BBF	2	\$ 5193	\$ 56	\$ 56

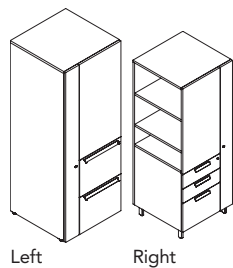
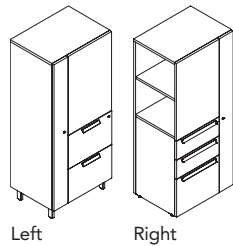
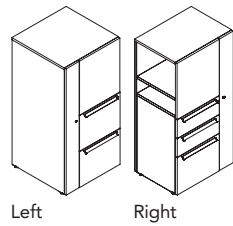

All units ship with hardware to gang as individual models must be connected to an adjacent unit. Exception: 24"D x 24"W non-footed units can be freestanding and do not require ganging.  
 \*Upcharges are added to L1 Laminate List Price depending on woodgrain laminate selection.  
 All towers have a hang feature included, 18"D units have coat hooks and 24"D units have coat rods.

<b>How to specify —</b> Select the Model Number from above.  WK   S   T             .	<b>1st Option:</b> <b>FSC Certified Wood:</b> F FSC Certified X No FSC	<b>2nd Option:</b> <b>Chassis Laminate and Predefined Edge:</b>	<b>3rd Option:</b> <b>Front Laminate and Predefined Edge:</b>
	.	.	.

<b>4th Option:</b> <b>Pull Type (if applicable):</b> MP Beam OP Halo AP Arch BP Bar SP Square See matrix on page 19.	<b>5th Option:</b> <b>Pull Color (if applicable):</b> MP Beam / OP Halo PJW Designer White PR6 Silver PJE Pyrite P8X Solar Black AP Arch PRO Anodized Silver P2 upcharge +\$17/pull	<b>6th Option:</b> <b>Foot Type (if applicable):</b> PF Post Foot  <b>Foot Color (if applicable):</b> PJW Designer White PR6 Silver P02 Flint P7B Loft PJE Pyrite (+\$12) P8X Solar Black (+\$12)	<b>7th Option:</b> <b>Lock (if applicable):</b> STD Standard OMT Omit Lock Core (Deduct \$20 per lock)
.	.	P   F   P       .	.

Example: WKNST651824RBBF.X.LM14EW.LM14EW.BPPJW.STD

For specification information see page 183.

GSA SIN 33721



Description	Model	L1 Laminate List Price	UPCHARGES*	
			L2 Laminate	
<b>Cubby Storage 7"H x 14"D (non-handed)</b>				
18"W	WKWC1814-SH	\$ 723	\$ 27	
24"W	WKWC2414-SH	\$ 775	\$ 29	
30"W	WKWC3014-SH	\$ 828	\$ 30	

\*Upcharges are added to L1 Laminate List Price depending on woodgrain laminate selection.

APPROACH

<p><i>How to specify —</i> Select the Model Number from above.</p>  <p>WK          </p> <p>                    .</p>	<p><i>1st Option:</i> <b>FSC Certified Wood:</b> F FSC Certified X No FSC</p>	<p><i>2nd Option:</i> <b>Laminate:</b></p>   <p>                   </p>
--	---	--

*Example:*

For specification information see pages 182-185.  
Post Foot (Y/N) add \$100 to listed price on footed option.

GSA SIN 33721

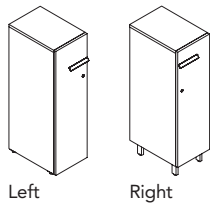

Left Right

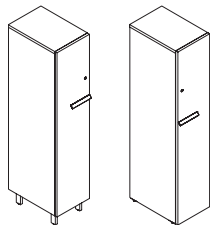

Left Right

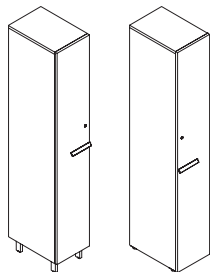

Left Right

Description	Model	Lock	L1 Laminate List Price	UPCHARGES*	
				L2 Laminate Chassis	Front
<b>42½"H Wardrobe</b>					
18"D Wardrobe Hinges on Left (shown)	WK □ T421218L	1	\$ 2543	\$ 28	\$ 28
18"D Wardrobe Hinges on Right (shown)	WK □ T421218R	1	\$ 2543	\$ 28	\$ 28
24"D Wardrobe Hinges on Left	WK □ T421224L	1	\$ 2582	\$ 29	\$ 29
24"D Wardrobe Hinges on Right	WK □ T421224R	1	\$ 2582	\$ 29	\$ 29
*Includes one adjustable shelf and location for a second adjustable shelf.					
<b>50"H Wardrobe</b>					
18"D Wardrobe Hinges on Left	WK □ T501218L	1	\$ 2619	\$ 29	\$ 29
18"D Wardrobe Hinges on Right	WK □ T501218R	1	\$ 2619	\$ 29	\$ 29
24"D Wardrobe Hinges on Left	WK □ T501224L	1	\$ 2673	\$ 30	\$ 30
24"D Wardrobe Hinges on Right	WK □ T501224R	1	\$ 2673	\$ 30	\$ 30
*Includes one adjustable shelf and location for a second adjustable shelf.					
<b>57½"H Wardrobe</b>					
18"D Wardrobe Hinges on Left (shown)	WK □ T571218L	1	\$ 2734	\$ 30	\$ 30
18"D Wardrobe Hinges on Right (shown)	WK □ T571218R	1	\$ 2734	\$ 30	\$ 30
24"D Wardrobe Hinges on Left	WK □ T571224L	1	\$ 2749	\$ 30	\$ 30
24"D Wardrobe Hinges on Right	WK □ T571224R	1	\$ 2749	\$ 30	\$ 30
*Includes two adjustable shelf locations and one fixed shelf 13" above base panel.					
<b>65"H Wardrobe</b>					
18"D Wardrobe Hinges on Left	WK □ T651218L	1	\$ 2772	\$ 31	\$ 31
18"D Wardrobe Hinges on Right	WK □ T651218R	1	\$ 2772	\$ 31	\$ 31
24"D Wardrobe Hinges on Left	WK □ T651224L	1	\$ 2787	\$ 31	\$ 31
24"D Wardrobe Hinges on Right	WK □ T651224R	1	\$ 2787	\$ 31	\$ 31
*Includes two adjustable shelf locations and one fixed shelf 13" above base panel.					
<b>72"H Wardrobe</b>					
18"D Wardrobe Hinges on Left (shown)	WK □ T721218L	1	\$ 2911	\$ 32	\$ 32
18"D Wardrobe Hinges on Right (shown)	WK □ T721218R	1	\$ 2911	\$ 32	\$ 32
24"D Wardrobe Hinges on Left	WK □ T721224L	1	\$ 2997	\$ 33	\$ 33
24"D Wardrobe Hinges on Right	WK □ T721224R	1	\$ 2997	\$ 33	\$ 33
*Includes three adjustable shelf locations and one fixed shelf 13" above base panel.					

All units ship with hardware to gang as individual models must be connected to an adjacent unit.  
All towers have a hang feature included, 18"D units have coat hooks and 24"D units have coat rods.  
\*Upcharges are added to L1 Laminate List Price depending on woodgrain laminate selection.

<b>How to specify —</b> Select the Model Number from above.  WK   T                     .	<b>1st Option:</b> <b>FSC Certified Wood:</b> F FSC Certified X No FSC	<b>2nd Option:</b> <b>Chassis Laminate and Predefined Edge:</b>	<b>3rd Option:</b> <b>Front Laminate and Predefined Edge:</b>
	.	.	.

<b>4th Option:</b> <b>Pull Type</b> (if applicable): MP Beam OP Halo AP Arch BP Bar SP Square See matrix on page 19.	<b>5th Option:</b> <b>Pull Color</b> (if applicable): MP Beam / OP Halo PJW Designer White PR6 Silver PJE Pyrite P8X Solar Black AP Arch PRO Anodized Silver P2 upcharge +\$17/pull	<b>6th Option:</b> <b>Foot Type</b> (if applicable): PF Post Foot  <b>Foot Color</b> (if applicable): PJW Designer White PR6 Silver P02 Flint P7B Loft PJE Pyrite (+\$12) P8X Solar Black (+\$12)	<b>7th Option:</b> <b>Lock</b> (if applicable): STD Standard OMT Omit Lock Core (Deduct \$20 per lock)
.	.	P   F   P                 .	.

Example: WKYST651824RBBF.X.LM14EW.LM14EW.BPPJW.PFP8X.OMT

For specification information see pages 182-185.  
Post Foot (Y/N) add \$100 to listed price on footed option.

GSA SIN 33721

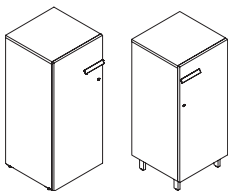
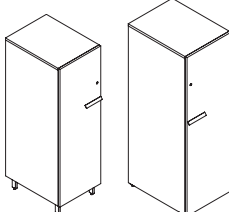
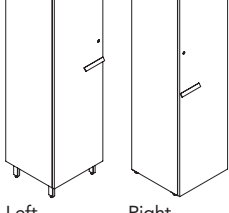
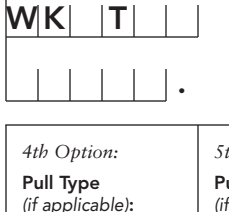
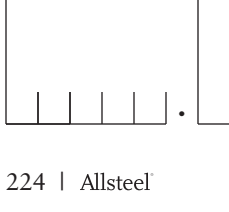
	Description	Model	Lock	L1 Laminate List Price	UPCHARGES*		
					L2 Laminate Chassis	Front	
 Left      Right	<b>42½"H Wardrobe</b>						
	18"D Wardrobe Hinges on Left	WK □ T421818L	1	\$ 2696	\$ 30	\$ 30	
	18"D Wardrobe Hinges on Right (shown)	WK □ T421818R	1	\$ 2696	\$ 30	\$ 30	
	24"D Wardrobe Hinges on Left	WK □ T421824L	1	\$ 2776	\$ 31	\$ 31	
	24"D Wardrobe Hinges on Right	WK □ T421824R	1	\$ 2776	\$ 31	\$ 31	
*Includes one adjustable shelf and location for a second adjustable shelf.							
 Left      Right	<b>50"H Wardrobe</b>						
	18"D Wardrobe Hinges on Left	WK □ T501818L	1	\$ 2650	\$ 30	\$ 30	
	18"D Wardrobe Hinges on Right	WK □ T501818R	1	\$ 2650	\$ 30	\$ 30	
	24"D Wardrobe Hinges on Left	WK □ T501824L	1	\$ 2729	\$ 30	\$ 30	
	24"D Wardrobe Hinges on Right	WK □ T501824R	1	\$ 2729	\$ 30	\$ 30	
*Includes one adjustable shelf and location for a second adjustable shelf.							
 Left      Right	<b>57½"H Wardrobe</b>						
	18"D Wardrobe Hinges on Left (shown)	WK □ T571818L	1	\$ 2933	\$ 32	\$ 32	
	18"D Wardrobe Hinges on Right (shown)	WK □ T571818R	1	\$ 2933	\$ 32	\$ 32	
	24"D Wardrobe Hinges on Left	WK □ T571824L	1	\$ 3021	\$ 33	\$ 33	
	24"D Wardrobe Hinges on Right	WK □ T571824R	1	\$ 3021	\$ 33	\$ 33	
*Includes two adjustable shelf locations and one fixed shelf 13" above base panel.							
 Left      Right	<b>65"H Wardrobe</b>						
	18"D Wardrobe Hinges on Left	WK □ T651818L	1	\$ 2994	\$ 33	\$ 33	
	18"D Wardrobe Hinges on Right	WK □ T651818R	1	\$ 2994	\$ 33	\$ 33	
	24"D Wardrobe Hinges on Left	WK □ T651824L	1	\$ 3083	\$ 34	\$ 34	
	24"D Wardrobe Hinges on Right	WK □ T651824R	1	\$ 3083	\$ 34	\$ 34	
*Includes two adjustable shelf locations and one fixed shelf 13" above base panel.							
 Left      Right	<b>72"H Wardrobe</b>						
	18"D Wardrobe Hinges on Left (shown)	WK □ T721818L	1	\$ 3178	\$ 35	\$ 35	
	18"D Wardrobe Hinges on Right (shown)	WK □ T721818R	1	\$ 3178	\$ 35	\$ 35	
	24"D Wardrobe Hinges on Left	WK □ T721824L	1	\$ 3274	\$ 36	\$ 36	
	24"D Wardrobe Hinges on Right	WK □ T721824R	1	\$ 3274	\$ 36	\$ 36	
*Includes three adjustable shelf locations and one fixed shelf 13" above base panel.							
All units ship with hardware to gang as individual models must be connected to an adjacent unit.							
All towers have a hang feature included, 18"D units have coat hooks and 24"D units have coat rods.							
*Upcharges are added to L1 Laminate List Price depending on woodgrain laminate selection.							

APPROACH

<b>How to specify —</b> Select the Model Number from above.  WK   T	<b>1st Option:</b> <b>FSC Certified Wood:</b> F FSC Certified X No FSC	<b>2nd Option:</b> <b>Chassis Laminate and Predefined Edge:</b>	<b>3rd Option:</b> <b>Front Laminate and Predefined Edge:</b>
	.	.	.

<b>4th Option:</b> <b>Pull Type</b> (if applicable): MP Beam OP Halo AP Arch BP Bar SP Square See matrix on page 19.	<b>5th Option:</b> <b>Pull Color</b> (if applicable): MP Beam / OP Halo PJW Designer White PR6 Silver PJE Pyrite P8X Solar Black AP Arch PRO Anodized Silver P2 upcharge +\$17/pull	<b>6th Option:</b> <b>Foot Type</b> (if applicable): PF Post Foot  <b>Foot Color</b> (if applicable): PJW Designer White PR6 Silver P02 Flint P7B Loft PJE Pyrite (+\$12) P8X Solar Black (+\$12)	<b>7th Option:</b> <b>Lock</b> (if applicable): STD Standard OMT Omit Lock Core (Deduct \$20 per lock)
.	.	.	.

Example: WKYT721818L.X.LM14EW.LM14EW.BPP27.PFP8X.STD

For specification information see pages 182-185.  
 Post Foot (Y/N) add \$100 to listed price on footed option.

GSA SIN 33721

Description	Model	Lock	L1 Laminate List Price	UPCHARGES*	
				Chassis	L2 Laminate Front
<b>42½"H Wardrobe</b>					
18"D Wardrobe Double Door	WK □ T422418	1	\$ 2902	\$ 32	\$ 32
24"D Wardrobe Double Door (shown)	WK □ T422424	1	\$ 2989	\$ 33	\$ 33
*Includes one adjustable shelf and location for a second adjustable shelf on right side of unit with left side being an open wardrobe.					
<b>50"H Wardrobe</b>					
18"D Wardrobe Double Door	WK □ T502418	1	\$ 2879	\$ 32	\$ 32
24"D Wardrobe Double Door	WK □ T502424	1	\$ 2966	\$ 33	\$ 33
*Includes one adjustable shelf and location for a second adjustable shelf on right side of unit with left side being an open wardrobe.					
<b>57½"H Wardrobe</b>					
18"D Wardrobe Double Door (shown)	WK □ T572418	1	\$ 3169	\$ 35	\$ 35
24"D Wardrobe Double Door (shown)	WK □ T572424	1	\$ 3264	\$ 36	\$ 36
*Includes two adjustable shelf locations and one fixed shelf 13" above base panel on right side of unit with left side being an open wardrobe.					
<b>65"H Wardrobe</b>					
18"D Wardrobe Double Door	WK □ T652418	1	\$ 3244	\$ 35	\$ 35
24"D Wardrobe Double Door	WK □ T652424	1	\$ 4060	\$ 44	\$ 44
*Includes two adjustable shelf locations and one fixed shelf 13" above base panel on right side of unit with left side being an open wardrobe.					
<b>72"H Wardrobe</b>					
18"D Wardrobe Double Door (shown)	WK □ T722418	1	\$ 3451	\$ 38	\$ 38
24"D Wardrobe Double Door (shown)	WK □ T722424	1	\$ 3556	\$ 39	\$ 39
*Includes three adjustable shelf locations and one fixed shelf 13" above base panel on right side of unit with left side being an open wardrobe.					

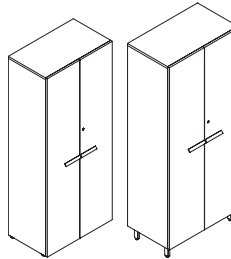
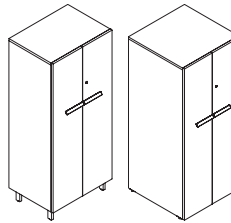
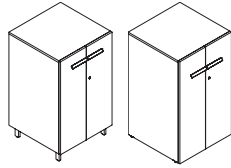

All units ship with hardware to gang as individual models must be connected to an adjacent unit. Exception: 24"D x 24"W non-footed units can be freestanding and do not require ganging.  
 All towers have a hang feature included, 18"D units have coat hooks and 24"D units have coat rods.  
 \*Upcharges are added to L1 Laminate List Price depending on woodgrain laminate selection.

<b>How to specify —</b> Select the Model Number from above.  WK   T	<b>1st Option:</b> <b>FSC Certified Wood:</b> F FSC Certified X No FSC	<b>2nd Option:</b> <b>Chassis Laminate and Predefined Edge:</b>	<b>3rd Option:</b> <b>Front Laminate and Predefined Edge:</b>
	_____ .	_____ .	_____ .

<b>4th Option:</b> <b>Pull Type</b> (if applicable): MP Beam OP Halo AP Arch BP Bar SP Square See matrix on page 19.	<b>5th Option:</b> <b>Pull Color</b> (if applicable): MP Beam / OP Halo PJW Designer White PR6 Silver PJE Pyrite P8X Solar Black AP Arch PRO Anodized Silver P2 upcharge +\$17/pull	<b>6th Option:</b> <b>Foot Type</b> (if applicable): PF Post Foot  <b>Foot Color</b> (if applicable): PJW Designer White PR6 Silver P02 Flint P7B Loft PJE Pyrite (+\$12) P8X Solar Black (+\$12)	<b>7th Option:</b> <b>Lock</b> (if applicable): STD Standard OMT Omit Lock Core (Deduct \$20 per lock)
_____ .	_____ .	_____ .	_____ .

Example: WKYT572418R.X.LM14EW.LM14EW.BPP27.PFP8X.STD

For specification information see pages 182-185.

GSA SIN 33721

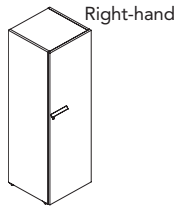

Description	MODEL – Handed Models: Add "L" for Left-hand model Add "R" for Right-hand model		Locks	L1 Laminate List Price	UPCHARGES*	
					L2 Laminate Chassis	Front
<b>18"W Tower with Hinged Door (handed)</b>						
56"H x 18"D Laminate Door	WKCLFN4H1818	□ H-HDL	1	\$ 2770	\$ 66	\$ 30
56"H x 24"D Laminate Door	WKCLFN4H1824	□ H-HDL	1	\$ 2826	\$ 69	\$ 31
71"H x 18"D Laminate Door	WKCLFN5H1818	□ H-HDL	1	\$ 2877	\$ 70	\$ 31
71"H x 24"D Laminate Door	WKCLFN5H1824	□ H-HDL	1	\$ 2927	\$ 71	\$ 32

Example of right-hand model shown: **WKCLFN4H1818RH-HDL**

All units ship with hardware to gang as individual models must be connected to an adjacent unit.

\*Upcharges are added to L1 Laminate List Price depending on woodgrain laminate selection.

\*All doors and drawers have pulls.

For specification information see pages 167-189.

Select Post Foot "Y" or Non-footed "N" (add \$100 for footed option). Next (Handed Models): select left-hand "L" or right-hand "R."

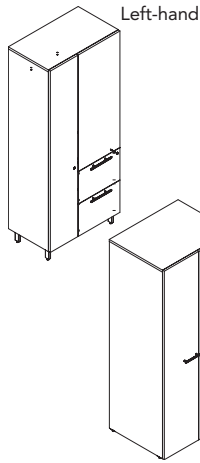

Description	MODEL – Handed Models: Add "L" for Left-hand model Add "R" for Right-hand model		Locks	L1 Laminate List Price	UPCHARGES*	
					L2 Laminate Chassis	Front
<b>30"W Personal Tower (handed)</b>						
72"H x 18"D Combination Tower L/R Door/File/File	WK	□ T723018	□ FF	2	\$ 4839	\$ 109 \$ 74
72"H x 24"D Combination Tower L/R Door/File/File	WK	□ T723024	□ FF	2	\$ 5443	\$ 124 \$ 82
Example of left-hand model shown: <b>WKYT723018LFF</b>						
<b>30"W Wardrobe (non-handed)</b>						
72"H x 18"D Laminate Front	WK	□ T723018	1	\$ 3720	\$ 84	\$ 56
72"H x 24"D Laminate Front	WK	□ T723024	1	\$ 3822	\$ 87	\$ 58

All units ship with hardware to gang as individual models must be connected to an adjacent unit. Exception: 24"D x 30"W non-footed units can be freestanding and do not require ganging.

\*Upcharges are added to L1 Laminate List Price depending on woodgrain laminate selection.

\*All doors and drawers have pulls.

APPROACH

<p><b>How to specify —</b> Select the Model Number from above.</p> <p>WK                     .</p>	<p><i>1st Option:</i> <b>FSC Certified Wood:</b></p> <p>F FSC Certified X No FSC</p> <p>  .</p>	<p><i>2nd Option:</i> <b>Chassis Laminate and Predefined Edge:</b></p> <p>                .</p>	<p><i>3rd Option:</i> <b>Front Laminate and Predefined Edge:</b></p> <p>                .</p>
--	---	---	---

<p><i>4th Option:</i> <b>Pull Type</b> (if applicable):</p> <p>MP Beam OP Halo AP Arch BP Bar SP Square See matrix on page 19.</p> <p>          .</p>	<p><i>5th Option:</i> <b>Pull Color</b> (if applicable):</p> <p>MP Beam / OP Halo PJV Designer White PR6 Silver PJE Pyrite P8X Solar Black AP Arch PRO Anodized Silver P2 upcharge +\$17/pull</p> <p>        .</p>	<p><i>6th Option:</i> <b>Foot Type</b> (if applicable):</p> <p>PF Post Foot</p> <p><b>Foot Color</b> (if applicable):</p> <p>PJV Designer White PR6 Silver P02 Flint P7B Loft PJE Pyrite (+\$12) P8X Solar Black (+\$12)</p> <p>P   F   P     .</p>	<p><i>7th Option:</i> <b>Lock</b> (if applicable):</p> <p>STD Standard OMT Omit Lock Core (Deduct \$20 per lock)</p> <p>        .</p>
---	--	---	---

Example: **WKCLFN4H1818LH-HDL.F.LM14EW.LM13EY.APPR6.STD**



For specification information see pages 182-185.

GSA SIN 33721

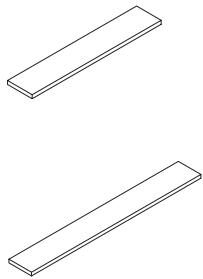

Description	Model	List Price	
		L1	L2
<b>8"D Floating Shelf</b>			
30" W	WKFS30	\$ 1241	\$ 1286
36" W	WKFS36	\$ 1304	\$ 1351
42" W (shown)	WKFS42	\$ 1366	\$ 1416
48" W	WKFS48	\$ 1428	\$ 1480
54" W	WKFS54	\$ 1492	\$ 1546
60" W (shown)	WKFS60	\$ 1554	\$ 1610
66" W	WKFS66	\$ 1618	\$ 1676
72" W	WKFS72	\$ 1679	\$ 1739
78" W	WKFS78	\$ 1742	\$ 1806

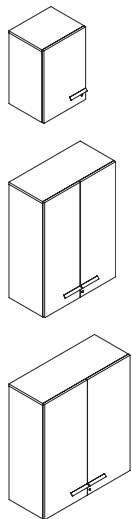

Description	MODEL – Handed Models: Add "L" for Left-hand model Add "R" for Right-hand model	Locks	L1 Laminate List Price	UPCHARGES*	
				L2 Laminate Chassis	Front
<b>18"W x 15"D Stack-On Storage with Hinged Door (handed)</b>					
27½"H Laminate Door	WKTWFN4H1815 □ H-HDL	1	\$ 1624	\$ 40	\$ 19
42½"H Laminate Door	WKTWFN5H1815 □ H-HDL	1	\$ 1825	\$ 43	\$ 20
Example of right-hand model shown: WKTWFN4H1815RH-HDL					
<b>30"W x 15"D Stack-On Storage with Hinged Doors (non-handed)</b>					
27½"H Laminate Door	WKTWFN4H3015-HDL	1	\$ 2053	\$ 48	\$ 22
42½"H Laminate Door	WKTWFN5H3015-HDL	1	\$ 2227	\$ 52	\$ 24
<b>36"W x 15"D Stack-On Storage with Hinged Doors (non-handed)</b>					
27½"H Laminate Door	WKTWFN4H3615-HDL	1	\$ 2032	\$ 50	\$ 23
42½"H Laminate Door	WKTWFN5H3615-HDL	1	\$ 2420	\$ 56	\$ 26

\*Upcharges are added to L1 Laminate List Price depending on woodgrain laminate selection.

APPROACH

<p><b>How to specify —</b> Select the Model Number from above.</p> <p>WK _____ .</p>	<p><b>1st Option:</b> <b>FSC Certified Wood:</b> F FSC Certified X No FSC</p>	<p><b>2nd Option:</b> <b>Chassis Laminate and Predefined Edge</b> (if applicable):</p>	<p><b>2nd Option:</b> <b>Top Laminate and Predefined Edge on Floating Shelf</b> (if applicable):</p>	<p><b>3rd Option:</b> <b>Front Laminate and Predefined Edge</b> (if applicable):</p>
--	---	--	--	--

<p><b>4th Option:</b> <b>Pull Type</b> (if applicable): MP Beam OP Halo AP Arch BP Bar SP Square See matrix on page 19.</p>	<p><b>5th Option:</b> <b>Pull Color</b> (if applicable): MP Beam / OP Halo PJV Designer White PR6 Silver PJE Pyrite P8X Solar Black AP Arch PRO Anodized Silver P2 upcharge +\$17/pull</p>	<p><b>6th Option:</b> <b>Lock</b> (if applicable): STD Standard OMT Omit Lock Core (Deduct \$20)</p>	<p><b>7th Option:</b> <b>End Cap Paint Color Predefined Edge</b> (if applicable):</p>
---	--	--	---

Example: WKTWFN4H1815LH-HDL.F.LM14EW.LSW1SW.APPR6.STD.PR6





Description	Model	Locks	List Price	
			L1	L2

### 28"H Credenzas

First, select Trough (F) or Troughless (T). If troughless, subtract \$100 from listed footed price.  
Next, select Footed (Y) or Non-footed (N). If non-footed, subtract \$100 from listed footed price.

### 35"H Hutch

48"W Laminate Hinged Doors	WKOH3548-HDL	1	\$ 2235	\$ 2259
60"W Laminate Hinged Doors (shown)	WKOH3560-HDL	2	\$ 2502	\$ 2529
66"W Laminate Hinged Doors	WKOH3566-HDL	2	\$ 2545	\$ 2573
72"W Laminate Hinged Doors	WKOH3572-HDL	2	\$ 2997	\$ 3030

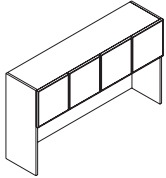
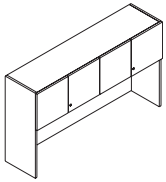

### 35"H Hutch

48"W Frosted Glass Hinged Doors	WKOH3548-HDG	—	\$ 2849	\$ 2952
60"W Frosted Glass Hinged Doors (shown)	WKOH3560-HDG	—	\$ 3200	\$ 3315
66"W Frosted Glass Hinged Doors	WKOH3566-HDG	—	\$ 3384	\$ 3505
72"W Frosted Glass Hinged Doors	WKOH3572-HDG	—	\$ 3987	\$ 4130

How to specify — Select the Model Number from above.	1st Option: FSC Certified Wood: F FSC Certified X No FSC	2nd Option: Chassis Laminate and Predefined Edge (if applicable):	3rd Option: Front Laminate and Predefined Edge:	4th Option: Lock (if applicable): STD Standard OMT Omit Lock Core (Deduct \$20) LN No Lock HDL models only
WK				

Example: WKOH3560-HDG.X.LM14EW.LM14EW.STD

Description	Model	List Price					
		Grade A	Grade B	Grade C	Grade D	Grade E	Grade F

19"H Tackboards for Hutches (nested in a metal frame)							
48"W Nominal Width 44¾" W	WTKFT4H44-HA	\$ 378	\$ 406	\$ 433	\$ 461	\$ 497	\$ 534
60"W Nominal Width 56¾" W	WTKFT4H56-HA	\$ 478	\$ 513	\$ 547	\$ 582	\$ 628	\$ 674
66"W (2pc) Nominal Width 62¾" W	WTKFT4H62-HA	\$ 527	\$ 566	\$ 604	\$ 642	\$ 693	\$ 744
72"W (2pc) Nominal Width 68¾" W	WTKFT4H68-HA	\$ 580	\$ 623	\$ 664	\$ 707	\$ 763	\$ 819

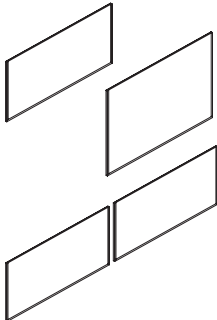

How to specify — Select the Model Number from above.	1st Option: Tackboard Fabric (if applicable): See page 14 for fabrics.	2nd Option: Tackboard Frame Paint: P1 P2 P3 See page 161 for finishes. P2 paint upcharge \$32 (except PR6) P3 paint upcharge \$82
WK T K F T 4 H   H A		

Example: WTKFT4H56-HA.APN911.PR6



For specification information see page 186. See page 333 for COM pricing on grades G-J.

GSA SIN 33721

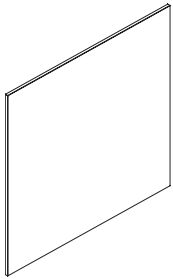

Description	Model	List Price					
		Grade A	Grade B	Grade C	Grade D	Grade E	Grade F
<b>45"H Tackboards</b>							
30"W	WTKKFT5H30-FA	\$ 600	\$ 630	\$ 658	\$ 707	\$ 756	\$ 804
36"W	WTKKFT5H36-FA	\$ 619	\$ 654	\$ 689	\$ 747	\$ 805	\$ 864
42"W	WTKKFT5H42-FA	\$ 671	\$ 712	\$ 752	\$ 820	\$ 887	\$ 955
48"W	WTKKFT5H48-FA	\$ 731	\$ 778	\$ 824	\$ 903	\$ 980	\$ 1057
54"W	WTKKFT5H54-FA	\$ 767	\$ 820	\$ 872	\$ 959	\$ 1047	\$ 1134
60"W	WTKKFT5H60-FA	\$ 826	\$ 884	\$ 942	\$ 1039	\$ 1136	\$ 1232
66"W (2 Piece)	WTKKFT5H66-FA	\$ 851	\$ 916	\$ 979	\$ 1086	\$ 1193	\$ 1299
72"W (2 Piece)	WTKKFT5H72-FA	\$ 941	\$ 1011	\$ 1081	\$ 1197	\$ 1313	\$ 1429
78"W (2 Piece)	WTKKFT5H78-FA	\$ 988	\$ 1064	\$ 1139	\$ 1265	\$ 1391	\$ 1516
84"W (2 Piece)	WTKKFT5H84-FA	\$ 1036	\$ 1118	\$ 1199	\$ 1335	\$ 1470	\$ 1607
90"W (3 Piece)	WTKKFT5H90-FA	\$ 1076	\$ 1164	\$ 1251	\$ 1396	\$ 1541	\$ 1686
96"W (2 Piece)	WTKKFT5H96-FA	\$ 1119	\$ 1212	\$ 1306	\$ 1461	\$ 1617	\$ 1771

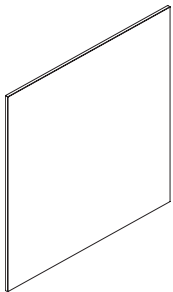

Description	Model	List Price					
		Grade A	Grade B	Grade C	Grade D	Grade E	Grade F
<b>49"H Tackboards (for use with trough units)</b>							
30"W	WTKKFT5H30-LA	\$ 623	\$ 655	\$ 687	\$ 739	\$ 791	\$ 844
36"W	WTKKFT5H36-LA	\$ 643	\$ 682	\$ 719	\$ 782	\$ 845	\$ 908
42"W	WTKKFT5H42-LA	\$ 701	\$ 746	\$ 790	\$ 864	\$ 937	\$ 1011
48"W	WTKKFT5H48-LA	\$ 762	\$ 813	\$ 864	\$ 948	\$ 1032	\$ 1117
54"W	WTKKFT5H54-LA	\$ 796	\$ 853	\$ 910	\$ 1006	\$ 1101	\$ 1195
60"W	WTKKFT5H60-LA	\$ 859	\$ 923	\$ 986	\$ 1092	\$ 1197	\$ 1303
66"W (2 Piece)	WTKKFT5H66-LA	\$ 884	\$ 954	\$ 1024	\$ 1140	\$ 1256	\$ 1372
72"W (2 Piece)	WTKKFT5H72-LA	\$ 978	\$ 1055	\$ 1131	\$ 1258	\$ 1384	\$ 1510
78"W (2 Piece)	WTKKFT5H78-LA	\$ 1027	\$ 1110	\$ 1192	\$ 1329	\$ 1467	\$ 1604
84"W (2 Piece)	WTKKFT5H84-LA	\$ 1076	\$ 1165	\$ 1253	\$ 1400	\$ 1548	\$ 1696
90"W (3 Piece)	WTKKFT5H90-LA	\$ 1121	\$ 1216	\$ 1311	\$ 1469	\$ 1627	\$ 1785
96"W (2 Piece)	WTKKFT5H96-LA	\$ 1164	\$ 1266	\$ 1367	\$ 1535	\$ 1704	\$ 1873

Description	45"H Models Use w/Full Height	49"H Models Use w/Layered Height	List Price	
			45"H	49"H
<b>Writable Boards</b>				
30"W	WTKKGT5H30-FA	WTKKGT5H30-LA	\$ 735	\$ 767
36"W	WTKKGT5H36-FA	WTKKGT5H36-LA	\$ 763	\$ 793
42"W	WTKKGT5H42-FA	WTKKGT5H42-LA	\$ 828	\$ 862
48"W	WTKKGT5H48-FA	WTKKGT5H48-LA	\$ 899	\$ 936
54"W	WTKKGT5H54-FA	WTKKGT5H54-LA	\$ 943	\$ 980
60"W	WTKKGT5H60-FA	WTKKGT5H60-LA	\$ 1016	\$ 1058
66"W	WTKKGT5H66-FA	WTKKGT5H66-LA	\$ 1045	\$ 1086
72"W	WTKKGT5H72-FA	WTKKGT5H72-LA	\$ 1161	\$ 1206
78"W (2 Piece)	WTKKGT5H78-FA	WTKKGT5H78-LA	\$ 1215	\$ 1264
84"W (2 Piece)	WTKKGT5H84-FA	WTKKGT5H84-LA	\$ 1278	\$ 1326
90"W (3 Piece)	WTKKGT5H90-FA	WTKKGT5H90-LA	\$ 1327	\$ 1382
96"W (2 Piece)	WTKKGT5H96-FA	WTKKGT5H96-LA	\$ 1378	\$ 1432

APPROACH

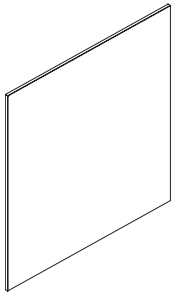

<p><b>How to specify —</b> Select the Model Number from above.</p>	<p><i>1st Option:</i> <b>Fabric</b> (if applicable): See page 14 for fabrics.</p>
--	---

W K T | K | | | | | | | | | . | | | | | | | | | |

Examples: WTKKFT5H48-FA.APN911 WTKKGT5H96-LA

For specification information see page 187.

GSA SIN 33721

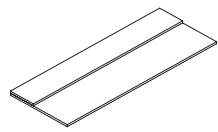

Description	Model	List Price
<b>Counterweights for Approach — Reference usage chart on pages 168-169</b>		
25 pounds	WKCACW25	\$ 304
35 pounds	WKCACW35	\$ 407
50 pounds	WKCACW50	\$ 458
65 pounds	WKCACW65	\$ 542

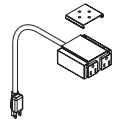

<b>Mini Tap Power</b>		
Mini Tap Power Port — 2 Power	WKMTMP	\$ 240
Mini Tap Power Port — 1 Power, 1 USB	WKMTMU	\$ 347
Mini Tap Mounting Bracket	WKMTMB	\$ 74

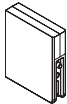

<b>End Cap — Specify Paint Color</b>		
1 — End Cap used to finish trough	WKEC	\$ 121



<b>End Cap — Specify Paint Color</b>		
Shortened End Cap (actual 2.7" W x 2" H)	WKSEC	\$ 120

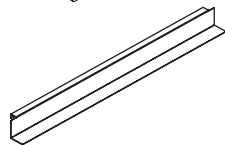

<b>Wire Manager for Height-Adjustable Trough (Flint only)</b>		
30" W	WKWT30	\$ 149

**How to specify —**  
Select the  
Model Number  
from above.

*1st Option:*  
**Paint Color**  
(if applicable):  
P27 Black  
PJW Designer White  
PR6 Silver

WK | | | | | | | | | | . | | | | |

*Examples:* WKCACW25 WKMTMP WKEC.PJW

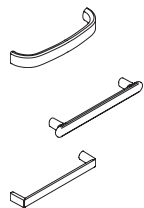

Description	Model	List Price
<b>Pull Packs — Hardware Included</b>		
Pull Pack QTY 2	YPPULL2	\$ 71
Pull Pack QTY 3	YPPULL3	\$ 105

*Utilize as retrofit, samples, replacements, etc.  
Not compatible with Involve Straight Pull  
Pyrite and Solar Black finish will assume +\$17/per pull upcharge. Ex: YPPULL2.M.P8X +\$34 upcharge*

**How to specify —**  
Select the  
Model Number  
from above.

<p><i>1st Option:</i> <b>Pull Type</b> (if applicable): M Beam O Halo S Square See matrix on page 19.</p>	<p><i>2nd Option:</i> <b>Pull Color</b> (if applicable): M Beam/O Halo PR6 Silver PJW Designer White PJE Pyrite +\$17/pull upcharge P8X Solar +\$17/pull upcharge S Square EL Matte Silver PJW Designer White P02 Flint P7B Loft PJE Pyrite +\$17/pull upcharge P8X Solar Black +\$17/pull upcharge</p>
---	---

Y P P U L L | | | . | | | | |

*Example:* YPPULL2.S.PJW

For specification information see pages 188-189.

GSA SIN 33721

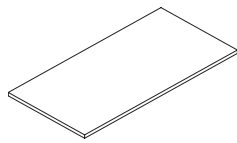

Description	Model	L1 Laminate List Price	UPCHARGES*	
			L1 Laminate	L2 Laminate
<b>30"D Laminate Height-Adjustable Tops with Grommets — 29"D nominal</b>				
66"W	WKAURS6630	\$ 898		\$ 180
72"W	WKAURS7230	\$ 960		\$ 181
<b>Note:</b> Actual top is undersized by 2" in width and 2" in depth to provide 1" clearance on each side of height-adjustable surface. Use listed dimension for space planning purposes.				
<b>36"D Laminate Height-Adjustable Tops with Grommets — 35"D nominal</b>				
72"W	WKAURS7236	\$ 1229		\$ 184
<b>Note:</b> Actual top is undersized by 2" in width and 2" in depth to provide 1" clearance on each side of height-adjustable surface. Use listed dimension for space planning purposes.				

Description	Model	List Price
<b>Cable Management Tray</b>		
24" Tray	AJTRGH24 <input type="checkbox"/>	\$ 123
36" Tray	AJTRGH36 <input type="checkbox"/>	\$ 147
<b>Note: Black only.</b>		
<b>Wire Management Channel (Black only)</b>		
92" Long	AEV920 <input type="checkbox"/>	\$ 227
<b>Under Worksurface Trough (Black Only)</b>		
17"W — Single Pack	Z617UWTRGH	\$ 104
17"W — Ten Pack	Z61710UWTRGH	\$ 1053
36"W — Single Pack	Z636UWTRGH	\$ 183
36"W — Ten Pack	Z63610UWTRGH	\$ 1785
<b>Cord Management Snake (Black Only)</b>		
58"	WKSWMC	\$ 415

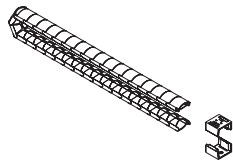
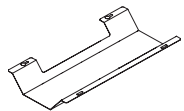
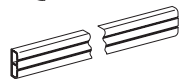
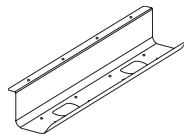

<b>How to specify —</b> Select the Model Number from above.	<i>1st Option:</i> <b>FSC Certified Wood</b> (if applicable): F FSC Certified X No FSC	<i>2nd Option:</i> <b>Paint Color</b> (if applicable):	<i>3rd Option:</i> <b>Top Laminate and Predefined Edge:</b> See page 161 for finishes.
WK                         .   .			.

<i>4th Option:</i> <b>Grommet Location:</b> See page 174. B Both Left and Right C Centered L Left R Right X No Grommet	<i>5th Option:</i> <b>Grommet Type:</b> P Oval Plastic M Oval Metal (Add \$12 per grommet) S Square Metal (Add \$12 per grommet)	<b>Grommet Color:</b> Metal is EL. Plastic grommet color is predetermined to match laminate.	

Examples: WKAURS6630.F.LM14EW.CMPR6  
 WKAURS7236.X.LM14EW.BP AJTRGH24.P27 AEV920  
 WKAURS7230.X.LM14EW.R.SEL

Shippable by small-package carrier.  
 Caseloads & Storage – 03/2023

For specification information see pages 188-189.

Open Market/GSA SIN 33721

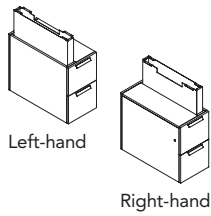

Description	Model	L1 Locks	L1 Laminate List Price	UPCHARGES*	
				L2 Laminate Chassis	Front
<b>Height-Adjustable* Slim Pedestal &amp; Shroud Kit — File / File</b>					
14¼"W x 30"D Left-hand	WKPSFNJ2830LH-HS	1	\$ 3401	\$ 67	\$ 45
14¼"W x 30"D Right-hand	WKPSFNJ2830RH-HS	1	\$ 3401	\$ 67	\$ 45

**Note:** \*27¼ – 47¾"H compatible. Requires 2-Stage T-Leg Powered Base purchased separately. See page 236.

\*New models are compatible with A6 height adjustable bases

\*Not compatible with fixed laminate or metal modesty due to width

### Height-Adjustable Shroud Kits 27¼" – 47¾"H

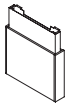

#### Non-Handed

Description	Model	L1 Locks	L1 Laminate List Price	UPCHARGES*	
				L2 Laminate Chassis	Front
4¼"W x 30"D	WKEPFNJ2830-HS		\$ 1038	\$ 28	N/A

**Note:** \*27¼ – 47¾"H compatible. Requires 2-Stage T-Leg Powered Base purchased separately. See page 236.

\*New models are compatible with A6 height adjustable bases

<p><b>How to specify —</b> Select the Model Number from above.</p> <p>_____</p> <p>_____ - _____ .</p>	<p><b>1st Option:</b> <b>FSC Certified Wood:</b></p> <p>F FSC Certified X No FSC</p> <p>_____ .</p>	<p><b>2nd Option:</b> <b>Chassis Laminate and Predefined Edge:</b></p> <p>See inside front cover for finishes.</p> <p>_____ .</p>	<p><b>3rd Option:</b> <b>Front Laminate and Predefined Edge:</b></p> <p>_____ .</p>
--	---	---	---

<p><b>4th Option:</b> <b>Pull Type</b> (if applicable):</p> <p>MP Beam OP Halo AP Arch BP Bar SP Square See matrix on page 19.</p> <p>_____</p>	<p><b>5th Option:</b> <b>Pull Color</b> (if applicable):</p> <p>MP Beam / OP Halo P2 upcharge +\$17/pull</p> <p>PJW Designer White PR6 Silver PJE Pyrite P8X Solar Black</p> <p>AP Arch PRO Anodized Silver P2 upcharge +\$17/pull</p> <p>_____ .</p>	<p><b>6th Option:</b> <b>Metal Sleeve Paint</b> (if applicable):</p> <p>P1 P2 P3 See page 161 for finishes. P2 \$16/shroud P3 \$38/shroud</p> <p>_____ .</p>	<p><b>7th Option:</b> <b>Height Adjustable Base</b> (if applicable):</p> <p>_____ .</p>	<p><b>8th Option:</b> <b>Height Adjustable Base Keypad</b> (if applicable):</p> <p>UD Basic Up/Down MEM Memory Preset PDL Paddle</p> <p>_____ .</p>	<p><b>9th Option:</b> <b>Lock</b> (if applicable):</p> <p>STD Standard OMT Omit Lock Core (Deduct \$20 per lock)</p> <p>_____</p>
---	---	--	---	---	---

Example: WKEPFNJ2830-HS.X.LM14EW.LSW1SW.MPPJE.OMT

5 Shippable by small-package carrier.

For specification information see pages 188-189.

GSA SIN 33721

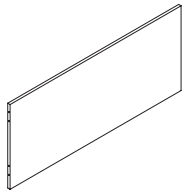

Description	Model	L1 Laminate List Price	UPCHARGES*	
			L2 Laminate Chassis	
<b>Height Adjustable Table Layered Modesty</b>				
Fixed Laminate Modesty Panel 24"H x 48"W for HAT	WKAUMPJ2848LL	\$ 584	\$ 22	
Fixed Laminate Modesty Panel 24"H x 54"W for HAT	WKAUMPJ2854LL	\$ 601	\$ 23	
Fixed Laminate Modesty Panel 24"H x 60"W for HAT	WKAUMPJ2860LL	\$ 619	\$ 24	
Fixed Laminate Modesty Panel 24"H x 66"W for HAT	WKAUMPJ2866LL	\$ 678	\$ 26	
Fixed Laminate Modesty Panel 24"H x 72"W for HAT	WKAUMPJ2872LL	\$ 697	\$ 27	

\*For use between WKEPFNJ2830-HS with WKBKHATFM bracket

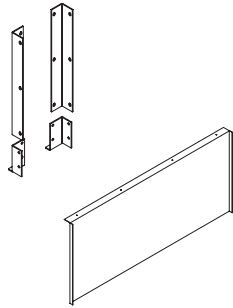

Description	Model	List Price	UPCHARGES*	
			P2	P3
<b>Bracket for Fixed Laminate HAT Modesty</b>				
Approach 24"H Fixed Modesty Bracket	WKBKHATFM	\$ 97	\$ 22	\$ 53
<b>Metal HAT Modesty</b>				
Metal Modesty Panel 28"H x 48"W for HAT	WKAUMP2848MM	\$ 403	N/A	
Metal Modesty Panel 28"H x 54"W for HAT	WKAUMP2854MM	\$ 420	N/A	
Metal Modesty Panel 28"H x 60"W for HAT	WKAUMP2860MM	\$ 439	N/A	
Metal Modesty Panel 28"H x 66"W for HAT	WKAUMP2866MM	\$ 455	N/A	
Metal Modesty Panel 28"H x 72"W for HAT	WKAUMP2872MM	\$ 472	N/A	

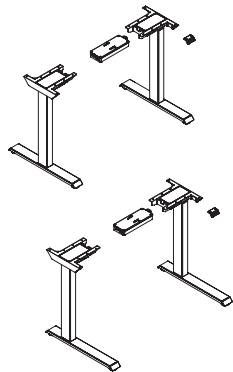

Description	Model			List Price
<b>2-Stage A6 Table Base</b>				
2 Stage, 2 Leg Rectangle T Foot	9.4	10.6	41.7	A6REC2S2LTF \$ 2088

\*For 24"D-30"D Rectangular Worksurfaces 48"W-72"W and Approach 36"D worksurface with shrouds

2 Stage, 2 Leg Rectangle C Foot	9.4	10.6	41.7	A6REC2S2LCF \$ 2088
---------------------------------	-----	------	------	---------------------

\*For 24"D-30"D Rectangular Worksurfaces 48"W-72"W and Approach 36"D worksurface with shrouds

A6 base standard travel only compatible with credenza for integrated HAT, see page 196.

APPROACH

How to specify — Select the Model Number from above.	1st Option: FSC Certified Wood (if applicable): F FSC Certified X No FSC	2nd Option: Laminate and Predefined Edge: See inside front cover for finishes.	3rd Option: Height Adjustable Base (if applicable): PR6 Silver PD8 White P71 Black	4th Option: HAT Base Feet (if applicable): X Standard Glides S Slide Glides (\$148 extra)	5th Option: Height Adjustable Base Keypad (if applicable): UD Basic Up/Down MEM Memory Preset PDL Paddle	6th Option: Bracket Paint (if applicable): P1 P2 P3 See page 161 for finishes.
_____ .	_____ .	_____ .	_____ .	X .	_____ .	_____ .

Examples: WKAUMPJ2866LL.X.LM14EW WKAUMP2866MM WKAUJB2SA6.PR6.MEM

Shippable by small-package carrier.



For specification information see page 189.

GSA SIN 33721

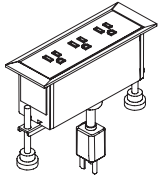

Description	Model	List Price
<b>Collaborative Table Surface-Mounted Power Modules</b> (Color: <b>SNW</b> Snow or <b>STRM</b> Storm)		
3 Power	WKPWDP3SM	\$ 549
2 Power, 1 USB	WKPWDP2SM	\$ 685

<p><i>How to specify —</i> Select the Model Number from above.</p>	<p><i>1st Option:</i> <b>Power Module Color</b> (if applicable): <b>SNW</b> Snow <b>STRM</b> Storm</p>
<p>WK   . S                                  </p>	
<p><i>Example: WKPWDP3SM.SNW</i></p>	



- Finishes ..... 240
- Involvement<sup>®</sup> Overview.....241-242
- Working with Involvement<sup>®</sup> .....243-262
- Pedestals, Credenzas, and Bookcases.....263-270
- Soft Seating.....271-276
- Storage Towers... ..277-281
- Stacking Storage..... 282
- Overheads, Shelves, Stanchions, Hutches, and Tackboards ....283-288
- Worksurfaces — 18"D / Linear Taper / EZ View ..... 289
- Worksurface Supports .....290-291
- Screens .....292-295



**PAINTED METAL FINISHES**

**GRADE P1**

Black.....	P27
Brownstone.....	P7D
Bungalow.....	P7C
Cinder.....	P7Q
Designer White.....	PJW
Flint.....	P02
Fossil.....	P28
Loft.....	P7B
Muslin.....	P4J
Parchment.....	P93
Pebble.....	P8R
Pewter.....	P8D
Salt.....	P8C
Titanium.....	P8T

**GRADE P2**

Champagne Metallic.....	PR5
Gunmetal Metallic.....	PR3
Platinum Metallic.....	PR2
Silver**.....	PR6
Solar Black.....	P8X

\*\*PR6 no upcharge on Involve; available as a Grade P2 color on stanchions. PR6 & P8X are not available on Concensys, Essentials bookcase, and vertical files.

**GRADE P3**

Amethyst ( <i>De-emphasized</i> ).....	P091
Atom.....	P8S
Blossom***.....	P8K
Bullseye.....	PJF
Cobalt Mica ( <i>De-emphasized</i> ).....	P090
Ember.....	P8P
Ion.....	P8N
Iris.....	P8J
Krypton.....	P8F
Ochre.....	P093
Regatta.....	P8M
Sienna.....	P092
Succulent***.....	P8A

*Metallic paints, due to varying reflectance, may appear to have less visual color consistency than other paint finishes, even when L/A/B values are exactly the same. (L/A/B — measurable aspects of color — values are maintained within a specified range, to ensure consistent appearance of paint colors.)*

*\*\*\*These colors are intended to be an inspirational option for the trending market. Product application is limited and color availability is approximately two years to coincide with evolving workplace trends.*

**PAINTED WOOD FINISHES**

Brownstone.....	M13
Bungalow.....	M12
Designer White.....	M17
Flint.....	M16
Loft.....	M11
Muslin.....	M15

**ELECTRICAL AND DATA COMPONENTS**

Black.....	E4
Brownstone.....	EY
Designer White.....	DW
Flint.....	E9
Loft.....	EV
Muslin.....	EU
Silver.....	ES

**Recommended Coordinate Colors:**  
 Bungalow use Muslin EU  
 Champagne Metallic use Muslin EU  
 Cinder use Brownstone EY  
 Fossil use Flint E9  
 Gunmetal Metallic use Brownstone EY  
 Parchment use Muslin EU  
 Pebble use Loft EV  
 Pewter use Flint E9  
 Platinum Metallic use Silver ES  
 Salt use Silver ES  
 Titanium use Silver ES

**LAMINATES**

**GRADE L1**

<b>SOLID COLORS</b>	
Black.....	P
Brownstone.....	LM13
Bungalow.....	LM12
Designer White.....	LDW1
Flint.....	LM16
Fossil Shale.....	LEH1
Loft.....	LM11
Muslin.....	LM15
Titanium.....	LTI1

<b>ABSTRACT</b>	
Ash.....	LT3B
Handspun Pearl.....	LAHP
Handspun Dove.....	LAHD
Handspun Slate.....	LAHS
Handspun Chestnut.....	LAHC
Silver Mesh.....	LT8D

<b>WOODGRAIN</b>	
Belair.....	LWBA
Bourbon Cherry.....	H
Field Elm.....	LWFE
Florence Walnut.....	LFW1
Kingswood Walnut.....	LK11
Natural Maple.....	LWD
NeoWalnut.....	LNU1
Pinnacle.....	PINC
Shaker Cherry.....	LW7C

**GRADE L2**

Beigewood.....	LWBE
Fawn Cypress.....	LFC1
Lowell Ash.....	LLA1
Mangalore Mango.....	LMM1
Natural Recon.....	LNR1
Phantom Charcoal.....	LPC1
Phantom Ecru.....	LPE1
Portico Teak.....	LPT1
Skyline Walnut.....	LSW1
Veranda Teak.....	LVT1

**GRADE L3**

Natural Walnut.....	LWNW
---------------------	------

**LAMINATE AND PAINTED WOOD STORAGE PULLS**

Silver.....	PR6
-------------	-----

**LAMINATE EDGE COLORS**

Belair.....	BA
Beigewood.....	DE
Black.....	E4
Bourbon Cherry.....	H
Brownstone.....	EY
Bungalow.....	EX
Designer White.....	DW
Fawn Cypress.....	FC
Field Elm.....	FE
Flint.....	E9
Florence Walnut.....	FW
Fossil.....	EH
Kingswood Walnut.....	KI
Loft.....	EV
Lowell Ash.....	DL
Mangalore Mango.....	MM
Muslin.....	EU
Natural Maple.....	DD
Natural Recon.....	NR
Natural Walnut.....	DN
NeoWalnut.....	NU
Parchment.....	EN
Phantom Charcoal.....	PC
Phantom Ecru.....	PE
Pinnacle.....	PI
Platinum Metallic†.....	EP
Plyband ♦.....	PL
Portico Teak.....	DP
Shaker Cherry.....	DF
Skyline Walnut.....	SW
Titanium.....	TI
Veranda Teak.....	VT

† Not available on Aware table tops.

♦ Edge is limited to flat edge surfaces: rectangle, square, trapezoid, polygon, or round. No curvilinear or combination curve and straight.

**METAL GROMMETS**

**FOR LAMINATE WORKSURFACES**

Oval/Square.....	EL
Matte Silver.....	EL

**FOR VENEER WORKSURFACES**

Oval.....	
Black.....	E4
Bronze.....	EZ
Matte Silver.....	EL
Square.....	
Matte Silver.....	EL

**PLASTIC GROMMETS**

**FOR WORKSURFACES**

Black.....	E4
Brownstone.....	EY
Bungalow.....	EX
Designer White.....	DW
Flint.....	E9
Fossil.....	EH
Loft.....	EV
Muslin.....	EU
Parchment.....	EN
Titanium.....	TI

**PLASTIC GROMMETS WITH WOODGRAIN EDGE**

If woodgrain edge is specified, the plastic grommet color is predetermined, based on finish selection.

Beigewood, Fawn Cypress, Natural Maple, and Natural Recon.....	Muslin EU
Kingswood Walnut and NeoWalnut.....	Brownstone EY
Phantom Charcoal and Skyline Walnut.....	Flint E9
Phantom Ecru.....	Loft EV
Portico Teak.....	Fossil EH
All other woodgrain options.....	Black E4

**LOCKS**

Black.....	E4
Chrome.....	ordered by base model
Matte Silver.....	EL

**NOTE:** Refer to individual product pages for upcharges.

Leg or Plinth Base models available. Leg base units are shown below.

## Pedestals — 24"H and 28"H



Mobile Box/File



Freestanding Box/File



Freestanding Open



Support Box/Box/File



Support File/File



Support Open

## Credenzas — 17½"H, left- and right-handed models available for handed units.



Single Lateral

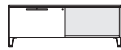

Single Lateral w/Open Cubby



Corner Table

## Credenzas — 24"H, left- and right-handed models available for handed units.



Box/Lateral



Box/Box Lateral

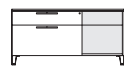

Box/Lateral w/Open Cubby



Sliding Door Open



Open

## Credenzas — 28"H, left- and right-handed models available for handed units.



2-High Lateral



Box/Box Lateral



Box/Box Project/Lateral



Sliding Door Open w/Cubbies



Open

## Credenzas and Bookcase — 42"H



3-High Lateral

## Bookcases — 65"H and 72½"H



Bookcase w/Lateral



Bookcase

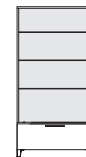

Bookcase w/Lateral

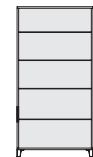

Bookcase

## Towers — 42"H (12"W only), 50"H and 57½"H (50"H shown); left- and right-handed models available.

12"W



Full-Width Door

18"W



Hinged Door Box/Box/File

18"W



Side Access File/File

24"W



Hinged Door Box/Box/File

24"W



Side Access File/File

## Towers — 65"H and 72½"H (65"H shown); left- and right-handed models available.

12"W



Full-Width Door (65"H)

18"W



Hinged Door Box/Box/File

18"W



Hinged Door File/File

18"W



Full-Width Door

24"W



Hinged Door Box/Box/File

24"W



Hinged Door File/File

24"W



Full-Width Door

Leg or Plinth Base models available. Leg base units are shown below.

## Stacking Storage — Hinged Door, left- and right-handed models available

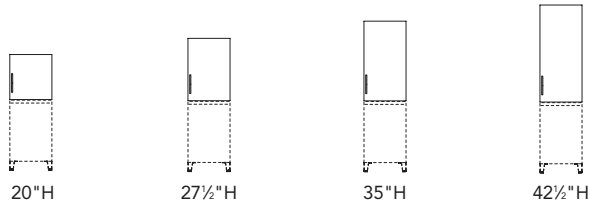

## Stacking Storage — Open

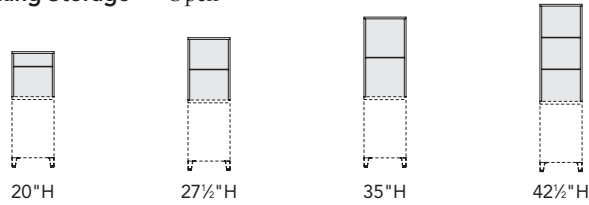

## Overheads and Shelves

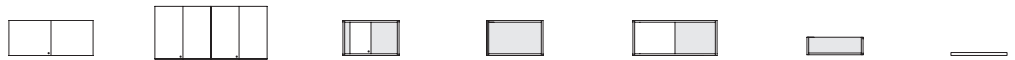

Hinged Door 15"H    Hinged Door 22½"H    Sliding Door    Open Bin    Dual Access Open    Book Shelf    Laminate Shelf

## Soft Seating and Tables



Seat Base w/Drawers    Seat Base w/Open Cubby    Banquette Cushion    Seat Base Cushion    Table Top    Bolster    Corner Table    Open Table

## Worksurfaces — Shapes below added for Involve to the hundreds available in our existing Worksurface selection.

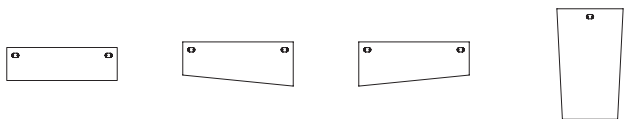

Primary 18"D    Linear Taper 18"D / 24"D    Linear Taper 24"D / 18"D    EZ View Transition

## Supports and Accessories



Open Metal End Supports    Closed Laminate End Supports    Post Leg    Worksurface Stanchion    Overhead Stanchion

## Modesty Panels and Screens

## Accessories



Modesty Panels    Back Panels    Privacy Panels    Divider Panels    Ped/Credenza Cushion    Pullout Shelf    Extra Metal Shelf    Power Module

Where, how, and even what defines work is changing constantly. It's obvious that businesses are trying to understand what it means to successfully change with the culture and trends.

With Involve, we set out to discover how furniture can be used today as an impetus to an organizations change and yet perform well into the future as the organization continues to evolve.

**Involve... one solution for all your needs.**

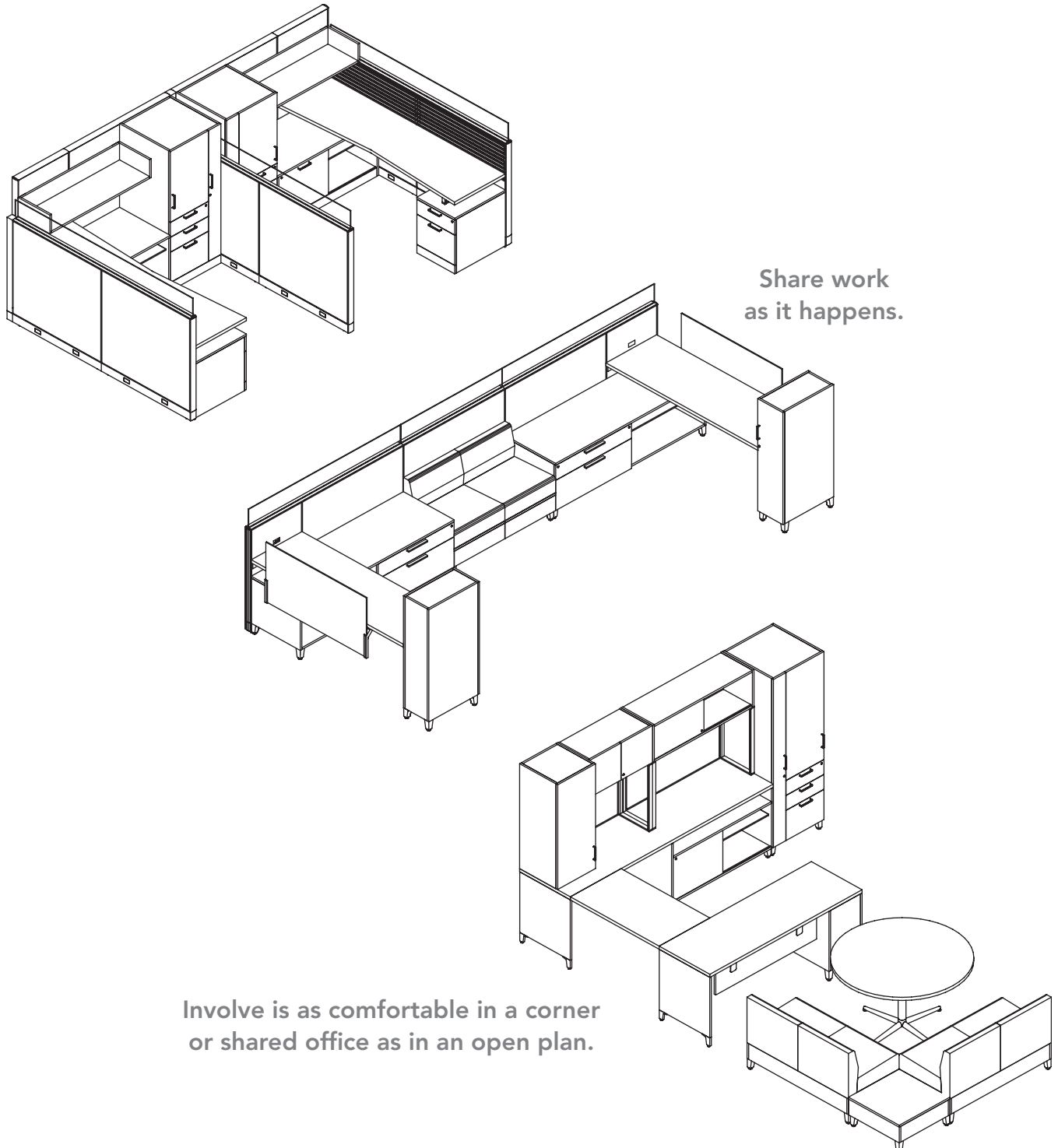

Share work  
as it happens.

Involve is as comfortable in a corner  
or shared office as in an open plan.

INVOLVE

**A Fresh Approach**

Furniture needs to work today with a fresh approach and innovative features. But support of tomorrow's needs is vitally important.

- Expand functionality of systems furniture, energize existing installs, and support changing work styles with Involve. Take existing investment and add functionality and relevance by changing out a few key pieces.
- The soft seating can be used within panel walls or pulled into freestanding or huddle room applications. The same casegoods work in private office or open plan configurations.
- Modularity of components allows for flexing of product application into the future. Involve lets you design for collaboration now while building in opportunity for future head count growth.

**Changing Work Styles**

From editing to brainstorming, number crunching to researching, today's work doesn't just happen in a task chair pulled up to a desk surface.

- Tired of the stodgy cubicle, users should be inspired by a fresh approach with innovative features that feel like furniture and less like a system.
- A task chair works for one job function and lounge seating works better for another. Involve supports the preferred posture for these activities while maintaining the desired home base for individuals.
- Untethered from the primary workstation, sharing of information can happen spontaneously around a screen or face to face. Involve components can be used across the floorplan offering the user multiple places to go as they work.

**Get inspired by Involve.**

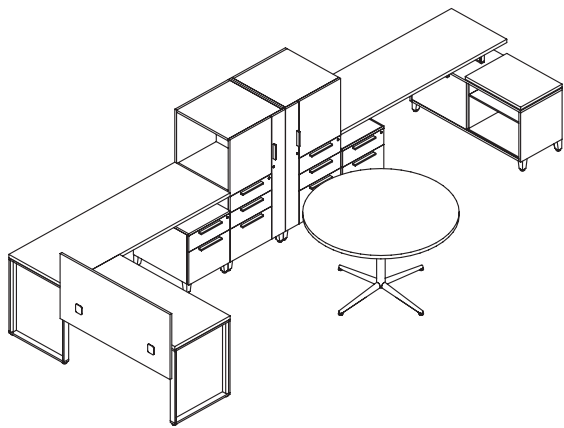

**Involve's modular design accommodates all the different ways work gets done.**

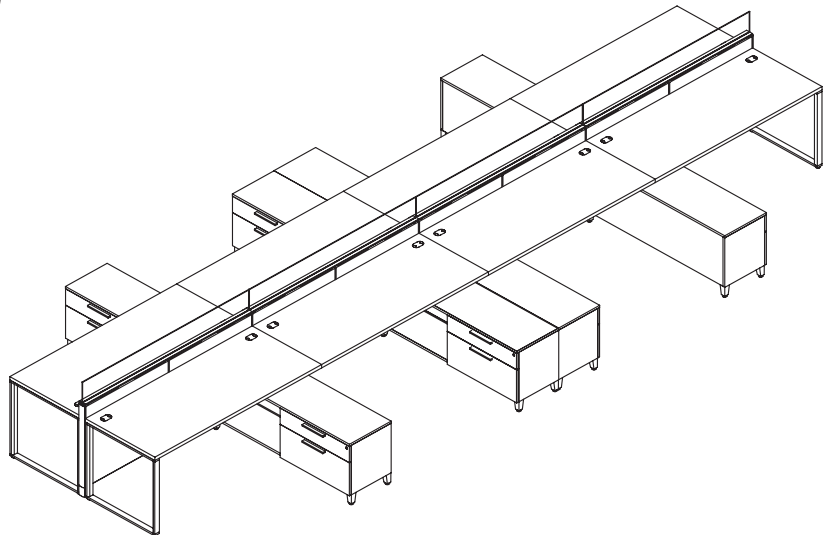

**Involve moves out of dedicated user spaces to create comfortable, functional meeting areas.**

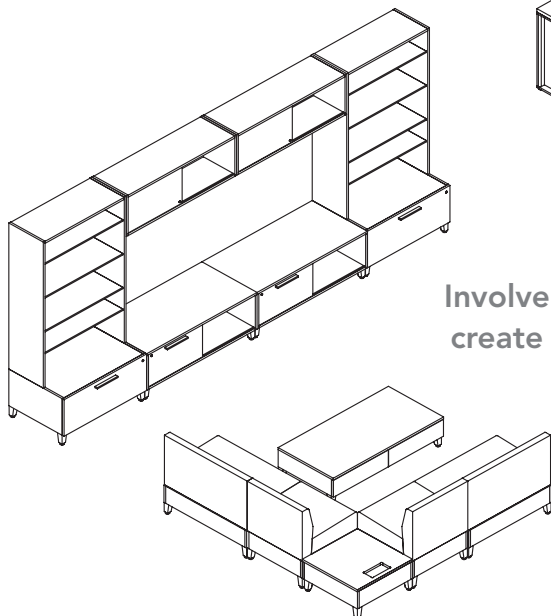

INVOLVE



Style		17½"H Credenza	24"H Credenza	28"H Credenza	42"H Credenza
Widths	Open	—	18", 24", 30", 36"	18", 24", 30", 36"	—
	Box/Lateral	—	30"	—	—
	Box/Box/Lateral	—	36"	24", 30"	—
	Box/Box/Project/Lateral	—	—	36"	—
	Lateral (1, 2, or 3 drawers)	30", 36"	—	30", 36"	36"
	Lateral/Open Cubby	48", 60", 72"	48", 60", 72"	—	—
	Combination	—	—	—	—
	Sliding Door w/shelf	—	36", 48"	36", 48"	—
	Closed (Table)	24"	—	—	—
	High Door/Low Open	—	—	—	—
Depths (some units 18"D or 24"D only)		18", 24"	18", 24"	18", 24"	18"
Pulls — Arch, Square Straight		Yes	Yes	Yes	Yes
Lock Options:					
	Lock	Standard	Standard	Standard	Standard
	Omit Core	Optional	Optional	Optional	Optional
	Master Keyed Lock	Standard	Standard	Standard	Standard
	Removable Lock Core	Yes — with special key	Yes — with special key	Yes — with special key	Yes — with special key
	Dual-Sided Locking	—	Yes	Yes	—
Suspension		Ball Bearing	Ball Bearing	Ball Bearing	Ball Bearing
Drawer Front Construction		¼" thick Laminate	¼" thick Laminate	¼" thick Laminate	¼" thick Laminate
Hinged Door Construction		¼" thick Laminate	¼" thick Laminate	¼" thick Laminate	¼" thick Laminate
Hex-head Glide		Yes	Yes	Yes	Yes
Counterweights		Required on freestanding applications	Required on freestanding applications	Required on most freestanding applications	Not required
Drawer Interiors:					
	Box Drawer	—	2¼"H	2¼"H	—
	Project Drawer	2⅝"H	—	2⅝"H	—
	Lateral Drawer	9"H	9"H	9"H	9"H
Front-to-Back Filing		Standard	Standard	Standard	Standard
Filing Options		Letter, Legal	Letter, Legal	Letter, Legal	Letter, Legal

Style		Pedestal	Towers	Bookcases	Stacking
Heights		24", 28"	50", 57½", 65", 72½"	65", 72½"	20", 27½", 35", 42½"
Widths	Open	18"	—	30", 36"	—
	Box/File	15½", 18"	—	—	—
	Box/Box/File	15½", 18"	18", 24"	—	—
	File/File	28"	18", 24"	—	—
	Shelves	—	—	30", 36"	18", 24"
	Shelves and Lateral (1 drawer)	—	—	30", 36"	—
Depths (some units 18"D or 24"D only)		18", 24"	18", 24"	15", 24"	18"
Pulls — Arch, Square, Straight		Yes	Yes	Yes	Yes
Lock Options:					
	Lock	Standard	Standard	Standard	No
	Omit Core	Optional	Optional	Optional	No
	Master Keyed Lock	Standard	Standard	Standard	No
	Removable Lock Core	Yes — with special key	Yes — with special key	Yes — with special key	No
Suspension		Ball Bearing	Ball Bearing	Ball Bearing	—
Drawer Front Construction		¼" thick Laminate	¼" thick Laminate	¼" thick Laminate	¼" thick Laminate
Hinged Door Construction		¼" thick Laminate	¼" thick Laminate	¼" thick Laminate	¼" thick Laminate
Hex-head Glide		Yes	Yes	Yes	—
Counterweights		Required on freestanding applications	Not required	Not required	Not required
Drawer Interiors:					
	Box Drawer	—	2¼"H	2¼"H	—
	File Drawer	9"H	9"H	9"H	—
Front-to-Back Filing		Standard	Standard	Standard	—
Filing Options		Letter	Letter	Letter, Legal	—

### Interior Dimensions for Credenzas, Pedestals, Towers, Bookcases, Stacking Storage, and Seat Bases

[GSA Reference Page](#)

Description	Height	Depth — 18"D, 24"D	Width
CREDENZAS Open	24"H — 17 <sup>3</sup> / <sub>8</sub> "	24"H — 17 <sup>3</sup> / <sub>8</sub> ", 23 <sup>3</sup> / <sub>8</sub> "	18" exterior = 16 <sup>3</sup> / <sub>8</sub> " interior
	28"H — 22 <sup>3</sup> / <sub>8</sub> "	28"H — 17 <sup>3</sup> / <sub>8</sub> ", 23 <sup>3</sup> / <sub>8</sub> "	24" exterior = 22 <sup>3</sup> / <sub>8</sub> " interior 30" exterior = 28 <sup>3</sup> / <sub>8</sub> " interior 36" exterior = 34 <sup>3</sup> / <sub>8</sub> " interior 48" exterior = 46 <sup>3</sup> / <sub>8</sub> " interior
Single Lateral	Lateral — 9"	30"W Lateral — 14", 17 <sup>1</sup> / <sub>2</sub> " 36"W Lateral — 12", 17 <sup>1</sup> / <sub>2</sub> "	30" exterior = 26 <sup>3</sup> / <sub>8</sub> " interior 36" exterior = 32 <sup>3</sup> / <sub>8</sub> " interior
Single Lateral w/Open Side	Lateral — 9"	24"W Lateral — 12", 17 <sup>1</sup> / <sub>2</sub> "	48" exterior = 43 <sup>3</sup> / <sub>8</sub> " interior
	Open Side — 12"	30"W Lateral — 14", 17 <sup>1</sup> / <sub>2</sub> "	60" exterior = 55 <sup>3</sup> / <sub>8</sub> " interior
		36"W Lateral — 12", 17 <sup>1</sup> / <sub>2</sub> " Open Side — 16 <sup>3</sup> / <sub>8</sub> ", 22 <sup>3</sup> / <sub>8</sub> "	72" exterior = 67 <sup>3</sup> / <sub>8</sub> " interior
Sliding Door	24"H — 17 <sup>3</sup> / <sub>8</sub> "	16", 22"	36" exterior = (2) 16 <sup>3</sup> / <sub>4</sub> " interior 48" exterior = (2) 22 <sup>3</sup> / <sub>4</sub> " interior
Box/Box/Lateral	Box — 2 <sup>1</sup> / <sub>4</sub> "	Box — 15"	36" exterior = 32 <sup>3</sup> / <sub>8</sub> " interior
	Project — 2 <sup>3</sup> / <sub>8</sub> "	Project — 15"	
	Lateral — 9"	Lateral — 12", 17 <sup>1</sup> / <sub>2</sub> "	
Box/Lateral w/Open Side	Box — 2 <sup>3</sup> / <sub>8</sub> "	Box — 15"	48" exterior = 43 <sup>3</sup> / <sub>8</sub> " interior
	Lateral — 9"	24"W Lateral — 12", 17 <sup>1</sup> / <sub>2</sub> "	60" exterior = 55 <sup>3</sup> / <sub>8</sub> " interior
	Open Side — 17 <sup>3</sup> / <sub>8</sub> "	30"W Lateral — 14", 17 <sup>1</sup> / <sub>2</sub> "	72" exterior = 67 <sup>3</sup> / <sub>8</sub> " interior
		36"W Lateral — 12", 17 <sup>1</sup> / <sub>2</sub> " Open Side — 16 <sup>3</sup> / <sub>8</sub> ", 22 <sup>3</sup> / <sub>8</sub> "	
File/File	(2) File — 9"	30"W Lateral — 14", 17 <sup>1</sup> / <sub>2</sub> "	30" exterior = 26 <sup>3</sup> / <sub>8</sub> " interior
		36"W Lateral — 12", 17 <sup>1</sup> / <sub>2</sub> "	36" exterior = 32 <sup>3</sup> / <sub>8</sub> " interior
Box/Box/File Support and Box/Box/Project/Lateral Support	Box — 2 <sup>1</sup> / <sub>4</sub> "	Box — 15"	24" exterior = 20 <sup>3</sup> / <sub>8</sub> " interior
	Project — 2 <sup>3</sup> / <sub>8</sub> "	Project — 15"	30" exterior = 26 <sup>3</sup> / <sub>8</sub> " interior
	File — 9"	24"W Lateral — 12", 17 <sup>1</sup> / <sub>2</sub> "	36" exterior = 32 <sup>3</sup> / <sub>8</sub> " interior
		30"W Lateral — 14", 17 <sup>1</sup> / <sub>2</sub> " 36"W Lateral — 12", 17 <sup>1</sup> / <sub>2</sub> "	
Combination	Cabinet — 12"	Cabinet — 16 <sup>3</sup> / <sub>8</sub> ", 22 <sup>3</sup> / <sub>8</sub> "	48" exterior = 45 <sup>3</sup> / <sub>8</sub> " interior
	Project — 2 <sup>3</sup> / <sub>8</sub> "	Project — 15"	
	Open Side — 4 <sup>3</sup> / <sub>8</sub> "	Open Side — 16 <sup>3</sup> / <sub>8</sub> ", 22 <sup>3</sup> / <sub>8</sub> "	
Open Bookcase	29 <sup>1</sup> / <sub>2</sub> "	17 <sup>1</sup> / <sub>8</sub> "	48" exterior = (2) 22 <sup>3</sup> / <sub>4</sub> " interior
Open w/Sliding Door and Shelves	29 <sup>1</sup> / <sub>2</sub> "	16"	48" exterior = (2) 22 <sup>3</sup> / <sub>4</sub> " interior
Lateral (42 high)	(3) File — 9"	15"	36" exterior = 32 <sup>3</sup> / <sub>8</sub> " interior
PEDESTALS Mobile and Support	Box — 2 <sup>1</sup> / <sub>4</sub> "	Mobile — 15"	Mobile — 12 <sup>1</sup> / <sub>8</sub> "
	File — 9 <sup>1</sup> / <sub>8</sub> "	Support — 15", 19"	Support — 12 <sup>1</sup> / <sub>8</sub> " and 14 <sup>3</sup> / <sub>8</sub> "
TOWERS Hinged Door and Side Access	Box — 2 <sup>1</sup> / <sub>4</sub> " File — 9 <sup>1</sup> / <sub>8</sub> "	15", 19"	14 <sup>3</sup> / <sub>8</sub> "
BOOKCASES Open Bookcase	65"H — 58 <sup>1</sup> / <sub>2</sub> "	14 <sup>1</sup> / <sub>8</sub> "	30" exterior = 28 <sup>3</sup> / <sub>8</sub> " interior
	72"H — 66"		36" exterior = 34 <sup>3</sup> / <sub>8</sub> " interior
	Bookcase with Lateral	65" BC — 45 <sup>3</sup> / <sub>4</sub> "	Bookcase — 14 <sup>1</sup> / <sub>8</sub> "
72" BC — 53 <sup>3</sup> / <sub>4</sub> "		Lateral — 17 <sup>1</sup> / <sub>2</sub> "	36" exterior = 34 <sup>3</sup> / <sub>8</sub> " interior
Lateral — 9"			
STACKING Hinged Door or Open (Actual exterior ht. 1/4" less than nominal)	20"H-18 <sup>1</sup> / <sub>4</sub> "H 35"H-33 <sup>1</sup> / <sub>4</sub> "H	16 <sup>3</sup> / <sub>8</sub> "	18" exterior = 16 <sup>3</sup> / <sub>8</sub> " interior
	27 <sup>1</sup> / <sub>2</sub> "H-25 <sup>3</sup> / <sub>4</sub> "H 42 <sup>1</sup> / <sub>2</sub> "H-40 <sup>1</sup> / <sub>4</sub> "H		24" exterior = 22 <sup>3</sup> / <sub>8</sub> " interior
SEAT BASES Open	4 <sup>3</sup> / <sub>4</sub> "	17 <sup>1</sup> / <sub>8</sub> "	24" exterior = 22 <sup>3</sup> / <sub>8</sub> " interior
			36" exterior = 34 <sup>3</sup> / <sub>8</sub> " interior
			48" exterior = 46 <sup>3</sup> / <sub>8</sub> " interior
Drawer	2 <sup>3</sup> / <sub>8</sub> "	15"	24" exterior = 20 <sup>3</sup> / <sub>8</sub> " interior
			36" exterior = 32 <sup>3</sup> / <sub>8</sub> " interior
			48" exterior = (2) 20 <sup>3</sup> / <sub>8</sub> " interior

# Involve® Laminate Wood Storage

## Features and Dimensions

Load Capacity for Laminate Wood Credenzas, Pedestals, Bookcases, Stacking Storage, Towers, and Overheads [GSA Reference Page](#)

Product Description	Style	Depth	15½"W	18"W	24"W	30"W	36"W	48"W	60"W	72"W	
<b>11"H CREDENZAS</b>	Open Table	18"D					57lbs.	77 lbs.			
		24"D					76 lbs.	103 lbs.			
<b>17½"H CREDENZAS</b>	Lateral	18"D			48 lbs.	62 lbs.	76 lbs.				
		24"D			56 lbs.	73 lbs.	89 lbs.				
	Lateral/Open Cubby	18"D							125 lbs.	159 lbs.	193 lbs.
		24"D							161 lbs.	205 lbs.	248 lbs.
<b>24"H CREDENZAS</b>	Box	18"D			14 lbs.	19 lbs.	23 lbs.				
		24"D			18 lbs.	23 lbs.	29 lbs.				
	Lateral	18"D			48 lbs.	62 lbs.	76 lbs.				
		24"D			56 lbs.	73 lbs.	89 lbs.				
	Box/Lateral/Open	18"D							170 lbs.	217 lbs.	263 lbs.
		24"D							222 lbs.	282 lbs.	342 lbs.
	Open	18"D		81 lbs.	111 lbs.	141 lbs.	170 lbs.				
		24"D		109 lbs.	150 lbs.	190 lbs.	230 lbs.				
	Sliding Door w/shelf	18"D						157 lbs.	213 lbs.		
		24"D						216 lbs.	293 lbs.		
<b>28"H CREDENZAS</b>	Box	18"D			14 lbs.	19 lbs.					
		24"D			18 lbs.	23 lbs.					
	Project Drawer	18"D						23 lbs.			
		24"D						29 lbs.			
	Lateral	18"D				62 lbs.	76 lbs.				
		24"D				73 lbs.	89 lbs.				
	Open Cubby w/shelf	18"D		104 lbs.	142 lbs.	180 lbs.	218 lbs.				
		24"D		140 lbs.	192 lbs.	243 lbs.	294 lbs.				
	Sliding Door w/shelf	18"D						210 lbs.	285 lbs.		
		24"D						287 lbs.	389 lbs.		
<b>42"H CREDENZAS</b>	Lateral	18"D				76 lbs.					
<b>24"H PEDESTALS</b>	Box Mobile	18"D	9 lbs.								
	File Mobile	18"D	29 lbs.								
	Box Freestanding	18"D		10 lbs.							
		24"D		13 lbs.							
	File Freestanding	18"D		35 lbs.							
		24"D		44 lbs.							
<b>28"H PEDESTALS</b>	Box Support	18"D	9 lbs.	10 lbs.							
		24"D	11 lbs.	13 lbs.							
	File Support	18"D	29 lbs.	35 lbs.							
		24"D	37 lbs.	44 lbs.							
<b>BOOKCASES</b>	65"H with/Lateral (15"D upper)	24"D				367 lbs.	445 lbs.				
	72½"H with/Lateral (15"D upper)	24"D				413 lbs.	501 lbs.				
	65"H Open (all shelves)	15"D				377 lbs.	456 lbs.				
	72½"H Open (all shelves)	15"D				426 lbs.	516 lbs.				
<b>STACKING STORAGE</b>	with/Doors (All units are non-locking,)	18"D									
<b>TOWERS</b>	Box Drawer	18"D		10 lbs.	14 lbs.						
		24"D		13 lbs.	18 lbs.						
	File Drawer	18"D		35 lbs.	48 lbs.						
		24"D		44 lbs.	56 lbs.						
	50"H Wardrobe Section	18"D			63 lbs.						
		24"D			86 lbs.						
	57½"H Wardrobe Section	18"D			74 lbs.						
		24"D			101 lbs.						
	65"H Wardrobe Section	24"D			116 lbs.						
	72½"H Wardrobe Section	24"D			131 lbs.						
	65"H Full Width Wardrobe	24"D		360 lbs.	492 lbs.						
	72½" Full Width Wardrobe	24"D		407 lbs.	556 lbs.						

### Load Capacity by Unit (continued)

GSA Reference Page

Product Description	Style	Depth	15½"W	18"W	24"W	30"W	36"W	48"W	60"W	72"W
SEAT BASES	Drawers	24"D			13 lbs.		22 lbs.	27 lbs.		
	Open	24"D			31 lbs.		48 lbs.	64 lbs.		
OVERHEADS	7½"H Open Bin			30 lbs.	38 lbs.	46 lbs.	55 lbs.	63 lbs.		
	7½"H Book Shelf			36 lbs.	46 lbs.	56 lbs.	65 lbs.	75 lbs.		
	15"H Slider Bin			61 lbs.	78 lbs.	95 lbs.	112 lbs.	129 lbs.	163 lbs.	
	15"H Binder Box w/shelf			70 lbs.	88 lbs.	107 lbs.	123 lbs.	142 lbs.	180 lbs.	
	15"H Hinged Door			64 lbs.	81 lbs.	104 lbs.	113 lbs.	130 lbs.	165 lbs.	
	15"H Dual Access w/Slider Door									
	15"H Dual Access Open					129 lbs.		175 lbs.	221 lbs.	
	22½"H Hinged Door			99 lbs.	126 lbs.	153 lbs.	176 lbs.	203 lbs.	257 lbs.	

### Quantity of Locks for Laminate Wood Credenzas, Pedestals, Bookcases, Stacking Storage, Towers, and Overheads

Note: Open units and shelves are non-locking and are therefore not included in the list below.

	Style	15½"W	18"W	24"W	30"W	36"W	42"W	48"W	60"W	72"W
17½"H CREDENZAS	Lateral (1 drawer)				1 lock	1 lock				
	Lateral/Open Cubby							1 lock	1 lock	1 lock
24"H CREDENZAS	Box/Lateral				1 lock					
	Box/Box/Lateral					2 locks				
	Box/Lateral/Open							1 lock	1 lock	1 lock
	Sliding Door w/shelf					1 lock		1 lock		
28"H CREDENZAS	Box/Box/Lateral			1 lock						
	Box/Box/Project/Lateral					2 locks				
	Lateral (2 drawer)				1 lock	1 lock				
	Sliding Door w/shelf					1 lock		1 lock		
42"H CREDENZAS	Lateral (3 drawer)							1 lock		
24"H PEDESTALS	Box/File	1 lock	1 lock							
28"H PEDESTALS	Box/Box/File	1 lock	1 lock							
	File/File	1 lock	1 lock							
BOOKCASES	with/Lateral				1 lock	1 lock				
STACKING STORAGE	with/Doors (All units are non-locking.)									
TOWERS	Wardrobe/Hinged Door/Box/Box/File			2 locks						
	Wardrobe/Hinged Door/File/File			2 locks						
	Wardrobe/Side Access/File/File			2 locks						
	Wardrobe/Side Access/Box/Box/File			2 locks						
	Wardrobe			1 lock						
	Hinged Door/Box/Box/File		1 lock							
	Hinged Door/File/File		1 lock							
	Side Access/File/File		1 lock							
OVERHEADS	Hinged Doors			1 lock	1 lock	1 lock	1 lock	2 locks	2 locks	
	Sliding Door			1 lock	1 lock	1 lock	1 lock	1 lock	1 lock	
	Dual Access w/Sliding Doors								2 locks	2 locks

## Top View of Drawers

15"W Pedestal  
and Tower Drawers

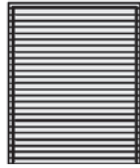

Letter Front-to-Back  
18"D Mobile – 14½" of filing  
24"D Support – 19" of filing

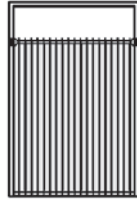

Legal Side-to-Side  
24"D Support – 12" of filing

18"W Pedestal  
and Tower Drawers

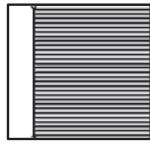

Letter Front-to-Back  
18"D – 14½" of filing  
24"D or 30"D – 19" of filing

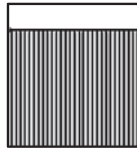

Side-to-Side  
18"D – 14½" of Letter filing  
24"D or 30"D – 14½" of Letter or Legal filing

24"W Credenza  
Lateral Drawers

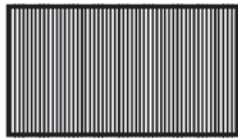

Letter Side-to-Side  
18"D – 20½" of filing



Letter Front-to-Back  
18"D – 15" of filing  
24"D – 17½" of filing

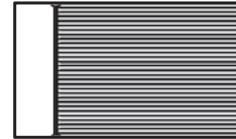

Legal Front-to-Back  
18"D – 15" of filing  
24"D – 17½" of filing

30"W Credenza  
Lateral Drawers



Letter Front-to-Back  
18"D – 30" of filing  
24"D – 35" of filing



Legal Front-to-Back  
18"D – 15" of filing  
24"D – 17½" of filing

36"W Credenza  
Lateral Drawers



Letter Front-to-Back  
18"D – 30" of filing  
24"D – 35" of filing



Legal Front-to-Back  
18"D – 15" of filing  
24"D – 17½" of filing

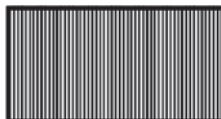

Letter Side-to-Side  
18"D and 24"D – 32½" of filing



Letter Side-to-Side and Legal Front-to-Back  
18"D – 17" of Letter S-T-S filing and 15" of Legal F-T-B filing  
24"D – 17½" of Letter or Legal F-T-B filing

Credenzas and pedestals ship fully assembled except for tops on 28"H and 42"H units are ordered separately to allow one surface to span multiple credenzas and pedestals. Tops are available in laminate with flat edge detail.

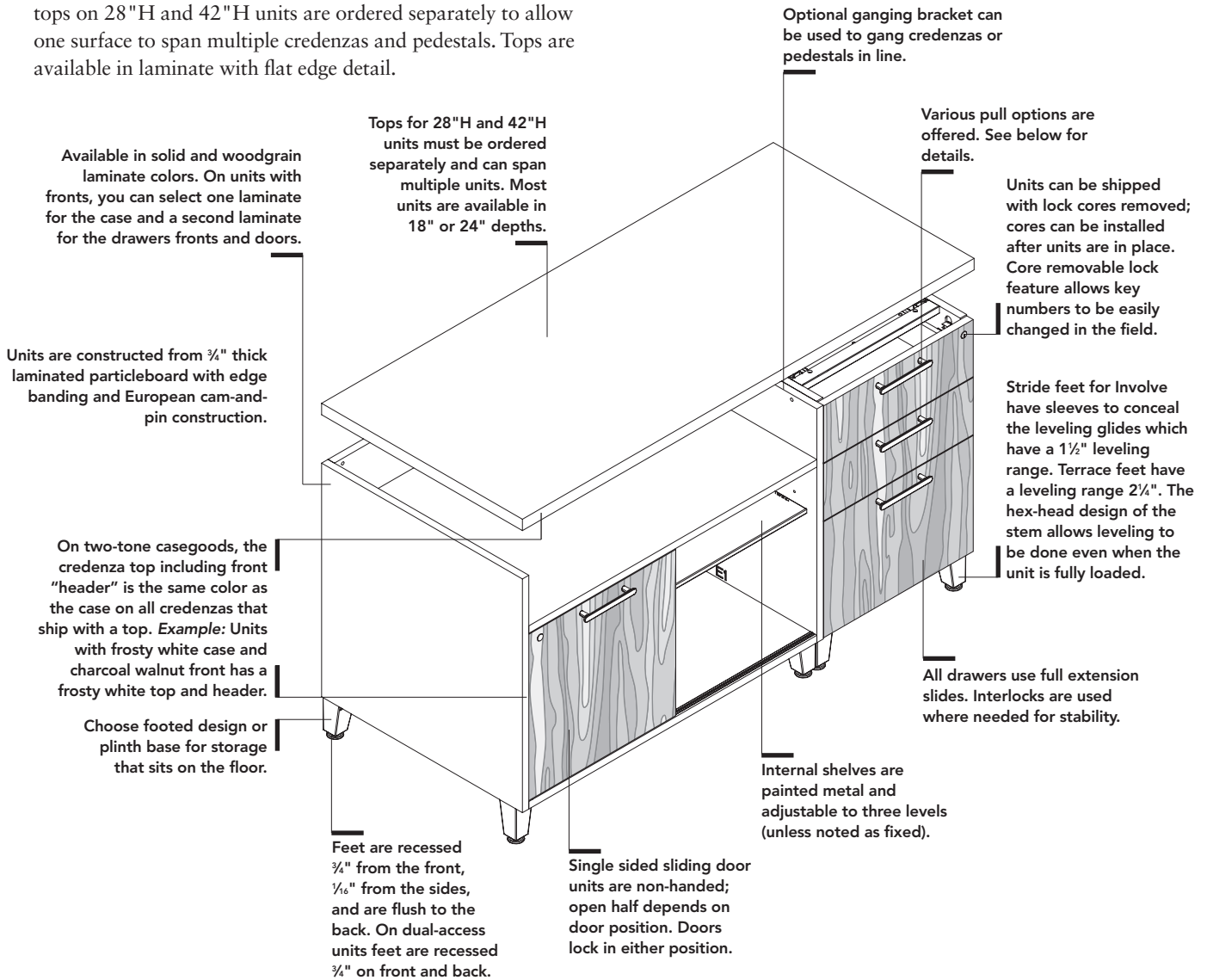

INVOLVE

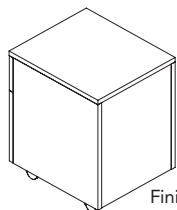

Finished back

Open and partially open units come assembled with a finished laminate back.

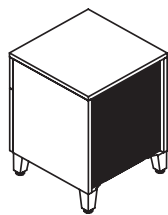

Units with drawers or doors come with an unfinished back that is recessed. A laminate back is available for units up to 28"H (ordered separately) for use when the back of the unit will be exposed.

### Available pull styles:

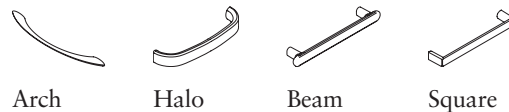

Arch Halo Beam Square

Storage that sits on the floor is available with plinth base or feet. Footed design provides increased air flow. **Two feet options** are available to integrate with Terrace or Stride Systems. Units ship assembled except for feet and pulls.

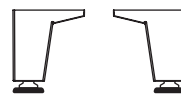

Terrace

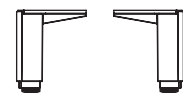

Stride

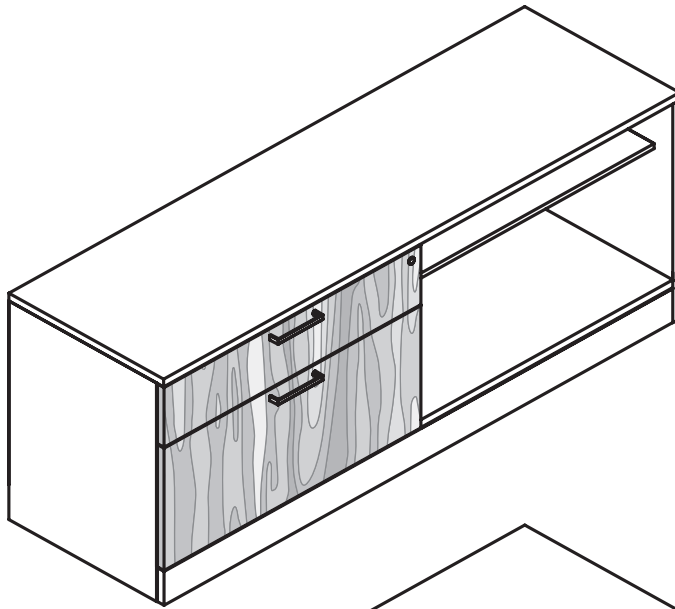

### Two Tone Combo Credenzas

- Chassis, top, and plinth base will match. See illustration at left.
- Door/drawer fronts will match.

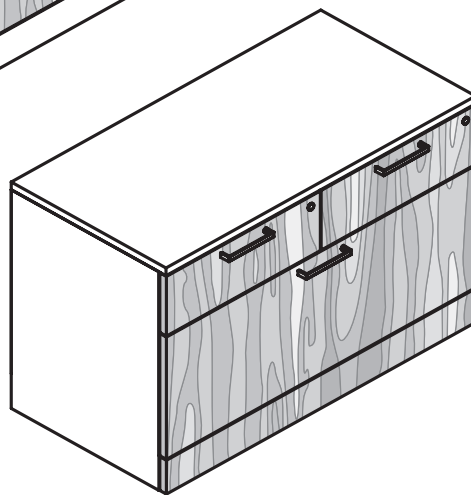

### Two Tone Credenza (non-combo unit)

- Chassis and top will match. See illustration at left.
- Drawer fronts and plinth base will match.
- For best aesthetics avoid placing aside of a two-tone combo unit.

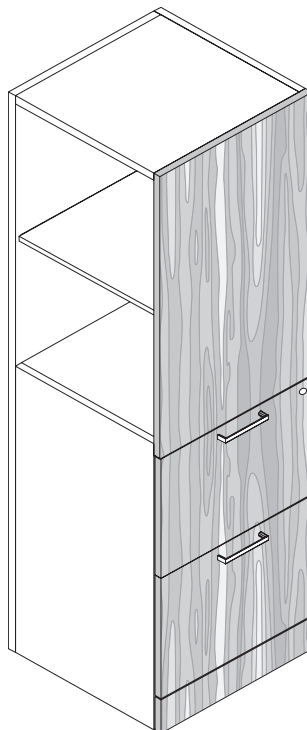

### Two Tone Tower and Wardrobe Plinth

- Units have matched front and kickplate as shown here.

**Note:** Plinth base follows front laminate on non-combo units, and chassis & top on combo units. For best aesthetics avoid placing a two-tone combo along side of a two-tone non-combo unit.

A seat cushion can be placed on the credenza or pedestal top for additional seating. **Soft seating units** are also available for use within the private office, open plan, reception areas, and beyond. Seat bases are ordered separately from seat base cushions and table tops. Seat bases can be used as tables when ordered with a side table top.

Seat Bases are ordered separately in widths of 24", 36", and 48". Seat Bases are 11"H x 24"D and are available with plinth base, Terrace® feet, or Stride® feet. Seat cushion(s) and/or table top(s) are ordered separately to complete the unit.

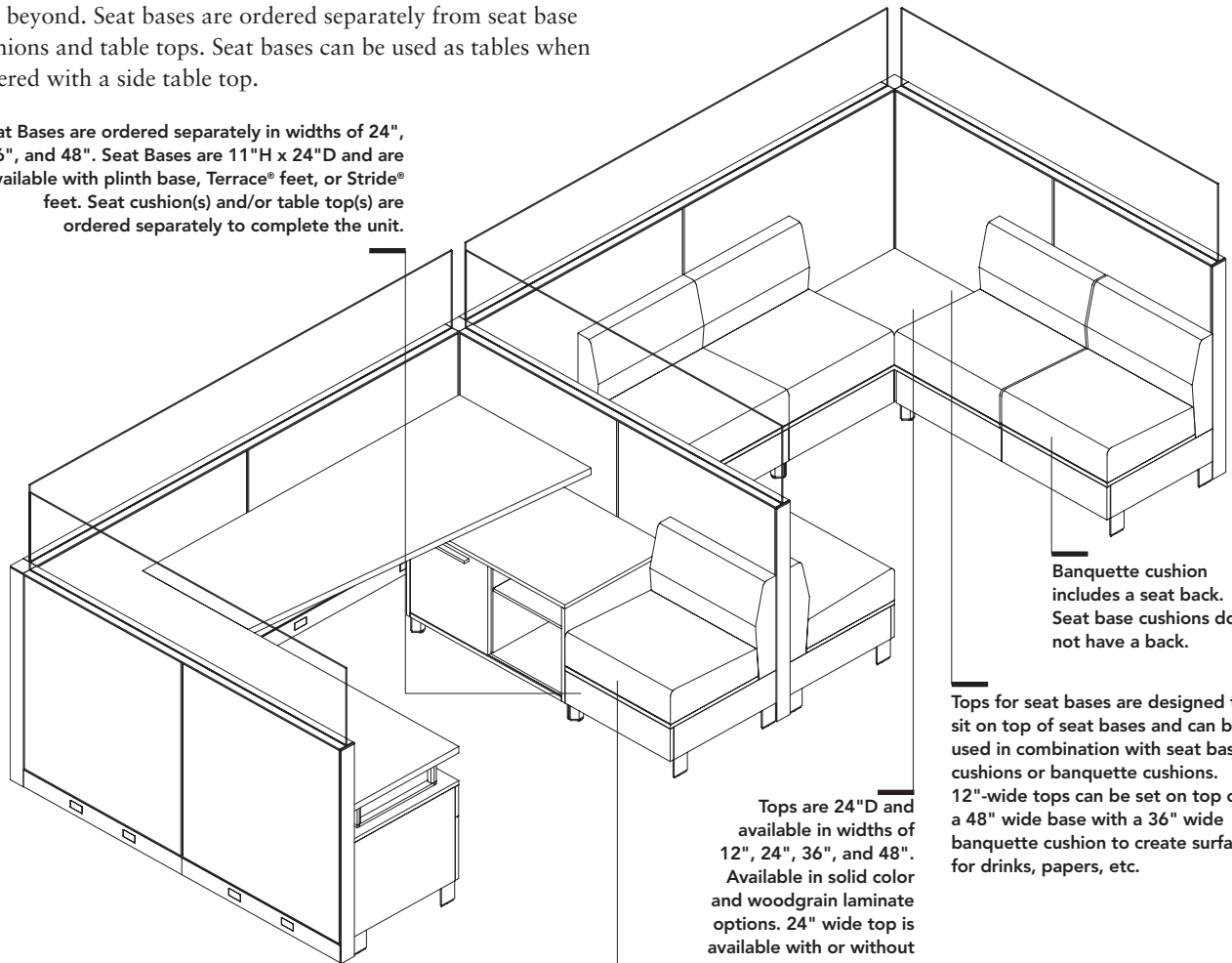

Seat cushions are designed to attach to the top of the seat bases. Offering includes: 24"W or 36"W banquette cushions or 24"W seat base cushions.

Tops are 24"D and available in widths of 12", 24", 36", and 48". Available in solid color and woodgrain laminate options. 24" wide top is available with or without power cutout. A power module is ordered separately.

Banquette cushion includes a seat back. Seat base cushions do not have a back.

Tops for seat bases are designed to sit on top of seat bases and can be used in combination with seat base cushions or banquette cushions. 12"-wide tops can be set on top of a 48" wide base with a 36" wide banquette cushion to create surface for drinks, papers, etc.

Seat base offering includes: with drawer or open. 48"W seat base with drawer has two drawers; design allows access to outbound drawers in corner applications. See illustration below showing four 48"W seat bases with 24"W cushions and tops in a U-shape configuration.

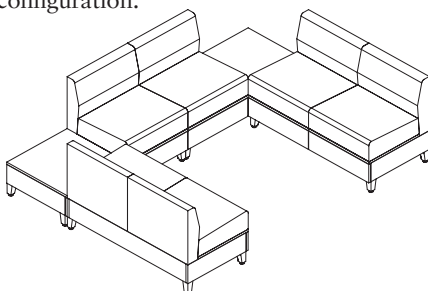

Seat bases are available in solid or woodgrain laminate options. Seat base with drawer can have a different laminate color on the drawer front than the case.

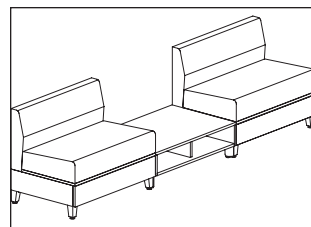

Corner table is used in a soft seating application. Corner table is 17½" high, 24" wide, and 24" deep. Illustration below is shown using plinth base units.

Open table is 11" high and is open at the front and back. Available in widths of 36" or 48" and depths of 18" and 24". Tables can be used to support electronics with back open for cord passage or can be used as a coffee table. 48" wide unit has a septum in the middle of the unit.

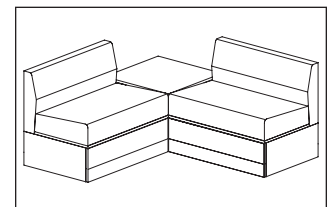



### Aesthetic Alignment

Tower heights align with Stride® and Terrace® panel segmentation.

### Construction and Options

See page 250 for Involve storage construction details; and base, pull, and finish options.

### Shelves

Internal shelves are painted metal and adjustable to three levels.

### Filing

File drawers can accommodate front-to-back letter filing.

### Wardrobe Door

All 24"W towers have full-height wardrobe doors with a coat hook.

### Core Removable Locks

Towers can be shipped with lock cores removed; cores can then be installed after towers are placed. Core removable lock feature allows key numbers to be easily changed in the field. It also facilitates installation.

### Quantity of Lock Cores

Wardrobes with shelves, 18"W towers, and 12"W towers have one lock to secure door. All other towers have two locks — one secures the wardrobe door and the other secures all drawers.

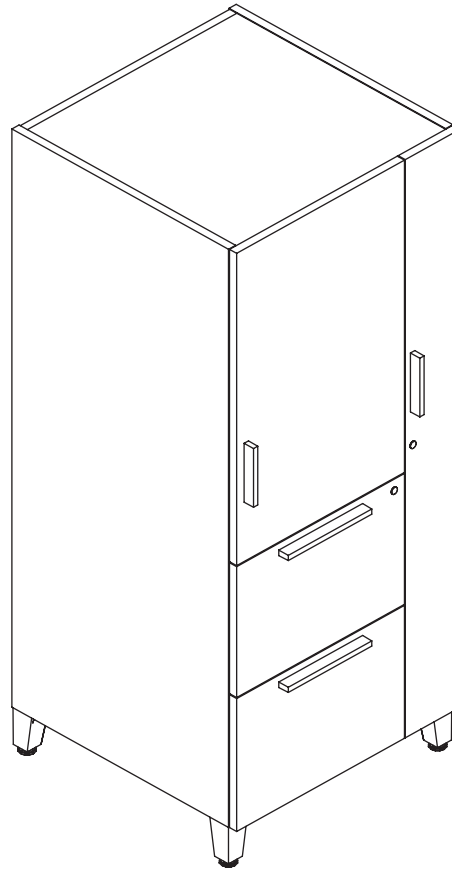

### Configurations

Towers are available in five heights: 42½", 50", 57½", 65" and 72½"H. Drawer configurations include box/box/file and file/file with portion above drawers being a hinged door; 50"H and 57½"H units offer a side access option in place of front facing hinged door. All 24"W units with drawers have a full-height 6"W wardrobe; 18"W units do not. Full wardrobes with 2 adjustable shelves and a coat hook are available in 65"H and 72½"H. 12"W units include 2 coat hooks and must be panel mounted or attached to a credenza or worksurface. Left- and right-handed units available for all configurations. Units ship assembled except for feet and pulls.

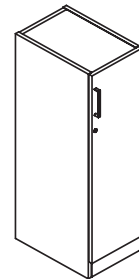

### Worksurface Support

Tower can accommodate addition of an "L" tower bracket or tower rail.

An "L" tower bracket can be ordered separately and fitted to any tower to support worksurfaces at 29½"H.

A tower rail can be ordered separately and fitted to any tower to support worksurfaces at a height range of 27½"H to 30½"H.

See page 281 for visuals of a "L" tower bracket and a tower rail.

Number of Adjustable Shelves in Tower

Unit Height	Sides Access	Front Access	12" Wide
42½"H	N/A	N/A	1
50"H	1	0*	2
57½"H	1	1	2
65"H	N/A	2	2
72½"H	N/A	2	N/A

\*Shelf can be ordered separately on pages 273 and 274.

**Stacking storage** ships fully assembled. Units are designed to be placed on top of a worksurface or credenza and are attached with double-sided tape. Units line up on-module with Stride® and Terrace® elevations when mounted atop everything except a 24" high credenza. Units are available with hinged doors and open configurations.

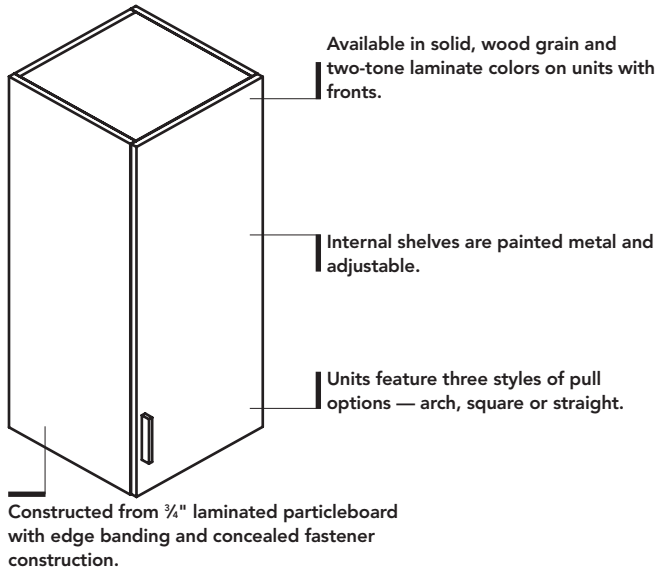

**Overhead storage** components maximize the use of space in the workstation and provide convenient access to binders, reference materials, software packages, and miscellaneous supplies. Overhead cabinets are available with sliding doors, hinged doors, open, and dual access with sliding door or open. Laminate selection includes solid color, woodgrain, or two-tone (case/doors).

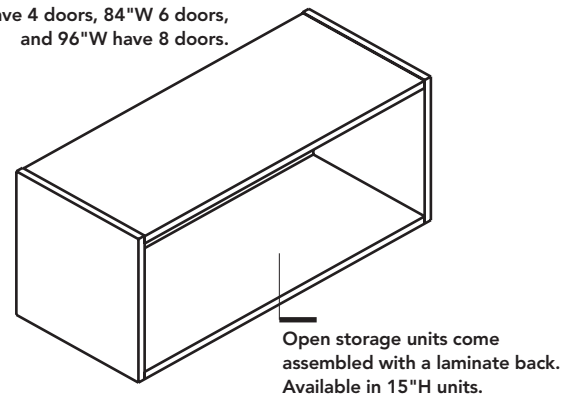
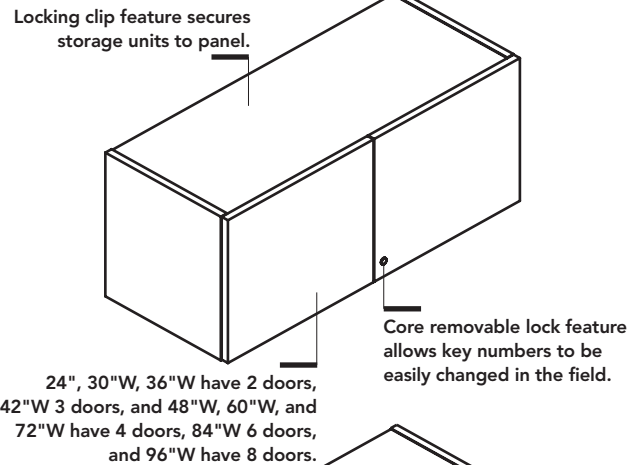
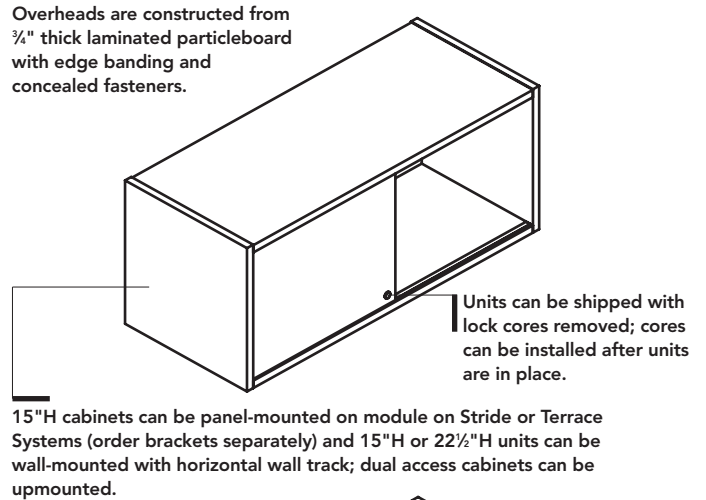

### Product Dimensions

#### Stacking Storage

Width 18", 24"  
 Inside Width 16 3/8", 22 3/8"  
 Depth 18"  
 Inside Depth 16 3/8"  
 Actual Height 19 1/4", 27 1/4",  
 34 1/4", 42 1/4"  
 Inside Height 18 1/4", 27 1/2",  
 33 1/4", 40 1/4"

#### Open Box

Width 24", 30", 36", 42", 48",  
 60"  
 Inside Width 1 3/4" less than  
 width  
 Depth 15"  
 Inside Depth 13 3/8"  
 Height 15"  
 Inside Height 13 3/8"

#### Overhead Storage Cabinet w/Doors

Width 24", 30", 36", 42", 48",  
 60", 72", 84", 96"  
 Inside Width 1 3/4" less than  
 width  
 Depth 15"  
 Inside Depth 12 7/8"  
 Height 15", 22 1/2" (to 60"W)  
 Inside Height 13 3/8", 20 7/8"

#### Overhead Storage — Dual Access

Open Width 36", 48", 60"  
 Inside Width 17 1/8", 23 3/8",  
 29 3/8", 35 3/8" per side  
 Depth 15"  
 Inside Depth — Slider 15 1/4"  
 Open 16 1/4"  
 Height 15"  
 Inside Height 13 3/8"

LED undercabinet light can be mounted beneath laminate overhead cabinets for a low profile lighting option. (Recessed tasklights not recommended as bottom of laminate wood storage is not recessed.)

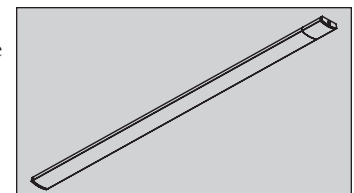

### Wood Storage — Floor Based

- Plinth base or footed design with choice of feet that coordinate with either Stride® or Terrace®. (Unless unit is mobile.)
- Units ship assembled except for feet and pulls.
- Three pull options: arch, square, or straight.
- ¾" thick laminated particleboard with edge banding and European cam-and-pin construction.
- Available laminates: solid, woodgrain, or two-tone (case one laminate / front (door or drawer) a different laminate).
- 72"W units require Solid color laminate case, front can be woodgrain or solid.
- Doors and drawers lock except for stacking storage units and hinged cupboard doors on towers.
- Single sided sliding door units are non-handed; open half depends on door position. Door locks in either position.
- Some models require counterweights, wood backs, or ganging — see page 256.
- File drawers 30"W and wider accommodate legal size documents.
- Center stability foot is included on units 60"W or larger and is always black.

### Mobile Pedestal (Plinth base or footed page 263)

- Box/file drawers; 24"H x 15½"W x 18"D.
- Has a top and finished back. Ships with counterweight.

### Freestanding Pedestals (Plinth base or footed page 263)

- Box/file drawers; 24"H x 18"W x 18"D or 24"D.
- Have a top and unfinished back.
- Requires counterweight (order separately) if freestanding — see page 256.
- Units ship assembled except for feet and pulls.

### Support Pedestals (Plinth base or footed page 263)

- Support pedestals include box/box/file, file/file, or open with one adjustable metal shelf.
- Support pedestals are 15½"W or 18"W; 18"D, 24"D and 30"D; and 28"H. They are meant to support worksurfaces; optional tops are available. With a top they are 29½"H.
- 30"D pedestals are designed to support 30"D worksurfaces; drawer depths are the same as 24"D pedestals.
- Open w/shelf models have finished laminate backs; backs on other models are open with spanner bar with optional laminate back ordered separately if back is exposed.

### 17½"H Credenzas (Plinth base or footed page 264)

- 18"D or 24"D; includes tops. Some models require counterweights or ganging — see page 256.
- Single lateral has one drawer, 30"W or 36"W. Requires counterweights. Optional laminate back ordered separately.
- Single lateral w/open side cubby is handed — drawer, left, or right; 48"W, 60"W, or 72"W.
- Center stability foot is included on units 60"W or larger and is always black.
- Table (closed base) units are 24"W x 24"D.
- Units ship assembled except for feet and pulls.

### 24"H Credenzas (Plinth base or footed pages 265-266)

- 18"D or 24"D with tops.
- Box/lateral is 30"W and box/box/lateral is 36"W. Optional laminate back ordered separately.
- Box/lateral w/open side are handed — drawer, left, or right; 48"W, 60"W, or 72"W.
- Center stability foot is included on units 60"W or larger and is always black.
- Sliding door w/adjustable metal shelf; 36"W or 48"W.
- Open binder units have an adjustable metal shelf; 18"W, 24"W, 30"W, or 36"W.
- Units ship assembled except for feet and pulls.

### 28"H Support Credenzas (Plinth Base or footed pages 267-268)

- 18"D or 24"D without tops.
- Units are designed to support worksurfaces; tops must be ordered separately. With top, credenzas are 29½"H.
- Box/box/lateral are 24"W or 30"W. box/box/project drawer/ lateral is 36"W. Optional laminate back ordered separately.
- Lateral/laterals are 30"W or 36"W. May require counterweights — see page 256. Optional laminate back ordered separately.
- Sliding door units w/adjustable metal shelf and an open top shelf; non-handed, 36"W or 48"W.
- Open cubby models have an adjustable metal shelf; 24"W, 30"W, or 36"W.
- Units ship assembled except for feet and pulls.

### 42"H Credenzas (Plinth base or footed page 269)

- Units are 18"D and designed to support worksurfaces; tops must be ordered separately. With worksurface, credenzas are 43½"H.
- 3-drawer lateral has a laminate back with seams and is 36"W.
- Aesthetic should be considered in applications where back is visible.
- Units ship assembled except for feet and pulls.

### Cam Cover Kits (page 272)

- 17½"H, 24"H, and 28"H credenzas ship without cam covers. Cam cover kits can be ordered separately. 20 cam covers in each kit.

### 15"W Box Drawer Pedestals and Accessory (page 264)

- Box drawers do not include pencil tray.
- Order pencil tray separately - A2280-000

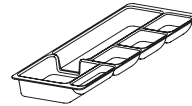

### Bookcases and Bookcases with Lateral File (Plinth base or footed page 270)

- Open bookcases are 15"D. 65"H have 2 adjustable and 1 fixed shelves. 72½"H have 2 adjustable and 2 fixed shelves.
- Bookcases w/lateral are 24"D with 15"D upper bookcase. 65"H have 2 fixed shelves. 72½"H have 1 fixed and 2 adjustable shelves.
- Pin-and-cam fasteners visible from the front are covered with cam covers.
- Backs of all units have exposed pin-and-cam fasteners. Optional cam covers are available to order. Aesthetic should be considered in applications where back is visible.
- Units ship assembled except for feet and pulls.

### Tops and Cushions for Pedestals and Credenzas (page 271)

- Laminate tops are 1¼" thick and 18"D or 24"D, for use on storage without tops in freestanding applications. Certain freestanding applications require counterweights or ganging — see below.
- Cushions are for use on 17½"H and 24"H storage with tops to create additional seating.

### Counterweight Kits (page 272)

- Counterweight is attached to the bottom of a credenza to inhibit tipping.
- Kits must be ordered separately (see page 272) based on type and depth of unit and field-installed.
- Units designated to be ganged must be ganged to at minimum a 36"W unit with non extendable elements (i.e. KL243618N).
- Counterweight kits required for freestanding pedestals and credenzas:

HEIGHT / WIDTH	DEPTH	REQUIRED KITS
<b>24"H Pedestals</b>		
18"W	18"D	2 Kits & Wood Back
	24"D	2 Kits*
	30"D	0 Kits
<b>28"H Pedestals</b>		
15"W or 18"W	18"D	2 Kits & Wood Back
	24"D	2 Kits
	30"D	0 Kits
<b>17"H Single Lateral Credenzas</b>		
30"W or 36"W	18"D	2 Kits & Ganged*
	24"D	0 Kits & Ganged
<b>17"H Single Lateral w/Open Side Credenzas</b>		
48"W, 60"W, or 72"W	18"D	1 Kit
	24"D	0 Kits
<b>24"H Lateral w/Box Drawer(s) Credenzas</b>		
30"W or 36"W	18"D	4 Kits & Ganged*
	24"D	4 Kits & Ganged*
<b>24"H Lateral w/Open Side Credenzas</b>		
48"W, 60"W, or 72"W	18"D	3 Kits
	24"D	0 Kits
<b>28"H Lateral w/Box Drawers Credenzas</b>		
24"W	18"D	2 Kits & Ganged*
	24"D	2 Kits & Ganged*
30"W or 36"W	18"D	4 Kits, Wood Back, & Ganged
	24"D	1 Kit & Ganged*
<b>28"H Lateral/Lateral Credenzas</b>		
30"W or 36"W	18"D	3 Kits & Wood Back
	24"D	3 Kits*

\*Units designated with an "\*" may have 1 counterweight kit removed if a finished wood back is installed.

- Counterweight kit(s) and/or wood backs are not required if ganged back-to-back.
- One counterweight kit can be removed for each additional 36" width of ganged storage to units with non extendable elements.  
**Example:** (1) 28"H x 36"W x 24"D Lateral/Lateral Credenza  
 + (2) 28"H x 36"W x 24"D Open Credenzas  
 (3) kits - (2) kits for 72" ganged = (1) **total kit required**

### Ganging Brackets (page 272)

- Ganging brackets attach to underside of Credenzas.
- Can be used in place of Counterweight Kits based on counterweight requirements above.
- Unique ganging bracket models for footed and plinth base models.

### Metal Shelves (pages 273-274)

- Pullout shelves have a 50 lb. weight capacity and are field-installed using supplied template.
- Pullout shelves are 2"H x 18"W, 24"W, 30"W, or 36"W; and 12"D, 18"D or 24"D in P1, P2, and P3 paint colors.
- Pullout shelves can be used in open cubby space with box/lateral credenzas with septum (exception of sliding door credenzas with septum).
- Additional metal shelves with pins in dimensions for open units are available in P1, P2, and P3 paint colors.

### Soft Seating — Bases/Tops/Cushions and Tables

(Plinth base or footed pages 275-276)

- Bases, either plinth base or leg base units, are ordered separately from seat cushions and table tops. 11"H x 24"D seat base comes with drawer(s) or open shelves; unfinished back and no top. 24"W, 36"W or 48"W.
- Order seat base top(s) 12"W, 24"W, 36"W, or 48"W; or 24"W seat base cushion(s); or banquette cushion(s) (24"W or 36"W) separately to fill entire width of seat base.
- 24"W seat base top is available with power module cutout. Power modules ordered separately with USB, iPod, or Ports.
- Seat base drawer fronts have finger pocket on underside.
- Low open table with top is 11"H and can be used in a soft seating application; 36"W or 48"W and 18"D or 24"D.
- Corner table w/top is closed on all sides; 17½"H x 24" x 24".
- When creating a 90° setup using three seat bases, use of ganging bracket replaces front visible foot on corner seat base.

### Personal Towers (Plinth base or footed pages 277-281)

- Available in heights of 42½", 50", 57½", 65", and 72½".
- Available in right-hand and left-hand configurations. Box/box/file and file/file — front hinged door or side access models with or without 6" wide full-height wardrobe.
- 12"W towers must be attached to a panel, worksurface, or credenza.
- 18"W towers must be attached to a worksurface with Z6LB or a credenza with an inset back using bracket KLGK.
- Pilot holes in case to use "L" tower bracket or tower rail.
- Shelves in hinged door models are adjustable.
- Shelves in side access models are adjustable.
- Full width wardrobe 18"W or 24"W with 2 adjustable metal shelves on 65"H or 72½"H. 24"D have hanging rod; 18"D have double-hook.
- Pin-and-cam fasteners visible from the front and behind a door are covered with cam covers.

### "L" Tower Bracket (page 281)

- Used to support a worksurface at 29½"H.
- Attaches using pre-drilled holes inside the tower.
- For use with laminate and painted wood storage only.
- The depth of the worksurface and tower should be equal.

### Tower Rail (page 281)

- The tower rail mounts to the user side of towers and is used to attach worksurfaces at a height range of 27½"H to 30½"H.
- Attaches using pre-drilled holes inside the tower.
- Requires rail bracket kit for worksurface — order separately.

### Stacking Storage (page 282)

- Units are 18" deep; 20", 27½", 35", and 42½"H. Open units 18"W or 24"W and hinged door units 18"W. 24"W hinged door with 6"W side display available 20"H or 27½"H.
- Units are non-locking and designed to be attached with double-sided tape on top of a 28"H properly supported storage unit worksurface and align with Stride®, Terrace® or Optimize™ elevations.
- Stacking Storage units can not be stacked on each other.
- 42½"H units have two adjustable-height metal shelves; 27½"H and 35"H units have one adjustable shelf.
- Pin-and-cam fasteners visible from the front and behind a door are covered with cam covers.

### Overhead Storage (pages 283-284)

- Units include: hinged door, sliding door, dual-access, and open.
- 15"H units are designed to mount on module to a panel (Terrace or Stride — order panel mount brackets separately) or mount atop stanchions — ordered separately. 15"H and 22½"H units mount to a hard wall using horizontal wall-mount bracket — ordered separately. 22½"H have fixed metal shelf and can only be wall mounted. *See page 252 for panel mounting rules.*
- No double stacking of laminate overheads.
- 24"-36"W hinged door cabinets have 2 doors with one lock on the front of the cabinet; 42"W 3 doors with two locks; 48"W, 60"W, and 72"W have 4 doors with a center security septum and two locks; 84"W 6 doors, two septums, and three locks; 96"W 8 doors, three septums, and four locks.
- Sliding door overheads have one door with one lock that can only be locked when the door is in the left-hand position.
- Back side of single sided units are not meant to be exposed.
- Dual-access units are 18"D and designed to be used between two stations with Terrace panel system. Open units are 36"W, 48"W or 60"W.
- Overhead cabinets feature self-engaging safety latch to secure the cabinet to panel.
- Specify low profile LED tasklights. *See page 285.*
- Pin-and-cam fasteners visible from the front, bottom, and behind a door are covered with cam covers.
- Overheads 72"W or greater cannot be panel mounted. For stanchion mounting and wall mounting only.
- When stanchion mounting 72"W or greater overheads, a taskpanel kit is required on one or both sides.
- A mid stanchion is required with overheads 72"W and wider.
- A taskpanel kit is required when attaching 72"W and wider overheads to a single adjacent tower using the tower-to-overhead bracket kit.
- Taskpanel kits are not required when attaching 72"W and wider overheads to two towers using the tower-to-overhead bracket kits.
- When wall mounting overheads 72"W and wider use two brackets: 2-36"W for 72"W, 2-42"W for 84"W, and 2-48"W for 96"W.
- When ordering a two-tone option for overheads 72"W or greater, the case must always be a solid laminate color.
- Woodgrain laminate option limited to doors for overheads 72"W or greater. Case must be a solid laminate color.

### Laminate Shelf, Book Shelf, and Open Box (page 284)

- Units are designed to mount on module to a panel (Optimize®, Terrace® or Stride® — brackets provided).
- Must conform to specific panel system rules for Overhead mounting
- Cannot be wall-mounted.
- Ship with panel mount brackets installed.
- Capacity not to exceed 50 lbs. on laminate shelf.

### Overhead Stanchions (page 285)

- Aluminum, mid, and non-handed; 5", 11", 12", 18", 19¼", 26", and 27"H.
- 15"D used with single sided overheads, 18"D with dual access.
- Stanchions for 24"H credenzas with tops aligns unit with panel or storage: 11" stanchions align with 35"H; 18"H aligns with 42½"H; 26" aligns with 50"H.
- Stanchions for 28"H credenzas on 29½"H surface aligns unit with panel or storage: 5" stanchions align with 50"H; 12"H aligns with 57½"H; 19¼" aligns with 65"H; 27"H aligns with 72½"H.
- Overheads 72"W and wider require a mid overhead stanchion.
- Unfinished back may be exposed in freestanding application.
- Overhead stanchions are not recommended to be used on freestanding desks.

### Tower-to-Overhead Bracket (page 285)

- Used when stanchion mounting 72"W, 84"W, or 96"W overheads to an adjacent tower.

### Horizontal Wall-Mount Brackets (page 285)

- Use to attach an overhead directly to wall.
- Attachment hardware not included.

### LED Undercabinet Light (page 285)

- Low profile energy-efficient LED tasklight for use with Involve overhead storage cabinets. Attachment hardware included.
- 95 footcandles at 18"; 3500K color temperature.
- 15W power supply is attached to plug: allow 1⅞"D space at outlet. Includes 3 cord retainer clips.

### Hutches (page 287)

- Units include: hinged door, sliding door, and open.
- Designed for use on top of 28"H credenzas with a worksurface of same or greater width — 35"H align with 65"H and 42½"H with 72½"H elevation.
- Laminate hutches are not recommended to be used on freestanding open gable desks.
- Laminate hutches ship fully assembled and attach to a worksurface with double sided tape.
- When ordering a two-tone hutch with a woodgrain case 66"W and wider, the woodgrain direction on the lower back runs horizontal (tackboard recommended). The upper back woodgrain runs in a vertical direction.
- 48"-72"W hinged door cabinets have 4 doors with two locks on the front of the cabinet and a center security septum, 84"W has 6 doors with three locks and two security septums.
- 48"-66"W sliding door overheads have one door with one lock. 72" and 84"W have 2 doors with two locks and two security septums. Doors can only be locked when the door is in the left-hand position.
- 35"H have 19¼" of clearance and 42½"H have 27¼".
- Specify low profile LED task lights.
- Pin-and-cam fasteners visible from the front, bottom, and behind a door are covered with cam covers.

### Tackboards for Hutches (page 288)

- Use tackboards to finish the back of a hutch.
- Tackboards are recommended on woodgrain laminate hutches since woodgrain runs horizontal as opposed to vertical.
- Specify paint color for metal frame and panel fabric.
- 66"W, 72"W, and 84"W ship as two tackboards and a center splicer for routing cables.

### Primary Center Grommet Worksurfaces for use with Hutches (page 289)

- For use with Involve laminate hutches (72"W and 84"W) when a grommet or scallop is needed in the center of the worksurface which the hutch is sitting on.
- Rectangular only, in 72"W and 84"W — laminate with flat or rabbet edge and veneer with square or rabbet edge.
- Always includes center grommet position; left, right, or left and right additional grommet positions are optional.
- Oval plastic grommets are standard; metal grommet(s) are optional.

Laminate worksurfaces are 1/4" thick with particle board core and with top surfaces finished in high-pressure laminate. Bottom surfaces are covered with a backer sheet.

Wire management grommets are standard in most worksurfaces (unless specified without grommets).

**Support Guidelines**

- Unsupported panel runs greater than 72" need floor support for improved stability.
- Worksurface bracket kit should be used to tie panels to worksurface for added stability.
- A panel run without a return needs a floor support.

Worksurface offering includes linear taper and sweep shaped worksurfaces to support the integration of Involve soft seating and 18"D storage into the workplace.

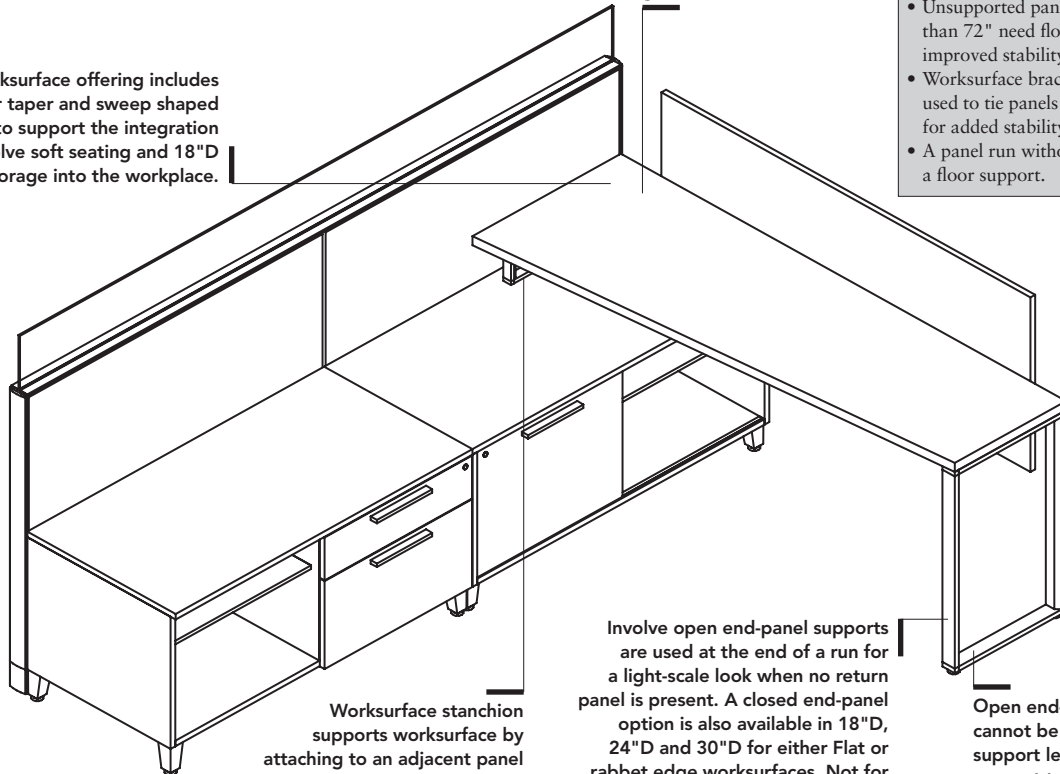

Worksurface stanchion supports worksurface by attaching to an adjacent panel and 24"H Involve storage below.

Involve open end-panel supports are used at the end of a run for a light-scale look when no return panel is present. A closed end-panel option is also available in 18"D, 24"D and 30"D for either Flat or rabbet edge worksurfaces. Not for use with T-mold worksurfaces.

Open end-panel supports cannot be used as in-line support leg, or used to connect two worksurfaces.

**Primary worksurfaces** are available in 18", 24", and 30" depths. Nominal worksurface width is equal to nominal panel width. Unsupported worksurface spans of 60"W-84"W require an external worksurface support channel. It is recommended for spans 48"W-59"W. See pages 260 and 291. Support hardware is ordered separately.

**Corner worksurfaces** with woodgrain laminate and veneer have grain direction diagonal to adjacent worksurfaces. One rear center support bracket is included. All other support hardware is ordered separately.

**Secondary worksurfaces** are available in 12", 18", and 24" depths. Support hardware is ordered separately.

Credenza and pedestal tops are specified separately for 28"H and 42"H units to allow the spanning of multiple peds or credenzas.

Threaded-metal inserts are standard for ease of installation and a positive fit. Worksurfaces can be panel hung or used in freestanding applications.

Worksurface stanchions are used to support worksurface when mounted atop a 24" high Involve credenza. Worksurface stanchions are 5/4"H and made of aluminum. They are available in depths of 12" and 18" and used to support surfaces 18", 24", and 30" deep.

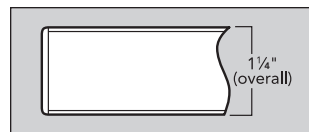

**Flat Edge trim** is available on laminate tops in eleven standard colors (customer specified) to match solid laminates and to complement patterned or in fourteen woodgrain edges color matched to the woodgrain laminates. Veneer worksurfaces have veneer edge.

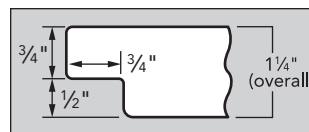

**Rabbet Edge trim** is available on select laminate and veneer tops. These worksurfaces and credenza tops have rabbet edge detail on all sides.

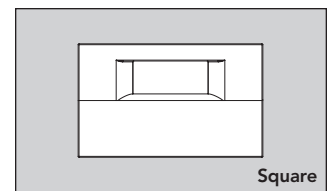
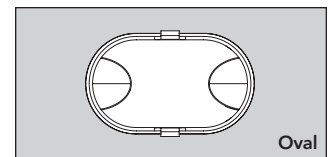

**Wire management grommets** are standard in most worksurfaces and are specified in plastic or metal. **Metal grommets** are available in oval or square (shown above).

### Primary and EZ View Worksurfaces (page 289)

- Wire management grommets standard, one for widths up to 42", two on widths 48"W and greater. Add "N" suffix for no grommets.
- Worksurfaces 66" and over require a cantilever bracket for center support in panel mounted applications. Specify 18" cantilever on 24"D, and 24" cantilever on 30"D worksurfaces.
- Desking worksurfaces should be specified for spans 60" and over when worksurfaces are not panel-attached with additional support along the width. For desking applications and widths greater than 72", additional to-the-floor support is recommended.
- Laminate flat edge worksurfaces can be specified with scallop wire management detail with no upcharge by adding suffix "S" to the model number.

### Primary Desking Worksurfaces (page 289)

- Ships with an external worksurface support channel which extends 1½" below the worksurface and is inset 6" from each end. Support channel is field installed to allow for larger worksurface spans and ships separately.
- Wire management grommets standard, one for widths up to 42", two on widths 48"W and greater. Add "N" suffix for no grommets.
- Laminate flat edge worksurfaces can be specified with scallop wire management detail with no upcharge by adding suffix "S" to the model number.

### EZ View Transition Worksurfaces (page 289)

- Surface is non-handed, with one wire management grommet centered on the 36"D end. Add "N" suffix for no grommets.

### External Worksurface Support Channel (page 291)

- Extends 1½" below the worksurface. Installs 7" from user's edge.
- Is required on a systems worksurface for additional support for spans greater than 60"; or if a full depth horizontal storage unit is installed under the worksurface.
- Required when mounting a Stride® modesty panel.
- When using Involve supports, specify a standard worksurface and an external support channel of a smaller size. The size of the external support channel will depend on the distance between supports.

### Freestanding O-Leg Supports - Metal (page 291)

- Available 29½"H and 18"D, 24"D, 30"D, and 36"D. Non-handed.
- Will work on both flat- and rabbet-edge worksurfaces.
- Can be used to build a free-standing table.
- Adjustable glides have a leveling range of 2".

### Panel-Mounted Brackets for O-Leg (page 291)

- Available in left- or right-handed.
- Brackets are optional and are used to tie to a Stride, Terrace, or Optimize panel.

### Freestanding Closed End Panel Supports — Laminate (page 290)

- Available 29½"H and 18"D, 24"D and 30"D. Non-handed.
- Can be used to build a freestanding desk or console table if specified with a full height modesty panel. See chart on page 292.
- Can not be used with rabbet edge worksurfaces.
- Includes laminate end-panel, attaching hardware and adjustable glides.
- Adjustable glides have a leveling range of 2¾".

### Panel-Mounted Closed End Panel Supports — Laminate (page 290)

- Available 29½"H and 18"D, 24"D and 30"D. Non-handed.
- Can not be used with rabbet edge worksurfaces.
- May not be used to build a freestanding table.
- Includes laminate end-panel, panel mount bracket (non-handed), attaching hardware and adjustable glides.
- Adjustable glides have a leveling range of 2¾".
- Includes hardware to convert freestanding end-panel to panel mount. 24"H or 30"H and left- or right-handed.

### Storage-to-Panel Brackets (page 290)

- Used to attach the back or side of storage to a panel frame to provide stability when used with Stride, Terrace, or Optimize frames.
- Handedness is determined by side of storage that attaches to panel when facing panel run.

### Post Leg (page 291)

- Used to support worksurfaces at 29½"H.
- Adjustable glides have a leveling range of 2¾".

### Worksurface Stanchion (page 291)

- Worksurface stanchions are 5¼"H for Involve credenza and made of aluminum.
- Used to support worksurface when mounted atop a 24"H Involve credenza. (4"H designed for 22"H Stride credenza.)
- Stanchions are field located on 24"H storage, either centered or offset 3" from edge to create additional piling space between storage and worksurface.
- Available in depths of 12" and 18". 12" is designed to work with 18"D worksurfaces and 18" with 24"D worksurfaces. Use two stanchions when mounting a 30"D or deeper worksurface. Stanchion orientation should run parallel to the length of the worksurface it is supporting.

### "L" Tower Bracket (page 291)

- Used to support a worksurface at 29½"H.
- Attaches using pre-drilled holes inside the tower.
- For use with laminate and painted wood storage only.
- The depth of the worksurface and tower should be equal.

### Tower Rail (page 291)

- The tower rail mounts to the user side of towers and is used to attach worksurfaces at a height range of 27½"H to 30½"H.
- Attaches using pre-drilled holes inside the Tower.
- Requires rail bracket kit for worksurface — order separately.



Light-scale screens provide space division. There are four options available: surface mounted modesties, privacy panels, divider panels, and taskpanels.

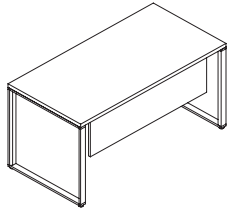

**Surface mounted modesties** are mounted to the underside of the desking worksurface or worksurface with external support channel. They are 11"H and available in laminate or frosted glass. Single or shared (laminate only) mounting models are available. Laminate models include a wire tray on one side of single units and on both sides of shared models. There is an optional wire tray available for glass units.

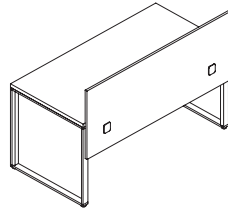

**Privacy panels** extend above and below the desking worksurface acting as both a screen and a modesty panel. They are 25"H and available in laminate or glass (frosted or writable). Single or shared (laminate only) mounting models are available. Laminate models include a wire tray on one side of single units and on both sides of shared models. There is an optional wire tray available for glass units.

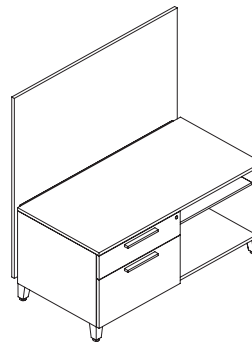

**Divider panels** attach to laminate back of credenza to provide space division between workstations. They are available in laminate in a 50" height.

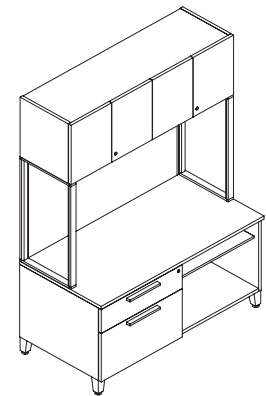

**Taskpanels** mount between stanchions under overhead storage cabinets. They are available as tackable, marker board, or laminate in 12", 18", 19", 26", or 27" heights.

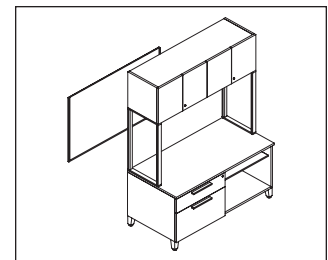
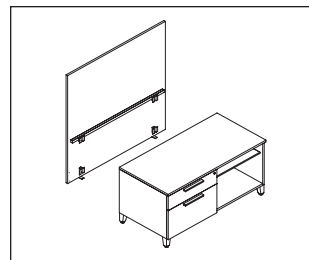

### Specification Rules for Modesties and Privacy Panels

When mounting a modesty panel or a privacy panel use a desking worksurface or worksurface with an external support channel added. When mounting a modesty flush to the edge of a worksurface supported by O-Legs the modesty is to be 7" in from the front edge, the modesty must be 14" narrower than worksurface width.

When using a power/data module between a privacy panel and a worksurface, the privacy panel must be mounted 1" away from edge of the worksurface. Privacy panel can be mounted flush to the edge of the worksurface if power/data module is not used.

When using a power/data module with a surface

mounted modesty panel, the modesty panel must be inset a minimum of 2" in from the edge of the worksurface.

Privacy panel width can be same width as worksurface. *Example:* 60"W privacy panel can be used on a 30"D x 60"W worksurface. Width of panel is undersized by 1/4" providing a 1/8" gap when centered. Placement or use of a modesty must be 12" narrower than worksurface width when using Involve open and closed gable ends.

When using modesty with a Stride post leg, the width of the modesty can be the same as the worksurface, but must be mounted 8" or more in from the front edge of the worksurface.

### Freestanding Table

#### Applications:

Privacy panels require a minimum worksurface depth of 30" for freestanding applications. Surface mounted modesties can be used with any depth freestanding application.

#### Panel Applications:

When using a privacy panel in a back-to-back application the adjacent panel run requires an extended straight connector to compensate for depth of shared privacy panel.

**Full-Height Modesty Panels** (page 292)

- Full height modesty panels are designed to create a desk. A desk can be created with a modesty panel, worksurface, and storage or gable ends on each side — see chart on page 292.
- Available in solid and woodgrain laminate color options. Modesties 61" wide or larger are limited to solid laminate colors only.
- It is recommended to recess the modesty in from the edge of the worksurface. When using with a 24"D surface, recess modesty 6". When using a 30"D surface, recess modesty 6" or 12".
- If attaching desk to a panel on one side, use a storage-to-panel bracket kit.

**Divider Panels** (page 294)

- Divider panels can be attached to the back of 24"H credenzas to provide space division between workstations.
- Offered in laminate in widths to attach to 30"W, 36"W, 48"W, and 60"W credenzas; and height to align with 50"H modules.
- Mounting brackets provide a 1" cord drop space between edge of worksurface and the ¼" thick divider panel.
- A cableway is provided on the inside of the divider panel to facilitate the passage of wires.
- Mounting brackets and cableway are available in black only.
- The mounting of the divider panel is designed to center the ¼" thick panel within the lateral space created by adding an extended straight connector in a panel spine.
- When specifying a divider panel to be attached to a credenza with an unfinished back, a laminate credenza back must also be specified for attachment of the divider panel brackets.
- Divider panel cannot span two credenzas side-to-side.
- Divider panels are designed to be used in single-sided application.
- Divider panel lines up with bottom of credenza case.
- Counterweight kits are still required in credenzas as rules state on page 256.

**Taskpanels** (page 295)

- Taskpanels are available in tackable material and attach between stanchions supporting and overhead storage cabinet.
- Taskpanels are available in 30"W, 36"W, 42"W, 48"W, 60"W, 72"W, 84"W, and 96"W. 72"W and wider consist of two panels. Nominal width of taskpanel should match width of overhead storage cabinet.
- Taskpanels are available 18"H or 26"H for use with 24"H credenzas; and 12"H, 19"H, or 27"H for use with 28"H credenzas. Nominal height of taskpanel should match stanchion height.
- Laminate and tackable taskpanels are encapsulated in a painted metal pan on sides and bottom.
- Back of unit has exposed fasteners. Aesthetic should be considered in applications where back is visible.



# Involve® Laminate Wood Storage

17½"H Credenzas and Table

For specification information see pages 250-258.

GSA SIN PENDING

Description	Solid Color "KL" (Feet +\$100) or "KLP" (Plinth); Or prefix for Woodgrain or Two-Tone "K2T" (Feet +\$100) or "K2TP" (Plinth) Model	Lock Qty	L1 Laminate List Price	UPCHARGES*			
				L2 Laminate Case	L2 Laminate Front	L3 Laminate Case	L3 Laminate Front
<b>17½"H Credenza — Single Lateral (unfinished back)#</b>							
30"W x 18"D	K □ F173018	1	\$ 2734	\$ 62	\$ 29	\$ 121	\$ 53
36"W x 18"D (shown)	K □ F173618	1	\$ 2955	\$ 66	\$ 32	\$ 132	\$ 57
30"W x 24"D	K □ F173024	1	\$ 2843	\$ 63	\$ 30	\$ 128	\$ 56
36"W x 24"D	K □ F173624	1	\$ 3078	\$ 68	\$ 34	\$ 137	\$ 59
<b>17½"H Credenza — Single Lateral with Open Cubby# (laminate back)</b>							
48"W x 18"D Lat/RH Open	K □ 174818RAF	1	\$ 3377	\$ 75	\$ 35	\$ 154	\$ 64
48"W x 18"D LH Open/Lat	K □ 174818LAF	1	\$ 3377	\$ 75	\$ 35	\$ 154	\$ 64
60"W x 18"D Lat/RH Open (shown)	K □ 176018RAF	1	\$ 3827	\$ 83	\$ 39	\$ 174	\$ 74
60"W x 18"D LH Open/Lat	K □ 176018LAF	1	\$ 3827	\$ 83	\$ 39	\$ 174	\$ 74
48"W x 24"D Lat/RH Open	K □ 174824RAF	1	\$ 3509	\$ 78	\$ 36	\$ 159	\$ 67
48"W x 24"D LH Open/Lat	K □ 174824LAF	1	\$ 3509	\$ 78	\$ 36	\$ 159	\$ 67
<b>17½"H Corner Table (closed; with top)</b>							
24"W x 24"D	K □ 172424CT		\$ 2328	\$ 53	\$ 53	\$ 105	\$ 105
<b>Laminate Back (optional for 17½"H Credenza with unfinished back)</b>				<b>L2 Laminate</b>	<b>L3 Laminate</b>		
30"W – Footed Base	KL CB1730		\$ 249	\$ 12	\$ 18		
30"W – Plinth Base	KL PCB1730		\$ 500	\$ 19	\$ 34		
36"W – Footed Base (shown)	KL CB1736		\$ 360	\$ 15	\$ 26		
36"W – Plinth Base (shown)	KL PCB1736		\$ 491	\$ 19	\$ 34		

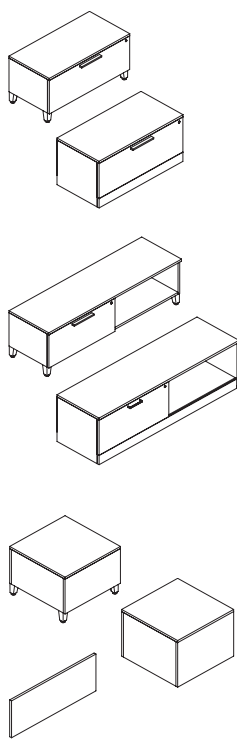

\*Upcharges are added to laminate list price depending on woodgrain laminate selection. \*\*72"W credenza case must always be solid color laminate. #Unit may require counterweight kits, see page 256.

Description	Model	List Price
<b>Box Drawer Accessories</b>		
Pencil Tray (Black only)	A2280-000	\$ 48

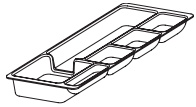

How to specify — Select the Model Number from above.	1st Option: Foot Type (if applicable):	2nd Option: Foot Paint Color (if applicable):	3rd Option: Pull Type (if applicable):	4th Option: Pull Color (if applicable):
KL Feet / Solid Color KLP Plinth/ Solid Color K2T Feet / Woodgrain or Two-Tone K2TP Plinth / Woodgrain or Two-Tone	TF Terrace Foot ZF Stride Foot (Add \$28)	P1 P2 See page 240 for finishes. Stride is limited to PR6 Silver.	MP Beam OP Halo SP Square AP Arch See matrix on page 19.	MP Beam / OP Halo PJW Designer White PR6 Silver PJE Pyrite P8X Solar Black P2 upcharge +\$17/pull SP Square PJW Designer White EL Matte Silver P02 Flint P7B Loft PJE Pyrite P8X Solar Black AP Arch PRO Anodized Silver P2 upcharge +\$17/pull
K                     .		P       .		

Continued below ▼

<b>5th Option: FSC Certified Wood:</b> FSC Select for FSC Certified Wood X No FSC	<b>6th Option: Laminate Color:</b> See page 240 for finishes. (If two-tone list case color here.)	<b>7th Option: Matching Edge:</b> See page 240 for finishes.	<b>8th Option: 2nd Laminate Color (Front) (if applicable):</b> See page 240 for finishes.	<b>9th Option: Matching Edge (if applicable):</b> See page 240 for finishes.	<b>10th Option: Lock (if applicable):</b> STD Standard OMT Omit Lock Core (Deduct \$20)	<b>11th Option: Lock Color (if applicable):</b> EL Silver
.		.		.		E   L

Examples: K2TF173018.TFPJW.APPR6.X.LWCWEDCW.LWCWEDCW.STDEL  
 KL174818RAF.ZFPR6.SPPR6.FSC.LM11EV.OMT  
 KL CB1730.FSC.LM11EV

INVOLVE

# Involve® Laminate Wood Storage

24"H Credenzas

For specification information see pages 250-258.

GSA SIN PENDING

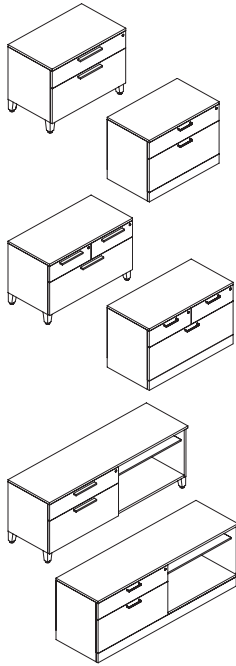

Description	Solid Color "KL" (Feet +\$100) or "KLP" (Plinth); Or prefix for Woodgrain or Two-Tone "K2T" (Feet +\$100) or "K2TP" (Plinth) Model	Lock Qty	L1 Laminate List Price	UPCHARGES*			
				L2 Laminate Case	L2 Laminate Front	L3 Laminate Case	L3 Laminate Front
<b>24"H Credenza — Box/Lateral (unfinished back)#</b>							
30"W x 18"D (shown)	K □ 243018BF	1	\$ 2932	\$ 68	\$ 34	\$ 137	\$ 59
30"W x 24"D	K □ 243024BF	1	\$ 3048	\$ 71	\$ 34	\$ 143	\$ 62
<b>24"H Credenza — Box/Box/Lateral (unfinished back)#</b>							
36"W x 18"D (shown)	K □ 243618E	2	\$ 3022	\$ 71	\$ 34	\$ 143	\$ 74
36"W x 24"D	K □ 243624E	2	\$ 3141	\$ 74	\$ 35	\$ 151	\$ 76
<b>24"H Credenza — Box/Lateral and Open Side with Metal Shelf (finished back)#</b>							
48"W x 18"D Lat/RH Open	K □ 244818RAF	1	\$ 4696	\$ 112	\$ 50	\$ 225	\$ 95
48"W x 18"D LH Open/Lat	K □ 244818LAF	1	\$ 4696	\$ 112	\$ 50	\$ 225	\$ 95
60"W x 18"D Lat/RH Open (shown)	K □ 246018RAF	1	\$ 4911	\$ 116	\$ 52	\$ 235	\$ 101
60"W x 18"D LH Open/Lat	K □ 246018LAF	1	\$ 4911	\$ 116	\$ 52	\$ 235	\$ 101
72"W x 18"D Lat/RH Open**	K □ 247218RAF	1	\$ 5337	N/A	N/A	N/A	N/A
72"W x 18"D LH Open/Lat**	K □ 247218LAF	1	\$ 5337	N/A	N/A	N/A	N/A
48"W x 24"D Lat/RH Open	K □ 244824RAF	1	\$ 4887	\$ 115	\$ 51	\$ 234	\$ 101
48"W x 24"D LH Open/Lat	K □ 244824LAF	1	\$ 4887	\$ 115	\$ 51	\$ 234	\$ 101
60"W x 24"D Lat/RH Open	K □ 246024RAF	1	\$ 5106	\$ 120	\$ 53	\$ 245	\$ 105
60"W x 24"D LH Open/Lat	K □ 246024LAF	1	\$ 5106	\$ 120	\$ 53	\$ 245	\$ 105
72"W x 24"D Lat/RH Open**	K □ 247224RAF	1	\$ 5550	N/A	N/A	N/A	N/A
72"W x 24"D LH Open/Lat**	K □ 247224LAF	1	\$ 5550	N/A	N/A	N/A	N/A



Laminate Back (optional for 24"H credenza with unfinished back)		L2 Laminate	L3 Laminate
30"W – Footed Base	KLCB2430	\$ 263	\$ 12 / \$ 19
30"W – Plinth Base	KLPCB2430	\$ 491	\$ 19 / \$ 34
36"W – Footed Base (shown)	KLCB2436	\$ 375	\$ 15 / \$ 27
36"W – Plinth Base (shown)	KLPCB2436	\$ 507	\$ 19 / \$ 36

\*Upcharges are added to laminate list price depending on woodgrain laminate selection.

#Unit may require counterweight kits, see page 256.

\*\*72"W credenza case must always be solid color laminate.

How to specify — Select the Model Number from above.	1st Option: Foot Type (if applicable): TF Terrace Foot ZF Stride Foot (Add \$28)	2nd Option: Foot Paint Color (if applicable): P1 P2 See page 240 for finishes. Stride is limited to PR6 Silver.	3rd Option: Pull Type (if applicable): MP Beam OP Halo SP Square AP Arch See matrix on page 19.	4th Option: Pull Color (if applicable): MP Beam / OP Halo PJV Designer White PR6 Silver PJE Pyrite P8X Solar Black P2 upcharge +\$17/pull	5th Option: SP Square PJV Designer White EL Matte Silver P02 Flint P7B Loft PJE Pyrite P8X Solar Black AP Arch PRO Anodized Silver P2 upcharge +\$17/pull
K           .		P     .		.	

Continued below ▼

5th Option: Metal Shelf Color (if applicable): P1 P2 P3 See page 240 for finishes. Add \$33 for P2 (except PR6) or \$58 for P3 Paints.	6th Option: FSC Certified Wood: FSC Select for FSC Certified Wood X No FSC	7th Option: Laminate Color: See page 240 for finishes. (If two-tone list case color here.)	8th Option: Matching Edge: See page 240 for finishes.	9th Option: 2nd Laminate Color (Front) (if applicable): See page 240 for finishes.	10th Option: Matching Edge (if applicable): See page 240 for finishes.	11th Option: Lock (if applicable): STD Standard OMT Omit Lock Core (Deduct \$20)	12th Option: Lock Color (if applicable): EL Silver
.	.		.		.		E   L

Examples: K2T243018BF.TFPJW.APPR6.PR6.X.LWCWEDCW.LWCWEDCW.STDEL

KL244824RAF.ZFPR6.SPPR6.P7B.FSC.LM11EV.OMT

# Involve® Laminate Wood Storage

24"H Credenzas

For specification information see pages 250-258.

GSA SIN PENDING

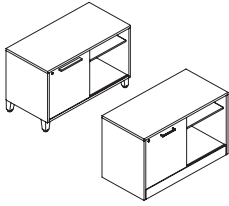

Description	Solid Color "KL" (Feet +\$100) or "KLP" (Plinth); Or prefix for Woodgrain or Two-Tone "K2T" (Feet +\$100) or "K2TP" (Plinth) Model	Lock Qty	L1 Laminate List Price	UPCHARGES*			
				L2 Laminate Case	L2 Laminate Front	L3 Laminate Case	L3 Laminate Front
<b>24"H Credenza — Sliding Door with Metal Shelf (non-handed, with laminate back)</b>							
36"W x 18"D (shown)	K□ 243618N	1	\$ 3418	\$ 79	\$ 38	\$ 164	\$ 69
36"W x 24"D	K□ 243624N	1	\$ 3556	\$ 81	\$ 39	\$ 171	\$ 71
48"W x 18"D	K□ 244818N	1	\$ 3844	\$ 91	\$ 41	\$ 184	\$ 80
48"W x 24"D	K□ 244824N	1	\$ 3995	\$ 93	\$ 42	\$ 189	\$ 83

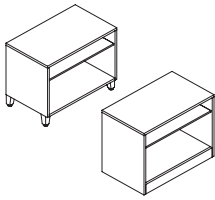

Description	Model	List Price	L2 Laminate	L3 Laminate
			Case	Front
<b>24"H Credenza — Open Binder with Metal Shelf (laminate back)</b>				
18"W x 18"D	K□ 241818A	\$ 1974	\$ 46	\$ 92
24"W x 18"D	K□ 242418A	\$ 2080	\$ 52	\$ 103
30"W x 18"D (shown)	K□ 243018A	\$ 2189	\$ 50	\$ 98
36"W x 18"D	K□ 243618A	\$ 2292	\$ 55	\$ 107
18"W x 24"D	K□ 241824A	\$ 2056	\$ 51	\$ 100
24"W x 24"D	K□ 242424A	\$ 2163	\$ 55	\$ 109
30"W x 24"D	K□ 243024A	\$ 2275	\$ 52	\$ 102
36"W x 24"D	K□ 243624A	\$ 2384	\$ 57	\$ 113

\*Upcharges are added to laminate list price depending on woodgrain laminate selection.

**Note:** Additional pullout shelves can only be added to box/lateral credenzas with center septum.

INVOLVE

How to specify — Select the Model Number from above.	1st Option: Foot Type (if applicable):	2nd Option: Foot Paint Color (if applicable):	3rd Option: Pull Type (if applicable):	4th Option: Pull Color (if applicable):
KL Feet / Solid Color KLP Plinth/ Solid Color K2T Feet / Woodgrain or Two-Tone K2TP Plinth / Woodgrain or Two-Tone	TF Terrace Foot ZF Stride Foot (Add \$28)	P1 P2 See page 240 for finishes. Stride is limited to PR6 Silver.	MP Beam OP Halo SP Square AP Arch See matrix on page 19.	MP Beam / OP Halo PJW Designer White PR6 Silver PJE Pyrite P8X Solar Black P2 upcharge +\$17/pull SP Square PJW Designer White EL Matte Silver P02 Flint P7B Loft PJE Pyrite P8X Solar Black AP Arch PRO Anodized Silver P2 upcharge +\$17/pull
K                     .		P         .		.

Continued below ▼

<b>5th Option:</b> Metal Shelf and Back Color (if applicable): P1 P2 P3 Add \$33 for P2 (except PR6) or \$58 for P3 Paints on shelf.	<b>6th Option:</b> FSC Certified Wood: FSC Select for FSC Certified Wood X No FSC	<b>7th Option:</b> Laminate Color: See page 240 for finishes. (If two-tone list case color here.)	<b>8th Option:</b> Matching Edge: See page 240 for finishes.	<b>9th Option:</b> 2nd Laminate Color (Front) (if applicable): See page 240 for finishes.	<b>10th Option:</b> Matching Edge (if applicable): See page 240 for finishes.	<b>11th Option:</b> Lock (if applicable): STD Standard Core OMT Omit Lock Core (Deduct \$20)	<b>12th Option:</b> Lock Color (if applicable): EL Silver
.	.		.		.		E   L

Examples: K2T243618N.TFPJW.APPR6.PR6.X.LWCWEDCW.LWCWEDCW.STDEL

KL243618DN.ZFPR6.SPPR6.P7B.FSC.LM11EV.OMT



# Involve® Laminate Wood Storage

28"H Credenzas

For specification information see pages 250-258.

GSA SIN PENDING

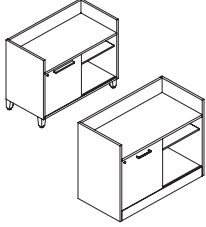

Description	Solid Color "KL" (Feet +\$100) or "KLP" (Plinth); Or prefix for Woodgrain or Two-Tone "K2T" (Feet +\$100) or "K2TP" (Plinth) Model	Lock Qty	L1 Laminate List Price	UPCHARGES*				
				L2 Laminate Case	L2 Laminate Front	L3 Laminate Case	L3 Laminate Front	
<b>28"H Support Credenza — Sliding Door with Metal Shelf (laminate back, without top; non-handed)</b>								
36"W x 18"D (shown)	K 283618N	1	\$ 3631	\$ 83	\$ 39	\$ 164	\$ 74	
36"W x 24"D	K 283624N	1	\$ 3776	\$ 90	\$ 41	\$ 180	\$ 76	
48"W x 18"D	K 284818N	1	\$ 4056	\$ 91	\$ 42	\$ 192	\$ 80	
48"W x 24"D	K 284824N	1	\$ 4220	\$ 101	\$ 44	\$ 202	\$ 83	

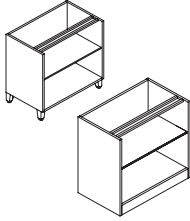

Description	Solid Color "KL" (Feet +\$100) or "KLP" (Plinth); Or prefix for Woodgrain or Two-Tone "K2T" (Feet +\$100) or "K2TP" (Plinth) Model	Lock Qty	L1 Laminate List Price	L2 Laminate	L3 Laminate
				Case	Front
<b>28"H Support Credenza — Open Cubby with Metal Shelf (laminate back, without top)</b>					
24"W x 18"D	K 282418A		\$ 2244	\$ 53	\$ 106
30"W x 18"D (shown)	K 283018A		\$ 2349	\$ 58	\$ 115
36"W x 18"D	K 283618A		\$ 2453	\$ 58	\$ 115
24"W x 24"D	K 282424A		\$ 2333	\$ 56	\$ 111
30"W x 24"D	K 283024A		\$ 2441	\$ 56	\$ 111
36"W x 24"D	K 283624A		\$ 2554	\$ 59	\$ 119

\*Upcharges are added to laminate list price depending on woodgrain laminate selection.

**Note:** Additional pullout shelves can only be added to box/lateral credenzas with center septum.

**How to specify —**

Select the Model Number from above.

- KL Feet / Solid Color
- KLP Plinth/ Solid Color
- K2T Feet / Woodgrain or Two-Tone
- K2TP Plinth / Woodgrain or Two-Tone

**1st Option:**

**Foot Type (if applicable):**

- TF Terrace Foot
- ZF Stride Foot (Add \$28)

**2nd Option:**

**Foot Paint Color (if applicable):**

- P1 P2
- See page 240 for finishes. Stride is limited to PR6 Silver.

**3rd Option:**

**Pull Type (if applicable):**

- MP Beam
- OP Halo
- SP Square
- AP Arch
- See matrix on page 19.

**4th Option:**

**Pull Color (if applicable):**

- MP Beam / OP Halo
- PJW Designer White
- PR6 Silver
- PJE Pyrite
- P8X Solar Black
- P2 upcharge +\$17/pull
- SP Square
- PJW Designer White
- EL Matte Silver
- P02 Flint
- P7B Loft
- PJE Pyrite
- P8X Solar Black
- AP Arch
- PRO Anodized Silver
- P2 upcharge +\$17/pull

Continued below ▼

**5th Option:**

**Metal Shelf Color (if applicable):**

- P1 P2 P3
- Add \$33 for P2 (except PR6) or \$58 for P3 Paints on shelf.

**6th Option:**

**FSC Certified Wood:**

- FSC Select for FSC Certified Wood
- X No FSC

**7th Option:**

**Laminate Color:**

- See page 240 for finishes.
- (If two-tone list case color here.)

**8th Option:**

**Matching Edge:**

- See page 240 for finishes.

**9th Option:**

**2nd Laminate Color (Front) (if applicable):**

- See page 240 for finishes.

**10th Option:**

**Matching Edge (if applicable):**

- See page 240 for finishes.

**11th Option:**

**Lock:**

- STD Standard
- OMT Omit Lock Core (deduct \$20 per lock)

**12th Option:**

**Lock Color (if applicable):**

- EL Silver

Examples: K2T283618N.TFPJW.APPR6.PR6.X.LWCWEDCW.LWCWEDCW.STDEL

KL283618A.ZFFPR6.SPPR6.P7B.FSC.LM11EV.OMT



# Involve® Laminate Wood Storage

42"H Storage

For specification information see pages 250-258.

GSA SIN PENDING

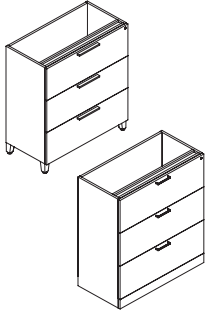

Description	Solid Color "KL" (Feet +\$100) or "KLP" (Plinth); Or prefix for Woodgrain or Two-Tone "K2T" (Feet +\$100) or "K2TP" (Plinth) Model	Lock Qty	L1 Laminate List Price	UPCHARGES*			
				L2 Laminate		L3 Laminate	
				Case	Front	Case	Front
42"H Credenza — 3 Drawer Lateral (without top; back has exposed fasteners)							
36"W x 18"D	K□ 423618FFF	1	\$ 4802	\$ 114	\$ 51	\$ 229	\$ 100

How to specify — Select the Model Number from above.	1st Option: Foot Type (if applicable):	2nd Option: Foot Paint Color (if applicable):	3rd Option: Pull Type (if applicable):	4th Option: Pull Color (if applicable):
KL Feet / Solid Color KLP Plinth/ Solid Color K2T Feet / Woodgrain or Two-Tone K2TP Plinth / Woodgrain or Two-Tone	TF Terrace Foot ZF Stride Foot (Add \$28)	P1 P2 See page 240 for finishes. Stride is limited to PR6 Silver.	MP Beam OP Halo SP Square AP Arch See matrix on page 19.	MP Beam / OP Halo PJW Designer White PR6 Silver PJE Pyrite P8X Solar Black P2 upcharge +\$17/pull SP Square PJW Designer White EL Matte Silver P02 Flint P7B Loft PJE Pyrite P8X Solar Black AP Arch PRO Anodized Silver P2 upcharge +\$17/pull
K                                     .		P       .		.

5th Option: FSC Certified Wood:	6th Option: Laminate Color:	7th Option: Matching Edge:	8th Option: 2nd Laminate Color (Front) (if applicable):	9th Option: Matching Edge (if applicable):	10th Option: Lock (if applicable):	11th Option: Lock Color (if applicable):
FSC Select for FSC Certified Wood X No FSC	See page 240 for finishes. (If two-tone list case color here.)	See page 240 for finishes.	See page 240 for finishes.	See page 240 for finishes.	STD Standard OMT Omit Lock Core (Deduct \$20)	EL Silver
.		.		.		E   L

Examples: K2T423618FFF.TFPJW.APPR6.X.LWCWEDCW.LWCWEDCW.STDEL

INVOLVE

# Involve® Laminate Wood Storage

65"H, 72½"H Bookcases

For specification information see pages 250-258.

GSA SIN PENDING

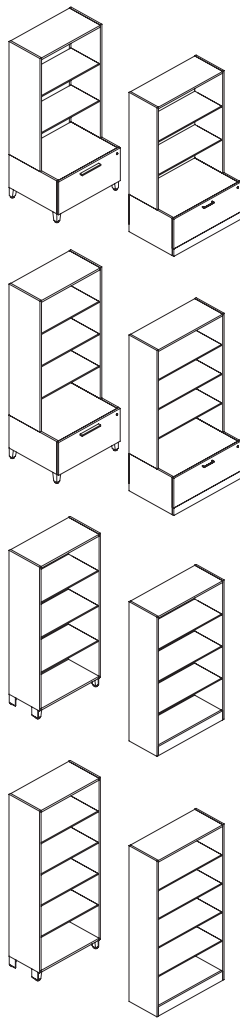

Description	Solid Color "KL" (Feet +\$100) or "KLP" (Plinth); Or prefix for Woodgrain or Two-Tone "K2T" (Feet +\$100) or "K2TP" (Plinth) Model	Lock Qty	L1 Laminate List Price	UPCHARGES*				
				L2 Laminate		L3 Laminate		
				Case	Front	Case	Laminate Front	Case
<b>65"H Bookcase with Lateral File and Metal Shelves</b>								
30"W x 24"D 2 Fixed Shelves	K □ BC653024F	1	\$ 4911	\$ 116	\$ 52	\$ 235	\$ 101	\$ 101
36"W x 24"D 2 Fixed Shelves	K □ BC653624F	1	\$ 5123	\$ 120	\$ 53	\$ 246	\$ 105	\$ 105
<b>72½"H Bookcase with Lateral File and Metal Shelves</b>								
30"W x 24"D 1 Fixed, 2 Adj. Shelves	K □ BC723024F	1	\$ 5188	\$ 121	\$ 53	\$ 248	\$ 106	\$ 106
36"W x 24"D 1 Fixed, 2 Adj. Shelves	K □ BC723624F	1	\$ 5405	\$ 129	\$ 56	\$ 260	\$ 111	\$ 111
<b>65"H Bookcase with Metal Shelves</b>				<b>L2 Laminate</b>		<b>L3 Laminate</b>		
30"W x 15"D 1 Fixed, 2 Adj. Shelves	K □ BC653015A		\$ 3844	\$ 90		\$ 184		
36"W x 15"D 1 Fixed, 2 Adj. Shelves	K □ BC653615A		\$ 4003	\$ 93		\$ 189		
<b>72½"H Bookcase with Metal Shelves</b>				<b>L2 Laminate</b>		<b>L3 Laminate</b>		
30"W x 15"D 2 Fixed, 2 Adj. Shelves	K □ BC723015A		\$ 4056	\$ 95		\$ 192		
36"W x 15"D 2 Fixed, 2 Adj. Shelves	K □ BC723615A		\$ 4268	\$ 101		\$ 204		

\*Upcharges are added to laminate list price depending on woodgrain laminate selection.

**How to specify —**

Select the Model Number from above.

- KL Feet / Solid Color
- KLP Plinth/ Solid Color
- K2T Feet / Woodgrain or Two-Tone
- K2TP Plinth / Woodgrain or Two-Tone

**1st Option:**

**Foot Type** (if applicable):

- TF Terrace Foot
- ZF Stride Foot (Add \$28)

**2nd Option:**

**Foot Paint** (if applicable):

- P1 P2
- See page 240 for finishes. Stride is limited to PR6 Silver.

**3rd Option:**

**Pull Type** (if applicable):

- MP Beam
- OP Halo
- SP Square
- AP Arch
- See matrix on page 19.

**4th Option:**

**Pull Color** (if applicable):

- MP Beam / OP Halo
- PJW Designer White
- PR6 Silver
- PJE Pyrite
- P8X Solar Black
- P2 upcharge +\$17/pull

- SP Square
- PJW Designer White
- EL Matte Silver
- P02 Flint
- P7B Loft
- PJE Pyrite
- P8X Solar Black
- AP Arch
- PRO Anodized Silver
- P2 upcharge +\$17/pull

Continued below ▼

**5th Option:**

**Metal Shelf Color:**

- P1 P2 P3
- See page 240 for finishes. Add \$58 for P2 (except PR6) or \$115 for P3 Paints.

**6th Option:**

**FSC Certified Wood:**

- FSC Select for FSC Certified Wood
- X No FSC

**7th Option:**

**Laminate Color:**

- See page 240 for finishes.
- (If two-tone list case color here.)

**8th Option:**

**Matching Edge:**

- See page 240 for finishes.

**9th Option:**

**2nd Laminate Color (Front)** (if applicable):

- See page 240 for finishes.

**10th Option:**

**Matching Edge** (if applicable):

- See page 240 for finishes.

**11th Option:**

**Lock Option** (if applicable):

- STD Standard
- OMT Omit Lock Core (deduct \$20 per lock)

**12th Option:**

**Lock Color** (if applicable):

- EL Silver

E L

Examples: K2T653024F.TFPJW.APPR6.P7D.X.LWCWEDCW.LWCWEDCW.STDEL

KLBC653015A.ZFPR6.SPPR6.P7B.FSC.LM11E



For specification information see pages 250-258.

GSA SIN PENDING

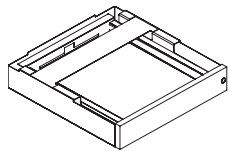
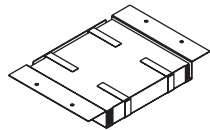

Description	Model	List Price	
		P1 Paint	P2 Paint
<b>Storage-to-Panel Bracket Kits for 24"H and 28"H Credenzas only — back or side mount, painted metal</b>			
24"H Left (requires laminate back for back mounting) (shown)	K624PBKL	\$ 177	\$ 196
24"H Right (requires laminate back for back mounting)	K624PBKR	\$ 177	\$ 196
28"H Left (requires laminate back for back mounting)	K630PBKL	\$ 195	\$ 214
28"H Right (requires laminate back for back mounting)	K630PBKR	\$ 195	\$ 214

<b>Storage-to-Panel Bracket Kits for 24"H and 28"H Credenzas only — back mount only, painted metal</b>			
24"H Left (does not require laminate back) (shown)	K624PBKML	\$ 177	\$ 196
24"H Right (does not require laminate back)	K624PBKMR	\$ 177	\$ 196
28"H Left (does not require laminate back)	K630PBKML	\$ 195	\$ 214
28"H Right (does not require laminate back)	K630PBKMR	\$ 195	\$ 214

<b>Counterweight Kit</b>			
For 18"D units	KLCW218	\$ 286	N/A
For 24"D units	KLCW224	\$ 427	N/A

<b>Ganging Brackets</b>			
For Involve Footed Storage and Seat Bases	KL GK	\$ 77	N/A
For Involve Plinth Base Storage and Seat Bases	KLPGK	\$ 77	N/A

<b>CAM Covers — matches laminate specified</b>			
CAM Covers (20 per pack)	KLCC	\$ 28	N/A

Description	Model	List Price		
		P1	P2	P3
<b>Laptop Drawer - Locking, laminate front, metal case</b>				
17 1/2"W x 18"D x 3 3/4"H (Interior 13"W x 16"D x 1 1/4"H)	U7WDA	\$ 1699	\$ 1721	\$ 1739

How to specify — Select the Model Number from above.	1st Option: <b>Laminate</b> (Laptop drawer front if applicable): See page 240 for finishes.	2nd Option: <b>Edge</b> (Laptop drawer edge if applicable): See page 240 for finishes.	3rd Option: <b>Paint</b> (If laptop drawer, list exterior case color here): See page 240 for finishes.	4th Option: <b>Paint</b> (Interior of laptop drawer if applicable): See page 240 for finishes.	5th Option: <b>Lock</b> (if applicable): <b>STD</b> Standard <b>OMT</b> Omit (Deduct \$20)	6th Option: <b>Lock or Tech</b> <b>Module Color</b> (if applicable): <b>EL</b> Silver
_____	_____	_____	_____	_____	_____	_____

Examples: K624PBKL.P7B KLCC.LM16  
U7WDA.LM11EV.P27.PR6.STDEL

Shippable by small-package carrier.

For specification information see pages 250-258.

GSA SIN PENDING

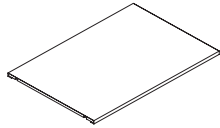

Description	Model	P1 Paint List Price	P2 Paint List Price	P3 Paint List Price
<b>Metal Shelves — ½"H</b>				
18"W x 18"D – for Units with Doors – use with KLC201818RH or LH	SH1818	\$ 201	\$ 234	\$ 259
18"W x 24"D – for Units with Doors – use with KLT501824LBBF, KLT502424RFF, KLT651824L, KLT721824R	SH1824	\$ 232	\$ 265	\$ 290
24"W x 24"D – for Units with Doors – use with KLT652424L or R	SH2424	\$ 233	\$ 266	\$ 291
30"W x 15"D – use with KLBC653015A or KLBC723015A (Bookcases)	SH3015A	\$ 257	\$ 290	\$ 315
36"W x 15"D – use with KLBC653615A or KLBC723615A (Bookcases)	SH3615A	\$ 268	\$ 301	\$ 326
18"W x 18"D – use with K □ 241818A, K □ 281818A, K □ C271818A, K □ C351818A, K □ C421818A, K □ 243618DA, K □ 283618DA (24"H & 28"H Credenzas and Stacking Storage)	SH1818A	\$ 247	\$ 280	\$ 305
24"W x 18"D – use with K □ 242418A, K □ 282418A, K □ C272418A, K □ C352418A, K □ C422418A (24"H & 28"H Credenzas and Stacking Storage)	SH2418A	\$ 257	\$ 290	\$ 315
30"W x 18"D – use with K □ 243018A, K □ 283018A (24"H & 28"H Credenzas)	SH3018A	\$ 268	\$ 301	\$ 326
36"W x 18"D – use with K □ 243618A, K □ 283618A, (24"H & 28"H Credenzas)	SH3618A	\$ 281	\$ 314	\$ 339
48"W x 18"D – use with K □ 284818DA, K □ 424818A (28"H & 42"H Credenza)	SH4818A	\$ 302	\$ 335	\$ 360
60"W x 18"D – use with K □ 286018DA (28"H Credenza)	SH6018A	\$ 325	\$ 358	\$ 383
18"W x 24"D – use with K □ 241824A, K □ 281824A (28"H Credenza)	SH1824A	\$ 248	\$ 281	\$ 306
24"W x 24"D – use with K □ 242424A, K □ 282424A (28"H Credenza)	SH2424A	\$ 281	\$ 314	\$ 339
30"W x 24"D – use with K □ 243024A, K □ 283024A (28"H Credenza)	SH3024A	\$ 293	\$ 326	\$ 351
36"W x 24"D – use with K □ 243624A, K □ 283624A (28"H Credenza)	SH3624A	\$ 302	\$ 335	\$ 360

**Involve Tower Shelving**

	Side Access	Shelf Model	Example of Model
Type	18"D	SH1818A	KLST502418LFF
	24"D	SH2418A	KLST572424RBBF
	Hinged Door (w/drawers)		
	All	SH1824	KLT502424LBBF
	Full Width Hinged Door		
	12"W x 18"D	SH1218	KLT421218L
	12"W x 24"D	SH1224	KLT421224R
	18"W x 24"D	SH1824	KLT651824R
	24"W x 24"D	SH2424	KLT722424L

**How to specify —**  
Select the Model Number from above.

**1st Option:**  
**Paint Color:**  
P1
P2
P3  
 See page 240 for finishes.  
 No upcharge for PR6.

Example: SH1818.P7B



# Involve® Laminate Wood Storage

Accessories

For specification information see pages 250-258.

GSA SIN PENDING

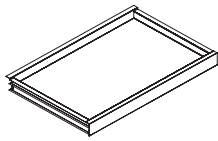

Description	Model	P1 Paint List Price	P2 Paint List Price	P3 Paint List Price
<b>18"D Pullout Metal Shelves — 2"H</b>				
18"W x 18"D Pullout Shelf	KPS1818	\$ 387	\$ 426	\$ 461
24"W x 18"D Pullout Shelf	KPS2418	\$ 404	\$ 443	\$ 478
30"W x 18"D Pullout Shelf	KPS3018	\$ 464	\$ 503	\$ 538
36"W x 18"D Pullout Shelf	KPS3618	\$ 495	\$ 534	\$ 569
24"W x 18"D Pullout Shelf for 48"W Storage w/Septum	KPSD2418	\$ 404	\$ 443	\$ 478
30"W x 18"D Pullout Shelf for 60"W Storage w/Septum	KPSD3018	\$ 464	\$ 503	\$ 538
36"W x 18"D Pullout Shelf for 72"W Storage w/Septum	KPSD3618	\$ 472	\$ 511	\$ 546

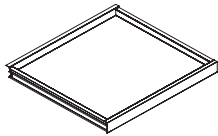

<b>24"D Pullout Metal Shelves — 2"H</b>				
18"W x 24"D Pullout Shelf	KPS1824	\$ 418	\$ 457	\$ 492
24"W x 24"D Pullout Shelf	KPS2424	\$ 441	\$ 480	\$ 515
30"W x 24"D Pullout Shelf	KPS3024	\$ 474	\$ 513	\$ 548
36"W x 24"D Pullout Shelf	KPS3624	\$ 508	\$ 547	\$ 582
24"W x 24"D Pullout Shelf for 48"W Storage w/Septum	KPSD2424	\$ 441	\$ 480	\$ 515
30"W x 24"D Pullout Shelf for 60"W Storage w/Septum	KPSD3024	\$ 474	\$ 513	\$ 548
36"W x 24"D Pullout Shelf for 72"W Storage w/Septum	KPSD3624	\$ 482	\$ 521	\$ 556

**Note:** Additional pullout shelves can only be added to box/lateral credenzas with center septum.

INVOLVE

<p><b>How to specify —</b> Select the Model Number from above.</p>	<p><b>1st Option:</b> <b>Paint Color:</b> P1 P2 P3 See page 240 for finishes. No upcharge for PR6.</p>
--	--

Example: KPSD3024.P02







# Involve® Laminate Wood Storage

12"W Leg Base Towers

For specification information see pages 250-258.

GSA SIN PENDING

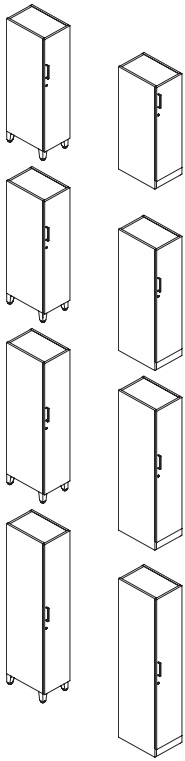

Description	Solid Color "KL" (Feet +\$100) or "KLP" (Plinth); Or prefix for Woodgrain or Two-Tone "K2T" (Feet +\$100) or "K2TP" (Plinth) Model	Lock Qty	L1 Laminate List Price	UPCHARGES*			
				L2 Laminate Case Front		L3 Laminate Case Front	
<b>42½"H Personal Towers — 12"W</b>							
18"D Right Hinged Dr., 1 Adj. Shelf	K □ T421218R (shown)	1	\$ 2904	\$ 68	\$ 33	\$ 137	\$ 59
18"D Left Hinged Dr., 1 Adj. Shelf	K □ T421218L	1	\$ 2904	\$ 68	\$ 33	\$ 137	\$ 59
24"D Right Hinged Dr., 1 Adj. Shelf	K □ T421224R	1	\$ 2947	\$ 69	\$ 33	\$ 138	\$ 60
24"D Left Hinged Dr., 1 Adj. Shelf	K □ T421224L	1	\$ 2947	\$ 69	\$ 33	\$ 138	\$ 60
<b>50"H Personal Towers — 12"W</b>							
18"D Right Hinged Dr., 2 Adj. Shelves	K □ T501218R (shown)	1	\$ 2994	\$ 69	\$ 33	\$ 142	\$ 62
18"D Left Hinged Dr., 2 Adj. Shelves	K □ T501218L	1	\$ 2994	\$ 69	\$ 33	\$ 142	\$ 62
24"D Right Hinged Dr., 2 Adj. Shelves	K □ T501224R	1	\$ 3059	\$ 74	\$ 34	\$ 148	\$ 62
24"D Left Hinged Dr., 2 Adj. Shelves	K □ T501224L	1	\$ 3059	\$ 74	\$ 34	\$ 148	\$ 62
<b>57½"H Personal Towers — 12"W</b>							
18"D Right Hinged Dr., 2 Adj. Shelves	K □ T571218R (shown)	1	\$ 3116	\$ 75	\$ 34	\$ 150	\$ 64
18"D Left Hinged Dr., 2 Adj. Shelves	K □ T571218L	1	\$ 3116	\$ 75	\$ 34	\$ 150	\$ 64
24"D Right Hinged Dr., 2 Adj. Shelves	K □ T571224R	1	\$ 3147	\$ 75	\$ 34	\$ 150	\$ 64
24"D Left Hinged Dr., 2 Adj. Shelves	K □ T571224L	1	\$ 3147	\$ 75	\$ 34	\$ 150	\$ 64
<b>65"H Personal Towers — 12"W</b>							
18"D Right Hinged Dr., 2 Adj. Shelves	K □ T651218R (shown)	1	\$ 3168	\$ 76	\$ 34	\$ 153	\$ 64
18"D Left Hinged Dr., 2 Adj. Shelves	K □ T651218L	1	\$ 3168	\$ 76	\$ 34	\$ 153	\$ 64
24"D Right Hinged Dr., 2 Adj. Shelves	K □ T651224R	1	\$ 3182	\$ 76	\$ 34	\$ 153	\$ 64
24"D Left Hinged Dr., 2 Adj. Shelves	K □ T651224L	1	\$ 3182	\$ 76	\$ 34	\$ 153	\$ 64

\*Upcharges are added to solid laminate list price depending on woodgrain laminate selection.

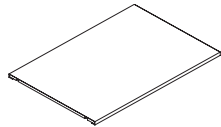

Description	Model	P1 Paint List Price	P2 Paint List Price	P3 Paint List Price
<b>Metal Shelves — ½"H</b>				
12"W x 18"D	SH1218	\$ 201	\$ 234	\$ 259
12"W x 24"D	SH1224	\$ 226	\$ 259	\$ 284

Note: Handed Panel Mounting Brackets are required; see page 70.

<b>How to specify —</b> <b>Select the Model Number from above.</b> KL Feet / Solid Color KLP Plinth/ Solid Color K2T Feet / Woodgrain or Two-Tone K2TP Plinth / Woodgrain or Two-Tone	<b>1st Option:</b> <b>Foot Type (if applicable):</b> TF Terrace Foot ZF Stride Foot (Add \$28)	<b>2nd Option:</b> <b>Foot Paint Color (if applicable):</b> P1 P2 See page 240 for finishes. Stride is limited to PR6 Silver.	<b>3rd Option:</b> <b>Pull Type (if applicable):</b> MP Beam OP Halo SP Square AP Arch See matrix on page 19.	<b>4th Option:</b> <b>Pull Color (if applicable):</b> MP Beam / OP Halo PJW Designer White PR6 Silver PJE Pyrite P8X Solar Black P2 upcharge +\$17/pull	SP Square PJW Designer White EL Matte Silver P02 Flint P7B Loft PJE Pyrite P8X Solar Black AP Arch PRO Anodized Silver P2 upcharge +\$17/pull
K           .		P       .		.	

Continued below ▼

<b>5th Option:</b> <b>Metal Shelf Color:</b> P1 P2 P3 See page 240 for finishes. Add \$33 for P2 (except PR6) or \$58 for P3 Paints.	<b>6th Option:</b> <b>FSC Certified Wood (if applicable):</b> FSC Select for FSC Certified Wood X No FSC	<b>7th Option:</b> <b>Laminate Color (if applicable):</b> See page 240 for finishes. (If two-tone list case color here.)	<b>8th Option:</b> <b>Matching Edge (if applicable):</b> See page 240 for finishes.	<b>9th Option:</b> <b>2nd Laminate Color (Front) (if applicable):</b> See page 240 for finishes.	<b>10th Option:</b> <b>Matching Edge (if applicable):</b> See page 240 for finishes.	<b>11th Option:</b> <b>Lock (if applicable):</b> STD Standard OMT Omit Lock Core (Deduct \$20)	<b>12th Option:</b> <b>Lock Color (if applicable):</b> EL Silver
.	.	.	.	.	.	.	E   L

Examples: K2TT421218R.APPR6.P7D.X.LM13EY.LM15EU.STDEL

KLTS01224R.SP6R6.P7B.FSC.LM11EV.OMT SH1218.P7D

# Involve® Laminate Wood Storage

50"H Towers

For specification information see pages 250-258.

GSA SIN PENDING

Description	Solid Color "KL" (Feet +\$100) or "KLP" (Plinth); Or prefix for Woodgrain or Two-Tone "K2T" (Feet +\$100) or "K2TP" (Plinth) Model	Lock Qty	L1 Laminate List Price	UPCHARGES*			
				L2 Laminate Case	L2 Laminate Front	L3 Laminate Case	L3 Laminate Front
<b>50"H Personal Hinged Door Towers — 24" W x 24" D</b>							
Wardrobe Right / File/File (shown)	K □ T502424RFF	2	\$ 4665	\$ 112	\$ 50	\$ 225	\$ 95
Wardrobe Left / File/File	K □ T502424LFF	2	\$ 4665	\$ 112	\$ 50	\$ 225	\$ 95
Wardrobe Right / Box/Box/File	K □ T502424RBBF	2	\$ 5230	\$ 125	\$ 54	\$ 252	\$ 112
Wardrobe Left / Box/Box/File (shown)	K □ T502424LBBF	2	\$ 5230	\$ 125	\$ 54	\$ 252	\$ 112
<b>50"H Personal Side Access Towers — 24" W x 24" D</b>							
Wardrobe Right / File/File (shown)	K □ ST502424RFF	2	\$ 4665	\$ 112	\$ 50	\$ 225	\$ 95
Wardrobe Left / File/File	K □ ST502424LFF	2	\$ 4665	\$ 112	\$ 50	\$ 225	\$ 95
Wardrobe Right / Box/Box/File	K □ ST502424RBBF	2	\$ 5230	\$ 125	\$ 54	\$ 252	\$ 107
Wardrobe Left / Box/Box/File (shown)	K □ ST502424LBBF	2	\$ 5230	\$ 125	\$ 54	\$ 252	\$ 107
<b>50"H Personal Side Access Towers — 24" W x 18" D</b>							
Wardrobe Right / File/File (shown)	K □ ST502418RFF	2	\$ 4205	\$ 100	\$ 44	\$ 202	\$ 89
Wardrobe Left / File/File	K □ ST502418LFF	2	\$ 4205	\$ 100	\$ 44	\$ 202	\$ 89
Wardrobe Right / Box/Box/File	K □ ST502418RBBF	2	\$ 4776	\$ 113	\$ 51	\$ 229	\$ 98
Wardrobe Left / Box/Box/File (shown)	K □ ST502418LBBF	2	\$ 4776	\$ 113	\$ 51	\$ 229	\$ 98
<b>50"H Personal Hinged Door Towers — 18" W x 24" D</b>							
RH Hinged Door/File/File (shown)	K □ T501824RFF	1	\$ 4286	\$ 102	\$ 44	\$ 203	\$ 89
LH Hinged Door/File/File	K □ T501824LFF	1	\$ 4286	\$ 102	\$ 44	\$ 203	\$ 89
RH Hinged Door/Box/Box/File	K □ T501824RBBF	1	\$ 4665	\$ 111	\$ 46	\$ 224	\$ 100
LH Hinged Door/Box/Box/File (shown)	K □ T501824LBBF	1	\$ 4665	\$ 111	\$ 46	\$ 224	\$ 93
<b>50"H Personal Side Access Towers — 18" W x 24" D</b>							
RH Side Access/File/File (shown)	K □ ST501824RFF	1	\$ 4286	\$ 102	\$ 44	\$ 203	\$ 89
LH Side Access/File/File	K □ ST501824LFF	1	\$ 4286	\$ 102	\$ 44	\$ 203	\$ 89
RH Side Access/Box/Box/File	K □ ST501824RBBF	1	\$ 4665	\$ 111	\$ 44	\$ 224	\$ 93
LH Side Access/Box/Box/File (shown)	K □ ST501824LBBF	1	\$ 4665	\$ 111	\$ 44	\$ 224	\$ 93
<b>50"H Personal Side Access Towers — 18" W x 18" D</b>							
RH Side Access/File/File (shown)	K □ ST501818RFF	1	\$ 4003	\$ 93	\$ 41	\$ 191	\$ 79
LH Side Access/File/File	K □ ST501818LFF	1	\$ 4003	\$ 93	\$ 41	\$ 191	\$ 82
RH Side Access/Box/Box/File	K □ ST501818RBBF	1	\$ 4354	\$ 105	\$ 44	\$ 208	\$ 87
LH Side Access/Box/Box/File (shown)	K □ ST501818LBBF	1	\$ 4354	\$ 105	\$ 44	\$ 208	\$ 87

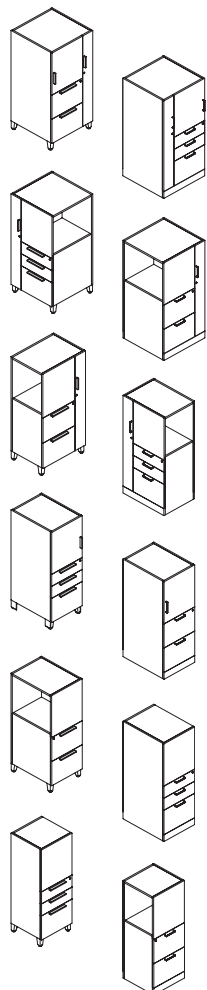

\*Upcharges are added to laminate list price depending on woodgrain laminate selection.

<b>How to specify —</b> <b>Select the Model Number from above.</b> KL Feet / Solid Color KLP Plinth/ Solid Color K2T Feet / Woodgrain or Two-Tone K2TP Plinth / Woodgrain or Two-Tone	<b>1st Option:</b> <b>Foot Type (if applicable):</b> TF Terrace Foot ZF Stride Foot (Add \$28)	<b>2nd Option:</b> <b>Foot Paint (if applicable):</b> P1 P2 See page 240 for finishes. Stride is limited to PR6 Silver.	<b>3rd Option:</b> <b>Pull Type (if applicable):</b> MP Beam OP Halo SP Square AP Arch See matrix on page 19.	<b>4th Option:</b> <b>Pull Color (if applicable):</b> MP Beam / OP Halo PJW Designer White PR6 Silver PJE Pyrite P8X Solar Black P2 upcharge +\$17/pull	<b>SP Square</b> PJW Designer White EL Matte Silver P02 Flint P7B Loft PJE Pyrite P8X Solar Black AP Arch PRO Anodized Silver P2 upcharge +\$17/pull
	K                     .	P           .	.	.	.

Continued below ▼

<b>5th Option:</b> <b>Metal Shelf Color:</b> P1 P2 P3 See page 240 for finishes. Add \$33 for P2 (except PR6) or \$58 for P3 Paints.	<b>6th Option:</b> <b>FSC Certified Wood:</b> FSC Select for FSC Certified Wood X No FSC	<b>7th Option:</b> <b>Laminate Color:</b> See page 240 for finishes. (If two-tone list case color here.)	<b>8th Option:</b> <b>Matching Edge:</b> See page 240 for finishes.	<b>9th Option:</b> <b>2nd Laminate Color (Front) (if applicable):</b> See page 240 for finishes.	<b>10th Option:</b> <b>Matching Edge (if applicable):</b> See page 240 for finishes.	<b>11th Option:</b> <b>Lock Option:</b> STD Standard OMT Omit Lock Core (deduct \$20 per lock)	<b>12th Option:</b> <b>Lock Color (if applicable):</b> EL Silver
.	.	.	.	.	.	.	E   L

Examples: K2TST502424RFF.TFPJW.APPR6.P7D.X.LWCWEDCW.LWCWEDCW.STDEL

KLT502424RFF.ZFFR6.SPPR6.P7B.FSC.LM11EV.OMT



# Involve® Laminate Wood Storage

65"H Towers

For specification information see pages 250-258.

GSA SIN PENDING

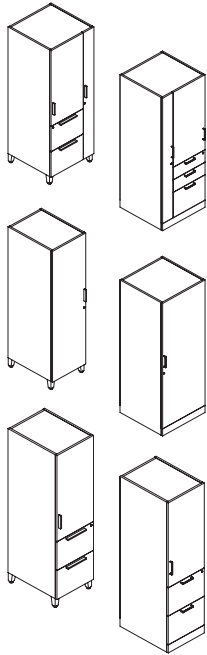

Description	Solid Color "KL" (Feet +\$100) or "KLP" (Plinth); Or prefix for Woodgrain or Two-Tone "K2T" (Feet +\$100) or "K2TP" (Plinth) Model	Lock Qty	L1 Laminate List Price	UPCHARGES*				
				L2 Laminate Case	L2 Laminate Front	L3 Laminate Case	L3 Laminate Front	
<b>65"H Personal Towers — 24"W x 24"D</b>								
Wardrobe Right / Hgd Door/File/File	K □ T652424RFF	2	\$ 5207	\$ 124	\$ 53	\$ 251	\$ 107	
Wardrobe Left / Hgd Door/File/File	K □ T652424LFF	2	\$ 5207	\$ 124	\$ 53	\$ 251	\$ 107	
Wardrobe Right / Hgd Dr/Box/Box/File	K □ T652424RBBF	2	\$ 5801	\$ 136	\$ 59	\$ 278	\$ 119	
Wardrobe Left / Hgd Dr/Box/Box/File	K □ T652424LBBF	2	\$ 5801	\$ 136	\$ 59	\$ 278	\$ 119	
<b>65"H Personal Towers — 24"W x 24"D</b>								
Right Hinged Door, 2 Adj. Shelves	K □ T652424R	1	\$ 3413	\$ 79	\$ 36	\$ 164	\$ 68	
Left Hinged Door, 2 Adj. Shelves	K □ T652424L	1	\$ 3413	\$ 79	\$ 36	\$ 164	\$ 68	
<b>65"H Personal Towers — 18"W x 24"D</b>								
Right Hinged Door, 2 Adj. Shelves	K □ T651824R	1	\$ 3182	\$ 76	\$ 35	\$ 153	\$ 64	
Left Hinged Door, 2 Adj. Shelves	K □ T651824L	1	\$ 3182	\$ 76	\$ 35	\$ 153	\$ 64	
<b>65"H Personal Hinged Door Towers — 18"W x 24"D</b>								
RH Hinged Door/File/File	K □ T651824RFF	1	\$ 4834	\$ 114	\$ 50	\$ 230	\$ 98	
LH Hinged Door/File/File	K □ T651824LFF	1	\$ 4834	\$ 114	\$ 50	\$ 230	\$ 98	
RH Hinged Door/Box/Box/File	K □ T651824RBBF	1	\$ 5004	\$ 119	\$ 52	\$ 240	\$ 107	
LH Hinged Door/Box/Box/File	K □ T651824LBBF	1	\$ 5004	\$ 119	\$ 52	\$ 240	\$ 107	

INVOLVE

<p><b>How to specify —</b> Select the Model Number from above.</p> <p>KL Feet / Solid Color KLP Plinth/ Solid Color K2T Feet / Woodgrain or Two-Tone K2TP Plinth / Woodgrain or Two-Tone</p>	<p><i>1st Option:</i> <b>Foot Type</b> (if applicable): TF Terrace Foot ZF Stride Foot (Add \$28)</p>	<p><i>2nd Option:</i> <b>Foot Paint</b> (if applicable): P1 P2 See page 240 for finishes. Stride foot is limited to PR6 Silver.</p>	<p><i>3rd Option:</i> <b>Pull Type</b> (if applicable): MP Beam OP Halo SP Square AP Arch See matrix on page 19.</p>	<p><i>4th Option:</i> <b>Pull Color</b> (if applicable): MP Beam / OP Halo P JW Designer White PR6 Silver P JE Pyrite P8X Solar Black P2 upcharge +\$17/pull</p>	<p><b>SP Square</b> P JW Designer White EL Matte Silver P O2 Flint P7B Loft P JE Pyrite P8X Solar Black AP Arch PRO Anodized Silver P2 upcharge +\$17/pull</p>
	<p>K                         .      </p>	<p>P       .      </p>	<p>        .      </p>	<p>        .      </p>	

Continued below ▼

<p><i>5th Option:</i> <b>Metal Shelf Color</b> (if applicable): P1 P2 P3 See page 240 for finishes. Add \$33 for P2 (except PR6) or \$58 for P3 Paints.</p>	<p><i>6th Option:</i> <b>FSC Certified Wood</b> (if applicable): FSC Select for FSC Certified Wood X No FSC</p>	<p><i>7th Option:</i> <b>Laminate Color</b> (if applicable): See page 240 for finishes. (If two-tone list case color here.)</p>	<p><i>8th Option:</i> <b>Matching Edge</b> (if applicable): See page 240 for finishes.</p>	<p><i>9th Option:</i> <b>2nd Laminate Color (Front)</b> (if applicable): See page 240 for finishes.</p>	<p><i>10th Option:</i> <b>Matching Edge</b> (if applicable): See page 240 for finishes.</p>	<p><i>11th Option:</i> <b>Lock Option</b> (if applicable): STD Standard OMT Omit Lock Core (deduct \$20 per lock)</p>	<p><i>12th Option:</i> <b>Lock Color</b> (if applicable): EL Silver</p>
<p>        .      </p>	<p>        .      </p>	<p>                    .      </p>	<p>                    .      </p>	<p>                    .      </p>	<p>                    .      </p>	<p>                    .      </p>	<p>E   L  </p>

Examples: K2TT652424RFF.TFPJW.APPR6.P7D.X.LWCWEDCW.LWCWEDCW.STDEL

KLT652424RFF.ZFPR6.SPPR6.P7B.FSC.LM11EV.OMT





# Involve® Laminate Wood Storage

## Overhead Storage

For specification information see pages 250-258. Finished backs available on page 286.

GSA SIN PENDING

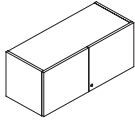

Description	Solid Color "KL" or "K2T" for Woodgrain or Two-Tone Model	Lock Qty	L1 Laminate List Price	UPCHARGES*			
				L2 Laminate Case	L2 Laminate Front	L3 Laminate Case	L3 Laminate Front
<b>Overhead Storage — Hinged Doors — 15"H x 15"D</b>							
24"W	K <input type="checkbox"/> OC152415H	1	\$ 1898	\$ 50	\$ 23	\$ 98	\$ 43
30"W	K <input type="checkbox"/> OC153015H	1	\$ 1955	\$ 52	\$ 26	\$ 102	\$ 44
36"W	K <input type="checkbox"/> OC153615H	1	\$ 1985	\$ 52	\$ 26	\$ 103	\$ 44
42"W	K <input type="checkbox"/> OC154215H	2	\$ 2061	\$ 52	\$ 26	\$ 103	\$ 44
48"W	K <input type="checkbox"/> OC154815H	2	\$ 2230	\$ 57	\$ 28	\$ 114	\$ 51
60"W	K <input type="checkbox"/> OC156015H	2	\$ 2448	\$ 62	\$ 29	\$ 127	\$ 55
72"W	K <input type="checkbox"/> OC157215H	2	\$ 3571	N/A	\$ 41	N/A	\$ 78
84"W	K <input type="checkbox"/> OC158415H	3	\$ 5097	N/A	\$ 53	N/A	\$ 106
96"W	K <input type="checkbox"/> OC159615H	4	\$ 6445	N/A	\$ 67	N/A	\$ 135

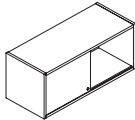

<b>Overhead Storage — Sliding Door — 15"H x 15"D</b>							
24"W	K <input type="checkbox"/> OC152415N	1	\$ 1695	\$ 44	\$ 22	\$ 89	\$ 40
30"W	K <input type="checkbox"/> OC153015N	1	\$ 1759	\$ 45	\$ 22	\$ 91	\$ 41
36"W	K <input type="checkbox"/> OC153615N	1	\$ 1857	\$ 50	\$ 23	\$ 98	\$ 43
42"W	K <input type="checkbox"/> OC154215N	1	\$ 1916	\$ 51	\$ 26	\$ 101	\$ 43
48"W	K <input type="checkbox"/> OC154815N	1	\$ 2013	\$ 53	\$ 26	\$ 105	\$ 45
60"W	K <input type="checkbox"/> OC156015N	1	\$ 2266	\$ 59	\$ 22	\$ 116	\$ 41
72"W	K <input type="checkbox"/> OC157215N	2	\$ 3035	N/A	\$ 35	N/A	\$ 66
84"W	K <input type="checkbox"/> OC158415N	2	\$ 4332	N/A	\$ 45	N/A	\$ 90
96"W	K <input type="checkbox"/> OC159615N	2	\$ 5378	N/A	\$ 57	N/A	\$ 113

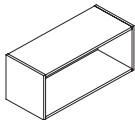

<b>Overhead Storage — Open Bin — 15"H x 15"D</b>			L2 Laminate	L3 Laminate
24"W	K <input type="checkbox"/> OC152415A	\$ 1387	\$ 38	\$ 69
30"W	K <input type="checkbox"/> OC153015A	\$ 1448	\$ 39	\$ 74
36"W	K <input type="checkbox"/> OC153615A	\$ 1507	\$ 40	\$ 76
42"W	K <input type="checkbox"/> OC154215A	\$ 1564	\$ 42	\$ 79
48"W	K <input type="checkbox"/> OC154815A	\$ 1625	\$ 43	\$ 81
60"W	K <input type="checkbox"/> OC156015A	\$ 1742	\$ 45	\$ 90
72"W	KLOC157215A	\$ 2368	N/A	N/A
84"W	KLOC158415A	\$ 3380	N/A	N/A
96"W	KLOC159615A	\$ 4194	N/A	N/A

**Note:** See Storage Mounting Kit bottom of next page.

<b>How to specify —</b> <b>KL</b> prefix for case/front with same Solid Color Laminate <b>K2T</b> prefix for any Woodgrain or Two-Tone Laminate  <b>K</b>	<b>1st Option:</b> <b>FSC Certified Wood</b> (if applicable): <b>FSC</b> Select for FSC Certified Wood <b>X</b> No FSC	<b>2nd Option:</b> See page 240 for finishes.  (If two-tone list case color here. No woodgrain on 72"W-96"W units.) 	<b>3rd Option:</b> <b>Matching Edge:</b> See page 240 for finishes. 	<b>4th Option:</b> <b>2nd Laminate Color (Front)</b> (if applicable): See page 240 for finishes. 
---	--	--	---	---

Continued below ▼

<b>5th Option:</b> <b>Matching Edge</b> (if applicable): See page 240 for finishes. 	<b>6th Option:</b> <b>Lock Option</b> (if applicable): <b>STD</b> Standard <b>OMT</b> Omit Lock Core (deduct \$20 per lock)	<b>7th Option:</b> <b>Lock Color</b> (if applicable): <b>EL</b> Silver  <b>E   L</b>
--	---	---

Examples: KLOC152415H.X.LM11EV.STDEL K2TOC152415N.LM11EV.LM16E9.OMT

# Involve® Laminate Wood Storage

## Overhead Storage (continued) & Shelves

For specification information see pages 250-258.

GSA SIN PENDING

Description	Solid Color "KL" or "K2T" for Woodgrain or Two-Tone Model	Lock Qty	L1 Laminate List Price	UPCHARGES*			
				L2 Laminate Case	L2 Laminate Front	L3 Laminate Case	L3 Laminate Front
<b>Overhead Storage — Hinged Doors with fixed Metal Shelf — 22½"H x 15"D (can only be wall mounted)</b>							
24"W	K □ OC232415H	1	\$ 2642	\$ 67	\$ 33	\$ 135	\$ 58
30"W	K □ OC233015H	1	\$ 2740	\$ 69	\$ 34	\$ 139	\$ 60
36"W (shown)	K □ OC233615H	1	\$ 2937	\$ 75	\$ 35	\$ 154	\$ 64
42"W	K □ OC234215H	1	\$ 3034	\$ 77	\$ 35	\$ 157	\$ 66
48"W	K □ OC234815H	2	\$ 3135	\$ 79	\$ 36	\$ 163	\$ 68
60"W	K □ OC236015H	2	\$ 3331	\$ 86	\$ 39	\$ 174	\$ 74
<b>Overhead Storage — Open Dual Access with Metal Backs — 15"H x 18"D for Terrace</b>							
36"W Open	K □ C153618S		\$ 1647	\$ 43		\$ 80	
48"W Open	K □ C154818S		\$ 2058	\$ 55		\$ 107	
60"W Open	K □ C156018S		\$ 2389	\$ 62		\$ 121	
Mounting Kit for 35"H, 50"H, & 65"H Frames	KLSPMK		\$ 139	P2 paint upcharge \$18 (except PR6)			
Mounting Kit for 42½"H & 57½"H Frames	KLSP45MK		\$ 145	P2 paint upcharge \$18 (except PR6)			
<b>Book Shelf — 7½"H x 15"D</b>							
24"W	K □ OC072415SH		\$ 979	\$ 29		\$ 52	
30"W	K □ OC073015SH		\$ 1027	\$ 29		\$ 55	
36"W (shown)	K □ OC073615SH		\$ 1077	\$ 30		\$ 57	
42"W	K □ OC074215SH		\$ 1124	\$ 33		\$ 58	
48"W	K □ OC074815SH		\$ 1173	\$ 34		\$ 60	
<b>Laminate Shelf — ¾"H x 10"D</b>							
24"W	KS2410		\$ 583	\$ 22		\$ 39	
30"W	KS3010		\$ 612	\$ 23		\$ 40	
36"W (shown)	KS3610		\$ 643	\$ 24		\$ 42	
42"W	KS4210		\$ 685	\$ 26		\$ 44	
48"W	KS4810		\$ 740	\$ 27		\$ 46	

\*Upcharges are added to laminate list price depending on woodgrain laminate selection.

**Note:** Mounting kits and laminate shelves require paint color specified; see kit example below. P2 paint upcharge \$18 (except PR6).

Description	Model	P1 Paint List Price	P2 Paint List Price
<b>Full Depth Horizontal Storage Mounting Kit</b>			
Panel Mounting Kit for 15"H Overhead to Stride® or Terrace® panel	ZHFPMK	\$ 189	\$ 210

<p><b>How to specify —</b></p> <p>Select the Model Number from above.</p> <p>KL prefix for case/front with same Solid Color Laminate</p> <p>K2T prefix for any Woodgrain or Two-Tone Laminate</p> <p><b>K</b>                                     .</p>	<p><b>1st Option:</b></p> <p><b>Metal Shelf, Back, Brackets, or Mounting Kit Paint Color (if applicable):</b></p> <p>□ P1 □ P2 □ P3 (No upcharge for PR6.)</p> <p>Add \$18 for P2 on Open Box Brackets and Laminate Shelf. Add \$33 for P2 or \$58 for P3 Paints on Book Shelf. Add \$58 for P2 or \$115 for P3 Paints on metal back.</p> <p>                .</p>	<p><b>2nd Option:</b></p> <p><b>FSC Certified Wood (if applicable):</b></p> <p>FSC Select for FSC Certified Wood X No FSC</p> <p>                .</p>	<p><b>3rd Option:</b></p> <p><b>Laminate Color (if applicable):</b></p> <p>See page 240 for finishes.</p> <p>(If two-tone list case color here.)</p> <p>                .</p>	
<p><b>4th Option:</b></p> <p><b>Matching Edge (if applicable):</b></p> <p>See inside front cover for finishes.</p> <p>                .</p>	<p><b>5th Option:</b></p> <p><b>2nd Laminate Color (Front) (if applicable):</b></p> <p>See inside front cover for finishes.</p> <p>                .</p>	<p><b>6th Option:</b></p> <p><b>Matching Edge (if applicable):</b></p> <p>See inside front cover for finishes.</p> <p>                .</p>	<p><b>7th Option:</b></p> <p><b>Lock Option (if applicable):</b></p> <p>STD Standard OMT Omit Lock Core (deduct \$20 per lock)</p> <p>                .</p>	<p><b>8th Option:</b></p> <p><b>Lock Color (if applicable):</b></p> <p>EL Silver</p> <p><b>E   L</b></p>

Continued below ▼

Examples: K2TOC232415H.X.LWCWEDCW.LWCWEDCW.STDEL KLSPMK.P7B KLC153618S.FSC.LM11EV KS2410.PR6.X.LM11

INVOLVE



# Involve® Laminate Wood Storage

Stanchions

For specification information see pages 250-258.

GSA SIN PENDING

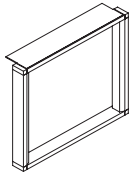

Description	Model	P1 Paint List Price	P2 Paint List Price	P3 Paint List Price
<b>Overhead Stanchions</b> — painted metal for use with 24"H credenzas				
11"H x 15"D Non-handed	K6OLG1115L <span>S</span>	\$ 454	\$ 487	\$ 519
11"H x 18"D Non-handed	K6OLG1118L <span>S</span>	\$ 467	\$ 500	\$ 534
11"H x 7½"D Mid	K6OLG1107 <span>S</span>	\$ 458	\$ 491	\$ 524
18"H x 15"D Non-handed	K6OLG1815L <span>S</span>	\$ 471	\$ 505	\$ 539
18"H x 7½"D Mid	K6OLG1807 <span>S</span>	\$ 471	\$ 505	\$ 539

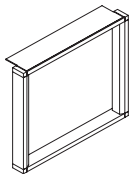

<b>Overhead Stanchions</b> — painted metal for use with 28"H credenzas				
5"H x 15"D Non-handed	K6OLG515L <span>S</span>	\$ 441	\$ 473	\$ 505
5"H x 18"D Non-handed	K6OLG518L <span>S</span>	\$ 553	\$ 593	\$ 632
12"H x 15"D Non-handed	K6OLG1215L <span>S</span>	\$ 562	\$ 603	\$ 642
12"H x 18"D Non-handed	K6OLG1218L <span>S</span>	\$ 578	\$ 620	\$ 661
12"H x 7½"D Mid	K6OLG1207 <span>S</span>	\$ 458	\$ 491	\$ 524
19¼"H x 15"D Non-handed	K6OLG1915L <span>S</span>	\$ 584	\$ 626	\$ 667
19¼"H x 7½"D Mid	K6OLG1907 <span>S</span>	\$ 471	\$ 505	\$ 539

**Note:** No upcharge for PR6 Silver paint on Involve.

Description	Model	P1 Paint List Price	P2 Paint List Price	P3 Paint List Price
<b>Tower-to-Overhead Bracket</b> — for use with wood overhead cabinets				
Attachment Bracket	K6TBK <span>S</span>	\$ 142	\$ 161	\$ 176

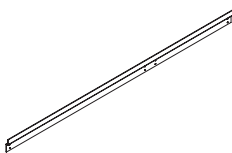

Description	Model	List Price
<b>Horizontal Wall-Mount Brackets</b> — for use with wood overhead cabinets		
24"W	YWC24Z <span>S</span>	\$ 118
30"W	YWC30Z <span>S</span>	\$ 136
36"W	YWC36Z <span>S</span>	\$ 148
42"W	YWC42Z <span>S</span>	\$ 167
48"W	YWC48Z <span>S</span>	\$ 183
60"W	YWC60Z <span>S</span>	\$ 225

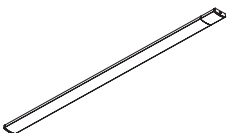

<b>Undercabinet LED Lights (white end caps)</b>		
17" Undercabinet LED Tasklight	ALED17U <span>S</span>	\$ 1014
31" Undercabinet LED Tasklight	ALED31U <span>S</span>	\$ 1522

Additional LED components available, see Frame and Tile Panel Systems price list.

**How to specify —**  
Select the  
Model Number  
from above.

*1st Option:*

**Paint**  
(if applicable):

P1 P2 P3

See page 240 for  
finishes.

**Note:** No upcharge  
for PR6 Silver paint  
on Involve.

Examples: K6O518L.P7B YWC24Z ALED17U

S Shippable by small-package carrier.

# Involve® Laminate Wood Storage

## Overhead Backs

For specification information see pages 250-258. Woodgrain laminate not available on 72"W-96"W.

GSA SIN PENDING



Description	Model	L1 Laminate List Price	UPCHARGES*	
			L2 Laminate	L3 Laminate
<b>Finished Backs for Overheads — 15"H for use in single-sided applications</b>				
30"W	KLBP1530 <input type="checkbox"/>	\$ 1293	\$ 43	\$ 86
36"W	KLBP1536 <input type="checkbox"/>	\$ 1300	\$ 44	\$ 87
42"W	KLBP1542 <input type="checkbox"/>	\$ 1334	\$ 44	\$ 89
48"W	KLBP1548 <input type="checkbox"/>	\$ 1342	\$ 45	\$ 90
60"W	KLBP1560 <input type="checkbox"/>	\$ 1423	\$ 46	\$ 93
72"W	KLBP1572	\$ 1621	N/A	N/A
84"W	KLBP1584	\$ 1877	N/A	N/A
96"W	KLBP1596	\$ 2100	N/A	N/A

INVOLVE

<p><b>How to specify —</b> Select the Model Number from above.</p>	<p><i>1st Option:</i> <b>Laminate Color for Overhead Finished Back (if applicable):</b> See page 240 for finishes.</p>	<p><i>2nd Option:</i> <b>Matching Laminate Edge for Overhead Finished Back (if applicable):</b> See page 240 for finishes.</p>
--	--	--

Example: KLBP1530.LM15EU

Shippable by small-package carrier.



# Involve® Laminate Wood Storage

Tackboards

For specification information see pages 250-258. Woodgrain laminate not available on 72"W-96"W.

GSA SIN PENDING

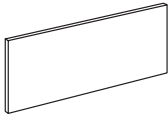

Description	Model	List Price				
		Grade A	Grade B	Grade C	Grade D	Grade E
<b>Tackboards for 35"H Hutches</b>						
48"W	K6TB3548T (shown)	\$ 749	\$ 818	\$ 887	\$ 1001	\$ 1116
60"W	K6TB3560T	\$ 845	\$ 932	\$ 1018	\$ 1161	\$ 1304
66"W	K6TB3566T	\$ 870	\$ 965	\$ 1059	\$ 1216	\$ 1374
72"W	K6TB3572T	\$ 970	\$ 1074	\$ 1177	\$ 1349	\$ 1520
84"W	K6TB3584T	\$ 1117	\$ 1237	\$ 1357	\$ 1558	\$ 1758
<b>Tackboards for 42½"H Hutches</b>						
48"W	K6TB4248T (shown)	\$ 826	\$ 909	\$ 993	\$ 1132	\$ 1271
60"W	K6TB4260T	\$ 930	\$ 1035	\$ 1140	\$ 1313	\$ 1487
66"W	K6TB4266T	\$ 959	\$ 1074	\$ 1189	\$ 1380	\$ 1572
72"W	K6TB4272T	\$ 1067	\$ 1193	\$ 1318	\$ 1526	\$ 1735
84"W	K6TB4284T	\$ 1170	\$ 1317	\$ 1463	\$ 1706	\$ 1949

\*Upcharges are added to solid laminate list price depending on woodgrain laminate selection.

INVOLVE

<p><b>How to specify —</b> Select the Model Number from above.</p>	<p><b>1st Option:</b> <b>Paint Color for Tackboard Frame</b> (if applicable):</p> <p>P1 P2 P3</p> <p>See page 240 for finishes. P2 paint upcharge \$32 (except PR6). P3 paint upcharge \$62.</p>	<p><b>2nd Option:</b> <b>Panel Fabric for Hutch Tackboard</b> (if applicable):</p> <p>See page 240 for finishes.</p>
--	--	--

Example: K6TB3548T.P02.APN917

Shippable by small-package carrier.

For specification information see pages 259-260. For additional worksurface sizes reference the *Stride®* or *Terrace®* worksurface sections. For non-standard worksurface sizes see 9120 Program in any Systems price book.

Veneer/Laminate  
GSA SIN PENDING

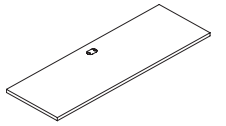
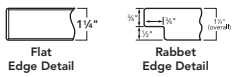

Specify Grommet Location

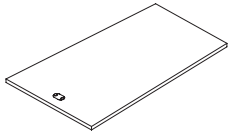

Top View

Description	Veneer w/Flat Edge Model	Laminate w/Flat Edge Model	Veneer w/Flat Edge			Laminate w/Flat Edge		
			V1 List Price	V3 List Price	V5 List Price	L1 List Price	L2 List Price	L3 List Price
<b>Primary Worksurfaces — specify grommet location</b>								
72"W x 18"D		T51872CS				\$ 758	\$ 790	\$ 814
84"W x 18"D		T51884CS				\$ 1035	\$ 1075	\$ 1111
72"W x 24"D		T52472CS				\$ 822	\$ 855	\$ 884
84"W x 24"D		T52484CS				\$ 1130	\$ 1173	\$ 1213
72"W x 30"D		T53072CS				\$ 932	\$ 968	\$ 1001
84"W x 30"D		T53084CS				\$ 1250	\$ 1296	\$ 1342
<b>30" D / 36" D EZ View Transition Worksurfaces (non-handed)</b>								
30"D x 60"W x 36"D		K5306036EZ				\$ 1436	\$ 1488	\$ 1543
30"D x 72"W x 36"D		K5307236EZ				\$ 1682	\$ 1742	\$ 1806
30"D x 78"W x 36"D		K5307836EZ				\$ 2017	\$ 2091	\$ 2168

**Notes:** 1) Add Suffix "N" to a model number for no grommets, no upcharge. *Examples:* K5306036EZN, K5307836EZN

<p><b>How to specify —</b> Select the Model Number from above.</p>	<p><b>1st Option:</b> Veneer or Laminate: See page 240 for finishes. (Upcharges are listed above.)</p>	<p><b>2nd Option:</b> Laminate Edge Color (if applicable): See page 240 for finishes.</p>	<p><b>3rd Option:</b> Grommet Location (if applicable): GC Center GCL Center and Left GCR Center and Right GCRL Center, Right, and Left</p>	<p><b>4th Option:</b> Grommet Type: P Oval Plastic (Will match edge trim on laminate) M Oval Metal (Add \$11 per grommet) S Square Metal (Add \$11 per grommet)</p>	<p><b>5th Option:</b> Grommet Color (Metal only): EL Matte Silver  Additional Oval Veneer Colors: EZ Bronze E4 Black</p>
--	--	---	---	---	--

*Examples:* T51848S.LM14.EW.P T51872CS.LM15EU.GCP

For specification information see pages 259-260.

GSA SIN 33721

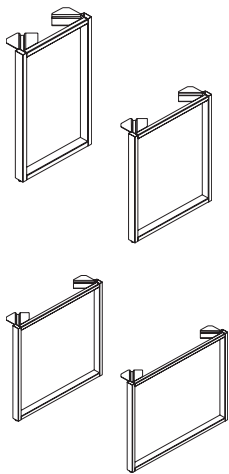

Description	Model	P1 Paint List Price	P2 Paint List Price	P3 Paint List Price
<b>29½"H Open End Panel Supports — Painted Metal</b>				
18"D Freestanding for Flat/Square Edge	K62918OLG	\$ 801	\$ 864	\$ 926
24"D Freestanding for Flat/Square Edge (shown)	K62924OLG	\$ 867	\$ 935	\$ 1002
30"D Freestanding for Flat/Square Edge	K62930OLG	\$ 931	\$ 1003	\$ 1075
<hr/>				
18"D Panel-Mount for Flat/Square Edge	K62918OLG	\$ 801	\$ 864	N/A
24"D Panel-Mount for Flat/Square Edge (shown)	K62924OLG	\$ 867	\$ 935	N/A
30"D Panel-Mount for Flat/Square Edge	K62930OLG	\$ 931	\$ 1003	N/A
36"D Panel-Mount for Flat/Square Edge	K62936OLG	\$ 996	\$ 1074	\$ 1151

**NOTE:** No upcharge for PR6 Silver paint on Involve.

Use of a panel-mounting bracket from page 291 can change the O-Leg from freestanding to panel-mounted.

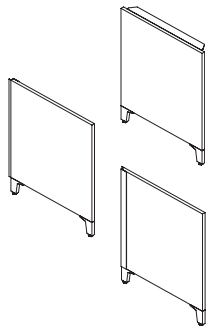

Description	Model	L1 Laminate List Price	L2 Laminate List Price	L3 Laminate List Price
<b>29½"H Closed End Panel Supports — Laminate with Metal Brackets</b>				
18"D Freestanding for Flat/Square Edge	K62918FEN	\$ 970	\$ 1008	\$ 1042
24"D Freestanding for Flat/Square Edge (shown)	K62924FEN	\$ 1008	\$ 1047	\$ 1083
30"D Freestanding for Flat/Square Edge	K62930FEN	\$ 1054	\$ 1094	\$ 1131
18"D Panel-Mount for Flat/Square Edge — Left	K62918LPEN	\$ 1051	\$ 1091	\$ 1128
18"D Panel-Mount for Flat/Square Edge — Right	K62918RPEN	\$ 1051	\$ 1091	\$ 1128
24"D Panel-Mount for Flat/Square Edge (shown) — Left	K62924LPEN	\$ 1088	\$ 1129	\$ 1167
24"D Panel-Mount for Flat/Square Edge (shown) — Right	K62924RPEN	\$ 1088	\$ 1129	\$ 1167
30"D Panel-Mount for Flat/Square Edge — Left	K62930LPEN	\$ 1120	\$ 1162	\$ 1203
30"D Panel-Mount for Flat/Square Edge — Right	K62930RPEN	\$ 1120	\$ 1162	\$ 1203



Description	Model	P1 Paint List Price	P2 Paint List Price
<b>Storage-to-Panel Bracket Kits for 24"H and 28"H Credenzas only — Painted Metal</b>			
24"H Left (requires laminate back) (shown)	K624PBKL	\$ 177	\$ 196
24"H Right (requires laminate back)	K624PBKR	\$ 177	\$ 196
28"H Left (requires laminate back)	K630PBKL	\$ 195	\$ 214
28"H Right (requires laminate back)	K630PBKR	\$ 195	\$ 214
<hr/>			
24"H Left (does not require laminate back)	K624PBKML	\$ 177	\$ 196
24"H Right (does not require laminate back)	K624PBKMR	\$ 177	\$ 196
28"H Left (does not require laminate back)	K630PBKML	\$ 195	\$ 214
28"H Right (does not require laminate back)	K630PBKMR	\$ 195	\$ 214

INVOLVE

<p><b>How to specify —</b> Select the Model Number from above.</p>	<p><b>1st Option:</b> FSC Certified Wood (if applicable):</p> <p>FSC Select for FSC Certified Wood X No FSC</p>	<p><b>2nd Option:</b> Laminate (if applicable): See page 240 for finishes.</p>	<p><b>3rd Option:</b> Edge Color (if applicable): See page 240 for finishes.</p>	<p><b>4th Option:</b> Paint:</p> <p><input type="radio"/> P1 <input type="radio"/> P2 <input type="radio"/> P3</p> <p>See page 240 for finishes.</p> <p>For P2 Paints (except PR6) on Closed End Panel Supports add \$32.</p>
--	---	--	--	---

Examples: K62918OLG.P7B K624PBKR.P7B K62918LPEN.X.LM11EV.P7B

For specification information see pages 259-260.

GSA SIN PENDING

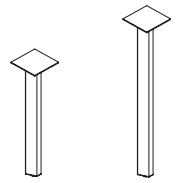

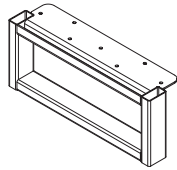

Description	Model	P1 Paint List Price	P2 Paint List Price	P3 Paint List Price
<b>Post Leg — Painted Metal</b>				
29½"H	K629SCF	\$ 418	\$ 447	N/A
40½"H	K640SCF	\$ 502	\$ 531	N/A

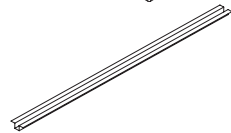

<b>Worksurface Stanchion — Painted Metal</b> (See below for replacement models.)				
12"D x 5¼"H for Involve 24"H Credenza	K6OLG0512	\$ 535	\$ 574	\$ 612
18"D x 5¼"H for Involve 24"H Credenza	K6OLG0518	\$ 550	\$ 590	\$ 629
12"D x 4"H for Stride 22"H Credenza	APOLG0512	\$ 403	\$ 431	\$ 453
18"D x 4"H for Stride 22"H Credenza	APOLG0518	\$ 439	\$ 467	\$ 489



<b>External Worksurface Support Channel</b> (Black Only)				
30"W for use on 42"W Worksurface	Z5SC42 	\$ 83	N/A	N/A
36"W for use on 48"W Worksurface	Z5SC48 	\$ 86	N/A	N/A
42"W for use on 54"W Worksurface	Z5SC54 	\$ 99	N/A	N/A
48"W for use on 60"W Worksurface	Z5SC60	\$ 106	N/A	N/A
54"W for use on 66"W Worksurface	Z5SC66	\$ 124	N/A	N/A
60"W for use on 72"W Worksurface	Z5SC72	\$ 133	N/A	N/A
66"W for use on 78"W Worksurface	Z5SC78	\$ 145	N/A	N/A

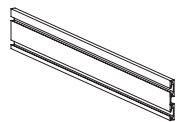

<b>Tower Rail</b> (supports worksurface on side of tower — requires rail bracket kit)				
18"W Tower Rail for 18"D Tower	K6TR18	\$ 193	\$ 204	N/A

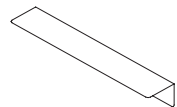

<b>"L" Tower Bracket — for Wood Towers</b>				
"L" Tower Bracket for 18"D or 24"D Tower	Z6LB	\$ 79	\$ 98	N/A

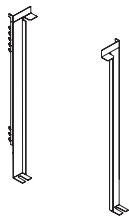

<b>Panel-Mount Brackets for O-Leg-to-Panel Attachment Bracket</b>				
Left-Handed O-Leg to Panel Bracket	KOLGBRKLFT	\$ 193	\$ 207	\$ 221
Right-Handed O-Leg to Panel Bracket	KOLGBRKRGT	\$ 193	\$ 207	\$ 221

**How to specify —**  
Select the Model Number from above.

*1st Option:*

**Paint**  
(if applicable):

See page 240 for finishes.

No upcharge for PR6 Silver paint on Involve.

Examples: K629SCF.P7B Z5SC60

 Shippable by small-package carrier.





# Notes

---

INVOLVE

For specification information see page 262.

GSA SIN PENDING

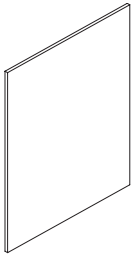

Description	Model	L1 Laminate List Price	L2 Laminate List Price	L3 Laminate List Price
<b>50"H Laminate Divider Panel — ¼" Thick</b>				
29"W	K6DP5029L	\$ 1056	\$ 1096	\$ 1134
35"W	K6DP5035L	\$ 1149	\$ 1192	\$ 1235
47"W	K6DP5047L	\$ 1251	\$ 1296	\$ 1343
59"W	K6DP5059L	\$ 1342	\$ 1392	\$ 1443

INVOLVE

<p><b>How to specify —</b> Select the Divider Panel Model Number from above.</p>	<p><i>1st Option:</i> <b>FSC Certified Wood:</b> FSC Select for FSC Certified Wood X No FSC</p>	<p><i>2nd Option:</i> <b>Laminate Color:</b> See page 240 for finishes.</p>	<p><i>3rd Option:</i> <b>Matching Edge:</b> See page 240 for finishes.</p>
--	---	---	--

Example: K6DP5029L.X.LM11EV



# Notes

---

INVOLVE

Finishes ..... 298  
Statement of Line ..... 299  
Working with Storage ..... 300-303  
Pedestals and Credenzas..... 305  
Storage Towers..... 306  
Credenzas..... 307-308



**PAINT FINISHES**

**GRADE P1**

Black	.....	P27
Brownstone	.....	P7D
Bungalow	.....	P7C
Cinder	.....	P7Q
Cove	.....	P096
Designer White	.....	PJW
Dune	.....	P094
Flint	.....	P02
Fossil	.....	P28
Harbor	.....	P097
Loft	.....	P7B
Muslin	.....	P4J
Parchment	.....	P93
Pebble	.....	P8R
Pewter	.....	P8D
Sage	.....	P095
Salt	.....	P8C
Titanium	.....	P8T

**GRADE P2**

Champagne Metallic	.....	PR5
Gunmetal Metallic	.....	PR3
Night Bronze	.....	P8B
Platinum Metallic	.....	PR2
Pyrite	.....	PJE
Silver	.....	PR6
Solar Black	.....	P8X

**GRADE P3**

Amethyst ( <i>De-emphasized</i> )	.....	P091
Atom	.....	P85
Blossom***	.....	P8K
Bullseye	.....	PJF
Cobalt Mica ( <i>De-emphasized</i> )	.....	P090
Ember	.....	P8P
Ion	.....	P8N
Iris	.....	P8J
Krypton	.....	P8F
Ochre	.....	P093
Regatta	.....	P8M
Sienna	.....	P092
Succulent***	.....	P8A

\*\*\*These colors are intended to be an inspirational option for the trending market. Product application is limited and color availability is approximately two years to coincide with evolving workplace trends.

*Metallic paints, due to varying reflectance, may appear to have less visual color consistency than other paint finishes, even when L/A/B values are exactly the same. (L/A/B — measurable aspects of color — values are maintained within a specified range, to ensure consistent appearance of paint colors.)*

**ELECTRICAL AND DATA COMPONENTS**

Black	.....	E4
Brownstone	.....	EY
Designer White	.....	DW
Flint	.....	E9
Loft	.....	EV
Muslin	.....	EU
Silver	.....	ES

Recommended Coordinate Colors:  
 Bungalow use Muslin EU  
 Carob use Black E4  
 Champagne Metallic use Muslin EU  
 Cinder use Brownstone EY  
 Fossil use Flint E9  
 Gunmetal Metallic use Brownstone EY  
 Parchment use Muslin EU  
 Pebble use Loft EV  
 Pewter use Flint E9  
 Platinum Metallic use Silver ES  
 Salt use Silver ES  
 Titanium use Silver ES

**LAMINATES**

**GRADE L1**

<b>SOLID COLORS</b>		
Black	.....	P
Brownstone	.....	LM13
Bungalow	.....	LM12
Designer White	.....	LDW1
Flint	.....	LM16
Fossil Shale	.....	LEH1
Loft	.....	LM11
Muslin	.....	LM15
Titanium	.....	LTI1
<b>ABSTRACT</b>		
Ash	.....	LT3B
Handspun Pearl	.....	LAHP
Handspun Dove	.....	LAHD
Handspun Slate	.....	LAHS
Handspun Chestnut	.....	LAHC
Silver Mesh	.....	LT8D

**WOODGRAIN**

Belair	.....	LWBA
Bourbon Cherry	.....	H
Field Elm	.....	LWFE
Florence Walnut	.....	LFW1
Kingswood Walnut	.....	LK11
Natural Maple	.....	LWD
NeoWalnut	.....	LNU1
Pinnacle	.....	PINC
Shaker Cherry	.....	LW7C

**GRADE L2**

Beigewood	.....	LWBE
Fawn Cypress	.....	LFC1
Lowell Ash	.....	LLA1
Mangalore Mango	.....	LMM1
Natural Recon	.....	LNR1
Phantom Charcoal	.....	LPC1
Phantom Ecu	.....	LPE1
Portico Teak	.....	LPT1
Skyline Walnut	.....	LSW1
Veranda Teak	.....	LVT1

**GRADE L3**

Natural Walnut	.....	LWNW
----------------	-------	------

All laminate surfaces are also offered with the FSC wood option. Add FSC in front of each laminate option. Refer to specification tools.

**LAMINATE EDGE COLORS**

Beigewood	.....	DE
Belair	.....	BA
Black	.....	E4
Bourbon Cherry	.....	H
Brownstone	.....	EY
Bungalow	.....	EX
Designer White	.....	DW
Fawn Cypress	.....	FC
Field Elm	.....	FE
Flint	.....	E9
Florence Walnut	.....	FW
Fossil	.....	EH
Kingswood Walnut	.....	KI
Loft	.....	EV
Lowell Ash	.....	DL
Mangalore Mango	.....	MM
Muslin	.....	EU
Natural Maple	.....	DD
Natural Recon	.....	NR
Natural Walnut	.....	DN
NeoWalnut	.....	NU
Parchment	.....	EN
Phantom Charcoal	.....	PC
Phantom Ecu	.....	PE
Pinnacle	.....	PI
Platinum Metallic	.....	EP
Plyband ♦	.....	PL
Portico Teak	.....	DP
Shaker Cherry	.....	DF
Skyline Walnut	.....	SW
Veranda Teak	.....	VT

♦ Edge is limited to flat edge surfaces: rectangle, square, trapezoid, polygon, or round. No curvilinear or combination curve and straight.

**NOTE:** Refer to individual product pages for upcharges.

**FSC Certified Wood at Allsteel**  
 See page 332 for more information.

STORAGE

Floor Based — Laminate with Metal

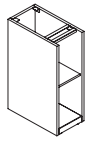

Open Support  
Pedestal

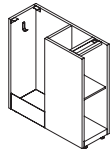

Open w/Bin  
Pedestal

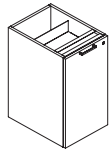

Pull Out Drawer  
Support Pedestal

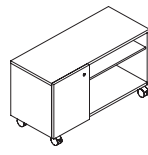

Mobile Credenza

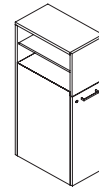

42½"H Tower

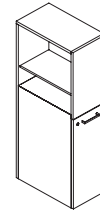

50"H Tower

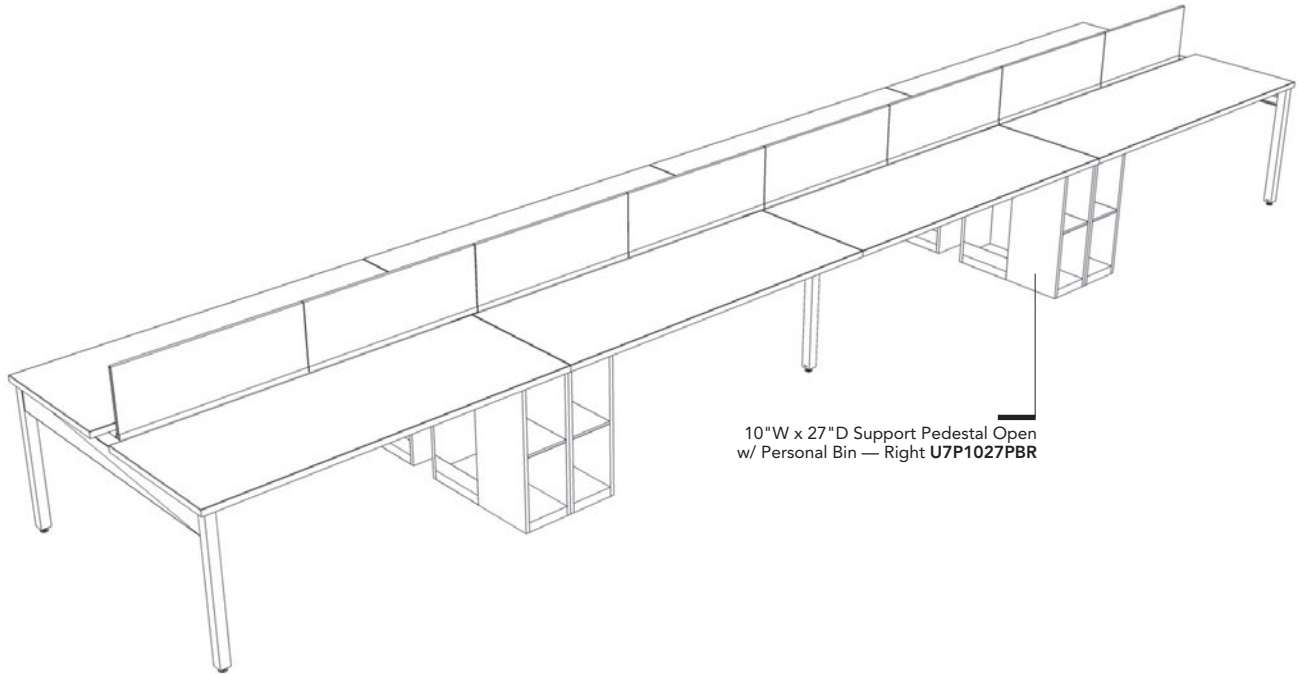

10"W x 27"D Support Pedestal Open w/ Personal Bin — Right U7P1027PBR

### All Storage

- All storage is made from ¾" thick with particleboard core with top and bottom surfaces finished in laminate. Horizontal storage sides and back are painted steel.
- Edge band is made of 1mm thick ABS plastic — flat edge trim only.
- Cam and pin construction. Storage is plinth base only unless unit is mobile.
- Available in solid and woodgrain laminates, models with doors or drawers are available with a two-tone option.
- Pull options: arch, square, linear, straight. All standard in PR6 Silver.
- Locks have a silver finish.



# Notes

---

# Notes

---

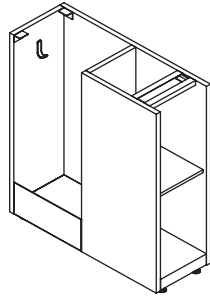

U7P1027PBR

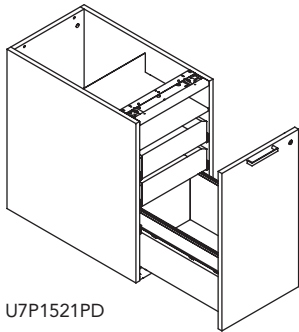

U7P1521PD

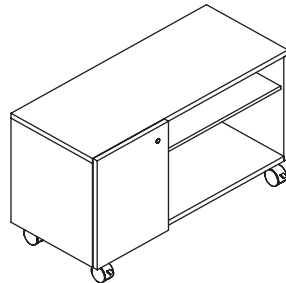

U7MC203615HL

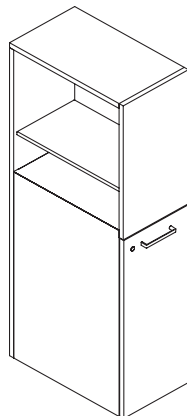

U7T501221ADR

### Open Support Pedestals (page 305)

- Constructed of laminate, shelves are painted steel.
- Open Support Pedestals may be used to add additional stability — see Further Stability Requirements in the Desking & Benching Price List on page 74.
- Support pedestals may be used to create freestanding desks, storage depth must match worksurface depth.
- 27" D models have a coat/bag hook located in back of unit.

### Pull-Out Drawer Support Pedestal (page 305)

- Case is constructed of laminate and painted steel.
- Box and file drawers are miter fold, ½" thick particle board, polypropylene wrapped.
- Configuration is box/box/file and one shelf at top of unit.
- Shelf is not adjustable but can be removed.
- All drawers hidden behind single laminate front.
- Straight, linear, arch and square pulls available as options.
- 1/8" leveling.
- Cannot be used as a freestanding, standalone unit.
- Outside overall dimensions: 15½" W and 21" or 27" D
- Box drawers extend 16" for both model depths.
- File drawers extend 16" on 21" D models and 20" on 27" D models.
- Front to back filing, standard letter size
- One lock, located in upper right hand corner of drawer front.
- Two-tone laminate option for drawer fronts
- Can be used to make a freestanding desk.

### Mobile Credenza (page 305)

- Constructed of laminate, shelf is painted steel.
- Mobile credenza has a hinged door with lock, no pull.
- Front casters are locking, back casters are non-locking.

### Side Access Towers (page 306)

- Top and sides are laminate, shelves are painted steel.
- Side Access Towers may be used to add additional stability — see Further Stability Requirements in the Desking & Benching Price List on page 74.
- 12" wide towers must be attached to a worksurface.
- Z6LB tower "L" bracket required when supporting a worksurface with a tower — storage depth must match worksurface depth.
- Tower drawers do not extend fully — 27" D towers have a 25" D drawer with 20" travel slides; 21" D towers have a 19" D drawer with 16" travel slides.
- 27" D models have a coat/bag hook located in back of drawer.

### "L" Tower Bracket (page 306)

- Z6LB tower "L" bracket required when supporting a worksurface with a tower.
- Storage depth must match worksurface depth.

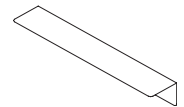

# Notes

---



# Storage

## Further™ — Side Access Towers

For specification information see pages 300-303.

Laminate

GSA SIN 33721

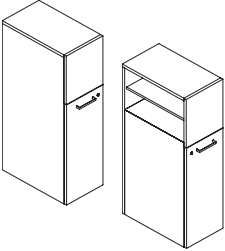
U7T421227ADL	Description	Model	List Price		
			L1	L2	L3
	<b>42½"H Side Access Towers — 12"W</b>				
	27"D w/Left Hand Side Access	U7T421227ADL <input type="checkbox"/>	\$ 4096	\$ 4237	\$ 4380
	27"D w/Right Hand Side Access	U7T421227ADR <input type="checkbox"/>	\$ 4096	\$ 4237	\$ 4380

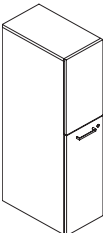
U7T501221ADL	Description	Model	List Price		
			L1	L2	L3
	<b>50"H Side Access Towers — 12"W</b>				
	21"D w/Left Hand Side Access (shown)	U7T501221ADL <input type="checkbox"/>	\$ 4164	\$ 4307	\$ 4453
	27"D w/Left Hand Side Access	U7T501227ADL <input type="checkbox"/>	\$ 4342	\$ 4492	\$ 4644
	21"D w/Right Hand Side Access (shown)	U7T501221ADR <input type="checkbox"/>	\$ 4164	\$ 4307	\$ 4453
	27"D w/Right Hand Side Access	U7T501227ADR <input type="checkbox"/>	\$ 4342	\$ 4492	\$ 4644

	Description	Model	P1 Paint	P2 Paint
			List Price	List Price
	<b>"L" Tower Bracket — for Towers</b>			
	"L" Tower Bracket for 21"D or 27"D	Z6LB	\$ 79	\$ 98

<b>How to specify —</b> Select the Model Number from above.	<b>1st Option:</b> <b>Pull Type</b> (if applicable): MP Beam OP Halo SP Square AP Arch LP Linear See matrix on page 19.	<b>2nd Option:</b> <b>Pull Color</b> (if applicable): MP Beam / OP Halo P JW Designer White EL Matte Silver P R6 Silver P JE Pyrite P 8X Solar Black P2 upcharge +\$17/pull	<b>3rd Option:</b> <b>Metal Shelves</b> <b>Paint Color</b> (if applicable): P1 P2 P3 Upcharge: P2 \$34 P3 \$80	<b>4th Option:</b> <b>FSC Certified Wood</b> (if applicable): FSC Select for FSC Certified Wood X No FSC
	_____ .	_____ .	_____ .	_____ .

Continued below ▼

<b>5th Option:</b> <b>Laminate</b> (if applicable): _____	<b>6th Option:</b> <b>Matching Edge</b> (if applicable): _____ .	<b>7th Option:</b> <b>Door Laminate</b> (if applicable): _____	<b>8th Option:</b> <b>Matching Edge</b> (if applicable): _____ .	<b>9th Option:</b> <b>Lock Option</b> (if applicable): STD Standard OMT Omit Lock Core (deduct \$20) _____	<b>10th Option:</b> <b>Lock Color</b> (if applicable): EL Silver E L
--	---	---	---	---	--

Examples: U7T501221ADL.LPPRO.LM11EV.LM11EV.STDEL Z6LB.PR6

Shippable by small-package carrier.

- 2- and 3-Bay credenzas ship fully assembled.
- Available in solid and woodgrain laminate colors. You can select one laminate for the case and a second laminate for the front doors and back panels. Credenza top including front edge is the same color as the case.
- Painted mesh in Designer White, Flint, or Silver at top and bottom of the front and back sides of unit provides passive ventilation.
- Edge guards on mesh and wire manager protects cords and fingers.
- Grommet models feature square Silver metal grommet.
- Six leveling glides on 72"W, four glides on 48"W. Leveling range is 1".
- Credenzas are constructed from ¾" thick high-pressure laminated particleboard with 1 mm edge banding and European cam-and-pin construction.
- Units are shipped with either lock cores removed or as non-locking. Core removable lock option allows key numbers to be easily changed in the field. Cores available on page 54. Note: Middle cabinet on 3-Bay units do not lock.
- Shelves are painted metal. Base shelves are secured, except center shelf in 72"W credenza.
- Interior bay dimensions are 22"W x 28½"H x 22⅜"D. Secured bottom shelves are 19"D to account for ventilation and wire management. Rated for 50 lbs.
- Removable back(s) snap on for easy component installation.
- Bottom wire management channel runs entire width of credenza.
- Optional top hung drawers (8½"H) use full extension slides; limit of one drawer per bay. Drawers cannot be used in same bay with AV rack, waste pullout, and will limit size of refrigerator.
- Slide out A/V storage rack features EIA spacing with twelve usable rack spaces.
- Units ship with one adjustable shelf per bay. Shelves are adjustable in 6" increments.
- Additional metal shelves are field-installed using supplied template, maximum of three per bay.

Description	Model	Ship Weight	Cubes	Solid Laminate List Price	UPCHARGES*			
					L2 Laminate Case Front/Back		L3 Laminate Case Front/Back	
<b>Buffet Credenza — 34"H x 24"D</b>								
72"W with Grommet / Removable Back Left and Right	AW4BC7224	336	56	\$ 9354	\$ 221	\$ 94	\$ 444	\$ 189
72"W no Grommet / Removable Back Left and Right	AW4BC7224NG	336	56	\$ 9343	\$ 221	\$ 94	\$ 444	\$ 189
<b>48"W with Grommet /</b>								
Removable Back Left (shown)	AW4BC4824L	235	38	\$ 6815	\$ 161	\$ 68	\$ 323	\$ 137
48"W no Grommet / Removable Back Left (shown)	AW4BC4824LNG	235	38	\$ 6803	\$ 161	\$ 68	\$ 323	\$ 137
<b>48"W with Grommet /</b>								
Removable Back Right	AW4BC4824R	235	38	\$ 6815	\$ 161	\$ 68	\$ 323	\$ 137
48"W no Grommet / Removable Back Right	AW4BC4824RNG	235	38	\$ 6803	\$ 161	\$ 68	\$ 323	\$ 137

Description	Model	Ship Weight	Cubes	List Price
<b>Credenza Storage Drawer</b> (Laminate front LM16 Flint only)				
Interior: 14½"W x 14½"D x 2½"H Particleboard body in a metal case	AW4DRAWER	30	4.1	\$ 888
<b>Slide Out Audio/Visual Storage Rack</b> (Black only, not specified) Weight capacity 125 lbs.				
19½"W x 18½"D x 22½"H Metal frame with 10-32 threaded holes	AW4AVRACK	29	4.8	\$ 3217
<b>Trash/Recycling Slide Out</b> (Platinum only, not specified) Weight capacity 100 lbs.				
14½"W x 22½"D x 18½"H Comes with 2 – 35 qt bins	AW4TRASH	36	2.8	\$ 668
<b>Metal Interior Shelf</b> (Painted in Flint, Designer White, or Silver only)				
23"W x 21"D x 2"H Weight capacity 50 lbs.	AW4SHELF	5	1.6	\$ 238

How to specify — Select the Model Number from above.	1st Option: FSC Certified Wood (if applicable): FSC Certified X No FSC	2nd Option: Case Laminate (if applicable):	3rd Option: Matching Edge Color (if applicable):	4th Option: 2nd Laminate Color (Front) (if applicable):	5th Option: Matching Edge Color (if applicable):	6th Option: Paint Color (if applicable): PJW Designer White P02 Flint PR6 Silver (No upcharge for PR6)	7th Option: Lock (if applicable): OMT Omit Cores NL No Locks or Holes
AW4							

Examples: AW4BC7224.X.LM14EW.LWDDD.PR6.NL AW4DRAWER.LM16E9





## Extensions — Introduction

Extensions accessory line by Allsteel is designed to help you create your own space.

- **Create a unique space**

Each person is unique, no one person works exactly like another, and different tasks require different tools. Extensions work tools allow each person the ability to create a unique environment that is all their own. Lots of paper to manage? Need active files within arm's reach? Want to maximize your worksurface space? Need light somewhere other than below a cabinet? Whatever the task, we have the tools to accommodate your workstyle.

- **Create a comfortable space**

With a full line of organization, ergonomic, and illumination tools, Extensions allow you to create a comfortable, ergonomic work area. Organization tools keep important items visible and within your reach. Ergonomic tools help you stay comfortable while working. Illumination tools allow you to put your light where it suits you.

- **Create an organized space**

Tired of all the piles of paper building up on your worksurface? Organization tools house your materials and keep them in an orderly fashion. With a combination of hanging or freestanding organizational accessories, Extensions let you manage everything from binders to paper clips.

- **Organization tools**

Work tools are a durable metal construction. Extensions allow you to manage your workspace smartly with tools like the phone caddy to elevate the phone off the worksurface, landscaped mail box trays to minimize worksurface intrusion, folder holders and tool box pencil holders that hang off the slat rail and each other.

Increase your efficiency with organization!

- **Ergonomic tools**

Ergonomics is more than just comfort, it's flexibility and safety. The adjustable keyboard options allow users to maintain and vary comfortable wrist and arm positions throughout the day, whether typing or mousing. Monitor Arms offer versatile adjustability while providing optimum comfort for the eyes, neck, and shoulders.

- **Illumination tools**

Sleek and flexible, our lighting components offer you several choices. Recessed task lights conserve space and feature electronic ballast for longer bulb life and cooler operating temperature. LED tasklights' slim design blends in with its surrounding while utilizing energy-efficient LED technology. The Link light offers award-winning style to a highly versatile and energy efficient light.

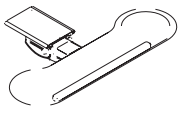
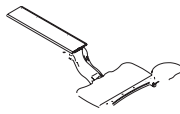
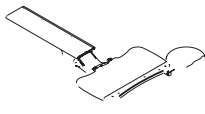
Articulating Keyboard Supports			
Features	Model AKTSHORT	Model AKTLONG	Model AKTMID
			
Keyboard Support	Platform style 28"W x 8"D	Platform Style 19"Wx11"D	Platform Style 19"Wx11"D
Keyboard Support Material	Phenolic	Phenolic	Phenolic
Suspension	<ul style="list-style-type: none"> <li>Nylon glides on lubricated slide track</li> <li>Intuitive lift and lock one touch height adjustment</li> </ul>	Lubricated slide track system: spring assisted	Lubricated slide track system: spring assisted
Platform Rotation	360 degrees	360 degrees	360 degrees
Platform Tilt	+10/-20 degrees	+10/-20 degrees	+10/-20 degrees
Platform Tilt Adjustment	Soft touch lever for precise tilt adjustment	Convenient tilt wheel assists desired tilt angle	Convenient tilt wheel assists desired tilt angle
Platform Height Adjustment Range	6½" (1½" above / 5¼" below)	12½" (7" above to 5½" below)	8" (3" above / 5" below)
Platform Height Adjustment	Lift platform to raise, lift slightly and tilt back to lower	Lift platform to raise, lift slightly and tilt back to lower	Lift platform to raise, lift slightly and tilt back to lower
Palm Rest	Detachable leatherette-covered gel palm rest	Fabric covered gel palm rest	Fabric covered gel palm rest
Mouse Pad	In-line to accommodate mouse on same level as keyboard.	Circular, swivel, tilt, LH/RH mounting, mouse catcher, gel rest	Circular, swivel, tilt, LH/RH mounting, mouse catcher, gel rest
Microsoft Natural Compatible	No	Yes — by removing palm rest	Yes — by removing palm rest
Track Depth	8"	23"	21"
Required Mounting Clearance	20"W x 8"D x ¼" Recess	19"W x 23"D + ¼" Recess	19"W x 23"D + ¼" Recess
Adjustable Wrist Rest	No	Fixed mounting and height	Fixed mounting and height
Ideal For	<ul style="list-style-type: none"> <li>Straight worksurfaces</li> <li>ADA/HFES compliance</li> <li>Extensive adjustability with mouse in line, mouse over or mouse forward of keyboard</li> <li>Height-Adjustable Table</li> </ul>	<ul style="list-style-type: none"> <li>Corner worksurface applications</li> <li>Sit to stand applications</li> </ul>	<ul style="list-style-type: none"> <li>Shallow worksurfaces</li> <li>Corner worksurface (17" or 21")</li> <li>Radius worksurface (42" or 48")</li> </ul>
Additional Information		<ul style="list-style-type: none"> <li>Track can be cut in the field to shorten track depth — may affect ability to fully recess platform</li> </ul>	<ul style="list-style-type: none"> <li>Track can be cut in the field to shorten track depth — may affect ability to fully recess platform</li> </ul>

**AKTSHORT Keyboard Support (page 311)**

- Lift and lock intuitive height adjustment.
- Compatible with Altitude Height Adjustable Tables
- Positive and negative tilt for best ergonomic positioning.
- +10°/-20° tilt adjustment and 360° rotation provides support of neutral position of shoulders, arms and wrists while accommodating multiple working postures.
- Surpasses ANSI/BIFMA standards.
- Black powder coat finish.
- Patented secondary slide and unique arm design provide minimal footprint.

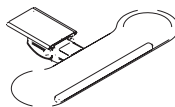

**Keyboard Spacer Kit (page 311)**

- Keyboard Spacer Kit required for mounting under Altitude worksurfaces.
- Kit provides ten spacers and hardware for mounting keyboard supports beneath an external worksurface support channel.
- Spacers are 2⅞"H providing more room beneath surface for mounting.

**CPU Hammock (page 311)**

- Features 360-degree swivel with an 11" track.
- Load capacity is 75 lbs.
- CPU must be minimum of ¾"W with maximum dimension of 64" in perimeter.
- Handy adjustment tool stores within unit.
- Safety feature prevents accidental release of straps and straps can be adjusted while CPU is installed.
- Can be used on Height Adjustable Tables as long as it is attached with spacer model AKMH. Take into account required leg room for users.







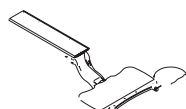
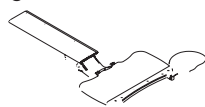



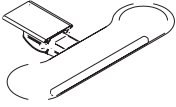

**AKTMID and AKTLONG Keyboard Support (page 311)**

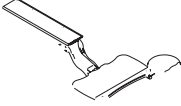
- Lift and lock intuitive height adjustment.
- Positive and negative tilt for the best ergonomic positioning.
- +10°/-20° tilt adjustment and 360° rotation provides support of neutral position of shoulders, arms, and wrists while accommodating multiple working postures.
- Non-handed mouse tray can be moved from right hand to left hand side.
- Surpasses ANSI/BIFMA standards.
- Black powder-coat finish.

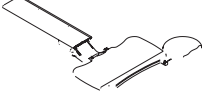

For specification information see page 310.

GSA SIN 33721

	Description	Model	List Price						
	<b>Compact Keyboard Support with 8" Track</b> 30"W x 13"D	AKTSHORT 	\$ 585						
	<b>STS Keyboard Support with 23" Track</b> 24"W x 12"D	AKTLONG 	\$ 717						
	<b>Articulating Keyboard Support with 21" Track</b> 24"W x 12"D	AKTMID 	\$ 616						
	<b>Keyboard Spacer Kit</b> 10 – 2½"H Spacers and Hardware	AKMH 	\$ 63						
	<b>CPU Hammock™ (Silver only)</b> 360° swivel CPU holder with adjustable straps	ACPU1 	\$ 418						
	<b>Metal Corner Sleeve</b> — for use with Optimize™, Concensys®, and Terrace® • Fits 1¼" thick square edge detail. (T-Mold worksurfaces) 22½"W leading edge x 18"D.	AWCS	<table border="1"> <thead> <tr> <th>P1 Paint List Price</th> <th>P2 Paint List Price</th> <th>P3 Paint List Price</th> </tr> </thead> <tbody> <tr> <td>\$ 147</td> <td>\$ 152</td> <td>\$ 157</td> </tr> </tbody> </table>	P1 Paint List Price	P2 Paint List Price	P3 Paint List Price	\$ 147	\$ 152	\$ 157
P1 Paint List Price	P2 Paint List Price	P3 Paint List Price							
\$ 147	\$ 152	\$ 157							

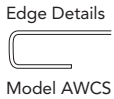

EXTENSIONS

**How to specify —**  
Select the Model Number from above.



Examples: AKMH ACPU1

 Shippable by small-package carrier.

Allsteel's tool rail works in conjunction with a variety of accessories. Modular accessories free up worksurface space and provide orderly storage that is well within reach. Units can be arranged and rearranged to respond to changing workflow. The work tools that attach to the tool rail are:

- Mail Box
- Folder Holder
- Phone Caddy
- Binder Bin
- Tool Box
- Clip Caddy™
- Sidebar™ Personal Shelf
- Paper Wave™
- Gripper Clip

Additional accessories that work with the tool rail work tools aesthetically are:

- Bookends
- Freestanding Mail Box

Coat hooks, marker boards and center drawers round out the organization offering.

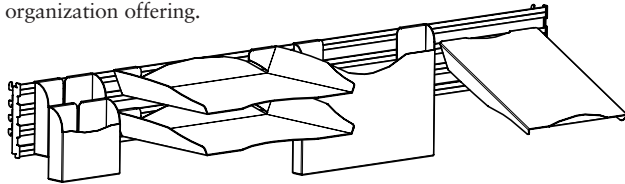

Tool rail, shown above, is height-adjustable in 1" increments using slots in panels or metal hutch. Tool rail shown with two tool boxes, two mail boxes, folder holder, and phone caddy. Folder holders and binder bins extend below a tool rail. Paper Wave and contents extend above a tool rail.



### Tool Rails and Work Tools (page 315)

- Sturdy aluminum extrusion with steel support construction.
- Powder coated for durable finish.
- Use to hang Extensions tools. Cannot be used to support monitor arms.
- Suggested weight capacity not to exceed 80 lbs.
- Consideration needs to be given to height of tools and location of worksurfaces.
- For use with Terrace®, Concensys®, and Optimize™ systems.
- 5" high rail (widths coordinate with panels).
- Attachment via vertical reveals.
- Can be hung from wall track. Good solution for above copiers.
- Systems tool rail is off-modular — can be used on a panel of equal width or one size smaller.
- May span two panels of appropriate size, i.e., 60" W Tool Rail on two 30" W panels.

### Tool Rail for Hutches (page 315)

- Will work on Universal, Terrace, Optimize, and Concensys system hutches produced after July 2, 2000 and Align™ metal hutches.
- Sturdy aluminum extrusion with steel support construction.
- Powder coated for durable finish.
- Use to hang Extensions tools. Cannot be used to support monitor arms.
- Suggested weight capacity not to exceed 80 lbs.
- Consideration needs to be given to height of tools and location of worksurfaces.

### Mail Box (page 316)

- Holds standard letter-size paper and inter-office envelopes.
- Minimal horizontal intrusion.

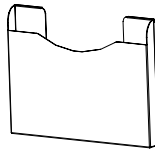

### Folder Holder (page 316)

- Holds manila envelopes.
- Is capable of hanging on other folder holders to maximize space.
- Stores vertically for easy access to files.



### Phone Caddy (page 316)

- Holds telephone at optimum ergonomic angle.
- Wire management cut-outs.
- Accommodates standard phone sizes.

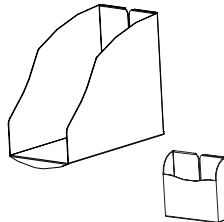

### Binder Bin (page 316)

- Holds folders, binders, and manuals.

### Tool Box (page 316)

- Holds pencils and other writing utensils, large post-it notes, and other desk top accessories.



### Clip Caddy™ (page 316)

- Holds paper clips and other small objects.



### Sidebar™ Personal Shelf (page 316)

- Holds office supplies and personal effects.

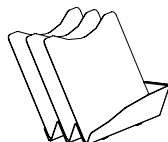

### Paper Wave™ (page 316)

- Provides 3 fully divided slots for organizing files.
- Keeps papers from "bowing" at bottom.

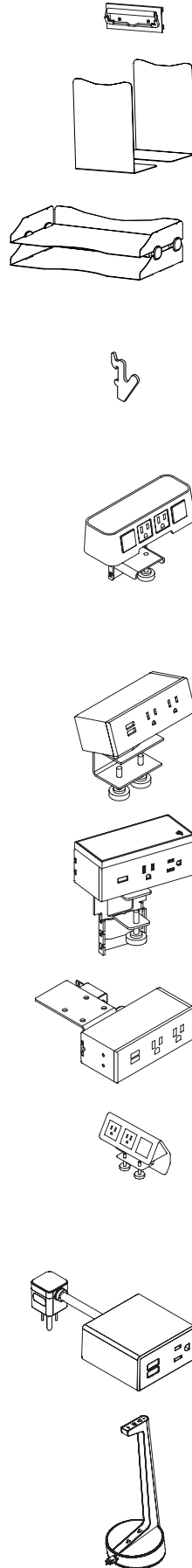

**Gripper Clip (page 316)**

- Binds project papers together.
- Mounts to tool rail or tool tile.

**Bookends (page 316)**

- Can be used on shelves or in cabinets.
- Used to hold books, binders, and catalogs upright.

**Freestanding Mail Box (page 316)**

- Incorporates similar aesthetic to mounted Mail Box.
- Mounting brackets allow for free access from front and back.
- Sold in pairs of two; will stack up to eight high.
- Individual mail box dimension = 1 3/4" H.
- Stacking brackets are black.

**Coat Hook APMC6 (page 316)**

- Hangs directly into slotted Terrace®, Optimize™, or Concensys® panel frame.
- Use for coat or bag.
- Package of six.
- Available in black only.

**Power/Data Modules — Clamp On Worksurface (page 322)**

- On-surface mounting option, fits on any worksurface with a 4" overhang.
- 6' Power cord. UL Listed.
- Includes adapters to allow use of commercially available data terminals or blanks to fill unused openings. Many of the AMP, AT&T, Krone, Leviton and most commercial data terminals can be used.

**Power/Data Modules — Clamp On Worksurface (page 322)**

- Worksurface clamp can be used on any surface with a 2 1/2" overhang.
- Must be installed at time of initial worksurface installation if installing between a worksurface and panel.
- 6' Power cord. UL Listed.
- The USB hub allows simultaneous powering of 2 USB-A devices. The USB hub is a charger only, no ability to connect to a PC. The charging capacity is limited and may not charge all devices.
- Qi compatible wireless charging available on select models.

**Power/Data Modules — Under Worksurface (page 322)**

- Under surface mounting can be used on any surface with a 5" clearance.
- 6' Power cord. UL Listed.
- Hardware not included.

**Worksurface Power/Data Module (page 322)**

- Provides easy access to technology at primary worksurface.
- Mounts to edge of a worksurface and requires 3/8" gap. Consider whether 3/8" gap will work with layout.
- Must be mounted at time of initial worksurface installation if mounting between a worksurface and a panel. Maintaining 3/8" gap may not be possible with worksurfaces that are panel wrapped.

**Miki Power Modules (page 322)**

- Table top and undermount units.
- Hardware not included on undermount.
- 6' Power cord, UL Listed.
- 1 AC power and 1 dual USB configuration.

**Vesta Mobile Power (page 322)**

- 3 AC power simplex, 1 dual USB-A, 1 USB-C configuration.
- 10' Retractable power cord, UL Listed.
- Unit weighs 13 lbs.

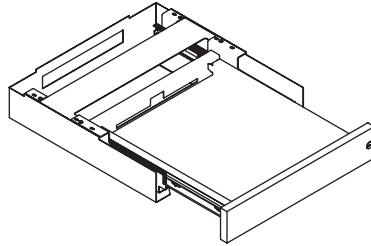
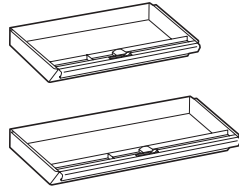

**Flat Brackets**

Front View



Top View

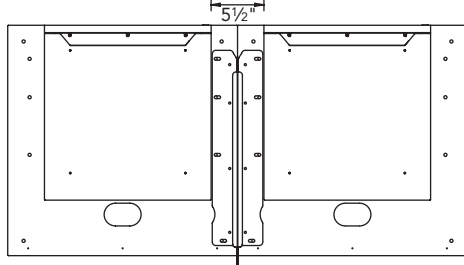

**Metal Center Drawers (page 317)**

- All metal center drawers feature pencil trays with three compartments for storage.
- Center drawers will not fit in center of 24" D worksurfaces which are wider than 60" due to location of center support bracket.
- For locking specifications, see pages 328-330.
- Ball-bearing slide suspension.

**Laptop Drawer — U7WDA (page 317)**

- Drawer body made of sheet metal.
- Drawer front made of 3/4" particleboard with laminate on both sides and fused laser edge banding.
- Core removable lock is located on right side drawer front
- 17 5/8" W x 18" D x 3 3/8" H Outside (interior 13" W x 16" D x 1 7/8" H)
- Minimum surface depth is 21" for surfaces not using an external stiffener; and 27" for surfaces using an external stiffener.
- Drawer extends 16"
- Maximum load: 45 lbs (functional BIFMA load)
- Drawer assembly and cover have cut out in back to allow for cables to exit drawer.
- Distance from floor to bottom of unit w/glides fully retracted is 24 3/4".
- Does not interfere with Further leg mounting plates so drawer can be placed directly next to either a system or table leg.
- When being placed next tower storage using the tower ell bracket (Z6LB) to support surface the drawer must be inset 3" to clear the ell bracket.
- Can be placed directly next to any support storage from any Allsteel product line (excluding towers).
- Flat brackets — drawer must be offset 3" from seam between surfaces to clear the bracket. See illustration at left.
- Can be used with rabbit edge worksurface models but there will be a larger reveal between surface and drawer.
- Can be used with knife edge worksurface models but reveal and depth need to be considered.

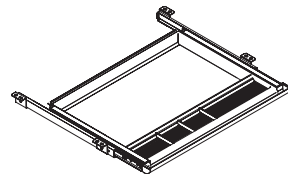

**Polymer Center Drawer - ACD1 (page 317)**

- 20 1/2" W x 17" D x 2" H
- Available in black only
- Made from ABS.
- Minimum clearance for mounting: 23" W x 16 1/4" D x 2" H.
- Retracts on 16" ball-bearing slides.
- Can be used on worksurfaces with Height Adjustable Bases as long as it is attached with spacer model AKMH.
- Can store up to 25 lbs.

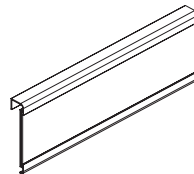

**Name Plate (page 316)**









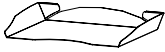
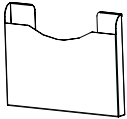

- Comes in a 10-pack.
- Metal backer installs under a Terrace or Optimize top cap, can be used with frameless glass.
- Cover is a transparent polycarbonate insert.
- Full plate is 8 1/2" W x 2 5/8" H.

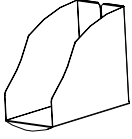

For specification information see pages 312-313.

GSA SIN 33721

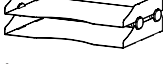
EXTENSIONS

	Description	Model	P1 Paint List Price	P2 Paint List Price	P3 Paint List Price
	<b>Mail Box</b> 9"D x 15"W	EAPT <span style="border: 1px solid black; padding: 0 2px;">S</span>	\$ 128	\$ 147	\$ 162
	<b>Folder Holder</b> 9"H x 12"W	EAFS <span style="border: 1px solid black; padding: 0 2px;">S</span>	\$ 131	\$ 150	\$ 165
	<b>Phone Caddy</b> 9"W x 11"D	EATS <span style="border: 1px solid black; padding: 0 2px;">S</span>	\$ 160	\$ 179	\$ 194
	<b>Binder Bin</b> 8½"H x 5¼"W x 10"D	EABS <span style="border: 1px solid black; padding: 0 2px;">S</span>	\$ 128	\$ 147	\$ 162
	<b>Tool Box</b> 5"H x 5¼"W x 1½"D	EADH <span style="border: 1px solid black; padding: 0 2px;">S</span>	\$ 102	\$ 121	\$ 136
	<b>Clip Caddy™</b> 2"H x 7"W x 3½"D	EAC <span style="border: 1px solid black; padding: 0 2px;">S</span>	\$ 91	\$ 110	\$ 125
	<b>Sidebar™ Personal Shelf</b> 2"H x 21"W x 7"D	EAPS <span style="border: 1px solid black; padding: 0 2px;">S</span>	\$ 131	\$ 150	\$ 165
	<b>Paper Wave™</b> Tray size: 2½"H x 6"W x 10"D Dividers: 9½"H x 9"W	EASS <span style="border: 1px solid black; padding: 0 2px;">S</span>	\$ 183	\$ 202	\$ 217
	<b>Gripper Clip</b> Package of 2 — 5"W x 2"H	EAPC ( <i>De-emphasized</i> ) <span style="border: 1px solid black; padding: 0 2px;">S</span>	\$ 131	\$ 150	\$ 165
	<b>Freestanding Mail Box</b> (specify paint color) Pair — 4¾"H x 13¼"W x 9"D	EAF <span style="border: 1px solid black; padding: 0 2px;">S</span>	\$ 263	\$ 282	\$ 297
	<b>Coat Hooks</b> (black only) Package of six	APMC6 <span style="border: 1px solid black; padding: 0 2px;">S</span>	\$ 128	N/A	N/A
	<b>Panel Name Plate</b> Package of 10	EACS	\$ 349	\$ 368	\$ 383

**Note:** Not for use on tool tile or rail, name plate installs under top cap on Terrace and Optimize.

**How to specify —**  
Select the Model Number from above.

**1st Option:**  
**Paint:**  
P1
P2
P3  
 See pages 16-19 for finishes.

P | | | | .



Examples: EAPT.P4J APMC6.P

S Shippable by small-package carrier.





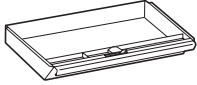

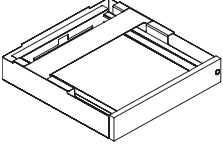
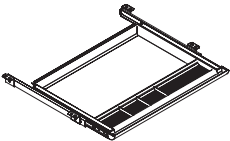

For specification information see page 314.

GSA SIN 33721

	Description	Model	List Price		
			P1	P2	P3
 <p>Angled front</p>	<b>Metal Center Drawer w/Lock</b> 19"W x 14¼"D x 3"H • 12" drawer extension (3/4). • Inside drawer dimension: 19"W x 13"D x 2⅝"H. • Minimum clearance for mounting: 21¼"W x 19¼"D.	CSDC19 <span style="border: 1px solid black; padding: 0 2px;">S</span>	\$ 296	\$ 317	\$ 335
 <p>Angled front</p>	24½"W x 14¼"D x 3"H • 12" drawer extension (3/4). • Inside drawer dimension: 24½"W x 13½"D x 2⅝"H. • Minimum clearance for mounting: 27⅝"W x 19¼"D.	CSDC25 <span style="border: 1px solid black; padding: 0 2px;">S</span>	\$ 304	\$ 325	\$ 343
	<b>Laptop Drawer — Locking, laminate front, metal case</b> 17⅝"W x 18"D x 3⅜"H • 16" drawer extension • Inside drawer dimensions: 13"W x 16"D x 1⅞"H • Minimum clearance for mounting: 17⅝"W x 21"D x 3⅜"H (see illustration)	U7WDA <span style="border: 1px solid black; padding: 0 2px;">S</span>	\$ 1699	\$ 1721	\$ 1739
	<b>Polymer Center Drawer</b> 20½"W x 17"D x 2"H • 11½" extension • Minimum clearance for mounting: 23"W x 16¼"D x 2"H	ACD1	\$ 236	N/A	N/A

EXTENSIONS

<p><b>How to specify —</b> Select the Model Number from above.</p>	<p><i>1st Option:</i> <b>Laminate Edge</b> (Laptop drawer front if applicable): See pages 16-19 for finishes.</p>	<p><i>2nd Option:</i> <b>Edge</b> (Laptop drawer edge if applicable): See pages 16-19 for finishes.</p>	<p><i>3rd Option:</i> <b>Paint</b> (If laptop drawer, list exterior case color here): See pages 16-19 for finishes. Power Data Module PR6 Silver.</p>	<p><i>4th Option:</i> <b>Paint</b> (Interior of laptop drawer if applicable): See pages 16-19 for finishes.</p>	<p><i>5th Option:</i> <b>Lock</b> (if applicable): <b>STD</b> Standard <b>OMT</b> Omit (Deduct \$20)</p>	<p><i>6th Option:</i> <b>Lock or Tech Module Color</b> (if applicable): <b>EL</b> Silver (Lock)</p>
						

Example: U7WDA.LM11EV.P27.PR6.STDEL

S Shippable by small-package carrier.

Allsteel Extensions offers Illumination in three styles — Undercabinet LED Light, Wand Light, and Splitty Light.

**Recessed Undercabinet LED Light**

Recessed task lights conserve space and provide an efficient solution for illuminating the workplace. All models are equipped with LED strips.

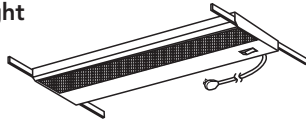

Recessed task light models mount under storage cabinets or shelves to provide optimal space utilization. Models are available in two styles and three sizes to correspond with the width of the cabinet or shelf. Task lights with a fused plug are available to meet Chicago electrical code.

**Undercabinet LED Light**

The Undercabinet LED Light is a low-profile, linear solution for overhead cabinets and shelves and is an ideal solution for painted wood storage. It utilizes energy-efficient LED technology which provides a long life. The Undercabinet LED Light provides the opportunity to mount the fixture where light is needed most.

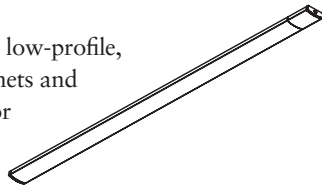

The Undercabinet LED Light features a metal trough reflector with diffuser lens. The light has a sleek 1/2" thick profile and provides two options for mounting, either magnetically or with hardware. Undercabinet LED Lights can be daisy-chained.

Optional undercabinet occupancy sensor is available which will automatically turn off the fixture after 30 minutes of no detection and back on immediately as the user re-enters the detection range using Passive Infrared (PIR) sensor technology. Unit features 360° lens with 90° outward detection angle, providing a 36" coverage diameter at 18". Occupancy sensor comes with connector and is required to be connected in the sequence shown below. Connect occupancy sensor to a light, or first light in daisy chain to control all linked lights.

**CONNECTION SEQUENCE\***

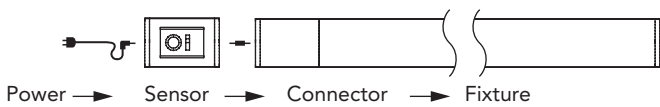

\*Cannot deviate from this sequence

**Recessed Task Lights (page 320)**

- Black Metal Construction with 9' long black cord attached to right rear corner of the fixture.
- LED strip comes installed within light.
  - 50,000 hour life span
  - 120V-277V
  - CCT 4000K
  - CRI 80+
- Includes 4 cord retainer clips.
- Shorter width models can be used on wider overheads, shelves and hutches.
- On/Off switch provides individual control of tasklight within the workstation.
- Daisy chain models require a master control model — 10 fixtures maximum.
- RECOMMENDATION: Provide a separate circuit for task lights to ensure proper, long-term operation.

**Undercabinet LED Lights (page 320)**

- Low profile energy-efficient LED task light for use with overhead storage cabinets and shelves.
- 20W power supply for 10W 17" unit (.166 amps).
- 20W power supply for 20W 31" unit (.166 amps).
- 60W power supply for daisy-chain starter units (.5 amps). Must order one starter unit for each daisy-chain application.

LED Light Combinations Must Not Exceed 60W in Combination	Power Usage
6X 17"	60W
3X 31"	60W
1X 31" + 4X 17"	60W
2X 31" + 2X 17"	60W

- The combinations that could max out 60W are featured above. *Daisy chained units have a power limit of 60W from one power entry. 17W units use 10W and 31W units use 20W.*
- Specify up to 5 additional 17" interconnect units (ALED17UJMP30) to daisy-chain together with 17" daisy-chain starter fixture (ALED17U60).  
*Example: Daisy-chain 4-17" undercabinet LED lights:*  
Specify: 1 ALED17U60  
Specify: 3 ALED17UJMP30 with 10" jumper cord
- Specify up to 2 additional 31" interconnect units (ALED31UJMP30) with 10" jumper cords to daisy-chain together with 31" tasklight (ALED31U60); or 17" daisy-chain starter fixture (ALED17U60).
- 3500K color temperature.
- 131 footcandles at 18" on ALED31U; 76 footcandles at 18" on ALED17U.
- Magnetic or screw-mount option — attachment hardware included.
- On 20 watt models, power drive is attached to plug: allow 1 1/8" D space at outlet.
- On 60 watt models, power drive brick is in center of cord.
- Includes 3 cord retainer clips.
- Meets California Title 24 Energy Efficiency Standards.
- "Instant On" switch with infinite dimming cycle from 100% to 15% with the last state memory, allowing the user to set their desired level of lighting.
- Fixture automatically turns off after 10 hours of use to reduce unwanted energy use.
- Optional occupancy sensor automatically turns off all interlinked fixtures after 30 minutes of no detection and back on immediately when detection is found.

Overhead Length	Suggested LED Sizes
24	17
30	17
36	17
42	31
48	17 + 17
60	31 + 17
72	31 + 31

Note: LED lights may need to be positioned along length properly to allow jumping to additional overheads. Suggested sizes above are recommendations for single overheads to provide as much light along length of overhead as possible.

The suggested sizes factor in 4 inches of room for the power inlet and occupancy sensor (optional).

EXTENSIONS

**Wand™ Task Light**

Wand freestanding task light offers a clean, simple design along with powerful LED technology to illuminate the workspace. The swivel base and arm tilt allow users to position the light just where they need it. The 7.7 watt LED light offers efficiency and long life, providing up to 25 years of daily use. The slim, sleek design makes it easy to integrate into any workspace. Wand task light is 97% recyclable. Occupancy sensor and/or charging models available.

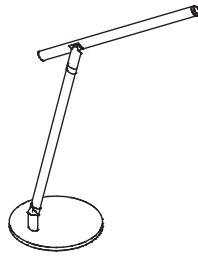

**Wand LED Freestanding Task Light (page 321)**

- Available in Silver or White. 9'4" cord is Silver.
- Full range dimming from 100% – 10% with last state memory.
- Uses 5W at highest setting and as low as 1 watt at its lowest setting, providing 75 to 12.7 footcandles of light, respectively (16" above worksurface).
- 7½" round swivel base and 16½"H tilt arm allow versatile positioning of the 13" lampshade.
- Designed for 50,000 hours of life.
- Color Temperature: 3500K. Color Rendering Index (CRI): 80.
- Materials: aluminum arm and lampshade, steel base.
- Weight: 4.4 lbs. 97% recyclable, 76% post-consumer.
- Certifications: UL and CUL. TAA compliant.
- Occupancy sensor available with automatic shut-off after 15 minutes if no motion is detected.
- USB model features USB-A (1), USB-C (1) charging within base of unit.
- USB model also features occupancy sensor. 7.5W (A) & 18W (C) power consumption.

**Splitty Task Light**

Splitty's organic and modern design compliments the workstation while also bringing rich features to the user. In addition to illuminating the space, Splitty can also be a teleconferencing tool through Splitty's 360-degree light head adjustment and soft touch, continuous dimming. Integrated charging allows for small personal device charging crucial to the modern worker's workplace toolkit while minimizing clutter within the station. Optional clamp or tool tile mounts available as accessories.

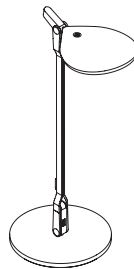

**Splitty Task Light (page 321)**

- Available in Silver, White, or Black (accessories available in silver only).
- Cord is 12' long.
- Cord is silver when black or silver finish specified, white when white light is specified.
- Soft touch on/off, dimming.
- Continuous dimming (100% – 3%) with last state memory.
- 5.8W of energy consumption. 7W at highest setting, 0.6W at lowest.
- 5" 360-degree swivel light head, 6.54" round swivel base and 17"H arm. Arm has full 180 degree rotation and 360 degree swivel.
- Designed for 60,000 hours of life.
- Color Temperature: 3500K, Color Rendering Index: 90.
- Materials: aluminum, plastic.
- USB-A has 5W of power consumption.
- USB-A (1) charging at bottom of light arm stem. Charging feature compatible for any mounting method.
- Clamp mount compatible with surfaces ¼" – 2¼" thick.
- Tool tile mount has 1½" adjustment range, minimum slot height of ⅝".

For specification information see pages 318-319.

Open Market / GSA SIN 33721 (as noted)

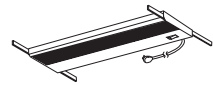

Open Market

Description	Watt Usage	Model	List Price
<b>Recessed Task Lights (Black only)</b> — Use recessed under overhead cabinets, storage shelves, or hutches, comes with cord retainer clips			
Task Light for 24"W	10	A870824	\$ 429
Task Light for 30"W and 36"W	14	A870830	\$ 433
Task Light for 42"W and 48"W	21	A870842	\$ 468
Task Light for 60"W, 66"W, and 72"W	28	A870860	\$ 506

**Recessed Task Lights (Black only)** — With fused plug (satisfies Chicago electrical code)

Task Light for 24"W	10	A870824CH	\$ 553
Task Light for 30"W and 36"W	14	A870830CH	\$ 564
Task Light for 42"W and 48"W	21	A870842CH	\$ 600
Task Light for 60"W, 66"W, and 72"W	28	A870860CH	\$ 634

**Note:** See below for GSA Approved Task Lights.

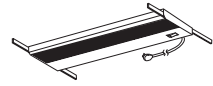

GSA SIN 33721

**GSA Recessed Task Lights** — Use recessed under overhead cabinets, storage shelves, or hutches

**Base Models** — Stand Alone

Task Light for 24"W	15	GS870924	\$ 548
Task Light for 30"W and 36"W	17	GS870930	\$ 566
Task Light for 42"W and 48"W	25	GS870948	\$ 608
Task Light for 60"W, 66"W, and 72"W	32	GS870960	\$ 651



GSA SIN 33721

**Cord Retainer Clips (Black only)**

Bag of 50 clips		AAPACM2	\$ 54
-----------------	--	---------	-------

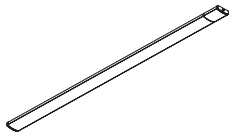

GSA SIN 33721

**LED Undercabinet Light** (white end caps)

17" Task Light w/20 watt power supply for 24"W or wider overhead	ALED17U	\$ 1014
17" Task Light w/60 watt power supply for daisy chain	ALED17U60	\$ 1110
17" 10 watt Interconnect Task Light w/10" Jumper Cord	ALED17UJMP30	\$ 783
31" Task Light w/20 watt power supply 36"W or wider overhead	ALED31U	\$ 1522
31" Task Light w/60 watt power supply for daisy chain	ALED31U60	\$ 1604
31" 20 watt Interconnect Task Light w/10" Jumper Cord	ALED31UJMP30	\$ 914
Undercabinet Occupancy Sensor 2 3/4"W + 1"W Connector	ALEDOCC*	\$ 617

\*Undercabinet Occupancy Sensor works with LED Undercabinet lights shipped after 11/1/2013.

**How to specify —**  
Select the Model Number from above.

*1st Option:*

**Cord Retainer Clip Color:**

Black only.

P | 2 | 7

Examples: A870824 A870824CH GS870924 AAPACM2.P27 ALED17U

Shippable by small-package carrier.

For specification information see pages 318-319.

Open Market / GSA SIN 33721



GSA SIN 33721

Description	Model	List Price
<b>Wand™ LED Task Light</b> (Silver or White)		
Freestanding LED Task Light	WANDFS	\$ 494
Freestanding LED Task Light (Occupancy Sensor)	WANDFSOC <span style="border: 1px solid black; padding: 0 2px;">S</span>	\$ 702

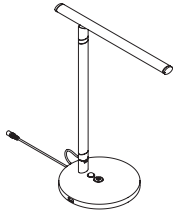

Freestanding LED Task light (Occupancy Sensor & Charging)	WANDFSUSB	\$ 732
---	-----------	--------



<b>Splitty Task Light</b> (Silver, White, or Black)		
Freestanding LED Task Light (Charging)	PRFTSKFS	\$ 669

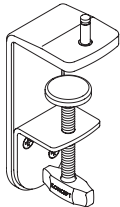

Clamp Mount (Silver only)	PRFTSKCL	\$ 77
---------------------------	----------	-------

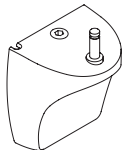

Tool Tile Mount (Silver only)	PRFTSKTR	\$ 77
-------------------------------	----------	-------

EXTENSIONS

<p><b>How to specify —</b> Select the Model Number from above.</p>	<p><i>1st Option:</i> <b>Color</b> (for Splitty): SVR Silver WHT White BLK Black</p> <p>(for Wand LED): SVR Silver WHT White</p>
--	--

Example: WANDFS.WHT

S Shippable by small-package carrier.

For specification information see page 313.

GSA Reference Page

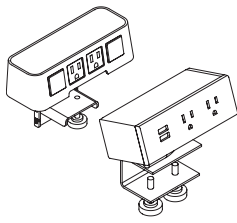

Description	Model	List Price
<b>Power/Data Modules — Worksurface Clamp</b>		
Dome — 2 Power, 2 Open Data with faceplate adapters (FOG Fog only)	ACOMDOME2	\$ 500
2 Power, 2 USB (SNW Snow or STRM Storm)	APWRMOD2WC	\$ 689
3 Power (SNW Snow or STRM Storm)	APWRMOD3WC	\$ 530
2 Power, 1 Dual USBA, Qi Power Module	APWRMOD2Q	\$ 760

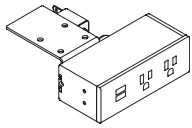
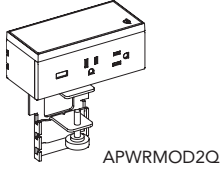

<b>Power/Data Modules — Under Worksurface Mount</b>		
2 Power, 2 USB (SNW Snow or STRM Storm)	APWRMOD2UWM	\$ 689
3 Power (SNW Snow or STRM Storm)	APWRMOD3UWM	\$ 530
4 Power Quad Tap (10' cord)	UNQTMP	\$ 442

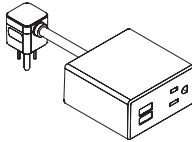
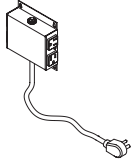

<b>Miki</b>		
1 Power, 1 USB Table Top	APWRMOD1TT	\$ 304
1 Power, 1 USB Under Worksurface Mount	APWRMOD1UWM	\$ 304

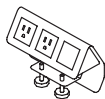

<b>Worksurface Power/Data Module (PR6 Silver only)</b>		
2 Simplex receptacles, 1 data position	A870302	\$ 383



<b>Vesta</b>		
3 Power Vesta – Corded	AVSTA3PWR	\$ 1941

<p><b>How to specify —</b> Select the Model Number from above.</p> <p>_____</p> <p>_____ .</p>	<p><i>1st Option:</i></p> <p><b>Color Option 1:</b></p> <p>FOG Fog SNW Snow STRM Storm BLK Black</p> <p>_____ .</p>	<p><i>2nd Option:</i></p> <p><b>Color Option 2</b> (if applicable):</p> <p>FOG Fog SNW Snow STRM Storm BLK Black</p> <p>_____</p>
--	---	---

Example: ACOMDOME2.FOG

EXTENSIONS

# Notes

---

EXTENSIONS

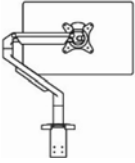
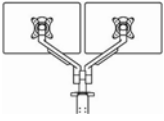
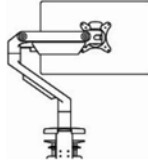
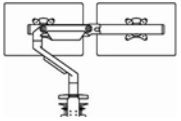
PIVOT MONITOR ARMS	Standard Dynamic Single	Standard Dynamic Dual	Heavy Duty Dynamic Single	Heavy Duty Dynamic Dual with Crossbar
Allsteel Model:	AMASTS	AMASD	AMASHD	AMADHD
				
Features:				
Price	\$464	\$936	\$798	\$1104
Colors	Black and Silver	Black and Silver	Black and Silver	Black and Silver
Monitor Rotation	180°	180°	180°	180°
Monitor Extension	18.75"	18.26"	20.75"	23"
Monitor Tilt Adjustment	+25°/-25°	+25°/-25°	+25°/-25°	+25°/-25°
Arm Height Adjustment	8.4" to 19"	9.6" to 20.1"	8.5" to 20"	8.5" to 20"
Weight Capacity	6.2 to 17 lbs.	6.2 to 17 lbs. per Arm	8 to 35 lbs.	17.5 lbs. per VESA Plate
Mounting Option	Grommet and Clamp Mounts	Grommet and Clamp Mounts	Grommet and Clamp Mounts	Grommet and Clamp Mounts
360° Lockout Feature	Yes	Yes	Yes	Yes
VESA Compatibility	75mm and 100mm	75mm and 100mm	75mm and 100mm	75mm and 100mm
Pole Height	N/A	N/A	N/A	N/A
Maximum Width per Monitor*	N/A	25"	N/A	25"
Worksurface Clamp Requirements	¾" to 2" Thick	¾" to 2" Thick	¾" to 2" Thick	¾" to 2" Thick
Worksurface Grommet Clamp Requirements	¾" to 2" Thick/Hole Diameter ⅜" to 2"	¾" to 2" Thick/Hole Diameter ⅜" to 2"	¾" to 2" Thick/Hole Diameter ⅜" to 2"	¾" to 2" Thick/Hole Diameter ⅜" to 2"
Environmental Info	94% Recycled Content	94% Recycled Content	94% Recycled Content	94% Recycled Content

\*Use of APACSM Slider Model will allow for wider monitor capabilities

### Pivot Standard Weight Monitor Arms

- Adaptable and adjustable to user preference the Pivot monitor arm offers a slim and refined design coupled with easy fingertip adjustment.
- Multiple points of adjustment including 360 degree swivel with optional 180 degree lockout, 18.75" extension, and 10" of height adjustment.
- Monitor tilts +25/-25 degrees.
- Standard weight arms utilize a tension spring that allows for effortless adjustment of monitors to proper ergonomic positions.
- Tension adjustment at multiple points allows for proper adjustment for monitors weight between 6-17 lbs.
- Model includes grommet and worksurface mounting options.
- Desk clamp mounts require ¾" – 2" thick surfaces; grommet mount requires hole diameter of ⅜" to 2" wide and accommodates up to 2" thick surfaces.
- Integrated cable management included with each model. Black models ship with all black cable management pieces, Silver models ship with grey wire management but optional white pieces ship in the box and can be installed on site.
- Dual monitor arm supports up to 25" wide monitors. Wider monitors may require use of optional slider mount model.
- Pivot arms are VESA 75mm and 100mm compatible.
- Quick release feature simplifies monitor installation and changes.

### Pivot Slider Mount

- Provides 11.8" of horizontal movement.
- Allows for wider monitors to be used on dual monitor arms and sit flush side by side.
- Not compatible with Pivot Heavy Duty Series.

### Pivot Heavy Duty Series

- Adaptable and adjustable to user preference the Pivot monitor arm offers a slim and refined design coupled with easy fingertip adjustment.
- Multiple points of adjustment including 360 degree swivel with optional 180 degree lockout, 20.75" extension, and 12" of height adjustment.
- Monitor tilts +25/-25 degrees.
- Tension adjustment at multiple points allows for proper adjustment for monitors weight between 8-35 lbs.
- Model includes grommet and worksurface mounting options.
- Desk clamp mounts require ¾" – 2" thick surfaces; grommet mount requires hole diameter of ⅜" to 2" wide and accommodates up to 2" thick surfaces.
- Integrated cable management included with each model. Black models ship with all black cable management pieces, Silver models ship with grey wire management but optional white pieces ship in the box and can be installed on site.
- Dual monitor arm supports up to 2 monitors weight 4-17.5 lbs each.
- Pivot arms are VESA 75mm and 100mm compatible.
- Quick release feature simplifies monitor installation and changes.

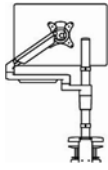
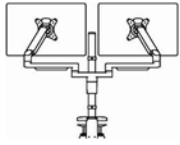
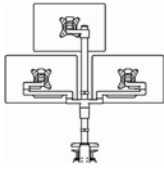

PIVOT MONITOR ARMS	Dynamic Single Post	Dynamic Dual Post	Triple Fixed Post
Allsteel Model:	APASD	APADD	APATF
			
Features:			
Price	\$628	\$879	\$1110
Colors	Silver	Silver	Silver
Monitor Rotation	180°	180°	180°
Monitor Extension	21"	21"	23"
Monitor Tilt Adjustment	+25°/-25°	+25°/-25°	+25°/-25°
Arm Height Adjustment	10.6"	10.6"	N/A
Weight Capacity	6.2 to 17 lbs.	6.2 to 17 lbs. per Arm	17 lbs. per arm
Mounting Option	Grommet and Clamp Mounts	Grommet and Clamp Mounts	Grommet and Clamp Mounts
360° Lockout Feature	Yes	Yes	Yes
VESA Compatibility	75mm and 100mm	75mm and 100mm	75mm and 100mm
Pole Height	17.7"	17.7"	27.5"
Maximum Width per Monitor*	25"	25"	25"
Worksurface Clamp Requirements	7/8" to 2" Thick	7/8" to 2" Thick	7/8" to 2" Thick
Worksurface Grommet Clamp Requirements	7/8" to 2" Thick/Hole Diameter 3/16" to 2"	7/8" to 2" Thick/Hole Diameter 3/16" to 2"	7/8" to 2" Thick/Hole Diameter 3/16" to 2"
Environmental Info	94% Recycled Content	94% Recycled Content	94% Recycled Content

\*Use of APACSM Slider Model will allow for wider monitor capabilities

### Pivot Post Series

- Adaptable and adjustable to user preference the Pivot monitor arm offers a slim and refined design coupled with easy fingertip adjustment.
- Multiple points of adjustment including 360 degree swivel with 21" extension and 10.6" of height adjustment.
- Monitor tilts +25/-25 degrees.
- Tension adjustment at multiple points allows for proper adjustment for monitors weight between 6.5-17 lbs per arm.
- Model includes grommet and worksurface mounting options.
- Desk clamp mounts require 7/8" – 2" thick surfaces; grommet mount requires hole diameter of 3/16" to 2" wide and accommodates up to 2" thick surfaces.
- Integrated cable management included with each model. Silver color option with grey wire management only.
- Dual monitor arm supports up to 25" wide monitors. Wider monitors may require use of optional slider mount model.
- Single and dual models have a post height of 17.7"; Triple monitor model has a post height of 27.5".
- Pivot arms are VESA 75mm and 100mm compatible.
- Quick release feature simplifies monitor installation and changes.

### Pivot Counterweight Kit

- Counterweight Kit to be used with monitors weighing less than 6 lbs.
- Gray color only.
- Counterweight weighs 1 lb. 6 oz.

### Pivot Conversion Kits

- Kit allows user to transform single monitor arm (Standard, Heavy Duty, or Post) into Dual Arm configuration
- Available in black and silver, Post arm only available in silver
- Required wire management included
- Once assembled, will aesthetically emulate dual configuration of chosen arm

# Accessories — Pivot Monitor Arms

Pivot

For specification information see pages 324-325.

GSA SIN PENDING, GSA SIN 33721

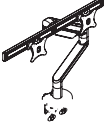
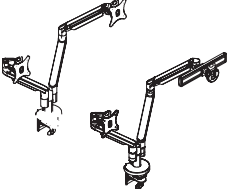
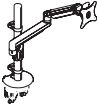
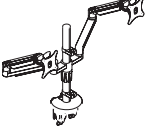
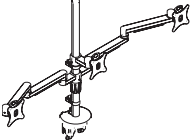
Description	Model	List Price
<b>Pivot Monitor Arms</b>		
 Dynamic Single Monitor - Standard Weight	AMASTS <input type="checkbox"/>	\$ 464
Dynamic Single Monitor - Standard Weight for GSA *Silver Only GSA SIN 33721.	AMASTS-G	\$ 548
 Dynamic Single Monitor - Heavy Weight	AMASHD <input type="checkbox"/>	\$ 798
 Dynamic Dual Monitor with Crossbar	AMADHD <input type="checkbox"/>	\$ 1104
Dynamic Dual Monitor - Standard Weight	AMASD <input type="checkbox"/>	\$ 936
 Dynamic Dual Monitor - Standard Weight for GSA *Silver Only **Slider Mount included. GSA SIN 33721.	AMASD-G	\$ 998
 Single Dynamic Post Arm *Silver Only	APASD <input type="checkbox"/>	\$ 628
 Double Dynamic Post Arm *Silver Only	APADD <input type="checkbox"/>	\$ 879
 Triple Fixed Post Mount *Silver Only	APATF <input type="checkbox"/>	\$ 1110

ACCESSORIES

How to specify —  
Select the  
Model Number  
from above.

1st Option:

Select the Color:

SVR Silver  
BLK Black

A | | | | | .

| | | |

Example: AMADHD.BLK

Shippable by small-package carrier.

# Accessories — Pivot Monitor Arms

Pivot

For specification information see pages 324-325.

Open Market



Description	Model	List Price
<b>Pivot Monitor Arms</b>		
Monitor Arm Sliding Mount	APACSM <input type="checkbox"/>	\$ 221

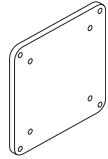

Monitor Arm Counterweight	APACW <input type="checkbox"/>	\$ 52
---------------------------	--------------------------------	-------

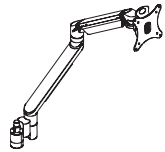

Pivot Monitor Arm Standard Single Conversion Kit	AMASTSCK	\$ 520
--	----------	--------

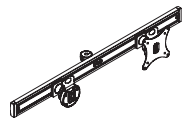

Pivot Monitor Arm Heavy Duty Single Conversion Kit	AMASHDCK	\$ 454
--	----------	--------

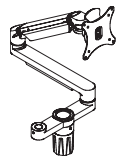

Pivot Single Post Arm Conversion Kit	APASDCK	\$ 661
* Silver Only		

ACCESSORIES

<p><b>How to specify —</b> Select the Model Number from above.</p>	<p><b>1st Option:</b> <b>Select the Color:</b> SVR Silver BLK Black</p>
<p>A               .</p>	<p>       </p>

Example:

## Laterals, Pedestals and Storage, Painted Wood Storage

### Standard Options

- Random Keying — The factory will assign key(s) arbitrarily using key numbers from chart below.
- Omit Lock Core — The factory will omit lock cores. Removable lock core kits with specific key number must be ordered to facilitate keying alike in the field.

### Vertical Files

#### Standard Options

- Random Keying — The factory will assign key(s) arbitrarily (see below chart for key numbers).

#### Key Alike Process







- Order standard product which will be shipped with factory installed locks and random numbered cores.
- Order the appropriate quantity of like numbered cores required for each workstation or keyed area.
- Simply replace the factory installed core with the replacement cores after product has been installed.

#### Replacing Lock Cores

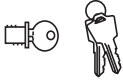
- Lock must be in the unlocked position.
- Insert core removal key and pull core straight out. (Reach units require rotating key 90° clockwise past unlocked position.)
- Insert new core with core removable key, hold core into lock and withdraw core removal key.
- Retain original core for future use.

	Random Keying	Omit Lock Core	Key Numbers	Lock Core Kit	Master Key
Align™ Laterals	X	X	101E-225E	ALKF23C*	AMKF22
Align New Low Credenzas, Towers, Pedestals (“YP” prefix models)	X	X	101E-225E	ALKF26EL	AMKF22
Align Old Pedestals (for New Pedestals after 11/2015 see above)	X	X	101E-225E	ALKF23C*	AMKF22
Align Old Towers (for New Towers after 2/2016 see above)	X	X	101E-225E	ALKF23C*	AMKF22
Align Metal Front Lockers	X	X	101E-225E	ALKF26EL	AMKF22
Align Laminate Front Lockers	X	X	101E-225E	ALKF23C*	AMKF22
Approach™ Desking and Storage	X	X	101E-225E	ALKF26EL	AMKF22
Center Drawer (CSDC19/25)	X	X	101E-225E	ALKF23C*	AMKF22
Essentials™ Laterals	X	X	101E-225E	ALKF23C	AMKF22
Essentials Overfile Cabinets	X	X	101E-225E	ALKF23C*	AMKF22
Essentials Pedestals	X	X	101E-225E	ALKF23C*	AMKF22
Essentials Personal Tower and Files	X	X	101E-225E	ALKF23C*	AMKF22
Further™ Laminate Storage	X	X	101E-225E	ALKF23C*	AMKF22
Hutches	X	X	101E-225E	ALKF23C*	AMKF22
Involve® Laminate Storage	X	X	101E-225E	ALKF23C*	AMKF22
Overheads (Flipper Door, including RTA)	X	X	101E-225E	ALKF23C*	AMKF22
Overheads (Receding Door)	X	X	101E-225E	ALKF23C*	AMKF22
Vertical Files A990/A940	X		101E-225E	ALKF23C*	AMKF22

\*ALKF23C is chrome. Optional black core for wood casegoods is ALKF23CE4. Optional matte silver core is ALKF26EL.





	Description	Model	List Price
	<b>Removable Lock Core Kits**</b>	<b>Key Numbers 101E-225E</b>	
	<b>Brushed Chrome</b> used on metal and painted wood casegoods product produced after 2/3/97; A980, A990, and A940 Series vertical files; Persona™ pedestals produced after 8/22/09; Reach® Storage units produced after 10/5/09; and receding door overheads produced after 8/1/10. Includes one core, two keys, one core removal tool, adapter and instructions	ALKF23C 	\$ 29
	<b>Black</b> used on veneer casegoods product. Includes one core, two keys, one core removal tool, adapter and instructions. Core matches manufactured lock on metal casegoods but Black core can be used with veneer and laminate product.	ALKF23CE4 	\$ 29
	<b>Matte Silver</b> used on Approach and Align metal credenzas, new pedestals, and new towers. Includes one core, two keys, one core removal tool, adapter, and instructions.	ALKF26EL 	\$ 29
 Open Market	<b>Master Key</b> (One key) Available to authorized dealers only on faxed orders. Will open ALKF23C, LKF23C, ALKF23CE4, LKF23CE4, LKF24, LKF25EL, and LKF25E4 locks numbered 101E-225E.	AMKF22 	\$ 30

**HOW TO ORDER:**

**Note:** Numbers 101E-225E are available. Orders without numbers specified will be keyed at random.

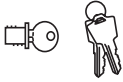
**SAMPLE ORDER:**

Quantity	Model	Color
6	ALKF23C	X121E
1	AMKF22	X

	<b>Brushed Chrome Removable Lock Core Kit* **</b>	<b>Key Numbers 101N-225N</b>	
	Includes one core, two keys, one core removal tool, adapter, and instructions	ALKF23CN 	\$ 29
 Open Market	<b>Master Key*</b> (One key) Available to authorized dealers only on electronic orders. Will open ALKF23CN and LKF23CN locks numbered 101N-225N.	AMF22 	\$ 30

N series lock cores (ALKF23CN) are a replacement part for legacy Allsteel products. N series lock cores were used in all Persona pedestals produced between January 1996 and August 2009 as well as Receding Door Overheads produced between January 1996 and August 2010. N series lock cores are NOT used in current product and should not be ordered for product produced after these dates. E series lock cores are used in current product, see above.

\*On existing Premium and Asset lateral, use N-Series locks.

\*\* Removable Lock Core Kits are intended for use with Allsteel systems furniture and are approved under GSA SIN PENDING. When purchased separately and used without Allsteel systems furniture, those Removable Lock Core Kits marked by (\*\*) are considered Open Market.

 Shippable by small-package carrier.

### EASY LOCK PROGRAM

The Allsteel Easy Lock Program simplifies the lock-core ordering process when multiple cores are being specified. The Easy Lock cores can be used with Allsteel storage that currently uses the **ALKF23C** cores (all storage except receding door overheads).

To ensure ease of ordering in different situations the Easy Lock cores can be specified in three different ways — random, specified or sequential.

#### Random Keying

The random keying option is provided for instances where there are multiple orders or phases to a project and the offices need to be keyed alike but the key numbering is not required. With the random keying option key numbers are not specified, however, the core kits will be in sequential order from a random starting point.

*Example: There are 15 offices which each have 5 black locks that need to be keyed alike, but the actual key numbers are not important.*

This order would look like: **LKFE5BLK.X.15**

This specifies that 15 5-core kits are needed in black with random key numbers.

#### Specified Keying

The Specified Keying option is provided for the instances where there is a specific key number desired for all of the cores ordered.

*Example: There are 10 offices which each have 2 silver locks that need to be keyed-alike with key number 202.*

This order would look like: **LKFE2SLV.X202.10**

This specifies that 10 2-core kits are needed in silver with key number 202.

#### Sequential Keying

Allsteel Sequential Keying option is provided for the instances when there are multiple orders or phases to a project and it is imperative that key numbers are not duplicated.

*Example: A multiple phase project has 60 total offices — 40 offices in Phase I, and 20 offices in Phase II. The project manager has expressed a need to have keyed-alike offices but doesn't want any of the offices to use the same key numbers.*

*The first 40 offices have 4 silver locks each that need to be keyed-alike.*

This order would look like: **LKFE4SLV.SEQ/101.40**

This specifies that 40 4-core kits are needed in silver and the starting number is 101.

*The second set of 20 offices only have 3 silver locks each that need to be keyed-alike; and it is important which key number starts off the sequence to ensure that no key number is duplicated. It is known that the first key range was key numbers 101-140.*

The second order would look like: **LKFE3SLV.SEQ/141.20**

This specifies that 20 3-core kits are needed in silver and key sequence has to start at key number 141.

#### HOW TO ORDER:

Numbers 101-225 are available. Orders without key numbers specified will be keyed at random.

SAMPLE ORDER FOR EXAMPLES GIVEN:

Model	Key Type	Quantity
LKFE5BLK.	X.	15
LKFE2SLV.	X202.	10
LKFE4SLV.	SEQ/101.	40
LKFE3SLV.	SEQ/141.	20

**Note:** Quantity required is last number in model.option string.

Description	Model / Color	List Price
<b>Easy Lock Lock-Core</b>		
Lock Core Kit — 1 core, 2 keys	LKFE1 _____	\$ 29
Lock Core Kit — 2 cores, 2 keys	LKFE2 _____	\$ 59
Lock Core Kit — 3 cores, 2 keys	LKFE3 _____	\$ 88
Lock Core Kit — 4 cores, 2 keys	LKFE4 _____	\$ 117
Lock Core Kit — 5 cores, 2 keys	LKFE5 _____	\$ 146
Lock Core Kit — 6 cores, 2 keys	LKFE6 _____	\$ 176
Lock Core Kit — 7 cores, 2 keys	LKFE7 _____	\$ 205
Lock Core Kit — 8 cores, 2 keys	LKFE8 _____	\$ 235
Add color suffix to model: <b>SLV</b> Silver, <b>BLK</b> Black, <b>MTS</b> Matte Silver		
<b>Note:</b> One core removal key minimum per order. One additional core removal key per 25 lock-cores will be shipped.		
<b>Master Key</b>		
(One key) Available to authorized dealers only on faxed orders.		
	AMKF22	\$ 30

#### How to specify using Easy Lock Program:

**Step 1** — Count the number of lock cores and color required in each workstation that need to be keyed alike.

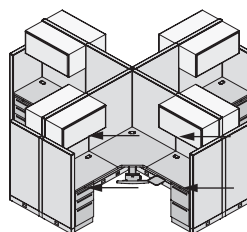

2 overheads with 1 lock-core each = 2  
 2 pedestals with 1 lock-core each = 2  
**Total silver lock-cores per station = 4**

**Step 2** — Count the total number of workstations needing 4 lock-cores.

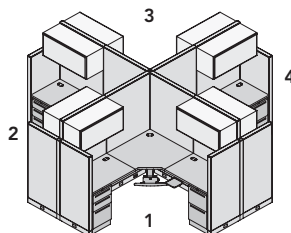

**4 total workstations**

**Step 3** — Specify model number based on total number of lock-cores in a station and quantity of kits based on number of workstations.

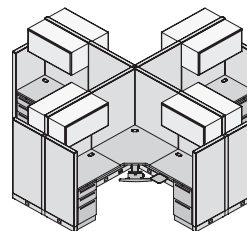

**LKFE4SLV.X.4**

Lock-Cores per station  
 Color of Core  
 Number of workstations

Exterior Width	Model	P1 Paint List Price	P2 Paint List Price	P3 Paint List Price
<b>Touch-Up Paint — Brush</b>				
Bottle of Touch-Up Paint with Brush — 0.5 oz.	APTK <span style="border: 1px solid black; padding: 0 2px;">S</span>	\$ 99	\$ 110	\$ 118
<b>Touch-Up Paint — Spray</b>				
Spray Can of Touch-Up Paint — 12 oz.	ARSLCC <span style="border: 1px solid black; padding: 0 2px;">S</span>	\$ 99	\$ 110	\$ 118

<p><b>How to specify —</b> Select the Model Number from above.</p> <p>A                     .</p>	<p><b>1st Option:</b> <b>Paint Color:</b>  <span style="border: 1px solid black; border-radius: 50%; padding: 2px;">P1</span> <span style="border: 1px solid black; border-radius: 50%; padding: 2px;">P2</span> <span style="border: 1px solid black; border-radius: 50%; padding: 2px;">P3</span></p> <p>See pages <a href="#">16-19</a> for options.</p> <p>                   </p>
---	--

Examples: APTK.P02 ARSLCC.P02

S Shippable by small-package carrier.

Model Number	Grade 13	Grade 14	Grade 15	Grade 16	Grade 17	Grade 18	Grade 19	Grade 20	Grade 21	Grade 22
Align™ and Essentials™ Pedestal Seat Cushion Tops — see page 55										
ASPT-24SC 23½"D	\$ 518	\$ 542	\$ 565	\$ 589	\$ 613	\$ 637	\$ 660	\$ 684	\$ 708	\$ 732
ASPT-30SC 29½"D	\$ 531	\$ 555	\$ 578	\$ 602	\$ 626	\$ 650	\$ 673	\$ 697	\$ 721	\$ 745
YPPA1815SC 17"D	\$ 473	\$ 497	\$ 520	\$ 544	\$ 568	\$ 592	\$ 615	\$ 639	\$ 663	\$ 687
YPPA2415SC 23"D	\$ 522	\$ 546	\$ 569	\$ 593	\$ 617	\$ 641	\$ 664	\$ 688	\$ 712	\$ 736
YPPA3015SC 29"D	\$ 537	\$ 561	\$ 584	\$ 608	\$ 632	\$ 656	\$ 679	\$ 703	\$ 727	\$ 751

Model Number	Description	Grade G	Grade H	Grade J
30"H Tackboards — see page 231				
WKTKFT4H30-FA	30"W	\$ 736	\$ 794	\$ 852
WKTKFT4H36-FA	36"W	\$ 796	\$ 865	\$ 934
WKTKFT4H42-FA	42"W	\$ 883	\$ 965	\$ 1045
WKTKFT4H48-FA	48"W	\$ 976	\$ 1070	\$ 1163
WKTKFT4H54-FA	54"W	\$ 1049	\$ 1153	\$ 1257
WKTKFT4H60-FA	60"W	\$ 1137	\$ 1253	\$ 1370
WKTKFT4H66-FA	66"W (2 Piece)	\$ 1197	\$ 1324	\$ 1452
WKTKFT4H72-FA	72"W (2 Piece)	\$ 1322	\$ 1461	\$ 1601
WKTKFT4H78-FA	78"W (2 Piece)	\$ 1398	\$ 1548	\$ 1700
WKTKFT4H84-FA	84"W (2 Piece)	\$ 1484	\$ 1647	\$ 1810
WKTKFT4H90-FA	90"W (3 Piece)	\$ 1558	\$ 1732	\$ 1906
WKTKFT4H96-FA	96"W (2 Piece)	\$ 1636	\$ 1822	\$ 2008

34"H Tackboards — see page 231				
WKTKFT4H30-LA	30"W	\$ 787	\$ 853	\$ 920
WKTKFT4H36-LA	36"W	\$ 850	\$ 930	\$ 1008
WKTKFT4H42-LA	42"W	\$ 943	\$ 1036	\$ 1127
WKTKFT4H48-LA	48"W	\$ 1043	\$ 1147	\$ 1253
WKTKFT4H54-LA	54"W	\$ 1120	\$ 1238	\$ 1357
WKTKFT4H60-LA	60"W	\$ 1218	\$ 1349	\$ 1480
WKTKFT4H66-LA	66"W (2 Piece)	\$ 1287	\$ 1431	\$ 1576
WKTKFT4H72-LA	72"W (2 Piece)	\$ 1415	\$ 1573	\$ 1731
WKTKFT4H78-LA	78"W (2 Piece)	\$ 1503	\$ 1675	\$ 1846
WKTKFT4H84-LA	84"W (2 Piece)	\$ 1590	\$ 1774	\$ 1958
WKTKFT4H90-LA	90"W (3 Piece)	\$ 1682	\$ 1880	\$ 2079
WKTKFT4H96-LA	96"W (2 Piece)	\$ 1763	\$ 1974	\$ 2185

Model Number	Description	Grade G	Grade H	Grade J
45"H Tackboards — see page 232				
WKTKFT5H30-FA	30"W	\$ 892	\$ 980	\$ 1067
WKTKFT5H36-FA	36"W	\$ 968	\$ 1072	\$ 1176
WKTKFT5H42-FA	42"W	\$ 1077	\$ 1198	\$ 1320
WKTKFT5H48-FA	48"W	\$ 1197	\$ 1336	\$ 1476
WKTKFT5H54-FA	54"W	\$ 1290	\$ 1447	\$ 1604
WKTKFT5H60-FA	60"W	\$ 1406	\$ 1580	\$ 1754
WKTKFT5H66-FA	66"W (2 Piece)	\$ 1491	\$ 1683	\$ 1875
WKTKFT5H72-FA	72"W (2 Piece)	\$ 1638	\$ 1847	\$ 2057
WKTKFT5H78-FA	78"W (2 Piece)	\$ 1742	\$ 1968	\$ 2194
WKTKFT5H84-FA	84"W (2 Piece)	\$ 1851	\$ 2095	\$ 2339
WKTKFT5H90-FA	90"W (3 Piece)	\$ 1947	\$ 2209	\$ 2470
WKTKFT5H96-FA	96"W (2 Piece)	\$ 2050	\$ 2330	\$ 2610

49"H Tackboards — see page 232				
WKTKFT5H30-LA	30"W	\$ 939	\$ 1033	\$ 1127
WKTKFT5H36-LA	36"W	\$ 1022	\$ 1135	\$ 1250
WKTKFT5H42-LA	42"W	\$ 1144	\$ 1276	\$ 1409
WKTKFT5H48-LA	48"W	\$ 1268	\$ 1420	\$ 1571
WKTKFT5H54-LA	54"W	\$ 1365	\$ 1537	\$ 1708
WKTKFT5H60-LA	60"W	\$ 1493	\$ 1682	\$ 1872
WKTKFT5H66-LA	66"W (2 Piece)	\$ 1581	\$ 1790	\$ 2000
WKTKFT5H72-LA	72"W (2 Piece)	\$ 1739	\$ 1967	\$ 2195
WKTKFT5H78-LA	78"W (2 Piece)	\$ 1852	\$ 2099	\$ 2346
WKTKFT5H84-LA	84"W (2 Piece)	\$ 1960	\$ 2226	\$ 2491
WKTKFT5H90-LA	90"W (3 Piece)	\$ 2070	\$ 2354	\$ 2638
WKTKFT5H96-LA	96"W (2 Piece)	\$ 2176	\$ 2479	\$ 2783

### FSC Certified Wood at Allsteel

Allsteel has received FSC Chain of Custody certification and can offer FSC certified products. Forest Stewardship Council (FSC) certification is intended to promote the sustainable harvesting of forests worldwide by setting requirements for the forest and everyone who handles the wood from forest to product. Certification provides a Chain of Customer number that we will pass on to customers who are pursuing LEED certification or who want to ensure that materials used to manufacture our wood products come from a well-managed forest. For more information, please contact Customer Support at 888-255-7833.



# Appendix

## Fabric Grade Pricing

Model Number	Grade 9	Grade 10	Grade 11	Grade 12	Grade 13	Grade 14	Grade 15	Grade 16	Grade 17	Grade 18	Grade 19	Grade 20	Grade 21	Grade 22
<b>Radii Storage Seat Cushions – 19"D</b> — see page <a href="#">126</a>														
AESC18	\$ 385	\$ 403	\$ 423	\$ 442	\$ 465	\$ 489	\$ 512	\$ 536	\$ 560	\$ 584	\$ 607	\$ 631	\$ 655	\$ 679
<b>Radii Storage Seat Cushions – 23"D</b> — see page <a href="#">126</a>														
AESC24	\$ 429	\$ 447	\$ 467	\$ 486	\$ 509	\$ 533	\$ 556	\$ 580	\$ 604	\$ 628	\$ 651	\$ 675	\$ 699	\$ 723
<b>Involve® Ped/Credenza Cushions – 18"D</b> — see page <a href="#">271</a>														
K5CT1815SC	\$ 621	\$ 659	\$ 697	\$ 736	\$ 782	\$ 830	\$ 877	\$ 925	\$ 972	\$ 1020	\$ 1067	\$ 1115	\$ 1162	\$ 1210
K5CT1818SC	\$ 643	\$ 681	\$ 719	\$ 758	\$ 804	\$ 852	\$ 899	\$ 947	\$ 994	\$ 1042	\$ 1089	\$ 1137	\$ 1184	\$ 1232
K5CT1824SC	\$ 671	\$ 709	\$ 747	\$ 786	\$ 832	\$ 880	\$ 927	\$ 975	\$ 1022	\$ 1070	\$ 1117	\$ 1165	\$ 1212	\$ 1260
K5CT1830SC	\$ 702	\$ 740	\$ 778	\$ 817	\$ 863	\$ 911	\$ 958	\$ 1006	\$ 1053	\$ 1101	\$ 1148	\$ 1196	\$ 1243	\$ 1291
K5CT1836SC	\$ 756	\$ 794	\$ 832	\$ 871	\$ 917	\$ 965	\$ 1012	\$ 1060	\$ 1107	\$ 1155	\$ 1202	\$ 1250	\$ 1297	\$ 1345
K5CT1848SC	\$ 771	\$ 809	\$ 847	\$ 886	\$ 932	\$ 980	\$ 1027	\$ 1075	\$ 1122	\$ 1170	\$ 1217	\$ 1265	\$ 1312	\$ 1360
<b>Involve Ped/Credenza Cushions – 24"D</b> — see page <a href="#">271</a>														
K5CT2415SC	\$ 729	\$ 778	\$ 827	\$ 876	\$ 937	\$ 997	\$ 1058	\$ 1119	\$ 1180	\$ 1241	\$ 1302	\$ 1363	\$ 1424	\$ 1485
K5CT2418SC	\$ 735	\$ 784	\$ 833	\$ 882	\$ 943	\$ 1003	\$ 1064	\$ 1125	\$ 1186	\$ 1247	\$ 1308	\$ 1369	\$ 1430	\$ 1491
K5CT2424SC	\$ 767	\$ 816	\$ 865	\$ 914	\$ 975	\$ 1035	\$ 1096	\$ 1157	\$ 1218	\$ 1279	\$ 1340	\$ 1401	\$ 1462	\$ 1523
K5CT2430SC	\$ 798	\$ 847	\$ 896	\$ 945	\$ 1006	\$ 1066	\$ 1127	\$ 1188	\$ 1249	\$ 1310	\$ 1371	\$ 1432	\$ 1493	\$ 1554
K5CT2436SC	\$ 835	\$ 884	\$ 933	\$ 982	\$ 1043	\$ 1103	\$ 1164	\$ 1225	\$ 1286	\$ 1347	\$ 1408	\$ 1469	\$ 1530	\$ 1591
K5CT2448SC	\$ 892	\$ 941	\$ 990	\$ 1039	\$ 1100	\$ 1160	\$ 1221	\$ 1282	\$ 1343	\$ 1404	\$ 1465	\$ 1526	\$ 1587	\$ 1648
<b>Involve Banquette Cushions – 24"D</b> — see page <a href="#">276</a>														
K5C2424	\$ 1766	\$ 1825	\$ 1883	\$ 1942	\$ 2015	\$ 2090	\$ 2163	\$ 2237	\$ 2310	\$ 2384	\$ 2457	\$ 2531	\$ 2604	\$ 2678
K5C2424FC	\$ 1956	\$ 2015	\$ 2073	\$ 2132	\$ 2205	\$ 2280	\$ 2353	\$ 2427	\$ 2500	\$ 2574	\$ 2647	\$ 2721	\$ 2794	\$ 2868
K5C3624	\$ 2146	\$ 2205	\$ 2263	\$ 2322	\$ 2395	\$ 2470	\$ 2543	\$ 2617	\$ 2690	\$ 2764	\$ 2837	\$ 2911	\$ 2984	\$ 3058
K5C3624FC	\$ 2337	\$ 2396	\$ 2454	\$ 2513	\$ 2586	\$ 2661	\$ 2734	\$ 2808	\$ 2881	\$ 2955	\$ 3028	\$ 3102	\$ 3175	\$ 3249
<b>Involve Seat Base Cushions – 24"D</b> — see page <a href="#">276</a>														
K5SC2424	\$ 880	\$ 908	\$ 938	\$ 967	\$ 1003	\$ 1039	\$ 1075	\$ 1112	\$ 1148	\$ 1184	\$ 1221	\$ 1257	\$ 1293	\$ 1329

# Cross Reference Index

by Model Number

Model	Page	Model	Page	Model	Page	Model	Page	Model	Page
2282-300	48, 101	APADD	326	AW4WCTIBC36W	308	ELF830SI	102	ISLAUT2PYB481854	85
2282-400	48, 101	APASD	326	AW4WCTIBC57W	308	ELF830SS	102	ISLAUT2PYB483652	86
A6REC252LFC	236	APASDCK	327	AW4WCTIP36W	308	ELF836NA	102	ISLAUT2PYB483654	86
A6REC252LTF	236	APATF	326	AW4WCTIP57W	308	ELF836NB	102	ISLAUT2PYB601852	85
A87P2UIR	276	APFB80	101	AWCS	311	ELF836NI	102	ISLAUT2PYB601855	85
A944	110	APGBP18SNPT	125	CSDC19	317	ELF836NS	102	ISLAUT2PYB603652	86
A945	110	APGBP18SNPTE	127	CSDC25	317	ELF836SA	102	ISLAUT2PYB603655	86
A994	110	APGBP186NPT	125	EACS	316	ELF836SB	102	ISLAUT2PYB721852	85
A995	110	APGBP186NPTE	127	EABS	316	ELF836SI	102	ISLAUT2PYB721853	85
A995C	110	APGBP189TFNE	125	EACS	316	ELF836SS	102	ISLAUT2PYB721856	85
A2280-000	48, 101, 195, 264	APGBP189TFNE	127	EADH	316	ELF842NA	102	ISLAUT2PYB723652	86
A870302	322	APGBP246NPT	125	EAFS	316	ELF842NB	102	ISLAUT2PYB723653	86
A870824	320	APGBP246NPTE	127	EAFI	316	ELF842NI	102	ISLAUT2PYB723656	86
A870824CH	320	APGBP249TFN	125	EAHSR36	315	ELF842NS	102	ISLAUT2PYB841852	85
A870830	320	APGBP249TFNE	127	EAHSR42	315	ELF842SA	102	ISLAUT2PYB841857	86
A870830CH	320	APGBS24SNPT	125	EAHSR48	315	ELF842SB	102	ISLAUT2PYB843652	85
A870842	320	APGBS24SNPTE	127	EAHSR60	315	ELF842SI	102	ISLAUT2PYB843657	86
A870842CH	320	APGBS249TFN	125	EAHSR66	315	ELF842SS	102	ISLAUT2PYB901853	85
A870860	320	APGBS249TFNE	127	EAHSR72	315	ESC230A	104	ISLAUT2PYB903653	86
A870860CH	320	APGCP189TFN	125	EAPC	316	ESC230B	104	ISLAUTNPNB241851	83
AAPACM2	320	APGCP189TFNE	127	EAPS	316	ESC230I	104	ISLAUTNPNB243651	83
ACD1	317	APGCP249TFN	125	EAPT	316	ESC230S	104	ISLAUTNPNB301851	83
ACMCM2IO	133	APGCP249TFNE	127	EASR24	315	ESC236A	104	ISLAUTNPNB303651	83
ACMCM2IT	133	APGCS249TFN	125	EASR30	315	ESC236I	104	ISLAUTNPNB361851	83
ACOMDOME2	322	APGCS249TFNE	127	EASR36	315	ESC236T	104	ISLAUTNPNB361853	83
ACPU1	311	APMAP186NFN	125	EASR42	315	ESC236S	104	ISLAUTNPNB363651	83
AECH	130	APMAP186NFNE	127	EASR48	315	ESC330A	104	ISLAUTNPNB363653	83
AEHF	130	APMAP246NFN	125	EASR60	315	ESC330B	104	ISLAUTNPNB421851	83
AELT	130	APMAP246NFNE	127	EASS	316	ESC330I	104	ISLAUTNPNB423651	83
AESC18	126	APMBP18SNPT	125	EATS	316	ESC330S	104	ISLAUTNPNB481851	83
AESC24	126	APMBP18SNPTE	127	EBC30	105	ESC336A	104	ISLAUTNPNB481852	83
AESS	130	APMBP186NPT	126	EBC42	105	ESC336B	104	ISLAUTNPNB481854	83
AEST	130, 217	APMBP186NPTE	128	EBC60	105	ESC336I	104	ISLAUTNPNB483651	83
AEV920	234	APMBP189TFN	125	EBC72	105	ESC336S	104	ISLAUTNPNB483652	83
AF397-203A	100	APMBP189TFNE	128	EBC82	105	ESC436A	104	ISLAUTNPNB483654	83
AF397-203B	100	APMBP246NPT	126	EBC230	105	ESC436B	104	ISLAUTNPNB601851	83
AF397-203I	100	APMBP246NPTE	128	EBC236	105	ESC436I	104	ISLAUTNPNB601852	83
AF397-203S	100	APMBP249TFN	125	EBC330	105	ESC436S	104	ISLAUTNPNB601855	83
AF397-233A	100	APMBP249TFNE	128	EBC336	105	ESC530A	104	ISLAUTNPNB603651	83
AF397-233B	100	APMBS24SNPT	125	EBC436	105	ESC530B	104	ISLAUTNPNB603652	83
AF397-233I	100	APMBS24SNPTE	128	EBC530	105	ESC530I	104	ISLAUTNPNB603655	83
AF397-233S	100	APMBS249TFN	125	EBC536	105	ESC530S	104	ISLAUTNPNB721851	83
AF398-202A	100	APMBS249TFNE	128	ECF530HA	103	ESC536A	104	ISLAUTNPNB721852	83
AF398-202B	100	APMC6	316	ECF530HB	103	ESC536B	104	ISLAUTNPNB721853	83
AF398-202I	100	APMCP189TFN	126	ECF530HI	103	ESC536I	104	ISLAUTNPNB721856	83
AF398-202S	100	APMCP189TFNE	128	ECF530HS	103	ESC536S	104	ISLAUTNPNB723651	83
AF398-232A	100	APMCP249TFN	126	ECF530NA	103	ETKP28H	101	ISLAUTNPNB723652	83
AF398-232B	100	APMCP249TFNE	128	ECF530NB	103	FBRZPWM	52.8	ISLAUTNPNB723653	83
AF398-232I	100	APMCS249TFN	126	ECF530NI	103	GS870924	320	ISLAUTNPNB723656	83
AF398-232S	100	APMCS249TFNE	128	ECF530NS	103	GS870930	320	ISLAUTNPNB841851	83
AJTRGH24	234	APOLG0512	53, 291	ECF536HA	103	GS870948	320	ISLAUTNPNB841852	83
AJTRGH36	234	APOLG0518	53, 291	ECF536HB	103	GS870960	320	ISLAUTNPNB841857	83
AKMH	311	APOLG0612	53	ECF536HI	103	ISLAAB2P484252	87	ISLAUTNPNB843651	83
AKTLONG	311	APOLG0618	53	ECF536HS	103	ISLAAB2P484254	87	ISLAUTNPNB843652	83
AKTMID	311	APTK	331	ECF536NA	103	ISLAAB2P604255	87	ISLAUTNPNB843657	83
AKTSHORT	311	APWRMOD1TT	322	ECF536NB	103	ISLAAB2P724253	87	ISLAUTNPNB901851	83
ALED17U	285, 320	APWRMOD1UWM	322	ECF536NS	103	ISLAAB2P724256	87	ISLAUTNPNB901853	83
ALED17U60	320	APWRMOD2Q	322	ELF330NA	102	ISLAAB2P844257	87	ISLAUTNPNB903651	83
ALED17UJMP30	320	APWRMOD2UWM	322	ELF330NB	102	ISLAAENB1842	87	ISLAUTNPNB903653	83
ALED31U	285, 320	APWRMOD3WC	322	ELF330NI	102	ISLAAESP3642	88	K2T113618A	275
ALED31U60	320	APWRMOD3UWM	322	ELF330NS	102	ISLAAEYB1842L	87	K2T113624A	275
ALED31UJMP30	320	ARSLCC	331	ELF336NA	102	ISLAAEYB1842R	87	K2T114818A	275
ALED31UJMP30	320	ASISLABEL5	54, 102	ELF336NB	102	ISLAAEYB3642	87	K2T114824A	275
ALKF23C	329	ASPT-245C	55, 101	ELF336NS	102	ISLAAO3642	88	K2T172424CT	264, 275
ALKF23CE4	329	ASPT-305C	55, 101	ELF342NA	102	ISLAE2P604052	87	K2T174818LAF	264
ALKF23CN	329	ASPT-24LL	48	ELF342NB	102	ISLAE2P724052	87	K2T174818RAF	264
ALKF26EL	54, 329	ASPT-30LL	48	ELF342NI	102	ISLAE2P844052	87	K2T174824LAF	264
AM387-203A	100	AUCH15N	130	ELF342NS	102	ISLAE2P904053	87	K2T174824RAF	264
AM387-203B	100	AUCH15NE	132	ELF430NA	102	ISLAEENB1842	87	K2T176018LAF	264
AM387-203I	100	AUCH15U	130	ELF430NB	102	ISLAEES3642	88	K2T176018RAF	264
AM387-203S	100	AUCH15UE	132	ELF430NI	102	ISLAAEYB1842L	87	K2T241518MBF	263
AM387-233A	100	AUCHL15N	130	ELF430NS	102	ISLAEYB1842R	87	K2T241818A	266
AM387-233B	100	AUCHL15NE	132	ELF436NA	102	ISLAEYB3642	87	K2T241818BF	263
AM387-233I	100	AUCHL15U	130	ELF436NB	102	ISLAEYB3642	87	K2T241824A	266
AM387-233S	100	AUCHL15UE	132	ELF436NA	102	ISLAUT1PYB483652	86	K2T241824BF	263
AM388-202A	100	AUCL15N	130	ELF436NB	102	ISLAUT1PYB483654	86	K2T242418A	266
AM388-202B	100	AUCL15NE	132	ELF436NI	102	ISLAUT1PYB603652	86	K2T242424A	266
AM388-202I	100	AUCL15U	130	ELF436NS	102	ISLAUT1PYB603655	86	K2T243018A	266
AM388-202S	100	AUFD15N	130	ELF442NA	102	ISLAUT1PYB723652	86	K2T243018BF	265
AM388-232A	100	AUFD15NE	132	ELF442NB	102	ISLAUT1PYB723653	86	K2T243024A	266
AM388-232B	100	AUFH15N	130	ELF442NI	102	ISLAUT1PYB723656	86	K2T243024BF	265
AM388-232I	100	AUFH15NE	132	ELF442NS	102	ISLAUT1PYB843652	86	K2T243618A	266
AM388-232S	100	AUFH15U	130	ELF530NA	102	ISLAUT1PYB843657	86	K2T243618E	265
AMADHD	326	AUFH15UE	132	ELF530NB	102	ISLAUT1PYB903653	86	K2T243618N	266
AMASD	326	AUFO15N	130	ELF530NS	102	ISLAUT2PNB241851	84	K2T243624A	266
AMASD-G	326	AVSTA3PWR	322	ELF536NA	102	ISLAUT2PNB301851	84	K2T243624E	265
AMASHD	326	AW4AVRACK	307	ELF536NB	102	ISLAUT2PNB361851	84	K2T243624N	266
AMASHDCK	327	AW4BC4824L	307	ELF536NS	102	ISLAUT2PNB361853	84	K2T244818LAF	265
AMASTS	326	AW4BC4824LNG	307	ELF442NA	102	ISLAUT2PNB421851	84	K2T244818N	266
AMASTSCK	327	AW4BC4824RNG	307	ELF542NA	102	ISLAUT2PNB481852	84	K2T244818RAF	265
AMASTS-G	326	AW4BC4824RNG	307	ELF542NB	102	ISLAUT2PNB481854	84	K2T244824LAF	265
AMF22	329	AW4BC7224	307	ELF542NI	102	ISLAUT2PNB601852	84	K2T244824N	266
AMKF22	329, 330	AW4BC7224NG	307	ELF542NS	102	ISLAUT2PNB601855	84	K2T244824RAF	265
AP22PBKRH	53, 70	AW4DRAWER	307	ELF830NA	102	ISLAUT2PNB721852	84	K2T246018LAF	265
AP22PBKRH	53, 70	AW4SHELF	307	ELF830NB	102	ISLAUT2PNB721853	84	K2T246018RAF	265
AP1050CST	101	AW4TRASH	307	ELF830NS	102	ISLAUT2PNB721856	84	K2T246024LAF	265
AP20040AG	101	AW4WC36LABEL	308	ELF830NI	102	ISLAUT2PNB841852	84	K2T246024RAF	265
AP519495	101	AW4WC57LABEL	308	ELF830NS	102	ISLAUT2PNB841857	84	K2T247218LAF	265
APACSM	327	AW4WC3620	308	ELF830SA	102	ISLAUT2PNB901853	84	K2T247218RAF	265
APACW	327	AW4WC5720	308	ELF830SB	102	ISLAUT2PYB481852	85	K2T247224LAF	265

INDEX

# Cross Reference Index

by Model Number

Model	Page	Model	Page	Model	Page	Model	Page	Model	Page
K2T247224RAF	265	K2TH4284A	287	K2TP283024A	268	K2TPT651824RBBF	280	K2TT721824RBBF	281
K2T281518BBF	263	K2TH4284H	287	K2TP283024BBF	267	K2TPT651824RFF	280	K2TT721824RFF	281
K2T281518FF	263	K2TH4284N	287	K2TP283024FF	267	K2TPT652424L	280	K2TT722424L	281
K2T281524BBF	263	K2TOC072415SH	284	K2TP283618A	268	K2TPT652424LBBF	280	K2TT722424LBBF	281
K2T281524FF	263	K2TOC073015SH	284	K2TP283618E	267	K2TPT652424LFF	280	K2TT722424LFF	281
K2T281530BBF	263	K2TOC073615SH	284	K2TP283618FF	267	K2TPT652424R	280	K2TT722424R	281
K2T281530FF	263	K2TOC074215SH	284	K2TP283624A	268	K2TPT652424RBBF	280	K2TT722424RBBF	281
K2T281818A	263	K2TOC074815SH	284	K2TP283624E	268	K2TPT652424RFF	280	K2TT722424RFF	281
K2T281818BBF	263	K2TOC152415A	283	K2TP283624E	267	K2TPT721824L	281	K5CT1536SC	305
K2T281818FF	263	K2TOC152415H	283	K2TP283624FF	267	K2TPT721824LBBF	281	K5CT1815SC	271
K2T281824A	263	K2TOC152415N	283	K2TP283624N	268	K2TPT721824LFF	281	K5CT1818L	271
K2T281824BBF	263	K2TOC153015A	283	K2TP284818N	268	K2TPT721824RFF	281	K5CT1818SC	271
K2T281824FF	263	K2TOC153015H	283	K2TP284824N	268	K2TPT721824R	281	K5CT1824L	271
K2T281830BBF	263	K2TOC153015N	283	K2TP423618FF	269	K2TPT721824RBBF	281	K5CT1824SC	55, 271
K2T281830FF	263	K2TOC153615A	283	K2TPB112424A	275	K2TPT722424L	281	K5CT1830L	271
K2T282418A	268	K2TOC153615H	283	K2TPB112424F	275	K2TPT722424LBBF	281	K5CT1830SC	55, 271
K2T282418BBF	267	K2TOC153615N	283	K2TPB113624A	275	K2TPT722424LFF	281	K5CT1836L	271
K2T282424A	268	K2TOC154215A	283	K2TPB113624F	275	K2TPT722424R	281	K5CT1836SC	55, 271
K2T282424BBF	267	K2TOC154215H	283	K2TPB114824A	275	K2TPT722424RBBF	281	K5CT1842SC	55
K2T283018A	268	K2TOC154215N	283	K2TPB114824F	275	K2TPT722424RFF	281	K5CT1848L	271
K2T283018BBF	267	K2TOC154815A	283	K2TPBC653015A	270	K2TST501818LBBF	278	K5CT1848SC	55, 271
K2T283018FF	267	K2TOC154815H	283	K2TPBC653024F	270	K2TST501818LFF	278	K5CT2415SC	271
K2T283024A	268	K2TOC154815N	283	K2TPBC653615A	270	K2TST501818RBBF	278	K5CT2418L	271
K2T283024BBF	267	K2TOC156015A	283	K2TPBC653624F	270	K2TST501818RFF	278	K5CT2418SC	271
K2T283024FF	267	K2TOC156015H	283	K2TPBC723015A	270	K2TST501824LBBF	278	K5CT2424L	271
K2T283618A	268	K2TOC156015N	283	K2TPBC723024F	270	K2TST501824LFF	278	K5CT2424SC	55, 271
K2T283618E	267	K2TOC157215H	283	K2TPBC723615A	270	K2TST501824RBBF	278	K5CT2430L	271
K2T283618FF	267	K2TOC157215N	283	K2TPBC723624F	270	K2TST501824RFF	278	K5CT2430SC	55, 271
K2T283618N	268	K2TOC158415H	283	K2TPF173018	264	K2TST502418LBBF	278	K5CT2436L	271
K2T283624A	268	K2TOC158415N	283	K2TPF173024	264	K2TST502418LFF	278	K5CT2436SC	55, 271
K2T283624E	267	K2TOC159615H	283	K2TPF173618	264	K2TST502418RBBF	278	K5CT2448L	271
K2T283624FF	267	K2TOC159615N	283	K2TPF173624	264	K2TST502418RFF	278	K5CT2448SC	55, 271
K2T283624N	268	K2TOC232415H	284	K2TPST501818LBBF	278	K2TST502424LBBF	278	K6DM2829L	292
K2T284818N	268	K2TOC233015H	284	K2TPST501818LFF	278	K2TST502424LFF	278	K6DM2830L	292
K2T284824N	268	K2TOC233615A	284	K2TPST501818RBBF	278	K2TST502424RBBF	278	K6DM2834L	292
K2T423618FF	269	K2TOC234215H	284	K2TPST501818RFF	278	K2TST502424RFF	278	K6DM2835L	292
K2TB112424A	275	K2TOC234815H	284	K2TPST501824LBBF	278	K2TST571818LBBF	279	K6DM2836L	292
K2TB112424F	275	K2TOC236015H	284	K2TPST501824LFF	278	K2TST571818LFF	279	K6DM2840L	292
K2TB113624A	275	K2TP113618A	275	K2TPST501824RBBF	278	K2TST571818RBBF	279	K6DM2841L	292
K2TB113624F	275	K2TP113624A	275	K2TPST501824RFF	278	K2TST571818RFF	279	K6DM2842L	292
K2TB114824A	275	K2TP114818A	275	K2TPST502418LBBF	278	K2TST571824LBBF	279	K6DM2843L	292
K2TB114824F	275	K2TP114824A	275	K2TPST502418LFF	278	K2TST571824LFF	279	K6DM2846L	292
K2TBC653015A	270	K2TP174242CT	264, 275	K2TPST502418RBBF	278	K2TST571824RBBF	279	K6DM2847L	292
K2TBC653024F	270	K2TP174818LAF	264	K2TPST502418RFF	278	K2TST571824RFF	279	K6DM2849L	292
K2TBC653615A	270	K2TP174818RAF	264	K2TPST502424LBBF	278	K2TST572418LBBF	279	K6DM2853L	292
K2TBC653624F	270	K2TP174824LAF	264	K2TPST502424LFF	278	K2TST572418LFF	279	K6DM2855L	292
K2TBC723015A	270	K2TP174824RAF	264	K2TPST502424RBBF	278	K2TST572418RBBF	279	K6DM2858L	292
K2TBC723024F	270	K2TP176018LAF	264	K2TPST502424RFF	278	K2TST572418RFF	279	K6DM2859L	292
K2TBC723615A	270	K2TP176018RAF	264	K2TPST571818LBBF	279	K2TST572424LBBF	279	K6DM2861L	292
K2TBC723624F	270	K2TP241818A	266	K2TPST571818LFF	279	K2TST572424LFF	279	K6DM2864L	292
K2TC153618S	284	K2TP241818BBF	263	K2TPST571818RBBF	279	K2TST572424RBBF	279	K6DM2870L	292
K2TC154818S	284	K2TP241824A	266	K2TPST571818RFF	279	K2TST572424RFF	279	K6DM2876L	292
K2TC156018S	284	K2TP241824BBF	263	K2TPST571824LBBF	279	K2T421218L	277	K6DMP2830L	292
K2TC201818A	282	K2TP242418A	266	K2TPST571824LFF	279	K2T421218R	277	K6DMP2834L	292
K2TC201818LH	282	K2TP242424A	266	K2TPST571824RBBF	279	K2T421224L	277	K6DMP2836L	292
K2TC201818RH	282	K2TP243018A	266	K2TPST571824RFF	279	K2T421224R	277	K6DMP2840L	292
K2TC202418A	282	K2TP243018BBF	265	K2TPST572418LBBF	279	K2T501218L	277	K6DMP2842L	292
K2TC271818A	282	K2TP243024A	266	K2TPST572418LFF	279	K2T501218R	277	K6DMP2846L	292
K2TC271818LH	282	K2TP243024BBF	265	K2TPST572418RBBF	279	K2T501224L	277	K6DP5029L	294
K2TC271818RH	282	K2TP243618A	266	K2TPST572418RFF	279	K2T501224R	277	K6DP5035L	294
K2TC272418A	282	K2TP243618E	265	K2TPST572424LBBF	279	K2T501824LBBF	278	K6DP5047L	294
K2TC351818A	282	K2TP243618N	266	K2TPST572424LFF	279	K2T501824LFF	278	K6DP5059L	294
K2TC351818LH	282	K2TP243624A	266	K2TPST572424RBBF	279	K2T501824RBBF	278	K6OLG0512	291
K2TC351818RH	282	K2TP243624E	265	K2TPST572424RFF	279	K2T501824RFF	278	K6OLG515L	285
K2TC352418A	282	K2TP243624N	266	K2TPT421218L	277	K2T502424LBBF	278	K6OLG50518	291
K2TC421818A	282	K2TP244818LAF	265	K2TPT421218R	277	K2T502424LFF	278	K6OLG518L	285
K2TC421818LH	282	K2TP244818RAF	266	K2TPT421224L	277	K2T502424RBBF	278	K6OLG1107	285
K2TC421818RH	282	K2TP244818A	265	K2TPT421224R	277	K2T502424RFF	278	K6OLG1115L	285
K2TC422418A	282	K2TP244824LAF	265	K2TPT501218L	277	K2T571218L	277	K6OLG1118L	285
K2TF173018	264	K2TP244824A	266	K2TPT501218R	277	K2T571218R	277	K6OLG1207	285
K2TF173024	264	K2TP244824RAF	265	K2TPT501224L	277	K2T571224L	277	K6OLG1215L	285
K2TF173618	264	K2TP246018LAF	265	K2TPT501224R	277	K2T571224R	277	K6OLG1218L	285
K2TF173624	264	K2TP246018RAF	265	K2TPT501824LBBF	278	K2T571824LBBF	279	K6OLG1807	285
K2TH3548A	287	K2TP246024LAF	265	K2TPT501824LFF	278	K2T571824LFF	279	K6OLG1815L	285
K2TH3548H	287	K2TP246024RAF	265	K2TPT501824RBBF	278	K2T571824RBBF	279	K6OLG1907	285
K2TH3548N	287	K2TP247218LAF	265	K2TPT501824RFF	278	K2T571824RFF	279	K6OLG1915L	285
K2TH3560A	287	K2TP247218RAF	265	K2TPT502424LBBF	278	K2T572424LBBF	279	K6TB1230T	295
K2TH3560H	287	K2TP247224LAF	265	K2TPT502424LFF	278	K2T572424LFF	279	K6TB1236T	295
K2TH3560N	287	K2TP247224RAF	265	K2TPT502424RBBF	278	K2T572424RBBF	279	K6TB1242T	295
K2TH3566A	287	K2TP281518BBF	263	K2TPT502424RFF	278	K2T572424RFF	279	K6TB1248T	295
K2TH3566H	287	K2TP281518FF	263	K2TPT571218L	277	K2T651218L	277	K6TB1260T	295
K2TH3566N	287	K2TP281524BBF	263	K2TPT571218R	277	K2T651218R	277	K6TB1830T	295
K2TH3572A	287	K2TP281524FF	263	K2TPT571224L	277	K2T651224L	277	K6TB1836T	295
K2TH3572H	287	K2TP281530BBF	263	K2TPT571224R	277	K2T651224R	277	K6TB1842T	295
K2TH3572N	287	K2TP281530FF	263	K2TPT571824LBBF	279	K2T651824L	280	K6TB1848T	295
K2TH3584A	287	K2TP281818A	263	K2TPT571824LFF	279	K2T651824LBBF	280	K6TB1860T	295
K2TH3584H	287	K2TP281818BBF	263	K2TPT571824RBBF	279	K2T651824LFF	280	K6TB1930T	295
K2TH3584N	287	K2TP281818FF	263	K2TPT571824RFF	279	K2T651824R	280	K6TB1936T	295
K2TH4248A	287	K2TP281824A	263	K2TPT572424LBBF	279	K2T651824RBBF	280	K6TB1942T	295
K2TH4248H	287	K2TP281824BBF	263	K2TPT572424LFF	279	K2T651824RFF	280	K6TB1948T	295
K2TH4248N	287	K2TP281824FF	263	K2TPT572424RBBF	279	K2T652424L	280	K6TB1960T	295
K2TH4260A	287	K2TP281830BBF	263	K2TPT572424RFF	279	K2T652424LBBF	280	K6TB2630T	295
K2TH4260H	287	K2TP281830FF	263	K2TPT651218L	277	K2T652424LFF	280	K6TB2636T	295
K2TH4260N	287	K2TP282418A	268	K2TPT651218R	277	K2T652424R	280	K6TB2642T	295
K2TH4266A	287	K2TP282418BBF	267	K2TPT651224L	277	K2T652424RBBF	280	K6TB2648T	295
K2TH4266H	287	K2TP282424A	268	K2TPT651224R	277	K2T652424RFF	280	K6TB2660T	295
K2TH4266N	287	K2TP282424BBF	267	K2TPT651824L	280	K2TT721824L	281	K6TB2730T	295
K2TH4272A	287	K2TP283018A	268	K2TPT651824LBBF	280	K2TT721824LBBF	281	K6TB2736T	295
K2TH4272H	287	K2TP283018BBF	267	K2TPT651824LFF	280	K2TT721824LFF	281	K6TB2742T	295
K2TH4272N	287	K2TP283018FF	267	K2TPT651824R	280	K2TT721824R	281	K6TB2748T	295

INDEX

# Cross Reference Index

by Model Number

Model	Page	Model	Page	Model	Page	Model	Page	Model	Page
K6TB2760T	295	KL282424BBF	267	KLH4266N	287	KLP282418A	268	KLPT571224L	277
K6TB3548T	288	KL283018A	268	KLH4272A	287	KLP282418BBF	268	KLPT571224R	277
K6TB3560T	288	KL283018BBF	268	KLH4272H	287	KLP282424A	267	KLPT571824LBBF	279
K6TB3566T	288	KL283018FF	267	KLH4272N	287	KLP282424BBF	267	KLPT571824LFF	279
K6TB3572T	288	KL283024A	268	KLH4284A	287	KLP283018A	268	KLPT571824RBBF	279
K6TB3584T	288	KL283024BBF	267	KLH4284H	287	KLP283018BBF	267	KLPT571824RFF	279
K6TB4248T	288	KL283024FF	267	KLH4284N	287	KLP283018FF	267	KLPT572424LBBF	279
K6TB4260T	288	KL283618A	268	KLOC072415SH	284	KLP283024A	268	KLPT572424LFF	279
K6TB4266T	288	KL283618E	268	KLOC073015SH	284	KLP283024BBF	268	KLPT572424RBBF	279
K6TB4272T	288	KL283618FF	267	KLOC073615SH	284	KLP283024FF	267	KLPT572424RFF	279
K6TB4284T	288	KL283618N	268	KLOC074215SH	284	KLP283618A	268	KLPT651218L	277
K6TBK	285	KL283624A	268	KLOC074815SH	284	KLP283618E	267	KLPT651218R	277
K6TR18	281, 291	KL283624E	267	KLOC152415A	283	KLP283618FF	267	KLPT651224L	277
K605LSSPK	275	KL283624FF	267	KLOC152415H	283	KLP283618N	268	KLPT651224R	277
K605RSSPK	275	KL283624N	268	KLOC152415N	283	KLP283624A	268	KLPT651824L	280
K624PBKL	272, 290	KL284818N	268	KLOC153015A	283	KLP283624E	267	KLPT651824LBBF	280
K624PBKML	272, 290	KL284824N	268	KLOC153015H	283	KLP283624FF	267	KLPT651824LFF	280
K624PBKMR	272, 290	KL423618FFF	269	KLOC153015N	283	KLP283624N	268	KLPT651824R	280
K624PBKR	272, 290	KL112424A	275	KLOC153615A	283	KLP284818N	268	KLPT651824RBBF	280
K629SCF	291	KL112424F	275	KLOC153615H	283	KLP284824N	268	KLPT651824RFF	280
K630PBKL	272, 290	KL113624A	275	KLOC153615N	283	KLP423618FFF	269	KLPT652424L	280
K630PBKML	272, 290	KL113624F	275	KLOC154215A	283	KLPB112424A	275	KLPT652424LBBF	280
K630PBKMR	272, 290	KL114824A	275	KLOC154215H	283	KLPB112424F	275	KLPT652424LFF	280
K630PBKR	272, 290	KL114824F	275	KLOC154215N	283	KLPB113624A	275	KLPT652424R	280
K640SCF	291	KLBC653015A	270	KLOC154815A	283	KLPB113624F	275	KLPT652424RBBF	280
K62918FEN	290	KLBC653024F	270	KLOC154815H	283	KLPB114824A	275	KLPT652424RFF	280
K62918LPEN	290	KLBC653615A	270	KLOC154815N	283	KLPB114824F	275	KLPT721824L	281
K62918OLG	290	KLBC653624F	270	KLOC156015A	283	KLPBC653015A	270	KLPT721824LBBF	281
K62918RPEN	290	KLBC723015A	270	KLOC156015H	283	KLPBC653024F	270	KLPT721824LFF	281
K62924FEN	290	KLBC723024F	270	KLOC156015N	283	KLPBC653615A	270	KLPT721824R	281
K62924LPEN	290	KLBC723615A	270	KLOC157215A	283	KLPBC653624F	270	KLPT721824RBBF	281
K62924OLG	290	KLBC723624F	270	KLOC157215H	283	KLPBC723015A	270	KLPT721824RFF	281
K62924RPEN	290	KLBP1530	286	KLOC157215N	283	KLPBC723024F	270	KLPT722424L	281
K62930FEN	290	KLBP1536	286	KLOC158415A	283	KLPBC723615A	270	KLPT722424LBBF	281
K62930LPEN	290	KLBP1542	286	KLOC158415H	283	KLPBC723624F	270	KLPT722424LFF	281
K62930OLG	290	KLBP1548	286	KLOC158415N	283	KLPCB1730	264	KLPT722424R	281
K62930RPEN	290	KLBP1560	286	KLOC159615A	283	KLPCB1736	264	KLPT722424RBBF	281
K62936OLG	290	KLBP1572	286	KLOC159615H	283	KLPCB2418	263	KLPT722424RFF	281
K5306036EZ	289	KLBP1584	286	KLOC159615N	283	KLPCB2430	265	KLSP45MK	284
K5307236EZ	289	KLBP1596	286	KLOC232415H	284	KLPCB2436	265	KLSPMK	284
K5307836EZ	289	KLC153618S	284	KLOC233015H	284	KLPCB2815	263	KLST501818LBBF	278
KL113618A	275	KLC154818S	284	KLOC233615H	284	KLPCB2818	263	KLST501818LFF	278
KL113624A	275	KLC156018S	284	KLOC234215H	284	KLPCB2824	267	KLST501818RBBF	278
KL114818A	275	KLC201818A	282	KLOC234815H	284	KLPCB2830	267	KLST501818RFF	278
KL114824A	275	KLC201818LH	282	KLOC236015H	284	KLPCB2836	267	KLST501824LBBF	278
KL172424CT	264, 275	KLC201818RH	282	KLP113618A	275	KLPF173018	264	KLST501824LFF	278
KL174818LAF	264	KLC202418A	282	KLP113624A	275	KLPF173024	264	KLST501824RBBF	278
KL174818RAF	264	KLC271818A	282	KLP114818A	275	KLPF173618	264	KLST501824RFF	278
KL174824LAF	264	KLC271818LH	282	KLP114824A	275	KLPF173624	264	KLST502418LBBF	278
KL174824RAF	264	KLC271818RH	282	KLP172424CT	264, 275	KLPGK	272	KLST502418LFF	278
KL176018LAF	264	KLC272418A	282	KLP174818LAF	264	KLPST501818LBBF	278	KLST502418RBBF	278
KL176018RAF	264	KLC351818A	282	KLP174818RAF	264	KLPST501818LFF	278	KLST502418RFF	278
KL241518MBF	263	KLC351818LH	282	KLP174824LAF	264	KLPST501818RBBF	278	KLST502424LBBF	278
KL241818A	266	KLC351818RH	282	KLP174824RAF	264	KLPST501818RFF	278	KLST502424LFF	278
KL241818BF	263	KLC352418A	282	KLP176018LAF	264	KLPST501824LBBF	278	KLST502424RBBF	278
KL241824A	266	KLC421818A	282	KLP176018RAF	264	KLPST501824LFF	278	KLST502424RFF	278
KL241824BF	263	KLC421818LH	282	KLP241818A	266	KLPST501824RBBF	278	KLST571818LBBF	279
KL242418A	266	KLC421818RH	282	KLP241818BF	266	KLPST501824RFF	278	KLST571818LFF	279
KL242424A	266	KLC422418A	282	KLP241824A	266	KLPST502418LBBF	278	KLST571818RBBF	279
KL243018A	266	KLCB1730	264	KLP241824BF	263	KLPST502418LFF	278	KLST571818RFF	279
KL243018BF	265	KLCB1736	264	KLP242418A	266	KLPST502418RBBF	278	KLST571824LBBF	279
KL243024A	266	KLCB2418	263	KLP242424A	266	KLPST502418RFF	278	KLST571824LFF	279
KL243024BF	265	KLCB2430	265	KLP243018A	266	KLPST502424LBBF	278	KLST571824RBBF	279
KL243618A	266	KLCB2436	265	KLP243018BF	265	KLPST502424LFF	278	KLST571824RFF	279
KL243618E	265	KLCB2815	263	KLP243024A	266	KLPST502424RBBF	278	KLST572418LBBF	279
KL243618N	266	KLCB2818	263	KLP243024BF	265	KLPST502424RFF	278	KLST572418LFF	279
KL243624A	266	KLCB2824	267	KLP243618A	266	KLPST571818LBBF	279	KLST572418RBBF	279
KL243624E	265	KLCB2830	267	KLP243618E	265	KLPST571818LFF	279	KLST572418RFF	279
KL243624N	266	KLCB2836	267	KLP243618N	266	KLPST571818RBBF	279	KLST572424LBBF	279
KL244818LAF	265	KLCC	272	KLP243624A	266	KLPST571818RFF	279	KLST572424LFF	279
KL244818N	266	KLCW218	272	KLP243624E	265	KLPST571824LBBF	279	KLST572424RBBF	279
KL244818RAF	265	KLCW224	272	KLP243624N	266	KLPST571824LFF	279	KLST572424RFF	279
KL244824LAF	265	KLF173018	264	KLP244818LAF	265	KLPST571824RBBF	279	KL421218L	277
KL244824N	266	KLF173024	264	KLP244818N	266	KLPST571824RFF	279	KL421218R	277
KL244824RAF	265	KLF173618	264	KLP244818RAF	265	KLPST572418LBBF	279	KL421224L	277
KL246018LAF	265	KLF173624	264	KLP244824LAF	265	KLPST572418LFF	279	KL421224R	277
KL246018RAF	265	KL GK	272	KLP244824N	266	KLPST572418RBBF	279	KL501218L	277
KL246024LAF	265	KLH3548A	287	KLP244824RAF	265	KLPST572418RFF	279	KL501218R	277
KL246024RAF	265	KLH3548H	287	KLP246018LAF	265	KLPST572424LBBF	279	KL501224L	277
KL247218LAF	265	KLH3548N	287	KLP246018RAF	265	KLPST572424LFF	279	KL501224R	277
KL247218RAF	265	KLH3560A	287	KLP246024LAF	265	KLPST572424RBBF	279	KL501824LBBF	278
KL247224LAF	265	KLH3560H	287	KLP246024RAF	265	KLPST572424RFF	279	KL501824LFF	278
KL247224RAF	265	KLH3560N	287	KLP247218LAF	265	KLPST572424RBBF	279	KL501824RBBF	278
KL281518BBF	263	KLH3566A	287	KLP247218RAF	265	KLPST572424RFF	279	KL501824RFF	278
KL281518FF	263	KLH3566H	287	KLP247224LAF	265	KLPST572424RBBF	279	KL502424LBBF	278
KL281524BBF	263	KLH3566N	287	KLP247224RAF	265	KLPST572424RFF	279	KL502424LFF	278
KL281524FF	263	KLH3572A	287	KLP281518BBF	263	KLPST501218L	277	KL502424RBBF	278
KL281530BBF	263	KLH3572H	287	KLP281518FF	263	KLPST501218R	277	KL502424RFF	278
KL281530FF	263	KLH3572N	287	KLP281524BBF	263	KLPST501224L	277	KL571218L	277
KL281818A	263	KLH3584A	287	KLP281524FF	263	KLPST501224R	277	KL571218R	277
KL281818BBF	263	KLH3584H	287	KLP281530BBF	263	KLPST501824LBBF	278	KL571224L	277
KL281818FF	263	KLH3584N	287	KLP281530FF	263	KLPST501824LFF	278	KL571224R	277
KL281824A	263	KLH4248A	287	KLP281818A	263	KLPST501824RBBF	278	KL571224RFF	277
KL281824BBF	263	KLH4248H	287	KLP281818BBF	263	KLPST501824RFF	278	KL571824LBBF	279
KL281824FF	263	KLH4248N	287	KLP281818FF	263	KLPST502424LBBF	278	KL571824RBBF	279
KL281830BBF	263	KLH4260A	287	KLP281824A	263	KLPST502424LFF	278	KL571824RFF	279
KL281830FF	263	KLH4260H	287	KLP281824BBF	263	KLPST502424RBBF	278	KL572424LBBF	279
KL282418A	268	KLH4260N	287	KLP281824FF	263	KLPST502424RFF	278	KL572424LFF	279
KL282418BBF	267	KLH4266A	287	KLP281830BBF	263	KLPST571218L	277	KL572424RBBF	279
KL282424A	268	KLH4266H	287	KLP281830FF	263	KLPST571218R	277	KL572424RFF	279

INDEX





# Cross Reference Index

by Model Number

Model	Page	Model	Page	Model	Page	Model	Page	Model	Page
WTKTFT5H30-LA	232	WKWC2414-SH	222	WKYST502418LBBF	221	WKYT571818RBBF	218	YPCF223018LOHAT	52.7
WTKTFT5H36-FA	232	WKWC3014-SH	222	WKYST502418LFF	221	WKYT571818RFF	218	YPCF223018O	51
WTKTFT5H36-LA	232	WKWSCW3018	205	WKYST502418RBBF	221	WKYT571824L	218	YPCF223018OFL	52.3
WTKTFT5H42-FA	232	WKWSCW3024	205	WKYST502418RFF	221	WKYT571824LBBF	218	YPCF223018OFM	52.1
WTKTFT5H42-LA	232	WKWSCW3618	205	WKYST502424LBBF	221	WKYT571824LFF	218	YPCF223018ROHAT	52.7
WTKTFT5H48-FA	232	WKWSCW3624	205	WKYST502424LFF	221	WKYT571824R	224	YPCF223024BFL	52
WTKTFT5H48-LA	232	WKWSCW4218	205	WKYST502424RBBF	221	WKYT571824RBBF	218	YPCF223024BFFM	51
WTKTFT5H54-FA	232	WKWSCW4224	205	WKYST502424RFF	221	WKYT571824RFF	218	YPCF223024O	51
WTKTFT5H54-LA	232	WKWSCW4818	205	WKYST571818LBBF	219	WKYT5724218	218	YPCF223618BFL	52
WTKTFT5H60-FA	232	WKWSCW4824	205	WKYST571818LFF	219	WKYT5724218LBBF	220	YPCF223618BFFM	51
WTKTFT5H60-LA	232	WKWSCW5418	205	WKYST571818RBBF	219	WKYT5724218LFF	220	YPCF223618BOL	52.3
WTKTFT5H66-FA	232	WKWSCW5424	205	WKYST571818RFF	219	WKYT5724218RBBF	220	YPCF223618BOM	52.1
WTKTFT5H66-LA	232	WKWSCW6018	205	WKYST571824LBBF	219	WKYT5724218RFF	220	YPCF223618BFOL	52.3
WTKTFT5H72-FA	232	WKWSCW6024	205	WKYST571824LFF	219	WKYT572424	225	YPCF223618BFOM	52.1
WTKTFT5H72-LA	232	WKWSCW6618	205	WKYST571824RBBF	219	WKYT572424LBBF	220	YPCF223618LOHAT	52.7
WTKTFT5H78-FA	232	WKWSCW6624	205	WKYST571824RFF	219	WKYT572424LFF	220	YPCF223618O	51
WTKTFT5H78-LA	232	WKWSCW7218	205	WKYST572418LBBF	221	WKYT572424RBBF	220	YPCF223618OFL	52.3
WTKTFT5H84-FA	232	WKWSCW7224	205	WKYST572418LFF	221	WKYT572424RFF	220	YPCF223618OFM	52.1
WTKTFT5H84-LA	232	WKWSCW7818	205	WKYST572418RBBF	221	WKYT651218L	223	YPCF223618RBFOL	52.3
WTKTFT5H90-FA	232	WKWSCW7824	205	WKYST572418RFF	221	WKYT651218R	223	YPCF223618RBFOM	52.1
WTKTFT5H90-LA	232	WKWSCW8418	205	WKYST572424LBBF	221	WKYT651224L	223	YPCF223618ROHAT	52.7
WTKTFT5H96-FA	232	WKWSCW8424	205	WKYST572424LFF	221	WKYT651224R	223	YPCF223624BFL	52
WTKTFT5H96-LA	232	WKWSCW9018	205	WKYST572424RBBF	221	WKYT651818L	224	YPCF223624BFFM	51
WTKTGT4H30-FA	231	WKWSCW9024	205	WKYST572424RFF	221	WKYT651818LBBF	218	YPCF223624O	51
WTKTGT4H30-LA	231	WKWSCW9618	205	WKYST571824LBBF	219	WKYT651818LFF	218	YPCF224218BFL	52
WTKTGT4H36-FA	231	WKWSCW9624	205	WKYST651818LBBF	219	WKYT651818R	224	YPCF224218BFFM	51
WTKTGT4H36-LA	231	WKWSCWFD1818	206	WKYST651818RBBF	219	WKYT651818RBBF	218	YPCF224218BOL	52.3
WTKTGT4H42-FA	231	WKWSCWFD1824	206	WKYST651818RFF	219	WKYT651818RFF	218	YPCF224218BOM	52.1
WTKTGT4H42-LA	231	WKWSCWFD3018	206	WKYST651824LBBF	219	WKYT651824L	224	YPCF224218BFOL	52
WTKTGT4H48-FA	231	WKWSCWFD3024	206	WKYST651824LFF	219	WKYT651824LBBF	218	YPCF224218BFOM	51
WTKTGT4H48-LA	231	WKWSCWFD3618	206	WKYST651824RBBF	219	WKYT651824LFF	218	YPCF224218LOHAT	52.7
WTKTGT4H54-FA	231	WKWSCWFD3624	206	WKYST651824RFF	219	WKYT651824R	224	YPCF224218O	51
WTKTGT4H54-LA	231	WKWSCWFD4218	206	WKYST652418LBBF	221	WKYT651824RBBF	218	YPCF224218OFL	52.3
WTKTGT4H60-FA	231	WKWSCWFD4224	206	WKYST652418LFF	221	WKYT651824RFF	218	YPCF224218OFM	52.1
WTKTGT4H60-LA	231	WKWSCWFD4818	206	WKYST652418RBBF	221	WKYT652418	225	YPCF224218RBFOL	52
WTKTGT4H66-FA	231	WKWSCWFD4824	206	WKYST652418RFF	221	WKYT652418LBBF	220	YPCF224218RBFOM	51
WTKTGT4H66-LA	231	WKWSCWFD5418	206	WKYST652424LBBF	221	WKYT652418LFF	220	YPCF224218ROHAT	52.7
WTKTGT4H72-FA	231	WKWSCWFD5424	206	WKYST652424LFF	221	WKYT652418RBBF	220	YPCF224224BFL	52
WTKTGT4H72-LA	231	WKWSCWFD6018	206	WKYST652424RBBF	221	WKYT652418RFF	220	YPCF224224BFFM	51
WTKTGT4H78-FA	231	WKWSCWFD6024	206	WKYST721818LBBF	219	WKYT652424	225	YPCF224224BFOL	52
WTKTGT4H78-LA	231	WKWSCWFD6618	206	WKYST721818LFF	219	WKYT652424LBBF	220	YPCF224224LBFFOM	51
WTKTGT4H84-FA	231	WKWSCWFD6624	206	WKYST721818RBBF	219	WKYT652424RBBF	220	YPCF224224RBFOL	52
WTKTGT4H84-LA	231	WKWSCWFD7218	206	WKYST721818RFF	219	WKYT652424RFF	220	YPCF224224RBFOM	51
WTKTGT4H90-FA	231	WKWSCWFD7224	206	WKYST721824LBBF	219	WKYT721218L	223	YPCF224818LBFOL	52
WTKTGT4H90-LA	231	WKWSCWFD7818	206	WKYST721824LFF	219	WKYT721218R	223	YPCF224818LBFOLHAT	52.3
WTKTGT4H96-FA	231	WKWSCWFD7824	206	WKYST721824RBBF	219	WKYT721224L	223	YPCF224818LBFOLHAT	51
WTKTGT4H96-LA	231	WKWSCWFD8418	206	WKYST721824RFF	219	WKYT721224R	223	YPCF224818LBFOMHAT	52.1
WTKTGT5H30-FA	232	WKWSCWFD8424	206	WKYST722418LBBF	221	WKYT721818L	224	YPCF224818RBFOL	52
WTKTGT5H30-LA	232	WKWSCWFD9018	206	WKYST722418LFF	221	WKYT721818LBBF	218	YPCF224818RBFOLHAT	52.3
WTKTGT5H36-FA	232	WKWSCWFD9024	206	WKYST722418RBBF	221	WKYT721818LFF	218	YPCF224818RBFOM	51
WTKTGT5H36-LA	232	WKWSCWFD9618	206	WKYST722418RFF	221	WKYT721818R	224	YPCF224818RBFOMHAT	52.1
WTKTGT5H42-FA	232	WKWSD6024	212	WKYST722424LBBF	221	WKYT721818RBBF	218	YPCF224824LBFOL	52
WTKTGT5H42-LA	232	WKWSD6030	212	WKYST722424LFF	221	WKYT721818RFF	218	YPCF224824LBFFOM	51
WTKTGT5H48-FA	232	WKWSD6624	212	WKYST722424RBBF	221	WKYT721824L	224	YPCF224824RBFOL	52
WTKTGT5H48-LA	232	WKWSD6630	212	WKYST722424RFF	221	WKYT721824LBBF	218	YPCF224824RBFOM	51
WTKTGT5H54-FA	232	WKWSD7224	212	WKYT421218L	223	WKYT721824LFF	218	YPCF226018LBFOL	52
WTKTGT5H54-LA	232	WKWSD7230	212	WKYT421218R	223	WKYT721824R	224	YPCF226018LBFOLHAT	52.3
WTKTGT5H60-FA	232	WKWSD7224	212	WKYT421224L	223	WKYT721824RBBF	218	YPCF226018LBFOM	51
WTKTGT5H60-LA	232	WKWSDPT1818	205	WKYT421224R	223	WKYT721824RFF	218	YPCF226018LBFOMHAT	52.1
WTKTGT5H66-FA	232	WKWSDPT1824	205	WKYT421818L	224	WKYT722418	225	YPCF226018RBFOL	52
WTKTGT5H66-LA	232	WKWSDPT1818	205	WKYT421818R	224	WKYT722418LBBF	220	YPCF226018RBFOLHAT	52.3
WTKTGT5H72-FA	232	WKWSDS6024	212	WKYT421824L	224	WKYT722418LFF	220	YPCF226018RBFOM	51
WTKTGT5H72-LA	232	WKWSDS6030	212	WKYT421824R	224	WKYT722418RBBF	220	YPCF226024LBFOL	52
WTKTGT5H78-FA	232	WKWSDS6624	212	WKYT4222418	225	WKYT722418RFF	220	YPCF226024LBFFOM	51
WTKTGT5H78-LA	232	WKWSDS6630	212	WKYT4222424	213	WKYT722424	225	YPCF226024LBFFOM	51
WTKTGT5H84-FA	232	WKWSDS7224	212	WKYT501218L	223	WKYT722424LBBF	220	YPCF226024RBFOL	52
WTKTGT5H84-LA	232	WKWSDS7230	212	WKYT501218R	223	WKYT722424LFF	220	YPCF226024RBFOM	51
WTKTGT5H90-FA	232	WKWSDS7224	212	WKYT501224L	223	WKYT722424RBBF	220	YPCF227218LBFOL	52
WTKTGT5H90-LA	232	WKWSDS7230	212	WKYT501224R	223	WKYT722424RFF	220	YPCF227218LBFOLHAT	52.3
WTKTGT5H96-FA	232	WKWSDPT1818	205	WKYT501818L	224	WKYT723018	226	YPCF227218LBFOM	51
WTKTGT5H96-LA	232	WKWSDPT1824	205	WKYT501818R	224	WKYT723018LFF	226	YPCF227218LBFOMHAT	52.1
WTKTGT5H96-LA	232	WKWSDS3024	213	WKYT501824L	224	WKYT723018RFF	226	YPCF227218RBFOL	52
WTKTGT5H96-LA	232	WKWSDS3030	213	WKYT501824R	224	WKYT723024	226	YPCF227218RBFOLHAT	52.3
WTKTGT5H96-LA	232	WKWSDS3624	213	WKYT501818L	224	WKYT723024LFF	226	YPCF227218RBFOM	51
WTKTGT5H96-LA	232	WKWSDS3630	213	WKYT501818R	224	WKYT723024RFF	226	YPCF227224LBFOL	52
WTKTGT5H96-LA	232	WKWSDS4224	213	WKYT501818RBBF	218	YPCABD02	54	YPCF227224LBFFOM	51
WTKTGT5H96-LA	232	WKWSDS4230	213	WKYT501818RFF	218	YPCABD10	54	YPCF227224RBFOL	52
WTKTGT5H96-LA	232	WKWSDS4824	213	WKYT501824LBBF	218	YPCACW25	54	YPCF227224RBFOM	51
WTKTGT5H96-LA	232	WKWSDS4830	213	WKYT501824LFF	218	YPCACW35	54	YPCF227224RBFOM	51
WTKTGT5H96-LA	232	WKWSDS4830	213	WKYT501824RBBF	218	YPCACW50	54	YPCF227224RBFOM	51
WTKTGT5H96-LA	232	WKWSDS5424	213	WKYT501824RFF	218	YPCACW65	54	YPCF227224RBFOM	51
WTKTGT5H96-LA	232	WKWSDS5430	213	WKYT501824RFF	218	YPCAFD02	54, 102	YPCF227224RBFOM	51
WTKTGT5H96-LA	232	WKWSDS6024	213	WKYT502418LBBF	220	YPCAFD10	54, 102	YPCF227224RBFOM	51
WTKTGT5H96-LA	232	WKWSDS6030	213	WKYT502418LFF	220	YPCAFR12	54	YPCF227224RBFOM	51
WTKTGT5H96-LA	232	WKWSDS6624	212	WKYT502418RBBF	220	YPCAFR15	54	YPCF227224RBFOM	51
WTKTGT5H96-LA	232	WKWSDS6630	212	WKYT502418RFF	220	YPCF222418BFL	52	YPCF227224RBFOM	51
WTKTGT5H96-LA	232	WKWSDS7224	212	WKYT502418RFF	220	YPCF222418BOL	52.3	YPCF227224RBFOM	51
WTKTGT5H96-LA	232	WKWSDS7230	212	WKYT502424LBBF	220	YPCF222418BOM	52.1	YPCF227224RBFOM	51
WTKTGT5H96-LA	232	WKWSDS7224	212	WKYT502424LFF	220	YPCF222418O	51	YPCF227224RBFOM	51
WTKTGT5H96-LA	232	WKWSDS7230	212	WKYT502424RBBF	220	YPCF222418OFL	52.3	YPCF227224RBFOM	51
WTKTGT5H96-LA	232	WKWSDS7224	212	WKYT502424RFF	220	YPCF222418OFM	52.1	YPCF227224RBFOM	51
WTKTGT5H96-LA	232	WKWSDS7230	212	WKYT502424RFF	220	YPCF222418OFL	52.3	YPCF227224RBFOM	51
WTKTGT5H96-LA	232	WKWSDS7224	212	WKYT502424RFF	220	YPCF222418OFL	52.3	YPCF227224RBFOM	51
WTKTGT5H96-LA	232	WKWSDS7230	212	WKYT502424RFF	220	YPCF222418OFL	52.3	YPCF227224RBFOM	51
WTKTGT5H96-LA	232	WKWSDS7224	212	WKYT502424RFF	220	YPCF222418OFL	52.3	YPCF227224RBFOM	51
WTKTGT5H96-LA	232	WKWSDS7230	212	WKYT502424RFF	220	YPCF222418OFL	52.3	YPCF227224RBFOM	51
WTKTGT5H96-LA	232	WKWSDS7224	212	WKYT502424RFF	220	YPCF222418OFL	52.3	YPCF227224RBFOM	51
WTKTGT5H96-LA	232	WKWSDS7230	212	WKYT502424RFF	220	YPCF222418OFL	52.3	YPCF227224RBFOM	51
WTKTGT5H96-LA	232	WKWSDS7224	212	WKYT502424RFF	220	YPCF222418OFL	52.3	YPCF227224RBFOM	51
WTKTGT5H96-LA	232	WKWSDS7230	212	WKYT502424RFF	220	YPCF222418OFL	52.3	YPCF227224RBFOM	51
WTKTGT5H96-LA	232	WKWSDS7224	212	WKYT502424RFF	220	YPCF222418OFL	52.3	YPCF227224RBFOM	51
WTKTGT5H96-LA	232	WKWSDS7230	212	WKYT502424RFF	220	YPCF222418OFL	52.3	YPCF227224RBFOM	51
WTKTGT5H96-LA	232	WKWSDS7224	212	WKYT502424RFF	220	YPCF222418OFL	52.3	YPCF227224RBFOM	51
WTKTGT5H96-LA	232	WKWSDS723							

# Cross Reference Index

by Model Number

Model	Page	Model	Page	Model	Page	Model	Page	Model	Page
YPCLP501218LM	75.1	YPCP224224LBFO	50	YPPFF221524BFL	47	YPTF651824RFFL	66	YPTSF571824RFFL	66
YPCLP501218RL	75.2	YPCP224224LBFOM	49	YPPFF221524BFL	46	YPTF651824RFFM	65	YPTSF571824RFFM	65
YPCLP501218RM	75.1	YPCP2242240	49	YPPM211530BFL	45	YPTF652424LBBFL	61	YPTSF572424LBBFL	62
YPCLP502418LL	77	YPCP22422424RBFOL	50	YPPM211530BFL	44	YPTF652424LBBFOM	59	YPTSF572424LBBFOM	60
YPCLP502418RL	77	YPCP22422424RBFOL	49	YPPM211524BFL	45	YPTF652424LFFL	61	YPTSF572424LFFL	62
YPCLP651218LL	75.2	YPCP224818LBFOL	50	YPPM211524BFL	44	YPTF652424LFFM	59	YPTSF572424LFFM	60
YPCLP651218RL	75.2	YPCP224818LBFOLHAT	52.4	YPPM211530BFL	45	YPTF652424RBBFL	61	YPTSF572424RBBFL	62
YPCLP652418LL	77	YPCP224818LBFOM	49	YPPM211530BFL	44	YPTF652424RBBFOM	59	YPTSF572424RBBFOM	60
YPCLP652418RL	77	YPCP224818LBFOMHAT	52.2	YPPM271518BFL	45	YPTF652424RFFL	61	YPTSF572424RFFL	62
YPCLP652418RM	76	YPCP224818RBFOL	50	YPPM271518BFL	44	YPTF652424RFFM	59	YPTSF572424RFFM	60
YPCM222418BFL	52.6	YPCP224818RBFOLHAT	52.4	YPPM271518FFL	45	YPTM421824LFFL	68	YPTSF651824LFFL	66
YPCM222418BFL	52.6	YPCP224818RBFOM	49	YPPM271518FFM	44	YPTM421824LFFM	67	YPTSF651824LFFM	65
YPCM222418BOL	52.6	YPCP224818RBFOMHAT	52.2	YPPM271524BFL	45	YPTM421824RFFL	68	YPTSF651824RFFL	66
YPCM222418BOM	52.5	YPCP224824LBFO	50	YPPM271524BFL	44	YPTM421824RFFM	67	YPTSF651824RFFM	65
YPCM222418OFL	52.6	YPCP224824LBFOM	49	YPPM271524FFL	45	YPTM501824LFFL	68	YPTSF652424LBBFL	62
YPCM222418OFM	52.5	YPCP224824RBFOL	50	YPPM271524FFM	44	YPTM501824LFFM	67	YPTSF652424LBBFOM	60
YPCM223018BFL	52.6	YPCP224824RBFOM	49	YPPM271530BFL	45	YPTM501824RFFL	68	YPTSF652424LFFL	62
YPCM223018BFL	52.5	YPCP224824RBFOMHAT	52.2	YPPM271530BFL	44	YPTM501824RFFM	67	YPTSF652424LFFM	60
YPCM223018BOL	52.6	YPCP226018LBFOL	50	YPPM271530FFL	45	YPTM571824LFFL	68	YPTSF652424RBBFL	62
YPCM223018BOM	52.5	YPCP226018LBFOLHAT	52.4	YPPM271530FFM	44	YPTM571824LFFM	67	YPTSF652424RBBFOM	60
YPCM223018OFL	52.6	YPCP226018RBFOL	50	YPPSF281518BFL	47	YPTM571824RFFL	68	YPTSF652424RFFL	62
YPCM223018OFM	52.5	YPCP226018RBFOLHAT	52.4	YPPSF281518BFL	46	YPTM571824RFFM	67	YPTSF652424RFFM	60
YPCM223618BFL	52.6	YPCP226018RBFOM	49	YPPSF281518FFL	47	YPTM651824LFFL	68	YPTSM421824LFFL	68
YPCM223618BFL	52.5	YPCP226018RBFOMHAT	52.2	YPPSF281518FFM	46	YPTM651824LFFM	67	YPTSM421824LFFM	65
YPCM223618BOL	52.6	YPCP226024LBFO	50	YPPSF281524BFL	45	YPTM651824RFFL	68	YPTSM421824RFFL	66
YPCM223618BOM	52.5	YPCP226024LBFOM	49	YPPSF281524BFL	44	YPTM651824RFFM	67	YPTSM421824RFFM	65
YPCM223618BOL	52.6	YPCP226024RBFOL	50	YPPSF281524FFL	46	YPTM651824RFFM	67	YPTSM421824RFFM	65
YPCM223618BOM	52.5	YPCP226024RBFOM	49	YPPSF281524FFM	45	YPTM651824RFFM	67	YPTSM421824RFFM	65
YPCM223618BOL	52.6	YPCP227218LBFOL	50	YPPSF281530BFL	46	YPTM651824RFFM	67	YPTSM421824RFFM	65
YPCM223618BOM	52.5	YPCP227218LBFOLHAT	52.4	YPPSF281530BFL	45	YPTM651824RFFM	67	YPTSM421824RFFM	65
YPCM223618OFL	52.6	YPCP227218RBFOL	50	YPPSF281530FFL	47	YPTM651824RFFM	67	YPTSM421824RFFM	65
YPCM223618OFM	52.5	YPCP227218RBFOLHAT	52.4	YPPSF281530FFM	46	YPTM651824RFFM	67	YPTSM421824RFFM	65
YPCM223618RBFOL	52.6	YPCP227218RBFOM	49	YPPSF281530FFM	45	YPTM651824RFFM	67	YPTSM421824RFFM	65
YPCM223618RBFOM	52.5	YPCP227218RBFOMHAT	52.2	YPPSF281530FFM	44	YPTM651824RFFM	67	YPTSM421824RFFM	65
YPCM224218BFL	52.6	YPCP227218RBFOLHAT	52.4	YPPSF281530FFM	44	YPTM651824RFFM	67	YPTSM421824RFFM	65
YPCM224218BFL	52.5	YPCP227218RBFOM	49	YPPSF281530FFM	43	YPTM651824RFFM	67	YPTSM421824RFFM	65
YPCM224218BOL	52.6	YPCP227218RBFOMHAT	52.2	YPPSF281530FFM	42	YPTM651824RFFM	67	YPTSM421824RFFM	65
YPCM224218BOM	52.5	YPCP227218RBFOL	50	YPPSF281530FFM	41	YPTM651824RFFM	67	YPTSM421824RFFM	65
YPCM224218BOL	52.6	YPCP227224LBFO	49	YPPSF281530FFM	40	YPTM651824RFFM	67	YPTSM421824RFFM	65
YPCM224218BOM	52.5	YPCP227224LBFOM	48	YPPSF281530FFM	39	YPTM651824RFFM	67	YPTSM421824RFFM	65
YPCM224218BOL	52.6	YPCP227224RBFOL	50	YPPSF281530FFM	38	YPTM651824RFFM	67	YPTSM421824RFFM	65
YPCM224218BOM	52.5	YPCP227224RBFOM	49	YPPSF281530FFM	37	YPTM651824RFFM	67	YPTSM421824RFFM	65
YPCM224218OFL	52.6	YPCP2282418O	56	YPPSF281530FFM	36	YPTM651824RFFM	67	YPTSM421824RFFM	65
YPCM224218OFM	52.5	YPCP2283018O	56	YPPSF281530FFM	35	YPTM651824RFFM	67	YPTSM421824RFFM	65
YPCM224218OFL	52.6	YPCP2283618O	56	YPPSF281530FFM	34	YPTM651824RFFM	67	YPTSM421824RFFM	65
YPCM224218OFM	52.5	YPDLF421218LL	73	YPPULL2	53, 233	YPTM651824RFFM	67	YPTSM421824RFFM	65
YPCM224218RBFOL	52.6	YPDLF421218LL	72	YPPULL3	53, 233	YPTM651824RFFM	67	YPTSM421824RFFM	65
YPCM224218RBFOM	52.5	YPDLF421218RL	73	YPPQLF422418LL	75	YPTM651824RFFM	67	YPTSM421824RFFM	65
YPCP222418BFL	50	YPDLF421218RL	72	YQQLF422418LL	74	YPTM651824RFFM	67	YPTSM421824RFFM	65
YPCP222418BFL	49	YDPLF651218LL	72	YQQLF422418RL	75	YPTM651824RFFM	67	YPTSM421824RFFM	65
YPCP222418BOL	52.4	YDPLF651218RL	72	YQQLF422418RL	74	YPTM651824RFFM	67	YPTSM421824RFFM	65
YPCP222418BOM	52.2	YDPLF652418LL	73	YQQLF652418LL	75	YPTM651824RFFM	67	YPTSM421824RFFM	65
YPCP222418OFL	52.4	YDPLF652418RL	73	YQQLF652418LL	74	YPTM651824RFFM	67	YPTSM421824RFFM	65
YPCP222418OFM	52.2	YDPLP651218LL	73	YQQLF652418RL	75	YPTM651824RFFM	67	YPTSM421824RFFM	65
YPCP222424BFL	50	YDPLP651218RL	72	YQQLP422418LL	75	YPTM651824RFFM	67	YPTSM421824RFFM	65
YPCP222424BFL	49	YDPLP651218RL	73	YQQLP422418LL	74	YPTM651824RFFM	67	YPTSM421824RFFM	65
YPCP222424OFL	49	YDPLP651218RL	72	YQQLP422418RL	75	YPTM651824RFFM	67	YPTSM421824RFFM	65
YPCP222424OFL	49	YDPLP651218RL	73	YQQLP422418RL	74	YPTM651824RFFM	67	YPTSM421824RFFM	65
YPCP222424BFL	49	YDPLP651218RL	72	YQQLP422418RL	73	YPTM651824RFFM	67	YPTSM421824RFFM	65
YPCP222424BFL	49	YDPLP651218RL	73	YQQLP422418RL	72	YPTM651824RFFM	67	YPTSM421824RFFM	65
YPCP222424OFL	49	YDPLP651218RL	72	YQQLP422418RL	71	YPTM651824RFFM	67	YPTSM421824RFFM	65
YPCP222424OFL	49	YDPLP651218RL	73	YQQLP422418RL	70	YPTM651824RFFM	67	YPTSM421824RFFM	65
YPCP222424BFL	49	YDPLP651218RL	72	YQQLP422418RL	69	YPTM651824RFFM	67	YPTSM421824RFFM	65
YPCP222424BFL	49	YDPLP651218RL	73	YQQLP422418RL	68	YPTM651824RFFM	67	YPTSM421824RFFM	65
YPCP222424OFL	49	YDPLP651218RL	72	YQQLP422418RL	67	YPTM651824RFFM	67	YPTSM421824RFFM	65
YPCP222424OFL	49	YDPLP651218RL	73	YQQLP422418RL	66	YPTM651824RFFM	67	YPTSM421824RFFM	65
YPCP222424BFL	49	YDPLP651218RL	72	YQQLP422418RL	65	YPTM651824RFFM	67	YPTSM421824RFFM	65
YPCP222424BFL	49	YDPLP651218RL	73	YQQLP422418RL	64	YPTM651824RFFM	67	YPTSM421824RFFM	65
YPCP222424OFL	49	YDPLP651218RL	72	YQQLP422418RL	63	YPTM651824RFFM	67	YPTSM421824RFFM	65
YPCP222424OFL	49	YDPLP651218RL	73	YQQLP422418RL	62	YPTM651824RFFM	67	YPTSM421824RFFM	65
YPCP222424BFL	49	YDPLP651218RL	72	YQQLP422418RL	61	YPTM651824RFFM	67	YPTSM421824RFFM	65
YPCP222424BFL	49	YDPLP651218RL	73	YQQLP422418RL	60	YPTM651824RFFM	67	YPTSM421824RFFM	65
YPCP222424OFL	49	YDPLP651218RL	72	YQQLP422418RL	59	YPTM651824RFFM	67	YPTSM421824RFFM	65
YPCP222424OFL	49	YDPLP651218RL	73	YQQLP422418RL	58	YPTM651824RFFM	67	YPTSM421824RFFM	65
YPCP222424BFL	49	YDPLP651218RL	72	YQQLP422418RL	57	YPTM651824RFFM	67	YPTSM421824RFFM	65
YPCP222424BFL	49	YDPLP651218RL	73	YQQLP422418RL	56	YPTM651824RFFM	67	YPTSM421824RFFM	65
YPCP222424OFL	49	YDPLP651218RL	72	YQQLP422418RL	55	YPTM651824RFFM	67	YPTSM421824RFFM	65
YPCP222424OFL	49	YDPLP651218RL	73	YQQLP422418RL	54	YPTM651824RFFM	67	YPTSM421824RFFM	65
YPCP222424BFL	49	YDPLP651218RL	72	YQQLP422418RL	53	YPTM651824RFFM	67	YPTSM421824RFFM	65
YPCP222424BFL	49	YDPLP651218RL	73	YQQLP422418RL	52	YPTM651824RFFM	67	YPTSM421824RFFM	65
YPCP222424OFL	49	YDPLP651218RL	72	YQQLP422418RL	51	YPTM651824RFFM	67	YPTSM421824RFFM	65
YPCP222424OFL	49	YDPLP651218RL	73	YQQLP422418RL	50	YPTM651824RFFM	67	YPTSM421824RFFM	65
YPCP222424BFL	49	YDPLP651218RL	72	YQQLP422418RL	49	YPTM651824RFFM	67	YPTSM421824RFFM	65
YPCP222424BFL	49	YDPLP651218RL	73	YQQLP422418RL	48	YPTM651824RFFM	67	YPTSM421824RFFM	65
YPCP222424OFL	49	YDPLP651218RL	72	YQQLP422418RL	47	YPTM651824RFFM	67	YPTSM421824RFFM	65
YPCP222424OFL	49	YDPLP651218RL	73	YQQLP422418RL	46	YPTM651824RFFM	67	YPTSM421824RFFM	65
YPCP222424BFL	49	YDPLP651218RL	72	YQQLP422418RL	45	YPTM651824RFFM	67	YPTSM421824RFFM	65
YPCP222424BFL	49	YDPLP651218RL	73	YQQLP422418RL	44	YPTM651824RFFM	67	YPTSM421824RFFM	65
YPCP222424OFL	49	YDPLP651218RL	72	YQQLP422418RL	43	YPTM651824RFFM	67	YPTSM421824RFFM	65
YPCP222424OFL	49	YDPLP651218RL	73	YQQLP422418RL	42	YPTM651824RFFM	67	YPTSM421824RFFM	65
YPCP222424BFL	49	YDPLP651218RL	72	YQQLP422418RL	41	YPTM651824RFFM	67	YPTSM421824RFFM	65
YPCP222424BFL	49	YDPLP651218RL	73	YQQLP422418RL	40	YPTM651824RFFM	67	YPTSM421824RFFM	65
YPCP222424OFL	49	YDPLP651218RL	72	YQQLP422418RL	39	YPTM651824RFFM	67	YPTSM421824RFFM	65
YPCP222424OFL	49	YDPLP651218RL	73	YQQLP422418RL	38	YPTM651824RFFM	67	YPTSM421824RFFM	65
YPCP222424BFL	49	YDPLP651218RL	72	YQQLP422418RL	37	YPTM651824RFFM	67	YPTSM421824RFFM	65
YPCP222424BFL	49	YDPLP651218RL	73	YQQLP422418RL	36	YPTM651824RFFM	67	YPTSM421824RFFM	65
YPCP222424OFL	49	YDPLP651218RL	72	YQQLP422418RL	35	YPTM651824RFFM	67	YPTSM421824RFFM	65
YPCP222424OFL	49	YDPLP651218RL	73	YQQLP422418RL	34	YPTM651824RFFM	67	YPTSM421824RFFM	65
YPCP222424BFL	49	YDPLP651218RL	72						



Model	Page
YPWF501224RL.....	71
YPWF501224RM.....	70
YPWF651218LL.....	71
YPWF651218LM.....	70
YPWF651218RL.....	71
YPWF651218RM.....	70
YPWF651224LL.....	71
YPWF651224LM.....	70
YPWF651224RL.....	71
YPWF651224RM.....	70
YPWP421218LL.....	71
YPWP421218LM.....	69
YPWP421218RL.....	71
YPWP421218RM.....	69
YPWP421224LL.....	71
YPWP421224LM.....	69
YPWP421224RL.....	71
YPWP421224RM.....	69
YPWP501218LL.....	71
YPWP501218LM.....	69
YPWP501218RL.....	71
YPWP501218RM.....	69
YPWP501224LL.....	71
YPWP501224LM.....	69
YPWP501224RL.....	71
YPWP501224RM.....	69
YPWP651218LL.....	71
YPWP651218LM.....	69
YPWP651218RL.....	71
YPWP651218RM.....	69
YPWP651224LL.....	71
YPWP651224LM.....	69
YPWP651224RL.....	71
YPWP651224RM.....	69
YPWTAWSBKT18.....	70
YPWTAWSBKT24.....	70
YWC24Z.....	285
YWC30Z.....	285
YWC36Z.....	285
YWC42Z.....	285
YWC48Z.....	285
YWC60Z.....	285
Z2NM.....	117
Z2UP24.....	117
Z2UP30.....	117
Z2UP36.....	117
Z2UP42.....	117
Z2UP48.....	117
Z2UP60.....	117
Z4UP24.....	117
Z4UP30.....	117
Z4UP36.....	117
Z4UP42.....	117
Z4UP48.....	117
Z4UP60.....	117
Z5SC42.....	89, 215, 291
Z5SC48.....	89, 215, 291
Z5SC54.....	89, 215, 291
Z5SC60.....	89, 215, 291
Z5SC66.....	89, 215, 291
Z5SC72.....	89, 215, 291
Z5SC78.....	89, 215, 291
Z5SC84.....	89, 215
Z6LB.....	281, 291, 306
Z6PL40HP.....	88
Z617UWTRGH.....	234
Z636UWTRGH.....	234
Z61710UWTRGH.....	234
Z63610UWTRGH.....	234
ZHFPMK.....	284
ZS24.....	117
ZS30.....	117
ZS36.....	117
ZS42.....	117
ZS48.....	117
ZS60.....	117



Allsteel®

Allsteel Inc.  
Muscatine, Iowa 52761

[allsteeloffice.com](http://allsteeloffice.com)

Form #A8709.A12 (12/23)