

Desking & Benching

Price & Specification Guide 2024

Prices effective February 1, 2024

PDF updated May 9, 2024

All content marked in red signifies an update to the previous version of this price guide published on February 1, 2024.

Limited Lifetime Warranty

Our unwavering commitment to our customers compels us to care, and our dedication to quality is just one of the ways we show our customers how much they mean to us.

We recognize that keeping up with the pace of change requires having products that work as hard as the people who use them. That's why each of our products is rigorously tested and certified to meet the highest industry standards.

In the unlikely event that any Allsteel product or component covered by the Allsteel Warranty should fail under normal workplace use because of defective material or workmanship, Allsteel promises to fix it. Because taking care of *people* is how Allsteel takes care of business.

For information on Allsteel's warranty coverage, visit AllsteelOffice.com.

Government Support – GovernmentSupport@hniworkplacefurnishings.com
Product, Parts, Non-Warranty Parts Orders – ProductSupport@hniworkplacefurnishings.com
Quick Ship Orders – QuickShip@hniworkplacefurnishings.com
Order Status – OrderStatus@hniworkplacefurnishings.com
General Inquiries – GeneralSupport@hniworkplacefurnishings.com

- Software support packages furnished to the customer, either by Allsteel® or by another source, which support the sale of Allsteel products are superseded by printed price lists.
- Prices are subject to change without notice. All orders are subject to prices in effect at the time of order.
- Please refer to your Allsteel Dealer Sales and Discount Policies for order placement information, terms and conditions.

- Ordering information appears at the bottom of each product page complete with examples on how to specify. Fabric and finish pages are referenced at the bottom of product pages.

This publication is available as a downloadable PDF on Allsteel websites.

Questions or Comments?

Please call us at: **888-ALLSTEEL**
888-255-7833

Warranty	Inside Front Cover
New, Revised, and Discontinued Products	4
COM, Specials Policies, and Programs	5-9
Upholstery and Finishes	10-16
MURAL	
Finishes	18-21
Introduction to Mural	22
Statement of Line	23
Overview	24
Planning Guidelines	25-28
Working with Electrical	29-33
Fence	
Frame	34
Tiles	35
Connectors	36
Integrated Height-Adjustable Tables	
Worksurfaces	37-38
Bases	39
Wire Management	40
Cable Management	40.1
Privacy	
Screen Frames	41
Screens	42-48
No-Screen Kits	49
Privacy Panel	51
Bent Screen	51
Accessories	
Accessories	50-54
FURTHER	
Finishes	56
Typicals	57-58
Introduction to Further	59-60
Statement of Line	61-62
Planning Guidelines	63-71
Worksurfaces And Supports	
Working with Worksurfaces and Supports	72-89
Electrical & Data	
Working with Electrical and Data	90-102
Electrical Infeeds, Power Kits, and Components	103-104
Beam Mounted Wire Manager	105
Data Components	106
Collaborative Hub	
Working with Collaborative Hub	107
Collaborative Hub Components	108
Screens	
Working with Screens	109-110
Fabric Screens and Modesty Panels	111-112
Glass Screens	113
User Movable and Lateral Screens	114
Stride Benching Screens	116
Stride Lateral Divider Screens	118
Further Adaptive Metal Screens	119
Further Adaptive Tackboard Accessories	119-120
STORAGE — Laminated with Metal	
Working with Storage	121-122
Pedestals and Credenzas	124
Storage Towers	125
Adaptive	
Adaptive Typical	126
Adaptive Statement of Line	127
Working with Adaptive Worksurfaces and Supports	128-139
Working with Adaptive Electrical and Data	140-142
Controls and Electrical & Data Components	143-144
Working with Screens, Storage, and Extensions	145-146
UNIVERSAL SCREENS	
Finishes	148-149
Partnership Program Upholstery	150
Specification Details	151-154
Fabric Screens	
Beam Mounted Screens	155
Elevated Screens	156
Above/Below Screens	157
Lateral Screens	158-160
Adjustable HAT Screens	161
Modesty Screens	162
Sit-on-Surface Screens	163

Glass Screens	
Beam Mounted Screens	164
Elevated Screens	165
Above/Below Screens	166
Lateral Screens	167-168
Side Screens	169
Modesty Screens	170
Acrylic Screens	
Beam Mounted Screens	171
Elevated Screens	172
Above/Below Screens	173
Lateral Screens	174-175
Side Screens	176
Modesty Screens	177
Sit-on-Surface Screens	178
Laminate Screens	
Beam Mounted Screens	179
Elevated Screens	180
Above/Below Screens	181
Lateral Screens	182-183
Side Screens	184
Modesty Screens	185
Organizers	186
GALLERY PANELS	
Finishes	188
Working with Gallery Panels	189-198
Gallery Panels	199-204
Gallery Panels for Use with Glass	205-209
Further Connector Kits	210
Connector Kits	211
Panel Systems Gallery Glass	212-214
RADII	
Finishes	216
Pedestal Functionality with Work Tools	218
Freestanding and Mobile Pedestals	220-223
Pedestal Functionality with Work Tools	224-225
Undermount, L-Cube, and Work Tools	226
Undercabinet Pedestals and Caddy	227-228
Digital Lock Keys and Accessories	229
ALTITUDE	
Paint Finishes, Laminates, Eased Edge	232
Fabrics	233
Working with Height-Adjustable Tables	234-239.2
Screens and Power Module	240
Altitude - Metal Screens	241-242
Power Rail Specifications	243-249
Working with Electrical and Data	250-254
Working with Organization Rail & Accessories & Screens	255
Altitude Height-Adjustable Tops, Bases, & Accessories	256-261
Altitude - A6	256-257
Worksurfaces for Height-Adjustable Bases	258-260
Cable Management	261-261.3
Power Rail - Electrical Components	262-264
A8 Screen Kits	265
Metal Screens and Tackboard Accessories	266-267
Power Rails and Accessories	268-271
Worksurface Mounted Rail and Accessories	272
EXTENSIONS™	
Introduction	274
Working with Ergonomic Accessories	275-276
Working with Organization Tools	277-282
Working with Illumination	283-286
Power/Data Modules and Wire Management	287-287.4
ACCESSORIES	
Working with Pivot Monitor Arms	288-291
APPENDIX AND INDEX	
Locking Specifications and Appendix	292-293
Touch-Up Paint	294
FSC and Storage Features & Dimensions	295-296
Fabric Grades G-J and Upholstery Grades 9-23	297
Index	298-304

Desking & Benching

New, Revised, and Discontinued Products

GSA/FEDERAL CONTRACT INFORMATION:

Model numbers identified with the following verbiage “When purchased separately without a configurable TAA compliant end product, not on GSA contract” is to mean that these configurable parts or components:

- Have no functionality or capability without being integrated into an end product; and
- Are considered Open Market if purchased without a configurable TAA compliant end product.

ITEMS ON GSA CONTRACT

Please note, in order to verify if an item is on GSA Contract or is “Open Market,” please use Compass quoting which is updated in real time with all GSA contract changes. If you need additional assistance, please contact your local sales representative.

NEW

Further expansion with A- and H-Leg supports

NEW FINISHES

Studio Paints

- Ochre – P093
- Sienna – P092
- Cove – P096
- Harbor – P097
- Sage – P095
- Dune – P094

Stratawood Beigewood Maple SE878

Stratawood Field Elm Maple SE599

Stratawood Belair Maple SE934

Stratawood Florence Walnut ST579

Natural Florence Walnut NT579

Quarter Florence Walnut QT579

Fawn Cypress Rift Oak RF108

Belair LWBA

Field Elm LWFE

NEW TEXTILES

Livi with Supreen

Oxford with Supreen

Rush

NEW EXTENSIONS

AJTRGH24

AJTRGH36

DE-EMPHASIZED PRODUCTS

Hinged Wire Management Troughs for under Worksurfaces —
UN924HT, UN936HT, UN948HT — 6/30/2024

DE-EMPHASIZED FABRICS

Mica — 12/31/2024

Hamilton — 12/31/2024

Optic — 6/30/2024

Taylor — 6/30/2024

COM Program

Allsteel understands that customers may at times want to specify fabrics outside of Allsteel's standard fabric offering. Our COM program was designed to make specifying COMs on Allsteel products a simpler, friendlier, and hassle-free process. This process is simple and easy to use, and is described below under "Allsteel to Supply (ATS)." If a Dealer wishes to manage the COM process themselves, they can do so by following guidelines under "Dealer to Supply (DTS)". **ATS is the preferred method for all COM fabrics.** With ATS, Company will provide acknowledgment based upon planned date of receipt of COM fabric and manage the entire process. DTS is allowed if it is not a partnership fabric or if Company does not have access to the supplier. **DTS may cause order delays and is strongly discouraged.** Find out more about Allsteel's COM process by emailing our COM Department at allsteelcomteam@allsteeloffice.com.

Allsteel to Supply (ATS):

1. Select the fabric you wish to use and check the COM Search on our [Website](#) at: AllsteelOffice.com/Design Resources/Textiles & Finishes/COM Search or COM Search quick link. You will need to have the COM supplier's name, fabric pattern name, and color name to search for approved fabrics.
2. If your fabric is listed as an approved fabric, you may place your order directly with Allsteel Customer Support. Please use the fabric code (e.g., S216426XP) from the COM Test Request on your order in the place of the standard fabric code.

If your fabric is not listed as approved, you will need to select the "Request COM Test" link on the COM Search website. If your fabric is not listed as approved, and it is not a Partnership fabric you may request a "Dealer to Supply" code. Select the "Request COM Test" link on the COM Search website. Your name, company name and email will be prepopulated fields. The secondary email, project name, and bid/contract number are optional information. The supplier, pattern, and color will show a list by clicking in the box and entering the first letter of the name and these are free form text boxes. Once that information is entered click add. (Multiple series can be added to the same request if they are the same supplier, pattern, and color.) Then click submit.
3. An email will be sent to the to the requestor stating the COM Request was successfully submitted. Up to four emails could be received: Testing materials requested, in testing, and final approval/denial with price grade and fabric code. It's rare actual test yardage is required. Testing is mainly done by reviewing the attributes of the fabric. The testing process takes approximately 48 hours. Written COM price quotes hold pricing for 90 days after issue date.
4. Once the fabric has been approved by Allsteel, enter your order directly with Allsteel Customer Support. Allsteel will purchase all COM fabric directly from the COM suppliers and schedule for production.

In the event that the Dealer decides to cancel a COM fabric order, the Dealer is responsible for the cost of the fabric plus a handling charge that is equal to 10% of the fabric cost.

Dealer to Supply (DTS):

1. Select the fabric you wish to use and check the COM Search on our [Website](#) at: AllsteelOffice.com/Design Resources/Textiles & Finishes/COM Search or COM Search quick link. Or call Allsteel Customer Support to see if the fabric you have chosen has already been tested and approved on the product you are interested in.

You will need to have the COM supplier's name, fabric pattern name, and color name for this inquiry.
2. If your fabric is not listed as approved, and it is not a Partnership fabric you may request a "Dealer to Supply" code. Select the "Request COM Test" link on the COM Search website. Your name, company name and email will be prepopulated fields. The secondary email, project name, and bid/contract number are optional information. The supplier, pattern, and color will show a list by clicking in the box and entering the first letter of the name and these are free form text boxes. Once that information is entered click add. (Multiple series can be added to the same request if they are the same supplier, pattern, and color.) Then click submit.
3. An email will be sent to the to the requestor stating the COM Request was successfully submitted. Up to four emails could be received: Testing materials requested, in testing, and final approval/denial with price grade and fabric code. It's rare actual test yardage is required. Testing is mainly done by reviewing the attributes of the fabric. The testing process takes approximately 48 hours.
4. Make sure to use a "Dealer to Supply" COM code (e.g., S216426ZP) and place your order directly with Allsteel Customer Support.
5. All "Dealer to Supply" orders will be charged Grade 4 pricing for seating, Grade 3 for Gather, and Grade D pricing for panels. Dealers will pay for the COM fabric separately.
6. All "Dealer to Supply" fabric must be sent on a fabric roll. Estimate the yardage required by using the yardage requirements listed in the price list by model. For questions please contact Allsteel Customer Support.
7. Place your fabric order directly with the COM Supplier with instructions for the fabric to be sent on a fabric roll to:

HNI Textile Distribution Center

COM Production Yardage — PO Number

Docks 20-22
301 Mulberry Avenue
Muscatine, IA 52761

Information that **MUST** be included in the packing slip attached to the DTS fabric:

1. Dealer's Purchase Order number to Allsteel
2. Allsteel's Tracking number for the COM fabric
3. Dealer Name
4. Yards of Fabric

If the fabric shipment does not match the correct fabric and yardage, Allsteel will notify the Dealer for resolution.

If Allsteel receives fabric with incorrect labeling or fabric yardage that cannot be linked to an Allsteel furniture order, Allsteel will hold the fabric for up to 4 weeks. After 4 weeks Allsteel will dispose of the fabric. There are no exceptions to this policy.

Specific to DTS orders - The customer should send only the amount needed for the order. Excess yardage, or yardage not attached to an order will be disposed of at Allsteel's discretion.

Any canceled orders are subject to cancellation charges up to the full value of the Allsteel product canceled. Allsteel will determine the actual cancellation charge at the time the cancellation is requested.

8. For additional details on "Dealer to Supply" fabric refer to your Allsteel terms and conditions.

Additional Policy Information:

The company assumes no responsibility for the overall appearance, flammability, normal durability, colorfastness, or any other quality standards. The company reserves the right to reject a COM if the quality of the COM is not satisfactory for the product. Should this occur, the customer will be notified with an explanation when the issue is found.

The company is not responsible for fabric that has become obsolete at the COM supplier, that is of poor quality, or that is delivered late to the manufacturer from the COM supplier.

All cancellations or changes to COM orders are subject to Company approval. Because of the nature of COM, special fabrics, finishes, and structural modifications, products ordered as specials and then canceled prior to shipment are subject to cancellation costs up to the full value of the product canceled. The company determines the actual cancellation charge at the time the cancellation is requested. Upon approval, a cancellation number is issued to the Customer.

Purchase orders will not be accepted or entered unless the testing process is complete with positive results.

If all testing has been previously completed, re-testing is only necessary if fabric is to be used on a different product, or pattern direction has changed from that previously approved.

Previous test results can be obtained by a customer on the COM Search on [our Website](#) or by calling Allsteel Customer Support.

All COM fabric will be applied to seating and panel systems Pattern Cut unless Railroad Cut is requested and approved on the COM Test Request. Any fabrics approved as a width pass, the dealer is responsible for clarifying Railroad Cut on orders containing items that are too large to support the Pattern Cut of a fabric application (any items larger than 48" high or wide).

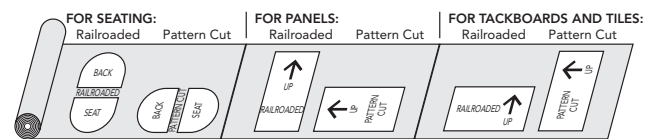

Fire Retardant

The Dealer is responsible for ensuring that the COM fabric is certified to meet all flame retardant requirements.

For more information, please contact Allsteel Customer Support.

YARDAGE REQUIREMENTS FOR FABRIC WITH REPEATS — FOR USE ON GATHER™ PRODUCTS

Fabric Width	Plain Fabric	2"– 14" Repeat	15"– 19" Repeat	20"– 27" Repeat	28"– 36" Repeat
54"	0	+15%	+20%	+25%	+30%
53"	+6%	+19%	+24%	+28%	+36%
52"	+13%	+23%	+28%	+33%	+38%
51"	+19%	+26%	+31%	+36%	+41%
50"	+25%	+30%	+35%	+40%	+45%
49"	+30%	+35%	+40%	+45%	+50%
48"	+35%	+40%	+45%	+50%	+55%
47"	+45%	+50%	+55%	+58%	+65%

Depending upon the pattern repeat, it may be necessary to pattern cut the fabric. This will require 10% additional fabric.

To calculate multiple repeats (vertical and horizontal), add each repeat for total yardage required. For example for a fabric width of 54": 7" vertical requires 15%, 15" horizontal requires 20% total additional yardage required equals 35% (15% + 20%). Therefore, if your chair requires 2 yards of fabric, multiply 2 by 35%. Then 2.7 yards will be yardage required.

Special Paint & Stain Policy

Allsteel at its own discretion may modify its standard products with non-standard paint and stain colors to meet specific needs. Dealer is required to submit a special paint or stain request via the COM Search on [our Website](#). A sample of the non-standard paint or stain color desired will be required for matching. Pricing, lead time, and order information will be provided at the time of approval.

- For each new requested stain or paint, there will be a \$500 net fee to cover supplier costs to match the special item.
- For existing, previously-approved stains or paints, there is no \$500 matching fee, however, there is a sample chip fee of \$175 net for stains and \$100 net for paints.
- Samples, preferably at least 3" x 5" chips, of the exact color desired should be sent to the Allsteel Tailored Products Group. Paint matches require (3) sample chips and stain matches require (3) sample chips. Please mail these sample chips to the address below and reference the Special Item Request Number from Tailored Solutions.

Allsteel Inc.

Attn: COM Team
200 Oak St.
Muscatine, IA 52761

- Allsteel will color match the sample and send control samples to the address provided in the request. Dealer will review Allsteel's color match and approve by signing the back of the sample chip. Send the signed sample back to the Allsteel Tailored Products Group.
- Special paints will be assigned a paint price grade.
- Orders will not be accepted until Allsteel receives the Dealer's written approval on the color match.
- Extended lead times will apply on orders containing special paints or stains.
- Due to manufacturing techniques, materials, and quality issues, some exclusions will apply and some matches may be declined.

Important Notes

- Natural veneer is subject to nature's quality control. Differences in grain and color are naturally occurring variations and cannot be controlled by the manufacturer and cannot be considered as product defects. Natural veneer has the characteristics and beauty of a living organism; with its own variations of grain, growth, and color patterns. For these reasons, Natural veneer is preferred by many for its warmth and personal characteristics.

- Color changes will occur over time when wood is exposed to light. For this reason, when new product is ordered as an addition to existing product, there will be color variances between the old and new product. Please remember when specifying new product that although the species of veneer will be the same, additional product is being manufactured from a different tree. It may take several months for the new furniture to mature to the color level of existing product. Even with this maturation process the additional product will not be an exact match.

Special Laminate Policy

The Company at its own discretion may modify its standard products with non-standard laminates to meet specific needs. Contact the Allsteel Tailored Products Group for pre-approved Wilsonart, Formica, Nevamar and Pionite laminates and pricing for special laminates. When requesting a special laminate please supply manufacturer, along with name and pattern number of laminate.

- Extended lead times will apply on orders containing special laminates.
- Due to manufacturing techniques, materials, and quality issues, some product exclusions will apply and some requests may be declined.

Allsteel Open Line Laminate Program

The Open Line Laminate (OLL) program makes it even easier for a customer to tailor their Allsteel product for a custom look. Select Allsteel furniture products accommodate hundreds of graded-in high-pressure laminates (HPL) from the leading laminate manufacturers' open lines.

Laminates that are currently available in the program can be viewed in specification tools.

Requests to add laminates to the standard specials program can be submitted through the CET Specials Integration tool as well as Community.

Matching edge options are not available offered for laminates in the OLL program. When selecting a laminate please select an edge option from the Allsteel standard offering. If a matching edge is required a modification request can be submitted through the CET Specials Integration tool as well as Community.

Due to manufacturing techniques, materials, quality issues of varying laminates, and minimum order quantities some product exclusions will apply, and some requests may be declined.

Extended lead times may apply on orders containing special laminates.

Contact the Tailored Products Group for questions or additional information regarding pre-approved laminates and pricing.

Allsteel

Phone: 888-255-7833 Option 4.2

Email: ASITPG@allsteeloffice.com

For edge band recommendations from the Allsteel standard offering, please email the HNI Workplace Colors, Materials and Finishes team at allsteel finishes@allsteeloffice.com.

Allsteel edge samples can be ordered through the Allsteel literature [Website](https://www.AllsteelOffice.com), <https://www.AllsteelOffice.com>.

For laminate samples, please contact the manufacturer directly:

Wilsonart

<https://www.wilsonart.com/>

1-800-433-3222

Formica

<https://www.formica.com/en-us/>

1-800-FORMICA (367-6422)

Nevamar and Pionite

<https://www.panolam.com>

877-726-6526

Everyday Advantage[®]

New terms and conditions for EDA:

1. Orders must clearly state “Everyday Advantage Order” and include the appropriate Everyday Advantage contract number:
 - Everyday Advantage Std-0125, Everyday Advantage Canada-0127
2. Everyday Advantage orders are not eligible for bid pricing.
3. Program discounting includes the complete Optimize, Further, and Terrace systems lines, private office solution, Approach and Involve storage. This program also includes Acuity, Access, Evo, Inspire, Lyric, Mimeo, Nimble, Quip, Relate, Seek, and Svelte, seating. Altitude, Aware, and Structure tables are also available, along with Align pedestals, lockers and metal storage and Essentials pedestals, and Raddi storage lines. In addition, Extensions ergonomic accessories and lighting are part of the standard offering. All other product not called out is available for order on the contract but will receive standard discounting of 55%–65%.
4. All textiles and finishes except for veneer and some wood finishes are available, depending on quantity and selection, and may have extended lead times.
5. Everyday Advantage orders are not limited to a minimum or maximum.
6. All orders ship based on standard lead times. Large-quantity orders of like products may be subject to longer lead times.
7. Standard freight terms apply.
8. If driver assistance is needed, standard driver assist charges will be added at time of order entry.

Allsteel Inc. reserves the right to amend or terminate this program at anytime with 30 days written notice. Allsteel is not liable for service delays caused by force majeure (circumstances beyond Allsteel's control).

GRADE A

APPOINT PANEL	
Artichoke.....	APN911
Blackberry.....	APN932
Bronze.....	APN922
Carbon.....	APN928
Chai.....	APN912
Cherry.....	APN930
Dark Pewter.....	APN917
Dune.....	APN915
Espresso.....	APN923
Frost.....	APN934
Framboise.....	APN931
Jet.....	APN927
Lawn.....	APN925
Mandarin.....	APN929
Morel.....	APN909
Nimbus.....	APN916
Platinum.....	APN924
Turquoise.....	APN926

*BINARY †	
Blush.....	BNRY12
Coal.....	BNRY06
Cream.....	BNRY01
Denim.....	BNRY08
Diamond.....	BNRY03
Graphite.....	BNRY05
Juniper.....	BNRY10
Lagoon.....	BNRY07
Lavender.....	BNRY11
Mineral.....	BNRY04
Reef.....	BNRY09
Sand Dollar.....	BNRY02

CENTURION^w	
Apricot.....	CU47
Bark.....	CU25
Black.....	CU10
Espresso.....	CU49
Fog.....	CU03
Frost.....	CU22
Goldenrod.....	CU27
Indigo.....	CU06
Iris.....	CU50
Iron Ore.....	CU19
Jade.....	CU83
Marsala.....	CU63
Morel.....	CU24
Navy.....	CU98
Peacock.....	CU97
Pear.....	CU84
Ruby.....	CU67
Sapphire.....	CU09

CIRCUIT † ♣	
Atlas.....	CIRC35
Dolphin.....	CIRC63
Island White.....	CIRC14
Moon.....	CIRC07
Night.....	CIRC49
Pacific.....	CIRC28
Quartz.....	CIRC01
Sienna.....	CIRC56
Silk.....	CIRC21
Snap Pea.....	CIRC42

ETCH	
Axis.....	ECH913
Blend.....	ECH914
Cast.....	ECH912
Highlight.....	ECH910
Midtone.....	ECH911
Outline.....	ECH908
Shade.....	ECH909
Tonal.....	ECH916
Vanish.....	ECH915

GRADE A – continued

LANDSCAPE	
Cornsilk.....	LN15
Drift.....	LN05
Khaki.....	LN20
Sheen.....	LN10
Slate.....	LN35
Umber.....	LN25
Urban.....	LN30

LUCY	
Aspen.....	LC932
Cornsilk.....	LC930
Dusk.....	LC922
Fawn.....	LC933
Graphite.....	LC934
Mist.....	LC920
Neutra.....	LC924
Pewter.....	LC935
Snowdrop.....	LC928

NOBLE	
Aegean.....	NBLE18
Amethyst.....	NBLE19
Aspen.....	NBLE14
Aster.....	NBLE20
Blossom.....	NBLE21
Bluebell.....	NBLE22
Bordeaux.....	NBLE01
Brick.....	NBLE02
Chambray.....	NBLE10
Chamomile.....	NBLE23
Clementine.....	NBLE04
Conifer.....	NBLE24
Cottage.....	NBLE25
Darkness.....	NBLE26
Dawn.....	NBLE13
Denim.....	NBLE09
Desert Sand.....	NBLE27
Dewfall.....	NBLE28
Dusted Sage.....	NBLE29
Flax.....	NBLE30
Grass.....	NBLE07
Gunmetal.....	NBLE15
Harmony.....	NBLE31
Harvest.....	NBLE12
Ice Caves.....	NBLE32
Icicle.....	NBLE33
Inky.....	NBLE34
Iris.....	NBLE35
Jade.....	NBLE06
Knight.....	NBLE17
Mesa.....	NBLE03
Monarch.....	NBLE36
Pacific.....	NBLE08
Pitch.....	NBLE37
Queen Bee.....	NBLE38
Rainforest.....	NBLE05
Regal.....	NBLE11
Sandcastle.....	NBLE39
Sedona.....	NBLE40
Stormy.....	NBLE16
Sunbeam.....	NBLE41
Voyager.....	NBLE42
Windy Day.....	NBLE43

REFLECTIONS	
Galvanized.....	REF929
Ice.....	REF920
Loggia.....	REF921
Mistral.....	REF928
Moonstone.....	REF923
Pewter.....	REF922
Stainless.....	REF924
Vanilla.....	REF925
Winter.....	REF927

REFUGE	
Artesian.....	RFG996
Dune.....	RFG992
Eclipse.....	RFG990
Frost †.....	RFG993
Glacier †.....	RFG991
Mineral.....	RFG998
Tidal.....	RFG994

TEMPEST	
Dragonfly.....	TP930
Frost.....	TP915
Full Stream.....	TP980
Gold Rush.....	TP910
Slate.....	TP945
Tumbleweed.....	TP970
Wind Chill.....	TP940
Zebra.....	TP935

GRADE A – continued

VAST	
Vineyard.....	VST01
Garden.....	VST02
Grasslands.....	VST03
Bay.....	VST04
Open Air.....	VST05
Atmosphere.....	VST06
Ocean.....	VST07
Mountain Range.....	VST08
Highway.....	VST09
Tundra.....	VST10
Beach.....	VST11
Desert.....	VST12
Country Side.....	VST13

GRADE B

COAST † ♣	
Channel.....	COA914
Dune.....	COA903
Headlands.....	COA910
Marsh.....	COA902
Pebble.....	COA912
Pier.....	COA913
Shoal.....	COA901
Silt.....	COA906
Tide.....	COA908

DISPERSE †	
Autumn.....	DISP03
Branch.....	DISP10
Coffee Bean.....	DISP13
Dusk.....	DISP09
Emerald City.....	DISP08
Gold Rush.....	DISP02
Igloo.....	DISP11
Ink.....	DISP06
Mist.....	DISP12
Oatmeal.....	DISP15
Prince.....	DISP07
Reservoir.....	DISP01
Rose.....	DISP04
Spring.....	DISP05
Steel.....	DISP16
Taupe.....	DISP14

MICA (De-emphasized)	
Anthracite.....	MCA911
Breeze.....	MCA918
Bronze.....	MCA913
Buff.....	MCA914
Cremini.....	MCA917
Crystal †.....	MCAWIT
Dew.....	MCA920
Dove.....	MCA912
Fresh.....	MCA916
Mineral.....	MCA915
Nectar.....	MCA919
Shale.....	MCA910

SPIN PANEL	
Alabaster.....	SPIN02
Cavern.....	SPIN03
Cobblestone.....	SPIN04
Ember.....	SPIN06
Flame.....	SPIN07
Heron.....	SPIN13
Oat.....	SPIN01
Ocean.....	SPIN12
Plum.....	SPIN15
Pool.....	SPIN11
Raven.....	SPIN10
Rhubarb.....	SPIN14
Tropic.....	SPIN08
Willow.....	SPIN05

TERRAIN	
Bay.....	TRRN05
Bayou.....	TRRN35
Canyon.....	TRRN30
Cliff.....	TRRN45
Crest.....	TRRN25
Delta.....	TRRN10
Plateau.....	TRRN15
Ridge.....	TRRN20
Valley.....	TRRN40

^w Limited to 48" W or less
 ▼ Panel fabric is not available on Further.
 ♣ Panel fabric is not available on Optimize.
 † Panel fabric is not available on Concensus.
 * Not available on 72" W

Notes

UPHOLSTERY

Finishes

FINISHES

Paint Name	Paint Code	Grade	Touch Ups	Pivot Monitor Arms	Pivot GSA Monitor Arms	Extensions	Metal Center Drawers
Black	P27	1	•			•	•
Black	P71	1	•				
Black	BLK	1		•			
Brownstone	P7D	1	•			•	•
Bungalow	P7C	1	•			•	•
Carbon	P4Q	1	•				
Charblack	CBK	1	•				
Charblack Metallic*	P80	1	•				
Cinder	P7Q	1	•			•	•
Designer White	WHT	1					
Designer White	PJW	1	•			•	•
Flint	P02	1	•			•	•
Fog	FOG	1					
Fossil	P28	1	•			•	•
Loft	P7B	1	•			•	•
Muslin	P4J	1	•			•	•
Nickel	P8L	1					
Parchment	P93	1	•			•	•
Pebble	P8R	1	•			•	•
Pewter	P8D	1	•			•	•
Platinum Metallic Texture	P6H	1					
Putty	PJS	1					
Salt	P8C	1	•			•	•
Shadow	P4K	1					
Textured Brownstone	P7J	1	•				
Textured Designer White	PK7	1	•				
Textured Flint	P7A	1	•				
Textured Loft	P7L	1	•				
Textured Muslin	P7M	1	•				
Textured Pebble	P8Y	1	•				
Textured Salt	P8Z	1	•				
Textured Titanium	P8V	1	•				
Titanium	P8T / T	1	•			•	•
Anodized Silver	PR0	2	•				
Champagne Metallic	PR5	2	•			•	•
Designer White High Gloss 65	P8W	2	•				
Graphite Metallic Texture	P85	2	•				
Gunmetal Metallic	PR3	2	•			•	•
Matte Gold	P8G	2					
Night Bronze	P8B	2	•			•	
Platinum Metallic	PR2	2	•			•	•
Pyrite	PJE	2	•			•	
Silver	PR6	2	•			•	
Silver Generic	SVR	2		•	•		
Silver Texture	PR8	2	•				
Solar Black	P8X	2	•			•	
Atom	P8S	3	•			•	
Blossom	P8K	3	•			•	
Bullseye	PJF	3	•			•	
Ember	P8P	3	•			•	
Ion	P8N	3	•			•	
Iris	P8J	3	•			•	
Krypton	P8F	3	•			•	
Regatta	P8M	3	•			•	
Succulent	P8A	3					
Markerboard White	MKP	6					

Finishes

Paint Name	Paint Code	Grade	Power Pole	Further Collaborative Hub Electrical	Further Adaptive Height-Adjustable Columns	Further	Cable Management Tray	Altitude A6 Table Bases	Altitude Table Bases	Altitude Table Bases and Utility Bay	Altitude Grommets and Power Rails	Gallery Panels Screens	Hands Free Pulls	Universal Screens	Radii
Black	P27	1	•		•	•	•								
Black	P71	1						•	•	•	•			•	•
Black	BLK	1		•											
Brownstone	P7D	1	•			•	•			•	•	•		•	•
Bungalow	P7C	1	•			•	•			•	•	•			
Carbon	P4Q	1													
Charblack	CBK	1					•								
Charblack Metallic*	P80	1													
Cinder	P7Q	1				•	•			•	•	•		•	•
Designer White	WHT	1		•											
Designer White	PJW	1	•		•	•	•	•		•	•	•		•	•
Flint	P02	1	•			•	•			•	•	•		•	•
Fog	FOG	1													
Fossil	P28	1				•	•			•	•	•		•	•
Loft	P7B	1	•			•	•			•	•	•		•	•
Muslin	P4J	1	•			•	•			•	•	•		•	•
Nickel	P8L	1						•							
Parchment	P93	1				•	•					•			
Pebble	P8R	1				•	•			•	•	•		•	•
Pewter	P8D	1				•	•			•	•	•		•	•
Platinum Metallic Texture	P6H	1													
Putty	PJS	1													
Salt	P8C	1				•	•			•	•	•		•	•
Shadow	P4K	1													
Textured Brownstone	P7J	1													
Textured Designer White	PK7	1													
Textured Flint	P7A	1													
Textured Loft	P7L	1													
Textured Muslin	P7M	1													
Textured Pebble	P8Y	1													
Textured Salt	P8Z	1													
Textured Titanium	P8V	1													
Titanium	P8T / T	1				•	•			•	•	•		•	•
Anodized Silver	PR0	2													
Champagne Metallic	PR5	2				•	•			•	•	•		•	•
Designer White High Gloss 65	P8W	2													
Graphite Metallic Texture	P85	2													
Gunmetal Metallic	PR3	2				•	•					•		•	•
Matte Gold	P8G	2													
Night Bronze	P8B	2				•				•	•	•			
Platinum Metallic	PR2	2				•	•					•			
Pyrite	PJE	2				•				•	•	•			
Silver	PR6	2				•	•	•		•	•	•		•	•
Silver Generic	SVR	2													
Silver Texture	PR8	2													
Solar Black	P8X	2				•				•	•	•		•	•
Atom	P8S	3				•				•	•	•		•	•
Blossom	P8K	3				•				•	•	•		•	•
Bullseye	PJF	3				•				•	•	•		•	•
Ember	P8P	3				•				•	•	•		•	•
Ion	P8N	3				•				•	•	•		•	•
Iris	P8J	3				•				•	•	•		•	•
Krypton	P8F	3				•				•	•	•		•	•
Regatta	P8M	3				•				•	•	•		•	•
Succulent	P8A	3													•
Markerboard White	MKP	6									•			•	

FINISHES

Finishes

FINISHES

Pattern Name	Code	Grade	Altitude	Further Gallery End Panels	Further Storage	Gallery Panels	Systems Worksurfaces	Universal Screens	Universal Modesty Panels	Mural
Ash	LT3B	1	•	•			•	•		•
Silver Mesh	LT8D	1	•	•			•	•		•
Black	P	1	•	•	•	•	•	•	•	•
Brownstone	LM13	1	•	•	•	•	•	•		•
Bungalow	LM12	1	•	•	•	•	•	•		•
Designer White 15051	LDW1	1	•	•	•	•	•	•	•	•
Flint	LM16	1	•	•	•	•	•	•	•	•
Fossil Shale	LEH1	1	•	•	•	•	•	•		•
Loft	LM11	1	•	•	•	•	•	•	•	•
Muslin	LM15	1	•	•	•	•	•	•		•
Titanium	LT11	1	•	•	•	•	•	•		•
Belair	LWBA	1	•	•	•	•	•	•		•
Bourbon Cherry	H	1	•	•	•	•	•	•	•	•
Field Elm	LWFE	1	•	•	•	•	•	•	•	•
Florence Walnut	LFW1	1	•		•	•	•	•	•	•
Kingswood Walnut	LK11	1	•		•	•	•	•	•	•
Natural Maple	LWD	1	•		•	•	•	•	•	•
NeoWalnut	LNU1	1	•		•	•	•	•	•	•
Pinnacle	PINC	1	•	•	•	•	•	•	•	•
Shaker Cherry	LW7C	1	•		•	•	•	•	•	•
Beigewood	LWBE	2	•		•	•	•	•	•	•
Fawn Cypress	LFC1	2	•		•	•	•	•	•	•
Lowell Ash	LLA1	2	•		•	•	•	•	•	•
Mangalore Mango	LMM1	2	•		•	•	•	•	•	•
Natural Recon	LNR1	2	•		•	•	•	•	•	•
Phantom Charcoal	LPC1	2	•		•	•	•	•	•	•
Phantom Ecru	LPE1	2	•		•	•	•	•	•	•
Portico Teak	LPT1	2	•		•	•	•	•	•	•
Skyline Walnut	LSW1	2	•		•	•	•	•	•	•
Veranda Teak	LVT1	2	•		•	•	•	•	•	•
Natural Walnut	LWNW	3	•		•	•	•	•	•	•
Open Line Laminate Program	N/A	Varies	•		•	•	•	•	•	•

Finishes

System Worksurfaces

Veneer Type	Stain Name	Code	Grade	
FSC Stratawood Cherry	Cinnamon Cherry	FSCSC260	2	•
FSC Stratawood Cherry	Lowell Ash	FSCSC394	2	•
FSC Stratawood Cherry	Clear Cherry	FSCSC700	2	•
FSC Stratawood Cherry	Light Cherry	FSCSC701	2	•
FSC Stratawood Cherry	Shaker Cherry	FSCSC774	2	•
FSC Stratawood Cherry	Burnished Cherry	FSCSC777	2	•
FSC Stratawood Maple	Field Elm	FSCSE599	2	•
FSC Stratawood Maple	Clear Maple	FSCSE800	2	•
FSC Stratawood Maple	Harvest Maple	FSCSE856	2	•
FSC Stratawood Maple	Beigewood	FSCSE878	2	•
FSC Stratawood Maple	Phantom Ecu	FSCSE912	2	•
FSC Stratawood Maple	Belair	FSCSE934	2	•
FSC Stratawood Rift Oak	Clear Oak	FSCSF300	2	•
FSC Stratawood Rift Oak	Dark Rift Oak	FSCSF331	2	•
FSC Stratawood Walnut	Florence Walnut	FSCST579	2	•
FSC Stratawood Walnut	Light Walnut	FSCST601	2	•
FSC Stratawood Walnut	Skyline Walnut	FSCST625	2	•
FSC Stratawood Walnut	Pinnacle Walnut	FSCST679	2	•
FSC Stratawood Walnut	Sumatra Walnut	FSCST693	2	•
FSC Natural Cherry	Cinnamon Cherry	FSCNC260	2	•
FSC Natural Cherry	Lowell Ash	FSCNC394	2	•
FSC Natural Cherry	Medium Red Cherry	FSCNC512	2	•
FSC Natural Cherry	Clear Cherry	FSCNC700	2	•
FSC Natural Cherry	Light Cherry	FSCNC701	2	•
FSC Natural Cherry	Shaker Cherry	FSCNC774	2	•
FSC Natural Cherry	Burnished Cherry	FSCNC777	2	•
FSC Natural Maple	Natural Maple-Clear	FSCNE800	2	•
FSC Natural Maple	Harvest Maple	FSCNE856	2	•
FSC Natural Walnut	Ebony Walnut	FSCNT509	2	•
FSC Natural Walnut	Florence Walnut	FSCNT579	2	•
FSC Natural Walnut	Light Walnut	FSCNT601	2	•
FSC Natural Walnut	Skyline Walnut	FSCNT625	2	•
FSC Natural Walnut	Nutmeg Walnut	FSCNT629	2	•
FSC Natural Walnut	Pinnacle Walnut	FSCNT679	2	•
FSC Natural Walnut	Sumatra Walnut	FSCNT693	2	•
FSC Natural Rift Oak	Fawn Cypress	FSCRF108	3	•
FSC Natural Rift Oak	Light Rift Oak	FSCRF301	3	•
FSC Natural Rift Oak	Dark Rift Oak	FSCRF331	3	•
FSC Natural Rift Oak	Phantom Ecu	FSCRF912	3	•
Natural Cherry	Cinnamon Cherry	NC260	2	•
Natural Cherry	Lowell Cherry	NC394	2	•
Natural Cherry	Medium Red Cherry	NC512	2	•
Natural Cherry	Light Cherry	NC701	2	•
Natural Cherry	Shaker Cherry	NC774	2	•
Natural Cherry	Burnished Cherry	NC777	2	•
Natural Maple	Natural Maple-Clear	NE800	2	•
Natural Maple	Harvest Maple	NE856	2	•
Natural Rift Cut Oak	Fawn Cypress	RF108	3	•
Natural Rift Cut Oak	Light Rift Oak	RF301	3	•
Natural Rift Cut Oak	Dark Rift Oak	RF331	3	•
Natural Rift Cut Oak	Phantom Ecu	RF912	3	•
Natural Walnut	Ebony Walnut	NT509	2	•
Natural Walnut	Florence Walnut	NT579	2	•
Natural Walnut	Light Walnut	NT601	2	•
Natural Walnut	Skyline Walnut	NT625	2	•
Natural Walnut	Nutmeg Walnut	NT629	2	•
Natural Walnut	Pinnacle Walnut	NT679	2	•
Natural Walnut	Sumatra Walnut	NT693	2	•

FINISHES

Finishes

System Worksurfaces

Veneer Type	Stain Name	Code	Grade	
Stratawood Cherry	Stratawood Cherry	SC260	2	•
Stratawood Cherry	Lowell Ash	SC394	2	•
Stratawood Cherry	Clear Cherry	SC700	2	•
Stratawood Cherry	Light Cherry	SC701	2	•
Stratawood Cherry	Shaker Cherry	SC774	2	•
Stratawood Cherry	Burnished Cherry	SC777	2	•
Stratawood Maple	Field Elm	SE599	2	•
Stratawood Maple	Clear Maple	SE800	2	•
Stratawood Maple	Harvest Maple	SE856	2	•
Stratawood Maple	Beigewood	SE878	2	•
Stratawood Maple	Phantom Ecrú	SE912	2	•
Stratawood Maple	Belair	SE934	2	•
Stratawood Silver Oak	Clear	SB100	2	•
Stratawood Silver Oak	Portico Teak	SB150	2	•
Stratawood Rift Oak	Clear Oak	SF300	2	•
Stratawood Rift Oak	Dark Rift Oak	SF331	2	•
Stratawood Walnut	Florence Walnut	ST579	2	•
Stratawood Walnut	Light Walnut	ST601	2	•
Stratawood Walnut	Skyline Walnut	ST625	2	•
Stratawood Walnut	Pinnacle Walnut	ST679	2	•
Stratawood Walnut	Sumatra Walnut	ST693	2	•

Pattern Name	Code	Grade	Beam	Halo	Square	Bar	Arch
Designer White	PJW	1	•	•	•	•	
Silver	PR6	1	•	•		•	
Black	P27	1				•	
Flint	P02	1			•		
Loft	P7B	1			•		
Matte Silver	EL	1			•		
Anodized Silver	PR0	1					•
Pyrite	PJE	2	•	•	•		
Solar Black	P8X	2	•	•	•		

- Finishes 18-21
- Introduction to Mural..... 22
- Statement of Line 23
- Overview..... 24
- Planning Guidelines..... 25-28
- Working with Electrical..... 29-33
- Fence*
- Frame 34
- Tiles..... 35
- Connectors..... 36
- Integrated Height-Adjustable Tables*
- Worksurfaces..... 37-38
- Bases 39
- Wire Management..... 40
- Privacy*
- Screen Frames 41
- Screens 42-48
- No-Screen Kits 49
- Privacy Panel..... 51
- Bent Screen..... 51
- Accessories*
- Accessories 50-54

PAINT FINISHES

FRAME, TILE, CONNECTORS, END TRIM, SHELVES, NO SCREEN FILLER KIT, WIRE MANAGER TROUGH, POWER POLE, PANEL FEET, STIFFENERS, MARKERBOARD TRAY

GRADE P1

Black	P71
Brownstone	P7D
Bungalow	P7C
Cinder	P7Q
Designer White	PJW
Cove	P096
Dune	P094
Flint	P02
Fossil	P28
Harbor	P097
Loft	P7B
Muslin	P4J
Parchment	P93
Pebble	P8R
Pewter	P8D
Sage	P095
Salt	P8C
Titanium	P8T

GRADE P2

Champagne Metallic	PR5
Gunmetal Metallic	PR3
Night Bronze	P8B
Platinum Metallic	PR2
Pyrite	PJE
Silver	PR6
Solar Black	P8X

GRADE P3

Atom	P8S
Blossom	P8K
Bullseye	PJF
Ember	P8P
Ion	P8N
Iris	P8J
Krypton	P8F
Ochre	P093
Regatta	P8M
Sienna	P092
Succulent	P8A

INTEG. DESK

GRADE P1

Black	P71
Brownstone	P7D
Cinder	P7Q
Designer White	PJW
Flint	P02
Fossil	P28
Loft	P7B
Muslin	P4J
Nickel	P8L
Parchment	P93
Pebble	P8R
Pewter	P8D
Salt	P8C
Titanium	P8T

GRADE P2

Champagne Metallic	PR5
Gunmetal Metallic	PR3
Night Bronze	P8B
Platinum Metallic	PR2
Silver	PR6

GRADE P3

Bullseye	PJF
Regatta	P8M

PAINT FINISHES – cont'd

COLLABORATIVE BOARD

GRADE P1

Black	P71
Brownstone	P7D
Bungalow	P7C
Cinder	P7Q
Designer White	PJW
Flint	P02
Fossil	P28
Loft	P7B
Muslin	P4J
Parchment	P93
Pebble	P8R
Pewter	P8D
Salt	P8C
Titanium	P8T

GRADE P2

Champagne Metallic	PR5
Gunmetal Metallic	PR3
Night Bronze	P8B
Platinum Metallic	PR2
Pyrite	PJE
Silver	PR6
Solar Black	P8X

GRADE P3

Atom	P8S
Blossom	P8K
Bullseye	PJF
Ember	P8P
Ion	P8N
Iris	P8J
Krypton	P8F
Ochre	P093
Regatta	P8M
Sienna	P092
Succulent	P8A

GRADE P6

Markerboard White	MKP
-------------------	-----

PLANTER

GRADE P1

Textured Brownstone	P7J
Textured Designer White	PK7
Textured Flint	P7A
Textured Loft	P7L
Textured Muslin	P7M
Textured Pebble	P8Y
Textured Salt	P8Z
Textured Titanium	P8V

GRADE P2

Silver Texture	PR8
Solar Black	P8X

SCREEN FINISHES

FABRIC SCREENS

GRADE A - APPOINT PANEL

100% Polyester	
Artichoke	APN911
Blackberry	APN932
Bronze	APN922
Carbon	APN928
Chai	APN912
Cherry	APN930
Dark Pewter	APN917
Dune	APN915
Espresso	APN923
Frost	APN934
Framboise	APN931
Jet	APN927
Lawn	APN925
Mandarin	APN929
Morel	APN909
Nimbus	APN916
Platinum	APN924
Turquoise	APN926

GRADE A - BINARY

83% Polyester, 17% Post-Consumer Recycled Polyester	
Blush	BNRY12
Coal	BNRY06
Cream	BNRY01
Denim	BNRY08
Diamond	BNRY03
Graphite	BNRY05
Juniper	BNRY10
Lagoon	BNRY07
Lavender	BNRY11
Mineral	BNRY04
Reef	BNRY09
Sand Dollar	BNRY02

GRADE A - ETCH

100% Polyester	
Axis	ECH913
Blend	ECH914
Cast	ECH912
Highlight	ECH910
Midtone	ECH911
Outline	ECH908
Shade	ECH909
Tonal	ECH916
Vanish	ECH915

GRADE A - LANDSCAPE

48% Post-Consumer Recycled Polyester, 40% Pre-Consumer Recycled Polyester, 12% Polyester	
Corn silk	LN15
Drift	LN05
Khaki	LN20
Sheen	LN10
Slate	LN35
Umber	LN25
Urban	LN30

SCREEN FINISHES – cont'd

FABRIC SCREENS – cont'd

GRADE A - NOBLE

60% Post-Consumer Recycled Polyester	
Aegean	NBLE18
Amethyst	NBLE19
Aspen	NBLE14
Aster	NBLE20
Blossom	NBLE21
Bluebell	NBLE22
Bordeaux	NBLE01
Brick	NBLE02
Chambray	NBLE10
Chamomile	NBLE23
Clementine	NBLE04
Conifer	NBLE24
Cottage	NBLE25
Darkness	NBLE26
Dawn	NBLE13
Denim	NBLE09
Desert Sand	NBLE27
Dewfall	NBLE28
Dusted Sage	NBLE29
Flax	NBLE30
Grass	NBLE07
Gunmetal	NBLE15
Harmony	NBLE31
Harvest	NBLE12
Ice Caves	NBLE32
Icicle	NBLE33
Inky	NBLE34
Iris	NBLE35
Jade	NBLE06
Knight	NBLE17
Mesa	NBLE03
Monarch	NBLE36
Pacific	NBLE08
Pitch	NBLE37
Queen Bee	NBLE38
Rainforest	NBLE05
Regal	NBLE11
Sandcastle	NBLE39
Sedona	NBLE40
Stormy	NBLE16
Sunbeam	NBLE41
Voyager	NBLE42
Windy Day	NBLE43

GRADE A - REFLECTIONS

56% Pre-Consumer Recycled Polyester, 44% Post-Consumer Recycled Polyester	
Galvanized	REF929
Ice	REF920
Loggia	REF921
Mistral	REF928
Moonstone	REF923
Pewter	REF922
Stainless	REF924
Vanilla	REF925
Winter	REF927

GRADE A - REFUGE

46% Polyester, 35% Pre-Consumer Recycled Polyester, 19% Post-Consumer Recycled Polyester	
Artesian	RFG996
Dune	RFG992
Eclipse	RFG990
Frost †	RFG993
Glacier †	RFG991
Mineral	RFG998
Tidal	RFG994

GRADE A - TEMPEST

73% Pre-Consumer Recycled Polyester, 27% Post-Consumer Recycled Polyester	
Dragonfly	TP930
Frost	TP915
Full Stream	TP980
Gold Rush	TP910
Slate	TP945
Tumbleweed	TP970
Wind Chill	TP940
Zebra	TP935

SCREEN FINISHES – cont'd

FABRIC SCREENS – cont'd

GRADE B - COAST

100% Polyester

Channel.....	COA914
Dune.....	COA903
Headlands.....	COA910
Marsh.....	COA902
Pebble.....	COA912
Pier.....	COA913
Shoal.....	COA901
Silt.....	COA906
Tide.....	COA908

GRADE B - DISPERSE

100% Polyester

Autumn.....	DISP03
Branch.....	DISP10
Coffee Bean.....	DISP13
Dusk.....	DISP09
Emerald City.....	DISP08
Gold Rush.....	DISP02
Igloo.....	DISP11
Ink.....	DISP06
Mist.....	DISP12
Oatmeal.....	DISP15
Prince.....	DISP07
Reservoir.....	DISP01
Rose.....	DISP04
Spring.....	DISP05
Steel.....	DISP16
Taupe.....	DISP14

GRADE B - SPIN PANEL

54% Polyester, 30% Pre-Consumer
Recycled Polyester, 16% Post-Consumer
Recycled Polyester

Alabaster.....	SPIN02
Cavern.....	SPIN03
Cobblestone.....	SPIN04
Ember.....	SPIN06
Flame.....	SPIN07
Heron.....	SPIN13
Oat.....	SPIN01
Ocean.....	SPIN12
Plum.....	SPIN15
Pool.....	SPIN11
Raven.....	SPIN10
Rhubarb.....	SPIN14
Tropic.....	SPIN08
Willow.....	SPIN05

GRADE B - TERRAIN

48% Polyester, 34% Pre-Consumer
Recycled Polyester, 18% Post-Consumer
Recycled Polyester

Bay.....	TRRN05
Bayou.....	TRRN35
Canyon.....	TRRN30
Cliff.....	TRRN45
Crest.....	TRRN25
Delta.....	TRRN10
Plateau.....	TRRN15
Ridge.....	TRRN20
Valley.....	TRRN40

SCREEN FINISHES – cont'd

SEATING

GRADE 1 - CENTURION™

100% Polyester

Apricot.....	CU47
Bark.....	CU25
Black.....	CU10
Espresso.....	CU49
Fog.....	CU03
Frost.....	CU22
Goldenrod.....	CU27
Indigo.....	CU06
Iris.....	CU50
Iron Ore.....	CU19
Jade.....	CU83
Marsala.....	CU63
Morel.....	CU24
Navy.....	CU98
Peacock.....	CU97
Pear.....	CU84
Ruby.....	CU67
Sapphire.....	CU09

GRADE 1 - DAPPER™

100% Polyester

Ash.....	DAPR20
Breeze.....	DAPR06
Canvas.....	DAPR25
Charcoal.....	DAPR01
Clover.....	DAPR22
Currant.....	DAPR00
Fawn.....	DAPR35
Fern.....	DAPR85
Gerbera.....	DAPR16
Grape.....	DAPR33
Jewel.....	DAPR08
Marigold.....	DAPR65
Onyx.....	DAPR10
Orchid.....	DAPR90
Parrot.....	DAPR59
Poppy.....	DAPR19
Sapphire.....	DAPR07
Scarlet.....	DAPR45
Sepia.....	DAPR30
Sky.....	DAPR44
Slate.....	DAPR15
Sorbet.....	DAPR55
Spring.....	DAPR80
Terracotta.....	DAPR13
Titanium.....	DAPR17
Varsity.....	DAPR09
Zest.....	DAPR70

*Limited to 48"W or less

VENEER SCREENS

GRADE 2 - STRATAWOOD CHERRY

Cinnamon Cherry.....	SC260
Lowell Ash.....	SC394
Clear Cherry.....	SC700
Shaker Cherry.....	SC774
Light Cherry.....	SC701
Burnished Cherry.....	SC777

GRADE 2 - STRATAWOOD MAPLE

Clear Maple.....	SE800
Harvest Maple.....	SE856
Phantom Ecru.....	SE912
Field Elm.....	SE599
Belair.....	SE934
Beigewood.....	SE878

GRADE 2 - STRATAWOOD SILVER OAK

Portico Teak.....	SB150
Clear.....	SB100

GRADE 2 - STRATAWOOD RIFT OAK

Clear Oak.....	SF300
Dark Rift Oak.....	SF331

SCREEN FINISHES – cont'd

VENEER SCREENS – cont'd

GRADE 2 - STRATAWOOD WALNUT

Light Walnut.....	ST601
Skyline Walnut.....	ST625
Pinnacle Walnut.....	ST679
Sumatra Walnut.....	ST693
Florence Walnut.....	ST579
Smoked Onyx.....	RE697
Nutmeg Walnut.....	RE629

GRADE 1 - ROTARY CUT MAPLE

Clear.....	RC800
------------	-------

LAMINATE SCREENS

L1 ABSTRACT

Handspun Pearl.....	LAHP
Handspun Dove.....	LAHD
Handspun Slate.....	LAHS
Handspun Chestnut.....	LAHC
Silver Mesh.....	LT8D

L1 SOLID

Black.....	P
Brownstone.....	LM13
Bungalow.....	LM12
Flint.....	LM16
Fossil Shale.....	LEH1
Loft.....	LM11
Muslin.....	LM15
Titanium.....	LT11
Designer White 15051.....	LDW1

L1 WOODGRAIN

Belair.....	LWBA
Bourbon Cherry.....	H
Field Elm.....	LWFE
Florence Walnut.....	LFW1
Kingswood Walnut.....	LK11
Natural Maple.....	LWD
NeoWalnut.....	LNU1
Pinnacle.....	PINC
Shaker Cherry.....	LW7C

L2 WOODGRAIN

Beigewood.....	LWBE
Lowell Ash.....	LLA1
Natural Recon.....	LNR1
Portico Teak.....	sLPT1
Skyline Walnut.....	LSW1
Veranda Teak.....	LVT1
Fawn Cypress.....	LFC1
Mangalore Mango.....	LMM1
Phantom Ecru.....	LPE1

L3 WOODGRAIN

Natural Walnut.....	LWNW
---------------------	------

L4 MARKERBOARD

White Markerboard.....	FMQ1
------------------------	------

PET SCREENS

Dark Grey.....	DGY4
Medium Grey.....	DGY3
Light Brown.....	DBR1
Light Blue.....	DLB1
Lightest Grey.....	DGY2
Black.....	DBK1

MESH SCREENS

Chalk.....	CHK
Greystone.....	GRS
Pewter.....	PEW

GLASS SCREENS

Markerboard.....	LM
------------------	----

ACRYLIC SCREENS

Clear.....	ASC
Frosted.....	ASF

FREESTANDING SCREEN FINISHES

MURAL BENT SCREEN

GRADE 1 PAINT

Textured Salt.....	P8Z
--------------------	-----

GRADE 2 PAINT

Solar Black.....	P8X
------------------	-----

FABRIC

Noble.....	NBLE
------------	------

MURAL PRIVACY PANEL

GRADE 1 PAINT

Black.....	P71
Brownstone.....	P7D
Bungalow.....	P7C
Cinder.....	P7Q
Designer White.....	PJW
Flint.....	P02
Fossil.....	P28
Loft.....	P7B
Muslin.....	P4J
Parchment.....	P93
Pebble.....	P8R
Pewter.....	P8D
Salt.....	P8C
Titanium.....	P8T

GRADE 2 PAINT

Champagne Metallic.....	PR5
Gunmetal Metallic.....	PR3
Night Bronze.....	P8B
Platinum Metallic.....	PR2
Pyrite.....	PJE
Silver.....	PR6
Solar Black.....	P8X

GRADE 3 PAINT

Atom.....	P8S
Blossom.....	P8K
Bullseye.....	PJF
Ember.....	P8P
Ion.....	P8N
Iris.....	P8J
Krypton.....	P8F
Ochre.....	P093
Regatta.....	P8M
Sienna.....	P092
Succulent.....	P8A

GRADE 6 PAINT

Markerboard White.....	MKP
------------------------	-----

MURAL PRIVACY PANEL

L1 ABSTRACT

Handspun Pearl.....	LAHP
Handspun Dove.....	LAHD
Handspun Slate.....	LAHS
Handspun Chestnut.....	LAHC

L1 SOLID

Black.....	P
Brownstone.....	LM13
Bungalow.....	LM12
Flint.....	LM16
Fossil Shale.....	LEH1
Loft.....	LM11
Muslin.....	LM15
Titanium.....	LT11
Designer White 15051.....	LDW1

L1 WOODGRAIN

Belair.....	LWBA
Bourbon Cherry.....	H
Field Elm.....	LWFE
Florence Walnut.....	LFW1
Kingswood Walnut.....	LK11
Natural Maple.....	LWD
NeoWalnut.....	LNU1
Pinnacle.....	PINC
Shaker Cherry.....	LW7C

FREESTANDING SCREEN FINISHES – cont'd

L2 WOODGRAIN

Beigewood.....	LWBE
Lowell Ash.....	LLA1
Natural Recon.....	LNR1
Portico Teak.....	LPT1
Skyline Walnut.....	LSW1
Veranda Teak.....	LVT1
Fawn Cypress.....	LFC1
Mangalore Mango.....	LMM1
Phantom Ecu.....	LPE1

L3 WOODGRAIN

Natural Walnut.....	LWNW
---------------------	------

EDGE OPTIONS:

Beigewood.....	DE
Belair.....	BA
Black.....	E4
Bourbon Cherry.....	H
Brownstone.....	EY
Bungalow.....	EX
Designer White.....	DW
Fawn Cypress.....	FC
Field Elm.....	FE
Flint.....	E9
Florence Walnut.....	FW
Fossil.....	EH
Kingswood Walnut.....	KI
Loft.....	EV
Lowell Ash.....	DL
Mangalore Mango.....	MM
Muslin.....	EU
Natural Maple.....	DD
Natural Recon.....	NR
Natural Walnut.....	DN
NeoWalnut.....	NU
Phantom Ecu.....	PE
Pinnacle.....	PI
Portico Teak.....	DP
Shaker Cherry.....	DF
Skyline Walnut.....	SW
Titanium.....	TI
Veranda Teak.....	VT

LAMINATE OPTIONS

FLAT EDGE INTEG. DESK TOP

GRADE L1 ABSTRACT

Ash.....	LT3B
Silver Mesh.....	LT8D
Handspun Pearl.....	LAHP
Handspun Dove.....	LAHD
Handspun Slt.....	LAHS
Handspun Chestnut.....	LAHC

GRADE L1 SOLID

Black.....	P
Brownstone.....	LM13
Bungalow.....	LM12
Flint.....	LM16
Fossil Shale.....	LEH1
Loft.....	LM11
Muslin.....	LM15
Titanium.....	LTI1
Designer White 15051.....	LDW1

GRADE L1 WOODGRAIN

Belair.....	LWBA
Bourbon Cherry.....	H
Field Elm.....	LWFE
Florence Walnut.....	LFW1
Kingswood Walnut.....	LK11
Natural Maple.....	LWD
NeoWalnut.....	LNU1
Pinnacle.....	PINC
Shaker Cherry.....	LW7C

LAMINATE OPTIONS – cont'd

GRADE L2 WOODGRAIN

Beigewood.....	LWBE
Lowell Ash.....	LLA1
Natural Recon.....	LNR1
Portico Teak.....	LPT1
Skyline Walnut.....	LSW1
Veranda Teak.....	LVT1
Fawn Cypress.....	LFC1
Mangalore Mango.....	LMM1
Phantom Ecu.....	LPE1

GRADE L3 WOODGRAIN

Natural Walnut.....	LWNW
---------------------	------

FLAT EDGE OPTION

Beigewood.....	DE
Belair.....	BA
Black.....	E4
Bourbon Cherry.....	H
Brownstone.....	EY
Bungalow.....	EX
Designer White.....	dw
Fawn Cypress.....	FC
Field Elm.....	FE
Flint.....	E9
Florence Walnut.....	FW
Fossil.....	EH
Kingswood Walnut.....	KI
Loft.....	EV
Lowell Ash.....	DL
Mangalore Mango.....	MM
Muslin.....	EU
Natural Maple.....	DD
Natural Recon.....	NR
Natural Walnut.....	DN
NeoWalnut.....	NU
Parchment.....	EN
Phantom Ecu.....	PC
Pinnacle.....	PI
Platinum Metallic.....	EP
Plyband.....	PL
Portico Teak.....	DP
Shaker Cherry.....	DF
Skyline Walnut.....	SW
Titanium.....	TI
Veranda Teak.....	VT

EASED EDGE INTEG. DESK TOP

GRADE L1 SOLID

Designer White.....	LDW1
Loft.....	LM11

GRADE L1 WOODGRAIN

Natural Maple.....	LWD
--------------------	-----

GRADE L2 WOODGRAIN

Natural Recon.....	LNR1
--------------------	------

SHELF

GRADE L1 ABSTRACT

Handspun Pearl.....	LAHP
Handspun Dove.....	LAHD
Handspun Slate.....	LAHS
Handspun Chestnut.....	LAHC

GRADE L1 SOLID

Black.....	P
Brownstone.....	LM13
Bungalow.....	LM12
Flint.....	LM16
Fossil Shale.....	LEH1
Loft.....	LM11
Muslin.....	LM15
Titanium.....	LTI1
Designer White 15051.....	LDW1

LAMINATE OPTIONS – cont'd

GRADE L1 WOODGRAIN

Belair.....	LWBA
Bourbon Cherry.....	H
Field Elm.....	LWFE
Florence Walnut.....	LFW1
Kingswood Walnut.....	LK11
Natural Maple.....	LWD
NeoWalnut.....	LNU1
Pinnacle.....	PINC
Shaker Cherry.....	LW7C

GRADE L2 WOODGRAIN

Beigewood.....	LWBE
Lowell Ash.....	LLA1
Natural Recon.....	LNR1
Portico Teak.....	LPT1
Skyline Walnut.....	LSW1
Veranda Teak.....	LVT1
Fawn Cypress.....	LFC1
Mangalore Mango.....	LMM1
Phantom Ecu.....	LPE1

GRADE L3 WOODGRAIN

Natural Walnut.....	LWNW
---------------------	------

EASED EDGE OPTION

GRADE L1 SOLID

Designer White.....	DW
Loft.....	EV

GRADE L1 WOODGRAIN

Natural Maple.....	DD
--------------------	----

GRADE L2 WOODGRAIN

Natural Recon.....	NR
--------------------	----

SHELF EDGE OPTION

Beigewood.....	DE
Belair.....	BA
Black.....	E4
Bourbon Cherry.....	H
Brownstone.....	EY
Bungalow.....	EX
Designer White.....	DW
Fawn Cypress.....	FC
Field Elm.....	FE
Flint.....	E9
Florence Walnut.....	FW
Fossil.....	EH
Kingswood Walnut.....	KI
Loft.....	EV
Lowell Ash.....	DL
Mangalore Mango.....	MM
Muslin.....	EU
Natural Maple.....	DD
Natural Recon.....	NR
Natural Walnut.....	DN
NeoWalnut.....	NU
Phantom Ecu.....	PE
Pinnacle.....	PI
Portico Teak.....	DP
Shaker Cherry.....	DF
Skyline Walnut.....	SW
Titanium.....	TI
Veranda Teak.....	VT

ENHANCED CONNECTOR OPTIONS

FLEX SLEEVE OPTIONS

Light.....	LT
Medium.....	MD
Dark.....	DK

ELECTRICAL AND DATA COMPONENTS

Black.....	E4
Brownstone.....	EY
Designer White.....	DW
Flint.....	E9
Loft.....	EV
Muslin.....	EU
Silver.....	ES

FABRIC WIRE MANAGER

GRADE 1

DAPPER

Ash.....	DAPR20
Breeze.....	DAPR06
Canvas.....	DAPR25
Charcoal.....	DAPR01
Chlover.....	DAPR22
Currant.....	DAPR00
Fawn.....	DAPR35
Fern.....	DAPR85
Gerbera.....	DAPR16
Grape.....	DAPR33
Jewel.....	DAPR08
Marigold.....	DAPR65
Onyx.....	DAPR10
Orchid.....	DAPR90
Parrot.....	DAPR59
Poppy.....	DAPR19
Sapphire.....	DAPR07
Scarlet.....	DAPR45
Sepia.....	DAPR30
Sky.....	DAPR44
Slate.....	DAPR15
Sorbet.....	DAPR55
Spring.....	DAPR80
Terracotta.....	DAPR13
Titanium.....	DAPR17
Varsity.....	DAPR09
Zest.....	DAPR70

HAMILTON (De-emphasized)

Biscotti.....	HAML11
Cabernet.....	HAML08
Carolina.....	HAML21
Charcoal.....	HAML17
Chocolate.....	HAML13
Cloud.....	HAML18
Dane.....	HAML16
Dusty Rose.....	HAML07
Esmeralda.....	HAML06
Fern.....	HAML04
Fresh.....	HAML03
Granola.....	HAML19
Lilac.....	HAML14
Lime.....	HAML05
Lipstick.....	HAML09
Oxford.....	HAML20
Passion Fruit.....	HAML02
Pepper.....	HAML15
Powder.....	HAML12
Sunrise.....	HAML01

Mural

FABRIC WIRE MANAGER cont'd

GRADE 3

MOXIE	
Barnwood	SX09
Basalt	SX23
Bayou	SX02
Bermuda	SX52
Biscotti	SX08
Blackberry	SX48
Blarney	SX49
Blueberry	SX05
Bonsai	SX20
Brigade	SX53
Butterscotch	SX54
Carob	SX24
Chalk	SX50
Chartreuse	SX34
Cherry	SX38
Cinnamon	SX13
Cobalt	SX01
Coconut	SX06
Concrete	SX43
Cozumel	SX55
Cumin	SX32
Dragonfly	SX44
Dover	SX56
Earl Grey	SX40
Elysian	SX04
Evergreen	SX21
Fatigue	SX18
Fawn	SX30
Flint	SX39
Forsythia	SX57
Grenache	SX58
Hazel	SX31
Hemp	SX45
Hickory	SX25
Holly	SX51
Jam	SX16
Kelly	SX33
Lemongrass	SX19
Lime	SX41
Macintosh	SX12
Midnight	SX59
Mulberry	SX15
Muslin	SX60
Pacifica	SX61
Parchment	SX07
Peacock	SX03
Phantom	SX62
Pineapple	SX42
Plum	SX17
Punch	SX46
Riverstone	SX47
Russet	SX14
Smokestack	SX22
Tangerine	SX37
Terracotta	SX11
Thicket	SX35
Walnut	SX10
Whirlwind	SX63

PURL

(80% Polyester, 20% Acrylic)

Alpaca	PURL08
Braid	PURL10
Deep	PURL12
Graze	PURL05
Loom	PURL06
Needle	PURL07
Pasture	PURL02
Ranch	PURL04
Shuttle	PURL09
Skein	PURL01
Thistle	PURL11
Yearling	PURL03

FABRIC WIRE MANAGER cont'd

GRADE 3 — cont'd

QUILL	
Aviary	QUL03
Feather	QUL02
Fountain	QUL06
Ink	QUL05
Metal	QUL04
Reed	QUL08
Scroll	QUL01
Well	QUL07

Mural offers a unique way to plan and divide space with a movable base structure that easily accommodates reconfiguration. A wide selection of inserts plus shelves, provide the desired privacy and functionality for each workspace; with movable and freestanding screens offering an additional level of privacy when needed. Integrated or freestanding height-adjustable surfaces allow users to change postures throughout the day for comfort and productivity. The result is a system that invites individuals to customize their workspace to fit their workstyle and reflect their personality.

It's All in the "Flex"

Mural's flex connector transforms a static station into an adaptable station. Bringing new meaning to organic configurations, Mural's possibilities are limitless.

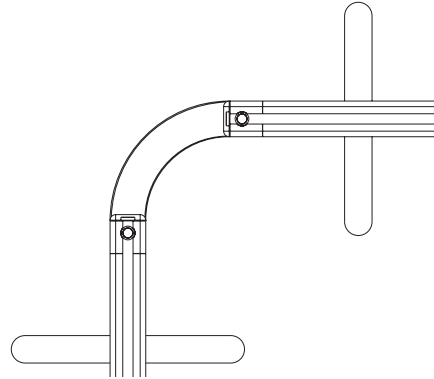

Integrated Height-Adjustability

Mural stations can integrate 2-stage or 3-stage height-adjustable tables with ease. Freestanding height-adjustable tables can also be paired with Mural's fence.

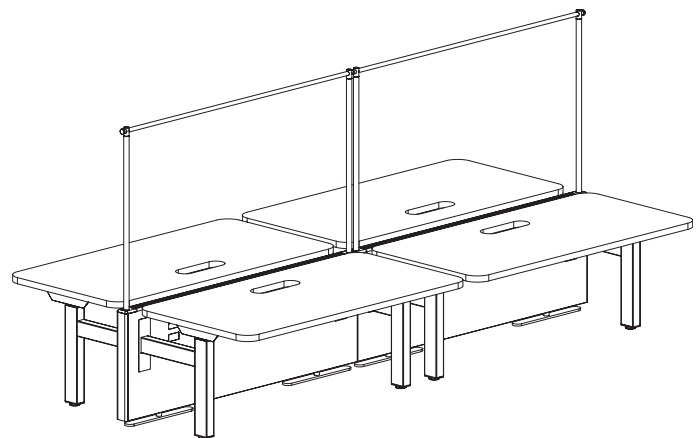

Privacy to Fit Your Organization's Need

Vertical screen frames support a variety of screening options that support user comfort and privacy.

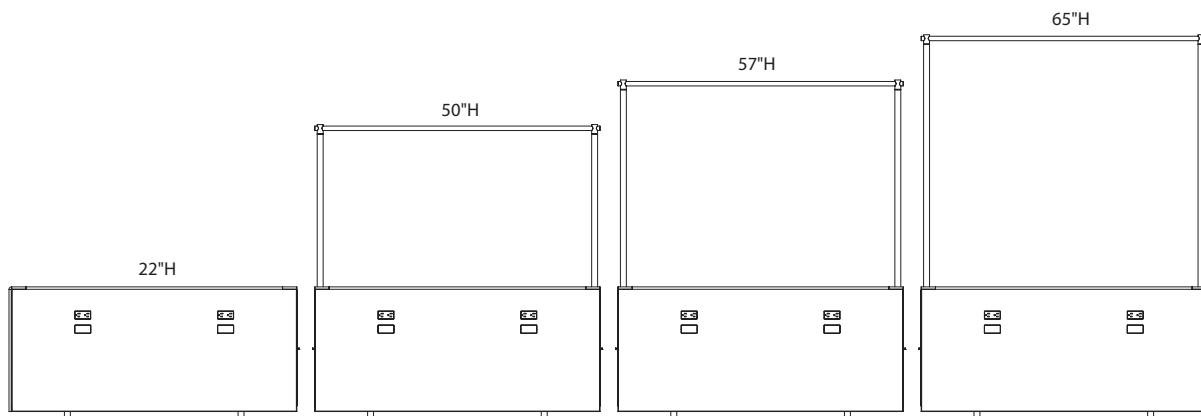

FENCE & CONNECTORS

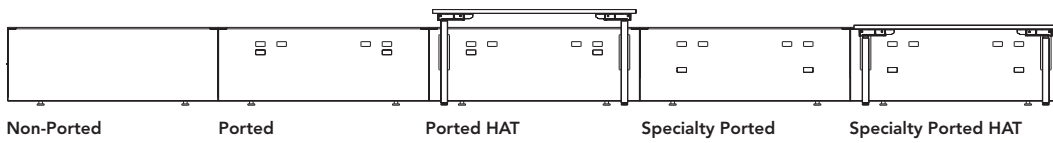

Non-Ported Ported Ported HAT Specialty Ported Specialty Ported HAT

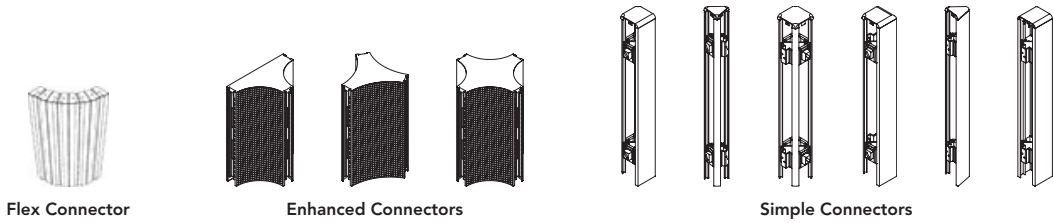

Flex Connector Enhanced Connectors Simple Connectors

PRIVACY

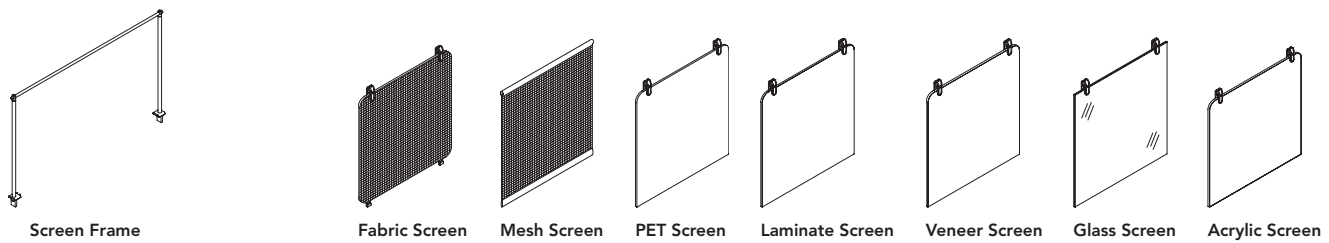

Screen Frame Fabric Screen Mesh Screen PET Screen Laminate Screen Veneer Screen Glass Screen Acrylic Screen

INTEGRATED HEIGHT-ADJUSTABLE TABLES

BASE

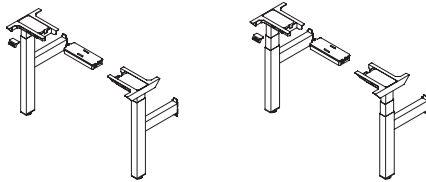

2-Stage 3-Stage

**Adjustable leg kits and crossbars sold separately.*

WORKSURFACES

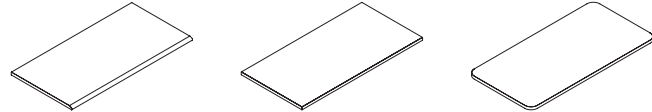

ACCESSORIES

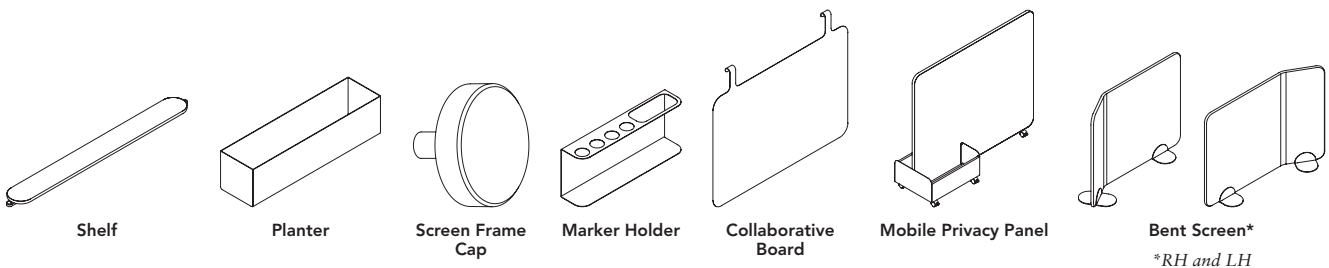

Shelf Planter Screen Frame Cap Marker Holder Collaborative Board Mobile Privacy Panel Bent Screen*
*RH and LH

POWER

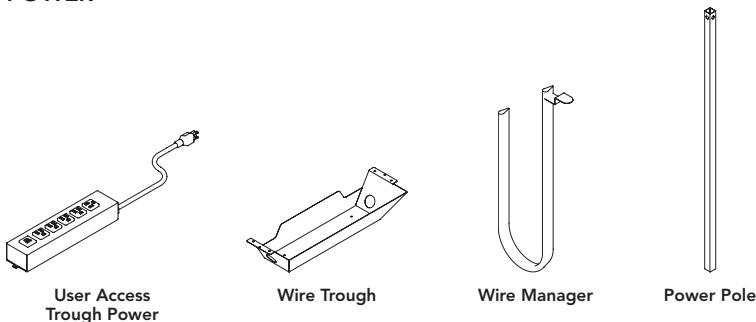

User Access Trough Power Wire Trough Wire Manager Power Pole

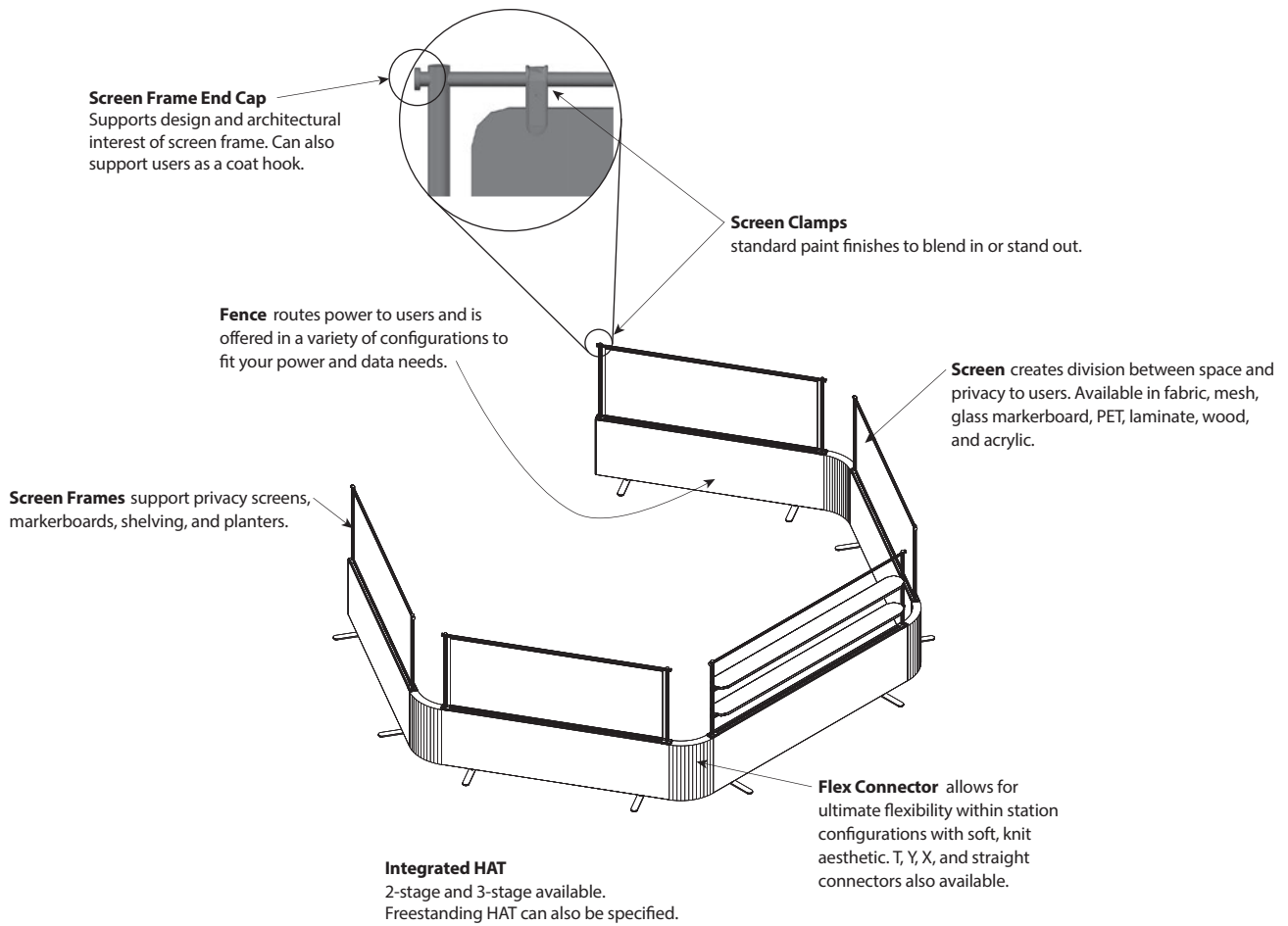

MURAL

NOTE: Mural Typicals can be found at <https://www.allsteeloffice.com/design-resources/idea-starters>.

Fence & Connectors

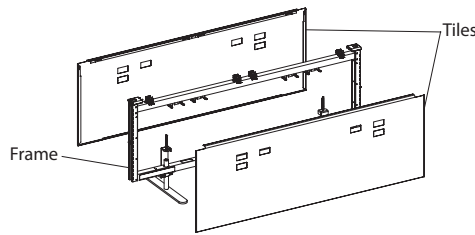

Fence:

- The fence is made up of a frame and tiles.
- Connectors attach to fence to create desired configurations.
- Screen Frames attach to top of fence for integrated vertical privacy solution.
- When screen frames are not specified, a No-Screen Frame Filler Kit (SAFILLERKITNF) should be specified.
- When screens are not used, a No-Screen Filler Kit should be specified to fill screen gap.
- In-line connections possible with and without connectors. Other connectors available, see connector section.
- Overall Depth: 2.6"
- Overall Height: 22"
- Overall Width: 30", 36", 42", 48", 54", 60", 66", 72", 84"

Frames:

- Pivoting foot included with frame.
- Pivoting foot dimensions: 17" L x 2" W.
- Pivoting foot allows for 3" of leveling adjustment.
- Pivoting foot can be turned in when adjacent to gallery panels, panel returns, and simple/enhanced connectors.
- Pivoting feet can be turned in when tethered to an integrated height-adjustable table.
- 30" W fence will only have room for one foot to be pivoted inwards.
- Frames > 60" W ship as two frames and are adjoined in the field.
- Pivoting feet must be turned out when using a 2-way Y connector on freestanding applications.
- Gallery panels must be at least 33" W x 42½" H and attached next to foot locations to turn feet in on single-sided applications.

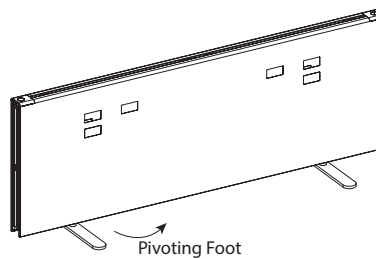

Tiles:

- Painted steel tile.
- Specified as non-ported, ported, and integrated desk (always ported).
- 2 data knockouts per side for ported tiles.
- Specialty tiles available with data ports spaced 6" lower than power in both ported and HAT tiles.
- Tiles up to 54" come with 2 electrical knockouts per side.
- 60" and greater tiles have 4 electrical knockouts per side.
- Port cover model available for day 2 reconfigurations.
- Data ports are knock-outs and do not have to be used.

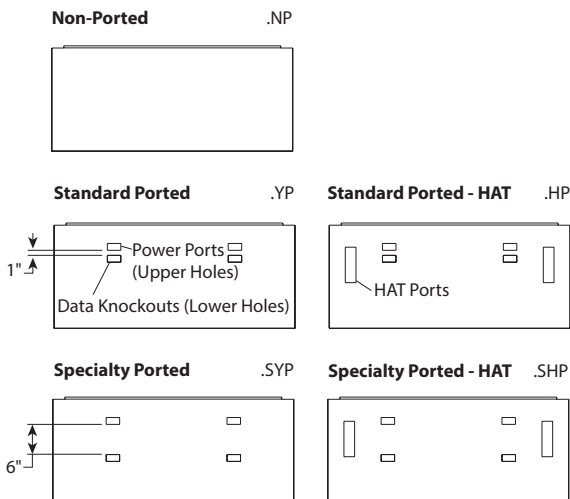

*Tiles shown are 48" W

Connectors:

- Organic and linear planning made possible through variety of connector options.
- Flex connector featuring knit cover, available in 3 colors.
- Flex connector enables end panels to be user movable.
- Enhanced connectors featuring knit cover available in X, Y, and T configurations.
- Simple Connectors available in straight, L, X, T, Y (2-way), and 7 (3-way) configurations.
- Enhanced connector top trim and simple connectors available in Allsteel standard paints.
- Use of extended straight connectors allow for equal length of run when there isn't a return fence specified.

Flex Connection	T-Connection	Y-Connection (3-way)	X-Connection	L-Connection	Y-Connection (2-way)	Straight Connection
SC12SFF	SC12TF/SC12TS	SC12YF/SC12YS3	SC12XF/SC12XS	SC12LS	SC12YS2	SC12SS

Screen Frames + Screens

Screen Frames:

- Screen frame supports screens, shelves, and planters.
- Screen frame cap sold separately.
- Adds additional height to fence: 26"H (50"H), 34"H (57½"H), 41"H (65"H).
- Screen frame width only compatible with associated fence (30"W Screen Frame = 30"W fence).
- Screen frame aligner hardware must be used in linear application.
- When specifying in-line, fence connections screen frame heights must match.
- Available in Allsteel standard paints.
- Maximum of 10 lbs for decorative accents suspended from screen frame. Consider collaborative board within weight requirements.

Screens:

- Available in fabric, PET, mesh, acrylic, glass, laminate, and veneer.
- Screen heights must match screen frame height. Refer to screen frame compatibility for width requirements.
- Screen clamps attach screens to screen frame.
- Screen clamps available in Allsteel standard paints.
- Screen clamps hardware always silver. Clamping pads will always be black.
- See screen frame compatibility chart.
- Mesh does not need screen clamps.
- Veneer screens larger than 60" wide are available with horizontal grain only.

Screen Filler Kits:

- When two half screens are used within screen frame, SAFILLERKIT1 should be specified.
- When screens are not used, but a screen frame is specified, filler kits should be used to fill fence gaps. See screen filler compatibility chart.
- When no screens or screen frames are used, SAFILLERKITNF should be specified.

Shelves:

- Pill shape laminate shelf available in Allsteel standard laminates.
- Maximum 2 shelves per screen frame.
- Do not specify monitor arms with integrated height-adjustable tables and screen frame shelves.
- All desktop mounted accessories could interfere with shelves on applications with integrated height adjustability. This should be considered when choosing location of shelves on screen frame.
- Shelves come with all screen frame mounting hardware. Hardware will always be black. Shelf screen clamp and stiffener are available in standard Allsteel paint finishes.
- Shelf hardware is only compatible with Mural Screen frames.
- Shelves can support decorative accents with a maximum weight capacity of 25 lbs.
- Shelf is ¾" thick
- For applications with integrated height adjustability, the following shelf limitations apply: (1) no shelves can be used with 26"H screen frames, (2) 1 shelf can be used with 34"H screen frames, (3) 2 shelves can be used with 41"H screen frames.

Planters:

- Planters introduce biophilia and personality to the workstation.
- Mount directly to laminate shelves. Planter comes with pilot holes and hardware. Shelves do not have pilot holes to allow for flexibility in placement.
- One planter per shelf.
- Internal dimensions: 6"H, 6"D, 24"W.
- Does not come with liner.
- Available in 10 paint finishes.

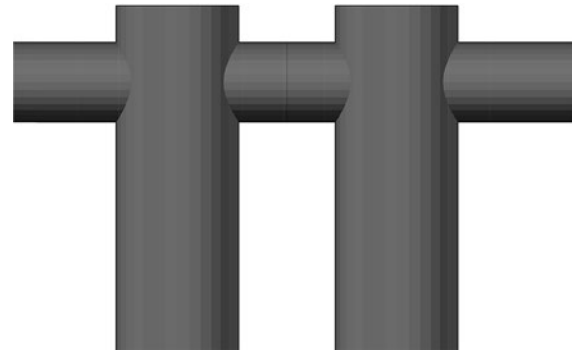

Screen Frame Compatibility

Screen Frame	Full Width	Half Width
30" W	25" W	—
36" W	31" W	—
42" W	37" W	—
48" W	43" W	—
54" W	49" W	—
60" W	55" W	27" W x2
66" W	61" W	30" W x2
72" W	67" W	33" W x2
84" W	79" W – Mesh Only	39" W x2

Screen Filler Kit Compatibility

Screen Frame	Filler Kit	Half Screen
30" W	SAFILLERKIT25	—
36" W	SAFILLERKIT31	—
42" W	SAFILLERKIT37	—
48" W	SAFILLERKIT43	—
54" W	SAFILLERKIT49	—
60" W	SAFILLERKIT55	SAFILLERKIT27
66" W	SAFILLERKIT61	SAFILLERKIT30
72" W	SAFILLERKIT67	SAFILLERKIT33
84" W	SAFILLERKIT79	SAFILLERKIT39

Collaborative Screens

Model Numbers	Screen	Size Volume	Weight
SS1724M	17x24	17.0 in ³	4.8 lb
SS2724M	27x24	26.9 in ³	7.6 lb

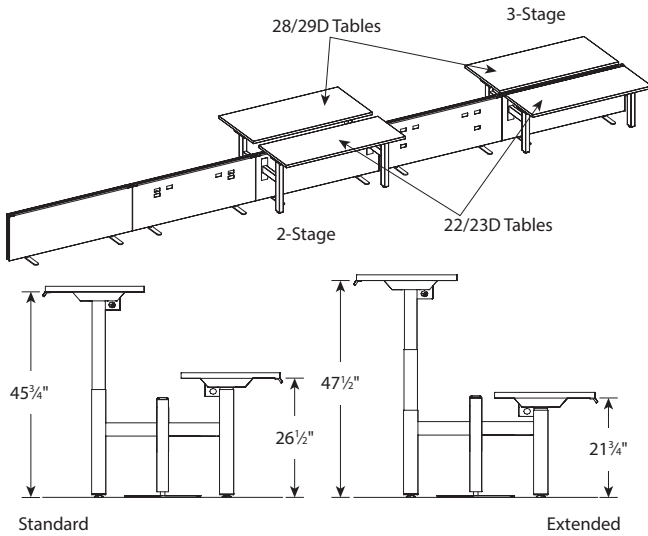

Worksurface:

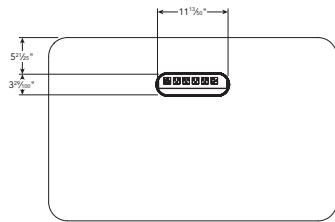

Mural Power Bay:

- User Access grommet conveniently tucks power and cords away into under worksurface tray.
- User access power possible through specifying Mural Power Bay grommet option, power, and wire management trough.
- Mural Power Bay grommet option specified on the .option. Grommet color is determined by laminate edge band.
- Grommet is always an oval and centered on worksurface, see visual above for dimensions.
- Power (SEDMUP) must be specified with either SEDMW20 or SEDMW30 to provide user access to power.

Collaborative Boards:

- User Movable, magnetic collaborative boards.
- Specify marker board paint for a writable surface option.
- Available in two sizes: 17" H x 24" W and 27" H x 24" W.

Bent Screens:

- Upholstered freestanding bent screen provides user privacy in solo stations and collaborative areas.
- Available as left-handed and right-handed.
- Foot is available in textured salt or solar black.
- Screen dimensions: 52" H x 68" W.

Wire Management:

- Under worksurface tray conveniently stores power strip and unneeded cords throughout the day.
- Tray is available Allsteel standard paints.
- 20" W trough compatible with 46" W and 52" W worksurfaces.
- 30" W trough compatible with worksurfaces 58" W and greater.
- Trough will always be black.
- Fabric wire manager offers a softer approach to wire management and discreetly routes cords to fence receptacles.
- Reference visual above for wire manager trough dimensions.

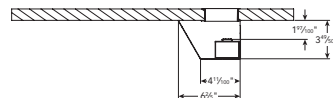

Integrated Height-Adjustable Bases:

- 2-stage (26 1/2" to 45 3/4") and 3-stage (21 3/4" to 47 1/2").
- 250 lbs weight rating.
- Tables feature collision detection, a feature designed to stop table travel when the table detects an obstacle.
- Memory control, basic up/down control, and paddle control available as an option.
- Compatible with 48" – 72" fence configurations.
- Height-adjustable legs and crossbar kit specified separately. Unique crossbar kits to accommodate single and dual sided applications as well as 22/23" D and 28/29" D worksurfaces.
- Dual sided crossbar kits should ONLY be specified when two integrated height-adjustable bases are specified.
- Must specify with Integrated HAT tile option.
- Leg seamlessly integrates into fence.
- 2 1/2" of leveling adjustment.
- Radii hanging pedestals on single-sided integrated Mural height adjustable tables are not allowed from a stability perspective.
- On a double-sided application (integrated HATs on both sides of the fence) it is allowed, Radii hanging pedestals will need to sit inset of the height adjustable leg.

A3 (T-Leg) A6 (C-Leg)

24"D 30"D 24"D 30"D

		A3 (T-Leg)	A6 (C-Leg)		
		24"D	30"D	24"D	30"D
AUFD15N	Flush Undermount Pull-Out Drawer	○	○	○	●
AUFH15N/AUFHL15N	Flush Undermount RH/LH Hinge Door	○	○	○	●
AUFO15N	Flush Undermount Open Bin	○	○	○	●
AUCL15N/AUCL15U	Console Undermount L-Cube	○	○	○	○
AUCH15N/AUCH15U	Console Undermount RH Hinge Door	○	○	○	○
AUCLH15N/AUCLH15U	Console Undermount LH Hinge Door	○	○	○	○

Legend

●	Works, unit may sit flush to LH or RH edge of worksurface
○	Works, unit must sit inset of height-adjustable leg

Mural Worksurfaces:

- Rectangular, Rounded, and Eased Edge worksurfaces available.
- Primary worksurface depths are 22" D, 23" D, 28" D, and 29" D.
- Mural Power Bay and standard grommet options available.
- Worksurfaces compatible with all integrated height-adjustable bases.
- 23" D, 28" D, and 29" D worksurfaces compatible with freestanding A6 T-Leg, C-Leg bases. 22" D worksurfaces compatible with freestanding A6 T-leg bases ONLY.

Marker Holder:

- Can hold 4 markers and an eraser.
- Magnetic attachment makes accessory easy to move from steel surfaces.
- Available in Allsteel Standard Paints.

Privacy Collaboration Panel:

- Rolling collaboration panel with dual-sided bin.
- Specify markerboard laminate for writable surface option.
- Panel and bin laminate specified separately for design flexibility.
- Screen Dimensions: 50" H x 60" W.
- Bin Dimensions: 8" H x 24" W x 8.5" D.

Marker Boards:

- Thoroughly erase your marker board after every use.
- Marker boards should be cleaned weekly with marker board cleaner. Reminder: Completely erase the board before applying any cleaners.
- Leaving ink on the board for an extended period of time may lead to images remaining on the board, commonly known as "ghosting", after erasing.
- To avoid ghosting, clean your board weekly with marker board cleaner.
- Expo brand dry-erase markers are recommended for best erasing results.
- Avoid using red and orange markers for easier cleaning and to reduce the likelihood of ghosting.
- Do not use permanent or non-dry erase markers.
- To maintain eraser performance, follow manufacturer's instructions.

Mural Electrical Systems

Power can come from a wall, floor or ceiling infeed.

Ceiling Infeed:

- Requires a power pole, either freestanding next to the system or integrated into an enhanced connector (X, T, Y).
- When power pole is freestanding, the electrical infeed either:
 - Leaves the pole at the floor level, enters the system in the same way that a floor infeed would.
 - Leaves the pole part-way to the floor and enters through the side infeed trim (SC22ETE). This method requires installers cut a hole in the power pole at the correct height to line up with the hole in the infeed trim.
- When integrated, with power pole mounting kit, the infeed goes directly through the top of the enhanced connector.

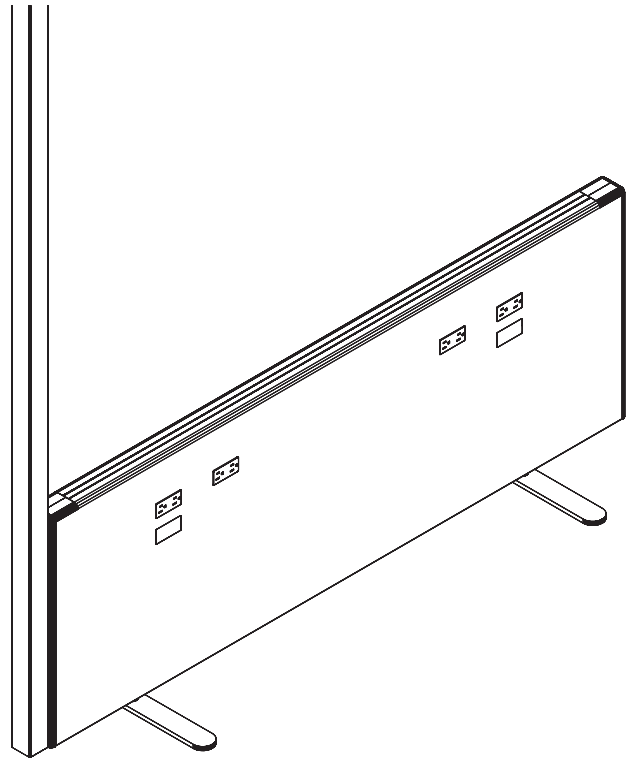

Floor Infeed:

- Enters through the bottom of the system.
- Points of entry are accessible at the center of each section of panel.
- Enhanced connectors have access point underneath for floor infeed.
- Infeed cannot be routed through simple connectors.

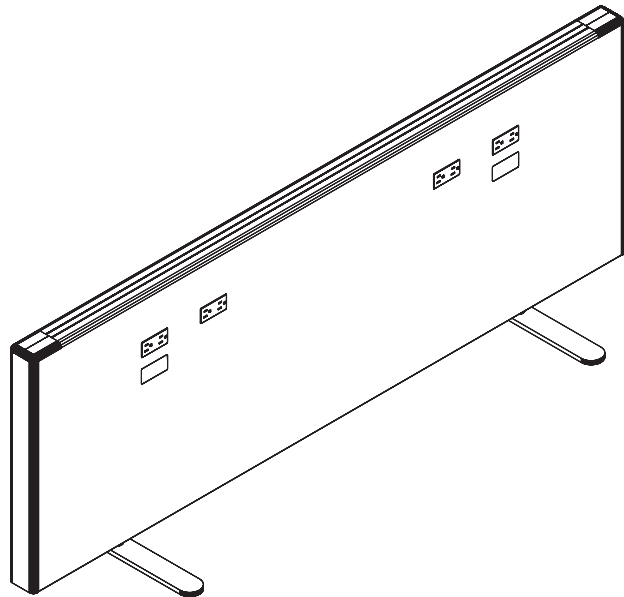

Wall Infeed:

- Requires use of the side infeed trim.
- Infeed enters through side of fence.
- Recommend this configuration when fence is located up against a wall to prevent user visibility of side infeed access.



Mural features capabilities for cable management, including electrical, voice, and data. The 8-wire electrical system is integrated at the beltline. The open structure of the frame allows voice and data cables to be routed both vertically and horizontally.

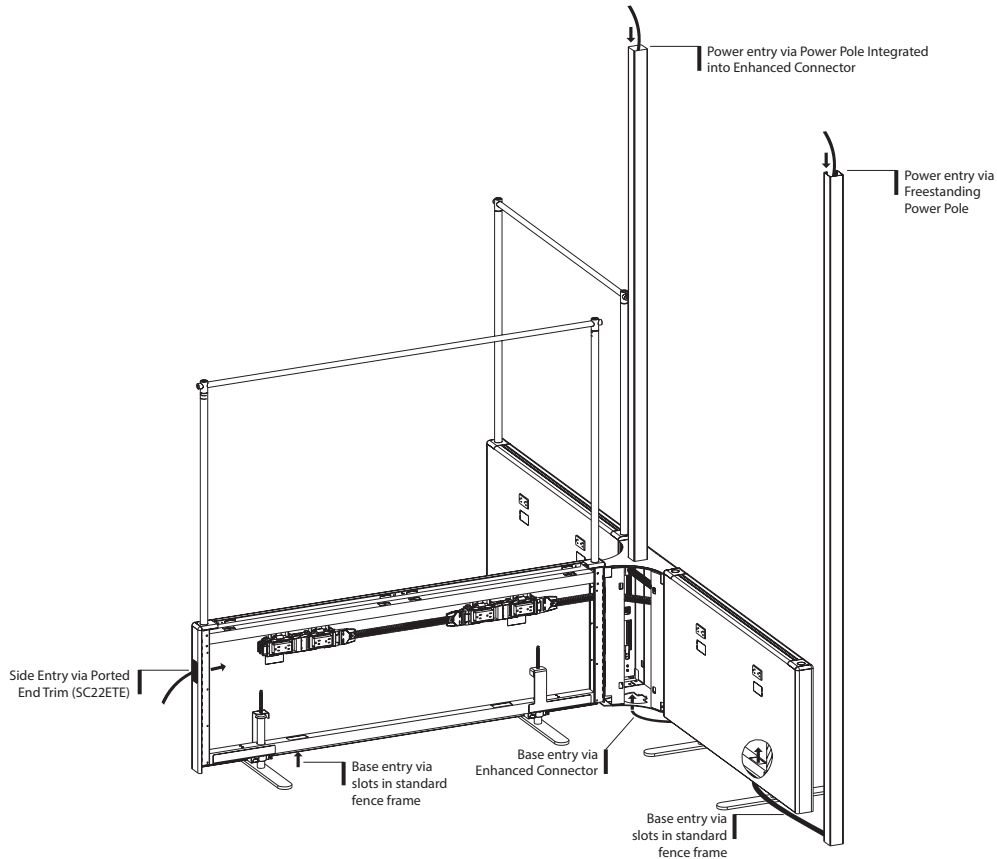

Square Power Pole for Fixed Supports (page 103)

- A870070 power pole is 10½' tall
- SE08PP1 Power Pole is 8' tall.
- Power Pole may be used over one of enhanced connectors.
- To extend the power pole for a taller ceiling, order quantity-2 with a splicer kit SE08PP2.

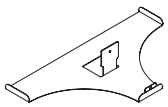

SE08TPP2

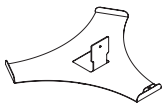

SE08YPP2

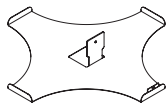

SE08XPP2

Mural Electrical Systems

The electrical system for Mural offers two options: 3+1 or 2+2. Both systems utilize an 8-wire, four-circuit electrical system, rated at 20 amps (15 amps Canadian). Connect a maximum of 13 receptacles (12 in Canada, and fewer in certain U.S. locales) to one circuit. Consult your electrician to ensure the planned electrical load is within permissible limits. Follow the steps below to help specify your Mural electrical.

1. **Infeeds** — Determine the location, quantity, and type of power infeeds needed.
2. **Fence Power Kits** — Specify a Fence Power Kit for each ported fence. Power kits are determined by the size of fence ordered and are connected to one another with beam-to-beam jumpers - order separately.
3. **Connector Jumper Kits** — Ordered separately from fence power kits. Available in specific lengths for simple connectors, enhanced connectors, flex connector, and panel pass-through configurations.
4. **Duplex Receptacles** — Determine which electrical system will be used after consulting an electrician: 2+2 or 3+1. System is determined by which circuits are used. Specify circuit specific receptacles to fill all port locations where electrical is needed. Number of ports is determined by the fences and fence power kits specified. Port covers must be placed in port locations where duplex receptacles are not specified.

Electrical Systems

Mural offers a choice of four electrical systems:

- Four-circuit, 3 + 1
 - Four-circuit, 2 + 2
 - Three-circuit, separate neutrals
 - Eight circuits; two four-circuit systems provided back-to-back.
-
- See page 32 for a detailed explanation of each electrical system.
 - All four systems utilize an 8-wire electrical system, rated at 20 amps per circuit (15 amps Canadian) - 16 amps plannable in U.S.
 - Mural fence and electrical components are UL Listed. Electrical components are also CSA certified.
 - Installation and use of the electrical system, the number of receptacles used on a given circuit and connections to the building power supply should be in compliance with all local and national electrical codes.

Caution: Electrical equipment cords or extension cords MUST NOT BE ROUTED through cable openings in fence sides.

Note: No more than one conduit that is connected to a power kit mounted to horizontal can be routed through the same cut out in the same horizontal at beltline. Attempting to use more will cause binding of conduit and may affect reveals on receptacles.

Hardwire New York Code (page 53)

- Hardwire (New York Code) junction box (model A871400) is used when local electrical codes require hardwire entry.
- For use in panels 30" W to 84" W.
- New York box can connect to a pass-through kit or directly to a power block.
- New York box takes the place of a receptacle. If using a ported tile, purchase port covers for this location.
- Customer to furnish all cabling and wiring from power entry to power source.
- Junction box can be positioned at any duplex receptacle location.

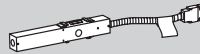

Hardwire Chicago Code (page 53)

- Wiring power kits and snap connectors are not allowed in Chicago — base pathways must be comprised of all-metallic components.
- Customer must furnish conduit, wiring, and designer-type receptacles for the base pathway and conduit, wiring, designer-type receptacles, and receptacle covers for the beltline.
- Power entry can be routed from the ceiling, via a power pole, or from the floor into a junction box.

Electrical Infeeds

- Power infeed cables deliver power from building to fence's electrical system.
- Infeed cables are housed in conduit to separate electrical system from communications and data lines.
- Select quantity of base or ceiling infeed cables depending on individual power requirements.

Sealtight Electrical Infeed (page 52)

- Sealtight electrical infeed cable is used when routing power from floor with footed panels.
- If pre-wired as infeed, sealtight must be routed from inside of fence. Should not be ordered prior to installation.

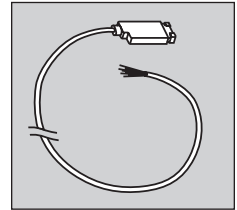

Ceiling Power Infeed (page 52)

- Ceiling power infeed connects to a prewired electrical power kit in the beltline and terminates in the junction box at the top of the integrated power pole.
- Can also be used as infeed.
- Most codes allow flex conduit to be exposed after installation. Verify code requirements before ordering for exposed application.

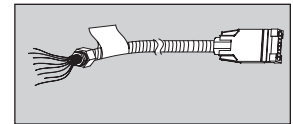

To Order:

- Determine which electrical system you will use after consulting your electrician and computer support personnel:
 - The Four-circuit system (4-Hot/2-Neutral/2-Ground)
 - 3 + 1 option
 - 2 + 2 option
 - The three-circuit system (3-Hot/3-Neutral/2-Ground)
 - The eight-circuit system (back-to-back four-circuit systems)
- Determine location, quantity, and circuit of duplexes.
- Determine the appropriate choice and use of isolated, isolated/dedicated, and separate neutrals circuits.
- Specify appropriate power kits and pass-through kits.
- Determine the location, quantity, and type of power infeed needed.

* Select power kits (SE(30-84)EK(3C/4C)), panel-to-panel standard jumpers/enhanced jumpers (SES(S/F)EJ(3/4)C), and pass-through kits (SES(M/G)EJ(3/4)C) with the last two digits corresponding with the panel width into which the component is to be positioned. Pass-through kits only cover space within the panel. Designers should still specify panel-to-panel jumpers between a pass-through to a power kit. Jumper kits do not stretch.

Flexconnect™ Electrical System Options

The four-circuit, eight-wire electrical system is widely specified and trusted by hundreds of thousands of end-users. This proven system delivers four circuits for every power infeed in either a 3 + 1 or 2 + 2 configuration. The isolated/dedicated circuits are ideal for sensitive computing equipment, while the common circuits are suitable for faxes, copiers, task lights and other peripherals. Both the 3 + 1 and 2 + 2 systems use the same pre-wired components, making it easy to adjust as electrical needs change.

Reference the Office Equipment Typical Load Values on page 33.

Four-circuit, 3 + 1 Receptacle Option

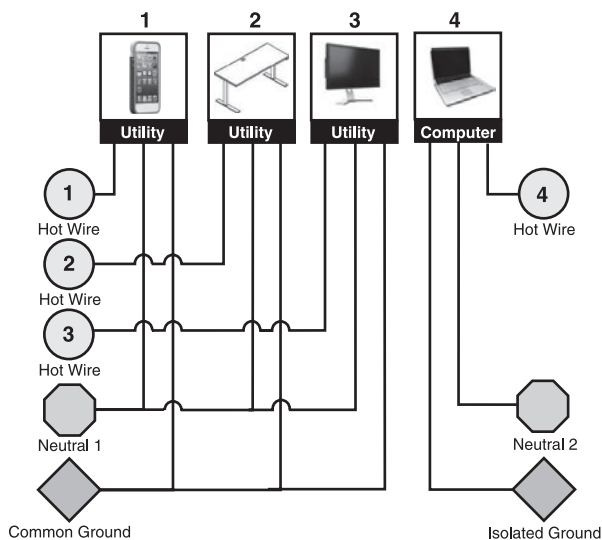

The 3 + 1 option is the electrical standard used on Allsteel systems for many years in most installations. This wiring option provides three utility circuits plus an isolated/dedicated circuit for more sensitive equipment. Circuit 2 (one of the 3 common circuits sharing a neutral wire) cannot be used with single-phase building electrical supply.

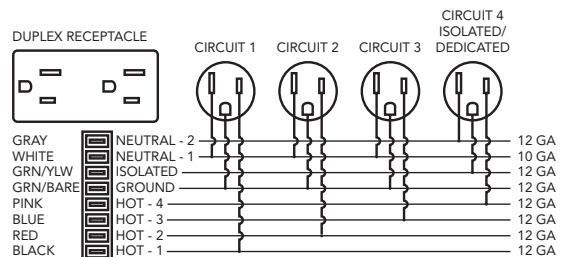

The 2 + 2 option is a wiring option that provides two utility circuits and two isolated circuits for more extensive computer usage applications.

Four-circuit, 2 + 2 Receptacle Option

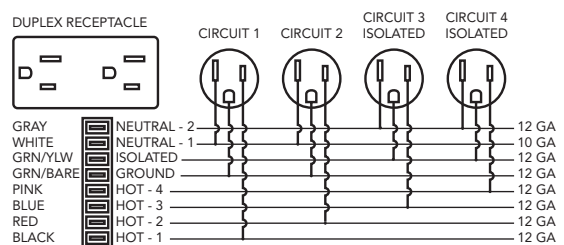
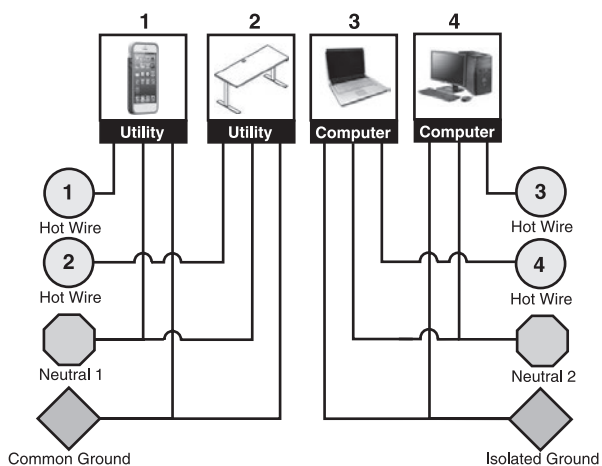

Office Equipment Typical Load Values

Item	*Amps
Desktop/2 Monitors	4
Laptop Computer	1
Laptop/2 Monitors/Docking Station	3
Paper Shredder	1.22
Radio	0.05
Scanner	3
Space Heater (1500 watts)	12
Task Light (equiv. 60-watt bulb)	
Fluorescent	0.12
LED	0.08
USB Charger	0.17
LCD Television (42")	1
LCD Monitor (21")	0.5
Bluetooth Speaker	0.1
Desktop Printer	
Inkjet	0.15
Laser	4 to 10
Multimedia Projector	1.7
Sit-to-Stand Height-Adjustable Desk	Idle 0.01 / Max 4
Office Kitchen	
Coffee Maker	10
Microwave	10
Toaster	12.5
Compact Refrigerator	1.5

*Chart is recommended for planning purposes. Check device specifications for exact amperage. Consult with your electrician regarding the applicable configurations.

Examples of Component Usage based on the *Office Equipment Typical Load Values Chart*

Power Option 3+1

Dedicated Circuit 4: 4 desktop computers with 2 monitors each; or 10 laptop computers
Utility Circuits 1, 2, 3: Height-adjustable tables and ancillary items

Power Option 2+2

Dedicated Circuit 3: 4 desktop computers with 2 monitors each; or 10 laptop computers
Dedicated Circuit 4: 4 desktop computers with 2 monitors each; or 10 laptop computers
Utility Circuits 1, 2: Height-adjustable tables and ancillary items

Data Faceplates & Jacks (page 54)

- Faceplates fit into knockout ports on ported steel tiles.
- Faceplates do not work in fence electrical ports.
- Faceplate options available to install either 3 or 4 data jacks.
- Faceplates available in one color – black.
- Faceplates and Jacks sold separately.
- CAT 5E and CAT 6 data jacks available.
- **Due to fence depth, data modules should not be used back-to-back.**

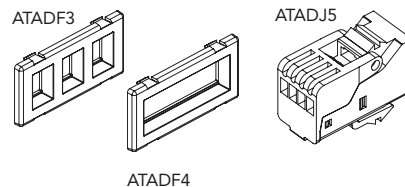

For specification information see pages 25-28.

GSA SIN 33721

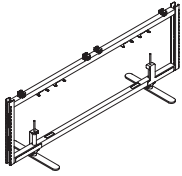

Description	Model	List Price
Mural Frame		
Mural Frame with Feet, 30" W	SF30F	\$ 518
Mural Frame with Feet, 36" W	SF36F	\$ 575
Mural Frame with Feet, 42" W	SF42F	\$ 617
Mural Frame with Feet, 48" W	SF48F	\$ 648
Mural Frame with Feet, 54" W	SF54F	\$ 672
Mural Frame with Feet, 60" W	SF60F (shown)	\$ 682
Mural Frame with Feet, 66" W	SF66F	\$ 912
Mural Frame with Feet, 72" W	SF72F	\$ 969
Mural Frame with Feet, 84" W	SF84F	\$ 1053

MURAL

<p>How to specify — Select the Model Number from above.</p> <p>S F F .</p>	<p><i>1st Option:</i> Foot: STD Standard</p> <p>S T D .</p>	<p><i>2nd Option:</i> Paint: P1 P2 P3 See page 18 for finishes.</p> <p> </p>
---	--	---

Example: SF30F.STD.P02

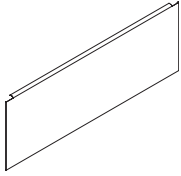

Description	Model	List Price
Mural Tiles		
Mural Tile 30"W, Painted	ST30MT	\$ 197
Mural Tile 36"W, Painted	ST36MT	\$ 210
Mural Tile 42"W, Painted	ST42MT	\$ 220
Mural Tile 48"W, Painted	ST48MT	\$ 231
Mural Tile 54"W, Painted	ST54MT	\$ 259
Mural Tile 60"W, Painted	ST60MT (shown)	\$ 271
Mural Tile 66"W, Painted	ST66MT	\$ 293
Mural Tile 72"W, Painted	ST72MT	\$ 326
Mural Tile 84"W, Painted	ST84MT	\$ 349

NOTE: 30"W-48"W, 84"W limited to non-ported, ported, and specialty ported tile styles.

<p>How to specify — Select the Model Number from above.</p> <p>S T M T .</p>	<p>1st Option: Tile Style: NP Non-Ported Tile YP Ported Tile* HP Integrated Desk Tile* SYP Specialty Ported Tile* SHP Specialty Integrated Desk Tile* *\$85/tile upcharge</p> <p> .</p>	<p>2nd Option: Paint: P1 P2 P3 See page 18 for finishes.</p> <p> </p>
---	--	---

Example: ST30MT.NP.P02



SC22ETS



SC22ETE





Description	Model	List Price
Mural End Trim		
Mural End Trim	SC22ETS	\$ 89
Mural End Trim with Infeed Access	SC22ETE	\$ 119

<p>How to specify — Select the Model Number from above.</p> <p>S C 2 2 E T .</p>	<p>1st Option: Paint: P1 P2 P3 See page 18 for finishes.</p> <p> </p>
---	---

Example: SC22ETS.P02

For specification information see pages 25-28.

GSA SIN 33721

		Description	Model	List Price
Mural Enhanced Connectors				
		Mural Flex Connector 12" W, Knit Mesh	SC12SFF	\$ 1404
SC12SFF	SC12TF	Mural T-Connector 12" W, Knit Mesh	SC12TF	\$ 1371
		Mural Y-Connector 12" W, Knit Mesh, 3-Way	SC12YF	\$ 2936
		Mural X-Connector 12" W, Knit Mesh	SC12XF	\$ 1476
				
SC12YF	SC12XF			







How to specify —
Select the Model Number from above.

1st Option:
Knit Mesh:

2nd Option:
Paint
(if applicable):
P1 P2 P3
See page 18 for finishes.

SC12 | | | | . | | | | .

Example:

		Description	Model	List Price
Mural Simple Connectors				
		Mural Straight Connector, Painted	SC12SS	\$ 225
SC12SS	SC12TS	Mural T-Connector, Painted	SC12TS	\$ 198
		Mural L-Connector, Painted	SC12LS	\$ 198
		Mural Y-Connector, Painted, 2-Way	SC12YS2	\$ 452
		Mural Y-Connector, Painted, 3-Way	SC12YS3	\$ 405
		Mural X-Connector, Painted	SC12XS	\$ 156
				
SC12LS	SC12YS2			
				
SC12YS3	SC12XS			

How to specify —
Select the Model Number from above.

1st Option:
Paint:
P1 P2 P3
See page 18 for finishes.

SC12 | | | | . | | | | .

Example: SC12SS.P02

MURAL

Integrated Height-Adjustable Tables

Mural — Worksurface

For specification information see pages 25-28.

GSA SIN 33721

Description	Model	List Price
Mural Rectangular Worksurfaces		
Mural Integ. Desk Top, 22"D x 46"W, Rectangular	SW2246NFS	\$ 626
Mural Integ. Desk Top, 22"D x 52"W, Rectangular	SW2252NFS	\$ 679
Mural Integ. Desk Top, 22"D x 58"W, Rectangular	SW2258DFS	\$ 845
Mural Integ. Desk Top, 22"D x 64"W, Rectangular	SW2264DFS	\$ 877
Mural Integ. Desk Top, 22"D x 70"W, Rectangular	SW2270DFS	\$ 901
Mural Integ. Desk Top, 23"D x 46"W, Rectangular	SW2346NFS	\$ 626
Mural Integ. Desk Top, 23"D x 52"W, Rectangular	SW2352NFS	\$ 679
Mural Integ. Desk Top, 23"D x 58"W, Rectangular	SW2358DFS	\$ 845
Mural Integ. Desk Top, 23"D x 64"W, Rectangular	SW2364DFS	\$ 877
Mural Integ. Desk Top, 23"D x 70"W, Rectangular	SW2370DFS	\$ 901
Mural Integ. Desk Top, 28"D x 46"W, Rectangular	SW2846NFS	\$ 704
Mural Integ. Desk Top, 28"D x 52"W, Rectangular	SW2852NFS	\$ 798
Mural Integ. Desk Top, 28"D x 58"W, Rectangular	SW2858DFS	\$ 945
Mural Integ. Desk Top, 28"D x 64"W, Rectangular	SW2864DFS	\$ 1002
Mural Integ. Desk Top, 28"D x 70"W, Rectangular	SW2870DFS	\$ 1028
Mural Integ. Desk Top, 29"D x 46"W, Rectangular	SW2946NFS	\$ 704
Mural Integ. Desk Top, 29"D x 52"W, Rectangular	SW2952NFS	\$ 798
Mural Integ. Desk Top, 29"D x 58"W, Rectangular	SW2958DFS	\$ 945
Mural Integ. Desk Top, 29"D x 64"W, Rectangular	SW2964DFS	\$ 1002
Mural Integ. Desk Top, 29"D x 70"W, Rectangular	SW2970DFS	\$ 1028
Mural Rounded Corner Worksurfaces		
Mural Integ. Desk Top, 22"D x 46"W, Rounded Corner	SW2246NFR	\$ 720
Mural Integ. Desk Top, 22"D x 52"W, Rounded Corner	SW2252NFR	\$ 781
Mural Integ. Desk Top, 22"D x 58"W, Rounded Corner	SW2258DFR	\$ 953
Mural Integ. Desk Top, 22"D x 64"W, Rounded Corner	SW2264DFR	\$ 1003
Mural Integ. Desk Top, 22"D x 70"W, Rounded Corner	SW2270DFR	\$ 1035
Mural Integ. Desk Top, 23"D x 46"W, Rounded Corner	SW2346NFR	\$ 720
Mural Integ. Desk Top, 23"D x 52"W, Rounded Corner	SW2352NFR	\$ 781
Mural Integ. Desk Top, 23"D x 58"W, Rounded Corner	SW2358DFR	\$ 953
Mural Integ. Desk Top, 23"D x 64"W, Rounded Corner	SW2364DFR	\$ 1003
Mural Integ. Desk Top, 23"D x 70"W, Rounded Corner	SW2370DFR	\$ 1035
Mural Integ. Desk Top, 28"D x 46"W, Rounded Corner	SW2846NFR	\$ 808
Mural Integ. Desk Top, 28"D x 52"W, Rounded Corner	SW2852NFR	\$ 916
Mural Integ. Desk Top, 28"D x 58"W, Rounded Corner	SW2858DFR	\$ 1071
Mural Integ. Desk Top, 28"D x 64"W, Rounded Corner	SW2864DFR	\$ 1152
Mural Integ. Desk Top, 28"D x 70"W, Rounded Corner	SW2870DFR	\$ 1181
Mural Integ. Desk Top, 29"D x 46"W, Rounded Corner	SW2946NFR	\$ 808
Mural Integ. Desk Top, 29"D x 52"W, Rounded Corner	SW2952NFR	\$ 916
Mural Integ. Desk Top, 29"D x 58"W, Rounded Corner	SW2958DFR	\$ 1071
Mural Integ. Desk Top, 29"D x 64"W, Rounded Corner	SW2964DFR	\$ 1152
Mural Integ. Desk Top, 29"D x 70"W, Rounded Corner	SW2970DFR	\$ 1181

How to specify — Select the Model Number from above.	1st Option: FSC: X No FSC F FSC Certified Wood	2nd Option: Laminate: See page 20 for finishes.	3rd Option: Edge: See page 20 for finishes.	4th Option: Grommet Location: G0 No Grommet GL Grommet Left GR Grommet Right GB Grommet Both GP1 Mural Power Bay (\$85) <i>Mural Power Bay only available as center mount in plastic. Plastic grommet finish determined by edge band.</i>	5th Option: Grommet Type (if applicable): P Oval Plastic M Oval Metal S Square Metal (\$13/grommet)	6th Option: Grommet Color (Metal only): EL Matte Silver Plastic grommet color determined by worksurface finish.
SW 2 . .						

Example:

Integrated Height-Adjustable Tables

Mural — Worksurface

For specification information see pages 25-28.

GSA SIN 33721

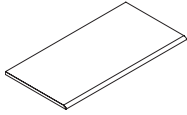

Description	Model	List Price
Mural Worksurfaces		
Mural Integ. Desk Top, 22"D x 46"W, Eased Edge	SW2246NE	\$ 829
Mural Integ. Desk Top, 22"D x 52"W, Eased Edge	SW2252NE	\$ 898
Mural Integ. Desk Top, 22"D x 58"W, Eased Edge	SW2258DE	\$ 1076
Mural Integ. Desk Top, 22"D x 64"W, Eased Edge	SW2264DE	\$ 1131
Mural Integ. Desk Top, 22"D x 70"W, Eased Edge	SW2270DE	\$ 1167
Mural Integ. Desk Top, 23"D x 46"W, Eased Edge	SW2346NE	\$ 829
Mural Integ. Desk Top, 23"D x 52"W, Eased Edge	SW2352NE	\$ 898
Mural Integ. Desk Top, 23"D x 58"W, Eased Edge	SW2358DE	\$ 1076
Mural Integ. Desk Top, 23"D x 64"W, Eased Edge	SW2364DE	\$ 1131
Mural Integ. Desk Top, 23"D x 70"W, Eased Edge	SW2370DE	\$ 1167
Mural Integ. Desk Top, 28"D x 46"W, Eased Edge	SW2846NE	\$ 930
Mural Integ. Desk Top, 28"D x 52"W, Eased Edge	SW2852NE	\$ 1053
Mural Integ. Desk Top, 28"D x 58"W, Eased Edge	SW2858DE	\$ 1213
Mural Integ. Desk Top, 28"D x 64"W, Eased Edge	SW2864DE	\$ 1302
Mural Integ. Desk Top, 28"D x 70"W, Eased Edge	SW2870DE	\$ 1334
Mural Integ. Desk Top, 29"D x 46"W, Eased Edge	SW2946NE	\$ 930
Mural Integ. Desk Top, 29"D x 52"W, Eased Edge	SW2952NE	\$ 1053
Mural Integ. Desk Top, 29"D x 58"W, Eased Edge	SW2958DE (shown)	\$ 1213
Mural Integ. Desk Top, 29"D x 64"W, Eased Edge	SW2964DE	\$ 1302
Mural Integ. Desk Top, 29"D x 70"W, Eased Edge	SW2970DE	\$ 1334

MURAL

How to specify — Select the Model Number from above.	1st Option: FSC: X No FSC F FSC Certified Wood	2nd Option: Laminate: See page 20 for finishes.	3rd Option: Edge: See page 20 for finishes.	4th Option: Grommet Location: GO No Grommet GL Grommet Left GR Grommet Right GB Grommet Both GP1 Mural Power Bay (\$85) <i>Mural Power Bay only available as center mount in plastic. Plastic grommet finish determined by edge band.</i>	5th Option: Grommet Type (if applicable): P Oval Plastic M Oval Metal S Square Metal (\$13/ grommet)	6th Option: Grommet Color (Metal only): EL Matte Silver Plastic grommet color determined by worksurface finish.
SW2 .		.	.			

Example:

Integrated Height-Adjustable Tables

Mural — HAT Base

For specification information see pages 25-28.

GSA SIN 33721

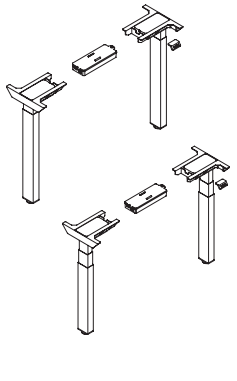
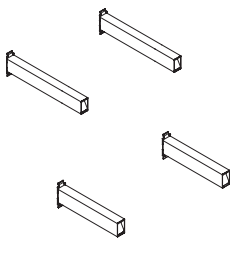
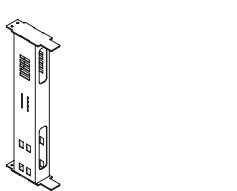
	Description	Model	List Price
	Mural Integrated Height-Adjustable Bases		
	Mural Integ. Desk, Std. Range	S2SD	\$ 2303
	Mural Integ. Desk, Ext. Range	S3SD	\$ 2527
	Mural Cross Bar, 22"D/24"D Desk, Single Sided	SCB24SS (shown)	\$ 197
	Mural Cross Bar, 22"D/24"D Desk, Dual Sided	SCB24DS (shown)	\$ 197
	Mural Cross Bar, 28"D/29 1/4"D Desk, Single Sided	SCB30SS	\$ 197
	Mural Cross Bar, 28"D/29 1/4"D Desk, Dual Sided	SCB30DS	\$ 197
	Mural Integ. Desk Mounting Kit	SKITD (shown)	\$ 414

MURAL



<p>How to specify — Select the Model Number from above.</p> <p>S .</p>	<p>1st Option: Select the Base Paint Color (if applicable):</p> <p>P1 P2 P3</p> <p>See page 18 for paint finishes.</p> <p> .</p>	<p>2nd Option: Select the Keypad (if applicable):</p> <p>UD Basic Up/Down MEM Memory Preset PDL Paddle</p> <p> .</p>
---	--	--

Example: S2SD24.P8L.PDL

Integrated Height-Adjustable Tables

For specification information see pages 25-33.

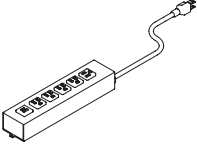
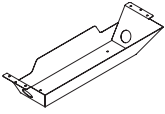
GSA SIN 33721

	Description	Model	List Price
	Wire Management		
	Under the Desk Power	SEDMUP	\$ 534
	* Available in black only.		
	20" W Wire Manager Trough	SEDMWM20	\$ 124
	30" W Wire Manager Trough	SEDMWM30	\$ 192
	* Available in black only.		
	Fabric Wire Manager (Pack of 2)	FBRZPWM	\$ 361
	* Metal Hook attachments available in black only.		

<p>How to specify — Select the Model Number from above.</p> <p>S E D M W M .</p> <p><i>Example:</i></p>	<p><i>1st Option:</i> Paint Color: P Black</p> <p>P </p>	<p><i>1st Option:</i> Fabric (if applicable): See pages 20-21 for fabrics.</p> <p> </p>
---	---	--

MURAL

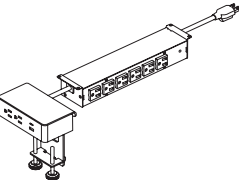
	Description	Model	List Price
	Power Module — Above/Below Worksurface		
	8 1/4" W x 16" D x 4 1/2" H	AABPWRMOD S	\$ 1234
	<ul style="list-style-type: none"> • Desktop unit includes 2 receptacles, 1 USB-A, & 1 USB-C (AC). • Under worksurface unit includes 6 receptacles. • Power cord choices include a 6' Straight cord (S) or Coiled cord (Q). • Desktop unit available in White (DWT) or Gray (DGY). • <i>Example: AABPWRMOD.AC.S.DWT</i> 		

<p>How to specify — Select the Model Number from above.</p> <p>A A B P W R M O D .</p>	<p><i>1st Option:</i> Ports (Final port option if applicable): AC USB-A+C</p> <p>A C .</p>	<p><i>2nd Option:</i> Cord Type (Power Module cord type if applicable): S Straight Cord Q Coiled Cord</p> <p> .</p>	<p><i>3rd Option:</i> Color Option (if applicable): DWT White DGY Gray</p> <p> </p>
--	--	---	--

Example: AAABPWRMOD.AC.Q.DWT

S Shippable by small-package carrier.

Integrated Height-Adjustable Tables

For specification information see page 239.2.

GSA SIN 33721

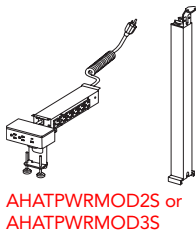

AHATPWRMOD2S or AHATPWRMOD3S

Description	Model	List Price		
		P1	P2	P3
Metal Telescoping HAT Wire Management				
	AHATPWRMOD2S	\$ 1614	\$ 1654	\$ 1675
	AHATPWRMOD3S	\$ 1646	\$ 1690	\$ 1711

- AHATPWRMOD2S pairs with 2-stage HAT bases.
- AHATPWRMOD3S pairs with 3-stage HAT bases.
- Desktop power module comes with 2 receptacles, 1 USB-A, and 1 USB-C port only, specify “AC” for this power configuration.
- Desktop power module available in White (DWT) or Gray (DGY) finishes, specify desired finish.
- Under worksurface power strip comes with 6 receptacles and is available in Black only, no specification needed.
- Metal Telescoping Chase available in the same paint finishes as Altitude HAT bases, specify desired paint finish.
- *Example: AHATPWRMOD2S.AC.DWT.PJW*

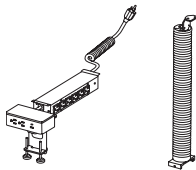

AHATPWRMOD2S or AHATPWRMOD3S

Description	Model	List Price		
		P1	P2	P3
Fabric HAT Wire Management				
	AHATPWRMODF	\$ 1476	\$ 1503	\$ 1516

- AHATPWRMODF pairs with 2-stage and 3-stage HAT bases.
- Desktop power module comes with 2 receptacles, 1 USB-A, and 1 USB-C port only, specify “AC” for this power configuration.
- Desktop power module available in White (DWT) or Gray (DGY) finishes, specify desired finish.
- Under worksurface power strip comes with 6 receptacles and is available in Black only, no specification needed.
- Fabric HAT Chase available in three fabric finishes of Light (LGT), Medium (MDD), and Dark (DRK), specify desired fabric finish.
- Fabric HAT mounting brackets available in the same paint finishes as Altitude HAT bases, specify desired paint finish.
- *Example: AHATPWRMODF.AC.DGY.LGT.PR5*

For more power and wire management options, please visit the [Extensions](#) pages.

<p>How to specify — Select the Model Number from above.</p>	<p>1st Option: Ports (Final port option if applicable): AC USB-A+C</p>	<p>2nd Option: Power Module Color Option (if applicable): DWT White DGY Gray</p>	<p>3rd Option: Fabric Chase Finish (if applicable): LGT Light MDD Medium DRK Dark</p>	<p>4th Option: Metal Paint Option (if applicable): See page 18 for finishes.</p>
<p>AHATPWRMOD . A C . D . . .</p>				

Example: AHATPWRMOD3S.AC.DWT.P8C

S Shippable by small-package carrier.

	Description	Model	List Price
	Mural Screen Frames		
	Mural Screen Frame 26"H x 30"W, Painted	SF2630P	\$ 496
	Mural Screen Frame 26"H x 36"W, Painted	SF2636P	\$ 505
	Mural Screen Frame 26"H x 42"W, Painted	SF2642P	\$ 513
	Mural Screen Frame 26"H x 48"W, Painted	SF2648P	\$ 522
	Mural Screen Frame 26"H x 54"W, Painted	SF2654P	\$ 531
	Mural Screen Frame 26"H x 60"W, Painted	SF2660P (shown)	\$ 540
	Mural Screen Frame 26"H x 66"W, Painted	SF2666P	\$ 552
	Mural Screen Frame 26"H x 72"W, Painted	SF2672P	\$ 561
Mural Screen Frame 26"H x 84"W, Painted	SF2684P	\$ 570	
	Mural Screen Frame 34"H x 30"W, Painted	SF3430P	\$ 522
	Mural Screen Frame 34"H x 36"W, Painted	SF3436P	\$ 531
	Mural Screen Frame 34"H x 42"W, Painted	SF3442P	\$ 540
	Mural Screen Frame 34"H x 48"W, Painted	SF3448P	\$ 548
	Mural Screen Frame 34"H x 54"W, Painted	SF3454P	\$ 558
	Mural Screen Frame 34"H x 60"W, Painted	SF3460P (shown)	\$ 569
	Mural Screen Frame 34"H x 66"W, Painted	SF3466P	\$ 579
	Mural Screen Frame 34"H x 72"W, Painted	SF3472P	\$ 591
	Mural Screen Frame 34"H x 84"W, Painted	SF3484P	\$ 601
	Mural Screen Frame 41"H x 30"W, Painted	SF4130P	\$ 547
	Mural Screen Frame 41"H x 36"W, Painted	SF4136P	\$ 558
	Mural Screen Frame 41"H x 42"W, Painted	SF4142P	\$ 567
	Mural Screen Frame 41"H x 48"W, Painted	SF4148P	\$ 577
	Mural Screen Frame 41"H x 54"W, Painted	SF4154P	\$ 586
	Mural Screen Frame 41"H x 60"W, Painted	SF4160P (shown)	\$ 597
	Mural Screen Frame 41"H x 66"W, Painted	SF4166P	\$ 608
	Mural Screen Frame 41"H x 72"W, Painted	SF4172P	\$ 618
	Mural Screen Frame 41"H x 84"W, Painted	SF4184P	\$ 631

MURAL

<p>How to specify — Select the Model Number from above.</p> <p>S F .</p>	<p>1st Option: Frame Paint: P1 P2 P3 See page 18 for finishes.</p> <p> .</p>	<p>2nd Option: Connector Paint: P1 P2 P3 See page 18 for finishes.</p> <p> .</p>
---	---	---

Example:

Description	Model	List Price
Mural Fabric Screens		
Mural Screen 26"H x 25"W, Fabric	AFS2625USF (shown)	\$ 943
Mural Screen 26"H x 31"W, Fabric	AFS2631USF	\$ 1008
Mural Screen 26"H x 37"W, Fabric	AFS2637USF	\$ 1055
Mural Screen 26"H x 43"W, Fabric	AFS2643USF	\$ 1131
Mural Screen 26"H x 49"W, Fabric	AFS2649USF	\$ 1186
Mural Screen 26"H x 55"W, Fabric	AFS2655USF	\$ 1255
Mural Screen 26"H x 61"W, Fabric	AFS2661USF	\$ 1299
Mural Screen 26"H x 67"W, Fabric	AFS2667USF	\$ 1405



Mural Fabric Half Screens		
Mural Screen 26"H x 27"W, Fabric	AFS2627USF (shown)	\$ 971
Mural Screen 26"H x 30"W, Fabric	AFS2630USF	\$ 986
Mural Screen 26"H x 33"W, Fabric	AFS2633USF	\$ 1044
Mural Screen 26"H x 39"W, Fabric	AFS2639USF	\$ 1108



Mural Fabric Screens		
Mural Screen 34"H x 25"W, Fabric	AFS3425USF (shown)	\$ 1021
Mural Screen 34"H x 31"W, Fabric	AFS3431USF	\$ 1078
Mural Screen 34"H x 37"W, Fabric	AFS3437USF	\$ 1106
Mural Screen 34"H x 43"W, Fabric	AFS3443USF	\$ 1211
Mural Screen 34"H x 49"W, Fabric	AFS3449USF	\$ 1246
Mural Screen 34"H x 55"W, Fabric	AFS3455USF	\$ 1371
Mural Screen 34"H x 61"W, Fabric	AFS3461USF	\$ 1456
Mural Screen 34"H x 67"W, Fabric	AFS3467USF	\$ 1520







Mural Fabric Half Screens		
Mural Screen 34"H x 27"W, Fabric	AFS3427USF (shown)	\$ 1049
Mural Screen 34"H x 30"W, Fabric	AFS3430USF	\$ 1070
Mural Screen 34"H x 33"W, Fabric	AFS3433USF	\$ 1102
Mural Screen 34"H x 39"W, Fabric	AFS3439USF	\$ 1204

MURAL

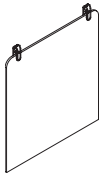
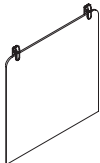
<p><i>How to specify —</i> Select the Model Number from above.</p>	<p><i>1st Option:</i> Fabric (if applicable): See page 18 for fabrics.</p>	<p><i>2nd Option:</i> Screen Clamp Paint: P1 P2 P3 See page 18 for finishes.</p>
<p>AFS .</p>	<p> .</p>	<p> .</p>

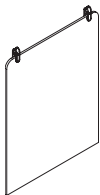
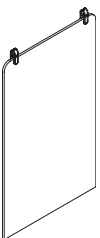
Example:

	Description	Model	List Price
	Mural PET Screens		
	Mural Screen 26"H x 25"W, PET	APS2625USF	\$ 816
	Mural Screen 26"H x 31"W, PET	APS2631USF	\$ 914
	Mural Screen 26"H x 37"W, PET	APS2637USF	\$ 1027
	Mural Screen 26"H x 43"W, PET	APS2643USF	\$ 1155
	Mural Screen 26"H x 49"W, PET	APS2649USF	\$ 1304
	Mural Screen 26"H x 55"W, PET	APS2655USF	\$ 1417
	Mural Screen 26"H x 61"W, PET	APS2661USF	\$ 1543
	Mural Screen 26"H x 67"W, PET	APS2667USF	\$ 1681
	Mural PET Half Screens		
	Mural Screen 26"H x 27"W, PET	APS2627USF (shown)	\$ 849
	Mural Screen 26"H x 30"W, PET	APS2630USF	\$ 918
	Mural Screen 26"H x 33"W, PET	APS2633USF	\$ 995
	Mural Screen 26"H x 39"W, PET	APS2639USF	\$ 1078
	Mural PET Screens		
	Mural Screen 34"H x 25"W, PET	APS3425USF (shown)	\$ 943
	Mural Screen 34"H x 31"W, PET	APS3431USF	\$ 1061
	Mural Screen 34"H x 37"W, PET	APS3437USF	\$ 1194
	Mural Screen 34"H x 43"W, PET	APS3443USF	\$ 1349
	Mural Screen 34"H x 49"W, PET	APS3449USF	\$ 1528
	Mural Screen 34"H x 55"W, PET	APS3455USF	\$ 1732
	Mural Screen 34"H x 61"W, PET	APS3461USF	\$ 1968
	Mural Screen 34"H x 67"W, PET	APS3467USF	\$ 2239
	Mural PET Half Screens		
	Mural Screen 34"H x 27"W, PET	APS3427USF (shown)	\$ 974
	Mural Screen 34"H x 30"W, PET	APS3430USF	\$ 1055
	Mural Screen 34"H x 33"W, PET	APS3433USF	\$ 1145
	Mural Screen 34"H x 39"W, PET	APS3439USF	\$ 1244
	Mural PET Screens		
	Mural Screen 41"H x 25"W, PET	APS4125USF (shown)	\$ 1099
	Mural Screen 41"H x 31"W, PET	APS4131USF	\$ 1240
	Mural Screen 41"H x 37"W, PET	APS4137USF	\$ 1402
	Mural Screen 41"H x 43"W, PET	APS4143USF	\$ 1586
	Mural Screen 41"H x 49"W, PET	APS4149USF	\$ 1800
	Mural Screen 41"H x 55"W, PET	APS4155USF	\$ 2044
	Mural Screen 41"H x 61"W, PET	APS4161USF	\$ 2326
	Mural Screen 41"H x 67"W, PET	APS4167USF	\$ 2408
	Mural PET Half Screens		
	Mural Screen 41"H x 27"W, PET	APS4127USF	\$ 1131
	Mural Screen 41"H x 30"W, PET	APS4130USF	\$ 1227
	Mural Screen 41"H x 33"W, PET	APS4133USF	\$ 1334
	Mural Screen 41"H x 39"W, PET	APS4139USF	\$ 1451

<p>How to specify — Select the Model Number from above.</p> <p>APIS .</p>	<p><i>1st Option:</i> PET: DGY4 Dark Grey DGY3 Medium Grey DBR1 Light Brown DBL1 Light Blue DGY2 Lightest Grey DBK1 Black</p> <p> .</p>	<p><i>2nd Option:</i> Screen Clamp Paint: P1 P2 P3 See page 18 for finishes.</p> <p> </p>
--	---	--

Example:

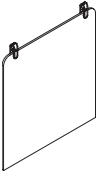
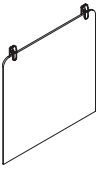
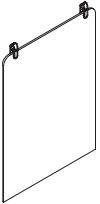
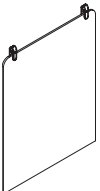
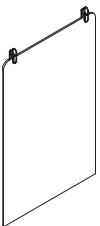
	Description	Model	List Price
	Mural Acrylic Screens		
	Mural Screen 26"H x 25"W, Acrylic	AAS2625USF (shown)	\$ 908
	Mural Screen 26"H x 31"W, Acrylic	AAS2631USF	\$ 974
	Mural Screen 26"H x 37"W, Acrylic	AAS2637USF	\$ 1052
	Mural Screen 26"H x 43"W, Acrylic	AAS2643USF	\$ 1122
	Mural Screen 26"H x 49"W, Acrylic	AAS2649USF	\$ 1177
	Mural Screen 26"H x 55"W, Acrylic	AAS2655USF	\$ 1231
	Mural Screen 26"H x 61"W, Acrylic	AAS2661USF	\$ 1369
	Mural Screen 26"H x 67"W, Acrylic	AAS2667USF	\$ 1427
	Mural Acrylic Half Screens		
	Mural Screen 26"H x 27"W, Acrylic	AAS2627USF (shown)	\$ 923
	Mural Screen 26"H x 30"W, Acrylic	AAS2630USF	\$ 959
	Mural Screen 26"H x 33"W, Acrylic	AAS2633USF	\$ 1009
	Mural Screen 26"H x 39"W, Acrylic	AAS2639USF	\$ 1105
	Mural Acrylic Screens		
	Mural Screen 34"H x 25"W, Acrylic	AAS3425USF (shown)	\$ 982
	Mural Screen 34"H x 31"W, Acrylic	AAS3431USF	\$ 1099
	Mural Screen 34"H x 37"W, Acrylic	AAS3437USF	\$ 1158
	Mural Screen 34"H x 43"W, Acrylic	AAS3443USF	\$ 1218
	Mural Screen 34"H x 49"W, Acrylic	AAS3449USF	\$ 1465
	Mural Screen 34"H x 55"W, Acrylic	AAS3455USF	\$ 1534
	Mural Screen 34"H x 61"W, Acrylic	AAS3461USF	\$ 1885
	Mural Screen 34"H x 67"W, Acrylic	AAS3467USF	\$ 1960
	Mural Acrylic Half Screens		
	Mural Screen 34"H x 27"W, Acrylic	AAS3427USF (shown)	\$ 1022
	Mural Screen 34"H x 30"W, Acrylic	AAS3430USF	\$ 1082
	Mural Screen 34"H x 33"W, Acrylic	AAS3433USF	\$ 1140
	Mural Screen 34"H x 39"W, Acrylic	AAS3439USF	\$ 1199
	Mural Acrylic Half Screens		
	Mural Screen 41"H x 27"W, Acrylic	AAS4127USF (shown)	\$ 1105
	Mural Screen 41"H x 30"W, Acrylic	AAS4130USF	\$ 1170
	Mural Screen 41"H x 33"W, Acrylic	AAS4133USF	\$ 1233
	Mural Screen 41"H x 39"W, Acrylic	AAS4139USF	\$ 1411

MURAL

<p>How to specify — Select the Model Number from above.</p>	<p>1st Option: Acrylic: ASC Clear ASF Frosted</p>	<p>2nd Option: Screen Clamp Paint: P1 P2 P3 See page 18 for finishes.</p>
<p>A A S .</p> <p><i>Example:</i></p>	<p> .</p>	<p> .</p>

	Description	Model	List Price
	Mural Glass Markerboard Screens		
	Mural Screen 26"H x 25"W, Glass	AGS2625USF (shown)	\$ 2952
	Mural Screen 26"H x 31"W, Glass	AGS2631USF	\$ 3141
	Mural Screen 26"H x 37"W, Glass	AGS2637USF	\$ 3331
	Mural Screen 26"H x 43"W, Glass	AGS2643USF	\$ 3519
	Mural Screen 26"H x 49"W, Glass	AGS2649USF	\$ 4099
	Mural Screen 26"H x 55"W, Glass	AGS2655USF	\$ 4310
	Mural Glass Markerboard Half Screens		
	Mural Screen 26"H x 27"W, Glass	AGS2627USF (shown)	\$ 2952
	Mural Screen 26"H x 30"W, Glass	AGS2630USF	\$ 3141
	Mural Screen 26"H x 33"W, Glass	AGS2633USF	\$ 3331
	Mural Screen 26"H x 39"W, Glass	AGS2639USF	\$ 3519
	Mural Glass Markerboard Screens		
	Mural Screen 34"H x 25"W, Glass	AGS3425USF (shown)	\$ 3230
	Mural Screen 34"H x 31"W, Glass	AGS3431USF	\$ 3440
	Mural Screen 34"H x 37"W, Glass	AGS3437USF	\$ 3647
	Mural Screen 34"H x 43"W, Glass	AGS3443USF	\$ 3856
	Mural Screen 34"H x 49"W, Glass	AGS3449USF	\$ 4063
	Mural Screen 34"H x 55"W, Glass	AGS3455USF	\$ 4274
	Mural Glass Markerboard Half Screens		
	Mural Screen 34"H x 27"W, Glass	AGS3427USF (shown)	\$ 3230
	Mural Screen 34"H x 30"W, Glass	AGS3430USF	\$ 3440
	Mural Screen 34"H x 33"W, Glass	AGS3433USF	\$ 3647
	Mural Screen 34"H x 39"W, Glass	AGS3439USF	\$ 3856

MURAL

<p><i>How to specify —</i></p> <p>Select the Model Number from above.</p> <p>AGS .</p>	<p><i>1st Option:</i></p> <p>Glass:</p> <p>GMB1 Markerboard</p> <p> .</p>	<p><i>2nd Option:</i></p> <p>Screen Clamp Paint:</p> <p>P1 P2 P3</p> <p>See page 18 for finishes.</p> <p> .</p>
---	--	--

Example:

Description	Model	List Price
Mural Mesh Screens		
Mural Screen 26"H x 25"W, Mesh	ASH2625USF (shown)	\$ 349
Mural Screen 26"H x 31"W, Mesh	ASH2631USF	\$ 430
Mural Screen 26"H x 37"W, Mesh	ASH2637USF	\$ 511
Mural Screen 26"H x 43"W, Mesh	ASH2643USF	\$ 573
Mural Screen 26"H x 49"W, Mesh	ASH2649USF	\$ 661
Mural Screen 26"H x 55"W, Mesh	ASH2655USF	\$ 742
Mural Screen 26"H x 61"W, Mesh	ASH2661USF	\$ 822
Mural Screen 26"H x 67"W, Mesh	ASH2667USF	\$ 898
Mural Screen 26"H x 79"W, Mesh	ASH2679USF	\$ 1120
<hr/>		
Mural Screen 34"H x 25"W, Mesh	ASH3425USF (shown)	\$ 405
Mural Screen 34"H x 31"W, Mesh	ASH3431USF	\$ 505
Mural Screen 34"H x 37"W, Mesh	ASH3437USF	\$ 573
Mural Screen 34"H x 43"W, Mesh	ASH3443USF	\$ 655
Mural Screen 34"H x 49"W, Mesh	ASH3449USF	\$ 754
Mural Screen 34"H x 55"W, Mesh	ASH3455USF	\$ 847
Mural Screen 34"H x 61"W, Mesh	ASH3461USF	\$ 935
Mural Screen 34"H x 67"W, Mesh	ASH3467USF	\$ 1010
Mural Screen 34"H x 79"W, Mesh	ASH3479USF	\$ 1259
<hr/>		
Mural Screen 41"H x 25"W, Mesh	ASH4125USF (shown)	\$ 436
Mural Screen 41"H x 31"W, Mesh	ASH4131USF	\$ 536
Mural Screen 41"H x 37"W, Mesh	ASH4137USF	\$ 636
Mural Screen 41"H x 43"W, Mesh	ASH4143USF	\$ 735
Mural Screen 41"H x 49"W, Mesh	ASH4149USF	\$ 835
Mural Screen 41"H x 55"W, Mesh	ASH4155USF	\$ 935
Mural Screen 41"H x 61"W, Mesh	ASH4161USF	\$ 1035
Mural Screen 41"H x 67"W, Mesh	ASH4167USF	\$ 1147
Mural Screen 41"H x 79"W, Mesh	ASH4179USF	\$ 1371

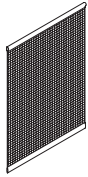
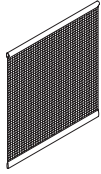

MURAL

<p><i>How to specify —</i> Select the Model Number from above.</p>	<p><i>1st Option:</i></p>
	<p>Mesh: CHK Chalk GRS Greystone PEW Pewter</p>
<p>ASH .</p>	<p> </p>

Example:

	Description	Model	List Price
	Mural Laminate Screens		
	Mural Screen 26"H x 25"W, Laminate	ALS2625USF (shown)	\$ 531
	Mural Screen 26"H x 31"W, Laminate	ALS2631USF	\$ 559
	Mural Screen 26"H x 37"W, Laminate	ALS2637USF	\$ 619
	Mural Screen 26"H x 43"W, Laminate	ALS2643USF	\$ 695
	Mural Screen 26"H x 49"W, Laminate	ALS2649USF	\$ 953
	Mural Screen 26"H x 55"W, Laminate	ALS2655USF	\$ 986
	Mural Screen 26"H x 61"W, Laminate	ALS2661USF	\$ 1018
	Mural Screen 26"H x 67"W, Laminate	ALS2667USF	\$ 1052
	Mural Laminate Half Screens		
	Mural Screen 26"H x 27"W, Laminate	ALS2627USF (shown)	\$ 534
	Mural Screen 26"H x 30"W, Laminate	ALS2630USF	\$ 556
	Mural Screen 26"H x 33"W, Laminate	ALS2633USF	\$ 582
	Mural Screen 26"H x 39"W, Laminate	ALS2639USF	\$ 637
	Mural Laminate Screens		
	Mural Screen 34"H x 25"W, Laminate	ALS3425USF (shown)	\$ 617
	Mural Screen 34"H x 31"W, Laminate	ALS3431USF	\$ 648
	Mural Screen 34"H x 37"W, Laminate	ALS3437USF	\$ 715
	Mural Screen 34"H x 43"W, Laminate	ALS3443USF	\$ 803
	Mural Screen 34"H x 49"W, Laminate	ALS3449USF	\$ 1108
	Mural Screen 34"H x 55"W, Laminate	ALS3455USF	\$ 1142
	Mural Screen 34"H x 61"W, Laminate	ALS3461USF	\$ 1173
	Mural Screen 34"H x 67"W, Laminate	ALS3467USF	\$ 1205
	Mural Laminate Half Screens		
	Mural Screen 34"H x 27"W, Laminate	ALS3427USF (shown)	\$ 620
	Mural Screen 34"H x 30"W, Laminate	ALS3430USF	\$ 643
	Mural Screen 34"H x 33"W, Laminate	ALS3433USF	\$ 670
	Mural Screen 34"H x 39"W, Laminate	ALS3439USF	\$ 735
	Mural Laminate Half Screens		
	Mural Screen 41"H x 27"W, Laminate	ALS4127USF (shown)	\$ 723
	Mural Screen 41"H x 30"W, Laminate	ALS4130USF	\$ 745
	Mural Screen 41"H x 33"W, Laminate	ALS4133USF	\$ 770
	Mural Screen 41"H x 39"W, Laminate	ALS4139USF	\$ 794

MURAL

<p>How to specify — Select the Model Number from above.</p> <p>ALS .</p>	<p>1st Option: FSC: X No FSC F FSC Certified Wood</p>	<p>2nd Option: Laminate: See page 20 for finishes.</p>	<p>3rd Option: Edge: See page 20 for finishes.</p>	<p>4th Option: Grain: VLG Horizontal grain or Solid only. VST Vertical Grain (up to 60"W only).</p>	<p>5th Option: Paint: P1 P2 P3 See page 18 for finishes.</p>
---	---	--	--	---	--

Example:

Description	Model	List Price
Mural Veneer Screens		
Mural Screen 26"H x 25"W, Veneer	AWS2625USF (shown)	\$ 871
Mural Screen 26"H x 31"W, Veneer	AWS2631USF	\$ 896
Mural Screen 26"H x 37"W, Veneer	AWS2637USF	\$ 921
Mural Screen 26"H x 43"W, Veneer	AWS2643USF	\$ 946
Mural Screen 26"H x 49"W, Veneer	AWS2649USF	\$ 970
Mural Screen 26"H x 55"W, Veneer	AWS2655USF	\$ 995
Mural Screen 26"H x 61"W, Veneer	AWS2661USF	\$ 1020
Mural Screen 26"H x 67"W, Veneer	AWS2667USF	\$ 1045
Mural Veneer Half Screens		
Mural Screen 26"H x 27"W, Veneer	AWS2627USF (shown)	\$ 871
Mural Screen 26"H x 30"W, Veneer	AWS2630USF	\$ 896
Mural Screen 26"H x 33"W, Veneer	AWS2633USF	\$ 921
Mural Screen 26"H x 39"W, Veneer	AWS2639USF	\$ 946
Mural Veneer Screens		
Mural Screen 34"H x 25"W, Veneer	AWS3425USF (shown)	\$ 990
Mural Screen 34"H x 31"W, Veneer	AWS3431USF	\$ 1014
Mural Screen 34"H x 37"W, Veneer	AWS3437USF	\$ 1039
Mural Screen 34"H x 43"W, Veneer	AWS3443USF	\$ 1064
Mural Screen 34"H x 49"W, Veneer	AWS3449USF	\$ 1089
Mural Screen 34"H x 55"W, Veneer	AWS3455USF	\$ 1114
Mural Screen 34"H x 61"W, Veneer	AWS3461USF	\$ 1138
Mural Screen 34"H x 67"W, Veneer	AWS3467USF	\$ 1163
Mural Veneer Half Screens		
Mural Screen 34"H x 27"W, Veneer	AWS3427USF (shown)	\$ 990
Mural Screen 34"H x 30"W, Veneer	AWS3430USF	\$ 1014
Mural Screen 34"H x 33"W, Veneer	AWS3433USF	\$ 1039
Mural Screen 34"H x 39"W, Veneer	AWS3439USF	\$ 1064
Mural Veneer Half Screens		
Mural Screen 41"H x 27"W, Veneer	AWS4127USF (shown)	\$ 1137
Mural Screen 41"H x 30"W, Veneer	AWS4130USF	\$ 1161
Mural Screen 41"H x 33"W, Veneer	AWS4133USF	\$ 1186
Mural Screen 41"H x 39"W, Veneer	AWS4139USF	\$ 1210

MURAL

<p>How to specify — Select the Model Number from above.</p>	<p><i>1st Option:</i> FSC: X No FSC F FSC Certified Wood</p>	<p><i>2nd Option:</i> Veneer: See page 19 for finishes.</p>	<p><i>3rd Option:</i> Grain: VLG Horizontal grain VST Vertical Grain (up to 60"W only).</p>	<p><i>4th Option:</i> Paint: P1 P2 P3 See page 18 for finishes.</p>
	<p>AWS .</p>	<p> .</p>	<p> .</p>	<p> .</p>

Example:

Description	Model	List Price
Mural Fence Filler Kits		
Mural No-Screen Filler Kit, Full Panel, 25"W	SAFILLERKIT25	\$ 113
Mural No-Screen Filler Kit, Full Panel, 31"W	SAFILLERKIT31	\$ 113
Mural No-Screen Filler Kit, Full Panel, 37"W	SAFILLERKIT37	\$ 113
Mural No-Screen Filler Kit, Full Panel, 43"W	SAFILLERKIT43	\$ 142
Mural No-Screen Filler Kit, Full Panel, 49"W	SAFILLERKIT49	\$ 142
Mural No-Screen Filler Kit, Full Panel, 55"W	SAFILLERKIT55 (shown)	\$ 142
Mural No-Screen Filler Kit, Full Panel, 61"W	SAFILLERKIT61	\$ 169
Mural No-Screen Filler Kit, Full Panel, 67"W	SAFILLERKIT67	\$ 169
Mural No-Screen Filler Kit, Full Panel, 79"W	SAFILLERKIT79	\$ 169
<hr/>		
Mural No-Screen Filler Kit, 2 Partial Panels	SAFILLERKIT1	\$ 57
<hr/>		
Mural No-Screen Filler Kit, Partial Panel, 28" W	SAFILLERKIT27	\$ 113
Mural No-Screen Filler Kit, Partial Panel, 31" W	SAFILLERKIT30	\$ 113
Mural No-Screen Filler Kit, Partial Panel, 34" W	SAFILLERKIT33	\$ 113
Mural No-Screen Filler Kit, Partial Panel, 40" W	SAFILLERKIT39	\$ 142
<hr/>		
Mural No-Screen Frame Filler Kit	SAFILLERKITNF (shown)	\$ 156
<hr/>		
Mural Screen Frame End Cap		
Mural Accessory End Cap, Hanger	SAHANGER	\$ 62

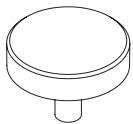
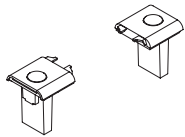

*Recommended to be specified with screen frame.

MURAL

<p>How to specify — Select the Model Number from above.</p> <p>SA .</p> <p><i>Example:</i></p>	<p>1st Option: Paint: P1 P2 P3 See page 18 for finishes.</p> <p> </p>
---	---

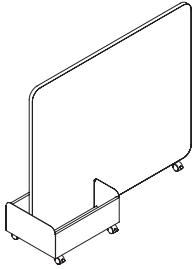

Description	Model	List Price
Mural Privacy Panel		
Privacy Panel w/ Bin, 50"H x 60"W	SS5060MS	\$ 1707

*Specify markerboard laminate to make it a writable surface.

How to specify — Select the Model Number from above.	1st Option: FSC: X No FSC F FSC Certified Wood	2nd Option: Privacy Panel Laminate:	3rd Option: Bin Laminate:	4th Option: Edge:	5th Option: Grain: VLG Horizontal grain or solid VST Vertical grain	6th Option: Paint: P1 P2 P3 See pages 18-20 for finishes.
SS5060MS

Example:

Description	Model	List Price
Mural Bent Screen		
Bent Privacy Panel, 52"H x 68" W, LH	SS5268BLH	\$ 4127
Bent Privacy Panel, 52"H x 68" W, RH	SS5268BRH	\$ 4127

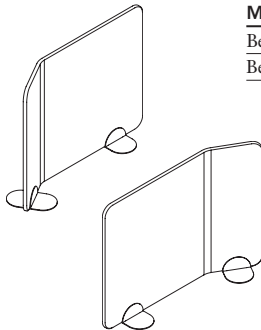

How to specify — Select the Model Number from above.	1st Option: Paint: P1 P2 P3 See page 18 for finishes.	2nd Option: Fabric (if applicable): See page 10 for fabrics.
SS5268B

Example:

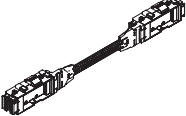
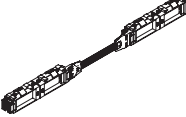
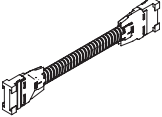
	Description	Model	List Price
 SE30EK4C  SE36EK4C  SE60EK4C  SESSEJ4C	Electrical Kits		
	Mural Electrical Kit for 30" W Frame, 4-cir	SE30EK4C (shown)	\$ 330
	Mural Electrical Kit for 36" W Frame, 4-cir	SE36EK4C (shown)	\$ 330
	Mural Electrical Kit for 42" W Frame, 4-cir	SE42EK4C	\$ 352
	Mural Electrical Kit for 48" W Frame, 4-cir	SE48EK4C	\$ 352
	Mural Electrical Kit for 54" W Frame, 4-cir	SE54EK4C	\$ 352
	Mural Electrical Kit for 60" W Frame, 4-cir	SE60EK4C (shown)	\$ 352
	Mural Electrical Kit for 66" W Frame, 4-cir	SE66EK4C	\$ 422
	Mural Electrical Kit for 72" W Frame, 4-cir	SE72EK4C	\$ 492
	Mural Electrical Kit for 84" W Frame, 4-cir	SE84EK4C	\$ 492
	Mural Electrical Kit for 30" W Frame, 3-cir	SE30EK3C	\$ 330
	Mural Electrical Kit for 36" W Frame, 3-cir	SE36EK3C	\$ 330
	Mural Electrical Kit for 42" W Frame, 3-cir	SE42EK3C	\$ 352
	Mural Electrical Kit for 48" W Frame, 3-cir	SE48EK3C	\$ 352
	Mural Electrical Kit for 54" W Frame, 3-cir	SE54EK3C	\$ 352
Mural Electrical Kit for 60" W Frame, 3-cir	SE60EK3C	\$ 352	
Mural Electrical Kit for 66" W Frame, 3-cir	SE66EK3C	\$ 422	
Mural Electrical Kit for 72" W Frame, 3-cir	SE72EK3C	\$ 492	
Mural Electrical Kit for 84" W Frame, 3-cir	SE84EK3C	\$ 492	
Jumpers			
Mural Panel to Panel Jumper, 4-Cir for Std Connector	SESSEJ4C (shown)	\$ 185	
Mural Panel to Panel Jumper, 4-Cir for Enhanced/Flex Connector	SESFEJ4C	\$ 185	
Mural Panel to Panel Jumper, 3-Cir for Std Connector	SESSEJ3C	\$ 185	
Mural Panel to Panel Jumper, 3-Cir for Enhanced/Flex Connector	SESFEJ3C	\$ 185	
Pass Throughs			
Mural Jumper for 30"W-54"W Panels, 4-Cir	SESMEJ4C	\$ 282	
Mural Jumper for 60"W-84"W Panels, 4-Cir	SELGEJ4C	\$ 282	
Mural Jumper for 30"W-54"W Panels, 3-Cir	SESMEJ3C	\$ 282	
Mural Jumper for 60"W-84"W Panels, 3-Cir	SELGEJ3C	\$ 282	

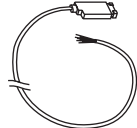
	Description	Four-circuit 3 + 1 2 + 2	List Price
  A871912	Duplex Receptacles for Beltline or Base Pathway — Mural (specify color)		
	Circuit 1	A873501 <input type="checkbox"/>	\$ 72
	Circuit 2	A873502 <input type="checkbox"/>	\$ 72
	Circuit 3 (3+1)	A873503 <input type="checkbox"/>	\$ 72
	Circuit 3 (2+2)	A873506 <input type="checkbox"/>	\$ 72
	Circuit 4 — iso/dedicated	A873504 <input type="checkbox"/>	\$ 72
Circuit 1, 20 AMP	A871601 <input type="checkbox"/>	\$ 72	
Electrical Infeed Cables			
6' Flex Cable	A871972 <input type="checkbox"/>	\$ 331	
12' Flex Cable	A871912 <input type="checkbox"/>	\$ 449	
18' Flex Cable	A871918 <input type="checkbox"/>	\$ 565	
12' Sealtight Cable Power Infeed	A877012 <input type="checkbox"/>	\$ 547	

<p>How to specify — Select the Model Number from above.</p> <p>S E </p>	<p><i>1st Option:</i> Paint (if applicable): P1 P2 P3 See page 18 for finishes.</p>
---	---

Example: SE30EK4C.P71

Shippable by small-package carrier.

Description	Model	List Price
Power Pole		
Mural System 8' Power Pole	SE08PP1	\$ 963
10'5" H Power Connector Pole	A870070	\$ 799
Mural System Power Pole Splicer Kit	SE08PP2	\$ 107
Mural System T-Power Pole Mounting Kit	SE08TPP2	\$ 107
Mural System Y-Power Pole Mounting Kit	SE08YPP2	\$ 107
Mural System X-Power Pole Mounting Kit	SE08XPP2	\$ 107

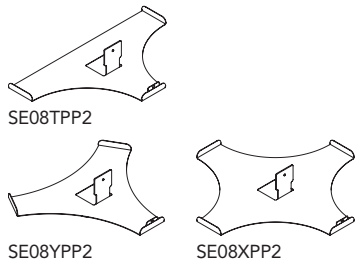
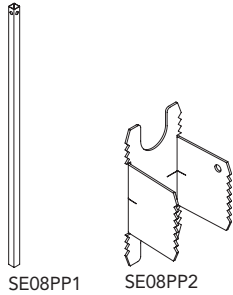

Description	Four-circuit 3 + 1 2 + 2	Three-circuit Separate Neutrals	List Price
Hardwire Power Infeed (New York Code)			
	A871400	A871400A S	\$ 431

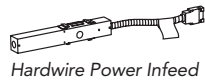

Note: Four-circuit components and Three-circuit components (with an "A" suffix) cannot be connected together.

Description	Chicago Code Model	List Price
Hardwire (Chicago Code) (Black only)		
Terrace Base Pathway Junction Box (Pack of 6)	873600 S	\$ 1145





How to specify —
Select the Model Number from above.

1st Option:
Paint (if applicable):
P1 P2 P3
See page 18 for finishes.

Example: _____ . _____



MURAL

Description	Model	List Price
Data Faceplates (will not work in beams)		
Three-Port Flex-Mode Faceplate, Black (E4)	ATADF3 	\$ 42
Four-Port Flex-Mode Faceplate, Black (E4)	ATADF4 	\$ 42

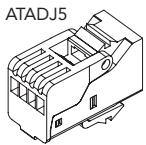
Notes: ATADF3 can install up to 3 jacks (CAT 3, 5E or 6). ATADF4 can install 4 jacks (CAT 3, 5E or 6).
Allsteel's data faceplates are designed for use with the jacks listed below. We do not guarantee compatibility with other manufacturers' product. A faceplate adapter is available for use with alternatively sourced data jacks, see the Standard Specials catalog for details.



ATADF4

Jacks		
RJ45 CAT 5E Jack — Black only		
Toolless	ATADJ5 	\$ 74
RJ45 CAT 6 Jack — Black only		
Requires Tool	ATADJ6 	\$ 98

Description	Model	P1 List Price	P2 List Price	P3 List Price
Tile Port Cover				
Tile Port Cover (Pack of 2)	GSYSRPC2 (shown)	\$ 61	\$ 65	\$ 68
Tile Port Cover (Pack of 12)	GSYSRPC12 (shown)	\$ 226	\$ 236	\$ 246

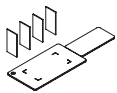

GSYSRPC2

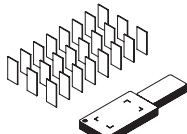

GSYSRPC12

<p>How to specify — Select the Model Number from above.</p>	<p>1st Option: Electrical Receptacle Color (if applicable): See page 18 for finishes.</p>
--	--

_____ . **E** _____

Example: ATADF3.E4

 Shippable by small-package carrier.

Finishes	56
Typicals	57-58
Introduction to Further	59-60
Statement of Line	61-62
Planning Guidelines.....	63-71
<i>Worksurfaces And Supports</i>	
Working with Worksurfaces and Supports.....	72-79
Worksurface Brackets and Support Channel.....	80
Rectangular Worksurfaces.....	81
120° and Corner Cove Worksurfaces.....	82-83
Worksurface Supports — Beams, Hubs, and Supports.....	84-89
<i>Electrical & Data</i>	
Working with Electrical and Data	90-102
Electrical Infeeds, Power Kits, and Components	103-104
Beam Mounted Wire Manager.....	105
Data Components	106
<i>Collaborative Hub</i>	
Working with Collaborative Hub	107
Collaborative Hub Components	108
<i>Screens</i>	
Working with Screens.....	109-110
Fabric Screens and Modesty Panels.....	111-112
Glass Screens.....	113
User Movable and Lateral Screens	114
Metal Screens Size Reference Matrix	115
Working with Stride Benching Screens	116
Further Adaptive Metal Screens	117
Stride Lateral Divider Screens	118
Further Adaptive Metal Screens	119
Further Adaptive Tackboard Accessories.....	119-120
<i>STORAGE — Laminate with Metal</i>	
Working with Storage	121-122
Storage Stanchions.....	123
Pedestals and Credenzas.....	124
Storage Towers.....	125
<i>Adaptive</i>	
Adaptive Typicals.....	126
Adaptive Statement of Line.....	127
Working with Adaptive Worksurfaces and Supports.....	128-139
Working with Adaptive Electrical and Data	140-142
Controls and Electrical & Data Components	143-144
Working with Screens, Storage, and Extensions.....	145-146

PAINT FINISHES

GRADE P1

Black	P27
Brownstone	P7D
Bungalow	P7C
Cinder	P7Q
Designer White	PJW
Flint	P02
Fossil	P28
Loft	P7B
Muslin	P4J
Parchment	P93
Pebble	P8R
Pewter	P8D
Salt	P8C
Titanium	P8T

GRADE P2

Champagne Metallic	PR5
Gunmetal Metallic	PR3
Night Bronze	P8B
Platinum Metallic	PR2
Pyrite	PJE
Silver	PR6
Solar Black	P8X

GRADE P3

Atom	P8S
Blossom***	P8K
Bullseye	PJF
Ember	P8P
Ion	P8N
Iris	P8J
Krypton	P8F
Ochre	P093
Regatta	P8M
Sienna	P092
Succulent***	P8A

***These colors are intended to be an inspirational option for the trending market. Product application is limited and color availability is approximately two years to coincide with evolving workplace trends.

Metallic paints, due to varying reflectance, may appear to have less visual color consistency than other paint finishes, even when L/A/B values are exactly the same. (L/A/B — measurable aspects of color — values are maintained within a specified range, to ensure consistent appearance of paint colors.)

ELECTRICAL AND DATA COMPONENTS

Black	E4
Brownstone	EY
Designer White	DW
Flint	E9
Loft	EV
Muslin	EU
Silver	ES

Recommended Coordinate Colors:
 Bungalow use Muslin EU
 Carob use Black E4
 Champagne Metallic use Muslin EU
 Cinder use Brownstone EY
 Fossil use Flint E9
 Gunmetal Metallic use Brownstone EY
 Parchment use Muslin EU
 Pebble use Loft EV
 Pewter use Flint E9
 Platinum Metallic use Silver ES
 Salt use Silver ES
 Titanium use Silver ES

LAMINATES

GRADE L1

SOLID COLORS	
Black*	P
Brownstone*	LM13
Bungalow*	LM12
Designer White*	LDW1
Flint*	LM16
Fossil Shale*	LEH1
Loft*	LM11
Muslin*	LM15
Titanium*	LTI1

ABSTRACT COLORS

Ash	LT3B
Handspun Pearl	LAHP
Handspun Dove	LAHD
Handspun Slate	LAHS
Handspun Chestnut	LAHC
Silver Mesh	LT8D

WOODGRAIN

Belair*	LWBA
Bourbon Cherry*	H
Field Elm*	LWFE
Florence Walnut*	LFW1
Kingswood Walnut*	LK11
Natural Maple*	LWD
NeoWalnut*	LNU1
Pinnacle*	PINC
Shaker Cherry*	LW7C

GRADE L2

Beigewood*	LWBE
Fawn Cypress*	LFC1
Lowell Ash*	LLA1
Mangalore Mango*	LMM1
Natural Recon*	LNR1
Phantom Charcoal*	LPC1
Phantom Ecu*	LPE1
Portico Teak*	LPT1
Skyline Walnut*	LSW1
Veranda Teak	LVT1

GRADE L3

Natural Walnut*	LWNW
-----------------------	------

*Storage available in these 30 laminates.

All laminate surfaces are also offered with the FSC wood option. Add FSC in front of each laminate option. Refer to specification tools.

LAMINATE EDGE COLORS

Beigewood	DE
Belair	BA
Black	E4
Bourbon Cherry	H
Brownstone	EY
Bungalow	EX
Designer White	DW
Fawn Cypress	FC
Field Elm	FE
Flint	E9
Florence Walnut	FW
Fossil	EH
Kingswood Walnut	KI
Loft	EV
Lowell Ash	DL
Mangalore Mango	MM
Muslin	EU
Natural Maple	DD
Natural Recon	NR
Natural Walnut	DN
NeoWalnut	NU
Parchment	EN
Phantom Charcoal	PC
Phantom Ecu	PE
Pinnacle	PI
Platinum Metallic	EP
Plyband ♦	PL
Portico Teak	DP
Shaker Cherry	DF
Skyline Walnut	SW
Veranda Teak	VT

♦ Edge is limited to flat edge surfaces: rectangle, square, trapezoid, polygon, or round. No curvilinear or combination curve and straight.

NOTE: Refer to individual product pages for upcharges.

FSC Certified Wood at Allsteel
 See page 295 for more information.

A full gallery of typicals from each Allsteel system can be found on our website:

<https://www.allsteeloffice.com/design-resources/idea-starters>.

Each typical includes a complete BOM with current pricing, downloadable CAD files and PDFs of each drawing.

Linear Shapes

Use the Allsteel Typicals Gallery to find the components used in a Further Station.

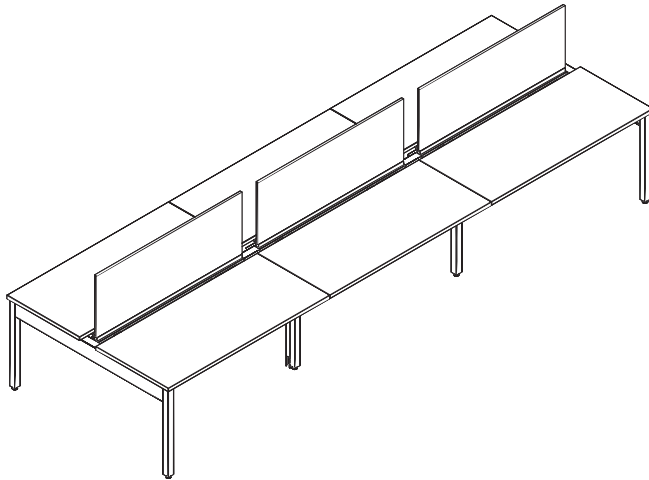

Further Beams Connected Bench 2'-6" x 5'

Bench configuration encourages collaboration.

Organic Shapes

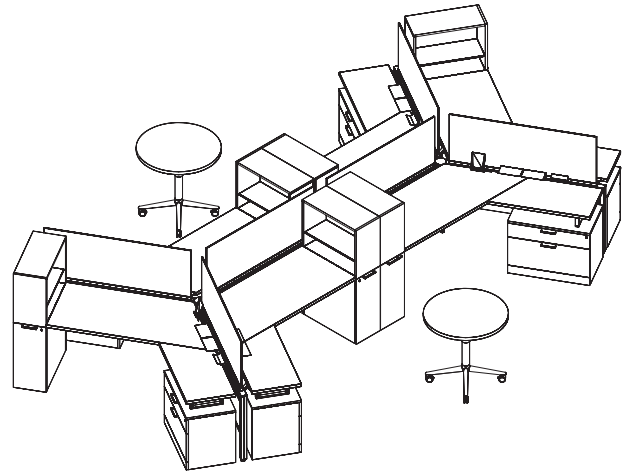

Further Beam Connected Dog Bone 7'-6" x 7'-6"

Trapezoid worksurfaces provide an open feeling.

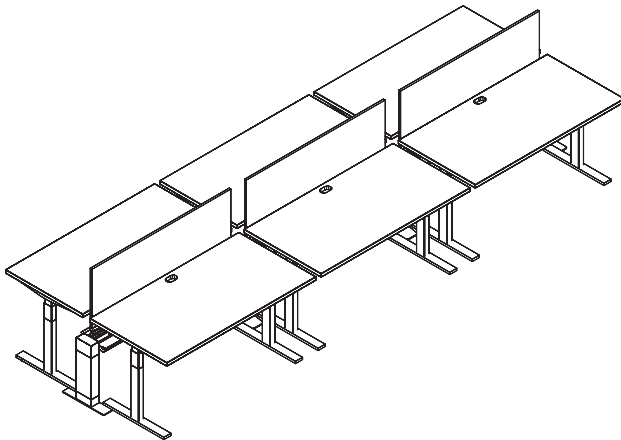

Further Bench w/Freestanding 2'-6" x 5'

Freestanding tables provide the ability to reconfigure as needed.

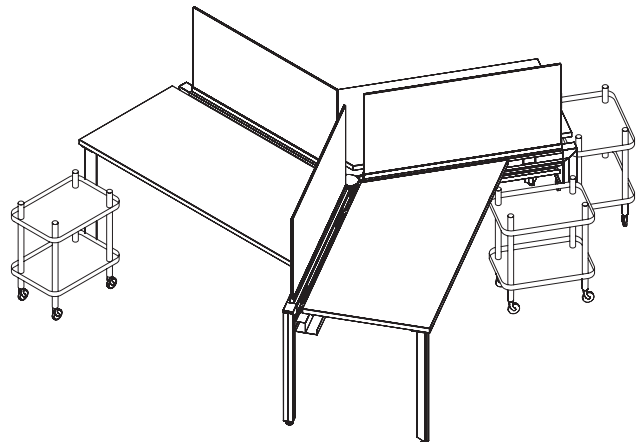

Further Pinwheel w/Freestanding 5'-6" x 6'

Mobile carts provide ability to reconfigure.

NOTE: Further Typicals can be found at <https://www.allsteeloffice.com/design-resources/idea-starters>.

A full gallery of typicals from each Allsteel system can be found on our website:

<https://www.allsteeloffice.com/design-resources/idea-starters>.

Each typical includes a complete BOM with current pricing, downloadable CAD files and PDFs of each drawing.

Single Sided

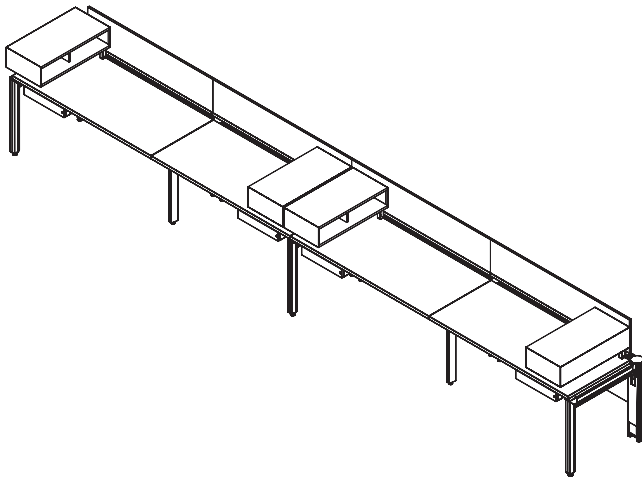

Further Touchdown 5' x 2'-9"

Storage and screens provide privacy.

90° Planning

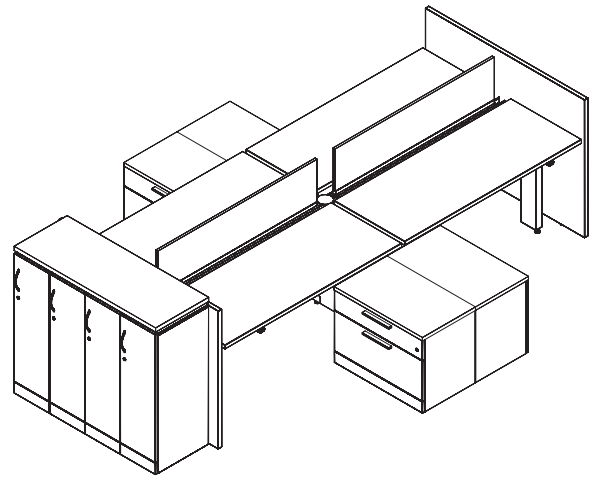

Further Short Bench 7' x 5'-6"

Gallery panels provide touch down privacy.

Dual Sided

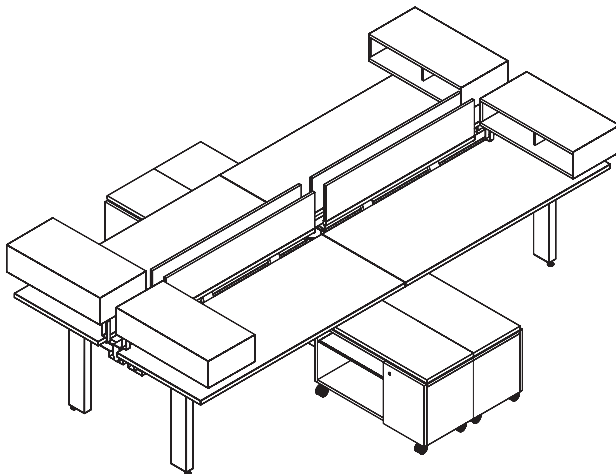

Further Small Beehive 5'-6" x 5'-6"

Mobile credenzas double as guest seating.

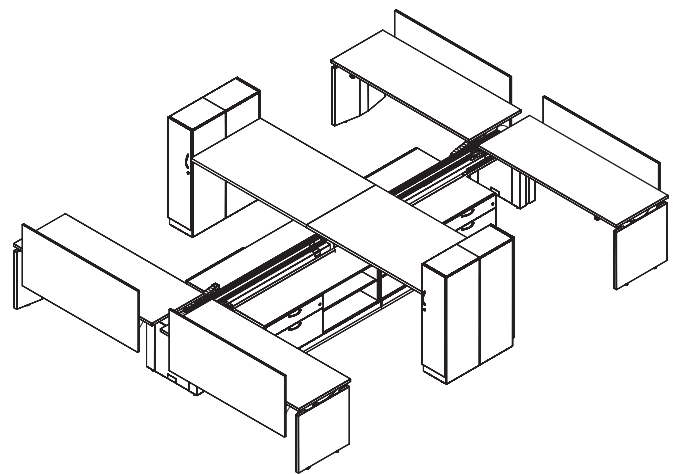

Further with Involve® 7' x 6'-2½"

Wardrobe towers provide storage for personal items and create space division.

NOTE: Further Typicals can be found at <https://www.allsteeloffice.com/design-resources/idea-starters>.

FURTHER

Choice is yours.

Further is an agile furniture solution that embraces the ever-changing workplace and frees people to adapt their environment — simply, elegantly and efficiently — at their own pace.

At the heart of Further is the hub. Ultimately flexible, the hub provides power and data support for a variety of applications, whether beam supported or freestanding.

Whether the planning approach is organic or linear, individual or team-based, Further can bring your design to life.

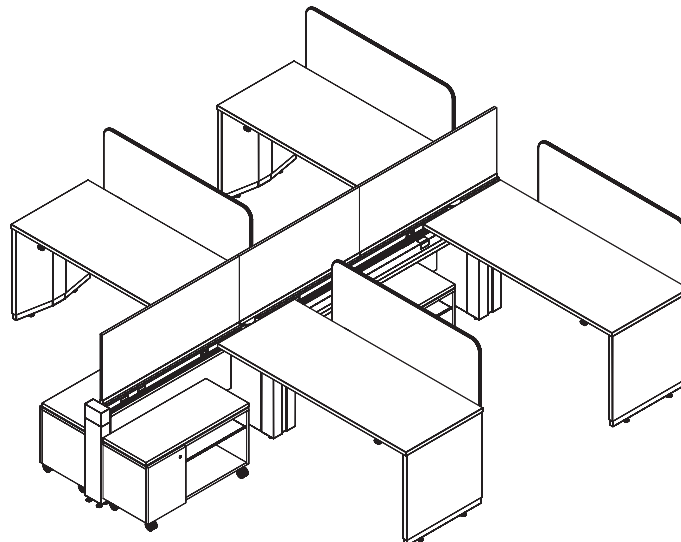
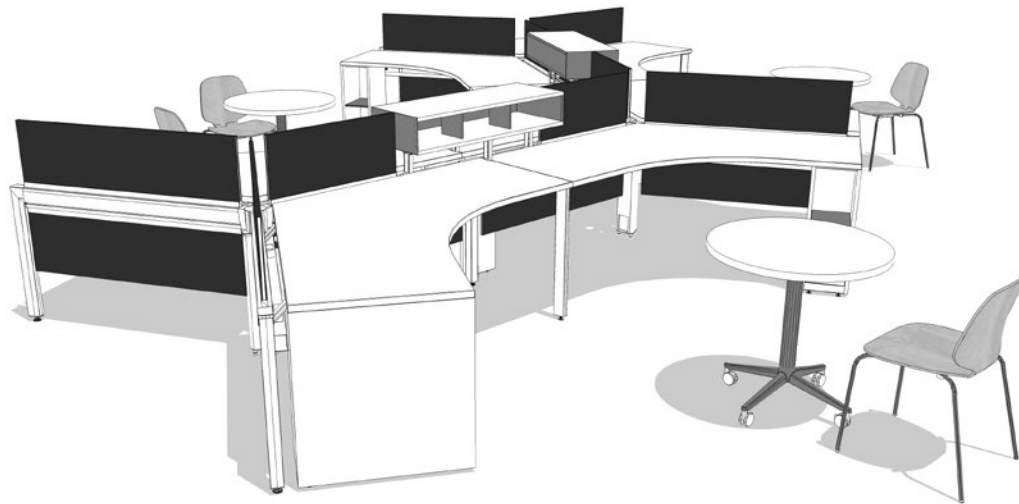
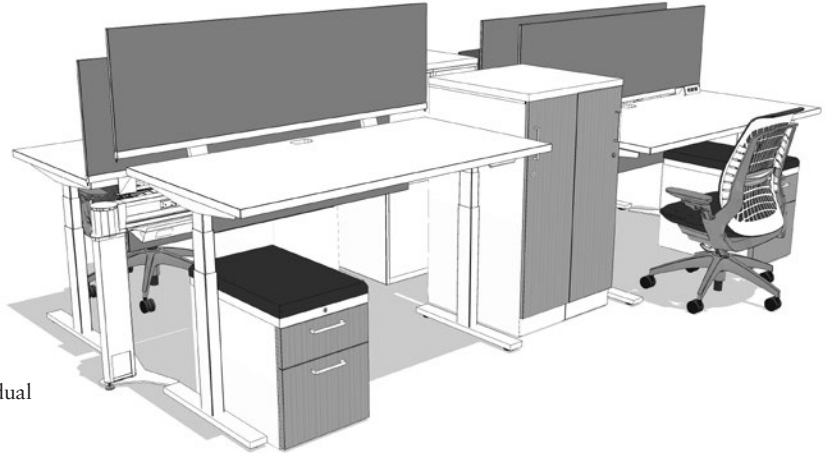

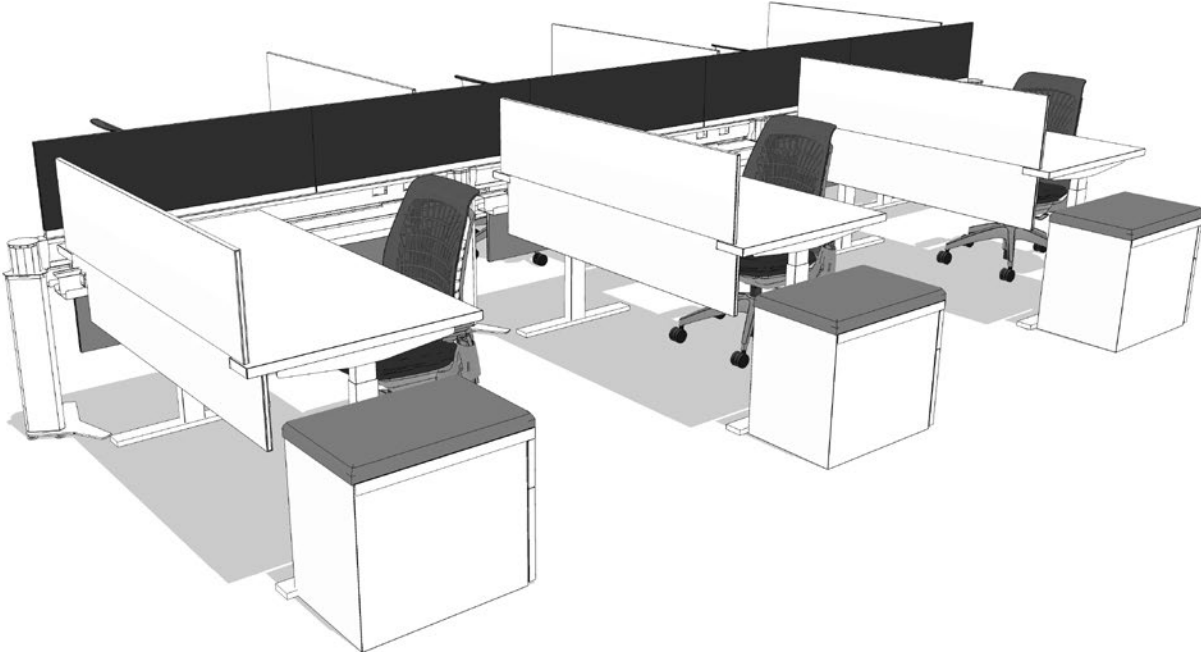

FURTHER

HUBS, BEAMS, and SUPPORTS

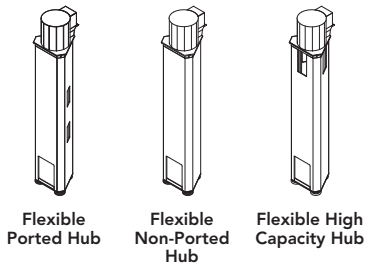

Flexible Ported Hub
Flexible Non-Ported Hub
Flexible High Capacity Hub

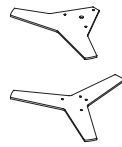

Hub Base Kits

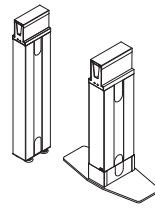

Linear In-Line Hubs

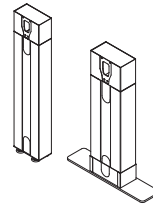

Linear End-of-Run Hubs

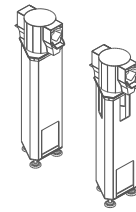

Low Flexible Hubs:
Standard and High-Capacity

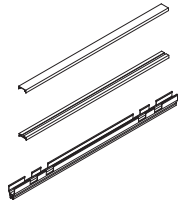

Beams and Trim

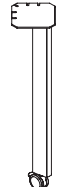
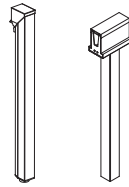

Legs

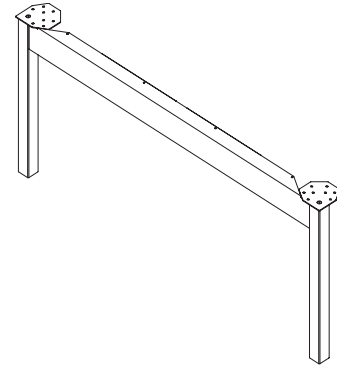
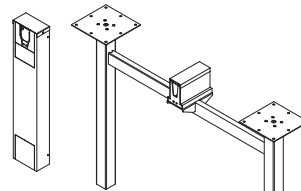

WORKSURFACES — Laminate

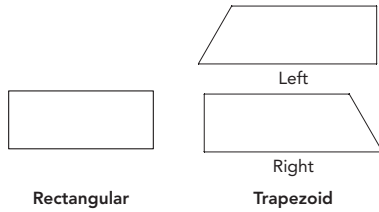

Rectangular

Trapezoid

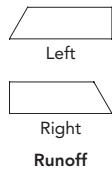

Runoff

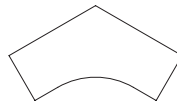

120°

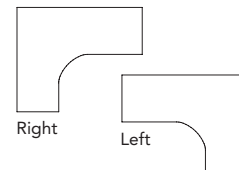

Corner Cove

ELECTRICAL & DATA

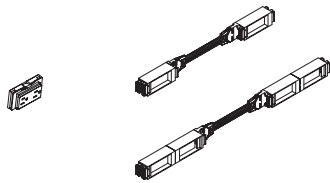

Duplexes

Power Kits

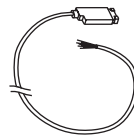

Infeeds

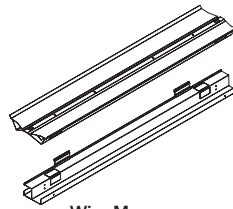

Wire Managers



Power Pole

SCREENS

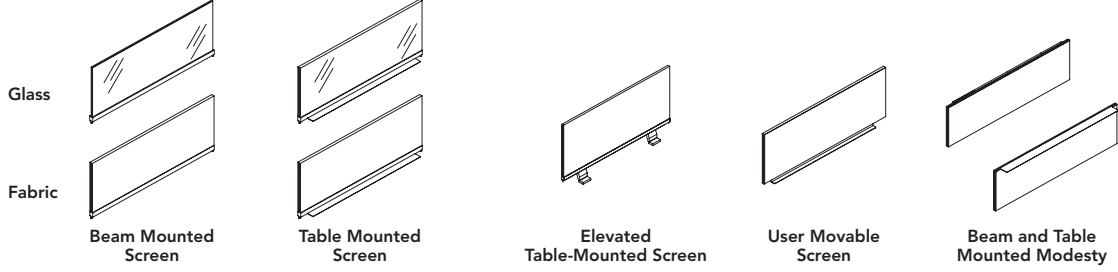

STORAGE

Floor Based — Laminate with Metal

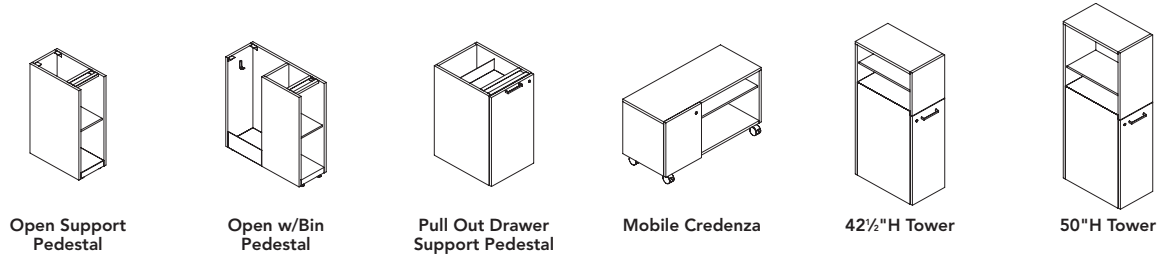

Dual Sided Bench — Tethered

TIP:

Benches look cleaner when specified using built up supports as shown here: less legs, fewer kit-of-parts

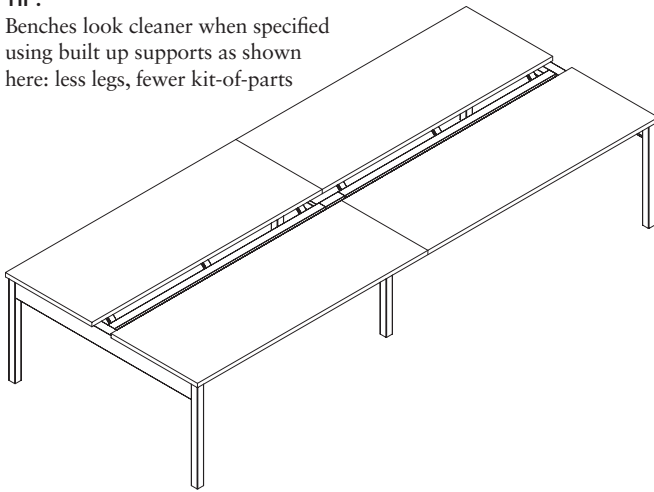

Dual-Sided Bench (Non-Sit-to-Stand):

- Maximum run length is 60'.
- Available in two styles: H-Leg and A-Leg for both End and Mid-Supports.
- Use infeed cover for H-Leg and A-Leg supports.
- Beam mounted storage shelf is allowed.

When specifying with Kit-of-Parts (Beam End Leg, In-Line Leg, Worksurface Legs and Hubs), adhere to the following rules:

- A support to the edge of the worksurfaces is required every 18' of run. This may be any of the following:
 - a) return beam
 - b) support storage
 - c) bench end
 - d) worksurface support leg at front edge of worksurface.
- When two worksurfaces are side by side parallel to the beam, a worksurface support leg in a shared application or worksurface support storage is required.
- A minimum of four worksurfaces are required when using a beam and beam end leg kits on both ends of a run.
- Cannot not use two in-line support legs in a row.



A-Leg Bench



Kit-of-Parts Bench

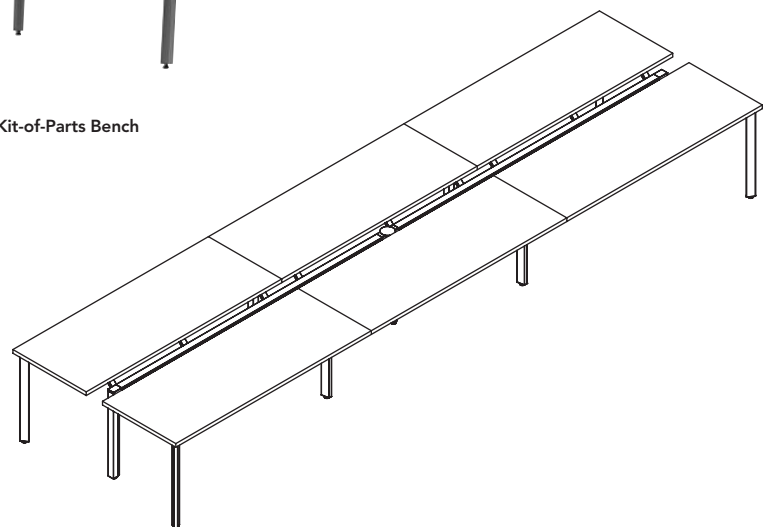

FURTHER

Single Sided Bench — Tethered

TIP:

Benches look cleaner when specified using built up supports as shown here: less legs, fewer kit-of-parts

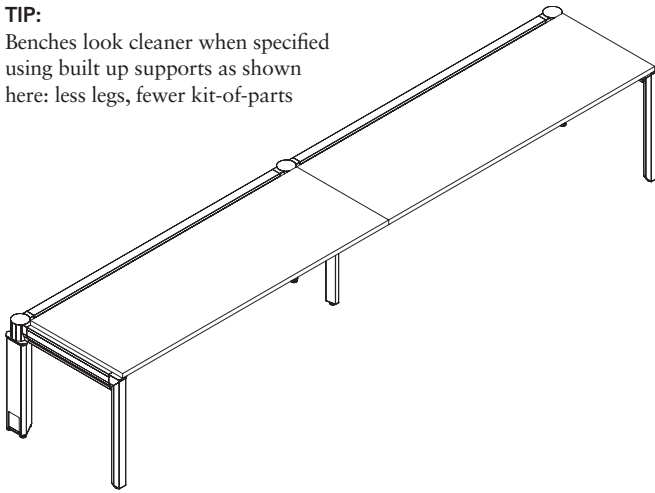

Single-Sided Bench

- Available in two styles: H-Leg and A-Leg for both End and Mid-Supports.
- Infeed can be routed through the H- or A-Frame supports.
- Use gusset bracket with every mid-support for stability. Adhere to this rule even when specifying In-Line legs or Hubs. Gusset bracket ordered separately - model UN6GBSS
- Beam mounted modesty screens recommended to provide privacy and conceal single-sided wire or data managers.
- Beam mounted storage shelf is allowed.

When specifying Kit-of-Parts bench (Beam End Leg, In-Line Leg, Worksurface Legs and/or Hubs), adhere to the following rules:

- Maximum run length is 26'.
- Maximum beam length allowed is 72".
- Worksurface support leg in a shared application or worksurface support storage is required.
- Gusset bracket is required at every mid-support leg or hub.
- Note: End-of-run worksurfaces overlay return beams halfway.

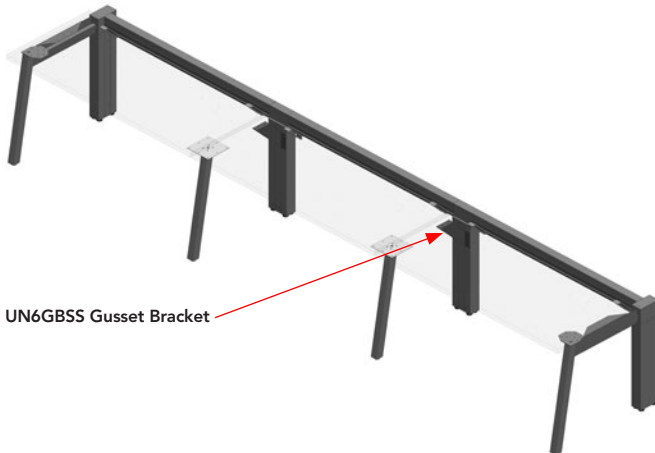

UN6GBSS Gusset Bracket

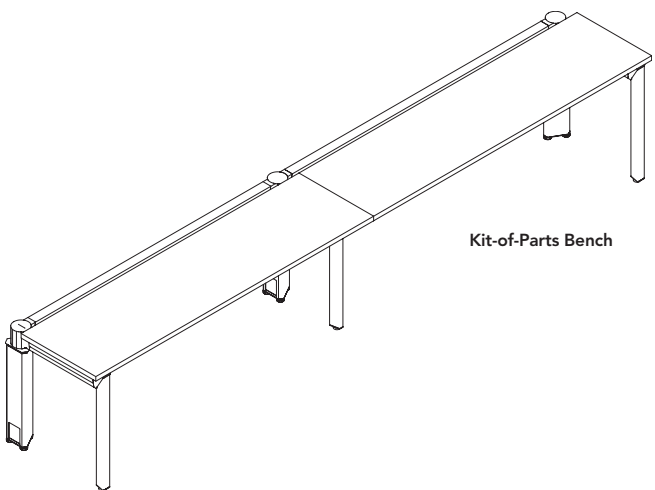

Kit-of-Parts Bench

FURTHER

Perpendicular to Beam

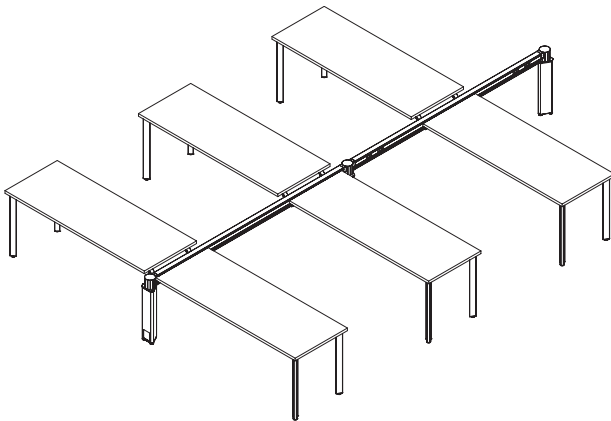

Perpendicular Workstations

- Maximum setup length is 60'. Maximum of two 96" beams can be used in a run.
- Worksurfaces mounted perpendicularly to beam require 2 worksurface mounting brackets U6WBTF. Brackets cannot be placed more than 6" from edge of worksurface.
- Perpendicular workstations may be used with return worksurfaces. A flat bracket must be used between the two surfaces in place of a shared support leg.
- Specifying a setup with only perpendicular worksurfaces requires either support storage on the non-beam side or all beam support to be hubs.
- In-line support leg cannot be used.
- Horizontal storage is allowed. Worksurface stanchions must have a surface to rest on.

Perpendicular workstations with return worksurfaces

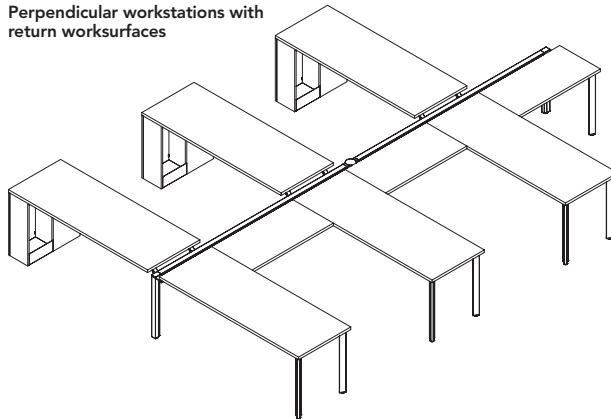

120° Pinwheel — Organic Tethered

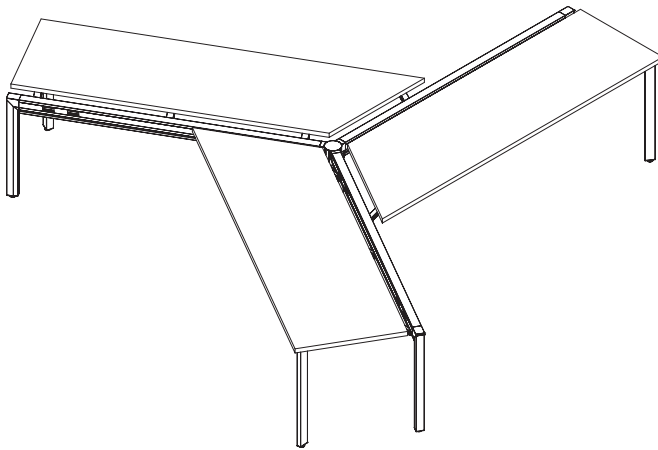

120° Organic Workstations

- Beam lengths match on module to short side of trapezoid surfaces only.
- Flexible hub required for 120° beam connections.
- When specified, runoff worksurface “hand” must be the opposite of the parent worksurface “hand” to match beam lengths.
- Horizontal storage is allowed. Worksurface stanchions must have a surface to rest on.
- When back-to-back worksurfaces are of equal depths (24" D or 27" D), Bench End and Mid-Supports can be specified.

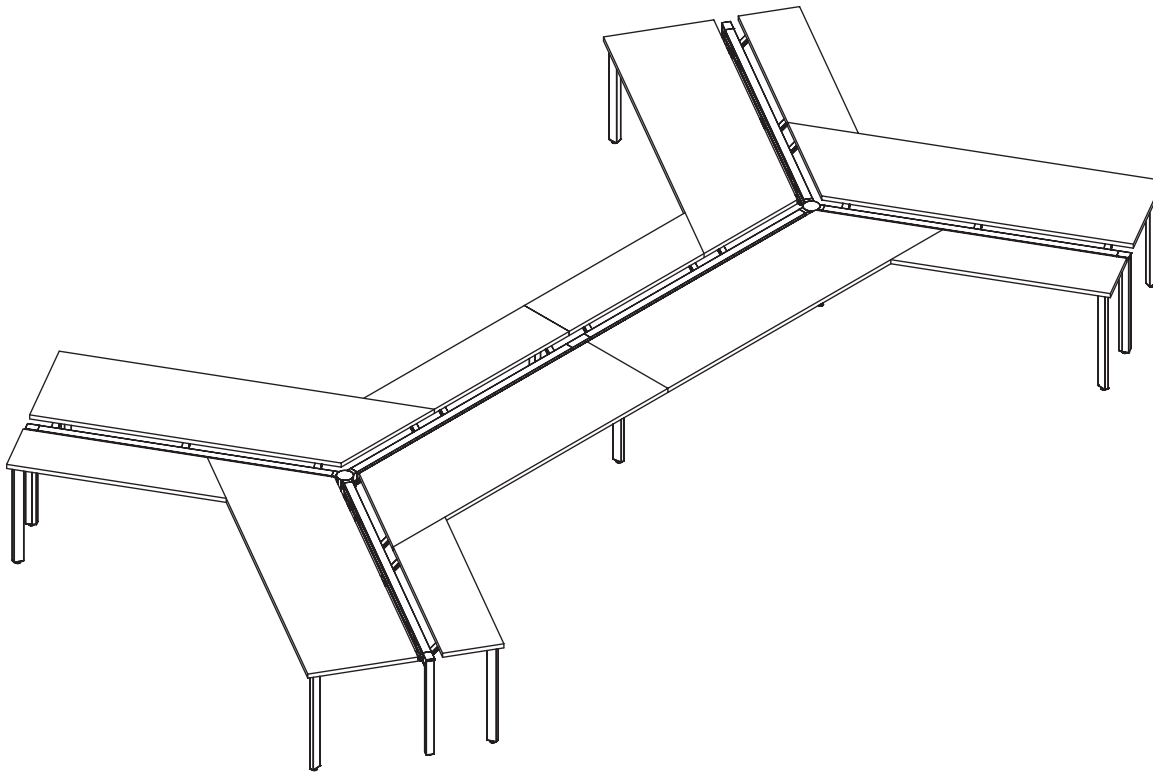

Freestanding Beams

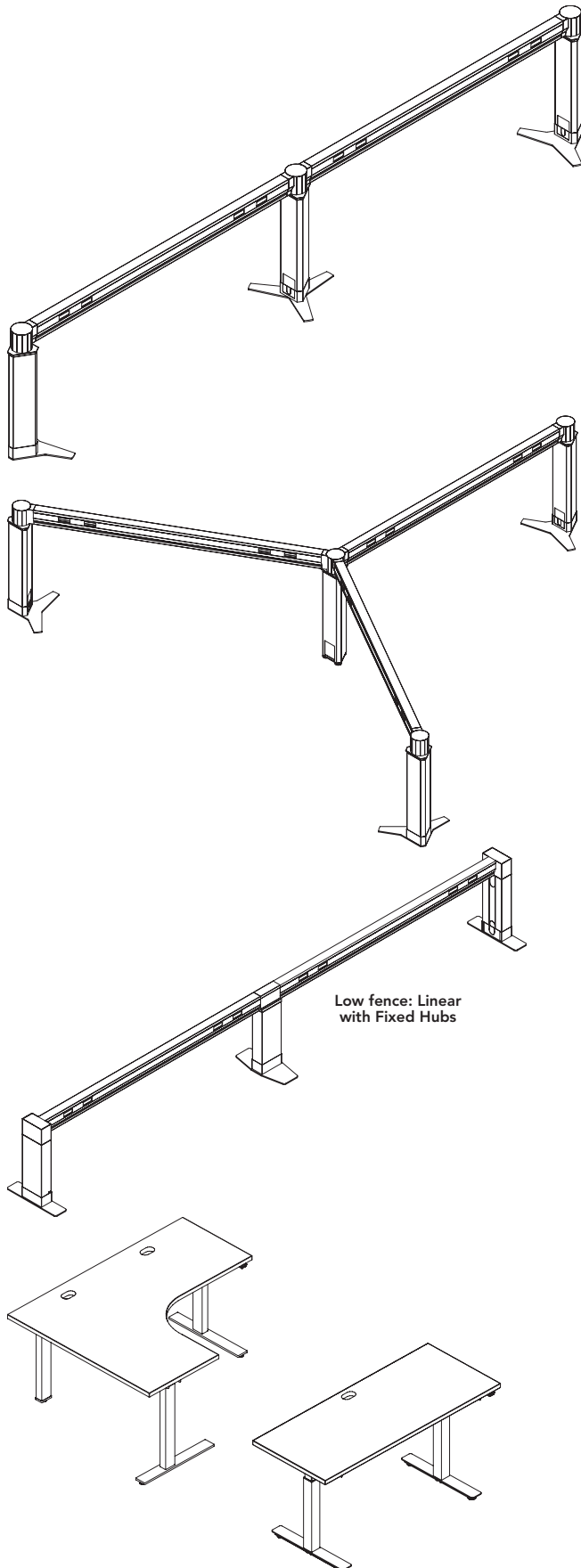

Freestanding Beams

- No restrictions on maximum setup length.
- Hubs must be used for support. Gallery Panels can be used at ends in lieu of hubs.
- Low hubs recommended when using height-adjustable worksurfaces to avoid height-adjustable desk to beam collision.
- Hub feet or floor anchor brackets required, except at L-, T-, or X-connections.
- Minimum 54" beam in a one beam with two hubs application.
- Minimum return run length using a beam end support leg is 36", use of hub is recommended for return beams.
- Glass screens are allowed when supported using Gallery Panels at both ends or L-, T- or X-connections.
- Beam mounted fabric screens are allowed.
- 13"H fabric screens can be used as Modesty with low beams.
- Beam mounted horizontal storage not allowed.
- Flexible and Fixed Hubs are interchangeable.
- Flexible and Fixed Hubs may be used in conjunction to create the desired applications.
- 1-shelf per freestanding beam allowed. Must have hub feet.

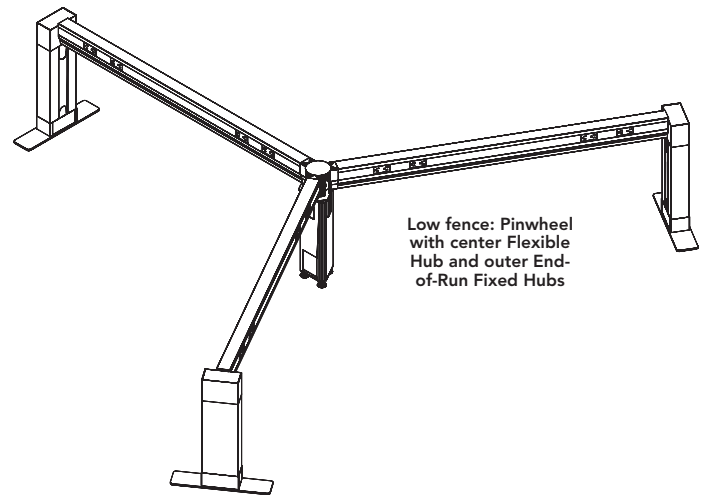

Low fence: Pinwheel with center Flexible Hub and outer End-of-Run Fixed Hubs

2- and 3-Stage Height-Adjustable Tables

Allsteel's Altitude electric height-adjustable tables provide the perfect combination of functionality and user control.

The sit-to-stand adjustment encourages posture changes throughout the day and has been shown to increase workplace satisfaction and overall comfort. These easy-to-operate tables can accommodate different workstyles, making it an ideal solution for any work environment.

Freestanding Beams

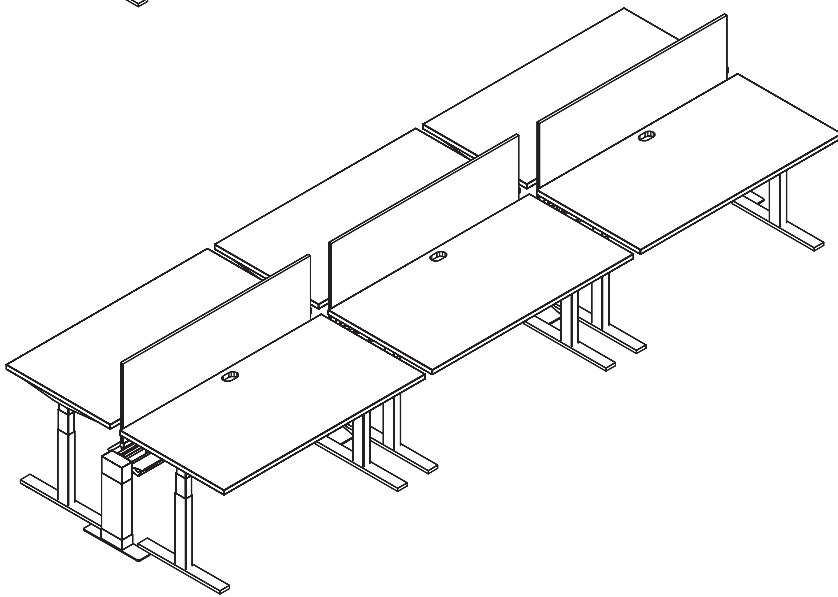
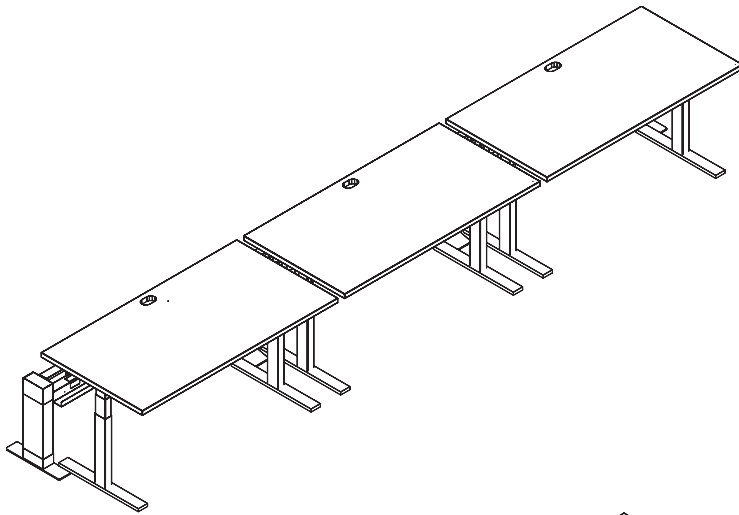

FURTHER

Adaptive Linear Benching — Height-Adjustable

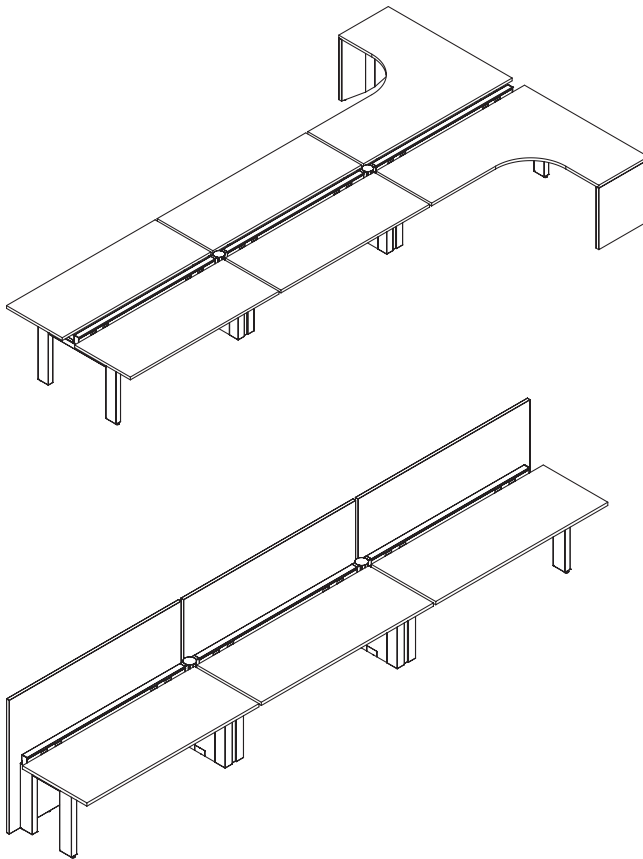

Adaptive Benching

- Mid-supports are required.
- A maximum of two mid-supports in a row may be used.
- Two end supports may be used in succession to extend 6-pack – requires 9" in-line beam connector.
- Single-sided setups require gallery panels to be mounted along spine of beam, or floor anchor brackets on all beam supports.
- Minimum of two single-sided stations allowed.
- Single-sided gallery panels must match the length of worksurfaces specified. Minimum height of the Gallery Panel must be 42"H.
- Adding power to a dual-sided two station application requires a hub at one end.
- Dual-sided two-station requires leg infill on each end support for stability. Contact Allsteel Tailored Products Group.
- Corner cove worksurfaces require a 3-leg control box kit and perpendicular outer support.

Adaptive Perpendicular — Height-Adjustable

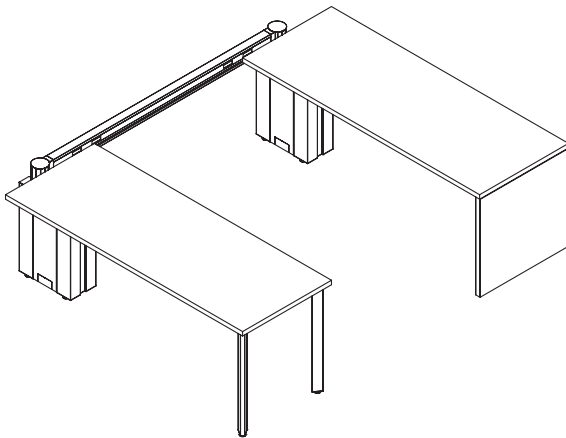

Adaptive Perpendicular Workstations

- No restriction on number of perpendicular mid supports used in a row.
- Worksurfaces are centered over perpendicular mid supports, but may be mounted up to 4 7/8" forward from mid support to reduce footprint.
- Minimum of 4 stations for dual-sided applications, 2 stations for single-sided applications.
- Perpendicular mid support does not complete height-adjustable station – must order perpendicular outer support.
- Fixed height stations require two worksurface support legs on non-beam side in place of a perpendicular outer support.
- A minimum beam length of 30" must be used between perpendicular mid supports for 27"D surfaces, and a minimum length of 24" for 24"D surfaces.
- Trapezoid worksurfaces not allowed.

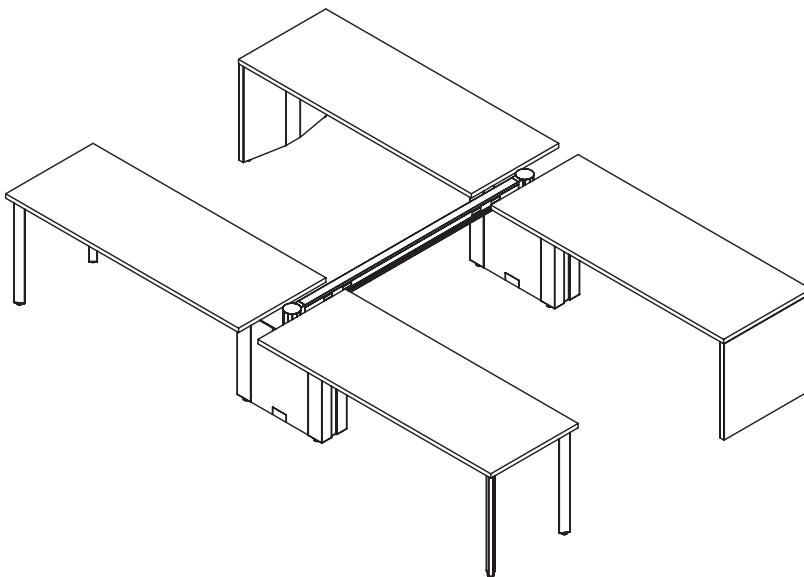

Adaptive Organic — Height-Adjustable

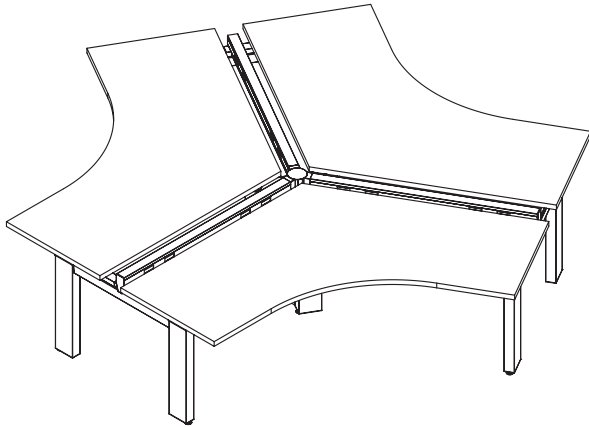

Adaptive 120° Workstations

- Requires a 120° mid support at all 3-way beam connections.
- End supports required on beams also connected to a 120° mid support.
- 7" in-line connector required to attach multiple 120° workstations.
- Single-sided end supports not allowed.

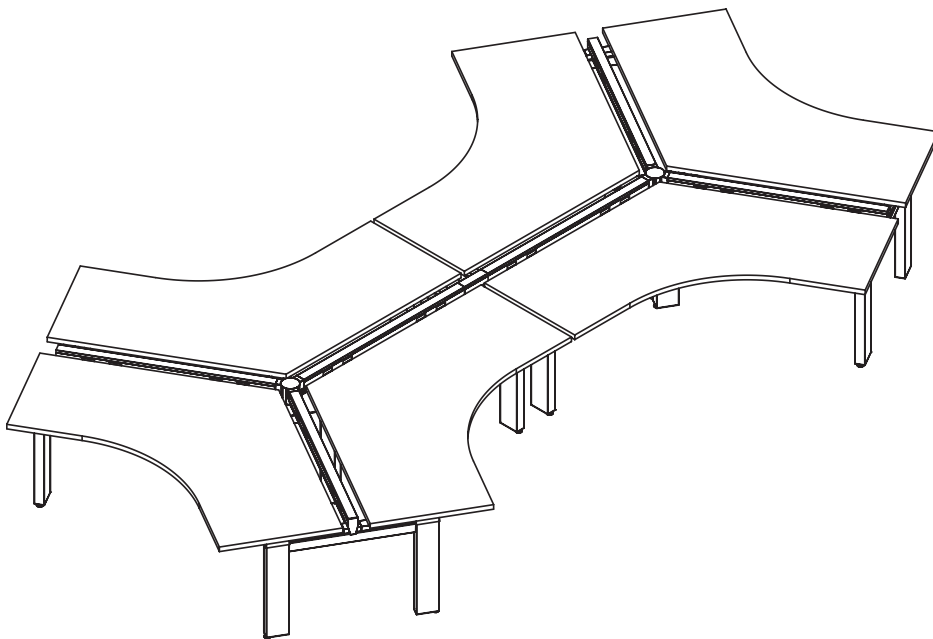

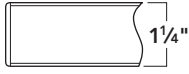

Flat Edge Detail

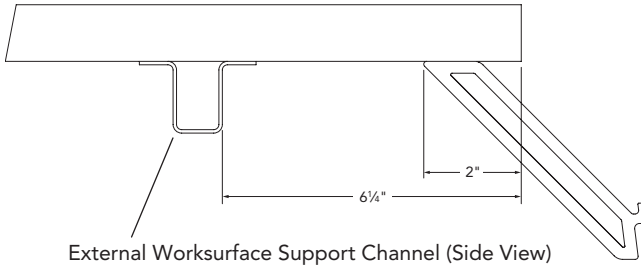

External Worksurface Support Channel (Side View)

The beam attaches to the shaded worksurface edge.

Rectangular Worksurfaces (Top View)



All Worksurfaces (pages 80-83)

- All worksurfaces for Further are 1 1/4" thick particleboard core with top surfaces finished in laminate, bottom surfaces covered with a backer sheet, and with a flat edge.
- Edge band is 2mm thick ABS plastic on all edges.
- All worksurfaces exclude grommets.
- 24" D worksurfaces support the use of storage from other Allsteel product lines.
- The gap from the back edge of the worksurface to the beam is 1 7/8".
- Back edge of the worksurface to the beam centerline distance is 3".
- Maximum worksurface overhang of a parent run is 12".
Worksurfaces that overhang the parent run by more than 12" require system legs or supporting storage to support the overhanging edge.
- Maximum 12" overhang when worksurfaces are used in freestanding or adjustable-height applications.
- Distance from floor to top of worksurface is 29 1/2" with glides fully retracted.
- External worksurface support channels are required for unsupported spans at 60" W or greater — see description below.
- Legs and supports from other product lines (Involve open legs, etc.) can be used but there are no pilot holes to support ease of installation and reconfiguration.

Rectangular Worksurfaces (page 81)

- Primary worksurface depths are 21", 24", and 27" (allows for gap and 24", 27", or 30" dimension to center of beam).
- Actual width and depth are equal to the nominal width and depth.

External Worksurface Support Channel (page 80)

- Must be added to unsupported spans at 60" W or greater. Pilot holes are included on worksurface to ensure accurate placement to avoid interference with screens, mounting plates etc.
- Extends 1 1/2" below the worksurface. Stiffener is 6 1/4" from back edge of the worksurface to the vertical wall of the stiffener.
- May interfere with storage or mounting of accessories.
- When using tethered surfaces order to match the size of worksurface.
Example: Z5SC72 goes with an 72" W worksurface. Stiffener is 12" shorter than worksurface. For worksurfaces over 84", add a worksurface support leg or support storage centered along the width of the surface.
- If floor support storage is used, subtract width of storage from size of stiffener.
- For freestanding tables order one size down. Stiffener is 18" shorter than worksurface. *Example:* Z5SC66 is used with a 72" W worksurface.

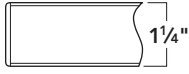

Flat Edge Detail

Shaded edge is side to attach to beam to be on module.

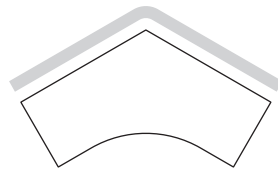

120° Worksurfaces (page 82)

- 120° worksurface depths are 21", 24", and 27".
- Can be configured with Altitude™ height-adjustable bases.
- Can be configured with support storage on either side of the worksurface.
- Requires 4 worksurface brackets U6WBTF when primary sides of surface are parallel with beams.
- T-mold is used on the edge of curved worksurfaces. This will have a noticeable visual difference when directly adjacent to straight worksurfaces.

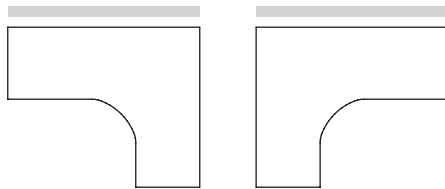

Corner Coves (page 83)

- Corner cove worksurface depths are 24" and 27"; widths are 60"W, 66"W, and 72"W; and return side is always 60"W and 24"D.
- Worksurfaces come with required external support channel.
- Can be configured in standard Further or Further Adaptive.
- T-mold is used on the edge of curved worksurfaces. This will have a noticeable visual difference when directly adjacent to straight worksurfaces.

Beam Configurations

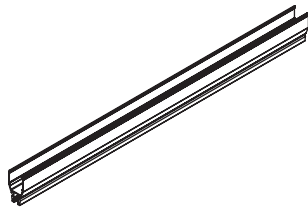

Beams —
Non-Ported
18"–96"

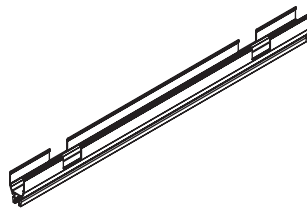

Beams — Ported
Short 36" and 42"

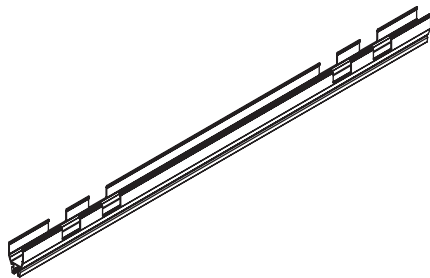

Beams — Ported
Long 48"–96"

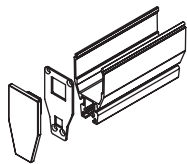

Cantilevered
Beam
6"–12"

Top Trim

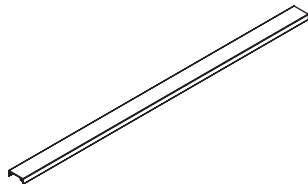

Flat — 6"–96"

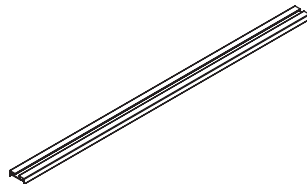

Rail — 6"–96"

Beams (page 84)

- Supplies power to user and supports worksurfaces, storage, and screens.
- Ported and non-ported options available in 6" increments. Ported beams require electrical receptacles or blank covers ordered separately.
- Flat or mounting top trim required to finish off beams – order separately.
- Beams do not connect directly in-line with one another, use in conjunction with beam support.
- Height of assembled beam with top trim is $4\frac{1}{4}"H \times 2\frac{1}{8}"D$.
- Order worksurface support brackets U6WBTF separately – quantity varies, see page 78.
- Electrical port locations are back-to-back, symmetric about beam center, and a standard distance away from beam ends on all lengths.
- 36" and 42" ported beams have 2 duplex receptacle locations on each side (4 total), 48"-96" ported beams have 4 on each side (8 total).
- Ported beams do not carry data cables internally. Data cables are routed externally through beam mounted wire-managers. See pages 95 and 105.
- Non-ported beams can be used in conjunction with beam end legs and benching end connector to create a benching end condition.

Cantilevered Beam (page 84)

- Cantilevered beams can extend the length of a run by 6", 9", or 12".
- Must mount to a flexible hub or adaptive mid support.
- Must order flat or mounting top trim separately.
- Model includes a finished end cap.
- Worksurfaces can be mounted on a cantilevered beam when used in conjunction with a worksurface support bracket.
- Horizontal storage cannot be mounted to a cantilevered beam.

Beam Top Trim (page 85)

- Available in 6"-96" lengths in flat or mounting rail and is required to finish off a beam. Must match beam length, no exceptions.
- Mounting top trim contains a reveal for mounting screens and storage.
- Mounting top trim is recommended for projects specified under Chicago electrical Codes.
- Flat top trim is recommended on beams used in a bench end kit.

Flexible Hubs

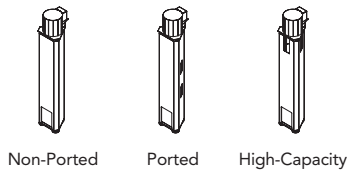

Hub Dimensions

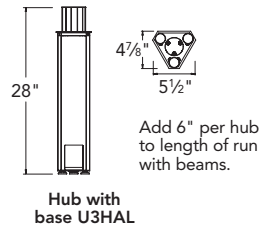

Flexible Hub to Beam Connectors

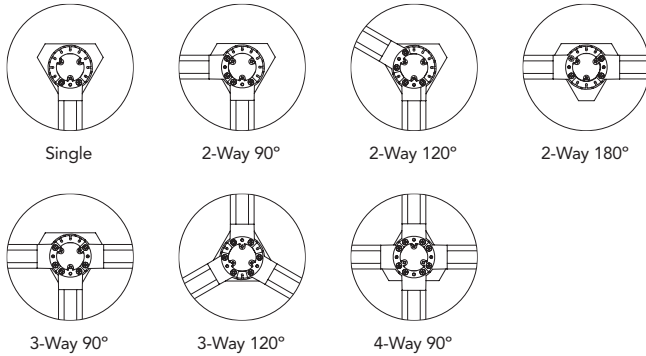

Fixed Hubs

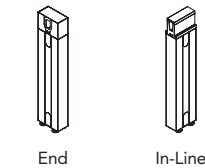

Fixed Hubs Dimensions

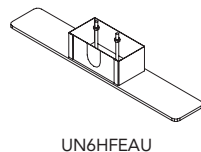
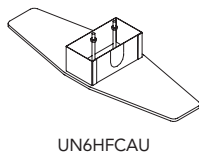
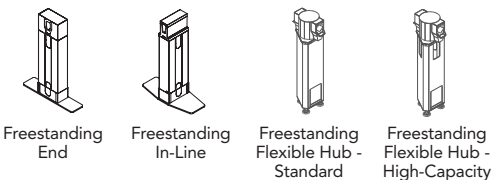
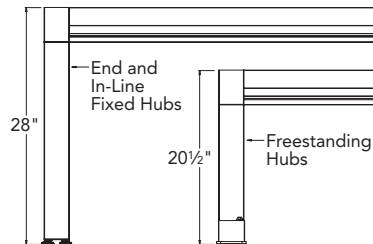

Floor Anchor Brackets

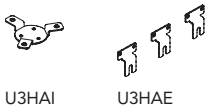

Carpet Grippers



U3CG12

Desking & Benching – 02/2024

All Beam Supports (pages 86-89)

- Usage rules vary depending on configuration, see specification rules and examples, pages 63-71.
- Include leveling glides with 2 3/4" adjustment.

Flexible Hub (page 86)

- Supports up to four beams attached in 30° increments; order hubs based on the number of beams that will be connected.
- Carries power and data to the beam structure; infeed can be routed through the side or bottom of hub.
- Hub has one removable cover for installation of power and data.
- Standard, ported, and high-capacity options available.
- Ported flexible hub requires a power kit and duplex receptacles – each ordered separately.
- Flexible high-capacity hub increases system data capacity. (see pages 94-95)
- Flexible high-capacity hub comes with 2 grommet covers as standard.
- Required when using power pole U2HPP.
- Includes flat trim; may be used to span a screen over the trim.
- Freestanding applications require flexible hub feet. (see page 67)
- No foot is needed on a Flexible Hub when connecting to 2 or more beams in a non-linear application.

Flexible Hub Base Kit (page 86)

- Attaches to flexible hub.
- Options available for two and three feet. Two feet used at the end of a run, three feet used in the center.
- Provide standard leveling of 2 3/4".

Fixed Hubs (page 86)

- Carries power and data to the beam structure; infeed can be routed through the side or bottom of hub.
- Hub has one removable cover for installation of power and data.
- In-line and end-of-run options available.
- In-line fixed hub supports two beams in a 180° condition and adds 6" to run.
- End-of-run fixed hub supports one beam and adds 3" to run.
- End-of-run fixed hubs can be turned 180° to remove the cover and access leveling glides and cables inside.
- Freestanding option available – See additional details below.
- For a free-standing application, it is ideal to specify the low hubs. See below.
- Specify UN6HFCAU for In-Line foot or UN6HFEAU for end-of-run foot separately.
- Required when using square power pole.

Low Hubs (page 87)

- From floor to top of the low Hub is 20 1/2".
- Fixed Hubs
 - include feet with standard leveling of 2 3/4".
 - are recommended for straight or linear applications.
- Flexible Hubs
 - feet are not required when used in L-, T-, or X-connection.
 - feet are required when using in linear application (feet ordered separately - see page 86).
 - may be used in conjunction with Fixed Hubs to create the desired applications.
 - are available in both standard- and high-capacity options.
 - include Hub-to-Beam connectors.
- Required when using square power pole.

Floor Anchor Brackets (page 86)

- Used to anchor beam and worksurface supports to the floor.
- Attach to standard leveling glides provided with all beam supports.
- May be required with hard-wired electrical depending on local code.
- May be used in place of flexible hub feet in freestanding applications.
- Hardware for mounting to floor is not included.
- Internal (hidden) option available for flexible hub. U3HAI
- External kit U3HAE contains 3 anchor brackets.

Carpet Grippers (page 86)

- Attach to leveling glides for added system rigidity when placed on carpeted surface.
- Kit U3CG12 contains 12 carpet grippers.

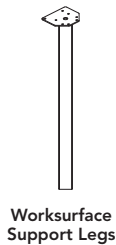

Worksurface Support Legs

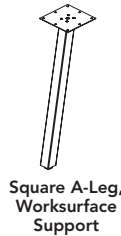

Square A-Leg, Worksurface Support

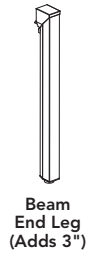

Beam End Leg (Adds 3")

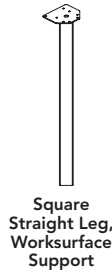

Square Straight Leg, Worksurface Support

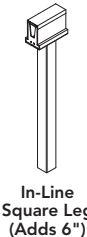

In-Line Square Leg (Adds 6")

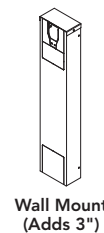

Wall Mount (Adds 3")

Beam End Leg (page 88)

- Supports a beam at the end of a run.
- Model includes vertical support leg, beam connector, and trim.
- Extends beam run by 3".

Worksurface Support Legs (page 88)

- Support worksurfaces that are tethered to the beam structure.
- Triangular Leg and Square Leg options available.
- Triangular Leg can be used to support free-standing tables.
- Can be used as a shared support leg centered between two worksurfaces. Includes tie-bracket for shared applications.
- When used as a shared support leg, must not be more than 15" back from front edge of worksurface on 24"D and 27"D worksurfaces; no more than 12" back on 15"D, 18"D and 21"D worksurfaces.

In-Line Legs (page 89)

- Supports between two beams.
- Dual sided applications may not use two in a row.
- Single sided applications must be used in conjunction with the gusset bracket UN6GBSS. Ordered separately.
- Includes flat trim.
- Screens may span over in-line leg flat trim.

Wall Mount (page 88)

- Attaches end of beam run to wall.
- Power infeed and data accessible.
- Mounts directly over or adjacent to a wall core.
- Mounting hardware for attaching to wall is to be supplied by installer. Requires hitting wall stud.
- Starts beam 3" from wall. On module worksurfaces sit flush to wall.
- Can be used in freestanding beam applications.

Bench End Triangular Supports with Built-up Components (pages 84, 85, and 88)

- Supports a beam and two worksurfaces at the end of a run.
- Bench end support cannot be used to make a freestanding table.
- Comprised of the following items, all ordered separately:
 - Non-ported beam
 - Flat top trim
 - Beam end support leg (Qty 2)
 - Bench end connector kit
 - Worksurface mounting bracket (Qty 2)
- Beam and top trim length to be 2X the worksurface depth.
- Beam mounted modesty may be used on bench end beam.
- Power cannot be routed from parent run into bench end support beam.

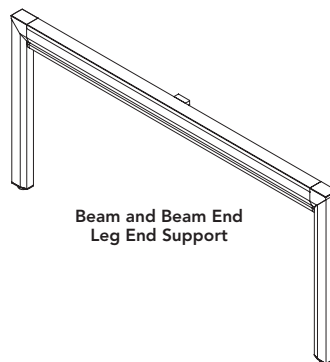

Beam and Beam End Leg End Support

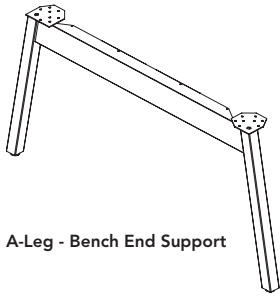

A-Leg - Bench End Support

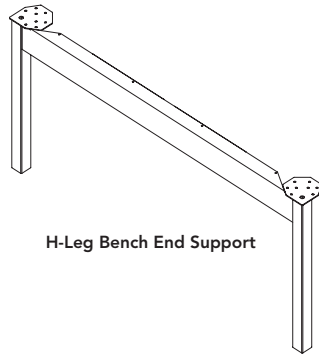

H-Leg Bench End Support

Bench End Support (Square leg page 89)

- Used in dual sided applications only.
- Supports a beam and two worksurfaces at the end of a run.
- Available in two styles: A-Leg and H-Leg.
- Power infeed accessible; infeed covers ordered separately.
- Bench end support cannot be used to make a freestanding table.
- Works with 24" and 27" deep worksurfaces.
- Beam mounted modesty cannot be used on bench end supports.
- Features "square" leg profile.

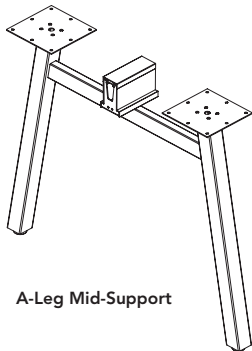

A-Leg Mid-Support

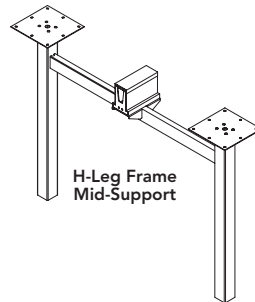

H-Leg Frame Mid-Support

Mid-Support (page 89)

- Used in dual sided applications only.
- Available in two styles: A-Leg and H-Leg.
- Power infeed accessible; infeed covers ordered separately.
- Includes flat trim; may be used to span a screen over the trim.
- Features "square" leg profile.
- Not compatible with Chicago or NYC J-boxes.

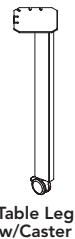
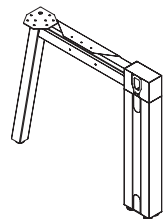

Table Leg w/Caster

Table Leg with Caster (page 88)

- Support worksurfaces in freestanding table applications.
- Unsupported spans over 60" require external support channel.
- Tables 78"W or greater require 2 additional legs in the center of the table (6 legs total) to resist bowing.
- Can be used with surfaces from other product lines, but pilot hole locations will not be available for installation or reconfiguration.



A-Leg, Single Sided End Support

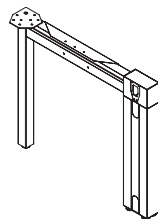

H-Leg, Single Sided End Support

Single Sided End Supports (page 89)

- Used in single sided applications, end of run.
- Available in two styles: A-Leg and H-Leg.
- Comes in Left and Right Hand configurations.
- Works with 24" and 27" deep worksurfaces.
- Infeed accessible.
- Bench end supports cannot be used to make a freestanding table.
- Features "square" leg profile.

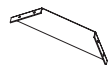

Gusset Bracket

Gusset Bracket (page 88)

- Must be used in single sided applications to provide stability to In-Line leg or Hubs.
- Specify one bracket per support.

Worksurface Brackets Required for Attaching to Beams
(Additional Supports Required)



WORKSURFACE SHAPE:	QTY OF WORKSURFACE SUPPORT BRACKETS (Model U6WBTF)			
	1	2	3	4
Rectangular* Perpendicular		21"W-60"W**	Wider than 60"	
Runoff***	15"W-39"W	Wider than 39"		
120°				46"W-52"W
Corner Cove (supported on one side)		60"W	Wider than 60"	

*Rectangular ends in return applications require an additional bracket.
 **Dimensions are taken from the short width side of surface.
 ***Runoff worksurface dimension is taken from short side of worksurface.

Worksurface Support Bracket (pages 80 or 88)

- Used to tether worksurfaces to the beam structure. All worksurfaces come with pilot holes for standard bracket locations along the back edge of worksurface.
- Brackets mount into the continuous reveal on each side of the beam.
- Worksurfaces cannot overhang worksurface support bracket by more than 12".
- Perpendicular worksurfaces require two worksurface support brackets no more than 6" from each edge.
- Quantity of brackets required varies by shape and size of worksurface – see chart and images to left.
- At least two brackets are required per worksurface. Support storage may replace one bracket on worksurfaces requiring three or more.

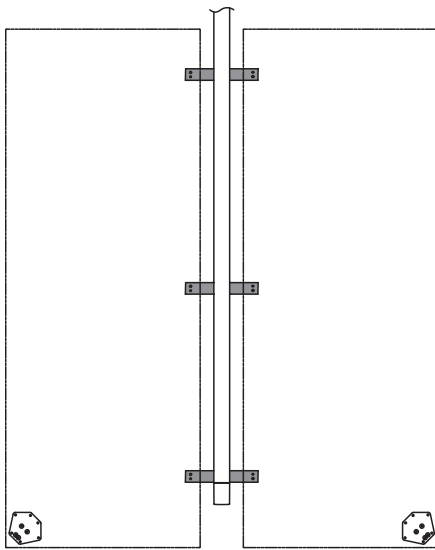

Rectangular with System Legs

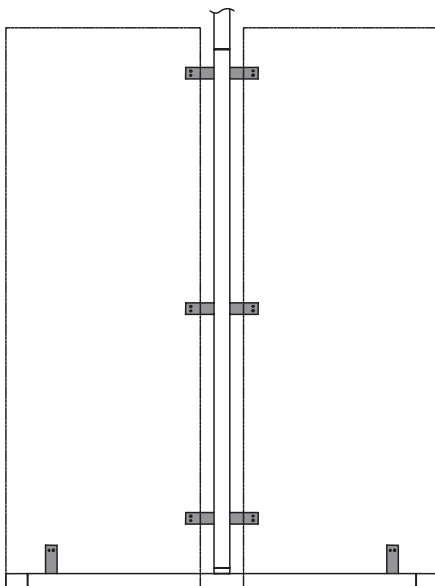
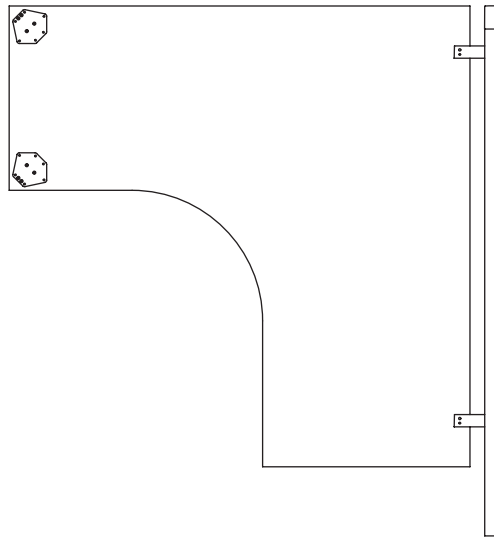

Rectangular with Bench End

FURTHER

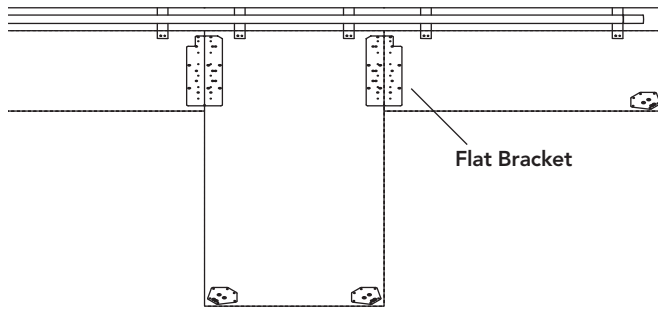

A **Flat Bracket** is required between the two surfaces when one worksurface is parallel to the beam and another is perpendicular.

Flat Bracket (page 88)

- Used to tether two worksurfaces together when floor support is not necessary.
- Required when one worksurface is parallel to the beam and another is perpendicular.
- 12" bracket used for 15" and 18" deep runoff surfaces.
- 24" bracket used for 21" and 24" deep worksurfaces.
- 30" bracket used for 27" worksurface.

For specification information see pages 63-79.

Laminate

GSA SIN 33721

U6WBTF

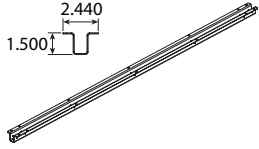

Description	Model	List Price
Worksurface Support Brackets		
Worksurface Support Bracket — Tethered fixed height	U6WBTF S	\$ 96
External Worksurface Support Channel (no color option) — 1½"H		
30"W External Support Channel for 42"W Worksurface	Z5SC42 S	\$ 86
36"W External Support Channel for 48"W Worksurface	Z5SC48 S	\$ 89
42"W External Support Channel for 54"W Worksurface	Z5SC54 S	\$ 102
48"W External Support Channel for 60"W Worksurface or 66" Table	Z5SC60	\$ 110
54"W External Support Channel for 66"W Worksurface or 72" Table	Z5SC66	\$ 128
60"W External Support Channel for 72"W Worksurface or 78" Table	Z5SC72	\$ 137
66"W External Support Channel for 78"W Worksurface	Z5SC78	\$ 150
72"W External Support Channel for 84"W Worksurface	Z5SC84	\$ 165

FURTHER

<p>How to specify — Select the Model Number from above.</p> <p>_____ .</p>	<p><i>1st Option:</i> Paint (if applicable):</p> <p>_____</p>
---	--

Examples: U6WBTF.P02 U6WBTF.P7G Z5SC60

S Shippable by small-package carrier.

Worksurfaces

Further™ — Rectangular

For specification information see pages 63-79.

Laminate

GSA SIN 33721

Description	Laminate w/Flat Edge Model	Beam Size	Laminate w/Flat Edge		
			L1	L2	L3
21" D Rectangular Worksurfaces					
U5F2160S	U5F2130S	24" W	\$ 470	\$ 490	\$ 506
	U5F2136S	30" W	\$ 530	\$ 552	\$ 570
	U5F2142S	36" W	\$ 589	\$ 612	\$ 632
	U5F2148S	42" W	\$ 638	\$ 665	\$ 684
	U5F2154S	48" W	\$ 689	\$ 717	\$ 737
	U5F2160S	54" W	\$ 746	\$ 776	\$ 798
	U5F2166S	60" W	\$ 827	\$ 859	\$ 883
	U5F2172S	66" W	\$ 902	\$ 936	\$ 963
	U5F2178S	72" W	\$ 1153	\$ 1195	\$ 1231
	U5F2184S	78" W	\$ 1201	\$ 1244	\$ 1283
	U5F2190S	84" W	\$ 1420	\$ 1469	\$ 1516
	U5F2196S	90" W	\$ 1479	\$ 1531	\$ 1580
24" D Rectangular Worksurfaces (27" to center of beam)					
U5F2466S	U5F2430S	24" Beam	\$ 518	\$ 540	\$ 556
	U5F2436S	30" Beam	\$ 565	\$ 588	\$ 607
	U5F2442S	36" Beam	\$ 617	\$ 642	\$ 661
	U5F2448S	42" Beam	\$ 659	\$ 686	\$ 706
	U5F2454S	48" Beam	\$ 724	\$ 753	\$ 774
	U5F2460S	54" Beam	\$ 798	\$ 829	\$ 853
	U5F2466S	60" Beam	\$ 873	\$ 906	\$ 932
	U5F2472S	66" Beam	\$ 948	\$ 984	\$ 1013
	U5F2478S	72" Beam	\$ 1221	\$ 1265	\$ 1306
	U5F2484S	76" Beam	\$ 1277	\$ 1322	\$ 1366
	U5F2490S	84" Beam	\$ 1513	\$ 1566	\$ 1616
	U5F2496S	90" Beam	\$ 1570	\$ 1624	\$ 1678
27" D Rectangular Worksurfaces					
U5F2760S	U5F2730S	24" W	\$ 565	\$ 588	\$ 607
	U5F2736S	30" W	\$ 606	\$ 631	\$ 650
	U5F2742S	36" W	\$ 643	\$ 670	\$ 689
	U5F2748S	42" W	\$ 685	\$ 713	\$ 733
	U5F2754S	48" W	\$ 766	\$ 796	\$ 819
	U5F2760S	54" W	\$ 851	\$ 883	\$ 909
	U5F2766S	60" W	\$ 922	\$ 956	\$ 984
	U5F2772S	66" W	\$ 1000	\$ 1037	\$ 1068
	U5F2778S	72" W	\$ 1294	\$ 1340	\$ 1384
	U5F2784S	78" W	\$ 1355	\$ 1403	\$ 1448
	U5F2790S	84" W	\$ 1608	\$ 1663	\$ 1719
	U5F2796S	90" W	\$ 1677	\$ 1734	\$ 1793

<p>How to specify — Select the Model Number from above.</p>	<p><i>1st Option:</i> Laminate (if applicable):</p>	<p><i>2nd Option:</i> Edge (if applicable):</p>
<p>U 5 F S . . </p>		

Examples: U5F2130S.LM11.EV U5F2730S.LWBR.DB Z5SC60.P02

Shippable by small-package carrier.

For specification information see pages 63-79.

Laminate

GSA SIN 33721

Description	Beam Size	Laminate w/Flat Edge Model	Laminate w/Flat Edge		
			L1	L2	L3
Corner Cove Worksurfaces — Left Handed (66" and 72" extend left)					
60" x 60" - 24"L / 24"R	54" / 54"	U5CC6024LS	\$ 1822	\$ 1881	\$ 1942
60" x 60" - 27"L / 24"R	54" / 54"	U5CC6027LS	\$ 1877	\$ 1937	\$ 2000
66" x 60" - 24"L / 24"R	60" / 54"	U5CC6624LS	\$ 1914	\$ 1975	\$ 2039
66" x 60" - 27"L / 24"R	60" / 54"	U5CC6627LS	\$ 1945	\$ 2007	\$ 2074
72" x 60" - 24"L / 24"R	66" / 54"	U5CC7224LS	\$ 1955	\$ 2017	\$ 2084
72" x 60" - 27"L / 24"R	66" / 54"	U5CC7227LS	\$ 2083	\$ 2150	\$ 2219

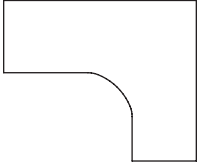
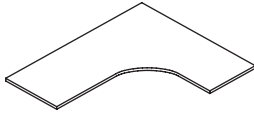

Corner Cove Worksurfaces — Right Handed (66" and 72" extend right)

60" x 60" - 24"L / 24"R	54" / 54"	U5CC6024RS	\$ 1822	\$ 1881	\$ 1942
60" x 60" - 24"L / 27"R	54" / 54"	U5CC6027RS	\$ 1877	\$ 1937	\$ 2000
60" x 66" - 24"L / 24"R	54" / 60"	U5CC6624RS	\$ 1914	\$ 1975	\$ 2039
60" x 66" - 24"L / 27"R	54" / 60"	U5CC6627RS	\$ 1945	\$ 2007	\$ 2074
60" x 72" - 24"L / 24"R	54" / 66"	U5CC7224RS	\$ 1955	\$ 2017	\$ 2084
60" x 72" - 24"L / 27"R	54" / 66"	U5CC7227RS	\$ 2083	\$ 2150	\$ 2219

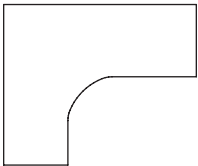
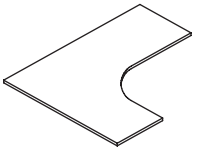

How to specify —
Select the Model Number from above.

1st Option:
Laminate:
See page 56 for finishes.

2nd Option:
Edge:

U5CC | | | | | | | | | | | | | | | | | | . | | | | | | | | | | | | | | | | | | .

Examples: U5CC7224LS.LM11.EV U5CC6624RS.LWBR.DB

FURTHER

Worksurface Supports

Further™ — Beams

For specification information see pages 63-79.

Painted Metal
GSA SIN 33721

UN6B36P

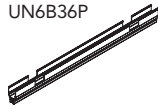

UN6B48P

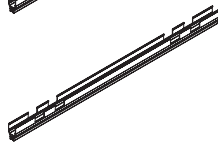

Description	Model	Applicable Beam Power Kit Model	List Price		
			P1	P2	P3
Beams with Back-to-Back Power Ports*					
36" W with 2 Ports Per Side	UN6B36P	UN8K36	\$ 607	\$ 622	\$ 635
42" W with 2 Ports Per Side	UN6B42P	UN8K42	\$ 667	\$ 682	\$ 695
48" W with 4 Ports Per Side	UN6B48P	UN8K48	\$ 721	\$ 739	\$ 757
54" W with 4 Ports Per Side	UN6B54P	UN8K54	\$ 798	\$ 816	\$ 834
60" W with 4 Ports Per Side	UN6B60P	UN8K60	\$ 875	\$ 895	\$ 917
66" W with 4 Ports Per Side	UN6B66P	UN8K66	\$ 950	\$ 970	\$ 992
72" W with 4 Ports Per Side	UN6B72P	UN8K72	\$ 1045	\$ 1067	\$ 1093
78" W with 4 Ports Per Side	UN6B78P	UN8K78	\$ 1283	\$ 1305	\$ 1331
84" W with 4 Ports Per Side	UN6B84P	UN8K84	\$ 1429	\$ 1454	\$ 1483
90" W with 4 Ports Per Side	UN6B90P	UN8K90	\$ 1524	\$ 1549	\$ 1578
96" W with 4 Ports Per Side	UN6B96P	UN8K96	\$ 1619	\$ 1647	\$ 1678

*Order applicable Beam Power Kit separately on page 104. Beam electrical covers to be ordered separately if duplex receptacles are not specified (see below).



USBEC2

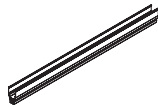

UN6B09CN

Description	Model	Chicago Code Model	List Price		
			P1	P2	P3
Beam Electrical Covers					
2 Pack	UNBEC2	UNBEC2CH*	\$ 65	\$ 65	\$ 65
12 Pack	UNBEC12	UNBEC12CH*	\$ 234	\$ 234	\$ 234

*Requires electrical mounting kit UN8EBKCH.

Beams (Non-Ported)

18" W	UN6B18N	\$ 341	\$ 353	\$ 362
21" W	UN6B21N	\$ 390	\$ 402	\$ 411
24" W	UN6B24N	\$ 427	\$ 439	\$ 448
30" W	UN6B30N	\$ 503	\$ 515	\$ 524
36" W	UN6B36N	\$ 576	\$ 591	\$ 604
42" W	UN6B42N	\$ 635	\$ 650	\$ 663
48" W	UN6B48N	\$ 691	\$ 709	\$ 727
54" W	UN6B54N	\$ 768	\$ 786	\$ 804
60" W	UN6B60N	\$ 844	\$ 864	\$ 886
66" W	UN6B66N	\$ 922	\$ 942	\$ 964
72" W	UN6B72N	\$ 1000	\$ 1022	\$ 1048
78" W	UN6B78N	\$ 1094	\$ 1116	\$ 1142
84" W	UN6B84N	\$ 1240	\$ 1265	\$ 1294
90" W	UN6B90N	\$ 1379	\$ 1404	\$ 1433
96" W	UN6B96N	\$ 1524	\$ 1552	\$ 1583



Cantilevered Beams

6" W	UN6B06CN	\$ 208	\$ 220	\$ 229
9" W	UN6B09CN	\$ 212	\$ 224	\$ 233
12" W	UN6B12CN	\$ 248	\$ 260	\$ 269

How to specify —
Select the Model Number from above.

1st Option:

Paint (if applicable):

U | | | | | | | | | | . | | | | | | | | | |

Examples: UN6B36P.P02 UNSBEC2.P7B UN6B18N.P02

Shippable by small-package carrier.

FURTHER

Worksurface Supports

Further™ — Beam Trim

For specification information see pages 63-79.

Painted Metal
GSA SIN 33721



Description	Model	List Price		
		P1	P2	P3
Beam Trim — Flat				
6" Cantilevered Beams Only	UN6B06F <input type="checkbox"/>	\$ 111	\$ 120	\$ 123
9" Cantilevered Beams Only	UN6B09F <input type="checkbox"/>	\$ 122	\$ 133	\$ 142
12" Cantilevered Beams Only	UN6B12F <input type="checkbox"/>	\$ 125	\$ 136	\$ 145
18"	UN6B18F <input type="checkbox"/>	\$ 152	\$ 163	\$ 172
21"	UN6B21F <input type="checkbox"/>	\$ 159	\$ 170	\$ 179
24"	UN6B24F <input type="checkbox"/>	\$ 160	\$ 171	\$ 180
30"	UN6B30F <input type="checkbox"/>	\$ 168	\$ 179	\$ 188
36"	UN6B36F <input type="checkbox"/>	\$ 181	\$ 194	\$ 204
42"	UN6B42F <input type="checkbox"/>	\$ 193	\$ 206	\$ 216
48"	UN6B48F <input type="checkbox"/>	\$ 199	\$ 215	\$ 229
54"	UN6B54F <input type="checkbox"/>	\$ 209	\$ 225	\$ 239
60"	UN6B60F <input type="checkbox"/>	\$ 217	\$ 235	\$ 253
66"	UN6B66F <input type="checkbox"/>	\$ 364	\$ 382	\$ 400
72"	UN6B72F <input type="checkbox"/>	\$ 385	\$ 405	\$ 427
78"	UN6B78F <input type="checkbox"/>	\$ 433	\$ 453	\$ 475
84"	UN6B84F <input type="checkbox"/>	\$ 442	\$ 464	\$ 490
90"	UN6B90F <input type="checkbox"/>	\$ 452	\$ 474	\$ 500
96"	UN6B96F <input type="checkbox"/>	\$ 458	\$ 483	\$ 512



Description	Model	List Price		
		P1	P2	P3
Beam Trim for Mounting Screens or Storage				
6" Cantilevered Beams Only	UN6B06M <input type="checkbox"/>	\$ 150	\$ 159	\$ 162
9" Cantilevered Beams Only	UN6B09M <input type="checkbox"/>	\$ 156	\$ 167	\$ 176
12" Cantilevered Beams Only	UN6B12M <input type="checkbox"/>	\$ 162	\$ 173	\$ 182
18"	UN6B18M <input type="checkbox"/>	\$ 198	\$ 209	\$ 218
21"	UN6B21M <input type="checkbox"/>	\$ 201	\$ 212	\$ 221
24"	UN6B24M <input type="checkbox"/>	\$ 205	\$ 216	\$ 225
30"	UN6B30M <input type="checkbox"/>	\$ 212	\$ 223	\$ 232
36"	UN6B36M <input type="checkbox"/>	\$ 233	\$ 246	\$ 256
42"	UN6B42M <input type="checkbox"/>	\$ 246	\$ 259	\$ 269
48"	UN6B48M <input type="checkbox"/>	\$ 257	\$ 273	\$ 287
54"	UN6B54M <input type="checkbox"/>	\$ 265	\$ 281	\$ 295
60"	UN6B60M <input type="checkbox"/>	\$ 271	\$ 289	\$ 307
66"	UN6B66M <input type="checkbox"/>	\$ 434	\$ 452	\$ 470
72"	UN6B72M <input type="checkbox"/>	\$ 485	\$ 505	\$ 527
78"	UN6B78M <input type="checkbox"/>	\$ 521	\$ 541	\$ 563
84"	UN6B84M <input type="checkbox"/>	\$ 530	\$ 552	\$ 578
90"	UN6B90M <input type="checkbox"/>	\$ 541	\$ 563	\$ 589
96"	UN6B96M <input type="checkbox"/>	\$ 552	\$ 577	\$ 606

How to specify —
Select the Model Number from above.

1st Option:
Paint
(if applicable):
 P1 P2 P3

Examples: UN6B06F.P02 UN6B06M.P7B

Shippable by small-package carrier.

Worksurface Supports

Further™ — Hub and Components

For specification information see pages 63-79.

Painted Metal
GSA SIN 33721

FLEXIBLE STANDARD-HEIGHT HUBS (Organic & Linear Applications)

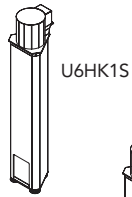

U6HK1S



U6HK1P

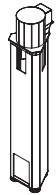

U6HK1HC

UN3CHBC

U3CHBG



U6HB2L



U6HB3L



U3HAI



U3CG12



U3HAE

Description	Model	List Price		
		P1	P2	P3
Flexible Non-Ported Connector Hubs — 28"H				
1 Beam to Hub (shown)	U6HK1S <input type="checkbox"/>	\$ 1332	\$ 1373	\$ 1433
2 Beams to Hub	U6HK2S <input type="checkbox"/>	\$ 1401	\$ 1442	\$ 1502
3 Beams to Hub	U6HK3S <input type="checkbox"/>	\$ 1460	\$ 1501	\$ 1561
4 Beams to Hub	U6HK4S <input type="checkbox"/>	\$ 1489	\$ 1530	\$ 1590

Note: Order hub base kit and anchors below for freestanding applications.

Description	Model	List Price		
		P1	P2	P3
Flexible Ported Connector Hubs — 28"H				
1 Beam to Hub (shown)	U6HK1P <input type="checkbox"/>	\$ 1460	\$ 1497	\$ 1555
2 Beams to Hub	U6HK2P <input type="checkbox"/>	\$ 1529	\$ 1566	\$ 1624
3 Beams to Hub	U6HK3P <input type="checkbox"/>	\$ 1588	\$ 1625	\$ 1683
4 Beams to Hub	U6HK4P <input type="checkbox"/>	\$ 1617	\$ 1654	\$ 1712

Note: Order hub base kit and anchors below for freestanding applications. Order electrical components separately on pages 103-104.

Description	Model	List Price		
		P1	P2	P3
Flexible High Capacity Connector Hubs — 28"H				
1 Beam to Hub (shown)	U6HK1HC <input type="checkbox"/>	\$ 1382	\$ 1423	\$ 1483
2 Beams to Hub	U6HK2HC <input type="checkbox"/>	\$ 1451	\$ 1492	\$ 1552
3 Beams to Hub	U6HK3HC <input type="checkbox"/>	\$ 1510	\$ 1551	\$ 1611
4 Beams to Hub	U6HK4HC <input type="checkbox"/>	\$ 1539	\$ 1580	\$ 1640

Note: Order hub base kit and anchors below for freestanding applications.

Description	Model	List Price		
		P1	P2	P3
Flexible Hub Components				
Connector Block — fills 90° of new U™ Beam Hub Connector*	UN3CHBC <input type="checkbox"/>	\$ 125	\$ 135	\$ 141
Connector Gap Filler (3 pack) — fills 90° of original Hub Connector*	U3CHBG <input type="checkbox"/>	\$ 98	\$ 108	\$ 114
Hub Base Kit — 2 Feet with leveling	U6HB2L <input type="checkbox"/>	\$ 489	\$ 507	\$ 525
Hub Base Kit — 3 Feet with leveling	U6HB3L <input type="checkbox"/>	\$ 519	\$ 537	\$ 555
Anchor — Internal (Black only)	U3HAI <input type="checkbox"/>	\$ 78	N/A	N/A
Anchor — External (P1 or P2)	U3HAE <input type="checkbox"/>	\$ 78	\$ 82	84
Carpet Grippers — 12 pack	U3CG12 <input type="checkbox"/>	\$ 33	N/A	N/A

*Order ala carte to aid in reconfiguration of hub connector kit.

FIXED STANDARD-HEIGHT HUBS (Only Linear Applications)

UN6HE2SQ

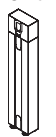

UN6HC2SQ

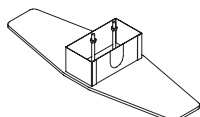

UN6HFCAU

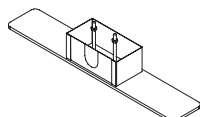

UN6HFEAU

Description	Model	List Price		
		P1	P2	P3
Fixed Standard-Height Hubs — 28"H				
1 Beam — End of Run	UN6HE2SQ <input type="checkbox"/>	\$ 846	\$ 905	\$ 994
2 Beams — In Line (2 Beams only at 180°)	UN6HC2SQ <input type="checkbox"/>	\$ 846	\$ 905	\$ 994
Fixed In-Line Hub Foot	UN6HFCAU	\$ 527	\$ 564	\$ 619
Fixed End-of-Run Hub Foot	UN6HFEAU	\$ 527	\$ 564	\$ 619

How to specify —
Select the Model Number from above.

1st Option:
Paint
(if applicable):

P1 P2 P3

U | | | | | . | | | | |

Examples: U6HK1S.P02 U6HK4SHC.P7B U3CG12

Shippable by small-package carrier.

Worksurface Supports

Further™ — Hub and Components

For specification information see pages 63-79.

Painted Metal
GSA SIN 33721

FIXED HUBS (Only Linear Applications)

UN6HLE2SQ

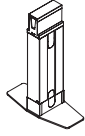
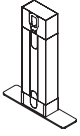

UN6HLC2SQ

Description	Model	List Price		
		P1	P2	P3
Fixed Low Height Freestanding Hubs — 20½"H (for freestanding power rail/fence applications)				
1 Beam — End of Run	UN6HLE2SQ S	\$ 1093	\$ 1170	\$ 1285
2 Beams — In Line (2 Beams only at 180°)	UN6HLC2SQ S	\$ 1093	\$ 1170	\$ 1285

UN6LHK2S



UN6LHK2HC

Description	Model	List Price		
		P1	P2	P3
Flexible Low-Height Freestanding Hubs — 20½"H				
Further Flex Low Hub with Hub to 2 Beam Connector	UN6LHK2S	\$ 1270	\$ 1347	\$ 1471
Further Flex Low Hub with Hub to 3 Beam Connector	UN6LHK3S	\$ 1329	\$ 1406	\$ 1530
Further Flex Low Hub with Hub to 4 Beam Connector	UN6LHK4S	\$ 1358	\$ 1435	\$ 1559
Further Flex Hi Cap Low Hub with Hub to 2 Beam Connector	UN6LHK2HC	\$ 1311	\$ 1390	\$ 1519
Further Flex Hi Cap Low Hub with Hub to 3 Beam Connector	UN6LHK3HC	\$ 1370	\$ 1449	\$ 1578
Further Flex Hi Cap Low Hub with Hub to 4 Beam Connector	UN6LHK4HC	\$ 1399	\$ 1478	\$ 1607

How to specify —
Select the
Model Number
from above.

1st Option:

Paint
(if applicable):

P1 P2 P3

UN6 | | | | | | | | | | . | | | | | | | |

Example: UN6LHK2S.P7B

S Shippable by small-package carrier.

Worksurface Supports

Further™ — Legs and Supports

For specification information see pages 63-79.

Painted Metal
GSA SIN 33721

FLEXIBLE LEGS

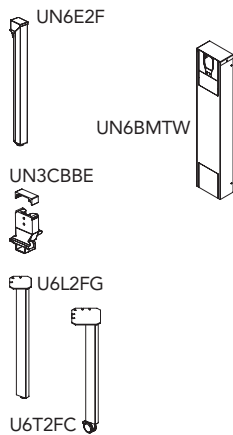

Description	Model	List Price		
		P1	P2	P3
Beam Legs (Triangular) — Seated Height				
Beam End Support Leg — Adds 3" to run	UN6E2F S	\$ 497	\$ 517	\$ 533
Beam Wall Mount — attaches beam run to wall (requires stud)	UN6BMTW S	\$ 570	\$ 593	\$ 618
Bench End Beam Connector Kit	UN3CBBE	\$ 159	\$ 169	\$ 175

Worksurface and Table Legs — Seated Height

Triangular Worksurface and Table Support Leg w/Glide	U6L2FG S	\$ 366	\$ 386	\$ 402
Triangular Table Support Leg w/Caster	U6T2FC S	\$ 397	\$ 417	\$ 433

Worksurface Legs (Square) — Seated Height

Square Straight Leg Worksurfaces Support w/ Glide	UN6L2FGSQ	\$ 261	\$ 281	\$ 308
Square A-Leg Worksurface Support w/ Glide	UN6ALSQ	\$ 274	\$ 294	\$ 321

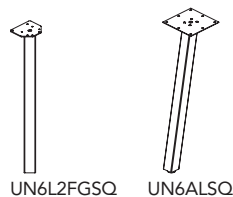

BRACKETS

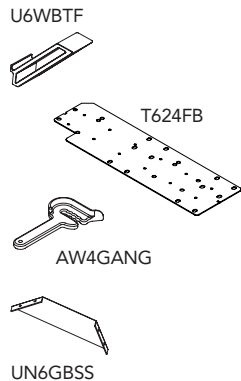

Description	Model	List Price		
		P1	P2	P3
Brackets				
Worksurface Support Bracket — Tethered fixed height	U6WBTF S	\$ 96	\$ 101	\$ 104
Flat Bracket for 12"D (no color option)	T612FB S	\$ 70	N/A	N/A
Flat Bracket for 24"D (no color option)	T624FB S	\$ 80	N/A	N/A
Flat Bracket for 30"D (no color option)	T630FB S	\$ 91	N/A	N/A
2 Ganging Bracket Links with Screws (no color option)	AW4GANG S	\$ 101	N/A	N/A
Gusset Bracket for Single Sided Applications	UN6GBSS	\$ 150	\$ 157	\$ 162

How to specify —
Select the
Model Number
from above.

1st Option:
Paint
(if applicable):
P1 P2 P3

Examples: UN6E2F.P02 UN6BMTW.P7B T612FB

S Shippable by small-package carrier.

Worksurface Supports

Further™ — Legs and Supports

For specification information see pages 63-79.

Painted Metal
GSA SIN 33721

FIXED LEGS

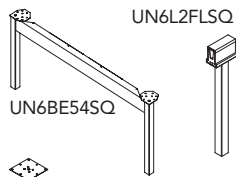

UN6L2FLSQ

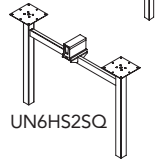

UN6BE54SQ

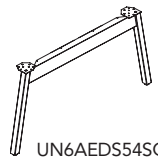

UN6AEDS54SQ

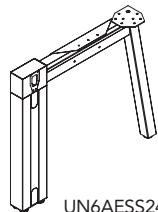

UN6AESS24RH

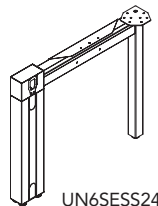

UN6SESS24RH

Description	Model	List Price		
		P1	P2	P3
Beam Supports (Square) — Seated Height				
54" W H-Leg - Bench End Support (for 2-24" W) — Adds 3" to run	UN6BE54SQ	\$ 1077	\$ 1154	\$ 1266
60" W H-Leg - Bench End Support (for 2-27" W) — Adds 3" to run	UN6BE60SQ	\$ 1095	\$ 1173	\$ 1287
In-Line Beam Support Leg with Flat Top Trim — Adds 6" to run	UN6L2FLSQ	\$ 415	\$ 446	\$ 493
H-Leg Mid-Support with Flat Top Trim	UN6HS2SQ	\$ 918	\$ 982	\$ 1079

Beam Supports (Square) — Seated Height

A-Leg Mid-Support with Flat Top Trim	UN6AMDS2SQ	\$ 965	\$ 1029	\$ 1126
54" W A-Leg Bench End Support (for 2-24" W) - Adds 3" to run	UN6AEDS54SQ (shown)	\$ 1129	\$ 1206	\$ 1318
60" W A-Leg Bench End Support (for 2-30" W) - Adds 3" to run	UN6AEDS60SQ	\$ 1152	\$ 1230	\$ 1344
A-Leg Single Sided End Support, 24" D, Right Hand	UN6AESS24RH (shown)	\$ 1179	\$ 1224	\$ 1269
A-Leg Single Sided End Support, 24" D, Left Hand	UN6AESS24LH	\$ 1179	\$ 1224	\$ 1269
A-Leg Single Sided End Support, 30" D, Right Hand	UN6AESS27RH	\$ 1218	\$ 1265	\$ 1311
A-Leg Single Sided End Support, 30" D, Left Hand	UN6AESS27LH	\$ 1218	\$ 1265	\$ 1311
H-Leg Single Sided End Support, 24" D, Right Hand	UN6SESS24RH (shown)	\$ 1144	\$ 1188	\$ 1231
H-Leg Single Sided End Support, 24" D, Left Hand	UN6SESS24LH	\$ 1144	\$ 1188	\$ 1231
H-Leg Single Sided End Support, 30" D, Right Hand	UN6SESS27RH	\$ 1181	\$ 1227	\$ 1271
H-Leg Single Sided End Support, 30" D, Left Hand	UN6SESS27LH	\$ 1181	\$ 1227	\$ 1271

How to specify —
Select the
Model Number
from above.

1st Option:
Paint
(if applicable):

P1 P2 P3

Example: UN6BE54SQ.P7B

Shippable by small-package carrier.

Further features cable management capabilities for electrical, voice, and data. The 8-wire electrical system can be integrated within beams. Voice and data cables are routed externally using beam mounted wire managers.

Electrical power harnesses in beam have capacity for 2 or 4 duplex receptacles per side depending on length.

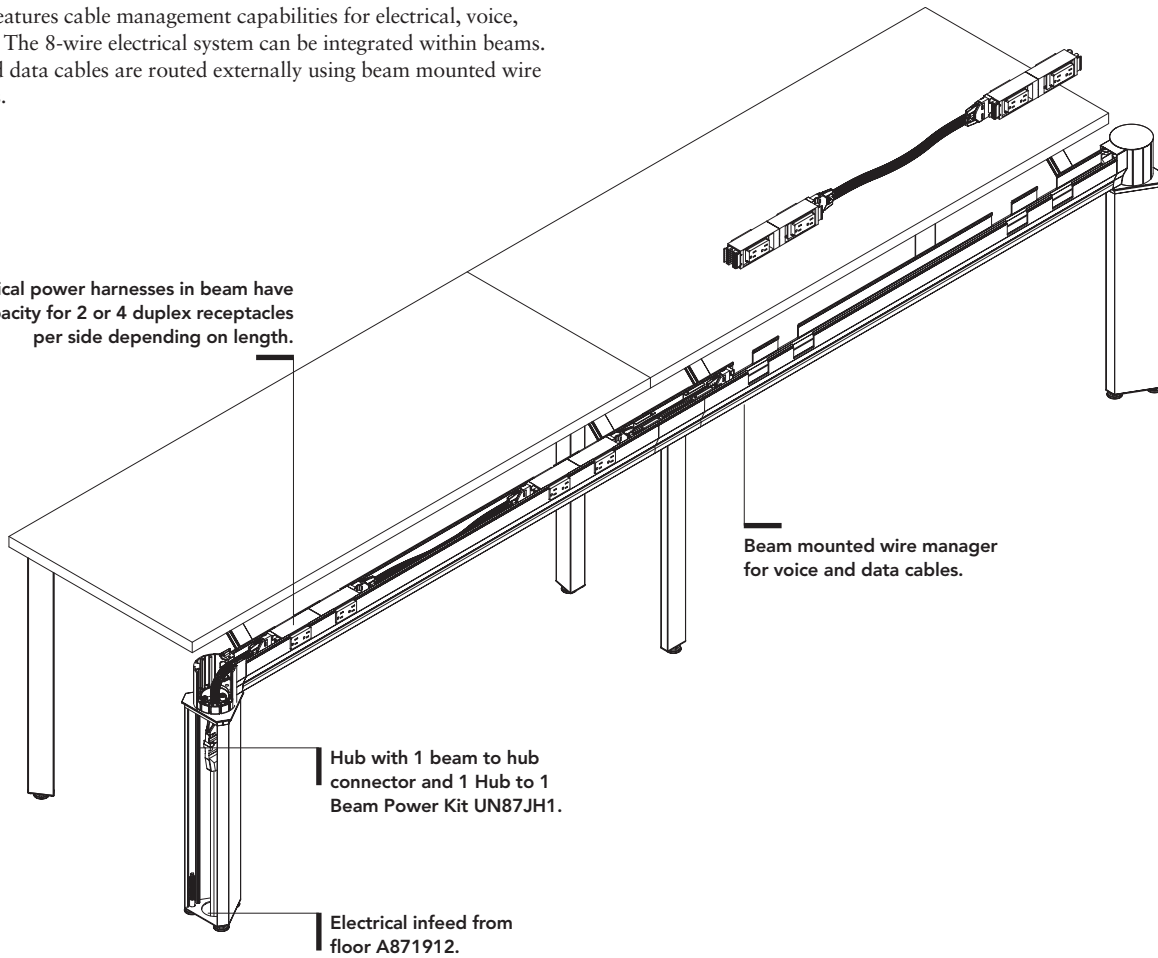

Further Electrical Systems

The electrical system for Further offers two options: 3+1 or 2+2. Both systems utilize an 8-wire, four-circuit electrical system, rated at 20 amps (15 amps Canadian). Connect a maximum of 13 receptacles (12 in Canada, and fewer in certain U.S. locales) to one circuit. Consult your electrician to ensure the planned electrical load is within permissible limits. Follow the steps below to help specify your Further electrical.

1. **Infeeds** — Determine the location, quantity, and type of power infeeds needed.
2. **Hub-to-Beam Power Kits** — Specify a Hub-to-Beam Power Kit with each Infeed. Order Kit based on the number of beams being powered at the infeed location. Ex: A Flexible Hub in the center of a 120° Pinwheel needs a Hub-to-3 Beam Power Kit. These kits connect to Beam Power Kits.
3. **Beam Power Kits & Jumpers** — Specify a Beam Power Kit for each ported beam. Power kits are determined by the size of beam ordered and are connected to one another with beam-to-beam jumpers - order separately.
4. **Duplex Receptacles** — Determine which electrical system will be used after consulting an electrician: 2+2 or 3+1. System is determined by which circuits are used. Specify circuit specific receptacles to fill all port locations where electrical is needed. Number of ports is determined by the beams and beam power kits specified. Port covers must be placed in port locations where duplex receptacles are not specified.

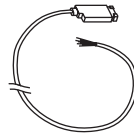

A871912

Electrical Infeed (page 103)

- Used to route power from a floor, wall, or ceiling core into the Further beam structure.
- Two infeeds can be routed into any hub, power pole, or H-leg. One infeed can be routed into the square leg bench end or wall mount.
- Available as sealtight cable in 12', or as flex cable in 12' or 18' lengths.
- Infeed cables cannot connect directly to beam power kits. Require a hub-to-beam power kit for all infeed locations.
- Consult your electrician to ensure the planned electrical load and cabling is within permissible national and local code limits.
- Infeed ordered separately for all hardwired applications. (see page 103)

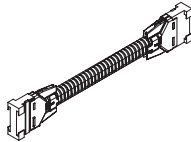

Beam-to-Beam Jumper (page 104)

- Used to pass power from one beam to another over beam support.
- Quantity varies on the number of beams being passed to. See illustration.
- Beam-to-beam jumpers do not need to be ordered for locations where hub-to-beam power kits are specified.

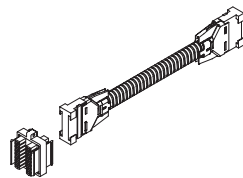

Hub-to-Beam Power Kits (page 104)

- Used to connect power from infeed cable to beam power kits.
- Order power kits based on the number of beams being connected to each infeed cable. If two infeed cables are entering the system in the same location, two hub-to-beam power kits should be ordered.
- Power can be routed into 1-4 beams from one infeed.

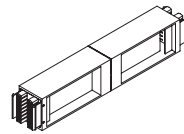

Ported Hub Power Kit (page 104)

- Installed within the ported flexible hub and delivers power to user.
- Requires two duplex receptacles – ordered separately.
- Can be used in conjunction with all hub-to-beam power kits.
- Must order an additional beam-to-beam jumper when placed in a location without an infeed cable.

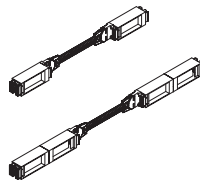

Beam Power Kits (page 104)

- Beam power kits are installed within the ported beam and deliver power to the user.
- Kits correlate to specific ported beam lengths; only one kit per beam.
- Quantity of duplex receptacles that can be used varies by length of beam specified. 36" and 42" ported beams have 2 ports on each side (4 total), 48" - 96" ported beams have 4 ports on each side (8 total). – duplex receptacles ordered separately.

Receptacle Color Recommended to Coordinate with Paint Color



Paint Color	Receptacle Color
Carob — P52.....	Black — E4
Champagne Metallic — PR5	Muslin — EU
Cinder — P7Q.....	Brownstone — BW
Designer White — PJW	Designer White — DW
Fossil — P28.....	Flint — E9
Gunmetal Metallic— PR3	Brownstone — EY
Parchment — P93.....	Muslin — EU
Pebble — P8R.....	Loft — EV
Pewter — P8D.....	Flint — E9
Platinum Metallic — PR2.....	Silver — ES
Salt — P8C.....	Silver — ES
Titanium — P8T.....	Silver — ES



Duplex Receptacles (page 104)

- Receptacles snap into power blocks of power kits.
- Quantity depends on the length of beams specified.
- Four circuits available.
- Circuit 3 must be specified as a utility (3+1) or isolated (2+2) circuit depending on the electrical system desired.
- Available in 8 colors and labeled with circuit number on receptacle face.
- May be replaced with electrical port covers in locations where power is not desired – ordered separately.

Electrical Port Cover (page 104)

- Fits into Further beam port locations in place of duplex receptacles.
- Does not fit into port sizes of other product lines.
- Requires electrical mounting kit UN8EBKCH.
- Chicago Code models available for hardwired applications.

Flexconnect™ Electrical System Options

The four-circuit, eight-wire electrical system is widely specified and trusted by hundreds of thousands of end-users. This proven system delivers four circuits for every power infeed in either a 3 + 1 or 2 + 2 configuration. The isolated/dedicated circuits are ideal for sensitive computing equipment, while the common circuits are suitable for faxes, copiers, task lights and other peripherals. Both the 3 + 1 and 2 + 2 systems use the same pre-wired components, making it easy to adjust as electrical needs change.

Reference the Office Equipment Typical Load Values on page 93.

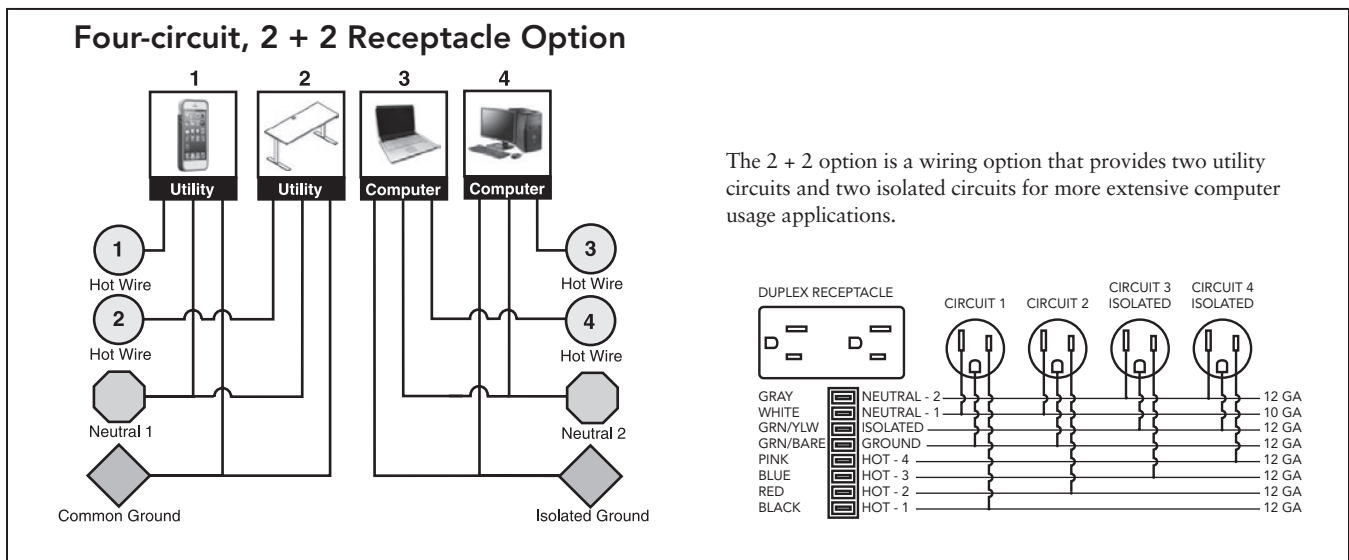
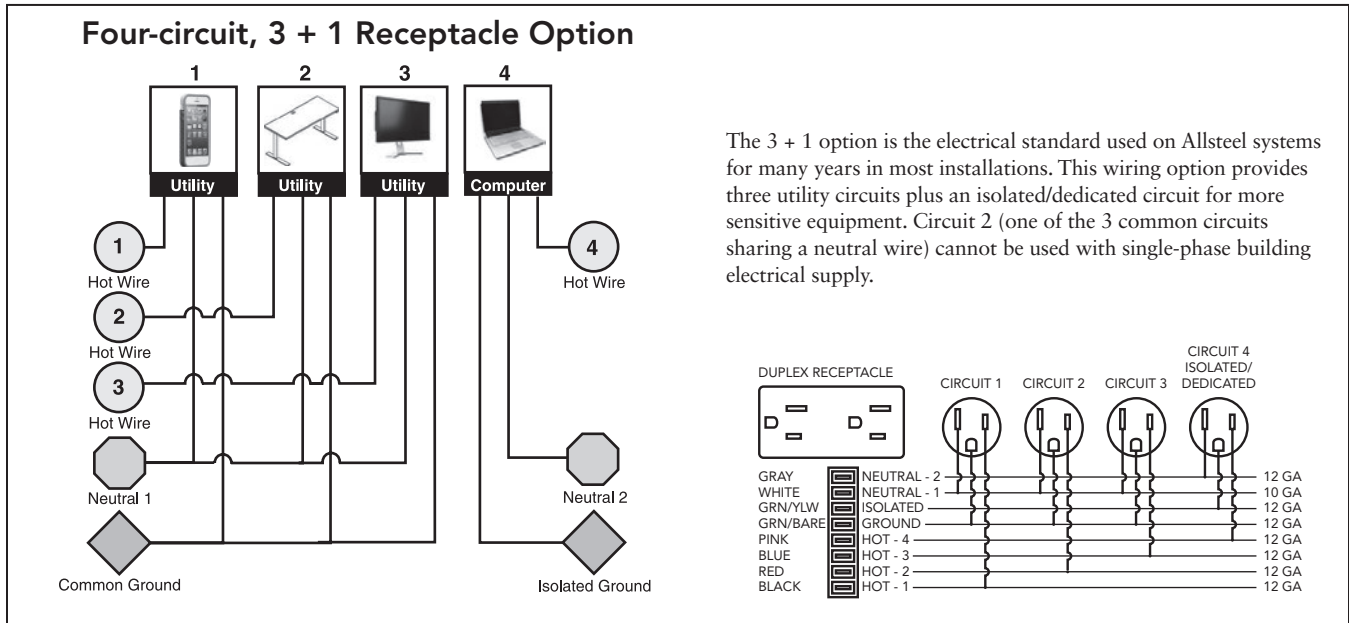

Office Equipment Typical Load Values

Item	*Amps
Desktop/2 Monitors	4
Laptop Computer	1
Laptop/2 Monitors/Docking Station	3
Paper Shredder	1.22
Radio	0.05
Scanner	3
Space Heater (1500 watts)	12
Task Light (equiv. 60-watt bulb)	
Fluorescent	0.12
LED	0.08
USB Charger	0.17
LCD Television (42")	1
LCD Monitor (21")	0.5
Bluetooth Speaker	0.1
Desktop Printer	
Inkjet	0.15
Laser	4 to 10
Multimedia Projector	1.7
Sit-to-Stand Height-Adjustable Desk	Idle 0.01 / Max 4
Office Kitchen	
Coffee Maker	10
Microwave	10
Toaster	12.5
Compact Refrigerator	1.5

*Chart is recommended for planning purposes. Check device specifications for exact amperage. Consult with your electrician regarding the applicable configurations.

Examples of Component Usage based on the *Office Equipment Typical Load Values Chart*

Power Option 3+1

Dedicated Circuit 4: 4 desktop computers with 2 monitors each; or 10 laptop computers
Utility Circuits 1, 2, 3: Height-adjustable tables and ancillary items

Power Option 2+2

Dedicated Circuit 3: 4 desktop computers with 2 monitors each; or 10 laptop computers
Dedicated Circuit 4: 4 desktop computers with 2 monitors each; or 10 laptop computers
Utility Circuits 1, 2: Height-adjustable tables and ancillary items

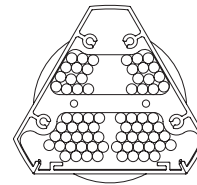
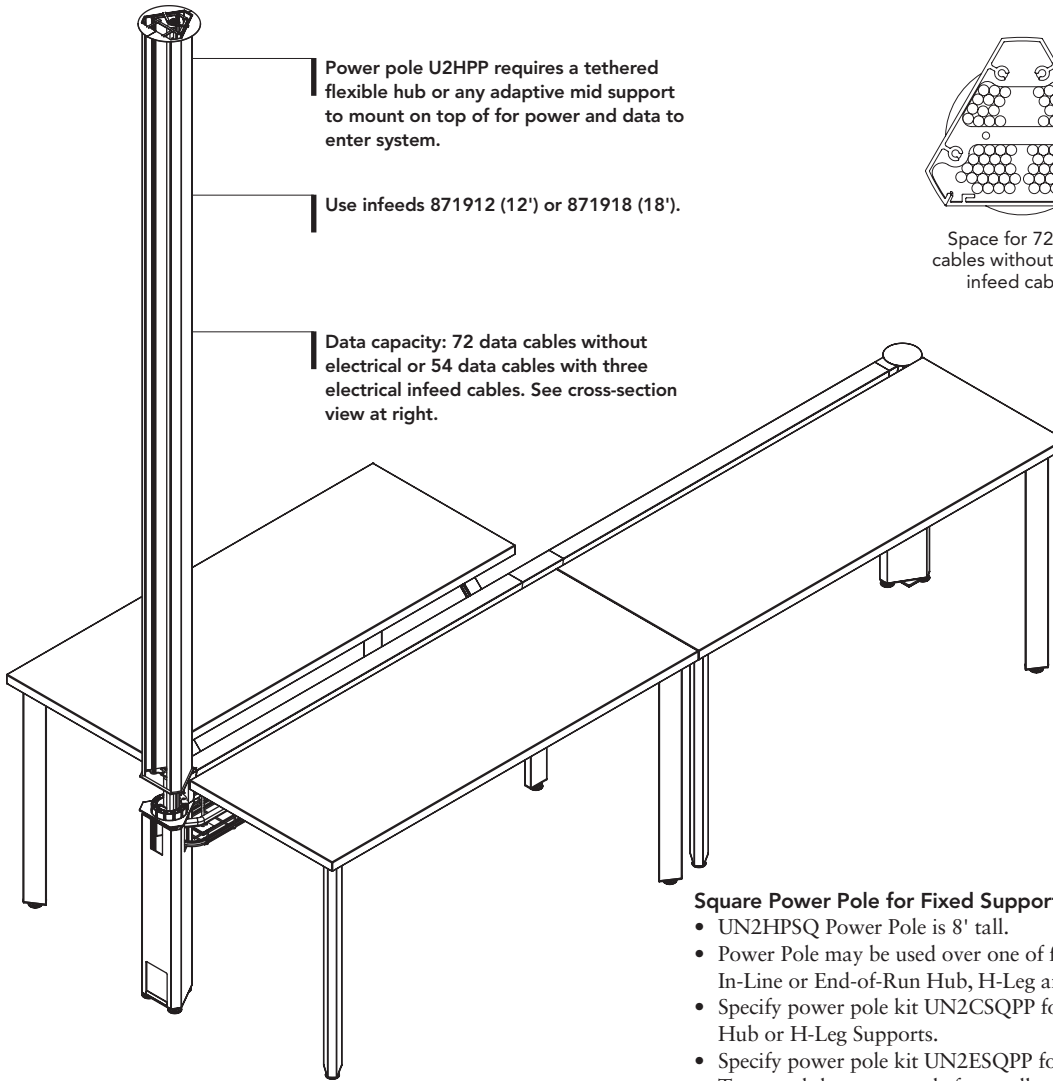

Space for 72 data cables without power infeed cables

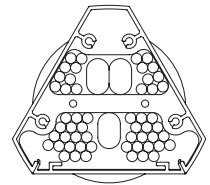

Space for 54 data cables with three power infeed cables

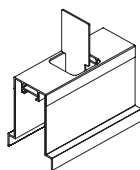

UN2CSQPP

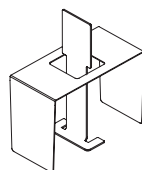

UN2ESQPP



Square Power Pole for Fixed Supports (page 103)

- UN2HPSQ Power Pole is 8' tall.
- Power Pole may be used over one of fixed supports: In-Line or End-of-Run Hub, H-Leg and In-Line Leg Supports.
- Specify power pole kit UN2CSQPP for In-Line Leg, In-Line Fixed Hub or H-Leg Supports.
- Specify power pole kit UN2ESQPP for End-of-Run Fixed Hub.
- To extend the power pole for a taller ceiling, order quantity-2 with a splicer kit UN2HPSQSK.

Power Pole (page 103)

- Used to shroud infeed and data cables that are routed to the beam structure from a ceiling.
- Requires a flexible hub or any adaptive mid support to mount over.
- Cannot be used in freestanding applications.
- Power pole stands 124¼" high with hub glides fully retracted. Extension available through Allsteel Tailored Products.
- Kit includes all necessary mounting hardware and ceiling trim.
- Mounts over 1-4 beams. Aesthetic trim cover included for end condition applications.

Infeed Cover (page 103)

- Shrouds single infeed or up to 24 data cables.
- Specify UN6WC for H-Leg or UN6AWC A-Leg supports.
- Attaches to the legs with VHB tape - included in hardware.
- Not compatible with Chicago or NYC junction boxes. Refer to hubs if needed.

Top Views of Hub

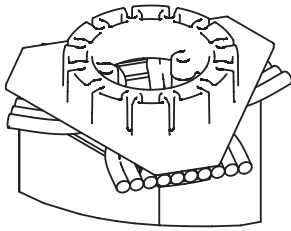

The top of the hub allows for a maximum of 30 (3.45 sq. in.) data cables (.300" dia.) to pass through the 1/2" gap around the perimeter of the hub

All quantities listed at 60% fill ratio

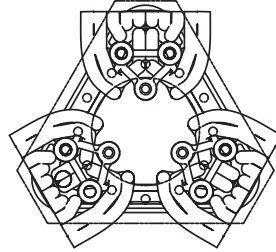

Cable capacities for routing voice and data cables through hub are provided at left for top, side, and bottom of hub.

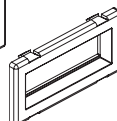
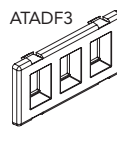
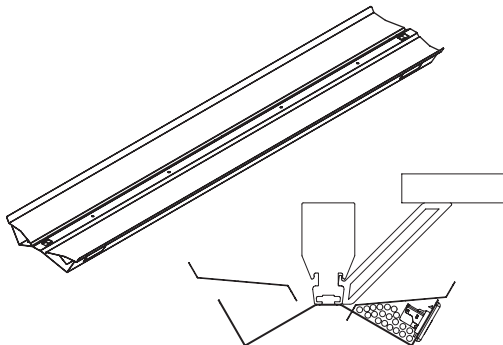
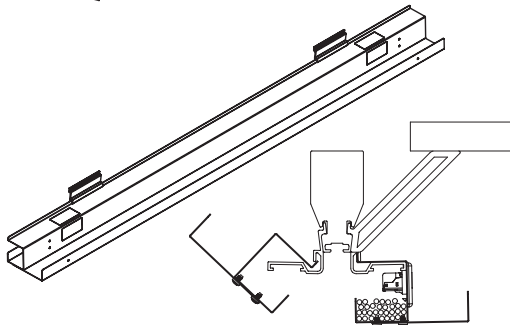
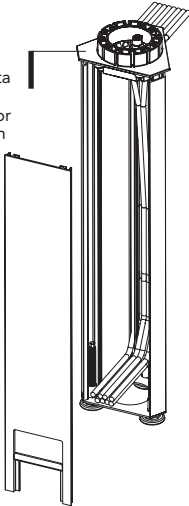

ATADF4

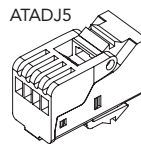

Data (page 105)

- Data is routed internally through any hub, power pole, wall-mount, or infeed cover; but is external to beam.
- Cabling is routed to users through beam-mounted wire managers. See illustrations at left.

Maximum Support Capacities

Support	Data*	Infeeds	Beams
Standard Flexible Hub	30	3	4
High Capacity Flexible Hub	84	3	4
Power Pole U2HPP	72	3	4
Power Pole UH2HPSQ	34	2	NA
In-Line Fixed Hub	24	1	2
End of Run Fixed Hub	24	1	1
H-Leg**	NA	2	2
Bench End**	NA	1	1
Infeed Cover	24	1	NA

*Reduce capacity of data cables by 6 for each infeed specified

*Data cable size is based on 0.25-diameter cable.

**Data capacity is determined by wire managers and infeed cover.

Single-Sided Wire Manager (page 105)

- Can be used with any single-sided, dual-sided, Further Adaptive, freestanding post and beam, and fixed-height applications.
- Holds user wires and up to 30 system data cables on one side of a beam.
- Mounts into the continuous reveal on either side of a beam – mounting clips included.
- Single-sided version is recommended when nesting storage.
- The data manager without the 2 1/2" D tray can be ordered separately to maximize space, or the tray may be removed in the field.
- Available from 36" to 78" widths in 6" increments.
- Includes mounting locations for Cord Management Chain when used with Adaptive supports or freestanding height-adjustable workstations.
- Specify 6" shorter than beam length when used with Adaptive supports.
- Two single-sided wire managers can be used on either side of beam to increase data capacity. (60 total)
- May be used in conjunction with beam mounted modesty screens.
- Includes 4 knockout port locations for data faceplates (2.7" W x 1.375" H) on all widths. Data faceplates ordered separately.

Dual-Sided Wire Manager (page 105)

- Holds user wires and up to 20 system data cables each side of a beam. (40 total)
- Mounts to underside of beam; does not use continuous side reveal.
- Available from 36" to 78" widths in 6" increments.
- Includes 8 knockout port locations for data faceplates on all widths. Data faceplates ordered separately.
- Ideal for use in a fixed-height dual sided application.
- Does not support wire chain.
- Cannot be used in conjunction with beam mounted modesty screens.
- Cannot be used on Further Adaptive. Must use single-sided wire manager.

Data Faceplates & Jacks (page 106)

- Faceplates fit into knockout ports on both available wire managers.
- Faceplates do not work in beam electrical ports.
- Faceplate options available to install either 3 or 4 data jacks.
- Faceplates available in one color – black.
- Faceplates and Jacks sold separately.
- CAT 5E and CAT 6 data jacks available.

Chicago code junction box **U8IKCH** is compatible with both 28"H and 20½"H flexible hubs. The box is 9½"H x 3½"W.

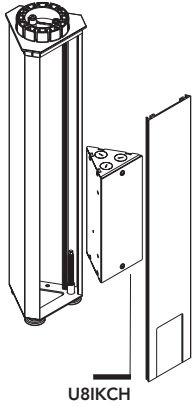

U8IKCH

Chicago code junction box **U8SBKCH** is compatible with both 28"H and 20½"H fixed hubs. The box is 11"H x 5.7"W x 2.3"D.

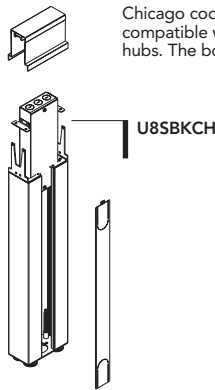

U8SBKCH

UN8BBKCH

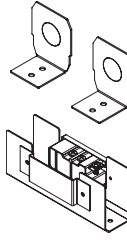

UN8EBKCH

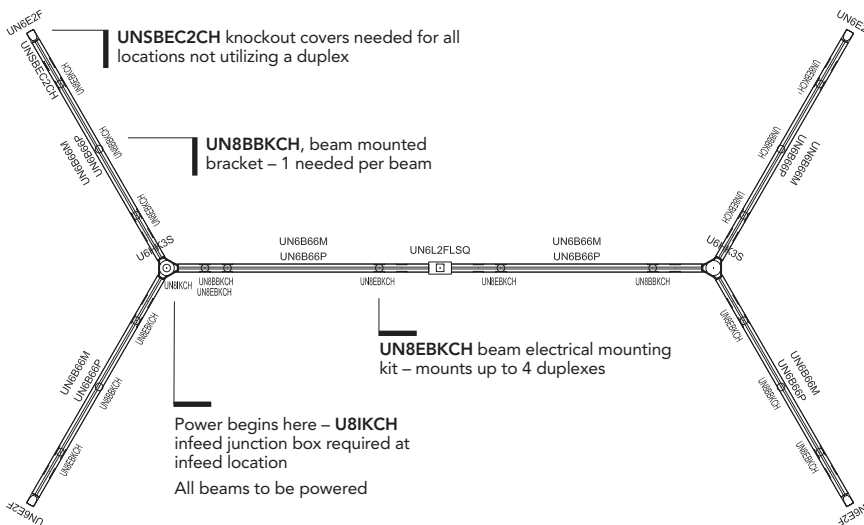
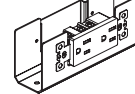

Hardwire – Chicago Code (page 103)

- Mounting rail top trim required for all hardwired powered beams.
- Cannot wire two receptacles back-to-back. Receptacles must be staggered.
- Junction box **U8IKCH** or **U8SBKCH** are required for all infeed locations.
- A ¾" diameter conduit fitting must be used at the knockout locations on the junction box and brackets to fit within enclosures.
- One beam kit **UN8BBKCH** required per beam. Kit includes two brackets to enclose beam to meet NEC and UL requirements.
- Electrical mounting kit **UN8EBKCH** is required for mounting duplex receptacles and/or electrical port covers. Kit includes two brackets.
- Electrical port covers can be installed in place of a duplex receptacle on the electrical mounting bracket. Cannot be installed without the electrical mounting kit **UN8EBKCH**.
- Ported flexible hubs cannot be used in hardwired applications.
- All wiring, conduit, and receptacles to be supplied by electrician.
- Use **U8IKCH** for flexible hubs and **U8SBKCH** for fixed hubs.

Hardwire – New York Code (page 103)

- Required for New York electrical.
- For flexible hubs and Further Adaptive, choose one of the 3 configurations:
 - **U8IKNY1** for Hub to 1 Beam
 - **U8IKNY2** for Hub to 2 Beam
 - **U8IKNY3** for Hub to 3 Beam
- For fixed hubs (not for use with Further Adaptive), choose one of the 2 configurations:
 - **U8SBKNY1** for Hub to 1 Beam
 - **U8SBKNY2** for Hub to 2 Beam
- Ported flexible hubs cannot be used in hardwired applications.
- All wiring and conduit to be supplied by electrician.

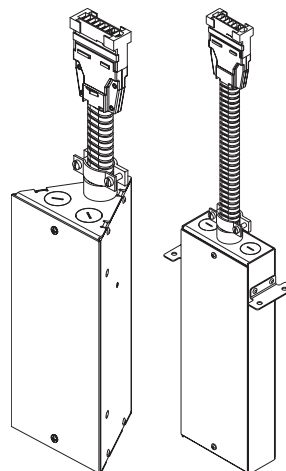

Further Electrical Example 1 — Dual-Sided Bench 4-Pack

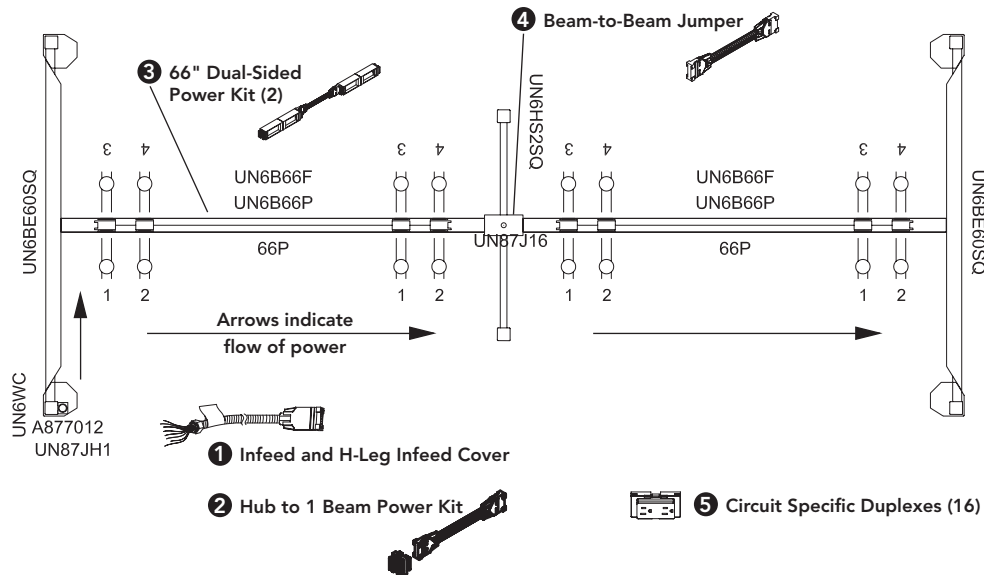
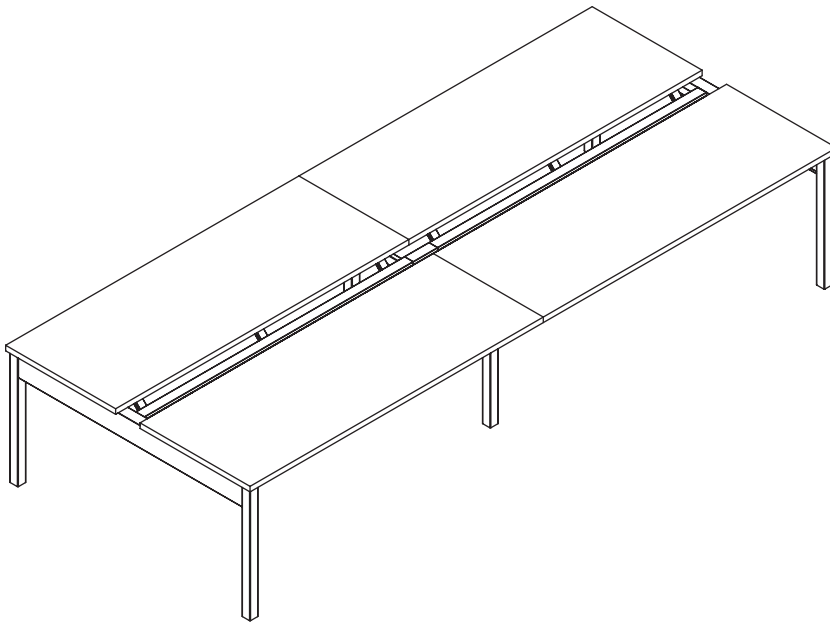

Further Electrical Example 2 — Dual-Sided Bench 6-Pack

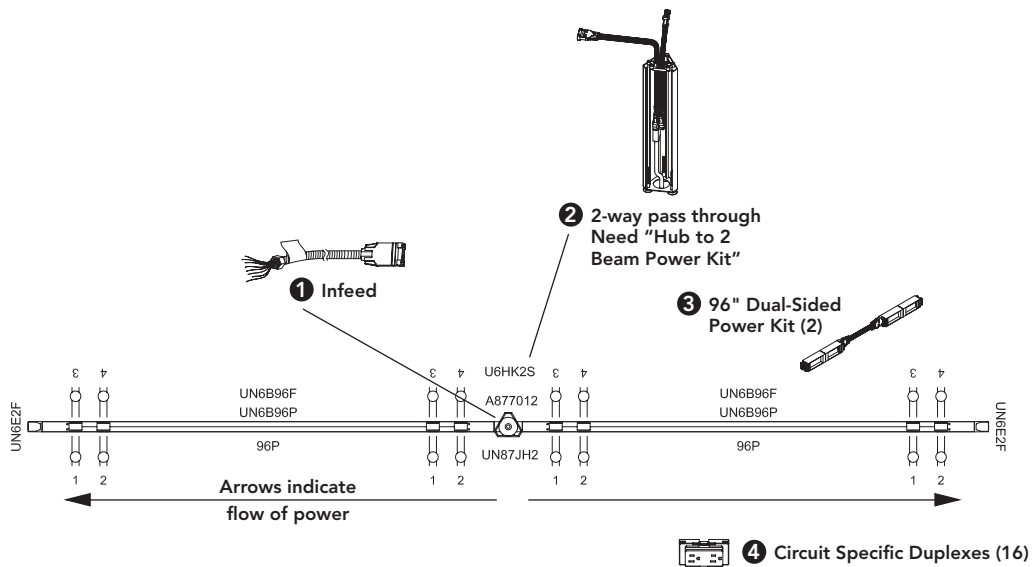
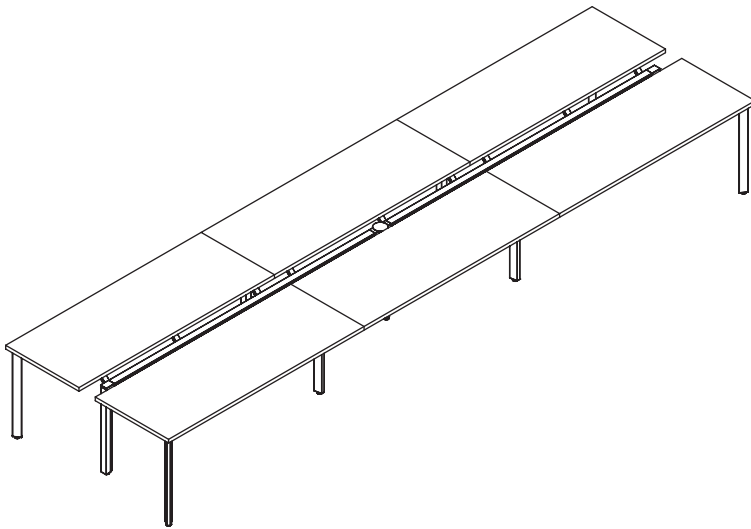

Further Electrical Example 3— Single-Sided Bench 2-Pack

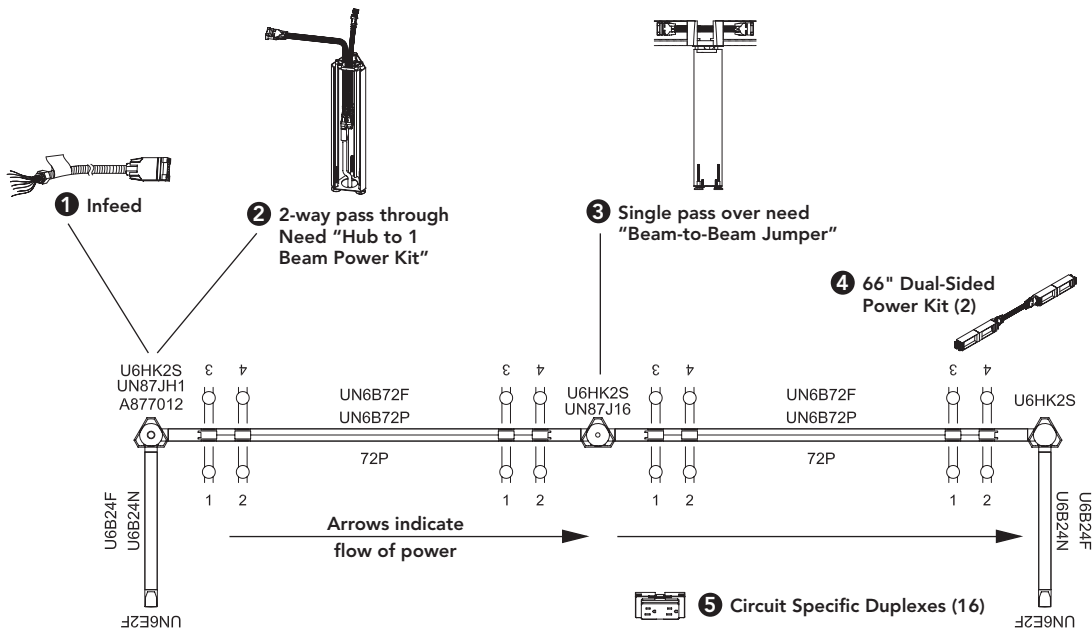
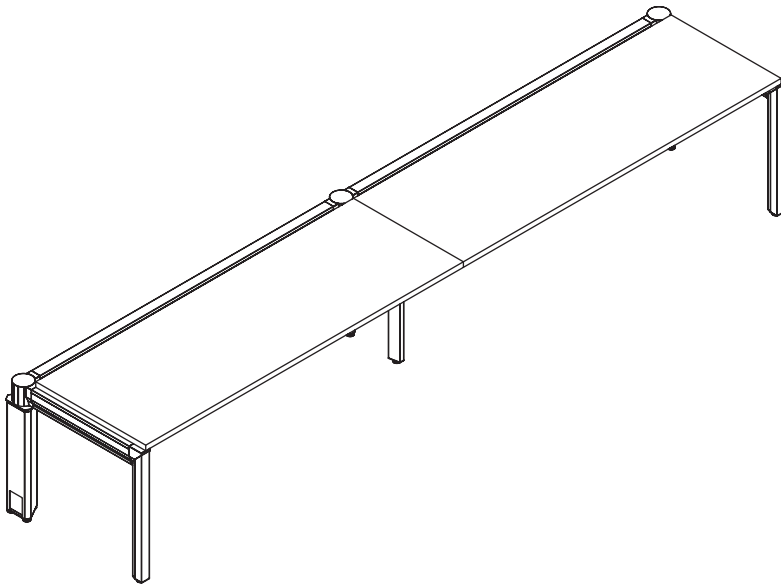

FURTHER

Further Electrical Example 4 — 120° Pinwheel with Power Pole

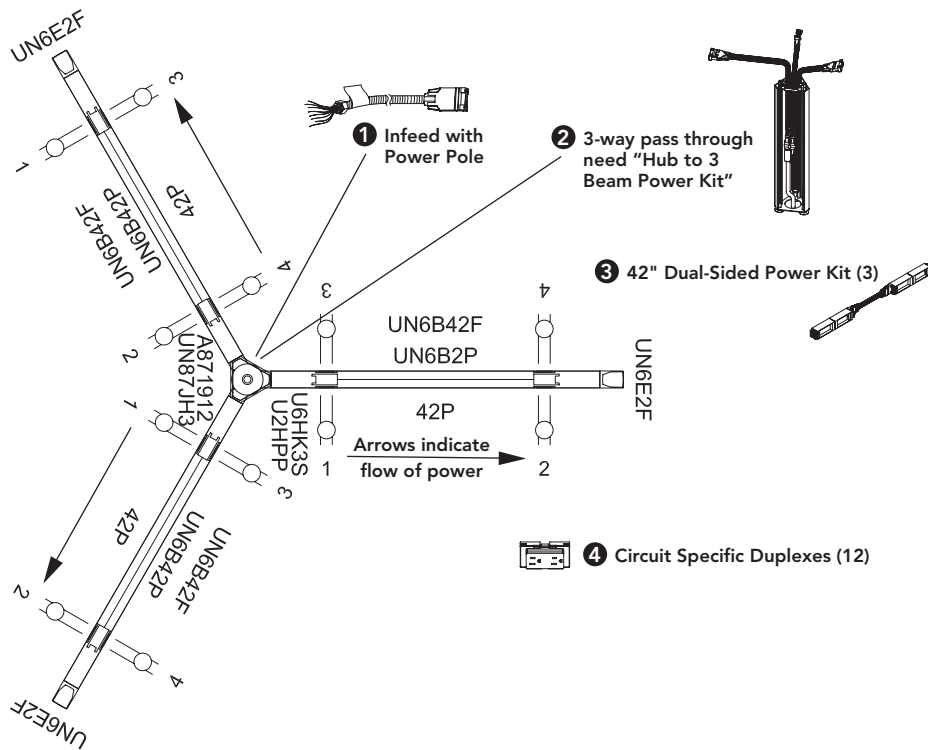
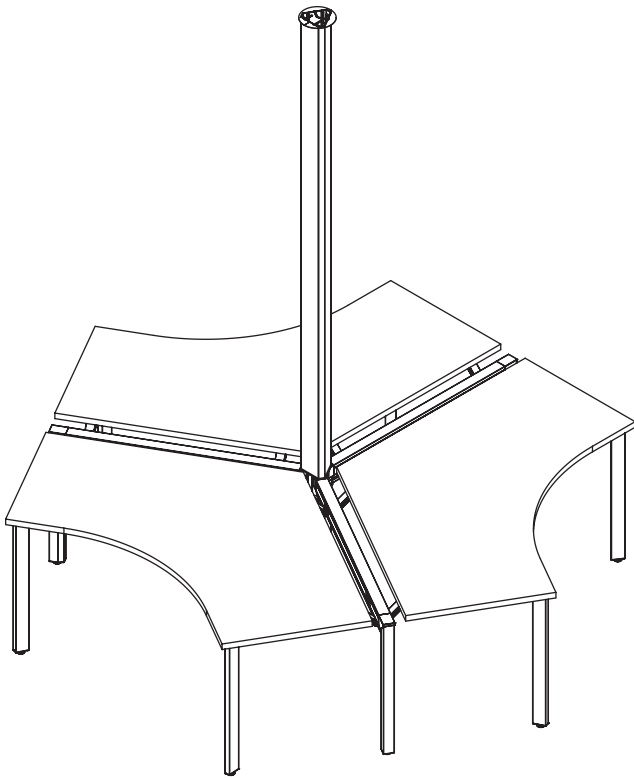

FURTHER

Further Electrical Example 5 — 120° Dogbone

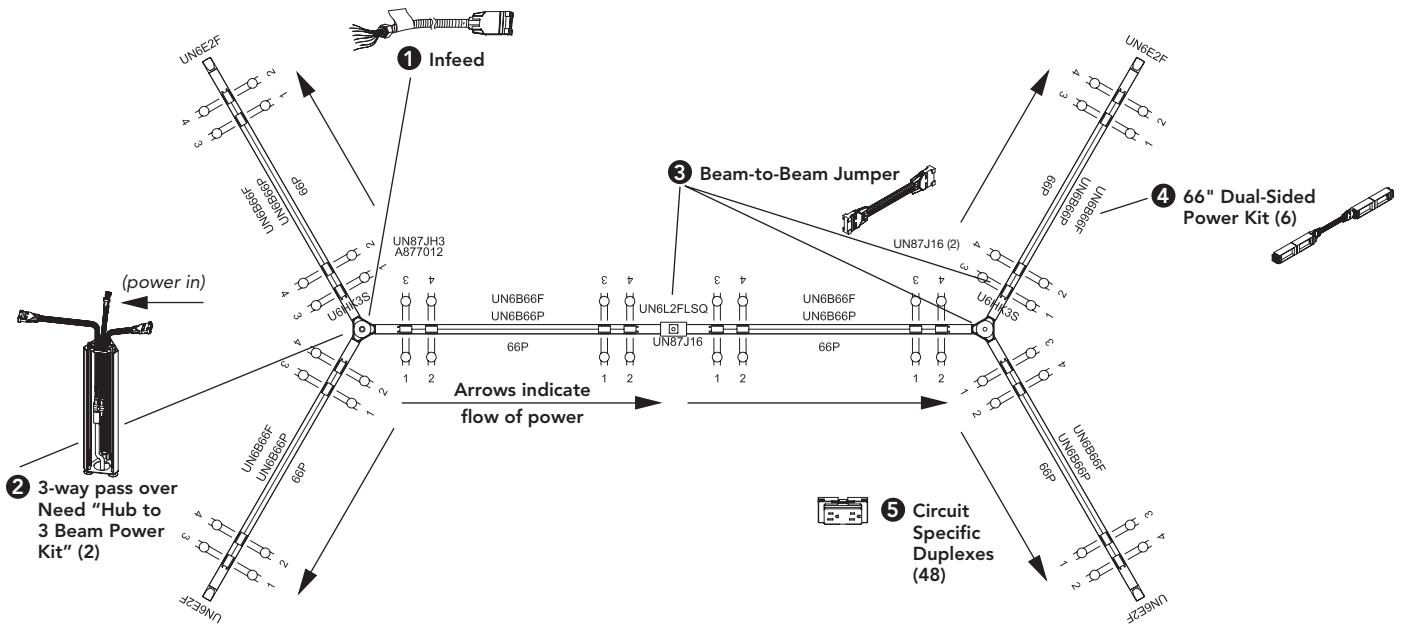
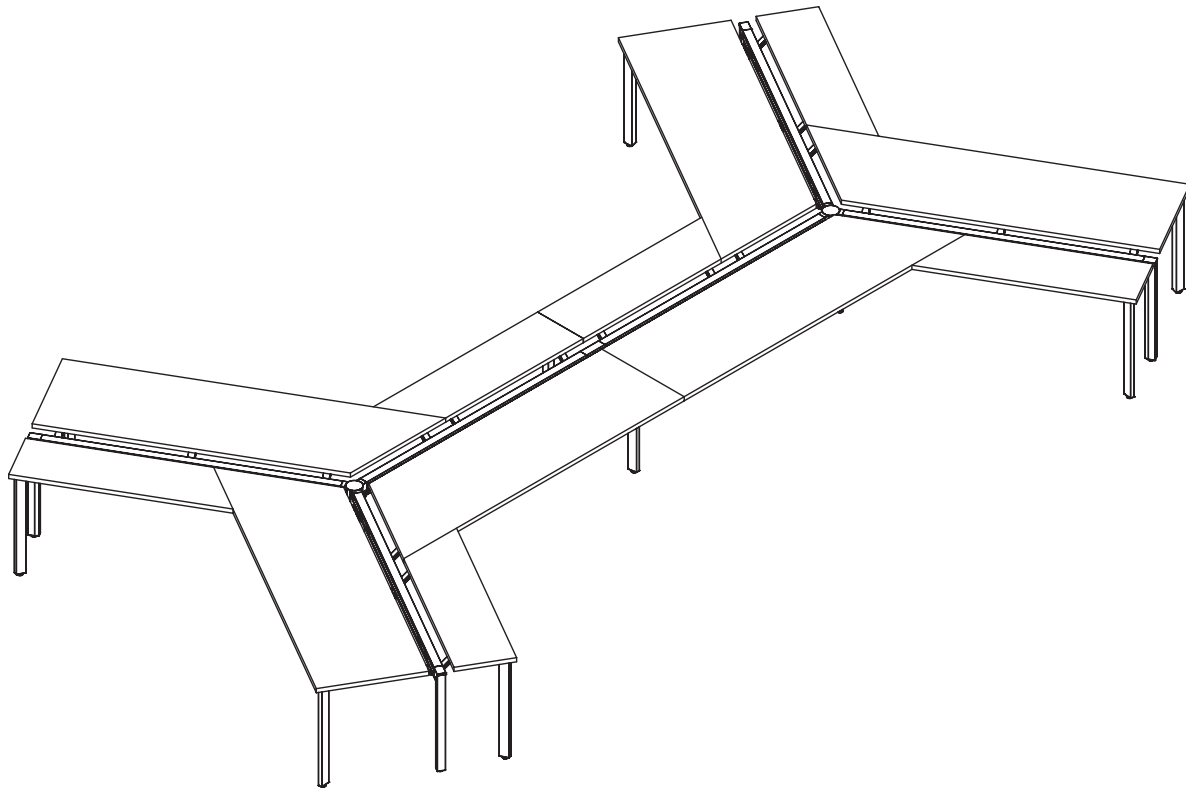

FURTHER

Further Electrical Example 6 — Freestanding

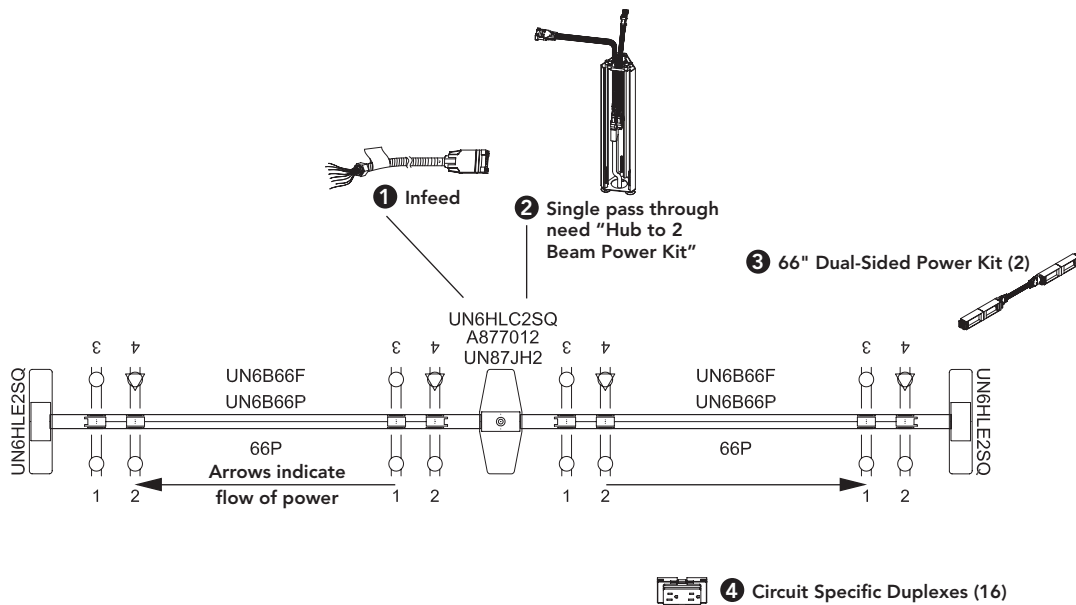
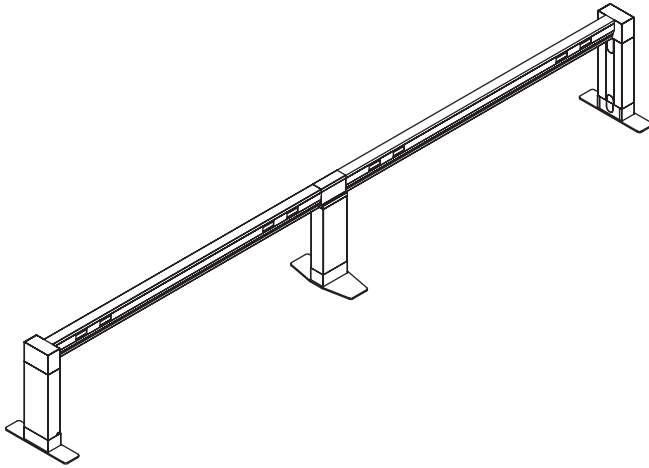

For specification information see pages 90-102.

GSA SIN 33721

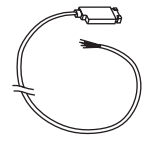

A871912

Description	Four-circuit		List Price
	3 + 1	2 + 2	
Electrical Infeed Cables			
6' Flex Cable	A871972		\$ 331
12' Flex Cable	A871912	[S]	\$ 449
18' Flex Cable	A871918	[S]	\$ 565
12' Sealtight Cable Power Infeed	A877012	[S]	\$ 547

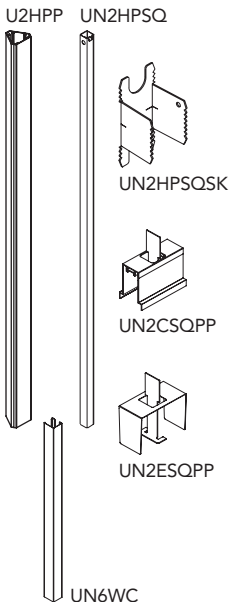

Description	Model	List Price		
		P1	P2	P3
Integrated Power/Communication Poles				
8'H Power/Communication Pole (mounts on top of hub)	U2HPP	\$ 2349	\$ 2408	\$ 2491
10'5"H Power Connector Pole (mounts to side of fixed hub)	A870070	\$ 799	N/A	N/A
8'H Square Power Pole	UN2HPSQ	\$ 1138	\$ 1156	\$ 1169
Square Power Pole Splicer Kit	UN2HPSQSK	\$ 125	\$ 129	\$ 130
Power Pole Kit for In-Line Fixed Hub, and H-Leg	UN2CSQPP	\$ 239	\$ 257	\$ 283
Power Pole Kit for End-of-Run Fixed Hub	UN2ESQPP	\$ 239	\$ 257	\$ 283

Infeed Cover					
Use with H-Leg Supports	UN6WC	[S]	\$ 199	\$ 216	\$ 235
Use with A-Leg Supports	UN6AWC		\$ 199	\$ 216	\$ 235

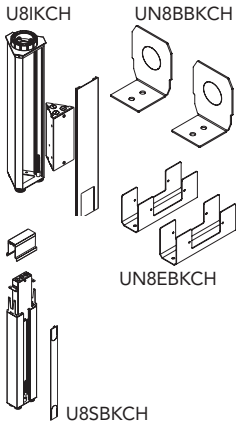

Description	Chicago Code		List Price
	Model		
Chicago Code Electrical			
Flexible Hub Chicago Box	U8IKCH	[S]	\$ 267
Fixed Hub Chicago Box	U8SBKCH**		\$ 336
Infeed to Beam Bracket	UN8BKCH	[S]	\$ 56
Beam Electrical Mounting Kit (to mount 4 duplexes or covers)	UN8EBKCH	[S]	\$ 125
Beam Electrical Covers — 2 Pack	UNSBEC2CH*	[S]	\$ 65
Beam Electrical Covers — 12 Pack	UNSBEC12CH*	[S]	\$ 234

*Requires electrical mounting kit UN8EBKCH.
**GSA SIN Pending

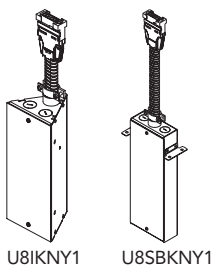

Description	New York Code		List Price
	Model		
New York Code Electrical			
Flexible Hub to 1 Beam Kit	U8IKNY1	[S]	\$ 590
Flexible Hub to 2 Beam Kit	U8IKNY2	[S]	\$ 1084
Flexible Hub to 3 Beam Kit	U8IKNY3	[S]	\$ 1285
Fixed Hub to 1 Beam Kit	U8SBKNY1		\$ 746
Fixed Hub to 2 Beam Kit	U8SBKNY2		\$ 971

<p>How to specify — Select the Model Number from above.</p> <p>_____ . _____</p>	<p><i>1st Option:</i> Electrical Infeed Color (if applicable): P Black</p> <p>P</p>	<p><i>1st Option:</i> Paint (if applicable): P1 P2 P3</p> <p>_____</p>
---	---	---

Examples: A871912.P U2HPP.P7G U8IKCH

[S] Shippable by small-package carrier.

Electrical & Data

Further™ — Jumpers, Hub & Beam Power Kits, and Receptacles

For specification information see pages 90-102.

GSA SIN 33721

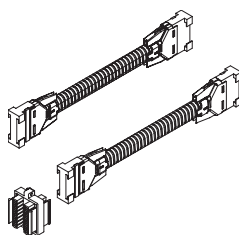

Description	Max. Receptacles Per Side	Model	List Price
Jumpers			
Beam-to-Beam Jumper		UN87J16	\$ 152
Hub to 1 Beam Power Kit		UN87JH1	\$ 236
Hub to 2 Beams Power Kit		UN87JH2	\$ 460
Hub to 3 Beams Power Kit		UN87JH3	\$ 679
Hub to 4 Beams Power Kit		UN87JH4	\$ 710

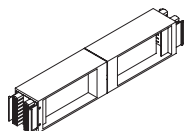

Hub Power Block			
Ported Hub Power Pack	2	UN8HP	\$ 546

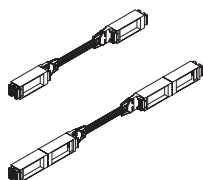

Beam Power Kits include jumpers and blocks for specific beam models. Order receptacles separately below.

Beam Dual-Sided Power Kits		Applicable Beam(s)	
36" Dual-Sided	2	UN8K36	UN6B36P \$ 404
42" Dual-Sided	2	UN8K42	UN6B42P \$ 464
48" Dual-Sided	4	UN8K48	UN6B48P \$ 541
54" Dual-Sided	4	UN8K54	UN6B54P \$ 562
60" Dual-Sided	4	UN8K60	UN6B60P \$ 577
66" Dual-Sided	4	UN8K66	UN6B66P \$ 822
72" Dual-Sided	4	UN8K72	UN6B72P \$ 840
78" Dual-Sided	4	UN8K78	UN6B78P \$ 855
84" Dual-Sided	4	UN8K84	UN6B84P \$ 879
90" Dual-Sided	4	UN8K90	UN6B90P \$ 1092
96" Dual-Sided	4	UN8K96	UN6B96P \$ 1114



Duplex Receptacles for Further Dual-Sided Power Kits			
Circuit 1	UN87U501		\$ 68
Circuit 2	UN87U502		\$ 68
Circuit 3 (3 + 1)	UN87U503		\$ 68
Circuit 3 (2 + 2)	UN87U506		\$ 68
Circuit 4 — isolated/dedicated	UN87U504		\$ 68

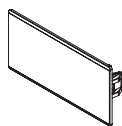

Description	Model	Chicago Code Model	List Price		
			P1	P2	P3
Electrical Accessories					
Beam Electrical Covers — 2 Pack	UNSBEC2	UNSBEC2CH*	\$ 65	\$ 65	\$ 65
Beam Electrical Covers — 12 Pack	UNSBEC12	UNSBEC12CH*	\$ 234	\$ 234	\$ 234

*Requires electrical mounting kit UN8EBKCH.

FURTHER

<p>How to specify — Select the Model Number from above.</p> <p>U . P </p>	<p><i>1st Option:</i> Color for Jumpers and Power Kits (if applicable): P Black</p>	<p><i>1st Option:</i> Electrical Receptacle Color (if applicable): See page 56 for finishes.</p>	<p><i>1st Option:</i> Paint Color for Electrical Covers (if applicable): See page 56 for finishes.</p> <p> </p> <p>E P </p>
---	--	---	---

Examples: UN8K36.P UN87U501.EV UNSBEC2.P7B

Shippable by small-package carrier.

For specification information see pages 90-102.

GSA SIN 33721

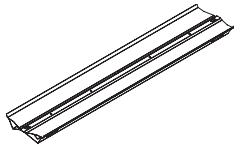

Description	Model	List Price		
		P1	P2	P3
Beam-Mounted Wire Manager — Double-Sided Painted Metal				
36" W Beam Mounted	UN6BWMC36	\$ 409	\$ 433	\$ 467
42" W Beam Mounted	UN6BWMC42	\$ 419	\$ 446	\$ 483
48" W Beam Mounted	UN6BWMC48	\$ 440	\$ 469	\$ 512
54" W Beam Mounted	UN6BWMC54	\$ 472	\$ 504	\$ 551
60" W Beam Mounted	UN6BWMC60	\$ 551	\$ 587	\$ 638
66" W Beam Mounted	UN6BWMC66	\$ 727	\$ 770	\$ 835
72" W Beam Mounted	UN6BWMC72	\$ 831	\$ 879	\$ 950
78" W Beam Mounted	UN6BWMC78	\$ 965	\$ 1018	\$ 1094

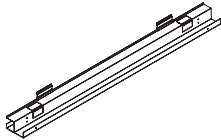

Beam-Mounted Wire Manager — Single-Sided Painted Metal				
36" W Beam Mounted	UN6SWMC36	\$ 433	\$ 476	\$ 540
42" W Beam Mounted	UN6SWMC42	\$ 476	\$ 524	\$ 594
48" W Beam Mounted	UN6SWMC48	\$ 527	\$ 580	\$ 656
54" W Beam Mounted	UN6SWMC54	\$ 578	\$ 633	\$ 715
60" W Beam Mounted	UN6SWMC60	\$ 635	\$ 697	\$ 792
66" W Beam Mounted	UN6SWMC66	\$ 698	\$ 765	\$ 865
72" W Beam Mounted	UN6SWMC72	\$ 768	\$ 839	\$ 943
78" W Beam Mounted	UN6SWMC78	\$ 846	\$ 920	\$ 1032



Beam-Mounted Shelf — 5"D Painted Metal				
24" W	UN924BMS	\$ 174	\$ 190	\$ 206
30" W	UN930BMS	\$ 196	\$ 213	\$ 230
36" W	UN936BMS	\$ 212	\$ 230	\$ 250
42" W	UN942BMS	\$ 232	\$ 251	\$ 274
48" W	UN948BMS	\$ 252	\$ 272	\$ 298
54" W	UN954BMS	\$ 282	\$ 304	\$ 332
60" W	UN960BMS	\$ 321	\$ 345	\$ 377

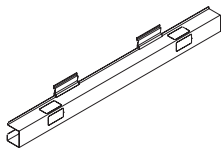

Beam-Mounted Data Manager without Tray — Single-Sided Painted Metal				
36" W	UN6SDMC36	\$ 347	\$ 372	\$ 408
42" W	UN6SDMC42	\$ 381	\$ 409	\$ 449
48" W	UN6SDMC48	\$ 420	\$ 450	\$ 495
54" W	UN6SDMC54	\$ 464	\$ 497	\$ 546
60" W	UN6SDMC60	\$ 508	\$ 545	\$ 598
66" W	UN6SDMC66	\$ 560	\$ 601	\$ 658
72" W	UN6SDMC72	\$ 614	\$ 658	\$ 723
78" W	UN6SDMC78	\$ 676	\$ 724	\$ 796

How to specify —
Select the Model Number from above.

1st Option:
Paint
(if applicable):

UN | | | | | | | | | | . | | | | |

Examples: UN6BWMC36.P7B UN924BMS.P7G

Shippable by small-package carrier.

For specification information see pages 90-102.

GSA SIN 33721

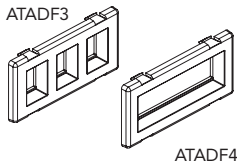

Description	Model	List Price
Data Faceplates (will not work in beams)		
Three-Port Flex-Mode Faceplate, Black (E4)	ATADF3 S	\$ 42
Four-Port Flex-Mode Faceplate, Black (E4)	ATADF4 S	\$ 42

Notes: ATADF3 can install up to 3 jacks (CAT 3, 5E or 6). ATADF4 can install 4 jacks (CAT 3, 5E or 6).

Allsteel's data faceplates are designed for use with the jacks listed below. We do not guarantee compatibility with other manufacturers' product. A faceplate adapter is available for use with alternatively sourced data jacks, see the Standard Specials catalog for details.

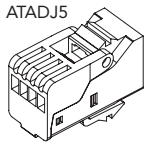

Jacks

RJ45 CAT 5E Jack — Black only		
Toolless	ATADJ5 S	\$ 74
RJ45 CAT 6 Jack — Black only		
Requires Tool	ATADJ6 S	\$ 98

FURTHER

<p>How to specify — Select the Model Number from above.</p>	<p><i>1st Option:</i> Data Faceplate Color <i>(if applicable):</i> E4 Black</p>
<div style="border: 1px solid black; display: inline-block; padding: 2px 5px;"> _____ . E4 </div>	

Examples: ATADF3.E4 ATADJ5

S Shippable by small-package carrier.

A Collaborative Standalone Hub provides access to power and data in teaming spaces in areas outside of the primary work area.

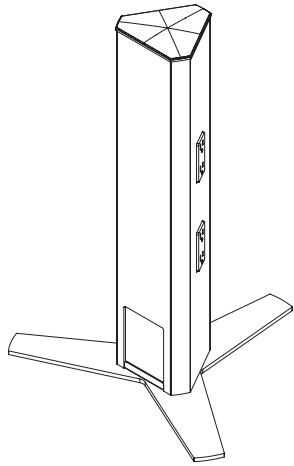

Collaborative Hub (page 108)

- Provides access to power in teaming spaces outside of the individual workspace.
- Used as a standalone unit, does not support or run power into beams.
- Three feet base kit or floor anchor brackets required – order separately.
- Options available with a standard power cord, whip, or for use with an electrical infeed cable.
- 6' power cord or whip included, infeed cable ordered separate.
- When powered through infeed cable, two duplex receptacles are required – sold separately.

Collaborative Hub Foot Kit (page 108)

- Attaches to the bottom of a Collaborative Hub.
- Nonleveling hub feet kit required for Collaborative Hub if no floor anchors are specified.

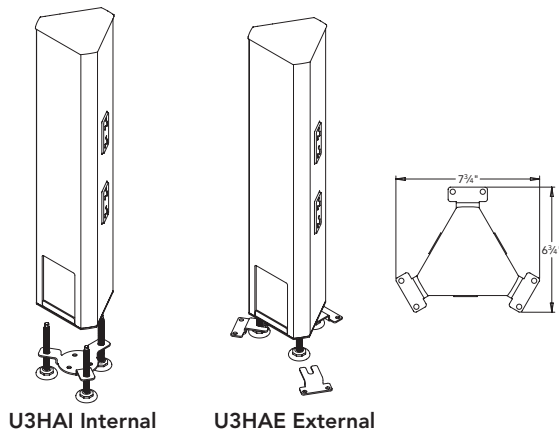
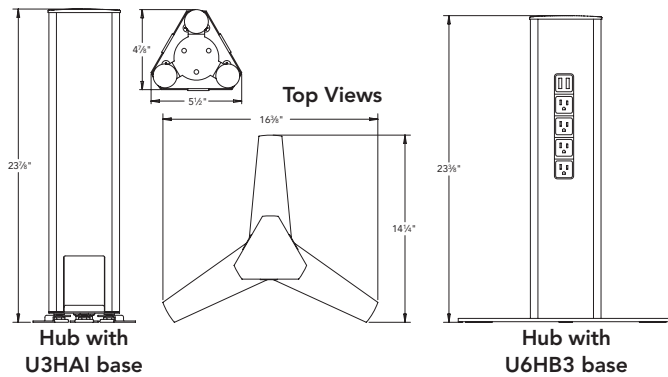

FURTHER

For specification information see page 107.

GSA SIN 33721

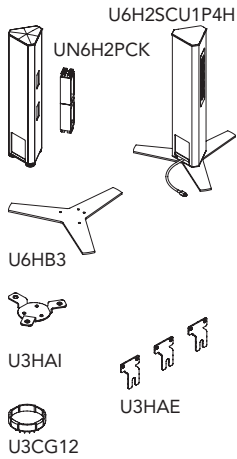

Description	Model	List Price		
		P1	P2	P3
Collaborative Hub Kits — 28"H (must order feet below)				
Infeed Hub (order 2 duplexes and infeed separately)	UN6H2PCK <input type="checkbox"/>	\$ 1630	\$ 1650	\$ 1673
Hardwire Hub (1 USB, 4 Simplex)	U6H2SCU1P4H <input type="checkbox"/>	\$ 2982	\$ 3005	\$ 3030
Corded Hub (1 USB, 4 Simplex)	U6H2SCU1P4C <input type="checkbox"/>	\$ 2871	\$ 2894	\$ 2919

Collaborative Hub Components

Hub Base Kit — 3 Feet non-leveling	U6HB3 <input type="checkbox"/>	\$ 290	\$ 308	\$ 326
Anchor — Internal (Black only)	U3HAI <input type="checkbox"/>	\$ 78	N/A	N/A
Anchor — External (P1 or P2)	U3HAE <input type="checkbox"/>	\$ 78	\$ 82	84
Carpet Grippers – 12 pack	U3CG12 <input type="checkbox"/>	\$ 33	N/A	N/A

FURTHER

<p>How to specify — Select the Model Number from above.</p>	<p><i>1st Option:</i> Electrical Color for Single Sided Hub Kit (if applicable): BLK Black WHT White</p>	<p><i>2nd Option:</i> Trim Faceplate for Single Sided Hub Kit (if applicable):</p>	<p><i>3rd Option:</i> Paint (if applicable):</p>
<p>U . </p>	<p>N/A </p>	<p> </p>	<p> </p>

Examples: UN6H2PCK.P02 U6HB3.P7B U3HAI U3CG12 U6H2SCU1PH.WHT.NA.PR6

Shippable by small-package carrier.
Desking & Benching – 02/2024

20½"H x 48"W Beam Center Screen — Fabric
U6BC2048F

13"H x 54"W Table Mounted Screen — Glass
U6TS1354G

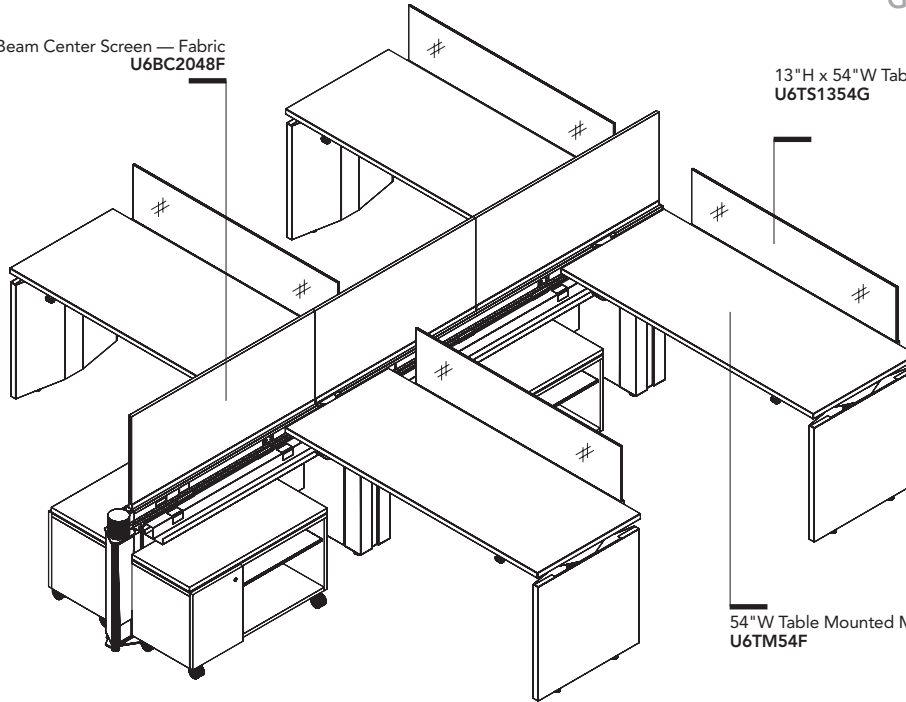

54"W Table Mounted Modesty — Fabric
U6TM54F

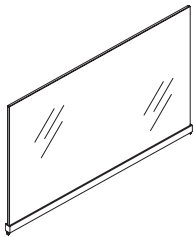

Beam Mounted Screen

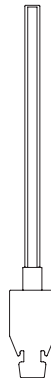

Beam Mounted Screens (pages 111 and 113)

- Attach to the top or bottom of a beam, available in 6" increments at 13"H and 20½"H.
- Options available for tackable fabric up to 60"W, and glass up to 96"W.
- Fabric required when mounting screen to the bottom of a beam.
- Mounting top trim required to use screens on the top of a beam.
- May pass over a hub, h-leg, or in-line support without the use of split top trim.
- Beam mounted storage may be used on the same beam as a screen. Subtract the width of the storage unit from the screen.
- Worksurface mounted modesty screens are possible, but will interfere with cord management.
- Beam mounted modesty panels must be specified 6" shorter than beams when with Further Adaptive.

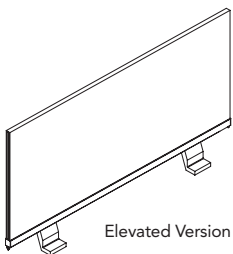

Elevated Version

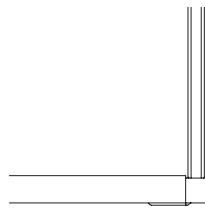

Flush Mount

Table Mounted Screens (pages 112 and 113)

- Attach to the edge of a worksurface, available in 6" increments at 13" and 20½"H from 30" - 60"W.
- Flush-mounted option available in tackable fabric and glass.
- Glass screens only allowed on 27" deep worksurfaces.
- Elevated option available in fabric only.
- Elevated screens provide 1¼" clearance for routing cords and attachment of monitor arms.
- Flush-mounted screens should be specified 12" shorter than width of worksurface when used between Table legs – see example left.

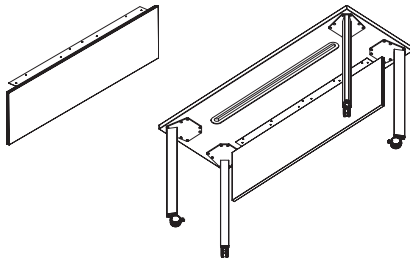
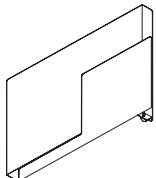
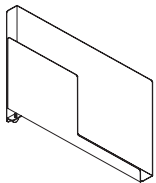

Table Mounted Modesty (page 112)

- Attaches to the underside of a worksurface, available in 6" increments at 13"H from 18" - 60"W.
- Specify 13" shorter than width of worksurface when used between Table legs – see example left.
- Must be inset at least 3" from back edge of worksurface if used with table mounted or user movable screens.



U6BL1221ML



U6BL1221MR

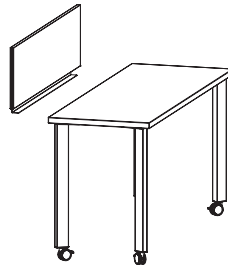

User Movable Screen (page 114)

- Mounts to the edge of a worksurface and may be transferred to other locations with ease. Available in 6" increments at 13"H from 18" - 60"W.
- Specify 12" shorter than worksurface edge when used between Table legs – see example left.
- Cannot be placed on mid support edge of worksurface when used with Further Adaptive.

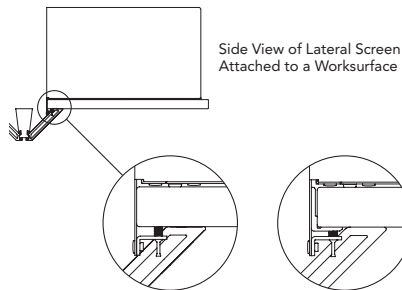

Side View of Lateral Screen Attached to a Worksurface

Close-up of Attachment —
Without Accessories Rail and With Accessories Rail

Lateral Screen (page 114)

- Clamps to back edge of worksurface at 12"H.
- 20" or 26"D models available. Screen is designed to sit back from front edge of worksurface.
- Space for folders is 1½" and holds approximately 340 sheets of paper.
- Folder storage is one-sided – LH and RH options available.
- Cannot be located right above run off support beams on Adaptive workspaces.

Screens

Further™ — Fabric Screens and Modesty Panels

For specification information see page 109.

GSA SIN 33721

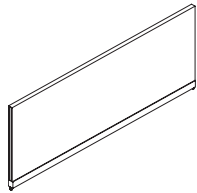

U6BC1336F

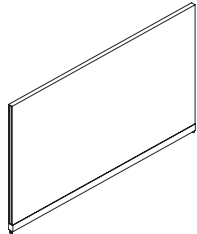

U6BC2036F

Description	Model	List Price					
		Grade A	Grade B	Grade C	Grade D	Grade E	Grade F
13"H Beam Center Screens — Fabric							
24"W Beam Mounted	U6BC1324F	\$ 821	\$ 845	\$ 869	\$ 910	\$ 949	\$ 988
30"W Beam Mounted	U6BC1330F	\$ 857	\$ 884	\$ 909	\$ 951	\$ 992	\$ 1036
36"W Beam Mounted	U6BC1336F	\$ 892	\$ 923	\$ 953	\$ 1004	\$ 1054	\$ 1106
42"W Beam Mounted	U6BC1342F	\$ 937	\$ 974	\$ 1009	\$ 1068	\$ 1127	\$ 1186
48"W Beam Mounted	U6BC1348F	\$ 967	\$ 1009	\$ 1049	\$ 1116	\$ 1184	\$ 1251
54"W Beam Mounted	U6BC1354F	\$ 1015	\$ 1062	\$ 1107	\$ 1183	\$ 1259	\$ 1335
60"W Beam Mounted	U6BC1360F	\$ 1084	\$ 1136	\$ 1186	\$ 1270	\$ 1354	\$ 1439

20½"H Beam Center Screens — Fabric							
24"W Beam Mounted	U6BC2024F	\$ 935	\$ 967	\$ 999	\$ 1051	\$ 1103	\$ 1155
30"W Beam Mounted	U6BC2030F	\$ 972	\$ 1013	\$ 1052	\$ 1118	\$ 1183	\$ 1250
36"W Beam Mounted	U6BC2036F	\$ 1007	\$ 1055	\$ 1103	\$ 1182	\$ 1262	\$ 1340
42"W Beam Mounted	U6BC2042F	\$ 1049	\$ 1105	\$ 1160	\$ 1252	\$ 1344	\$ 1435
48"W Beam Mounted	U6BC2048F	\$ 1119	\$ 1183	\$ 1247	\$ 1351	\$ 1456	\$ 1562
54"W Beam Mounted	U6BC2054F	\$ 1206	\$ 1278	\$ 1350	\$ 1468	\$ 1588	\$ 1705
60"W Beam Mounted	U6BC2060F	\$ 1267	\$ 1347	\$ 1425	\$ 1558	\$ 1689	\$ 1821

How to specify —
Select the Model Number from above.

1st Option:
Fabric:

2nd Option:
Center Screens End Cap Paint Color (if applicable):
 See page 56 for finishes.

3rd Option:
Paint Color:
 See page 56 for finishes.

U 6 B | | | | | | | | | | F . | | | | | | | | | | . | | | | | | | | | | .

Example: U6BC1324F.APN911.PR6.PR6

Shippable by small-package carrier.

Screens

Further™ — Fabric Screens and Modesty Panels

For specification information see pages 109-110.

GSA SIN 33721

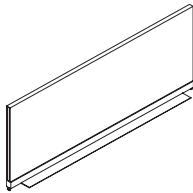

U6TS1336F

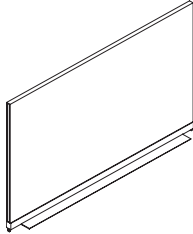

U6TS2036F

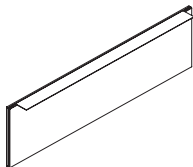
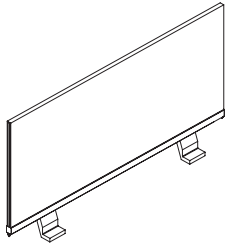
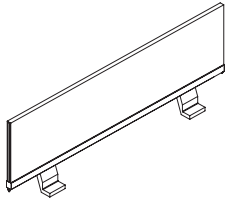

U6TM36F

Description	Model	List Price					
		Grade A	Grade B	Grade C	Grade D	Grade E	Grade F
13"H Table Mounted Screens — Fabric							
30"W Table Mounted	U6TS1330F	\$ 857	\$ 884	\$ 909	\$ 951	\$ 992	\$ 1036
36"W Table Mounted	U6TS1336F	\$ 894	\$ 925	\$ 955	\$ 1006	\$ 1056	\$ 1108
42"W Table Mounted	U6TS1342F	\$ 935	\$ 972	\$ 1007	\$ 1066	\$ 1125	\$ 1184
48"W Table Mounted	U6TS1348F	\$ 967	\$ 1009	\$ 1049	\$ 1116	\$ 1184	\$ 1251
54"W Table Mounted	U6TS1354F	\$ 1015	\$ 1062	\$ 1107	\$ 1183	\$ 1259	\$ 1335
60"W Table Mounted	U6TS1360F	\$ 1084	\$ 1136	\$ 1186	\$ 1270	\$ 1354	\$ 1439

20½"H Table Mounted Screens — Fabric							
30"W Table Mounted	U6TS2030F	\$ 972	\$ 1013	\$ 1052	\$ 1118	\$ 1183	\$ 1250
36"W Table Mounted	U6TS2036F	\$ 1009	\$ 1057	\$ 1105	\$ 1184	\$ 1264	\$ 1342
42"W Table Mounted	U6TS2042F	\$ 1047	\$ 1103	\$ 1158	\$ 1250	\$ 1342	\$ 1433
48"W Table Mounted	U6TS2048F	\$ 1119	\$ 1183	\$ 1247	\$ 1351	\$ 1456	\$ 1562
54"W Table Mounted	U6TS2054F	\$ 1206	\$ 1278	\$ 1350	\$ 1468	\$ 1588	\$ 1705
60"W Table Mounted	U6TS2060F	\$ 1267	\$ 1347	\$ 1425	\$ 1558	\$ 1689	\$ 1821

13"H Elevated Table Mounted Screen — ¼" Thick Tackable Fabric							
30"W	U6TTS1330F	\$ 920	\$ 947	\$ 973	\$ 1016	\$ 1061	\$ 1103
36"W	U6TTS1336F	\$ 957	\$ 986	\$ 1013	\$ 1059	\$ 1105	\$ 1151
42"W	U6TTS1342F	\$ 1001	\$ 1034	\$ 1066	\$ 1120	\$ 1172	\$ 1226
48"W	U6TTS1348F	\$ 1043	\$ 1081	\$ 1118	\$ 1179	\$ 1241	\$ 1303
54"W	U6TTS1354F	\$ 1093	\$ 1136	\$ 1177	\$ 1247	\$ 1315	\$ 1385
60"W	U6TTS1360F	\$ 1159	\$ 1206	\$ 1252	\$ 1328	\$ 1406	\$ 1482

20½"H Elevated Table Mounted Screen — ¼" Thick Tackable Fabric							
30"W	U6TTS2030F	\$ 1043	\$ 1080	\$ 1117	\$ 1176	\$ 1237	\$ 1298
36"W	U6TTS2036F	\$ 1078	\$ 1123	\$ 1167	\$ 1239	\$ 1312	\$ 1385
42"W	U6TTS2042F	\$ 1120	\$ 1172	\$ 1223	\$ 1307	\$ 1392	\$ 1478
48"W	U6TTS2048F	\$ 1201	\$ 1260	\$ 1319	\$ 1416	\$ 1512	\$ 1608
54"W	U6TTS2054F	\$ 1294	\$ 1360	\$ 1425	\$ 1534	\$ 1643	\$ 1752
60"W	U6TTS2060F	\$ 1354	\$ 1428	\$ 1501	\$ 1622	\$ 1744	\$ 1864

13"H Table Mounted Modesty — Fabric							
18"W Table Mounted	U6TM18F	\$ 634	\$ 653	\$ 671	\$ 701	\$ 730	\$ 761
24"W Table Mounted	U6TM24F	\$ 673	\$ 696	\$ 719	\$ 757	\$ 794	\$ 832
30"W Table Mounted	U6TM30F	\$ 698	\$ 727	\$ 756	\$ 804	\$ 851	\$ 897
36"W Table Mounted	U6TM36F	\$ 758	\$ 792	\$ 828	\$ 885	\$ 941	\$ 998
42"W Table Mounted	U6TM42F	\$ 796	\$ 838	\$ 877	\$ 944	\$ 1011	\$ 1077
48"W Table Mounted	U6TM48F	\$ 853	\$ 899	\$ 945	\$ 1020	\$ 1096	\$ 1171
54"W Table Mounted	U6TM54F	\$ 914	\$ 966	\$ 1017	\$ 1103	\$ 1186	\$ 1272
60"W Table Mounted	U6TM60F	\$ 993	\$ 1048	\$ 1102	\$ 1191	\$ 1282	\$ 1372

FURTHER

<p>How to specify — Select the Model Number from above.</p>	<p>1st Option: Fabric:</p>	<p>2nd Option: Mounted Screens End Cap Paint Color (if applicable):</p> <p>P1 P2 P3</p> <p>See page 56 for finishes.</p>	<p>3rd Option: Paint Color:</p> <p>See page 56 for finishes.</p>
<p>U 6 T F . . . </p>			

Examples: U6TS1330F.APN911.PR6.PR6 U6TM18F.APN911.PR6

Shippable by small-package carrier.

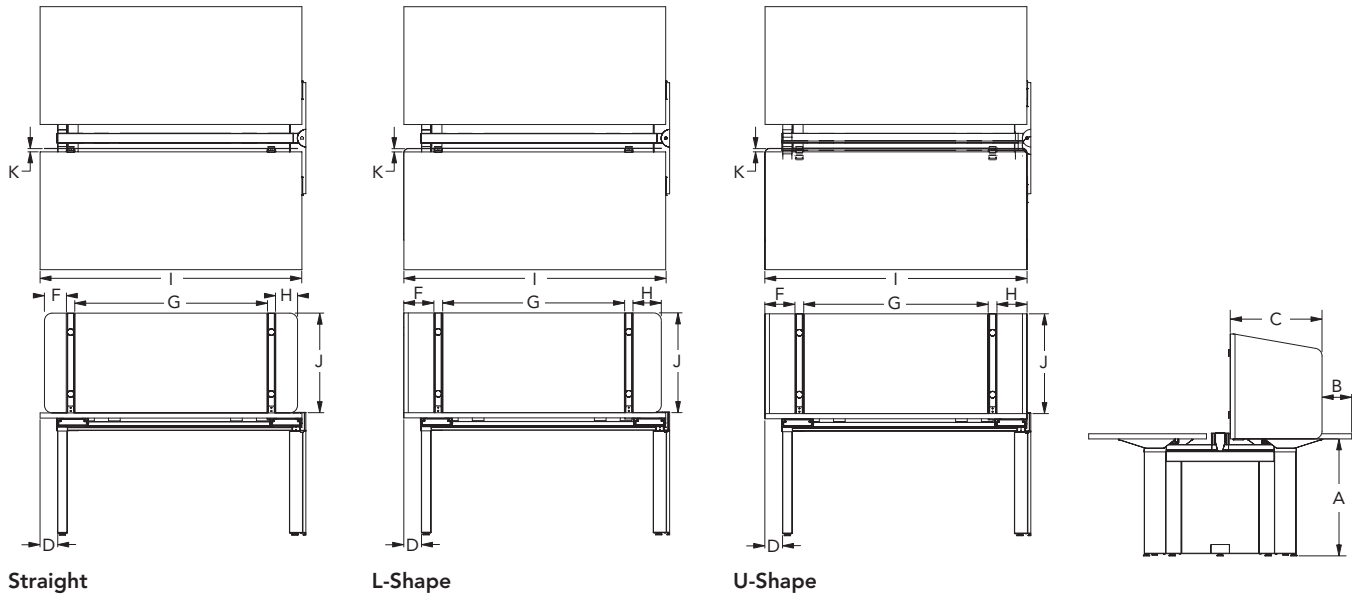

Size Reference Matrix

Models	A	B	C1	C2	D	E	F	G1	G2	H	I	J1	J2	K
	Under Desk Height	Wing to Front	Wing Width STD	Wing Width EXT	Left Leg to Edge	Right Leg to Edge	Left Side Panel to Support	Distance Between Supports	Distance Between Center/Right Support	Right Side Panel to Support	Overall Width	Desktop to Base of Panel	Desktop to Top of Panel	Cable Drop Space
AFAMS2048LH	26.8	6.8	21.1	24.3	4.1	-	6.9	29.7	-	6.4	48.1	-	22.9	0.7
AFAMS2054LH	26.8	6.8	21.1	24.3	4.1	-	6.9	35.7	-	6.4	54.1	-	22.9	0.7
AFAMS2060LH	26.8	6.8	21.1	24.3	4.1	-	6.9	41.7	-	6.4	60.1	-	22.9	0.7
AFAMS2066LH	26.8	6.8	21.1	24.3	4.1	-	6.9	22.8	22.8	6.4	66.1	-	22.9	0.7
AFAMS2072LH	26.8	6.8	21.1	24.3	4.1	-	6.9	25.8	25.8	6.4	72.1	-	22.9	0.7
AFAMS2048RH	26.8	6.8	21.1	24.3	4.0	-	6.4	29.7	-	6.9	48.1	-	22.9	0.7
AFAMS2054RH	26.8	6.8	21.1	24.3	4.0	-	6.4	35.7	-	6.9	54.1	-	22.9	0.7
AFAMS2060RH	26.8	6.8	21.1	24.3	4.0	-	6.4	41.7	-	6.9	60.1	-	22.9	0.7
AFAMS2066RH	26.8	6.8	21.1	24.3	4.0	-	6.4	22.8	22.8	6.9	66.1	-	22.9	0.7
AFAMS2072RH	26.8	6.8	21.1	24.3	4.0	-	6.4	25.8	25.8	6.9	72.1	-	22.9	0.7
AFAMS2048US	26.8	6.8	21.1	24.3	4.1	-	6.9	30.3	-	6.9	48.1	-	22.9	0.7
AFAMS2054US	26.8	6.8	21.1	24.3	4.1	-	6.9	36.3	-	6.9	54.1	-	22.9	0.7
AFAMS2060US	26.8	6.8	21.1	24.3	4.1	-	6.9	42.3	-	6.9	60.1	-	22.9	0.7
AFAMS2066US	26.8	6.8	21.1	24.3	4.1	-	6.9	23.1	23.1	6.9	66.1	-	22.9	0.7
AFAMS2072US	26.8	6.8	21.1	24.3	4.1	-	6.9	26.1	26.1	6.9	72.1	-	22.9	0.7
AFAMS2048SS	26.8	-	-	-	4.0	-	5.0	32.0	-	5.0	48.0	-	22.9	0.7
AFAMS2054SS	26.8	-	-	-	4.0	-	5.0	38.0	-	5.0	54.0	-	22.9	0.7
AFAMS2060SS	26.8	-	-	-	4.0	-	5.0	44.0	-	5.0	60.0	-	22.9	0.7
AFAMS2066SS	26.8	-	-	-	4.0	-	5.0	24.0	24.0	5.0	66.0	-	22.9	0.7
AFAMS2072SS	26.8	-	-C1	-	4.0	-	5.0	27.0	27.0	5.0	72.0	-	22.9	0.7

Lateral Divider Screens (page 118)

- Optional addition to the bench that provides space division and privacy. Lateral divider screens run perpendicular to the center trough.
- Lateral divider screens are sized to match worksurface depth, however it is not required that they are used on worksurface of the same depth.
- Standard depth screens will overhang worksurface $\frac{1}{2}$ ".
- There are three types of lateral divider screens: tackable fabric, Frosted or Clear glass, and writable glass.
- Lateral divider screens attach to the underside on the back of the worksurface anywhere along the length of the bench within $7\frac{1}{2}$ " of each end.
- Lateral divider screens do not have to be mounted at the worksurface seam.
- Lateral divider screens may be used on standard systems worksurfaces, however, the screen mounts and aligns with the back edge of the worksurface. Not to be used on standard rabbet edge worksurfaces.
- Specify a shorter depth screen if using a lateral screen on a Stride Sit-to-Stand surface.
- Screens that match surface depths are available through Allsteel Tailored Products.

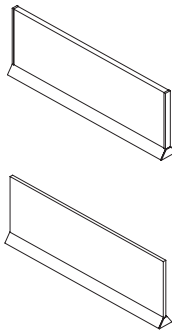
**Tackable Fabric Lateral Divider Screens** (page 118)

- $\frac{3}{4}$ " thick tackable fabric
- Available 8"H and 13"H.
- Nominal depths are 27", 30", and 36".
- Actual depths are $22\frac{3}{4}$ "D, $25\frac{3}{4}$ "D, and $31\frac{3}{4}$ "D.

Glass Lateral Divider Screens (page 118)

- $\frac{3}{8}$ " thick laminated clear or frosted glass.
- Available 8"H and 13"H.
- Nominal depths are 27", 30", and 36".
- Actual depths are $22\frac{3}{4}$ "D, $25\frac{3}{4}$ "D, and $31\frac{3}{4}$ "D.

Further Adaptive — Metal Screens (page 119)

- Powder coated magnetic metal privacy screen.
- Metal surfaces can be easily disinfected with cleaners. See cleaning guide for more details at AllsteelOffice.com.
- Available in all standard paint colors.
- Provides ½" gap along the back for accessory mount and cord drop.
- Available in 48"W, 54"W, 60"W, 66"W and 72"W.
- 66"W and 72"W screens include 3rd center bracket.
- Available in Straight, L- and U-shape configurations. Above the desk only.
- L- and U-Shape screens are compatible with shrouded Further Adaptive Desk legs.
- Optional tackable accessories specified separately.
- 66"W tackable accessory comes as a set of (2) 24"W.
- 72"W tackable accessory comes as a set of (2) 20"W.
- Available in standard and extended wings.
- Wings mount flush to the edge of the surface with a VHB tape (included in hardware).
- 20"W tackable accessory must only be applied to both standard and extended wings without accessory slots.
- Wings are available with accessory slots that accept Raddii Hot File, Side Saddle and Coat hook.
- Top slot can accept one Raddii accessory.
- Bottom slot can accept a Coat hook and one other accessory.
- Accessories can hang on either side of the wing.
- TIP: If the Hot File is used in the top slot, it will block access for accessories in the bottom slot.
- Do not hang more than 5lbs of weight on wings.
- Screens are compatible with Raddii undermount storage.
- Not compatible with standard 120-worksurfaces. Contact Allsteel TPG for custom sizes.

Size Reference Matrix

Tackboards	Wing	48"W	54"W	60"W	66"W	72"W
Actual Dimensions	20"W	30"W	36"W	42"W	20"W	24"W
Set of Tackboards	1	1	1	1	2	2

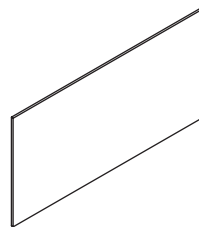

Accessories — Tackboard (page 119)

- Tackable accessories come with metal frame available in standard paint colors and fabric options.
- Attach to the screen using a dual lock tape (included in hardware).

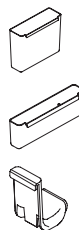

Accessories — Raddii (page 120)

- Wings are available with accessory slots that accept Raddii Hot File, Side Saddle and Coat hook.
- Top slot can accept one Raddii accessory.
- Bottom slot can accept a Coat hook and one other accessory.
- Accessories can hang on either side of the wing.
- TIP: If the Hot File is used in the top slot, it will block access for accessories in the bottom slot.

Accessories — Further Worksurface Rail Mount (page 272)

- Accessory rail must be field cut to fit between the screen brackets.
- The following accessories are not compatible with screens: U9WTC and U9TM.

Benching

Stride® — Lateral Divider Screens

GSA SIN 33721

For specification information see page 116.
(See page 297 for COM pricing on fabric Grades G-J for Fabric Screens.)

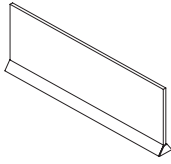

Description	Model	Clear List Price	Frosted List Price	Smoked List Price
8"H Lateral Divider Screen — 3/8" Thick Glass				
27"D	Z6BL0827G S	\$ 902	\$ 948	\$ 1020
30"D	Z6BL0830G S	\$ 946	\$ 999	\$ 1069
36"D	Z6BL0836G S	\$ 993	\$ 1052	\$ 1123

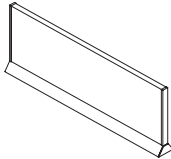

Description	Model	List Price					
		Grade A	Grade B	Grade C	Grade D	Grade E	Grade F
8"H Lateral Divider Screen — 3/4" Thick Tackable Fabric							
27"D	Z6BL0827F S	\$ 809	\$ 819	\$ 829	\$ 845	\$ 861	\$ 876
30"D	Z6BL0830F S	\$ 833	\$ 844	\$ 855	\$ 873	\$ 890	\$ 907
36"D	Z6BL0836F S	\$ 920	\$ 933	\$ 945	\$ 967	\$ 987	\$ 1009

FURTHER

<p>How to specify — Select the Model Number from above.</p>	<p><i>1st Option:</i> Paint (if applicable): P1 P2 P3 See page 56 for finishes.</p>	<p><i>1st Option:</i> Fabric (if applicable): See page 10 for fabrics.</p>	<p><i>1st Option:</i> Glass (if applicable): LC Clear LF Frosted GSM1 Smoked</p>	<p><i>2nd Option:</i> Paint (if applicable): P1 P2 P3 See page 56 for finishes.</p>
<p>_____ . P _____</p>		<p>_____ . L _____</p>		<p>P _____</p>

Examples: Z6BL0836F.IMP905.P02 Z6BL0827G.LC.P28











S Shippable by small-package carrier.

Screens

Further™ Adaptive — Metal Screens / Tackboard Accessories

For specification information see pages 115-117.

GSA SIN 33721

		Description	Model	P1 Paint List Price	P2 Paint Upcharge	P3 Paint Upcharge
		22"H Metal L-Screen				
		48"W	AFAMS2048LH (shown)	\$ 833	\$ 866	\$ 899
		54"W	AFAMS2054LH	\$ 906	\$ 942	\$ 978
		60"W	AFAMS2060LH	\$ 1014	\$ 1055	\$ 1094
		66"W	AFAMS2066LH	\$ 1109	\$ 1153	\$ 1196
		72"W	AFAMS2072LH	\$ 1160	\$ 1206	\$ 1251
		22"H Metal L-Screen				
		48"W	AFAMS2048RH	\$ 833	\$ 866	\$ 899
		54"W	AFAMS2054RH	\$ 906	\$ 942	\$ 978
		60"W	AFAMS2060RH	\$ 1014	\$ 1055	\$ 1094
		66"W	AFAMS2066RH	\$ 1109	\$ 1153	\$ 1196
		72"W	AFAMS2072RH	\$ 1160	\$ 1206	\$ 1251
		22"H Metal U-Screen				
		48"W	AFAMS2048US (shown)	\$ 1086	\$ 1130	\$ 1171
		54"W	AFAMS2054US	\$ 1145	\$ 1191	\$ 1235
		60"W	AFAMS2060US	\$ 1196	\$ 1243	\$ 1290
		66"W	AFAMS2066US	\$ 1312	\$ 1364	\$ 1415
		72"W	AFAMS2072US	\$ 1377	\$ 1432	\$ 1485
		22"H Metal U-Screen				
		48"W	AFAMS2048SS (shown)	\$ 710	\$ 739	\$ 766
		54"W	AFAMS2054SS	\$ 746	\$ 776	\$ 805
		60"W	AFAMS2060SS	\$ 796	\$ 828	\$ 858
		66"W	AFAMS2066SS	\$ 906	\$ 942	\$ 978
		72"W	AFAMS2072SS	\$ 978	\$ 1018	\$ 1056
		22"H Metal Straight Screen				
		48"W	AFAMS2048SS (shown)	\$ 710	\$ 739	\$ 766
		54"W	AFAMS2054SS	\$ 746	\$ 776	\$ 805
		60"W	AFAMS2060SS	\$ 796	\$ 828	\$ 858
		66"W	AFAMS2066SS	\$ 906	\$ 942	\$ 978
		72"W	AFAMS2072SS	\$ 978	\$ 1018	\$ 1056
		15"H Tackboard Accessories				
		20"W	AAS1520 <input type="checkbox"/>	\$ 309	\$ 322	\$ 333
		48"W	AAS1548 <input type="checkbox"/> (shown)	\$ 367	\$ 383	\$ 396
		54"W	AAS1554 <input type="checkbox"/>	\$ 406	\$ 423	\$ 438
		60"W	AAS1560 <input type="checkbox"/>	\$ 423	\$ 441	\$ 456
		66"W	AAS1566 <input type="checkbox"/>	\$ 617	\$ 641	\$ 666
		72"W	AAS1572 <input type="checkbox"/>	\$ 675	\$ 702	\$ 729

<p>How to specify — Select the Model Number from above.</p>	<p>1st Option: Wing Type :</p> <p>STD Standard EXT Extended</p>	<p>2nd Option: Accessories Slots:</p> <p>X No Accessory Cut Out SLT Accessory Cut Out</p>	<p>3rd Option: Paint Option:</p> <p><input type="radio"/> P1 <input type="radio"/> P2 <input type="radio"/> P3 See page 56 for finishes.</p>	<p>4th Option: Paint Option:</p> <p>NA Screen</p>	<p>5th Option: Accessories Color (if applicable):</p> <p>DW Designer White E9 Flint</p>
	<p>_____ . _____ . _____ . P ____ . NA . _____</p>				

Examples: AAS1548.PR6.APN911 AFAMS2048LH.STD.SLT.PR6.NA

Shippable by small-package carrier.

For specification information see pages 115-117.

GSA SIN Pending

Work Tools



Description	Model	List Price
Hot File (Designer White Only) 9½"H x 12¼"W x 3¾"D	AEHF	\$ 64
Side Saddle (Designer White Only) 4"H x 12¼"W x 2½"D	AESS	\$ 53
Bag or Coat Hook (Designer White Only) 3¼"H x 1⅝"W x 2¼"D	AECH	\$ 41

FURTHER

<p>How to specify — Select the Model Number from above.</p> <p>_____ .</p>	<p><i>1st Option:</i> Paint Option (if applicable):</p> <p>P1 P2 P3 See page 56 for finishes.</p> <p>P _____ .</p>	<p><i>2nd Option:</i> Fabric Option (if applicable):</p> <p>See page 10 for fabric options.</p> <p>_____ .</p>	<p><i>3rd Option:</i> Accessories Color (if applicable):</p> <p>DW Designer White E9 Flint</p> <p>_____</p>
---	---	---	--

Examples: AEHF.PJW

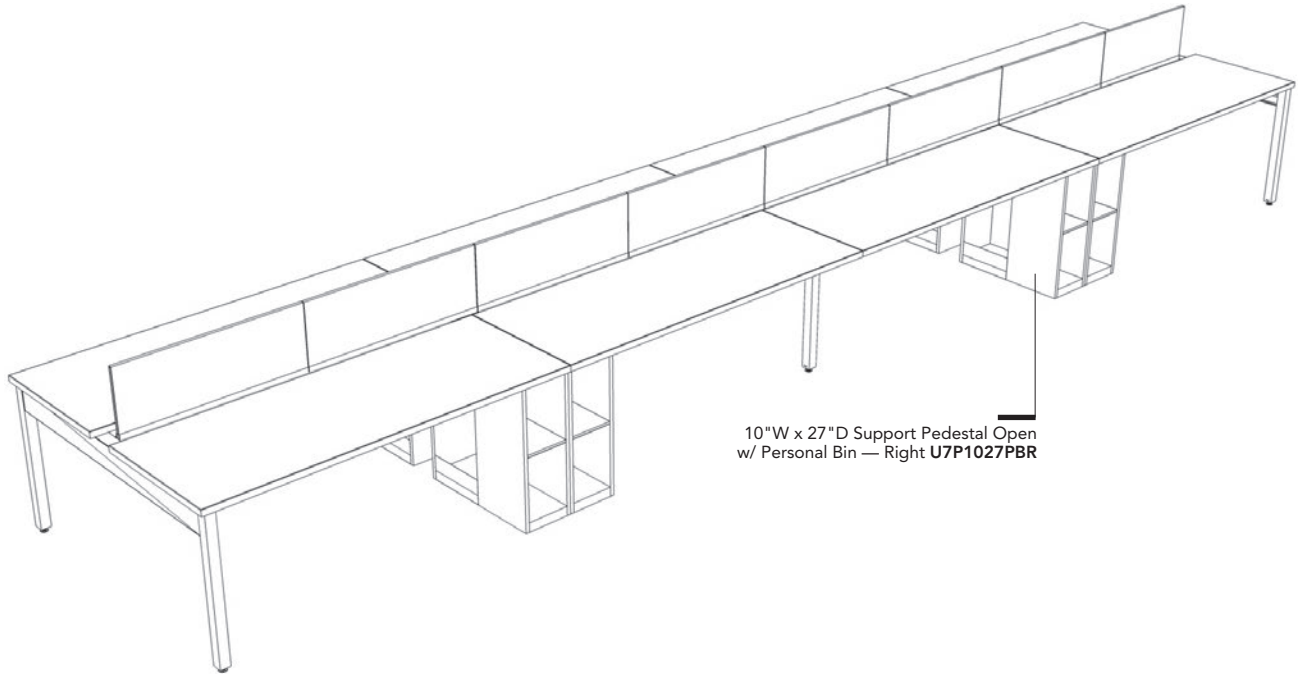

All Storage

- All storage is made from ¾" thick with particleboard core with top and bottom surfaces finished in laminate. Horizontal storage sides and back are painted steel.
- Edge band is made of 1mm thick ABS plastic — flat edge trim only.
- Cam and pin construction. Storage is plinth base only unless unit is mobile.
- Available in solid and woodgrain laminates, models with doors or drawers are available with a two-tone option.
- Pull options: arch, square, linear, straight. All standard in PR6 Silver.
- Locks have a silver finish.

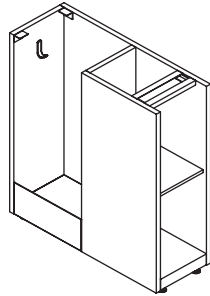

U7P1027PBR

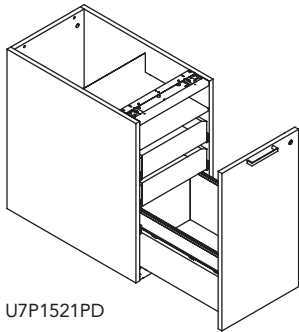

U7P1521PD

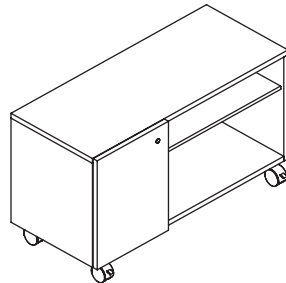

U7MC203615HL

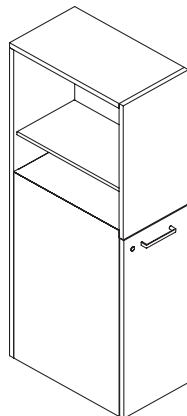

U7T501221ADR

Open Support Pedestals (page 124)

- Constructed of laminate, shelves are painted steel.
- Open Support Pedestals may be used to add additional stability — see Further Stability Requirements on page 78.
- Support pedestals may be used to create freestanding desks, storage depth must match worksurface depth.
- 27" D models have a coat/bag hook located in back of unit.

Pull-Out Drawer Support Pedestal (page 124)

- Case is constructed of laminate and painted steel.
- Box and file drawers are miter fold, ½" thick particle board, polypropylene wrapped.
- Configuration is box/box/file and one shelf at top of unit.
- Shelf is not adjustable but can be removed.
- All drawers hidden behind single laminate front.
- Straight, linear, arch and square pulls available as options.
- 1/8" leveling.
- Cannot be used as a freestanding, standalone unit.
- Outside overall dimensions: 15½" W and 21" or 27" D
- Box drawers extend 16" for both model depths.
- File drawers extend 16" on 21" D models and 20" on 27" D models.
- Front to back filing, standard letter size
- One lock, located in upper right hand corner of drawer front.
- Two-tone laminate option for drawer fronts
- Can be used to make a freestanding desk.

Mobile Credenza (page 124)

- Constructed of laminate, shelf is painted steel.
- Mobile credenza has a hinged door with lock, no pull.
- Front casters are locking, back casters are non-locking.

Side Access Towers (page 125)

- Top and sides are laminate, shelves are painted steel.
- Side Access Towers may be used to add additional stability — see Further Stability Requirements on page 78.
- 12" wide towers must be attached to a worksurface.
- Z6LB tower "L" bracket required when supporting a worksurface with a tower — storage depth must match worksurface depth.
- Tower drawers do not extend fully — 27" D towers have a 25" D drawer with 20" travel slides; 21" D towers have a 19" D drawer with 16" travel slides.
- 27" D models have a coat/bag hook located in back of drawer.

"L" Tower Bracket (page 125)

- Z6LB tower "L" bracket required when supporting a worksurface with a tower.
- Storage depth must match worksurface depth.

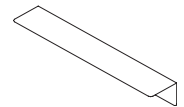

Storage

Further™ — Horizontal and Beam-Mounted Storage Stanchion

For specification information see pages 121-122.

GSA SIN 33721

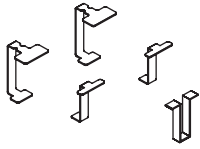

Description	Model	List Price		
		P1	P2	P3
Worksurface Storage Stanchion				
Horizontal Storage Single Sided Stanchion Kit	U7HSK1	\$ 494	\$ 507	\$ 517

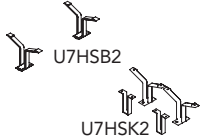

Description	Model	List Price		
		P1	P2	P3
Beam Mounted Storage Stanchions				
Shelf Stanchion Kit 2-Pack	U7HSB2 <input type="checkbox"/>	\$ 295	\$ 308	\$ 318
Horizontal Storage Stanchion Kit 4-Pack	U7HSK2 <input type="checkbox"/>	\$ 596	\$ 612	\$ 626

How to specify —
Select the Model Number from above.

1st Option:
Paint
(if applicable):
 P1 P2 P3

U7H | | | | .

| | | |

Examples U7HSK1.PR6

Shippable by small-package carrier.

Storage

Further™ — Pedestals and Credenzas

For specification information see pages 121-122.

Laminate

GSA SIN 33721

Description	Model	List Price		
		L1	L2	L3
Open Support Pedestal — 10"W x 28"H				
27"D w/Personal Bin Left	U7P1027PBL S	\$ 2344	\$ 2426	\$ 2505
27"D w/Personal Bin Right	U7P1027PBR	\$ 2344	\$ 2426	\$ 2505

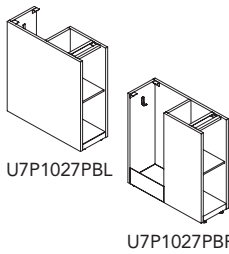

Pull-Out Drawer Support Pedestal — 15"W x 28"H				
21"D — Shelf/Box/Box/File	U7P1521PD S	\$ 2857	\$ 2955	\$ 3055

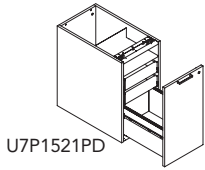

Mobile Credenza — 15"D x 20"H				
36"W — Hinged Door Left	U7MC203615HL S	\$ 3538	\$ 3659	\$ 3783
36"W — Hinged Door Right	U7MC203615HR S	\$ 3538	\$ 3659	\$ 3783

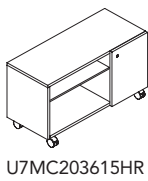

Description	Model	List Price											
		Grade 1	Grade 2	Grade 3	Grade 4	Grade 5	Grade 6	Grade 7	Grade 8	Grade 9	Grade 10	Grade 11	Grade 12
Seat Cushion — For Further Mobile Credenza only (Specify seating fabric — no leathers)													
36"W x 15"D	K5CT1536SC	\$ 434	\$ 474	\$ 512	\$ 550	\$ 600	\$ 651	\$ 701	\$ 752	\$ 802	\$ 854	\$ 904	\$ 955

FURTHER

<p>How to specify — Select the Model Number from above.</p> <p>U 7 . </p>	<p><i>1st Option:</i> Pull Type (if applicable):</p> <p>AP Arch HP Straight (Involve) LP Linear SP Square</p>	<p><i>2nd Option:</i> Pull Color (if applicable):</p> <p>PRO Anodized Silver</p>	<p><i>3rd Option:</i> Metal Shelves Paint Color (if applicable):</p> <p>P1 P2 P3</p> <p>Upcharge:</p> <table border="1"> <thead> <tr> <th></th> <th>P2</th> <th>P3</th> </tr> </thead> <tbody> <tr> <td>Open/21"D Pull-Out</td> <td>\$ 20</td> <td>\$ 42</td> </tr> <tr> <td>Open w/Bin/27"D Pull-Out</td> <td>\$ 23</td> <td>\$ 50</td> </tr> <tr> <td>Credenza</td> <td>\$ 23</td> <td>\$ 52</td> </tr> </tbody> </table>		P2	P3	Open/21"D Pull-Out	\$ 20	\$ 42	Open w/Bin/27"D Pull-Out	\$ 23	\$ 50	Credenza	\$ 23	\$ 52	<p><i>4th Option:</i> FSC Certified Wood (if applicable):</p> <p>FSC Select for FSC Certified Wood X No FSC</p>
		P2	P3													
Open/21"D Pull-Out	\$ 20	\$ 42														
Open w/Bin/27"D Pull-Out	\$ 23	\$ 50														
Credenza	\$ 23	\$ 52														
<p>Continued below ▼</p>																

<p><i>5th Option:</i> Laminate (if applicable):</p> <p> . </p>	<p><i>6th Option:</i> Matching Edge (if applicable):</p> <p> . </p>	<p><i>7th Option:</i> Door Laminate (if applicable):</p> <p> . </p>	<p><i>8th Option:</i> Matching Edge (if applicable):</p> <p> . </p>	<p><i>9th Option:</i> Lock Option (if applicable):</p> <p>STD Standard OMT Omit Lock Core (deduct \$20)</p> <p> </p>	<p><i>10th Option:</i> Lock Color (if applicable):</p> <p>EL Silver</p> <p>E L </p>	<p><i>Only Option for Seat Cushion:</i> Specify Seating Upholstery</p> <p> </p>
---	--	--	--	---	---	---

Examples: U7P1027PBL.PR6.FSC.LM11EV.LM11EV.STDEL
K5CT1536SC.PNS012

S Shippable by small-package carrier.

Storage

Further™ — Side Access Towers

For specification information see pages 121-122.

Laminate

GSA SIN 33721

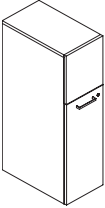
U7T421227ADL	Description	Model	List Price		
			L1	L2	L3
	42½"H Side Access Towers — 12"W				
	27"D w/Left Hand Side Access	U7T421227ADL <input type="checkbox"/>	\$ 4219	\$ 4365	\$ 4512
	27"D w/Right Hand Side Access	U7T421227ADR <input type="checkbox"/>	\$ 4219	\$ 4365	\$ 4512

U7T421227ADR

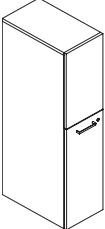
U7T501221ADL	Description	Model	List Price		
			L1	L2	L3
	50"H Side Access Towers — 12"W				
	21"D w/Left Hand Side Access (shown)	U7T501221ADL <input type="checkbox"/>	\$ 4289	\$ 4437	\$ 4587
	27"D w/Left Hand Side Access	U7T501227ADL <input type="checkbox"/>	\$ 4473	\$ 4628	\$ 4785
	21"D w/Right Hand Side Access (shown)	U7T501221ADR <input type="checkbox"/>	\$ 4289	\$ 4437	\$ 4587
	27"D w/Right Hand Side Access	U7T501227ADR <input type="checkbox"/>	\$ 4473	\$ 4628	\$ 4785

U7T501221ADR

	Description	Model	P1 Paint	P2 Paint
			List Price	List Price
	"L" Tower Bracket — for Towers			
	"L" Tower Bracket for 21"D or 27"D	Z6LB	\$ 82	\$ 102

<p>How to specify — Select the Model Number from above.</p>	<p>1st Option: Pull Type (if applicable):</p> <p>AP Arch Pull LP Linear Pull SP Square Pull HP Straight Pull (Involve)</p>	<p>2nd Option: Paint Color:</p> <p>Arch Pull E4 Black EL Silver</p> <p>Linear and Straight Pull PRO Anodized Silver</p> <p>Square Pull EL Silver</p>	<p>3rd Option: Metal Shelves Paint Color (if applicable):</p> <p><input type="checkbox"/> P1 <input type="checkbox"/> P2 <input type="checkbox"/> P3</p> <p>Upcharge: P2 \$36 P3 \$83</p>	<p>4th Option: FSC Certified Wood (if applicable):</p> <p>FSC Select for FSC Certified Wood X No FSC</p>
--	--	---	--	--

Continued below ▼

<p>5th Option: Laminate (if applicable):</p>	<p>6th Option: Matching Edge (if applicable):</p>	<p>7th Option: Door Laminate (if applicable):</p>	<p>8th Option: Matching Edge (if applicable):</p>	<p>9th Option: Lock Option (if applicable):</p> <p>STD Standard OMT Omit Lock Core (deduct \$20)</p>	<p>10th Option: Lock Color (if applicable):</p> <p>EL Silver</p>
--	---	---	---	--	--

Examples: U7T421227ADL.SPEL.FSC.LM11EV.LM11EV.STDEL Z6LB.PR6 Shippable by small-package carrier.

A full gallery of typicals from each Allsteel system can be found on our website:

<https://www.allsteeloffice.com/design-resources/idea-starters>.

Each typical includes a complete BOM with current pricing, downloadable CAD files and PDFs of each drawing.

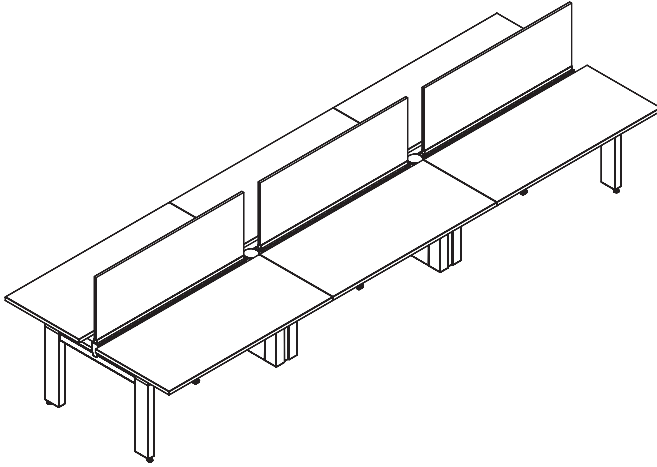

Further Height-Adjustable Bench 2'-6" x 5'

All 4 stations are height-adjustable.

Bench configuration encourages collaboration.

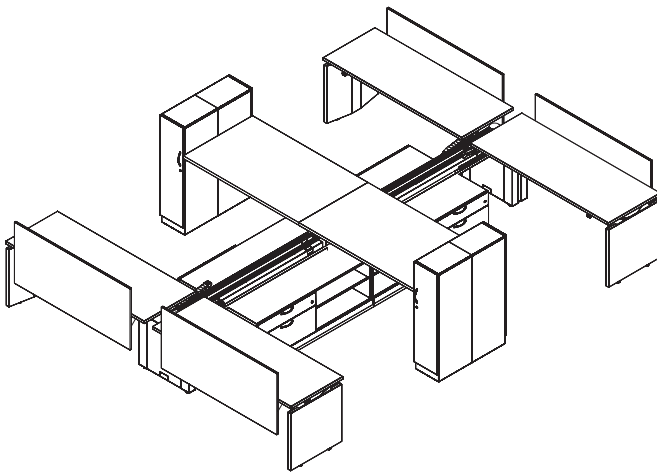

Further Height-Adjustable Bench w/Towers 7' x 5'-6"

All 4 stations are height-adjustable.

Wardrobe and credenzas provide personal storage.

NOTE: Further Typicals can be found at <https://www.allsteeloffice.com/design-resources/idea-starters>.

Further Adaptive configurations use many of the standard Further components to create height-adjustable workstations. This Further Adaptive section contains just 40 models. For a complete Statement of Line of Further components see pages 61-62.

WORKSURFACES — LAMINATE

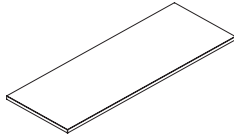

Rectangular
Standard 24" or 27"D x 48"-72"W



120°
Standard 24" or 27"D x 46¼"-52¼"W

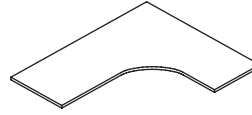

Corner Covs
Standard 24" or 24"/27"D x 60"-72"W

SUPPORTS

Fixed Leg Kits

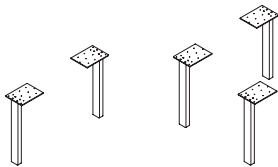

Height-Adjustable Leg Kits

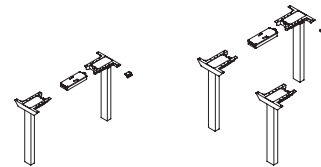

Mid-Supports

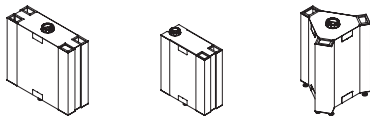

Dual-Sided Single-Sided 120 Degree

Perpendicular Mid Supports

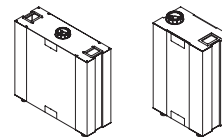

Dual-Sided Single-Sided

End Supports

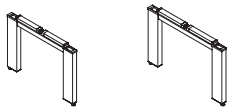

Dual-Sided Single-Sided

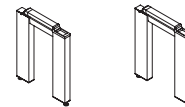

Single-Sided

Perpendicular Outer Support

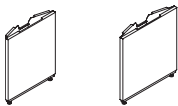

Beam

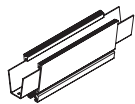

7" and 9" Beam-to-Beam Extension

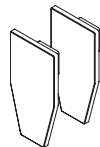

Beam End Cap 2-Pack

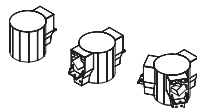

Mid Support to Beam Connectors

Electrical



17" and 19" Jumpers



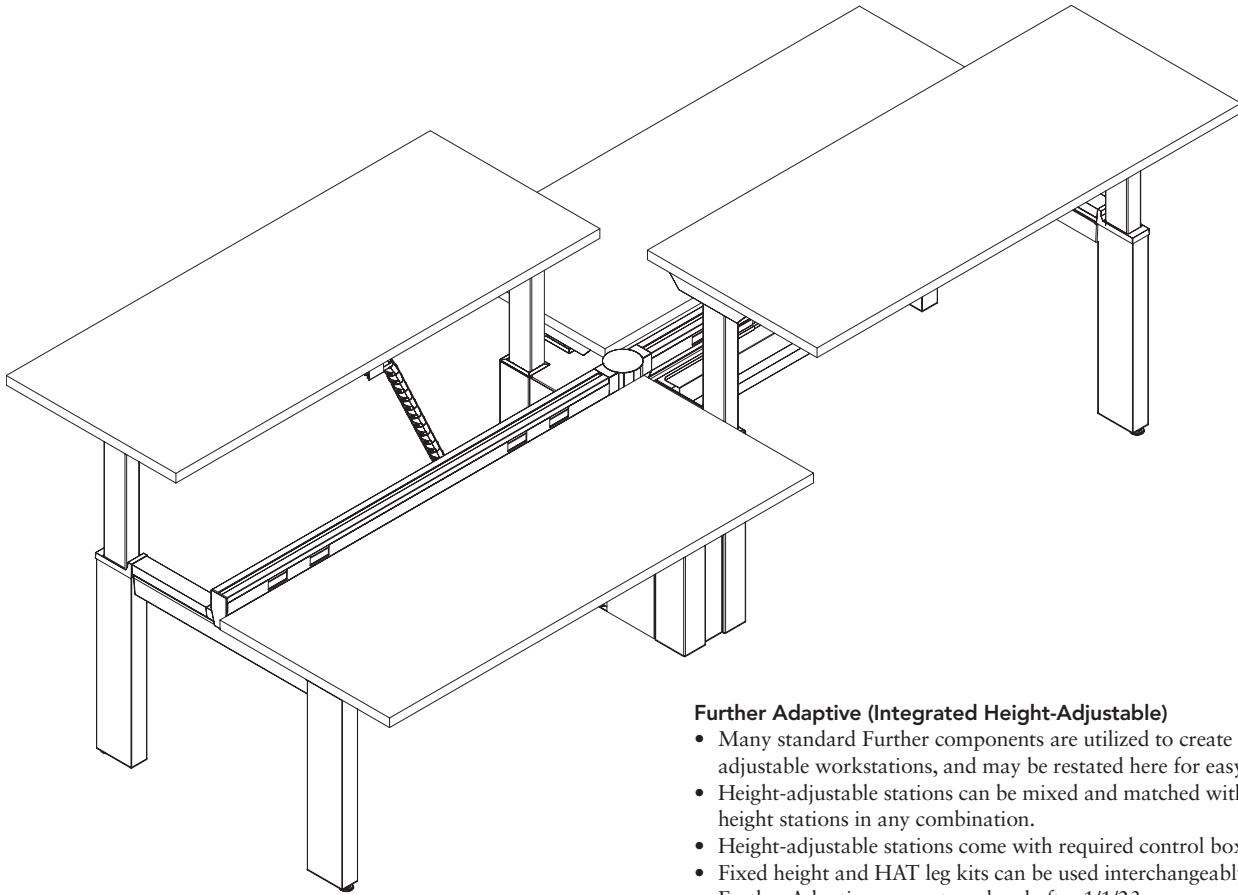

Further Adaptive (Integrated Height-Adjustable)

- Many standard Further components are utilized to create height-adjustable workstations, and may be restated here for easy reference.
- Height-adjustable stations can be mixed and matched with fixed height stations in any combination.
- Height-adjustable stations come with required control box kit.
- Fixed height and HAT leg kits can be used interchangeably with Further Adaptive supports ordered after 1/1/23.
- Mid-supports are required.
- A maximum of two mid-supports in a row may be used.
- Two end supports may be used in succession to extend 6-pack – requires 9" in-line beam connector.
- Single-sided setups require gallery panels to be mounted along spine of beam, or floor anchor brackets on all beam supports.
- Minimum of two single-sided stations allowed.
- Single-sided gallery panels must match the length of worksurfaces specified. Minimum height of the Gallery Panel must be 42" H.
- Adding power to a dual-sided two station application requires a hub at one end.
- Corner cove worksurfaces require a 3-leg HAT kit and perpendicular outer support.

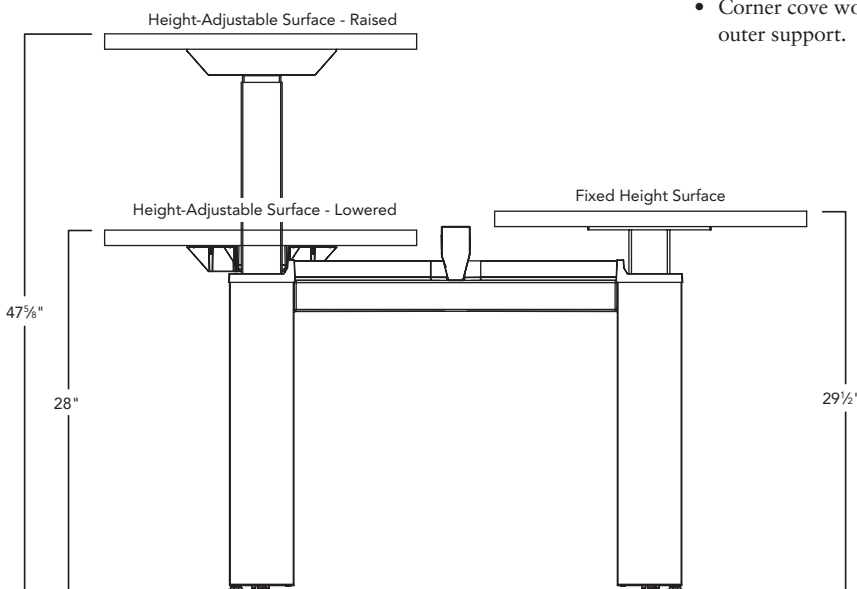

FURTHER

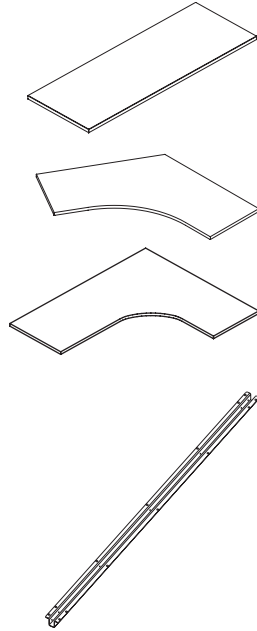

Worksurfaces (page 137)

- Standard 48"-72"W Further worksurfaces are used for height-adjustable workstations.
- 21"D worksurfaces cannot be used.
- A 1" gap exists between surfaces to eliminate pinch points.
- Worksurfaces cannot overhang supports on ends by more than 12".
- Distance from floor to top of height-adjustable worksurfaces ranges from 28" to 47⁵/₈" with glides fully retracted. See illustration left.
- Distance from floor to top of worksurface for fixed height remains at 29¹/₂" with glides fully retracted. See illustrations below.
- Load maximum: 300 lbs, including weight of worksurface.

External Worksurface Support Channel (page 137)

- External stiffeners to be used on 60"W worksurfaces and greater.
- Specify stiffener 12" shorter than standard. (ex. 60"W worksurface uses stiffener Z5SC48)
- Extends 1¹/₂" below the worksurface. Stiffener is 6¹/₄" from back edge of the worksurface.
- May interfere with storage or mounting of accessories.

Adaptive Perpendicular — Height-Adjustable

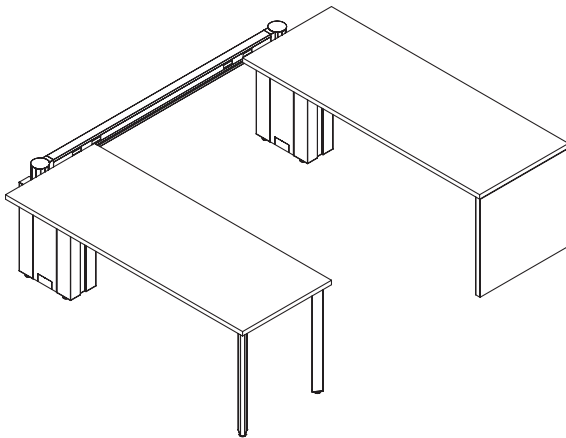

Adaptive Perpendicular Workstations

- No restriction on number of perpendicular mid supports used in a row.
- Worksurfaces are centered over perpendicular mid supports, but may be mounted up to 4 7/8" forward from mid support to reduce footprint.
- Minimum of 4 stations for dual-sided applications, 2 stations for single-sided applications.
- Perpendicular mid support does not complete height-adjustable station – must order perpendicular outer support and HAT kit.
- Fixed height stations require two worksurface support legs on non-beam side in place of a perpendicular outer support.
- A minimum beam length of 30" must be used between perpendicular mid supports for 27"D surfaces, and a minimum length of 24" for 24"D surfaces.

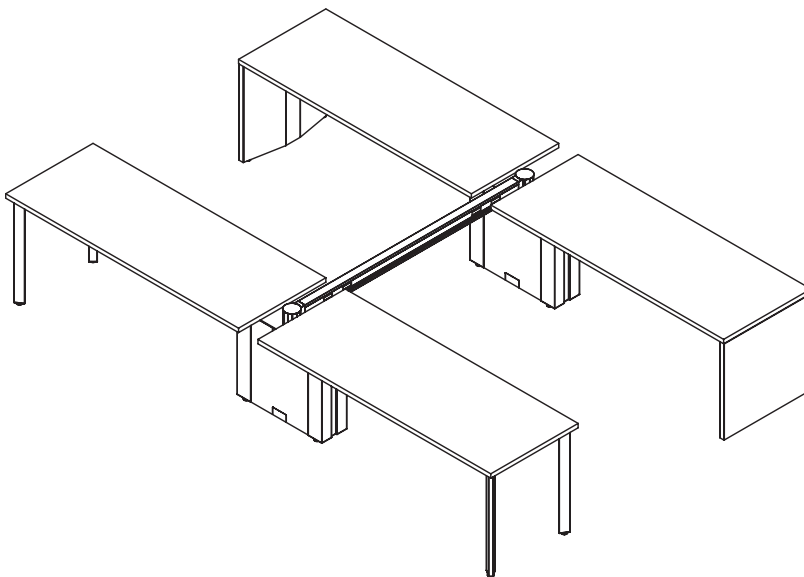

Adaptive Organic — Height-Adjustable

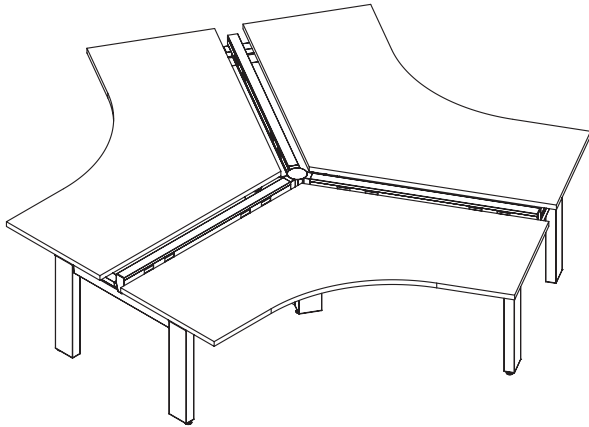

Adaptive 120° Workstations

- Requires a 120° mid support at all 3-way beam connections.
- End supports required on beams also connected to a 120° mid support.
- 7" in-line connector required to attach multiple 120° workstations.
- Single-sided end supports not allowed.
- One (1) 3-Leg HAT or fixed kit will be used per worksurface.

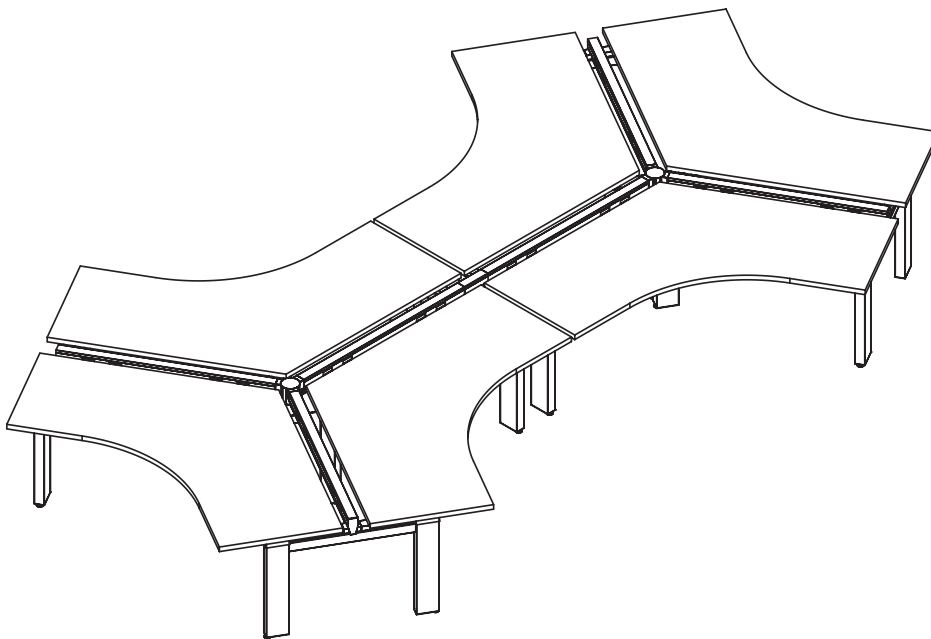

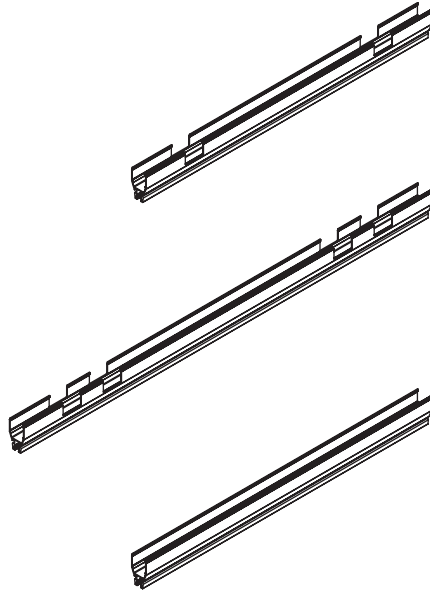

Beams (page 84)

- Supply power to users and support screens, but do not support worksurfaces or storage in adaptive applications.
- Ported and non-ported options available in 6" increments.
- Flat or mounting top trim required to finish off beams – order separately.
- Beams do not connect directly in-line with one another, use in conjunction with adaptive supports.
- Height of assembled beam with top trim is 4¼".
- Electrical port locations are back-to-back, symmetric about beam center, and a standard distance away from beam ends on all lengths.
- 36" and 42" ported beams have 2 receptacle locations on each side (4 total), 48"-96" ported beams have 4 on each side (8 total).
- Ported beams do not carry data cables internally. Routed externally through beam mounted wire-managers. See page 95.

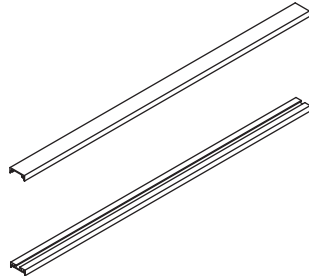

Beam Top Trim (page 85)

- Available in 6"-96" lengths in flat or mounting rail and is required to finish off a beam. Must match beam length, no exceptions.
- Mounting top trim contains a reveal for mounting screens.
- Mounting top trim must be used for projects specified under Chicago electrical Codes.

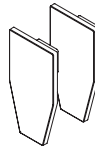

Beam End Cap (page 139)

- Caps off a beam at the end of a parent run.
- Used in conjunction with adaptive end support.
- Model ships with 2 end caps.

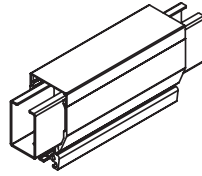

In-Line Beam Connector (page 139)

- Connects two end supports used in succession to extend a parent run.
- 7" connector used between 120° workstations, 9" connector used in linear benching applications.
- When routing power through an in-line beam connector, special length beam-to-beam jumpers are required; 7" – 17" (UN87J17), 9" – 19" (UN87J19).
- Needed every third beam for larger linear parent runs. Can be used after two beams in an 8-station typical to keep symmetry (gap will be 1"). See examples at left and below. For 120° applications use 7" beam length.
- Includes Flat trim; may be used to span a screen over the trim.

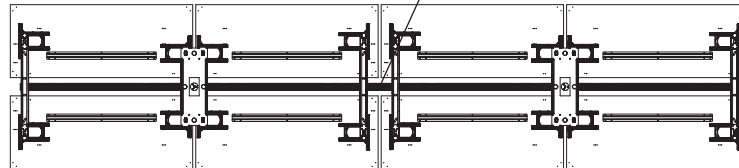
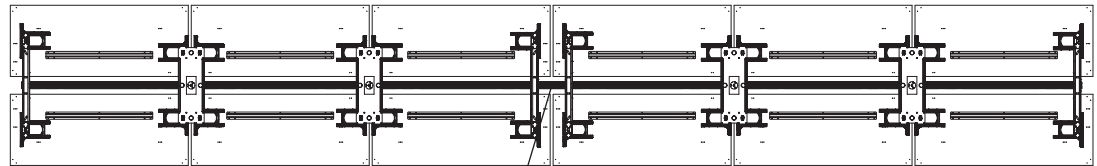
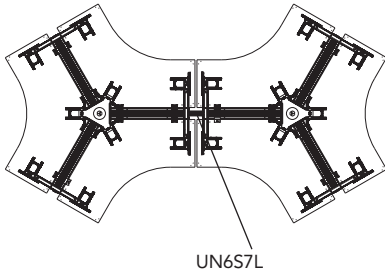

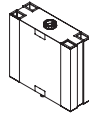

All Adaptive Supports (pages 138-139)

- Used in place of standard Further beam and worksurface supports.
- Specify a mid support to beam connector when specifying the Adaptive mid supports.
- Height-adjustable columns available in 20 Allsteel paint finishes.
- Load maximum: 250 lbs. per surface, including weight of worksurface.
- Include leveling glides with 2¼" adjustment.
- Columns are ordered separately from supports.



End Supports (page 138)

- Supports a beam and worksurface(s) at the end of a run. Cannot be used throughout the run.
- Available in dual- and single-sided models.
- 24" and 27" deep models to be used with corresponding worksurfaces.
- Two end supports may be used in succession to extend parent run. This application requires an in-line beam connector – ordered separately.

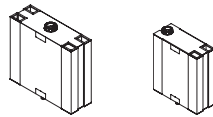

Mid Supports (page 138)

- Supports a beam and worksurface(s) in the middle of a run.
- Available in dual- and single-sided models.
- Same model used for both 24" and 27" deep worksurfaces.
- Hub to two beam connector kit UN3CHB2 required.
- Carries power and data to the beam structure; infeed can be routed through the side or bottom of support.

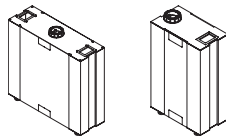

Perpendicular Mid Support (page 138)

- Used to support beam side of worksurface in perpendicular applications.
- Available in dual- and single-sided models.
- Same model used for both 24" and 27" deep worksurfaces.
- Hub to one or two beam connector kit required.
- Carries power and data to the beam structure; infeed can be routed through the side or bottom of support.

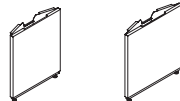

Perpendicular Outer Support (page 138)

- Used to support non-beam side of worksurface in perpendicular applications.
- Supports only one worksurface (not a shared support). 24"D and 27"D height-adjustable models available.
- In fixed height applications, two worksurface support legs are used – see illustration at upper left.

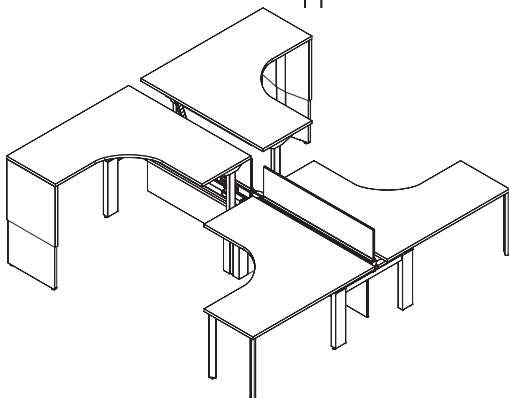
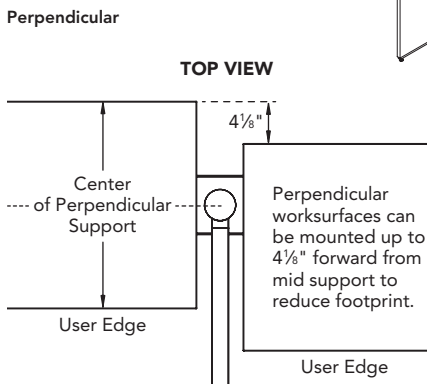

Maximum Support Capacities

Support	Data*	Infeeds	Beams
Linear Mid Support	88	2	2
Perpendicular Mid Support	88	2	2
120° Mid Support	132	3	3

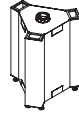
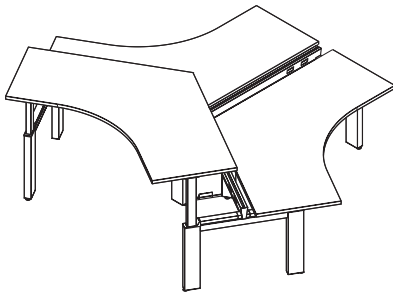

120° Mid Support (page 138)

- Used to support center of 120° worksurfaces in organic applications. Requires three dual-sided end supports – see example left.
- Same model used for 24" and 27" deep worksurfaces.
- Carries power and data to the beam structure; infeed can be routed through the side or bottom of support.

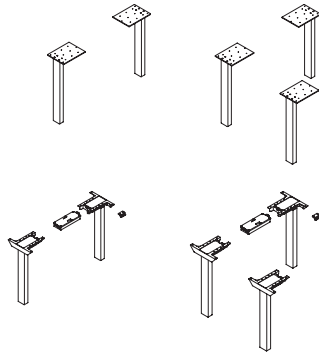

Fixed Leg Kits (page 138)

- 2-leg and 3-leg kits available.
- Includes required mounting hardware for fixed height stations.
- Ordered in addition to necessary supports.

Height-Adjustable Kits (page 138)

- 2-leg and 3-leg kit available.
- Columns, gussets, and control boxes are all included with the height-adjustable kits.
- Ordered in addition to necessary supports.
- Kits can be used to retrofit workstations.
- 2-stage models can range from 26½"H to 45¾"H.
- Basic up/down, memory preset, and paddle.
- Available in 20 Allsteel paint finishes.
- Anti-collision feature.
- 250 lbs. weight capacity.

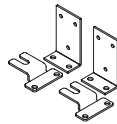

Adaptive Floor Anchor Brackets (page 139)

- Used to mount single-sided Adaptive supports to floor if gallery panels are not desired.
- Kit includes brackets for 2 end supports and 2 mid supports.
- Hardware for mounting to floor is not included.

Mid Support to Beam Connectors

1 Beam to Mid Support Model UN3CHB1

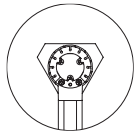

Single

2 Beams to Mid Support — Model UN3CHB2

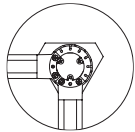

2-Way 90°

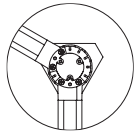

2-Way 120°

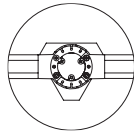

2-Way 180°

3 Beams to Mid Support — Model UN3CHB3

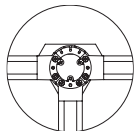

3-Way 90°

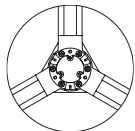

3-Way 120°

Mid Support to Beam Connector Kits (page 138)

- Reconfigurable connector kits used in conjunction with mid support to support beams.
- Ordered by quantity of beams joined to hub — 1, 2, or 3 beams; or connector gap filler and connector blocks can be ordered ala carte to aid in reconfiguration.
- Kits include top casting mounting bracket, top casting, hub to beam connector(s), gap fillers, connector gap fillers, and full top trim.
- Beams can be mounted in 30 degree increments using the same hub and beam connector kit. *Example:* 3 beam connector kit can make a 120 degree or a "T" arrangement. See beam connector kit illustration at left.
- When connector kit is mounted, a gap is created to pass data cords out.

	Old Model	New Model
Mid Supports – Dual Sided 4 Packs for 24"D or 27"D	U6MSD4HA	UNMD
	U6MSD3HA1F	
	U6MSD2HA2F	
	U6MSD1HA3F	
	U6MSD4F	
Mid Supports – Single Sided 4 Packs for 24"D or 27"D	U6MSDL2HA	UNMS
	U6MSD1HA1F	
	U6MSDL2F	
120 Mid Supports for 24"D or 27"D	U6MS1203HA	UNM120
	U6MS1202HA1F	
	U6MS1201HA2F	
	U6MS1203F	
Perpendicular Mid Support Dual Sided 2 Pack	U6MSS2HA	UNMPED
	U6MSS1HA1F	
	U6MSS2F	
Perpendicular Mid Support Single Sided	U6MSEP1HA	UNMPES
	U6MSEP1F	
End Supports – Dual Sided (depth specific)	UN6E24D2HA	UNE24D
	UN6E24D1HA1F	
	UN6E24D2F	
	UN6E27D2HA	UNE27D
	UN6E27D1HA1F	
UN6E27D2F		
End Supports – Single Sided (depth specific)	U6E24SS1HA	UNE24S
	U6E24SS1F	
	U6E27SS1HA	UNE27S
	U6E27SS1F	
Perpendicular Outer Support	U6PE241HA	UN6PE24
	U6PE271HA	UN6PE27
Retrofit Kit for Linear Adaptive Applications	U6LHAKIT	UNHAT2LEG

Leg kits are ordered separately from supports.



For Adaptive specification information see pages 126-136.
Models listed below are a subset from pages 126-136 that are used for Adaptive applications.

Laminate

GSA SIN 33721

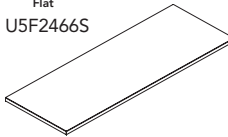
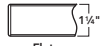
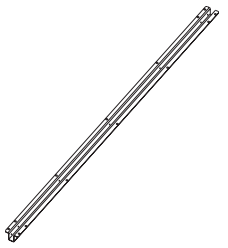

U5F2760S

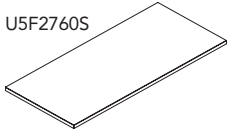

U5F244646C

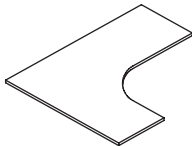
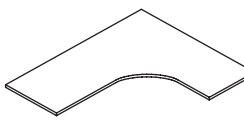

Description	Model	List Price
External Worksurface Support Channel (no color option) — 1½"H		
36"W External Support Channel for 48"W Worksurface	Z5SC48 [S]	\$ 89
42"W External Support Channel for 54"W Worksurface	Z5SC54 [S]	\$ 102
48"W External Support Channel for 60"W Worksurface or 66" Table	Z5SC60	\$ 110

Description	Beam Size	Laminate w/Flat Edge Model	Laminate w/Flat Edge		
			L1	L2	L3
24"D Rectangular Worksurfaces for Adaptive (27" to center of beam)					
48"W	42" Beam	U5F2448S	\$ 659	\$ 686	\$ 706
54"W	48" Beam	U5F2454S	\$ 724	\$ 753	\$ 774
60"W	54" Beam	U5F2460S	\$ 798	\$ 829	\$ 853
66"W	60" Beam	U5F2466S	\$ 873	\$ 906	\$ 932
72"W	66" Beam	U5F2472S	\$ 948	\$ 984	\$ 1013

Description	Beam Size	Laminate w/Flat Edge Model	L1	L2	L3
27"D Rectangular Worksurfaces for Adaptive (30" to center of beam)					
48"W	42"W	U5F2748S	\$ 685	\$ 713	\$ 733
54"W	48"W	U5F2754S	\$ 766	\$ 796	\$ 819
60"W	54"W	U5F2760S	\$ 851	\$ 883	\$ 909
66"W	60"W	U5F2766S	\$ 922	\$ 956	\$ 984
72"W	66"W	U5F2772S	\$ 1000	\$ 1037	\$ 1068

Description	Beam Size	Laminate w/Flat Edge Model	L1	L2	L3
24"D 120° Worksurfaces for Adaptive (27"D to center of beam)					
46¼"W Back Left and Right	42" Beam	U5F244646C	\$ 1159	\$ 1201	\$ 1239
52¼"W Back Left and Right	48" Beam	U5F245252C	\$ 1262	\$ 1307	\$ 1349

Description	Beam Size	Laminate w/Flat Edge Model	L1	L2	L3
27"D 120° Worksurfaces for Adaptive (30"D to center of beam)					
46¼"W Back Left and Right	42" Beam	U5F274646C	\$ 1188	\$ 1231	\$ 1269
52¼"W Back Left and Right	48" Beam	U5F275252C	\$ 1302	\$ 1348	\$ 1392

Corner Cove Worksurfaces — Left Handed (66" and 72" extend left)					
Description	Beam Size	Laminate w/Flat Edge Model	L1	L2	L3
60" x 60" - 24"L / 24"R	54" / 54"	U5CC6024LS	\$ 1822	\$ 1881	\$ 1942
60" x 60" - 27"L / 24"R	54" / 54"	U5CC6027LS	\$ 1877	\$ 1937	\$ 2000
66" x 60" - 24"L / 24"R	60" / 54"	U5CC6624LS	\$ 1914	\$ 1975	\$ 2039
66" x 60" - 27"L / 24"R	60" / 54"	U5CC6627LS	\$ 1945	\$ 2007	\$ 2074
72" x 60" - 24"L / 24"R	66" / 54"	U5CC7224LS	\$ 1955	\$ 2017	\$ 2084
72" x 60" - 27"L / 24"R	66" / 54"	U5CC7227LS	\$ 2083	\$ 2150	\$ 2219

Corner Cove Worksurfaces — Right Handed (66" and 72" extend right)					
Description	Beam Size	Laminate w/Flat Edge Model	L1	L2	L3
60" x 60" - 24"L / 24"R	54" / 54"	U5CC6024RS	\$ 1822	\$ 1881	\$ 1942
60" x 60" - 24"L / 27"R	54" / 54"	U5CC6027RS	\$ 1877	\$ 1937	\$ 2000
60" x 66" - 24"L / 24"R	54" / 60"	U5CC6624RS	\$ 1914	\$ 1975	\$ 2039
60" x 66" - 24"L / 27"R	54" / 60"	U5CC6627RS	\$ 1945	\$ 2007	\$ 2074
60" x 72" - 24"L / 24"R	54" / 66"	U5CC7224RS	\$ 1955	\$ 2017	\$ 2084
60" x 72" - 24"L / 27"R	54" / 66"	U5CC7227RS	\$ 2083	\$ 2150	\$ 2219

<p>How to specify — Select the Model Number from above.</p>	<p>1st Option: Laminate (if applicable):</p>	<p>2nd Option: Edge (if applicable):</p>	
<div style="display: flex; justify-content: space-between;"> _ _ _ _ _ _ _ _ _ _ _ _ _ _ _ _ _ </div>	<div style="display: flex; justify-content: space-between;"> _ _ _ _ _ _ _ _ _ _ _ _ _ _ _ _ _ </div>	<div style="display: flex; justify-content: space-between;"> _ _ _ _ </div>	

Examples: Z5SC60 U5F2448S.LM11.EV U5F2760S.LWBR.DB

[S] Shippable by small-package carrier.

For specification information see pages 126-136.

GSA SIN 33721

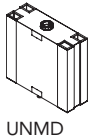

UNMD

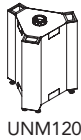

UNM120



UNMS



UNE24D

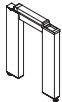

UNE24S



UN6PE24

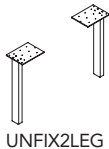

UNFIX2LEG



UNHAT2LEG



UN3CHB1



UN3CHB2



UN3CHB3

Description	Model	List Price		
		P1	P2	P3
Mid Supports				
Dual-Sided Mid Support	UNMD	\$ 2509	\$ 2787	\$ 2925
Single-Sided Mid Support	UNMS	\$ 2254	\$ 2486	\$ 2601
120 Degree Mid Support	UNM120	\$ 2781	\$ 3086	\$ 3238
Dual-Sided Perpendicular Mid Support	UNMPED	\$ 1203	\$ 1335	\$ 1400
Single-Sided Perpendicular Mid Support	UNMPES	\$ 2117	\$ 2349	\$ 2464

End Supports				
Dual-Sided End Support, 24"D	UNE24D	\$ 1236	\$ 1351	\$ 1407
Dual-Sided End Support, 27"D	UNE27D	\$ 1536	\$ 1716	\$ 1804
Single-Sided End Support, 24"D	UNE24S	\$ 1185	\$ 1351	\$ 1434
Single-Sided End Support, 27"D	UNE27S	\$ 1383	\$ 1576	\$ 1673

Outer Supports				
Perpendicular Outer Support, 24"D	UN6PE24	\$ 1185	\$ 1301	\$ 1358
Perpendicular Outer Support, 27"D	UN6PE27	\$ 1391	\$ 1522	\$ 1587

2- and 3-Leg Kits				
2-Leg Fixed Height Kit	UNFIX2LEG	\$ 938	\$ 1041	\$ 1093
2-Leg Height Adjustable Kit	UNHAT2LEG	\$ 2242	\$ 2561	\$ 2720
3-Leg Fixed Height Kit	UNFIX3LEG	\$ 1406	\$ 1561	\$ 1637
3-Leg Height Adjustable Kit	UNHAT3LEG	\$ 3863	\$ 4341	\$ 4579

Mid Support to Beam Connectors — configure as needed, see page 135					
1 Beam to Mid Support Connector w/Top Trim and Gap Filler	UN3CHB1	<input type="checkbox"/>	\$ 357	\$ 375	\$ 411
2 Beams to Mid Support Connector w/Top Trim and Gap Filler	UN3CHB2	<input type="checkbox"/>	\$ 426	\$ 444	\$ 480
3 Beams to Mid Support Connector w/Top Trim and Gap Filler	UN3CHB3	<input type="checkbox"/>	\$ 485	\$ 503	\$ 539

How to specify —
Select the Model Number from above.

1st Option:
Paint color:
 P1 P2 P3

2nd Option:
Select the Keypad
(if applicable):
UD Basic Up/Down
MEM Memory Preset
PDL Paddle

Example: UN3CHB1.PR6

Shippable by small-package carrier.

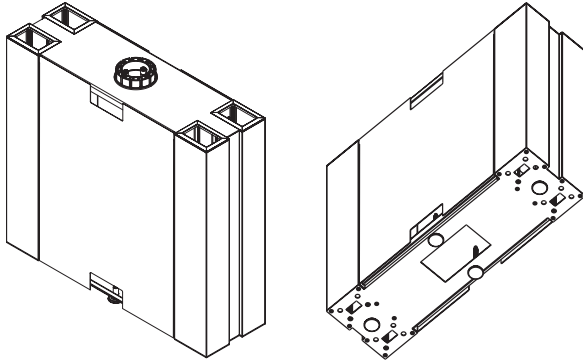

Adaptive Electrical (pages 143-144)

- Most electrical rules and options remain the same for Adaptive applications.
- Power infeeds cannot enter system through end supports.

Application	Beam Size	Bench Connector	Jumper Model
Linear	48-72"	UN6S9L	UN87J19
120°	42"	UN6S7L	UN87J19
120°	48"	UN6S7L	UN87J17

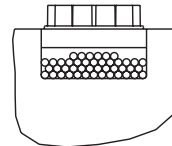

Upper knock-out opening (5.30 sq. in.) on access panel on mid support (both 2 & 4-column, 4-column shown) accepts up to 44 voice/data cables (.300" dia.)
All quantities listed at 60% fill ratio.

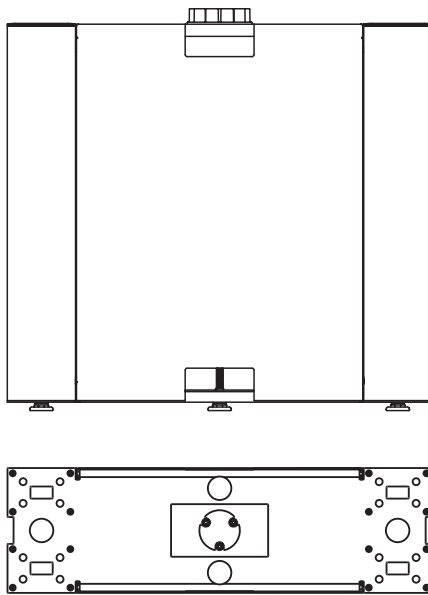

Lower knock-out opening (5.72 sq. in.) on access panel on mid support (both 2 & 4-column, 4-column shown) accepts up to 39 voice/data cables (.300" dia.) when electrical shares opening with one infeed.
All quantities listed at 60% fill ratio.

Lower knock-out opening (5.72 sq. in.) on access panel on mid support (both 2 & 4-column, 4-column shown) accepts up to 44 voice/data cables (.300" dia.) without power. Maximum of 72 cables in wire management.
All quantities listed at 60% fill ratio.

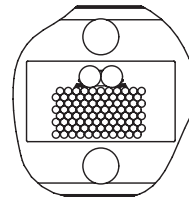
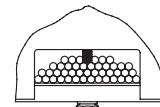
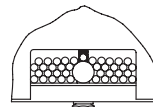

Bottom 6" x 3/4" opening (19.50 sq. in.) of mid support (both 2 & 4-column, 4-column shown) accepts up to 88 voice/data cables (.300" dia.) when electrical shares opening with two infeeds.

88 cables shown = 44 per access panel upper knock-out.

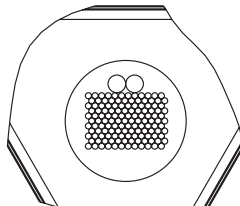
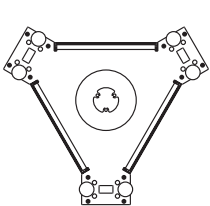
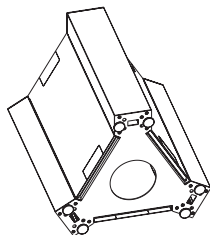

Bottom 6" dia. opening (28.27 sq. in.) of 120 mid support accepts up to 132 voice/data cables (.300" dia.) when electrical shares opening with two infeeds. 132 cables shown = 44 per access panel upper knock-out.

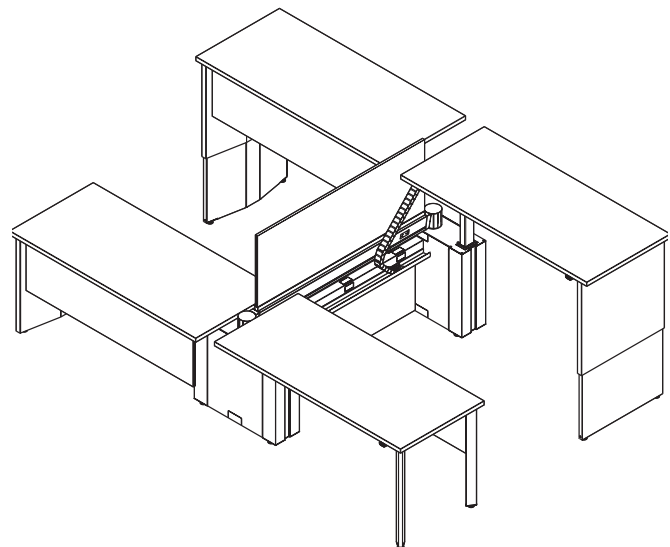

FURTHER

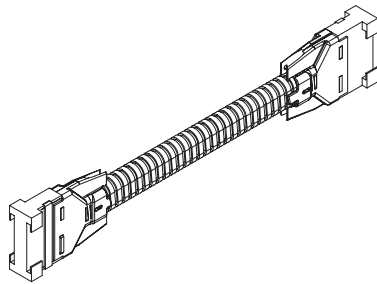
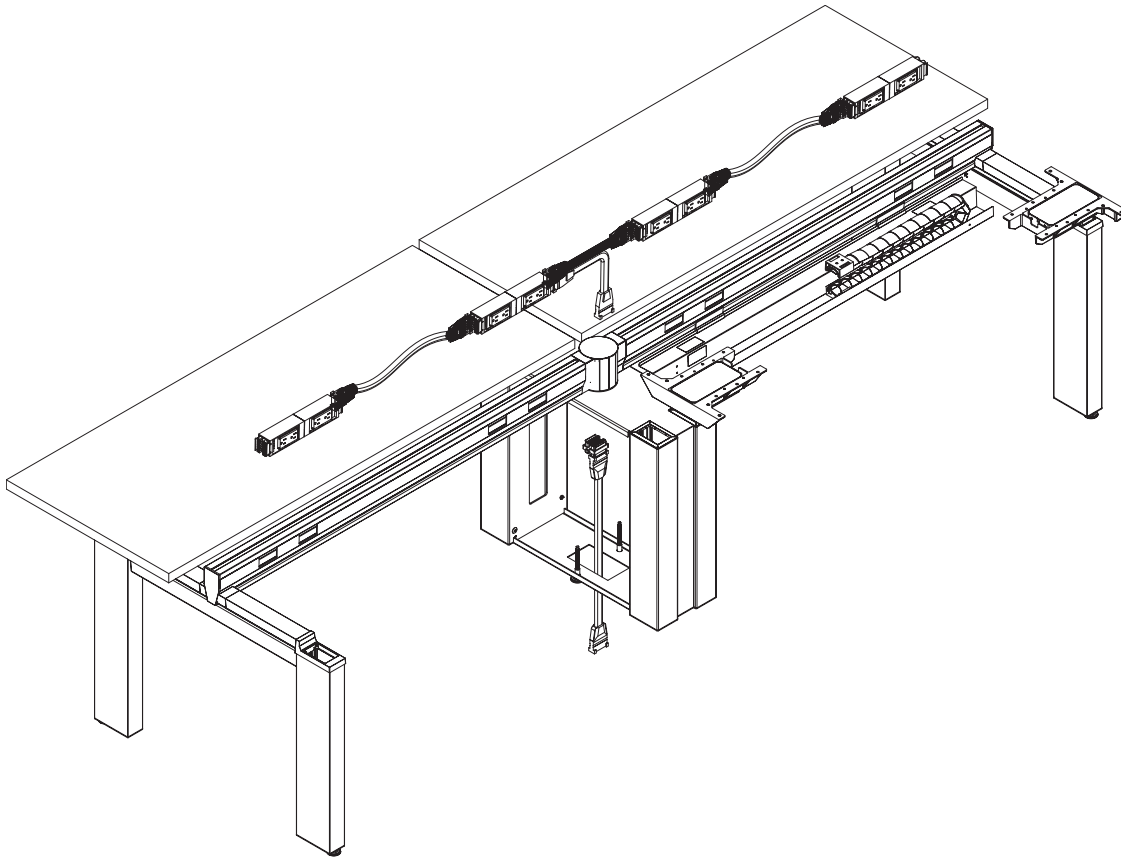

Beam-to-Beam Jumper (page 143)

- Standard 16" jumpers are used over mid supports.
- 17" jumper used over 7" connector.
- 19" jumper used over 9" connector.
- Special length jumpers are required when routing power over two end supports through an in-line beam connector.

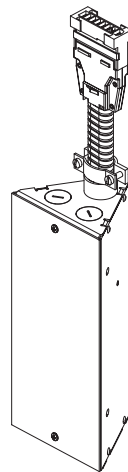

Hardwire – New York Code (page 103)

- Required for New York electrical.
- For flexible hubs and Further Adaptive, choose one of the 3 configurations:
 - U8IKNY1 for Hub to 1 Beam
 - U8IKNY2 for Hub to 2 Beam
 - U8IKNY3 for Hub to 3 Beam



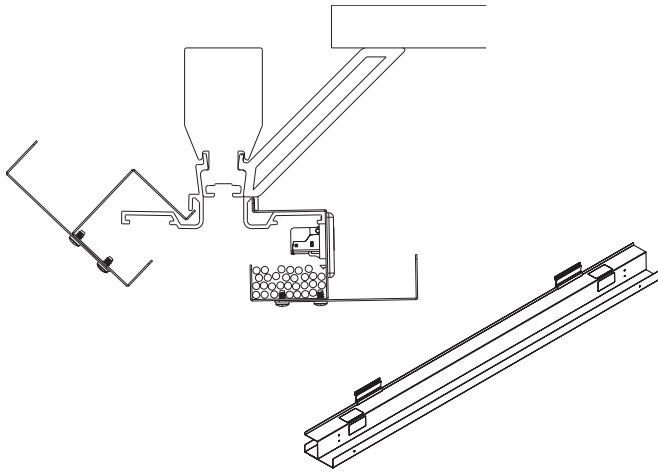

Single-Sided Wire Manager (page 105)

- Can be used with any single-sided, dual-sided, Further Adaptive, freestanding post and beam, and fixed-height applications.
- Holds user wires and up to 30 system data cables on one side of a beam.
- Mounts into the continuous reveal on either side of a beam – mounting clips included.
- Single-sided version is recommended when nesting storage.
- The data manager without the 2½" D tray can be ordered separately to maximize space, or the tray can be removed in the field.
- Available from 36" to 78" widths in 6" increments.
- Includes mounting locations for Cord Management Chain when used with Adaptive supports or freestanding height-adjustable workstations.
- Specify 6" shorter than beam length when used with Adaptive supports.
- Two single-sided wire managers can be used on either side of beam to increase data capacity. (60 total)
- May be used in conjunction with beam mounted modesty screens.
- Includes 4 knockout port locations for data faceplates (2.7"W x 1.375"H) on all widths. Data faceplates ordered separately.

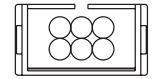

6 cables (.300" dia.)

Cord Management Chain (page 144)

- Used to route and conceal power/data cables from worksurface to beam power receptacles.
- Houses 6 cables at .300" diameter – see illustration left.
- Chain is 36" and must be used in conjunction with a single-sided wire manager. Specify wire manager to be 6" shorter than beam length.
- Chain can be mounted in two orientations – see illustrations left.
- Chain is plastic and comes in one color – Black.
- Recommended cord length for electrical accessories is 60".
- Maximum of two chains can be mounted to a wire manager tray that is 48" or greater.

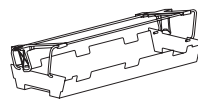
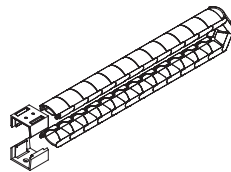

AFDTRGH20

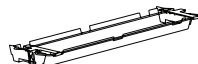

AFDTRGH32

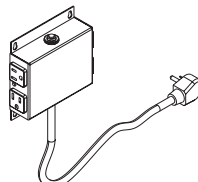

APWR4TAP

Flip-Down Wire Trough (page 144)

- Mounts beneath a worksurface. Used to conceal extra cord slack and power strips.
- May be used in conjunction with quad tap unit APWR4TAP to reduce the number of cords routed from a worksurface to a beam.
- For any worksurface less than 58"W, a 20"W Flip-Down Trough is recommended.
- For worksurfaces 58"W and wider, a 20"W or 32"W Flip-Down Trough may be used.
- Flush-mount Raddi Storages are not recommended to use in conjunction with Flip-Down Trough.
- Only AKTSHORT keyboard tray is recommended for use in conjunction with the Flip-Down Trough.

Power Module — Under Worksurface, Quad Tap (page 278.1)

- Under surface mounting can be used under any surface with a 5" x 5" x 1.5" clearance.
- 10' straight power cord only, no specification needed.
- 4 receptacles, unit is black finish only, no specification needed.

For more power and wire management options, please visit the [Extensions](#) pages.

For Adaptive specification information see pages 140-142.

GSA SIN 33721

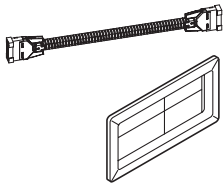

Description	Model	List Price
Electrical & Data (See pages 140-141 for specification and balance of electrical models.)		
17" Jumper for Adaptive	UN87J17 <input type="checkbox"/>	\$ 153
19" Jumper for Adaptive	UN87J19 <input type="checkbox"/>	\$ 157
Wireway Grommet — pack of 6	TAWG <input type="checkbox"/>	\$ 187

How to specify —
Select the Model Number from above.

1st Option:
Jumper Color
(if applicable):
P Black

_____ . P

Example: UN87J17.P

Shippable by small-package carrier.



For Adaptive specification information see pages 140-142.

GSA SIN 33721

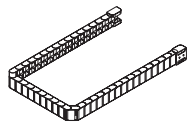

WKSWMC

Description	Model		List Price	
Wire Management Chains				
36"	A9CLWMC	<input type="checkbox"/>	\$	357
58"	WKSWMC	<input type="checkbox"/>	\$	428

- Specify model A9CLWMC for 36" chain, specify model WKSWMC for 58" chain.
- A9CLWMC available in Black (E4), White (DW), or Silver (TI).
- WKSWMC available in Black only, no specification needed.
- Example: A9CLWMC.DW or WKSWMC

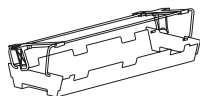

AFDTRGH20

Description	Model		List Price		
			P1	P2	P3
Flip-Down Wire Management Trough					
20"W	AFDTRGH20	<input type="checkbox"/>	\$ 378	N/A	N/A
32"W	AFDTRGH32	<input type="checkbox"/>	\$ 429	N/A	N/A

- Available in 20" or 32" widths.
- Flip-Down Troughs available in Black only, specify "P" for Black.
- Example: AFTRGH20.P

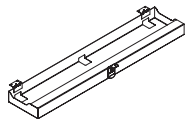

Description	Model		List Price		
			P1	P2	P3
Hinged Wire Management Troughs for under Worksurfaces					
24"W	UN924HT	<i>(De-emphasized)</i>	\$ 349	\$ 369	\$ 398
36"W	UN936HT	<i>(De-emphasized)</i>	\$ 365	\$ 386	\$ 417
48"W	UN948HT	<i>(De-emphasized)</i>	\$ 385	\$ 407	\$ 440

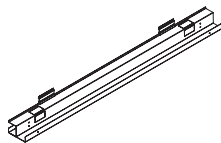

Description	Model		List Price		
			P1	P2	P3
Beam Mounted Wire Manager — Single Sided Stationary Painted Metal					
36"W Beam Mounted	UN6SWMC36		\$ 433	\$ 476	\$ 540
42"W Beam Mounted	UN6SWMC42		\$ 476	\$ 524	\$ 594
48"W Beam Mounted	UN6SWMC48		\$ 527	\$ 580	\$ 656
54"W Beam Mounted	UN6SWMC54		\$ 578	\$ 633	\$ 715
60"W Beam Mounted	UN6SWMC60		\$ 635	\$ 697	\$ 792
66"W Beam Mounted	UN6SWMC66		\$ 698	\$ 765	\$ 865
72"W Beam Mounted	UN6SWMC72		\$ 768	\$ 839	\$ 943
78"W Beam Mounted	UN6SWMC78		\$ 846	\$ 920	\$ 1032

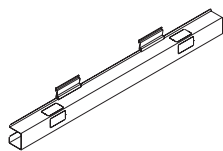

Description	Model		List Price		
			P1	P2	P3
Beam-Mounted Data Manager without Tray — Single-Sided Painted Metal					
36"W	UN6SDMC36	<input type="checkbox"/>	\$ 347	\$ 372	\$ 408
42"W	UN6SDMC42	<input type="checkbox"/>	\$ 381	\$ 409	\$ 449
48"W	UN6SDMC48	<input type="checkbox"/>	\$ 420	\$ 450	\$ 495
54"W	UN6SDMC54	<input type="checkbox"/>	\$ 464	\$ 497	\$ 546
60"W	UN6SDMC60	<input type="checkbox"/>	\$ 508	\$ 545	\$ 598
66"W	UN6SDMC66	<input type="checkbox"/>	\$ 560	\$ 601	\$ 658
72"W	UN6SDMC72	<input type="checkbox"/>	\$ 614	\$ 658	\$ 723
78"W	UN6SDMC78		\$ 676	\$ 724	\$ 796

How to specify —
Select the Model Number from above.

1st Option:
Paint Color
(if applicable):
 P1 P2 P3

Examples: A9CLWMC UN6SWMC36.PR6

Shippable by small-package carrier.

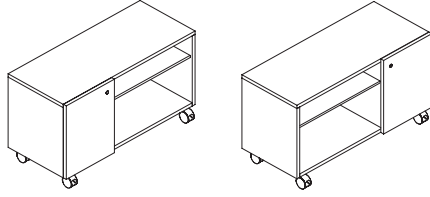

Storage (pages 121-125)

- Laminate shelves (24" & 30" W) can be mounted on Adaptive surfaces using worksurface mounted stanchion kits (U7HSK1).
- Storage below 26"H can be used underneath Adaptive surfaces when not directly underneath height-adjustable leg, otherwise storage must be below 23⁷/₈"H. Taller storage units can be used if keypad with preset height capabilities (ATBCMC) is specified.
- Storage below 26"H can be used underneath fixed supports. Normal Further storage units may be used if positioned to not interfere with plates. See below.

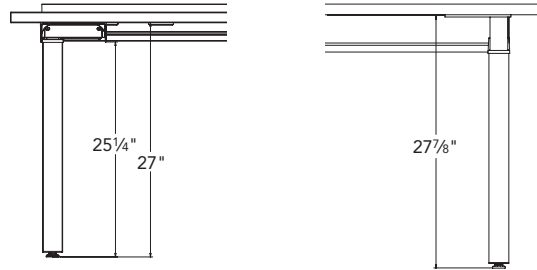

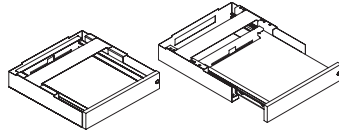

Laptop Drawer (pages 279 and 282)

- Laptop Drawers (U7WDA) must clear worksurface gussets.
- Drawer must be inset $11\frac{3}{4}$ " from the side edge and 9" on mid support side. See illustration at left.
- Laptop drawer cannot be used on 24" x 60", 24" x 66", or 24" x 72" due to external stiffener placement.
- Clearance below drawer is $22\frac{5}{8}$ " when worksurface is fully lowered. See illustration at left.

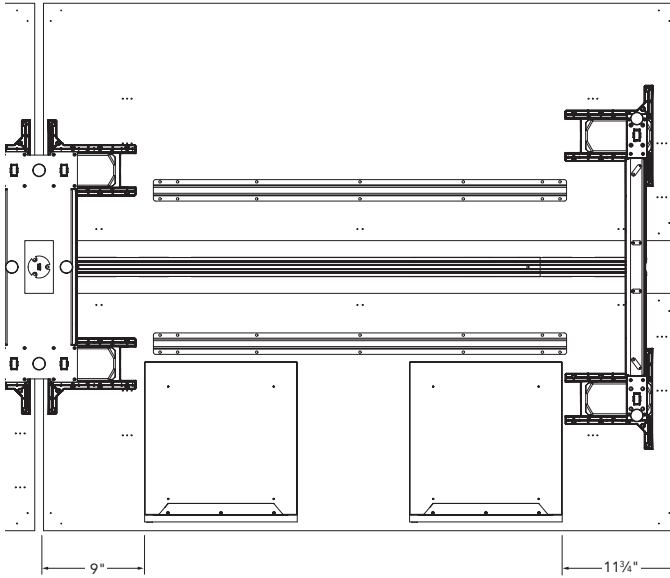

Front View

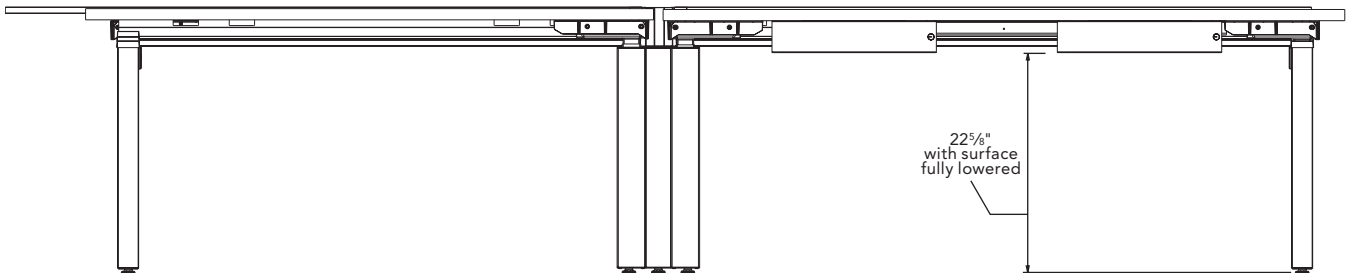

Universal Screens

Finishes	148-149
Partnership Program Upholstery	150
Specification Details	151-154
<i>Fabric Screens</i>	
Beam Mounted Screens	155
Elevated Screens	156
Above/Below Screens	157
Lateral Screens	158-160
Adjustable HAT Screens.....	161
Modesty Screens.....	162
Sit-on-Surface Screens	163
<i>Glass Screens</i>	
Beam Mounted Screens	164
Elevated Screens	165
Above/Below Screens	166
Lateral Screens	167-168
Side Screens.....	169
Modesty Screens.....	170
<i>Acrylic Screens</i>	
Beam Mounted Screens	171
Elevated Screens	172
Above/Below Screens	173
Lateral Screens	174-175
Side Screens.....	176
Modesty Screens.....	177
Sit-on-Surface Screens	178
<i>Laminate Screens</i>	
Beam Mounted Screens	179
Elevated Screens	180
Above/Below Screens	181
Lateral Screens	182-183
Side Screens.....	184
Modesty Screens.....	185
<i>Organizers</i>	186

PAINT FINISHES

GRADE P1

Black P71
Brownstone P7D
Bungalow P7C
Cinder P7Q
Cove P096
Designer White PJW
Dune P094
Flint P02
Fossil P28
Harbor P097
Loft P7B
Muslin P4J
Parchment P93
Pebble P8R
Pewter P8D
Sage P095
Salt P8C
Titanium P8T

GRADE P2

Champagne Metallic PR5
Gunmetal Metallic PR3
Matte Gold P8G
Night Bronze P8B
Platinum Metallic PR2
Pyrite PJE
Silver PR6
Solar Black P8X

GRADE P3

Atom P8S
Blossom P8K
Bullseye PJF
Ember P8P
Ion P8N
Iris P8J
Krypton P8F
Ochre P093
Regatta P8M
Sienna P092
Succulent P8A

GRADE P6

Markerboard MKP
-------------	-----------

LAMINATE FINISHES

GRADE L1

Black P
Bourbon Cherry H
Charcoal S
Cognac COGN
Designer White LDW1
Field Elm LWFE
Florence Walnut LFW1
Handspun Chestnut LAHC
Handspun Dove LAHD
Handspun Pearl LAHP
Handspun Slate LAHS
Harvest C
Kingswood Walnut LK1
Loft LOFT
Mahogany N
Mocha MOCH
Natural Maple D
Pinnacle PINC
Shaker Cherry F
Silver Mesh B9
Sterling Ash LSA1

GRADE L2

Beigewood LWBE
Fawn Cypress LFC1
Lowell Ash LLA1
Natural Recon LNR1
Phantom Ecrú LPE1
Portico Teak LPT1
Skyline Walnut LSW1

EDGE FINISHES

Beigewood DE
Belair BA
Black E4
Bourbon Cherry H
Brownstone EY
Bungalow EX
Designer White DW
Fawn Cypress FC
Field Elm FE
Flint E9
Florence Walnut FW
Fossil EH
Kingswood Walnut KI
Loft EV
Lowell Ash DL
Mangalore Mango MM
Muslin EU
Natural Maple DD
Natural Recon DR
Natural Walnut DN
Neo Walnut NU
Parchment EN
Phantom Charcoal PC
Phantom Ecrú PE
Pinnacle PI
Platinum Metallic EP
Portico Teak DP
Shaker Cherry DF
Skyline Walnut SW
Titanium TI
Veranda Teak VT

GRADE A

APPOINT PANEL

<i>100% Polyester</i>	
Artichoke APN911
Blackberry APN932
Bronze APN922
Carbon APN928
Chai APN912
Cherry APN930
Dark Pewter APN917
Dune APN915
Espresso APN923
Frost APN934
Framboise APN931
Jet APN927
Lawn APN925
Mandarin APN929
Morel APN909
Nimbus APN916
Platinum APN924
Turquoise APN926

BINARY

<i>83% Polyester, 17% Post-Consumer Recycled Polyester</i>	
Blush BNRY12
Coal BNRY06
Cream BNRY01
Denim BNRY08
Diamond BNRY03
Graphite BNRY05
Juniper BNRY10
Lagoon BNRY07
Lavender BNRY11
Mineral BNRY04
Reef BNRY09
Sand Dollar BNRY02

ETCH

<i>100% Polyester</i>	
Axis ECH913
Blend ECH914
Cast ECH912
Highlight ECH910
Midtone ECH911
Outline ECH908
Shade ECH909
Tonal ECH916
Vanish ECH915

LANDSCAPE

<i>48% Post-Consumer Recycled Polyester, 40% Pre-Consumer Recycled Polyester, 12% Polyester</i>	
Corn silk LN15
Drift LN05
Khaki LN20
Sheen LN10
Slate LN35
Umber LN25
Urban LN30

GRADE A – continued

NOBLE

<i>60% Post-Consumer Recycled Polyester</i>	
Agean NBLE18
Amethyst NBLE19
Aspen NBLE14
Aster NBLE20
Blossom NBLE21
Bluebell NBLE22
Bordeaux NBLE01
Brick NBLE02
Chambray NBLE10
Chamomile NBLE23
Clementine NBLE04
Conifer NBLE24
Cottage NBLE25
Darkness NBLE26
Dawn NBLE13
Denim NBLE09
Desert Sand NBLE27
Dewfall NBLE28
Dusted Sage NBLE29
Flax NBLE30
Grass NBLE07
Gunmetal NBLE15
Harmony NBLE31
Harvest NBLE12
Ice Caves NBLE32
Icicle NBLE33
Inky NBLE34
Iris NBLE35
Jade NBLE06
Knight NBLE17
Mesa NBLE03
Monarch NBLE36
Pacific NBLE08
Pitch NBLE37
Queen Bee NBLE38
Rainforest NBLE05
Regal NBLE11
Sandcastle NBLE39
Sedona NBLE40
Stormy NBLE16
Sunbeam NBLE41
Voyager NBLE42
Windy Day NBLE43

REFLECTIONS

<i>56% Pre-Consumer Recycled Polyester, 44% Post-Consumer Recycled Polyester</i>	
Galvanized REF920
Ice REF929
Loggia REF921
Mistral REF928
Moonstone REF923
Pewter REF922
Stainless REF924
Vanilla REF925
Winter REF927

REFUGE

<i>46% Polyester, 35% Pre-Consumer Recycled Polyester, 19% Post-Consumer Recycled Polyester</i>	
Artesian RFG996
Dune RFG992
Eclipse RFG990
Frost † RFG993
Glacier † RFG991
Mineral RFG998
Tidal RFG994

TEMPEST

<i>73% Pre-Consumer Recycled Polyester, 27% Post-Consumer Recycled Polyester</i>	
Dragonfly TP930
Frost TP915
Full Stream TP980
Gold Rush TP910
Slate TP945
Tumbleweed TP970
Wind Chill TP940
Zebra TP935

^w Limited to 48" W or less

GRADE B

DISPERSE

100% Polyester

Autumn.....	DISP03
Branch.....	DISP10
Coffee Bean.....	DISP13
Dusk.....	DISP09
Emerald City.....	DISP08
Gold Rush.....	DISP02
Igloo.....	DISP11
Ink.....	DISP06
Mist.....	DISP12
Oatmeal.....	DISP15
Prince.....	DISP07
Reservoir.....	DISP01
Rose.....	DISP04
Spring.....	DISP05
Steel.....	DISP16
Taupe.....	DISP14

SPIN PANEL

54% Polyester, 30% Pre-Consumer

Recycled Polyester, 16% Post-Consumer

Recycled Polyester

Alabaster.....	SPIN02
Cavern.....	SPIN03
Cobblestone.....	SPIN04
Ember.....	SPIN06
Flame.....	SPIN07
Heron.....	SPIN13
Oat.....	SPIN01
Ocean.....	SPIN12
Plum.....	SPIN15
Pool.....	SPIN11
Raven.....	SPIN10
Rhubarb.....	SPIN14
Tropic.....	SPIN08
Willow.....	SPIN05

TERRAIN

48% Polyester, 34% Pre-Consumer

Recycled Polyester, 18% Post-Consumer

Recycled Polyester

Bay.....	TRRN05
Bayou.....	TRRN35
Canyon.....	TRRN30
Cliff.....	TRRN45
Crest.....	TRRN25
Delta.....	TRRN10
Plateau.....	TRRN15
Ridge.....	TRRN20
Valley.....	TRRN40

SEATING – GRADE 1

CENTURION^W

100% Polyester

Apricot.....	CU47
Bark.....	CU25
Black.....	CU10
Espresso.....	CU49
Fog.....	CU03
Frost.....	CU22
Goldenrod.....	CU27
Indigo.....	CU06
Iris.....	CU50
Iron Ore.....	CU19
Jade.....	CU83
Marsala.....	CU63
Morel.....	CU24
Navy.....	CU98
Peacock.....	CU97
Pear.....	CU84
Ruby.....	CU67
Sapphire.....	CU09

DAPPER^W

100% Polyester

Ash.....	DAPR20
Breeze.....	DAPR06
Canvas.....	DAPR25
Charcoal.....	DAPR01
Clover.....	DAPR22
Currant.....	DAPR00
Fawn.....	DAPR35
Fern.....	DAPR85
Gerbera.....	DAPR16
Grape.....	DAPR33
Jewel.....	DAPR08
Marigold.....	DAPR65
Onyx.....	DAPR10
Orchid.....	DAPR90
Parrot.....	DAPR59
Poppy.....	DAPR19
Sapphire.....	DAPR07
Scarlet.....	DAPR45
Sepia.....	DAPR30
Sky.....	DAPR44
Slate.....	DAPR15
Sorbet.....	DAPR55
Spring.....	DAPR80
Terracotta.....	DAPR13
Titanium.....	DAPR17
Varsity.....	DAPR09
Zest.....	DAPR70

^W Limited to 48"W or less

ALLSTEEL MATERIALS PARTNERSHIP PROGRAM — See program explanation at bottom of page.

GRADE 2

Maharam MELD
68% Recycled Polyester,
32% Polyester

Amethyst.....SMHMMLD18
Antler.....SMHMMLD13
Bare.....SMHMMLD26
Blonde.....SMHMMLD27
Bride.....SMHMMLD10
Bulb.....SMHMMLD09
Clementine.....SMHMMLD23
Comet.....SMHMMLD29
Crater.....SMHMMLD14
Creek.....SMHMMLD40
Fox.....SMHMMLD24
Fuchsia.....SMHMMLD17
Globe.....SMHMMLD42
Gloss.....SMHMMLD08
Grate.....SMHMMLD07
Heat.....SMHMMLD22
Honeydew.....SMHMMLD30
Isle.....SMHMMLD39
Kale.....SMHMMLD34
Kiss.....SMHMMLD25
Knight.....SMHMMLD04
Magma.....SMHMMLD20
Mariner.....SMHMMLD41
Merlot.....SMHMMLD19
Mimosas.....SMHMMLD28
Mulberry.....SMHMMLD16
Nordic.....SMHMMLD36
Panda.....SMHMMLD02
Perennial.....SMHMMLD15
Pipe.....SMHMMLD06
Quill.....SMHMMLD05
Reef.....SMHMMLD37
Rooster.....SMHMMLD21
Seashell.....SMHMMLD12
Seed.....SMHMMLD33
Skyline.....SMHMMLD03
Spa.....SMHMMLD43
Stark.....SMHMMLD11
Vast.....SMHMMLD01
Vine.....SMHMMLD32
Waterfall.....SMHMMLD35
Wave.....SMHMMLD38
Wild.....SMHMMLD31

GRADE 4

HBF Textiles BLINK

Bright Blue..... 1048-59
Dark Violet..... 1048-77
Dove Grey..... 1048-83
Lemon Yellow..... 1048-22
Ocean Blue..... 1048-56
Peppery..... 1048-90
Red Orange..... 1048-44
Sea Green..... 1048-67
Silvery..... 1048-80

GRADE 4 – continued

Maharam MESSENGER
78% Recycled

Apple.....SMHMGRM96
Ash.....SMHMGRM77
Aster*.....SMHMGRM67
Azure.....SMHMGRM41
Balsa*.....SMHMGRM01
Bayou.....SMHMGRM08
Beyond*.....SMHMGRM85
Blanch.....SMHMGRM89
Cactus*.....SMHMGRM45
Capri.....SMHMGRM61
Cassis.....SMHMGRM66
Catalyst*.....SMHMGRM98
Cherry.....SMHMGRM69
Chestnut*.....SMHMGRM52
Chili*.....SMHMGRM83
Cloud.....SMHMGRM31
Depth.....SMHMGRM38
Dipper.....SMHMGRM92
Electric*.....SMHMGRM88
Everglade.....SMHMGRM87
Fennel*.....SMHMGRM59
Fireside*.....SMHMGRM82
Fossil*.....SMHMGRM76
Gale*.....SMHMGRM93
Hunter.....SMHMGRM94
Husk*.....SMHMGRM81
Hydrangea*.....SMHMGRM50
Ice.....SMHMGRM46
Krill*.....SMHMGRM97
Lilac*.....SMHMGRM51
Lime.....SMHMGRM95
Longspur.....SMHMGRM90
Lumine.....SMHMGRM54
Maize*.....SMHMGRM72
Mao.....SMHMGRM25
Neon*.....SMHMGRM48
Nile.....SMHMGRM40
Onyx.....SMHMGRM29
Oyster*.....SMHMGRM79
Pensive*.....SMHMGRM80
Peridot*.....SMHMGRM60
Poppy*.....SMHMGRM24
Robust*.....SMHMGRM84
Satsuma.....SMHMGRM71
Shadow*.....SMHMGRM07
Snow.....SMHMGRM58
Spice*.....SMHMGRM68
Squall*.....SMHMGRM63
Tangelo.....SMHMGRM53
Tobacco*.....SMHMGRM06
Tusk*.....SMHMGRM78
Ultramarine*.....SMHMGRM62
Vibrant*.....SMHMGRM70
Vireo.....SMHMGRM91
Voyage.....SMHMGRM86
Zinc*.....SMHMGRM10

GRADE 9

Maharam MEDIUM
100% Polyester

Alloy.....SMHMMDM03
Cosmic.....SMHMMDM50
Delight.....SMHMMDM36
Espresso.....SMHMMDM07
Flax.....SMHMMDM04
Hike.....SMHMMDM47
Laser.....SMHMMDM14
Marina.....SMHMMDM22
Nasturtium.....SMHMMDM53
Nautical.....SMHMMDM39
Pacific.....SMHMMDM49
Pecan.....SMHMMDM08
Pistachio.....SMHMMDM29
Pool.....SMHMMDM40
Port.....SMHMMDM16
Prospect.....SMHMMDM32
Pumpkin.....SMHMMDM12
Raven.....SMHMMDM01
Sculpture.....SMHMMDM45
Smoke.....SMHMMDM02
Tangle.....SMHMMDM48
Thatched.....SMHMMDM46
Washed.....SMHMMDM44

Multi-use fabrics are noted with the following designators: **B** – Tackboards, **C** – Concensys®, **O** – Optimize™, **T** – Terrace®, **F** – Further™.

* Colorway not shown on Textiles card; all Partnership Program memo samples are available from supplier. See contact information below.

ALLSTEEL PARTNERSHIP PROGRAM

Allsteel understands that customers may want to specify panel and seating textiles outside of Allsteel's standard offering. Allsteel's Partnership Program consists of on-trend and design-forward patterns that have been tested and approved by Allsteel for use on Allsteel products. A subset of these approved patterns is available on cards in the textile binder, while numerous others are available on our website, allsteeloffice.com.

For memo samples, please contact our partners:

- Camira, memos@camirafabrics.com 1.616.288.0655
- CF Stinson, cfstinson.com 1.800.841.6279
- HBF Textiles, hbftextiles.com 1.877.494.5727
- Maharam, maharam.com 1.800.645.3943
- Ultrafabrics, ultrafabricsinc.com, 1.877.309.6648

The intent of the **Partnership Program** is to offer a wide variety of on-trend textiles to meet your varied needs, but since these textiles are not part of our standard offering they may be subject to extended lead times. Because new materials will be introduced regularly, Allsteel reserves the right to change the offering at any time.

AVAILABLE SCREEN MATERIALS, MOUNTING METHODS, AND SIZES

Desktop Mounted Screens

		Elevated	Top Mount	Side Mount	F-2-B	S.O.S.	Lat Org	Modesty
Acrylic	H	13, 20	12, 20, 27	13, 20, 27	13, 20, 27	13, 20		13
	W	34, 36, 40, 42, 46, 48, 52, 54, 58, 60, 64, 66, 70, 72	21, 22, 24, 27, 28, 30, 36	21, 22, 24, 27, 28, 30, 36	21, 22, 24, 27, 28, 30, 36	36, 42, 48, 54, 60, 66, 72		30, 36, 42, 48, 54, 60, 66, 72
Fabric	H	13, 20, 27	13, 20	13, 20	13, 20, 27	13, 20		13
	W	34, 36, 40, 42, 46, 48, 52, 54, 58, 60, 64, 66, 70, 72	21, 22, 24, 27, 28, 30, 36	21, 22, 24, 27, 28, 30, 36	21, 22, 24, 27, 28, 30, 36	36, 42, 48, 54, 60, 66, 72		30, 36, 42, 48, 54, 60, 66, 72
Laminate	H	13, 20	13, 20, 27	13, 20, 27	13, 20, 27			13
	W	34, 36, 40, 42, 46, 48, 52, 54, 58, 60, 64, 66, 70, 72	21, 22, 24, 27, 28, 30, 36	21, 22, 24, 27, 28, 30, 36	21, 22, 24, 27, 28, 30, 36			30, 36, 42, 48, 54, 60, 66, 72
Glass	H	13, 20	13, 20	13, 20	13, 20			11
	W	34, 36, 40, 42, 46, 48, 52, 54, 58, 60, 64, 66, 70, 72	21, 22, 24, 27, 28, 30, 36	21, 22, 24, 27, 28, 30, 36	21, 22, 24, 27, 28, 30, 36			36, 42, 48, 54, 60
Metal	H						20	
	W						21, 27	

Above/Below Screens

		Movable A/B	Fixed A/B
Acrylic	H		27
	W		34, 36, 40, 42, 46, 48, 52, 54, 58, 60, 64, 66, 70, 72
Fabric	H	27, 34	27, 34
	W	34, 36, 40, 42, 46, 48, 52, 54, 58, 60, 64, 66, 70, 72	34, 36, 40, 42, 46, 48, 52, 54, 58, 60, 64, 66, 70, 72
Laminate	H		27
	W		34, 36, 40, 42, 46, 48, 52, 54, 58, 60, 64, 66, 70, 72
Glass	H		25
	W		36, 42, 48, 54, 60

Series-Specific Screens

		Further	Further Modesty
Acrylic	H	13, 20, 28	
	W	24, 30, 36, 42, 48, 54, 60, 66, 72	
Fabric	H	13, 20, 28	13, 20
	W	24, 30, 36, 42, 48, 54, 60, 66, 72	24, 30, 36, 42, 48, 54, 60, 66, 72
Laminate	H	13, 20, 28	
	W	24, 30, 36, 42, 48, 54, 60, 66, 72	
Glass	H	13, 20	
	W	24, 30, 36, 42, 48, 54, 60, 66, 72, 78, 84, 90, 96	

SUPPORT CLEARANCE RULES

	Above/ Below Movable	Above/Below Fixed	Elevated Mount	Top Mount	Side Mount	Front-to-Back	Sit-on- Surface	Modesty*
Recommended Inset from Edge of Worksurface								
Approach O-Leg	>9"	No Inset	No Inset	No Inset	Not Compatible	2"	No Inset	6"
Approach Splay Leg	>9"	No Inset	No Inset	No Inset	Not Compatible	Not Compatible	No Inset	6"
End Panel Leg	18"	6"	12"	No Inset	Not Compatible	Not Compatible	No Inset	6"
Huddle Post Leg	9"	No Inset	No Inset	No Inset	No Inset	No Inset	No Inset	6"
Altitude Base	No Inset	No Inset	No Inset	No Inset	No Inset	No Inset	No Inset	No Inset
Approach Shroud	6"	No Inset	No Inset	No Inset	No Inset	No Inset	No Inset	6"
Pedestal	>Ped Width	Ped Width -12"	Ped Width - 6"	No Inset	Not Compatible	Not Compatible	No Inset	Ped Width

* Recommended mounting location for modesty screens is inset 3-6" from approach edge of worksurface. Screens can be mounted flush to the edge if desired. When using modesty panels, please check for interference with worksurface supports based on inset location.

SCREEN MOUNTING TECH AND SPEC INFORMATION

Movable Above/Below

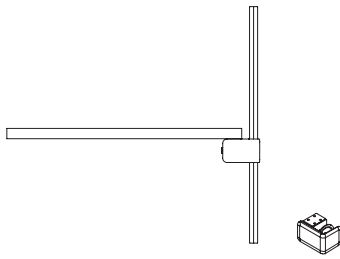

- Available in Fabric only.
- Screen is offset from edge of worksurface by 1" for cord management and to allow the use of worksurface-mounted accessories.
- Mounting brackets attach to underside of worksurface.
- Screen is secured to brackets with thumb screws, allowing users to adjust height up/down.
- Min. height above or below worksurface is 6".
- Brackets are secured on the outside edge of the screen.
- Brackets are available in standard paint options and ship uninstalled.

Sit-on-Surface Screen

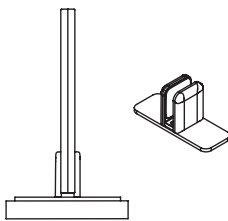

- Available in Fabric or Acrylic.
- Screen is slightly offset from top of worksurface.
- Brackets come with anti-slip neoprene foam pads and do not physically attach to worksurface.
- Brackets are designed to be rotated 90 degrees when needed.
- Screen is secured to brackets by tightening two set screws in bracket against screen material.
- Brackets are available in standard paint options and ship uninstalled.

Top Mount Screen

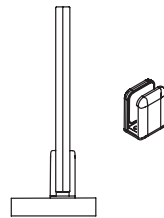

- Available in Fabric or Acrylic.
- Screen is slightly offset from top of worksurface.
- Mounting brackets attach to the top of the worksurface with either double-sided tape or wood screws.
- Screen is secured to brackets by tightening two set screws in bracket against screen material.
- Bracket location flexible and can be adjusted as needed. Recommended inset location is ~6-12" from edge of screen.
- Brackets are available in standard paint options and ship uninstalled.

Fixed Above/Below

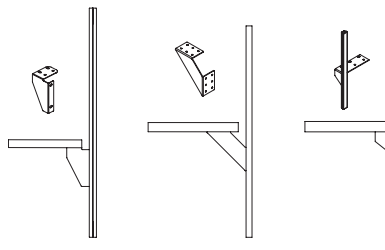

- Available in Fabric, Acrylic, or Laminate.
- Screen is offset from edge of worksurface by 1" for cord management and to allow the use of worksurface-mounted accessories.
- Mounting brackets attach to underside of worksurface.
- Fabric Screens are secured to brackets via metal fasteners to threaded inserts embedded in screen. Brackets are inset 10" (30-40"W) or 12" (42"W+) from edge of screen depending on size. Brackets are available in black paint only and ship installed.
- Acrylic Screens are secured to brackets via a metal fastener. Brackets are located on edge of screen. Brackets are available in standard paint options and ship uninstalled.
- Laminate Screens are secured to brackets via wood screws. Brackets are inset 10" (30-42"W) or 12" (48"W+). Brackets are available in black paint only and ship uninstalled.

Side Mount Screen

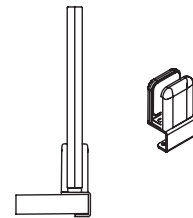

- Available in Fabric or Acrylic.
- Screen is slightly offset from top of worksurface.
- Mounting brackets wrap around the side edge of the worksurface.
- Screen is secured to brackets by tightening two set screws in bracket against screen material.
- Bracket location flexible and can be adjusted as needed. Recommended inset location is ~6-12" from edge of screen.
- Can only be used with flat-edged worksurfaces/tables.
- Brackets are available in standard paint options and ship uninstalled.

Elevated Screen

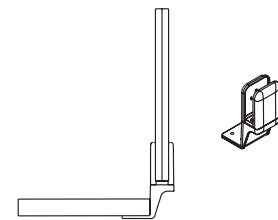

- Available in Fabric, Acrylic, or Glass.
- Screen is offset from top of worksurface by 1" for cord management and to allow the use of worksurface-mounted accessories.
- Mounting brackets attach to the underside of the worksurface.
- Screen is secured to brackets by tightening two set screws in bracket against screen material.
- Bracket location flexible and can be adjusted as needed. Recommended inset location is ~6-12" from edge of screen.
- Can only be used with flat-edged worksurfaces/tables.
- Brackets are available in standard paint options and ship uninstalled.

SCREEN MOUNTING TECH AND SPEC INFORMATION

Front-to-Back Screen

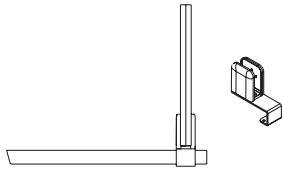

- Available in Fabric, Acrylic, or Glass.
- Screen is slightly offset from top of worksurface.
- Mounting brackets wrap around front and rear edge of the worksurface.
- Screen is secured to brackets by tightening two set screws in bracket against screen material.
- Bracket location is fixed on either side of the screen.
- Can only be used with flat-edged worksurfaces/tables.
- Brackets are available in standard paint options and ship uninstalled.

Further Beam Mount

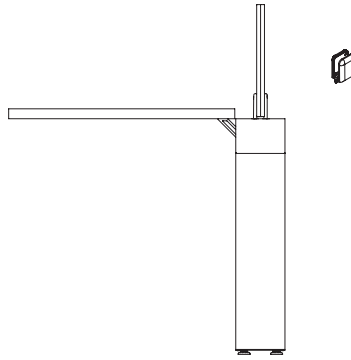

- Available in Fabric, Glass, Acrylic, or Laminate.
- Mounting brackets secure to slot in center of beam.
- Screens will provide access between screen and rear edge of worksurface for access to power rail or for mounting worksurface accessories.
- Screen is secured to brackets by tightening two set screws in bracket against screen material.
- Bracket location flexible and can be adjusted as needed. Recommended inset location is ~6-12" from edge of screen.
- For Further Adaptive applications select a desktop-mounted screen.
- Brackets are available in standard paint options and ship uninstalled.

Modesty Panel

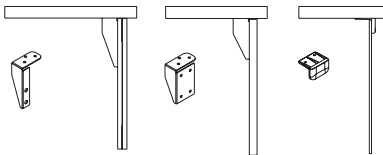

- Available in Fabric, Acrylic, or Laminate.
- Mounting brackets attach to the underside of the worksurface.
- Fabric modesty is secured to brackets via metal fasteners to threaded inserts embedded in screen. Brackets are inset 10" (30-40"W) or 12" (42"W+) from edge of screen depending on size. Brackets are available in black paint only and ship installed.
- Acrylic modesty is secured to brackets via metal fasteners through predrilled holes in modesty panel. Brackets are inset 10" (36"W) or 12" (42"W+) from edge of screen depending on size. Brackets are available in standard paint options and ship uninstalled.
- Laminate modesty is secured to brackets via wood screws. Brackets are inset 10" (30-42"W) or 12" (48"W+). Brackets are available in black paint only and ship uninstalled.

For specification information see pages 151-154.

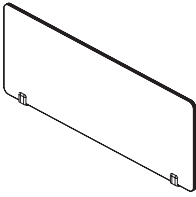

Description	Model	List Price					
		Grade A	Grade B	Grade C	Grade D	Grade E	Grade F
13"H Beam Mounted Center Screen — Fabric							
24"W	AFS1324BSF	\$ 647	\$ 677	\$ 705	\$ 734	\$ 774	\$ 812
30"W	AFS1330BSF	\$ 695	\$ 728	\$ 760	\$ 792	\$ 837	\$ 879
36"W	AFS1336BSF	\$ 729	\$ 765	\$ 800	\$ 834	\$ 881	\$ 926
42"W	AFS1342BSF	\$ 766	\$ 804	\$ 841	\$ 878	\$ 928	\$ 977
48"W	AFS1348BSF	\$ 806	\$ 848	\$ 887	\$ 927	\$ 980	\$ 1034
54"W	AFS1354BSF	\$ 848	\$ 892	\$ 934	\$ 977	\$ 1035	\$ 1092
60"W	AFS1360BSF	\$ 885	\$ 931	\$ 977	\$ 1021	\$ 1082	\$ 1143
66"W	AFS1366BSF	\$ 930	\$ 979	\$ 1027	\$ 1077	\$ 1142	\$ 1207
72"W	AFS1372BSF	\$ 981	\$ 1034	\$ 1087	\$ 1138	\$ 1208	\$ 1276

20"H Beam Mounted Center Screen — Fabric

24"W	AFS2024BSF	\$ 743	\$ 780	\$ 815	\$ 851	\$ 899	\$ 946
30"W	AFS2030BSF	\$ 792	\$ 833	\$ 871	\$ 910	\$ 962	\$ 1014
36"W	AFS2036BSF	\$ 828	\$ 871	\$ 912	\$ 953	\$ 1009	\$ 1063
42"W	AFS2042BSF	\$ 865	\$ 910	\$ 954	\$ 997	\$ 1057	\$ 1115
48"W	AFS2048BSF	\$ 905	\$ 953	\$ 999	\$ 1047	\$ 1109	\$ 1171
54"W	AFS2054BSF	\$ 948	\$ 998	\$ 1047	\$ 1098	\$ 1165	\$ 1231
60"W	AFS2060BSF	\$ 993	\$ 1047	\$ 1100	\$ 1152	\$ 1223	\$ 1294
66"W	AFS2066BSF	\$ 1047	\$ 1104	\$ 1162	\$ 1217	\$ 1294	\$ 1369
72"W	AFS2072BSF	\$ 1106	\$ 1167	\$ 1228	\$ 1289	\$ 1371	\$ 1451

28"H Beam Mounted Center Screen — Fabric

24"W	AFS2824BSF	\$ 837	\$ 880	\$ 922	\$ 964	\$ 1021	\$ 1076
30"W	AFS2830BSF	\$ 894	\$ 941	\$ 987	\$ 1034	\$ 1095	\$ 1155
36"W	AFS2836BSF	\$ 936	\$ 986	\$ 1034	\$ 1084	\$ 1150	\$ 1215
42"W	AFS2842BSF	\$ 981	\$ 1034	\$ 1087	\$ 1138	\$ 1208	\$ 1276
48"W	AFS2848BSF	\$ 1027	\$ 1083	\$ 1138	\$ 1193	\$ 1269	\$ 1342
54"W	AFS2854BSF	\$ 1078	\$ 1137	\$ 1196	\$ 1256	\$ 1334	\$ 1411
60"W	AFS2860BSF	\$ 1131	\$ 1195	\$ 1256	\$ 1320	\$ 1402	\$ 1486
66"W	AFS2866BSF	\$ 1136	\$ 1200	\$ 1263	\$ 1326	\$ 1409	\$ 1493
72"W	AFS2872BSF	\$ 1201	\$ 1269	\$ 1336	\$ 1403	\$ 1494	\$ 1583

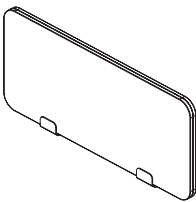

Description	Model	List Price					
		Grade A	Grade B	Grade C	Grade D	Grade E	Grade F
13"H Beam Mounted Modesty Screen — Fabric							
24"W	AFS1324BMF	\$ 523	\$ 553	\$ 581	\$ 610	\$ 650	\$ 688
30"W	AFS1330BMF	\$ 571	\$ 604	\$ 636	\$ 668	\$ 713	\$ 755
36"W	AFS1336BMF	\$ 605	\$ 641	\$ 676	\$ 710	\$ 757	\$ 802
42"W	AFS1342BMF	\$ 642	\$ 680	\$ 717	\$ 754	\$ 804	\$ 853
48"W	AFS1348BMF	\$ 682	\$ 724	\$ 763	\$ 803	\$ 856	\$ 910
54"W	AFS1354BMF	\$ 724	\$ 768	\$ 810	\$ 853	\$ 911	\$ 968
60"W	AFS1360BMF	\$ 761	\$ 807	\$ 853	\$ 897	\$ 958	\$ 1019
66"W	AFS1366BMF	\$ 806	\$ 855	\$ 903	\$ 953	\$ 1018	\$ 1083
72"W	AFS1372BMF	\$ 857	\$ 910	\$ 963	\$ 1014	\$ 1084	\$ 1152

20"H Beam Mounted Modesty Screen — Fabric

24"W	AFS2024BMF	\$ 619	\$ 656	\$ 691	\$ 727	\$ 775	\$ 822
30"W	AFS2030BMF	\$ 668	\$ 709	\$ 747	\$ 786	\$ 838	\$ 890
36"W	AFS2036BMF	\$ 704	\$ 747	\$ 788	\$ 829	\$ 885	\$ 939
42"W	AFS2042BMF	\$ 741	\$ 786	\$ 830	\$ 873	\$ 933	\$ 991
48"W	AFS2048BMF	\$ 781	\$ 829	\$ 875	\$ 923	\$ 985	\$ 1047
54"W	AFS2054BMF	\$ 824	\$ 874	\$ 923	\$ 974	\$ 1041	\$ 1107
60"W	AFS2060BMF	\$ 869	\$ 923	\$ 976	\$ 1028	\$ 1099	\$ 1170
66"W	AFS2066BMF	\$ 923	\$ 980	\$ 1038	\$ 1093	\$ 1170	\$ 1245
72"W	AFS2072BMF	\$ 982	\$ 1043	\$ 1104	\$ 1165	\$ 1247	\$ 1327

How to specify —

Select the Model Number from above.

1st Option:

Fabric:
See pages 148-149 for fabrics.

2nd Option:

Paint Color:
P1 P2 P3
See page 148 for finishes.

A F S | | | | | | | | .

Example:

For specification information see pages 151-154.

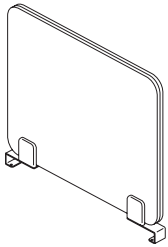

Description	Model	List Price					
		Grade A	Grade B	Grade C	Grade D	Grade E	Grade F
13"H Front-to-Back — Fabric							
21"W	AFS1321LDF	\$ 643	\$ 667	\$ 692	\$ 716	\$ 749	\$ 779
24"W	AFS1324LDF	\$ 668	\$ 695	\$ 721	\$ 747	\$ 780	\$ 815
27"W	AFS1327LDF	\$ 682	\$ 710	\$ 736	\$ 763	\$ 799	\$ 835
30"W	AFS1330LDF	\$ 711	\$ 740	\$ 769	\$ 797	\$ 836	\$ 875
36"W	AFS1336LDF	\$ 740	\$ 771	\$ 802	\$ 833	\$ 874	\$ 915
20"H Front-to-Back — Fabric							
21"W	AFS2021LDF	\$ 740	\$ 771	\$ 802	\$ 833	\$ 874	\$ 915
24"W	AFS2024LDF	\$ 767	\$ 800	\$ 833	\$ 865	\$ 910	\$ 952
27"W	AFS2027LDF	\$ 783	\$ 817	\$ 851	\$ 885	\$ 930	\$ 975
30"W	AFS2030LDF	\$ 808	\$ 844	\$ 880	\$ 915	\$ 963	\$ 1009
36"W	AFS2036LDF	\$ 844	\$ 884	\$ 921	\$ 959	\$ 1009	\$ 1060
27"H Front-to-Back — Fabric							
21"W	AFS2721LDF	\$ 815	\$ 852	\$ 888	\$ 924	\$ 972	\$ 1019
24"W	AFS2724LDF	\$ 848	\$ 888	\$ 926	\$ 964	\$ 1014	\$ 1065
27"W	AFS2727LDF	\$ 864	\$ 905	\$ 944	\$ 983	\$ 1035	\$ 1087
30"W	AFS2730LDF	\$ 900	\$ 943	\$ 984	\$ 1025	\$ 1082	\$ 1137
36"W	AFS2736LDF	\$ 939	\$ 984	\$ 1029	\$ 1072	\$ 1133	\$ 1192

Description	Model	List Price					
		Grade A	Grade B	Grade C	Grade D	Grade E	Grade F
13"H Front-to-Back HAT Screen — Fabric							
22"W	AFS1322LHF	\$ 655	\$ 680	\$ 705	\$ 730	\$ 764	\$ 797
28"W	AFS1328LHF	\$ 697	\$ 726	\$ 753	\$ 781	\$ 818	\$ 855
20"H Front-to-Back HAT Screen — Fabric							
22"W	AFS2022LHF	\$ 753	\$ 785	\$ 817	\$ 848	\$ 890	\$ 933
28"W	AFS2028LHF	\$ 790	\$ 824	\$ 860	\$ 893	\$ 939	\$ 984
27"H Front-to-Back HAT Screen — Fabric							
22"W	AFS2722LHF	\$ 831	\$ 869	\$ 906	\$ 943	\$ 992	\$ 1041
28"W	AFS2728LHF	\$ 882	\$ 924	\$ 964	\$ 1004	\$ 1059	\$ 1112

How to specify —
Select the Model Number from above.

A | F | S | | | | | | | | | | | .
Example:

1st Option:
Fabric:
See pages 148-149 for fabrics.

| | | | | .

2nd Option:
Paint Color:
P1 P2 P3
See page 148 for finishes.

| | | |

For specification information see pages 151-154.

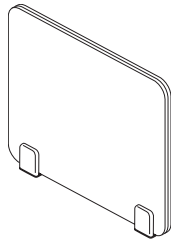

Description	Model	List Price					
		Grade A	Grade B	Grade C	Grade D	Grade E	Grade F
13"H Top Mount Screen — Fabric							
21"W	AFS1321LDT	\$ 643	\$ 667	\$ 692	\$ 716	\$ 749	\$ 779
24"W	AFS1324LDT	\$ 668	\$ 695	\$ 721	\$ 747	\$ 780	\$ 815
27"W	AFS1327LDT	\$ 682	\$ 710	\$ 736	\$ 763	\$ 799	\$ 835
30"W	AFS1330LDT	\$ 711	\$ 740	\$ 769	\$ 797	\$ 836	\$ 875
36"W	AFS1336LDT	\$ 740	\$ 771	\$ 802	\$ 833	\$ 874	\$ 915
20"H Top Mount Screen — Fabric							
21"W	AFS2021LDT	\$ 740	\$ 771	\$ 802	\$ 833	\$ 874	\$ 915
24"W	AFS2024LDT	\$ 767	\$ 800	\$ 833	\$ 865	\$ 910	\$ 952
27"W	AFS2027LDT	\$ 783	\$ 817	\$ 851	\$ 885	\$ 930	\$ 975
30"W	AFS2030LDT	\$ 808	\$ 844	\$ 880	\$ 915	\$ 963	\$ 1009
36"W	AFS2036LDT	\$ 844	\$ 884	\$ 921	\$ 959	\$ 1009	\$ 1060

Description	Model	List Price					
		Grade A	Grade B	Grade C	Grade D	Grade E	Grade F
13"H Top Mount HAT Screen — Fabric							
22"W	AFS1322LHT	\$ 655	\$ 680	\$ 705	\$ 730	\$ 764	\$ 797
28"W	AFS1328LHT	\$ 697	\$ 726	\$ 753	\$ 781	\$ 818	\$ 855
20"H Top Mount HAT Screen — Fabric							
22"W	AFS2022LHT	\$ 753	\$ 785	\$ 817	\$ 848	\$ 890	\$ 933
28"W	AFS2028LHT	\$ 790	\$ 824	\$ 860	\$ 893	\$ 939	\$ 984
27"H Top Mount HAT Screen — Fabric							
22"W	AFS2722LHT	\$ 831	\$ 869	\$ 906	\$ 943	\$ 992	\$ 1041
28"W	AFS2728LHT	\$ 882	\$ 924	\$ 964	\$ 1004	\$ 1059	\$ 1112

<p>How to specify — Select the Model Number from above.</p> <p>AFS .</p> <p><i>Example:</i></p>	<p>1st Option: Fabric: See pages 148-149 for fabrics.</p> <p> .</p>	<p>2nd Option: Paint Color: P1 P2 P3 See page 148 for finishes.</p> <p> </p>
---	--	--

For specification information see pages 151-154.

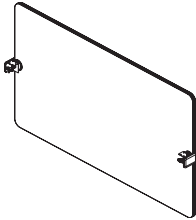

Description	Model	List Price					
		Grade A	Grade B	Grade C	Grade D	Grade E	Grade F
27"H Above/Below Screen — Fabric							
36"W	AFS2736DAS	\$ 892	\$ 937	\$ 982	\$ 1025	\$ 1086	\$ 1145
42"W	AFS2742DAS	\$ 932	\$ 980	\$ 1027	\$ 1075	\$ 1137	\$ 1200
48"W	AFS2748DAS	\$ 974	\$ 1026	\$ 1075	\$ 1126	\$ 1193	\$ 1259
54"W	AFS2754DAS	\$ 1020	\$ 1074	\$ 1128	\$ 1180	\$ 1252	\$ 1323
60"W	AFS2760DAS	\$ 1068	\$ 1125	\$ 1183	\$ 1238	\$ 1315	\$ 1390
66"W	AFS2766DAS	\$ 1127	\$ 1188	\$ 1249	\$ 1310	\$ 1392	\$ 1472
72"W	AFS2772DAS	\$ 1189	\$ 1255	\$ 1320	\$ 1384	\$ 1472	\$ 1558

34"H Above/Below Screen - Fabric

Description	Model	List Price					
		Grade A	Grade B	Grade C	Grade D	Grade E	Grade F
36"W	AFS3436DAS	\$ 856	\$ 899	\$ 941	\$ 983	\$ 1039	\$ 1093
42"W	AFS3442DAS	\$ 893	\$ 939	\$ 983	\$ 1027	\$ 1087	\$ 1146
48"W	AFS3448DAS	\$ 933	\$ 981	\$ 1028	\$ 1076	\$ 1139	\$ 1201
54"W	AFS3454DAS	\$ 1238	\$ 1308	\$ 1375	\$ 1443	\$ 1535	\$ 1627
60"W	AFS3460DAS	\$ 1297	\$ 1370	\$ 1443	\$ 1515	\$ 1613	\$ 1707
66"W	AFS3466DAS	\$ 1372	\$ 1451	\$ 1528	\$ 1605	\$ 1709	\$ 1813
72"W	AFS3472DAS	\$ 1416	\$ 1498	\$ 1577	\$ 1659	\$ 1768	\$ 1874

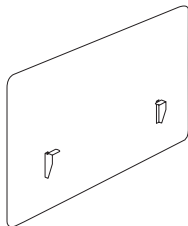

Description	Model	List Price					
		Grade A	Grade B	Grade C	Grade D	Grade E	Grade F
27"H Above/Below Adjustable HAT Screen — Fabric							
34"W	AFS2734DAS	\$ 872	\$ 916	\$ 959	\$ 1002	\$ 1059	\$ 1117
40"W	AFS2740DAS	\$ 911	\$ 958	\$ 1003	\$ 1048	\$ 1110	\$ 1171
46"W	AFS2746DAS	\$ 953	\$ 1002	\$ 1050	\$ 1100	\$ 1165	\$ 1230
52"W	AFS2752DAS	\$ 997	\$ 1050	\$ 1102	\$ 1153	\$ 1222	\$ 1291
58"W	AFS2758DAS	\$ 1044	\$ 1100	\$ 1155	\$ 1210	\$ 1283	\$ 1356
64"W	AFS2764DAS	\$ 1096	\$ 1155	\$ 1214	\$ 1273	\$ 1351	\$ 1428
70"W	AFS2770DAS	\$ 1157	\$ 1221	\$ 1284	\$ 1347	\$ 1430	\$ 1514

34"H Above/Below Adjustable HAT Screen — Fabric

Description	Model	List Price					
		Grade A	Grade B	Grade C	Grade D	Grade E	Grade F
34"W	AFS3434DAS	\$ 837	\$ 879	\$ 919	\$ 959	\$ 1015	\$ 1068
40"W	AFS3440DAS	\$ 874	\$ 918	\$ 961	\$ 1004	\$ 1063	\$ 1120
46"W	AFS3446DAS	\$ 913	\$ 960	\$ 1006	\$ 1050	\$ 1112	\$ 1174
52"W	AFS3452DAS	\$ 1209	\$ 1276	\$ 1342	\$ 1408	\$ 1498	\$ 1586
58"W	AFS3458DAS	\$ 1269	\$ 1341	\$ 1411	\$ 1481	\$ 1575	\$ 1670
64"W	AFS3464DAS	\$ 1334	\$ 1411	\$ 1484	\$ 1559	\$ 1661	\$ 1760
70"W	AFS3470DAS	\$ 1377	\$ 1456	\$ 1534	\$ 1611	\$ 1716	\$ 1819

<p>How to specify — Select the Model Number from above.</p> <p>A F S .</p>	<p>1st Option: Fabric: See pages 148-149 for fabrics.</p> <p> .</p>	<p>2nd Option: Paint Color: P1 P2 P3 See page 148 for finishes.</p> <p> .</p>
--	--	---

Example:

For specification information see pages 151-154.

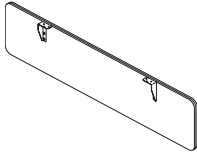

Description	Model	List Price					
		Grade A	Grade B	Grade C	Grade D	Grade E	Grade F
13"H Modesty Screen — Fabric							
30"W	AFS1330MPD	\$ 762	\$ 795	\$ 827	\$ 859	\$ 904	\$ 946
36"W	AFS1336MPD	\$ 796	\$ 832	\$ 867	\$ 901	\$ 948	\$ 993
42"W	AFS1342MPD	\$ 833	\$ 871	\$ 908	\$ 945	\$ 995	\$ 1044
48"W	AFS1348MPD	\$ 874	\$ 916	\$ 955	\$ 995	\$ 1048	\$ 1102
54"W	AFS1354MPD	\$ 915	\$ 959	\$ 1001	\$ 1044	\$ 1102	\$ 1159
60"W	AFS1360MPD	\$ 952	\$ 998	\$ 1044	\$ 1088	\$ 1149	\$ 1210
66"W	AFS1366MPD	\$ 998	\$ 1047	\$ 1095	\$ 1145	\$ 1210	\$ 1275
72"W	AFS1372MPD	\$ 1048	\$ 1101	\$ 1154	\$ 1205	\$ 1275	\$ 1343

How to specify —
Select the Model Number from above.

1st Option:
Fabric:
See pages 148-149 for fabrics.

2nd Option:
Paint Color:
P1 P2 P3
See page 148 for finishes.

AFS | | | | | | | | | | | | | | | | | | | | .

Example:

Fabric

Open Market

For specification information see pages 151-154.

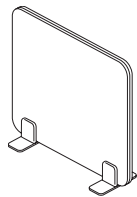

Description	Model	List Price					
		Grade A	Grade B	Grade C	Grade D	Grade E	Grade F
13"H Sit-on-Surface Screen — Fabric							
36"W	AFS1336SFS	\$ 630	\$ 661	\$ 692	\$ 723	\$ 764	\$ 805
42"W	AFS1342SFS	\$ 662	\$ 695	\$ 728	\$ 761	\$ 806	\$ 849
48"W	AFS1348SFS	\$ 696	\$ 732	\$ 768	\$ 803	\$ 850	\$ 897
54"W	AFS1354SFS	\$ 731	\$ 771	\$ 808	\$ 846	\$ 896	\$ 946
60"W	AFS1360SFS	\$ 771	\$ 813	\$ 853	\$ 893	\$ 948	\$ 1001
66"W	AFS1366SFS	\$ 812	\$ 856	\$ 899	\$ 942	\$ 1001	\$ 1058
72"W	AFS1372SFS	\$ 857	\$ 904	\$ 950	\$ 998	\$ 1059	\$ 1121
20"H Sit-on-Surface Screen — Fabric							
36"W	AFS2036SFS	\$ 734	\$ 774	\$ 811	\$ 849	\$ 899	\$ 950
42"W	AFS2042SFS	\$ 773	\$ 815	\$ 855	\$ 895	\$ 951	\$ 1004
48"W	AFS2048SFS	\$ 814	\$ 859	\$ 901	\$ 945	\$ 1004	\$ 1061
54"W	AFS2054SFS	\$ 859	\$ 906	\$ 953	\$ 1000	\$ 1062	\$ 1124
60"W	AFS2060SFS	\$ 907	\$ 957	\$ 1008	\$ 1057	\$ 1125	\$ 1190
66"W	AFS2066SFS	\$ 958	\$ 1012	\$ 1066	\$ 1118	\$ 1190	\$ 1261
72"W	AFS2072SFS	\$ 1014	\$ 1072	\$ 1130	\$ 1187	\$ 1263	\$ 1340

How to specify —

Select the Model Number from above.

A|F|S | | | | | | | | | | | .

Example:

1st Option:

Fabric:
See pages 148-149 for fabrics.

| | | | | .

2nd Option:

Paint Color:
P1 P2 P3
See page 148 for finishes.

| | | .

For specification information see pages [151-154](#).

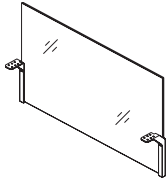

Description	Model	P1 Paint				P2 Paint			
		Clear	Frosted	Writable	Smoked	Clear	Frosted	Writable	Smoked
25"H Above/Below Screen — Glass									
36"W	AGS2536DFS	\$ 1090	\$ 1221	\$ 1221	\$ 1199	\$ 1103	\$ 1234	\$ 1234	\$ 1212
42"W	AGS2542DFS	\$ 1195	\$ 1342	\$ 1342	\$ 1317	\$ 1208	\$ 1355	\$ 1355	\$ 1330
48"W	AGS2548DFS	\$ 1269	\$ 1427	\$ 1427	\$ 1401	\$ 1282	\$ 1440	\$ 1440	\$ 1414
54"W	AGS2554DFS	\$ 1354	\$ 1525	\$ 1525	\$ 1498	\$ 1367	\$ 1538	\$ 1538	\$ 1511
60"W	AGS2560DFS	\$ 1422	\$ 1604	\$ 1604	\$ 1575	\$ 1435	\$ 1617	\$ 1617	\$ 1588

NOTE: Glass screens cannot be used with height adjustable tables.

How to specify —
Select the Model Number from above.

1st Option:

Glass:

- LC Clear
- LF Frosted
- LM Writable
- GSM1 Smoked

2nd Option:

Paint Color:



See page [148](#) for finishes.

AGS | | | | | | | | | | | | .

Example:

For specification information see pages 151-154.

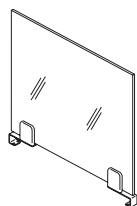

Description	Model	P1 Paint				P2 Paint			
		Clear	Frosted	Writable	Smoked	Clear	Frosted	Writable	Smoked
13"H Front-to-Back Screen — Glass									
21"W	AGS1321LDF	\$ 940	\$ 1041	\$ 1041	\$ 1024	\$ 957	\$ 1058	\$ 1058	\$ 1041
24"W	AGS1324LDF	\$ 965	\$ 1070	\$ 1070	\$ 1052	\$ 982	\$ 1087	\$ 1087	\$ 1069
27"W	AGS1327LDF	\$ 971	\$ 1077	\$ 1077	\$ 1058	\$ 988	\$ 1094	\$ 1094	\$ 1075
30"W	AGS1330LDF	\$ 977	\$ 1084	\$ 1084	\$ 1066	\$ 994	\$ 1101	\$ 1101	\$ 1083
36"W	AGS1336LDF	\$ 1017	\$ 1129	\$ 1129	\$ 1111	\$ 1034	\$ 1146	\$ 1146	\$ 1128
20"H Front-to-Back Screen — Glass									
21"W	AGS2021LDF	\$ 1010	\$ 1121	\$ 1121	\$ 1103	\$ 1027	\$ 1138	\$ 1138	\$ 1120
24"W	AGS2024LDF	\$ 1039	\$ 1155	\$ 1155	\$ 1135	\$ 1056	\$ 1172	\$ 1172	\$ 1152
27"W	AGS2027LDF	\$ 1046	\$ 1163	\$ 1163	\$ 1143	\$ 1063	\$ 1180	\$ 1180	\$ 1160
30"W	AGS2030LDF	\$ 1052	\$ 1170	\$ 1170	\$ 1150	\$ 1069	\$ 1187	\$ 1187	\$ 1167
36"W	AGS2036LDF	\$ 1097	\$ 1221	\$ 1221	\$ 1202	\$ 1114	\$ 1238	\$ 1238	\$ 1219

Description	Model	P1 Paint				P2 Paint			
		Clear	Frosted	Writable	Smoked	Clear	Frosted	Writable	Smoked
13"H Front-to-Back HAT Screen — Glass									
22"W	AGS1322LHF	\$ 940	\$ 1041	\$ 1041	\$ 1024	\$ 957	\$ 1058	\$ 1058	\$ 1041
28"W	AGS1328LHF	\$ 971	\$ 1077	\$ 1077	\$ 1058	\$ 988	\$ 1094	\$ 1094	\$ 1075
20"H Front-to-Back HAT Screen — Glass									
22"W	AGS2022LHF	\$ 1010	\$ 1121	\$ 1121	\$ 1103	\$ 1027	\$ 1138	\$ 1138	\$ 1120
28"W	AGS2028LHF	\$ 1046	\$ 1163	\$ 1163	\$ 1143	\$ 1063	\$ 1180	\$ 1180	\$ 1160

<p>How to specify — Select the Model Number from above.</p>	<p>1st Option: Glass: LC Clear LF Frosted LM Writable GSM1 Smoked</p>	<p>2nd Option: Paint Color: P1 P2 P3 See page 148 for finishes.</p>
<p>AGS .</p>	<p> .</p>	<p> .</p>

Example:

For specification information see pages 151-154.

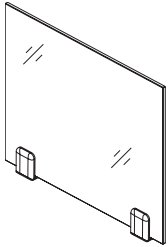

Description	Model	P1 Paint				P2 Paint			
		Clear	Frosted	Writable	Smoked	Clear	Frosted	Writable	Smoked
13"H Top Mount Screen — Glass									
21"W	AGS1321LDT	\$ 940	\$ 1041	\$ 1041	\$ 1024	\$ 957	\$ 1058	\$ 1058	\$ 1041
24"W	AGS1324LDT	\$ 965	\$ 1070	\$ 1070	\$ 1052	\$ 982	\$ 1087	\$ 1087	\$ 1069
27"W	AGS1327LDT	\$ 971	\$ 1077	\$ 1077	\$ 1058	\$ 988	\$ 1094	\$ 1094	\$ 1075
30"W	AGS1330LDT	\$ 977	\$ 1084	\$ 1084	\$ 1066	\$ 994	\$ 1101	\$ 1101	\$ 1083
36"W	AGS1336LDT	\$ 1017	\$ 1129	\$ 1129	\$ 1111	\$ 1034	\$ 1146	\$ 1146	\$ 1128
20"H Top Mount Screen — Glass									
21"W	AGS2021LDT	\$ 1010	\$ 1121	\$ 1121	\$ 1103	\$ 1027	\$ 1138	\$ 1138	\$ 1120
24"W	AGS2024LDT	\$ 1039	\$ 1155	\$ 1155	\$ 1135	\$ 1056	\$ 1172	\$ 1172	\$ 1152
27"W	AGS2027LDT	\$ 1046	\$ 1163	\$ 1163	\$ 1143	\$ 1063	\$ 1180	\$ 1180	\$ 1160
30"W	AGS2030LDT	\$ 1052	\$ 1170	\$ 1170	\$ 1150	\$ 1069	\$ 1187	\$ 1187	\$ 1167
36"W	AGS2036LDT	\$ 1097	\$ 1221	\$ 1221	\$ 1202	\$ 1114	\$ 1238	\$ 1238	\$ 1219

Description	Model	P1 Paint				P2 Paint			
		Clear	Frosted	Writable	Smoked	Clear	Frosted	Writable	Smoked
13"H Top Mount HAT Screen — Glass									
22"W	AGS1322LHT	\$ 940	\$ 1041	\$ 1041	\$ 1024	\$ 957	\$ 1058	\$ 1058	\$ 1041
28"W	AGS1328LHT	\$ 971	\$ 1077	\$ 1077	\$ 1058	\$ 988	\$ 1094	\$ 1094	\$ 1075
20"H Top Mount HAT Screen — Glass									
22"W	AGS2022LHT	\$ 1010	\$ 1121	\$ 1121	\$ 1103	\$ 1027	\$ 1138	\$ 1138	\$ 1120
28"W	AGS2028LHT	\$ 1046	\$ 1163	\$ 1163	\$ 1143	\$ 1063	\$ 1180	\$ 1180	\$ 1160

How to specify —
Select the Model Number from above.

1st Option:

Glass:
LC Clear
LF Frosted
LM Writable
GSM1 Smoked

2nd Option:

Paint Color:
P1 P2 P3
See page 148 for finishes.

AGS | | | | | | | | | | | | | | | | | | | | .
Example:

Glass

Open Market

For specification information see pages 151-154.

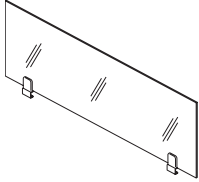

Description	Model	P1 Paint				P2 Paint			
		Clear	Frosted	Writable	Smoked	Clear	Frosted	Writable	Smoked
13"H Side Mount Screen — Glass									
21"W	AGS1321LDS	\$ 940	\$ 1041	\$ 1041	\$ 1024	\$ 957	\$ 1058	\$ 1058	\$ 1041
24"W	AGS1324LDS	\$ 965	\$ 1070	\$ 1070	\$ 1052	\$ 982	\$ 1087	\$ 1087	\$ 1069
27"W	AGS1327LDS	\$ 971	\$ 1077	\$ 1077	\$ 1058	\$ 988	\$ 1094	\$ 1094	\$ 1075
30"W	AGS1330LDS	\$ 977	\$ 1084	\$ 1084	\$ 1066	\$ 994	\$ 1101	\$ 1101	\$ 1083
36"W	AGS1336LDS	\$ 1017	\$ 1129	\$ 1129	\$ 1111	\$ 1034	\$ 1146	\$ 1146	\$ 1128
20"H Side Mount Screen — Glass									
21"W	AGS2021LDS	\$ 1010	\$ 1121	\$ 1121	\$ 1103	\$ 1027	\$ 1138	\$ 1138	\$ 1120
24"W	AGS2024LDS	\$ 1039	\$ 1155	\$ 1155	\$ 1135	\$ 1056	\$ 1172	\$ 1172	\$ 1152
27"W	AGS2027LDS	\$ 1046	\$ 1163	\$ 1163	\$ 1143	\$ 1063	\$ 1180	\$ 1180	\$ 1160
30"W	AGS2030LDS	\$ 1052	\$ 1170	\$ 1170	\$ 1150	\$ 1069	\$ 1187	\$ 1187	\$ 1167
36"W	AGS2036LDS	\$ 1097	\$ 1221	\$ 1221	\$ 1202	\$ 1114	\$ 1238	\$ 1238	\$ 1219

Description	Model	P1 Paint				P2 Paint			
		Clear	Frosted	Writable	Smoked	Clear	Frosted	Writable	Smoked
13"H Side Mount HAT Screen — Glass									
22"W	AGS1322LHS	\$ 940	\$ 1041	\$ 1041	\$ 1024	\$ 957	\$ 1058	\$ 1058	\$ 1041
28"W	AGS1328LHS	\$ 971	\$ 1077	\$ 1077	\$ 1058	\$ 988	\$ 1094	\$ 1094	\$ 1075
20"H Side Mount HAT Screen — Glass									
22"W	AGS2022LHS	\$ 1010	\$ 1121	\$ 1121	\$ 1103	\$ 1027	\$ 1138	\$ 1138	\$ 1120
28"W	AGS2028LHS	\$ 1046	\$ 1163	\$ 1163	\$ 1143	\$ 1063	\$ 1180	\$ 1180	\$ 1160

<p>How to specify — Select the Model Number from above.</p>	<p>1st Option: Glass: LC Clear LF Frosted LM Writable GSM1 Smoked</p>	<p>2nd Option: Paint Color: P1 P2 P3 See page 148 for finishes.</p>	
AGS .	.	.	

Example:

For specification information see pages [151-154](#).

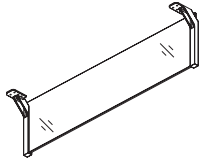

Description	Model	P1 Paint				P2 Paint			
		Clear	Frosted	Writable	Smoked	Clear	Frosted	Writable	Smoked
11"H Modesty Screen — Glass									
36"W	AGS1136MPD	\$ 970	\$ 1082	\$ 1082	\$ 1064	\$ 983	\$ 1095	\$ 1095	\$ 1077
42"W	AGS1142MPD	\$ 1030	\$ 1151	\$ 1151	\$ 1132	\$ 1043	\$ 1164	\$ 1164	\$ 1145
48"W	AGS1148MPD	\$ 1052	\$ 1176	\$ 1176	\$ 1157	\$ 1065	\$ 1189	\$ 1189	\$ 1170
54"W	AGS1154MPD	\$ 1123	\$ 1258	\$ 1258	\$ 1236	\$ 1136	\$ 1271	\$ 1271	\$ 1249
60"W	AGS1160MPD	\$ 1164	\$ 1307	\$ 1307	\$ 1283	\$ 1177	\$ 1320	\$ 1320	\$ 1296

NOTE: Glass screens cannot be used with height adjustable tables.

How to specify —
Select the Model Number from above.

1st Option:

Glass:

- LC Clear
- LF Frosted
- LM Writable
- GSM1 Smoked

2nd Option:

Paint Color:



See page [148](#) for finishes.

AGS | | | | | | | | | | | | | | | | | | .

Example:

| | | | | | | | .

| | | | | .

Acrylic

Open Market

For specification information see pages 151-154.

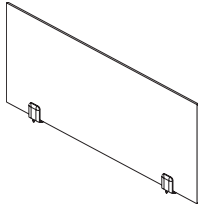

Description	Model	List Price by Acrylic Type	
		Clear	Frosted
13"H Beam Mounted Center Screen — Acrylic			
24"W	AAS1324BSF	\$ 449	\$ 636
30"W	AAS1330BSF	\$ 491	\$ 741
36"W	AAS1336BSF	\$ 499	\$ 755
42"W	AAS1342BSF	\$ 589	\$ 934
48"W	AAS1348BSF	\$ 612	\$ 957
54"W	AAS1354BSF	\$ 679	\$ 1107
60"W	AAS1360BSF	\$ 702	\$ 1119
66"W	AAS1366BSF	\$ 769	\$ 1266
72"W	AAS1372BSF	\$ 792	\$ 1289

20"H Beam Mounted Center Screen — Acrylic			
24"W	AAS2024BSF	\$ 620	\$ 996
30"W	AAS2030BSF	\$ 687	\$ 994
36"W	AAS2036BSF	\$ 702	\$ 1147
42"W	AAS2042BSF	\$ 859	\$ 1463
48"W	AAS2048BSF	\$ 882	\$ 1473
54"W	AAS2054BSF	\$ 1017	\$ 1763
60"W	AAS2060BSF	\$ 1027	\$ 1786
66"W	AAS2066BSF	\$ 1174	\$ 2065
72"W	AAS2072BSF	\$ 1196	\$ 2076

28"H Beam Mounted Center Screen — Acrylic			
24"W	AAS2824BSF	\$ 649	\$ 1051
30"W	AAS2830BSF	\$ 777	\$ 1251
36"W	AAS2836BSF	\$ 859	\$ 1454
42"W	AAS2842BSF	\$ 1070	\$ 1873
48"W	AAS2848BSF	\$ 1092	\$ 1896
54"W	AAS2854BSF	\$ 1279	\$ 2109
60"W	AAS2860BSF	\$ 1302	\$ 2132
66"W	AAS2866BSF	\$ 1490	\$ 2479
72"W	AAS2872BSF	\$ 1513	\$ 2502

<p>How to specify — Select the Model Number from above.</p> <p>AAS .</p>	<p>1st Option: Acrylic: ASC Clear ASF Frosted</p> <p> .</p>	<p>2nd Option: Paint Color: P1 P2 P3 See page 148 for finishes.</p> <p> .</p>	<p>3rd Option: Corner: SQ Square RD Round</p> <p> .</p>
---	--	--	--

Example:

For specification information see pages 151-154.

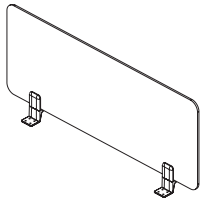

Description	Model	List Price by Acrylic Type	
		Clear	Frosted
13"H Elevated Screen — Acrylic			
11"H x 36"W	AAS1336DFS	\$ 524	\$ 748
11"H x 42"W	AAS1342DFS	\$ 592	\$ 894
11"H x 48"W	AAS1348DFS	\$ 626	\$ 916
11"H x 54"W	AAS1354DFS	\$ 682	\$ 1055
11"H x 60"W	AAS1360DFS	\$ 717	\$ 1078
11"H x 66"W	AAS1366DFS	\$ 760	\$ 1206
11"H x 72"W	AAS1372DFS	\$ 795	\$ 1229

20"H Elevated Screen — Acrylic			
18"H x 36"W	AAS2036DFS	\$ 678	\$ 1024
18"H x 42"W	AAS2042DFS	\$ 813	\$ 1263
18"H x 48"W	AAS2048DFS	\$ 848	\$ 1286
18"H x 54"W	AAS2054DFS	\$ 919	\$ 1517
18"H x 60"W	AAS2060DFS	\$ 941	\$ 1539
18"H x 66"W	AAS2066DFS	\$ 1045	\$ 1758
18"H x 72"W	AAS2072DFS	\$ 1068	\$ 1792

Description	Model	List Price by Acrylic Type	
		Clear	Frosted
13"H Elevated HAT Screen — Acrylic			
11"H x 34"W	AAS1334DFS	\$ 513	\$ 736
11"H x 40"W	AAS1340DFS	\$ 557	\$ 825
11"H x 46"W	AAS1346DFS	\$ 603	\$ 905
11"H x 52"W	AAS1352DFS	\$ 671	\$ 1044
11"H x 58"W	AAS1358DFS	\$ 694	\$ 1067
11"H x 64"W	AAS1364DFS	\$ 750	\$ 1195
11"H x 70"W	AAS1370DFS	\$ 783	\$ 1217

20"H Elevated HAT Screen — Acrylic			
18"H x 34"W	AAS2034DFS	\$ 655	\$ 1012
18"H x 40"W	AAS2040DFS	\$ 802	\$ 1230
18"H x 46"W	AAS2046DFS	\$ 825	\$ 1274
18"H x 52"W	AAS2052DFS	\$ 907	\$ 1505
18"H x 58"W	AAS2058DFS	\$ 929	\$ 1527
18"H x 64"W	AAS2064DFS	\$ 1033	\$ 1746
18"H x 70"W	AAS2070DFS	\$ 1056	\$ 1782

<p>How to specify — Select the Model Number from above.</p>	<p>1st Option: Acrylic: ASC Clear ASF Frosted</p>	<p>2nd Option: Paint Color: P1 P2 P3 See page 148 for finishes.</p>	<p>3rd Option: Corner: SQ Square RD Round</p>
<p>AAS .</p> <p><i>Example:</i></p>	<p> .</p>	<p> .</p>	<p> .</p>

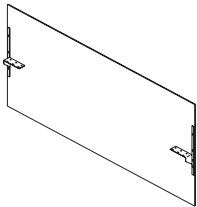
For specification information see pages [151-154](#).

Description	Model	List Price
27"H Above/Below Screen — Acrylic		
27"H x 36" W	AAS2736DFS	\$ 1021
27"H x 42" W	AAS2742DFS	\$ 1137
27"H x 48" W	AAS2748DFS	\$ 1159
27"H x 54" W	AAS2754DFS	\$ 1347
27"H x 60" W	AAS2760DFS	\$ 1370
27"H x 66" W	AAS2766DFS	\$ 1557
27"H x 72" W	AAS2772DFS	\$ 1580

Description	Model	List Price
27"H Above/Below HAT Screen — Acrylic		
27"H x 34" W	AAS2734DFS	\$ 991
27"H x 40" W	AAS2740DFS	\$ 1080
27"H x 46" W	AAS2746DFS	\$ 1148
27"H x 52" W	AAS2752DFS	\$ 1253
27"H x 58" W	AAS2758DFS	\$ 1359
27"H x 64" W	AAS2764DFS	\$ 1463
27"H x 70" W	AAS2770DFS	\$ 1568

How to specify —
Select the Model Number from above.

1st Option:
Acrylic:
ASF Frosted

2nd Option:
Paint Color:
P1 P2 P3
See page 148 for finishes.

3rd Option:
Corner:
SQ Square
RD Round

AAS | | | | | | | | | | | | | | | | .

Example:

For specification information see pages [151-154](#).

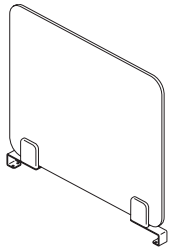

Description	Model	List Price by Acrylic Type	
		Clear	Frosted
13"H Front-to-Back Screen — Acrylic			
21"W	AAS1321LDF	\$ 494	\$ 681
24"W	AAS1324LDF	\$ 517	\$ 704
27"W	AAS1327LDF	\$ 526	\$ 736
30"W	AAS1330LDF	\$ 559	\$ 809
36"W	AAS1336LDF	\$ 567	\$ 823
20"H Front-to-Back Screen — Acrylic			
21"W	AAS2021LDF	\$ 633	\$ 949
24"W	AAS2024LDF	\$ 688	\$ 1064
27"W	AAS2027LDF	\$ 732	\$ 1150
30"W	AAS2030LDF	\$ 755	\$ 1062
36"W	AAS2036LDF	\$ 770	\$ 1215
27"H Front-to-Back Screen — Acrylic			
21"W	AAS2721LDF	\$ 697	\$ 1077
24"W	AAS2724LDF	\$ 717	\$ 1119
27"W	AAS2727LDF	\$ 822	\$ 1320
30"W	AAS2730LDF	\$ 845	\$ 1343
36"W	AAS2736LDF	\$ 1021	\$ 1169

Description	Model	List Price by Acrylic Type	
		Clear	Frosted
13"H Front-to-Back HAT Screen — Acrylic			
13"H x 22"W	AAS1322LHF	\$ 505	\$ 692
13"H x 28"W	AAS1328LHF	\$ 537	\$ 747
20"H Front-to-Back HAT Screen — Acrylic			
20"H x 22"W	AAS2022LHF	\$ 642	\$ 977
20"H x 28"W	AAS2028LHF	\$ 744	\$ 1365
27"H Front-to-Back HAT Screen — Acrylic			
27"H x 22"W	AAS2722LHF	\$ 702	\$ 1088
27"H x 28"W	AAS2728LHF	\$ 834	\$ 1332

<p>How to specify — Select the Model Number from above.</p> <p>A A S .</p> <p><i>Example:</i></p>	<p>1st Option: Acrylic: ASC Clear ASF Frosted</p> <p> .</p>	<p>2nd Option: Paint Color: P1 P2 P3 See page 148 for finishes.</p> <p> .</p>	<p>3rd Option: Corner: SQ Square RD Round</p> <p> .</p>
--	--	--	--

For specification information see pages [151-154](#).

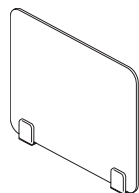

Description	Model	List Price by Acrylic Type	
		Clear	Frosted
13"H Top Mount Screen — Acrylic			
21"W	AAS1321LDT	\$ 494	\$ 681
24"W	AAS1324LDT	\$ 517	\$ 704
27"W	AAS1327LDT	\$ 526	\$ 736
30"W	AAS1330LDT	\$ 559	\$ 809
36"W	AAS1336LDT	\$ 567	\$ 823
20"H Top Mount Screen — Acrylic			
21"W	AAS2021LDT	\$ 633	\$ 949
24"W	AAS2024LDT	\$ 688	\$ 1064
27"W	AAS2027LDT	\$ 732	\$ 1150
30"W	AAS2030LDT	\$ 755	\$ 1062
36"W	AAS2036LDT	\$ 770	\$ 1215
27"H Top Mount Screen — Acrylic			
21"W	AAS2721LDT	\$ 697	\$ 1077
24"W	AAS2724LDT	\$ 717	\$ 1119
27"W	AAS2727LDT	\$ 822	\$ 1320
30"W	AAS2730LDT	\$ 845	\$ 1343
36"W	AAS2736LDT	\$ 1021	\$ 1169

Description	Model	List Price by Acrylic Type	
		Clear	Frosted
13"H Top Mount HAT Screen — Acrylic			
13"H x 22"W	AAS1322LHT	\$ 505	\$ 692
13"H x 28"W	AAS1328LHT	\$ 537	\$ 747
20"H Top Mount HAT Screen — Acrylic			
20"H x 22"W	AAS2022LHT	\$ 642	\$ 977
20"H x 28"W	AAS2028LHT	\$ 744	\$ 1365
27"H Top Mount HAT Screen — Acrylic			
27"H x 22"W	AAS2722LHT	\$ 702	\$ 1088
27"H x 28"W	AAS2728LHT	\$ 834	\$ 1332

<p>How to specify — Select the Model Number from above.</p> <p>AAS .</p>	<p>1st Option: Acrylic: ASC Clear ASF Frosted</p> <p> .</p>	<p>2nd Option: Paint Color: P1 P2 P3 See page 148 for finishes.</p> <p> .</p>	<p>3rd Option: Corner: SQ Square RD Round</p> <p> </p>
---	--	--	--

Example:

Acrylic

Open Market

For specification information see pages 151-154.

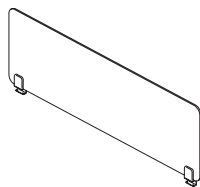

Description	Model	List Price by Acrylic Type	
		Clear	Frosted
13"H Side Mount Screen — Acrylic			
21"W	AAS1321LDS	\$ 494	\$ 681
24"W	AAS1324LDS	\$ 517	\$ 704
27"W	AAS1327LDS	\$ 526	\$ 736
30"W	AAS1330LDS	\$ 559	\$ 809
36"W	AAS1336LDS	\$ 567	\$ 823
20"H Side Mount Screen — Acrylic			
21"W	AAS2021LDS	\$ 633	\$ 949
24"W	AAS2024LDS	\$ 688	\$ 1064
27"W	AAS2027LDS	\$ 732	\$ 1150
30"W	AAS2030LDS	\$ 755	\$ 1062
36"W	AAS2036LDS	\$ 770	\$ 1215
27"H Side Mount Screen — Acrylic			
21"W	AAS2721LDS	\$ 697	\$ 1077
24"W	AAS2724LDS	\$ 717	\$ 1119
27"W	AAS2727LDS	\$ 822	\$ 1320
30"W	AAS2730LDS	\$ 845	\$ 1343
36"W	AAS2736LDS	\$ 1021	\$ 1169

Description	Model	List Price by Acrylic Type	
		Clear	Frosted
13"H Side Mount HAT Screen — Acrylic			
13"H x 22"W	AAS1322LHS	\$ 505	\$ 692
13"H x 28"W	AAS1328LHS	\$ 537	\$ 747
20"H Side Mount HAT Screen — Acrylic			
20"H x 22"W	AAS2022LHS	\$ 642	\$ 977
20"H x 28"W	AAS2028LHS	\$ 744	\$ 1365
27"H Side Mount HAT Screen — Acrylic			
27"H x 22"W	AAS2722LHS	\$ 702	\$ 1088
27"H x 28"W	AAS2728LHS	\$ 834	\$ 1332

<p>How to specify — Select the Model Number from above.</p>	<p>1st Option: Acrylic: ASC Clear ASF Frosted</p>	<p>2nd Option: Paint Color: P1 P2 P3 See page 148 for finishes.</p>	<p>3rd Option: Corner: SQ Square RD Round</p>
<p>AAS .</p>	<p> .</p>	<p> .</p>	<p> .</p>

Example:

For specification information see pages 151-154.

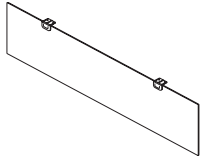

Description	Model	List Price by Acrylic Type	
		Clear	Frosted
13"H Modesty Screen — Acrylic			
13"H x 30"W	AAS1330MPD	\$ 412	\$ 412
13"H x 36"W	AAS1336MPD	\$ 420	\$ 420
13"H x 42"W	AAS1342MPD	\$ 510	\$ 510
13"H x 48"W	AAS1348MPD	\$ 533	\$ 533
13"H x 54"W	AAS1354MPD	\$ 600	\$ 600
13"H x 60"W	AAS1360MPD	\$ 623	\$ 623
13"H x 66"W	AAS1366MPD	\$ 690	\$ 690
13"H x 72"W	AAS1372MPD	\$ 713	\$ 713

How to specify —
Select the
Model Number
from above.

AAS | | | | | | | | | | | | | | | | | | | | .

Example:

1st Option:

Acrylic:

ASC Clear

ASF Frosted

| | | | | .

2nd Option:

Paint Color:

P1 P2 P3

See page 148
for finishes.

| | | | | .

3rd Option:

Corner:

SQ Square

RD Round

| | | .

For specification information see pages 151-154.

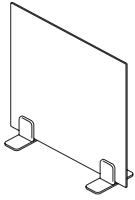

Description	Model	List Price by Acrylic Type	
		Clear	Frosted
13"H Sit-on-Surface Screen — Acrylic			
13"H x 36"W	AAS1336SFS	\$ 545	\$ 801
13"H x 42"W	AAS1342SFS	\$ 635	\$ 980
13"H x 48"W	AAS1348SFS	\$ 646	\$ 1003
13"H x 54"W	AAS1354SFS	\$ 725	\$ 1153
13"H x 60"W	AAS1360SFS	\$ 748	\$ 1165
13"H x 66"W	AAS1366SFS	\$ 815	\$ 1312
13"H x 72"W	AAS1372SFS	\$ 838	\$ 1335
20"H Sit-on-Surface Screen — Acrylic			
20"H x 36"W	AAS2036SFS	\$ 668	\$ 1196
20"H x 42"W	AAS2042SFS	\$ 905	\$ 1509
20"H x 48"W	AAS2048SFS	\$ 917	\$ 1520
20"H x 54"W	AAS2054SFS	\$ 1063	\$ 1809
20"H x 60"W	AAS2060SFS	\$ 1073	\$ 1832
20"H x 66"W	AAS2066SFS	\$ 1220	\$ 2111
20"H x 72"W	AAS2072SFS	\$ 1242	\$ 2122

<p>How to specify — Select the Model Number from above.</p>	<p>1st Option: Acrylic: ASC Clear ASF Frosted</p>	<p>2nd Option: Paint Color: P1 P2 P3 See page 148 for finishes.</p>	<p>3rd Option: Corner: SQ Square RD Round</p>
<p>A A S .</p> <p style="text-align: center;"><i>Example:</i></p>	<p> .</p>	<p> .</p>	<p> </p>

Laminate

Open Market

For specification information see pages 151-154.

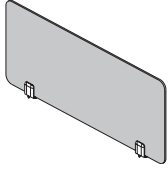

Description	Model	List Price		
		L1	L2	L3
13"H Beam Mounted Center Screen — Laminate				
24"W	ALS1324BSF	\$ 396	\$ 406	\$ 411
30"W	ALS1330BSF	\$ 415	\$ 426	\$ 432
36"W	ALS1336BSF	\$ 414	\$ 425	\$ 431
42"W	ALS1342BSF	\$ 423	\$ 435	\$ 440
48"W	ALS1348BSF	\$ 431	\$ 443	\$ 449
54"W	ALS1354BSF	\$ 508	\$ 525	\$ 532
60"W	ALS1360BSF	\$ 518	\$ 536	\$ 543
66"W	ALS1366BSF	\$ 605	\$ 627	\$ 637
72"W	ALS1372BSF	\$ 624	\$ 647	\$ 657
20"H Beam Mounted Center Screen — Laminate				
24"W	ALS2024BSF	\$ 491	\$ 507	\$ 514
30"W	ALS2030BSF	\$ 502	\$ 519	\$ 525
36"W	ALS2036BSF	\$ 512	\$ 529	\$ 536
42"W	ALS2042BSF	\$ 522	\$ 540	\$ 547
48"W	ALS2048BSF	\$ 533	\$ 551	\$ 560
54"W	ALS2054BSF	\$ 619	\$ 642	\$ 652
60"W	ALS2060BSF	\$ 630	\$ 653	\$ 664
66"W	ALS2066BSF	\$ 753	\$ 783	\$ 798
72"W	ALS2072BSF	\$ 764	\$ 795	\$ 810
28"H Beam Mounted Center Screen — Laminate				
24"W	ALS2824BSF	\$ 570	\$ 590	\$ 599
30"W	ALS2830BSF	\$ 581	\$ 602	\$ 611
36"W	ALS2836BSF	\$ 593	\$ 614	\$ 624
42"W	ALS2842BSF	\$ 603	\$ 625	\$ 635
48"W	ALS2848BSF	\$ 615	\$ 638	\$ 648
54"W	ALS2854BSF	\$ 908	\$ 948	\$ 965
60"W	ALS2860BSF	\$ 920	\$ 961	\$ 978
66"W	ALS2866BSF	\$ 1163	\$ 1217	\$ 1242
72"W	ALS2872BSF	\$ 1184	\$ 1239	\$ 1265

<p>How to specify — Select the Model Number from above.</p>	<p>1st Option: FSC: F FSC Wood X Non-FSC Wood</p>	<p>2nd Option: Laminate: See page 148 for finishes.</p>	<p>3rd Option: Edge: See page 148 for finishes.</p>	<p>4th Option: Grain Direction: VLG Horizontal VST Vertical</p>	<p>5th Option: Paint Color: P1 P2 P3 See page 148 for finishes.</p>	<p>6th Option: Corner: SQ Square RD Round</p>
<p>ALS .</p>	<p> .</p>	<p> .</p>	<p> .</p>	<p>V .</p>	<p> .</p>	<p> </p>

Example:

For specification information see pages 151-154.

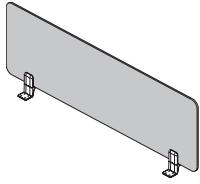

Description	Model	List Price		
		L1	L2	L3
13"H Elevated Screen — Laminate				
36"W	ALS1336DFS	\$ 443	\$ 453	\$ 458
42"W	ALS1342DFS	\$ 452	\$ 463	\$ 468
48"W	ALS1348DFS	\$ 461	\$ 472	\$ 478
54"W	ALS1354DFS	\$ 506	\$ 521	\$ 526
60"W	ALS1360DFS	\$ 515	\$ 530	\$ 536
66"W	ALS1366DFS	\$ 582	\$ 600	\$ 609
72"W	ALS1372DFS	\$ 601	\$ 620	\$ 629

20"H Elevated Screen — Laminate				
36"W	ALS2036DFS	\$ 517	\$ 532	\$ 538
42"W	ALS2042DFS	\$ 527	\$ 543	\$ 549
48"W	ALS2048DFS	\$ 537	\$ 553	\$ 559
54"W	ALS2054DFS	\$ 661	\$ 683	\$ 694
60"W	ALS2060DFS	\$ 671	\$ 694	\$ 704
66"W	ALS2066DFS	\$ 796	\$ 826	\$ 841
72"W	ALS2072DFS	\$ 817	\$ 848	\$ 863

Description	Model	List Price		
		L1	L2	L3
13"H Elevated HAT Screen — Laminate				
34"W	ALS1334DFS	\$ 454	\$ 465	\$ 470
40"W	ALS1340DFS	\$ 449	\$ 460	\$ 465
46"W	ALS1346DFS	\$ 457	\$ 468	\$ 473
52"W	ALS1352DFS	\$ 504	\$ 517	\$ 524
58"W	ALS1358DFS	\$ 513	\$ 528	\$ 534
64"W	ALS1364DFS	\$ 578	\$ 596	\$ 603
70"W	ALS1370DFS	\$ 598	\$ 617	\$ 626

20"H Elevated HAT Screen — Laminate				
34"W	ALS2034DFS	\$ 514	\$ 529	\$ 535
40"W	ALS2040DFS	\$ 524	\$ 539	\$ 545
46"W	ALS2046DFS	\$ 534	\$ 550	\$ 556
52"W	ALS2052DFS	\$ 691	\$ 715	\$ 727
58"W	ALS2058DFS	\$ 668	\$ 691	\$ 701
64"W	ALS2064DFS	\$ 793	\$ 823	\$ 837
70"W	ALS2070DFS	\$ 814	\$ 845	\$ 860

How to specify —
Select the Model Number from above.

AL | S | | | | | | | | | | | | | | | .

1st Option:
FSC:
F FSC Wood
X Non-FSC Wood

2nd Option:
Laminate:
See page 148 for finishes.

3rd Option:
Edge:
See page 148 for finishes.

4th Option:
Grain Direction:
VLG Horizontal
VST Vertical

5th Option:
Paint Color:
P1 P2 P3
See page 148 for finishes.

6th Option:
Corner:
SQ Square
RD Round

Example:

UNIVERSAL SCREENS

Laminate

Open Market

For specification information see pages 151-154.

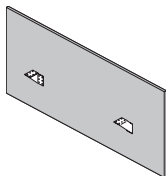

Description	Model	List Price		
		L1	L2	L3
27"H Above/Below Screen — Laminate				
36"W	ALS2736DFS	\$ 658	\$ 679	\$ 689
42"W	ALS2742DFS	\$ 675	\$ 697	\$ 707
48"W	ALS2748DFS	\$ 695	\$ 718	\$ 729
54"W	ALS2754DFS	\$ 714	\$ 738	\$ 750
60"W	ALS2760DFS	\$ 735	\$ 760	\$ 773
66"W	ALS2766DFS	\$ 757	\$ 784	\$ 797
72"W	ALS2772DFS	\$ 780	\$ 808	\$ 822

Description	Model	List Price		
		L1	L2	L3
27"H Above/Below HAT Screen — Laminate				
34"W	ALS2734DFS	\$ 654	\$ 675	\$ 685
40"W	ALS2740DFS	\$ 666	\$ 688	\$ 698
46"W	ALS2746DFS	\$ 685	\$ 708	\$ 718
52"W	ALS2752DFS	\$ 705	\$ 729	\$ 739
58"W	ALS2758DFS	\$ 724	\$ 749	\$ 761
64"W	ALS2764DFS	\$ 746	\$ 773	\$ 784
70"W	ALS2770DFS	\$ 769	\$ 797	\$ 810

NOTE: Laminate Above/Below screens cannot be used with height adjustable tables unless paired with a Radii undermount pedestal.

<p>How to specify — Select the Model Number from above.</p>	<p>1st Option: FSC: F FSC Wood X Non-FSC Wood</p>	<p>2nd Option: Laminate: See page 148 for finishes.</p>	<p>3rd Option: Edge: See page 148 for finishes.</p>	<p>4th Option: Grain Direction: VLG Horizontal VST Vertical</p>	<p>5th Option: Paint Color: P1 P2 P3 See page 148 for finishes.</p>	<p>6th Option: Corner: SQ Square RD Round</p>											
<table border="1" style="width: 100%; border-collapse: collapse;"> <tr> <td style="width: 33px; text-align: center;">A</td> <td style="width: 33px; text-align: center;">L</td> <td style="width: 33px; text-align: center;">S</td> <td style="width: 33px; text-align: center;"> </td> <td style="width: 33px; text-align: center;"> </td> <td style="width: 33px; text-align: center;"> </td> <td style="width: 33px; text-align: center;"> </td> <td style="width: 33px; text-align: center;"> </td> <td style="width: 33px; text-align: center;"> </td> <td style="width: 33px; text-align: center;"> </td> <td style="width: 33px; text-align: center;">.</td> </tr> </table>	A	L	S								V .	.	
A	L	S								.							

Example:

UNIVERSAL SCREENS

For specification information see pages 151-154.

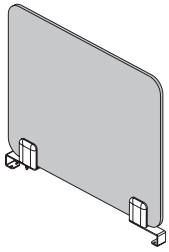

Description	Model	List Price		
		L1	L2	L3
13"H Front-to-Back Screen — Laminate				
21"W	ALS1321LDF	\$ 402	\$ 409	\$ 412
24"W	ALS1324LDF	\$ 462	\$ 472	\$ 477
27"W	ALS1327LDF	\$ 467	\$ 478	\$ 483
30"W	ALS1330LDF	\$ 471	\$ 482	\$ 487
36"W	ALS1336LDF	\$ 480	\$ 491	\$ 497
20"H Front-to-Back Screen — Laminate				
21"W	ALS2021LDF	\$ 470	\$ 481	\$ 486
24"W	ALS2024LDF	\$ 557	\$ 573	\$ 579
27"W	ALS2027LDF	\$ 562	\$ 578	\$ 585
30"W	ALS2030LDF	\$ 568	\$ 585	\$ 591
36"W	ALS2036LDF	\$ 578	\$ 595	\$ 602
27"H Front-to-Back Screen — Laminate				
21"W	ALS2721LDF	\$ 501	\$ 513	\$ 519
24"W	ALS2724LDF	\$ 635	\$ 655	\$ 664
27"W	ALS2727LDF	\$ 641	\$ 661	\$ 671
30"W	ALS2730LDF	\$ 646	\$ 667	\$ 676
36"W	ALS2736LDF	\$ 658	\$ 679	\$ 689

Description	Model	List Price		
		L1	L2	L3
13"H Front-to-Back HAT Screen — Laminate				
22"W	ALS1322LHF	\$ 404	\$ 411	\$ 414
28"W	ALS1328LHF	\$ 468	\$ 479	\$ 484
20"H Front-to-Back HAT Screen — Laminate				
22"W	ALS2022LHF	\$ 458	\$ 468	\$ 473
28"W	ALS2028LHF	\$ 565	\$ 582	\$ 588
27"H Front-to-Back HAT Screen — Laminate				
22"W	ALS2722LHF	\$ 516	\$ 529	\$ 535
28"W	ALS2728LHF	\$ 643	\$ 663	\$ 673

How to specify —
Select the Model Number from above.

1st Option: FSC:
 F FSC Wood
 X Non-FSC Wood

2nd Option: Laminate:
 See page 148 for finishes.

3rd Option: Edge:
 See page 148 for finishes.

4th Option: Grain Direction:
 VLG Horizontal
 VST Vertical

5th Option: Paint Color:
 P1 P2 P3
 See page 148 for finishes.

6th Option: Corner:
 SQ Square
 RD Round

ALS | | | | | | | | | | | . | .
Example:

For specification information see pages 151-154.

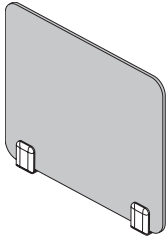

Description	Model	List Price		
		L1	L2	L3
13"H Top Mount Screen — Laminate				
21"W	ALS1321LDT	\$ 402	\$ 409	\$ 412
24"W	ALS1324LDT	\$ 462	\$ 472	\$ 477
27"W	ALS1327LDT	\$ 467	\$ 478	\$ 483
30"W	ALS1330LDT	\$ 471	\$ 482	\$ 487
36"W	ALS1336LDT	\$ 480	\$ 491	\$ 497
20"H Top Mount Screen — Laminate				
21"W	ALS2021LDT	\$ 470	\$ 481	\$ 486
24"W	ALS2024LDT	\$ 557	\$ 573	\$ 579
27"W	ALS2027LDT	\$ 562	\$ 578	\$ 585
30"W	ALS2030LDT	\$ 568	\$ 585	\$ 591
36"W	ALS2036LDT	\$ 578	\$ 595	\$ 602
27"H Top Mount Screen — Laminate				
21"W	ALS2721LDT	\$ 501	\$ 513	\$ 519
24"W	ALS2724LDT	\$ 635	\$ 655	\$ 664
27"W	ALS2727LDT	\$ 641	\$ 661	\$ 671
30"W	ALS2730LDT	\$ 646	\$ 667	\$ 676
36"W	ALS2736LDT	\$ 658	\$ 679	\$ 689

Description	Model	List Price		
		L1	L2	L3
13"H Top Mount HAT Screen — Laminate				
22"W	ALS1322LHT	\$ 404	\$ 411	\$ 414
28"W	ALS1328LHT	\$ 468	\$ 479	\$ 484
20"H Top Mount HAT Screen — Laminate				
22"W	ALS2022LHT	\$ 458	\$ 468	\$ 473
28"W	ALS2028LHT	\$ 565	\$ 582	\$ 588
27"H Top Mount HAT Screen — Laminate				
22"W	ALS2722LHT	\$ 516	\$ 529	\$ 535
28"W	ALS2728LHT	\$ 643	\$ 663	\$ 673

<p>How to specify — Select the Model Number from above.</p>	<p>1st Option: FSC: F FSC Wood X Non-FSC Wood</p>	<p>2nd Option: Laminate: See page 148 for finishes.</p>	<p>3rd Option: Edge: See page 148 for finishes.</p>	<p>4th Option: Grain Direction: VLG Horizontal VST Vertical</p>	<p>5th Option: Paint Color: P1 P2 P3 See page 148 for finishes.</p>	<p>6th Option: Corner: SQ Square RD Round</p>
<p>AL S .</p>	<p> .</p>	<p> .</p>	<p> .</p>	<p>V .</p>	<p> .</p>	<p> .</p>

Example:

For specification information see pages 151-154.

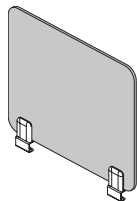

Description	Model	List Price		
		L1	L2	L3
13"H Side Mount Screen — Laminate				
21"W	ALS1321LDS	\$ 402	\$ 409	\$ 412
24"W	ALS1324LDS	\$ 462	\$ 472	\$ 477
27"W	ALS1327LDS	\$ 467	\$ 478	\$ 483
30"W	ALS1330LDS	\$ 471	\$ 482	\$ 487
36"W	ALS1336LDS	\$ 480	\$ 491	\$ 497
20"H Side Mount Screen — Laminate				
21"W	ALS2021LDS	\$ 470	\$ 481	\$ 486
24"W	ALS2024LDS	\$ 557	\$ 573	\$ 579
27"W	ALS2027LDS	\$ 562	\$ 578	\$ 585
30"W	ALS2030LDS	\$ 568	\$ 585	\$ 591
36"W	ALS2036LDS	\$ 578	\$ 595	\$ 602
27"H Side Mount Screen — Laminate				
21"W	ALS2721LDS	\$ 501	\$ 513	\$ 519
24"W	ALS2724LDS	\$ 635	\$ 655	\$ 664
27"W	ALS2727LDS	\$ 641	\$ 661	\$ 671
30"W	ALS2730LDS	\$ 646	\$ 667	\$ 676
36"W	ALS2736LDS	\$ 658	\$ 679	\$ 689

Description	Model	List Price		
		L1	L2	L3
13"H Side Mount HAT Screen — Laminate				
22"W	ALS1322LHS	\$ 404	\$ 411	\$ 414
28"W	ALS1328LHS	\$ 468	\$ 479	\$ 484
20"H Side Mount HAT Screen — Laminate				
22"W	ALS2022LHS	\$ 458	\$ 468	\$ 473
28"W	ALS2028LHS	\$ 565	\$ 582	\$ 588
27"H Side Mount HAT Screen — Laminate				
22"W	ALS2722LHS	\$ 516	\$ 529	\$ 535
28"W	ALS2728LHS	\$ 643	\$ 663	\$ 673

<p>How to specify — Select the Model Number from above.</p>	<p>1st Option: FSC: F FSC Wood X Non-FSC Wood</p>	<p>2nd Option: Laminate: See page 148 for finishes.</p>	<p>3rd Option: Edge: See page 148 for finishes.</p>	<p>4th Option: Grain Direction: VLG Horizontal VST Vertical</p>	<p>5th Option: Paint Color: P1 P2 P3 See page 148 for finishes.</p>	<p>6th Option: Corner: SQ Square RD Round</p>
<p>ALS .</p>	<p> .</p>	<p> .</p>	<p> .</p>	<p>V .</p>	<p> .</p>	<p> .</p>

Example:

For specification information see pages 151-154.

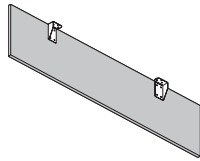

Description	Model	List Price		
		L1	L2	L3
13"H Modesty Screen — Laminate				
30"W	ALS1330MPD	\$ 482	\$ 493	\$ 499
36"W	ALS1336MPD	\$ 481	\$ 492	\$ 498
42"W	ALS1342MPD	\$ 490	\$ 502	\$ 507
48"W	ALS1348MPD	\$ 499	\$ 511	\$ 517
54"W	ALS1354MPD	\$ 575	\$ 592	\$ 599
60"W	ALS1360MPD	\$ 586	\$ 604	\$ 611
66"W	ALS1366MPD	\$ 672	\$ 694	\$ 704
72"W	ALS1372MPD	\$ 692	\$ 715	\$ 725

How to specify — Select the Model Number from above.	1st Option: FSC: F FSC Wood X Non-FSC Wood	2nd Option: Laminate: See page 148 for finishes.	3rd Option: Edge: See page 148 for finishes.	4th Option: Grain Direction: VLG Horizontal VST Vertical	5th Option: Paint Color: P1 P2 P3 See page 148 for finishes.	6th Option: Corner: SQ Square RD Round
ALS 	V .	.	.

Example:

Metal

Open Market

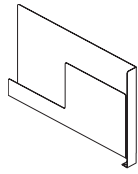

Left shown

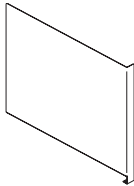

Right shown

Description	Model	List Price		
		P1	P2	P3
Metal Lateral Organizers				
20"H x 20"W, Left Handed	U6BL2021ML	\$ 566	\$ 596	\$ 625
20"H x 20"W, Right Handed	U6BL2021MR	\$ 566	\$ 596	\$ 625
27"H x 20"W, Left Handed	U6BL2027ML	\$ 602	\$ 632	\$ 661
27"H x 20"W, Right Handed	U6BL2027MR	\$ 602	\$ 632	\$ 661

Notes: Clamps to back edge of worksurface at 20"H and 27"H.

Screen is designed to sit back from front edge of worksurface.

Space for folders is 1½" and holds approximately 340 sheets of paper.

Folder storage is one-sided — LH and RH options available.

- Finishes 188
- Gallery Panels 189
- Basic Characteristics..... 190
- Dimensions 191
- Working with Integrated Glass 192
- Further - End Panel (Dual-Sided) 193
- Further - End Panel (Single-Sided)..... 194
- Benching..... 195
- Mural — Planning Guidelines 196
- Storage and Worksurface Connectors..... 197
- Accessories - Tackboards 198
- 22"H Application 199-200
- 30"H Application 201
- 35"H Application 202
- 42"H Application 203
- 50"H Application 204
- 22"H Application for Use with Glass 205-206
- 30"H Application for Use with Glass 207
- 35"H Application for Use with Glass 208
- 42"H Application for Use with Glass 209
- Further Connector Kits 210
- Benching Connector Kits..... 211
- Panel Systems Gallery Glass 212-214

Gallery Panels

Laminates and Paint Finishes

PAINT FINISHES

GRADE P1

Black	P71
Brownstone	P7D
Bungalow	P7C
Cinder	P7Q
Designer White	PJW
Flint	P02
Fossil	P28
Loft	P7B
Muslin	P4J
Parchment	P93
Pebble	P8R
Pewter	P8D
Salt	P8C
Titanium	P8T

GRADE P2

Champagne Metallic	PR5
Gunmetal Metallic	PR3
Night Bronze	P8B
Platinum Metallic	PR2
Pyrite	PJE
Silver	PR6
Solar Black	P8X

Metallic paints, due to varying reflectance, may appear to have less visual color consistency than other paint finishes, even when L/A/B values are exactly the same. (L/A/B — measurable aspects of color — values are maintained within a specified range, to ensure consistent appearance of paint colors.)

GRADE P3

Atom	P8S
Blossom***	P8K
Bullseye	PJF
Ember	P8P
Ion	P8N
Iris	P8J
Krypton	P8F
Ochre	P093
Regatta	P8M
Sienna	P092
Succulent***	P8A

***These colors are intended to be an inspirational option for the trending market. Product application is limited and color availability is approximately two years to coincide with evolving workplace trends.

LAMINATES

GRADE L1

SOLID COLOR

Black	P
Brownstone	LM13
Bungalow	LM12
Designer White	LDW1
Flint	LM16
Fossil Shale	LEH1
Loft	LM11
Muslin	LM15
Titanium	LTI1

WOODGRAIN

Belair	LWBA
Bourbon Cherry	H
Field Elm	LWFE
Florence Walnut	LFW1
Kingswood Walnut	LK11
Natural Maple	LWD
NeoWalnut	LNU1
Pinnacle	PINC
Shaker Cherry	LW7C

GRADE L2

Beigewood	LWBE
Fawn Cypress	LFC1
Lowell Ash	LLA1
Mangalore Mango	LMM1
Natural Recon	LNR1
Phantom Charcoal	LPC1
Phantom Ecu	LPE1
Portico Teak	LPT1
Skyline Walnut	LSW1
Veranda Teak	LVT1

GRADE L3

Natural Walnut	LWNW
----------------------	------

LAMINATE EDGE COLORS

Beigewood	DE
Belair	BA
Black	E4
Bourbon Cherry	H
Brownstone	EY
Bungalow	EX
Designer White	DW
Fawn Cypress	FC
Field Elm	FE
Flint	E9
Florence Walnut	FW
Fossil	EH
Kingswood Walnut	KI
Loft	EV
Lowell Ash	DL
Mangalore Mango	MM
Muslin	EU
Natural Maple	DD
Natural Recon	NR
Natural Walnut	DN
NeoWalnut	NU
Parchment	EN
Phantom Charcoal	PC
Phantom Ecu	PE
Pinnacle	PI
Plyband	PL
Portico Teak	DP
Shaker Cherry	DF
Skyline Walnut	SW
Titanium	TI
Veranda Teak	VT

Forest Stewardship Council (FSC) is a non-profit organization devoted to encouraging the responsible management of the world's forests. FSC sets high standards that ensure forestry is practiced in an environmentally responsible, socially beneficial, and economically viable way. Allsteel received its FSC Chain of Custody certification in 2010 and can offer FSC Certified products. Select wood-based products can be ordered as FSC certified, either by choosing the FSC option or selecting an FSC laminate or veneer finish at the time of order. For more information, please contact Customer Support at 888-255-7833. (FSC Trademark license code: FSC-CO14704.)

NOTE: Refer to individual product pages for upcharges.

Gallery Panels

Gallery Panels are ideal for bringing natural wood elements to workstations and providing privacy. Allsteel Gallery Panels are designed to work universally across 4 product platforms. Please follow the product guidelines for proper specification.

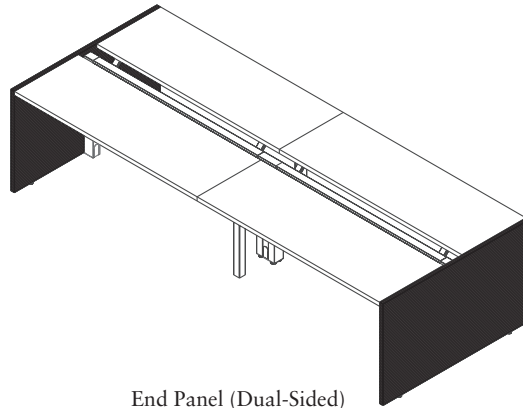

End Panel (Dual-Sided)

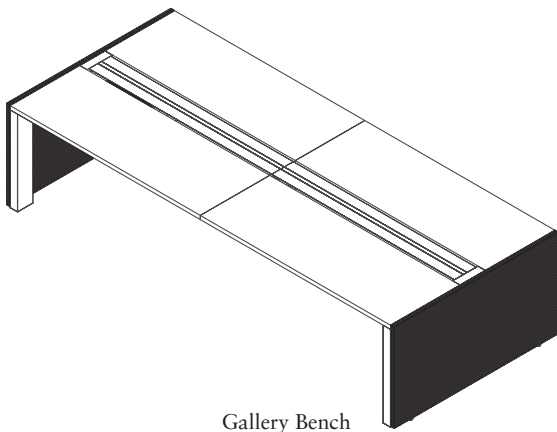

Gallery Bench

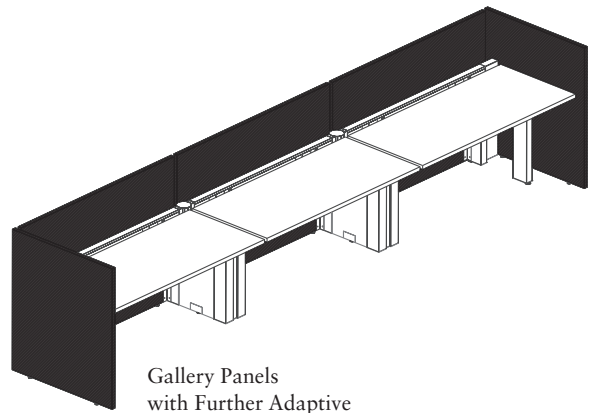

Gallery Panels
with Further Adaptive

- Available in End configuration.
- Made of 1 1/8" board with HPL laminate.
- Use 1 1/8" thickness for space planning.
- Can be specified with matching or contrasting edge.
- Edge band is 2mm ABS.
- Available in woodgrain and solid laminates.
- Horizontal laminate available on all sizes. Vertical laminate is available on widths 18"W to 60"W, and 87"W to 117"W.
- Widths are available in 3" increments from 33"W to 87"W.
- Sizes up to 84"W come as a single piece. Sizes 87"W though 147"W are split panels and come in two-pieces.
- Standard benching Gallery Panels are specified in single-piece panels. Contact Allsteel Tailored Products Group for split panels.
- Grain matching is not available on split panels.
- Gallery Panels offer 2 1/2" leveling capability.
- Overall heights line up with adjacent panel or benching systems.
- Gallery Panel widths are true to size.
- Available with and without the integrated glass option.
- Glass is specified separately.
- Gallery Panels for use with glass have separate model numbers.
- Can be used with Single Sided Further adaptive for privacy and stability along the beam.
- All configurations are non-handed and secured using hidden fasteners.
- Please adhere to all standard systems specification guidelines.
- Gallery Panels are constructed of laminated particle board. Because of their nature, such components have a tendency to bow due to humidity and changes in climate.

Gallery Panels

Dimensions

GSA SIN 33721

Gallery Panel Widths

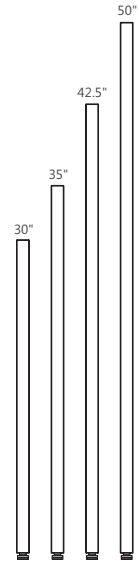
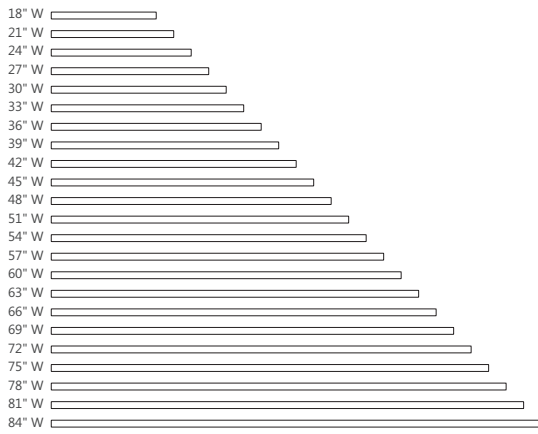

Gallery Panel Heights

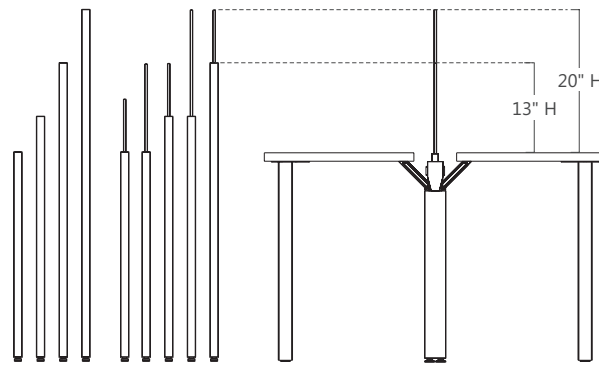

Gallery Panels

- Gallery Panels for use with glass offer a routed top edge.
- Glass mounts directly into the Gallery Panel route via a gasket.
- The routing is inset 1½" from each end of the panel.
- Single-piece Gallery Panels for use with integrated glass require glass 3" shorter than the panel width.
- Glass is available in 3 colors: Clear, Frosted, Smoked.
- Glass height is available in 7½"H, 13"H, 15"H.
- Glass is available on all Gallery Panel widths.
- For benching systems, maximum allowable benching height cannot exceed 50"H with or without glass. Overall Gallery Panel height includes the glass.
- Specify glass models separate from Gallery Panel models.
- Glass Panels at 30"W and under are not UL listed.

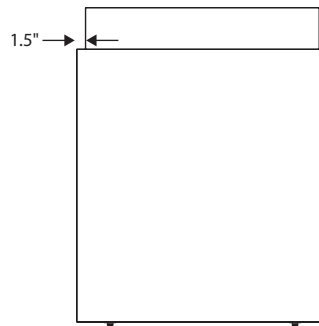

Single Panel with Glass

Find the Gallery Glass width appropriate for your Gallery Panel width.

Shaded example:
For the 18"W Gallery Panel, Gallery Glass should be ordered with width of 15".

Gallery Panel Width \ Gallery Glass Height	7.5"H
	Gallery Glass Order Width
18"W Gallery Panel	15"W
21"W Gallery Panel	18"W
24"W Gallery Panel	21"W
27"W Gallery Panel	24"W
30"W Gallery Panel	27"W
33"W Gallery Panel	30"W
36"W Gallery Panel	33"W
39"W Gallery Panel	36"W
42"W Gallery Panel	39"W
45"W Gallery Panel	42"W
48"W Gallery Panel	45"W
51"W Gallery Panel	48"W
54"W Gallery Panel	51"W
57"W Gallery Panel	54"W
60"W Gallery Panel	57"W
63"W Gallery Panel	60"W
66"W Gallery Panel	63"W
69"W Gallery Panel	66"W
72"W Gallery Panel	69"W
75"W Gallery Panel	72"W
78"W Gallery Panel	75"W
81"W Gallery Panel	78"W
84"W Gallery Panel	81"W

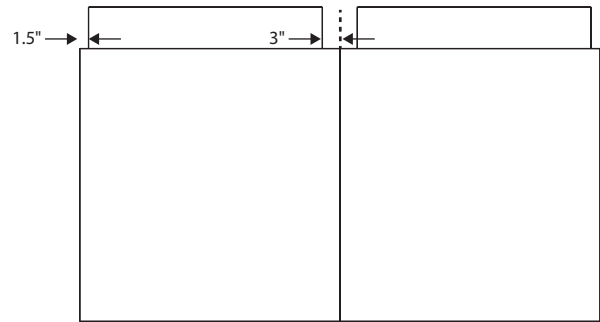

Split Panel with Glass

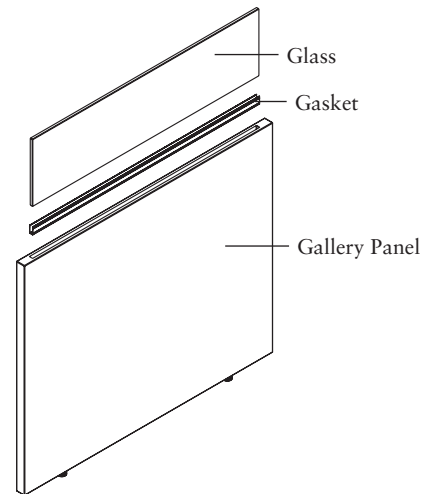

- Gallery Panels provide support for beam and worksurfaces.
- Provides privacy to one or both ends of the system in a dual-sided application.
- End Panel sizes are available from 48" W to 84" W.
- Maximum overall height is 50" H. Integrated glass is included in overall height.
- All T-configurations connect using one of the following connector kits:
 - GFCKSH - standard-height tethered applications
 - GFCKA - Adaptive or standard-height freestanding beam applications.
 - GFCKLH - low freestanding beam applications
- Connector kits are infeed and data accessible.
- Chicago and NY electrical junction boxes are not compatible with the kits.
- Connector kits do not accept power poles.
- End Panel can be used for off-modular planning, connector kit location must be field-measured.
- In standard height tethered applications, use Z6LB bracket to tie worksurface to Gallery Panel.
- Gallery Panels line up with the edge of the worksurface.
- In tethered applications, the gallery panel must meet or exceed the depth of the worksurfaces.
- In a freestanding application, minimum beam run must total 98" W. This includes connector kit.

Front edge of worksurface is flush to Gallery Panel in End Panel configuration

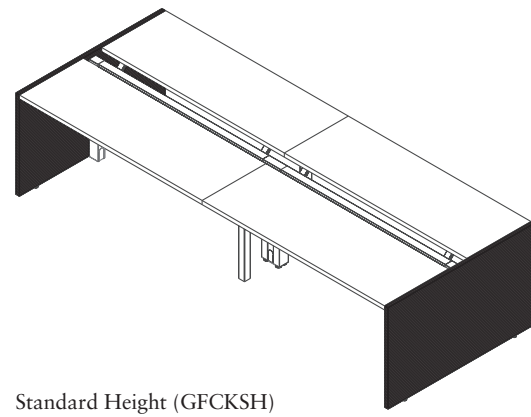
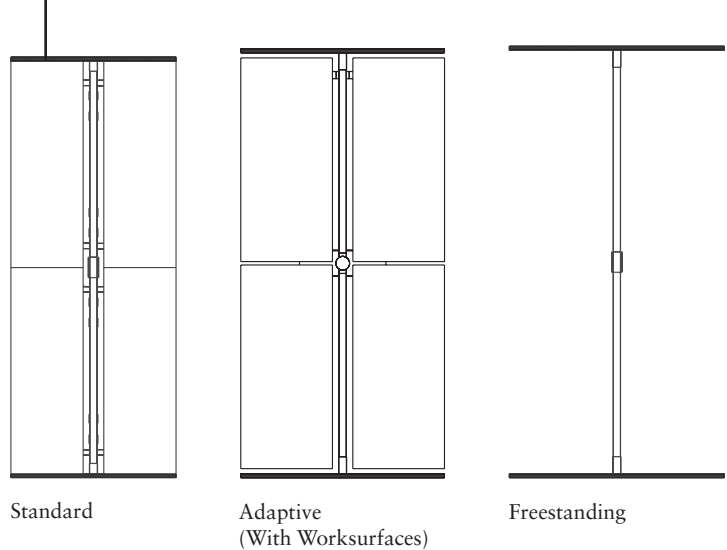

Standard Height (GFCKSH)

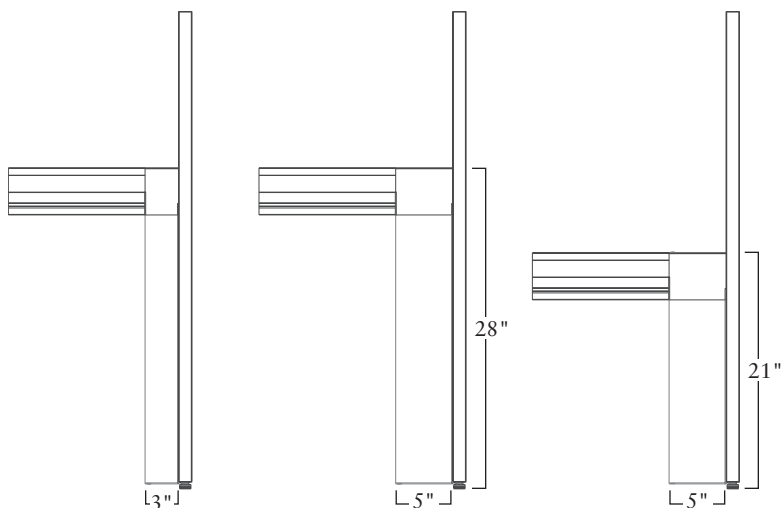

Standard Height (GFCKSH)

Adaptive and freestanding standard height (GFCKA)

Low Fence (GFCKLH)

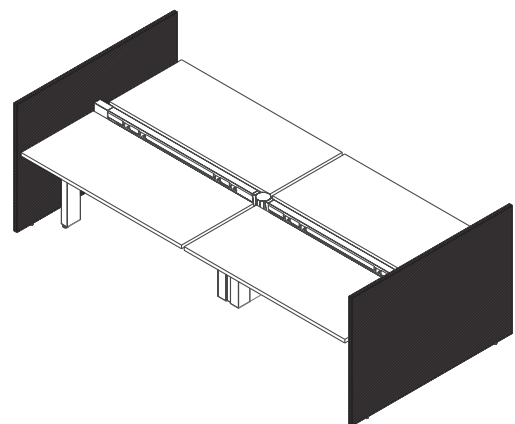

Gallery Panels

Further™ - End Panel (Single-Sided)

GSA SIN 33721

- Gallery Panels provide support for beam and worksurface.
- Provides privacy to one or both ends of the system in a single-sided application.
- Single-Sided End Panel sizes are available from 33"W to 84"W.
- Maximum overall height is 50"H. Integrated glass is included in overall height.
- All Single-Sided End Panels connect using one of the following connector kits:
 - GFCKSH - standard-height tethered applications
 - GFCKA - Adaptive or standard-height freestanding beam applications.
 - GFCKLH - low freestanding beam applications
- Connector kits are infed and data accessible. Connector kits do not accept power poles.
- Chicago and NY electrical junction boxes are not compatible with the kits.
- In standard height tethered applications, use Z6LB bracket to tie worksurface to Gallery Panel.
- Gallery Panels extend 1½" past front edge of the worksurface. Specify gallery panel 6" longer than the depth of worksurface.
- In tethered applications, the gallery panel must meet or exceed the depth of the worksurfaces.
- In a freestanding application, minimum beam run must total 98"W. This includes connector kit.
- Single-Sided End Panels may not utilize a single beam between two gallery panels.
- Gallery Panel sizes 66"W or greater require storage or worksurface tie in. Please reference storage and worksurface support sections for more details.
- Single-sided Adaptive requires a minimum of 42"H Gallery Panels along the beam run. Panel widths must match worksurface widths.
- One connector kit (U6GPSS) required for each gallery panel – ordered separately.
- Standard specification creates 1" gap between all gallery panels.
- End Gallery Panels may be specified to align with back panels.
- U3SSHAFAs used to mount single-sided Adaptive supports to floor if Gallery panels are not desired.
- Kit includes brackets for 2 end supports and 2 mid-supports.
- Hardware for mounting to floor is not included.

Front edge of Gallery Panel sits 1½" proud of front edge of worksurface in L-configuration

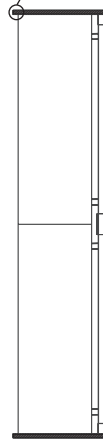

Standard

1" gap between end panel and spine panels



Single-Sided Adaptive

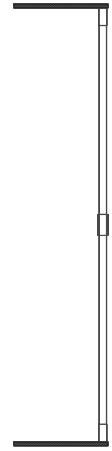

Freestanding

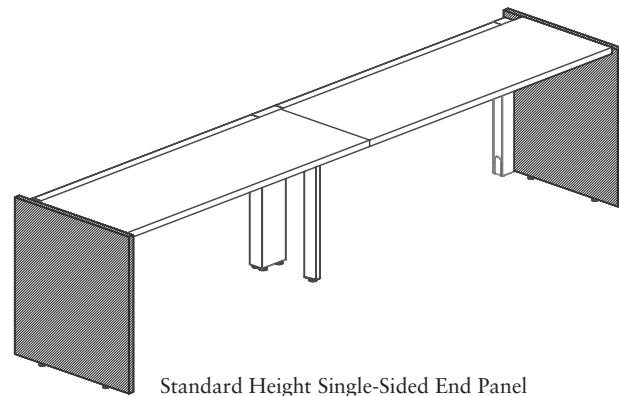

Standard Height Single-Sided End Panel

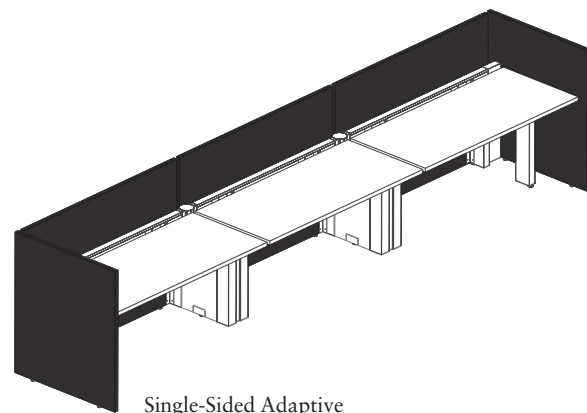

Single-Sided Adaptive

- Provides privacy to one or both ends of the system.
- End Panel (Dual-Sided) sizes are available from 54"W to 84"W.
- End Panel (Single-Sided) sizes are available from 33"W to 84"W.
- Maximum overall height is 50"H. Integrated glass is included in overall height.

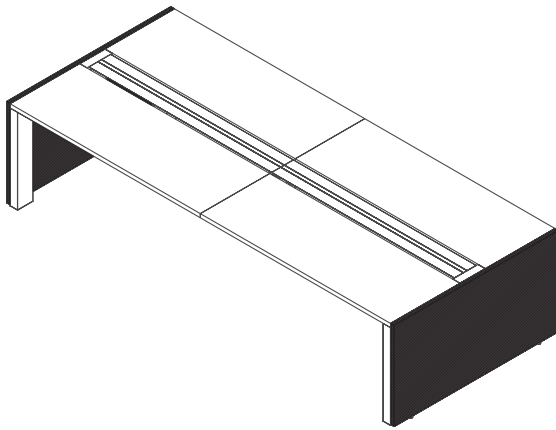

Front edge of panel sits 1¼" proud of worksurface in Single-Sided configuration

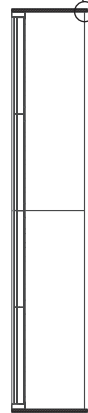

Single-Sided

Front edge of worksurface is flush to Gallery Panel in Dual-Sided configuration

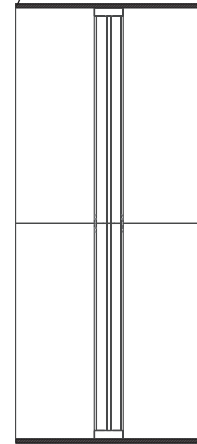

Dual-Sided

Gallery Panels

Overview:

- Gallery Panels provide support for fence and worksurfaces.
- Provides privacy to one or both ends of the system in a dual-sided application.
- Gallery Panels line up with the edge of the worksurface.
- Freestanding Mural to Gallery Panels (no integrated tables) requires a minimum 98" of Mural system spine length OR gallery panels on both ends of spine.
- Maximum overall height is 50" H. Integrated glass is included in overall height.
- In tethered applications, the gallery panel must meet or exceed the depth of the worksurfaces.

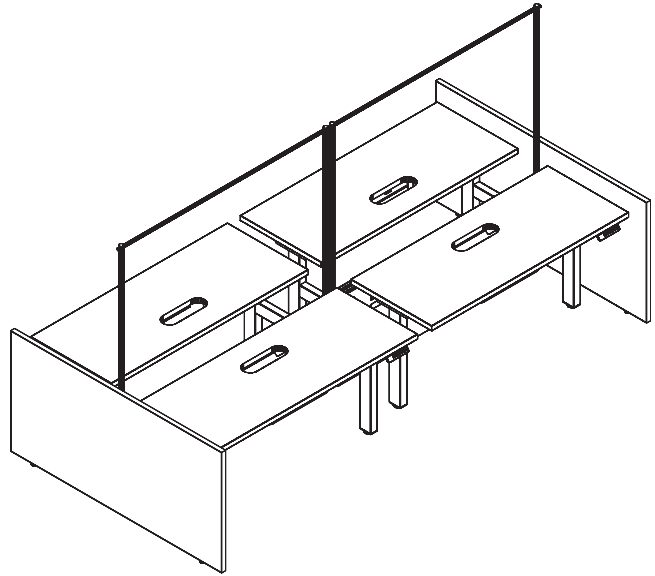

End Panel:

- Dual-sided applications end of run available in all single and split gallery panel sizes.
- Single-sided applications available in all single gallery panel sizes.
- Mural end panels connect using GSCKP connector kit.
- When split gallery panels are specified, hardware kit must also be specified GSHW.
- Single End Panel sizes are available from 48" W to 84" W.
- Split End Panel seams must align with parent run.
- Gallery Panel sizes 129" W or greater require storage or worksurface tie in on both sides of panel. Please reference storage and worksurface support sections for more details.

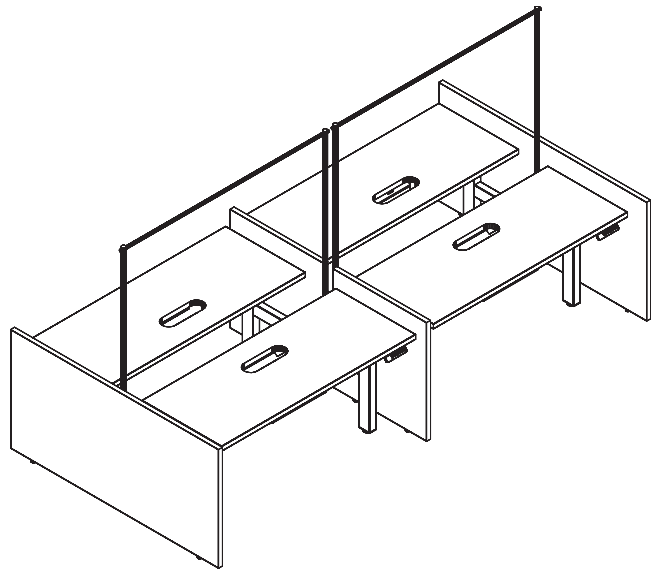

Mid-Panel:

- Dual-sided applications with mid-placement available in all single gallery panel sizes.
- Single-sided applications available in all single gallery panel sizes.
- Mid-connector kit required per gallery panel to attach to fence.
- For dual-sided applications, specify GSCKPMD.
- For single-sided applications, specify GSCKPMS.
- Mid Panels are available in 18"-84" widths in 3" increments.
- Gallery panels 66" W and greater require worksurface or storage tie-in. Please reference storage and worksurface support section for details.

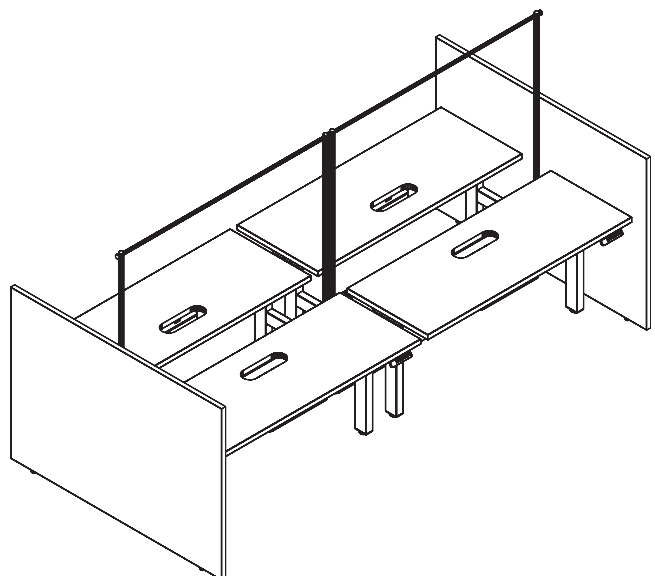

Connector Kits:

- Connector kits are infed and data accessible.
- Connector kits do not accept power poles.
- End Panel can be used for off-modular planning, connector kit location must be field-measured.

- To connect to laminate storage use GSGKL or GSGKM for metal storage.
- To connect to worksurface use Z6LB bracket when used in perpendicular to parent run or use standard systems cantilever brackets when used in parallel to parent run in panel systems.
- Perpendicular surfaces connected to a Gallery Panel over 60"W require (2) Z6LB Brackets.

Panel Systems

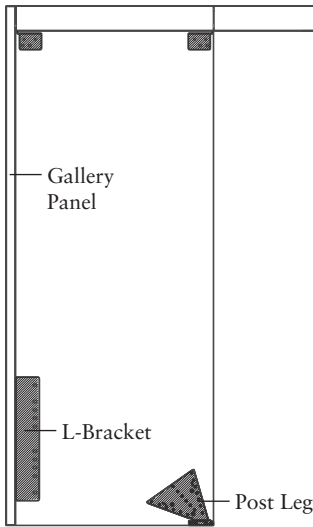

Perpendicular panel system with L-bracket (Z6LB) and post leg.

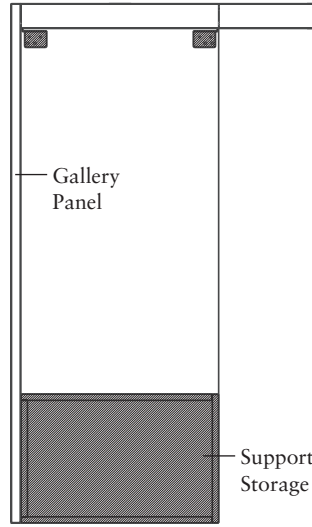

Perpendicular panel system with storage support.

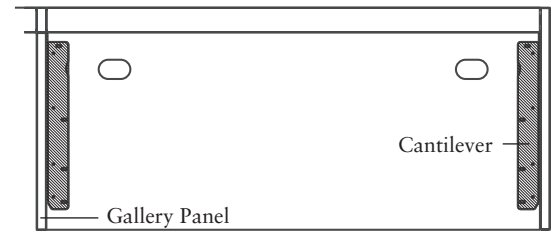

Panel system with cantilever support.

Further System

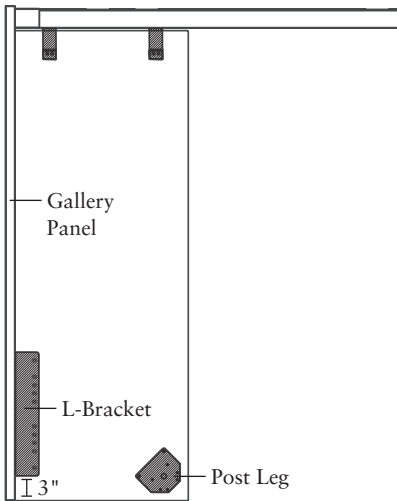

Further perpendicular with L-bracket (Z6LB), worksurface brackets, and post leg.

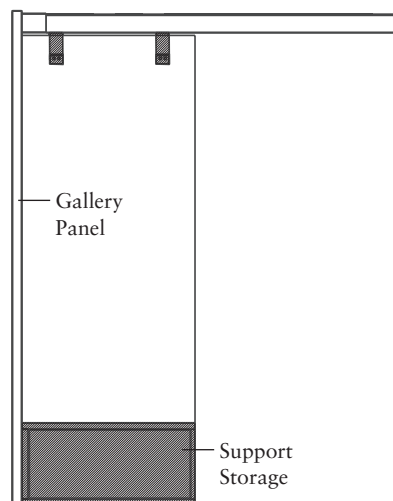

Further perpendicular with storage support and worksurface brackets.

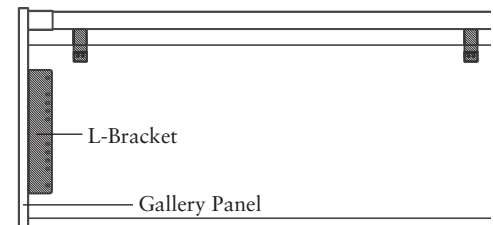

Further perpendicular with L-bracket (Z6LB) and worksurface brackets.

Gallery Panels

- Provides tackable surface
- Comes with steel-painted trim
- Available in 36" W and in two heights: 11" H and 18½" H
- For use with a minimum 39" W Gallery Panel
- Mounts directly to Gallery Panel. Mounting hardware included.

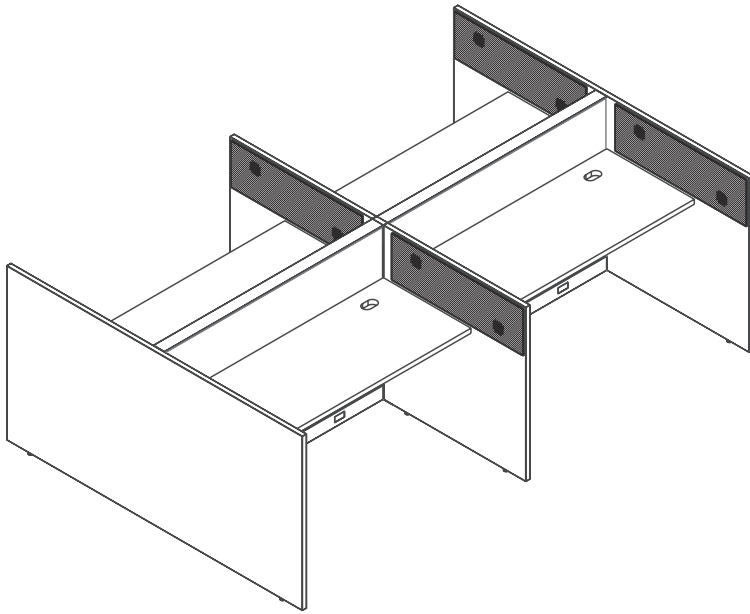

Tackboard Accessory on Mid and End Gallery Panels. Example of the typical is illustrated using a Panel System.

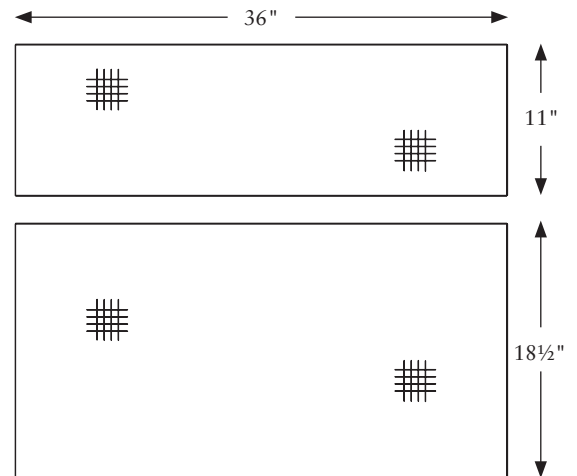

Tackboard Accessory dimensions

Gallery Panel Stiffeners

- Required for single-piece panels 75" W and greater that are used in a wing or single-sided end condition and do not have a horizontally-mounted credenza.
- For panels 75" W and 78" W, order model (GSTFN7578). Stiffener width is 72".
- For panels 81" W and 84" W, order model (GSTFN8184). Stiffener width is 78".
- Attaches directly to one side of the Gallery Panel with a painted metal cover, attachment hardware included.
- Placement on panel face must be at least 18" above the floor but is not restricted to a specific location on the panel.
- Stiffener is 1½" x 1½".
- Available in any Allsteel standard paint color

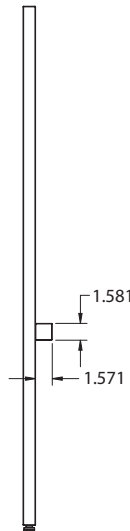

Gallery Panels

22"H Application

For Gallery Panel connectors see page 210-211.

GSA SIN 33721

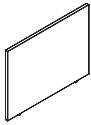

Description	Model	List Price		
		L1	L2	L3
22"H Gallery Panels				
18"W	G2218	\$ 431	\$ 450	\$ 468
21"W	G2221	\$ 450	\$ 470	\$ 490
24"W	G2224	\$ 476	\$ 497	\$ 518
27"W	G2227	\$ 510	\$ 532	\$ 554
30"W	G2230	\$ 582	\$ 607	\$ 631
33"W	G2233	\$ 617	\$ 644	\$ 670
36"W	G2236	\$ 648	\$ 676	\$ 703
39"W	G2239	\$ 703	\$ 733	\$ 763
42"W	G2242	\$ 762	\$ 794	\$ 827
45"W	G2245	\$ 832	\$ 868	\$ 903
48"W	G2248	\$ 870	\$ 907	\$ 944
51"W	G2251	\$ 886	\$ 924	\$ 961
54"W	G2254	\$ 927	\$ 968	\$ 1006
57"W	G2257	\$ 970	\$ 1012	\$ 1052
60"W	G2260	\$ 1016	\$ 1060	\$ 1102
63"W	G2263	\$ 1032	\$ 1077	\$ 1119
66"W	G2266	\$ 1054	\$ 1099	\$ 1144
69"W	G2269	\$ 1129	\$ 1177	\$ 1224
72"W	G2272	\$ 1163	\$ 1212	\$ 1261
75"W	G2275	\$ 1319	\$ 1375	\$ 1430
78"W	G2278	\$ 1369	\$ 1427	\$ 1485
81"W	G2281	\$ 1419	\$ 1479	\$ 1539
87"W	G2287	\$ 1447	\$ 1517	\$ 1584
93"W	G2293	\$ 1496	\$ 1568	\$ 1638
99"W	G2299	\$ 1518	\$ 1590	\$ 1662
105"W	G22105	\$ 1551	\$ 1625	\$ 1697
84"W	G2284	\$ 1557	\$ 1623	\$ 1688
111"W	G22111	\$ 1636	\$ 1714	\$ 1790
117"W	G22117	\$ 1684	\$ 1764	\$ 1841
123"W	G22123	\$ 1698	\$ 1778	\$ 1856
129"W	G22129	\$ 1743	\$ 1825	\$ 1905
135"W	G22135	\$ 1823	\$ 1908	\$ 1992
141"W	G22141	\$ 1914	\$ 2003	\$ 2091
147"W	G22147	\$ 2016	\$ 2109	\$ 2201

<p>How to specify — Select the Model Number from above.</p>	<p>1st Option: FSC: F FSC Wood X Non-FSC Wood</p>	<p>2nd Option: Laminate: See page 188 for finishes.</p>	<p>3rd Option: Edge: See page 188 for finishes.</p>	<p>4th Option: Grain: VLG Horizontal grain or Solid only. VST Vertical Grain (available only for single panels 60"W or less.</p>	<p>5th Option: Glide:</p>
G 2 2 	V .	G

Example: G2218.X.LT11.TI.VLG.G

Gallery Panels

22"H Application

For Gallery Panel connectors see page 210-211.

GSA SIN 33721

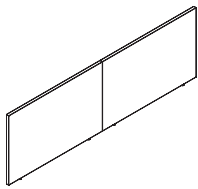

Description	Model	List Price		
		L1	L2	L3
22"H Gallery Split Panels				
81"W	GS2281	\$ 1346	\$ 1403	\$ 1461
87"W	GS2287	\$ 1628	\$ 1698	\$ 1765
93"W	GS2293	\$ 1677	\$ 1749	\$ 1819
99"W	GS2299	\$ 1699	\$ 1771	\$ 1843
105"W	GS22105	\$ 1732	\$ 1806	\$ 1878
111"W	GS22111	\$ 1817	\$ 1895	\$ 1971
117"W	GS22117	\$ 1865	\$ 1945	\$ 2022
123"W	GS22123	\$ 1879	\$ 1959	\$ 2037
129"W	GS22129	\$ 1924	\$ 2006	\$ 2086
135"W	GS22135	\$ 2004	\$ 2089	\$ 2173
141"W	GS22141	\$ 2095	\$ 2184	\$ 2272
147"W	GS22147	\$ 2197	\$ 2290	\$ 2382

<p>How to specify — Select the Model Number from above.</p>	<p>1st Option: FSC: F FSC Wood X Non-FSC Wood</p>	<p>2nd Option: Laminate: See page 188 for finishes.</p>	<p>3rd Option: Edge: See page 188 for finishes.</p>	<p>4th Option: Grain: VLG Horizontal grain or Solid only. VST Vertical Grain (available only for single panels 60"W or less.</p>	<p>5th Option: Glide:</p>
<p>GS22 . .</p>				<p>V .</p>	<p>G </p>

Example: GS2281.X.LT11.TI.VLG.G

Gallery Panels

30"H Application

For Gallery Panel connectors see page 210-211.

GSA SIN 33721

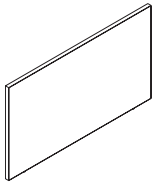

Description	Model	Configuration	List Price		
			L1	L2	L3
30"H Gallery Panels					
33"W	G3033	S	\$ 685	\$ 710	\$ 734
36"W	G3036	S	\$ 720	\$ 747	\$ 772
39"W	G3039	S	\$ 782	\$ 811	\$ 838
42"W	G3042	S	\$ 846	\$ 876	\$ 906
45"W	G3045	S	\$ 923	\$ 956	\$ 989
48"W	G3048	D, S	\$ 967	\$ 1001	\$ 1037
51"W	G3051	D, S	\$ 983	\$ 1019	\$ 1054
54"W	G3054	D, S	\$ 1030	\$ 1067	\$ 1104
57"W	G3057	D, S	\$ 1076	\$ 1116	\$ 1153
60"W	G3060	D, S	\$ 1128	\$ 1169	\$ 1209
63"W	G3063	D, S	\$ 1148	\$ 1190	\$ 1230
66"W	G3066	D, S	\$ 1173	\$ 1216	\$ 1256
69"W	G3069	D, S	\$ 1256	\$ 1301	\$ 1346
72"W	G3072	D, S	\$ 1292	\$ 1338	\$ 1384
75"W	G3075	D, S	\$ 1465	\$ 1518	\$ 1570
78"W	G3078	D, S	\$ 1522	\$ 1577	\$ 1630
81"W	G3081	D, S	\$ 1575	\$ 1631	\$ 1687
84"W	G3084	D, S	\$ 1731	\$ 1792	\$ 1853

Note: Configuration is not included in model number

- S End Single Sided
- D End Dual Sided

<p>How to specify — Select the Model Number from above.</p>	<p>1st Option: FSC: F FSC Wood X Non-FSC Wood</p>	<p>2nd Option: Laminate: See page 188 for finishes.</p>	<p>3rd Option: Edge: See page 188 for finishes.</p>	<p>4th Option: Grain: VLG Horizontal grain or Solid only. VST Vertical Grain (available only for single panels 60"W or less.</p>	<p>5th Option: Glide:</p>
<p>G 3 0 .</p>	<p> .</p>	<p> .</p>	<p> .</p>	<p>V .</p>	<p>G </p>

Example: G3033.X.LT11.TI.VLG.G

Gallery Panels

35"H Application

For Gallery Panel connectors see page 210-211.

GSA PENDING

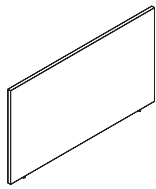

Description	Model	Configuration	List Price		
			L1	L2	L3
35"H Gallery Panels					
33"W	G3533	S	\$ 811	\$ 841	\$ 870
36"W	G3536	S	\$ 860	\$ 892	\$ 922
39"W	G3539	S	\$ 918	\$ 952	\$ 985
42"W	G3542	S	\$ 959	\$ 995	\$ 1030
45"W	G3545	S	\$ 1018	\$ 1056	\$ 1092
48"W	G3548	D, S	\$ 1062	\$ 1102	\$ 1140
51"W	G3551	D, S	\$ 1098	\$ 1139	\$ 1178
54"W	G3554	D, S	\$ 1138	\$ 1181	\$ 1221
57"W	G3557	D, S	\$ 1184	\$ 1228	\$ 1270
60"W	G3560	D, S	\$ 1222	\$ 1267	\$ 1311
63"W	G3563	D, S	\$ 1250	\$ 1296	\$ 1341
66"W	G3566	D, S	\$ 1286	\$ 1333	\$ 1379
69"W	G3569	D, S	\$ 1348	\$ 1397	\$ 1445
72"W	G3572	D, S	\$ 1411	\$ 1463	\$ 1513
75"W	G3575	D, S	\$ 1521	\$ 1577	\$ 1631
78"W	G3578	D, S	\$ 1600	\$ 1658	\$ 1716
81"W	G3581	D, S	\$ 1720	\$ 1782	\$ 1844
84"W	G3584	D, S	\$ 1883	\$ 1951	\$ 2018

Note: Configuration is not included in model number

- S End Single Sided
- D End Dual Sided

<p>How to specify — Select the Model Number from above.</p>	<p>1st Option: FSC: F FSC Wood X Non-FSC Wood</p>	<p>2nd Option: Laminate: See page 188 for finishes.</p>	<p>3rd Option: Edge: See page 188 for finishes.</p>	<p>4th Option: Grain: VLG Horizontal grain or Solid only. VST Vertical Grain (available only for single panels 60"W or less.</p>	<p>5th Option: Glide:</p>
<p>G 3 5 .</p>	<p> .</p>	<p> .</p>	<p> .</p>	<p>V .</p>	<p>G </p>

Example: G3533.X.LT11.TI.VLG.G

Gallery Panels

42"H Application

For Gallery Panel connectors see page 210-211.

GSA SIN 33721

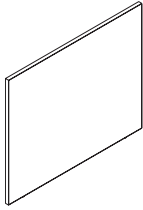

Description	Model	Configuration	List Price		
			L1	L2	L3
42"H Gallery Panels					
33"W	G4233	S	\$ 906	\$ 938	\$ 971
36"W	G4236	S	\$ 959	\$ 993	\$ 1027
39"W	G4239	S	\$ 1027	\$ 1064	\$ 1100
42"W	G4242	S	\$ 1071	\$ 1111	\$ 1148
45"W	G4245	S	\$ 1110	\$ 1151	\$ 1190
48"W	G4248	D, S	\$ 1155	\$ 1197	\$ 1237
51"W	G4251	D, S	\$ 1228	\$ 1272	\$ 1315
54"W	G4254	D, S	\$ 1266	\$ 1312	\$ 1356
57"W	G4257	D, S	\$ 1297	\$ 1344	\$ 1389
60"W	G4260	D, S	\$ 1346	\$ 1394	\$ 1441
63"W	G4263	D, S	\$ 1382	\$ 1431	\$ 1480
66"W	G4266	D, S	\$ 1427	\$ 1479	\$ 1528
69"W	G4269	D, S	\$ 1455	\$ 1508	\$ 1558
72"W	G4272	D, S	\$ 1538	\$ 1593	\$ 1647
75"W	G4275	D, S	\$ 1593	\$ 1650	\$ 1706
78"W	G4278	D, S	\$ 1693	\$ 1753	\$ 1813
81"W	G4281	D, S	\$ 1891	\$ 1958	\$ 2024
84"W	G4284	D, S	\$ 2036	\$ 2109	\$ 2180

Note: Configuration is not included in model number

- S End Single Sided
- D End Dual Sided

<p>How to specify — Select the Model Number from above.</p>	<p>1st Option: FSC: F FSC Wood X Non-FSC Wood</p>	<p>2nd Option: Laminate: See page 188 for finishes.</p>	<p>3rd Option: Edge: See page 188 for finishes.</p>	<p>4th Option: Grain: VLG Horizontal grain or Solid only. VST Vertical Grain (available only for single panels 60"W or less.</p>	<p>5th Option: Glide:</p>
G 4 2 	V .	G

Example: G4233.X.LT11.TI.VLG.G

Gallery Panels

50"H Application

For Gallery Panel connectors see page 210-211.

GSA SIN 33721

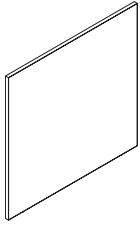

Description	Model	Configuration	List Price		
			L1	L2	L3
50"H Gallery Panels					
33"W	G5033	S	\$ 1005	\$ 1041	\$ 1077
36"W	G5036	S	\$ 1054	\$ 1092	\$ 1129
39"W	G5039	S	\$ 1119	\$ 1160	\$ 1199
42"W	G5042	S	\$ 1179	\$ 1222	\$ 1263
45"W	G5045	S	\$ 1266	\$ 1312	\$ 1356
48"W	G5048	D, S	\$ 1297	\$ 1344	\$ 1389
51"W	G5051	D, S	\$ 1332	\$ 1380	\$ 1426
54"W	G5054	D, S	\$ 1388	\$ 1437	\$ 1486
57"W	G5057	D, S	\$ 1424	\$ 1476	\$ 1525
60"W	G5060	D, S	\$ 1466	\$ 1519	\$ 1571
63"W	G5063	D, S	\$ 1498	\$ 1552	\$ 1605
66"W	G5066	D, S	\$ 1539	\$ 1594	\$ 1648
69"W	G5069	D, S	\$ 1585	\$ 1642	\$ 1697
72"W	G5072	D, S	\$ 1628	\$ 1686	\$ 1744
75"W	G5075	D, S	\$ 1737	\$ 1798	\$ 1860
78"W	G5078	D, S	\$ 1907	\$ 1975	\$ 2041
81"W	G5081	D, S	\$ 2069	\$ 2143	\$ 2216
84"W	G5084	D, S	\$ 2212	\$ 2291	\$ 2368

Note: Configuration is not included in model number

- S End Single Sided
- D End Dual Sided

<p>How to specify — Select the Model Number from above.</p>	<p>1st Option: FSC: F FSC Wood X Non-FSC Wood</p>	<p>2nd Option: Laminate: See page 188 for finishes.</p>	<p>3rd Option: Edge: See page 188 for finishes.</p>	<p>4th Option: Grain: VLG Horizontal grain or Solid only. VST Vertical Grain (available only for single panels 60"W or less.</p>	<p>5th Option: Glide:</p>
<p>G 5 0 .</p>	<p> .</p>	<p> .</p>	<p> .</p>	<p>V .</p>	<p>G </p>

Example: G5033.X.LT11.TI.VLG.G

Gallery Panels

22"H Application for Use with Glass

For Gallery Panel Glass see page 212-214.
For Gallery Panel connectors see page 210-211.

GSA SIN 33721

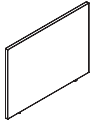

Description	Model	List Price			Accepts Glass Models
		L1	L2	L3	7½"H, 13"H, 15"H
22"H Gallery Panels with Glass					
18"W	G2218G	\$ 676	\$ 705	\$ 733	G4 □□ 18GS
21"W	G2221G	\$ 695	\$ 725	\$ 754	G4 □□ 21GS
24"W	G2224G	\$ 721	\$ 752	\$ 782	G4 □□ 24GS
27"W	G2227G	\$ 757	\$ 789	\$ 821	G4 □□ 27GS
30"W	G2230G	\$ 827	\$ 863	\$ 898	G4 □□ 30GS
33"W	G2233G	\$ 862	\$ 899	\$ 935	G4 □□ 33GS
36"W	G2236G	\$ 894	\$ 932	\$ 971	G4 □□ 36GS
39"W	G2239G	\$ 949	\$ 990	\$ 1030	G4 □□ 39GS
42"W	G2242G	\$ 1007	\$ 1051	\$ 1092	G4 □□ 42GS
45"W	G2245G	\$ 1076	\$ 1122	\$ 1167	G4 □□ 45GS
48"W	G2248G	\$ 1115	\$ 1163	\$ 1209	G4 □□ 48GS
51"W	G2251G	\$ 1130	\$ 1178	\$ 1225	G4 □□ 51GS
54"W	G2254G	\$ 1174	\$ 1224	\$ 1273	G4 □□ 54GS
57"W	G2257G	\$ 1215	\$ 1267	\$ 1318	G4 □□ 57GS
60"W	G2260G	\$ 1261	\$ 1315	\$ 1368	G4 □□ 60GS
63"W	G2263G	\$ 1277	\$ 1332	\$ 1385	G4 □□ 63GS
66"W	G2266G	\$ 1299	\$ 1355	\$ 1409	G4 □□ 66GS
69"W	G2269G	\$ 1375	\$ 1433	\$ 1492	G4 □□ 69GS
72"W	G2272G	\$ 1409	\$ 1469	\$ 1528	G4 □□ 72GS
75"W	G2275G	\$ 1564	\$ 1630	\$ 1696	G4 □□ 75GS
78"W	G2278G	\$ 1615	\$ 1683	\$ 1751	G4 □□ 78GS
81"W	G2281G	\$ 1663	\$ 1734	\$ 1804	G4 □□ 81GS
87"W	G2287G	\$ 1693	\$ 1773	\$ 1851	G4 □□ 87GS
93"W	G2293G	\$ 1742	\$ 1824	\$ 1904	G4 □□ 93GS
99"W	G2299G	\$ 1763	\$ 1846	\$ 1927	G4 □□ 99GS
105"W	G22105G	\$ 1796	\$ 1880	\$ 1963	G4 □□ 105GS
84"W	G2284G	\$ 1801	\$ 1878	\$ 1954	G4 □□ 84GS
111"W	G22111G	\$ 1880	\$ 1967	\$ 2054	G4 □□ 111GS
117"W	G22117G	\$ 1929	\$ 2019	\$ 2107	G4 □□ 117GS
123"W	G22123G	\$ 1943	\$ 2033	\$ 2123	G4 □□ 123GS
129"W	G22129G	\$ 1989	\$ 2081	\$ 2172	G4 □□ 129GS
135"W	G22135G	\$ 2068	\$ 2163	\$ 2258	G4 □□ 135GS
141"W	G22141G	\$ 2159	\$ 2257	\$ 2356	G4 □□ 141GS
147"W	G22147G	\$ 2261	\$ 2364	\$ 2466	G4 □□ 147GS

Note: Fill in model number blanks with one of the following options to determine glass height.

- 07 7.5"H glass
- 13 13"H glass
- 15 15"H glass

How to specify — Select the Model Number from above.	1st Option: FSC: F FSC Wood X Non-FSC Wood	2nd Option: Laminate: See page 188 for finishes.	3rd Option: Edge: See page 188 for finishes.	4th Option: Grain: VLG Horizontal grain or Solid only. VST Vertical Grain (available only for single panels 60"W or less.	5th Option: Glide:
G S 2 2 	V .	G .

Example: G2218G.X.LT11.TI.VLG.G

Gallery Panels

22"H Application for Use with Glass

For Gallery Panel Glass see page 212-214.
 For Gallery Panel connectors see page 210-211.

GSA SIN 33721

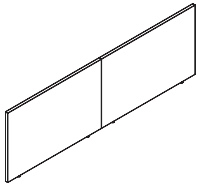

Description	Model	List Price			Accepts Glass Models 7½"H, 13"H, 15"H
		L1	L2	L3	
22"H Gallery Split Panels with Glass					
81"W	GS2281G	\$ 1592	\$ 1659	\$ 1726	G4 □ □ 81GS
87"W	GS2287G	\$ 1874	\$ 1954	\$ 2032	G4 □ □ 89GS
93"W	GS2293G	\$ 1923	\$ 2005	\$ 2085	G4 □ □ 93GS
99"W	GS2299G	\$ 1944	\$ 2027	\$ 2108	G4 □ □ 99GS
105"W	GS22105G	\$ 1977	\$ 2061	\$ 2144	G4 □ □ 105GS
111"W	GS22111G	\$ 2061	\$ 2148	\$ 2235	G4 □ □ 111GS
117"W	GS22117G	\$ 2110	\$ 2200	\$ 2288	G4 □ □ 117GS
123"W	GS22123G	\$ 2124	\$ 2214	\$ 2304	G4 □ □ 123GS
129"W	GS22129G	\$ 2170	\$ 2262	\$ 2353	G4 □ □ 129GS
135"W	GS22135G	\$ 2249	\$ 2344	\$ 2439	G4 □ □ 135GS
141"W	GS22141G	\$ 2340	\$ 2438	\$ 2537	G4 □ □ 141GS
147"W	GS22147G	\$ 2442	\$ 2545	\$ 2647	G4 □ □ 147GS

Note: Fill in model number blanks with one of the following options to determine glass height.

- 07 7.5"H glass
- 13 13"H glass
- 15 15"H glass

<p>How to specify — Select the Model Number from above.</p>	<p>1st Option: FSC: F FSC Wood X Non-FSC Wood</p>	<p>2nd Option: Laminate: See page 188 for finishes.</p>	<p>3rd Option: Edge: See page 188 for finishes.</p>	<p>4th Option: Grain: VLG Horizontal grain or Solid only. VST Vertical Grain (available only for single panels 60"W or less.</p>	<p>5th Option: Glide:</p>
<p>GS 2 2 . .</p>					

Example: GS2281G.X.LT11.TI.VLG.G

Gallery Panels

30"H Application for Use with Glass

For Gallery Panel Glass see page 212-214.
For Gallery Panel connectors see page 210-211.

GSA SIN 33721

GALLERY PANELS

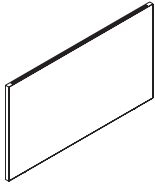

Description	Model	Configuration	List Price			Accepts Glass Models
			L1	L2	L3	7½"H, 13"H, 15"H
30"H Gallery Panels with Glass						
33"W	G3033G	S	\$ 933	\$ 966	\$ 999	G4 □□ 30GS
36"W	G3036G	S	\$ 967	\$ 1001	\$ 1037	G4 □□ 33GS
39"W	G3039G	S	\$ 1027	\$ 1064	\$ 1100	G4 □□ 36GS
42"W	G3042G	S	\$ 1090	\$ 1130	\$ 1168	G4 □□ 39GS
45"W	G3045G	S	\$ 1166	\$ 1209	\$ 1249	G4 □□ 42GS
48"W	G3048G	D, S	\$ 1211	\$ 1255	\$ 1297	G4 □□ 45GS
51"W	G3051G	D, S	\$ 1228	\$ 1272	\$ 1315	G4 □□ 48GS
54"W	G3054G	D, S	\$ 1276	\$ 1322	\$ 1367	G4 □□ 51GS
57"W	G3057G	D, S	\$ 1321	\$ 1368	\$ 1415	G4 □□ 54GS
60"W	G3060G	D, S	\$ 1371	\$ 1420	\$ 1468	G4 □□ 57GS
63"W	G3063G	D, S	\$ 1391	\$ 1441	\$ 1489	G4 □□ 60GS
66"W	G3066G	D, S	\$ 1416	\$ 1466	\$ 1517	G4 □□ 63GS
69"W	G3069G	D, S	\$ 1501	\$ 1555	\$ 1608	G4 □□ 66GS
72"W	G3072G	D, S	\$ 1537	\$ 1592	\$ 1646	G4 □□ 69GS
75"W	G3075G	D, S	\$ 1708	\$ 1769	\$ 1829	G4 □□ 72GS
78"W	G3078G	D, S	\$ 1768	\$ 1830	\$ 1893	G4 □□ 75GS
81"W	G3081G	D, S	\$ 1822	\$ 1887	\$ 1951	G4 □□ 78GS
84"W	G3084G	D, S	\$ 1975	\$ 2046	\$ 2116	G4 □□ 81GS

Note: Configuration is not included in model number

- S End Single Sided
- D End Dual Sided

Note: Fill in model number blanks with one of the following options to determine glass height.

- 07 7.5"H glass
- 13 13"H glass
- 15 15"H glass

<p><i>How to specify —</i> Select the Model Number from above.</p>	<p><i>1st Option:</i> FSC: F FSC Wood X Non-FSC Wood</p>	<p><i>2nd Option:</i> Laminate: See page 188 for finishes.</p>	<p><i>3rd Option:</i> Edge: See page 188 for finishes.</p>	<p><i>4th Option:</i> Grain: VLG Horizontal grain or Solid only. VST Vertical Grain (available only for single panels 60"W or less.</p>	<p><i>5th Option:</i> Glide:</p>
<p>G 3 0 .</p>	<p> .</p>	<p> .</p>	<p> .</p>	<p>V .</p>	<p>G </p>

Example: G3033G.X.LT11.TI.VLG.G

Gallery Panels

35"H Application for Use with Glass

GSA SIN 33721

For Gallery Panel Glass see page 212-214.
For Gallery Panel connectors see page 210-211.

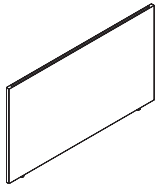

Description	Model	Configuration	List Price			Accepts Glass Models 7½"H, 13"H, 15"H
			L1	L2	L3	
35"H Gallery Panels with Glass						
33"W	G3533G	S	\$ 1051	\$ 1091	\$ 1128	G4 □ □ 30GS
36"W	G3536G	S	\$ 1100	\$ 1142	\$ 1181	G4 □ □ 33GS
39"W	G3539G	S	\$ 1160	\$ 1203	\$ 1244	G4 □ □ 36GS
42"W	G3542G	S	\$ 1199	\$ 1244	\$ 1286	G4 □ □ 39GS
45"W	G3545G	S	\$ 1258	\$ 1305	\$ 1350	G4 □ □ 42GS
48"W	G3548G	D, S	\$ 1299	\$ 1347	\$ 1393	G4 □ □ 45GS
51"W	G3551G	D, S	\$ 1335	\$ 1384	\$ 1432	G4 □ □ 48GS
54"W	G3554G	D, S	\$ 1380	\$ 1430	\$ 1479	G4 □ □ 51GS
57"W	G3557G	D, S	\$ 1416	\$ 1469	\$ 1519	G4 □ □ 54GS
60"W	G3560G	D, S	\$ 1466	\$ 1520	\$ 1573	G4 □ □ 57GS
63"W	G3563G	D, S	\$ 1492	\$ 1547	\$ 1601	G4 □ □ 60GS
66"W	G3566G	D, S	\$ 1528	\$ 1584	\$ 1639	G4 □ □ 63GS
69"W	G3569G	D, S	\$ 1585	\$ 1643	\$ 1700	G4 □ □ 66GS
72"W	G3572G	D, S	\$ 1642	\$ 1702	\$ 1761	G4 □ □ 69GS
75"W	G3575G	D, S	\$ 1753	\$ 1817	\$ 1880	G4 □ □ 72GS
78"W	G3578G	D, S	\$ 1831	\$ 1898	\$ 1963	G4 □ □ 75GS
81"W	G3581G	D, S	\$ 1960	\$ 2032	\$ 2102	G4 □ □ 78GS
84"W	G3584G	D, S	\$ 2123	\$ 2201	\$ 2277	G4 □ □ 81GS

Note: Configuration is not included in model number

- S End Single Sided
- D End Dual Sided

Note: Fill in model number blanks with one of the following options to determine glass height.

- 07 7.5"H glass
- 13 13"H glass
- 15 15"H glass

<p><i>How to specify —</i> Select the Model Number from above.</p>	<p><i>1st Option:</i> FSC: F FSC Wood X Non-FSC Wood</p>	<p><i>2nd Option:</i> Laminate: See page 188 for finishes.</p>	<p><i>3rd Option:</i> Edge: See page 188 for finishes.</p>	<p><i>4th Option:</i> Grain: VLG Horizontal grain or Solid only. VST Vertical Grain (available only for single panels 60"W or less.</p>	<p><i>5th Option:</i> Glide:</p>
G 3 5 . .				V .	G

Example: G3533G.X.LT11.TI.VLG.G

Gallery Panels

42"H Application for Use with Glass

For Gallery Panel Glass see page 212-214.
For Gallery Panel connectors see page 210-211.

GSA SIN 33721

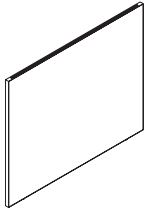

Description	Model	Configuration	List Price			Accepts Glass Models
			L1	L2	L3	7½"H
42"H Gallery Panels with Glass						
33"W	G4233G	S	\$ 1151	\$ 1193	\$ 1233	G40730GS
36"W	G4236G	S	\$ 1204	\$ 1248	\$ 1289	G40733GS
39"W	G4239G	S	\$ 1273	\$ 1319	\$ 1364	G40736GS
42"W	G4242G	S	\$ 1318	\$ 1365	\$ 1411	G40739GS
45"W	G4245G	S	\$ 1355	\$ 1403	\$ 1451	G40742GS
48"W	G4248G	D, S	\$ 1400	\$ 1450	\$ 1499	G40745GS
51"W	G4251G	D, S	\$ 1472	\$ 1525	\$ 1577	G40748GS
54"W	G4254G	D, S	\$ 1510	\$ 1564	\$ 1618	G40751GS
57"W	G4257G	D, S	\$ 1544	\$ 1599	\$ 1654	G40754GS
60"W	G4260G	D, S	\$ 1590	\$ 1647	\$ 1703	G40757GS
63"W	G4263G	D, S	\$ 1626	\$ 1684	\$ 1742	G40760GS
66"W	G4266G	D, S	\$ 1671	\$ 1730	\$ 1790	G40763GS
69"W	G4269G	D, S	\$ 1700	\$ 1760	\$ 1820	G40766GS
72"W	G4272G	D, S	\$ 1782	\$ 1846	\$ 1909	G40769GS
75"W	G4275G	D, S	\$ 1836	\$ 1902	\$ 1966	G40772GS
78"W	G4278G	D, S	\$ 1936	\$ 2006	\$ 2072	G40775GS
81"W	G4281G	D, S	\$ 2136	\$ 2213	\$ 2288	G40778GS
84"W	G4284G	D, S	\$ 2281	\$ 2362	\$ 2442	G40781GS

Note: Configuration is not included in model number

- S End Single Sided
- D End Dual Sided

<p>How to specify — Select the Model Number from above.</p>	<p>1st Option: FSC: F FSC Wood X Non-FSC Wood</p>	<p>2nd Option: Laminate: See page 188 for finishes.</p>	<p>3rd Option: Edge: See page 188 for finishes.</p>	<p>4th Option: Grain: VLG Horizontal grain or Solid only. VST Vertical Grain (available only for single panels 60"W or less.</p>	<p>5th Option: Glide:</p>
G 4 2 	V .	G

Example: G4233G.X.LT11.TI.VLG.G

Gallery Panel Connectors

Further™ Connector Kits

GSA SIN 33721

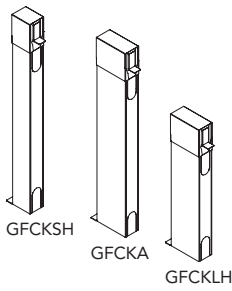

Description	Model	List Price		
		P1	P2	P3
Further Benching Connector Kit				
Further Tethered Standard Height Connector	GFCKSH	\$ 515	\$ 552	\$ 607
Further Adaptive and Freestanding Standard Height Connector	GFCKA	\$ 508	\$ 545	\$ 599
Further Low Height Connector (Freestanding)	GFCKLH	\$ 582	\$ 624	\$ 685

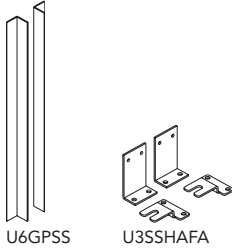

Description	Model	P1	P2	P3
For Adaptive Gallery Panel in Single Sided Applications	U6GPSS	\$ 158	\$ 171	\$ 187
For Single Sided applications without Gallery Panels	U3SSHAF A	\$ 75	\$ 83	\$ 90

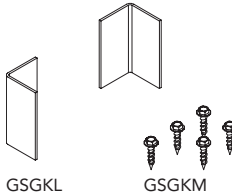

Storage Mounting Brackets				
Description	Model	P1	P2	P3
Gallery Laminate Storage Ganging Kit	GSGKL	\$ 80	N/A	N/A
Gallery Metal Storage Ganging Kit	GSGKM	\$ 19	N/A	N/A

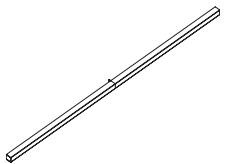

Gallery Panel Stiffener				
Description	Model	P1	P2	P3
Stiffener for 75"W/78"W Panels	GSTFN7578	\$ 181	\$ 196	\$ 215
Stiffener for 81"W/84"W Panels	GSTFN8184	\$ 202	\$ 219	\$ 242

Mural Connector Kits				
Description	Model	P1	P2	P3
Gallery Panel End Connector	GSCKP	\$ 145	\$ 152	\$ 158
Gallery Panel Mid Connector Dual Sided	GSCKPM D	\$ 169	\$ 177	\$ 185
Gallery Panel Mid Connector Single Sided	GSCKPMS	\$ 201	\$ 211	\$ 219
Split Gallery Panel Hardware Kit Dowel	GSHW	\$ 181	N/A	N/A

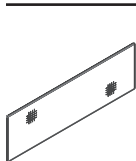

Description	Model	List Price					
		Grade A	Grade B	Grade C	Grade D	Grade E	Grade F
Tackable Accessory							
11"H x 36"W	ZS42SF S	\$ 503	\$ 533	\$ 562	\$ 610	\$ 658	\$ 706
18½"H x 36"W	ZS50SF	\$ 597	\$ 643	\$ 687	\$ 761	\$ 834	\$ 909

S Shippable by small-package carrier.

<p>How to specify — Select the Model Number from above.</p>	<p><i>1st Option:</i> Paint for Connector Kits and Brackets (if available): P1 P2 P3 See page 188 for finishes.</p>	<p><i>1st Option:</i> Fabric for Cantilevered Storage Accessory: See page 10 for fabrics.</p>	<p><i>2nd Option:</i> Trim Paint for Cantilevered Storage Accessory: P1 P2 P3 See page 188 for finishes.</p>
--	--	--	---

Examples: GZCKP.P71 GCKPM.P71 GZ3CON30.P71 GSGKL GSGKM ZS50SF.EXG903.P27

Gallery Panel Connectors

Connector Kits

GSA SIN 33721

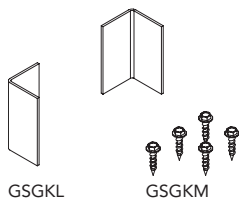

Description	Model	List Price		
		P1	P2	P3
Storage Mounting Brackets				
Gallery Laminate Storage Ganging Kit	GSGKL	\$ 80	N/A	N/A
Gallery Metal Storage Ganging Kit	GSGKM	\$ 19	N/A	N/A

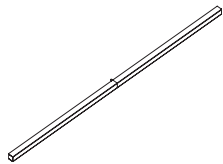

Gallery Panel Stiffener				
Stiffener for 75"W/78"W Panels	GSTFN7578	\$ 181	\$ 196	\$ 215
Stiffener for 81"W/84"W Panels	GSTFN8184	\$ 202	\$ 219	\$ 242

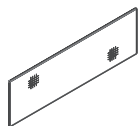

Description	Model	List Price					
		Grade A	Grade B	Grade C	Grade D	Grade E	Grade F
Tackable Accessory							
11"H x 36"W	ZS425F S	\$ 503	\$ 533	\$ 562	\$ 610	\$ 658	\$ 706
18½"H x 36"W	ZS50SF	\$ 597	\$ 643	\$ 687	\$ 761	\$ 834	\$ 909

S Shippable by small-package carrier.

<p>How to specify — Select the Model Number from above.</p> <p>_____ .</p>	<p><i>1st Option:</i> Paint for Connector Kits and Brackets (if available): P1 P2 P3 See page 188 for finishes.</p> <p>_____ .</p>	<p><i>1st Option:</i> Fabric for Cantilevered Storage Accessory: See page 10 for fabrics.</p> <p>_____ .</p>	<p><i>2nd Option:</i> Trim Paint for Cantilevered Storage Accessory: P1 P2 P3 See page 188 for finishes.</p> <p>_____ P _____</p>
---	---	---	---

Examples: GZCKP.P71 GCKPM.P71 GZ3CON30.P71 GSGKL GSGKM ZS50SF.EXG903.P27

Gallery Glass

Panel Systems Gallery Glass

GSA SIN 33721

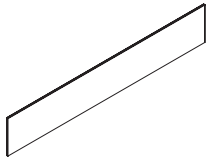

Description	Model	List Price		
		Clear Glass	Frosted Glass	Smoked Glass
7½"H Gallery Glass — Single Panel				
15"W	G40715GS	\$ 212	\$ 233	\$ 240
18"W	G40718GS	\$ 218	\$ 240	\$ 247
21"W	G40721GS	\$ 222	\$ 244	\$ 252
24"W	G40724GS	\$ 226	\$ 249	\$ 256
27"W	G40727GS	\$ 246	\$ 270	\$ 278
30"W	G40730GS	\$ 263	\$ 290	\$ 297
33"W	G40733GS	\$ 289	\$ 318	\$ 327
36"W	G40736GS	\$ 325	\$ 357	\$ 368
39"W	G40739GS	\$ 352	\$ 386	\$ 399
42"W	G40742GS	\$ 394	\$ 434	\$ 446
45"W	G40745GS	\$ 428	\$ 471	\$ 484
48"W	G40748GS	\$ 465	\$ 511	\$ 525
51"W	G40751GS	\$ 475	\$ 522	\$ 537
54"W	G40754GS	\$ 514	\$ 564	\$ 581
57"W	G40757GS	\$ 569	\$ 625	\$ 643
60"W	G40760GS	\$ 667	\$ 732	\$ 754
63"W	G40763GS	\$ 776	\$ 853	\$ 877
66"W	G40766GS	\$ 839	\$ 921	\$ 948
69"W	G40769GS	\$ 918	\$ 1008	\$ 1037
72"W	G40772GS	\$ 982	\$ 1078	\$ 1110
75"W	G40775GS	\$ 1050	\$ 1152	\$ 1186
78"W	G40778GS	\$ 1156	\$ 1268	\$ 1306
81"W	G40781GS	\$ 1215	\$ 1334	\$ 1372

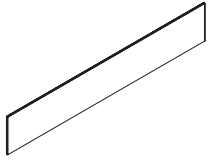

7½"H Gallery Glass — Split Panels (order quantity must be in multiples of 2)				
39"W	G40739GS	\$ 352	\$ 386	\$ 399
42"W	G40742GS	\$ 394	\$ 434	\$ 446
45"W	G40745GS	\$ 428	\$ 471	\$ 484
48"W	G40748GS	\$ 465	\$ 511	\$ 525
51"W	G40751GS	\$ 475	\$ 522	\$ 537
54"W	G40754GS	\$ 514	\$ 564	\$ 581
57"W	G40757GS	\$ 569	\$ 625	\$ 643
60"W	G40760GS	\$ 667	\$ 732	\$ 754
63"W	G40763GS	\$ 776	\$ 853	\$ 877
66"W	G40766GS	\$ 839	\$ 921	\$ 948
69"W	G40769GS	\$ 918	\$ 1008	\$ 1037

<p><i>How to specify —</i> Select the Model Number from above.</p>	<p><i>1st Option:</i> Glass: LC Clear Glass LF Frosted Glass GSM1 Smoked Glass</p>
<p>G 4 0 7 .</p>	<p> .</p>

Examples: G40715GS.LC G40739GS.GSM1

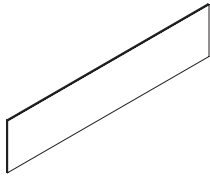

Description	Model	List Price		
		Clear Glass	Frosted Glass	Smoked Glass
13"H Gallery Glass — Single Panel				
24"W	G41324GS	\$ 515	\$ 572	\$ 590
27"W	G41327GS	\$ 562	\$ 623	\$ 644
30"W	G41330GS	\$ 604	\$ 670	\$ 691
33"W	G41333GS	\$ 635	\$ 705	\$ 728
36"W	G41336GS	\$ 673	\$ 747	\$ 770
39"W	G41339GS	\$ 726	\$ 806	\$ 832
42"W	G41342GS	\$ 750	\$ 832	\$ 859
45"W	G41345GS	\$ 766	\$ 850	\$ 877
48"W	G41348GS	\$ 791	\$ 877	\$ 906
51"W	G41351GS	\$ 804	\$ 891	\$ 921
54"W	G41354GS	\$ 861	\$ 955	\$ 985
57"W	G41357GS	\$ 880	\$ 976	\$ 1008
60"W	G41360GS	\$ 905	\$ 1003	\$ 1036
63"W	G41363GS	\$ 970	\$ 1076	\$ 1111
66"W	G41366GS	\$ 1052	\$ 1167	\$ 1205
69"W	G41369GS	\$ 1113	\$ 1234	\$ 1274
72"W	G41372GS	\$ 1193	\$ 1323	\$ 1366
75"W	G41375GS	\$ 1281	\$ 1421	\$ 1466
78"W	G41378GS	\$ 1363	\$ 1511	\$ 1560
81"W	G41381GS	\$ 1438	\$ 1594	\$ 1646

13"H Gallery Glass — Split Panels *(order quantity must be in multiples of 2)*

39" W	G41339GS	\$ 726	\$ 806	\$ 832
42" W	G41342GS	\$ 750	\$ 832	\$ 859
45" W	G41345GS	\$ 766	\$ 850	\$ 877
48" W	G41348GS	\$ 791	\$ 877	\$ 906
51" W	G41351GS	\$ 804	\$ 891	\$ 921
54" W	G41354GS	\$ 861	\$ 955	\$ 985
57" W	G41357GS	\$ 880	\$ 976	\$ 1008
60" W	G41360GS	\$ 905	\$ 1003	\$ 1036
63" W	G41363GS	\$ 970	\$ 1076	\$ 1111
66" W	G41366GS	\$ 1052	\$ 1167	\$ 1205
69" W	G41369GS	\$ 1113	\$ 1234	\$ 1274

<p><i>How to specify —</i> Select the Model Number from above.</p>	<p><i>1st Option:</i> Glass: LC Clear Glass LF Frosted Glass GSM1 Smoked Glass</p>
<p>G 4 1 3 .</p>	<p> .</p>

Examples: G41324GS.LC G41339GS.GSM1

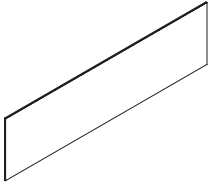

Description	Model	List Price		
		Clear Glass	Frosted Glass	Smoked Glass
15"H Gallery Glass — Single Panel				
15" W	G41515GS	\$ 538	\$ 597	\$ 617
18" W	G41518GS	\$ 562	\$ 623	\$ 644
21" W	G41521GS	\$ 588	\$ 653	\$ 673
24" W	G41524GS	\$ 618	\$ 685	\$ 708
27" W	G41527GS	\$ 638	\$ 708	\$ 731
30" W	G41530GS	\$ 664	\$ 737	\$ 760
33" W	G41533GS	\$ 697	\$ 774	\$ 798
36" W	G41536GS	\$ 759	\$ 842	\$ 869
39" W	G41539GS	\$ 794	\$ 880	\$ 910
42" W	G41542GS	\$ 814	\$ 903	\$ 932
45" W	G41545GS	\$ 828	\$ 919	\$ 948
48" W	G41548GS	\$ 848	\$ 941	\$ 971
51" W	G41551GS	\$ 867	\$ 961	\$ 992
54" W	G41554GS	\$ 922	\$ 1023	\$ 1055
57" W	G41557GS	\$ 935	\$ 1037	\$ 1070
60" W	G41560GS	\$ 943	\$ 1046	\$ 1079
63" W	G41563GS	\$ 1000	\$ 1109	\$ 1145
66" W	G41566GS	\$ 1083	\$ 1201	\$ 1240
69" W	G41569GS	\$ 1139	\$ 1263	\$ 1304
72" W	G41572GS	\$ 1218	\$ 1350	\$ 1395
75" W	G41575GS	\$ 1315	\$ 1458	\$ 1506
78" W	G41578GS	\$ 1386	\$ 1536	\$ 1585
81" W	G41581GS	\$ 1467	\$ 1626	\$ 1679

15"H Gallery Glass — Split Panels *(order quantity must be in multiples of 2)*

39" W	G41539GS	\$ 794	\$ 880	\$ 910
42" W	G41542GS	\$ 814	\$ 903	\$ 932
45" W	G41545GS	\$ 828	\$ 919	\$ 948
48" W	G41548GS	\$ 848	\$ 941	\$ 971
51" W	G41551GS	\$ 867	\$ 961	\$ 992
54" W	G41554GS	\$ 922	\$ 1023	\$ 1055
57" W	G41557GS	\$ 935	\$ 1037	\$ 1070
60" W	G41560GS	\$ 943	\$ 1046	\$ 1079
63" W	G41563GS	\$ 1000	\$ 1109	\$ 1145
66" W	G41566GS	\$ 1083	\$ 1201	\$ 1240
69" W	G41569GS	\$ 1139	\$ 1263	\$ 1304

How to specify —
Select the Model Number from above.

1st Option:

Glass:

- LC Clear Glass
- LF Frosted Glass
- GSM1 Smoked Glass

G 4 1 5 | | | | | .

| | | | | .

Examples: G41515GS.LC G41539GS.GSM1

- Finishes 216
- Digital Lock Specifications 217
- Pedestal Functionality with Work Tools 218
- Digital Locking Guide..... 219
- Freestanding and Mobile Pedestals220-223
- Pedestal Functionality with Work Tools224-225
- Undermount, L-Cube, and Work Tools 226
- Undercabinet Pedestals..... 227
- Caddy..... 228
- Digital Lock Keys and Accessories 229

PAINTED METAL FINISHES

GRADE P1

Black.....	P71
Brownstone.....	P7D
Bungalow.....	P7C
Cinder.....	P7Q
Designer White.....	PJW
Flint.....	P02
Fossil.....	P28
Loft.....	P7B
Muslin.....	P4J
Parchment.....	P93
Pebble.....	P8R
Pewter.....	P8D
Salt.....	P8C
Titanium.....	P8T

GRADE P2

Champagne Metallic.....	PR5
Gunmetal Metallic.....	PR3
Silver**.....	PR6
Solar Black.....	P8X

**PR6 no upcharge on Involve; available as a Grade P2 color on stanchions. PR6 & P8X are not available on Concensys, Essentials bookcase, and vertical files.

GRADE P3

Atom.....	P8S
Blossom***.....	P8K
Bullseye.....	PJF
Ember.....	P8P
Ion.....	P8N
Iris.....	P8J
Krypton.....	P8F
Ochre***.....	P093
Regatta.....	P8M
Sienna***.....	P092
Succulent***.....	P8A

Metallic paints, due to varying reflectance, may appear to have less visual color consistency than other paint finishes, even when L/A/B values are exactly the same. (L/A/B — measurable aspects of color — values are maintained within a specified range, to ensure consistent appearance of paint colors.)

****These colors are intended to be an inspirational option for the trending market. Product application is limited and color availability is approximately two years to coincide with evolving workplace trends.*

METAL STORAGE PULLS

BEAM

Designer White.....	PJW
Silver.....	PR6
Pyrite.....	PJE
Solar Black.....	P8X

HALO

Designer White.....	PJW
Silver.....	PR6
Pyrite.....	PJE
Solar Black.....	P8X

BAR

Designer White.....	PJW
Black.....	P27
Silver.....	PR6

SQUARE

Designer White.....	PJW
Flint.....	P02
Loft.....	P7B
Matte Silver.....	EL
Pyrite.....	PJE
Solar Black.....	P8X

RADII CONSOLE—POLY LINER

Cool Grey.....	CGR
----------------	-----

RADII USB

Designer White.....	DW
Flint.....	E9
Storm.....	STRM

LOCKS

Black.....	E4
Chrome.....	ordered by base model
Matte Silver.....	EL

NOTE: Refer to individual product pages for upcharges.

RADII WORKTOOLS COLOR OPTIONS

DW- Designer White
E9- Flint

FABRICS

GRADE 1

APEX.....	APX
Basalt.....	APX25
Beet.....	APX12
Blackberry.....	APX20
Chive.....	APX05
Iris.....	APX03
Kiwi.....	APX06
Lemonade.....	APX08
Navy.....	APX13
Papaya.....	APX09
Pumice.....	APX23
Rain.....	APX19
Resort.....	APX15
Royal.....	APX14
Tiki.....	APX29
Tomato.....	APX11

CENTURION.....	CU
Apricot.....	CU47
Bark.....	CU25
Black.....	CU10
Espresso.....	CU49
Fog.....	CU03
Frost.....	CU22
Goldenrod.....	CU27
Indigo.....	CU06
Iris.....	CU50
Iron Ore.....	CU19
Jade.....	CU83
Marsala.....	CU63
Morel.....	CU24
Navy.....	CU98
Peacock.....	CU97
Pear.....	CU84
Ruby.....	CU67
Sapphire.....	CU09

FABRICS – CONTINUED

GRADE 1 – CONTINUED

CONTOURETT.....	CU
Baltic.....	UR94
Beach.....	UR23
Black.....	UR10
Bordeaux.....	UR63
Buff.....	UR22
Cloud.....	UR18
Coffee Bean.....	UR49
Crater.....	UR51
Flame.....	UR62
Graphite.....	UR19
Iron.....	UR20
Luggage.....	UR26
Marine.....	UR92
Navy.....	UR95
Nimbus.....	UR93
Ocean.....	UR96
Pumpkin.....	UR42
Quarry.....	UR24
Red.....	UR64
Safari.....	UR27
Sage.....	UR82
Steel.....	UR21
Storm.....	UR17
Taupe.....	UR28
Trunk.....	UR50

DAPPER.....	DAPR
Ash.....	DAPR20
Breeze.....	DAPR06
Canvas.....	DAPR25
Charcoal.....	DAPR01
Clover.....	DAPR22
Currant.....	DAPR00
Fawn.....	DAPR35
Fern.....	DAPR85
Gerbera.....	DAPR16
Grape.....	DAPR33
Jewel.....	DAPR08
Marigold.....	DAPR65
Onyx.....	DAPR10
Orchid.....	DAPR90
Parrot.....	DAPR59
Poppy.....	DAPR19
Sapphire.....	DAPR07
Scarlet.....	DAPR45
Sepia.....	DAPR30
Sky.....	DAPR44
Slate.....	DAPR15
Sorbet.....	DAPR55
Spring.....	DAPR80
Terracotta.....	DAPR13
Titanium.....	DAPR17
Varsity.....	DAPR09
Zest.....	DAPR70

ENSEMBLE.....	ENSB
Aquamarine.....	ENSB30
Ash.....	ENSB39
Greige.....	ENSB36
Harbor.....	ENSB34
Navy.....	ENSB35
Oat.....	ENSB37
Pear.....	ENSB33
Sand.....	ENSB38
Scarlet.....	ENSB32
Slate.....	ENSB31
Stone.....	ENSB40

FABRICS – CONTINUED

GRADE 1 – CONTINUED

HAMILTON (De-emphasized).....	HAML
Agave.....	HAML28
Azure.....	HAML10
Biscotti.....	HAML11
Cabernet.....	HAML08
Caribbean.....	HAML29
Carolina.....	HAML21
Charcoal.....	HAML17
Chocolate.....	HAML13
Cloud.....	HAML18
Dane.....	HAML16
Deep.....	HAML27
Dove Grey.....	HAML33
Dusty Rose.....	HAML07
Esmeralda.....	HAML06
Fern.....	HAML04
Fresh.....	HAML03
Garnet.....	HAML22
Granola.....	HAML19
Hearth.....	HAML34
Lilac.....	HAML14
Lime.....	HAML05
Lipstick.....	HAML09
Mellow.....	HAML25
Mossy Green.....	HAML26
Oxford.....	HAML20
Passion Fruit.....	HAML02
Pepper.....	HAML15
Powder.....	HAML12
Royalty.....	HAML31
Serene.....	HAML30
Sunny Day.....	HAML24
Sunrise.....	HAML01
Terracotta.....	HAML23
Winter Sky.....	HAML32

OPTIC (De-emphasized).....	OP
Aurora.....	OP72
Bark.....	OP24
Canopy.....	OP84
Char.....	OP49
Ruby.....	OP42
Sand.....	OP17
Sky.....	OP83
Slate.....	OP19
Sprout.....	OP74
Starry Night.....	OP11
Storm.....	OP56

Digital Keypad Lock Specification Information (page 229)

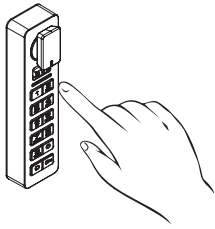

The digital keypad lock options support applications where workstations or storage banks are shared by multiple users. This is an alternative to a standard key lock. This feature facilitates the use of storage by multiple users through eliminating the need to keep and hand-off physical keys. These locks ship in “shared mode” by default; shared mode indicates that the lock will “forget” the paired 4-digit code, allowing the unit to be used by multiple users.

Digital keypad locks:

- Ship factory installed
- Offered in a polished silver finish
- Digital keypad lock requires input of a user-selected 4-digit code
- Digital keypad powered using 2 premium lithium CR2450 batteries
- Battery life is dependent on the frequency of operation but can last up to 5-7 years

Programming Key

- A Programming Key is a device used to initialize locks out of factory default mode and register Manager Keys to the locks.
- Only one Programming Key should be specified per installation site because multiple Programming Keys are not compatible with each other.
- Once a programming key is used with a unit, it is tied to that lock. Another programming key can not be used.
- Add-on digital lock orders should be programmed with the original programming key.

Manager Key

- A Manager Key is used to bypass a locked unit; this operates as the “master” key and it is recommended that building facilitators have at least one Manager Key.
- Up to 6 Manager Keys may be registered to each lock.
- Manager Keys provide external power to locks in case of battery failure.

Description	Model	List Price
Digital Lock Keys and Accessories		
Programming Key	YPLDIGPRG	\$ 340
Manager Key	YPLDIGMGR	\$ 263

Radii is a new generation of metal storage pedestals, undermounts, and Work Tools designed to accommodate more personal items and less paper. In the evolving digital age, the need to store paper files dwindles, people archive fewer documents, while the need to stow personal belongings grows. Conventional storage options that were designed for lateral paper filing don't adequately accommodate items employees stow, such as a backpack, purse, gym shoes, office supplies, or other everyday essentials workers want to keep within reach.

The desire for products to do more with less is quickly becoming a necessity. Radii delivers efficiency that is obvious in a solution that succinctly stows today's objects in a user-customizable way.

RADII STORAGE

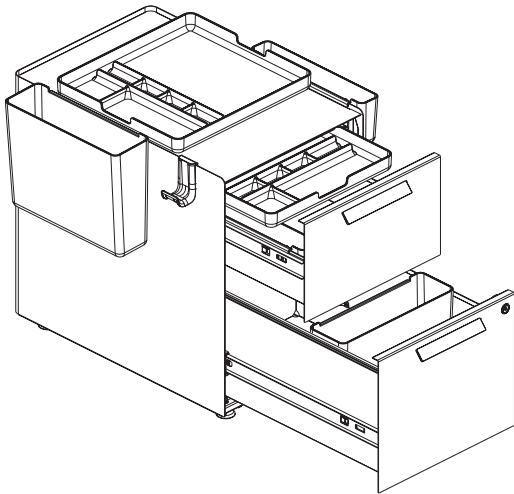

Pedestals

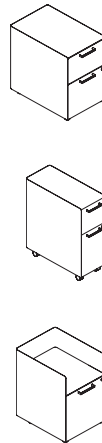

- Available with casters or glides
- Casters allow clearance for pedestal to straddle Altitude foot.
- Rear casters swivel, front casters are fixed, casters do not lock.
- Freestanding pedestals are not meant to support worksurfaces.
- Drawer slides are not full extension.
- Counterweight installed when required. No additional counterweight is required.
- Case wrapper creates a utility lip at top of case from which Work Tools can hang.
- 15"W pedestals can fit a Hot File Bin sideways in drawer to serve as a space divider.
- Hot File and Side Saddle can hang on inside file drawer lip.
- Alcove unit has a single drawer with open enclosure at top to stow backpack or other personal items.
- Drawers are labeled as "Box"/"Box +" and "File"/"File +"; see dimension table below.
- Drawers labeled as "+" have a taller drawer front and added space above the drawer body that can either accept the hidden Radii accessory tray or allow for the drawer to stow larger items, such as a backpack.
- All pedestals with a drawer marked "+" ship with one accessory tray, additional trays may be purchased separately (20³/₈" H unit does not ship with or accept hidden tray).
- Radii pedestals offered with an electronic locking option
- Slim peds (10"W) with electronic locking only accept Square Pull.
- Manager and programming key purchased separately, see page 24 of Casegoods and Storage pricebook.

Pedestal Functionality Represented by
 Freestanding Pedestal 21½"H
 15"W x 23"D Box with Tray/File.
 Additional Work Tools ordered separately.

Drawer Type	Exterior Drawer Height	Accepts Tray	Filing	
			15"W Pedestal	10"W Pedestal
Box	6"	No	No	No
Box +	9"	Yes	No	No
File	12"	No	Front-to-Back Only, Letter Only	Side-to-Side Only, Letter or Legal
File +	15"	Yes	Front-to-Back Only, Letter Only	Side-to-Side Only, Letter or Legal

Drawer Type	Drawer Capacity*	
	15"W Pedestal	10"W Pedestal
Box	4¼"H x 12½"W x 17¾"D (19"D Pedestals) or 21¾"D (23"D Pedestals)	4¼"H x 7½"W x 21¾"D
Box +	7¼"H x 12½"W x 17¾"D (19"D Pedestals) or 21¾"D (23"D Pedestals)	7¼"H x 7½"W x 21¾"D
File	10¾"H x 12½"W x 17¾"D (19"D Pedestals) or 21¾"D (23"D Pedestals)	10¾"H x 7½"W x 21¾"D
File +	13⅝"H x 12½"W x 17¾"D (19"D Pedestals) or 21¾"D (23"D Pedestals)	13⅝"H x 7½"W x 21¾"D

*If using hidden tray in + drawer, subtract approximately 3" from usable height

Digital Lock Programming

Locks are shipped with factory default settings (only operates by pressing **C** **0π**). Each lock must be set up to operate with a Programming Key and Manager Keys.

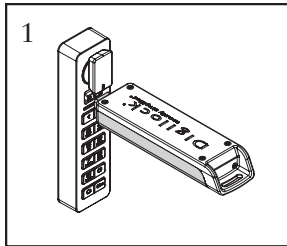

1
Insert the Programming Key.
A two-tone beep will be heard and the LED will flash.

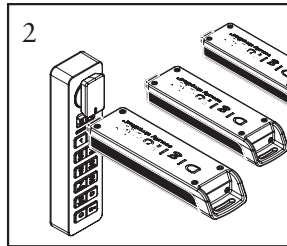

2
While the LED is flashing, insert one Manager Key at a time.
A beep will be heard for each Manager Key programmed.

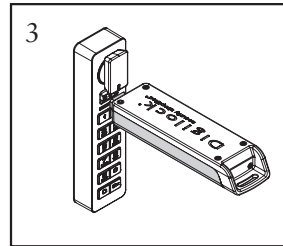

3
Insert the Programming Key.
A two-tone beep will be heard and the LED will turn off.

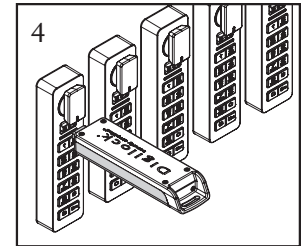

4
Repeat above steps for each lock or follow instructions to Express Register Manager Keys to setup all locks.

RADII STORAGE

Programming Instructions

Express Register Manager Credentials

Express Register Manager Keys The Programming Key can quickly program multiple locks to operate with the same Manager Keys.

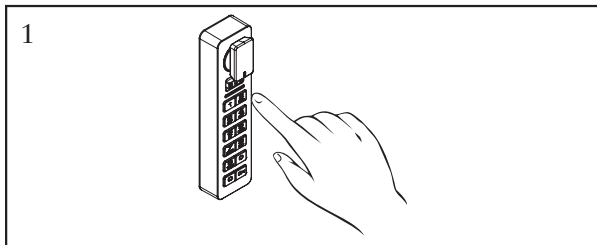

1
Go to a lock already programmed to operate with the Manager Keys. Press: **C** **0π** **6** **1** **0π**. The LED will flash.

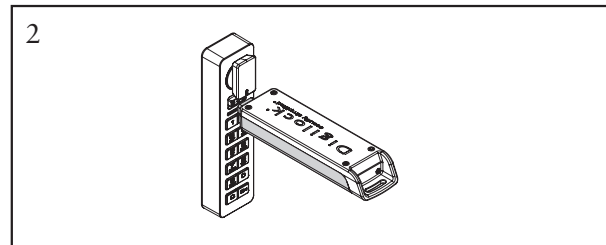

2
While the LED is flashing, insert the Programming Key.
A two-tone beep will be heard and the LED will turn off.

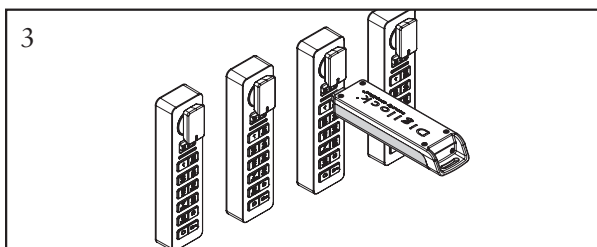

3
Insert the Programming Key to program each lock to operate with the same Manager Keys.
Two sets of two-tone beeps will be heard and the LED will flash twice to indicate successful programming.

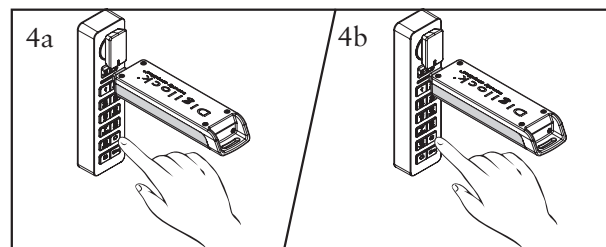

4a
End Express Registration mode.*
Go to any programmed lock.
Press: **C** **0π** then insert the Programming Key.

*The Programming Key will continue to function in Express Registration mode until it is used to operate a lock.

NOTE: For more information on digital lock use, please reference digital lock user guide(s) available on hniproductinstall.com.

See page 229 for manager key and programming key.

For specification information see page 218.

GSA SIN 33721

RADII STORAGE

	Description	Model	P1 List Price
	10"W x 23"D with Tray	APGBS24SNPT	\$ 951
	15"W x 19"D with Tray	APGBP18SNPT	\$ 984
	10"W x 23"D with Tray	APGBS249TFN	\$ 1015
	15"W x 19"D with Tray	APGBP189TFN	\$ 1044
	15"W x 23"D with Tray	APGBP249TFN	\$ 1111
	15"W x 19"D with Tray	APGBP186NPT	\$ 1044
	15"W x 23"D with Tray	APGBP246NPT	\$ 1111
	10"W x 23"D with Tray	APGCS249TPN	\$ 1113
	15"W x 19"D with Tray	APGCP189TPN	\$ 1085
	15"W x 23"D with Tray	APGCP249TPN	\$ 1130
	15"W x 19"D Does not accommodate Work Tool Tray	APMAP186NFN	\$ 973
	15"W x 23"D Does not accommodate Work Tool Tray	APMAP246NFN	\$ 1021
	10"W x 23"D Alcove/File with Tray	APMBS24SNPT	\$ 951
	15"W x 19"D Alcove/Tray-File	APMBP18SNPT	\$ 984
	10"W x 23"D with Tray	APMBS249TFN	\$ 1054
	15"W x 19"D with Tray	APMBP189TFN	\$ 1044
	15"W x 23"D with Tray	APMBP249TFN	\$ 1111

<p>How to specify — Select the Model Number from above.</p>	<p>1st Option: Pull Type (if applicable):</p> <p>M Beam O Halo B Bar S Square See matrix on page 15.</p>	<p>2nd Option: Pull Color (if applicable):</p> <p>M Beam / O Halo P JW Designer White PR6 Silver P JE Pyrite P8X Solar Black P2 upcharge +\$18/pull</p>	<p>3rd Option: Paint: P1 P2 P3 See page 216 for finishes. P2 add \$46 P3 add \$91</p>
<p>A P .</p>		<p> .</p>	<p>P .</p>

Continued below ▼

<p>4th Option: Front Paint: P1 P2 P3 See page 216 for finishes. NA Match Case P1 add \$12 P2 add \$34 P3 add \$57</p>	<p>5th Option: Tray Color: DW Designer White E9 Flint</p>	<p>6th Option: Lock Option: STD Standard OMT Omit Lock Core (deduct \$20 per lock)</p>
<p>P .</p>	<p>DW .</p>	<p> </p>

Examples: APGBS24SNPT.OPR6.PR3.PR3.DW.STD APMBP249TFN.BP27.P7B.P7B.DW.OMT

For specification information see page 218.

GSA SIN 33721

Description	Model	P1 List Price
Mobile Box and File + Pedestal 23½"H		
15"W x 19"D with Tray	APMBP186NPT	\$ 1044
15"W x 23"D with Tray	APMBP246NPT	\$ 1111
Mobile Box + and File + Pedestal 26½"H		
10"W x 23"D with Tray	APMCS249TPN	\$ 1113
15"W x 19"D with Tray	APMCP189TPN	\$ 1085
15"W x 23"D with Tray	APMCP249TPN	\$ 1130

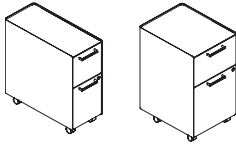
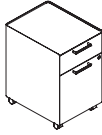

RADI STORAGE

<p>How to specify — Select the Model Number from above.</p>	<p>1st Option: Pull Type <i>(if applicable):</i> M Beam O Halo B Bar S Square See matrix on page 15.</p>	<p>2nd Option: Pull Color <i>(if applicable):</i> M Beam / O Halo P2 upcharge +\$18/pull</p> <p>Pull Color <i>(if applicable):</i> P27 Black P28 Designer White PR6 Silver PJE Pyrite P8X Solar Black P2 upcharge +\$18/pull</p>	<p>3rd Option: Paint: P1 P2 P3 See page 216 for finishes. P2 add \$46 P3 add \$91</p>
A .		. .	P .

Continued below ▼

<p>4th Option: Front Paint: P1 P2 P3 See page 216 for finishes. NA Match Case P1 add \$12 P2 add \$34 P3 add \$57</p>	<p>5th Option: Tray Color: DW Designer White E9 Flint</p>	<p>6th Option: Lock Option: STD Standard OMT Omit Lock Core (deduct \$20 per lock)</p>
P .	DW .	. .

Examples: APGCS249TPN.BP27.PR6.PR6.DW.STD APMCP189TPN.BP27.PJW.PJW.DW.OMT

Description	Model	Base	2	3	4	5	6	7	8
		List Price							
Seat Cushion									
15"W x 19"D	AESC18	\$ 255	\$ 271	\$ 285	\$ 300	\$ 320	\$ 339	\$ 358	\$ 378
15"W x 23"D	AESC24	\$ 300	\$ 316	\$ 330	\$ 345	\$ 365	\$ 384	\$ 403	\$ 423

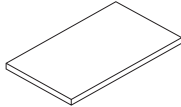

<p>How to specify — Select the Seat Cushion Model Number from above.</p>	<p>1st Option: Upholstery: See page 216 for fabrics.</p>
A E S C .	. .

Example: AESC18.CU10

For specification information see page 218.

GSA SIN 33721

RADII STORAGE

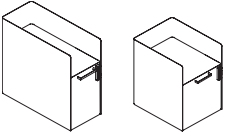
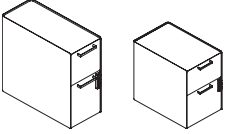
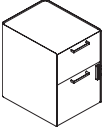
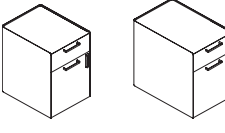
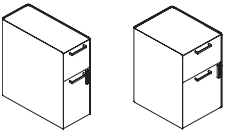
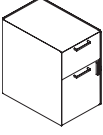
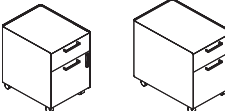
		Description	Model	P1 List Price
	Freestanding Alcove and File + Pedestal 21½"H with Electronic Lock			
		10"W x 23"D with Tray	APGBS24SNPTE	\$ 951
		15"W x 19"D with Tray	APGBP18SNPTE	\$ 984
	Freestanding Box + and File Pedestal 21½"H with Electronic Lock			
		10"W x 23"D with Tray	APGBS249TFNE	\$ 1015
		15"W x 19"D with Tray	APGBP189TFNE	\$ 1044
		15"W x 23"D with Tray	APGBP249TFNE	\$ 1111
	Freestanding Box and File + Pedestal 21½"H with Electronic Lock			
		15"W x 19"D with Tray	APGBP186NPTE	\$ 1044
		15"W x 23"D with Tray	APGBP246NPTE	\$ 1111
	Freestanding Box + and File + Pedestal 24½"H with Electronic Lock			
		10"W x 23"D with Tray	APGCS249TPNE	\$ 1113
		15"W x 19"D with Tray	APGCP189TPNE	\$ 1085
		15"W x 23"D with Tray	APGCP249TPNE	\$ 1130
	Mobile Box and File Pedestal 20"H with Electronic Lock			
		15"W x 19"D Does not accommodate Work Tool Tray	APMAP186NFNE	\$ 973
		15"W x 23"D Does not accommodate Work Tool Tray	APMAP246NFNE	\$ 1021

<p>How to specify — Select the Model Number from above.</p>	<p>1st Option: Pull Type (if applicable):</p> <ul style="list-style-type: none"> M Beam O Halo B Bar S Square <p>See matrix on page 15.</p>	<p>2nd Option: Pull Color (if applicable):</p> <ul style="list-style-type: none"> M Beam / O Halo PJW Designer White PR6 Silver PJE Pyrite P8X Solar Black <p>P2 upcharge +\$18/pull</p>	<p>3rd Option: Paint:</p> <p>P1 P2 P3</p> <p>See page 216 for finishes.</p> <p>P2 add \$46</p> <p>P3 add \$91</p>
<p>A P . </p>	<p> .</p>	<p> .</p>	<p>P .</p>

Continued below ▼

<p>4th Option: Front Paint:</p> <p>P1 P2 P3</p> <p>See page 216 for finishes.</p> <ul style="list-style-type: none"> NA Match Case P1 add \$12 P2 add \$34 P3 add \$57 	<p>5th Option: Tray Color:</p> <ul style="list-style-type: none"> DW Designer White E9 Flint 	<p>6th Option: Lock Option:</p> <p>EBNL Digital Lock add \$422</p> <p>See page 229 for required manager key and programming key.</p>
<p>P .</p>	<p> .</p>	<p> </p>

Example: APGBS24NPTE.SPR6.PDW.PDW.E9.EBNL

Representative Image

Space Claim

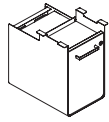

AUFD

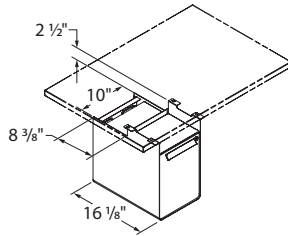

Flush Undermount
Pull-Out Drawer

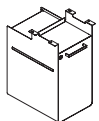

AU FH
FH HD-Flush

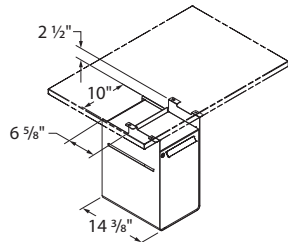

Flush Undermount
RH Hinged Door

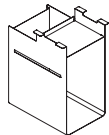

AUFO
Open-Flush

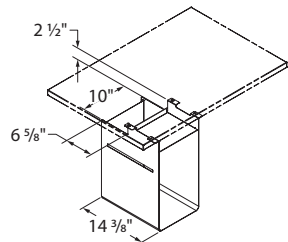

Flush Undermount
Open Bin

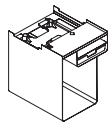

AUCL
L Shelf-Console

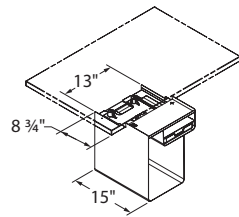

Console Undermount
Open L-Cube

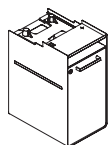

AUCH
RH HD-Console

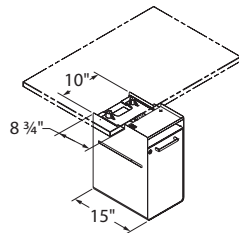

Console Undermount
RH Hinged Door Bin

Undermounts

- Undermount units are mounted inset from the left or right edge of the worksurface dependent on table supports.
- Compatible with all Allsteel benching and desking applications, except where noted.
- Can accommodate 2 Hot File units within interior sitting side-by-side.
- Slim tray fits in the Drawer and Open L units only.
- Ensure weight limit of height adjustable table system is considered before adding undermount storage (see table for unit weight and storage capacity).
- Standard BIFMA loading standards based on open volume of storage area.
- For undermount applications with Altitude tables, see the matrix on page 225.
- Manager and programming key purchased separately, see page 24 of Casegoods and Storage price book.
- Radii pedestals offered with an electronic locking option.
- Slim peds (10" W) with electronic locking only accept Square Pull.

Flush Undermounts

- Unit to be mounted under worksurface using hardware supplied with unit.
- Unit mounts flush to front edge of worksurface.
- Open and hinged door units contain side slot which can be used to hang Work Tools.
- Open and hinged door units do not fit Work Tool Trays.
- Drawer unit ships with hangrail to accommodate side-to-side filing.

Console Undermounts

- Open L unit comes with Work Tool Tray, console soft touch pad, and bottom soft touch liner.
- Hinged Door Console Unit comes with console soft touch pad ONLY.
- Unit available with or without USB. Either version ships with soft touch pad for console and contains a perforation for easy cord routing.
- Slots built into upper portion of case for Work Tools Hook to hang from.
- Unit mounts under worksurface with easy locating interface bracket. Bracket screws to worksurface, unit snaps onto bracket.
- Unit protrudes 6" from front of worksurface.

Work Tools

- Side Saddle and Hot File work on Terrace Tool Tiles and Tool Rails.
- Bag Hook weight limit 20 lbs.

Model Number	Unit Weight		Storage Capacity (lb.)	Internal		
				Weight + Capacity (Added weight to table)	Height	Width
AUFD15N	25	29	54	10"	7 ¹ / ₈ "	14 ⁷ / ₈ "
AUFH15N	22	42	64	16 ³ / ₄ "	9 ⁷ / ₈ "	13 ³ / ₈ "
AUFHL15H	22	42	64	16 ³ / ₄ "	9 ⁷ / ₈ "	13 ³ / ₈ "
AUFO15N	17	42	59	16 ³ / ₄ "	9 ⁷ / ₈ "	13 ³ / ₈ "
AUCL15N	22	43	65	11 ¹ / ₈ "	9 ⁷ / ₈ "	14 ¹ / ₄ "
AUCL15U	22	43	65	11 ¹ / ₈ "	9 ⁷ / ₈ "	14 ¹ / ₄ "
AUCH15U	25	48	73	17"	9 ⁷ / ₈ "	14"
AUCH15N	25	48	73	17"	9 ⁷ / ₈ "	14"
AUHL15U	25	48	73	17"	9 ⁷ / ₈ "	14"
AUHL15N	25	48	73	17"	9 ⁷ / ₈ "	14"

		A6 (T-Leg)		A6 (C-Leg)	
		24"D	30"D	24"D	30"D
AUFD15N	Flush Undermount Pull-Out Drawer	○	○	○	●
AUFH15N/AUFHL15N	Flush Undermount RH/LH Hinge Door	○	○	○	●
AUFO15N	Flush Undermount Open Bin	○	○	○	●
AUCL15N/AUCL15U	Console Undermount L-Cube	○	○	○	○
AUCH15N/AUCH15U	Console Undermount RH Hinge Door	○	○	○	○
AUHL15N/AUHL15U	Console Undermount LH Hinge Door	○	○	○	○



Legend



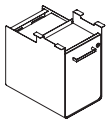
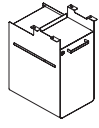
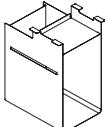
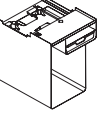
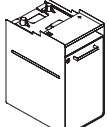

●	Works, unit may sit flush to LH or RH edge of work surface
○	Works, unit must sit inset of height-adjustable leg
X	Does not work

For specification information see page 218.

GSA SIN 33721

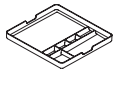
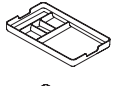
RADI STORAGE

	Description	Model	P1 List Price
	Flush Undermount Pull-Out Drawer 18"H (Ships with Work Tool Tray)		
	10"W x 16½"D	AUFD15N	\$ 741
	Flush Undermount Right-Hinged Door 20"H		
	10"W x 14½"D	AUFH15N	\$ 735
	Flush Undermount Left-Hinged Door 20"H		
	10"W x 14½"D	AUFHL15N	\$ 697
	Flush Undermount Open Bin 20"H		
	10"W x 14½"D	AUFO15N	\$ 589
	Console Undermount Open L-Cube 16"H (Ships with Work Tool Tray)		
	13"W x 15"D with Non-USB Console	AUCL15N	\$ 822
	13"W x 15"D with USB Console	AUCL15U	\$ 948
	Console Undermount Right Hinged Door Bin 20"H		
	10"W x 15"D with Non-USB Console	AUCH15N	\$ 811
	10"W x 15"D with USB Console	AUCH15U	\$ 966
	Console Undermount Left Hinged Door Bin 20"H		
	10"W x 15"D with Non-USB Console	AUCHL15N	\$ 811
	10"W x 15"D with USB Console	AUCHL15U	\$ 966

	Description	Model	List Price
	Large Tray for 15"W models		
	1½"H x 13½"W x 14½"D	AELT	\$ 84
	Small Tray for 10"W models		
	1½"H x 8½"W x 14½"D	AEST	\$ 64
	Hot File		
	9½"H x 12¼"W x 3½"D	AEHF	\$ 64
	Side Saddle		
	4"H x 12¼"W x 2½"D	AESS	\$ 53
	Bag or Coat Hook		
	3¼"H x 1½"W x 2¼"D	AECH	\$ 41

<p>How to specify — Select the Model Number from above.</p> <p>A .</p>	<p>1st Option: Pull Type (if applicable):</p> <p>M Beam O Halo B Bar S Square See matrix on page 15.</p> <p>P .</p>	<p>2nd Option: Pull Color (if applicable):</p> <p>M Beam / O Halo PJW Designer White PR6 Silver PJE Pyrite P8X Solar Black P2 upcharge +\$18/pull</p> <p>B Bar P27 Black PJW Designer White PR6 Silver S Square PJW Designer White EL Matte Silver P02 Flint P7B Loft PJE Pyrite P8X Solar Black P2 upcharge +\$18/pull</p> <p> .</p>	<p>3rd Option: Paint: P1 P2 P3 See page 216 for finishes. P2 add \$34 P3 add \$68</p> <p>P .</p>	<p>4th Option: Front Paint: P1 P2 P3 See page 216 for finishes. NA Match Case P1 add \$12 P2 add \$29 P3 add \$46</p> <p>P .</p>
--	--	--	--	--

Continued below ▼

<p>5th Option: Tray and Accessories Color (if applicable): DW Designer White E9 Flint</p> <p> .</p>	<p>6th Option: Console Poly Liner: PL (if applicable)</p> <p>P L </p>	<p>7th Option: Console Color (if applicable): CGR Cool Grey</p> <p>C G R .</p>	<p>8th Option: Lock Option: STD Standard OMT Omit Lock Core (deduct \$20)</p> <p> </p>	<p>9th Option: USB Color (if applicable): STRM Storm</p> <p>S T R M </p>
--	---	--	--	--

Examples: AUFH15N.OPR6.PJW.STD AUCL15U.PR6.DW.PLCGR.STRM AELT.DW

For specification information see page 218.

GSA SIN 33721

		Description	Model	P1 List Price
	Flush Undermount Pull-Out Drawer 18"H (Ships with Work Tool Tray) with Electronic Lock			
		10"W x 16½"D	AUFD15NE	\$ 741
	Flush Undermount Right-Hinged Door 20"H with Electronic Lock			
		10"W x 14½"D	AUFH15NE	\$ 709
	Flush Undermount Left-Hinged Door 20"H with Electronic Lock			
		10"W x 14½"D	AUFHL15NE	\$ 697
	Console Undermount Right Hinged Door Bin 20"H with Electronic Lock			
		10"W x 15"D, Non-USB Console	AUCH15NE	\$ 811
		10"W x 15"D, USB Console	AUCH15UE	\$ 966
	Console Undermount Left Hinged Door Bin 20"H with Electronic Lock			
		10"W x 15"D, Non-USB Console	AUCL15NE	\$ 811
		10"W x 15"D, USB Console	AUCL15UE	\$ 966

RADI STORAGE

<p>How to specify — Select the Model Number from above.</p>	<p>1st Option: Pull Type (if applicable):</p> <p>M Beam O Halo B Bar S Square</p> <p>Slim Peds (10"W) only accept Square Pull. See matrix on page 15.</p>	<p>2nd Option: Pull Color (if applicable):</p> <p>M Beam / O Halo P2 upcharge +\$18/pull</p> <table style="width: 100%; border: none;"> <tr> <td style="vertical-align: top;"> <p>PJW Designer White PR6 Silver PJE Pyrite P8X Solar Black</p> </td> <td style="vertical-align: top;"> <p>B Bar P27 Black PJW Designer White PR6 Silver</p> </td> <td style="vertical-align: top;"> <p>S Square PJW Designer White EL Matte Silver P02 Flint P7B Loft PJE Pyrite P8X Solar Black P2 upcharge +\$18/pull</p> </td> </tr> </table>	<p>PJW Designer White PR6 Silver PJE Pyrite P8X Solar Black</p>	<p>B Bar P27 Black PJW Designer White PR6 Silver</p>	<p>S Square PJW Designer White EL Matte Silver P02 Flint P7B Loft PJE Pyrite P8X Solar Black P2 upcharge +\$18/pull</p>	<p>3rd Option: Paint: P1 P2 P3 See page 216 for finishes.</p> <p>P2 add \$34 P3 add \$68</p>	<p>4th Option: Front Paint: P1 P2 P3 See page 216 for finishes.</p> <p>NA Match Case P1 add \$12 P2 add \$29 P3 add \$46</p>
<p>PJW Designer White PR6 Silver PJE Pyrite P8X Solar Black</p>	<p>B Bar P27 Black PJW Designer White PR6 Silver</p>	<p>S Square PJW Designer White EL Matte Silver P02 Flint P7B Loft PJE Pyrite P8X Solar Black P2 upcharge +\$18/pull</p>					
A .	.	.	P .	P .			

Continued below ▼

<p>5th Option: Tray and Accessories Color (if applicable):</p> <p>DW Designer White E9 Flint</p>	<p>6th Option: Console Poly Liner:</p> <p>PL (if applicable)</p>	<p>7th Option: Console Color (if applicable):</p> <p>CGR Cool Grey</p>	<p>8th Option: Lock Option:</p> <p>EBNL Digital Lock add \$422 See page 229 for required manager key and programming key.</p>	<p>9th Option: USB Color (if applicable):</p> <p>STRM Storm</p>
.	P L	C G R .		S T R M

Example: AUCL15NE.SPR6.PDW.PDW.E9.PLCGR.EBNL

For specification information see page 218.

GSA SIN 33721

RADII STORAGE

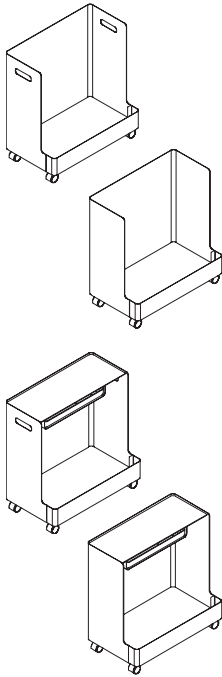

Description	Model	List Price
Radii Caddy No Shelf		
22 7/8"H x 12 1/2"W x 21"D	ACMCM21O	\$ 763

Radii Caddy with Shelf		
22 7/8"H x 12 1/2"W x 21"D	ACMCM21T	\$ 914

Notes: Paint 1 for case color and Paint 2 for top and bottom shelf color
 Handle options: YHDL for handle cutout and NHDL for no handle cutout
 Radii work tools available in Designer White-DW or Flint-E9
 Casters only
 Accepts Radii work tools

<p>How to specify — Select the Model Number from above.</p> <p>ACMCM21 .</p>	<p>1st Option: Handle: YHDL Handle Cutout NHDL No Handle Cutout</p> <p> .</p>	<p>2nd Option: Case Color (if applicable): P1 P2 See page 216 for finishes.</p> <p> .</p>	<p>3rd Option: Top and Bottom Shelf Paint: P1 P2 See page 216 for finishes.</p> <p> .</p>	<p>4th Option: Tray and Accessories Color (if applicable): DW Designer White E9 Flint</p> <p> </p>
---	--	--	--	--

Examples: ACMCM21O.YHDL.PJW.P02 ACMCM21T.NHDL.PR6.PR6.DW

For specification information see page 217.

GSA SIN PENDING



Description	Model	List Price
Digital Lock Keys and Accessories		
Programming Key	YPLDIGPRG	\$ 340
Manager Key	YPLDIGMGR	\$ 263

RADI STORAGE

How to specify —

Select the Model Number from above.

Y | P | L | | | | | | | | | |

Example: YPLDIGPRG

Notes

RADII STORAGE

- Software support packages furnished to the customer, either by Allsteel® or by another source, which support the sale of Allsteel products are superseded by printed price lists.
- Prices are subject to change without notice. All orders are subject to prices in effect at the time of order.
- Please refer to your Allsteel Dealer Sales and Discount Policies for order placement information, terms and conditions.
- Additional copies of this Specification and Price List are available upon request from Allsteel Literature at 1-866-255-7833.

- Ordering information appears at the bottom of each product page complete with examples on how to specify. Fabric and finish pages are referenced at the bottom of product pages.

This publication is available as an interactive or downloadable PDF at www.allsteeloffice.com.

Questions or Comments?

Please call us at: **888-ALLSTEEL**
888-255-7833

Paint Finishes, Laminates, Eased Edge	232
Fabrics.....	233
Working with Height-Adjustable Tables	234-239.2
Screens and Power Module	240
Altitude - Metal Screens.....	241-242
Power Rail Specifications	243-249
General Overview	243
Power Rail Typical.....	244
Working with Altitude Power Rails	245
Low Rail with Floor Legs	245
Raised Rail.....	245
Screens	245
Working with Cable Management	246
Working with Power Rail Electricals	247
General Notes about Electrical and Circuitry	247
Electrical Infeeds.....	247
Routing Power	248-249
Working with Electrical and Data	250-254
Working with Organization Rail & Accessories & Screens.....	255
Altitude Height-Adjustable Tops, Bases, & Accessories.....	256-261
Altitude – A6.....	256-257
Worksurfaces for Height-Adjustable Bases	258-260
Cable Management.....	261-261.3
Power Rail – Electrical Components	262-264
A8 Screen Kits.....	265
Metal Screens and Tackboard Accessories.....	266-267
Power Rails and Accessories	268-271
Worksurface Mounted Rail and Accessories	272



BASE COLORS

GRADE P1

Black.....	P71
Brownstone.....	P7D
Cinder.....	P7Q
Cove.....	P096
Designer White.....	PJW
Dune.....	P094
Flint.....	P02
Fossil.....	P28
Harbor.....	P097
Loft.....	P7B
Muslin.....	P4J
Nickel.....	P8L
Parchment.....	P93
Pebble.....	P8R
Pewter.....	P8D
Sage.....	P095
Salt.....	P8C
Titanium.....	P8T

GRADE P2

Champagne Metallic.....	PR5
Gunmetal Metallic.....	PR3
Night Bronze.....	P8B
Platinum Metallic.....	PR2
Silver.....	PR6

GRADE P3

Bullseye*.....	PJF
Regatta*.....	P8M

***Altitude Basic is only offered in one finish, Silver (SVR)

POWER RAIL PAINT COLORS

GRADE P1

Black.....	P71
Brownstone.....	P7D
Bungalow.....	P7C
Cinder.....	P7Q
Designer White.....	PJW
Flint.....	P02
Fossil.....	P28
Loft.....	P7B
Muslin.....	P4J
Pebble.....	P8R
Pewter.....	P8D
Salt.....	P8C
Titanium.....	P8T

GRADE P2

Champagne Metallic.....	PR5
Gunmetal Metallic.....	PR3
Night Bronze.....	P8B
Pyrite.....	PJE
Silver.....	PR6
Solar Black.....	P8X

GRADE P3

Atom.....	P8S
Blossom***.....	P8K
Ember.....	P8P
Ion.....	P8N
Iris.....	P8J
Krypton.....	P8F
Ochre.....	P093
Regatta.....	P8M
Sienna.....	P092
Succulent***.....	P8A

***These colors are intended to be an inspirational option for the trending market. Product application is limited and color availability is approximately two years to coincide with evolving workplace trends.

A8 SCREEN BRACKET PAINT COLORS

GRADE P1

Black.....	P71
Designer White.....	PJW

GRADE P2

Silver.....	PR6
-------------	-----

LAMINATES

GRADE L1

SOLID COLORS

Black.....	P
Brownstone.....	LM13
Bungalow.....	LM12
Designer White.....	LDW1
Flint.....	LM16
Fossil Shale.....	LEH1
Loft.....	LM11
Muslin.....	LM15
Titanium.....	LTI1

ABSTRACT

Ash.....	LT3B
Handspun Pearl.....	LAHP
Handspun Dove.....	LAHD
Handspun Slate.....	LAHS
Handspun Chestnut.....	LAHC
Silver Mesh.....	LT8D

WOODGRAIN

Belair.....	LWBA
Bourbon Cherry.....	H
Field Elm.....	LWFE
Florence Walnut.....	LWF1
Kingswood Walnut.....	LK11
Natural Maple.....	LWD
NeoWalnut.....	LNU1
Pinnacle.....	PINC
Shaker Cherry.....	LW7C

GRADE L2

Beigewood.....	LWBE
Fawn Cypress.....	LFC1
Lowell Ash.....	LLA1
Mangalore Mango.....	LMM1
Natural Recon.....	LNR1
Phantom Charcoal.....	LPC1
Phantom Ecru.....	LPE1
Portico Teak.....	LPT1
Skyline Walnut.....	LSW1
Veranda Teak.....	LVT1

GRADE L3

Natural Walnut.....	LWNW
---------------------	------

EASED EDGE LAMINATES

GRADE L1

Designer White.....	LDW1
Loft.....	LM11
Natural Maple.....	LWD

GRADE L2

Natural Recon.....	LNR1
--------------------	------

STRAIGHT/ROUNDED EDGE COLORS

Beigewood.....	DE
Belair.....	BA
Black.....	E4
Bourbon Cherry.....	H
Brownstone.....	EY
Bungalow.....	EX
Designer White.....	DW
Fawn Cypress.....	FC
Field Elm.....	FE
Flint.....	E9
Florence Walnut.....	FW
Fossil.....	EH
Kingswood Walnut.....	KI
Loft.....	EV
Lowell Ash.....	DL
Mangalore Mango.....	MM
Muslin.....	EU
Natural Maple.....	DD
Natural Recon.....	NR
Natural Walnut.....	DN
NeoWalnut.....	NU
Parchment.....	EN
Phantom Charcoal.....	PC
Phantom Ecru.....	PE
Pinnacle.....	PI
Platinum Metallic.....	EP
Plyband.....	PL
Portico Teak.....	DP
Shaker Cherry.....	DF
Skyline Walnut.....	SW
Titanium.....	TI
Veranda Teak.....	VT

ELECTRICAL & DATA COMPONENTS

Black.....	E4
Brownstone.....	EY
Designer White.....	DW
Flint.....	E9
Loft.....	EV
Muslin.....	EU
Silver.....	ES

METAL ACCESSORIES PAINT COLORS

GRADE P1

Black.....	P71
Brownstone.....	P7D
Bungalow.....	P7C
Charblack.....	CBK
Cinder.....	P7Q
Cove.....	P096
Designer White.....	PJW
Dune.....	P094
Flint.....	P02
Fossil.....	P28
Harbor.....	P097
Loft.....	P7B
Muslin.....	P4J
Parchment.....	P93
Pebble.....	P8R
Pewter.....	P8D
Platinum Metallic Texture.....	P6H
Sage.....	P095
Salt.....	P8C
Textured Brownstone.....	P7J
Textured Designer White.....	PK7
Textured Flint.....	P7A
Textured Loft.....	P7L
Textured Muslin.....	P7M
Textured Pebble.....	P8Y
Textured Salt.....	P8Z
Textured Titanium.....	P8V
Titanium.....	P8T
White.....	PD8

GRADE P2

Champagne Metallic.....	PR5
Graphite Metallic Texture.....	P85
Gunmetal Metallic.....	PR3
Matte Gold.....	P8G
Night Bronze.....	P8B
Platinum Metallic.....	PR2
Pyrite.....	PJE
Silver.....	PR6
Silver Generic.....	SVR
Silver Texture.....	PR8
Solar Black.....	P8X

GRADE P3

Atom.....	P8S
Blossom.....	P8K
Bullseye.....	PJF
Ember.....	P8P
Ion.....	P8N
Iris.....	P8J
Krypton.....	P8F
Regatta.....	P8M
Succulent.....	P8A
Ochre.....	P093
Sienna.....	P092

All of Allsteel's tables are level® - 2 certified to the ANSI/BIFMA e3 Furniture Sustainability Standard. See www.levelcertified.org for more information.

NOTE: Refer to individual product pages for upcharges.

Fabrics

For use with Screen Kits.

GRADE A

NOBLE

Aegean	NBLE18
Amethyst.....	NBLE19
Aspen	NBLE14
Aster	NBLE20
Blossom.....	NBLE21
Bluebell	NBLE22
Bordeaux.....	NBLE01
Brick	NBLE02
Chambray	NBLE10
Chamomile.....	NBLE23
Clementine	NBLE04
Conifer.....	NBLE24
Cottage	NBLE25
Darkness	NBLE26
Dawn	NBLE13
Denim	NBLE09
Desert Sand.....	NBLE27
Dewfall	NBLE28
Dusted Sage.....	NBLE29
Flax.....	NBLE30
Grass.....	NBLE07
Gunmetal	NBLE15
Harmony.....	NBLE31
Harvest	NBLE12
Ice Caves	NBLE32
Icicle.....	NBLE33
Inky.....	NBLE34
Iris.....	NBLE35
Jade.....	NBLE06
Knight	NBLE17
Mesa	NBLE03
Monarch	NBLE36
Pacific	NBLE08
Pitch.....	NBLE37
Queen Bee	NBLE38
Rainforest	NBLE05
Regal.....	NBLE11
Sandcastle	NBLE39
Sedona	NBLE40
Stormy	NBLE16
Sunbeam	NBLE41
Voyager	NBLE42
Windy Day	NBLE43

GRADE E

BLAZER LITE

(100% Pure New Wool)

Angel.....	PCAMBLT49
Aspire.....	PCAMBLT52
Balance.....	PCAMBLT41
Bliss.....	PCAMBLT48
Buddha.....	PCAMBLT56
Cuddle	PCAMBLT62
Dainty	PCAMBLT64
Daydream	PCAMBLT46
Devoted.....	PCAMBLT58
Faith.....	PCAMBLT68
Freedom	PCAMBLT69
Graceful	PCAMBLT51
Happy	PCAMBLT55
Harmony.....	PCAMBLT63
Haven	PCAMBLT40
Hope	PCAMBLT50
Hush	PCAMBLT42
Love	PCAMBLT47
Mood	PCAMBLT44
Pamper.....	PCAMBLT66
Pastel.....	PCAMBLT65
Pillow.....	PCAMBLT43
Praise	PCAMBLT54
Retreat	PCAMBLT39
Shelter	PCAMBLT60
Solace.....	PCAMBLT70
Tender.....	PCAMBLT53
True	PCAMBLT61
Verity	PCAMBLT57
Wish.....	PCAMBLT67
Worship	PCAMBLT59

Altitude height-adjustable bases are available in five styles:

A6

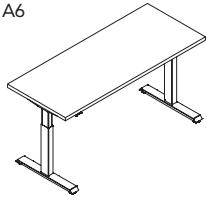

T-leg with
Rectangular Worksurface

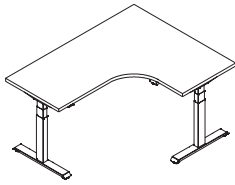

T-leg with
Corner Cove Worksurface

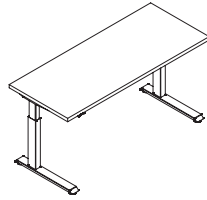

C-leg with
Rectangular Worksurface

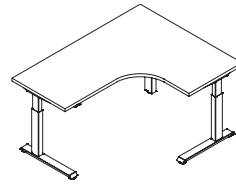

C-leg with
Corner Cove Worksurface

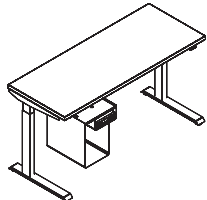

Altitude HAT
with Undermount
Radii Console

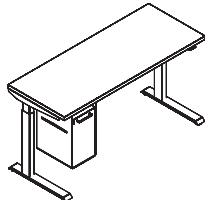

Altitude HAT
with Flush Undermount
Radii

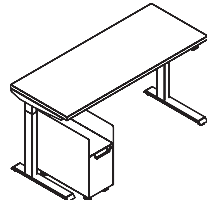

Altitude HAT
with Freestanding Mobile
Alcove Radii

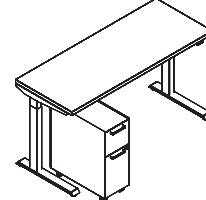

Altitude HAT
with Freestanding Mobile
Alcove Radii

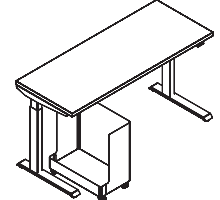

Altitude HAT with
Freestanding Mobile
Radii Caddy

A8 Screens

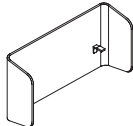

U Screen Kit

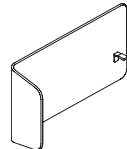

L Screen Kit (Left)

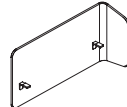

L Screen Kit (Right)

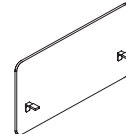

Rectangular Screen Kit

Metal Screens



L Screen (Left)



L Screen (Right)



U Screen

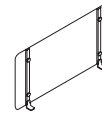

Straight

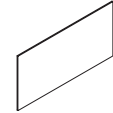

Tackboard Accessory

Altitude Power Rail

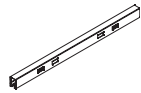

Altitude Power Rail

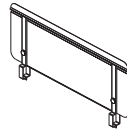

Altitude Rail Screen

A6 Clearance Dimensions

Rectangle

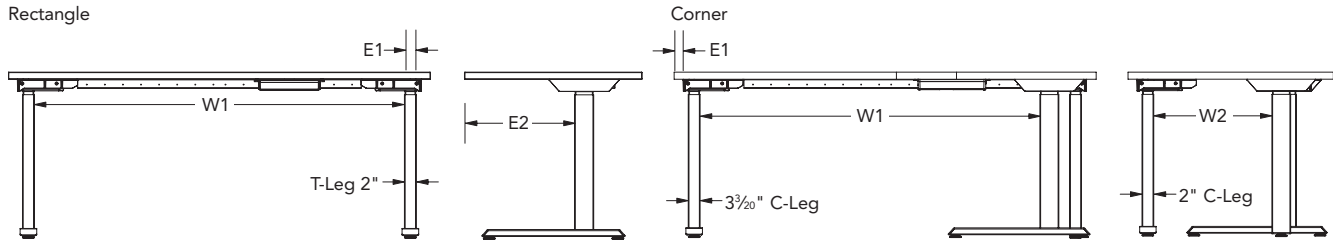

Base Style:	A6-T Base				A6-C Base			
Dimension Location:	E1	W1	W2	E2	E1	W1	W2	E2
Altitude Top: (Surface dimensions are nominal. Actual widths are reduced by 2")	Edge of table to outside of leg	Between legs	Between legs	Edge of table to the outside of leg	Edge of table to outside of leg	Between legs	Between legs	Edge of table to the outside of leg
24" x 48" Rectangle*	2½"	35¼"	—	10%"	2½"	35¼"	—	14%"
24" x 54" Rectangle	2½"	41¼"	—	10%"	2½"	41¼"	—	14%"
24" x 60" Rectangle	2½"	47¼"	—	10%"	2½"	47¼"	—	14%"
24" x 66" Rectangle	2½"	53¼"	—	10%"	2½"	53¼"	—	14%"
24" x 72" Rectangle	2½"	59¼"	—	10%"	2½"	59¼"	—	14%"
30" x 48" Rectangle	2½"	35¼"	—	13%"	2½"	35¼"	—	17%"
30" x 54" Rectangle	2½"	41¼"	—	13%"	2½"	41¼"	—	17%"
30" x 60" Rectangle	2½"	47¼"	—	13%"	2½"	47¼"	—	17%"
30" x 66" Rectangle	2½"	53¼"	—	13%"	2½"	53¼"	—	17%"
30" x 72" Rectangle	2½"	59¼"	—	13%"	2½"	59¼"	—	17%"
60" x 36" Corner Cove	2½"	43"	26"	10%"	2½"	43"	29½"	14%"
60" x 48" Corner Cove	2½"	43"	32"	10%"	2½"	43"	35½"	14%"
72" x 36" Corner Cove	2½"	55"	26"	10%"	2½"	55"	29½"	14%"
72" x 48" Corner Cove	2½"	55"	32"	10%"	2½"	55"	35½"	14%"

Bottom Views

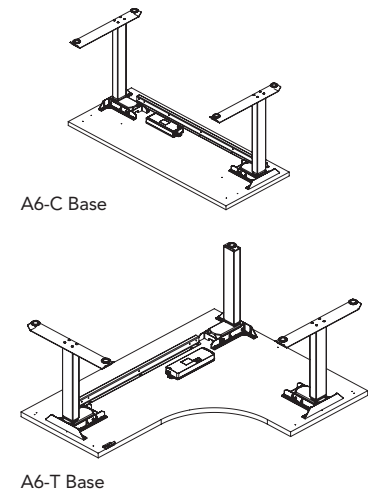

ALTITUDE

Feature	Altitude Basic	A6
Range Adjustment	26¼" – 43½"H + Adjustable Glide	2-Stage 26½" to 45¼" + ½" Adjustable Glide
Base Only, Without Work Surface		3-Stage 21¼" to 47½" + ½" Adjustable Glide
Range Adjustment	27¾" to 44"H + Adjustable Glide	2-Stage 27¾" to 46¾" + ½" Adjustable Glide
Includes Standard Allsteel 1½" Work Surface		3-Stage 22¾" to 48¾" + ½" Adjustable Glide
Foot Configuration	<ul style="list-style-type: none"> T Foot Standard leveling glide 	<ul style="list-style-type: none"> T Foot or C Foot Standard options include leveling glide, slide glides, and casters
Leg Options	2 leg	2 and 3 leg
UL Certified Weight Rating	180 lbs	<ul style="list-style-type: none"> 250 lbs for 2-leg 350 lbs for 2-leg Max 375 lbs for 3-leg 500 lbs for 3-leg Max
Cross Bar Design	Yes	A6 models ordered prior to 4/5/2021 have cross bar understructure, A6 models ordered after 4/5/2021 do not
Colors	Silver Only	20 Allsteel Paint Finishes offered, see Altitude Tables Finishes page
Control Pad	Up/down only	Basic up/down, memory preset, paddle, foot pedal
Wire Management	Allsteel standard options available Hinged trough not recommended	Allsteel standard options available
Power Access	Desktop power modules available	Desktop power modules available
Warranty	5 years	If Purchased Before 3/1/2021: 10 Years Metal Base, 7 Years Electronics If Purchased After 3/1/2021: 10 Years for Entire Product

Height-Adjustable Worksurfaces, Bases, and Controls

Height-Adjustable Worksurfaces (page 258)

- Height-adjustable worksurfaces are available in laminate with flat edge and rectangular veneer with matching square edge.
- Matrix with actual worksurface sizes can be found on page 237.
- T-mold is used on the edge of curved worksurfaces. This will have a noticeable visual difference when directly adjacent to straight worksurfaces.
- Worksurface dimensions are nominal. Actual widths are reduced by 2" (1" each side) and worksurface depths are reduced by ¼". Corner cove depth is nominal, actual is 1" less.
- Rectangular undersized worksurface models' (model number ending in -U) actual widths and depths are reduced by 2".
- Corner Cove undersized worksurface models' (model number ending in -LD) actual dimensions are reduced by 2".
- Altitude worksurfaces are pre-drilled with mounting location for bases.
- Rectangular worksurface grommet location is limited to center location due to mounting of worksurface supports at each end of the worksurface.
- Certain two-piece top configurations may require two stiffeners depending on the footprint of your station.
- 2-leg standard bases can accommodate worksurface configurations from 24"D x 24"W to 30"D x 72"W.
- 2-leg Max bases can accommodate worksurface configurations from 24"D x 24"W to 30"D x 96"W.
- 3-Leg standard bases can accommodate worksurface configurations from 24"D x 48"W x 36"W to 30"D x 72"W x 48"W.
- 3-Leg Max bases can accommodate worksurface configurations from 24"D x 48"W x 36"W to 30"D x 72"W x 72"W.
- Altitude A6 bases specified with a work surface 60"W and greater require the use of an external stiffener. An external stiffener is included in Altitude work surface models 60"W and greater (all models ending with letter -D). If a non-Altitude work surface is being used, an external stiffener may need to be specified separately.

Height-Adjustable Bases (pages 256-257)

- Electronic height-adjustable base units are available in six styles: A6-T Base with 2 legs, A6-C Base with 2 legs, A6-T Base with 3 legs, A6-C Base with 3 legs, A6-T Max Base with 2 legs, A6-C Max Base with 2 legs, A6-T Max Base with 3 legs, and A6-C Max Base with 3 legs.
- **A6 2-stage and 3-stage have a travel speed of 1.25"/second. A-6 Max bases have a travel speed of 1.96"/second.** Motor devices have a continuous cycle time of 2 minutes with an 18 minute rest period before it can be cycled again.
- Control box is powered by 110-120V/60Hz/4A. Standby power is < 0.1 Watts. Power cords on A6-T models are 10'.
- Pedestals taller than 24½" for 2-stage models and 19½" for 3-stage models when placed under table will limit range in lowest position.
- Mobile box/file pedestals will clear feet on height adjustable base but will extend past edge of worksurface in that position. See chart on page 235.
- Moving worksurfaces can collide with other components. It is important to ensure free range of motion prior to operating the table.
- All tables have adjustable glides providing ½" adjustment on A6.
- Slide glides offered as a .option and model level. Only available on 2-leg bases.
- Casters available on model level for retrofitting on 2-Leg Bases ONLY.
- Altitude A6 tables feature collision detection, a feature designed to stop table travel when the table detects an obstacle.
- A6 load capacity is 250 lbs for 2-leg models, 375 lbs for 3-leg models, 350 lbs for 2-leg Max models, and 500 lbs for 3-leg Max models. This includes the weight of the worksurface.
- G1 Glide enables the A63-stage height adjustable bases to reach the BIFMA G1 height requirements. Glides come in a pack of 4. Glide is always black.

A6 Control Options

- Memory Controls are now a .option.
- Up/Down: Basic Up/Down control.
- Memory Control: 4 memory pre-set options allow the user to adjust their height to their preferred heights.
- Paddle: Simple, aesthetic control with 1 memory pre-set option and reminder mode.
- Bluetooth Capability: A6 optional Bluetooth capability is sold as accessory model A6BLUETOOTH. Bluetooth is enabled through smartphone app AiDesk. Bluetooth control will only work with 2-leg A6 tables. Bluetooth control will **not** work with 3-leg A6 tables. No additional controls are required for use, but they can be used in addition to the bluetooth control (bluetooth plug in uses different port than other controls).

Note: HAT-to-Panel bracket does not work with the Max Base.

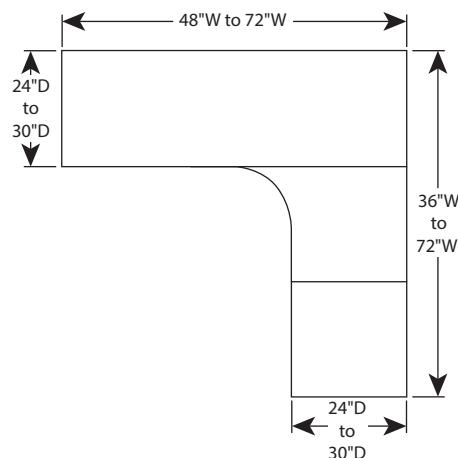
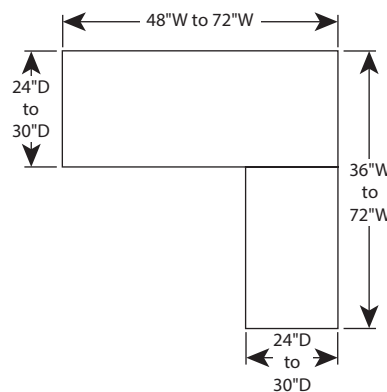
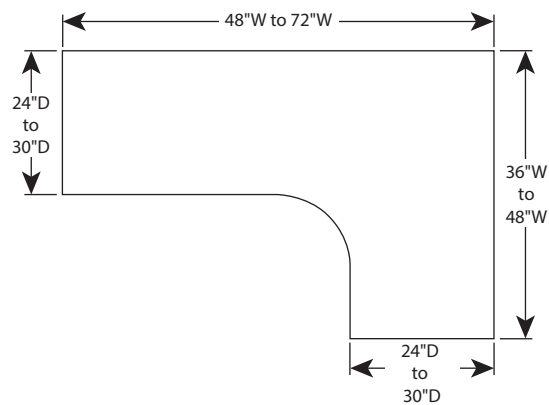

For specification information see page 236.

Rectangular Laminate Tops – 24"D

Base Model(s)	Actual Dimensions
AF5RS4824, AVF5RS4824	46"W x 23¼"D
AF5RS5424, AVF5RS5424	52"W x 23¼"D
AF5RS6024D, AVF5RS6024D	58"W x 23¼"D
AF5RS6624D, AVF5RS6624D	64"W x 23¼"D
AF5RS7224D, AVF5RS7224D	70"W x 23¼"D
AF5RS7824D	76"W x 23¼"D
AF5RS8424D	82"W x 23¼"D
AF5RS9024D	88"W x 23¼"D
AF5RS9624D	94"W x 23¼"D

Rounded Corner Laminate Tops – 24"D

Base Model(s)	Actual Dimensions
AF5RND4824	46"W x 23¼"D
AF5RND5424	52"W x 23¼"D
AF5RND6024D	58"W x 23¼"D
AF5RND6624D	64"W x 23¼"D
AF5RND7224D	70"W x 23¼"D
AF5RND7824D	76"W x 23¼"D
AF5RND8424D	82"W x 23¼"D
AF5RND9024D	88"W x 23¼"D
AF5RND9624D	94"W x 23¼"D

Rectangular Laminate Tops – 30"D

Base Model(s)	Actual Dimensions
AF5RS4830, AVF5RS4830	46"W x 29¼"D
AF5RS5430, AVF5RS5430	52"W x 29¼"D
AF5RS6030D, AVF5RS6030D	58"W x 29¼"D
AF5RS6630D, AVF5RS6630D	64"W x 29¼"D
AF5RS7230D, AVF5RS7230D	70"W x 29¼"D
AF5RS7830D	76"W x 29¼"D
AF5RS8430D	82"W x 29¼"D
AF5RS9030D	88"W x 29¼"D
AF5RS9630D	94"W x 29¼"D

Rounded Corner Laminate Tops – 30"D

Base Model(s)	Actual Dimensions
AF5RND4830	46"W x 29¼"D
AF5RND5430	52"W x 29¼"D
AF5RND6030D	58"W x 29¼"D
AF5RND6630D	64"W x 29¼"D
AF5RND7230D	70"W x 29¼"D
AF5RND7830D	76"W x 29¼"D
AF5RND8430D	82"W x 29¼"D
AF5RND9030D	88"W x 29¼"D
AF5RND9630D	94"W x 29¼"D

Undersized Rectangular Worksurface – 24"D

Base Model(s)	Actual Dimensions
AF5RS3624U	34"W x 22"D
AF5RS4224U	40"W x 22"D
AF5RS4824U	46"W x 22"D
AF5RS5424U	52"W x 22"D
AF5RS6024UD	58"W x 22"D
AF5RS6624UD	64"W x 22"D
AF5RS7224UD	70"W x 22"D
AF5RS7824UD	76"W x 22"D
AF5RS8424UD	82"W x 22"D
AF5RS9024UD	88"W x 22"D
AF5RS9624UD	94"W x 22"D

Undersized Rectangular Worksurface – 30"D

Base Model(s)	Actual Dimensions
AF5RS3630U	34"W x 28"D
AF5RS4230U	40"W x 28"D
AF5RS4830U	46"W x 28"D
AF5RS5430U	52"W x 28"D
AF5RS6030UD	58"W x 28"D
AF5RS6630UD	64"W x 28"D
AF5RS7230UD	70"W x 28"D
AF5RS7830UD	76"W x 28"D
AF5RS8430UD	82"W x 28"D
AF5RS9030UD	88"W x 28"D
AF5RS9630UD	94"W x 28"D

120 Degree Corner Worksurface – 24"D

Base Model(s)	Actual Dimensions
AF5120S4224D	22"A x 40"B x 40"C x 22"D
AF5120S4824D	22"A x 46"B x 46"C x 22"D
AF5120S5424D	22"A x 52"B x 52"C x 22"D

120 Degree Corner Worksurface – 30"D

Base Model(s)	Actual Dimensions
AF5120S4224D	28"A x 40"B x 40"C x 28"D
AF5120S4824D	28"A x 46"B x 46"C x 28"D
AF5120S5424D	28"A x 52"B x 52"C x 28"D

ALTITUDE

For specification information see page 236.

Corner Cove Laminate Tops – 24"D Extended Left

Base Model(s)	Actual Dimensions
A5822ELS	23¼"A x 58¼"B x 34½"C x 23¼"D
A5622ELS	23¼"A x 58¼"B x 46¼"C x 23¼"D
A5922ELS	23¼"A x 70¼"B x 34½"C x 23¼"D
A7222ELS	23¼"A x 70¼"B x 46¼"C x 23¼"D

Corner Cove Laminate Tops – 24"D Extended Right

Base Model(s)	Actual Dimensions
A5822ERS	23¼"A x 58¼"B x 34½"C x 23¼"D
A5622ERS	23¼"A x 58¼"B x 46¼"C x 23¼"D
A5922ERS	23¼"A x 70¼"B x 34½"C x 23¼"D
A7222ERS	23¼"A x 70¼"B x 46¼"C x 23¼"D

Undersized Corner Cove Worksurface, Left Hand – 24"D

Base Model(s)	Actual Dimensions
AF5CCS603624LD	22"A x 58"B x 34"C x 22"D
AF5CCS604824LD	22"A x 58"B x 46"C x 22"D
AF5CCS723624LD	22"A x 70"B x 34"C x 22"D
AF6CCS724824LD	22"A x 70"B x 46"C x 22"D

Undersized Corner Cove Worksurface, Right Hand – 24"D

Base Model(s)	Actual Dimensions
AF5CCS603624RD	22"A x 58"B x 34"C x 22"D
AF5CCS604824RD	22"A x 58"B x 46"C x 22"D
AF5CCS723624RD	22"A x 70"B x 34"C x 22"D
AF6CCS724824RD	22"A x 70"B x 46"C x 22"D

Undersized Corner Cove Worksurface, Left Hand – 30"D

Base Model(s)	Actual Dimensions
AF5CCS604830LD	28"A x 58"B x 46"C x 28"D
AF5CCS724830LD	28"A x 70"B x 46"C x 28"D

Undersized Corner Cove Worksurface, Right Hand – 30"D

Base Model(s)	Actual Dimensions
AF5CCS604830RD	28"A x 58"B x 46"C x 28"D
AF5CCS724830RD	28"A x 70"B x 46"C x 28"D

Cable & Wire Management

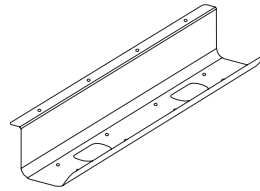

AJTRGH24 or AJTRGH36

Cable Management Tray (page 261)

- Attaches under the worksurface to contain cables.
- Metal tray shelf is 4" deep. Can hold electrical power strip and/or surge protector.
- 24" and 36" lengths, use multiple units for larger worksurfaces.
- Attachment hardware included, paint option is black only.
- Zip tie attachment points located in base of tray. Zip ties not included.

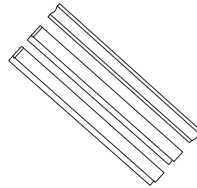

AWRSTRIP

Wire Management Strips/Channels (page 261)

- Self adhesive backing to attach to panels and underside of worksurfaces.
- Flexible strips allow cabling to enter/exit and can be contained inside the strips' cavities.
- Includes two wire management profiles. Smaller profile allows for qty. 3, .3" diameter cords, has area of .32 in². Larger "J" shaped profile allows for qty. 10, .3" diameter cords, has area of 1.14 in².

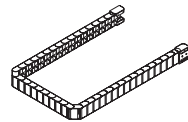

A9CLWMC or WKSWMC

Cord Management Chains (page 261)

- Works with Approach and Altitude A6-units.
- Used to route and conceal power/data cables from control box and other devices. Includes all mounting hardware and a plate to secure to a leveling glide.
- Houses 6 cables at 0.300" diameter.
- Made of plastic chain with plastic attachment brackets at each end.
- Specify WKSWMC for 58" chain. Only comes in Black finish.
- Specify A9CLWMC for 36" chain. Comes in Black, White, and Silver.
- Has two connecting points: Top section connects underneath a worksurface and bottom section can connect underneath power rails or to panel raceways using double-sided tape. Hardware included.

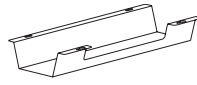

APWRTRGH17 or APWRTRGH36

Under Worksurface Trough (page 261)

- Used to conceal wires and control box below worksurfaces. Trough can be configured at various height/width combinations to meet capacity needs. Ships flat and is bent to desired shape.
- On 48"W and 54"W worksurfaces use one 17"W trough. 54"W has space to use 2 – 17"W, if necessary.
- On 60"W, 66"W, and 72"W worksurfaces use the 36" trough.
- On 84"W worksurface use 2 – 17"W troughs.

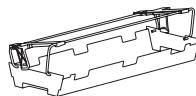

AFDTRGH20

Flip-Down Wire Trough (page 261)

- Mounts beneath a worksurface. Used to conceal extra cord slack and power strips.
- May be used in conjunction with quad tap unit APWR4TAP to reduce the number of cords routed from a worksurface to a beam.
- For any worksurface less than 58"W, a 20"W Flip-Down Trough is recommended.
- For worksurfaces 58"W and wider, a 20"W or 32"W Flip-Down Trough may be used.
- Flush-mount Raddi Storages are not recommended to use in conjunction with Flip-Down Trough.
- Only AKTSHORT keyboard tray is recommended for use in conjunction with the Flip-Down Trough.

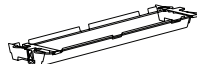

AFDTRGH32

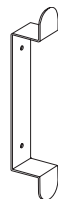

AWIRECLT

Metal Wire Cleat (page 261)

- Supplied with screws and VHB tape for attachment to various surface types.
- For wood/particle board/MDF surfaces, use screw attachment.
- For painted metal/glass/non-porous surfaces, use VHB tape.
- Example use cases:
 - 1) Used alongside telescoping/fabric HAT wire chases to secure excess length of cord at plug-end.
 - 2) Secured to wall next to TV monitor in meeting room to manage HDMI cable when not in use.
 - 3) Screwed underneath worksurface to provide quick and easy management of excess length of cords and cabling.

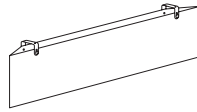

APWRMODEST36 or APWRMODEST48

Cable & Wire Management

Fabric Power Modesty (page 261.2)

- Fabric Power Modesty presents as modesty panel hanging by leather straps under a worksurface; inner compartment conceals cords and power strips as a wire management application.
- Recommended worksurface width pairings:
 - 1) 48-60" W Desk — Use APWRMODEST36 Centered.
 - 2) 66-72" W Desk — Use APWRMODEST48 Centered or APWRMODEST36 offset.
 - 3) 84" W Desk — Use APWRMODEST48 offset.
- Modesty fills 11.5 inches below the bottom of the worksurface with space for cords to enter/exit between the worksurface and the top of the Power Modesty.
- Two entry/exit points for cords are located at the bottom of the Power Modesty unit.
- Modesty panel is designed to present as a thin modesty panel from the front, but provides 3" depth cavity for wires, power strips, etc.
- Maximum weight capacity for Power Modesty is 25 lbs.
- Modesty panel not to be used to store electronics that require airflow for thermal management (computers).
- Users can access interior of panel (to modify wire placement) via "wings" on either side of product, secured via user-operable Velcro connection.
- Users may also dismount Power Modesty from leather straps by unlooping leather straps from button attachments.
- Leather straps on Power Modesty always come in medium brown color.
- Power Modesty available in Appoint, Binary, Centurion, Noble, Reflections, Disperse, and Spin fabric series.

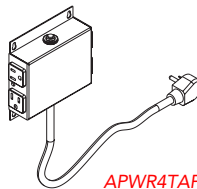

APWR4TAP

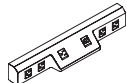

FDPWRC, CFDPWRC, FDPWRSC, or CFDPWRSC

Power Module — Under Worksurface, Quad Tap (page 261.1)

- Under surface mounting, used on any worksurface with a 5" x 5" x 1.5" clearance.
- 10' Power cord. UL Listed.
- May be used in conjunction with Flip-Down Trough to reduce the number of cords routed from a worksurface to a beam.
- 4 receptacles, unit is black finish only, no specification needed.

Concealed Power Module (page 261.1)

- Contains 5 simplex outlets, 1 USB-A, and 1 USB-C.
- Available in plastic or metal. Metal power module is required for Chicago code.
- Cord options include straight and curly.
 - Straight cord is 144"
 - Curly cord is 120"
- If desired application is to set power module inside an under worksurface trough, MUST be specified with SPLA-ALT-BEAMA (contact Allsteel TPG for more information).
- Cannot be attached directly to the bottom of the worksurface.

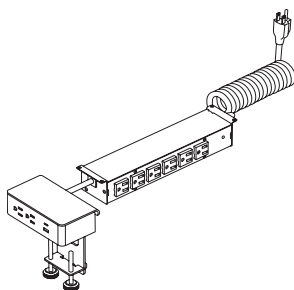

AABPWRMOD.AC.Q

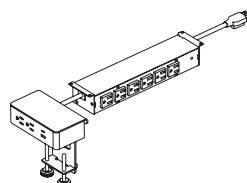

AABPWRMOD.AC.S

Power Module — Above/Below Worksurface (page 261.2)

- Above/Below power module provides access to power on the desktop and below the worksurface.
- Desktop mount can be used on any surface with a 6" W x 3" D clearance along the worksurface edge.
- Under surface mounting can be used with a 12" W x 3" D x 2" H clearance under the surface.
- Plugs will take additional depth (approx. 3").
- Two wire management "P-Clips" included with mounting hardware.
- Below worksurface power strip supplies six grounded A/C receptacles, desktop unit supplies two receptacles, 1 USB-A port, and 1 USB-C port.
- Desktop and under worksurface units are connected by a 2' long straight cord and cannot be disconnected.
- Power cord choices include a 6' straight cord or a coiled cord that is 6' long uncoiled, approximately 8" long coiled (compressed).
- Desktop unit available in White and Gray finishes.
- Under worksurface unit available in black only, no specification needed.
- UL 962A and UL 111 Listed. UL 1310 Recognized.

Cable & Wire Management

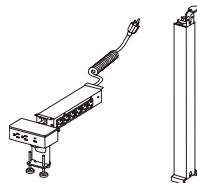

AHATPWORMOD2S or AHATPWORMOD3S

Metal Telescoping HAT Wire Management (page 261.3)

- Separate models available for use on either 2-Stage or 3-Stage Altitude A6 Tables. Not compatible with Altitude A3, A5, or A8.
- Equipped with 2-Stage or 3-Stage Telescoping Wire Chase and custom Above/Below Power Module intended for cord management on 2- and 3-Stage height adjustable tables.
- Telescoping chase includes a unique Above/Below Power Module and is NOT compatible with any other power module.
- Above/Below Power Module supplies 6 grounded A/C receptacles below the worksurface and 2 receptacles, 1 USB-A, and 1 USB-C port above the worksurface on the desktop unit. Desktop power module available in White and Gray finishes, below-worksurface power strip only available in black only.
- Telescoping Chase available in the same paint finishes as the Altitude height adjustable bases except for “Nickel.”
- To match Metal Telescoping Chase to HAT base, specify matching paint color as HAT base. To match Telescoping Chase to a “Nickel” HAT base, specify “Platinum Metallic,” or “PR2.”
- Two “P-Clips” included for wire management between desktop power module and under worksurface power strip.

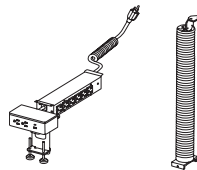

AHATPWORMOD2S or AHATPWORMOD3S

Fabric Elastic HAT Wire Management (page 261.3)

- Model compatible for use on either 2-Stage or 3-Stage Altitude A6 Tables. Not compatible with Altitude A3, A5, or A8.
- Equipped with Fabric Elastic Wire Chase and custom Above/Below Power Module intended for cord management on 2- and 3-Stage height adjustable tables.
- Fabric Elastic Chase includes a unique Above/Below Power Module and is NOT compatible with any other power module.
- Above/Below Power Module supplies 6 grounded A/C receptacles below the worksurface and 2 receptacles, 1 USB-A, and 1 USB-C port above the worksurface on the desktop unit.
- Desktop power module available in White and Gray finishes, below-worksurface power strip only available in black only.
- Fabric Elastic Chase available in Light, Medium, and Dark fabric finishes.
- Includes a metal foot and an under worksurface mounting bracket to attach Fabric Elastic Chase along the side of a HAT leg.
- To match metal brackets to HAT base, specify matching paint color as HAT base. To match brackets to a “Nickel” HAT base, specify “Platinum Metallic,” or “PR2.”
- Two “P-Clips” included for wire management between desktop power module and under worksurface power strip.

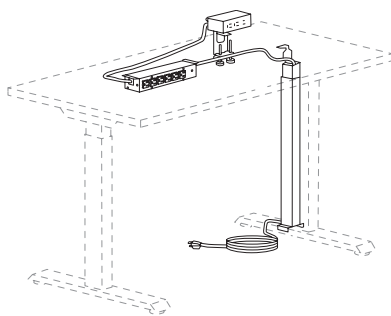

2-Stage Metal Telescoping HAT Wire Management

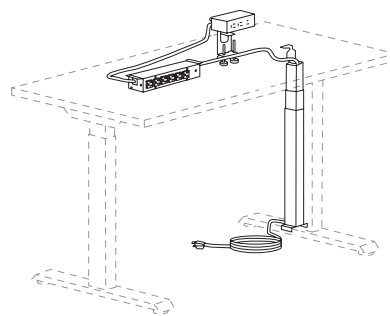

3-Stage Metal Telescoping HAT Wire Management

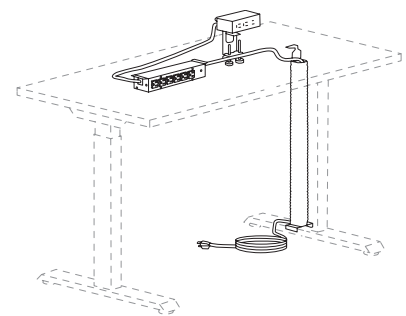

2 or 3-stage Fabric Elastic HAT Wire Management

For more power and wire management options, please visit the Extensions pages.

Screens

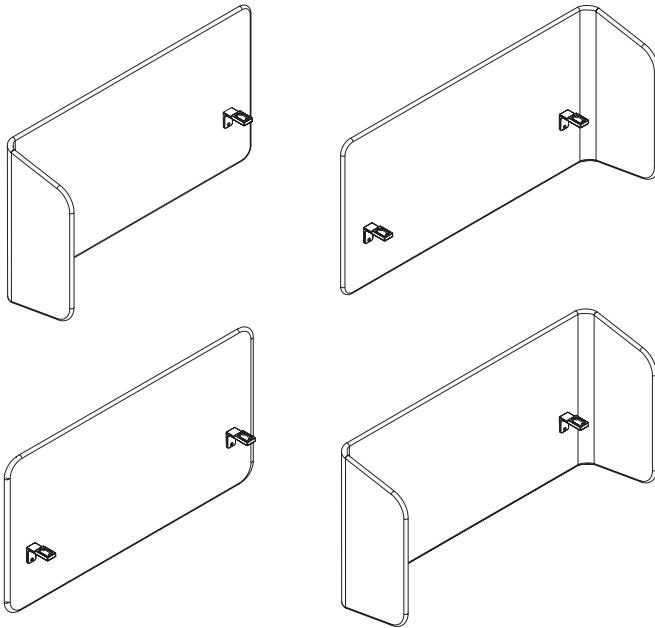

- See Table 1 for overall table width and depth for each screen shape.
- Adding a screen adds 3" to depth of the table.
- Adding a screen adds 1" to the width of the table per return wing.
- RH L-screens have return wing on user's right; LH opposite.
- When using a 24"D worksurface with Altitude screens, you must specify a T-foot.

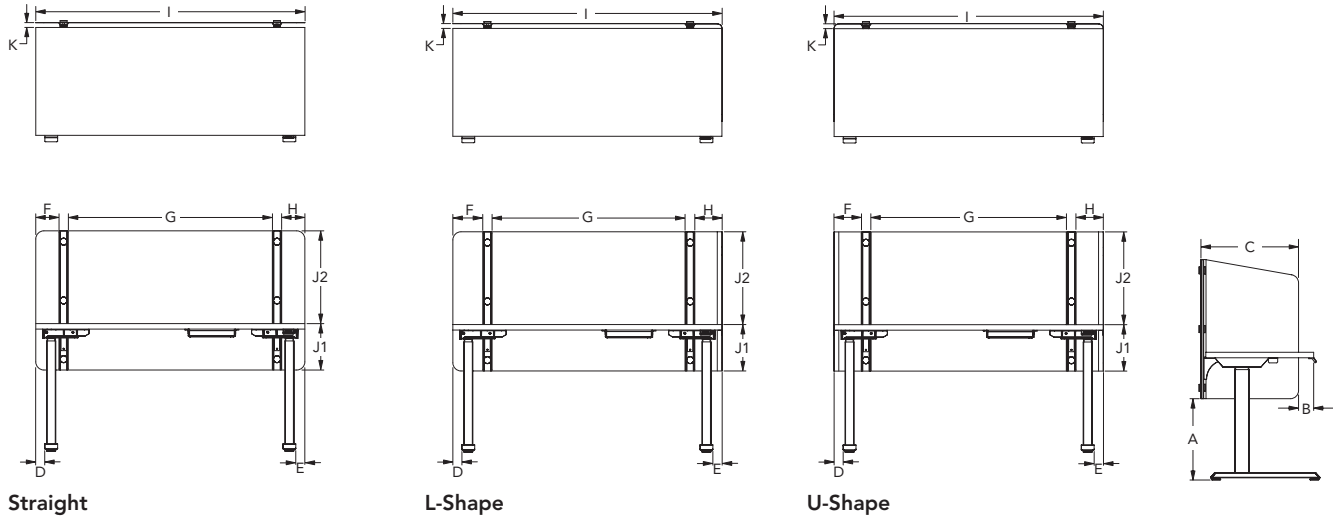

Size Reference Matrix

Models	A	B	C1	C2	D	E	F	G1	G2	H	I	J1	J2	K
	Under Desk Height	Wing to Front	Wing Width STD	Wing Width EXT	Left Leg to Edge	Right Leg to Edge	Left Side Panel to Support	Distance Between Supports	Distance Between Center/Right Support	Right Side Panel to Support	Overall Width	Desktop To Base of Panel	Desktop To Top of Panel	Cable Drop Space
AMS2048LH	24.7	3.3	21.1	24.3	2.0	2.0	5.9	29.7	-	6.4	46.1	2.9	20.0	1.0
AMS2054LH	24.7	3.3	21.1	24.3	2.0	2.0	5.9	35.7	-	6.4	52.1	2.9	20.0	1.0
AMS2060LH	24.7	3.3	21.1	24.3	2.0	2.0	5.9	41.7	-	6.4	58.1	2.9	20.0	1.0
AMS2066LH	24.7	3.3	21.1	24.3	2.0	2.0	5.9	22.8	22.8	6.4	64.1	2.9	20.0	1.0
AMS2072LH	24.7	3.3	21.1	24.3	2.0	2.0	5.9	25.8	25.8	6.4	70.1	2.9	20.0	1.0
AMS2048RH	24.7	3.3	21.1	24.3	2.0	2.0	6.4	29.7	-	5.9	46.1	2.9	20.0	1.0
AMS2054RH	24.7	3.3	21.1	24.3	2.0	2.0	6.4	35.7	-	5.9	52.1	2.9	20.0	1.0
AMS2060RH	24.7	3.3	21.1	24.3	2.0	2.0	6.4	41.7	-	5.9	58.1	2.9	20.0	1.0
AMS2066RH	24.7	3.3	21.1	24.3	2.0	2.0	6.4	22.8	22.8	5.9	64.1	2.9	20.0	1.0
AMS2072RH	24.7	3.3	21.1	24.3	2.0	2.0	6.4	25.8	25.8	5.9	70.1	2.9	20.0	1.0
AMS3248LH	17.5	3.3	21.1	24.3	2.0	2.0	5.9	29.7	-	6.4	46.1	10.0	20.0	1.0
AMS3254LH	17.5	3.3	21.1	24.3	2.0	2.0	5.9	35.7	-	6.4	52.1	10.0	20.0	1.0
AMS3260LH	17.5	3.3	21.1	24.3	2.0	2.0	5.9	41.7	-	6.4	58.1	10.0	20.0	1.0
AMS3266LH	17.5	3.3	21.1	24.3	2.0	2.0	5.9	22.8	22.8	6.4	64.1	10.0	20.0	1.0
AMS3272LH	17.5	3.3	21.1	24.3	2.0	2.0	5.9	25.8	25.8	6.4	70.1	10.0	20.0	1.0
AMS3248RH	17.5	3.3	21.1	24.3	2.0	2.0	6.4	29.7	-	5.9	46.1	10.0	20.0	1.0
AMS3254RH	17.5	3.3	21.1	24.3	2.0	2.0	6.4	35.7	-	5.9	52.1	10.0	20.0	1.0
AMS3260RH	17.5	3.3	21.1	24.3	2.0	2.0	6.4	41.7	-	5.9	58.1	10.0	20.0	1.0
AMS3266RH	17.5	3.3	21.1	24.3	2.0	2.0	6.4	22.8	22.8	5.9	64.1	10.0	20.0	1.0
AMS3272RH	17.5	3.3	21.1	24.3	2.0	2.0	6.4	25.8	25.8	5.9	70.1	10.0	20.0	1.0
AMS2048US	24.7	3.3	21.1	24.3	2.0	2.0	5.9	30.3	-	5.9	46.1	2.9	20.0	1.0
AMS2054US	24.7	3.3	21.1	24.3	2.0	2.0	5.9	36.3	-	5.9	52.1	2.9	20.0	1.0
AMS2060US	24.7	3.3	21.1	24.3	2.0	2.0	5.9	42.3	-	5.9	58.1	2.9	20.0	1.0
AMS2066US	24.7	3.3	21.1	24.3	2.0	2.0	5.9	23.1	23.1	5.9	64.1	2.9	20.0	1.0
AMS2072US	24.7	3.3	21.1	24.3	2.0	2.0	5.9	26.1	26.1	5.9	70.1	2.9	20.0	1.0
AMS3248US	17.5	3.3	21.1	24.3	2.0	2.0	5.9	30.3	-	5.9	46.1	10.0	20.0	1.0
AMS3254US	17.5	3.3	21.1	24.3	2.0	2.0	5.9	36.3	-	5.9	52.1	10.0	20.0	1.0
AMS3260US	17.5	3.3	21.1	24.3	2.0	2.0	5.9	42.3	-	5.9	58.1	10.0	20.0	1.0
AMS3266US	17.5	3.3	21.1	24.3	2.0	2.0	5.9	23.1	23.1	5.9	64.1	10.0	20.0	1.0
AMS3272US	17.5	3.3	21.1	24.3	2.0	2.0	5.9	26.1	26.1	5.9	70.1	10.0	20.0	1.0
AMS2048SS	24.7	-	-	-	2.0	2.0	5.0	32.0	-	5.0	46.0	2.9	20.0	1.0
AMS2054SS	24.7	-	-	-	2.0	2.0	5.0	38.0	-	5.0	52.0	2.9	20.0	1.0
AMS2060SS	24.7	-	-	-	2.0	2.0	5.0	44.0	-	5.0	58.0	2.9	20.0	1.0
AMS2066SS	24.7	-	-	-	2.0	2.0	5.0	24.0	24.0	5.0	64.0	2.9	20.0	1.0
AMS2072SS	24.7	-	-	-	2.0	2.0	5.0	27.0	27.0	5.0	70.0	2.9	20.0	1.0
AMS3248SS	17.5	-	-	-	2.0	2.0	5.0	32.0	-	5.0	46.0	10.0	20.0	1.0
AMS3254SS	17.5	-	-	-	2.0	2.0	5.0	38.0	-	5.0	52.0	10.0	20.0	1.0
AMS3260SS	17.5	-	-	-	2.0	2.0	5.0	44.0	-	5.0	58.0	10.0	20.0	1.0
AMS3266SS	17.5	-	-	-	2.0	2.0	5.0	24.0	24.0	5.0	64.0	10.0	20.0	1.0
AMS3272SS	17.5	-	-	-	2.0	2.0	5.0	27.0	27.0	5.0	70.0	10.0	20.0	1.0

ALTITUDE

Altitude — Metal Screens (page 266)

- Powder coated magnetic metal privacy screen.
- Metal surfaces can be easily disinfected with cleaners. See cleaning guide for more details at AllsteelOffice.com.
- Available in all standard paint colors.
- Provides 1" gap along the back for accessory mount and cord drop.
- Available in 48"W, 54"W, 60"W, 66"W and 72"W.
- 66"W and 72"W screens include 3rd center bracket.
- Available in Straight, L- and U-shape configurations. Above and Above/Below desk applications.
- L- and U-Shape screens are not compatible with shrouded Height Adjustable Table legs.
- Optional tackable accessories specified separately.
- 66"W tackable accessory comes as a set of (2) 24"W.
- 72"W tackable accessory comes as a set of (2) 20"W.
- Available in standard and extended wings.
- Wings mount flush to the edge of the surface with an L-Bracket.
- 20"W tackable accessory must only be applied to both standard and extended wings without accessory slots.
- Wings are available with accessory slots that accept Radii Hot File, Side Saddle and Coat hook.
- Top slot can accept one Radii accessory.
- Bottom slot can accept a Coat hook and one other accessory.
- Accessories can hang on either side of the wing.
- TIP: If the Hot File is used in the top slot, it will block access for accessories in the bottom slot.
- Do not hang more than 5lbs of weight on wings.
- Screens are compatible with Radii undermount storage.
- Not compatible with standard 120-worksurfaces. Contact Allsteel TPG for custom sizes.
- When using a 24"D worksurface with Altitude screens, you must specify a T-foot.

Size Reference Matrix

Tackboards	Wing	48"W	54"W	60"W	66"W	72"W
Actual Dimensions	20"W	30"W	36"W	42"W	20"W	24"W
Set of Tackboards	1	1	1	1	2	2

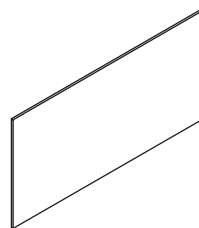

Accessories — Tackboard (page 267)

- Tackable accessories come with metal frame available in standard paint colors and fabric options.
- Attach to the screen using a dual lock tape (included in hardware).

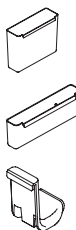

Accessories — Radii (page 267)

- Wings are available with accessory slots that accept Radii Hot File, Side Saddle and Coat hook.
- Top slot can accept one Radii accessory.
- Bottom slot can accept a Coat hook and one other accessory.
- Accessories can hang on either side of the wing.
- TIP: If the Hot File is used in the top slot, it will block access for accessories in the bottom slot.

Accessories — Further Worksurface Rail Mount (page 272)

- Accessory rail must be field cut to fit between the screen brackets.
- The following accessories are not compatible with screens: U9WTC and U9TM.

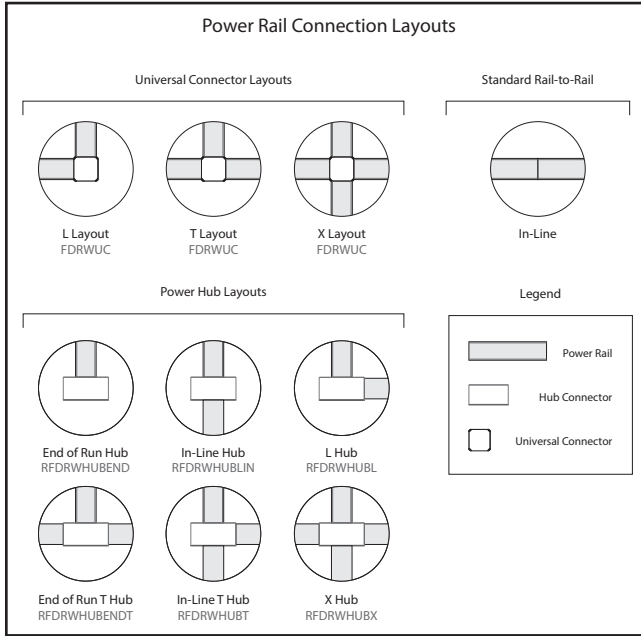

GENERAL OVERVIEW

- Accommodates power and lay-in capacity for data cables.
- Available in 48", 54", 60", 66", and 72" lengths.
- Maximum of 2 duplexes and 2 data ports per side of rail.
- Models come equipped with hardware for in-line connections.
- Fiber optic cables can follow 90 degree turns at the intersection of the power rails.
- Power harnesses snap into electrical brackets within the power rail and accept duplex receptacles.
- Electrical power harness accepts up to 2 duplex receptacles per side of rail.
- End caps are required at an end-of-run, unless connected to an end-of-run power pole or a hub.
- Power rail can be set low to the floor using the floor legs or raised off the floor at 20½" H with elevated legs.

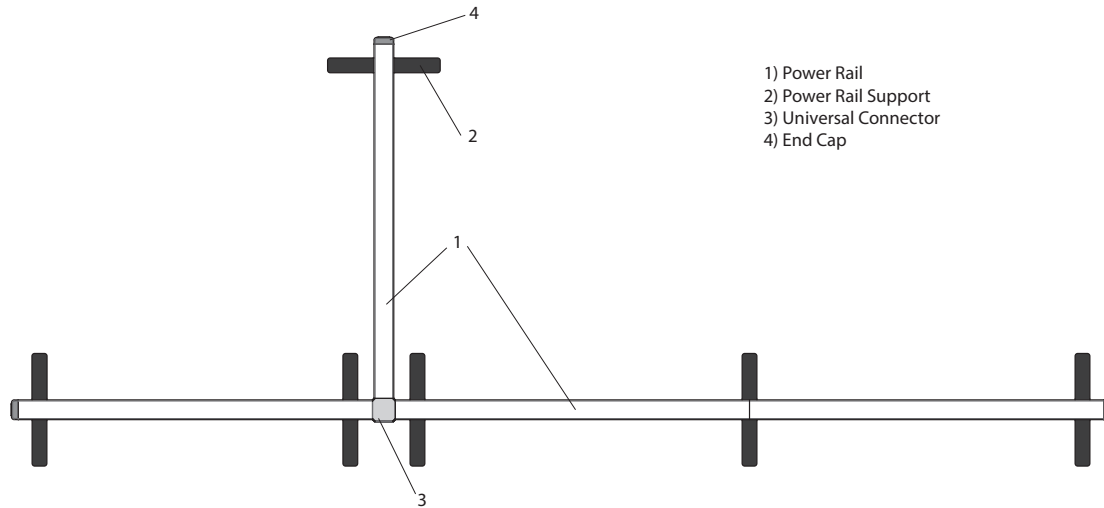

ALTITUDE

Power Rail Typicals

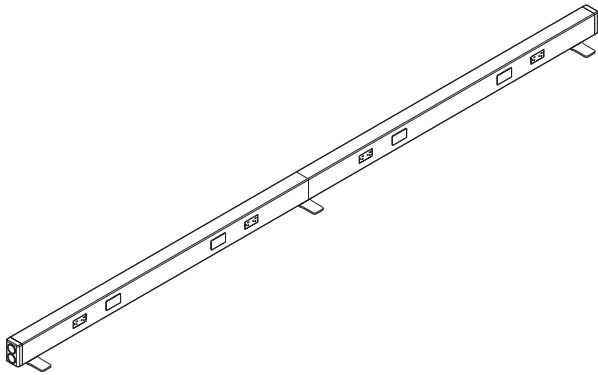

Low Rail, (2) 60"W Rail
Linear Configuration

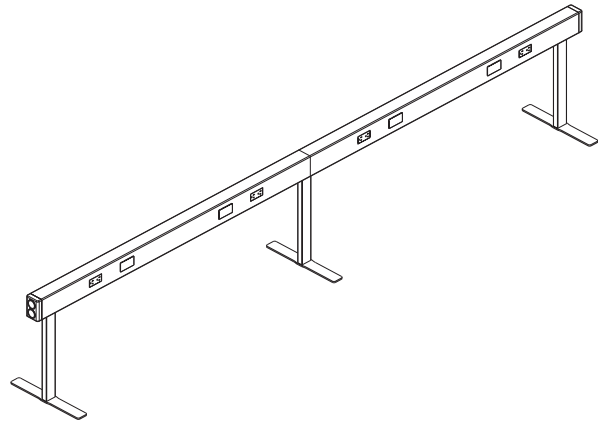

Raised Rail, (2) 60"W Rail
Linear Configuration

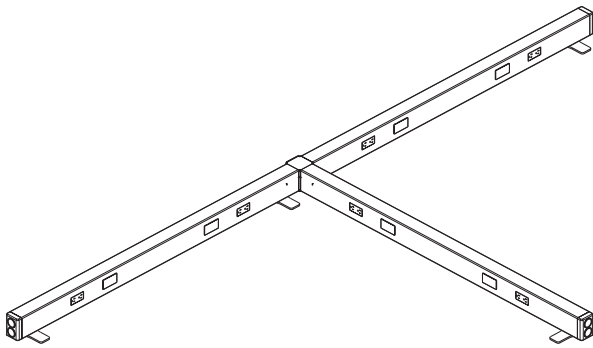

Low Rail, (3) 60"W Rail
T-Configuration

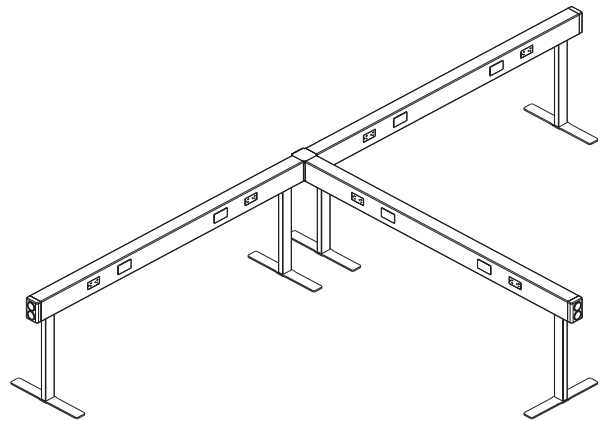

Raised Rail, (3) 60"W Rail
T-Configuration

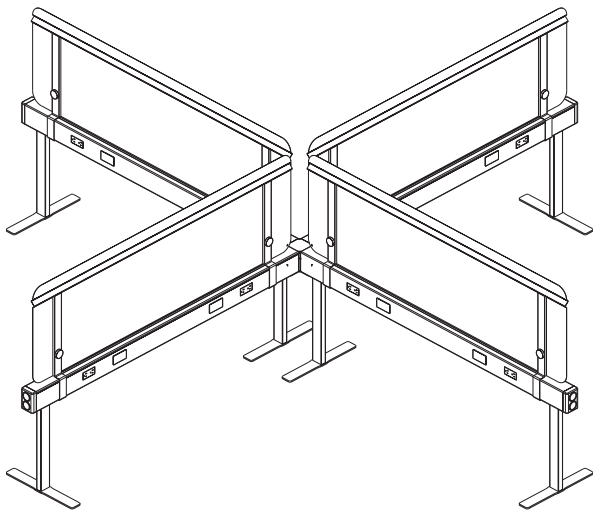

Raised Rail, (4) 60"W Rail
X-Configuration with Screens

ALTITUDE

WORKING WITH ALTITUDE POWER RAILS

Low Rail with Floor Legs:

- Each power rail is supported by (2) floor legs.
- Floor legs have a leveling mechanism that can adjust up to 1¼"H.
- Legs are specified separately and come in qty of 1. Each leg is 7¼"D x 2¼"W.
- Leg is inset 2.8" from end of the power rail.
- Universal connector allows "L", "T" and "X" configurations.
- Can connect directly to another power rail in linear applications without use of the universal connector.
- Cannot mount screens on the low rail.
- Power infeed can access the power rail in multiple ways:
 - through a receptacle position on the power rail (side infeed).
 - through the end cap on to the first power block.
 - through power pole using a power pole connector kit.

Raised Rail

- Power rails can be raised up to 20½"H using Elevated Legs and/or Hubs.
- Elevated Legs and Hubs can be used in conjunction to create the desired capability and aesthetic.
- Can be in Linear, L-, T- or X-configurations using Elevated Legs, Hubs or Universal Connector.
- Supports screens. See screens section for more details.
- Elevated Legs
 - Inset 2.8" from end of the power rail.
 - Can be shared in between the two rails in linear configuration.
 - Cannot route power and/or data.
 - Specified separately and come in qty of 1. Foot is included.
 - Leg is 15¼"D x 2¼"W x 17¾"H.
 - Order RFDRAWAB separately to anchor to floor. Appropriate fasteners per floor type sourced locally.
- Support Hubs
 - Connect directly to the power rail.
 - Can be shared in between the two rails.
 - L-, T- and X-hubs can be shared in between power rails.
 - End of Run hub is only specified at end condition.
 - Can route power and/or data.
 - Can integrate power pole. Power Pole connector kit is specified separately and come in qty of 1. Foot is included.

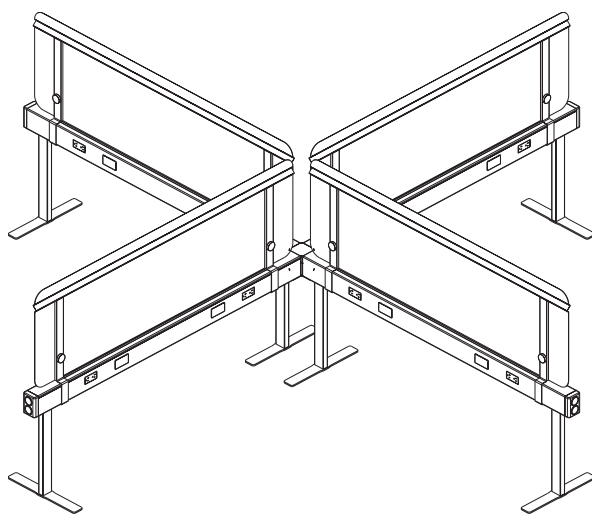

Screens

- Constructed of painted steel material.
- Standard Allsteel paint options can be applied.
- Screen height is 20"H, provides overall height of 42"H above fixed floor.
- Painted steel is magnetic and cleanable. Refer to cleaning solutions page at Allsteel Office website.
- Attachment hardware included.

ALTITUDE

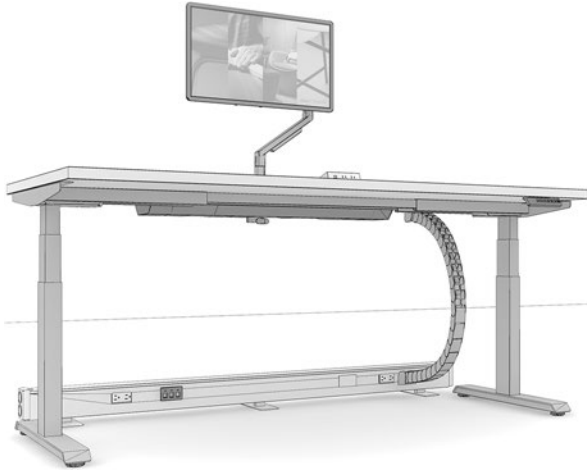

Altitude Desk + 60"W Low Rail + WKSVMC

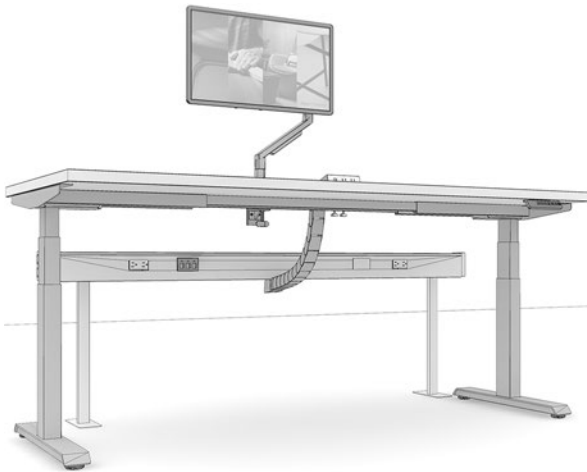

Altitude Desk + 60"W Raised Rail + A9CLWMC

WORKING WITH CABLE MANAGEMENT

- Used to route and conceal power/data cables from control box and other devices. Includes all mounting hardware.
- Houses 6 cables @ 0.300" diameter.
- Specify WKSVMC for 58" chain. Only comes in Black Finish. Recommended for use with Low Rail.
- Specify A9CLWMC for 36" chain. Comes in Black, White and Silver. Recommended for use with Raised Rail.
- Links the power rail to a height adjustable desk.
- Has two connecting points: Top section connects underneath the Height Adjustable Desk and the bottom section connects underneath the power rail using a double-sided tape. Hardware included.
- When mounting the chain to underneath the rail, an adapter link is required. Included in the hardware.

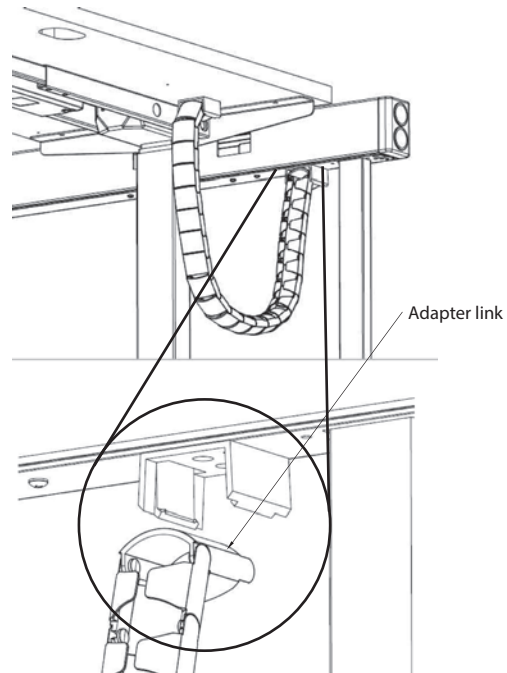

WORKING WITH POWER RAIL ELECTRICALS

General Notes about Electrical and Circuitry:

- Power Rail offers a choice of four electrical systems:
 - Four-circuit, 3 + 1
 - Four-circuit, 2 + 2
 - Three-circuit, separate neutrals
 - Eight circuits; two four-circuit systems provided back to back.
 - See Altitude Pricer section “Working with Electrical” for a detailed explanation of each electrical system.
 - All four systems utilize an 8-wire electrical system, rated at 20 amps.
- Per circuit (15 amps Canadian) — 16 amps plannable in U.S.
 - Power Rail and electrical components are UL Listed. Electrical
- Components are also CSA certified.
 - Installation and use of the electrical system, the number of receptacles.
- Used on a given circuit and connections to the building power supply.
- Should follow all local and national electrical codes.

Electrical Infeeds

- Power infeed cables deliver power from building to panel's electrical system.
- Infeed cables are housed in conduit to separate electrical system from communications and data lines.
- Select quantity of base or ceiling infeed cables depending on individual power requirements.
- Refer to rail supports for infeed access points.

Routing Power

- Power infeed can access the raised power rail in multiple ways:
 - Through power pole using a power pole connector kit.
 - Through Support Hubs.
 - Through the infeed vertebrae.

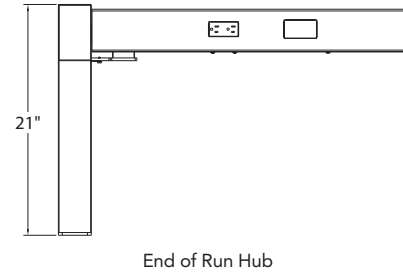
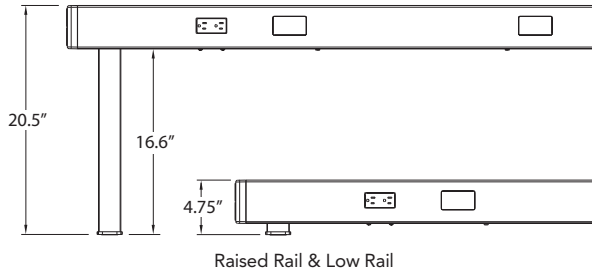

ALTITUDE

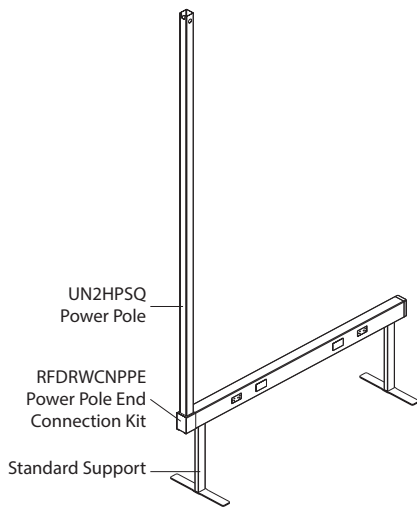

RFDRWCNPPE + UN2HPSQ
Connected to 60" W Rail

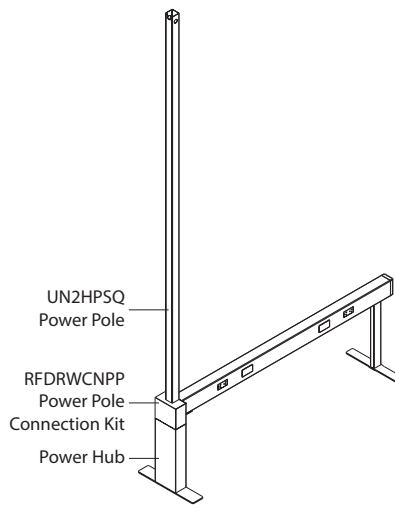

RFDRWHUBEND + RFDRWCNPP
UN2HPSQ connected to 60" W Rail

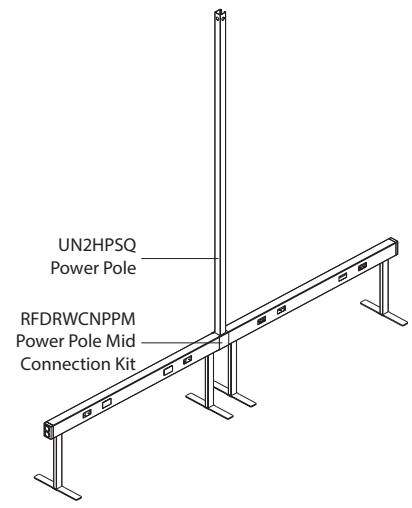

UN2HPSQ + RFDRWCNPPM
Connected to 60" W Rail

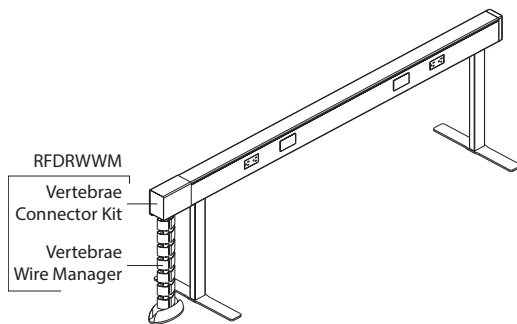

RFDRWWM
Connected to 60" W Rail

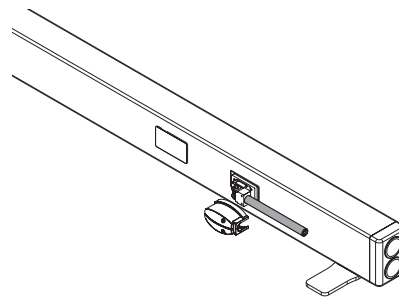

Connected to 60" W Rail through
Receptacle Knockout

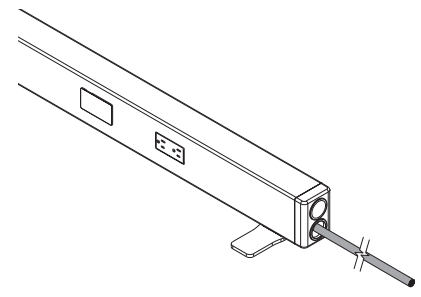

Connected to 60" W Rail through End Cap

Electrical Systems

General Notes about Electric, Circuitry, and Chicago Code:

- Power Rail offers a choice of four electrical systems:
 - Four-circuit, 3 + 1
 - Four-circuit, 2 + 2
 - Three-circuit, separate neutrals
 - Eight circuits; two four-circuit systems provided back to back.
- See pages 250-251 for a detailed explanation of each electrical system.
- All four systems utilize an 8-wire electrical system, rated at 20 amps per circuit (15 amps Canadian) — 16 amps plannable in U.S.
- Power Rail and electrical components are UL Listed. Electrical components are also CSA certified.
- Installation and use of the electrical system, the number of receptacles used on a given circuit and connections to the building power supply should be in compliance with all local and national electrical codes.

Caution: Electrical equipment cords or extension cords MUST NOT BE ROUTED through cable openings in frame sides.

Note: No more than one conduit that is connected to a harness mounted to horizontal can be routed through the same cut out in the same horizontal at beltline. Attempting to use more will cause binding of conduit and may affect reveals on receptacles.

Hardwire New York Code (page 263)

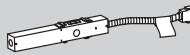
- Hardwire (New York Code) junction box (model A871400) is used when local electrical codes require hardwire entry. 
- For use in panels 48" W to 72" W.
- Unit must connect to a power harness.
- Customer to furnish all cabling and wiring from power entry to power source.
- Junction box can be positioned at any duplex receptacle location.
- For NY infeed through the end cap:
 - Order 24" pass-thru harness with power block A871124.
 - Will not have power at first cut-out from infeed.
- For NY infeed through a power rail cut-out:
 - Order 48"-72" pass-thru harness with power block. *Harness width must match power rail width.*
 - Will not have power at cut-out location used for infeed.
- For any power rail not used for infeed, order standard electrical power harness.

Hardwire Chicago Code (page 264)

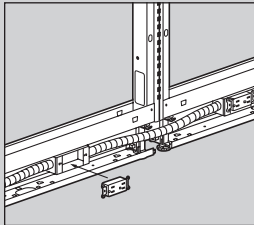
- Wiring harnesses and snap connectors are not allowed in Chicago — base pathways must be comprised of all-metallic components.
- The base pathway, junction box (model 873600) clips directly into receptacle locations and can be used both single- and double-sided.
- Customer must furnish conduit, wiring, and designer-type receptacles for the base pathway and conduit, wiring, designer-type receptacles, and receptacle covers for the beltline.
- Power entry can be routed from the floor into a junction box (model 873600). 

Electrical Infeeds

- Power infeed cables deliver power from building to panel's electrical system.
- Infeed cables are housed in conduit to separate electrical system from communications and data lines.
- Select quantity of base or ceiling infeed cables depending on individual power requirements.

Base Infeed (page 263)

- Sealtight base pathway power infeed mounts into any receptacle position in the base pathway area.
- A heavy rubber sheathing shields conduit, allowing infeed to be exposed.
- A jumper is required to connect base pathway power to beltline.

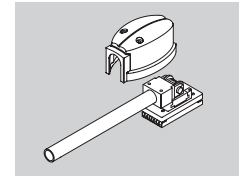

Sealtight Electrical Infeed (page 263)

- Sealtight electrical infeed cable is used with footed panels.
- Should not be ordered prior to installation to have pre-wired as infeed must be routed from inside of panel out to be connected to power.
- Cannot be connected to power harness in panel frame that infeed is brought into unless additional pass-thru harness without power block is used to feed from below beltline to above beltline.

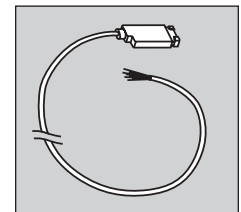

Power Infeed (page 263)

- Power infeed connects to a prewired electrical harness in the power rail.
- Most codes allow flex conduit to be exposed after installation. Verify code requirements before ordering for exposed application.

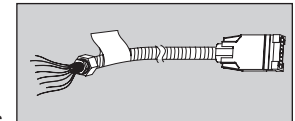

ALTITUDE

To Order:

- Determine which electrical system you will use after consulting your electrician and computer support personnel:
 - The Four-circuit system (4-Hot/2-Neutral/2-Ground)
 - 3 + 1 option
 - 2 + 2 option
 - The three-circuit system (3-Hot/3-Neutral/2-Ground)
 - The eight-circuit system (back-to-back four-circuit systems)
- Determine location, quantity, and circuit of duplexes.
- Determine the appropriate choice and use of isolated, isolated/dedicated, and separate neutrals circuits.
- Specify appropriate power harnesses* and pass-thru cables.*
- Determine the location, quantity, and type of power infeed needed.

* Select power harness models (A8712XX), with the last two digits corresponding with the panel width into which the component is to be positioned.
The initial cable length can be stretched approximately 3" to transverse "T", "X", "L", and extended straight connectors.

Flexconnect™ Electrical System Options

The four-circuit, eight-wire electrical system is widely specified and trusted by hundreds of thousands of end-users. This proven system delivers four circuits for every power infeed in either a 3 + 1 or 2 + 2 configuration. The isolated/dedicated circuits are ideal for sensitive computing equipment, while the common circuits are suitable for faxes, copiers, task lights and other peripherals. Both the 3 + 1 and 2 + 2 systems use the same pre-wired components, making it easy to adjust as electrical needs change.

You can also choose a three-circuit, eight-wire system that has a dedicated neutral for every hot circuit. The three-circuit components have model numbers with an "A" suffix and appear in a gray box in this price.

All three systems utilize an eight-wire electrical system rated at 20 amps per circuit (15 amps Canadian). Concensys panels and electrical components are UL listed and CSA certified.

Four-circuit, 3 + 1 Receptacle Option

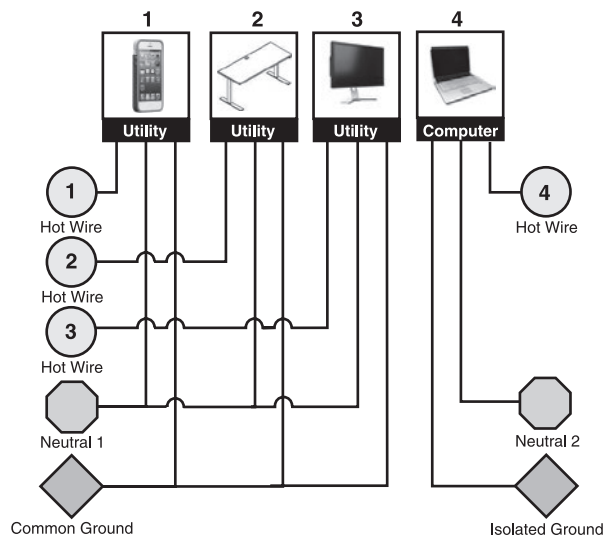

The 3 + 1 option is the electrical standard used on Allsteel systems for many years in most installations. This wiring option provides three utility circuits plus an isolated/dedicated circuit for more sensitive equipment. Circuit 2 (one of the 3 common circuits sharing a neutral wire) cannot be used with single-phase building electrical supply.

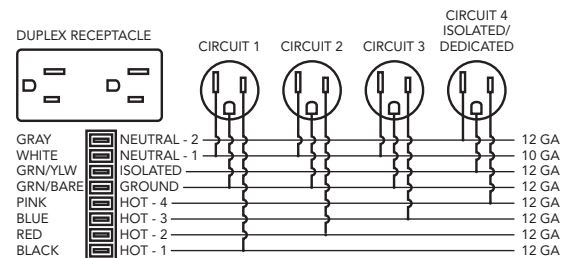

Four-circuit, 2 + 2 Receptacle Option

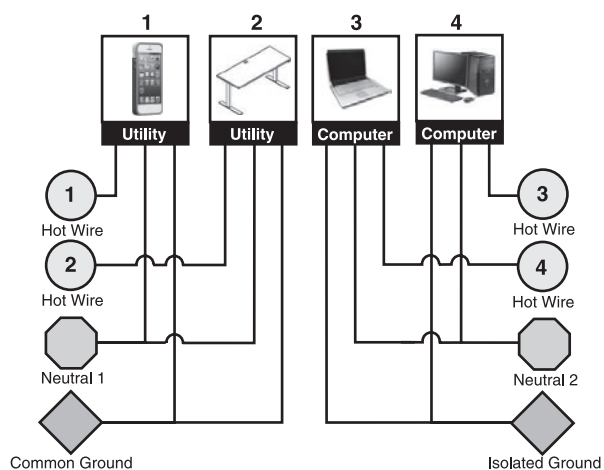

The 2 + 2 option is a wiring option that provides two utility circuits and two isolated circuits for more extensive computer usage applications.

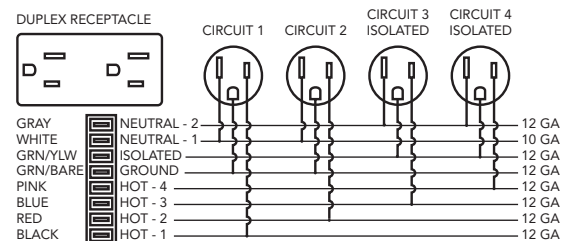

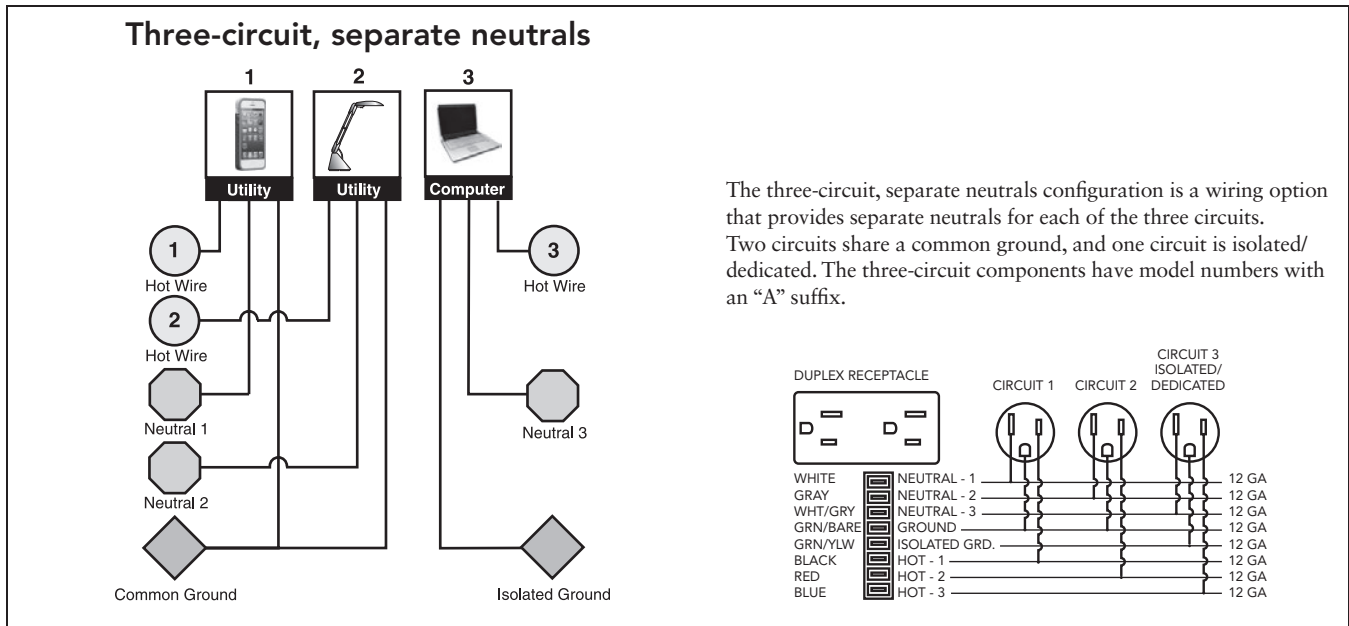

Altitude System Receptacle Usage					
Two 8-wire, 20 amp (15 amp Canadian) electrical systems are offered					
Electrical System	Circuitry	Receptacle Capacity			
Four-circuit 4-Hot/2-Neutral/2-Ground	3 + 1	Common Circuit-1 A873501	Common Circuit-2 ⁽¹⁾ A873502	Common Circuit-3 A873503	Iso/Dedicated Circuit-4 A873504
	2 + 2	Common Circuit-1 A873501	Common Circuit-2 A873502	Isolated Circuit-3 A873506	Isolated Circuit-4 A873504
Three-circuit 3-Hot/3-Neutral/2-Ground	w/separate neutrals	Common Circuit-1 A871501A	Common Circuit-2 A871502A	Iso/Dedicated Circuit-3 A871503A	N/A

(1) Circuit 2 (one of the 3 common circuits sharing a neutral wire) cannot be used with a single-phase building electrical supply.

Notes:

- Four-circuit components and three-circuit components (with suffix "A") cannot be used together.
- Components of the two systems are keyed differently to prevent components of one system being connected to components of another system.
- Allsteel model numbers are printed on the UL labels, and components are color-coded to provide visual identification of the different components.
- Four-circuit components have black plastic parts.
- Three-circuit components have rust-colored terminal ends and receptacle backs are rust-colored.

Duplex Receptacle



15 amp receptacle

ALTITUDE

Infeeds

- Power infeed cables deliver power from building to Power Rail's electrical system.
- Infeed cables are housed in conduit to separate electrical system from communications and data lines.
- Select quantity of infeed cables depending on individual power requirements.

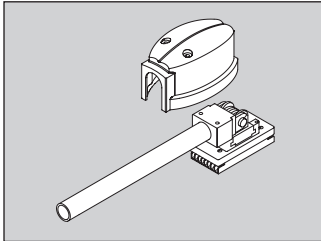

Base Infeed:

- Sealtight base pathway power infeed mounts into any receptacle position in the power rail housing.
- A heavy rubber sheathing shields conduit, allowing infeed to be exposed.

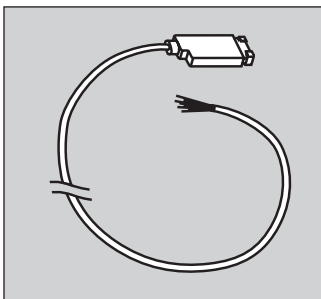

Sealtight Electrical Infeed:

- Sealtight electrical infeed is used for power entering through the end cap.
- Should not be ordered prior to installation to have pre-wired as infeed must be routed from inside of the power rail out to be connected to power.

Power Harness

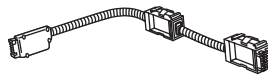

Electrical power harnesses are used to distribute power in the power rail. **Power blocks** on electrical power harness accept duplex receptacles.

- Electrical power harnesses are used to distribute power in Power Rails. Harnesses must be installed in each power rail housing.
- Specify harness length to match rail housing length. Each power harness accepts four duplex receptacles (two on each side of power rail housing).
- Connectors at both ends of power harnesses allow power distribution in either direction.
- Harness power blocks snap directly onto brackets in power rail housing.

Power Blocks

- Power blocks snap directly onto brackets in the power rail and accept receptacles (sold separately) on each side of harness.

Duplexes

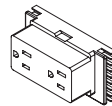

Duplex Receptacles

Receptacle Color Recommended to Coordinate with Paint Color

Paint Color	Receptacle Color
Bungalow — P7C	Muslin — EU
Champagne Metallic — PR5	Muslin — EU
Cinder — P7Q	Brownstone — EY
Fossil — P28	Flint — E9
Gunmetal Metallic — PR3	Brownstone — EY
Parchment — P93	Muslin — EU
Pebble — P8R	Loft — EV
Pewter — P8D	Flint — E9
Platinum — PR2	Loft — EV
Platinum Metallic — P42	Silver — E5
Salt — P8C	Silver — E5
Titanium — P8T	Silver — E5

- Duplex receptacles snap into power blocks of power harnesses.
- Duplexes are available in multiple colors. See inside front cover for finishes.
- Each receptacle is labeled to indicate which circuit it will be connected to: 1, 2, 3 or 4.
- Duplexes are model specific to support either 3 + 1 and 2 + 2 electrical infeed; or have an "A" suffix and are designed to support a three-circuit separate neutral electrical infeed.
- At least one duplex must be installed in upper housing side of rail housing assembly (see page 254, "Working with Electrical and Data").

Data

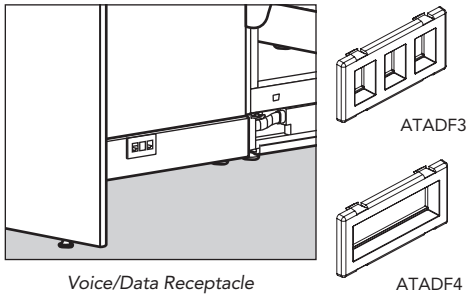

Voice/Data Receptacle

Data Faceplates:

- Fit into data port openings in Power Rail Housing.
- Due to rail housing depth, data modules should not be used back-to-back.

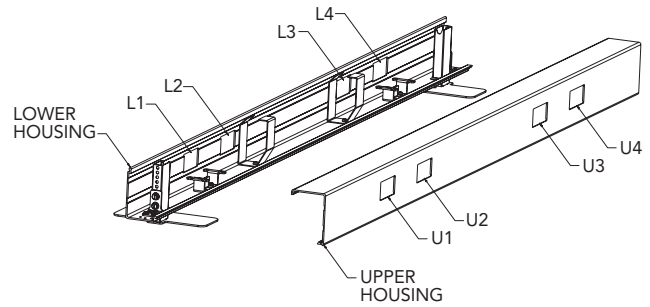

- Ports 1 and 4 accept duplexes, port covers and base infeeds.
- Ports 2 and 3 accept data and port covers.
- Either U1 or U4 must always contain a duplex.
- Data cannot be back-to-back (data in L2 + U2 or L3 + U3 combinations are not permitted).

Port Cover

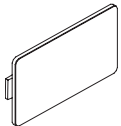

- Port covers must be used where no duplex or data faceplate is present.
- Fits into Power Rail port locations in place of duplex receptacles and data faceplates.
- Does not fit into port sizes of other product lines.

Cable Capacity

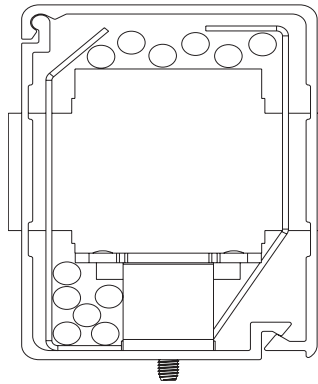

- The power rail housing allows continuous voice and data lines to run without interruption.
- Lay-in is provided for environments where systems furniture or cabling are subject to frequent change.
- Lower cavity allows 6 voice/data cables (1/4" dia).
- Upper cavity lay-in allows 6 voice/data cables (1/4" dia).

Power Rail Receptacle Locations

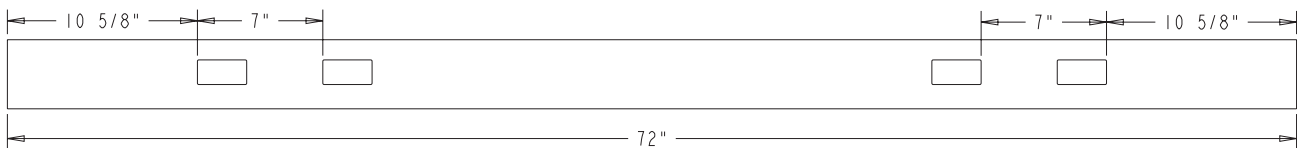
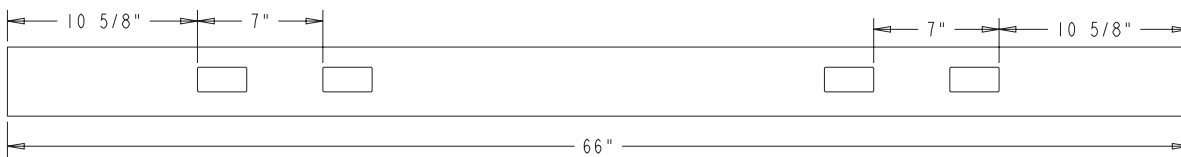
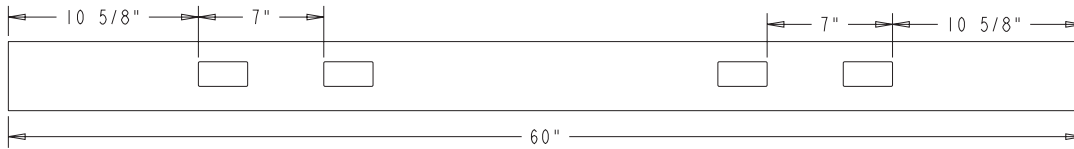
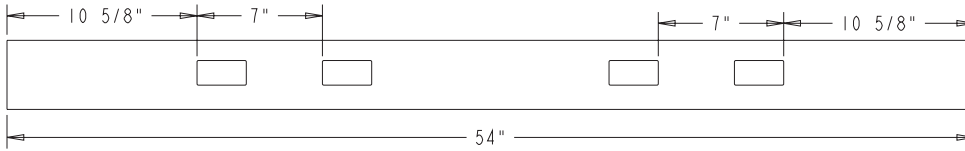
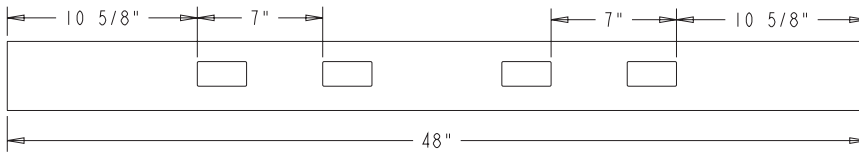

- For example, in a four-circuit system:
 - Circuit 1 — calculators, fans, etc.
 - Circuit 2 — task lights (could be wired to wall switch)
 - Circuit 3 — CRT or flat screen monitors
 - Circuit 4 — CPUs
- Use circuit 4 for power-sensitive electronic equipment.

Placement of pedestals and lateral files may render some duplex locations inaccessible. Pedestal placement may also affect compatibility with pull-up receptacles.

Rail Accessories

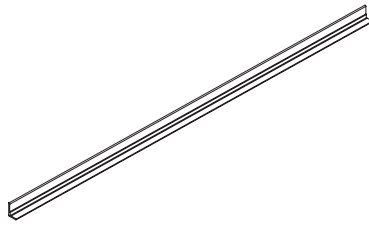

Side View



Top View

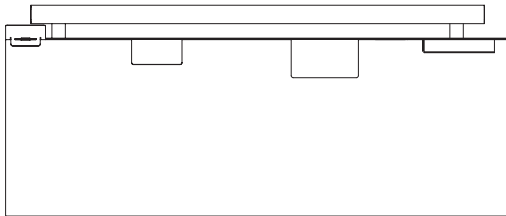

Phone/
Tablet
Stand Pencil
Holder Rail
Mounted
Shelf Vertical
Paper Tray

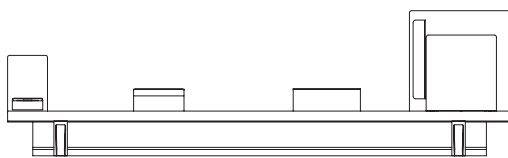

Front View

Worksurface Mounted Rail (page 272)

- Aluminum extrusion designed to mount to flat edge worksurfaces. Comes with rail and hardware for mounting.
- Mounted rail extends $\frac{3}{4}$ " on underside of worksurface which may interfere with the mounting of storage and screens.
- Widths available for Altitude tables 12" through 66" in 6" increments. Can pass across seams of ganged worksurfaces in tethered applications.
- Passes behind worksurface bracket on tethered applications.
- For freestanding applications rail should be 6" shorter than worksurface (i.e. 54" rail for 60" worksurface).

Rail Mounted Accessories

Not recommended for use on panel systems with attached worksurfaces due to fit up issues created with worksurface and panel. Adding accessory rail shifts worksurface — $\frac{3}{8}$ " away from panel along that edge. Forcing worksurface into place crushes fabric tile and with tiles of other material (steel, marker board, etc) is likely to scratch, dent, or otherwise damage tile during installation.

U9TM Phone/Tablet Stand (page 272)

- $6\frac{1}{2}$ "H x $4\frac{3}{4}$ "W and angles back $1\frac{1}{4}$ ".
- Has a $\frac{1}{4}$ " x 1" slot in bottom flange to allow for routing cables. Requires $1\frac{1}{4}$ " space behind worksurface edge in order to be used.



U9TP Pencil Holder (page 272)

- $2\frac{3}{8}$ "H x 6"W x 3"D.
- Holds approximately twenty #2 pencils.



U9TS Rail Mounted Shelf (page 272)

- 8"W x $4\frac{1}{2}$ "D and sits $2\frac{3}{8}$ " higher than top of worksurface.
- Holds up to 8 pounds.

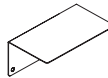

U9TF Vertical Paper Tray (page 272)

- Sits 12"H x $1\frac{1}{2}$ "W x 12"D from back of worksurface.
- Folder front stands 9" high from worksurface top, $\frac{1}{4}$ " space holds about 280 sheets of copy paper.

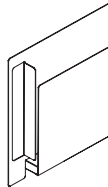

U9WTC Cord Organizer (page 272)

- Can attach to both bottom of worksurface or slides into rail.
- 4"W x $\frac{7}{8}$ "D, made from sheet metal.
- Top sits flush with worksurface if mounted to worksurface.
- 4 cable cut outs: 2 — .250" diameter and 2 — 0.147" diameter; .250" diameter cut outs are centered between the .147" diameter cut outs.



Universal Hook (page 272)

- Mounts to underside of worksurface and provides storage for bags, coats and purses. Can be used as a horizontal wire manager.



ALTITUDE

For specification information see pages 235-236.

GSA SIN 33721

	Description	Model	List Price		
			P1	P2	P3
	2-Stage				
	2 Stage, 2 Leg Rectangle T Foot	A6REC2S2LTF	\$ 2151	\$ 2324	\$ 2582
	*Bases purchased in April 2021 or later accommodate 24"D-30"D Rectangular Worksurfaces 24"W-72"W, bases purchased prior to this date accommodate 24"D-30"D Rectangular Worksurfaces 48"W-72"W				
	2 Stage, 2 Leg Rectangle C Foot	A6REC2S2LCF	\$ 2151	\$ 2324	\$ 2582
	*Bases purchased in April 2021 or later accommodate 24"D-30"D Rectangular Worksurfaces 24"W-72"W, bases purchased prior to this date accommodate 24"D-30"D Rectangular Worksurfaces 48"W-72"W				
	3-Stage				
	A6 3 Stage, 2 Leg Rectangle T Foot	A6REC3S2LTF	\$ 2413	\$ 2607	\$ 2897
	*Bases purchased in April 2021 or later accommodate 24"D-30"D Rectangular Worksurfaces 24"W-72"W, bases purchased prior to this date accommodate 24"D-30"D Rectangular Worksurfaces 48"W-72"W				
	A6 3 Stage, 2 Leg Rectangle C Foot	A6REC3S2LCF	\$ 2413	\$ 2607	\$ 2897
	*Bases purchased in April 2021 or later accommodate 24"D-30"D Rectangular Worksurfaces 24"W-72"W, bases purchased prior to this date accommodate 24"D-30"D Rectangular Worksurfaces 48"W-72"W				
	A6 Max 3 Stage, 2 Leg T Foot	A6MREC3S2LTF	\$ 3349	\$ 3617	\$ 4020
	*Bases purchased in April 2021 or later accommodate 24"D-30"D Rectangular Worksurfaces 24"W-96"W, bases purchased prior to this date accommodate 24"D-30"D Rectangular Worksurfaces 48"W-96"W				
	*350 LB Max Lift Capacity				
	A6 Max 3 Stage, 2 Leg C Foot	A6MREC3S2LCF	\$ 3349	\$ 3617	\$ 4020
	*Bases purchased in April 2021 or later accommodate 24"D-30"D Rectangular Worksurfaces 24"W-96"W, bases purchased prior to this date accommodate 24"D-30"D Rectangular Worksurfaces 48"W-96"W				
	*350 LB Max Lift Capacity				

ALTITUDE

<p>How to specify — Select the Model Number from above.</p>	<p>1st Option: Select the Base Paint Color (if applicable): P1 P2 P3 See page 232 for paint finishes.</p>	<p>2nd Option: Select Feet Options (if applicable): X Standard Glides S Slide Glides (\$153 extra)</p>	<p>3rd Option: Select the Keypad (if applicable): UD Basic Up/Down MEM Memory Preset PDL Paddle</p>
--	--	---	--

Example: A6RND3S2LCF.P8L.X.PDL

For specification information see pages 235-236.

GSA SIN 33721

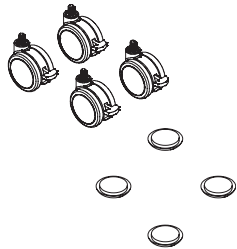
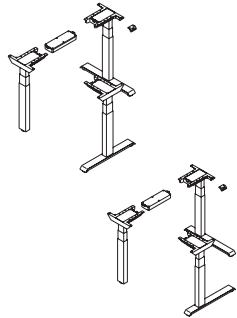
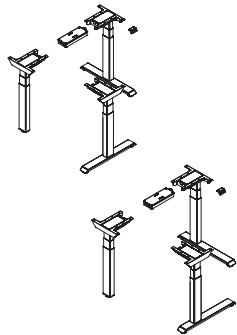
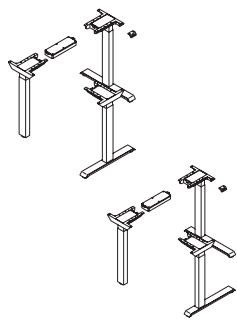

Description	Model	List Price		
		P1	P2	P3
2-Stage				
A6 2 Stage, 3 Leg Rectangle T Foot	A6REC2S3LTF	\$ 3480	\$ 3829	\$ 4351
A6 2 Stage, 3 Leg Rectangle C Foot	A6REC2S3LCF	\$ 3480	\$ 3829	\$ 4351
3-Stage				
A6 3 Stage, 3 Leg Rectangle T Foot	A6REC3S3LTF	\$ 3792	\$ 4096	\$ 4552
*3-leg standard bases can accommodate worksurface configurations from 24"D x 48"W x 36"W to 30"D x 72"W x 48"W.				
A6 3 Stage, 3 Leg Rectangle C Foot	A6REC3S3LCF	\$ 3792	\$ 4096	\$ 4552
*3-leg standard bases can accommodate worksurface configurations from 24"D x 48"W x 36"W to 30"D x 72"W x 48"W.				
A6 Max 3 Stage, 3 Leg Rectangle T Foot	A6MREC3S3LTF	\$ 4378	\$ 4817	\$ 5473
*3-Leg Max bases can accommodate worksurface configurations from 24"D x 48"W x 36"W to 30"D x 72"W x 72"W. *500 lb Max Lift Capacity				
A6 Max 3 Stage, 3 Leg Rectangle C Foot	A6MREC3S3LCF	\$ 4378	\$ 4817	\$ 5473
*3-Leg Max bases can accommodate worksurface configurations from 24"D x 48"W x 36"W to 30"D x 72"W x 72"W. *500 lb Max Lift Capacity				
Foot Retrofit Options				
Casters (Use on 2-leg bases ONLY)	A6CASTER*	\$ 277	N/A	N/A
* A6 casters are intended for use with Allsteel A6 height-adjustable tables. When purchased separately and used without Allsteel furniture, the A6 casters marked by (*) are considered Open Market.				
Slide Glides (Use on 2-leg bases ONLY)	A6SLDGLIDE	\$ 201	N/A	N/A
G1 Glide (4-Pack)	A6G1GLIDE	\$ 217	N/A	N/A
*Glide enables 3-stage base to reach G1 requirement heights.				
Bluetooth Control				
A6 Bluetooth Accessory	A6BLUETOOTH	\$ 142	N/A	N/A
* Bluetooth control will only work with 2-leg A6 tables. Bluetooth control will not work with 3-leg A6 tables.				

ALTITUDE

<p>How to specify — Select the Model Number from above.</p>	<p>1st Option: Select the Base Paint Color (if applicable): P1 P2 P3 See page 232 for paint finishes.</p>	<p>2nd Option: Select Feet Options (if applicable): X Standard Glides</p>	<p>3rd Option: Select the Keypad (if applicable): UD Basic Up/Down MEM Memory Preset PDL Paddle</p>
<p>_____ .</p>	<p>_____ .</p>	<p>_____ .</p>	<p>_____</p>

Example: A6RND3S3LCF.P8L.X.PDL

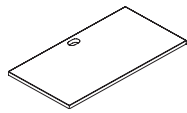

Description	Laminate w/Flat Edge Model	Veneer w/Square Edge Model	Ship Weight	List Price Laminate w/Flat Edge			List Price Veneer w/Square Edge	
				L1	L2	L3	V2	V3
Rectangular Laminate Tops — 24"D (60" to 96" ships with stiffener)								
78"W – 96"W Tops can ONLY be used with Altitude MAX Base								
48"W	AF5RS4824	AVF5RS4824	46	\$ 626	\$ 651	\$ 671	\$ 2005	\$ 2187
54"W	AF5RS5424	AVF5RS5424	48	\$ 679	\$ 706	\$ 727	\$ 2100	\$ 2291
60"W	AF5RS6024D	AVF5RS6024D	53	\$ 845	\$ 873	\$ 895	\$ 2341	\$ 2554
66"W	AF5RS6624D	AVF5RS6624D	74	\$ 877	\$ 906	\$ 929	\$ 2347	\$ 2560
72"W	AF5RS7224D	AVF5RS7224D	82	\$ 901	\$ 930	\$ 953	\$ 2459	\$ 2682
78"W	AF5RS7824D		76	\$ 933	\$ 951	\$ 967	—	—
84"W	AF5RS8424D		81	\$ 839	\$ 857	\$ 873	—	—
90"W	AF5RS9024D		86	\$ 976	\$ 994	\$ 1010	—	—
96"W	AF5RS9624D		91	\$ 999	\$ 1017	\$ 1033	—	—

Rounded Corner Laminate Tops — 24"D (60" to 96" ships with stiffener)

78"W – 96"W Tops can ONLY be used with Altitude MAX Base

48"W	AF5RND4824		46	\$ 720	\$ 738	\$ 754	—	—
54"W	AF5RND5424		48	\$ 781	\$ 799	\$ 815	—	—
60"W	AF5RND6024D		53	\$ 953	\$ 971	\$ 987	—	—
66"W	AF5RND6624D		78	\$ 1003	\$ 1021	\$ 1037	—	—
72"W	AF5RND7224D		85	\$ 1035	\$ 1053	\$ 1069	—	—
78"W	AF5RND7824D		76	\$ 1070	\$ 1088	\$ 1104	—	—
84"W	AF5RND8424D		81	\$ 980	\$ 998	\$ 1014	—	—
90"W	AF5RND9024D		86	\$ 1121	\$ 1139	\$ 1155	—	—
96"W	AF5RND9624D		91	\$ 1146	\$ 1164	\$ 1180	—	—

Rectangular Laminate Tops — 30"D (60" to 96" ships with stiffener)

78"W – 96"W Tops can ONLY be used with Altitude MAX Base

48"W	AF5RS4830	AVF5RS4830	52	\$ 704	\$ 731	\$ 753	\$ 2204	\$ 2404
54"W	AF5RS5430	AVF5RS5430	59	\$ 798	\$ 827	\$ 853	\$ 2302	\$ 2511
60"W	AF5RS6030D	AVF5RS6030D	63	\$ 945	\$ 976	\$ 1000	\$ 2539	\$ 2770
66"W	AF5RS6630D	AVF5RS6630D	78	\$ 1002	\$ 1034	\$ 1060	\$ 2547	\$ 2778
72"W	AF5RS7230D	AVF5RS7230D	87	\$ 1028	\$ 1060	\$ 1087	\$ 2656	\$ 2897
78"W	AF5RS7830D		92	\$ 1062	\$ 1080	\$ 1096	—	—
84"W	AF5RS8430D		98	\$ 972	\$ 990	\$ 1006	—	—
90"W	AF5RS9030D		105	\$ 1114	\$ 1132	\$ 1148	—	—
96"W	AF5RS9630D		111	\$ 1142	\$ 1160	\$ 1176	—	—

Rounded Corner Laminate Tops — 30"D (60" to 96" ships with stiffener)

78"W – 96"W Tops can ONLY be used with Altitude MAX Base

48"W	AF5RND4830		52	\$ 808	\$ 826	\$ 842	—	—
54"W	AF5RND5430		59	\$ 916	\$ 934	\$ 950	—	—
60"W	AF5RND6030D		63	\$ 1071	\$ 1089	\$ 1105	—	—
66"W	AF5RND6630D		82	\$ 1130	\$ 1148	\$ 1164	—	—
72"W	AF5RND7230D		90	\$ 1181	\$ 1199	\$ 1215	—	—
78"W	AF5RND7830D		92	\$ 1219	\$ 1237	\$ 1253	—	—
84"W	AF5RND8430D		98	\$ 1136	\$ 1154	\$ 1170	—	—
90"W	AF5RND9030D		105	\$ 1281	\$ 1299	\$ 1315	—	—
96"W	AF5RND9630D		111	\$ 1313	\$ 1331	\$ 1347	—	—

Note: Height-adjustable worksurface dimensions are nominal. Actual widths are reduced by 2" (1" on each side, and worksurface depths are reduced by 3/4". Corner cove depth is nominal, actual is 1" less. This is to allow for pinch-points and unobstructed table movement.

How to specify — Select the Model Number from above.	1st Option: Laminate or Veneer Type and Finish (if applicable): See page 232 for finishes.	2nd Option: Paint (if applicable): See page 232 for finishes.	3rd Option: Laminate Edge Color (if applicable): See page 232 for finishes.	4th Option: Grommet Location (if applicable): GC Grommet Center GO No Grommet	5th Option: Grommet Type (if applicable): P Oval Plastic M Oval Metal S Square Metal (Add \$13 per grommet for metal.)	6th Option: Grommet Color (Metal only): EL Matte Silver Plastic grommet color determined by worksurface finish.
_____ .	_____ .	_____ .	_____ .	_____ .	_____ .	_____ .

Examples: AF5RS4824.LM14EW.GO AVF5RS4824.SC777.GC.SEL

For specification information see page 236.

GSA SIN PENDING

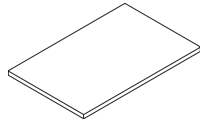

Description	Laminate w/Flat Edge Model	Ship Weight	List Price		
			L1	L2	L3
Undersized Rectangular Worksurface - 24"D (60" to 96" ships with stiffener)					
78"W - 96"W Tops can ONLY be used with Altitude MAX base.					
36"W	AF5RS3624U	23	\$ 511	\$ 536	\$ 560
42"W	AF5RS4224U	27	\$ 558	\$ 586	\$ 612
48"W	AF5RS4824U	31	\$ 626	\$ 657	\$ 686
54"W	AF5RS5424U	35	\$ 679	\$ 712	\$ 744
60"W	AF5RS6024UD	49	\$ 896	\$ 938	\$ 977
66"W	AF5RS6624UD	53	\$ 936	\$ 979	\$ 1020
72"W	AF5RS7224UD	57	\$ 966	\$ 1010	\$ 1052
78"W	AF5RS7824UD	62	\$ 1009	\$ 1054	\$ 1098
84"W	AF5RS8424UD	66	\$ 918	\$ 959	\$ 998
90"W	AF5RS9024UD	70	\$ 1066	\$ 1113	\$ 1159
96"W	AF5RS9624UD	74	\$ 1099	\$ 1147	\$ 1194

Undersized Rectangular Worksurface - 30"D (60" to 96" ships with stiffener)

78"W - 96"W Tops can ONLY be used with Altitude MAX base.

36"W	AF5RS3630U	29	\$ 568	\$ 596	\$ 623
42"W	AF5RS4230U	35	\$ 604	\$ 634	\$ 662
48"W	AF5RS4830U	40	\$ 704	\$ 738	\$ 771
54"W	AF5RS5430U	45	\$ 798	\$ 838	\$ 875
60"W	AF5RS6030UD	60	\$ 997	\$ 1043	\$ 1087
66"W	AF5RS6630UD	65	\$ 1062	\$ 1110	\$ 1157
72"W	AF5RS7230UD	70	\$ 1094	\$ 1143	\$ 1191
78"W	AF5RS7830UD	76	\$ 1137	\$ 1189	\$ 1238
84"W	AF5RS8430UD	81	\$ 1052	\$ 1099	\$ 1145
90"W	AF5RS9030UD	86	\$ 1205	\$ 1259	\$ 1312
96"W	AF5RS9630UD	91	\$ 1241	\$ 1296	\$ 1350

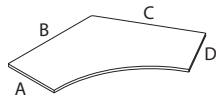

120 Degree Corner Worksurface - 24"D

24" A x 42" B x 42" C x 24" D	AF5120S4224D	59	\$ 1073	\$ 1122	\$ 1170
24" A x 48" B x 48" C x 24" D	AF5120S4824D	69	\$ 1185	\$ 1239	\$ 1292
24" A x 54" B x 54" C x 24" D	AF5120S5424D	79	\$ 1400	\$ 1464	\$ 1525

120 Degree Corner Worksurface - 30"D

30" A x 42" B x 42" C x 30" D	AF5120S4230D	68	\$ 1073	\$ 1122	\$ 1170
30" A x 48" B x 48" C x 30" D	AF5120S4830D	79	\$ 1508	\$ 1578	\$ 1644
30" A x 54" B x 54" C x 30" D	AF5120S5430D	92	\$ 1723	\$ 1802	\$ 1879

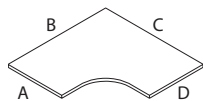

Symmetrical Corner Cove Worksurface — 24"D

24" A x 54" B x 54" C x 24" D	AF5CCS5424	56	\$ 1190	\$ 1247	\$ 1303
-------------------------------	------------	----	---------	---------	---------

Symmetrical Corner Cove Worksurface — 30"D

30" A x 54" B x 54" C x 30" D	AF5CCS5430	66	\$ 1300	\$ 1362	\$ 1423
-------------------------------	------------	----	---------	---------	---------

ALTITUDE

How to specify — Select the Model Number from above.	1st Option: FSC Certified Wood:	2nd Option: Laminate:	3rd Option: Laminate Edge Color:	4th Option: Grommet Location (if applicable):	5th Option: Grommet Type (if applicable):	6th Option: Grommet Color (Metal only):
FSC FSC Mixed Credit X Standard Wood	See page 232 for finishes.	See page 232 for finishes.	GC Grommet Center GO No Grommet	P Oval Plastic M Oval Metal S Square Metal (Add \$13 per grommet for metal.)	EL Matte Silver Plastic grommet color determined by worksurface finish.	
_____ _____	_____ _____	_____ _____	_____ _____	_____ _____	_____ _____	

Example:

For specification information see page 236.

GSA SIN 33721

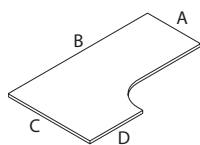
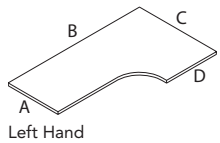
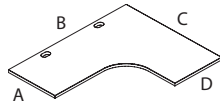
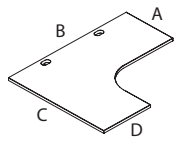

Description	Laminate w/Flat Edge Model	Ship Weight	List Price		
			L1	L2	L3

Corner Cove Laminate Tops — 24"D Extended Left					
24" A x 60" B x 36" C x 24" D	A5822ELS	54	\$ 1048	\$ 1084	\$ 1118
24" A x 60" B x 48" C x 24" D	A5622ELS	75	\$ 1148	\$ 1188	\$ 1225
24" A x 72" B x 36" C x 24" D	A5922ELS	63	\$ 1169	\$ 1209	\$ 1246
24" A x 72" B x 48" C x 24" D	A5722ELS	86	\$ 1462	\$ 1511	\$ 1557

Corner Cove Laminate Tops — 24"D Extended Right					
24" A x 60" B x 36" C x 24" D	A5822ERS	54	\$ 1048	\$ 1084	\$ 1118
24" A x 60" B x 48" C x 24" D	A5622ERS	75	\$ 1148	\$ 1188	\$ 1225
24" A x 72" B x 36" C x 24" D	A5922ERS	63	\$ 1169	\$ 1209	\$ 1246
24" A x 72" B x 48" C x 24" D	A5722ERS	86	\$ 1462	\$ 1511	\$ 1557

Note: Height-adjustable worksurface dimensions are nominal. Actual widths are reduced by 2" (1" on each side" and worksurface depths are reduced by 3/4". Corner cove depth is nominal, actual is 1" less. This is to allow for pinch-points and unobstructed table movement.

Undersized Corner Cove Worksurface, Left Hand — 24"D					
24" A x 60" B x 36" C x 24" D	AF5CCS603624LD	58	\$ 1098	\$ 1148	\$ 1197
24" A x 60" B x 48" C x 24" D	AF5CCS604824LD	67	\$ 1199	\$ 1254	\$ 1308
24" A x 72" B x 36" C x 24" D	AF5CCS723624LD	66	\$ 1236	\$ 1292	\$ 1347
24" A x 72" B x 48" C x 24" D	AF5CCS724824LD	75	\$ 1527	\$ 1597	\$ 1664

Undersized Corner Cove Worksurface, Right Hand — 24"D					
24" A x 60" B x 36" C x 24" D	AF5CCS603624RD	58	\$ 1098	\$ 1148	\$ 1197
24" A x 60" B x 48" C x 24" D	AF5CCS604824RD	67	\$ 1199	\$ 1254	\$ 1308
24" A x 72" B x 36" C x 24" D	AF5CCS723624RD	66	\$ 1236	\$ 1292	\$ 1347
24" A x 72" B x 48" C x 24" D	AF5CCS724824RD	75	\$ 1527	\$ 1597	\$ 1664

Undersized Corner Cove Worksurface, Left Hand — 30"D					
30" A x 60" B x 48" C x 30" D	AF5CCS604830LD	77	\$ 1282	\$ 1341	\$ 1399
30" A x 72" B x 48" C x 30" D	AF5CCS724830LD	88	\$ 1617	\$ 1691	\$ 1764

Undersized Corner Cove Worksurface, Right Hand — 30"D					
30" A x 60" B x 48" C x 30" D	AF5CCS604830RD	77	\$ 1282	\$ 1341	\$ 1399
30" A x 72" B x 48" C x 30" D	AF5CCS724830RD	88	\$ 1617	\$ 1691	\$ 1764

ALTITUDE

<p>How to specify — Select the Model Number from above.</p>	<p>1st Option: Laminate or Veneer Type and Finish (if applicable): See page 232 for finishes.</p>	<p>2nd Option: Paint (if applicable): See page 232 for finishes.</p>	<p>3rd Option: Laminate Edge Color (if applicable): See page 232 for finishes.</p>	<p>4th Option: Grommet Location and Type:</p> <p>GC Center P Oval Plastic M Oval Metal</p> <p>GB Grommet LH/RH P Oval Plastic M Oval Metal S Square Metal</p> <p>GO No Grommet</p>
<p>Examples:</p>				

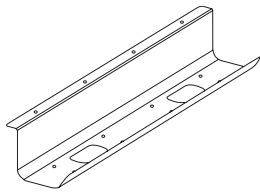

AJTRGH24

Description	Model	List Price		
		P1	P2	P3
Cable Management Trays				
24"W	AJTRGH24 <input type="checkbox"/>	\$ 123	N/A	N/A
36"W	AJTRGH36 <input type="checkbox"/>	\$ 147	N/A	N/A

- Available in 24" or 36" widths.
- Metal Cable Management Trays available in Black only, specify "P" for finish.
- Example: AJTRGH24.P

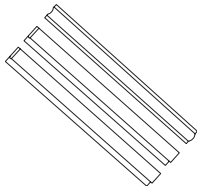

AWRSTRIP

Wire Management Strips/Channels				
	AWRSTRIP <input type="checkbox"/>	\$ 270	N/A	N/A

- Four wire management strips/channels in black only, no specification needed.
- Example: AWRSTRIP

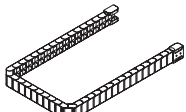

WKSWMC

Wire Management Chains				
36"	A9CLWMC <input type="checkbox"/>	\$ 357	N/A	N/A
58"	WKSWMC <input type="checkbox"/>	\$ 428	N/A	N/A

- Specify model A9CLWMC for 36" chain, specify model WKSWMC for 58" chain.
- A9CLWMC available in Black (E4), White (DW), or Silver (TI).
- WKSWMC available in Black only, no specification needed.
- Example: A9CLWMC.DW or WKSWMC

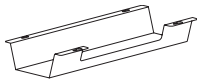

APWRTRGH17

Under Worksurface Troughs				
17"W	APWRTRGH17 <input type="checkbox"/>	\$ 108	N/A	N/A
36"W	APWRTRGH36 <input type="checkbox"/>	\$ 189	N/A	N/A

- Available in 17" or 36" widths.
- Under Worksurface Troughs available in Black only, no specification needed.
- Example: APWRTRGH17

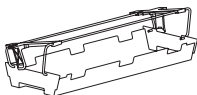

AFDTRGH20

Flip-Down Wire Management Trough				
20"W	AFDTRGH20 <input type="checkbox"/>	\$ 378	N/A	N/A
32"W	AFDTRGH32 <input type="checkbox"/>	\$ 429	N/A	N/A

- Available in 20" or 32" widths.
- Flip-Down Troughs available in Black only, specify "P" for Black.
- Example: AFTRGH20.P



AWIRECLT

Metal Wire Cleat				
	AWIRECLT <input type="checkbox"/>	\$ 129	\$ 142	\$ 148

- Available in standard metal paint finishes, see page 232 for options and specify desired finish.
- Example: AWIRECLT.PJW

ALTITUDE

<p>How to specify — Select the Model Number from above.</p>	<p>1st Option: Paint (if applicable): See page 232 for finishes.</p> <p>Plastics (if applicable): DW White TI Silver E4 Black</p>
--	---

Examples: AJTRGH24.P A9CLWMC.DW AWIRECLT.PR6

Shippable by small-package carrier.

For specification information see page 239.1.

GSA SIN 33721

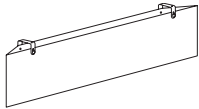

APWRMODEST36

Description	Model	List Price	
		A	B
Fabric Power Modesty			
	APWRMODEST36 S	\$ 1162	\$ 1196
	APWRMODEST48 S	\$ 1258	\$ 1297

- Available in Appoint, Binary, Centurion, Noble, Reflections, Disperse, and Spin panel fabric series.
- Specify desired fabric.
- Example: APWRMODEST36.NBLE16

<p>How to specify — Select the Model Number from above.</p> <p>_____ .</p>	<p><i>1st Option:</i> Fabric (if applicable): See page 10 for fabrics.</p> <p>_____</p>
---	--

Example: APWRMODEST36.NBLE16

ALTITUDE

Description	Model	List Price
Power Module — Above/Below Worksurface		
8¼"W x 16"D x 4½"H	AABPWRMOD S	\$ 1234

AABPWRMOD.AC.S

- Desktop unit includes 2 receptacles, 1 USB-A, & 1 USB-C (AC).
- Under worksurface unit include 6 receptacles.
- Power cord choices include a 6' Straight cord (S) or Coiled cord (Q).
- Desktop unit available in White (DWT) or Gray (DGY).
- Example: AABPWRMOD.AC.S.DWT

<p>How to specify — Select the Model Number from above.</p> <p>_____ .</p>	<p><i>1st Option:</i> Ports (Final port option if applicable): AC USB-A+C</p> <p>_____ .</p>	<p><i>2nd Option:</i> Cord Type (Power Module cord type if applicable): S Straight Cord Q Coiled Cord</p> <p>_____ .</p>	<p><i>3rd Option:</i> Color Option (if applicable): DWT White DGY Gray</p> <p>_____ .</p>
---	---	---	--

Example: AABPWRMOD.AC.Q.DWT

S Shippable by small-package carrier.

For specification information see page 239.2.

GSA SIN 33721

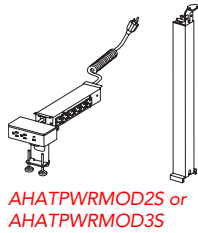

Description	Model	List Price		
		P1	P2	P3
Metal Telescoping HAT Wire Management				
	AHATPWRMOD2S	\$ 1614	\$ 1654	\$ 1675
	AHATPWRMOD3S	\$ 1646	\$ 1690	\$ 1711

- AHATPWRMOD2S pairs with 2-stage HAT bases.
- AHATPWRMOD3S pairs with 3-stage HAT bases.
- Desktop power module comes with 2 receptacles, 1 USB-A, and 1 USB-C port only, specify “AC” for this power configuration.
- Desktop power module available in White (DWT) or Gray (DGY) finishes, specify desired finish.
- Under worksurface power strip comes with 6 receptacles and is available in Black only, no specification needed.
- Metal Telescoping Chase available in the same paint finishes as Altitude HAT bases, specify desired paint finish.
- *Example: AHATPWRMOD2S.AC.DWT.PJW*

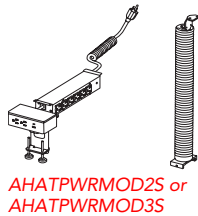

Description	Model	List Price		
		P1	P2	P3
Fabric HAT Wire Management				
	AHATPWRMODF	\$ 1476	\$ 1503	\$ 1516

- AHATPWRMODF pairs with 2-stage and 3-stage HAT bases.
- Desktop power module comes with 2 receptacles, 1 USB-A, and 1 USB-C port only, specify “AC” for this power configuration.
- Desktop power module available in White (DWT) or Gray (DGY) finishes, specify desired finish.
- Under worksurface power strip comes with 6 receptacles and is available in Black only, no specification needed.
- Fabric HAT Chase available in three fabric finishes of Light (LGT), Medium (MDD), and Dark (DRK), specify desired fabric finish.
- Fabric HAT mounting brackets available in the same paint finishes as Altitude HAT bases, specify desired paint finish.
- *Example: AHATPWRMODF.AC.DGY.LGT.PR5*

ALTITUDE

<p>How to specify — Select the Model Number from above.</p> <p>AHATPWRMOD . A C . D . . .</p>	<p><i>1st Option:</i> Ports (Final port option if applicable): AC USB-A+C</p>	<p><i>2nd Option:</i> Power Module Color Option (if applicable): DWT White DGY Gray</p>	<p><i>3rd Option:</i> Fabric Chase Finish (if applicable): LGT Light MDD Medium DRK Dark</p>	<p><i>4th Option:</i> Metal Paint Option (if applicable): See page 232 for finishes.</p>
--	--	--	---	---

Example: AHATPWRMOD3S.AC.DWT.P8C AHATPWRMODF.AC.DGY.LGT.PR5

S Shippable by small-package carrier.

For specification information see page 252.

GSA SIN 33721

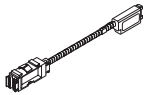
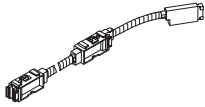

Description	Max. Recept. Cap. per Panel Side	Four-circuit 3 + 1 2 + 2	Three-circuit Separate Neutrals		List Price
Electrical Power Harnesses					
For 48" W Frames	2	A871248*	A871248A	<input type="checkbox"/>	\$ 416
For 54" W Frames	2	A871254*	A871254A	<input type="checkbox"/>	\$ 414
For 60" W Frames	2	A871260*	A871260A	<input type="checkbox"/>	\$ 416
For 66" W Frames	2	A871266*	A871266A	<input type="checkbox"/>	\$ 414
For 72" W Frames	2	A871272*	A871272A	<input type="checkbox"/>	\$ 417

Note: Four-circuit components and Three-circuit components (with an "A" suffix) cannot be connected together.

Electrical Pass-Thru Harnesses with Power Block

For 24" W Frames**	1	A871124	A871124A	<input type="checkbox"/>	\$ 239
For 48" W Frames†	1	A871148*††	A871148A	<input type="checkbox"/>	\$ 255
For 60" W Frames†	1	A871160*	A871160A	<input type="checkbox"/>	\$ 255
For 72" W Frames†	1	A871172	A871172A	<input type="checkbox"/>	\$ 341

Electrical harnesses are intended for use with Allsteel systems furniture and are approved under GSA SIN 33721. When purchased separately and used without Allsteel systems furniture, those electrical harnesses marked by () are considered Open Market.

**Only used with NY Infeed through End Cap.

†48"-72" are only used with NY infeed through power rail cut-out.

††When purchased separately without a configurable TAA compliant end product, not on GSA contract.

<p>How to specify — Select the Model Number from above.</p> <p>_____ .</p>	<p>1st Option: Color: P Black</p>
---	---

Examples: A871248.P A871224.P A871224A.P A871124.P A8710144A.P

Shippable by small-package carrier.

For specification information see page 240.
(See page 297 for COM pricing on fabric grades G-J.)

Description	Model	Ship Weight	Cubes	List Price	
				A	D
U Screen Kit					
48"	FDSC48U	30.0	16.6	\$ 2032	\$ 2157
54"	FDSC54U	31.0	18.6	\$ 2102	\$ 2232
60"	FDSC60U (shown)	32.0	20.6	\$ 2163	\$ 2297
66"	FDSC66U	33.0	22.6	\$ 2290	\$ 2434
72"	FDSC72U	34.0	24.6	\$ 2463	\$ 2618
L Screen Kit					
Left Hand 48"	FDSC48LL	26.5	16.6	\$ 1322	\$ 1395
Right Hand 48"	FDSC48LR	26.5	16.6	\$ 1322	\$ 1395
Left Hand 54"	FDSC54LL	27.5	18.6	\$ 1549	\$ 1636
Right Hand 54"	FDSC54LR	27.5	18.6	\$ 1549	\$ 1636
Left Hand 60"	FDSC60LL (shown)	28.5	20.6	\$ 1619	\$ 1712
Right Hand 60"	FDSC60LR (shown)	28.5	20.6	\$ 1619	\$ 1712
Left Hand 66"	FDSC66LL	29.5	22.6	\$ 1928	\$ 2047
Right Hand 66"	FDSC66LR	29.5	22.6	\$ 1928	\$ 2047
Left Hand 72"	FDSC72LL	30.5	24.6	\$ 2030	\$ 2155
Right Hand 72"	FDSC72LR	30.5	24.6	\$ 2030	\$ 2155
Rectangular Screen Kit					
48"	FDSC48R	23.0	3.7	\$ 1279	\$ 1350
54"	FDSC54R	24.0	4.1	\$ 1310	\$ 1383
60"	FDSC60R (shown)	25.0	4.6	\$ 1407	\$ 1486
66"	FDSC66R	26.0	5.0	\$ 1617	\$ 1714
72"	FDSC72R	27.0	5.6	\$ 1721	\$ 1826

Note: Installation brackets are now attached to the screen from the factory.

<p>How to specify — Select the Model Number from above.</p>	<p>1st Option: Select the Screen Fabric: See page 233 for selections and color codes.</p>	<p>2nd Option: Select the Screen Bracket Paint: P1 P2 See page 232 for selections and color codes.* P2 (\$16 extra)</p>
--	--	--



Examples: FDSC48U.PCAMBLT40.P71 FDSC48LL.PCAMBLT70.P71 FDSC48R.PCAMBLT39.P71

For specification information see pages 241-242.

GSA SIN 33721

Description	Model	P1 Paint List Price	P2 Paint Upcharge	P3 Paint Upcharge
20"H Metal Rectangular Screen				
48"W	AMS2048SS (shown)	\$ 710	\$ 739	\$ 766
54"W	AMS2054SS	\$ 746	\$ 776	\$ 805
60"W	AMS2060SS	\$ 796	\$ 828	\$ 858
66"W	AMS2066SS	\$ 906	\$ 942	\$ 978
72"W	AMS2072SS	\$ 978	\$ 1018	\$ 1056
30"H Metal Rectangular Screen				
48"W	AMS3248SS (shown)	\$ 870	\$ 904	\$ 938
54"W	AMS3254SS	\$ 906	\$ 942	\$ 978
60"W	AMS3260SS	\$ 964	\$ 1002	\$ 1041
66"W	AMS3266SS	\$ 1086	\$ 1130	\$ 1171
72"W	AMS3272SS	\$ 1145	\$ 1191	\$ 1235
15"H Tackboard Accessories				
20"W	AAS1520 S	\$ 309	\$ 322	\$ 333
48"W	AAS1548 S (shown)	\$ 367	\$ 383	\$ 396
54"W	AAS1554 S	\$ 406	\$ 423	\$ 438
60"W	AAS1560 S	\$ 423	\$ 441	\$ 456
66"W	AAS1566 S	\$ 617	\$ 641	\$ 666
72"W	AAS1572 S	\$ 675	\$ 702	\$ 729

<p>How to specify — Select the Model Number from above.</p>	<p>1st Option: Wing Type : STD Standard EXT Extended</p>	<p>2nd Option: Accessories Slots: X No Accessory Cut Out SLT Accessory Cut Out</p>	<p>3rd Option: Paint Option: P1 P2 P3 See page 56 for finishes.</p>	<p>4th Option: Paint Option: NA Screen</p>	<p>5th Option: Accessories Color (if applicable): DW Designer White E9 Flint</p>
<p>Examples: AAS1548.PR6.APN911 AFAMS2048LH.STD.SLT.PR6.NA AFAMS2048SS.PR6.NA</p>					

Work Tools	Description	Model	List Price
	Hot File (Designer White Only) 9½"H x 12¼"W x 3¾"D	AEHF	\$ 64
	Side Saddle (Designer White Only) 4"H x 12¼"W x 2½"D	AESS	\$ 53
	Bag or Coat Hook (Designer White Only) 3¼"H x 1½"W x 2¼"D	AECH	\$ 41

<p>How to specify — Select the Model Number from above.</p>	<p>1st Option: Paint Option (if applicable): P1 P2 P3 See page 232 for finishes.</p>	<p>2nd Option: Fabric Option (if applicable): See page 10 for fabric options.</p>	<p>3rd Option: Paint Option: NA Screen</p>	<p>4th Option: Accessories Color (if applicable): DW Designer White E9 Flint</p>
<p>Example: AEHF.PJW</p>				

S Shippable by small-package carrier.

For specification information see pages 243-248.

GSA SIN 33721

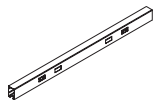

Description	Model	Ship Weight	Cubes	List Price		
				P1	P2	P3
Power Rail						
48"	RFDRW48	7	0.6	\$ 632	\$ 680	\$ 750
54"	RFDRW54	8	0.6	\$ 667	\$ 717	\$ 790
60"	RFDRW60 (shown)	9	0.7	\$ 768	\$ 824	\$ 909
66"	RFDRW66	10	0.8	\$ 819	\$ 879	\$ 967
72"	RFDRW72	11	0.9	\$ 924	\$ 991	\$ 1090

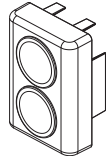

Power Rail End Cap	FDRWEC	1.5	0.1	\$ 235	\$ 253	\$ 278
--------------------	--------	-----	-----	--------	--------	--------

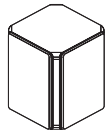

Power Rail Universal Connector	FDRWUC	3	0.1	\$ 428	\$ 458	\$ 503
--------------------------------	--------	---	-----	--------	--------	--------

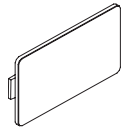

Electrical Port Cover						
2 Pack	FDEPC2	1	0.1	\$ 64	\$ 70	\$ 76
12 Pack	FDEPC12	2	0.1	\$ 220	\$ 237	\$ 260

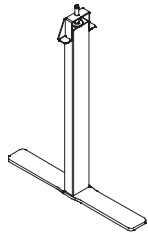

Elevated Power Rail Legs 20.5"H	RFDRWLEG	5	0.1	\$ 385	\$ 388	\$ 388
---------------------------------	----------	---	-----	--------	--------	--------

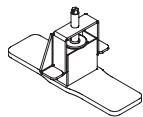

Floor Mount Legs	FDRWLEG	5	0.1	\$ 84	\$ 87	\$ 89
------------------	---------	---	-----	-------	-------	-------



Altitude Power Rail Floor Anchor Bracket	RFDRWAB	2	0.1	\$ 55	\$ 73	\$ 80
--	---------	---	-----	-------	-------	-------

ALTITUDE

How to specify —
Select the Model Number from above.

1st Option:

Paint:



See page 232 for selections and color codes.*

Examples: _____ . _____

Examples:

For specification information see pages 243-248.

GSA SIN 33721

Description	Model	Ship Weight	Cubes	List Price		
				P1	P2	P3
Hubs						
End of Run Linear Configuration	RFDRWHUBEND	10	4	\$ 1097	\$ 1104	\$ 1110
End of Run T-Configuration	RFDRWHUBENDT	10	4	\$ 1097	\$ 1104	\$ 1110
Inline Linear Configuration	RFDRWHUBLIN	14	4	\$ 1097	\$ 1104	\$ 1110
Inline X-Configuration	RFDRWHUBX	14	4	\$ 1097	\$ 1104	\$ 1110
Inline T-Configuration	RFDRWHUBT	13	4	\$ 1097	\$ 1104	\$ 1110
L-Configuration Hub	RFDRWHUBL	13	4	\$ 1097	\$ 1104	\$ 1110

ALTITUDE

<p>How to specify — Select the Model Number from above.</p>	<p>1st Option: Paint: P1 P2 P3 See page 232 for selections and color codes.*</p>
--	--

Examples:

For specification information see pages 243-248.

GSA SIN 33721

Description	Model	Ship Weight	Cubes	List Price		
				P1	P2	P3
Power Pole						
8' H Square Power Pole	UN2HPSQ	17	1	\$ 1138	\$ 1156	\$ 1169
Square Power Pole Splicer Kit	UN2HPSQSK	0.5	0.1	\$ 125	\$ 129	\$ 130
Power Pole Connector	RFDRWCNPP	1	0.1	\$ 236	\$ 239	\$ 241
Power Pole Connector - End Condition	RFDRWCNPPE	1	0.1	\$ 236	\$ 239	\$ 241
Power Pole Connector - Mid Condition	RFDRWCNPPM	1	0.1	\$ 236	\$ 239	\$ 241

UN2HPSQ



UN2HPSQSK

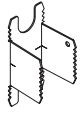

RFDRWCNPP

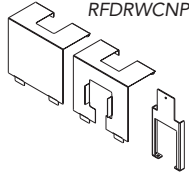

RFDRWCNPPE

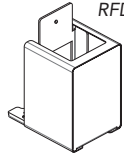

RFDRWCNPPM

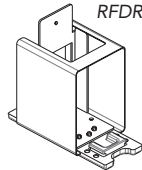

Wire Management

Vertebrae Wire Manager	RFDRWWM	3	0.1	\$ 721	\$ 739	\$ 746
------------------------	---------	---	-----	--------	--------	--------

*Includes connector for Power Rail attachment

*Vertebrae available in clear only, connector available in 32 standard paints.



ALTITUDE

How to specify —

Select the Model Number from above.



Examples:

1st Option:

Paint:



See page 232 for selections and color codes.*



For specification information see pages 243-248.

GSA SIN 33721

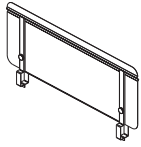

Description	Model	Ship Weight	Cubes	List Price		
				P1	P2	P3
Allsteel Metal Screen						
48"	RFDRWSC48	10	3.52	\$ 394	\$ 404	\$ 416
54"	RFDRWSC54	11	3.84	\$ 418	\$ 428	\$ 440
60"	RFDRWSC60	12	4.21	\$ 433	\$ 445	\$ 458
66"	RFDRWSC66	13	4.58	\$ 441	\$ 453	\$ 466
72"	RFDRWSC72	14	4.96	\$ 473	\$ 485	\$ 498

<p>How to specify — Select the Model Number from above.</p> <p>_____ .</p>	<p>1st Option: Paint: P1 P2 P3 See page 232 for selections and color codes.*</p> <p>_____</p>
---	---

















Examples:

Accessories

Worksurface Mounted Rail and Accessories



For specification information see page 255.

GSA SIN 33721

Description	Model	List Price		
		P1	P2	P3
Accessories Rail — Worksurface Mounted				
12"W	U912WTR 	\$ 120	\$ 128	\$ 132
18"W	U918WTR 	\$ 128	\$ 136	\$ 140
24"W	U924WTR 	\$ 147	\$ 155	\$ 159
30"W	U930WTR 	\$ 164	\$ 175	\$ 182
36"W	U936WTR 	\$ 186	\$ 197	\$ 204
42"W	U942WTR 	\$ 201	\$ 212	\$ 219
48"W	U948WTR 	\$ 212	\$ 227	\$ 232
54"W	U954WTR 	\$ 221	\$ 237	\$ 241
60"W	U960WTR 	\$ 232	\$ 249	\$ 255
66"W	U966WTR 	\$ 279	\$ 296	\$ 302
Rail Mounted Accessories				
Phone/Tablet Stand — 6½"H x 4¼"W	U9TM 	\$ 181	\$ 194	\$ 204
Pencil Holder — 2½"H x 6"W x 3"D	U9TP 	\$ 110	\$ 121	\$ 128
Shelf — 8"W x 4½"D; 2½" above top of worksurface	U9TS 	\$ 132	\$ 145	\$ 155
Vertical Paper Tray — 12"H x 1⅞"W x 12"D	U9TF 	\$ 198	\$ 211	\$ 221
Cord Organizer				
4"W x ⅞"D Metal with 4 cable cutouts	U9WTC 	\$ 196	\$ 205	\$ 212
Universal Hook (Black only)				
Package of 2	AGSAUHK 	\$ 132	—	—

How to specify —
Select the Model Number from above.

U | 9 | | | | | | | | .

1st Option:
Paint:
  
See page 232 for selections and color codes.*

| | | |

Examples: U912WTR.PR6 U9TF.P7G AGSAUHK.P27

 Shippable by small-package carrier.

ALTITUDE

Notes

ALTITUDE

Extensions — Introduction

Extensions accessory line by Allsteel is designed to help you create your own space.

- **Create a personalized space**

Each person works differently, different work styles require different tools. As our workplace needs shift from paper filing to personal storage, the tools that support us day-to-day need to adapt to the changing ways we are expected to work. Whether it's the need for paper filing, a place to plug a charger in, or a small shelf for trinkets, Extensions help you bear it all.

- **Create a comfortable space**

Encourage wellness and peace of mind while you work with Extensions. Whether by clearing valuable desk space, routing cords out of the way, powering your technology, or illuminating tasks with a gentle glow, this full line of work tools help you stay calm and in control of your workspace.

- **Create an empowered space**

Without all the right tools you need to succeed, having a productive workday can feel like an impossible task. With a full line of ergonomic, organization, illumination, power, and wire management tools, Extensions put the right tools within reach, allowing you to get your work done seamlessly and efficiently.

- **Organization tools**

Embracing organization work tools can help add efficiency and excitement to your daily workflow. Durably made but thoughtfully designed to help you organize and store the tools you need throughout your day, Extensions organizational tools help you find that perfect place for anything.

- **Ergonomic tools**

Ergonomics is more than just comfort, it's flexibility and safety. The adjustable keyboard options allow users to maintain and vary comfortable wrist and arm positions throughout the day, whether typing or mousing. Monitor Arms offer versatile adjustability while providing optimum comfort for the eyes, neck, and shoulders.

- **Illumination tools**

Sleek and flexible, our lighting components offer you several choices. Recessed task lights conserve space and feature electronic ballast for longer bulb life and cooler operating temperature. LED tasklights' slim design blends in with its surrounding while utilizing energy-efficient LED technology.

- **Power/Data tools**

At the heart of every workspace is a power module that keeps you plugged-in and running throughout the day. These indispensable accessories provide wired or wireless connectivity anywhere and everywhere you could possibly need it, transforming your workplace into a hub of activity.

- **Wire Management tools**

Eliminate the cord clutter under your desk with our extensive wire management offering. Allsteel wire management accessories effortlessly weave wires out of the way and clear your workspace with ease. Both free-standing and height adjustable, table-integrated solutions ensure that your space stays as clear as your workflow.

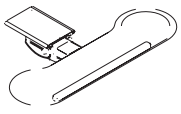
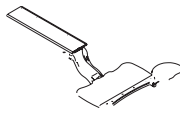
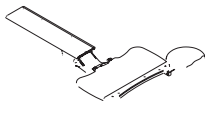
Articulating Keyboard Supports			
Features	Model AKTSHORT	Model AKTLONG	Model AKTMID
			
Keyboard Support	Platform style 28"W x 8"D	Platform Style 19"Wx11"D	Platform Style 19"Wx11"D
Keyboard Support Material	Phenolic	Phenolic	Phenolic
Suspension	<ul style="list-style-type: none"> Nylon glides on lubricated slide track Intuitive lift and lock one touch height adjustment 	Lubricated slide track system: spring assisted	Lubricated slide track system: spring assisted
Platform Rotation	360 degrees	360 degrees	360 degrees
Platform Tilt	+10/-20 degrees	+10/-20 degrees	+10/-20 degrees
Platform Tilt Adjustment	Soft touch lever for precise tilt adjustment	Convenient tilt wheel assists desired tilt angle	Convenient tilt wheel assists desired tilt angle
Platform Height Adjustment Range	6½" (1½" above / 5¼" below)	12½" (7" above to 5½" below)	8" (3" above / 5" below)
Platform Height Adjustment	Lift platform to raise, lift slightly and tilt back to lower	Lift platform to raise, lift slightly and tilt back to lower	Lift platform to raise, lift slightly and tilt back to lower
Palm Rest	Detachable leatherette-covered gel palm rest	Fabric covered gel palm rest	Fabric covered gel palm rest
Mouse Pad	In-line to accommodate mouse on same level as keyboard.	Circular, swivel, tilt, LH/RH mounting, mouse catcher, gel rest	Circular, swivel, tilt, LH/RH mounting, mouse catcher, gel rest
Microsoft Natural Compatible	No	Yes — by removing palm rest	Yes — by removing palm rest
Track Depth	8"	23"	21"
Required Mounting Clearance	20"W x 8"D x ¼" Recess	19"W x 23"D + ¼" Recess	19"W x 23"D + ¼" Recess
Adjustable Wrist Rest	No	Fixed mounting and height	Fixed mounting and height
Ideal For	<ul style="list-style-type: none"> Straight worksurfaces ADA/HFES compliance Extensive adjustability with mouse in line, mouse over or mouse forward of keyboard Height-Adjustable Table 	<ul style="list-style-type: none"> Corner worksurface applications Sit to stand applications 	<ul style="list-style-type: none"> Shallow worksurfaces Corner worksurface (17" or 21") Radius worksurface (42" or 48")
Additional Information		<ul style="list-style-type: none"> Track can be cut in the field to shorten track depth — may affect ability to fully recess platform 	<ul style="list-style-type: none"> Track can be cut in the field to shorten track depth — may affect ability to fully recess platform

AKTSHORT Keyboard Support (page 276)

- Lift and lock intuitive height adjustment.
- Compatible with Altitude Height Adjustable Tables
- Positive and negative tilt for best ergonomic positioning.
- +10°/-20° tilt adjustment and 360° rotation provides support of neutral position of shoulders, arms and wrists while accommodating multiple working postures.
- Surpasses ANSI/BIFMA standards.
- Black powder coat finish.
- Patented secondary slide and unique arm design provide minimal footprint.

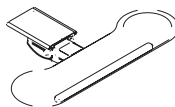

Keyboard Spacer Kit (page 276)

- Keyboard Spacer Kit required for mounting under Altitude worksurfaces.
- Kit provides ten spacers and hardware for mounting keyboard supports beneath an external worksurface support channel.
- Spacers are 2⅞"H providing more room beneath surface for mounting.

CPU Hammock (page 276)

- Features 360-degree swivel with an 11" track.
- Load capacity is 75 lbs.
- CPU must be minimum of 3¼"W with maximum dimension of 64" in perimeter.
- Handy adjustment tool stores within unit.
- Safety feature prevents accidental release of straps and straps can be adjusted while CPU is installed.
- Can be used on Height Adjustable Tables as long as it is attached with spacer model AKMH. Take into account required leg room for users.

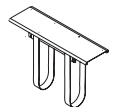





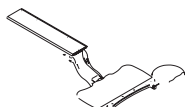
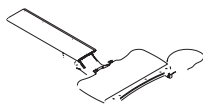



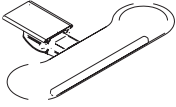

AKTMID and AKTLONG Keyboard Support (page 276)

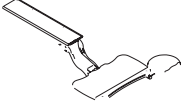
- Lift and lock intuitive height adjustment.
- Positive and negative tilt for the best ergonomic positioning.
- +10°/-20° tilt adjustment and 360° rotation provides support of neutral position of shoulders, arms, and wrists while accommodating multiple working postures.
- Non-handed mouse tray can be moved from right hand to left hand side.
- Surpasses ANSI/BIFMA standards.
- Black powder-coat finish.

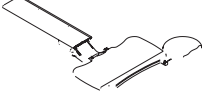

For specification information see page 275.

GSA SIN 33721

	Description	Model	List Price						
	Compact Keyboard Support with 8" Track 30"W x 13"D	AKTSHORT 	\$ 603						
	STS Keyboard Support with 23" Track 24"W x 12"D	AKTLONG 	\$ 739						
	Articulating Keyboard Support with 21" Track 24"W x 12"D	AKTMID 	\$ 635						
	Keyboard Spacer Kit 10 – 2½"H Spacers and Hardware	AKMH 	\$ 65						
	CPU Hammock™ (Silver only) 360° swivel CPU holder with adjustable straps	ACPU1 	\$ 431						
	Metal Corner Sleeve — for use with Optimize™, Concensys®, and Terrace® • Fits 1¼" thick square edge detail. (T-Mold worksurfaces) 22½"W leading edge x 18"D.	AWCS	<table border="1"> <thead> <tr> <th>P1 Paint List Price</th> <th>P2 Paint List Price</th> <th>P3 Paint List Price</th> </tr> </thead> <tbody> <tr> <td>\$ 152</td> <td>\$ 158</td> <td>\$ 163</td> </tr> </tbody> </table>	P1 Paint List Price	P2 Paint List Price	P3 Paint List Price	\$ 152	\$ 158	\$ 163
P1 Paint List Price	P2 Paint List Price	P3 Paint List Price							
\$ 152	\$ 158	\$ 163							

Edge Details



Model AWCS

EXTENSIONS

How to specify —
Select the Model Number from above.



Examples: AKMH ACPU1

 Shippable by small-package carrier.

Allsteel's tool rail works in conjunction with a variety of accessories. Modular accessories free up worksurface space and provide orderly storage that is well within reach. Units can be arranged and rearranged to respond to changing workflow. The work tools that attach to the tool rail are:

- Mail Box
- Folder Holder
- Phone Caddy
- Binder Bin
- Tool Box
- Clip Caddy™
- Sidebar™ Personal Shelf
- Paper Wave™
- Cup Holder
- Hook
- Hanging File Holder
- Magnetic Picture Holder
- Small Bin
- Small Shelf
- Small Tray

Additional accessories that work with the **tool rail work tools** aesthetically are:

- Bookends
- Freestanding Mail Box

Coat hooks, marker boards and center drawers round out the organization offering.

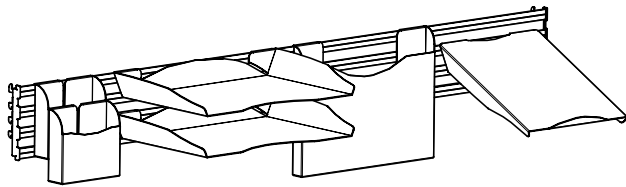

Tool rail, shown above, is height-adjustable in 1" increments using slots in panels or metal hutch. Tool rail shown with two tool boxes, two mail boxes, folder holder, and phone caddy. Folder holders and binder bins extend below a tool rail. Paper Wave and contents extend above a tool rail.

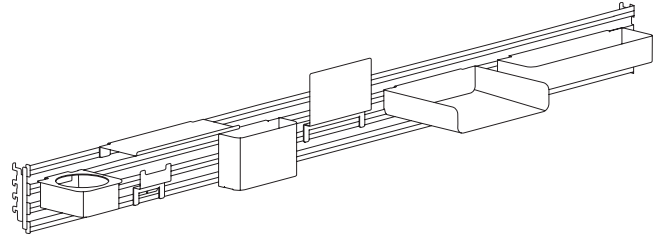

Tool rail, shown with cup holder, small shelf, hook, small bin, magnetic picture holder, small tray, and hanging file holder.

Tool Rails and Work Tools (page 280)

- Sturdy aluminum extrusion with steel support construction.
- Powder coated for durable finish.
- Use to hang Extensions tools. Cannot be used to support monitor arms.
- Suggested weight capacity not to exceed 80 lbs.
- Consideration needs to be given to height of tools and location of worksurfaces.
- For use with Terrace®, Concensys®, and Optimize™ systems.
- 5" high rail (widths coordinate with panels).
- Attachment via vertical reveals.
- Can be hung from wall track. Good solution for above copiers.
- Systems tool rail is off-modular — can be used on a panel of equal width or one size smaller.
- May span two panels of appropriate size, i.e., 60" W Tool Rail on two 30" W panels.

Tool Rail for Hutches (page 280)

- Will work on Universal, Terrace, Optimize, and Concensys system hutches produced after July 2, 2000 and Align™ metal hutches.
- Sturdy aluminum extrusion with steel support construction.
- Powder coated for durable finish.
- Use to hang Extensions tools. Cannot be used to support monitor arms.
- Suggested weight capacity not to exceed 80 lbs.
- Consideration needs to be given to height of tools and location of worksurfaces.

Mail Box (page 281)

- Holds standard letter-size paper and inter-office envelopes.
- Minimal horizontal intrusion.

Folder Holder (page 281)

- Holds manila envelopes.
- Is capable of hanging on other folder holders to maximize space.
- Stores vertically for easy access to files.

Phone Caddy (page 281)

- Holds telephone at optimum ergonomic angle.
- Wire management cut-outs.
- Accommodates standard phone sizes.

Binder Bin (page 281)

- Holds folders, binders, and manuals.

Tool Box (page 281)

- Holds pencils and other writing utensils, large post-it notes, and other desk top accessories.

Clip Caddy™ (page 281)

- Holds paper clips and other small objects.

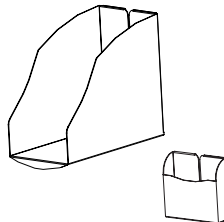
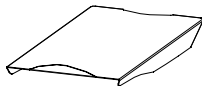
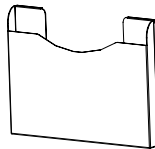



Sidebar™ Personal Shelf (page 281)

- Holds office supplies and personal effects.

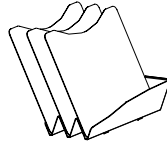

Paper Wave™ (page 281)

- Provides 3 fully divided slots for organizing files.
- Keeps papers from “bowing” at bottom.

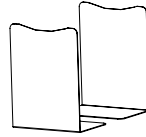

Bookends (page 281)

- Can be used on shelves or in cabinets.
- Used to hold books, binders, and catalogs upright.

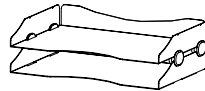

Freestanding Mail Box (page 281)

- Incorporates similar aesthetic to mounted Mail Box.
- Mounting brackets allow for free access from front and back.
- Sold in pairs of two; will stack up to eight high.
- Individual mail box dimension = 1¼"H.
- Stacking brackets are black.



Coat Hook APMC6 (page 281)

- Hangs directly into slotted Terrace® or Optimize™ panel frame.
- Use for coat or bag.
- Package of six.
- Available in black only.

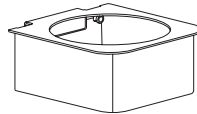

Cup Holder (page 281.1)

- Holds most cups and thermoses. Weight capacity is 5 lbs.

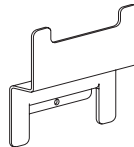

Hook (page 281.1)

- Hangs small personal effects such as headphones, keys, or hand wallets. Weight capacity is 10 lbs.



Hanging File Holder (page 281.1)

- Hangs files and folders from hanging file clips. Hanging file clips not included. Weight capacity is 5 lbs.

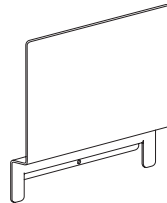

Magnetic Picture Holder (page 281.1)

- Allows for pictures to be hung via magnets. Magnets not included. Weight capacity is 5 lbs.

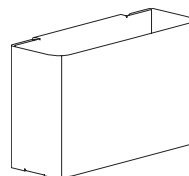

Small Bin (page 281.1)

- Houses office supplies or other personal effects such as pencils, pens, sticky notes, journals, etc. Weight capacity is 5 lbs.



Small Shelf (page 281.1)

- Provides additional shelf storage in workstation and displays office supplies or personal effects. Weight capacity is 5 lbs.



Small Tray (page 281.1)

- Holds office supplies and other personal effects. Weight capacity is 5 lbs.

EXTENSIONS



ACPWRMOD

Power/Data Module — Clamp On Worksurface (page 287)

- On-surface mounting option, fits on any worksurface with a 4" overhang.
- 10' straight power cord only. UL Listed.
- Includes adapters to allow use of commercially available data terminals or blanks to fill unused openings. Many of the AMP, AT&T, Krone, Leviton, and most commercial data terminals can be used.
- Available in Fog only.

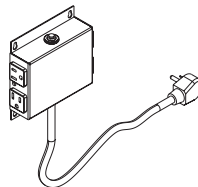

APWR4TAP

Power Module — Under Worksurface, Quad Tap (page 287)

- Under surface mounting can be used under any surface with a 5" x 5" x 1.5" clearance.
- 10' straight power cord only, no specification needed.
- 4 receptacles, unit is black finish only, no specification needed.

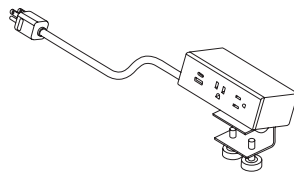

APWRMOD.AC.S

Power Modules — Clamp On Worksurface, Rectangular (page 287)

- Worksurface clamp can be used on any surface with a 2½" overhang.
- Must be installed at time of initial worksurface installation if installing between a worksurface and panel.
- 10' straight power cord only. UL Listed.
- The USB hub allows simultaneous powering of 2 receptacles, 1 USB-A device, and 1 USB-C device. The USB hub is a charger only, no ability to connect to a PC. The charging capacity is limited and may not charge all devices.
- Four wire management "P-Clips" included with mounting hardware.
- Specify "QA" for Qi compatible wireless charging on AWPRMOD. USB-C port no longer included when wireless charging specified.
- Available in Snow and Storm finishes.

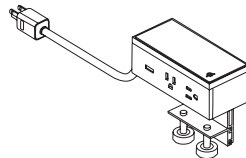

APWRMOD.QA.S

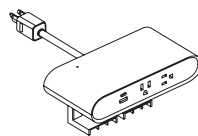

ARNDPWRMOD.QA.S

Power Modules — Clamp On Worksurface, Round (page 287)

- Worksurface clamp can be used on any surface with a 2½" overhang.
- Must be installed at time of initial worksurface installation if installing between a worksurface and panel.
- 9' straight power cord only. UL Listed.
- The USB hub allows simultaneous powering of 1 USB-A device and 1 USB-C device. The USB hub is a charger only, no ability to connect to a PC. The charging capacity is limited and may not charge all devices.
- Specify "QA" for Qi compatible wireless charging on ARNDPWRMOD.
- Available in Snow and Storm finishes.

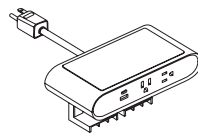

ARNDPWRMOD.AC.S

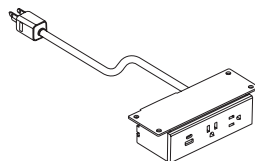

AUPWRMOD.AC.S

Power Module — Under Worksurface, Rectangular (page 287)

- Under surface mounting can be used on any surface with a 5" clearance.
- Power cord choices include 10' Straight, 5' Interlink, 10' Hardwire, and 10' Chevron Fog & Storm Braided cords. All are UL listed.
- Four wire management "P-Clips" included with mounting hardware.
- Available in Snow, Storm, and Black finishes.

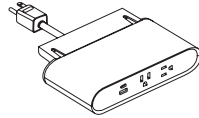

AURNDPWRMOD.AC.S

Power Module — Under Worksurface, Round (page 287)

- Under surface mounting can be used on any surface with a 5" clearance.
- 9' straight power cord only. UL Listed.
- Available in Snow, Storm, and Black finishes.

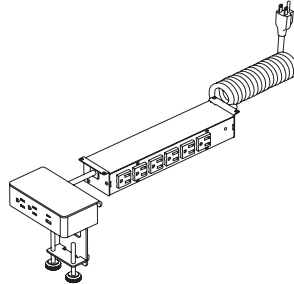

AABPWRMOD.AC.Q

Power Module — Above/Below Worksurface (page 287)

- Above/Below power module provides access to power on the desktop and below the worksurface.
- Desktop mount can be used on any surface with a 6"W x 3"D clearance along the worksurface edge.
- Under surface mounting can be used with a 12"W x 3"D x 2"H clearance under the surface.
- Plugs will take additional depth (approx. 3").
- Two wire management "P-Clips" included with mounting hardware.
- Below worksurface power strip supplies six grounded A/C receptacles, desktop unit supplies two receptacles, 1 USB-A port, and 1 USB-C port.
- Desktop and under worksurface units are connected by a 2' long straight cord and cannot be disconnected.
- Power cord choices include a 6' straight cord or a coiled cord that is 6' long uncoiled, approximately 8" long coiled (compressed).
- Desktop unit available in White and Gray finishes.
- Under worksurface unit available in black only, no specification needed.
- UL 962A and UL 111 Listed. UL 1310 Recognized.

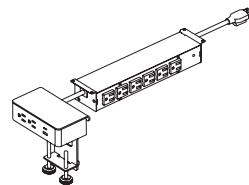

AABPWRMOD.AC.S

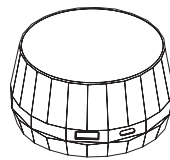

APWRPCK

Power Module — Sit-on-Surface, Puck (page 287.1)

- Unit sits on top of a worksurface.
- Includes 5' DC Connector cord, transformer block, and 6' AC straight cord for 11' of total cord length. UL 1310 Listed.
- Unit allows for simultaneous powering of 1 USB-A and 1 USB-C device.
- Unit is a charger only, no ability to connect to a PC other than to charge.
- Available in White and Silver finish only, no specification needed.

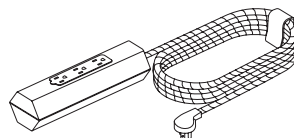

APWRSTRP

Power Strip — Sit-on-Surface, Wood (page 287.1)

- Unit sits on top of a worksurface.
- 10' Braided cord in White nylon, leather cord management strap included. UL Listed.
- Ultra-low profile 45 degree flat plug.
- 3 grounded power outlets.
- Solid Ash Wooden housing, no specification needed.

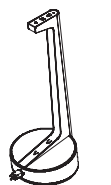

AVSTA3PWR

Vesta Mobile Power (page 287.1)

- 3 AC power simplex, 1 dual USB-A, 1 USB-C configuration.
- 10' Retractable power cord, UL Listed.
- Unit weighs 13 lbs.
- For cordless, battery-powered unit, please contact the Tailored Product Group (TPG).
- Available in Snow, Storm, Black, and Fog. Separate finish options available for outside and inside of unit.

Cable & Wire Management

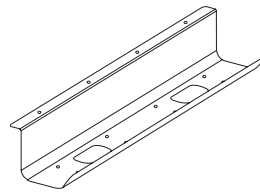

AJTRGH24 or AJTRGH36

Cable Management Tray (page 287.2)

- Attaches under the worksurface to contain cables.
- Metal tray shelf is 4" deep. Can hold electrical power strip and/or surge protector.
- 24" and 36" lengths, use multiple units for larger worksurfaces.
- Attachment hardware included, paint option is black only.
- Zip tie attachment points located in base of tray. Zip ties not included.

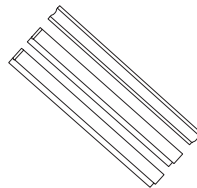

AWRSTRIP

Wire Management Strips/Channels (page 287.2)

- Self adhesive backing to attach to panels and underside of worksurfaces.
- Flexible strips allow cabling to enter/exit and can be contained inside the strips' cavities.
- Includes two wire management profiles. Smaller profile allows for qty. 3, .3" diameter cords, has area of .32 in². Larger "J" shaped profile allows for qty. 10, .3" diameter cords, has area of 1.14 in².

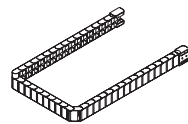

A9CLWMC or WKSWMC

Cord Management Chains (page 287.2)

- Works with Approach and Altitude A6-units.
- Used to route and conceal power/data cables from control box and other devices. Includes all mounting hardware and a plate to secure to a leveling glide.
- Houses 6 cables at 0.300" diameter.
- Made of plastic chain with plastic attachment brackets at each end.
- Specify WKSWMC for 58" chain. Only comes in Black finish.
- Specify A9CLWMC for 36" chain. Comes in Black, White, and Silver.
- Has two connecting points: Top section connects underneath a worksurface and bottom section can connect underneath power rails or to panel raceways using double-sided tape. Hardware included.

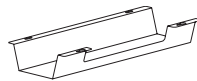

APWRTRGH17 or APWRTRGH36

Under Worksurface Trough (page 287.2)

- Used to conceal wires and control box below worksurfaces. Trough can be configured at various height/width combinations to meet capacity needs. Ships flat and is bent to desired shape.
- On 48"W and 54"W worksurfaces use one 17"W trough. 54"W has space to use 2 – 17"W, if necessary.
- On 60"W, 66"W, and 72"W worksurfaces use the 36" trough.
- On 84"W worksurface use 2 – 17"W troughs.

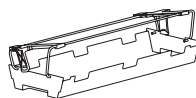

AFDTRGH20

Flip-Down Wire Trough (page 287.2)

- Mounts beneath a worksurface. Used to conceal extra cord slack and power strips.
- May be used in conjunction with quad tap unit APWR4TAP to reduce the number of cords routed from a worksurface to a beam.
- For any worksurface less than 58"W, a 20"W Flip-Down Trough is recommended.
- For worksurfaces 58"W and wider, a 20"W or 32"W Flip-Down Trough may be used.
- Flush-mount Raddi Storages are not recommended to use in conjunction with Flip-Down Trough.
- Only AKTSHORT keyboard tray is recommended for use in conjunction with the Flip-Down Trough.



AFDTRGH32



ALEGCHASE26

O-Leg Chase (page 287.3)

- Works with O-Legs from Allsteel Approach.
- Matches leg profile on models WKTBTTL2824 and WKTBTTL2830.
- Magnetically aligns and adheres itself to the inside of the leg and allows for user to reposition and adjust wires as needed without the use of tools.
- Metal chase measures 26"H, can fit qty. 12, .3" diameter cords. Has cross section area of 1.56 in².
- Available in standard metal paint finishes.

Cable & Wire Management

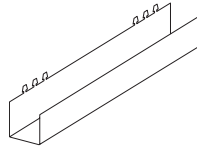

AMPCHASE

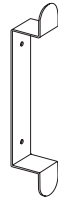

AWIRECLT

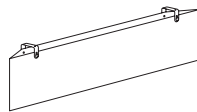

APWRMODEST36 or APWRMODEST48

Panel Mounted Wire Chase (page 287.3)

- Attaches between panels on Stride, Terrace, and Optimize via a slotted standard.
- Designed to sit below a worksurface and provide additional cord management from the base rail to beltline/under-worksurface height.
- Available in standard metal paint finishes.

Metal Wire Cleat (page 287.2)

- Supplied with screws and VHB tape for attachment to various surface types.
- For wood/particle board/MDF surfaces, use screw attachment.
- For painted metal/glass/non-porous surfaces, use VHB tape.
- Example use cases:
 - 1) Used alongside telescoping/fabric HAT wire chases to secure excess length of cord at plug-end.
 - 2) Secured to wall next to TV monitor in meeting room to manage HDMI cable when not in use.
 - 3) Screwed underneath worksurface to provide quick and easy management of excess length of cords and cabling.

Fabric Power Modesty (page 287.4)

- Fabric Power Modesty presents as modesty panel hanging by leather straps under a worksurface; inner compartment conceals cords and power strips as a wire management application.
- Recommended worksurface width pairings:
 - 1) 48-60" W Desk — Use APWRMODEST36 Centered.
 - 2) 66-72" W Desk — Use APWRMODEST48 Centered or APWRMODEST36 offset.
 - 3) 84" W Desk — Use APWRMODEST48 offset.
- Modesty fills 11.5 inches below the bottom of the worksurface with space for cords to enter/exit between the worksurface and the top of the Power Modesty.
- Two entry/exit points for cords are located at the bottom of the Power Modesty unit.
- Modesty panel is designed to present as a thin modesty panel from the front, but provides 3" depth cavity for wires, power strips, etc.
- Maximum weight capacity for Power Modesty is 25 lbs.
- Modesty panel not to be used to store electronics that require airflow for thermal management (computers).
- Users can access interior of panel (to modify wire placement) via “wings” on either side of product, secured via user-operable Velcro connection.
- Users may also dismount Power Modesty from leather straps by unlooping leather straps from button attachments.
- Leather straps on Power Modesty always come in medium brown color.
- Power Modesty available in Appoint, Binary, Centurion, Noble, Reflections, Disperse, and Spin fabric series.

Cable & Wire Management

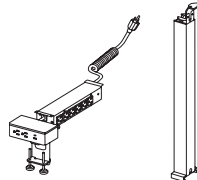

AHATPWORMOD2S or AHATPWORMOD3S

Metal Telescoping HAT Wire Management (page 287.4)

- Separate models available for use on either 2-Stage or 3-Stage Altitude A6 Tables. Not compatible with Altitude A3, A5, or A8.
- Equipped with 2-Stage or 3-Stage Telescoping Wire Chase and custom Above/Below Power Module intended for cord management on 2- and 3-Stage height adjustable tables.
- Telescoping chase includes a unique Above/Below Power Module and is NOT compatible with any other power module.
- Above/Below Power Module supplies 6 grounded A/C receptacles below the worksurface and 2 receptacles, 1 USB-A, and 1 USB-C port above the worksurface on the desktop unit. Desktop power module available in White and Gray finishes, below-worksurface power strip only available in black only.
- Telescoping Chase available in the same paint finishes as the Altitude height adjustable bases except for “Nickel.”
- To match Metal Telescoping Chase to HAT base, specify matching paint color as HAT base. To match Telescoping Chase to a “Nickel” HAT base, specify “Platinum Metallic,” or “PR2.”
- Two “P-Clips” included for wire management between desktop power module and under worksurface power strip.

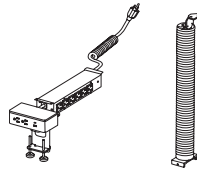

AHATPWORMOD2S or AHATPWORMOD3S

Fabric Elastic HAT Wire Management (page 287.4)

- Model compatible for use on either 2-Stage or 3-Stage Altitude A6 Tables. Not compatible with Altitude A3, A5, or A8.
- Equipped with Fabric Elastic Wire Chase and custom Above/Below Power Module intended for cord management on 2- and 3-Stage height adjustable tables.
- Fabric Elastic Chase includes a unique Above/Below Power Module and is NOT compatible with any other power module.
- Above/Below Power Module supplies 6 grounded A/C receptacles below the worksurface and 2 receptacles, 1 USB-A, and 1 USB-C port above the worksurface on the desktop unit.
- Desktop power module available in White and Gray finishes, below-worksurface power strip only available in black only.
- Fabric Elastic Chase available in Light, Medium, and Dark fabric finishes.
- Includes a metal foot and an under worksurface mounting bracket to attach Fabric Elastic Chase along the side of a HAT leg.
- To match metal brackets to HAT base, specify matching paint color as HAT base. To match brackets to a “Nickel” HAT base, specify “Platinum Metallic,” or “PR2.”
- Two “P-Clips” included for wire management between desktop power module and under worksurface power strip.

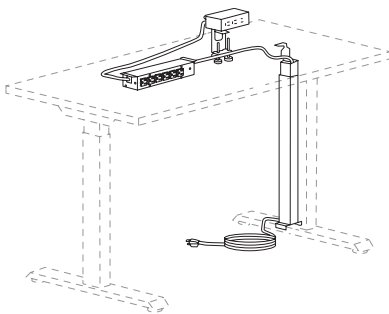

2-Stage Metal Telescoping HAT Wire Management

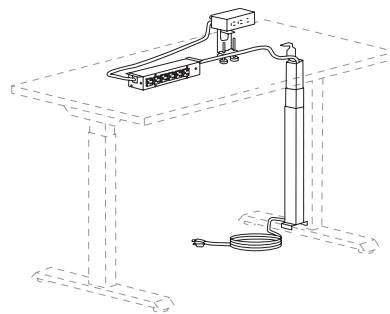

3-Stage Metal Telescoping HAT Wire Management

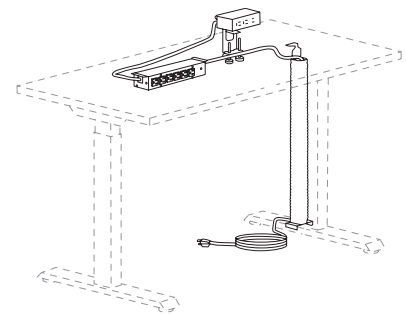

2 or 3-stage Fabric Elastic HAT Wire Management

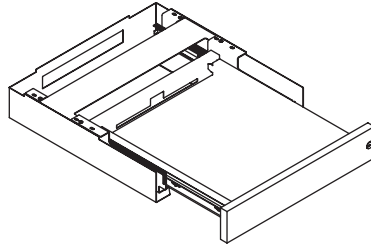
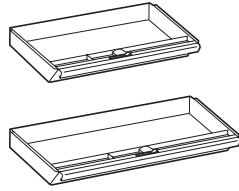

Flat Brackets

Front View

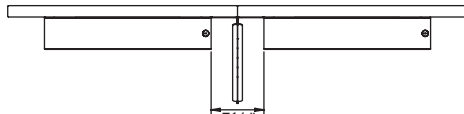

Top View

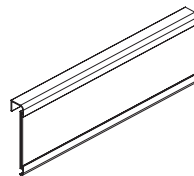
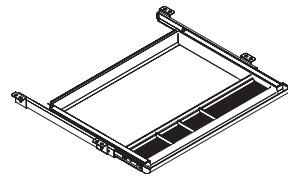
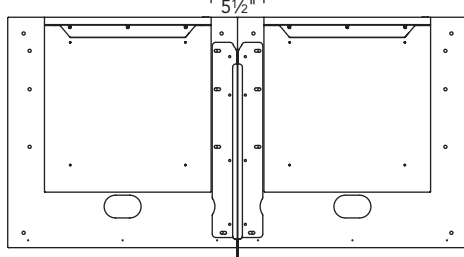

Metal Center Drawers (page 282)

- All metal center drawers feature pencil trays with three compartments for storage.
- Center drawers will not fit in center of 24" D worksurfaces which are wider than 60" due to location of center support bracket.
- For locking specifications, see pages 292-293.
- Ball-bearing slide suspension.

Laptop Drawer — U7WDA (page 282)

- Drawer body made of sheet metal.
- Drawer front made of 3/4" particleboard with laminate on both sides and fused laser edge banding.
- Core removable lock is located on right side drawer front
- 17 5/8" W x 18" D x 3 3/8" H Outside (interior 13" W x 16" D x 1 7/8" H)
- Minimum surface depth is 21" for surfaces not using an external stiffener; and 27" for surfaces using an external stiffener.
- Drawer extends 16"
- Maximum load: 45 lbs (functional BIFMA load)
- Drawer assembly and cover have cut out in back to allow for cables to exit drawer.
- Distance from floor to bottom of unit w/glides fully retracted is 24 3/4".
- Does not interfere with Further leg mounting plates so drawer can be placed directly next to either a system or table leg.
- When being placed next tower storage using the tower ell bracket (Z6LB) to support surface the drawer must be inset 3" to clear the ell bracket.
- Can be placed directly next to any support storage from any Allsteel product line (excluding towers).
- Flat brackets — drawer must be offset 3" from seam between surfaces to clear the bracket. See illustration at left.
- Can be used with rabbit edge worksurface models but there will be a larger reveal between surface and drawer.
- Can be used with knife edge worksurface models but reveal and depth need to be considered.

Polymer Center Drawer - ACD1 (page 282)

- 20 1/2" W x 17" D x 2" H
- Available in black only
- Made from ABS.
- Minimum clearance for mounting: 23" W x 16 1/4" D x 2" H.
- Retracts on 16" ball-bearing slides.
- Can be used on worksurfaces with Height Adjustable Bases as long as it is attached with spacer model AKMH.
- Can store up to 25 lbs.





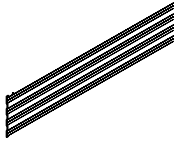

Name Plate (page 281)

- Comes in a 10-pack.
- Metal backer installs under a Terrace or Optimize top cap, can be used with frameless glass.
- Cover is a transparent polycarbonate insert.
- Full plate is 8 1/2" W x 2 5/8" H.





For specification information see pages 277-278.

GSA SIN 33721

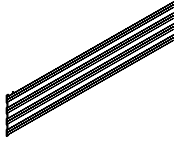

Description	Model	P1 Paint List Price	P2 Paint List Price	P3 Paint List Price
5"H Tool Rails — for Panels				
24"W	EASR24 	\$ 267	\$ 305	\$ 340
30"W	EASR30 	\$ 283	\$ 321	\$ 356
36"W	EASR36 	\$ 295	\$ 333	\$ 368
42"W	EASR42 	\$ 308	\$ 346	\$ 381
48"W	EASR48 	\$ 317	\$ 355	\$ 390
60"W	EASR60 	\$ 373	\$ 411	\$ 446



5"H Tool Rails — for Metal Hutches				
36"W	EAHSR36 	\$ 295	\$ 332	\$ 366
42"W	EAHSR42 	\$ 308	\$ 345	\$ 379
48"W	EAHSR48 	\$ 317	\$ 354	\$ 388
60"W	EAHSR60 	\$ 373	\$ 410	\$ 444
66"W	EAHSR66 	\$ 385	\$ 422	\$ 456
72"W	EAHSR72 	\$ 415	\$ 452	\$ 486

How to specify —
Select the Model Number from above.

1st Option:

Paint:



See page 12 for finishes.







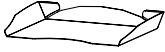
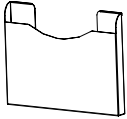

_____ . **P** _____

Example: EASR36.P02

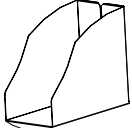
 Shippable by small-package carrier.

For specification information see pages 277-278.

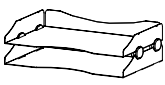
GSA SIN 33721

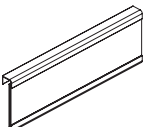
	Description	Model	P1 Paint List Price	P2 Paint List Price	P3 Paint List Price
	Mail Box 9"D x 15"W	EAPT S	\$ 132	\$ 152	\$ 168
	Folder Holder 9"H x 12"W	EAFS S	\$ 135	\$ 155	\$ 171
	Phone Caddy 9"W x 11"D	EATS S	\$ 165	\$ 185	\$ 201
	Binder Bin 8½"H x 5¼"W x 10"D	EABS S	\$ 132	\$ 152	\$ 168
	Tool Box 5"H x 5¼"W x 1½"D	EADH S	\$ 106	\$ 126	\$ 142
	Clip Caddy™ 2"H x 7"W x 3½"D	EAAC S	\$ 94	\$ 114	\$ 130
	Sidebar™ Personal Shelf 2"H x 21"W x 7"D	EAPS S	\$ 135	\$ 155	\$ 171
	Paper Wave™ Tray size: 2½"H x 6"W x 10"D Dividers: 9½"H x 9"W	EASS S	\$ 189	\$ 209	\$ 225
	Freestanding Mail Box (specify paint color) Pair — 4½"H x 13¼"W x 9"D	EAFT S	\$ 271	\$ 291	\$ 307
	Coat Hooks (black only) Package of six	APMC6 S	\$ 132	N/A	N/A
	Panel Name Plate Package of 10	EACS	\$ 360	\$ 380	\$ 396
	Note: Not for use on tool tile or rail, name plate installs under top cap on Terrace and Optimize.				

EXTENSIONS











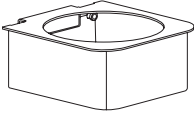

<p>How to specify — Select the Model Number from above.</p> <p>_____ .</p>	<p><i>1st Option:</i> Paint: P1 P2 P3 See page 12 for finishes.</p> <p>P _____</p>
---	---

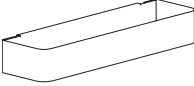
Examples: EAPT.P4J APMC6.P

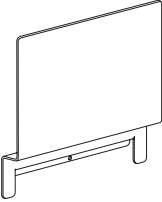
S Shippable by small-package carrier.

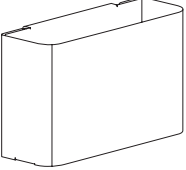
For specification information see pages 277-278.

GSA SIN 33721

	Description	Model	P1 Paint List Price	P2 Paint List Price	P3 Paint List Price
	Cup Holder 4 7/8"H x 2"W x 11 1/8"D	AAPAC 	\$ 259	\$ 285	\$ 298
	Hook 4 1/8"H x 3 3/8"W x 7 1/4"D	AAPAH 	\$ 195	\$ 215	\$ 224
	Hanging Folder Holder 4 3/8"H x 2 1/2"W x 14"D	AAPAHF 	\$ 258	\$ 284	\$ 297
	Magnetic Picture Holder 9"H x 10"W x 10 1/2"D	AAPAMP 	\$ 231	\$ 254	\$ 266
	Small Bin 5 1/8"H x 3 3/8"W x 7 1/4"D	AAPASB 	\$ 237	\$ 261	\$ 273
	Small Shelf 4"H x 2"W x 11 1/8"D	AAPASH 	\$ 222	\$ 244	\$ 255
	Small Tray 8 3/8"H x 2 7/8"W x 10 1/4"D	AAPAST 	\$ 260	\$ 286	\$ 299

EXTENSIONS

How to specify —
Select the Model Number from above.

_____ .

1st Option:
Paint:
  
See page 12 for finishes.

P _____

Examples: AAPAST.P4J AAPASB.P

 Shippable by small-package carrier.

For specification information see page 279.

GSA SIN 33721

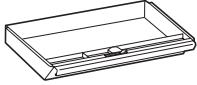
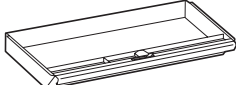
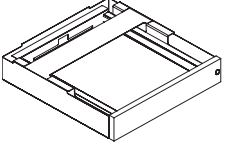
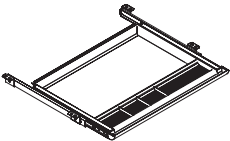
	Description	Model	List Price		
			P1	P2	P3
 <p>Angled front</p>	Metal Center Drawer w/Lock 19"W x 14¼"D x 3"H • 12" drawer extension (3/4). • Inside drawer dimension: 19"W x 13"D x 2⅝"H. • Minimum clearance for mounting: 21¼"W x 19¼"D.	CSDC19 S	\$ 305	\$ 327	\$ 346
	 <p>Angled front</p>	24½"W x 14¼"D x 3"H • 12" drawer extension (3/4). • Inside drawer dimension: 24½"W x 13½"D x 2⅝"H. • Minimum clearance for mounting: 27⅞"W x 19¼"D.	CSDC25 S	\$ 314	\$ 336
	Laptop Drawer — Locking, laminate front, metal case 17⅞"W x 18"D x 3⅜"H • 16" drawer extension • Inside drawer dimensions: 13"W x 16"D x 1⅞"H • Minimum clearance for mounting: 17⅞"W x 21"D x 3⅜"H (see illustration)	U7WDA S	\$ 1750	\$ 1773	\$ 1792
		Polymer Center Drawer 20½"W x 17"D x 2"H • 11½" extension • Minimum clearance for mounting: 23"W x 16¼"D x 2"H	ACD1	\$ 244	N/A

How to specify — Select the Model Number from above. _____ _____	1st Option: Laminate (Laptop drawer front if applicable): See pages 12-16 for finishes. _____	2nd Option: Edge (Laptop drawer edge if applicable): See pages 12-16 for finishes. _____	3rd Option: Paint (If laptop drawer, list exterior case color here): See page 12 for finishes. Power Data Module PR6 Silver. _____	4th Option: Paint (Interior of laptop drawer if applicable): See page 12 for finishes. _____	5th Option: Lock (if applicable): STD Standard OMT Omit (Deduct \$20) _____	6th Option: Lock or Tech Module Color (if applicable): EL Silver (Lock) _____
--	---	--	--	--	--	--

Example: U7WDA.LM11EV.P27.PR6.STDEL

S Shippable by small-package carrier.

Allsteel Extensions offers Illumination in three styles — Undercabinet LED Light, Wand Light, and Splitty Light.

Recessed Undercabinet LED Light

Recessed task lights conserve space and provide an efficient solution for illuminating the workplace. All models are equipped with LED strips.

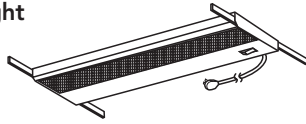

Recessed task light models mount under storage cabinets or shelves to provide optimal space utilization. Models are available in two styles and three sizes to correspond with the width of the cabinet or shelf. Task lights with a fused plug are available to meet Chicago electrical code.

Undercabinet LED Light

The Undercabinet LED Light is a low-profile, linear solution for overhead cabinets and shelves and is an ideal solution for painted wood storage. It utilizes energy-efficient LED technology which provides a long life. The Undercabinet LED Light provides the opportunity to mount the fixture where light is needed most.

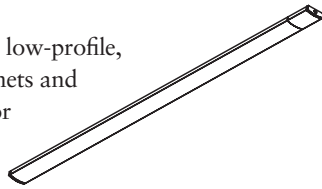

The Undercabinet LED Light features a metal trough reflector with diffuser lens. The light has a sleek 1/2" thick profile and provides two options for mounting, either magnetically or with hardware. Undercabinet LED Lights can be daisy-chained.

Optional undercabinet occupancy sensor is available which will automatically turn off the fixture after 30 minutes of no detection and back on immediately as the user re-enters the detection range using Passive Infrared (PIR) sensor technology. Unit features 360° lens with 90° outward detection angle, providing a 36" coverage diameter at 18". Occupancy sensor comes with connector and is required to be connected in the sequence shown below. Connect occupancy sensor to a light, or first light in daisy chain to control all linked lights.

CONNECTION SEQUENCE*

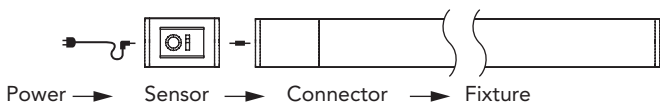

*Cannot deviate from this sequence

Recessed Task Lights (page 285)

- Black Metal Construction with 9' long black cord attached to right rear corner of the fixture.
- LED strip comes installed within light.
 - 50,000 hour life span
 - 120V-277V
 - CCT 4000K
 - CRI 80+
- Includes 4 cord retainer clips.
- Shorter width models can be used on wider overheads, shelves and hutches.
- On/Off switch provides individual control of tasklight within the workstation.
- Daisy chain models require a master control model — 10 fixtures maximum.
- RECOMMENDATION: Provide a separate circuit for task lights to ensure proper, long-term operation.

Undercabinet LED Lights (page 285)

- Low profile energy-efficient LED task light for use with overhead storage cabinets and shelves.
- 20W power supply for 10W 17" unit (.166 amps).
- 20W power supply for 20W 31" unit (.166 amps).
- 60W power supply for daisy-chain starter units (.5 amps). Must order one starter unit for each daisy-chain application.

LED Light Combinations Must Not Exceed 60W in Combination	Power Usage
6X 17"	60W
3X 31"	60W
1X 31" + 4X 17"	60W
2X 31" + 2X 17"	60W

- The combinations that could max out 60W are featured above. *Daisy chained units have a power limit of 60W from one power entry. 17W units use 10W and 31W units use 20W.*
- Specify up to 5 additional 17" interconnect units (ALED17UJMP30) to daisy-chain together with 17" daisy-chain starter fixture (ALED17U60).
Example: Daisy-chain 4-17" undercabinet LED lights:
Specify: 1 ALED17U60
Specify: 3 ALED17UJMP30 with 10" jumper cord
- Specify up to 2 additional 31" interconnect units (ALED31UJMP30) with 10" jumper cords to daisy-chain together with 31" tasklight (ALED31U60); or 17" daisy-chain starter fixture (ALED17U60).
- 3500K color temperature.
- 131 footcandles at 18" on ALED31U; 76 footcandles at 18" on ALED17U.
- Magnetic or screw-mount option — attachment hardware included.
- On 20 watt models, power drive is attached to plug: allow 1 1/8" D space at outlet.
- On 60 watt models, power drive brick is in center of cord.
- Includes 3 cord retainer clips.
- Meets California Title 24 Energy Efficiency Standards.
- "Instant On" switch with infinite dimming cycle from 100% to 15% with the last state memory, allowing the user to set their desired level of lighting.
- Fixture automatically turns off after 10 hours of use to reduce unwanted energy use.
- Optional occupancy sensor automatically turns off all interlinked fixtures after 30 minutes of no detection and back on immediately when detection is found.

Overhead Length	Suggested LED Sizes
24	17
30	17
36	17
42	31
48	17 + 17
60	31 + 17
72	31 + 31

Note: LED lights may need to be positioned along length properly to allow jumping to additional overheads. Suggested sizes above are recommendations for single overheads to provide as much light along length of overhead as possible.

The suggested sizes factor in 4 inches of room for the power inlet and occupancy sensor (optional).

Wand™ Task Light

Wand freestanding task light offers a clean, simple design along with powerful LED technology to illuminate the workspace. The swivel base and arm tilt allow users to position the light just where they need it. The 7.7 watt LED light offers efficiency and long life, providing up to 25 years of daily use. The slim, sleek design makes it easy to integrate into any workspace. Wand task light is 97% recyclable. Occupancy sensor and/or charging models available.

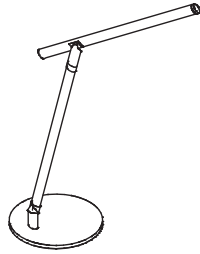

Wand LED Freestanding Task Light (page 286)

- Available in Silver or White. 9'4" cord is Silver.
- Full range dimming from 100% – 10% with last state memory.
- Uses 5W at highest setting and as low as 1 watt at its lowest setting, providing 75 to 12.7 footcandles of light, respectively (16" above worksurface).
- 7½" round swivel base and 16½"H tilt arm allow versatile positioning of the 13" lampshade.
- Designed for 50,000 hours of life.
- Color Temperature: 3500K. Color Rendering Index (CRI): 80.
- Materials: aluminum arm and lampshade, steel base.
- Weight: 4.4 lbs. 97% recyclable, 76% post-consumer.
- Certifications: UL and CUL. TAA compliant.
- Occupancy sensor available with automatic shut-off after 15 minutes if no motion is detected.
- USB model features USB-A (1), USB-C (1) charging within base of unit.
- USB model also features occupancy sensor. 7.5W (A) & 18W (C) power consumption.

Splitty Task Light

Splitty's organic and modern design compliments the workstation while also bringing rich features to the user. In addition to illuminating the space, Splitty can also be a teleconferencing tool through Splitty's 360-degree light head adjustment and soft touch, continuous dimming. Integrated charging allows for small personal device charging crucial to the modern worker's workplace toolkit while minimizing clutter within the station. Optional clamp or tool tile mounts available as accessories.

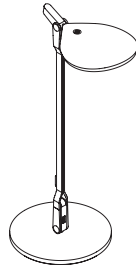

Splitty Task Light (page 286)

- Available in Silver, White, or Black (accessories available in silver only).
- Cord is 12' long.
- Cord is silver when black or silver finish specified, white when white light is specified.
- Soft touch on/off, dimming.
- Continuous dimming (100% – 3%) with last state memory.
- 5.8W of energy consumption. 7W at highest setting, 0.6W at lowest.
- 5" 360-degree swivel light head, 6.54" round swivel base and 17"H arm. Arm has full 180 degree rotation and 360 degree swivel.
- Designed for 60,000 hours of life.
- Color Temperature: 3500K, Color Rendering Index: 90.
- Materials: aluminum, plastic.
- USB-A has 5W of power consumption.
- USB-A (1) charging at bottom of light arm stem. Charging feature compatible for any mounting method.
- Clamp mount compatible with surfaces ¼" – 2¼" thick.
- Tool tile mount has 1½" adjustment range, minimum slot height of ⅝".

For specification information see pages 283-284.

Open Market / GSA SIN 33721

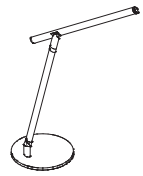

GSA SIN 33721

Description	Model	List Price
Wand™ LED Task Light (Silver or White)		
Freestanding LED Task Light	WANDFS <input type="checkbox"/>	\$ 509
Freestanding LED Task Light (Occupancy Sensor)	WANDFSOC <input type="checkbox"/>	\$ 724

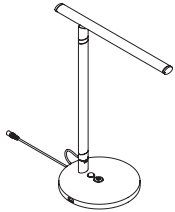

Freestanding LED Task light (Occupancy Sensor & Charging)	WANDFSUSB	\$ 754
---	-----------	--------



Splitty Task Light (Silver, White, or Black)		
Freestanding LED Task Light (Charging)	PRFTSKFS	\$ 690

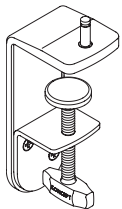

Clamp Mount (Silver only)	PRFTSKCL	\$ 80
---------------------------	----------	-------

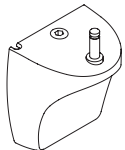

Tool Tile Mount (Silver only)	PRFTSKTR	\$ 80
-------------------------------	----------	-------

EXTENSIONS

<p>How to specify — Select the Model Number from above.</p>	<p><i>1st Option:</i> Color (for Splitty): SVR Silver WHT White BLK Black</p> <p>(for Wand LED): SVR Silver WHT White</p>
--	--

Example: WANDFS.WHT

Shippable by small-package carrier.

For specification information see pages 278.1-278.2.

GSA SIN 33721

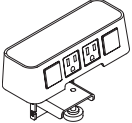
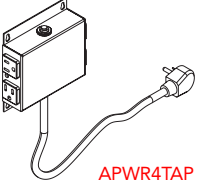
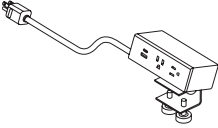
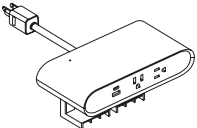
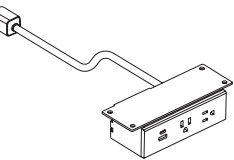
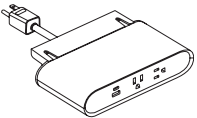
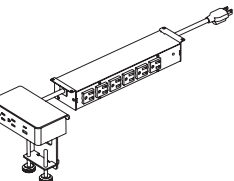
	Description	Model	List Price
 ACPWRMOD	Power/Data Module — Clamp On Worksurface 8"W x 7"D x 5½"H • 2 receptacles, 2 data terminals/blanks • 10' straight power cord only. UL Listed. • Available in Fog only, specify ACPWRMOD.FOG	ACPWRMOD S	\$ 515
 APWR4TAP	Power/Data Module — Under Worksurface, Quad Tap 7"W x 12"D x 3"H • 4 receptacles • 10' Straight cord only, no specification needed. • Available in Black only, no specification needed. • Example: APWR4TAP	APWR4TAP S	\$ 456
 APWRMOD.AC.S	Power Modules — Clamp On Worksurface, Rectangular 7½"W x 12¼"D x 5⅛"H • 2 receptacles, 1 USB-A, & 1 USB-C (AC) • Specify "QA" for 2 receptacles, 1 USB-A, & Qi wireless charging. • 10' Straight cord only (S). • Available in Snow (SNW) & Storm (STRM). • Example: APWRMOD.AC.S.SNW	APWRMOD S	\$ 761
 ARNDPWRMOD.QA.S	Power Modules — Clamp On Worksurface, Round 8¼"W x 16"D x 4½"H • 2 receptacles, 1 USB-A, & 1 USB-C (AC) • Specify "QA" for 2 receptacles, 1 USB-A, 1 USB-C, & Qi wireless charging. • 9' Straight cord only (S). • Available in Snow (SNW) & Storm (STRM.) • Example: ARNDPWRMOD.AC.S.SNW	ARNDPWRMOD S	\$ 713
 AUPWRMOD.AC.S	Power Module — Under Worksurface, Rectangular 7⅞"W x 9¼"D x 5⅜"H • 2 receptacles, 1 USB-A, & 1 USB-C (AC) • Power cord choices include a 10' Straight (S), 5' Interlink (I), 10' Hardwire (H), and 10' Chevron Fog & Storm Braided (B) cord. • Available in Snow (SNW), Storm (STRM), & Black (BLK). • Example: AUPWRMOD.AC.S.BLK	AUPWRMOD S	\$ 761
 AURNDPWRMOD.AC.S	Power Module — Under Worksurface, Round 8¼"W x 16"D x 4½"H • 2 receptacles, 1 USB-A, & 1 USB-C (AC) • 9' Straight cord only (S). • Available in Snow (SNW), Storm (STRM), & Black (BLK). • Example: AURNDPWRMOD.AC.S.BLK	AURNDPWRMOD S	\$ 713
 AABPWRMOD.AC.S	Power Module — Above/Below Worksurface 8¼"W x 16"D x 4½"H • Desktop unit includes 2 receptacles, 1 USB-A, & 1 USB-C (AC) • Under worksurface unit includes 6 receptacles. • Power cord choices include a 6' Straight cord (S) or Coiled cord (Q). • Desktop unit available in White (DWT) or Gray (DGY). • Example: AABPWRMOD.AC.S.DWT	AABPWRMOD S	\$ 1234

<p>How to specify — Select the Model Number from above.</p>	<p>1st Option: Ports (Final port option if applicable): AC USB-A+C QA Wireless Charging with 1 USB-A port (+\$125)</p>	<p>2nd Option: Cord Type (Power Module cord type if applicable): S Straight Cord B Braided Chevron Fog & Storm Cord (+\$91) I Interlink Cord (+\$55) H Hardwire Cord (+\$106) Q Coiled Cord</p>	<p>3rd Option: Color Option (if applicable): SNW Snow STRM Storm BLK Black DWT White DGY Gray</p>
--	--	--	--

Example: APWRMOD.AC.S.SNW ACPWRMOD.FOG

S Shippable by small-package carrier.

For specification information see pages 278.1-278.2.

GSA SIN 33721

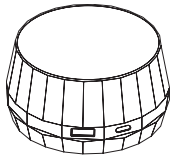

APWRPCK

Description	Model	List Price
Power/Data Module — Clamp On Worksurface		
5"W x 8"D x 4"H	APWRPCK <input type="checkbox"/>	\$ 693
<ul style="list-style-type: none"> • 1 USB-A & 1 USB-C port • 11' straight cord only, no specification needed. • Available in White & Silver only, no specification needed. • <i>Example: APWRPCK</i> 		

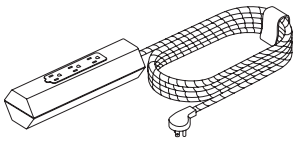

APWRSTRP

Power Strip — Sit-on-Surface, Wood		
4 3/8"W x 1 8/8"D x 4 3/8"H	APWRSTRP <input type="checkbox"/>	\$ 795
<ul style="list-style-type: none"> • 3 receptacles • 10' Braided cord in white nylon only, leather cord management strap included, no specification needed. • Available in wood finish only, no specification needed. • <i>Example: APWRSTRP</i> 		



AVSTA3PWR

Vesta Mobile Power		
6 1/2"W x 10"D x 8"H	AVSTA3PWR <input type="checkbox"/>	\$ 2000
<ul style="list-style-type: none"> • 3 receptacles, 1 dual USB-A, 1 USB-C • 10' Straight retractable cord only, no specification needed. • Available in Snow, Storm, Black, and Fog. Separate finish options available for outside and inside of unit. • <i>Example: AVSTA3PWR.STRM.SNW</i> 		

<p>How to specify — Select the Model Number from above.</p>	<p><i>1st Option:</i> Color Option 1 (if applicable):</p> <p>FOG Fog SNW Snow STRM Storm BLK Black</p>	<p><i>2nd Option:</i> Color Option 2 (if applicable):</p> <p>FOG Fog SNW Snow STRM Storm BLK Black</p>
<p>_____ .</p>	<p>_____ .</p>	<p>_____</p>

Example: AVSTA3PWR.STRM.SNW

Shippable by small-package carrier.

For specification information see pages 278.3-278.4.

GSA SIN 33721

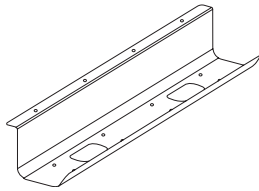

AJTRGH24

Description	Model	List Price		
		P1	P2	P3
Cable Management Trays				
24"W	AJTRGH24 <input type="checkbox"/>	\$ 123	N/A	N/A
36"W	AJTRGH36 <input type="checkbox"/>	\$ 147	N/A	N/A

- Available in 24" or 36" widths.
- Metal Cable Management Trays available in Black only, specify "P" for finish.
- Example: AJTRGH24.P

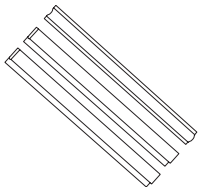

AWRSTRIP

Wire Management Strips/Channels				
	AWRSTRIP <input type="checkbox"/>	\$ 270	N/A	N/A

- Four wire management strips/channels in black only, no specification needed.
- Example: AWRSTRIP

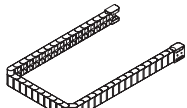

WKSWMC

Wire Management Chains				
36"	A9CLWMC <input type="checkbox"/>	\$ 357	N/A	N/A
58"	WKSWMC <input type="checkbox"/>	\$ 428	N/A	N/A

- Specify model A9CLWMC for 36" chain, specify model WKSWMC for 58" chain.
- A9CLWMC available in Black (E4), White (DW), or Silver (TI).
- WKSWMC available in Black only, no specification needed.
- Example: A9CLWMC.DW or WKSWMC

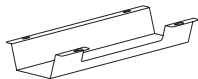

APWRTRGH17

Under Worksurface Troughs				
17"W	APWRTRGH17 <input type="checkbox"/>	\$ 108	N/A	N/A
36"W	APWRTRGH36 <input type="checkbox"/>	\$ 189	N/A	N/A

- Available in 17" or 36" widths.
- Under Worksurface Troughs available in Black only, no specification needed.
- Example: APWRTRGH17

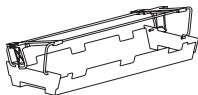

AFDTRGH20

Flip-Down Wire Management Trough				
20"W	AFDTRGH20 <input type="checkbox"/>	\$ 378	N/A	N/A
32"W	AFDTRGH32 <input type="checkbox"/>	\$ 429	N/A	N/A

- Available in 20" or 32" widths.
- Flip-Down Troughs available in Black only, no specification needed.
- Example: AFDTRGH20



AWIRECLT

Metal Wire Cleat				
	AWIRECLT <input type="checkbox"/>	\$ 129	\$ 142	\$ 148

- Available in standard metal paint finishes, see page 232 for options and specify desired finishes.
- Example: AWIRECLT.PJW

<p>How to specify —</p> <p>Select the Model Number from above.</p>	<p>1st Option:</p> <p>Paint (if applicable): See pages 12-13 for finishes.</p> <p>Plastics (if applicable):</p> <p>DW White TI Silver E4 Black</p>
---	---

Examples: AJTRGH24.P A9CLWMC.DW

Shippable by small-package carrier.

For specification information see pages 278.3-278.4.

GSA SIN 33721



ALEGCHASE26

Description	Model	List Price		
		P1	P2	P3
O-Leg Chase				
26"H	ALEGCHASE26 S	\$ 174	\$ 191	\$ 200

- O-Leg Chase is 26"H.
- Available in standard metal paint finishes, see page 232 for options and specify desired finishes.
- *Example: ALEGCHASE26.P27*

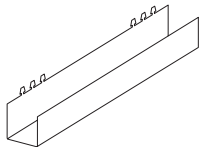

AMPCHASE

Panel Mounted Wire Chase				
17"H	AMPCHASE S	\$ 147	\$ 162	\$ 169

- Panel Chase is 17"H.
- Available in standard metal paint finishes, see page 232 for options and specify desired finishes.
- *Example: AMPCHASE.P27*

<p>How to specify — Select the Model Number from above.</p>	<p><i>1st Option:</i> Paint (if applicable): See pages 12-13 for finishes.</p> <p>Plastics (if applicable): DW White TI Silver E4 Black</p>
--	--

Examples: ALEGCHASE26.P27

S *Shippable by small-package carrier.*

For specification information see pages 278.4-278.5.

GSA SIN 33721

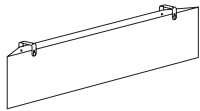

APWRMODEST36

Description	Model	List Price	
		A	B
Fabric Power Modesty			
	APWRMODEST36 <input type="checkbox"/>	\$ 1162	\$ 1196
	APWRMODEST48 <input type="checkbox"/>	\$ 1258	\$ 1297

- Available in ApPOINT, Binary, Centurion, Noble, Reflections, Disperse, and Spin panel fabric series.
- Specify desired fabric.
- *Example: APWRMODEST36.NBLE16*

How to specify —
Select the Model Number from above.

1st Option:
Fabric
(if applicable):
See page 10 for fabrics.

Example: APWRMODEST36.NBLE16

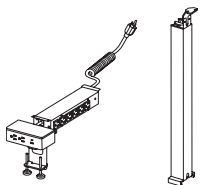

AHATPWORMOD2S or AHATPWORMOD3S

Description	Model	List Price		
		P1	P2	P3
Metal Telescoping HAT Wire Management				
	AHATPWORMOD2S <input type="checkbox"/>	\$ 1614	\$ 1654	\$ 1675
	AHATPWORMOD3S <input type="checkbox"/>	\$ 1646	\$ 1690	\$ 1711

- AHATPWORMOD2S pairs with 2-stage HAT bases.
- AHATPWORMOD3S pairs with 3-stage HAT bases.
- Desktop power module comes with 2 receptacles, 1 USB-A, and 1 USB-C port only, specify “AC” for this power configuration.
- Desktop power module available in White (DWT) or Gray (DGY) finishes, specify desired finish.
- Under worksurface power strip comes with 6 receptacles and is available in Black only, no specification needed.
- Metal Telescoping Chase available in the same paint finishes as Altitude HAT bases, specify desired paint finish.
- *Example: AHATPWORMOD2S.AC.DWT.PJW*

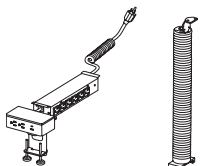

AHATPWORMOD2S or AHATPWORMOD3S

Fabric HAT Wire Management		AHATPWORMODF <input type="checkbox"/>	\$ 1476	\$ 1503	\$ 1516
-----------------------------------	--	---------------------------------------	---------	---------	---------

- AHATPWORMODF pairs with 2-stage and 3-stage HAT bases.
- Desktop power module comes with 2 receptacles, 1 USB-A, and 1 USB-C port only, specify “AC” for this power configuration.
- Desktop power module available in White (DWT) or Gray (DGY) finishes, specify desired finish.
- Under worksurface power strip comes with 6 receptacles and is available in Black only, no specification needed.
- Fabric HAT Chase available in three fabric finishes of Light (LGT), Medium (MDD), and Dark (DRK), specify desired fabric finish.
- Fabric HAT mounting brackets available in the same paint finishes as Altitude HAT bases, specify desired paint finish.
- *Example: AHATPWORMODF.AC.DGY.LGT.PR5*

How to specify —
Select the Model Number from above.

1st Option:
Ports
(Final port option if applicable):
AC USB-A+C

2nd Option:
Power Module Color Option
(if applicable):
DWT White
DGY Gray

3rd Option:
Fabric Chase Finish
(if applicable):
LGT Light
MDD Medium
DRK Dark

4th Option:
Metal Paint Option
(if applicable):
See page 232 for finishes.

AHATPWORMOD . AC . D

*Example: AHATPWORMOD3S.AC.DWT.P8C
AHATPWORMODF.AC.DGY.LGT.PR5*

Shippable by small-package carrier.

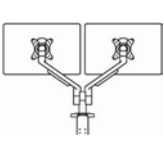
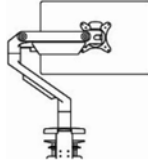
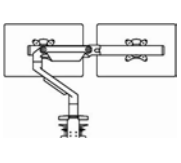
PIVOT MONITOR ARMS	Standard Dynamic Single	Standard Dynamic Dual	Heavy Duty Dynamic Single	Heavy Duty Dynamic Dual with Crossbar
Allsteel Model:	AMASTS	AMASD	AMASHD	AMADHD
				
Features:				
Price	\$488	\$983	\$838	\$1160
Colors	Black and Silver	Black and Silver	Black and Silver	Black and Silver
Monitor Rotation	180°	180°	180°	180°
Monitor Extension	18.75"	18.26"	20.75"	23"
Monitor Tilt Adjustment	+25°/-25°	+25°/-25°	+25°/-25°	+25°/-25°
Arm Height Adjustment	8.4" to 19"	9.6" to 20.1"	8.5" to 20"	8.5" to 20"
Weight Capacity	6.2 to 17 lbs.	6.2 to 17 lbs. per Arm	8 to 35 lbs.	17.5 lbs. per VESA Plate
Mounting Option	Grommet and Clamp Mounts	Grommet and Clamp Mounts	Grommet and Clamp Mounts	Grommet and Clamp Mounts
360° Lockout Feature	Yes	Yes	Yes	Yes
VESA Compatibility	75mm and 100mm	75mm and 100mm	75mm and 100mm	75mm and 100mm
Pole Height	N/A	N/A	N/A	N/A
Maximum Width per Monitor*	N/A	25"	N/A	25"
Worksurface Clamp Requirements	¾" to 2" Thick	¾" to 2" Thick	¾" to 2" Thick	¾" to 2" Thick
Worksurface Grommet Clamp Requirements	¾" to 2" Thick/Hole Diameter ⅜" to 2"	¾" to 2" Thick/Hole Diameter ⅜" to 2"	¾" to 2" Thick/Hole Diameter ⅜" to 2"	¾" to 2" Thick/Hole Diameter ⅜" to 2"
Environmental Info	94% Recycled Content	94% Recycled Content	94% Recycled Content	94% Recycled Content

*Use of APACSM Slider Model will allow for wider monitor capabilities

Pivot Standard Weight Monitor Arms

- Adaptable and adjustable to user preference the Pivot monitor arm offers a slim and refined design coupled with easy fingertip adjustment.
- Multiple points of adjustment including 360 degree swivel with optional 180 degree lockout, 18.75" extension, and 10" of height adjustment.
- Monitor tilts +25/-25 degrees.
- Standard weight arms utilize a tension spring that allows for effortless adjustment of monitors to proper ergonomic positions.
- Tension adjustment at multiple points allows for proper adjustment for monitors weight between 6-17 lbs.
- Model includes grommet and worksurface mounting options.
- Desk clamp mounts require ¾" – 2" thick surfaces; grommet mount requires hole diameter of ⅜" to 2" wide and accommodates up to 2" thick surfaces.
- Integrated cable management included with each model. Black models ship with all black cable management pieces, Silver models ship with grey wire management but optional white pieces ship in the box and can be installed on site.
- Dual monitor arm supports up to 25" wide monitors. Wider monitors may require use of optional slider mount model.
- Pivot arms are VESA 75mm and 100mm compatible.
- Quick release feature simplifies monitor installation and changes.

Pivot Slider Mount

- Provides 11.8" of horizontal movement.
- Allows for wider monitors to be used on dual monitor arms and sit flush side by side.
- Not compatible with Pivot Heavy Duty Series.

Pivot Heavy Duty Series

- Adaptable and adjustable to user preference the Pivot monitor arm offers a slim and refined design coupled with easy fingertip adjustment.
- Multiple points of adjustment including 360 degree swivel with optional 180 degree lockout, 20.75" extension, and 12" of height adjustment.
- Monitor tilts +25/-25 degrees.
- Tension adjustment at multiple points allows for proper adjustment for monitors weight between 8-35 lbs.
- Model includes grommet and worksurface mounting options.
- Desk clamp mounts require ¾" – 2" thick surfaces; grommet mount requires hole diameter of ⅜" to 2" wide and accommodates up to 2" thick surfaces.
- Integrated cable management included with each model. Black models ship with all black cable management pieces, Silver models ship with grey wire management but optional white pieces ship in the box and can be installed on site.
- Dual monitor arm supports up to 2 monitors weight 4-17.5 lbs each.
- Pivot arms are VESA 75mm and 100mm compatible.
- Quick release feature simplifies monitor installation and changes.

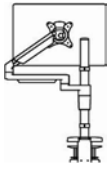
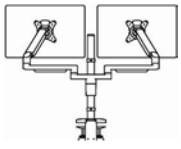
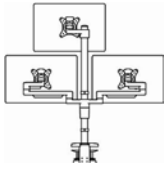
PIVOT MONITOR ARMS	Dynamic Single Post	Dynamic Dual Post	Triple Fixed Post
Allsteel Model:	APASD	APADD	APATF
			
Features:			
Price	\$660	\$923	\$1166
Colors	Silver	Silver	Silver
Monitor Rotation	180°	180°	180°
Monitor Extension	21"	21"	23"
Monitor Tilt Adjustment	+25°/-25°	+25°/-25°	+25°/-25°
Arm Height Adjustment	10.6"	10.6"	N/A
Weight Capacity	6.2 to 17 lbs.	6.2 to 17 lbs. per Arm	17 lbs. per arm
Mounting Option	Grommet and Clamp Mounts	Grommet and Clamp Mounts	Grommet and Clamp Mounts
360° Lockout Feature	Yes	Yes	Yes
VESA Compatibility	75mm and 100mm	75mm and 100mm	75mm and 100mm
Pole Height	17.7"	17.7"	27.5"
Maximum Width per Monitor*	25"	25"	25"
Worksurface Clamp Requirements	7/8" to 2" Thick	7/8" to 2" Thick	7/8" to 2" Thick
Worksurface Grommet Clamp Requirements	7/8" to 2" Thick/Hole Diameter 3/16" to 2"	7/8" to 2" Thick/Hole Diameter 3/16" to 2"	7/8" to 2" Thick/Hole Diameter 3/16" to 2"
Environmental Info	94% Recycled Content	94% Recycled Content	94% Recycled Content

*Use of APACSM Slider Model will allow for wider monitor capabilities

Pivot Post Series

- Adaptable and adjustable to user preference the Pivot monitor arm offers a slim and refined design coupled with easy fingertip adjustment.
- Multiple points of adjustment including 360 degree swivel with 21" extension and 10.6" of height adjustment.
- Monitor tilts +25/-25 degrees.
- Tension adjustment at multiple points allows for proper adjustment for monitors weight between 6.5-17 lbs per arm.
- Model includes grommet and worksurface mounting options.
- Desk clamp mounts require 7/8" – 2" thick surfaces; grommet mount requires hole diameter of 3/16" to 2" wide and accommodates up to 2" thick surfaces.
- Integrated cable management included with each model. Silver color option with grey wire management only.
- Dual monitor arm supports up to 25" wide monitors. Wider monitors may require use of optional slider mount model.
- Single and dual models have a post height of 17.7"; Triple monitor model has a post height of 27.5".
- Pivot arms are VESA 75mm and 100mm compatible.
- Quick release feature simplifies monitor installation and changes.

Pivot Counterweight Kit

- Counterweight Kit to be used with monitors weighing less than 6 lbs.
- Gray color only.
- Counterweight weighs 1 lb. 6 oz.

Pivot Conversion Kits

- Kit allows user to transform single monitor arm (Standard, Heavy Duty, or Post) into Dual Arm configuration
- Available in black and silver, Post arm only available in silver
- Required wire management included
- Once assembled, will aesthetically emulate dual configuration of chosen arm

Accessories — Pivot Monitor Arms

Pivot

For specification information see pages 288-289.

GSA SIN PENDING, GSA SIN 33721

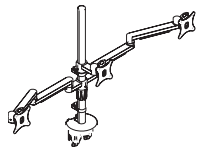
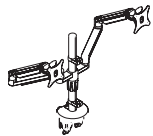
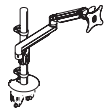
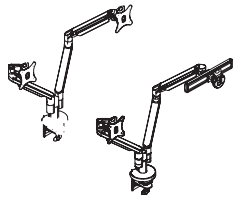
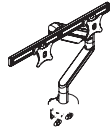

Description	Model	List Price
Pivot Monitor Arms		
Dynamic Single Monitor - Standard Weight	AMASTS <input type="checkbox"/>	\$ 488
Dynamic Single Monitor - Standard Weight for GSA *Silver Only Open for order Fall 2020 – GSA SIN 33721.	AMASTS-G	\$ 576
Dynamic Single Monitor - Heavy Weight	AMASHD <input type="checkbox"/>	\$ 838
Dynamic Dual Monitor with Crossbar	AMADHD <input type="checkbox"/>	\$ 1160
Dynamic Dual Monitor - Standard Weight	AMASD <input type="checkbox"/>	\$ 983
Dynamic Dual Monitor - Standard Weight for GSA *Silver Only **Slider Mount included. Open for order Fall 2020 – GSA SIN 33721.	AMASD-G	\$ 1048
Single Dynamic Post Arm *Silver Only	APASD <input type="checkbox"/>	\$ 660
Double Dynamic Post Arm *Silver Only	APADD <input type="checkbox"/>	\$ 923
Triple Fixed Post Mount *Silver Only	APATF <input type="checkbox"/>	\$ 1166

ACCESSORIES

How to specify —
Select the
Model Number
from above.

1st Option:
Select the Color:
SVR Silver
BLK Black

A | | | | | | | .

| | | |

Example: AMADHD.BLK

Shippable by small-package carrier.

Accessories — Pivot Monitor Arms

Pivot

For specification information see pages 288-289.

Open Market



Description	Model	List Price
Pivot Monitor Arms		
Monitor Arm Sliding Mount	APACSM <input type="checkbox"/>	\$ 233

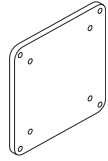

Monitor Arm Counterweight	APACW <input type="checkbox"/>	\$ 55
---------------------------	--------------------------------	-------

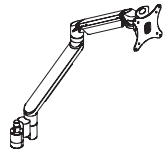

Pivot Monitor Arm Standard Single Conversion Kit	AMASTSCK	\$ 546
--	----------	--------

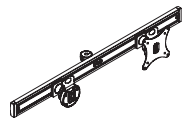

Pivot Monitor Arm Heavy Duty Single Conversion Kit	AMASHDCK	\$ 477
--	----------	--------

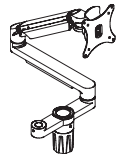

Pivot Single Post Arm Conversion Kit	APASDCK	\$ 695
* Silver Only		

How to specify —
Select the Model Number from above.

1st Option:
Select the Color:
SVR Silver
BLK Black

A | | | | | .

| | | |

Example:

Further Laminate Storage





Standard Options

- Random Keying — The factory will assign key(s) arbitrarily using key numbers from chart below.
- Omit Lock Core — The factory will omit lock cores. Removable lock core kits with specific key number must be ordered to facilitate keying alike in the field.

Replacing Lock Cores

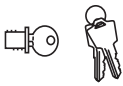
- Lock must be in the unlocked position.
- Insert core removal key and pull core straight out.
- Insert new core with core removable key, hold core into lock and withdraw core removal key.
- Retain original core for future use.

	Random Keying	Omit Lock Core	Key Numbers	Lock Core Kit	Master Key
Further Laminate Storage	X	X	101E-225E	ALKF23C	AMKF22





	Description	Model	List Price
	Brushed Chrome Removable Lock Core Kit** Used on metal and painted wood casegoods product produced after 2/3/97; A980, A990, and A940 Series Vertical Files; Persona Pedestals produced after 8/22/09; Reach Storage units produced after 10/5/09; and Receding Door Overheads produced after 8/1/10. Includes one core, two keys, one core removal tool, adapter and instructions	Key Numbers 101E-225E ALKF23C*** 	\$ 30
 Open Market	Master Key (One key) Available to authorized dealers only on faxed orders. Will open LKF23C, LKF23CE4, LKF24, LKF25EL, and LKF25E4 locks numbered 101E-225E.	AMKF22 	\$ 31

HOW TO ORDER:

NOTE: Numbers 101E-225E are available. Orders without numbers specified will be keyed at random.

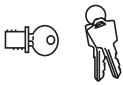
SAMPLE ORDER:

Quantity	Model	Color
6	LKF23C	X121E
1	MKF22	X

	Brushed Chrome Removable Lock Core Kit** Includes one core, two keys, one core removal tool, adapter and instructions	Key Numbers 101N-225N ALKF23CN*** 	\$ 30
 Open Market	Master Key* (One key) Available to authorized dealers only on faxed orders. Will open LKF23CN locks numbered 101N-225N.	AMF22 	\$ 31

*On existing Premium and Asset lateral, use N-Series locks.

** Removable Lock Core Kits are intended for use with Allsteel systems furniture and are approved under GSA SIN 33721. When purchased separately and used without Allsteel systems furniture, those Removable Lock Core Kits marked by (**) are considered Open Market.

*** When purchased separately without a configurable TAA compliant end product, not on GSA contract.

 Shippable by small-package carrier.

Desking & Benching – 02/2024

EASY LOCK PROGRAM

The Allsteel Easy Lock Program simplifies the lock-core ordering process when multiple cores are being specified. The Easy Lock cores can be used with Allsteel storage that currently uses the **ALKF23C** cores (all storage except Receding Door Overheads).

To ensure ease of ordering in different situations the Easy Lock cores can be specified in three different ways — Random, Specified or Sequential.

Random Keying

The Random Keying option is provided for instances where there are multiple orders or phases to a project and the offices need to be keyed alike but the key numbering is not required. With the random keying option key numbers are not specified, however, the core kits will be in sequential order from a random starting point.

Example: There are 15 offices which each have 5 black locks that need to be keyed alike, but the actual key numbers are not important.

This order would look like: **LKFE5BLK.X.15**

This specifies that 15 5-core kits are needed in black with random key numbers.

Specified Keying

The Specified Keying option is provided for the instances where there is a specific key number desired for all of the cores ordered.

Example: There are 10 offices which each have 2 silver locks that need to be keyed-alike with key number 202.

This order would look like: **LKFE2SLV.X202.10**

This specifies that 10 2-core kits are needed in silver with key number 202.

Sequential Keying

Allsteel Sequential Keying option is provided for the instances when there are multiple orders or phases to a project and it is imperative that key numbers are not duplicated.

Example: A multiple phase project has 60 total offices — 40 offices in Phase I, and 20 offices in Phase II. The project manager has expressed a need to have keyed-alike offices but doesn't want any of the offices to use the same key numbers.

The first 40 offices have 4 silver locks each that need to be keyed-alike.

This order would look like: **LKFE4SLV.SEQ/101.40**

This specifies that 40 4-core kits are needed in silver and the starting number is 101.

The second set of 20 offices only have 3 silver locks each that need to be keyed-alike; and it is important which key number starts off the sequence to ensure that no key number is duplicated. It is known that the first key range was key numbers 101-140.

The second order would look like: **LKFE3SLV.SEQ/141.20**

This specifies that 20 3-core kits are needed in silver and key sequence has to start at key number 141.

HOW TO ORDER:

Numbers 101-225 are available. Orders without key numbers specified will be keyed at random.

SAMPLE ORDER FOR EXAMPLES GIVEN:

Model	Key Type	Quantity
LKFE5BLK.	X.	15
LKFE2SLV.	X202.	10
LKFE4SLV.	SEQ/101.	40
LKFE3SLV.	SEQ/141.	20

NOTE: Quantity required is last number in model.option string.

Description	Model / Color	List Price
Easy Lock Lock-Core		
Lock Core Kit — 1 core, 2 keys	LKFE1 _____	\$ 30
Lock Core Kit — 2 cores, 2 keys	LKFE2 _____	\$ 61
Lock Core Kit — 3 cores, 2 keys	LKFE3 _____	\$ 91
Lock Core Kit — 4 cores, 2 keys	LKFE4 _____	\$ 121
Lock Core Kit — 5 cores, 2 keys	LKFE5 _____	\$ 151
Add color suffix to model: SLV Silver, BLK Black, MTS Matte Silver		
Note: One core removal key minimum per order. One additional core removal key per 25 lock-cores will be shipped.		
Note: When purchased separately without a configurable TAA compliant end product, not on GSA contract.		
Master Key		
(One key) Available to authorized dealers only on faxed orders.		
	AMKF22	\$ 31

How to specify using Easy Lock Program:

Step 1 — Count the number of lock cores and color required in each workstation that need to be keyed alike.

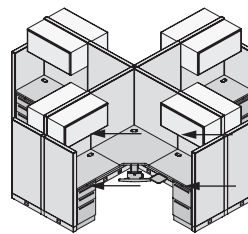

2 overheads with 1 lock-core each = 2
 2 pedestals with 1 lock-core each = 2
Total silver lock-cores per station = 4

Step 2 — Count the total number of workstations needing 4 lock-cores.

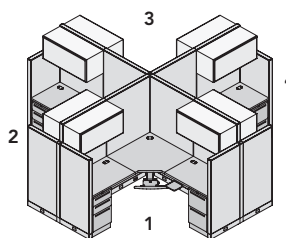

4 total workstations

Step 3 — Specify model number based on total number of lock-cores in a station and quantity of kits based on number of workstations.

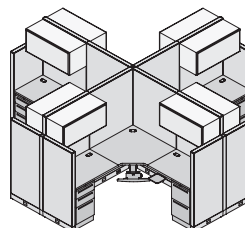

LKFE4SLV.X.4

Lock-Cores per station
 Color of Core
 Number of workstations

Description	Model	P1 Paint List Price	P2 Paint List Price	P3 Paint List Price
Touch-Up Paint — Brush				
Bottle of Touch-Up Paint with Brush — 0.5 oz.	APTK S	\$ 102	\$ 114	\$ 122
Touch-Up Paint — Spray				
Spray Can of Touch-Up Paint — 12 oz.	ARSLCC S	\$ 102	\$ 114	\$ 122

How to specify —
Select the Model Number from above.

A | | | | | | | | | | .

1st Option:

Paint Color:

P1 P2 P3

See available Touch-Up Paint colors listed above. Some colors are limited to brush or spray.

| | | | | | | | | |

Examples: APTK.P02 ARSLCC.P02

S Shippable by small-package carrier.

FSC Certified Wood at Allsteel

Allsteel has received FSC Chain of Custody certification from Scientific Certification Systems (SCS) and can now offer FSC certified products. Forest Stewardship Council (FSC) certification is intended to promote the sustainable harvesting of forests worldwide by setting requirements for the forest and everyone who handles the wood from forest to product. Certification provides a Chain of Customer number that we will pass on to customers who are pursuing LEED certification or who want to ensure that materials used to manufacture our wood products come from a well-managed forest. For more information, please contact Customer Support at 888-255-7833.

Load Capacity for Laminate Wood: Nitch, Horizontal Storage, Pedestals, Mobile Credenzas, and Towers

Product Description	Style	Depth	10"W	12"W	15½"W	24"W	30"W	36"W	42"W	48"W	54"W	60"W	72"W	
7½"H Nitch	Open	15"D				36 lbs.	45 lbs.	54 lbs.	63 lbs.					
Horizontal	Open — Single Sided	15"D				81 lbs.	102 lbs.	122 lbs.						
	Open — Dual Sided	16"D				79 lbs.	99 lbs.	120 lbs.	140 lbs.	161 lbs.	181 lbs.	202 lbs.	243 lbs.	
	Sliding Door — Single Sided	15"D				74 lbs.	94 lbs.	113 lbs.	133 lbs.	152 lbs.	171 lbs.	191 lbs.		
	Sliding Door — Dual Sided	16"D				68 lbs.	85 lbs.	103 lbs.	121 lbs.	138 lbs.	156 lbs.	174 lbs.	209 lbs.	
Pedestal	Open Support	21"D	72 lbs.											
	Open Support w/Bin Left	27"D	79 lbs.											
	Open Support w/Bin Right	27"D	79 lbs.											
	Box Pull-Out Drawer	21"D			10 lbs.				124 lbs.					
		27"D			10 lbs.									
	File Pull-Out Drawer	21"D			35 lbs.									
		27"D			44 lbs.									
Shelf Pull-Out Drawer	21"D			10 lbs.										
	27"D			10 lbs.										
Credenza	Mobile with Hinged Door Left				10 lbs.									
	Mobile with Hinged Door Right	15"D						124 lbs.						
Tower	42½"H Wardrobe Section	21"D		40 lbs.										
		27"D		53 lbs.										
	50"H Wardrobe Section	21"D		68 lbs.										
		27"D		90 lbs.										
	Tower Drawer	21"D		40 lbs.										
		27"D		53 lbs.										

Quantity of Locks for Laminate Wood: Horizontal Storage, Pedestals, Mobile Credenzas, and Towers

NOTE: Open units and shelves are non-locking and are therefore not included in the list below.

Product Description	Style	Depth	10"W	12"W	15½"W	24"W	30"W	36"W	42"W	48"W	54"W	60"W	72"W
Horizontal	Sliding Door — Single Sided	15"D				1 lock	1 lock	1 lock	1 lock	1 lock	1 lock	1 lock	
	Sliding Door — Dual Sided	16"D				2 locks	2 locks	2 locks	2 locks	2 locks	2 locks	2 locks	2 locks
Pedestal	Pull-Out Drawer Support	21"D			1 lock								
		27"D			1 lock								
Credenza	Mobile with Hinged Door Left	15"D						1 lock					
	Mobile with Hinged Door Right	15"D						1 lock					
Tower	42½"H Wardrobe Section	21"D		1 lock									
		27"D		1 lock									
	50"H Wardrobe Section	21"D		1 lock									
		27"D		1 lock									

Interior Dimensions for Nitch, Horizontal Storage, Pedestals, Credenzas, and Towers

Description	Height	Depth	Width	Description	Height	Depth	Width
NITCH				42"H TOWERS			
24"W	5 ⁷ / ₈ "	12 ³ / ₄ "	11 ⁵ / ₈ "	21"D SA Bottom Shelf	5 ¹ / ₂ "	19 ³ / ₈ "	11 ¹ / ₈ "
30"W	5 ⁷ / ₈ "	14 ⁷ / ₈ "	14 ⁵ / ₈ "	21"D SA Top Shelf	5 ¹ / ₂ "	19 ³ / ₈ "	10 ⁵ / ₈ "
36"W	5 ⁷ / ₈ "	14 ⁷ / ₈ "	17 ⁷ / ₈ "	21"D Drawer Bottom	12 ³ / ₈ "	18 ³ / ₈ "	7 ⁷ / ₈ "
42"W Side Cavities	5 ⁷ / ₈ "	14 ⁷ / ₈ "	13 ³ / ₄ "	21"D Drawer Back	19 ³ / ₈ "	5 ³ / ₈ "	7 ⁷ / ₈ "
42"W Center Cavity	5 ⁷ / ₈ "	14 ⁷ / ₈ "	13 ³ / ₈ "	21"D Drawer Shelf	4 ¹ / ₄ "	5 ³ / ₈ "	7"
HORIZONTAL STORAGE				50"H TOWERS			
24"W Open	13 ³ / ₈ "	14 ⁷ / ₈ "	23 ³ / ₄ "	27"D SA Bottom Shelf	5 ¹ / ₂ "	25 ³ / ₈ "	11 ¹ / ₈ "
30"W Open	13 ³ / ₈ "	14 ⁷ / ₈ "	29 ³ / ₄ "	27"D SA Top Shelf	5 ¹ / ₂ "	25 ³ / ₈ "	10 ⁵ / ₈ "
36"W Open	13 ³ / ₈ "	14 ⁷ / ₈ "	35 ³ / ₄ "	27"D Drawer Bottom	12 ³ / ₈ "	24 ³ / ₈ "	7 ⁷ / ₈ "
24"W Slider	13 ³ / ₈ "	14 ¹ / ₈ "	11 ¹ / ₂ "	27"D Drawer Back	19 ³ / ₈ "	11 ³ / ₈ "	7 ⁷ / ₈ "
30"W Slider	13 ³ / ₈ "	14 ¹ / ₈ "	14 ¹ / ₂ "	27"D Drawer Shelf	4 ¹ / ₄ "	11 ³ / ₈ "	7"
36"W Slider	13 ³ / ₈ "	14 ¹ / ₈ "	17 ¹ / ₂ "	50"H TOWERS			
42"W Slider	13 ³ / ₈ "	14 ¹ / ₈ "	20 ¹ / ₂ "	21"D SA Bottom Shelf	4 ¹ / ₈ "	19 ³ / ₈ "	11 ¹ / ₈ "
48"W Slider	13 ³ / ₈ "	14 ¹ / ₈ "	23 ¹ / ₂ "	21"D SA Top Shelf	14 ¹ / ₄ "	19 ³ / ₈ "	10 ⁵ / ₈ "
54"W Slider	13 ³ / ₈ "	14 ¹ / ₈ "	26 ¹ / ₂ "	21"D Drawer Bottom	12 ³ / ₈ "	18 ³ / ₈ "	7 ⁷ / ₈ "
60"W Slider	13 ³ / ₈ "	14 ¹ / ₈ "	29 ¹ / ₂ "	21"D Drawer Back	19 ³ / ₈ "	5 ³ / ₈ "	7 ⁷ / ₈ "
24"W Shared Open	13 ³ / ₈ "	14 ⁷ / ₈ "	11 ¹ / ₂ "	21"D Drawer Shelf	4 ¹ / ₄ "	5 ³ / ₈ "	7"
30"W Shared Open	13 ³ / ₈ "	14 ⁷ / ₈ "	14 ¹ / ₂ "	27"D SA Bottom Shelf	4 ¹ / ₈ "	25 ³ / ₈ "	11 ¹ / ₈ "
36"W Shared Open	13 ³ / ₈ "	14 ⁷ / ₈ "	17 ¹ / ₂ "	27"D SA Top Shelf	14 ¹ / ₄ "	25 ³ / ₈ "	10 ⁵ / ₈ "
42"W Shared Open	13 ³ / ₈ "	14 ⁷ / ₈ "	20 ¹ / ₂ "	27"D Drawer Bottom	12 ³ / ₈ "	24 ³ / ₈ "	7 ⁷ / ₈ "
48"W Shared Open	13 ³ / ₈ "	14 ⁷ / ₈ "	23 ¹ / ₂ "	27"D Drawer Back	19 ³ / ₈ "	11 ³ / ₈ "	7 ⁷ / ₈ "
54"W Shared Open	13 ³ / ₈ "	14 ⁷ / ₈ "	26 ¹ / ₂ "	27"D Drawer Shelf	4 ¹ / ₄ "	11 ³ / ₈ "	7"
60"W Shared Open	13 ³ / ₈ "	14 ⁷ / ₈ "	29 ¹ / ₂ "	Tower File Hanger	11 ¹ / ₄ "	12 ³ / ₄ "	7 ⁷ / ₈ "
66"W Shared Open	13 ³ / ₈ "	14 ⁷ / ₈ "	32 ¹ / ₂ "	(Same for all Towers)			
72"W Shared Open	13 ³ / ₈ "	14 ⁷ / ₈ "	35 ¹ / ₂ "				
24"W Shared Slider	13 ³ / ₈ "	12 ⁷ / ₈ "	11 ¹ / ₂ "				
30"W Shared Slider	13 ³ / ₈ "	12 ⁷ / ₈ "	14 ¹ / ₂ "				
36"W Shared Slider	13 ³ / ₈ "	12 ⁷ / ₈ "	17 ¹ / ₂ "				
42"W Shared Slider	13 ³ / ₈ "	12 ⁷ / ₈ "	20 ¹ / ₂ "				
48"W Shared Slider	13 ³ / ₈ "	12 ⁷ / ₈ "	23 ¹ / ₂ "				
54"W Shared Slider	13 ³ / ₈ "	12 ⁷ / ₈ "	26 ¹ / ₂ "				
60"W Shared Slider	13 ³ / ₈ "	12 ⁷ / ₈ "	29 ¹ / ₂ "				
66"W Shared Slider	13 ³ / ₈ "	12 ⁷ / ₈ "	32 ¹ / ₂ "				
72"W Shared Slider	13 ³ / ₈ "	12 ⁷ / ₈ "	35 ¹ / ₂ "				
PEDESTALS							
Open — Bottom Shelf	12 ³ / ₈ "	19 ³ / ₄ "	8 ³ / ₈ "				
Open — Top Shelf	12 ³ / ₈ "	20 ¹ / ₈ "	8 ³ / ₈ "				
Side Access — Bottom Shelf	12 ³ / ₈ "	12 ⁷ / ₈ "	8 ³ / ₈ "				
Side Access — Top Shelf	12 ³ / ₈ "	12 ¹ / ₂ "	8 ³ / ₈ "				
Side Access — Back Area	26 ¹ / ₈ "	12 ³ / ₄ "	9 ¹ / ₈ "				
Pull-Out Drawer — Shelf	4"	12 ³ / ₈ "	14 ¹ / ₈ "				
Pull-Out Drawer — Box	2 ³ / ₄ "	14 ¹ / ₂ "	12 ¹ / ₈ "				
21"D Pull-Out Drawer — File	9 ¹ / ₈ "	14 ¹ / ₂ "	12 ¹ / ₈ "				
27"D Pull-Out Drawer — File	9 ¹ / ₈ "	19"	12 ¹ / ₈ "				
CREDENZAS							
Bottom Shelf	10 ¹ / ₄ "	14 ³ / ₈ "	22 ³ / ₈ "				
Top Shelf	4 ³ / ₄ "	13 ⁵ / ₈ "	22 ³ / ₈ "				
Cubby	15 ¹ / ₂ "	14 ³ / ₈ "	11 ¹ / ₄ "				

Model Number	Description	Grade G	Grade H	Grade J
Elevated Table Mounted Screen — see page 112				
U6TTS1330F	13"H x 30"W Screen	\$ 1181	\$ 1260	\$ 1338
U6TTS1336F	13"H x 36"W Screen	\$ 1234	\$ 1316	\$ 1399
U6TTS1342F	13"H x 42"W Screen	\$ 1323	\$ 1419	\$ 1515
U6TTS1348F	13"H x 48"W Screen	\$ 1413	\$ 1525	\$ 1636
U6TTS1354F	13"H x 54"W Screen	\$ 1510	\$ 1634	\$ 1759
U6TTS1360F	13"H x 60"W Screen	\$ 1620	\$ 1758	\$ 1897
U6TTS2030F 20½"H x 30"W Screen \$ 1407 \$ 1515 \$ 1623				
U6TTS2036F 20½"H x 36"W Screen \$ 1517 \$ 1648 \$ 1780				
U6TTS2042F 20½"H x 42"W Screen \$ 1630 \$ 1784 \$ 1936				
U6TTS2048F 20½"H x 48"W Screen \$ 1783 \$ 1958 \$ 2132				
U6TTS2054F 20½"H x 54"W Screen \$ 1949 \$ 2144 \$ 2339				
U6TTS2060F 20½"H x 60"W Screen \$ 2084 \$ 2301 \$ 2520				
Stride Tackable Fabric Lateral Screens — see page 118				
Z6BL0827F	8"H x 27"D Screen	\$ 904	\$ 933	\$ 962
Z6BL0830F	8"H x 30"D Screen	\$ 939	\$ 969	\$ 1002
Z6BL0836F	8"H x 36"D Screen	\$ 1047	\$ 1084	\$ 1121
Stride Tackable Fabric Accessory for Cantilever Storage — see page 210				
ZS42SF	for use w/ 42½"H unit	\$ 794	\$ 880	\$ 967
ZS50SF	for use w/ 50"H unit	\$ 1042	\$ 1176	\$ 1308

Model Number	Description	Grade G	Grade H	Grade J
Altitude® A8 Screen Kits — see page 265				
FDSC48U	48"W	\$ 2257	\$ 2282	\$ 2344
FDSC54U	54"W	\$ 2335	\$ 2361	\$ 2426
FDSC60U	60"W	\$ 2405	\$ 2431	\$ 2497
FDSC66U	66"W	\$ 2547	\$ 2575	\$ 2647
FDSC72U	72"W	\$ 2742	\$ 2771	\$ 2849
FDSC48LL 48"W \$ 1453 \$ 1468 \$ 1504				
FDSC48LR 48"W \$ 1453 \$ 1468 \$ 1504				
FDSC54LL 54"W \$ 1706 \$ 1724 \$ 1767				
FDSC54LR 54"W \$ 1706 \$ 1724 \$ 1767				
FDSC60LL 60"W \$ 1785 \$ 1803 \$ 1849				
FDSC60LR 60"W \$ 1785 \$ 1803 \$ 1849				
FDSC66LL 66"W \$ 2140 \$ 2163 \$ 2223				
FDSC66LR 66"W \$ 2140 \$ 2163 \$ 2223				
FDSC72LL 72"W \$ 2254 \$ 2280 \$ 2342				
FDSC72LR 72"W \$ 2254 \$ 2280 \$ 2342				
FDSC48R 48"W \$ 1404 \$ 1420 \$ 1454				
FDSC54R 54"W \$ 1439 \$ 1454 \$ 1490				
FDSC60R 60"W \$ 1549 \$ 1564 \$ 1602				
FDSC66R 66"W \$ 1791 \$ 1811 \$ 1860				
FDSC72R 72"W \$ 1908 \$ 1929 \$ 1980				

Cross Reference Index

by Model Number

INDEX

Model	Page	Model	Page	Model	Page	Model	Page	Model	Page
873600.....	53, 264	A873501.....	52, 263	AAS1360SFS.....	178	AAS2072DFS.....	172	AAS3449USF.....	44
A6BLUETOOTH.....	257	A873502.....	52, 263	AAS1364DFS.....	172	AAS2072SFS.....	178	AAS3455USF.....	44
A6CASTER.....	257	A873503.....	52, 263	AAS1366BSF.....	171	AAS2625USF.....	44	AAS3461USF.....	44
A6G1GLIDE.....	257	A873504.....	52, 263	AAS1366DFS.....	172	AAS2627USF.....	44	AAS3467USF.....	44
A6MREC3S2LCF.....	256	A873506.....	52, 263	AAS1366MPD.....	177	AAS2630USF.....	44	AAS4127USF.....	44
A6MREC3S2LTF.....	256	A876072.....	263	AAS1366SFS.....	178	AAS2631USF.....	44	AAS4130USF.....	44
A6MREC3S3LCF.....	257	A876072A.....	263	AAS1370DFS.....	172	AAS2633USF.....	44	AAS4133USF.....	44
A6MREC3S3LTF.....	257	A877012.....	52, 103, 263	AAS1372BSF.....	171	AAS2637USF.....	44	AAS4139USF.....	44
A6REC2S2LCF.....	256	AABPWRMOD.....	40,	AAS1372DFS.....	172	AAS2639USF.....	44	ACD1.....	282
A6REC2S2LTF.....	256		261.2, 287	AAS1372MPD.....	177	AAS2643USF.....	44	ACMCM21O.....	228
A6REC2S3LCF.....	257	AAPAC.....	281.1	AAS1372SFS.....	178	AAS2649USF.....	44	ACMCM21T.....	228
A6REC2S3LTF.....	257	AAPACM2.....	285	AAS1520.....	119, 267	AAS2655USF.....	44	ACPU1.....	276
A6REC3S2LCF.....	256	AAPAH.....	281.1	AAS1548.....	119, 267	AAS2661USF.....	44	ACPWRMOD.....	287
A6REC3S2LTF.....	256	AAPAHF.....	281.1	AAS1554.....	119, 267	AAS2667USF.....	44	AECH.....	120, 226, 267
A6REC3S3LCF.....	257	AAPAMP.....	281.1	AAS1560.....	119, 267	AAS2721LDF.....	174	AEHF.....	120, 226, 267
A6REC3S3LTF.....	257	AAPASB.....	281.1	AAS1566.....	119, 267	AAS2721LDS.....	176	AELT.....	226
A6SLDGLIDE.....	257	AAPASH.....	281.1	AAS1572.....	119, 267	AAS2721LDT.....	175	AESC18.....	221
A9CLWMC.....	144, 261, 287.2	AAPAST.....	281.1	AAS2021LDF.....	174	AAS2722LHF.....	174	AESC24.....	221
A5622ELS.....	260	AAS1321LDF.....	174	AAS2021LDS.....	176	AAS2722LHS.....	176	AESS.....	120, 226, 267
A5622ERS.....	260	AAS1321LDS.....	176	AAS2021LDT.....	175	AAS2722LHT.....	175	AEST.....	226
A5722ELS.....	260	AAS1321LDT.....	175	AAS2022LHF.....	174	AAS2724LDF.....	174	AF5CCS5424.....	259
A5722ERS.....	260	AAS1322LHF.....	174	AAS2022LHS.....	176	AAS2724LDS.....	176	AF5CCS5430.....	259
A5822ELS.....	260	AAS1322LHS.....	176	AAS2022LHT.....	175	AAS2724LDT.....	175	AF5CCS603624LD.....	260
A5822ERS.....	260	AAS1322LHT.....	175	AAS2024BSF.....	171	AAS2727LDF.....	174	AF5CCS603624RD.....	260
A5922ELS.....	260	AAS1324BSF.....	171	AAS2024LDF.....	174	AAS2727LDS.....	176	AF5CCS604824LD.....	260
A5922ERS.....	260	AAS1324LDF.....	174	AAS2024LDS.....	176	AAS2727LDT.....	175	AF5CCS604824RD.....	260
A870070.....	53, 103	AAS1324LDS.....	176	AAS2024LDT.....	175	AAS2728LHF.....	174	AF5CCS604830LD.....	260
A870824.....	285	AAS1324LDT.....	175	AAS2027LDF.....	174	AAS2728LHS.....	176	AF5CCS604830RD.....	260
A870824CH.....	285	AAS1327LDF.....	174	AAS2027LDS.....	176	AAS2728LHT.....	175	AF5CCS723624LD.....	260
A870830.....	285	AAS1327LDS.....	176	AAS2027LDT.....	175	AAS2730LDF.....	174	AF5CCS723624RD.....	260
A870830CH.....	285	AAS1327LDT.....	175	AAS2028LHF.....	174	AAS2730LDS.....	176	AF5CCS724824LD.....	260
A870842.....	285	AAS1328LHF.....	174	AAS2028LHS.....	176	AAS2730LDT.....	175	AF5CCS724824RD.....	260
A870842CH.....	285	AAS1328LHS.....	176	AAS2028LHT.....	175	AAS2734DFS.....	173	AF5CCS724830LD.....	260
A870860.....	285	AAS1328LHT.....	175	AAS2030BSF.....	171	AAS2736DFS.....	173	AF5CCS724830RD.....	260
A870860CH.....	285	AAS1330BSF.....	171	AAS2030LDF.....	174	AAS2736LDF.....	174	AF5RND4824.....	258
A871124.....	262	AAS1330LDF.....	174	AAS2030LDS.....	176	AAS2736LDS.....	176	AF5RND4830.....	258
A871124A.....	262	AAS1330LDS.....	176	AAS2030LDT.....	175	AAS2736LDT.....	175	AF5RND5424.....	258
A871148.....	262	AAS1330LDT.....	175	AAS2034DFS.....	172	AAS2740DFS.....	173	AF5RND5430.....	258
A871148A.....	262	AAS1330MPD.....	177	AAS2036BSF.....	171	AAS2742DFS.....	173	AF5RND6024D.....	258
A871160.....	262	AAS1334DFS.....	172	AAS2036DFS.....	172	AAS2746DFS.....	173	AF5RND6030D.....	258
A871160A.....	262	AAS1336BSF.....	171	AAS2036LDF.....	174	AAS2748DFS.....	173	AF5RND6624D.....	258
A871172.....	262	AAS1336DFS.....	172	AAS2036LDS.....	176	AAS2752DFS.....	173	AF5RND6630D.....	258
A871172A.....	262	AAS1336LDF.....	174	AAS2036LDT.....	175	AAS2754DFS.....	173	AF5RND7224D.....	258
A871248.....	262	AAS1336LDS.....	176	AAS2036SFS.....	178	AAS2758DFS.....	173	AF5RND7230D.....	258
A871248A.....	262	AAS1336LDT.....	175	AAS2040DFS.....	172	AAS2760DFS.....	173	AF5RND7824D.....	258
A871254.....	262	AAS1336MPD.....	177	AAS2042BSF.....	171	AAS2764DFS.....	173	AF5RND7830D.....	258
A871254A.....	262	AAS1336SFS.....	178	AAS2042DFS.....	172	AAS2766DFS.....	173	AF5RND8424D.....	258
A871260.....	262	AAS1340DFS.....	172	AAS2042SFS.....	178	AAS2770DFS.....	173	AF5RND8430D.....	258
A871260A.....	262	AAS1342BSF.....	171	AAS2046DFS.....	172	AAS2772DFS.....	173	AF5RND9024D.....	258
A871266.....	262	AAS1342DFS.....	172	AAS2048BSF.....	171	AAS2824BSF.....	171	AF5RND9030D.....	258
A871266A.....	262	AAS1342MPD.....	177	AAS2048DFS.....	172	AAS2830BSF.....	171	AF5RND9624D.....	258
A871272.....	262	AAS1342SFS.....	178	AAS2048SFS.....	178	AAS2836BSF.....	171	AF5RND9630D.....	258
A871272A.....	262	AAS1346DFS.....	172	AAS2052DFS.....	172	AAS2842BSF.....	171	AF5RS3624U.....	259
A871400.....	53, 263	AAS1348BSF.....	171	AAS2054BSF.....	171	AAS2848BSF.....	171	AF5RS3630U.....	259
A871400A.....	53, 263	AAS1348DFS.....	172	AAS2054DFS.....	172	AAS2854BSF.....	171	AF5RS4224U.....	259
A871501A.....	263	AAS1348MPD.....	177	AAS2054SFS.....	178	AAS2860BSF.....	171	AF5RS4230U.....	259
A871502A.....	263	AAS1348SFS.....	178	AAS2058DFS.....	172	AAS2866BSF.....	171	AF5RS4824.....	258
A871503A.....	263	AAS1352DFS.....	172	AAS2060BSF.....	171	AAS2872BSF.....	171	AF5RS4824U.....	259
A871601.....	52, 263	AAS1354BSF.....	171	AAS2060DFS.....	172	AAS3425USF.....	44	AF5RS4830.....	258
A871601A.....	263	AAS1354DFS.....	172	AAS2060SFS.....	178	AAS3427USF.....	44	AF5RS4830U.....	259
A871912.....	52, 103, 263	AAS1354MPD.....	177	AAS2064DFS.....	172	AAS3430USF.....	44	AF5RS5424.....	258
A871912A.....	263	AAS1354SFS.....	178	AAS2066BSF.....	171	AAS3431USF.....	44	AF5RS5424U.....	259
A871918.....	52, 103, 263	AAS1358DFS.....	172	AAS2066DFS.....	172	AAS3433USF.....	44	AF5RS5430.....	258
A871918A.....	263	AAS1360BSF.....	171	AAS2066SFS.....	178	AAS3437USF.....	44	AF5RS5430U.....	259
A871972.....	52, 103, 263	AAS1360DFS.....	172	AAS2070DFS.....	172	AAS3439USF.....	44	AF5RS6024D.....	258
A871972A.....	263	AAS1360MPD.....	177	AAS2072BSF.....	171	AAS3443USF.....	44	AF5RS6024UD.....	259

Cross Reference Index

by Model Number

INDEX

Model	Page	Model	Page	Model	Page	Model	Page	Model	Page
AF5RS6030D.....	258	AFS1324LDT.....	159	AFS2024LDF.....	158	AFS2722LHS.....	160	AFS3434DTS.....	157
AF5RS6030UD.....	259	AFS1327LDF.....	158	AFS2024LDS.....	160	AFS2722LHT.....	159	AFS3436DAS.....	161
AF5RS6624D.....	258	AFS1327LDS.....	160	AFS2024LDT.....	159	AFS2724LDF.....	158	AFS3436DTS.....	157
AF5RS6624UD.....	259	AFS1327LDT.....	159	AFS2027LDF.....	158	AFS2727LDF.....	158	AFS3437USF.....	42
AF5RS6630D.....	258	AFS1328LHF.....	158	AFS2027LDS.....	160	AFS2728LHF.....	158	AFS3439USF.....	42
AF5RS6630UD.....	259	AFS1328LHS.....	160	AFS2027LDT.....	159	AFS2728LHS.....	160	AFS3440DAS.....	161
AF5RS7224D.....	258	AFS1328LHT.....	159	AFS2028LHF.....	158	AFS2728LHT.....	159	AFS3440DTS.....	157
AF5RS7224UD.....	259	AFS1330BMF.....	155	AFS2028LHS.....	160	AFS2730LDF.....	158	AFS3442DAS.....	161
AF5RS7230D.....	258	AFS1330BSF.....	155	AFS2028LHT.....	159	AFS2734DAS.....	161	AFS3442DTS.....	157
AF5RS7230UD.....	259	AFS1330LDF.....	158	AFS2030BMF.....	155	AFS2734DFS.....	156	AFS3443USF.....	42
AF5RS7824D.....	258	AFS1330LDS.....	160	AFS2030BSF.....	155	AFS2734DTS.....	157	AFS3446DAS.....	161
AF5RS7824UD.....	259	AFS1330LDT.....	159	AFS2030LDF.....	158	AFS2736DAS.....	161	AFS3446DTS.....	157
AF5RS7830D.....	258	AFS1330MPD.....	162	AFS2030LDS.....	160	AFS2736DFS.....	156	AFS3448DAS.....	161
AF5RS7830UD.....	259	AFS1334DFS.....	156	AFS2030LDT.....	159	AFS2736DTS.....	157	AFS3448DTS.....	157
AF5RS8424D.....	258	AFS1336BMF.....	155	AFS2034DFS.....	156	AFS2736LDF.....	158	AFS3449USF.....	42
AF5RS8424UD.....	259	AFS1336BSF.....	155	AFS2036BMF.....	155	AFS2740DAS.....	161	AFS3452DAS.....	161
AF5RS8430D.....	258	AFS1336DFS.....	156	AFS2036BFS.....	155	AFS2740DFS.....	156	AFS3452DTS.....	157
AF5RS8430UD.....	259	AFS1336LDF.....	158	AFS2036DFS.....	156	AFS2740DTS.....	157	AFS3454DAS.....	161
AF5RS9024D.....	258	AFS1336LDS.....	160	AFS2036LDF.....	158	AFS2742DAS.....	161	AFS3454DTS.....	157
AF5RS9024UD.....	259	AFS1336LDT.....	159	AFS2036LDS.....	160	AFS2742DFS.....	156	AFS3455USF.....	42
AF5RS9030D.....	258	AFS1336MPD.....	162	AFS2036LDT.....	159	AFS2742DTS.....	157	AFS3458DAS.....	161
AF5RS9030UD.....	259	AFS1336SFS.....	163	AFS2036SFS.....	163	AFS2746DAS.....	161	AFS3458DTS.....	157
AF5RS9624D.....	258	AFS1340DFS.....	156	AFS2040DFS.....	156	AFS2746DFS.....	156	AFS3460DAS.....	161
AF5RS9624UD.....	259	AFS1342BMF.....	155	AFS2042BMF.....	155	AFS2746DTS.....	157	AFS3460DTS.....	157
AF5RS9630D.....	258	AFS1342BSF.....	155	AFS2042BSF.....	155	AFS2748DAS.....	161	AFS3461USF.....	42
AF5RS9630UD.....	259	AFS1342DFS.....	156	AFS2042DFS.....	156	AFS2748DFS.....	156	AFS3464DAS.....	161
AF5120S4224D.....	259	AFS1342MPD.....	162	AFS2042SFS.....	163	AFS2748DTS.....	157	AFS3464DTS.....	157
AF5120S4230D.....	259	AFS1342SFS.....	163	AFS2046DFS.....	156	AFS2752DAS.....	161	AFS3466DAS.....	161
AF5120S4824D.....	259	AFS1346DFS.....	156	AFS2048BMF.....	155	AFS2752DFS.....	156	AFS3466DTS.....	157
AF5120S4830D.....	259	AFS1348BMF.....	155	AFS2048BSF.....	155	AFS2752DTS.....	157	AFS3467USF.....	42
AF5120S5424D.....	259	AFS1348BSF.....	155	AFS2048DFS.....	156	AFS2754DAS.....	161	AFS3470DAS.....	161
AF5120S5430D.....	259	AFS1348DFS.....	156	AFS2048SFS.....	163	AFS2754DFS.....	156	AFS3470DTS.....	157
AFAMS2048LH.....	119	AFS1348MPD.....	162	AFS2052DFS.....	156	AFS2754DTS.....	157	AFS3472DAS.....	161
AFAMS2048RH.....	119	AFS1348SFS.....	163	AFS2054BMF.....	155	AFS2758DAS.....	161	AFS3472DTS.....	157
AFAMS2048SS.....	119	AFS1352DFS.....	156	AFS2054BSF.....	155	AFS2758DFS.....	156	AGS1136MPD.....	170
AFAMS2048US.....	119	AFS1354BMF.....	155	AFS2054DFS.....	156	AFS2758DTS.....	157	AGS1142MPD.....	170
AFAMS2054LH.....	119	AFS1354BSF.....	155	AFS2054SFS.....	163	AFS2760DAS.....	161	AGS1148MPD.....	170
AFAMS2054RH.....	119	AFS1354DFS.....	156	AFS2058DFS.....	156	AFS2760DFS.....	156	AGS1154MPD.....	170
AFAMS2054SS.....	119	AFS1354MPD.....	162	AFS2060BMF.....	155	AFS2760DTS.....	157	AGS1160MPD.....	170
AFAMS2054US.....	119	AFS1354SFS.....	163	AFS2060BSF.....	155	AFS2764DAS.....	161	AGS1321LDF.....	167
AFAMS2060LH.....	119	AFS1358DFS.....	156	AFS2060DFS.....	156	AFS2764DFS.....	156	AGS1321LDS.....	169
AFAMS2060RH.....	119	AFS1360BMF.....	155	AFS2060SFS.....	163	AFS2764DTS.....	157	AGS1321LDT.....	168
AFAMS2060SS.....	119	AFS1360BSF.....	155	AFS2064DFS.....	156	AFS2766DAS.....	161	AGS1322LHF.....	167
AFAMS2060US.....	119	AFS1360DFS.....	156	AFS2066BMF.....	155	AFS2766DFS.....	156	AGS1322LHS.....	169
AFAMS2066LH.....	119	AFS1360MPD.....	162	AFS2066BSF.....	155	AFS2766DTS.....	157	AGS1322LHT.....	168
AFAMS2066RH.....	119	AFS1360SFS.....	163	AFS2066DFS.....	156	AFS2770DAS.....	161	AGS1324BSF.....	164
AFAMS2066SS.....	119	AFS1364DFS.....	156	AFS2066SFS.....	163	AFS2770DFS.....	156	AGS1324LDF.....	167
AFAMS2066US.....	119	AFS1366BMF.....	155	AFS2070DFS.....	156	AFS2770DTS.....	157	AGS1324LDS.....	169
AFAMS2072LH.....	119	AFS1366BSF.....	155	AFS2072BMF.....	155	AFS2772DAS.....	161	AGS1324LDT.....	168
AFAMS2072RH.....	119	AFS1366DFS.....	156	AFS2072BSF.....	155	AFS2772DFS.....	156	AGS1327LDF.....	167
AFAMS2072SS.....	119	AFS1366MPD.....	162	AFS2072DFS.....	156	AFS2772DTS.....	157	AGS1327LDS.....	169
AFAMS2072US.....	119	AFS1366SFS.....	163	AFS2072SFS.....	163	AFS2824BSF.....	155	AGS1327LDT.....	168
AFDTRGH20.....	144, 261, 287.2	AFS1370DFS.....	156	AFS2625USF.....	42	AFS2830BSF.....	155	AGS1328LHF.....	167
AFDTRGH32.....	144, 261, 287.2	AFS1372BMF.....	155	AFS2627USF.....	42	AFS2836BSF.....	155	AGS1328LHS.....	169
		AFS1372BSF.....	155	AFS2630USF.....	42	AFS2842BSF.....	155	AGS1328LHT.....	168
		AFS1372DFS.....	156	AFS2631USF.....	42	AFS2848BSF.....	155	AGS1330BSF.....	164
AFS1321LDF.....	158	AFS1372MPD.....	162	AFS2633USF.....	42	AFS2854BSF.....	155	AGS1330LDF.....	167
AFS1321LDS.....	160	AFS1372SFS.....	163	AFS2637USF.....	42	AFS2860BSF.....	155	AGS1330LDS.....	169
AFS1321LDT.....	159	AFS2021LDF.....	158	AFS2639USF.....	42	AFS2866BSF.....	155	AGS1330LDT.....	168
AFS1322LHF.....	158	AFS2021LDS.....	160	AFS2643USF.....	42	AFS2872BSF.....	155	AGS1334DFS.....	165
AFS1322LHS.....	160	AFS2021LDT.....	159	AFS2649USF.....	42	AFS3425USF.....	42	AGS1336BSF.....	164
AFS1322LHT.....	159	AFS2022LHF.....	158	AFS2655USF.....	42	AFS3427USF.....	42	AGS1336DFS.....	165
AFS1324BMF.....	155	AFS2022LHS.....	160	AFS2661USF.....	42	AFS3430USF.....	42	AGS1336LDF.....	167
AFS1324BSF.....	155	AFS2022LHT.....	159	AFS2667USF.....	42	AFS3431USF.....	42	AGS1336LDS.....	169
AFS1324LDF.....	158	AFS2024BMF.....	155	AFS2721LDF.....	158	AFS3433USF.....	42	AGS1336LDT.....	168
AFS1324LDS.....	160	AFS2024BSF.....	155	AFS2722LHF.....	158	AFS3434DAS.....	161	AGS1340DFS.....	165

Cross Reference Index

by Model Number

INDEX

Model	Page	Model	Page	Model	Page	Model	Page	Model	Page
AGS1342BSF	164	AGS2084BSF	164	ALS1328LHT	183	ALS2046DFS	180	ALS2848BSF	179
AGS1342DFS	165	AGS2090BSF	164	ALS1330BSF	179	ALS2048BSF	179	ALS2854BSF	179
AGS1346DFS	165	AGS2096BSF	164	ALS1330LDF	182	ALS2048DFS	180	ALS2860BSF	179
AGS1348BSF	164	AGS2536DFS	166	ALS1330LDS	184	ALS2052DFS	180	ALS2866BSF	179
AGS1348DFS	165	AGS2542DFS	166	ALS1330LDT	183	ALS2054BSF	179	ALS2872BSF	179
AGS1352DFS	165	AGS2548DFS	166	ALS1330MPD	185	ALS2054DFS	180	ALS3425USF	47
AGS1354BSF	164	AGS2554DFS	166	ALS1334DFS	180	ALS2058DFS	180	ALS3427USF	47
AGS1354DFS	165	AGS2560DFS	166	ALS1336BSF	179	ALS2060BSF	179	ALS3430USF	47
AGS1358DFS	165	AGS2625USF	45	ALS1336DFS	180	ALS2060DFS	180	ALS3431USF	47
AGS1360BSF	164	AGS2627USF	45	ALS1336LDF	182	ALS2064DFS	180	ALS3433USF	47
AGS1360DFS	165	AGS2630USF	45	ALS1336LDS	184	ALS2066BSF	179	ALS3437USF	47
AGS1364DFS	165	AGS2631USF	45	ALS1336LDT	183	ALS2066DFS	180	ALS3439USF	47
AGS1366BSF	164	AGS2633USF	45	ALS1336MPD	185	ALS2070DFS	180	ALS3443USF	47
AGS1366DFS	165	AGS2637USF	45	ALS1340DFS	180	ALS2072BSF	179	ALS3449USF	47
AGS1370DFS	165	AGS2639USF	45	ALS1342BSF	179	ALS2072DFS	180	ALS3455USF	47
AGS1372BSF	164	AGS2643USF	45	ALS1342DFS	180	ALS2625USF	47	ALS3461USF	47
AGS1372DFS	165	AGS2649USF	45	ALS1342MPD	185	ALS2627USF	47	ALS3467USF	47
AGS1378BSF	164	AGS2655USF	45	ALS1346DFS	180	ALS2630USF	47	ALS4127USF	47
AGS1384BSF	164	AGS3425USF	45	ALS1348BSF	179	ALS2631USF	47	ALS4130USF	47
AGS1390BSF	164	AGS3427USF	45	ALS1348DFS	180	ALS2633USF	47	ALS4133USF	47
AGS1396BSF	164	AGS3430USF	45	ALS1348MPD	185	ALS2637USF	47	ALS4139USF	47
AGS2021LDF	167	AGS3431USF	45	ALS1352DFS	180	ALS2639USF	47	AMADHD	290
AGS2021LDS	169	AGS3433USF	45	ALS1354BSF	179	ALS2643USF	47	AMASD	290
AGS2021LDT	168	AGS3437USF	45	ALS1354DFS	180	ALS2649USF	47	AMASD-G	290
AGS2022LHF	167	AGS3439USF	45	ALS1354MPD	185	ALS2655USF	47	AMASHD	290
AGS2022LHS	169	AGS3443USF	45	ALS1358DFS	180	ALS2661USF	47	AMASHDCK	291
AGS2022LHT	168	AGS3449USF	45	ALS1360BSF	179	ALS2667USF	47	AMASTS	290
AGS2024BSF	164	AGS3455USF	45	ALS1360DFS	180	ALS2721LDF	182	AMASTSCK	291
AGS2024LDF	167	AGSAUHK	272	ALS1360MPD	185	ALS2721LDS	184	AMASTS-G	290
AGS2024LDS	169	AHATPWRMOD2S	40.1,	ALS1364DFS	180	ALS2721LDT	183	AMF22	292
AGS2024LDT	168		261.3, 287.4	ALS1366BSF	179	ALS2722LHF	182	AMKF22	292, 293
AGS2027LDF	167	AHATPWRMOD3S	40.1,	ALS1366DFS	180	ALS2722LHS	184	AMPCHASE	287.3
AGS2027LDS	169		261.3, 287.4	ALS1366MPD	185	ALS2722LHT	183	AMS2048LH	266
AGS2027LDT	168	AHATPWRMODF	40.1,	ALS1370DFS	180	ALS2724LDF	182	AMS2048RH	266
AGS2028LHF	167		261.3, 287.4	ALS1372BSF	179	ALS2724LDS	184	AMS2048SS	267
AGS2028LHS	169	AJTRGH24	261, 287.2	ALS1372DFS	180	ALS2724LDT	183	AMS2048US	266
AGS2028LHT	168	AJTRGH36	261, 287.2	ALS1372MPD	185	ALS2727LDF	182	AMS2054LH	266
AGS2030BSF	164	AKMH	276	ALS2021LDF	182	ALS2727LDS	184	AMS2054RH	266
AGS2030LDF	167	AKTLONG	276	ALS2021LDS	184	ALS2727LDT	183	AMS2054SS	267
AGS2030LDS	169	AKTMID	276	ALS2021LDT	183	ALS2728LHF	182	AMS2054US	266
AGS2030LDT	168	AKTSHORT	276	ALS2022LHF	182	ALS2728LHS	184	AMS2060LH	266
AGS2034DFS	165	ALED17U	285	ALS2022LHS	184	ALS2728LHT	183	AMS2060RH	266
AGS2036BSF	164	ALED17U60	285	ALS2022LHT	183	ALS2730LDF	182	AMS2060SS	267
AGS2036DFS	165	ALED17UJMP30	285	ALS2024BSF	179	ALS2730LDS	184	AMS2060US	266
AGS2036LDF	167	ALED31U	285	ALS2024LDF	182	ALS2730LDT	183	AMS2066LH	266
AGS2036LDS	169	ALED31U60	285	ALS2024LDS	184	ALS2734DFS	181	AMS2066RH	266
AGS2036LDT	168	ALED31UJMP30	285	ALS2024LDT	183	ALS2736DFS	181	AMS2066SS	267
AGS2040DFS	165	ALEDOCC	285	ALS2027LDF	182	ALS2736LDF	182	AMS2066US	266
AGS2042BSF	164	ALEGCHASE26	287.3	ALS2027LDS	184	ALS2736LDS	184	AMS2072LH	266
AGS2042DFS	165	ALKF23C	292	ALS2027LDT	183	ALS2736LDT	183	AMS2072RH	266
AGS2046DFS	165	ALKF23CN	292	ALS2028LHF	182	ALS2740DFS	181	AMS2072SS	267
AGS2048BSF	164	ALS1321LDF	182	ALS2028LHS	184	ALS2742DFS	181	AMS2072US	266
AGS2048DFS	165	ALS1321LDS	184	ALS2028LHT	183	ALS2746DFS	181	AMS3248LH	266
AGS2052DFS	165	ALS1321LDT	183	ALS2030BSF	179	ALS2748DFS	181	AMS3248RH	266
AGS2054BSF	164	ALS1322LHF	182	ALS2030LDF	182	ALS2752DFS	181	AMS3248SS	267
AGS2054DFS	165	ALS1322LHS	184	ALS2030LDS	184	ALS2754DFS	181	AMS3248US	266
AGS2058DFS	165	ALS1322LHT	183	ALS2030LDT	183	ALS2758DFS	181	AMS3254LH	266
AGS2060BSF	164	ALS1324BSF	179	ALS2034DFS	180	ALS2760DFS	181	AMS3254RH	266
AGS2060DFS	165	ALS1324LDF	182	ALS2036BSF	179	ALS2764DFS	181	AMS3254SS	267
AGS2064DFS	165	ALS1324LDS	184	ALS2036DFS	180	ALS2766DFS	181	AMS3254US	266
AGS2066BSF	164	ALS1324LDT	183	ALS2036LDF	182	ALS2770DFS	181	AMS3260LH	266
AGS2066DFS	165	ALS1327LDF	182	ALS2036LDS	184	ALS2772DFS	181	AMS3260RH	266
AGS2070DFS	165	ALS1327LDS	184	ALS2036LDT	183	ALS2824BSF	179	AMS3260SS	267
AGS2072BSF	164	ALS1327LDT	183	ALS2040DFS	180	ALS2830BSF	179	AMS3260US	266
AGS2072DFS	165	ALS1328LHF	182	ALS2040DFS	180	ALS2836BSF	179	AMS3266LH	266
AGS2078BSF	164	ALS1328LHS	184	ALS2042BSF	179	ALS2842BSF	179	AMS3266RH	266

Cross Reference Index

by Model Number

Model	Page	Model	Page	Model	Page	Model	Page	Model	Page
AMS3266SS	267	APS2655USF	43	ASH4179USF	46	AWS4139USF	48	G2233G	205
AMS3266US	266	APS2661USF	43	ATADF3	54, 106, 264	CFDPWRC	261.1	G2236	199
AMS3272LH	266	APS2667USF	43	ATADF4	54, 106, 264	CFDPWRSC	261.1	G2236G	205
AMS3272RH	266	APS3425USF	43	ATADJ5	54, 106, 264	CSDC19	282	G2239	199
AMS3272SS	267	APS3427USF	43	ATADJ6	54, 106, 264	CSDC25	282	G2239G	205
AMS3272US	266	APS3430USF	43	AUCH15N	226	EAAC	281	G2242	199
APACSM	291	APS3431USF	43	AUCH15NE	227	EABS	281	G2242G	205
APACW	291	APS3433USF	43	AUCH15U	226	EACS	281	G2245	199
APADD	290	APS3437USF	43	AUCH15UE	227	EADH	281	G2245G	205
APASD	290	APS3439USF	43	AUCL15N	226	EAFS	281	G2248	199
APASDCK	291	APS3443USF	43	AUCL15NE	227	EAFU	281	G2248G	205
APATF	290	APS3449USF	43	AUCL15U	226	EAHSR36	280	G2251	199
APGBP18SNPT	220	APS3455USF	43	AUCL15UE	227	EAHSR42	280	G2251G	205
APGBP18SNPTE	222	APS3461USF	43	AUCL15N	226	EAHSR48	280	G2254	199
APGBP186NPT	220	APS3467USF	43	AUCL15U	226	EAHSR60	280	G2254G	205
APGBP186NPTE	222	APS4125USF	43	AUFD15N	226	EAHSR66	280	G2257	199
APGBP189TFN	220	APS4127USF	43	AUF15NE	227	EAHSR72	280	G2257G	205
APGBP189TFNE	222	APS4130USF	43	AUFH15N	226	EAPS	281	G2260	199
APGBP246NPT	220	APS4131USF	43	AUFH15NE	227	EAPT	281	G2260G	205
APGBP246NPTE	222	APS4133USF	43	AUFHL15N	226	EASR24	280	G2263	199
APGBP249TFN	220	APS4137USF	43	AUFHL15NE	227	EASR30	280	G2263G	205
APGBP249TFNE	222	APS4139USF	43	AUFO15N	226	EASR36	280	G2266	199
APGBS24SNPT	220	APS4143USF	43	AUPWRMOD	287	EASR42	280	G2266G	205
APGBS24SNPTE	222	APS4149USF	43	AURNDPWRMOD	287	EASR48	280	G2269	199
APGBS249TFN	220	APS4155USF	43	AVF5RS4824	258	EASR60	280	G2269G	205
APGBS249TFNE	222	APS4161USF	43	AVF5RS4830	258	EASS	281	G2272	199
APGCP189TPN	220	APS4167USF	43	AVF5RS5424	258	EATS	281	G2272G	205
APGCP189TPNE	222	APTK	294	AVF5RS5430	258	FBRZPWM	40	G2275	199
APGCP249TPN	220	APWR4TAP	261.1, 287	AVF5RS6024D	258	FDEPC2	268	G2275G	205
APGCP249TPNE	222	APWRMOD	287	AVF5RS6030D	258	FDEPC12	268	G2278	199
APGCS249TPN	220	APWRMODEST36	261.2, 287.4	AVF5RS6624D	258	FDPWRC	261.1	G2278G	205
APGCS249TPNE	222	APWRMODEST48	261.2, 287.4	AVF5RS6630D	258	FDPWRSC	261.1	G2281	199
APMAP186NFN	220	APWRMODEST48	261.2, 287.4	AVF5RS7224D	258	FDRWEC	268	G2281G	205
APMAP186NFNE	222	APWRPCK	287.1	AVF5RS7230D	258	FDRWLEG	268	G2284	199
APMAP246NFN	220	APWRSTRP	287.1	AVSTA3PWR	287.1	FRDWUC	268	G2284G	205
APMAP246NFNE	222	APWRTRGH17	261, 287.2	AW4GANG	88	FDSC48LL	265	G2287	199
APMBP18SNPT	220	APWRTRGH36	261, 287.2	AWCS	276	FDSC48LR	265	G2287G	205
APMBP18SNPTE	223	ARNDPWRMOD	287	AWIRECLT	261, 287.2	FDSC48R	265	G2293	199
APMBP186NPT	221	ARSLCC	294	AWRSTRIP	261, 287.2	FDSC48U	265	G2293G	205
APMBP186NPTE	223	ASH2625USF	46	AWS2625USF	48	FDSC54LL	265	G2299	199
APMBP189TFN	223	ASH2631USF	46	AWS2627USF	48	FDSC54LR	265	G2299G	205
APMBP189TFNE	223	ASH2637USF	46	AWS2630USF	48	FDSC54R	265	G3033	201
APMBP246NPT	221	ASH2643USF	46	AWS2631USF	48	FDSC54U	265	G3033G	207
APMBP246NPTE	223	ASH2649USF	46	AWS2633USF	48	FDSC60LL	265	G3036	201
APMBP249TFN	220	ASH2655USF	46	AWS2637USF	48	FDSC60LR	265	G3036G	207
APMBP249TFNE	223	ASH2661USF	46	AWS2639USF	48	FDSC60R	265	G3039	201
APMBS24SNPT	220	ASH2667USF	46	AWS2643USF	48	FDSC60U	265	G3039G	207
APMBS24SNPTE	223	ASH2679USF	46	AWS2649USF	48	FDSC66LL	265	G3042	201
APMBS249TFN	220	ASH3425USF	46	AWS2655USF	48	FDSC66LR	265	G3042G	207
APMBS249TFNE	223	ASH3431USF	46	AWS2661USF	48	FDSC66R	265	G3045	201
APMC6	281	ASH3437USF	46	AWS2667USF	48	FDSC66U	265	G3045G	207
APMCP189TPN	221	ASH3443USF	46	AWS3425USF	48	FDSC72LL	265	G3048	201
APMCP189TPNE	223	ASH3449USF	46	AWS3427USF	48	FDSC72LR	265	G3048G	207
APMCP249TPN	221	ASH3455USF	46	AWS3430USF	48	FDSC72R	265	G3051	201
APMCP249TPNE	223	ASH3461USF	46	AWS3431USF	48	FDSC72U	265	G3051G	207
APMCS249TPN	221	ASH3467USF	46	AWS3433USF	48	G2218	199	G3054	201
APMCS249TPNE	223	ASH3479USF	46	AWS3437USF	48	G2218G	205	G3054G	207
APS2625USF	43	ASH4125USF	46	AWS3439USF	48	G2221	199	G3057	201
APS2627USF	43	ASH4131USF	46	AWS3443USF	48	G2221G	205	G3057G	207
APS2630USF	43	ASH4137USF	46	AWS3449USF	48	G2224	199	G3060	201
APS2631USF	43	ASH4143USF	46	AWS3455USF	48	G2224G	205	G3060G	207
APS2633USF	43	ASH4149USF	46	AWS3461USF	48	G2227	199	G3063	201
APS2637USF	43	ASH4155USF	46	AWS3467USF	48	G2227G	205	G3063G	207
APS2639USF	43	ASH4161USF	46	AWS4127USF	48	G2230	199	G3066	201
APS2643USF	43	ASH4167USF	46	AWS4130USF	48	G2230G	205	G3066G	207
APS2649USF	43			AWS4133USF	48	G2233	199	G3069	201

Cross Reference Index

by Model Number

Model	Page	Model	Page	Model	Page	Model	Page	Model	Page
G3069G.....	207	G4260G.....	209	G40760GS.....	212	GS22117.....	200	SAFILLERKIT61.....	49
G3072.....	201	G4263.....	203	G40763GS.....	212	GS22117G.....	206	SAFILLERKIT67.....	49
G3072G.....	207	G4263G.....	209	G40766GS.....	212	GS22123.....	200	SAFILLERKIT79.....	49
G3075.....	201	G4266.....	203	G40769GS.....	212	GS22123G.....	206	SAFILLERKITNF.....	49
G3075G.....	207	G4266G.....	209	G40772GS.....	212	GS22129.....	200	SAHANGER.....	49
G3078.....	201	G4269.....	203	G40775GS.....	212	GS22129G.....	206	SAPLANTER24.....	50
G3078G.....	207	G4269G.....	209	G40778GS.....	212	GS22135.....	200	SAS0630W.....	50
G3081.....	201	G4272.....	203	G40781GS.....	212	GS22135G.....	206	SAS0636W.....	50
G3081G.....	207	G4272G.....	209	G41324GS.....	213	GS22141.....	200	SAS0642W.....	50
G3084.....	201	G4275.....	203	G41327GS.....	213	GS22141G.....	206	SAS0648W.....	50
G3084G.....	207	G4275G.....	209	G41330GS.....	213	GS22147.....	200	SAS0654W.....	50
G3533.....	202	G4278.....	203	G41333GS.....	213	GS22147G.....	206	SAS0660W.....	50
G3533G.....	208	G4278G.....	209	G41336GS.....	213	GS870924.....	285	SAS0666W.....	50
G3536.....	202	G4281.....	203	G41339GS.....	213	GS870930.....	285	SAS0672W.....	50
G3536G.....	208	G4281G.....	209	G41342GS.....	213	GS870948.....	285	SAS0684W.....	50
G3539.....	202	G4284.....	203	G41345GS.....	213	GS870960.....	285	SATRAY.....	50
G3539G.....	208	G4284G.....	209	G41348GS.....	213	GSCCKP.....	210	SC12LS.....	36
G3542.....	202	G5033.....	204	G41351GS.....	213	GSCCKPMD.....	210	SC12SFF.....	36
G3542G.....	208	G5036.....	204	G41354GS.....	213	GSCCKPMS.....	210	SC12SS.....	36
G3545.....	202	G5039.....	204	G41357GS.....	213	GSGKL.....	210, 211	SC12TF.....	36
G3545G.....	208	G5042.....	204	G41360GS.....	213	GSGKM.....	210, 211	SC12TS.....	36
G3548.....	202	G5045.....	204	G41363GS.....	213	GSHW.....	210	SC12XF.....	36
G3548G.....	208	G5048.....	204	G41366GS.....	213	GSTFN7578.....	210, 211	SC12XS.....	36
G3551.....	202	G5051.....	204	G41369GS.....	213	GSTFN8184.....	210, 211	SC12YF.....	36
G3551G.....	208	G5054.....	204	G41372GS.....	213	GSYSRPC2.....	54	SC12YS2.....	36
G3554.....	202	G5057.....	204	G41375GS.....	213	GSYSRPC12.....	54	SC12YS3.....	36
G3554G.....	208	G5060.....	204	G41378GS.....	213	K5CT1536SC.....	124	SC22ETE.....	35
G3557.....	202	G5063.....	204	G41381GS.....	213	LKFE.....	293	SC22ETS.....	35
G3557G.....	208	G5066.....	204	G41515GS.....	214	PRFTSKCL.....	286	SCB24DS.....	39
G3560.....	202	G5069.....	204	G41518GS.....	214	PRFTSKFS.....	286	SCB24SS.....	39
G3560G.....	208	G5072.....	204	G41521GS.....	214	PRFTSKTR.....	286	SCB30DS.....	39
G3563.....	202	G5075.....	204	G41524GS.....	214	RFDRW48.....	268	SCB30SS.....	39
G3563G.....	208	G5078.....	204	G41527GS.....	214	RFDRW54.....	268	SE08PP1.....	53
G3566.....	202	G5081.....	204	G41530GS.....	214	RFDRW60.....	268	SE08PP2.....	53
G3566G.....	208	G5084.....	204	G41533GS.....	214	RFDRW66.....	268	SE08TPP2.....	53
G3569.....	202	G22105.....	199	G41536GS.....	214	RFDRW72.....	268	SE08XPP2.....	53
G3569G.....	208	G22105G.....	205	G41539GS.....	214	RFDRWAB.....	268	SE08YPP2.....	53
G3572.....	202	G22111.....	199	G41542GS.....	214	RFDRWCNPP.....	270	SE30EK3C.....	52
G3572G.....	208	G22111G.....	205	G41545GS.....	214	RFDRWCNPP2.....	270	SE30EK4C.....	52
G3575.....	202	G22117.....	199	G41548GS.....	214	RFDRWCNPPM.....	270	SE36EK3C.....	52
G3575G.....	208	G22117G.....	205	G41551GS.....	214	RFDRWHUBEND.....	269	SE36EK4C.....	52
G3578.....	202	G22123.....	199	G41554GS.....	214	RFDRWHUBENDT.....	269	SE42EK3C.....	52
G3578G.....	208	G22123G.....	205	G41557GS.....	214	RFDRWHUBL.....	269	SE42EK4C.....	52
G3581.....	202	G22129.....	199	G41560GS.....	214	RFDRWHUBLIN.....	269	SE48EK3C.....	52
G3581G.....	208	G22129G.....	205	G41563GS.....	214	RFDRWHUBT.....	269	SE48EK4C.....	52
G3584.....	202	G22135.....	199	G41566GS.....	214	RFDRWHUBX.....	269	SE54EK3C.....	52
G3584G.....	208	G22135G.....	205	G41569GS.....	214	RFDRWLEG.....	268	SE54EK4C.....	52
G4233.....	203	G22141.....	199	G41572GS.....	214	RFDRWSC48.....	271	SE60EK3C.....	52
G4233G.....	209	G22141G.....	205	G41575GS.....	214	RFDRWSC54.....	271	SE60EK4C.....	52
G4236.....	203	G22147.....	199	G41578GS.....	214	RFDRWSC60.....	271	SE66EK3C.....	52
G4236G.....	209	G22147G.....	205	G41581GS.....	214	RFDRWSC66.....	271	SE66EK4C.....	52
G4239.....	203	G40715GS.....	212	GFCKA.....	210	RFDRWSC72.....	271	SE72EK3C.....	52
G4239G.....	209	G40718GS.....	212	GFCKLH.....	210	RFDRWWM.....	270	SE72EK4C.....	52
G4242.....	203	G40721GS.....	212	GFCKSH.....	210	S2SD.....	39	SE84EK3C.....	52
G4242G.....	209	G40724GS.....	212	GS2281.....	200	S3SD.....	39	SE84EK4C.....	52
G4245.....	203	G40727GS.....	212	GS2281G.....	206	SAFILLERKIT1.....	49	SEDMUP.....	40
G4245G.....	209	G40730GS.....	212	GS2287.....	200	SAFILLERKIT25.....	49	SEDMWM20.....	40
G4248.....	203	G40733GS.....	212	GS2287G.....	206	SAFILLERKIT27.....	49	SEDMWM30.....	40
G4248G.....	209	G40736GS.....	212	GS2293.....	200	SAFILLERKIT30.....	49	SELGEJ3C.....	52
G4251.....	203	G40739GS.....	212	GS2293G.....	206	SAFILLERKIT31.....	49	SELGEJ4C.....	52
G4251G.....	209	G40742GS.....	212	GS2299.....	200	SAFILLERKIT33.....	49	SESEFEJ3C.....	52
G4254.....	203	G40745GS.....	212	GS2299G.....	206	SAFILLERKIT37.....	49	SESEFEJ4C.....	52
G4254G.....	209	G40748GS.....	212	GS22105.....	200	SAFILLERKIT39.....	49	SESEMEJ3C.....	52
G4257.....	203	G40751GS.....	212	GS22105G.....	206	SAFILLERKIT43.....	49	SESEMEJ4C.....	52
G4257G.....	209	G40754GS.....	212	GS22111.....	200	SAFILLERKIT49.....	49	SESEJ3C.....	52
G4260.....	203	G40757GS.....	212	GS22111G.....	206	SAFILLERKIT55.....	49	SESEJ4C.....	52

Cross Reference Index

by Model Number

INDEX

Model	Page	Model	Page	Model	Page	Model	Page	Model	Page
SF30F.....	34	SW2346NE.....	38	U5CC7227RS	83, 137	U6BC2030G	113	U6TS2030G.....	113
SF36F.....	34	SW2346NFR.....	37	U5F2130S.....	81	U6BC2036F	111	U6TS2036F.....	112
SF42F.....	34	SW2346NFS	37	U5F2136S.....	81	U6BC2036G	113	U6TS2036G.....	113
SF48F.....	34	SW2352NE.....	38	U5F2142S.....	81	U6BC2042F	111	U6TS2042F.....	112
SF54F.....	34	SW2352NFR.....	37	U5F2148S.....	81	U6BC2042G	113	U6TS2042G.....	113
SF60F.....	34	SW2352NFS	37	U5F2154S.....	81	U6BC2048F	111	U6TS2048F.....	112
SF66F.....	34	SW2358DE.....	38	U5F2160S.....	81	U6BC2048G	113	U6TS2048G.....	113
SF72F.....	34	SW2358DFR.....	37	U5F2166S.....	81	U6BC2054F	111	U6TS2054F.....	112
SF84F.....	34	SW2358DFS.....	37	U5F2172S.....	81	U6BC2054G	113	U6TS2054G.....	113
SF2630P.....	41	SW2364DE.....	38	U5F2178S.....	81	U6BC2060F	111	U6TS2060F.....	112
SF2636P.....	41	SW2364DFR.....	37	U5F2184S.....	81	U6BC2060G	113	U6TS2060G.....	113
SF2642P.....	41	SW2364DFS.....	37	U5F2190S.....	81	U6BC2066G	113	U6TTS1330F	112
SF2648P.....	41	SW2370DE.....	38	U5F2196S.....	81	U6BC2072G	113	U6TTS1336F	112
SF2654P.....	41	SW2370DFR.....	37	U5F2430S.....	81	U6BC2078G	113	U6TTS1342F	112
SF2660P.....	41	SW2370DFS.....	37	U5F2436S.....	81	U6BC2084G	113	U6TTS1348F	112
SF2666P.....	41	SW2846NE.....	38	U5F2442S.....	81	U6BC2090G	113	U6TTS1354F	112
SF2672P.....	41	SW2846NFR.....	37	U5F2448S.....	81, 137	U6BC2096G	113	U6TTS1360F	112
SF2684P.....	41	SW2846NFS	37	U5F2454S.....	81, 137	U6BL1221ML.....	114	U6TTS2030F	112
SF3430P.....	41	SW2852NE.....	38	U5F2460S.....	81, 137	U6BL1221MR	114	U6TTS2036F	112
SF3436P.....	41	SW2852NFR.....	37	U5F2466S.....	81, 137	U6BL1227ML.....	114	U6TTS2042F	112
SF3442P.....	41	SW2852NFS	37	U5F2472S.....	81, 137	U6BL1227MR	114	U6TTS2048F	112
SF3448P.....	41	SW2858DE.....	38	U5F2478S.....	81	U6BL2021ML.....	186	U6TTS2054F	112
SF3454P.....	41	SW2858DFR.....	37	U5F2484S.....	81	U6BL2021MR	186	U6TTS2060F	112
SF3460P.....	41	SW2858DFS.....	37	U5F2490S.....	81	U6BL2027ML.....	186	U6TU1318F.....	114
SF3466P.....	41	SW2864DE.....	38	U5F2496S.....	81	U6BL2027MR	186	U6TU1324F.....	114
SF3472P.....	41	SW2864DFR.....	37	U5F2730S.....	81	U6GPSS.....	210	U6TU1330F.....	114
SF3484P.....	41	SW2864DFS.....	37	U5F2736S.....	81	U6H2SCU1P4C	108	U6TU1336F.....	114
SF4130P.....	41	SW2870DE.....	38	U5F2742S.....	81	U6H2SCU1P4H.....	108	U6TU1342F.....	114
SF4136P.....	41	SW2870DFR.....	37	U5F2748S.....	81, 137	U6HB2L.....	86	U6TU1348F.....	114
SF4142P.....	41	SW2870DFS.....	37	U5F2754S.....	81, 137	U6HB3.....	108	U6TU1354F.....	114
SF4148P.....	41	SW2946NE.....	38	U5F2760S.....	81, 137	U6HB3L.....	86	U6TU1360F.....	114
SF4154P.....	41	SW2946NFR.....	37	U5F2766S.....	81, 137	U6HK1HC.....	86	U6WBTF.....	80, 88
SF4160P.....	41	SW2946NFS	37	U5F2772S.....	81, 137	U6HK1P.....	86	U7HSB2.....	123
SF4166P.....	41	SW2952NE.....	38	U5F2778S.....	81	U6HK1S.....	86	U7HSK1.....	123
SF4172P.....	41	SW2952NFR.....	37	U5F2784S.....	81	U6HK2HC.....	86	U7HSK2.....	123
SF4184P.....	41	SW2952NFS	37	U5F2790S.....	81	U6HK2P.....	86	U7MC203615HL.....	124
SKITD.....	39	SW2958DE.....	38	U5F2796S.....	81	U6HK2S.....	86	U7MC203615HR	124
SS1724M	50	SW2958DFR.....	37	U5F214646C	82	U6HK3HC.....	86	U7P1027PBL.....	124
SS2724M	50	SW2958DFS.....	37	U5F215252C	82	U6HK3P.....	86	U7P1027PBR	124
SS5060MS.....	51	SW2964DE.....	38	U5F244646C	82, 137	U6HK3S.....	86	U7P1521PD.....	124
SS5268BLH.....	51	SW2964DFR.....	37	U5F245252C	82, 137	U6HK4HC.....	86	U7T421227ADL.....	125
SS5268BRH.....	51	SW2964DFS.....	37	U5F274646C	82, 137	U6HK4P.....	86	U7T421227ADR.....	125
ST30MT	35	SW2970DE.....	38	U5F275252C	82, 137	U6HK4S.....	86	U7T501221ADL.....	125
ST36MT	35	SW2970DFR.....	37	U6BC1324F.....	111	U6L2FG.....	88	U7T501221ADR.....	125
ST42MT	35	SW2970DFS.....	37	U6BC1324G	113	U6T2FC.....	88	U7T501227ADL.....	125
ST48MT	35	T612FB.....	88	U6BC1330F.....	111	U6TM18F.....	112	U7T501227ADR.....	125
ST54MT	35	T624FB.....	88	U6BC1330G	113	U6TM24F.....	112	U7WDA.....	282
ST60MT	35	T630FB.....	88	U6BC1336F.....	111	U6TM30F.....	112	U8IKCH.....	103
ST66MT	35	TAWG.....	143	U6BC1336G	113	U6TM36F.....	112	U8IKNY1.....	103
ST72MT	35	U2HPP.....	103	U6BC1342F.....	111	U6TM42F.....	112	U8IKNY2.....	103
ST84MT	35	U3CG12.....	86, 108	U6BC1342G	113	U6TM48F.....	112	U8IKNY3.....	103
SW2246NE.....	38	U3CHBG.....	86	U6BC1348F.....	111	U6TM54F.....	112	U8SBKCH.....	103
SW2246NFR.....	37	U3HAE.....	86, 108	U6BC1348G	113	U6TM60F.....	112	U8SBKNY1.....	103
SW2246NFS	37	U3HAI.....	86, 108	U6BC1354F.....	111	U6TS1330F.....	112	U8SBKNY2.....	103
SW2252NE.....	38	U3SSHAF.....	139, 210	U6BC1354G	113	U6TS1330G.....	113	U9TF.....	272
SW2252NFR.....	37	U5CC6024LS	83, 137	U6BC1360F.....	111	U6TS1336F.....	112	U9TM.....	272
SW2252NFS	37	U5CC6024RS	83, 137	U6BC1360G	113	U6TS1336G.....	113	U9TP.....	272
SW2258DE.....	38	U5CC6027LS	83, 137	U6BC1366G	113	U6TS1342F.....	112	U9TS.....	272
SW2258DFR.....	37	U5CC6027RS	83, 137	U6BC1372G	113	U6TS1342G.....	113	U9WTC	272
SW2258DFS.....	37	U5CC6624LS	83, 137	U6BC1378G	113	U6TS1348F.....	112	U912WTR	272
SW2264DE.....	38	U5CC6624RS	83, 137	U6BC1384G	113	U6TS1348G.....	113	U918WTR	272
SW2264DFR.....	37	U5CC6627LS	83, 137	U6BC1390G	113	U6TS1354F.....	112	U924WTR	272
SW2264DFS.....	37	U5CC6627RS	83, 137	U6BC1396G	113	U6TS1354G.....	113	U930WTR	272
SW2270DE.....	38	U5CC7224LS	83, 137	U6BC2024F.....	111	U6TS1360F.....	112	U936WTR	272
SW2270DFR.....	37	U5CC7224RS	83, 137	U6BC2024G	113	U6TS1360G.....	113	U942WTR	272
SW2270DFS.....	37	U5CC7227LS	83, 137	U6BC2030F.....	111	U6TS2030F.....	112	U948WTR	272

Cross Reference Index

by Model Number

INDEX

Model	Page	Model	Page	Model	Page	Model	Page
U954WTR	272	UN6B66P	84, 104	UN6SWMC36	105, 144	YPLDIGMGR	217, 229
U960WTR	272	UN6B72F	85	UN6SWMC42	105, 144	YPLDIGPRG	217, 229
U966WTR	272	UN6B72M	85	UN6SWMC48	105, 144	Z5SC42	80
UN2CSQPP	103	UN6B72N	84	UN6SWMC54	105, 144	Z5SC48	80, 137
UN2ESQPP	103	UN6B72P	84, 104	UN6SWMC60	105, 144	Z5SC54	80, 137
UN2HPSQ	103, 270	UN6B78F	85	UN6SWMC66	105, 144	Z5SC60	80, 137
UN2HPSQSK	103, 270	UN6B78M	85	UN6SWMC72	105, 144	Z5SC66	80
UN3CBBE	88	UN6B78N	84	UN6SWMC78	105, 144	Z5SC72	80
UN3CHB1	138	UN6B78P	84, 104	UN6WC	103	Z5SC78	80
UN3CHB2	138	UN6B84F	85	UN8BBKCH	103	Z5SC84	80
UN3CHB3	138	UN6B84M	85	UN8EBKCH	103	Z6BL0827F	118
UN3CHBC	86	UN6B84N	84	UN8HP	104	Z6BL0827G	118
UN3TBE	139	UN6B84P	84, 104	UN8K36	84, 104	Z6BL0830F	118
UN6AEDS54SQ	89	UN6B90F	85	UN8K42	84, 104	Z6BL0830G	118
UN6AEDS60SQ	89	UN6B90M	85	UN8K48	84, 104	Z6BL0836F	118
UN6AESS24LH	89	UN6B90N	84	UN8K54	84, 104	Z6BL0836G	118
UN6AESS24RH	89	UN6B90P	84, 104	UN8K60	84, 104	Z6LB	125
UN6AESS27LH	89	UN6B96F	85	UN8K66	84, 104	ZS42SF	210, 211
UN6AESS27RH	89	UN6B96M	85	UN8K72	84, 104	ZS50SF	210, 211
UN6ALSQ	88	UN6B96N	84	UN8K78	84, 104		
UN6AMDS2SQ	89	UN6B96P	84, 104	UN8K84	84, 104		
UN6AWC	103	UN6BE54SQ	89	UN8K90	84, 104		
UN6B06CN	84	UN6BE60SQ	89	UN8K96	84, 104		
UN6B06F	85	UN6BMTW	88	UN87J16	104		
UN6B06M	85	UN6BWMC36	105	UN87J17	143		
UN6B09CN	84	UN6BWMC42	105	UN87J19	143		
UN6B09F	85	UN6BWMC48	105	UN87JH1	104		
UN6B09M	85	UN6BWMC54	105	UN87JH2	104		
UN6B12CN	84	UN6BWMC60	105	UN87JH3	104		
UN6B12F	85	UN6BWMC66	105	UN87JH4	104		
UN6B12M	85	UN6BWMC72	105	UN87U501	104		
UN6B18F	85	UN6BWMC78	105	UN87U502	104		
UN6B18M	85	UN6E2F	88	UN87U503	104		
UN6B18N	84	UN6GBSS	88	UN87U504	104		
UN6B21F	85	UN6H2PCK	108	UN87U506	104		
UN6B21M	85	UN6H2C2SQ	86	UN924BMS	105		
UN6B21N	84	UN6HE2SQ	86	UN924HT	144		
UN6B24F	85	UN6HFCAU	86	UN930BMS	105		
UN6B24M	85	UN6HFEAU	86	UN936BMS	105		
UN6B24N	84	UN6HLC2SQ	87	UN936HT	144		
UN6B30F	85	UN6HLE2SQ	87	UN942BMS	105		
UN6B30M	85	UN6HS2SQ	89	UN948BMS	105		
UN6B30N	84	UN6L2FGSQ	88	UN948HT	144		
UN6B36F	85	UN6L2FLSQ	89	UN954BMS	105		
UN6B36M	85	UN6LHK2HC	87	UN960BMS	105		
UN6B36N	84	UN6LHK2S	87	UNE24D	138		
UN6B36P	84, 104	UN6LHK3HC	87	UNE24S	138		
UN6B42F	85	UN6LHK3S	87	UNE27D	138		
UN6B42M	85	UN6LHK4HC	87	UNE27S	138		
UN6B42N	84	UN6LHK4S	87	UNFIX2LEG	138		
UN6B42P	84, 104	UN6PE24	138	UNFIX3LEG	138		
UN6B48F	85	UN6PE27	138	UNHAT2LEG	138		
UN6B48M	85	UN6S7L	139	UNHAT3LEG	138		
UN6B48N	84	UN6S9L	139	UNM120	138		
UN6B48P	84, 104	UN6SDMC36	105, 144	UNMD	138		
UN6B54F	85	UN6SDMC42	105, 144	UNMPED	138		
UN6B54M	85	UN6SDMC48	105, 144	UNMPES	138		
UN6B54N	84	UN6SDMC54	105, 144	UNMS	138		
UN6B54P	84, 104	UN6SDMC60	105, 144	UNSBEC2	84, 104		
UN6B60F	85	UN6SDMC66	105, 144	UNSBEC2CH	84, 103, 104		
UN6B60M	85	UN6SDMC72	105, 144	UNSBEC12	84, 104		
UN6B60N	84	UN6SDMC78	105, 144	UNSBEC12CH	84, 103, 104		
UN6B60P	84, 104	UN6SESS24LH	89	WANDFS	286		
UN6B66F	85	UN6SESS24RH	89	WANDFSOC	286		
UN6B66M	85	UN6SESS27LH	89	WANDFSUB	286		
UN6B66N	84	UN6SESS27RH	89	WKSWMC	144, 261, 287, 2		

Notes



Allsteel®

Allsteel Inc.
Muscatine, Iowa 52761

allsteeloffice.com

Form #A8744.A4 (05/24)